

Errata

Title & Document Type: 8664A, 8665A/B Signal Generator Operating and Calibration Manual

Manual Part Number: 08665-90078

Revision Date: July 1993

HP References in this Manual

This manual may contain references to HP or Hewlett-Packard. Please note that Hewlett-Packard's former test and measurement, semiconductor products and chemical analysis businesses are now part of Agilent Technologies. We have made no changes to this manual copy. The HP XXXX referred to in this document is now the Agilent XXXX. For example, model number HP8648A is now model number Agilent 8648A.

About this Manual

We've added this manual to the Agilent website in an effort to help you support your product. This manual provides the best information we could find. It may be incomplete or contain dated information, and the scan quality may not be ideal. If we find a better copy in the future, we will add it to the Agilent website.

Support for Your Product

Agilent no longer sells or supports this product. You will find any other available product information on the Agilent Test & Measurement website:

www.tm.agilent.com

Search for the model number of this product, and the resulting product page will guide you to any available information. Our service centers may be able to perform calibration if no repair parts are needed, but no other support from Agilent is available.

2 153335

HP 8664A, 8665A/B SYNTHESIZED SIGNAL GENERATOR (Including Options 001, 003, 004, 008, and 010) Operation and Calibration Manual

SERIAL NUMBERS

This manual applies directly to instruments with serial numbers prefixed:

All instruments covered by this manual: 3203A and all *MAJOR* changes that apply to your instrument.

rev. 12JUL93 (REV. C)

For additional important information about serial numbers, refer to "INSTRUMENTS COVERED BY THIS MANUAL" in Section 1.

Third Edition

This material may be reproduced by or for the U.S. Government pursuant to the Copyright License under the clause at DFARS 52.227-7013 (APR 1988).

Copyright ©HEWLETT-PACKARD COMPANY 1990
P.O. Box 2500, SPOKANE, WASHINGTON, U.S.A. 99220-2500

Operation and Calibration Manual HP Part 08665-90078

Other Documents Available:

Service Diagnostics Manual HP Part 08645-90104 (A Generic Manual)

Microfiche Operation and Calibration Manual HP Part 08665-90029

Microfiche Service Diagnostics Manual HP Part 08645-90028 (A Generic Microfiche)

Printed in U.S.A. : July 1993



CERTIFICATION

Hewlett-Packard Company certifies that this product met its published specifications at the time of shipment from the factory. Hewlett-Packard further certifies that its calibration measurements are traceable to the United States National Bureau of Standards, to the extent allowed by the Bureau's calibration facility, and to the calibration facilities of other International Standards Organization members.

WARRANTY

This Hewlett-Packard instrument product is warranted against defects in material and workmanship for a period of one year from date of shipment. During the warranty period, Hewlett-Packard Company will at its option, either repair or replace products which prove to be defective.

For warranty service or repair, this product must be returned to a service facility designated by HP. Buyer shall prepay shipping charges to HP and HP shall pay shipping charges to return the product to the Buyer. However, Buyer shall pay all shipping charges, duties, and taxes for products returned to HP from another country.

HP warrants that its software and firmware designated by HP for use with an instrument will execute its programming instructions when properly installed on that instrument. HP does not warrant that the operation of the instrument, or software, or firmware will be uninterrupted or error free.

LIMITATION OF WARRANTY

The foregoing warranty shall not apply to defects resulting from improper or inadequate maintenance by Buyer, Buyer-supplied software or interfacing, unauthorized modification or misuse, operation outside of the environmental specifications for the product, or improper site preparation or maintenance.

NO OTHER WARRANTY IS EXPRESSED OR IMPLIED. HP SPECIFICALLY DISCLAIMS THE IMPLIED WARRANTIES OF MERCHANTABILITY AND FITNESS FOR A PARTICULAR PURPOSE.

EXCLUSIVE REMEDIES

THE REMEDIES PROVIDED HEREIN ARE BUYER'S SOLE AND EXCLUSIVE REMEDIES. HP SHALL NOT BE LIABLE FOR ANY DIRECT, INDIRECT, SPECIAL, INCIDENTAL, OR CONSEQUENTIAL DAMAGES, WHETHER BASED ON CONTRACT, TORT, OR ANY OTHER LEGAL THEORY.

ASSISTANCE

Product maintenance agreements and other customer assistance agreements are available for Hewlett-Packard products.

For any assistance, contact your nearest Hewlett-Packard Sales and Service Office.

SAFETY CONSIDERATIONS

GENERAL

This product and related documentation must be reviewed for familiarization with safety markings and instructions before operation.

This product is a Safety Class I instrument (provided with a protective earth terminal).

BEFORE APPLYING POWER

Verify that the product is set to match the available line voltage and the correct fuse is installed.

SAFETY EARTH GROUND

An uninterruptible safety earth ground must be provided from the main power source to the product input wiring terminals, power cord, or supplied power cord set.

SAFETY SYMBOLS



Instruction manual symbol: the product will be marked with this symbol when it is necessary for the user to refer to the instruction manual (refer to Table of Contents.)



Indicates hazardous voltages.



Indicates earth (ground) terminal.

WARNING

The WARNING sign denotes a hazard. It calls attention to a procedure, practice, or the like, which, if not correctly performed or adhered to, could result in personal injury. Do not proceed beyond a WARNING sign until the indicated conditions are fully understood and met.

CAUTION

The CAUTION sign denotes a hazard. It calls attention to an operating procedure, practice, or the like, which, if not correctly performed or adhered to, could result in damage to or destruction of part or all of the product. Do not proceed beyond a CAUTION sign until the indicated conditions are fully understood and met.

WARNING

Any interruption of the protective (grounding) conductor (inside or outside the instrument) or disconnecting the protective earth terminal will cause a potential shock hazard that could result in personal injury. (Grounding one conductor of a two conductor outlet is not sufficient protection).

Whenever it is likely that the protection has been impaired, the instrument must be made inoperative and be secured against any unintended operation.

If this instrument is to be energized via an autotransformer (for voltage reduction) make sure the common terminal is connected to the earth terminal of the power source.

Servicing instructions are for use by service trained personnel only. To avoid dangerous electric shock, do not perform any servicing unless qualified to do so.

Adjustments described in the manual are performed with power supplied to the instrument while protective covers are removed. Energy available at many points may, if contacted, result in personal injury.

Capacitors inside the instrument may still be charged even if the instrument has been disconnected from its source of supply.

For continued protection against fire hazard, replace the line fuse(s) only with 250V fuse(s) of the same current rating and type (for example, normal blow, time delay, etc.) Do not use repaired fuses or short circuited fuseholders.

TABLE OF CONTENTS

Chapter 1 Learning About the Synthesized Signal Generator

Getting Started the Easy Way	1-1
What's in this Guide?	1-1
Equipment You Will Need	1-1
Meet the Signal Generator	1-2

Chapter 2 What About Modulating?

In this Chapter	2-1
The Directory	2-1
Frequency Modulation – An Overview	2-2
Frequency Modulation – An Introduction	2-2
Carrier Frequency Accuracy	2-3
Audio Frequency Rates	2-3
Group Delay	2-4
Mode Selection	2-4
Frequency Modulation – An Exercise	2-6
Equipment Needed	2-6
Procedure #1 – FM Using the Internal Audio Source	2-6
Procedure #2 – FM Using an External Audio Source	2-10
Frequency Modulation – Things to Remember	2-13
Amplitude Modulation – An Overview	2-14
Amplitude Modulation – An Introduction	2-14
Amplitude Modulation – An Exercise	2-15
Equipment Needed	2-15
Procedure #1 – AM Using the Internal Audio Source	2-16
Procedure #2 – AM Using an External Audio Source	2-19
Amplitude Modulation – Things to Remember	2-22
Pulse Modulation – An Overview	2-23
Pulse Modulation – An Introduction	2-23
Pulse Modulation – Synchronization	2-24
External or Internal Control Signal	2-25
Sync Output	2-25
RF Pulse Output	2-26
Video Output	2-28
Pulse Modulation – An Exercise	2-29
Equipment Needed	2-29
Procedure #1 – Pulse Modulation Using Direct Pulse Control	2-29
Simultaneous Modulation – An Overview	2-39
Simultaneous Modulation – An Introduction	2-39

Simultaneous Modulation – An Exercise	2-40
Equipment Needed	2-40
Procedure – Simultaneous FM and AM	2-40
Simultaneous Modulation – Things to Remember	2-45

Chapter 3 What About Sweeping?

In this Chapter	3-1
The Directory	3-1
Frequency Sweep – General Information	3-2
Selecting Start, Stop, Center, and Span Frequencies	3-3
Sweep Markers	3-6
X-Axis	3-6
Z-Axis	3-7
Sweep Types	3-7
Digitally-Stepped Sweep	3-7
Phase-Continuous Sweep	3-8
Sweep Spacing and Sweep Time	3-10
Linear or Log Sweep Spacing	3-10
Permissible Sweep Times	3-10
Sweep Triggering	3-11
Auto Sweep	3-11
Single Sweep	3-11
Manual Sweep	3-12
Stopping the Sweep	3-12
Sweep Triggering Characteristics	3-13
Calculating Steps in a Digitally-Stepped Sweep	3-13
Sweep Exercise	3-15
Equipment Needed	3-15
Procedure	3-15

Chapter 4 What About Programming?

In this Chapter	4-1
The Directory	4-1
Introduction to HP-SL	4-2
Getting Started with HP-SL	4-3
How is HP-SL Organized?	4-3
The HP-SL Colon	4-4
Programming with HP-SL	4-5
HP-SL Command Statements	4-5
More about the Colon	4-6
The HP-SL Semicolon	4-6
More about HP-SL Command Statements	4-6
Combining the HP-SL Semicolon and Colon	4-7
What Else do I Need to Know?	4-8
Introduction to the Programming Reference Information	4-9

HP-IB Address	4-10
How to Display or Change the HP-IB Address	4-10
HP-IB Capabilities	4-11
HP-IB Control Language Dictionary	4-13
Table of Contents	4-13
HP-SL Notes	4-14
HP-IB Device Status Dictionary	4-56
Table of Contents	4-56
IEEE 488.2 Definitions	4-58
Condition Register	4-58
Event Register	4-58
Transition Filter	4-58
Event Enable Register	4-59
Queue	4-59
Summary Bit	4-59
Status Register Model	4-59
IEEE 488.2 HP-IB Status Byte Register	4-60
Device Dependent Summary Bits	4-61
MAV Summary Bit	4-61
RQS and MSS Summary Bits	4-61
IEEE 488.2 Service Request Enable Register	4-62
IEEE 488.2 Standard Event Status Register	4-62
Power On Bit	4-62
User Request Bit	4-62
Command Error Bit	4-63
Execution Error Bit	4-63
Device Dependent Error Bit	4-63
Query Error Bit	4-63
Request Control Bit	4-63
Operation Complete Bit	4-63
Standard Event Status Enable Register	4-63
HP-SL Device Dependent Condition/Event Status Registers	4-64
Device Dependent Bit Definitions	4-64
Signal Generator Signal Integrity Condition/Event Status Registers	4-66
Hardware Integrity Summary Bit	4-66
Modulation Integrity Summary Bit	4-67
Reference Integrity Summary Bit	4-67
Frequency Integrity Summary Bit	4-67
Amplitude Integrity Summary Bit	4-68
Calibration Integrity Condition Bit	4-68
IEEE 488.2 and HP-SL Status Register Syntax	4-69
Example HP-SL Programs	4-71
Table of Contents	4-71
A Tool for Developing HP-SL Programs	4-71

Appendix A Installation

Unpack Your Signal Generator	A-1
Connect Power	A-1
Turn On Instrument	A-1

Appendix B Options and Accessories

Available for the Signal generator	B-1
--	-----

Appendix C Special Functions

How to Access the Special Functions	C-1
---	-----

Appendix D Error Messages

What Happens When You Get an Error Message	D-1
--	-----

Appendix E HP-SL Quick Reference Guide

Introduction to HP-SL Syntax Drawings	E-1
Command Statements	E-1
Command Message	E-1
Subsystem Syntax	E-2
HP-SL Notes	E-2

Appendix F Synthesized Audio Oscillator

In this Appendix	F-1
The Directory	F-2
A Quick Demonstration	F-3
Procedure to Sum Channel 1 with Channel 2.	F-3
An Explanation of the Synthesized Audio Oscillator	F-7
Block Diagrams - An Introduction	F-8
Subcarrier Sources - Maximum that may be Active	F-10
Subcarrier Sources - Maximum Voltage Levels	F-10
Audio Source: Channel 1	F-11

Audio Source: Channel 2	F-12
Subcarrier Modulation Sources in Channel 1	F-14
Modulating the RF Carrier	F-19
Increment/Decrement the Internal Audio Source	F-21
Save and Recall Settings	F-21
Typical Applications	F-22

Appendix G Miscellaneous Operating Features

Everything Else You Need to Know	G-1
Table of Contents	G-1
Amplitude Offset	G-2
Auto Sequence	G-2
Clear All	G-2
Display	G-3
Display Special	G-3
Display Recall	G-3
Display Sequence	G-3
EMF	G-4
Frequency Offset	G-4
Knob Hold	G-5
Knob Increment	G-5
Phase Decrement	G-6
Phase Increment	G-6
Sequence	G-6
Set Sequence	G-6

Appendix H Questions and Answers

Answers to Commonly Asked Questions	H-1
---	-----

Appendix I Glossary

1

Learning About the Synthesized Signal Generator

Getting Started the Easy Way

This *Operation Guide* shows you how to use the Synthesized Signal Generator (herein referred throughout the manual as “the Signal Generator”). If this is your first introduction to the Signal Generator, we recommend that you read this chapter as an orientation to the rest of the *Operation Guide*.

Note

If you are unpacking a new Signal Generator, you will want to refer to to the installation suggestions provided in appendix A.

What's in this Guide?

This *Operation Guide* helps you learn how to operate the Signal Generator from both the front panel and via HP-IB. Specifically:

- Chapter 2 shows you how easy it is to FM, AM, Pulse, and simultaneously modulate the Signal Generator. (Appendix F provides information about generating complex audio signals.)
- Chapter 3 shows you how to frequency sweep the Signal Generator using digitally-stepped or phase-continuous sweep.
- Chapter 4 describes how to program the Signal Generator with HP-SL. (Appendix E provides syntax drawings for HP-SL.)

Equipment You Will Need

The following table lists the recommended equipment for application procedures in this *Operation Guide*. You may substitute equipment; however, be aware that your displayed results could be different than the results illustrated in this *Operation Guide*.

Table 1-1. List of Recommended Equipment.

Equipment	Recommended Model Numbers	Used in Chapter(s)
Spectrum Analyzer	HP 8562A/B, or HP 8566B, or HP 8568B	1-3
Oscilloscope	HP 1741A, or HP 54100A, or HP 54200A, or HP 54100A, or HP 54100D, or HP 54110D, or HP 54120T	2
Function Generator	HP 3312A, or HP 3314A, or HP 8111A, or HP 8116A, or HP 8904A	2

Meet the Signal Generator

The Signal Generator is specifically designed as a low-noise general purpose RF frequency signal generator with modulation, amplitude control, and sweep functions. It is an excellent choice for performing out-of-channel tests on high-performance radios.

Specifically, the Signal Generator meets general purpose RF testing needs in the following ways:

- Frequency ranges of 100 kHz to 3.0 GHz (Model HP 8664A); 100 kHz to 4.2 GHz (Model HP 8665A, *Instruments with serial prefix 3015A and above have a frequency underrange to 10 KHz, and overrange to 4.5 GHz.*); and 100 kHz to 6.0 GHz (Model HP 8665B).
- Output amplitude of +13 dBm (+9 dBm if equipped with Option 008) to -139.9 dBm for all models.
- Modulation formats of AM, FM, Φ M, and Pulse (for models equipped with Option 008). FM peak deviation rates are 10 MHz at 3.0 GHz for the HP 8664A, 20 MHz at 4.2 GHz for the HP 8665A, and 20 MHz at 6.0 GHz for the HP 8665B.
- Internal modulation source of 0.1 Hz to 400 kHz with sine, square, triangle, sawtooth, or white Gaussian noise waveforms.
- Internal dual-source modulation.
- Module level service diagnostics.
- Digitally-stepped, or phase-continuous frequency sweeping.
- Remote ATE programming through HP-IB (Hewlett-Packard's implementation of IEEE Standard 488.2).

Note

Refer to appendix H where you will find answers to commonly asked questions about operating the Signal Generator.

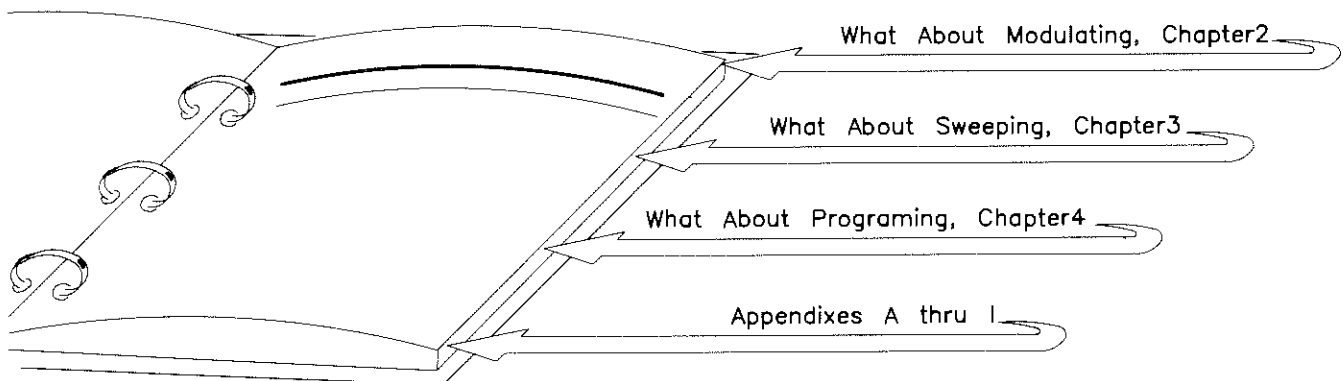

2

What About Modulating?

In this Chapter

This chapter describes how to modulate the Signal Generator. Three kinds of modulation are discussed: FM, AM, and Pulse (for instruments equipped with Option 008). Instructions to modulate the Signal Generator with both an internal and an external audio source are given; also, one example of simultaneous modulation is given.

Additional information contained in this chapter is about:

- **Special Functions.** How to select special functions relating to modulation.
- **Save and Recall registers.** How to save and recall front-panel settings.
- **Digitized and Linear FM Synthesis.** How carrier frequency accuracy, audio frequency rates, and group delay affect frequency modulation.
- **Mode Selection.** How to control the RF output quality (when FM deviation, switching time, and phase noise are considerations).

Note

Appendix F provides instructions to create complex audio signals for modulating the RF Output.

The Directory

Use the illustration shown below and find the subject you want. Turn to that subject, and notice a look-up table which provides you with an overview of the specific topics covered in that section of the chapter.

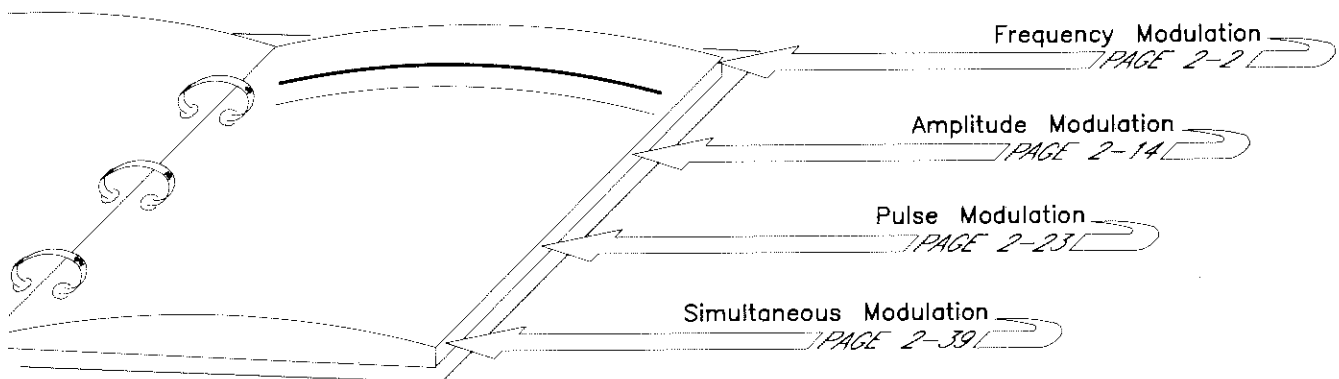

Frequency Modulation – An Overview

If You Need to Know:	Refer to:
Frequency Modulation	
<ul style="list-style-type: none"> • <i>About Digitized vs Linear FM synthesis in relation to carrier frequency accuracy, audio frequency rates, group delay, and modes of operation</i> 	<p>Frequency Modulation—An Introduction (2-2 to 2-5)</p>
<ul style="list-style-type: none"> • <i>How to FM the Signal Generator using the internal audio source</i> 	<p>Frequency Modulation—An Exercise. Procedure #1 (2-6 to 2-9)</p>
<ul style="list-style-type: none"> • <i>How to FM the Signal Generator with an external audio source</i> 	<p>Frequency Modulation—An Exercise. Procedure #2 (2-10 to 2-12)</p>
<ul style="list-style-type: none"> • <i>The key things to remember about frequency modulating the Signal Generator</i> 	<p>Frequency Modulation—Things to Remember (2-13)</p>

Frequency Modulation – An Introduction

The Signal Generator accurately simulates many different types of FM signals used in RF communication systems. Also, a wide variety of unsymmetrical modulation signals, such as digital FSK squelching sequences, and FM telemetry can be coupled to the front-panel FM connector.

You can FM the RF output over a wide bandwidth, with deviations up to 20 MHz (10 MHz in the HP 8664A) using either internally or externally generated modulation signals. External modulation signals can be ac or dc coupled. You can simultaneously modulate AM, FM, and pulse. The FM connector has an input impedance of 600 Ω.

The Signal Generator has an internal audio source that generates waveforms at rates up to 400 kHz. (The audio output has a typical bandwidth of 400 kHz which affects complex waveforms with frequency components greater than 400 kHz.) Five different internal audio waveforms are available when you access Special Function 130: sine, square, triangle, sawtooth, or white Gaussian noise as demonstrated in Procedure #1.

The Signal Generator generates FM in two ways. Digitized FM synthesis is the default method, and Linear FM synthesis is the method you access from Special Function 120; you have control over selection of either method.

Both Digitized FM and Linear FM synthesis have their advantages and disadvantages. Your signal generation and testing needs will determine which method to use. Let's examine the different factors to be considered:

Carrier Frequency Accuracy

Carrier frequency accuracy is a measure of the frequency shift in the RF output relative to its desired frequency.

Digitized DC FM synthesis has better carrier frequency accuracy than linear DC FM. This accuracy is a function of the programmed FM deviation. Linear DC FM synthesis produces carrier frequency inaccuracies since the synthesis phase locked loop is no longer locked.

Linear AC FM synthesis has better carrier frequency accuracy than digitized AC FM. Digitized AC FM synthesis produces slight frequency inaccuracies that are more apparent as FM deviation increases. The inaccuracies are a function of the programmed FM deviation.

Audio Frequency Rates

The Signal Generator allows an external audio source, and/or its internal audio source to frequency modulate the RF output. The external or internal audio waveform can be sine, or can be complex (for example, square, sawtooth, and so forth). Also, you may create complex audio signals for modulating the RF carrier as described in appendix F.

Digitized FM synthesis is primarily used for single-tone audio modulation with a sinewave; however, complex waveforms can be used as long as all appreciable harmonic components are less than 10 kHz. The maximum internal audio frequency rate can be 400 kHz; external audio frequency rates up to 800 kHz can be input.

Linear FM synthesis is primarily used for complex audio modulation. The maximum internal audio frequency rate is also 400 kHz; external audio frequency rates 800 kHz can be input. The lower 3 dB frequency corner for linear FM synthesis is 200 Hz for external audio frequency rates.

Group Delay

Group delay is a measure of the time delay between the information input at the **FM** Modulation Input connector, and the signal effects at the **RF** Output connector. Effects from group delay are apparent only when the complex audio modulation signal has significant harmonic content between 10 kHz and 100 kHz. Group delay is a function of both the modulation rate and the method of FM synthesis.

Digitized FM synthesis causes a greater amount of group delay than Linear FM synthesis. Having the FM delay equalizer (Special Function 124) turned on or off also affects the amount of group delay, as shown in figure 2-1:

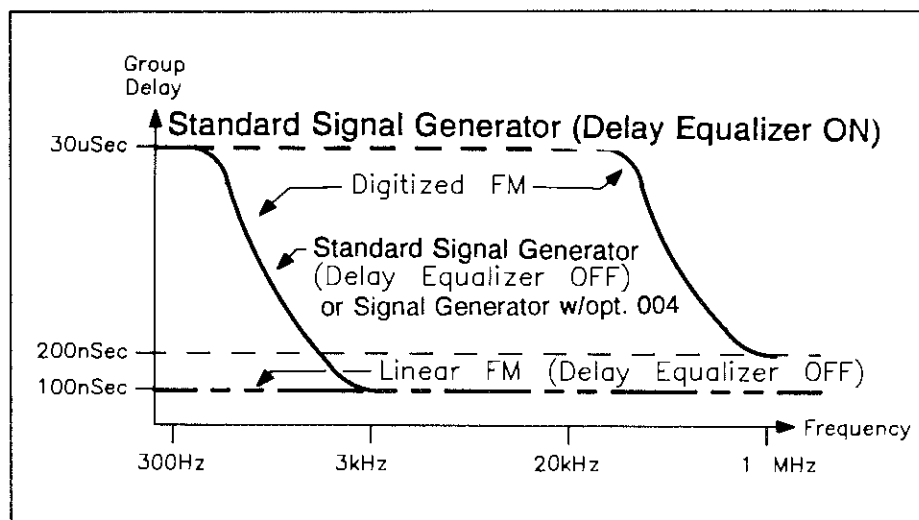

Figure 2-1. Group Delay for Digitized and Linear FM Synthesis.

Mode Selection

On the lower-right side of the Signal Generator's front panel, you will notice a group of keys under the label **MODE SELECT**. With these keys, the Signal Generator allows you control the frequency synthesis scheme used to derive the RF output. A standard Signal Generator provides you with **MODE 1** synthesis only. The low noise Option 004 allows you to have **MODE 2** synthesis.

In most applications, the Signal Generator can be kept in the **AUTO SELECT** mode. If your Signal Generator is equipped with Option 004, you will notice that either the **MODE 1** or the **MODE 2** LED annunciators lights up as frequency or FM deviation is changed. This is a visual indication that the Signal Generator is automatically selecting the "best" mode of operation for the selected frequency and modulation settings. In the **AUTO SELECT** mode, the "best" mode of operation is an RF output with the lowest phase noise.

In other applications, you may want to select an RF output with faster switching or with more FM deviation. In this case, take the Signal Generator out of the Auto Select mode by pressing the Mode key of your choice. There are three basic factors to consider when you select a synthesis mode—they are (1) switching time, (2) FM deviation, and (3) phase noise. A typical comparison of these three factors for an RF output of 1 GHz is shown in figure 2-2:

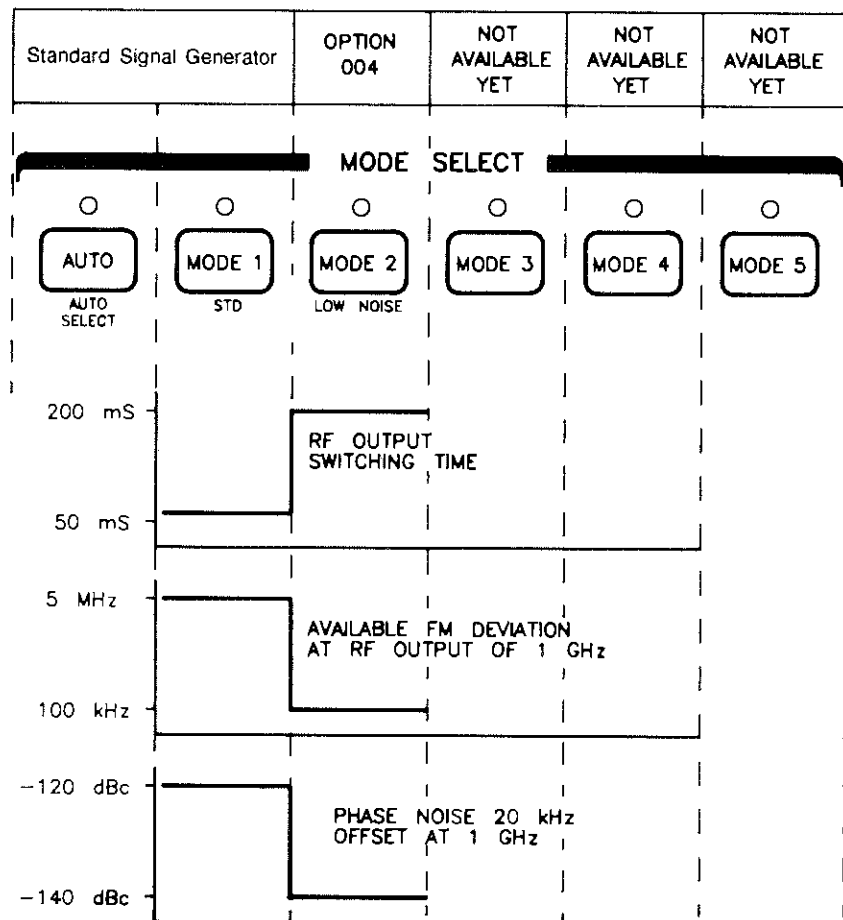

Figure 2-2. Typical Modes of Operation for RF Output of 1 GHz with FM On.

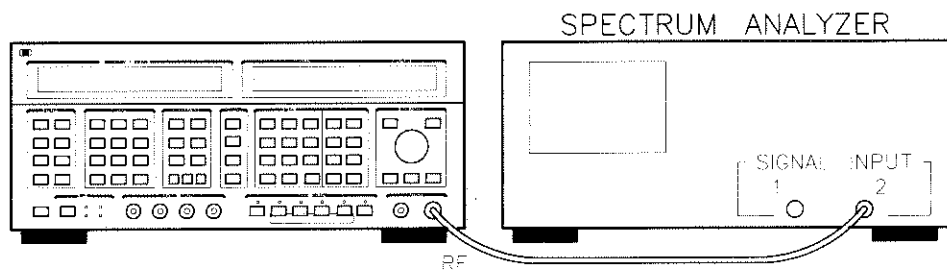

Figure 2-3. Equipment Setup for FM Procedure #1.

Frequency Modulation – An Exercise

The following exercise is made up of two procedures. Each procedure takes about 10 minutes to complete. The first procedure frequency modulates the Signal Generator using the internal audio source. The second procedure frequency modulates the Signal Generator using an external audio source.

Equipment Needed

Both procedures require use of the following equipment:

Equipment	Recommended Model Numbers
Spectrum Analyzer	HP 8562A/B, or HP 8566B, or HP 8568B
Function Generator	HP 3312A, or HP 3314A, or HP 8111A, HP 8116A, or HP 8904A

Procedure #1 – FM Using the Internal Audio Source

Procedure #1 starts with step 1 shown on the next page. A preview of the four major steps in the procedure is as follows:

- Set up and adjust the spectrum analyzer, and connect it to the Signal Generator.
- Adjust the RF output to 2.5 GHz, and the output amplitude to 0 dBm on the Signal Generator.
- Adjust the FM deviation to 10 MHz, and the audio frequency rate to 100 kHz on the Signal Generator.
- Observe and modify the results.

Set Up and Adjust the Spectrum Analyzer

1. Connect the Signal Generator to the spectrum analyzer as shown in figure 2-3. Turn on the equipment, and make the following adjustments to the spectrum analyzer:

Center Frequency 2.5 GHz
 Frequency Span 100 MHz
 Reference Level 0 dBm

Adjust RF Output and Output Amplitude on the Signal Generator

2. Press the green INSTR PRESET key. Doing so presets the Signal Generator to a known state for the following steps.
3. Press the FREQ key, and enter a frequency of 2.5 GHz.

Remember

On the Signal Generator, a "▽ cursor" appears in either the FREQUENCY/STATUS or the MODULATION/AMPLITUDE display, and points to the currently active function. This means, for example, that presently you could repeatedly change the frequency of the Signal Generator without having to first press the FREQ key.

4. Press the AMPTD key, and enter an output amplitude of 0 dBm. You will notice that the "▽ cursor" is now in the MODULATION/AMPLITUDE display. The following display should appear on the spectrum analyzer:

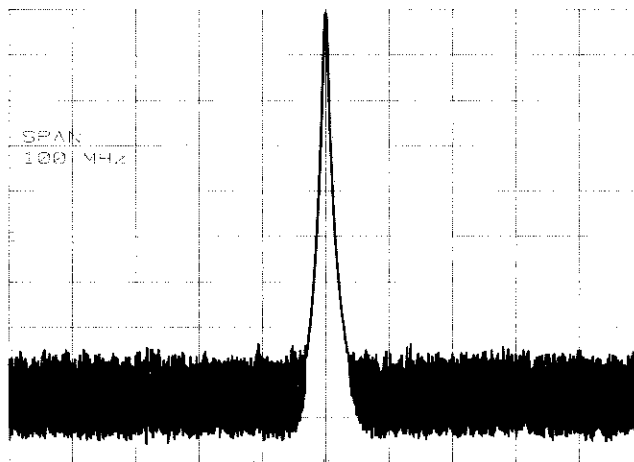

Adjust FM Deviation and Audio Frequency Rate on the Signal Generator

5. Press the **FM** key, and enter an FM deviation of 10 MHz. When FM deviation is first turned on, the audio frequency rate defaults to 1 kHz.

Notice that the yellow annunciators above the **FM** and **INT** keys light up; this indicates that FM, using its internal audio source, is active.

6. Press the **AUDIO FREQ** key, and enter an audio frequency rate of 100 kHz. The Signal Generator should now show the following in the MODULATION/AMPLITUDE display:

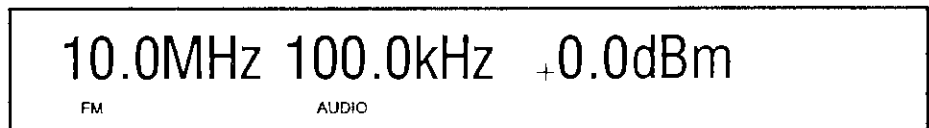

Observe and Modify the Results.

7. The following display should appear on the spectrum analyzer:

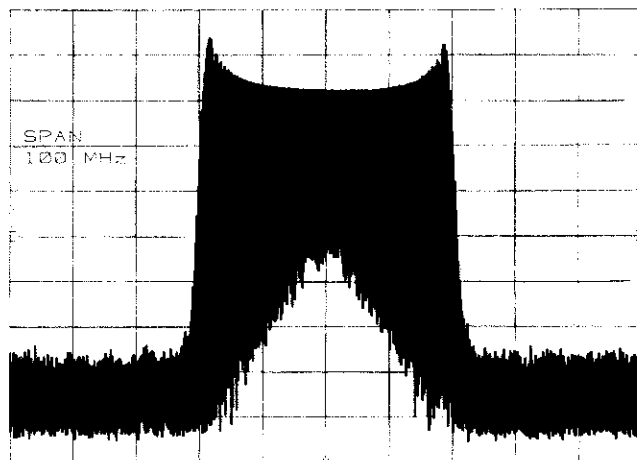

8. Press the **SAVE** key. The Signal Generator should show the following in the FREQUENCY/STATUS display:

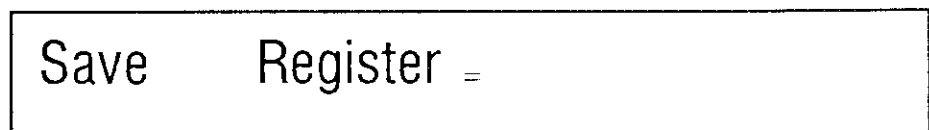

9. Press the **0** key, and the **ON** key. This step enters the frequency, modulation and amplitude settings in Register 0 for use in Procedure #2; the FREQUENCY/STATUS display should now show the last RF output setting (2.5 GHz).

-
10. Press the FM key, the INCR/DECR  key, and turn the knob counterclockwise to decrease the FM deviation. You will notice the spectrum analyzer display changing as FM deviation is adjusted.

Return FM deviation to 10 MHz, and proceed to the next step where you will change the audio frequency waveform by using Special Function 130.

11. Press the SPECIAL key. The Signal Generator should now show the following in the FREQUENCY/STATUS display:

Enter Special Number

12. Enter number "130" and press the ON key. The Signal Generator should now show the following in the FREQUENCY/STATUS display:

130:Audio Wave Sine

13. Turn the knob to change the audio frequency waveform. Notice how the spectrum analyzer responds to the square, triangle, sawtooth, and white Gaussian noise waveforms.

Note

The AUDIO output has a typical bandwidth of 400 kHz for all waveforms. This affects complex waveforms with frequency components greater than 400 kHz.

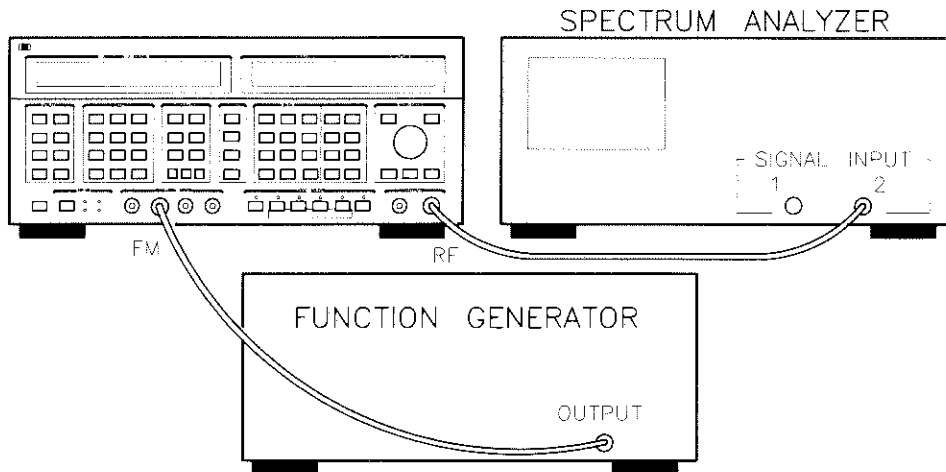

Figure 2-4. Equipment Setup for FM Procedure #2.

**Procedure #2 – FM
Using an External
Audio Source**

Procedure #2 starts with step 1 shown below. A preview of the four major steps in the procedure is as follows:

- Set up and adjust a spectrum analyzer and function generator, and connect them to the Signal Generator.
- Adjust the RF output to 2.5 GHz, and the output amplitude to 0 dBm on the Signal Generator.
- Adjust the FM deviation to 10 MHz on the Signal Generator.
- Observe and modify the results.

Set Up and Adjust the Spectrum Analyzer and Function Generator

1. Connect the Signal Generator to the spectrum analyzer and function generator as shown in figure 2-4. Turn on the equipment and make the following adjustments:

On the Spectrum Analyzer

Center Frequency 2.5 GHz
 Frequency Span 100 MHz
 Reference Level..... 0 dBm

On the Function Generator

Frequency 600 kHz
 Amplitude..... 1 Vpk (at the FM input)
 Waveform Sine

Adjust RF Output and Output Amplitude on the Signal Generator

2. Press the green INSTR PRESET key. Doing so presets the Signal Generator to a known state for the following steps.
3. Press the FREQ key, and enter a frequency of 2.5 GHz.
4. Press the AMPTD key, and enter an output amplitude of 0 dBm. The following display should appear on the spectrum analyzer:

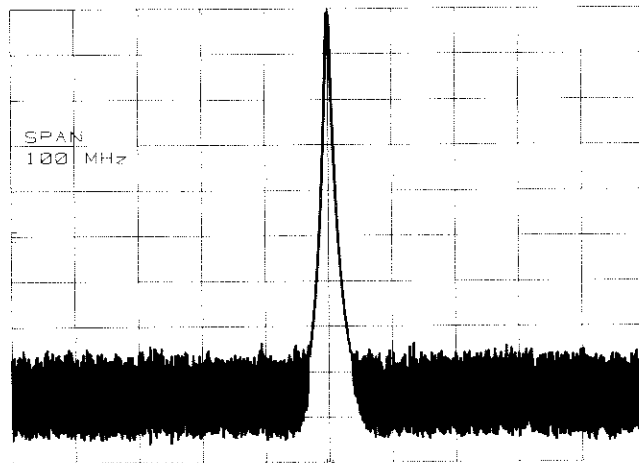

Adjust FM Deviation on the Signal Generator

5. Press the FM key, the EXT AC key, the INT key, and then enter an FM deviation of 10 MHz. The INT key is pressed in this step to turn off the internal audio source.

Notice that the yellow annunciators above the **FM** and **EXT AC** keys light up; this indicates that FM using an external audio source is active.

The Signal Generator should now show the following in the MODULATION/AMPLITUDE display:

<div style="display: flex; justify-content: space-between;"> 10.0MHz Ext AC +0.0dBm </div> <div style="display: flex; justify-content: space-between; font-size: 0.8em; margin-top: 5px;"> FM EXT LO </div>

Remember

The EXT HI and EXT LOW annunciators in the MODULATION/AMPLITUDE display indicate if the amplitude of the external audio source is too high or too low. When the amplitude is at 1 Vpk ±1%, both annunciators are off. However, both annunciators only work at external audio rates from 20 Hz to 100 kHz.

Observe and Modify the Results

6. The following display should appear on the spectrum analyzer:

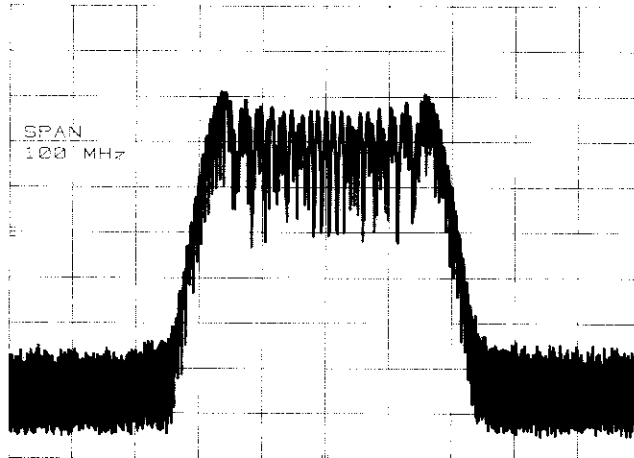

7. Press the **SAVE** key, and put the current front-panel settings in Register 1.
8. Press the **RECALL** key. The Signal Generator should show the following in the **FREQUENCY/STATUS** display:

Recall Register =

9. Press the **0** and the **ON** key to recall the settings from Procedure #1. Notice that the display on the spectrum analyzer reflects the recalled settings from Procedure #1.
10. Recall Register 1 to return to the Procedure #2 settings. Notice once again that the display on the spectrum analyzer reflects the recalled settings for Procedure #2.

Remember

The Signal Generator has 50 available storage registers. The first 10, Registers 0-9, accepts all front panel settings (except for some Special Functions). The next 40, Registers 10-49, accepts only frequency and amplitude settings.

Performing an Instrument Preset, or unplugging the Signal Generator does not alter contents of the 50 storage registers.

**Frequency
Modulation
– Things to
Remember**

The following list is a summary of the most important points previously discussed in the FM modulation section:

- Digitized FM synthesis, and Linear FM synthesis are two methods of generating FM in the Signal Generator. Special Function 120 allows you to choose between either method.
- Carrier frequency accuracy, audio frequency rates, and group delay are three factors to consider when you decide on a method of FM synthesis.
- FM deviation, switching time, and phase noise are three factors to consider if you decide to use a mode of operation other than the Auto mode.
- Resolution for FM deviation is 2.5 % of the front-panel setting.
- The internal audio source generates sine, square, triangle, sawtooth, or white Gaussian noise waveforms. Access Special Function 130 to change the internal audio source waveform.
- Refer to appendix F for information about creating complex audio signals that modulate the RF carrier.

Amplitude Modulation – An Overview

If You Need to Know:	Refer to:
<u>Amplitude Modulation</u>	
• <i>Some general information about amplitude modulation</i>	Amplitude Modulation–An Introduction (2-14)
• <i>How to AM the Signal Generator using the internal audio source</i>	Amplitude Modulation–An Exercise. Procedure #1 (2-15 to 2-18)
• <i>How to AM the Signal Generator with an external audio source</i>	Amplitude Modulation–An Exercise. Procedure #2 (2-19 to 2-21)
• <i>The key things to remember about amplitude modulating the Signal Generator</i>	Amplitude Modulation–Things to Remember (2-22)

Amplitude Modulation – An Introduction

The Signal Generator amplitude modulates the RF output with the internal audio source, or with an ac or dc-coupled external audio source applied to the front-panel **AM** connector. You cannot use both the internal audio source and an external audio source at the same time. The **AM** connector has an input impedance of 600 Ω.

The Signal Generator has an internal audio source that generates waveforms at rates up to 400 kHz; however, for precise AM depth, the audio frequency rates should not exceed the specified **AM 3 dB bandwidth** limits shown in chapter 1 of the Signal Generator *Calibration Manual*.

You can simultaneously modulate AM with FM or pulse modulation. Refer to appendix F if you need complex audio signals for modulating the RF carrier.

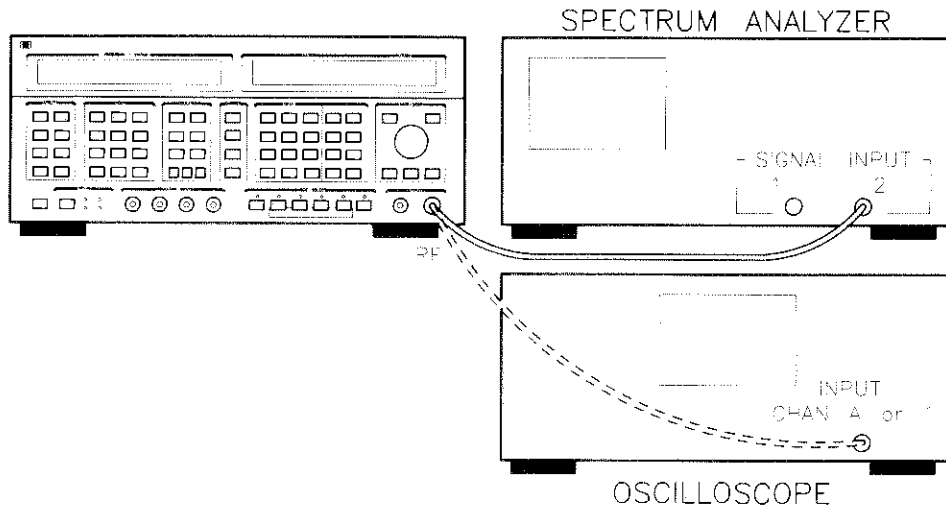

Figure 2-5. Equipment Setup for AM Procedure #1.

Amplitude Modulation – An Exercise

The following exercise is made up of two procedures. Each procedure takes about 10 minutes to complete. The first procedure amplitude modulates the Signal Generator using the internal audio source. The second procedure amplitude modulates the Signal Generator using an external audio source. In both procedures, you have the choice of viewing results either on a spectrum analyzer or on an oscilloscope.

Equipment Needed

Both procedures require use of the following equipment:

Equipment	Recommended Model Numbers
Spectrum Analyzer	HP 8562A/B, or HP 8566B, or HP 8568B
Function Generator	HP 3312A, or HP 3314A, or HP 8111A, HP 8116A, or HP 8904A
Oscilloscope	HP 1741A, or HP 54100A, or HP 54200A

**Procedure #1 – AM
Using the Internal
Audio Source**

Procedure #1 starts with step 1 shown on the next page. A preview of the four major steps in the procedure is as follows:

1. Set up and adjust the spectrum analyzer (or oscilloscope), and connect it to the Signal Generator.
2. Adjust the RF output to 20 MHz, and the output amplitude to 0 dBm on the Signal Generator.
3. Adjust the AM depth to 50%, and the audio frequency rate to 10 kHz on the Signal Generator.
4. Observe and modify the results.

Set Up and Adjust the Spectrum Analyzer (or Oscilloscope)

1. Connect the Signal Generator to the spectrum analyzer (or oscilloscope) as shown in figure 2-5. Turn on the equipment, and make the following adjustments:

On the Spectrum Analyzer

Center Frequency 20 MHz
Frequency Span 25 kHz
Reference Level..... 0 dBm

On the Oscilloscope

Volts/Div 0.5
Time/Div 25 μ sec

Adjust RF Output and Output Amplitude on the Signal Generator

2. Press the green INSTR PRESET key. Doing so presets the Signal Generator to a known state for the following steps.
3. Press the FREQ key, and enter a frequency of 20 MHz.

Remember

On the Signal Generator, a "∇ cursor" appears in either the FREQUENCY/STATUS or the MODULATION/AMPLITUDE display, and points to the currently active function. This means, for example, that presently you could change the frequency of the Signal Generator without having to first press the FREQ key.

4. Press the **AMPTD** key, and enter an output amplitude of 0 dBm. You will notice that the "▽ cursor" is now in the MODULATION/AMPLITUDE display.

Adjust AM Depth and Audio Frequency Rate on the Signal Generator

5. Press the **AM** key, and enter an AM depth of 50%. When AM depth is first turned on, the audio frequency rate defaults to 1 kHz.

Notice that the yellow annunciators above the **AM** and **INT** keys light up; this indicates that AM, using its internal audio source, is active.

6. Press the **AUDIO FREQ** key, and enter an audio frequency rate of 10 kHz. The Signal Generator should now show the following in the MODULATION/AMPLITUDE display:

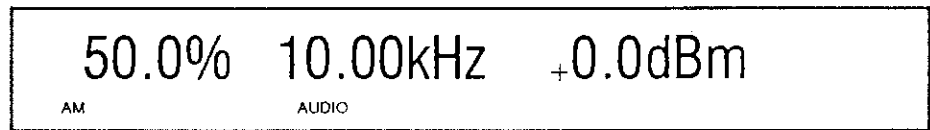

Observe and Modify the Results.

7. The following display should appear on the spectrum analyzer (or oscilloscope):

Spectrum Analyzer

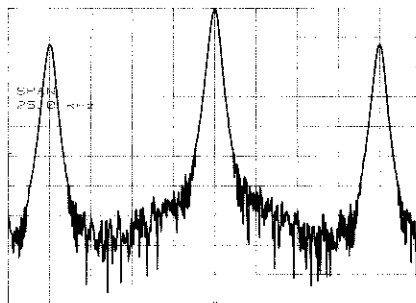

Oscilloscope

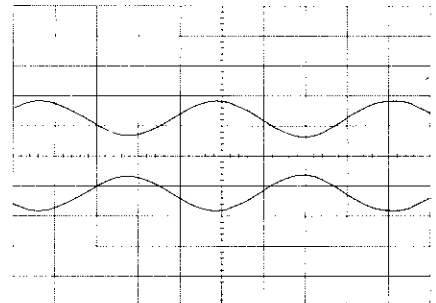

8. Press the **SAVE** key. The Signal Generator should now show the following in the FREQUENCY/STATUS display:

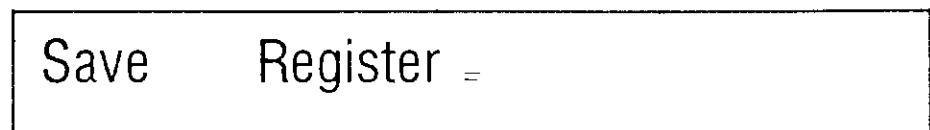

9. Press the **0** key, and the **ON** key. This step enters the frequency, modulation and amplitude settings in Register 0 for use in Procedure #2; the FREQUENCY/STATUS display should now show the last RF output setting (20 MHz).
10. Press the **AM** key, and turn the knob counterclockwise to decrease the **AM depth**. You will notice the spectrum analyzer (or oscilloscope) display changing as AM depth is adjusted.

Return AM depth to 50%, and proceed to the next step where you will change the audio frequency waveform using Special Function 130.

11. Press the **SPECIAL** key. The Signal Generator should now show the following in the FREQUENCY/STATUS display:

Enter Special Number

12. Enter number "130" and press the **ON** key. The Signal Generator should now show the following in the FREQUENCY/STATUS display:

130:Audio Wave Sine

13. Turn the knob to change the audio frequency waveform. Notice how the spectrum analyzer (or oscilloscope) responds to the square, triangle, sawtooth, and white Gaussian noise waveforms.

Note

The AUDIO output has a typical bandwidth of 400 kHz for all waveforms. This affects complex waveforms with frequency components greater than 400 kHz.

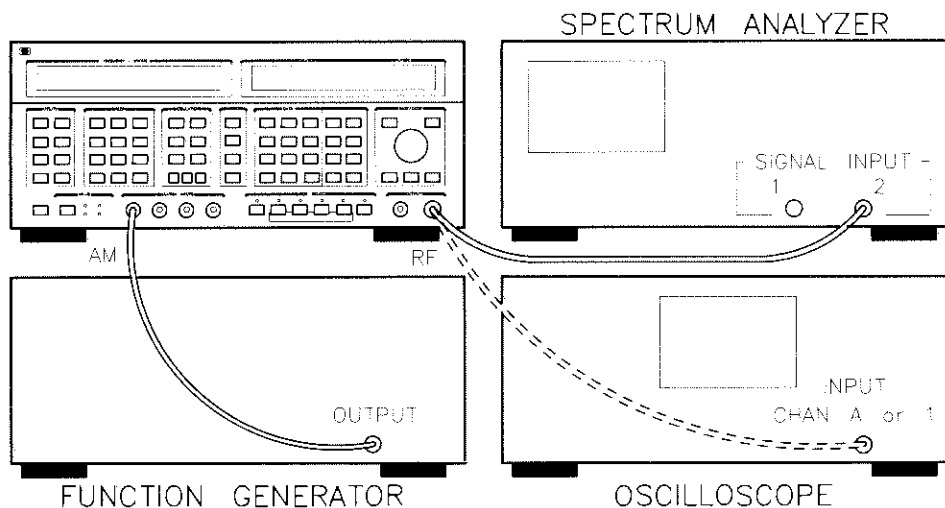

Figure 2-6. Equipment Setup for AM Procedure #2.

**Procedure #2 – AM
Using an External
Audio Source**

Procedure #2 starts with step 1 shown below. A preview of the five major steps in the procedure is as follows:

- Set up and adjust the spectrum analyzer (or oscilloscope) and function generator, and connect them to the Signal Generator.
- Adjust the RF output to 100 MHz, and the output amplitude to 0 dBm on the Signal Generator.
- Adjust the AM depth to 90% on the Signal Generator.
- Adjust output amplitude on the function generator.
- Observe and modify the results.

**Set Up and Adjust the Spectrum Analyzer (or Oscilloscope),
and Function Generator**

1. Connect the Signal Generator to a spectrum analyzer (or oscilloscope) and function generator as shown in figure 2-6. Turn on the equipment and make the following adjustments:

On the Spectrum Analyzer

Center Frequency 100 MHz
 Frequency Span 50 kHz
 Reference Level..... 0 dBm

On the Oscilloscope

Volts/Div0.2
Time/Div 25 μ sec

On the Function Generator

Frequency 10 kHz
Amplitude..... 1 V_{pk}
Waveform Sine

Adjust RF Output and Output Amplitude on the Signal Generator

2. Press the green INSTR PRESET key. Doing so presets the Signal Generator to a known state for the following steps.
3. Press the FREQ key, and enter a frequency of 100 MHz.
4. Press the AMPTD key, and enter an output amplitude of 0 dBm.

Adjust AM Depth on the Signal Generator

5. Press the AM key, the EXT AC key, and then enter an AM depth of 90%.

Notice that the yellow annunciators above the AM and EXT AC keys light up; this indicates that AM using an external audio source is active.

The Signal Generator should now show the following in the MODULATION/AMPLITUDE display:

90.0%	Ext AC	+0.0dBm
AM		EXT LO

Remember

The EXT HI and EXT LOW annunciators in the MODULATION/AMPLITUDE display indicate if the amplitude of the external audio source is too high or too low. When the amplitude is at 1 V_{pk} \pm 1%, both annunciators are off. However, both annunciators only work at external audio rates from 20 Hz to 100 kHz.

Adjust Output Amplitude on the Function Generator

Note Proceed to step 7 if both the EXT HI and EXT LOW annunciators are off.

6. Slowly adjust the output amplitude on the function generator until both the EXT HI and EXT LOW annunciators are off. The Signal Generator requires the input signal to the AM connector to be $1 \text{ Vpk} \pm 1\%$.

Observe and Modify the Results

7. The following display should appear on the spectrum analyzer (or oscilloscope):

Spectrum Analyzer

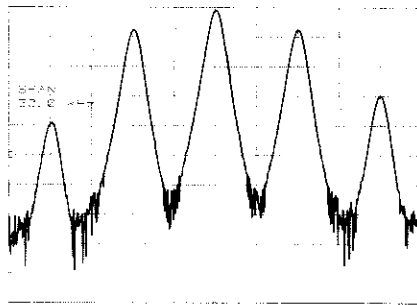

Oscilloscope

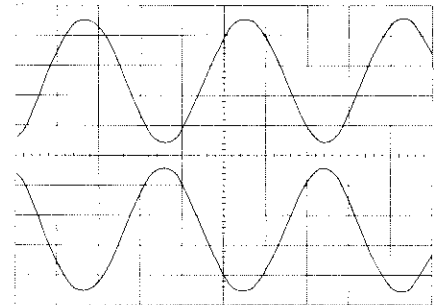

8. Press the **SAVE** key, and put the current front-panel settings in Register 1.
9. Press the **RECALL** key. The Signal Generator should show the following in the FREQUENCY/STATUS display:

Recall Register =

10. Press the **0** and the **ON** key to recall the settings from Procedure #1. You will have to re-adjust the spectrum analyzer for a center frequency of 20 MHz. Then, notice that the display on the spectrum analyzer reflects the recalled settings from Procedure #1.
 11. **Recall Register 1 to return to the Procedure #2 settings.** Re-adjust the spectrum analyzer's center frequency to 100 MHz. Notice once again that the display on the spectrum analyzer reflects the recalled settings for Procedure #2.
-

Remember

The Signal Generator has 50 available storage registers. The first 10, Registers 0–9, accept all front panel settings (except for some Special Functions). The next 40, Registers 10–49, accept only frequency and amplitude settings.

Performing an Instrument Preset, or unplugging the Signal Generator does not alter contents of the 50 storage registers.

**Amplitude
Modulation
– Things to
Remember**

The following list is a summary of the most important points previously discussed in the AM modulation section:

- For accurate AM depth, audio frequency rates should not exceed the specified limits shown in chapter 1 of the Signal Generator Calibration Manual for the RF output.
- An internal or external audio source can be used to amplitude modulate the RF output.
- The internal audio source generates sine, square, triangle, saw-tooth, or white Gaussian noise waveforms. Access Special Function 130 to change the internal audio source waveform.
- Refer to appendix F for information about creating complex audio signals for modulating the RF carrier.

Pulse Modulation – An Overview

If You Need to Know:	Refer to:
<u>Pulse Modulation</u>	
• <i>Some general information about pulse modulation</i>	Pulse Modulation—An Introduction (2-23)
• <i>The four events that occur in the process of generating a pulse</i>	Pulse Modulation—Synchronization (2-24)
• <i>How to Pulse Modulate the Signal Generator using direct pulse control</i>	Pulse Modulation—An Exercise. Procedure # 1 (2-29 to 2-32)
• <i>How to Pulse Modulate the Signal Generator with the internal pulse generator</i>	Pulse Modulation—An Exercise. Procedure # 2 (2-33 to 2-37)
• <i>The key things to remember about pulse modulating the Signal Generator</i>	Pulse Modulation—Things to Remember (2-38)

Pulse Modulation – An Introduction

Pulse Modulation is available on the Signal Generator equipped with Option 008. With this option, you can perform radar test measurements for searching, tracking, and surveillance simulation. The Signal Generator also provides variable pulse delay and width features for radar component testing.

The Signal Generator’s internal audio source, or an external signal (dc-coupled) is used to pulse modulate the RF output. The RF output is specified to a maximum level of +9 dBm for pulse modulation. Pulse modulation is controlled by either using *direct pulse control*, or by using the *internal pulse generator*.

Direct pulse control refers to the internal or external source controlling the timing and width of the pulsed RF output. In contrast, using the internal pulse generator you directly control the delay, width, and triggering edge of the pulsed RF output through Special Functions 212-214.

You can simultaneously modulate AM or FM with pulse modulation. Special Function 210 allows you to select an input impedance of $50\ \Omega$ for the **PULSE** connector, or to keep the preset Schottky TTL input impedance value of $100\ k\Omega$.

Pulse Modulation – Synchronization

There are four events occurring in the process of generating a pulse modulated output from the Signal Generator.

1. An external or internal control signal must be present.
2. A sync output is generated.
3. An RF pulse output is generated.
4. A video output is generated (simultaneously with an RF pulse output).

The illustration in figure 2-7 shows an RF output pulse synchronized from the rising edge of a control signal. Refer to figure 2-7 as you review each event in detail.

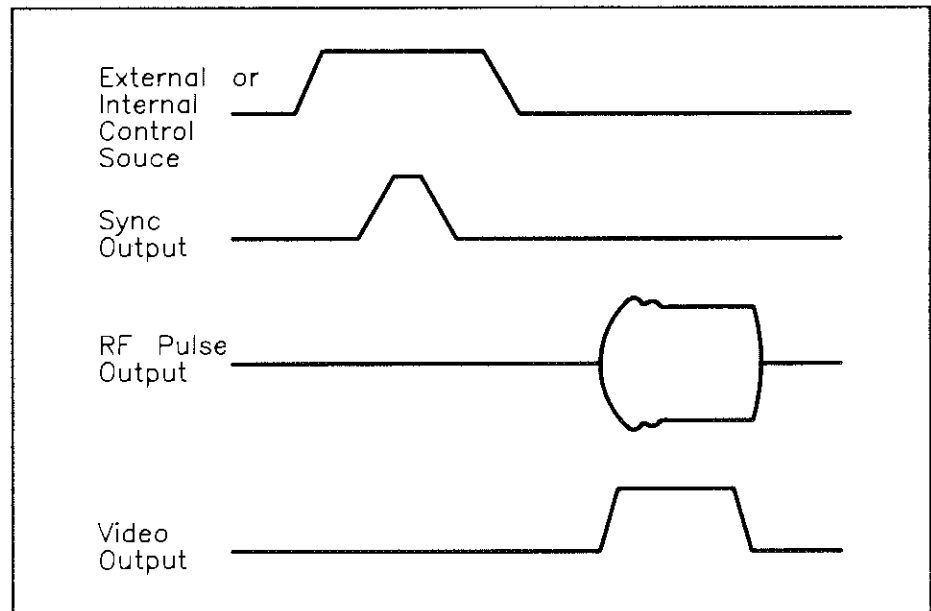

Figure 2-7. Rising Edge Synchronization for the Pulse Modulation Output.

External or Internal Control Signal

The *External or Internal Control Signal* is used to initiate a pulse modulated RF output. This control signal determines the Pulse Repetition Frequency (PRF) of the RF output.

- The external control signal must be a TTL level into the load you've selected (50 Ω or 100 k Ω), it must be dc-coupled to the front panel **PULSE** connector, and can be at a rate from dc to 10 MHz.
- The internal control signal originates from the internal audio source (refer to appendix F), and can be at a rate from 0.1 Hz to 400 kHz. For best results when pulse modulating, use the internal audio source in its preset condition. That is, a sine wave with no subcarrier modulation sources turned on.

Sync Output

The next event to occur is a TTL level *Sync Output* signal. A sync output signal is typically 50 ns in duration (into 50 Ω), and is used to synchronize the *RF Pulse Output*.

A sync output signal is generated in one of three ways:

- It occurs *once* relative to the positive edge of the external or internal control signal. (This is the default condition.)
- It occurs *once* relative to the negative edge of the external or internal control signal. (This is valid only when using the internal pulse generator, and Special Function 214, `Pulse Trig Edge` is set to `Neg`).
- It occurs *once*, relative to the positive edge of the external or internal control signal. (This is valid only when using the internal pulse generator, and Special Function 214, `Pulse Trig Edge` is set to `Both`).

The sync output is monitored from the rear-panel **SYNC** connector. The presence of an external or internal control signal will always generate a sync output signal.

Trigger Delay Time (T_d)

Trigger delay (T_d) is the time starting from the external or internal control signal occurrence to the sync output occurrence. Figure 2-8 illustrates a sync output occurring on the rising edge of the external or internal control signal. However, T_d is synchronized to start:

- half-way up the rising edge, or
- half-way down the falling edge

of the external or internal control signal, and end half-way up the rising edge of the sync output signal.

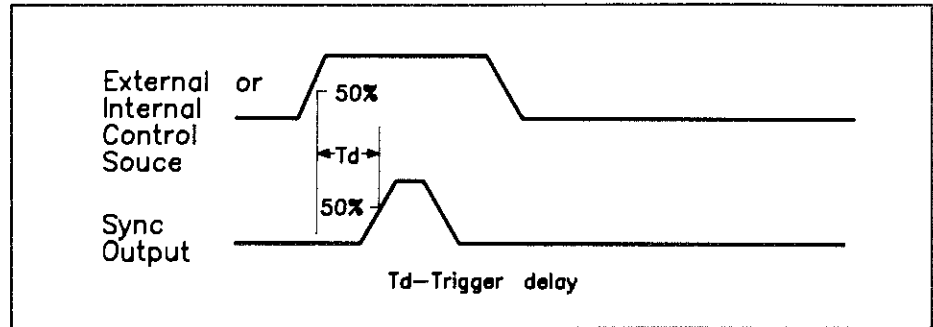

Figure 2-8. Trigger Delay Time for the Sync Output.

The amount of trigger delay time depends upon whether you are using direct pulse control, or are using the internal pulse generator. (Trigger delay time is longer when using the internal pulse generator.)

RF Pulse Output

The *RF Pulse Output* occurs after the sync output. (The *RF Pulse Output* occurs twice if direct pulse control is being used, and if Special Function 214 is set to *Both*. The second pulse occurs in relation the negative edge of the control signal after $T_d + P_d$.)

An RF pulse output is described in terms of its characteristics, as shown in figure 2-9. Specifications for each characteristic are found in chapter 1 of the *Calibration Manual*.

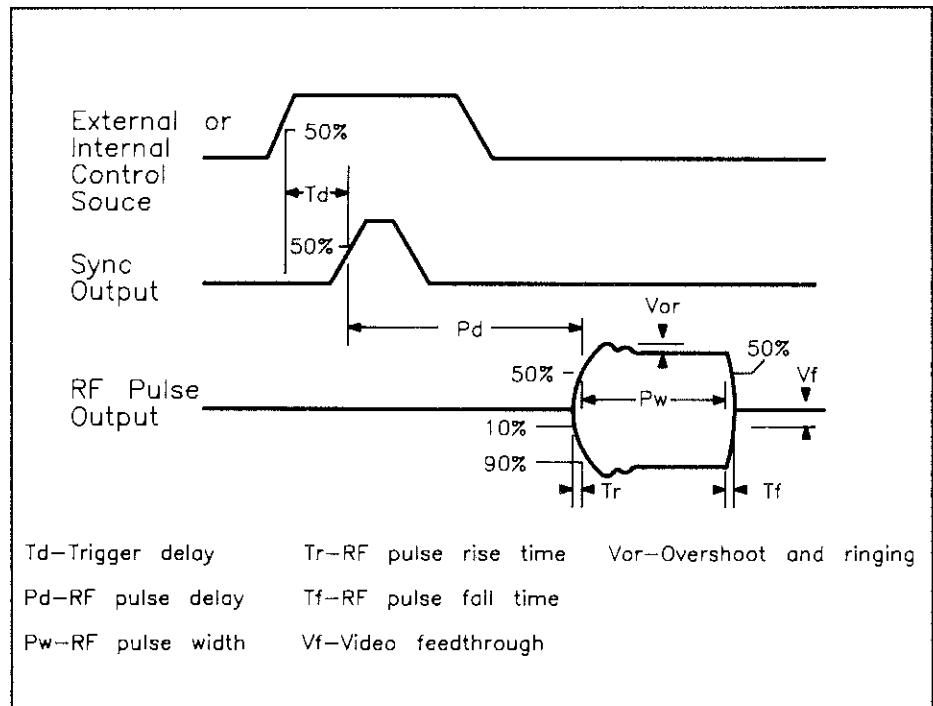

Figure 2-9. RF Pulse Output Characteristics.

RF pulse delay (P_d) is the time from a sync pulse occurrence to an RF pulse output occurrence. P_d starts half-way up the rising edge of the sync output, and ends half-way into the leading edges of an RF pulse output. The amount of RF pulse delay depends upon whether you are using direct pulse control, or are using the internal pulse generator.

Direct Pulse Control for P_d . When direct pulse control is used, the typical RF pulse delay time is less than 30 ns. The operator cannot vary P_d under direct pulse control.

Internal Pulse Generator for P_d . When the internal pulse generator is used, the amount of P_d can be varied from 50 ns to 1 s. Simply activate Special Function 212 and select the amount of pulse delay needed.

RF Pulse Rise Time (T_r)

RF pulse rise time (T_r) is the interval of time required for the leading edges of an RF pulse output to change from 10% to 90% of its peak amplitude.

Overshoot and Ringing (V_{or})

Overshoot and ringing (V_{or}) is an initial transient response of the pulse output. Overshoot refers to the pulse momentarily exceeding its steady-state amplitude. Ringing refers to the positive and negative excursions that take place before the pulse reaches its final amplitude value. Overshoot and ringing is typically less than $\pm 25\%$ of the peak pulse output.

RF Pulse Width (P_w)

Pulse width (P_w) is the time interval between the leading and trailing edges of an RF pulse output. Pulse width duration starts half-way into the leading edges of the pulse, and ends half-way into the trailing edges of the pulse. The actual pulse width duration depends upon whether you are using direct pulse control, or are using the internal pulse generator.

Direct Pulse Control for (P_w). When direct pulse control is used, pulse width is determined by the external or internal control signal, as follows:

- An external control signal typically sets P_w to be equal to the duration of the external signal when it is at a TTL high, less the RF pulse width compression ($T_w - P_w$).
- An internal control signal typically sets P_w to be equal to half the PRF period.

Internal Pulse Generator for (P_w). When the internal pulse generator is used, the amount of P_w can be varied from 10 ns to 1 s. Simply activate Special Function 213 and select the amount of pulse width needed.

RF Pulse Fall Time (T_f)

RF pulse fall time (T_f) is the interval of time required for the trailing edges of an RF pulse output to change from 90% to 10% of its peak amplitude.

Video Feedthrough (V_f)

Video feedthrough (V_f) is the spurious content of the RF output, expressed in dBc, that is harmonically related to the PRF. Typically, video feedthrough is less than -50 dBc for rates less than or equal to 100 kHz.

Video Output

The *Video Output* occurs simultaneously with an RF pulse output and lasts for approximately the same duration as the pulse. The video output is monitored from the rear-panel **VIDEO** connector. The presence of an RF pulse output always coincides with a video output signal, as shown in figure 2-10:

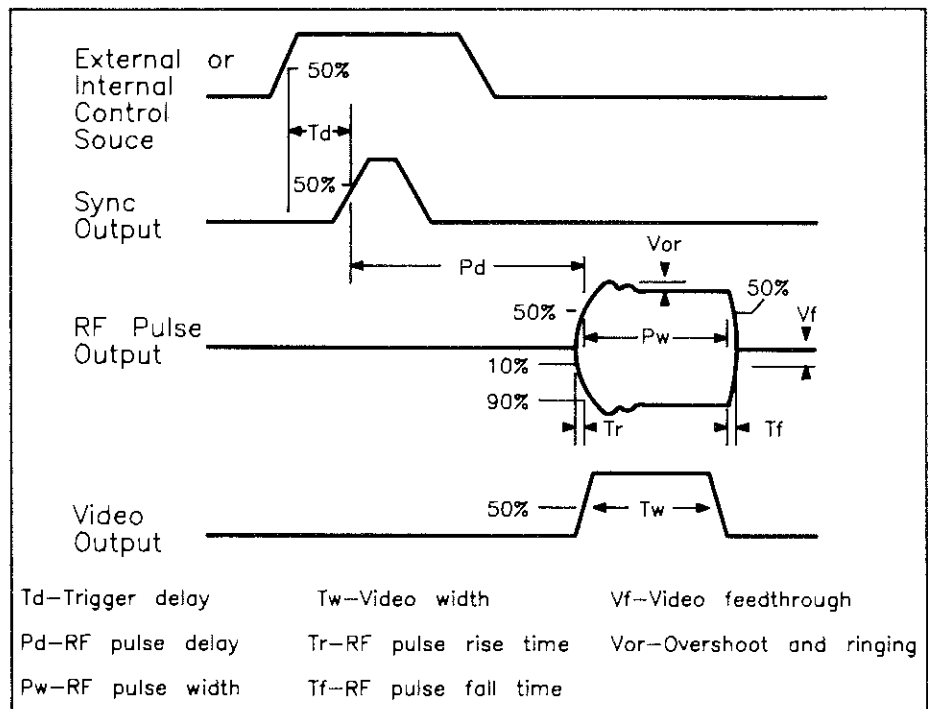

Figure 2-10. Video Output in Relation to the RF Pulse Output.

Video Width (T_w)

Video width (T_w) is the time interval between the rising and falling edges of the video output. Video width duration starts half-way up the rising edge, and ends half-way down the falling edge of the video output signal. Video width approximately corresponds to the width of the RF pulse output.

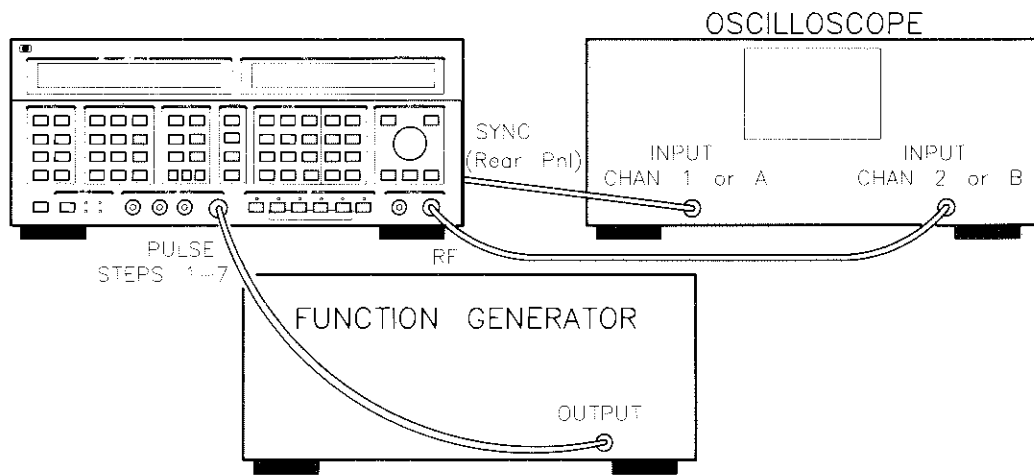

Figure 2-11. Equipment Setup for Pulse Modulation Procedure #1.

Pulse Modulation – An Exercise

The following exercise is made up of two procedures. Each procedure takes about 15 minutes to complete. The first procedure (#1) pulse modulates the Signal Generator using direct pulse control. The second procedure (#2) pulse modulates the Signal Generator using the internal pulse generator. Results from the pulse modulation exercise are displayed on an oscilloscope.

Equipment Needed

This procedure requires use of the following equipment:

Equipment	Recommended Model Numbers
Function Generator	HP 3312A, or HP 3314A, or HP 8111A, HP 8116A, or HP 8904A
Oscilloscope*	HP 54100A, or HP 54100D, or HP 54110D, or HP 54120T
*If your oscilloscope does not have a 1 GHz bandwidth, reduce the RF output frequency in the following procedures.	

Procedure #1 – Pulse Modulation Using Direct Pulse Control

The procedure starts with step 1 shown on the next page. A preview of the six major steps in the procedure is as follows:

- Set up and adjust an oscilloscope and function generator, and connect them to the Signal Generator.
- Adjust the Signal Generator RF output to 1 GHz, and the output amplitude to 0 dBm.
- Set up external pulse modulation on the Signal Generator.
- Observe and modify the results.
- Set up internal pulse modulation on the Signal Generator.
- Observe and modify the results.

Set Up and Adjust an Oscilloscope and Function Generator

1. Connect the Signal Generator to an oscilloscope and function generator as shown in figure 2-11. Turn on the equipment, and make the following adjustments:

On the Oscilloscope

Volts/Div 200 mV
 Time/Div 100 μ s

On the Function Generator

Frequency 3 kHz
 Amplitude 4 Vp-p (+2 V offset)
 Waveform Square (50% duty cycle)

Adjust RF Output and Output Amplitude on the Signal Generator

2. Press the green INSTR PRESET key. Doing so presets the Signal Generator to a known state for the following steps. In the preset condition, the Signal Generator uses direct pulse control for pulse modulation.
3. Press the FREQ key, and enter a frequency of 1 GHz.

Remember

On the Signal Generator, a “ ∇ cursor” appears in either the FREQUENCY/STATUS or the MODULATION/AMPLITUDE display, and points to the currently active function. This means, for example, that presently you could change frequency on the Signal Generator without having to first press the FREQ key.

4. Press the AMPTD key, and enter an output amplitude of 0 dBm. You will notice that the “ ∇ cursor” is now in the MODULATION/AMPLITUDE display.

Set Up External Pulse Modulation on the Signal Generator

5. Press the PULSE key, and then press the ON key. This step activates an external control signal for the RF pulse output.

Notice that the yellow annunciators above the PULSE and EXT DC keys light up; this indicates that pulse modulation using the external audio source is active. The Signal Generator should now show the following in the MODULATION/AMPLITUDE display:

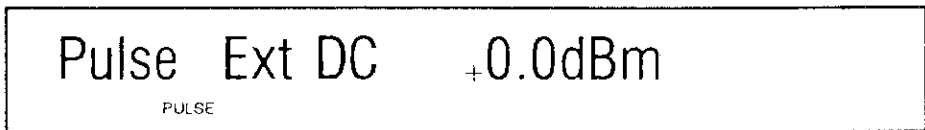

Note

Depending upon the function generator used, you may want to specify a different input impedance for the PULSE connector. Refer to Special Function 210 in appendix C.

Observe and Modify the Results

6. The following display should appear on the oscilloscope:

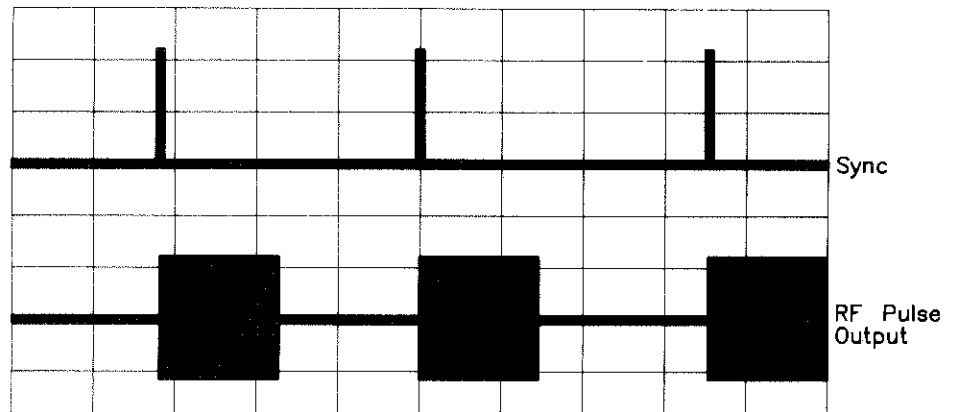

7. Vary the duty cycle and rate of the external audio source, and notice the corresponding changes on the oscilloscope.

Caution

Do not apply more than ± 10 Vpk (or +7 V dc or -3.5 V dc) to the PULSE connector or you may damage the pulse input circuitry on the Signal Generator.

Set Up Internal Pulse Modulation on the Signal Generator

8. Disconnect the function generator cable to the Signal Generator.
9. Press the INT key on the Signal Generator. Notice the yellow annunciator light above the EXT DC key goes off, and the yellow annunciator light above the INT key goes on.
10. Press the AUDIO FREQ key, and enter an audio frequency rate of 3 kHz. This step activates the internal control signal for the RF pulse output. The Signal Generator should now show the following in the MODULATION/AMPLITUDE display:

<div style="font-size: 24pt; font-weight: bold; margin-bottom: 5px;">Pulse 3.000kHz +0.0dBm</div> <div style="display: flex; justify-content: space-around; font-size: 10pt;"> PULSE AUDIO </div>

Observe and Modify the Results

11. The following display should appear on the oscilloscope:

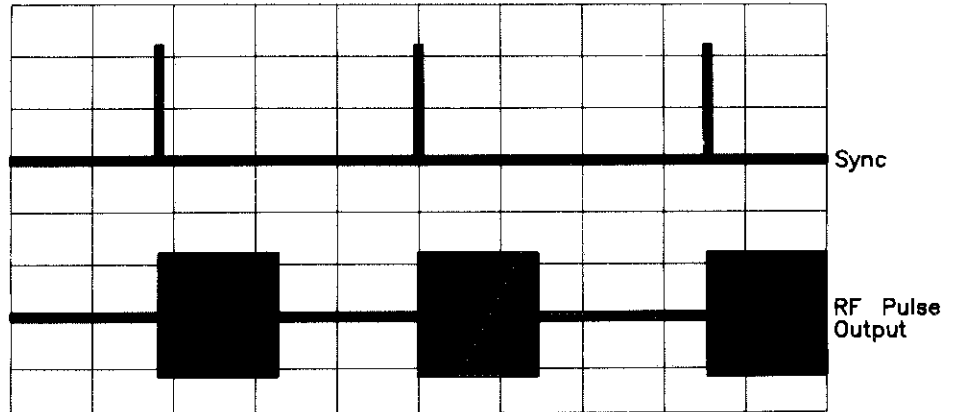

12. Vary the audio frequency rate. Notice the corresponding changes on the oscilloscope.

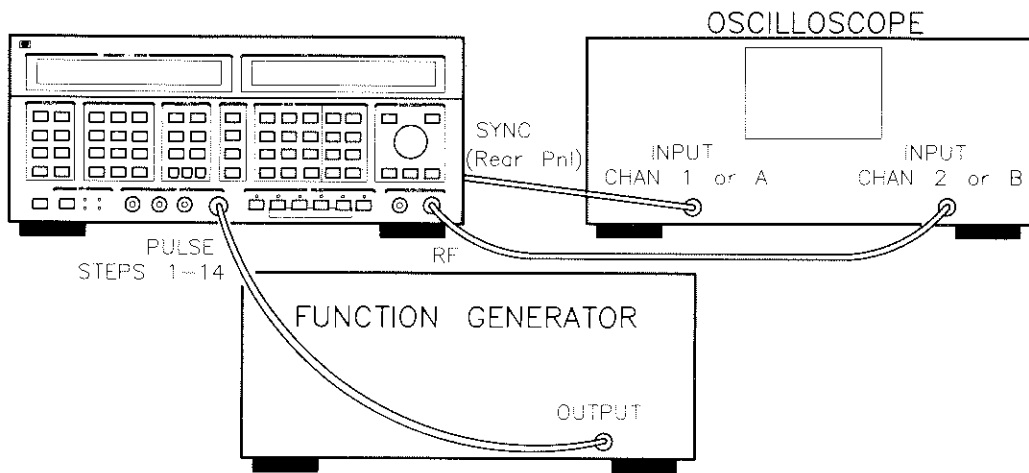

Figure 2-12. Equipment Setup for Pulse Modulation Procedure #2.

**Procedure #2 –
Pulse Modulation
Using the Internal
Pulse Generator**

The procedure starts with step 1 shown below. A preview of the six major steps in the procedure is as follows:

- Set up and adjust an oscilloscope and function generator, and connect them to the Signal Generator.
- Adjust the Signal Generator RF output to 1 GHz, and the output amplitude to 0 dBm.
- Set up external pulse modulation on the Signal Generator.
- Observe and modify the results.
- Set up internal pulse modulation on the Signal Generator.
- Observe and modify the results.

Set Up and Adjust an Oscilloscope and Function Generator

1. Connect the Signal Generator to an oscilloscope and function generator as shown in figure 2-12. Turn on the equipment, and make the following adjustments:

On the Oscilloscope

Volts/Div 200 mV
Time/Div 1 μ s

On the Function Generator

Frequency 900 Hz
Amplitude 4 Vp-p (+2 V offset)
Waveform Square (50% duty cycle)

Caution

Do not apply more than ± 10 Vpk (or +7 V dc or -3.5 V dc) to the PULSE connector or you may damage the Synthesized Signal Generator's circuitry.

Adjust RF Output and Output Amplitude on the Signal Generator

2. Press the green INSTR PRESET key. Doing so presets the Signal Generator to a known state for the following steps.
3. Press the FREQ key, and enter a frequency of 1 GHz.

Remember

On the Signal Generator, a "∇ cursor" appears in either the FREQUENCY/STATUS or the MODULATION/AMPLITUDE display, and points to the currently active function. This means, for example, that presently you could change frequency on the Signal Generator without having to first press the FREQ key.

4. Press the AMPTD key, and enter an output amplitude of 0 dBm. You will notice that the "∇ cursor" is now in the MODULATION/AMPLITUDE display.

Set Up External Pulse Modulation on the Signal Generator

5. Press the SPECIAL key, enter number "211", and then press the ON key. This special function allows you to select the internal pulse generator for pulse modulation. The Signal Generator should now show the following in the FREQUENCY/STATUS display:

211:Pulse Cntl Direct

6. Turn the knob clockwise until Pulse Gen is displayed. With Pulse Gen displayed, the Signal Generator uses the internal pulse generator for pulse modulation.
7. Press the PULSE key, and then press the ON key. This step activates an external control signal for the RF pulse output.

Notice that the yellow annunciators above the PULSE and EXT DC keys light up; this indicates that pulse modulation using the external audio source is active. The Signal Generator should now show the following in the MODULATION/AMPLITUDE display:

Pulse Ext DC +0.0dBm
PULSE

Note *Depending upon the function generator used, you may want to specify a different input impedance for the PULSE connector. Refer to Special Function 210 in appendix C.*

Observe and Modify the Results

8. The following display should appear on the oscilloscope:

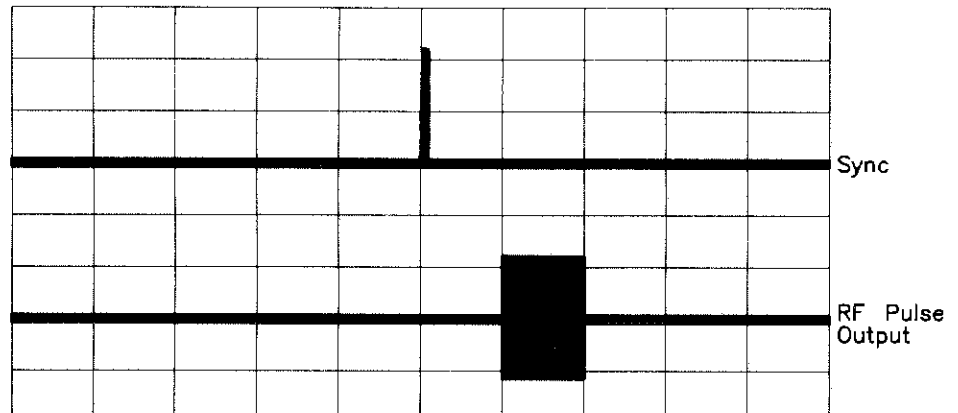

9. Press the **SPECIAL** key, enter number "212", and then press the **ON** key. This special function allows you to vary the pulse delay time (P_d). The Signal Generator should now show the following in the FREQUENCY/STATUS display:

212:Pulse Delay 1.000us

10. Turn the knob to vary the pulse delay time. You will notice the RF pulse output changing in relation to the sync output. Change the oscilloscope time/division as necessary to observe your results.

11. Press the **SPECIAL** key, enter number "213", and then press the **ON** key. This special function allows you to change the pulse width (P_w). The Signal Generator should now show the following in the FREQUENCY/STATUS display:

213:Pulse Width 1.000us

12. Turn the knob to change the pulse width. You will notice the the RF pulse output changing in width. Change the oscilloscope time/division as necessary to observe your results.
13. Press the **SPECIAL** key, enter number "214", and then press the **ON** key. This special function allows you to select the trigger edge for the RF pulse output. The Signal Generator should now show the following in the FREQUENCY/STATUS display:

214:Pulse Trig Edge Pos

14. Turn the knob to select either the negative edge (**Neg**), or both edges (**Both**) of the external control signal for triggering the RF pulse output. The RF pulse output occurs at different positions on the oscilloscope display for the **POS** and **NEG** edges. Two pulses corresponding to the positive and negative edge positions appears when **BOTH** is selected. Change the oscilloscope time/division as necessary to observe your results.

Set Up Internal Pulse Modulation on the Signal Generator

15. Disconnect the cable from the function generator to the Signal Generator.
16. Press the **INT** key on the Signal Generator. Notice the yellow annunciator light above the **EXT DC** key goes off, and the yellow annunciator light above the **INT** key goes on.
17. Set the oscilloscope back to 1 μ s time/division, and the triggering edge on Special Function 214 back to positive. Pulse width and delay should also be set back to the preset value of 1 μ s.
18. Press the **AUDIO FREQ** key, and enter an audio frequency rate of 900 Hz. This step activates the internal control signal for the RF pulse output. The Signal Generator should now show the following in the MODULATION/AMPLITUDE display:

Pulse 900.0 Hz +0.0dBm

PULSE

AUDIO

Observe and Modify the Results

19. The following display should appear on the oscilloscope:

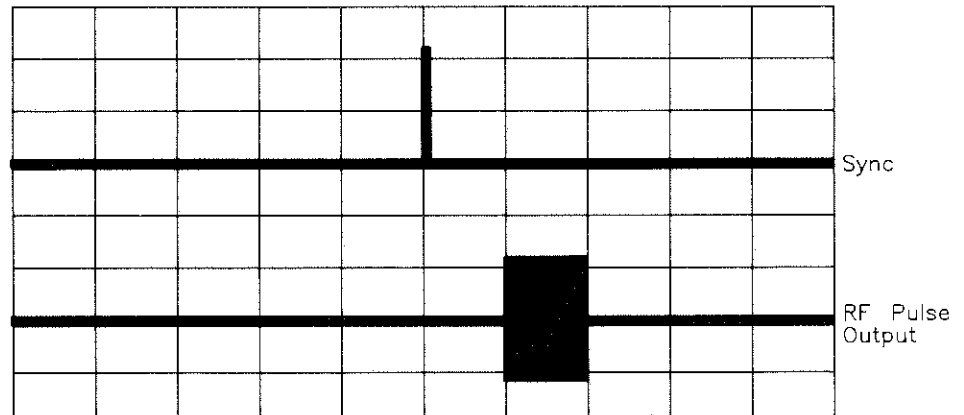

20. Modify pulse delay (Special Function 212), pulse width (Special Function 213), or the pulse triggering edge (Special Function 214). Notice the same results as seen when the external control signal (square wave with 50% duty cycle) was used for the RF pulse output.
21. Disconnect the SYNC output, and connect the oscilloscope to the rear-panel VIDEO connector. You will notice a video output occurring for each RF pulse output.

Pulse Modulation – Things to Remember

The following list is a summary of the most important points discussed in the pulse modulation section:

- The Signal Generator generates pulse modulation using either direct pulse control, or the internal pulse generator.
- Using the internal pulse generator allows you to have control over the pulse delay, width, and triggering edge.
- When using an external source (dc-coupled only), input a TTL pulse to turn on pulse modulation from the Signal Generator. This external pulse determines the pulse repetition frequency (PRF) of the RF pulse output.
- Damage to circuitry in the Signal Generator could result if the external audio source outputs a pulse greater than ± 10 Vpk (or $+7$ Vpk or -3.5 V dc).
- The RF output is specified to a maximum level of $+9$ dBm for pulse modulation.
- Special Function 210 allows you to select the input impedance of the **PULSE** connector.
- Special Function 211 allows you to turn on the internal pulse generator.
- Special Function 212 allows you to vary the pulse delay time.
- Special Function 213 allows you to change the pulse width.
- Special Function 214 allows you to select either the negative or both edges of the external or internal control signal for triggering the RF pulse output if the positive edge is not wanted.

Simultaneous Modulation – An Overview

If You Need to Know:	Refer to:
<u>Simultaneous Modulation</u>	
<ul style="list-style-type: none"> • <i>Some general information about simultaneous modulation</i> 	<p>Simultaneous Modulation—An Introduction (2-39)</p>
<ul style="list-style-type: none"> • <i>How to simultaneously modulate FM with AM</i> 	<p>Simultaneous Modulation—An Exercise (2-40 to 2-43)</p>
<ul style="list-style-type: none"> • <i>The key things to remember about simultaneous modulating the Signal Generator</i> 	<p>Simultaneous Modulation—Things to Remember (2-45)</p>

Simultaneous Modulation – An Introduction

The Signal Generator generates simultaneous modulation in one of five ways:

1. Simultaneous FM and AM is selected using a common or separate audio source.
2. Simultaneous FM at two rates using both the internal and an external audio source.
3. Simultaneous FM and AM using a common audio source (either internal or external), and FM from a separate audio source.
4. Pulse modulation may be selected and entered along with any of the three ways mentioned in statements 1-3.
5. Phase modulation may be selected with AM and/or Pulse modulation. If phase modulation is selected, FM is turned off.

Refer to appendix F to learn about the multifunction synthesis capabilities of the Signal Generator. Special Functions allow you to generate a subcarrier from complex audio signals that is applied, in turn, as a modulating wave to the RF carrier signal.

The **AM**, and **FM** Modulation Input connectors have an external input impedance of 600 Ω. The **ΦM** Modulation Input connector has an input impedance of 50 Ω. With Option 008, the **PULSE** Modulation Input connector has an input impedance of 50 Ω, or 100 kΩ (with Special Function 210 turned off).

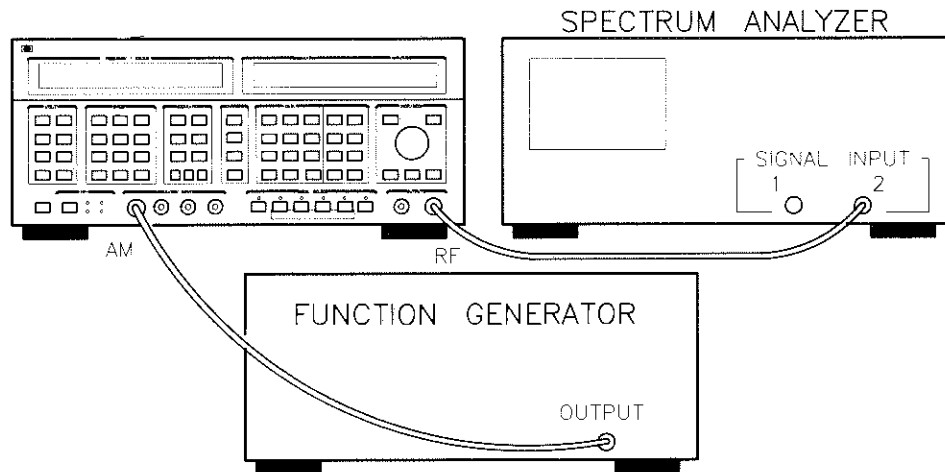

Figure 2-13. Equipment Setup for Simultaneous FM and AM Procedure.

Simultaneous Modulation – An Exercise

There are many possible combinations and applications for simultaneous modulation. In this exercise, the Signal Generator simultaneously modulates FM with AM. The application for this exercise represents an FM radio signal fading 30 dB as a result of interference. This procedure takes about 15 minutes.

Equipment Needed

This procedure requires use of the following equipment:

Equipment	Recommended Model Numbers
Spectrum Analyzer	HP 8562A/B, or HP 8566B, or HP 8568B
Function Generator	HP 3312A, or HP 3314A, or HP 8111A, HP 8116A, or HP 8904A

Procedure – Simultaneous FM and AM

In the procedure, you will set up the Signal Generator with a wanted FM signal modulated by the internal audio source, and then introduce an AM signal used for fading, which is modulated with an external audio source.

A preview of the five major steps in the procedure is as follows:

- Set up and adjust the spectrum analyzer and function generator, and connect them to the Signal Generator.
- Adjust the RF output to 150 MHz, and the output amplitude to 0 dBm on the Signal Generator.
- Adjust the AM depth to 90% on the Signal Generator.
- Adjust the FM deviation to 75 kHz, and the audio frequency rate to 1 kHz on the Signal Generator.
- Observe and modify the results.

Set Up and Adjust the Spectrum Analyzer, and Function Generator

1. Connect the Signal Generator to the spectrum analyzer and function generator as shown in figure 2-8. Turn on the equipment and make the following adjustments:

On the Spectrum Analyzer

Center Frequency 150 MHz
 Frequency Span 500 kHz
 Reference Level..... +10 dBm

On the Function Generator

Frequency 0.5 Hz
 Amplitude..... 1 Vpk
 Waveform Sine

Adjust RF Output and Output Amplitude on the Signal Generator

2. Press the green INSTR PRESET key. Doing so presets the Signal Generator to a known state for the following steps.

Remember

On the Signal Generator a “∇ cursor” appears in either the FREQUENCY/STATUS or the MODULATION/AMPLITUDE display, and points to the currently active function. This means, for example, that presently you could change the frequency of the Signal Generator without having to first press the FREQ key.

3. Press the **FREQ** key, and enter a frequency of 150 MHz.
4. Press the **AMPTD** key, and enter an output amplitude of 0 dBm. You will notice that the “∇ cursor” is now in the MODULATION/AMPLITUDE display.

Adjust AM Depth on the Signal Generator

5. Press the **AM** key, the **EXT DC** key, and then enter an AM depth of 90%.

Notice that the yellow annunciators above the **AM** and **EXT DC** keys light up; this indicates that AM using an external audio source is active.

The Signal Generator should now show the following in the MODULATION/AMPLITUDE display:

90.0% Ext DC +0.0dBm
AM

Remember

*The **EXT HI** and **EXT LOW** annunciators in the MODULATION/AMPLITUDE display indicate if the amplitude of the external audio source is too high or too low. When the amplitude is at 1 Vpk ±1%, both annunciators are off. However, both annunciators only work at external audio rates from 20 Hz to 100 kHz.*

Since the external audio rate is at 0.5 Hz, you can ignore the **EXT HI** and **EXT LOW** annunciator displays.

6. The following display should appear on the spectrum analyzer: The RF output should be slowly changing for an amplitude swing of about 30 dB.

Note

Increase the function generator's output amplitude if a 30 dB swing is not present. Decrease the function generator's output amplitude if more than a 30 dB swing is present.

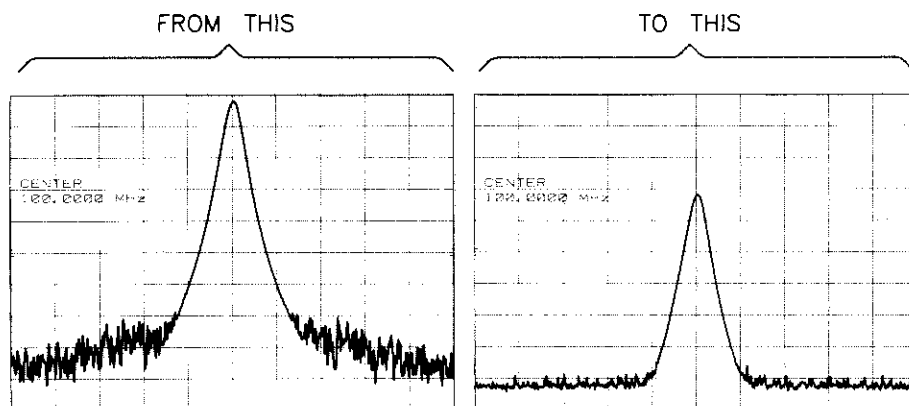
**Adjust FM Deviation**

7. Press the **FM** key, and enter an FM deviation of 75 kHz. When FM deviation is first turned on, the audio frequency rate defaults to 1 kHz.

Notice that the yellow annunciators above the **FM** and **INT** keys light up; this indicates that FM, using its internal audio source, is active.

The Signal Generator should now show the following in the MODULATION/AMPLITUDE display:

75.0kHz	1.000kHz	+0.0dBm
FM	AUDIO	

Observe and Modify the Results

8. The following display should appear on the spectrum analyzer:
The FM signal should be slowly changing for an amplitude swing of about 30 dB.

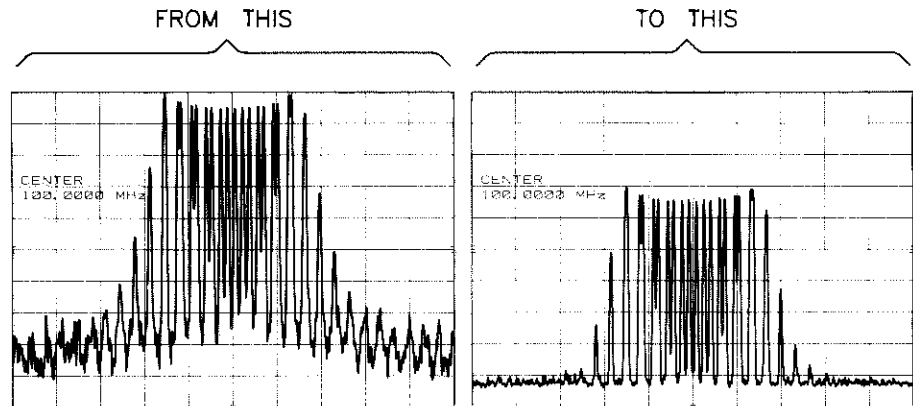

9. Vary the function generator's output amplitude in 0.1 Vpk steps, and notice the corresponding changes on the spectrum analyzer. The amplitude swing of the FM signal will be greater as output amplitude is increased, and a smaller as output amplitude is decreased.

When you are done, put the function generator's output amplitude back to the 1 Vpk setting for the 30 dB swing.

10. Vary the function generator's audio frequency rate in small steps. The amplitude swings of the FM signal take longer to change as the audio frequency rate is decreased, and will change faster as the audio frequency rate is increased.

When you are done, put the function generator's audio frequency rate back to 0.5 Hz.

11. Vary AM depth on the Signal Generator. The amplitude swings of the FM signal are smaller as the AM depth is decreased.

Simultaneous Modulation – Things to Remember



The following list is a summary of the most important points discussed in the simultaneous modulation section:

- There are five ways simultaneous modulation can be generated, to page 2-39.
- The **AM**, and **FM** Modulation Input connectors have an external input impedance of 600 Ω . The **FM** Modulation Input connector has an input impedance of 50 Ω . With Option 008, the **PULSE** Modulation Input connector has an input impedance of 50 Ω , or 100 k Ω (with Special Function 210 turned off, the preset condition).
- All features and limitations previously described for FM, AM, and Pulse apply when simultaneously modulating the Signal Generator.
- During simultaneous internal and external FM, the typical input voltage allowed is +0.4 Vpk to +1 Vpk. Under these conditions, the amount of available external deviation is reduced. (Read the following note for further information.)

Note

You may want to reduce the output level of the internal audio source during simultaneous internal and external AM and/or FM modulation. Doing so would allow you to increase the amount of external modulation. The sum of the internal and external voltages should not exceed 1.4 Vpk or clipping may occur.

The output level of the internal audio source can be adjusted from 0 V dc to 1 V dc in 1 mV steps. Adjusting the output level affects the amount of internal modulation such that a decrease in output level proportionately decreases the amount of internal modulation.

*Vary the output level of the internal audio source by first pressing the blue **SHIFT** key, and then the **AUDIO LEVEL** key. Turn the knob or press one of the   keys to change the output level.*

3

What About Sweeping?

In this Chapter

This chapter describes how to frequency sweep the Signal Generator. Information is provided regarding front-panel control of frequency sweeping. Refer to chapter 4 if you need information about HP-SL programming control over HP-IB.

Two types of sweep are available to help you characterize RF devices: digitally-stepped and phase-continuous sweep. This chapter focuses on each frequency sweep feature; advantages and limitations are mentioned where appropriate. At the end of this chapter is an exercise that may be helpful to you.

The Directory

Use the following illustration to find the subject you want. Turn to that subject for specific information.

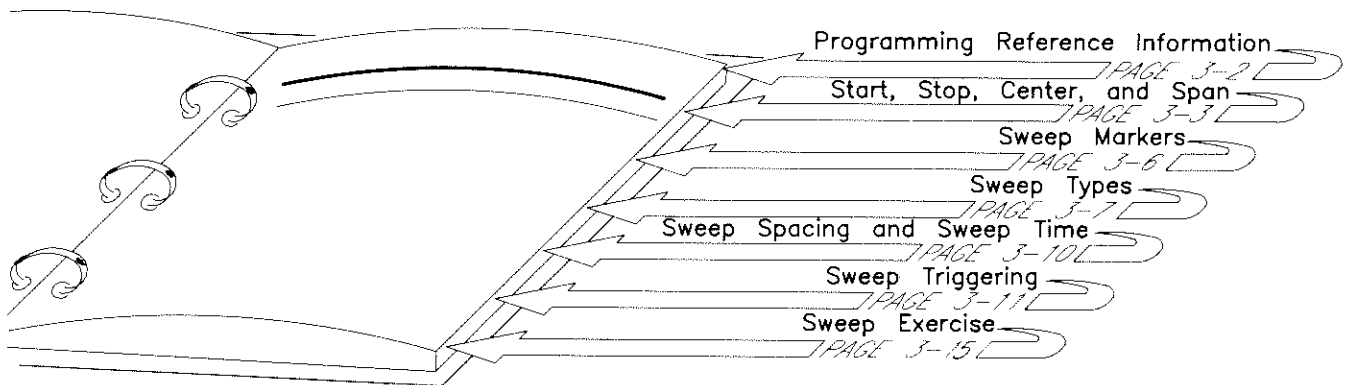

Frequency Sweep – General Information

The process to frequency sweep the Signal Generator can be summarized in five basic steps. The following steps reflect the order in which sweeping is described in this chapter; you are not constrained to use this sequence of steps once you become familiar with the process of frequency sweeping the Signal Generator:

1. Set up a start, stop, center, or span frequency.
2. Activate sweep markers (optional step).
3. Decide which type of frequency sweeping to use (digitally-stepped, or phase-continuous).
4. Select the sweep spacing (linear is the default spacing, log is selectable from the front panel), and set the sweep time.
5. Trigger the Signal Generator to frequency sweep (using Auto, Single, or Manual).

The Signal Generator has attributes of two different types of instruments. First, it acts as a non-swept CW signal source, and second, it acts as a frequency-swept signal source (that is, a sweeper). By pressing any of the front-panel keys shaded in figure 3-1, the Signal Generator becomes a sweeper.

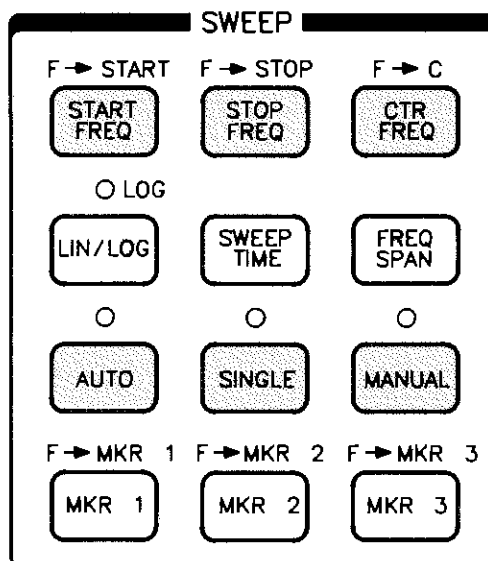

Figure 3-1. Keys that Turn the Signal Generator into a Sweeper.

When the Signal Generator has become a sweeper, whether the RF signal source is paused or running, you will notice a **SWEEP** annunciator in the FREQUENCY/STATUS display. For example, after an instrument preset, if you were to press the **START FREQ** key, you would see the following display:

Start	100,000.00 Hz
	SWEEP

Selecting Start, Stop, Center, and Span Frequencies

The Signal Generator must be set up with the start, stop, center, and span frequency values before you activate a frequency-swept measurement. Simply press any one of the front-panel keys shaded in figure 3-2:

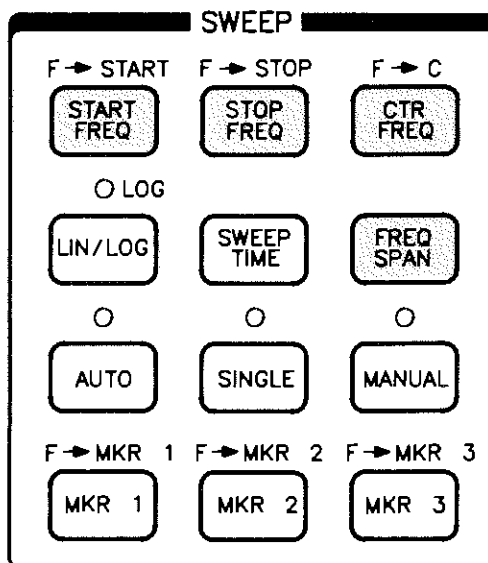

Figure 3-2. Start, Stop, Center, and Span Frequency Keys.

You may then specify a sweep frequency in one of four ways, as follows:

- Use the front-panel DATA keys shaded in figure 3-3:

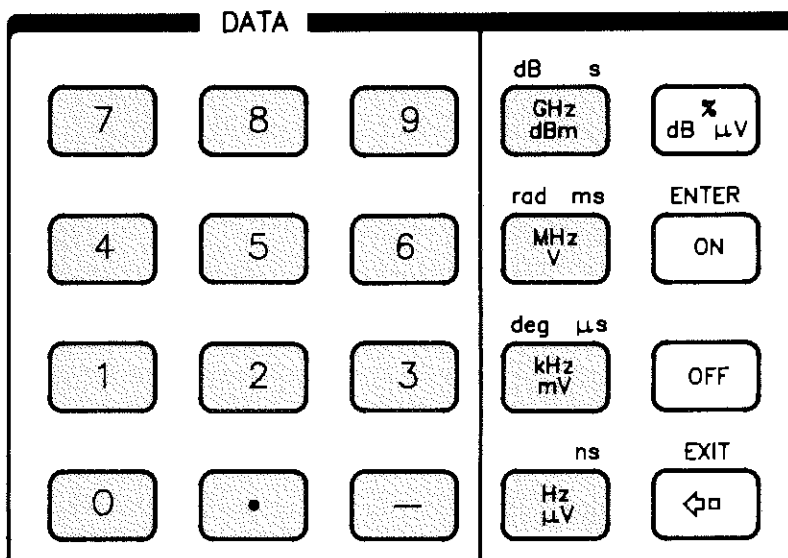

Figure 3-3. Data Keys for Start, Stop, Center, and Span.

- Press one of the increment or decrement front-panel keys shaded in figure 3-4:

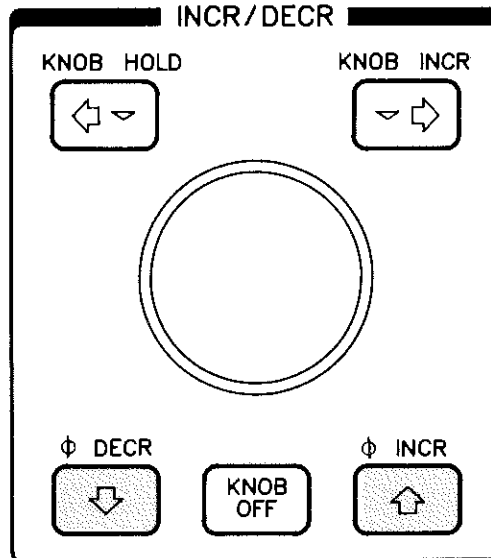

Figure 3-4. Increment/Decrement Keys for Start, Stop, Center, and Span.

- Turn the knob (shaded in figure 3-5) clockwise to increase frequency, or turn the knob counterclockwise to decrease the displayed frequency:

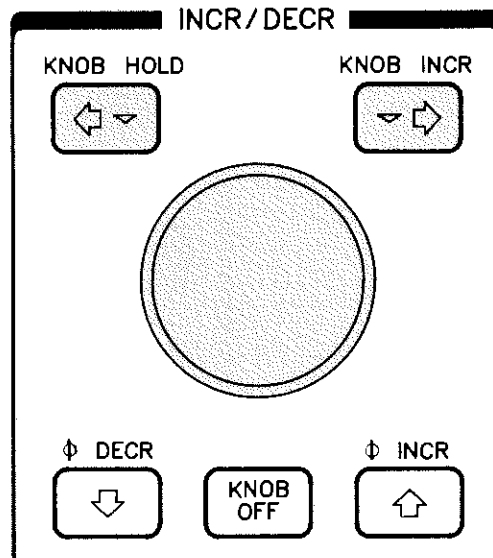

Figure 3-5. Knob for Start, Stop, Center, and Span.

- Sometimes it is useful to make the start, stop, center, or span equal to the value of the RF output frequency last displayed. To do this, press the blue **SHIFT** key, and then one of the start, stop, center, or span keys shaded in figure 3-6.

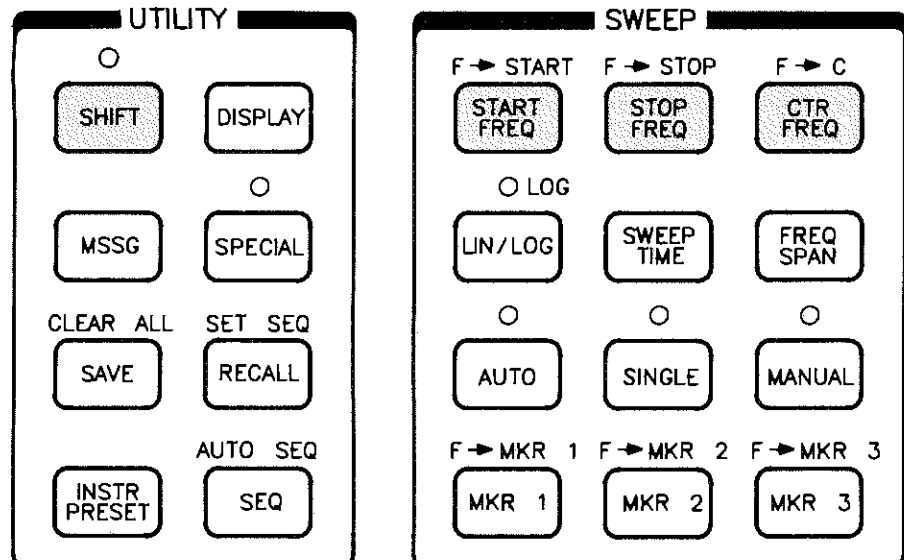

Figure 3-6. Shift Key for Start, Stop, Center, and Span.

When you specify a sweep frequency, the start, stop, center, and span frequency values are interactive; they affect each other in the following ways:

If START FREQ is changed:

STOP FREQ is unchanged
 CTR FREQ is set to $(\text{START FREQ} + \text{STOP FREQ})/2$
 FREQ SPAN is set to $(\text{STOP FREQ} - \text{START FREQ})$

If STOP FREQ is changed:

START FREQ is unchanged
 CTR FREQ is set to $(\text{START FREQ} + \text{STOP FREQ})/2$
 FREQ SPAN is set to $(\text{STOP FREQ} - \text{START FREQ})$

If CTR FREQ is changed:

FREQ SPAN is unchanged
 START FREQ is set to $(\text{CTR FREQ} - (\text{FREQ SPAN}/2))$
 STOP FREQ is set to $(\text{CTR FREQ} + (\text{FREQ SPAN}/2))$

If FREQ SPAN is changed:

CTR FREQ is unchanged
 START FREQ is set to $(\text{CTR FREQ} - (\text{FREQ SPAN}/2))$
 STOP FREQ is set to $(\text{CTR FREQ} + (\text{FREQ SPAN}/2))$

Sweep Markers

Up to three sweep markers can be set to locate positions of interest during the frequency sweep. When you set a sweep marker, the Signal Generator is not put into the sweep mode; this allows you to set sweep markers at any time. Simply press one of the front-panel keys shaded in figure 3-7:

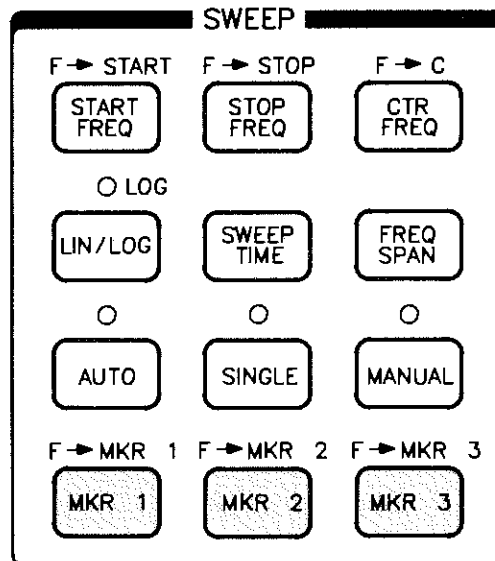

Figure 3-7. Marker Keys.

For example, if you were to press the **MKR 1** key after an instrument preset, you would see the following:

Mkr 1 OFF

Select a frequency for the marker position in any one of the four ways previously mentioned for selecting start, stop, center, and span frequencies. Press the marker key, and then the **OFF** key to disable a sweep marker.

Sweep markers are active only when the Signal Generator is a sweeper. The X-axis and Z-axis outputs are used to display the sweep markers. Voltage levels from the X-axis and Z-axis outputs are compatible with most typical analog oscilloscopes as follows:

X-Axis

The rear-panel **X AXIS** output connector provides a voltage ramp with a nominal +0 to +10 V dc signal when sweep is triggered in one of three ways (Auto, Single, or Manual). As shown in figure 3-8, voltage points at the extremities of the X-axis ramp coincide with start and stop frequency values. That is, +0 V dc is the start frequency value, and +10 V dc is the stop frequency value. As the sweep time decreases, the slope of the X-axis ramp increases.

Z-Axis The rear-panel **Z AXIS** output connector provides a +1 V dc output signal that changes to a +5 V dc pulse during retrace to blank the oscilloscope CRT, and also changes to a 0 V dc level whenever a sweep marker is present as shown in figure 3-8.

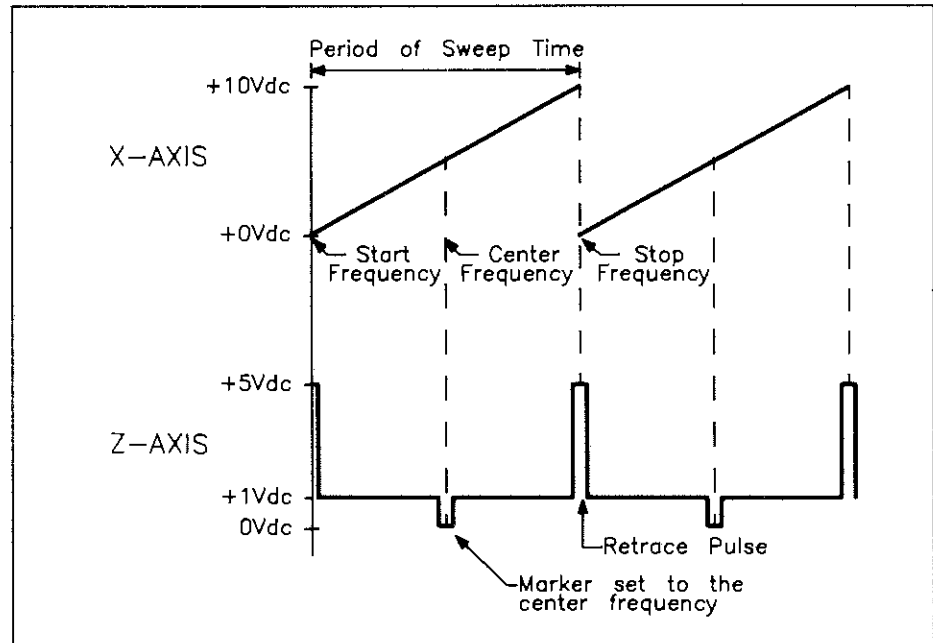

Figure 3-8. X-Axis and Z-Axis.

Sweep Types

Two types of frequency sweep are available:

- Digitally-stepped sweep.
- Phase-continuous sweep.

Both digitally-stepped and phase-continuous sweep have synthesized frequency accuracy. Continue reading for a description of each sweep type.

Digitally-Stepped Sweep

The digitally-stepped sweep can be used to characterize broad band devices such as wideband filters, RF power amplifiers, and mixers by sweeping between two selected endpoints. The frequency sweep is synthesized across any span in either a linear or log frequency spacing. The number of discrete steps is determined by both the frequency span, the active Mode Select synthesis, and the sweep time selected by the user.

The main advantage of digitally-stepped sweeping is that it provides an RF synthesized sweep across a broad frequency range. This sweep type is useful for quick verification of broadband RF devices when used with a stored graphic display such as the Maximum Hold feature on certain spectrum analyzers.

Sweep time for the digitally-stepped sweep can range from 0.5 to 1000 seconds with each discrete step requiring 90 msec (typically) to complete.

To reduce the amount of transient switching spurs when each frequency change occurs, the output amplitude is reduced approximately 60 dB between each frequency step. This amplitude reduction may cause dropouts on the displayed frequency response of the RF device being swept; if this kind of characterization is not satisfactory, use phase-continuous sweep.

Note

The mechanical design of the Signal Generator prevents start and stop frequency values from being valid when they are set on opposite sides of 3 GHz during digitally-stepped sweep. The error message Frequency span too large appears in this situation.

Phase-Continuous Sweep

With phase-continuous sweep, precise measurements can be made when characterizing narrowband devices such as passband filters, SAWs, cavity tuned resonators, receiver crystals, or ceramic IF filters. The frequency sweep occurs between two selected endpoints in a linear, phase-continuous manner, subject to the span limitations shown in table 3-1.

Narrowband devices generally have large time constants. This means that they respond slowly to stepping transients, and it also implies that they cannot be swept too quickly. Since phase-continuous sweeping has no discrete steps, you can sweep high-Q devices more rapidly than with the digitally-stepped sweep, and be assured of not missing critical response peaks or dips.

Another advantage of phase-continuous sweep is that it has synthesized frequency accuracy. This is vital when sweeping a narrow frequency range because there is less room for frequency error.

Sweep time for the phase-continuous sweep can range from 10 msec to 10 seconds and is not dependant upon the span frequency selected. However, the maximum and minimum span is limited by frequency range of the start and stop frequencies. This relationship is shown in table 3-1.

Table 3-1. Maximum and Minimum Span in Phase-Continuous Sweep.

Frequency Range (MHz)	Maximum Span* (MHz)	Minimum Span* (Hz)
4200 to 6000	40	800
3000 to 4200	40	800
1500 to 3000	20	400
750 to 1500	10	200
375 to 750	5	100
187.5 to 375	2.5	50
10 to 187.5	10	50
0.1 to 10	<10	50

* Maximum and minimum span shown is valid for Mode 1 frequency synthesis.
The start frequency can never be less than 90 kHz.

Phase-continuous sweep is enabled by activating Special Function 112.

- The Signal Generator cannot have internal modulation on, and cannot have the internal audio frequency on when you enable the phase-continuous sweep, or you will get the error message: "Mod and sweep conflict".
- Log sweep is not allowed with phase-continuous sweep, or you will get the error message: "Log sweep not allowed".

Note

The mechanical design of the Signal Generator prevents start and center frequency values from being valid when they are set on opposite sides of 3 GHz during phase-continuous sweep. The error message Frequency span too large appears in this situation.

Sweep Spacing and Sweep Time

The Signal Generator allows you to choose two types of sweep spacing, linear and log. Setting the sweep spacing and sweep time will not put the Signal Generator into the sweep mode. Also, various sweep times are available, depending upon whether digitally-stepped sweep or phase-continuous sweep is running. Sweep spacing and sweep time keys are shaded in figure 3-9:

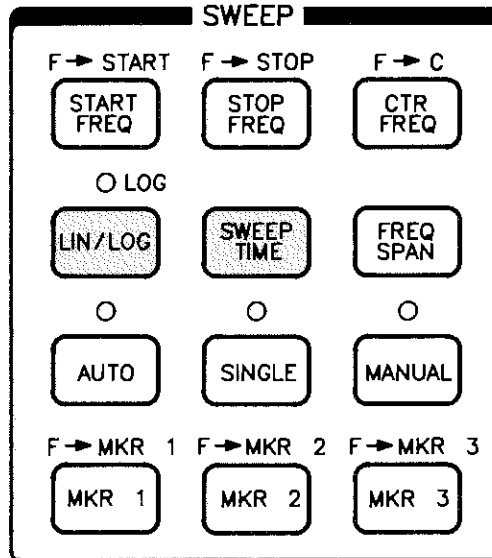

Figure 3-9. Sweep Spacing and Sweep Time Keys.

Linear or Log Sweep Spacing

Selecting either linear or log sweep spacing is done with the front-panel **LIN/LOG** key. When log sweep spacing is active, the yellow LED annunciator above the **LIN/LOG** key lights up.

Permissible Sweep Times

The graph in figure 3-10 lists the permissible sweep times for each sweep type.

TIME	SWEEP	
	DIGITALLY-STEPPED	PHASE-CONTINUOUS
10 Milliseconds		
20 Milliseconds		
50 Milliseconds		
100 Milliseconds		
200 Milliseconds		
500 Milliseconds		
1 Second		
2 Seconds		
5 Seconds		
10 Seconds		
20 Seconds		
50 Seconds		
100 Seconds		
200 Seconds		
500 Seconds		
1000 Seconds		

Figure 3-10. Sweep Times for Each Sweep Type.

You may set the sweep time in one of three ways:

- Turn the knob.
- Press either the or the key.
- Enter a sweep time, chosen from figure 3-10, by using the Data keys. (If you choose an incorrect sweep time, the Signal Generator will display an error if the sweep time is out of range, or it will choose the closest allowable sweep time within the range shown in figure 3-10.)

Sweep Triggering

Auto and Single sweep triggering may be done in conjunction with digitally-stepped, and phase-continuous sweep. Manual sweep triggering is available only with digitally-stepped sweep). Sweep triggering keys are shaded in figure 3-11:

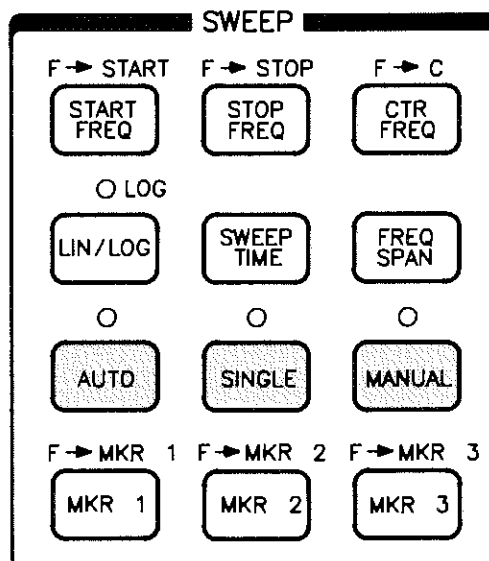

Figure 3-11. Sweep Trigger Keys.



Auto Sweep

The Auto sweep continually repeats the sweep sequence from the start frequency to the stop frequency. Press the **AUTO** key to start the Auto sweep. When Auto sweep is running, the yellow LED annunciator above the **AUTO** key lights up. Press the **AUTO** key again to turn off the sweep.



Single Sweep

The Single sweep starts or restarts a single sweep sequence. Single sweep initiates one sweep only when you press the **SINGLE** key; at the end of the sweep, the RF output returns to the Start Frequency value. When Single sweep is running, the yellow LED annunciator above the **SINGLE** key lights up for the duration of the sweep.

Manual Sweep

Selecting Manual sweep by pressing the **MANUAL** key does not start a sweep, but enables the knob, or the  and  keys to control a sweep. When Manual sweep is running, the yellow LED annunciator above the **MANUAL** key lights up, and the FREQUENCY/STATUS display shows the current frequency of the RF output. For example, if you press the **MANUAL** key after doing an instrument preset, you will see the following:

Manual	100,000.00 Hz
	SWEEP

When you turn the knob or press one of the  or  keys to activate a sweep, the RF output changes in discrete steps determined by three different factors:

- Sweep time. The number of sweep steps may be different depending upon the sweep time you select.
- Mode Select. The number of sweep steps may be different between one frequency synthesis Mode and another.
- Linear or log sweep. The frequency of the RF output is different depending upon whether linear or log sweep is active.

Stopping the Sweep

There are two ways to stop the sweep and make the Signal Generator a non-swept CW signal source:

- Press the **FREQ** key.
- Press the blue **SHIFT** key and then the **EXIT** key.

Note

If you press a front-panel key or change a sweep parameter while the Signal Generator is sweeping, the instrument becomes momentarily unsynchronized and the active sweep output is interrupted. When this happens, the current sweep sequence stops and a new sweep sequence is started.

Sweep Triggering Characteristics

A synchronization period occurs whenever the Signal Generator performs an Auto, or Single **phase-continuous** sweep. The synchronization period may pose a problem, depending upon the kind of measurement you are making.

- The synchronization period happens everytime the **SINGLE** key is pressed.
- The synchronization period happens once when the **AUTO** key is pressed, and then a shorter synchronization period happens successively after each sweep when the RF output moves from the stop frequency to the start frequency. (The shorter synchronization periods between each sweep vary in duration depending upon the sweep time set at the front panel.)

Three triggering characteristics always happen during the synchronization period and prior to the actual start of the sweep, as follows:

1. The RF output turns off and/or shifts in frequency (several times) in a seemingly random manner immediately after a sweep is triggered.
2. The RF output is then set to the start frequency, and remains there for approximately 10 msec before the sweep begins.
3. The Z-axis blanking signal is active during the entire synchronization period, and becomes un-blanked only during the actual sweep.

After the synchronization period, the sweep begins at the start frequency and ends at the stop frequency.

Calculating Steps in a Digitally-Stepped Sweep

The number of steps in a digitally-stepped sweep can be calculated from the sweep-time and step-time values, as follows:

- **Sweep Time.** Is set from the front panel **SWEEP TIME** key, and may range from 0.5 to 1000 seconds.
- **Step Time.** Is set by the Signal Generator and is dependent upon the frequency synthesis mode, as follows:

Mode	(Minimum) Step Time (ms)
1	125
2	225
3	300

The formula to calculate the number of steps in a sweep is:

$$\frac{\text{Number of steps} = \text{Sweep Time} - (\text{Step Time} \times 0.3)}{\text{Step Time}}$$

The Signal Generator allows for a maximum number of steps equal to 1023 (even if your calculations exceeds this value). The Signal Generator also rounds down any calculation to the last step (for example, a calculated value of 9.7 steps is rounded down to 9 steps for each sweep).

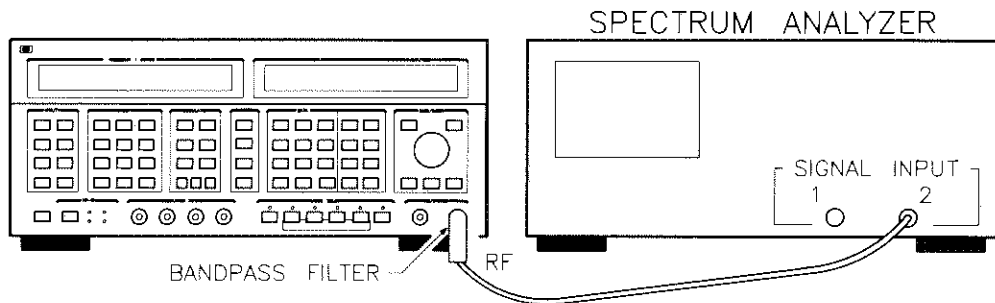

Figure 3-12. Equipment Setup for the Sweep Exercise.

Sweep Exercise

The following exercise takes about 15 minutes to complete. In the procedure, you will characterize a bandpass filter using digitally-stepped sweep, and phase-continuous sweep.

Equipment Needed

This procedure uses the following equipment:

Equipment	Recommended Model Numbers
Spectrum Analyzer	HP 8562A/B, or HP 8566B, or HP 8568B
Bandpass Filter	HP 11697A*
* You may use any bandpass, highpass or lowpass filter. However, your results will be different than those shown in the following procedure.	

Procedure

The procedure starts on the next page with step 1. A review of the five major steps in the procedure are:

- Set up and adjust a spectrum analyzer, and connect it to the HP 11697A bandpass filter and Signal Generator.
- Set the start and stop frequencies for the sweep.
- Set the sweep time.
- Trigger the sweep.
- Observe and modify the results.

Set Up and Adjust the Spectrum Analyzer

1. Connect the Signal Generator to a bandpass filter and spectrum analyzer as shown in figure 3-12. Turn on the equipment and make the following adjustments on the spectrum analyzer:

Center Frequency 500 MHz
 Frequency Span 1000 MHz
 Reference Level 10 dBm

Set the Start, and Stop Frequencies

2. Press the green INST PRESET key. Doing so presets the Signal Generator to a known state for the following steps.
3. Press the AMPTD key and enter an output amplitude of 0 dBm.
4. Press the START FREQ key, and enter a start frequency of 300 kHz. You should then see the following in the FREQUENCY/STATUS display:

<p>Start 300.000,00 kHz</p> <p style="text-align: center; font-size: small;">SWEEP</p>

5. Press the STOP FREQ key, and enter a stop frequency of 1 GHz. You should then see the following in the FREQUENCY/STATUS display:

<p>Stop 1.000,000,000,00 GHz</p> <p style="text-align: center; font-size: small;">SWEEP</p>
--

6. Press the CTR FREQ key. You will see that the Signal Generator has automatically calculated the center frequency to be 500,150,000.00 Hz.
7. Press the FREQ SPAN key. You will see that the Signal Generator has automatically calculated the span frequency to be 999,700,000.00 Hz.

Set the Sweep Time

8. Press the SWEEP TIME key, and enter a sweep time of 10 seconds. There are four ways to set the sweep time as previously mentioned in this chapter. You should then see the following in the FREQUENCY/STATUS display:

<p>Sweep Time 10.00 s</p> <p style="text-align: center; font-size: small;">SWEEP</p>

Trigger the Sweep

9. Press the **AUTO sweep** key. Notice that the yellow LED annunciator above the **AUTO sweep** key lights to indicate that the sweep is continually repeated from the start frequency to the stop frequency.

Observe and Modify the Results

10. The following display should appear on the spectrum analyzer. Use the Maximum Hold function on the spectrum analyzer to capture the bandpass filter response using digitally-stepped sweep:

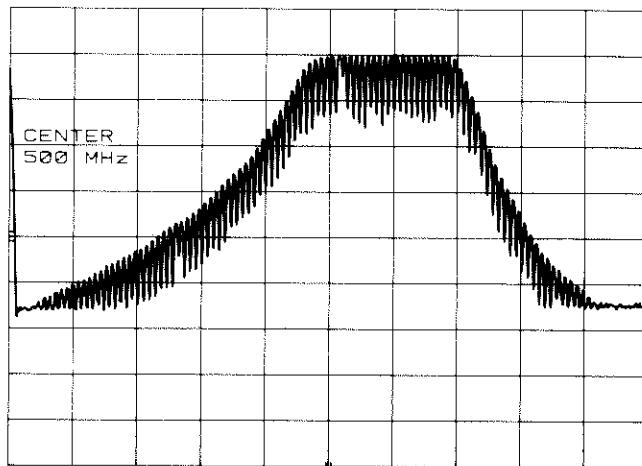

11. Press the **AUTO sweep** key, to turn off the sweep. The yellow LED annunciator light above the **AUTO sweep** key should turn off.
12. Press the Utility **SPECIAL** key, enter number "112" and press the **ENTER** key. You should then see the following in the FREQUENCY/STATUS display:

112:Phase Cont Sweep OFF

SWEEP

13. Press the **ON** key to activate Special Function 112. This step allow you to activate phase-continuous sweep. The yellow LED annunciator above the **SPECIAL** key should light up to indicate that a special function is active.

With phase-continuous sweep, you may characterize any segment of the bandpass filter response that is of interest to you.

14. Make the following adjustments on the spectrum analyzer to look at the bandpass filter response where the 3 dB roll-off occurs.

Center Frequency	460 MHz
Frequency Span	10 MHz
Reference Level	10 dBm

15. Press the **SPAN FREQ** key, and enter a span frequency of 5 MHz.
16. Press the **CTR FREQ** key, and enter a center frequency of 460 MHz. The Signal Generator will automatically calculate the start frequency to be 455 MHz, and the stop frequency to be 465 MHz.
17. Press the **AUTO** sweep key to activate the phase-continuous sweep. The following display should appear on the spectrum analyzer with the Maximum Hold function active:

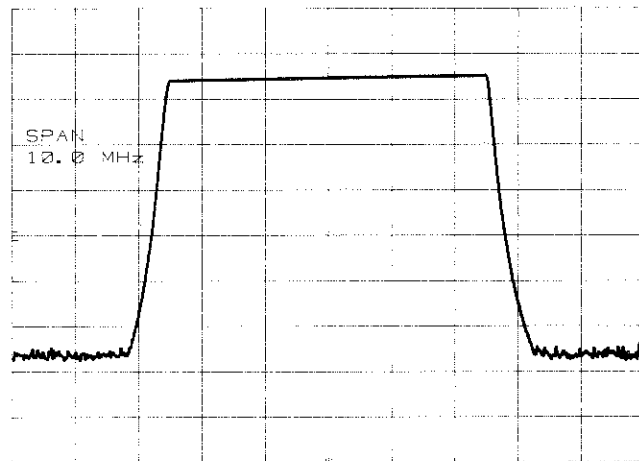

18. Try duplicating any of the previous steps using another sweep mode, either **Single** or **Manual**.
19. Try duplicating any of the previous steps using a different sweep time.
20. Try duplicating any of the previous steps using a logarithmic sweep instead of a linear sweep. Remember, log sweep spacing is not allowed with phase-continuous sweep.

4

What About Programming?

In this Chapter

This chapter has three main objectives. First, it provides you with an introduction to the Hewlett-Packard System Language (HP-SL) which is the new programming language for remote control of the Signal Generator over HP-IB. Second, it provides tutorial information helpful to the HP-SL programmer. Third, it provides reference information for programming the Signal Generator with HP-SL.

Novice programmers of HP-SL should read this chapter thoroughly up to the *Programming Reference Information* section. Once you understand the concept of programming with HP-SL, use the reference information as needed.

Note

Refer to appendix F for "HP-SL Quick Reference Information" once you become familiar with the information in this chapter.

The Directory

Use the illustration shown below as your guide for each subject in this chapter. If you are unfamiliar with HP-SL, please read the first eight pages, they have been written especially for you.

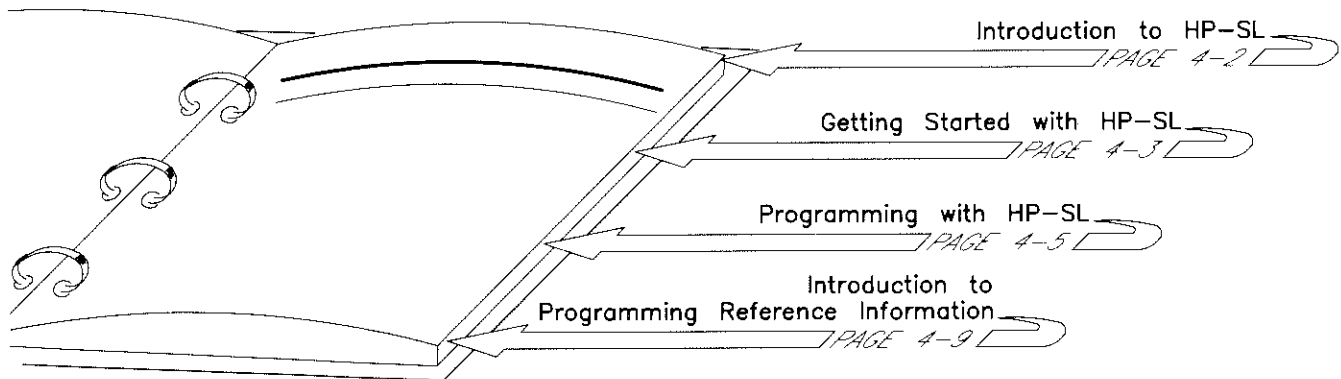

Introduction to HP-SL

Hewlett-Packard Systems Language (HP-SL) is the new programming language adopted by Hewlett-Packard for controlling instrument functions. This language uses standard HP-IB hardware (connectors and cables) and will be used in many future Hewlett-Packard products.

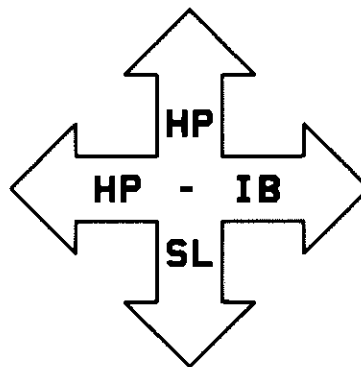

HP-SL isn't just another set of HP-IB commands. The general use of HP-SL provides you with programming commands that are common from one Hewlett-Packard product to another thereby eliminating "device specific" commands.

HP-SL uses easy to learn, self explanatory commands, and is flexible for both novice and expert programmers. Once you become familiar with the organization and structure of HP-SL, you will see that it reduces your effort to write programs for controlling instrumentation regardless of the programming language you use.

HP-SL was developed to conform to the new IEEE 488.2 standard (which replaces IEEE 728-1982). The advantage of the IEEE 488.2 standard is that it provides codes, formats, protocols, and common commands that were not available in the previous IEEE 488.1 standards. For more information, refer to the IEEE 488.2 standard itself.

Another advantage of HP-SL is that commands can be grouped in a single output statement without regard to the order in which the commands are combined. This eliminates the problem of "sequence dependency", where the lines in a program must be written in a specific order to prevent illegal instrument states from occurring.

Getting Started with HP-SL

How is HP-SL Organized?

This section explains how HP-SL is organized, and introduces you to its basic structure. Once you understand the fundamental parts of HP-SL, proceed to the next section titled *Programming With HP-SL* where command messages are described.

HP-SL commands are organized in a "tree" structure. In its simplest form, figure 4-1 helps you visualize HP-SL syntax. Starting from the base of the tree, you move along a path from the root, up the tree to the different branches as shown in trees "A-D". Each branch represents an optional path that the programmer can use in writing a command statement. Keywords on the trunk and branches are used to build command statements and command messages.

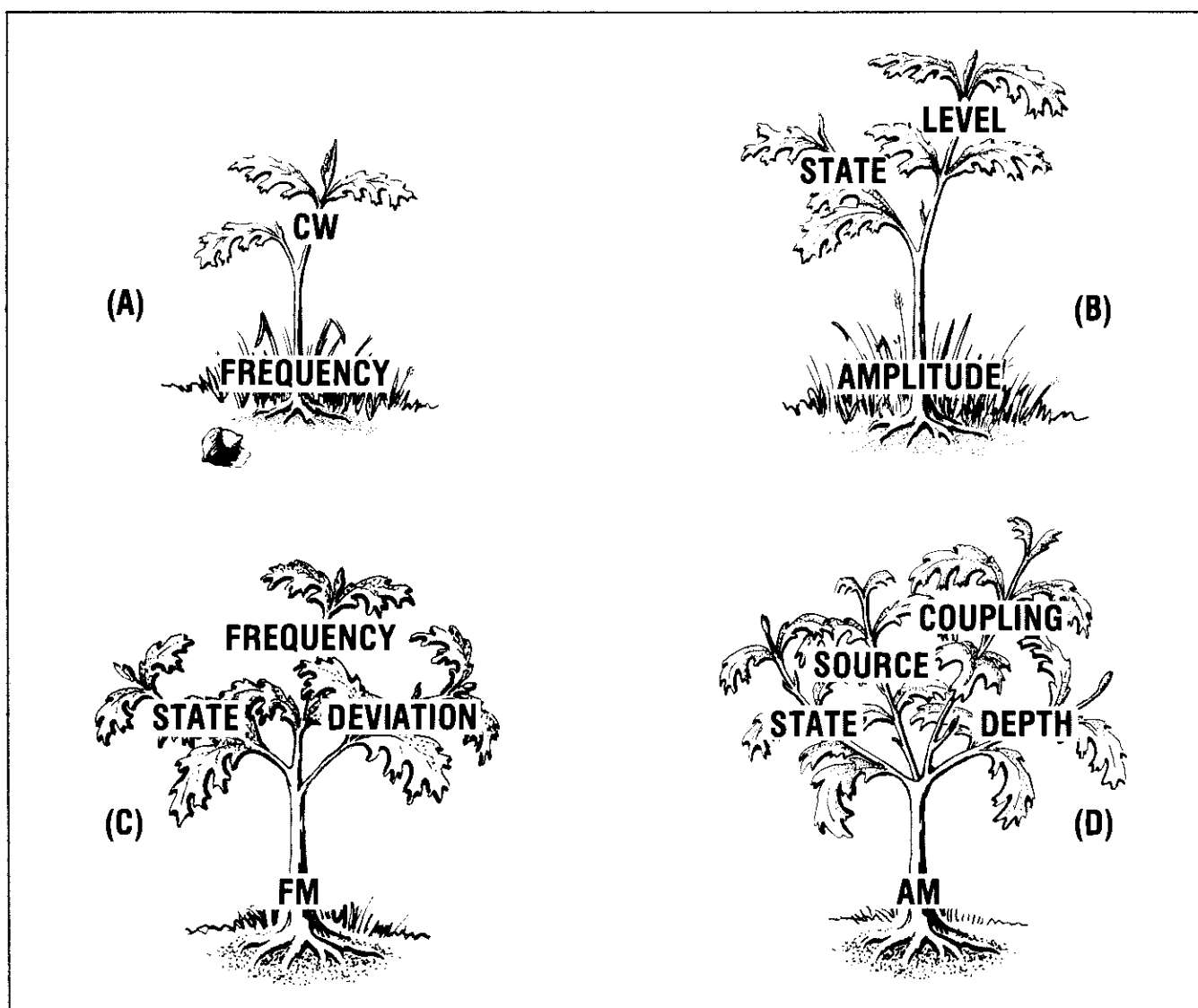

Figure 4-1. Simple HP-SL Tree Structures.

The HP-SL Colon

HP-SL uses the colon " : " to separate the keyword in the root from a branch. For example, the command statement for setting a CW frequency of 1 GHz, as shown in tree "A", would be as follows:

```
FREQUENCY:CW 1GHZ
```

Notice that the command parameter 1 GHz was added to the command statement.

Example command statements for trees "B-D" depict a sampling of the different command parameters available for your use; command parameters must always be preceded by a space:

Tree B

```
AMPLITUDE:LEVEL 10DBM  
AMPLITUDE:STATE ON
```

Tree C

```
FM:DEVIATION 10KHZ  
FM:FREQUENCY 1KHZ  
FM:STATE ON
```

Tree D

```
AM:DEPTH 50%  
AM:SOURCE EXTERNAL  
AM:COUPLING AC  
AM:STATE ON
```

Programming with HP-SL

This section explains how to generate command messages in HP-SL. A command message is two or more command statements put on the same line.

Once you understand the concepts contained in this section, you will be able to start programming the Signal Generator. You may then proceed to the *Programming Reference Information* section for further details on HP-SL programming.

HP-SL Command Statements

Let's expand the analogy of the HP-SL "tree". In reality, the tree structure as previously described is really more complex. You will find that an HP-SL command statement has a hierarchy that may contain many branches. Tree "A" from figure 4-1 is shown in greater (but not complete) detail in figure 4-2 to depict the branching that occurs. Any command that ends with a question mark "?" is a query for information from the Signal Generator.

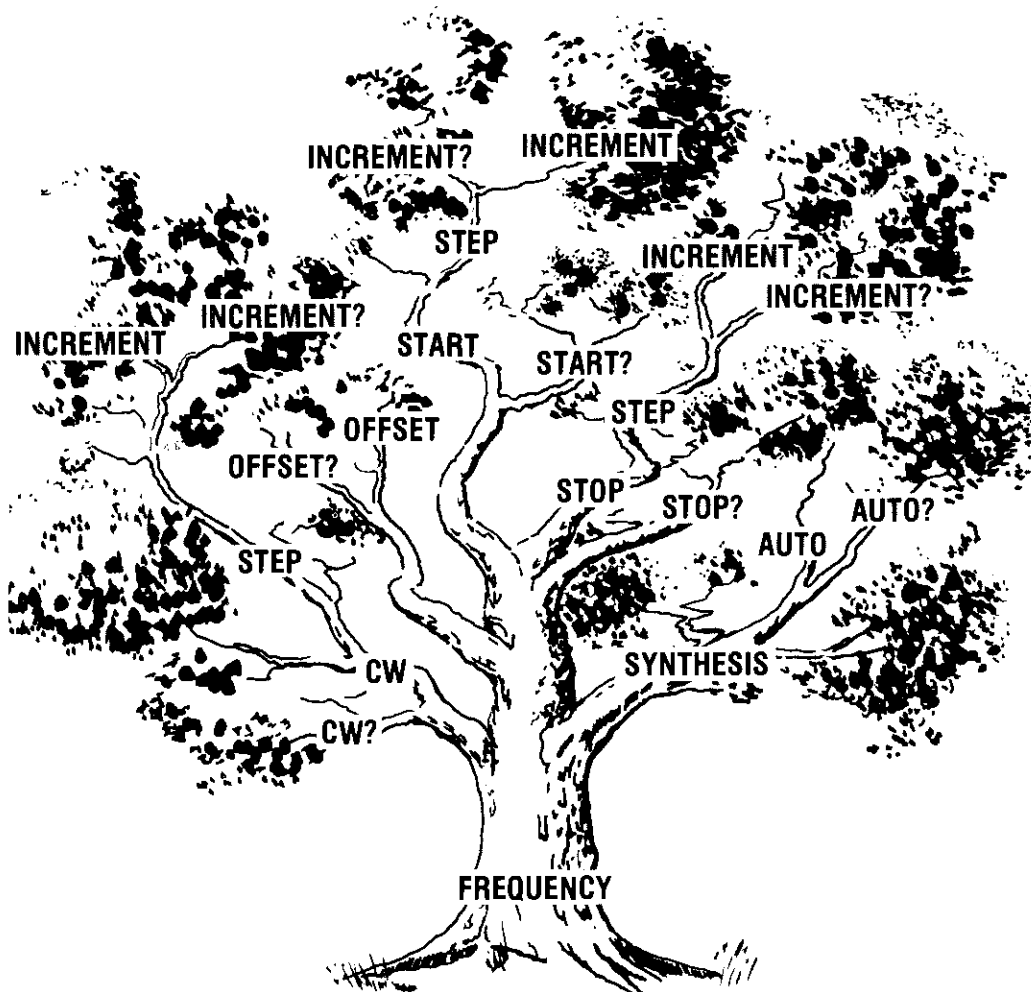

Figure 4-2. Expanding the Detail of Tree "A".

More about the Colon

The colon has another function in the command statement. It is used to connect segments of the same branch. For example, to set the Signal Generator at a frequency increment of 5 MHz, you could write the following command statement:

```
FREQUENCY:STEP:INCREMENT 5MHZ
```

Notice how the colon is used to connect one segment of the branch to the next. Also, the keyword "CW" was left out. You will find that HP-SL has optional keywords in its branches that may be kept in or left out depending upon your programming needs.

An important concept to understand with HP-SL is that only one input or output command may be put in a command statement. You could not have tried to change the RF output and set the frequency increment in the same command statement. To have more than one input or output command on the same line you must create a command message.

The HP-SL Semicolon

The semicolon " ; " is used to create a command message, and has two functions. It separates one command statement from another on the same line of code, and it backs the following command down the HP-SL hierarchy to the previous keyword.

You can see how the semicolon works by using two branches from the tree in figure 4-2. For example, to set an RF output of 175 MHz with the Signal Generator in Mode 2 frequency synthesis, you would write the following in HP-SL:

```
FREQUENCY 175MHZ;FREQUENCY:SYNTHESIS 2
```

In this case, the semicolon is simply used to separate one command statement from the other.

**More about HP-SL
Command Statements**

There is no "one way" to program with HP-SL. You may write programs in HP-SL that reflect your style of programming. The previous example may have been written in a number of ways. For example:

```
FREQUENCY:CW 175MHZ;SYNTHESIS 2
```

In this case, notice how the semicolon is used not only to separate one command statement from the other, but also to back the command "SYNTHESIS" down to the previous colon in the HP-SL hierarchy.

The command statements shown so far have been lengthy. In the *Reference Information Section*, you will see that all statements can be written in a short form. For example, the previous command statement may be rewritten as follows:

```
FREQ: CW 175MHZ; SYNT 2
```

Remember

Command statements are not sequence dependent. A line of code may be written with the command statements placed in any order as long as you never have conflicting conditions in a command message.

A conflicting condition occurs when ambiguous command statements are found in the same command message. Turning FM on and then off, or setting the RF output frequency to one value and then to another value are examples of ambiguous command statements in the same command message.

The path for each command statement starts at the root and proceeds up the tree to the different branches. The previous command statement could be rewritten as:

```
FREQ: SYNT 2; CW 175MHZ.
```

Optional keywords may be ignored; use the colon and semicolon in the appropriate places, and have a space before command parameters.

Combining the HP-SL Semicolon and Colon

A special case exists when the semicolon and colon " ; : " are placed next to each other between command statements. This situation lets you start with another keyword at the root of any tree. By using the semicolon & colon sequence in the command statement, you may even string together operations from other trees.

For example, if you were to string an operation from another tree (say setting output amplitude to 10 dBm) to the previous command statement, you could do it as follows (in the short form):

```
FREQ: CW 175MHZ; SYNT 2; : AMPL 10DBM
```

Note

Never leave a space after a colon or you will get the following message:

```
Error- Space after colon
```

***What Else do I
Need to Know?***

Always use the common command *RST (equivalent to instrument preset) on a separate line of code. If *RST is put on a line of code with other command statements, the other command statements would be ignored by the instrument preset.

You will need to initially rely upon the reference information contained in the remaining part of this chapter in order to complete your introduction to HP-SL programming. In time, you will find that the syntax and mnemonics used in HP-SL are predictable. Your reliance on the reference section will then be reduced.

It may be necessary for you to run some example programs to gain experience with HP-SL before attempting to write programs of your own. If this is true, refer to the illustration found on the next page, and you will see where the example programs are located. All example programs are written in BASIC, however, you may use any programming language with HP-SL.

Note

Appendix D contains a list of any error messages you may receive while programming with HP-SL.

Introduction to the Programming Reference Information

The remaining part of this chapter provides you with detailed reference information for programming the Signal Generator with HP-SL. HP-IB addressing, HP-IB capabilities, and data input/output information is available for all of your remote operating needs.

All data input/output operations are described in the *HP-IB Control Language Dictionary* and the *HP-IB Device Status Dictionary* sections. Helpful example programs are provided for your use at the end of these sections.

Use the illustration shown below as your guide for each subject in this section. Turn to the subject you want; where it is appropriate, you will find a table of contents which gives an overview of the specific topics covered for that subject.

Note

Refer to appendix F for "HP-SL Quick Reference Information" once you become familiar with the information in the "HP-IB Control Language Dictionary".

Also, you may want to refer to the document "Tutorial Description of the Hewlett-Packard Interface Bus" HP Part Number 5952-0156 for detailed information about the HP-IB bus.

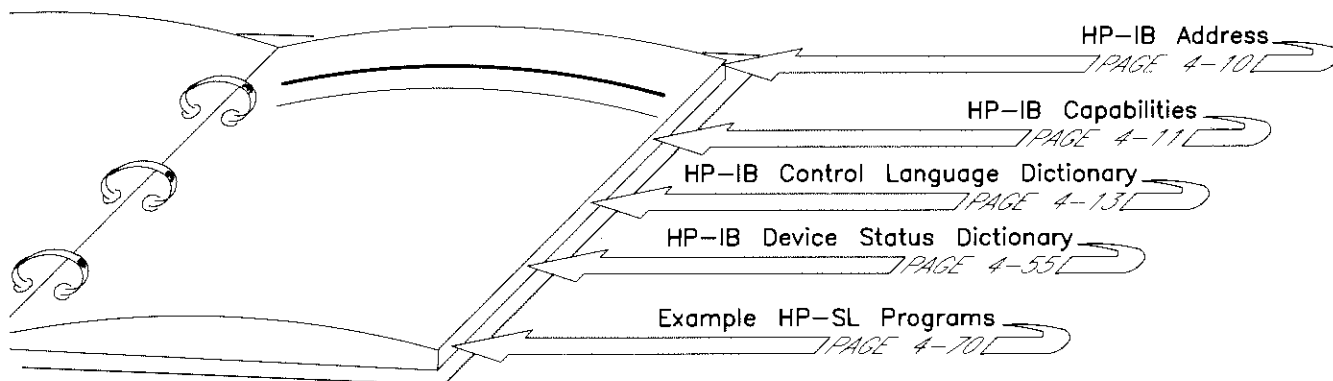

HP-IB Address

The HP-IB address for the Signal Generator is set at the factory to 19. You can display or change the HP-IB address at any time from the front panel. Any HP-IB address from 00 to 30 can be assigned.

The HP-IB address is stored in non-volatile memory, and remains valid through switching the Power from Standby to On and unplugging the ac power cord; performing a RAM wipe (Special Function 172) does not change the HP-IB address.

How to Display or Change the HP-IB Address

Display the HP-IB address:

1. If the yellow **REM** (remote) annunciator is turned on, press the **LOCAL** key to put the Signal Generator into Local operation. All front panel keys (except for the Power switch and the **LOCAL** key) are inoperative when the Signal Generator is in Remote operation.
2. Press the blue **SHIFT** key, and then the **ADRS** key. You will see the following in the FREQUENCY/STATUS display:

HP-IB Address = 19

Change the HP-IB address:

3. Select a new HP-IB address from 00 to 30, and press the **ENTER** key. The new HP-IB address should then be displayed.
4. Press the **FREQ** key to clear the HP-IB address off of the front-panel display. Then, re-display the HP-IB address to verify the new HP-IB address.

HP-IB Capabilities

The Signal Generator Synthesized Signal Generator is designed to be compatible with a controller that interfaces in terms of the 14 bus messages summarized in table 4-1. This table describes each of the interface functions available as defined by the IEEE Standard 488 and the identical ANSI Standard MC1.1.

When the Signal Generator is in the remote mode (the front-panel **REM** annunciator lights up), all front-panel controls are disabled except the **POWER** switch, and the **LOCAL** key (the **LOCAL** key can be disabled by configuring the Signal Generator in Local Lockout over HP-IB).

Table 4-1. HP-IB Capability Reference Table. (1 of 2)

HP-IB Capability	Applicable	Response	Related Commands and Controls*	Interface Functions*
Talker/Listener	Yes	All Signal Generator functions with the exception of Knob control are programmable over HP-IB. The Signal Generator can send query responses and status information. The front-panel annunciators (TALK, REM, LSTN, SRQ) show the Signal Generator's current HP-IB state.	MLA MTA EOI	AH1 SH1 T6 L4
Trigger	No	The Signal Generator does not have a device trigger capability.	GET	DT0
Clear	Yes	The Signal Generator responds equally to DCL and SDC bus commands. The Clear capability does not reset instrument parameters.	DCL SDC	DC1
Remote	Yes	The Signal Generator's remote mode is enabled when the REN bus line is true. However, it remains in local (that is, the keyboard is active) until it is first addressed to listen. The output signal is unchanged when the Signal Generator enters remote mode. The front-panel RMT annunciator turns on when in remote mode.	REN MLA	RL1
Local	Yes	The Signal Generator returns to front-panel control when it enters local mode. The output signal is unchanged. Responds either to the GTL bus command or the front-panel Local key. The LOCAL key will not work if the instrument is in the LOCAL LOCKOUT state.	GTL	RL1

* Commands, Control Lines, and interface Functions are defined in IEEE Std 488 (and the identical ANSI Standard MC1.1). Knowledge of these might not be necessary if your controller's manual describes programming in terms of the fourteen HP-IB messages shown in the left column.

Table 4-1. HP-IB Capability Reference Table. (2 of 2)

HP-IB Capability	Applicable	Response	Related Commands and Controls*	Interface Functions*
Local Lockout	Yes	The LOCAL key is disabled during Local Lockout so that only the controller or the POWER switch can return the Signal Generator to Local.	LLO	RL1
Clear Lockout/ Set Local	Yes	The Signal Generator returns to Local and Local Lockout is no longer true when the REN bus line goes false.	$\overline{\text{REN}}$	RL1
Pass Control/ Take Control	No	The Signal Generator cannot take control of HP-IB.	ATN IFC	C0
Request Service	Yes	The Signal Generator sets the SRQ bus line true if there is an unmasked bit in the status byte.	SRQ	SR1
Abort	Yes	The Signal Generator stops talking or listening.	IFC	T6 L4
Status Byte	Yes	The Signal Generator responds to a Serial Poll Enable (SPE) bus command by sending an 8-bit byte when addressed to talk. Bit 6 (RQS bit) is true if the Signal Generator has sent the Service Request Message. Each bit requires different conditions for clearing.	SPE SPD MTA	T6
Status Bit	No	The Signal Generator does not respond to a parallel poll.	ATN EOI	PP0
Extended Talker/ Listener	No	The Signal Generator does not have secondary addressing capabilities for talking or listening.	MSA	TE0 LE0
Driver Electronics	Yes	The Signal Generator uses tri-state electrical drivers.	None	E2

* Commands, Control Lines, and Interface Functions are defined in IEEE Std 488 (and the identical ANSI Standard MC1.1). Knowledge of these might not be necessary if your controller's manual describes programming in terms of the fourteen HP-IB messages shown in the left column.

HP-IB Control Language Dictionary

All IEEE 488.2 common commands, and HP-SL commands are contained in the control language dictionary. All devices that comply with the IEEE 488.2 standard must have a set of common commands. The requirement of having common commands guarantees that all devices will have a minimum set of capabilities to permit programmers to write code that will work with all devices.

Before you proceed to use the dictionary, please read the HP-SL notes starting on the next page. The notes provide you with essential information and directions for using the dictionary.

The dictionary is alphabetically arranged by subsystems. A table of contents for all subsystems is as follows:

Table of Contents

AM Subsystem	4-18
Amplitude Subsystem	4-19
Calibration Subsystem	4-22
Diagnostic Subsystem	4-22
Display Subsystem	4-22
FM Subsystem	4-23
Frequency Subsystem	4-25
HP-SL System Commands	4-29
IEEE 488.2 Common Commands	4-30
Initialize Subsystem	4-32
LF Source Subsystem	4-33
Marker Subsystem	4-43
Modulation Subsystem	4-43
Phase Modulation Subsystem	4-44
Phase Subsystem	4-45
Power Meter Subsystem	4-45
Pulse Subsystem	4-46
Reference Oscillator Subsystem	4-48
Sequence Subsystem	4-49
Status Subsystem	4-50
Sweep Subsystem	4-54
Take Sweep Subsystem	4-55
Voltmeter Subsystem	4-55

HP-SL Notes

The entire dictionary is for use with the IEEE 488.2 standard.

All HP-SL entries in the dictionary can be written in uppercase or lowercase letters. Also, all entries are shown in either **bold** or *italics* typeface.

Any HP-SL entries in the dictionary that are written in *italics* are commands which allow you to set or query parameters which have only one accepted value, or are commands that cause an event which has no useful effect on the Signal Generator, or are commands that are aliases to another. In any case, the commands are accepted for purposes of HP-SL compatibility.

All HP-SL entries in the dictionary show the "short form" of the command in uppercase letters. The "long form" of the command includes both the uppercase and lowercase letters. For example, the keyword "frequency" is listed as "FREQuency". This indicates that "FREQ" is all that is required to execute this command. You could even have "FrEq" as the command since case is ignored.

Command messages sent to the Signal Generator must be terminated by a linefeed character (ASCII character 10) or EOI on the last character (unless the EOI would be embedded within a BCList or BSList string).

Commands statements must be separated by a semicolon. The keywords within the command message are separated by colons. Refer to the first part of this chapter for details about the HP-SL colon and semicolon.

All HP-SL entries in the dictionary that are enclosed in square brackets " [] " are considered optional keywords. The optional keywords are assumed by default and may be omitted.

Command parameters that you may choose between are separated by a vertical bar " | ". Parameters available with the commands in the dictionary include frequency ranges, amplitude ranges, On state, Off state, ac coupling, dc coupling, and so forth.

HP-SL Notes (Continued)

When the command parameter is acting like a switch, "ON", "OFF", "1", or "0" may be sent (ON=1 and OFF=0). But when responding to a query, either a "1" or a "0" will be sent.

Where MINimum and MAXimum are listed as command parameters, they will set that function to its specified minimum or maximum value. For example, the command statement "FREQ MAX" will set the standard Signal Generator to 1030 MHz. MINimum and MAXimum may also be coupled to a subsystem state. For example, if FM is off, FM? MAX is not limited by the RF frequency and would be 10 MHz. But if FM is on, FM? MAX is reduced by the synthesis mode and may be less than 10 MHz.

All HP-SL entries in the dictionary are arranged in a manner that explicitly defines its hierarchy in the tree structure. The keyword at the root is located at the extreme left, branching from the root is indicated by indentation. For example, a portion of the FM subsystem command tree is as follows:

```

FM
  [:DEVIation]
    :STEP
      [:INCRement]
  :STATe
  :COUPling

```

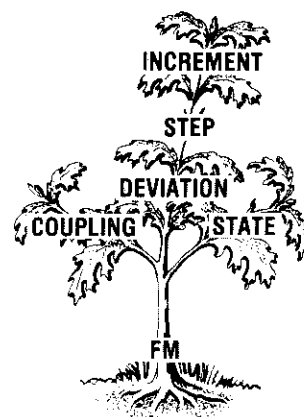

The following command statements and messages can be derived from this portion of the FM subsystem command tree. You will notice that several of the command statements are aliases for each other due to implicit couplings of optional keywords.

```

FM
FM:DEVIation
FM:DEVIation:STEP
FM:DEVIation:STEP:INCRement
FM:STEP
FM:STEP:INCRement
FM:STATe
FM:COUPling

```

**HP-SL Notes
(Continued)**

Any command message whose first character is an asterisk (such as *CLS) is treated as though the leading asterisk were a colon. For example, "FM:SOURce EXTERNAL;*CLS" is interpreted as "FM:SOURce EXTERNAL" and "*CLS".

When you query a command which has mnemonic settings, like GROund or INTernal, the shortform version will be returned. For example, after setting "AM:COUPling" to "GRO", "GROUND", or "GND" the response from a query would always be "GRO".

To read instrument settings over HP-IB, send the query form of the command statement with the correct syntax as specified with a "?" in the dictionary, and address the Signal Generator to talk.

Phase Modulation "ΦM" will be referred to as PM in the dictionary.

<AM term>	When found in the dictionary, this indicates that a "% " or "PCT" termination is required in the command statement. If no termination is specified, then a "% " value is assumed.
<ampl step term>	When found in the dictionary, this indicates that a "dB", "V", "mV", "uV" termination is required in the command statement. If no termination is specified, then a "dB" value is assumed.
<ampl step unit>	When found in the dictionary, this indicates that a "dB", or "V" termination must be specified in the command statement.
<ampl term>	When found in the dictionary, this indicates that "dBm", "dBmW" ("dBmW" is alias for "dBm"), "dBuV", "V", "mV", "uV", or no termination is required in the command statement. If the command statement is not terminated, then "AMPLitude:UNIT" is assumed, except on "STEP" in which case "AMPLitude:STEP:UNIT" is assumed.
<ampl unit term>	When found in the dictionary, this indicates that a "dBm", "dBmW", "V", or "dBuV" termination must be specified in the command statement.
<angle term>	When found in the dictionary, this indicates that a "DEG", "RAD", or no termination must be specified in the command statement. If no termination is specified, then a "RAD" (radian) value is assumed.
<coupling type>	When found in the dictionary, this indicates that sources "AC", "DC", "GROund", or "GND" are available.

**HP-SL Notes
(Continued)**

<freq term>	When found in the dictionary, this indicates that "HZ", "KHZ", "MHZ", "MAHZ", "GHZ", or no termination is required in the command statement. If the command statement is not terminated, then "HZ" is assumed.
<lin ampl term>	When found in the dictionary, this indicates that "V", "mV", "uV", or no termination is required in the command statement. If the command statement is not terminated, then "V" is assumed.
<mod_type>	When found in the dictionary, this indicates that "AM", "FM", "PM", or "PULSe" is required in the command statement.
<non-decimal numeric program data>	When found in the dictionary, this indicates that the pound symbol "#" should be followed by either a "B" and a binary representation of a number, or "Q" and a octal representation of a number, or "H" and a hexadecimal representation of a number. For example, the number 943 could be represented as "B1110101111", or "Q1657", or "H3AF".
<nrf>	When found in the dictionary, this indicates that an ASCII representation of a number is required in the command statement. The number may be integer or floating-point, and may include a decimal exponent. (nrf stands for - flexible numeric representation - for further information, refer to the IEEE 488.2 standard.)
<ohms term>	When found in the dictionary, this indicates that an "OHM", "KOHM", "MOHM" or no termination is required in the command statement. If the command statement is not terminated, "OHM" is assumed.
<source list>	When found in the dictionary, this indicates that "INTernal", or "EX-Ternal", or more than one source separated by commas is required in the command statement. For example: "INTernal,EXTernal" or "EXTernal,INTernal".
<time term>	When found in the dictionary, this indicates that "S", "mS", "uS", "nS" or no termination is required in the command statement. If the command statement does not have a termination "S" (seconds) is assumed.

AM Subsystem

AM

[:DEPTh]? [MINimum | MAXimum]

[:DEPTh] <nrf> [<AM term>] | UP | DOWN | MINimum | MAXimum
Sets AM depth in percent. *RST value is 0%.

:STEP

[:INCRement]? [MINimum | MAXimum]

[:INCRement] <nrf> [<AM term>] | MINimum | MAXimum

Sets AM depth step size in percent. MINimum/MAXimum refers to the smallest/largest programmable step size, not the smallest/largest allowed change. *RST value is 1% .

:STATe?

:STATe ON | OFF | 1 | 0

Turns AM modulation ON or OFF. AM is not turned ON by just setting AM:DEPth. *RST value is OFF.

:SOURce?

:SOURce <source list>

Selects AM source: "EXTernal" or "INTernal". "INTernal,EXTernal" is accepted but will cause an execution error since the Signal Generator does not use both the internal audio source and an external audio source at the same time. *RST value is INTernal.

:COUPling?

:COUPling <coupling type>

Set source coupling for AM. GROund coupling is equivalent to having NONE displayed on the front panel; it does not turn AM OFF, but all sources are disconnected. *RST value is DC.

:FREQuency? [MINimum | MAXimum]

:FREQuency <nrf> [<freq term>] | UP | DOWN | MINimum | MAXimum
Alias to LFSOURCE:FREQUENCY.

:STEP

[:INCRement]? [MINimum | MAXimum]

[:INCRement] <nrf> [<freq term>] | MINimum | MAXimum

Alias to LFSOURCE:FREQUENCY:STEP.

Amplitude Subsystem

POWER may be used in place of AMPLitude as an alias. AMPLitude:OUT may be used in place of AMPLitude to specify front-panel output. AMPLitude:SOURce may be used in place of AMPLitude to refer to driving source voltage (EMF).

AMPLitude or POWer

[[:OUT] or :SOURce

[[:LEVel]? [MINimum | MAXimum]

[[:LEVel] <nrf> [<ampl term>] | UP | DOWN | MINimum | MAXimum

Sets CW AMPLitude. LEVEL is assumed if omitted in the command statement. *RST value is -140.0 dBm.

:STEP

[[:INCRement]? [MINimum | MAXimum]

[[:INCRement] <nrf> [<ampl step term>] | MINimum | MAXimum

Set/query the AMPLitude step size. MINimum/MAXimum refers to the smallest/largest programmable step size, not the allowed change. *RST value is 10 dB.

:UNIT?

:UNIT <ampl step unit>

Set/query the UNIT for amplitude steps. Allowable values of UNIT are V and dB.

If STEP:UNIT is specified as volts, an AMPLitude increment causes the amplitude to be stepped in volts regardless of AMPLitude:UNIT.

If STEP:UNIT is specified as dB, an AMPLitude increment causes the amplitude to be stepped in dB regardless of AMPLitude:UNIT. This allows operations such as setting level in volts and changing it in dB steps.

Setting AMPLitude:STEP with a UNITs suffix causes AMPLitude:STEP:UNIT to be set to dB or V based on the units sent. *RST value is dB.

:STATe?

:STATe ON | OFF | 1 | 0

Turns RF output ON or OFF. OFF disables the output. Setting LEVEL does not turn this ON implicitly. *RST value is OFF.

:UNIT?

:UNIT <ampl unit term>

Specifies the units of AMPLitude for the Signal Generator. This command sets the implied UNIT for all parameters which have units of power or amplitude (except when the AMPLitude:STEP:UNIT command is sent). It is also used in a query response for these parameters.

If AMPLitude is set with a units suffix different than AMPLitude:UNIT, that UNIT is used in the command, but AMPLitude:UNIT is not changed. *RST is dBm.

:ULIMit? [MINimum | MAXimum]

:ULIMit <nrf> [<ampl term>] | MINimum | MAXimum

Sets MAXimum upper limit for AMPLitude. This command is equivalent to activating Special Function 103 from the front panel.

ULIMit is affected by POWER:GAIN in the same way as AMPLitude. If AMPLitude:ULIMit is set to less than AMPLitude, then AMPLitude is set to AMPLitude:ULIMit and an error is issued.

The MINimum value that can be set is 1 dB more than the minimum allowable amplitude setting. *RST value is 19.9 dBm.

:ATTenuation? [MINimum | MAXimum]

:ATTenuation <nrf> [dB] | UP | DOWN | MINimum | MAXimum

Sets or reads the value of the attenuator. This command is equivalent to activating Special Function 101 from the front panel.

Units are in dB of attenuation. Setting attenuation in dB sets POW:ATT:AUTO to OFF. Changing attenuation in dB changes the output level. *RST value is dependent on the option configuration, and is coupled to POWER:LEVEL.

:STEP

[:INCRement]?

Reads the attenuator step size.

:AUTO?

:AUTO ON | OFF | 1 | 0

When set ON, the firmware will control the attenuators.

Turning it OFF, causes the attenuator range to hold to its present setting. This command is equivalent to activating Special Function 100 from the front panel. *RST value is ON.

:GAIN? [MINimum | MAXimum]

:GAIN <nrf> [dB] | MINimum | MAXimum

Adjusts displayed/entered power level. Changing the GAIN does not change the actual output level, but it does change the displayed values shown on the front panel. *RST value is 0 dB.

:ALC

:BANDwidth

:AUTO?

:AUTO ON | OFF | 1 | 0

Enables or disables automatic selection of ALC bandwidth based on frequency and modulation. When OFF the widest ALC BANDwidth is forced. This command is equivalent to activating Special Function 104 from the front panel (in which case, off = narrowband and on = wideband). *RST value is ON.

:MUTing?

:MUTing ON | OFF | 1 | 0

The muting command is equivalent to activating Special Function 105 from the front panel.

Calibration Subsystem

CALibration

[[:ALL]]?

Performs an instrument self-calibration, and then returns an error code (an error code of "0" indicates no failures). Alias to *CAL?

:AMPLitude

:STATe?

:STATe ON | OFF | 1 | 0

Enables or disables the use of AMPLitude correction data. This command is equivalent to activating Special Function 102 from the front panel. *RST value is ON.

Diagnostic Subsystem

These command descriptions are detailed in the Service Diagnostics Manual (part number 08645-90024).

Display Subsystem

Front Panel display and annunciators may be blanked completely or in selective function groups.

DISPlay

:STATe?

:STATe ON | OFF | 1 | 0

:ANNotation

[[:ALL]]?

[[:ALL]] ON | OFF | 1 | 0

Enables/disables the front-panel display. This command is equivalent to activating Special Function 191 from the front panel. *RST value is ON.

:FREQuency?

:FREQuency ON | OFF | 1 | 0

Enables/disables front-panel display of RF output frequency. This command is equivalent to activating Special Function 192 from the front panel. *RST value is ON.

:MODulation?

:MODulation ON | OFF | 1 | 0

Enables/disables front-panel display of modulation. This command is equivalent to activating Special Function 193 from the front panel. *RST value is ON.

:AMPLitude?

:AMPLitude ON | OFF | 1 | 0

Enables/disables front-panel display of amplitude. This command is equivalent to activating Special Function 195 from the front panel. *RST value is ON.

:LFSource?

:LFSource ON | OFF | 1 | 0

Enables/disables front-panel display of audio source. This command is equivalent to activating Special Function 194 from the front panel. *RST value is ON.

:RADix?

:RADix US | EUROpean

When US (United States) is active, numbers shown on the front panel use a decimal to indicate the "ones" digit position. Commas are used to indicate thousands, millions, and so forth, positions.

When EUROpean is active, the commas and decimals shown on the front panel are reversed. For example 123456789 Hz would be shown as 123,456,789.00 Hz in US mode and 123.456.789,00 Hz in EUROpean.

This command affects the front-panel display only, all numbers sent over HP-IB must be sent in the US radix.

This command is equivalent to activating Special Function 196 from the front panel. *RST value is US.

FM Subsystem

The Signal Generator cannot do simultaneous FM and PM. If PM is on, and someone requests FM, the following will happen: PM is turned off, FM is turned on, and an error is displayed on the front panel.

FM

[:DEVIation]? [MINimum | MAXimum]

[:DEVIation] <nrf> [<freq term>] | UP | DOWN | MINimum | MAXimum

Set/query FM deviation. *RST value is 1 kHz.

:STEP

[:INCRement]? [MINimum | MAXimum]

[:INCRement] <nrf> [<freq term>] | MINimum | MAXimum

Set/query the step size for FM. MINimum/MAXimum refers to the smallest/largest programmable step size, not the smallest/largest allowed change. *RST value is 1 kHz.

:STATe?

:STATe ON | OFF | 1 | 0

Queries/turns FM ON or OFF. *RST value is OFF.

:SOURce?

:SOURce <source list>

Selects FM source: "INTernal", "EXTernal", or "INTernal,EXTernal". *RST value is INTernal.

:COUPling?

:COUPling <coupling type>

Set/query coupling for FM. GROund coupling is equivalent to having NONE displayed on the front panel; it does not turn FM OFF but disconnects all sources. *RST value is DC.

:MODE?

:MODE LINEar | DIGitized

Set/query true (LINEar) or synthesized (DIGitized) FM. This command is equivalent to activating Special Function 120 from the front panel. *RST value is DIGitized.

:FREQuency? [MINimum | MAXimum]

:FREQuency <nrf> [<freq term>] | UP | DOWN | MINimum | MAXimum

Alias to LFSOURCE:FREQUENCY.

:STEP

[:INCRement]? [MINimum | MAXimum]

[:INCRement] <nrf> [<freq term>] | MINimum | MAXimum

Alias to LFSOURCE:FREQUENCY:STEP.

:DELay?

:DELay ON | OFF | 1 | 0

Enables or disables the FM Delay Equalizer circuitry. This command is equivalent to activating Special Function 124 from the front panel. *RST value is ON.

:IMPedance?

Returns the FM input impedance value of 600 Ω .

Frequency Subsystem

FREQUENCY

[:CW] ? [MINimum | MAXimum]

[:CW] <nrf> [<freq term>] | UP | DOWN | MINimum | MAXimum
Set/query non-swept frequency. Does not disable SWEep. *RST value is 1500 MHz.

:STEP

[:INCRement] ? [MINimum | MAXimum]

[:INCRement] <nrf> [<freq term>] | MINimum | MAXimum

Sets STEP size for RF output frequency related commands (FREQUENCY, FREQUENCY:START, FREQUENCY:STOP, CENTER, SPAN, MARKER, MARKER2, MARKER3).

MINimum/MAXimum refers to the smallest/ largest programmable step size, not the smallest/largest allowed change. *RST value is 10 MHz.

:START ? [MINimum | MAXimum]

:START <nrf> [<freq term>] | UP | DOWN | MINimum | MAXimum

Sets START frequency for a sweep. Does not enable SWEep. May change other SWEep parameters as listed in the following "Rules for Couplings Between:". *RST value is 100,000 Hz. (Instruments with serial prefix 3015A and above have a *RST value to 10 KHz.)

:STEP

[:INCRement] ? [MINimum | MAXimum]

[:INCRement] <nrf> [<freq term>] | MINimum | MAXimum

Alias to FREQUENCY:STEP.

:STOP ? [MINimum | MAXimum]

:STOP <nrf> [<freq term>] | UP | DOWN | MINimum | MAXimum

Sets STOP frequency for a sweep. Does not enable SWEep. May change other SWEep parameters as listed in the following "Rules for Couplings Between:". *RST value is 2,999,999,999.99 MHz.

:STEP

[:INCRement] ? [MINimum | MAXimum]

[:INCRement] <nrf> [<freq term>] | MINIMUM | MAXIMUM

Alias to FREQUENCY:STEP.

:CENTer? [MINimum | MAXimum]

:CENTer <nrf> [<freq term>] | UP | DOWN | MINimum | MAXimum

Sets CENTER frequency for a sweep. Does not enable SWEEP. May change other SWEEP parameters as listed in the following "Rules for Couplings Between:". *RST value is (START+STOP)/2.

:STEP

[:INCREMENT]? [MINimum | MAXimum]

[:INCREMENT] <nrf> [<freq term>] | MINimum | MAXimum

Alias to FREQUENCY:STEP.

:SPAN? [MINimum | MAXimum]

:SPAN <nrf> [<freq term>] | UP | DOWN | MINimum | MAXimum

Sets frequency SPAN for a sweep. Does not enable SWEEP. May change other SWEEP parameters as listed in the following "Rules for Couplings Between:". *RST value is STOP-START.

:STEP

[:INCREMENT]? [MINimum | MAXimum]

[:INCREMENT] <nrf> [<freq term>] | MINimum | MAXimum

Alias to FREQUENCY:STEP.

Rules for

Couplings Between: FREQUENCY:START, FREQUENCY:STOP,
FREQUENCY:CENTer, and FREQUENCY:SPAN

If only START is sent in the command message:

STOP is unchanged
CENTer is set to (START + STOP)/2
SPAN is set to (STOP - START)

If only STOP is sent in the command message:

START is unchanged
CENTer is set to (START + STOP)/2
SPAN is set to (STOP - START)

If only CENTer is set in the command message:

SPAN is unchanged
START is set to (CENTer - (SPAN/2))
STOP is set to (CENTer + (SPAN/2))

If only SPAN is set in the command message:

CENter is unchanged
 START is set to $(\text{CENter} - (\text{SPAN}/2))$
 STOP is set to $(\text{CENter} + (\text{SPAN}/2))$

If START and STOP are set in the same command message:

CENter is set to $(\text{START} + \text{STOP})/2$
 SPAN is set to $(\text{STOP} - \text{START})$

If START and CENter are set in the same command message:

STOP is set to $(\text{START} + 2(\text{CENter} - \text{START}))$
 SPAN is set to $2(\text{CENter} - \text{START})$

If START and SPAN are set in the same command message:

STOP is set to $(\text{START} + \text{SPAN})$
 CENter is set to $(\text{START} + (\text{SPAN}/2))$

If STOP and CENter are set in the same command message:

START is set to $(\text{STOP} - 2(\text{STOP} - \text{CENter}))$
 SPAN is set to $2(\text{STOP} - \text{CENter})$

If STOP and SPAN are set in the same command message:

START is set to $(\text{STOP} - \text{SPAN})$
 CENter is set to $(\text{STOP} - (\text{SPAN}/2))$

If CENter and SPAN are set in the same command message:

START is set to $(\text{CENter} - (\text{SPAN}/2))$
 STOP is set to $(\text{CENter} + (\text{SPAN}/2))$

If more than two of START, STOP, CENter SPAN commands are sent in one statement, the last two sweep parameters modified will be used, as described in the "Rules for Couplings Between". All changes to the other parameters will be ignored.

:MANual? [MINimum | MAXimum]

:MANual <nrf> [<freq term>] | UP | DOWN | MINimum | MAXimum

Controls frequency during a manual sweep. Limits are FREQUENCY:START to FREQUENCY:STOP. *RST value is the same as FREQUENCY:START.

:OFFSet? [MINimum | MAXimum]

:OFFSet <nrf> [<freq term>] | MINimum | MAXimum

Sets a reference frequency for other absolute frequency settings in the Signal Generator (CW, START, STOP, but not FM or SPAN).

Changes entered/displayed values but does not change RF output frequency. *RST value is 0 Hz. The coupling equation is as follows:

$$\text{Entered/Displayed Frequency} = (\text{Hardware Freq} \times \text{Multiplier}) + \text{Offset}$$

:MULTIplier? [**MINimum** | **MAXimum**]

:MULTIplier <nrf> | **MINimum** | **MAXimum**

Sets a reference multiplier for other frequency settings in the Signal Generator (CW, START, STOP, as well as FM and SPAN). This command is equivalent to activating Special Function 111 from the front panel.

This command changes the entered/displayed values, but does not actually change the RF output frequency.

Resolution for this command is integer values, or one over integer values (1/2, 1/3, 1/4 ...). *RST value is 1.

The coupling equation is as follows:

$$\text{Entered/Displayed Frequency} = (\text{Hardware Freq} \times \text{Multiplier}) + \text{Offset}$$

OR

Entered/Displayed Frequency = (Hardware Freq × Multiplier) in cases where offset is not to be used.

:SYNThesis?

:SYNThesis <nrf>

Sets synthesis mode for the Signal Generator. This command is equivalent to pressing one of the **MODE SELECT** keys on the front panel.

Setting this value sets FREQUENCY:SYNThesis:AUTO to OFF. *RST value is dependent on hardware configuration.

:AUTO?

:AUTO **ON** | **OFF** | **1** | **0**

Turning AUTO to ON, allows the firmware to select the synthesis mode. This command is equivalent to pressing the **MODE SELECT** key **AUTO** on the front panel. Turning AUTO to OFF, leaves the Signal Generator in its current synthesis mode. *RST value is ON.

:MODE?

:MODE **CW** | **SWEep**

Determines which commands control the frequency subsystem. If SWEep is selected, then the commands FREQUENCY:START, STOP, CENTER, SPAN, and MANUAL control the frequency subsystem. *RST value is CW.

:INSTantaneous?

Returns the instantaneous RF output frequency during DIGitized FM. This command is equivalent to activating Special Function 121 from the front panel.

HP-SL System Commands

SYSTem

:ERRor? [NUMeric | STRing]

Reads an error from the system error queue. Returns a zero if the queue is empty. If SYSTem:ERRor? or SYSTem:ERRor? NUMeric is used, the Signal Generator returns only a number as described in the table shown below. If SYSTem:ERRor? STRing is used, the Signal Generator returns a number followed by a comma, and a quoted string containing a standard generic error message, a colon, and a specific error message.

Numeric	Error Message	Numeric	Error Message
100	Command Error	211	Legal Command but Settings Conflict
101	Invalid Character Received	212	Argument out of Range
110	Command Header Error	222	Insufficient Capability or Configuration
111	Header Delimiter Error	232	Output Buffer Full or Overflow
120	Numeric Argument Error	300	Device Failure
121	Wrong Data Type (Numeric Expected)	310	RAM Error
123	Numeric Overflow	311	RAM Failure
129	Missing Numeric Argument	312	RAM Data Loss
130	Non Numeric Argument Error	313	Calibration Data Loss
131	Wrong Data Type (Char Expected)	320	ROM Error
132	Wrong Data Type (String Expected)	321	ROM Checksum
133	Wrong Data Type (Block Type #D Required)	322	Hardware and Firmware Incompatible
139	Missing Non Numeric Argument	330	Power on Test Failed
142	Too Many Arguments	340	Self Test Failed
143	Argument Delimiter Error	400	Query Error
144	Invalid Message Unit Delimiter	410	Query Interrupted
200	No Can Do	420	Query Unterminated
201	Not Executable in Local Mode	422	Addressed to Talk with Nothing to Say
202	Settings Lost Due to RTL* or PON*	430	Query Deadlocked

* Return to Local (RTL) or Power On (PON).

For example, if an attempt is made to set the frequency to a value higher than is possible, SYSTem:ERRor? would return: -212 which is an argument out of range error. Under the same conditions a SYSTem:ERRor? STRing query would return: -212, "ARGUMENT OUT OF RANGE:FREQUENCY TOO HIGH" Refer to appendix D for a descriptive list of all error messages.

:STATe

:CALL

This event causes all save/recall registers to be cleared.

:SECurity?

:SECurity ON | OFF | 1 | 0

Controls the security mode of the Signal Generator. This command is equivalent to activating Special Function 173 from the front panel. When in the secure mode, any display annunciators which have been disabled cannot be re-enabled. This value is not affected by *RST or *RCL. This value is not effected by power cycles unless memory is lost during power down. When this value is switched from ON to OFF, all memory in the Signal Generator is erased when the equivalent of Special Function 172 (RAM Wipe) is performed.

IEEE 488.2 Common commands

***CAL?** Self calibration query

Causes the Signal Generator to perform an internal self-calibration and returns an integer error code. An error code of zero indicates no failures, other numbers indicate some error. A list of specific error codes are defined in the *Assembly Level Repair, Service Diagnostics Manual* (HP part number 08645-90024). This command is equivalent to activating Special Function 171 from the front panel.

***CLS** Clear status command

Clears the status register and associated status data structures summarized in the Status Byte, such as the Event Status Register. Clears output and error queues. Clears all event registers.

***ESE** <nrf> <non-decimal numeric program data> Event status enable command

Sets the Standard Event Status Enable Register. A more detailed description of the status reporting is included in the *"HP-IB Device Status Dictionary"*.

***ESE?** Event status enable query

Queries the Standard Event Status Enable Register. A more detailed description of the status reporting is included in the *"HP-IB Device Status Dictionary"*.

***ESR?** Event status register query

Queries the Standard Event Status Register. A more detailed description of the status reporting is included in the *"HP-IB Device Status Dictionary"*.

***IDN?** Identification query

Returns an identification string which is 4 fields separated by commas.

Field 1 : Is always HEWLETT-PACKARD.

Field 2 : Is model number like 8665A.

Field 3 : Is a serial number in HP format e.g. 2833A00873 or a 0 if the serial number is unknown (Equivalent to activating Special Function 190).

Field 4 : Is the firmware version number.

For example: HEWLETT-PACKARD,8665A,2833A00873,REV 1.0.0

***OPC Operation complete command**

Will cause the OPC bit to be set in the standard event status register when a sweep or learn operation is complete. Since the bus is released before a sweep is completed, you may re-synchronize after these operations are complete.

***OPC? Operation complete query**

Will cause an ASCII 1 to be returned when a sweep or learn operation is complete. Since the bus is released before a sweep or learn is completed, you may re-synchronize after these operations are complete.

***OPT? Option query**

Identifies reportable options in current instrument configuration. Each option is indicated by a mnemonic and multiple reportable options are separated by commas. If the Signal Generator has no reportable options in place, the option query returns a zero. For example, "COMM_DISCR" refers to Option 004, the Low Noise Mode; "GAAS_PULSE" refers to Option 008, Pulse Modulation.

***RST Reset command**

Causes the Signal Generator to do an instrument preset. Sets all operating parameters to the known states listed in this Dictionary. It does not effect the status reporting information, nor does it clear the error or message queue, and does not affect contents of the 50 storage registers.

The *RST command must be put on a separate line of code.

***SAV <nrf> Save instrument state**

Saves the instrument state in the specified register number. The Signal Generator has 50 available storage registers. The first 10 registers (0-9) accepts all front-panel settings (except for some special functions). The next 40 registers (10-49) accepts only frequency and amplitude settings.

***SRE <nrf> <non-decimal numeric program data> Service request enable command**

Sets the Service Request Enable Register. A more detailed description of the status reporting is included in the "*HP-IB Device Status Dictionary*".

***SRE? Service request enable query**

Queries the Service Request Enable Register. A more detailed description of the status reporting is included in the "*HP-IB Device Status Dictionary*".

***STB? Read status byte query**

Set/query the HP-IB Status Byte. A more detailed description of the status reporting is included in the "*HP-IB Device Status Dictionary*".

***RCL <nrf> Recall instrument state**

Recalls the instrument state which was stored in the specified register number. The Signal Generator has 50 available storage registers. The first 10 registers (0-9) accepts all front-panel settings (except for some special functions). The next 40 registers (10-49) accepts only frequency and amplitude settings.

***TST? Self-test query**

Causes the Signal Generator to perform internal instrument level diagnostics and returns an integer error code. An error code of zero indicates no failures, other numbers indicate some error. A list of specific error codes are defined in the Service Diagnostics Manual (part number 08645-90024). This command is equivalent to activating Special Function 170 from the front panel.

***WAI Wait-to-continue command**

Causes the Signal Generator to not accept any further input or output between the end of the message containing *WAI, and the completion of all command processing for that message.

Initialize Subsystem

INITialize

:STATE?

:STATE PAUSE | RUN

Returns PAUSE or RUN to determines if the Signal Generator is actually sweeping or idle. This parameter only has meaning when FREQuency:MODE is SWEep. *RST value is PAUSE.

:MODE?

:MODE CONTInuous | SINGLE

Determines if the Signal Generator is performing single sweep or continuous sweep. After a single SWEep is done, INITIALize:STATE becomes PAUSE, and an INITIALize command is required to restart the SWEep. *RST value is CONTInuous.

:ABORT

Aborts any current sweep. Sets INITIALize:STATE to PAUSE.

[:IMMEDIATE]

Sets INITIALize:STATE to RUN, and starts a single SWEep or a continuous SWEep. If a SWEep is already in progress, it is aborted and restarted.

LF Source Subsystem

LFSOURCE

[:FREQUENCY]? [MINimum | MAXimum]

[:FREQUENCY] <nrf> [<freq term>] | UP | DOWN | MINimum | MAXimum

Sets frequency of the audio source. This command is equivalent to the command <mod_type>:FREQ. *RST value is 1 kHz.

:STEP

[:INCRement]? [MINimum | MAXimum]

[:INCRement] <nrf> [<freq term>] | MINimum | MAXimum

Sets the step for the audio source. MINimum/MAXimum refers to the smallest/largest programmable step size, not the smallest/largest allowed change. *RST value is 100 Hz.

:STATE?

:STATE ON | OFF | 1 | 0

Turns the LF source ON or OFF. Setting the frequency or level for the LF does not by itself turn the source ON.

Any attempt to turn LFSOURCE:STATE OFF while any <mod_type>'s STATE is ON, and its SOURCE includes INTERNAL will result in an error. In other words, the Signal Generator will not turn off the LFSOURCE while it is being used for modulation. *RST value is OFF.

:WAVEform?

:WAVEform SINE | SQUARE | TRIangle | SAWTooth | WGNoise

Selects a waveform for the LF Source: SINE, SQUARE, TRIangle, SAWTooth or White Gaussian Noise (WGNoise) is available. This command is equivalent to activating Special Function 130 from the front panel. *RST value is SIN.

:LEVEL? [MINimum | MAXimum]

:LEVEL <nrf> [<lin ampl term>] | UP | DOWN | MINimum | MAXimum

Sets level of the audio source in volts. *RST value is 1 V.

:STEP

[:INCRement]? [MINimum | MAXimum]

[:INCRement] <nrf> [<lin ampl term>] | MINimum | MAXimum

Sets the LFSOURCE:LEVEL step. MINimum/MAXimum refers to the smallest/largest programmable step size, not the smallest/largest allowed change. *RST value is 0.1 V.

:TRIGger**[:IMMediate]**

Causes a one-shot trigger of the LFSOURCE if SOURCE is set to EXT. This command is equivalent to activating Special Function 132 with 131 turned ON, from the front panel.

:SOURCE?**:SOURCE EXTernal | CONTInuous**

Defines whether the LFSOURCE is continuous or triggered by an external transition. This command is equivalent to activating Special Function 131 from the front panel. In which case, ON would be EXTernal and OFF would be CONTInuous. *RST value is CONTInuous.

:FREQUency2? [MINimum | MAXimum]**:FREQUency2 <nrf> [<freq term>] | UP | DOWN | MINimum | MAXimum**

Sets the frequency of the audio source in Channel 2. This command is equivalent to setting frequency for the second audio source with Special Function 133 turned ON. The short form of this command is "FREQ2". The *RST value is 400 Hz.

:STEP**[:INCRement]? [MINimum | MAXimum]****[:INCRement] <nrf> [<freq term>] | MINimum | MAXimum**

Sets the LFSOURCE:FREQUency2 step size for the audio source in Channel 2. MINimum/MAXimum refers to the smallest/largest programmable step size, not the smallest/largest allowed change. *RST value is 100 Hz.

:WAVEform2?**:WAVEform2 SIN | SQUARE | TRIangle | SAWTooth | WGNoise**

Selects a waveform for the audio source in Channel 2: SINE, SQUARE, TRIangle, SAWTooth or White Gaussian Noise (WGNoise). This command is equivalent to activating Special Function 135 from the front panel. The short form of this command is "WAV2". The *RST value is SINE.

:STATe2?

:STATe2 **ON | OFF | 1 | 0**

Turns the audio source in Channel 2 either ON or OFF. Setting the frequency or level does not by itself turn the audio source in Channel 2 ON. This command is equivalent to activating Special Function 133 from the front panel. The short form of this command is "STAT2". The *RST value is OFF.

:LEVe2? **[MINimum | MAXimum]**

:LEVe2 **<nrf> [<lin ampl term>] | UP | DOWN | MINimum | MAXimum**

Sets the level of the audio source in Channel 2. This command is equivalent to activating Special Function 134 from the front panel. The short form of this command is "LEV2". The *RST value is 100 mV.

:STEP

[:INCRement]? [MINimum | MAXimum]

[:INCRement] <nrf> [<lin ampl term>] | MINimum | MAXimum

Sets the LFSOURCE:LEVe2 step size for the audio source in Channel 2. MINimum/MAXimum refers to the smallest/largest programmable step size, not the smallest/largest allowed change. *RST value is 100 mV.

:PHASe2

[:ADJust]? [MINimum | MAXimum]

[:ADJust] <nrf> [<angle term>] | UP | DOWN | MINimum | MAXimum

Adjusts the phase of the audio source in Channel 2 in terms of degrees or radians. This command is equivalent to activating Special Function 136 from the front panel. The short form of this command is "PHAS2". The *RST value is 0°.

:STEP

[:INCRement]? [MINimum | MAXimum]

[:INCRement] <nrf> [<angle term>] | MINimum | MAXimum

Sets the LFSOURCE:PHASe2 step size for the audio source in Channel 2. MINimum/MAXimum refers to the smallest/largest programmable step size, not the smallest/largest allowed change. *RST value is 1°(0.017 radians).

:AM**[:DEPT_h]?** [MINimum | MAXimum]**[:DEPT_h]** <nrf> [<am term>] | UP | DOWN | MINimum | MAXimum

Sets the percentage of AM depth applied to the audio source in Channel 1. This command is equivalent to setting AM depth on the sub-carrier with Special Function 137 turned ON. *RST value is 0%.

:STEP**[:INCRement]?** [MINimum | MAXimum]**[:INCRement]** <nrf> [<am term>] | MINimum | MAXimum

Sets the LFSOURCE:AM:DEPT_h step size for the AM source in Channel 1. MINimum/MAXimum refers to the smallest/largest programmable step size, not the smallest/largest allowed change. *RST value is 1%.

:STATE?**:STATE** ON | OFF | 1 | 0

Turns the AM source in Channel 1 either ON or OFF. Setting AM frequency or depth does not by itself turn the AM source in Channel 1 ON. This command is equivalent to activating Special Function 137 from the front panel. *RST value is OFF.

[:FREQUency]? [MINimum | MAXimum]**[:FREQUency]** <nrf> [<freq term>] | UP | DOWN | MINimum | MAXimum

Sets the frequency rate for the AM source in Channel 1. This command is equivalent to activating Special Function 138 from the front panel. *RST value is 100 Hz.

:STEP**[:INCRement]?** [MINimum | MAXimum]**[:INCRement]** <nrf> [<freq term>] | MINimum | MAXimum

Sets the LFSOURCE:AM:FREQUency step size for the AM source in Channel 1. MINimum/MAXimum refers to the smallest/largest programmable step size, not the smallest/largest allowed change. *RST value is 100 Hz.

:WAVEform?**:WAVEform** SIN | SQUARE | TRIangle | SAWTooth | WGNoise

Selects a waveform for the AM source in Channel 1: SINE, SQUARE, TRIangle, SAWTooth or White Gaussian Noise (WGNoise). This command is equivalent to activating Special Function 139 from the front panel. *RST value is SINE.

:PHASe

[:ADJust]? [MINimum | MAXimum]

[:ADJust] <nrf> [<angle term>] | UP | DOWN | MINimum | MAXimum

Adjusts the phase of the AM source in Channel 1 in terms of degrees or radians. This command is equivalent to activating Special Function 140 from the front panel. *RST value is 0°.

:STEP

[:INCRement]? [MINimum | MAXimum]

[:INCRement] <nrf> [<angle term>] | MINimum | MAXimum

Sets the LFSOURCE:AM:PHASe step size for the AM source in Channel 1. MINimum/MAXimum refers to the smallest/largest programmable step size, not the smallest/largest allowed change. *RST value is 1°(0.017 radians).

:FM

[:DEViation]? [MINimum | MAXimum]

[:DEViation] <nrf> [<freq term>] | UP | DOWN | MINimum | MAXimum

Sets the amount of FM deviation applied to the audio source in Channel 1. This command is equivalent to setting FM deviation on the sub-carrier with Special Function 141 turned ON. *RST value is 0 Hz.

:STEP

[:INCRement]? [MINimum | MAXimum]

[:INCRement] <nrf> [<freq term>] | MINimum | MAXimum

Sets the LFSOURCE:FM:DEViation step size for the FM source in Channel 1. MINimum/MAXimum refers to the smallest/largest programmable step size, not the smallest/largest allowed change. *RST value is 10 Hz.

:STATe?

:STATe ON | OFF | 1 | 0

Turns the FM source in Channel 1 either ON or OFF. Setting FM frequency or deviation does not by itself turn the FM source in Channel 1 ON. This command is equivalent to activating Special Function 141 from the front panel. *RST value is OFF.

:FREQUency? [MINimum | MAXimum]

:FREQUency <nrf> [<freq term>] | UP | DOWN | MINimum | MAXimum

Sets the frequency rate for the FM source in Channel 1. This command is equivalent to activating Special Function 142 from the front panel. *RST value is 100 Hz.

:STEP

[:INCRement]? [MINimum | MAXimum]

[:INCRement] <nrf> [<freq term>] | MINimum | MAXimum

Sets the LFSOURCE:FM:FREQUENCY step size for the FM source in Channel 1. MINimum/MAXimum refers to the smallest/largest programmable step size, not the smallest/largest allowed change. *RST value is 100 Hz.

:WAVEform?

:WAVEform SIN | SQUARE | TRIangle | SAWTooth | WGNoise

Selects a waveform for the FM source in Channel 1: SINE, SQUARE, TRIangle, SAWTooth or White Gaussian Noise (WGNoise). This command is equivalent to activating Special Function 143 from the front panel. *RST value is SINE.

:PHASe

[:ADJust]? [MINimum | MAXimum]

[:ADJust] <nrf> [<angle term>] | UP | DOWN | MINimum | MAXimum

Adjusts the phase of the FM source in Channel 1 in terms of degrees or radians. This command is equivalent to activating Special Function 144 from the front panel. *RST value is 0°.

:STEP

[:INCRement]? [MINimum | MAXimum]

[:INCRement] <nrf> [<angle term>] | MINimum | MAXimum

Sets the LFSOURCE:FM:PHASE step size for the FM source in Channel 1. MINimum/MAXimum refers to the smallest/largest programmable step size, not the smallest/largest allowed change. *RST value is 1°(0.017 radians).

:PM

[:DEVIation]? [MINimum | MAXimum]

[:DEVIation] <nrf> [<angle term>] | UP | DOWN | MINimum | MAXimum

Sets the amount of Φ M deviation applied to the audio source in Channel 1. This command is equivalent to setting Φ M deviation on the sub-carrier with Special Function 145 turned ON. *RST value is 0°.

:STEP

[:INCRement]? [MINimum | MAXimum]

[:INCRement] <nrf> [<angle term>] | MINimum | MAXimum

Sets the LFSOURCE:PM:DEVIATION step size for the Φ M source in Channel 1. MINimum/MAXimum refers to the smallest/largest programmable step size, not the smallest/largest allowed change. *RST value is 1° (0.017 radians).

:STATE?

:STATE ON | OFF | 1 | 0

Turns the Φ M source in Channel 1 either ON or OFF. Setting Φ M frequency or deviation does not by itself turn the Φ M source in Channel 1 ON. This command is equivalent to activating Special Function 145 from the front panel. *RST value is OFF.

:FREQUency? [MINimum | MAXimum]

:FREQUency <nrf> [<freq term>] | UP | DOWN | MINimum | MAXimum

Sets the frequency rate for the Φ M source in Channel 1. This command is equivalent to activating Special Function 146 from the front panel. *RST value is 100 Hz.

:STEP

[:INCRement]? [MINimum | MAXimum]

[:INCRement] <nrf> [<freq term>] | MINimum | MAXimum

Sets the LFSOURCE:PM:FREQUENCY step size for the Φ M source in Channel 1. MINimum/MAXimum refers to the smallest/largest programmable step size, not the smallest/largest allowed change. *RST value is 100 Hz.

:WAVEform?

:WAVEform SIN | SQUARE | TRIangle | SAWTOoth | WGNoise

Selects a waveform for the Φ M source in Channel 1: SINE, SQUARE, TRIangle, SAWTOoth or White Gaussian Noise (WGNoise). This command is equivalent to activating Special Function 147 from the front panel. *RST value is SINE.

:PHASe**[:ADJusT]? [MINimum | MAXimum]****[:ADJusT] <nrf> [<angle term>] | UP | DOWN | MINimum | MAXimum**

Adjusts the phase of the Φ M source in Channel 1 in terms of degrees or radians. This command is equivalent to activating Special Function 148 from the front panel. *RST value is 0°.

:STEP**[:INCRement]? [MINimum | MAXimum]****[:INCRement] <nrf> [<angle term>] | MINimum | MAXimum**

Sets the LFSOURCE:PM:PHASe step size for the Φ M source in Channel 1. MINimum/MAXimum refers to the smallest/largest programmable step size, not the smallest/largest allowed change. *RST value is 1°(0.017 radians).

:PULSe**:STATe?****:STATe ON | OFF | 1 | 0**

Turns the Pulse source in Channel 1 either ON or OFF. Setting Pulse frequency does not by itself turn the Pulse source in Channel 1 ON. This command is equivalent to activating Special Function 149 from the front panel. *RST value is OFF.

:FREQuency? [MINimum | MAXimum]**:FREQuency <nrf> [<freq term>] | UP | DOWN | MINimum | MAXimum**

Sets the frequency rate for the Pulse source in Channel 1. This command is equivalent to activating Special Function 150 from the front panel. *RST value is 100 Hz.

:STEP**[:INCRement]? [MINimum | MAXimum]****[:INCRement] <nrf> [<freq term>] | MINimum | MAXimum**

Sets the LFSOURCE:PULSe:FREQuency step size for the Pulse source in Channel 1. MINimum/MAXimum refers to the smallest/largest programmable step size, not the smallest/largest allowed change. *RST value is 100 Hz.

:PHASe**[:ADJust]? [MINimum | MAXimum]****[:ADJust] <nrf> [<angle term>] | UP | DOWN | MINimum | MAXimum**

Adjusts the phase of the Pulse source in Channel 1 in terms of degrees or radians. This command is equivalent to activating Special Function 151 from the front panel. *RST value is 0°.

:STEP**[:INCRement]? [MINimum | MAXimum]****[:INCRement] <nrf> [<angle term>] | MINimum | MAXimum**

Sets the LFSOURCE:PULSE:PHASe step size for the Pulse source in Channel 1. MINimum/MAXimum refers to the smallest/largest programmable step size, not the smallest/largest allowed change. *RST value is 1°(0.017 radians).

:AVIonics

:SETup

:VOR

Configures the instrument for VOR receiver testing. This command is equivalent to activating Special Function 220 from the front panel.

:LOCalizer

Configures the instrument for Localizer receiver testing. This command is equivalent to activating Special Function 221 from the front panel.

:GSLope

Configures the instrument for Guideslope receiver testing. This command is equivalent to activating Special Function 222 from the front panel.

:OMBeacon

Configures the instrument for Outer Marker (OM) beacon testing. This command is equivalent to activating Special Function 223 from the front panel.

:MMBeacon

Configures the instrument for Middle (MM) beacon testing. This command is equivalent to activating Special Function 224 from the front panel.

:IMBeacon

Configures the instrument for Inner Marker (IM) beacon testing. This command is equivalent to activating Special Function 225 from the front panel.

Marker Subsystem

The Signal Generator firmware contains three markers. The behavior of all of the markers is identical, however, MARKer 1 has two references (that is, MARKer or MARKer1, MARKer2, and MARKer3).

MARKer or MARKer1 or MARKer2 or MARKer3

[:FREQUency]? [MINimum | MAXimum]

[:FREQUency] <nrf> [<freq term>] | UP | DOWN | MINimum | MAXimum

Sets frequency of selected marker. The marker may be set outside of the START and STOP frequency range, if so, the marker is not shown but is still considered active.

The markers will have the same offset and multiplier values as determined by **FREQ:OFFSet** and **FREQ:MULT**. *RST value is 100,000.00 Hz.

:STEP

Step size for the markers will always be in increments equal to **FREQ:CW:STEP**.

[:INCRement]? [MINimum | MAXimum]

[:INCRement] <nrf> [<freq term>] | MINimum | MAXimum

*Alias to **FREQUency:STEP**.*

:STATe?

:STATe ON | OFF | 1 | 0

Turns the specified marker ON or OFF. Marker state is not turned ON when the marker frequency is set. *RST condition is OFF.

:AOFF

Turns off all markers (this is *RST condition). This command will be accepted for any specific marker (**MARK2:AOFF**) but will still turns off all the markers. This command cannot be queried.

Modulation Subsystem

MODulation

:STATe?

:STATe ON | OFF | 1 | 0

The **MODulation:STATe ON** and **MODulation:STATe OFF** commands toggle on and off the modulation type (<mod_type>) that was previously selected. If the modulation is already on when the **MODulation:STATe ON** command is received, the command has no effect.

The command **MODulation:STATe OFF** turns off all modulation types, and turns **LF-Source:STATe OFF**.

The command MOD:STATE? will give the response "1" if any modulation state is on, and will give the response "0" if all modulation states are off. *RST causes the list of "previously active modulation types" to be FM.

Phase Modulation Subsystem

The Signal Generator cannot do simultaneous FM and PM. If FM is on, and someone requests PM, the following will happen: FM is turned off, PM is turned on, and an error displayed on the front panel.

PM

:STATE?

:STATE ON | OFF | 1 | 0

Turns PM ON or OFF. *RST value is OFF.

:SOURCE?

:SOURCE <source list>

Selects PM source: "INTERNAL", "EXTERNAL", or "INTERNAL,EXTERNAL". *RST value is INTERNAL.

:COUPLing?

:COUPLing <coupling type>

Set source coupling for FM. GROund coupling is equivalent to having NONE displayed on the front panel, it does not turn FM off, but disconnects all sources. *RST value is DC.

:FREQuency? [MINimum | MAXimum]

:FREQuency <nrf> [<freq term>] | UP | DOWN | MINimum | MAXimum

Alias to LFSOURCE:FREQuency.

:STEP

[:INCRement]? [MINimum | MAXimum]

[:INCRement] <nrf> [<freq term>] | MINimum | MAXimum

Alias to LFSOURCE:FREQuency:STEP.

Phase Subsystem

This subsystem allows you to increment or decrement the phase of the RF output signal in steps relative to the present frequency reference.

PHASe

[:ADJust]? [MINimum | MAXimum]

[:ADJust] <nrf> [<angle term>] | UP | DOWN | MINimum | MAXimum

Controls the phase offset value relative to the reference. This command is equivalent to activating Special Function 110 from the front panel. *RST value is 0.

:STEP

[INCRement]? [MINimum | MAXimum]

[INCRement] <nrf> [<angle term>] | MINimum | MAXimum

Controls the step size in degrees. MINimum/MAXimum refers to the smallest/largest programmable step size, not the smallest/largest allowed change. *RST value is one degree. (NOTE - base unit for angle measurements is radians. All queries will be returned in radians).

:REFerence

This event resets the PHASe value to 0 without changing the actual PHASe of the Signal Generator. This means that any further references to PHASe will be considered to be relative to the PHASe at the time this command was last issued.

Power Meter Subsystem

PMETer

[:POWER]?

Queries the internal power meter. This command is equivalent to activating Special Function 182 from the front panel. The power meter connector is located inside the Signal Generator, under the top cover.

Pulse Subsystem

The following Pulse Subsystem commands are valid for an Signal Generator equipped with Option 008.

PULSe

[:STATe]?

[:STATe] ON | OFF | 1 | 0

Turns PULSe ON or OFF. *RST value is OFF.

:SOURce?

:SOURce <source list>

Selects the PULSe source: INTernal, or EXTernal (dc-coupled only). *RST value is EXTernal.

:IMPedance? [MINimum | MAXimum]

:IMPedance <nrf> [<ohms term>] | MINimum | MAXimum

Set/query input impedance of the PULSE connector. The Pulse input impedance may be set to 50 Ω , which would be equivalent to activating Special Function 210 from the front panel. *RST value is 100 k Ω .

:CONDitioning?

:CONDitioning ON | OFF | 1 | 0

Set/query the type of Pulse Control being used for pulse modulation. Turning CONDitioning to OFF activates direct pulse control, which is equivalent to setting Special Function 211 to "Direct". Turning CONDitioning ON activates the internal pulse generator, which is equivalent to setting Special Function 211 to "Pulse Gen". *RST value is OFF (direct pulse control).

:DELay? [MINimum | MAXimum]

:DELay <nrf> [<time term>] | UP | DOWN | MINimum | MAXimum

Set/query the amount of pulse delay. This command is equivalent to activating Special Function 212 from the front panel. *RST value is 1 μ s.

:STEP

[:INCRement]? [MINimum | MAXimum]

[:INCRement] <nrf> [<time term>] | MINimum | MAXimum

Set/query the step size for Pulse modulation delay. MINimum/MAXimum refers to the smallest/largest programmable step size, not the smallest/largest allowed change. *RST value is 1 μ s.

:WIDTH? [MINimum | MAXimum]

:WIDTH <nrf> [<time term>] | UP | DOWN | MINimum | MAXimum

Set/query the amount of pulse width. This command is equivalent to activating Special Function 213 from the front panel. *RST value is 1 μ s.

:STEP

[:INCRement]? [MINimum | MAXimum]

[:INCRement] <nrf> [<time term>] | MINimum | MAXimum

Set/query the step size for Pulse modulation width. MINimum/MAXimum refers to the smallest/largest programmable step size, not the smallest/largest allowed change. *RST value is 1 μ s.

:SLOPe?

:SLOPe POSitive | NEGative | BOTH

Set/query the pulse triggering edge. This command is equivalent to activating Special Function 214 from the front panel. *RST value is POSitive.

:FREQuency? [MINimum | MAXimum]

:FREQuency <nrf> [<freq term>] | UP | DOWN | MINimum | MAXimum

Alias to LFSource:FREQuency.

:STEP

[:INCRement]? [MINimum | MAXimum]

[:INCRement] <nrf> [<freq term>] | MINimum | MAXimum

Alias to LFSource:FREQuency:STEP.

Reference Oscillator Subsystem

ROSCillator

:CALibration? [MINimum | MAXimum]

:CALibration <nrf> | UP | DOWN | MINimum | MAXimum

Adjusts frequency of internal reference oscillator. Values used to adjust the reference frequency are in the range of 0 to 255. A change in the value of "1" corresponds to about a 4 Hz change in the reference frequency. The value required to set the reference to exactly 10 MHz will vary from instrument to instrument. Value is returned to calibrated value at *RST. This command is equivalent to activating Special Function 160 from the front panel.

:STEP

[:INCRement]?

The reference oscillator calibration increment is always one. This command is included to meet an HP-SL requirement of allowing the step size to be queried on any value which can be stepped.

:SOURce?

:SOURce

A "SOURCe?" query returns the status of the current reference source (INT or EXT). The query command is equivalent to activating Special Function 161 from the front panel.

:AUTO?

:AUTO ON | OFF | 1 | 0

Set/query whether use of an external timebase is allowed. This command is equivalent to activating Special Function 162 from the front panel. When ON (1), the internal reference oscillator or an external timebase source may be used. When OFF (0), only the internal reference oscillator may be used. *RST value is ON (1).

Sequence Subsystem

SEQuence

:REGister?

:REGister <register list>

Sets up a list of save/recall registers to sequence through. This command is equivalent to setting up the auto sequence registers from the front panel **SET SEQ** key. The register sequence is cleared from memory when you send the null list SEQuence:REGister. The REGister command sets up registers 0-9 only. The maximum sequence length is 10 registers. Sending any command statement or message over HP-IB aborts the Auto Sequence state.

The syntax used to generate a <register list> is:

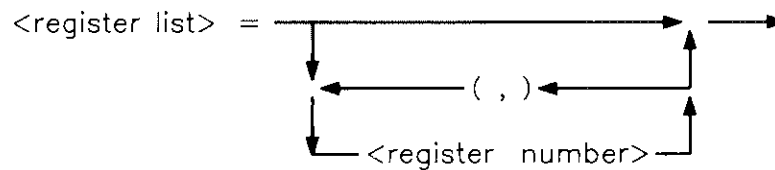

<register number> = number of save/recall register

[:IMMediate]

Sequences to the next register in the register list.

:STATe?

:STATe ON | OFF | 1 | 0

When ON, the Auto Sequence state is active. This command is equivalent to pressing the front panel **AUTO SEQ** key where the Signal Generator automatically sequences through the register list. The step time for each register is 1 second, except if a sweep sequence occurs (in which case the step time lasts for the duration of the sweep). *RST value is OFF (0).

Status Subsystem

STATus

[:DEVIce]

[:EVENT]?

Queries the Device Dependent Event Status Register.

:CONDition?

Queries the Device Dependent Condition Status Register.

:ENABle <nrf> | <non-decimal numeric program data>

:ENABle?

Set/query the Device Dependent Event Enable Register.

:PTRansition?

Queries the Device Dependent Positive Transition Filter. Always returns 65535.

:NTRansition?

*Queries the Device Dependent Negative Transition Filter.
Always returns 0.*

:DQUestionable

[:EVENT]?

Queries the HP-SL Signal Integrity Event Status Register.

:CONDition?

Queries the HP-SL Signal Integrity Condition Status Register.

:ENABle <nrf> | <non-decimal numeric program data>

:ENABle?

Set/query the HP-SL Signal Integrity Event Enable Register.

:PTRansition?

Queries the HP-SL Signal Integrity Positive Transition Filter. Always returns 65535.

:NTRansition?

Queries the HP-SL Signal Integrity Negative Transition Filter. Always returns 0.

:SINTEGRITY**[:EVENT]?**

Queries the Signal Generator Signal Integrity Event Status Register.

:CONDition?

Queries the Signal Generator Signal Integrity Condition Status Register.

:ENABLE <nrf> | <non-decimal numeric program data>

:ENABLE?

Set/query the Signal Generator Signal Integrity Event Enable Register.

:PTRansition?

Queries the Signal Generator Signal Integrity Positive Transition Filter. Always returns 65535.

:NTRansition?

Queries the Signal Generator Signal Integrity Negative Transition Filter. Always returns 0.

:HARDware**[:EVENT]?**

Queries the Signal Generator HARDware Integrity Event Status Register.

:CONDition?

Queries the Signal Generator HARDware Integrity Condition Status Register.

:ENABLE <nrf> | <non-decimal numeric program data>

:ENABLE?

Set/query the Signal Generator HARDware Integrity Event Enable Register.

:PTRansition?

Queries the Signal Generator HARDware Integrity Positive Transition Filter. Always returns 65535.

:NTRansition?

Queries the Signal Generator HARDware Integrity Negative Transition Filter. Always returns 0.

:AMPLitude

[:EVENT]?

Queries the AMPLitude Integrity Event Status Register.

:CONDition?

Queries the AMPLitude Integrity Condition Status Register.

:ENABle <nrf> | <non-decimal numeric program data>

:ENABle?

Set/query the AMPLitude Integrity Event Enable Register.

:PTRansition?

Queries the AMPLitude Integrity Positive Transition Filter. Always returns 65535.

:NTRansition?

Queries the AMPLitude Integrity Negative Transition Filter. Always returns 0.

:FREQuency

[:EVENT]?

Queries the FREQuency Integrity Event Status Register.

:CONDition?

Queries the FREQuency Integrity Condition Status Register.

:ENABle <nrf> | <non-decimal numeric program data>

:ENABle?

Set/query the FREQuency Integrity Event Enable Register.

:PTRansition?

Queries the FREQuency Integrity Positive Transition Filter. Always returns 65535.

:NTRansition?

Queries the FREQuency Integrity Negative Transition Filter. Always returns 0.

:REFeRence**[:EVENT]?**

Queries the REFeRence Integrity Event Status Register.

:CONDition?

Queries the REFeRence Integrity Condition Status Register.

:ENABle <nrf> | <non-decimal numeric program data>

:ENABle?

Set/query the REFeRence Integrity Event Enable Register.

:PTRansition?

Queries the REFeRence Integrity Positive Transition Filter. Always returns 65535.

:NTRansition?

Queries the REFeRence Integrity Negative Transition Filter. Always returns 0.

:MODulation**[:EVENT]?**

Queries the MODulation Integrity Event Status Register.

:CONDition?

Queries the MODulation Integrity Condition Status Register.

:ENABle <nrf> | <non-decimal numeric program data>

:ENABle?

Set/query the MODulation Integrity Event Enable Register.

:PTRansition?

Queries the MODulation Integrity Positive Transition Filter. Always returns 65535.

:NTRansition?

Queries the MODulation Integrity Negative Transition Filter. Always returns 0.

Sweep Subsystem

Other commands used with the sweep function are found in the Initialize Subsystem.

SWEep

[:FREQUENCY]

:TIME? [MINimum | MAXimum]

:TIME <nrf> [<time term>] | UP | DOWN | MINimum | MAXimum

Sets the sweep time. The commands UP and DOWN will step to the next/previous valid setting since the Signal Generator has 1, 2, 5, 10, 20, 50 ... steps on sweep time.

This command does not turn the SWEep ON. The command statements FREQ:MODE SWEep or INITIALize:STATE RUN activate the SWEep. *RST value is 1 second.

:STEP

[:INCRement]?

Always returns 3. This indicates that the step on the sweep time is 3 steps per decade.

:MODE?

Always returns LOG. This indicates that the sweep time is stepped logarithmically.

:MODE?

:MODE AUTO | MANual

Selects sweep type. AUTO allows single or continuous sweeps, MANual allows control of frequency with FREQUENCY:MANual. *RST value is AUTO.

:SPACing?

:SPACing LINear | LOGarithmic

Selects LINear or LOGarithmic sweep. *RST value is LINear.

:GENERation?

:GENERation STEPped | ANALog

Selects STEPped, or phase continuous (ANALog) SWEep. This command is equivalent to activating Special Function 112 from the front panel. *RST value is STEPped.

Take Sweep Subsystem

TSweep

Has the same effect as:

```
INIT:ABORt  
SWE:MODE AUTO  
FREQ:MODE SWEEP  
INIT:MODE SINGle  
INIT:IMMediate
```

This causes any sweep action to stop and a single sweep to take place.

Voltmeter Subsystem

VMETer

[[:VOLTage]?

Uses the internal voltmeter to measure voltage at the rear-panel **VM IN** (voltmeter input) connector.

:MODE?

:MODE AC | DC

Selects DC or AC (rms) measurement for voltmeter. This command is equivalent to activating Special Functions 180 or 181 from the front panel. *RST is DC.

HP-IB Device Status Dictionary

The Signal Generator has a great amount of status information available for your needs via the HP-IB bus. Unfortunately, the single 8 bit status byte register defined in the IEEE 488 standard is not large enough or flexible enough to contain the necessary information for an instrument with the complexity of the Synthesized Signal Generator. Consequently, the Signal Generator contains different levels of registers to overcome this limitation.

The new IEEE 488.2 standard, does however, expand the status byte definition to provide an extremely flexible mechanism for organizing status information. In addition, Hewlett Packard Systems Language (HP-SL) defines a portion of the 488.2 device status model in order to promote as much commonality as possible within various HP instruments. The *HP-IB Device Status Dictionary* describes in detail the Signal Generator implementation of the IEEE 488.2 standard, and HP-SL device status models.

To use the *HP-IB Device Status Dictionary*, refer to the table of contents shown below. All entries in the table of contents are arranged in an order of progressive dependency.

Figure 4-3 helps you understand how each set of registers are progressively dependent upon each other. For example, a bit in the HP-IB Status Byte Register "DEV" is dependent upon the status of bits in the Device Dependent Condition/Event Status Register, and so forth.

Table of Contents	IEEE 488.2 Definitions	4-58
	IEEE 488.2 HP-IB Status Byte Register	4-60
	IEEE 488.2 HP-IB Standard Event Status Register.....	4-62
	HP-SL Device Dependent Condition/Event Status Registers.....	4-64
	Sig. Gen. Signal Integrity Condition/Event Status Registers.....	4-66
	IEEE 488.2 and HP-SL Status Register Syntax	4-69

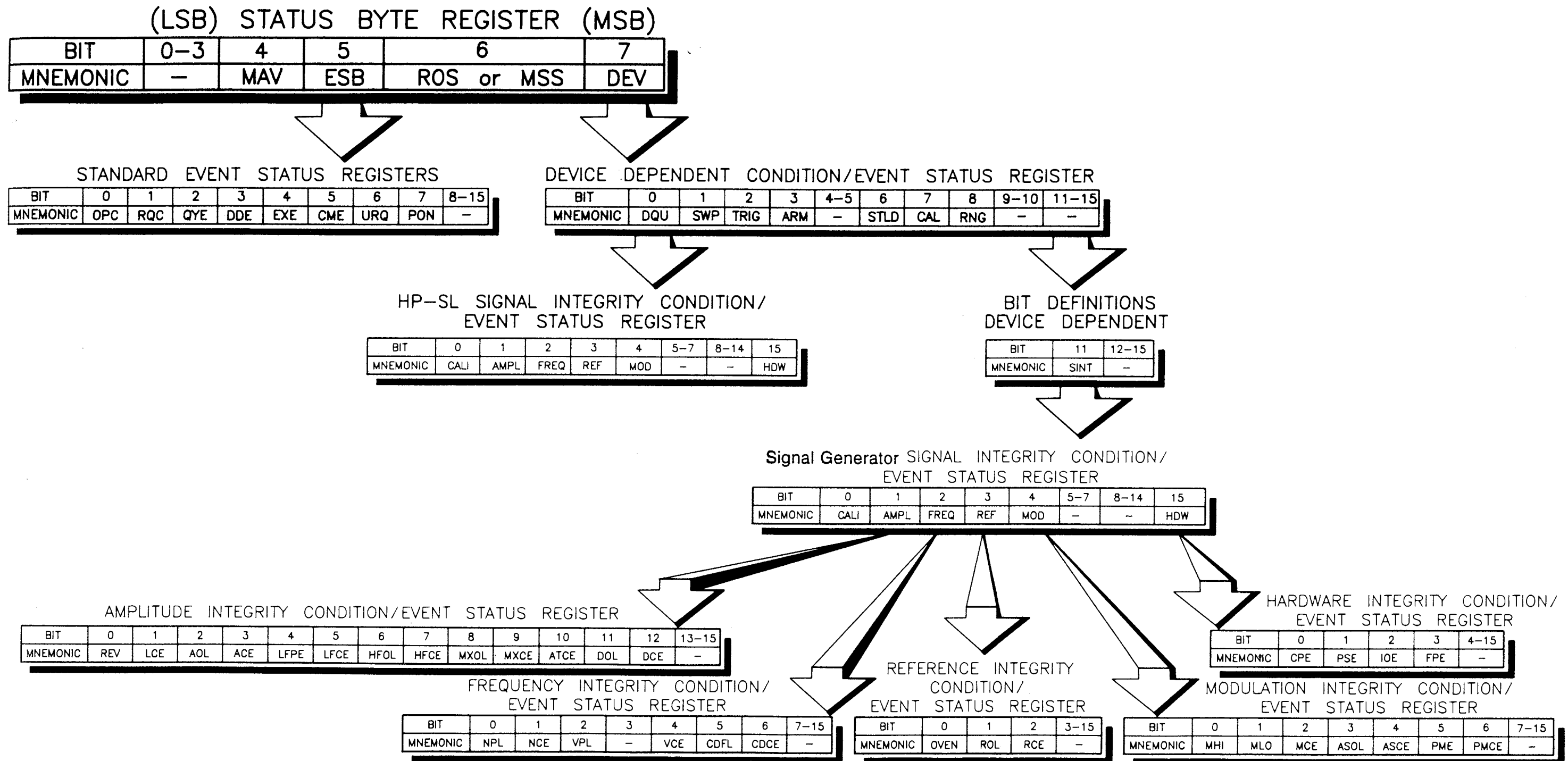

Figure 4-3. Register Map for the HP-SL Device Status Dictionary.

IEEE 488.2 Definitions

Condition Register

The full IEEE 488.2 and HP-SL specifications for device status reporting are beyond the scope of this document, but the following definitions taken from the IEEE 488.2 standard will be sufficient to explain the HP 8645A implementation.

A condition is a device state which is either TRUE or FALSE. A condition register reflects these states in its condition bits. A condition register may range from 1 to 16 bits in length and may contain unused bits. All unused bits are read as a value of zero. A condition bit may also be a summary bit, in which case it represents the status of an event register or a queue.

Event Register

An event register captures changes in conditions. Each bit in an event register corresponds to a condition bit in an associated condition register (or a device condition if there is no condition register).

An event becomes TRUE when there is a certain transition of the associated device condition. Event bits are "sticky" bits; they cannot be cleared (even if they no longer reflect the associated condition) until the event register is read by a user application.

An event register may range from 1 to 16 bits in length and may contain unused bits. All unused bits are read as a value of zero. An event register is cleared after it has been read by a user application and may also be cleared by the IEEE 488.2 *CLS common command.

Transition Filter

A transition filter defines the condition bit changes that set the associated event bit. There are two transition filters for every event register, a positive filter and a negative filter.

When a bit is set in a transition filter, the associated event bit is set after a FALSE to TRUE (positive filter) or TRUE to FALSE (negative filter) transition in the associated condition bit. If a bit is set in both transition filters then the event bit is set after any transition of the condition bit.

Transition filters may or may not be programmable, depending on the implementation. A transition register may range from 1 to 16 bits in length and may contain unused bits. All unused bits are read as a value of zero. A *RST command will reset programmable transition filters to their device dependent default values.

Event Enable Register

Event enable registers select which event bits in the corresponding event register will cause a TRUE summary message when set. Each event bit will have a corresponding enable bit in the event enable register. Each event enable register will be the same length as the corresponding event status register.

All unused bits are read as a value of zero and cannot be written to by the associated event enable command. Any time a bit in the event status register or the event enable register changes, a logical AND is performed on all bits of the event status register and the event enable register. If the result is not zero then the associated summary message is set TRUE.

Queue

A queue is a data structure containing a sequential list of data. Data may be placed in the queue in any order and a single item of data is removed every time the queue is read. A queue has a summary message that is TRUE whenever there is data in the queue and FALSE when the queue is empty.

The data in a queue may be in any format, but all data items must be in that same format. A queue may be cleared using the *CLS command (except for the IEEE 488.2 output queue).

Summary Bit

A summary bit is a condition bit that reflects the current status of the associated summary message. The summary message may be generated by the current values of an event status register and an event enable register or the contents of a queue.

Status Register Model

The diagram in figure 4-4 shows the relationship between the various components of a status register.

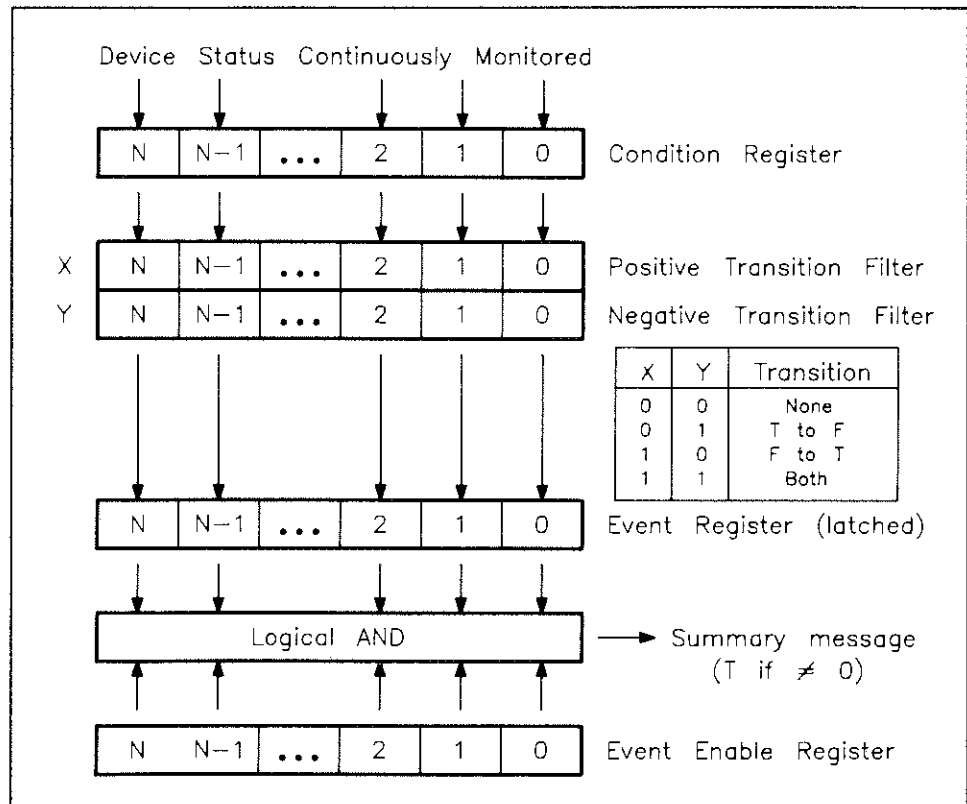

Figure 4-4. Status Register Map.

IEEE 488.2 HP-IB Status Byte Register

The IEEE 488.2 standard and HP-SL defines the 8 bit HP-IB status byte register as follows :

Table 4-2. Status Byte Register.

Bit #	Mnemonic	Definition
7	DEV	HP-SL device dependent event status register summary bit.
6	RQS or MSS	IEEE 488.2 master status summary bit.
5	ESB	IEEE 488.2 standard event status register summary bit.
4	MAV	IEEE 488.2 output queue summary bit.
0-3	-	Device dependent summary bits.

**Device Dependent
Summary Bits**

Bits 0 through 3 are not defined in IEEE 488.2 or HP-SL and may be used as the device designer sees fit, as long as their use does not violate the IEEE 488.2 rules for summary bits. Bits 0 through 3 are not used in the Signal Generator implementation and will always be read as zero.

The status byte register is accessed using the *STB common command and *STB? common query or by performing a HP-IB serial poll operation.

MAV Summary Bit

Bit 4, the MAV (message available) summary bit indicates that there are characters in the instrument output queue. The output queue is read by addressing the instrument to talk and reading data bytes until a line feed character is sent with the EOI control line asserted.

A complete description of the behavior of the output queue is beyond the scope of the *HP-IB Device Status Dictionary*. Interested readers should refer to IEEE 488.2 for the complete definition and behavior of the output queue.

**RQS and MSS
Summary Bits**

Bit 6 of the HP-IB status register has two definitions, depending on the method used to access the status register.

If the register is accessed via the HP-IB serial poll mechanism, then the bit is called the RQS (request service) bit and indicates to the active controller that the instrument is asserting the service request control line (SRQ). The RQS bit is cleared after the active controller performs a serial poll operation.

When the register is accessed via the IEEE 488.2 *STB? common query, then the bit is called the MSS (master status summary) bit and indicates that the device has at least one reason for requesting service. Unlike the RQS bit, the MSS bit is not cleared as a result of a serial poll and will always reflect the current status of all of the instrument status registers.

**IEEE 488.2
Service Request
Enable Register**

The service request enable register is an 8 bit register that enables corresponding summary bits in the status byte register. When a status bit is enabled and makes a FALSE to TRUE transition, the instrument will generate a service request.

A service request will also be generated when a status bit is enabled and the bit is already set. The service request enable register is accessed using the *SRE common command and the *SRE? common query. Bit 6 of the service request enable register is unused and will always be read as a zero. The service request enable register may be cleared when the instrument is turned on.

**IEEE 488.2
Standard Event
Status Register**

The standard event status register is a 16 bit event register with the following bit definitions :

Table 4-3. Standard Event Status Register.

Bit #	Mnemonic	Definition
8-15	-	Reserved for future use by IEEE.
7	PON	Power on.
6	URQ	User request.
5	CME	Command error.
4	EXE	Execution error.
3	DDE	Device dependent error.
2	QYE	Query error.
1	RQC	Request control.
0	OPC	Operation complete.

The standard event status register is accessed using the *ESR common command and the *ESR? common query. Because this is an event register, the register is cleared after it is read.

Power On Bit

The power on event bit 7 is set TRUE whenever there has been an OFF to ON transition of the instrument power supply.

User Request Bit

The user request bit 6 is set whenever one of a set of device dependent local instrument controls is activated. At present this feature is not implemented in the Signal Generator firmware and the bit will always be read as a zero.

Command Error Bit	The command error bit 5 is set whenever the parser detects an error in the format or contents of a program message. The HP 8665A implementation will place an HP-SL defined error code in the HP-SL error queue that may specify the exact error (bad header, missing argument, wrong data type, etc.).
Execution Error Bit	The execution error bit 4 is set whenever the current command cannot be processed due to an out of range parameter, conflicting settings, etc. The Signal Generator implementation will place an HP-SL defined error code in the HP-SL error queue.
Device Dependent Error Bit	The device dependent error bit 3 is used to indicate an error that is neither a command error or an execution error. The HP 8665A implementation uses this bit to indicate a hardware failure. An HP-SL defined error code will be placed in the HP-SL error queue that may specify the exact error (self test failure, ROM CRC error, etc.).
Query Error Bit	The query error bit 2 indicates that there is a problem with the output queue. Either there has been an attempt to read the queue when it was empty or the output data has been lost. For a complete description of query errors consult the IEEE 488.2 standard.
Request Control Bit	The request control bit 1 is used to initiate the IEEE 488.2 pass control protocol. The feature is not implemented in the HP 8665A firmware and the bit will always be read as a zero.
Operation Complete Bit	The operation complete bit 0 is set in response to the *OPC common command and indicates that all overlapped commands have completed execution. The Signal Generator firmware supports two overlapped operations; the frequency sweep, and the fast hop learn cycle. For a complete description of the 'operation complete flag', consult the IEEE 488.2 standard.
Standard Event Status Enable Register	The standard event status enable register is a 16 bit register that allows one or more event bits in the standard event status register to be reflected in the ESB summary message in the HP-IB status byte. This register follows all the rules of an event enable register. The standard event status enable register is accessed using the *ESE common command and the *ESE? common query. The standard event status enable register may be cleared when the instrument is turned on.

HP-SL Device Dependent Condition/Event Status Registers

HP-SL defines a group of status registers used to contain device dependent status information. These registers include a condition register, an event register, two transition filters, and an enable register. Each register has the following bit definitions :

Table 4-4. Device Dependent Condition/Event Status Registers.

Bit #	Mnemonic	Definition
11-15	-	Device dependent.
9-10	-	Reserved for use by HP-SL language subset.
8	RNG	Autorange operation in progress.
7	CAL	Calibration in progress.
6	STLD	Signal is settled.
4-5	-	Reserved for future use by HP-SL.
3	ARM	The instrument is ready to be armed.
2	TRIG	The instrument is ready to be triggered.
1	SWP	A sweep cycle is in progress.
0	DQU	HP-SL signal integrity summary bit.

The commands used to access these registers are too complex to explain in the *HP-IB Device Status Dictionary*. Refer to *IEEE 488.2 and HP-SL Status Register Syntax* found later on in this chapter for a complete description of the status register syntax.

Device Dependent Bit Definitions.

The Signal Generator firmware defines the device dependent bits 11-15 in the *Device Dependent Condition/Event Status Register* as follows :

Table 4-5. Device Dependent Bit 11-15 Definitions.

Bit #	Mnemonic	Definition
12-15	-	Reserved for future use by HP-SL.
11	SINT	Signal Generator signal integrity summary bit.

Note

The programmer should be aware that in order to write fully transportable device status routines, only HP-SL mnemonics that do not use any device dependent status bits should be used.

Signal Integrity Bit	The signal integrity summary bit 11 is described in detail later on in this chapter in the section titled <i>Signal Generator Signal Integrity Condition/Event Status Registers</i> .
Autorange Bit	The autorange bit 8 is set whenever the instrument halts the current measurement in order to automatically select the proper range. The Signal Generator firmware does not support any autorange operations and this bit will always be read as a zero.
Calibration Bit	The calibration bit 7 is set whenever the instrument is performing a calibration operation. Because the Signal Generator calibration is not an overlapped command, the condition register bit will always be read as a zero but the event register bit may be used to see if the instrument has been calibrated since the last time the event register was read.
Signal Settled Bit	The signal settled bit 6 is set when the output signal has settled to its final value. The Signal Generator firmware does not currently support this feature and this bit will always be read as a one.
Waiting for Arm Bit	The waiting for arm bit 3 is not supported in the Signal Generator, and will always be read as a zero.
Waiting for Trigger Bit	The waiting for trigger bit 2 is not supported in the Signal Generator, and will always be read as a zero.
Sweep in Progress Bit	The sweep in progress bit 1 is set whenever the instrument is in the sweep active state.
Data Questionable Bit	<p>The data questionable bit 0 refers to the HP-SL signal integrity status registers in the following ways.</p> <p>The HP-SL signal integrity status registers have the same bit definitions as the device dependent signal integrity registers with the following critical difference.</p> <p>The HP-SL signal integrity condition status register bits are current device conditions, not summary bits. These device conditions are derived from the condition and enable registers associated with the corresponding summary bits in the device dependent signal integrity condition status register.</p> <p>The Signal Generator firmware provides these two redundant registers so that novice programmers can follow the exact HP-SL model while expert programmers can expand the signal integrity condition bits to the full resolution of the instrument.</p>

**Signal Generator
Signal Integrity
Condition/Event
Status Registers**

The Signal Generator firmware defines a group of status registers used to contain information about the integrity of the output signal. These registers include a condition register, an event register, two transition filters, and an enable register. Each register has the following bit definitions :

Table 4-6. Signal Generator Signal Integrity Condition/Event Status Registers.

Bit #	Mnemonic	Definition
15	HDW	Misc. hardware integrity summary bit.
8-14	-	Device dependent summary bits.
5-7	-	Reserved for future use by HP-SL.
4	MOD	Modulation integrity summary bit.
3	REF	Reference integrity summary bit.
2	FREQ	Frequency integrity summary bit.
1	AMPL	Amplitude integrity summary bit.
0	CALI	Calibration integrity condition bit.

Note

Each of the summary bits in these registers refer to other groups of condition/event registers whose format is device dependent.

**Hardware Integrity
Summary Bit**

The hardware integrity summary bit 15 indicates that there is some reason to suspect that the miscellaneous support hardware is not performing correctly. The Signal Generator firmware defines the hardware integrity condition/event register bits as follows :

Table 4-7. Hardware Integrity Summary Bit.

Bit #	Mnemonic	Definition
4-15	-	Reserved for future use.
3	FPE	Front panel hardware error.
2	IOE	I/O board hardware error.
1	PSE	Power supply error.
0	CPE	CPU hardware error.

Modulation Integrity Summary Bit

The modulation integrity summary bit 4 indicates that there is some reason to suspect that the modulation performance of the instrument is not correct. The Signal Generator firmware defines the modulation integrity condition/event register bits as follows:

Table 4-8. Modulation Integrity Summary Bit.

Bit #	Mnemonic	Definition
7-15	-	Reserved for future use.
6	PMCE	Pulse modulation calibration error.
5	PME	Pulse modulation timer error.
4	ASCE	Audio source calibration error.
3	ASOL	Audio source PLL out of lock.
2	MCE	Mod distribution calibration error.
1	MLO	External modulation too low.
0	MHI	External modulation too high.

Reference Integrity Summary Bit

The reference integrity summary bit 3 indicates that there is some reason to suspect that the instrument reference frequency is not correct. The Signal Generator firmware defines the reference integrity condition/event register bits as follows:

Table 4-9. Reference Integrity Summary Bit.

Bit #	Mnemonic	Definition
3-15	-	Reserved for future use.
2	RCE	Reference calibration error.
1	ROL	Reference out of lock.
0	OVEN	Crystal reference oven cold.

Frequency Integrity Summary Bit

The frequency integrity summary bit 2 indicates that there is some reason to suspect that the output frequency performance of the instrument is not correct. The Signal Generator firmware defines the frequency integrity condition/event register bits as follows (on the next page):

Table 4-10. Frequency Integrity Summary Bit.

Bit #	Mnemonic	Definition
7-15	-	Reserved for future use.
6	CDCE	140 nS coax FLL calibration error.
5	CDFL	140 nS coax FLL out of lock.
4	VCE	VCO calibration error.
3	-	Reserved.
2	VPL	VCO PLL out of lock.
1	NCE	NF calibration error.
0	NPL	NF PLL out of lock.

Amplitude Integrity Summary Bit

The amplitude integrity summary bit 1 indicates that there is some reason to suspect that the output amplitude of the instrument is not correct. The Signal Generator firmware defines the amplitude integrity condition/event register bits as follows:

Table 4-11. Amplitude Integrity Summary Bit.

Bit #	Mnemonic	Definition
13-15	-	Reserved for future use.
12	DCE	Freq doubler calibration error.
11	DOL	Freq doubler ALC out of lock.
10	ATCE	Attenuator calibration error.
9	MXCE	Microwave extender calibration error.
8	MXOL	Microwave extender out of lock.
7	HFCE	High frequency calibration error.
6	HFOL	High frequency out of lock.
5	LFCE	Low frequency calibration error.
4	LFPE	Low frequency power error.
3	ACE	ALC calibration error.
2	AOL	ALC out of lock.
1	LCE	Level calibration error.
0	REV	Reverse power detected.

Calibration Integrity Condition Bit

The calibration integrity condition bit 0 indicates that an error has occurred during a calibration or diagnostic operation. This bit will remain set until the entire instrument has been re-calibrated with no errors using the +CAL? query.

IEEE 488.2 and HP-SL Status Register Syntax

All of the status registers defined in the previous sections may be accessed using the following commands :

Table 4-12. IEEE 488.2 and HP-SL Status Register Syntax. (1 of 2)

Command syntax	Definition
*CLS	Clears all event registers and queues.
*STB?	HP-IB status byte register.
*SRE <nrf> ?	HP-IB service request enable register.
*ESR?	IEEE 488.2 standard event status register.
*ESE <nrf> ?	IEEE 488.2 standard event status enable register.
STATUS	
[:DEVICE]	
[:EVENT]?	HP-SL device dependent event status register.
:CONDition?	HP-SL device dependent condition status register.
:PTRansition ⁽¹⁾ ?	HP-SL device dependent positive transition filter.
:NTRansition ⁽¹⁾ ?	HP-SL device dependent negative transition filter.
:ENABle <nrf> ?	HP-SL device dependent event enable register.
:DQUestionable	
[:EVENT]?	HP-SL signal integrity event status register.
:CONDition?	HP-SL signal integrity condition status register.
:PTRansition ⁽¹⁾ ?	HP-SL signal integrity positive transition filter.
:NTRansition ⁽¹⁾ ?	HP-SL signal integrity negative transition filter.
:ENABle ⁽²⁾ <nrf> ?	HP-SL signal integrity event enable register.
:SINTegrity	
[:EVENT]?	Signal Generator signal integrity event status register.
:CONDition?	Signal Generator signal integrity condition status register.
:PTRansition ⁽¹⁾ ?	Signal Generator signal integrity positive transition filter.
:NTRansition ⁽¹⁾ ?	Signal Generator signal integrity negative transition filter.
:ENABle ⁽²⁾ <nrf> ?	Signal Generator signal integrity event enable register.
:HARDware	
[:EVENT]?	Signal Generator hardware integrity event status register.
:CONDition?	Signal Generator hardware integrity condition status register.
:PTRansition ⁽¹⁾ ?	Signal Generator hardware integrity positive transition filter.
:NTRansition ⁽¹⁾ ?	Signal Generator hardware integrity negative transition filter.
:ENABle ⁽²⁾ <nrf> ?	Signal Generator hardware integrity event enable register.

⁽¹⁾ The Signal Generator firmware does not implement programmable transition filters. All positive transition filters will be fixed at all ones and all negative transition filters will be fixed at all zeros.

⁽²⁾ The Signal Generator firmware will set the default value of these event enable registers to all ones.

Table 4-12. IEEE 488.2 and HP-SL Status Register Syntax. (2 of 2)

Command syntax	Definition
<pre> :MODulation [:EVENT]? :CONDition? :PTRansition⁽³⁾ ? :NTRansition⁽³⁾ ? :ENABle⁽⁴⁾ <nrf> ? :REFerence [:EVENT]? :CONDition? :PTRansition⁽³⁾ ? :NTRansition⁽³⁾ ? :ENABle⁽⁴⁾ <nrf> ? :FREQuency [:EVENT]? :CONDition? :PTRansition⁽³⁾ ? :NTRansition⁽³⁾ ? :ENABle⁽⁴⁾ <nrf> ? :AMPLitude [:EVENT]? :CONDition? :PTRansition⁽³⁾ ? :NTRansition⁽³⁾ ? :ENABle⁽⁴⁾ <nrf> ? </pre>	<pre> Signal Generator modulation integrity event status register. Signal Generator modulation integrity condition status register. Signal Generator modulation integrity positive transition filter. Signal Generator modulation integrity negative transition filter. Signal Generator modulation integrity event enable register. Signal Generator reference integrity event status register. Signal Generator reference integrity condition status register. Signal Generator reference integrity positive transition filter. Signal Generator reference integrity negative transition filter. Signal Generator reference integrity event enable register. Signal Generator frequency integrity event status register. Signal Generator frequency integrity condition status register. Signal Generator frequency integrity positive transition filter. Signal Generator frequency integrity negative transition filter. Signal Generator frequency integrity event enable register. Signal Generator amplitude integrity event status register. Signal Generator amplitude integrity condition status register. Signal Generator amplitude integrity positive transition filter. Signal Generator amplitude integrity negative transition filter. Signal Generator amplitude integrity event enable register. </pre>
<p>(3) The Signal Generator firmware does not implement programmable transition filters. All positive transition filters will be fixed at all ones and all negative transition filters will be fixed at all zeros.</p> <p>(4) The Signal Generator firmware will set the default value of these event enable registers to all ones.</p>	

Example HP-SL Programs

All of the following examples have been written in BASIC Programming Language, however, you may convert the examples into PASCAL or into any other language.

Table of Contents	A Tool for Developing HP-SL Programs	4-72
	AM Examples	4-72
	Amplitude Examples	4-73
	FM Example	4-73
	Frequency Examples.....	4-74
	EMF Mode Examples	4-75
	HP-IB Device Status Examples	4-75
	Initialize Example	4-76
	Modulation Example	4-77
	Phase Examples	4-77

A Tool for Developing HP-SL Programs

Programs written in HP-SL are not instrument dependent; that is, HP-SL has removed the one-to-one correspondence between front-panel keystrokes and HP-IB codes. In previous instruments, development of controller programs could be done by trying out functions on the front panel, and then converting the keystrokes into HP-IB codes to send to the instrument.

The following program, written in BASIC, allows you to send command statements and messages to test their effect on the HP 8665A. In addition, the program traps error conditions and reads the error messages back to the controller in an underlined format.

The program is written for Signal Generator instruments with an HP-IB address of 19. You may modify the program to have any HP-IB address.

When you run the program, simply type in the command statement or message and press the **ENTER** key. For example, the command statement:

```
FREQ 1.234 MHz
```

Will set an RF output frequency of 1.234 MHz. If the command statement or message contains a query "?", the program will generate a response in an inverse video window.

A Tool for Developing HP-SL Programs

```
100 DIM A$[255],L$[255],E$[255]
200 PRINT "ENTER MESSAGE STRING TO SEND TO 8665. REPLIES ARE SHOWN IN INVERSE"
300 PRINT "AND ERROR MESSAGES ARE UNDERLINED."
400 PRINT "#####"
500 ON KBD GOSUB 1100
600 CLEAR 719
700 OUTPUT 719;"*ESE 60;*SRE 48"
800 GOSUB 1600
900 ON INTR 7 GOSUB 1600
1000 GOTO 1000
1100 OUTPUT 2;KBD$;
1200 INPUT "ENTER MESSAGE STRING TO SEND TO 8665:",A$
1300 PRINT A$
1400 OUTPUT 719;A$
1500 RETURN
1600 Z=SPOLL(719)
1700 IF BIT(Z,4)=0 THEN GOTO 2000
1800 ENTER 719;L$
1900 PRINT CHR$(129);L$;CHR$(128)
2000 OUTPUT 719;"*ESR?"
2100 ENTER 719;Z
2200 OUTPUT 719;"SYST:ERR? STR"
2300 ENTER 719;E$
2400 IF E$[1;1]="0" THEN GOTO 2700
2500 PRINT CHR$(132);E$;CHR$(128)
2600 GOTO 2200
2700 ENABLE INTR 7;2
2800 RETURN
2900 END
```

AM Examples

Set the AM depth to a value of 57% and select External AC, AM.

```
100 ! Set the Source to external and the coupling to AC.
200 OUTPUT 719;"AM:SOUR EXT;COUP AC"
300 ! Set the AM depth to a value of 57% and turn AM on.
400 OUTPUT 719;"AM:DEPT 57%;STATE ON"
```

Set the AM depth to 73% with internal AM at 2.5 kHz modulation frequency.

```
100 ! Set the Source to internal and no coupling.
200 OUTPUT 719;"AM:SOUR INT"
300 ! Set the AM depth to a value of 73%.
400 OUTPUT 719;"AM 73 %"
500 ! Set the LFSource Frequency to 2.5 kHz.
600 OUTPUT 719;"LFS:FREQ 2.5 KHZ"
```

Amplitude Examples

Set amplitude to 100 mV, increment in 0.1 dB steps until some other measurement returns proper reading. Query amplitude in volts.

```
100 ! Set output level to 100 mV and enable RF output
200 OUTPUT 719;"AMPL 100mV;AMPL:STATE ON"
300 ! Set default instrument amplitude units to return volts
400 ! and default instrument amplitude step to dB this allows
500 ! logarithmic stepping of the amplitude in volts.
600 OUTPUT 719;"AMPL:UNIT V;STEP:UNIT DB"
700 ! Set increment to 0.1 dB.
800 OUTPUT 719;"AMPL:STEP:INCR 0.1"
900 ! Loop testing value and incrementing output level by 0.1 dB
1000 ! Make what ever tests are required here, if proper level
1100 ! has been reached, goto line 1700
1200 ! Increase source amplitude by 0.1 dB.
1300 OUTPUT 719;"AMPL UP"
1400 ! Jump back to test.
1500 GOTO 1000
1600 ! Read current amplitude back from source.
1700 OUTPUT 719;"AMPL?"
1800 ENTER 719;Level
1900 PRINT "Level required was ";Level;" Volts."
```

FM Example

Set the FM deviation to a value read in from controller keyboard. Also set the FM Source to external.

```
100 ! Set the Source to external and the coupling to DC.
200 OUTPUT 719;"FM:SOUR EXT;COUP DC"
300 ! Input the FM deviation from the console.
400 INPUT "Enter the FM Deviation in kHz: ",Fm_deviation
500 ! Set the FM deviation to the value given as input.
600 OUTPUT 719;"FM ";Fm_deviation;"KHZ"
700 ! Now turn FM on.
800 OUTPUT 719;"FM:STATE ON"
```

Frequency Examples

Reset the instrument, then set frequency to 137 MHz, and turn amplitude on at 4.5 dBm:

```

100 ! Set instrument to known state.
200 OUTPUT 719;"*RST"
300 ! Set frequency to 137 MHz
400 OUTPUT 719;"FREQ 137MHZ"
500 ! Set output level to 4.5 dBm and enable RF output
600 OUTPUT 719;"AMPL 4.5DBM;AMPL:STATE ON"

```

Reset the instrument, turn amplitude on and set frequency and amplitude to values read in from controller keyboard:

```

100 ! Set instrument to known state.
200 OUTPUT 719;"*RST"
300 ! Input the Frequency and the Amplitude from the console.
400 INPUT "Enter frequency in MHz: ",Freq
500 INPUT "Enter amplitude in dBm: ",Ampl
600 ! Set the Frequency and Amplitude to the input values.
700 OUTPUT 719;"FREQ ";Freq;"MHZ;AMPL ";Ampl;"DBM;AMPL:STATE ON"

```

Reset the instrument, turn amplitude on at 0 dBm and step frequency from 200 to 300 MHz in 1 MHz steps, making some measurement at each frequency:

```

100 ! Set instrument to known state.
200 OUTPUT 719;"*RST"
300 ! Set frequency to 200 MHz and set frequency increment to 1MHz.
400 OUTPUT 719;"FREQ 200MHZ;FREQ:STEP 1MHZ"
500 ! Turn RF on at 0 dBm
600 OUTPUT 719;"AMPL 0;AMPL:STATE ON"
700 FOR X = 0 TO 100
800 ! Add code to make whatever
900 ! measurement is needed here.
1000 ! Increase frequency by 1MHz
1100 OUTPUT 719;"FREQ UP"
1200 NEXT X

```

The instrument is to be used as a local oscillator where it's output frequency will be doubled, and that signal will be mixed with the "frequency of interest" and put through a 10.7 MHz I.F. bandpass filter.

This means (Frequency of interest) = (L.O. Frequency) X 2 - 10.7 MHz. Set up frequency offsets and multipliers to allow the signal generator to be programmed to the frequency of interest, rather than the L.O. frequency.

```

100 ! Set freq multiplier to two and frequency offset to -10.7MHz
200 OUTPUT 719;"FREQ:MULT 2;OFFSET -10.7MHZ"
300 ! Set signal generator so that frequency of interest will be
400 ! 107.7 (actual signal generator output frequency is 59.2 MHz).
500 OUTPUT 719;"FREQ 107.7MHZ"

```

EMF Mode Examples

```
10 ! SAMPLE PROGRAM TO TURN EMF MODE ON AND OFF IN PSG.
20 !
30 Address=719
40 OUTPUT Address; "AMPLITUDE:SOURCE:UNIT V" ! SETS EMF MODE
50 !
60 OUTPUT Address; "AMPLITUDE:OUT:UNIT V" ! SETS NON EMF MODE
70 !
80 END
```

HP-IB Device Status Examples

The following section presents several examples of the use of HP 8665A device status mnemonics.

Example 1:

Configure the instrument to generate a service request whenever an error is placed in the error queue.

```
*ESE 60;*SRE 32
```

Enable the CME, EXE, QYE, and DDE bits in the standard event status register and the ESB summary message in the HP-IB status byte.

Example 2:

Configure the instrument to generate a service request whenever the fractional-N phase locked loop goes out of lock.

```
STAT:ENAB 2048;SINT:ENAB 4;FREQ:ENAB 1;*SRE 128
```

Enable the signal integrity summary message, the frequency integrity summary message, the NPL event bit, and the DEV summary message in the HP-IB status byte.

Example 3:

Respond to a service request and decode the instrument status.

```
*STB?           Read the HP-IB status byte.
data = 128      The DEV summary message is set.
STAT?          Read the device dependent event status
                register.
data = 2048     The HP-SL signal integrity summary bit is set.
STAT:DQU?      Read the Signal Generator signal integrity event
                status register.
data = 4        The frequency integrity summary bit is
                set.
STAT:SINT:FREQ? Read the Signal Generator frequency integrity event
                status register.
data = 1        The NF PLL has been out of lock.
STAT:SINT:FREQ:COND? Read the frequency integrity condition
                status register.
data = 0        The NF PLL is not currently out of lock.
```

It is clear from this dialog that there has been a transient out of lock in the NF PLL.

Initialize Example

Set up a ten second logarithmic sweep. Prompt user for the start frequency and sweep over a 200 MHz span. Put markers at start freq +50 MHz, +100 MHz, and +150 MHz. Make a single sweep.

```
100 ! Get start frequency from user.
200 INPUT "Enter Start Frequency in Hz: ";Startfreq
300 ! Set start frequency and span for sweep.
400 OUTPUT 719;"FREQ:START ";Startfreq;"SPAN 200MHZ"
500 ! Set sweep time to 10 Sec. and select log sweep
600 OUTPUT 719;"SWEEP:TIME 10;SPACING LOG"
700 ! Set markers
800 OUTPUT 719;"MARKER ";Startfreq+50000000;"MARKER:STATE ON"
900 OUTPUT 719;"MARK2 ";Startfreq+100000000;"MARK2:STATE ON"
1000 OUTPUT 719;"MARK3 ";Startfreq+150000000;"MARK3:STATE ON"
1100 ! Become sweeper, enable auto sweeping and select single.
1200 OUTPUT 719;"FREQ:MODE SWEEP;:SWEEP:MODE AUTO"
1300 OUTPUT 719;"INITialize:MODE SINGLE"
1400 ! The next line will cause the sweep to begin.
1500 OUTPUT 719;"INITialize:IMMediate"
```

Modulation Example

If in the middle of some procedure, it may be necessary to make some measurement which require that the Signal Generator be at the current RF output frequency and output amplitude level, but all modulation must be turned off.

The following example will disable all modulation, make necessary measurements, and then turn back on whatever modulation was on before this section of code started. (Note: this section of programming code will work regardless of what modulation(s) were on when it was executed.)

```

.      .
.      .
.      .
7100  ! Shut off all modulation.
7200  OUTPUT  719;"MOD:STATE OFF"
7300  ! Make any necessary tests/measurements ...
7400  !
7500  ! Return modulation to the state it was in before line 7200
7600  OUTPUT  719;"MOD:STATE ON"
.      .
.      .
.      .

```

Phase Examples

Adjust the phase to set the quadrature between two sources.

```

100  ! Set the phase step to 1 degree
200  OUTPUT  719;"PHAS:STEP 1DEG"
300  ! Continue adjusting the Phase by 1 degree until the voltage is
400  ! equal.
450  DONE = 0
500  REPEAT
600  ! Measure mixer voltage using appropriate equipment and store
700  ! the value as "Measurement".
800  ! If measurement is greater than 0.1 V increment phase.
900  IF (Measurement) > 0.1V THEN
1000  OUTPUT  719;"PHAS UP"
1100  ELSE
1200  ! If measurement is less than -0.1 V decrement phase.
1300  IF (Measurement) < -0.1V THEN OUTPUT  719;"PHAS DOWN"
1400  ! If measurement is okay then set done to quit looping.
1500  ELSE
1600  Done = 1
1700  UNTIL (Done = 1)

```

Shift Carrier Phase by 30 degrees and make a measurement. Then set the Phase back to 0.

```
100 ! Set Phase value to 0.
200 OUTPUT 719,"PHAS:REF"
300 ! Shift Phase by 30 degrees.
400 OUTPUT 719,"PHAS 30DEG"
500 ! Make some appropriate measurement.
600 ! Set Phase back to zero.
700 OUTPUT 719,"PHAS 0DEG"
```

A

Installation

Unpack Your Signal Generator

Inspect the shipping container for damage. If the shipping container is damaged or the cushioning material inside is stressed, keep them until you have checked the shipment for completeness and the instrument for proper operation.

If items are missing from your shipment, or if there is mechanical damage or defect, notify the nearest Hewlett-Packard office. If the shipping container or cushioning material shows signs of stress, notify the carrier as well as the Hewlett-Packard office. Keep the shipping materials for inspection by the carrier.

Connect Power

The Signal Generator requires a power source of 100 to 120 V ac ($\pm 10\%$) at 48 to 440 Hz, or 220 to 240 V ac ($\pm 10\%$) at 48 to 440 Hz. Power consumption is 500 VA maximum. If you need further information about the power requirements for your instrument, refer to the Signal Generator *Calibration Manual*.

Warning

This is a Safety Class I product (i.e., provided with a protective earth terminal). An uninterruptible safety earth ground must be provided from the Main power source to the product input wiring terminals, power cord, or supplied power cord set. Whenever it is likely that the protection has been impaired, the instrument must be made inoperative and be secured against any unintended operation.

Turn On Instrument

If you are operating this instrument in extreme environmental conditions, refer to section 2 in the Signal Generator *Calibration Manual* for specific Operating Environment limitations.

Press the **POWER** key to the ON position. The front panel annunciators momentarily light up for a quick visual inspection.

If the **MSSG** annunciator is displayed in the lower right corner of the FREQUENCY/STATUS display, an instrument error has occurred. Press the UTILITY **MSSG** key as many times as needed to scroll through the error messages. Refer to appendix D for error message descriptions.

B

Options and Accessories

Available for the Signal generator

The following table lists the options and accessories that are presently available for the Signal generator. Refer to your nearest Hewlett-Packard office for ordering information, and for an update on options that have been made available since the printing of this *Operation Guide*.

Option:

- 001: High Stability Time Base.
- 003: Rear Panel Inputs/Outputs (deletes front panel inputs/outputs)
- 004: Low Noise Mode
- 008: Pulse Modulation
- 010: Reduced Leakage Configuration
- 907: Front Handle Kit (5061-9690)
- 908: Rack Flange Kit (5061-9678)
- 909: Combined Front Handle/Rack Flange Kit (5061-9684)
- 910: Extra Manual Set (includes service manual)
- 915: Add service manual
- W03: 90 day On-site Warranty (replaces 1-year standard warranty)
- W30: 3 year Extended Warranty

Accessories Available:

- Service Kit (08665-61116)
- Transit Case (9211-2662)
- Transit Case Wheels (1490-0913)
- Non-tilting Rack Slide Kit (1494-0059)
- Tilting Rack Slide Kit (1494-0063)

C

Special Functions

How to Access the Special Functions

There are two ways to access special functions for the Signal generator.

1. Press the **SPECIAL** key and then turn either the knob or one of the knob \uparrow \downarrow keys to show the available special functions in the FREQUENCY/STATUS display. Access the special function of your choice by pressing the **ENTER** key.

-OR-

2. Press the **SPECIAL** key and enter the special function number of your choice. Access the special function by pressing the **ENTER** key.

The yellow annunciator above the **SPECIAL** key lights up to indicate that a special function is invoked. At any time, you may display all of the special functions that are invoked by pressing the **DISPLAY** key, and then the **SPECIAL** key.

Listed numerically, the special functions are as follows:

100:Auto Attenuation

This special function allows you to lock or unlock the attenuators at their present setting. When ON (unlocked), the instrument's output amplitude can be set at any level within the range of the instrument. When OFF (locked), the instrument's output amplitude can only be set within the vernier range of the locked attenuators.

101:Attenuation

This special function gives you the choice of manually selecting which attenuators to switch in for operating the instrument. Activating this special function essentially turns off Auto Attenuation described in Special Function 100.

102:Amptd Correction

This special function allows you to either have a calibrated or an uncalibrated output amplitude level. When ON, internal calibration data is used. When OFF, the internal calibration data is not used.

103:Amptd Limit

This special function allows you to specify the upper limit for the instrument's output amplitude.

104:Wideband ALC

This special function allows you to determine the ALC bandwidth. When OFF, the ALC is configured for the most narrow bandwidth. When ON, the ALC is configured for the widest bandwidth possible for the RF output selected.

105:Amplitude Muting

This special function, when OFF, allows you to minimize the affect of changes that occur when the Signal generator is in transition from one output amplitude level to another or from one center frequency value to another as seen at the RF Output. Typically, the carrier frequency can swing several MHz while in transition, and the output amplitude may change ± 6 dBm while in transition. In the default condition, Amplitude Muting ON, output amplitude and center frequency changes occur with 20 to 40 dB of attenuation.

110:Rel Φ Adjust

This special function allows you to increment or decrement the phase of the RF output signal in one-degree steps relative to the present frequency reference.

111:Freq Multiplier

This special function allows you to use an external divider or multiplier on the RF output and still have the instrument display the final RF output signal. A positive integer, for example +2 would cause the frequency display to be multiplied by 2. A negative integer, for example -2 would cause the frequency display to be divided by 2. The front-panel **OFFSET** annunciator turns on when the frequency multiplier is a value other than +1.

112:Phase Cont Sweep

This special function allows you to put the instrument's sweep in a phase-continuous mode. During phase-continuous frequency sweep, the instrument sweeps between two selected endpoints in a linear, phase-continuous manner. This sweep function resembles a true sweeper in that it has no frequency transients; yet it is fully synthesized, yielding a very linear, precise sweep.

120:FM Synthesis

This special function allows you to have the instrument synthesize the FM signal in a digitized or linear manner. Digitized FM is best for single-tone modulation and provides a very accurate center frequency at low deviation rates. Linear FM is best for multi-tone modulation and provides a more constant group delay than the Digitized FM.

121:F(t)

This special function displays the phase-locked loop frequency during digitized FM. The display is continually updated.

124:FM Delay Equalizer

This special function allows you to turn off the FM Delay Equalizer circuitry. When ON (the preset condition), you will have the following advantages and disadvantages:

Advantages:

- Good switching speed.
- Good spectral purity across the whole frequency range.
- Good FM indicator accuracy.
- Low FM distortion for sinusoidal waveforms.

Disadvantages:

- 30 μ sec of group delay exists on the FM modulating signal path.
- FM with complex waveforms will result in preshoot as a result of the group delay.
- Phase shift resulting from the DCFM delay equalizer can cause instability in phase-locked loop measurements for peak frequency deviation settings greater than 50 kHz.

You may want to turn OFF the FM Delay Equalizer circuitry. The following advantages and disadvantages will then apply:

Advantages:

- Good FM indicator accuracy.
- Low FM distortion for both sinusoidal and complex waveforms.
- The 30 μ sec group delay exists only up to 200 Hz, making this state better suited to phase-noise measurements.
- Good spectral purity beyond 200 Hz.

Disadvantages:

- High close in phase noise (30 dB higher at 100 Hz offset).
- High line spurs.
- Poor switching speed - typically 1 second.

130:Audio Wave

This special function allows you to select the waveform for the audio source. You have five choices: sine, square, triangle, sawtooth, or white Gaussian noise.

131:Audio Triggered

This special function (when ON) enables Special Function 132.

132:Trig Audio

This special function, when enabled by Special Function 131, allows you to trigger the audio source to output a single 360° cycle. When the audio is triggered for a single cycle of white Gaussian noise, the result is a burst of noise for the duration of “1/audio frequency”. You can output any one of the five audio waveforms. Triggering is done from the front-panel **ON** key.

133:Aud2 Freq

This special function allows you to turn on and off the audio source for Channel 2, and it allows you to set the audio source frequency for Channel 2. The audio source frequency for Channel 2 may be set to a minimum of 0.1 Hz, a maximum of 400 kHz, or any value in between.

134:Aud2 Level

This special function allows you to adjust the level of the audio source for Channel 2. The level for the audio source in Channel 2 may be set to a minimum of 0 V, a maximum of 1 V, or any value in between.

135:Aud2 Wave

This special function allows you to select the waveform for the audio source in Channel 2. You have five choices: sine, square, triangle, sawtooth, or white Gaussian noise.

136:Aud2 Φ

This special function allows you to adjust the phase of the audio source in Channel 2. Phase may be expressed in terms of radians or degrees. The front-panel display immediately changes units of degrees and radians when you switch between the **deg** and **rad** keys. Entries may be scaled; for example, entering 560° would yield -160°.

137:Aud AM Depth

This special function allows you to turn on and off the subcarrier AM source in Channel 1, and it allows you to set the percentage of depth for the subcarrier AM source. Depth may be set to a minimum of 0%, a maximum of 100%, or any value in between.

138:Aud AM Freq

This special function allows you to set frequency for the subcarrier AM source in Channel 1. The frequency may be set to a minimum of 0.1 Hz, a maximum of 400 kHz, or any value in between.

139:Aud AM Wave

This special function allows you to select the waveform for the subcarrier AM source in Channel 1. You have five choices: sine, square, triangle, sawtooth, or white Gaussian noise.

140:Aud AM Φ

This special function allows you to adjust phase of the subcarrier AM source relative to the phase of the audio source in Channel 1. Phase may be expressed in terms of radians or degrees. The front-panel display immediately changes units of degrees and radians when you switch between the **deg** and **rad** keys. Entries may be scaled; for example, entering 560° would yield -160°.

141:Aud FM Dev

This special function allows you to turn on and off the subcarrier FM source in Channel 1, and it allows you to set the amount of deviation for the subcarrier FM source. Deviation may be set to a minimum of 0 Hz, a maximum of 400 kHz, or any value in between.

142:Aud FM Freq

This special function allows you to set frequency for the subcarrier FM source in Channel 1. The frequency may be set to a minimum of 0.1 Hz, a maximum of 400 kHz, or any value in between.

143: Aud FM Wave

This special function allows you to select the waveform for the subcarrier FM source in Channel 1. You have five choices: sine, square, triangle, sawtooth, or white Gaussian noise.

144: Aud FM Φ

This special function allows you to adjust phase of the subcarrier FM source relative to the phase of the audio source in Channel 1. Phase may be expressed in terms of radians or degrees. The front-panel display immediately changes units of degrees and radians when you switch between the **deg** and **rad** keys. Entries may be scaled; for example, entering 560° would yield -160° .

145: Aud Φ M Dev

This special function allows you to turn on and off the subcarrier Φ M source in Channel 1, and it allows you to set the amount of deviation for the subcarrier Φ M source. Deviation may be set to a minimum of 0° , a maximum of 179.9° , or any value in between. Φ M deviation may be expressed in terms of radians or degrees. The front-panel display immediately changes units of degrees and radians when you switch between the **deg** and **rad** keys.

146: Aud Φ M Freq

This special function allows you to set frequency for the subcarrier Φ M source in Channel 1. The frequency may be set to a minimum of 0.1 Hz, a maximum of 400 kHz, or any value in between.

147: Aud Φ M Wave

This special function allows you to select a waveform for the subcarrier Φ M source in Channel 1. You have five choices: sine, square, triangle, sawtooth, or white Gaussian noise.

148: Aud Φ M Φ

This special function allows you to adjust phase of the subcarrier Φ M source relative to the phase of the audio source in Channel 1. Phase may be expressed in terms of radians or degrees. The front-panel display immediately changes units of degrees and radians when you switch between the **deg** and **rad** keys. Entries may be scaled; for example, entering 560° would yield -160° .

149:Aud Pulse

This special function allows you to turn on and off the subcarrier Pulse source in Channel 1.

150:Aud Pulse Freq

This special function allows you to set frequency for the subcarrier Pulse source in Channel 1. The frequency may be set to a minimum of 0.1 Hz, a maximum of 50 kHz, or any value in between.

151:Aud Pulse Φ

This special function allows you to adjust phase of the subcarrier Pulse source relative to the phase of the audio source in Channel 1. Phase may be expressed in terms of radians or degrees. The front-panel display immediately changes units of degrees and radians when you switch between the **deg** and **rad** keys. Entries may be scaled; for example, entering 560° would yield -160°.

160:Ref Calibration

This special function allows you to adjust the frequency of the internal reference oscillator. Values used to adjust the reference frequency are in the range of 0 to 255. A change in the value of "1" corresponds to about a 4 Hz change in the reference frequency. The value required to set the reference to approximately 10 MHz will vary from instrument to instrument. When an instrument preset or power on/off is done, the reference frequency value is returned to its calibrated value. (Activate service Special Function 331 to save the reference calibration value.)

161:Ref Source

This special function monitors whether the instrument is using its internal reference oscillator source or if an external timebase source is connected.

162:Allow EXT Ref

This special function allows you to prevent use of an external timebase source (which would also affect the use of the High Stability timebase Option 001). When ON, the preset condition, the Signal Generator may use the internal reference oscillator source, or an external timebase source. When OFF, the Signal Generator will only use the internal reference oscillator.

170:Test

This special function tests the instrument and module hardware for failures. Turn the knob to select the test you want, and then press the **ENTER** key. The message `Result Code = 0` indicates that the instrument is operating normally. A result code other than the numeral "0" appearing on the front-panel display indicates a failure. All result codes are listed in the *Assembly Level Repair, Service Diagnostics Manual*.

171:Recal

This special function allows you to recalibrate the whole instrument. A recalibration takes about 3 to 5 minutes. The message `Result Code = 0` appears if the recalibration passes. All error codes are defined in the *Assembly Level Repair, Service Diagnostics Manual*.

172:RAM Wipe

This special function allows you to do a 'hard' reset of the instrument to wipe out the memory contents of RAM (including the calibration data). This eliminates any instrument settings entered by the user through the front panel or through HP-IB. An instrument recalibration is then automatically done.

173:Security

This special function allows you to secure Special Functions 191 to 195. When ON, Special Functions 191 to 195 cannot be turned off without first forcing an automatic RAM wipe as described in Special Function 172. When this special function is active (turned ON), it executes a RAM wipe when turned OFF. Also, if the instrument's power switch is turned to STBY (standby) and then back to ON, a RAM wipe will be executed.

180:DC Voltmeter

This special function allows you to use the instrument as a DC voltmeter. DC voltages are monitored from the rear-panel **VOLTMETER IN** connector. The front-panel displays a continuously updated DC voltage reading. The following typical operating characteristics apply:

Range: ± 50 V dc
Sensitivity: 0.5 V dc
Maximum Input Voltage: ± 180 V dc
Input Impedance: 130 k Ω
Accuracy: 270 mV $\pm 2.7\%$
Resolution: 100 mV

181:AC Voltmeter

This special function allows you to use the instrument as an AC voltmeter. AC voltages are monitored from the rear-panel **VOLTMETER IN** connector. The front-panel displays a continuously updated AC voltage reading in V rms. The following typical operating characteristics apply:

Range: ± 50 Vpk
Bandwidth: 10 kHz
Sensitivity: 0.5 Vpk
Maximum Input Voltage: ± 180 Vpk
Input Impedance: 130 k Ω
Accuracy: 290 mV $\pm 3.2\%$
Resolution: 100 mV

182:Power Meter

This special function allows you to use the instrument as a power meter. Power is monitored from a connector located under the instrument's top cover. The front-panel displays a continuously updated power reading in dBm. The following typical operating characteristics apply:

Power Range: -10 to +20 dBm
Frequency Range: 250 kHz to 2 GHz
Accuracy: ± 5 dBm at -10 to 0 dBm
 ± 3 dBm at 0 to +10 dBm
 ± 1 dBm at +10 to +20 dBm
Maximum Input Power: 25 dBm
Input Impedance: 50 Ω AC coupled

190:Serial #

This special function displays the instrument's serial number.

191:Blank Display

This special function allows you to blank out all instrument settings displayed on the front panel (including the LED annunciator lights). User interaction with the instrument is not displayed on the front panel, even though front-panel keystrokes are valid. Special Function 173 should be used in conjunction with SPCL 191 for total display security.

To turn off this feature, press **SPECIAL 191 ENTER OFF**, and then cycle the power at the switch. The Signal Generator will then power up with full display.

Note

If Special Function 173 is used with Special Function 191 and the power is cycled when restoring the instrument to full display, a RAM WIPE is activated and the Signal Generator will do a re-calibration. (See the descriptions for Special Functions 172 and 173.)

192:Blank Frequency

This special function allows you to blank out just the frequency setting from being displayed on the front panel. When ON, each segment in the Frequency/Status display will show a dash, Mode Select LED annunciators turn off, and any special functions relating to frequency are blanked.

Special Function 173 should be turned on first before entering Special Function 192 in order to have frequency display security.

193:Blank Modulation

This special function allows you to blank out just the modulation level setting from being displayed on the front panel. When ON, each segment in the Modulation Level display will show a dash, Modulation LED annunciators turn off, and any special functions relating to modulation are blanked.

Special Function 173 should be turned on first before entering Special Function 193 in order to have modulation display security.

194:Blank Audio

This special function allows you to blank out just the audio frequency setting from being displayed on the front panel. When ON, each segment in the Modulation Frequency display will show a dash, and any special functions relating to audio frequency are blanked.

Special Function 173 should be turned on first before entering Special Function 194 in order to have audio display security.

195:Blank Amptd

This special function allows you to blank out just the RF amplitude setting from being displayed on the front panel. When ON, each segment in the Amplitude display will show a dash, and any special functions relating to RF amplitude are blanked.

Special Function 173 should be turned on first before entering Special Function 195 in order to have amplitude display security.

196:European Radix

This special function allows you to determine which 'radix mark' and which 'separator mark' to use in a number. A radix mark is the divider between the integer portion of a number and the fractional portion of a number. The separator mark is the separator between groups of digits in a large number.

When OFF, the radix mark displayed on the front panel is a period and the separator mark is a comma. When ON, the radix mark displayed on the front panel is a comma, and the separator mark is a period. For example, 123456789 Hz would be shown as 123,456,789.00 Hz in normal operation, however, it would be shown as 123.456.789,00 with the European Radix ON.

210:50 Ohm Pulse

This special function is available with Option 008. When ON, the **PULSE** Modulation Input connector will have an input impedance of 50 Ω . When OFF, the preset condition, the **PULSE** Modulation Input connector has an input impedance of 100 k Ω .

211:Pulse Ctrl

This special function is available with Option 008. When set to **Direct**, the preset condition, pulse modulation using direct pulse control is active. When set to **Pulse Gen**, pulse modulation using the internal pulse generator is active. Special Functions 212-214 may then be used to determine the pulse delay, width, and triggering edge.

212:Pulse Delay

This special function is available with Option 008. It allows you to determine the amount of pulse delay (P_d) for the RF pulse output. Pulse delay is entered by turning the knob, or by using the front-panel **DATA** keys. The preset value of delay is 1.00 μ second.

213:Pulse Width

This special function is available with Option 008. It allows you to determine the pulse width (P_w) of the RF pulse output. Pulse width is entered by turning the knob, or by using the front-panel **DATA** keys. The preset value of width is 1.00 μ second.

214:Pulse Trig Edge

This special function is available with Option 008. It allows you to determine if the RF pulse output should occur on the negative edge, or on the positive edge, or on both edges of the triggering signal. Turn the knob to make your selection. The preset pulse triggering edge is positive.

220:VOR Setup

This special function allows you to generate a composite VOR test signal. The instrument is set for a bearing of 0° to the station on a carrier of 108.0 MHz.

221:Localizer Setup

This special function allows you to generate a composite Localizer test signal. The instrument is set for 0 DDM on a carrier of 108.1 MHz.

222:Glideslope Setup

This special function allows you to generate a composite Glideslope test signal. The instrument is set for 0 DDM on a carrier of 334.7 MHz.

223:OM Beacon Setup

This special function allows you to generate an OM Beacon test signal. The instrument is set for a 2 Hz pulsed tone beacon.

224:MM Beacon Setup

This special function allows you to generate an MM Beacon test signal. The instrument is set for a 2 Hz pulsed tone beacon.

225:IM Beacon Setup

This special function allows you to generate an IM Beacon test signal. The instrument is set for a 2 Hz pulsed tone beacon.

300:Service Mode

This special function allows you to run the instrument's service diagnostic routines. The service-diagnostic switch (referred to in the *Assembly Level Repair, Service Diagnostics Manual*) must be in the correct position in order to access and run any of the diagnostic tests.

D

Error Messages

What Happens When You Get an Error Message

The Signal Generator interacts with the user to communicate error messages about its operating condition. The error messages suggest or imply that a problem exists either with the instrument or the way in which the user is operating the instrument. Error messages are presented to the user in two ways.

First, if the user attempts to operate the instrument beyond its capabilities, intentionally or not, an error message is immediately shown in the FREQUENCY/STATUS display. Refer to table D-1 for a description of the error messages that occur under these circumstances.

Second, if the instrument detects a malfunction at power up, or as a result of performing service diagnostics or calibration, an error message is put into the message queue. You will know that this has occurred because the **MSSG** annunciator lights up in the FREQUENCY/STATUS display. Refer to table 7-2 for a description of the error messages that occur under these circumstances.

The error messages in the message queue can then be viewed at the users request by simply pressing the Utility **MSSG** key on the front panel; repetitively pressing the **MSSG** key allows you to view all of the error messages.

To view the error messages again, simply press the blue **SHIFT** key, and then the **MSSG** key. If you have corrected the malfunction shown in the error message list, the message for that error will not reappear.

Note

A hardware failure message does not always indicate that a hardware problem exists. Certain operating conditions may also cause a hardware problem.

Also, if you program the Signal Generator to operate outside of its specified operating ranges a hardware failure may occur. For example, if the current output amplitude and AM depth results in an output signal greater than approximately +16 dBm you may get a hardware failure message.

Table D-1. Error Messages Immediately Shown to the User. (1 of 9)

Error Message	Description
AM depth too large	The entered amount of AM depth is greater than the maximum permitted (100%). Also, AM depth is limited by the current amplitude setting, by Special Function 103 (Amptd Limit). For example, if the current amplitude setting is +19.9 dBm, the maximum AM depth is 0%.
AM depth too small	The AM depth value entered is less than the minimum permitted (0%).
AM incr too large	The AM increment value entered is greater than the maximum permitted (100%).
AM incr too small	The AM increment value entered is less than the minimum permitted (0.1%).
Amptd incr too large	The amplitude increment value entered is greater than the maximum permitted (100 dB or 1V).
Amptd incr too small	The amplitude increment value entered is less than the minimum permitted (0.1 dB or 0.001 μ V).
Amptd limit too high	The Amplitude Limit value entered is greater than the maximum permitted (+19.9 dBm specified by Special Function 103).
Amptd limit too low	The Amplitude Limit value entered is less than the minimum permitted (-137 dBm specified by Special Function 103).
Amptd offset too large	The amplitude offset value entered is greater than the maximum permitted (50 dB).
Amptd offset too small	The amplitude offset value entered is less than the minimum permitted (-50 dB).
Amptd setting too low	The carrier amplitude value entered is less than the minimum permitted (-140 dBm).
Amptd setting too high	The carrier amplitude value entered is greater than the maximum permitted (+19.9 dBm).
Argument out of range	An attempt was made over HP-IB to send an invalid numeral in the command parameter. For example, sending "FM:STATE 2"(there is no STATE 2), or "FREQ:SYNT 6" (there is no Mode 6 synthesis) would give you this error.
Attenuation too large	The attenuation value entered is greater than the maximum permitted (145 dB).
Attenuation too small	The attenuation value entered is less than the minimum permitted (0 dB).
Audio2 freq too high	The frequency of the audio source in Channel 2, entered from Special Function 133, is greater than the maximum permitted (400 kHz).
Audio2 freq too low	The frequency of the audio source in Channel 2, entered from Special Function 133, is less than the minimum permitted (0.1 Hz).

Table D-1. Error Messages Immediately Shown to the User. (2 of 9)

Error Message	Description
Audio2 level too high	The level of the audio source in Channel 2, entered from Special Function 134, is greater than the maximum permitted (1V).
Audio2 level too low	The level of the audio source in Channel 2, entered from Special Function 134, is less than the minimum permitted (0V).
Audio Φ incr too large	The increment value for phase in the audio source is greater than the maximum permitted (359.9°).
Audio Φ incr too small	The increment value for phase in the audio source is less than the minimum permitted (0.1°).
Audio Φ M dev too large	The Φ M deviation for the audio source in Channel 1, entered from Special Function 145, is greater than the maximum permitted (179.9°).
Audio Φ M dev too small	The Φ M deviation for the audio source in Channel 1, entered from Special Function 145, is less than the minimum permitted (0°).
Audio Φ M freq too high	The Φ M frequency for the audio source in Channel 1, entered from Special Function 146, is greater than the maximum permitted (400 kHz).
Audio Φ M freq too low	The Φ M frequency for the audio source in Channel 1, entered from Special Function 146, is less than the minimum permitted (0.1 Hz).
Audio Φ M incr too large	The increment value of Φ M deviation for the audio source in Channel 1, entered from Special Function 145, is greater than the maximum permitted (179.9°).
Audio Φ M incr too small	The increment value of Φ M deviation for the audio source in Channel 1, entered from Special Function 145, is less than the minimum permitted (0.1°).
Audio AM depth too large	Depth for the subcarrier AM source in Channel 1, entered from Special Function 137, is greater than the maximum permitted (100%).
Audio AM depth too small	Depth for the subcarrier AM source in Channel 1, entered from Special Function 137, is less than the minimum permitted (0%).
Audio AM freq too high	Frequency for the subcarrier AM source in Channel 1, entered from Special Function 138, is greater than the maximum permitted (400 kHz).
Audio AM freq too low	Frequency for the subcarrier AM source in Channel 1, entered from Special Function 138, is less than the minimum permitted (0.1 Hz).
Audio AM incr too large	The increment value of depth for the subcarrier AM source in Channel 1, entered from Special Function 137, is greater than the maximum permitted (100%).
Audio AM incr too small	The increment value of depth for the subcarrier AM source in Channel 1, entered from Special Function 137, is less than the minimum permitted (0.1%).

Table D-1. Error Messages Immediately Shown to the User. (3 of 9)

Error Message	Description
Audio FM dev too large	Deviation for the subcarrier FM source in Channel 1, entered from Special Function 141, is greater than the maximum permitted (400 kHz).
Audio FM dev too small	Deviation for the subcarrier FM source in Channel 1, entered from Special Function 141, is less than the minimum permitted (0 kHz).
Audio FM freq too high	Frequency for the subcarrier FM source in Channel 1, entered from Special Function 142, is greater than the maximum permitted (400 kHz).
Audio FM freq too low	Frequency for the subcarrier FM source in Channel 1, entered from Special Function 142, is less than the minimum permitted (0.1 Hz).
Audio FM incr too large	The increment value of deviation for the subcarrier FM source in Channel 1, entered from Special Function 141, is greater than the maximum permitted (400 kHz).
Audio FM incr too small	The increment value of deviation for the subcarrier FM source in Channel 1, entered from Special Function 141, is less than the minimum permitted (0.1 Hz).
Audio freq incr too low	The audio frequency increment value entered is less than the minimum permitted (0.1 Hz).
Audio freq incr too high	The audio frequency increment value entered is greater than the maximum permitted (400 kHz).
Audio freq too low	The audio frequency value entered is less than the minimum permitted (0.1 Hz).
Audio freq too high	The audio frequency value entered is greater than the maximum permitted (400 kHz).
Audio level/AM conflict	The sum of the audio levels in Channels 1 and 2 cannot exceed 1 V (pk) with the subcarrier AM source in Channel 1 ON.
Audio level conflict	The sum of the audio levels in Channels 1 and 2 cannot exceed 1 V (pk).
Audio level incr high	The audio level increment value entered is greater than the maximum permitted (1 V).
Audio level incr low	The audio level increment value entered is less than the minimum permitted (1.0 mV).
Audio level too high	The audio level value entered is greater than the maximum permitted (1 V).
Aud lev/source conflict	The sum of the audio levels in Channels 1 and 2 cannot exceed 1 V (pk), and too many audio sources are turned ON.

Table D-1. Error Messages Immediately Shown to the User. (4 of 9)

Error Message	Description
Aud pulse freq too high	Frequency of the subcarrier Pulse source entered from Special Function 150 is greater than the maximum permitted (50 kHz).
Aud pulse freq too low	Frequency of the subcarrier Pulse source entered from Special Function 150 is less than the minimum permitted (0.1 Hz).
Bad char during numeric	While the instrument was reading in a numeric argument, a character other than "0" through "9" occurred at a place where it is not valid to end the number.
Bad/missing exponent	After getting a valid mantissa and an "E" (for exponential), a character was found that was not a digit "0" through "9" or a \pm sign, or the character was not a digit "0" through "9" after an "E+" or an "E-".
Bad register number	The recalled Save Register does not contain a SAVE setting, or the recalled Save Register is less than 0 or greater than 49.
Bad sequence entry	An attempt was made to enter a register value less than 0 or greater than 9 into the Save/Recall Sequence list.
Cannot continue	An attempt has been made to restart diagnostic testing after altering an internal cable or module without being in the repair mode, or you have come to the point where no additional tests are available or the test sequence has ended.
Center freq too high	The center frequency value entered for the sweep is greater than the maximum permitted.
Center freq too low	The center frequency value entered for the sweep is less than the minimum permitted.
Empty sequence list	An attempt was made to sequence through an empty Save/Recall sequence list.
EOC during numeric	While the instrument was reading in a numeric argument, an end-of-command (EOC) condition occurred at a place where it is not valid to end the number (for example, after a \pm sign, after a decimal with no leading digits, or after an "E" for exponential).
EOM during numeric	While the instrument was reading in a numeric argument, an end-of-message (EOM) condition occurred at a place where it is not valid to end the number (for example, after a \pm sign, after a decimal with no leading digits, or after an "E" for exponential).
EOM in #B/Q/H W/O data	An end-of-message (EOM) was encountered without getting any data in, or without getting the "B" (for binary), "Q" (for octal), or "H" (for hexadecimal) while the instrument was reading in a non-decimal numeric argument.
EOM in arbitrary block	An end-of-message (EOM) was encountered before the end of data while the instrument was reading in an "arbitrary block program data".

Table D-1. Error Messages Immediately Shown to the User. (5 of 9)

Error Message	Description
Error-EOC after colon	An end-of-command (EOC) was encountered after a colon in the command header. A colon in the command header must always be followed by a keyword mnemonic.
Error-EOC after comma	An end-of-command (EOC) was found after a comma. A comma in the data string must be followed with an additional data item(s).
Error-EOM after colon	An end-of-message (EOM) condition was encountered after a colon in the command header. A colon in the command header must always be followed by a keyword mnemonic.
Error-EOM after comma	An end-of-message (EOM) was found after a comma. A comma in the data string must be followed with an additional data item(s).
Error-Space after colon	A space character was encountered after a colon in the command header. A colon in the command header must always be followed by a keyword mnemonic.
Exponent too big	The numeric exponent was either less than -127 or greater than 127 .
FM deviation too large	The FM deviation value entered is greater than the maximum permitted. Refer to the specifications in the technical data sheet or to section 1 in the <i>Calibration Manual</i> for FM deviation limits.
FM deviation too small	The FM deviation value entered is less than the minimum permitted. Refer to the specifications in the technical data sheet or to section 1 in the <i>Calibration Manual</i> for FM deviation limits.
FM incr too large	The FM increment value entered is greater than the maximum permitted (100 MHz).
FM incr too small	The FM increment value entered is less than the minimum permitted (0.001 Hz).
FM out of range for mode	An attempt was made to change from a Mode Select setting with a higher deviation range, to a Mode Select setting with less deviation range for the set RF output. Push the Mode Select AUTO key to let the Signal Generator determine the best mode for the deviation and RF output you have selected.
Freq divider too large	The frequency divider value entered is greater than the maximum permitted (-10 from the front panel, 0.1 over HP-IB).
Freq incr too large	The frequency increment value entered is greater than the maximum permitted (10 GHz).
Freq incr too small	The frequency increment value entered is less than the minimum permitted (0.01 Hz).
Freq mult too large	The frequency multiplier value entered is greater than the maximum permitted (10).
Freq offset too large	The frequency offset value entered is greater than the maximum permitted (50 GHz).
Freq offset too small	The frequency offset value entered is less than the minimum permitted (-50 GHz).

Table D-1. Error Messages Immediately Shown to the User. (6 of 9)

Error Message	Description
Freq setting too high	The frequency value entered is greater than the maximum permitted.
Freq setting too low	The frequency value entered is less than the minimum permitted.
Frequency span too large	The frequency span value entered for the sweep is greater than the maximum permitted.
Frequency span too small	The frequency span value entered for the sweep is less than the minimum permitted.
Hardware not installed	An attempt was made to activate a Mode Select setting presently not installed in the instrument.
HP-IB Command error	This is a generic HP-IB command error. Something is wrong with the command, but the firmware does not recognize the specific problem.
HP-IB No response data	The instrument was given the HP-IB interface command to "talk", but has not been told to "say" anything.
HP-IB Query interrupted	The instrument was given a command to return some data, then given another command before the entire response was read back from the instrument.
HP-IB Query unterminated	The instrument was given the HP-IB interface command to talk, and has received part of a message including a command to return some data, but the message was not terminated (not completely sent, or no end-of-message sent).
Insufficient capability	An attempt has been made to activate a function or feature presently not configured or accessible.
Int modulation enabled	An attempt has been made over HP-IB to turn off the audio source with the internal modulation source turned on.
Invalid char after '.'	While the instrument was reading in a numeric argument, a character other than "0" through "9", or an "E" (for exponential) with no digits before the decimal occurred.
Invalid char after sign	While the instrument was reading in a numeric argument, a character other than "0" through "9", or a decimal point occurred after the \pm sign.
Invalid data mnemonic	A mnemonic was not recognized as the instrument was reading in a non-numeric parameter.
Invalid header mnemonic	A keyword mnemonic in the command header is not recognized as a keyword. Incorrect protocol or a spelling mistake might be the cause.
Invalid suffix	While the instrument was reading in a numeric argument, an invalid suffix occurred after a comma, semicolon, or end-of-command.
Log sweep not allowed	An attempt has been made to do phase continuous log sweep.
Marker freq too high	The marker frequency value entered is greater than the maximum permitted.
Marker freq too low	The marker frequency value entered is less than the minimum permitted (100,000.00 Hz).

Table D-1. Error Messages Immediately Shown to the User. (7 of 9)

Error Message	Description
Missing space after '?'	A non-blank character other than a semicolon followed a question mark. The question mark must either be followed by an end-of-message, an end or command, or a space before a parameter.
Mod and sweep conflict	An attempt was made to phase continuous sweep with internal modulation on, or with internal or external FM, Φ M, or the audio source turned on.
Needs space after header	The characters following the command header must have a space or an end-of-command message.
No manual Φ cont. sweep	An attempt was made to do Manual phase continuous sweep.
No such special	An invalid Special Function number was entered. Refer to Appendix C for a list of available Special Functions.
Not allowed-Security on	An attempt has been made to turn on a "Blanked" display area when the security Special Function 173 is active.
Notice >> FM turned off	An attempt was made to turn on Φ M with FM on, or an attempt was made to go from CW to sweep or from sweep to CW with FM set to a value out of range for the frequency that was entered.
Notice >> Φ M turned off	An attempt was made to turn on FM with Φ M already on.
Notice Aud state changed	A conflict has occurred which causes a subcarrier modulation source to be turned off in order to allow modulation on the RF carrier.
Not in service mode	An attempt has been made over HP-IB to access a service Special Function that is not accessible because the service mode switch has been turned off.
Numeric overflow	The number was out of range for the parameter being set.
Pulse delay incr high	The pulse delay increment value entered is greater than the maximum permitted (1 second).
Pulse delay incr low	The pulse delay increment value entered is less than the minimum permitted (1 nsecond).
Pulse delay too long	The pulse delay value entered is more than the maximum permitted (1 second).
Pulse delay too short	The pulse delay value entered is less than the minimum permitted (50 nseconds).
Pulse width incr high	The pulse width increment value entered is greater than the maximum permitted (1 second).
Pulse width incr low	The pulse width increment value entered is less than the minimum permitted (1 nsecond).
Pulse width too long	The pulse width value entered is more than the maximum permitted (1 second).
Pulse width too short	The pulse width value entered is less than the minimum permitted (50 nseconds).

Table D-1. Error Messages Immediately Shown to the User. (8 of 9)

Error Message	Description
Reference cal too high	The reference calibration value entered is greater than the maximum permitted (255).
Reference cal too low	The reference calibration value entered is less than the minimum permitted (0).
Reverse power detected	A reverse power condition was detected at either the RF Output. (Disconnect the affected output from any external equipment and re-enter the key sequence that originally resulted in the error. If an error is still detected by the instrument, a reverse power problem still exists.)
Sequence overflow	An attempt was made to enter more than 10 entries into the Save/Recall Sequence list.
Settings conflict	Certain operating conditions are in conflict. For example, an attempt was made over HP-IB to set the Amplitude Limit to a value less than the current amplitude setting.
Start frequency too high	The start frequency value entered for the sweep is greater than the maximum permitted.
Start frequency too low	The start frequency value entered for the sweep is less than the minimum permitted.
Stop frequency too high	The stop frequency value entered for the sweep is greater than the maximum permitted.
Stop frequency too low	The stop frequency value entered for the sweep is less than the minimum permitted.
Sweep settings conflict	An attempt was made over HP-IB to send a command message with conflicting sweep statements.
Sweep time too large	The sweep time value entered is greater than the maximum permitted. Refer to the specifications in section 1 of the <i>Calibration Manual</i> for sweep time limits.
Sweep time too small	The sweep time value entered is less than the minimum permitted. Refer to the specifications in section 1 of the <i>Calibration Manual</i> for sweep time limits.
Too many audio sources	There cannot be more than three other audio sources turned ON with the audio source in Channel 1 turned ON.
Too many commands	Too many commands were sent in a single message. The message must be broken up into several messages with less commands in each one.
Unexpected '?'	A question mark was found in the data string. A question mark should only occur immediately after the command header.
Unexpected colon	A colon was found in the command header in an invalid location (for example, after another colon, after a question mark, or found with a command parameter).

Table D-1. Error Messages Immediately Shown to the User. (9 of 9)

Error Message	Description
Unexpected comma	A comma was found in the command header, before the first argument, or after another comma. Commas are only allowed between certain arguments in the command header or message.
Unexpected EOC	An unexpected end-of-command (EOC) condition was found by the instrument before a valid command was complete. This includes not having a required parameter in a command.
Unexpected EOM	An unexpected end-of-message (EOM) condition was found by the instrument before a valid command was complete. This includes not having a required parameter in a command.
Unrecognized '#' format	In a non-decimal numeric argument you must use a binary, octal, hexadecimal, or "arbitrary block program data" format.
Wrong char after suffix	An unexpected character was encountered by the instrument after reading in a numeric suffix. This may indicate a missing comma, semicolon, or an end-of-message.
Wrong position for '?'	A question mark was found at the start of the message, after a colon or a space, or after an argument or a suffix. Question marks must follow directly after command header mnemonics.

Table D-2. Error Messages Put In the Message Queue for the User. (1 of 4)

Error Message	Description
Hardware Failure 1	A communications discriminator failure has been detected at power up, or detected as a result of a self-calibration or self-test. Refer to figure D-1 for corrective action.
Hardware Failure 2	A VCO failure has been detected at power up, or detected as a result of a self-calibration or self-test. Refer to figure D-1 for corrective action.
Hardware Failure 3	A Fractional-N failure has been detected at power up, or detected as a result of a self-calibration or self-test. Refer to figure D-1 for corrective action.
Hardware Failure 4	A modulation distribution failure has been detected at power up, or detected as a result of a self-calibration or self-test. Refer to figure D-1 for corrective action.
Hardware Failure 5	An ALC failure has been detected at power up, or detected as a result of a self-calibration or self-test. Refer to figure D-1 for corrective action.
Hardware Failure 6	An attenuator failure has been detected at power up, or detected as a result of a self-calibration or self-test. Refer to figure D-1 for corrective action.
Hardware Failure 7	An audio source failure has been detected at power up, or detected as a result of a self-calibration or self-test. Refer to figure D-1 for corrective action.
Hardware Failure 8	A reference failure has been detected at power up, or detected as a result of a self-calibration or self-test. Refer to figure D-1 for corrective action.
Hardware Failure 9	A doubler failure has been detected at power up, or detected as a result of a self-calibration or self-test. Refer to figure D-1 for corrective action.
Hardware Failure 10	A High Frequency Output Section failure has been detected at power up, or detected as a result of a self-calibration or self-test. Refer to figure D-1 for corrective action.
Hardware Failure 11	A Low Frequency Output Section failure has been detected at power up, or detected as a result of a self-calibration or self-test. Refer to figure D-1 for corrective action.
Hardware Failure 12	A Microwave Extender Automatic-Level-Control (ALC) out-of-lock (OOL) condition occurred. Refer to figure D-1 for corrective action.
Hardware Failure 13	A front panel failure has been detected at power up, or detected as a result of a self-calibration or self-test. Refer to figure D-1 for corrective action.
Hardware Failure 14	A power supply failure has been detected at power up, or detected as a result of a self-calibration or self-test. Refer to figure D-1 for corrective action.
Hardware Failure 15	An I/O board failure has been detected at power up, or detected as a result of a self-calibration or self-test. Refer to figure D-1 for corrective action.

Table D-2. Error Messages Put In the Message Queue for the User. (2 of 4)

Error Message	Description
Hardware Failure 16	A controller failure has been detected at power up, or detected as a result of a self-calibration or self-test. Refer to figure D-1 for corrective action.
Hardware Failure 17	A Pulse Modulator failure has been detected at power up, or detected as a result of a self-calibration or self-test. Refer to figure D-1 for corrective action.
Hardware Failure 18	A frequency counter failure has been detected at power up. Refer to figure D-1 for corrective action.
Hardware Failure 21	A communications discriminator out-of-lock (OOL) condition exists. Refer to figure D-1 for corrective action.
Hardware Failure 22	A VCO out-of-lock (OOL) condition exists. Refer to figure D-1 for corrective action.
Hardware Failure 23	A Fractional-N (NF) phase-locked-loop (PLL) out-of-lock (OOL) condition exists. Refer to figure D-1 for corrective action.
Hardware Failure 24	A VCO frequency-locked-loop (FLL) out-of-lock (OOL) condition exists. Refer to figure D-1 for corrective action.
Hardware Failure 25	A VCO phase-locked-loop (PLL) out-of-lock (OOL) condition exists. Refer to figure D-1 for corrective action.
Hardware Failure 26	A fast controller failure has been detected at power up, or detected as a result of a self-calibration or self-test. Refer to figure D-1 for corrective action.
Hardware Failure 27	An audio source out-of-lock (OOL) condition exists. Refer to figure D-1 for corrective action.
Hardware Failure 28	A reference out-of-lock (OOL) condition exists. Refer to figure D-1 for corrective action.
Hardware Failure 30	A High Frequency Output Section Automatic-Level-Control (ALC) out-of-lock (OOL) condition occurred. Refer to figure D-1 for corrective action.
Hardware Failure 31	A ROM failure has been detected at power up, or detected as a result of a self-calibration or self-test. Refer to figure D-1 for corrective action.
Hardware Failure 32	A ROM failure has been detected at power up, or detected as a result of a self-calibration or self-test. Refer to figure D-1 for corrective action.
Hardware Failure 33	A ROM failure has been detected at power up, or detected as a result of a self-calibration or self-test. Refer to figure D-1 for corrective action.

Table D-2. Error Messages Put In the Message Queue for the User. (3 of 4)

Error Message	Description
Hardware Failure 34	A ROM failure has been detected at power up, or detected as a result of a self-calibration or self-test. Refer to figure D-1 for corrective action.
Hardware Failure 35	A voltmeter failure has been detected at power up, or detected as a result of a self-calibration or self-test. Refer to figure D-1 for corrective action.
Hardware Failure 36	A RAM failure has been detected at power up, or detected as a result of a self-calibration or self-test. Refer to figure D-1 for corrective action.
Calibration Error 1	A condition occurred where invalid level calibration data resides in either the Output or the Attenuator modules. Follow the external calibration procedures outlined in figure D-1 .
Calibration Error 2	At some time during the calibration or self-test, a condition occurred where some hardware was unable to be calibrated. Fix the hardware and re-calibrate. Refer to figure D-1 for corrective action. This error message will always be accompanied by other error messages.
Calibration Error 3	A sensor indicates that inside temperature has varied $\pm 10^{\circ}$ Centigrade ($\pm 18^{\circ}$ Fahrenheit) from where the temperature was when the instrument was last calibrated. A re-calibration by activating Special Function 171 may be necessary for the instrument to maintain its specifications.
Amplitude Error 1	An Automatic-Level-Control (ALC) out-of-lock (OOL) condition exists. An operating condition may have caused the OOL error, or a hardware problem may exist; check out both possibilities.
Amplitude Error 2	A doubler amplitude out-of-lock (OOL) condition exists. An operating condition may have caused the OOL error, or a hardware problem may exist; check out both possibilities.
Amplitude Error 3	An Automatic-Level-Control (ALC) out-of-lock (OOL) condition occurred. Refer to figure D-1 for corrective action.
Amplitude Error 4	A pulse amplitude error has occurred as a result of the pulse repetition rate being greater than the pulse width. Refer to figure D-1 for corrective action.
User Memory Cleared	A memory failure has been detected, all battery backup memory is lost. Refer to figure D-1 for corrective action.
Reverse power detected	A reverse power condition was detected at the RF Output. (Disconnect the affected output from any external equipment and re-enter the key sequence that originally resulted in the error. If an error is still detected by the instrument, a reverse power problem still exists.)

Note *The "Transient Errors" listed in the following table (4 of 4) will only appear if Special Function 328 is activated. Refer to the Service Documentation for corrective action if you see one of these messages.*

Table D-2. Error Messages Put In the Message Queue for the User. (4 of 4)

Error Message	Description
Transient Error 1	A transient communications discriminator out-of-lock (OOL) condition occurred. Refer to the service documentation for corrective action.
Transient Error 3	A transient Fractional-N (NF) phase-locked-loop (PLL) out-of-lock (OOL) condition occurred. Refer to the service documentation for corrective action.
Transient Error 4	A transient pulse timing error has occurred as a result of the pulse repetition rate being greater than the pulse width. Refer to the service documentation for corrective action.
Transient Error 5	A transient Automatic-Level-Control (ALC) out-of-lock (OOL) condition occurred. Refer to the service documentation for corrective action.
Transient Error 7	A transient audio source out-of-lock (OOL) condition occurred. Refer to the service documentation for corrective action.
Transient Error 8	A transient reference out-of-lock (OOL) condition occurred. Refer to the service documentation for corrective action.
Transient Error 9	A transient doubler out-of-lock (OOL) condition occurred. Refer to the service documentation for corrective action.
Transient Error 12	A transient Microwave Extender out-of-lock (OOL) condition occurred. Refer to the service documentation for corrective action.
Transient Error 22	A transient VCO out-of-lock (OOL) condition exists. Refer to the service documentation for corrective action.
Transient Error 24	A transient VCO frequency-locked-loop (FLL) out-of-lock (OOL) condition occurred. Refer to the service documentation for corrective action.
Transient Error 25	A transient VCO phase-locked-loop (PLL) out-of-lock (OOL) condition occurred. Refer to the service documentation for corrective action.
Transient Error 30	A transient High Frequency Output Section Automatic-Level-Control (ALC) out-of-lock (OOL) condition occurred. Refer to the service documentation for corrective action.

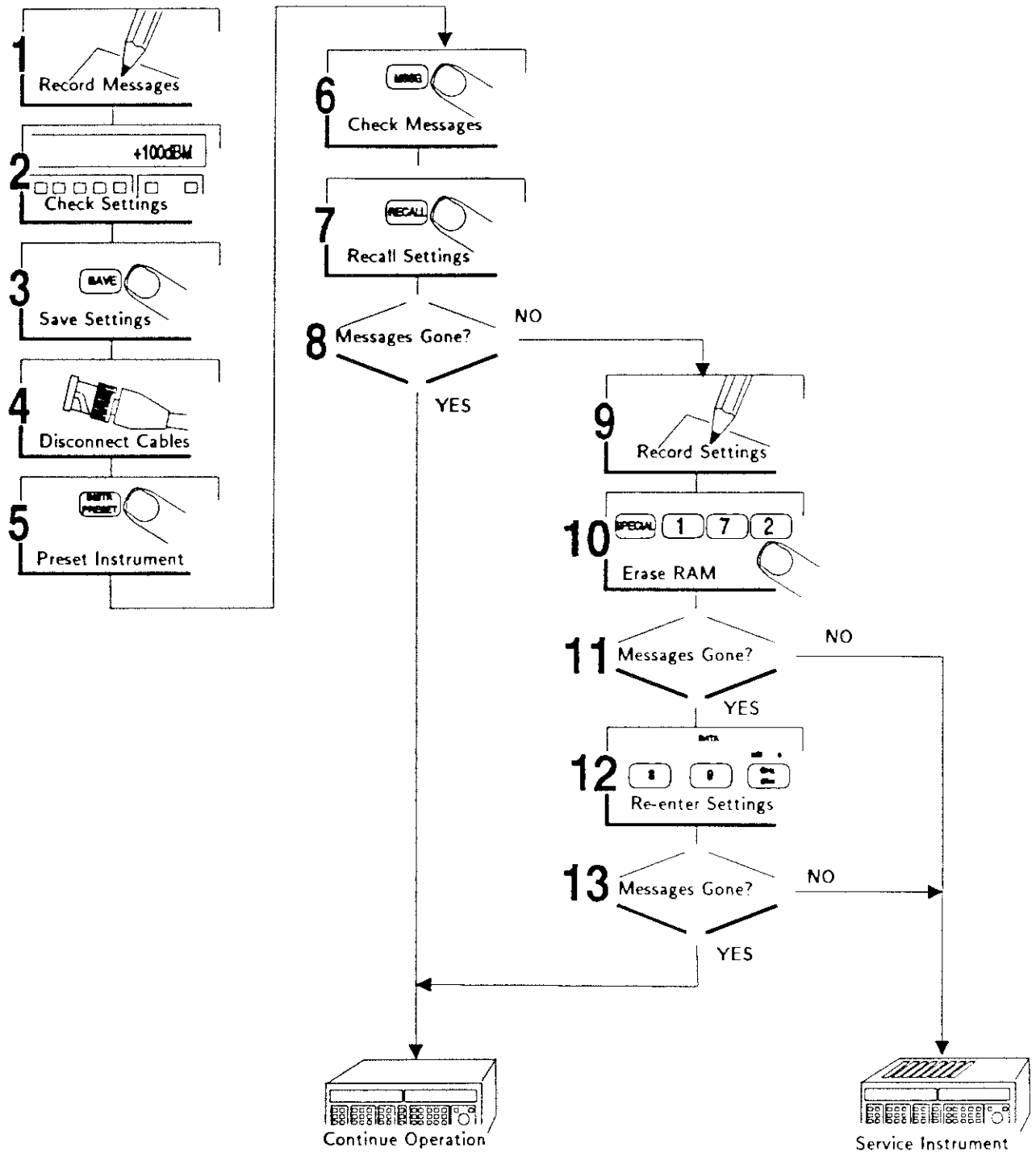

Figure D-1. Corrective Action for Error Messages

E

HP-SL Quick Reference Guide

Introduction to HP-SL Syntax Drawings

This appendix provides syntax drawings on the Hewlett-Packard System Language (HP-SL) for remote operation of the Signal Generator over the Hewlett-Packard Interface Bus (HP-IB). Use this appendix once you are familiar with HP-SL protocol. Refer to chapter 4 *What About Programming?* for an introduction to HP-SL, and for programming reference information.

Command Statements

Command statements are used to either modify or query the Signal Generator. A general representation of a command statement is shown in figure E-1. Keywords are recognized in the command statement as those listed in either the *HP-IB Control Language Dictionary* or the *HP-SL Device Status Dictionary*.

Keywords may be followed by a question mark for a query, or by a space and then a command parameter (as described in the *HP-SL Notes* in chapter 4).

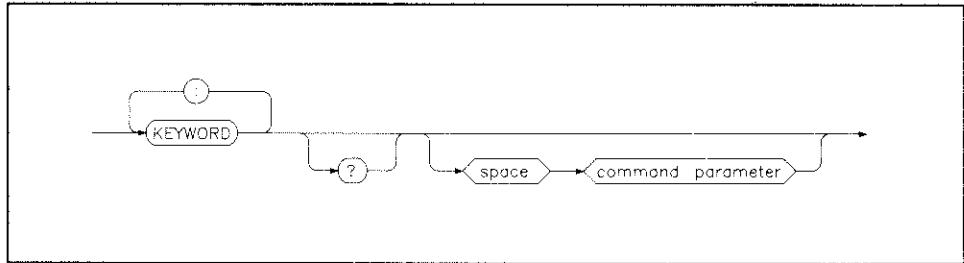

Figure E-1. Command Statement Syntax Drawing.

Command Message

One or more command statements on a line of programming code make up a command message. A general representation of a command message is shown in figure E-2. All command messages are terminated by either a new line (ASCII character 10), or an HP-IB end or identify (EOI). (The EOI is not a separate character but is a bus message sent along with a data character "new line" or the last character of the command statement.)

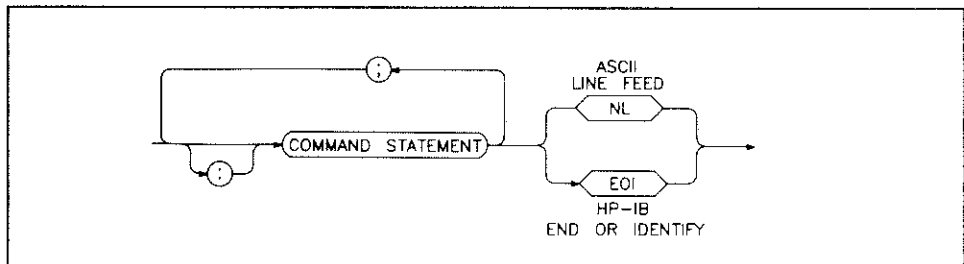
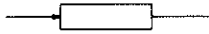
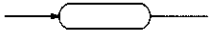

Figure E-2. Command Message Syntax Drawing.

Subsystem Syntax*MINimum***HP-SL Notes**

All subsystem syntax drawings are represented pictorially. The following rules apply to all syntax drawings:

- A rounded envelope indicates that the HP-SL command must be included in the command statement.
- A rectangular box indicates an optional HP-SL command which may or may not be included in the command statement.
- A diamond shaped envelope usually indicates a command parameter preceded by a space, and in some cases the diamond shaped envelope is used to indicate that a "term" (terminator) is required to finish the command statement. Refer to the *HP-SL Notes* shown below for a description of each command parameter.
- Any HP-SL command written in *italics* is an alias to another HP-SL command.

◊*AM term*◊ indicates that a "%", "PCT" termination is required. "% " is assumed as the default value .

◊*ampl step term*◊ indicates that a "dB", "V", "mV", "uV" termination is required. "dB" is assumed as the default value.

◊*ampl step unit*◊ indicates that a "dB", or "V" termination must be specified.

◊*ampl term*◊ indicates that "dBm", "dBmW" ("dBmW" is alias for "dBm"), "dBuV", "V", "mV", "uV", or no termination is required.

◊*ampl unit term*◊ indicates that a "dBm", "dBmW", "V", or "dBuV" termination must be specified.

◊*angle term*◊ indicates that a "DEG", "RAD", or no termination must be specified. "RAD" (radian) is assumed as the default value.

◊*coupling type*◊ indicates that sources "AC", "DC", "GROund", or "GND" are available.

◊*freq term*◊ indicates that "HZ", "KHZ", "MHZ", "MAHZ", "GHZ", or no termination is required. "HZ" is assumed as the default value.

◊*lin ampl term*◊ indicates that "V", "mV", "uV", or no termination is required. "V" is assumed as the default value.

◊*mod type*◊ indicates that "AM", "FM", "PM", or "PULSe" is required.

◊*non-decimal numeric program data*◊ indicates that the pound symbol "#" should be followed by either a "B" and a binary representation of a number, or "Q" and a octal representation of a number, or "H" and a hexadecimal representation of a number.

$\langle \text{nrf} \rangle$ indicates that an ASCII representation of a number is required.

$\langle \text{ohms term} \rangle$ indicates that an "OHM", "KOHM", "MOHM" or no termination is required. "OHM" is assumed as the default value.

$\langle \text{source list} \rangle$ indicates that "INTernal", or "EXTernal", or more than one source separated by commas is required.

$\langle \text{space} \rangle$ indicates an ASCII character in the range of 0 through 9 or 11 through 32 decimal.

$\langle \text{time term} \rangle$ indicates that "S", "mS", "uS", "nS" or no termination is required. "S" (seconds) is assumed as the default value.

Table of Contents

AM Subsystem	E-5
Amplitude Subsystem	E-6
Calibration Subsystem	E-8
Display Subsystem	E-8
FM Subsystem	E-9
Frequency Subsystem	E-10
HP-SL System Commands	E-12
IEEE 488.2 Common Commands	E-12
Initialize Subsystem	E-12
LF Source Subsystem	E-13
Marker Subsystem	E-19
Modulation Subsystem	E-19
Phase Modulation Subsystem	E-20
Phase Subsystem	E-20
Power Meter Subsystem	E-21
Pulse Subsystem	E-21
Reference Oscillator Subsystem	E-22
Sequence Subsystem	E-22
Status Subsystem	E-23
Sweep Subsystem	E-24
Take Sweep Subsystem	E-24
Voltmeter Subsystem	E-24

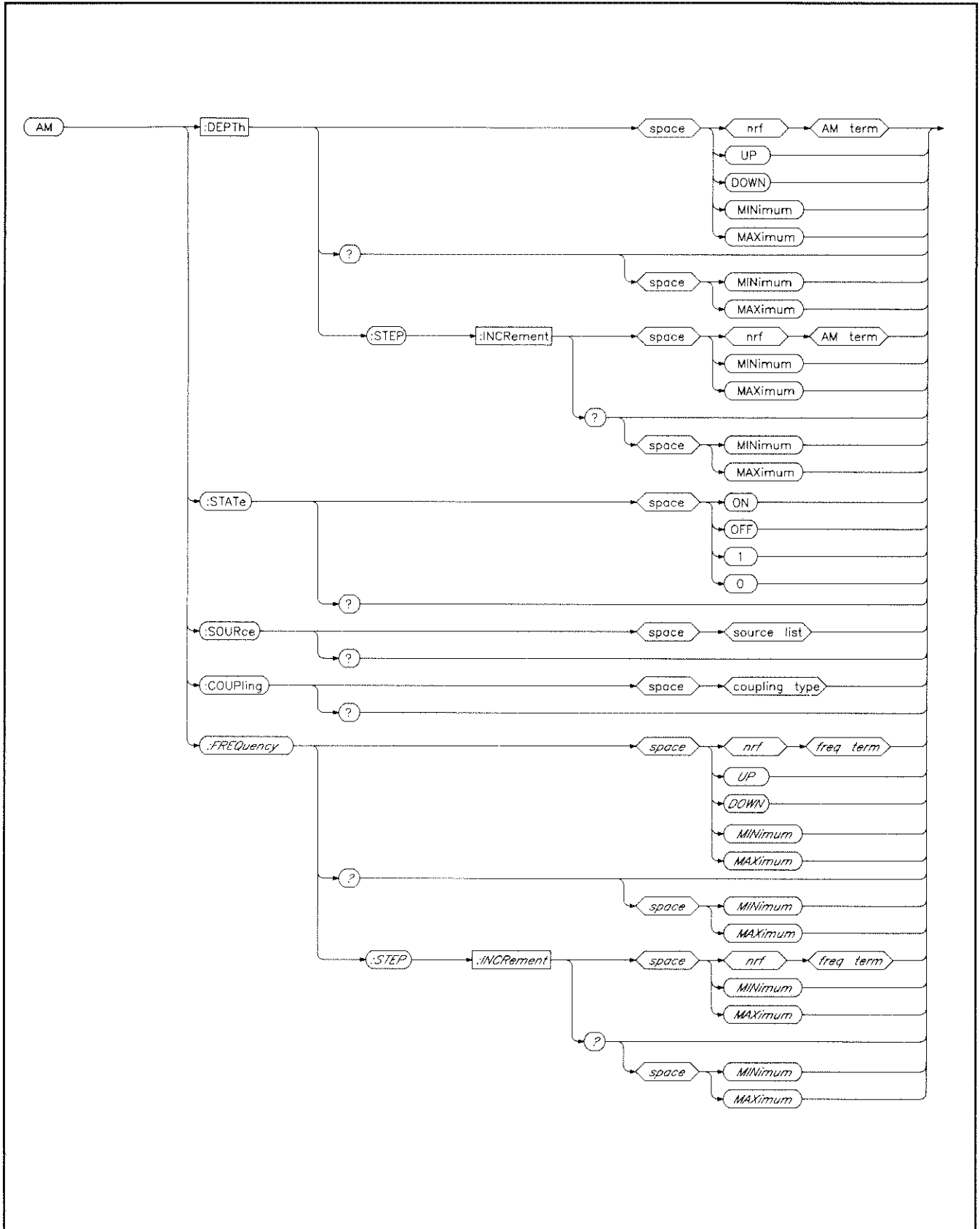

Figure E-3. AM Subsystem.

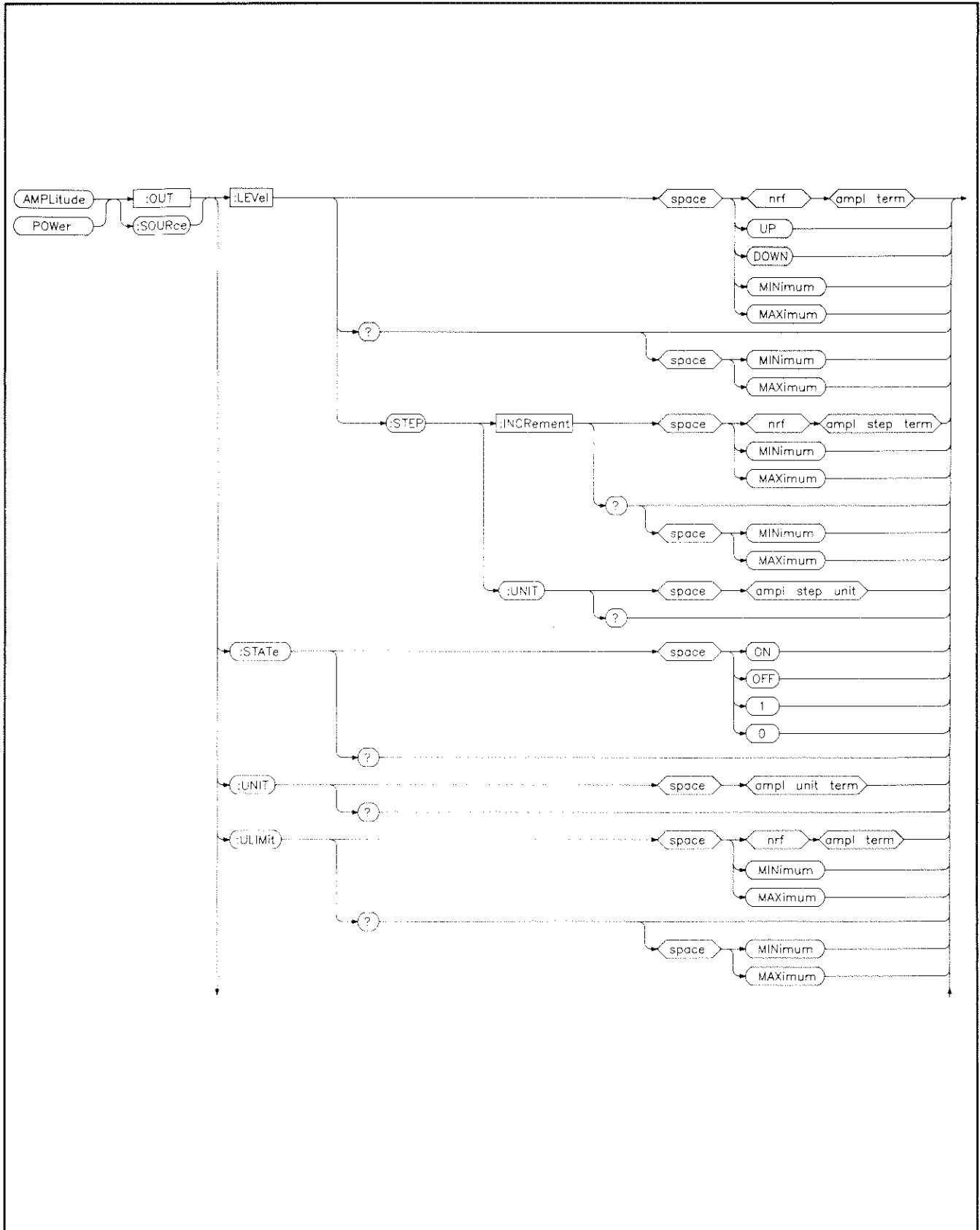

Figure E-4. Amplitude Subsystem. (1 of 2)

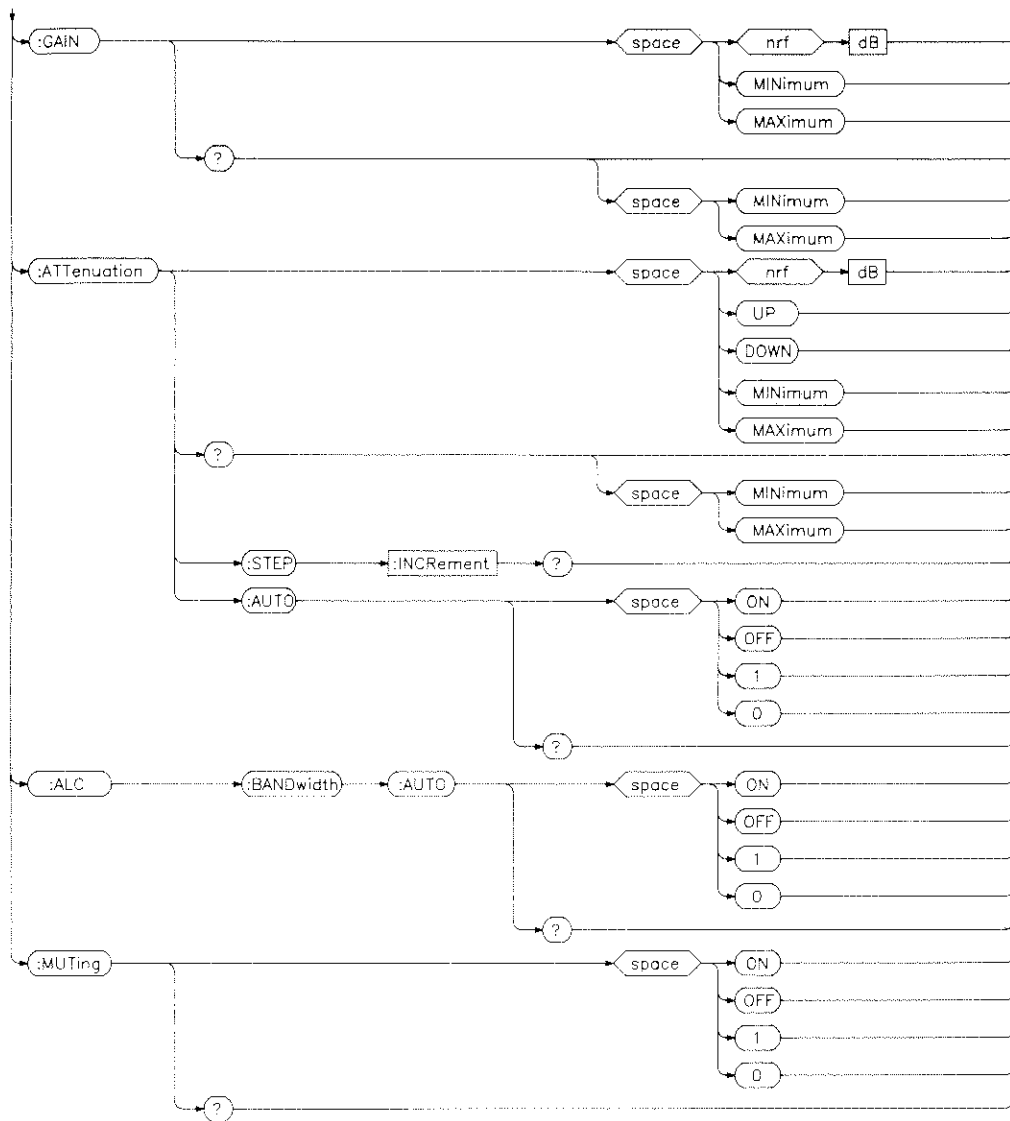

Figure E-4. Amplitude Subsystem. (2 of 2)

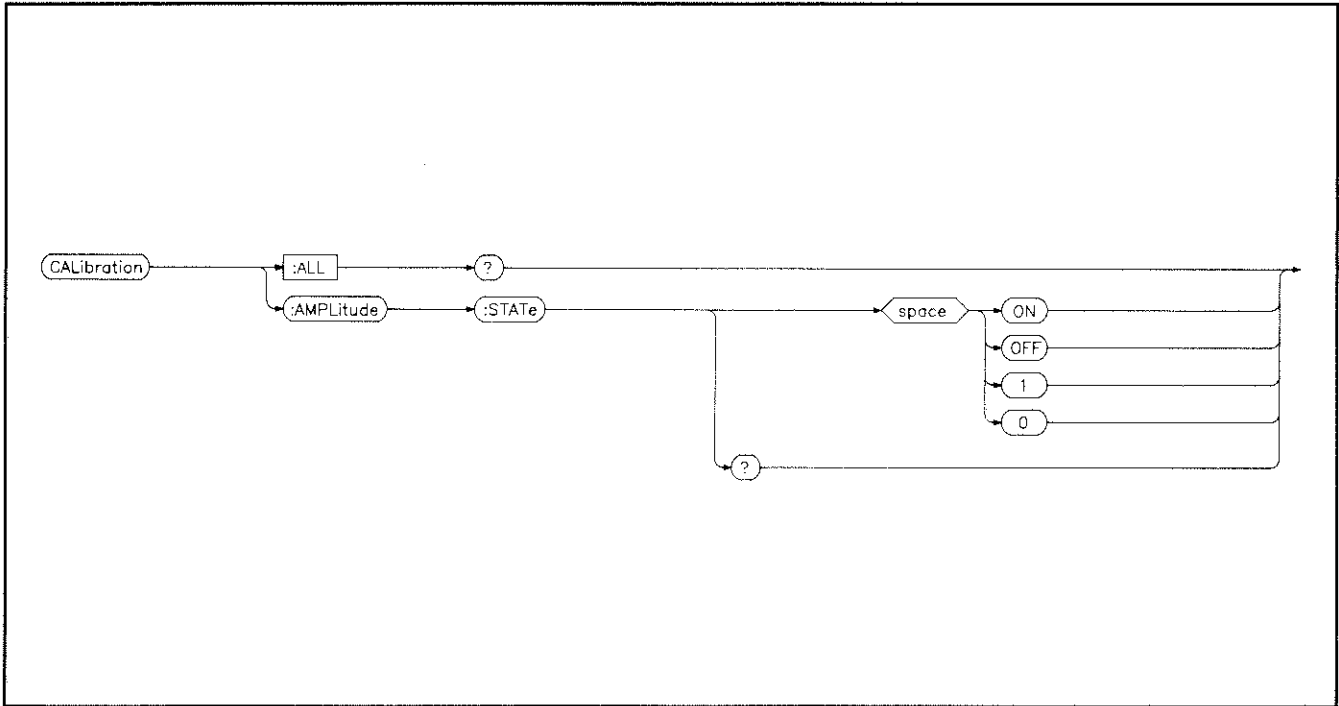

Figure E-5. Calibration Subsystem.

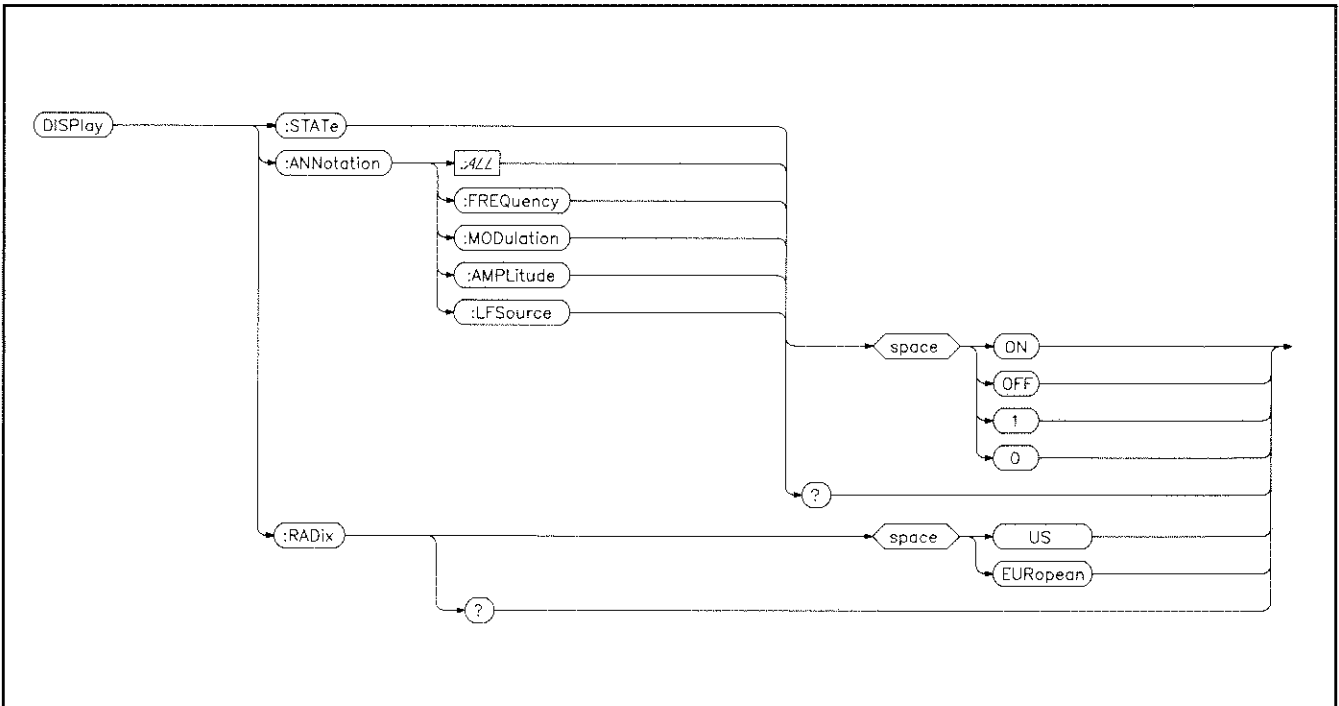

Figure E-6. Display Subsystem.

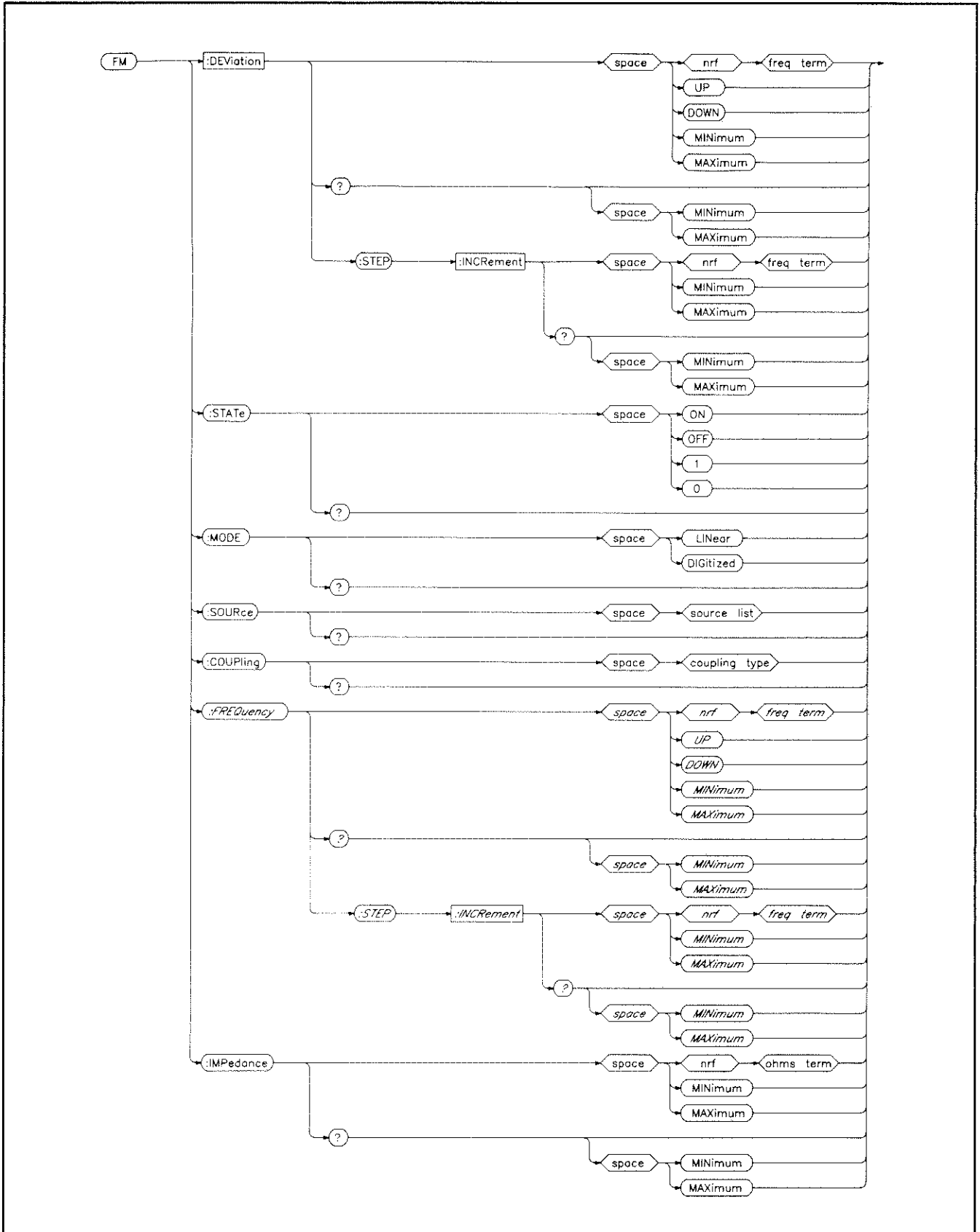

Figure E-7. FM Subsystem.

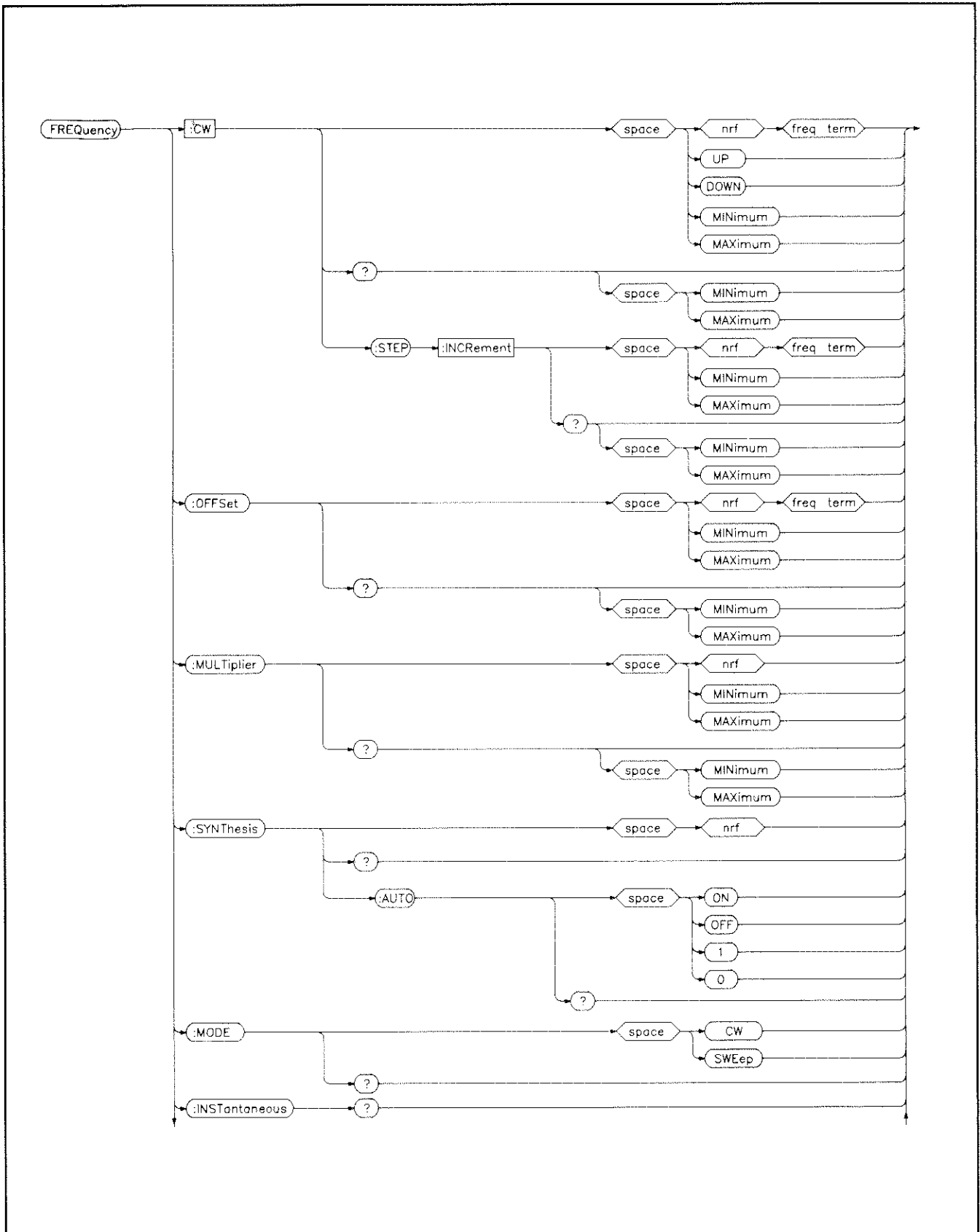

Figure E-8. Frequency Subsystem. (1 of 2)

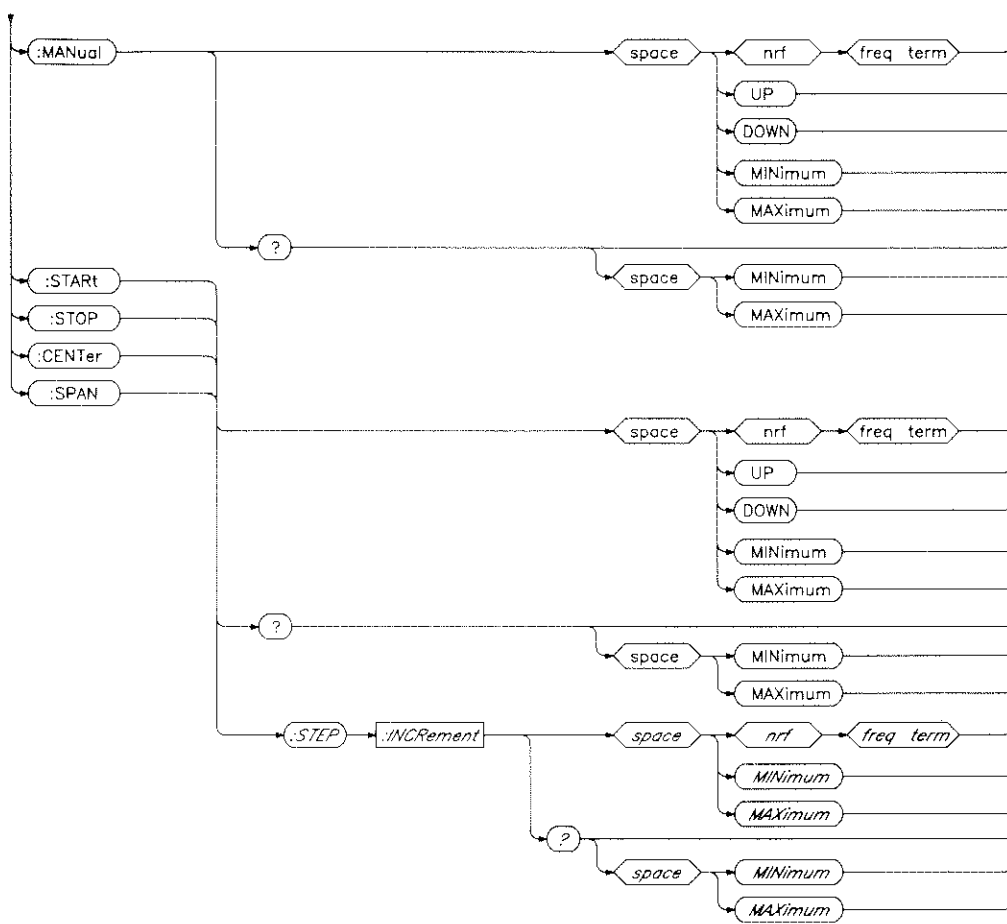

Figure E-8. Frequency Subsystem. (2 of 2)

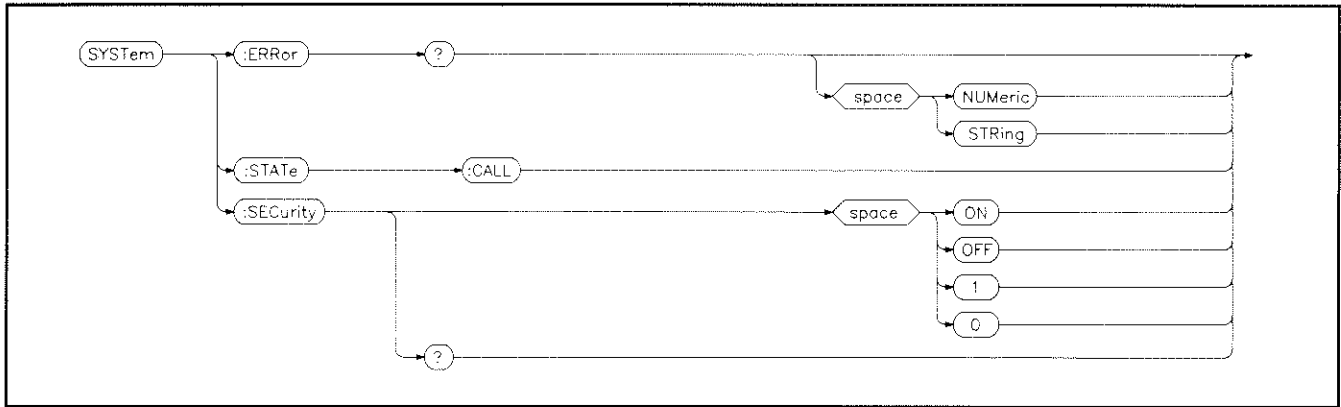

Figure E-9. HP-SL System Commands.

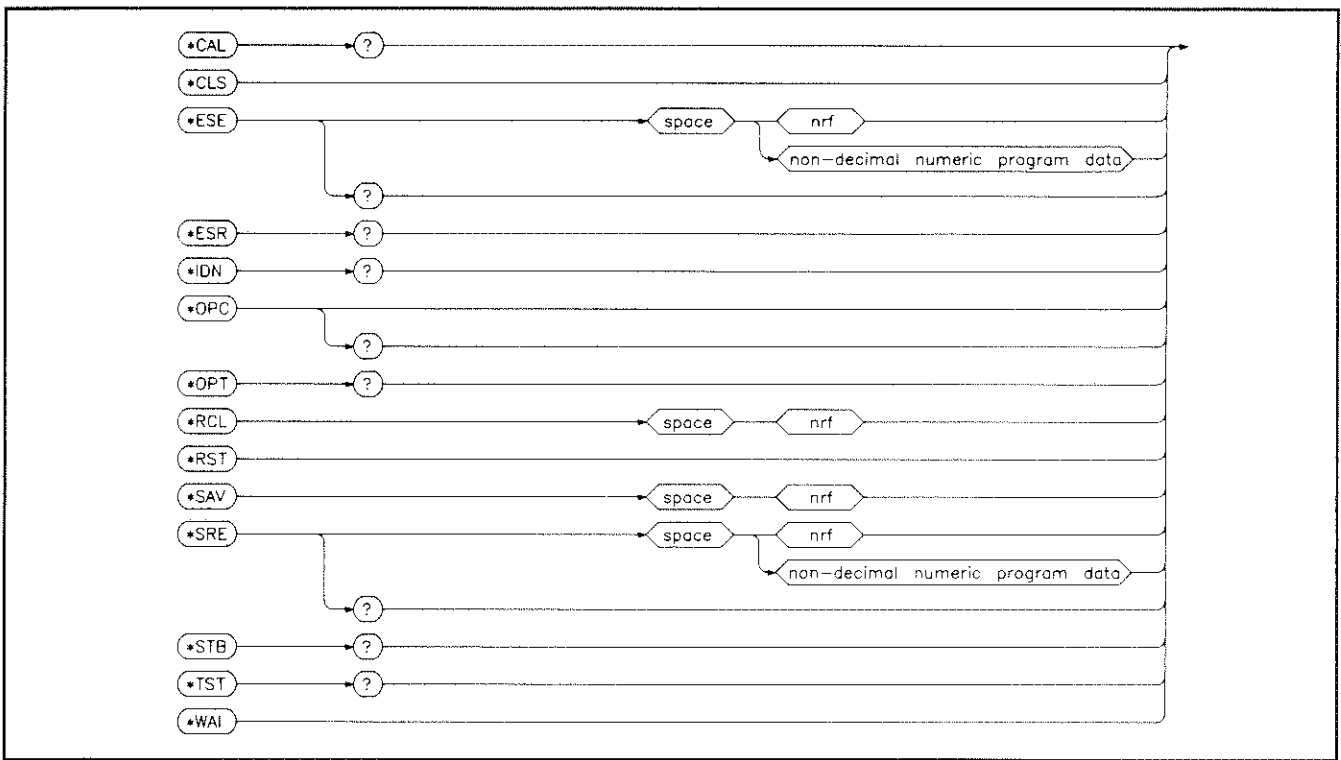

Figure E-10. IEEE 488.2 Common Commands.

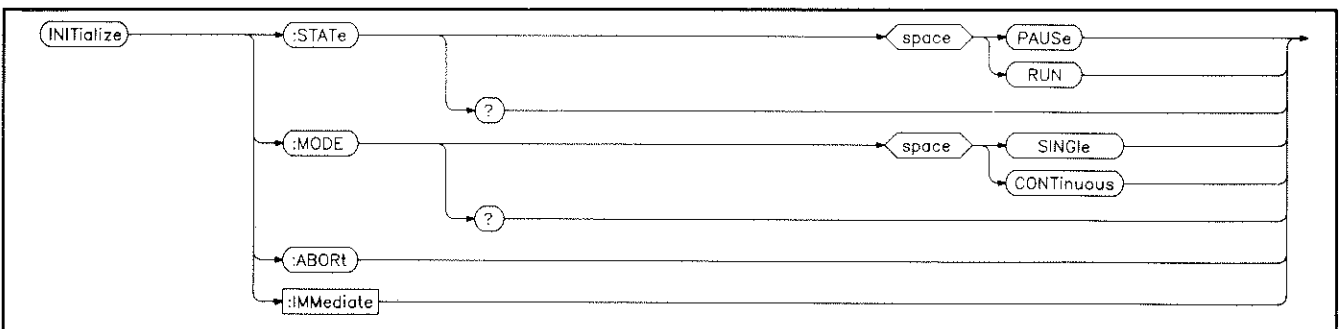

Figure E-11. Initialize Subsystem.

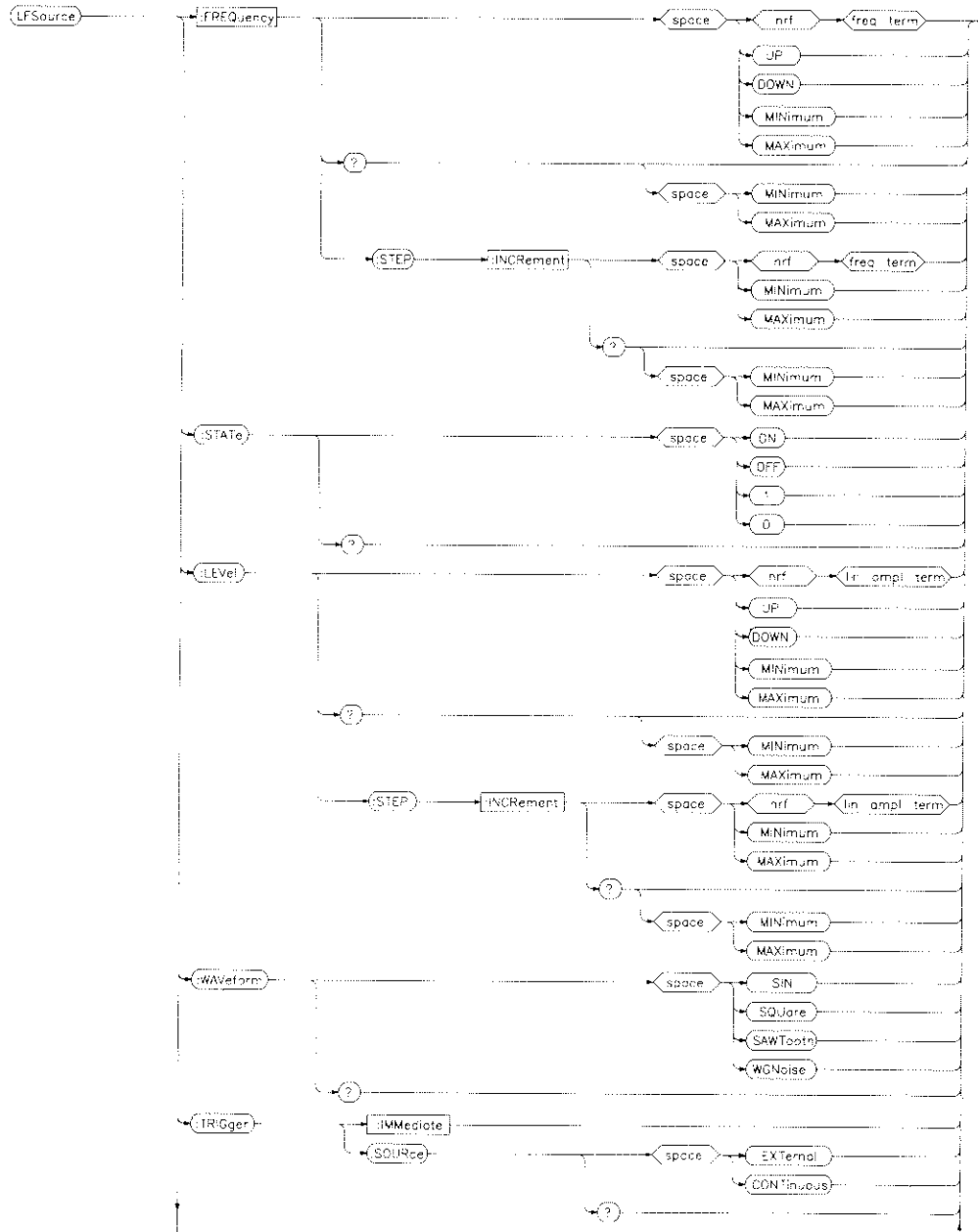

Figure E-12. LF Source Subsystem. (1 of 6)

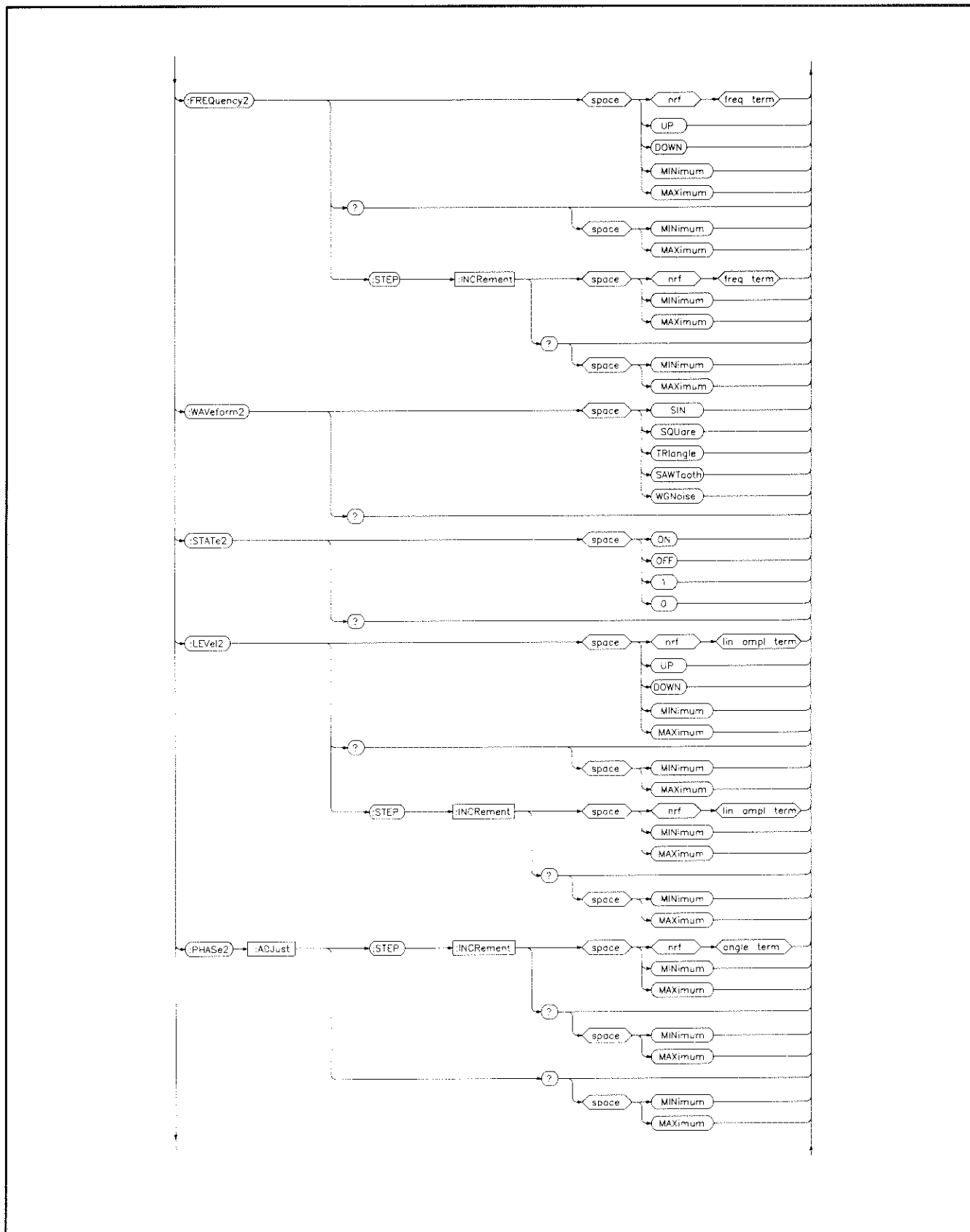

Figure E-12. LF Source Subsystem. (2 of 6)

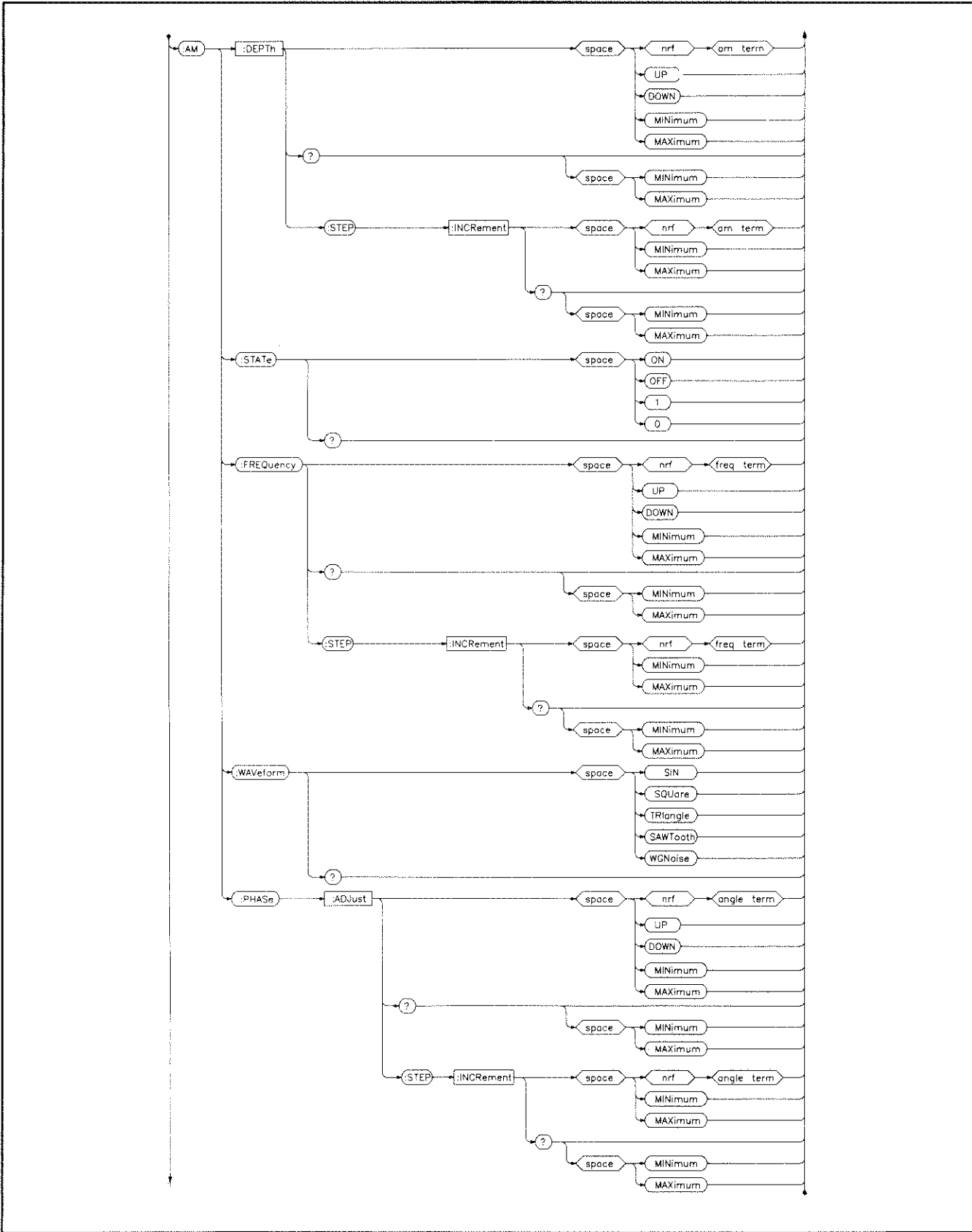

Figure E-12. LF Source Subsystem. (3 of 6)

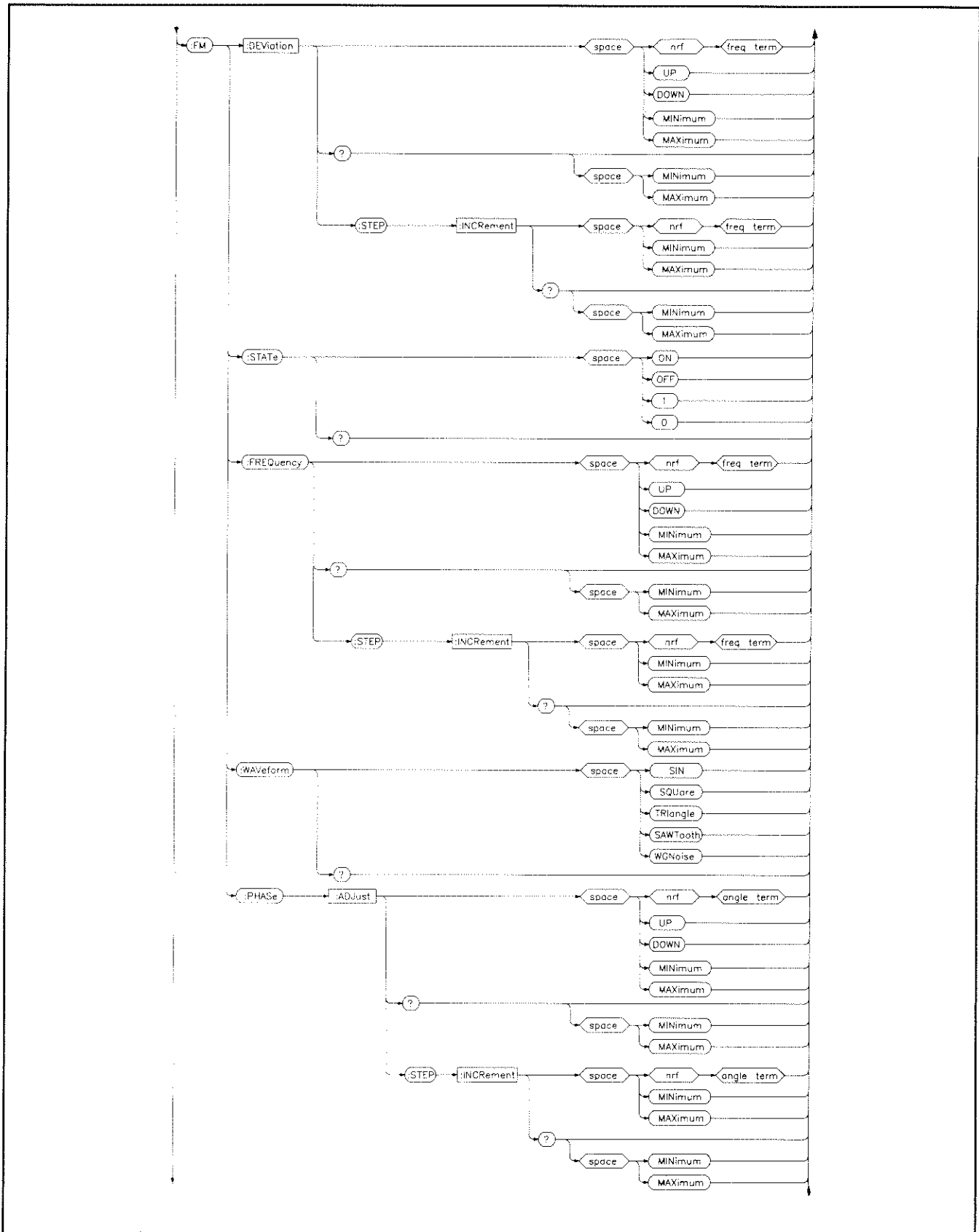

Figure E-12. LF Source Subsystem. (4 of 6)

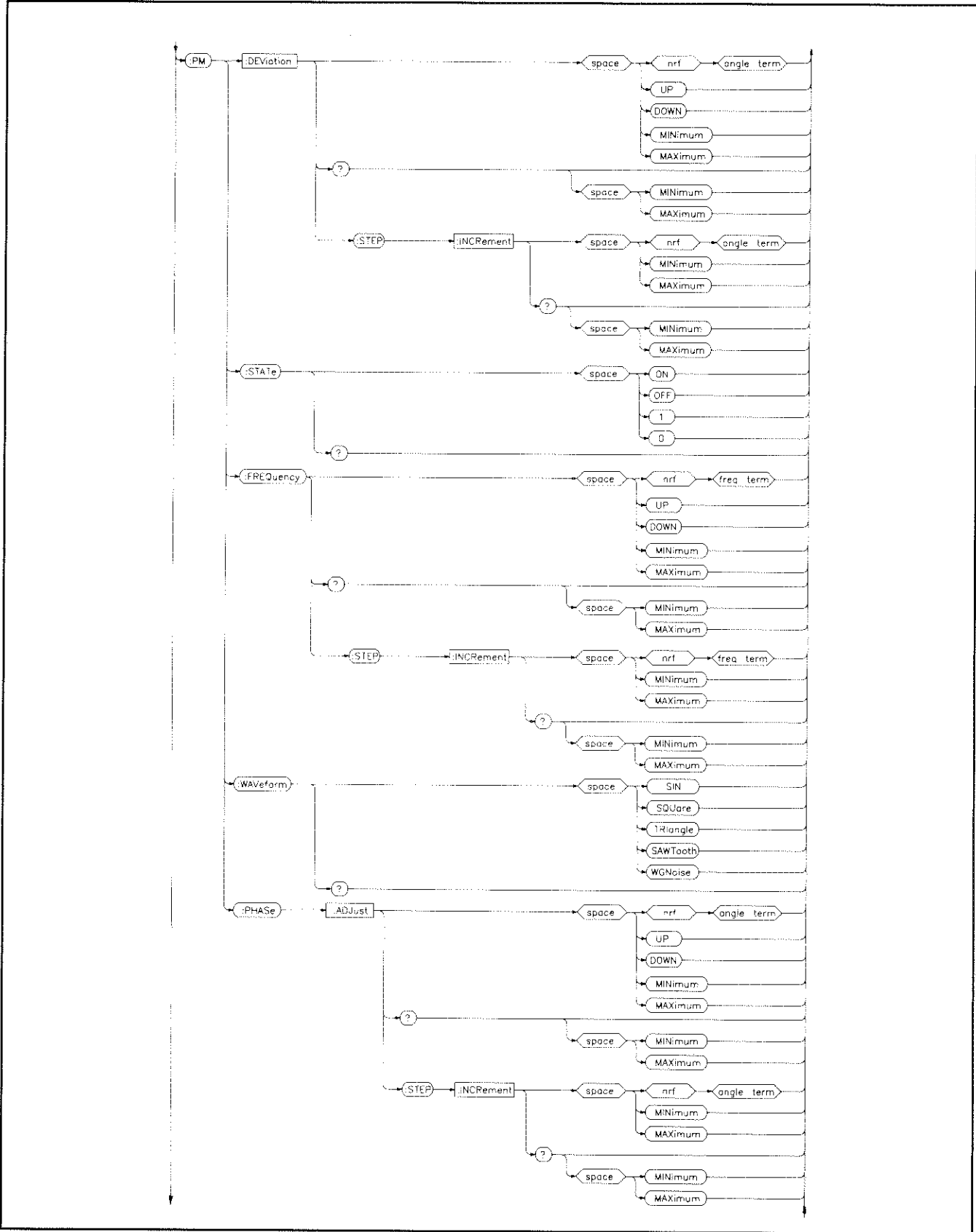

Figure E-12. LF Source Subsystem. (5 of 6)

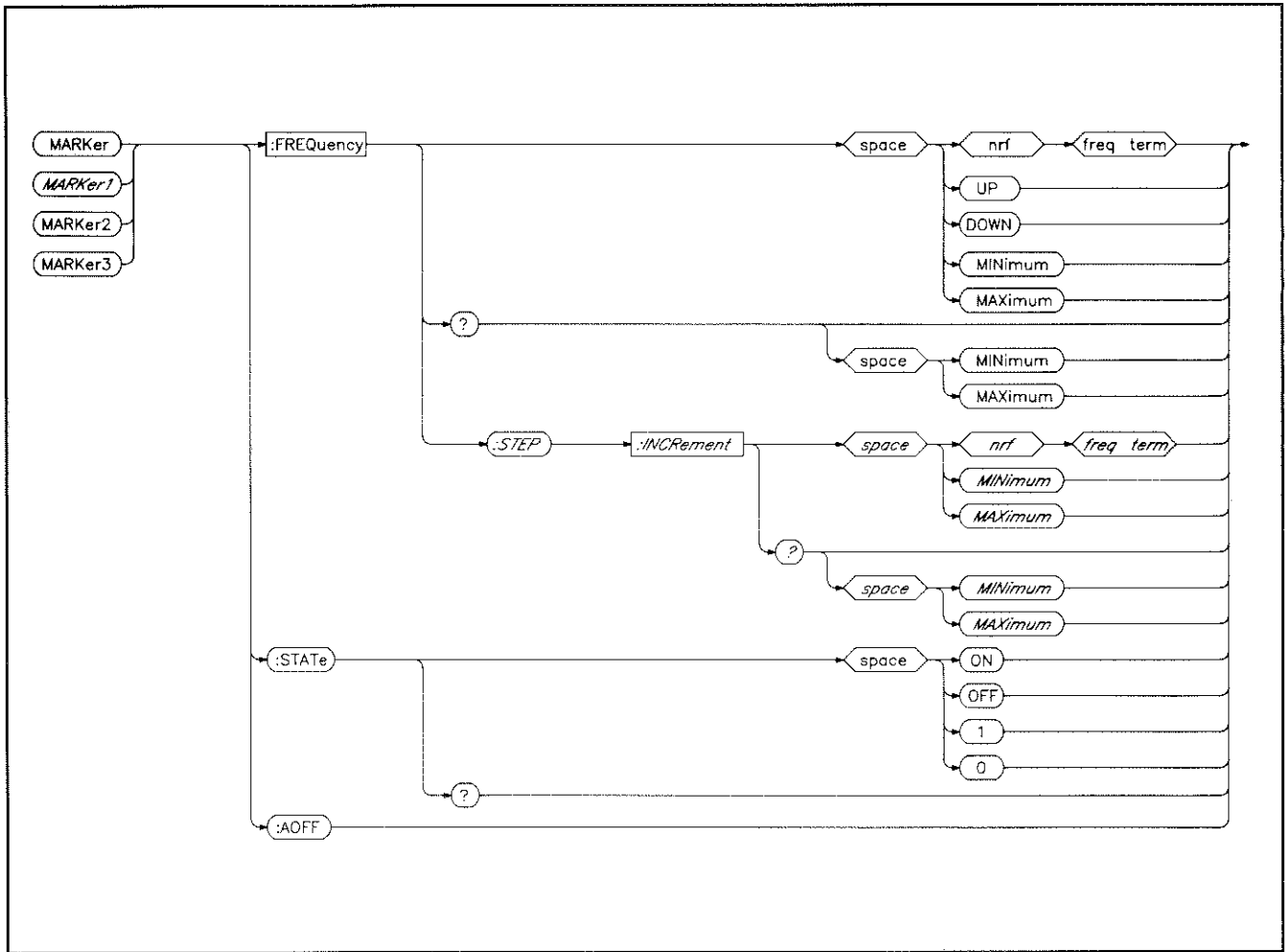

Figure E-13. Marker Subsystem.

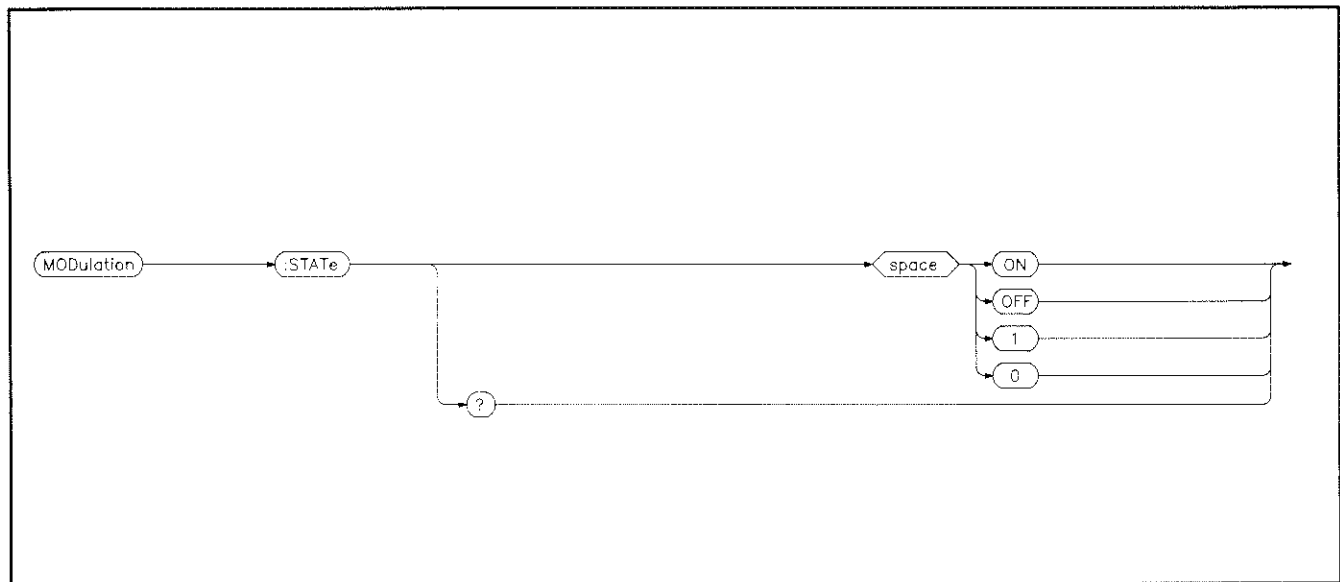

Figure E-14. Modulation Subsystem.

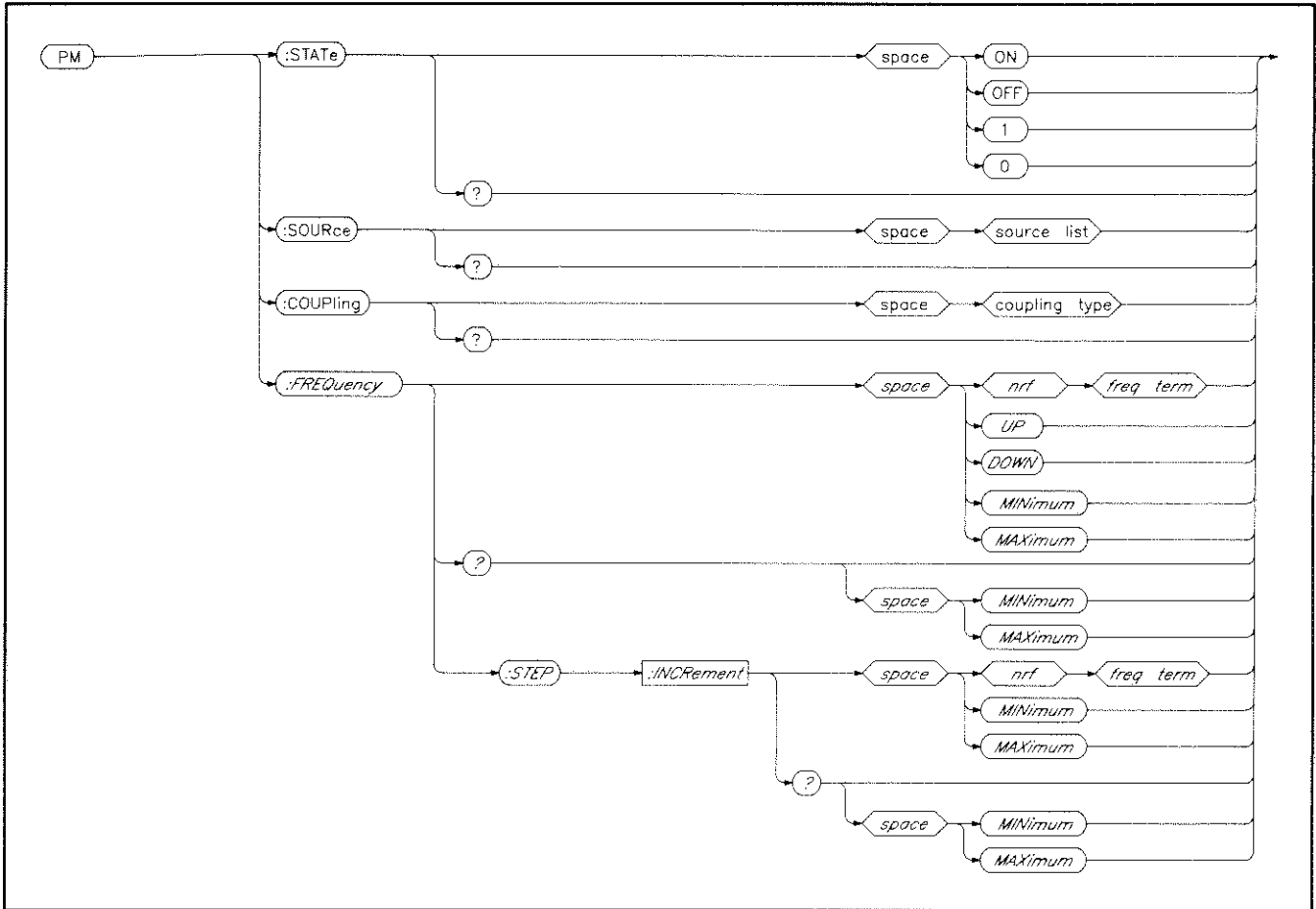

Figure E-15. Phase Modulation Subsystem.

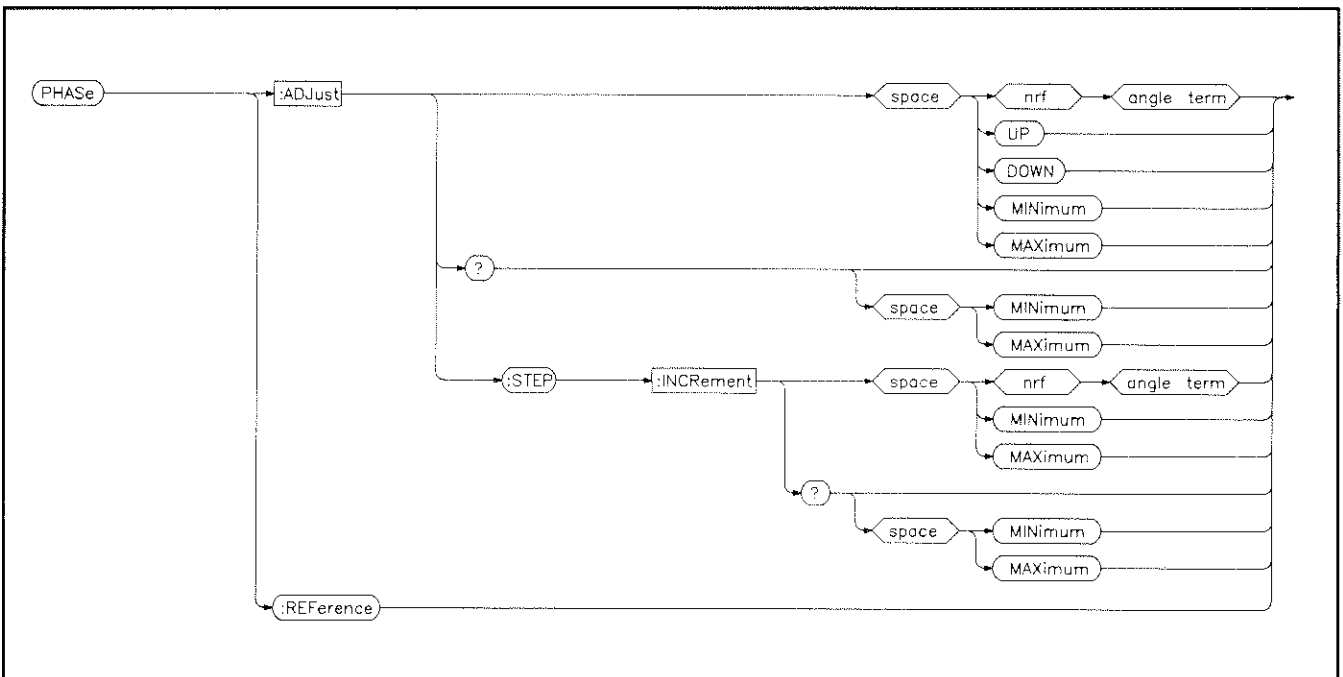

Figure E-16. Phase Subsystem.

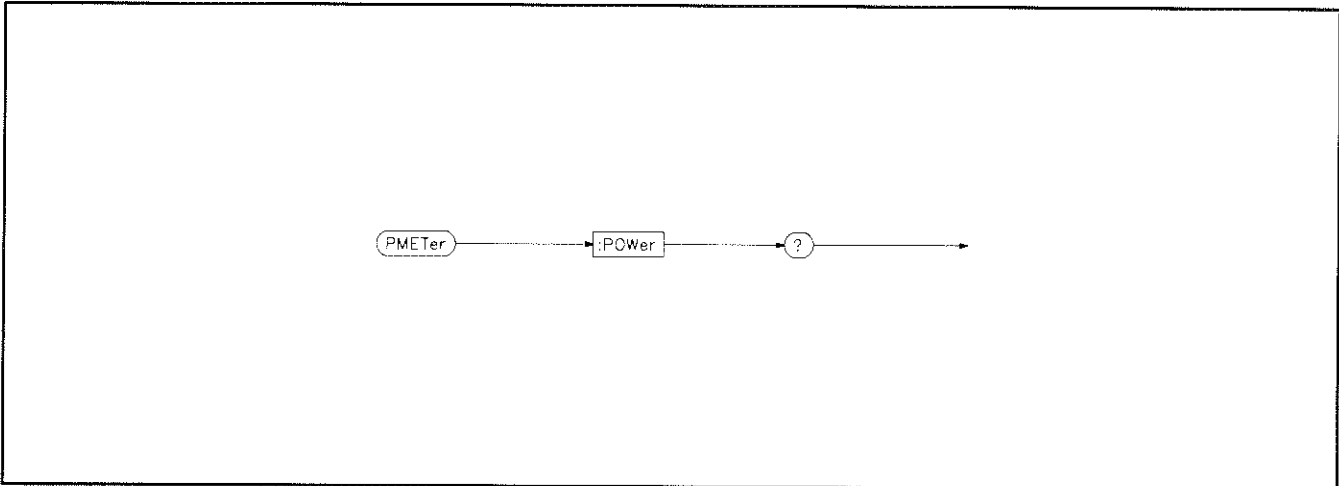

Figure E-17. Power Meter Subsystem.

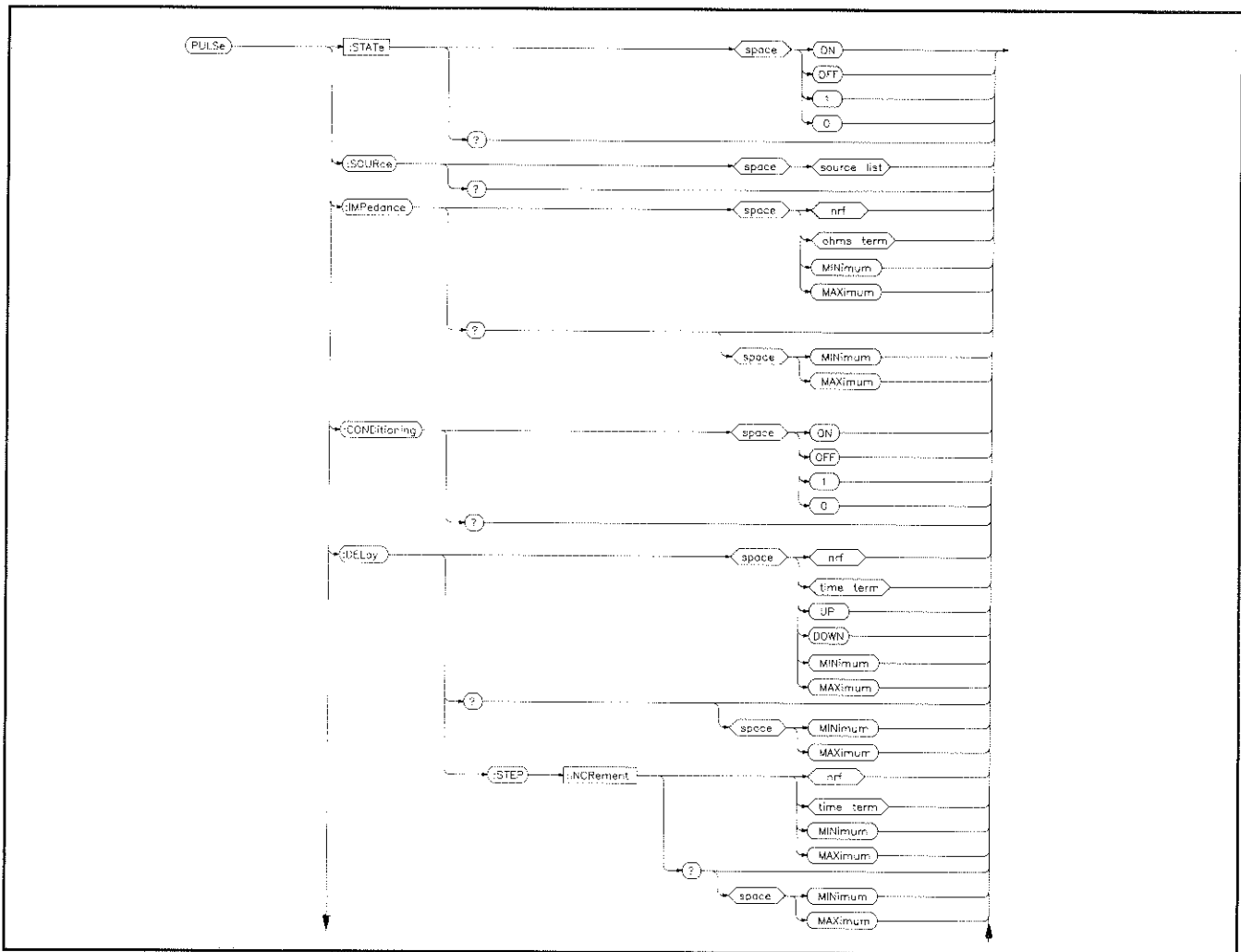

Figure E-18. Pulse Subsystem. (1 of 2)

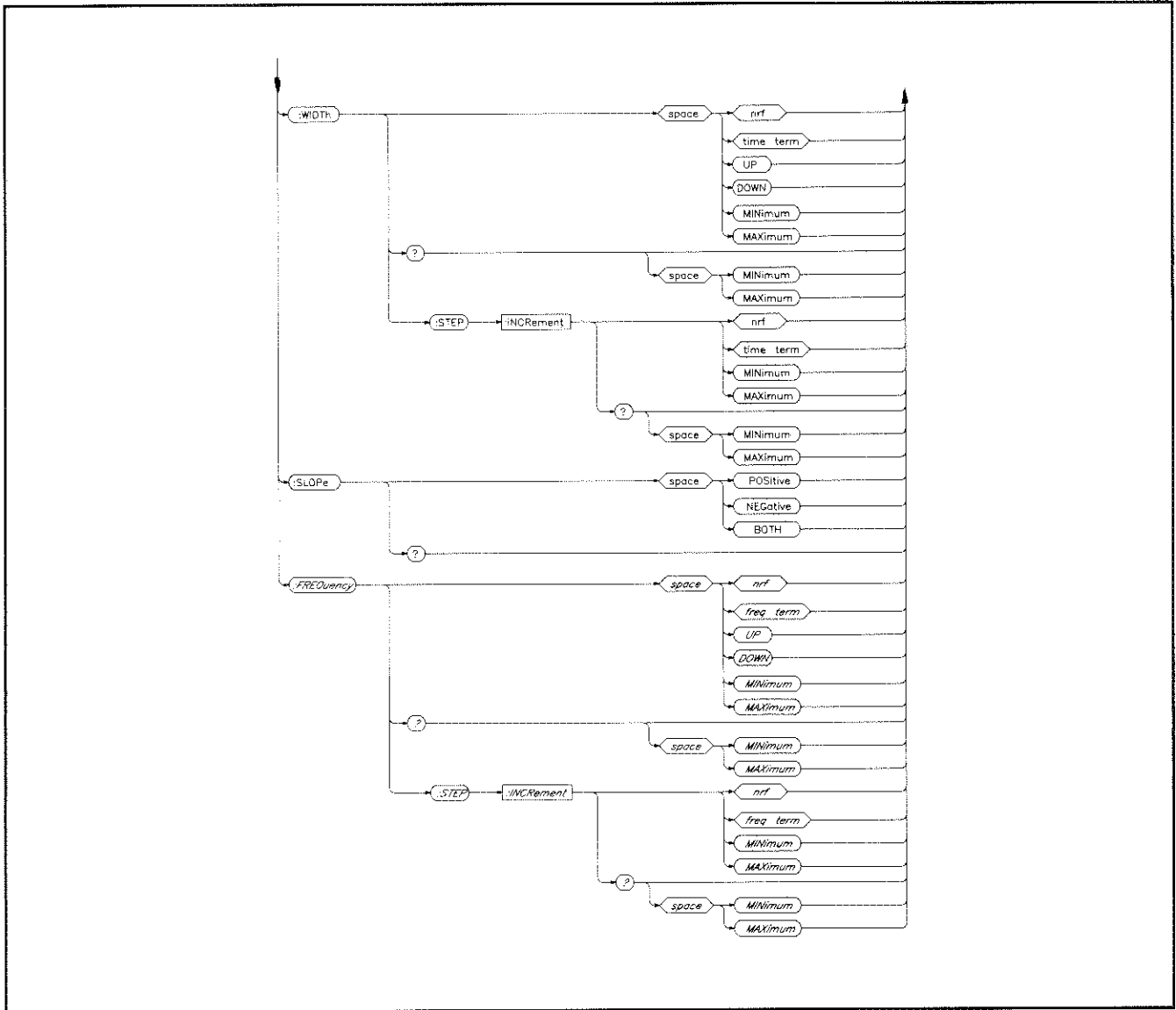

Figure E-18. Pulse Subsystem. (2 of 2)

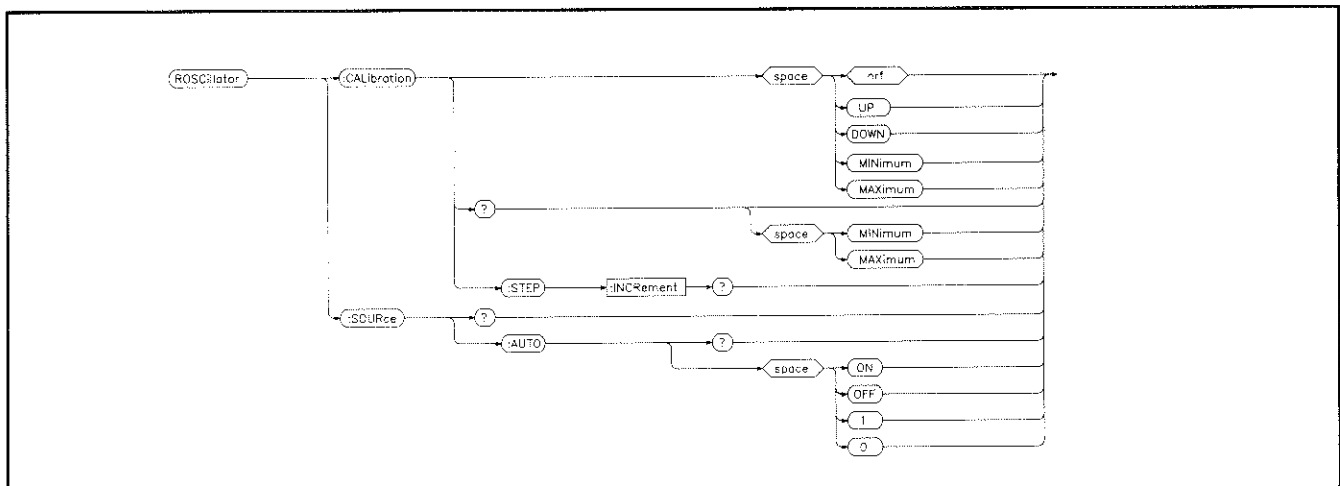

Figure E-19. Reference Oscillator Subsystem.

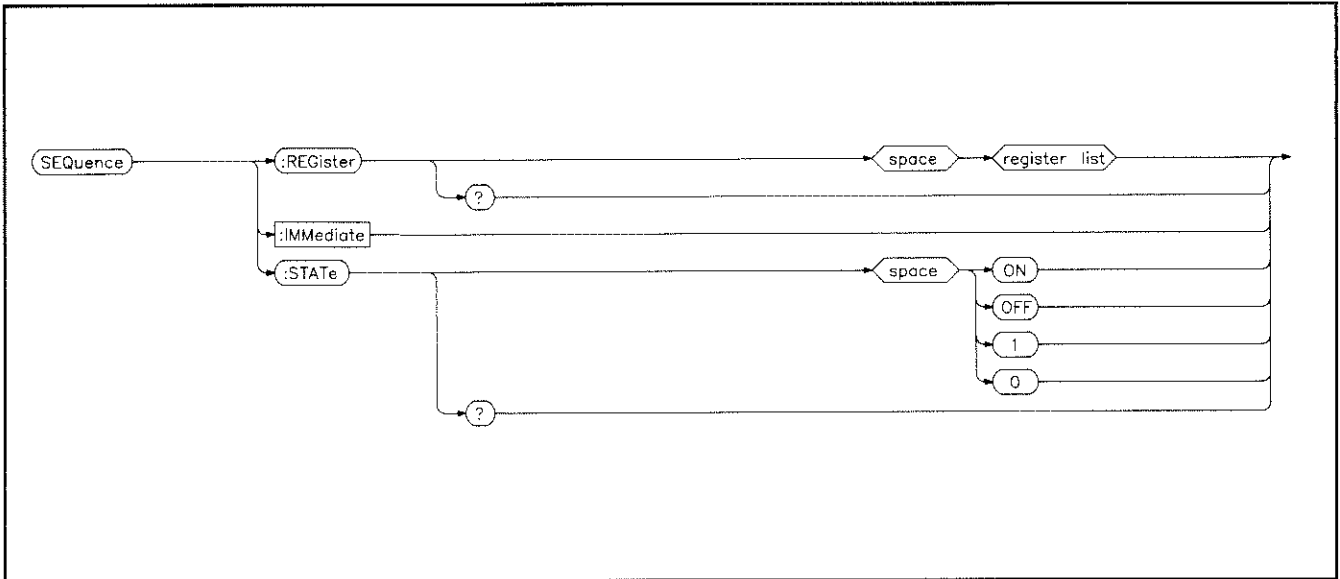

Figure E-20. Sequence Subsystem.

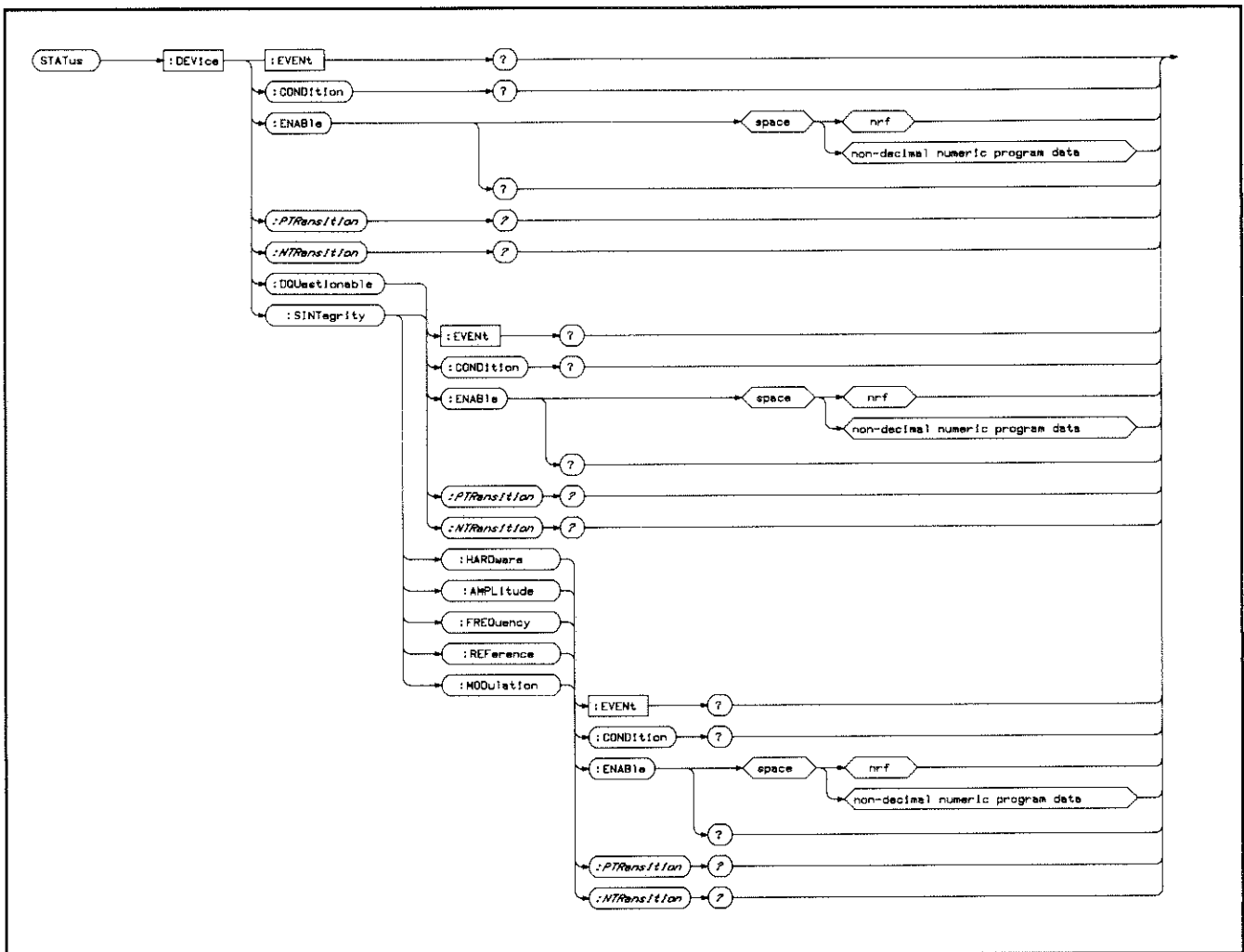

Figure E-21. Status Subsystem.

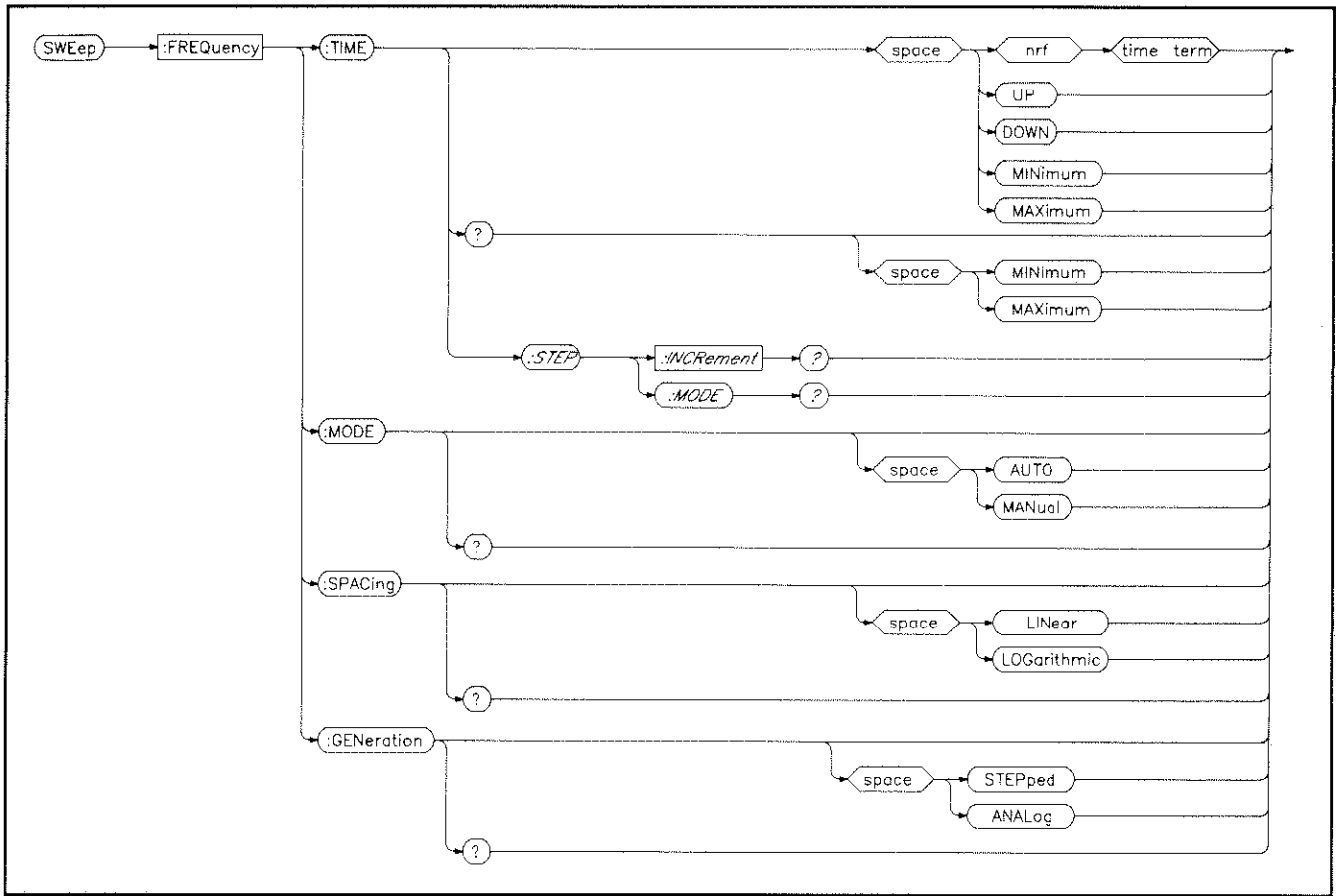

Figure E-22. Sweep Subsystem.

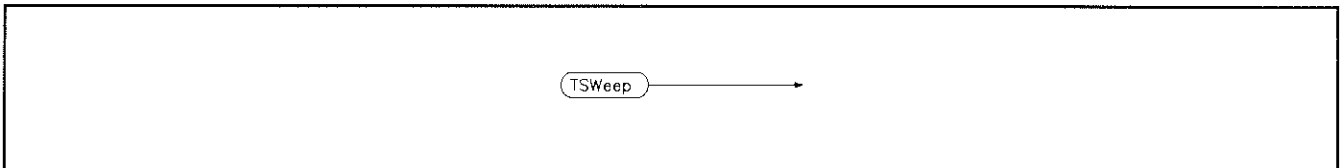

Figure E-23. Take Sweep Subsystem.

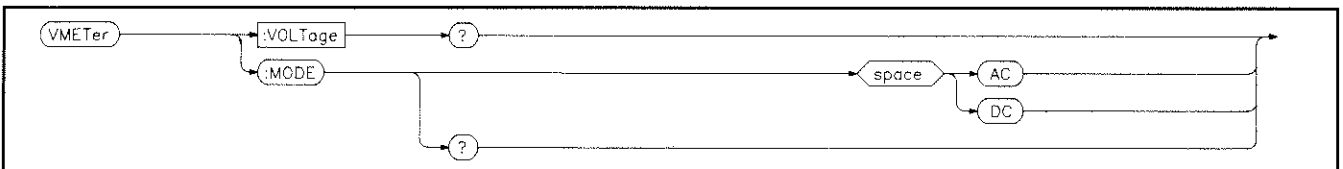

Figure E-24. Voltmeter Subsystem.

F

Synthesized Audio Oscillator

In this Appendix

This appendix describes how to use the Synthesized Audio Oscillator in the Signal Generator. The Synthesized Audio Oscillator provides multifunction synthesis capabilities allow you to generate a subcarrier from complex audio signals. The subcarrier is applied, in turn, as a modulating wave to the RF carrier signal. You will also see that the **AUDIO** connector provides access to the complex audio signals for external applications.

The Synthesized Audio Oscillator consists of two audio source channels; each may be summed together. In addition, the audio signal in one channel may be modulated with a combination of AM, FM, Φ M, or Pulse. Five fundamental waveforms are at your disposal: sine, square, triangle, sawtooth, and white Gaussian noise. Read this appendix to:

- Learn how to use the audio source as a subcarrier to modulate the RF carrier.
- Understand the multifunction synthesis capabilities by reviewing block diagrams.
- Create complex audio signals by activating Special Functions.
- Apply the multifunction synthesis feature set to your specific testing or experimental needs.

The Synthesized Audio Oscillator uses Special Functions 130 through 151 and 220 through 225. As you will see, these special functions control the multifunction synthesis for the Internal Audio Source. (A brief description of each special function is found in appendix C.)

The Directory

Use the illustration shown below as your guide for each subject in this appendix. Two choices are recommended for first time users:

1. Get some "hands on" experience by doing the *Quick Demonstration* starting on the next page.
2. Otherwise, turn to the section titled *An Explanation of the Synthesized Audio Oscillator* for specific information about the multifunction synthesis capabilities of the Signal Generator.

Refer to the section titled *Typical Applications* once you are familiar with generating complex audio signals.

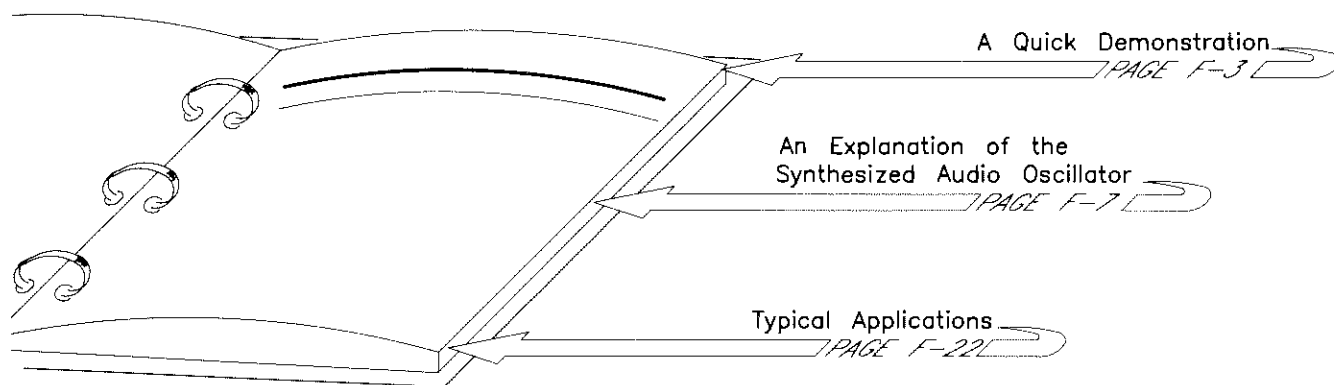

A Quick Demonstration

In the following procedure (which takes about 15 minutes), you will learn how to make the Signal Generator sum the audio source in Channel 1 with the audio source in Channel 2 to simulate dual-tone modulation on a subcarrier. The next section of this appendix *An Explanation of the Synthesized Audio Oscillator* fully describes both Channels 1 and 2.

Use an oscilloscope to observe the results of the following procedure:

Procedure to Sum Channel 1 with Channel 2.

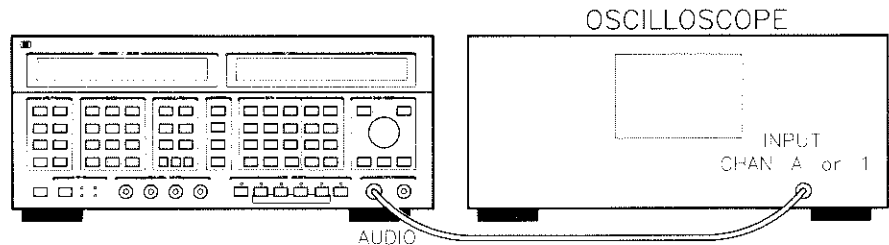

Figure F-1. Equipment Setup for the Quick Demonstration

Set Up and Adjust the Oscilloscope

1. Connect the Signal Generator to the oscilloscope as shown in figure F-1. Turn on the equipment and make the following adjustments:

On the Oscilloscope:

Volts/Div 500 mV
 Time/Div 300 μ sec

Adjust the Audio Source in Channel 1

2. Press the green INSTR PRESET key. Doing so presets the Signal Generator to a known state for the following steps.
3. Press the AUDIO FREQ key, and then the ON key. An audio frequency of 1 kHz should be displayed on the front panel.
4. Press the blue SHIFT key, and then the AUDIO LEVEL key. The Signal Generator should now show the following in the MODULATION/AMPLITUDE display:

1.000 V 1.000kHz RF OFF

AUDIO

5. Turn the knob counterclockwise to reduce the audio level to 500 mV. In a following step, the audio source in Channel 2 will also be set to 500 mV; this is because the Signal Generator cannot sum together more than 1 Vpk from both channels.

A 1 kHz sine wave 500 mV is then applied to the oscilloscope from the 600 Ω AUDIO output connector.

Adjust the Audio Source in Channel 2

6. Press the SPECIAL key, number "134", and press the ON key.
7. Adjust the audio source level in Channel 2 to be 500 mV (pk). The Signal Generator should now show the following in the FREQUENCY/STATUS display:

134:Aud2 Level 500. mV

8. Press the SPECIAL key, number "133", and press the ON key. The Signal Generator should now show the following in the FREQUENCY/STATUS display:

133:Aud2 Freq OFF

9. Press the ON key, and then adjust the audio source of Channel 2 to a frequency of 1 kHz. A 1 kHz sine wave 1 Vpk should appear on the oscilloscope display. The 1 Vpk signal is the result of Channel 1 and Channel 2 being summed together.

Observe and Modify the Results

10. Press the **SPECIAL** key, number "135", and press the **ON** key. The Signal Generator should now show the following in the **FREQUENCY/STATUS** display:

135:Aud2 Wave Sine

11. Turn the knob. For each waveform, a different composite signal appears on the oscilloscope display:

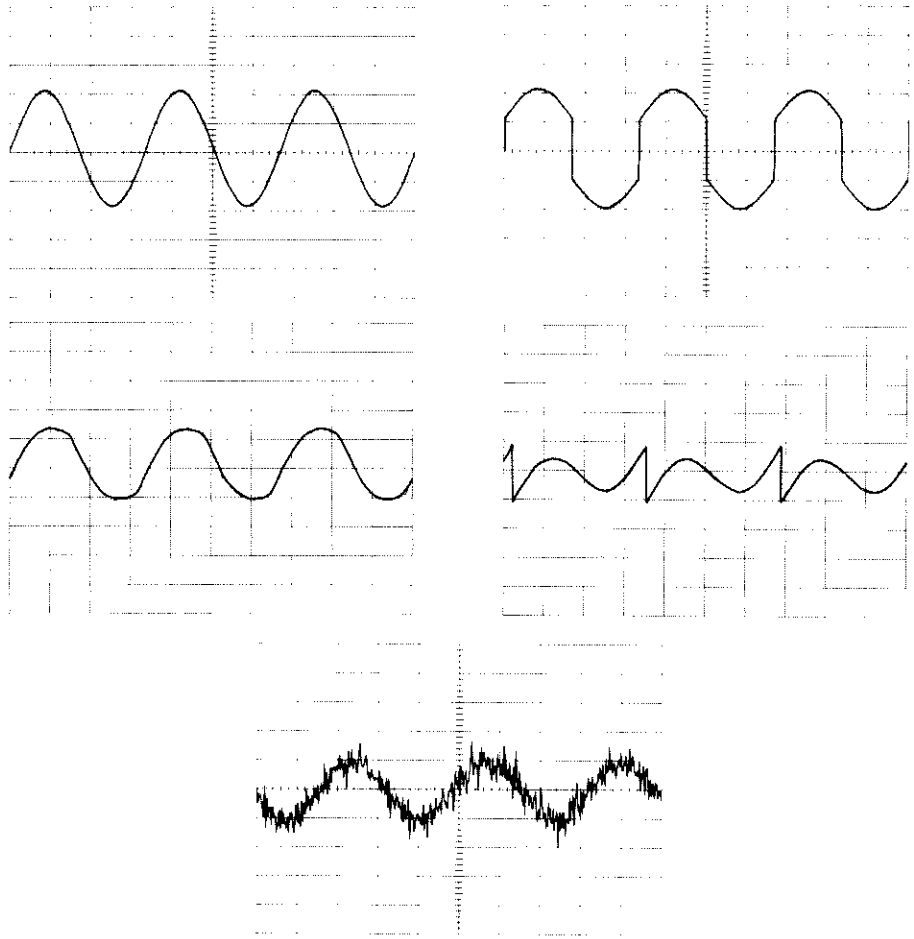
**Remember**

*The signal from the Internal Audio Source can be used to modulate the RF carrier. The same signal taken from the **AUDIO** connector may also be used for external applications (for example, on an external speaker).*

12. Turn the knob to display the sine wave on the oscilloscope.

13. Press the **SPECIAL** key, number "136", and press the **ON** key.
14. Turn the knob to adjust the audio source in Channel 2 to be +180° out of phase with the audio source in Channel 1. Notice the sine wave shown in the oscilloscope display decreases in amplitude until 0 V dc is left.
15. Press the **SPECIAL** key, number "135", and press the **ON** key. Turn the knob. For each waveform, a different composite signal appears on the oscilloscope display (the Volts/Division setting on your oscilloscope may need to be changed to get the same displays shown below):

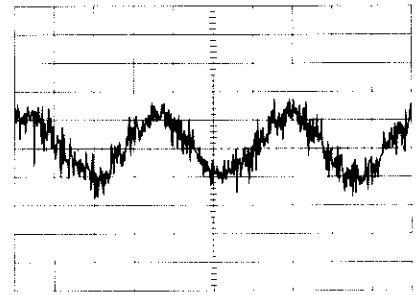
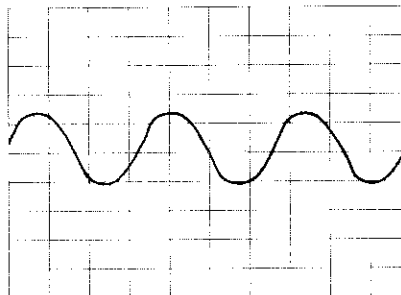
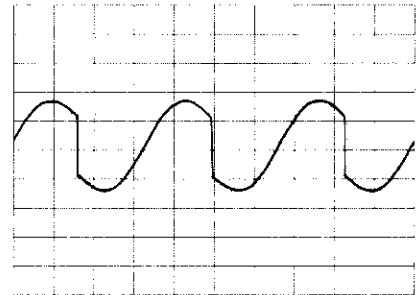
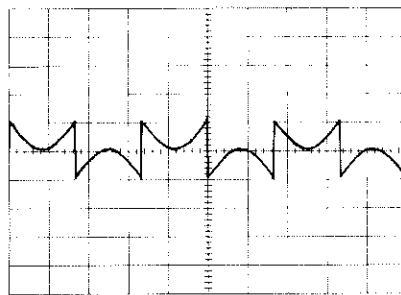

Note

The subcarrier waveforms shown above do not refer to a specific application. They are simply shown to provide you with an example of the multifunction synthesis that takes place. Refer to "Typical Applications" for specific application examples.

An Explanation of the Synthesized Audio Oscillator

If You Need to Know:	Refer to:
<ul style="list-style-type: none"> • <i>how the Internal Audio Source generates Complex audio signals</i> 	<p>Block Diagrams – An Introduction (F-8)</p>
<ul style="list-style-type: none"> • <i>how many subcarrier sources can be active at any time</i> 	<p>Subcarrier Sources – Maximum that may be Active (F-10)</p>
<ul style="list-style-type: none"> • <i>what is the maximum output voltage from the Internal Audio Source</i> 	<p>Subcarrier Sources – Maximum Voltage Levels (F-10)</p>
<ul style="list-style-type: none"> • <i>about the main audio source</i> 	<p>Audio Source: Channel 1 (F-11)</p>
<ul style="list-style-type: none"> • <i>about the second audio source</i> 	<p>Audio Source: Channel 2 (F-12)</p>
<ul style="list-style-type: none"> • <i>how to modulate the main audio source</i> 	<p>Subcarrier Modulation Sources in Channel 1 (F-14)</p>
<ul style="list-style-type: none"> • <i>how to modulate the RF carrier</i> 	<p>Modulating the RF Carrier (F-19)</p>
<ul style="list-style-type: none"> • <i>how to set increment and decrement values</i> 	<p>Increment/Decrement the Internal Audio Source (F-21)</p>
<ul style="list-style-type: none"> • <i>how to save and recall storage registers</i> 	<p>Save and Recall Settings (F-21)</p>

**Block Diagrams –
An Introduction**

The Signal Generator is depicted by the simplified block diagram shown in figure F-2. The Internal Audio Source shown in figure F-2 produces audio frequency signals from 0.1 Hz to 400 kHz. By activating Special Function 130, the audio frequency waveform may be changed; five waveforms, sine, square, triangle, sawtooth, and white Gaussian noise are available.

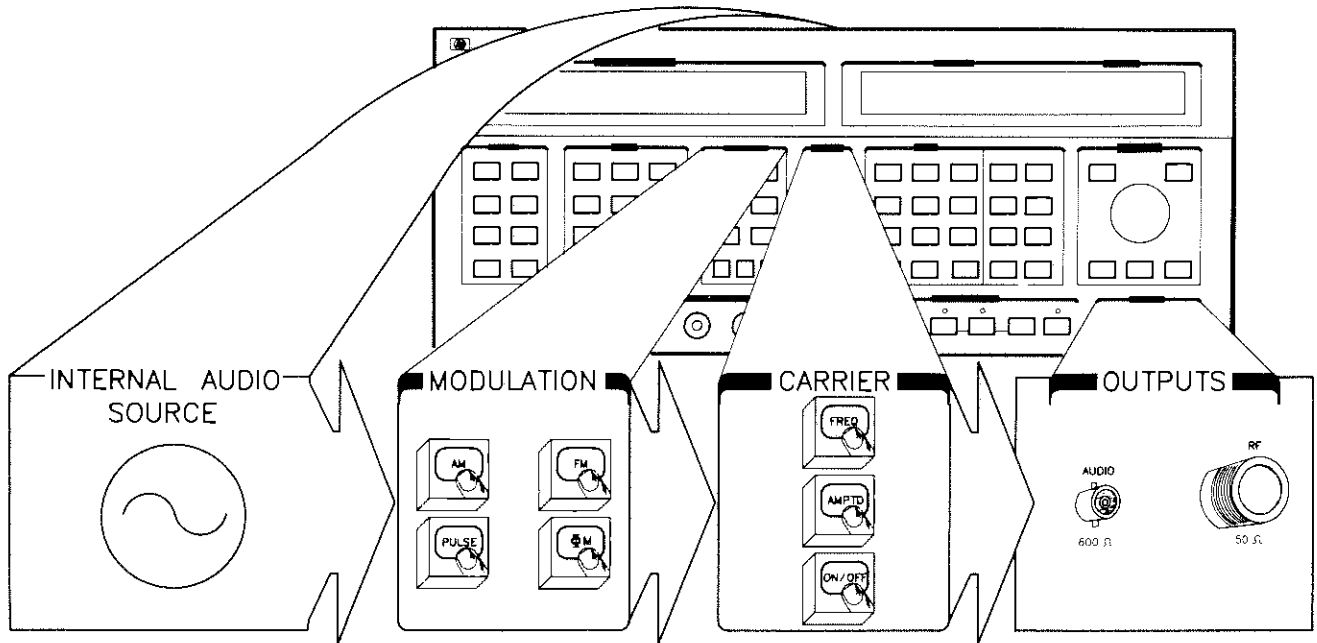

Figure F-2. Simplified Overall Block Diagram

When you use Special Functions 133-135, the Internal Audio Source becomes a two channel multifunction synthesizer as shown in figure F-3. The audio source in Channel 1 may be modulated; AM, FM, Φ M, and Pulse subcarrier modulation are available.

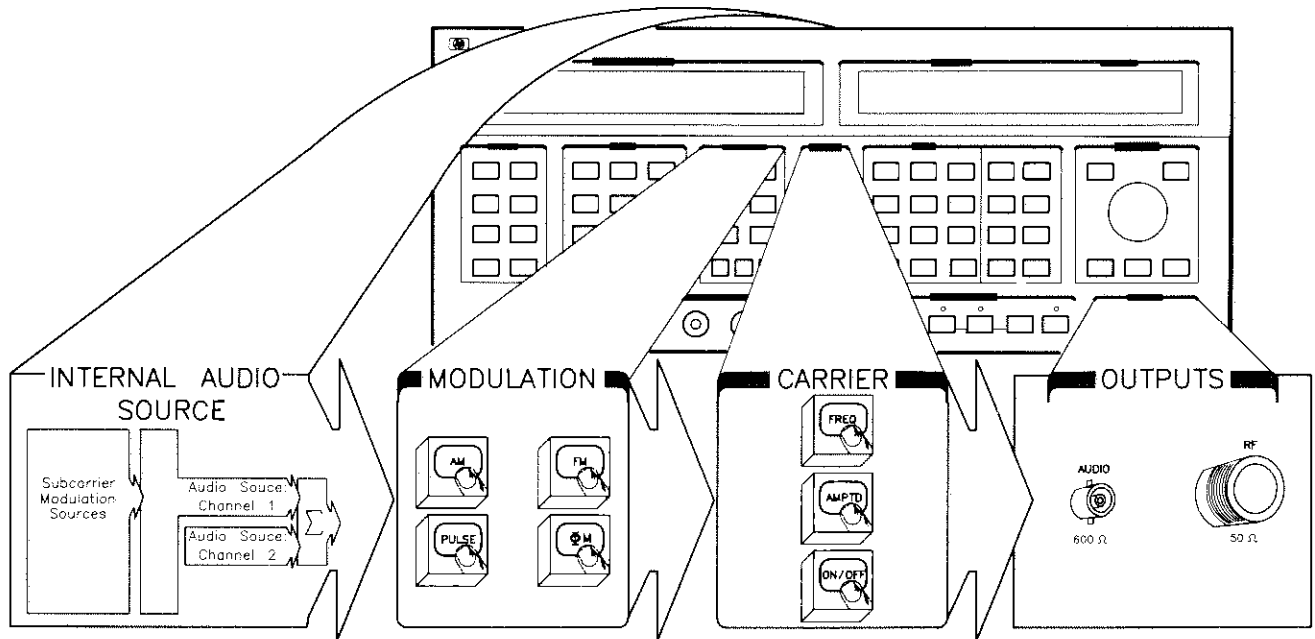
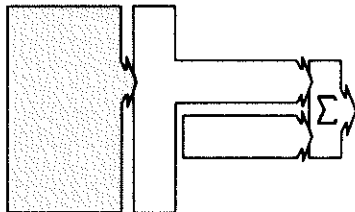

Figure F-3. The Internal Audio Source Using Special Functions 133-135

**Subcarrier Sources
– Maximum that
may be Active**



It is not permissible to turn **ON** all the subcarrier sources at once. The following rule applies to the maximum allowed **ON** at any time:

Rule: The audio source in Channel 1 may be turned **ON** in combination with any **three** other sources.

Besides the audio source in Channel 1, there are five other sources, as follows:

- Audio Source: Channel 2
- Subcarrier AM Source
- Subcarrier FM Source
- Subcarrier Φ M Source
- Subcarrier Pulse Source

Note

The error message "Too many audio sources" appears if you exceed the maximum limit described above.

**Subcarrier Sources
– Maximum
Voltage Levels**

The Internal Audio Source may have a maximum of 1 Vpk summed (Σ) together from the audio sources in Channels 1 and 2. The preset condition of the Signal Generator sets the **AUDIO LEVEL** of the audio source in Channel 1 to 1 Vpk into 600 Ω . You must reduce this level before turning **ON** any one of the other five sources.

Note

The error message "Audio level conflict" appears if you attempt to exceed the maximum summed limit of 1 Vpk for Channels 1 and 2.

*Also, the error message "Audio level/AM conflict" appears if you attempt to exceed the maximum summed limit of 1 Vpk for Channels 1 and 2 with the subcarrier AM source in Channel 1 turned **ON**.*

Audio Source: Channel 1

The *Quick Demonstration* showed that frequency, level, and on/off state are controlled by keys on the front panel; whereas, waveform is controlled only after Special Function 130 is activated. As shown in figure F-4, the audio source in Channel 1 has four parts:

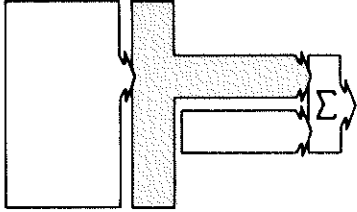

- Audio Frequency
- Audio Level
- Waveform
- On/Off State

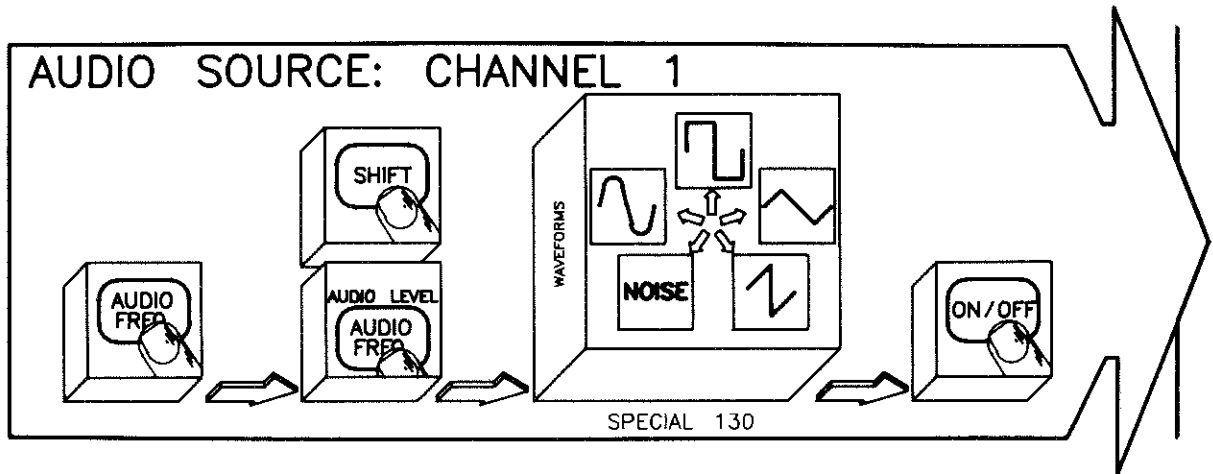

Figure F-4. Block Diagram of the Audio Source in Channel 1.

Note

The audio source in Channel 1 is the reference to which the phase of the other sources is relative to.

The audio source in Channel 1 operates within the limits shown in table F-1. You'll receive an appropriate error message if the limits are exceeded. (appendix D provides error message descriptions.)

Table F-1. Limits for the Audio Source in Channel 1.

Limits	Frequency	Level
Minimum	0.1 Hz	0 Vpk
Maximum	400 kHz*	1 Vpk
Resolution	4 digits	0.001 Vpk

* The **AUDIO** output has a typical bandwidth of 400 kHz for all waveforms. This affects complex waveforms with frequency components greater than 400 kHz.

**Audio Source:
Channel 2**

The *Quick Demonstration* showed that special functions are used to control the audio source in Channel 2. As shown in figure F-5, the audio source in Channel 2 has five parts:

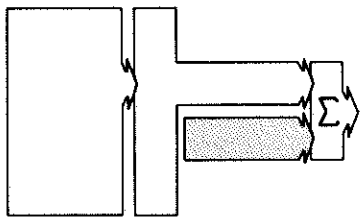

- On/Off State
- Frequency
- Level
- Waveform
- Phase

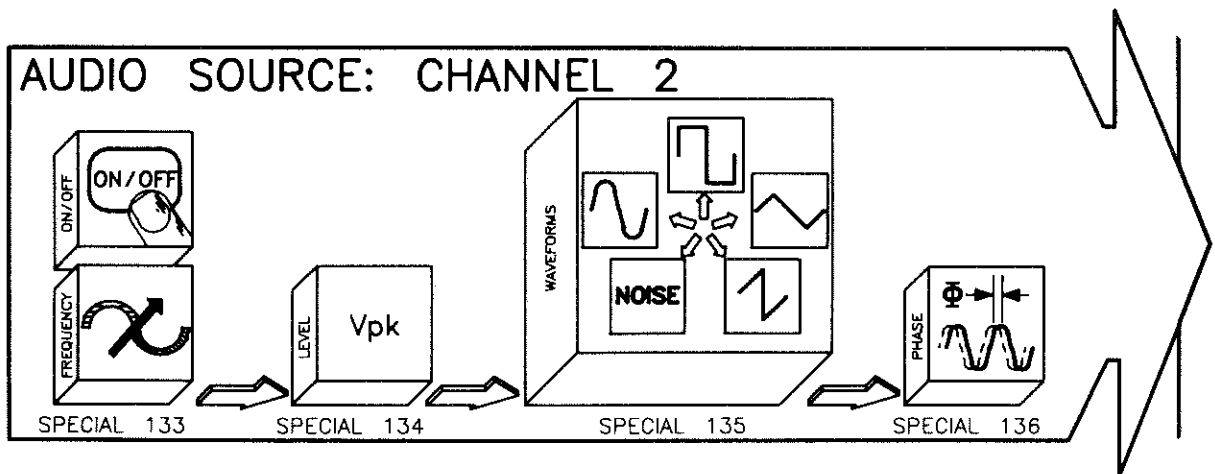

Figure F-5. Block Diagram of the Audio Source in Channel 2.

Remember

The phase of the audio source in Channel 2 is relative to the phase of the audio source in Channel 1.

The audio source in Channel 2 operates within the limits shown in table F-2. You'll receive an appropriate error message if the limits are exceeded. (Appendix D provides error message descriptions.)

Table F-2. Limits for the Audio Source in Channel 2.

Limits	Frequency	Level	Phase**
Minimum	0.1 Hz	0 Vpk	-179.9°
Maximum	400 kHz*	1 Vpk	+180°
Resolution	4 digits	0.001 Vpk	0.1°

* The **AUDIO** output has a typical bandwidth of 400 kHz for all waveforms. This affects complex waveforms with frequency components greater than 400 kHz.

** Phase may also be expressed in terms of radians by pressing the front panel **rad** key. Any entry beyond the maximum and minimum limits will be scaled. For example, entering 560° would yield -160°.

Subcarrier Modulation Sources in Channel 1

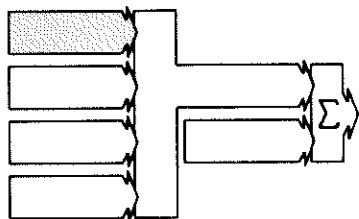

Four subcarrier sources (AM, FM, Φ M, and Pulse) are available to modulate the audio source in Channel 1. Each subcarrier modulation source may be modified to control frequency, phase, level, depth, or deviation; also, each may be turned ON and OFF.

AM Modulating the Audio Source in Channel 1.

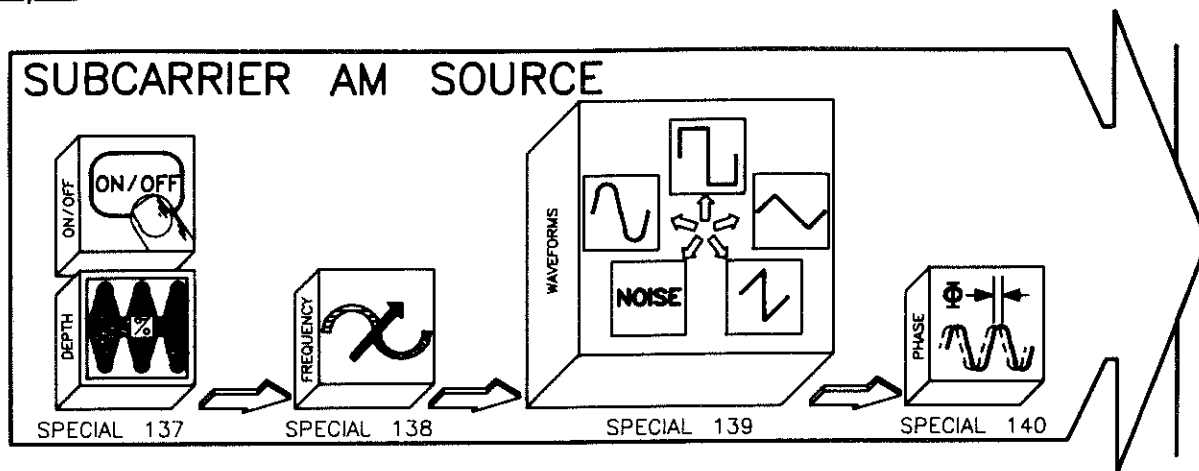

Figure F-6. Block Diagram of the Subcarrier AM Source

Remember

The phase of each subcarrier modulation source is relative to the phase of the audio source in Channel 1.

The on/off state, depth, frequency, waveform, and phase of the subcarrier AM source in Channel 1 is controlled by special functions as shown in figure F-6. The subcarrier AM source operates within the limits shown in table F-3. You'll receive an appropriate error message if the limits are exceeded. (Appendix D provides error message descriptions.)

Note

A common operator's mistake occurs when the subcarrier AM source is turned ON with the AUDIO LEVEL of the audio source in Channel 0 set to 1 Vpk (the preset condition), or to a value greater than the amount allowed for the desired AM depth. The error message Audio level/AM conflict will then appear. Simply reduce the AUDIO LEVEL to an appropriate value for the amount of subcarrier AM depth selected.

Table F-3. Limits for the Subcarrier AM Source.

Limits	Depth	Frequency	Phase**
Minimum	0 %	0.1 Hz	-179.9°
Maximum	100 %	400 kHz*	+180°
Resolution	0.1 %	4 digits	0.1°

* The AUDIO output has a typical bandwidth of 400 kHz for all waveforms. This affects complex waveforms with frequency components greater than 400 kHz.

** Phase may also be expressed in terms of radians by pressing the front panel **rad** key. Any entry beyond the maximum and minimum limits will be scaled. For example, entering 560° would yield -160°.

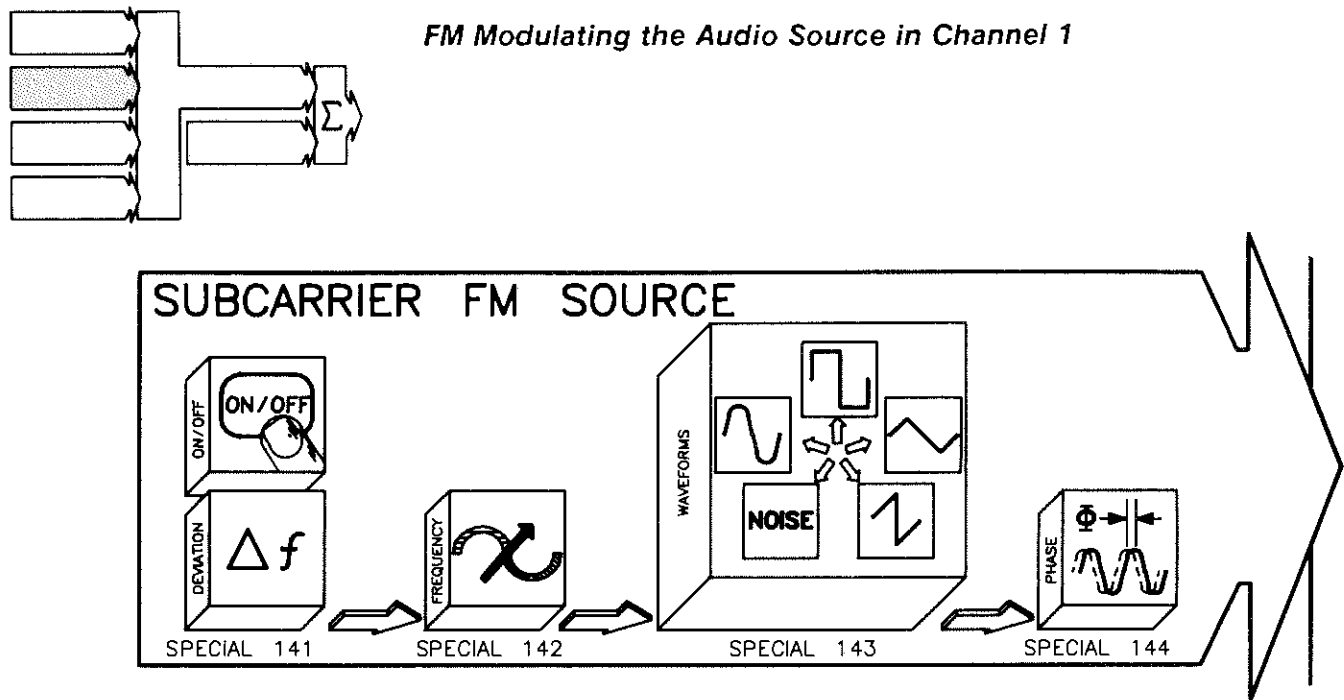

Figure F-7. Block Diagram of the Subcarrier FM Source.

The on/off state, deviation, frequency, waveform, and phase of the subcarrier FM source in Channel 1 is controlled by Special Functions as shown in figure F-7. The subcarrier FM source operates within the limits shown in table F-4. You'll receive an error message if the limits are exceeded. (Appendix D provides error message descriptions.)

Table F-4. Limits for the Subcarrier FM Source.

Limits	Deviation	Frequency	Phase**
Minimum	0 Hz	0.1 Hz	-179.9°
Maximum	400 kHz	400 kHz*	+180°
Resolution	0.001 Hz	4 digits	0.1°

* The AUDIO output has a typical bandwidth of 400 kHz for all waveforms. This affects complex waveforms with frequency components greater than 400 kHz.
 ** Phase may also be expressed in terms of radians by pressing the front panel **rad** key. Any entry beyond the maximum and minimum limits will be scaled. For example, entering 560° would yield -160°.

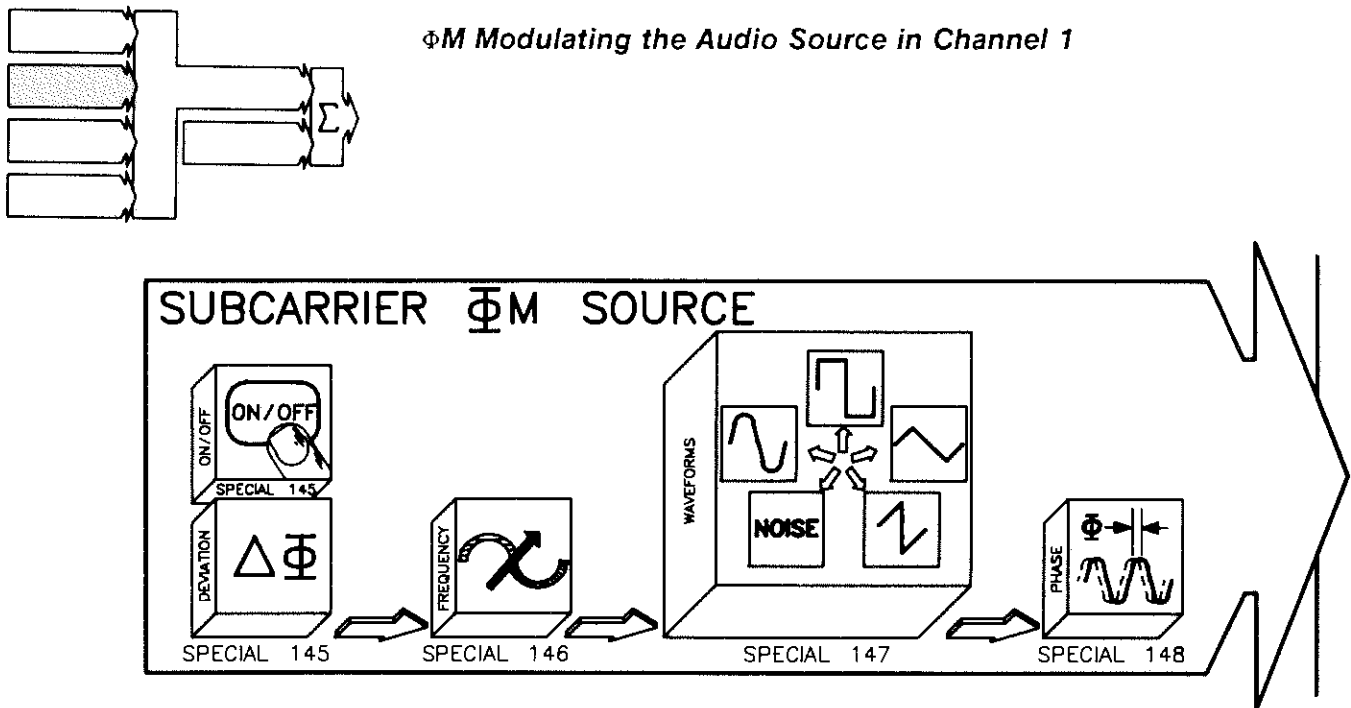

Figure F-8. Block Diagram of the Subcarrier Φ M Source.

The on/off state, deviation, frequency, waveform, and phase of the subcarrier Φ M source in Channel 1 is controlled by Special Functions as shown in figure F-8. The subcarrier Φ M source operates within the limits shown in table F-5. You'll receive an error message if the limits are exceeded. (Appendix D provides error message descriptions.)

Table F-5. Limits for the Subcarrier Φ M Source.

Limits	Deviation	Frequency	Phase**
Minimum	0°	0.1 Hz	-179.9°
Maximum	+179.9°	400 kHz*	+180°
Resolution	0.1°	4 digits	0.1°

* The **AUDIO** output has a typical bandwidth of 400 kHz for all waveforms. This affects complex waveforms with frequency components greater than 400 kHz.

** Phase may also be expressed in terms of radians by pressing the front panel **rad** key. Any entry beyond the maximum and minimum limits will be scaled. For example, entering 560° would yield -160°.

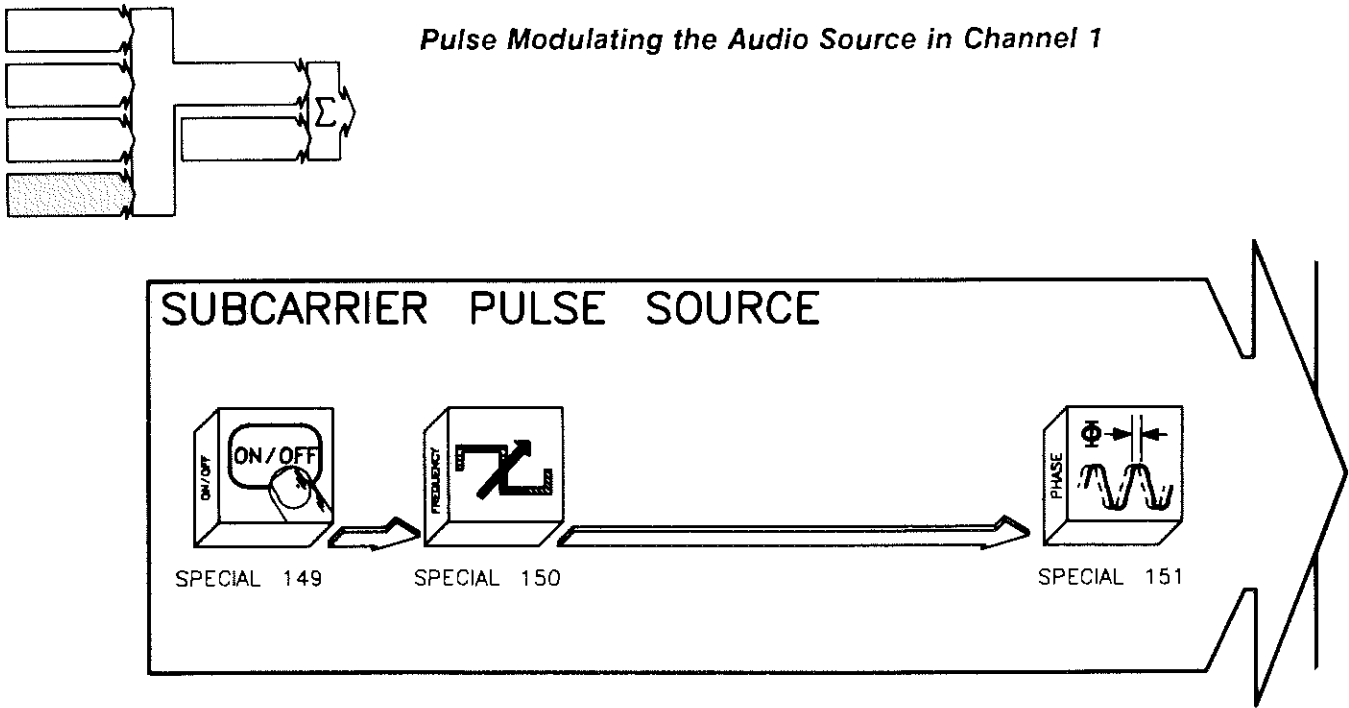

Figure F-9. Block Diagram of the Subcarrier Pulse Source.

The on/off state, frequency, and phase of the subcarrier Pulse source in Channel 1 is controlled by Special Functions as shown in figure F-9. The subcarrier Pulse source operates within the limits shown in table F-6. You'll receive an error message if the limits are exceeded. (Appendix D provides error message descriptions.)

Table F-6. Limits for the Subcarrier Pulse Source.

Limits	Frequency	Phase*
Minimum	0.1 Hz	-179.9°
Maximum	50 kHz	+180°
Resolution	4 digits	0.1°

* Phase may also be expressed in terms of radians by pressing the front panel **rad** key. Any entry beyond the maximum and minimum limits will be scaled. For example, entering 560° would yield -160°.

**Modulating
the RF Carrier**

In standard operation (no special functions active), the Audio Source on the Signal Generator provides a sinusoidal waveform with an **AUDIO LEVEL** that may be reduced from a value of 1 V (pk) to 0 V (pk). Reducing the **AUDIO LEVEL** allows you to turn **ON** the audio source in Channel 2, and to set depth for the subcarrier AM source.

As shown in figure F-10, the Signal Generator requires a 1 Vpk signal from an external audio source, and/or a 1 Vpk signal from the Internal Audio Source to provide calibrated operation when the RF carrier is being modulated. Voltage levels less than these reduce the amount of modulation on the RF carrier.

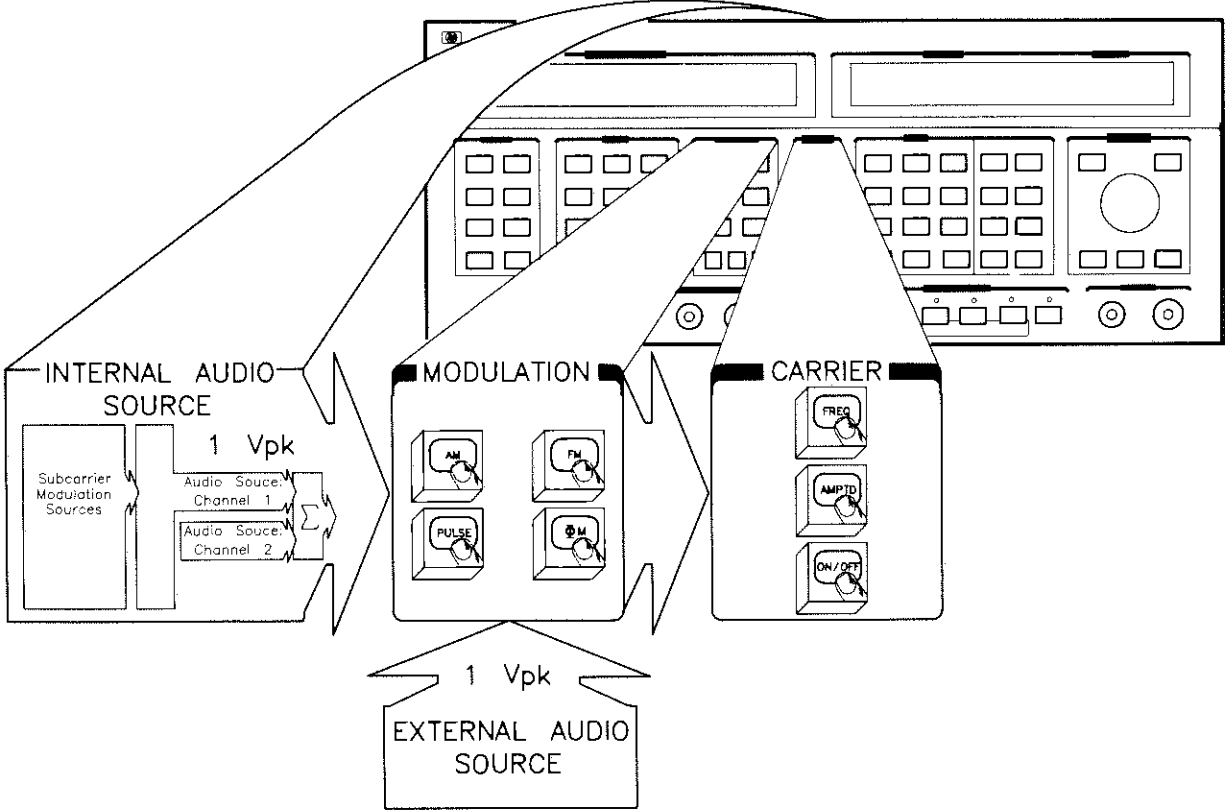

Figure F-10. Voltage Levels to Produce a Calibrated RF Output.

Internal Audio Source voltage originates from:

- Channel 1 only, or
- summing Channel 1 with any of the other subcarrier modulation sources, or
- summing Channels 1 and 2, or
- summing Channels 1 and 2 with any of the other subcarrier modulation sources.

If you use the Internal Audio Source, you can calculate the amount of modulation on the RF carrier by using the following formulas:

$$\begin{aligned}\% \text{ Depth} &= (V_{pk} \text{ from Int. Aud. Source} \bullet \text{ displayed AM depth}) \\ \text{FM Deviation} &= (V_{pk} \text{ from Int. Aud. Source} \bullet \text{ displayed FM deviation}) \\ \Phi M \text{ Deviation} &= (V_{pk} \text{ from Int. Aud. Source} \bullet \text{ displayed } \Phi M \text{ deviation})\end{aligned}$$

For example, if you FM the RF carrier with the Internal Audio Source at an audio level of 0.5 Vpk (Channel 1 only), you will get half the specified amount of deviation shown in the **MODULATION** display. However, if you also turn on the audio source in Channel 2 and set its level to 0.5 Vpk (summing Channels 1 and 2 to get 1 Vpk), the Signal Generator will output the full amount of deviation.

Audio frequency rates up to 400 kHz are allowed, which is also the typical bandwidth of the audio output circuitry. This bandwidth affects complex waveforms with frequency components greater than 400 kHz, causing waveform degradation.

When the Internal Audio Source is used, the maximum bandwidth is specified as the maximum rate (AM bandwidth is a function of the carrier frequency). Refer to the specification table in the *Calibration Manual* for maximum rates. If higher FM bandwidths are required than those specified, see Special Function 124 in appendix C.

**Increment/Decrement
the Internal
Audio Source**

The **INCR SET** key allows you to change increment and decrement values for frequency, level, phase, depth, and deviation of the Internal Audio Source. Use the following procedure:

1. **Select the special function.** For example, after an instrument preset, if Special Function 138 is active, you would then see the following in the FREQUENCY/STATUS display:

138:Aud AM Freq 100 Hz

2. **Press the INCR SET key.** With Special Function 138 active, you would see the following:

Audio Freq Incr 100 Hz

3. **Change the increment value.** If you want the Audio Frequency Increment to be 10 Hz instead of 100 Hz, simply press the **1**, **0**, and **Hz** keys. You can then verify that the new increment value is 10 Hz by pressing the **INCR SET** key once again.

Increment values can have a global affect. In the previous example, the new increment value of 10 Hz for Special Function 138 would be effective whenever frequency is incremented or decremented for any audio source. Increment values for phase exhibit the same global affect in the Internal Audio Source.

**Save and
Recall Settings**

The Signal Generator has 50 available storage registers. The first 10, Registers 0-9, accept all front panel settings for Special Functions 133-151. The remaining 40, Registers 10-49, accepts only RF frequency and output amplitude settings.

Performing an Instrument Preset, or unplugging the Signal Generator does not alter the contents of the 50 storage registers.

Typical Applications

The multifunction synthesis capabilities of the Signal Generator creates complex signals for:

1. VHF omnidirectional range (VOR),
 2. ILS two-tone signaling,
 3. dual-tone modulation,
 4. audio-tone sweep,
 5. AM radio testing,
 6. amplitude sweep,
 7. modem testing,
 8. AM noise generation,
- and more...

The following collection of waveforms present a sample of the many different waveforms possible using the Signal Generator. The collection is intended to give you an indication of the capabilities of the instrument and to stimulate ideas for creating other waveforms. In most cases, the waveforms may be altered to match your specific application by changing frequency, phase, waveforms, or their amplitudes.

Each waveform in the collection is numerically organized by the list shown above. Use the foldout in figure F-11, and the list of special functions in table F-7 to assist you in generating waveforms with your Signal Generator.

Note

*Waveforms in the collection are output at the **AUDIO** connector (600 Ω), and viewed on an oscilloscope. If the waveform is designated as being applied to an RF carrier, the display is output from the **RF OUTPUT** connector, and viewed on a spectrum analyzer.*

Table F-7 Special Functions 130 to 151

SPECIAL FUNCTIONS						
Number	Name (Abbreviated)	Limits		Number	Name (Abbreviated)	Limits
130	Audio Wave	5 Waveforms		141	Aud FM Dev	0 Hz to 400 kHz
131	Audio Triggered	ON/OFF		142	Aud FM Freq	0.1 Hz to 400 kHz
132	Trig Audio	Press ON		143	Aud FM Wave	5 Waveforms
133	Aud2 Freq	0.1 Hz to 400 kHz		144	Aud FM Φ	* -179.9° to $+180^\circ$
134	Aud2 Level	0 V to 1 V		145	Aud Φ M Dev	0° to $+179.9^\circ$
135	Aud2 Wave	5 Waveforms		146	Aud Φ M Freq	0.1 Hz to 400 kHz
136	Aud2 Φ	* -179.9° to $+180^\circ$		147	Aud Φ M Wave	5 Waveforms
137	Aud AM Depth	0 to 100%		148	Aud Φ M Φ	* -179.9° to $+180^\circ$
138	Aud AM Freq	0.1 Hz to 400 kHz		149	Aud Pulse	ON/OFF
139	Aud AM Wave	5 Waveforms		150	Aud Pulse Freq	0.1 Hz to 50 kHz
140	Aud AM Φ	* -179.9° to $+180^\circ$		151	Aud Pulse Φ	* -179.9° to $+180^\circ$

* Phase may also be expressed in terms of radians by pressing the front panel **rad** key. Any entry beyond these limits will be scaled. For example, entering 560° would yield -160° .

No. 1. Signal Generator Synthesized Audio Oscillator Waveform

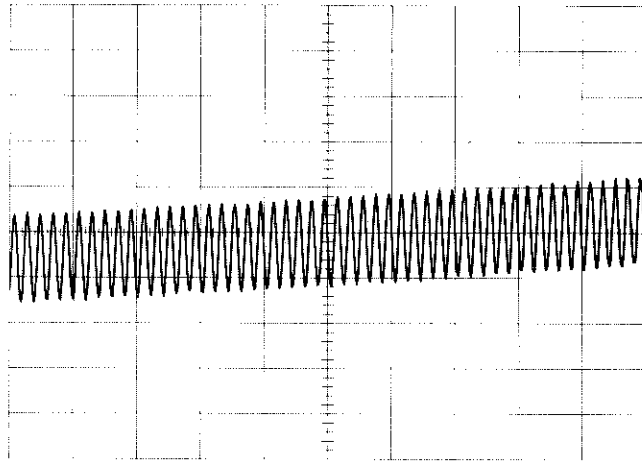

Waveform Name/Description: VHF omnidirectional range (VOR) composite signal.

Waveform Application: Avionics receiver test and metrology for VOR test equipment.

Instrument Settings

Source	Frequency	Phase	Waveform	Amplitude	Deviation
Audio-Channel 1	9960 Hz	0°	Sine	0.5 V	-
Audio-Channel 2	30 Hz	0°	Sine	0.5 V	-
Subcarrier FM	30 Hz	0° ⁽¹⁾	Sine	-	480 Hz

⁽¹⁾ The phase of the FM Source sets the bearing direction.

Waveform Applied to an RF Carrier: The RF carrier has AM at a 90% depth.

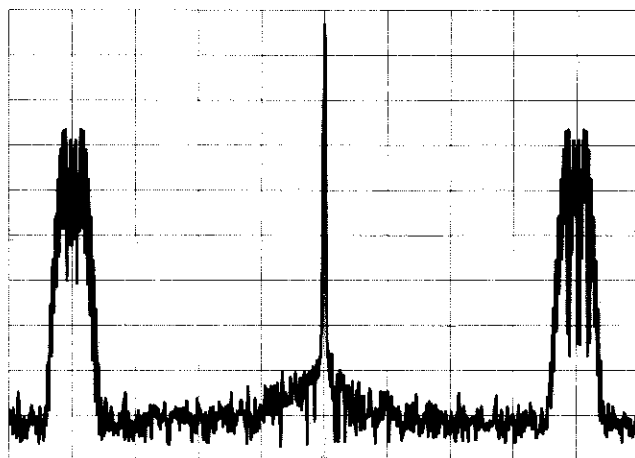

No. 2. Signal Generator Synthesized Audio Oscillator Waveform

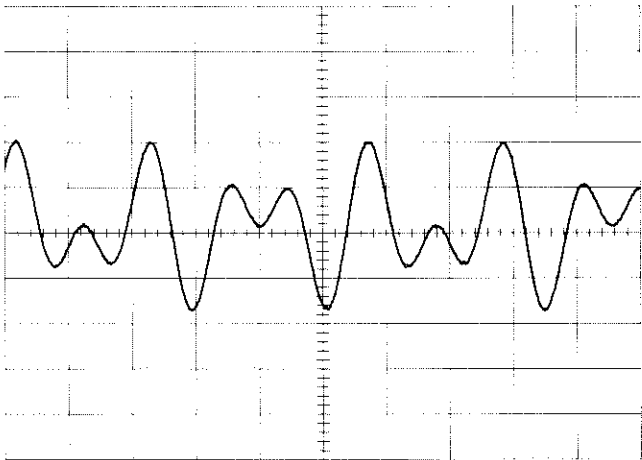

Waveform Name/Description: ILS two-tone composite signal.

Waveform Application: ILS receiver testing.

Instrument Settings

Source	Frequency	Phase	Waveform	Amplitude
Audio-Channel 1	90 Hz	0°	Sine	0.5 V
Audio-Channel 2	150 Hz	0°	Sine	0.5 V
Comments: Difference in depth of modulation is set by the relative amplitudes of Channels 1 & 2.				

Waveform Applied to an RF Carrier: The RF carrier has AM at a 50% depth.

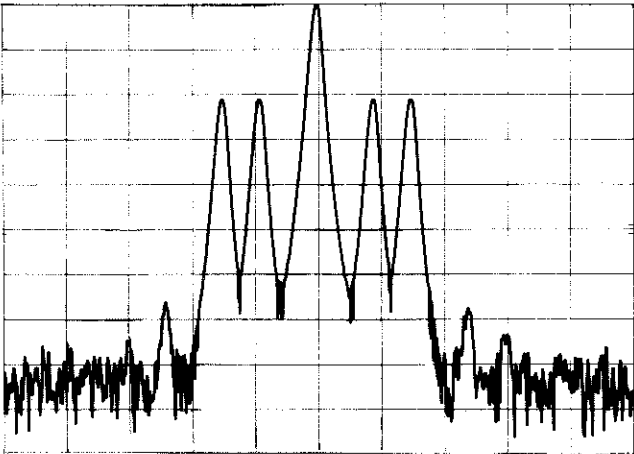

No. 3. Signal Generator Synthesized Audio Oscillator Waveform

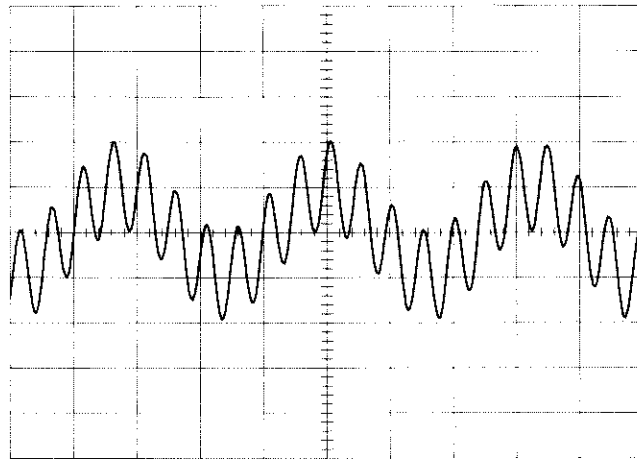

Waveform Name/Description: Dual-tone modulation.

Waveform Application: Sub-audible squelch testing, pocket pagers.

Instrument Settings

Source	Frequency	Phase	Waveform	Amplitude
Audio-Channel 1	1 kHz	0°	Sine	0.5 V
Audio-Channel 2	150 Hz	0°	Sine	0.5 V

Waveform Applied to an RF Carrier: The RF carrier has AM at a 50% depth.

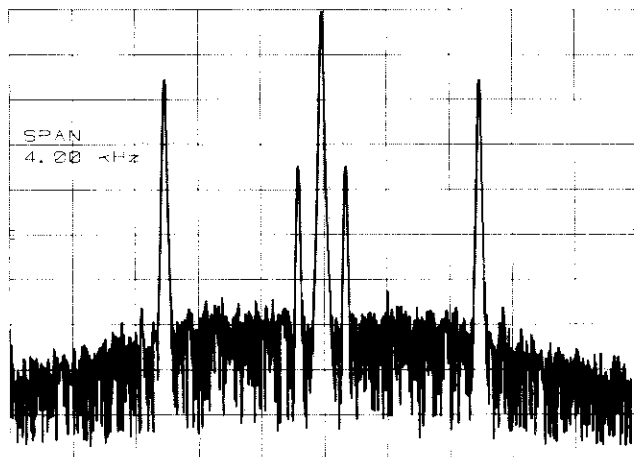

No. 4. Signal Generator Synthesized Audio Oscillator Waveform

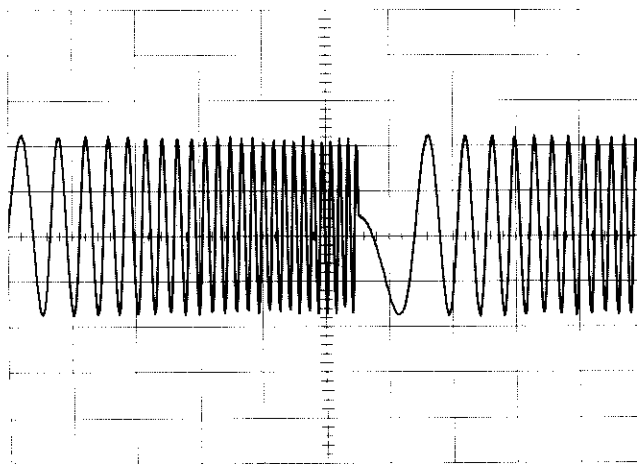

Waveform Name/Description: Audio-tone sweep.

Waveform Application: Audio response of FM receiver.

Instrument Settings

Source	Frequency	Phase	Waveform	Amplitude	Deviation
Audio-Channel 1	2.5 kHz	0°	Sine	1 V	-
Subcarrier FM	150 Hz ⁽¹⁾	0°	Sawtooth	-	2.5 kHz

⁽¹⁾ Change the FM Source frequency to vary rate for the audio-tone sweep.

No. 5. Signal Generator Synthesized Audio Oscillator Waveform

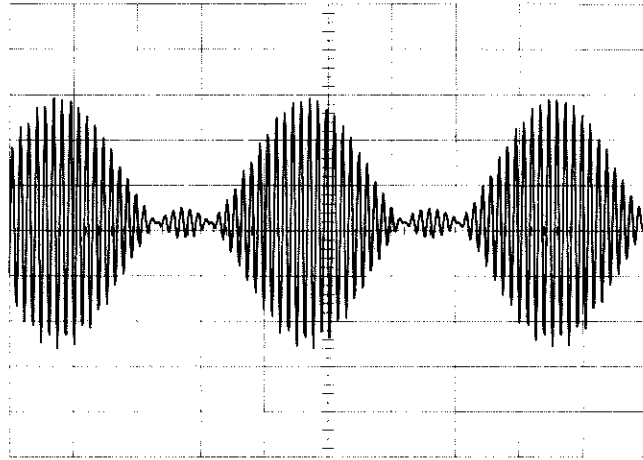

Waveform Name/Description: AM signal with over 100% negative peak modulation.

Waveform Application: AM radio testing.

Instrument Settings

Source	Frequency	Phase	Waveform	Amplitude	Depth
Audio-Channel 1	50 kHz	0°	Sine	450 mV	-
Audio-Channel 2	50 kHz	180°	Sine	100 mV	-
Subcarrier AM	1 kHz	0°	Sine	-	100%

Comments: A 180° phase inversion of the carrier occurs at the trough of the modulating waveform.

No. 6. Signal Generator Synthesized Audio Oscillator Waveform

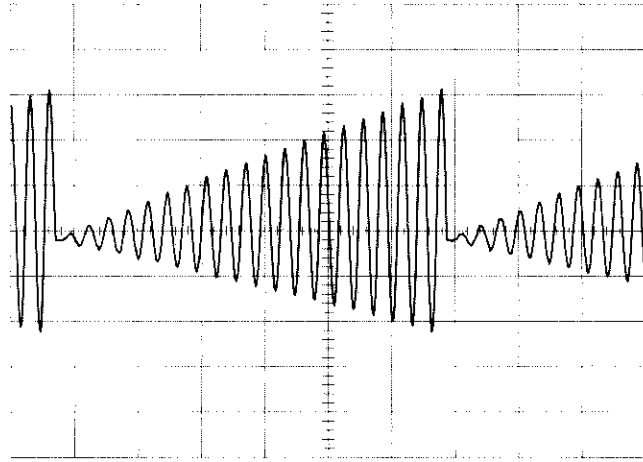

Waveform Name/Description: Amplitude sweeps.

Waveform Application: Receiver testing.

Instrument Settings

Source	Frequency	Phase	Waveform	Amplitude	Depth
Audio-Channel 1	1 kHz	0°	Sine	500 mV	-
Subcarrier AM	50 Hz	0°	Sawtooth	-	100%

No. 7. Signal Generator Synthesized Audio Oscillator Waveform

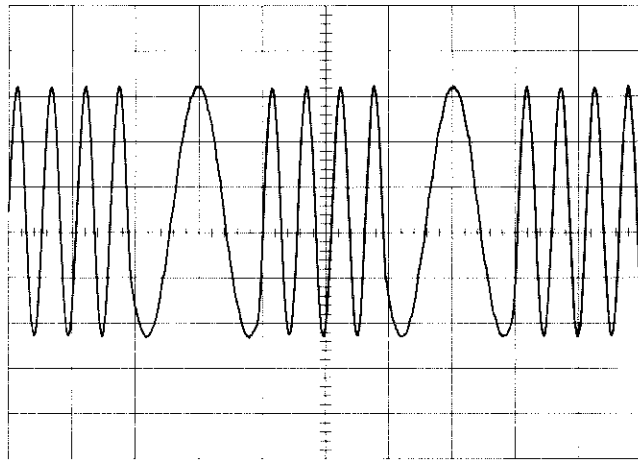

Waveform Name/Description: Two-tone FSK with 50% duty cycle.

Waveform Application: Modem testing.

Instrument Settings

Source	Frequency	Phase	Waveform	Amplitude	Deviation
Audio-Channel 1	10 kHz	0°	Sine	1 V	-
Subcarrier FM	2 kHz	0°	Square	-	5 kHz

Comments: The frequencies of the two tones are the frequency of Audio-Channel 1 plus or minus the amplitude of the FM Source. The data rate is set by the frequency of the FM Source.

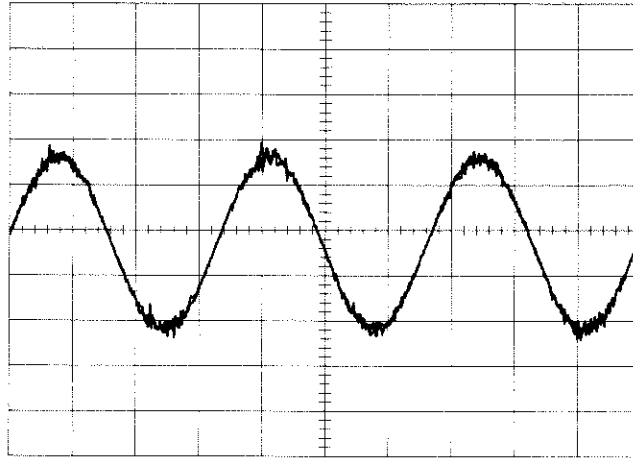
No. 8. Signal Generator Synthesized Audio Oscillator Waveform

Waveform Name/Description: Sine wave with AM noise.

Waveform Application: Receiver rejection of AM noise.

Instrument Settings

Source	Frequency	Phase	Waveform	Amplitude
Audio-Channel 1	1 kHz	0°	Sine	800 mV
Subcarrier AM	100 Hz	0°	Noise	20%

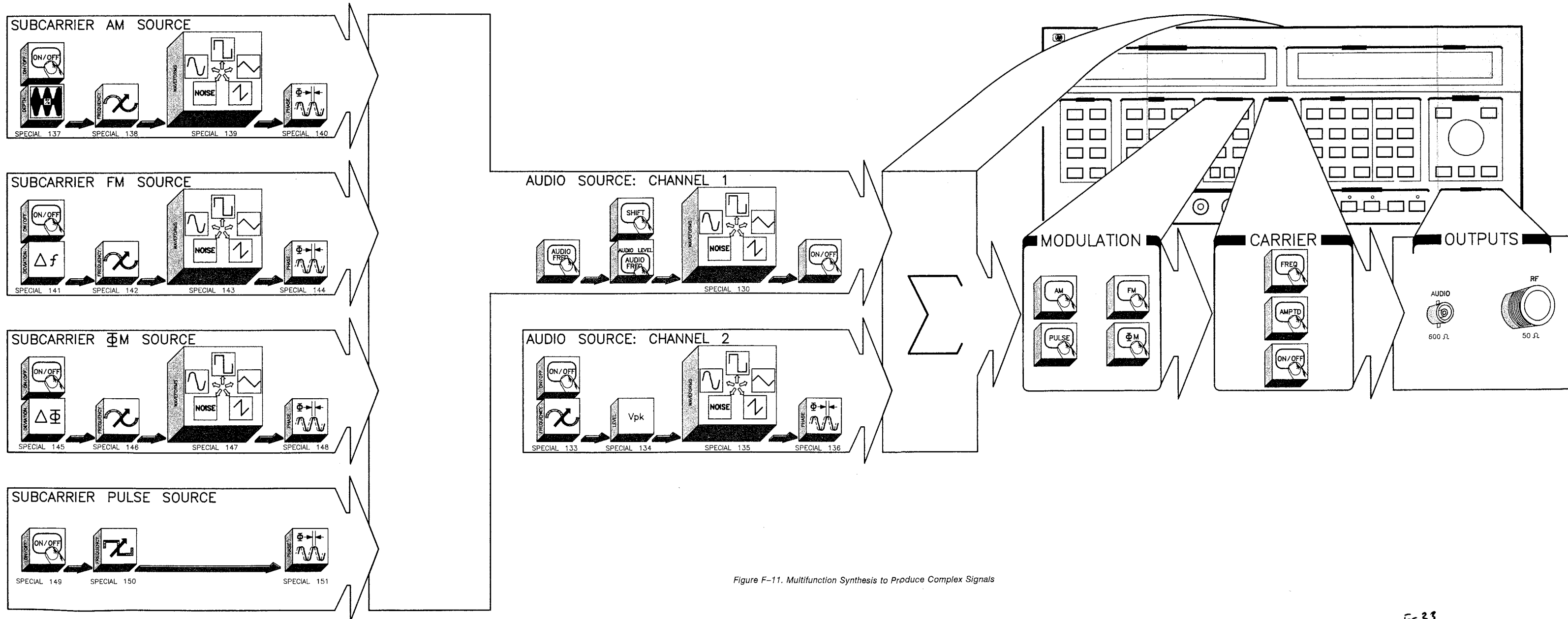

Figure F-11. Multifunction Synthesis to Produce Complex Signals

G

Miscellaneous Operating Features

Everything Else You Need to Know

The chapters and appendixes in this *Operation Guide* have provided you with operating information for most of your needs. This appendix describes the operating features that include everything else you need to know to operate the Signal Generator.

The miscellaneous operating features are alphabetically arranged. A table of contents for each feature is as follows:

Table of Contents

Amplitude Offset	G-2
Auto Sequence	G-2
Clear All	G-2
Display	G-3
EMF	G-4
Frequency Offset	G-4
Knob Hold	G-5
Knob Increment	G-5
Phase Decrement	G-6
Phase Increment	G-6
Sequence	G-6
Set Sequence	G-6

Amplitude Offset

The **CARRIER AMPTD OFS** key allows you to change the output amplitude displayed on the front panel by a value ranging from +50 dB to -50 dB without changing the actual output amplitude value. Press the blue **SHIFT** key, and then the **AMPTD OFS** key; you will see the following in the **FREQUENCY/STATUS** display:

Amptd Offset OFF

Simply enter the amplitude offset that you want. The default amplitude offset value is 0 dB.

Auto Sequence

The **UTILITY AUTO SEQ** key allows you to continually sequence through the first 10 storage registers (0-9) in the order you determine by using the **SET SEQ** key; any storage register 0-9 may be recalled more than once in the Auto Sequence.

Press the blue **SHIFT** key, and then the **AUTO SEQ** key to start the Auto Sequence routine. The Auto Sequence routine performs a frequency sweep under the following condition:

- If a frequency sweep occurs when the Auto Sequence is active, the Signal Generator outputs a single sweep and then proceeds to output the settings recalled from the next sequence. (Frequency sweep parameters must be saved while the Signal Generator is sweeping.)

Stop the Auto Sequence by pressing the blue **SHIFT** key, and then the **EXIT** key.

Clear All

The **UTILITY CLEAR ALL** key allows you to clear all storage registers from memory. When you press the **CLEAR ALL** key, you will see the following in the **FREQUENCY/STATUS** display:

Clr Registers (Press ON)

Simply press the **ON** key to execute the clear all function.

Display

The **UTILITY DISPLAY** key allows you to see the settings for three things:

- The currently active special functions.
- The settings for any storage register.
- The storage register numbers used with the sequence function.

Press the **DISPLAY** key, and you will see the following:

Press SPECIAL, RECALL, or SEQ

Display Special

Press the **SPECIAL** key to see the numeral of any special function that has been activated. For example, if Special Functions 112, and 130 are active, you would see the following in the **FREQUENCY/STATUS** display:

112,130

Display Recall

Press the **RECALL** key to see the following in the **FREQUENCY/STATUS** display:

Display Register # =

Simply enter the number of the storage register you want to recall, and press the **ENTER** key. Then for approximately 5 seconds, the contents of the storage register are displayed. The RF output does not change to the settings in the displayed storage register.

Display Sequence

Press the **SEQ** key to see the storage register sequence that was set up by using the **SET SEQ** key. For example, if a sequence was set up using storage registers 0, 5, 2, and 6, you would see the following in the **FREQUENCY/STATUS** display:

Seq=0,5,2,6

Only 10 storage registers are allowed in a sequence. The storage registers may be any from 0 through 9; storage registers 10 through 49 are not allowed in the sequence.

EMF The CARRIER **emf** key allows you to display the output amplitude in emf units. When emf units are active, the output amplitude is referenced in volts to an open circuit output impedance. Press the blue **SHIFT** key, and then the **emf** key; you will see the following in the FREQUENCY/STATUS display:

Amptd	Units	EMF	OFF
-------	-------	-----	-----

Simply press the **ON** key to activate the emf function. You will notice that the **emf** annunciator appears in the AMPLITUDE display. The emf function has no effect on output amplitude values in dBm. However, if the displayed output amplitude is 1 V, for example, it would be 2 V_{emf}.

Frequency Offset

The CARRIER **FREQ OFS** key allows you to change the RF output displayed on the front panel by a value from +50 GHz to -50 GHz without changing the actual RF output value. Press the blue **SHIFT** key, and then the **FREQ OFS** key; you will see the following in the FREQUENCY/STATUS display:



Offset OFF

Simply enter the frequency offset that you want. The default value of frequency offset is 0 Hz.

Knob Hold

The INCR/DECR **Knob Hold** key allows you to hold knob control to one of the following functions:



- Frequency
- Amplitude
- Audio Frequency
- AM Depth
- FM Deviation
- Start Frequency
- Stop Frequency
- Center Frequency
- Span Frequency
- Marker Frequency

When the Knob Hold is active, you may change any other function by entering the parameter value with the Data keys, or the INCR/DECR  and  keys.

To activate the Knob Hold, select a function (so the “▽” cursor is located in that area), press the blue **SHIFT** key, and then the **Knob Hold** key.



When you select another function, a duplicate “▽” cursor appears to indicate that the function is active.

Knob Increment

The INCR/DECR **Knob InCR** key allows you to set knob increment values for any front-panel function that can be modified by turning the knob, or pressing the  or  keys. Use the following directions:

1. Select the function you want.
2. Press the blue **SHIFT** key, and the **Knob InCR** key.
3. Press the **INCR SET** key, and then enter the new Knob Increment value.

There are two ways to turn off the Knob Increment, as follows:

- Press the **Knob Off** key.
- Press either the INCR/DECR  or  keys.

Phase Decrement

The INCR/DECR Φ **DECR** key allows you to decrease the phase of the RF output in one-degree decrements each time the key is pressed. If the Φ **DECR** key remains pressed, the phase of the RF output continues to decrease in one-degree decrements. This feature is equivalent to having Special Function 110 active and turning the knob counterclockwise.

Phase Increment

The INCR/DECR Φ **INCR** key allows you to increase the phase of the RF output in one-degree increments each time the key is pressed. If the Φ **INCR** key remains pressed, the phase of the RF output continues to increase in one-degree increments. This feature is equivalent to having Special Function 110 active and turning the knob clockwise.

Sequence

The UTILITY **SEQ** key allows you to sequence through the first 10 storage registers (0-9), one register at a time, in the order you determine by using the **SET SEQ** key; any storage register may be recalled more than once in the sequence.

Repetitively press the **SEQ** key (or activate the rear-panel **SEQ** connector) to cycle through each storage register in the sequence. The Signal Generator will output the settings for each storage register that was saved in the sequence.

Set Sequence

The UTILITY **SET SEQ** key allows you to recall storage registers 0-9 in any order. You may only set up to 10 registers in the sequence; however, storage registers 0-9 may be recalled more than once. Storage registers 10 through 49 are not allowed in the sequence. The **AUTO SEQ** key or the **SEQ** key are used to recall the set sequences.

Press the blue **SHIFT** key, and then the **SET SEQ** key; you will then see the following in the FREQUENCY/STATUS display:

Seq #0 => Register

Simply enter the storage register you want in the #0 sequence position, and then press the **ENTER** key. The sequence position number increments up one number at a time to #9 and then automatically exits the set sequence mode. If you want less than 10 storage registers in the sequence, exit the sequence mode by pressing the blue **SHIFT** key, and then the **EXIT** key.

You may display the sequence positions set for each storage register. Refer to the "*Display*" directions in this appendix.

H

Questions and Answers

Answers to Commonly Asked Questions

This appendix is intended to provide answers to some of the most commonly asked questions about the Signal Generator. While this is not an exhaustive list of questions, it is a forum for dealing with issues pertaining to operation of the Signal Generator.

The following list in the left column shows the topic for each subject discussed. The list in the right column shows you where to find a corresponding question and answer (Q/A) to the subject.

Phase Modulation	Q/A #1
FM bandwidth	Q/A #2
Synthesized Audio Oscillator.....	Q/A #3
Carrier frequency shift.....	Q/A #4
Square wave modulation accuracy.....	Q/A #5
FM turn off with frequency changes	Q/A #6
FM deviation changes and front panel settings	Q/A #7
Carrier frequency jumps.....	Q/A #8
Phase noise reference applications.....	Q/A #9
Amplitude turn off with frequency changes	Q/A #10
Amplitude turn off with amplitude changes	Q/A #11
Output attenuator switching	Q/A #12
Internal modulation accuracy.....	Q/A #13

Question #1 Can I use Phase modulation on the Signal Generator at higher modulation rates than those indicated in the Specification table? Also, can I adjust the Phase modulation's peak deviation?

Answer #1 No. Phase modulation rates are limited to the values shown in the Specification table for each frequency band. Yes, Phase modulation's peak deviation is adjusted by changing the **AUDIO LEVEL** from the front panel for the internal modulation source, or by changing the external signal level.

Question #2 The maximum FM bandwidth is specified as 800 kHz, can I exceed this FM rate?

Answer #2 Yes. With an external modulation input signal you may exceed the specified value of 800 kHz with the consequence of reducing the amount of FM deviation. Typical rates may be up to 5 MHz with less than $\frac{1}{10}$ maximum deviation.

Question #3 Does the internal modulation source in the Signal Generator perform the same functions as the HP 8904A?

Answer #3 Unlike the HP 8904A which is capable of summing 4 audio channels, the Signal Generator is capable of summing 2 audio channels. That is, the Internal Audio Source (as described in appendix F) in the Signal Generator can generate up to two waveforms simultaneously, and then combine them with summation and modulation into one signal for modulating the RF output.

Question #4 Does the carrier frequency shift when FM is activated in the Digitized FM Synthesis mode?

Answer #4 In Digitized FM Synthesis (the instrument's preset condition), FM at rates less than the synthesis PLL bandwidth is accomplished by digitizing the input waveform (200KHz sampling rate) and using the digitized value to change the fractional divide number used in the phase locked loop. Any dc offset in the FM modulation path will change the divide ratio, and thus the center frequency of the synthesis PLL. When ac-coupling is selected for external FM, A coupling capacitor reduces the dc offsets at the analog to digital convertor, however some offset will remain. Internal FM always uses dc coupling.

The frequency offset introduced by digitized FM is specified to be less than $\pm 0.4\%$ of the peak FM deviation setting. This offset will be a function of the deviation setting.

Selecting "Linear" as the FM synthesis mode (Special Function 120) removes this problem by turning off the digitizer. This does however require that the modulation rates be greater than the synthesis PLL bandwidth (200 Hz) if external ac-coupling is desired. Selecting Internal or External dc coupling as the FM source will cause the PLL to be disabled. Modulation frequency response will extend to dc, however center frequency accuracy will be much worse than the digitized FM synthesis case.

Question #5 Can a square wave modulating waveform be accurately reproduced by the Signal Generator in FM?

Answer #5 Yes. The Signal Generator must be correctly set up in order to achieve an accurate reproduction of the square wave. The preset condition of the Signal Generator digitizes the FM input waveform, which creates approximately 30 μ s of group delay for signals less than approximately 30 kHz.

Since, typical square waves contain many harmonics which could be greater than 30 kHz, the Signal Generator circuitry kept in the preset condition will produce a preshoot which distorts the waveform.

To avoid problems caused by group delay, Special Function 124 may be used to turn off the delay equalizer. This is done at the cost of higher close in phase noise, slower switching times, and higher line related spurs.

Question #6 Why does FM turn off briefly when frequency is changed?

Answer #6 The Controller IC for the fractional-N synthesis PLL must be set up for the new carrier frequency. To do this the digital input port which feeds the digitized FM signal to the controller must be used. Thus FM must be temporarily turned off.

Question #7 Why doesn't the FM deviation change when the front-panel setting is changed in small increments?

Answer #7 The modulation section of the Signal Generator uses a 0.2 dB step attenuator to provide vernier control of the FM deviation. This means that the smallest change in FM deviation is 0.2dB or 2.33 % of setting. The front-panel display shows 3 digits of resolution, which can represent as small as a 0.1 % step. The Signal Generator always chooses the closest 2.33 % step to the front panel displayed setting.

Question #8 Why do I see discrete jumps in carrier frequency as the dc modulating voltage is varied when using external dc-coupled FM?

Answer #8 discrete jumps in carrier frequency during external dc-coupled FM occur when the Signal Generator is in its preset condition. As such, the jumps happen as the external dc-coupled signal is being used to control the divide ratio in the instrument's synthesis PLL.

Question #9 Why should Mode 2 (**LOW NOISE**) and linear FM synthesis be used in phase noise reference applications requiring the Signal Generator to be phase-locked to the source under test?

Answer #9 Quantization errors occur if the Signal Generator remains in its preset condition — digitized FM synthesis. When the signal generator is used as a tuneable reference source in phase noise measurements and is locked to the UUT, the FM input signal will essentially be at dc with a small noise voltage riding on it. Under this condition, the noise signal experiences a gain which varies depending upon the dc level and the magnitude of the noise. If the dc level falls at the center of a quantization level, the small signal gain will be small. If the dc level falls at the threshold between two quantization levels, the small signal gain will be large. This variation in gain causes inaccuracies in noise measurements at small offset frequencies from the carrier.

To avoid quantization induced errors, linear FM synthesis must be used. In **STD** mode, dc-coupled FM using linear FM synthesis turns off the synthesis PLL in the Signal Generator resulting in carrier frequency accuracy and resolution which is determined by oscillator pretune only. The frequency resolution will be approximately 100 ppm or at 1 GHz approximately 100 kHz. This poor frequency resolution can be improved by utilizing Mode 2 (the Low Noise Option 004). In Mode 2, the synthesis PLL is still removed during dc-coupled linear FM, however the output frequency is held by a frequency locked loop. Thus the resolution is much better (approximately 2 ppm). In addition, the frequency locked loop improves the Signal Generator phase noise. (Refer to the specifications found in section 1 of the *Calibration Manual* for Option 004 in Linear FM.)

Question #10 Why does the amplitude turn off briefly when frequency is changed?

Answer #10 The output amplitude is turned off for approximately 40 ms each time frequency is changed. This prevents output amplitude transients which can occur when the output section loses signal during a frequency change. The ALC system tries to correct for the loss of signal by turning up the output section gain, then when the signal re-appears the output section gain is too high causing an excessive output until the ALC can compensate.

If signal dropouts, on frequency changes, adversely affects your application, and if you can withstand positive output power spikes, Special Function 105 can be used to disable the amplitude muting.

Question #11 Why does the amplitude turn off briefly when amplitude is changed?

Answer #11 When changing amplitude, attenuators may switch in or out to effect some multiple of 5 dB steps. It is possible that during an attenuator switching operation, one attenuator may switch out (thru line) before a larger attenuator switches in. The result is a potentially large output power spike. For example, say the attenuator is initially set at 35 dB attenuation (20, 10 and 5 dB sections in), and it is switching to 40 dB attenuation (40 dB section in). It is possible that the 20, 10 and 5 dB sections could go to thru line before the thru line of the 40 dB section is opened. This would result in a 35 dB spike in amplitude.

To avoid this output spike mechanism, the ALC is commanded to shut down the output power just prior to a level change. If this momentary loss of signal causes problems with your application, and if you can stand positive amplitude spikes, Special Function 105 "amplitude muting" may be used to disable the amplitude muting during amplitude changes (and frequency changes).

Question #12 Why do the output attenuators switch at different output-power settings, at different carrier frequencies?

Answer #12 The Signal Generator always tries to keep the output power from its output section between +5 and +10 dBm (assuming < +10 dBm is set on the front panel). Since cable loss and attenuator loss is a function of carrier frequency, the attenuators must be switched at different output-power settings as the insertion loss between the output section and the front panel changes. Maintaining the output section output power in the +5 to +10 dBm range provides the best level accuracy and AM performance.

If your application is adversely affected by an attenuator switch (caused by only a change in frequency), you can force a particular attenuator setting with Special Functions 100 and 101.

Question #13 Why is internal modulation inaccurate after the front-panel audio-output level is set to anything other than 1 Volt?

Answer #13 Control of the front-panel audio-output level is accomplished by changing the output level of the internal audio source. To provide calibrated internal modulation (FM, AM or phase modulation), the level of the internal audio source must be 1 volt. Refer to appendix F for more information.

Glossary

Alias.

A keyword or command statement in a program that is an alternate (synonymous) term for commands of the same type. For example, the command statement FM:FREQUENCY:STEP is an alias for the command statement LFSOURCE:FREQUENCY:STEP.

Argument.

An argument is an independent variable (command parameter) whose value or state determines the value or state of a function. For example, the argument in the command statement FREQ:CW 150MHZ is "150MHZ".

Auto Select.

When the front-panel **AUTO** key is active, the Signal Generator will choose a signal path with the best possible spectral purity for the present control setting.

Command Header.

The command header is the first part of the command statement which is used to direct the control of the command. For example, in the command statement FM:STATE ON, the command header is simply "FM:STATE".

Command Message.

A command message is a line of information in a program containing one or more command statements. For example, the command statements to set FM deviation to 10 kHz, and to turn FM deviation on would make a command message as follows: FM 10KHZ;FM:STATE ON.

Command Parameter.

A command parameter is an independent variable (argument) whose value or state determines the value or state of a function. For example, the command parameter in the command statement FREQ:CW 150MHZ is "150MHZ".

Command Statement.

A command statement is a string of mnemonics used to accomplish one task, that is, either to set or query a function. For example, the string of mnemonics used to set the Auto selection of frequency synthesis would be as follows: `FREQ:SYNT:AUTO ON`.

Direct Pulse Control.

The pulse modulation term "direct pulse control" refers to the internal or external source having control over timing and width of the pulsed RF output. Refer to Pulse Modulation in chapter 2 for more information.

Glideslope.

The Glideslope signal is part of the Instrument Landing System. It provides up and down orientation for the ideal angle of descent to the runway.

Header.

Same as "Command Header". This is the first part of the command statement which is used to direct the control of the command. For example, in the command statement `FM:STATE ON`, the header is simply "FM:STATE".

HP-SL.

HP-SL is the acronym for "Hewlett-Packard System Language". Refer to Chapter 4 for a thorough discussion of HP-SL.

ILS.

ILS is the acronym for "Instrument Landing System". ILS is a group of navigation signals used for aircraft landings.

Internal Audio Source.

The internal audio source refers to the circuitry that generates the modulation source for the RF carrier. Modulation rates are from 0.1 Hz to 400 kHz, which exceeds the typical audio frequency range of 20 kHz.

Internal Pulse Generator.

The pulse modulation term “internal pulse generator” refers to the control you have over the delay, width, and triggering edge of the pulsed RF output by activating Special Functions 212-214. Refer to Pulse Modulation in chapter 2 for more information.

Localizer.

Localizer is one of the Instrument Landing System signals. It provides left and right orientation to the center of the runway.

Marker Beacon.

The Marker Beacon signals are part of the Instrument Landing System. The three markers indicate distance from the end of the runway.

Mode Select.

A row of **MODE SELECT** keys on the front panel represent the internal signal paths that are used to minimize phase noise and spurs on the RF output, as a function of the selected FM deviation. The **AUTO** key is used to choose the signal path that provides the best possible spectral purity for any control setting.

Multifunction Synthesis.

This term refers to the operating capabilities that allow the Signal Generator to generate complex waveforms for modulating the RF carrier.

Overshoot and Ringing.

The pulse modulation term “overshoot and ringing” (abbreviated V_{or}) refers to the initial transient response of the pulse output when the pulse momentarily exceeds its steady state output (overshoot), and the hysteresis that takes place as the pulse reaches its steady-state amplitude (ringing). Refer to Pulse Modulation in chapter 2 for more information.

Pulse Repetition Frequency.

The pulse modulation term “pulse repetition frequency” (abbreviated PRF) refers to the rate in which the RF pulse output occurs. The external or internal control signal determines the PRF. Refer to Pulse Modulation in chapter 2 for more information.

RF Pulse Delay.

The pulse modulation term “RF pulse delay” (abbreviated P_d) refers to the time that must elapse before an RF pulse output occurs relative to the sync output signal. Refer to Pulse Modulation in chapter 2 for more information.

RF Pulse Width.

The pulse modulation term “RF pulse width” (abbreviated P_w) refers to the distance between the leading and trailing edges of the RF pulse output. Refer to Pulse Modulation in chapter 2 for more information.

Short Form.

HP-SL commands may be written in a long or short form. The short form of any command will be three or four characters in length. For example the short form of the command AMPLitude is AMPL. The *HP-IB Control Language Dictionary* in Chapter 4 lists all short form commands in upper case lettering.

Subcarrier Sources.

The subcarrier sources are used to generate a modulated wave which is applied, in turn, as a modulating wave to the RF carrier. As described in appendix F, there are four subcarrier sources (AM, FM, Φ M, and Pulse) that may be applied to the audio source in Channel 1.

Syntax.

Syntax refers to the make-up or structure of command statements and messages in HP-SL for use over the HP-IB bus.

Synthesized Audio Oscillator.

This internal modulation source uses digital synthesis to generate waveforms of sine, sawtooth, triangle, squarewave, and white Gaussian noise, all with variable frequency, amplitude, and relative phase. Refer to appendix F for more information.

Tree Structure.

HP-SL commands are organized in a tree structure. Commands start at a “root level” and proceed to branch out from the root. Multiple branching occurs with tree structure organization.

Trigger Delay.

The pulse modulation term “trigger delay” (abbreviated T_d) refers to the time that must elapse before a sync output occurs relative to the external or internal control signal. Refer to Pulse Modulation in chapter 2 for more information.

Video Feedthrough.

The pulse modulation term “video feedthrough” (abbreviated V_f) refers to the amount of RF power, expressed in dBc, that is present when an RF pulse output has reached less than 10% of its peak amplitude on the trailing edge of the pulse. Refer to Pulse Modulation in chapter 2 for more information.

Video Width.

The pulse modulation term “video width” (abbreviated T_w) refers to the distance between the rising and falling edges of the video output. Refer to Pulse Modulation in chapter 2 for more information.

VOR.

VOR is the acronym for VHF Omni-Range. The VOR signal provides directional information to in-flight aircraft.

INDEX

50 ohm pulse, C-11

A

- abort, 4-12
- ac coupling, for AM, 2-14
- ac coupling, for FM, 2-2
- ac voltmeter, C-9
- accuracy, carrier frequency, 2-3
- address selection, HP-IB, 4-10
- alc bandwidth, C-2
- alc system, H-4
- alias, I-1
- allow external reference, C-7
- AM 3 dB bandwidth, 2-14
- AM bandwidth, F-20
- AM example, HP-SL, 4-71
- AM ext. audio, exercise review, 2-19
- AM int. audio, exercise review, 2-15
- AM noise generation, F-22
- AM noise, example, F-31
- AM radio testing, F-22, F-28
- AM signal, example, F-28
- AM source, audio level, F-15
- AM source, audio subcarrier, F-14
- AM subsystem, HP-SL, 4-18
- AM term, 4-15, E-2
- AM, ac coupling, 2-14
- AM, an exercise, 2-15
- AM, an introduction, 2-14
- AM, an overview, 2-14
- AM, coupling, 2-14
- AM, dc coupling, 2-14
- AM, equipment, 2-15
- AM, things to remember, 2-22
- ampl step term, 4-15, E-2
- ampl step unit, 4-15, E-2
- ampl term, 4-15, E-2
- ampl unit term, 4-15, E-2
- amplitude example, HP-SL, 4-72
- amplitude integ. sum. bit, 4-67
- amplitude muting, C-2, H-5
- amplitude offset, G-2
- amplitude subsystem, HP-SL, 4-19
- amplitude sweep, example, F-29
- amptd correction, C-1
- amptd limit, C-1
- AMPTD OFS key, G-2
- angle term, 4-15, E-2
- annunciator, EXT HI, 2-11, 2-20, 2-42
- annunciator, EXT LOW, 2-11, 2-20, 2-42
- annunciator, sweep, 3-2
- ANSI standard, MC1.1, 4-11
- appendix D, error messages, 4-8
- argument, I-1
- ASCII, new line, E-1
- asterisk, in command message, 4-15
- attenuation, C-1
- attenuator loss, H-5
- attenuator switching, H-5
- audio 2 frequency, C-4
- audio 2 level, C-4
- audio 2 phase, C-4
- audio 2 waveform, C-4
- audio AM depth, C-5
- audio AM frequency, C-5
- audio AM phase, C-5
- audio AM wave, C-5
- audio connector, F-1
- audio connector impedance, F-22
- audio FM deviation, C-5
- audio FM frequency, C-5
- audio FM phase, C-6
- audio FM waveform, C-6
- audio freq. rates. max., 2-3
- audio freq. waveform, change, 2-8, 2-17

audio frequency rates, 2-3, F-20
 audio level, for AM source, F-15
 audio level, maximum voltages, F-10
 audio level, on RF carrier, F-19
 audio level, voltages, F-19
 audio mod. signal, complex, 2-4
 audio mod., complex, 2-3
 audio mod., single-tone, 2-3
 audio oscillator, F-1
 audio output, bandwidth, F-13
 audio PM deviation, C-6
 audio PM frequency, C-6
 audio PM phase, C-6
 audio PM waveform, C-6
 audio pulse, C-7
 audio pulse frequency, C-7
 audio pulse phase, C-7
 audio response, FM receiver, F-27
 audio signals, F-1
 audio source Φ M deviation, F-20
 audio source bandwidth, F-20
 audio source channels, F-1
 audio source decrement, F-21
 audio source degradation, F-20
 audio source increment, F-21
 audio source phase reference, F-11
 audio source, channel 1, F-11
 audio source, channel 2, F-12
 audio source, channel 1 limits, F-12
 audio source, channel 2 limits, F-13
 audio source, depth, F-20
 audio source, external, 2-3
 audio source, FM deviation, F-20
 audio source, internal, 2-3
 audio source, internal output level, 2-44
 audio source, modulated, F-14
 audio triggered, C-4
 audio wave, C-4
 audio-output level, H-5
 audio-tone sweep, F-22
 audio-tone sweep, example, F-27
 auto attenuation, C-1
 auto select, I-1

AUTO SELECT mode, 2-5
 AUTO SEQ key, G-2
 auto sequence, G-2
 auto sweep, 3-12
 AUTO, key, 3-12
 autorange bit, 4-64
 avionics, 4-42

B

bandwidth, affecting audio source, F-20
 bandwidth, ALC, C-2
 bandwidth, FM, 2-2
 bandwidth, for AM, F-20
 bandwidth, for FM, F-20
 bandwidth, maximum FM, H-2
 bandwidth, of audio output, F-13
 beacon, IM setup, 4-42, C-12
 beacon, MM setup, 4-42, C-12
 beacon, OM setup, 4-42, C-12
 blank amplitude, C-10
 blank audio, C-10
 blank display, C-9
 blank frequency, C-10
 blank modulation, C-10
 broadband RF devices, 3-9

C

cable loss, H-5
 calibration bit, 4-64
 calibration integ. cond. bit, 4-67
 calibration subsystem, HP-SL, 4-22
 carrier frequency accuracy, 2-3, 2-13
 carrier frequency shift, H-1, H-2
 carrier frequency, jumps, H-3
 cavity tuned resonators, 3-9
 center frequency accuracy, H-2
 center frequency, sweep, 3-3
 ceramic IF filters, 3-9
 channel 1, audio source, F-11
 clear all, G-2
 CLEAR ALL key, G-2
 clear lockout/set local, 4-12

clear, HP-IB, 4-11
 command error bit, 4-62
 command header, I-1
 command message, I-1
 command messages, 4-3, 4-15
 command message, asterisk, 4-15
 command message, definition, E-1
 command message, introduction, 4-6
 command message, syntax, E-1
 command parameter, I-1
 command parameter, introduction, 4-4
 command parameter, syntax, E-1
 command statements, 4-3, 4-15, I-1
 command statement, definition, E-1
 command statement, introduction, 4-4
 command statement, syntax, E-1
 command statements, ambiguous, 4-7
 common commands, 4-2
 common command, *RST, 4-8
 common commands, IEEE 488.2, 4-13
 complex audio mod., 2-3
 complex audio signals, F-1
 complex waveforms, C-3
 component testing, for radar, 2-23
 condition register, 4-57
 conflicting conditions, HP-SL, 4-7
 connector impedances, 2-39
 control language dictionary, 4-13
 control signals, for pulse modulation, 2-25
 coupling type, 4-15, E-2
 coupling, AM signals, 2-14
 coupling, FM signals, 2-2
 crystals, receiver, 3-9
 cushioning material, A-1

D

damage to pulse input, 2-34
 damage, to pulse input, 2-31
 data input/output operations, 4-9
 data questionable bit, 4-64
 dc coupling, H-2
 dc coupling, for AM, 2-14
 dc coupling, for FM, 2-2

dc modulating voltage, H-3
 dc offset, H-2
 dc voltmeter, C-8
 dc-coupled FM, H-3
 dc-coupled signal, H-3
 DCFM delay equalizer, C-3
 decrement, the audio source, F-21
 delay, pulse, 2-23
 depth, for audio source, F-20
 deviation, FM, 2-1
 device dep. bit definitions, 4-63
 device dependant summary bits, 4-60
 device dependent error bit, 4-62
 device specific commands, 4-2
 device status dictionary, 4-55
 device status reporting, 4-57
 diagnostic subsystem, HP-SL, 4-22
 digital FSK, 2-2
 digitally-stepped sweep, 3-8, 3-9, 3-11
 digitized FM input waveform, H-3
 digitized FM synthesis, 2-1, 2-3, 2-4, 2-13, C-2, H-2, H-4
 direct pulse control, 2-23, 2-38, I-2
 direct pulse control, an exercise, 2-29
 display, G-3
 DISPLAY key, G-3
 display recall, G-3
 display sequence, G-3
 display special, G-3
 display subsystem, HP-SL, 4-22
 doubler, option, B-1
 driver electronics, 4-12
 dual-tone modulation, example, F-26

E

emf, G-4
 emf key, G-4
 enable register, service request, 4-61
 enhanced spectral purity, option, B-1
 equipment recommended, list of, 1-1
 error messages, A-1, D-1
 error messages, appendix D, 4-8

error, log sweep not allowed, 3-10
 error, mod and sweep conflict, 3-10
 error-space after colon, 4-7
 european radix, C-10
 event enable register, 4-58
 event register, 4-57
 example HP-SL programs, 4-70
 example programs, HP-SL, 4-8
 execution error bit, 4-62
 EXIT key, 3-13, G-2
 EXT HI annunciator, 2-11, 2-20, 2-42
 EXT LOW annunciator, 2-11, 2-20, 2-42
 extended talker/listener, 4-12
 extended warranty, option, B-1
 external audio source, 2-3
 external control signal, 2-25
 external timebase source, C-7

F

f(t), C-3
 FM bandwidth, 2-2, F-20, H-2
 FM delay equalizer, C-3
 FM deviation, 2-1, 2-2, 2-13, H-3
 FM deviation, greater, 2-5
 FM deviation, on audio source, F-20
 FM distortion, C-3
 FM example, HP-SL, 4-72
 FM ext. audio, exercise review, 2-10
 FM indicator accuracy, C-3
 FM input waveform, H-3
 FM int. audio, exercise review, 2-5
 FM receiver, audio response, F-27
 FM source, subcarrier, F-16
 FM subsystem, HP-SL, 4-23
 FM switching time, 2-1
 FM synthesis, 2-3, 2-4, 2-13, C-2
 FM synthesis, digitized, 2-1
 FM synthesis, linear, 2-1
 FM telemetry, 2-2
 FM, ac coupling, 2-2
 FM, an exercise, 2-5
 FM, an introduction, 2-2
 FM, an overview, 2-2

FM, coupling, 2-2
 FM, dc coupling, 2-2
 FM, equipment, 2-5
 FM, external mod. signals, 2-2
 FM, generation, 2-3
 FM, internal mod. signals, 2-2
 FM, things to remember, 2-13
 Fractional-N synthesis, H-3
 freq multiplier, C-2
 FREQ OFS key, G-4
 freq term, 4-17, E-2
 frequency example, HP-SL, 4-73
 frequency integ. sum. bit, 4-66
 frequency offset, G-4
 frequency shift, 2-3
 frequency span limits, table, 3-10
 frequency span, limits, 3-9
 frequency subsystem, 4-25
 frequency sweeping, basic steps, 3-2
 FSK, example, F-30
 function generator, recommended, 1-1

G

glideslope, I-2
 glideslope, setup, 4-42, C-12
 group delay, C-3, H-3
 group delay, effects of, 2-4
 group delay, graph, 2-4
 GSlope, 4-42

H

handle kits, option, B-1
 hardware integrity summary bit, 4-65
 harmonic content, on group delay, 2-4
 header, I-2
 high stability timebase, C-7
 high-Q devices, 3-9
 HP 8665A sig. integ. status reg., 4-65
 HP-IB bus, 4-55
 HP-IB control language, 4-13
 HP-IB device status dictionary, 4-55
 HP-IB messages, 4-11, 4-12

HP-IB, address selection, 4-10
 HP-IB, capabilities, 4-11
 HP-SL, I-2
 HP-SL ?, 4-5
 HP-SL commands, 4-13
 HP-SL dev. dep. status register, 4-63
 HP-SL hierarchy, 4-5
 HP-SL notes, 4-14
 HP-SL programming, 4-5
 HP-SL programming tool, 4-71
 HP-SL query, 4-5, 4-15
 HP-SL quick reference, E-1
 HP-SL reference information, 4-9
 HP-SL subsystem syntax, E-2
 HP-SL system commands, 4-29
 HP-SL table of contents, E-3
 HP-SL, *RST, 4-8
 HP-SL, a development tool, 4-70
 HP-SL, colon, 4-4
 HP-SL, command message, 4-6
 HP-SL, command parameter, 4-4
 HP-SL, command statement, 4-4
 HP-SL, conflicting conditions, 4-7
 HP-SL, example programs, 4-8
 HP-SL, getting started, 4-3
 HP-SL, introduction, 4-2
 HP-SL, keywords, 4-6
 HP-SL, more about colon, 4-6
 HP-SL, not sequence dependent, 4-7
 HP-SL, semicolon, 4-6
 HP-SL, short form, 4-6
 HP-SL, tree structure, 4-3, 4-15

I

IEEE 488.2 common commands, 4-30
 IEEE 488.2 definitions, 4-57
 IEEE 488.2 standard, 4-2, 4-55
 IEEE 488.2, common commands, 4-13
 IF filters, ceramic, 3-9
 ILS, I-2
 ILS, example, F-25
 ILS, signaling, F-22
 IM beacon setup, 4-42, C-12

impedance, Φ M connector, 2-39
 impedance, AM connector, 2-39
 impedance, FM connector, 2-39
 impedance, pulse connector, 2-39
 INCR SET, key, F-21
 increment, the audio source, F-21
 initialize example, HP-SL, 4-75
 initialize subsystem, HP-SL, 4-32
 input impedance, pulse connector, 2-24, 2-31, C-11
 installation, A-1
 instrument preset, *RST, 4-8
 internal audio source, 2-2, 2-3, F-1, H-2, H-5, I-2
 internal audio source, output level, 2-44
 internal audio source, voltage, F-19, F-20
 internal audio waveform, 2-3
 internal control signal, 2-25
 internal modulation, 2-44
 internal modulation source, H-2, I-4
 internal pulse generator, 2-23, 2-38, I-2
 internal pulse generator, exercise, 2-33
 internal reference oscillator, C-7

K

keywords, 4-3
 keyword at HP-SL root, 4-15
 keywords, optional, 4-14
 knob hold, G-4
 KNOB HOLD key, G-4
 KNOB INCR key, G-5
 knob increment, G-5
 KNOB OFF key, G-5

L

IF source subsystem, HP-SL, 4-33
 lin ampl term, 4-17, E-2
 lin/log, key, 3-11
 line spurs, C-3
 linear FM synthesis, 2-1, 2-3, 2-4, 2-13, C-2, H-2, H-4
 linear sweep, 3-13
 linear sweep spacing, 3-11
 linefeed character, 4-14

localizer, I-3
 localizer, setup, 4-42, C-12
 local lockout, 4-11
 local lockout, HP-IB, 4-11, 4-12
 local, HP-IB, 4-11
 log sweep, 3-13
 log sweep not allowed, error, 3-10
 log sweep spacing, 3-11
 Low Noise, Option 004, H-4

M

manual sets, option, B-1
 manual sweep, 3-13
 MANUAL, key, 3-13
 marker beacon, I-3
 marker subsystem, HP-SL, 4-42.1
 MAV summary bits, 4-60
 maximum audio freq. rates, 2-3
 maximum FM bandwidth, H-2
 mechanical damage, A-1
 mechanical defects, A-1
 memory contents, of RAM, C-8
 messages, error, A-1, D-1
 MM beacon setup, 4-42, C-12
 mod and sweep conflict, error, 3-10
 mod type, E-2
 MODE SELECT, 3-13, I-3
 Mode Select keys, 2-5
 Mode Select Synthesis, 3-8
 mode selection, 2-1
 modem testing, F-22, F-30
 modes of operation, 2-5
 modulation accuracy, H-1
 modulation example, HP-SL, 4-75
 modulation integ. sum. bit, 4-66
 modulation subsystem, HP-SL, 4-42.1
 mod_type, 4-17
 MSSG, key, A 1, D 1

multi-tone modulation, C-2
 multifunction synthesis, F-1, I-3

N

narrowband devices, 3-9
 new line, ASCII char.10, E-1
 noise generation, F-22
 noise voltage, H-4
 non-dec. num. prog. data, 4-17
 non-decimal numeric prog. data, E-2
 nrf, 4-17, E-3

O

offset annunciator, C-2
 offset, amplitude, G-2
 offset, frequency, G-4
 ohms term, 4-17, E-3
 OM beacon setup, 4-42, C-12
 operation complete bit, 4-62
 options, B-1
 Option 008, pulse modulation, 2-23, C-11
 optional keywords, 4-14
 oscillator, internal reference, C-7
 oscilloscope, recommended, 1-1
 out-of-lock, D-1
 output attenuators, H-5
 output attenuator switching, H-1
 output level, of internal audio source, 2-44
 output power spike, H-5
 output power, maintaining, H-5
 overshoot, I-3
 overshoot, for pulse, 2-27

P

packaging material, A-1
 pass/take control, 4-12
 phase cont sweep, C-2
 phase decrement, G-5
 phase example, HP-SL, 4 76
 phase increment, G 5
 phase modulation, H 1
 phase modulation subsystem, HP-SL, 4 43

phase noise, 2-1, 2-13
 phase noise measurements, H-4
 phase noise, lowest, 2-5
 phase reference, for audio source, F-11
 phase subsystem, HP-SL, 4-44
 phase, of RF output, C-2
 phase-continuous sweep, 3-8, 3-9, 3-10
 phase-continuous, sweep, 3-11
 phase-locked-loop bandwidth, H-2
 phase-locked-loop frequency, C-3
 Φ M deviation, for audio source, F-20
 Φ M source, subcarrier, F-17
 PLL bandwidth, H-2
 PLL frequency, C-3
 pocket pagers, F-26
 power meter, C-9
 power meter subsystem, HP-SL, 4-44
 power on bit, 4-61
 power source, A-1
 power spike, H-5
 POWER, key, A-1
 programming codes, 4-2
 programming formats, 4-2
 programming protocol, 4-2
 programming quick reference, E-1
 programming reference information, 4-9
 programming, HP-SL, 4-5
 programming, HP-SL commands, 4-2
 PULSE connector, 2-31, 2-34, C-11
 PULSE connector, input impedance, 2-24, C-11
 pulse control, C-11
 pulse delay, 2-23, C-11, I-3
 pulse duration, 2-27
 pulse fall time, 2-28
 pulse modulation control signals, 2-25
 pulse modulation, an exercise, 2-29
 pulse modulation, equipment, 2-29
 pulse modulation, exercise review, 2-29
 pulse modulation, overview, 2-23
 pulse modulation, things to remember, 2-38
 pulse repetition frequency, 2-25, I-3
 pulse rise time, 2-27
 pulse source, subcarrier, F-18

pulse subsystem, 4-45
 pulse synchronization, 2-24
 pulse synchronization, illustration, 2-24
 pulse triggering edge, 2-23, C-11
 pulse width, 2-23, 2-27, C-11, I-3

Q

quantization errors, H-4
 query, E-1
 query error bit, 4-62
 queue, 4-58
 quick reference, HP-SL, E-1

R

rack slide kit, B-1
 radar searching, 2-23
 radar surveillance, 2-23
 radar test measurements, 2-23
 radar tracking, 2-23
 RAM wipe, special function 4-10, C-8
 rates, audio frequency, 2-3
 recal, C-8
 recalibrate, C-8
 RECALL key, G-3
 receiver crystals, 3-9
 receiver rejection, example, F-31
 receiver testing, F-29
 recommended equipment, list of, 1-1
 reduced leakage, option, B-1
 ref calibration, C-7
 ref in connector, C-7
 ref source, C-7
 reference information, 4-9
 reference integ. sum. bit, 4-66
 reference oscillator subsystem, 4-47
 reference oscillator, internal, C-7
 rel phase adjust, C-2
 remote mode, 4-11
 remote, HP-IB, 4-11
 request control bit, 4-62
 request service, 4-12
 result code, message, C-8

retrofit kit, B-1
 RF carrier signal, F-1
 RF output connector impedance, F-22
 RF output, calibrated, F-19
 RF pulse delay, I-3
 RF pulse fall time, 2-28
 RF pulse output, 2-26
 RF pulse rise time, 2-27
 RF pulse width, 2-27, I-4
 ringing, I-3
 ringing, for pulse, 2-27
 rise time, for pulse, 2-27
 RQS and MSS summary bits, 4-60
 *RST, common command, 4-8
 RST, common command, 4-8
 rules for couplings, sweep, 4-26

S

safty class 1, A-1
 save and recall, audio source, F-21
 save & recall registers, 2-1
 SAWS, 3-9
 sawtooth, int. waveform, 2-2, 2-13, 2-22
 security, C-8
 SEQ key, G-3, G-5
 sequence, G-5
 sequence dependency, 4-2
 sequence subsystem, 4-48
 serial number, C-9
 service diagnostics, C-11
 service manual, option, B-1
 service mode, C-12
 service request enable register, 4-61
 SET SEQ key, G-2, G-3, G-5, G-6
 set sequence, G-6
 shipping container, A-1
 short form, I-4
 short form, HP-SL, 4-6
 signal integrity bit, 4-64
 signal settled bit, 4-64
 simultaneous mod., an exercise, 2-40
 simultaneous mod., equipment, 2-40
 simultaneous mod., exercise review, 2-40
 simultaneous mod., things to remember, 2-44
 simultaneous modulation, 2-39
 sine, int. waveform, 2-2, 2-13, 2-22
 single sweep, 3-12
 single, key, 3-12
 single-tone audio mod., 2-3
 single-tone modulation, C-2
 source list, 4-17, E-3
 space, E-3
 span frequency, sweep, 3-3
 special functions, 2-1, C-1
 special function 100, C-1, 4-20, H-5
 special function 101, C-1, 4-20, H-5
 special function 102, C-1, 4-22
 special function 103, C-1, 4-20
 special function 104, C-2, 4-21
 special function 105, C-2, 4-21, H-5
 special function 110, 4-44, C-2
 special function 111, 4-28, C-2
 special function 112, 3-10, 3-16, 4-53, C-2
 special function 120, C-2
 special function 120, 2-3, 2-13, 4-24
 special function 121, 4-28, C-3
 special function 124, 4-24, C-3, H-3
 special function 130, 2-2, 2-8, 2-13, 2-17, 2-22, 4-33, C-4
 special function 131, 4-34, C-4
 special function 132, 4-34, C-4
 special function 133, 4-34, C-4
 special function 133, 4-35, C-4
 special function 134, 4-35, C-4
 special function 135, 4-34, C-4
 special function 136, 4-35, C-4
 special function 137, 4-36, C-5
 special function 138, 4-36, C-5
 special function 139, 4-36, C-5
 special function 140, 4-37, C-5
 special function 141, 4-37, C-5

- special function 142, 4-38, C-5
- special function 143, 4-38, C-6
- special function 144, 4-38, C-6
- special function 145, 4-39, C-6
- special function 146, 4-39, C-6
- special function 147, 4-39, C-6
- special function 148, 4-40, C-6
- special function 149, 4-40, C-7
- special function 150, 4-40, C-7
- special function 151, 4-41, C-7
- special function 160, 4-47, C-7
- special function 161, 4-47, C-7
- special function 162, 4-47, C-7
- special function 170, 4-32, C-8
- special function 171, C-8, 4-30
- special function 172, 4-10, 4-30, C-8
- special function 173, 4-30, C-8
- special function 180, 4-54, C-8
- special function 181, 4-54, C-9
- special function 182, 4-44, C-9
- special function 190, 4-30, C-9
- special function 191, 4-22, C-9
- special function 192, 4-22, C-10
- special function 193, 4-22, C-10
- special function 194, 4-23, C-10
- special function 195, 4-23, C-10
- special function 196, 4-23, C-10
- special function 210, 2-24, 2-31, 2-35, 2-38, 2-39, 4-45, C-11
- special function 211, 4-45, C-11
- special function 212, 2-27, 2-35, 2-38, 4-45, C-11
- special function 213, 2-27, 2-35, 2-38, 4-46, C-11
- special function 214, 2-25, 2-26, 2-36, 2-38, 4-46, C-11
- special function 220, F-1, C-11
- special function 221, F-1, C-12
- special function 222, F-1, C-12
- special function 223, F-1, C-12
- special function 224, F-1, C-12
- special function 225, F-1, C-12
- special function 300, C-12
- special functions, recalled, F-21
- special functions, saved, F-21
- SPECIAL key, G-3
- spectral purity, C-3
- spectrum analyzer, recommended, 1-1
- spurious content, of RF output, 2-28
- spurs, transient switching, 3-9
- square brackets, in HP-SL, 4-14
- square, int. waveform, 2-2, 2-13, 2-22
- square-wave modulation, H-3
- sqelch testing, F-26
- standard event status enable reg., 4-62
- standard event status register, 4-61
- start and stop error, 3-9
- start frequency, sweep, 3-3
- status bit, 4-12
- status byte, 4-12, 4-55
- status register model, 4-58
- status register syntax, 4-68
- status register, standard event, 4-61
- status subsystem, 4-49
- step attenuator, H-3
- stepping transients, 3-9
- stop frequency, sweep, 3-3
- storage registers, 2-12, 2-21
- storage registers, audio source, F-21
- sub-audible sqelch testing, F-26
- subcarrier generation, F-1
- subcarrier sources, I-4
- subcarrier sources, active, F-10
- subcarrier sources, modulation, F-14
- subcarrier sources, voltage, F-10
- subcarrier, Φ M source, F-17
- subcarrier, AM source, F-14
- subcarrier, FM source, F-16
- subcarrier, pulse source, F-18
- summary bit, 4-58
- surveillance, radar, 2-23
- SWEEP annunciator, 3-2
- sweep exercise, 3-14
- sweep frequency formulas, 3-5
- sweep in progress bit, 4-64
- sweep markers, 3-7
- sweep spacing, 3-11
- sweep subsystem, 4-53

sweep time, 3-9, 3-11, 3-13
 sweep triggering, 3-12
 sweep types, 3-8
 sweep, audio-tone, F-22
 sweep, digitally-stepped, 3-8, 3-9, 3-11
 sweep, phase-continuous, 3-8, 3-9, 3-11
 sweeping, basic steps, 3-2
 switching speed, C-3
 switching spurs, 3-9
 switching time, 2-13
 switching time, FM, 2-1
 switching, speed, 2-5
 SYNC connector, 2-25
 sync output, I-4
 sync output signal, 2-25
 synchronization, for pulse modulation, 2-24
 syntax, for HP-SL, E-1
 syntax, HP-SL, I-4
 syntax, HP-SL subsystems, E-2
 synthesis mode, 3-13
 synthesized audio oscillator, I-4
 synthesized sweep, 3-9

T

take sweep subsystem, 4-54
 talker/listener, HP-IB, 4-11
 test, C-8
 time constants, 3-9
 time term, 4-17, E-3
 timebase source, external, C-7
 timebase, high stability, C-7
 timebase, option, B-1
 tracking, radar, 2-23
 transients, stepping, 3-9
 transition filter, 4-57
 tree structure, HP-SL, 4-3, 4-15, I-4
 trigger delay, I-5
 trigger delay time, 2-25
 trigger delay, illustration, 2-26
 trigger, HP-IB, 4-11
 triggered audio, C-4
 triggering edge, pulse, 2-23
 triggering signal, for pulse, C-11

two-tone FSK, example, F-30
 two-tone signal, example, F-25
 typical applications, F-22

U

unpacking, 1-1
 user request bit, 4-61

V

vernier control, of FM deviation, H-3
 vertical bar, in HP-SL, 4-14
 VHF, example, F-24
 VHF, range, F-22
 VIDEO connector, 2-28
 video feedthrough, 2-28, I-5
 video output, 2-28
 video width, 2-28, I-5
 voltage levels, for RF output, F-19
 voltage levels, for subcarrier, F-10
 voltage, for int. audio source, F-20
 voltage, power source, A-1
 voltmeter in connector, C-8, C-9
 voltmeter subsystem, 4-54
 VOR, I-5
 VOR, example, F-24
 VOR, range, F-22
 VOR, setup, 4-42, C-11

W

w.g. noise, int. waveform, 2-2, 2-13, 2-22
 waiting for arm bit, 4-64
 waiting for trigger bit, 4-64
 warranty, extended, B-1
 waveform degradation, F-20
 waveform, sawtooth, 2-2, 2-13, 2-22
 waveform, sine, 2-2, 2-13, 2-22
 waveform, square, 2-2, 2-13, 2-22
 waveform, w.g. noise, 2-2, 2-13, 2-22
 wideband ALC, C-2
 width, pulse, 2-23

X

x-axis output, 3-7

Z

z-axis output, 3-7, 3-8

TABLE OF CONTENTS

Section 1 General Information

Introduction to Signal Generator Documentation	1-1
Operation Guide	1-1
Calibration Manual	1-1
Service Diagnostics Manual	1-2
Specifications	1-2
Safety Considerations	1-2
Description	1-3
RF Output	1-3
Output Amplitude	1-3
Modulation	1-4
Sweep	1-4
Hewlett-Packard Interface Bus (HP-IB)	1-4
Compatibility	1-4
Selecting the HP-IB Address	1-4
Instruments Covered by this Manual	1-5
Serial Numbers	1-5
Documentation Updating	1-5
Additional Equipment Information	1-6
Electrical Options	1-6
Mechanical Options	1-6
Documentation Options	1-7
Available Electrical and Mechanical Equipment	1-7
Accessories Supplied	1-7
Recommended Test Equipment	1-7

Section 2 Installation

Introduction	2-1
Initial Inspection	2-1
Preparation for Use	2-1
Power Requirements	2-1
Line Voltage and Fuse Selection	2-3
Power Cables	2-3

HP-IB Address Selection	2-5
Interconnections	2-5
Mating Connectors	2-5
Operating Environment	2-5
Bench Operation	2-5
Rack Mounting	2-6
Storage and Shipment	2-6
Environment	2-6
Packaging	2-6

**Section 3
Performance Tests**

Introduction	3-1
Equipment Required	3-1
Performance Test Record	3-1
Calibration Cycle	3-1
Internal Voltmeter Verification	3-1
Basic Functional Checks	3-2
Preliminary Test - Internal Voltmeter Verification	3-4
Performance Test 1 - Carrier Amplitude Test	3-5
Performance Test 2 - AM Test	3-13
Performance Test 3 - FM Test (Low Deviations and Rates)	3-20
Performance Test 4 - FM Test (High Deviations and Rates)	3-26
Performance Test 5 - Spectral Purity Test (SSB Phase Noise)	3-30
Performance Test 6 - Spectral Purity Test (Harmonics)	3-42
Performance Test 7 - Pulse Modulation Test (Option 008)	3-45
Performance Test 8 - Internal Audio Oscillator Test	3-52
Performance Test 9 - Leakage Test (Option 010)	3-53
Performance Test Record	3-55

Section 1

GENERAL INFORMATION

1-1. INTRODUCTION TO THE SIGNAL GENERATOR DOCUMENTATION

Documentation for the Signal Generator includes an *Operation and Calibration Manual*, and a *Service Diagnostics Manual-Assembly Level Repair*. The *Operation and Calibration Manual* is made up of a *Operation Guide* and a *Calibration Manual* both in the same 3-ringed binder. These manuals contain all the information required to install, operate, test, and service the models of Synthesized Signal Generators listed on this manual's title page. The Synthesized Signal Generator will be referred to as the Signal Generator throughout this manual.

The information to operate, calibrate, and service this instrument is as follows:

- The *Operation Guide* is provided with each instrument.
- The *Calibration Manual* is provided with each instrument.
- The *Service Diagnostics Manual-Assembly Level Repair* is not included with the instrument but is obtained separately by ordering through your nearest Hewlett-Packard office. Refer to the title page of this manual for part numbers.

Operation Guide

The *Operation Guide* documents front-panel operation, including special functions, error messages, and HP-SL programming. All operating information for the Signal Generator is found in the *Operation Guide*.

Calibration Manual

Section 1, General Information describes the Signal Generator, options, accessories, specifications, and other basic information.

Section 2, Installation provides information about initial inspection, preparation for use (including address selection for remote operation), instrument storage, and shipment.

Section 3, Performance Tests documents the tests that verify performance of the instrument against the critical specifications in table 1-1 (table 1-1A lists HP 8664A specifications, table 1-1B lists HP 8665A/B specifications).

Service Diagnostics Manual-Assembly Level Repair

This Manual documents repairing the Signal Generator to the assembly level using internal diagnostic firmware routines. This manual does not include component level repair.

Additional copies of any operation, calibration, or service manual can be ordered separately through your nearest Hewlett-Packard office. The part numbers are listed on the title page of this manual, and in the paragraph 1-8, *Additional Equipment Information under Documentation Options*.

1-2. SPECIFICATIONS

Instrument specifications are listed in table 1-1, *Specifications* (table 1-1A lists HP 8664A specifications, table 1-1B lists HP 8665A/B specifications). These are the performance standards, or limits, against which the instrument may be tested 30 minutes after turn-on. The Signal Generator has a general operating temperature range of 0 to +55°C. Whenever the instrument senses an ambient temperature variation of $\pm 10^\circ\text{C}$, a recalibration should be done to ensure that all specifications are being met. The error message **Temp Drift. Recalibrate** is put into the message queue if the temperature variation occurs. Activate Special Function 171 to recalibrate the instrument.

Information printed in *Italics* are *Supplemental Characteristics*, and are not warranted specifications but are typical characteristics included as additional information for the user.

1-3. SAFETY CONSIDERATIONS

This product is a Safety Class I instrument (that is, one provided with a protective earth terminal). Review the Signal Generator and all related documentation to become familiar with safety markings and instructions before operation. Refer to the *Warnings* and *Cautions* found in section 2 for safety information.

Safety information pertinent to the task at hand (installation, operation, performance testing, adjustment, or service) are found throughout these manuals.

1-4. DESCRIPTION

The Hewlett-Packard Synthesized Signal Generators have an RF output range of 100 kHz upto 6000 MHz, depending upon the model. Its output amplitude is leveled and calibrated from +16 to -139.9 dBm (+9 dBm with Pulse Modulation Option 008). AM, FM, Pulse (with Option 008 only), or Phase Modulation functions can be selected. The RF output frequency, output amplitude, and modulation functions may be remotely programmed via the Hewlett-Packard Interface Bus using the new Hewlett-Packard Standard Language (HP-SL). The unique modular design, internal calibration, and service diagnostic features permit accurate calibration and service.

RF Output

The Signal Generator covers an RF output range of 100 kHz to 6000 MHz, depending upon the model:

The HP 8664A RF range is 100 kHz to 3000 MHz;

The HP 8665A RF range is 100 kHz to 4200 MHz;

The HP 8665B RF range is 100 kHz to 6000 MHz.

NOTE

HP 8665A Synthesized Signal Generators with serial prefix 3015A and above have a frequency underrange to 10 KHz, and overrange to 4.5 GHz.

Frequency resolution is 0.01 Hz. A 12-digit display of the RF output in Hz, kHz, MHz, and GHz gives easy viewing of the desired frequency. Pushbutton keys and rotation of the Knob permit accurate tuning, and incrementing of the RF output.

Frequency accuracy and stability are dependent upon the reference source being used, which will be either the internal reference oscillator or an external source operating at 10 MHz. An optional 10 MHz reference with a temperature stabilized crystal is available for increased stability (Option 001).

Output Amplitude

The Signal Generator has precise power levels from +13 to -139.9 dBm over the entire frequency range. For instruments equipped with Option 008, the maximum output level is +9 dBm. Output amplitude display resolution is 0.1 dBm. An 8 digit display provides easy viewing of the desired output. Easy conversion of units between dBm, +V, EMF, and so forth is possible.

Reverse Power protection for the HP 8664A is 25 Watts into 50 Ω from 0.1 to 2060 MHz, and 1 Watt into 50 Ω from 2060 to 3000 MHz.

Reverse Power protection for the HP 8665A is 25 Watts into 50 Ω from 0.1 to 2060 MHz, and 1 Watt into 50 Ω from 2060 to 4200 MHz. Static protection to 2 kV.

Reverse Power protection for the HP 8665B is 1 Watt into 50 Ω . Static protection to 2 kV.

Modulation

The Signal Generator features AM, FM, Φ M, and Pulse modulation which can be simultaneously mixed, for example, AM/FM, AM/ Φ M, AM/Pulse, FM/Pulse, Φ M/Pulse, AM/FM/Pulse, or AM/ Φ M/Pulse. The Signal Generator also features versatile simultaneous internal and external modulation capability for AM, FM, Pulse, and Φ M.

With the Synthesized Audio Oscillator (refer to appendix F in the *Operation Guide*), the Internal Audio Source produces sine, square, triangle, sawtooth, and white Gaussian noise waveforms from 0.1 Hz to 400 kHz. However, the **AUDIO** output has a typical bandwidth of 400 kHz which affects complex waveforms with frequency components greater than 400 kHz. A 16 digit display and LED annunciators shows information for the internal or external modulation source. Direct keyboard entry for modulation selection is provided.

Sweep

The Signal Generator has two types of sweep: phase-continuous, and digitally-stepped. Linear or log frequency spacing may be selected with digitally-stepped sweeping; only linear frequency spacing is available when phase-continuous sweeping.

1-5. HEWLETT-PACKARD INTERFACE BUS (HP-IB)

Compatibility

The Signal Generator is fully programmable via the HP Interface Bus. The Signal Generator's capabilities are defined by the following interface functions: SH1, AH1, T6, TE0, L4, LE0, SR1, RL1, PP0, DC1, DT0, C0, E2. The Signal Generator interfaces with the bus via open-collector TTL circuitry. An explanation of the compatibility code may be found in IEEE Standard 488.2, in *IEEE Standard and Digital Interface for Programmable Instrumentation* or the identical ANSI Standard MC1.1.

For detailed information relating to programmable control of the Signal Generator over HP-IB using HP-SL, refer to chapter 4 in the *Operation Guide*.

Selecting the HP-IB Address

The instrument's HP-IB address is preset to 19 (decimal) when shipped from the factory.

The HP-IB address is front-panel programmable. To change your instrument's HP-IB address, press the blue **SHIFT** key, and then the **ADRS** key. You will see the current address in the **FREQUENCY/STATUS** display. Key in the desired decimal number between 00 and 30 if you want to change the HP-IB address, and then press the **ENTER** key.

1-6. INSTRUMENTS COVERED BY THIS MANUAL

This manual documents Signal Generators supplied with electrical options 001, 003, 004, 008, and 010. These, and various mechanical options are described in this manual under paragraph 1-8, *Additional Equipment Information*.

Serial Numbers

This instrument has a two-part serial number in the form 1234A00123 which is stamped on the serial number plate attached to the rear of the instrument (above and slightly to the right of the fan louvre). The first four digits and the letter are the serial number prefix, and the last five digits form the sequential suffix that is unique to each instrument. The prefix is the same for all identical instruments; it changes only when a change is made to the instrument.

The contents of these manuals apply directly to instruments having the same serial number prefix(es) as listed under SERIAL NUMBERS on the respective manual title pages.

For information concerning a serial number prefix not listed in the range provided on the title page, contact your nearest Hewlett-Packard office.

1-7. DOCUMENTATION UPDATING

This manual may be revised as needed to make corrections and to document hardware and firmware changes. The latest revision of the manual can be purchased from the Hewlett-Packard locations shown below:

Inside the U.S.A. Call *HP Parts Direct Ordering* at 800-227-8164. They can also help determine if a new revision is available.

Outside the U.S.A. Contact the local Hewlett-Packard Sales and Service office for ordering information.

1-8. ADDITIONAL EQUIPMENT INFORMATION

Options are variations to the standard instrument which can be ordered during, or after the original purchase. If options were not ordered with the shipment but are now desired, they may be ordered from your nearest Hewlett-Packard office using the part number included in the following paragraphs. The following list defines all currently available options.

Electrical Options

High Stability Timebase, (Option 001). This option provides the Signal Generator with a temperature regulated 10 MHz crystal High Stability Time Base for increased frequency stability (less than 5×10^{-10} /day). A BNC 10 MHz time base output connector is provided on the rear panel as a time base reference.

Rear Panel Inputs/Outputs, (Option 003). This option provides rear-panel (instead of front-panel) connections for AM/FM/PULSE/PHASE MODULATION INPUTS, AUDIO and RF OUTPUTS.

Enhanced Spectral Purity, (Option 004). This option provides the Signal Generator with better phase noise and spurious performance.

Pulse Modulation, (Option 008). This option provides the Signal Generator with the Hewlett-Packard designed GaAs pulse modulator.

Reduced Leakage Configuration, (Option 010). This option provides the Signal Generator with RF leakage performance reduced to less than $0.05 \mu\text{V}$ (typically).

Mechanical Options

Front Handle Kit (Option 907). Ease of handling is increased with the front-panel handles. Order HP part 5062-3990.

Rack Flange Kit (Option 908). This kit contains all necessary hardware and installation instructions for mounting the Signal Generator in a rack with 482.5 millimeter (standard 19-inch) spacing. Order HP part 5062-3978.

Rack Flange and Front Handle Combination Kit (Option 909). This kit is simply a front handle kit and a rack flange kit packaged together. The combination is made up of unique parts which include both functions. Order HP part 5062-3984.

Chassis Slide-Mount Kit. This kit is extremely useful when the Signal Generator is rack mounted. Access to internal circuits and components or the rear panel is possible without removing the instrument from the rack. Order HP part 1494-0059 for 432 mm (17 in.) fixed slides. (To order adapters for non-HP rack enclosures, use HP part 1494-0023.)

Chassis-Tilt, Slide-Mount Kit. This kit is the same as the Chassis Slide Mount Kit above except it also allows the tilting of the instrument up or down 90°. Order HP part 1494-0063 for 432 mm (17 in.) tilting slides. To order adapters for non-HP rack enclosures, use HP part 1494-0023.

Documentation Options

Extra Manual Set (Option 910). Provides an additional copy of the *Operation and Calibration Manual* (HP part 08665-90026), and two copies of the *Service Diagnostics Manual-Assembly Level Repair* (HP part 08645-90024).

Add Service Manual (Option 915). Provides a copy of the *Service Diagnostics Manual-Assembly Level Repair* (HP part 08645-90024) enabling a qualified service person to troubleshoot and repair the Signal Generator to the module and cable level.

1-9. AVAILABLE ELECTRICAL AND MECHANICAL EQUIPMENT

Service Accessory Kit. A Service accessory Kit (HP part 08665-61116) is available which contains accessories (special test fixtures, cables, etc.) useful in servicing the Signal Generator.

Transit Case. Protection when transporting is increased with the Transit Case. Order HP part number 9211-2662. For ease of use when handling, Transit Case Wheels can be ordered using HP part number 1490-0913 (includes 4 wheels).

1-10. ACCESSORIES SUPPLIED

The Accessories Supplied are pieces of equipment which are shipped with every Signal Generator.

Line Power Cable. The line power cable may be supplied in several different plug configurations according to the Mains voltage available, and the country of destination of the original shipment. For the part numbers of the power cables and Mains plugs available, refer to *Power Cables* in section 2 of this manual.

Fuses. Fuses with a 4A rating for 115 V ac (HP 2110-0055) and a 2.5A rating for 230 V ac (HP 2110-0083) are supplied. One fuse is factory installed according to the voltage available in the country of original destination. This same information (part numbers and ratings of the fuses available) is in the paragraph *Line Voltage and Fuse Selection* in section 2 of this manual.

Coaxial Timebase Cable. A coaxial time base cable is supplied if the Signal Generator is equipped with Option 001. This cable must be connected between the rear-panel OVEN REF output connector from the High Stability Time Base, and the REF IN input connector.

1-11. RECOMMENDED TEST EQUIPMENT

Table 1-2, *Recommended Test Equipment* lists the test equipment required for testing, adjusting, and servicing the Signal Generator. The Critical Specifications column describes the essential requirements for each piece of test equipment. Other equipment can be substituted if it meets or exceeds these critical specifications.

Table 1-1. HP 8664A/65A/65B Specifications (1 of 4)

Specifications	HP 8664A HP 8665A/B																																																	
Frequency Range: Resolution: Accuracy (std. timebase): < 1 year of calibration	.1 – 3000 MHz HP 8664A .1 – 4200 MHz HP 8665A .1 – 6000 MHz HP 8665B .01 Hz $.375 \times 10^{-6}$ times carrier in Hz																																																	
Internal reference oscillator (Applies only to instruments with serial prefix 3203A and above) Aging: Temperature: Line voltage: Output: External reference input: Electronic frequency control (EFC):	<table style="width: 100%; border: none;"> <tr> <td style="text-align: center;"><u>Standard high stability</u></td> <td style="text-align: center;"><u>Option 001 high stability with EFC</u></td> </tr> <tr> <td style="text-align: center;">$\pm 1.5 \times 10^{-8}$/day after ten days</td> <td style="text-align: center;">$\pm 3 \times 10^{-10}$/day after ten days</td> </tr> <tr> <td style="text-align: center;">$\pm 7 \times 10^{-10}$, 0 to 55°C</td> <td style="text-align: center;">$\pm 6 \times 10^{-10}$, 0 to 55°C</td> </tr> <tr> <td style="text-align: center;">$\pm 2 \times 10^{-10}$, (+5%, -10%)</td> <td style="text-align: center;">$\pm 1 \times 10^{-10}$, $\pm 10\%$</td> </tr> <tr> <td style="text-align: center;">10 MHz, > 0.15V_{rms} level into 50Ω</td> <td style="text-align: center;">10 MHz, > 1 V_{rms} level into 50Ω</td> </tr> </table> <p>Accepts 10 MHz ± 5 ppm and a level range of 0.5V to 2 V_{rms} into 50Ω.</p> <p>Option 001 only, ± 0.01 ppm for ± 1 Vdc at rear panel connector, voltage range ± 10 Vdc, input impedance 10kΩ.</p>	<u>Standard high stability</u>	<u>Option 001 high stability with EFC</u>	$\pm 1.5 \times 10^{-8}$ /day after ten days	$\pm 3 \times 10^{-10}$ /day after ten days	$\pm 7 \times 10^{-10}$, 0 to 55°C	$\pm 6 \times 10^{-10}$, 0 to 55°C	$\pm 2 \times 10^{-10}$, (+5%, -10%)	$\pm 1 \times 10^{-10}$, $\pm 10\%$	10 MHz, > 0.15V _{rms} level into 50Ω	10 MHz, > 1 V _{rms} level into 50Ω																																							
<u>Standard high stability</u>	<u>Option 001 high stability with EFC</u>																																																	
$\pm 1.5 \times 10^{-8}$ /day after ten days	$\pm 3 \times 10^{-10}$ /day after ten days																																																	
$\pm 7 \times 10^{-10}$, 0 to 55°C	$\pm 6 \times 10^{-10}$, 0 to 55°C																																																	
$\pm 2 \times 10^{-10}$, (+5%, -10%)	$\pm 1 \times 10^{-10}$, $\pm 10\%$																																																	
10 MHz, > 0.15V _{rms} level into 50Ω	10 MHz, > 1 V _{rms} level into 50Ω																																																	
Spectral Purity SSB phase noise (dBc/Hz): (@ 20 kHz offset) <table style="width: 100%; border: none;"> <thead> <tr> <th style="text-align: left;">Carrier (MHz)</th> <th style="text-align: center;">Standard</th> <th style="text-align: center;">Option 004</th> </tr> </thead> <tbody> <tr><td>4120 – 6000</td><td style="text-align: center;">-105</td><td style="text-align: center;">-116</td></tr> <tr><td>3000 – 4120</td><td style="text-align: center;">-105</td><td style="text-align: center;">-122</td></tr> <tr><td>2060 – 3000</td><td style="text-align: center;">-111</td><td style="text-align: center;">-122</td></tr> <tr><td>1030 – 2060</td><td style="text-align: center;">-111</td><td style="text-align: center;">-128</td></tr> <tr><td>515 – 1030</td><td style="text-align: center;">-117</td><td style="text-align: center;">-134</td></tr> <tr><td>257.5 – 515</td><td style="text-align: center;">-122</td><td style="text-align: center;">-139</td></tr> <tr><td>187.5 – 257.5</td><td style="text-align: center;">-128</td><td style="text-align: center;">-144</td></tr> <tr><td>.1 – 187.5</td><td style="text-align: center;">-117</td><td style="text-align: center;">-131</td></tr> </tbody> </table> Nonharmonics: Harmonics: Subharmonics: Residual FM (Hz rms): <table style="width: 100%; border: none;"> <thead> <tr> <th style="text-align: left;">Carrier (MHz)</th> <th style="text-align: center;">Std./Opt.004</th> </tr> <tr> <th style="text-align: left;">3 kHz BW</th> <th style="text-align: center;">15 kHz BW</th> </tr> </thead> <tbody> <tr><td>2060 – 6000¹</td><td style="text-align: center;">< 60/ < 10</td><td style="text-align: center;">< 80/ < 32</td></tr> <tr><td>1030 – 2060</td><td style="text-align: center;">< 30/ < 5</td><td style="text-align: center;">< 37/ < 8</td></tr> <tr><td>515 – 1030</td><td style="text-align: center;">< 15/ < 2.5</td><td style="text-align: center;">< 20/ < 8</td></tr> <tr><td>257.5 – 515</td><td style="text-align: center;">< 7.5/ < 1.2</td><td style="text-align: center;">< 10/ < 4</td></tr> <tr><td>187.5 – 257.5</td><td style="text-align: center;">< 7.5/ < 1.2</td><td style="text-align: center;">< 10/ < 4</td></tr> <tr><td>.1 – 187.5</td><td style="text-align: center;">< 15/ < 2.5</td><td style="text-align: center;">< 20/ < 8</td></tr> </tbody> </table> Residual AM: (.3 to 3 kHz Post Det. BW)	Carrier (MHz)	Standard	Option 004	4120 – 6000	-105	-116	3000 – 4120	-105	-122	2060 – 3000	-111	-122	1030 – 2060	-111	-128	515 – 1030	-117	-134	257.5 – 515	-122	-139	187.5 – 257.5	-128	-144	.1 – 187.5	-117	-131	Carrier (MHz)	Std./Opt.004	3 kHz BW	15 kHz BW	2060 – 6000 ¹	< 60/ < 10	< 80/ < 32	1030 – 2060	< 30/ < 5	< 37/ < 8	515 – 1030	< 15/ < 2.5	< 20/ < 8	257.5 – 515	< 7.5/ < 1.2	< 10/ < 4	187.5 – 257.5	< 7.5/ < 1.2	< 10/ < 4	.1 – 187.5	< 15/ < 2.5	< 20/ < 8	<p>< -100 dBc, > 10 kHz offset, 187.5 – 2060 MHz < -90 dBc, > 10 kHz offset, 2060 – 6000¹ MHz and .1 – 187.5 MHz</p> <p>< -30 dBc, output $\leq +6$ dBm</p> <p>< -75 dBc, .1 – 1500 MHz < -40 dBc, 1500 – 3000 MHz < -50 dBc, 3000 – 6000¹ MHz</p>
Carrier (MHz)	Standard	Option 004																																																
4120 – 6000	-105	-116																																																
3000 – 4120	-105	-122																																																
2060 – 3000	-111	-122																																																
1030 – 2060	-111	-128																																																
515 – 1030	-117	-134																																																
257.5 – 515	-122	-139																																																
187.5 – 257.5	-128	-144																																																
.1 – 187.5	-117	-131																																																
Carrier (MHz)	Std./Opt.004																																																	
3 kHz BW	15 kHz BW																																																	
2060 – 6000 ¹	< 60/ < 10	< 80/ < 32																																																
1030 – 2060	< 30/ < 5	< 37/ < 8																																																
515 – 1030	< 15/ < 2.5	< 20/ < 8																																																
257.5 – 515	< 7.5/ < 1.2	< 10/ < 4																																																
187.5 – 257.5	< 7.5/ < 1.2	< 10/ < 4																																																
.1 – 187.5	< 15/ < 2.5	< 20/ < 8																																																

Table 1-1. HP 8664A/65A/65B Specifications (2 of 4)

<p>Output Level</p> <p>Range:</p> <p>Resolution:</p> <p>Absolute accuracy:</p> <p>Reverse power protection:</p>	<p>+13 to -139.9 dBm +9 dBm, Opt. 008</p> <p>.01 Hz</p> <p>± 1 dB, output ≥ -119.9 dBm, 1 - 1000 MHz ± 1.5 dB, output ≥ -119.9 dBm, 1000 to 3000 MHz ± 2 dB, output ≥ -119.9 dBm, 3000 to 6000¹ ± 3 dB, output ≥ -129.9 dBm, <1 MHz</p> <p>25 watts², .1 - 2060 MHz 1 watt, >2060MHz</p>
<p>Amplitude Modulation</p> <p>Depth:</p> <p>Resolution:</p> <p>Bandwidth (3 dB):</p> <p>Accuracy: 1 kHz rate</p> <p>Distortion: 30% depth, 1 kHz rate</p> <p>Incidental phase modulation: (at 30% depth, 1 kHz rate)</p>	<p>0 - 100%, output $\leq +7$ dBm</p> <p>.1 %</p> <p>dc to >10kHz for > 10 MHz</p> <p>$\pm(6\%$ of setting + 1%) up to 90% depth</p> <p>< 4%</p> <p><0.2radians peak, ≤ 2000 MHz <0.4radians peak, >2000MHz</p>
<p>Frequency Modulation</p> <p>Maximum peak deviation:</p> <p>Resolution:</p> <p>Bandwidth (3 dB):</p> <p>Carrier accuracy in FM:</p> <p>Indicator accuracy:</p> <p>Distortion:</p> <p>Incidental AM:</p>	<p>20 MHz, 3000 - 6000¹ MHz 10 MHz, 1500 - 3000 MHz 5 MHz, 750 - 1500 MHz 2.5 MHz, 375 - 750 MHz 1.25 MHz, 187.5 - 375 MHz 5 MHz, 10 - 187.5 MHz</p> <p>2.5 % of setting</p> <p>dc to 800 kHz</p> <p>$\pm 0.6\%$ of setting</p> <p>$\pm 9\%$, <20 kHz rates $\pm 11\%$, <20 kHz rates, Opt. 004</p> <p><1%, 20 Hz to 20 kHz rates</p> <p><0.3%, deviation ≤ 20 kHz</p>

¹ 3000 MHz - HP8664A, 4200 MHz - HP8665A, 6000 MHz - HP8665B

Table 1-1. HP 8664A/65A/65B Specifications (3 of 4)

<p>Pulse Modulation, Option 008 On/off ratio: Rise/fall time, 10 – 90%: Repetition rate: Internal width/delay: Output level accuracy:</p>	<p>> 80 dB < 8 ns dc to 10 MHz Variable from 50 ns to 1s. Accuracy: $\pm 10\% \pm 2$ nsec. Same as standard</p>
<p>Internal Modulation Source Number of sources: Waveforms and rates: Frequency accuracy: Output level (into 600Ω): Output resolution: Total Harmonic Distortion:</p>	<p>Two sources simultaneously available through summation, independently adjustable in frequency, phase, amplitude and waveform. Source One may also be internally modulated with AM, FM, phase modulation and pulse modulation to create a subcarrier waveform. Sine, white Gaussian noise; 0.1 Hz to 400 kHz Triangle, Sawtooth, Square; 0.1 Hz to 50 kHz Same as timebase 1 Vpk 2 mV pk < 0.2%, rates < 20 kHz</p>
<p>Frequency Sweep Digital sweep: Markers/Z axis output: Phase continuous sweep:</p>	<p>Digitally stepped sweep over entire frequency range. Linear/log selection. .5 to 1000 sec sweeps. Three markers available /Z axis output nominally +5 V/X axis output nominally 0 to 10V. 40 MHz of span available at maximum carrier frequency. 20 ms to 10 sec sweep times.</p>
<p>Remote Programming Interface: Control language: IEEE-488 functions:</p>	<p>HP-IB (IEEE 488.2-1987). Hewlett-Packard Systems Language (HP-SL). All functions controlled except power. SH1, AH1, T6, TEO, L4, LEO, SR1, RL1, PPO, DC1, DTO, CO, E2.</p>

Table 1-1. HP 8664A/65A/65B Specifications (4 of 4)

General	
Power requirements:	±10% of 100V, 120V, 220V or 240V; 48 to 440 Hz; 500 VA.
Operating temperature:	0 to 55°C
Leakage:	Conducted and radiated interference meets MIL STD 461B REO2 and FTZ 1046. Leakage is measured into a resonant dipole antenna one inch from the instrument's surface with output level <0 dBm (all inputs/outputs properly terminated, $f_c < 1$ GHz). Leakage is typically <16µV or <2µV with Option 010, measured at the front panel. The older two-turn loop method of measurement is typically <1µV or <0.1µV for Option 010.
Acoustic noise:	Typically <5.5bels
Storage registers:	Ten full function and 40 frequency/amplitude registers.
Calibration & diagnostics:	Internal calibration and diagnostics functions are available to the user. Built-in test capability locates circuit malfunctions to allow repair through module replacement.
Calibration interval:	Recommended two years (MTBC).
Weight:	35 kg (78 lbs)
Dimensions:	177H X 426W X 601D mm (7 X 16.8 X 23.7 in.). Opt. 010 adds 35 mm (1.4 in.) to depth.

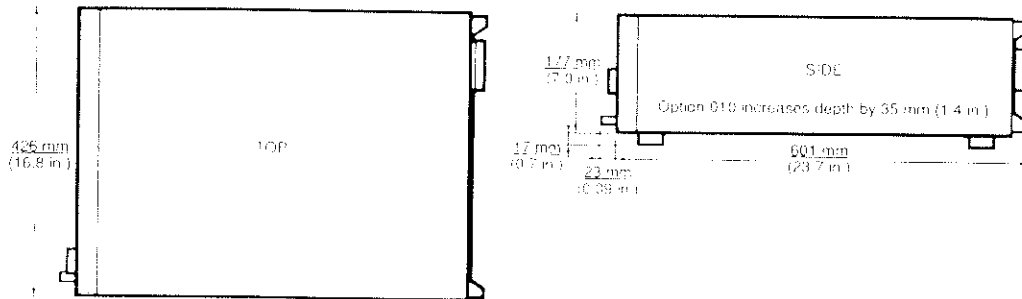

Table 1-2. Recommended Test Equipment (1 of 2)

Instrument Type	Critical Specifications	Recommended Model
Audio Source	Level: 1 Vpk into 50 ohms Frequency: 1 kHz to 100 kHz	HP 3325A
Digital Voltmeter	Range: -40 to +40 V Accuracy: $\pm 0.2\%$ ± 0.1 V	HP 3478A
Digitizing Oscilloscope	Vertical Sensitivity: 0.01 mV/div Bandwidth: 1 GHz Time/Div: 1 ns Input: Dual Channel, 50 ohms	HP 54110D with 2 HP 54002A
Distortion Analyzer	Distortion Range: < 0.1% Range: 20 Hz to 100 kHz	HP 339A, HP 8903B, or HP 8903E
Measuring Receiver, Sensor Module (RF), and Sensor Module (Microwave)	<p>Frequency Range: 250 kHz to 1300 MHz Input Level: -127 to +17 dBm Compatible with HP 11793A Microwave Converter RF Power Accuracy: 0.2 dB Tuned RF Level: 0.36 dB RSS Referenced to -10 dBm input</p> <p>Amplitude Modulation: Rates: 20 Hz to 100 kHz Depth: to 90% Accuracy: $\pm 2\%$ at 1 kHz Demodulated Output Distortion: 0.5% for 50% depth; < 1.0% for 90% depth Incidental ΦM: < 0.05 radians for 30% depth at 1 kHz rate (50 Hz to 3 kHz bandwidth) Residual AM: < 0.01% rms (0.3 to 3 kHz BW)</p> <p>Frequency Modulation: Rates: 20 Hz to 200 kHz Deviation: to 400 kHz Accuracy: $\pm 3\%$ at 1 kHz Demodulated Output Distortion: < 0.3% Incidental AM: 0.2% depth at 20 kHz FM deviation Residual FM: See specifications for External Local Oscillator for Measuring Receiver</p>	HP 8902A Opt. 003 and HP 11722A and HP 11792A Opt. 001

Table 1-2. Recommended Test Equipment (2 of 2)

Instrument Type	Critical Specifications	Recommended Model
Microwave Converter	Input Frequency Range: 0 to 4.4 GHz Compatible with HP 8902A Measuring Receiver.	HP 11793A
Microwave Signal Generator	Frequency Range: 2 to 4.4 GHz Output level: +13 dBm.	HP 8672A
Phase Noise Measurement System	The Performance Tests for SSB Phase Noise are complex and the procedure has been written specifically using the HP 3048A, no substitutions are recommended.	HP 3048A Opt. 101 and Opt. 201
Power Supply	Output Range: -40 to +40 V.	HP 6218C or HP 6236B
Reference Signal Generator	Residual FM: Less than or equal to the specification for the HP 8665A or HP 8665A Opt. 004.	Signal Generator Opt. 004, HP 8662A, or HP 8663A
Spectrum Analyzer, RF	Frequency Range: 0.1 to 12.8 GHz Resolution Bandwidth: <1 kHz to 3 kHz	HP 8562B

Section 2 INSTALLATION

2-1. INTRODUCTION

This section provides the information needed to install the Signal Generator. Included is information pertinent to initial inspection, power requirements, line voltage, fuse selection, power cables, time base selection, HP-IB address selection, interconnection, mating connectors, operating environment, instrument mounting, storage, and shipment.

2-2. INITIAL INSPECTION

WARNING

To avoid hazardous electrical shock, do not perform electrical tests when there are any signs of shipping damage to any portion of the outer enclosure (covers and panels).

Inspect the shipping container for damage. If the shipping container or cushioning material is damaged, it should be kept until the contents of the shipment have been checked for completeness and the instrument has been checked mechanically and electrically. Procedures for checking electrical performance are given in section 3, *Performance Tests*. If the contents are incomplete, if there is mechanical damage or defect, or if the instrument does not pass the electrical performance tests, notify the nearest Hewlett-Packard office. If the shipping container is damaged, or the cushioning material shows signs of stress, notify the carrier as well as the Hewlett-Packard office. Keep the shipping materials for the carrier's inspection.

2-3. PREPARATION FOR USE

Power Requirements

The Signal Generator requires a power source of ($\pm 10\%$) 100, 120, 220, or 240 V ac from 48 to 440 Hz. Power consumption is 500 VA maximum.

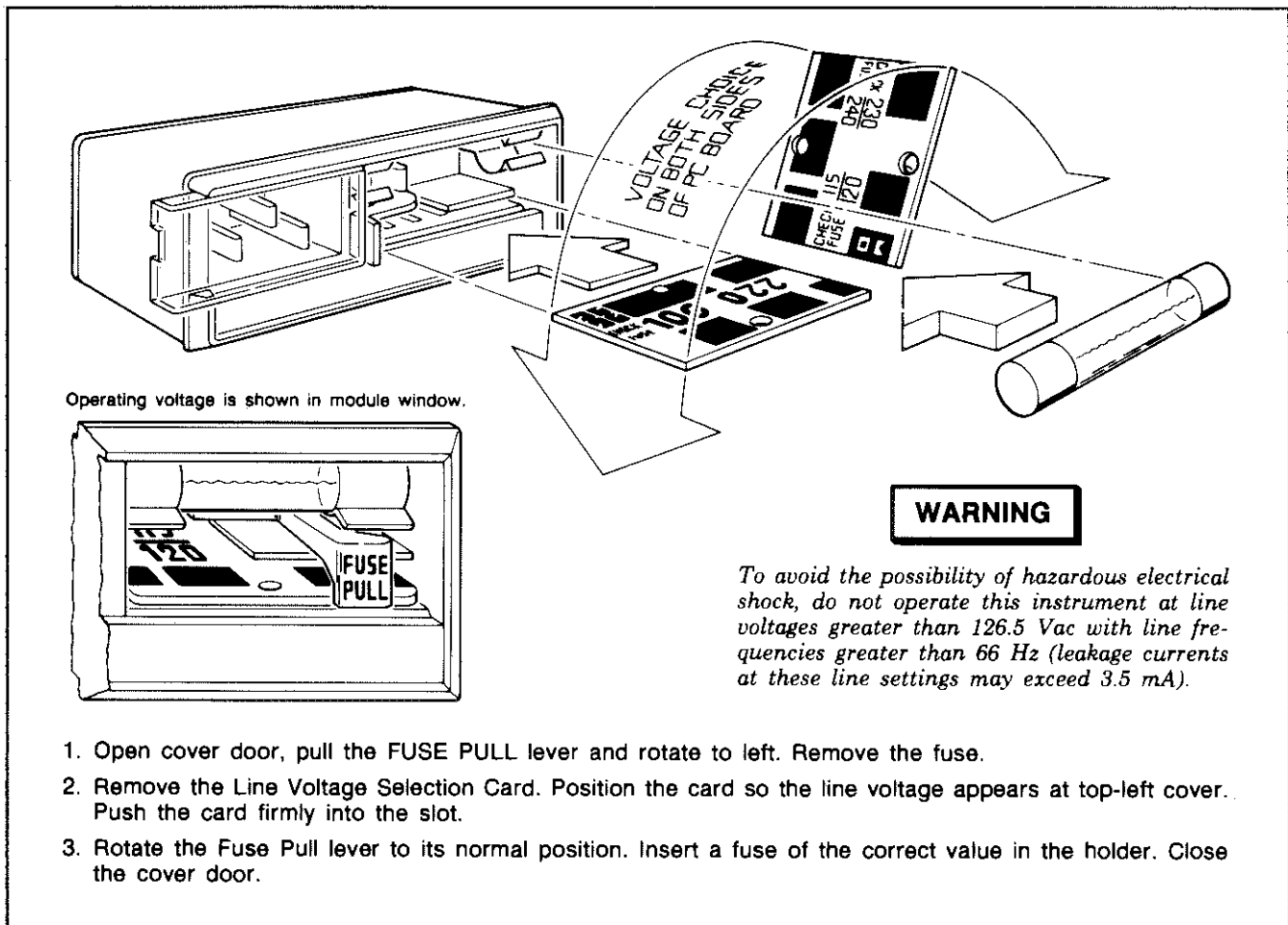

Figure 2-1. Line Voltage and Fuse Selection

WARNING

This is a Safety Class I product (i.e., provided with a protective earth terminal). An uninterruptible safety earth ground must be provided from the Mains power source to the product input wiring terminals, power cord, or supplied power cord set. Whenever it is likely that the protection has been impaired, the instrument must be made inoperative and be secured against any unintended operation.

If this instrument is to be energized via an external autotransformer for voltage reduction, make sure that the common terminal is connected to the earthed pole of the power source.

Line Voltage and Fuse Selection

CAUTION

BEFORE PLUGGING THIS INSTRUMENT into the Mains (line) voltage, be sure the correct voltage and fuse has been selected.

Verify that the Line Voltage Selection Card and fuse are matched to the power source. See figure 2-1, *Line Voltage and Fuse Selection*.

Fuses may be ordered under the HP part numbers listed in table 2-1, *Line Fuse Rating and HP Part Number*.

WARNING

For protection against fire hazard, the line fuse should only be a 250 V fuse with the correct current rating.

Table 2-1. Line Fuse Rating and HP Part Number

Line Voltage	Rating	Part Number
100, 120 V ac	4A, 250 V	2110-0055
220, 240 V ac	2.5A, 250 V	2110-0083









Power Cables

WARNING

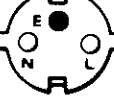
BEFORE CONNECTING THIS INSTRUMENT, the protective earth terminal of the instrument must be connected to the protective conductor of the (Mains) power cord. The Mains plug shall only be inserted in a socket outlet provided with a protective earth contact. The protective action must not be negated by the use of an extension cord (power cable) without a protective conductor (grounding). Grounding one conductor of a two-conductor outlet is not sufficient protection.

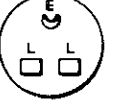
This instrument is equipped with a three-wire power cable. When connected to an appropriate ac power receptacle, this cable grounds the instrument cabinet. The type of Mains plug shipped with each instrument depends on the country of destination. Refer to table 2-2, *Power Cable and Mains Plug Part Numbers* for the part numbers of the power cables and Mains plugs available.

Table 2-2. Power Cable and Mains Plug Part Numbers

Plug Type	Cable HP Part Number	C D	Plug Description	Cable Length (inches)	Cable Color	For Use In Country
250V 	8120-1351 8120-1703	0 4	90°/STR BS1363A* 90°/90°	90 90	Mint Gray Mint Gray	United Kingdom, Cyprus, Nigeria, Rhodesia, Singapore
250V 	8120-1369 8120-0696	0 4	STR/STR NZSS198/ASC112* STR/90°	79 80	Gray Gray	Australia, New Zealand
250V 	8120-1689 8120-1692	7 2	STR/STR* STR/90°	79 79	Mint Gray Mint Gray	East and West Europe, Saudi Arabia, Egypt, (unpolarized in many nations)
125V 	8120-1378 8120-1521 8120-1751	1 6 1	STR/STR NEMA5-15P* STR/90° STR/STR	80 80 90	Jade Gray Jade Gray Jade Gray	United States, Canada, Mexico, Philippines, Taiwan U.S./Canada
100V (Same plug as above)	8120-4753 8120-4754	2 3	STR/STR STR/90°	90 90	Dark Gray Dark Gray	Japan only Japan only
250V 	8120-2104 8120-2296 8120-3997	3 4 4	STR/STR SEV1011 1959-24507 Type 12 STR/90° STR/90°	79 79 177	Gray Gray Gray	Switzerland
250V 	8120-0698	6	STR/STR NEMA6-15P	90	Black	United States, Canada
250V 	8120-2956 8120-2957 8120-3997	3 4 4	90°/STR 90°/90° STR/STR	79	Gray	Denmark
250V 	8120-4211 8120-4600	7 8	STR/STR*IEC83-B1 STR/90°	79 79	Black Gray	South Africa, India
250V 	8120-1860 8120-1575 8120-2191 8120-4379	6 0 8 8	STR/STR*CEE22-V1 (Systems Cabinet Use) STR/STR STR/90° 90°/90°	59 31 59 80	Jade Gray Jade Gray Jade Gray Jade Gray	

* Part number shown for plug is industry identifier for plug only. Number shown for cable is HP Part Number for complete cable including plug. E = Earth Ground; L = Line; N = Neutral; STR = Straight

2-4. HP-IB ADDRESS SELECTION

The instrument's HP-IB address is preset to 19 (decimal) when shipped from the factory.

The HP-IB address is front-panel programmable. To change your instrument's HP-IB address, press the blue SHIFT key, and then the ADRS key to show the current address in the FREQUENCY/STATUS display. Key in the desired decimal number between 00 and 30, then press the ENTER key.

2-5. INTERCONNECTIONS

Interconnection data for the Hewlett-Packard Interface Bus is provided in figure 2-2, *Hewlett-Packard Interface Bus Connections*.

Mating Connectors

Coaxial Connectors. Coaxial mating connectors used with the Signal Generator should be either 50 Ω BNC male connectors or 50 Ω Type N male connectors that are compatible with those specified in US MIL-C-39012.

Interface Connector. The HP-IB mating connector is shown in figure 2-2, *Hewlett-Packard Interface Bus Connections*. Note that the two securing screws are metric.

2-6. OPERATING ENVIRONMENT

The operating environment should be within the following limitations:

- Temperature 0° C to + 55° C
- Humidity < 95% relative at 40° C
- Altitude..... < 4570 meters (15,000 feet)

2-7. BENCH OPERATION

The instrument cabinet has plastic feet that are shaped to ensure self-alignment of instruments when they are stacked.

2-8. RACK MOUNTING

NOTE

The Signal Generator weighs approximately 31 to 35 kg (68 to 78 lbs) net, and 42 to 47 kg (93 to 103 lbs) shipping depending upon the options ordered. Care must be exercised when lifting to avoid personal injury. Use equipment slides when rack mounting.

Specific rack mounting information is provided with the rack mounting kits. If a kit was not ordered with the Signal Generator as an option, it may be ordered through the nearest Hewlett-Packard office. Paragraph 1-8, under *Mechanical Options* in section 1 includes information and part numbers for other types of rack mount kits.

Slide rack mount kits allow the convenience of rack mounting with the flexibility of easy access. Slide kits for the Signal Generator are listed below.

Standard Slide Kit for HP rack enclosures	HP 1494-0059
Special Tilt Slide Kit for HP rack enclosures.....	HP 1494-0063
Slide Adapter Bracket Kit for Standard Slides (for non HP rack enclosures)	HP 1494-0023

2-9. STORAGE AND SHIPMENT

Environment

The instrument should be stored in a clean, dry environment. The following environmental limitations apply to both storage and shipment.

Temperature	-55° C to + 75° C
Humidity	< 95% relative
Altitude.....	15 300 meters (50,000 feet)

Packaging

Original Packaging. Containers and materials identical to those used in factory packaging are available through Hewlett-Packard offices. If the instrument is being returned to Hewlett-Packard for servicing, attach a tag indicating the type of service required, return address, model number, and full serial number. Also, mark the container FRAGILE to assure careful handling. In any correspondence, refer to the instrument by model number and full serial number.

Other Packaging. The following general instructions should be used for repackaging with commercially available materials.

- a. Wrap the instrument in heavy paper or plastic. (If shipping to a Hewlett-Packard office or service center, attach a tag indicating the type of service required, return address, model number, and full serial number.)
- b. Use a strong shipping container. A double-wall carton made of 2.4 MPa (350 psi) test material is adequate.
- c. Use enough shock-absorbing material (75 to 100 millimeter layer; 3 to 4 inches) around all sides of the instrument to provide a firm cushion and to prevent movement in the container. Protect the front-panel with cardboard.
- d. Seal the shipping container securely.
- e. Mark the shipping container FRAGILE to assure careful handling.

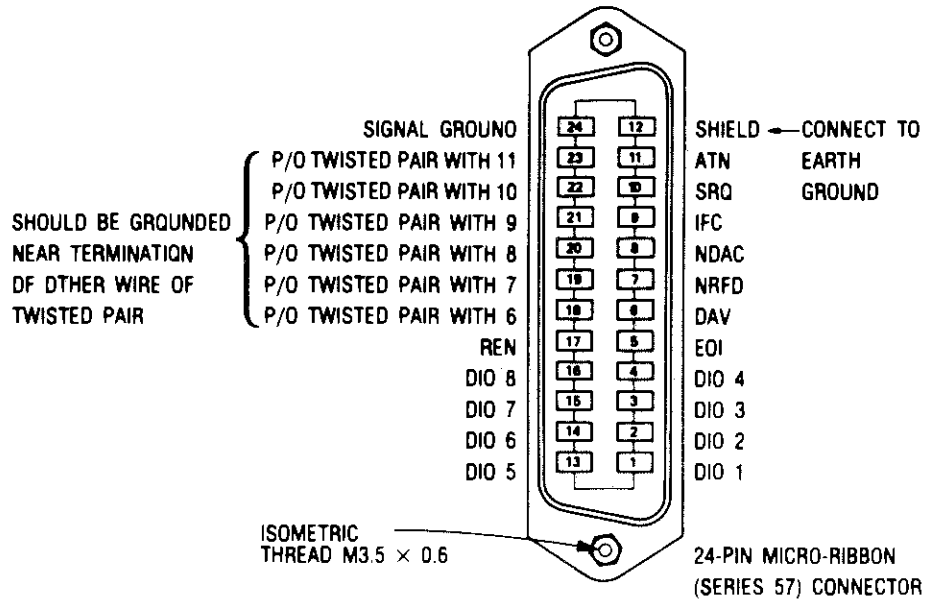

Logic Levels

The Hewlett-Packard Interface Bus logic levels are TTL compatible, i.e., the true (1) state is 0.0 Vdc to +0.4 Vdc and the false (0) state is 2.5 Vdc to +5 Vdc.

Programming and Output Data Format

Refer to Section III, "Operation".

Mating Connector

HP 1251-0293; Amphenol 57-30240.

Mating Cables Available

HP 10833A, 1 metre (3.3 ft.), HP 10833B, 2 metres (6.6 ft.)
 HP 10833C, 4 metres (13.2 ft.), HP 10833D, 0.5 metres (1.6 ft.)

Cabling Restrictions

1. A Hewlett-Packard Interface Bus system may contain no more than 2 metres (6.6 ft.) of connecting cable per instrument.
2. The maximum accumulative length of connecting cable for any Hewlett-Packard Interface Bus system is 20 metres (65.6 ft.).

Figure 2-2. Hewlett-Packard Interface Bus Connections

Section 3

PERFORMANCE TESTS

3-1. INTRODUCTION

The procedures in this section test the instrument's electrical performance using the specifications of table 1-1 as performance standards. All tests are performed without accessing the interior of the instrument.

NOTE

Before beginning the performance tests, the Signal Generator should be allowed a 30 minute warm-up period after turn-on. Line voltage must be within $\pm 10\%$ of nominal if the results of the performance tests are to be considered valid.

Unless otherwise stated, the specifications assume the Signal Generator is operating with its Mode Select set to Auto which automatically optimizes the internal hardware configuration for best performance.

3-2. EQUIPMENT REQUIRED

Equipment required for the performance tests is listed in table 1-2, *Recommended Test Equipment*. Any equipment that satisfies the critical specifications provided in the table may be substituted for the recommended model(s).

3-3. PERFORMANCE TEST RECORD

Results of the performance tests may be tabulated on the *Performance Test Record* at the end of the procedures. The *Performance Test Record* lists all of the tested specifications and their acceptable limits. The results, recorded at incoming inspection, can be used for comparison in periodic maintenance and troubleshooting and after repairs or adjustments.

3-4. CALIBRATION CYCLE

This instrument requires periodic verification of performance. Depending on the use and environmental conditions, the instrument should be checked using the following performance tests every three years.

3-5. INTERNAL VOLTMETER VERIFICATION

Internal to the Signal Generator is a precision dc voltmeter. This voltmeter is used to collect calibration correction data when the Recal function is invoked. During normal instrument operation, Recal is automatically run whenever a significant temperature change is noted by the instrument. Recal should also be run prior to running the Performance Tests. The accuracy of the voltmeter is not explicitly specified but must be within $\pm 1\%$ of reading ± 0.25 V for the Recal operation to give valid results.

3-6. BASIC FUNCTIONAL CHECKS

The basic functions of the Signal Generator can be verified by performing the instrument operating examples in the Signal Generator *Operation Guide* and comparing the output signals with the waveforms shown in the guide. Table 3-1 lists the functions that can be verified using the *Operation Guide*.

If you suspect an instrument failure when performing the Basic Functional Checks, test the Signal Generator by activating Special Function 170. Special Function 170 verifies most of the Signal Generator's circuitry. At the conclusion of the test, a result code equal to "0" indicates that the instrument is operating normally. Refer to the *Service Diagnostics Manual* whenever a result code other than "0" appears.

Table 3-1. Basic Functional Checks (1 of 2)

Refer to <i>Operation Guide</i>	Functions and Operations Verified
Chapter 2 <i>What About Modulating?</i>	Special Functions Save and Recall Digitized FM Synthesis Linear FM Synthesis Synthesis Mode Selection Output Amplitude Modulation Frequency Amplitude Pulse Simultaneous
Chapter 3 <i>What About Sweeping?</i>	Frequency Range Start, Stop, Center, and Span Frequencies Sweep Markers Digitally-Stepped Sweep Phase-Continuous Sweep Sweep Spacing Sweep Triggering
Chapter 4 <i>What About Programming?</i>	HP-SL Programming Frequencies HP-IB Address
Appendix D <i>Error Messages</i>	Messages

Table 3-1. Basic Functional Checks (2 of 2)

Refer to <i>Operation Guide</i>	Functions and Operations Verified
Appendix F <i>Synthesized Audio Oscillator</i>	Special Functions Audio Level Audio Frequency
Appendix G <i>Miscellaneous Operating Features</i>	Amplitude Offset Auto Sequence Clear All Display EMF Frequency Offset Knob Hold Knob Increment Phase Increment/Decrement Sequence Set Sequence

Preliminary Test

INTERNAL VOLTMETER VERIFICATION

Specification

The accuracy of the internal voltmeter is not explicitly specified but it should be $\pm 1\%$ of reading ± 0.25 V for the Recal routine to be valid.

Description

A dc voltage is applied to the voltmeter input of the Signal Generator. The voltage is measured by both the Signal Generator's internal voltmeter and an external voltmeter and the two readings are compared.

NOTE

This test should be run before beginning the Performance Tests.

Equipment

Digital Voltmeter HP 3478A
Power Supply HP 6218C or HP 6236B

Procedure

1. Remove any connection to the Signal Generator's rear-panel VM IN connector.
2. On the Signal Generator, press INSTR PRESET then key in SPECIAL 180 ENTER to set the internal voltmeter to read the voltage at the Signal Generator's rear-panel VM IN connector. The reading should be between -0.25 and $+0.25$ V dc.

Voltmeter Offset: -0.25 _____ $+0.25$ V dc

3. Connect the dc power supply and digital voltmeter to the Signal Generator's rear-panel VM IN connector using a BNC tee. (If a dual power supply is used, stack the + and - outputs to obtain the 40 V if needed.)
4. Set the power supply to $+40$ V and set the voltmeter to read $+40$ V dc. The Signal Generator should display approximately $+40$, but more importantly it should agree with the reading of the external voltmeter within ± 0.65 V dc (that is, $\pm 1\%$ of 40 V ± 0.25 V).

Voltmeter Accuracy at $+40$ V: -0.65 _____ $+0.65$ V dc

5. Reverse the power supply leads to produce -40 V at the Signal Generator's VM IN connector. The Signal Generator should display approximately -40 and should agree with the reading of the external voltmeter within ± 0.65 V dc (that is, $\pm 1\%$ of 40 V ± 0.25 V).

Voltmeter Accuracy at -40 V: -0.65 _____ $+0.65$ V dc

Performance Test 1

CARRIER AMPLITUDE TEST

Specification

Characteristic	Performance Limits	Conditions
Output		
Maximum Level	+13 dBm +9 dBm	not Option 008 Option 008
Minimum Level	-139.9 dBm	output \geq -119.9 dBm
Absolute Accuracy	± 3.0 dB ± 1 dB ± 1.5 dB ± 2.0 dB	0.1 to 1 MHz 1 to 1000 MHz 1000 to 3000 MHz 3000 to 6000 MHz

Description

The carrier amplitude specifications are verified with an HP 8902A Measuring Receiver. The higher amplitudes are measured directly with the measuring receiver's built-in power meter. Lower amplitudes are measured using the very sensitive tuned RF level feature of the measuring receiver. For frequencies beyond the tuning range of the measuring receiver, the signal is down-converted.

Carrier amplitude is set in the instrument both by switching attenuator pads (in 5 dB steps) and also by electronic vernier level control. Both types of amplitude control are checked.

Equipment

Measuring Receiver	HP 8902A
Microwave Converter	HP 11793A
Microwave Signal Generator	HP 8672A
Sensor Module (Microwave)	HP 11792A Option 001
Sensor Module (RF)	HP 11722A

Procedure

Initial Setup

1. Connect the equipment as shown in figure 3-1. (Connect the RF input of the sensor module directly to the Signal Generator's RF output connector.)

NOTE

Verify that the measuring receiver's calibration factors match the sensor module. (The calibration factors must encompass a frequency range of 0.1 to 1300 MHz. The measuring receiver will display Error 15 if the signal frequency goes outside the calibration factor range.) Also zero the sensor module and calibrate the power measurement using the measuring receiver's built-in power reference.

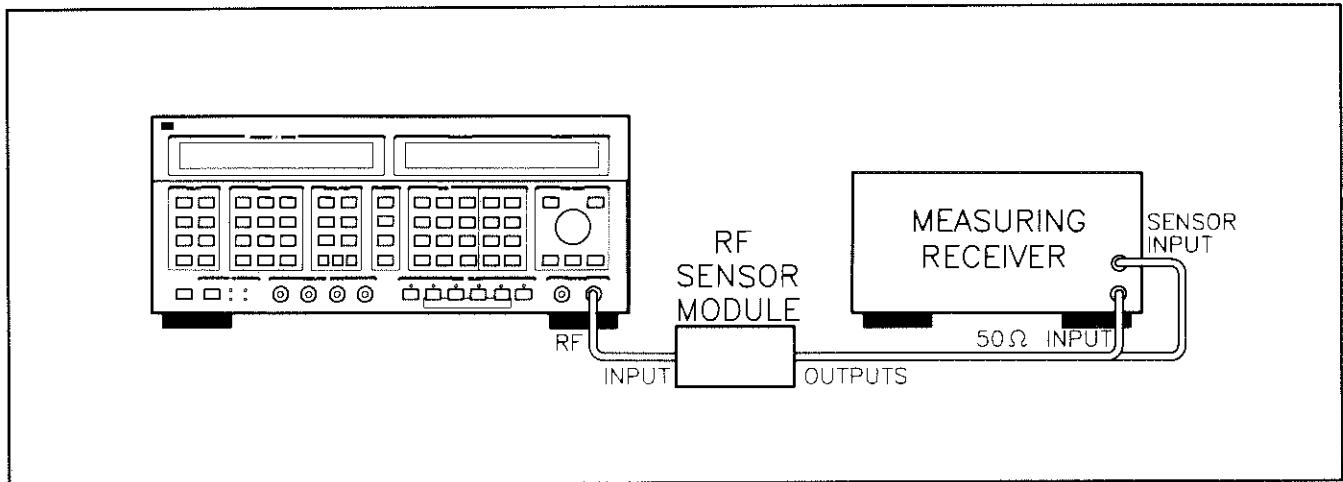

Figure 3-1. Carrier Amplitude (Direct) Test Setup

2. On the Signal Generator, press INSTR PRESET.
3. Preset the measuring receiver, then select the RF power measurement with units of dBm.

Low-Frequency, High-Amplitude Accuracy

4. Set the Signal Generator's carrier frequency and amplitude as indicated in the following table. Also key the frequency into the measuring receiver to invoke the appropriate calibration factor. The output power should be within the limits given in the table.

Signal Generator Carrier		Amplitude Limits (dBm)		
Frequency (MHz)	Amplitude (dBm)	Minimum	Actual	Maximum
1055.5	+9	+8	_____	+10
1055.5 ⁽¹⁾	+13	+12	_____	+14
155.5 ⁽¹⁾	+13	+12	_____	+14
155.5	+9	+8	_____	+10
1.5 ⁽¹⁾	+13	+12	_____	+14
1.5	+9	+8	_____	+10
0.1	+9	+6	_____	+12
0.1 ⁽¹⁾	+13	+10	_____	+16

⁽¹⁾ Except Option 008

Low-Frequency, Low-Amplitude Accuracy

5. On the Signal Generator, perform the following steps.
 - a. Key in **FREQ 1000 MHz** and **AMPTD 6 dBm**.
 - b. Key in **SPECIAL 101 ENTER**. The **FREQUENCY/STATUS** display should show an attenuation of **+0.0 dB**.
 - c. Key in **INCR SET 5 dB** to set the attenuation increment to **5 dB**.
6. On the measuring receiver, press the automatic operation key then select the tuned RF level measurement mode with units of dBm. (For the moment, ignore the uncalibrated and recalibrate annunciators if showing.)
7. On the Signal Generator, increment the attenuation (using the \uparrow key) in 5 dB steps and note the level displayed on the measuring receiver. The carrier amplitude should be within the limits given in the following table.

NOTE

When the recalibration annunciator appears on the measuring receiver's display, press the measuring receiver's CALIBRATE key, wait for completion of the calibration, then proceed.

Signal Generator Display		Amplitude Limits (dB REL)		
Attenuation (dB)	Amplitude (dBm)	Minimum	Actual	Maximum
+5	0	0	_____	+1
+10	-5	-6	_____	-4
+15	-10	-11	_____	-9
+20	-15	-16	_____	-14
+25	-20	-21	_____	-19
+30	-25	-26	_____	-24
+35	-30	-31	_____	-29
+40	-35	-36	_____	-34
+45	-40	-41	_____	-39
+50	-45	-46	_____	-44
+55	-50	-51	_____	-49
+60	-55	-56	_____	-54
+65	-60	-61	_____	-59
+70	-65	-66	_____	-64
+75	-70	-71	_____	-69
+80	-75	-76	_____	-74
+85	-80	-81	_____	-79
+90	-85	-86	_____	-84
+95	-90	-91	_____	-89
+100	-95	-96	_____	-94
+105	-100	-101	_____	-99
+110	-105	-106	_____	-104
+115	-110	-111	_____	-109
+120	-115	-116	_____	-114
+125	-120	-121	_____	-119

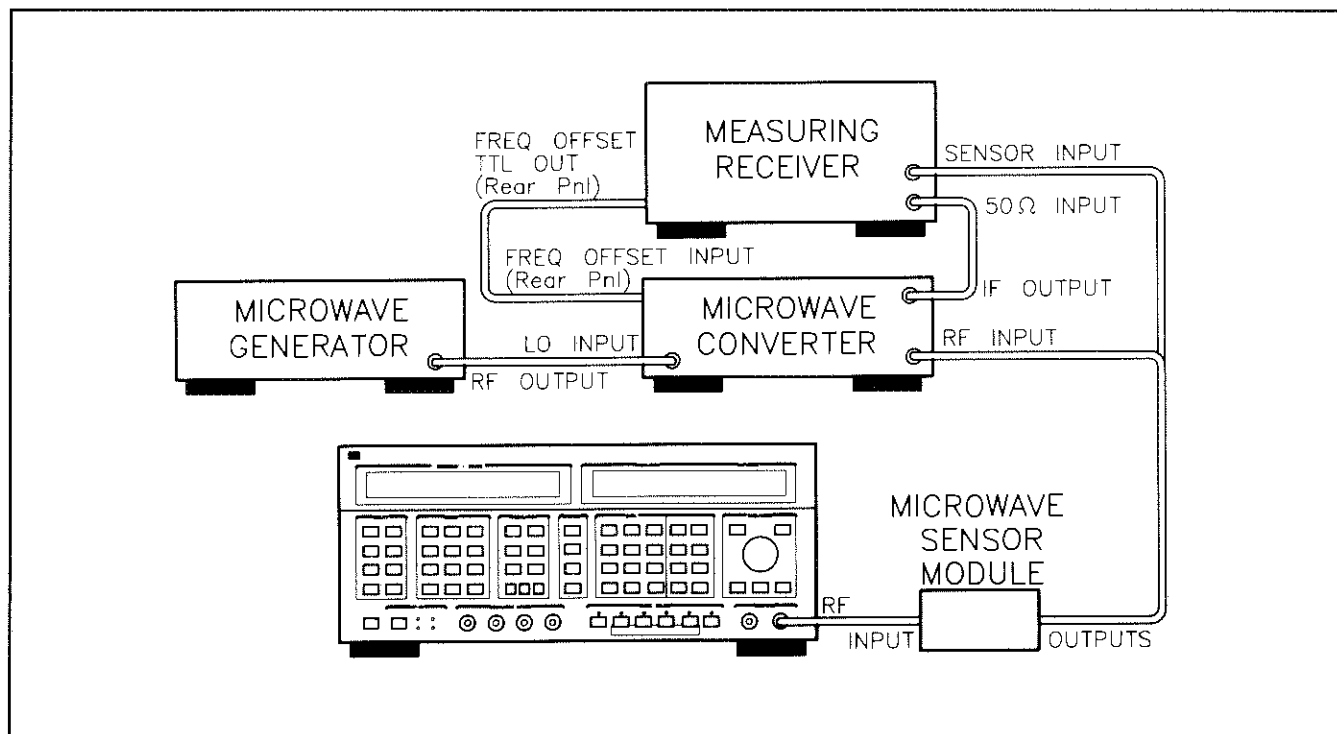

Figure 3-2. Carrier Amplitude (Down-Converted) Test Setup

High-Frequency, Maximum Level

10. Connect the equipment to the microwave converter as shown in figure 3-2. (Connect the microwave input of the sensor module directly to the Signal Generator's RF output connector.)

NOTE

Verify that the measuring receiver's calibration factors match the sensor module. To select the calibration factors for the microwave sensor module, invoke Special Function 27.1. (The calibration factors must encompass a frequency range of 1000 to 6000 MHz.) Also zero the sensor module and calibrate the power measurement.

9. On the Signal Generator, press INSTR PRESET.
10. Preset the measuring receiver, then select the RF power measurement with units of dBm. Key in 27.1 SPCL to select the calibration factors for the microwave sensor module.
11. Set the Signal Generator's carrier frequency and amplitude as indicated in the following table. Also key the frequency into the measuring receiver. The carrier amplitude should be within the limits given in the table.

High-Frequency, High-Amplitude Accuracy

12. Set the Signal Generator's carrier frequency and amplitude as indicated in the following table. Also key the frequency into the measuring receiver. The output power should be within the limits given in the table.

Signal Generator Carrier		Amplitude Limits (dBm)		
Frequency (MHz)	Amplitude (dBm)	Minimum	Actual	Maximum
5955.5 ⁽³⁾	+9	+7.0	_____	+11.0
4155.5 ⁽²⁾	+9	+7.0	_____	+11.0
4155.5 ^{(1), (2)}	+13	+11.0	_____	+15.0
2955.5 ⁽¹⁾	+13	+11.5	_____	+14.5
2955.5	+9	+7.5	_____	+10.5

(1) Except Option 008.
(2) HP8665A and HP8665B only.
(3) HP8665B only.

High-Frequency, Low-Amplitude Accuracy (2955.5 MHz)

13. On the Signal Generator under test, key in SPECIAL 101 ENTER then key in 0 dB. Also key in INCR SET 5 dB.
14. On the microwave signal generator, set the frequency to 3155.5 MHz and amplitude to +13 dBm. (Ignore amplitude overranging messages.)
15. On the measuring receiver, perform the following steps.
 - a. Preset the instrument.
 - b. Key in 27.3 SPCL (to set the measuring receiver and microwave converter to the frequency offset mode).
 - c. Key in 3155.5 MHz (to input the LO frequency information into the measuring receiver).
 - d. Select the tuned RF level measurement mode with units of dBm.
16. On the Signal Generator under test, key in SPECIAL ENTER then increment the attenuation in 5 dB steps and note the level displayed on the measuring receiver. The carrier amplitude should be within the limits given in the following table.

NOTE

If the recalibration annunciator appears, press the measuring receiver's CALIBRATE key, wait for completion of the calibration, then proceed.

Signal Generator Display		Amplitude Limits (dB REL)		
Attenuation (dB)	Amplitude (dBm)	Minimum	Actual	Maximum
+5	0	0	_____	+1
+10	-5	-6	_____	-4
+15	-10	-11	_____	-9
+20	-15	-16	_____	-14
+25	-20	-21	_____	-19
+30	-25	-26	_____	-24
+35	-30	-31	_____	-29
+40	-35	-36	_____	-34
+45	-40	-41	_____	-39
+50	-45	-46	_____	-44
+55	-50	-51	_____	-49
+60	-55	-56	_____	-54
+65	-60	-61	_____	-59
+70	-65	-66	_____	-64
+75	-70	-71	_____	-69
+80	-75	-76	_____	-74
+85	-80	-81	_____	-79
+90	-85	-86	_____	-84
+95	-90	-91	_____	-89
+100	-95	-96	_____	-94
+105	-100	-101	_____	-99
+110	-105	-106	_____	-104

High-Frequency, Low-Amplitude Accuracy (4155.5 MHz; HP8665A only)

17. On the Signal Generator under test, key in **FREQ 4166.6 MHz** and **SPECIAL ENTER 0 dB**.
18. On the microwave signal generator, set the frequency to **4355.5 MHz**.
19. On the measuring receiver, perform the following steps.
 - a. Select the frequency measurement mode.
 - b. Key in **27.3 SPCL**.
 - c. Key in **4355.5 MHz**. (The measuring receivers display should read **4155.5 MHz**.)
 - d. Select the tuned RF level measurement mode.
20. On the Signal Generator under test, increment the attenuation in **5 dB** steps and note the level displayed on the measuring receiver. The carrier amplitude should be within the limits given in the following table.

Signal Generator Display		Amplitude Limits (dB REL)		
Attenuation (dB)	Amplitude (dBm)	Minimum	Actual	Maximum
+5	0	0	_____	+1
+10	-5	-6	_____	-4
+15	-10	-11	_____	-9
+20	-15	-16	_____	-14
+25	-20	-21	_____	-19
+30	-25	-26	_____	-24
+35	-30	-31	_____	-29
+40	-35	-36	_____	-34
+45	-40	-41	_____	-39
+50	-45	-46	_____	-44
+55	-50	-51	_____	-49
+60	-55	-56	_____	-54
+65	-60	-61	_____	-59
+70	-65	-66	_____	-64
+75	-70	-71	_____	-69
+80	-75	-76	_____	-74
+85	-80	-81	_____	-79
+90	-85	-86	_____	-84
+95	-90	-91	_____	-89
+100	-95	-96	_____	-94
+105	-100	-101	_____	-99
+110	-105	-106	_____	-104

High-Frequency, Low-Amplitude Accuracy (5955.5 MHz; HP8665B only)

21. On the Signal Generator under test, key in **FREQ 5955.5 MHz** and **SPECIAL ENTER 0 dB**.
22. On the microwave signal generator, set the frequency to **5755.5 MHz**.
23. On the measuring receiver, perform the following steps.
 - a. Select the frequency measurement mode.
 - b. Key in **27.3 SPCL**.
 - c. Key in **5755.5 MHz**. (The measuring receivers display should read **5955.5 MHz**.)
 - d. Select the tuned RF level measurement mode.
24. On the Signal Generator under test, increment the attenuation in **5 dB** steps and note the level displayed on the measuring receiver. The carrier amplitude should be within the limits given in the following table.

Signal Generator Display		Amplitude Limits (dB REL)		
Attenuation (dB)	Amplitude (dBm)	Minimum	Actual	Maximum
+5	0	0	_____	+2
+10	-5	-7	_____	-2
+15	-10	-12	_____	-8
+20	-15	-17	_____	-11
+25	-20	-22	_____	-18
+30	-25	-27	_____	-23
+35	-30	-32	_____	-28
+40	-35	-37	_____	-33
+45	-40	-42	_____	-73
+80	-75	-77	_____	-78
+85	-80	-82	_____	-83

Performance Test 2

AM TEST

Specification

Characteristic	Performance Limits	Conditions
Spectral Purity		
Residual AM	<0.04% rms	0.3 to 3 kHz post-detection bandwidth
Amplitude Modulation		
AM Depth	0 to 99.9% 0 to 99.9%	output < +7 dBm; not Option 008 output < +3 dBm; Option 008
Indicator Accuracy	±(6% of setting + 1%)	to 90% depth; 1 kHz rate to 70% depth; 1 kHz rate; ≥ 3000 MHz (HP8665B only)
Distortion		400 and 1000 Hz rates
	<2% <4% <6%	0 to 30% depth 30 to 70% depth 70 to 90% depth
3 dB Bandwidth	>5 kHz >10 kHz	1 to 10 MHz carrier >10 MHz carrier
Incidental Phase Modulation		at 30% depth; 1 kHz rate
	<0.3 rad peak <0.6 rad peak	0.1 to 2000 MHz carrier >2 GHz carrier

Description

For carrier frequencies below 1300 MHz, the AM specifications are verified directly with an HP 8902A Measuring Receiver. For higher carrier frequencies, the signal is down-converted to within the range of the measuring receiver.

Equipment

Measuring Receiver	HP 8902A
Microwave Converter	HP 11793A
Microwave Generator	HP 8672A

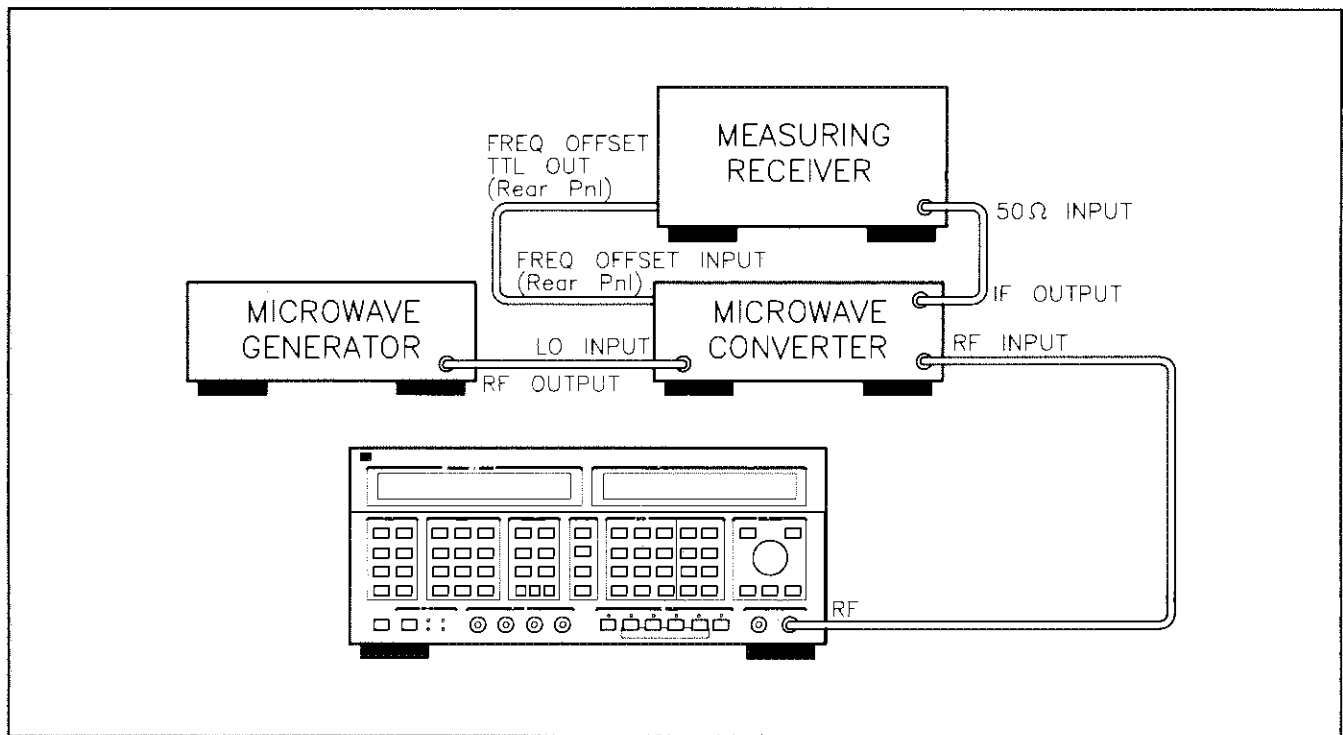

Figure 3-3. AM Test Setup

Procedure

Initial Setup

NOTE

Verify that the measuring receiver's AM is calibrated using its built-in AM calibrator.

1. Connect the equipment as shown in figure 3-3.
2. On the microwave generator, set the frequency to 4400 MHz and amplitude to +13 dBm. (Ignore amplitude overranging messages.)
3. Preset the measuring receiver, then set it as follows.
 - a. Select the AM measurement.
 - b. Set the high-pass filter to 300 Hz.
 - c. Set the low-pass filter to 3 kHz.
 - d. Set the detector to RMS.

Residual AM

4. On the Signal Generator, press INSTR PRESET, then set it as follows.
 - a. Key in **FREQ 1261 MHz**.
 - b. Key in **AMPTD 9 dBm**.
 - c. Key in **SPECIAL 100 ENTER OFF** to set automatic attenuation to off.
 - d. Set the amplitude as indicated in the following table. The residual AM should be within the limits given in the table. (Note that the Signal Generator's AM function is off.)

Signal Generator Carrier Amplitude (dBm)	Residual AM Limits (%)	
	Actual	Maximum
9	_____	0.02

Indicator Accuracy

5. Set the measuring receiver as follows.
 - a. Set the detector to $\text{peak} \pm /2$ (that is, to average $\text{peak}+$ and $\text{peak}-$). (To do this press the **PEAK +** and **PEAK -** keys simultaneously.)
 - b. Set the high-pass filter off.
 - c. Set the low-pass filter off.
6. On the Signal Generator:
 - a. Press **INSTR PRESET**.
 - b. Key in **AMPTD 0 dBm**.
 - c. Key in **AM ON**. (Note that the modulation source is set to internal with a modulation rate of 1 kHz.)
 - d. Set the AM depth and Carrier Frequency as indicated in the following table.

7. For carrier frequencies in the table greater than 1300 MHz:
 - a. Set the microwave generator to a frequency 200 MHz from the carrier frequency.
 - b. Then on the measuring receiver enable frequency offset mode by keying in 27.3 SPCL followed by the microwave generator frequency (which would be 4400 MHz or 5800 MHz in this case).
 - c. The AM depth, as read on the measuring receiver, should be within the limit shown in the table.

Carrier Frequency (MHz)	Signal Generator AM Depth (%)	AM Depth Limits (%)		
		Minimum	Actual	Maximum
1261	30	27.2	_____	32.8
1261	90	83.6	_____	96.4
4200 ⁽¹⁾	30	27.2	_____	32.8
4200 ⁽¹⁾	90	83.6	_____	96.4
6000 ⁽²⁾	30	27.2	_____	32.8
6000 ⁽²⁾	90	83.6	_____	96.4

(1) HP 8665A only.
 (2) HP 8665B only.

Distortion

8. Set the measuring receiver to measure the audio distortion on the demodulated 1 kHz AM and key in 28.0 SPCL to exit frequency offset mode.
9. Set the Signal Generator's AM depth and Carrier Frequency as indicated in the following table.
 - a. For carrier frequencies in the table greater than 1300 MHz set the microwave generator to a frequency 200 MHz from the carrier frequency.
 - b. Then on the measuring receiver enable frequency offset mode by keying in 27.3 SPCL followed by the microwave generator frequency (which would be 4400 MHz or 5800 MHz in this case).
 - c. The AM distortion, as read on the measuring receiver, should be within the limit shown in the table.

Carrier Frequency (MHz)	Signal Generator AM Depth (%)	AM Distortion Limits (%)	
		Actual	Maximum
1261	30	_____	2
4200 ⁽¹⁾	30	_____	2
6000 ⁽²⁾	30	_____	2
⁽¹⁾ HP 8665A only. ⁽²⁾ HP 8665B only.			

3 dB Bandwidth

10. Set the measuring receiver to measure AM depth.
 - a. For carrier frequencies in the table greater than 1000 MHz set the microwave generator to a frequency 200 MHz from the carrier frequency.
 - b. Then on the measuring receiver enable frequency offset mode by keying in 27.3 SPCL followed by the microwave generator frequency (which would be 3800 MHz in this case).
 - c. The AM depth, as read on the measuring receiver, should be within the limit shown in the table.
11. Set the Signal Generator’s carrier frequency as indicated in the following table. For each setting perform the following steps.
 - a. After setting the Signal Generator’s carrier frequency, allow the measuring receiver to retune.
 - b. Key in AUDIO FREQ 1 kHz, Amplitude 0 dBm, AM 30%.
 - c. Set the measuring receiver ratio display off (if it is on). Then set the ratio back on to establish a new ratio reference. (Also, set the ratio to read in dB, that is, log.)
 - d. Set the Signal Generator’s audio (modulation) frequency as shown in the table.
 - e. Note the dB change in AM depth on the measuring receiver. The depth should be between -3 and +3 dB (relative).

Signal Generator Settings		Relative AM Depth Limits (dB)		
Carrier Frequency (MHz)	Audio Frequency (kHz)	Minimum	Actual	Maximum
100	10	-3	_____	+3
3600 ⁽¹⁾	10	-3	_____	+3

(1) HP 8665A or HP 8665B only.

Incidental Phase Modulation (1261 MHz)

12. On the Signal Generator, key in AM 30 % and AUDIO FREQ 1 kHz.
13. On the measuring receiver, disable frequency offset mode then set the measuring receiver to read phase modulation (ΦM) and set its detector to peak+ then to peak-. (If the phase modulation reading is fluctuating, average several readings.) The worst-case of the peak+ and peak- phase deviation readings should be 0.3 rad or less.

Incidental ΦM Limit at 1261 MHz: _____ 0.3 rad peak

Note: If your instrument is a HP 8665A do steps 14 and 15 only. If your instrument is a HP 8665B do steps 16 and 17 only.

Incidental Phase Modulation (HP 8665A only)

14. On the measuring receiver:

- a. Key in 27.3 SPCL (to set the measuring receiver and microwave converter to the frequency offset mode) then key in 4200 MHz (to input the LO frequency information into the measuring receiver).
- b. Set the microwave generator to 4200 MHz.

15. On the Signal Generator, key in **FREQ 4000 MHz**. The worst-case of the peak+ and peak- phase deviation readings should be 0.6 rad or less.

Incidental Φ M Limit at 4200 MHz: _____ 0.6 rad peak

Incidental Phase Modulation (HP 8665B only)

16. On the measuring receiver:

- a. Key in 27.3 SPCL (to set the measuring receiver and microwave converter to the frequency offset mode) then key in 5800 MHz (to input the LO frequency information into the measuring receiver).
- b. Set the microwave generator to 5800 MHz.

17. On the Signal Generator, key in **FREQ 6000 MHz**. The worst-case of the peak+ and peak- phase deviation readings should be 0.6 rad or less.

Incidental Φ M Limit at 6000 MHz: _____ 0.6 rad peak

Performance Test 3

FM TEST (LOW DEVIATIONS AND RATES)

Specification

Characteristic	Performance Limits	Conditions
Spectral Purity Residual FM	<15 Hz rms <7.5 Hz rms <15 Hz rms <60 Hz rms	48 to 63 Hz power line frequency 0.3 to 3 kHz post-detection bandwidth 0.1 to 187.5 MHz carrier 187.5 to 750 MHz carrier 750 to 1500 MHz carrier 1500 to 6000 MHz carrier 0.3 to 3 kHz post-detection bandwidth; low noise mode (Option 004)
	<2.5 Hz rms <1.25 Hz rms <2.5 Hz rms <10 Hz rms	0.1 to 187.5 MHz carrier 187.5 to 750 MHz carrier 750 to 1500 MHz carrier 1500 to 6000 MHz carrier 0.05 to 15 kHz post-detection bandwidth
	<20 Hz rms <10 Hz rms <20 Hz rms <80 Hz rms	0.1 to 187.5 MHz carrier 187.5 to 750 MHz carrier 750 to 1500 MHz carrier 1500 to 6000 MHz carrier 0.05 to 15 kHz post-detection bandwidth; low-noise mode (Option 004)
	<8 Hz rms <4 Hz rms <8 Hz rms <32 Hz rms	0.1 to 187.5 MHz carrier 187.5 to 750 MHz carrier 750 to 1500 MHz carrier 1500 to 6000 MHz carrier

(Table continued on next page)

(Table continued from previous page)

Characteristic	Performance Limits	Conditions
Frequency Modulation		
Maximum Peak Deviation	20 MHz	3000 to 6000 MHz carrier
	10 MHz	1500 to 3000 MHz carrier
	5 MHz	750 to 1500 MHz carrier
	2.5 MHz	375 to 750 MHz carrier
	1.25 MHz	187.5 to 375 MHz carrier
	5 MHz	10 to 187.5 MHz carrier
		low-noise mode (Option 004)
	400 kHz	3000 to 6000 MHz carrier
	200 kHz	1500 to 3000 MHz carrier
	100 kHz	750 to 1500 MHz carrier
Maximum Rate (3 dB Bandwidth)	50 kHz	375 to 750 MHz carrier
	25 kHz	187.5 to 375 MHz carrier
	100 kHz	10 to 187.5 MHz carrier
	800 kHz	
	Indicator Accuracy	
	$\pm 9\%$ of FM deviation setting $\pm 11\%$ of FM deviation setting	low-noise mode (Option 004)
Distortion	<1%	20 Hz to 20 kHz rates
Incidental AM	<0.4% depth	deviation <20 kHz
Carrier Frequency Accuracy in FM	$\pm 0.6\%$ of deviation setting.	

Description

The FM specifications which can be verified directly with an HP 8902A Measuring Receiver are checked in these tests. The restrictions are that (1) the peak deviation must be less than 400 kHz, (2) the modulation rate must be less than 200 kHz for carrier frequencies, and (3) the local oscillator's residual FM must be no more than the HP 8664 or HP 8665. This latter restriction can be overcome by choosing an external local oscillator with better or equal performance (such as an HP 8662A or a second HP 8664A/8665A/8665B).

Except for the heterodyne band (10 to 187.5 MHz), the FM indicator accuracy is checked at the high end, geometric midpoint, and low end of each carrier range. In instrument operation, a low-pass filter switches in or out at the midpoint. Indicator accuracy is checked at the highest frequency where the lower-frequency filter is in.

This test is followed by Performance Test 4, *FM Test (High Deviations and Rates)*, which uses an HP 3048A Phase Noise Measurement System. This system can measure some FM specifications outside the range of the HP 8902A. Performance Tests 3 and 4 have some overlap.

Equipment

Distortion Analyzer	HP 8903B or HP 8903E
Measuring Receiver	HP 8902A Option 003
Microwave Converter	HP 11793A
Microwave Signal Generator	HP 8672A
Reference Signal Generator	HP 8662A, HP 8663A, HP 8664A, or HP 8665A/B

Procedure

Initial Setup

NOTE

Verify that the measuring receiver's FM is calibrated using its built-in FM calibrator.

1. Connect the equipment as shown in figure 3-4 making note of the following details.
 - a. If the measuring receiver does not have series 030 options (high selectivity), remove the rear-panel coaxial jumper from the local oscillator's input and output.
 - b. Connect the reference signal generator's output to the measuring receiver's rear-panel local oscillator input.
 - c. Connect the Signal Generator-under-test's RF output connector directly to the RF input of the microwave converter.

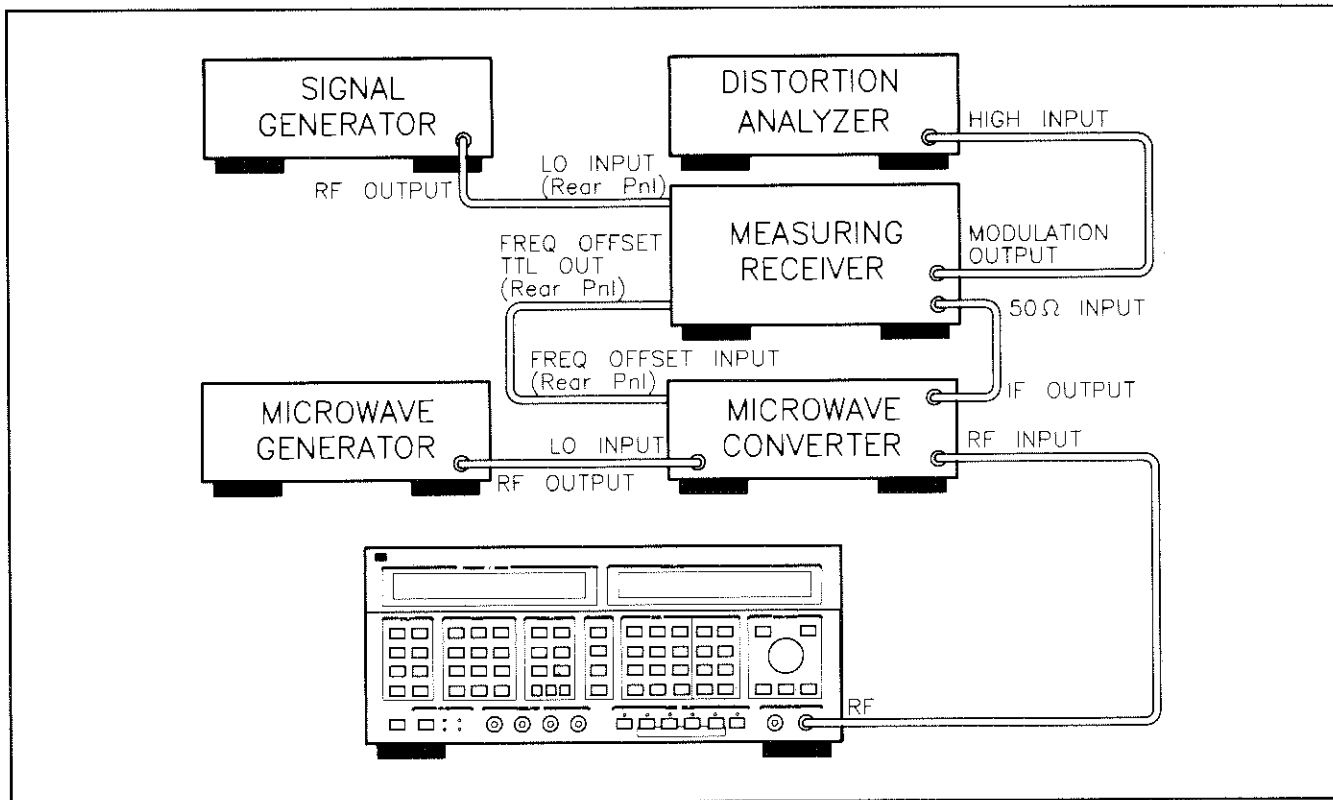

Figure 3-4. FM (Low Deviation and Rates) Test Setup

2. On the microwave signal generator, set the frequency to 4400 MHz and amplitude to +13 dBm. (Ignore amplitude overranging messages.)
3. Set the reference signal generator's carrier to 181.501 MHz at 0 dBm. If the generator is an HP 8665A with Option 004, press MODE 1 in the MODE SELECT key group.
4. On the Signal Generator under test, press INSTR PRESET then key in FREQ 180.001 MHz and AMPTD 0 dBm.
5. Preset the measuring receiver, then set it to read FM with the RMS detector. (If the measuring receiver has series 030 options (high selectivity), invoke special function 23.1 to switch the local oscillator to external.)

Residual FM

6. Set the Signal Generator-under-test's carrier frequency and mode select, the reference signal generator's carrier frequency, and the measuring receiver's high-pass and low-pass filters as indicated in the following table. For each setting, allow the measuring receiver to retune. The residual FM should be within the limits given in the table.

Signal Generator Under Test		Reference Generator Carrier (MHz)	Measuring Receiver Filter		Residual FM Limits (Hz rms)	
Carrier (MHz)	Mode		High-Pass	Low-Pass	Actual	Maximum
187	1	188.5	300 Hz	3 kHz	_____	15
187	1	188.5	50 Hz	15 kHz	_____	20
1200.004	2 ⁽¹⁾	1201.504	50 Hz	15 kHz	_____	8
1200.004	2 ⁽¹⁾	1201.504	300 Hz	3 kHz	_____	5
187	2 ⁽¹⁾	188.5	50 Hz	15 kHz	_____	8
187	2 ⁽¹⁾	188.5	300 Hz	3 kHz	_____	2.5

⁽¹⁾ Option 004

7. On the measuring receiver, key in 27.3 SPCL (to set the measuring receiver and the microwave converter to the frequency offset mode) then key in 2040 MHz.
8. Set the reference signal generator's carrier frequency to 201.5 MHz.
9. Set the Signal Generator-under-test to carrier frequency 2240 MHz.
10. Set the Signal Generator-under-test's mode select and the measuring receiver's high-pass and low-pass filters as indicated in the following table. For each setting, the residual FM should be within the limits given in the table.

Signal Generator Under Test Mode	Measuring Receiver Filter		Residual FM Limits (Hz rms)	
	High-Pass	Low-Pass	Actual	Maximum
1	300 Hz	3 kHz	_____	60
1	50 Hz	15 kHz	_____	80
2 ⁽¹⁾	50 Hz	15 kHz	_____	32
2 ⁽¹⁾	300 Hz	3 kHz	_____	10

(¹) Option 004

Indicator Accuracy and Distortion

11. If the measuring receiver does not have series 030 options, disconnect the reference generator from the rear panel and re-connect the coaxial jumper. If the measuring receiver has series 030 options, invoke special function 23.0 to switch the local oscillator back to internal.
12. On the Signal Generator under test, press INSTR PRESET, then set it as follows.
 - a. Key in **FREQ 375 MHz**.
 - b. Key in **AMPTD 0 dBm**.
 - c. Key in **AUDIO FREQ 20 kHz**.
 - d. Key in **FM ON**.
13. Preset the measuring receiver, then set it as follows.
 - a. Set the measurement mode to **FM**.
 - b. Set the detector to **peak±/2** (that is, to average peak+ and peak-.) To do this press the **PEAK +** and **PEAK -** keys simultaneously.
14. Set the distortion analyzer to measure the distortion on the demodulated FM which will have an audio rate of 20 kHz. (Select 80 kHz low-pass filtering if available.)
15. On the Signal Generator under test, set the instrument as indicated in the following table. For each setting, perform the following steps.
 - a. Set the carrier frequency, peak FM deviation, and Mode Select as indicated in the table.
 - b. Read the FM peak deviation on the measuring receiver and the demodulated FM distortion on the distortion analyzer. The FM deviation and distortion should be within the limits shown in the table.

Signal Generator Settings			FM Deviation Limits (kHz peak)			FM Distortion Limits (%)	
Carrier Freq. (MHz)	Peak FM Dev. (kHz)	Mode	Minimum	Actual	Maximum	Actual	Maximum
375	200	1	182	_____	218	_____	1
500	200	1	182	_____	218	_____	1
749	200	1	182	_____	218	_____	1
1030	100	2 ⁽¹⁾	89	_____	111	_____	1
770	100	2 ⁽¹⁾	89	_____	111	_____	1
515	10	2 ⁽¹⁾	8.9	_____	11.1	_____	1

(1) Option 004

16. Record the FM Deviation for the 375 MHz carrier and Mode 1 for use in Performance Test 4.

FM Deviation for 375 MHz carrier in Mode 1: _____ kHz

Incidental AM

17. Set the Signal Generator under test as follows.

- a. Press MODE 1.
- b. Key in FREQ 187 MHz, AMPTD 0 dBm.
- c. Key in FM 20 kHz.

18. Preset the measuring receiver then set it to read AM. The AM depth should read 0.3% or less.

Incidental AM Limit in Mode 1: _____ 0.3%

Carrier Frequency Accuracy in FM

- 19. Set the measuring receiver to measure carrier frequency. Set the counter resolution to 10 Hz (special function 7.1).
- 20. On the Signal Generator under test, press INT (to turn off the internal modulation oscillator) and set MODE SELECT to MODE 1.
- 21. On the Signal Generator under test, set the carrier frequency and the FM peak deviation as indicated in the following table. For each step press FM OFF then press FM ON and note the shift in carrier frequency as read on the measuring receiver. (The frequency error measurement mode in the measuring receiver can also be used to measure carrier shift.) The carrier shift should be within the limits shown in the table.

NOTE

The FM system in the Signal Generator is turned on but no actual FM is generated because the audio source is turned off.

Signal Generator Settings		Carrier Shift Limits (kHz)	
Carrier Frequency (MHz)	FM Deviation (MHz peak)	Actual	Maximum
516	2.5	_____	15
1030	2.5	_____	15

Performance Test 4

FM TEST (HIGH DEVIATIONS AND RATES)

Specification

Characteristic	Performance Limits	Conditions
Frequency Modulation		
Maximum Peak Deviation	20 MHz	3000 to 6000 MHz carrier
	10 MHz	1500 to 3000 MHz carrier
	5 MHz	750 to 1500 MHz carrier
	2.5 MHz	375 to 750 MHz carrier
	1.25 MHz	187.5 to 375 MHz carrier
	5 MHz	10 to 187.5 MHz carrier
		low-noise mode (Option 004)
Maximum Rate (3 dB Bandwidth)	400 kHz	3000 to 6000 MHz carrier
	200 kHz	1500 to 3000 MHz carrier
	100 kHz	750 to 1500 MHz carrier
	50 kHz	375 to 750 MHz carrier
	25 kHz	187.5 to 375 MHz carrier
	100 kHz	10 to 187.5 MHz carrier
Maximum Rate (3 dB Bandwidth)	800 kHz	
Indicator Accuracy		dc to 20 kHz rates
	±9% of FM deviation setting ±11% of FM deviation setting	low-noise mode (Option 004)
Distortion	<1%	20 Hz to 20 kHz rates

Description

Measurements are made on signals with FM peak deviations up to 20 MHz and rates up to 800 kHz. These signals cannot be made directly by the HP 8902A Measuring Receiver which was used in Performance Test 3. (However, Performance Tests 3 and 4 have some overlap.)

FM is demodulated by an HP 3048A Phase Noise Measurement System. A power splitter and delay line (both supplied with the system) and an RF phase detector (built into the system's interface) are used as a delay-line FM discriminator. The demodulated FM is analyzed by an RF spectrum analyzer (optionally supplied with the system). The test is not run by a system program; rather, the system's interface is manually controlled from the controller's keyboard.

Equipment

Audio Source	HP 3325A
Phase Noise Measurement System	HP 3048A Option 101

NOTE

Since this test is written specifically for the HP 3048A, no substitute of equipment is recommended.

For this test, the HP 3048A is assumed to have the HP 11848-60132 Noise Floor Test Fixture (supplied with system) and an HP 3585A spectrum analyzer (which must have a 1 MΩ input). The HP 3561A Dynamic Signal Analyzer is required for the system but is not used in this test.

Procedure

Initial Setup and Establishing Quadrature

1. Run Performance Test 3, *FM Test (Low Deviations and Rates)*. Record the values measured in step 16 for use later in this test.
2. Connect the equipment as shown in figure 3-5. Check that the SPECTRUM ANALYZER output connector on the front panel of the HP 11848A Phase Noise Interface is terminated in 50 Ω. Also, check that the delay line connectors are tight.

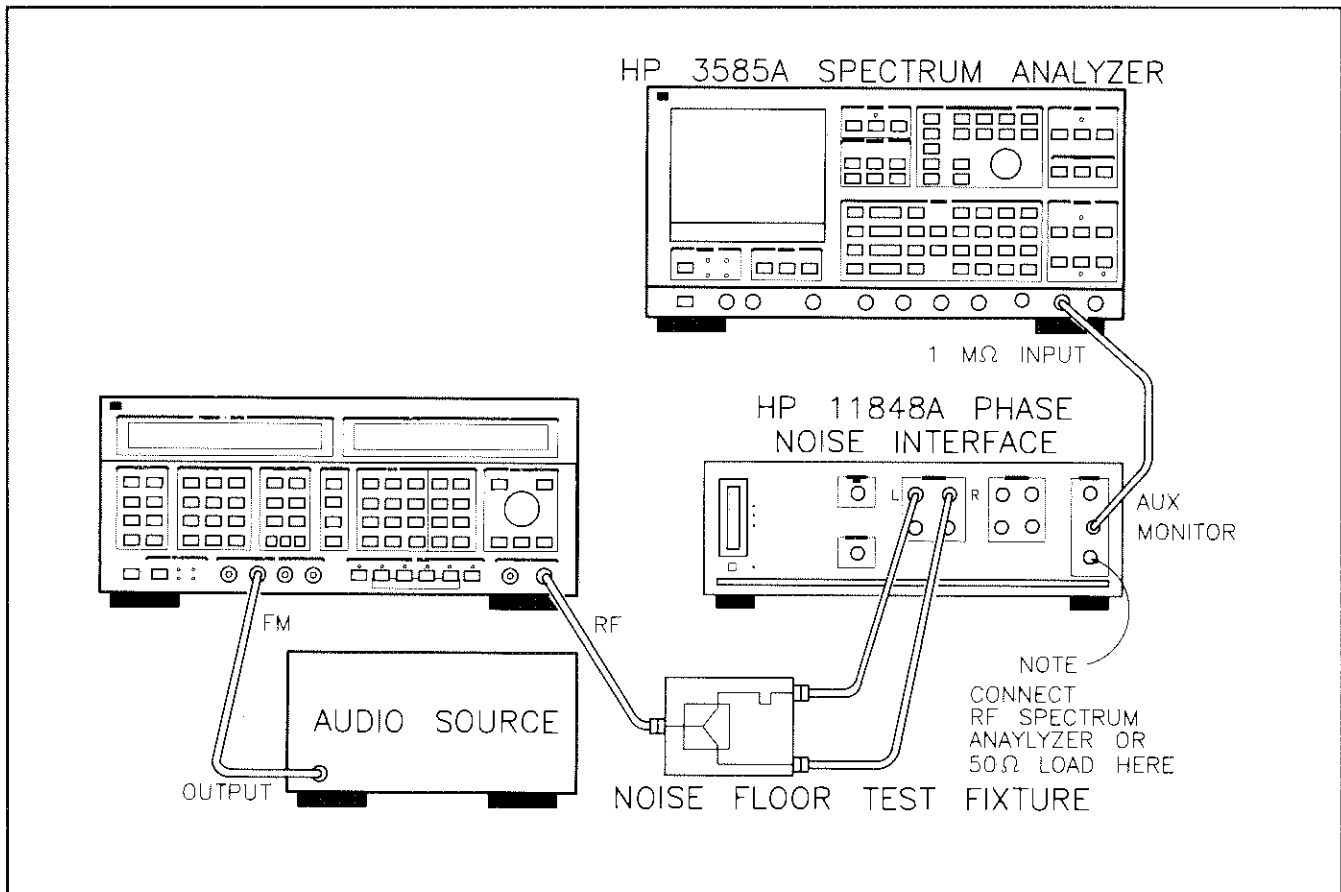

Figure 3-5. FM (High Deviation and Rates) Test Setup

3. On the Signal Generator press INSTR PRESET then key in FREQ 400 MHz and AMPTD 19 dBm. (9 dBm if pulse modulation opt. 008 is installed.) Key in SPECIAL 105 ENTER OFF to turn amplitude muting off.
4. Boot up the phase noise measurement system to the Main Software Menu level then set the system as follows.
 - a. Press the **Spcl. Funct'n** softkey available at the Main Software Level menu.
 - b. Press the **11848A Control** softkey to initiate manual control of the system's interface.
 - c. Press the **Preset** softkey to preset the interface.
 - d. Use the cursor control keys to move the cursor to the "SELECTED 'K' SWITCHES:" line then key in 10 and 12. (Refer to figure 3-6.)
 - e. Use the cursor control keys to move the cursor to the "SELECTED 'S' SWITCHES:" line then key in 3 while not changing the "8" already present on the line.
 - f. Press the **Send Command** softkey to initiate the commands. The display should appear as in figure 3-6 except for the cursor position, the values following "GAIN1:" and "GAIN2:" (which will be entered later), and the bottom line.
5. Tune the Signal Generator's carrier frequency until the front-panel meter of the system's interface reads approximately 0.
6. Set the phase noise measurement system as follows.
 - a. Use the system's cursor control keys to move the cursor to the "GAIN1:" line then key in 28.

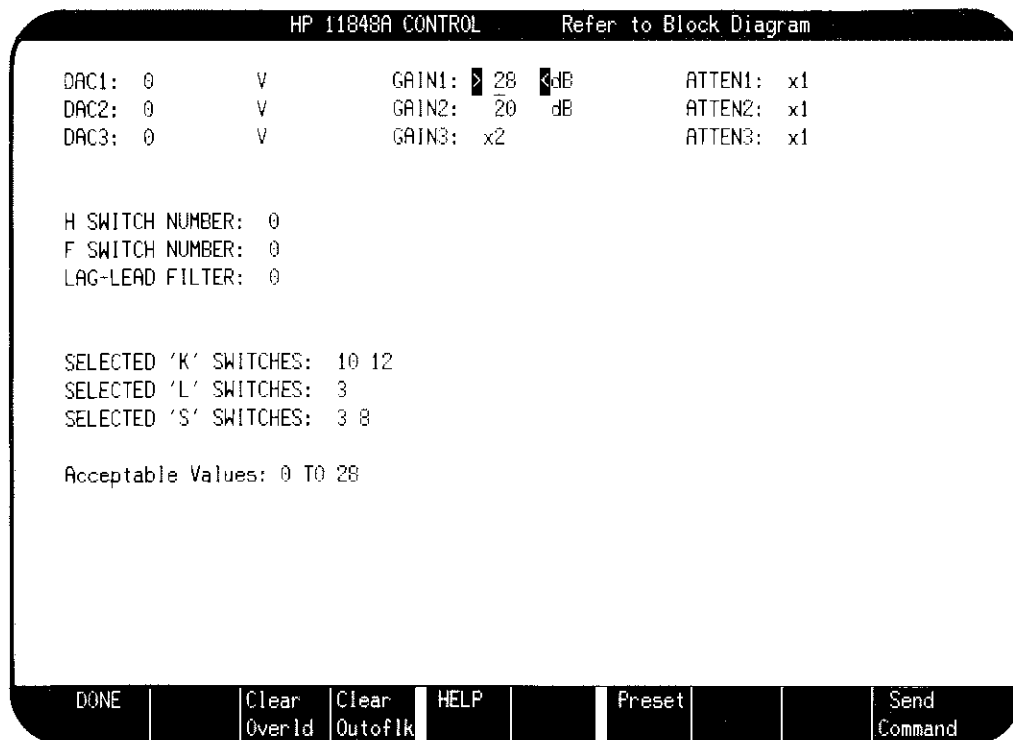

Figure 3-6. HP 11848A Control Display for FM Test

- b. Use the system's cursor control keys to move the cursor to the "GAIN2:" line then key in 20.
 - c. Press the Send Command softkey to initiate the commands. (The display should now appear as in figure 3-6.)
7. Fine tune the Signal Generator's carrier frequency until the front-panel meter of the system's interface reads approximately 0. This establishes quadrature in the interface's phase detector to make it function as a linear phase detector. The Signal Generator's carrier frequency may be in the range of 350-500 MHz to establish quadrature.
 8. Set the RF spectrum analyzer to span from 0 to 100 kHz. Set the input impedance to 1 M Ω .

Indicator Accuracy

9. Let D equal the value in kHz of FM deviation measured in Performance Test 3, step 16, for a 375 MHz carrier in Mode 1. Calculate $700 - D$. (For example, if the value for D is 340 kHz, $700 - 340 = 360$.)

700 Minus the Value of D : _____ kHz

10. Set the Signal Generator as follows.
 - a. Key in FM then the value $(700 - D)$ calculated in step 9 above (for example 360) then press kHz.
 - b. Key in AUDIO FREQ 20 kHz.
11. Adjust the RF spectrum analyzer's reference level so that the 20 kHz signal is at a convenient graticule line near the center of the display. (This line represents 350 kHz peak deviation.)
12. On the Signal Generator, key in FM 2.5 MHz. The 20 kHz signal should increase between 16.4 and 17.8 dB (that is, 17.1 ± 0.7 dB or $2.5 \text{ MHz}/350 \text{ kHz} \pm 9\%$ expressed in dB).

Indicator Accuracy: 16.4 _____ 17.8 dB

Distortion

13. Note the level of the harmonics of 20 kHz. The harmonics should be greater than 40 dB down from the fundamental (that is, 1% or less).

FM Distortion: _____ -40 dB

Maximum Rate (3 dB Bandwidth)

14. On the Signal Generator, press the INT key to turn the internal FM off then press the EXT AC key.
15. On the audio source, set the frequency to 20 kHz, and set the amplitude to 4.67 dBm (1 V_{pk} into 600 Ω from a 50 Ω source).

NOTE

The EXT HI or EXT LO annunciators on the Signal Generator may or may not be on. Either condition is acceptable. The level of the modulation input signal is set more accurately by the audio source setting than by the annunciators.

16. Set the RF spectrum analyzer to span from 0 to 1 MHz. Note the level of the 20 kHz signal.
17. On the audio source, set the frequency to 800 kHz. The 800 kHz signal viewed on the spectrum analyzer should be within 3 dB of the level of the signal which was at 20 kHz.

Maximum Rate: -3 _____ +3 dB

Performance Test 5

SPECTRAL PURITY TEST (SSB PHASE NOISE)

Specification

Characteristic	Performance Limits	Conditions
Spectral Purity SSB Phase Noise	-105 dBc/Hz -111 dBc/Hz -117 dBc/Hz -122 dBc/Hz -128 dBc/Hz -117 dBc/Hz	CW, AM, or FM (FM at minimum specified deviation) 20 kHz frequency offset 3000 to 6000 MHz carrier 1500 to 3000 MHz carrier 750 to 1500 MHz carrier 375 to 750 MHz carrier 187.5 to 375 MHz carrier 0.1 to 187.5 MHz carrier
Spectral Purity SSB Phase Noise (cont'd)	-116 dBc/Hz -122 dBc/Hz -128 dBc/Hz -134 dBc/Hz -139 dBc/Hz -144 dBc/Hz -131 dBc/Hz	20 kHz frequency offset; Mode 2; Option 004 4120 to 6000 MHz carrier 2060 to 4120 MHz carrier 1030 to 2060 MHz carrier 515 to 1030 MHz carrier 257.5 to 515 MHz carrier 187.5 to 257.5 MHz carrier 0.1 to 30 MHz carrier
Nonharmonic Spurious Signals	< -100 dBc < -90 dBc < -90 dBc	>10 kHz offset frequency 187.5 to 2060 MHz carrier 0.1 to 187.5 MHz carrier 2060 to 6000 MHz carrier

Description

The single-sideband (SSB) phase noise and non-harmonic spurious signals are measured by a system that is specifically designed to measure these parameters—the HP 3048A Phase Noise Measurement System. Measurements are made using a phase detector in a phase lock loop.

This method requires a reference signal generator that must have lower phase noise than the source being tested. A second HP 8664A or HP 8665A/B can be used as this source (and thus both sources are measured as a pair) but the following considerations apply: (1) If the measured results are within specification, both generators meet the specification individually. (2) If the measured results are out of specification, at least one generator is out of specification and a third source must be measured against the first two to determine which one is faulty.

Equipment

Phase Noise Measurement System.....	HP 3048A Option 201
Reference Signal Generator	HP 8664A or HP 8665A/B Option 004

NOTE

Option 201 for the HP 3048A adds the 1.2 to 18 GHz phase detector and is required if the phase noise on carriers above 1.6 GHz is to be measured. Measurement of carriers above 1.6 GHz can also be made using a down converter. Refer to the documentation for the HP 3048A.

Option 004 for the reference signal generator is needed only if the Signal Generator under test has Option 004. Neither the reference source nor the Signal Generator under test will be under remote control.

If a suitable reference source is unavailable, the 10 MHz A oscillator in the HP 11848A Phase Noise Interface to the HP 3048A system can be used as reference for a 10 MHz carrier.

Procedure

Initial Setup

1. Connect the equipment as shown in figure 3-7.

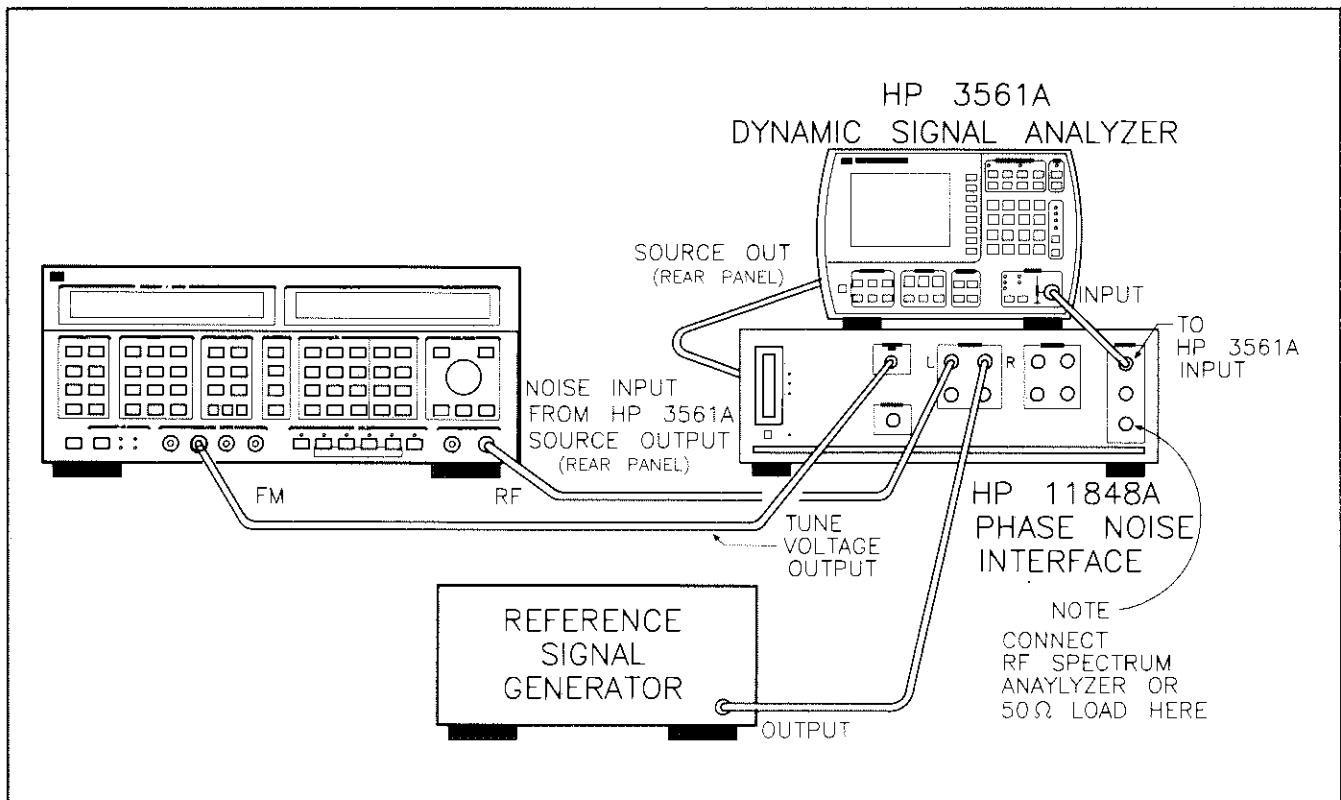

Figure 3-7. SSB Phase Noise Test Setup

2. Set the reference signal generator's carrier to 550 MHz at 6 dBm. If the reference signal generator is an HP8664A or HP 8665A/B with Option 004, select Mode 2.
3. Set the Signal Generator under test as follows.
 - a. Press INSTR PRESET.
 - b. Key in **FREQ 550 MHz**.
 - c. Key in **AMPTD 13 dBm**. (9 dBm if pulse modulation Opt. 008 is installed.)
 - d. Key in **FM 128 Hz**.
 - e. Press **INT** in the **MODULATION** key group to turn the internal modulation source off.
 - f. Press **EXT DC** in the **MODULATION** key group to enable DC FM.
 - g. Press **MODE 1** in the **MODE SELECT** key group.
4. Set the HP 3048A to the Main Software Level menu. Refer to figure 3-8.

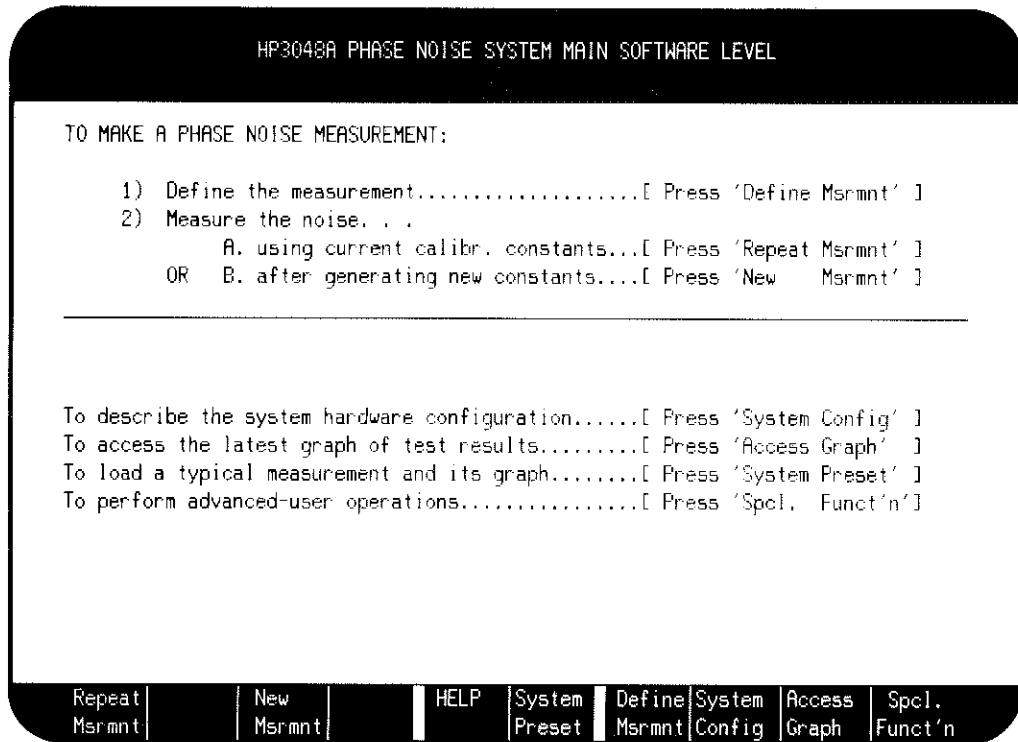

Figure 3-8. Main Software Level Menu

Example Measurement

NOTE

The following steps are the procedure for making a single-sideband phase noise measurement on a 550 MHz carrier in Mode 1. For other carrier frequencies and for Mode 2, the procedure is similar. If these measurements are to be repeated in the future for this or other HP 8664A or HP 8665A/B generators, it will be advantageous to record the test file entries for each carrier frequency; these test files can be recalled as needed later on instead of having to re-enter them each time.

5. On the HP 3048A press the Define Msrmnt softkey to obtain the Measurement Definition menu. Refer to figure 3-9.

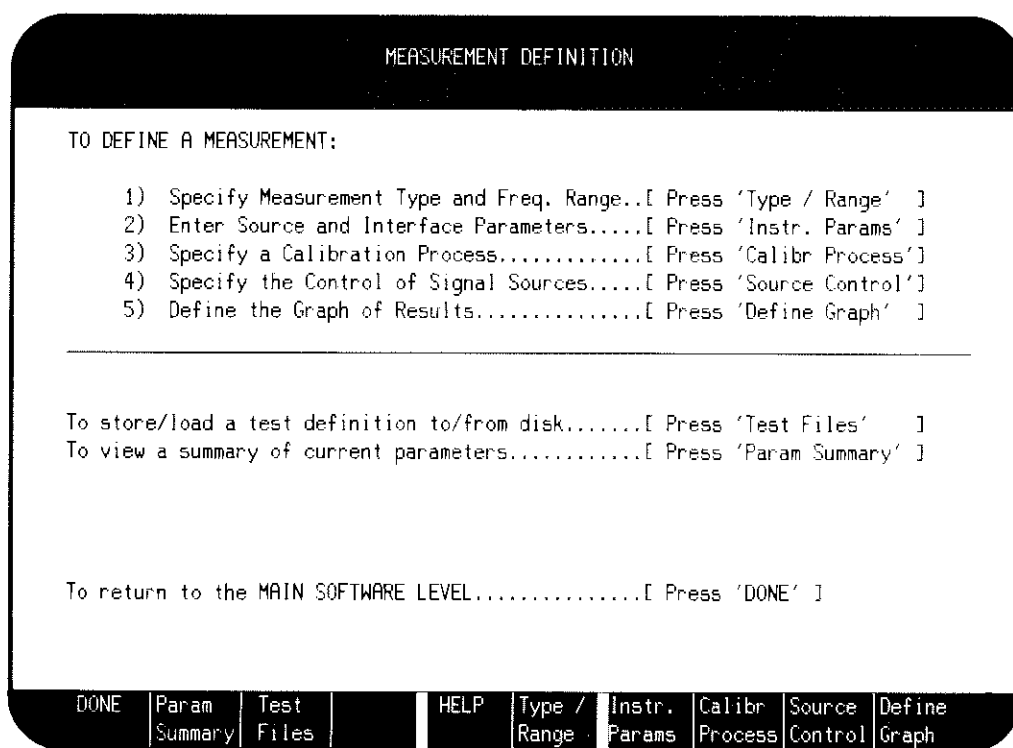

Figure 3-9. Measurement Definition Menu

- On the HP 3048A press the **Type / Range** softkey to obtain the Measurement Type and Frequency Range Specification menu. Set the measurement type and offset frequency range as shown in figure 3-10. When done, press the **DONE** softkey.

NOTE

The start frequency is shown as 10 Hz. This low offset will slow the measurement time but give a more confidence in the general phase noise performance of the Signal Generator. To measure the phase noise to its specification only, change the start frequency to 1 kHz.

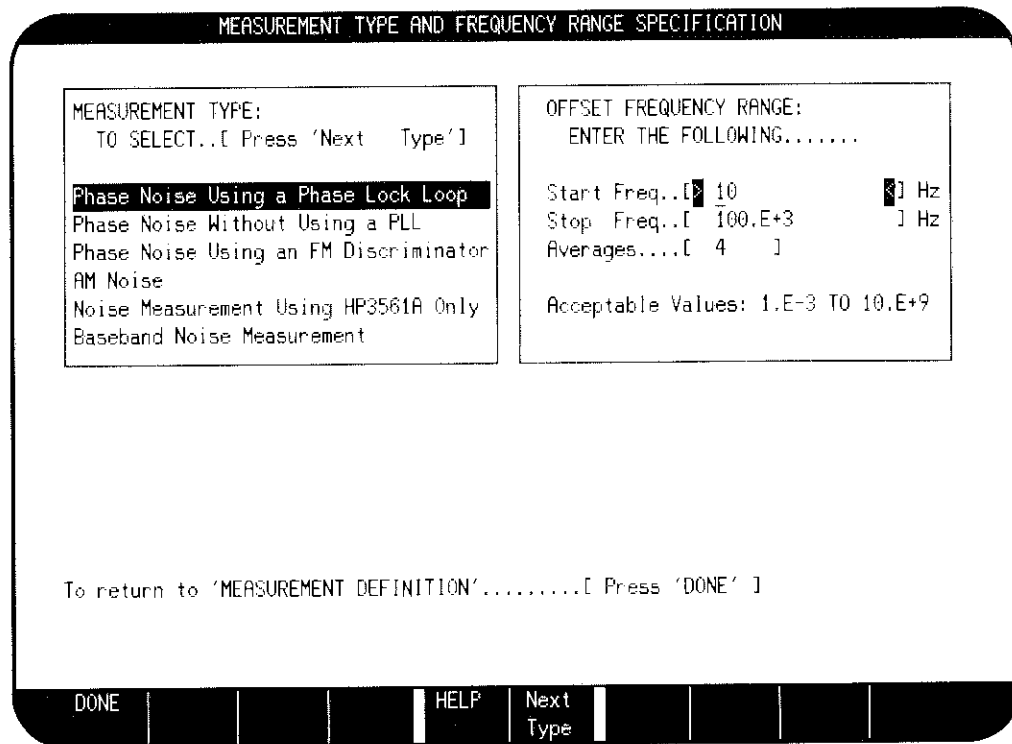

Figure 3-10. Measurement Type and Frequency Range Specification Menu

- On the HP 3048A press the **Instr. Params** softkey to obtain the Source and Interface Parameter Entry menu. Set the parameters and phase detector as shown in figure 3-11. When done, press the **DONE** softkey.

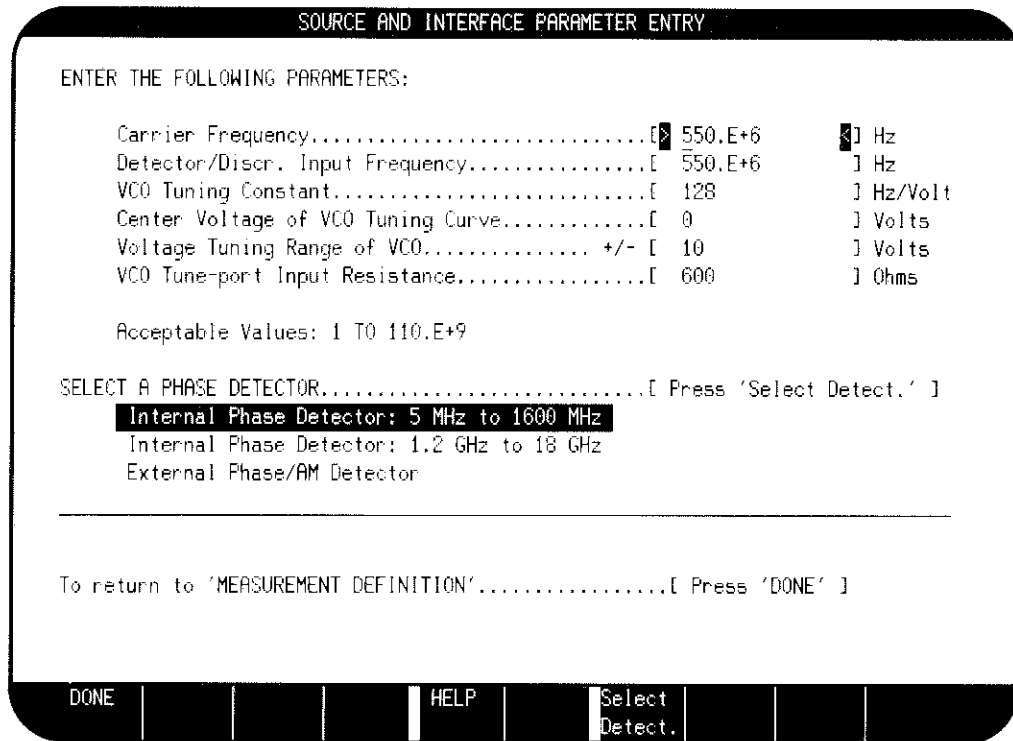

Figure 3-11. Source and Interface Parameter Entry Menu

- On the HP 3048A press the **Calibr Process** softkey to obtain the Determination of Phase Detector Constant and VCO Tuning Constant menu. Set the method of determining the phase detector and VCO tuning constants and the verification of the phase lock loop suppression as shown in figure 3-12. (The displayed Computed Constant may be quite different from the one in figure 3-12. It will be updated later.) When done, press the **DONE** softkey.

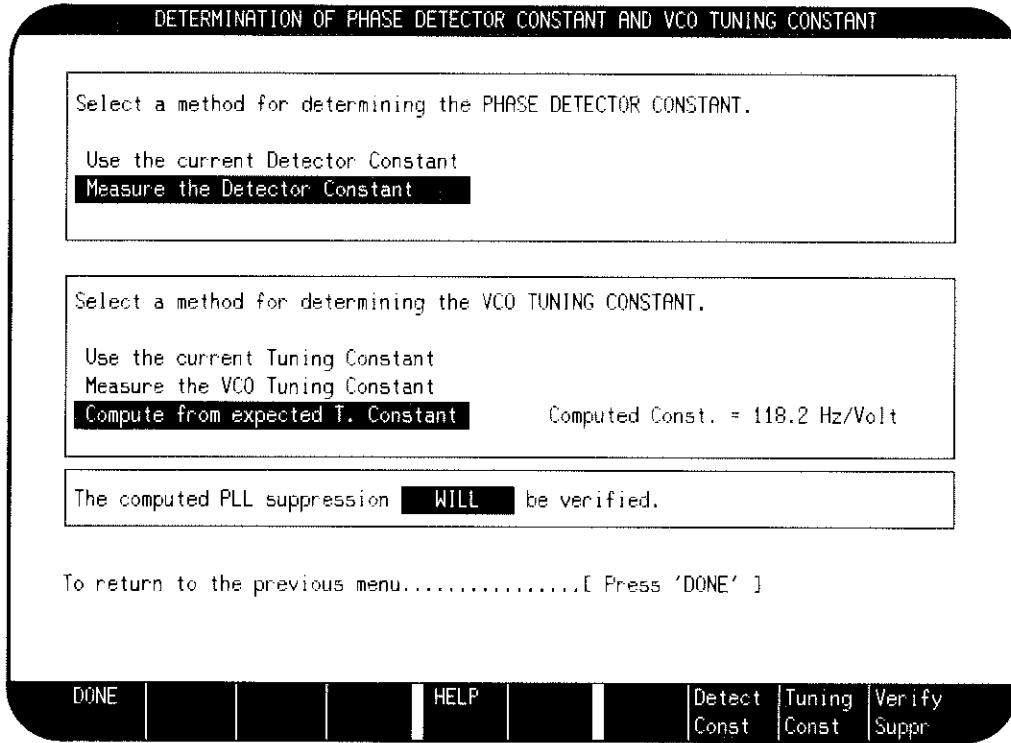

Figure 3-12. Determination of Phase Detector and VCO Tuning Constant Menu

9. On the HP 3048A press the **Source Control** softkey to obtain the Source Control for Measurement Using a Phase Lock Loop menu. Set the various devices in the system as shown in figure 3-13. When done, press the **DONE** softkey.

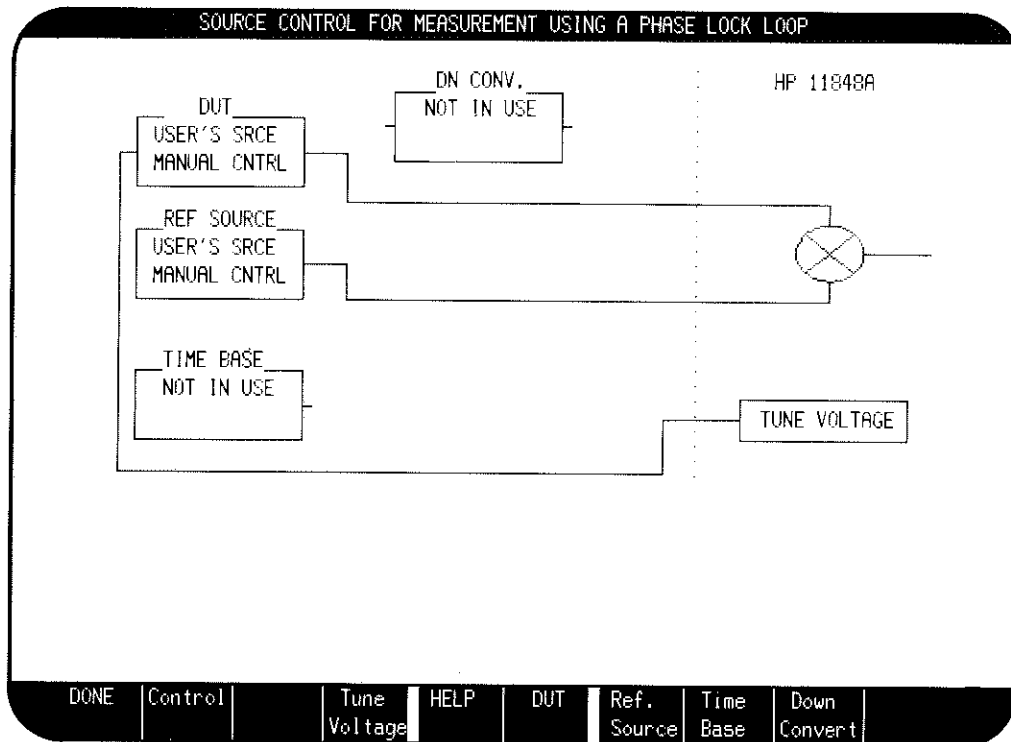

Figure 3-13. Source Control for Measurement Using a Phase Lock Loop Menu

10. On the HP 3048A press the **Define Graph** softkey to obtain the Graph Definition menu. Set the graph parameters and graph type as shown in figure 3-14. Change the title as appropriate for your particular setup. (You may wish to include the model and serial number of the device under test. For example, "The HP 8665A with serial number 2833A00101." Note that date, time, and carrier frequency information will automatically appear on the measurement result graph.) When done, press the **DONE** softkey. (For measuring offsets only down to 1 kHz, set the minimum x coordinate to 1 kHz. See the note following step 6.)

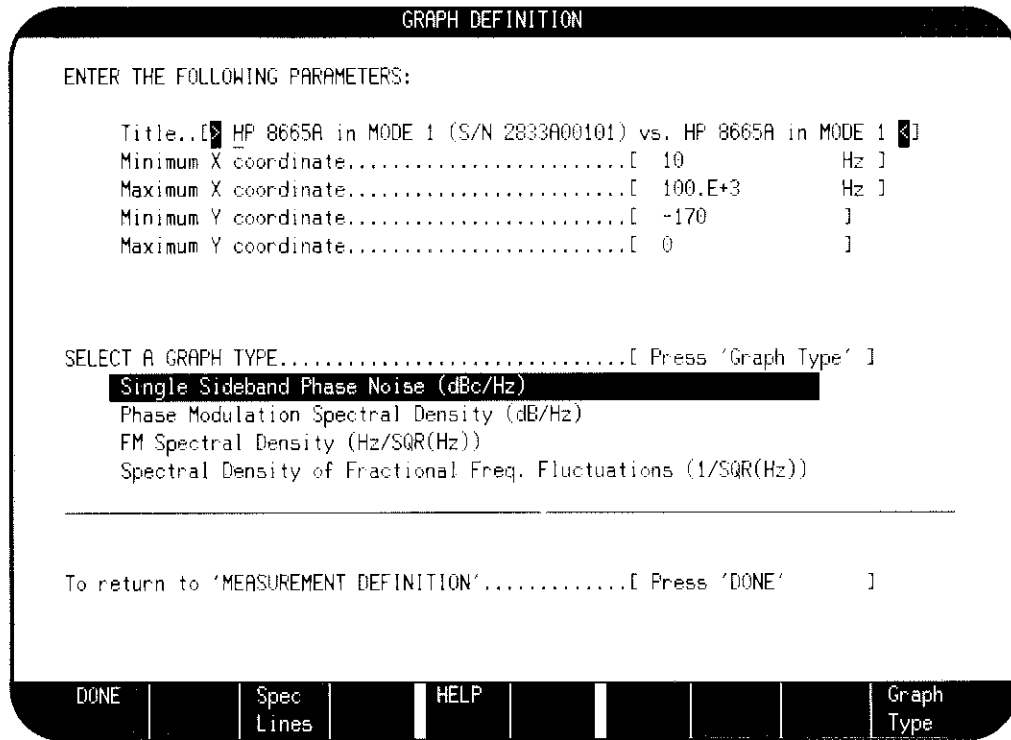

Figure 3-14. Graph Definition Menu

11. On the HP 3048A press the DONE softkey again to obtain the Main Software Level menu.
12. On the HP 3048A press the New Msrmnt softkey then press the Yes, Proceed softkey.
13. When the connect diagram appears on the display, verify that the instrument connections are properly made then press the Proceed softkey. The phase noise measurement should proceed without error and the phase noise plot should appear as in figure 3-15. Ignoring spurious signals, the phase noise ($\mathcal{L}(f)$) should be less than -79 dBc at a 1 kHz offset frequency, less than -122 dBc at 20 kHz, and less than -138 dBc at 100 kHz. Spurious signals for offset frequencies greater than 10 kHz should be down more than 100 dBc.

NOTE

Spurious signals can also be generated by the reference signal generator or may be picked up by interconnecting cables.

Non-harmonic spurious signals, >10 kHz offset: _____ -100 dBc

NOTE

Figure 3-15 also shows a listing of measurement parameters. This listing with the graph itself can be printed by holding down the keyboard's SHIFT key and pressing the **Hard Copy** softkey.

If you intend to make measurements of this same type frequently, the setup information (carrier frequency, tuning constant, source control, etc.) can be easily stored as test files, then loaded as needed. Refer to the HP 3048A Reference Manual on storing and loading test files.

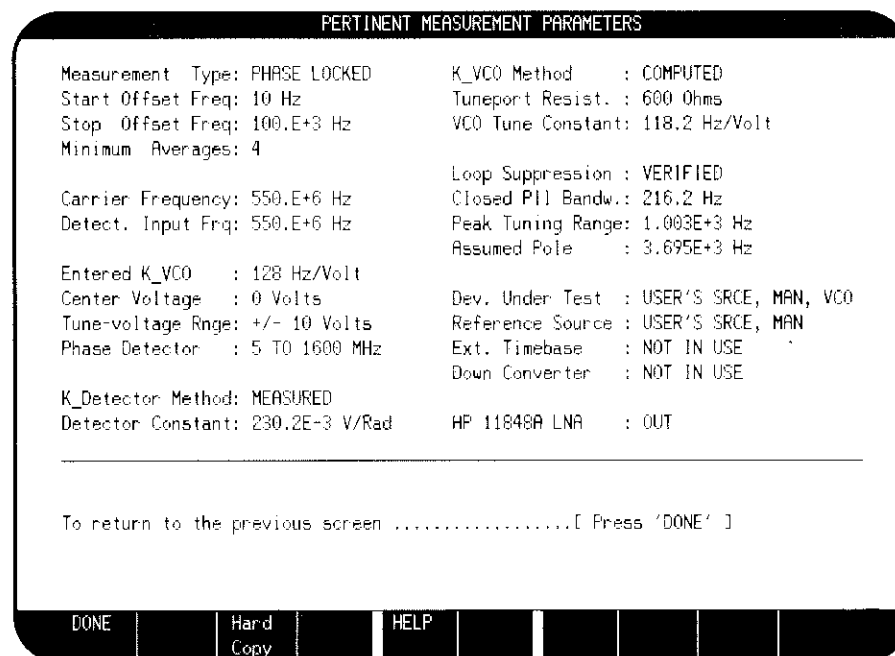
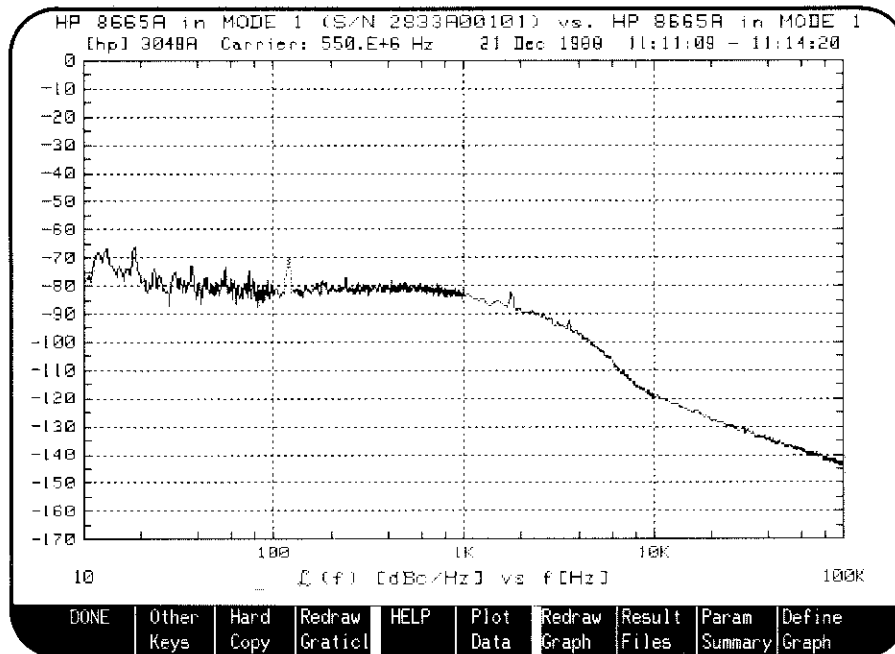

Figure 3-15. Phase Noise Plot and Pertinent Measurement Parameters

Further Measurements (Below 1600 MHz)

- To measure single-sideband phase noise for other carrier frequencies and modes of operation, set the signal generators and phase noise measurement system as outlined in the following table. The phase noise should be within the limits indicated in the table.

Spurious signals offset frequencies greater than 10 kHz should be down more than 100 dBc for carrier frequencies 187.5 to 2060 MHz and more than 90 dBc at carrier frequencies between 2060 and 6000 MHz and between 0.1 and 187.5 MHz.

Non-harmonic spurious signals, >10 kHz offset, 187.5 to 1100 MHz: _____ -100 dBc
 Non-harmonic spurious signals, >10 kHz offset, 0.1 to 187.5 MHz: _____ -90 dBc

Carrier Frequency (MHz) ⁽¹⁾	Sig. Gen. Settings		HP 3048A VCO Tuning (Hz/V)	Phase Noise Limits (dBc)	
	Mode Select	FM Peak Dev. (Hz)		20 kHz Offset	
				Actual	Max.
1100	1	250	250	_____	-117
1100	2 ⁽²⁾	250	250	_____	-128
550	2 ⁽²⁾	200	200	_____	-134
550	1	200	200	_____	-122
300	1	100	100	_____	-128
300	2 ⁽²⁾	100	100	_____	-139
200	2 ⁽²⁾	100	100	_____	-144
150	2 ⁽²⁾	250	250	_____	-128
150	1	250	250	_____	-117
40	2 ⁽²⁾	250	250	_____	-131

(1) Make the carrier frequency change to the following:
 a. the Signal Generator under test,
 b. the reference signal generator,
 c. the HP 3048A Source and Interface Parameter Entry menu (for Carrier Frequency and Detector/Disc. Input Frequency), and
 d. the Graph Definition menu (in the Title).

(2) Option 004

Further Measurements (Above 1200 MHz)

- Set the level of the reference signal generator to 6 dBm and move its output to the R port of the 1.2 GHz to 18 GHz phase detector of the HP 11848A.
- Set the level of the Signal Generator being tested to 9 dBm and move its output to the L port of the 1.2 GHz to 18 GHz phase detector of the HP 11848A.

17. Call up the Source and Interface Parameter Entry menu (shown in figure 3-11) and select the phase detector labeled "Internal Phase Detector: 1.2 GHz to 18 GHz".
18. Proceed with the measurements using the technique of step 14. The phase noise should be within the limits indicated in the table. Spurious signals should be as indicated below.

Non-harmonic spurious signals, >10 kHz offset, 2100 to 6000 MHz: _____ -90 dBc

Carrier Frequency (MHz) ⁽¹⁾	Sig. Gen. Settings		HP 3048A VCO Tuning (Hz/V)	Phase Noise Limits (dBc)	
	Mode Select	FM Peak Dev. (Hz)		20 kHz Offset	
				Actual	Max.
4150	1	1000	1000	_____	-105
4150	2 ⁽²⁾	1000	1000	_____	-116
2100	2 ⁽²⁾	500	500	_____	-122
2100	1	500	500	_____	-111

(1) Make the carrier frequency change to the following:

- a. the Signal Generator under test,
- b. the reference signal generator,
- c. the HP 3048A Source and Interface Parameter Entry menu (for Carrier Frequency and Detector/Disc. Input Frequency), and
- d. the Graph Definition menu (in the Title).

(2) Option 004

Performance Test 6

SPECTRAL PURITY TEST (HARMONICS)

Specification

Characteristic	Performance Limits	Conditions
Spectral Purity		
Spurious Signals		
Harmonics	< -30 dBc	output <6 dBm
Subharmonics	< -75 dBc < -40 dBc < -50 dBc	0.1 to 1500 MHz carrier 1500 to 3000 MHz carrier 3000 to 6000 MHz carrier

Description

Harmonics and subharmonics are observed directly on an RF spectrum analyzer while the Signal Generator is swept slowly over its frequency range.

Equipment

RF Spectrum Analyzer HP 8562B or HP 853A/8559A

Procedure

Initial Setup

1. Set the Signal Generator as follows.
 - a. Press INSTR PRESET.
 - b. Key in AMPTD 6 dBm.
 - c. Key in SWEEP TIME 10 s.
2. Set the spectrum analyzer as follows.
 - a. Set the frequency span 0 to 10 GHz with compatible resolution bandwidth and display smoothing. (If this span width is not available, use the widest span possible and, as the measurement progresses, readjust the center frequency as needed to span the complete range in segments.)
 - b. Set the vertical scale to 10 dB per division log.
 - c. Set the vertical sensitivity and attenuation to view a +6 dBm signal with at least 40 dB of uncompressed range.
3. Connect the Signal Generator's RF output connector to the spectrum analyzer's input.

Harmonics

4. Perform the following steps to determine the RF harmonic distortion.
 - a. Set the Signal Generator carrier amplitude as given in the following table.
 - b. If the Signal Generator is sweeping, press the AUTO key to stop the sweep.
 - c. Set the Signal Generator start and stop frequencies as given in the table.
 - d. On the Signal Generator, press the AUTO key to initiate a sweep.
 - e. In general, observe the second and third harmonics of the signal (that is, the difference in level between the fundamental and the highest harmonic component) as the fundamental sweeps over its range. The harmonics should be within the limits shown in the table.

NOTE

Sweep limitations of the spectrum analyzer or difficulty in observing the harmonics may make it necessary to change the spectrum analyzer's sweep range and resolution bandwidth. Also, it may be helpful (particularly at low carrier frequencies) to stop the Signal Generator's sweep and examine the harmonics while in CW. If a harmonic appears to be close to or out of specification, stop the Signal Generator's sweep and more carefully check the amplitude of the fundamental and harmonic.

Signal Generator Settings			Harmonics Limits (dBc)	
Start Frequency (MHz)	Stop Frequency (MHz)	Amplitude (dBm)	Actual	Maximum
0.1	2999	6	_____	-30
3000	4200 ⁽¹⁾	6	_____	-30
3000	6000 ⁽²⁾	6	_____	-30
⁽¹⁾ HP 8665A only ⁽²⁾ HP 8665B only				

Subharmonics

5. Set the spectrum analyzer to span 0 to 5 GHz. Increase the vertical gain, sweep time, resolution bandwidth, and display smoothing as necessary to obtain a dynamic range of 80 dB. (A slight compression of the signal is acceptable.)

NOTE

As with the measurement of harmonics, the spectrum analyzer sweeps may need to be broken into smaller segments and the resolution bandwidth be reduced. It may be necessary to reduce (or even stop) the Signal Generator's sweep to match the spectrum analyzer sweep.

6. Set the Signal Generator to sweep 0.1 to 2999 MHz then 3000 to 4200 MHz. For each case, observe the subharmonics of the signal as the fundamental sweeps over its range. The subharmonics should be down more than 75 dB over the fundamental range to 0.1 to 1500 MHz, more than 40 dB from 1500 to 3000 MHz range, and more than 50 dB from 3000 to 4200 MHz.

Subharmonics, 0.1 to 1500 MHz carrier: _____ -75 dBc
 Subharmonics, 1500 to 3000 MHz carrier: _____ -40 dBc
 Subharmonics, 3000 to 6000 MHz carrier: _____ -50 dBc

Performance Test 7

PULSE MODULATION TEST (OPTION 008)

Specification

Characteristic	Performance Limits	Conditions
Pulse Modulator		Option 008. See figure below for definitions.
On/Off Ratio	80 dB	
Rise/Fall Time	<8 ns	10% to 90% points
Internal Pulse Generator		Option 008
Pulse Repetition Frequency	0.1 Hz to 400 kHz	
Pulse Delay/Width	50 ns to 1s	
Accuracy	$\pm 10\%$ of setting ± 2 ns $\pm 10\%$ of setting ± 2 ns	10 to 200 ns
<p>Pulse Modulation Definitions</p> <p>The diagram shows four waveforms: External/Internal Control Source (a step function), Sync Output (a trapezoidal pulse), RF Pulse Output (a trapezoidal pulse with overshoot and ringing), and Video Output (a trapezoidal pulse). Key parameters are labeled: Td (Trigger delay) from the control source to the sync output; Pd (RF pulse delay) from the sync output to the RF pulse; Pw (RF pulse width) at 50% level; Tr (RF pulse rise time) from 10% to 90% level; Tf (RF pulse fall time) from 90% to 10% level; Tw (Video width) at 50% level; Vor (Overshoot and ringing) at the peak of the RF pulse; and Vf (Video feedthrough) at the end of the RF pulse.</p> <p>Td—Trigger delay Tw—Video width Vf—Video feedthrough Pd—RF pulse delay Tr—RF pulse rise time Vor—Overshoot and ringing Pw—RF pulse width Tf—RF pulse fall time</p>		

Description

The pulse on/off ratio is measured statically on a spectrum analyzer by setting a CW reference then noting how far the amplitude drops when the Signal Generator is switched to the pulse modulation mode with no pulse input. The other pulse specifications are measured directly with a high-frequency, digitizing oscilloscope.

Equipment

Digitizing Oscilloscope..... HP 54110D
Spectrum Analyzer..... HP 8562A or HP 853A/8559A

Procedure

Pulse On/Off Ratio

1. Connect the Signal Generator's RF output to the spectrum analyzer's input.
2. Set the Signal Generator as follows.
 - a. Press INSTR PRESET.
 - b. Key in FREQ 100 MHz.
 - c. Key in AMPTD 9 dBm.
 - d. Key in PULSE ON.
 - e. Press INT in the MODULATION key group.
 - f. Key in AUDIO FREQ 0.5 Hz.
3. Set the spectrum analyzer as follows.
 - a. Set the center frequency to 100 MHz.
 - b. Set the vertical gain and the input attenuation to view the 9 dBm signal with an 80 dB dynamic range.
 - c. Set a span suitable for viewing the RF signal which is switching on and off at a 0.5 Hz rate.

4. Set the Signal Generator's carrier frequency and the spectrum analyzer's center frequency as indicated in the following table. For each carrier frequency, observe the change in amplitude as the Signal Generator is pulsed on and off. The amplitude should drop at least 80 dB between pulse on and pulse off.

Carrier Frequency (MHz)	On/Off Ratio (dB)	
	Minimum	Actual
100	80	_____
200	80	_____
500	80	_____
1499	80	_____
2999	80	_____
4200 ⁽¹⁾	80	_____
6000 ⁽²⁾	80	_____

(1) HP 8665A only.
 (2) HP 8665B only.

Risetime and Faltime

5. Set the Signal Generator as follows.
 - a. Key in **FREQ 10 MHz**.
 - b. Key in **AMPTD 0 dBm**.
 - c. Key in **AUDIO FREQ 399 kHz**.
6. Connect the Signal Generator's RF output to channel 1 of the oscilloscope.
7. Connect the Signal Generator's rear-panel SYNC output to channel 2 of the oscilloscope. Use the same length cable as in step 6.
8. Set the digitizing oscilloscope as follows.
 - a. Preset or autoscale the oscilloscope (if available).
 - b. Set the display to view both channel 1 and channel 2 on a split screen.
 - c. Set the input coupling of both channels, if necessary, to dc with 50 Ω input impedance.
 - d. Set the triggering to trigger on the positive slope of channel 2 at approximately 1V.
 - e. Set the sweep speed to 200 ns per division.
 - f. Set the timebase delay to 0 ns at center. Channel 1 should show the leading edge of the RF pulse burst. Channel 2 should show an entire synchronization pulse.
 - g. Set the sweep speed to 2 ns per division.
 - h. Set the delay time (approximately 10 ns) to view the rising edge of the RF and synchronization pulses.
 - i. Set the display to now view channel 1 only (channel 2 off and split screen off).
 - j. Set the vertical sensitivity of channel 1 to a convenient level (approximately 100 mV per division).
 - k. Set the offset to 0V.

9. Set the Signal Generator's carrier frequency as given in the following table. For each setting, measure the 10% to 90% risetime. Compare the waveform with figure 3-16. The risetime should be less than 8 ns. (If the oscilloscope has vertical and horizontal markers, they can be used to simplify these measurements.)

Carrier Frequency (MHz)	Risetime Limits (ns)	
	Actual	Maximum
10	_____	8
20	_____	8
50	_____	8
100	_____	8
200	_____	8
500	_____	8

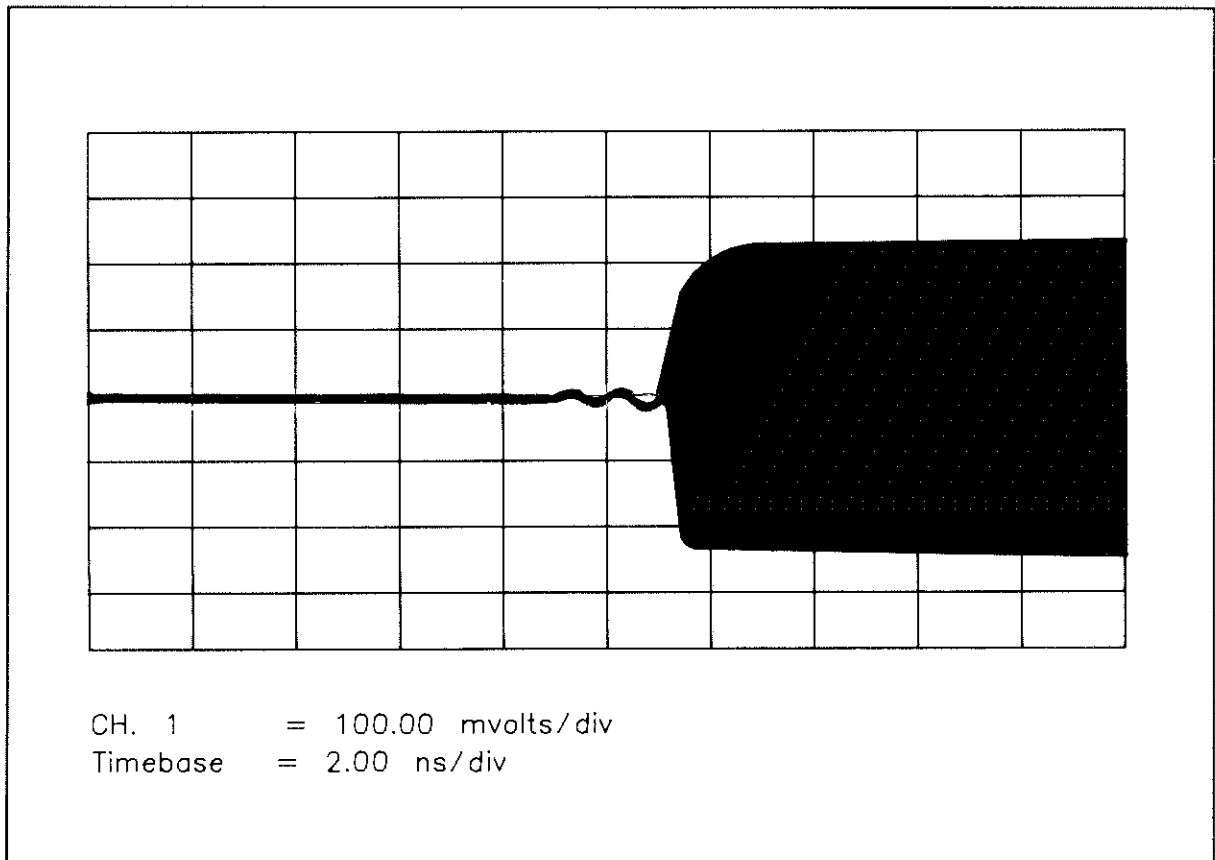

Figure 3-16. Pulse Modulation Pulse Risetime Waveform

10. On the oscilloscope, change the delay time to approximately 1.28 μs and fine adjust the delay to view the falling edge of the RF pulse.
11. Set the Signal Generator's carrier frequency as given in the following table. For each setting, measure the 10% to 90% falltime. Compare the waveform with figure 3-17. The falltime should be less than 8 ns.

Carrier Frequency (MHz)	Falltime Limits (ns)	
	Actual	Maximum
500	_____	8
200	_____	8
100	_____	8
50	_____	8
20	_____	8
10	_____	8

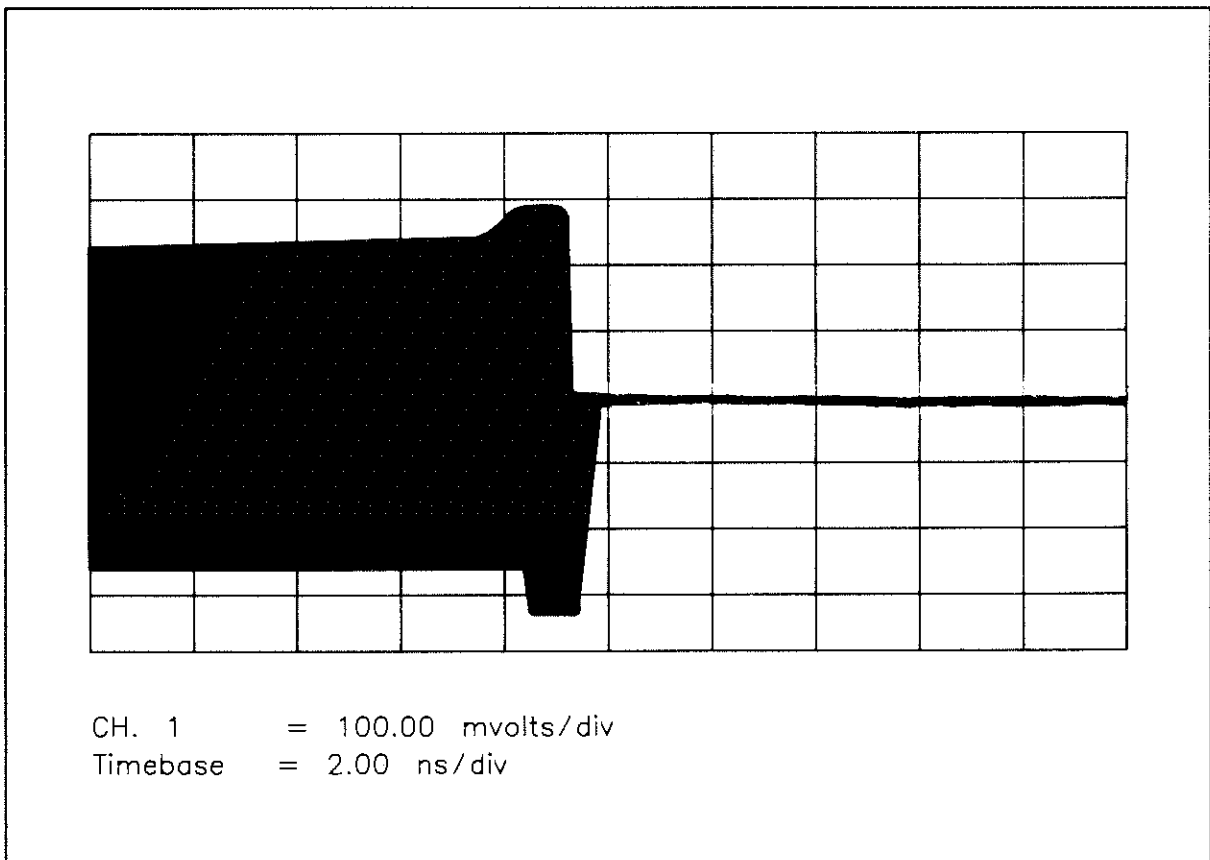

Figure 3-17. Pulse Modulation Pulse Falltime Waveform

Pulse Delay and Width Accuracy

12. Set the Signal Generator as follows.
 - a. Key in **FREQ 500 MHz**.
 - b. Key in **SPECIAL 211 ENTER**.
 - c. Rotate the **Knob** until the display reads "211:Pulse Ctrl Pulse Gen".
 - d. Key in **SPECIAL 212 ENTER 50 ns**. The sets the pulse delay to 50 ns.
 - e. Key in **SPECIAL 213 ENTER 50 ns**. The sets the pulse width to 50 ns.
13. Set the oscilloscope as follows.
 - a. Set the display to view both channel 1 and channel 2 on a split screen.
 - b. Set the sweep speed to 10 ns per division.
 - c. Set the delay time to approximately 40 ns the fine adjust it until the 50% point on the rising edge of the synchronization pulse (channel 2) is one division from the far left. Compare the waveforms with those in figure 3-18.
14. Set the controls as indicated in the following steps and table. For each setting measure the pulse delay and pulse width; the measurements should be within the limits indicated in the table.
 - a. On the Signal Generator, set the audio frequency as shown in the table by keying in **AUDIO FREQ**, then keying in the frequency.

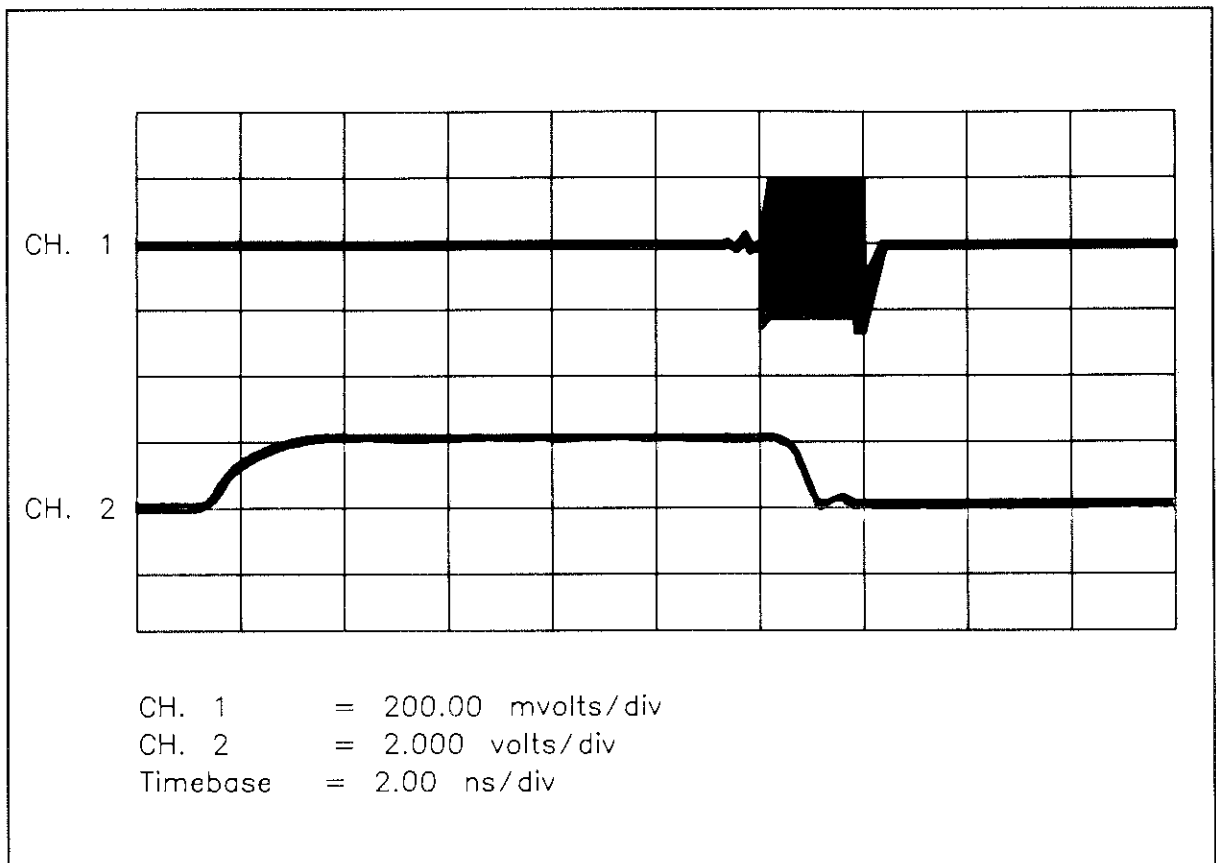

Figure 3-18. Pulse Modulation Synchronization and RF Pulse Waveforms

- b. On the Signal Generator, set the pulse delay time as shown in the table by keying in SPECIAL 212 ENTER, then keying in the pulse delay.
- c. On the Signal Generator, set the pulse width as shown in the table by keying in SPECIAL 213 ENTER, then keying in the pulse width.
- d. On the oscilloscope, set the sweep speed and time delay as shown in the table.
- e. Measure the pulse delay time and width. (If the oscilloscope has horizontal markers, they can be used to simplify these measurements.) The times should be within the limits given in the table.

Signal Generator Settings			Oscilloscope Settings		Pulse Delay Limits (ns)			Pulse Width Limits (ns)		
Pulse Frequency (kHz)	Pulse Delay (ns)	Pulse Width (ns)	Sweep Speed (ns/div)	Time Delay (ns)	Minimum	Actual	Maximum	Minimum	Actual	Maximum
399	50	50	40	10	43	_____	57	43	_____	57
39.9	500	100	400	100	448	_____	552	88	_____	112
3.99	5000	1000	4000	1000	4498	_____	5502	898	_____	1102

Performance Test 8

INTERNAL AUDIO OSCILLATOR TEST

Specification

Characteristic	Performance Limits	Conditions
Internal Modulation Source Distortion	<0.1%	output 1V peak; rate <20 kHz

Description

The distortion of the internal modulation source is measured directly on a distortion analyzer.

Equipment

Distortion AnalyzerHP 8903B or HP 8903E

Procedure

1. Connect the input of the distortion analyzer directly to the Signal Generator’s AUDIO output connector.
2. Set the distortion analyzer to measure distortion. Set its low-pass filter to 80 kHz or greater.
3. On the Signal Generator press INSTR PRESET.
4. On the Signal Generator, key in the audio frequency as listed in the following table. For each setting measure the audio distortion. The distortion should less than 0.1%.

Audio Frequency Setting (Hz)	Distortion Limits (%)	
	Actual	Maximum
20	_____	0.2
100	_____	0.2
1 000	_____	0.2
10 000	_____	0.2
20 000	_____	0.2

Performance Test 9

OPTION 010 LEAKAGE TEST

Specification

2 μV measured into a resonant dipole 1 inch from the instrument's surface (except rear panel) with output level < 0 dBm and all inputs/outputs properly terminated.

Description

Leakage is measured using a resonate dipole. The output of the antenna is amplified by an RF amplifier and measured on a spectrum analyzer. The calibrated output of the signal generator under test is used to calibrate the amplifier/spectrum analyzer combination.

Equipment

Spectrum Analyzer	HP 8560A
RF Amplifier	HP 8447E
Antenna	HP 8644A/K03
Type N 50 ohm load	HP 908A
BNC 50 ohm load	HP 1250-0207

Procedure

Set-Up and Calibration

1. Press the INSTR PRESET key of the signal generator. Then set as follows:

Frequency	1029.1 MHz
Amplitude	2.0 μV

2. Connect the RF Output of the signal generator to the input of the RF Amplifier. Connect the output of the RF Amplifier to the input of the spectrum analyzer.
3. Set the spectrum analyzer center frequency to 1029.1 MHz and input attenuation to 0dB. Set the span so the signal is at least 20 dB above the noise level and the sweep speed is 400 mSec or faster. Try a 100 kHz span as a starting point. Change the reference level so the signal peak is at mid screen. If the spectrum analyzer has display line capability, set a line at the signal peak. This line on the spectrum analyzer display represents a 2 μV signal level from the antenna. All leakage picked up by the antenna must be below this level.
4. Disconnect the cable from the RF Output connector of the signal generator, and connect it to the antenna. Put 50 ohm loads on the RF OUTPUT and all the front panel and rear panel BNC connectors of the signal generator. Set the signal generator RF amplitude to -0.1 dBm.

Measurement

Frequency (MHz)	Length Antenna Element	Max Leakage (dB) ¹
1029.1	5.9 cm (2.30 in)	_____
975.1	6.1 cm (2.40 in)	_____
925.1	6.5 cm (2.56 in)	_____
875.1	7.0 cm (2.74 in)	_____
825.1	7.5 cm (2.95 in)	_____
775.1	8.1 cm (3.18 in)	_____
725.1	8.7 cm (3.44 in)	_____
454.1	14.9 cm (5.87 in)	_____

¹ Upper limit is 0 dB.

5. For each frequency in the above table do the following:
- Set the signal generator carrier frequency and the spectrum analyzer center frequency to the frequency in the table.
 - Set the antenna elements length to the value given in the table. Measure from the outside of the center hub to the tip of the dipole.
 - Move the antenna over all the surfaces (except the rear panel) of the signal generator keeping the spacers in contact with the covers. This keeps the actual antenna elements 1 inch away from the surface. Do not allow the antenna elements to get closer than 1 inch to the RF Output connector or any of the front panel BNC connectors.
 - Move the antenna slowly. The antenna should move less than one inch per spectrum analyzer sweep cycle.
 - Monitor the signal level displayed on the spectrum analyzer. The signal level must stay below the reference line set above for the test to pass. For each frequency note the maximum signal level in relation to the reference line. Write this value in the table. For example if the highest signal level was 5 dB below the reference, enter - 5.0 in the table.
6. To measure leakage at other frequencies use the formula below to determine antenna element length and follow the procedure in step 5.

$$\ell = \frac{7500}{f} - 1.6$$

Where:

ℓ = antenna element length in centimeters

f = frequency in MHz.

Table 3-2. Performance Test Record (1 of 15)

Hewlett-Packard Company HP 8664A, HP 8665A, HP 8665B Synthesized Signal Generator				
		Tested By _____		
Serial Number _____		Date _____		
Test No.	Test Description	Results		
		Minimum	Actual	Maximum
1	CARRIER AMPLITUDE PERFORMANCE TEST			
	Low-Frequency, Maximum Level			
	<i>Frequency and Amplitude Settings—Not Option 008</i>			
	0.1 MHz; +14.5 dBm	+13 dBm	_____	
	1 MHz; +14 dBm	+13 dBm	_____	
	10 MHz; +14 dBm	+13 dBm	_____	
	100 MHz; +14 dBm	+13 dBm	_____	
	1000 MHz; +14 dBm	+13 dBm	_____	
	<i>Frequency and Amplitude Settings—Option 008</i>			
	0.1 MHz; +10.5 dBm	+9 dBm	_____	
	1 MHz; +10 dBm	+9 dBm	_____	
	10 MHz; +10 dBm	+9 dBm	_____	
	100 MHz; +10 dBm	+9 dBm	_____	
	1000 MHz; +10 dBm	+9 dBm	_____	
	Low-Frequency, High-Amplitude Accuracy			
	<i>Frequency and Amplitude Settings</i>			
	1000 MHz; +6 dBm	+5 dBm	_____	+7 dBm
	1000 MHz; +7 dBm	+6 dBm	_____	+8 dBm
	1000 MHz; +8 dBm	+7 dBm	_____	+9 dBm
	1000 MHz; +9 dBm	+8 dBm	_____	+10 dBm
	1000 MHz; +10 dBm (except Option 008)	+9 dBm	_____	+11 dBm
	1000 MHz; +11 dBm (except Option 008)	+10 dBm	_____	+12 dBm
	1000 MHz; +12 dBm (except Option 008)	+11 dBm	_____	+13 dBm
	1000 MHz; +13 dBm (except Option 008)	+12 dBm	_____	+14 dBm
	100 MHz; +13 dBm (except Option 008)	+12 dBm	_____	+14 dBm
	100 MHz; +12 dBm (except Option 008)	+11 dBm	_____	+13 dBm
	100 MHz; +11 dBm (except Option 008)	+10 dBm	_____	+12 dBm
	100 MHz; +10 dBm (except Option 008)	+9 dBm	_____	+11 dBm
100 MHz; +9 dBm	+8 dBm	_____	+10 dBm	
100 MHz; +8 dBm	+7 dBm	_____	+9 dBm	
100 MHz; +7 dBm	+6 dBm	_____	+8 dBm	
100 MHz; +6 dBm	+5 dBm	_____	+7 dBm	

Table 3-2. Performance Test Record (2 of 15)

Test No.	Test Description	Results		
		Minimum	Actual	Maximum
1	CARRIER AMPLITUDE PERFORMANCE TEST (Cont'd)			
	Low-Frequency, High-Amplitude Accuracy (cont'd)			
	<i>Frequency and Amplitude Settings</i>			
	10 MHz; +6 dBm	+5 dBm	_____	+7 dBm
	10 MHz; +7 dBm	+6 dBm	_____	+8 dBm
	10 MHz; +8 dBm	+7 dBm	_____	+9 dBm
	10 MHz; +9 dBm	+8 dBm	_____	+10 dBm
	10 MHz; +10 dBm (except Option 008)	+9 dBm	_____	+11 dBm
	10 MHz; +11 dBm (except Option 008)	+10 dBm	_____	+12 dBm
	10 MHz; +12 dBm (except Option 008)	+11 dBm	_____	+13 dBm
	10 MHz; +13 dBm (except Option 008)	+12 dBm	_____	+14 dBm
	1 MHz; +13 dBm (except Option 008)	+12 dBm	_____	+14 dBm
	1 MHz; +12 dBm (except Option 008)	+11 dBm	_____	+13 dBm
	1 MHz; +11 dBm (except Option 008)	+10 dBm	_____	+12 dBm
	1 MHz; +10 dBm (except Option 008)	+9 dBm	_____	+11 dBm
	1 MHz; +9 dBm	+8 dBm	_____	+10 dBm
	1 MHz; +8 dBm	+7 dBm	_____	+9 dBm
	1 MHz; +7 dBm	+6 dBm	_____	+8 dBm
	1 MHz; +6 dBm	+5 dBm	_____	+7 dBm
	0.1 MHz; +6 dBm	+3 dBm	_____	+9 dBm
	0.1 MHz; +7 dBm	+4 dBm	_____	+10 dBm
	0.1 MHz; +8 dBm	+5 dBm	_____	+11 dBm
	0.1 MHz; +9 dBm	+6 dBm	_____	+12 dBm
	0.1 MHz; +10 dBm (except Option 008)	+7 dBm	_____	+13 dBm
	0.1 MHz; +11 dBm (except Option 008)	+8 dBm	_____	+14 dBm
	0.1 MHz; +12 dBm (except Option 008)	+9 dBm	_____	+15 dBm
	0.1 MHz; +13 dBm (except Option 008)	+10 dBm	_____	+16 dBm

Table 3-2. Performance Test Record (3 of 15)

Test No.	Test Description	Results		
		Minimum	Actual	Maximum
1	CARRIER AMPLITUDE PERFORMANCE TEST (Cont'd)			
	Low-Frequency, Low-Amplitude Accuracy, 1000 MHz			
	<i>Attenuation and Amplitude Settings</i>			
	+5 dB, +1 dBm	-0 dB REL	_____	+2 dB REL
	+10 dB, -4 dBm	-5 dB REL	_____	-3 dB REL
	+15 dB, -9 dBm	-10 dB REL	_____	-8 dB REL
	+20 dB, -14 dBm	-15 dB REL	_____	-13 dB REL
	+25 dB, -19 dBm	-20 dB REL	_____	-18 dB REL
	+30 dB, -24 dBm	-25 dB REL	_____	-23 dB REL
	+35 dB, -29 dBm	-30 dB REL	_____	-28 dB REL
	+40 dB, -34 dBm	-35 dB REL	_____	-33 dB REL
	+45 dB, -39 dBm	-40 dB REL	_____	-38 dB REL
	+50 dB, -44 dBm	-45 dB REL	_____	-43 dB REL
	+55 dB, -49 dBm	-50 dB REL	_____	-48 dB REL
	+60 dB, -54 dBm	-55 dB REL	_____	-53 dB REL
	+65 dB, -59 dBm	-60 dB REL	_____	-58 dB REL
	+70 dB, -64 dBm	-65 dB REL	_____	-63 dB REL
	+75 dB, -69 dBm	-70 dB REL	_____	-68 dB REL
	+80 dB, -74 dBm	-75 dB REL	_____	-73 dB REL
	+85 dB, -79 dBm	-80 dB REL	_____	-78 dB REL
	+90 dB, -84 dBm	-85 dB REL	_____	-83 dB REL
	+95 dB, -89 dBm	-90 dB REL	_____	-88 dB REL
	+100 dB, -94 dBm	-95 dB REL	_____	-93 dB REL
	+105 dB, -99 dBm	-100 dB REL	_____	-98 dB REL
	+110 dB, -104 dBm	-105 dB REL	_____	-103 dB REL
	+115 dB, -109 dBm	-110 dB REL	_____	-108 dB REL
	+120 dB, -114 dBm	-115 dB REL	_____	-113 dB REL
	+125 dB, -119 dBm	-120 dB REL	_____	-118 dB REL
	High-Frequency, Maximum Level			
	<i>Frequency and Amplitude Settings-Not Option 008</i>			
	2990 MHz; +14.5 dBm	+13 dBm	_____	
	4200 MHz; +15.0 dBm (HP 8665A/B)	+13 dBm	_____	
	6000 MHz; +15.0 dBm (HP 8665B)	+13 dBm	_____	
<i>Frequency and Amplitude Settings-Option 008</i>				
2990 MHz; +10.5 dBm	+9 dBm	_____		
4200 MHz; +11.0 dBm (HP 8665A/B)	+9 dBm	_____		
6000 MHz; +11.0 dBm (HP 8665B)	+9 dBm	_____		

Table 3-2. Performance Test Record (4 of 15)

Test No.	Test Description	Results		
		Minimum	Actual	Maximum
1	CARRIER AMPLITUDE PERFORMANCE TEST (Cont'd)			
	High-Frequency, High-Amplitude Accuracy			
	<i>Frequency and Amplitude Settings</i>			
	6000 MHz; +13 dBm(HP 8665B)	+11.0 dBm	_____	+15.0 dBm
	6000 MHz; +11 dBm (HP 8665B)	+9.0 dBm	_____	+13.0 dBm
	6000 MHz; +9 dBm (HP 8665B, except opt. 008)	+7.0 dBm	_____	+11.0 dBm
	6000 MHz; +6 dBm (HP 8665B, except opt. 008)	+4.0 dBm	_____	+8.0 dBm
	4200 MHz; +6 dBm (HP 8665A/B)	+4.0 dBm	_____	+8.0 dBm
	4200 MHz; +9 dBm (HP 8665A/B)	+7.0 dBm	_____	+11.0 dBm
	4200 MHz; +11 dBm (HP 8665A/B, except opt. 008)	+9.0 dBm	_____	+13.0 dBm
	4200 MHz; +13 dBm (HP 8665A/B, except opt. 008)	+11.0 dBm	_____	+15.0 dBm
	2900 MHz; +13 dBm (except Option 008)	+11.5 dBm	_____	+14.5 dBm
	2900 MHz; +11 dBm (except Option 008)	+9.5 dBm	_____	+12.5 dBm
	2900 MHz; +9 dBm	+7.5 dBm	_____	+10.5 dBm
	2900 MHz; +6 dBm	+4.5 dBm	_____	+7.5 dBm
	High-Frequency, Low-Amplitude Accuracy, 2990 MHz			
	<i>Attenuation and Amplitude Settings</i>			
	+5 dB, +1 dBm	-0.5 dB REL	_____	+2.5 dB REL
	+10 dB, -4 dBm	-5.5 dB REL	_____	-2.5 dB REL
	+15 dB, -9 dBm	-10.5 dB REL	_____	-7.5 dB REL
	+20 dB, -14 dBm	-15.5 dB REL	_____	-12.5 dB REL
	+25 dB, -19 dBm	-20.5 dB REL	_____	-17.5 dB REL
	+30 dB, -24 dBm	-25.5 dB REL	_____	-22.5 dB REL
	+35 dB, -29 dBm	-30.5 dB REL	_____	-27.5 dB REL
	+40 dB, -34 dBm	-35.5 dB REL	_____	-32.5 dB REL
	+45 dB, -39 dBm	-40.5 dB REL	_____	-37.5 dB REL
	+50 dB, -44 dBm	-45.5 dB REL	_____	-42.5 dB REL
	+55 dB, -49 dBm	-50.5 dB REL	_____	-47.5 dB REL
	+60 dB, -54 dBm	-55.5 dB REL	_____	-52.5 dB REL
	+65 dB, -59 dBm	-60.5 dB REL	_____	-57.5 dB REL
	+70 dB, -64 dBm	-65.5 dB REL	_____	-62.5 dB REL
	+75 dB, -69 dBm	-70.5 dB REL	_____	-67.5 dB REL
	+80 dB, -74 dBm	-75.5 dB REL	_____	-72.5 dB REL
+85 dB, -79 dBm	-80.5 dB REL	_____	-77.5 dB REL	
+90 dB, -84 dBm	-85.5 dB REL	_____	-82.5 dB REL	
+95 dB, -89 dBm	-90.5 dB REL	_____	-87.5 dB REL	
+100 dB, -94 dBm	-95.5 dB REL	_____	-92.5 dB REL	
+105 dB, -99 dBm	-100.5 dB REL	_____	-97.5 dB REL	
+110 dB, -104 dBm	-105.5 dB REL	_____	-102.5 dB REL	

Table 3-2. Performance Test Record (5 of 15)

Test No.	Test Description	Results		
		Minimum	Actual	Maximum
1	CARRIER AMPLITUDE PERFORMANCE TEST (Cont'd)			
	High-Frequency, Low-Amplitude Accuracy, 4200 MHz			
	HP 8665A Only			
	<i>Attenuation and Amplitude Settings</i>			
	+5 dB, +1 dBm	-1.0 dB REL	_____	+2.0 dB REL
	+10 dB, -4 dBm	-6.0 dB REL	_____	-2.0 dB REL
	+15 dB, -9 dBm	-11.0 dB REL	_____	-7.0 dB REL
	+20 dB, -14 dBm	-16.0 dB REL	_____	-12.0 dB REL
	+25 dB, -19 dBm	-21.0 dB REL	_____	-17.0 dB REL
	+30 dB, -24 dBm	-26.0 dB REL	_____	-22.0 dB REL
	+35 dB, -29 dBm	-31.0 dB REL	_____	-27.0 dB REL
	+40 dB, -34 dBm	-36.0 dB REL	_____	-32.0 dB REL
	+45 dB, -39 dBm	-41.0 dB REL	_____	-37.0 dB REL
	+50 dB, -44 dBm	-46.0 dB REL	_____	-42.0 dB REL
	+55 dB, -49 dBm	-51.0 dB REL	_____	-47.0 dB REL
	+60 dB, -54 dBm	-56.0 dB REL	_____	-52.0 dB REL
	+65 dB, -59 dBm	-61.0 dB REL	_____	-57.0 dB REL
	+70 dB, -64 dBm	-66.0 dB REL	_____	-62.0 dB REL
	+75 dB, -69 dBm	-71.0 dB REL	_____	-67.0 dB REL
	+80 dB, -74 dBm	-76.0 dB REL	_____	-72.0 dB REL
	+85 dB, -79 dBm	-81.0 dB REL	_____	-77.0 dB REL
	+90 dB, -84 dBm	-86.0 dB REL	_____	-82.0 dB REL
+95 dB, -89 dBm	-91.0 dB REL	_____	-87.0 dB REL	
+100 dB, -94 dBm	-96.0 dB REL	_____	-92.0 dB REL	
+105 dB, -99 dBm	-101.0 dB REL	_____	-97.0 dB REL	
+110 dB, -104 dBm	-106.0 dB REL	_____	-102.0 dB REL	

Table 3-2. Performance Test Record (6 of 15)

Test No.	Test Description	Results		
		Minimum	Actual	Maximum
1	CARRIER AMPLITUDE PERFORMANCE TEST (Cont'd)			
	High-Frequency, Low-Amplitude Accuracy, 6000 MHz			
	HP 8665B Only			
	<i>Attenuation and Amplitude Settings</i>			
	+5 dB, +1 dBm	-1.0 dB REL	_____	+2.0 dB REL
	+10 dB, -4 dBm	-6.0 dB REL	_____	-2.0 dB REL
	+15 dB, -9 dBm	-11.0 dB REL	_____	-7.0 dB REL
	+20 dB, -14 dBm	-16.0 dB REL	_____	-12.0 dB REL
	+25 dB, -19 dBm	-21.0 dB REL	_____	-17.0 dB REL
	+30 dB, -24 dBm	-26.0 dB REL	_____	-22.0 dB REL
	+35 dB, -29 dBm	-31.0 dB REL	_____	-27.0 dB REL
	+40 dB, -34 dBm	-36.0 dB REL	_____	-32.0 dB REL
	+45 dB, -39 dBm	-41.0 dB REL	_____	-37.0 dB REL
	+50 dB, -44 dBm	-46.0 dB REL	_____	-42.0 dB REL
	+55 dB, -49 dBm	-51.0 dB REL	_____	-47.0 dB REL
	+60 dB, -54 dBm	-56.0 dB REL	_____	-52.0 dB REL
	+65 dB, -59 dBm	-61.0 dB REL	_____	-57.0 dB REL
	+70 dB, -64 dBm	-66.0 dB REL	_____	-62.0 dB REL
	+75 dB, -69 dBm	-71.0 dB REL	_____	-67.0 dB REL
	+80 dB, -74 dBm	-76.0 dB REL	_____	-72.0 dB REL
+85 dB, -79 dBm	-81.0 dB REL	_____	-77.0 dB REL	
+90 dB, -84 dBm	-86.0 dB REL	_____	-82.0 dB REL	
+95 dB, -89 dBm	-91.0 dB REL	_____	-87.0 dB REL	
+100 dB, -94 dBm	-96.0 dB REL	_____	-92.0 dB REL	
+105 dB, -99 dBm	-101.0 dB REL	_____	-97.0 dB REL	
+110 dB, -104 dBm	-106.0 dB REL	_____	-102.0 dB REL	

Table 3-2. Performance Test Record (7 of 15)

Test No.	Test Description	Results		
		Minimum	Actual	Maximum
2	AM TEST			
	Residual AM			
	13 dBm carrier (except Option 008)		_____	0.02%
	9 dBm carrier		_____	0.02%
	0 dBm carrier		_____	0.02%
	Indicator Accuracy			
	10% depth	8.4%	_____	11.6%
	50% depth	46.0%	_____	54.0%
	90% depth	83.6%	_____	96.4%
	Distortion			
	30% depth		_____	2%
	70% depth		_____	4%
	90% depth		_____	6%
	3 dB Bandwidth			
	<i>Carrier Frequency and AM Rate Settings</i>			
	1 MHz; 5 kHz	-3 dB	_____	+3 dB
	10 MHz; 10 kHz	-3 dB	_____	+3 dB
	100 MHz; 10 kHz	-3 dB	_____	+3 dB
	1000 MHz; 10 kHz	-3 dB	_____	+3 dB
	4000 MHz; 10 kHz (HP 8665A/B)	-3 dB	_____	+3 dB
	Incidental Phase Modulation			
1000 MHz carrier		_____	0.3 rad pk	
4000 MHz carrier		_____	0.6 rad pk	
6000 MHz carrier		_____	0.6 rad pk	

Table 3-2. Performance Test Record (8 of 15)

Test No.	Test Description	Results		
		Minimum	Actual	Maximum
3	FM TEST (LOW DEVIATIONS AND RATES)			
	Residual FM			
	<i>Frequency, Mode Select, and Bandwidth Settings</i>			
	180.001 MHz; Mode 1; 0.3 to 3 kHz		_____	15 Hz rms
	180.001 MHz; Mode 1; 0.05 to 15 kHz		_____	20 Hz rms
	740.005 MHz; Mode 1; 0.05 to 15 kHz		_____	20 Hz rms
	740.005 MHz; Mode 1; 0.3 to 3 kHz		_____	15 Hz rms
	1200.001 MHz; Mode 1; 0.3 to 3 kHz		_____	30 Hz rms
	1200.001 MHz; Mode 1; 0.05 to 15 kHz		_____	37 Hz rms
	1200.004 MHz; Mode 2 (Option 004); 0.05 to 15 kHz		_____	8 Hz rms
	1200.004 MHz; Mode 2 (Option 004); 0.3 to 3 kHz		_____	5 Hz rms
	740.002 MHz; Mode 2 (Option 004); 0.3 to 3 kHz		_____	2.5 Hz rms
	740.002 MHz; Mode 2 (Option 004); 0.05 to 15 kHz		_____	8 Hz rms
	180.004 MHz; Mode 2 (Option 004); 0.05 to 15 kHz		_____	8 Hz rms
	180.004 MHz; Mode 2 (Option 004); 0.3 to 3 kHz		_____	2.5 Hz rms
	Maximum Frequency (MHz); Mode 1; 0.3 to 3 kHz		_____	60 Hz rms
	Maximum Frequency (MHz); Mode 1; 0.05 to 15 kHz		_____	80 Hz rms
	Maximum Frequency (MHz); Mode 2 (Option 004); 0.05 to 15 kHz		_____	32 Hz rms
	Maximum Frequency (MHz); Mode 2 (Option 004); 0.3 to 3 kHz		_____	10 Hz rms
	Indicator Accuracy			
	<i>Carrier Frequency, FM Deviation, and Mode Select Settings</i>			
	10 MHz; 350 kHz; Mode 1	318.5 kHz pk	_____	381.5 kHz pk
	180 MHz; 350 kHz; Mode 1	318.5 kHz pk	_____	381.5 kHz pk
	190 MHz; 350 kHz; Mode 1	318.5 kHz pk	_____	381.5 kHz pk
	260 MHz; 350 kHz; Mode 1	318.5 kHz pk	_____	381.5 kHz pk
	370 MHz; 350 kHz; Mode 1	318.5 kHz pk	_____	381.5 kHz pk
380 MHz; 350 kHz; Mode 1	318.5 kHz pk	_____	381.5 kHz pk	
525 MHz; 350 kHz; Mode 1	318.5 kHz pk	_____	381.5 kHz pk	
745 MHz; 350 kHz; Mode 1	318.5 kHz pk	_____	381.5 kHz pk	
755 MHz; 350 kHz; Mode 1	318.5 kHz pk	_____	381.5 kHz pk	
1060 MHz; 350 kHz; Mode 1	318.5 kHz pk	_____	381.5 kHz pk	
1290 MHz; 350 kHz; Mode 1	318.5 kHz pk	_____	381.5 kHz pk	

Table 3-2. Performance Test Record (9 of 15)

Test No.	Test Description	Results		
		Minimum	Actual	Maximum
3	FM TEST (LOW DEVIATIONS AND RATES) (Cont'd)			
	Indicator Accuracy (cont'd)			
	<i>Carrier Frequency, FM Deviation, and Mode Select Settings (cont'd)</i>			
	1290 MHz; 100 kHz; Mode 2 (Option 004)	89 kHz pk	_____	111 kHz pk
	1060 MHz; 100 kHz; Mode 2 (Option 004)	89 kHz pk	_____	111 kHz pk
	755 MHz; 100 kHz; Mode 2 (Option 004)	89 kHz pk	_____	111 kHz pk
	745 MHz; 50 kHz; Mode 2 (Option 004)	44.5 kHz pk	_____	55.5 kHz pk
	525 MHz; 50 kHz; Mode 2 (Option 004)	44.5 kHz pk	_____	55.5 kHz pk
	380 MHz; 25 kHz; Mode 2 (Option 004)	22.25 kHz pk	_____	27.75 kHz pk
	370 MHz; 25 kHz; Mode 2 (Option 004)	22.25 kHz pk	_____	27.75 kHz pk
	260 MHz; 25 kHz; Mode 2 (Option 004)	22.25 kHz pk	_____	27.75 kHz pk
	190 MHz; 25 kHz; Mode 2 (Option 004)	22.25 kHz pk	_____	27.75 kHz pk
	180 MHz; 100 kHz; Mode 2 (Option 004)	89 kHz pk	_____	111 kHz pk
	10 MHz; 100 kHz; Mode 2 (Option 004)	89 kHz pk	_____	111 kHz pk
	1800 MHz; 350 kHz; Mode 1	318.5 kHz pk	_____	381.5 kHz pk
	2110 MHz; 350 kHz; Mode 1	318.5 kHz pk	_____	381.5 kHz pk
	2990 MHz; 350 kHz; Mode 1	318.5 kHz pk	_____	381.5 kHz pk
	3010 MHz (HP 8665A/B); 350 kHz; Mode 1	318.5 kHz pk	_____	381.5 kHz pk
	4200 MHz (HP 8665A); 350 kHz; Mode 1	318.5 kHz pk	_____	381.5 kHz pk
	6000 MHz (HP 8665B); 350 kHz; Mode 1	318.5 kHz pk	_____	381.5 kHz pk
	6000 MHz (HP 8665B); 350 kHz; Mode 2 (Option 004)	311.5 kHz pk	_____	388.5 kHz pk
	4200 MHz (HP 8665A); 350 kHz; Mode 2 (Option 004)	311.5 kHz pk	_____	388.5 kHz pk
	3010 MHz (HP 8665A/B); 350 kHz; Mode 2 (Option 004)	311.5 kHz pk	_____	388.5 kHz pk
	2990 MHz; 200 kHz; Mode 2 (Option 004)	178 kHz pk	_____	222 kHz pk
	2110 MHz; 200 kHz; Mode 2 (Option 004)	178 kHz pk	_____	222 kHz pk
	1800 MHz; 200 kHz; Mode 2 (Option 004)	178 kHz pk	_____	222 kHz pk

Table 3-2. Performance Test Record (10 of 15)

Test No.	Test Description	Results		
		Minimum	Actual	Maximum
3	FM TEST (LOW DEVIATIONS AND RATES) (Cont'd)			
	Distortion			
	<i>Carrier Frequency, FM Deviation, and Mode Select Settings</i>			
	10 MHz; 350 kHz; Mode 1		_____	1%
	180 MHz; 350 kHz; Mode 1		_____	1%
	190 MHz; 350 kHz; Mode 1		_____	1%
	260 MHz; 350 kHz; Mode 1		_____	1%
	370 MHz; 350 kHz; Mode 1		_____	1%
	380 MHz; 350 kHz; Mode 1		_____	1%
	525 MHz; 350 kHz; Mode 1		_____	1%
	745 MHz; 350 kHz; Mode 1		_____	1%
	755 MHz; 350 kHz; Mode 1		_____	1%
	1060 MHz; 350 kHz; Mode 1		_____	1%
	1290 MHz; 350 kHz; Mode 1		_____	1%
	1800 MHz; 350 kHz; Mode 1		_____	1%
	2110 MHz; 350 kHz; Mode 1		_____	1%
	2990 MHz; 350 kHz; Mode 1		_____	1%
	3010 MHz (HP 8665A/B); 350 kHz; Mode 1		_____	1%
	4200 MHz (HP 8665A); 350 kHz; Mode 1		_____	1%
	6000 MHz (HP 8665B); 350 kHz; Mode 1		_____	1%
	6000 MHz (HP 8665B); 350 kHz; Mode 2 (Option 004)		_____	1%
	4200 MHz (HP 8665A); 350 kHz; Mode 2 (Option 004)		_____	1%
	3010 MHz (HP 8665A/B); 350 kHz; Mode 2 (Option 004)		_____	1%
	2990 MHz; 200 kHz; Mode 2 (Option 004)		_____	1%
	2110 MHz; 200 kHz; Mode 2 (Option 004)		_____	1%
	1800 MHz; 200 kHz; Mode 2 (Option 004)		_____	1%
	1290 MHz; 100 kHz; Mode 2 (Option 004)		_____	1%
	1060 MHz; 100 kHz; Mode 2 (Option 004)		_____	1%
	755 MHz; 100 kHz; Mode 2 (Option 004)		_____	1%
	745 MHz; 50 kHz; Mode 2 (Option 004)		_____	1%
	525 MHz; 50 kHz; Mode 2 (Option 004)		_____	1%
	380 MHz; 25 kHz; Mode 2 (Option 004)		_____	1%
370 MHz; 25 kHz; Mode 2 (Option 004)		_____	1%	
260 MHz; 25 kHz; Mode 2 (Option 004)		_____	1%	
190 MHz; 25 kHz; Mode 2 (Option 004)		_____	1%	
180 MHz; 100 kHz; Mode 2 (Option 004)		_____	1%	
10 MHz; 100 kHz; Mode 2 (Option 004)		_____	1%	

Table 3-2. Performance Test Record (11 of 15)

Test No.	Test Description	Results		
		Minimum	Actual	Maximum
3	FM TEST (LOW DEVIATIONS AND RATES) (Cont'd)			
	Incidental AM		_____	0.4%
	Carrier Frequency Accuracy in FM			
	<i>Carrier Frequency and FM Deviation Settings</i>			
	150 MHz; 5 MHz pk		_____	30 kHz
	300 MHz; 1.25 MHz pk		_____	7.5 kHz
	600 MHz; 2.5 MHz pk		_____	15 kHz
	1200 MHz; 5 MHz pk		_____	30 kHz
4	FM TEST (HIGH DEVIATIONS AND RATES)			
	Indicator Accuracy	16.4 dB	_____	17.8 dB
	Distortion		_____	-40 dB
	Maximum Rate (3 dB Bandwidth)	-3 dB	_____	+3 dB
5	SPECTRAL PURITY TEST (SSB PHASE NOISE)			
	SSB Phase Noise			
	<i>Frequency and Mode Select Settings and Offset</i>			
	1100 MHz; Mode 1; 20 kHz		_____	-117 dBc
	1100 MHz; Mode 2 (Option 004); 20 kHz		_____	-128 dBc
	550 MHz; Mode 2 (Option 004); 20 kHz		_____	-134 dBc
	550 MHz; Mode 1; 20 kHz		_____	-122 dBc
300 MHz; Mode 1; 20 kHz		_____	-128 dBc	
	300 MHz; Mode 2 (Option 004); 20 kHz		_____	-139 dBc

Table 3-2. Performance Test Record (12 of 15)

Test No.	Test Description	Results		
		Minimum	Actual	Maximum
5	SPECTRAL PURITY TEST (SSB PHASE NOISE) (Cont'd)			
	SSB Phase Noise (cont'd)			
	<i>Frequency and Mode Select Settings and Offset (cont'd)</i>			
	200 MHz; Mode 2 (Option 004); 20 kHz		_____	-144 dBc
	150 MHz; Mode 2 (Option 004); 20 kHz		_____	-128 dBc
	150 MHz; Mode 1; 20 kHz		_____	-117 dBc
	40 MHz; Mode 2 (Option 004); 20 kHz		_____	-131 dBc
	Non-Harmonic Spurious (worst case)			
	>10 kHz offset; 187.5 to 1100 MHz		_____	-100 dBc
	>10 kHz offset; 0.1 to 187.5 MHz		_____	-90 dBc
	4150 MHz; Mode 1; 20 kHz		_____	-105 dBc
	4150 MHz; Mode 2 (Option 004); 20 kHz		_____	-116 dBc
	2100 MHz; Mode 2 (Option 004); 20 kHz		_____	-122 dBc
	2100 MHz; Mode 1; 20 kHz		_____	-111 dBc
Non-Harmonic Spurious (worst case)				
>10 kHz offset; 2100 to 6000 MHz		_____	-90 dBc	

Table 3-2. Performance Test Record (13 of 15)

Test No.	Test Description	Results		
		Minimum	Actual	Maximum
6	SPECTRAL PURITY TEST (HARMONICS)			
	Harmonics			
	<i>Frequency Span and Amplitude Settings</i>			
	0.1 to 2999 MHz; 6 dBm		_____	-30 dBc
	3000 to 4200 MHz; 6 dBm (HP 8665A)		_____	-30 dBc
	3000 to 6000 MHz; 6 dBm (HP 8665B)		_____	-30 dBc
	Subharmonics			
	0.1 to 1500 MHz carrier		_____	-75 dBc
	1500 to 3000 MHz carrier		_____	-40 dBc
	3000 to 6000 MHz carrier		_____	-50 dBc
7	PULSE MODULATION TEST			
	On/Off Ratio			
	100 MHz carrier	80 dB	_____	
	200 MHz carrier	80 dB	_____	
	500 MHz carrier	80 dB	_____	
	1499 MHz carrier	80 dB	_____	
	2999 MHz carrier	80 dB	_____	
	4200 MHz carrier (HP 8665A)	80 dB	_____	
	6000 MHz carrier (HP 8665B)	80 dB	_____	
	Risetime			
	10 MHz carrier		_____	8 ns
	20 MHz carrier		_____	8 ns
	50 MHz carrier		_____	8 ns
	100 MHz carrier		_____	8 ns
200 MHz carrier		_____	8 ns	
500 MHz carrier		_____	8 ns	

Table 3-2. Performance Test Record (14 of 15)

Test No.	Test Description	Results		
		Minimum	Actual	Maximum
7	PULSE MODULATION TEST (cont'd)			
	Falltime			
	500 MHz carrier		_____	8 ns
	200 MHz carrier		_____	8 ns
	100 MHz carrier		_____	8 ns
	50 MHz carrier		_____	8 ns
	20 MHz carrier		_____	8 ns
	10 MHz carrier		_____	8 ns
	Pulse Delay Accuracy			
	50 ns delay	43 ns	_____	57 ns
	500 ns delay	448 ns	_____	552 ns
	5000 ns delay	4498 ns	_____	5502 ns
	Pulse Width Accuracy			
	50 ns delay	43 ns	_____	57 ns
100 ns delay	88 ns	_____	112 ns	
1000 ns delay	898 ns	_____	1102 ns	
8	INTERNAL AUDIO OSCILLATOR TEST			
	Distortion			
	20 Hz		_____	0.2%
	100 Hz		_____	0.2%
	1 000 Hz		_____	0.2%
	10 000 Hz		_____	0.2%
	20 000 Hz		_____	0.2%

Table 3-2. Performance Test Record (15 of 15)

Test 9 – Leakage Test (Option 010)

Frequency (MHz)	Length Antenna Element	Max Leakage (dB) ¹
1029.1	5.9 cm (2.30 in)	_____
975.1	6.1 cm (2.40 in)	_____
925.1	6.5 cm (2.56 in)	_____
875.1	7.0 cm (2.74 in)	_____
825.1	7.5 cm (2.95 in)	_____
775.1	8.1 cm (3.18 in)	_____
725.1	8.7 cm (3.44 in)	_____
454.1	14.9 cm (5.87 in)	_____
¹ Upper limit is 0 dB.		