

Agilent 8114A 100 V / 2A
Programmable Pulse Generator

User's Guide

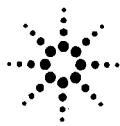

Agilent Technologies

Important Note

Hewlett-Packard's (HP) Test and Measurement Business is now part of Agilent Technologies (AGILENT), a new company created by Hewlett-Packard. Information in this manual may refer to Hewlett-Packard, but applies to your Agilent Technologies product.

Hewlett-Packard, HP, and Agilent branded products with the same model number are interchangeable.

User's Guide

HP 8114A 100 V/2 A Programmable Pulse Generator



**HP Part No. 08114-91012
Printed in Germany May 1995**

**Edition 2.0
E0595**

Notice

Copyright

© 1993 Hewlett-Packard GmbH.
Herrenberger Str. 130
71034 Böblingen
Federal Republic of Germany

All Rights Reserved. Reproduction, adaptation or translation without prior written permission is prohibited, except as allowed under the copyright laws.

Warranty

The information contained in this document is subject to change without notice.

Hewlett-Packard makes no warranty of any kind with regard to this material, including, but not limited to, the implied warranties or merchantability and fitness for a particular purpose.

Hewlett-Packard shall not be liable for errors contained herein or for incidental or consequential damages in connection with the furnishing, performance, or use of this material.

Complete product warranty information is given in the User Guide.

Safety

This is a Safety Class 1 instrument (provided with terminal for protective earthing). Before applying power, verify that the correct safety precautions are taken (see the following warnings). In addition, note the external markings on the instrument that are described under **Safety Symbols**. Do not operate the instrument with its covers removed. Replace fuse only with specified type.

Warning

Before turning on the instrument, you must connect the protective earth terminal of the instrument to the protective earth conductor of the (mains) power cord. The mains plug must only be inserted in a socket outlet with a protective earth contact. Do not negate the protective action by using an extension power cord without a protective grounding conductor. Grounding one conductor of a two-conductor outlet is not sufficient protection.

Service instructions are for trained service personnel. To avoid dangerous electric shock, do not perform any service unless qualified to do so. Do not attempt internal service or adjustment unless another person, capable of rendering first aid and resuscitation, is present.

If you energize this instrument using an auto-transformer (for voltage reduction) make sure that the common terminal is connected to the earth terminal of the power source.

Whenever it is likely that the ground protection is impaired, you must make the instrument inoperative and secure it against any unintended operation.

Do not operate the instrument in the presence of flammable gases or fumes. Operation of any electrical instrument in such an environment constitutes a definite safety hazard.

Do not install substitute parts or perform any unauthorized modification to the instrument.

Capacitors inside the instrument may retain a charge even if the instrument is disconnected from its source of supply.

Safety Symbols



Instruction Manual symbols: The instrument is marked with this symbol when it is necessary for you to refer to the instruction manual in order to avoid the hazard of electric shock.



Instruction Manual symbols: The instrument is marked with this symbol when it is necessary for you to refer to the instruction manual in order to protect against damage to the instrument.



Protected conductor symbol

WARNING

The Warning symbol calls attention to a procedure, practice, or the like, which, if not correctly performed or adhered to, could result in personal injury or loss of life. Do not proceed beyond a Warning symbol until the indicated conditions are fully understood and met.

CAUTION

The Caution symbol calls attention to a procedure, practice, or the like, which, if not correctly performed or adhered to, could result in damage to or destruction of part or all of the equipment. Do not proceed beyond a Caution symbol until the indicated conditions are fully understood and met.

Notice

Warranty

This Hewlett-Packard product has a warranty against defects in material and workmanship for a period of one year from date of shipment. During the warranty period, Hewlett-Packard Company will, at its option, either repair or replace products that prove to be defective.

For warranty service or repair, this product must be returned to a service facility designated by Hewlett-Packard. The Buyer shall pay Hewlett-Packard's round-trip travel expenses.

For products returned to Hewlett-Packard for warranty service, the Buyer shall prepay shipping charges to Hewlett-Packard and Hewlett-Packard shall pay shipping charges to return the product to the Buyer. However, the Buyer shall pay all shipping charges, duties and taxes for products returned to Hewlett-Packard from another country.

Hewlett-Packard warrants that its software and firmware designated by Hewlett-Packard for use with an instrument will execute its programming instructions when properly installed on that instrument. Hewlett-Packard does not warrant that the operation of the instrument software, or firmware, will be uninterrupted or error free.

Limitation of Warranty

The foregoing warranty shall not apply to defects resulting from improper or inadequate maintenance by the Buyer, Buyer-supplied software or interfacing, unauthorized modification or misuse, operation outside of the environmental specifications for the product, or improper site preparation or maintenance.

No other warranty is expressed or implied. Hewlett-Packard specifically disclaims the implied warranties of merchantability and fitness for a particular purpose.

Exclusive Remedies

The remedies supplied are the Buyer's sole and exclusive remedies. Hewlett-Packard shall not be liable for any direct, indirect, special, incidental, or consequential damages, whether based on contract, tort or any other legal theory.

Assistance

Product maintenance agreements and other customer assistance agreements are available for Hewlett-Packard products. For any assistance, contact your nearest Hewlett-Packard Sales Office.

Certification

Hewlett-Packard Company certifies that this product met its published specifications at the time of shipment. Hewlett-Packard further certifies that its calibration measurements are traceable to the United States Institute of Standards and Technology, to the extent allowed by the Institute's calibrating facility, and to the calibration facilities of other International Standards Organization members.

About this edition

HP Part Number
08114-91012

Printed in Germany

Edition 2.0
E0595

About this book This book is a guide to operating and programming the HP 8114A.

Installing Line voltage, fuse and other installation information.

Introducing the HP 8114A

An overview of the instrument frontpanel and features, and a Getting Started guide.

Operating Reference A reference guide for using the frontpanel parameter-screens to operate the instrument.

Programming Reference



A SCPI reference guide for programming the instrument using HP-IB.

Testing the HP 8114A

Performance tests for checking the HP 8114A against its specifications.

Specifications The specifications of the HP 8114A.

Contents

1. Installing the HP 8114A	
Initial Inspection	1-1
Power Requirements	1-2
	1-2
Replacing the Fuse	1-2
Power Cable	1-3
Rack-Mounting Accessories	1-4
Ventilation Requirements	1-5
Thermal Protection	1-5
Overheating Detection	1-5
Fan Failure	1-5
 Battery	1-6
Operating Environment	1-6
	1-6
2. Introducing the HP 8114A	
Faster Characterization and Test	2-1
Benchtop Testing	2-1
Automated Testing	2-1
Reliable Testing	2-1
An Overview of the Frontpanel	2-2
Controls	2-2
Inputs / Outputs	2-3
An Overview of the Rearpanel	2-5
Inputs / Outputs	2-5
The Parameter Pages	2-6
Parameter Page summary	2-7
Functional Overview	2-8

1 TRIGGER	2-9
2 OUTPUT	2-9
3 LIMITS	2-9
4 CONFIG	2-10
5 MEMCARD	2-10
Getting started	2-11
Selftest	2-11
Selecting a parameter	2-12
Adjusting the selected parameter value	2-13
Selecting a parameter page	2-13
Changing a setting	2-14
Toggling between GRAPHICS and TEXT pages	2-15
Adjusting a parameter or setting	2-15
Switching the Output on and off	2-16
Short-cut for quickly adjusting important parameters	2-16

3. Operating Reference

Introduction	3-1
Using Help	3-2
Parameter Help ON FIELD	3-2
Example - Delay parameter	3-2
Example - Delay Format	3-3
Concept Help CONCEPT	3-3
Serial Numbers and Software Revision SERIAL #	3-4
Warning Help WARNINGS	3-4
Error Queue ERROR QU	3-4
Frontpanel Controls	3-5
Softkeys [] and [MORE]	3-5
[SHIFT] /LOCAL	3-5
[HELP] /AUTOSET	3-5
[STORE] /RECALL	3-6
[MAN]	3-6
DATA ENTRY	3-6
CURSOR/VERNIER	3-6
MODIFY knob	3-7

Connectors	3-7
EXT INPUT	3-7
TRIGGER OUT	3-7
INHIBIT INPUT	3-7
TRIGGER Page	3-9
CONTINUOUS PULSES Mode	3-9
CONTINUOUS BURST Mode	3-11
TRIGGERED PULSES Mode	3-11
TRIGGERED BURST Mode	3-13
GATED PULSES Mode	3-15
GATED BURST Mode	3-17
EXT WIDTH Mode	3-18
OUTPUT page	3-19
Modifying the value of a parameter	3-19
Modifying the format of a parameter	3-20
ON/OFF Parameter	3-20
Pulse-period Parameter	3-21
Output Delay Parameter	3-22
Delay	3-22
Delay%	3-22
Phase	3-22
Pulse Width Parameter	3-23
Width	3-23
DutyCyc	3-23
TraDel	3-24
Duty-cycle/Amplitude Dependency	3-24
Level Parameters	3-25
Base-Ampl	3-25
High-Low	3-25
mV V mA A Voltage/Current Mode	3-25
50 Ω into OUTPUT Source Impedance Parameter	3-26
50.0 Ω Load Impedance Parameter	3-26
Output Voltage and Power Protection	3-26
... JL ... Output Polarity	3-26
Inh ON/OFF Inhibit the Output	3-27
LIMITS page	3-29
MEMCARD page	3-30
Dir Path Current Directory Parameter	3-30
Filename Filename Parameter	3-31

Perform Operation Memory Card	
Operations	3-31
ReadCard	3-32
Recall	3-32
Store	3-32
Store All	3-33
Delete	3-34
Format	3-34
CONFIG page	3-35
HP-IB Address	3-35
Perform Selftest	3-35
Warnings and Errors	3-36
Warnings	3-36
Errors	3-37
AUTOSET	3-37
An Example of Warning and Error Reporting	3-37

4. HP 8114A Programming Reference



Common Command Summary IEEE 488.2	4-1
SCPI Command Summary	4-2
Status Model	4-6
Overview	4-6
Condition Register	4-7
Transition Filters	4-7
Event Register	4-7
Enable register	4-8
Status Byte	4-8
Standard Event Status Group	4-9
OPERation Status Group	4-10
QUESTionable Status Group	4-11
Programming the HP 8114A Trigger Modes	4-12
CONTINUOUS	4-13
TRIGGERED	4-13
GATED	4-13
EXT WIDTH	4-13
PULSES	4-13
BURST of	4-14
Command Dictionary	4-15
Form	4-15
Parameter	4-15

Parameter Suffix	4-15
Functional Coupling	4-15
Value Coupling	4-15
Range Coupling	4-15
*RST value	4-15
Specified Limits	4-15
Absolute Limits	4-16
Example	4-16
:DISPlay[:WINDow][:STATe]	4-17
:MMEMory:CATalog?	4-18
:MMEMory:CDIRectory	4-19
:MMEMory:COpy	4-20
:MMEMory:DELete	4-21
:MMEMory:INITialize	4-22
:MMEMory:LOAD:STATe	4-23
:MMEMory:STORe:STATe	4-24
:OUTPut[:STATe]	4-25
:OUTPut:IMPedance[:INTernal]	4-26
:OUTPut:IMPedance:EXTernal	4-27
:OUTPut[:STATe]	4-28
:OUTPut:POLarity	4-29
[:SOURce]:CURR[:LEV][:IMM][:AMPLitude]	4-30
[:SOUR]:CURRent[:LEV][:IMM]:BASeline	4-32
[:SOUR]:CURR[:LEV][:IMMEDIATE]:HIGH	4-34
[:SOUR]:CURR[:LEV][:IMM]:LOW	4-36
[:SOURce]:CURRent:LIMit[:HIGH]	4-38
[:SOURce]:CURRent:LIMit:LOW	4-39
[:SOURce]:CURRent:LIMit:STATe	4-40
[:SOURce]:FREQUency[:CW]:FIXed]	4-41
[:SOURce]:HOLD	4-42
[:SOURce]:PHASe[:ADJust]	4-43
[:SOURce]:PULSe:DCYCLE	4-44
[:SOURce]:PULSe:DELay	4-45
[:SOURce]:PULSe:DELay:HOLD	4-46
[:SOURce]:PULSe:DELay:UNIT	4-47
[:SOURce]:PULSe:DOUBle[:STATe]	4-48
[:SOURce]:PULSe:DOUBle:DELay	4-49
[:SOURce]:PULSe:DOUBle:DELay:HOLD	4-50
[:SOURce]:PULSe:DOUBle:DELay:UNIT	4-51
[:SOURce]:PULSe:HOLD	4-52
[:SOURce]:PULSe:LIMit[:WIDth]	4-53



[:SOURce]:PULSe:LIMit:DCYCLE	4-54
[:SOURce]:PULSe:LIMit:STATe	4-55
[:SOURce]:PULSe:PERiod	4-56
[:SOURce]:PULSe:TrailingDELay	4-57
[:SOURce]:PULSe:WIDTh	4-58
[:SOURce]:VOLT[:LEV][:IMM][:AMPLitude]	4-59
[:SOUR]:VOLTage[:LEV][:IMM]:BASeline	4-60
[:SOUR]:VOLT[:LEV][:IMMEDIATE]:HIGH	4-61
[:SOUR]:VOLT[:LEV][:IMM]:LOW	4-63
[:SOURce]:VOLTage:LIMit[:HIGH]	4-65
[:SOURce]:VOLTage:LIMit:LOW	4-66
[:SOURce]:VOLTage:LIMit:STATe	4-67
:STATus:OPERation	4-68
:STATus:PRESet	4-70
:STATus:QUEStionable	4-71
:SYSTem:ERRor?	4-73
:SYSTem:KEY	4-74
:SYSTem:KEY?	4-76
:SYSTem:PRESet	4-77
:SYSTem:SECurity[:STATe]	4-78
:SYSTem:SET	4-79
:SYSTem:VERsion?	4-80
:SYSTem:WARning[:COUNt]?	4-81
:SYSTem:WARning:STRing?	4-82
:SYSTem:WARning:BUFFer?	4-83
:TRIGger:COUNt	4-84
:TRIGger:EWIDth[:STATe]	4-86
:TRIGger:INHibit[:STATe]	4-87
:TRIGger:INHibit[:STATe]:MODE	4-88
:TRIGger:INHibit[:STATe]:INPut	4-89
:TRIGger:LEVel	4-90
:TRIGger:SENSe	4-91
:TRIGger:SLOPe	4-92
:TRIGger:SOURce	4-93
Default Values, standard settings	4-94

5. Testing the HP 8114A	
Introduction	5-1
Conventions Used	5-1
Test Results Tables	5-1
Recommended Test Equipment and	
Accessories	5-2
50 Ohm Feedthrough Termination	5-4
Getting Started	5-5
Instrument Serial Numbers	5-5
Test 1: Period	5-6
Test Specifications	5-6
Equipment Needed	5-6
Procedure	5-6
Test 2: Width	5-8
Test Specifications	5-8
Equipment Needed	5-8
Procedure	5-8
Test 3: Delay	5-12
Test Specifications	5-12
Equipment Needed	5-12
Procedure	5-12
Test 4: Double Pulse Delay	5-17
Test Specifications	5-17
Equipment Needed	5-17
Procedure	5-17
Test 5: Jitter	5-22
Test 5.1: Period Jitter	5-22
Test Specifications	5-22
Equipment Needed	5-22
Procedure	5-22
Test 5.2: Width Jitter	5-26
Test Specifications	5-26
Equipment Needed	5-26
Procedure	5-26
Test 5.3: Delay Jitter	5-29
Test Specifications	5-29
Equipment Needed	5-29
Procedure	5-29
Test 6: Amplitude	5-32
Test Specifications	5-32
Equipment Needed	5-32

Calculating out Measurement Uncertainties	5-32
a) Calculation for 50Ω into 50Ω	
measurements	5-33
Procedure	5-33
b) Calculation for HIZ (High-Z) into 50Ω	
measurements	5-35
Procedure	5-35
A) Amplitude Test (from 50Ω into 50Ω)	5-38
Procedure	5-38
B) Amplitude Test (from HIZ {High-Z}	
into 50Ω)	5-40
Procedure	5-40
Test 7: Variable Baseline (Option 001)	5-42
Test Specifications	5-42
Equipment Needed	5-42
Procedure	5-42
Test 8: Transition Time	5-45
Test Specifications	5-45
Equipment Needed	5-45
Test 8.1a: Leading Edge Test	5-46
Procedure	5-46
Test 8.1b: Trailing Edge Test	5-48
Procedure	5-48
Test 8.2a: Leading Edge Test	5-49
Procedure	5-49
Test 8.2b: Trailing Edge Test	5-51
Procedure	5-51
Test 9: Pulse Aberration Test	5-52
Test Specifications	5-52
Equipment Needed	5-52
Procedure	5-52
1) Overshoot and Ringing	5-53
2) Preshoot	5-54
HP 8114A Performance Test Records	5-56

6. HP 8114A Pulse Generator Specifications	
General	6-1
Environmental	6-1
Safety	6-1
Power requirements	6-1
Maximum Dimensions (H x W x D)	6-2
Weight	6-2
Net	6-2
Shipping	6-2
Recalibration period	6-2
Warranty	6-2
Acoustic Noise Pressure	6-2
Declaration of Conformity	6-3
We declare that the product	6-3
Supplementary Information	6-3
Output	6-4
Amplitude	6-4
	6-4
Range:	6-4
Current:	6-4
Accuracy:	6-4
Resolution:	6-4
Baseline:	6-5
Variable Baseline (Option 001)	6-5
Range:	6-5
Accuracy:	6-5
Polarity	6-5
Source Impedance	6-5
Load Compensation	6-5
Connector	6-6
On/Off:	6-6
Output Protection	6-6
	6-6
Limits	6-6
Pulse Performance	6-6
Overshoot/Preshoot/Ringing:	6-6
Settling time:	6-6
Transition Times:	6-6

Pulse Timing	6-6
Repeatability:	6-6
Period	6-7
Range:	6-7
Accuracy:	6-7
Resolution:	6-7
RMS-Jitter:	6-7
Width	6-8
Range	6-8
Accuracy:	6-8
Resolution:	6-8
RMS-Jitter:	6-8
Duty-cycle	6-9
Standard HP 8114A (Baseline = 0 V)	6-9
Variable Baseline Option 001	6-10
Delay	6-11
Fixed delay	6-11
Variable Range	6-11
Accuracy	6-11
Resolution	6-11
RMS-Jitter	6-11
Double Pulse Delay	6-12
Minimum Period	6-12
Range	6-12
Accuracy	6-12
Resolution	6-12
Minimum Period	6-12
Trigger Output	6-13
Level	6-13
Output Impedance	6-13
Trigger pulse width	6-13
Maximum external voltage	6-13
	6-13
Transition times	6-13
Delay from External Input to Trigger	
Output	6-13
External Input	6-14
Input impedance	6-14
Threshold	6-14
Maximum external voltage	6-14

	6-14
Input transitions	6-14
Input frequency	6-14
Minimum pulse width	6-14
Input sensitivity	6-14
Inhibit Input	6-15
Inhibit on Edge	6-15
Inhibit on Level	6-15
Input Impedance	6-15
Threshold	6-15
Input transitions	6-15
Input frequency	6-15
Minimum pulse width	6-15
Input sensitivity	6-15
Inhibit response time	6-15
Maximum external voltage	6-15
	6-15
Trigger Modes	6-16
Continuous	6-16
Triggered	6-16
Gated	6-16
External Width	6-16
Pulse Modes	6-17
Double Pulse	6-17
Human Interface	6-18
Display	6-18
Help Key	6-18
Memory	6-18
Clear Memory:	6-18
Memorycard	6-18
Remote Control	6-19
Function Code	6-19
Programming times	6-19

Index

Figures

1-1. Power Cables - Plug Identification	1-3
2-1.	2-8
2-2. MEMCARD page, No card present.	2-10
3-1. HELP on pulse-delay parameter	3-2
3-2. HELP on pulse-delay format	3-3
3-3. Timing Diagram: CONTINUOUS PULSES	3-9
3-4. Triggering on Rising Edge	3-11
3-5. Triggering on Both Edges	3-12
3-6. Timing Diagram: TRIGGERED BURST	3-13
3-7. Timing Diagram: GATED PULSES Pulse-Period: internal Osc	3-15
3-8. Timing Diagram: GATED BURST	3-17
3-9. OUTPUT page, text mode	3-19
3-10. OUTPUT page, graphics mode	3-19
3-11. Effect of minimum triggering period setting	3-21
3-12. OUTPUT Timing parameter graphic, Delay	3-22
3-13. OUTPUT Timing parameter graphic, Width	3-23
3-14. OUTPUT Timing parameter graphic, Trailing Delay	3-24
3-15. Inhibiting the Output using a Rising Edge .	3-27
3-16. Inhibiting the Output using a Level	3-28
3-17. LIMITS page	3-29
3-18. Level graphics with Limits ON on OUTPUT	3-29
3-19. MEMCARD page, No card present.	3-30
3-20. MEMCARD page, Dir Path Example	3-30
3-21. MEMCARD page, Subdirectory Example . . .	3-31
3-22. MEMCARD page, Filename Example	3-31

3-23.	MEMCARD page, Store Operation	3-32
3-24.	CONFIG page	3-35
4-1.	HP 8114A Status Groups	4-6
4-2.	Component registers in a Status Group	4-7
4-3.	HP 8114A TRIGGER model	4-12
5-1.	50 Ohm, 0.1%, 10 W Feedthrough Termination	5-4
5-2.	The Product and Serial Number Screen With Variable Baseline (Option 001) Fitted	5-5
5-3.	Equipment Set-up 2 for Amplitude Test	5-34
6-1.	Duty-cycle / Amplitude Ranges	6-9
6-2.	Baseline Duty-cycle / Amplitude Ranges	6-10

Tables

1-1. Line Voltage and Fuse Selection	1-2
1-2. Rack-Mounting Accessories	1-4
3-1. Filename suffixes	3-33
4-1. HP 8114A IEEE 488.2 Common Command Summary	4-1
4-2. HP 8114A SCPI Command Summary	4-2
4-3. HP 8114A Status Groups - Registers Used	4-8
4-4. Status Byte bits	4-9
4-5. Standard Event Status Group bits	4-9
4-6. OPERation Status Group bits	4-10
4-7. QUEStionable Status Group bits	4-11
4-8. Trigger sources set by :TRIG:SOUR	4-13
4-9. :SYSTem:KEY parameter reference	4-75
4-10. Triggering sources and modes set by :TRIGger:SOURce	4-93
4-11. HP 8114A Default Values	4-94
5-1. Recommended Test Equipment List	5-2
5-2. Recommended Accessories	5-3
5-3. Period Settings and TR Reference	5-7
5-4. Width Settings and TR Reference	5-10
5-5. Width Settings and TR Reference	5-11
5-6. Delay Settings and TR Reference	5-14
5-7. Delay Settings and TR Reference	5-16
5-8. Double Delay Settings and TR Reference	5-19
5-9. Double Delay Settings and TR Reference	5-21
5-10. Amplitude Levels: 50 Ω into 50 Ω	5-39
5-11. Amplitude Levels: HIZ (High-Z) into 50 Ω	5-41
5-12. Baseline Levels Test	5-44
5-13. Leading Edge Setting	5-47
5-14. Trailing Edge Setting	5-48
5-15. Leading Edge Setting	5-50
5-16. Trailing Edge Setting	5-51

Installing the HP 8114A

Initial Inspection

Inspect the shipping container for damage. If the container or cushioning material is damaged, keep it until the contents of the shipment have been checked for completeness and the instrument has been verified both mechanically and electrically.

Warning



To avoid the hazard of electric shock, do not perform electrical tests when there are signs of shipping damage to any part of the instrument's outer covers or panels.

If the contents are incomplete, or there is mechanical damage, or if the instrument does not pass the Performance Tests in Chapter 5, notify the nearest Hewlett-Packard office. Keep the shipping materials for inspection by the carrier. The HP office will arrange for repair or replacement without awaiting settlement.

Power Requirements



Caution



BEFORE APPLYING AC LINE POWER TO THE HP 8114A, ensure that the correct line fuse is installed in the fuse holder and the correct power cable is fitted.

The HP 8114A can operate from any single-phase AC power source supplying 100 – 240 V in the frequency range from 50 to 60 Hz , or 100 – 120 V at 400 Hz. The maximum power consumption is 500 VA with all options installed.

Table 1-1. Line Voltage and Fuse Selection

Line Voltage	Fuse Type	HP Part Number
100 – 240 V~	T 4A, 250 V	2110-0014

Replacing the Fuse

1. Remove the power cord.
2. Unscrew the fuse-holder at the rear of the instrument beside the power-inlet socket (See “An Overview of the Rearpanel” in Chapter 2).
3. Replace the fuse with the equivalent part (See Table 1-1).
4. Refit the fuse-holder.

Power Cable

In accordance with international safety standards, this instrument is equipped with a three-wire power cable. When connected to an appropriate AC power receptacle, this cable grounds the instrument cabinet. The type of power cable shipped with each instrument depends on the country of destination. Refer to Figure 1-1 for the part numbers of the power cables available.

Warning



To avoid the possibility of injury or death, the precautionary Warnings given on the inside front-cover of the manual must be followed before the instrument is switched on.

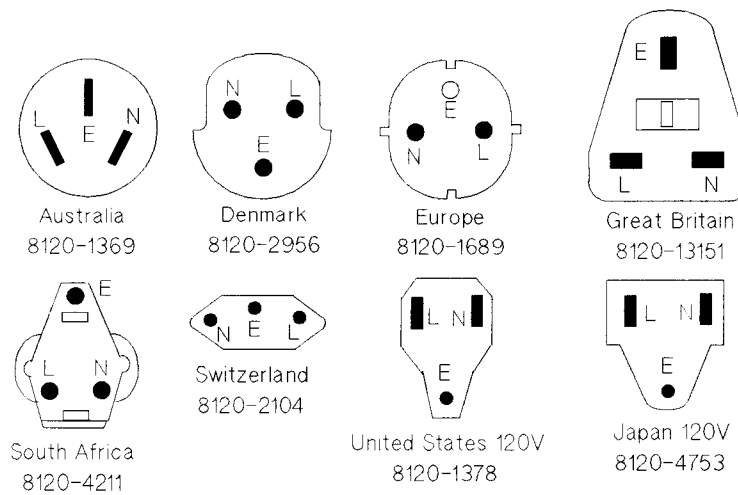

Figure 1-1. Power Cables - Plug Identification

The following work should be carried out by a qualified electrician - all local electrical codes being strictly observed. If the plug on the cable does not fit the power outlet, or the cable is to be attached to a terminal block, cut the cable at the plug end and re-wire it.

The color coding used in the cable will depend on the cable supplied. If a new plug is to be connected, it must

Installing the HP 8114A

meet local safety requirements and include the following features:

- Adequate load-carrying capacity (see table of specifications).
- Ground connection.
- Cable clamp.

Rack-Mounting Accessories

Use the following information to order accessories for rack-mounting the HP 8114A:

Table 1-2. Rack-Mounting Accessories

HP Part Number	Description
5062-3977	Rack Mount Kit
5062-3989	Handle Kit
5062-3983	Rack Mount and Handle Kit
1490-0060	Rack Slide Kit

Note that Option UN2, Rear Panel Connectors, cannot be retrofitted, but must be specified when initially ordering an instrument.

Ventilation Requirements

The HP 8114A is fitted with two cooling fans. Make sure that there is adequate clearance of 3 inches (75 mm) at the rear and 1/2 inch (12 mm) at the top and bottom to ensure adequate airflow. If the airflow is restricted the internal operating temperature will be higher, reducing the instrument's reliability or causing the instrument's thermal-protection circuits to automatically switch off the instrument.

Thermal Protection

Overheating Detection

The HP 8114A monitors its internal temperature in the region of the power supply. If the temperature exceeds approximately 80°C, the power supply is switched off. The instrument must be switched off to allow the detection circuit to recover (after the temperature falls below approximately 77°C).

Fan Failure

If either of the fans is prevented from operating by a blockage, or the power supply to the fans is interrupted, the power supply is automatically switched off within approximately 10 seconds. Note that after the fault condition has been fixed, the instrument must be switched off to allow the detection circuit to recover.

Installing the HP 8114A



Battery

Warning



This instrument contains a lithium battery. The battery is not user-replacable and replacement should only be carried out by qualified service personnel.

There is a danger of explosion if the battery is incorrectly replaced.

The battery must be replaced with the same or equivalent type (HP Part No. 1420-0394). Discard used batteries according to local regulations.

Operating Environment

Storage Temperature:	-40°C to +70°C
Operating Temperature:	0°C to 55°C
Humidity:	95% R.H. (0°C to 40°C)





Warning



- **The HP 8114A is not designed for outdoor use. Do not expose the HP 8114A to rain or other excessive moisture. Protect the HP 8114A from humidity and temperature changes which could cause condensation within the instrument.**
- **Do not operate the HP 8114A in the presence of flammable gases, fumes or powders. Operation of any electrical instrument in such an environment constitutes a definite safety hazard.**

Installing the HP 8114A

-  When working with output voltages of 30 - 100V amplitude, the output voltage can be dangerous to life. Care should therefore be taken when connecting the HP 8114A to external devices.
-  When working in HI Ω (High-Z) mode, if you remove the external load the output voltage can be higher than the programmed voltage. V_{pp} can be as much as 130 V, even when set as low as $2 V_{pp}$.

Caution

HP 8114A is capable of providing output voltages that may exceed the input capabilities of connected test equipment. The user should ensure that the HP 8114A is operated in a way that prevents damage to connected test equipment.

Introducing the HP 8114A

Faster Characterization and Test

The HP 8114A 100 V/2 A Programmable Pulse Generator generates clean pulses with low jitter at all specified settings in any triggering mode across a wide operating temperature range.

Benchtop Testing

The graphic display shows all pulse parameters at a glance, the Cursor keys and the Modify knob allow fast and simple operation.

Automated Testing

The SCPI programming commands, optional rearpanel connectors and 5.25in rack height allow quick and efficient integration into automated test systems.

Reliable Testing

High pulse integrity with 100 ps timing resolution and period RMS-jitter down to 45 ps, ensures consistent, reliable timing.

An Overview of the Frontpanel

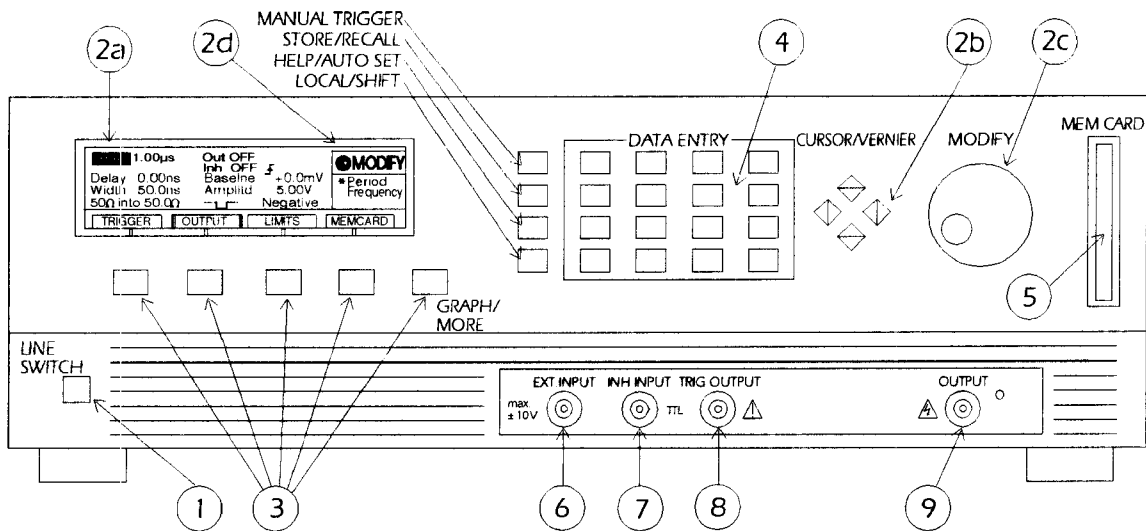

Controls

1. Switch on and off using the Line Switch.
2. Move the parameter cursor **a** using the CURSOR keys **b**. Use the Modify knob **c** to modify the selected parameter value or menu selection in the Modify window **d**

You can also use the cursor keys in **SHIFT** mode to modify the parameter:

- Use the **SHIFT** CURSOR **←** and **→** keys to **select** a digit.
 - Use the **SHIFT** CURSOR **↑** key to increment and the **↓** key to decrement the digit, or use the knob.
3. When a **menu** is displayed in the Modify Window:
 - Use the **SHIFT** CURSOR **↑** and **↓** keys to **select** an option
 - The horizontal CURSOR keys are inoperative.



4. *Select a parameter page using the Softkeys.* The **MEMCARD** and the **CONFIG** pages both use the same softkey. Toggle between them by pressing **(MORE)**. Use **(SHIFT) (MORE)** or press a softkey twice to toggle from the text display to the graphic display, when available.
5. Use the **DATA ENTRY** keys to type a value directly into the Modify Window, or select a commonly used parameter quickly using the **(SHIFT)** functions above the keys.
6. Use a plug-in **MEMORY CARD** to store and recall instrument settings or update firmware.

Inputs / Outputs

Note



If your HP 8114A has Option UN2 Rear Panel Connectors, the Input/Output connectors are fitted on the Rear Panel. Refer to “An Overview of the Rearpanel”.

7. **EXT INPUT** Connect an external signal here to trigger or gate the output signal.
 -  Input voltage: up to ± 10 V maximum. Input protected up to ± 50 V.
8. **INH INPUT** Connect an external TTL signal here to inhibit the pulse signal, holding it at its baseline level. The following methods can be used:
 - **Inhibit on Edge:** An active edge inhibits the pulse signal until it is reset from the front panel or from HP-IB.
 - **Inhibit on Level:** An active level inhibits the output signal.
 -  Nominal Input Voltage: <0.8 V/ >2.4 V Input protected up to ± 50 V.
9. **TRIGGER OUT** TTL signal with rising edge, marking start of each pulse-period. Output Voltage +2.5 V

(into 50Ω). This doubles into open circuit.



Output is protected against -2 V to +7 V external voltages.

10. **OUTPUT** Pulse output.



Maximum Output Voltage ± 100 V.

Warning



■ **When working with output voltages of 30 - 100V amplitude, the output voltage can be dangerous to life. Care should therefore be taken when connecting the HP 8114A to external instruments.**



■ **When working in HI \bar{Z} (High-Z) Mode, if you remove the external load the output voltage can be higher than the programmed voltage. V_{pp} can be as much as 130 V, even when set as low as 2 V_{pp} .**

Caution



HP 8114A is capable of providing output voltages that may exceed the input capabilities of connected test equipment. The user should ensure that the HP 8114A is operated in a way that prevents damage to connected test equipment.



Output is protected against 100 V_{pp} from an external 50Ω source (± 20 Vdc from an external 0Ω source)

An Overview of the Rearpanel

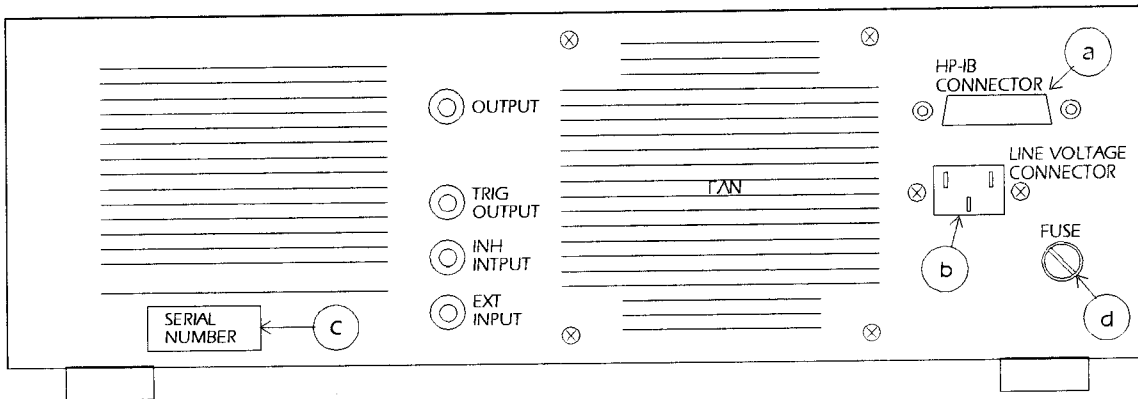

Inputs / Outputs

Note



If your HP 8114A has Option UN2 Rear Panel Connectors, the Inputs/Outputs described in "An Overview of the Frontpanel" are fitted on the rear panel in the positions shown in the figure.

The following items are always fitted on the rear panel:

- a. **HP-IB Connector**
- b. **Line Voltage Connector**
- c. **Serial Number** The HP 8114A mainframe serial number.
- d. **Fuse** 250 V, T 4A, 2110-0014

The Parameter Pages

All of the parameters and settings that control the HP 8114A are available on one of five parameter pages. The parameter pages group together parameters which are most likely to be used together.

The following illustration gives an example of the **OUTPUT** page. This is indicated by bold vertical bars either side of the page name.

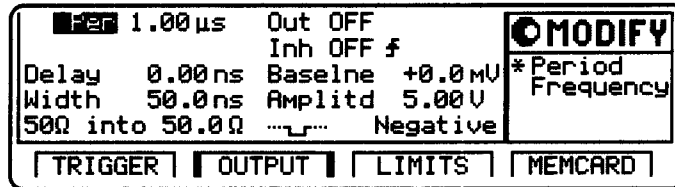

OUTPUT page

Use the four softkeys directly below the display to move between the parameter pages. (The page names shown in the illustration are displayed above the softkeys).

The **MEMCARD** and the **CONFIG** pages both use the same softkey. Toggle between them by pressing **(MORE)**. Press the softkey to activate the page.

Parameter Page summary

TRIGGER	The overall operating modes of the instrument: triggering, pulse types, period and triggering sources.
OUTPUT	All timing, voltage/current and impedance parameters for the output.
LIMITS	Output voltage and current limits.
MEM-CARD	Memory card operations.
CONFIG	Selftest and HP-IB address.

A more detailed guide to each parameter page is given later in this chapter under the heading: "Functional Overview". This section provides a cross-reference between the parameter pages and the block-diagram of the instrument.

Functional Overview

The Functional Overview block diagram shows the various functional blocks in the HP 8114A. You can see how these relate to the Parameter pages by comparing the numbers in the diagram with the lists that follow.

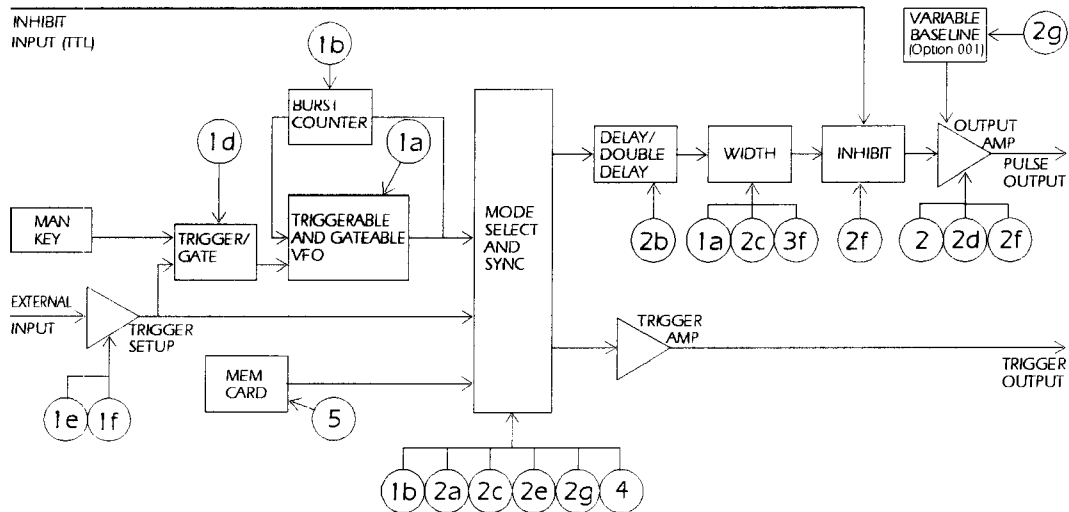

HP 8114A Functional Block Diagram

The following illustration gives an example of a page display. The shaded headings that follow refer to the softkeys shown at the bottom of the display. Use the four softkeys to move between the parameter pages.

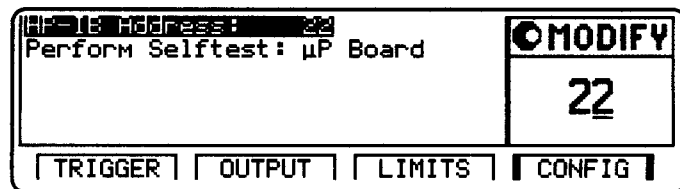

Figure 2-1.

1 TRIGGER

Use the **TRIGGER** page to:

- a. Select the Triggering mode.(CONTINUOUS, TRIGGERED, GATED, EXT WIDTH)
- b. Select the Triggered Event.(PULSES, BURST)
- c. Select the Pulse type (Single or Double)
- d. Select the Trigger/Gate source (MAN Key or EXT INPUT)
- e. Select the Trigger slope (Rising, Falling or Both) or Gate level (High, Low or Both)
- f. Set the Trigger/Gate threshold.

2

2 OUTPUT

Use the **OUTPUT** page to control the timing *and* level parameters:

- a. Select Period or Frequency and adjust value
- b. Select Delay mode (Absolute, Percentage of Period, or Phase) and adjust value
- c. Select Width mode (Width, Duty Cycle, Trail Del) and adjust value
- d. Set Output Impedance (50Ω or high-impedance)
- e. Switch Output ON or OFF
- f. Switch External Inhibit ON or OFF and select type of inhibiting
- g. Select Pulse Level mode:
 - Baseline and Amplitude levels
 - High and Low levels and adjust the levels
- h. Set polarity of output pulse (Positive or Negative)

3 LIMITS

Use the **LIMITS** page to set up pulse level limits (current and voltage), and width/duty-cycle limits, to protect the Device Under Test (DUT):

- a. Switch Level Limits OFF or ON
- b. Set high voltage limit for the pulse
- c. Set low voltage limit for the pulse
- d. Set high current limit for the pulse
- e. Set low current limit for the pulse
- f. Switch width/duty-cycle Limits OFF or ON
- g. Set width limit
- h. Set duty-cycle limit

4 CONFIG

Use the **CONFIG** page to:

- a. Perform selftest
- b. Set the HP-IB address of the instrument.

5 MEMCARD

Here is an example of a typical **MEMCARD** page, before a card is inserted

Dir Path <no_path>	MODIFY * .		
Filename <no_file>			

Perform Operation			
TRIGGER	OUTPUT	LIMITS	MEMCARD

Figure 2-2. MEMCARD page, No card present.

Use the **MEMCARD** page to:

- a. Format memory cards
- b. Store instrument settings on a card
- c. Store the current instrument setting
- d. Recall settings from a card.

Getting started

Selftest

A few seconds after switching on the instrument the HP 8114A display switches on, indicating that the instrument selftest is running. This takes a few seconds. After the selftest finishes, HP 8114A displays a page similar to the following:

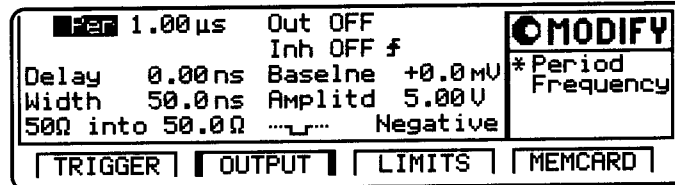

OUTPUT Text page showing default settings

The parameter cursor is located on pulse period.

The parameter values may be different if, for example, the instrument was last switched off at different settings. To recall the default settings proceed as follows:

Recalling the default settings

1. Press the **OUTPUT** softkey
2. Press **SHIFT STORE** to select the RECALL function.
3. Press **0** to recall the default settings which are stored in memory 0.

If the selftest fails

If the selftest fails, you see a flashing E at the bottom of the screen. Press **HELP** to see a list of the selftest error messages. Use the knob or CURSOR keys to scroll through the list if necessary. To return to normal operation press **HELP** again, or **EXIT HELP**.

Note that the selftest error messages are removed from the error queue after this.

Introducing the HP 8114A

2 Selecting a parameter

Use the CURSOR keys to move the parameter cursor between the available parameters. The name and the value of the selected parameter are displayed in the Modify Window at the right of the display.

Select the Width parameter:

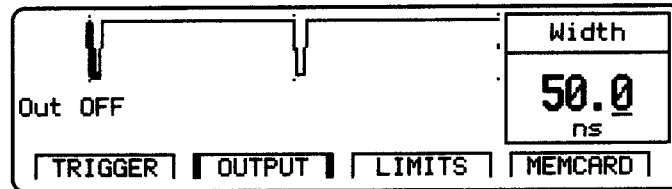

Adjusting the selected parameter value

Use the MODIFY knob to adjust the selected parameter.

Normally, you cannot adjust a parameter outside its specified, or currently valid, range with the knob. However, you can press **(SHIFT)** to overcome this limitation, and then over/under program the parameter.

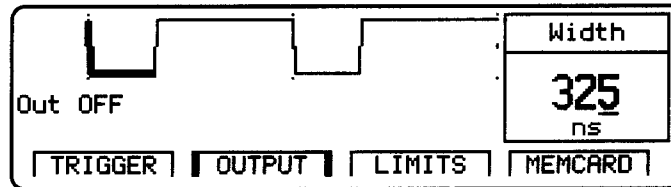

You can also type a value in directly using the DATA ENTRY keys, for example: **(3)(2)(5)(nano)**

(Use **CURSOR-left** **(←)** to backspace during data entry, or **(SHIFT)(ENTER)** to CANCEL)

You can also use the VERNIER keys to step individual digits:

1. Press **(SHIFT)** to enter shift mode. The **CURSOR** keys now function as **VERNIER** keys.
2. Use **(←)** and **(→)** to move the digit cursor.
3. Use **(↑)** to increment and **(↓)** to decrement the digit.
4. Press **(SHIFT)** again to exit shift-mode. The **CURSOR** keys return to their standard role of moving the parameter cursor.

Selecting a parameter page

1. Use the four softkeys directly below the display to move between the parameter pages. (The page names are displayed above the keys).
2. The **MEMCARD** and the **CONFIG** pages both use the same softkey. Toggle between them by pressing **(MORE)**. Press the softkey to activate the page.

Now press **TRIGGER** to select the Trigger Mode page:

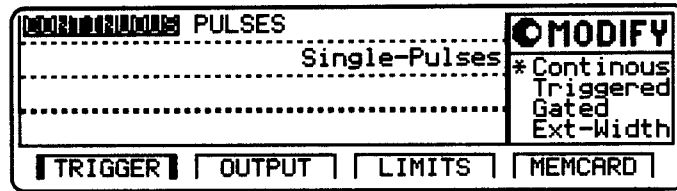

TRIGGER page

Note that on this page the parameter cursor is located on the triggered mode which is currently set to CONTINUOUS, indicated by * against the menu of options displayed in the Modify Window.

Changing a setting

Use the MODIFY knob to change the setting of the selected parameter. Set the trigger mode to TRIGGERED:

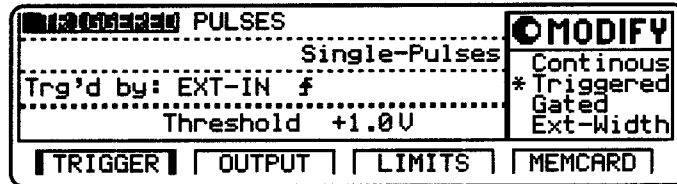

You can also use the VERNIER keys to change the setting:

1. Press **(SHIFT)** to enter shift mode. The **CURSOR** keys now function as **VERNIER** keys.
2. Use **(↑)** and **(↓)** to select a setting from the list in the **Modify Window**.
3. Press **(SHIFT)** again to exit shift-mode. The **CURSOR** keys return to their standard role of moving the parameter cursor.

Toggling between GRAPHICS and TEXT pages

The **OUTPUT** page can be displayed in either a text-based or graphics-based mode. To toggle between text and graphics, do one of the following:

1. Press **(SHIFT)MORE** (GRAPH)
2. Press the softkey for the **OUTPUT** page a second time.

On the **OUTPUT** page, the currently selected parameter determines whether the timing graphics or levels graphics are displayed in graphics mode.

Adjusting a parameter or setting

To adjust a parameter/setting on the current page:

1. Use the **CURSOR** keys to move the parameter cursor onto the parameter/setting you want to adjust.

The **Modify Window** at the right side of the display shows a list of options for the selected setting. In graphics mode the value of the selected parameter is shown at the top of this window.

2. Use the **MODIFY** knob to adjust the value of the parameter, or to choose a different setting from the settings list. The selected setting is indicated by a *.
3. Use the **DATA ENTRY** keys to enter a parameter value directly into the **Modify Window** without using the knob. Enter the value followed by the appropriate unit key.

Press **CANCEL** (**(SHIFT)ENTER**) to cancel the data entry, or use the **cursor-left** (**←**) key to backspace the digit-cursor.

4. Press **(SHIFT)** to enter shift-mode and use the **VERNIER (CURSOR)** keys to move the digit-cursor within the **Modify Window**. **VERNIER** a particular digit with the knob or the **(↑)** and **(↓)** **VERNIER** keys.

2 Switching the Output on and off

When you switch the HP 8114A on, the outputs are switched off to protect the device under test. The LED next to the Output BNC connector indicates the Output state.

Press ON/OFF (**SHIFT** **O**) to quickly switch the output on or off.

Short-cut for quickly adjusting important parameters

The most commonly used parameters can be accessed quickly using the short-cut (**SHIFT**) functions above the DATA ENTRY keys.

1. Press (**SHIFT**) and the DATA ENTRY key for the parameter you want.

The appropriate parameter page is automatically selected and the parameter cursor is placed on the chosen parameter.

2. Use the DATA ENTRY keys or MODIFY knob to adjust the parameter.

Operating Reference

Introduction

This chapter is a reference guide for operating the HP 8114A using the frontpanel controls. It contains information on using the **HELP** key and the main frontpanel controls, followed by a reference section for each of the parameter pages selected by the softkeys under the display:

- Using Help
- Frontpanel Controls
- **TRIGGER** Page
- **OUTPUT** Page
- **LIMITS** Page
- **CONFIG** Page
- **MEMCARD** Page

Using Help

Parameter Help ON FIELD

If there are no Warnings or Errors (See “Warnings and Errors”), press the **HELP** key at any time to obtain information about the current location of the parameter cursor. The help information gives a short description of the parameter or setting options and the SCPI command(s) syntax for programming the parameter or setting.

Use the **MODIFY** knob or **CURSOR** keys to scroll through the help information if there is more than one screen available.

Press **EXIT HELP** or **HELP** again to return to normal operation.

Example - Delay parameter

Press **HELP** with the parameter cursor on the *value* of the pulse-delay parameter:

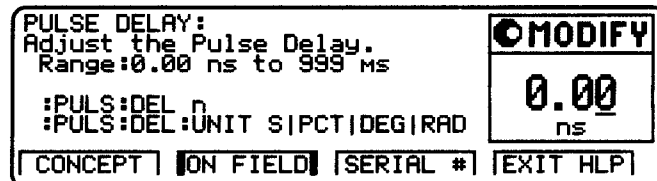
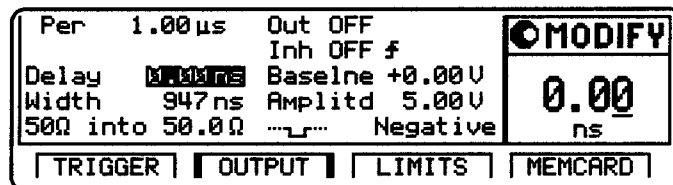
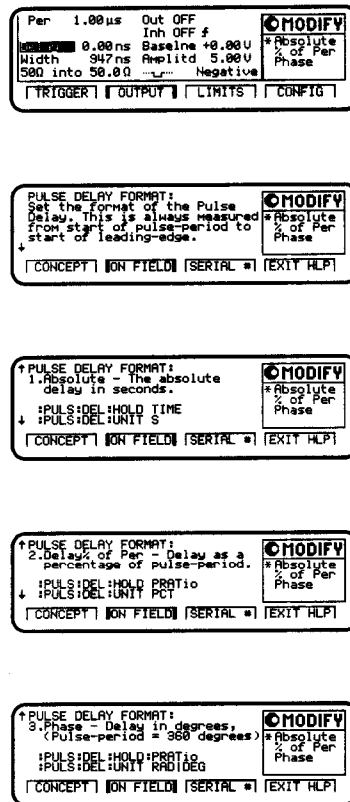

Figure 3-1. **HELP** on pulse-delay parameter

Example - Delay Format

Press **(HELP)** with the parameter cursor on the *format* of the pulse-delay parameter:



3

Figure 3-2. (HELP) on pulse-delay format

Concept Help CONCEPT

If there are no Warnings or Errors (See “Warnings and Errors”), press the **(HELP)** key followed by the **CONCEPT** softkey to view a short description of the HP 8114A.

Frontpanel Controls

Serial Numbers and Software Revision SERIAL

If there are no Warnings or Errors (See “Warnings and Errors”), press the **HELP** key followed by the **SERIAL #** softkey to see the HP 8114A serial number followed by the software revision code of the instrument’s firmware.

3

Warning Help WARNINGS

If a Warning condition occurs, indicated by a flashing **W**, press **HELP** to see a list of the current warning messages.

Error Queue ERROR QU

If an Error condition occurs, indicated by a flashing **E**, press **HELP** to see a list of the current error messages.

Frontpanel Controls

Softkeys and

Use the softkeys to select the parameter pages. The names of the parameter pages are displayed above the softkeys.

The **MEMCARD** and the **CONFIG** pages both use the same softkey. Toggle between them by pressing . Press the softkey to activate the page.

/LOCAL

Press  to enter SHIFT-mode. A flashing S indicates that you are in SHIFT-mode. The extra functions available in SHIFT-mode are shown in blue *above* the DATA ENTRY keys.



In SHIFT-mode you can use the knob to adjust a parameter outside its specified, or currently valid, range. You cannot use the knob to do this when not in SHIFT-mode.

Note that when using the VERNIER keys (CURSOR keys in SHIFT-mode) you must press  again to exit from SHIFT-mode.

When the instrument is programmed via the HP-IB it enters remote mode and disables the frontpanel controls. Press the  key to return to LOCAL operating mode.

/AUTOSET

Press  to obtain help on the currently selected parameter/setting.

Press AUTOSET ( ) to set the instrument to a valid setting based on the actual period setting.

Frontpanel Controls

STORE/RECALL

Press **STORE** to store the current instrument setting in one of 9 memories.

Press **RECALL** (**SHIFT** **STORE**) to recall a complete instrument setting from one of the 9 memories, or to recall the default instrument settings from memory 0.

3

MAN

Use the **MAN** key to generate a manual trigger or gate signal when the HP 8114A is running in **TRIGGERED** or **GATED** trigger mode with the **MAN** key as the selected trigger/gate source.

DATA ENTRY

Use the **DATA ENTRY** keys to quickly enter a parameter value into the **Modify Window**. Enter the numeric value followed by the appropriate unit key.

During the data entry you can press **CANCEL** (**SHIFT** **ENTER**) to cancel the entry or use the cursor-left **←** to backspace the digit-cursor.

Use the **SHIFT** **DATA ENTRY** functions indicated in blue above the keys to quickly select a particular parameter.

Normally, you cannot adjust a parameter outside its specified, or currently valid, range with the knob. However, you can use the **DATA ENTRY** keys to over/under program the parameter.

CURSOR/VERNIER

Use the **CURSOR** keys to move the parameter-cursor on the parameter page. The parameter-cursor highlights the currently selected parameter or setting. This parameter or setting is then displayed in the **Modify Window** at the right hand side of the display.

In **SHIFT**-mode the **CURSOR** keys move the digit-cursor within the **Modify Window** and **VERNIER** the value of the selected digit.

MODIFY knob Use the knob to modify the selected parameter in the Modify Window, or to select a setting from the list displayed in the Modify window.

Normally, you cannot adjust a parameter outside its specified, or currently valid, range with the knob. However, you can press **(SHIFT)** to overcome this limitation, and then over/under program the parameter.

3

Connectors

EXT INPUT

You can use an external signal connected to the EXT INPUT to trigger the HP 8114A by selecting **TRIGGERED** mode and Triggered by: EXT-IN on the **TRIGGER** page.

You can use an external signal connected to the EXT INPUT to gate (enable/disable) the HP 8114A by selecting **GATED** mode and Gated by: EXT-IN on the **TRIGGER** page.

You can use an external signal applied to the EXT INPUT to generate leading and trailing edges by selecting **EXT_WIDTH** mode and Width: EXT-IN on the **TRIGGER** page. Note that threshold can be set from -10 V to +20 V

TRIGGER OUT

The TRIGGER OUT signal generates a TTL output pulse for each pulse-period generated by the HP 8114A.

INHIBIT INPUT

You can use an external TTL signal applied to the INHIBIT INPUT to inhibit the HP 8114A output signal. On the **OUTPUT** page, select **Inh ON** and then select the method required:

- **Inhibit on Edge:** An active edge inhibits the output signal until it is reset from the front panel or from HP-IB. Select **Rising** or **Falling** edge, using the knob.

Frontpanel Controls

- **Inhibit on Level:** An active level inhibits the output signal. Select High or Low as the active level, using the knob.

3

TRIGGER Page

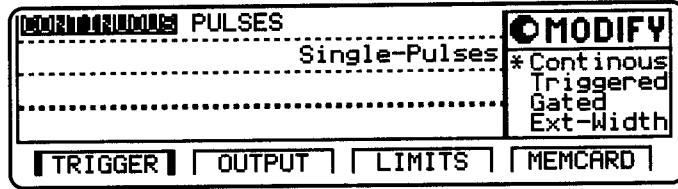

3

Typical TRIGGER page

Use the TRIGGER page to set up the overall operating modes of the HP 8114A.

To change a setting, move the parameter cursor onto the setting using the CURSOR keys and modify the setting with the MODIFY knob.

The following sections explain the mode combinations in more detail.

CONTINUOUS PULSES Mode

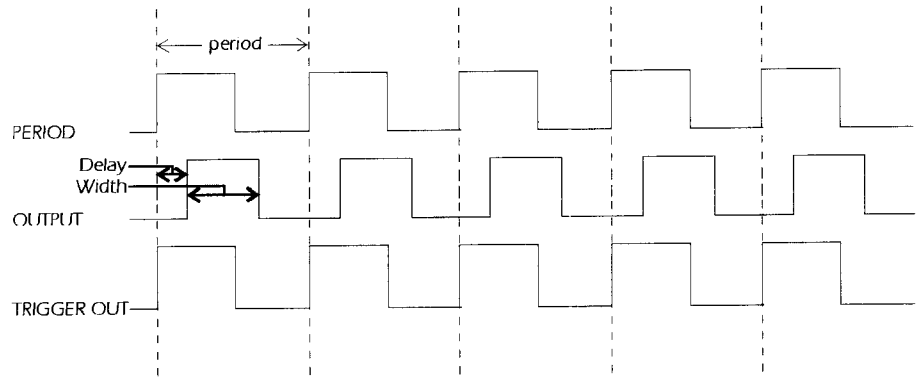

Figure 3-3. Timing Diagram: CONTINUOUS PULSES

Note



Figure 3-3 does not show the intrinsic fixed delay between the TRIGGER OUT and the OUTPUT signals. Refer to Chapter 6 for the typical values of this delay.

- Pulse-periods are generated continuously

TRIGGER TRIGGERED PULSES

- Select between Single and Double-pulses per pulse-period :

Single-Pulses Single pulse per period, delay parameter sets delay to leading-edge from start of period.

Double-Pulses Double pulse per period, double-delay parameter sets delay between leading-edges of pulses.

- TRIGGER OUT marks each pulse period.

3

CONTINUOUS BURST **Mode**

A burst of pulse-periods is repeated continuously. The OUTPUT signal and TRIGGER OUT signal are the same as in CONTINUOUS PULSES mode.

TRIGGERED PULSES **Mode**

3

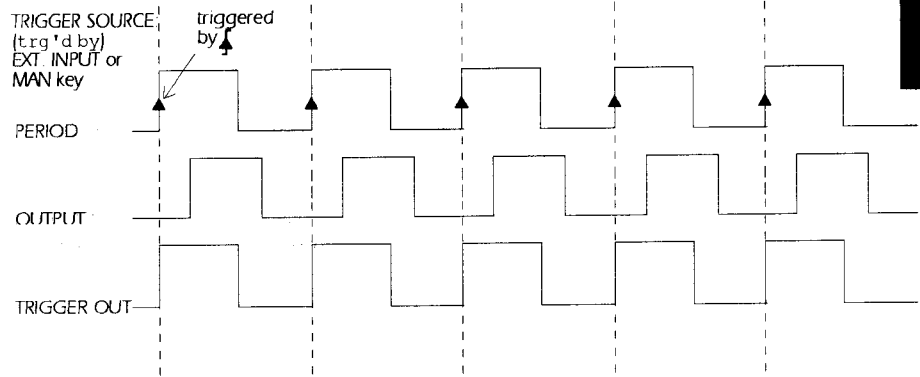

Figure 3-4. Triggering on Rising Edge

Note



Figure 3-4 does not show the intrinsic fixed delays between the EXT INPUT and the TRIGGER OUT signals, and between the TRIGGER OUT and the OUTPUT signals. Refer to Chapter 6 for the typical values of these delays.

- Single pulse-periods are triggered by (Trig'd by) an active edge at the selected triggering source:
 - MAN Key (MAN) on frontpanel, triggered by press or release or both.
 - EXT INPUT (External signal) triggered by rising or falling or both edges (See Figure 3-5).

TRIGGER TRIGGERED PULSES

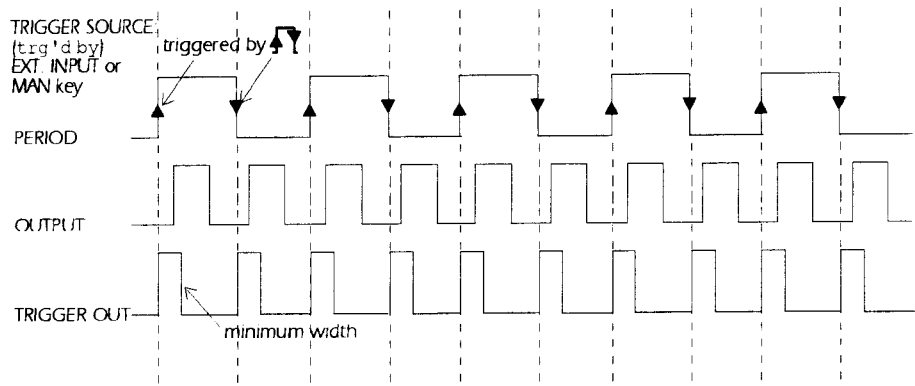

Figure 3-5. Triggering on Both Edges

- Select between Single and Double-pulses per pulse-period:

Single-Pulses Single pulse per period, delay parameter sets delay to leading-edge from start of period.

Double-Pulses Double pulse per period, double-delay parameter sets delay to the start of the second pulse.

- TRIGGER OUT marks each pulse period.

TRIGGERED BURST Mode

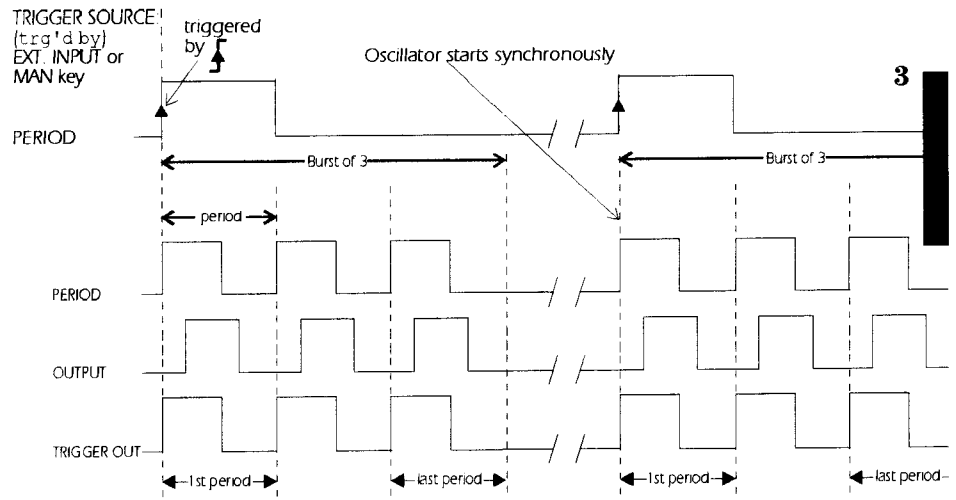

Figure 3-6. Timing Diagram: TRIGGERED BURST

Note



Figure 3-6 does not show the intrinsic fixed delays between the EXT INPUT and the TRIGGER OUT signals, and between the TRIGGER OUT and the OUTPUT signals. Refer to Chapter 6 for the typical values of these delays.

- A burst of pulse-periods is triggered by (Trig'd by) an active edge at the selected triggering source:
 - MAN Key (MAN) on frontpanel, triggered by press or release or both.
 - EXT INPUT (External signal) triggered by rising or falling or both edges.

TRIGGER GATED PULSES

- Select the number of pulse-periods per burst in the range 2 – 65536.
- Select between Single and Double-pulses per pulse-period for each OUTPUT:
 - Single-Pulses Single pulse per period, delay parameter sets delay to leading-edge from start of period.
 - Double-Pulses Double pulse per period, double-delay parameter sets delay to the start of the second pulse.

3

GATED PULSES **Mode**

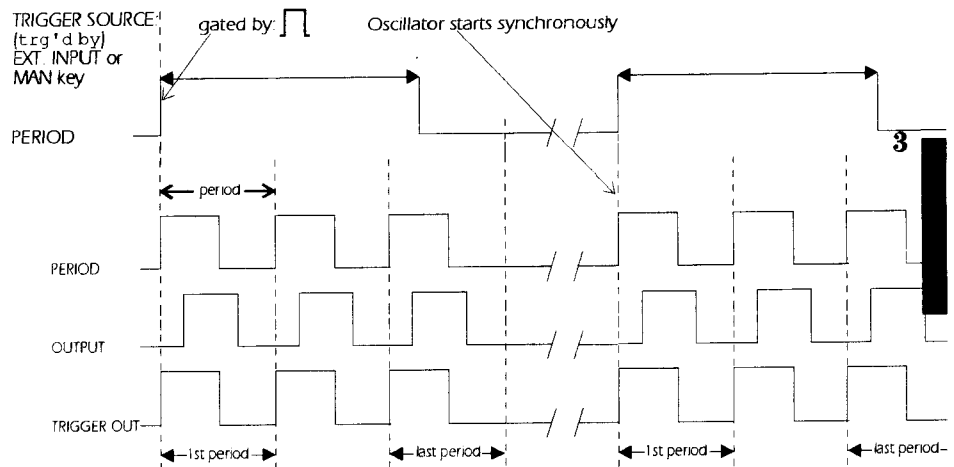

Figure 3-7.
Timing Diagram: GATED PULSES Pulse-Period:
 internal Osc

Note



Figure 3-7 does not show the intrinsic fixed delays between the EXT INPUT and the TRIGGER OUT signals, and between the TRIGGER OUT and the OUTPUT signals. Refer to Chapter 6 for the typical values of these delays.

- Pulse-periods are Gated by (enabled by) an active level at the selected triggering source:
 - MAN Key **(MAN)** on frontpanel, gated while pressed or released or both.
 - EXT INPUT (External signal) gated by high, low or both levels.

TRIGGER GATED BURST

- Select between Single and Double-pulses per pulse-period for each OUTPUT:

Single-Pulses Single pulse per period, delay parameter sets delay to leading-edge from start of period.

Double-Pulses Double pulse per period, double-delay parameter sets delay between leading-edges of pulses.

3

GATED BURST Mode

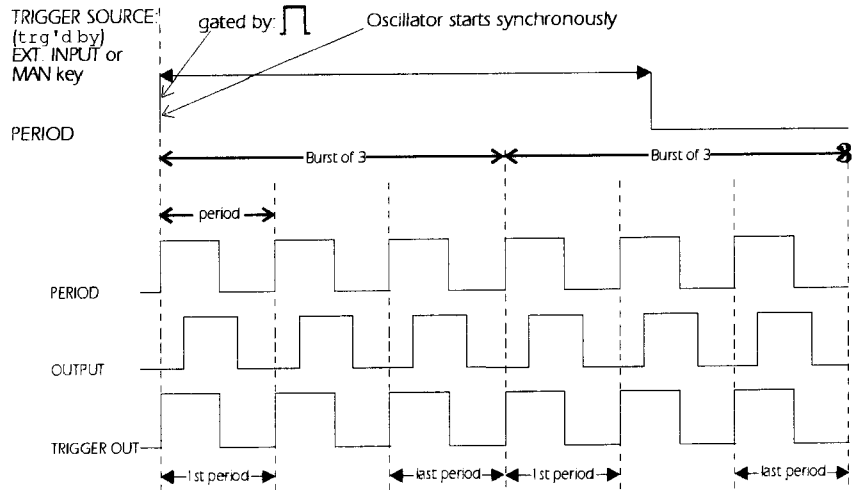

Figure 3-8. Timing Diagram: GATED BURST

Note



Figure 3-8 does not show the intrinsic fixed delays between the EXT INPUT and the TRIGGER OUT signals, and between the TRIGGER OUT and the OUTPUT signals. Refer to Chapter 6 for the typical values of these delays.

- Bursts of pulse-periods are Gated by (enabled by) an active level at the selected triggering source:
 - MAN Key (MAN) on frontpanel, gated while pressed or released or both.
 - EXT INPUT (External signal) gated while high or low or both.

- Select the number of pulse-periods per burst in the range 2 - 65536.
- Select between Single and Double-pulses per pulse-period:
 - Single-Pulses Single pulse per period, delay parameter sets delay to leading-edge from start of period.
 - Double-Pulses Double pulse per period, double-delay parameter sets delay to the start of the second pulse.

Note



The last burst cycle is completed

EXT WIDTH **Mode**

- The pulse width is determined by an external signal:
 - MANKey Pressing the **(MAN)** key generates a leading-edge, releasing the **(MAN)** key generates a trailing-edge.
 - EXT-IN A rising-edge at the EXT INPUT generates a leading-edge, a falling-edge at the EXT INPUT generates a trailing-edge.
- Set the threshold of the EXT INPUT, and whether rising-edge, falling-edge, or both, on the **TRIGGER** page.
- The period, delay, and width of the output pulse are not programmable in this mode as they are determined by the external signal.
- Output levels can be set up to maximum amplitude of 20 Volts (from 50 Ω into 50 Ω).

OUTPUT page

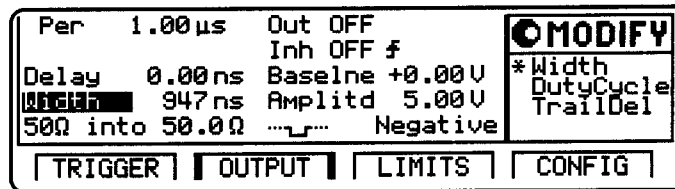

Figure 3-9. OUTPUT page, text mode

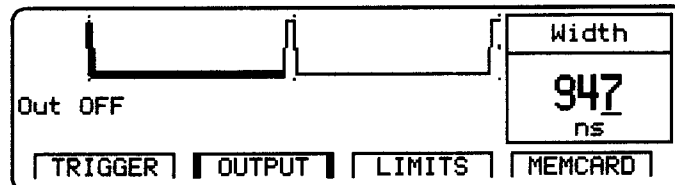

Figure 3-10. OUTPUT page, graphics mode

Use the **OUTPUT** page to view and control the pulse-timing and level parameters

You can toggle between graphics and text mode by pressing the **OUTPUT** softkey or **SHIFT** **MORE**. You move to the timing graphics if you are currently on a timing parameter, or to the level graphics if you are currently on a level parameter.

Note that in graphics mode you can only adjust the values of each parameter, not the parameter format. If you want to change the format of a parameter, for example Width to Duty Cycle, you must be in text mode to select the parameter name with the cursor.

Modifying the value of a parameter

You can adjust a parameter value in graphics or text mode. Example pages are shown in the following subsections for graphics mode only.

1. Move the parameter cursor onto the value you want to modify using the **CURSOR** keys.

2. Modify the value with the knob.

Note that when you use the knob, the parameter range can be restricted to prevent any warnings or errors occurring (See “Warnings and Errors”). If you want to set a value outside this temporary range, use the DATA ENTRY keys or press **SHIFT** and turn the knob. If you try to set values outside the absolute maximum or minimum limits, the HP 8114A will limit these settings to predetermined values.

Modifying the format of a parameter

Note



You can only modify the format of a parameter in text mode.

Many parameters can be displayed in different formats, for example the pulse-period can be displayed as a period or a frequency. To modify the format of a parameter:

1. If you are in GRAPHics mode, select TEXT mode with **SHIFT MORE**.
2. Move the cursor onto the parameter name.
3. Use the MODIFY knob to select a parameter format from the list in the MODIFY window.

ON/OFF Parameter

Switch the OUTPUT signal on and off.

Note that you can use the short-cut keys **SHIFT 0** to quickly toggle the OUTPUT on and off.

Pulse-period Parameter

Set the pulse-period as either `Period` or `Frequency`.

Note that in `TRIGGERED` mode the minimum period or maximum frequency is displayed. This sets the minimum period/maximum frequency of the external triggering signal at the External Input.

You can set the minimum period or maximum frequency of the external trigger signal to protect the device under test. The instrument then determines the absolute maximum safe duty-cycle and amplitude based on the width and amplitude settings, and the specified duty-cycle and amplitude limits. For example, if you set the external trigger frequency at 1MHz and the required output voltage at 30V, then the duty-cycle is limited by the instrument, as illustrated in Figure 6-1. Control of the external frequency is provided by a mask that allows triggering by external pulses that meet these requirements. The following figure illustrates this:

3

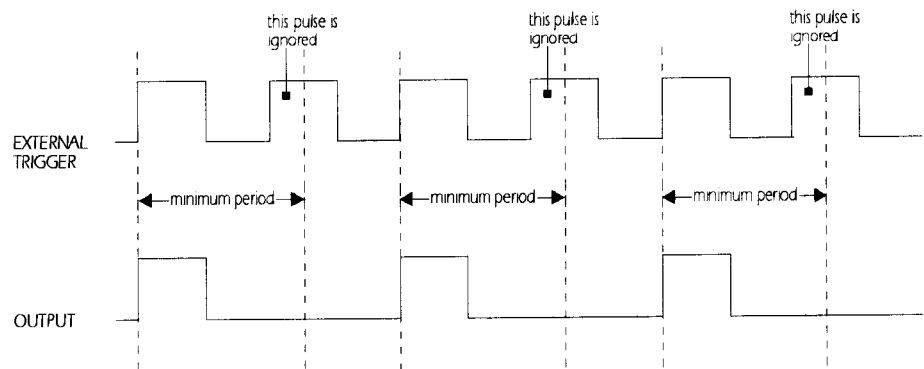

Figure 3-11.
Effect of minimum triggering period setting

Additional trigger edges arriving within the minimum period are ignored (over triggering).

Output Delay Parameter

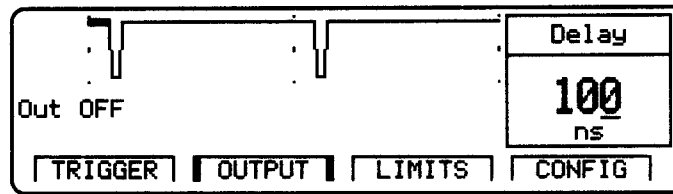

Figure 3-12. OUTPUT Timing parameter graphic, Delay

Delay the leading-edge of the pulse within the pulse-period. There are three delay formats available, selectable in text mode:

Delay

Delay is the absolute delay from the start of a pulse-period to the start of the leading-edge of the pulse. The absolute delay is independent of the pulse-period so the leading-edge does not move relative to the start of the period if you change the period.

Delay%

Delay% is the delay from the start of the pulse-period to the start of the leading-edge expressed as a percentage of the pulse-period. In this format if you change the period, the leading-edge moves relative to the start of the period in order to maintain the percentage delay.

Phase

Phase is the phase delay in degrees from the start of the pulse-period to the start of the leading-edge. ($360^\circ = 1$ pulse-period). In this format if you change the period, the leading-edge moves relative to the start of the period in order to maintain the phase delay.

Pulse Width Parameter

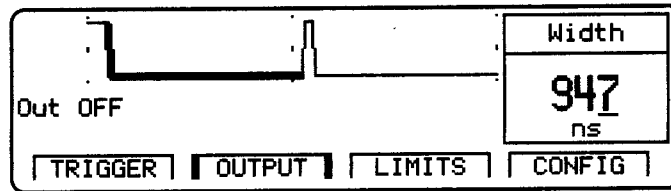

3

Figure 3-13.

OUTPUT Timing parameter graphic, Width

Set the width of the output pulse. There are three width formats available, selectable in text mode:

Width

Width is the absolute pulse width measured from start of the leading-edge to start of the trailing edge. In this format the pulse width is independent of changes in pulse-period and delay.

DutyCyc

DutyCycle is the pulse width measured from start of the leading-edge to start of the trailing edge expressed as a percentage of the period. In this format if you adjust the period, the absolute width is adjusted to maintain the duty-cycle.

TraDel

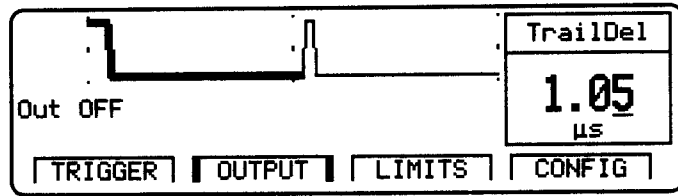

Figure 3-14.

OUTPUT Timing parameter graphic, Trailing Delay

TrailingDelay is the absolute delay from the start of the pulse-period to the start of the trailing-edge. In this format the trailing-edge remains fixed relative to the start of the pulse-period if you adjust the pulse-delay (leading-edge delay) or the pulse-period.

Duty-cycle/Amplitude Dependency

Note



The maximum available duty-cycle is dependent on the pulse amplitude/baseline settings, and vice-versa. This means that the pulse width/duty-cycle can be limited by amplitude/baseline settings. Refer to "Duty-cycle" in Chapter 6

Level Parameters

Set and display the pulse levels in terms of either Baseline and Amplitude, or High- and Low-level.

Base-Ampl

Select Baseline and Amplitude-level format for the pulse levels. Two configurations are possible:

- **In a standard instrument** the Baseline is fixed at 0 V. The output pulses are then positive or negative of this according to polarity selected.
- **In an instrument fitted with option 001** the baseline is variable from -25 V to +25 V. The output signal then goes positive or negative from the baseline.

3

Note



The output window for the HP 8114A is +50V to -50V (50Ω into 50Ω). Therefore, the position of the baseline can limit the maximum available amplitude, depending on the output polarity selected.

For example, if the baseline is set at +20 V, the output amplitude can be varied up to a **positive** limit of only 30 V, but to a **negative** limit of 50 V. Refer to Figure 6-2. The maximum available output amplitude may also be limited by the current duty-cycle (pulse width) setting. Refer to Figure 6-2.

High-Low

Select High and Low-level format for the pulse levels.

mV V mA A **Voltage/Current Mode**

Note



This parameter is only available in text mode.

Move the parameter cursor onto the level Units to select between setting the pulse-levels in Volt or in Ampere.

OUTPUT

50Ω into OUTPUT Source Impedance Parameter

Toggle the OUTPUT impedance between 50Ω and HIZ.

Note



This parameter is only available in text mode.

3

50.0Ω Load Impedance Parameter

Adjust the load impedance value expected at the OUTPUT to compensate for non-50Ω loads. The displayed level-parameters are then calculated using this value and therefore represent the levels at a non-50Ω static load.

Output Voltage and Power Protection

Note



When the OUTPUT is switched on, the HP 8114A monitors the actual voltage and current levels at the OUTPUT. The OUTPUT is automatically switched off if voltage levels or power dissipation reach levels that could damage the OUTPUT circuits. The available OUTPUT levels could therefore be limited by external voltages and loads, causing the OUTPUT to switch off.

... ▭ ... Output Polarity

Note



This parameter is only available in text mode.

Toggle the OUTPUT polarity between positive or negative output pulses.

Inh ON/OFF **Inhibit the Output**

Inhibit the HP 8114A output signal by selecting **Inh ON** and then selecting whether to inhibit on a rising or falling edge, or to inhibit on a level.

When inhibiting on an edge you can use an external signal applied to the **INH INPUT**, an HP-IB command (:TRIGger:INHibit[:STATe]:MODE), or the knob. When inhibiting on a level you can use an external signal applied to the **INH INPUT** or the HP-IB command.

3

Use the following HP-IB command:

The following illustrations show the effect on the output signal using edge inhibit and level inhibit:

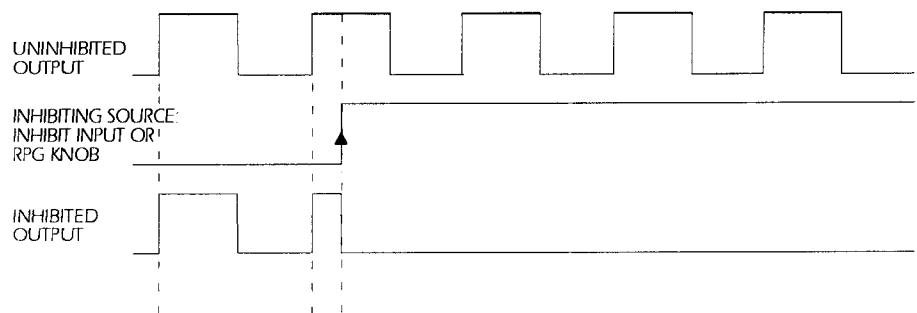

Figure 3-15.
Inhibiting the Output using a Rising Edge

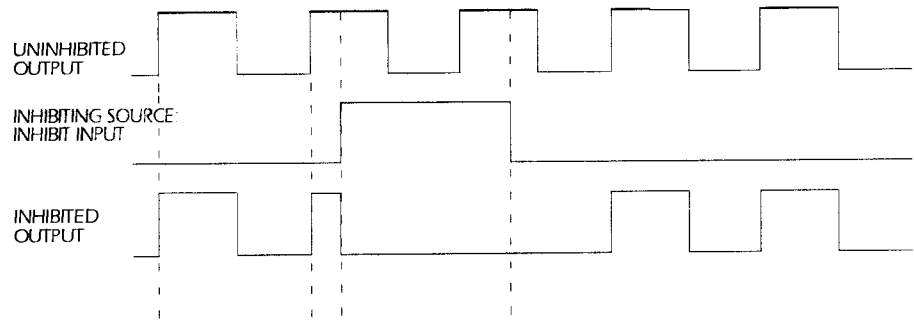

Figure 3-16. Inhibiting the Output using a Level

Edge inhibit requires a reset as the transition is latched in the instrument. Use the knob to reset the inhibit.

Level inhibit is automatically released when the level is no longer applied. In `Ext-Width` mode the output remains inhibited until the next transition of the external input.

Inhibit delay is approximately 200 ns.

LIMITS page

Lev-Limits ON	Wid-Limits ON	MODIFY
High-V +10.0V	Width 999ns	-200 mA
Low-V -10.0V	DutyCyc 100%	
High-A +200mA		
Low-A -200mA		
TRIGGER		OUTPUT
LIMITS		MEMCARD

3

Figure 3-17. LIMITS page

Use the **LIMITS** page to set up voltage, current, width and duty-cycle limits for the pulse level parameters to prevent accidental damage of the device under test.

Level limits and Width limits can be switched ON or OFF independently.

After you switch on one or both of the limits, the appropriate pulse level/timing parameters on the **OUTPUT** pages cannot be adjusted outside the ranges on the **LIMITS** page. Note that because voltage, current, and width limits apply, the available ranges of the impedance parameters are also affected.

When output level limits are on, the limits are indicated on the **OUTPUT** pages in graphics mode and the level bar is scaled accordingly:

	+10V	Out OFF	Amplitude
	-10V		5.00 V
TRIGGER		OUTPUT	MEMCARD
LIMITS			

Figure 3-18.
Level graphics with Limits ON on OUTPUT

MEMCARD page

3

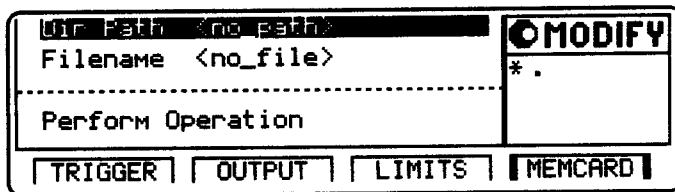

Figure 3-19. MEMCARD page, No card present.

Use the MEMCARD page to:

- Store instrument settings to the memory-card.
- Recall instrument settings from the memory-card.
- Delete files from the memory-card.
- Format a memory card.

Note that the HP 8114A uses DOS formatted memory-cards and you cannot create or delete directories using the HP 8114A.

Dir Path **Current Directory Parameter**

Move the cursor onto Dir Path to change directory on the memory-card or to view the subdirectories in the current directory (The current directory name is displayed next to Dir Path).

All the sub-directories in the current directory are listed in the MODIFY window.

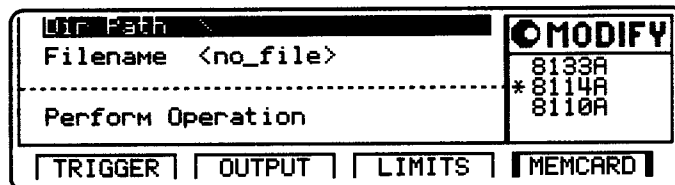

Figure 3-20. MEMCARD page, Dir Path Example

To change directory

1. Use the MODIFY knob to select the directory name from the list of files and directories in the MODIFY window.
2. Press **ENTER**.

3

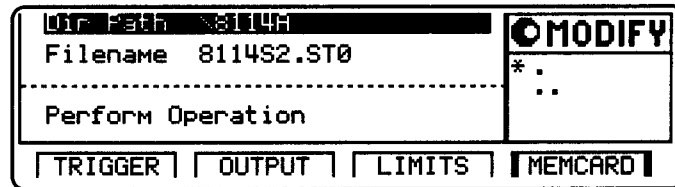

Figure 3-21. MEMCARD page, Subdirectory Example

Note that when you are in a sub-directory you can return to the parent-directory by selecting .. from the directory list in the MODIFY window.

Filename **Filename Parameter**

Move the cursor onto the Filename parameter to view and select a file from the current directory. Use the MODIFY knob to scroll through the filenames listed in the MODIFY window.

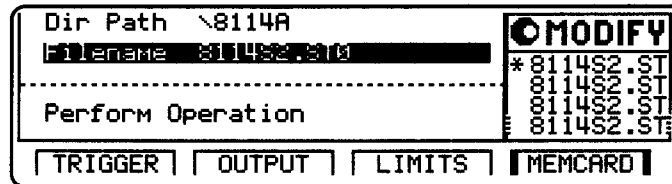

Figure 3-22. MEMCARD page, Filename Example

Perform Operation **Memory Card Operations**

Move the cursor onto Perform Operation and use the knob to select the operation:

ReadCard

Read the DOS file-system information from the memory-card after inserting a new card. Press **(ENTER)** to carry out the operation.

Recall

Recall the selected file as the current-instrument setting. Press **(ENTER)** to carry out the operation.

Store

Store the current instrument-setting to the memory-card.

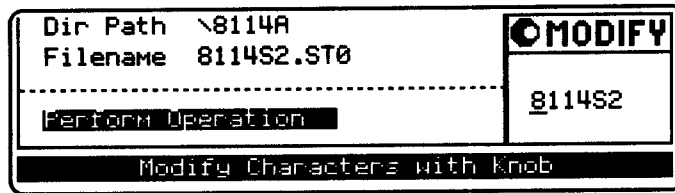

Figure 3-23. MEMCARD page, Store Operation

Press **(ENTER)** once to start editing the filename for the setting in the MODIFY window. The currently selected filename is used as default.

Caution

If you do not modify the filename, the existing file will be overwritten when you press **(ENTER)**.

Press **(SHIFT)(ENTER)** to CANCEL the store operation at any time..

To modify the filename

1. Move the character cursor with the CURSOR keys.
The filename can be up to 8 characters long.
2. Modify a character using the knob.
3. When you have finished, press **(ENTER)** to store the setting.

Note that the DOS filename suffix `.ST0` is added automatically to the filename when you store the current settings.

Store All

Store the current instrument-setting and the instrument-setting memories 1 to 9 to the memory-card. Each setting is stored in a separate file with the same name but different suffixes:

3

Table 3-1. Filename suffixes

Setting	Filename Suffix
Current Setting	<code>.ST0</code>
Memory 1	<code>.ST1</code>
Memory 2	<code>.ST2</code>
.	.
.	.
Memory 9	<code>.ST9</code>

Press `(ENTER)` once to start editing the filename for the setting in the MODIFY window. The currently selected filename is used as default.

Caution



If you do not modify the filename, the existing file will be overwritten when you press `(ENTER)`.

Press `(SHIFT)(ENTER)` to CANCEL the store operation at any time..

To modify the filename

1. Move the character cursor with the CURSOR keys.
The filename can be up to 8 characters long.
2. Modify a character using the knob.
3. When you have finished, press `(ENTER)` to store the setting.

MEMCARD

Note that the DOS filename suffixes `STx` are added automatically to the filenames when you store the settings.

Delete

Delete the selected file from the memory-card. Press **ENTER** to carry out the operation.

Format

Caution



Formatting a memory-card destroys any existing files on the card.

Format the memory-card. Press **ENTER** to carry out the operation.

CONFIG page

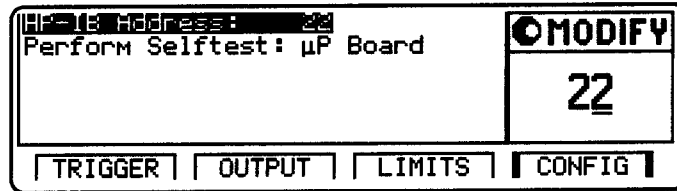

3

Figure 3-24. CONFIG page

Use the CONFIG page to:

- Set the HP-IB address of the HP 8114A.
- Perform a selftest.

HP-IB Address	Set the HP 8114A HP-IB address in the range 0 to 30.
Perform Selftest	<p>Perform a selftest by pressing ENTER. You can choose between testing the microprocessor board (μP Board) and the pulse signal generating boards (Signal).</p> <p>If the selftest fails, a flashing E is displayed. Press HELP to see the list of error messages.</p>

Warnings and Errors

The HP 8114A has two levels of error reporting called warnings and errors. Error and warning checking is always enabled.

3

----- Maximum programmable range of selected parameter -----				
Probably invalid	Probably valid	← ALL signal parameters in specification →	Probably valid	Probably invalid
ERROR	WARNING		WARNING	ERROR
Setting not implemented	←----- Setting implemented in hardware ----->			Setting not implemented

Warnings

A warning is generated when the output signal *could* be invalid due to a combination of worst case uncertainties at the current settings of all relevant parameters. For example, when adjusting the pulse width, the leading edge, trailing edge, and pulse period settings and their uncertainties have to be considered in order to check if the width setting will fit within the pulse period. Refer to “An Example of Warning and Error Reporting”. Note that the warning limits are therefore not fixed for a particular parameter, but vary with the settings of the related parameters. It is also possible that the error and warning limits are the same, that is, a warning does not occur before the error limit is reached.

If a warning occurs, the settings are still implemented in the hardware since the worst case conditions used to evaluate the warning limits are very unlikely to occur in practice.

A blinking W indicates that one or more warnings have occurred. Press **HELP** to view the warning list. Multiple warnings can exist together.

Errors An error is generated when an invalid mode is chosen, or the required parameter settings cannot be implemented in the output hardware. Multiple errors can occur, but only the first error detected is displayed.

An error is indicated by a blinking E at the bottom of the screen.

Note

If you are using the knob to adjust parameters it is normally not possible to generate warnings or errors. All parameters are automatically limited to settings which guarantee specified operation.

If you do want to use the knob to adjust a parameter beyond its warning limits:

1. Adjust to the limit with the knob
2. Press **(SHIFT)** and adjust beyond the limit with the knob.

AUTOSET

You can press **(SHIFT)****(HELP)** to carry out an AUTOSET. The instrument resets all parameters, based on the current period setting, to remove all warning and error conditions.

An Example of Warning and Error Reporting

1. Switch on instrument and RECALL standard settings with **(SHIFT)****(STORE)****(0)**. The period is now set to 1 μ s.
2. Switch on OUTPUT with **(SHIFT)****(0)**.
3. On the **OUTPUT** page, move the parameter cursor onto the value of the **width** parameter (50n ϵ).
4. Use the knob to make the **width** as large as possible (approximately 947n ϵ)

This limit is intended to guarantee that the actual output pulse is within specifications, for the actual period.

The limit is calculated taking into account a worst case combination of minimum period from the period

setting ($1 \mu\text{s}$) and maximum width from the width setting (947 ns), and transition of 7 ns.

5. Press **SHIFT** and adjust the Width above its warning limit. A flashing W appears to indicate that a warning condition has occurred.

Note that as long as no errors occur, the output hardware is set up and attempts to generate the required output.

6. Press **HELP** to see the warning message:

Width too close to period

7. Press **HELP** again to return to the Width parameter.

8. Increase the Width further until a flashing error message appears (approximately $1.11 \mu\text{s}$):

OUTPUT: Width > Period

You have reached the current upper error-limit of the Width parameter. The setting is not implemented in the output hardware.

9. Press **SHIFT HELP** to carry out an AUTOSET.

HP 8114A Programming Reference

Common Command Summary IEEE 488.2

Table 4-1.
HP 8114A IEEE 488.2 Common Command Summary

4

Command	Parameter	Description
*CLS	—	Clear the status structure
*ESE	<0-255>	Set the Event Status Register Mask
*ESE?	<0-255>	Read the Event Status Register Mask
*ESR?	—	Read the Event Status Register
*IDN?	—	Read the Instrument's Identification string
*LRN?	—	Read the complete Instrument Setting
*OPC	—	Generate the Operation Complete message when all pending actions are complete
*OPC?	—	Set the Operation Complete bit when all pending actions are complete
*OPT?	—	Read the installed options
*RCL	<0-9>	Recall a complete Instrument Setting from memory
*RST ¹	—	Reset the instrument to standard settings
*SAV	<1-9>	Save the complete Instrument Setting to memory
*SRE	<0-255>	Set the Service Request Enable Mask
*SRE?	<0-255>	Read the Service Request Enable Mask
*STB?	—	Read the Status Byte
*TRG	—	Trigger
*TST?	—	Execute instrument's self-test
*WAI	—	Wait until all pending actions are complete

¹ See the default settings in table 4-13, at the end of this section.

SCPI Command Summary

Table 4-2. HP 8114A SCPI Command Summary

Command	Parameter	Description
:DISPlay [:WINDow] [:STATe]	ON OFF 1 0	Set/read frontpanel display state
:MMEMory		
:CATalog?	[A:]	Read directory of memory card
:CDIRectory	[<name>]	Change directory on memory card
:COPY	<source>[,A:],<dest>[,A:]	Copy a file on memory card
:DELete	<name>[,A:]	Delete a file from memory card
:INITialize	[A:[,DOS]]	Initialize memory card to DOS format
:LOAD :STATe	<n>,<name>[,A:]	Load file from memory card to memory n
:STORE :STATe	<n>,<name>[,A:]	Store memory n to memory card
:OUTPut [:STATe]	ON OFF 1 0	Set/read channel output state
:IMPedance [:INTernal]	<value>	Set/read internal source impedance of output
:EXTernal	<value>	Set/read expected external load impedance at output
:POLarity	POSitive NEGative	Set/read output polarity

4

Table 4-2.
HP 8114A SCPI Command Summary (continued)

Command	Parameter	Description
[[:SOURce]		
:CURRent ¹		
[[:LEVel]		
[[:IMMediate]		
[[:AMPLitude]	<value>	Set/read channel amplitude current
:BASeline	<value>	Set/read channel baseline current
:HIGH	<value>	Set/read channel high-level current
:LOW	<value>	Set/read channel low-level current
:LIMit ¹		
[[:HIGH]		Set/read maximum current limit
:LOW		Set/read minimum current limit
:STATe	ON OFF 1 0	Enable/Disable the current limits.
:FREQuency		
[[:CW]:FIXed]	<value>	Set/read frequency of pulses
:HOLD ¹	VOLT CURR	Switch between VOLTage and CURRent command subtrees
:PHASe	<value>	
[[:ADJust]	<value>	Set/read channel phase
:PULSe		
:DCYClE	<value>	Set/read channel duty-cycle
:DELay	<value>	Set/read channel delay (to leading edge)
:HOLD	TIME PRATio	Hold absolute delay delay as period ratio fixed with varying frequency
:UNIT	S SEC PCT DEG RAD	Set/read delay units
:DOUBle		
[[:STATe]	OFF ON	Enable/disable double pulses per pulse-period
:DELay	<value>	Set/read delay between double pulses
:HOLD	TIME PRATio	Hold absolute delay delay as period ratio fixed with varying frequency
:UNIT	S SEC PCT	Set/read delay units
:HOLD	WIDTh DCYClE TDELay	Hold Width Duty-cycle Trailing edge delay fixed with varying frequency

4

¹ The CURRent and VOLTage subsystems cannot be used at the same time. Use the :HOLD command to select between them.
The Standard HP 8114A cannot program current via the HP-IB bus. Convert the required current with the help of the Ohm's law into voltage and program the voltage.
With Option 001 installed the commands can be used.

Table 4-2.
HP 8114A SCPI Command Summary (continued)

Command	Parameter	Description
[:SOURce]		(Continued from previous page)
:PULSe		
:LIMIT		
[:WIDth]	<value>	Set Width limit on/off
:DCYCLe	<value>	Set Duty-cycle limit on/off
:STATe	OFF ON	Enable/disable limits
:PERiod	<value>	Set/read pulse-period
:TrailingDELay	,value>	Set/read trailing edge delay
:WIDTh	<value>	Set/read channel pulse width
:VOLTage ¹		
[:LEVel]		
[:IMMediate]		
[:AMPLitude]	<value>	Set/read channel amplitude voltage
:BASeline	<value>	Set/read channel baseline voltage
:HIGH	<value>	Set/read channel high-level voltage
:LOW	<value>	Set/read channel low-level voltage
:LIMit		
[:HIGH]		Set/read maximum voltage limit
:LOW		Set/read minimum voltage limit
:STATe	ON OFF 1 0	Enable/Disable the voltage limits.
:STATus		
:OPERation		
[:EVENT]?		Read Operation event register
:CONDition?		Read Operation condition register
:ENABle	Numeric	Set/Read Operation enable register
:NTRansition	Numeric	Set/Read Operation negative-transition register
:PTRansition	Numeric	Set/Read Operation positive-transition register
:PRESet		Clear and preset status groups

¹ The CURRENT and VOLTage subsystems cannot be used at the same time. Use the :HOLD command to select between them.

Table 4-2.
HP 8114A SCPI Command Summary (continued)

Command	Parameter	Description
:STATUS :QUESTIONable [:EVENT]? :CONDition? :ENABle :NTRansition :PTRansition	Numeric Numeric Numeric	(Continued from previous page) Read Questionable event register Read Questionable condition register Set/Read Questionable enable register Set/Read Questionable negative-transition register Set/Read Questionable positive-transition register
:SYSTem :ERRor? :KEY :KEY? :PRESet :SECurity [:STATe] :SET :VERsion? :WARning [:COUNt]? :STRing? :BUFFer?	Numeric Numeric Block data ON OFF Block data	Read error queue Simulate key press Read last key pressed Same as *RST, but display not affected Set/read complete instrument Switch security on and off Set/read complete instrument setting Read SCPI compliance version Read number of active warnings Read active warnings as concatenated string Read maximum possible length of concatenated string
:TRIGger [:SEquence :START] :COUNt :EWIDth :STATe :INHibit [:STATe] :MODE :INPut :LEVel :SENSe :SLOPe :SOURce	< value > ON OFF 1 0 ON OFF 1 0 RISE FALL HIGH LOW RESet SET < value > EDGE LEVel POS NEG EITH IMM EXT MAN	Set/read number of triggered periods to be generated in a burst Set/read External WQidth mode Switch Inhibit Input on or off Inhibit on edge or level Reset or set inhibit (edge inhibit only) Set/read threshold level at EXT INPUT Set/read trigger on edge or gate on level Set/read trigger slope at EXT INPUT Set/read trigger source (VFO EXT INPUT MAN key)

4

Status Model

Overview

4

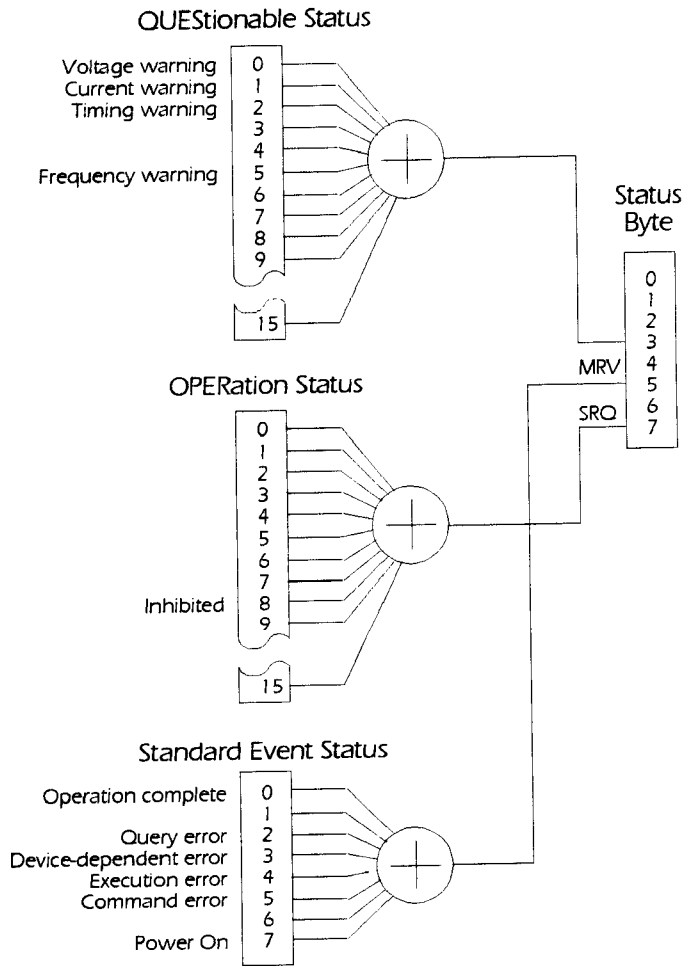

Figure 4-1. HP 8114A Status Groups

The HP 8114A has a status reporting system conforming to IEEE 488.2 and SCPI. Figure 4-1 shows the status groups available in the HP 8114A. Each status group is made up of component registers, as shown in Figure 4-2.

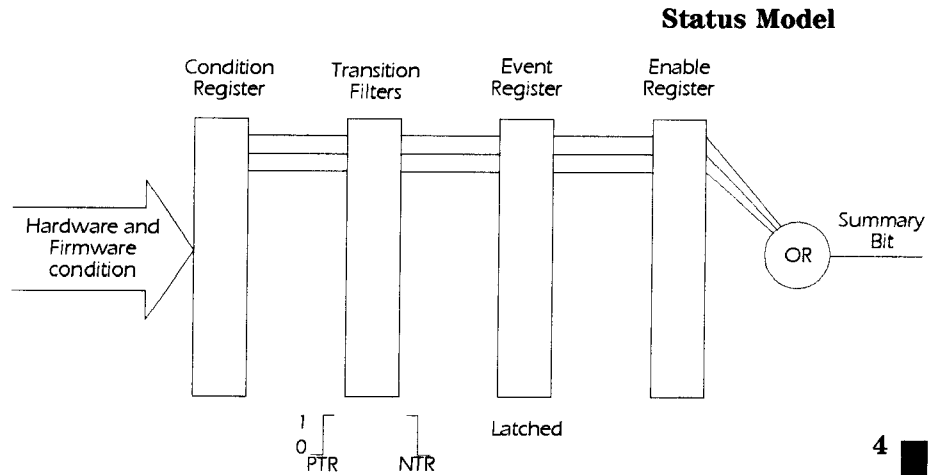

Figure 4-2. Component registers in a Status Group

Condition Register

A condition register contains the current status of the hardware and firmware. It is continuously updated and is not latched or buffered. You can only read condition registers. If there is no command to read the condition register of a particular status group, then it is simply invisible to you.

Transition Filters

Transition filters are used to detect changes of state in the condition register and set the corresponding bit in the event register. You can set transition filter bits to detect positive transitions (PTR), negative transitions (NTR) or both. Transition filters are therefore read-write registers. They are unaffected by *CLS.

Event Register

An event register latches transition events from the condition register as specified by the transition filters or records status events. Querying (reading) the event register clears it, as does the *CLS command. There is no buffering, so while a bit is set, subsequent transition events are not recorded. Event registers are read-only.

Status Model

Enable register

The enable register defines which bits in an event register are included in the logical OR into the summary bit. The enable register is logically ANDed with the event register and the resulting bits ORed into the summary bit. Enable registers are read-write, and are not affected by *CLS or querying.

Although all status groups have all of these registers, not all status groups actually use all of the registers. Table 4-3 summarizes the registers used in the HP 8114A status groups.

Table 4-3.
HP 8114A Status Groups - Registers Used

Status Group	Registers in Group				
	CONDition	NTR	PTR	EVENT	ENABLe
QUESTionable	✓	✓	✓	✓	✓
OPERation	✓	✓	✓	✓	✓
Standard Event Status	x	x	x	✓ ¹	✓ ²
Status Byte	x	x	x	✓ ³	✓ ⁴

1 Use *ESR? to query.

2 Use *ESE to set, *ESE? to query

3 Use *STB? to query

4 Use *SRE to set, *SRE? to query

Status Byte

The status byte summarizes the information from all other status groups. The summary bit for the status byte actually appears in bit 6 (RQS) of the status byte. When RQS is set it generates an SRQ interrupt to the controller indicating that at least one instrument on the bus requires attention. You can read the status byte using a serial poll or *STB?.

Table 4-4. Status Byte bits

Bit	Description
0	Unused, always 0
1	Unused, always 0
2	Unused, always 0
3	QUESTionable Status Summary Bit
4	MAV - Message AVailable in output buffer
5	Standard Event Status summary bit
6	RQS - ReQuest Service
7	OPERation Status summary Bit, unused

Standard Event Status Group

4

Table 4-5. Standard Event Status Group bits

Bit	Description
0	Operation Complete, set by *OPC
1	Unused, always 0
2	Query Error
3	Device Dependant Error
4	Execution Error
5	Command Error
6	Unused, always 0
7	Power On

Status Model

OPERation Status Group

The HP 8114A uses only bit 8 in this Status Group, to indicate that the output pulses are inhibited.

Table 4-6. OPERation Status Group bits

Bit	Description
0	Unused, always 0
1	Unused, always 0
2	Unused, always 0
3	Unused, always 0
4	Unused, always 0
5	Unused, always 0
6	Unused, always 0
7	Unused, always 0
8	Pulse inhibited
9	Unused, always 0
10	Unused, always 0
11	Unused, always 0
12	Unused, always 0
13	Unused, always 0
14	Unused, always 0
15	Always 0

QUESTIONable Status Group

Table 4-7. QUESTIONable Status Group bits

Bit	QUESTIONable
0	Voltage warning
1	Current warning
2	Time warning
3	Unused, always 0
4	Unused, always 0
5	Frequency warning
6	Unused, always 0
7	Unused, always 0
8	Unused, always 0
9	Unused, always 0
10	Unused, always 0
11	Unused, always 0
12	Unused, always 0
13	Unused, always 0
14	Unused, always 0
15	Always 0

4

The QUESTIONable Status group is used to report warning conditions amongst the voltage, current, pulse timing and frequency parameters. For more information on warning conditions refer to “Warnings and Errors” in Chapter 3. Warnings occur when a parameter, although not outside its maximum limits, could be causing an invalid signal at the output because of the actual settings and uncertainties of related parameters.

Programming the HP 8114A Trigger Modes

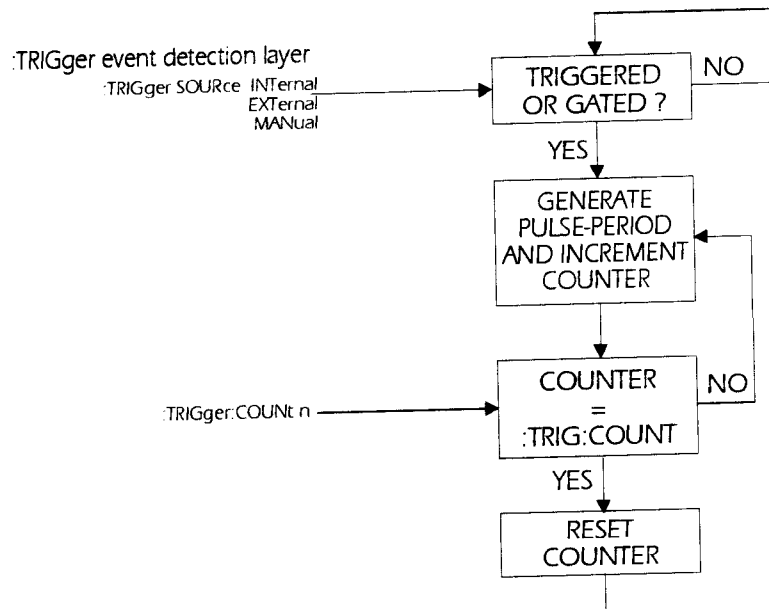

Figure 4-3. HP 8114A TRIGGER model

You program the triggering capabilities of the HP 8114A using the SCPI :TRIGger subsystem. Using this command subsystem you can program the operating modes of the instrument which are set up using the TRIGGER screen on the frontpanel.

Use the :TRIGger subsystem to select the triggering modes of the instrument: CONTINUOUS, TRIGGERED, GATED, and the triggering and number of pulse-periods per BURST length.

Programming Trigger Modes

- CONTINUOUS** Set CONTINUOUS mode by TRIGGERing the HP 8114A from its internal oscillator:
- :TRIGGER:SOURCE IMMEDIATE *Trigger from internal osc.*
- TRIGGERED** Set TRIGGERED mode by TRIGGERing the HP 8114A on edges from the EXT INPUT:
- :TRIGGER:SOURCE EXTERNAL *Trigger from EXT INPUT*
 :TRIGGER:SENSE EDGE *Trigger on edge*
 :TRIGGER:SLOPE POSITIVE *Trigger on positive edge*
 :TRIGGER:LEVEL 1V *Set EXT INPUT threshold*
- GATED** Set GATED mode by TRIGGERing the HP 8114A on levels from the EXT INPUT:
- :TRIGGER:SOURCE EXTERNAL *Trigger from EXT INPUT*
 :TRIGGER:SENSE LEVEL *Trigger on signal level*
 :TRIGGER:SLOPE POSITIVE *Trigger on positive level*
- EXT WIDTH** Set EXT WIDTH mode using the :TRIGGER:EWIDTH[:STATE] command:
- :TRIGGER:EWIDTH ON *Switch on EXT WIDTH mode*
- This command disables the TRIGGER system. The TRIGGER system is re-enabled by switching OFF EWIDTH mode.
- PULSES** Set PULSES mode by setting the :TRIGGER:COUNT to 1 so that a single triggered pulse-period is generated for every TRIGGER. The trigger source sets the pulse-period:
- :TRIGGER:COUNT *Single pulse-period per TRIGGER.*
 :TRIGGER:SOURCE INTERNAL *Pulse-period from internal osc.*

4

Table 4-8.
Trigger sources set by :TRIG:SOUR

Trigger source	:TRIGGER:SOURCE
(internal)CONTINUOUS	INTERNAL IMMEDIATE
External Input	EXTERNAL
MANUAL Key	MANUAL

Programming Trigger Modes

BURST of Set BURST of mode by setting the :TRIGger:COUNT to the burst count required.

:TRIGger:COUNT 16 *Burst of 16 pulse-periods*
:TRIGger:SOURce INTernal *Continuous mode*

4

Command Dictionary

The following reference sections list the HP 8114A commands in alphabetical order. In addition to a command description, the attributes of each command are described under the following headings. Not all of these attributes are applicable to all commands.

Form	Set	The command can be used to program the instrument
	Query	The command can be used to interrogate the instrument. Add a ? to the command if necessary.
	Event	The command performs a one-off action.
Parameter	The type of parameter, if any, accepted by the command.	
Parameter Suffix	The suffixes which may follow the parameter.	
Functional Coupling	Any other commands which are implicitly executed by the command.	
Value Coupling	Any other parameter which is also changed by the command.	
Range Coupling	Any other parameters whose valid ranges may be changed by the command.	
*RST value	The value/state following a *RST command.	
Specified Limits	The specified limits of a parameter.	

Programming Trigger Modes

Absolute Limits Some parameters can be programmed beyond their specified limits.

Example Example programming statements which assume:

- HP BASIC 5.0/5.1/6.1
- HP-IB Interface Select Code = 7
- HP 8114A HP-IB Address = 14

:DISPlay[:WINDow][:STATe]

Form Set & Query

Parameter ON|OFF|1|0

***RST value** ON

Description This command is used to turn the frontpanel display on and off. Switching off the display improves the programming speed of the instrument.

Note  *RST switches the display back on. Use :SYSTem:PRESet to perform an *RST without switching the display back on.

Example

OUTPUT 714;":DISP OFF" *Switch off the frontpanel display*

:MMEMory:CATalog?

Form Query

Parameter ["A:"]

***RST value** Not applicable

Description Use this command to get a listing of the contents of the currently selected directory on the memory card. As there is only one memory card slot, the parameter A: is optional. The information returned is:

<bytes_used>, <bytes_free> {, <file_entry>}

<bytes_used> The total number of bytes used on the memory card.

<bytes_free> The total number of bytes still available on the memory card.

<file_entry> String containing the name, type and size of one file:

"<file_name>, <file_type>, <file_size>"

Note



- The <file_type> is always blank.
- A directory name has <file_size> = 0

4

:MMEMory:CDIRectory

Form	Event
Parameter	["directory_name"]
*RST value	Not applicable
Description	<p>Use this command to change the current directory on the memory card. If you don't specify a directory name parameter, the root directory is selected.</p> <p>Note that you cannot use DOS pathnames as directory names, you can only select a directory name within the current directory.</p> <p>Use the directory name ".." to move back to the parent directory of the current directory, unless you are already in the root directory "\".</p>

4

Examples

OUTPUT 714;":MMEM:CDIR"	<i>Select root directory</i>
OUTPUT 714;":MMEM:CDIR ""PERFORM""	<i>Select directory "PERFORM"</i>
OUTPUT 714;":MMEM:CDIR ""..""	<i>Select parent directory</i>

:MMEMory:COPY

Form Event

Parameter "filename"[,"A:"],"copyname"[,"A:"]

***RST** Not applicable

Description Use this command to copy an existing file *filename* in the current directory to a new file *copyname*. If *copyname* is the name of a sub-directory in the current directory, a copy of the file *filename* is made in the sub-directory. Use ".." as *copyname* to copy a file into the parent directory of the current directory.

Examples

```
OUTPUT 714;":MMEM:COPY ""test1","","test2"" Copy test1 to test2
OUTPUT 714;":MMEM:COPY ""test1","",".."" Copy test1 into par-
ent directory
```

:MMEMory:DElete

Form	Event
Parameter	"filename"["A:"]
*RST	Not applicable
Description	Use this command to delete file <i>filename</i> from the currently selected directory.

4

:MMEMory:INITialize

Form Event

Parameter ["A:":["DOS"]]

***RST** Not applicable

Description

Caution



Initializing a memory card destroys any existing data on the card.

Use this command to initialize a memory card to DOS format.

:MMEMory:LOAD:STATe

Form	Event
Parameter	<n>,"filename"[,"A:"]
*RST	Not applicable
Specified Limits	<n> = 0 to 9 (integer)
Description	Use this command to load a complete instrument setting from file <i>filename</i> in the current directory into memory <n> in the HP 8114A. Memories 1 to 9 are the internal memories. Use memory 0 to load a setting as the current instrument setting.

4

Examples

OUTPUT 714;":MMEM:LOAD:STAT 1,""FREQPERF""	<i>Load FREQPERF into memory 1</i>
OUTPUT 714;":MMEM:LOAD:STAT 0,""AMPTEST""	<i>Load AMPTEST as current setting</i>
OUTPUT 714;":*SAV 2"	<i>Save current setting in memory 2</i>
OUTPUT 714;":*RCL 3"	<i>Recall memory 3 as current setting</i>

:MMEMory:STORe:STATe

Form Event

Parameter <n>,"filename"[,"A:"]

***RST** Not applicable

Specified Limits <n> = 0 to 9 (integer)

Description Use this command to store a complete instrument setting from memory <n> to file *filename* in the current directory on the memory card.

Memories 1 to 9 are the internal memories. Use memory 0 to store the current instrument setting to a file.

Examples

OUTPUT 714;":MMEM:STOR:STAT 1,""FREQPERF""	<i>Store memory 1 to file FREQPERF</i>
OUTPUT 714;":MMEM:STOR:STAT 0,""AMPTEST""	<i>Store current setting to file AMPTEST</i>
OUTPUT 714;":*SAV 2"	<i>Save current setting in memory 2</i>
OUTPUT 714;":*RCL 3"	<i>Recall memory 3 as current setting</i>

:OUTPut[:STATe]

Form	Set & Query
Parameter	ON OFF 1 0
*RST value	OFF
Description	Use this command to switch the OUTPUT on or off
Example	

OUTPUT 714;":OUTP ON" *Switch on OUTPUT*

:OUTPut:IMPedance[:INTernal]

Form Set & Query

Parameter Numeric

Parameter Suffix OHM with engineering prefixes, or MOHM is Megaohms.

***RST value** 50 Ω

Specified Limits 50 Ω or HIZ (High-Z)

Description Use this command to program the source impedance of the OUTPUT connector. Note that only two settings are available. If you try to program values $<100\Omega$, the impedance is set to 50 Ω . For values $\geq 100\Omega$, the impedance is set to HIZ (High-Z).

Example

```
OUTPUT 714;":OUTP:IMP 50OHM"  Set OUTPUT  
                               impedance  
                               to 50  $\Omega$   
OUTPUT 714;":OUTP:IMP 100OHM" Set OUTPUT to high  
                               impedance
```

:OUTPut:IMPedance:EXternal

Form	Set & Query
Parameter	Numeric
Parameter Suffix	OHM with engineering prefixes, or MOHM is Megaohms.
*RST value	50.0 Ω
Specified Limits	0.1 Ω to 999 k Ω for 50 Ω source impedance
Description	Use this command to set the expected load impedance of the device-under-test at the OUTPUT connectors. If you have a non-50 Ω load, the output levels at the device-under-test will not be the levels you program or set via the frontpanel <i>unless</i> you set the expected load using this command.

Example

```
OUTPUT 714;":OUTP:IMP:EXT 47.6OHM" Set load impedance  
at OUTPUT  
impedance to 47.6  $\Omega$   
OUTPUT 714;":OUTP:IMP:EXT 999KOHM" Set load impedance  
at OUTPUT  
impedance to 999 k $\Omega$ 
```

4

:OUTPut[:STATE]

Form Set & Query

Parameter ON|OFF|1|0

***RST value** OFF

Description Use this command to switch the OUTPUT on or off

Example

OUTPUT 714;":OUTP ON" *Switch on OUTPUT*

4

:OUTPut:POLarity

Form	Set & Query
Parameter	POSitive NEGative
Parameter Suffix	Not Applicable
*RST value	NEGative
Specified Limits	Not Applicable
Description	Use this command to program the polarity of the OUTPUT.

Example

```
OUTPUT 714;":OUTP:POS"  Set OUTPUT to positive pulses
OUTPUT 714;":OUTP:NEG"  Set OUTPUT to negative pulses
```

4

[:SOURce] :CURRent [:LEVel] [:IMMediate] [:AMPLitude]

Form Set & Query

Parameter Numeric

Parameter suffix A with engineering prefixes.

***RST value** 100 mA (50 Ω into 50 Ω)

Specified Limits 20 mA to 2 A

Value coupling *Amplitude = High - Low*

Baseline = low (Positive pulses)
Baseline = high (Negative pulses)

Range coupling Baseline

Description This command programs the amplitude current of the OUTPUT signal. Note that to set the OUTPUT levels in terms of current, you first have to execute the [:SOURce] :HOLD CURRent command to enable the [:SOURce] :CURRent subsystem.

Note



This command can be used with Option 001 installed, only. When Option 001 is not installed, convert the required current with the help of the Ohm's law into voltage and program the voltage.

The available current range is limited by the combination of:

[:SOURce]:CURRent[:LEVel][:IMMediate][:AMPLitude]

- Specified Voltage/Duty-cycle limits
- Actual OUTPUT Impedance setting :OUTPut:IMPedance
- Actual Expected Load impedance setting
:OUTPut:IMPedance:EXTernal

Example

```
OUTPUT 714;":HOLD CURR"  Enable CURRENT  
                        subsystem  
OUTPUT 714;":CURR 750MA" Set OUTPUT amplitude to 750 mA
```

[[:SOURce]:CURRent[:LEVel][:IMMediate]:BASeline

Form Set & Query

Parameter Numeric

Parameter suffix A with engineering prefixes.

***RST value** 0.0 μ A (50 Ω into 50 Ω)
Baseline = low (Positive pulses)
Baseline = high (Negative pulses)

Value coupling *Amplitude = High - Low*

Baseline = low (Positive pulses)
Baseline = high (Negative pulses)

Range coupling Amplitude

Description This command programs the baseline current of the OUTPUT signal. A variable baseline is available only if Option 001 is installed. Note that to set the OUTPUT levels in terms of current, you first have to execute the [[:SOURce]:HOLD CURRent command to enable the [[:SOURce]:CURRent subsystem.

Note



This command can be used with Option 001 installed, only.
When Option 001 is not installed, convert the required current with the help of the Ohm's law into voltage and program the voltage.

The available current range is limited by the combination of:

- Specified Voltage/Duty-cycle limits

[[:SOURce]:CURRent[:LEVel][[:IMMEdiate]:BASeline

- Actual OUTPUT Impedance setting :OUTPut:IMPedance
- Actual Expected Load impedance setting :OUTPut:IMPedance:EXTernal

Example

```
OUTPUT 714;":HOLD CURR"      Enable CURRENT  
                               subsystem  
OUTPUT 714;":CURR:BAS 200mA" Set OUTPUT baseline  
                               to 200 mA
```

[[:SOURce]:CURRent[:LEVel][:IMMediate]:HIGH

Form Set & Query

Parameter Numeric

Parameter suffix A with engineering prefixes.

Value coupling *Amplitude = High – Low*

Baseline = low (Positive pulses)
Baseline = high (Negative pulses)

Range coupling Low-level

***RST value** 0 mA (50 Ω into 50 Ω)

Specified Limits -2 A to 2 A typical

Description This command programs the High-level current of the OUTPUT signal. Note that to set the OUTPUT levels in terms of current, you first have to execute the [[:SOURce]:HOLD CURRent command to enable the [[:SOURce]:CURRent subsystem.

Note  This command can be used with Option 001 installed, only. When Option 001 is not installed, convert the required current with the help of the Ohm's law into voltage and program the voltage.

The available current range is limited by the combination of:

- Specified Voltage/Duty-cycle limits

[[:SOURce]:CURRent[:LEVel]][:IMMediate]:HIGH

- Actual OUTPUT Impedance setting :OUTPut:IMPedance
- Actual Expected Load impedance setting
:OUTPut:IMPedance:EXTErnal

Example

```
OUTPUT 714;":HOLD CURR"      Enable CURRENT  
                               subsystem  
OUTPUT 714;":CURR:HIGH 1 A"  Set OUTPUT High-  
                               level current to 1 A
```

4

[[:SOURce]:CURRent[:LEVel]][:IMMediate]:LOW

Form Set & Query

Parameter Numeric

Parameter suffix A with engineering prefixes.

Value coupling *Amplitude = High – Low*

Baseline = low (Positive pulses)

Baseline = high (Negative pulses)

Range coupling High-level

***RST value** -100 mA (50 Ω into 50 Ω)

Specified Limits -2 A to 2 A typical

Description This command programs the Low-level current of the OUTPUT signal. Note that to set the OUTPUT levels in terms of current, you first have to execute the [[:SOURce]:HOLD CURRent] command to enable the [[:SOURce]:CURRent] subsystem.

Note  This command can be used with Option 001 installed, only. When Option 001 is not installed, convert the required current with the help of the Ohm's law into voltage and program the voltage.

The available current range is limited by the combination of:

- Specified Voltage/Duty-cycle limits

[:SOURce]:CURRent[:LEVel][:IMMediate]:LOW

- Actual OUTPUT Impedance setting :OUTPut:IMPedance
- Actual Expected Load impedance setting :OUTPut:IMPedance:EXTErnal

Example

OUTPUT 714;":HOLD CURR"	<i>Enable CURRENT subsystem</i>
OUTPUT 714;":CURR:LOW 500MA"	<i>Set OUTPUT Low-level to 500 mA</i>

[[:SOURce]:CURRent:LIMit[:HIGH]

Form Set & Query

***RST value** +2 A

Description Use this command to set/read the High-level current limit. If you switch on current limiting, the High-level current cannot be set above the programmed limit. Note that the current is *NOT* limited by the OUTPUT hardware, this is a software limit.

Note  This command can be used with Option 001 installed, only. When Option 001 is not installed, convert the required current with the help of the Ohm's law into voltage and program the voltage.

Example

OUTPUT 714;":HOLD CURR"	<i>Enable CURRENT subsystem</i>
OUTPUT 714;":CURR:LIM 500MA"	<i>Set OUTPUT High-level current limit to 500 mA</i>
OUTPUT 714;":CURR:LIM:STAT ON"	<i>Switch on OUTPUT limits</i>

[:SOURce]:CURRent:LIMit:LOW**Form** Set & Query***RST value** -2 A

Description Use this command to set/read the Low-level current limit. If you switch on current limiting, the Low-level current cannot be set below the programmed limit. Note that the current is *NOT* limited by the OUTPUT hardware, this is a software limit.

Note

This command can be used with Option 001 installed, only. When Option 001 is not installed, convert the required current with the help of the Ohm's law into voltage and program the voltage.

Example

OUTPUT 714;":HOLD CURR"	<i>Enable CURRENT subsystem</i>
OUTPUT 714;":CURR:LIM:LOW -500MA"	<i>Set OUTPUT Low-level current limit to -500 mA</i>
OUTPUT 714;":CURR:LIM:STAT ON"	<i>Switch on OUTPUT limits</i>

[:SOURce]:CURRent:LIMit:STATe

Form Set & Query

Parameter ON|OFF|1|0

***RST value** OFF

Description This command switches the output limits on or off. When you switch on the output limits you cannot program the output-levels beyond the programmed limits, until you switch off the output-limits. The limits apply whether you program High/Low levels or Amplitude/Baseline levels.

Note  This command can be used with Option 001 installed, only. When Option 001 is not installed, convert the required current with the help of the Ohm's law into voltage and program the voltage.

You can switch the limits on and off in both the [:SOURce]:CURRent and the [:SOURce]:VOLTage subsystems *but the current and voltage limits are not enabled/disabled independently*. The voltage and current limits are always enabled/disabled together.

Example

OUTPUT 714;":HOLD CURR"	<i>Enable CURRENT subsystem</i>
OUTPUT 714;":CURR:LIM 500MA"	<i>Set OUTPUT High-level current limit to 50 mA</i>
OUTPUT 714;":CURR:LIM:LOW -500MA"	<i>Set OUTPUT Low-level current limit to -50 mA</i>

[:SOURce]:CURRent:LIMit:STATe

OUTPUT 714; ":CURR:LIM:STAT ON"

*Switch on OUTPUT
limits*

[[:SOURce]:FREQuency[:CW|:FIXed]

Form Set & Query

Parameter Numeric

Parameter Suffix Hz with engineering prefixes, or MHZ for Megahertz.

Value coupling $Period = \frac{1}{Frequency}$

***RST value** 1.00 MHz

Specified limits See [[:SOURce]:PULSe:PERiod

Description Use this command to set/read the pulse frequency. Select the frequency source for the pulse frequency using :TRIGger:SOURce. The currently selected source is programmed by this command. Note that the specified limits and available resolution depend on the selected source.

In Trig'd by: EXT-IN mode the frequency parameter sets the maximum triggering frequency accepted at the External Input.

Example

OUTPUT 714;":FREQ 10MHz" *Set pulse frequency to 10 MHz*

[:SOURce]:HOLD

Form	Set & Query
Parameter	VOLTage CURRent
*RST value	VOLT
Description	Use this command to enable either the [:SOURce]:VOLTage or [:SOURce]:CURRent subsystems. You can control the signal levels of the HP 8114A OUTPUT in terms of voltage or current.
Note	 This command can be used with Option 001 installed, only. When Option 001 is not installed, convert the required current with the help of the Ohm's law into voltage and program the voltage.

4

[[:SOURce]:PHASe[:ADJust]

Form Set & Query

Parameter Numeric

Parameter suffix DEG or RAD. A parameter without a suffix is interpreted as RAD.

Functional coupling Programming the pulse phase also executes [[:SOURce]:PULSe:HOLD PHASe so that the pulse phase is held constant when the signal frequency is changed.

Value coupling $Delay = \frac{Phase}{360} \times Period$

***RST value** 0.0

Specified limits 0 to 360°, constrained by delay and period limits.

Description Use this command to set/read the relative phase-delay of the output signal. This is equivalent to setting an absolute or percentage pulse-delay with [[:SOURce]:PULSe:DELay.

If you want the phase delay to remain constant when the pulse-period is varied (rather than the absolute pulse delay) use [[:SOURce]:PULSe:DELay:HOLD PRATio.

Example

OUTPUT 714;":PHAS 180DEG"

Set OUTPUT phase to 180°

OUTPUT 714;":PULS:DEL:HOLD PRAT"

Hold OUTPUT phase constant with varying period

[:SOURce]:PULSe:DCYClE

Form	Set & Query
Parameter	Numeric
Value coupling	$Width = \frac{Duty - cycle}{100} \times Period$
Range coupling	Maximum available Amplitude/Baseline is dependent on duty-cycle - see Figure 6-1
*RST value	5.0% (derived from Width and Period)
Specified limits	0.1 – 99.9%, constrained by Width & Period limits and Amplitude/Baseline setting.
Description	Use this command to program the duty-cycle of the pulse signal. If you want to set an absolute pulse width use [:SOURce]:PULSe:WIDTh. If you want the pulse duty-cycle to remain constant when the pulse-period is varied (rather than the absolute pulse width) use [:SOURce]:PULSe:HOLD DCYClE

Example

```

OUTPUT 714;":PULS:DCYC 25PCT"  Set OUTPUT duty-
                                cycle to 25%
OUTPUT 714;":PULS:HOLD DCYC"   Hold duty-cycle con-
                                stant with
                                varying period

```

[:SOURce]:PULSe:DELay

Form Set & Query

Parameter Numeric

Parameter suffix S with engineering prefixes. You can change the default unit using [:SOURce]:PULSe:DELay:UNIT.

Value coupling

$$Phase = \frac{Delay}{Period} \times 360$$
$$Delay\% = \frac{Delay}{Period} \times 100$$

***RST value** 0.0

Specified limits 0.00 ns to 999 ms (limited by period–4 ns)

Description Use this command to set/read the pulse-delay. Delay is the time between the start of the pulse-period and the start of the leading-edge of the pulse.

If you want the pulse-delay to remain constant when the pulse-period is varied (rather than the phase-delay) use [:SOURce]:PULSe:DELay:HOLD TIME.

Example

```
OUTPUT 714;":PULS:DEL 500NS"      Set OUTPUT delay  
                                   to 500 ns  
OUTPUT 714;":PULS:DEL:HOLD TIM"   Hold OUTPUT de-  
                                   lay constant with  
                                   varying period
```

[:SOURce]:PULSe:DELay:HOLD

Form	Set & Query				
Parameter	TIME PeriodRATio				
*RST value	TIM				
Description	Use this command to set/read the coupling between the pulse-period and the pulse-delay:				
	<table> <tr> <td>TIME</td> <td>The absolute pulse-delay is held fixed when the pulse-period is varied (Pulse phase varies).</td> </tr> <tr> <td>PeriodRATio</td> <td>The pulse phase-delay (delay as ratio of period) is held fixed when the pulse-period is varied (Pulse-delay varies).</td> </tr> </table>	TIME	The absolute pulse-delay is held fixed when the pulse-period is varied (Pulse phase varies).	PeriodRATio	The pulse phase-delay (delay as ratio of period) is held fixed when the pulse-period is varied (Pulse-delay varies).
TIME	The absolute pulse-delay is held fixed when the pulse-period is varied (Pulse phase varies).				
PeriodRATio	The pulse phase-delay (delay as ratio of period) is held fixed when the pulse-period is varied (Pulse-delay varies).				

4

Example

OUTPUT 714;":PULS:DEL 500NS"	<i>Set OUTPUT delay to 500 ns</i>
OUTPUT 714;":PULS:DEL:HOLD TIM"	<i>Hold OUTPUT delay constant with varying period</i>

[:SOURce]:PULSe:DELay:UNIT

Form Set & Query

Parameter S|SEC|PCT|DEG|RAD

***RST value** S

Description Use this command to set/read the default units for the pulse-delay parameter. The default unit of a parameter is the unit used when the parameter is programmed to a value without a unit suffix.

Example

```
OUTPUT 714;":PULS:DEL:UNIT PCT" Set OUTPUT delay  
unit to %  
OUTPUT 714;":PULS:DEL 50" Set OUTPUT delay  
to 50% of period
```

[:SOURce]:PULSe:DOUble[:STATe]

Form	Set & Query
Parameter	OFF ON
*RST value	OFF
Description	Use this command to switch double-pulse mode on or off. In double-pulse mode two pulses are generated per pulse-period and the delay between the leading edges of the first and second pulse can be adjusted.

4

[:SOURce] :PULSe :DOUBle :DELay

Form Set & Query

Parameter Numeric

Parameter suffix S with engineering prefixes. You can change the default unit using [:SOURce] :PULSe :DOUBle :DELay :UNIT.

Value coupling
$$DblDel\% = \frac{DblDel}{Period} \times 100$$

***RST value** 0.0

Specified limits 20.0 ns to 999 ms (limited by period–4 ns)

Description Use this command to set/read the delay between the leading edges of the two pulses in double-pulse mode. The first pulse always starts at the start of the pulse-period.

If you want the double-delay to remain constant when the pulse-period is varied (rather than the double-delay as percentage of period) use [:SOURce] :PULSe :DOUBle :DELay :HOLD TIME.

Example

OUTPUT 714; ":PULS:DOUB ON"	<i>Switch on Double-pulses on OUTPUT</i>
OUTPUT 714; ":PULS:DOUB:DEL 500NS"	<i>Set inter-pulse delay to 500 ns</i>
OUTPUT 714; ":PULS:DOUB:DEL:HOLD TIM"	<i>Hold inter-pulse delay fixed with varying pulse-period</i>

[:SOURce]:PULSe:DOUBle:DELAy:HOLD

Form	Set & Query				
Parameter	TIME PeriodRATio				
*RST value	TIM				
Description	Use this command to set/read the coupling between the pulse-period and the Double-pulse delay:				
	<table> <tr> <td>TIME</td> <td>The absolute double-pulse delay is held fixed when the pulse-period is varied.</td> </tr> <tr> <td>PeriodRATio</td> <td>The double-pulse delay as percentage of period is held fixed when the pulse-period is varied.</td> </tr> </table>	TIME	The absolute double-pulse delay is held fixed when the pulse-period is varied.	PeriodRATio	The double-pulse delay as percentage of period is held fixed when the pulse-period is varied.
TIME	The absolute double-pulse delay is held fixed when the pulse-period is varied.				
PeriodRATio	The double-pulse delay as percentage of period is held fixed when the pulse-period is varied.				

4

Example

OUTPUT 714;":PULS:DOUB ON"	<i>Switch on Double-pulses on OUTPUT</i>
OUTPUT 714;":PULS:DOUB:DEL 50PCT"	<i>Set inter-pulse delay to 50% of pulse-period</i>
OUTPUT 714;":PULS:DOUB:DEL:HOLD PRAT"	<i>Hold inter-pulse delay as fixed percentage of pulse-period</i>

[[:SOURce]:PULSe:DOUBle:DELay:UNIT

Form Set & Query

Parameter S|SEC|PCT

***RST value** S

Description Use this command to set/read the default units for the double-delay parameter. The default unit of a parameter is the unit used when the parameter is programmed to a value without a unit suffix.

Example

OUTPUT 714;":PULS:DOUB:DEL:UNIT PCT" *Set OUTPUT double-delay unit to %*
OUTPUT 714;":PULS:DOUB:DEL 50" *Set OUTPUT inter-pulse delay to 50% of period*

[:SOURce]:PULSe:HOLD

Form	Set & Query
Parameter	WIDTh DCYClE TrailingDELAY
*RST value	WIDTh
Description	Use this command to set whether the pulse width, the pulse-duty-cycle or the pulse trailing-edge delay is held constant when the pulse-period is changed.

4

Example

OUTPUT 714;":PULS:DEL:HOLD TIM"	<i>Hold OUTPUT delay fixed when frequency varies</i>
OUTPUT 714;":PULS:DEL 20NS"	<i>Set OUTPUT delay to 20 ns</i>
OUTPUT 714;":PULS:HOLD DCYC"	<i>Hold OUTPUT Duty-cycle fixed when frequency varies</i>
OUTPUT 714;":PULS:DCYC 25PCT"	<i>Set OUTPUT Duty-cycle to 25%</i>

[[:SOURce]:PULSe:LIMit[:WIDth]

Form Set & Query

Parameter OFF|ON

***RST value** OFF

Description Use this command to set to set the Width limit. This command is used with DCYCLe. If you attempt to set a value larger than the set limit, the limit will be enforced by the instrument.

Example

OUTPUT 714;":PULS:LIM 500NS" *Set the pulse width to 500 ns*

[:SOURce]:PULSe:LIMit:DCYClE

Form Set & Query

Parameter numeric

***RST value** 100%

Description Use this command to set to set the Duty-cycle limit. This command is used with WIDTH. If you attempt to set a value larger than the set limit, the limit will be enforced by the instrument.

4

Example

OUTPUT 714;":PULS:LIM:DCYC 20PCT" *Set the duty-cycle limit to 20%*

[[:SOURce]:PULSe:LIMit:STATe

Form Set & Query

Parameter OFF|ON

***RST value** OFF

Description Use this command to set the WIDTH and DCYCLE limits on or off.

Example

OUTPUT 714;":PULS:LIM:STAT ON"

Set the width/duty-cycle limits ON

OUTPUT 714;":PULS:LIM:STAT OFF"

Set the width/duty-cycle limits OFF

[:SOURce]:PULSe:PERiod

Form	Set & Query
Parameter	Numeric
Parameter Suffix	S with engineering prefixes.
Value coupling	$Frequency = \frac{1}{Period}$
*RST value	1 μ s
Specified limits	66.7 ns to 999 ms Single Pulses 133.4 ns to 999 ms Double Pulses
Description	Use this command to set/read the pulse-period. In Trig'd by: EXT-IN mode the period parameter sets the maximum period accepted at the External Input.
Example	

OUTPUT 714;":PULS:PER 100NS" *Set pulse frequency to 100 ns*

[:SOURce]:PULSe:TrailingDELay

Form Set & Query

Parameter Numeric

Parameter Suffix S with engineering prefixes.

***RST value** 50 ns

Description Use this command to program the delay of the trailing-edge of the pulse relative to the start of the pulse-period. This is an alternative method of programming the pulse width.

Example

<code>OUTPUT 714;":PULS:DEL 500NS"</code>	<i>Set OUTPUT delay to 500 ns</i>
<code>OUTPUT 714;":PULS:DEL:HOLD TIM"</code>	<i>Hold OUTPUT delay constant with varying period</i>
<code>OUTPUT 714;":PULS:TDEL 750NS"</code>	<i>Set OUTPUT trailing delay to 750 ns</i>

[:SOURce]:PULSe:WIDTh

Form	Set & Query
Parameter	Numeric
Parameter suffix	S with engineering prefixes
*RST value	50 ns
Specified limits	10 ns to 150 ms (Maximum = Period – 3.3 ns)
Description	<p>Use this command to program the width of the pulse signal. If you want to set width as duty-cycle use [:SOURce]:PULSe:DCYClE.</p> <p>If you want the pulse width to remain constant when the pulse-period is varied (rather than the duty-cycle) use [:SOURce]:PULSe:HOLD WIDTh</p>

Example

OUTPUT 714;":PULS:WIDT 100NS"	<i>Set OUTPUT pulse width to 100 ns</i>
OUTPUT 714;":PULS:HOLD WIDT"	<i>Hold pulse width constant with varying period</i>

[[:SOURce]:VOLTage[:LEVel][:IMMediate]][:AMPLitude]

Form Set & Query

Parameter Numeric

Parameter suffix V with engineering prefixes.

Value coupling

Baseline = low (Positive pulses)
Baseline = high (Negative pulses)

Range coupling Baseline

***RST value** 5.00 V

Specified limits 1.00 V to 50.0 V (50 Ω into 50 Ω)
2.00 V to 100 V (HIZ (High-Z) into 50 Ω)

Description

This command programs the amplitude voltage of the OUTPUT signal. Note that to set the OUTPUT levels in terms of voltage, you first have to execute the [[:SOURce]:HOLD VOLTage] command to enable the [[:SOURce]:VOLTage] subsystem.

The available voltage range is limited by the combination of:

- Specified Voltage/Duty-cycle limits
- Actual OUTPUT Impedance setting :OUTPut:IMPedance
- Actual Expected Load impedance setting :OUTPut:IMPedance:EXTernal
- Baseline setting (Option 001 only)

Example

```
OUTPUT 714;":HOLD VOLT"  Enable VOLTAGE subsystem
OUTPUT 714;":VOLT 5V"    Set OUTPUT amplitude to 2.5 V
```

[:SOURce]:VOLTage[:LEVel][:IMMediate]:BASeline

Form	Set & Query
Parameter	Numeric
Parameter suffix	V with engineering prefixes.
Value coupling	Baseline = low (Positive pulses) Baseline = high (Negative pulses)
Range coupling	Amplitude
*RST value	0.0 mV
Description	<p>This command programs the baseline voltage of the OUTPUT signal. Variable baseline is available only if Option 001 is installed. Note that to set the OUTPUT levels in terms of voltage, you first have to execute the [:SOURce]:HOLD VOLTage command to enable the [:SOURce]:VOLTage subsystem.</p> <p>The available voltage range is limited by the combination of:</p> <ul style="list-style-type: none"> ■ Specified current limits ■ Actual OUTPUT Impedance setting :OUTPut:IMPedance ■ Actual Expected Load impedance setting :OUTPut:IMPedance:EXTernal ■ Actual Amplitude setting
Example	<pre>OUTPUT 714;":HOLD VOLT" <i>Enable VOLTAGE subsystem</i> OUTPUT 714;":VOLT:BAS -10V" <i>Set OUTPUT base- line to -10 V</i></pre>

[[:SOURce]:VOLTage[:LEVel][:IMMediate]:HIGH

Form	Set & Query
Parameter	Numeric
Parameter suffix	V with engineering prefixes.
Value coupling	<i>Amplitude = High - Low</i> Baseline = low (Positive pulses) Baseline = high (Negative pulses)
Range coupling	Low-level
*RST value	0 V
Specified limits	-49 V to 50 V (50 Ω into 50 Ω)
Description	<p>This command programs the High-level voltage of the OUTPUT signal. Note that to set the OUTPUT levels in terms of voltage, you first have to execute the [[:SOURce]:HOLD VOLTage command to enable the [[:SOURce]:VOLTage subsystem.</p> <p>The available voltage range is limited by the combination of:</p> <ul style="list-style-type: none">■ Specified current limits■ Actual OUTPUT Impedance setting :OUTPut:IMPedance■ Actual Expected Load impedance setting :OUTPut:IMPedance:EXTernal

[[:SOURce]:VOLTage[:LEVel]][:IMMEdiate]:HIGH

Example

```
OUTPUT 714;":HOLD VOLT"      Enable VOLTAGE subsystem  
OUTPUT 714;":VOLT:HIGH 4.8V" Set OUTPUT High-level to 4.8 V
```

4



[[:SOURce]:VOLTage[:LEVel][:IMMediate]:LOW

Form Set & Query

Parameter Numeric

Parameter suffix V with engineering prefixes.

Value coupling *Amplitude = High – Low*

Baseline = low (Positive pulses)
Baseline = high (Negative pulses)

Range coupling High-level

***RST value** -5 V

Specified limits -50 V to 49 V (50 Ω into 50 Ω)

Description This command programs the Low-level voltage of the OUTPUT signal. Note that to set the OUTPUT levels in terms of voltage, you first have to execute the [[:SOURce]:HOLD VOLTage command to enable the [[:SOURce]:VOLTage subsystem.

The available voltage range is limited by the combination of:

- Specified Voltage/Duty-cycle limits
- Actual OUTPUT Impedance setting :OUTPut:IMPedance
- Actual Expected Load impedance setting :OUTPut:IMPedance:EXTernal

[[:SOURce]:VOLTage[:LEVel]][:IMMediate]:LOW

Example

```
OUTPUT 714;":HOLD VOLT"  Enable VOLTAGE  
                        subsystem  
OUTPUT 714;":VOLT:LOW 5V" Set OUTPUT Low-  
                        level to 5 V
```



[:SOURce]:VOLTage:LIMit[:HIGH]

Form Set & Query

***RST value** 100 V

Description Use this command to set/read the High-level voltage limit. If you switch on voltage limiting, the High-level voltage cannot be set above the programmed limit. Note that the voltage is *NOT* limited by the OUTPUT hardware, this is a software limit.

Example

OUTPUT 714;":HOLD VOLT"	<i>Enable VOLTAGE subsystem</i>
OUTPUT 714;":VOLT:LIM 3V"	<i>Set OUTPUT High-level voltage limit to 3 V</i>
OUTPUT 714;":VOLT:LIM:STAT ON"	<i>Switch on OUTPUT limits</i>

[:SOURce]:VOLTage:LIMit:LOW

Form Set & Query

***RST value** -100 V

Description Use this command to set/read the Low-level voltage limit. If you switch on voltage limiting, the Low-level voltage cannot be set below the programmed limit. Note that the voltage is *NOT* limited by the OUTPUT hardware, this is a software limit.

Example

OUTPUT 714;":HOLD VOLT"	<i>Enable VOLTAGE subsystem</i>
OUTPUT 714;":VOLT:LIM:LOW 0V"	<i>Set OUTPUT Low-level voltage limit to 0 V</i>
OUTPUT 714;":VOLT:LIM:STAT ON"	<i>Switch on OUTPUT limits</i>

4

[:SOURce]:VOLTage:LIMit:STATe

Form Set & Query

Parameter ON|OFF|1|0

***RST value** OFF

Description This command switches the output limits on or off. When you switch on the output limits cannot program the output-levels beyond the programmed limits, until you switch off the voltage-limits. The limits apply whether you program High/Low levels or Amplitude/Offset levels.

Note  You can switch the limits on and off in both the [:SOURce]:CURRent and the [:SOURce]:VOLTage subsystems *but the current and voltage limits are not enabled/disabled independently*. The voltage and current limits are always enabled/disabled together.

Example

OUTPUT 714;":HOLD VOLT"	<i>Enable VOLTAGE subsystem</i>
OUTPUT 714;":VOLT:LIM 3V"	<i>Set OUTPUT High-level voltage limit to 3 V</i>
OUTPUT 714;":VOLT:LIM:LOW 0V"	<i>Set OUTPUT Low-level voltage limit to 0 V</i>
OUTPUT 714;":VOLT:LIM:STAT ON"	<i>Switch on OUTPUT limits</i>

:STATus:OPERation

This command tree accesses the OPERation status group. The OPERation status group uses only bit 8. When this bit is set the HP 8114A output is inhibited.

The following commands are used to access the registers within the status group:

:STATus:OPERation[:EVENT]?

Form	Query
*RST value	Not Applicable
Description	This command reads the event register in the OPERation status group.

4

:STATus:OPERation:CONDition?

Form	Query
*RST value	Not Applicable
Description	This command reads the condition register in the OPERation status group.

:STATus:OPERation:ENABLE

Form	Set & Query
Parameter	Numeric
*RST value	Not affected by *RST
Specified limits	0 - 32767
Description	This command sets or queries the enable register in the OPERation status group.

:STATus:OPERation

:STATus:OPERation:NTRansition

Form	Set & Query
Parameter	Numeric
*RST value	Not Applicable
Specified limits	0-32767
Description	This command sets or queries the negative-transition register in the OPERation status group.

4

:STATus:OPERation:PTRansition

Form	Set & Query
Parameter	Numeric
*RST value	Not Applicable
Specified limits	0-32767
Description	This command sets or queries the positive-transition register in the OPERation status group.

:STATus:OPERation:INHibit

Form	Set & Query
Parameter	Numeric
*RST value	Not Applicable
Specified limits	0-32767
Description	This command sets or queries the positive-transition register in the OPERation status group.

:STATus:PRESet

Form Event

***RST value** Not Applicable

Description This command

- Clears all status group event-registers
- Clears the error queue
- Presets the status group enable-, PTR-, and NTR-registers as follows:

Status Group	Register	Preset value
OPERation	ENABle	0000000000000000
	PTR	0111111111111111
	NTR	0000000000000000
QUESTionable	ENABle	0000000000000000
	PTR	0111111111111111
	NTR	0000000000000000

:STATus:QUEStionable

This command tree accesses the QUEStionable status group. The QUEStionable status group contains warning bits for voltage, current, time and frequency parameters. A warning occurs when the output signal *could* be out of specification due to the combined specification uncertainties of many parameters, although all parameters are set within their individually specified limits. If a parameter is set outside its specified limits an error is generated.

The following commands are used to access the registers within the status group:

:STATus:QUEStionable[:EVENT]?

Form	Query
*RST value	Not Applicable
Description	This command reads the event register in the QUEStionable status group.

:STATus:QUEStionable:CONDition?

Form	Query
*RST value	Not Applicable
Description	This command reads the condition register in the QUEStionable status group.

:STATus:QUEStionable:ENABle

Form	Set & Query
Parameter	Numeric
*RST value	Not affected by *RST
Specified limits	0 – 32767

Description This command sets or queries the enable register in the QUEStionable status group.

:STATus:QUEStionable:NTRansition

Form Set & Query
Parameter Numeric
***RST value** Not Applicable
Specified limits 0-32767

Description This command sets or queries the negative-transition register in the QUEStionable status group.

4



:STATus:QUEStionable:PTRansition

Form Set & Query
Parameter Numeric
***RST value** Not Applicable
Specified limits 0-32767

Description This command sets or queries the positive-transition register in the QUEStionable status group.

:SYSTem:ERRor?

Form Query

***RST value** Not Applicable

Description Use this command to read the HP 8114A error queue. The HP 8114A error queue can store up to 30 error codes on a first-in-first-out basis. When you read the error queue, the error number and associated message are put into the instrument's output buffer.

If the queue is empty, the value 0 is returned, meaning No Error. If the queue overflows at any time, the last error code is discarded and replaced with -350 meaning Queue overflow.

4

:SYSTem:KEY

Form	Set & Query
Parameter	Numeric
Parameter suffix	No suffix allowed
*RST value	-1
Specified limits	See Table 4-9
Description	This command simulates pressing a key on the frontpanel. Simulated key-press are also recorded as the last key pressed.

Note



1. :SYST:KEY 19 sets the instrument to LOCAL mode.
2. In remote mode *only* the softkeys under the display and the **SHIFT** (LOCAL) key are active. Since the instrument normally switches to remote mode when any command is received, including :SYSTem:KEY, simulating one of the other disabled keys has no effect.
3. If you want to simulate full frontpanel operation, you must prevent the instrument from entering remote mode by using the REN line of the HP-IB to maintain local mode (LOCAL 7 in BASIC).

If you do this, the :SYSTem:KEY command is the only command which works. Any other commands will be buffered in the HP 8114A, blocking any further :SYSTem:KEY commands, until remote mode is enabled.

Table 4-9. :SYSTEM:KEY parameter reference

No.	Key Description	No.	Key Description
-1	No key pressed (Query only)	15	CURSOR (⇒)
0	DATA ENTRY (0)	16	(MAN)
1	DATA ENTRY (1)	17	(STORE)
2	DATA ENTRY (2)	18	(HELP)
3	DATA ENTRY (3)	19	(SHIFT)
4	DATA ENTRY (4)	20	(MORE)
5	DATA ENTRY (5)	21	Softkey 1 (LEFT)
6	DATA ENTRY (6)	22	Softkey 2
7	DATA ENTRY (7)	23	Softkey 3
8	DATA ENTRY (8)	24	Softkey 4 (RIGHT)
9	DATA ENTRY (9)	25	DATA ENTRY (nano)
10	DATA ENTRY (.)	26	DATA ENTRY (micro\Mega)
11	DATA ENTRY (±)	27	DATA ENTRY (milli\kilo)
12	CURSOR (↑)	28	DATA ENTRY (ENTER)
13	CURSOR (↓)	29	MODIFY Knob left (anticlockwise)
14	CURSOR (←)	30	MODIFY Knob right (clockwise)

4

:SYSTem:KEY?

Form	Query
Parameter	ON OFF
*RST value	-1
Description	This command reads the last key pressed. The buffer is emptied by *RST and returns the value -1 when empty.

4

:SYSTem:PRESet

Form Set & Query

Parameter ON|OFF

***RST value** OFF

Description This command performs the same functions as *RST except that :DISP[:WIND][:STATE] is not influenced. This increases programming speed.

4

:SYSTem:SECurity[:STATe]

Form Set & Query

Parameter ON|OFF

***RST value** OFF

Description

Caution 

Do not switch on system security unless you are willing to erase the instrument settings stored in the instrument. All instrument memories, including the current setting, will be overwritten with the default settings if you

- Switch off system security
- Switch the instrument off and on again

If you accidentally switch on system security, and want to rescue the settings stored in the instrument, store the settings on a memory card. You can then recall them from the memory card later.

Use this command to switch on system security mode. Switch on system security if you need to make sure that all instrument settings stored in the instrument are erased automatically when the instrument is switched off, or when security mode is switched off..

The instrument settings are erased by overwriting them with the default settings.

System security mode is not available via the frontpanel. If you want to erase all settings by hand:

1. **SHIFT** **STORE** **0** to RECALL the default settings from memory 0.
2. **STORE** **1**, **STORE** **2**, ... , **STORE** **9** to store the defaults in memories 1 to 9.

:SYSTEM:SET

Form Set & Query

Parameter Block data

***RST value** Not applicable

Description In query form, the command reads a block of data containing the instrument's complete set-up. The set-up information includes all parameter and mode settings, but does not include the contents of the instrument setting memories, the status group registers or the :DISPlay[:WINDow][:STATe] The data is in a binary format, not ASCII, and cannot be edited.

In set form, the block data must be a complete instrument set-up read using the query form of the command.

4

:SYSTem:VERSion?

Form	Query
*RST value	"1992.0"
Description	This command reads the SCPI revision to which the instrument complies.

:SYSTem:WARNing[:COUNT]?

Form Query

***RST value** Not applicable

Description Use this command to read the number of warnings which are currently active. Note that the warning status of voltage, current, time and frequency are also summarised by bits in the QUESTionable Status register.

4

:SYSTem:WARNIng:STRing?

Form	Query
*RST value	Not applicable
Description	Use this command to read all the currently active warning messages. The warning messages are concatenated to form a single string with a ; as separator between the messages.

4

:SYSTem:WARNing:BUFFer?

Form Query

***RST value** Not applicable

Description Use this command to read the maximum possible number of characters which could be returned by :SYST:WARN:STR? if all warnings were active.

4

:TRIGger:COUNT

Form	Set & Query
Parameter	Numeric
*RST value	2
Specified limits	2 to 65536
Description	Use this command to set/read the number of trigger events (pulse-periods) to be generated for each triggering event. This corresponds to selecting the event mode on the TRIGGER screen: PULSES Set a trigger count of 1 so that a single pulse-period is generated for each triggering event. BURST of Set a trigger count of 2 to 65536 so that a burst of 2 to 65536 pulse-periods is generated for each triggering event.

4

:TRIGger:COUNT

Examples

To set TRIGGERED BURST of 16 Single-Pulses, each burst triggered by a positive edge at the EXT INPUT:

```
OUTPUT 714;":TRIG:SOUR EXT"      Set triggering from  
                                  EXT INPUT  
OUTPUT 714;":TRIG:SENS EDGE"    Set triggering on edges  
OUTPUT 714;":TRIG:SLOP POS"     Set triggering on positive edges  
OUTPUT 714;":TRIG:COUN 16"      Burst length 16  
OUTPUT 714;":PULS:DOUB OFF      Ensure single pulses at  
                                  OUTPUT
```

To set GATED PULSES Single-Pulses, gated by a positive level at the EXT INPUT:

```
OUTPUT 714;":TRIG:SOUR EXT"      Set triggering from  
                                  EXT INPUT  
OUTPUT 714;":TRIG:SENS LEV"     Set triggering on levels  
OUTPUT 714;":TRIG:SLOP POS"     Set triggering on positive level  
OUTPUT 714;":TRIG:COUN 1"       1 pulse-period  
OUTPUT 714;":PULS:DOUB OFF      Ensure single pulses at  
                                  OUTPUT
```

4

:TRIGger:EWIDth:[STATe]

Form	Set & Query
Parameter	ON OFF 1 0
*RST value	OFF
Description	<p>This command enables the EXT WIDTH trigger mode available on the TRIGGER screen using the frontpanel. When EXT WIDTH mode is switched on, the rest of the :TRIGger and :TRIG system is disabled.</p> <p>In EXT WIDTH mode a signal applied to the EXT INPUT determines the width and period of the output signal(s) from the HP 8114A. You can still control the edge transition-times and levels of the output signal(s).</p>

4

:TRIGger:INHibit[:STATe]

Form Set & Query

Parameter ON|OFF|1|0

***RST value** OFF

Description This command switches ON or OFF the Inh trigger mode available on the **OUTPUT** screen.

4

:TRIGger:INHibit[:STATe]:MODE

Form	Set & Query
Parameter	RISE FALL HIGH LOW
*RST value	RISE
Description	This command, available on the OUTPUT screen, selects whether the output is triggered (RISE/FALL) or gated (HIGH/LOW) by an inhibit signal.

4

:TRIGger:INHibit[:STATe]:INPut

Form Set & Query

Parameter RESet|SET

***RST value** RESet

Description This command, available on the **OUTPUT** screen, resets (enables) the output after being latched during triggering (RISE/FALL).

4

:TRIGger:LEVel

Form	Set & Query
Parameter	Numeric
Parameter Suffix	V with engineering prefixes.
*RST value	+1.0 V
Specified Limits	-10 V to +10 V
Description	Use this command to program the triggering threshold of the EXT INPUT connector.
Example	OUTPUT 714;":TRIGger:LEV 2.5V" <i>Set EXT INPUT threshold to 2.5 V</i>

:TRIGger:SENSe

Form	Set & Query
Parameter	EDGE LEVel
*RST value	EDGE
Description	<p>Use this command to select TRIGGERED or GATED mode by choosing whether the HP 8114A triggers on the edge(s) or level of the triggering signal.</p> <p>When sensing edges, the HP 8114A triggers when the triggering signal crosses the selected threshold level (:TRIGger:LEV) in the selected direction (:TRIGger:SLOP). This corresponds to the TRIGGERED mode selected on the TRIGGER screen when using the frontpanel.</p> <p>When sensing levels, the HP 8114A triggers as long as the triggering signal is above (:TRIGger:SLOP POS), or below (:TRIGger:SLOP NEG) the selected threshold level (:TRIGger:LEV). This corresponds to the GATED mode selected on the TRIGGER screen when using the frontpanel.</p>

4

:TRIGger:SLOPe

Form	Set & Query
Parameter	POSitive NEGative EITHer
*RST value	POS
Description	<p>Use this command to select the trigger slope for the triggering signal when triggering on edges. Use EITHER to trigger on both the positive and negative edges of the triggering signal. This allows you to trigger at twice the frequency of the triggering signal.</p> <p>If you are triggering on levels, use this command to select whether the HP 8114A triggers during the positive or negative cycle of the signal.</p>

4

:TRIGger:SOURce

Form Set & Query

Parameter IMMEDIATE|INTERNAL|EXTERNAL|MANUAL

***RST value** IMM

Description Use this command to select the triggering mode of the HP 8114A by selecting the source of the triggering signal:

Table 4-10.
Triggering sources and modes set by
:TRIGger:SOURce

Triggering source	:TRIGger:SOURce	Mode
Internal osc.	IMMEDIATE INTERNAL	CONTINUOUS
EXT INPUT	EXTERNAL	¹ TRIGGERED GATED by: EXT IN
MAN key	MANUAL	¹ TRIGGERED GATED by: MANKey

¹ Use :TRIG:SENSE EDGE|LEVEL to choose between TRIGGERED and GATED

Default Values, standard settings

Table 4-11. HP 8114A Default Values

Parameter	*RST, Default Values
:DISPlay [:WINDow] [:STATe]	ON
:MMEMemory :CATalog?	not applicable
:CDIRectory	not applicable
:COPY	not applicable
:DELete	not applicable
:INITialize	not applicable
:LOAD :STATe	not applicable
:STORe :STATe	not applicable
:OUTPut [:STATe]	OFF
:IMPedance [:INTernal]	50Ω
:EXTernal	50Ω
:POLarity	NEGative

4

Default Values

Table 4-11. HP 8114A Default Values (continued)

Parameter		*RST, Default Values
[:SOURce] :CURRent [:LEVel]	[:IMM] [:AMPL]	100mA (from 500 into 500)
	:BASeline	0mA (from 500 into 500)
	:HIGH	0mA from(50 0 into 500)
	:LOW	-100mA (from 500 into 500)
:LIMit	[:HIGH]	2 A
	:LOW	-2 A
	:STATe	OFF
:FREQ	[:CW]:FIXed]	1.00MHz
:HOLD		VOLT
:PHASe	[:ADJust]	0.0
:PULSe	:DCYCLE	5% (derived from Width and Period)
	:DELay	0.0
	:HOLD	TIME
	:UNIT	S
:DOUBle	[:STATe]	OFF
	:DELay	0.0
	:HOLD	TIME
	:UNIT	S
:HOLD		WIDTh

4

Table 4-11. HP 8114A Default Values (continued)

Parameter			*RST, Default Values	
[:SOURce] :PULSe	:LIMIT	[:WIDTH]	999 ns	
		:DCYCLE	100%	
		:STATe	OFF	
		:PERiod	1 μ s	
		:Trailing DELay	50ns	
		:WIDTh	50ns	
	:VOLtage	[:LEVel]	[IMMediate] [:AMPLitude]	5 V
			:BASeline	0 V
			:HIGH	0 V
			:LOW	-5 V
		LIMit[:HIGH]		100 V
		:LOW		-100 V
		:STATe		OFF
	:STATus	:OPERation	[:EVENT]	not applicable
		:CONDition?	not applicable	
		:ENABle	not affected	
		:NTRansition	not applicable	
		:PTRansition	not applicable	
:PRESet			not applicable	
:QUEStionable		[:EVENT]?	not applicable	
		:CONDition?	not applicable	
		:ENABle	not affected	
		:NTRansition	not applicable	
		:PTRansition	not applicable	

4

**Table 4-11.
HP 8114A Default Values (continued)**

Parameter	*RST, Default Values
:SYSTem :ERRor?	not applicable
:KEY	-1
:PRESet	not applicable
:SECurity [:STATe]	OFF
:SET	not applicable
:VERSion	"1992.0"
:WARning [:COUNT]?	not applicable
:STRing?	not applicable
:BUFFer?	not applicable
:TRIGger :COUNT	2
:TRIGger :EWIDth :STATe	OFF
:TRIGger :INHibit [:STATe]	OFF
:TRIGger :INHibit [:STATe] :MODE	OFF
:TRIGger :INHibit [:STATe] :INPut	OFF
:LEVel	1.0V
:SENSe	EDGE
:SLOPe	POSitive
:SOURce	IMMediate

4

Testing the HP 8114A

Introduction

Use the tests in this chapter if you want to check that the HP 8114A 15MHz 100V/2A Pulse Generator is working correctly. Before starting any testing allow all test equipment to warm up for at least 30 minutes.

Conventions Used

When referring to actions that you perform during the tests, the following conventions are used:

FUNCTION

This indicates that a labelled button must be pressed

TRIGGER

This shows that a soft-key must be pressed. A soft-key is an unlabelled button whose label is shown on the display, and which can vary according to the job that the button is doing

CONTINUOUS PULSES

This is an option shown on the display, and is selected by use of the vernier keys. It is shown in upper or lower case to match the case displayed.

Test Results Tables

Tables for entering the results of the tests are included at the end of this chapter. The tests are numbered and reference numbers for each Test Result (TR) are given in a small table at the end of each test. The reference number shows you where the actual results should be entered in the Test Results Tables.

The Test Results tables at the end of the chapter should be photocopied, and the Test Results entered on the copies. Then, if the tests need to be repeated, the tables can be copied again.

Recommended Test Equipment and Accessories

The following tables list the recommended test equipment you need to perform all the tests in this chapter. You can use alternative instruments if they meet the critical specifications given. The test set-ups and procedures assume you are using the recommended equipment.

Table 5-1. Recommended Test Equipment List

Test Equipment	Model	Critical Specifications
Oscilloscope	HP 54121T	20 GHz, 10 bit vertical resolution, Histogram capability
Counter	HP 5334A/B	Period and Time Interval measurements
Digital Voltmeter	HP 3458A	DCV up to 20 V
Pulse Generator	HP 8112A	50 MHz
Delay line	HP 54008A	22 ns

5

Caution



HP 8114A is capable of providing output voltages that may exceed the input capabilities of connected test equipment. The user should ensure that the setting-up instructions in this chapter are followed exactly, to prevent damage to connected test equipment.

Table 5-2. Recommended Accessories

Accessories	Model	Critical Specifications
Digitizing Oscilloscopes Accessories		
Attenuators	HP 33340C#020 HP 33340C#006	20 dB 6 dB
SMA/BNC Adaptor	1250-1700	
Power Splitter	HP 15104A	
50 Ω Feedthrough Termination	HP 10100C See "50 Ohm Feedthrough Termination"	2 W, 1% 10 W, 0.1%
Adapter	1251-2277	BNC to Banana
Cable Assemblies, BNC	8120-1840	122cm
Torque Wrench	8710-1582	5/16 in, 5 lb-in (56 Ncm)
Power Attenuator	Weinschel 40-20-34	20dB, 150W
Adapter	1250-1474 1250-1476 1250-0781	N(f) to BNC(f) N(m) to BNC(f) BNC tee(m)(f)(f)
Coaxial Short	1250-2152	SMA(f)

Note



When you connect the test equipment for the first time, and whenever you change the set-up during the course of these tests, use the 8710 - 1582 torque wrench to tighten and loosen SMA connectors. This will ensure that the connectors are at the correct tightness and give the best signal transfer.

5

50 Ohm Feedthrough Termination

The following figure provides a schematic and a parts list except for the case. The case must provide shielding and maintain grounding integrity.

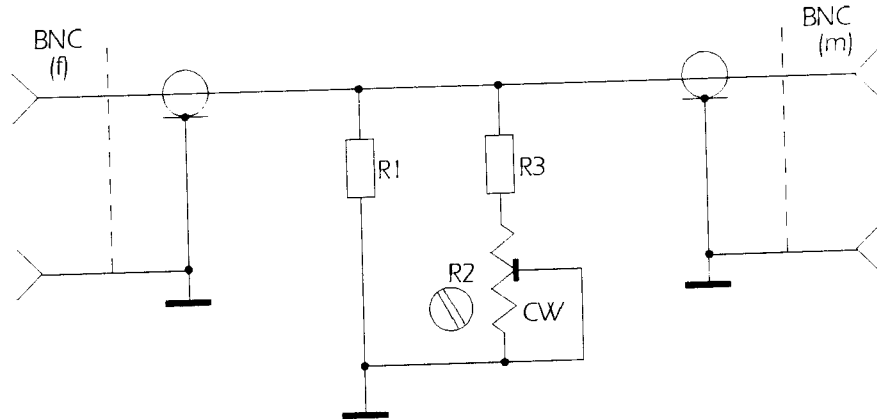

Figure 5-1.
50 Ohm, 0.1%, 10 W Feedthrough Termination

The following parts are required:

1. R1 = 53.6 Ω , 1%, 10 W; HP Part Number: 0699-0146.
2. R2 = 200 Ω , 10%, 0.5 W, Variable trimmer; HP Part Number: 2100-3350.
3. R3 = 681 Ω , 1%, 0.5 W; HP Part Number: 0757-0816.
4. BNC (M): HP Part Number: 1250-0045.
5. BNC (F): HP Part Number: 1250-0083.

Getting Started

Instrument Serial Numbers

You will need to write the serial numbers of the instrument. These can be found as follows:

Press **HELP**, **SERIAL #**

The HP 8114A display lists the instrument's product and serial numbers.

The display on your instrument should look similar to this:

```

  Prod.Nr. Serial Nr.
TIM-Bd.   8114T 3330G00056
FRAME     8114A 3330G00056
BASE-Opt. 81140 3330G00056
SW-REV.:  00.20.00
DATE      : 10/04/93

```

MODIFY
* Continuous
Triggered
Gated
Ext-Width

[CONCEPT] [ON FIELD] [SERIAL #] [EXIT HLP]

5

Figure 5-2.
The Product and Serial Number Screen With Variable Baseline (Option 001) Fitted

The contents of the screen are as follows:

TIM-Bd.	Timing Board Serial Number
FRAME	Instrument Product Number and Serial Number
BASE-Opt.	Variable Baseline Option (001) Serial Number (When this option is fitted)
SW-REV.:	The current Software Revision number
DATE :	Date when the current Software Revision was installed.

Test 1: Period

Test Specifications	Range	66.7 ns to 999 ms
	Resolution	3 digits, best case 100 ps
	Accuracy	±5% ±100 ps
	RMS-Jitter	0.03% + 25 ps (0.05% + 25ps for period <100 ns)

Equipment Needed Counter
Cable, 50 Ω, coaxial, BNC

Procedure

1. On the HP 8114A press **TRIGGER** and set up page as follows:
 - CONTINUOUS PULSES
 - Single Pulses
2. On the HP 8114A press **OUTPUT** and set up page as shown in the following illustration:

Per	66.7ns	Out ON	● MODIFY
		Inh OFF f	
Delay	0.00ns	Baselne +0.00V	50.0 %
DutyCyc	50.0%	Amplitd 5.00V	
50Ω into	50.0Ω	Positive	
TRIGGER		OUTPUT	
LIMITS		CONFIG	

Configuring the Output Page

3. Connect the HP 8114A to the Counter as follows:

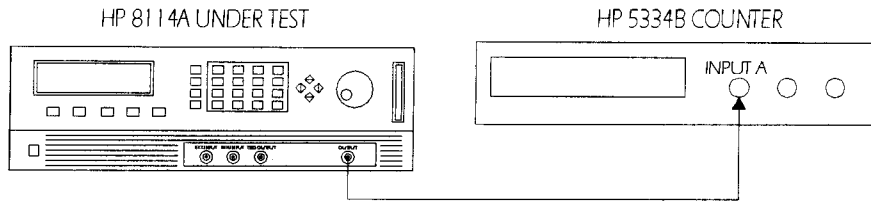

Connecting HP 8114A to the Counter

4. Set the Counter to:
 FUNCTION Period A
 INPUT A 50 Ω

5. Check the HP 8114A period at the following settings:

5

**Table 5-3.
 Period Settings and TR Reference**

Period	Acceptable Range	TR entry
66.7 ns	63.27ns to 70.14 ns	1 - 1
100 ns	94.9 ns to 105.1 ns	1 - 2
500 ns	474.9 ns to 525.1 ns	1 - 3
1 μ s	949.9 ns to 1050.1 ns	1 - 4
5 μ s	4.75 μ s to 5.25 μ s	1 - 5
50 μ s	47.5 μ s to 52.5 μ s	1 - 6
500 μ s	475 μ s to 525 μ s	1 - 7
5 ms	4.75ms to 5.25 ms	1 - 8
50 ms	47.5 ms to 52.5 ms	1 - 9
500 ms	475 ms to 525 ms	1 - 10

Test 2: Width

Test Specifications	Range	10.0 ns to 150 ms
	Resolution	3 digits, best case 100 ps
	Accuracy	$\pm 5\% \pm 500$ ps
	RMS-Jitter	0.03% + 25 ps (0.05% + 25 ps for 50 ns < width < 100 ns)

Equipment Needed	Digitizing Oscilloscope with Accessories
	Counter
	Cable, 50 Ω , coaxial, BNC

- Procedure** 1. Connect HP 8114A to the Scope as shown:

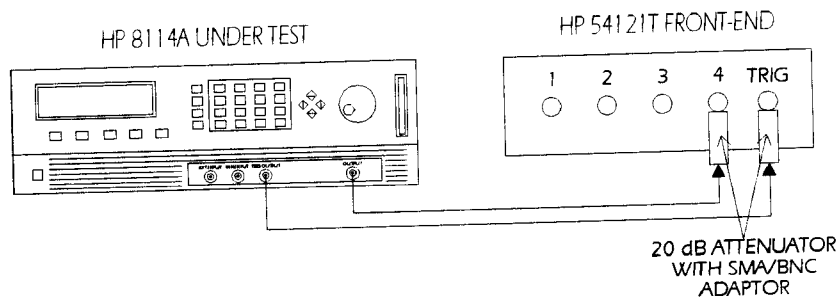

Connecting HP 8114A to the Scope

2. On the HP 8114A press **TRIGGER** and set up page as follows:
- CONTINUOUS PULSES
 - Single Pulses

3. On the HP 8114A press **(MORE)** and set up **OUTPUT** page as shown in the following illustration:

Per	1.00 μ s	Out ON	MODIFY
		Inh OFF f	
Delay	0.00 ns	Baselne +0.00V	500 ns
Width	10.0 ns	Amplitd 5.00V	
50 Ω into 50.0 Ω		... Positive	
TRIGGER		OUTPUT	LIMITS
		CONFIG	

Configuring the Output Page

4. Set the Digitizing Oscilloscope HP 54121T:
- Press **(AUTOSCALE)**
 - Select the Display menu and set the Number of Averages to 32
 - Select the delta V menu and turn the voltage markers On
 - Set the preset levels to 50% -50% and press **(AUTO LEVEL SET)**
 - Select the delta t menu and turn the time markers ON
 - Set START ON EDGE = POS 1 and STOP ON EDGE = NEG1
5. Change the oscilloscope timebase to 2 ns/div
6. Change the HP 8114A width to 10.0 ns
7. Center the pulse in the Scope display in TIMEBASE, Delay = 38 ns
8. Press Delta t, then **(PRECISE EDGE FIND)** key for each new Width setting; reset scope delay to 16 ns

5

9. Check the HP 8114A pulse width at the following settings, repeating step 8 for each width setting made on the HP 8114A:

Table 5-4.
Width Settings and TR Reference

Oscilloscope Timebase	Delay	Width	Acceptable Range	TR Entry
2 ns/div	0 ns	10.0 ns	9.000 ns to 11.000 ns	2 - 1
10 ns/div	0 ns	50.0 ns	47.00 ns to 53.00 ns	2 - 2
20 ns/div	25 ns	100 ns	94.5 ns to 105.5 ns	2 - 3
100 ns/div	250 ns	500 ns	474.5 ns to 525.5 ns	2 - 4

10. Connect the HP 8114A to the Counter as shown:

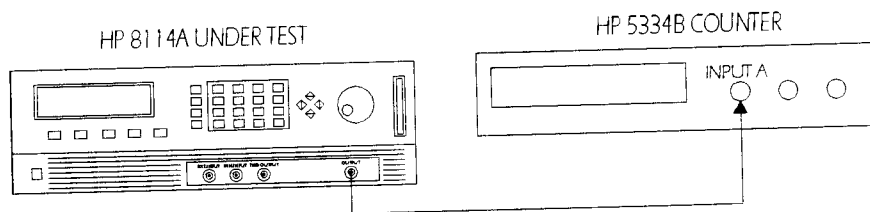

Connecting HP 8114A to the Counter

11. Set the Counter to:

FUNCTION TI A → B
INPUT A 50 Ω
COM A On
INPUT B 50 Ω, negative slope
SENSE On

12. Set the HP 8114A period to 999 ms

13. Check the HP 8114A width at the following settings:

Table 5-5.
Width Settings and TR Reference

Width	Acceptable Range	TR Entry
1 μs	949.5 ns to 1050.5 μs	2 - 5
5 μs	4.75 μs to 5.25 μs	2 - 6
50 μs	47.5 μs to 52.5 μs	2 - 7
500 μs	475 μs to 525 μs	2 - 8
5 ms	4.75 ms to 5.25 ms	2 - 9
50 ms	47.5 ms to 52.5 ms	2 - 10
500ms	475 ms to 525 ms	2 - 11

5

Test 3: Delay

Test Specifications	Range	Fixed: typical 42.0 ns Variable: 0.00 ns to 999 ms
	Resolution	3 digits, best case 10 ps
	Accuracy	$\pm 5\% \pm 1$ ns
	RMS-Jitter	0.03% + 25 ps (0.05% + 25 ps for 50 ns <delay <100 ns)

Equipment Needed	Digitizing Oscilloscope with Accessories
	Pulse Generator
	Counter
	Cable, 50 Ω , coaxial, BNC

Procedure 1. Connect HP 8114A to the Scope as shown:

5

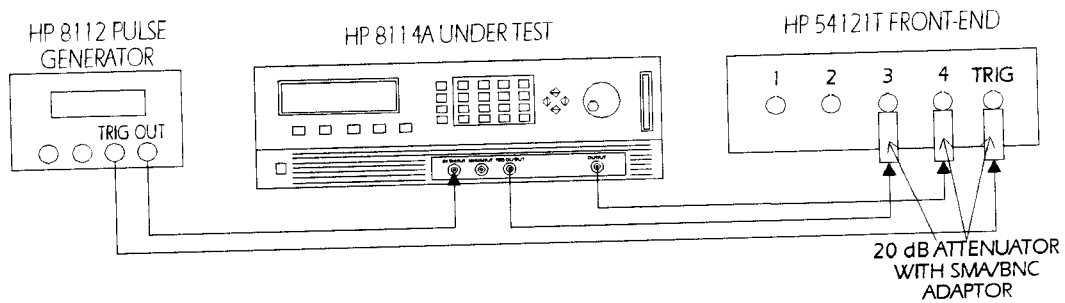

Connecting HP 8114A to the Scope

2. Set the Pulse Generator to:

Period	1 μ s
Width	100 ns
Amplitude	1 V
Offset	0 V
Output	Enable

- Select the **TRIGGER** page on the HP 8114A and set up as follows:

TRIGGERED PULSES		MODIFY
Single-Pulses		
Trg'd by: EXT-IN f		+0.0
Threshold +0.00V		V
TRIGGER	OUTPUT	LIMITS
		CONFIG

The TRIGGER Page Set-up

- On the HP 8114A set up **OUTPUT** page as shown in the following illustration:

minPer 1.00 μ s	Out ON	MODIFY
	Inh OFF f	
Delay 0.00 ns	Baseline +0.00V	0.00
Width 100 ns	Amplitd 5.00V	ns
50 Ω into 50.0 Ω	Positive	
TRIGGER	OUTPUT	LIMITS
		CONFIG

5

Configuring the Output Page

5. Set the Digitizing Oscilloscope HP 54121T:

- Press **AUTOSCALE**
- Set timebase to TIME/DIV = 10 ns/div
- Center the positive-going edges of the two signals
- Select the Display menu and set the screen function to single; set the number of averages to 32
- Select the Delta V menu and turn the voltage markers ON and assign marker 1 to channel 3 and marker 2 to channel 4
- Set Preset levels to 50% - 50% and press **AUTO LEVEL SET**
- Select the Delta t menu and turn the time markers ON
- Set START ON EDGE= POS1 and STOP ON EDGE= POS 1
- Press the **PRECISE EDGE FIND** key

6. Check the HP 8114A delay at the following settings:

Note



Record the value of the fixed delay and subtract it from the other readings.

**Table 5-6.
Delay Settings and TR Reference**

Oscilloscope Timebase	Delay	Acceptable Range	TR Entry
10 ns/div	0.00 ns	fixed Delay	3 - 1
10 ns/div	5.00 ns	3.75 ns to 6.25 ns	3 - 2
10 ns/div	10.0 ns	8.50 ns to 11.50 ns	3 - 3
20 ns/div	50.0 ns	46.5 ns to 53.5 ns	3 - 4
20 ns/div	100 ns	94 ns to 106 ns	3 - 5
100 ns/div	500 ns	474 ns to 526 ns	3 - 6

7. Connect the HP 8114A to the Counter as follows:

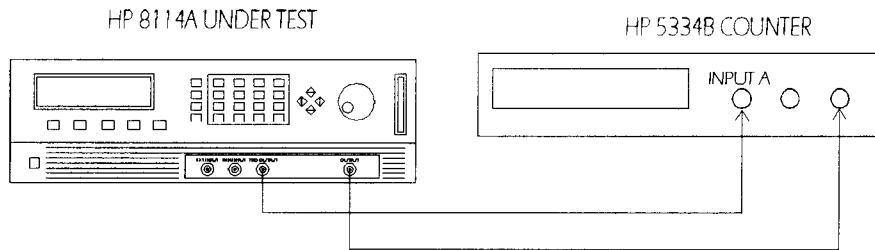

Connecting HP 8114A to the Counter

8. On the HP 8114A **TRIGGER** page select:

CONTINUOUS PULSES

9. On the HP 8114A **OUTPUT** page set:

Per to 999 ms

Width to 500 ns

10. Set the Counter to:

FUNCTION	TI A → B
INPUT A	50 Ω
INPUT B	50 Ω

5

11. Check the HP 8114A delay at the following settings:

Note



Subtract the fixed delay from the other readings

**Table 5-7.
Delay Settings and TR Reference**

Delay	Acceptable Range	TR Entry
1 μ s	949 ns to 1051 ns	3 - 7
5 μ s	4.749 μ s to 5.251 μ s	3 - 8
50 μ s	47.5 μ s to 52.5 μ s	3 - 9
500 μ s	475 μ s to 525 μ s	3 - 10
5 ms	4.75 ms to 5.25 ms	3 - 11
50 ms	47.5 ms to 52.5 ms	3 - 12
500ms	475 ms to 525 ms	3 - 13

5

Test 4: Double Pulse Delay

Test Specifications	Range	20 ns to 999 ms
	Resolution	3 digits, best case 100 ps
	Accuracy	$\pm 5\% \pm 250$ ps
	Min. Period	133.4 ns

Equipment Needed	Digitizing Oscilloscope with Accessories
	Counter
	Cable, 50 Ω , coaxial, BNC

- Procedure** 1. Connect HP 8114A to the Scope as shown:

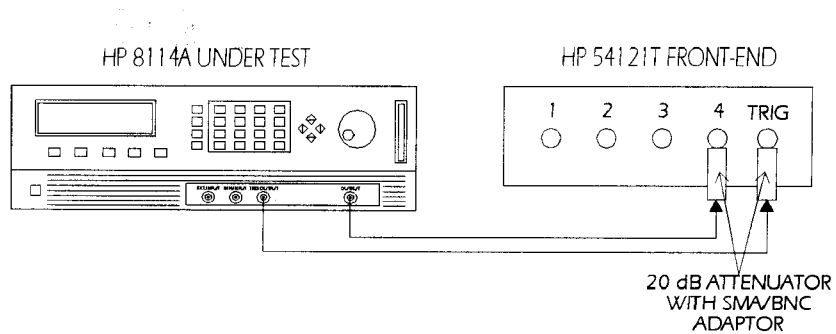

Connecting HP 8114A to the Scope

2. Select the **TRIGGER** page on the HP 8114A and set up as follows:

PULSES		MODIFY
Double-Pulses		* Continuous
.....		Triggered
.....		Gated
.....		Ext-Width
TRIGGER	OUTPUT	LIMITS
		CONFIG

The **TRIGGER** Page Set-up

3. On the HP 8114A set up **OUTPUT** page as shown in the following illustration:

Per	1.00 μ s	Out ON	MODIFY
		Inh OFF f	
Db1Del	20.0ns	Baseline +0.00V	20.0 ns
Width	10.0ns	Amplitd 5.00V	
50 Ω into	50.0 Ω	Positive	
TRIGGER	OUTPUT	LIMITS	CONFIG

Configuring the Output Page

4. Set the Digitizing Oscilloscope HP 54121T:
 - Press **AUTOSCALE**
 - Set scope timebase to 5 ns/div
 - Center the double pulse signal
 - Select the Display menu and set the Number of Averages to 32
 - Select the Delta V menu and turn the Voltage markers On

- Set Preset Levels = 50% -50% and press **AUTO LEVEL SET**
 - Select the Delta t menu and turn the Time markers On
 - Set START ON EDGE = POS1 and STOP ON EDGE = POS2
5. Press the **PRECISE EDGE FIND** key for each new double delay setting
 6. Check the HP 8114A double delay at the following settings:

**Table 5-8.
Double Delay Settings and TR Reference**

Oscilloscope Timebase	Double Delay	Acceptable Range	TR Entry
5 ns/div	20.0 ns	18.75 ns to 21.25 ns	4 - 1
10 ns/div	50.0 ns	47.25 ns to 52.75 ns	4 - 2
20 ns/div	100 ns	94.75 ns to 105.25 ns	4 - 3

5

7. Connect the HP 8114A to the Counter as shown:

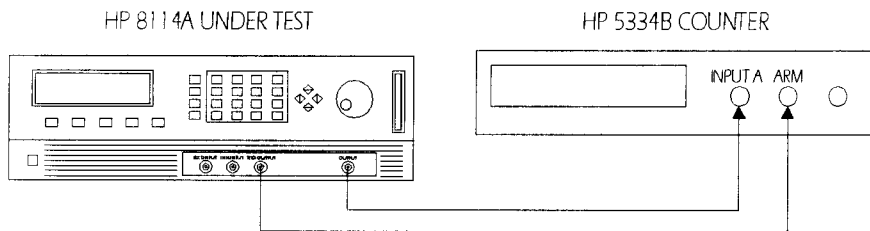

Connecting HP 8114A to the Counter

8. Set the Counter to:

FUNCTION	Period A
INPUT A	50 Ω
AUTO TRIG	OFF
EXT ARM SELECT	a. Start (ST): leading edge b. Stop (SP): trailing edge

9. Select the **TRIGGER** page on the HP 8114A and set up as follows:

TRIGGERED PULSES		MODIFY
Double-Pulses		*MAN Key
Trg'd by: MAN	f	EXT INPUT
TRIGGER	OUTPUT	LIMITS
CONFIG		

The **TRIGGER** Page Set-up

10. On the HP 8114A set up the **OUTPUT** page as shown in the following illustration:

minPer 999 ms	Out ON	MODIFY
	Inh OFF f	
Db1Del 500 ns	Baseline +0.00V	500
Width 20.0 ns	Amplitd 5.00V	ns
50 Ω into 50.0 Ω	Positive	
TRIGGER	OUTPUT	LIMITS
CONFIG		

Configuring the Output Page

11. Check the HP 8114A double pulse delay at the following settings, pressing **(MAN)** to trigger a single cycle each time:

Table 5-9.
Double Delay Settings and TR Reference

Double Delay	Acceptable Range	TR Entry
500 ns	474.75 ns to 525.25 ns	4 - 4
1 μ s	949.75 ns to 1050.25 μ s	4 - 5
5 μ s	4.759 μ s to 5.25 μ s	4 - 6
50 μ s	47.5 μ s to 52.5 μ s	4 - 7
500 μ s	475 μ s to 525 μ s	4 - 8
5 ms	4.75 ms to 5.25 ms	4 - 9
50 ms	47.5 ms to 52.5 ms	4 - 10
500 ms	475 ms to 525 ms	4 - 11

Test 5: Jitter

The following tests are required:

1. Period Jitter
2. Width Jitter
3. Delay Jitter

Test 5.1: Period Jitter

Test Specifications RMS-Jitter: 0.03% + 25 ps (0.05% + 25 ps for period < 100 ns)





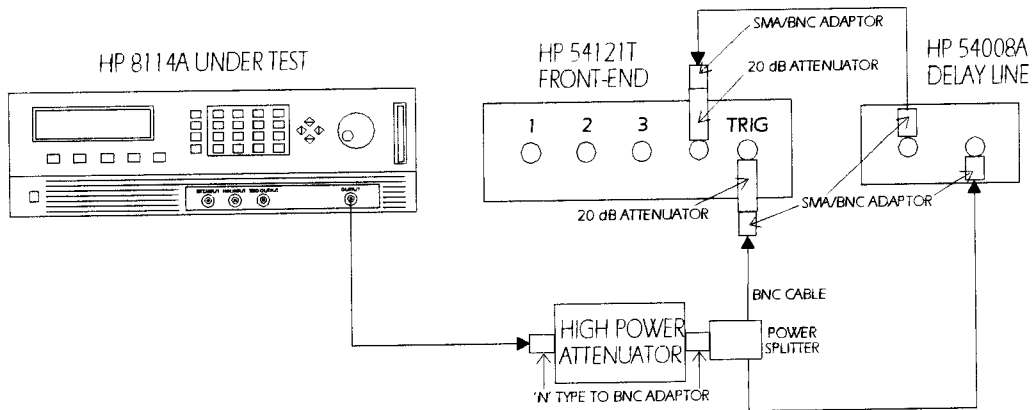

Equipment Needed Digitizing Oscilloscope with Accessories
Delay Line (22 ns)
Power Splitter
All cables: 50 Ω , coaxial, BNC, 122 cm (4 ft)
High Power Attenuator

Procedure 1. Connect HP 8114A to the Scope as shown:



Equipment Set-up for Jitter Test

2. On the HP 8114A press **TRIGGER** and set up page as follows:
 - CONTINUOUS PULSES
 - Single Pulses
3. On the HP 8114A set up the **OUTPUT** page as shown in the following illustration:

Per	100 ns	Out ON	
		Inh OFF f	
Delay	0.00 ns	Baseline +0.00 V	
DutyCyc	15.0%	Amplitd  V	
50Ω into	50.0Ω	Positive	
   			

Configuring the Output Page

4. Set the Digitizing Oscilloscope HP 54121T:
 - Press **AUTOSCALE**
 - Select the Display menu and set the Number of Averages to 64
 - Select the Channel menu and set the Attenuation factor of channel 4 to 10
 - Set the VOLTS/DIV of channel 4 to 10 mV/div
 - Set OFFSET to 1V
 - Select the Timebase menu and set the TIME/DIV to 100 ps/div
 - Center the first positive-going edge of the signal (approximate Delay = 29 ns)
 - Select the Delta V menu and turn the V markers On
 - Set the Marker 1 Position to 980 mV and the Marker 2 Position to 1 V

- Select the Delta t menu and turn the T Markers On
 - Set START ON EDGE = POS1 and STOP ON EDGE = POS1
 - Press the **PRECISE EDGE FIND** key
5. RECORD the delta t reading. This is the rise time of the reference signal within a 1% amplitude window of the signal connected to Input 4. This value is needed later to calculate the correct jitter. (delta.t.up)
 6. Select the Timebase menu and center the second positive-going edge of the signal (approximate Delay = 129 ns)
 7. Press **MORE** and **HISTOGRAM**
 - Select the Window submenu and set:
 - Source is channel 4
 - Choose the Time Histogram
 - Press **WINDOW MARKER 1** and set it to 980 mV
 - Press **WINDOW MARKER 2** and set it to 1 V
 8. Select the Acquire submenu, set the Number of Samples to 1000 and press **START ACQUIRING**
 9. After the data for the time histogram has been acquired (# Samples = 100%), select the Result submenu.
 10. Press **MEAN** and **SIGMA**. RECORD the value of sigma

5

11. The RMS-jitter is calculated as follows:

$$RMS - jitter = \frac{6\sigma - \Delta t_{up}}{6}$$

12. The RMS-jitter for period of 100 ns is 75 ps. Enter the result in the Test Report as TR entry 5.1 - 1

13. Set the HP 8114A period to 500 ns

14. Repeat steps 6 to 11

Note



TIME/DIV = 200 ps/div; approximate Delay = 530 ns

15. The RMS-jitter for period of 500 ns is 175 ps. Enter the result in the Test Report as TR entry 5.1 - 2

5

A thick vertical black bar located on the right side of the page, positioned next to the number 5.

Test 5.2: Width Jitter

Test Specifications RMS-Jitter 0.03% + 25 ps (0.05% + 25 ps for 50 ns
< width < 100 ns)

Equipment Needed

- Digitizing Oscilloscope with Accessories
- Delay Line (22 ns)
- Power Splitter
- All cables 50 Ω , coaxial, BNC, 122cm (4ft)
- High Power Attenuator

Procedure 1. Connect HP 8114A to the Scope as shown:

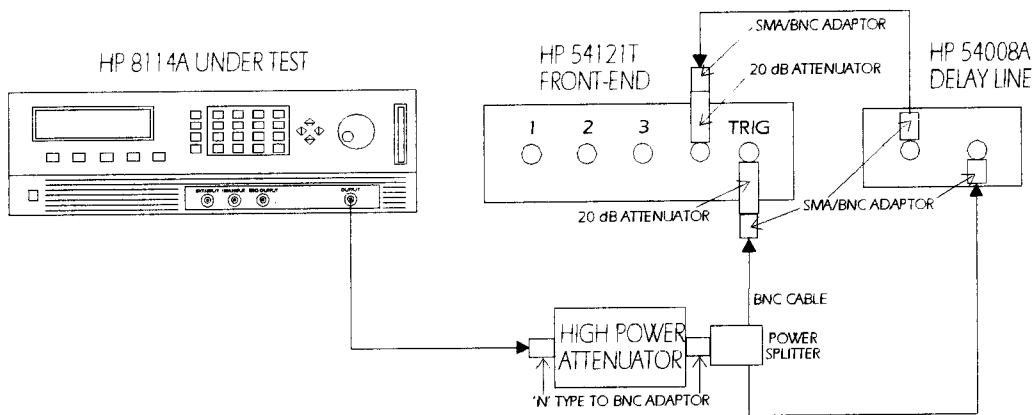

Equipment Set-up for Jitter Test

2. On the HP 8114A set up the **OUTPUT** page as shown in the following illustration:

Per	2.00 μ s	Out ON	MODIFY 10.0 ns
		Inh OFF f	
Delay	0.00 ns	Baseline +0.00 V	
Width	10.0 ns	Amplitd 40.0 V	
	50 Ω into 50.0 Ω	Positive	
[TRIGGER] [OUTPUT] [LIMITS] [CONFIG]			

Configuring the Output Page

3. Set the Digitizing Oscilloscope HP 54121T:
- Press **AUTOSCALE**
 - Select the Display menu and set the Number of Averages to 128
 - Select the Channel menu and set the Attenuation factor of channel 4 to 10
 - Set the VOLTS/DIV of channel 4 to 10 mV/div
 - Set OFFSET to 1 V
 - Select the Timebase menu and set the TIME/DIV to 100 ps/div
 - Center the first negative-going edge of the signal (approximate Delay = 38.8 ns)
 - Select the Delta V menu and turn the V markers On
 - Set the Marker 1 Position to 1.02 V and the Marker 2 Position to 1.00 V
 - Select the Delta t menu and turn the T Markers On
 - Set START ON EDGE = NEG1 and STOP ON EDGE = NEG1
 - Press the **PRECISE EDGE FIND** key

5

4. RECORD the delta t reading. This is the fall time of the reference signal within a 1% amplitude window of the signal connected to Input 4. This value is needed later to calculate the correct jitter. (delta.t.dn)
5. Set the HP 8114A pulse width to 50 ns
6. Select the Timebase menu and center the first negative-going edge of the signal (approximate Delay = 78.8 ns)
7. Press **MORE** and **HISTOGRAM**
8. Select the Window submenu and set:
 - Source is channel 4
 - Choose the Time Histogram
 - Press **WINDOW MARKER 1** and set it to 1.02 V
 - Press **WINDOW MARKER 2** and set it to 1.00 V
9. Select the Acquire submenu, set the Number of Samples to 1000 and press **START ACQUIRING**
10. After the data for the time histogram has been acquired (# Samples = 100%), select the Result submenu.
11. Press **MEAN** and **SIGMA**. RECORD the value of sigma
12. The RMS-jitter is calculated as follows:

$$RMS - jitter = \frac{6sigma - delta.t.dn}{6}$$
13. The RMS-jitter for pulse width of 50 ns is 50 ps. Enter the result in the Test Report as TR entry 5.2 - 1
14. Set the HP 8114A for pulse width of 500ns
15. Repeat steps 7 to 13

Note

TIME/DIV = 200ps/div. Approximate delay = 529 ns

16. The RMS-jitter for pulse width of 500 ns is 175 ps. Enter the result in the Test Report as TR entry 5.2 - 2

Test 5.3: Delay Jitter

Test Specifications RMS-Jitter 0.03% + 25 ps (0.05% + 25 ps for 50 ns < delay < 100 ns)

Equipment Needed Digitizing Oscilloscope with Accessories
All cables: 50 Ω , coaxial, BNC, 122cm (4ft)
High Power Attenuator

Procedure 1. Connect HP 8114A to the Scope as shown:

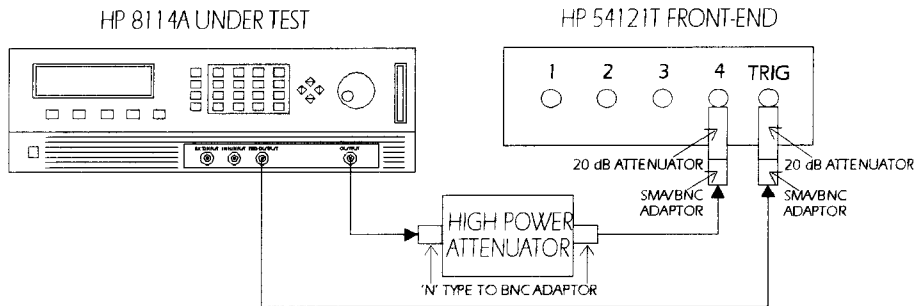







5

Equipment Set-up for Delay Jitter Test

2. For calculating the RMS-jitter, the rise time of the reference signal within a 1% amplitude window is required. If this value is not already measured in the Period Jitter test, then perform the first 6 steps of the Period Jitter test.

- On the HP 8114A set up the **OUTPUT** page as shown in the following illustration:

Per	1.00 μ s	Out ON	
		Inh OFF f	
Delay	50.0 ns	Baseline +0.00 V	
Width	50.0 ns	Amplitd 20.0 V	
50 Ω into	50.0 Ω	Positive	
   			

Configuring the Output Page

- Set the Digitizing Oscilloscope HP 54121T:
 - Press **AUTOSCALE**
 - Select the Display menu and set the Number of Averages to 64
 - Set the VOLTS/DIV = 10 mV/div
 - Set OFFSET to 1 V
 - Select the Timebase menu and set the TIME/DIV to 100 ps/div
 - Center the first positive-going edge of the signal (approximate Delay = 98.5 ns)
5. Press **MORE** and **HISTOGRAM**
6. Select the Window submenu and press **WINDOW MARKER 1** and set it to 980 mV
7. Press **WINDOW MARKER 2** and set it to 1 V
8. Select the Acquire submenu, set the Number of Samples to 1000 and press **START ACQUIRING**
9. After the data for the time histogram has been acquired (# Samples = 100%), select the Result submenu

10. Press **(MEAN)** and **(SIGMA)**. RECORD the values of sigma

11. The RMS-jitter is calculated as follows:

$$RMS - jitter = \frac{6sigma - delta.t.up}{6}$$

12. The RMS-jitter for delay of 50 ns is 50 ps. Enter the result in the Test Report as TR entry 5.3 - 1

13. Set HP 8114A for delay of 500 ns

14. Repeat steps 9 to 12

Note



TIME/DIV = 200 ps/div. Approximate delay = 549 ns

15. The RMS jitter for delay of 500 ns is 175 ps. Enter the result in the Test Report as TR entry 5.3 - 2

5

A thick vertical black bar located to the right of the page number 5.

Test 6: Amplitude

The following tests are required:

1. From 50Ω into 50Ω
2. From HIZ (High-Z) into 50Ω

Test Specifications

Range: A) 1.00 V to 50.0 V (50Ω into 50Ω)
 B) 2.00 V to 100 V (HIZ into 50Ω)
Accuracy: $\pm 1\%$ of amplitude ± 100 mV
Resolution: 3 digits, best case 10 mV
Baseline: 0 V ± 100 mV $\pm 0.5\%$ of amplitude

Equipment Needed

1. Digitizing Voltmeter (DVM)
2. High Power attenuator
3. 50Ω , 0.1%, 10 W Feedthrough

5

Calculating out Measurement Uncertainties

Measurement uncertainties need to be calculated out as follows:

- a) For 50Ω into 50Ω measurements, the Attenuation Factor must be calculated
- b) For HIZ (High-Z) into 50Ω measurements, the Attenuation Factor, Load impedance, and Adjust factor must be calculated.

Do these calculations as follows:

a) Calculation for 50Ω into 50Ω measurements

- Procedure**
1. On the HP 8114A set up the **OUTPUT** page as shown in the following illustration:

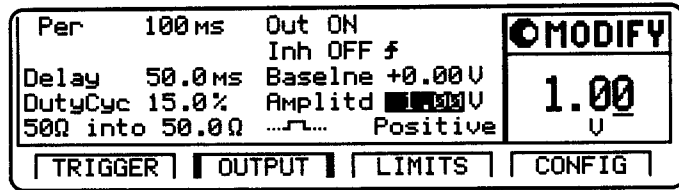

Configuring the Output Page

2. Connect HP 8114A to the DVM as shown:

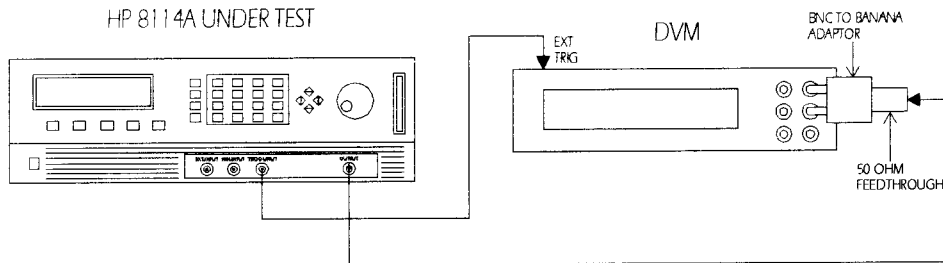

Equipment Set-up 1 for Amplitude Test

3. Set the DVM HP 3458A to:
 Function: DCV
 Trigger: TRIG EXT
 AD-Converter integration time NPLC: 0.1
 (NPLC = Number of Power Line Cycles)
4. Take the reading as V_1
5. Connect HP 8114A to the DVM as shown:

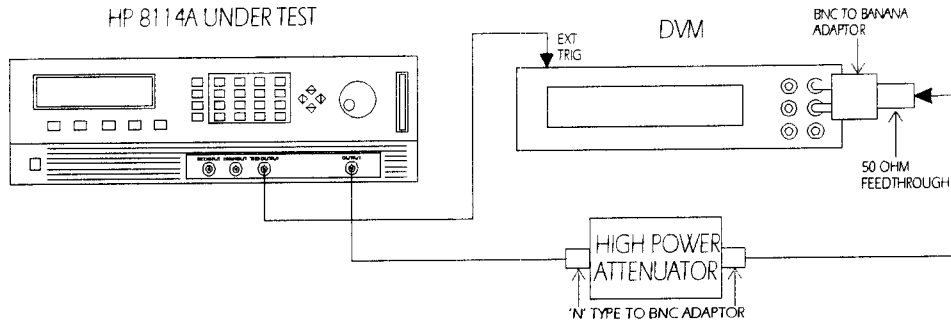

Figure 5-3. Equipment Set-up 2 for Amplitude Test

6. Take the reading as V_2
7. Calculate the Attenuation Factor to at least 2 decimal places:

$$G_1 = \frac{V_1}{V_2}$$

b) Calculation for HIZ (High-Z) into 50Ω measurements

Procedure

1. Connect the High Power Attenuator to the DVM as shown:

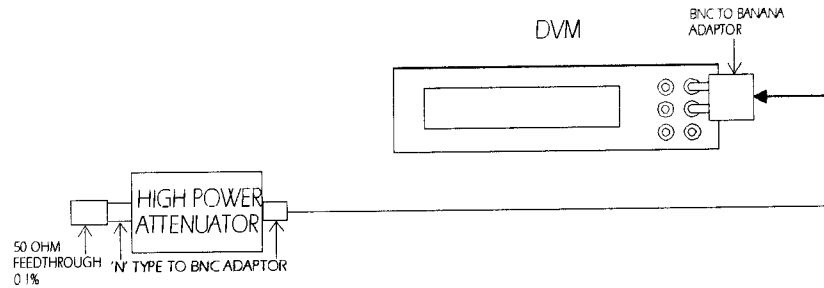

Connecting the Attenuator to the DVM

2. Set the DVM HP 3458A to:
Function: OHM
3. Take the reading as R_1
4. Take the reading for the Coaxial Short, R_2 , as shown:

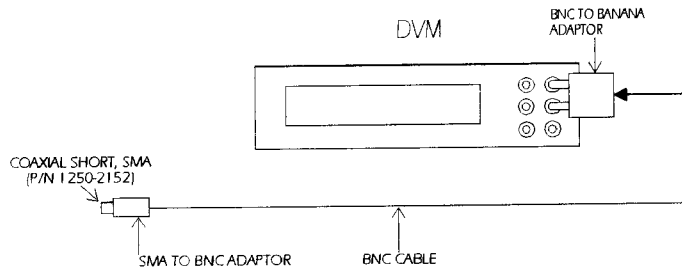

Measuring the Coaxial Short

5

- Calculate the load impedance: $R_L = R_1 - R_2$
- On the HP 8114A set up the **OUTPUT** page as shown in the following illustration:

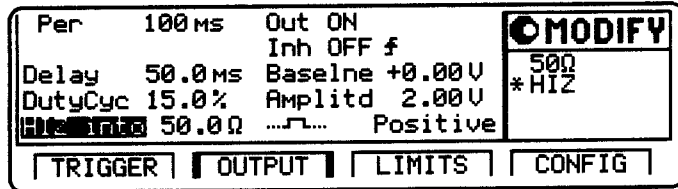

Configuring the Output Page

- Set the DVM HP 3458A to:

Function: DCV
 Trigger: TRIG EXT
 NPLC: 0.1

- Connect HP 8114A to the DVM as shown:

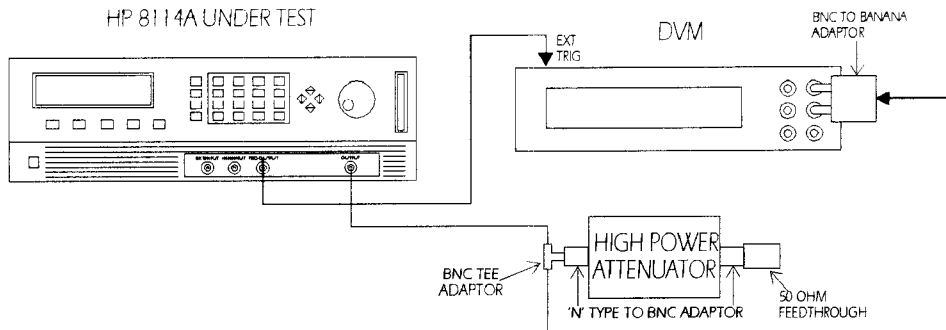

- Take the reading as V_3

Connect HP 8114A to the DVM as shown:

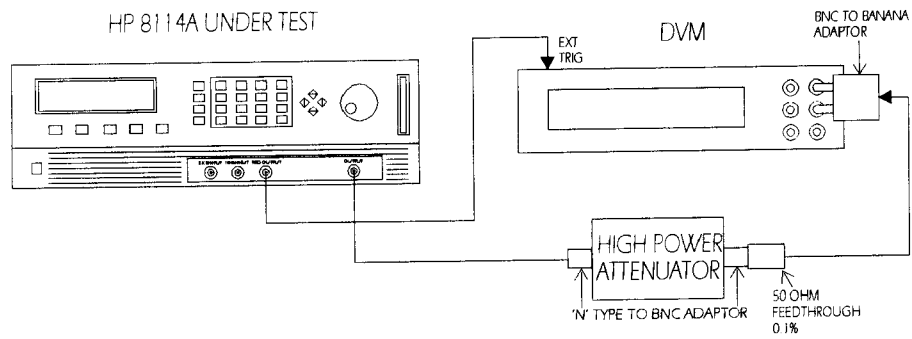

10. Take the reading as V_4

11. Calculate the attenuation factor G_2 :

$$G_2 = \frac{V_3}{V_4}$$

12. Calculate the adjust factor A_d :

$$A_d = \frac{R_L}{R_o}$$

$$R_o = 50\Omega$$

5

A) Amplitude Test (from 50Ω into 50Ω)

Procedure 1. Connect HP 8114A to the DVM as shown:

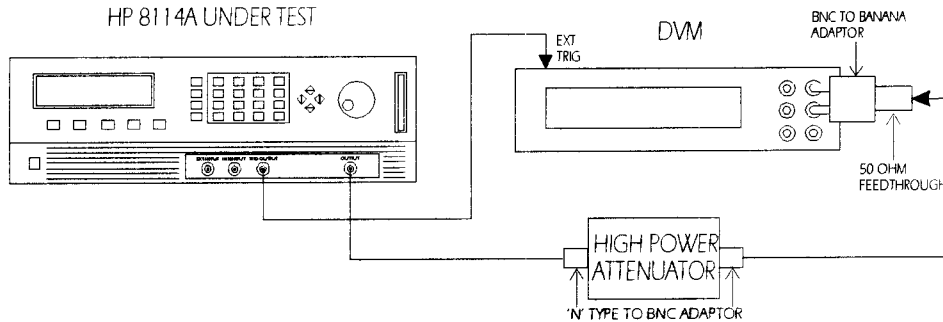

5

2. On the HP 8114A set up the **OUTPUT** page as shown in the following illustration:

Per	100 ms	Out ON	MODIFY
		Inh OFF f	
Delay	50.0 ms	Baseline +0.00 V	1.00 V
DutyCyc	15.0%	Amplitd 1.00 V	
50Ω into 50.0Ω		Positive	
TRIGGER OUTPUT LIMITS CONFIG			

Configuring the Output Page

- Set HP 8114A Delay to 0 ns
- Take the baseline reading as $B_{50\Omega}$
- Set HP 8114A Delay to 50 ms and Amplitude to 1 V
- Take the high-level reading as $H_{50\Omega}$
- Calculate the Amplitude:

$$A_{50\Omega} = (H_{50\Omega} - B_{50\Omega}) \times G_1$$

8. Repeat steps 3 to 7 for the following settings:

Table 5-10.
Amplitude Levels: 50Ω into 50Ω

Amplitude	Amplitude limit		TR Entry
	minimum	maximum	
1 V	0.89 V	1.11 V	6 - 1
2 V	1.88 V	2.12 V	6 - 2
5 V	4.85 V	5.15 V	6 - 3
10 V	9.80 V	10.2 V	6 - 4
20 V	19.7 V	20.3 V	6 - 5
50 V	49.4 V	50.6 V	6 - 6

B) Amplitude Test (from HIZ {High-Z} into 50Ω)

Procedure 1. Connect HP 8114A to the DVM as shown:

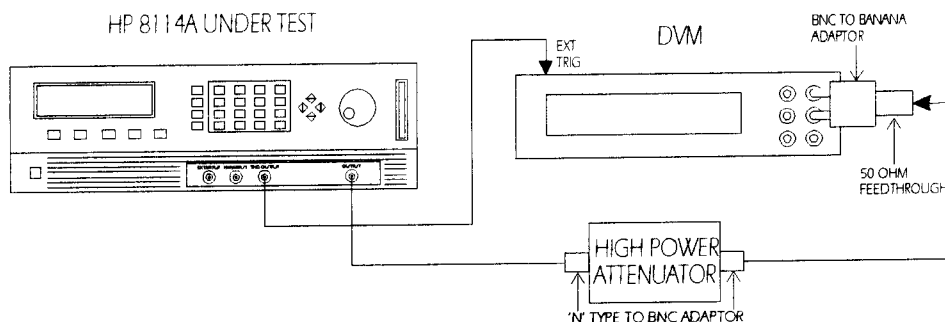

5

2. On the HP 8114A set up the **OUTPUT** page as shown in the following illustration:

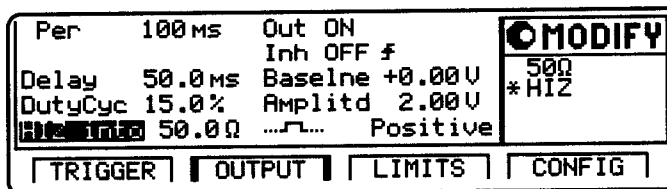

Configuring the Output Page

3. Set HP 8114A Delay to 0 ns
4. Take the baseline reading as B_{HIZ}
5. Set HP 8114A Delay to 50 ms and Amplitude to 2 V

6. Take the high-level reading as H_{HIZ}

7. Calculate the Amplitude:

$$A_{HIZ} = ((H_{HIZ} - B_{HIZ}) \times G_2) / A_d$$

8. Repeat steps 3 to 7 for the following settings:

Table 5-11.
Amplitude Levels: HIZ (High-Z) into 50Ω

Amplitude	Amplitude limit		TR Entry
	minimum	maximum	
2 V	1.88 V	2.12 V	6 - 7
5 V	4.85 V	5.15 V	6 - 8
10 V	9.80 V	10.2 V	6 - 9
20 V	19.7 V	20.3 V	6 - 10
50 V	49.4 V	50.6 V	6 - 11
100 V	98.9 V	101.1 V	6 - 12

5

Test 7: Variable Baseline (Option 001)

Note



This test is only to be performed if **Option 001** is installed.

Test Specifications

Range: -25 V to +25 V
Accuracy: $\pm 1\% \pm 100 \text{ mV} \pm 0.5\%$ of amplitude
50 Ω source impedance only

Equipment Needed

1. Digitizing Voltmeter (DVM)
2. High Power attenuator
3. 50 Ω , 0.1%, 10W Feedthrough

5

Procedure

1. On the HP 8114A set up the **OUTPUT** page as shown in the following illustration:

Per	100 ms	Out	ON	MODIFY	
		Inh	OFF f		
Delay	0.00 ns	Baseline	25.00 V	-25.0 U	
DutyCyc	15.0%	Amplitd	1.00 V		
50 Ω into 50.0 Ω		Positive		
TRIGGER		OUTPUT		LIMITS	CONFIG

Configuring the Output Page

2. Connect HP 8114A to the DVM as shown:

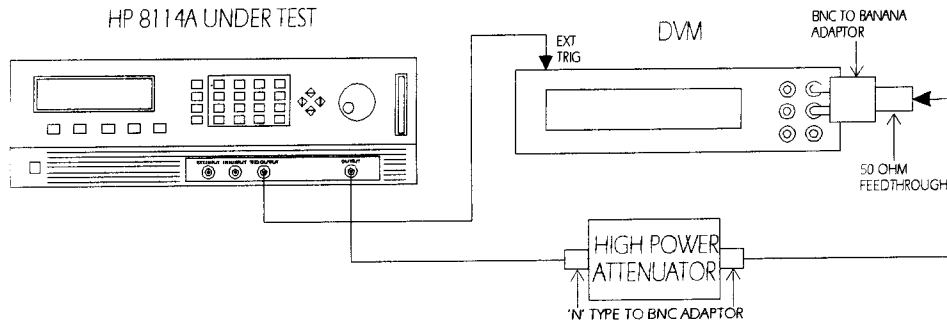

Equipment Set-up 1 for Variable Baseline Test

3. Set the DVM HP 3458A to:

Function: DCV

Trigger: TRIG EXT

AD-Converter integration time NPLC: 0.1
(NPLC = Number of Power Line Cycles)

4. Take the DVM readings for the following baseline settings (VB). Multiply the readings by the attenuation factor G_1 (derived from the amplitude test, test 6).

$$B = VB \times G_1$$

Compare the calculated value with the given limits:

5

Table 5-12. Baseline Levels Test

Baseline Level	Limits		TR Entry
	minimum	maximum	
-25 V	-25.355 V	-24.645 V	7 - 1
-20 V	-20.305 V	-19.695 V	7 - 2
-10 V	-10.205 V	-9.795 V	7 - 3
-5 V	-5.155 V	-4.485 V	7 - 4
-2 V	-2.125 V	-1.875 V	7 - 5
±0 V	-0.105 V	+0.105 V	7 - 6
+2 V	+1.875 V	+2.125 V	7 - 7
+5 V	+4.845 V	+5.155 V	7 - 8
+10 V	+9.795 V	+10.205 V	7 - 9
+20 V	+19.695 V	+20.305 V	7 - 10
+25 V	+24.645 V	+25.355 V	7 - 11

Test 8.1a: Leading Edge Test

Leading edge for amplitudes $>5\text{ V}$ from 50Ω into 50Ω .

Procedure 1. Connect HP 8114A to the Scope as shown:

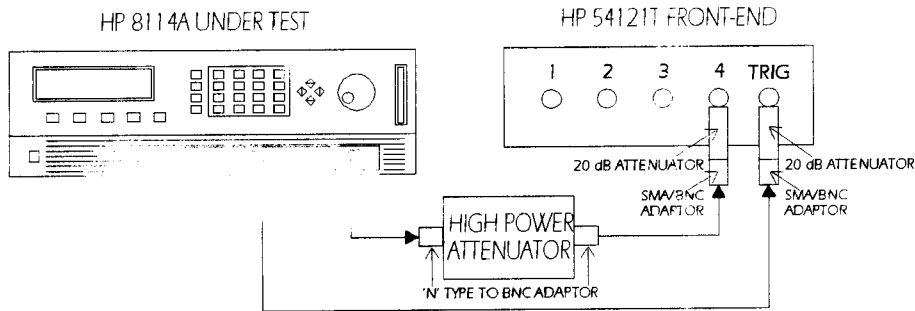

Connecting HP 8114A to the Scope

On the HP 8114A press **TRIGGER** and set up page as follows:

- CONTINUOUS PULSES
- Single Pulses

2. On the HP 8114A set-up the **OUTPUT** page as shown in the following illustration:

Per	500 μs	Out	ON	MODIFY
		Inh	OFF f	
Delay	0.00 ns	Baseline	+0.00 V	10.0
DutyCyc	50.0%	Amplitd	10.0 V	
50 Ω into	50.0 Ω	Positive		
TRIGGER OUTPUT LIMITS CONFIG				

Configuring the Output Page

3. Set the Digitizing Oscilloscope HP 54121T:
 - Press **AUTOSCALE**
 - Center one pulse on screen, e.g.: TIME/DIV = 50 μ s/div, DELAY = 365 μ s,
 - Select the Display menu and set the Number of Averages to 32
 - Select the Channel menu and set the Attenuation factor to 10
 - Select the Delta V menu and turn the voltage markers On
 - Set the Preset Levels = 10-90% and press **AUTO LEVEL SET**
 - Select the Timebase menu and set TIME/DIV = 2 ns/div, DELAY = 40.7 ns
 - Select the Delta t menu and turn the markers On
 - Set START ON EDGE = POS1 and STOP ON EDGE = POS1
4. Set period of HP 8114A to: Period = 1 μ s
5. After the averaging, while the oscilloscope is in the Delta t menu, Press the **PRECISE EDGE FIND** key
6. Check the HP 8114A rise time at the following leading edge setting:

5

Table 5-13. Leading Edge Setting

Oscilloscope TIME/DIV	Period	Acceptable Range	TR Entry
2 ns/div	1 μ s	<7 ns	8.1a

Test 8.1b: Trailing Edge Test

Trailing edge for amplitudes >5 V from 50Ω into 50Ω .

Note



The Leading Edge test must be performed before you start this test.

Procedure

1. Set the Digitizing Oscilloscope HP 54121T:
 - Select the Timebase menu and set TIME/DIV = 2 ns/div, DELAY = 542 ns
 - Select the Delta t menu
 - Set START ON EDGE = NEG1 and STOP ON EDGE = NEG1
2. While the oscilloscope is in the Delta t menu, press the **PRECISE EDGE FIND** key
3. Check the HP 8114A output signal falls at the following trailing edge setting:

Table 5-14. Trailing Edge Setting

Oscilloscope TIME/DIV	Delay	Period	Acceptable Range	TR Entry
2 ns/div	542 ns	1 μ s	<7 ns	8.1b

Test 8.2a: Leading Edge Test

Leading edge for amplitudes >10 V from HIZ (High-Z) into 50Ω.

- Procedure** 1. Connect HP 8114A to the Scope as shown:

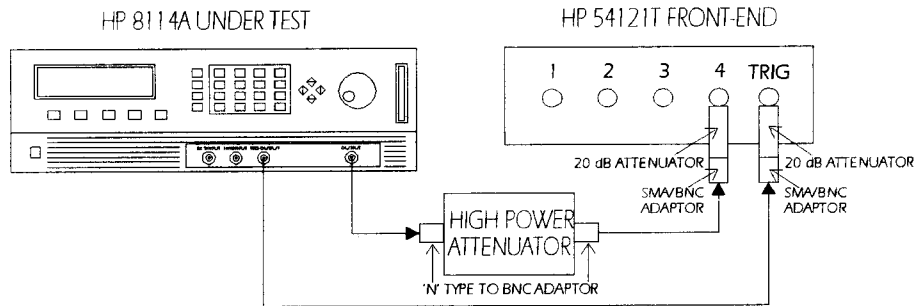

Connecting HP 8114A to the Scope

On the HP 8114A press **TRIGGER** and set up page as follows:

- CONTINUOUS PULSES
- Single Pulses

2. On the HP 8114A set-up the **OUTPUT** page as shown in the following illustration:

Per	500 μs	Out ON	MODIFY				
		Inh OFF f					
Delay	0.00 ns	Baseline +0.00 V	20.0				
DutyCyc	50.0%	Amplitd 20.0 V					
HIZ into	50.0 Ω	Positive	U				
<table border="1"> <tr> <td>TRIGGER</td> <td>OUTPUT</td> <td>LIMITS</td> <td>CONFIG</td> </tr> </table>				TRIGGER	OUTPUT	LIMITS	CONFIG
TRIGGER	OUTPUT	LIMITS	CONFIG				

Configuring the Output Page

3. Set the Digitizing Oscilloscope HP 54121T:
 - Press **AUTOSCALE**
 - Center one pulse on screen, e.g.: TIME/DIV = 50 μ S/div, DELAY = 365 μ S,
 - Select the Display menu and set the Number of Averages to 32
 - Select the Channel menu and set the Attenuation factor to 10
 - Select the Delta V menu and turn the voltage markers On
 - Set the Preset Levels = 10-90% and press **AUTO LEVEL SET**
 - Select the Timebase menu and set TIME/DIV = 5 ns/div, DELAY = 27 ns
 - Select the Delta t menu and turn the markers On
 - Set START ON EDGE = POS1 and STOP ON EDGE = POS1
4. Set period of HP 8114A to: Period = 1 μ s
5. After the averaging, while the oscilloscope is in the Delta t menu, Press the **PRECISE EDGE FIND** key
6. Check the HP 8114A rise time at the following leading edge setting:

Table 5-15. Leading Edge Setting

Oscilloscope TIME/DIV	Period	Acceptable Range	TR Entry
5 ns/div	1 μ s	<12 ns	8.2a

Test 8.2b: Trailing Edge Test

Trailing edge for amplitudes >10 V from HIZ (High-Z) into 50Ω .

Note



The Leading Edge test must be performed before you start this test.

Procedure

1. Set the Digitizing Oscilloscope HP 54121T:
 - Select the Timebase menu and set TIME/DIV = 5 ns/div, DELAY = 529 ns
 - Select the Delta t menu
 - Set START ON EDGE = NEG1 and STOP ON EDGE = NEG1
2. After the averaging, while the oscilloscope is in the Delta t menu, Press the **PRECISE EDGE FIND** key
3. Check the HP 8114A output signal falls at the following trailing edge setting:

Table 5-16. Trailing Edge Setting

Oscilloscope TIME/DIV	Delay	Period	Acceptable Range	TR Entry
5 ns/div	529 ns	1 μ s	<12 ns	8.2b

Test 9: Pulse Aberration Test

The following tests are required:

- 1) Overshoot and Ringing
- 2) Preshoot

Test Specifications Overshoot/Ringing/Preshoot:
±5% of amplitude ±100 mV

Equipment Needed Digitizing Oscilloscope with Accessories
High Power Attenuator

5

Procedure 1. Connect HP 8114A to the Scope as shown:

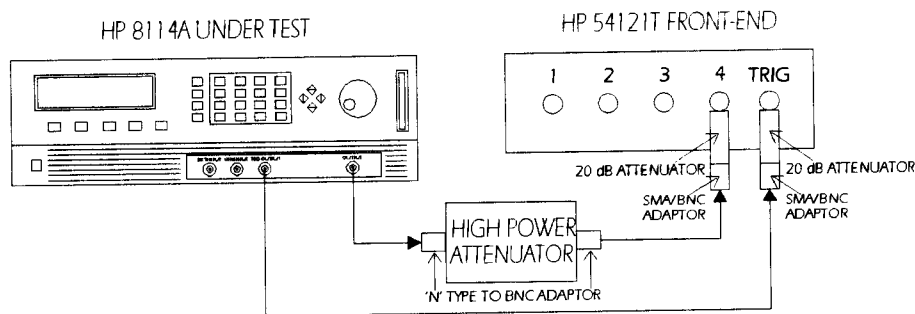







Connecting HP 8114A to the Scope

On the HP 8114A press **TRIGGER** and set up page as follows:

- CONTINUOUS PULSES
- Single Pulses

- On the HP 8114A set up the **OUTPUT** page as shown in the following illustration:

Per	1.00 μ s	Out	ON	
		Inh	OFF f	
Delay	0.00 ns	Baseline	+0.00 V	
DutyCyc	50.0%	Amplitd	25.0 V	
50 Ω into 50.0 Ω		...	Positive	
   				

Configuring the Output Page

1) Overshoot and Ringing

- Set the digitizing oscilloscope HP 54121T:
 - Press **AUTOSCALE**
 - Select the Display menu and set the Number of Averages to 32
 - Select the Channel menu and set the Attenuation factor to 100
 - Center one pulse horizontally and vertically on screen (e.g. TIME/DIV = 100 ns/div, DELAY = 800 ns)
 - Select the delta V menu and turn the voltage markers On
 - Set the VARIABLE LEVELS = 95% - 105% and press **AUTO LEVEL SET**
 - Select the channel menu and center vertically the top pulse (offset = 25 V)
 - Set the VOLTS/DIV = 1 V/div
 - Select the Timebase menu and set TIME/DIV = 20 ns/div, DELAY = 30 ns
- Check that Overshoot and Ringing are within the $\pm 5\%$ of amplitude ± 100 mV window (within the two marker positions)

5. Enter the result in the Test Report as TR entry 9 - 1

Note



Take the oscilloscope's trace flatness error (GaAs input circuit) into account.

6. Set HP 8114A to: Amplitude = 5 V

7. Repeat steps 3 to 5, but this time set the Scope to:

- VARIABLE LEVELS = 93% - 107% and press **AUTO LEVEL SET**
- OFFSET = 5 V
- VOLTS/DIV = 200 mV/Div
- TIMEBASE = 20 ns/Div

8. Enter the result in the Test Report as TR entry 9 - 2

2) Preshoot

9. Set HP 8114A to:

- Period = 1 μ s
- Amplitude = 5 V
- Baseline = 0 V
- Delay = 50 ns

10. Set the digitizing oscilloscope, HP 54121T:

- Press **AUTOSCALE**
- Select the Display menu and set the Number of Averages to 32
- Select the Channel menu and set the Attenuation factor to 100
- Center one pulse horizontally and vertically on screen (e.g. TIME/DIV = 100 ns/div, DELAY = 800 ns)
- Select the delta V menu and turn the voltage markers On
- Set the VARIABLE LEVELS = -7% to +7% and press **AUTO LEVEL SET**
- Select the channel menu and center vertically the bottom of the pulse (offset = 0 V)
- Set the VOLTS/DIV = 200 mV/div
- Select the Timebase menu and set TIME/DIV = 20 ns/div

5

11. Check that Preshoot is within the $\pm 5\%$ of amplitude ± 100 mV window.
12. Enter the result in the Test Report as TR entry 9 - 3

5



HP 8114A Performance Test Records

Test Facility:

_____	Report No. _____
_____	Date _____
_____	Customer _____
_____	Tested By _____

Model HP 8114A 100V/2A Pulse Generator

Serial No. _____ Ambient temperature _____ °C

Options _____ Relative humidity _____ %

Firmware Rev. _____ Line frequency _____ Hz

Special Notes:

Test Equipment Used

Description	Model No.	Trace No.	Cal. Due Date
1. Oscilloscope	HP 54121T	_____	_____
2. Counter	HP 5334B	_____	_____
4. Digital Voltmeter	HP 3458A	_____	_____
3. Pulse Generator	HP 8112A	_____	_____
5. Delay Line	HP 54008A	_____	_____
6. _____	_____	_____	_____
7. _____	_____	_____	_____
8. _____	_____	_____	_____
9. _____	_____	_____	_____
10. _____	_____	_____	_____
11. _____	_____	_____	_____
12. _____	_____	_____	_____
13. _____	_____	_____	_____
14. _____	_____	_____	_____
15. _____	_____	_____	_____
16. _____	_____	_____	_____
17. _____	_____	_____	_____
18. _____	_____	_____	_____

5



Test Results for HP 8114A Pulse Generator

Serial No. _____ Ambient temperature _____ °C
Customer _____ Relative humidity _____ %
CSO# _____ Line frequency _____ Hz
Tested by _____ Date _____

Comments:



5

Period

Scope Uncertainty factor _____

TR Entry	Test	Limit Minimum	Actual Result	Limit Maximum	Pass	Fail
1 - 1	66.7 ns	63.27 ns	_____	70.14 ns	___	___
1 - 2	100 ns	94.9 ns	_____	105.1 ns	___	___
1 - 3	500 ns	474.9 ns	_____	525.1 ns	___	___
1 - 4	1 μ s	949.9 ns	_____	1050.1 ns	___	___
1 - 5	5 μ s	4.75 μ s	_____	5.25 μ s	___	___
1 - 6	50 μ s	47.5 μ s	_____	52.5 μ s	___	___
1 - 7	500 μ s	475 μ s	_____	525 μ s	___	___
1 - 8	5 ms	4.75ms	_____	5.25 ms	___	___
1 - 9	50 ms	47.5 ms	_____	52.5 ms	___	___
1 - 10	500 ms	475 ms	_____	525 ms	___	___

5

Period Jitter

Scope Uncertainty factor _____

TR Entry	Test	Actual Result	Limit Maximum	Pass	Fail
5.1 - 1	100 ns	_____	75 ps	___	___
5.1 - 2	500 ns	_____	175 ps	___	___

5

Width

Scope Uncertainty factor _____

TR Entry	Test	Limit Minimum	Actual Result	Limit Maximum	Pass	Fail
2 - 1	10.0 ns	9.00 ns	_____	11.0 ns	___	___
2 - 2	50.0 ns	47.0 ns	_____	53.0 ns	___	___
2 - 3	100 ns	94.5 ns	_____	105.5 ns	___	___
2 - 4	500 ns	474.5 ns	_____	525.5 ns	___	___

Width (continued)

Counter Uncertainty factor _____

TR Entry	Test	Limit Minimum	Actual Result	Limit Maximum	Pass	Fail
2 - 5	1 μ s	949.5 ns	_____	1050.5 μ s	___	___
2 - 6	5 μ s	4.75 μ s	_____	5.25 μ s	___	___
2 - 7	50 μ s	47.5 μ s	_____	52.5 μ s	___	___
2 - 8	500 μ s	475 μ s	_____	525 μ s	___	___
2 - 9	5 ms	4.75 ms	_____	5.25 ms	___	___
2 - 10	50 ms	47.5 ms	_____	52.5 ms	___	___
2 - 11	500ms	475 ms	_____	525 ms	___	___

5

Width Jitter

Scope Uncertainty factor _____

TR Entry	Test	Actual Result	Limit Maximum	Pass	Fail
5.2 - 1	50 ns	_____	50 ps	___	___
5.2 - 2	500 ns	_____	175 ps	___	___

5

Delay

Scope Uncertainty factor _____

TR Entry	Test	Limit Minimum	Actual Result	Limit Maximum	Pass	Fail
3 - 1	0.00 ns		_____	Fixed Delay	___	___
3 - 2	5.00 ns	3.75 ns	_____	6.25 ns	___	___
3 - 3	10.0 ns	8.50 ns	_____	11.50 ns	___	___
3 - 4	50.0 ns	46.5 ns	_____	53.5 ns	___	___
3 - 5	100 ns	94 ns	_____	106 ns	___	___
3 - 6	500 ns	474 ns	_____	526 ns	___	___

5

Delay (continued)

Counter Uncertainty factor _____

TR Entry	Test	Limit Minimum	Actual Result	Limit Maximum	Pass	Fail
3 - 7	1 μ s	949 ns	_____	1051 ns	___	___
3 - 8	5 μ s	4.749 μ s	_____	5.251 μ s	___	___
3 - 9	50 μ s	47.5 μ s	_____	52.5 μ s	___	___
3 - 10	500 μ s	475 μ s	_____	525 μ s	___	___
3 - 11	5 ms	4.75 ms	_____	5.25 ms	___	___
3 - 12	50 ms	47.5 ms	_____	52.5 ms	___	___
3 - 13	500ms	475 ms	_____	525 ms	___	___

Delay Jitter

Scope Uncertainty factor _____

TR Entry	Test	Actual Result	Limit Maximum	Pass	Fail
5.3 - 1	50 ns	_____	50 ps	___	___
5.3 - 2	500 ns	_____	175 ps	___	___

5

Double Pulse Delay

Scope Uncertainty factor _____

TR Entry	Test	Limit Minimum	Actual Result	Limit Maximum	Pass	Fail
4 - 1	20.0 ns	18.75 ns	_____	21.25 ns	___	___
4 - 2	50.0 ns	47.25 ns	_____	52.75 ns	___	___
4 - 3	100 ns	94.75 ns	_____	105.25 ns	___	___

Counter Uncertainty factor _____

TR Entry	Test	Limit Minimum	Actual Result	Limit Maximum	Pass	Fail
4 - 4	500 ns	474.75 ns	_____	525.25 ns	___	___
4 - 5	1 μ s	949.75 ns	_____	1050.25 μ s	___	___
4 - 6	5 μ s	4.759 μ s	_____	5.25 μ s	___	___
4 - 7	50 μ s	47.5 μ s	_____	52.5 μ s	___	___
4 - 8	500 μ s	475 μ s	_____	525 μ s	___	___
4 - 9	5 ms	4.75 ms	_____	5.25 ms	___	___
4 - 10	50 ms	47.5 ms	_____	52.5 ms	___	___
4 - 11	500 ms	475 ms	_____	525 ms	___	___

5



Amplitude: 50Ω into 50Ω

TR Entry	Test	Measured $B_{50\Omega}$	$H_{50\Omega}$	Calculated Amplitude $(H_{50\Omega} - B_{50\Omega}) \times G_1$	Amplitude Minimum	limits Maximum	Pass	Fail
6 - 1	1 V	_____	_____	_____	0.89 V	1.11 V	_____	_____
6 - 2	2 V	_____	_____	_____	1.88 V	2.12 V	_____	_____
6 - 3	5 V	_____	_____	_____	4.85 V	5.15 V	_____	_____
6 - 4	10 V	_____	_____	_____	9.80 V	10.2 V	_____	_____
6 - 5	20 V	_____	_____	_____	19.7 V	20.3 V	_____	_____
6 - 6	50 V	_____	_____	_____	49.4 V	50.6 V	_____	_____

5

Amplitude: HIZ into 50Ω

TR Entry	Test	Measured B_{HIZ}	H_{HIZ}	Calc'd Amplitude $\{(H_{HIZ} - B_{HIZ}) \times G_2\} / A_d$	Amplitude Minimum	limits Maximum	Pass	Fail
6 - 7	2 V	_____	_____	_____	1.88 V	2.12 V	_____	_____
6 - 8	5 V	_____	_____	_____	4.85 V	5.15 V	_____	_____
6 - 9	10 V	_____	_____	_____	9.80 V	10.2 V	_____	_____
6 - 10	20 V	_____	_____	_____	19.7 V	20.3 V	_____	_____
6 - 11	50 V	_____	_____	_____	49.4 V	50.6 V	_____	_____
6 - 12	100 V	_____	_____	_____	98.9 V	101.1 V	_____	_____

Variable Baseline (Option 001)

Note



This test is only to be performed if **Option 001** is installed.

TR Entry	Test	Variable Baseline		Baseline Minimum	limits Maximum	Pass	Fail
		Measured VB	Calculated B = VB x G ₁				
7 - 1	-25 V	_____	_____	-25.355 V	-24.645 V	___	___
7 - 2	-20 V	_____	_____	-20.305 V	-19.695 V	___	___
7 - 3	-10 V	_____	_____	-10.205 V	-9.795 V	___	___
7 - 4	-5 V	_____	_____	-5.155 V	-4.845 V	___	___
7 - 5	-2 V	_____	_____	-2.125 V	-1.875 V	___	___
7 - 6	±0 V	_____	_____	-0.105 V	+0.105 V	___	___
7 - 7	+2 V	_____	_____	+1.875 V	+2.125 V	___	___
7 - 8	+5 V	_____	_____	+4.845 V	+5.155 V	___	___
7 - 9	+10 V	_____	_____	+9.795 V	+10.2005	___	___
7 - 10	+20 V	_____	_____	+19.695 V	+20.305 V	___	___
7 - 11	+25 V	_____	_____	+24.645 V	+25.355 V	___	___

5



Leading Edge for Amplitudes >5 V from 50Ω into 50Ω

Scope Uncertainty factor _____

TR Entry	Test	Actual Result	Limit Maximum	Pass	Fail
8.1a	Leading	_____	<7 ns	___	___

Trailing Edge for Amplitudes >5 V from 50Ω into 50Ω

TR Entry	Test	Actual Result	Limit Maximum	Pass	Fail
8.1b	Trailing	_____	<7 ns	___	___

Leading Edge for Amplitudes >10 V from HIZ (High-Z) into 50Ω

TR Entry	Test	Actual Result	Limit Maximum	Pass	Fail
8.2a	Leading	_____	<12 ns	___	___

Trailing Edge for Amplitudes >10 V from HIZ (High-Z) into 50Ω

TR Entry	Test	Actual Result	Limit Maximum	Pass	Fail
8.2b	Trailing	_____	<12 ns	___	___

5

Overshoot and Ringing

Scope Uncertainty factor _____

TR Entry	Test	Acceptable range	Pass	Fail
9 - 1	25 V	$\pm 5\%$ of ampl. $\pm 100\text{mV}$	_____	_____
9 - 2	5 V	$\pm 5\%$ of ampl. $\pm 100\text{mV}$	_____	_____

Preshoot

TR Entry	Test	Acceptable range	Pass	Fail
9 - 3	0 V	$\pm 5\%$ of ampl. $\pm 100\text{mV}$	_____	_____

5



HP 8114A Pulse Generator Specifications

Specifications describe the instrument's warranted performance. Non-warranted values are described as typical. All specifications apply after a 30 minute warm-up phase with 50 Ohm source impedance into a 50 Ohm load, and are valid from 0°C to 55°C ambient temperature. Non-warranted values are described as 'typical'. Parameters are over- and under-programmable outside their specified ranges.

General

Environmental

Operating temperature:	0°C to +55°C
Storage temperature:	-40°C to +70°C
Humidity:	95% (0°C to 40°C)
EMC:	conforms to EN55011 Group 1 Class A
Battery:	Lithium (Panasonic CR2477-1HF)

Safety IEC348, safety class 1

Power requirements 100-240 Vac, ±10%, 50-60 Hz;
 100-120 Vac, ±10%, 400 Hz
 Power consumption: 500 VA max.

HP 8114A Specifications

Maximum Dimensions (H x W x D)

133 mm H x 426 mm W x 422 mm D (5.2 in x 16.8 in x 16.6 in)

Weight

Net

14 kg (30.8 lb)

Shipping

17 kg (37.4 lb)

Recalibration period 1 year recommended

Warranty 1 year standard

Acoustic Noise Pressure

Acoustic Noise Pressure

For ambient temperature up to 30°C,
under normal operation and at the
typical operator position:

LpA - 45.1 dBA

Measured in accordance with
ISO 7779/EN 27779.

Geräuschemissionswerte

Bei einer Umgebungstemperatur bis 30°C

LpA - 45.1 dBA

am Arbeitsplatz, normaler Betrieb.

Angabe ist das Ergebnis einer
Typprüfung nach ISO 7779/EN 27779.

6

Declaration of Conformity

Manufacturer: Hewlett-Packard GmbH
Böblingen Instruments Division
Herrenberger Str. 130
D-71034 Böblingen Germany

We declare that the product

HP 8114A 100V/2A Programmable Pulse Generator
conforms to the following standards:

Safety: IEC 1010-1 (1990) including Amendment 1
(1992)

EN 61010 (1993)

CSA C22.2 Nr.1010.1

EMC: EN 55011 (1991)/CISPR 11 Group 1, Class A

EN 50082-1 (1991)

IEC 801-2 ESD: 4kV cd, 8kV ad

IEC 801-3 Radiated Immunity: 3V/m

IEC 801-4 Fast Transients: 0.5kV, 1kV

6

Supplementary Information

During the measurement against EN 55011, the I/O ports were terminated with their nominal impedance, the HP-IB connector was terminated with the cable HP 10833B. When the product is connected to other devices, the user must ensure that the connecting cables and the other devices are adequately shielded to prevent radiation.

Böblingen 6th September 1993

Hans Baisch

Product Regulations Consultant

Output

Amplitude



Range:

1.00 V to 50.0 V (doubles into open circuit) 2.00 V to 100 V (HIZ (High-Z) into 50 Ω)

Warning



- When working with output voltages of 30 - 100V amplitude, the output voltage can be dangerous to life. Care should therefore be taken when connecting the HP 8114A to external instruments.

-  When working in HIZ (High-Z) Mode, if you remove the external load the output voltage can be higher than the programmed voltage. V_{pp} can be as much as 130 V, even when set as low as 2 V_{pp} .
-

Current:

40.0 mA to 2.00 A

Accuracy:

$\pm 1\%$ of amplitude ± 100 mV

Resolution:

3 digits, best case 10 mV

Baseline: 0 V ± 100 mV $\pm 0.5\%$ of amplitude

Variable Baseline (Option 001)

50 Ω source impedance only, pulse within ± 50 V window

Range:

-25.0 V to +25 V

Accuracy:

$\pm 1\%$ ± 100 mV $\pm 0.5\%$ of amplitude

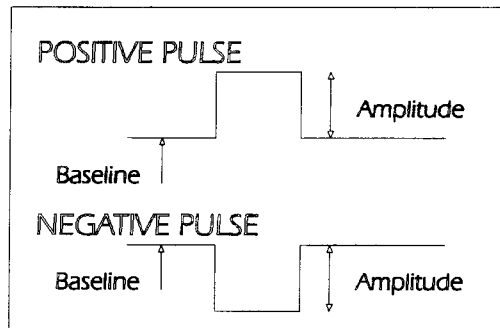

6

Polarity Positive or negative pulses selectable

Source Impedance 50 Ω or High Impedance (>10k Ω typ.) selectable

Load Compensation For loads $\neq 50\Omega$ the actual load can be entered to correct output values

HP 8114A Specifications

Connector BNC

On/Off: Relay connects/disconnects output

Output Protection



Maximum external voltage 100 Vpp from external 50 Ω source
(± 20 Vdc from external 0 Ω source)

Limits Programmable level and duty-cycle limits restrict the available output range to protect the DUT.

Pulse Performance

Overshoot/Preshoot/Ringing:

< $\pm 5\%$ of amplitude ± 100 mV

Settling time:

<100 ns typical

Transition Times:

Measured between 10% and 90% of amplitude,
50 Ω into 50 Ω : <7ns (ampl >5 V)
HIZ (High-Z) into 50 Ω <12 ns (ampl >10 V)

Pulse Timing Measured at 50% of amplitude

Repeatability:

factor 4 better than accuracy

6

Period Can be set as period or frequency

Range:

66.7 ns to 999 ms (**Frequency:** 1.00 Hz to 15.0 MHz)

Accuracy:

$\pm 5\% \pm 100$ ps

Resolution:

3 digits, best case 100 ps

RMS-Jitter:

0.03% + 25 ps (0.05% + 25 ps in the 66.7 ns to 100 ns range)



Width

Can be set as width, duty-cycle or trailing-edge delay.

Range 10 ns to 150 ms

Accuracy:

$\pm 5\% \pm 500$ ps

Resolution:

3 digits, best case 100 ps

RMS-Jitter:

0.03% + 25 ps (0.05% + 25 ps in the 50 ns to 100 ns range)

Duty-cycle

0.1% to 100%
(Subject to width and period specifications).

Standard HP 8114A (Baseline = 0 V)

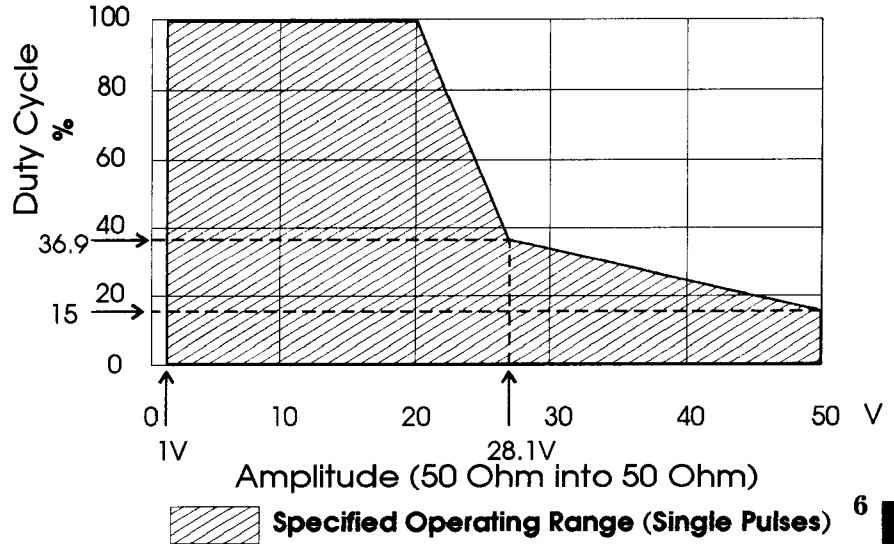

Figure 6-1. Duty-cycle / Amplitude Ranges

Figure 6-1 shows the maximum possible duty-cycle for a given pulse amplitude from 50Ω into 50Ω. Note that amplitude doubles from HIZ (High-Z) into 50Ω.

In double-pulse mode the actual duty-cycle of the signal is twice the value displayed on the HP 8114A screen because two pulses are generated per pulse period. Therefore, the duty-cycle available, and set, will be limited to half the value given by Figure 6-1.

Variable Baseline Option 001

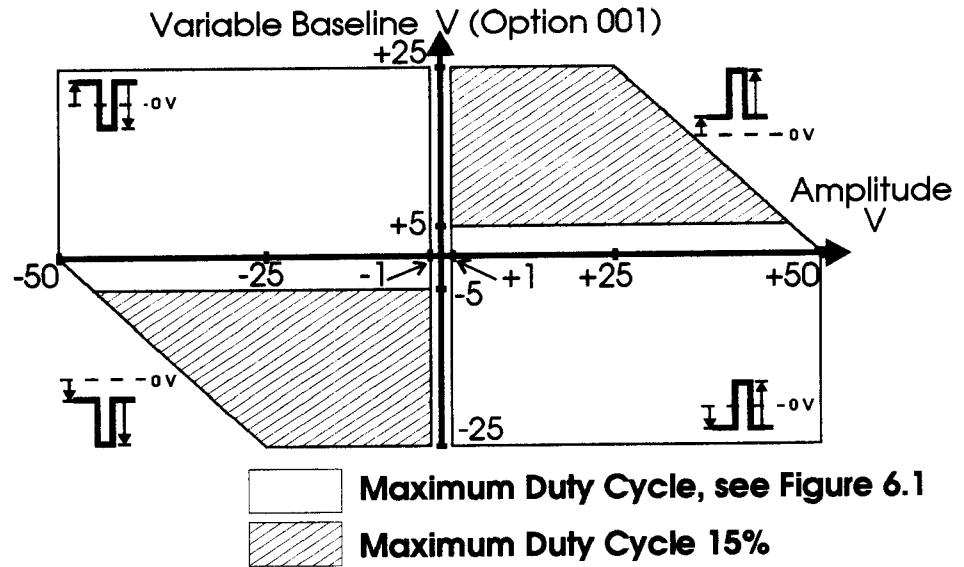

Figure 6-2. Baseline Duty-cycle / Amplitude Ranges

Refer to Figure 6-2. Under the following conditions Figure 6-1 still applies for the maximum duty-cycle:

- Positive pulse with negative Baseline
- Negative pulse with positive Baseline
- $-5 \text{ V} \leq \text{Baseline} \leq +5 \text{ V}$, negative or positive pulses

Under the following conditions maximum duty-cycle is 15%:

- Baseline $> +5 \text{ V}$ and positive pulses
- Baseline $< -5 \text{ V}$ and negative pulses

Note also, that the pulse is limited to a $\pm 50 \text{ V}$ window (50 Ω into 50 Ω) so that for positive pulses with positive Baseline, or negative pulses with negative baseline, the maximum available amplitude becomes limited by the Baseline setting

Delay	Can be set as absolute delay, phase, or % of period.
Fixed delay	42 ns typical (measured between Trigger Output and Output)
Variable Range	0.00 ns to 999 ms (Maximum value: period - 4 ns)
Accuracy	$\pm 5\% \pm 1$ ns
Resolution	3 digits, best case 10 ps
RMS-Jitter	0.03% + 25 ps (0.05% + 25 ps in the 50 ns to 100 ns range)

Double Pulse Delay

Double pulse delay replaces delay when double pulses are selected. The delay between double pulses can be set as absolute delay or % of period.

Minimum Period	133.4 ns
Range	20.0 ns to 999 ms (Maximum value: period - width - 4 ns)
Accuracy	$\pm 5\% \pm 250$ ps
Resolution	3 digits, best case 100 ps
Minimum Period	133.4 ns

Trigger Output

Level Fixed TTL (2.5 V into 50 Ω)

Output Impedance 50 Ω typical

Trigger pulse width 50% of period, typical

Maximum external voltage



-2 V/+7 V

Transition times 5 ns typical

Delay from External Input to Trigger Output

24 ns typical

External Input

An external signal at the external input can be used to trigger or gate the output signal.

Input impedance 10 k Ω

Threshold -10 V to +10 V with 100 mV resolution

Maximum external voltage



± 50 V

Input transitions <100 ns

Input frequency dc to 15MHz

Minimum pulse width

10 ns typical

Input sensitivity ≤ 300 mV_{pp} typical

6

Inhibit Input

An external TTL signal at the Inhibit Input can be used to inhibit the pulse signal, holding the output signal at its baseline level.

Inhibit on Edge An active edge inhibits the pulse signal until reset from the front panel, or HP-IB.

Inhibit on Level An active level inhibits the pulse signal

Input Impedance 100 k Ω

Threshold 1.5 V (TTL) typical

Input transitions <100 ns

Input frequency dc to 5 MHz

Minimum pulse width
100 ns typical

Input sensitivity ≤ 300 mV_{pp} typical

Inhibit response time
200 ns typical

Maximum external voltage

 ± 50 V

6

Trigger Modes

Continuous A continuous train of pulses or bursts of pulses is generated

Triggered A transition (rising, falling, or both) at the external input or MANual trigger key triggers a pulse or burst of pulses.

Gated Active level (high or low) at the external input or MANual Trigger key enables pulses or bursts of pulses. The last pulse or burst of pulses is always completed.

External Width Period and width of the output signal are taken from a signal at the External Input. Levels can be set up to maximum amplitude of 20 Volts (from 50 Ω into 50 Ω).

Pulse Modes

1s2>Burst Set a burst of 2 to 65536 pulses.
(A normal pulse is equivalent to a burst of 1 pulse)

Double Pulse

Two pulses generated per pulse-period. First pulse starts at the start of pulse-period; double delay sets delay to the start of the second pulse. Double pulses are available in all Trigger Modes except External Width.

Human Interface

Display All pulse parameters at a glance on one display.

Help Key Displays context-sensitive information.

Memory The current setting, plus nine user settings are stored in non-volatile memory when the instrument is switched off.

Clear Memory:

Clears all stored user settings.

Memorycard Instrument settings (350 bytes each) are stored in MS-DOS formatted PCMCIA memorycards. Cards can also be used for convenient firmware updates.

Remote Control Operates according to IEEE standard 488.2, 1987 and SCPI 1992.0

Function Code SH1, AH1, T6, L4, SR1, RL1, PP0, DC1, DT1, C0.

Programming times (All checks and display off)

ASCII Command	Typical Execution Time
One parameter or mode	5 . . . 20 ms
Recall setting	<250 ms

Index

- A**
 - Accessories, 5-2
 - AC line voltage, 1-2
 - Adjusting a parameter value, 2-13
 - Adjusting a setting, 2-14
 - Adjusting parameters, 2-15
 - Adjust parameter, 3-19
 - Amplitude, 3-25, 6-9
 - Amplitude current, 4-30
 - Amplitude voltage, 4-59
 - AUTOSET, 3-5, 3-37

- B**
 - Baseline, 3-25, 6-9
 - Battery, 1-6
 - Block Diagram, 2-8
 - BURST length, 4-84
 - BURST mode, 4-84
 - BURST Mode, 3-11, 3-13, 3-17

- C**
 - CD, 3-31
 - Change directory, 3-31
 - Changing a setting, 2-14
 - Clear Error Queue, 4-70
 - Clear Status, 4-70
 - Command Summary, 4-2
 - Common Commands, 4-1
 - Condition Register, 4-7
 - CONFIG, 2-10
 - CONFIG , 3-35
 - CONTINUOUS BURSTMode, 3-11
 - CONTINUOUS mode, 4-93
 - CONTINUOUS Mode, 3-9, 3-11

Current
 amplitude, 4-30
Current levels, 3-25
Current limits, 3-29
Current Limits, 4-40
CURSOR, 3-6
CURSOR keys, 2-2

D DATA ENTRY, 3-6
DATA ENTRY keys, 2-3
DbDel, 4-49, 4-50
Default settings, 2-11
Default units, 4-47, 4-51
Delay, 3-22, 4-45, 4-46, 4-47
Delay%, 3-22, 4-45, 4-46, 4-47
Delay Test, 5-14
Delay Test Results, 5-16
Delete, 3-34
DIR, 4-18
Directory, 3-30
Display
 ON/OFF, 4-17
Double-delay, 4-49, 4-50, 4-51
Double Delay Test, 5-19
Double Delay Test Results, 5-21
Double-pulses, 4-48
Duty-cycle, 3-23, 4-44, 6-9

E E, 2-11, 3-4
Enable Register, 4-8
Error checking, 3-36
Error Queue, 4-73
Errors, 3-4, 3-36
Event Register, 4-7
EXT INPUT, 2-3, 3-7
EXT INPUT Threshold, 4-90
EXT WIDTH, 4-86
EXT WIDTH mode, 4-86
EXT WIDTH Mode, 3-18

- F** Failure
 - selftest, 2-11
- Feedthrough Termination
 - 10 W, 50 Ohm, 5-4
- Filename suffixes, 3-33
- Firmware Revision, 3-4
- Format, 3-34
 - Parameter, 3-20
- Frontpanel Overview, 2-2
- Functional Coupling, 4-15
- Functional Overview, 2-8

- G** Gated by, 4-92, 4-93
- GATED level, 4-92
- GATED mode, 4-91, 4-93
- GATED Mode, 3-15, 3-17
- Getting started, 2-11
- GRAPHICS, 2-15

- H** Help, 3-2, 3-5
- High-level, 3-25
- High-level current, 4-34
- High-level current limit, 4-38
- High-level voltage, 4-61
- High-level voltage limit, 4-65
- HP-IB Address, 3-35

- I** Impedance
 - Load, 3-26
 - OUTPUT, 3-26
 - Source, 3-26
- INHibit, 4-87
 - INPut, 4-89
 - MODE, 4-88
- Inhibit HP 8114A Output, 3-27
- INHibit mode, 4-87
- INH INPUT, 2-3, 3-7
- Inspection, 1-1
- Instrument Serial numbers, 5-5
- Instrument Setting, 4-79

- K** Key-code Reference, 4-74

- L** Last Key Pressed, 4-74
 - LIMITS, 2-9
 - LIMITS , 3-29
 - Line Switch, 2-2
 - Load Compensation, 3-26
 - Load Impedance, 3-26, 4-27
 - LOCAL, 3-5
 - Low-level, 3-25
 - Low-level current, 4-36
 - Low-level current limit, 4-39
 - Low-level voltage, 4-63
 - Low-level voltage limit, 4-66

- M** MAN, 3-6, 3-11, 3-13, 3-15, 3-17
 - Manual Trigger, 3-6
 - MEMCARD, 2-10
 - MEMCARD , 3-30
 - Memory card
 - Catalog/DIR, 4-18
 - Change directory, 4-19
 - Copy file, 4-20
 - Delete file, 4-21
 - Format, 4-22
 - Initialize, 4-22
 - Load from, 4-23
 - Store to, 4-24
 - Memory Card, 3-30, 3-32
 - Delete, 3-34
 - Format, 3-34
 - Recall, 3-32
 - Store, 3-32
 - Store All, 3-33
 - MEMORY CARD, 2-3
 - MODIFY, 2-2
 - Modify filename, 3-33
 - MODIFY knob, 2-2
 - MODIFY Knob, 3-7
 - MORE, 3-5

Moving the parameter cursor, 2-12

- O**
 - OFF, 3-20
 - Offset, 3-25
 - Offset current, 4-32
 - Offset voltage, 4-60
 - % of Per, 4-45, 4-46, 4-47
 - ON, 3-20
 - Operating Environment, 1-6
 - Operational Status Group, 4-68
 - Operation Status, 4-10
 - OUTPUT, 3-19
 - OUTPUT Impedance, 3-26, 4-26
 - OUTPUT On/Off, 3-20
 - OUTPUT ON/OFF, 4-25, 4-28
 - Output Polarity, 3-26
 - OUTPUT Polarity, 4-29
 - Output Protection, 3-26
 - Overheating, 1-5
 - Overview
 - Frontpanel, 2-2
 - Functional, 2-8
 - Rearpanel, 2-5

- P**
 - Pages, 2-13
 - Parameter cursor, 2-12
 - Parameter format, 3-20
 - Path, 3-30
 - Performance Test Records, 5-56
 - Performance Tests, 5-1
 - Phase, 3-22, 4-43
 - Polarity of Output, 3-26
 - Power
 - cable, 1-3
 - requirements, 1-2
 - Power Switch, 2-2
 - Programming
 - BURST mode, 4-14
 - CONTINUOUS mode, 4-13
 - EXT WIDTH mode, 4-13

- GATED mode, 4-13
- PULSES mode, 4-13
- TRIGGERED mode, 4-13
- Pulse amplitude, 6-9
- Pulse Frequency, 4-41
- Pulse-period, 4-56
- PULSES Mode, 3-9, 3-11, 3-15
- Pulse width, 4-58

Q Questionable Status, 4-11
Questionable Status Group, 4-71

R Range Coupling, 4-15
ReadCard, 3-32
Reading the Error Queue, 4-73
Reading the Keyboard, 4-76
Rearpanel Overview, 2-5
Recall, 3-32
RECALL, 3-6
Recalling the default settings, 2-11
Recommended Test Equipment, 5-2
Records, 5-56
Registers, 4-8
Reset, 4-77

S S, 3-5
SCPI
 Command Dictionary, 4-15
 Command Summary, 4-2
 Version, 4-80
Screens, 2-13
Selecting
 pages, 2-13
 parameters, 2-15
Selecting a parameter, 2-12
Selftest, 2-11, 3-35
Selftest failure, 2-11
Serial Numbers, 3-4
SHIFT, 3-5
Simulating Key-presses, 4-74

- Single-pulses, 4-48
- Softkeys, 3-5
- Software Revision, 3-4
- Source Impedance, 3-26
- Specifications, 6-1
- Standard Event Status, 4-9
- Status Byte, 4-8
- Status Group
 - Operational, 4-68
 - Questionable, 4-71
- Status Groups, 4-6
- Status Model, 4-6
- Status Model Preset, 4-70
- Store, 3-32
- STORE, 3-6
- Store All, 3-33
- System Preset, 4-77
- System Security, 4-78

T

- Test Accessories, 5-2
- Test Equipment list, 5-2
- Testing, 5-1
- Test Records, 5-56
- Tests
 - Amplitude, 5-32
 - Delay, 5-12
 - Delay Jitter, 5-29
 - Double Pulse Delay, 5-17
 - Jitter, 5-22
 - Leading Edge, 5-46, 5-49
 - Overshoot and Ringing, 5-53
 - Period, 5-6
 - Period Jitter, 5-22
 - Preshoot, 5-54
 - Pulse Aberration Test, 5-52
 - Trailing Edge, 5-48, 5-51
 - Transition Time, 5-45
 - TT, 5-45
 - Variable Baseline, 5-42
 - Width, 5-8
 - Width Jitter, 5-26

TEXT, 2-15
Thermal Protection, 1-5
Trailing Delay, 3-24
Trailing edge delay, 4-57
Transition Filters, 4-7
Transition Time leading Edge, 5-47, 5-50
TRIGGER, 2-9, 3-9
TRIGGERED BURST Mode, 3-13
Triggered by, 4-92, 4-93
TRIGGERED mode, 4-91, 4-93
TRIGGERED Mode, 3-11, 3-13
TRIGGERED slope, 4-92
TRIGGER OUT, 2-3, 3-7

V Value Coupling, 4-15
Ventilation, 1-5
Verification Tests, 5-1
VERNIER, 3-6
Voltage levels, 3-25
Voltage limits, 3-29
Voltage Limits, 4-67

W W, 3-4
Warnings, 3-4, 3-36, 4-81
Weight, 6-2
Width, 3-23
Width Test, 5-10
Width Test Results, 5-11

Copyright Agilent Technologies 1993, 2000
Edition E0595
Printed in Germany



08114-91012



Agilent Technologies

