

Agilent 53210A 350 MHz RF Counter

User's Guide



Agilent Technologies

Notices

© Agilent Technologies, Inc. 2011

No part of this manual may be reproduced in any form or by any means (including electronic storage and retrieval or translation into a foreign language) without prior agreement and written consent from Agilent Technologies, Inc. as governed by United States and international copyright laws.

Manual Part Number

53210-90001

Edition

Second Edition, September 2011

Printed in Malaysia

Agilent Technologies, Inc.
5301 Stevens Creek Blvd.
Santa Clara, CA 95052 USA

Product manuals are provided with your instrument on CD-ROM and/or in printed form. Printed manuals are an option. Manuals are also available on the web on the instrument's product page.

Software Updates / Licenses

Periodically, Agilent releases software updates to fix known defects and incorporate product enhancements. To search for software updates and the latest documentation for your product, go to the product page at:

www.agilent.com/find/53210A

A portion of the software in this product is licensed under terms of the General Public License Version 2 ("GPLv2"). The text of the license and source code can be found at:

www.agilent.com/find/GPLV2

This product utilizes Microsoft Windows CE. Agilent highly recommends that all Windows-based computers connected to Windows CE instruments utilize current anti-virus software. For more information, go to the product page at:

www.agilent.com/find/53210A

Technology Licenses

The hardware and/or software described in this document are furnished under a license and may be used or copied only in accordance with the terms of such license.

Declaration of Conformity

Declarations of Conformity for this product and for other Agilent products may be downloaded from the Web. Go to <http://regulations.corporate.agilent.com> and click on "Declarations of Conformity." You can then search by product number to find the latest version.

Warranty

The material contained in this document is provided "as is," and is subject to being changed, without notice, in future editions. Further, to the maximum extent permitted by applicable law, Agilent disclaims all warranties, either express or implied, with regard to this manual and any information contained herein, including but not limited to the implied warranties of merchantability and fitness for a particular purpose. Agilent shall not be liable for errors or for incidental or consequential damages in connection with the furnishing, use, or performance of this document or of any information contained herein. Should Agilent and the user have a separate written agreement with warranty terms covering the material in this document that conflict with these terms, the warranty terms in the separate agreement shall control.

Assistance

This product comes with the standard product warranty. Warranty options, extended support contacts, product maintenance agreements and customer assistance agreements are also available. Contact your nearest Agilent Technologies Sales and Ser-

vice office for further information on Agilent Technologies' full line of Support Programs.

Certification

Agilent Technologies certifies that this product met its published specifications at time of shipment from the factory. Agilent Technologies further certifies that its calibration measurements are traceable to the United States National Institute of Standards and Technology, to the extent allowed by the Institute's calibration facility, and to the calibration facilities of other International Standards Organization members.

Exclusive Remedies

THE REMEDIES PROVIDED HEREIN ARE THE CUSTOMER'S SOLE AND EXCLUSIVE REMEDIES. AGILENT TECHNOLOGIES SHALL NOT BE LIABLE FOR ANY DIRECT, INDIRECT, SPECIAL, INCIDENTAL, OR CONSEQUENTIAL DAMAGES, WHETHER BASED ON CONTRACT, TORT, OR ANY OTHER LEGAL THEORY.

Restricted Rights Legend

U.S. Government Restricted Rights. Software and technical data rights granted to the federal government include only those rights customarily provided to end user customers. Agilent provides this customary commercial license in Software and technical data pursuant to FAR 12.211 (Technical Data) and 12.212 (Computer Software) and, for the Department of Defense, DFARS 252.227-7015 (Technical Data - Commercial Items) and DFARS 227.7202-3 (Rights in Commercial Computer Software or Computer Software Documentation).

Trademarks

Microsoft and Windows are U.S. registered trademarks of Microsoft Corporation.

Waste Electrical and Electronic Equipment (WEEE) Directive 2002/96/EC

This product complies with the WEEE Directive (2002/96/EC) marking requirement. The affixed product label (see below) indicates that you must not discard this electrical/electronic product in domestic household waste.

Product Category: With reference to the equipment types in the WEEE directive Annex 1, this product is classified as a "Monitoring and Control instrumentation" product.

Do not dispose in domestic household waste.

To return unwanted products, contact your local Agilent office, or see www.agilent.com/environment/product for more information.



Lithium Battery Recycling

The 53210A counter contains a 3V "coin cell" lithium battery. Agilent recommends that this battery be replaced every year at the instrument's 1-year calibration interval. Replacement procedures are provided in the 53210A/53220A/53230A Service Guide.

Option 300 provides battery operation of the 53210A using a 12 lithium battery. Performance of this battery will degrade over time as a function of the number of battery charge/discharge cycles.

Refer to local, state, or Federal regulations when disposing of, or recycling either battery.



Safety Information

The following general safety precautions must be observed during all phases of operation of this instrument. Failure to comply with these precautions or with specific warnings or operating instructions in the product manuals violates safety standards of design, manufacture, and intended use of the instrument. Agilent Technologies assumes no liability for the customer's failure to comply with these requirements.

General

Do not use this product in any manner not specified by the manufacturer. The protective features of this product may be impaired if it is used in a manner not specified in the operation instructions.

Before Applying Power

Verify that all safety precautions are taken. Note the instrument's external markings described under "Safety Symbols".

Ground the Instrument

The 53210A is provided with a ground-type power plug. The instrument chassis and cover must be connected to an electrical ground to minimize shock hazard. The ground pin must be firmly connected to an electrical ground (safety ground) terminal at the power outlet. Any interruption of the protective (grounding) conductor or disconnection of the protective earth terminal will cause a potential shock hazard that could result in personal injury.

Fuses

The 53210A is provided with an internal line fuse appropriate for the line voltages listed on the instrument. This fuse is not user accessible.

Do Not Operate in an Explosive Atmosphere

Do not operate the instrument in the presence of flammable gases or fumes.

Do Not Operate Near Flammable Liquids

Do not operate the instrument in the presence of flammable liquids or near containers of such liquids.

Do Not Remove the Instrument Cover

Only qualified, service-trained personnel who are aware of the hazards involved should remove instrument covers. Always disconnect the power cable and any external circuits before removing the instrument cover.

Do Not Modify the Instrument

Do not install substitute parts or perform any unauthorized modification to the product. Return the product to an Agilent Sales and Service Office for service and repair to ensure that safety features are maintained.

In Case of Damage

Instruments that appear damaged or defective should be made inoperative and secured against unintended operation until they can be repaired by qualified service personnel.

Cleaning the Instrument

Clean the outside of the instrument with a soft, lint-free, slightly-dampened cloth. Do not use detergents or chemical solvents.

Safety Notices

CAUTION

A **CAUTION** notice denotes a hazard. It calls attention to an operating procedure, practice, or the like that, if not correctly performed or adhered to, could result in damage to the product or loss of important data. Do not proceed beyond a **CAUTION** notice until the indicated conditions are fully understood and met.

WARNING

A **WARNING** notice denotes a hazard. It calls attention to an operating procedure, practice, or the like that, if not correctly performed or adhered to, could result in personal injury or death. Do not proceed beyond a **WARNING** notice until the indicated conditions are fully understood and met.

Safety Symbols



Chassis Ground



Refer to manual for additional safety information.



Standby Power. Unit is not completely disconnected from AC mains when power switch is in standby position. IEC Measurement Category I.

CAT I

Do NOT connect inputs to AC mains or to circuits derived from AC mains.

WARNING

Do not connect the input channels of the 53210A to AC line-voltage mains or to circuits derived from AC mains. The instrument must be used in CAT I (isolated from mains) applications only. Do not use in other IEC Measurement Category (CAT II, CAT III, or CAT IV) applications. Failure to observe these precautions may result in electric shock and serious personal injury.

WARNING

The BNC shells of the input terminals are connected to the instrument chassis. Verify signal polarity before making any connections to the input terminals.

Protection Limits

The Agilent 53210A 350 MHz RF Counter provides protection circuitry to prevent damage to the instrument and to protect against the danger of electric shock, provided the Protection Limits are not exceeded and the instrument is properly grounded. To ensure safe operation of the instrument, do not exceed the Protection Limits defined on the front panel:

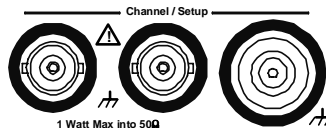

WARNING

During battery operation, the maximum measured signal supplied by the user is $\pm 42V$.

WARNING

Product Options 201/202 add a parallel Channel 1 input to the rear panel of the instrument. Signals on the center conductor of either panel's channel BNCs are also present on the corresponding center conductor of the BNC on the opposite panel.

Installing the Instrument

The Agilent 53210A operates in the following line-voltage ranges:

100 - 240V, 50-60 Hz

100 - 127V, 440 Hz

90 VA Max

Instrument ventilation is through the sides and rear. Do not obstruct the ventilation holes in any of these locations.

Battery Operation

When operating the 53210A under battery power (Option 300), failure to observe the following warnings may result in damage to the instrument, electric shock, and serious personal injury:

WARNING

Connect the instrument chassis to earth ground during battery operation to minimize shock hazard. Any interruption or disconnection of the protective earth terminal will cause a potential shock hazard that could result in personal injury.

WARNING

Under battery power, the instrument chassis may float to the potential of the measured signal supplied by the user.

Contents

1 Preparation for Use 11

Front and Rear Panel Overview 13

Front Panel 13

Rear Panel 14

Display 15

About the Instrument 15

Materials Included 15

Operating and Storage Environments 17

Electrical Requirements 17

Applying Power 18

Power-On LED Status 18

Standby Power 19

Battery Operation 20

Battery Care 22

Using Built-In Help 23

Utility Functions 23

Display Configuration 23

User Interaction 26

Reference Settings 28

How the User's Guide is Organized 32

2 53210A Software Installation and Interface Configuration 35

Software Requirements 36

Using the Counter Web-Enabled Interface 37

 Connecting the Counter and Viewing its Home Page 37

 Web Interface Overview 39

Installing the Agilent IO Libraries 41

 Installing Instrument Drivers 43

 Adding Instruments to the PC Interface 43

 Configuring the LAN Interface 44

 Configuring the USB Interface 49

 Configuring the GPIB Interface 52

 Using Interactive IO 55

Firmware and Driver Updates 56

 Disabling Calibration Security 56

 SCPI Language Emulation Mode 57

 Downloading and Installing the Update Utility 57

 Downloading the Firmware Update 58

 Installing the Firmware Update 58

 Downloading IVI-COM Driver Updates 61

3 53210A Measurements 63

Counter Measurement Summary 64

Reference Oscillator Configuration 64

 Reference Oscillator Source 65

 Standby Power to the Reference Oscillator (Option 010) 68

Setting the Measurement Time Out 70

SCPI Syntax Conventions 71

The MEASure and CONFigure Commands 73

 Using MEASure 74

 Using CONFigure 75

Frequency Measurements	77
Frequency Ratio Measurements	79
Period Measurements	81
4 53210A Input Signal Conditioning	85
Channel Characteristics	86
Signal Conditioning Path	86
Input Impedance	88
Input Range	90
Input Coupling	92
Bandwidth Limiting (Low-Pass) Filter	93
Threshold Level and Sensitivity	95
Noise Rejection (Hysteresis)	101
Threshold Slope	103
Measuring Input Signal Levels and Signal Strength	104
5 Triggering and Gating	105
Settings Summary	106
Trigger and Gate Time Line	106
Trigger and Gate Cycle	107
System Trigger	109
Wait-For-Trigger and Triggered States	114
Measurement Gate	117
Gate Set Up	117
Frequency Measurements	119
Enabling Gate Signals on the 'Gate In/Out' BNC	125

6 53210A Math, Graphing, and Data Logging 127

- Math Functions 128
 - Enabling the CALCulate1 Subsystem 129
 - Smoothing Data 130
 - Scaling Functions 131
 - Statistics 139
 - Limit Checking 143
- Histograms 147
 - Viewing Histograms 148
 - Histogram Configuration 149
- Trend Charts 160
 - Viewing Trend Charts 161
- Data Logging 166

7 Formats and Data Flow 173

- Reading Formats and Data Flow 174
 - Specifying a Format 175
 - Setting the Block Transfer Byte Order 175
 - Data Flow 176
- Counter File System 183
 - Creating Folders and Files in Flash Memory and on the USB Drive 185
 - User-Defined Power-On States 194
 - Managing Folders and Files 197

8 Instrument Status 203

- Agilent 53210A Status System 205
 - Questionable Data Register Group 205
 - Standard Operation Register Group 206
 - Standard Event Register 208
 - Status Byte Register 209

A Error Messages 211

Index 223

Contents

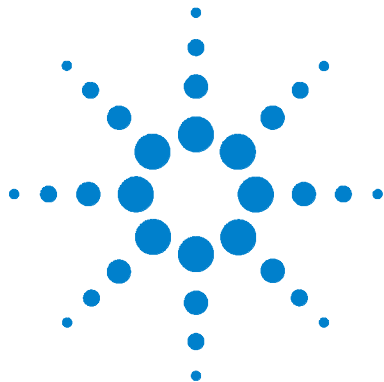

1 Preparation for Use

Front and Rear Panel Overview	13
Front Panel	13
Rear Panel	14
Display	15
About the Instrument	15
Materials Included	15
Operating and Storage Environments	17
Electrical Requirements	17
Applying Power	18
Power-On LED Status	18
Standby Power	19
Battery Operation	20
Battery Care	22
Using Built-In Help	23
Utility Functions	23
Display Configuration	23
User Interaction	26
Reference Settings	28
How the User's Guide is Organized	32

Welcome. This user's guide contains configuration and operating information for the Agilent 53210A 350 MHz RF Counter.

The 53210A is a 2U, 1/2-module width LXI Class C instrument. The 2U, 1/2-module width references refer to the 53210A's physical size relative to standard EIA rack cabinet dimensions. LXI, an acronym for LAN eXtensions for Instrumentation, is an instrumentation standard for devices that use the Ethernet (LAN) as their primary remote communications interface.



1 Preparation for Use

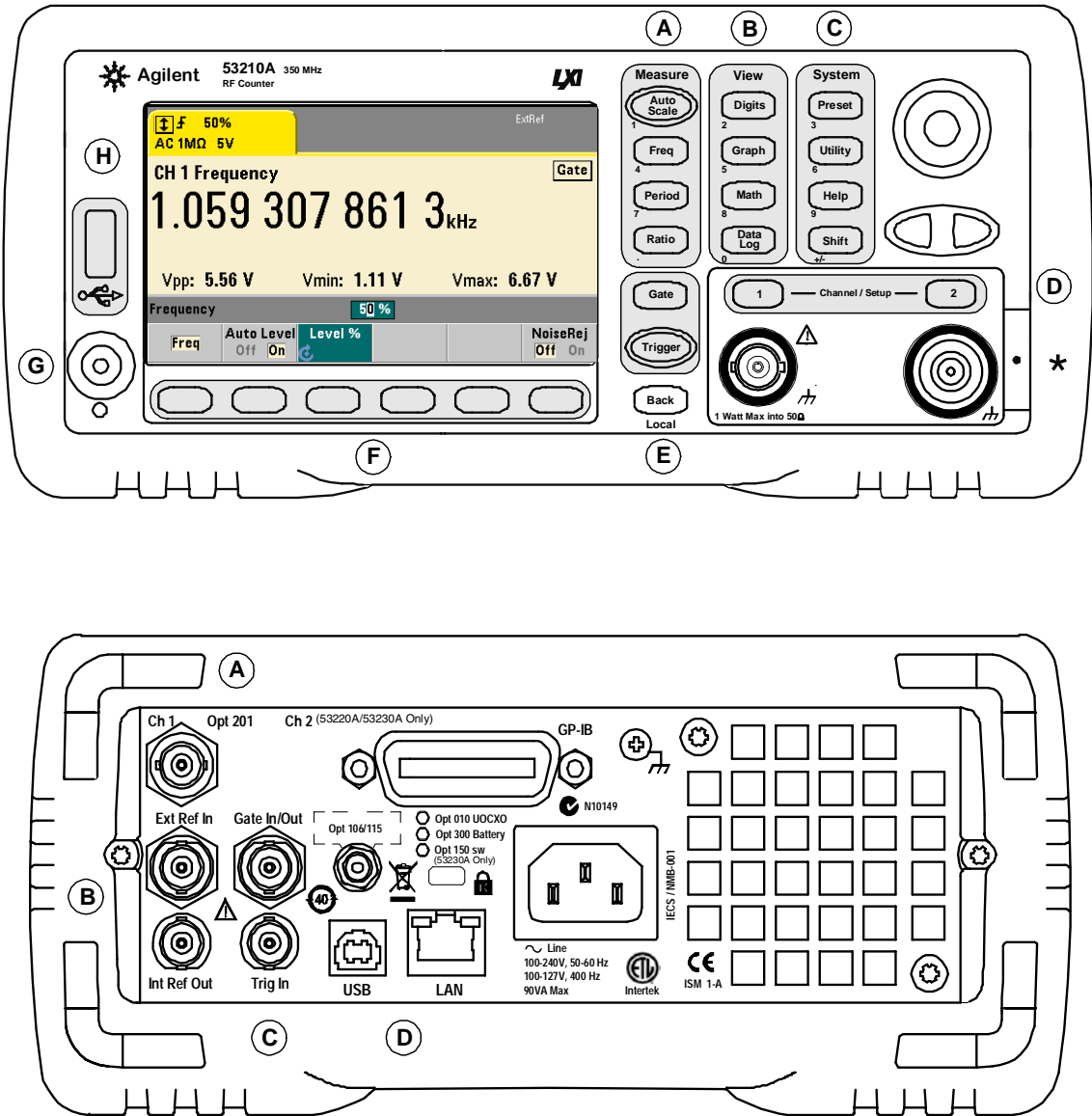

Figure 1-1. The 53210A Universal Frequency Counter/Timer.

Front and Rear Panel Overview

Figure 1-1 shows the front and rear panels of the Agilent 53210A 350 MHz RF Counter.

Front Panel

The shaded areas of the front panel represent keys that perform similar functions. These areas are briefly described below.

A. Measure Keys - display soft key menus from which the measurement function is selected. Auto Scale senses the input signal (greater than 100 Hz) on input channel 1, 2, or 3 and automatically sets the range and input threshold required to make the selected measurement. Counter measurements are covered in **Chapter 3**.

B. View Keys - select how measurement data is displayed on the front panel. Display configuration is covered later in this chapter. Graphics, math, and data logging are covered in **Chapter 6**.

C. System Keys - provide instrument-wide configuration which includes setting the counter preset state and access to utility functions and to the counter's built-in help system. For measurement configuration involving numeric entry, Shift changes the key definitions to the numbers at the lower left of the keys.

D. Channel Keys - select the input channel and displays the soft key menu used to configure the input signal path. Note that Figure 1-1 includes Channel 3 Option 106 / 115. Signal path configuration is covered in **Chapter 4**.

E. Gate and Trigger Keys - select the gating and triggering soft key menus used to control the measurement. Gating and triggering are covered in **Chapter 5**.

F. Soft Keys - are the menus from which the counter is configured. The menus and soft keys themselves are defined by the "functional" keys described above.

G. Power/Standby Button - switches the instrument between 'on' and 'off', or between 'on' and 'standby'.

Standby power (when enabled) is provided by the line voltage or Battery Option 300 and is used to maintain the temperature of the oven-controlled crystal oscillator (OCXO) - Option 010. See “Applying Power” in **this chapter** for more information.

H. USB ‘Host’ Port - available for transferring measurement data and instrument configurations between the counter and a USB storage device. The front panel port is for information transfer only. The rear panel USB port is used for instrument (I/O) control. Data flow is covered in **Chapter 7**.

Rear Panel

The 53210A rear panel shown in Figure 1-1 includes product Option 201 (parallel rear panel input) and GPIB interface. The rear panel terminals are briefly described below.

A. Parallel Rear Panel Inputs - product Options 201 and 202 add a parallel input on the rear panel. Note that this IS NOT a separate input. Signals on the center conductor of either panel’s channel BNC are ALSO present on the opposite panel’s center conductor. Signal path configuration is covered in **Chapter 4**.

B. Ext Ref In - is the connector for providing an external reference oscillator signal. Valid external reference oscillator (time base) frequencies are 1, 5, and 10 MHz.

Int Ref Out - is the connector for accessing the counter’s internal 10 MHz reference oscillator. The oscillator signal is a 0.5 Vrms (into 50Ω) sine wave.

Reference oscillator usage and configuration are covered in **Chapter 3**.

C. Gate In/Out - is an *input* for external gate signals, and an *output* for routing the counter’s internal gate to other devices. Additional information on this connector is covered in the section “Enabling Gate Signals on the ‘Gate in/Out’ BNC” in **Chapter 5**.

Trig In - is the connector for supplying an external trigger signal to the counter. Triggering is covered in **Chapter 5**.

D. USB and LAN - are the standard input/output (I/O) ports. Configuration of these ports and the GPIB interface is covered in **Chapter 2**.

Display

The layout of the 53210A display is shown in Figure 1-2.

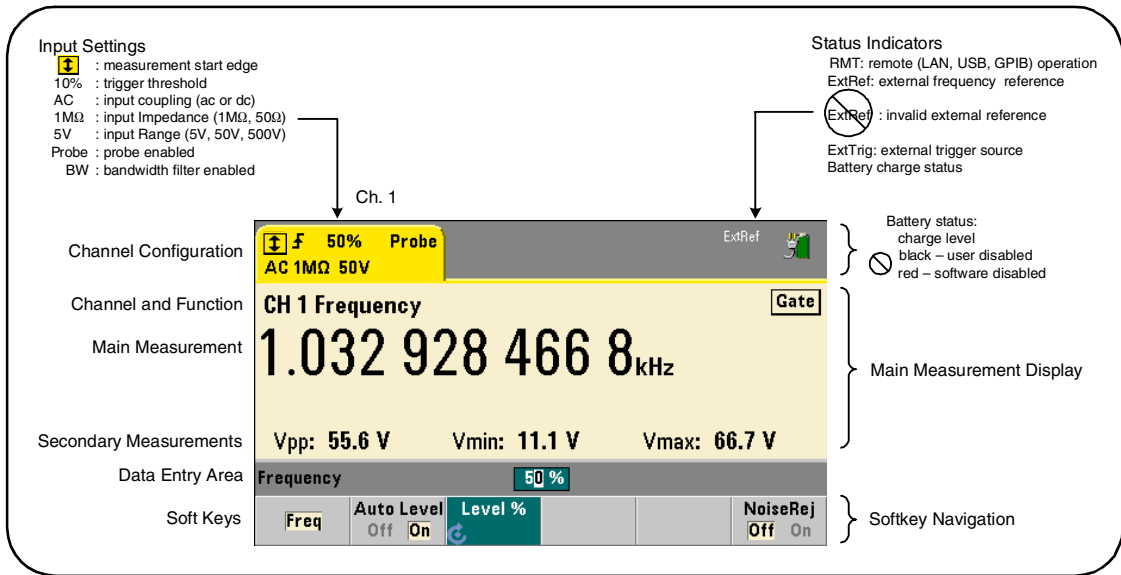

Figure 1-2. The 53210A Display.

About the Instrument

This section lists the accessories shipped with the 53210A and contains information on its specified operating and storage environments and electrical requirements.

Materials Included

The following accessories are shipped standard with the 53210A counter:

1 Preparation for Use

- 1 Power cord
- 2 USB cable
- 3 Agilent I/O Libraries Suite CD-ROM
- 4 Agilent 53210A/53220A/53230A Product Reference CD-ROM

Additionally, your instrument may have shipped with one or more of the following options installed.

Table 1-1. 53210A Product Options.

Opt. 010: Ultra High-Stability OCXO Timebase
Opt. 106: 6 GHz Microwave Input (Ch. 2)
Opt. 115: 15 GHz Microwave Input (Ch. 2)
Opt. 201: Add parallel Channel 1 input on rear panel
Opt. 202: Install Option 106/115 on front panel
Opt. 203: Install Option 106/115 on rear panel
Opt. 300: Internal Lithium Ion Smart Battery and Charger
Opt. 400: GPIB Interface

NOTE

Each of the product options listed in Table 1-1 is available after the original purchase of the instrument. Refer to the 53210A/53220A/53230A Service Guide (p/n 53220-90010) for installation instructions for each of these options.

No Manuals?

There are three printed manuals available with the 53210A:

- Agilent 53210A Quick Start Tutorial (p/n 53210-90005)
- Agilent 53210A User's Guide (p/n 53210-90001)
- Agilent 53210A/53220A/53230A Service Guide (p/n 53220-90010)

53210A Option 0B0 (delete printed manuals) is the default product documentation option. If Option 0B0 was ordered, only the Quick Start Tutorial and 53210A/53220A/53230A Product Reference CD-ROM are shipped with the instrument. All manuals are available on the CD. To obtain printed manuals from Agilent, contact your Agilent representative.

Operating and Storage Environments

When **operating** the 53210A counter, note the following environmental specifications:

Environment:	EN61010, Pollution Degree 2; Indoor Locations
Temperature:	0 °C to +55 °C
Humidity:	5% to 80% RH (non-condensing)
Altitude:	up to 3000 meters, or 10,000 feet

When **storing** the 53210A counter, note the following storage specification:

Temperature:	-30 °C to +70 °C
---------------------	------------------

Use care when moving the counter from cold to warm conditions as condensation may develop. Ensure that any condensation has evaporated and that the counter has thermally stabilized before turning on the instrument.

Electrical Requirements

The electrical (power) requirements of the 53210A are summarized below.

Power Supply:	CAT I (do not connect to AC mains) 100 to 240V @ 50/60 Hz (-5% to +10%) 100 to 120V @ 400 Hz ($\pm 10\%$)
Power Consumption:	90 VA max when power is on or battery option is charging. 6 VA max during power off or standby

Line voltage and frequency are sensed at power on and no input power adjustments (e.g. fuse changes, line voltage selection) are required.

NOTE

For additional information, refer to the Safety Information pages at the beginning of this guide. For a complete list of 53210A product specifications, refer to the data sheet included on the 53210A/53220A/53230A Product Reference CD (p/n 53220-13601), or on the Web at:

www.agilent.com/find/53210A

Applying Power

Connect the power cord and press the “on/standby” button on the front panel (⏻). During the power-on sequence the counter performs an auto-calibration and self-test which includes:

- power supply verification
- FPGA test
- front panel verification
- measurement board verification
- channel 2 test (if present)
- Option 300 battery test (300 if present)

NOTE

If the 53210A does not turn on when the on/standby button is pressed, verify AC power is available to the instrument and that the power cord is securely connected. If the instrument still does not turn on, the cooling fan is not audible, or if the front panel display is off when power is applied, return the unit to Agilent for repair.

Power-On LED Status

The led located under the on/standby button is an indication of the on/off/standby condition of the instrument. The different conditions are summarized in the table below. The ‘off’ status is determined by the presence of OXCO Option 010.

Table 1-2. Power-On LED Status and Color.

		Instrument 'Off'		
Power Source	Instrument 'On'	OCXO w/ Standby enabled	OCXO w/ Standby disabled	No OCXO
AC Line	green	amber	off	off
Opt. 300 Battery (enabled)	green	amber (blinking)	off	off
Opt. 300 Battery (disabled)	off	off	off	off

Standby Power

The power modes of the 53210A counter are 'on' 'off', and 'standby'. In standby mode with the instrument connected to line voltage, standby power is supplied to maintain the temperature within the ultra high-stability oven controlled crystal oscillator (Option 010).

Battery Option 300 itself supplies standby power for the OCXO when the 53210A is not connected to line voltage.

Refer to "Standby Power to the Reference Oscillator" in **Chapter 3** for information on enabling/disabling standby power.

Cycling Power and Counter Accuracy

With standby power enabled, repeated power cycling (line or battery) does not affect the standard or ultra-high stability OCXO.

Battery Operation

WARNING

During battery operation, the maximum measured signal supplied by the user is $\pm 42V$.

Also, connect the instrument chassis to earth ground during battery operation to minimize shock hazard. Any interruption or disconnection of the protective earth terminal will cause a potential shock hazard that could result in personal injury.

Under battery power, the instrument chassis may float to the potential of the measured signal supplied by the user.

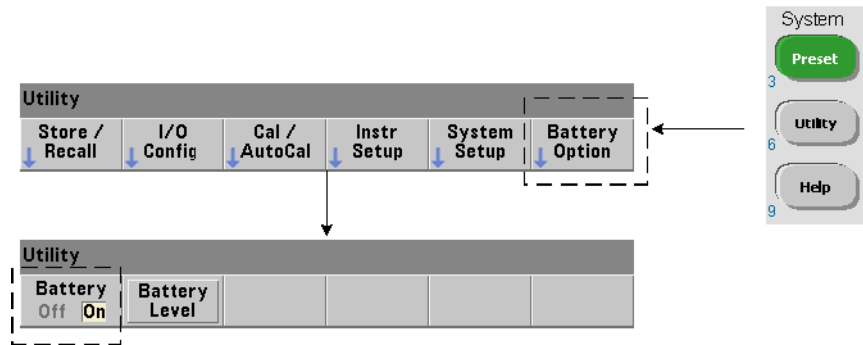

With Battery Option 300 installed and **enabled**, the 53210A counter can be operated using battery power for up to three hours.

Removing AC power when the battery is enabled switches the counter to battery power automatically with no interruption of operation. Similarly, there is no interruption in the transition back to line power, **provided line power is connected before the battery is disabled**.

Enabling and Disabling the Battery

When using the instrument with the Battery Option 300 for the first time after purchase, or if the instrument has not been used for an extended period, the battery **must be charged** before use. With line power connected and the instrument either on or off, allow **four hours** for the battery to reach full charge.

Battery Option 300 is **disabled** when the instrument is shipped from the factory. Battery control (enable/disable) is provided by the front panel keys shown on the previous page or using the command:

```
SYSTem:BATTeRy:ENABle {OFF|ON}
SYSTem:BATTeRy:ENABle? (query form)
```

- **ON** enables the battery. **Off** disables the battery. The battery state is stored in non-volatile memory and does not change when power is cycled or following a reset (*RST) or instrument preset (SYSTem:PREset or Preset key).

The battery should remain enabled while the counter is using AC power. The battery should only be **disabled** if the instrument is stored and unused for an extended period. This will minimize battery drain.

Reading the Battery Level Pressing the Battery Level soft key or sending the command:

```
SYSTem:BATTeRy:LEVel?
```

reads the battery charge (in percent) relative to a fully charged (100%) battery.

Battery in Use The presence and status (enabled or disabled) of the battery is indicated by a battery icon in the upper-right corner of the display (Figure 1-2). Remotely, the instrument can be queried as to whether it is currently using AC power or battery power with the command:

```
SYSTem:BATTeRy:STATus?
```

The command returns **AC** if the instrument is using line power, or **BATT** if using the internal battery.

The following table summarizes battery operation:

Operating Time (typ):	3 hours (below +35 °C)
Standby Time (typ):	24 hours (below +35 °C, OCXO powered)
Recharge Time (typ):	4 hours to 100% capacity or 2 hours to 90% capacity
Temperature Range:	0 °C to +55 °C (operating) - battery charges below +35 °C -10 °C to +60 °C (storage)

1 Preparation for Use

NOTE

If battery operation is in use above the maximum specified operating temperature, the battery will shut down the instrument to preserve its use. AC power must be applied to recover from a shut down caused by this condition.

NOTE

For a complete list of battery and all 53210A product specifications, refer to the data sheet included on the 53210A/53220A/53230A Product Reference CD (p/n 53220-13601), or on the Web at:

www.agilent.com/find/53210A

Battery Care

When the battery is **enabled** and the instrument is **not** connected to AC power, the battery discharges at **30%** of full capacity **per day**. When the battery is **disabled** and AC power is not connected, the battery discharges at **10%** of full capacity **per month**.

When storing the instrument without AC power applied, do not allow the battery to discharge below **10%**. The following equation can be used to determine instrument storage time without AC power - and still enable the instrument to be fully recharged:

$$\text{months battery disabled} * 10\% + \text{days battery enabled} * 30\% = 90\%$$

A fully discharged battery may need to be replaced if it has not been recharged for six to 18 months.

Using Built-In Help

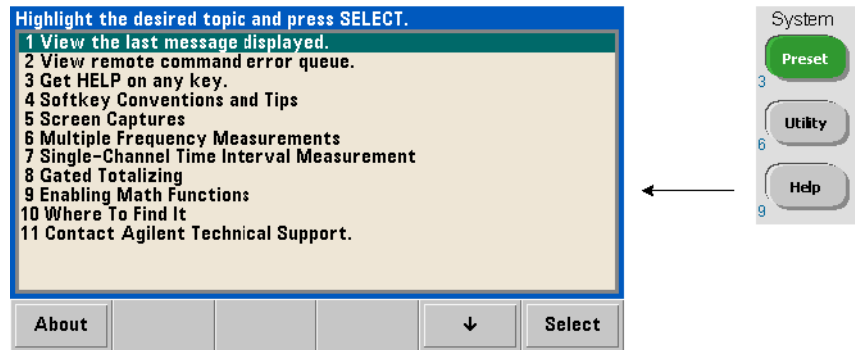

Instrument help is available by pressing and holding any front panel key or softkey. Pressing the Help key enables you to select additional help topics including front panel measurement examples.

Utility Functions

Utility functions enable you to configure features of the instrument indirectly related to measurement selection and configuration. These functions include:

- **display configuration** - display control and numeric data formatting
- **user interaction** - localized language selection, audible indicators
- **reference settings** - time/date, measurement time out, time base, auto-leveling, 53100 series emulation, NISPOM security

Display Configuration

Measurements can be displayed in numerical or graphical form using the following keys.

1 Preparation for Use

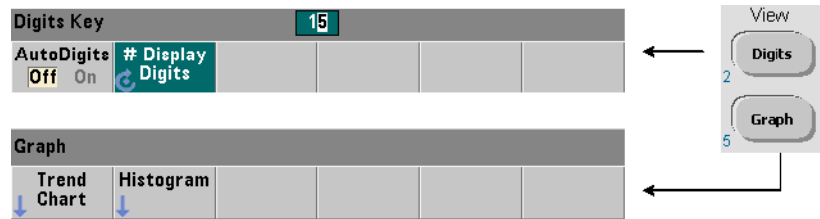

With AutoDigits On, the number of digits displayed is automatically set based on the gate time. When Off, the number of digits is set with the rotary knob or [Shift]ed numeric keys. See “Resolution and Gate Time” in Chapter 5 for more information when AutoDigits On is set.

When Graph is selected, the data is displayed in a trend chart or histogram. Trend charts and histograms are covered in **Chapter 6**.

Numeric Format

The format (radix, decimal group separator) of numeric data that appears in the main measurement display (Figure 1-2) is set using the following keys.

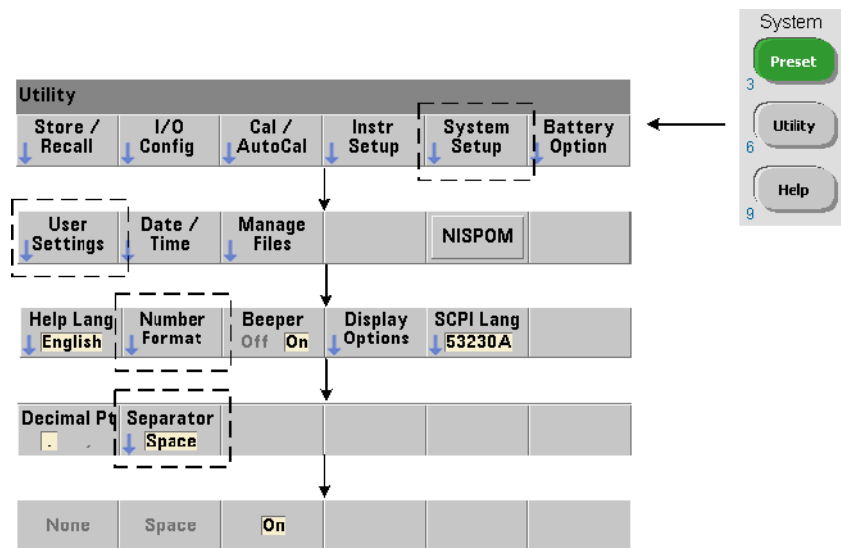

The format also applies to numeric readings within trend charts, histograms, limit testing, etc.

Radix The decimal separator (radix point) between the integer and fractional parts of the reading can be a decimal point (.) or comma (,).

Digit Group Separator A digit group separator between every three digits on either side of the decimal separator (radix) allows easier viewing of the displayed reading. The separator can be one of the following:

None - there is no space between digits (e.g. 10.967342515 MHz)

Space - a space is inserted between every three digits (e.g. 10.967 342 515 MHz)

On - a comma (,) or decimal point (.) is inserted between every three digits depending on the decimal separator (radix) selected.

decimal point radix: 10.967,342,515 MHz

comma radix: 10,967.342.515 MHz

Screen Control

Screen control is available through the keys shown below.

The display screen can be turned off to increase reading throughput and its screen saver mode can be used to conserve power. Screen brightness can be adjusted for optimal viewing in different environments.

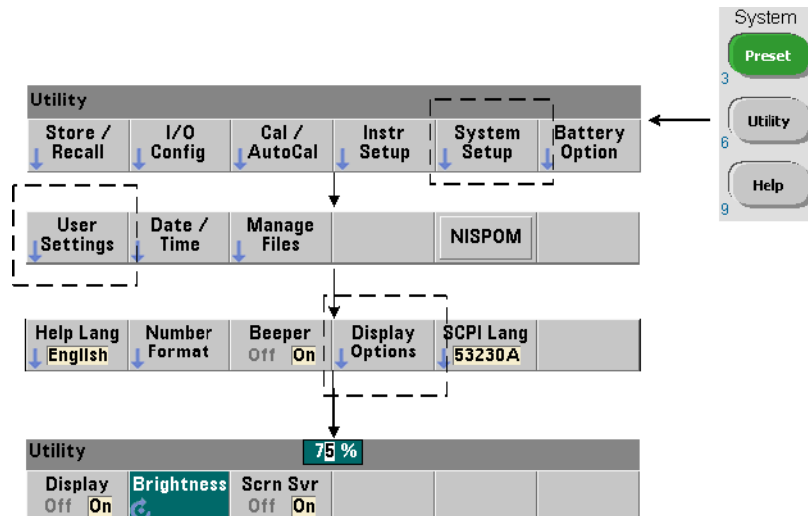

1 Preparation for Use

Note that pressing any key with the display turned off, turns the display back on.

Screen Capture

For documentation of product testing or as a convenience in gathering data, the contents of the counter display can be captured and saved.

The keys related to this feature are shown below.

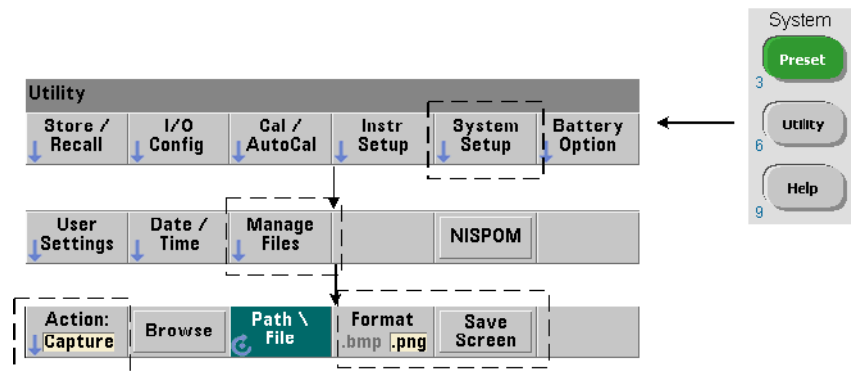

The content captured is the display state at the time the [Utility] key is pressed. The file format is selectable as either bmp (bitmap file format) or png (portable network graphics (bitmap) format). Files may store in internal flash memory or to an external USB device.

See Chapter 7 for information on selecting paths and creating file names.

User Interaction

The features described in this section are related to the user's physical interaction with the instrument.

Selecting the Instrument 'Help' language

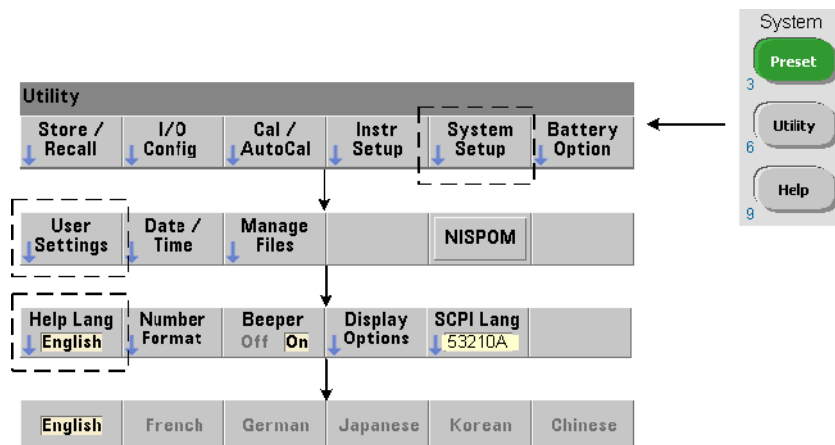

Programming messages, context-sensitive help, and other help topics are viewable in six languages. The selected language remains “active” until changed using the key sequence shown.

Note that menu soft key labels appear only in English.

Beeper Setting

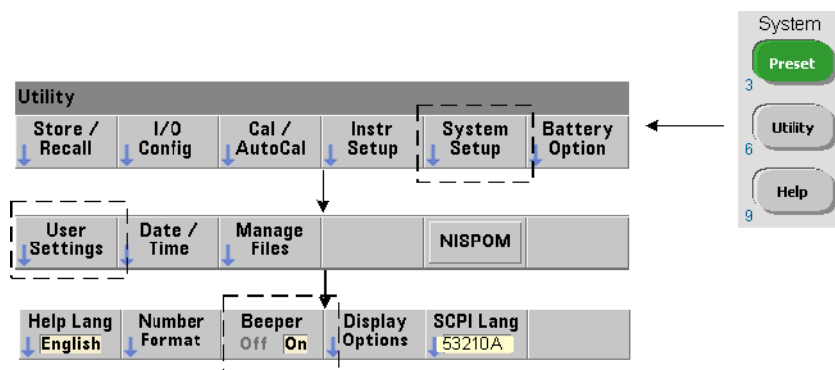

The counter's Beeper is an indication of a programming error generated from the front panel or over the remote interface. Turning off the beeper disables the audio indication.

Note that the beeper setting does not apply to the tone heard when front panel keys are pressed.

Reference Settings

Reference settings are counter settings that apply to all counter measurements.

Date and Time

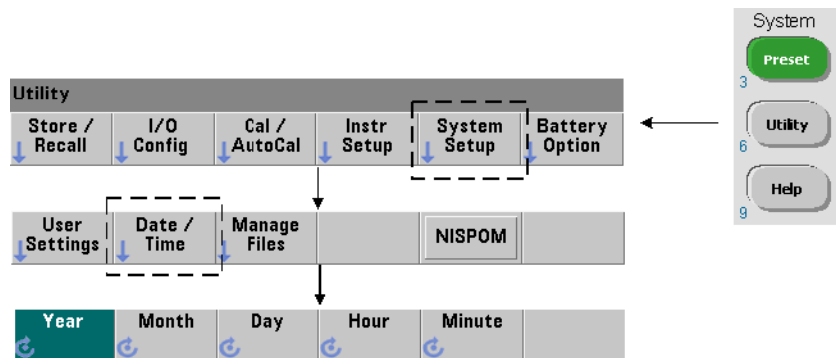

The date and time settings for the counter's real-time clock are set using the commands:

SYSTEM:DATE <year>, <month>, <day>
SYSTEM:DATE? (query form)

SYSTEM:TIME <hour>, <minute>, <second>
SYSTEM:TIME? (query form)

The date and time range values are:

year: 2000-2099	hour: 0-23
month: 1-12	minute: 0-59
day: 1-31	second: 0-59.999

The real-time clock is battery-backed and retains the date and time when

power is off. There is no automatic setting of, or automatic return to the current date and time.

Measurement Time Out

The measurement time-out is the time allowed for **each** measurement to complete. If a measurement **does not** complete before the time out expires, $9.91E37$ (not a number) is returned and the display indication is: -----. The sequence continues with the next reading in the sample count.

Specifying a time out prevents the instrument from pausing indefinitely if for some reason a measurement is unable to complete.

The default and factory-set time out is **1 second**. Refer to “Setting the Measurement Time Out” in Chapter 3 for more information.

Time Base

53210A measurements are based on a reference oscillator - also referred to as an internal/external clock or **time base**. A valid reference oscillator signal must be present for measurements to occur.

Refer to “Reference Oscillator Configuration” in Chapter 3 for detailed information on selecting and configuring the reference oscillator source.

Auto Level

The threshold level is the trigger (input) level at which the counter begins the measurement. Auto-level is the automatic setting of this threshold based on the positive and negative peaks of the input signal.

1 Preparation for Use

The minimum frequency at which auto-leveling can occur is set as shown.

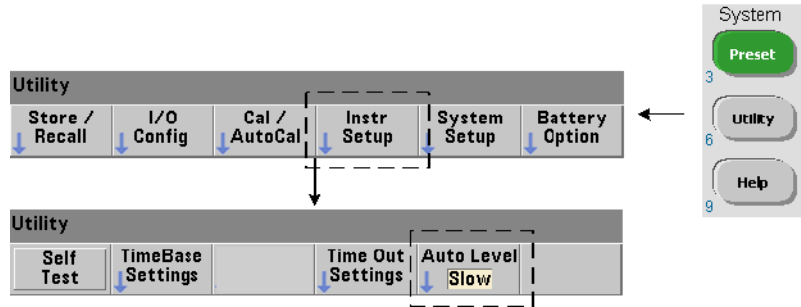

Slow sets the minimum frequency for auto-leveling at 50 Hz. Fast sets the minimum frequency for auto-leveling at 10 kHz.

Refer to “Threshold Level and Sensitivity” in Chapter 4 for additional information on using auto-level.

Agilent 53100 Series Counter Emulation Mode

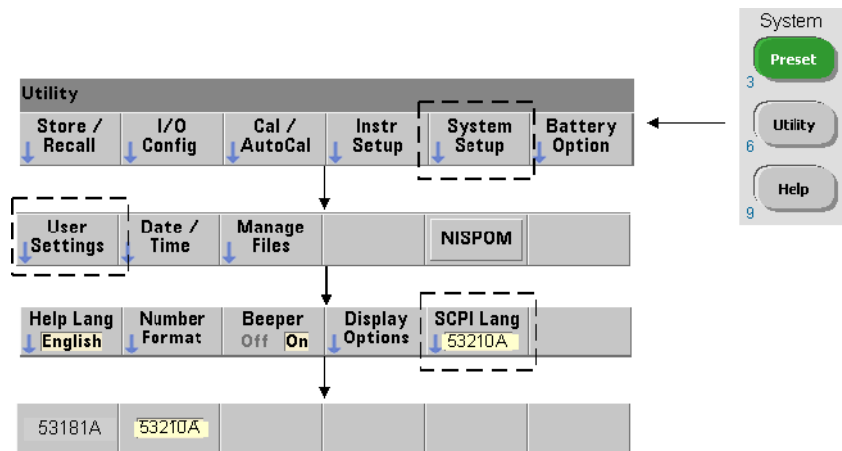

The 53210A's emulation mode enables the Agilent 53181A SCPI command set to be used with the counter.

The emulation mode can also be enabled using the command:

```
SYSTem:LANGUage "<language>"
SYSTem:LANGUage? (query form)
```

- **language** selects the SCPI command set used. Specifying 53181A enables the emulation mode. Specifying either 53210A disables the mode.

With 53100-series compatibility mode selected, all programming is through the counter's remote interface (LAN, USB, GPIB). The counter display responds according to the remote commands received.

Pressing any front panel key while in 53100 compatibility mode returns the counter to 53200 series mode as prompted. Setting or changing to either mode requires the instrument to be restarted. **When updating the instrument firmware "53210A mode" must be set.**

Documentation of the 53181A command set **is not** provided with this (53210A) instrument. Usage of this older SCPI command set is discouraged for new use, but is available for customers who require it.

Securing the Instrument

The 53210A counter can be secured to the National Industrial Security Program Operating Manual (NISPOM) standard as shown below.

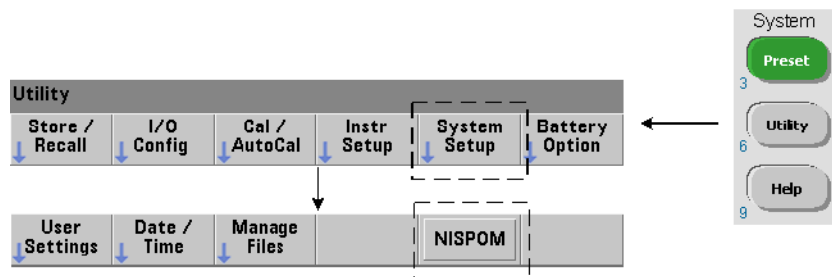

How the User's Guide is Organized

This user's guide is written for the operator using the instrument from the front panel, and for the programmer controlling the counter from a remote (LAN, USB, GPIB) interface. As such, most topics include a front panel key sequence followed by the corresponding SCPI commands. For example:

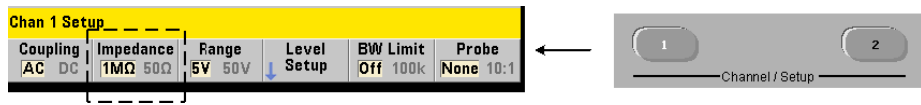

The input impedance of the 53210A counter can be set to either 50Ω or 1 MΩ using the command:

```
INPut[1]:IMPedance {<impedance>|MINimum|MAXimum| DEFault}
```

```
INPut[1]:IMPedance? [{MINimum|MAXimum|DEFault}]
```

(query form)

The description of operation which follows typically applies to both front panel and remote usage.

For general reference, the information in this manual is organized as shown in Figure 1-3.

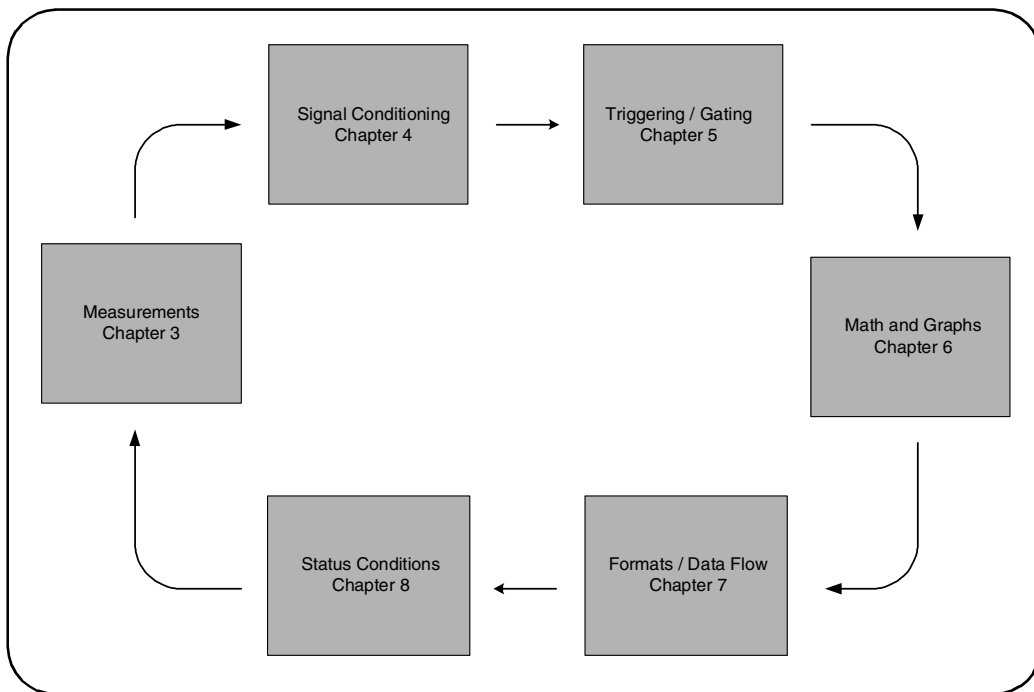
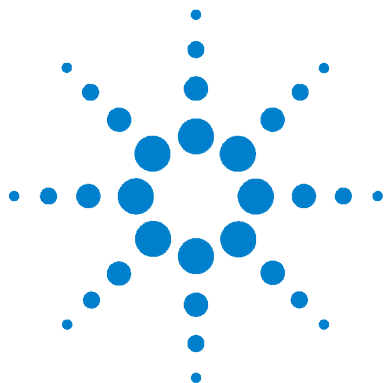

Figure 1-3. 53210A User's Guide Organization.

1 Preparation for Use



2 53210A Software Installation and Interface Configuration

Software Requirements	36
Using the Counter Web-Enabled Interface	37
Connecting the Counter and Viewing its Home Page	37
Web Interface Overview	39
Installing the Agilent IO Libraries	41
Installing Instrument Drivers	43
Adding Instruments to the PC Interface	43
Configuring the LAN Interface	44
Configuring the USB Interface	49
Configuring the GPIB Interface	52
Using Interactive IO	55
Firmware and Driver Updates	56
Disabling Calibration Security	56
SCPI Language Emulation Mode	57
Downloading and Installing the Update Utility	57
Downloading the Firmware Update	58
Installing the Firmware Update	58
Downloading IVI-COM Driver Updates	61

This chapter contains information on IO libraries, drivers, and interfaces used to program the 53210A from selected development environments. The chapter includes an introduction to using the counter's web-enabled interface and provides information on updating the instrument firmware.



Software Requirements

The environments available to program the 53210A are dependent upon the IO libraries and drivers installed. The IO software included with the 53210A is contained on the following CD:

- Agilent Automation-Ready CD: **Agilent IO Libraries Suite**

The IVI-C and IVI-COM drivers for the instrument can be found on the web at:

www.agilent.com/find/53210A

Table 2-1 summarizes the environments, IO driver recommendations, and the location (media) where specific drivers and libraries can be found.

Table 2-1. 53210A Development Environments and Drivers.

Interface	Development Environment	IO Driver Recommendations
LAN	Web-enabled instrument interface > SCPI Command Interface window	Java™ -enabled Web browser (available from www.java.com)
LAN, GPIB, USB	Agilent Connection Expert > Interactive IO window	Agilent IO Libraries CD*
LAN, GPIB, USB	Microsoft® Visual Studio® > Visual C++	VISA - Agilent IO Libraries CD* IVI-C - Web
LAN, GPIB, USB	Microsoft® Visual Studio® > Visual Basic	VISA-COM - Agilent IO Libraries* IVI-COM -Web
LAN, GPIB, USB	Microsoft® Visual Studio® .NET > C#, C++, Visual Basic	IVI-COM - Web
LAN, GPIB, USB	Agilent VEE	IVI-COM -Web
LAN, GPIB, USB	National Instruments LabVIEW™	53210A native mode driver IVI-C - Web
LAN, GPIB, USB	National Instruments LabWindows/CVI	IVI-C - Web
* Visit www.agilent.com for the latest version of the Agilent IO Libraries Suite.		

Using the Counter Web-Enabled Interface

Operating the 53210A counter from its Web interface requires a Java™-enabled Web browser **but no additional** (i.e. user-installed) libraries or drivers. The Web interface provides access to the counter's SCPI command set.

NOTE

This section describes the Web pages and windows primarily used to program the 53210A. Refer to "Help with this Page" associated with each Web page for additional information on functions or pages not covered in this manual.

Connecting the Counter and Viewing its Home Page

Connect the counter **directly** to the PC or to the PC through a **network** switch using a standard LAN cable.

Obtaining the IP Address

Turn on the counter and open the Web browser. Allow a few moments for the counter's IP address to be assigned (either through DHCP or AUTO IP). The IP address can be read from the counter front panel as shown.

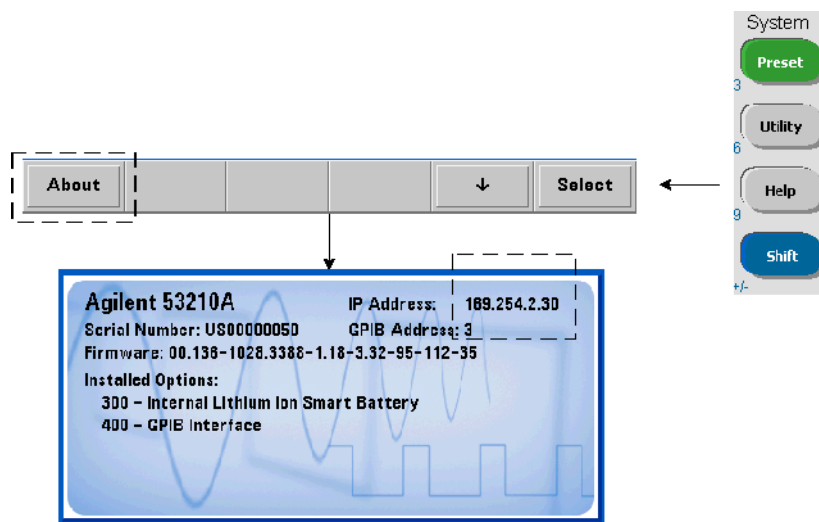

Enter the IP address in the browser’s address window. With “Advanced information ...” selected, the counter’s Web home page should appear as shown in Figure 2-1.

Browser Configuration

In some network configurations a proxy server may prevent access to the instrument (i.e. “page cannot be displayed”) after the IP address is entered. In this situation, the proxy must be configured from the browser such that the proxy is not used for (IP) addresses within the range of those that can be assigned to the 53210A.



Figure 2-1. The 53210A Web-Enabled Interface ‘Welcome Page’.

NOTE

For ease in (Internet) browser navigation when controlling multiple instruments, open a separate browser session for each Web-enabled instrument.

NOTE

Although no additional libraries or drivers are required to use the Web interface, the interface is also accessible from Agilent Connection Expert (ACE). See “Opening the Web Interface from Agilent Connection Expert” for more information.

Web Interface Overview

The following information is an introduction to the counter’s Web interface.

The counter welcome page (Figure 2-1) displays IO information, can be used to identify a connected instrument, and contains menu tabs for accessing additional counter functionality.

To easily identify the counter among other instruments using its Web interface home page, clicking on:

Turn On Front Panel Identification Indicator

changes the counter display to “**LXI Web Identify**” until the indicator is turned off by clicking on:

Turn Off Front Panel Identification Indicator

Programming the Counter

Selecting the ‘Remote Control’ icon (second from top) on the welcome page opens the Interactive IO window shown in Figure 2-2. From this window, SCPI commands can be sent to the instrument.

NOTE

Web interface pages other than the 'Welcome Page' may be password protected. When shipped from the factory no password is set; however, an 'Enter Password' dialog box may appear. Click on the dialog box to continue.

If the page is password protected and the password is unknown, pressing [Utility], (I/O Config), (LAN Reset) on the front panel clears the password.

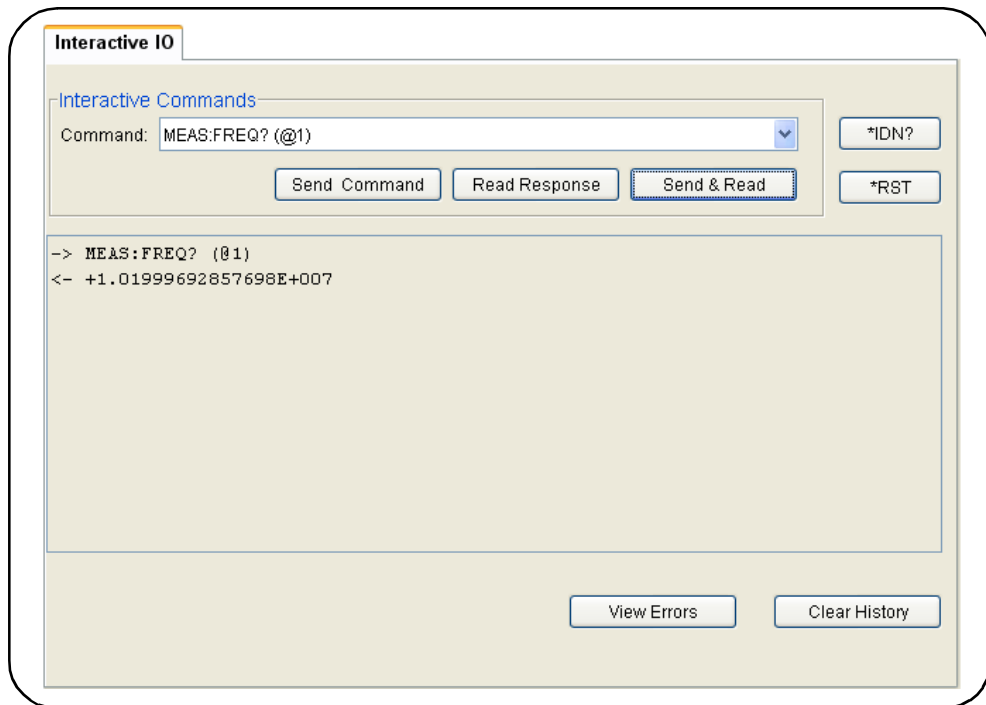

Figure 2-2. The Web UI SCPI Command Interface.

Any command in the counter's SCPI command set can be sent to the instrument. Query commands which include '?' in the syntax return data and can be sent by selecting Send & Read after the command is entered. Commands which do not return data are sent using Send Command.

Changing LAN Settings and Using Password Protection

The Network Configuration Page icon provides access to the counter's LAN settings, and enables you to set a password to prevent unauthorized access to the Web instrument interface. Select Modify Configuration to change and save settings.

Installing the Agilent IO Libraries

The Agilent IO Libraries include the VISA and VISA-COM libraries used for programming the 53210A in Microsoft® development environments (Table 2-1). The VISA and VISA-COM libraries allow you to send commands from the 53210A SCPI command set to the instrument. The IO libraries also include **Agilent Connection Expert** described and used later in this chapter.

NOTE

The Agilent IO Libraries (VISA and VISA-COM) must be installed **prior** to installing any other I/O drivers (e.g. IVI-C, IVI-COM).

NOTE

The Agilent IO Libraries and utilities are often updated to include additional features and improve usability. The figures used in this chapter represent the latest version of the IO Libraries available at the time of printing. While you may have a different version, the process of configuring and adding instruments to an interface remains basically the same.

The IO Libraries are contained on the Agilent Automation-Ready CD or may be downloaded from the Electronic Test & Measurement Software page at:

<http://www.agilent.com>

Before installing the IO libraries, review Table 2-2 to verify that your computer meets the specifications required for the latest version of the software.

Table 2-2. Agilent IO Libraries Suite System Requirements.

Operating System	Windows XP (SP 3 or later)	Windows Vista /Windows 7 32/64-bit editions
Processor	600 MHz or higher required 800 MHz recommended	1 GHz 32-bit (x86) 1 GHz 64-bit (x64)
Available Memory	256 MB minimum 1 GB or greater recommended	1 GB minimum
Available Disk Space	1.5 GB * 1 GB recommended for Microsoft .NET Framework 2.0 SP2 * 65 MB for Agilent IO Libraries Suite	1.5 GB * 1 GB recommended for Microsoft .NET Framework 2.0 SP1 * 65 MB for Agilent IO Libraries Suite
Video	Super VGA (800x600) w/ 256 colors or more	Support for DirectX 9 graphics w/128 MB graphics memory recommended (Super VGA graphics is supported.)
Web Browser	Microsoft Internet Explorer 6.0 or greater	Microsoft Internet Explorer 7 or greater
Note: because of the installation procedure, less memory may be required for operation than for installation.		

Loading the Software

Close all applications on your computer. Insert the Agilent Automation-Ready CD into the CD drive. Follow the instructions as prompted for a *typical* installation. **Accept all default directories specified if prompted.**

If the IO libraries installation does not start automatically, select **Start > Run** from the Windows **start** menu and type <drive>:\autorun\auto.exe where <drive> is the designator of the CD drive.

NOTE

If another vendor's implementation of VISA (Virtual Instrument Software Architecture) is currently installed on your computer, continue installation of the Agilent IO Libraries by installing Agilent VISA in **side-by-side** mode. More information on **side-by-side** operation can be found in IO Libraries Suite Help (available after installation is complete) under "Using Agilent's and Other Vendors' Products Together."

After the IO libraries have been installed, close the installation wizard. If applicable, continue with instrument driver installation as described below. Otherwise, continue with the "Adding Instruments to the PC Interface" section of this chapter.

Installing Instrument Drivers

Interchangeable Virtual Instrument (IVI) drivers (when available) are used for programming the 53210A with Agilent VEE, with National Instruments® LabVIEW™, or in Microsoft® development environments.

Install the appropriate driver based on the development environment you are using (Table 2-1). **Accept all default directories specified during installation if prompted. Setup type "Typical" is applicable for most users.**

NOTE

Installing the Agilent IO Libraries installs the Interchangeable Virtual Instrument (IVI) Shared Components. The IVI Shared Components are required **before** the IVI drivers (e.g. IVI-COM, IVI-C) can be installed.

Adding Instruments to the PC Interface

During installation of the Agilent IO Libraries, the IO interfaces (LAN, USB, GPIB) detected on the PC are configured. This section contains information for programmatically adding the 53210A to those interfaces using the Agilent IO Libraries 'Connection Expert' utility.

Simultaneous LAN/USB/GPIB connections to the instrument are allowed.

NOTE

The figures used in this chapter represent the latest version of the IO Libraries available at the time of printing. While you may have a different version, the process of configuring and adding instruments remains basically the same.

Remote Interface Configuration

The following sections cover front panel configuration of the LAN, USB, and GPIB interfaces. The interfaces can also be configured programmatically using the ‘Remote Interface Configuration’ commands in the SCPI **SYSTEM** subsystem. This subsystem, plus descriptions of all SCPI commands, is located in the ‘Programming Reference’ section of the 53210A/53220A/53230A Product Reference CD.

Configuring the LAN Interface

With the counter connected to the LAN interface, the IP address can be read from the front panel as follows.

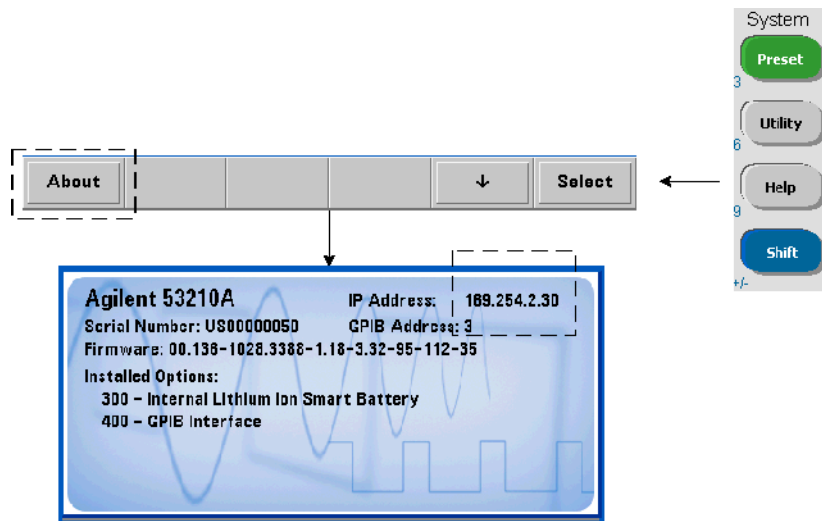

Once the IP address is known, start the Connection Expert utility by clicking the ‘Agilent IO Control’ icon and selecting “Agilent Connection Expert” from the pop up menu as shown in Figure 2-3.

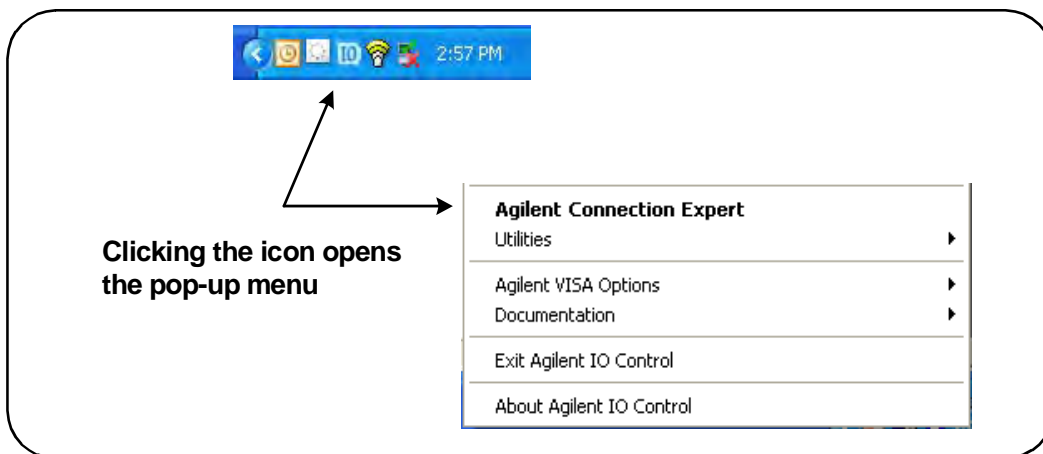

Figure 2-3. Starting Agilent Connection Expert.

Locating the Instruments

Agilent Connection Expert opens with a welcome screen and window similar to that shown in Figure 2-4. The computer interfaces configured during installation are displayed in the left column (**Explorer** pane), the properties of the configured interface are displayed in the right column (**Properties** pane).

To search the network for the counter, highlight the LAN interface (LAN (TCP/IP0)) and select “Add Instrument” located on the Connection Expert tool bar. After selecting ‘Add Instrument’, Connection Expert performs an automatic find (Auto Find) of all instruments on the same subnet as the computer.

Select the counter from the list and then click ‘OK’. Communication paths to the instruments are verified and the instruments are added to the configured interface. Instruments added to the LAN in this manner are subsequently programmed using **VXI-11 protocol**.

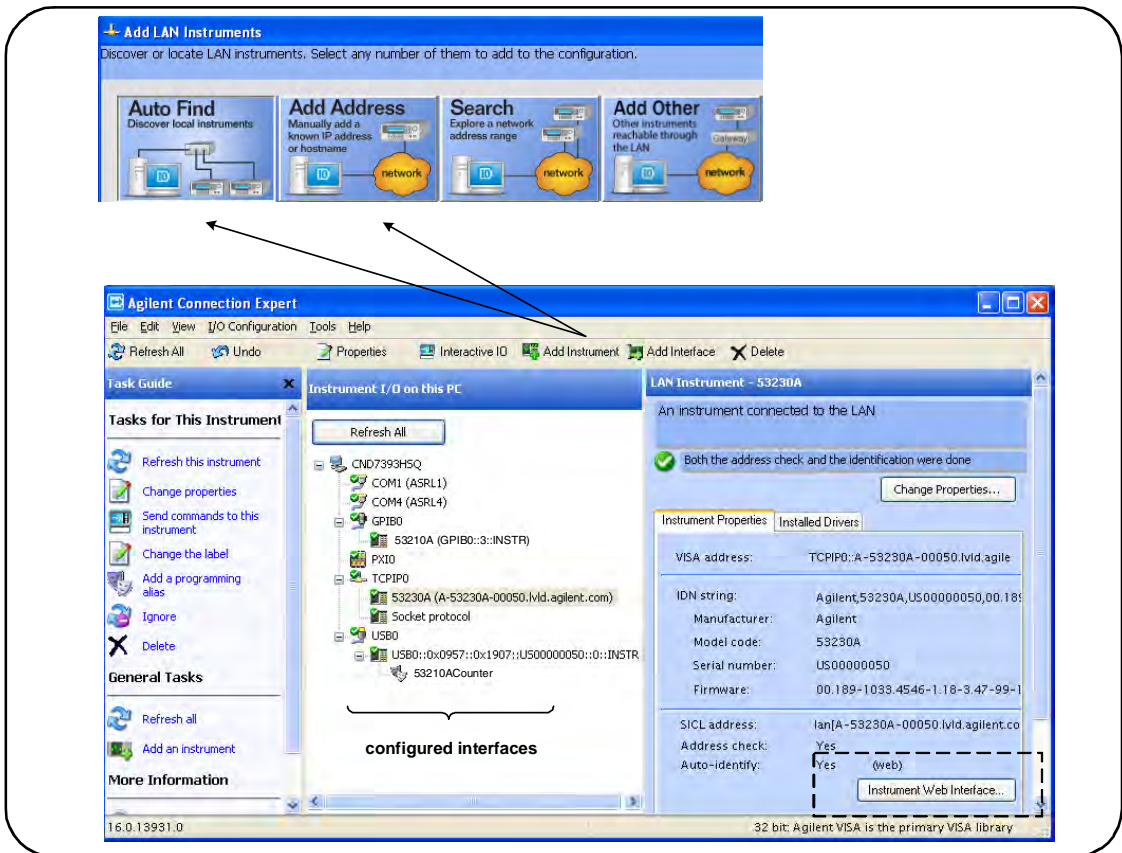

Figure 2-4. Agilent Connection Expert Interface Window.

Using the Sockets Protocol For higher performance, instruments added to the LAN configuration can also use the **Sockets** protocol. To use this connection, select 'Add Address' from the 'Add Instruments' menu (Figure 2-4). In this window, enter the instrument's host name or IP address and under 'Optional Socket Connection', select 'Use socket connection' (Figure 2-5). Note that an instrument can have both VXI-11 **and** Sockets connections in the configuration (Figure 2-4).

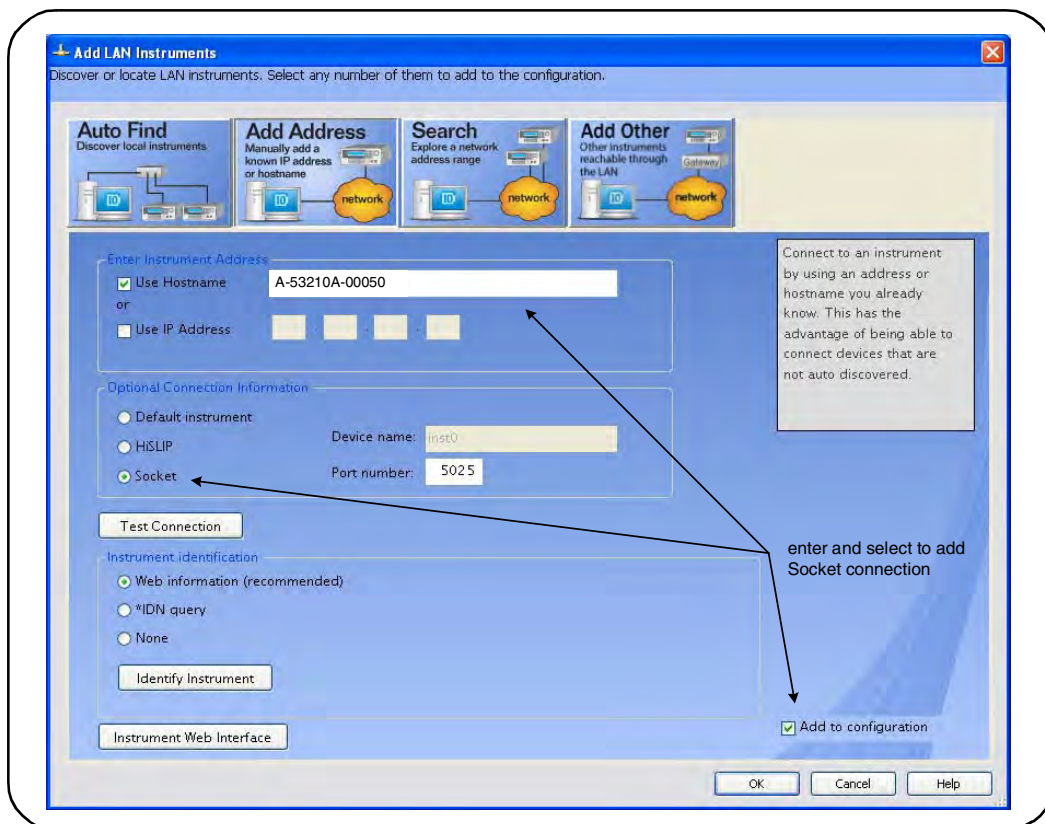

Figure 2-5. Adding a Sockets Connection.

About IP Addresses and Host Names

Dynamic Host Configuration Protocol (DHCP) and Automatic IP are enabled on the 53210A when shipped from Agilent. This allows the instrument to automatically obtain an address on the network. If there is a DHCP server on the network, the server will assign the address to the instrument.

If there is not a DHCP server on the network, the 53210A will automatically determine the address to use. The address will be in the range 169.254.1.1 to 169.254.255.255.

Host Names

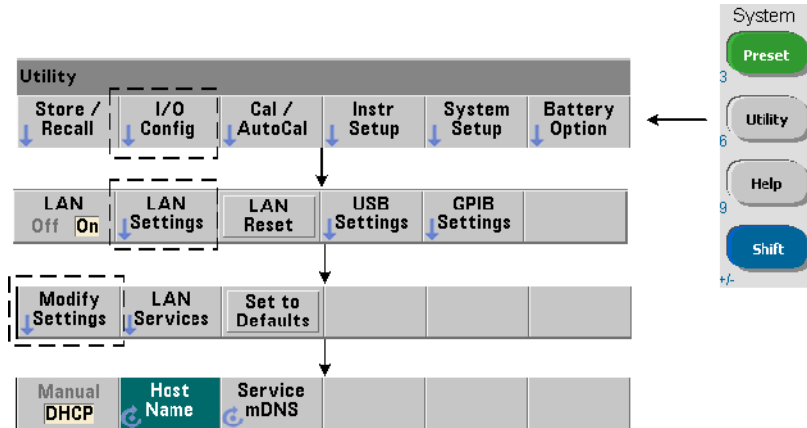

The 53210A has a default host name. The format of the host name is:

A-53210A-nnnnn

where 'nnnnn' are the last five digits of the instrument's serial number. The instrument host name is reported by Connection Expert for network servers that support Dynamic Domain Name Service (DNS). For network servers that do not support Dynamic DNS, only the IP address is reported.

Instrument Addressing During programming, the 53210A is accessed through its address string which consists of an IP address:

TCPIP0::169.254.2.30::inst0::INSTR (VXI-11)
 TCPIP0::169.254.2.30::5025::SOCKET (Sockets)

or host name:

TCPIP0::A-53210A-00050.agilent.com::inst0::INSTR

Disabling the LAN Interface

The LAN interface can be disabled from the front panel by selecting I/O Config followed by LAN Off and cycling power on the instrument. When disabled, the interface cannot be configured by the Connection Expert utility.

Opening the Web Interface from Agilent Connection Expert

The LAN interface is the **only** IO interface from which the counter's Web-enabled user interface can be accessed. To open the Web UI, highlight the configured LAN instrument (Figure 2-4) and select "Instrument Web Interface..." from the Connection Expert window.

Configuring the USB Interface

The 53210A is a high-speed USB 2.0 device. Connection to the instrument is through the Type B USB connector located on the instrument rear panel.

NOTE

The first time the 53210A is connected to the PC via the USB cable, a "hardware wizard" utility within the PC **may** start and prompt you for installation software for the product. There is no installation software for the USB interface other than the libraries on the Agilent Automation-Ready CD that ships with the 53210A. Continue through the "wizard" application **without** searching for software and using the default selections.

Adding Instruments to the USB Configuration

With the 53210A and PC connected through the USB cable, start Agilent Connection Expert (Figure 2-4) if it is not already open. The PC should detect the presence of the USB device. If necessary, **right-click** the USB interface (USB0) and then select "Refresh This Interface".

Connection Expert will attempt to establish a communication path to the instrument. If successful, the instrument will be added to the list of USB configured instruments (Figure 2-4). The USB address can be read from the front panel as shown below.

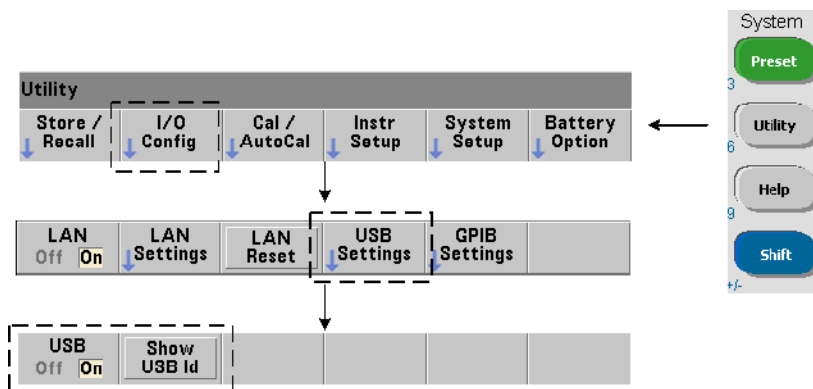

The USB Address String

When programming the 53210A over USB, the instrument’s USB address is included in the address string as follows:

USB0::2391::1287::0123456789::0::INSTR

To simplify addressing during programming, a VISA alias can be assigned and used in place of the complete address. To assign an alias from Connection Expert, right-click on the default alias name and then select “Change Properties”. Enter the alias and then select ‘OK’ (Figure 2-6).

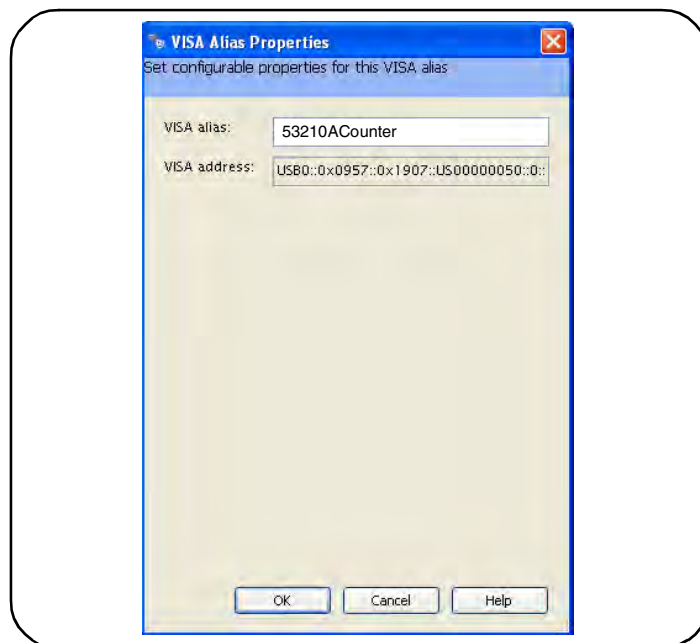

Figure 2-6. Setting a VISA Alias for the USB Address String.

Disabling the USB Interface

The USB interface can be disabled from the front panel by selecting I/O Config, followed by USB Settings, and then USB Off. When disabling or enabling the USB interface, you must cycle power for the change to take affect. When disabled, the interface cannot be configured by the Connection Expert utility.

Using the USB Interface with Interactive IO

The Web-enabled instrument interface **is not** available from the USB interface. An alternate programming method is to use the Connection Expert 'Interactive IO' utility (see "Using Interactive IO").

Configuring the GPIB Interface

NOTE

The following information assumes a GPIB card or USB/GPIB interface is present on your computer.

Programming access to the 53210A is also available through the GPIB interface. GPIB cables can be connected to the PC in a “star” (all cables connect directly to the computer) or “linear” (instrument to instrument) configuration.

Adding Instruments to the GPIB Configuration

To add instruments to the GPIB interface, highlight GPIB0 and select “Add Instrument” on the Connection Expert tool bar (Figure 2-4). In the ‘New GPIB Instrument’ window that appears (Figure 2-7), select the counter’s GPIB address (**note: factory-set address = 3**) and select ‘OK’.

Connection Expert will attempt to establish a communication path to the instrument. If the counter is at the address specified, the instrument will be added to the list of GPIB-configured instruments.

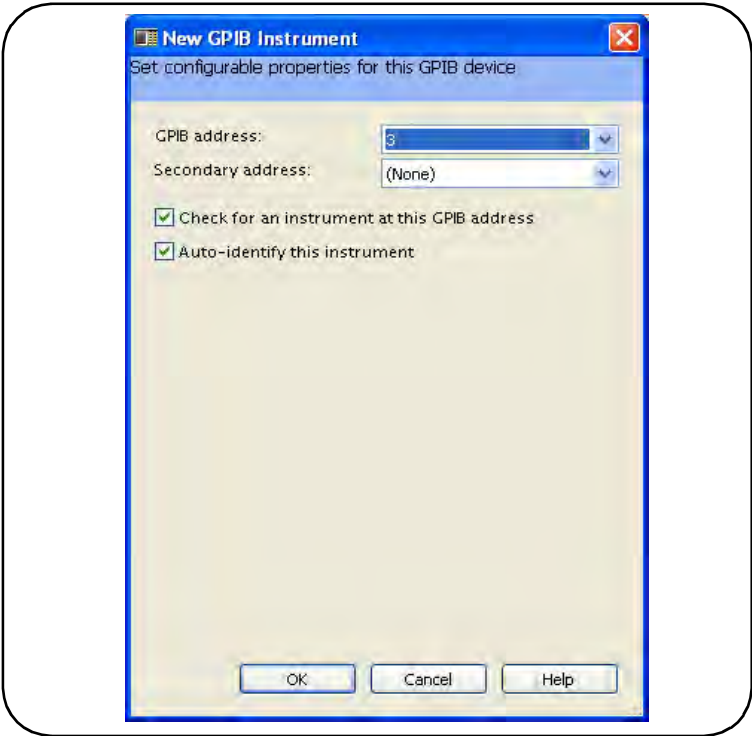
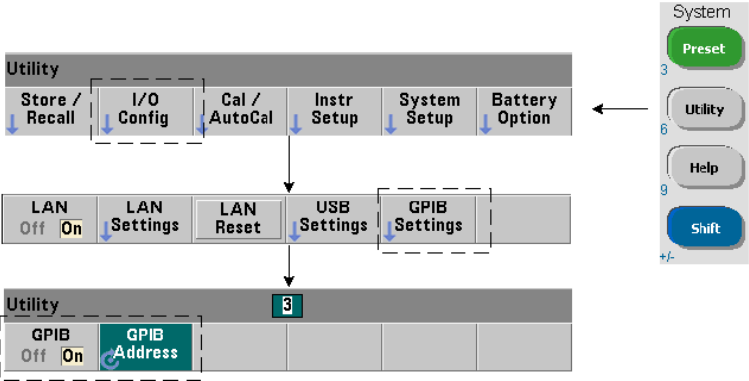

Figure 2-7. Selecting the GPIB Address.

The counter's GPIB address can be read from the front panel as shown below.



The GPIB Address String

When programming the counter over GPIB, the instrument's GPIB address is included in the address string as shown below:

```
GPIB0::3::INSTR
```

Changing the GPIB Address

To change the GPIB address, select GPIB Address and using the rotary knob or Shifted numeric keys, set the desired address. Once the address is changed, you must cycle power for the change to take affect.

If the GPIB address is changed, the new address IS NOT updated in Connection Expert interface window (Figure 2-4).

From the (Connection Expert) window, highlight the GPIB instrument and then select 'Change Properties ...'. Within the configurable properties window (Figure 2-7), change the address to the new address setting and select 'OK'.

Disabling the GPIB Interface

The GPIB interface can be disabled from the front panel by selecting I/O Config, followed by GPIB Settings, and then GPIB Off. When disabling or enabling the interface you must cycle power for the change to take affect. When disabled, the interface cannot be configured by the Connection Expert utility.

Using the GPIB Interface with Interactive IO

The Web-enabled instrument interface **is not** available from the GPIB interface. An alternate programming method is to use the Connection Expert 'Interactive IO' utility (see "Using Interactive IO).

Using Interactive IO

The Connection Expert 'Interactive IO' utility provides another method (Table 2-1) of sending commands to the 53210A. Interactive IO is accessible from **any** of the PC's IO interfaces, and allows you to send any command in the 53210A SCPI command set to the instrument. You can also choose from a menu of IEEE-488 Common commands (e.g. *IDN?, *RST, *TST?).

Interactive IO can be used to:

- troubleshoot communication problems
- issue a “device clear”
- learn the instrument's command set

Figure 2-8 shows how Interactive IO is started for a selected interface.

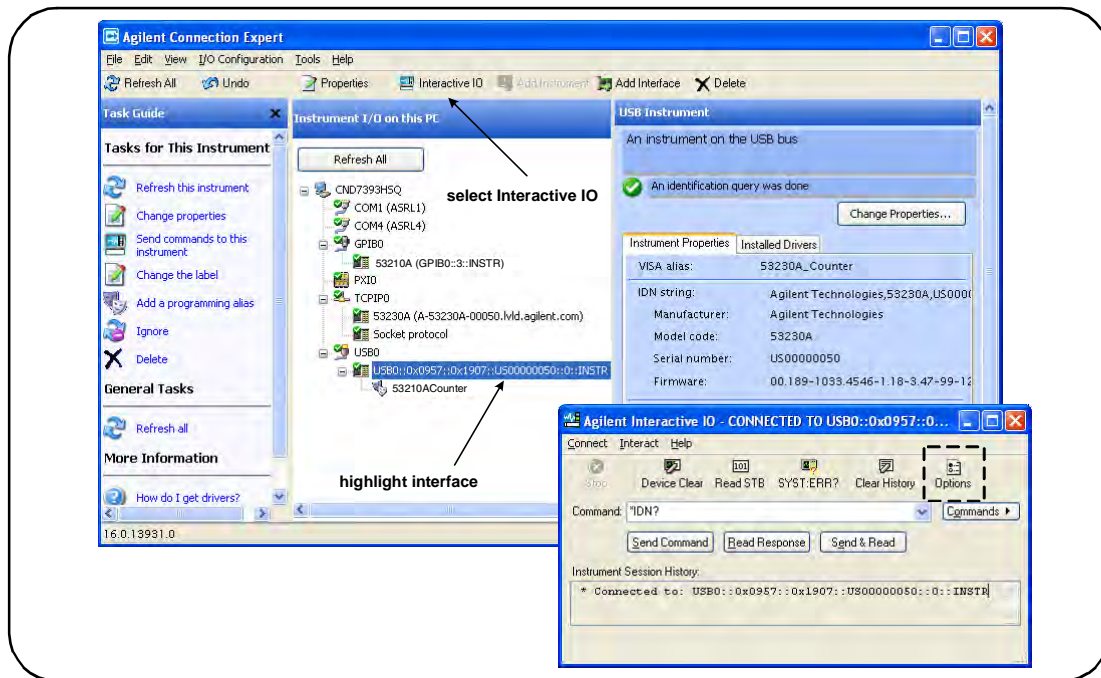

Figure 2-8. Starting Interactive IO for a Selected Interface.

NOTE

If the Interactive IO window is used to send the self-test (*TST?) command to the 53210A, the “timeout” period may have to be increased to allow the results to be returned. This is done using the ‘Options’ tab on the Interactive IO window. The 53210A self-test takes approximately seven seconds to complete.

Firmware and Driver Updates

Firmware and driver updates (when available) for the 53210A are available via the Web. This section contains information for locating and downloading the updates to your computer, and then installing the updates in the instrument.

Disabling Calibration Security

Before firmware updates can be installed, the counter’s calibration security feature must be *disabled*. This done using the command:

```
CALibration:SECurity:STATE {OFF|ON}, <code>  
CALibration:SECurity:STATE? (query form)
```

To unsecure the instrument, you must provide the security code in addition to setting the state to **OFF**. The security code is set to AT53210A when the instrument is shipped from the factory. Note, however, the security code may have been changed once the counter has been in use.

After the firmware update is complete, the counter can be re-secured by setting the state to **ON** and providing the security code. The calibration count is **unaffected** when changing the security state or by a firmware update.

The calibration count can be read with the command:

```
CALibration:COUNT?
```

SCPI Language Emulation Mode

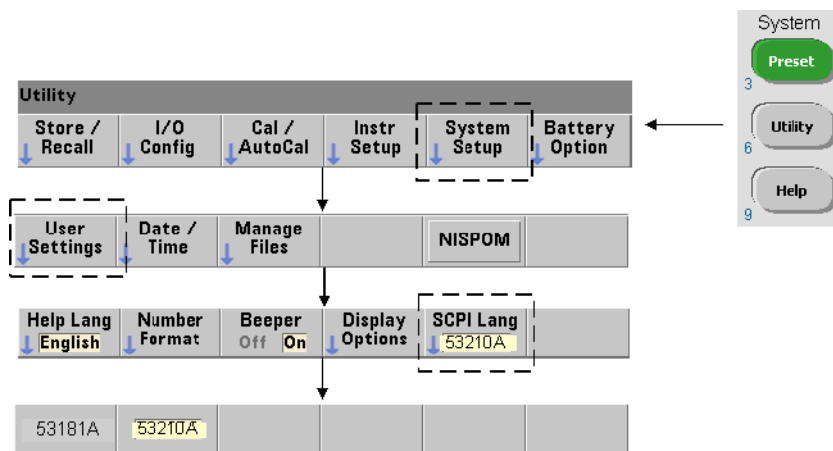

If the 53210A is sometimes used in 53181A SCPI language (emulation) mode, the instrument must be returned to its original (53210A) mode before the firmware can be updated.

Downloading and Installing the Update Utility

53210A firmware updates are installed in the instrument using the Agilent firmware update utility. The utility and firmware update can be found on the Web at:

www.agilent.com/find/53210A

Once this page is displayed, select the ‘**Technical Support**’ tab and then select ‘Drivers & Software’. Click on ‘532x0A Firmware Update’ and under ‘Documents & Downloads’ select the utility:

53210A/53220A/53230A Firmware Update Utility

When prompted, select ‘Run’ to install the utility. The default installation directory is C:\Program Files\Agilent\Firmware Update Utility Type 2. The utility will also be added to the ‘start’ menu under “Agilent”.

Downloading the Firmware Update

Return to the Web page and under ‘Documents & Downloads’ select:

532x0A Firmware Update Revision <revision number>

When prompted, select ‘Run’ to download (save) the file to your PC. **Note the directory location as you will need to specify the path to the firmware file when you run the update utility.**

NOTE

Firmware updates are available from the LAN interface only. Note the IP address before starting the utility.

Installing the Firmware Update

After the update file is downloaded from the web site it can be installed.

1. From the installation directory or ‘start’ menu, start the utility. A window similar to that shown in Figure 2-9 should appear.

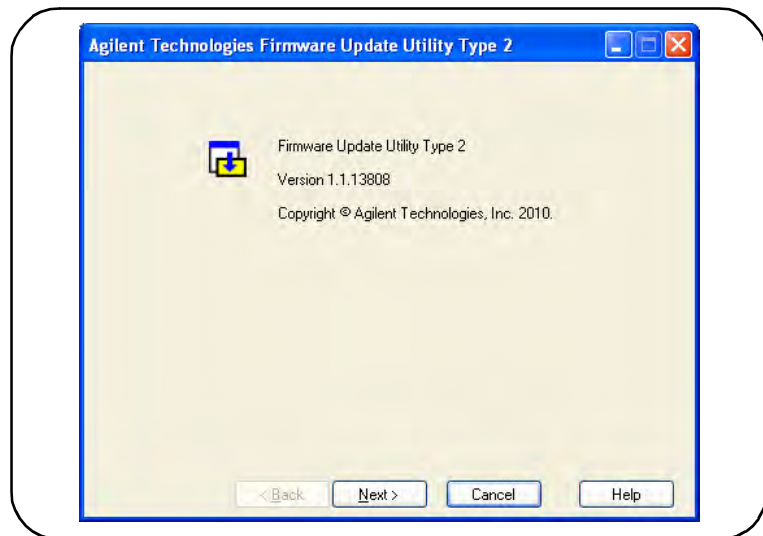

Figure 2-9. Firmware Update Utility File Selection Window.

2. Press Next and using the Browse button, specify the path to the firmware file (Figure 2-10). Once specified, the instrument model number will appear in the 'Applicable Models' window along with the revision and instrument description. Select Next.

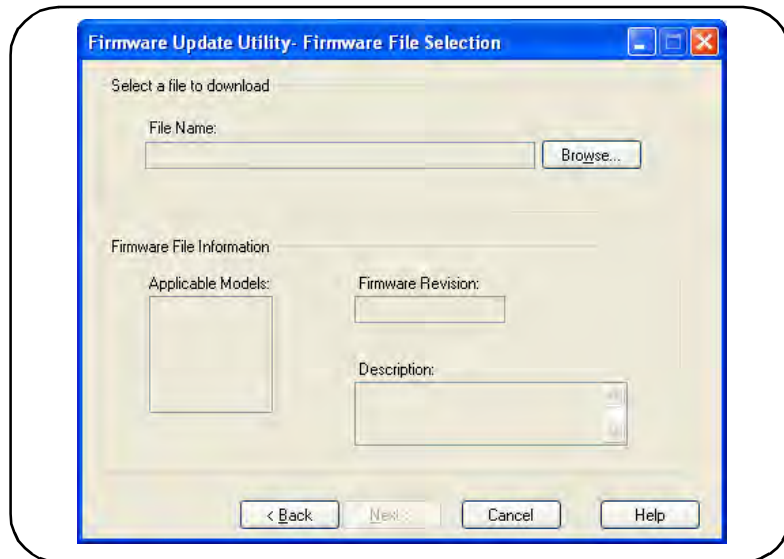

Figure 2-10. Selecting the Update File Path.

3. Enter the counter's IP address or host name (Figure 2-11). Select 'Update' to start the update process.

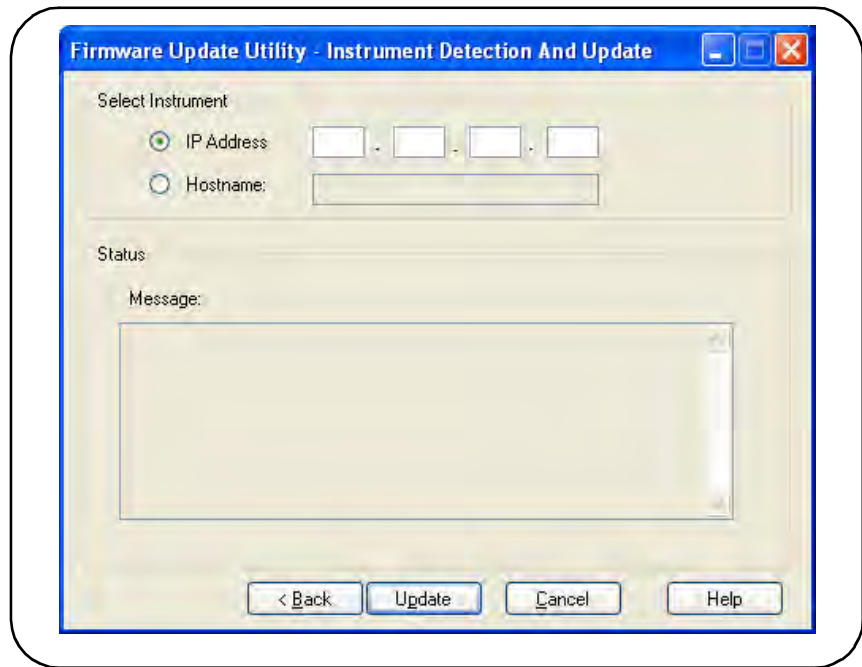

Figure 2-11. Specifying the Address or Host Name.

The firmware update takes a few moments to complete. The 53210A will reboot once the update is complete.

NOTE

Following a firmware update, Agilent Connection Expert (if running) may report that the 53210A configuration has changed. This is represented by a yellow triangle and an exclamation point (!) next to the updated instrument. Select the instrument name, select 'Change Properties', and then select either 'Test Connection' or 'Identify Instrument' to update Connection Expert.

Downloading IVI-COM Driver Updates

IVI-COM and LabVIEW drivers for the 53210A (when available) are provided on the Web at:

www.agilent.com/find/53210A

Once this page is displayed, select the **‘Technical Support’** tab and then select **‘Drivers and Software’**. The drivers and associated **‘readme’** files are located within this list.

2 53210A Software Installation and Interface Configuration

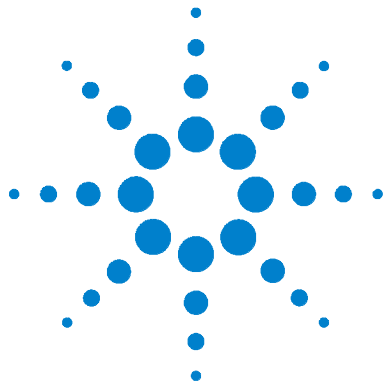

3 53210A Measurements

Counter Measurement Summary	64
Reference Oscillator Configuration	64
Reference Oscillator Source	65
Standby Power to the Reference Oscillator (Option 010)	68
Setting the Measurement Time Out	70
SCPI Syntax Conventions	71
The MEASure and CONFigure Commands	73
Using MEASure	74
Using CONFigure	75
Frequency Measurements	77
Frequency Ratio Measurements	79
Period Measurements	81

This chapter contains general programming information and examples of the measurements that can be made with the 53210A counter.



Counter Measurement Summary

The Agilent 53210A counter measurements are summarized in Table 3-1. The table includes the front panel keys under which specific measurements are selected via soft-keys. Also provided are the equivalent SCPI commands and channel restrictions.

Table 3-1. Agilent 53210A Measurement Summary

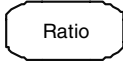
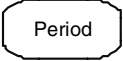
Measurement	Key	Command	Instrument	Channels
Frequency		CONFIgure:FREQUency MEASure:FREQUency?	53210A	1,2
Frequency Ratio		CONFIgure:FREQUency:RATio MEASure:FREQUency:RATio?	53210A	1,2
Period		CONFIgure:PERiod MEASure:PERiod?	53210A	1,2

Reference Oscillator Configuration

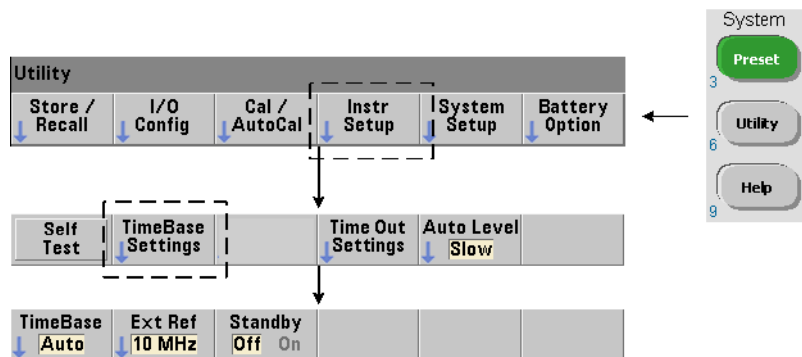

53210A measurements are based on a reference oscillator - also referred to as an internal/external clock or time base. A valid reference oscillator signal must be present for measurements to occur.

The following information applies to the counter's standard temperature compensated crystal oscillator (TCXO) and Option 010 Ultra High-Stability oven-controlled crystal oscillator (OCXO) references.

Reference Oscillator Source

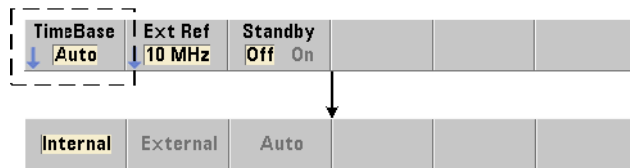

The reference oscillator (time base) is either the counter's internal oscillator or the internal oscillator tuned to an external reference. The source commands are:

```
[SENSe:]ROSCillator:SOURce {INTERNAL|EXTERNAL}
[SENSe:]ROSCillator:SOURce? (query form)
```

```
[SENSe:]ROSCillator:SOURce:AUTO {OFF|ON}
[SENSe:]ROSCillator:SOURce:AUTO? (query form)
```

- **INTERNAL** selects the counter's internal 10 MHz oscillator. The signal is a 0.5 Vrms (into 50Ω) sine wave. The internal oscillator signal is also present on the counter's rear panel Int Ref Out connector.

- **EXTERNAL** selects an external reference signal applied to the rear panel Ext Ref In connector. The signal must be:

- 1 MHz , 5 MHz, or 10 MHz
- 100 mVrms to 2.5 Vrms
- sine wave

and the frequency must be specified by the `SENSe:ROSCillator:EXTer-nal:FREQuency` command.

- **:AUTO ON** enables automatic selection of the reference oscillator source. If a 1, 5, or 10 MHz signal is present on the counter's Ext Ref In connector, source EXTernal is set. If a valid signal is not present **or is lost**, the source **automatically** switches to INTernal.

Note that specifying an oscillator source (INTernal or EXTernal) using [SENSe:]ROSCillator:SOURce disables automatic selection.

- **:AUTO Off** disables automatic selection of the oscillator source. The source is then set by the [SENSe:]ROSCillator:SOURce command.

The reference oscillator source is set to INTernal with automatic selection enabled (On) when the counter is shipped from the factory or following the SYSTem:SECure:IMMEDIATE command. Settings are stored in non-volatile memory and are not changed after a reset (*RST) or instrument preset (SYSTem:PREset or Preset key).

Specifying the External Reference Frequency

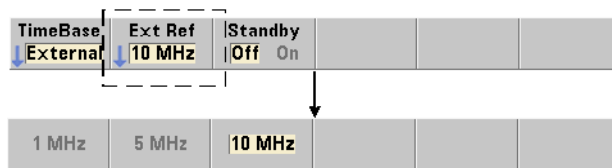

When the reference oscillator source is EXTernal as set by either SENSE:ROSCillator:SOURce or SENSE:ROSCillator:SOURce:AUTO, the lock frequency of the external signal (to which the internal oscillator is tuned) **must** be indicated using the command:

```
[SENSe:]ROSCillator:EXTernal:FREQUENCY {1E6|5E6|10E6|
MINimum|MAXimum|DEFAULT}
```

```
[SENSe:]ROSCillator:EXTernal:FREQUENCY? [{MINimum|MAXimum|
DEFAULT}] (query form)
```

The external reference frequency setting is 10 MHz when the counter is shipped from the factory or following the `SYSTEM:SECure:IMMediate` command. The setting is stored in non-volatile memory and is not changed after a reset (`*RST`) or instrument preset (`SYSTEM:PREset` or `Preset` key).

External Reference Example

The following example configures the counter to tune to an external reference if present, and the expected external frequency is 10 MHz.

```
SENS:ROSC:SOUR:AUTO ON // tune to external ref if present
SENS:ROSC:EXT:FREQ 10E6 // signal will be 10 MHz
```

Detecting a Valid External Reference Signal

ExtRef will appear in the top, right corner of the display when a valid (external) reference is present. If a valid frequency is not present or was not specified, the message “No valid external timebase” is displayed. The error is also logged in the error queue.

The presence of a valid external reference can be determined programmatically with the command:

```
[SENSe:]ROSCillator:EXTernal:CHECK ONCE
```

Prior to sending the command, `SENSe:ROSCillator:SOURce EXTernal` and `SENSe:ROSCillator:SOURce:AUTO OFF` must be set.

The following example checks for an external reference signal applied to the Ext Ref In connector.

```
SENS:ROSC:SOUR EXT // set source, also disables
// automatic source selection
SENS:ROSC:EXT:CHEC ONCE // check for valid signal
SYST:ERR? // read the error queue
```

The error queue can be read from the front panel as follows:

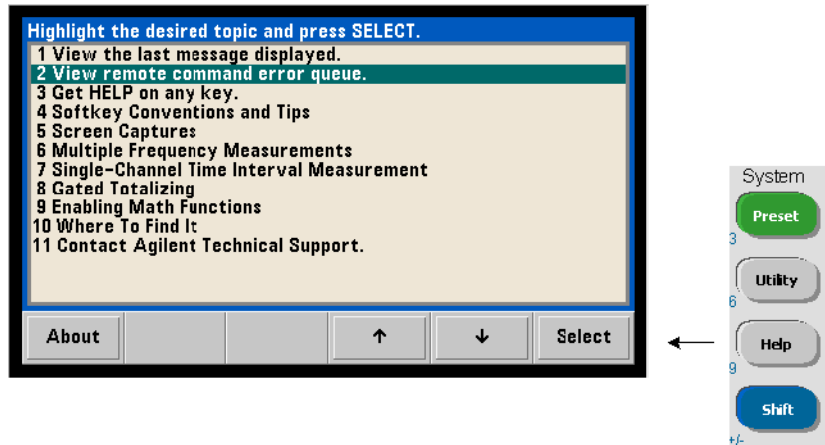

The status of the external reference (time base) is also monitored by the counter's Questionable Data register. The register can be queried with the command:

STATus:QUESTIONable:EVENT?

A value of +1024 (bit 10) indicates an invalid frequency (time base) error. Reading the register **clears all bits** in the register. See Chapter 8 for information on the counter's status system.

Standby Power to the Reference Oscillator (Option 010)

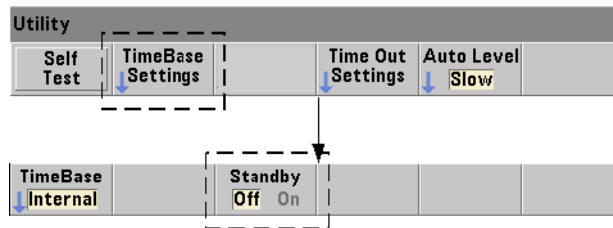

Standby power to maintain the operating temperature of the counter's internal OCXO reference oscillator (Option 010) is provided by the the line voltage or from Battery Option 300. Standby power is enabled and disabled using the command:

```
[SENSe:]ROSCillator:INTernal:POWer:STANdby {OFF|ON}
[SENSe:]ROSCillator:INTernal:POWer:STANdby?      (query form)
```

- **On** enables standby power which maintains the temperature of the OCXO when the front panel power button is switched 'off' (standby). If line power is removed from the instrument and Battery Option 300 is installed **and enabled**, standby power is supplied by the battery. Battery-supplied standby power is 24 hours.

- **Off** disables standby power from either the line voltage or battery to the internal oscillator when the front panel power button is switched 'off'.

With standby power **Off**, cycling power on the instrument also cycles power to the oscillator. **This may affect the oscillator's calibrated accuracy, and stability may not occur until the specified warm-up time (45 minutes) is reached.**

Note that disabling standby power with Battery Option 300 installed and the line voltage removed *will* extend the time the battery remains charged.

Standby power is disabled (**Off**) when the counter is shipped from the factory or following the `SYSTem:SECure:IMMediate` command. The current setting is stored in non-volatile memory and is not changed after a reset (`*RST`) or instrument preset (`SYSTem:PREset` or Preset key).

Setting the Measurement Time Out

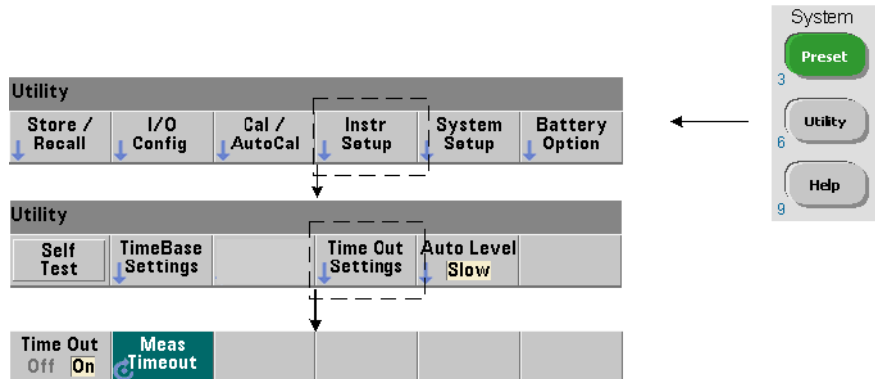

The measurement time-out is the time allowed for **each** measurement to complete. If a measurement **does not** complete before the time out expires, 9.91E37 (not a number) is returned and the display indication is: -----. The sequence continues with the next reading in the sample count.

Specifying a time out prevents the instrument from pausing indefinitely if for some reason a measurement is unable to complete.
The measurement time out is set with the command:

```
SYSTem:TIMEout {<time>|MINimum|MAXimum|INFINITY|DEFAULT}
SYSTem:TIMEout? [{MINimum|MAXimum|DEFAULT}]
```

(query form)

- **time** is the specified time out in the range of 10 ms to 2,000s with 1 ms resolution. The time out setting can affect reading throughput when multiple readings are taken during the trigger cycle. Trigger delays, gate times, and gate delays (Chapter 5) should be considered when setting an optimum time out value.

The time out setting is stored in non-volatile memory and **is not** changed following a reset (*RST) or instrument preset (SYSTem:PREset or Preset key).

When shipped from the factory the measurement time out is set to 1 second. Specifying a time of `9.9E+37` or sending the `SYSTem:SECurity:IMMediate` command also disables the time out. When the time out is **disabled**, the instrument will wait **indefinitely** for the measurement to complete.

SCPI Syntax Conventions

Programming the counters through their LAN, USB, and GPIB interface is achieved using the Standard Commands for Programmable Instruments (SCPI) control language. A typical example of the SCPI language syntax is shown for the following MEASure command:

```
MEASure:FREQuency? [{<expected>|MINimum|MAXimum|DEFault}
[, {<resolution>|MINimum|MAXimum|DEFault}]] [, <channel>]]
```

The programming conventions are as follows.

Command Keywords and Abbreviated Commands

Command keywords (e.g. MEASure, FREQuency?) are separated by a colon (:). Upper case letters indicate the abbreviated spelling of the keyword or parameter. Either the abbreviated form or the entire command/parameter must be used.

Optional Keywords and Parameters

Optional (implied) keywords and parameters are indicated by square brackets (e.g. [, <channel>]) and are not included when the command is sent. If an optional parameter is not specified, a default value is used.

Separating Commands and Parameters and Linking SCPI Commands

A space must separate the last keyword and the first parameter. Commas (,) separate multiple parameters. The '@' symbol must precede **each** counter channel number and parentheses must enclose each channel:

```
MEAS:FREQ:RAT? 5E6, (@2), (@1)
```

Multiple Subsystems To send multiple SCPI commands in a single string, commands within different subsystems (root nodes) must be separated by a semicolon (;) and a colon (:). For example, the string:

```
INP:COUP AC;:TRIG:SOUR EXT
```

requires a semicolon and a colon because the subsystems/root nodes (INPut and TRIGger) are not the same.

Same Subsystem For commands that share the same subsystem, multiple commands can also be sent in a single string. The first command references the root node, and subsequent commands separated by semicolons, are referenced to the same level as the previous command. As an example, the command sequence representing the CALCulate2 subsystem:

```
CALC2:TRAN:HIST:STAT ON  
CALC2:TRAN:HIST:POIN 15  
CALC2:TRAN:HIST:RANG:AUTO ON  
CALC2:TRAN:HIST:RANGe:AUTO:COUNT 300
```

can be sent in a string as:

```
CALC2:TRAN:HIST:STAT ON;POIN 15;RANG:AUTO ON;AUTO:COUN 300
```

Separate Command Lines or Strings? Sending commands in a single string rather than in separate command lines can eliminate “settings conflict” errors. When sent on separate lines, the counter checks for errors as each command (line) is parsed. When sent as a string, the entire string is parsed before error conditions are checked.

Linking IEEE 488-2 Common Commands and SCPI Commands

In a command string containing both IEEE 488.2 common commands (e.g. *RST, *WAI, *OPC?) and SCPI instrument commands, the common commands are separated from the SCPI commands by a semicolon (;). An example is shown in the following string:

```
CALC:STAT ON;AVER:STAT ON;:INIT;*WAI;:CALC:AVER:AVER?
```

NOTE

Information on the SCPI programming conventions is also included in the 'Programmer's Reference' section of the Agilent 53210A/53220A/ 53230A Product Reference CD.

The MEASure and CONFigure Commands

Each time the counter takes a measurement it does so from a configuration based on multiple parameters. The **easiest** and most common starting point for setting these parameters **programmatically** is using commands within the CONFigure and MEASure subsystems. These commands are considered "high-level" commands as multiple counter parameters are set or defaulted from a single command. "Low-level" commands are those within other subsystems (i.e. INPut, TRIGger, SENSE) that allow you to change a parameter value from that set, or defaulted to, using CONFigure or MEASure.

Executing commands from the CONFigure and MEASure subsystems is equivalent to setting parameters individually using the commands/subsystems shown in Table 3-2.

Table 3-2. Counter Configuration using CONFigure and MEASure

Parameter	CONFigure/MEASure Setting	Low-Level Command/Subsystem
Input	range, low-pass filtering, coupling, impedance and noise rejection are unchanged from previous or their power-on settings.	INPut[[1]:RANGe INPut[1]:FILTer INPut[1]:COUPling INPut[1]:IMPedance INPut[1]:NREJect
Trigger source	IMMEDIATE	TRIGger:SOURce
Trigger slope	NEGATIVE	TRIGger:SLOPe
Trigger delay	0.0 seconds	TRIGger:DELay
Trigger count	1 trigger	TRIGger:COUNt
Sample count	1 sample	SAMPle:COUNT
GATE Source	Based on measurement function specified by the CONFigure or MEASure command.	SENSe:FREQuency:GATE:SOURce
External Gate Source	Gate In/Out BNC	OUTPut:STATe
Math Graphics	Disabled, including the individual calculate functions. Other parameters are unchanged.	CALCulate1 subsystem CALCulate2 subsystem
Auto-level Frequency	Unchanged	SYSTem:ALEVel:FREQuency
Measurement Timeout	Unchanged	SYSTem:TImeout
Reference oscillator	Unchanged from previous settings.	SENSe:ROSCillator:SOURce SENSe:ROSCillator:SOURce:AUTO SENSe:ROSCillator:EXTeRnal:FREQuency
Reading Format Data Storage Instrument Status	Unchanged from previous settings. Unchanged from previous settings. Unchanged from previous settings.	FORMat Subsystem DATA Subsystem STATus Subsystem

Using MEASure

Measurements using commands from the MEASure subsystem are made as the command is executed, and are based on parameters specified within the syntax. The results are sent to the instrument's output buffer.

For example, the MEASure command:

```
MEAS:FREQ? 60.0, 1e-3, (@1)
```

takes a single measurement with five digit (1 mHz) resolution of an expected 60 Hz signal on channel 1. All other counter parameters (input configuration, trigger sources, etc.), are set to values predefined for the given MEASure command, or remain unchanged from previously programmed values.

Because the measurement is taken immediately, changes to the counter configuration are limited to the parameters within the command.

Using CONFigure

Measurements using commands from the CONFigure subsystem allow the use of low-level commands to change counter parameters before the measurement is taken. For example, assume the following configuration is required:

- frequency measurement
- external trigger - positive slope
- trigger count = 2
- sample count (readings per trigger) = 5
- gate time = 5 ms

The MEASure:FREQuency? command cannot be used since it immediately triggers a measurement after setting the trigger source to 'internal', the trigger count to '1', and the sample count to '1'. The gate time is set to 0.1 seconds.

Using CONFigure and the appropriate low-level commands, the configuration can be changed before the measurement is initiated (the abbreviated form of the SCPI commands are shown):

```
//configure counter for frequency measurements
//change parameter values from those set by CONFigure
CONF:FREQ 1.0E6, (@2)
    TRIG:SOUR EXT
    TRIG:SLOP POS
    TRIG:COUN 2
    SAMP:COUN 5
    SENS:FREQ:GATE:TIME 0.005
    SENS:FREQ:GATE:SOUR TIME
INIT
```

Using CONFigure?

The following command:

CONFigure?

returns the measurement function configured by the *last* CONFigure or MEASure? command sent to the instrument. Sending CONFigure? after power is cycled generates a settings conflict error until CONFigure or MEASure? is sent.

For example:

```
CONF:FREQ 1.0E6, (@2)
CONF?
```

returns (including quotes):

```
"FREQ +1.000000000000000E+006,+1.000000000000000E-004, (@2) "
```

which includes the function, expected value, (calculated) resolution, and channel. If a channel number is not specified in the CONFigure or MEASure command, no channel is included in the return string.

Frequency Measurements

NOTE

The SCPI commands listed in these examples are provided as an introduction to how frequency measurements are made. Commands may be included even though they specify default values - but which should be considered when modifying the examples for actual use. Refer to the 'Programmer's Reference' on the Agilent 53210A/53220A/53230A Product Reference CD for additional information.

Frequency

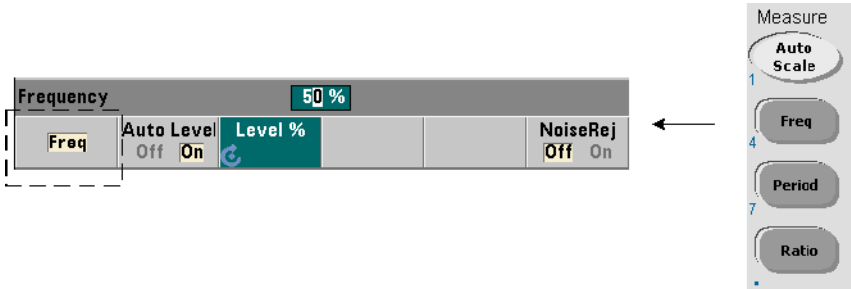

A standard frequency measurement is shown in Figure 3-1.

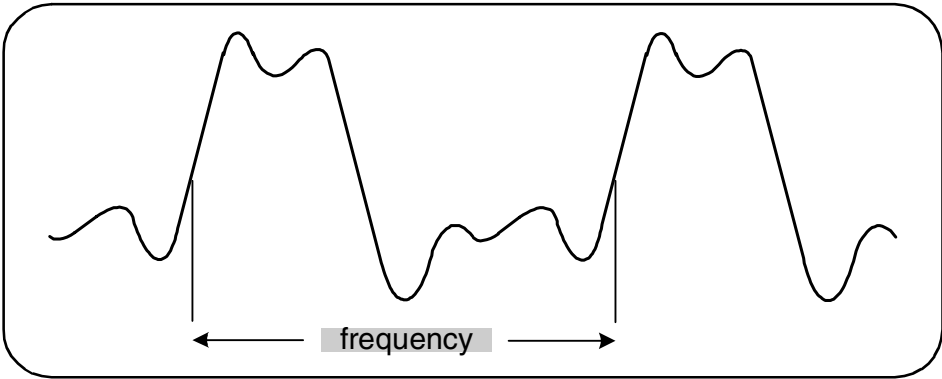

Figure 3-1. Standard Frequency Measurement.

The commands used to make frequency measurements are:

```
MEASure:FREQuency? [{<expected>|MINimum|MAXimum|DEFAULT}
[, {<resolution>|MINimum|MAXimum|DEFAULT}]][, <channel>]
```

```
CONFIgure:FREQuency [{<expected>|MINimum|MAXimum|DEFAULT}
[, {<resolution>|MINimum|MAXimum|DEFAULT}]][, <channel>]
```

- **expected** is the expected input signal frequency. **resolution** is the desired measurement resolution in hertz. The parameter ranges are:

expected (channel 1): 0.1 Hz - 350 MHz (default = 10 MHz)

expected (channel 2 Option 106): 100 MHz - 6.0 GHz (default = 500 MHz)

expected (channel 2 Option 115): 300 MHz - 15 GHz (default = 500 MHz)

resolution (all channels): $1.0E-15 * \text{expected}$ to $1.0E-5 * \text{expected}$
(default resolution corresponds to a 0.1s gate time)

- **channel** is counter channel 1 or 2 specified as (@1) or (@2).

Frequency Measurement Examples

```
// using MEASure? - measure 20 MHz signal with 0.1 Hz
// resolution
*RST // reset to start from known state
MEAS:FREQ? 20E6, 0.1, (@1)
-----
// using CONFIgure - measure 20 MHz signal with
// 0.1 Hz resolution, take 10 readings
*RST // reset to start from known state
CONF:FREQ 20E6, 0.1, (@1)
SAMP:COUN 10 // take 10 readings
READ?
```

Notes

1. See Chapter 5 for information on triggering and number of readings per trigger (sample count).

Frequency Ratio Measurements



A frequency ratio measurement is the measurement of two signals in which one signal generally serves as a reference (Figure 3-2). The signals can be different wave shapes and applied to any 2-channel combination on the counter.

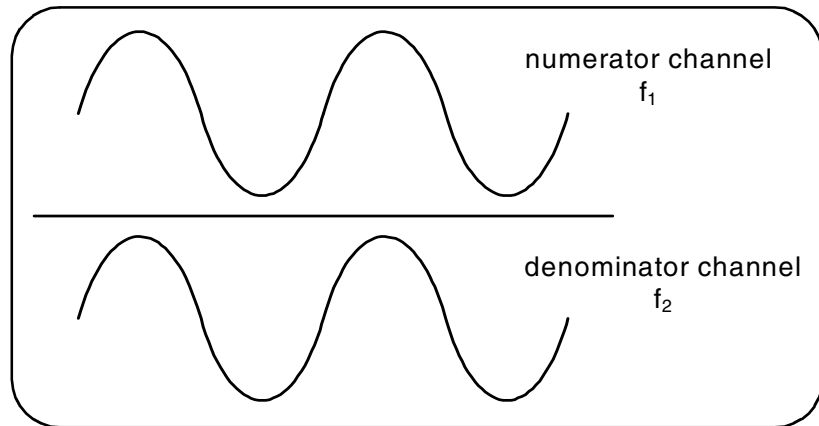

Figure 3-2. Ratio of Two Input Signal Measurements.

The commands used to make frequency ratio measurements are:

```
MEASure:FREQuency:RATio? [{<expected>|MINimum|MAXimum|
DEFAult} [, {<resolution>|MINimum|MAXimum|DEFAult}]]
[, <channel_pair>]
```

```
CONFigure:FREQuency:RATio [{<expected>|MINimum|MAXi-
mum|DEFAult} [, {<resolution>|MINimum|MAXimum|DEFAult}]]
[, <channel_pair>]
```

- **expected** is the expected *ratio* of the two input signals. **resolution** is the desired resolution of the ratio measurement. The parameter ranges are:

expected (Option 106): 0.28 to 6.0E10 (default = 1.0)

expected (Option 115): 0.85 to 15.0E10 (default = 1.0)

resolution (all channels): $1.0E-15 * \text{expected}$ to $1.0E-5 * \text{expected}$
(default resolution corresponds to a 0.1s gate time)

- **channel_pair** settings are (@1), (@2) | (@2), (@1). Within the pair, the first channel represents the ratio's numerator and the second channel represents the ratio's denominator. The default channel_pair is (@1), (@2).

Frequency Ratio Examples

```
// using MEASure? - ratio measurement expecting a 1:1
// ratio, set 6 digits of resolution of ratio measurement
*RST // reset to start from known state
MEAS:FREQ:RAT? 1, 1.0E-6, (@1), (@2)
```

```
-----
// using CONFigure - ratio measurement expecting a 1:1
// ratio, set 9 digits of ratio resolution
*RST // reset to start from known state
CONF:FREQ:RAT 1, 1.0E-9, (@1), (@2)
INP:LEV 1.5 // set a 1.5V threshold level (ch. 1)
READ?
```

Notes

1. The digits of resolution in the above ratio measurements is set by the resolution parameter ($1.0E-6$, $1.0E-9$). In effect, the exponent corresponds to the number of digits. See “Frequency Measurements” in Chapter 5 for information on the relationship between gate time and reading resolution.
2. See Chapter 4 for additional information on counter threshold levels and on configuring the input signal path.

Period Measurements

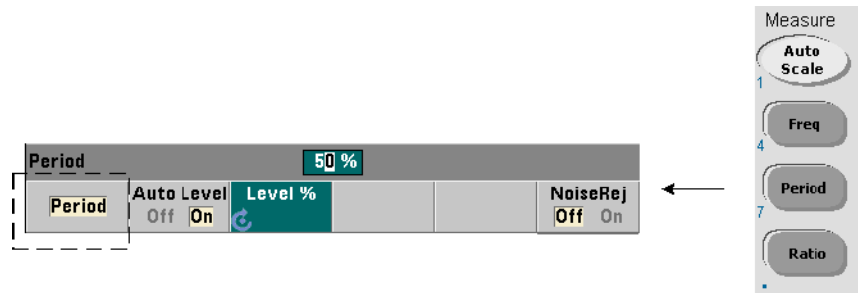

A standard period measurement is shown in Figure 3-3.

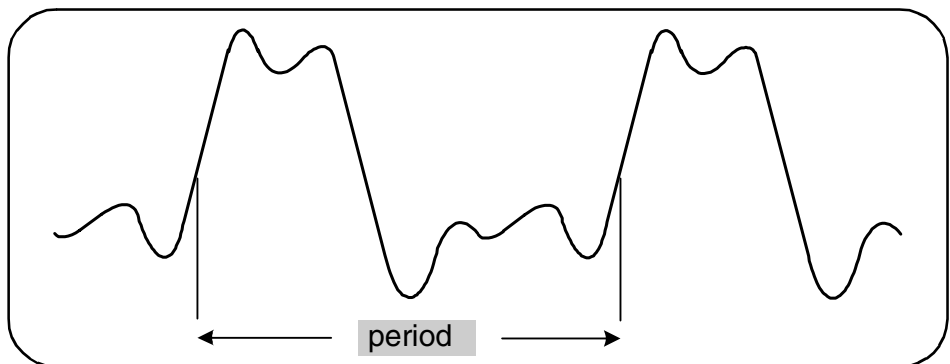

Figure 3-3. Standard Period Measurement.

The commands used to make period measurements are:

```
MEASure:PERiod? [{<expected>|MINimum|MAXimum|DEFAULT}
[, {<resolution>|MINimum|MAXimum|DEFAULT}]][, <channel>]
```

```
CONFIgure:PERiod [{<expected>|MINimum|MAXimum|DEFAULT}
[, {<resolution>|MINimum|MAXimum|DEFAULT}]][, <channel>]
```

- **expected** is the expected input signal period. **resolution** is the desired measurement resolution in seconds. The parameter ranges are:

expected (channel 1): 2.8 nsec to 10 sec (default = 100 nsec)

expected (channel 2 Option 106): 160 psec to 10 nsec (default = 2 nsec)

expected (channel 2 Option 115): 66 psec to 3.33 nsec (default = 2 psec)

resolution (all channels): $1.0E-15 * \text{expected}$ to $1.0E-5 * \text{expected}$
(default resolution corresponds to a 0.1s gate time)

- **channel** is counter channel 1 or 2 specified as (@1) or (@2).

Period Measurement Examples

```
// using MEASure? - measure the period of a 100 ns (10 MHz)
// signal with 12-digit resolution
*RST // reset to start from known state
MEAS:PER? 100E-9, 1E-12, (@1)
```

```
-----
// using CONFIgure - measure the period of a 100 ns (10 MHz)
// signal with 12-digit resolution
*RST // reset to start from known state
SYST:TIM 1.0 // 1s measurement timeout (per meas)
CONF:FREQ 100E-9, 1E-12, (@1)
SAMP:COUN 10 // take 10 readings
READ?
```

Notes

1. See Chapter 5 for information on triggering and number of readings per trigger (sample count).
2. See Chapter 4 for additional information on counter threshold levels and on configuring the input signal path.

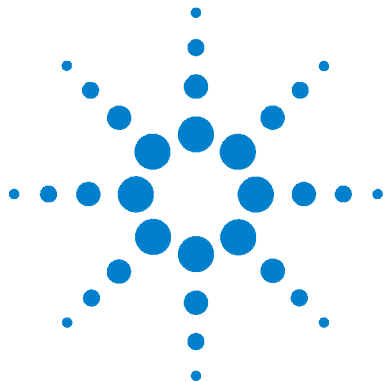

4 53210A Input Signal Conditioning

Channel Characteristics	86
Signal Conditioning Path	86
Input Impedance	88
Input Range	90
Input Coupling	92
Bandwidth Limiting (Low-Pass) Filter	93
Threshold Level and Sensitivity	95
Noise Rejection (Hysteresis)	101
Threshold Slope	103
Measuring Input Signal Levels and Signal Strength	104

This chapter contains information on configuring the input channels relative to the characteristics of the input signal expected. Configuration includes the channel's impedance, range/probe factor, coupling, filtering, and threshold level/sensitivity settings.



Channel Characteristics

There is one, plus an optional second input channel on the 53210A counter. Product **Option 201** adds parallel (additional) rear panel access to channel 1. Product **Options 106** and **115** add a 6 GHz or 15 GHz second channel. **Option 202** places the second channel (Option 106 / 115) on the front panel and **Option 203** places Option 106 / 115 on the rear panel.

NOTE

If a parallel channel 1 input is present on the rear panel (**Option 201**), all input specifications apply to the **rear** terminal **only**, and are relative to 50 Ω input impedance. Performance of the front panel input in this instance is not specified. Also, when calibrating the instrument, the rear panel input terminal is used.

When programming the counter from an I/O interface, configuration is provided by commands within the SCPI **INPut** subsystem. Within the commands, **INPut[1]** or **INPut** in the syntax refers to channel 1. As such, these commands **do not** apply to the optional second channel (Option 106 or Option 115).

The counter's standard (baseband) channel and optional second channel can be configured independently. Measurements on the channels do not occur simultaneously, however. Switching between channels retains the channel configuration, but ends the current measurement. The newly selected channel is re-initiated and measurements begin when the programmed trigger conditions are met.

Signal Conditioning Path

Figure 4-1 represents the counter's signal conditioning path.

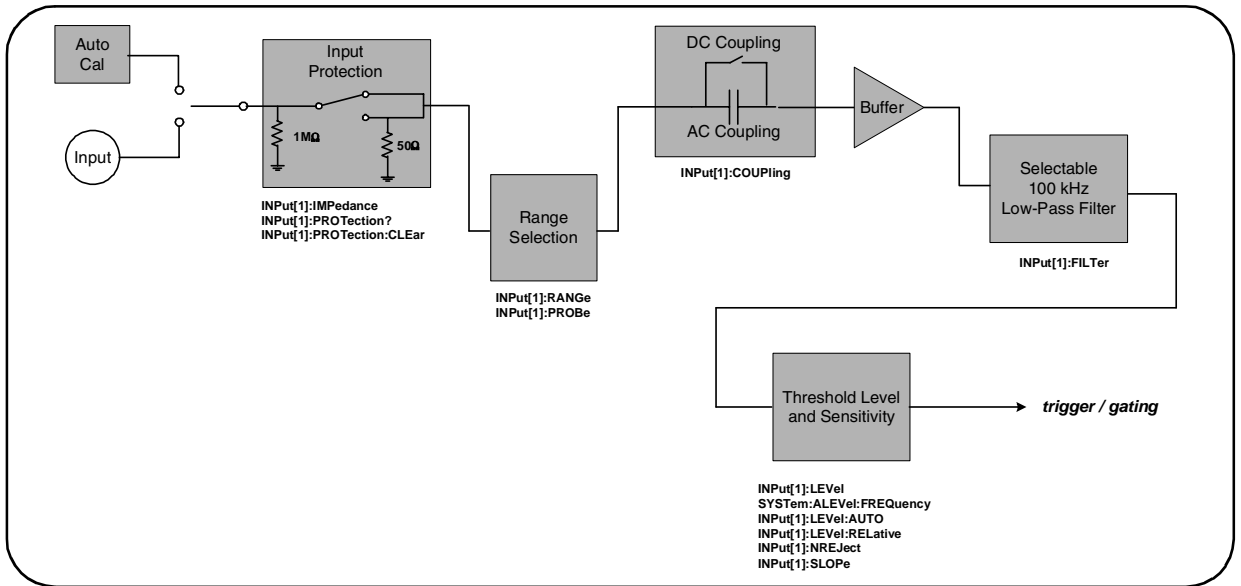

Figure 4-1. 53210A Input Signal Conditioning.

Table 4-1 is a summary of power-on/reset values for the signal conditioning parameters.

Table 4-1. Input Channel Reset/Preset Settings Summary.

Parameter	Setting
Impedance	1 M Ω
Range (1:1 probe)	5V
Range (10:1) probe	50V
Probe factor	1:1
Coupling	AC
Low pass filter	Off
Auto-level	Enabled
Level (absolute)	0.0V
Level (relative)	50%
Noise Rejection	Disabled
Slope	Positive

Input Impedance



The input impedance of the 53210A counter can be set to either 50Ω or 1 MΩ using the command:

```
INPut[1]:IMPedance {<impedance>|MINimum|MAXimum| DEFault}
```

```
INPut[1]:IMPedance? [{MINimum|MAXimum|DEFault}]
```

(query form)

The 50Ω and 1 MΩ impedances allow for impedance matching (termination) and bridging applications respectively.

Using Probes If using a 1:1 or 10:1 probe, the input impedance of the counter should be set to match the compatibility (e.g. 50Ω, 1 MΩ, high Z) of the probe. See “Setting the Probe Factor” for more information.

Following a reset (*RST) or front panel preset (Preset), the impedance is set to 1 MΩ. CONFigure and MEASure do not change the input impedance setting.

Impedance Example

```
//period measurement of expected 10 MHz signal,
//maximum resolution, use channel 1
CONF:FREQ 0.1E6,MAX,(@1)
    INP:IMP 1.0E6 //set impedance to 1 Mohm
```

Input Protection

The maximum input voltage (including any DC offset) allowed with **50Ω** input impedance is ± 5.125 Vp. If the input voltage exceeds $\sim \pm 10.0$ Vp, the input protection relay **opens** - changing the input impedance to 1 MΩ. (The display and Impedance softkey will still indicate a 50Ω setting however.)

With the relay open, the corresponding channel key flashes until the **input voltage is removed or reduced below the damage threshold** and the **key is pressed**. This sets the impedance back to 50Ω.

To programmatically determine if the protection relay has been **opened**, the command:

```
INPut[1]:PROTection?
```

queries the relay state (0 = relay closed, 1 = relay **open**). With the **input voltage removed or reduced below the damage threshold**, the protection relay is reset (closed) with the command:

```
INPut[1]:PROTection:CLEar
```

setting the input impedance back to 50Ω.

Voltage Overload Bit The opening of the input protection relay corresponds to the 'Voltage Overload' bit (bit 0) being set in the counter's Questionable Data Register group. The bit in the Condition register is cleared by the `INPut:PROTection:CLEar` command or by changing the input impedance to 1 MΩ. The bit in the Event register is cleared by reading the register. See Chapter 8 - "Instrument Status" for more information.

Input Range

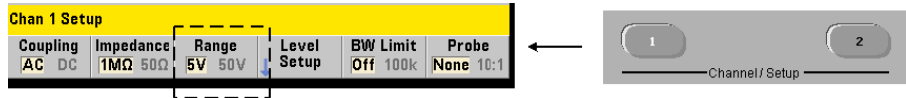

The signal operating ranges (input ranges) of the 53210A counter are $\pm 5.0\text{V}$, $\pm 50\text{V}$, and $\pm 500\text{V}$ and are dependent on the probe factor. The range is set using the command:

```
INPut[1]:RANGe {<range>|MINimum|MAXimum|DEFault}
INPut[1]:RANGe? [{MINimum|MAXimum|DEFault}] (query form)
```

When a 1:1 probe factor is selected (see “Setting the Probe Factor”), the available ranges are 5.0V and 50.0V. When a 10:1 probe factor is selected the available ranges are 50.0V and 500.0V.

CONFigure and MEASure do not change the input range setting. Following a reset (*RST) or a front panel preset (Preset), the range is set to 5.0V.

Using Auto Scale

For input signals greater than 100 Hz, Auto Scale detects the signal on the input channel and sets the range to 5V or 50V depending on the amplitude. Auto Scale is **not** the same as an instrument preset which sets a default range of 5V.

Range Example

```
//period measurement of expected 10 MHz signal,
//maximum resolution, use channel 1
CONF:PER 0.1E-6,MAX,@1
    INP:IMP 1E6 //set impedance to 1 Mohm
    INP:RANG 50 //set 50V range
```

Setting the Probe Factor

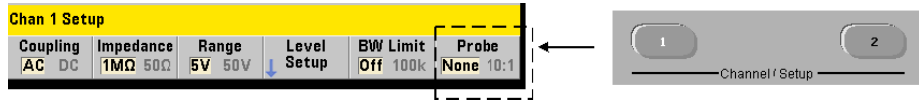

For better access to test points on the device under test (DUT), Agilent recommends its **N2870A**, **N2873A**, and **N2874A** Passive Probes for use with the 53220A/ 53230A counter. The 35 MHz (BW) N2870A 1:1 probe and the 500 MHz N2873A and 1.5 GHz N2874A 10:1 probes are popular accessories commonly used with Agilent oscilloscopes.

When using probes with the counter, specifying a probe factor references and displays **threshold levels** and **p-p levels** relative to actual levels on the DUT, rather than to the level at the channel input. The probe factor is set with the command:

```
INPut[1]:PROBE {<factor>|MINimum|MAXimum|DEFAULT}
INPut[1]:PROBE? [{MINimum|MAXimum|DEFAULT}]
```

(query form)

Probe **factor** settings are **1** for a 1:1 probe (N2870A), and **10** for a 10:1 probe (N2873A or N2874A). When set to 1, the counter ranges are 5V and 50V. When set to 10, the counter ranges are 50V and 500V.

Probe Input Compatibility The input compatibility of the N2870A and N2873A probes is 1 MΩ respectively. The compatibility of the N2874A is 50Ω . Each is compatible with the counter's 20 pF input capacitance. When using a probe, the counter input impedance should be set accordingly (1MΩ, 50Ω).

CONFigure and MEASure do not change the probe factor setting. Following a reset (*RST) or an instrument preset (SYSTEM:PRESet or Preset key), the probe factor is set to 1.

Input Coupling

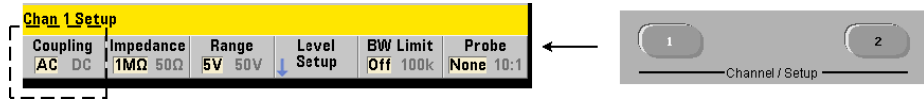

The input to the 53210A counter is either DC (direct) coupled or AC (capacitive) coupled, and is set using the the command:

```
INPut[1]:COUpling {AC|DC}
INPut[1]:COUpling? (query form)
```

AC coupling removes the signal's DC content and centers the signal at 0V. The measurable frequency range (channels 1 and 2) with AC coupling is:

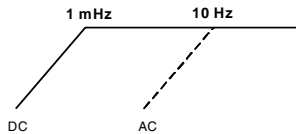

- AC = 10 Hz - 350 MHz
- DC = 1 mHz - 350 MHz

DC coupling extends the frequency range across the full bandwidth of the instrument (1 mHz - 350 MHz). **CONFigure** and **MEASure** do not change the coupling setting. Following a reset (*RST) or front panel preset (Preset), the coupling is set to AC.

When selecting AC or DC coupling, the amplitude of the input signal must also be considered. DC coupling is applicable for most measurements, especially those requiring a specific trigger level. Rather than reducing the signal amplitude by changing the counter range, AC coupling can be used to bring the signal in contact with the hysteresis window defined by the trigger level. This is represented in Figure 4-2 (also see 'Threshold Level and Sensitivity').

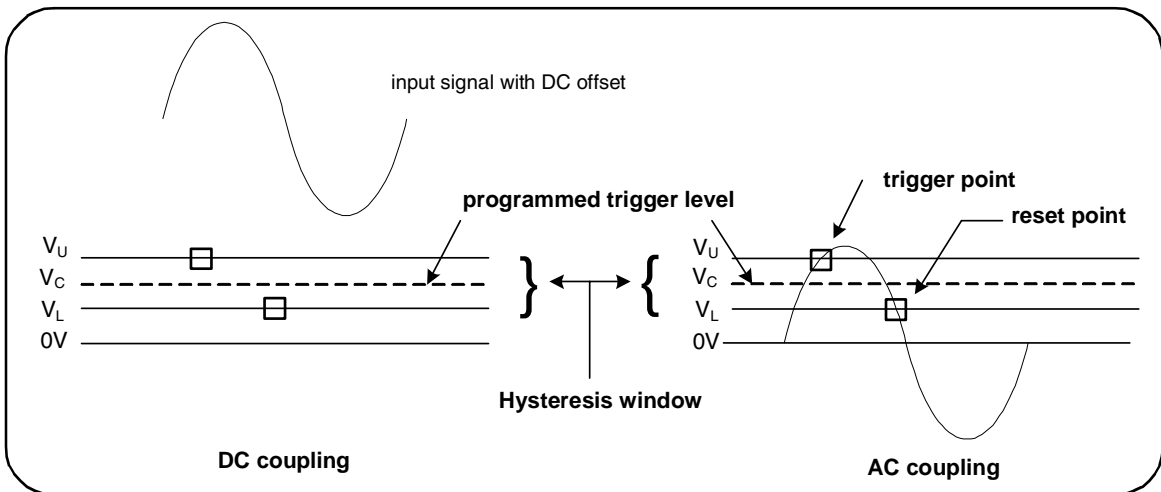

Figure 4-2. Using AC Coupling to Reach Trigger Points.

Settling Time Between DC and AC Coupling

There is an inherent settling time when changing from DC to AC coupling. As a measure of this time, a signal with a 5V DC component (DC coupled) will typically center around 0V (AC coupled) in one second.

Coupling Example

```
//period measurement of expected 10 MHz signal,
//maximum resolution, use channel 1
CONF:PER 0.1E-6,MAX,(@1)
INP:COUP AC //set AC coupling
```

Bandwidth Limiting (Low-Pass) Filter

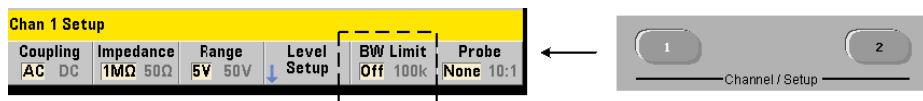

For measurement applications of 100 kHz or less, a 100 kHz low-pass filter can

be enabled within the signal path to eliminate noise introduced by higher-frequency components of the input signal.

The bandwidth filter is switched into the signal path using the command:

```
INPut[1]:FILTer[:LPASs][:STATe] {OFF|ON}
INPut[1]:FILTer[:LPASs][:STATe]?           (query form)
```

On - enables the filter. **OFF** - disables the filter.

Figure 4-3 shows the effects on the instrument's **measurable frequency range** when the filter is enabled.

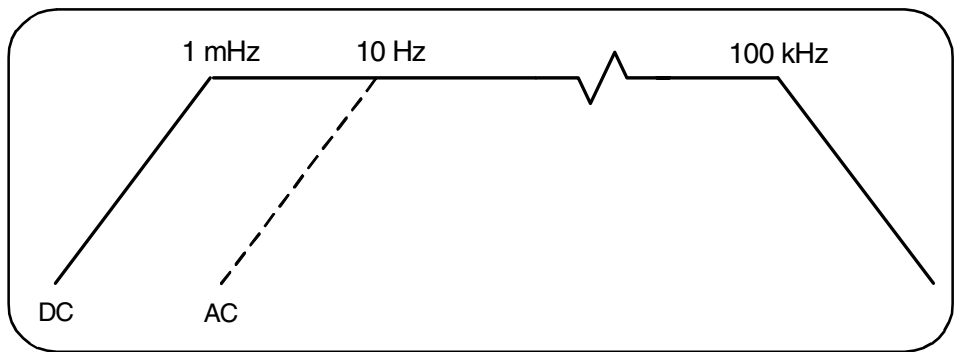

Figure 4-3. Measurable Frequency Range with Bandwidth Filter Enabled.

From the figure:

- DC coupling = 1 mHz - 100 kHz
- AC coupling = 10 Hz - 100 kHz

CONFigure and MEASure do not change the filter setting. Following a reset (*RST) or front panel preset (Preset), the low-pass filter is disabled (off).

Threshold Level and Sensitivity

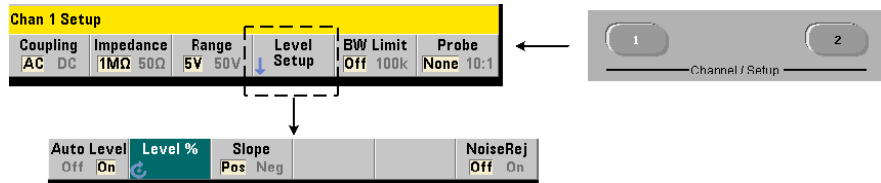

The threshold level is the trigger (input) level at which the counter begins the signal count (i.e. measurement). This level is the center of the hysteresis band - the band which represents counter sensitivity. For a count to occur, the signal must cross the upper and lower limits of the band in opposite directions (polarities). Figure 4-4 identifies these characteristics and conditions of the input signal. The dynamic range of the input signal is indicated on the front panel.

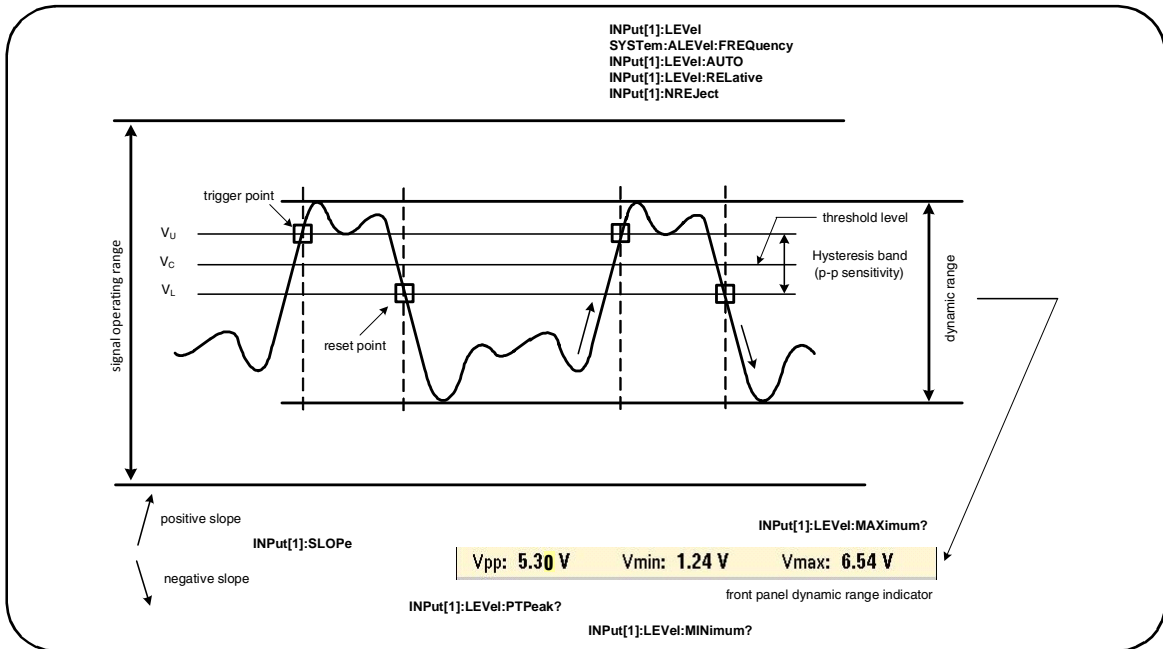

Figure 4-4. Input Signal Threshold Level and Sensitivity.

Specifying an Absolute Threshold Level



The input threshold level can be specified as an **absolute** value. An absolute level is set with the command:

```
INPut[1]:LEVel[:ABSolute] {<volts>|MINimum|
MAXimum|DEFault}
```

```
INPut[1]:LEVel[:ABSolute]? [{MINimum|MAXimum|
DEFault}] (query form)
```

Absolute threshold levels for the input ranges are:

- 5V range: $\pm 5.125\text{V}$ (2.5 mV resolution)
- 50V range: $\pm 51.25\text{V}$ (25 mV resolution)
- 500V range (w/10:1 probe): $\pm 512.5\text{V}$ (250 mV resolution)

LEVel sets the absolute threshold for all measurements.

Setting an absolute level **disables** the counter's auto-level function.

CONFigure and MEASure enable auto-leveling and set the threshold to 50%. A reset (*RST) or front panel preset (Preset) also enables auto-leveling and sets the threshold to 50%.

NOTE

If auto-leveling is enabled, querying the absolute level on the current measurement channel returns the most recently measured input threshold voltage. If the channel is not the measurement channel, 9.91E+37 (not a number) is returned.

Using Auto-Level

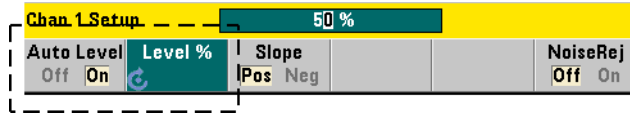

Automatic setting of the input threshold level is based on the positive and negative peaks of the input signal. Auto-level is enabled with the command:

```
INPut[1]:LEVel:AUTO {OFF|ON|ONCE}
INPut[1]:LEVel:AUTO?           (query form)
```

OFF disables auto-leveling; **ON** enables auto-leveling. Auto-level **ONCE** immediately sets an auto-level and then disables auto-leveling.

When auto-level is enabled, the threshold level is specified as a percentage (%) of the peak-to-peak input voltage (see “Setting Relative Threshold Levels”).

The **CONF**igure and **MEAS**ure commands enable auto-leveling and set a 50% threshold level. A reset (***RST**) or front panel preset (**Pres**et) also enables auto-leveling at a 50% threshold level.

Setting Relative Threshold Levels

Relative threshold levels are percentages of the peak-to-peak input signal amplitude. Relative thresholds are set with the command:

```
INPut[1]:LEVel:RELative {<percent>|MINimum|MAXimum|
DEFault}
INPut[1]:LEVel:RELative? [{MINimum|MAXimum| DEFault}]
                           (query form)
```

Threshold values are from 10% to 90% with 5% resolution. A relative value of 10% corresponds to the signal’s negative peak; a relative value of 90% corresponds to the signal’s positive peak. **In order to specify a relative threshold level, auto-level must be enabled.**

LEVEl sets the relative threshold for all measurements.

CONFigure and MEASure set the threshold to 50% and **enable auto-leveling**. A reset (*RST) or front panel preset (Preset) also sets the threshold to 50% and enables auto-leveling.

Relative Threshold Example

```
//set a relative trigger threshold
CONF:FREQ 1E6, 0.1, (@1) // measure 1 MHz signal
    INP:IMP 50           // set impedance 50 ohms
    INP:RANG 5           // set range to 5V
    INP:COUP AC         // set AC coupling
    INP:LEV:REL 30      // threshold level at 30%
```

Measuring Low Frequency Signals

For all counter functions, auto-level **should not** be used for frequencies < 50 Hz. Threshold levels should be set using absolute values (see “Specifying an Absolute Threshold Level”).

The MEASure command should not be used with frequencies less than 50 Hz as the command configures the counter (including enabling auto-level) and makes an immediate measurement.

For frequencies in this range, use the CONFigure command and turn off auto-level by specifying an absolute threshold level. For example:

```
//measure a 10 Hz signal
CONF:FREQ 10, (@1) // measure 10 Hz signal
    INP:IMP 50       // set impedance to 50 ohms
    INP:RANG 5       // set range to 5V
    INP:COUP AC     // set AC coupling
    INP:LEV 1       // 1V threshold, turns off auto-level
INIT                // take reading
```

Input Coupling and Threshold Levels

Figure 4-5 shows a scale of how relative thresholds apply to the input signal.

When the signal includes a DC offset, the absolute value of a relative threshold is a function of the input coupling (AC or DC).

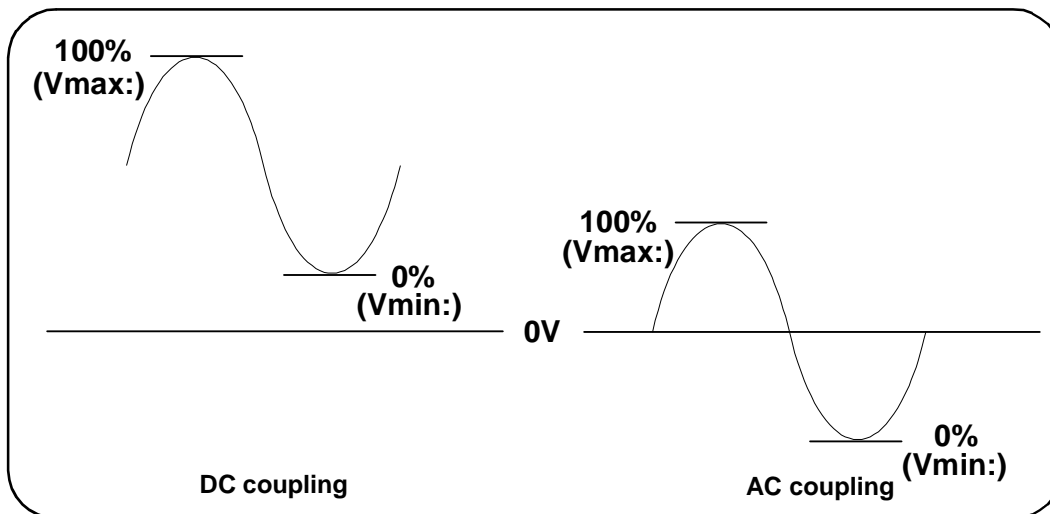

Figure 4-5. Input Coupling and Relative Threshold Levels.

For example, a 3 Vpp input signal with a 2 VDC offset and DC coupling would have a Vmax: value of 3.5V and a Vmin value of 0.5V (Vmax, Vmin, and Vpp are viewable on the front panel). With AC coupling, Vmax and Vmin would be $\pm 1.5V$ respectively.

If a 30% relative threshold is specified for the DC-coupled signal described above, the corresponding (absolute) value is 1.4V. The same relative threshold for an AC-coupled signal has an absolute value of -0.6V.

The **absolute** value of any relative threshold level can be queried using:

```
INPut[1]:LEVel[:ABSolute]?
```

or computed as:

```
Vmin + (% threshold x Vpp)
level w/DC coupling: 0.5 + (0.30 x 3) = 1.4V
```

level w/AC coupling: $-1.5 + (0.30 \times 3) = -0.6V$

System Auto-Level Range

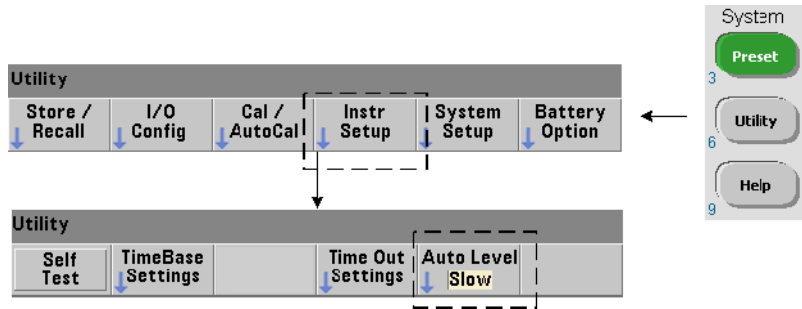

Auto-leveling is available for two input frequency ranges: 50 Hz to < 10 kHz and frequencies ≥ 10 kHz. The auto-level period is shorter for frequencies ≥ 10 kHz when an (auto-level) frequency range is set from the front panel or specified by the command:

SYSTEM:ALEVEL:FREQUENCY {<frequency>|MINimum|MAXimum|DEFAULT}

SYSTEM:ALEVEL:FREQUENCY? [{MINimum|MAXimum|DEFAULT}]
(query form)

The **frequency** parameter values are:

Interface	Frequencies ≥ 10 kHz	Frequencies 50 Hz to < 10 kHz
Front Panel	Fast	Slow
SCPI	10.0E3 Maximum	50.0 MINimum

A frequency setting of 10 kHz decreases the auto-level period for all frequencies ≥ 10 kHz. A frequency setting of 50 Hz provides auto-leveling for frequencies down to 50 Hz. The frequency selected should be based on the **lowest** expected frequency in the measurement.

The auto-level frequency is a **system** setting which applies to all counter channels, and should be noted when making two-channel measurements.

The default setting is 50 Hz. The value is stored in non-volatile memory and does not change when power is cycled or following a reset (*RST) or a front panel preset (Preset). CONFIGure and MEASure enable auto-level and set a relative threshold of 50%, but do not change the auto-level frequency.

System Auto-Level Range Example

```
CONF:FREQ 100E6, (@1) // measure 100 MHz signal
  SYST:ALEV:FREQ 10.0E3 // set auto-level frequency
  INP:IMP 50 // set impedance to 50 ohms
  INP:RANG 5 // set range to 5V
  INP:COUP AC // set AC coupling
  INP:LEV:REL 65 // set 65% relative threshold
```

Noise Rejection (Hysteresis)

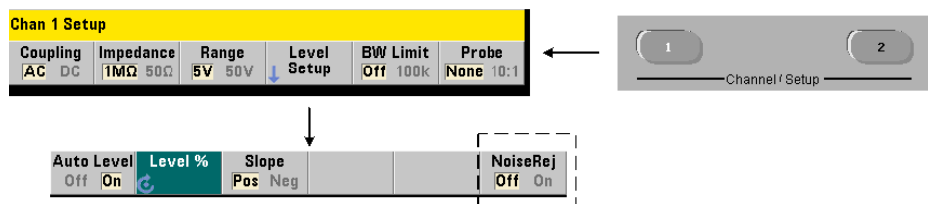

Threshold sensitivity (Figure 4-4) to the input signal is a function of the amount of noise rejection or hysteresis. Noise rejection (the hysteresis band) at the counter input is increased or decreased with the command:

```
INPut[1]:NREJection {OFF|ON}
INPut[1]:NREJection?                (query form)
```

ON enables noise rejection, thus **increasing** hysteresis and **decreasing** sensitivity by 50%. This setting should be used when noise is present in the signal environment. However, if the threshold level is close to a peak amplitude (positive or negative), a count will not occur if the signal does not cross both hysteresis levels due to the increased hysteresis band. OFF disables noise rejection which **decreases** hysteresis and **increases** sensitivity.

CONFigure and MEASure do not change the noise rejection setting. Following a reset (*RST) or instrument preset (Preset), noise rejection is disabled (off).

Noise Rejection from Bandwidth Limiting For input signals up to 100 kHz, reducing the counter’s bandwidth from 350 MHz to 100 kHz (see “Bandwidth Limiting Filter”) also provides noise rejection. Additional noise rejection for frequencies in this range is then obtained through INPut:NREJection ON.

Noise Rejection Example

```
//period measurement of expected 10 MHz signal,
//use channel 1
CONF:PER 0.1E-6, .001, (@1)
  INP:IMP 1.0E6 //set impedance to 1 Mohm
  INP:RANG 50 //set range to 50
  INP:COUP AC //set AC coupling
  INP:LEV 3 //set 3V threshold level (absolute)
  INP:NREJ ON //enable noise rejection
```

Threshold Slope

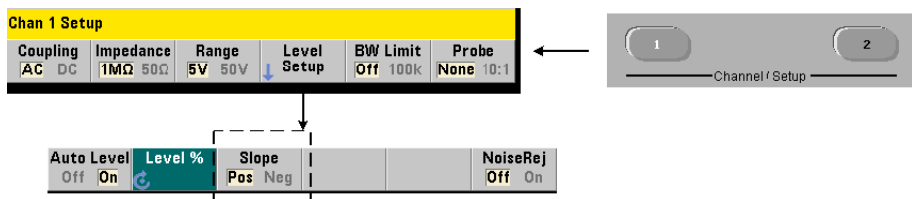

The slope (edge) of the input signal on which the threshold level occurs is specified with the command:

```
INPut[1]:SLOPe {POSitive|NEGative}
INPut[1]:SLOPe? (query form)
```

POSitive - the trigger point occurs on the positive (rising) edge. The reset point occurs on the negative (falling) edge (Figure 4-4).

NEGative - the trigger point occurs on the negative edge, with the reset point occurring on the positive edge.

CONFigure and MEASure do not change the slope setting. Following a reset (*RST) or instrument preset (Preset), the positive (rising) slope is selected.

Input Slope Example

```
//set the threshold slope
CONF:FREQ 1E6, 0.1, (@1) // measure 1 MHz signal
  SYST:ALEV:FREQ 10E3 // set minimum auto-level frequency
  INP:IMP 50 // set impedance to 50 ohms
  INP:RANG 5 // set range to 5V
  INP:COUP AC // set AC coupling
  INP:LEV:REL 70 // 70% threshold level
  INP:SLOP POS // trigger on positive slope
```

Measuring Input Signal Levels and Signal Strength

Minimum, maximum, and peak-to-peak levels of the input signal are indicated on the bottom of the counter's main measurement display area and an example is included in Figure 4-4. These characteristics of the peak-to-peak signal can also be measured with the commands:

```
INPut[1]:LEVel:MINimum? (minimum value of p-p signal)
INPut[1]:LEVel:MAXimum? (maximum value of p-p signal)
INPut[1]:LEVel:PTPeak? (p-p amplitude)
```

The minimum and maximum values include any DC levels (offsets) present with the signals. The counter's input impedance also affects the amplitude at the input.

Channel 2 Signal Strength

The relative signal strength on channel 2 Option 106 or 115 (6 GHz or 15 GHz microwave input) is displayed on the counter and can also be measured with the command:

INPut2:STrength?

The relative strengths returned by the command indicate the following:

Strength	Description
0	Signal strength too low. May not be able to make measurement. Signal power must be ≥ -27 dBm.
1	Signal strength weak, but acceptable.
2,3	Good signal.
4	Signal may have exceeded level at which an accurate measurement can be made ($> +19$ dBm). Signal levels $\geq +27$ dBm may damage the instrument.

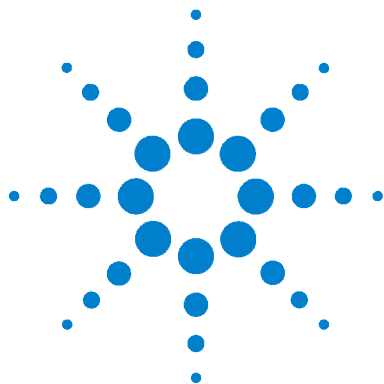

5 Triggering and Gating

Settings Summary	106
Trigger and Gate Time Line	106
Trigger and Gate Cycle	107
System Trigger	109
Wait-For-Trigger and Triggered States	114
Measurement Gate	117
Gate Set Up	117
Frequency Measurements	119
Enabling Gate Signals on the 'Gate In/Out' BNC	128

53210A counter measurements are made by triggering the instrument and gating the input signal to select the portion or duration during which the input signal is measured.

This chapter covers the counter's trigger and gate cycles as they relate to counter measurements.



Settings Summary

Table 5-1 is a summary of power-on/reset settings for the trigger and gating parameters covered in this section.

Table 5-1. Trigger and Gate Settings Summary.

Parameter	Setting
Trigger	
Trigger source	Immediate
Trigger slope	Negative
Trigger delay	0.0s
Trigger count	1
Sample count	1
Frequency	
Frequency gate source	Time
Frequency gate time	0.1s
Frequency gate polarity	Negative

Trigger and Gate Time Line

Triggering and gating are part of every counter measurement. The relationship of these actions relative to the measurement are shown in the time line of Figure 5-1.

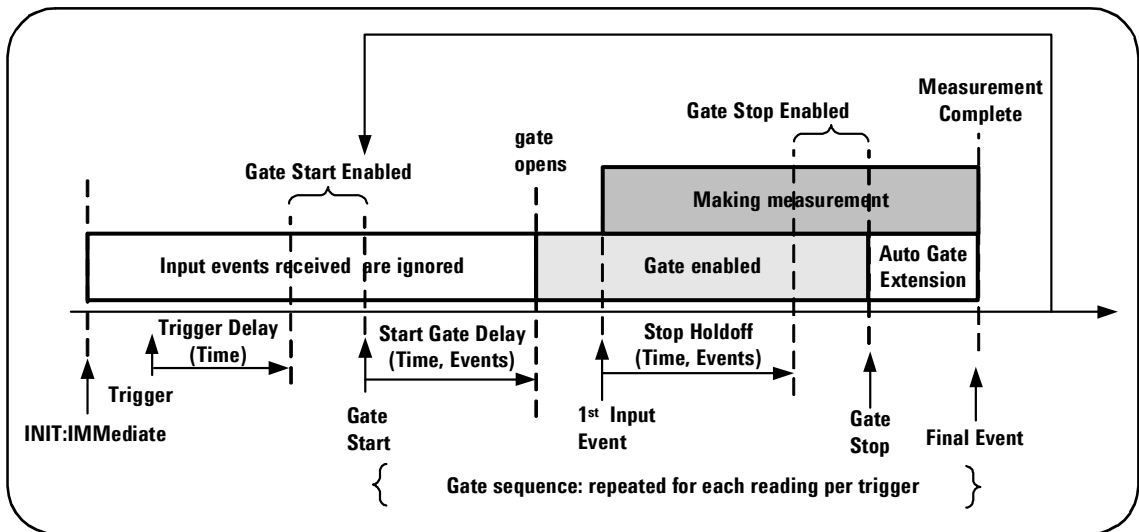

Figure 5-1. Triggering and Gating Time Line.

Trigger and Gate Cycle

The elements of triggering and gating **summarized** in Figure 5-1 are shown in detail in the programming cycle of Figure 5-2. The following sections contain descriptions and examples of each step in the cycle.

NOTE

The SCPI commands and parameters listed throughout this chapter are provided as a guide to how the counter is operated programmatically. The commands are described in detail in the 'Programmer's Reference' section of the Agilent 53210A/53220A/53230A Product Reference CD.

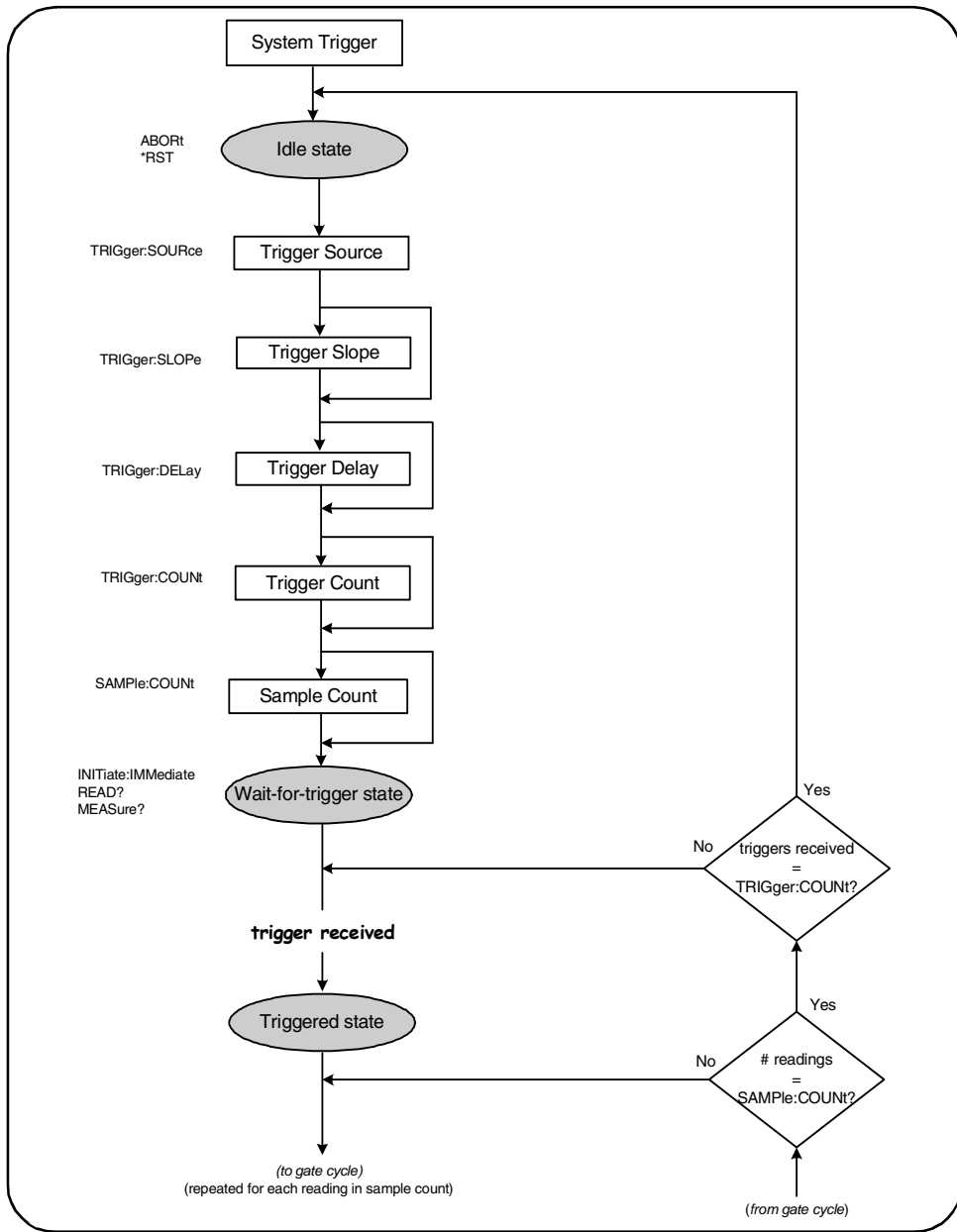

Figure 5-2. Trigger and Gate Cycle - Triggering.

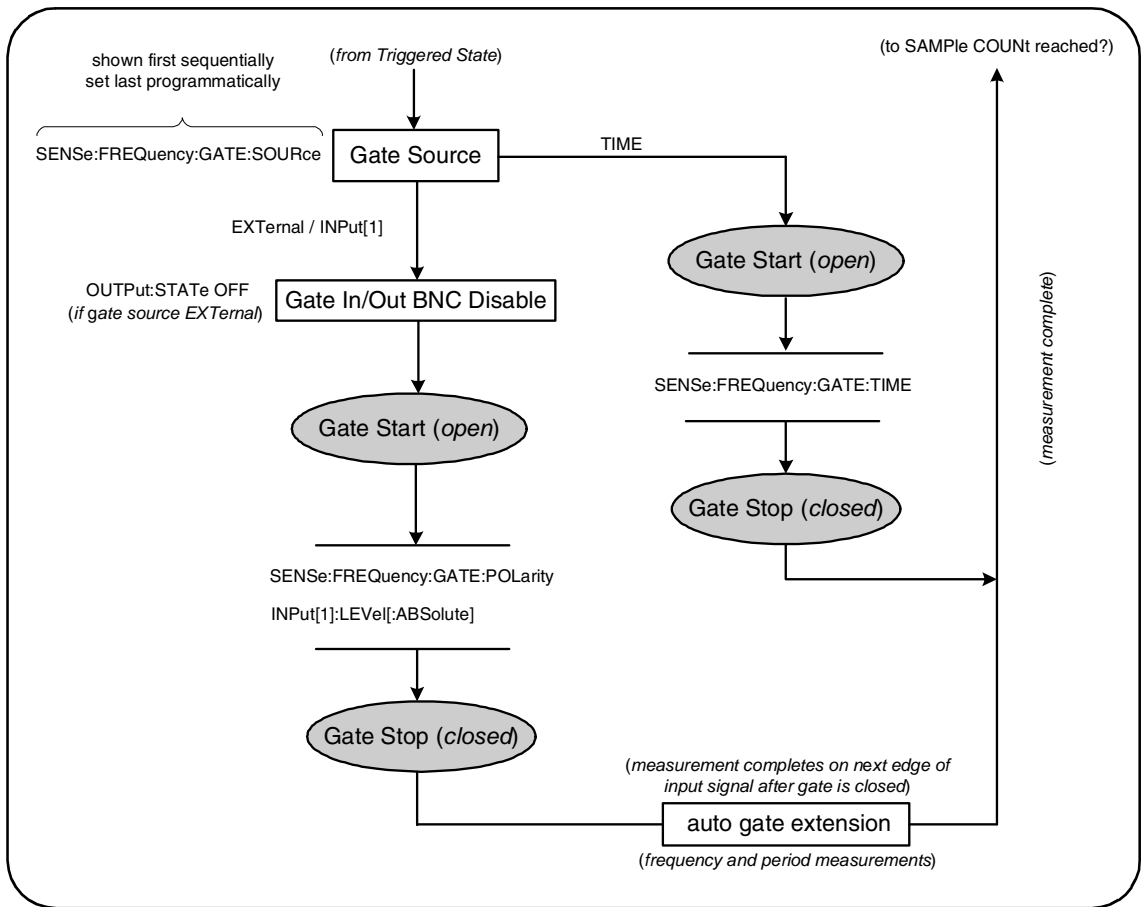

Figure 5-2 (cont'd). Trigger and Gate Cycle - Gating.

System Trigger

The counter operates in one of three states depending on the status of the system trigger: *idle*, *wait for trigger*, and *triggered*.

Idle State

Counter configuration generally occurs while the instrument is in the *idle* state (Figure 5-2). This includes configuration of the **system trigger**.

As shown, the counter is placed in the *idle* state by either of the following the commands:

ABORT - aborts a measurement in progress.

***RST** - resets the counter to its factory default values.

The counter **also** returns to the *idle* state after the total number of measurements determined by the **TRIGger:COUNT** and **SAMPle:COUNT** settings are complete (i.e. # of measurements = **TRIGger:COUNT** x **SAMPle:COUNT**).

System Trigger Source

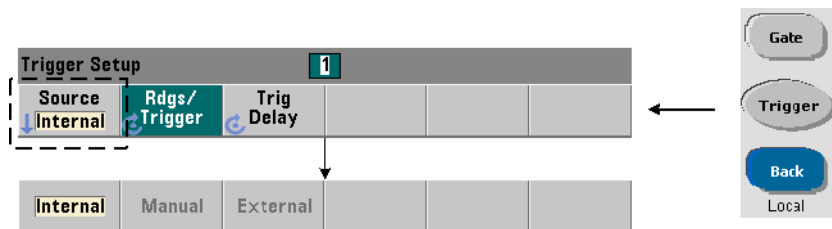

The system trigger is configured using the commands within the **TRIGger** and **SAMPle** subsystems. Figure 5-2 show the sequence in which the commands are commonly used.

The system trigger source which starts the trigger/gate cycle is set with the command:

```
TRIGger:SOURCE {IMMediate|EXternal|BUS}
TRIGger:SOURCE? (query form)
```

- trigger source **IMMEDIATE** sets a continuous trigger signal. By default, **CONFigure** sets the trigger source to **IMMEDIATE**.

- trigger source **EXTERNAL** sets the trigger source to an external trigger applied to the rear panel 'Trig In' BNC connector.

- trigger source **BUS** causes the instrument to be triggered by the *TRG command received over an IO interface.

Trigger Source Example

```
//configure for frequency, set system trigger parameters
CONF:FREQ 5E6,0.1,(@2)
  TRIG:SOUR EXT // trigger source external
```

System Trigger Slope

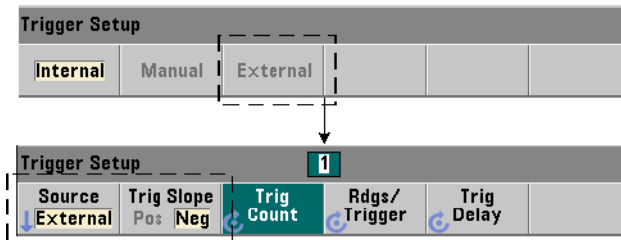

When the system trigger source is set to **EXTERNAL**, the triggering slope (edge) of the signal is set with the command:

```
TRIGger:SLOPe {POSitive|NEGative}
TRIGger:SLOPe? (query form)
```

- trigger slope **POSitive** selects the signal's rising edge, and trigger slope **NEGative** selects the signal's falling edge. The signal is applied to the 'Trig In' BNC. By default, **CONFigure** sets the trigger slope to **NEGative**.

Trigger Slope Example

```
//configure for frequency, set system trigger parameters
CONF:FREQ 5E6,0.1,(@2)
    TRIG:SOUR EXT // trigger source external
    TRIG:SLOP POS // trigger slope - positive
```

System Trigger Delay

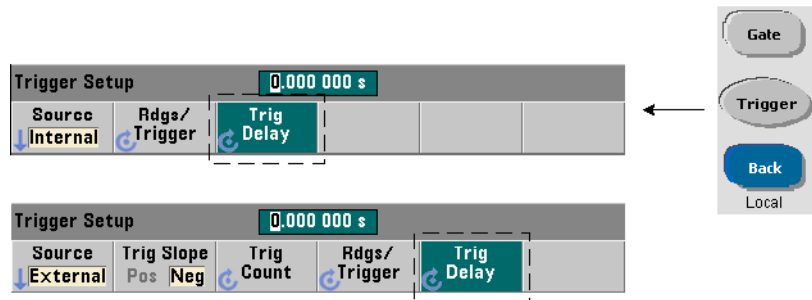

The delay between receipt of the internal or external system trigger signal and the start of the **first** measurement (Figure 5-2) is set with the command:

```
TRIGger:DElay {<time>|MINimum|MAXimum|DEFault}
TRIGger:DElay? [{MINimum|MAXimum|DEFault}] (query form)
```

- specifies the delay in seconds. CONFigure and MEASure set a default delay of 0.0s.

Trigger Delay Example

```
//configure for frequency, set system trigger parameters
CONF:FREQ 5E6,0.1,(@2)
    TRIG:SOUR EXT // trigger source external
    TRIG:SLOP POS // external trigger slope - positive
    TRIG:DEL 1 // 1s delay after trigger received
```

System Trigger Count

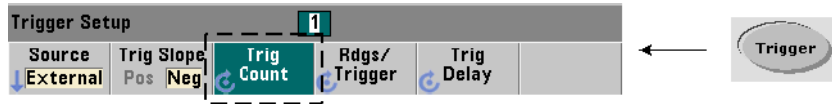

The number of system triggers the counter will receive before returning to the *idle* state from the *wait-for-trigger* state is set with the command:

```
TRIGger:COUNT {<count>|MINimum|MAXimum|DEFAULT}
TRIGger:COUNT? [{MINimum|MAXimum|DEFAULT}] (query form)
```

The trigger **count** range is 1 to 1,000,000. CONFigure and MEASure set a default trigger count of '1'.

Trigger Count Example

```
//configure for frequency, set system trigger parameters
CONF:FREQ 5E6,0.1,(@2)
  TRIG:SOUR EXT // trigger source external
  TRIG:SLOP POS // external trigger slope - positive
  TRIG:DEL 1 // 1s delay after trigger received
  TRIG:COUN 2 // accept 2 system triggers
```

Sample Count

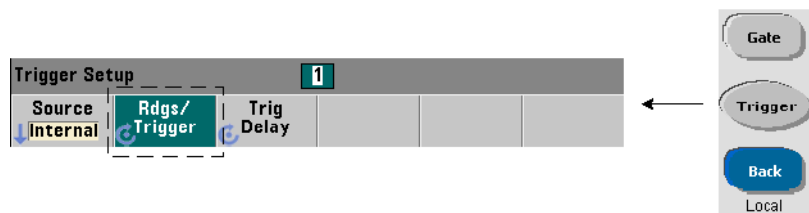

The trigger count multiplied by the sample count (TRIG:COUN x SAMP:COUN) determines the number of readings taken before the counter returns to the *idle* state. The sample count is set with the command:

5 Triggering and Gating

```
SAMPlE:COUNT {<count>| MINimum|MAXimum|DEFault}
SAMPlE:COUNT? [{MINimum|MAXimum|DEFault}]          (query form)
```

The **count** range is 1 to 1,000,000. CONFigure and MEASure set a default sample count of '1'.

Reading memory can store up to 1,000,000 readings. If the product of the trigger count and the sample count is greater than 1,000,000 readings, data must be read from reading memory fast enough to prevent memory overflow. If memory does overflow, new readings will overwrite the first (oldest) readings stored. The most recent readings are always preserved. See Chapter 8 - "Instrument Status" for information on monitoring reading memory count.

Sample Count Example

```
//configure for frequency, set system trigger and sample
//count parameters; take 2 sets of 100 readings
CONF:FREQ 5E6,0.1,(@2)
  TRIG:SOUR EXT // trigger source external
  TRIG:SLOP POS // external trigger slope - positive
  TRIG:DEL 1 // 1s delay after trigger received
  TRIG:COUN 2 // accept 2 system triggers
  SAMP:COUN 100 // take 100 rdgs for each trigger
```

Wait-For-Trigger and Triggered States

In order for the counter to **accept** triggers which start the trigger and gate cycle, the counter must be **initiated**. Initiating the counter places the instrument in the *wait-for-trigger* state (Figure 5-3).

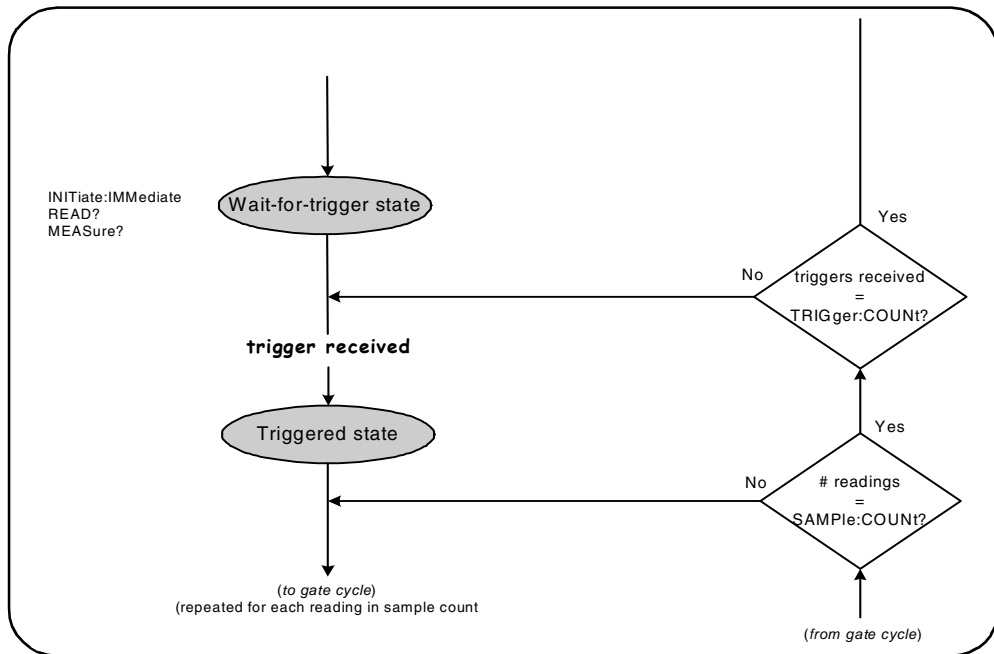

Figure 5-3. The Counter 'Wait-for-trigger' State.

The counter can be initiated using the following commands:

INITiate[:IMMediate]

- places the counter in the wait-for-trigger state. In this state, trigger signals are recognized and accepted. Readings taken after the counter is initiated by **INITiate[:IMMediate]** are displayed and stored in the counter's reading memory (see Chapter 7 "Formats and Data Flow" for more information).

Initiating Example

```
//configure for frequency, set system trigger parameters
CONF:FREQ 5E6,0.1,(@2)
  TRIG:SOUR EXT // trigger source external
  TRIG:SLOP POS // external trigger slope - positive
  TRIG:DEL 1 // 1s delay after trigger received
  TRIG:COUN 2 // accept 2 system triggers
  SAMP:COUN 100 // take 100 readings per system trigger
INIT // initiate the counter - wait for trigger state
FETc? // retrieve measurements from reading memory
```

READ?

- equivalent to executing `INITiate:IMMediate` directly followed by `FETCh?`. With `READ?`, readings are displayed, stored in reading memory, and instantaneously read into the output buffer (see Chapter 7 “Formats and Data Flow” for more information).

READ? Example

```
//configure for frequency, set system trigger parameters
CONF:FREQ 5E6,0.1,(@2)
  TRIG:SOUR EXT // trigger source external
  TRIG:SLOP POS // external trigger slope - positive
  TRIG:DEL 1 // 1s delay after trigger received
  TRIG:COUN 2 // accept 2 system triggers
  SAMP:COUN 100 // take 100 readings per system trigger
READ? //initiate the counter - fetch readings from memory
```

Once initiated, a valid trigger signal and a satisfied delay period (if specified) moves the counter to the *triggered* state and the beginning of the gate cycle. The counter remains in the *triggered* state until the sample count (readings per trigger) is reached. The counter then returns to the *wait-for-trigger* state until the next system trigger is received. The counter returns to the *idle* state once the product of the trigger count x sample count is reached.

Measurement Gate

Control of the measurement gate allows you to select the duration of the measurement. The gating sequence of the trigger/gate cycle begins after a system trigger signal is received, and is repeated for **each** measurement specified in the sample count.

NOTE

The gate sequence occurs while the counter is in the *triggered* state (Figure 5-2). Although shown in the figure after the counter is initiated, gate **configuration** like system trigger **configuration**, occurs while counter is in the *idle* state.

NOTE

Counter measurements are based on configurations comprised of multiple parameters. The **easiest** and most common starting point for setting these parameters **programmatically** is using commands within the CONFigure and MEASure subsystems (Chapter 3). These subsystem commands are considered “high-level”, as multiple counter parameters are set or defaulted from a single command. “Low-level” commands such as the gating commands described here allow you to change selected gating parameters without altering other areas of the counter configuration.

Gate Set Up

The counter’s **gate source** determines the path through the gate cycle and the related parameters that must be considered. A gate source is required for all frequency measurements.

Although selection of the gate source is shown at the beginning of the cycle (Figures 5-2 and 5-4), programmatically it should occur after all other gate parameters have been set. This prevents potential “settings conflict” errors between the SENSE subsystem commands, and is illustrated in the examples and program segments that use these commands.

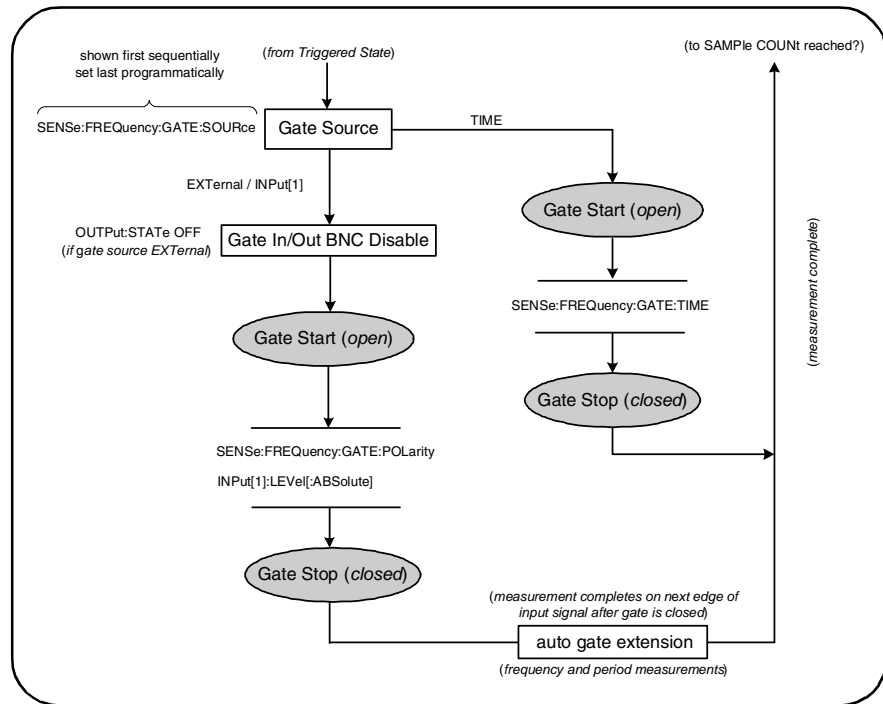
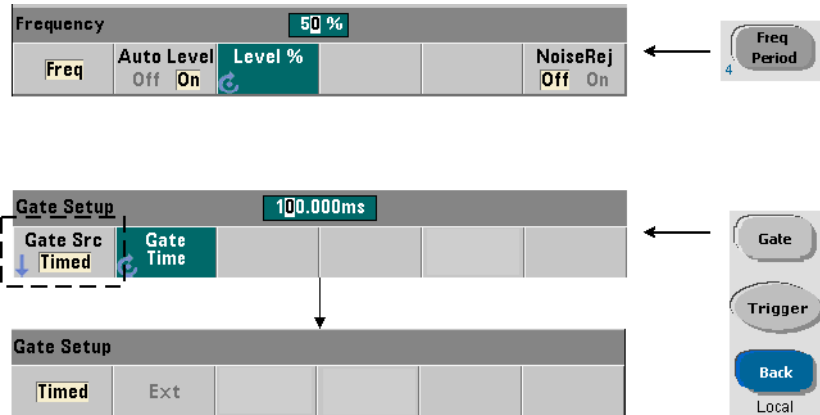

Figure 5-4. Gate Source Sequence.

Typical counter measurements and most applications use an internal signal as the gate source to control the gate for a specified (or default) period of time. For applications requiring synchronization with external events or requiring more precise gate control, an external gate or advanced gating is used. External gate signals are applied to the counter's rear panel 'Gate In/Out' BNC or to the channel 1 or channel 2 input.

Frequency Measurements



For frequency and period measurements the command used to set/change the gate source is:

```
[SENSe:]FREquency:GATE:SOURce {TIME|EXtErnal|INPUt[1]}
```

```
[SENSe:]FREquency:GATE:SOURce? (query form)
```

- gate source **TIME** is used to achieve a desired resolution in **number of digits**. It uses an internal gate signal and is the *default* gate source. It enables the gate to remain open for a specified period while the input signal is measured. The longer the gate time, the greater the resolution.

Resolution and Gate Time

Reading resolution (in digits) is a function of the gate time.

Table 5-2 shows the digits of resolution achieved with the 53210A for a given gate time. The table also includes formulas for estimating digits as a function of gate time or expected values, and gate times as a function of digits.

Table 5-2. Resolution and Gate Time.

Gate Time (53210A) ($T_{SS} = 100 \text{ ps}$)	Resolution (Digits) Reciprocal	Calculating Digits and Gate Time
1 msec	7	Digits as a function of gate time: $\text{Digits} = \text{Log}_{10}(\text{gate time}/T_{SS})$
10 msec	8	
100 msec	9	
1 sec	10	Digits as a function of expected value (CONFigure, MEASure) $\text{Digits} = \text{Log}_{10}(\text{expected value}) - \text{Log}_{10}(\text{resolution})$
10 sec	11	
100 sec	12	
1000 sec	13	Gate time as a function of digits: $\text{gate time} = (10^{\text{digits}}) * T_{SS}$

Setting the Gate Time

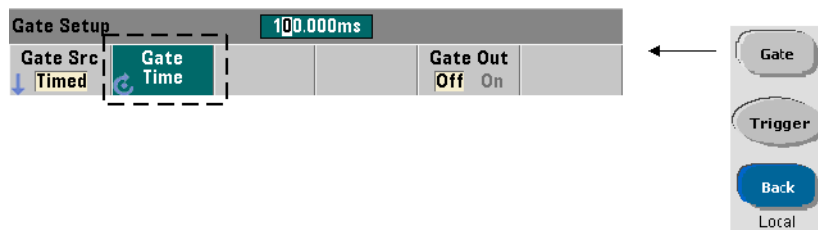

A measurement gate time can be specified directly with the command:

```
[SENSe:]FREQuency:GATE:TIME {<time>|MINimum|MAXimum|
DEfAult}
```

```
[SENSe:]FREQuency:GATE:TIME? {MINimum|MAXimum|DEfAult}
(query form)
```

CONFigure and MEASure automatically set the gate source to TIME, and the gate time according to their optional *expected value* and *resolution* parameters. Specifying these parameters or using default values with these commands **simplifies** counter programming. However, setting/changing the gate time separate from the CONFigure/MEASure command allows you to change **only** the gate time while preserving other configuration settings.

Querying the Gate Time The gate time set by the *expected value* and *resolution* parameters can be determined after execution of the CONFIGure or MEASure command.

For example, assume a measurement requiring 9-digit (10 mHz) resolution of a 5 MHz signal is required. Because digits of resolution is **approximately** equal to $\text{Log}_{10}(\textit{expected value}) - \text{Log}_{10}(\textit{resolution})$, this measurement could be configured as:

```
MEAS:FREQ? 5e6, 5E-3, (@1) // expected freq, resolution
```

A typical measurement using this configuration might return:

```
+4.99999949990003E+006
```

With the counter display registering:

```
4.999 999 50MHz (9 digits)
```

Querying the gate time after sending this command returns:

```
SENS:FREQ:GATE:TIME?
+1.00000000000000E-001 (100 ms)
```

From Table 5-2 this corresponds to 9 digits of resolution. To achieve a desired resolution (digits) in terms of *gate time*, locate the number of digits in Table 5-2 and select the corresponding gate time:

```
SENS:FREQ:GATE:TIME 100e-3 // set gate time = 100 ms
SENS:FREQ:GATE:SOUR TIME // set gate source
```

As another example, assume a measurement requiring 7-digit resolution of a 5 ns (200 MHz) signal. Recalling that $\text{Log}_{10}(\textit{expected value}) - \text{Log}_{10}(\textit{resolution})$ is approximately equal to digits of resolution, the measurement can be configured as:

```
MEAS:PER? 5E-9, 5E-16, (@1) // per meas of 200 MHz signal
```

5 Triggering and Gating

A typical measurement using this configuration might return:

```
+5.00010899135045E-009
```

With the counter display registering:

```
5.000 109nsec (7 digits)
```

Querying the gate time after sending this command returns:

```
SENS:FREQ:GATE:TIME?  
+1.00000000000000E-003 (1 ms)
```

Again using Table 5-2, if a resolution of 7-digits is required the corresponding gate time can be located and sent directly as:

```
SENS:FREQ:GATE:TIME 1e-3 // set gate time = 1 ms
```

External Gate Sources

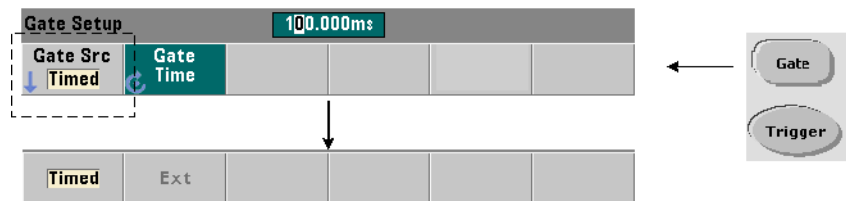

Gate sources **EXTernal** and **INPut [1]** are external sources. **EXTernal** is the counter's rear panel 'Gate In/Out' BNC, and **INPut [1]** is the counter's channel 1 input (front or rear panel - Opt. 201). Note that the **INPut [1]** source is only available when channel 2 is installed (Option 106 or 115) and is the measurement channel.

NOTE

OUTput : STATE **OFF** must be set when using gate source **EXTernal**. See “Enabling Gate Signals on the ‘Gate In/Out BNC” for more information and for information on using gate signals to synchronize other instruments.

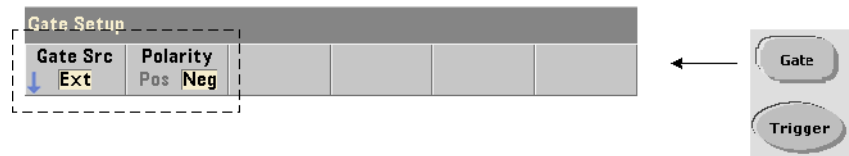
External Gate Signal Polarity

When using any external gate source the polarity of the gate signal and therefore, the duration of the gate, is set or changed with the command:

```
[SENSE:]FREQUENCY:GATE:POLARITY {POSITIVE|NEGATIVE}
[SENSE:]FREQUENCY:GATE:POLARITY?                (query form)
```

POSITIVE starts the measurement on a positive edge on the Gate In/Out BNC or channel 1 input, and stops the measurement on the next negative edge. NEGATIVE starts the measurement on a negative edge on the Gate In/Out BNC or channel 1 input, and stops the measurement on the **next** positive edge.

CONFigure and MEASure do not change the polarity setting. Following a reset (*RST) or counter preset (SYSTEM:PRESet), the negative edge is selected.

To set the polarity of the external gate signal:

```
// select the gate polarity and source
CONF:PER
SENS:FREQ:GATE:POL POS // set polarity
SENS:FREQ:GATE:SOUR EXT // set source
```

External Gate Signal Threshold

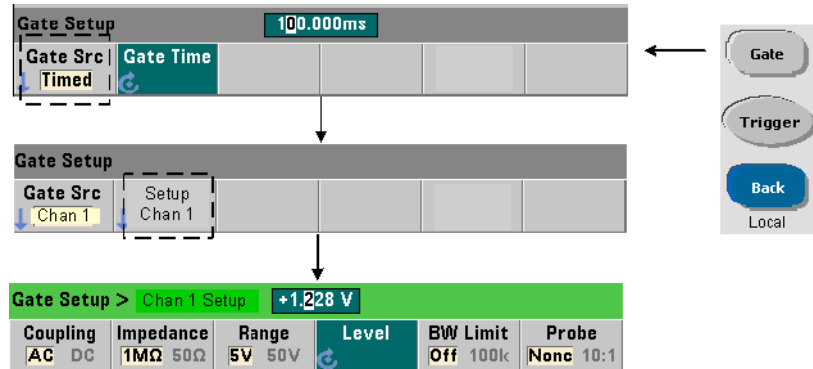

For external source INPut [1], a **fixed** input threshold voltage must be specified in addition to the gate signal polarity. This is done using the command:

```
INPut[1]:LEVel[:ABSolute]{<volts>|MINimum|MAXimum|
DEFault}
```

```
INPut[1]:LEVel[:ABSolute]?[ {MINimum|MAXimum|DEFault} ]
                                     (query form)
```

The specified edge (polarity) of the gate signal crossing the threshold opens the gate. The opposite edge (polarity) of the signal crossing the threshold closes the gate. (More information on the INPut subsystem can be found in Chapter 4 - “53210A Signal Conditioning”.)

When using external source INPut [1] as the gate source, channel 2 (Option 106 or 115) must be the measurement channel.

To set the polarity and level for an external gate source:

```
// select the gate polarity, source, and threshold level
CONF:FREQ
SENS:FREQ:GATE:POL POS // set polarity
SENS:FREQ:GATE:SOUR INP // set source - channel 1
INP:LEV 4 // set threshold - 4V
```

When using external source `INPut [1]`, the channel selected as the gate source cannot be the same channel on which the **measured** signal is applied. That is, the gate source channel cannot be involved in the measurement.

Enabling Gate Signals on the ‘Gate In/Out’ BNC

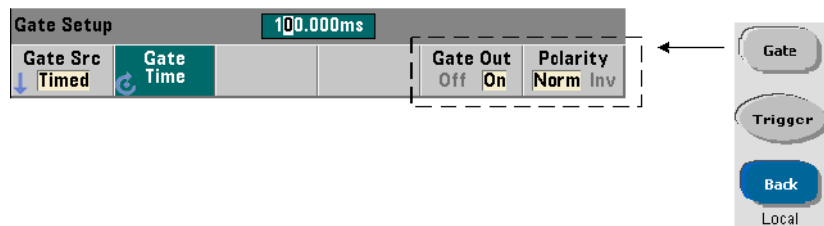

For timing and synchronization with other instruments, gate signals from source `TIME` (internal) and `INPut [1]` can be routed to the rear panel ‘Gate In/ Out’ connector and assigned a polarity using the commands:

```
OUTPut[:STATe] {OFF|ON}
OUTPut[:STATe]?
```

(query form)

```
OUTPut:POLarity {NORMAL|INVERTed}
OUTPut:POLarity?
```

(query form)

- **ON** enables “Gate Out” - gate signals from sources `TIME` and `INPut [1]` are routed to the rear panel BNC.

- **OFF** disables “Gate Out” - the BNC is an external (“Gate In”) source. Therefore, `OUTPut:STATe OFF` must be set when the gate source is `EXTERNAL`.

NORMAL selects a rising (positive going) signal; **INVERTed** selects a falling (negative going) signal.

5 Triggering and Gating

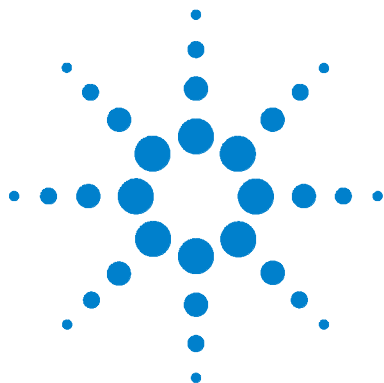

6 53210A Math, Graphing, and Data Logging

Math Functions	128
Enabling the CALCulate1 Subsystem	129
Smoothing Data	130
Scaling Functions	131
Statistics	139
Limit Checking	143
Histograms	147
Trend Charts	160
Data Logging	166
Graphics Functions and Reading Memory	172

The Agilent 53210A counter features math operations that allow you to scale readings, test limits, and statistically analyze data. Its graphics functions compute and display histograms and trend charts of **real time** measurement data.

This chapter provides information on how these features are used through the SCPI CALCulate subsystem and with the front panel Math, Graph, and Data Log keys.



Math Functions

The 53210A counter math functions include smoothing, null/scale, statistics, and limit checking. Figure 6-1 is a description of how the functions are enabled.

The math functions are enabled at two levels: 1) the `CALCulate[1]` subsystem as a whole is enabled, and 2) the individual math operation is enabled. Math operations begin once the measurements are started either by `INITiate:IMMEDIATE` or `READ?`, or as soon as the operation is selected from the front panel (with internal triggering). Readings are processed real time and displayed, stored in reading memory, and sent to the output buffer (they are not post-processed from reading memory).

The number of readings processed for a given trigger cycle (Chapter 5: “Triggering and Gating”) is determined by the trigger count (`TRIGger:COUNT`) and the number of readings per trigger (`SAMPlE:COUNT`). **The default trigger count and sample count set by each command is ‘1’.** Each time the counter is initiated reading memory is cleared and a new set of math-processed data is generated. From the front panel, readings are processed continually if the trigger source remains at its default `INTernal` setting.

The math and graphics functions covered in this chapter are enabled individually (Figure 6-1). However, multiple operations may be enabled at the same time and performed on the same set of readings.

NOTE

The SCPI commands and parameters listed throughout this chapter are provided as a guide to how the counter is operated programmatically. The commands are described in detail in the ‘Programmer’s Reference’ section of the Agilent 53210A/53220A/ 53230A Product Reference CD.

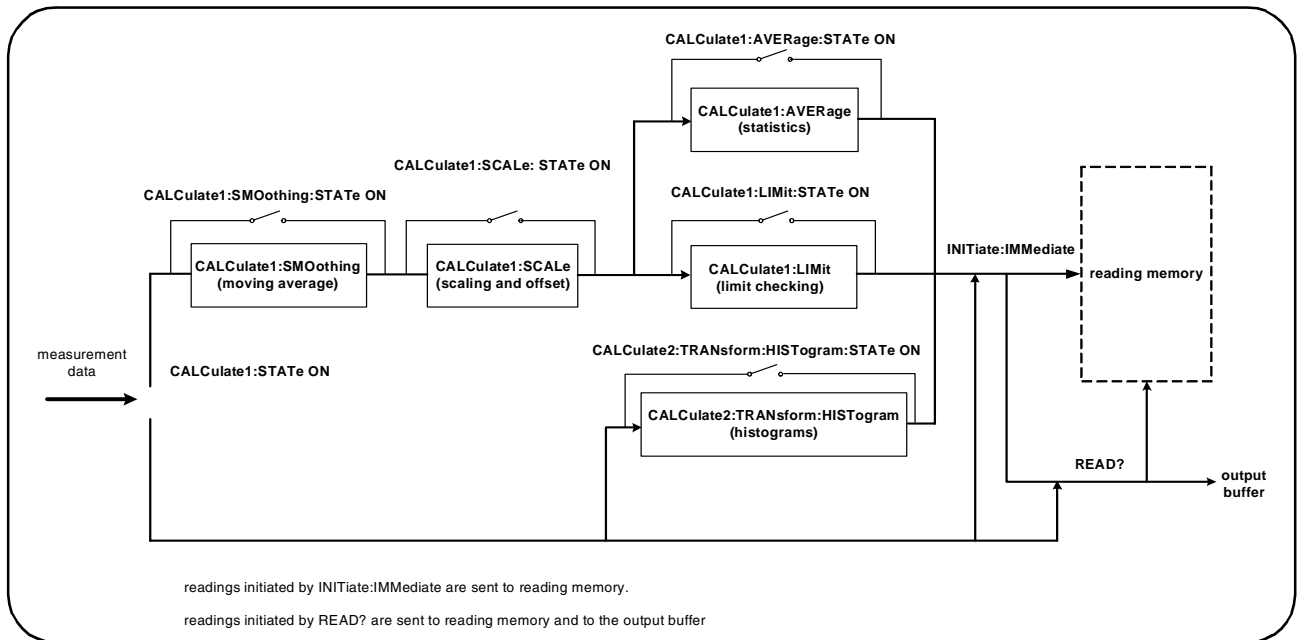

Figure 6-1. Enabling the Math Operations.

Enabling the CALCulate1 Subsystem

Individual math operations require the CALCulate1 subsystem **and** the specific math operation to be enabled before the operation is performed. The command used to enable the CALCulate1 subsystem is:

```
CALCulate[1][:STATe] {OFF|ON}
CALCulate[1][:STATe]? (query form)
```

ON enables the subsystem, **OFF** disables the subsystem. With the **subsystem disabled**, measurement data is sent directly to the output buffer and/or reading memory with no math operations performed, **regardless of any math operations enabled**.

A reset (*RST), instrument preset (SYSTEM:PRESet), or changing the measurement function disables the CALCulate1 subsystem.

Smoothing Data

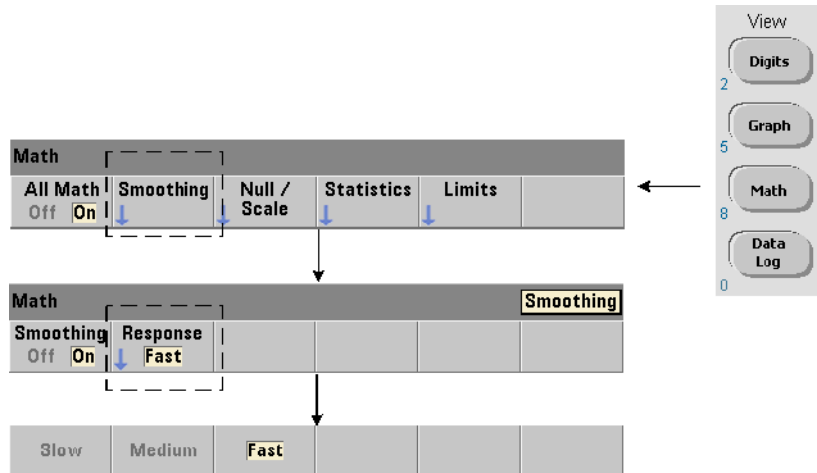

Measurements can be “smoothed” and scaled prior to performing math operations on the incoming data.

To **reduce random noise**, a moving average (boxcar) filter can be inserted into the data path (Figure 6-1). To enable the filter and specify the number of readings (subset) to average, the following commands are used:

```
CALCulate[1]:SMOothing[:STATe] {OFF|ON}
CALCulate[1]:SMOothing[:STATe]?           (query form)
```

```
CALCulate[1]:SMOothing:RESPonse {SLOW|MEDIUM|FAST}
CALCulate[1]:SMOothing:RESPonse?       (query form)
```

ON enables the moving average filter - placing it in the data path. **OFF** disables the filter. A reset (*RST) or instrument preset (SYSTEM:PRESet) disables the filter.

The number of readings to average is specified as:

SLOW - 100 readings: with ± 100 ppm change required to reset filter

MEDium - 50 readings: with ± 300 ppm change required to reset filter

FAST - 10 readings: with ± 1000 ppm change required to reset filter

The filter is reset if the measurement function or channel is changed, if another set of readings is initiated, or if a measurement is outside the range corresponding to the number of readings specified (SLOW, MEDium, FAST).

After the filter is reset, the reading is the average of all readings up to the specified response (10, 50, 100). At that point, the reading is the moving average of the last 10, 50, or 100 measurements. Equal weighting is applied to all measurements in the average.

A reset (*RST) or instrument preset (SYSTEM:PRESet) sets the response to FAST.

Smoothing Example

```
//frequency measurement of expected 1 kHz signal - ch 1
//reduce noise on 5,000 readings
CONF:FREQ 1E3, (@1)
    SAMP:COUN 5000      // take 5000 reading
    CALC:STAT ON       // enable CALCulate1 subsystem
    CALC:SMO:STAT ON   // enable moving average filter
    CALC:SMO:RESP SLOW // average 100 readings
INIT
```

Scaling Functions

When scaling is **enabled** statistical analysis, limit checking, histograms, and trend charts use **scaled** data. Figure 6-2 shows the display with scaling functions enabled.

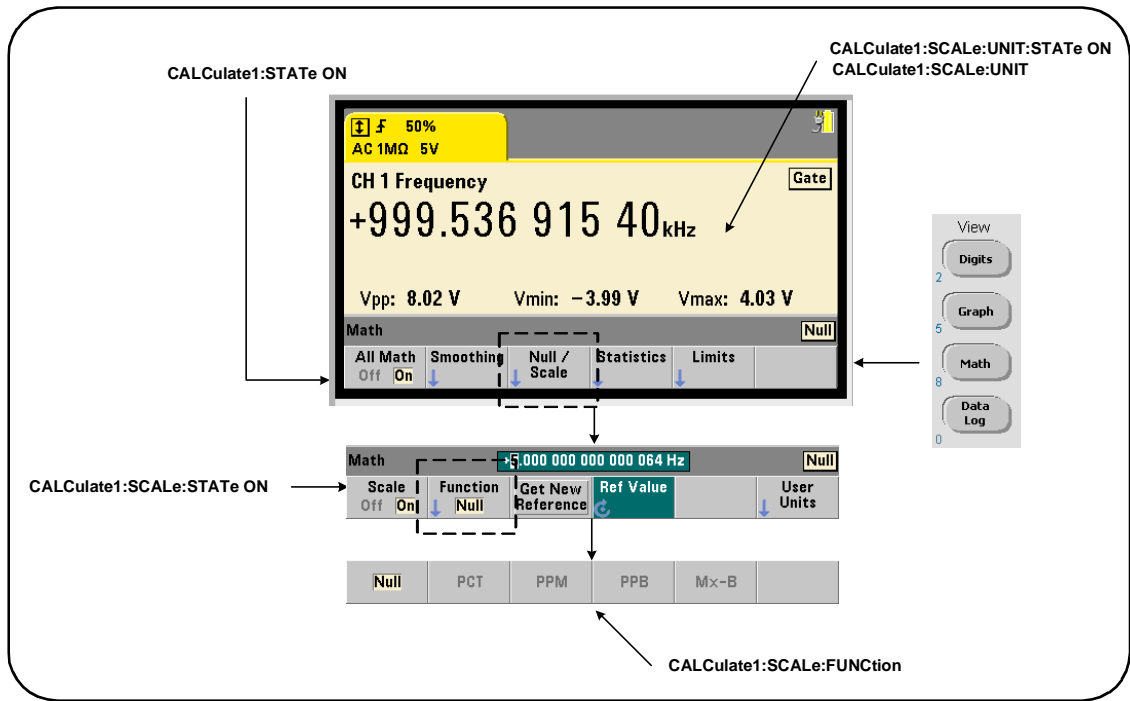

Figure 6-2. 53210A Display with Scaling Functions Enabled.

Enabling the Scale Functions

All 53210A scaling functions are enabled with the command:

```
CALCulate[1]:SCALE[:STATE] {OFF|ON}
CALCulate[1]:SCALE[:STATE]?
```

(query form)

ON enables scaling. **OFF** disables scaling.

Following a reset (*RST) or instrument preset (SYSTEM:PRESet), scaling is disabled.

Using the Scale Functions

The counter scaling functions include null, percent change (PCT), part per million change (PPM), part per billion change (PPB), and scale (Mx-B). The function is selected with the command:

```
CALCulate[1]:SCALE:FUNCTION {NULL|PCT|PPM|PPB|SCALE}
CALCulate[1]:SCALE:FUNCTION? (query form)
```

NULL - performs a null operation. The result is the measurement minus the reference value. (See “Scale Reference Value” for information on setting the reference).

PCT - performs a percent change operation. The result is the difference between the measurement and the reference value, expressed in percentage.

PPM - performs a parts per million change operation. The result is the difference between the measurement and the reference value, expressed in parts per million.

PPB - performs a parts per billion change operation. The result is the difference between the measurement and the reference value, expressed in parts per billion.

SCALE - performs an Mx-B operation. The result is the measurement (x) multiplied by the gain value M (CALCulate1:SCALE:GAIN command) minus the offset value B (CALCulate1:SCALE:OFFSet). If CALCulate1:SCALE:INVert is enabled (On), the measurement will first be inverted (1/x), resulting in a M/x-B operation.

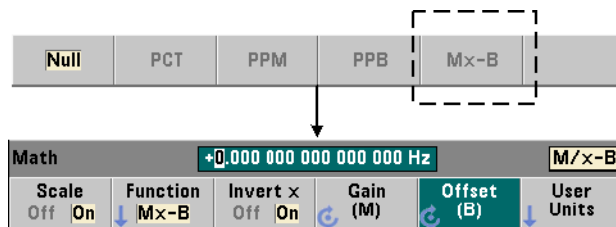

Scaling function results must be in the range of $-1.0\text{E}+24$ to $-1.0\text{E}-24$, 0.0 , or $+1.0\text{E}-24$ to $1.0\text{E}+24$. Results outside these limits will be replaced with $-9.9\text{E}+37$ (negative infinity), 0 , or $+9.9\text{E}+37$ (positive infinity).

Following a reset (*RST) or instrument preset (SYSTEM:PRESet), the scaling function is set to NULL.

Scale Reference Value



The NULL, PCT, PPM, and PPB scaling functions require a reference value. For PCT, PPM, and PPB the value cannot be '0'. The reference can be obtained automatically or specified directly with the commands:

```
CALCulate[1]:SCALE:REFERENCE:AUTO {OFF|ON}
CALCulate[1]:SCALE:REFERENCE:AUTO?           (query form)
```

```
CALCulate[1]:SCALE:REFERENCE {<reference>|MINimum|MAXimum|
DEFault}
```

```
CALCulate[1]:SCALE:REFERENCE? [{MINimum|MAXimum|DEFault}]
                                   (query form)
```

ON - automatically selects the first measurement as the reference for all subsequent readings in the reading count (trigger count x sample count). **OFF** disables automatic selection and requires the reference to be specified directly.

Following a reset (*RST) or instrument preset (SYSTEM:PRESet), automatic reference selection is enabled (ON).

<reference> - specifies the reference value directly. The reference is used for all readings in the reading count.

Following a reset (*RST) or instrument preset (SYSTEM:PRESet), a reference value of 0.0 is set and automatic reference is enabled.

From the front panel, pressing Get New Reference takes a reference measurement on the first trigger received after the key is pressed. A reference can be entered manually by selecting Ref Value and using the knob or SHIFTed numeric keys.

Reference Example

```
//determine the percentage difference of 100 frequency
//measurements to a reference value of 50000.000
CONF:FREQ 50E3, (@1)
    SAMP:COUN 100           // take 100 readings
    CALC:STAT ON           // enable CALCulate1 subsystem
    CALC:SCAL:STAT ON      // enable scaling
    CALC:SCAL:FUNC PCT     // select scale function (PCT)
    CALC:SCAL:REF 50.000E3 // set reference value
INIT
```

Scale Gain and Offset

The function CALCulate[1]:SCALE:FUNCTION SCALE performs an **Mx-B** operation on each reading where **M** is the gain value, **x** is the reading, and **B** is the offset. The gain value used in the equation is set with the command:

```
CALCulate[1]:SCALE:GAIN {<gain>|MINimum|MAXimum|DEFAULT}
CALCulate[1]:SCALE:GAIN? [{MINimum|MAXimum|DEFAULT}]
                                                                    (query form)
```

gain values can range from:

-1.0E+15 to -1.0E-15, 0.0, +1.0E-15 to +1.0E+15

The default gain is 1.0 and is the value set following a reset (*RST) or instrument preset (SYSTEM:PRESet).

The offset value (**B**) is set with the command:

```
CALCulate[1]:SCALE:OFFSET {<offset>|MINimum|MAXimum|
Default}
```

```
CALCulate[1]:SCALE:OFFSET? [{MINimum|MAXimum|Default}]
(query form)
```

offset values can range from

-1.0E+15 to -1.0E-15, 0.0, +1.0E-15 to +1.0E+15

The default offset is 0.0 and is the value set following a reset (*RST) or instrument preset (SYSTEM:PRESet).

Inverting the Reading (1/x) Each reading as it is taken can be inverted **prior** to its use in the Mx-B equation which thus becomes **M/x-B**. Inversion is enabled with the command:

```
CALCulate[1]:SCALE:INVert {OFF|ON}
CALCulate[1]:SCALE:INVert?
(query form)
```

ON - inverts the reading. **OFF** disables reading inversion.

Following a reset (*RST) or instrument preset (SYSTEM:PRESet) reading inversion is disabled.

NOTE

When Invert x is enabled (On) the front panel reading units (Hz, sec) are turned off. See "Assigning Reading Units" if displayed units are required.

Assigning Reading Units

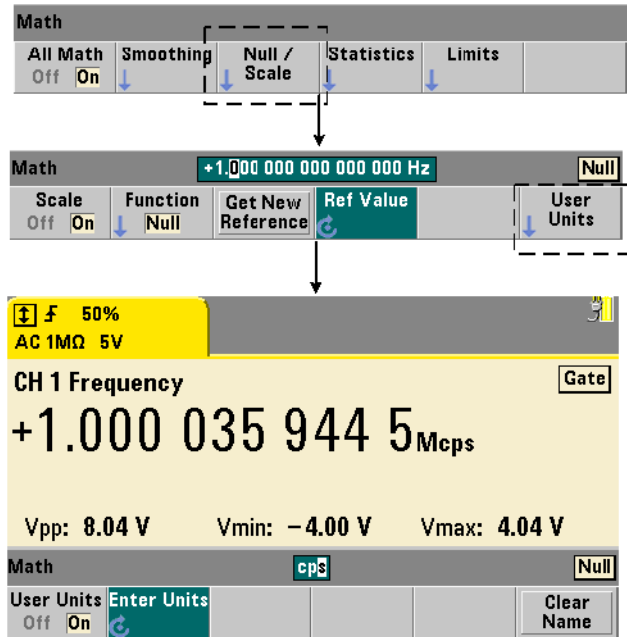

For ease in identifying readings from the front panel, a user-defined “units string” can be assigned to any scale function. The user string replaces the instrument-assigned measurement units (Hz, pct, ppm, ...). The unit prefix (μ , m, k, M) remains.

The units string is displayed on the counter and defined using the commands:

```
CALCulate[1]:SCALE:UNIT:STATE {OFF|ON}
CALCulate[1]:SCALE:UNIT:STATE? (query form)
```

```
CALCulate[1]:SCALE:UNIT "<units>"
CALCulate[1]:SCALE:UNIT? (query form)
```

ON - displays user-defined units on the front panel. **OFF** - turns off the user-defined units.

units are one to four characters. Double quotes enclosing the string are included in the command. The assigned units appear in the **counter display only**.

Following a reset (*RST) or instrument preset (SYSTEM:PRESet) user-defined units are disabled.

From the front panel, units are entered by pressing the User Units softkey, enabling the units (On), and using the rotary knob and arrows to enter and select the character position.

Scaling Example

The following example is a typical sequence of scaling commands from the SCPI CALCulate[1] subsystem.

```
//Scale 500 readings (M/x-B) and assign reading units
CONF:FREQ (@1)           // frequency measurement
  SAMP:COUN 500           // 500 readings/trigger
  SENS:FREQ:GATE:TIME .010 // set minimum gate time
  CALC:STAT ON           // enable CALCulate1 subsystem
  CALC:SCAL:STAT ON      // enable scaling operation
  CALC:SCAL:FUNC SCAL     // set scaling function = Mx-B
  CALC:SCAL:INV ON       // invert readings (M/x-B)
  CALC:SCAL:GAIN 100     // set gain (M)
  CALC:SCAL:OFFS 0       // set offset (B)
  CALC:SCAL:UNIT:STAT ON // enable user-defined units
  CALC:SCAL:UNIT "sec"   // assign units to readings
INIT                     // initiate readings
```

For an input frequency of 1 MHz, the counter should display readings of approximately +100.00... usec.

Statistics

Statistical calculations are performed continually on readings as they are taken, or until the total reading count (TRIGger:COUNT x SAMPLe:COUNT) is reached. The commands used to generate statistical data are covered in this section.

As mentioned, multiple operations can be enabled at the same time. Figure 6-3 is an example with statistics and limit checking enabled.

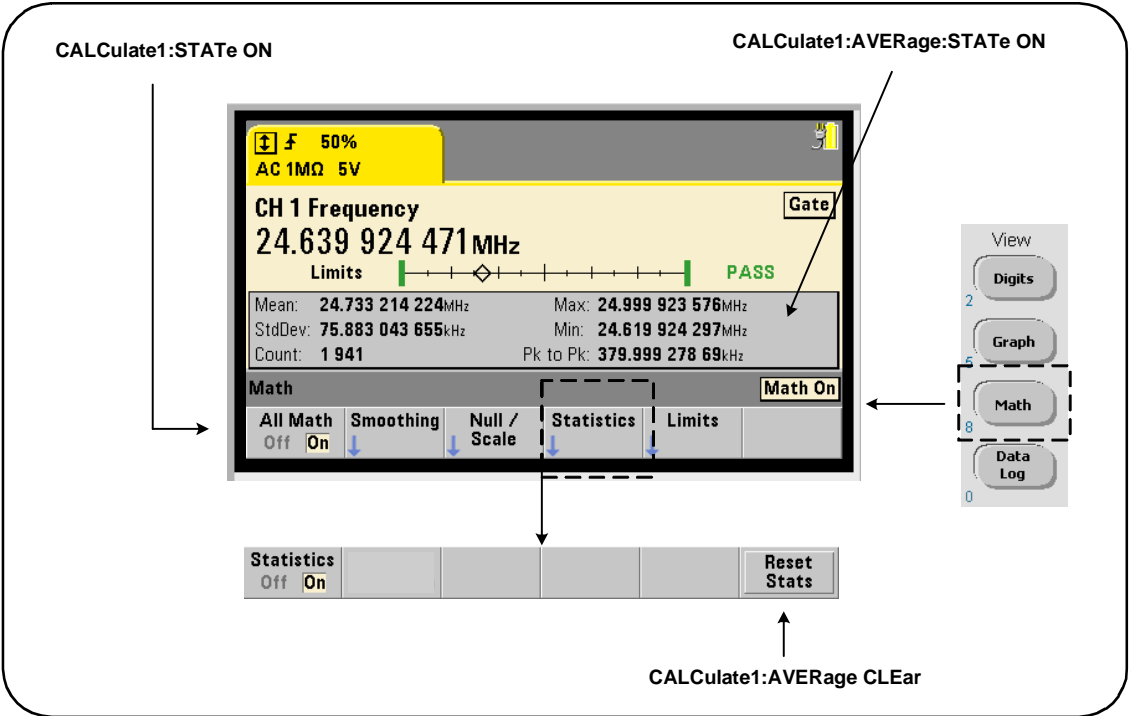

Figure 6-3. Counter Display with Limit Testing and Statistics Enabled.

Enabling Statistics

Before statistical calculations are performed they must be enabled using the command:

CALCulate[1]:AVERage:STATE {OFF|ON}
CALCulate[1]:AVERage[:STATE]? (query form)

ON - enables statistical calculations on the readings as they occur. Statistical data includes: mean, standard deviation, maximum value, minimum value, and average peak-to-peak value.

OFF - disables statistics computation.

Following a reset (*RST) or instrument preset (SYSTEM:PRESet), statistical computations are disabled.

Reading Count

Statistical calculations start when Math and the Statistics function are enabled. The number of readings on which a given set of statistics are based is shown as the Count value (Figure 6-3). The count can also be queried with the command:

CALCulate[1]:AVERage:COUNt:CURRENT?

The count can be read at any time after the measurements have been initiated (i.e. INITiate:IMMediate, READ?, MEASure?).

Following a reset (*RST) or instrument preset (SYSTEM:PRESet), the count is set to '1'.

Mean, Standard Deviation, Minimum Value, Maximum Value

The mean (average), standard deviation, minimum value, and maximum value for the current reading count can be determined with the command:

CALCulate[1]:AVERage:ALL?

If the readings have been scaled (see “Scaling Functions”), the statistics are based on the scaled readings.

Example: Enabling and Computing Statistics

The following example returns the mean, standard deviation, minimum value, and maximum value for a set of 500 readings. The trigger count setting, although it defaults to '1', is shown for completeness. A 'wait' statement is included to delay the analysis until **all** readings are complete.

```
CONF:FREQ (@1)           // frequency measurement on ch 1
  TRIG:COUN 1             // trigger count is 1
  SAMP:COUN 500           // 500 readings per trigger
  SENS:FREQ:GATE:TIME 10e-3 // 10 ms gate time
  CALC:STAT ON           // enable CALCulate1 subsystem
  CALC:AVER:STAT ON     // enable statistics
INIT                     // initiated the measurements
*WAI                     // wait for all rdgs to complete
CALC:AVER:ALL?        // compute statistics
```

Typical data returned for this command is:

<i>mean</i>	<i>std. dev</i>
+5.50020355962701E+006	+2.59738014535884E+006
<i>min value</i>	<i>max value</i>
+1.04179550991303E+006,	+9.94903904473447E+006

Average Value, Minimum Value, Maximum Value, Average Peak-to-Peak Value

Individual characteristics of a given set of readings can be determined using the following commands. Before any of the commands are used, statistics must be enabled with `CALCulate[1]:AVERage:STATE ON`.

CALCulate[1]:AVERage:AVERage?

- returns the average (mean) of all readings in the reading count.

CALCulate[1]:AVERage:MINimum?

- returns the minimum value of all readings in the current reading count.

CALCulate[1]:AVERage:MAXimum?

- returns the maximum value of all readings in the current reading count.

CALCulate[1]:AVERage:PTPeak?

- returns the average peak-to-peak value (average maximum value - average minimum value) of all readings in the reading count.

Example: Computing Individual Statistics

The following example shows these reading parameters queried individually.

```

CONF:PER (@1)                // configure period measurement
  TRIG:COUN 2                 // trigger count = 2
  SAMP:COUN 100              // 100 rdgs per trigger
  SENS:FREQ:GATE:TIME 10e-3  // 10 ms gate time
  CALC:STAT ON              // enable CALCulate1 subsystem
  CALC:AVER:STAT ON        // enable statistics
INIT                          // initiate the measurements
*WAI                          // wait for all rdgs to complete
CALC:AVER:MIN?           // query individual parameters
CALC:AVER:MAX?
CALC:AVER:AVER?
CALC:AVER:PTP?

```

Standard Deviation

Standard deviation is available with both counters using the command:

CALCulate[1]:AVERage:SDEVIation?

The CALCulate1 subsystem and statistics must also be enabled before the standard deviation can be determined.

Clearing/Resetting Statistics

The current set of reading statistics is clear by any of the following:

- enabling statistical functions - `CALCulate[1]:AVERage[:STATe] ON`
- a new measurement cycle - `INITiate:IMMediate, READ?, MEASure?`
- sending a new SCPI command or changing a current SCPI parameter
- a reset or instrument preset - `*RST, SYSTem:PRESet`

These steps also clear **all readings** in reading memory. To clear statistics **without** clearing reading memory, the following command is used:

```
CALCulate[1]:AVERage:CLEar[:IMMediate]
```

Limit Checking

Limit checking enables counter measurements to be compared on a reading-by-reading basis to a lower limit and upper limit.

Limits that are exceeded are reported in the counter's Questionable Data register (bits 11 and 12). Register definitions and are contained in Chapter 8.

When enabled, limit checking appears on the counter display as shown in Figure 6-4.

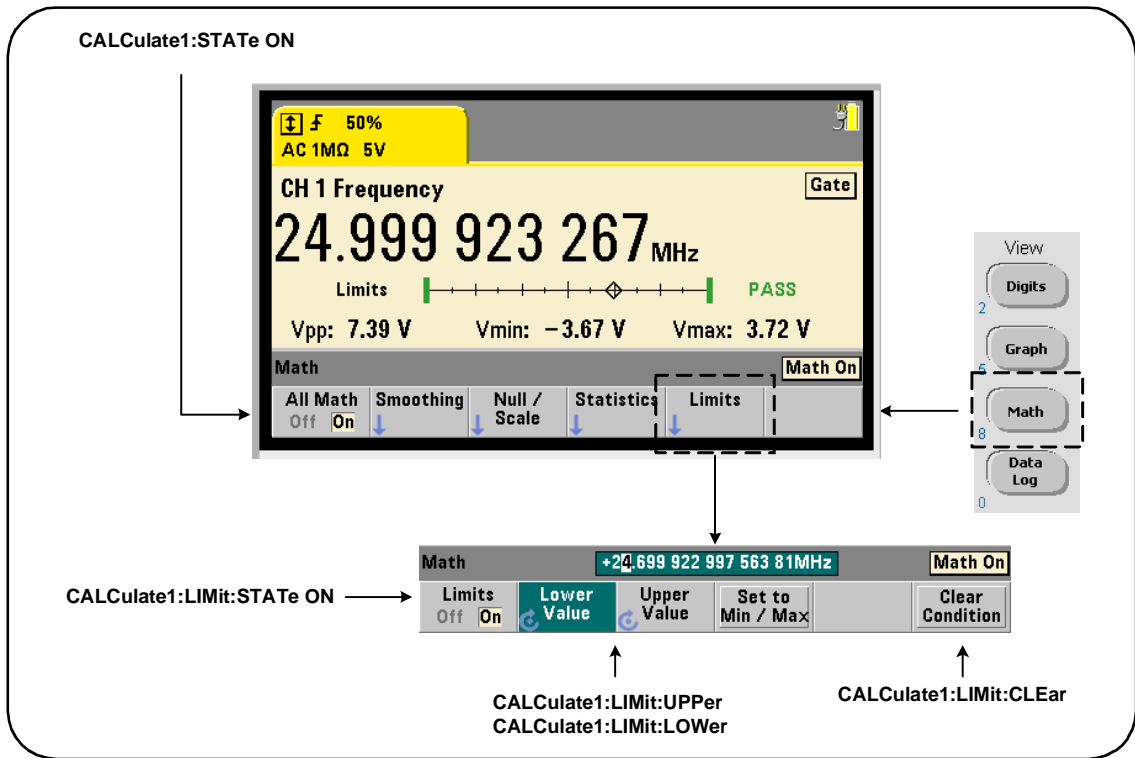

Figure 6-4. 53210A Limit Checking.

Enabling Limit Checking

Limit checking is enabled with the command:

```
CALCulate[1]:LIMit[:STATe] {OFF|ON}
CALCulate[1]:LIMit[:STATe]? (query form)
```

ON - enables limit checking.

OFF disables (bypasses) limit checking. Enabling limit checking enables **both** lower and upper limit boundaries.

Setting Lower and Upper Limits

Lower and upper limits are set using the commands:

```
CALCulate[1]:LIMit:LOWer[:DATA] {<value>} |MINimum|MAXimum|
DEFault}
```

```
CALCulate[1]:LIMit:LOWer[:DATA]? |MINimum|MAXimum| DEFault}
(query form)
```

```
CALCulate[1]:LIMit:UPPer[:DATA] {<value>} |MINimum|MAXimum|
DEFault}
```

```
CALCulate[1]:LIMit:UPPer[:DATA]? |MINimum|MAXimum| DEFault}
(query form)
```

The lower limit and upper limit **value** ranges are:

-1.0E+15 to -1.0E-15, 0.0, 1.0E-15 to 1.0E+15

The default limits and the limits set following a reset (*RST) or instrument preset (SYSTEM:PRESet) are 0.0.

When using limits, both a lower limit **and** an upper limit must be specified. **Any** of the following steps will prevent a “settings conflict” error (e.g. lower limit greater than upper limit) due to the order in which limits are set:

- setting the upper limit first
- setting both limits on the same line programmatically
- enabling limit testing *after* the limits are set

To programmatically determine if a reading (or readings) outside the limit boundaries has occurred, the command:

```
STATus:QUESTionable:EVENT?
```

is used to read the Questionable Data register. A value of +2048 (bit 11) indicates a reading below the lower limit. A value of +4096 (bit 12) indicates a reading above the upper limit. Reading the register also **clears all bits** in the

register (see “Clearing Limit Conditions”).

Example: Limit Checking

The following is an example of enabling and using limit checking.

```
CONF:FREQ (@1)           // configure measurement
  SAMP:COUN 500          // check limit on 500 rdgs
  CALC:STAT ON           // enable math operations
  CALC:LIM:STAT ON       // enable limit checking
  CALC:LIM:LOW 99.9E3;UPP 100.1E3 // set limits
INIT                     // initiate the measurements
*WAI                     // wait for readings to complete
STAT:QUES:EVEN?         // query questionable data register
```

Notice that the limits are set on the same line to prevent a settings conflict error. This Error can also be avoided by enabling limit checking *after* the limits are set.

Clearing Limit Conditions

The ‘Limit’ annunciator is turned off and bits 11 and 12 (only) in the Questionable Data Register are cleared by any of the following:

- enabling limit checking - `CALCulate[1]:LIMit[:STATe] ON`
- a new measurement cycle - `INITiate:IMMediate, READ?, MEASure?`
- sending a new SCPI command or changing a current SCPI parameter
- a reset or instrument preset - `*RST, SYSTem:PRESet`

These steps also clear **all readings** in reading memory. (`*RST` and `SYSTem:PRESet` additionally reset the lower and upper limits to 0.0.)

To turn off the ‘Limit’ annunciator and clear only the limit-sensing bits (11/12 in the Condition register) **without** clearing reading memory, the following command is used:

```
CALCulate[1]:LIMit:CLEar[:IMMediate]
```

Histograms

The distribution for a given set of counter measurements (**except continuous totalize and time stamp measurements**) can be represented graphically using the 53210A histogram feature. The following example (Figure 6-5) represents the basic format of a counter histogram.

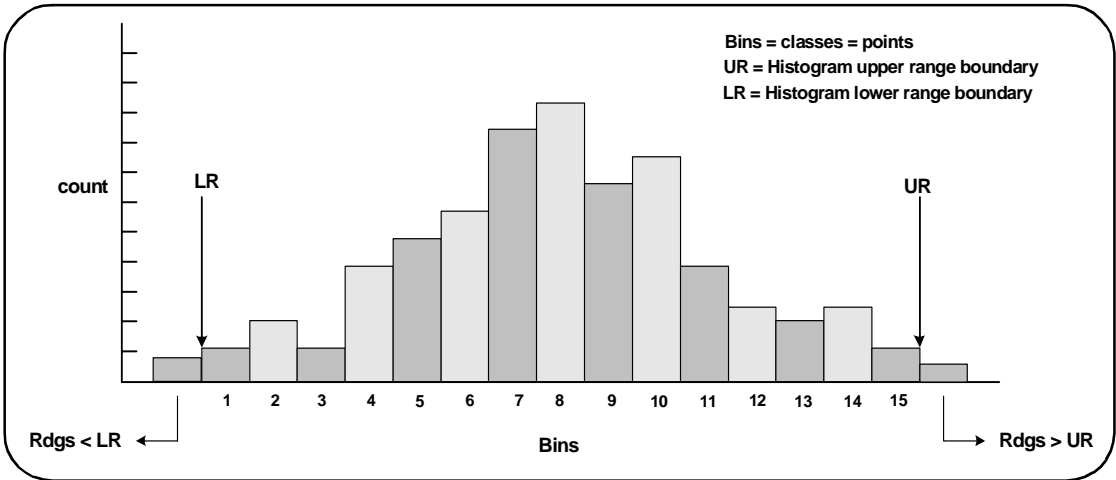
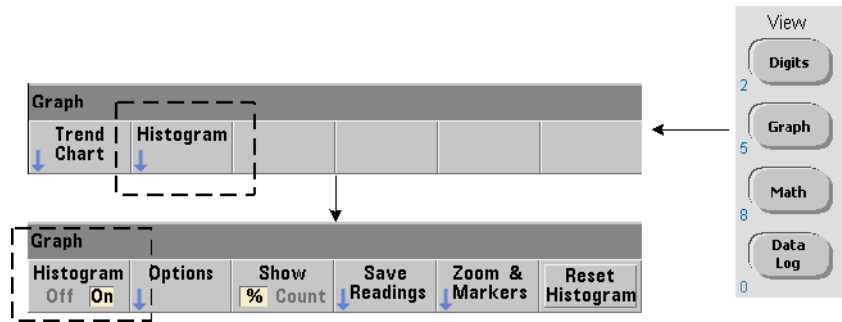

Figure 6-5. 53210A Histogram Structure.

Note that histograms and math functions (e.g. statistics, scaling, limits, etc.) can be used simultaneously with the same measurement data.

Viewing Histograms



At power-on or when the front panel Preset key is pressed, numeric data is displayed. Remotely, histograms can be displayed by changing the display mode using the command:

```
DISPlay[:WINDow]:MODE {NUMeric|HISTogram|TCHart}
DISPlay[:WINDow]:MODE? (query form)
```

The Graph key followed by the Histogram softkey enables and automatically starts histograms from the front panel. Histograms can also be turned off from the softkey menu.

Remotely, a reset (*RST) or instrument preset (SYSTem:PRESet) does not change the display mode.

Histograms correspond to readings in reading memory - starting at the time the histogram is **enabled** and ending when the product of the trigger count (TRIGger:COUNT) and sample count (SAMPle:COUNT) is reached. If triggering is continuous (i.e. internal), the histogram continually updates from the point it was enabled.

Figure 6-6 describes the information provided in a typical histogram window.

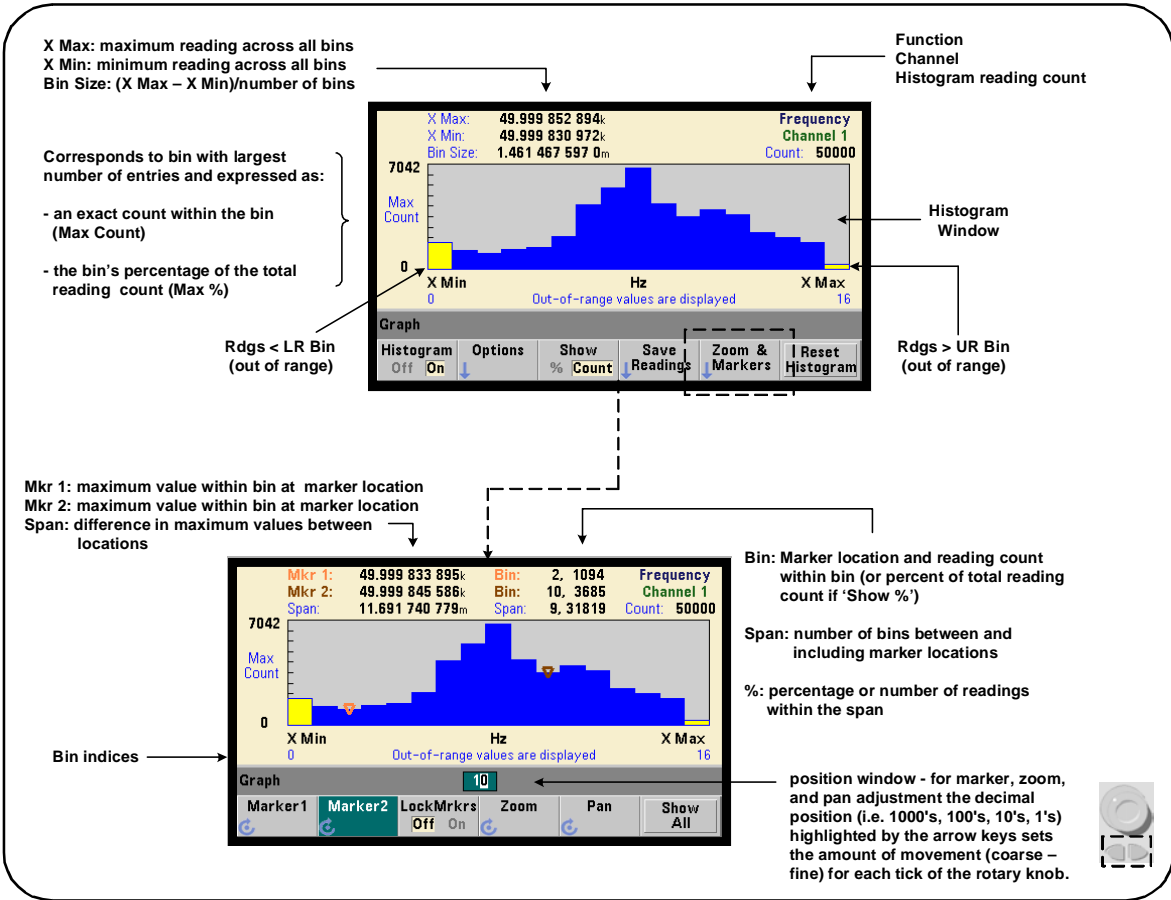

Figure 6-6. Histogram Display Format.

Histogram Configuration

Histograms are configured using the softkeys and commands shown in Figure 6-7.

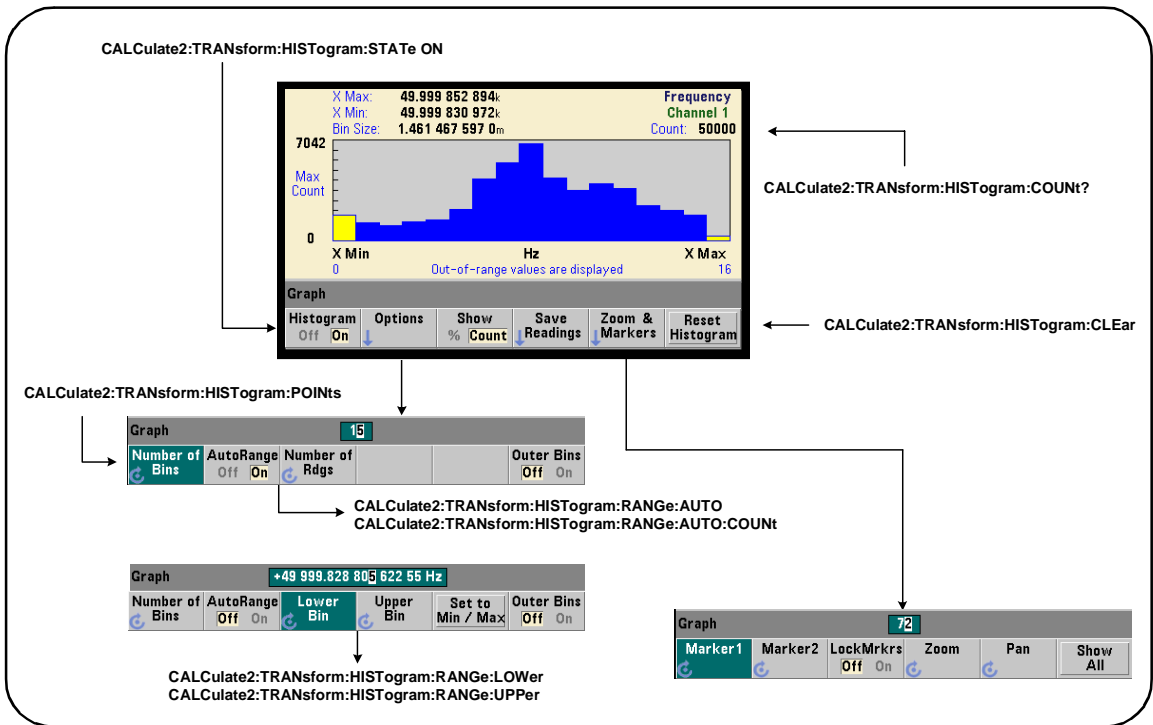

Figure 6-7. 15-Bin (Point) Histogram.

Histogram computation is enabled with the command:

```
CALCulate2:TRANSform:HISTogram[:STATE] {OFF|ON}
CALCulate2:TRANSform:HISTogram[:STATE]? (query form)
```

ON - enables histogram computation.

OFF - disables histogram computation. Following a reset (*RST), instrument preset (SYSTEM:PRESet), or front panel (Preset) histograms are disabled.

The number of readings represented by a histogram (Figure 6-7) can be queried with the command:

CALCulate2:TRANSform:HISTogram:COUNT?

Setting Up the Histogram

The counter builds a histogram based on number of bins (points), a lower range, and an upper range.

Number of Bins

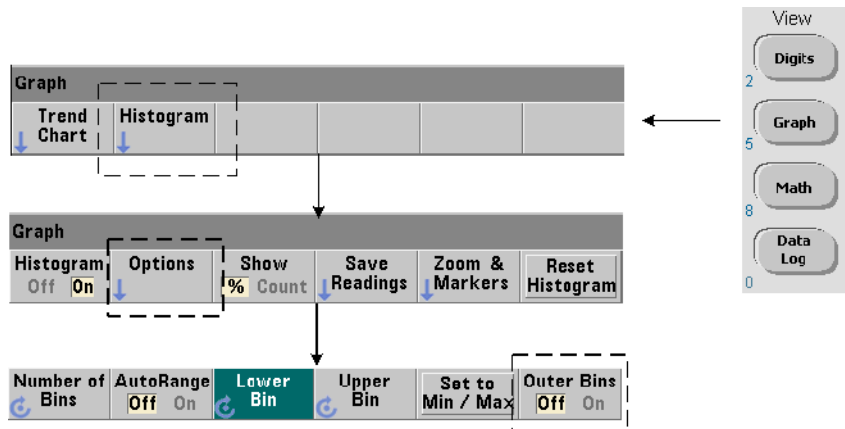

The number of bins is specified with the command:

CALCulate2:TRANSform:HISTogram:POINTS {<value>|MINimum|MAXimum|DEFAULT}

CALCulate2:TRANSform:HISTogram:POINTS? [{MINimum|MAXimum|DEFAULT}] (query form)

value - specifies the number of bins (points) between the lower and upper range values. **value** can range from 10 to 1,000. Following a reset (*RST) or instrument preset (SYST:PRESet) the number of bins is set to 100.

Displaying the Outer Bins

Two additional bins independent of the number specified are **always** included with the histogram. The bins contain readings less than the lower range value and readings greater than the upper range value (Figures 6-5 and 6-6). A number of readings greater than expected in either bin may indicate a drift in the measured quantity.

The bins are viewed using the Outer Bins softkey, and the bin indices (Figure 6-6) account for the bins whether they are displayed or not.

Bin Representation

The softkey:

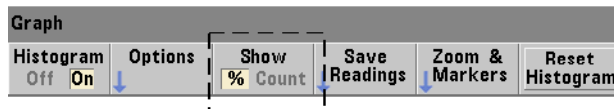

corresponds to the **bin** with the largest number of entries and is expressed as an exact count (Count), or the bin's percentage (%) of the total reading count. This setting is only available from the front panel.

Lower and Upper Ranges

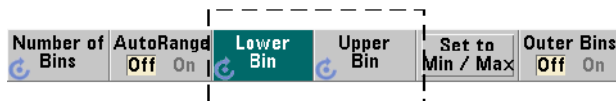

The lower and upper ranges of the histogram are specified directly with the commands:

```
CALCulate2:TRANSform:HISTogram:RANGe:LOWer {<value>
|MINimum|MAXimum|DEFAULT}
```

```
CALCulate2:TRANSform:HISTogram:RANGe:LOWer? [{MINimum|
MAXimum|DEFAULT} (query form)
```

```
CALCulate2:TRANSform:HISTogram:RANGe:UPPer {<value>
```

|MINimum|MAXimum|DEFault}

CALCulate2:TRANSform:HISTogram:RANGE:UPPer? [{MINimum
|MAXimum|DEFault}] (query form)

value - directly specifies the histogram lower and upper range values. The value ranges are:

-1.0E+15 to -1.0E-15, 0.0, 1.0E-15 to 1.0E+15

The default lower and upper ranges and the ranges set following a reset (*RST) or instrument preset (SYSTEM:PRESet) are 0.0.

When setting the ranges, both a lower range **and** an upper range must be specified. **Any** of the following steps will prevent a “settings conflict” error (e.g. lower range greater than upper range) due to the order in which ranges are set:

- setting the upper range first
- setting both ranges on the same line programmatically
- enabling the histogram *after* the ranges are set
- setting the ranges automatically

Setting the Bin Ranges to Min and Max

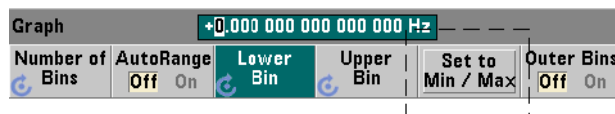

With AutoRange Off, the Set to Min/Max softkey is another method for setting the histogram bin ranges (lower and upper). Depending on the instrument state, Set to Min/Max will set the ranges as follows:

- When ‘Statistics’ (under the Math key) are enabled, the minimum and maximum values from the reading statistics are used.
- If readings are in progress and ‘Statistics’ are off, the instrument will select a minimum and a maximum value from (up to) the last 10,000 readings taken.
- If no previous readings are available, a minimum bin range of 0 and a maximum bin range of 1 000 000 000.0 are set.

Automatic Range Setting



Alternately, lower and upper range values can be set automatically based on a minimum value and maximum value obtained from the first ‘n’ number of readings taken.

Automatic range selection is enabled with the commands:

```
CALCulate2:TRANSform:HISTogram:RANGE:AUTO {OFF|ON}
CALCulate2:TRANSform:HISTogram:RANGE:AUTO?      (query form)
```

ON - enables automatic selection of the histogram lower and upper range values.

OFF - disables automatic selection.

Following a reset (*RST) or instrument preset (SYSTEM:PRESet) automatic range selection is *enabled*.

The number of readings from which the minimum and maximum range values are selected (**ON**) is set with the command:

```
CALCulate2:TRANSform:HISTogram:RANGE:AUTO:COUNT {<value>
|MINimum|MAXimum|DEFAULT}
```

```
CALCulate2:TRANSform:HISTogram:RANGE:AUTO:COUNT?
[ {MINimum|MAXimum|DEFAULT} ] (query form)
```

value - specifies the **first** 'n' number of readings from which lower and upper range values are obtained. 10 to 1,000 readings can be specified.

The default number and the number set following a reset (*RST) or instrument preset (SYSTEM:PRESet) is 100.

Example: Setting up a Histogram

The following example creates a 15-bin histogram of 3,000 counter measurements. The lower and upper ranges are automatically determined from the first 300 readings taken.

```
CONF:FREQ 50E3, (@1) // configure frequency measurement
  SYST:TIM .1 // 100 ms measurement timeout
  TRIG:SOUR BUS // set software triggers as source
  TRIG:COUN 1 // trigger count = 1
  SAMP:COUN 3000 // 3000 readings per trigger
  SENS:FREQ:GATE:SOUR TIME // set gate source
  SENS:FREQ:GATE:TIME 1E3 // set a 1 ms gate time
  DISP:MODE HIST // histogram display mode
  CALC2:TRAN:HIST:POIN 15 // specify 15 bins
  CALC2:TRAN:HIST:RANG:AUTO ON // auto-select ranges
  CALC2:TRAN:HIST:RANG:AUTO:COUN 300 // use first 300 rgs
  CALC2:TRAN:HIST:STAT ON // enable histogram
INIT // initiate the counter
*TRG // send a software trigger
```

Resetting the Histogram

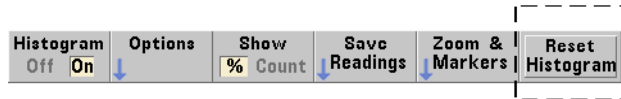

The data from which the current histogram is created is cleared by any of the following:

- pressing the Reset Histogram softkey
- enabling/disabling or changing any part of the histogram
 - number of bins, lower or upper range
- a new measurement cycle - INITiate:IMMediate, READ?, MEASure
- sending a new SCPI command or changing a current SCPI parameter
- an instrument reset or present - *RST, SYSTem:PRESet

These actions also clear **all** readings in reading memory and in the output buffer.

To clear histogram data **without** clearing the readings in reading memory, the following command is used:

```
CALCulate2:TRANSform:HISTogram:CLEar[:IMMediate]
```

Saving Readings

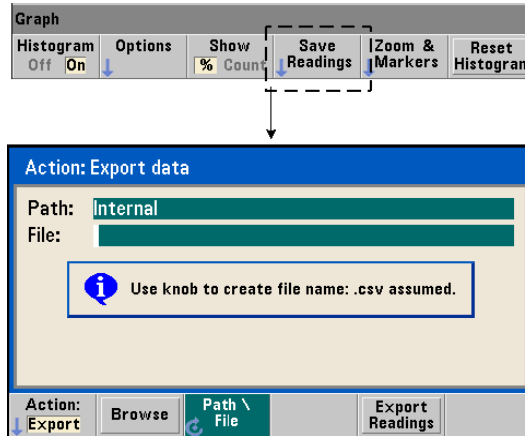

The readings used to create the histogram can be saved to internal flash memory or to an external USB memory device as comma-separated values (CSV) in one measurement per line ASCII format.

Selecting Save Readings opens the Export action window from which a path and file name can be selected or created. The number of readings exported is the total number in reading memory at the time Export Readings is pressed - which may not be the total reading count (TRIGger:COUNT x SAMPLe:COUNT).

Exporting readings **clears reading memory** and re-starts the histogram on the next trigger received.

Zoom & Markers View

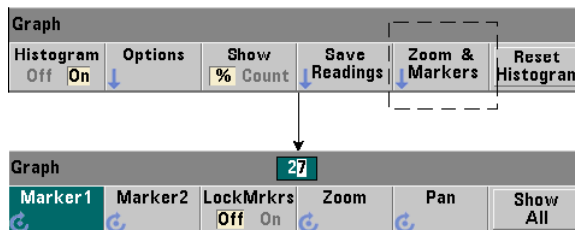

NOTE

For marker, zoom, and pan adjustment the decimal position (i.e. 100's, 10's, 1's) highlighted by the arrow keys sets the amount of movement (coarse or fine) for each tick of the rotary knob.

Graph

72

The 'Marker' softkeys allow you to position markers on individual bins within the histogram, and if desired, *lock* the relative distance between the markers. When locked together, moving either Marker1 or Marker2 with the front panel knob or using [Shift] followed by a bin number, also moves the other marker while maintaining the distance between the two. The data corresponding to the marker positions is shown above the histogram window.

Zoom determines the number of bins displayed by increasing the resolution at the center region of the histogram. Each time the zoom is adjusted, the X Min and X Max indices (Figure 6-6) are changed to show the current bin range.

Pan scans the histogram (left or right) once a zoom percentage has been set. By moving the Pan window, regions of interest can be brought into view; and Zoom used again to expand the region. Pan, used interchangeably with Zoom in this manner, maintains the zoom percentage.

Show All restores the histogram window to the total number of bins specified - including the outer bins, and resets the zoom and pan.

Histogram Data in Numeric Form

Data describing the histogram is available in numeric form through either of two query commands.

CALCulate2:TRANSform:HISTogram:ALL?

Returns the following comma-separated sequence describing the current histogram:

```
lower range value
upper range value
number of readings taken
bin data
```

The bin data includes:

```
number of measurements less than the lower range value,
number of readings in each bin,
number of readings greater than the upper range value
```

An example data string for a 15-bin histogram based on 3,000 readings of a 50 kHz input signal is:

```
+4.998912590059145E+004, +5.001118414176608E+004, +3000, +0, +
4, +8, +27, +71, +221, +422, +612, +695, +504, +254, +113, +41, +20, +4
, +4, +0
```

Notice in this sample there were no readings below the lower range value or above the upper range value.

CALCulate2:TRANSform:HISTogram:DATA?

Returns **only the bin data** of the current histogram in the sequence:

```
number of measurements less than the lower range value,
number of readings in each bin,
number of readings greater than the upper range value
```

Trend Charts

Reading trends for a given number of counter measurements (**except continuous totalize**) or timestamps can be represented within a 53210A trend chart, also known as a run chart.

Figure 6-8 shows the components of a typical counter trend chart.

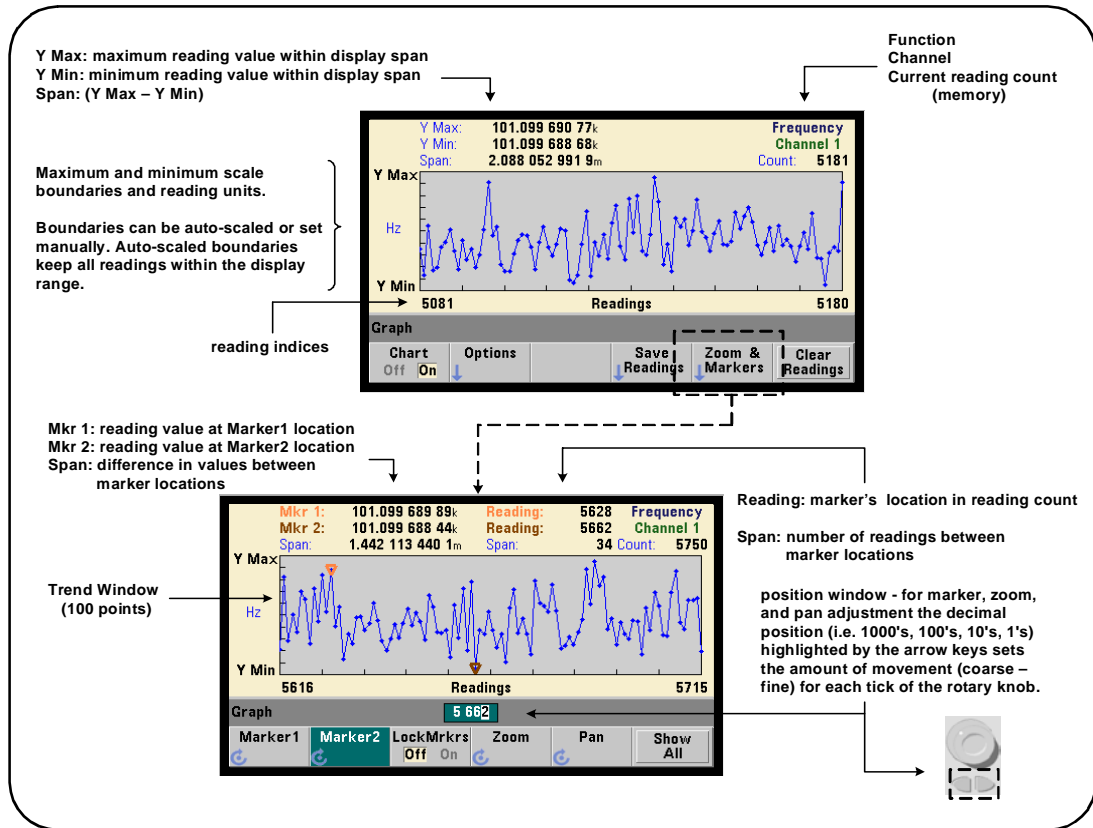
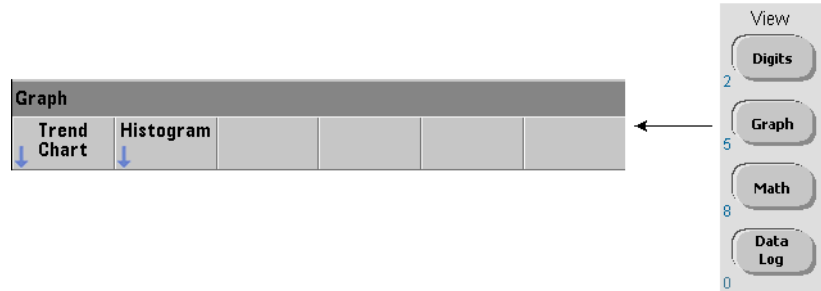

Figure 6-8. Trend Chart Display Format (without decimation).

Viewing Trend Charts



At power-on or following a reset (*RST) or instrument preset (Preset), numeric data is displayed. The display can be changed to a trend chart by changing the display mode using the command:

```
DISPlay[:WINDow]:MODE {NUMeric|HISTogram|TCHart}
DISPlay[:WINDow]:MODE? (query form)
```

The display mode (TCHart) is the **only** trend chart parameter that can be set programmatically (i.e. using SCPI commands). All other trend chart parameters are set using **the front panel**.

Pressing the Graph key followed by the Trend Chart softkey starts the trend chart from the front panel.

Trend charts correspond to **all** readings in reading memory for a given trigger count (TRIGger:COUNT) and sample count (SAMPle:COUNT). If triggering is continuous (i.e. internal), the trend chart continually updates.

Trend Chart Configuration

Figure 6-9 shows the softkey menus associated with trend chart configuration and control of the trend window.

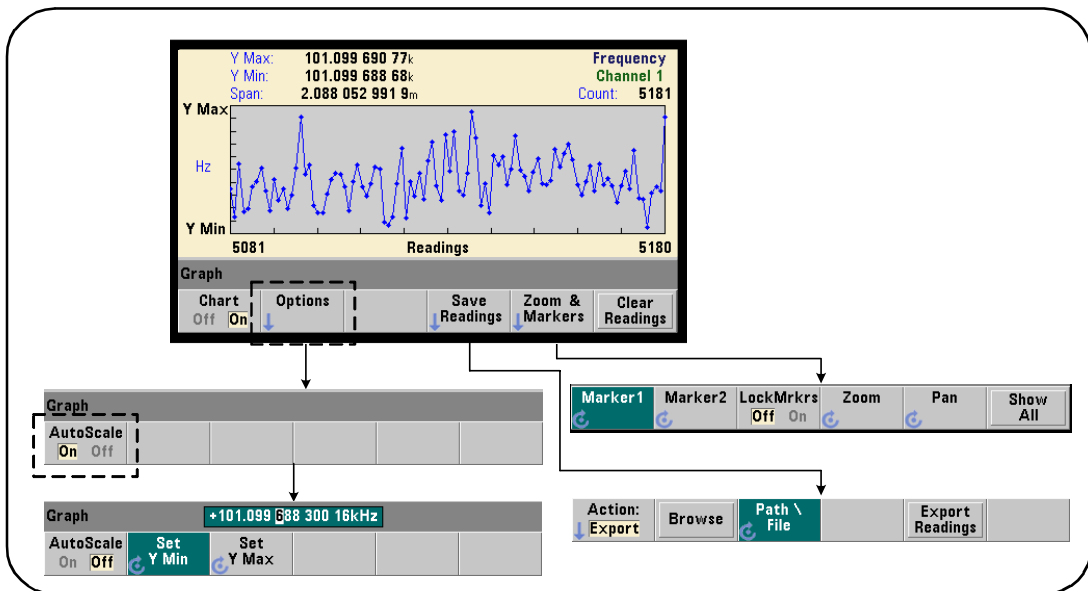

Figure 6-9. Trend Chart Configuration and Control.

Trend Chart Boundaries

The trend chart boundaries (Y Max and Y Min) can be set automatically (AutoScale On) or manually (AutoScale Off) using the menus under the Options soft key (Figure 6-9). Auto-scaled (on) boundaries keep all readings within the trend window. Manually-set boundaries (off) can result in readings outside the window. Manual boundaries are set using the front panel knob or [Shift]ed numeric keys.

If reading limits are set using the Math function, setting YMax and YMin will scale (but not change) the limits within the YMax and YMin boundaries. YMax and YMin cannot specify a boundary smaller than the Math reading limits.

A maximum of 100 readings or decimation points can be displayed in the trend window.

Clearing the Trend Chart



Clearing the trend chart clears reading memory and restarts the reading count on the next trigger received.

Saving Readings

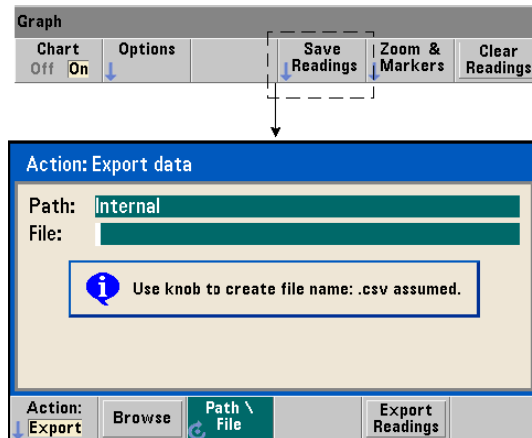

The readings represented by the trend chart can be saved to internal flash memory or to an external USB memory device as comma-separated values (CSV) in one measurement per line ASCII format.

Selecting Save Readings opens the Export action window from which a path and file name can be selected or created. The number of readings exported is the number of readings in memory (Figure 6-8) at the time Export Readings is pressed - which may not be the total reading count (TRIGger: COUNT x SAMPlE: COUNT).

Exporting readings **clears reading memory** and re-starts the trend chart on the next trigger received.

Zoom & Markers Window

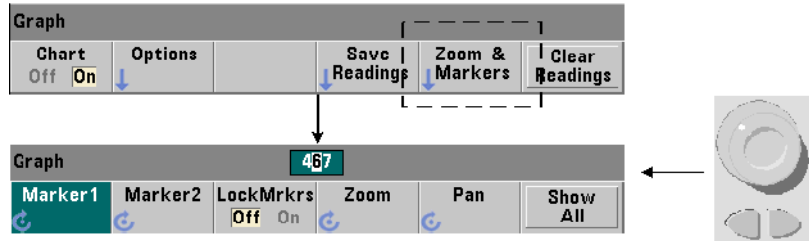

NOTE

For marker, zoom, and pan adjustment the decimal position (i.e. 1000's, 100's, 10's, 1's) highlighted by the arrow keys sets the amount of movement (coarse or fine) for each tick of the rotary knob.

Graph 28 840 Math On

The 'Marker' softkeys allow you to position markers on individual readings or decimation points within the **trend chart**, and if desired, *lock* the relative distance between the markers. When locked together, moving either Marker1 or Marker2 with the front panel knob or using [Shift] followed by a reading number, moves both markers while maintaining the distance between the two. The data corresponding to the marker positions is shown above the trend window.

Zoom determines the number of readings displayed by increasing the resolution at the center region of the trend chart window. Each time the zoom is adjusted, the reading indices (Figure 6-8) are changed to show the current reading range.

Pan scans the trend chart (left or right) once a zoom percentage has been set. By moving the Pan window, regions of interest can be brought into view; and Zoom used again to expand the region. Pan, used interchangeably with Zoom in this manner, maintains the zoom percentage.

With Pan, each reading or decimation point can also be viewed - up to the window maximum of 100 readings/points at a time.

Show All updates the trend window to represent the current reading count. The reading indices are 0 and the Count value, and zoom and pan are also reset.

Reading Decimation

The trend window displays a maximum of 100 readings. When **greater than** 100 readings are displayed, the readings are decimated - grouped together and represented by decimation points. The number of readings in a decimation group is the reading count/100.

Figure 6-10 is a trend chart of 100,000 readings in which the readings have been decimated.

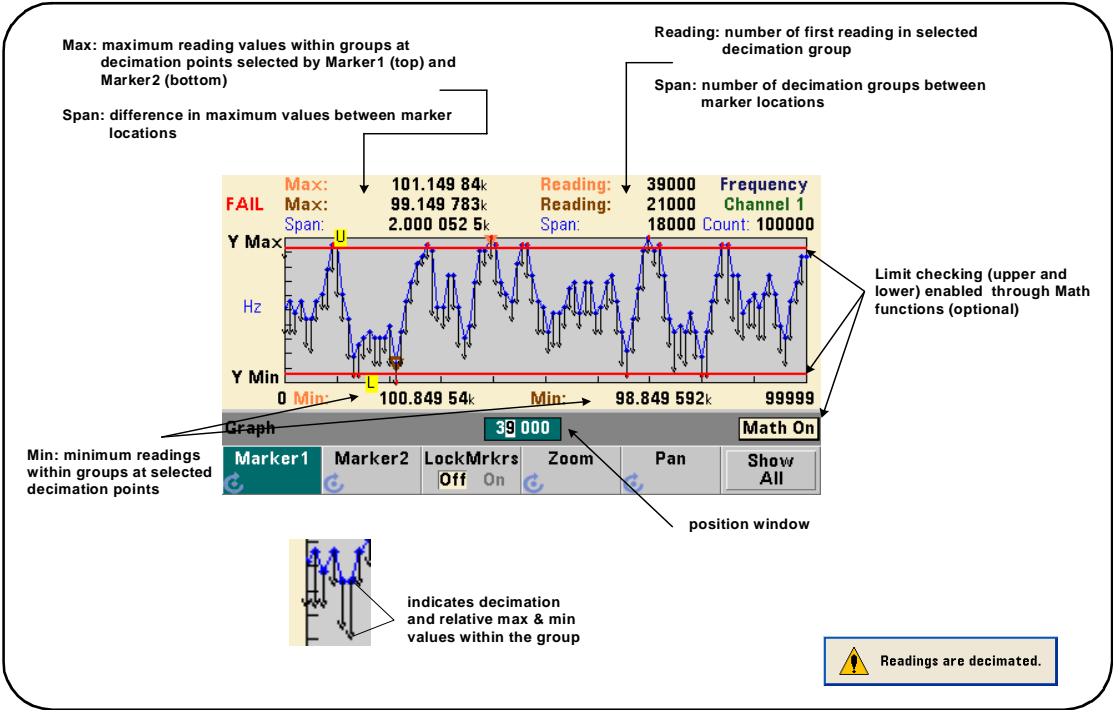

Figure 6-10. Trend Chart Display Format (with Decimation).

There are 1,000 readings in each decimation group in Figure 6-10 (100,000 readings/100 points displayed). The number of readings in each group changes if Show All is pressed and readings continue to be taken.

When a marker is moved to a decimation point, the number of the **first** reading in the corresponding group is displayed. This number should be noted if it is necessary to view individual readings within a group.

Viewing Readings Within a Decimation Group Decimated reading values that are grouped and represented by a single decimation point can be viewed individually using markers and the trend chart's Pan control.

- 1 Select a marker and using the knob, move the marker to the decimation point with the reading level of interest. The reading number corresponding to the marker position is the **first** reading in the group. This may not be the maximum or minimum value within the group.
- 2 Select 'Pan' and using the [Shift]ed numeric keys, enter the number of the first reading. The reading indices show a span of 100 **readings**, beginning with the first reading in the group.
- 3 Select Marker1 or Marker2 and using the arrow keys, highlight the rightmost (1's) place in the position window. Rotate the knob to move the marker one reading at a time. The reading value and number are shown as the marker is advanced.

For decimation groups with more than 100 readings, select 'Pan' and enter the next reading number after the upper reading index (Figure 6-8) to view the next 100 readings.

Data Logging

The data logging feature of the 53210A counter allows you to log and analyze up to **1,000,000** readings. Data logging is enabled and configured from the front panel **only**, and is available with all counter measurements except continuous totalizing.

NOTE

Logged readings ARE NOT saved to internal flash memory or external USB memory until the logging duration is complete. If power is lost and if battery Option 300 is not enabled or it also loses power before logging is complete, all data will be lost.

Figure 6-11 shows the keys and windows associated with the data logger application.

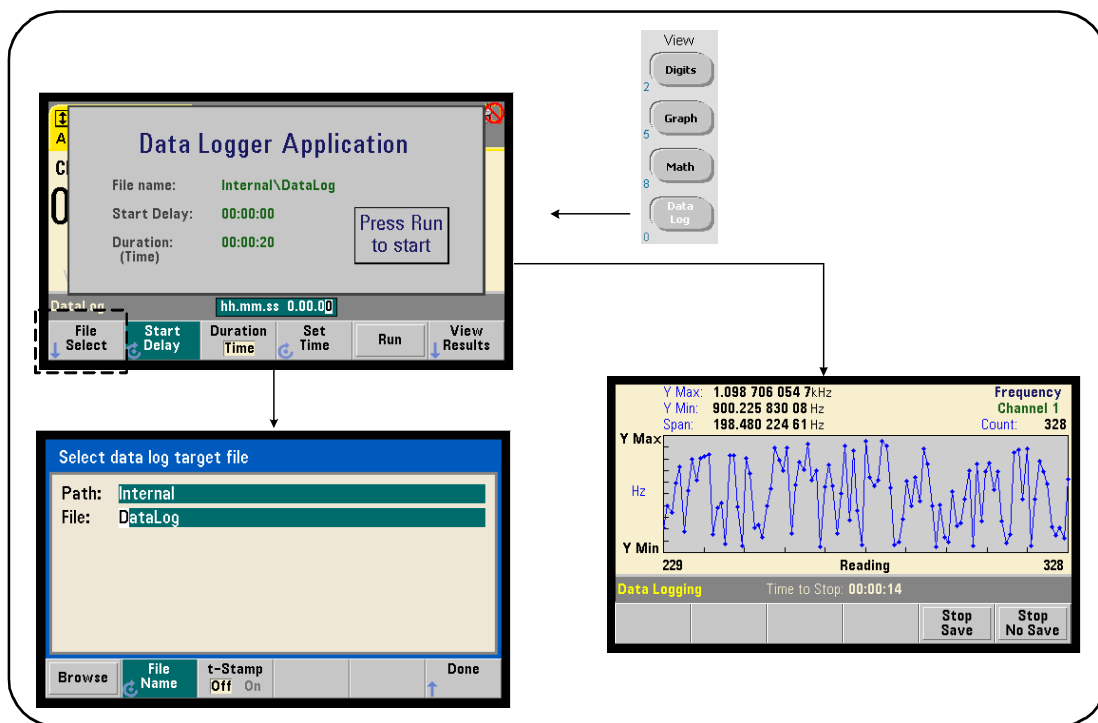

Figure 6-11. Starting the Counter Data Logger.

Configuring the Data Logger

All logged readings are **saved** in the counter's internal flash memory or to an external USB storage device **after** logging is complete. The readings are viewable in trend (run) chart format while logging is in progress and when complete.

Data logging occurs for a **duration** specified as a period of time or a number of readings to be logged. Once enabled, the **start** of data logging can be **delayed** for a period of time.

Specifying a Data Log File



Logged readings saved in internal flash memory or in external USB memory are comma-separated values (CSV) in one measurement per line ASCII format. A default path and file name (Internal\DataLog) is used if one is not specified.

The drive (Internal or External) is selected using the browse feature and the file name is specified using the rotary knob and arrow keys to select or change characters.

Pressing [Done] saves the path and file name and returns to the application menu. Data logging will not start if an invalid path/file is specified.

Adding a Time Stamp to the Data Log File

A time stamp (t-Stamp) in the form:

yyyymmdd_hhmmss e.g. DataLog_20100925_105535.csv

is appended (On) to the file name when data logging completes or when the (Stop Save) soft key is pressed. The time stamp also appears on the spreadsheet tab when the data log (.csv) file is opened.

Setting the Duration

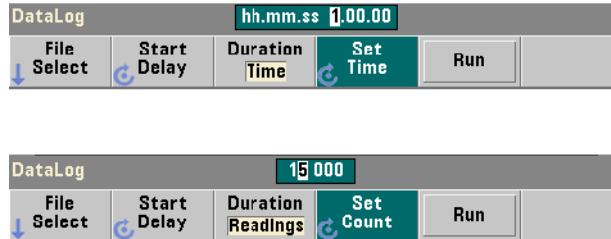

In terms of Time, the data logging duration is specified in `hh.mm.ss` format. The value is set using the rotary knob and arrow keys, or using the [Shift]ed numeric keys. By highlighting specific digits in the time window, greater resolution (i.e. minutes and seconds) of the logging time can be specified.

The maximum data logging period is 99.00.00. The reading limit, however, is 1,000,000 readings which may occur before the time duration is reached.

In terms of Readings, data logging continues until the specified number of readings are complete. The reading count is set using the rotary knob and arrow keys, or using the [Shift]ed numeric keys. A maximum of 1,000,000 readings can be specified.

For the Time Stamp measurement function, only **reading** duration is available.

Setting a Start Delay

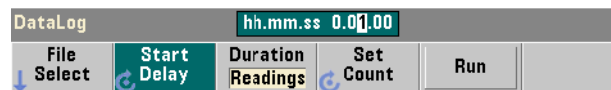

When required, a delay can be set between the time the Run key is pressed, and the start of data logging. The start delay is specified in `hh.mm.ss` format and is set using the rotary knob and arrow keys, or using the [Shift]ed numeric keys. By highlighting specific digits in the delay window, greater resolution (i.e. minutes and seconds) of the delay time can be specified.

The maximum delay setting is 99:00:00.

Starting the Data Logger

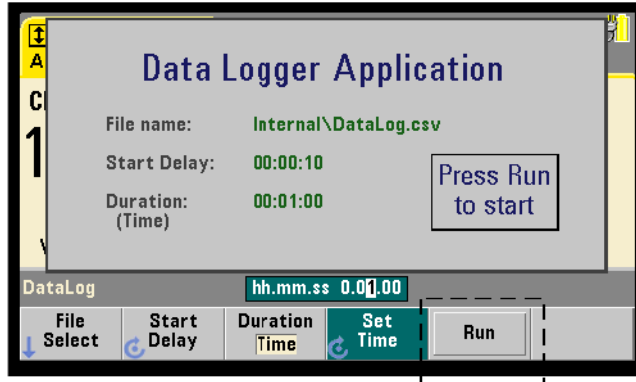

Pressing the Run softkey enables data logging. Data logging begins following any specified start delay when a valid path/file exists. A default path and file name of:

Internal\DataLog

is used when the data logger application is started. Select Yes to overwrite the file and begin.

Viewing Readings



A trend chart is populated as readings are logged. **After** data logging completes, the readings are stored in the file specified. Pressing View Results when logging is stopped and the readings are saved, or when logging is complete, displays a trend chart of the saved readings.

Figure 6-12 is an example of a trend chart as readings are logged. (Figures 6-8

and 6-10 contain more information on the trend chart window.)

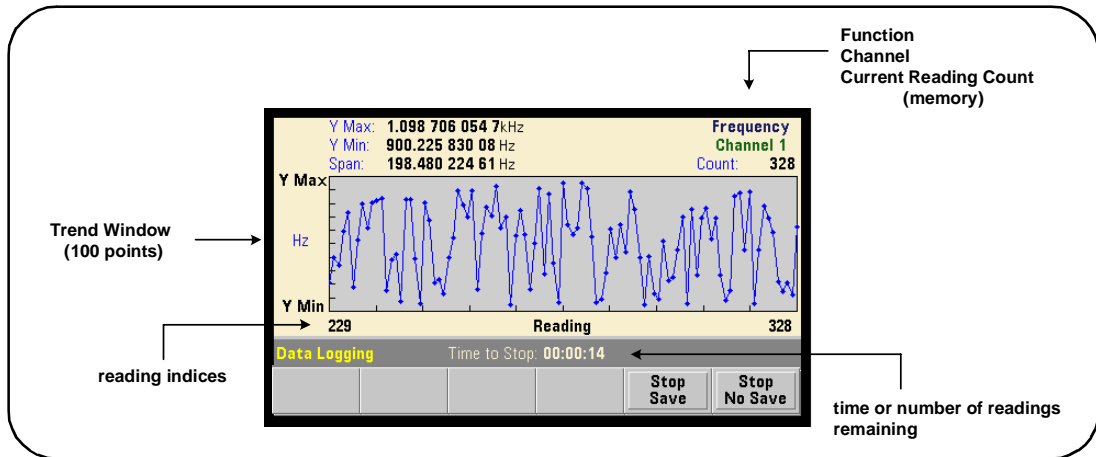

Figure 6-12. Trend Chart Display During Data Logging.

When logging is complete, the Marker, Pan, and Zoom softkeys can be used to review the data. Note that pressing the Graph key followed by the Trend Chart softkey does not retain the data in the display.

If greater than 100 readings are logged the readings are decimated - grouped together and represented by decimation points (see “Trend Charts” and “Reading Decimation”).

Stopping the Application

Pressing Stop Save or Stop No Save stops data logging before the duration (time or number of readings) is reached. All readings logged to that point are saved or discarded depending on the key pressed.

Graphics Functions and Reading Memory

Figure 6-13 summarizes the effects on reading memory when statistics and histograms are reset, and when trend charts are cleared.

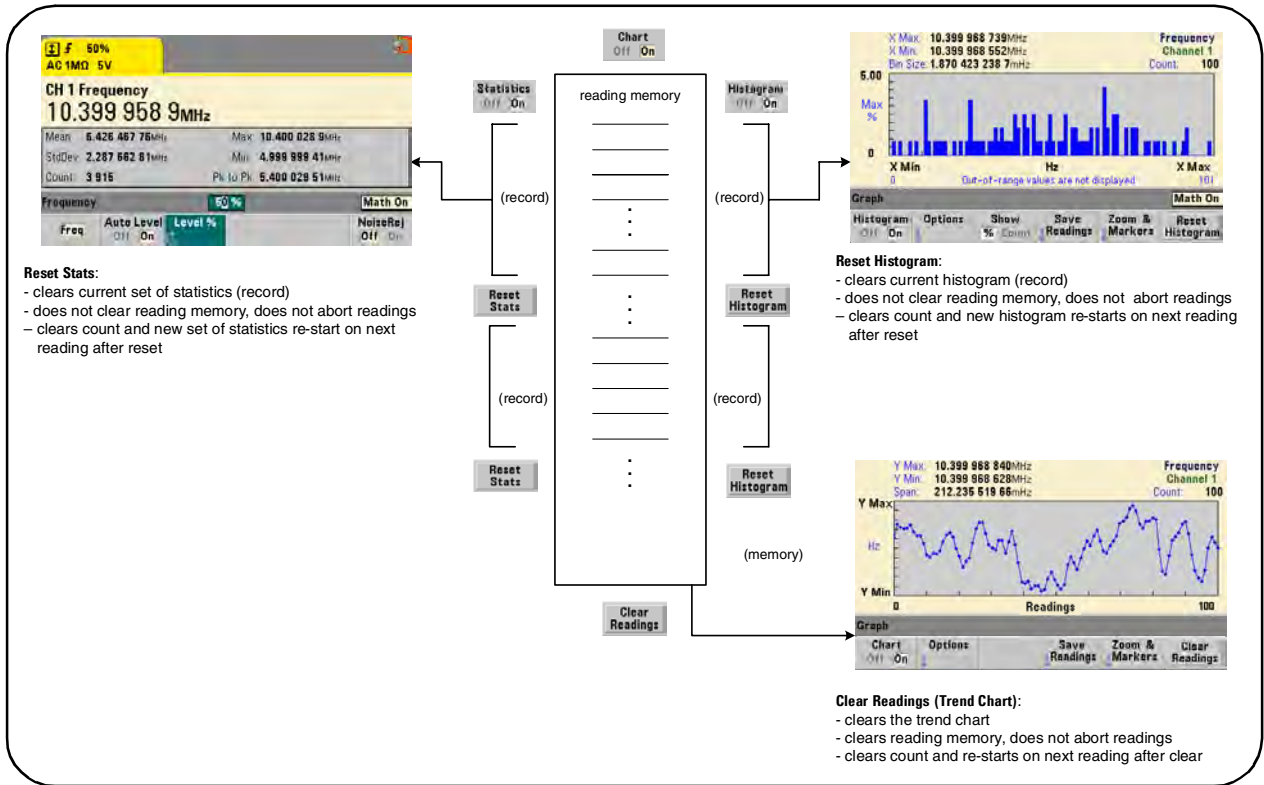
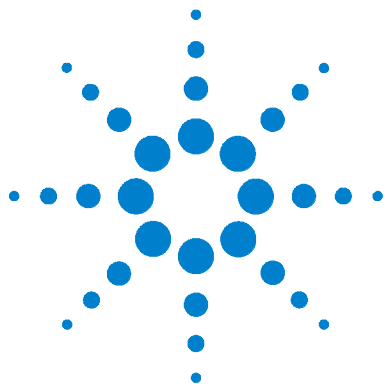

Figure 6-13. Reading Memory and Resetting/Clearing Graphics.



7 Formats and Data Flow

Reading Formats and Data Flow	174
Specifying a Format	175
Setting the Block Transfer Byte Order	175
Data Flow	176
Counter File System	183
Creating Folders and Files in Flash Memory and on the USB Drive	185
User-Defined Power-On States	194
Managing Folders and Files	197

The Agilent 53210A counter allow you to specify the measurement (reading) format and storage location - both of which affect throughput speed.

This chapter explains how data formats are set and the movement and storage of measurements and other information within the instrument.



Reading Formats and Data Flow

A (counter) data format is specified when a particular format (ASCII, REAL) is required. The data is converted to that format when sent to the output buffer directly, or when transferred **from** reading memory.

The command used to set the data format is:

```
FORMat[:DATA] {ASCII|REAL}[,<length>]
FORMat[:DATA]?
```

(query form)

The formats (and lengths) are described in Table 7-1.

Table 7-1. Counter Data Formats

Type	Representation	Length
ASCII	+4.57538162393720E+006	15 (digits)
REAL	definite length or indefinite length arbitrary block format	64 (bits)

Format **ASCII** are ASCII characters. Each reading is comma-separated. The instrument always returns **15 significant digits**.

Format **REAL** is IEEE 754 binary data (**64-bit**). The data may be transferred in IEEE 488.2 indefinite-length or definite-length block format. Byte order is controlled by the FORMat:BORe command.

Indefinite-Length Block: # 0 < 8-bit data bytes > NL ^END
(using MEASure?, READ?, FETCh?)

Definite-Length Block: # <non-zero digit> <block length> <8-bit data bytes>
(using R?, DATA:REMOve?)

<non-zero digit> indicates the number of digits representing <block length>. <block length> indicates the number of 8-bit data bytes which follow.

Format ASCII is set following an instrument reset (*RST) or front panel preset (PRESet). A line feed (LF) and End-Of-Identify (EOI) follow the last reading in both formats.

Specifying a Format

Data formats can be specified during counter configuration as shown in the following segment:

```
CONF:FREQ 1.0E6
      FORM REAL, 64
SAMP:COUN 5
INIT
FETC?
```

In this segment, measurements initiated by INIT are stored in reading memory. When FETC?(ed) from memory to the output buffer the readings are converted to REAL format.

Setting the Block Transfer Byte Order

Indefinite-length and definite-length REAL (binary) data transfers (Table 7-1) associated with the READ?, FETCh?, R?, and DATA:REMOve? commands have a default byte order of NORMAl in which the most-significant byte (MSB) is sent first (big-endian byte order). The command used to specify or change the byte order is:

```
FORMat:BORDER {NORMAl | SWAPped}
FORMat:BORDER?                                     (query form)
```

With the SWAPped byte order the least-significant byte of each data point (reading) is sent first (little-endian byte order). Most PCs use the swapped (little-endian) byte order.

Following a reset (*RST) or front panel preset (Preset), the byte order is set to NORMAl.

Reading Transfer Size

Each reading read from the output buffer in ASCII format is 23 bytes. Each readings in REAL format is eight bytes.

Data Flow

The flow of measurement data within the counter is summarized in Figure 7-1.

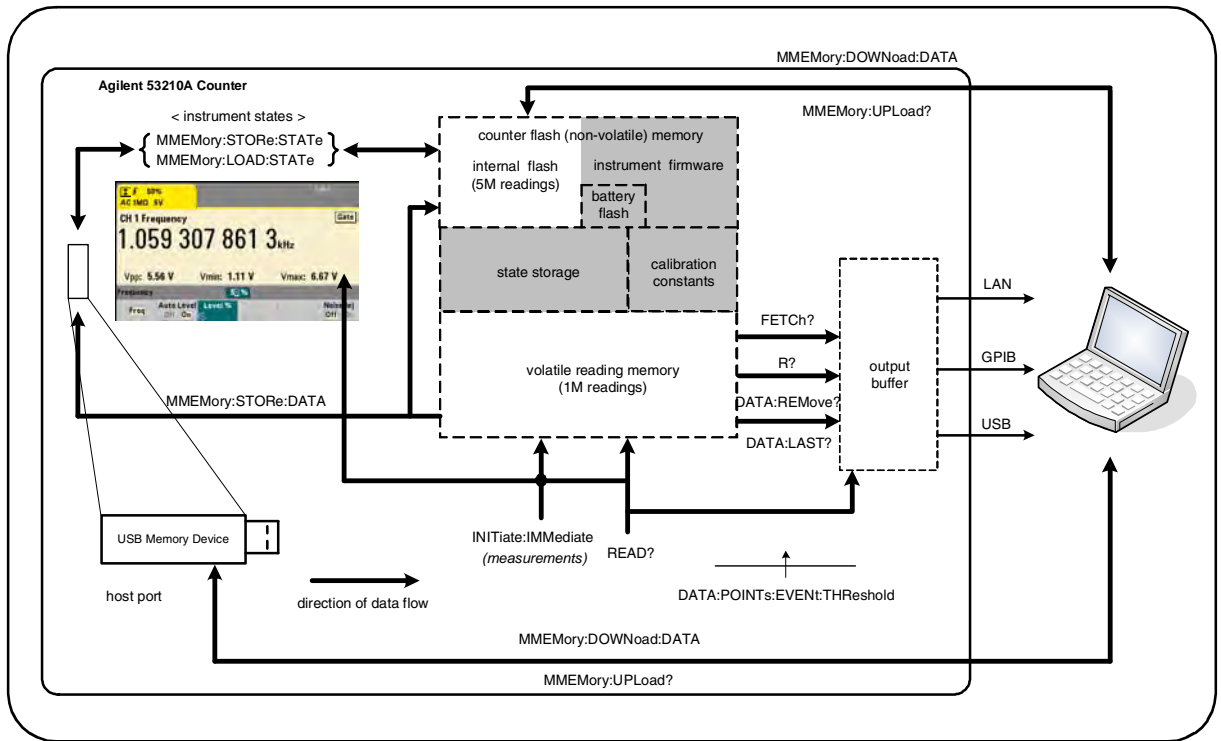

Figure 7-1. Data Flow within the 53210A Counter.

Reading locations include the **front panel**, **reading memory** (volatile), **output buffer**, **internal flash memory** (non-volatile), and **external USB memory**.

The commands which determine data flow are listed in Table 7-2 and are described in the following paragraphs.

Table 7-2. Commands Affecting Data Flow

Command	Locations Accessed	Readings Transferred	Reading Memory Cleared	Allowed during Measurement
Read?	Front Panel Reading Memory Output Buffer	All	No	No
INITiate:IMMediate	Front Panel Reading Memory	None	Yes	No
FETCh?	Reading Memory Output Buffer	All	No	No
R?	Reading Memory Output Buffer	All or specified count	Yes	Yes
DATA:REMove?	Reading Memory Output Buffer	Specified Count	Yes	Yes
DATA:LAST?	Reading Memory Output Buffer	1	No	Yes
MMEMORY:STORe:DATA	Reading Memory Internal Flash External USB	All	No	No

Front Panel Display

Counter measurements taken from the **front panel** or from an IO interface appear in the display as indicated in Figure 7-1. See Chapter 1 for an overview of display features.

Reading Memory

In addition to being displayed, all counter readings are stored in the counter's **volatile reading memory** (Figure 7-1). Memory capacity is 1,000,000 readings. Reading memory has the following attributes:

- 1 reading memory is cleared after a function change, during execution of the **READ?**, **INITiate:IMMediate**, or **MEASure?** command, after cycling power, or following an instrument reset (***RST**) or preset (**SYSTem:PRESet**).

- 2 all readings are **stored** in an internal counter format - the programmed format (FORMat subsystem) is set when readings are transferred to the output buffer.
- 3 if **reading memory** overflows the first (oldest) readings are overwritten and the 'Reading Mem Ovfl' bit (14) in the Questionable Data Register is set. The most recent measurements are retained.

Output Buffer

Data is available to the PC over the LAN, USB, and GPIB interfaces once it is in the output buffer (Figure 7-1). The following section explains how readings are transferred from memory to the buffer. If during a transfer the **output buffer** fills, command execution is paused until readings are removed by the PC - creating room in the buffer. No readings are lost.

Transferring Readings from Memory to the Output Buffer

The following commands transfer readings from volatile reading memory to the buffer.

READ? - is equivalent to executing INITiate:IMMediate directly followed by FETCh?. With READ?, once **all** readings specified by TRIGger:COUNT and SAMPlE:COUNT are complete and in memory, they are instantaneously read into the **output buffer** (Figure 7-1).

If the data format is REAL (FORMat subsystem), each block of readings generated by READ? is preceded by an IEEE 488.2 Indefinite-Length block header (Table 7-1). As such, when sending multiple commands in a single command string, READ? should always be the last command in the string.

READ? Example

```
// frequency meas of 500 kHz signal with uHz resolution
CONF:FREQ 500E3, 1E-6, (@1) // configure counter
    TRIG:COUN 1           // set trigger count
    SAMP:COUN 10          // take 10 readings
READ?                  // read readings when complete
```

FETCh? - is used following **INITiate:IMMEDIATE**. After **all** measurements specified by **TRIGger:COUNT** and **SAMPlE:COUNT** are complete, **FETCh?** transfers the readings from reading memory to the output buffer. Since **reading memory is not erased** by this action, readings can be “fetched” from memory multiple times. If there are no readings available or measurements in progress when a “fetch” is performed, err -230, “Data corrupt or stale” is generated.

If the data format is **REAL** (**FORMat** subsystem), each block of readings fetched by **FETCh?** is preceded by an IEEE 488.2 Indefinite-Length Block header (Table 7-1). When sending multiple commands in a single command string, **FETCh?** should always be the last command in the string.

FETCh? Example

```
// frequency meas of 500 kHz signal with uHz resolution
CONF:FREQ 500E3, 1E-6, (@1) // configure counter
    TRIG:COUN 1           // set trigger count
    SAMP:COUN 10          // take 10 readings
INIT:IMM                // initiate counter to start rdgs
FETCh?                 // fetch rdgs from memory when complete
```

R? [<max_count>] - is used following **INITiate:IMMEDIATE**. Transfers all, or **up to** the specified **max_count** number of readings to the output buffer and **erases** those readings (beginning with the oldest) in reading memory.

Unlike **FETCh?**, **R?** can be used to transfer readings before the total reading count is reached (**TRIGger:COUNT** x **SAMPlE:COUNT**) to prevent a memory overflow. If there are no readings available or measurements in progress when “R?” is sent, err -230, “Data corrupt or stale” is generated.

Readings are transferred in Definite-Length Block format (Table 7-1), whether in ASCII or **REAL** (binary) format (**FORMat** subsystem). The ‘oldest’ reading is transferred first (first in - first out).

R? Example

```
// frequency meas of 500 kHz signal with uHz resolution
CONF:FREQ 500E3, 1E-6, (@1) // configure counter
    TRIG:COUN 2           // set trigger count
    SAMP:COUN 2500       // set readings/trigger
INIT:IMM                // initiate counter to start readings

wait 2500 seconds

R? 2500                // read and remove first 2500 readings

wait 2500 seconds

R?                    // read and remove all remaining readings
```

DATA:REMOve? <count>[,WAIT] - is used following **INITiate:IMMediate**. Transfers **count** number of readings to the output buffer and **erases** the readings in reading memory. Unlike **FETCh?**, **DATA:REMOve?** can be used to transfer readings before the total reading count is reached (**TRIGger:COUNT** x **SAMPle:COUNT**) to prevent a memory overflow. However, **count** is a required parameter and, therefore, **count** number of readings must be available before they can be removed. Including **WAIT** will cause the command to wait until **count** readings are available. This will prevent error -222, "Data Out of Range" from occurring if the specified count is not available.

If the data format is **REAL** (**FORMat** subsystem), the readings are transferred in Definite-Length Block format (Table 7-1). The 'oldest' reading is transferred first (first in - first out).

DATA:REMove? Example

```
// frequency meas of 500 kHz signal with uHz resolution
CONF:FREQ 500E3, 1E-6, (@1) // configure counter
    TRIG:COUN 2 // set trigger count
    SAMP:COUN 2500 // set readings/trigger
INIT:IMM // initiate counter to start readings
DATA:REM? 2500,WAIT // wait for-read first 2500 readings
DATA:REM? 2500,WAIT // wait for-read last 2500 readings
```

DATA:LAST? - returns the last reading taken and **includes reading units** (Hz, s). The reading is not deleted from memory and the command can be sent before the total reading count (TRIGger:COUNT x SAMPlE:COUNT) is reached.

DATA:LAST? Example

```
//frequency meas of 500 kHz signal with uHz resolution
CONF:FREQ 500E3, 1E-6, (@1) // configure counter
    TRIG:COUN 1 // set trigger count
    SAMP:COUN 100 // take 100 readings )
INIT:IMM // initiate counter to start rdgs
```

wait 20 seconds

```
DATA:LAST? // retrieve reading (with units) 20s after start
FETC? // fetch all rdgs from memory when complete
```

A typical response showing a subset of the data is:

```
+4.999962418998650E+005 HZ
...+4.999962370997962E+005, +4.999962418998650E+005, +4.9999
62407190446E+005, +4.999962443559675E+005, ...
```

Querying the Reading Count

The total number of readings in memory at any given time can be determined with the command:

DATA:POINTS?

The reading count can be read before the total reading count is reached (TRIGger:COUNT x SAMPlE:COUNT).

Setting a Reading Threshold in Memory

The following command allows you to set a reading threshold in the counter's volatile memory:

```
DATA:POINTS:EVENT:THReshold <count>
```

```
DATA:POINTS:EVENT:THReshold?
```

(query form)

- when **count** number of readings have entered reading memory, bit 12 (Rdg Mem Threshold) in the Standard Operation Register is set to '1'. By monitoring this bit, readings can be transferred from memory to the output buffer once a given number of measurements have occurred.

Once the threshold is reached, the number of readings in memory must drop below the threshold level in order to detect when the threshold is reached again.

Memory Threshold Example

(Note, this example is also contained on the Agilent 53210A/53220A/53230A Product Reference CD ROM.)

This program sets up the counter to take 1,250,000 readings. Because volatile reading memory capacity is 1,000,000 readings, readings will be over-written (memory overflow) if data is not retrieved before memory fills. To prevent memory overflow, a reading threshold is set and monitored. When the number of readings in memory reaches the threshold, all readings in memory at that time are retrieved.

```

*RST;*CLS // reset, start from known state
SYST:TIM .001 // set a 1 ms measurement timeout
CONF:FREQ 1E6, 0.1, (@1) // configure measurements
    TRIG:COUN 5 // send 5 system triggers
    SAMP:COUN 250E3 // take 250k readings/trigger
    FORM:DATA REAL, 64 // set data format to binary
    DATA:POIN:EVEN:THR 10E3 // set memory threshold to 10k
INIT // initiate readings
// loop until all readings complete
For (cnt=0;cnt<1.25E6;cnt +=10000)
    Do
        {spoll=STAT:OPER:COND?; // serial poll condition reg
        sleep (100) // wait 100 ms
        }while !(spoll&4096) // repeat until threshold is reached
R? 10E3 // retrieve readings from memory 10k at a time

```

Counter File System

Measurements in volatile reading memory and counter configuration states can be stored in files within the counter's **internal** (non-volatile) flash memory, or on a **external** USB memory device connected to the 'host' port on the front panel (Figure 7-1).

Files are created within folders on the root directory, or within sub-folders relative to the root directory. The relationship of folders and files in internal flash memory and on the USB drive is shown in Figure 7-2.

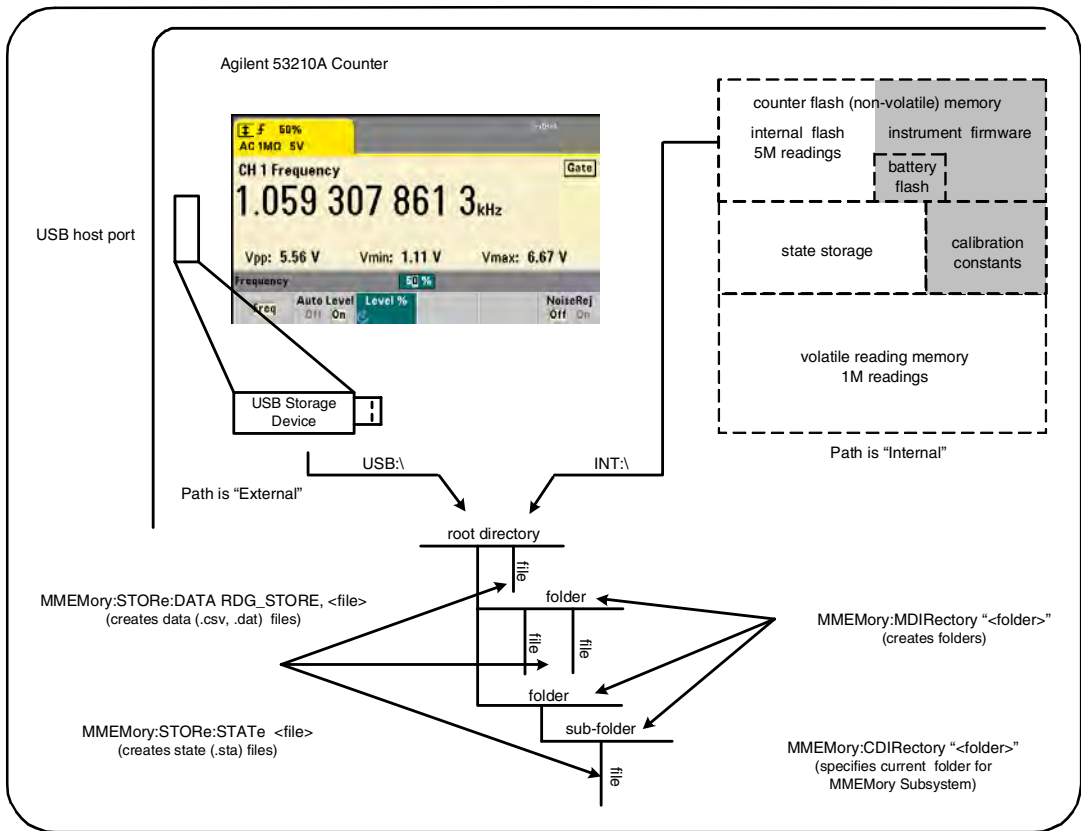
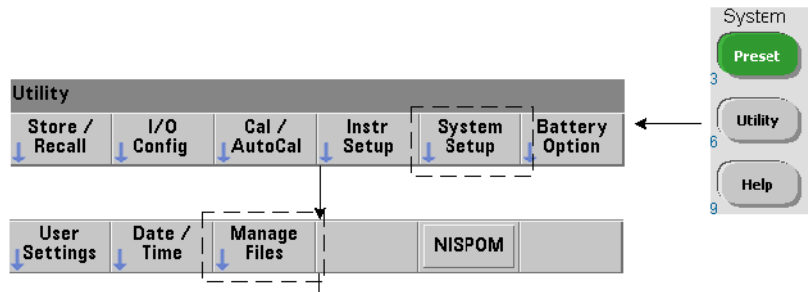

Figure 7-2. Folders and Files within Internal Memory and USB Storage.

Creating Folders and Files in Flash Memory and on the USB Drive



Folders and files are created in instrument memory and on a USB drive as described in the following sections.

Creating Folders

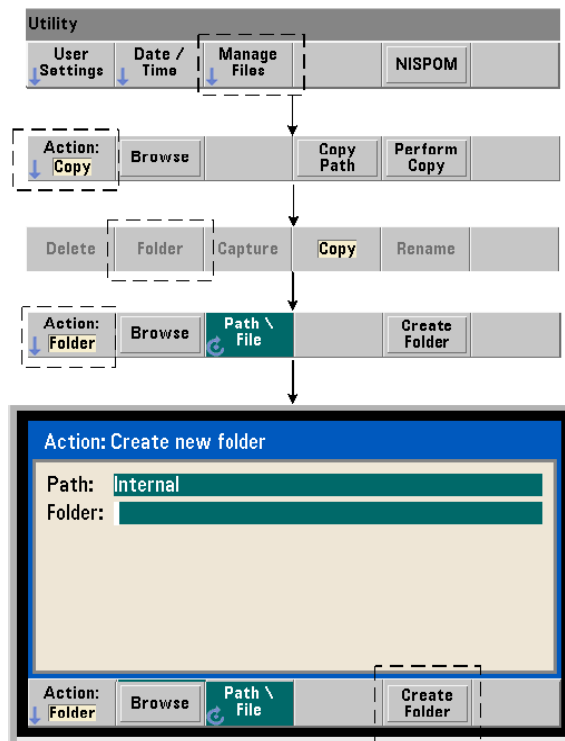

Folders and sub-folders are created using the command:

```
MMEMemory:MDIRectory "<folder>"
```

- **folder** has the form drive:path. drive is either INT (internal flash memory) or USB (external memory device). path is an absolute path and folder name beginning with \ or /. INT:\ is the default drive:path.

The folder parameter cannot exceed 240 characters, and the characters \ / : * ? " < > | cannot be contained within the folder name. To create a folder:

```
//create folder 'dut_1' with sub-folder 'data1' in the root
//directory of internal flash memory
MME:MDIR "INT:\dut_1"
MME:MDIR "INT:\dut_1\data1"
```

Note that a folder and sub-folder cannot be created within the same command.

Entering a Folder Name from the Front Panel

With the "Create new folder" window displayed as shown on the previous page, enter a folder name (or any file name) as follows:

- 1 Press the 'Browse' soft key and use the front panel knob to highlight the counter's internal flash memory (Internal), or if present, the USB drive connected to the front panel host port (External). Press the 'Select' soft key to select the drive.
- 2 To create a folder name, rotate the knob to select a character. The knob scrolls through A-Z (upper case), a-z (lower case), numbers 0-9, selected keyboard characters, decimal point (.), underscore (_), and space. Once the desired character is set, press the right arrow (>) key under the knob to move to the next position.
- 3 Repeat until the folder name is complete. Use the left arrow key (<) to backspace and change a character. Changing the character to a space erases the character. Press 'Create Folder' to create the folder.

Specifying a Default Folder

Designating a folder as the default (current) folder eliminates the need to specify an absolute path each time a sub-folder or file is created or referenced. The command:

```
MMEMemory:CDIRectory "<folder>"
MMEMemory:CDIRectory? (query form)
```

selects **folder** as the **current folder** used by subsequent **MME**Memory subsystem commands. **folder** is of the form `drive:path` (see **MME**Memory:DIRectory for `drive:path` details).

For example, an alternate way to create folders `dut_1` and `data1` is:

```
//create folder 'dut_1' and select it as the current folder
//create sub-folder 'data1'
MMEM:MDIR "INT:\dut_1"
MMEM:CDIR "INT:\dut_1"
MMEM:MDIR "data1"
```

When specifying a folder name the **current** folder is referenced. If a **current** folder (**MME**M:CDIR) **has not** been specified and a drive name (INT or USB) is not included, the default drive 'INT:' is referenced. For example:

```
MMEM:MDIR "dut_2"
```

creates the folder 'dut_2' on the root drive INT.

Following a reset (*RST) or instrument preset (SYSTEM:PRESet), the counter resets the current folder to the root directory on the internal flash file system ("INT:\").

Creating Data Files

See "Histograms" or "Trend Charts and Data Logging" in Chapter 6 for information on storing measurement data from the front panel.

The command used to transfer data from reading memory to a file in internal flash memory or on a USB device (Figures 7-1 and 7-2) is:

```
MMEemory:STORe:DATA RDG_STORE, "<file>"
```

<file> is created during execution of the command and the file parameter format is "[drive:path]<file_name>". drive is either INT (internal flash memory) or USB (external memory device). path is an absolute path and folder name. If a folder is specified, it must have been previously created.

The combination of folder and file name cannot exceed 240 characters, and cannot contain the characters \/:*?"<>|.

The format of the transferred readings is specified by the file_name extension. If **.csv** is specified, the data is stored as comma-separated values (CSV) in one measurement per line ASCII format. If **.dat** is specified, the data is stored as REAL values with little-endian byte order.

The following sequence of commands creates a folder on a USB memory device, takes a set of frequency measurements, and then creates a file and copies the measurements to the folder from (volatile) reading memory.

Creating a Data File Example

```
MMEM:MDIR "USB:\dut_1" // create folder in USB memory
MMEM:CDIR "USB:\dut_1" // specify a current folder
CONF:FREQ 100E3,(@1) // configure measurement
      SAMP:COUN 50 // set 50 measurements
INIT // initiate measurements
*WAI // wait for readings to complete
MMEM:STOR:DATA RDG_STORE, "data1.csv" // create file, copy
```

Creating State Files

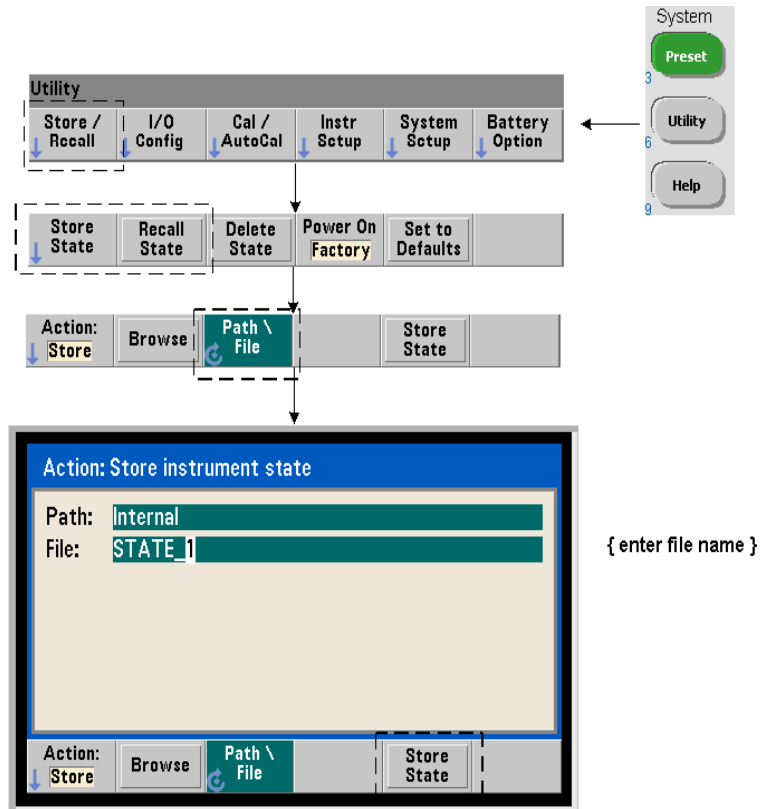

Instrument states can be stored in the instrument's internal flash memory or on a USB memory device and recalled later to restore a specific configuration (Figure 7-2).

The commands used to store and load counter states are:

```
MMEMemory:STORe:STATe <"file">
MMEMemory:LOAD:STATe <"file">
```

<file> is created during execution of the STORe command. The parameter format is "[drive:path]<file_name>". drive is either INT (internal flash

memory) or USB (external memory device). path is an absolute path and folder name. If a folder is specified, it must have been previously created (see MMEemory:MDIRectory).

The combination of folder and file name cannot exceed 240 characters, and cannot contain the characters \ / : * ? " < > |. State files have a .sta extension.

State File Example

The following example shows the interaction between folders created from the front panel and state files created/stored programmatically. For this sequence, folder SETUP_1 was created on the internal flash drive from the **front panel**. It is then specified (programmatically) as the current folder and a state file is stored and recalled from that folder.

```
MMEM:CDIR "INT:\SETUP_1"          // specify as current folder
configure instrument programmatically or from front panel

MMEM:STOR:STAT "test1.sta" // store the configuration
recall the configuration (state) at later date (even if
power is cycled)...

MMEM:LOAD:STAT "INT:\SETUP_1\test1.sta" // load state
```

Saving States from the Front Panel

With the instrument **configured as required**, the state is stored from the front panel as follows:

- 1 Use the Utility key and soft keys indicated on the previous page to set file action 'Store'.
- 2 Press the 'Browse' soft key to display the 'File System' window. Use the front panel knob to highlight the root directory or a folder in the counter's internal flash memory (Internal) or on the USB drive (External). If folders are not visible, press 'Browse' again to view the directory structure.

Press the 'Select' soft key to select the directory or folder.

- 3 Enter the file name. The knob scrolls through A-Z (upper case), a-z (lower case), numbers 0-9, selected keyboard characters, decimal point (.), underscore (_), and space. Once the desired character is set, press the right arrow (>) key under the knob to move to the next position.
- 4 Repeat until the file name is complete. Use the left arrow key (<) to backspace and change a character. Changing the character to a space erases the character.
- 5 Press 'STORE STATE' to store the state under the file name defined. A .sta extension is added to the file name.
- 6 States (state files) are recalled by pressing the 'RECALL STATE' soft key, highlighting the file name, and pressing 'Select'. The state is recalled immediately.

Storing User Preferences

Non-volatile I/O settings and user preferences can be stored and recalled using the commands:

```
MMEMemory:STORe:PREFeRences <file>
MMEMemory:LOAD:PREFeRences <file>
```

<file> is created during execution of the STORe command. The parameter format is "[drive:path]<file_name>". drive is either INT (internal flash memory) or USB (external memory device). path is an absolute path and folder name. If a folder is specified, it must have been previously created (see MMEMemory:MDIRectory).

The combination of folder and file name cannot exceed 240 characters, and cannot contain the characters \ / : * ? " < > |. Preference files have a .prf extension.

User preferences include settings such as:

- display brightness, radix, separator, and screen saver state
- Help language selected
- state recall and select settings
- reference oscillator source, external reference frequency, standby setting
- auto-level minimum frequency
- battery state (enabled, disabled)
- beeper setting
- measurement time out
- 531xx SCPI compatibility language setting

When loading a preferences file that specifies a static IP address for LAN, be careful that this does not result in two instruments with the same IP address on your LAN. This could result in LAN configuration errors on both instruments.

User preferences **cannot** be stored or loaded (retrieved) using the front panel.

Using *SAV and *RCL

Additional commands that can be used to save and recall instrument states are the IEEE-488.2 common commands *SAV and *RCL. With these commands, up to five states can be saved and recalled by **location number** from the counter's internal flash memory. States saved using this method can also be specified for recall at power-on.

***SAV** {0|1|2|3|4}

Saves the current instrument state in one of five {0|1|2|3|4} flash memory state locations. State location '0' is a valid location; however, the instrument state at **power-down** is automatically saved in location '0' and will overwrite any state saved there. All parameters of the counter's state are saved with the exception of "user-preference" parameters such as those which configure the front panel display.

An example of the command is:

```
*SAV 1 //save the current state in state location 1
```

State locations 0-4 are represented by the following file names in the root directory of internal flash memory:

```
STATE_0.sta
STATE_1.sta
STATE_2.sta
STATE_3.sta
STATE_4.sta
```

Saved counter states are recalled using the command:

```
*RCL {0|1|2|3|4}
```

{0|1|2|3|4} are the five state locations. An example of the command is:

```
*RCL 1 //recall the configuration from state location 1
```

When recalling a state using *RCL, only the **location number** is specified.

When recalling a numbered state location from the **front panel**, the location file name is used (e.g. STATE_1.sta).

See “User-Defined Power-On States” for more information.

Verifying a Recalled State Before a state is recalled, its storage location can be queried to determine if a valid state exists or if the location is empty.

```
MEMory:STATe:VALid? {0|1|2|3|4}
```

queries the specified state location. If ‘0’ is returned the location is empty. If ‘1’ is returned a valid state exists. For example:

```
//verify a valid state is stored in location 3; 0 = no state
//saved, 1 = valid state in location 3
MEM:STAT:VAL? 3
```

User-Defined Power-On States

The 53210A counter can be set to power-up from one of five saved state locations or from a state file (Figure 7-2). For this to occur:

1. the state must currently be **saved**
2. recall must be **enabled**
3. the state location or file name must be **selected**

This sequence is provided by the following commands:

```
//save state in instrument state locations 0-4
*SAV {0|1|2|3|4}
```

or

```
//store state in state file (.sta) - internal or USB
MMEemory:STORe:STATe <"file">
```

```
//enable automatic recall at power-on
MEMory:STATe:RECall:AUTO {ON|OFF}
MEMory:STATe:RECall:AUTO? (query form)
```

```
//select the state location or file recalled at power-on
MEMory:STATe:RECall:SELEct {0|1|2|3|4|<file>}
MEMory:STATe:RECall:SELEct? (query form)
```

If automatic recall is **enabled** and a state location or file name is **not selected**, the counter will power-on in the state it was in when last turned off (location 0).

Following are examples of a state recalled from a numbered state location and from a state file in internal flash memory.

```

// configure counter

*SAV 2           // save state in location 2
MEM:STAT:REC:AUTO ON // enable state recall at power-on
MEM:STAT:REC:SEL 2 // recall state in loc. 2 at power-on

// when power is cycled, state in location 2 is recalled

and

MMEM:MDIR "INT:\SETUP_A" // create folder in INT memory

//configure counter

// store state in file
MMEM:STOR:STAT "INT:\SETUP_A\test_A.sta"
MEM:STAT:REC:AUTO ON // enable state recall at power-on
MEM:STAT:REC:SEL "test_A.sta" // recall file at power-on

//when power is cycled, state test_A.sta is recalled

```

NOTE

When shipped from the factory, automatic state recall is **disabled** (MEM:STAT:REC:AUTO OFF). With state recall disabled, factory defaults (*RST) are set at power-on.

Specifying Power-On States from the Front Panel

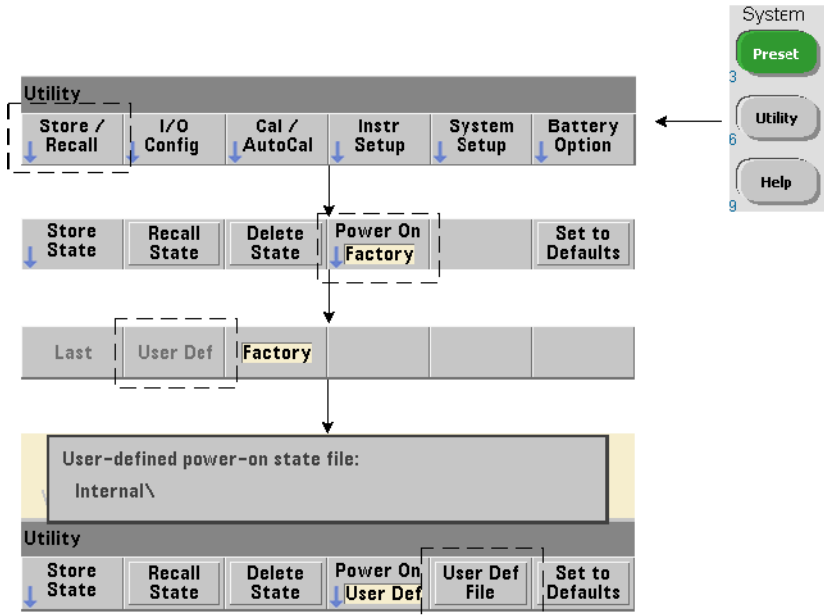

A specific power-on state can be selected from the front panel as follows:

- 1 From the Store/Recall menu, select User Def using the 'Power On' soft key.
- 2 Press User Def File to view the file system. Select the desired state to be set at power-on by selecting the desired folder and file name. Remember that instrument state locations 0-4 are identified by file name (e.g. STATE_3.sta). For states saved in other files (locations), specify the appropriate file with the .sta extension.

Selecting Last using the 'Power On' soft key will recall the instrument state at the time the counter was last turned off (state location 0). With Factory selected, the counter will power-up in its factory-set state.

Managing Folders and Files

Folders, data files, and state files created in internal flash memory and on a USB storage device can be managed (i.e. deleted, copied, moved, cataloged) from the front panel or using additional commands within the `MMEMemory` and `MEMemory` subsystems.

Deleting Folders

Folders are deleted (removed) using the command:

```
MMEMemory:RDIrectory "<folder>"
```

When deleting a folder from an **I/O interface**, the folder must be empty (containing no sub-folders or files). The folder designated as the current folder (`MMEMemory:CDIrectory`) cannot be deleted. From the **front panel**, un-empty folders **can** be deleted (as prompted) as can the (SCPI designated) current folder.

Deleting a Folder Example

The following example deletes a sub-folder (empty) followed by its root folder.

```
//create USB folder `dut_2` and sub-folder `data2`
MMEMemory:MDIR "USB:\dut_2"
MMEMemory:MDIR "USB:\dut_2\data2"
//remove sub-folder `data2` then remove folder `dut_2`
MMEMemory:RDIR "USB:\dut2\data2"
MMEMemory:RDIR "USB:\dut_2"
```

Deleting Files

Data and state files located on the instrument's internal flash drive or on a USB memory device (Figure 7-2) are deleted using the command:

```
MMEMemory:DElete <"file">
```

The file format is "[drive:path]<file_name>". drive is either INT (internal flash memory) or USB (external memory device). If the file deleted is not

in the specified current directory, path is an absolute folder path beginning with ‘\’ and starting at the root folder. The file name must include the file extension. For example:

```
\\ delete data file data1.csv in USB folder dut_1
MEMEM:DEL "USB:\dut_1\data1.csv"
```

State files saved in state locations 0 - 4 can also be deleted with the commands:

```
MEMory:STATe:DELEte {0|1|2|3|4}
MEMory:STATe:DELEte:ALL
```

```
//delete the contents of state location 2
MEM:STAT:DEL 2
```

```
//delete the contents of all numeric state locations
MEM:STAT:DEL:ALL
```

Deleting Folders and Files from the Front Panel

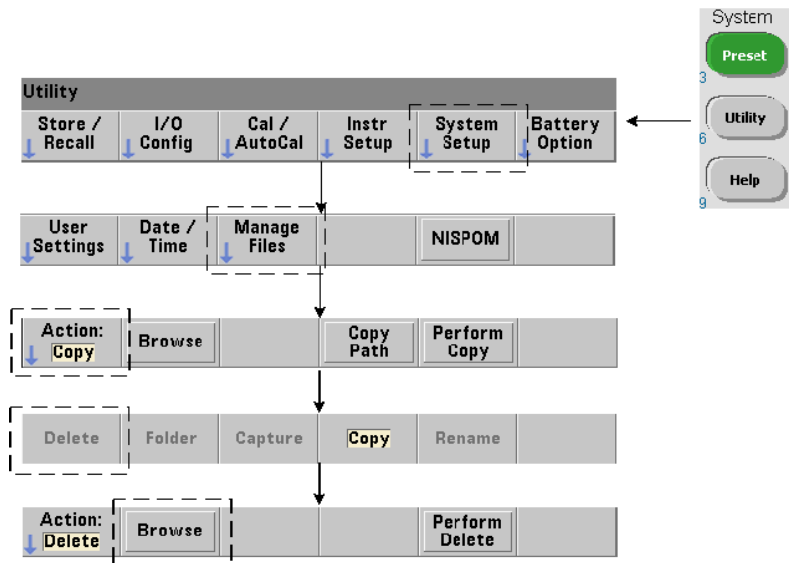

Folders and Files are deleted using the front panel as follows:

- 1 After pressing the 'Manage Files' softkey, press the ' Action' softkey and select 'Delete'. (The action should be selected first.)
- 2 Press the 'Browse' softkey and use the front panel knob to highlight the drive, folder, or file, and then press 'Select'. Press 'Browse' again to view (and select) the contents within a folder.
- 3 When folder or file appears in within the Path: or File: window, press 'Perform Delete'.

Deleting State Files

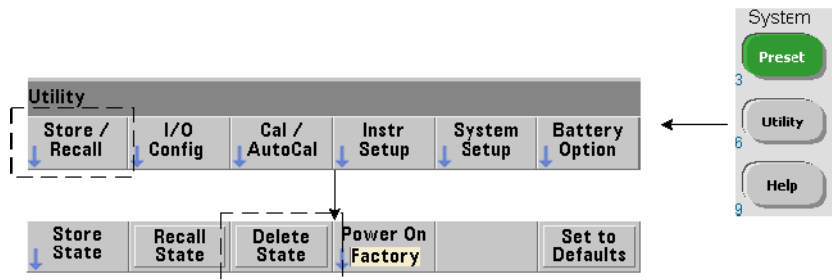

Additionally, state files can be deleted as follows:

- 1 Press the 'Store/Recall' softkey to display the state menu.
- 2 Press 'Delete State' to open the File System window. All state files (.sta extension) on the root drive and within directories are listed. Use the front panel knob to highlight the desired file.
- 3 Press 'Select' to delete the file. **Note, pressing 'Select' deletes the state file immediately.**

Copying and Moving Files

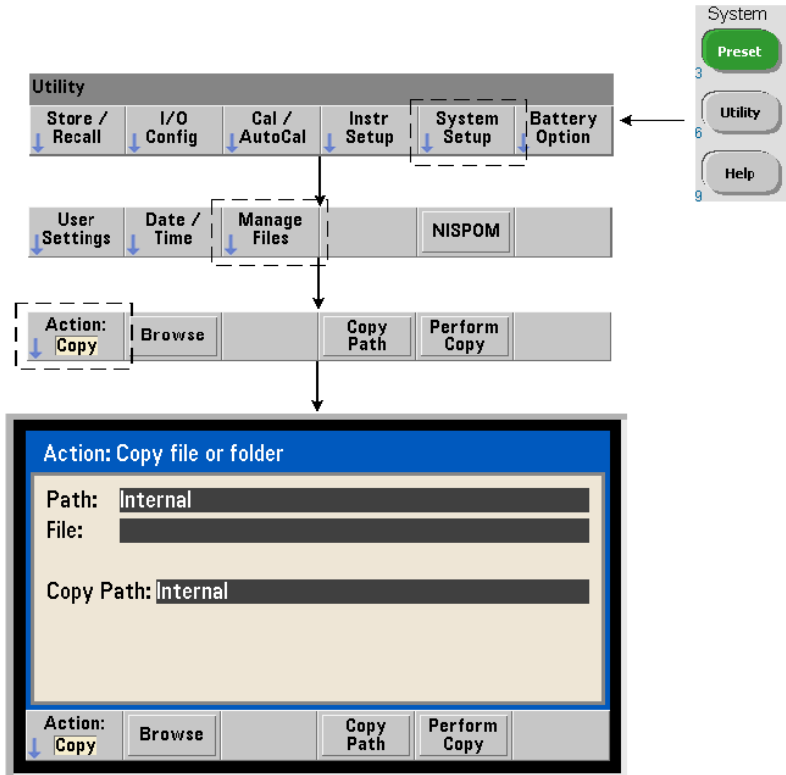

Files can be copied or moved within the drive or between drives.

```
MMEMemory:COPY <"file1">, <"file2">
```

```
MMEMemory:MOVE <"file1">, <"file2">
```

copies or moves (source) file1 to (destination) file2. The file format is “[drive:path]<file_name>”. drive is either INT (internal flash memory) or USB (external memory device). If the file copied or moved is not in the specified current folder (MME**Memory**:CDIRectory), path in the source and destination drives must be an absolute folder path beginning with ‘\’. File names must include the extension.

The destination **folder** in the copy or move command must currently exist. The folder is not created during the copy or move.

The following examples show different locations to which files may be copied:

```
//copy file from folder to root of USB drive
MMEM:COPY "INT:\dut_1\state1.sta" , "USB:\"

//move file from folder to root of USB drive
MMEM:MOVE "INT:\dut_1\state1.sta" , "USB:\"

//copy file from INT folder to existing USB folder
MMEM:COPY "INT:\dut_1\state1.sta" , "USB:\duts"

//copy file from folder to existing folder - new file name
MMEM:COPY "INT:\dut_1\state1.sta" , "USB:\duts\s1.sta"

//rename file from state1.sta to state2.sta
MMEM:MOVE "INT:\dut_1\state1.sta" , "INT:\dut_1\state2.sta"
```

Copying Files and Folders from the Front Panel

With file action Copy selected as shown on the previous page, folders and files are copied as follows:

- 1 Press the 'Browse' softkey and use the front panel knob to highlight the *source* folder or file, and then press 'Select'. (Press 'Browse' again to view the contents within a folder.)
- 2 Press 'Copy Path' and highlight the *destination* drive or folder and then press 'Select'. Press 'Perform Copy' to copy the folder or file.

Folder Catalogs

A catalog of **all** sub-folders and files, or **separate** catalogs of **data** (.csv and .dat) and **state** (.sta) files per folder can be obtained using the following commands.

In addition to the list of files, the commands also provide the total amount of

memory used and the total amount of memory available (free) on the specified drive.

```
MMEMemory:CATalog[:ALL]? [<"folder">]  
MMEMemory:CATalog:DATA? [<"folder">]  
MMEMemory:CATalog:STATe? [<"folder">]
```

The folder parameter format is drive:path. drive is either INT (internal flash memory) or USB (external memory device). path is an absolute path and folder name beginning with \. If a folder is not specified, the contents of the specified current folder (MME**Memory**:CDIRectory) or the contents of the drive's root directory are returned.

The format of the data returned is:

```
<total memory used>, <total memory free>, <"file listing">
```

"file listing" with quotes ("") included is further separated into:

```
"<file name>, <file type>, <file size>"
```

Memory used, memory free, and file size are given in bytes. Examples of what the individual CATalog commands might return for a folder on an external USB memory device containing a sub-folder plus a .csv data file, a .dat data file, and a state file are given as follows:

```
MMEMemory:CATalog[:ALL]?  
253657088,519798784,"data1.csv,ASC,12500","state1.sta,STAT,860","  
data2.dat,BIN,1600","dut_a,FOLD,0"
```

```
MMEMemory:CATalog:DATA?  
253657088,519798784,"data1.csv,ASC,12500","data2.dat,BIN,1600"
```

```
MMEMemory:CATalog:STATe?  
253657088,519798784,"state1.sta,STAT,860"
```



8 Instrument Status

Agilent 53210A Status System	205
Questionable Data Register Group	205
Standard Operation Register Group	206
Standard Event Register	208
Status Byte Register	209

This chapter covers the status registers used to monitor conditions within the 53210A counter.



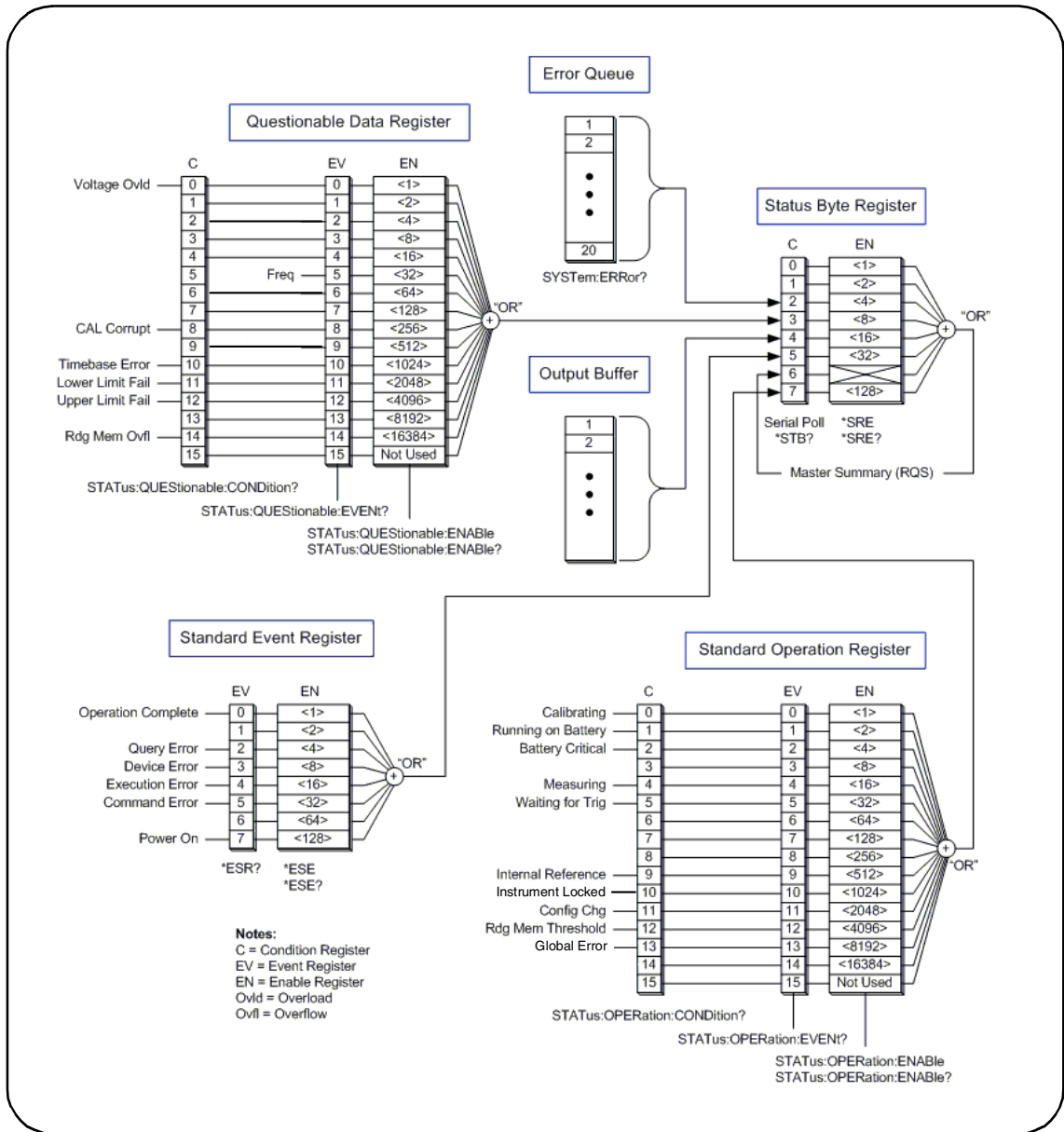

Figure 8-1. The 53210A Status System.

Agilent 53210A Status System

This chapter provides an overview of the 53210A Status System. Refer to the **STATUS** subsystem and the IEEE-488 commands within the Programmer's Reference for bit definitions and additional information. The reference is located on the 53210A/53220A/53230A Product Reference CD (p/n 53220-13601).

Questionable Data Register Group

The counter's Questionable Data Register Group monitors the following conditions and events within the counter:

- input voltage overload
- frequency measurement hardware time out
- calibration data
- time base error
- lower-limit exceeded
- upper limit exceeded
- reading memory overflow

Condition Register

The Condition Register within the Questionable Data Register Group monitors current conditions that may impact the integrity of the counter measurements. The Condition Register is read with the command:

```
STATUS:QUESTIONABLE:CONDITION?
```

Reading the register does not clear the bit(s) in the register. The bit is cleared when the condition is removed.

Event Register

The Event Register within the Questionable Data Register Group also monitors conditions that may impact the integrity of the counter measurements.

The Event Register is read with the command:

```
STATus:QUESTIONable[:EVENT]?
```

Unlike the Condition Register, the bits in the Event Register remain set following the condition that occurred. The bits are cleared by reading the register.

Enable Register

The Enable register specifies which bits in the Event register can generate a summary bit which is subsequently used to generate a service request.

Bits within the Event Register are enabled with the command:

```
STATus:QUESTIONable:ENABLE <enable>
```

```
STATus:QUESTIONable:ENABLE? (query form)
```

- **enable**: decimal value corresponding to the binary-weighted sum of the bits in the register. For example, to enable the bit monitoring possible time base errors: STAT:QUES:ENAB 1024.

Standard Operation Register Group

The counter's Standard Operation Register Group monitors operational conditions within the counter. These include:

- calibration in progress
- battery operation
- battery charge status
- measurement in progress
- waiting for trigger
- internal reference oscillator in use
- remote interface lock and remote interface errors
- configuration change
- reading memory threshold reached

Condition Register

The Condition Register within the Standard Operation Register Group monitors current conditions regarding the operational state of the instrument. The Condition Register is read with the command:

```
STATus:OPERation:CONDition?
```

Reading the register does not clear the bit(s) in the register. The bit is cleared when the condition is removed.

Event Register

The Event Register within the Standard Operation Register Group also monitors the instrument state. The Event Register is read with the command:

```
STATus:OPERation[:EVENT]?
```

Unlike the Condition Register, the bits in the Event Register remain set following the state that occurred. The bits are cleared by reading the register.

Enable Register

The Standard Operation Register Group Enable Register specifies which bits in the Event register can generate a summary bit which is subsequently used to generate a service request.

Bits within the (operational) event register are enabled with the command:

```
STATus:OPERation:ENABLE <enable>
```

```
STATus:OPERation:ENABLE? (query form)
```

- **enable**: decimal value corresponding to the binary-weighted sum of the bits in the register. For example, to enable the bit monitoring low (critical) battery charge: STAT:OPER:ENAB 4.

Standard Event Register

The Standard Event Register monitors programming conditions including:

- operation complete
- query errors
- device errors
- execution errors
- command execution errors
- power-on state

Reading the Standard Event Register

The Standard Event Register is read with the command:

***ESR?**

Reading the register does not clear the bits. The bits are cleared by sending *CLS.

Enabling the Standard Event Register

The Standard Event Enable register specifies which bits in the Standard Event Status register can generate a summary bit which is subsequently used to generate a service request.

Bits within the standard event register are enabled with the command:

***ESE <enable>**

***ESE?** (query form)

- **enable**: decimal value corresponding to the binary-weighted sum of the bits in the register. For example, to enable the bit monitoring command syntax errors: *ESE 32.

*ESE? returns the weighted-sum of all enabled bits.

Status Byte Register

The Status Byte register contains the summary bits of the Questionable Data Register Group, the Standard Operation Register Group, the Standard Event Register, the counter error queue, and the output buffer (Figure 8-1).

The Master Summary RQS bit (Bit 6) is set (1) when any other bit in the Status Byte register is set.

Reading the Status Byte Register

The Status Byte register is read with either of the following commands:

***STB?**

SPOLL

Both commands return the decimal weighted sum of all set bits in the register. The difference between the commands is that *STB? does not clear bit 6 (RQS). The serial poll (SPOLL) does clear bit 6.

All bits in the Status Byte register (except bit 4) are cleared with the command:

***CLS**

Bit 4 is cleared when data is read from the output buffer.

Service Request Enable Register

The Service Request Enable register specifies which (status group) summary bit(s) will send a service request message to the computer.

The bits are specified with the command:

***SRE <enable>**

***SRE?** (query form)

- **enable**: decimal value corresponding to the binary-weighted sum of the bits in the register. For example, to enable the bit representing the Questionable Data Register Group: *SRE 8.

Chapter 7 and Product Reference CD (p/n 53220-13601) contain examples using the STATus subsystem.



Appendix A

53210A Error Messages

Appendix A contains a description of the error messages associated with the 53210A RF counter.



Table A-1. 53210A Error Message Descriptions.

Code	Message	Description
Command Errors		
-100	Command Error	Generic syntax error - a Command Error as has occurred.
-101	Invalid character	An invalid character is present in the command's header or in a parameter.
-102	Syntax error	An unrecognized (misspelled) command was received or separator between parameters is missing.
-103	Invalid separator	An invalid separator (e.g. something other than a comma, space, or semicolon) was received.
-104	Data type error	The wrong data type (number, character, string, expression) was used when specifying a parameter.
-108	Parameter not allowed	More parameters were received than expected for the command header.
-109	Missing parameter	Command requires a parameter or parameters.
-110	Command header error	An error was detected in the command header but more specific information is not available.
-111	Header separator error	An invalid separator follows the command header. A valid separator is usually a (blank) space.
-112	Program mnemonic too long	The command header contains more than 12 characters.
-113	Undefined header	The command header is syntactically correct, but undefined for the instrument.
-114	Header suffix out of range	A numeric suffix included as part of the command header is out of range (e.g. '3' when only '1' or '2' is valid).
-120	Numeric data error	A numeric data element was detected but more specific information is not available.
-121	Invalid character in number	A character other than a number, comma, or decimal point is embedded in the number specified.

-123	Exponent too large	The magnitude of the exponent is greater than 32,000.
-124	Too many digits	The mantissa (the positive fractional part of the number) contains more than 255 digits.
-128	Numeric data not allowed	A number was specified in the command header or in a parameter where numeric data is not allowed.
-130	Suffix error	An error was detected in the suffix (units) of a numeric parameter, but more specific information is not available.
-131	Invalid suffix	The parameter suffix is specified incorrectly (e.g. 10 MZ rather than 10 MHZ).
-134	Suffix too long	A suffix contains more than 12 characters.
-138	Suffix not allowed	A suffix was specified for a numeric parameter when one is not allowed.
-140	Character data error	A character error was detected in the command header or in a parameter, but more specific information is not available.
-141	Invalid character data	Either an invalid character was received, or the character is not valid for the command header.
-144	Character data too long	The character data contains more than 12 characters.
-148	Character data not allowed	A valid character was specified when another data type (numeric, boolean) is required.
-150	String data error	An error was encountered in the string specified, but more specific information is not available.
-151	Invalid string data	A required string parameter was received but is invalid.
-158	String data not allowed	A valid string was specified when another data type (numeric, boolean) is required.
-160	Block data error	An error was encountered in the block data, but more specific information is not available.
-161	Invalid block data	The number of bytes in a definite length data block does not match the number of bytes indicated by the block header.

A 53210A Error Messages

-168	Block data not allowed	A block data element was encountered at an instance where it is not allowed by the instrument.
-170	Expression error	An error was encountered in a parameter expression, but more specific information is not available.
-171	Invalid expression	The expression used to calculate a parameter value is invalid.
-178	Expression data not allowed	An expression was encountered at an instance where it is not allowed by the instrument.
Execution Errors		
-203	Command Protected	A password-protected command or query could not be executed because the command was disabled.
-213	INIT ignored	INITiate:IMMEDIATE was received while the counter is currently initiated.
-221	Settings conflict	The statement appended to the 'Settings conflict' message describes the conflict and how it was resolved.
-222	Data out of range	The parameter value received was outside the range for the given command.
-223	Too much data	The block, element, or string parameter received is valid, but memory limitations prevent command execution.
-224	Illegal Parameter Value	An exact value from a list of choices was expected.
-225	Out of memory; measurement data overrun	Internal buffers are full as data is taken at a faster rate than can be processed. Decreasing the reading rate (gate time) can prevent this error.
-230	Data corrupt or stale	Attempting to retrieve data following a reset or change to the counter configuration.
-240	Hardware error	Most hardware errors are detected at instrument power-on. If a hardware error occurs, cycle power again. If the error remains, contact Agilent.
-241	Hardware missing	The function specified requires optional channel 2. The channel is either missing or incorrectly installed.

-250	Mass storage error; file read/write error	An error occurred reading from, or writing to a file in internal flash memory or on a USB memory device. File space may have been exceeded or the USB device removed before the operation was complete.
-252	Missing Media	Internal flash memory or the USB device was not found during a file operation.
-254	Media full	Internal flash memory or the USB device has no memory space available to create the folder or file, or to perform the file operation.
-256	File or folder name not found	The folder or file name specified in command does not exist.
-257	File name error; invalid character in name	The file or folder name contains an invalid character (\ / : * ? " < >).
-257	File name error; path too long	The combination of the directory path and file name is greater than 239 characters.
-257	File name error; not a folder name	The folder name specified in the memory operation is the name of an existing file.
-257	File name error; path is a folder name	The file name specified in the memory operation is the name of an existing folder.
-257	File name error; file or folder already exists	The name specified when creating a file or folder already exists in internal flash memory or on the USB device.
-257	File name error; relative path not allowed	The “..” convention cannot be used to indicate the parent folder.
-257	File name error; folder is default folder	The folder presently specified as the default/current folder (MMEMory:CDIRectory) cannot be deleted.
-257	File name error; path name missing	The folder or file operation specified does not include a valid path name.
-257	File name error; drive name missing or not recognized	The drive name is missing or is invalid in the path specified. Valid drive names are INT (internal flash memory) and USB (external USB memory device).
-257	File name error; access denied	The folder or file operation requested cannot be performed on a protected or system file.

A 53210A Error Messages

-257	File name error; file too large	The file uploaded to the counter is greater than 1 GByte.
-257	File name error; folder not empty	When deleting a folder from an I/O (remote) interface, the folder must be empty - no sub-folders or files. Un-empty folders CAN be deleted from the front panel.
-257	File name error; unknown file extension	Depending on the memory operation and file type, valid file extensions are .csv, .dat, .sta, and .prf.
Device Specific Errors		
-310	System Error; internal software error	At power-on, the firmware is unable to obtain information from the instrument's non-volatile memory to complete initialization. Cycle power again. Contact Agilent if the error remains.
-310	System Error; failed to erase calibration data in PIC EEPROM	For system errors related to erasing, reading, or writing calibration data, verify that the instrument has the latest firmware revision installed. Firmware updates can be located beginning at the "Technical Support" tab at www.agilent.com/find/53210A . If the error condition remains, contact Agilent.
-310	System Error; failed to erase system information in PIC EEPROM	For system errors related to erasing, reading, or writing system information, verify that the instrument has the latest firmware revision installed. Firmware updates can be located beginning at the "Technical Support" tab at www.agilent.com/find/53210A . If the error condition remains, contact Agilent.
-310	System Error; I2C Comms Failure	I2C related errors if they occur, will occur most often during boot up when power is cycled. If this type of error occurs cycle power again. If the error remains, contact Agilent with a complete description of the error message.
-313	Calibration memory lost; memory corruption detected	The instrument was unable to reference calibration data in non-volatile memory. Perform a recalibration.

-313	Calibration memory lost; due to firmware revision change	The instrument's calibration data has been erased following a instrument firmware update. Recalibration of the instrument is required.
-314	Save/recall memory lost; memory corruption detected	The instrument state saved by the *SAV? command in non-volatile (flash) memory has been lost.
-314	Save/recall memory lost; due to firmware revision change	The instrument state saved by the *SAV? command in non-volatile (flash) memory has been lost due to a firmware update.
-315	Configuration memory lost; memory corruption detected	User-preference settings such as I/O settings, the reference oscillator setting, measurement time out setting,... have been lost.
-315	Configuration memory lost; due to firmware revision change	User-preference settings such as I/O settings, the reference oscillator setting, measurement time out setting,... have been lost due to a firmware update.
-330	Self-test failed	See the appended message for more information.
-350	Error queue overflow	An error has occurred; however, the instrument error queue is full and the error was not recorded.
Query Errors		
-410	Query IINTERRUPTED	The counter received a command before it was finished responding to a previous query.
-420	Query UNTERMINATED	The computer attempts to read a query response from the counter after having issued an incomplete query command.
-430	Query DEADLOCKED	The counter's input and output buffers are full and the instrument cannot continue.
-440	Query UNTERMINATED after indefinite response	A query command was received in the same string after a query (e.g. *IDN?) requesting an indefinite length response.
Instrument Errors		
+100	Network Error	A LAN network error has occurred or there is a possible hardware failure. Run the instrument self-test to determine if a hardware failure exists. If so, contact Agilent.
+110	LXI mDNS Error	

A 53210A Error Messages

+263	Not able to execute while instrument is measuring	A command was received while a measurement is in progress
+291	Not able to recall state: it is empty	The state storage location (0-4) specified by the *RCL command is empty
+292	State file size error	Attempted to load a .sta (state) file that is too large.
+293	State file corrupt	The .sta (state) file specified does not contain valid instrument state information.
+294	Preference file size error	Attempted to load a .prf (preference) file that is too large.
+295	Preference file corrupt	The .prf (preference) file specified does not contain valid user-preference setting information.
+301	Input termination protection relay opened	An input signal greater than or equal to + 10Vp is present on a channel. The input impedance is set to 1 M Ω . Removing or reducing the signal below the damage level and pressing the flashing (channel) key or sending INPut:PROTection:CLEar resets the protection relay.
+302	Cannot reset input protection; high voltage present	The input signal present on the channel is greater than or equal to + 10Vp when a reset of the relay was attempted (key or using INPut:PROTection:CLEar).
+315	Channel 2 power too high for operation	For continuous wave (CW) measurements signal power must be \leq +19 dBm.
+316	Channel 2 power too low for operation	For continuous wave (CW) measurements signal power must be \geq -27 dBm.
+317	Channel 2 power changed during measurement	The measurement could not be completed due to a change (too low or too high) in input signal power.
+319	Channel 2 frequency shift detected during measurement	The FM tolerance of the input signal frequency exceeded \pm 50% during the current measurement gate.
+320	Input signal frequency shift caused counter overflow	The FM tolerance of the input signal frequency exceeded \pm 50% during the current measurement gate.

+321	Measurement timeout occurred	The time allotted for an individual measurement to complete was exceeded. The default time out is 1s. The time out is set from the front panel under 'Utility' -> 'Instr Setup', or using the SYSTem:TIMEout command:
+514	Not allowed; Instrument locked by another I/O session	A lock (SYSTem:LOCK:REQuest?) was requested from another I/O interface.
+540	Cannot use overload as math reference	An overload value (9.91E+37) cannot be used as a reference for the NULL, PCT, PPM, and PPB scaling functions.
+541	Cannot use zero as math reference for PCT, PPM, or PPB scaling functions	A zero (0) value cannot be used as a reference for the PCT, PPM, and PPB scaling functions.
+580	No valid external timebase	An external time base frequency other than 1, 5, or 10 MHz is applied to the counter, or the external time base frequency is incorrectly specified by the SENSE:ROSCillator:EXTernal:FREQuency command.
+800	Non-volatile memory write failure	The user preferences (.prf) file is invalid and could not be stored in internal flash memory or on the USB memory device.
+810	State has not been stored	The instrument state file specified by the MMEMory:LOAD:STATE <"file"> contains an invalid instrument state and cannot be loaded.
+820	Model and Serial Numbers not restored	Following replacement of the P500 processor (controller) board or main measurement board, the model number and/or serial number do not match or have not been re-stored. Re-store the model number and serial number as prompted from the front panel. Refer to the service guide for additional information.
+821	Controller and measurement board model numbers do not match	
+822	Controller and measurement board serial numbers do not match	
Calibration Errors		

A 53210A Error Messages

+701	Calibration error; security defeated	Shorting the calibration secure jumper (CAL ENABLE) when turning ON the instrument will cause this error to occur indicating the security password has been overwritten. See “Resetting the Security Code to a Null” in the service guide for details.
+702	Calibration error; calibration memory is secured	A calibration cannot be performed when calibration memory is secured. See “To Unlock The Counter For Calibration” and “To Lock the Counter” in Chapter 2 of the service guide for more information. Use the CAL:SEC:STAT ON command to enter the security code using the remote interface.
+703	Calibration error; secure code provided was invalid	The security code specified was invalid.
+704	Calibration error; secure code too long	The security code specified is greater than 12 characters.
+705	Calibration error; calibration aborted	An in-progress calibration was aborted (stopped) by the user.
+706	Calibration error; provided value out of range	A calibration value was entered that was outside the expected range of valid inputs.
+707	Calibration error; computed correction factor out of range	If this error occurs, cycle power and run the instrument self-test. Verify the calibration setup (instrument settings, connections) and recalibrate the counter. Contact Agilent if there is a self-test failure or the unit fails to calibrate.
+711	Calibration error; calibration string too long	The message to be stored in calibration memory is greater than 40 characters.
+712	Calibration failed	A hardware failure occurred. Contact Agilent.
+713	Channel 2 calibration signal not detected	The calibration source signal is not connected to channel 2.
+714	Channel 2 calibration signal power level error	The power level of the calibration signal was outside the expected range of the specified level.
+715	Channel 2 calibration signal frequency error	The frequency of the calibration signal was outside the expect range of the specified value.

+716	Channel 2 calibration signal is not CW	The Channel 2 calibration signal must be a continuous wave (CW) and not a pulsed signal.
+717	Channel 2 calibration timeout occurred	Calibration at the specified power level did not complete within the ~ 1.2 seconds allowed. Perform a self-test to verify operation of the Channel 2 board and re-check the parameters of the input signal.
+720	Auto-calibration failed; input signal detected	No signal should be present on the input channel during an auto-cal.
+742	Calibration data lost: corrections	The instrument's calibration data was lost due to a firmware update that may have made the current calibration data invalid, or due to a hardware failure. Recalibrate the instrument.
+748	Calibration memory write failure	An error occurred as calibration data was being written to the counter's internal flash memory. Run the self-test to verify counter operation and repeat the calibration procedure.
+750	Calibration data not restored	Following repair, calibration data was not restored as prompted from the front panel.
Self-Test Errors		
+901	Self-Test failed: auto-calibration failure	A failure occurred during the auto-calibration portion of the self-test. Repeat the self-test. If the auto-calibration failure remains there is an issue with the instrument hardware. Contact Agilent.
+903	Self-Test failed: real-time clock setting lost	Reset the instrument clock using the 'Utility' -> 'System Setup' -> 'Date/Time' keys, or using the SYSTem:TIME or SYSTem:DATE commands. Re-run the self-test.

A 53210A Error Messages

+904	Self-Test failed: main CPU error accessing boot environment	Verify and if necessary, install the latest firmware update and re-run the self-test. If the failure occurs with the latest firmware revision installed, contact Agilent.
+905	Self-Test failed: failed to read FPGA revision	
+906	Self-Test failed: FPGA revision is less than expected	
+907	Self-Test failed: PIC communication failure	
+908	Self-Test failed: battery test failed	These self-tests perform a communication test to detect the presence of the battery, GPIB, and Channel 2 options. Verify and if necessary, install the latest firmware update and re-run the self-test. If the failure occurs with the latest firmware revision installed, contact Agilent.
+909	Self-Test failed: GPIB test failed	
+910	Self-Test failed: channel 2 test failed	
+911	Self-Test failed: front panel revision check failed	Verify and if necessary, install the latest firmware update and re-run the self-test. If the failure occurs with the latest firmware revision installed, contact Agilent.
+912	Self-Test failed: measurement board test failed	

Index

A

- absolute threshold level 96
- ac coupling 92
- address string
 - GPIB 50, 54
- addressing
 - changing the GPIB address 54
 - IP addresses and host names 48
- Agilent Connection Expert
 - adding GPIB instruments 52
 - adding LAN instruments 44
 - adding USB instruments 49
 - interactive IO 54, 55
 - locating LAN instruments 45
- Agilent IO Libraries
 - installation 41
 - system requirements 42
- applying power 18
- ascii data formats 174
- ASCII format
 - reading length 176
- auto level 29
- auto-level 97
 - frequency range 100
 - system auto-level 100
- auto-level frequency example 101
- automatic range setting 154

B

- bandwidth limiting 93
 - noise rejection 102
- battery level 21
- battery operation 20
 - battery in use 21
 - enabling and disabling the battery 20
 - reading the battery level 21

- beeper 27
- block data transfers 175
 - byte order 175
- boxcar filter 130

C

- CALCulate1 subsystem 129
- calibration security
 - disabling for firmware updates 56
- cataloging folders 201
- changing counter settings after CONFigure 75
- changing the GPIB address 50, 54
- channel 2signal strength 104
- channel characteristics 86
- channel options 86
- checking lower limits 145
- checking upper limits 145
- clearing histogram data 156, 163
- clearing limit conditions 146
- clearing statistical values 143
- computer configuration 48
- CONFigure and MEASure commands 73
- CONFigure commands 75
- CONFigure? 76
- Connection Expert
 - adding instruments to USB configuration 49
- copying files 200
- copying files from the front panel 201
- counter accuracy 19
- counter measurement summary 64
- coupling 92
 - example 93, 131
- coupling and threshold levels 99
- creating data files 187

- creating folders 185
- creating state files 189
- cycling power 19

D

- data flow 176
- data formats
 - ASCII 175
 - REAL 175
- data scaling 131
- data smoothing 130
 - example 131
- date and time
 - setting 28
- dc coupling 92
- decimation 165
- definite-length arbitrary block 174
- deleting files 197
- deleting folders 197
- development environments 36
- digit group separator 25
- digits of resolution 119
- disabling gate out 125
- disabling the battery 20
- display configuration 23
- display modes 148, 161
- display overview 15
- downloading firmware updates 57
- downloading the IVI-COM driver 61
- driver requirements 36
- driver updates 56

E

- electrical operating conditions 17
- electrical requirements 17
- emulation mode
 - 53100 series 30
 - disabling for firmware updates 57
- enabling 144
- enabling histograms 149
- enabling limit checking 144
- enabling scale functions 132
- enabling statistical functions 139
- enabling the battery 20
- environment
 - operating and storage 17
- environmental operating conditions 17
- error messages 211
- examples
 - creating a data file 188
 - creating state files 190
 - DATA
 - LAST? 181
 - REMove? 181
 - data scaling 138
 - deleting a folder 197
 - FETCh? 179
 - frequency measurements 78
 - frequency ratio measurements 80
 - memory threshold 182
 - period measurements 82
 - R? 180
 - READ? 178
 - setting the auto-level frequency 101
 - using an external reference oscillator 67
- external gate signal polarity 123
- external gate signal threshold 124
- EXternal gate source 125
- external reference oscillator
 - detecting the frequency 67
- external reference oscillator example 67
- external reference oscillator frequency 66

F

- file system 183

- files
 - copying 201
- files and folders 197
- firmware updates 56
 - disabling calibration security 56
 - disabling emulation mode 57
 - downloads 57
 - installation 58
 - update utility 57
- flash memory 183
- folder names
 - entering from front panel 186
- folders
 - catalog of 201
 - data and configuration files 185, 187
 - default 187
 - deleting 197
 - state files 189
- frequency measurements 77
 - external gate signal polarity 123
 - external gate signal threshold 124
 - gating 119
 - setting the gate time 120
- frequency ratio measurements 79
- front panel
 - description 177
 - fields 177
- front panel display modes 148, 161
- front panel keys
 - input channel configuration 86
- front panel overview 13

G

- gain and offset 135
- Gate Out BNC 125
- gate signal polarity
 - frequency measurements 123
- gate signal threshold
 - frequency measurements 124
- gate source 117
- gate time
 - frequency measurements 120
 - and resolution 119

- gating 117
 - frequency measurements 119
 - gate cycle 107
 - setting the gate source 117
 - settings summary 106
- gating cycle 107
- general programming information 36
- GPIB
 - adding instruments 52
 - address string 54
 - changing the address 50, 54
 - interface configuration 43

H

- help
 - built-in 23
- help language
 - Chinese 27
 - French 27
 - German 27
 - Japanese 27
 - Korean 27
- histogram ranges
 - automatically setting 154
- histograms 147
 - bins 151
 - clearing data 163
 - displaying on the front panel 148, 161
 - enabling 149
 - example 155
 - lower and upper ranges 152
 - resetting 156
 - setting minimum and maximum bin ranges 153
 - setting up 151, 162
 - viewing data 161
- host name and IP address
 - obtaining 38
- host names and IP addresses 47
- hysteresis 101

I

- idle state 110
- impedance 88
 - example 88
- indefinite-length arbitrary block 174
- initiating the counter 114
- input
 - auto-level 97
 - channel characteristics 86
 - coupling 92
 - impedance 88
 - low-pass filter 93
 - measuring signal levels 104
 - measuring signal strength 104
 - noise rejection 101
 - noise rejection example 102
 - probe factor 91
 - probe input compatibility 91
 - probes 88
 - protection limits 89
 - range 90
 - settings summary 87
 - signal path 86
 - slope example 103
 - threshold level and sensitivity 95
 - threshold level example 98
 - threshold slope 103
 - voltage overload bit 89
- input slope example 103
- instrument addressing
 - GPIB address string 54
 - IP addresses and host names 48
 - USB address string 50
- instrument help 23
- instrument manuals 16
- instrument overview 15
- instrument states 190, 192
- Interactive IO 55
- interactive IO 54
- internal flash memory 183
- internet browser configuration 38

IO

- adding GPIB instruments 52
- adding LAN instruments 44
- IO interface
 - adding instruments 43
- IO libraries 41
 - system requirements 42
- IO software installation 41
- IP address and host name
 - obtaining 38
- IP addresses and host names 47
- IVI drivers
 - installation 43
- IVI-COM
 - driver updates 56, 61

L

- LAN
 - adding instruments 44
 - interface configuration 43
- LAN cards, multiple 56
- limit checking 143, 144
 - clearing limits 146
 - clearing the Questionable Data register 146
 - example 146
 - Questionable Data register 143
 - setting lower and upper limits 145
- locating instruments 45
- low-pass filter 93

M

- M/x-B 136
- managing folders and files 197
 - copying files 200
 - deleting files 197
 - moving files 200
- manuals 16
- materials included with counter 15

math functions

- enabling 129
- limit checking 143
- M/x-B 136
- scaling 133
- smoothing data 130
- math operations
 - statistical functions 139
 - mean 140
- MEASure commands 73, 74
- measurement gate 117
- measurement time out 29, 70
- measurements
 - frequency 77
 - frequency ratio 79
 - period 81
- measuring low frequency signals, low-frequency signals. 98
- memory
 - internal flash 183
- moving average filter 130
- moving files 200
- Mx-B 133, 135

N

- NISPOM 31
- noise rejection 101
- noise rejection example 102
- noise rejection from bandwidth limiting 102
- numeric format 24
 - digit group separator 25
 - radix 25

O

- operating and storage environments 17
- operating conditions 17
- operating environment 17
- option 300
 - battery 20
- options 16
- output buffer
 - description 178
 - transferring readings to 178

Index

overview

- display 15
- front panel 13
- instrument 15
- rear panel 14

P

PC IO interfaces

- LAN, GPIB, USB 43

period measurements 81

power-on states 194

probe factor 91

probe input compatibility 91

probes 88

- input range 90

product options 16

programming environments 36

protection relay 89

proxy server 38, 48

Q

questionable condition register

- voltage overload bit 89

Questionable Data register

- clearing 146

questionable event register

- voltage overload bit 89

R

radix 25

range 90

range example 90

reading count

- query 181

- statistical functions 140

reading decimation 165

reading formats 174

reading memory 177

- creating data files 187

- creating folders 185

- creating state files 189

- default folder 187

- reading threshold 182

- transferring readings to output buffer 178

reading the battery level 21

reading transfer size 176

reading transfers

- memory to output buffer 178

reading units 137

real data formats 174

REAL format

- reading length 176

rear panel overview 14

reference oscillator

- configuration 64

- external frequencies 66

- standby power 68

- using an external reference 64

reference settings

- auto level 29

- date and time 28

- measurement time out 29, 70

- time base 29

reference values

- example 135

- scaling functions 134

relative threshold level 97

removing folders 197

resetting histograms 156

resetting limits 146

resolution

- gate time 119

- digits 119

RF signal strength 104

S

safety information 3

safety symbols 4

sample count 113

saving states from the front panel 190

scale functions

- assigning reading units 137

- enabling 132

- example 138

- gain and offset 135

- M/x-b 136

- Mx-B 133

- NULL 133

- PCT 133

- PPB 133

- PPM 133

- reference value 134

- SCALE 133

scaling data 131

SCPI formats 71

screen capture 26

screen control 25

securing the instrument

NISPON 31

self-test

- increasing the timeout using Interactive IO 56

sensitivity 95

setting the gate source 117

setting up histogram data 151, 162

shipped with counter 15

signal conditioning

- settings summary 86

signal conditioning path 86

signal levels 104

signal strength 104

slope

- threshold 103

slope example 103

smoothing data

- example 131

software installation

- Agilent IO libraries 41

- IVI drivers 43

- system requirements 42

standard deviation 140, 142

standby power 19, 68

- statistical functions 139
 - average peak-to-peak value 141
 - average value 141
 - clearing values 143
 - enabling 139
 - example 141, 142
 - maximum value 140
 - mean 140
 - minimum value 140
 - reading count 140
 - standard deviation 140, 142
- storage and operating environments 17
- storing instrument states 192
- synchronization with other instruments 125
- syntax conventions
 - SCPI 71
- system auto-level range 100, 101
- system trigger 109
 - count 113
 - delay 112
 - sample count 113
 - slope 111
 - source 110

T

- threshold
 - reading memory 182
- threshold level 95
 - absolute 96
 - auto-level 97
 - example 98
 - relative 97
 - with DC and AC coupling 99
- threshold slope 103
- time and date
 - setting 28
- time base 29
- timeout
- increasing using Interactive IO 56
 - measurement 29, 70
- transients 17
- trend charts
 - reading decimation 165

- trigger cycle 107
- triggering
 - idle state 110
 - sample count 113
 - settings summary 106
 - system trigger 109
 - system trigger count 113
 - system trigger delay 112
 - system trigger slope 111
 - system trigger source 110
 - trigger cycle 107

U

- updating firmware 56
- USB
 - adding instruments 49
 - address string 50
 - interface configuration 43
- USB storage devices 183
- user preferences
 - storing and loading 191
- user-assigned units 137
- user-defined power-on states 194
- using instrument help 23
- utility functions 23
 - beeper setting 27
 - display configuration 23
 - help language 27
 - numeric format 24
 - reference settings 28
 - screen capture 26
 - screen control 25

V

- viewing histogram data 161
- volatile memory 177
- voltage overload bit 89

W

- wait for trigger state 114
- Waste Electrical and Electronic Equipment Directive 3

- Web-enabled instrument interface and Interactive IO 54
- Web-enabled interface
 - browser configuration 38
 - connecting to the instrument 37
 - getting started 37

