Operating Guide

This guide describes how to use the Agilent 53150A, 53151A, and 53152A Microwave Frequency Counters. The information in this guide applies to instruments having the number prefix listed below, unless accompanied by a “Manual Updating Changes” package indicating otherwise.

SERIAL PREFIX NUMBER: 3735A, US3925, and US4050 (53150A)
3736A, US3926, and US4051 (53151A)
3737A, US3927, and US4052 (53152A)

Agilent 53150A/151A/152A
Microwave Frequency Counter

© Copyright Agilent Technologies, Inc. 1999, 2002

All Rights Reserved. Reproduction, adaptation, or translations without prior written permission is prohibited, except as allowed under the copyright laws.

Printed: August 2002

Printed in U.S.A.

**Manual part number
53150-90013**

Certification and Warranty

Certification

Agilent Technologies, Inc. certifies that this product met its published specification at the time of shipment from the factory. Agilent further certifies that its calibration measurements are traceable to the United States National Institute of Standards and Technology (formerly National Bureau of Standards), to the extent allowed by the Institute's calibration facility, and to the calibration facilities of other International Standards Organization members.

Warranty

Agilent warrants Agilent hardware, accessories and supplies against defects in materials and workmanship for a period of one year from date of shipment. If Agilent receives notice of such defects during the warranty period, Agilent will, at its option, either repair or replace products which prove to be defective. Replacement products may be either new or like-new.

Agilent warrants that Agilent software will not fail to execute its programming instructions, for the period specified above, due to defects in material and workmanship when properly installed and used. If Agilent receives notice of such defects during the warranty period, Agilent will replace software media which does not execute its programming instructions due to such defects.

For detailed warranty information, see back matter.

Safety Considerations

General

This product and related documentation must be reviewed for familiarization with this safety markings and instructions before operation.

Before Cleaning

Disconnect the product from operating power before cleaning.

Warning Symbols That May Be Used In This Book



Instruction manual symbol; the product will be marked with this symbol when it is necessary for the user to refer to the instruction manual.



Indicates hazardous voltages.



Indicates earth (ground) terminal.



or



Indicates terminal is connected to chassis when such connection is not apparent.



Indicates Alternating current.



Indicates Direct current.

Safety Considerations (cont'd)

WARNING

BODILY INJURY OR DEATH MAY RESULT FROM FAILURE TO HEED A WARNING. DO NOT PROCEED BEYOND A WARNING UNTIL THE INDICATED CONDITIONS ARE FULLY UNDERSTOOD AND MET.

CAUTION

Damage to equipment, or incorrect measurement data, may result from failure to heed a caution. Do not proceed beyond a *CAUTION* until the indicated conditions are fully understood and met.

Safety Earth Ground

An uninterruptible safety earth ground must be maintained from the mains power source to the product's ground circuitry.

WARNING

WHEN MEASURING POWER LINE SIGNALS, BE EXTREMELY CAREFUL AND ALWAYS USE A STEP-DOWN ISOLATION TRANSFORMER WHICH OUTPUT IS COMPATIBLE WITH THE INPUT MEASUREMENT CAPABILITIES OF THIS PRODUCT. THIS PRODUCT'S FRONT AND REAR PANELS ARE TYPICALLY AT EARTH GROUND. *THUS, NEVER TRY TO MEASURE AC POWER LINE SIGNALS WITHOUT AN ISOLATION TRANSFORMER.*

For additional safety and acoustic noise information, see back matter.

Contents

Contents and Organization	viii
Related Documents	ix
Types of Service Available if Instrument Fails	x
Repackaging for Shipment	xi
Description of the Microwave Frequency Counter	xii
Options	xiii
Accessories Supplied and Available	xiv
Agilent 53150A/151A/152A Quick Reference Guide	xv

1 Getting Started

The Front Panel at a Glance	1-2
The Front Panel Indicators at a Glance	1-3
The Front Panel Menus at a Glance	1-4
The Display Annunciators at a Glance	1-5
The Display Special Characters at a Glance	1-6
The Rear Panel at a Glance	1-7
Operating the Counter	1-8
Turning the Counter On	1-10
Turning the Display Backlight Off or On	1-11
Using the Menu	1-12
Displaying the Menu	1-12
Navigating in the Menu and Changing Settings	1-12
Setting the Serial Port Baud Rate (Menu Example)	1-15
Selecting the Input Channel	1-16
Measuring Frequency	1-17
Measuring Relative Frequency	1-19
Offsetting a Frequency Measurement	1-20
Measuring Power (Channel 2 Only)	1-22
Selecting the Unit of Measurement for Power	1-23
Measuring Relative Power	1-24
Offsetting a Power Measurement	1-24

- Using Power Correction 1-26
 - Power Correction Theory of Operation 1-26
 - Increasing Profile Accuracy 1-27
 - Selecting a Power-Correction Profile 1-28
 - Entering Data Points in a Power-Correction Profile 1-28
- Setting the Measurement Rate 1-32
- Setting the Number of Averages 1-33
- Setting the Resolution 1-34

2 Operating Your Frequency Counter

- Introduction 2-2
- Chapter Summary 2-2
- How this Counter Works for You 2-3
- Summary of the Measurement Sequence 2-4
- Using the Selection Keys 2-5
 - Sequencing Through the Menu 2-5
 - Numeric Entry 2-6
 - Changing States 2-7
- Using the Clear and Reset/Local Keys 2-9
 - Acknowledging Messages 2-9
- Other Function Selection Keys 2-10
- Measuring Frequency 2-12
- Setting the Resolution and the Measurement Rate 2-14
 - Setting the Resolution 2-14
 - Resolution Setting Example 2-15
 - Setting the Measurement Rate 2-16
 - Rate Setting Example 2-16
- Setting the Number of Averages 2-17
 - Averages Setting Example 2-17
- Measuring Relative Frequency 2-20
 - Relative Frequency Example 2-20
- Offsetting a Frequency Measurement 2-21
 - Frequency Offset Example 2-21
- Measuring Power 2-24
 - Power Measurement Example 2-24

Measuring Relative Power	2-26
Relative Power Example	2-26
Offsetting a Power Measurement	2-27
Power Offset Example	2-27
Using Power Correction	2-30
Power Correction Theory of Operation	2-31
Increasing Profile Accuracy	2-32
Power Correction Examples	2-32
Power Correction Example: Selecting a Correction Profile	2-33
Power Correction Example: Editing Data Point Values	2-35
Using the Menu	2-39
Navigating in the Menu and Changing Settings	2-41
Reference Oscillator (REF OSC)	2-42
Do Self Test	2-43
Battery Voltage (BATT VOLTAGE)	2-43
Operating Hours (OP HOURS)	2-43
Model Number, Firmware Version, Serial Number, and Option Codes	2-43
Preset	2-45
RS-232 Serial Port Data Rate (BAUD)	2-46
Frequency Modulation (FM)	2-46
Channel 1 Low-Pass Filter (CH1 LPF)	2-46
Recall User Settings (RECALL)	2-46
Save User Settings (SAVE)	2-46
Power Correction (PWR CORR)	2-46
3	Specifications
Introduction	3-2
A	Rack Mounting the Counter
Rack Mounting the Counter	A-2

B Messages

- Overview B-2
- Status Messages B-2
- Self-Test Messages B-3
- Error Messages B-4

C Using the Battery Option

- Overview C-2
- Operating the Counter from the Batteries C-2
- Operating the Counter from a DC Power Source C-3
- Replacing the Batteries C-4
 - Removing the Batteries C-4
 - Installing Batteries C-5
- Charging the Batteries C-8
- Precautions C-9

In This Guide

This book is the operating guide for the Agilent 53150A (20 GHz), 53151A (26.5 GHz), and 53152A (46 GHz) Frequency Counters. It consists of a table of contents, this preface, a quick reference guide, three chapters, three appendices, and an index.

This preface contains the following information:

- Contents and Organization pg. viii
- Related Documents pg. ix
- Types of Service Available if Instrument Fails pg. x
- Repackaging for Shipment pg. xi
- Description of the Microwave Frequency Counter pg. xii
- Options pg. xiii
- Accessories Supplied and Available pg. xiv
- Manuals Supplied pg. xiv

Contents and Organization

The **Quick Reference Guide** consists of a Menu Tree (tear-out sheet) that serves as a tool to trigger your memory or get you quickly reacquainted with the instrument.

Chapter 1 Getting Started is a quick-start guide that gives you a brief overview of the Counter's keys, indicators, menus, display, and connectors. A graphical procedure for performing a measurement is also provided.

Chapter 2 Operating Your Instrument is an operator's reference. You are given an overview of each group of front-panel keys, operating functions, and menus followed by a series of exercises that guide you through the operation of the Counter.

Chapter 3 Specifications lists the specifications and characteristics of the Counter.

Appendix A Rack Mounting the Counter provides rack-mounting procedures for the Counter.

Appendix B Messages lists and explains all of the messages that are displayed on the Counter's front panel and/or sent over the RS-232 serial interface.

Appendix C Using the Battery Option explains how to use the Counter with the Battery option.

Index

Related Documents

For more information on frequency counters refer to the following Series 200 Application Notes:

- *Fundamentals of Electronic Frequency Counters*,
Application Note 200—Agilent part number 02-5952-7506.
- *Understanding Frequency Counter Specifications*,
Application Note 200-4—Agilent part number 02-5952-7522.
- *Fundamentals of Time and Frequency Standards*,
Application Note 52-1—Agilent part number 02-5952-7870.

Types of Service Available if Instrument Fails

If your Counter fails within one year of original purchase, Agilent will repair it free of charge. If your instrument fails after your one-year warranty expires, Agilent will repair it, or you can repair it yourself.

There are three types of repair services:

- Standard repair service—if downtime is not critical.
- Express Repair/Performance Calibration Service—if downtime is critical.
- Owner repair—repair the unit yourself using the *Assembly-Level Service Guide*.

Standard Repair Services (Worldwide)

Contact your nearest Agilent Service Center to arrange to have your Counter repaired.

Express Repair/Performance Calibration Service (USA Only)

If downtime is critical, you can receive your repaired Counter via overnight shipment. Just call **1-800-403-0801** and ask for Express Repair/Performance Calibration Service. When your Counter is repaired, it will be returned via overnight shipment.

Repair Instrument Yourself

If you choose to repair the instrument yourself or would like more details on self test and calibration, use the procedures in the *Assembly-Level Service Guide*.

Repackaging for Shipment

For the Express Repair/Performance Calibration Service described above, return your failed Counter to the designated Agilent Service Center, using the instrument's original shipping carton (if available). Agilent notifies you when your failed instrument is received.

If the instrument is to be shipped to Agilent for service or repair, be sure you do the following:

- Attach a tag to the instrument identifying the owner and indicating the required service or repair. Include the instrument model number and full serial number.
- Place the instrument in its original container (if available) with appropriate packaging material.
- Secure the container with strong tape or shipping bands.

If the original shipping container is not available, place your unit in a container with at least 4 inches of compressible packaging material around all sides of the unit. Use static free packaging materials to avoid additional damage to your unit.

Agilent suggests that you always insure shipments.

Description of the Microwave Frequency Counter

The Agilent 53150A, 53151A, and 53152A Microwave Frequency Counters are capable of measuring frequencies from 10 Hz to 125 MHz on Channel 1 and from 50 MHz to 20 GHz (53150A), 26.5 GHz (53151A), and 46 GHz (53152A) on Channel 2. These frequency counters are also capable of measuring power on Channel 2 (in the same frequency ranges). All three Counters have a maximum frequency resolution of 1 Hz.

The Agilent 53150A/151A/152A provides GPIB and RS-232 serial interfaces and are suitable for bench-top and ATE operation.

The basic measurement functions of the Agilent 53150A/151A/152A include Frequency, Relative Frequency, Frequency Offset, and Power (including Power Offset and Relative Power). All of these features are accessible from the front panel and over the GPIB and RS-232 interfaces.

The Agilent 53150A/151A/152A includes the following additional measurement functions and features that are designed specifically for manufacturing and service applications:

- 1, 2, 5, and 10 MHz external reference capability
- Optional high-stability oven oscillator for high-accuracy needs and lengthened calibration cycles
- Frequency and power offset capabilities for relative measurements
- SCPI programming capability
- Battery and dc input option for operation in locations where AC power is unavailable
- Optional soft carrying case for safe transportation and mobile use

Programmable control is performed via an GPIB or an RS-232 serial interface. The GPIB and RS-232C ports are standard for the Agilent 53150A, 53151A, and 53152A.

Options

The options available for the Agilent 53150A/151A/152A are listed below. Specifications for the options are listed in Chapter 3, “Specifications.” Options ordered with the Counter are installed at the factory and are ready for operation on delivery. Refer to the "Retrofitting Options" chapter in the *Agilent 53150A / 151A / 152A Assembly-Level Service Guide* for information on installing options in the field.

Hardware

- High Stability Oven Timebase, Option 001
- Battery/DC Power Input, Option 002
- Rack Mount Kit, Option 1CM
- Soft Carrying Case, Option 007

Support

- 3-year Return to Agilent for Repair, Option W30
- 3-year Return to Agilent for Calibration, Option W32
- 3-year Return to Agilent for Standards Compliant Calibration, Option W34
- 5-year Return to Agilent for Repair, Option W50
- 5-year Return to Agilent for Calibration, Option W52
- 5-year Return to Agilent for Standards Compliant Calibration, Option W54

Retrofit

- Options 001 and 002 can be installed only by authorized Agilent Technologies Repair Centers.

Accessories Supplied and Available

Accessories Supplied

- Power cord, 2.3 meters (Part number dependent upon destination country)
- Fuse (Agilent P/N 2110-0007)

Accessories Available

- Soft Carrying Case, (Agilent P/N 53150-80016)
- Automotive Power Adapter (Agilent P/N 53150-60214)
- Battery (Agilent P/N 53150-80010)
- GPIB Cables (Agilent P/N 10833A/B/C/D)
- RS-232 Cable (Agilent P/N 53150-60215)

Manuals Supplied

Agilent 53150A / 151A / 152A Operating Guide
(Agilent P/N 53150-90013)

Agilent 53150A / 151A / 152A Programming Guide
(Agilent P/N 53150-90014)

Agilent 53150A / 151A / 152A Assembly-Level Service Guide
(Agilent P/N 53150-90015)

Agilent 53150A/151A/152A Quick Reference Guide

The Quick Reference Guide is designed for experienced users of the Agilent 53150A, 53151A, and 53152A. It is intended to be used as a tool to trigger your memory. If you are using the Counter for the first time, Agilent recommends that you at least read Chapter 1, “Getting Started,” first.

The Quick Reference Guide, which follows this page, consists of a menu tree that may be torn out of the guide for external use.

Agilent 53150A/151A/152A Frequency Counter

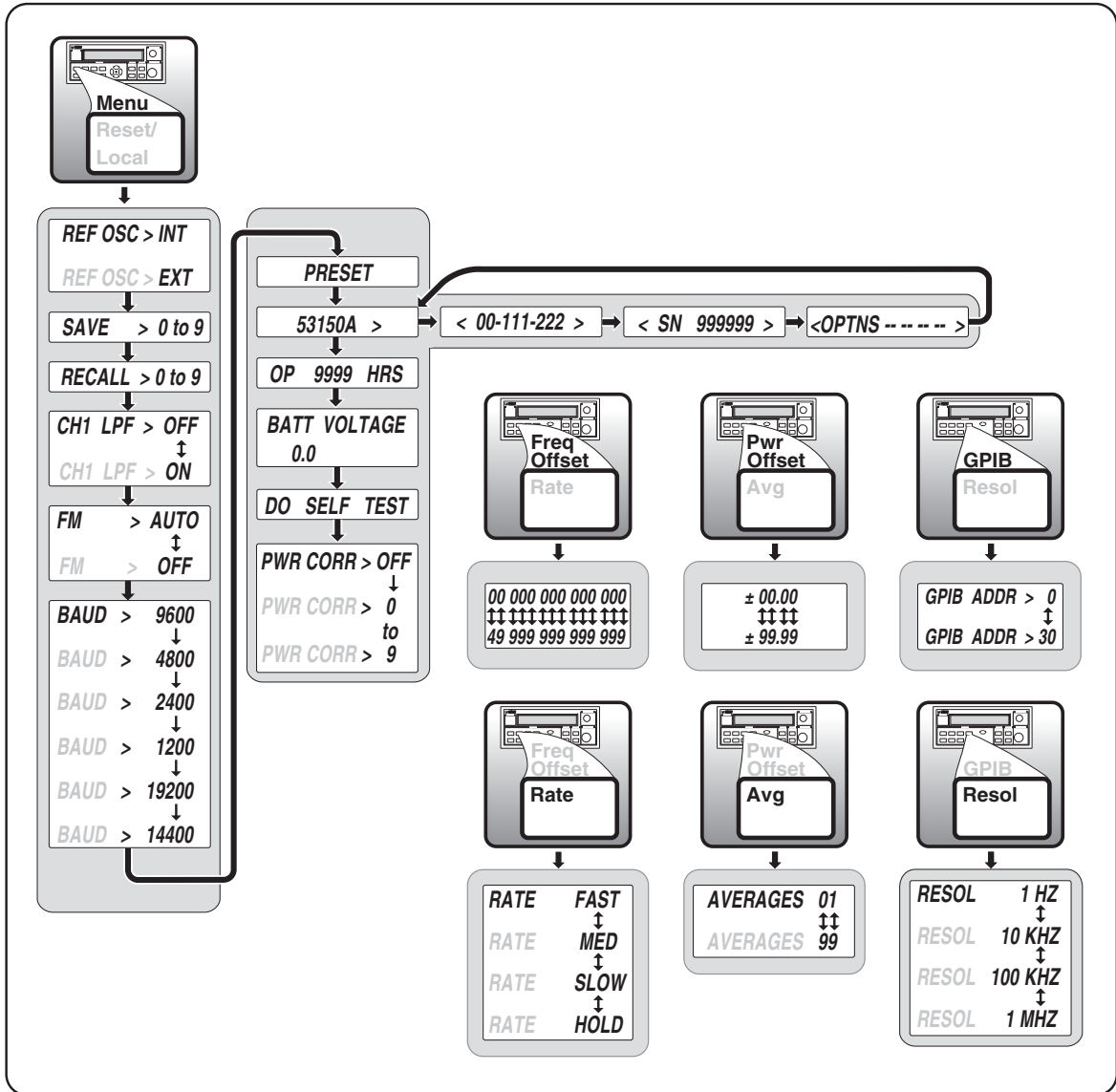

1

Getting Started

The Front Panel at a Glance

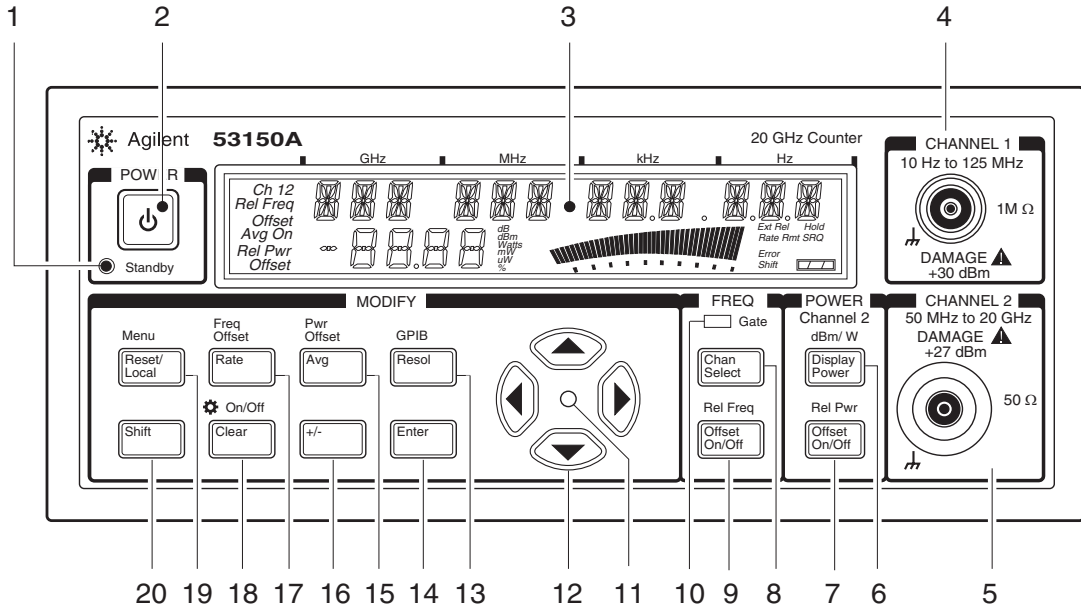

- | | |
|--|------------------------------------|
| 1 Standby indicator | 11 Selection keys active indicator |
| 2 Power/Standby switch | 12 Selection (arrow) keys |
| 3 LCD display | 13 Resolution / GPIB key |
| 4 Channel 1 input connector | 14 Enter key |
| 5 Channel 2 input connector | 15 Average / Power Offset key |
| 6 Display Power / dBm/W key (Channel 2) | 16 Sign (+/-) key |
| 7 Offset On/Off / Relative Power key (Channel 2) | 17 Rate / Frequency Offset key |
| 8 Channel Selection key | 18 Clear / Backlight On/Off key |
| 9 Offset On/Off / Relative Frequency key | 19 Reset/Local / Menu key |
| 10 Gate indicator | 20 Shift key |

The Front Panel Indicators at a Glance

The front panel includes three LED indicators. These are listed and described in the following table.

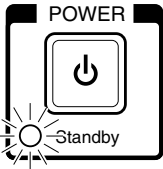
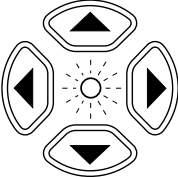
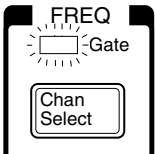
Indicator	Description
	<p>The Standby indicator is lit whenever the Main ~ Power switch on the rear panel is turned ON, and the POWER switch on the front panel is OFF (out). During Standby, most of the instrument's circuits do not receive power. However, the timebase and the cooling fan are powered so that the temperature in the timebase components remains stable, and if the Battery option is installed, the battery-charging circuits are powered. When you press the POWER switch on the front panel, the Standby indicator goes off, and all of the Counter's circuits receive power.</p>
	<p>When the LED indicator between the arrow keys flashes, the arrow keys can be used to navigate and change values in menus.</p> <p>When you make a change in a menu, always press the Enter key to save the setting and exit the menu.</p>
	<p>The Gate LED indicator flashes to indicate the rate at which measurements are triggered. The flash rate of the LED varies with the settings of the measurement rate (Rate key) and the measurement resolution (Resol key). The flash rate of the LED provides a rough indication of the number of measurements that are being taken in a given period of time.</p>

NOTE

It is normal for the fan in the Counter to run when the Counter is in Standby mode. Power is supplied to the timebase whenever the Main ~ Power switch is on to maintain long term measurement reliability, and the fan helps maintain timebase temperature stability.

The Front Panel Menus at a Glance

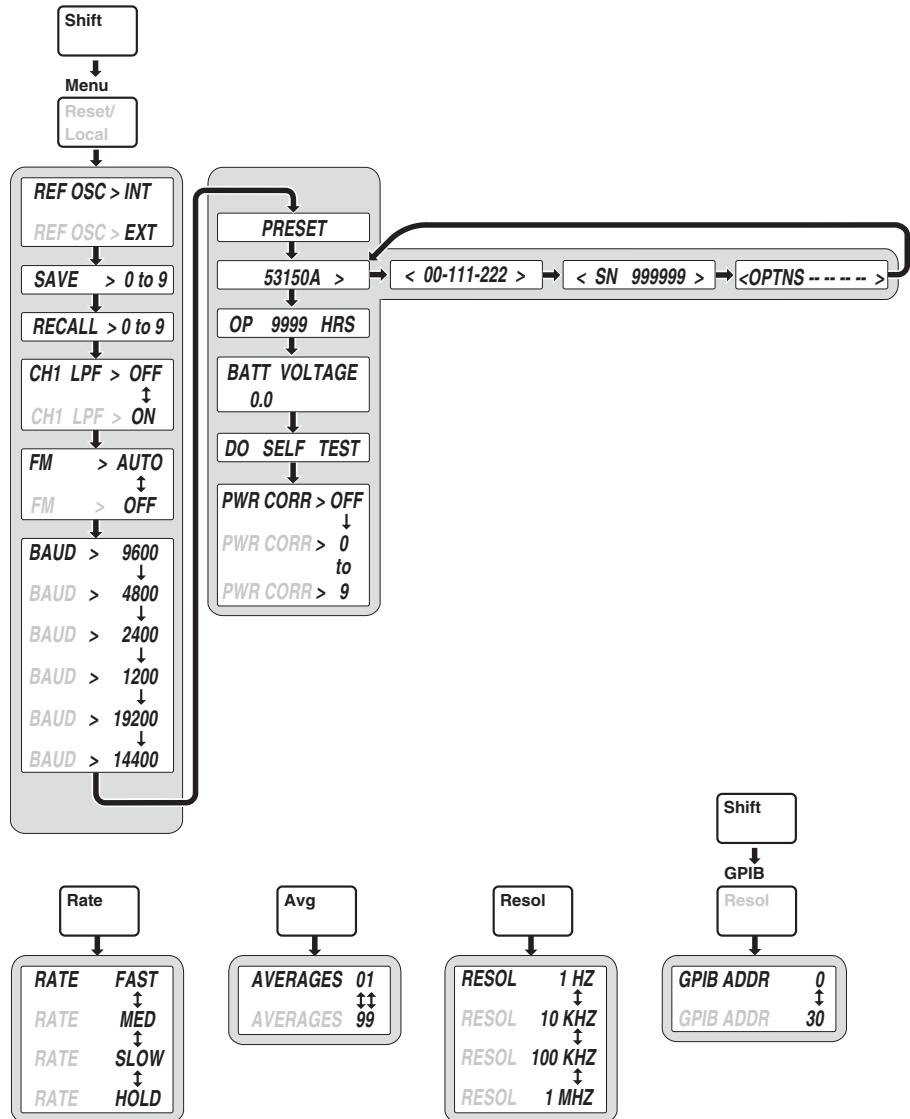

The Display Annunciators at a Glance

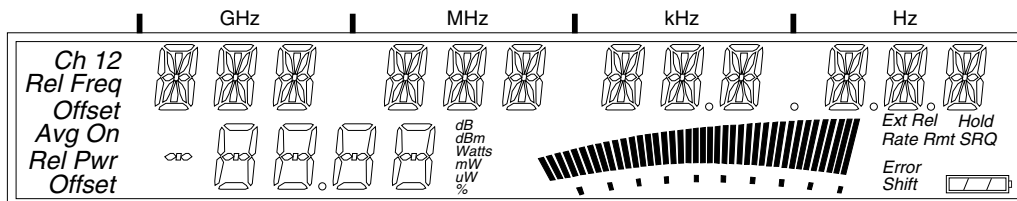

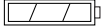
Annunciator	Description
Ch 1 or Ch 2	Indicates which channel is selected to measure an input signal.
Freq	Indicates that the value displayed is a frequency reading.
Rel Freq	The displayed frequency value is relative to a previously zeroed value.
Freq Offset	The displayed frequency value is offset by a previously entered frequency value.
Avg On	The displayed frequency value is the result of a number of individual frequency measurements that have been averaged.
Pwr	The Counter is set to measure Power (Channel 2 only).
Rel Pwr	The displayed power measurement is relative to a previously zeroed power value.
Pwr Offset	The displayed power value is offset by a previously entered power value.
dB, dBm, W, mW, μW, %	Indicates the unit of measurement for the currently displayed power value.
	Provides a real-time analog representation of the Power measurement (intended for peaking and similar procedures).
Ext Ref	The Counter is using an external reference signal for frequency measurements.
Hold	Indicates the Counter is in Hold (single-measurement) mode.
Rmt, SRQ	Shows the current state of the GPIB interface (Rmt = Remote operation via GPIB; SRQ = Service ReQuest).
Error	Indicates that a front-panel key command is unacceptable in the current context.
Shift	Indicates that all front-panel keys are redefined to the function printed above the key.
	Shows the amount of charge in the batteries (if the Battery option is installed).

The Display Special Characters at a Glance

Special Characters	Description
)	Points to the current value for a Menu setting.
(Indicates that the value for the current Menu setting can be changed using the selection (arrow) keys.
⌂	When the letter “c” is displayed in the hundredths position of the power display, Power Correction mode is in effect.

NOTE

The first two special characters shown above are intended to help you navigate within the Menu. When the right pointer (**)** is flashing, it indicates the current setting for the selected Menu option. When the left pointer (**(**) is flashing, it indicates that you can use the selection (arrow) keys to change the setting for the current Menu option.

The Rear Panel at a Glance

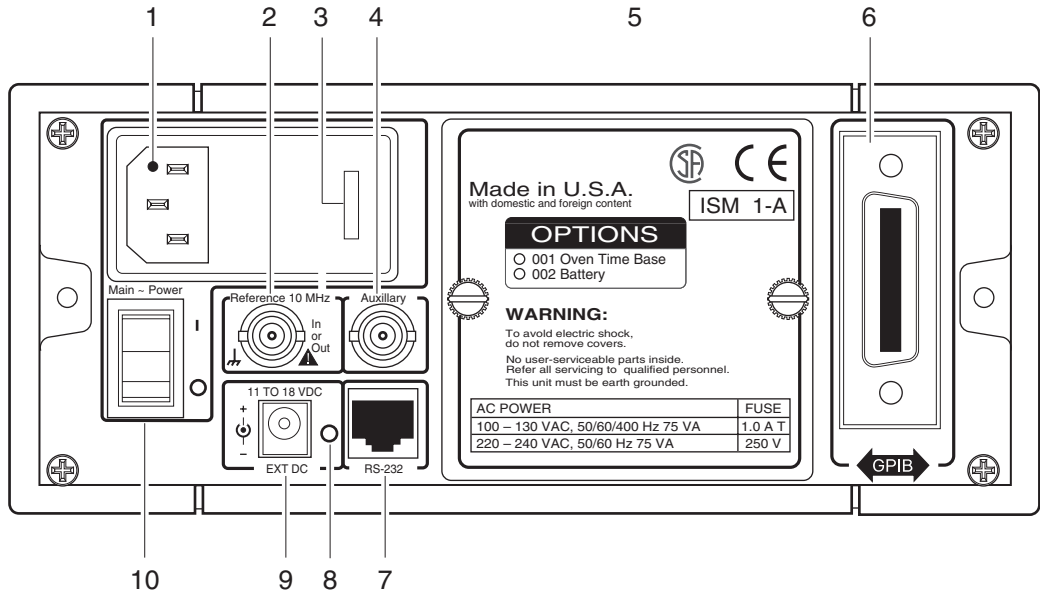

- 1 AC Input/Power module (Senses incoming voltage and adjusts automatically)
- 2 External Reference connector (BNC)
1, 2, 5, or 10 MHz Input
10 MHz Output
- 3 Fuse Holder (behind door)
- 4 Auxiliary connector (reserved)*
- 5 Battery compartment (optional) or cover plate
- 6 GPIB (IEEE-488.1) Interface connector
- 7 RS-232 Interface connector (RJ12)
- 8 Main AC Power On indicator
- 9 EXT DC power-input connector (functional only when Battery option is installed)
- 10 Main ~ Power switch

* The Auxiliary connector is not installed on standard production units.

Operating the Counter

The procedures in this section are designed to familiarize you with the Frequency Counter's features and controls. Agilent suggests that you follow the steps for each of these procedures, even if you do not presently need to make any measurements or to adjust any of the Counter's settings. The following procedures are provided:

- Turning the Counter On
- Turning the Display Backlight Off or On
- Selecting an Input Channel
- Using the Menu
- Setting the Serial Port Baud Rate
- Measuring Frequency
- Measuring Relative Frequency
- Offsetting a Frequency Measurement
- Measuring Power
- Measuring Relative Power
- Offsetting a Power Measurement
- Using Power Correction
- Setting the Measurement Rate
- Setting the Number of Averages
- Setting the Resolution

Operating the Counter

The following legend defines the meanings of the icons used throughout this chapter.

Legend

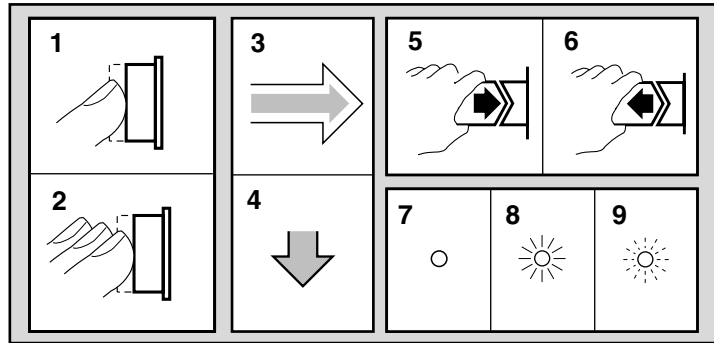

- | | | |
|---|----------------------------|-----------------------------|
| 1 Press key one time and release | 3 Result | 7 Indicator off |
| 2 Multiple key presses | 4 Auto operation | 8 Indicator on |
| | 5 Connect signal | 9 Indicator flashing |
| | 6 Disconnect signal | |

Turning the Counter On

To turn on the Counter, turn on the Main ~ Power switch on the rear panel (see page 1-7), and then press and release the POWER button on the front panel.

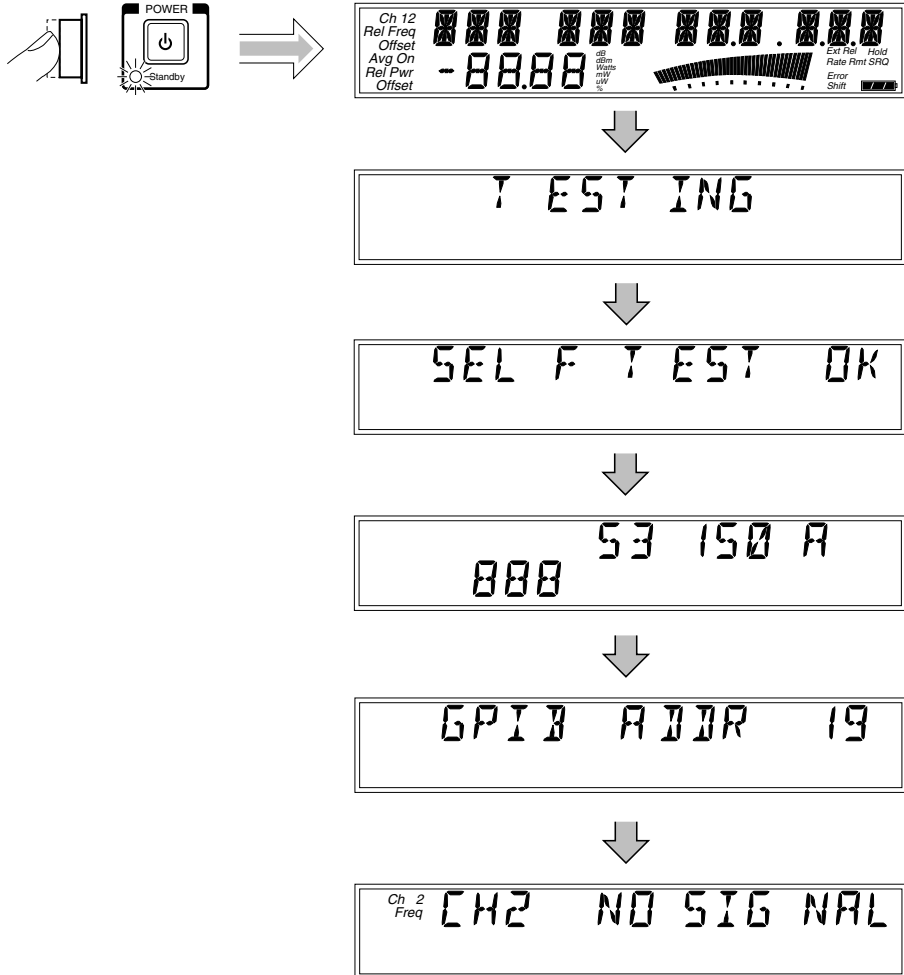

Operating the Counter**NOTE**

If a signal was applied to the Channel 2 input connector prior to turning on the Counter, CH2 NO SIGNAL is displayed momentarily. As soon as the Counter acquires the input signal, it displays the signal's value.

NOTE

The internal Reference Oscillator requires 10 to 15 minutes to reach a stable operating temperature. Since the Reference Oscillator receives power only when the Counter is on or in Standby mode, no measurements should be taken unless the Counter's Main ~ Power switch has been in the on (1) position for at least that amount of time.

Turning the Display Backlight Off or On

When you first turn the Counter on, the backlight for the LCD display is always lit. You can toggle the backlight off and on by pressing the **Shift** key and then the **On/Off (Clear)** key, as shown below.

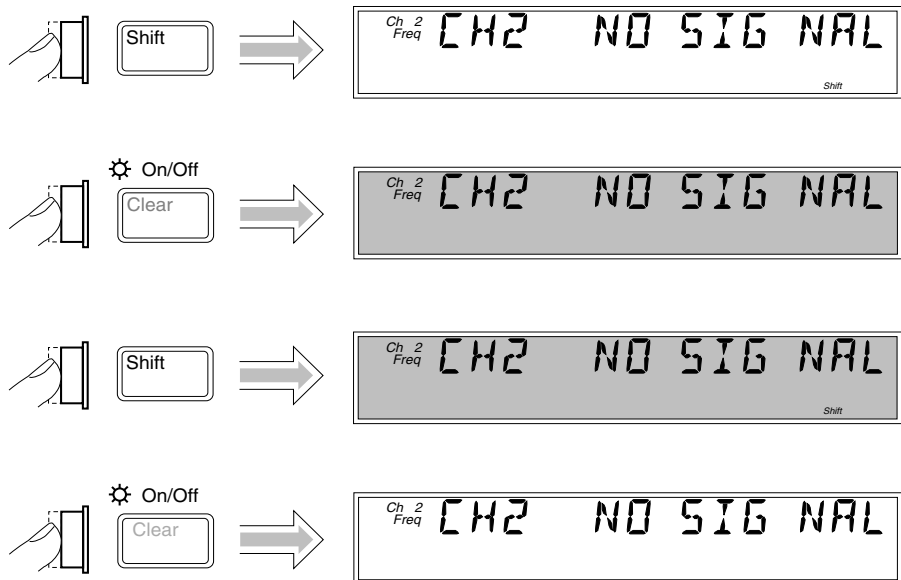
**NOTE**

If your Counter has the Battery option, you can extend the length of time the Counter can operate from the batteries by turning off the display backlight.

Operating the Counter**Using the Menu**

The Agilent 53150A/151A/152A Counter has one menu that you use to control a number of the Counter's features and functions.

Displaying the Menu

To display the Menu, press the **Shift** key and then the **Menu (Reset/Local)** key, as shown below.

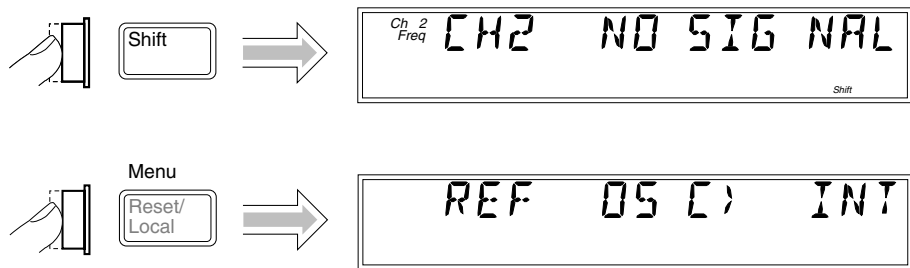
***Navigating in the Menu and Changing Settings***



Use the Selection (arrow) keys to navigate to the setting you want to change and then to actually make the changes. For example, the diagram on the next page shows how to change the setting of the Reference Oscillator from INTernal to EXTernal. (In this example, a reference signal is applied to the External Reference connector, but no signal is applied to the Channel 2 input.)

NOTE

The Counter will not switch to EXTernal unless a suitable reference signal is available at the External Reference connector.

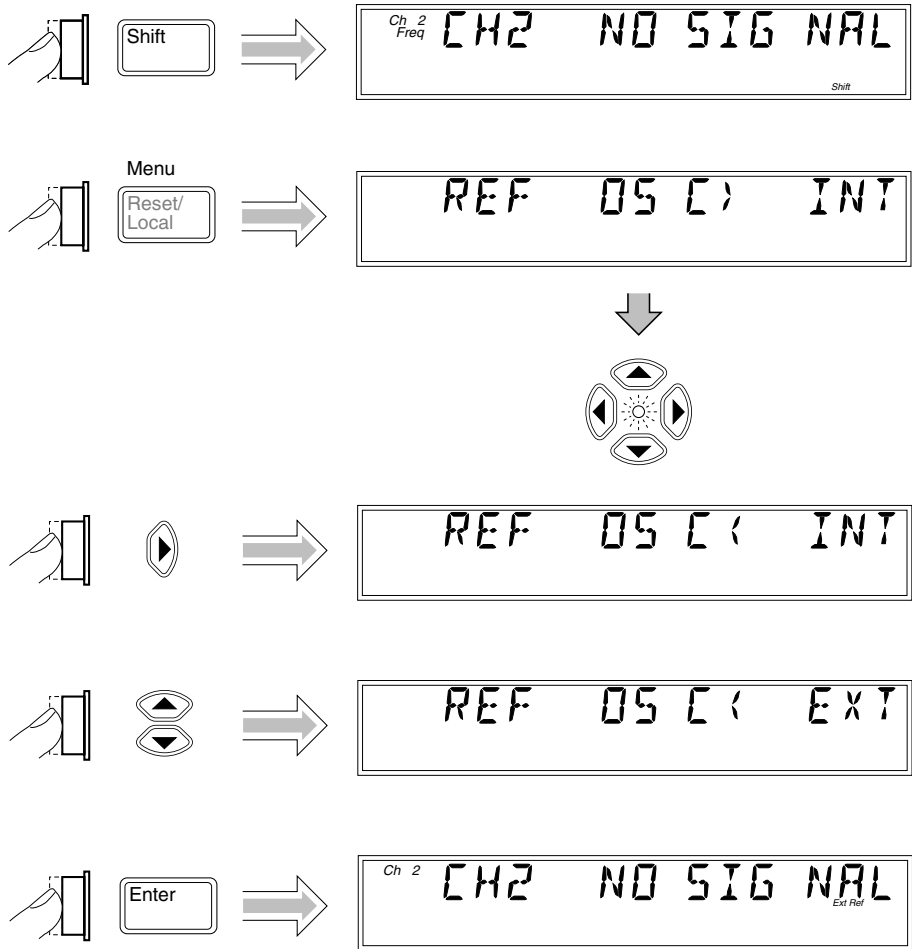
Chapter 1 Getting Started
Operating the Counter



When you select the Menu, the indicator between the arrow keys flashes to indicate that the arrow keys are now active. Since the Reference Oscillator setting is the first one displayed when you invoke the Menu (unless you've used the Menu to change another setting since you turned the Counter on), you don't have to use the  (up-arrow) key or the  (down-arrow) key to get to it.

Operating the Counter

When you press the  (right-arrow) key, the flashing annunciator () changes direction, and the current setting for the Reference Oscillator (INT [internal] or EXT [external]) flashes. This indicates that you can now change this setting. Use either the up-arrow key or the down-arrow key to change the setting.

If there are more than two settings available for the currently selected function, you can cycle through the available settings by repeatedly pressing either the up-arrow key or the down-arrow key. For example, to change the setting for the Baud rate for the serial port, use the sequence on the next page.

Press either the **Enter** key or the left arrow key to accept the currently displayed setting. The **Enter** key accepts the setting and exits the Menu; the left arrow key accepts the setting but does not exit the Menu. Use the left arrow key to accept a setting if you want to change additional menu settings. The **Clear** key reverses an unaccepted setting change.

You navigate to and adjust the remaining settings available in the Menu in the manner described above. The Menu also contains some items that provide information only (no settings are required [or possible] for these), such as Battery Voltage, Operation Hours, and information that identifies the Counter (Agilent model number, firmware version number, serial number, and installed option codes). These menu options and the ones described below are shown in “The Front Panel Menus at a Glance” on page 1-4.

There is also a menu item called Preset and one called Do Self Test. If you press the **Enter** key while PRESET is displayed, all of the Counter’s settings are returned to the factory-default settings. If you press **Enter** while DO SELF TEST is displayed, the Counter repeats the tests that are normally performed when the Counter is first turned on.

NOTE

Remember to terminate each value you change in any of the menu options by pressing the **Enter** key or the left arrow key. You can abort a change to any menu option while the Menu is displayed by pressing the **Reset/Local** key or the **Clear** key. Both keys nullify any changes you made to the current menu option, but they do not affect any changes to other menu options. The **Clear** key terminates the current menu session, but the **Reset/Local** key does not.

Chapter 1 Getting Started
Operating the Counter

Setting the Serial Port Baud Rate (Menu Example)

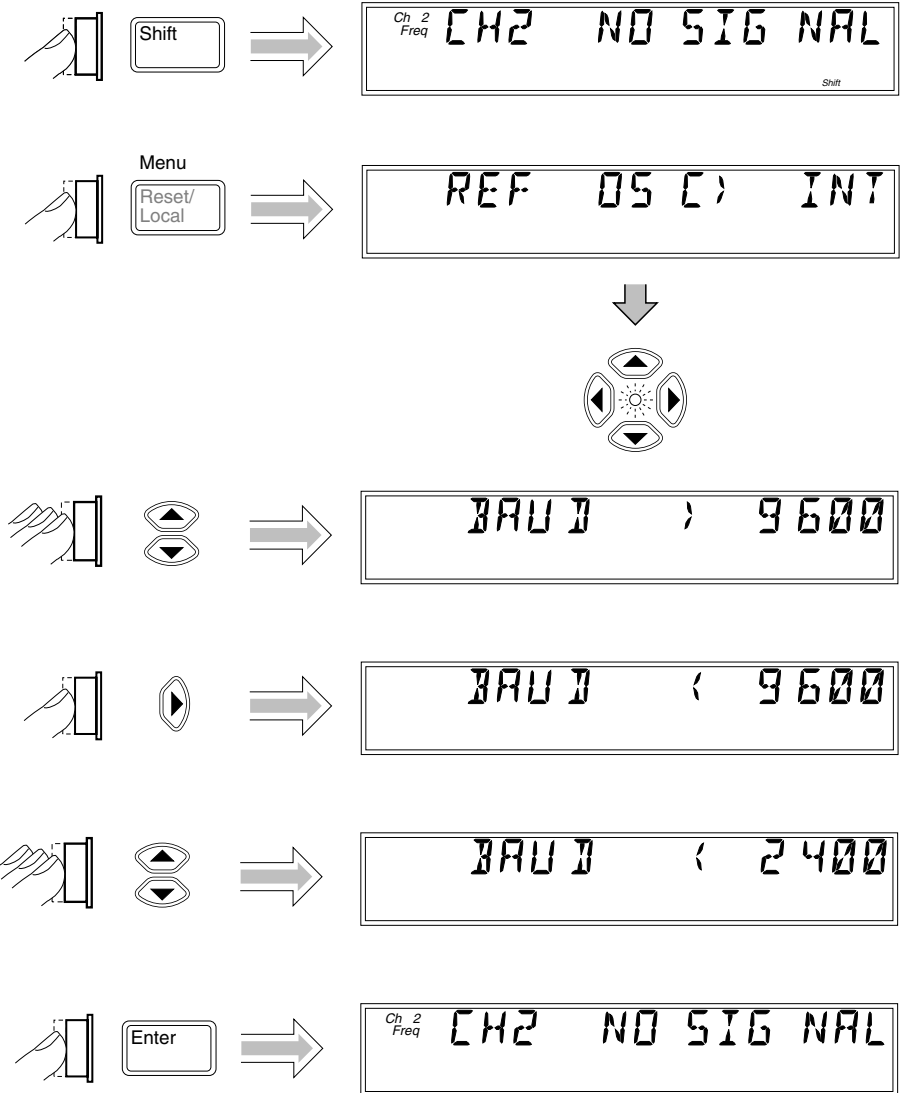

Selecting the Input Channel

You can toggle between Channels 1 and 2 by pressing the **Chan Select** key.

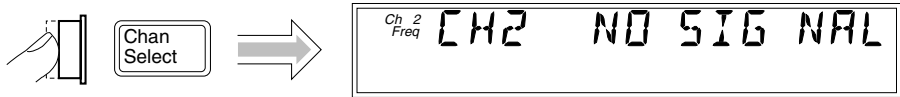
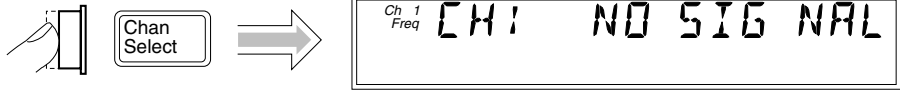

Measuring Frequency

The following diagram shows the basic sequence to use to make a frequency measurement using Channel 1. This example assumes that the Counter is on and has completed the Self Test. For the purposes of this example, use the 10 MHz reference output on the Counter's rear panel as a signal source for input to Channel 1.

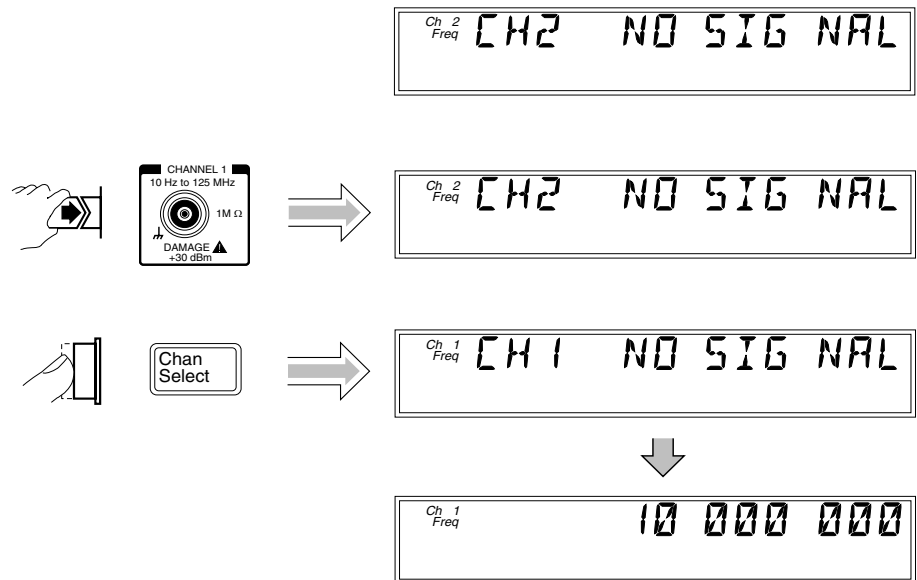

The same procedure applies to making a basic frequency measurement on Channel 2. However, since Channel 2 is automatically selected when you turn on the Counter, the channel-selection step is unnecessary (unless you previously selected Channel 1).

CAUTION

The Channel 2 input path circuits contain sensitive GaAs semiconductors. To prevent damage to these components, always adhere to standard ESD (Electro-Static Discharge) prevention procedures, and ensure that the maximum power specification for this channel (+27 dBm) is not exceeded.

NOTES

The Counter displays CH2 NO SIGNAL or CH1 NO SIGNAL and shuts down all unnecessary circuits when a signal of insufficient amplitude (or no signal) is applied to the corresponding input. This extends the reliability of the affected components, and if the Battery option is installed, extends the length of time the Counter can operate from the batteries.

When the frequency of a signal applied to the Channel 2 input exceeds the maximum rated frequency for the instrument, the Counter displays CH2 TOO HIGH.

CAUTION

The 2.9 mm Planar Crown* connector used for the Channel 2 input on the Agilent 53152A must be handled with care to prevent damage and/or contamination, especially since it acts as a wave guide as well as an electrical connection. Observe the following precautions when handling this connector:

1. If you remove the outer portion of the connector, do not touch the exposed surfaces of either part of the connector with your bare skin or any material that is not intended for cleaning this type of connector.
2. Avoid dropping or striking either portion of the connector.

If the connector becomes contaminated, it can be cleaned with isopropyl alcohol and a lint-free cloth or other suitable cleaning implement.

* Planar Crown® is a registered trademark of Weinschel Corp.

Measuring Relative Frequency

You can measure the difference in frequency from one measurement to another (drift) using the Relative Frequency function. You do this by pressing the **Shift** and **Rel Freq** (**Offset On/Off**) keys as shown in the diagram below (this example assumes that a signal is currently applied to Channel 1).

The Counter stores the current frequency reading when you press the **Rel Freq** key. It then subtracts this value from all subsequent readings and displays the difference until you press the **Rel Freq** key again.

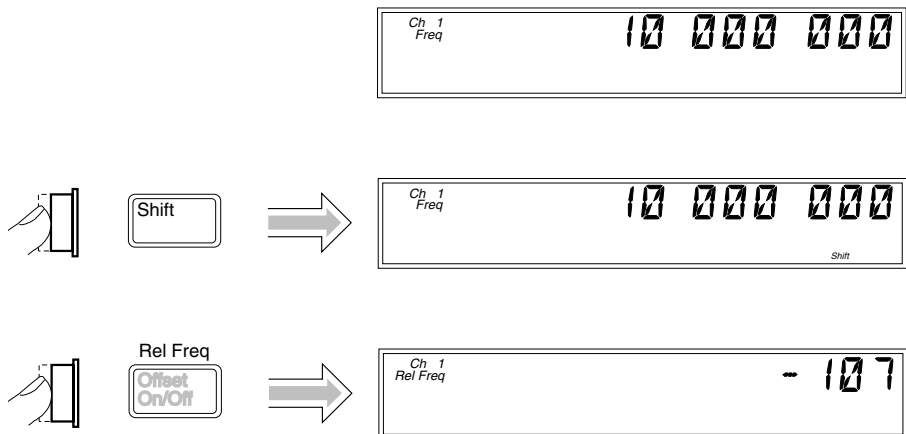

NOTE

If the input signal fluctuates, the value displayed varies as the Counter continues to take measurements. You can vary the speed at which measurements are taken by varying the settings for Rate and Resolution (see "Setting the Measurement Rate" and "Setting the Resolution" on pages 1-32 and 1-34).

Offsetting a Frequency Measurement

You can use the Frequency Offset (Freq Offset) function to add or subtract a constant value to/from a frequency measurement. For example, you can use an offset to compensate for a systematic error or to display the difference in frequency between two signals.

NOTE

The Frequency Offset and Relative Frequency functions can be used simultaneously.

To display an offset frequency measurement, you need to set the value and sign (+/-) of the offset and to turn the Frequency Offset function on. In the diagram on the next page, the Frequency Offset function is enabled first, and the offset value is then entered. However, the order doesn't matter, so you can also enter the offset value first, and then turn the offset function on.

NOTE

When you are entering a value for Frequency Offset (or Power Offset), you can use the **Reset** key to restore all of the displayed digits to zero. These are the only two functions in which the **Reset** key has this effect.

Chapter 1 Getting Started
Operating the Counter

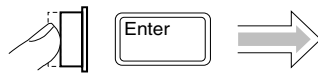
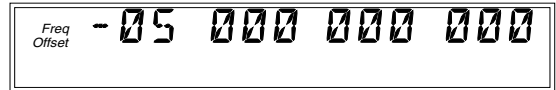
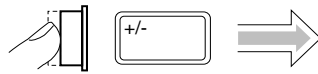
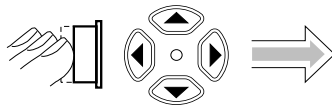
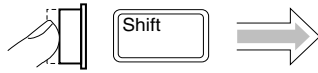
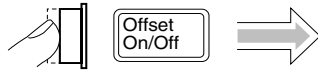

Measuring Power (Channel 2 Only)

The Agilent 53150A/151A/152A Counter can measure signal power (in the same frequency ranges as for frequency measurements) on Channel 2. The example procedure for measuring power in the following diagram assumes that the Counter has previously been set up to measure a 25 GHz input on Channel 2.

NOTE

When the power of a signal applied to the Channel 2 input exceeds the maximum rated power for the instrument, the Counter displays HI.

CAUTION

The Channel 2 input path circuits contain sensitive GaAs semiconductors. To prevent damage to these components, always adhere to standard ESD (Electro-Static Discharge) prevention procedures, and ensure that the maximum power specification for this channel (+27 dBm) is not exceeded.



Selecting the Unit of Measurement for Power

The Counter's power-measurement function can display values in either of two sets of units of measurement—dB and dBm or W, mW, and μ W (the Counter automatically selects the most appropriate unit when either set of units is selected). Use the procedure in the following diagram to select the unit of measurement for power (this procedure assumes that a signal is currently applied on Channel 2 and that power is being displayed):

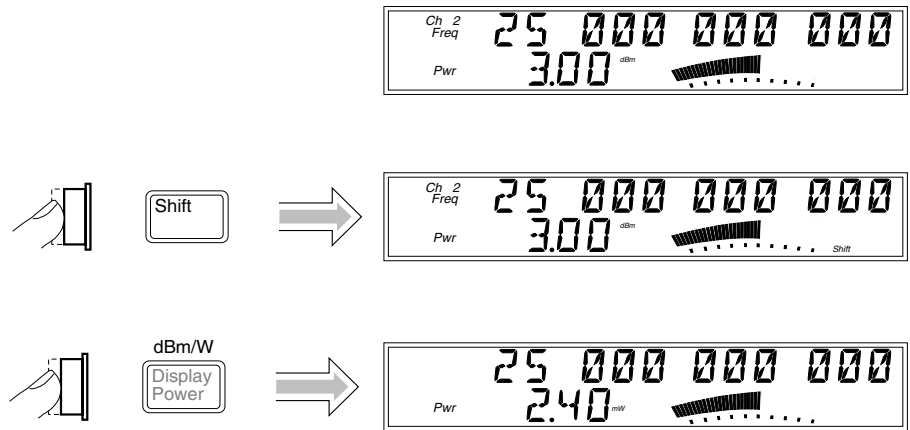

NOTE

The Counter is specified for signals having amplitudes of up to +7.00 dBm. If a signal having an amplitude greater than +9 or +10 dBm is applied, and power measurement is enabled, the annunciators for the power reading display "HI" to indicate that the signal's amplitude exceeds the specification. If a signal having an amplitude of less than -40.00 dBm is applied, the power annunciators display "LO" to indicate that the signal level is too low to be measured by this instrument.

CAUTION

The Channel 2 input path circuits contain sensitive GaAs semiconductors. To prevent damage to these components, always adhere to standard ESD (Electro-Static Discharge) prevention procedures, and ensure that the maximum power specification for this channel (+27.00 dBm) is not exceeded.

Measuring Relative Power

You can measure the difference in power from one measurement to another (drift) using the Relative Power function. You do this by pressing the **Shift** and **Rel Pwr (Offset On/Off)** keys, as shown in the diagram below (this example assumes that a signal is currently applied to Channel 2).

The Counter stores the current power reading when you press the **Rel Pwr** key. It then subtracts this value from all subsequent readings and displays the difference until you press the **Rel Pwr** key again.

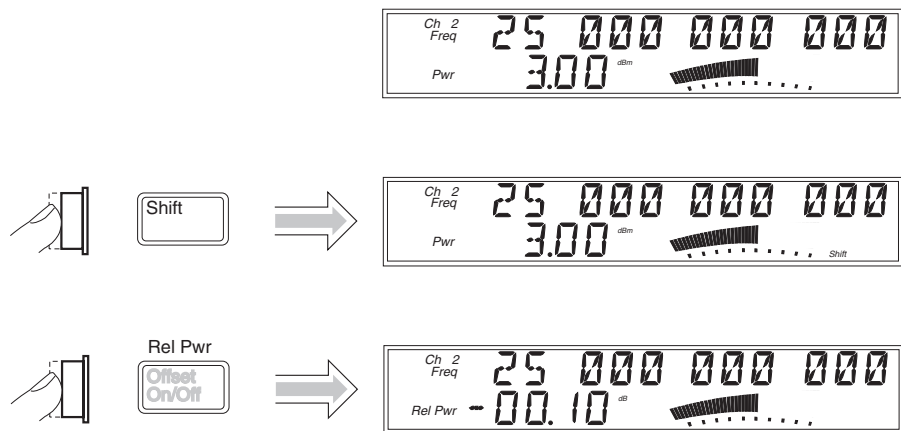

Offsetting a Power Measurement

You can use the Power Offset (Pwr Offset) function to add or subtract a constant value to/from a power measurement. For example, you can use an offset to compensate for a systematic error or to display the difference in power between two signals.

NOTE

The Power Offset and Relative Power functions can be used simultaneously.

To display an offset power measurement, you need to set the value and sign (+/-) of the offset and to turn the Power Offset function on. In the following diagram, the Power Offset function is enabled first, and the

Chapter 1 Getting Started

Operating the Counter

offset value is then entered. However, the order doesn't matter, so you can also enter the offset value first, and then turn the offset function on.

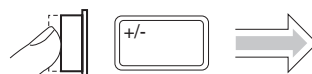
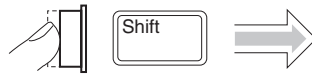

Using Power Correction

The Power Correction function in the main Menu allows you to set the Counter to automatically compensate for power loss (or gain) that occurs in the test configuration, such as attenuation resulting from cable impedance. You can choose from nine power-correction profiles that are stored in nonvolatile memory, and you can modify the contents of these profiles.

Each profile is defined by two to ten data points (a data point consists of a loss value and a frequency value). When Power Correction is enabled, the Counter automatically adds a correction to the power reading (determined from the data points in the profile) that compensates for the loss (or gain) at the frequency being measured. When a measured frequency does not match any of the frequency values defined in the currently selected profile, the Counter interpolates for the measured frequency to determine the appropriate value to add to the power measurement. The correction profiles require a minimum of two data points per profile.

Power Correction Theory of Operation

When the Counter interpolates between data points to determine the amount of correction to apply to the current measurement, it computes the correction based on a straight line plotted between the frequency values in the two closest data points. Therefore, a graph of a power-correction profile would show a “curve” that consists of two to nine straight-line segments, rather than a true curve, as shown below.

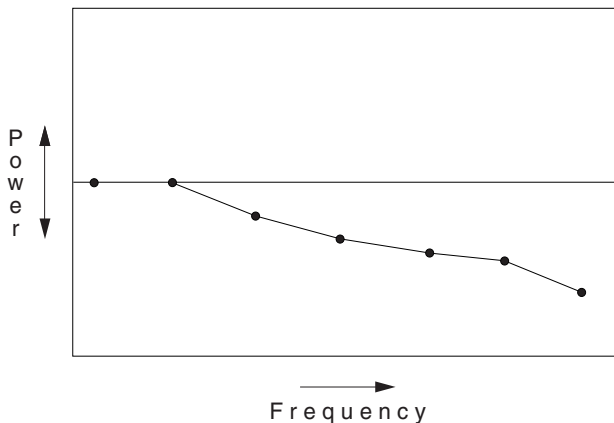

NOTE

As the graph shows, the Counter never computes power-correction values for loss above the zero axis. Conversely, corrections are never computed for gain below the zero axis. Once the correction value reaches the zero axis, no further corrections are applied.

When the Counter interpolates for frequencies that are above or below the range of frequencies specified in the currently selected profile, it never computes a value that would fall on the opposite side of the zero axis from the closest specified frequency. In other words, if there are two or more data points that contain loss values, the Counter never computes or applies a correction that would be indicative of gain. Conversely, if there are two or more data points that contain gain values (negative loss values), the Counter never applies a correction that would be indicative of loss. Since there can be no further change in the loss or gain values once the zero axis is reached, no power corrections are applied when the input frequency reaches or passes a point in the profile that intersects the zero axis. Effectively, the Counter computes only loss-correction values or gain-correction values—never both within the same profile.

When you enter values in power-correction data points and then exit the data-point display (using either the left-arrow key or the Enter key), the Counter immediately sorts all of the data-points into order by the frequency values. Therefore, if you enter a pair of values in a data point, exit the data-point display, and then immediately return to the display for that data point, you may see different values than the ones you just entered. The values you entered may now be contained in a differently numbered data point in the same profile, if they were previously entered out of order by frequency.

Increasing Profile Accuracy

To increase the accuracy of a power-correction profile, you can add data points between the existing data points in the profile (if less than 10 data points are in use), thus bringing the data points closer together and shortening the straight-line segments. If all ten data points are in use, you can add data points by using two or more profiles for a single test configuration. If you do this, you must select the profile you need (from the Menu) for the range of frequencies being measured. This means that you must select a different profile whenever the measured frequency moves outside the range of frequencies defined by the data points in the currently selected profile.

Selecting a Power-Correction Profile

The diagram on page 1-29 shows how to turn Power Correction on or off and how to select a power-correction profile.

NOTE

Pressing the **Enter** key when the number of a power-correction profile (1-9) is displayed selects that profile, enables Power Correction, and exits the Menu. If you intend to enter data in the currently displayed profile, press the right-arrow key instead of the **Enter** key to select the power-correction profile without exiting the Menu.

Entering Data Points in a Power-Correction Profile

The diagram on page 1-30 shows how to enter data points (frequency and loss values) in power-correction profiles. A minimum of two valid data points is required for Power Correction; you can enter up to ten data points in each power-correction profile. Each of the power-correction profiles initially contains two valid data points—0.0 dB loss at 1 GHz, and 0.0 dB loss at the highest frequency the Counter can measure (20 GHz for the 53150A, 26.5 GHz for the 53151A, or 46 GHz for the 53152A). The remaining eight data points contain values of 0.0 dB loss at 0.0 GHz. When entering data, you can change the values in an existing data point or enter new values in a data point that currently has zero values.

Chapter 1 Getting Started
Operating the Counter

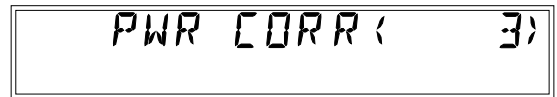
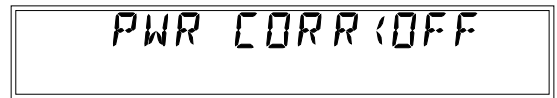
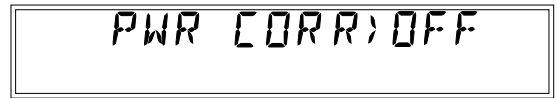
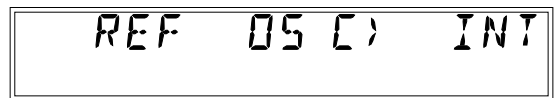
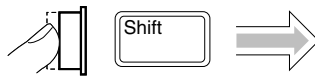
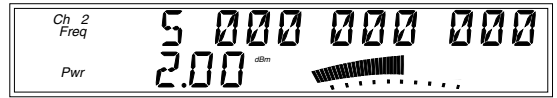

NOTE

When Power Correction is enabled, a lower-case letter “c” is displayed in the hundredths position of the power display.

Chapter 1 Getting Started
Operating the Counter

PWR CORR(3)



(LO 55) 10.6Z)
00.00° ...



(LO 55) 10.0 6Z)
00.00° ...



(LO 55(10.0 6Z)
00.00° ...

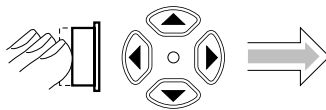

(LO 55(12.2 6Z)
03.2° ...

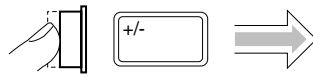

(LO 55(12.2 6Z)
-03.2° ...



PWR CORR(3)

1

NOTES

Pressing the **Enter** key after entering values exits the Menu and restores the measurement display. To remain in the Power Correction menu so you can enter or change values in another data point in the currently selected, press the left-arrow key repeatedly (after entering the values for a data point) until “PWR CORR” is re-displayed, and then press the up- or down-arrow key to choose the next data point you want to edit.

When you are entering or editing values in data points, the 10 single-line annunciators that are part of the analog power display are used to indicate which data point is being displayed. The left-most annunciator indicates that the data displayed is contained in the lowest data point, data point 1. When the first two annunciators on the left are activated, this indicates data point 2, and so on through data point 10, which is indicated by all 10 annunciators.

The Power Correction function can be used to correct for gain from amplification as well as for loss from attenuation. Since Power Correction is intended primarily to correct for loss, loss values are entered as positive numbers. To enter values for gain, use the Sign key (+/-) to change the sign of the value you enter.

Setting the Measurement Rate

The measurement rate determines how frequently the Counter takes measurements. You can set the measurement rate to FAST, MED (medium), SLOW, or HOLD (single measurement taken each time you press the **Reset/Local** key).

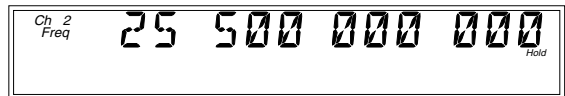
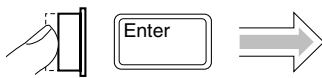
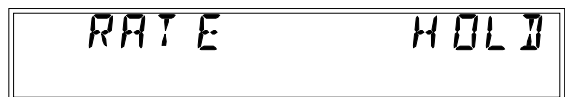
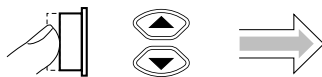
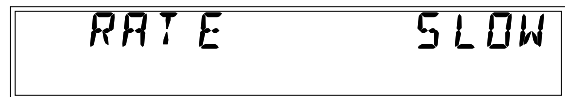
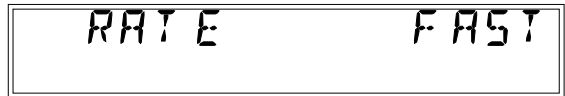
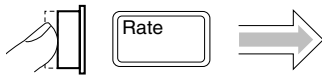

Setting the Number of Averages

You can set the number of measurements the Counter takes and averages before displaying the result. The default setting is one (no average computations are performed when the number of averages is set to one), and the maximum setting is 99. Note that the tens position (10 through 90) and the units position (0 through 9) are adjusted separately, and that you cannot set the number of averages to zero.

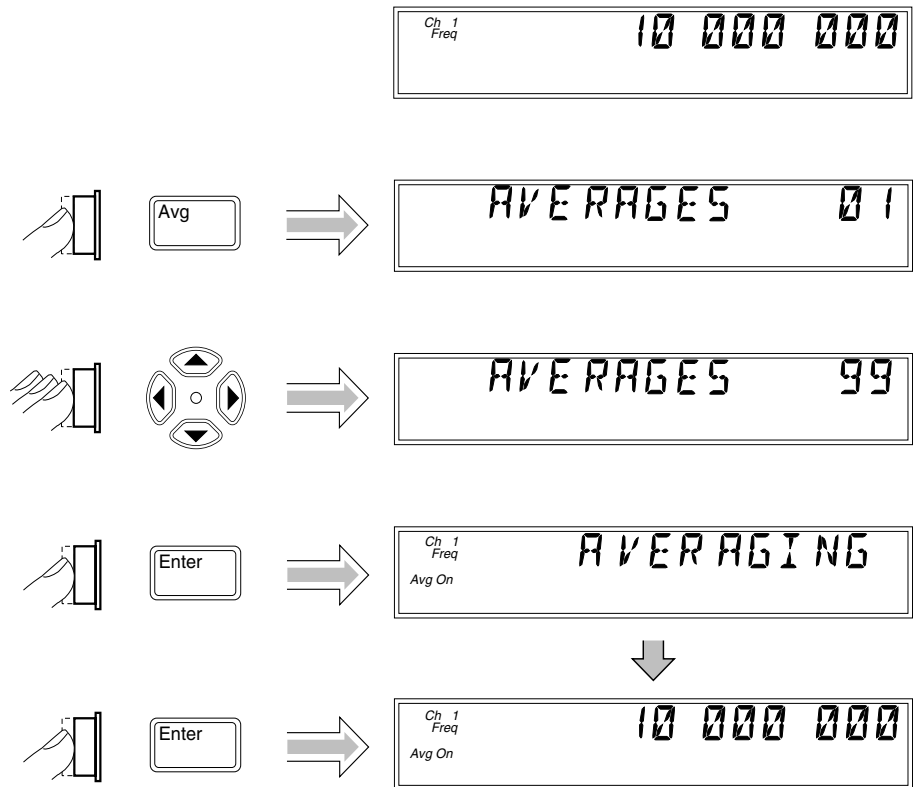

NOTE

For most of the Counter's settings, when you continue to press either the up-arrow or the down-arrow key when you reach the end of the available settings, the value for the setting "rolls over" to the value at the opposite end of the range. For example, if the GPIB address is set to 31, and you press the up-arrow key, the value changes to one.

However, when you adjust the value in the units position for the number of measurements to be averaged, rollover does not occur. If you press the up-arrow when the value in the tens position is zero and the value in the units position is nine, or if you press the down-arrow when the value in the tens position is zero and the value in the units position is one, there is no change. If the value in the units position could roll over (in either direction), it would allow you to set a value of zero for the number of averages. Since at least one measurement must be taken, zero is an illegal value.

NOTE

When the resolution setting is high (e.g., 1 Hz), and a large number of averages is selected, it takes a considerable amount of time for the Counter to take the measurements, compute the averages, and display a reading. As a result, the rate at which the display is updated is considerably slower than at small numbers of averages and lower resolution settings. For example, when the resolution is set to 1 Hz, and the number of averages is set to 60, a new reading is displayed every 60 seconds (approximately).

Setting the Resolution

Since less time is required to compute each measurement as the resolution of the measurements is reduced, the resolution setting affects the rate at which measurements are taken and displayed, as well as the number of digits displayed for the measurements. As a result, the rate at which the Gate indicator flashes changes when you change the resolution.

As shown in the procedure in the diagram on the next page, the available resolution settings are 1 Hz (the default setting), 10 Hz, 100 Hz, 1 KHz, 10 KHz, 100 KHz, and 1 MHz.

Chapter 1 Getting Started
Operating the Counter

Ch 2
Freq 25 500 000 000

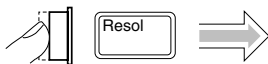

RESOL 1 HZ

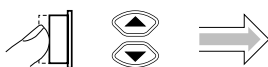

RESOL 10 HZ



RESOL 100 HZ

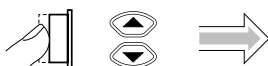

RESOL 1 KHZ



RESOL 10 KHZ

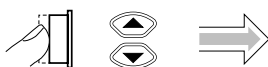

RESOL 100 KHZ

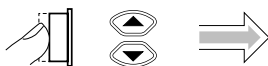

RESOL 1 MHZ

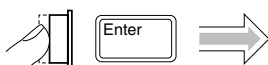

Ch 2
Freq 25 500

Chapter 1 Getting Started
Operating the Counter



Introduction

This chapter contains information and usage procedures for the front-panel keys, operating functions, and menus of the Agilent 53150A/151A/152A Microwave Frequency Counter.

Chapter Summary

- How this Counter Works for You pg. 2-3
- Summary of the Measurement Sequence pg. 2-4
- Using the Selection Keys pg. 2-5
- Numeric Entry pg. 2-6
- Changing States pg. 2-7
- Acknowledging Messages pg. 2-9
- Using the Clear and Reset/Local Keys pg. 2-9
- Other Function Selection Keys pg. 2-10
- Measuring Frequency pg. 2-12
- Setting the Resolution and Measurement Rate pg. 2-14
- Setting the Number of Averages pg. 2-17
- Measuring Relative Frequency pg. 2-20
- Offsetting a Frequency Measurement pg. 2-21
- Measuring Power pg. 2-24
- Measuring Relative Power pg. 2-26
- Offsetting a Power Measurement pg. 2-27
- Using Power Correction pg. 2-30
- Using the Menu pg. 2-39

How this Counter Works for You

The following is a list of some of the key things the Counter does for you.

- Presets the menus to default states and values at power-up
- The Counter's **Menu** key and other front-panel keys allow you to select such things as the timebase source, the GPIB address, and the RS-232 serial-port baud rate. The Counter also allows you to store your selections in non-volatile memory; thus, these settings are not lost when power has been off or after a remote-interface reset.
- Automatically displays measurement(s) when you have selected a measurement function.
- Accepts your entry for a menu item when you press the **Enter** key. You *must* press the **Enter** key to complete each setting and/or selection.
- Saves user configuration settings.

Summary of the Measurement Sequence

1. Turn on the Main ~ Power switch on the back panel, and then press and release the POWER button on the front panel.

NOTE

The internal Reference Oscillator receives power only when the Main ~ Power switch is on. Therefore, the frequency of the reference signal may drift until the oscillator stabilizes. Specifications for the stability of the standard internal timebase and the optional Oven Timebase are provided in Chapter 3.

2. Connect the input signal to the appropriate input connector (Channel 1 or Channel 2).
3. Connect an external reference signal to the External Reference connector on the back panel (if desired).
4. Press the **Chan Select** key to select the input channel (if necessary).
5. Press the **Display Power** key if you need to measure power (Channel 2 only).
6. Press the frequency and/or power **Offset On/Off** keys to enable offset measurements (if desired), and then use the **Freq Offset (Shift + Rate)** and/or **Pwr Offset (Shift + Avg)** keys to enter the offset values.
7. Use the **Resol**, **Rate**, and **Avg** keys to configure the display.
8. Use the **Menu (Shift + Reset/Local)** key to set the reference-oscillator source, to select the Channel 1 low-pass filter, to configure the Counter's response to frequency modulation, to enable and configure Power Correction, and/or to select a previously saved set of user settings.
9. If you intend to operate the counter remotely using the GPIB, use the **GPIB (Shift + Resol)** key to configure the GPIB.
10. If you intend to operate the counter remotely using the serial interface, use the **Menu (Shift + Reset/Local)** key to adjust the serial port Baud rate.

Using the Selection Keys

There are six Selection keys—four “arrow” keys, the **Enter** key, and the sign (+/−) key. The functions of the arrow keys depend on the Counter’s operating mode (i.e., sequencing through choices in the Menu, numeric entry, state change, etc.). This section describes how the Selection keys function in these different operating modes.

Sequencing Through the Menu

To access the Menu, press the **Shift** key, and then press the **Menu (Reset/Local)** key.

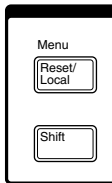

- Press the up- or down-arrow key to go forward to the next menu function or back to the previous menu function. Pressing either of these keys repeatedly cycles through the list of menu functions.
- Press the right-arrow key to select a function. When you do this, the flashing annunciator () changes direction and the current setting flashes to indicate that you can now use the up- and down-arrow keys to cycle through the available settings.
- Press the up- or down-arrow key to move through the list of available settings for a function. Pressing either of these keys repeatedly cycles through the list of settings.
- Press the Sign (+/−) key to change the sign of numeric values.
- Press the **Enter** key to accept the currently displayed setting and exit the Menu.

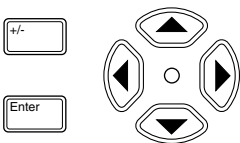

NOTE

In most cases, when you reach the top or bottom of a list of settings, or the left or right end of a numerical field, the focus rolls over to the opposite end of the list of settings, or wraps around to the opposite end of the numeric field. In some situations, however, this does not occur, because if it did, you could choose an illegal setting. For these settings, you have to use the opposite button to cycle back through the values or settings.



Numeric Entry

Several menu functions, and several functions that have dedicated keys on the front panel, require you to enter numeric values.

- Press the ◀ (left-arrow) and ▶ (right-arrow) keys to move left and right to select adjustable digits (the selected digit flashes).
- Press the ▲ (up-arrow) and/or ▼ (down-arrow) key to increment and decrement the selected (flashing) digit of the displayed value (see note on previous page).
- Press the Sign (+/-) key to change the sign of the numeric value.
- Press the **Enter** key to complete a numeric entry. (If you change the value of a numeric entry, but you forget to press the **Enter** key, the value of the entry is *not* changed.)

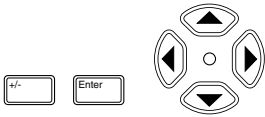

Changing States

Several menu functions, and several functions that have dedicated keys on the front panel, require you to choose from a list of available states. These functions and the states you can choose for each of them are:

- Reference Oscillator (REF OSC)
 - Internal (INT)
 - External (EXT)
- Serial Port Baud Rate (BAUD)
 - 1200
 - 2400
 - 4800
 - 9600
 - 14400
 - 19200
- Frequency Modulation (FM)
 - Automatic (AUTO)
 - Off (OFF)
- Channel 1 Low-Pass Filter (CH1 LPF)
 - On (ON)
 - Off (OFF)
- Measurement Rate (**Rate** key)
 - Fast (FAST)
 - Medium (MED)
 - Slow (SLOW)
 - Hold (HOLD)
- Resolution (**Resol** key)
 - 1 Hz, 10 Hz, 100 Hz, 1 KHz, 10 KHz, 100 KHz, 1 MHz

Using the Selection Keys

Use the Selection keys as described below to change the state of these functions:

- When the annunciator () in the display flashes, press the right-arrow key to move the focus from the displayed menu function (or front-panel-key function) to the setting for that function.
- Press the up- or down-arrow key to cycle through the available choices.

Press the **Enter** key to complete the setting. (If you change the setting of a function, but you forget to press the **Enter** key, the setting of the function is *not* changed.)

NOTE

The Sign key has no function and is ignored in menu selections and front-panel functions that have state-change selections only.

Using the **Clear** and **Reset/Local** Keys

The **Clear** key and the **Reset/Local** key have similar functions in the Menu and in other front-panel-key function settings, but their effects vary with the Counter's state and condition. In general, the **Reset/Local** key restores the setting that was in effect when you entered the Menu or front-panel-key function, but it does not close the Menu or the function-setting display. The **Clear** key also restores the previous setting, but it closes the Menu or the front-panel-key function-setting display at the same time.

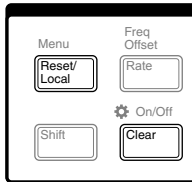

If you press the **Reset/Local** key while the Counter is taking measurements, it resets the current operation and forces the Counter to reacquire and re-measure the signal.

Pressing the **Reset/Local** key while the Counter is in Remote Mode forces the Counter into Local Mode and enables all of the front-panel controls.

Acknowledging Messages

When a message is displayed, press the **Reset/Local** key, the **Clear** key, or the **Enter** key (after reading the message) to acknowledge it and erase it from the display.

Other Function Selection Keys

Other Function Selection Keys

There are several functions that you access directly from front-panel keys (not from within the Menu). These functions are:

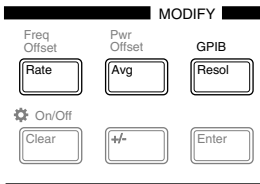

- Measurement Rate (**Rate** key)
- Number of Averages (**Avg** key)
- Display Resolution (**Resol** key)
- GPIB Address (**GPIB** key)

Use the Selection keys in the manner described earlier in this chapter (see “Numeric Entry” and “Changing States”) to adjust the settings for these functions. Detailed procedures for using the **Rate**, **Avg**, **Resol**, and **GPIB** keys are provided later in this chapter.

There are also a number of functions that are toggled between states (no selections are displayed) using named front-panel keys. These are:

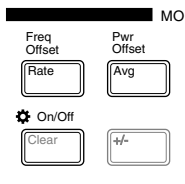

- Display backlight on and off (**On/Off**). Press **Shift**, and then press the **On/Off / Clear** key.
- Channel selection (**Chan Select**). Press **Chan Select** to switch between the two input channels.
- Display power measurement (**Display Power**). Press **Display Power** to turn the power-measurement function on and off.
- Frequency offset measurement (**FREQ Offset On/Off**). Press the **Offset On/Off** key in the FREQ area of the front panel to turn the frequency offset function on or off.
- Power offset measurement (**POWER Offset On/Off**). Press the **Offset On/Off** key in the POWER area of the front panel to turn the power offset function on or off (the Display Power function must be on).

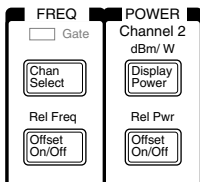

Other Function Selection Keys

- Relative frequency measurement (**Rel Freq**). Press **Shift**, and then press the **Rel Freq (Offset On/Off)** key to measure the difference in frequency between the current measurement and the measurement taken at the time you pressed the **Rel Freq** key (drift).
- Relative power measurement (**Rel Pwr**). Press **Shift**, and then press the **Rel Pwr (Offset On/Off)** key to measure the difference in power between the current measurement and the measurement taken at the time you pressed the **Rel Pwr** key.

Measuring Frequency

- 1 **Connect the Counter to a power source, and set the Main ~ Power switch on the back panel to 1 (on).**

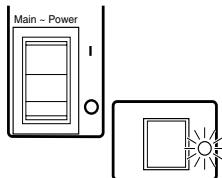

If the Counter is connected to an AC power source, the Main AC Power indicator on the back panel and the Standby indicator on the front panel light. If the Counter is connected to an external DC power source or is operated from internal batteries (with Battery option only), the Standby indicator lights, but the Main AC Power indicator does not.

- 2 **Press the POWER button on the front panel.**

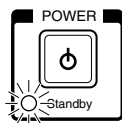

The Standby indicator goes off, and all segments of the front-panel display are temporarily activated. TESTING is displayed while the Counter performs its power-on self-test. If the Counter passes all of the tests, SELF TEST OK is displayed, and the Counter then displays its model number, firmware version number, GPIB address, and CH2 NO SIGNAL. The Counter is now ready to measure the frequency of a signal applied to the Channel 2 input. Note that the Ch 2 and Freq annunciators are activated.

- 3 **Connect an input signal to Channel 2.**

CAUTION

The Channel 2 input path circuits contain sensitive GaAs semiconductors. To prevent damage to these components, always adhere to standard ESD (ElectroStatic Discharge) prevention procedures, and ensure that the maximum power specification for this channel (+27 dBm) is not exceeded.

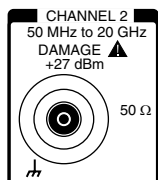

The Counter automatically displays the measured frequency of the input signal. To set the resolution, measurement rate, and/or the number of averages, see the appropriate procedure in the section titled “Operating the Counter,” or refer to “Setting the Resolution,” “Setting the Measurement Rate,” and “Setting the Number of Averages,” later in this chapter.

NOTE

When the frequency of a signal applied to the Channel 2 input exceeds the maximum rated frequency for the instrument, the Counter displays CH2 TOO HIGH.

- 4 To measure the frequency of a signal applied to the Channel 1 input, press the Chan Select key.**



CHANNEL 1 is displayed momentarily, and the Ch 1 and Freq annunciators are activated. If a signal is presently applied to the Channel 1 input, the measured frequency is then displayed. If no signal is applied, CH1 NO SIGNAL is displayed until an input signal is connected to the Channel 1 input connector.

Setting the Resolution and Measurement Rate

The number of measurements the Counter makes in a given amount of time is affected by the Rate setting, the Resolution setting, and the quality of the input signal (signal quality affects the amount of time the Counter requires to determine an accurate measurement). By adjusting the Resolution and Rate settings, you can affect how often the Counter takes measurements.

Setting the Resolution

The Counter's resolution setting determines the number of digits displayed for measurements and the precision of the measurements. Since less time is required to compute each measurement as the resolution of the measurements is reduced, the resolution setting also affects the rate at which measurements are taken and displayed. As a result, the flash rate of the Gate indicator changes when you change the resolution.

The numerals shown for the value of the measurement are displayed in four groups of three digits, as shown below (the leading zero is suppressed):

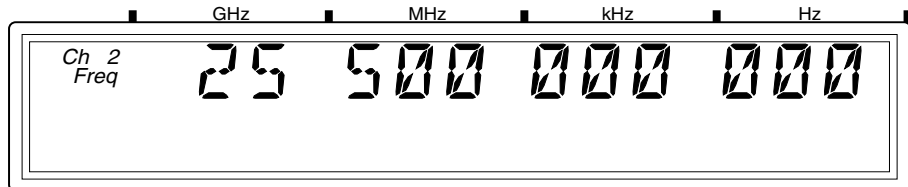

Resolution Setting Example

For the following example, use the 10 MHz output from the reference timebase as the input to Channel 1.

1 Press the Resol key to enter the resolution-setting mode.

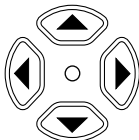

The current resolution setting is displayed (the current value and the indicator between the arrow keys are flashing to indicate that you can use the up- and down-arrow keys to change the setting).

2 Press the up-arrow or down-arrow key to decrease or increase the resolution.

You can press these keys as many times as necessary to locate the setting you want to use. The available resolution settings are 1 Hz (the default setting), 10 Hz, 100 Hz, 1 KHz, 10 KHz, 100 KHz, and 1 MHz.

3 Press the Enter key to activate your setting and exit the resolution-setting mode.

The setting you chose is now in effect. The number of digits displayed for the measurement is adjusted accordingly; you can observe the affect on measurement speed by monitoring the flash rate of the Gate indicator.

NOTE

The measurement resolution has a direct effect on the amount of time the Counter requires to complete a measurement. Measurements made at the Counter's maximum resolution setting (1 Hz) are noticeably slower than at lower resolutions. This is especially noticeable when the Counter is set to average a number of measurements.

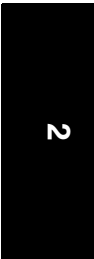

Setting the Measurement Rate

The measurement Rate setting determines how frequently the counter initiates measurements. Since the actual measurement rate is also affected by the resolution setting and the signal quality, as mentioned earlier, the available rate settings (FAST, MED, and SLOW) do not equate to a fixed number of measurements in a given amount of time. The HOLD setting turns off automatic measurements, so that a single measurement is made each time you press the **Reset/Local** key.

Rate Setting Example

- 1 Press the Rate key to enter the rate-setting mode.**

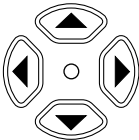

The current rate setting is displayed (the current value and the indicator between the arrow keys are flashing to indicate that you can use the up- and down-arrow keys to change the setting).

- 2 Press the up-arrow or down-arrow key to decrease or increase the measurement rate.**

You can press these keys as many times as necessary to locate the setting you want to use. The available resolution settings are FAST, MED, SLOW, and HOLD.

- 3 Press the Enter key to activate your setting and exit the rate-setting mode.**

The setting you chose is now in effect. The measurement rate is adjusted accordingly; you can observe the effect on measurement speed by monitoring the flash rate of the Gate indicator. There is no annunciator on the display for the rate setting, unless you set the rate to HOLD.

- 4 If you set the rate to HOLD, press the Reset/Local key to initiate a measurement.**



The Counter displays the MEASURING message while it computes the measurement, and then displays the result. Press the **Reset/Local** key again each time you want to take an additional measurement.

Setting the Number of Averages

You can set the Counter to take a variable number of frequency, power, or voltage measurements and average them mathematically before displaying the result. You can use this feature to determine the effective measurement of a signal that is fluctuating. When measuring the frequency of a fluctuating signal, you can also use averaging to retain some of the precision of a maximum-resolution measurement.

The default number of averages is 1, which means that no averages are performed, and the maximum setting is 99. Note that the tens position (10 through 90) and the units position (0 through 9) are adjusted separately, and that it is not possible to set the number of averages to 0.

NOTE

When a large number of averages is selected for a frequency measurement in combination with a high resolution setting (e.g., 1 Hz), it takes a considerable amount of time for the Counter to take the measurements, compute the averages, and display an initial reading. For example, when the number of averages is set to 60, and the resolution is set to 1 Hz, the first reading is displayed after 60 seconds (approximately). Subsequent computations do not require as much time, since the averaging function computes a running average. However, the rate at which the display is updated after the initial average computation is also slower than at lower resolution settings.

Averages Setting Example

- 1 Press the Avg key to enter the averages-setting mode.**

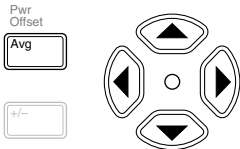

The current averages setting is displayed (the current value and the indicator between the arrow keys are flashing to indicate that you can use the up- and down-arrow keys to change the setting).

- 2 Press the up-arrow or down-arrow key to decrease or increase the value for the units position of the number of averages.**

Setting the Number of Averages**NOTE**

For most of the Counter's settings, when you continue to press either the up-arrow or the down-arrow key when you reach the end of the available settings, the value for the setting "rolls over" to the value at the opposite end of the range. For example, if the GPIB address is set to 31, and you press the up-arrow key, the value changes to 1. However, when you adjust the value in the units position for the number of measurements to be averaged, rollover does not occur. If you press the up-arrow when the value in the tens position is 0 and the value in the units position is 9, or if you press the down-arrow when the value in the tens position is 0 and the value in the units position is 1, there is no change. If the value in the units position could roll over (in either direction), it would allow you to set a value of 0 for the number of averages. Since at least one measurement must be taken, 0 is an illegal value.

- 3 Press the left-arrow key once to move the focus to the tens position, and then use the up- and/or down-arrow key to set the value for the tens position (if desired).**

Note that the tens and units values are set separately.

- 4 Press the Enter key to activate your setting and exit the averages-setting mode.**

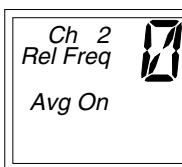

The Avg On annunciator is activated, and the Counter displays AVERAGING while it takes the first set of measurements. The length of time that the AVERAGING message is displayed varies primarily with setting for the number of averages, since this determines the number of measurements that must be made and averaged before displaying a result. When the first set of averages is complete and the result is displayed, the Counter immediately takes another measurement, discards the oldest measurement included in the current average computation, recomputes the average and displays the new result. This continues until you change the setting for the number of averages or disable averaging (by setting the number of averages to 0).

Setting the Number of Averages

In certain situations, the length of time that the AVERAGING message is displayed can be affected by additional factors. When you are measuring frequency, the current resolution setting, the rate setting, and the quality of the signal all affect the length of time required to make the measurements and complete the average computation.

If the measurement rate is set to HOLD, and a value larger than 1 is set for averages, the first set of measurements is not initiated until you press the **Reset/Local** key. When you do, the Counter displays the AVERAGING message while it takes the first set of measurements. When the first set of measurements is complete, and the averaging result is displayed, the Counter remains in this state until you press the **Reset/Local** key to initiate another set of measurements, change the value for averages back to one, or change the setting for the measurement rate to SLOW, MED, or HIGH. When the measurement rate is set to HOLD, the Counter performs a block-average computation instead of a running-average computation.

Measuring Relative Frequency

You can measure the difference in frequency from one measurement to another (frequency drift) or between two separate input signals using the Relative Frequency function.

Relative Frequency Example

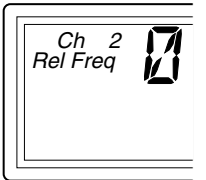

Press the **Shift** key, and then press the **Rel Freq (FREQ Offset On/Off)** key. The Shift annunciator activates when you press the **Shift** key. When you press the **Rel Freq (FREQ Offset On/Off)** key, the Shift annunciator disappears, and the Rel Freq annunciator in the upper-left corner of the display activates. At the same time, the Counter saves the frequency measurement it was displaying at the time you pressed the **Rel Freq** key, and it computes and displays the difference between that measurement and the current measurement.

You can also use the Relative Frequency function to measure the difference between two different signals. To do this, activate the Relative Frequency function, as described in the previous paragraph, disconnect the cable supplying the signal to the input connector, and then connect the second signal to the same input connector. The value displayed when the Counter acquires the second signal is the frequency difference between the two signals.

Offsetting a Frequency Measurement

You can use the Frequency Offset (Freq Offset) function to add or subtract a constant value to/from a frequency measurement. For example, you can use an offset to compensate for a systematic error or to display the difference in frequency between two signals.

To display an offset frequency measurement, you need to set the value and sign (+/-) of the offset and to turn the Frequency Offset function on. In the following example, the Frequency Offset function is enabled first, and the offset value is then entered. However, the order doesn't matter, so you can also enter the offset value first, and then turn the offset function on.

Frequency Offset Example

- 1 **Connect a cable from the 10 MHz reference output on the back panel to the Channel 1 input connector, and press the Chan Select key (if necessary) to activate Channel 1.**

The display should look like this:

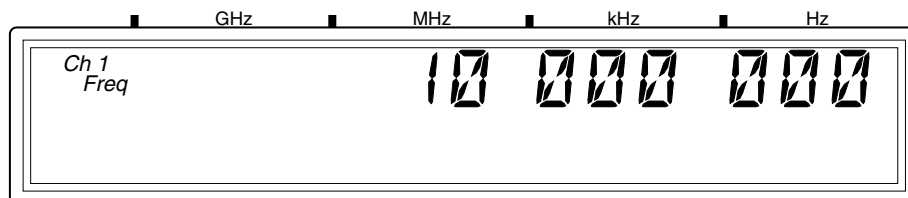

- 2 **Press the Shift key, and then press the Freq Offset (Rate) key.**

The Shift annunciator activates when you press the **Shift** key. When you press the **Freq Offset** key, the Shift annunciator disappears, and the Freq Offset annunciator at the left side of the display activates.

Offsetting a Frequency Measurement

- 3 Use the left- and right-arrow keys to move the focus to the digit(s) in the frequency-offset display that you need to adjust to enter the offset value, and then use the up- and down-arrow keys to adjust the value for each digit. Enter a value of 500 Hz.

The flashing digit is the digit that currently has the focus. This means that you can change the value of the flashing digit using the up- and down-arrow keys.

- 4 Press the sign (+/-) key (if desired) to change the sign of the offset value.

The display should look like this:

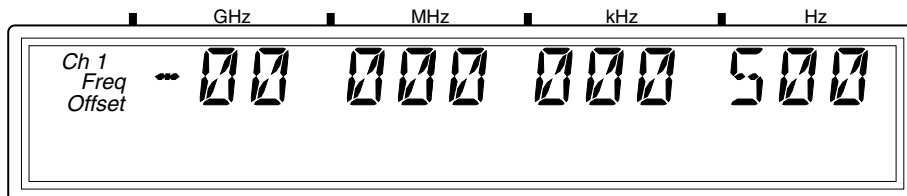

- 5 Press the Enter key to confirm the offset value and exit the offset-entry display.

The Freq Offset annunciator is deactivated, and the measurement display returns.

NOTE

When you are entering a value for Frequency Offset (or Power Offset), you can use the **Reset** key to restore all of the displayed digits to zero. These are the only two functions in which the **Reset** key has this effect.

Chapter 2 Operating Your Frequency Counter
Offsetting a Frequency Measurement

6 Press the Offset On/Off key.

The Freq Offset annunciator is activated, and the value of the display is adjusted to reflect the value and sign of the offset entered in Steps 2 and 3.

The display should look like this:

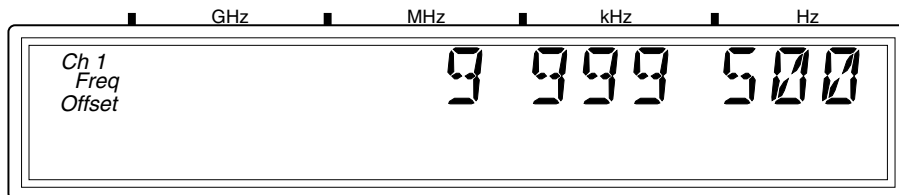

Since the offset function can be used to add or subtract a fixed value to/from the measurement result, you can use this feature to tune or align the odd frequencies of a local oscillator (LO). If you enter the target frequency as a negative offset, the Counter displays the difference between the LO's frequency and the target frequency. You can then adjust the LO until the Counter displays a value of zero.

NOTE

The maximum value that can be entered for Frequency Offset is $\pm 49,999,999,999$ Hz.

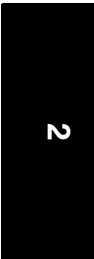

Measuring Power

The Agilent 53150A/53151A/53152A can also measure signal power (in the same frequency ranges as for frequency measurements) on Channel 2. The power measurement, which is shown in a dedicated area of the display, includes a digital readout and an analog representation that is useful when peaking signals. The display can be configured to show power in units of dB, dBm, W, mW, μ W, and percentage (%).

CAUTION

The Channel 2 input path circuits contain sensitive GaAs semiconductors. To prevent damage to these components, always adhere to standard ESD (ElectroStatic Discharge) prevention procedures, and ensure that the maximum power specification for this channel (+27 dBm) is not exceeded.

Power Measurement Example

This example assumes that a signal is currently applied to the Channel 2 input connector.

- 1 **Press the Display Power key to enable power measurement.**

The Pwr annunciator at the left side of the display is activated, and the Counter's digital and analog power displays show the power measurement in dB or dBm (the default units of measurement).

The display should look like this:

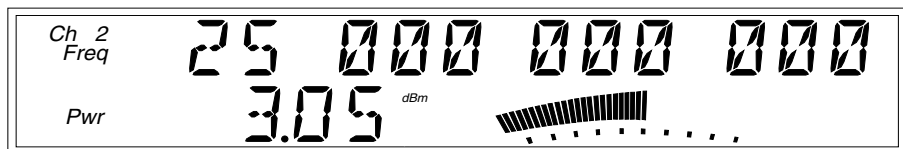

Measuring Power**2 Press the Shift key, and then press the dBm/W (Display Power) key.**

When you press the Shift key, the Shift annunciator is activated. When you press the dBm/W (Display Power) key, the Shift annunciator goes off, and the units of measurement annunciator group to the right of the digital power measurement changes from dB or dBm to W, mW, or μ W, as shown below:

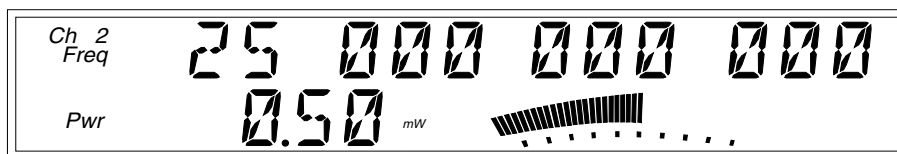

NOTE

When the power of a signal applied to the Channel 2 input exceeds the maximum rated power for the instrument, the Counter displays HI.

Measuring Relative Power

You can measure the difference in power from one measurement to another or between two separate input signals using the Relative Power function.

Relative Power Example

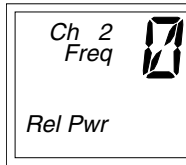

Press the **Shift** key, and then press the **Rel Pwr** (**PWR Offset On/Off**) key. The Shift annunciator activates when you press the **Shift** key. When you press the **Rel Pwr** key, the Shift annunciator disappears, and the Rel Pwr annunciator at the left side of the display activates. At the same time, the Counter saves the power measurement it was displaying at the time you pressed the **Rel Pwr** key, and it computes and displays the difference in power between that measurement and the current measurement.

NOTE

When the Counter is set to measure power in dBm, relative power is expressed in dB. When the Counter is set to measure power in Watts, mW, or, μ W, power relative power is expressed as a percentage (%).

You can also use the Relative Power function to measure the difference in power between two different signals. To do this, activate the Relative Power function, as described in the previous paragraph, disconnect the cable supplying the signal to the input connector, and then connect the second signal to the same input connector. The value displayed when the Counter acquires the second signal is the power difference between the two signals.

Offsetting a Power Measurement

You can use the Power Offset (Pwr Offset) function to add or subtract a constant value to/from a power measurement. For example, you can use an offset to compensate for a systematic error, to display the difference in power between two signals, or to compensate for losses and attenuation in cables or components that are between the signal source and the Counter.

To display an offset power measurement, you set the value and sign (+/-) of the offset and turn the Power Offset function on. In the following example, the Power Offset function is enabled first, and the offset value is then entered. However, the order doesn't matter, so you can also enter the offset value first, and then turn the offset function on.

Power Offset Example

- 1 Connect a signal to the Channel 2 input connector, and activate power measurement by pressing the Display Power key.**

The display should look like this (except for the values, which are simulated in the illustration):

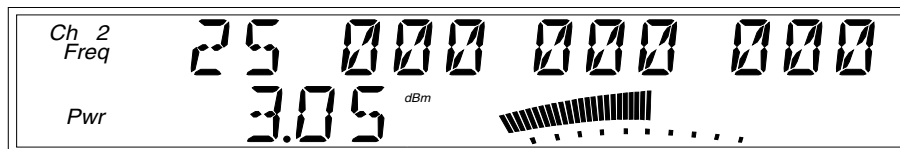

Offsetting a Power Measurement

- 2 Press the Shift key, and then press the Pwr Offset (Avg) key.**

The Shift annunciator activates when you press the Shift key. When you press the Pwr Offset key, the Shift annunciator and the frequency display disappear, the Pwr Offset annunciator at the left side of the display activates, and the power offset value is set to 00.00, as shown below:

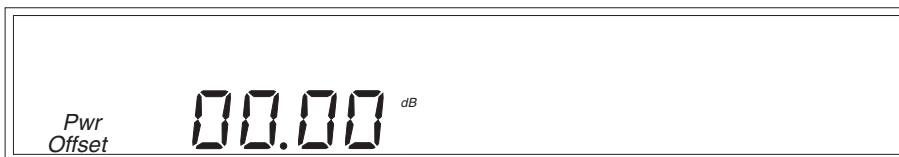

- 3 Use the left- and right-arrow keys to move the focus to the digit(s) in the power-offset display that you need to adjust to enter the offset value, and then use the up- and down-arrow keys to adjust the value for each digit.**

The flashing digit is the digit that currently has the focus. This means that you can change the value of the flashing digit using the up- and down-arrow keys.

NOTE

If you enter a value for Power Offset that results in a power reading that is out of the Counter's specified power-measurement range, the Counter displays HI in the power display when the Power Offset function is enabled.

- 4 Press the Sign (+/-) key (if desired) to change the sign of the offset value.**

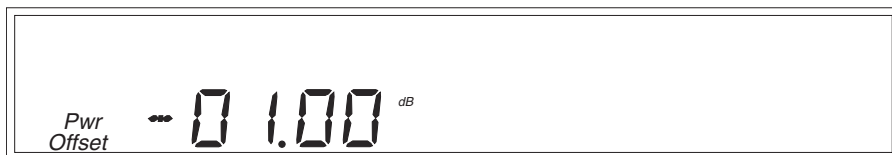

Offsetting a Power Measurement

- 5 Press the **Enter** key to confirm the offset value and exit the offset-entry display.

The Pwr Offset annunciator is deactivated, and the measurement display returns.

- 6 Press the **Offset On/Off** key (in the **POWER** area of the front panel).

The Pwr Offset annunciator is activated, and the value of the display is adjusted to reflect the value and sign of the offset entered in Steps 3 and 4.

The display should now look like this (values are simulated):

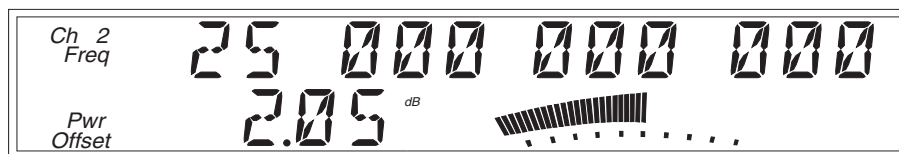

NOTE

When you are entering a value for Power Offset (or Frequency Offset), you can use the **Reset** key to restore all of the displayed digits to zero. These are the only two functions in which the **Reset** key has this effect.

Using Power Correction

The Power Correction function in the main Menu allows you to set the Counter to automatically compensate for power loss (or gain) that occurs in the test configuration, such as attenuation resulting from cable impedance. You can choose from nine power-correction profiles that are stored in nonvolatile memory, and you can modify the contents of these profiles.

Each profile is defined by two to ten data points (a data point consists of a loss value and a frequency value). When Power Correction is enabled, the Counter automatically adds a correction to the power reading (determined from the data points in the profile) that compensates for the loss (or gain) at the frequency being measured. When a measured frequency does not match any of the frequency values defined in the currently selected profile, the Counter interpolates for the measured frequency to determine the appropriate loss value to add to the power measurement.

A minimum of two valid data points is required for Power Correction; you can enter up to ten data points in each power-correction profile. Each of the power-correction profiles initially contains two valid data points—0.0 dB loss at 1 GHz, and 0.0 dB loss at the highest frequency the Counter can measure (20 GHz for the 53150A, 26.5 GHz for the 53151A, or 46 GHz for the 53152A). The remaining eight data points contain values of 0.0 dB loss at 0.0 GHz. When entering data, you can change the values in an existing data point or enter new values in a data point that currently has zero values. The data points are automatically sorted into order by frequency as you finish entering each one.

Power Correction Theory of Operation

When the Counter interpolates between data points to determine the amount of correction to apply to the current measurement, it computes the correction based on a straight line plotted between the frequency values in the two closest data points. Therefore, a graph of a power-correction profile would show a “curve” that consists of two to nine straight-line segments, rather than a true curve, as shown below.

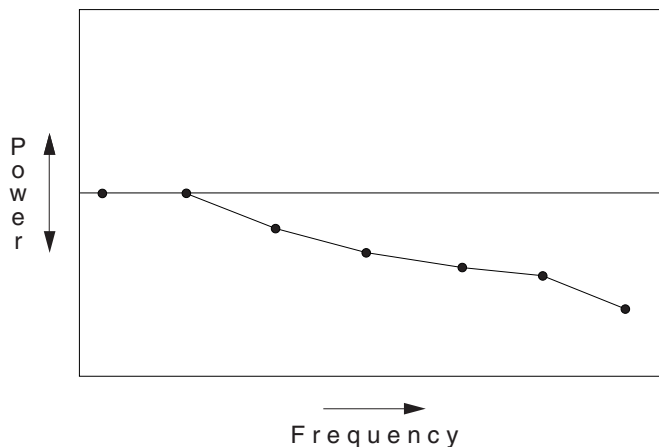

NOTE

When the frequency value of a signal is beyond either end of the curve specified by the values in the currently selected profile’s data points, the Counter computes a correction by extending the straight line defined in the last two data points in the profile.

As the graph above shows, the Counter never computes power-correction values for loss above the zero axis. Conversely, corrections are never computed for gain below the zero axis. When the Counter interpolates for frequencies that are above or below the range of frequencies specified in the currently selected profile, it never computes a value that would fall on the opposite side of the zero axis from the closest specified frequency. In other words, if there are two or more data points that contain loss values, the Counter never computes or applies a correction that would be indicative of gain. Conversely, if there are two or more data points that contain gain values (negative loss values), the Counter never applies a correction that would be indicative of loss.

Using Power Correction

Since there can be no further change in the loss or gain values once the zero axis is reached, no power corrections are applied when the input frequency reaches or passes a point in the profile that intersects the zero axis. Effectively, the Counter computes only loss-correction values or gain-correction values—never both within the same profile.

When you enter values in power-correction data points and then exit the data-point display (using either the left-arrow key or the Enter key), the Counter immediately sorts all of the data-points into order by the frequency values. Therefore, if you enter a pair of values in a data point, exit the data-point display, and then immediately return to the display for that data point, you may see different values than the ones you just entered. The values you entered may now be contained in a differently numbered data point in the same profile, if they were previously entered out of order by frequency.

Increasing Profile Accuracy

To increase the accuracy of a power-correction profile, you can add data points between the existing data points in the profile (if less than 10 data points are in use), thus bringing the data points closer together and shortening the straight-line segments. If all ten data points are in use, you can add data points by using two or more profiles for a single test configuration. If you do this, you must select the profile you need (from the Menu) for the range of frequencies being measured. This means that you must select a different profile whenever the measured frequency moves outside the range of frequencies defined by the data points in the currently selected profile.

Power Correction Examples

The procedures for using Power Correction and entering loss (or gain) and frequency values in power-correction profiles are demonstrated in the Power Correction examples on the following pages. The first example, on page 2-33, shows how to select a power-correction profile and enable Power Correction and also shows how to disable Power Correction.

The second example, on page 2-35, shows how to enter data in the power-correction profiles.

Power Correction Example: Selecting a Correction Profile

- 1 Press the Shift key, and then press the Menu (Reset/Local) key.
- 2 Press either the up- or down-arrow key repeatedly until “PWR CORR > OFF” is displayed as shown below:

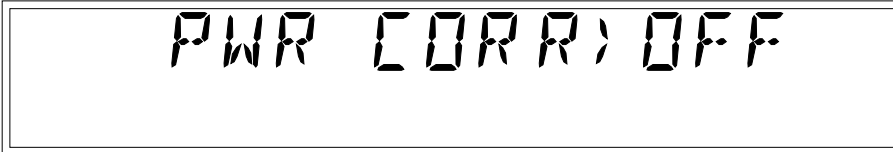
A rectangular LCD display showing the text "PWR CORR: OFF" in a seven-segment font. The text is centered and occupies most of the display area.

- 3 Press the right-arrow key once.

The flashing pointer in the Power Correction display changes direction to indicate that you can now use the up- and down-arrow keys to select a power-correction profile (or select OFF to disable Power Correction). The current setting for Power Correction (OFF or a number between 1 and 9) also flashes.

- 4 Press the up- and/or down-arrow key repeatedly until the number of the power-correction profile you want to use is displayed. For this example, choose profile number 3.

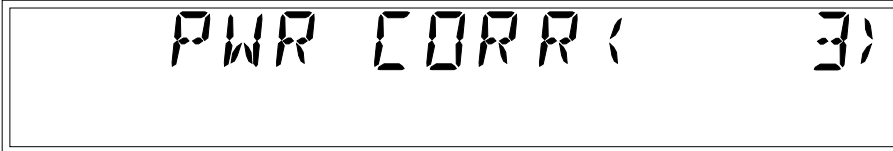
A rectangular LCD display showing the text "PWR CORR (3)" in a seven-segment font. The number "3" is highlighted with a larger, brighter font, indicating it is the selected profile.

If no data points were entered into the correction profiles previously, each of the nine power-correction profiles contains only two valid data points—0.0 dB loss at 1 GHz and 0.0 dB loss at the highest frequency the Counter can measure (20 GHz for the 53150A, 26.5 GHz for the 53151A, or 46 GHz for the 53152A). The remaining eight data points in each of the profiles initially contain values of 0.0 dB loss at 0.0 GHz. (This example assumes that valid loss and frequency values were previously entered in two or more of the data points in this profile.)



5 Press the Enter key to select profile number 3.

Power Correction is enabled using profile number 3, and the measurement display returns. The power reading now includes an adjustment for the loss incurred at the measured frequency. The amount of the adjustment is derived from the loss and frequency values in the data points in the selected profile. A lower-case letter “c” is shown in the hundredths position of the power-measurement display to indicate that Power Correction is enabled.

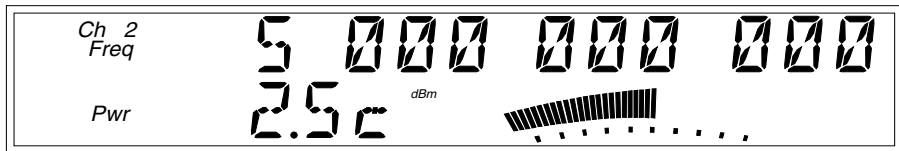

NOTE

Pressing the **Enter** key when the number of a power-correction profile (1-9) is displayed selects that profile, enables Power Correction, and exits the Menu. If you intend to enter data in the currently displayed profile, press the right-arrow key instead of the **Enter** key to select the power-correction profile without exiting the Menu.

You can also select a power-correction profile by pressing the right- or left-arrow key (instead of the **Enter** key). When you press either arrow key, you do not exit the Menu. As the next example shows, you should select a profile with the right-arrow key when you intend to enter or change the loss and/or frequency values in the selected profile. You should select the power-correction profile with the left-arrow key if you are done working with the power-correction settings, but you want to change settings for other functions in the Menu.

Power Correction Example: Editing Data Point Values

- 1 Select a power-correction profile using the up- and/or down-arrow keys (as shown in steps 1 through 4 in the previous example). For this example, choose profile number 3.

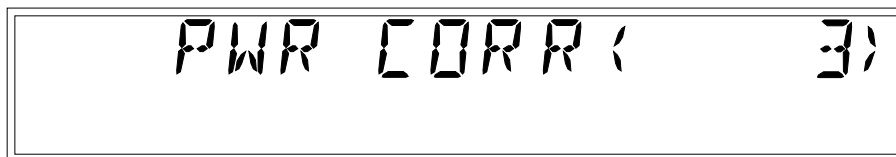

- 2 Press the right-arrow key.

The display changes to show the loss and frequency values stored in the data point that contains the lowest frequency value in the current profile. The left and right pointers that are before and after the word “LOSS” are flashing.

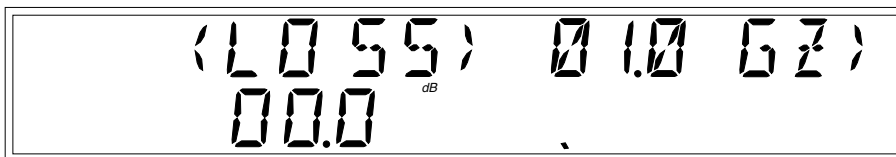

The ten small, single-line annunciators that are below the analog power display are used to indicate which of the ten data points is currently displayed. In the example shown above, only the first annunciator is activated, which indicates that the values displayed are for data point 1, the lowest data point.

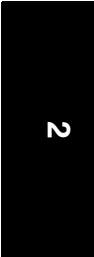

- 3 To insert values in an empty data point, press the up- and/or down-arrow key repeatedly to cycle through the data points in the selected profile to locate one that contains values of 0.0 for both loss and frequency.**

For a profile that has not been previously used, the first two data points displayed contain values of 00.0 dB loss at 1.0 GHz and 00.0 dB loss at the highest frequency the Counter can measure (20 GHz for the 53150A, 26.5 GHz for the 53151A, or 46 GHz for the 53152A). The remaining data points contain values of 00.0 dB loss at 00.0 GHz. In profiles that have been previously used, all data points containing non-zero values are displayed in order from lowest to highest, and any zero-value data points are displayed above the non-zero data points. All data points are automatically sorted into order by frequency and saved whenever you select a different profile or exit the Power Correction menu.

- 4 To change a value (or values) in a data point, press the up- and/or down-arrow key repeatedly until the data point that contains the value(s) you want to change is displayed, and then press the right-arrow key (the number of the data point displayed is indicated by the number of annunciators to the right of the loss value).**

The pointer to the left of the word “LOSS” stops flashing, the pointer to the right of the word “LOSS” changes direction and flashes, and the first digit of the frequency value flashes. This indicates that you can now adjust the value of the first digit in the frequency setting.

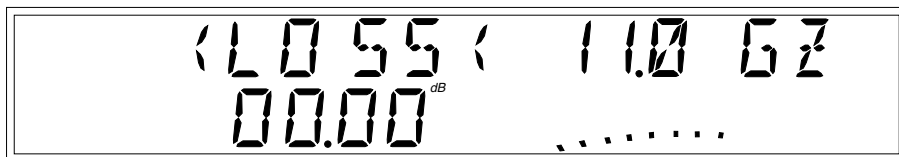

- 5 To adjust the value of the tens position of the frequency setting, press the up- or down-arrow key until the desired value is displayed.**

- 6 Use the right-arrow key to move to each of the remaining digits in the frequency setting, and use up- and down-arrow keys to adjust their values, if necessary.

The currently selected digit flashes to indicate that it is the one that changes when you press the up- and down-arrow keys. You can also use the left-arrow key to back up to a previous digit, if necessary. However, be aware that the digit to the left of the one you are adjusting increments automatically to the next higher or lower value when the value of the currently selected digit exceeds nine or is incremented below zero.

- 7 To adjust the loss value, press the right-arrow key while the digit in the tenths position of the frequency value and the pointer to the right of "GZ" are flashing.

The pointer at the right end of the display changes direction, and the first digit (tens position) of the loss value flashes. You can now adjust its value using the up- and down-arrow keys.

- 8 Use the left- and right-arrow keys to navigate to the remaining digits in the loss setting, and adjust their values (if necessary) with the up- and down-arrow keys.

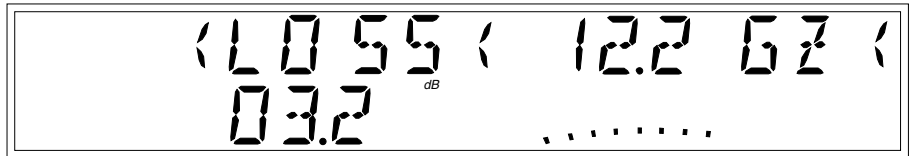

- 9 Press the Sign (+/-) key to change the sign of the loss value (if necessary).

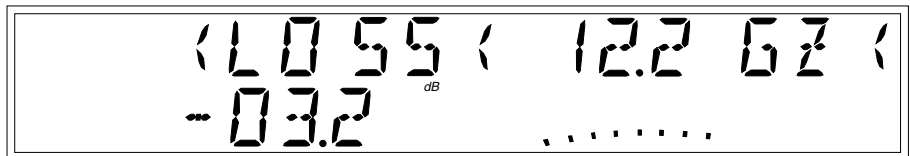

- To add or adjust the values in another data point, press the left-arrow key repeatedly until “PWR CORR” is re-displayed, and repeat steps 2 through 10. To edit data points within another power-correction profile, press the left-arrow key repeatedly until “PWR CORR” is re-displayed, and repeat steps 1 through 10.**

NOTE

When a data point is entered in a profile, all of the data points in that profile are sorted by frequency and stored in that order. Therefore, the data points in a profile are always in order from the lowest frequency to the highest when you access a correction profile. The first data point displayed is always the data point that contains the lowest frequency value.

- If you are done entering data-point values, press the Enter key to accept your changes, save the data-point values, and return to the measurement display.**

Power Correction is now enabled using the profile number 3.

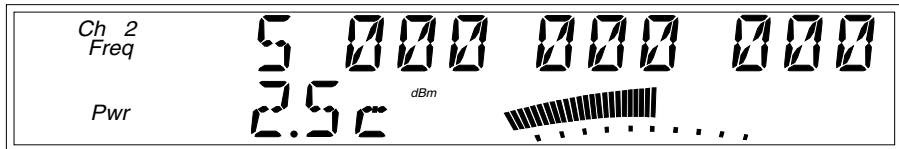

NOTE

You can include your selection of a power-correction profile in any of the nine sets of user settings stored in non-volatile memory (see page 2-46) by enabling the profile and then saving the set. If you save set 0 (zero) while Power-Correction is enabled, the currently-selected profile will be in effect whenever you turn on the Counter.

The data in the saved user settings and in all of the power-correction profiles is stored in non-volatile memory. If the Counter ever requires repair, and the main circuit-board assembly is replaced, these stored values will be lost. Therefore, to protect these values and ensure they are available for future use, you should keep an external record of them.

Using the Menu

The Agilent 53150A/151A/152A Counter's Menu makes it easy to control a number of the Counter's features and functions. You use the Selection (arrow) keys to navigate to the setting you want to change and then to actually make the changes.

- 1 Press the **Shift** key and then the **Menu (Reset/Local)** key to display the Menu.

When you press the **Shift** key, the Shift annunciator (near the bottom-right corner of the display) activates. When you press the **Menu (Reset/Local)** key, the Shift annunciator goes off, and the first menu item is displayed. If you have not previously invoked the Menu since you last turned the Counter on, the first menu item is REF OSC, the Reference Oscillator.

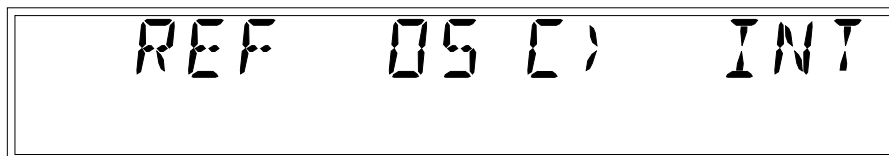

- 2 Press the **right-arrow key** to change the setting for the **Reference Oscillator**.

The flashing annunciator () in the display reverses direction to indicate that you can now change the setting by pressing either the up-arrow key or the down-arrow key. In the case of the Reference Oscillator function, which has only two possible settings (INTernal and EXTernal), pressing either the up- arrow or the down-arrow has the same effect (it toggles the setting from INT to EXT or from EXT to INT).

NOTE

The Counter will not switch to EXTernal unless a suitable reference signal is available at the External Reference connector.

Using the Menu

3 Press the Enter key to activate the setting and exit the Menu.

The setting you chose is put into effect, and the Menu closes.

If you need to exit the Menu without changing any of the settings, press the **Clear** key. To restore the setting of any menu item to the setting that was in effect when you opened the Menu, press the **Reset/Local** key (this restores the original setting for the current menu item but does not close the Menu).

The Menu contains the following items (these items are displayed in the order they are listed if you repeatedly press the up-arrow key after opening the Menu):

- REF OSC — Sets the Counter to use the internal timebase or an external timebase connected to the Reference connector on the back panel.
- DO SELF TEST — Starts the sequence of built-in tests.
- BATT VOLTAGE — Displays the current voltage level in the rechargeable battery packs (only if the Battery option is installed).
- OP HRS — Displays the total number of hours the Counter has been in operation since it was last calibrated.
- Model number, firmware version number, serial number, OPTNS (installed options).
- PRESET — Resets all user-settable functions to the factory default settings.
- BAUD — Sets the data rate for the RS-232 serial port.
- FM — Turns the Counter's ability to compensate for frequency modulation on (AUTO) or OFF.
- CH1 LPF — Turns the Channel 1 Low-Pass Filter (approx. 50 KHz) ON or OFF.
- RECALL — Reads and implements a stored set of user settings from one of nine (0 – 9) that are stored in non-volatile memory.

Using the Menu

- **SAVE** — Saves a copy of the current user settings in non-volatile memory. Nine sets (0 – 8) can be saved, and set 0 is automatically read on startup. To have the Counter automatically start up with your preferred settings, save these settings in set 0.
- **PWR CORR** — Activates (or deactivates) the Power Correction function and allows you to edit and select power-correction profiles. Power Correction is used to compensate for losses in the test configuration, such as attenuation resulting from cable impedance.

Each of these menu items is described in more detail on the following pages.

Navigating in the Menu and Changing Settings

When you select the Menu (with the **Shift** and **Menu [Reset/Local]** keys), the indicator between the arrow keys flashes to indicate that the arrow keys are now active. Since the Reference Oscillator setting is the first one displayed when you invoke the Menu (unless you've used the Menu to change another setting since you turned the Counter on), you don't have to use the up-arrow key or the down-arrow key to get to it.

When you press the right-arrow key, the flashing annunciator () changes direction, and the current setting for the Reference Oscillator **INT** (internal) or **EXT** (external) flashes. This indicates that you can now change this setting. Use either the up-arrow key or the down-arrow key to change the setting.

If there are more than two settings available for the currently selected function, you can cycle through the available settings by repeatedly pressing either the up-arrow key or the down-arrow key. For example, to change the setting for the Baud rate for the serial port, invoke the Menu, and then repeatedly press the up-arrow or down-arrow key until **BAUD** is shown on the display. Then, press the right-arrow key to select the **BAUD** option, and press the up- or down-arrow repeatedly until the setting you want is displayed. Finally, press the **Enter** key to implement your choice.

You navigate to and adjust the remaining settings available in the Menu in the same manner. Each time you modify a setting and press the **Enter** key, the Menu closes, so you have to reinvoke it each time to change additional settings.

Using the Menu

Some of the menu items listed on the previous page provide information only (no settings are required [or possible] for these), such as Battery Voltage, Operation Hours, and information that identifies the Counter (Agilent model number, firmware version number, serial number, and installed option codes). These menu options are described in the remainder of this chapter and also in “The Front Panel Menus at a Glance” on page 1-4.

NOTE

Always terminate each setting you change in a menu option by pressing the **Enter** key. You can abort any change while the Menu is displayed by pressing the **Reset/Local** key or the **Clear** key. Both keys nullify the change you made to the current menu option, but they do not affect any of the other menu options. The **Clear** key terminates the current menu session, but the **Reset/Local** key does not.

Reference Oscillator (REF OSC)

By default, the Counter uses its internal 10 MHz reference oscillator (or the optional Oven Timebase, Option 001) as a timebase for all measurements, unless REF OSC is set to EXT, and it detects a 1, 2, 5, or 10 MHz reference signal on the Reference connector on the back panel. If an external reference signal is present, you can force the Counter to use the internal reference oscillator by setting the REF OSC menu option to INT.

The available settings are EXT (external) and INT (internal), and the default setting is INT.

NOTE

When REF OSC is set to internal (INT), the Counter outputs a 10 MHz, 1 V p-p signal on the Reference connector on the back panel.

Using the Menu***Do Self Test***

The Counter automatically performs a series of tests on critical components each time you turn it on. If at any time during operation, you want to repeat these tests, you can do so by invoking the Menu, navigating to DO SELF TEST, and pressing the **Enter** key.

The individual tests that comprise the Self Test, and the error messages that are displayed if problems are detected, are described in Appendix B, “Messages.”

Battery Voltage (BATT VOLTAGE)

If the Battery Option (Option 002) is installed, the current battery voltage is displayed in digital and analog form in this menu item, so you can estimate the remaining time that the Counter can operate from the batteries. The batteries are fully charged when the voltage reading is 13.5 V, and the minimum battery voltage for proper operation is approximately 10 V. For additional information on the Battery Option, see Appendix C.

Operating Hours (OP HOURS)

This is an informational menu item that displays the total number of hours the Counter has been in operation since its last calibration. This value does not include Standby hours. This information is useful for scheduling routine maintenance and calibration. For additional information on maintenance and calibration, see the *Agilent 53150A / 151A / 152A Assembly-Level Service Guide*.

Model Number, Firmware Version, Serial Number, and Option Codes

This menu item displays a series of numbers and codes that are used to identify the Counter, its software version number, and the options that are installed. These items are displayed sequentially, and you use the left- and right-arrow keys to move between the information fields. Note that there are several numbers displayed in the field that contains the firmware version. These are in the following pattern:

```
( X X - V V V - Y Y Y )
  Z Z Z Z
```

Using the Menu

VVV is the version number of the Counter's firmware, and XX, YYY, and ZZZZ are other numerical codes that are reserved for Agilent internal use. The flashing annunciators at either end of the first line of the display indicate that you can use the equivalent arrow key to scroll left and/or right to the next field of information.

The option-code display lists the code number for each of the installed options. For example, in a Counter that has the Battery and Oven Timebase options installed, the display would show: <OPTNS 1-2- - ->.

Chapter 2 Operating Your Frequency Counter

Using the Menu

Preset

When PRESET is displayed, pressing the **Enter** key loads the default settings for most of the Counter's functions. These functions and their default settings are listed in the following table:

Table 2-1. Factory Default Function Settings

Function	Available Settings	Default Setting
Reference Oscillator (REF OSC)	INT (Internal) EXT (External)	INT (Internal)
Frequency Modulation (FM)	AUTO, OFF	AUTO
Channel 1 Low-Pass Filter (CH1 LPF)	OFF, ON	OFF
Recall Settings (RECALL)	0 through 8	0
Save Settings (SAVE)	0 through 8	0
Measurement Rate (Rate key)	FAST, MED, SLOW, HOLD	FAST
Averages (Avg key)	01 through 99	01
Resolution (Resol key)	1 Hz, 10 Hz, 100 Hz; 1KHz, 10 KHz, 100 KHz, 1 MHz	1 Hz
Display Backlight On/Off (On/Off key)	On, Off	On
Channel Selection (Chan Select key)	Channel 1, Channel 2	Channel 2
Power Measurement Units (dBm/W key)	dBm (dBm, dB) W (W, mW, μ W)	dBm
Frequency Offset (FREQ Offset On/Off key)	Off, On (freq. limits depend on model)	Off (0)
Relative Frequency (Rel Freq key)	Off, On	Off
Power Offset (POWER Offset On/Off key)	Off, On (-99.99 through +99.99 dBm)	Off (0)
Relative Power (Rel Pwr key)	Off, On	Off

Using the Menu

RS-232 Serial Port Data Rate (BAUD)

The Baud rate for the RS-232 serial port is configurable at 2400, 4800, 9600, 14,400, and 19,200 bps. The default setting is 9600 bps.

Frequency Modulation (FM)

The Counter can measure signals that are modulated in frequency, such as a microwave radio carrier. When FM is set to AUTO (the default setting), the Counter automatically detects FM signals and modifies its measurement algorithm accordingly. Since this increases the time it takes to compute each measurement, you can turn this feature OFF to increase measurement speed, or leave it set to AUTO to increase accuracy when measuring FM signals.

Channel 1 Low-Pass Filter (CH1 LPF)

The Counter has a built-in 50 KHz low-pass filter that can be enabled from the Menu to eliminate measurement distortions that result from noise in low-frequency signals. When the low-pass filter is enabled, signals above 50 KHz cannot be measured on Channel 1.

Recall User Settings (RECALL)

Up to nine sets of settings you make for the Counter's configurable functions can be saved in non-volatile memory. The RECALL menu option allows you to select and implement any of the sets you have previously saved. The settings in set zero are automatically loaded on power-up. The Save and Recall functions enable faster and easier operation, reduce operator errors, and reduce training requirements.

Save User Settings (SAVE)

The SAVE menu option allows you to save the Counter's current settings for configurable functions in non-volatile memory for use at a later time. Nine sets of settings can be saved. The Save and Recall functions enable faster and easier operation, reduce operator errors, and reduce training requirements.

Power Correction (PWR CORR)

Used to compensate for losses in the test configuration. See page 2-30.

Introduction

The specifications of the Agilent 53150A, 53151A, and 53152A are provided in this chapter.

Measurement Specifications and Characteristics

All measurement specifications are over the full signal and temperature ranges unless otherwise noted.

Input Characteristics	Agilent 53150A	Agilent 53151A	Agilent 53152A
Frequency Range Channel 1 (Normal mode) (Low pass filter enabled) Channel 2	10 Hz–125 MHz 10 Hz–50 kHz 50 MHz–20 GHz	10 Hz–125 MHz 10 Hz–50 kHz 50 MHz–26.5 GHz	10 Hz–125 MHz 10 Hz–50 kHz 50 MHz–46 GHz
Sensitivity Channel 1 10–30 Hz 30 Hz–125 MHz Channel 2 50–300 MHz 0.3–12.4 GHz 12.4–18 GHz 18–20 GHz 20–26.5 GHz 26.5–40 GHz 40–46 GHz	40 mV rms 25 mV rms –20 dBm –33 dBm –33 dBm –29 dBm N/A N/A N/A	40 mV rms 25 mV rms –20 dBm –33 dBm –33 dBm –29 dBm –25 dBm N/A N/A	40 mV rms 25 mV rms –20 dBm –33 dBm –30 dBm –27 dBm –27 dBm –23 dBm –17 dBm
Maximum Input Channel 1 Channel 2 50 MHz–2 GHz 2–46 GHz	2 V _{rms} +5 dBm +13 dBm	2 V _{rms} +5 dBm +13 dBm	2 V _{rms} +5 dBm +13 dBm
Damage Level Channel 1 Channel 2	120 V (dc + ac pk) linearly derated to 5 V _{rms} at 125 MHz +27 dBm	120 V (dc + ac pk) linearly derated to 5 V _{rms} at 125 MHz +27 dBm	120 V (dc + ac pk) linearly derated to 5 V _{rms} at 125 MHz +27 dBm
Impedance (Nominal) Channel 1 Channel 2	1 M Ω / 60 pF 50 Ω	1 M Ω / 60 pF 50 Ω	1 M Ω / 60 pF 50 Ω
Connector Channel 1 Channel 2	BNC female SMA/APC-3.5 compatible female	BNC female SMA/APC-3.5 compatible female	BNC female 2.92 mm removable, SMA/APC-3.5 compatible female
SWR - Channel 2 50–300 MHz 0.25–10 GHz 10–20 GHz 20–26.5 GHz 26.5–46 GHz	1.5:1 typical 2.0:1 typical 3.0:1 typical N/A N/A	1.5:1 typical 2.0:1 typical 3.0:1 typical 3.0:1 typical N/A	1.5:1 typical 2.0:1 typical 3.0:1 typical 2.5:1 typical 2.5:1 typical
Coupling Channel 1 Channel 2	ac ac	ac ac	ac ac
Acquisition Time (1 MHz FM rate) Channel 1 Channel 2 (FM Auto/FM Off)	N/A 125 ms/100 ms	N/A 125 ms/100 ms	N/A 140 ms/115 ms
Resolution Selection Channel 1/Channel 2	1 Hz to 1 MHz	1 Hz to 1 MHz	1 Hz to 1 MHz
Coupling Channel 1 Channel 2	ac ac	ac ac	ac ac

Input Characteristics	Agilent 53150A	Agilent 53151A	Agilent 53152A
Emissions ("kickback noise") Channel 1 Channel 2 (measuring/no input)	N/A -40 dBm/<-70 dBm	N/A -40 dBm/<-70 dBm	N/A -40 dBm/<-70 dBm
Residual Stability* Channel 1 Channel 2 *Counter and source tied to same timebase	N/A 0.6 LSD rms	N/A 0.8 LSD rms	N/A 1.25 LSD rms
Accuracy Channel 1/Channel 2	± 1 LSD ± residual stability ± timebase error x frequency	± 1 LSD ± residual stability ± timebase error x frequency	± 1 LSD ± residual stability ± timebase error x frequency
Measurement Time Channel 1 Channel 2	1/Resolution + 20 ms 1/Resolution + Acquisition time + 20 ms	1/Resolution + 20 ms 1/Resolution + Acquisition time + 20 ms	1/Resolution + 20 ms 1/Resolution + Acquisition time + 20 ms
FM Tolerance Channel 1 Channel 2 (FM Auto) (FM Off)	N/A 20 MHz p-p max @ 10 MHz rate 1 MHz p-p @ 10 MHz rate	N/A 20 MHz p-p max @ 10 MHz rate 1 MHz p-p @ 10 MHz rate	N/A 20 MHz p-p max to 26.5 GHz, 12 MHz p-p max above 26.5 GHz @ 10 MHz rate 1 MHz p-p @ 10 MHz rate
AM Tolerance Channel 1, Channel 2	Any index provided minimum signal level is not less than sensitivity	Any index provided minimum signal level is not less than sensitivity	Any index provided minimum signal level is not less than sensitivity
Amplitude Discrimination Channel 1 Channel 2 below 300 MHz above 300 MHz	N/A N/A Automatically measures the largest signal present provided signal is >10 dB (typical) above any signal separated by less than 75 MHz; >20 dB (typical) above any signal separated by more than 75 MHz	N/A N/A Automatically measures the largest signal present provided signal is >10 dB (typical) above any signal separated by less than 75 MHz; >20 dB (typical) above any signal separated by more than 75 MHz	N/A N/A Automatically measures the largest signal present provided signal is >10 dB (typical) above any signal separated by less than 75 MHz; >20 dB (typical) above any signal separated by more than 75 MHz
Power Measurement Channel 1 Channel 2 Range Accuracy at input connector** (0 dBm to -20 dBm) 0.05-12.4 GHz 12.4-20 GHz 20-26.5 GHz 26.5-46 GHz Resolution Display **see graphs for typical data	N/A Counter sensitivity to +7 dBm ±1.5 dB ±1.5 dB N/A N/A 0.01 dB dBm or milliwatts/microwatts	N/A Counter sensitivity to +7 dBm ±1.5 dB ±1.5 dB ±2.0 dB N/A 0.01 dB dBm or milliwatts/microwatts	N/A Counter sensitivity to +7 dBm ±1.0 dB ±1.5 dB ±1.5 dB ±2.0 dB 0.01 dB dBm or milliwatts/microwatts

Typical* power measurement uncertainty at 25°C for various input levels

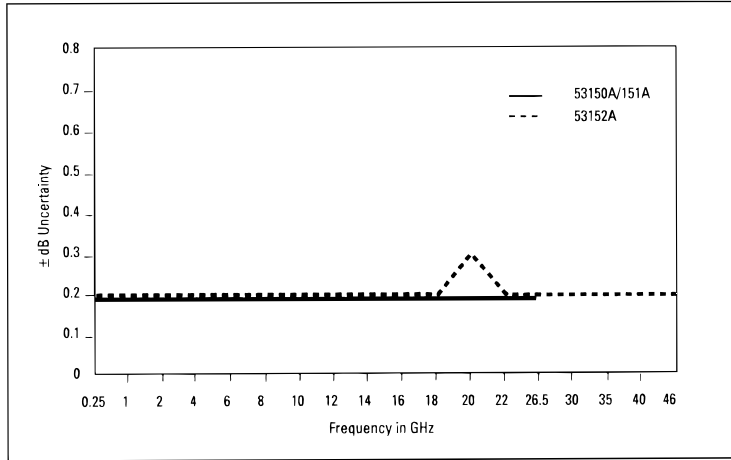

Graph 1.

-10 dBm input level at 25°C.

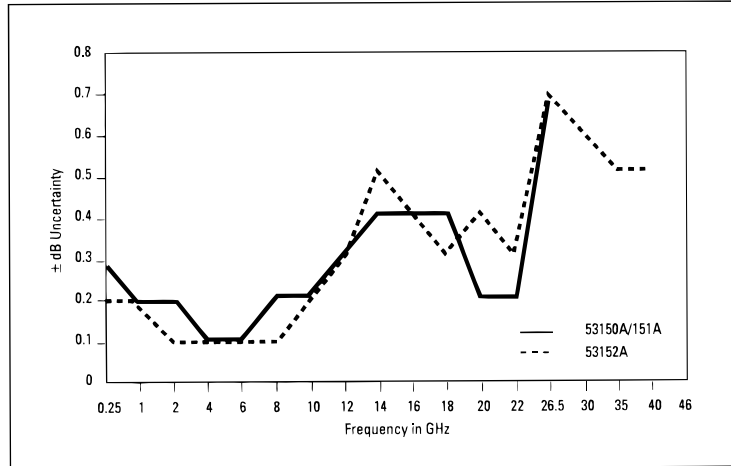

Graph 2.

0 dBm and -20 dBm input level at 25°C.

* Typical means approximately 2/3 of all units will meet these characteristics.

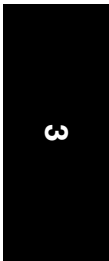

Typical* power measurement uncertainty at -25 dBm input level

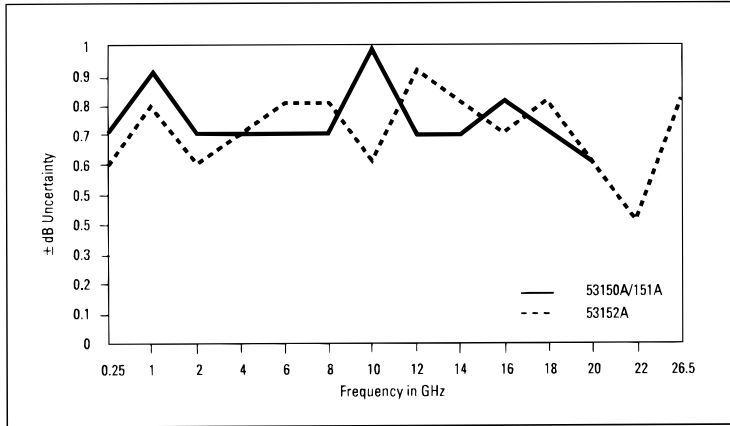

Graph 3.

-25 dBm input level at 25°C.

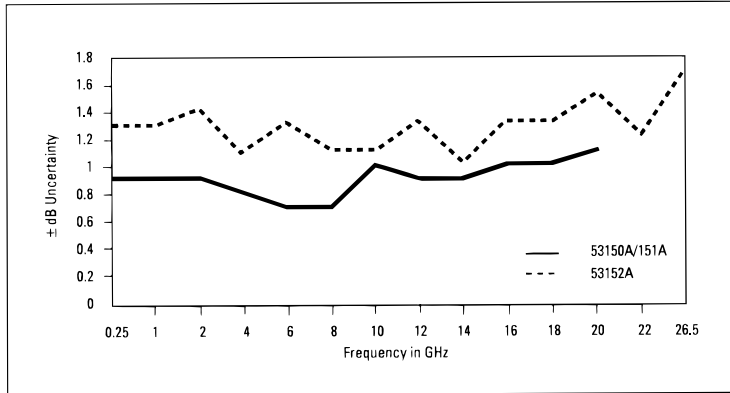

Graph 4.

-25 dBm input level from

* Typical means approximately 2/3 of all units will meet these characteristics.

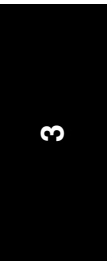

Timebase**Frequency:** 10 MHz**Output:** 10 MHz sine wave, 1 Vrms into 50 Ω **External Timebase Input:** 1, 2, 5, 10 MHz;
1 to 5 Vrms into 50 Ω **Connector:** BNC female located on rear panel**Internal Timebase Stability**

	TCXO (Standard)	Oven (Option 001)
Aging Rate Per Day Per Month	— <1 x 10 ⁻⁷	<5 x 10 ⁻¹⁰ <1.5 x 10 ⁻⁸
Short Term (1 sec. avg. time)	<1 x 10 ⁻⁹	<2 x 10 ⁻¹⁰
Line Variation ($\pm 10\%$)	<1 x 10 ⁻⁷	<1 x 10 ⁻¹⁰
Warm-up	—	<1 x 10 ⁻⁸ within 5 min. after turn-on at 25°C
Temperature Stability (0–55°C)	<1 x 10 ⁻⁶	<1 x 10 ⁻⁸

General Information**Save and Recall:** Up to 9 complete instrument setups may be saved and later recalled. These setups are retained when power is removed.**Sample Rate:** User-selectable Fast (nominally 20 ms between readings), Medium (nominally 250 ms between readings), Slow (nominally 1 s between readings) and Hold.**Self Test:** Internal memory and count circuitry automatically tested at startup, via menu selection, or remotely. Error messages displayed to indicate failed tests.**Size:** 213 mm W x 88.5 mm H x 300 mm D**Operating temperature:** 0–55°C

With battery option: 0–40°C

Weight: 4 kg without battery option, 6.4 kg with battery option**Warranty:** 1 year**Programming:** GPIB (IEEE-488.1-1987, IEEE 488.2-1987) or RS-232C**Language:** SCPI-1992.0 (Standard Commands for Programmable Instruments)**RS-232C Rates:** User-selectable 2400 to 19200 baud**Power Supply****ac:** 90–132 Vac; 47.5–66 Hz or 360–440 Hz
216–264 Vac; 47.5–66 Hz

line selection: automatic

power requirements: 75 VA max. (25 W typ.)

dc: (Option 002 only): 11–18 Vdc; 2A max.**Battery (Option 002):**

Type: VHS camcorder, lead acid (2 each)

Charge Time: 8 hours in unit

Capacity: 2.5 hours min. at 25°C

Math Functions:**Offset:** Last reading and/or entered offset to reading for either power or frequency**Averaging:** 1 to 99 measurement running average**Cable Loss Compensation:** Offsets power reading via linear interpolation of user-entered attenuations with up to 9 independent frequency points.**Display:** Backlit LCD. Backlight can be turned on or off via front panel control.**Sleep Mode (Option 002 only):** Automatically activated if no input is present for 5 minutes.**Safety:** Designed in compliance with IEC-1010, CAN/CSA 1010.1**EMC:** Designed in compliance with IEC-11, EN50082-1, IEC801-2, -3, -4**Accessories Supplied**

Operating, programming, and service manuals and ac power cord.

Accessories Available

Spare Battery 53150-80010

dc Power Input Cable 53150-60214

Options

Opt 001 Oven Timebase

Opt 002 Battery and dc input

Opt 1BP Mil-Std-45662A Calibration with data

Opt W30 Three Years of Return Repair Service

Opt W50 Five Years of Return Repair Service

Opt 1CM Rack Mount Kit

A

Rack Mounting the Counter

Rack Mounting the Counter

Rack Mounting the Counter

You can mount the Counter in a standard 19-inch cabinet using one of two optional kits available from Agilent:

- Option 1CM Rack Mount Kit (Agilent 53150-67001 Rack Adapter Kit) for single instrument (Half Module) rack mounting. Instructions and mounting hardware are included with the rack-mounting kit.
- Agilent 5061-9694 Lock Link Kit for two-instrument, side-by-side rack mounting. Instructions and mounting hardware are included with the rack-mounting kit. (Two Option 1CM Rack Mount Kits are also required when mounting two instruments.)

To rack-mount the Counter, you must first remove the front and rear rubber bumpers, the carrying handle, and the handle pivots:

NOTE

Unlike the hardware used elsewhere in this instrument, all hardware used to attach the rack mounts and the handle pivots is metric.

- 1 Rotate the handle to its vertical position, pull the ends outward, and set it aside.

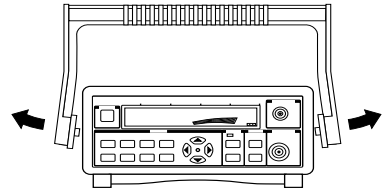

- 2 To remove the rubber bumpers, lift the center of the top of the bumper upward, stretch a corner of the bumper diagonally, then slide it off the end of the Counter.

Appendix A Rack Mounting the Counter
Rack Mounting the Counter



- 3** To rack-mount the Counter by itself, perform the steps shown in the following illustration. (Refer to the instructions that are provided with the Rack Adapter Kit for details.)

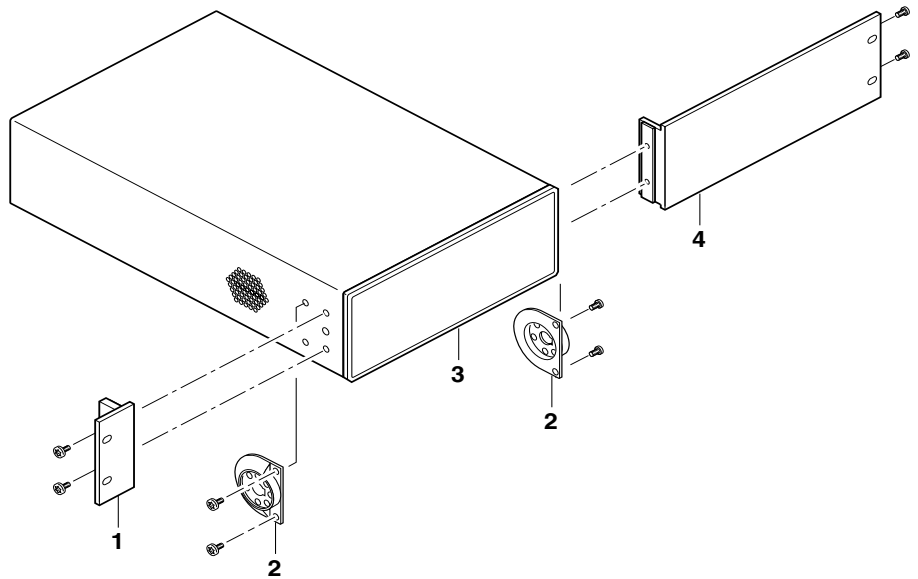

1 Rack Flange
2 Handle Pivot

3 Agilent 53150A/151A/152A Counter
4 Panel Filler (Adapter) Assembly



Rack Mounting the Counter

- 4 To rack-mount the Counter with another instrument side-by-side, obtain the 5061-9694 Lock Link Kit. (Refer to the instructions that are provided with the Lock Link Kit for details.)

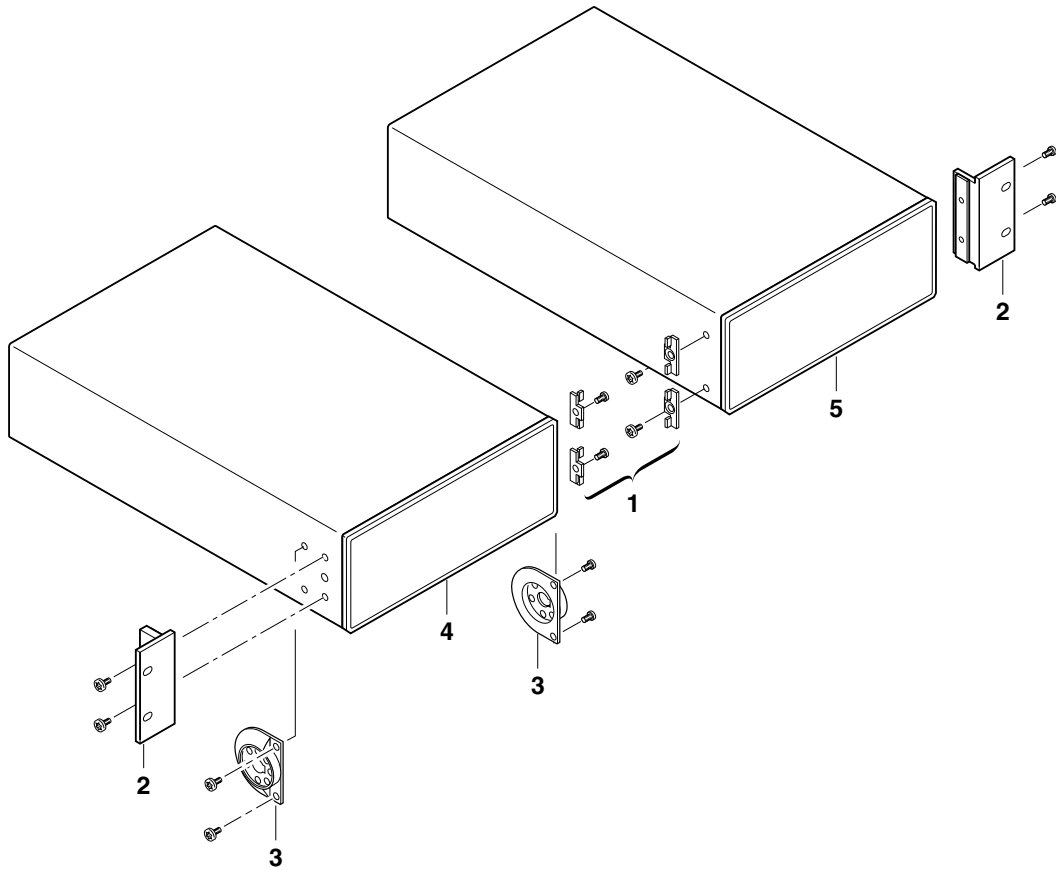

1 Lock Links

2 Rack Flange

3 Handle Pivot

4 Agilent 53150A/151A/152A Counter

5 Second Agilent 53150A/151A/152A Counter or other half-rack-size instrument

B

Messages

Overview

Overview

The Agilent 53150A/151A/152A provides two types of messages that are displayed on the Counter's front panel and/or sent over the RS-232 serial interface. The first type is status messages, which are displayed during normal operation. The second type is error messages, which are sent via RS-232 and/or displayed when the Counter detects an error during the Self-Test procedure or during normal operation.

NOTE

All messages sent over the RS-232 interface are also available via GPIB. However, these messages are not automatically sent over the GPIB interface. For information on retrieving messages over the GPIB interface, see the *Agilent 53150A/151A/152A Programming Guide*.

Status Messages

Table 3-1 lists and describes the status messages that are displayed on the Counter's front panel.

Table 3-1. Status Messages

Message	Description
TESTING	The Counter is performing its Self-Test.
SELF TEST OK	No critical errors were detected during the self-test.
MEASURING	The Counter is sampling the signal and computing a measurement.
AVERAGING	The Counter is taking measurements and computing the number of averages determined by the Averages setting.
CH 1 NO SIGNAL CH 2 NO SIGNAL	The Counter is operational, but no signal can be detected on the selected input channel.
CHANNEL 1 CHANNEL 2	Identifies the currently selected channel after you press the Chan Select key to switch channels. CHANNEL 1 or CHANNEL 2 is displayed until the Counter can display a measurement or determine that no signal is present.

Self-Test Messages

Self-Test Messages

Table 3-2 lists and describes messages that are generated by the Counter during Self-Test to indicate whether a component passed or failed its test. These messages are sent via the RS-232 serial output only—they do not appear on the Counter's front-panel display.

Table 3-2. Self-Test Messages

Message	Description
ROM TEST FAIL ROM TEST OK	ROM failed read test. ROM passed read test.
RAM DATA LINES OK RAM DATA ERROR RAM ADDR LINES OK RAM ADDR ERROR RAM TEST OK	RAM data lines passed test. RAM data lines failed test. RAM address lines passed test. RAM address lines failed test. RAM tests completed with no errors detected.
EEPROM FAIL - CONFIGURATION DATA	The configuration data saved in EEPROM memory is defective.
ROM FAIL; Computed checkbyte does not match the value stored in EEPROM.	The checksum of the ROM data does not match the value stored in EEPROM.
EEPROM FAIL - CONFIGURATION DATA; Needs to be (re)initialized.	The EEPROM org code does not verify with current revision of ROM code.
EEPROM FAIL - POWER CAL DATA; Using default data	The checksum of the EEPROM power-calibration table is bad. Factory default calibration data will be used.
EEPROM FAIL - SAVED SETTINGS; Using default data	The checksum of the user settings stored in EEPROM is bad. Factory default settings will be used.
EEPROM FAIL - SAVED SETTINGS; Invalid EEPROM SAV n Data.	The checksum of one set of user settings (1 – 9) stored in EEPROM is bad.
GP-IB FAIL; Conf. Test	The GP-IB hardware failed its confidence test.

Error Messages

Error Messages

Table 3-3 lists and describes messages that are generated by the Counter during Self-Test or during operation to indicate that a problem has been detected. These messages are displayed on the Counter's front-panel display and are also sent via the RS-232 serial output (note that, in many cases, the exact message text that is displayed on the front panel is a condensed form of the message that is sent via RS-232).

Table 3-3. Error Messages

Message	Display	RS-232	Description
12V FAIL	X	X	The +12 VDC output from the power supply is not within specifications.
-12V FAIL	X	X	The -12 VDC output from the power supply is not within specifications.
-5V FAIL	X	X	The -5 VDC output from the power supply is not within specifications.
ADC FAIL	X	X	A failure was detected in the ADC.
B1 SIGNAL PATH FAIL		X	A failure was detected in the Channel 1 signal path.
PATH FAIL	X		
B1 THRESHOLD FAIL		X	A failure was detected in the Channel 1 threshold circuit.
THRS FAIL	X		
B2 RF THRESHOLD FAIL		X	A failure was detected in the Channel 2 RF threshold circuit.
THRS FAIL	X		
B2 THROUGH-PATH THRESHOLD FAIL		X	A failure was detected in the Channel 2 through-path threshold circuit.
THRS THRU	X		
B2 HETERODYNE PATH THRESHOLD FAIL		X	A failure was detected in the Channel 2 heterodyne-path threshold circuit.
THRS HET	X		
EEPROM FAIL - WRITE		X	A failure was detected while writing to EEPROM.
EEP WRT FAIL	X		

Error Messages**Table B-3. Error Messages (continued)**

Message	Display	RS-232	Description
FRONT PANEL FAIL		X	The front panel or its interconnecting cable are defective or not properly connected.
FPANEL FAIL	X		
FPGA FAIL	X	X	A failure was detected in the FPGA (Field Programmable Gate Array).
GPIB FAIL	X	X	A failure was detected in the GPIB hardware.
HETERODYNE PATH FAIL		X	A failure was detected in the heterodyne-path circuit.
HET PATH FAIL	X		
IIC FAIL	X	X	An attempt to write to the LCD display failed.
INSTCFG FAIL	X	X	The instrument's configuration data is missing or has become corrupted.
OVER TEMPERATURE		X	The Counter's internal temperature is above the acceptable limit.
OVERTEMP	X		
PWR CAL FAIL	X	X	The instrument's power-calibration data is missing or has become corrupted.
POWER METER FAIL		X	A failure was detected in the Channel 2 power-measurement circuit.
PWR CKT FAIL	X		
RAM FAIL	X	X	A failure was detected in RAM.
ROM FAIL	X	X	A failure was detected in ROM.
SAV SET FAIL	X	X	One or more of the sets of user settings is missing or has become corrupted.
SERVICE FAIL	X	X	The instrument's service data is missing or has become corrupted.
THRU PATH FAIL		X	A failure was detected in the through-path circuit of Channel 2.
THRU FAIL	X		
VCO/COUNT CHAIN FAIL		X	A failure was detected in the VCO or the Count Chain.
VCO/CNT FAIL	X		

Appendix B Messages
Error Messages



C

Using the Battery Option

Overview

Overview

The Battery option (Option 002) allows you to operate the Counter away from a source of AC power using internal rechargeable batteries or the external DC (EXT DC) power connector on the rear panel. You can charge the batteries inside the Counter when you are not using it, if an AC power source is available. (To charge the batteries inside the Counter, it must be in Standby mode.) You can also charge the batteries outside the Counter using an AC or suitable DC power source and the optional External Charger (Agilent P/N 53150-60217).

Operating the Counter from the Batteries

When the Counter is powered from the internal batteries, it operates in the same manner as it does when it is powered from an external AC or DC source, except that the cooling fan does not operate, and the Main AC Power On LED is not lit. Whenever a battery-equipped Counter is on (not in Standby), the battery annunciator in the lower-right corner of the front-panel display (see Figure C-1) indicates the approximate charge level remaining in the batteries. This allows you to estimate the amount of time you can continue to operate from battery power before recharging the batteries or replacing them with fully charged batteries.

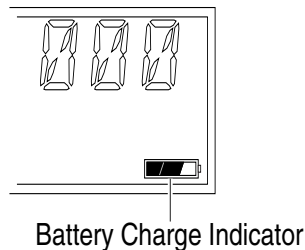

Figure C-1. Battery Charge Level Indicator

Operating the Counter from a DC Power Source

When all three segments of the battery annunciator are activated, the battery charge level is at 83% or more. When only two segments are activated, the charge level is approximately 50%, and when only the first segment is activated, the charge level is approximately 17%.

A pair of fully charged batteries in good condition provides enough power to operate the Counter for approximately three hours at 25° C. Various conditions, such as ambient temperature and the measurement configuration, can affect the length of time the Counter can operate from a fully charged set of batteries.

A battery that reads approximately 13.6 VDC when measured with a voltmeter (or the Battery Voltage reading in the menu display) is fully charged. A battery that reads 11 VDC or less is at or near the minimum effective charge level.

NOTE

Operating the Counter with the display backlight turned off lengthens the time the Counter can operate from the batteries. When operating from battery power, the Counter automatically turns the backlight off after five minutes if no front-panel keys are pushed, no GPIB commands are received, and/or no signal is applied to either input during that period.

Operating the Counter from a DC Power Source

Counters that have the Battery option can operate from an external DC power source (with or without batteries in the Counter). The external DC power source must supply +11 to +18 VDC at 2.0 A (min.). It must use a 2.1 mm coaxial plug, and its DC output plug must be wired so the inner connector is positive and the outer connector is negative. To use an external DC power source, make sure the Main ~ Power switch on the back panel is set to 1 (on), insert the coaxial plug into the EXT DC socket on the back panel as shown in Figure C-2, and turn the Counter on in the normal manner.

Appendix C Using the Battery Option

Replacing the Batteries

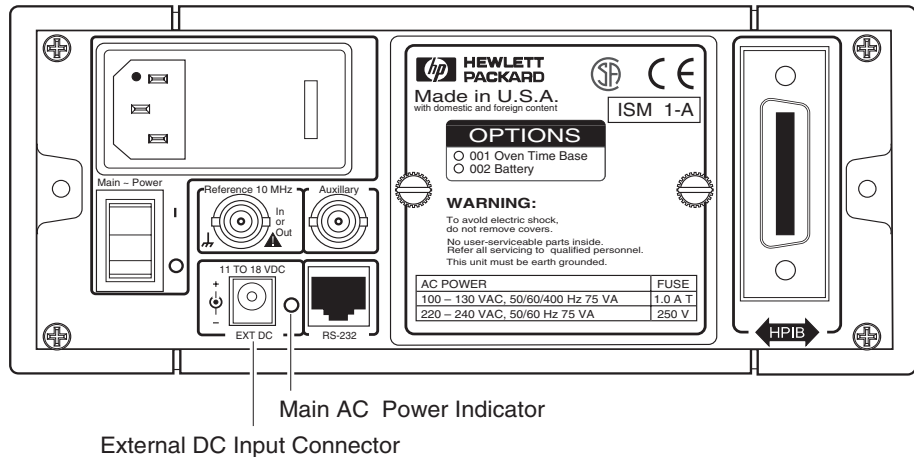

Figure C-2. External DC Power Socket

Replacing the Batteries

Counters equipped with the Battery option use sealed lead-acid VHS camcorder batteries. You can obtain additional batteries of this type from Agilent (Agilent P/N 53150-80010) and from other suppliers who carry test equipment and/or video camera accessories.

Removing the Batteries

To remove the batteries, use the following procedure:

- 1 Turn off the Counter, and disconnect all external cables (including the power cord).
- 2 Turn the two thumb screws that secure the battery sled to the Counter's back panel counterclockwise until both thumb screws are completely out of the threaded holes in the back panel (see Figure C-3).

Replacing the Batteries

NOTE

The thumbscrews require a considerable amount of turning force, since they pull the battery sled partially out of the Counter and also extract the battery terminals from the battery connector as you turn them. To prevent the battery sled from binding and increasing the force necessary to turn the thumbscrews, either turn both thumbscrews simultaneously, or alternately turn the thumbscrews one-half turn each, until both thumbscrews are fully out of the threaded holes in the back panel.

- 3 Slide the battery sled out the back of the Counter.

CAUTION

Avoid placing the battery sled and/or the batteries where the battery terminals could contact any conductive surfaces.

- 4 Lift the terminal end of either or both batteries up out of the battery sled, and then pull the battery(ies) out of the sled.

Installing Batteries

To install batteries in the Counter, use the following procedure:

- 1 If you have not previously removed the battery sled from the Counter and the batteries from the sled, do so now (see “Removing the Batteries” on the previous page).
- 2 Position the battery sled so that the back (taller) end is to your left as shown in Figure C-3

Appendix C Using the Battery Option
Replacing the Batteries

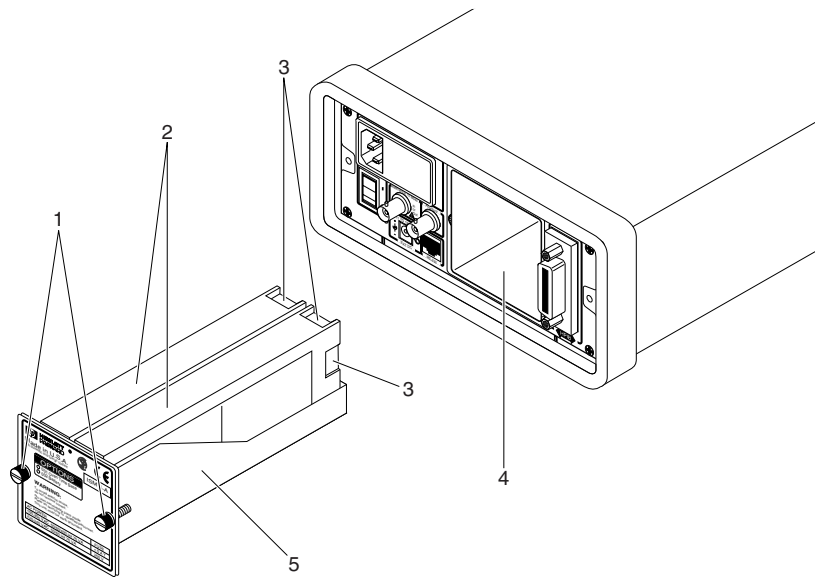

- | | |
|---------------------|-------------------|
| 1 Thumbscrews | 4 Battery chamber |
| 2 Batteries | 5 Battery sled |
| 3 Battery terminals | |

Figure C-3. Removing and Installing Batteries

Replacing the Batteries

- 3 Holding one of the batteries so the battery terminals are to your right and the plus sign at the terminal end is facing away from you, insert the left-hand end of the battery into the taller end of the battery sled with the far side of the battery against the far side of the sled. Lower the right end of the battery into the sled, and push down on the battery until it is down as far as it can go. Insert the second battery next to the first one in the same manner.

NOTE

The batteries fit snugly into the sled, so it is important to keep them aligned with the sides of the sled. If you attempt to insert a battery, and it is not parallel with the sides of the sled, it will bind.

- 4 When both batteries are fully inserted in the sled, insert the sled into the battery-chamber opening in the Counter's back panel (terminal end first).
- 5 Slide the sled into the battery chamber until you can start the thumbscrews into the threaded holes in the Counter's back panel (turn the thumbscrews clockwise). You may have to push against the back end of the battery sled to insert it far enough for the thumb screws to contact the back panel.
- 6 Tighten the two thumb screws on the battery sled until both thumbscrews are fully hand tight and the back cover of the battery sled is flush against the Counter's back panel.

NOTE

The thumbscrews require a considerable amount of turning force, since they push the battery sled into the Counter and also insert the battery terminals into the battery connectors as you turn them. To prevent the battery sled or the terminals from binding or jamming, either turn both thumbscrews simultaneously, or alternately turn the thumbscrews one-half turn each, until the battery sled is fully inserted.

Charging the Batteries

The batteries are charged automatically whenever the instrument is connected to an AC power source and is in Standby mode. The amount of time required to fully charge the batteries is dependent on several factors, including the current charge level, the condition of the batteries, the ambient temperature, and the power source used for charging. In general, it takes approximately eight hours to charge two batteries inside the instrument.

The Agilent part numbers for the batteries are provided in the section titled “Accessories Supplied and Available” on page xiv.

Precautions

Precautions

Observe the following precautions when handling and charging the batteries:

- Do not attempt to use or charge the batteries when they are exposed to temperatures below -10°C (15°F) or above 40°C (105°F). (Most batteries of this type have an internal safety device that prevents them from operating outside of this temperature range.)
- Charge the batteries only with a charger intended for this type of battery or inside the Counter.
- Do not allow the battery terminals to contact any conductive surfaces.
- Avoid discharging the batteries completely.
- Recharge the batteries as soon as possible after use.
- Handle the batteries carefully to avoid internal damage and/or damage to the casings. Do not drop or throw the batteries or otherwise expose them to strong physical shock.
- Do not incinerate the batteries or subject them to extremely high temperatures.

Appendix C Using the Battery Option
Precautions

C

Index

SYMBOLS

(Freq Offset), 1-20
(Resol key), 2-45

A

AC Input/Power module, 1-7
Accessories
 Available, xiv
 Supplied, xiv
Acknowledging Messages, 2-9
analog, 1-5
analog power display, 2-24
analog representation, 2-24
Annunciators, 1-5
 Analog power display, 1-5
 Avg On, 1-5
 Battery charge, 1-5
 Battery charge-level indicator, 1-5
 Ch1, 1-5
 Ch2, 1-5
 dB, dBm, W, mW, uW, %, 1-5
 Error, 1-5
 Ext Ref, 1-5
 Freq, 1-5
 Freq Offset, 1-5
 Hold, 1-5
 Pwr, 1-5
 Pwr Offset, 1-5
 Rel Freq, 1-5
 Rel Pwr, 1-5
 Rmt, SRQ, 1-5
 Shift, 1-5
arrow keys, 2-5
AUTO, 2-7, 2-46
Auxiliary connector, 1-7
average, 2-17
Average / Power Offset key, 1-2
Averages (Avg key), 2-45
Averages Setting Example, 2-17
averages-setting mode, 2-17, 2-18

AVERAGING, 2-18, 2-19, B-2
Avg, 2-4
Avg key, 2-10, 2-17, 2-45
Avg On, 1-5, 2-18

B

backlight, 1-11
BATT VOLTAGE, 2-40
batteries, 2-43, C-4
battery annunciator, C-2
battery chamber, C-7
Battery compartment, 1-7
Battery Option, 2-43
 Battery compartment, 1-7
 battery voltage, 2-43
 battery voltage level, 2-40
Battery option, 1-3, 1-5, 1-18, 2-40, C-2-4
BATT VOLTAGE, 2-40
batteries, C-4
battery chamber, C-7
battery charge-level annunciator, C-2
Battery charge-level indicator, 1-5
battery sled, C-4, C-5
Battery Voltage, 1-14
conserving battery power, 1-11
cooling fan, C-2
DC input connector, C-3
DC power connector, C-2
display backlight, 1-11
EXT DC power-input connector, 1-7
EXT DC socket, C-3
External Charger, C-2
external DC power connector, C-2
external DC power source, C-3
full charge, C-3
installing batteries, C-5

- operating the Counter from a DC power source, C-3
- operating the Counter from the batteries, C-2
- rechargeable batteries, C-2
- removing the batteries, C-4
- replacing the batteries, C-4
- battery sled, C-4, C-5
- Battery Voltage, 1-14, 2-41, C-3
- Battery Voltage (BATT VOLTAGE), 2-43
- battery voltage level, 2-40
- BAUD, 2-7, 2-40, 2-41
- Baud rate, 1-14, 2-4, 2-41, 2-46

C

- cable impedance, 2-30
- calibration, 2-43
- Ch 1 annunciator, 2-13
- CH 1 NO SIGNAL, B-2
- Ch 2 annunciator, 2-12
- CH 2 NO SIGNAL, B-2
- CH1 LPF, 2-7, 2-40, 2-45
- CH1 NO SIGNAL, 1-18, 2-13
- CH2 NO SIGNAL, 1-18, 2-12
- Chan Select key, 1-16, 2-4, 2-10, 2-45
- Changing States, 2-7
- CHANNEL 1, 2-13, B-2
- Channel 1 input connector, 1-2
- Channel 1 Low-Pass Filter, 2-7, 2-45
- Channel 1 Low-Pass Filter (CH1 LPF), 2-45, 2-46
- CHANNEL 2, B-2
- Channel 2, 1-18, 1-22, 2-12, 2-24, 2-27
- connector, 1-18
- Channel 2 input connector, 1-2
- Channel Select, 2-45
- Channel selection, 2-10
- Channel Selection (Chan Select key), 2-45
- Channel Selection key, 1-2
- charge level, C-2
- Clear / Backlight On/Off key, 1-2
- Clear key, 1-14, 2-9, 2-40

- Connector
 - External Reference, 2-4
 - cooling fan, C-2

D

- data points, 2-30, 2-33
- data rate, 2-40
- dB, dBm, 1-5, 2-24
- dBm/W key, 2-25, 2-45
- DC output plug, C-3
- DC power connector, C-2
- DC power source, C-2, C-3
- dedicated keys, 2-7
- Default Function Settings, 2-45
- default settings, 2-45
- Description of the Counter, xii
- difference, 2-20, 2-26
- difference in frequency, 2-21
- Display
 - left pointer, 1-6
 - Menu, 1-6
 - right pointer, 1-6
 - Special characters, 1-6
- Display backlight, 2-10
- Display Backlight On/Off, 2-45
- display backlight On/Off key, 2-10
- Display Power / dBm/W key, 1-2
- Display Power key, 2-4, 2-10, 2-24, 2-27
- Display Resolution, 2-10
- Display Special Characters, 1-6
- Displaying the Menu, 1-12
- DO SELF TEST, 2-40
- Do Self Test, 1-14, 2-43
- drift, 1-24, 2-4, 2-10, 2-20

E

Electro-Static Discharge, 1-17
 electro-static discharge prevention
 procedure, 1-17
 Enter key, 1-2, 1-14, 2-5
 Error, 1-5
 Error Messages, B-4
 -12V FAIL, B-4
 12V FAIL, B-4
 -5V FAIL, B-4
 ADC FAIL, B-4
 EEP WRT FAIL, B-4
 FPANEL FAIL, B-5
 FPGA FAIL, B-5
 GPIB FAIL, B-5
 HET PATH FAIL, B-5
 IIC FAIL, B-5
 INSTCFG FAIL, B-5
 OVERTEMP, B-5
 PATH FAIL, B-4
 PWR CAL FAIL, B-5
 PWR CKT FAIL, B-5
 RAM FAIL, B-5
 SAV SET FAIL, B-5
 SERVICE FAIL, B-5
 THRS FAIL, B-4
 THRS HET, B-4
 THRS THRU, B-4
 THRU FAIL, B-5
 VCO/CNT FAIL, B-5
 error messages, 2-43
 ESD, 1-17
 EXT, 2-7, 2-39, 2-41, 2-42
 EXT DC power-input connector, 1-7
 EXT DC socket, C-3
 Ext Ref, 1-5
 EXTERNAL, 2-39
 External Charger, C-2
 external DC power connector, C-2
 external DC power source, C-3
 External Reference connector, 1-7, 1-12
 external reference signal, 2-4, 2-42
 external timebase, 2-40

F

factory default settings, 2-40, 2-45
 fan, 1-3
 FAST, 2-7, 2-16
 firmware, 2-44
 Firmware Version, 2-43
 firmware version number, 1-14, 2-12,
 2-40, 2-42
 flash rate, 1-3, 2-14, 2-15
 flashing annunciator, 2-5
 FM, 2-7, 2-40, 2-45, 2-46
 FM signals, 2-46
 Freq, 1-5
 Freq annunciator, 2-12, 2-13
 Freq Offset, 1-5, 1-20, 2-4, 2-21
 Freq Offset annunciator, 2-21, 2-23
 Freq Offset key, 2-21
 FREQ Offset On/Off key, 2-10, 2-45
 Frequency, measuring, 1-17
 frequency difference, 2-20
 frequency drift, 2-20
 Frequency Modulation, 2-7, 2-45
 frequency modulation, 2-40
 Frequency Modulation (FM), 2-45, 2-46
 Frequency Offset, 1-20, 2-21
 Frequency Offset (FREQ Offset On/Off
 key), 2-45
 Frequency Offset Example, 2-21
 Frequency Offset function, 2-21
 Frequency offset measurement, 2-10
 frequency value, 2-30
 frequency-offset display, 2-22
 Front Panel
 Annunciators, 1-5
 arrow keys, 2-5
 Average / Power Offset key, 1-2
 Avg key, 2-4, 2-10
 Chan Select key, 2-4, 2-10
 Channel 1 input connector, 1-2
 Channel 2 input connector, 1-2
 Channel Selection key, 1-2
 Clear / Backlight On/Off key, 1-2
 Clear key, 2-9

Display Power / dBm/W key, 1-2
 Display Power key, 2-4, 2-10
 Enter key, 1-2
 Freq Offset key, 2-4
 FREQ Offset On/Off key, 2-10
 Gate indicator, 1-2
 Gate LED indicator, 1-3
 GPIB key, 2-10
 LCD display, 1-2
 Menu key, 2-4
 Menus at a Glance, 1-4
 Offset On/Off / Relative Frequency
 key, 1-2
 Offset On/Off / Relative Power
 key, 1-2
 Offset On/Off keys, 2-4
 POWER Offset On/Off key, 2-10
 Power/Standby switch, 1-2
 Pwr Offset key, 2-4
 Rate / Frequency Offset key, 1-2
 Rate key, 2-4, 2-10
 Rel Freq key, 2-10
 Rel Pwr key, 2-11
 Reset/Local / Menu key, 1-2
 Reset/Local key, 2-9
 Resol key, 2-4, 2-10
 Resolution / GPIB key, 1-2
 Selection (arrow) keys, 1-2
 Selection keys, 2-5
 Selection keys active indicator, 1-2
 Shift key, 1-2
 Sign (+/-) key, 1-2
 Sign key, 2-5
 Standby indicator, 1-2, 1-3
 Front panel
 Rel Freq key, 1-19
 Rel Pwr key, 1-24
 Front Panel at a Glance, 1-2
 front-panel keys, 2-10
 full charge, C-3
 fully charged, C-3
 Function Selection Keys, 2-10
 Fuse Holder, 1-7

G

Gate indicator, 1-2, 2-14, 2-15, 2-16
 Gate LED Indicator
 flash rate, 1-3
 measurement rate, 1-3
 Gate LED indicator, 1-3
 Gater LED Indicator
 measurement resolution, 1-3
 GP-IB, 2-4
 GP-IB address, 2-12
 GP-IB Interface connector, 1-7
 GPIB key, 2-10
 GZ, 2-37

H

HI, 1-23
 HOLD, 2-7, 2-16, 2-19
 Hold, 1-5
 How this Counter Works for You, 2-3

I

icons, 1-9
 Input Channel
 Chan Select key, 1-16
 selecting, 1-16
 installed option codes, 2-42
 Installing Batteries, C-5
 INT, 2-7, 2-39, 2-41
 INTERNAL, 2-39
 internal 10 MHz ref oscillator, 2-4, 2-42
 internal timebase, 2-4, 2-40

L

LCD display, 1-2, 1-11
 backlight, 1-11
 LED Display
 Annunciator, 1-5
 left pointer, 1-6
 Legend
 icons, 1-9
 LO, 1-23
 Lock Link Kit, A-2
 LOSS, 2-36
 loss value, 2-30
 Low-Pass Filter, 2-40, 2-45
 low-pass filter, 2-46

M

Main Power On indicator, 1-7
 Main Power switch, 1-7
 main power switch, 1-10
 Manuals, supplied, xiv
 maximum power specification, 1-17
 measurement algorithm, 2-46
 Measurement Rate, 2-7, 2-10, 2-45
 measurement rate, 1-3, 2-16
 Measurement Rate (Rate key), 2-45
 measurement resolution, 1-3
 Measurement Sequence, 2-4
 MEASURING, 2-16, B-2
 Measuring Frequency, 1-17, 2-12
 Measuring Power, 1-22, 2-24
 Measuring Relative Frequency, 1-19, 2-20
 Measuring Relative Power, 1-24, 2-26
 MED, 2-7, 2-16
 Menu, 1-6, 1-14, 2-4, 2-39, 2-40, 2-41
 Battery Voltage, 1-14
 changing settings, 1-12
 displaying, 1-12
 Do Self Test, 1-14
 firmware version number, 1-14
 model number, 1-14
 navigating, 1-12
 Operation Hours, 1-14
 option codes, 1-14
 Preset, 1-14

serial number, 1-14

using, 1-12

menu, 1-12, 1-13

Menu (Reset/Local) key, 1-12, 2-5

menu function, 2-5

Menu key, 2-4, 2-39, 2-41

menu options, 2-42

messages, B-2

minimum battery voltage, 2-43

minimum effective charge, C-3

Model Number, 2-43

Model number, 2-40

model number, 1-14, 2-12, 2-42

N

Navigating in the Menu and Changing

Settings, 1-12, 2-41

noise, 2-46

non-volatile memory, 2-30, 2-40, 2-46

Number of Averages, 2-10

number of averages, 2-17, 2-18

Numeric Entry, 2-6

numeric entry, 2-5

numeric values, 2-5

O

OFF, 2-7

offset function, 2-23

Offset On/Off / Power key, 1-2

Offset On/Off / Relative Frequency
 key, 1-2

Offset On/Off key, 2-10, 2-23, 2-29

Offset On/Off keys, 2-4

offset value, 1-25, 2-21, 2-22, 2-28

offset-entry, 2-22

Offsetting a Frequency

Measurement, 1-20, 2-21

Offsetting a Power Measurement, 1-24,
 2-27

ON, 2-7

On/Off (Clear) key, 1-11

On/Off key, 2-45

Operating Hours (OP HOURS), 2-43

operating modes, 2-5

- Operating the Counter from a DC Power Source, C-3
- Operating the Counter from the Batteries, C-2
- Operation
 - acknowledging messages, 2-9
 - changing states, 2-7
 - displaying the Menu, 1-12
 - function selection keys, 2-10
 - measuring frequency, 1-17, 2-12
 - measuring power, 1-22
 - measuring relative frequency, 2-20
 - measuring relative power, 1-24, 2-26
 - measuring relative frequency, 1-19
 - navigating in the Menu, 1-12
 - navigating in the menu and changing settings, 2-41
 - numeric entry, 2-6
 - offsetting a frequency
 - measurement, 1-20, 2-21
 - offsetting a power measurement, 1-24, 2-27
 - operating the Counter from the batteries, C-2
 - other function selection keys, 2-10
 - selecting the input channel, 1-16
 - selecting the unit of measurement for power, 1-23
 - sequencing through the Menu, 2-5
 - setting the measurement rate, 1-32, 2-16
 - setting the number of averages, 2-17
 - setting the resolution, 2-14
 - setting the resolution and the measurement rate, 2-14
 - Turning the Counter On, 1-10
 - using Power Correction, 2-30
 - using the Clear and Reset/Local keys, 2-9
 - using the Menu, 1-12, 2-39
 - using the selection keys, 2-5
- Operation Hours, 1-14, 2-42
- Operation
 - measuring power, 2-24
- Option Codes, 2-43
- option codes, 1-14, 2-42
- optional Oven Timebase, 2-4, 2-42
- Options, xiii
 - Battery, 1-3
 - Hardware, xiii
 - Oven Timebase, 2-4, 2-42
 - Support, xiii
- OPTNS, 2-40
- Other Function Selection Keys, 2-10
- Oven Timebase, 2-4, 2-42
- P**
 - peaking, 2-24
 - percentage, 2-24, 2-26
 - Planar Crown, 1-18
 - Power Correction
 - cable impedance, 2-30
 - data points, 2-30, 2-33
 - disabling, 2-33
 - enabling, 2-33
 - frequency, 2-33
 - frequency value, 2-30
 - GZ, 2-37
 - interpolation, 2-30
 - LOSS, 2-36
 - loss, 2-33
 - loss value, 2-30
 - lower-case letter "c", 2-34
 - profiles, 2-30
 - PWR CORR > OFF, 2-33
 - selecting a correction profile, 2-33
 - Power Correction Example
 - Selecting a Correction Profile, 2-33
 - Power Correction examples, 2-32
 - Power Correction function, 2-30
 - power difference, 2-26
 - power loss, 2-30
 - Power measurement, 1-5
 - power measurement, 2-24
 - Power Measurement Example, 2-24
 - Power Measurement Units (dBm/W key), 2-45

- Power Offset, 1-24, 1-25, 2-45
 - Power Offset (POWER Offset On/Off key), 2-45
 - Power Offset Example, 2-27
 - Power Offset function, 1-24, 2-27
 - Power offset measurement, 2-10
 - POWER Offset On/Off key, 2-10, 2-45
 - Power switch, 1-10
 - Power/Standby switch, 1-2
 - power-correction profiles, 2-30
 - power-measurement function, 2-10
 - power-on self-test, 2-12
 - precision, 2-14, 2-17
 - PRESET, 2-40, 2-45
 - Preset, 1-14, 2-45
 - Pwr, 1-5
 - Pwr annunciator, 2-24
 - PWR CORR, 2-38
 - PWR CORR> OFF, 2-33
 - Pwr Offset, 1-5, 2-4, 2-27
 - Pwr Offset annunciator, 2-28, 2-29
 - Pwr Offset key, 2-28
- Q**
- Quick Reference Guide, xv
- R**
- Rack Mount Kit, A-2
 - Rack Mounting the Counter, A-2
 - Rate, 1-19, 2-4
 - rate, 2-14
 - Rate / Frequency Offset key, 1-2
 - Rate key, 2-7, 2-10, 2-16, 2-45
 - Rate setting, 2-14
 - Rate Setting Example, 2-16
 - rate-setting mode, 2-16
 - Rear Panel, 1-7
 - AC Input/Power module, 1-7
 - Auxiliary connector, 1-7
 - Battery compartment, 1-7
 - EXT DC power-input connector, 1-7
 - External Reference connector, 1-7
 - Fuse Holder, 1-7
 - GP-IB Interface connector, 1-7
 - Main Power On indicator, 1-7
 - Main Power switch, 1-7
 - RJ12 connector, 1-7
 - RS-232 Interface connector, 1-7
 - Rear Panel at a Glance, 1-7
 - RECALL, 2-40, 2-45, 2-46
 - Recall Settings, 2-45
 - Recall Settings (RECALL), 2-45
 - Recall User Settings (RECALL), 2-46
 - rechargeable batteries, C-2
 - rechargeable battery packs, 2-40
 - REF OSC, 2-7, 2-39, 2-40, 2-42, 2-45
 - Reference connector, 2-40, 2-42
 - Reference Oscillator, 1-11, 1-12, 1-13, 1-14, 2-4, 2-7, 2-39, 2-41, 2-42, 2-45
 - Reference Oscillator (REF OSC), 2-45
 - Reference Oscillator function, 2-39
 - Rel Freq, 1-5
 - Rel Freq (Offset On/Off) key, 1-19, 2-10
 - Rel Freq annunciator, 2-20
 - Rel Freq key, 1-19, 2-10, 2-20, 2-45
 - Rel Pwr, 1-5
 - Rel Pwr (Offset On/Off) key, 1-24
 - Rel Pwr (Offset On/Off) keys, 1-24
 - Rel Pwr annunciator, 2-26
 - Rel Pwr key, 1-24, 2-11, 2-26, 2-45
 - Related Documents, ix
 - Relative Frequency, 2-45
 - Relative Frequency (Rel Freq key), 2-45
 - Relative Frequency function, 2-20
 - Relative Power, 1-24, 2-45
 - Relative Power (Rel Pwr key), 2-45
 - Relative Power Example, 2-26
 - Relative Power function, 2-26
 - Relative power measurement, 2-11
 - Removing the Batteries, C-4
 - repackaging, xi
 - Replacing the Batteries, C-4
 - Reset/Local / Menu key, 1-2
 - Reset/Local key, 1-14, 2-4, 2-9, 2-16, 2-19
 - Resol, 2-4
 - Resol key, 2-7, 2-10, 2-15, 2-45
 - Resolution, 1-19, 2-7, 2-10

resolution, 2-14
 Resolution (Resol) key, 2-45
 Resolution / GPIB key, 1-2
 Resolution setting, 2-14
 resolution setting, 2-14, 2-15, 2-16
 Resolution Setting Example, 2-15
 right pointer, 1-6
 RJ12, 1-7
 Rmt, 1-5
 routine maintenance, 2-43
 RS-232, 2-40, B-3
 RS-232 Interface
 Baud rate, 1-14
 RS-232 Interface connector, 1-7
 RS-232 serial port, 2-46
 RS-232 Serial Port Data Rate
 (BAUD), 2-46

S

SAVE, 2-40, 2-45, 2-46
 Save and Recall functions, 2-46
 Save Settings, 2-45
 Save Settings (SAVE), 2-45
 Save User Settings (SAVE), 2-46
 Selecting a Correction Profile, 2-33
 Selecting the Input Channel, 1-16
 Selecting the Unit of Measurement for
 Power, 1-23
 Selection (arrow) keys, 1-2, 1-12
 Selection keys, 2-5, 2-8
 Selection keys active indicator, 1-2
 Self Test, 2-43
 SELF TEST OK, 2-12, B-2
 Self-Test, B-3
 Self-Test Messages, B-3
 Sequencing Through the Menu, 2-5
 serial interface, 2-4
 Serial Number, 2-43
 serial number, 1-14, 2-40, 2-42
 serial port, 2-4, 2-40
 Serial Port Baud Rate, 2-7

Service
 Repackaging for Shipment, xi
 Setting the Measurement Rate, 1-32, 2-16
 Setting the Number of Averages, 2-17
 Setting the Resolution, 2-14
 Setting the Resolution and the
 Measurement Rate, 2-14
 Shift, 1-5
 Shift annunciator, 2-21
 Shift key, 1-2, 2-5
 side-by-side rack mounting, A-2
 Sign (+/-) key, 1-2, 2-5, 2-28
 Sign key, 2-8
 signal quality, 2-14, 2-16
 SLOW, 2-7, 2-16
 Special characters, 1-6
 Specifications
 maximum power, Channel 2, 1-17
 SRQ, 1-5
 Standby, 1-3
 Standby indicator, 1-2, 1-3
 Standby mode, 1-3, 1-11, C-2
 state change, 2-5
 Status Messages, B-2
 Summary of the Measurement
 Sequence, 2-4

T

test configuration, 2-30
 TESTING, 2-12, B-2
 tests, 1-14, 2-43
 timebase, 1-3
 Turning the Counter On, 1-10

U

- Unit of Measurement, 1-23
- units of measurement annunciator
 - group, 2-25
- user setting, 2-40
- Using Power Correction, 2-30
- Using the Clear and Reset/Local Keys, 2-9
- Using the Menu, 2-39
- Using the Selection Keys, 2-5

V

- version number, 2-44

W

- W, mW, uW, 1-5, 2-24



Service and Support

Contacting Agilent Technologies:

For more information about Agilent test and measurement products, applications, and services, visit our web site at <http://www.agilent.com/services/English/index.html>.

Agilent's Test and Measurement Fax Service for United States and Canada:

Technical information for test and measurement products and services is available 24 hours a day, 7 days a week, by calling **1-800-800-5281**.

Technical Support:

If you need technical assistance with an Agilent test and measurement product or application, you can find a list of local service representatives on the web site listed above. If you do not have access to the Internet, one of the following centers can direct you to your nearest representative:

Asia Pacific:

Hong Kong, SAR

Tel: (852) 2599-7777

Fax: (852) 2506-9284

Australia/New Zealand:

Blackburn, Victoria, Australia

Tel: 1-800-629-485 (Australia)

Tel: 0-800-738-378 (New Zealand)

Fax: (61-3) 9272-0749

Canada:

Mississauga, ON, Canada

Tel: 877-894-4414

Fax: (905) 206-4700

Europe:

European Marketing Organisation
The Netherlands

Tel: +31 20 547 9999

Fax: +31 20 547 7799

Japan:

Measurement Assistance Center
Tokyo, Japan

Tel: 81-426-56-7832

Fax: 81-426-56-7843

Latin America:

Latin America Region Headquarters
Miami, FL, U.S.A.

Tel: (305) 267-4245

Fax: (305) 267-4288

United States:

Test & Measurement Call Center
Englewood, CO, U.S.A.

Tel: (800) 452-4844

Fax: (303) 662-3726

Continued from front matter. . .

Warranty (cont'd)

Agilent does not warrant that the operation of Agilent products will be uninterrupted or error free. If Agilent is unable, within a reasonable time, to repair or replace any product to a condition as warranted, customer will be entitled to a refund of the purchase price upon prompt return of the product.

Agilent products may contain remanufactured parts equivalent to new in performance or may have been subjected to incidental use.

The warranty period begins on the date of delivery or on the date of installation if installed by Agilent. If customer schedules or delays Agilent installation more than 30 days after delivery, warranty begins on the 31st day from delivery.

Warranty does not apply to defects resulting from
(a) improper or inadequate maintenance or calibration,
(b) software, interfacing, parts or supplies not supplied by Agilent, (c) unauthorized modification or misuse,
(d) operation outside of the published environmental specifications for the product, or
(e) improper site preparation or maintenance.

TO THE EXTENT ALLOWED BY LOCAL LAW, THE ABOVE WARRANTIES ARE EXCLUSIVE AND NO OTHER WARRANTY OR CONDITION, WHETHER WRITTEN OR ORAL, IS EXPRESSED OR IMPLIED AND AGILENT SPECIFICALLY DISCLAIMS ANY IMPLIED WARRANTIES OR CONDITIONS OF MERCHANTABILITY, SATISFACTORY QUALITY, AND FITNESS FOR A PARTICULAR PURPOSE.

Agilent will be liable for damage to tangible property per incident up to the greater of \$300,000 or the actual amount paid for the product that is the subject of the claim, and for damages for bodily injury or death, to the extent that all such damages are determined by a court of competent jurisdiction to have been directly caused by a defective Agilent product.

TO THE EXTENT ALLOWED BY LOCAL LAW, THE REMEDIES IN THIS WARRANTY STATEMENT ARE CUSTOMER'S SOLE AND EXCLUSIVE REMEDIES. EXCEPT AS INDICATED ABOVE, IN NO EVENT WILL AGILENT OR ITS SUPPLIERS BE LIABLE FOR LOSS OF DATA OR FOR DIRECT, SPECIAL, INCIDENTAL, CONSEQUENTIAL (INCLUDING LOST PROFIT OR DATA), OR OTHER DAMAGE, WHETHER BASED IN CONTRACT, TORT, OR OTHERWISE.

For consumer transactions in Australia and New Zealand: the warranty terms contained in this statement, except to the extent lawfully permitted, do not exclude, restrict or modify and are in addition to the mandatory statutory rights applicable to the sale of this product to you.

Assistance

Product maintenance agreements and other customer assistance agreements are available for Agilent products.

For any assistance, contact your nearest Agilent Sales and Service Office.

Safety Considerations (cont'd)

WARNING

INSTRUCTIONS FOR ADJUSTMENTS WHILE COVERS ARE REMOVED AND FOR SERVICING ARE FOR USE BY SERVICE-TRAINED PERSONNEL ONLY. TO AVOID DANGEROUS ELECTRIC SHOCK, DO NOT PERFORM SUCH ADJUSTMENTS OR SERVICING UNLESS QUALIFIED TO DO SO.

WARNING

ANY INTERRUPTION OF THE PROTECTIVE GROUNDING CONDUCTOR (INSIDE OR OUTSIDE THE PRODUCT'S CIRCUITRY) OR DISCONNECTING THE PROTECTIVE EARTH TERMINAL WILL CAUSE A POTENTIAL SHOCK HAZARD THAT COULD RESULT IN PERSONAL INJURY. (GROUNDING ONE CONDUCTOR OF A TWO CONDUCTOR OUTLET IS NOT SUFFICIENT PROTECTION.)

Whenever it is likely that the protection has been impaired, the instrument must be made inoperative and be secured against any unintended operation.

If this instrument is to be energized via an autotransformer (for voltage reduction), make sure the common terminal is connected to the earthed pole terminal (neutral) of the power source.

Instructions for adjustments while covers are removed and for servicing are for use by trained personnel only. To avoid dangerous electric shock, do not perform such adjustments or servicing unless qualified to do so.

For continued protection against fire, replace the line fuse(s) with fuses of the same current rating and type (for example, normal blow, time delay). Do not use repaired fuses or short-circuited fuseholders.

Acoustic Noise Emissions

LpA<47 dB at operator position, at normal operation, tested per EN 27779. All data are the results from type test.

Geräuschemission

LpA<47 dB am Arbeitsplatz, normaler Betrieb, geprüft nach EN 27779. Die Angaben beruhen auf Ergebnissen von Typenprüfungen.

Electrostatic Discharge Immunity Testing

When the product is tested with 8kV AD, 4kV CD and 4kV ID according to IEC801-2, a system error may occur that may affect measurement data made during these disturbances. After these occurrences, the system self-recovers without user intervention.



Manufacturer's Name: Agilent Technologies, Inc.

Manufacturer's Address: 5301 Stevens Creek Blvd
Santa Clara, California 95051
U.S.A.

Declares, that the product

Product Name: CW Microwave Frequency Counter
Model Number: 53150A, 53151A, and 53152A
Product Options: This declaration covers all options of the above product.

Conforms with the following European Directives:

The product herewith complies with the requirements of the Low Voltage Directive 73/23/EEC and the EMC Directive 89/336/EEC (including 93/68/EEC) and carries the CE Marking accordingly.

Conforms with the following product standards:

EMC	Standard	Limit
	IEC 61326-1:1997+A1:1998 / EN 61326-1:1997+A1:1998	Group 1 Class A ^[1]
	CISPR 11:1990 / EN 55011:1991	4kV CD, 8kV AD
	IEC 61000-4-2:1995+A1:1998 / EN 61000-4-2:1995	3 V/m, 80-1000 MHz
	IEC 61000-4-3:1995 / EN 61000-4-3:1995	0.5kV signal lines, 1kV power lines
	IEC 61000-4-4:1995 / EN 61000-4-4:1995	0.5 kV line-line, 1 kV line-ground
	IEC 61000-4-5:1995 / EN 61000-4-5:1995	3V, 0.15-80 MHz 1 cycle, 100%
	IEC 61000-4-6:1996 / EN 61000-4-6:1996	
	IEC 61000-4-11:1994 / EN 61000-4-11:1994	
	Canada: ICES-001:1998	
	Australia/New Zealand: AS/NZS 2064.1	

^[1] The product was tested in a typical configuration with Agilent Technologies test systems.

Safety IEC 61010-1:1990+A1:1992+A2:1995 / EN 61010-1:1993+A2:1995
Canada: CSA C22.2 No. 1010.1:1992

July 31, 2001

Date

Art Nanawa
Product Regulations Manager

