

**85027D**  
**Directional Bridge**  
**Operating and Service Manual**

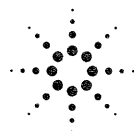

**Agilent Technologies**

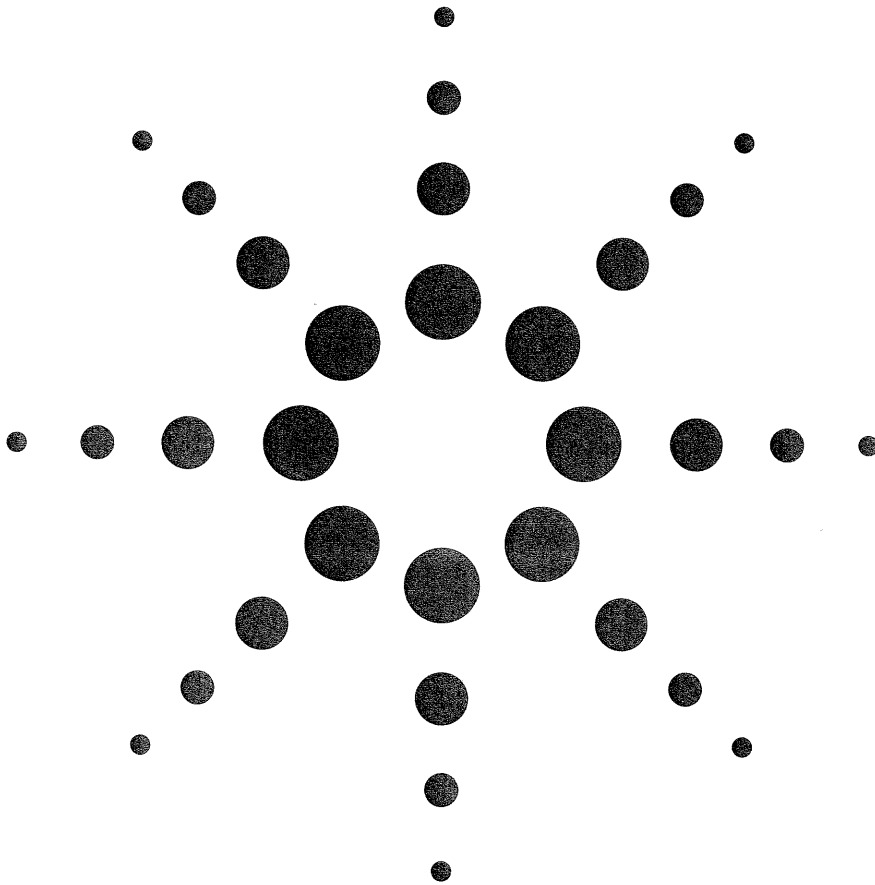

# Notice

---

## Hewlett-Packard to Agilent Technologies Transition

This documentation supports a product that previously shipped under the Hewlett-Packard company brand name. The brand name has now been changed to Agilent Technologies. The two products are functionally identical, only our name has changed. The document still includes references to Hewlett-Packard products, some of which have been transitioned to Agilent Technologies.

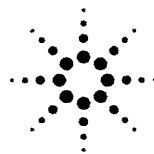

**Agilent Technologies**



# ADDENDUM

## MANUAL CHANGES

---

This addendum contains information received too late to be included in the manual shipped with your product. Use the information below to update your manual.

### Manual Identification

This addendum applies to the following document:

**Model Number:** HP 85027D

**Date Printed:** February 1991

**Part Number:** 85027-90031

### Instructions

Make the following changes to your manual.

- On page 1-3, under the test port match specification change:
  - 30 to 40 GHz,  $\geq 15.5$  dB, ( $\leq 1.40$  SWR) to read  
30 to 40 GHz,  $\geq 13$  dB ( $\leq 1.57$  SWR)
  - 40 to 50 GHz,  $\geq 10.5$  dB ( $\leq 1.85$  SWR) to read  
40 to 50 GHz,  $\geq 9.5$  dB ( $\leq 2.0$  SWR) typical
- On page 4-15, under the test port match specification change:
  - 30 to 40 GHz,  $\geq 15.5$  dB to read  
30 to 40 GHz,  $\geq 13$  dB



# HP 85027D DIRECTIONAL BRIDGE

## SERIAL NUMBERS

This manual applies directly to HP 85027D directional bridge with the following serial number prefix:

Serial Prefix: 3100A

For additional information concerning serial numbers, refer to *Instruments Covered By Manual* in the *General Information* section of this manual.

©Copyright                      HEWLETT-PACKARD COMPANY                      1988  
1400 FOUNTAINGROVE PARKWAY, SANTA ROSA, CA 95403 U.S.A.

MANUAL PART NO. 85027-90031  
Microfiche Part Number 85027-90032

Printed: FEBRUARY 1991  
Edition 1



## **CERTIFICATION**

*Hewlett-Packard Company certifies that this product met its published specifications at the time of shipment from the factory. Hewlett-Packard further certifies that its calibration measurements are traceable to the United States National Bureau of Standards, to the extent allowed by the Bureau's calibration facility, and to the calibration facilities of other International Standards Organization members.*

## **WARRANTY**

This Hewlett-Packard instrument product is warranted against defects in material and workmanship for a period of one year from date of delivery. During the warranty period, Hewlett-Packard Company will, at its option, either repair or replace products which prove to be defective.

For warranty service or repair, this product must be returned to a service facility designated by HP. Buyer shall prepay shipping charges to HP and HP shall pay shipping charges to return the product to Buyer. However, Buyer shall pay all shipping charges, duties, and taxes for products returned to HP from another country.

HP warrants that its software and firmware designated by HP for use with an instrument will execute its programming instructions when properly installed on that instrument. HP does not warrant that the operation of the instrument, or software, or firmware will be uninterrupted or error free.

### **LIMITATION OF WARRANTY**

The foregoing warranty shall not apply to defects resulting from improper or inadequate maintenance by Buyer, Buyer-supplied software or interfacing, unauthorized modification or misuse, operation outside of the environmental specifications for the product, or improper site preparation or maintenance.

**NO OTHER WARRANTY IS EXPRESSED OR IMPLIED. HP SPECIFICALLY DISCLAIMS THE IMPLIED WARRANTIES OF MERCHANTABILITY AND FITNESS FOR A PARTICULAR PURPOSE.**

### **EXCLUSIVE REMEDIES**

**THE REMEDIES PROVIDED HEREIN ARE BUYER'S SOLE AND EXCLUSIVE REMEDIES. HP SHALL NOT BE LIABLE FOR ANY DIRECT, INDIRECT, SPECIAL, INCIDENTAL, OR CONSEQUENTIAL DAMAGES, WHETHER BASED ON CONTRACT, TORT, OR ANY OTHER LEGAL THEORY.**

## **ASSISTANCE**

*Product maintenance agreements and other customer assistance agreements are available for Hewlett-Packard products.*

*For any assistance, contact your nearest Hewlett-Packard Sales and Service Office. Addresses are provided at the back of this manual.*



# TABLE OF CONTENTS

## HP 85027D

### Directional Bridge

#### Section 1. General Information

Introduction	1-1
Instruments Covered By The Manual	1-1
Instrument Keys/Softkeys	1-1
Safety Considerations	1-2
Product Description	1-2
Specifications	1-2
Items Supplied With The HP 85027D	1-2
Equipment Required But Not Supplied	1-2
Equipment Available	1-3
Recommended Test Equipment	1-3

#### Section 2. Installation

Introduction	2-1
Initial Inspection	2-1
Preparation For Use	2-1
Power Requirements	2-1
Mating Connectors	2-1
Environmental Requirements	2-2
Operating Environment	2-2
Storage and Shipment	2-2
Returning The Product For Service	2-2
Packaging	2-2

#### Section 3. Operation

Introduction	3-1
Features	3-1
Operating Instructions	3-1
Connecting the HP 85027D	3-2
Reflection Measurements	3-3
Transmission Measurements	3-3
Operator's Check	3-4
Equipment	3-4
Procedure	3-4

#### Section 4. Performance Tests

Introduction	4-1
Equipment Required	4-1
Directivity	4-2
Equipment	4-2
Description	4-2

Procedure for 0.01 to 4 GHz	4-3
Procedure for 4 to 40 GHz	4-4
Procedure for 40 to 47 GHz	4-6
Directivity Nomogram Instructions	4-7
Measurement Uncertainty	4-7
Test Port Match	4-10
Equipment	4-10
Description	4-10
Procedure	4-10
Dynamic Accuracy (AC and DC)	4-13
Equipment	4-13
Description	4-13
Procedure AC Mode	4-14
Procedure DC Mode	4-14

#### Section 5. Adjustments

Introduction	5-1
Adjustment Procedures	5-1
Equipment	5-2
AC Adjustment Procedure	5-2
DC Adjustment Procedure	5-3
Feedthrough Null Adjustment Procedure	5-3
DC Mode RF Adjustment Check	

#### Section 6. Replaceable Parts

Introduction	6-1
Restored Exchange Lists	6-1
Replaceable Parts List	6-1
Ordering Information	6-2

#### Section 7. Service

Introduction	7-1
Theory of Operation	7-1
Troubleshooting Procedures	7-1
Gaining Internal Access	7-2
Cable Continuity Check	7-2
Power Cable Replacement	7-2
Microcircuit Tests	7-3
A2 Preamp/Amplifier Assembly Replacement	7-3
A1 Bridge Microcircuit Assembly Replacement	7-4
Power Supply Check	7-4
Signal Path Check	7-5
Clock/Control Check	7-5

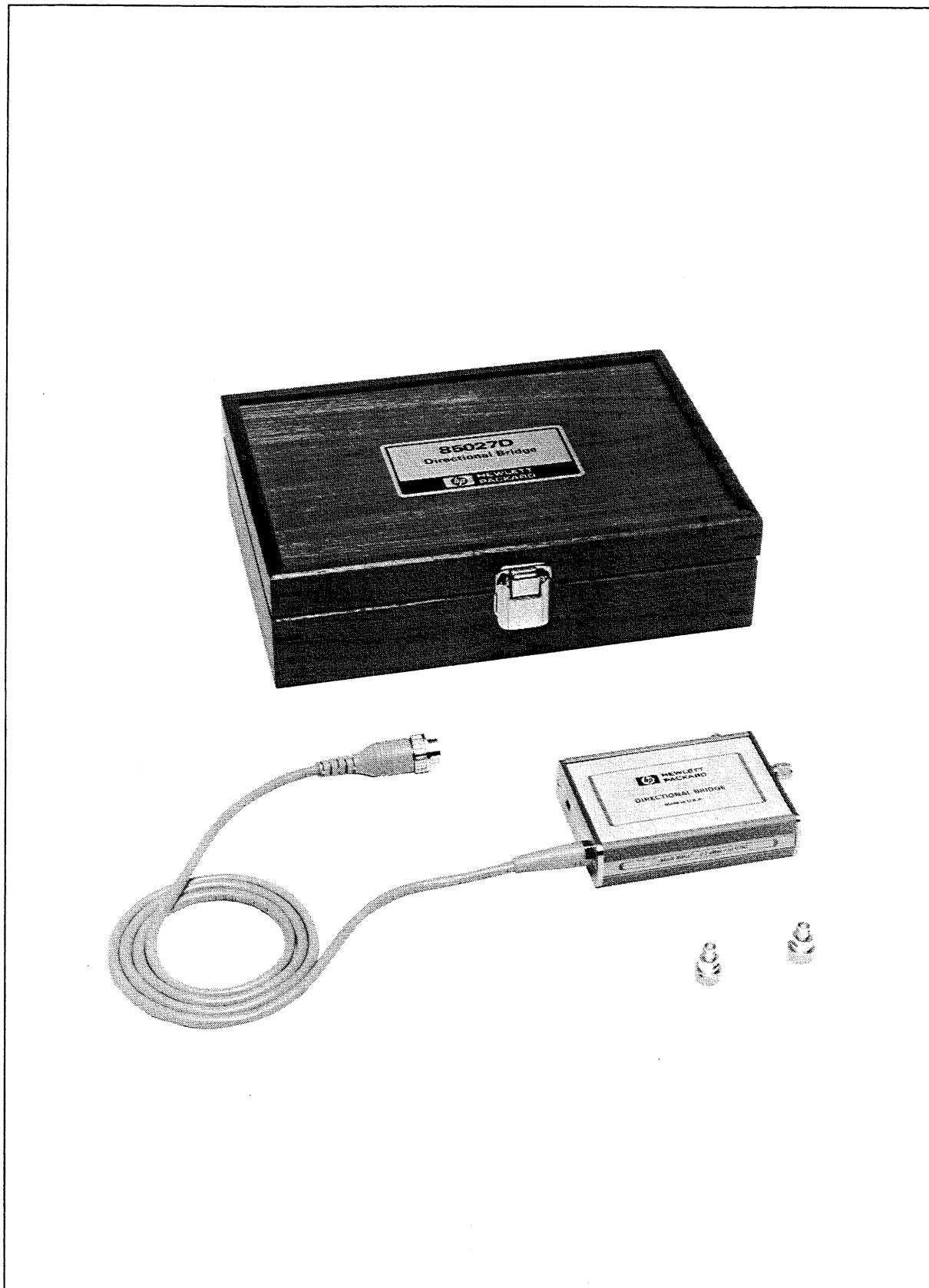

Figure 1-1. HP 85027D and Accessories

# Section 1. General Information

---

## INTRODUCTION

This manual contains the information required to install, operate, test, adjust, and service the HP 85027D directional bridge (also referred to as the "bridge"). The bridge and supplied accessories are shown in Figure 1-1.

Listed on the title page of this manual is a microfiche part number. Use this number to order microfilm transparencies of this manual. The latest manual changes supplement and relevant service notes are included in the microfilm package.

## INSTRUMENTS COVERED BY THE MANUAL

A serial number label is attached to the side of the HP 85027D (see Figure 1-2). The serial number is in two parts. The first four digits followed by a letter comprise the serial number prefix; the last five digits are the suffix. The prefix is the same for all identical instruments. The prefix changes only when a change is made to the instrument. The suffix is assigned sequentially and is different for each instrument.

The content of this manual applies directly to HP 85027D directional bridges having the same serial number prefix as those listed under *Serial Numbers* on the title page of this manual.

A bridge manufactured after the printing of this manual may have a serial prefix that is not listed on the title page. An unlisted serial prefix indicates that the product may be different from those documented in this manual. A manual changes supplement will be included with the manual to document differences.

In addition to change information, the supplement may contain information that applies to all instruments, regardless of serial number. To keep this manual as current as possible, periodically request the latest manual changes supplement. The supplement for this manual is keyed to its print date and part number, which appear on the title page. Copies of the supplement are available from Hewlett-Packard.

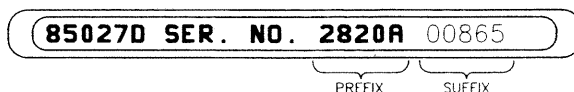

Figure 1-2. Typical Serial Number Label

## INSTRUMENT KEYS/SOFTKEYS

This manual contains step by step performance instructions for specific tests and measurements. Instrument keys are identified with **BOLD** type and softkeys are differentiated with **BOLD ITALICS**.

## SAFETY CONSIDERATIONS

There are no hazardous voltages in this directional bridge.

## PRODUCT DESCRIPTION

The HP 85027D is a microwave directional bridge that has a frequency range of 0.01 to 50 GHz, a 2.4 mm (male) test port connector, and a 2.4 mm (female) RF input. The bridge makes modulated (AC) or unmodulated (DC) scalar reflection measurements with the HP 8757 scalar network analyzer. The HP 85027D also performs AC measurements with the HP 8756 and HP 8755 scalar network analyzers.

A single zero-biased modified barrier diode detector in the bridge performs reflection measurements by sampling the return loss of the device under test. A detector can be added for simultaneous transmission measurements. A power splitter can be used with the bridge or detector (or both) for ratio measurements. The RF input signal is typically supplied by a sweep oscillator or a synthesized sweeper.

## SPECIFICATIONS

Table 1-1 lists the HP 85027D specifications. The instrument is tested to these performance standards. Table 1-2 lists supplemental (nonwarranted) characteristics. These are also identified as *typical* or *nominal*. These supplemental characteristics are not specifications but are included as additional information for the user.

## ITEMS SUPPLIED WITH THE HP 85027D

The following accessories and documents are supplied with the HP 85027D:

Description	HP Model or Part Number
Short PSC-2.4 <sup>1</sup> (f)	HP 85140B
Open PSC-2.4 (f)	HP 85141B
Connector Care Application Note #326	HP P/N 5954-1566
Operating Note 2.4 mm ADAPTERS and CALIBRATION ACCESSORIES	HP P/N 11900-90003

## EQUIPMENT REQUIRED BUT NOT SUPPLIED

Transmission measurements require one or more HP 85025 detectors and a scalar network analyzer. Use the HP 8757 for AC and DC measurements; use the HP 8756 or HP 8755 for AC-only measurements. Ratio measurements can be made with the addition of a power splitter. The HP 11667C power splitter has a frequency range of DC to 50 GHz. Swept frequency measurements require a swept signal source. In addition, the RF source signal must be amplitude modulated by a 27.778 kHz square wave signal for AC detection measurements. The HP 8350 sweep oscillator, HP 8340, HP 8341, or HP 8360 synthesized sweepers provide square wave modulation.

1. PSC-2.4 are metrology grade 2.4 mm Precision Slotless Connectors developed at Hewlett-Packard. The slotless center conductor provides higher performance and repeatability. They are compatible with all 2.4 mm connectors.

## EQUIPMENT AVAILABLE

Hewlett-Packard produces adapters from 2.4 mm to other coaxial connector types. Refer to *2.4 mm ADAPTERS and CALIBRATION ACCESSORIES* (included with the HP 85027D), for a list of these products and their specifications.

## RECOMMENDED TEST EQUIPMENT

Table 1-3 lists the equipment required to test the bridge. Other equipment may be substituted if it meets or exceeds the critical specifications indicated in the table. Use this list, also, as a reference for the equipment necessary to make reflection and transmission measurements.

Table 1-1. HP 85027D Specifications

<b>Frequency Range</b>	0.01 to 50 GHz	
<b>Maximum Input Power</b>	+23 dBm or $\pm 10$ volts	
<b>Directivity (+25° ± 5°C)</b>		
0.01 to 26.5 GHz	≥ 35 dB	
26.5 to 40 GHz	≥ 30 dB	
40 to 50 GHz	≥ 25 dB	
<b>Test Port Match (+25° ± 5°C)</b>		
0.01 to 16 GHz	≥ 21.5 dB	(≤ 1.18 SWR)
16 to 30 GHz	≥ 18.5 dB	(≤ 1.27 SWR)
30 to 40 GHz	≥ 15.5 dB	(≤ 1.40 SWR)
40 to 50 GHz	≥ 10.5 dB	(≤ 1.85 SWR) typically
<b>Dynamic Accuracy (+25° ± 5°C, 50 MHz, input power ≥ 0 dBm)</b>		
<b>Mechanical Specifications</b>		
	<b>Connector Type</b>	<b>Pin Depth</b>
Test Port	2.4 mm male	0.000 to 0.0015 in (0.000 to 0.038 mm) <sup>1</sup>
Input Port	2.4 mm female	0.000 to 0.002 in (0.000 to 0.051 mm) <sup>2</sup>

1. Allowable recession of male contact pin shoulder behind the outer conductor mating plane.

2. Allowable recession of the end of the female center pin behind the outer conductor mating plane.

Table 1-2. HP 85027D Supplemental Characteristics

<b>Typical Insertion Loss</b>	
At 0.01 GHz	6.5 dB
At 18 GHz	8.0 dB
At 26.5 GHz	10.0 dB
At 50 GHz	12.0 dB
<b>Typical Minimum Input Power for a 35 dB Return Loss at 40 GHz</b>	
HP 8757	0 dBm
HP 8756/55	+5 dBm
<b>Nominal Impedance</b>	50 ohms
<b>Dimensions</b>	26 mm high x 124 mm wide x 118 mm deep (1.0 inch x 4.9 inches x 4.6 inches)
<b>Cable Length</b>	1219 mm (48 inches)
<b>Net Weight</b>	425 gm (15 oz)
<b>Shipping Weight</b>	1.8 kg (4 lb)

Table 1-3. Recommended Test Equipment

Type	Critical Specification	Suggested Model or HP Part Number (P/N)
Scalar Network Analyzer	HP 85027 AC/DC compatible	HP 8757
Swept RF Source:	HP 8757 compatible	HP 8350B
Mainframe		
RF Plug-in	0.01 to 40 GHz	HP 83597A
RF Plug-in	40 to 50 GHz	HP 83550A
Millimeter-wave Source Module	40 to 50 GHz	HP 83555A
Detector	0.01 to 50 GHz	HP 85025D
Power Splitter	0.01 to 50 GHz	HP 11667C
Power Meter		HP 436A
Power Sensor	50 MHz	HP 8481A
10 dB Step Attenuator		HP 8495A Opt. 001, Opt. 890
Termination 50 Ohm PSC-2.4		HP 85138B
Termination 50 Ohm DC to 4 GHz, PSC-2.4	Return loss $\geq$ 42 dB	HP P/N 85056-60009
Sliding Mismatch 2.4 mm (f)		HP 915F
Airline 5 cm		HP P/N 85057-60001
Open PSC-2.4		HP 85141B*
Short PSC-2.4		HP 85140B*
Adapters	2.4 mm (m) to 2.4 mm (m) Waveguide to 2.4 mm (m) Type-N (m) to 2.4 mm (f) Type-N (m) to 2.4 mm (m)	HP 11900A HP Q281B HP 11903D HP 11903A

\*Included with the HP 85027D.

## Section 2. Installation

---

### INTRODUCTION

This section explains inspection procedures, environmental requirements, and packaging requirements.

### INITIAL INSPECTION

If the shipping container or cushioning material is damaged, do not discard them until the bridge has been checked mechanically and electrically.

1. Check the package for completeness.
2. Check connectors, cable, and body for mechanical damage.
3. Electrically test the bridge. Refer to *Operation or Performance Tests* in this manual.

Notify Hewlett-Packard if the shipping contents are not complete, if there is mechanical damage or defect, or if the bridge does not pass electrical tests. Notify the carrier if the shipping container is damaged or the cushioning material shows signs of stress. Keep all shipping materials for the carrier's inspection. Hewlett-Packard will arrange for repair or replacement without waiting for a claim settlement.

### PREPARATION FOR USE

#### Power Requirements



**Maximum power input to the bridge is +23 dBm RF power or  $\pm 10$  volts DC. Exceeding these limits will damage the bridge.**

Power for the HP 85027D is supplied by the network analyzer.

#### Mating Connectors

The precision 2.4 mm connector is a durable microwave connector. As with any precision microwave device, take care to properly handle the connector when making connections. Visually inspect and clean the connectors before every use.

Measure the mechanical tolerances of the bridge's RF connectors prior to first use, and periodically thereafter. Detailed instructions for gaging the precision 2.4 mm connector are available in the Hewlett-Packard *Microwave Connector Care* manual, HP Part Number 08510-90064. See Table 1-1 for pin depth specifications.

To extend the life of the 2.4 mm connectors, use the precision 2.4 mm adapters referenced in *Equipment Available*.

## **ENVIRONMENTAL REQUIREMENTS**

**Humidity:** Protect this product from temperature extremes which can cause internal condensation.

### **Operating Environment**

**Temperature:** 0°C to +55°C (+32°F to +131°F).  
**Altitude:** Up to 4,572 metres (15,000 feet).

### **Storage and Shipment**

**Temperature:** -40°C to +75°C (-40°F to +167°F).  
**Altitude:** Up to 15,240 metres (50,000 feet).

## **RETURNING THE PRODUCT FOR SERVICE**

If you return the instrument to Hewlett-Packard, follow the *Packaging* instructions in this manual. Complete a blue service tag (located at the end of this manual) and attach it to the bridge.

### **Packaging**

Containers and materials identical to those used in factory packaging are available through Hewlett-Packard offices. If you choose to package the instrument with commercially available materials, follow these instructions:

1. Place the bridge completely inside an anti-static bag.
2. Use a strong shipping container. A double-wall carton made of 350-pound test material is adequate.
3. Use a 7 to 10 cm (3 to 4 in) layer of shock-absorbing material around all sides of the instrument to provide a firm cushion and prevent movement inside the container.
4. Seal the container securely.
5. Mark the shipping container **FRAGILE**.



## Section 3. Operation

---

### INTRODUCTION

This section describes the typical operating modes of the directional bridge and provides an operator's check for verifying system function.



#### SUSCEPTIBLE TO DAMAGE FROM ESD.

**ESD (electrostatic discharge) can damage the highly sensitive microcircuits in this device.**

**An electrostatic discharge as low as 100 volts can destroy your bridge.**

**Use this device at a static-safe workstation and wear a grounding strap. NEVER touch the center contacts of the connectors or the cable contact pins.**

### FEATURES

Figure 3-1 describes the HP 85027D features. Description numbers match the numbers on the illustration.

### OPERATING INSTRUCTIONS

The HP 85027D is designed specifically to operate with the HP 8757 scalar network analyzer. The bridge is also compatible with the HP 8756 and HP 8755 analyzers. A configuration switch is located on the bottom cover of the bridge. Set the switch to the **HP 8757** position for use with the HP 8757 analyzer. Set the switch to the **HP 8756/HP 8755** position for use with either of those analyzers. Improper configuration of this switch will result in unacceptable performance.

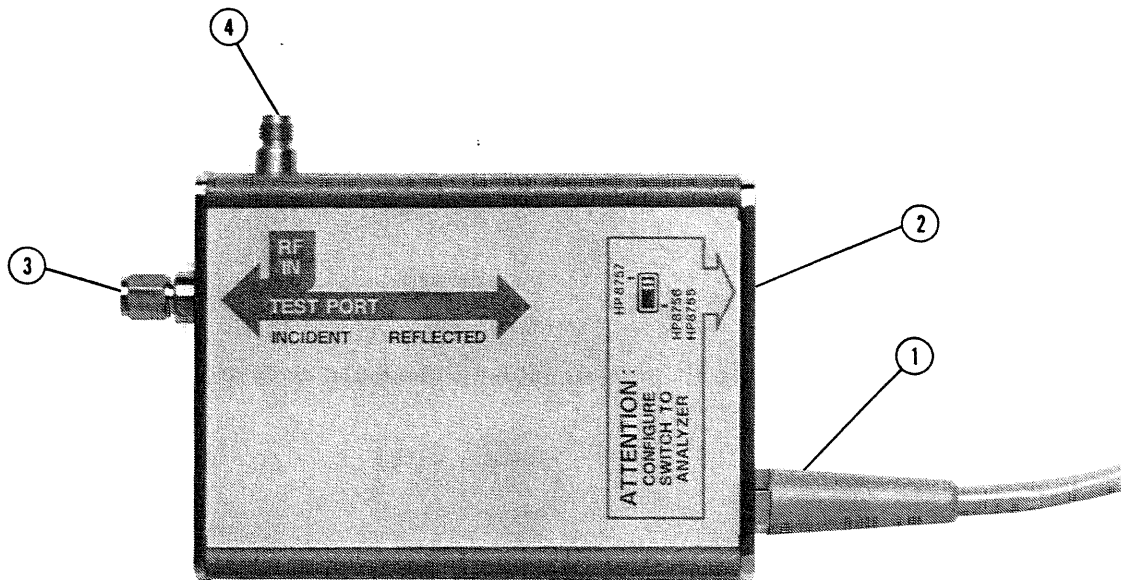

1. **Power supply cable W1.** This cable supplies DC voltages to the bridge, performs control functions, and sends reflected signal information to the analyzer.
2. **Configuration switch S1.** This switch sets the bridge for use with either the HP 8757 or the HP 8756/HP 8755.
3. **Test port connector J2 (2.4 mm — male).** Connect the DUT, calibration short or open here.
4. **RF Input connector J1 (2.4 mm — female).** Apply the RF signal here.

*Figure 3-1. HP 85027D Features*

## CONNECTING THE HP 85027D

1. Connect the power supply cable's DC connector into an analyzer input connector. (Input A is typically used for connection of the bridge for reflection measurements.) The HP 85027D connector is keyed; insert the plug with the key downward.
2. Secure the DC connector in the analyzer by turning the OUTER shell clockwise.
3. Connect the bridge RF input port to the source by turning the mating male connector OUTER nut clockwise.



## OPERATOR'S CHECK

The purpose of this procedure is to provide a quick check of the bridge's functionality. Follow this procedure to perform a return loss measurement of a 50 ohm termination. Compare the measurement results to the specifications. Specifications include the termination return loss plus the measurement uncertainty. Successfully completed, this measurement indicates that the bridge is functioning and that its directivity is within or near specifications.

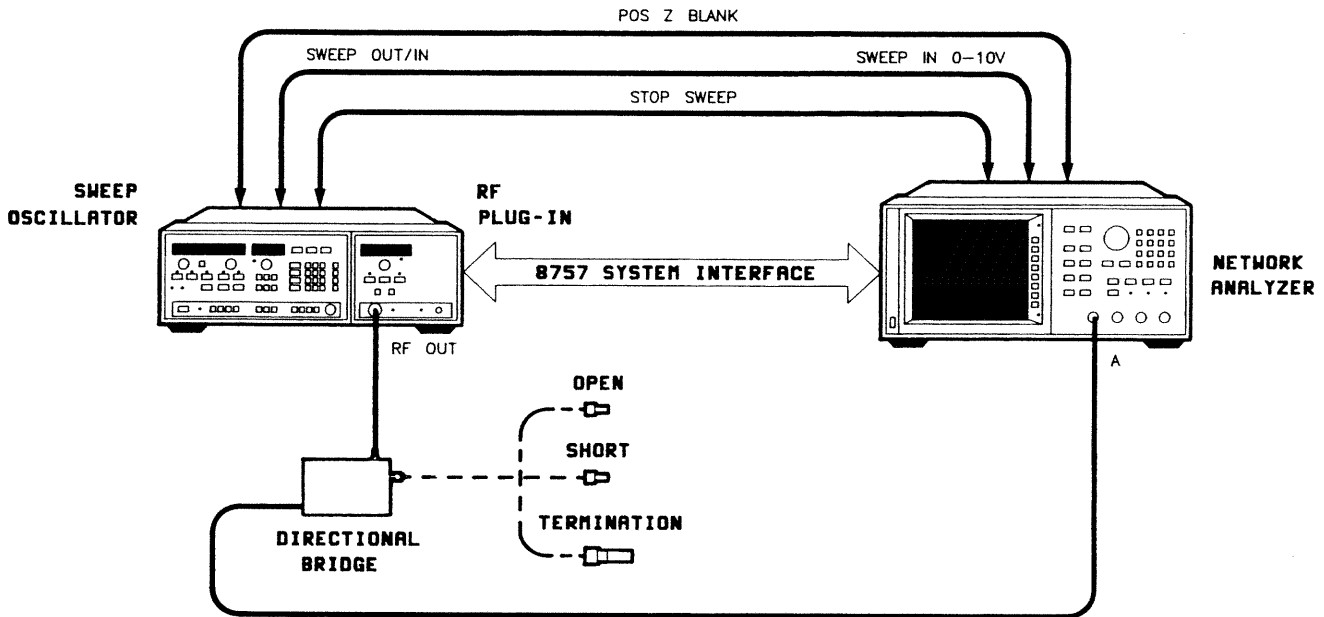

Figure 3-3. Operator's Check Setup

## Equipment

Scalar Network Analyzer .....	HP 8757
Sweep Oscillator .....	HP 8350B
RF Plug-in .....	HP 83597A
Open PSC-2.4 .....	HP 85141B*
Short PSC-2.4 .....	HP 85140B*
Termination 50 Ohm PSC-2.4 .....	HP 85138B

**Note:** For use with the HP 8756 or HP 8755, set the configuration switch in step 1 to **HP 8756/HP 8755**, and omit steps 6 and 7.

## Procedure

1. Connect the equipment as shown in Figure 3-3 with no connection to the bridge test port. Allow 30 minutes warm-up. Set the bridge configuration switch to **HP 8757**.
2. On the analyzer, press [**PRESET**]; both the analyzer and source will reset. Press [**CHAN 2 OFF**].

3. Calibrate the analyzer. Press **[CAL] [SHORT/OPEN]**. Connect the short to the bridge test port.  
Press **[STORE SHORT]**. Remove the short and replace it with the open.

Press **[STORE OPEN] [DISPLAY] [MEAS-MEM]** to normalize the measurement. Remove the open. Connect the termination to the bridge test port.

4. On the analyzer, press **[CURSOR]**. Use the front panel knob to move the cursor to the worst case return loss in each of the frequency bands listed.

FREQUENCY BAND	SPECIFICATION
10 MHz to 26.5 GHz	$\geq 26$ dB
26.5 GHz to 40 GHz	$\geq 21$ dB

5. Remove the termination from the bridge test port.
6. On the analyzer, perform a DC Zero.

**NOTE:** The DC mode operator's check can only be performed with the HP 8757.

Press **[SYSTEM] [MODE DC] [CAL] [DC DET ZERO] [AUTOZRO]** to activate DC mode and perform a DC zero.

When the zero is complete, the display will indicate: **AUTO ZERO COMPLETED**.

7. Continue with steps 3 through 5. The specifications are the same for both AC and DC modes.

This completes the procedure for the *Operator's Check*. Incorrect results may be caused by any portion of the system. If your measurement results are not within the specifications, proceed with these steps.

1. Check the measurement setup. Be sure the equipment is properly connected and the connections are clean and secure.
2. Verify that the equipment used is properly calibrated.
3. Repeat the measurement using a different HP 85138B termination. The quality of the load is essential to the accuracy of the measurement.

If the bridge still fails the operator's check, use the *Performance Tests* to further characterize the failure.



## Section 4. Performance Tests

---

### INTRODUCTION

The procedures in this section test the directivity, test port match, and dynamic accuracy of the HP 85027D directional bridge to the specifications in Table 1-1. A *Performance Test Record* is included at the end of this section to record results. If the results of these tests are not within specifications, refer to the *Troubleshooting* section of this manual.

### EQUIPMENT REQUIRED

The equipment required to test the HP 85027D is listed in Table 1-3, *Recommended Test Equipment*. Test equipment substitution is acceptable if it meets or exceeds the critical specifications given in Table 1-3.

# DIRECTIVITY

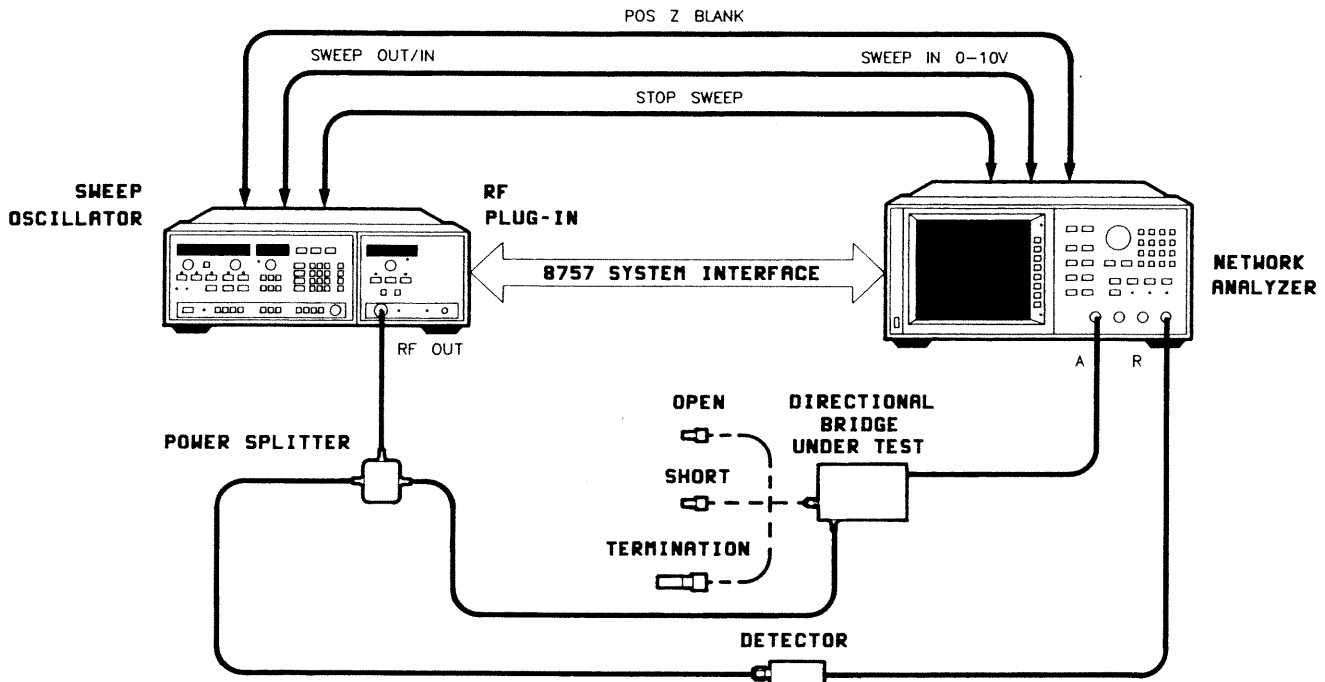

Figure 4-1. Directivity Test Setup 0.01 to 4 GHz

## EQUIPMENT

Scalar Network Analyzer .....	HP 8757
Sweep Oscillator .....	HP 8350B
RF Plug-in .....	HP 83597A
Power Splitter .....	HP 11667C
Detector .....	HP 85025D
Open PSC-2.4 .....	HP 85141B*
Short PSC-2.4 .....	HP 85140B*
50 Ohm Fixed Termination PSC-2.4 .....	HP Part Number 85056-60009
Sliding Mismatch .....	HP 915F
RF plug-in .....	HP 83550A
Millimeter-wave Source Module .....	HP 83555A
Adapter Waveguide to 2.4 mm (m) .....	HP Q281B

## DESCRIPTION

Bridge directivity is the residual signal present when a perfect 50 ohm load is connected to the bridge test port. Directivity is usually the major error term in low reflection measurements. The directivity of the bridge must be known in order to determine the uncertainty of any return loss measurement.

\*Included with the HP 85027D.



The uncertainty of the directivity measurement system must be known in order to determine the range of possible directivity values. The *Performance Test Record* includes system uncertainty values for use with the recommended test setups. The major contributors to these uncertainties are: the directivity of the load for the 0.01 to 4 GHz measurements, and the return loss of the airline portion of the sliding mismatch for the 4 to 50 GHz measurements.

To measure the low frequency directivity of the bridge, a 0 dB reference is established using a short/open calibration. Next a fixed load is connected to the test port. The signal measured by the bridge is the directivity error plus some error from the imperfect load.

The limitation of this measurement is the load accuracy. Reflections from the load contribute to the measured directivity. It is important that the reflection coefficient of the device connected to the bridge be much smaller than the bridge directivity.

At high frequencies, a sliding mismatch is used to determine directivity. The sliding mismatch produces an error signal (approximately -20 dB) that is combined with the directivity of the bridge. This combined signal produces a ripple pattern whose peak to peak amplitude is proportional to the bridge directivity.

#### **PROCEDURE FOR 0.01 TO 4 GHz:**

1. Connect the equipment as shown in Figure 4-1. Allow 30 minutes warm-up. Set the bridge configuration switch to **HP 8757**.
2. On the analyzer, press **[PRESET] [CHAN 2 OFF] [MEAS] [A/R]** to set the analyzer to display A/R in the AC detection mode.
3. On the source, press **[POWER LEVEL] [4] [DBM] [STOP] [4] [GHZ]** to set the source power level to +4 dBm and the frequency range from 0.01 to 4 GHz.
4. Calibrate the analyzer. Press **[CAL] [SHORT/OPEN]**. Connect the short to the bridge test port.  
Press **[STORE SHORT]**. Remove the short and connect the open to the bridge test port.  
Press **[STORE OPEN] [DISPLAY] [MEAS-MEM]** to normalize the measurement. Remove the open and connect the termination to the bridge test port.
5. Press **[AVG] [AVG ON]**. Allow the trace to settle.  
Press **[CURSOR] [MAX]** to read the value of the worst case directivity. Record this value on the *Performance Test Record* as **Dir**.
6. Using the system uncertainty shown on the *Performance Test Record*, determine the range of possible directivity values by following the *Measurement Uncertainty* portion of the *Directivity Nomogram Instructions*.

Record these maximum and minimum values on the *Performance Test Record* as **Dir Range**.

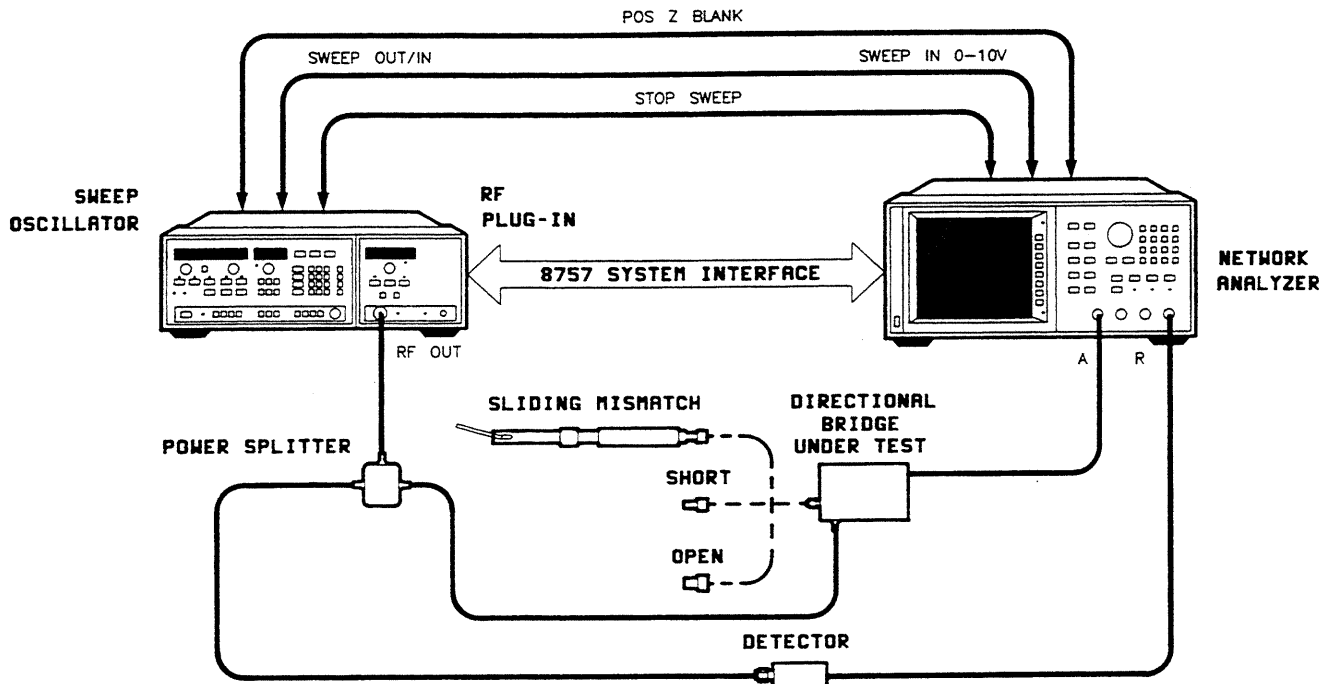

Figure 4-2. Directivity Test Setup 4 to 40 GHz

## PROCEDURE FOR 4 TO 40 GHz:

1. Connect the equipment as shown in Figure 4-2. Orient the bridge so the sliding mismatch will be vertical when connected to the bridge test port. Allow 30 minutes warm-up. Set the bridge configuration switch to **HP 8757**.
2. On the analyzer, press **[PRESET] [CHAN 2 OFF] [MEAS] [A/R]** to display A/R in the AC detection mode:
3. On the source, press **[START] [4] [GHZ]**.
4. Calibrate the analyzer. Press **[CAL] [SHORT/OPEN]**. Connect the short to the bridge test port. Press **[STORE SHORT]**. Remove the short and connect the open to the bridge test port. Press **[STORE OPEN] [DISPLAY] [MEAS-MEM]** to normalize the measurement. Remove the open and connect the sliding mismatch to the bridge test port.
5. On the analyzer, press **[SCALE] [AUTO SCALE] [CURSOR]**. Press **[AVG] [AVG FACTOR]** and use the step keys to set the averaging factor to 16.
6. Slide the mismatch element to find the largest envelope of ripple between 4 GHz and 26.5 GHz.
7. Use the analyzer front panel knob to position the cursor to the peak value. Figure 4-3 shows examples of peak and trough values in an envelope. These example values will be used later in the example nomogram. Press **[AVG] [AVG ON]**. Allow the trace to settle. Record the cursor value as **Peak Value** on the *Performance Test Record*.

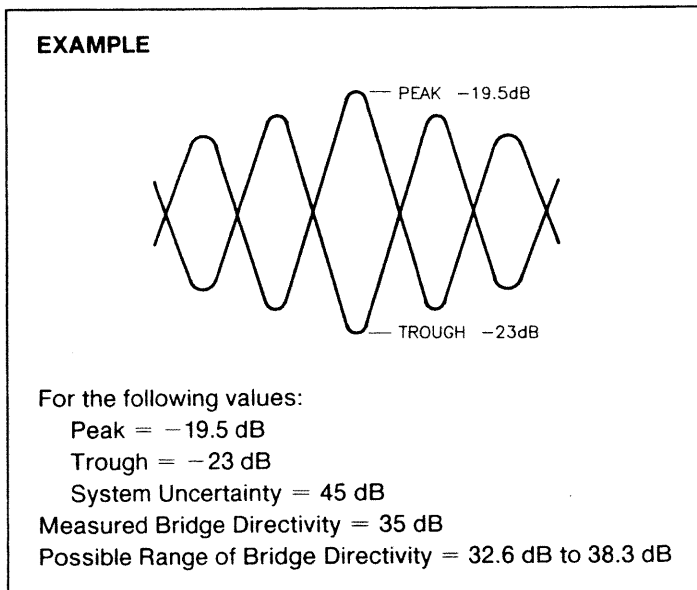

Figure 4-3. Peak and Trough of Envelope

8. Press **[AVG] [AVG OFF]**. Without moving the cursor, slide the mismatch element so the cursor is at the trough value.

Press **[AVG] [AVG ON]**. Allow the trace to settle. Record the cursor value as **Trough Value** on the *Performance Test Record*.

9. Determine the bridge directivity using one of following two methods.
  - a. Use the following equation to determine the value for directivity (**DIR** on the *Performance Test Record*). Then determine the maximum and minimum directivity values by following the *Measurement Uncertainty* portion of the *Directivity Nomogram Instructions*. Record these values as **Dir Range**.

$$\text{Directivity} = -20 \text{ LOG}_{10}[(10^{\text{Peak Value}/20} - 10^{\text{Trough Value}/20})/2]$$

- b. Follow the *Directivity Nomogram Instructions* to use the nomogram in Figure 4-5B to determine the directivity (**DIR**) and the maximum and minimum directivity values (**Dir Range**).
10. Repeat steps 6 through 10 for a frequency band of 26.5 to 40 GHz.

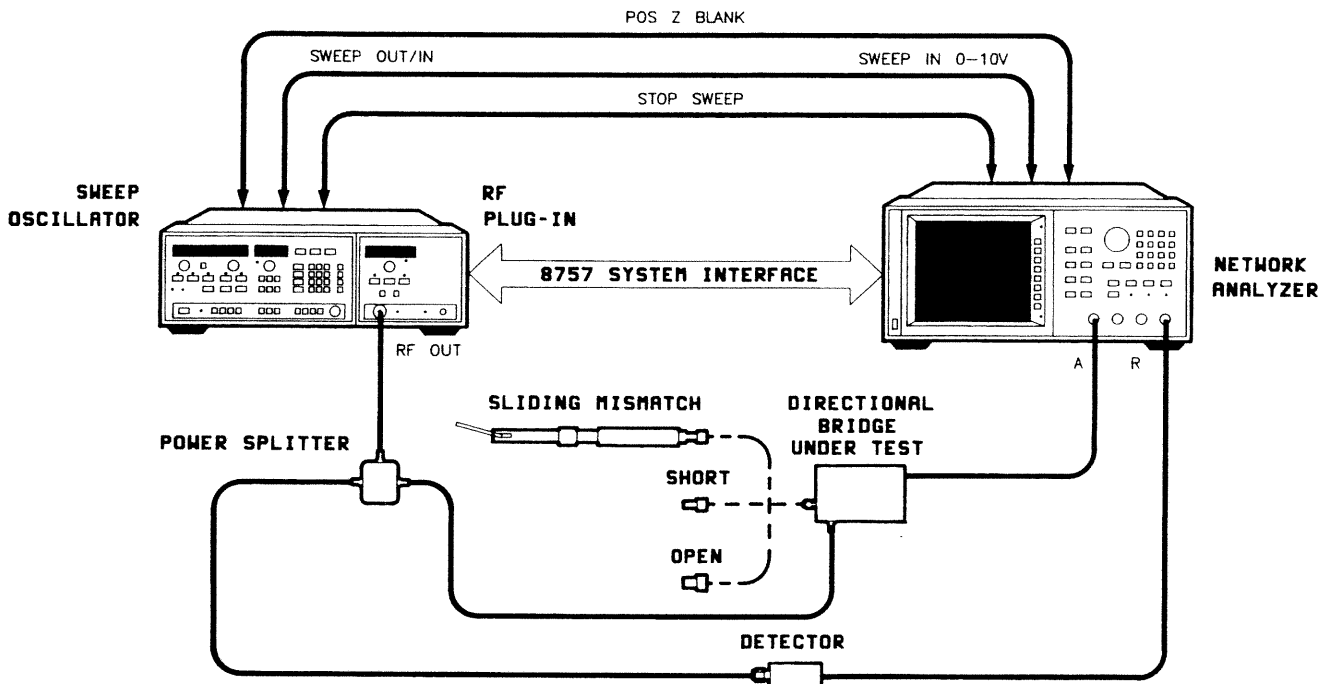

Figure 4-4. Directivity Test Setup 40 to 50 GHz

### PROCEDURE 40 TO 50 GHz:

1. Connect the equipment as shown in Figure 4-4. Orient the bridge so the sliding mismatch will be vertical when connected to the bridge test port. Allow 30 minutes warm-up. Set the bridge configuration switch to **HP 8757**.
2. On the analyzer, press **[PRESET] [CHAN 2 OFF] [MEAS] [A/R]** to display A/R in the AC detection mode:
3. On the source, press **[START] [4] [0] [GHZ] [STOP] [5] [0] [GHZ]**.
4. Continue with steps 4 through 9 of the directivity procedure for 4 to 40 GHz, substituting 40 to 50 GHz as the frequency band.

## DIRECTIVITY NOMOGRAM INSTRUCTIONS

1. Determine the **Peak Value** and **Trough Value**.
2. Using the directivity nomogram in Figure 4-5B, align a straight edge to cross the Trough Scale at the value measured for the **Trough Value** and the Peak Scale at the value measured for the **Peak Value**.
3. Without moving the straight edge, read the calculated directivity as the value where the straight edge intersects the directivity scale. Figure 4-5A shows an example using the values from Figure 4-3.

## Measurement Uncertainty

4. Using a compass, set one leg at  $\infty$  on the directivity scale in Figure 4-5B. Set the other leg at the system uncertainty (given on the *Performance Test Record*).
5. Without changing the spacing of the compass, place one leg at the directivity obtained in one of the following ways:
  - a. Step 3 above.
  - b. The measured worst case directivity in the 0.01 to 4 GHz procedure.
  - c. Calculated by the equation used in the 4 to 40 GHz and 40 to 50 GHz procedures.

Scribe a circle with the other leg. The points where the circle intersects the directivity scale are the upper and lower limits of the range of possible directivity values.

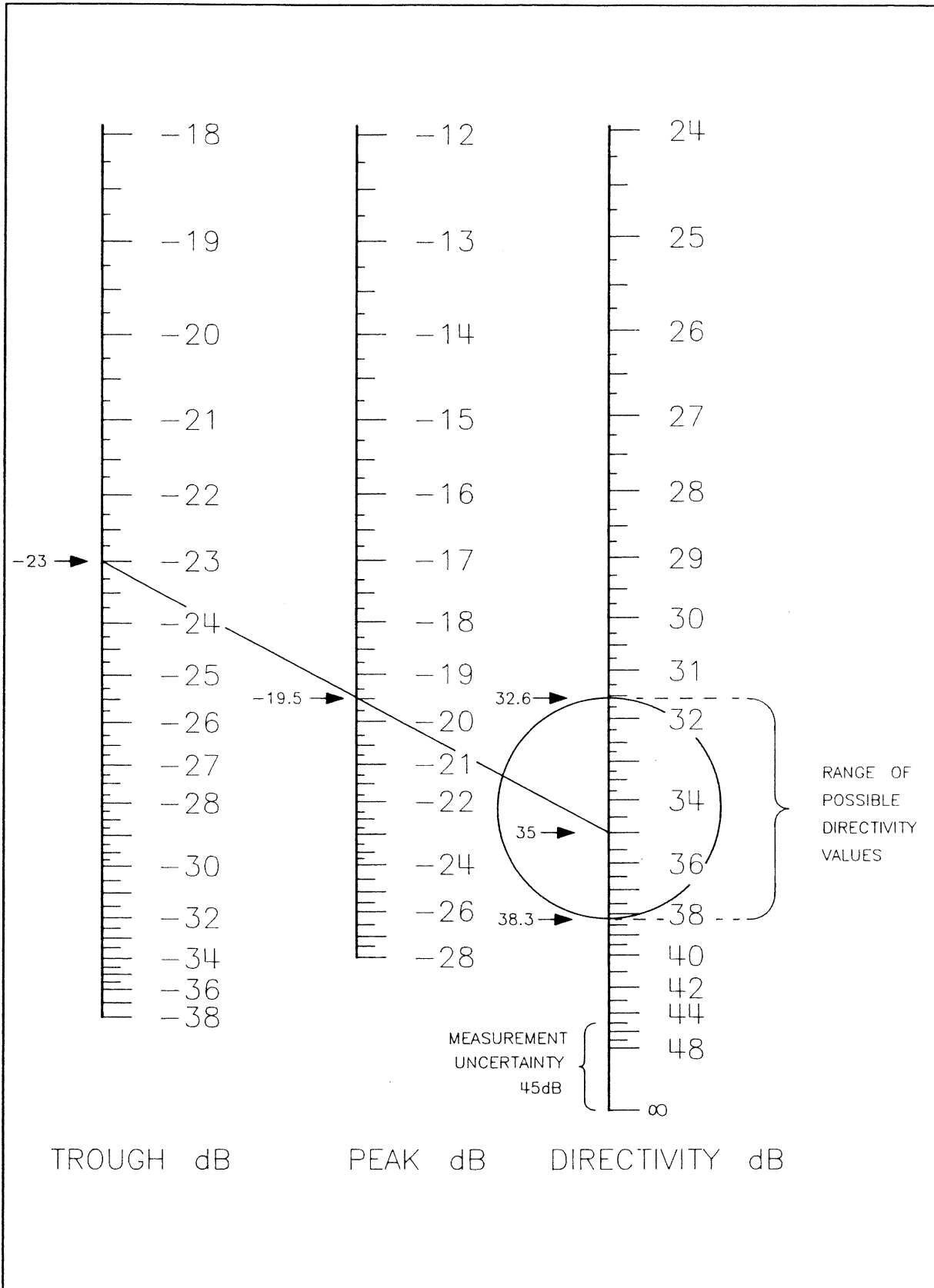

Figure 4-5A. Directivity Nomogram Example

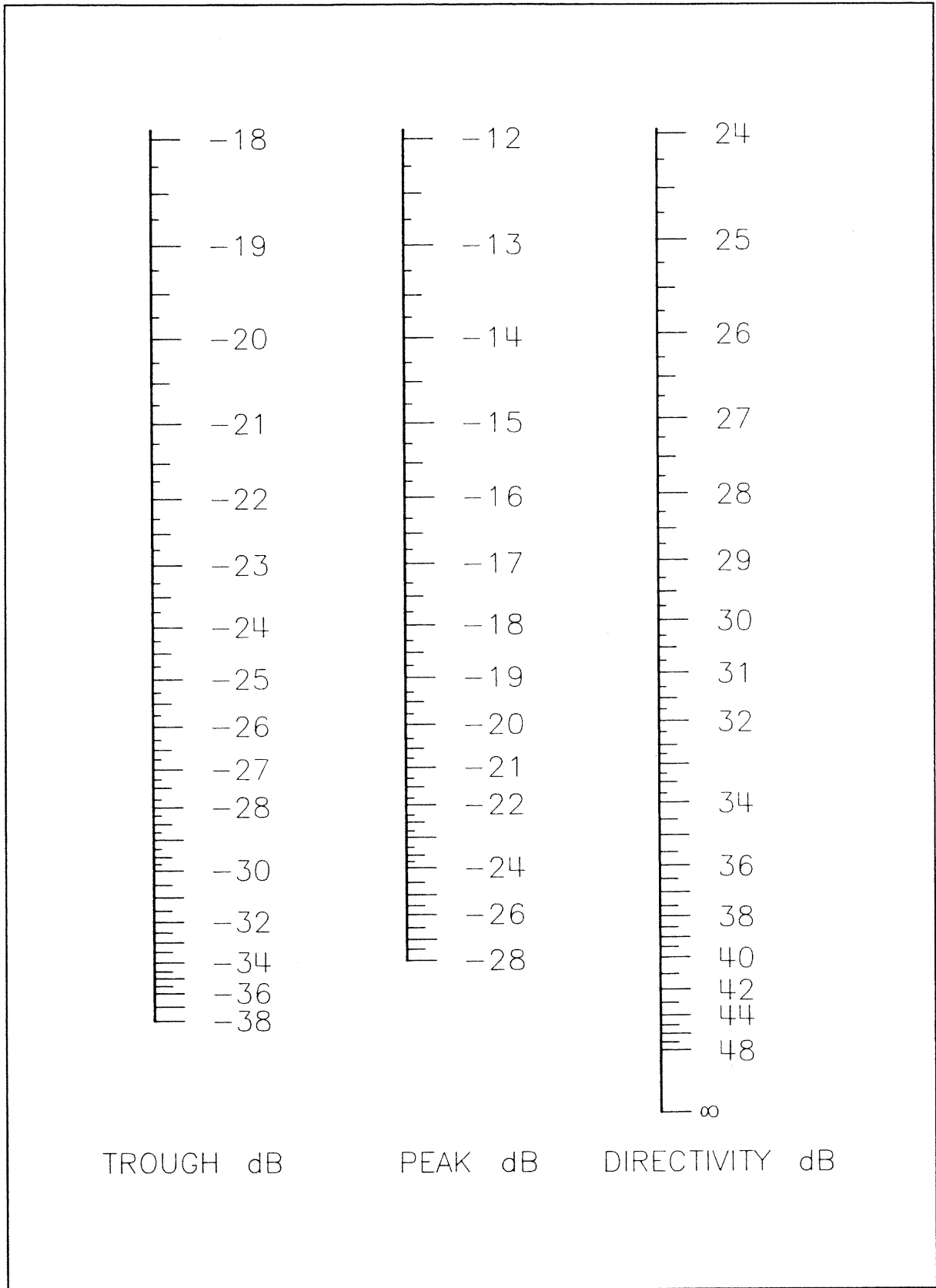

Figure 4-5B. Directivity Nomogram

## TEST PORT MATCH

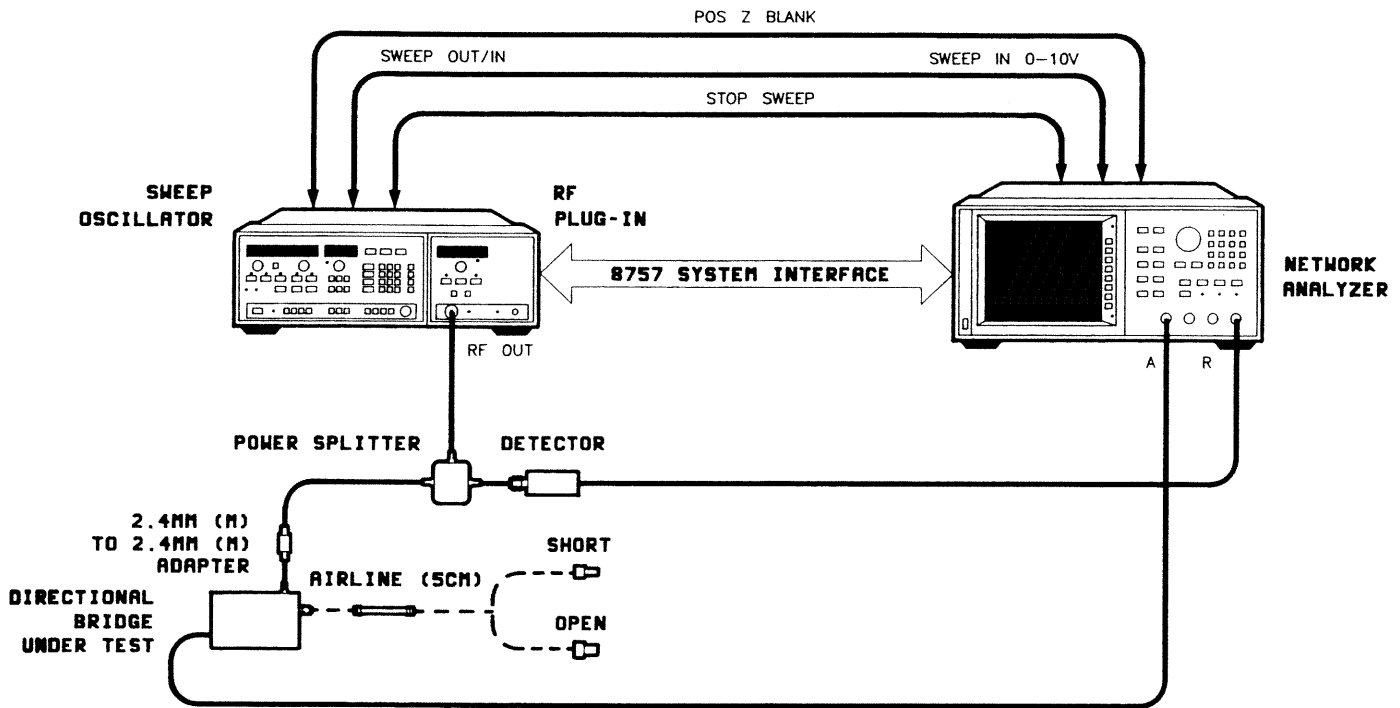

Figure 4-6. Test Port Match Test Setup

### EQUIPMENT

Scalar Network Analyzer .....	HP 8757
Sweep Oscillator .....	HP 8350B
RF Plug-in .....	HP 83597A
Power Splitter .....	HP 11667C
Detector .....	HP 85025D
Open PSC-2.4 .....	HP 85141B*
Short PSC-2.4 .....	HP 85140B*
Adapter 2.4 mm (m) to 2.4 mm (m) .....	HP 11900A
Airline 5 cm .....	HP P/N 85057-60001

### DESCRIPTION

This test measures the bridge test port match. The reflections from a short and open are used to produce a ripple pattern. The absolute amplitude of this ripple pattern corresponds to the actual test port match. The short and open are placed at the end of a 5 cm airline to produce a more dense ripple pattern. If an airline is not available, this test can be performed without it, however the less compact ripple pattern is more difficult to analyze.

\*Included with the HP 85027D.



## PROCEDURE

1. Connect the equipment as shown in Figure 4-6. Allow 30 minutes warm-up. Set the bridge configuration switch to **HP 8757**. Press **[PRESET]**, both the analyzer and the source will reset.
2. Set up and calibrate channel 1 on the analyzer. Press **[MEAS] [A/R] [SCALE]** and set the scale factor to **[1] [DB]**. Set the reference to center screen, if it is not already there.

Press **[CAL] [SHORT/OPEN]** and connect the short to the airline.

Press **[STORE SHORT]** and disconnect the short. Connect the open to the airline.

Press **[STORE OPEN] [DISPLAY] [MEAS-MEM]**.

3. Press **[HOLD ON]**. Disconnect the open.
4. Press **[CHANNEL 2]** and repeat step 2 for channel 2.
5. Disconnect the open, connect the short to the airline, and press **[CURSOR]**. The HP 8757 will display two ripple patterns offset by 180 degrees. The absolute amplitude of the peak to peak difference between these two traces corresponds to the test port match. By turning the analyzer knob, use the cursors to find the worst case test port match values (largest peak to peak difference) for each frequency range listed on the *Performance Test Record*. Refer to Figure 4-7 for an example of the cursors at a worst case value.

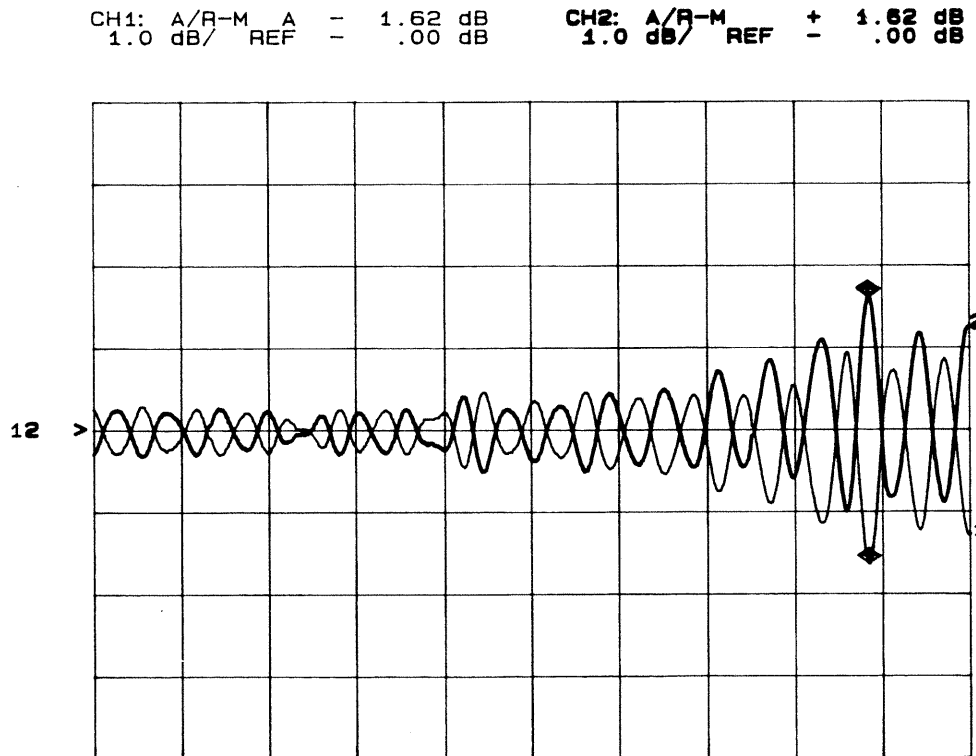
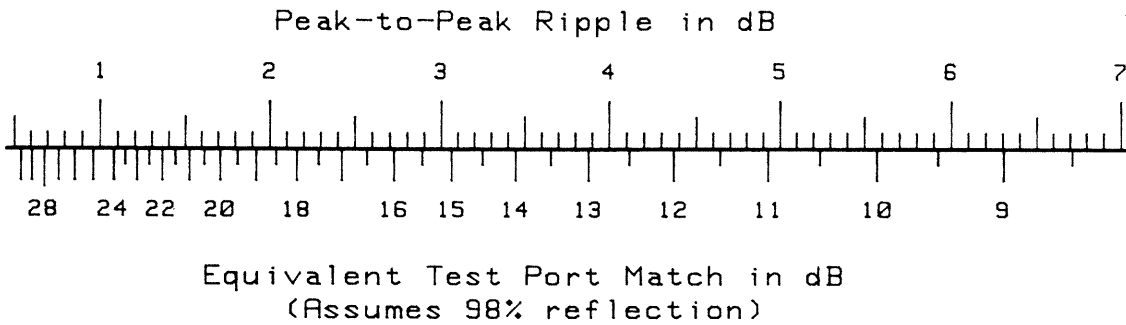

Figure 4-7. Cursors at Worst Case Test Port Match Values

6. For each frequency range, add the absolute values of cursor 1 and 2 power levels at the worst case point. Record these values on the *Performance Test Record* as **Peak-to-Peak Ripple**.
7. For each of the values recorded on the *Performance Test Record*, use the following graph to determine the actual test port match in dB. Plot the peak-to-peak ripple and read the corresponding equivalent test port match in dB. Record these values on the *Performance Test Record* and compare them to the specifications.



## DYNAMIC ACCURACY (AC and DC)

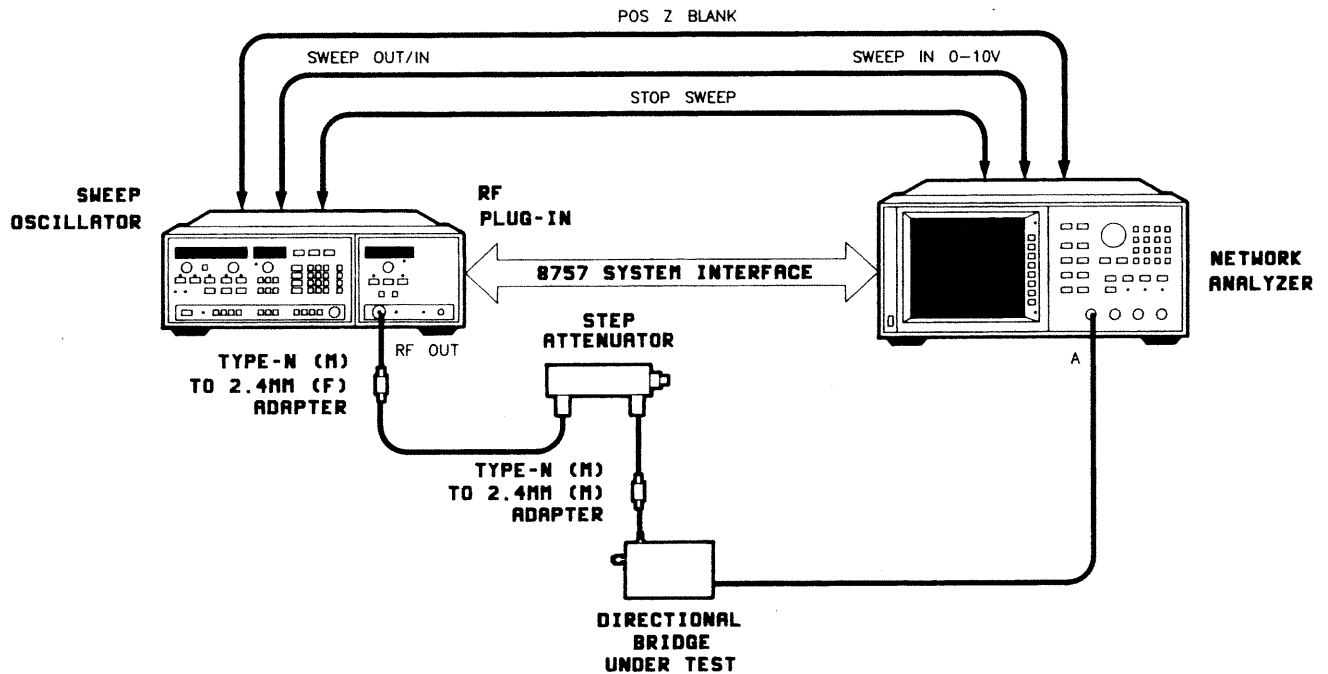

Figure 4-8. Dynamic Accuracy Test Setup

### EQUIPMENT

Scalar Network Analyzer .....	HP 8757
Sweep Oscillator .....	HP 8350B
RF Plug-in .....	HP 83597A
10 dB Step Attenuator .....	HP 8495A Opt. 001 Opt. 890
Adapter Type-N (m) to 2.4 mm (f) .....	HP 11903D
Adapter Type-N (m) to 2.4 mm (m) .....	HP 11903A

### DESCRIPTION

The dynamic accuracy graph, in *Specifications*, shows the maximum error in  $\pm$  dB relative to various attenuated levels of RF input to the bridge. Dynamic accuracy is a measurement of the detector diode response to power variation. This performance test measures the maximum error in dB for both AC and DC modes. Attenuator inaccuracy contributes errors to these measurements, so a calibrated attenuator is used. Calibrated step attenuators include a calibration report at 50 MHz that lists the actual attenuation of each step, and is available as an option with the step attenuator.

## PROCEDURE AC MODE

1. Connect the equipment as shown in Figure 4-8. Allow 30 minutes for warm-up. Set the configuration switch on the bridge to **HP 8757**. Press **[PRESET]** on the analyzer. Both the analyzer and the source will reset.

For each of the attenuator settings specified, record the required calibration data of the 10 dB step attenuator as **ATTEN ERROR** on the *Performance Test Record*.

2. On the RF plug-in, press **[CW]**; the CW lamp will light. Press **[5] [0] [MHZ] [POWER LEVEL] [4] [DBM]**.
3. Set the 10 dB step attenuator to 0 dB attenuation.
4. On the analyzer, press **[DISPLAY] [MEAS→MEM] [MEAS-MEM]**.
5. Set the 10 dB step attenuator to 10 dB.
6. On the analyzer measure the AC error. Press **[CURSOR]**. Enter the cursor value in the **MEAS AC ERROR** column of the *Performance Test Record*, Table 4-1.
7. Set the 10 dB step attenuator to each of the settings (**ATTEN SETTINGS**) listed on the *Performance Test Record* and record the cursor readings (**MEAS AC ERROR**) for each setting.
8. Calculate the actual AC dynamic accuracy as follows:

$$\text{ACTUAL AC ACCY} = \text{MEAS AC ERROR} - \text{ATTEN ERROR}$$

## PROCEDURE DC MODE

9. Reset the 10 dB step attenuator to 0 dB.
10. On the analyzer, press **[SYSTEM] [MODE DC] [CAL] [DC DET ZERO] [AUTOZRO]**. When the zero is complete, the display will indicate: **AUTO ZERO COMPLETED**.

Press **[DISPLAY] [MEAS→MEM] [MEAS-MEM]**.

11. Set the 10 dB step attenuator to 10 dB.
12. On the analyzer, measure the DC error. Press **[CURSOR]**. Enter the cursor value in the **MEAS DC ERROR** column of the *Performance Test Record*.
13. Set the 10 dB step attenuator to each of the settings listed on the *Performance Test Record* and record the cursor readings (**MEAS DC ERROR**) for each setting.
14. Calculate the actual DC dynamic accuracy as follows:

$$\text{ACTUAL DC ACCY} = \text{MEAS DC ERROR} - \text{ATTEN ERROR}$$

This completes the *Performance Tests* section. If the bridge failed one or more of these tests, proceed to the *Troubleshooting* section.

Table 4-1. Performance Test Record

<b>HP 85027D DIRECTIONAL BRIDGE</b>						
Serial Number: _____				Date: _____		
Tested By: _____				Temperature: _____		
<b>DIRECTIVITY</b>						
Frequency Band	Specification	Peak Value	Trough Value	Dir	System Uncertainty	
0.01 to 4 GHz	35 dB	Not Used	Not Used	_____dB	-42 dB	
4 to 20 GHz	35 dB	_____dB	_____dB	_____dB	-45 dB	
20 to 26.5 GHz	35 dB	_____dB	_____dB	_____dB	-42 dB	
26.5 to 40 GHz	30 dB	_____dB	_____dB	_____dB	-38 dB	
40 to 50 GHz	25 dB	_____dB	_____dB	_____dB	-36 dB	
<b>TEST PORT MATCH</b>						
Frequency Band	Specification	Peak-to-Peak Ripple	Test Result	System Uncertainty		
0.01 to 16 GHz	≥ 21.5 dB	_____	_____	-30 dB		
16 to 30 GHz	≥ 18.5 dB	_____	_____	-27 dB		
30 to 40 GHz	≥ 15.5 dB	_____	_____	-23 dB		
<b>DYNAMIC ACCURACY</b>						
Atten Settings	AC/DC Specification	Atten Error	Meas AC Error	Actual AC Accy	Meas DC Error	Actual DC Accy
0 dB	Reference					
10 dB	± 0.4 dB	_____	_____	_____	_____	_____
20 dB	± 0.4 dB	_____	_____	_____	_____	_____
30 dB	± 0.5 dB	_____	_____	_____	_____	_____
40 dB	± 1.0 dB	_____	_____	_____	_____	_____



## Section 5. Adjustments

---

### INTRODUCTION

These adjustments match the preamplifier to the microcircuit characteristics. Perform these adjustments only if:

1. The internal bridge microcircuit assembly (A1) is replaced.
2. The preamplifier assembly (A2) is repaired or replaced.

Perform all of the adjustments in the order given.

### ADJUSTMENT PROCEDURES

Figure 5-1 shows the locations of the adjustment potentiometers.

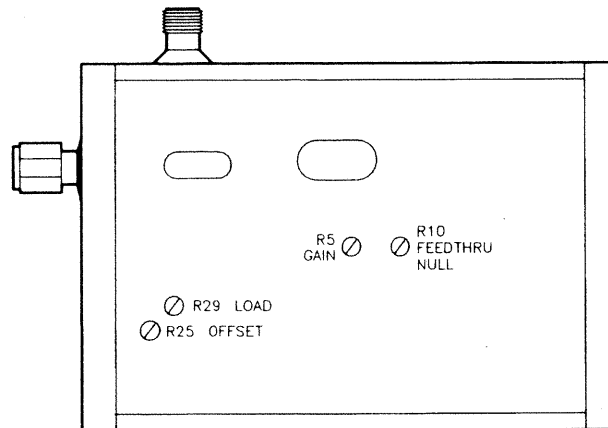

Figure 5-1. Adjustment Potentiometer Locations

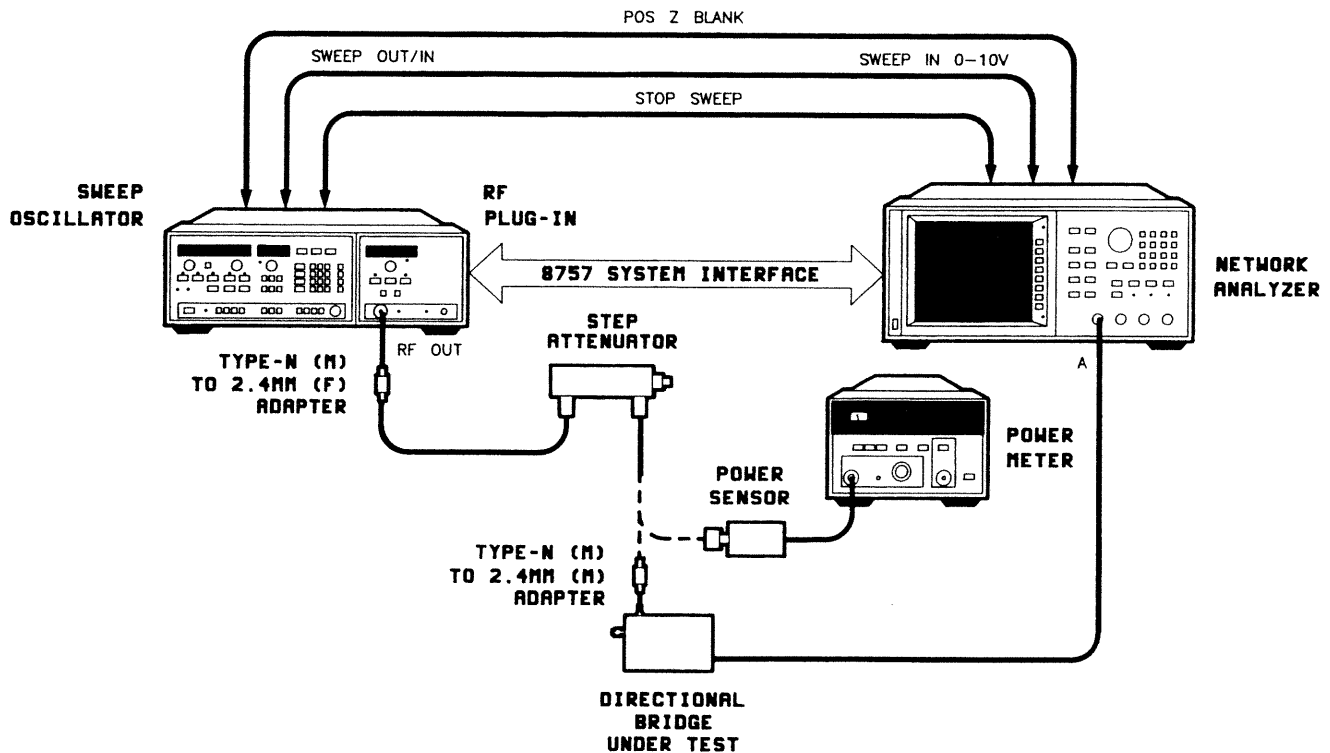

Figure 5-2. Adjustment Test Equipment Setup

## Equipment

Scalar Network Analyzer .....	HP 8757
Sweep Oscillator .....	HP 8350B
RF Plug-in .....	HP 83597A
Power Meter .....	HP 436A
Power Sensor .....	HP 8481A
10 dB Step Attenuator .....	HP 8495A Opt. 001 Opt. 890
Adapter Type-N (m) to 2.4 mm (m) .....	HP 11903A
Adapter Type-N (m) to 2.4 mm (f) .....	HP 11903D

## AC Adjustment Procedure

1. Connect the equipment as shown in Figure 5-2 with the power sensor connected to the attenuator. Allow 30 minutes for warm-up. Set the bridge configuration switch to **HP 8757**.
2. Set the attenuation to 0 dB.
3. On the analyzer, press **[PRESET]**. Both the analyzer and source will reset.
4. On the source, press **[CW]**. The CW lamp will light.

Press **[5] [0] [MHZ] [ MOD]**. The modulation lamp will turn off.

Adjust the plug-in front panel knob until the power meter reads +4.5 dBm.



5. Remove the back label from the bridge.
6. Disconnect the power sensor from the attenuator and press [**MOD**]. The modulation lamp will light.
7. Connect the bridge input port to the attenuator, leaving the test port open. On the analyzer, press [**AVG**] [**AVG ON**] [**SPEC**] [**SMOOTH ON**] [**CURSOR**].
8. Adjust R5 (see Figure 5-1) for a cursor reading of  $-8 \pm 0.1$  dBm.

**NOTE:** The  $\pm 0.1$  dB margin in steps 8 through 10 is a starting point for this adjustment. The specification, verified later in the procedure, is  $\pm 0.8$  dB.

9. Set the attenuator to 30 dB and adjust R29 (Figure 5-1) for a cursor reading of **calibrated**  $-38$  dBm (calibrated  $-30$  dB  $- 8$  dB). Adjust R29 so the measured value is within  $\pm 0.1$  dBm of **calibrated**  $-38$  dBm.
10. Set the attenuator to 0 dB. If the cursor does not read  $-8 \pm 0.1$  dBm, adjust R29 until this value is reached.
11. Repeat steps 8 through 10 until: the change in level is equal to the **calibrated**  $30$  dB  $\pm 0.1$  dB and with 0 dB attenuation, the cursor indicates  $-8 \pm 0.1$  dBm.

**NOTE:** If it is not possible to adjust R5/R29 to obtain a 30 dB change, repeat steps 2-11, using a different power setting in step 4. Increase or decrease this power in 1 db steps with the range of  $+1.5$  dBm to  $+7.5$  dBm, then repeat this adjustment.

### DC Adjustment Procedure

1. On the analyzer, press [**SYSTEM**] [**MODE DC**] [**CAL**] [**DC DET ZERO**] [**AUTOZRO**]. When the zero is complete, the display will indicate: AUTO ZERO COMPLETED.
2. On the analyzer, press [**REF**] [**REF LEVEL**] [**-**] [**5**] [**0**] [**DBM**] [**REF POSN**]. Adjust the analyzer front panel knob to set the reference at center screen, if it is not already there. Press [**SCALE**] [**5**] [**dB**].
3. Turn off the plug-in RF power. Press [**RF**]. The lamp will turn out.
4. Set the attenuator to 70 dB attenuation.
5. On the analyzer, press [**CAL**] [**CONFIG SYSTEM**] [**MORE**] [**AUTOCAL**].
6. On the bridge, use a jumper to short pad Y (where the yellow wire terminates) to ground.
7. Adjust R25 for a minimum reading on the analyzer ( $< -50$  dBm).
8. Remove the short.
9. On the analyzer, press [**AUTOCAL ON**].

### Feedthrough Null Adjustment Procedure

1. On the analyzer, press [**CAL**] [**DC DET ZERO**] [**AUTOZERO**].
2. Adjust R10 for as high a trace as possible. Adjust slowly. Averaging and smoothing mask adjustment effects.
3. Repeat steps 1 and 2 until there is no change.

## DC Mode RF Adjustment Check

1. Turn on the plug-in's RF power. Press [RF]. The lamp will light.
2. Set the attenuator to 0 dB. Allow the trace to settle.
3. On the analyzer, press [DISPLAY] [MEAS→MEM] [MEAS-MEM]. The cursor will indicate 0.0 dB.
4. Set the attenuator to 30 dB. The cursor will measure the calibrated  $-30$  dB to within 0.8 dB.
5. If the value is not within 0.8 dB of the calibrated  $-30$  dB, adjust R5 and R29 until the **difference** between the 0 dB and 30 dB attenuator setting is within 0.8 dB of the calibrated 30 dB. Adjust R5 when the attenuator setting is 0 dB. Adjust R29 when at 30 dB.
6. Repeat the AC adjustment procedure using a tolerance limit of  $\pm 0.8$  dB in steps 8 through 10.

## Section 6. Replaceable Parts

---

### INTRODUCTION

This section contains information for ordering parts. Exchange assemblies, manufacturer codes, reference designations, and abbreviations are also described.

### RESTORED EXCHANGE ASSEMBLIES

The bridge microcircuit can be replaced with either a new or restored assembly. The Module Exchange Program (Figure 6-1) describes the process for exchanging a defective assembly with a restored assembly. The restored assembly is more economical than a new assembly and, as with new assemblies, a one year warranty applies through the instrument's support life. The defective assembly must be returned for credit (after you receive the replacement). For this reason, new microcircuit assemblies must be ordered for spare parts. The part numbers for both new and restored bridge microcircuits assemblies are given in Table 6-1.

### REPLACEABLE PARTS LIST

Table 6-1 and 6-2 list all of the replaceable components and assemblies for the HP 85027D directional bridge. The tables provide the following information:

- Reference Designation — The component or assembly is identified with this code in Figures 6-2 and 6-3 and on the schematics in this manual. The alphabetic code used in the reference designation is defined in Table 6-3.
- HP Part Number — Use this number to order the replacement part from Hewlett-Packard.
- CD (Check Digit) — Use this number, in addition to the HP Part Number, to order replacement parts. It is cross-referenced to the HP Part Number as a doublecheck of the part number accuracy.
- Qty — The total quantity of the part in the instrument.
- Description — Description of the replacement part. The abbreviations used in the descriptions are defined in Table 6-3.
- Mfr Code — The five digit code of the primary manufacturer of the part. Refer to Table 6-3 for the list of manufacturers corresponding to the codes.
- Mfr Part Number — The primary manufacturer's part number for the part.

## ORDERING INFORMATION

To order a part from the replaceable parts list, indicate the Hewlett-Packard part number (with check digit to ensure efficient processing) and the quantity desired. Address the order to the nearest Hewlett-Packard office.

Only the parts listed are replaceable. Any attempt to perform a disassembly or repair procedure not described in the *Service* section will void the warranty.

Table 6-1. *Manufacturers' Code List, Reference Designators, and Abbreviations*

<b>MANUFACTURERS CODE LIST</b>			
<b>Code</b>	<b>Manufacturer</b>	<b>Address</b>	<b>Zip Code</b>
00000	Any satisfactory supplier		
04379	Ametek Inc	Paoli PA	19301
04713	Motorola Semiconductor Products	Phoenix AZ	85008
06383	Panduit Corp	Tinley Park IL	60477
06665	Precision Monolithics Inc	Santa Clara CA	95050
10430	KEM-MIL-CO	Alameda CA	94501
24546	Corning Glass Works (Bradford)	Bradford PA	16701
25088	Siemens Corp	Iselin NJ	08830
27014	National Semiconductor Corp	Santa Clara CA	95051
28480	Hewlett-Packard Co Corporate HQ	Palo Alto CA	94304
32997	Bourns Inc Trimpot Prod Div	Riverside CA	92507

  

<b>REFERENCE DESIGNATORS</b>			
A	assembly	R	resistor
AT	termination assembly	TP	test point
C	capacitor	S	switch
CR	diode	U	integrated circuit
J	jack	VR	diode
L	inductor	W	cable
MP	miscellaneous part		

  

<b>ABBREVIATIONS</b>			
ADJ	adjustable	RMS	root-mean-square
ASSY	assembly	SGL	signal
BD	board	SI	silicon
CER	ceramic	SIG	signal
DBLHX	double chamfered, hex	SLDR	solder
FXD	fixed	STR	straight
G	giga (10 <sup>9</sup> )	TA	tantalum
K	kilo (10 <sup>3</sup> )	THD	thread
MA	milli-amp	TML	terminal
MEG	mega (10 <sup>6</sup> )	TRMR	trimmer
MFR	manufacturer	TRN	turn
MHZ	megahertz	UF	microfarad
PF	picofarad	VDC	volts, direct current
P/O	part of	W	watt
PRCN	precision	ZNR	zener
RGLTR	regulator		

**The module exchange program described here is a fast, efficient, economical method of keeping your Hewlett-Packard instrument in service.**

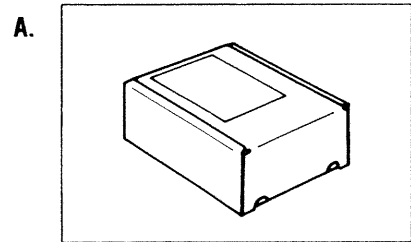
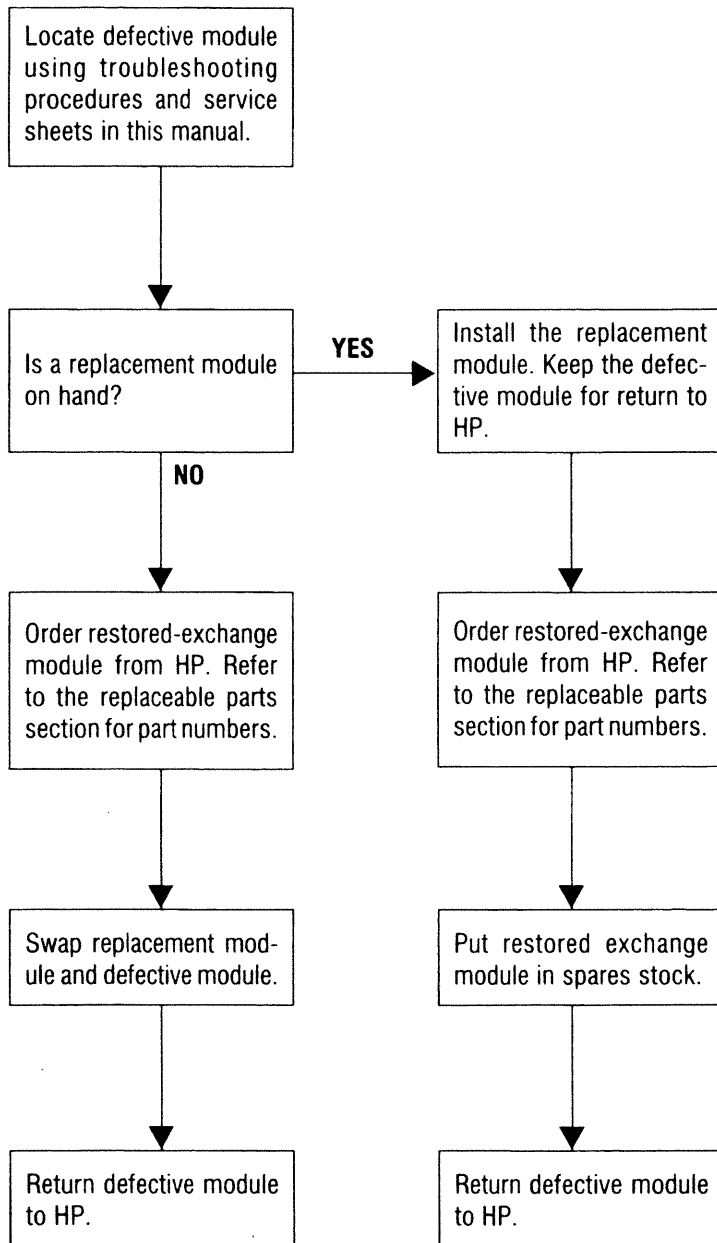

Restored-exchange modules are shipped individually in boxes like this. In addition to the circuit module, the box contains:  
Exchange assembly failure report  
Return address label

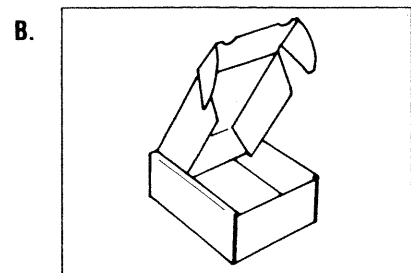

Open box carefully - it will be used to return defective module to HP. Complete failure report. Place it and defective module in box. Be sure to remove enclosed return address label.

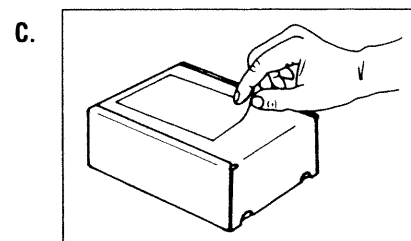

Seal box with tape. Inside U.S.A.\*, stick preprinted return address label over label already on box, and return box to HP. Outside U.S.A., do not use address label; instead address box to the nearest HP office.

\*HP pays postage on boxes mailed in U.S.A.

Figure 6-1. Module Exchange Program

Table 6-2. HP 85027D Replaceable Parts

Reference Designation	HP Part Number	C D	Qty	Description	Mfr Code	Mfr Part Number
A1 (NEW)	5086-7509	5	1	BRIDGE MICROCIRCUIT ASSEMBLY (NEW)	28480	5086-7509
A1 (REBUILT)	5086-6509	2		BRIDGE MICROCIRCUIT ASSEMBLY (REBUILT)	28480	5086-6509
A2	85027-60053	4	1	PREAMPLIFIER ASSEMBLY	28480	85027-60053
AT1	P/O A1		1	LOAD CARTRIDGE	28480	P/O A1
J1	P/O A1		1	INPUT CONNECTOR	28480	P/O A1
J2	P/O A1		1	TEST PORT CONNECTOR	28480	P/O A1
MP1*	85027-00001	6	1	DRESS COVER	28480	85027-00001
MP2	85027-20005	2	1	CABLE COVER	28480	85027-20005
MP3	85027-20051	8	1	FRAME 2.4	28480	85027-20051
MP4	85027-20050	7	1	PORT COVER	28480	85027-20004
MP5	0535-0694	3	1	NUT-HEX DBL-CHAM M8 X 1.0 4MM THK	00000	Order by Description
MP7*	0360-0002	6	1	TERMINAL-SLDR LUG PL-MTG FOR-#2-SCR	00000	Order by Description
MP8	0515-1445	2	4	SCREW-THD-RLG-M3 X 0.5 8MM-LG	00000	Order by Description
MP10	0515-0914	8	4	SCREW-MACH M3 X 0.5 6MM-LB 90-DEG-FLH-HD	00000	Order by Description
MP11	0515-0912	6	4	SCREW-MACH M3 X 0.5 8MM-LG PAN-HD	00000	Order by Description
MP12*	85027-80046	7	1	ID LABEL 85027D (FRONT LABEL)	28480	85027-80046
MP13*	85027-80012	7	1	FOAM PAD	28480	85027-80012
MP14*	5180-8446	1	1	WOOD INSTRUMENT CASE	28480	5180-8446
MP15*	2190-0584	0	4	WASHER-LK HLCL 3.0 MM 3.1-MM-ID	00000	Order by Description
MP16*	85027-80023	0	1	LABEL ID SERIAL NUMBER 85027D	28480	85027-80023
MP17*	85027-80021	8	1	LABEL INFO KIT CONTENTS	28480	85027-80021
MP18	85027-80004	7	1	LABEL IN RF TEST (BACK LABEL)	28480	85027-80004
MP19	85027-80005	8	1	LABEL WARNING MAXIMUM INPUT (SIDE)	28480	85027-80005
MP20	85027-80048	9	1	LABEL ID - BOX	28480	85027-80048
MP21	85027-80024	1	1	LABEL 2.4 WARNING	28480	85027-80024
W1	85025-60003	2	1	CABLE ASSY	28480	85025-60003
				ACCESSORIES		
1	HP 85140B			SHORT PSC-2.4	28480	HP 85140B
2	HP 85141B			OPEN PSC-2.4	28480	HP 85141B

Table 6-2. A2 Preamplifier Assembly Replaceable Parts

Reference Designation	HP Part Number	C D	Qty	Description	Mfr Code	Mfr Part Number
A2	85027-60053	4	1	A2 PREAMPLIFIER ASSEMBLY BOARD		
A2C1	0160-5375	2	8	PREAMPLIFIER ASSEMBLY BOARD	28480	85027-60053
A2C2	0160-5375	2		CAPACITOR-FXD .1UF ± 10% 50VDC CER	28480	0160-5375
A2C3	0160-5375	2		CAPACITOR-FXD .1UF ± 10% 50VDC CER	28480	0160-5375
A2C4	0160-5375	2		CAPACITOR-FXD .1UF ± 10% 50VDC CER	28480	0160-5375
A2C5	0180-2683	1	1	CAPACITOR-FXD 4.7UF ± 20% 35VDC TA	28480	0180-2683
A2C6	0160-5375	2		CAPACITOR-FXD .1UF ± 10% 50VDC CER	28480	0160-5375
A2C7	0160-5375	2		CAPACITOR-FXD .1UF ± 10% 50VDC CER	28480	0160-5375
A2C8	0160-5375	2		CAPACITOR-FXD .1UF ± 10% 50VDC CER	28480	0160-5375
A2C9	0160-5375	2		CAPACITOR-FXD .1UF ± 10% 50VDC CER	28480	0160-5375
A2C10	0180-2661	5	2	CAPACITOR-FXD 1UF ± 10% 50VDC TA	25088	DIROGSIA50K
A2C11	0180-2661	5		CAPACITOR-FXD 1UF ± 10% 50VDC TA	25088	DIROGSIA50K
A2C12	0160-0573	2	1	CAPACITOR-FXD 4700PF ± 20% 100VDC CER	28480	0160-0573
A2CR1	1901-0050	3	2	DIODE-SWITCHING 80V 200MA 2NS DO-35	28480	1901-0050
A2CR2	1901-0050	3		DIODE-SWITCHING 80V 200MA 2NS DO-35	28480	1901-0050
A2CR3	1901-0539	3	1	DIODE-SM SIG SCOTTKY	28480	1901-0539
A2MP1	85027-20001	8	1	BD-AD/DC BRIDGE	28480	85027-20001
A2R1	0698-7212	9	7	RESISTOR 100 1% .05W F TC=0 ± 100	24546	C3-1/8-TO-100R-F
A2R2	0698-7279	8	1	RESISTOR 61.9K 1% .05W F TC=0 ± 100	24546	C3-1/8-TO-6192-F
A2R3	0698-7249	2	1	RESISTOR 3.48K 1% .05W F TC=0 ± 100	24546	C3-1/8-TO-3481-F
A2R4	0698-7284	5	1	RESISTOR 100K 1% .05W F TC=0 ± 100	24546	C3-1/8-TO-1003-F
A2R5	2100-3091	1	2	RESISTOR-TRMR 2K 10% C TOP-ADJ 17-TRN	32997	3292W-1-202
A2R6	0698-7212	9		RESISTOR 100 1% .05W F TC=0 ± 100	24546	C3-1/8-TO-100R-F
A2R7	0698-7212	9		RESISTOR 100 1% .05W F TC=0 ± 100	24546	C3-1/8-TO-100R-F
A2R8	0698-7212	9		RESISTOR 100 1% .05W F TC=0 ± 100	24546	C3-1/8-TO-100R-F
A2R9	0698-8615	8	1	RESISTOR 75K 1% .05W F TC=0 ± 100	28480	0698-8615
A2R10	2100-3097	7	1	RESISTOR-TRMR 100K 10% C TOP-ADJ 17-TRN	32997	3292W-1-104
A2R11	0698-7212	9		RESISTOR 100 1% .05W F TC=0 ± 100	24546	C3-1/8-TO-100R-F
A2R12	0698-7212	9		RESISTOR 100 1% .05W F TC=0 ± 100	24546	C3-1/8-TO-100R-F
A2R14	0698-7288	9	1	RESISTOR 147K 1% .05W F TC=0 ± 100	24546	C3-1/8-TO-1473-F
A2R15	0698-7236	7	1	RESISTOR 1K 1% .05W F TC=0 ± 100	24546	C3-1/8-TO-1001-F
A2R16	0698-7253	8	2	RESISTOR 5.11K 1% .05W F TC=0 ± 100	24546	C3-1/8-TO-5111-F
A2R17	0698-7212	9		RESISTOR 100 1% .05W F TC=0 ± 100	24546	C3-1/8-TO-100R-F
A2R18	0698-7229	8	1	RESISTOR 511 1% .05W F TC=0 ± 100	24546	C3-1/8-TO-511R-F
A2R19	0698-7247	0	1	RESISTOR 2.87K 1% .05W F TC=0 ± 100	24546	C3-1/8-TO-2871-F
A2R21	0698-7261	8	1	RESISTOR 11K 1% .05W F TC=0 ± 100	24546	C3-1/8-TO-1102-F
A2R22	0698-7253	8		RESISTOR 5.11K 1% .05W F TC=0 ± 100	24546	C3-1/8-TO-5111-F
A2R23	0698-7251	6	2	RESISTOR 4.22K 1% .05W F TC=0 ± 100	24546	C3-1/8-TO-4221-F
A2R24	0698-7251	6		RESISTOR 4.22K 1% .05W F TC=0 ± 100	24546	C3-1/8-TO-4221-F
A2R25	2100-3091	1		RESISTOR-TRMR 2K 10% C TOP-ADJ 17-TRN	32997	3292W-1-202
A2R28	0698-7224	3	1	RESISTOR 316 1% .05W F TC=0 ± 100	24546	C3-1/8-TO-316R-F
A2R29	2100-3286	6	1	RESISTOR-TRMR 10K 10% C TOP-ADJ 17-TRN	32997	3292W-1-103
A2R30	0698-7277	6	1	RESISTOR 51.1K 1% .05W F TC=0 ± 100	24546	C3-1/8-TO-5112-F
A2RT1	0837-0379	1	1	THERMISTOR PTC BEAD RADIAL LEADS 2K	04379	DU100202J
A2S1	3101-2851	2	1	SWITCH	28480	3101-2851
A2U1	1NB7-8045	6	1	PREAMP HYBRID ASSEMBLY	28480	1NB7-8045
A2U2	1NB7-8039	8	1	CLOCK HYBRID ASSEMBLY	28480	1NB7-8039
A2U3	1826-0412	1	1	IC COMPARATOR PRCN DUAL 8-DIP-P PKG	27014	LM393N
A2U4	1826-0772	6	1	IC V RGL TR-ADJ-POS 1.2/32V TO-92 PKG	28480	1826-0772
A2U5	1826-0285	6	1	IC V RGLTR TO-92	04713	MC79L05C
A2U6	1826-0932	0	1	IC OP AMP PRCN 8-DIP-C PKG	06665	OP-27FZ
A2VR1	1902-3245	6	2	DIODE-ZNR 21.5V 5% DO-35 PD = .4W	28480	1902-3245
A2VR2	1902-3245	6		DIODE-ZNR 21.5V 5% DO-35 PD = .4W	28480	1902-3245

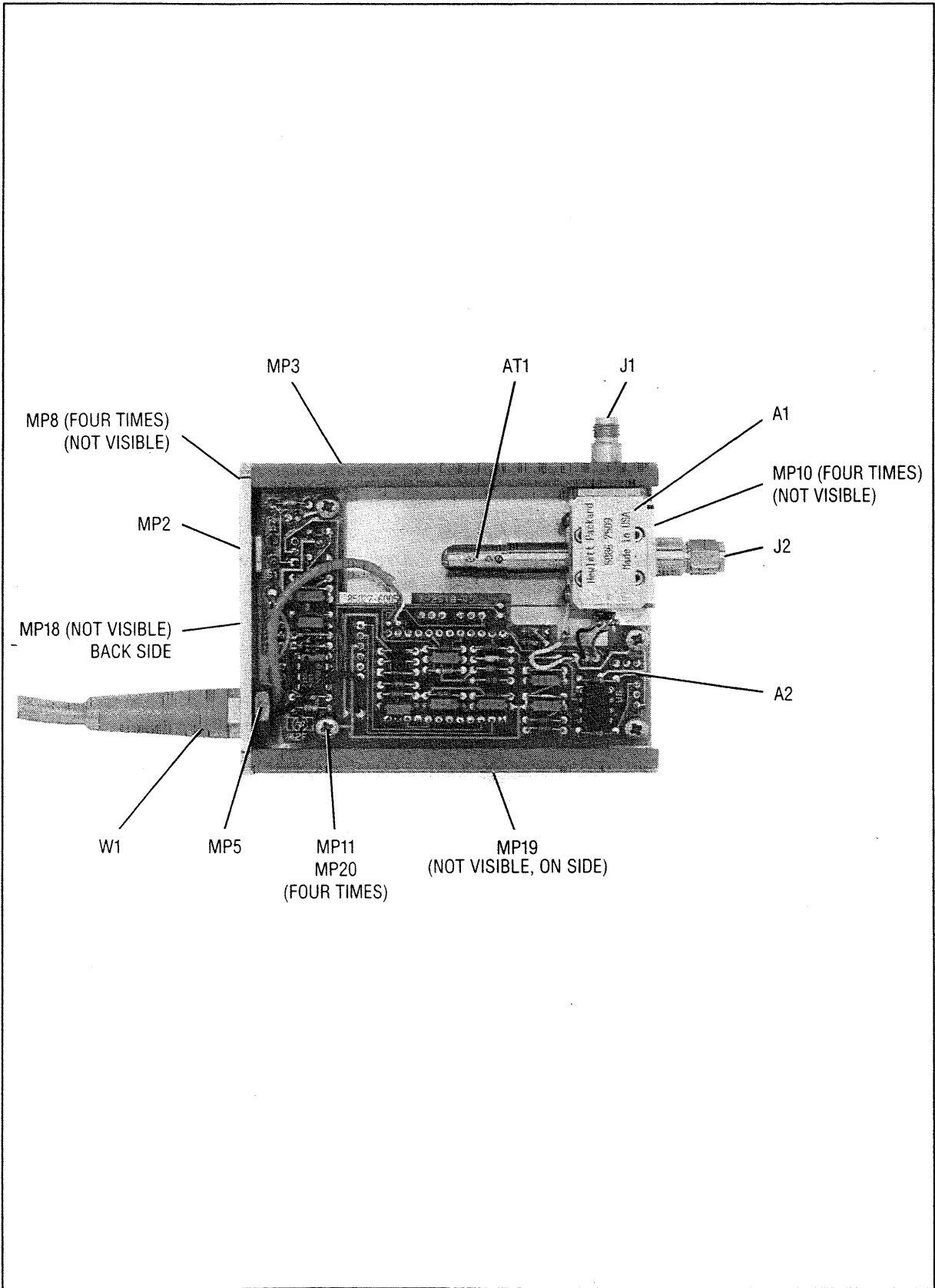

Figure 6-2. HP 85027D Replaceable Parts Identification



Vertical text on the left margin, likely a page number or reference code, oriented vertically.

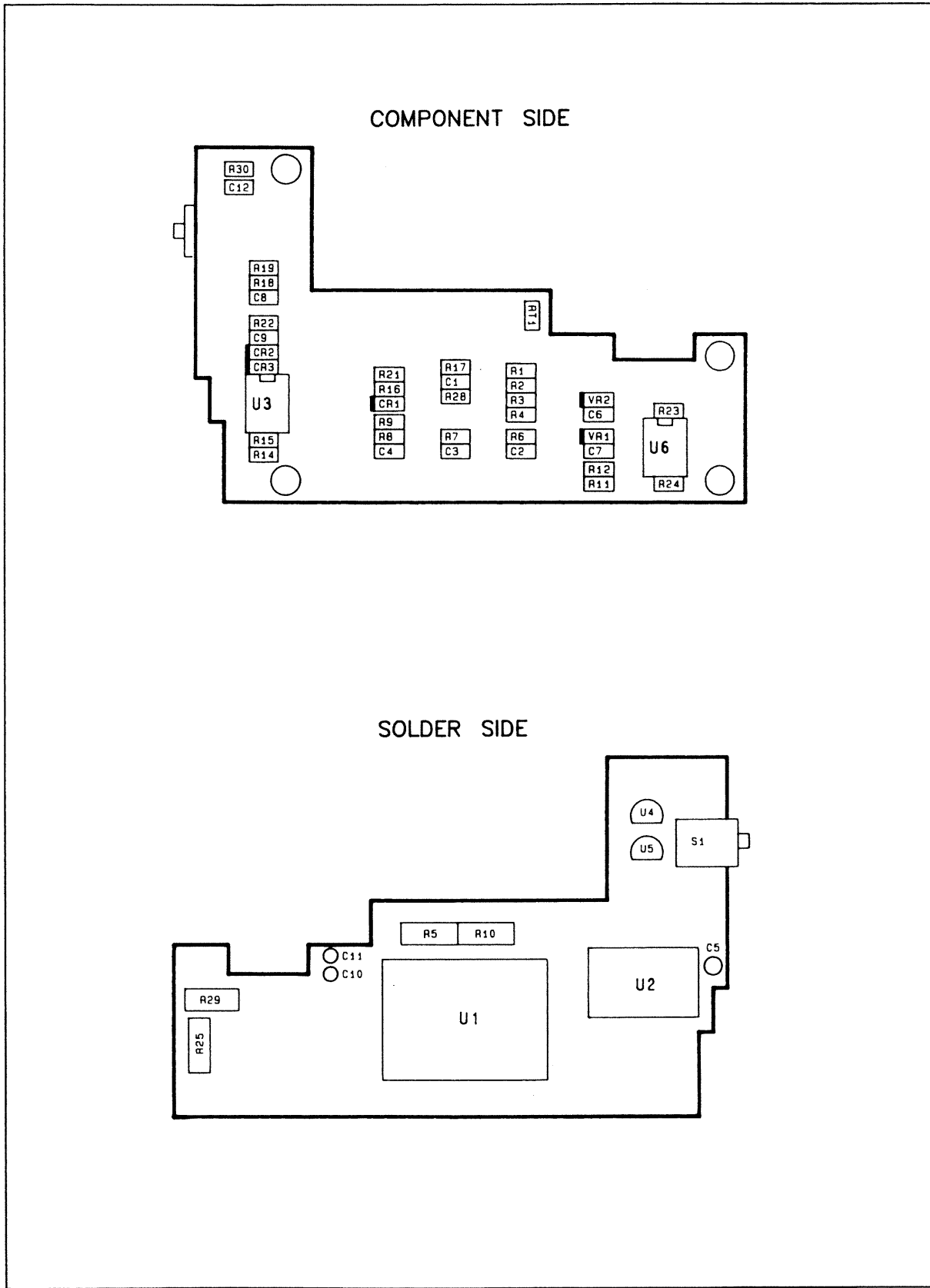

Figure 6-3. A2 Preamplifier Assembly Component Location Diagram



## Section 7. Service

---

### INTRODUCTION

This section contains troubleshooting and repair information. After identifying failures in the performance tests, use these procedures to isolate trouble to components or assemblies.

### THEORY OF OPERATION

The HP 85027D detects RF or microwave signals which are either 27.778 kHz square wave modulated (AC mode) or unmodulated (DC mode). In both detection modes, the bridge provides a 27.778 kHz square wave signal to the analyzer for interpretation and display.

In AC mode, the signal is amplitude modulated at the RF source. The bridge demodulates (envelope detects) this signal to produce a 27.778 kHz square wave signal whose peak-to-peak voltage corresponds to the magnitude of the signal at the bridge test port. Since only the modulated signal is detected, unmodulated broadband noise and extraneous signals are excluded. Additionally, this technique provides nearly drift-free operation.

In DC mode, the RF source's signal is not modulated. Instead the bridge converts the signal into an equivalent DC voltage chopped at a 27.778 kHz rate. It amplifies the chopped signal to simulate the signal produced by AC detection and outputs this signal to the analyzer. This technique is preferable for devices such as amplifiers with ALC circuits, or filters with very narrow bandwidths.

### TROUBLESHOOTING PROCEDURES

If the bridge fails any performance tests, use these procedures.



**CAUTION**

**ESD (electrostatic discharge) can damage the highly sensitive microcircuits in this device.**

**An electrostatic discharge as low as 100 volts can destroy your bridge.**

**Use this device at a static-safe workstation and wear a grounding strap. NEVER touch the connector center conductors or the cable contact pins.**

## Gaining Internal Access

To access the interior of the directional bridge, follow these steps:

1. Disconnect the bridge from the analyzer.
2. Remove the two screws which hold the port cover, MP4, in place.
3. Remove the port cover.
4. Slide the dress cover, MP1, out of the bridge housing. The circuit board and the bridge assembly are now accessible.

## Cable Continuity Check

1. Disconnect the bridge from the analyzer.
2. Measure the continuity of the conductors of the power cable, W1. Check from the connector pins to the wire connections inside the bridge housing. Table 7-1 lists W1 connector pins and the corresponding wires.
3. If there are any discontinuities, replace cable W1 by following the instructions in the *Power Cable Replacement* procedure.

Table 7-1. Conductor in Power Cable W1

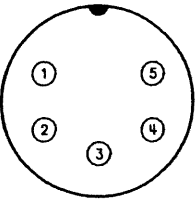
	Connector Pin	Conductor (Label)	Signal
	1	White (W)	Output
	2	Green (G)	Return
	3	Yellow (Y)	Control
	4	Blue (B)	-12.6V
	5	Red (R)	+15V

## Power Cable Replacement

1. To replace the power cable, W1, open the bridge by following the instructions in *Gaining Internal Access*.
2. Desolder the wires connected to the power cable/preamplifier assembly.
3. Remove the two screws from the cable cover, MP2.
4. Remove the 1/2 inch hex nut, MP5, which fastens the cable to the end plate.
5. Replace the cable and reinstall it by reversing steps 1 through 4. Table 7-1 shows where to solder the wires.

## Microcircuit Tests

### Input Port and Test Port Resistance Checks

1. Disconnect the bridge from the analyzer.
2. Measure the resistance from the center contact of input port connector, J1, to the center contact of test port connector, J2. The resistance between these points is  $33 \pm 2$  ohms.
3. Measure the resistance from the center contact of input connector, J1, to signal ground (the black/white wire connected to the microcircuit housing). The resistance between these points is  $83 \pm 2$  ohms.
4. Measure the resistance from the center contact of test port connector, J2, to signal ground. The resistance between these points is  $83 \pm 2$  ohms.
5. If the bridge fails any of these checks, the bridge microcircuit assembly, A1, is defective and must be replaced. Refer to *A1 Bridge Microcircuit Assembly Replacement*.

### Diode Check

1. Connect the input port of the bridge to the RF Out port of the sweep oscillator. Do not terminate the bridge test port.
2. Set the RF output of the sweep oscillator to 50 MHz, CW, with the 27.778 kHz square wave modulation on.
3. With an RMS DMM, measure the voltage across the two output pins of the microcircuit. The bridge diode is probably good if the reading is approximately 0.07V RMS.
4. If the reading in step 3 is low, the microcircuit is defective and must be replaced.

## A2 Preamplifier Assembly Replacement

1. To remove the preamplifier assembly, open up the bridge and desolder the power cable wires (see *Gaining Internal Access and Power Cable Replacement*).
2. At the circuit board pads, desolder the signal, signal ground, and chassis ground wires from the microcircuit.
3. Remove the four screws and lock washers which fasten the circuit board to the standoffs.
4. Reverse the above procedure to install the repaired or replacement preamplifier assembly.
5. Refer to *Adjustments* to electrically match the A2 preamplifier assembly to the A1 bridge microcircuit.
6. Reassemble the remaining parts of the bridge.

## A1 Bridge Microcircuit Assembly Replacement

1. Remove the two screws holding the port cover, MP4, and remove the port cover.
2. Remove the two screws holding the cable cover, MP2. This allows the cable and cable cover to move freely.
3. Desolder the white/black wires (signal ground and chassis ground) and the white/red wire (signal) at the microcircuit.
4. Remove the four screws and lock washers which fasten the A2 preamplifier assembly to the standoffs.
5. Remove the A2 preamplifier assembly with the cable cover and cable from the housing.
6. Turn the bridge over. Remove the four screws which fasten the microcircuit assembly. Take out the microcircuit assembly,
7. Line up the replacement bridge microcircuit assembly and reinstall the four microcircuit assembly screws.
8. Reverse steps 1 through 5.
9. Refer to *Adjustments* to electrically match the microcircuit to the A2 preamplifier assembly.
10. Attach the new label to the bridge housing.

## Power Supply Check

1. Open the bridge by following the instructions in *Gaining Internal Access*.
2. Connect the power cord of the bridge (W1) to the analyzer and turn on the analyzer.
3. Refer to Figure 7-1 and check the power supply voltages of +15, -12.6, +8 and -5 volts at the four pads indicated. The power supply tolerances follow:

Supply	Tolerance
+15V	$\pm 0.05V$
+8V	$\pm 0.03V$
-5V	$\pm 0.02V$
-12V	$\pm 0.05V$

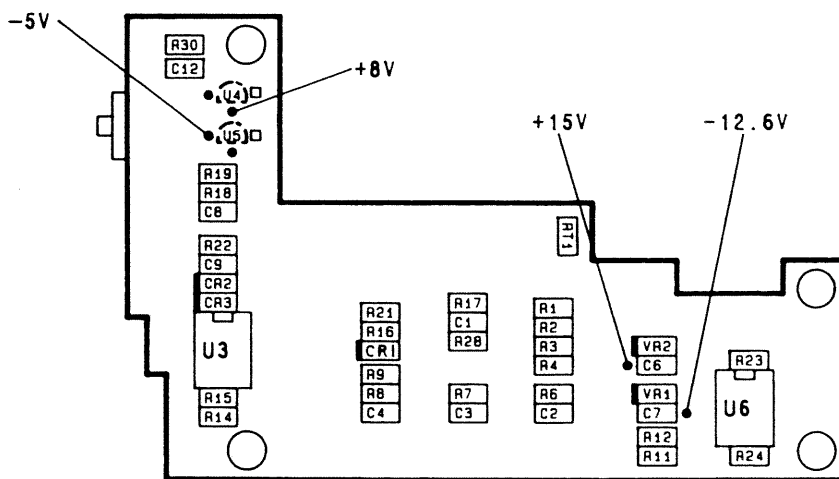

Figure 7-1. A2 Preamplifier Power Supply Check Points

Problems with the +15V or -12V supply may be due to a failure in the HP 8757 or a broken wire in the bridge power supply cable. Disconnect the bridge from the HP 8757 and measure the voltages at the analyzer connector. Table 7-1 shows the +15V and -12V output pins.

### **Signal Path Check**

1. Check the output of the buffer amplifier at U6 pin 6. The voltage should be the same as that measured in step 3 of the microcircuit diode check with the same input conditions.
2. Check the output of U1 pin 14 with the gain potentiometer (R5) centered. The voltage should be approximately 0.44V RMS.

### **Clock/Control Check**

1. With the directional bridge configuration switch set to **HP 8756/HP 8755**, verify that there is no square wave output at U2 pins 1, 2 and 4.
2. Set the directional bridge configuration switch to the **HP 8757** position.
3. Configure the HP 8757 for DC mode.
4. Verify a square wave output of 27.778 kHz exists at U1 pin 14.
5. If U1 pin 14 does not have a square wave output, check for a square wave of 27.778 kHz at U2 pins 1 and 2, and a square wave of 55.555 kHz at U1 pin 9, and U2 pin 4.
  - a. If these square waves are present, then U1 is probably bad.
  - b. If these square waves are not present, and U2 pin 8 is NOT low (-5V), then U2 is probably bad.









**Table 1-1. Hewlett-Packard Sales and Service Offices**

<b>US FIELD OPERATIONS</b>		
<p><b>Headquarters</b> Hewlett-Packard Company 19320 Pruneridge Avenue Cupertino, CA 95014, USA (800) 752-0900</p>	<p><b>California, Northern</b> Hewlett-Packard Co. 301 E. Evelyn Mountain View, CA 94041 (415) 694-2000</p>	<p><b>California, Southern</b> Hewlett-Packard Co. 1421 South Manhattan Ave. Fullerton, CA 92631 (714) 999-6700</p>
<p><b>Colorado</b> Hewlett-Packard Co. 24 Inverness Place, East Englewood, CO 80112 (303) 649-5000</p>	<p><b>Georgia</b> Hewlett-Packard Co. 2000 South Park Place Atlanta, GA 30339 (404) 955-1500</p>	<p><b>Illinois</b> Hewlett-Packard Co. 5201 Tollview Drive Rolling Meadows, IL 60008 (708) 255-9800</p>
<p><b>New Jersey</b> Hewlett-Packard Co. 150 Green Pond Road Rockaway, NJ 07866 (201)627-6400</p>	<p><b>Texas</b> Hewlett-Packard Co. 930 E. Campbell Rd. Richardson, TX 75081 (214) 231-6101</p>	
<b>EUROPEAN FIELD OPERATIONS</b>		
<p><b>Headquarters</b> Hewlett-Packard S.A. 150, Route du Nant-d'Avril 1217 Meyrin 2/Geneva Switzerland (41 22) 780.8111</p>	<p><b>France</b> Hewlett-Packard France 1 Avenue Du Canada Zone D'Activite De Courtaboeuf F-91947 Les Ulis Cedex France (33 1) 69 82 60 60</p>	<p><b>Germany</b> Hewlett-Packard GmbH Hewlett-Packard Strasse 6380 Bad Homburg v.d.H Germany (49 6172) 16-0</p>
<p><b>Great Britain</b> Hewlett-Packard Ltd Eskdale Road, Winnersh Triangle Wokingham, Berkshire RF11 5DZ England (44 734) 696622</p>		
<b>INTERCON FIELD OPERATIONS</b>		
<p><b>Headquarters</b> Hewlett-Packard Company 3495 Deer Creek Rd. Palo Alto, California 94304-1316 (415) 857-5027</p>	<p><b>Australia</b> Hewlett-Packard Australia Ltd. 31-41 Joseph Street Blackburn, Victoria 3130 (61 3) 895-2895</p>	<p><b>Canada</b> Hewlett-Packard (Canada) Ltd. 17500 South Service Road Trans-Canada Highway Kirkland, Quebec H9J 2X8 Canada (514) 697-4232</p>
<p><b>China</b> China Hewlett-Packard Co. 38 Bei San Huan X1 Road Shuang Yu Shu Hai Dian District Beijing, China (86 1) 256-6888</p>	<p><b>Japan</b> Yokogawa-Hewlett-Packard Ltd. 1-27-15 Yabe, Sagamihara Kanagawa 229, Japan (81 427) 59-1311</p>	<p><b>Singapore</b> Hewlett-Packard Singapore (Pte.) Ltd 1150 Depot Road Singapore 0410 (65) 273-7388</p>
<p><b>Taiwan</b> Hewlett-Packard Taiwan 8th Floor, H-P Building 337 Fu Hsing North Road Taipei, Taiwan (886 2) 712-0404</p>		

