

---

**TEK** OPERATORS  
MANUAL

Part No. 070-6839-00  
Product Group 48

---

# **371**

## **Programmable High Power Curve Tracer**

---

First Printing NOV 1987  
Revised JAN 1988

### INSTRUMENT SERIAL NUMBERS

Each instrument has a serial number on a panel insert, tag, or stamped on the chassis. The first number or letter designates the country of manufacture. The last five digits of the serial number are assigned sequentially and are unique to each instrument. Those manufactured in the United States have six unique digits. The country of manufacture is identified as follows:

B000000	Tektronix, Inc. Beaverton, Oregon, USA
100000	Tektronix Guernsey, Ltd., Channel Islands
200000	Tektronix United Kingdom, Ltd., London
300000	Sony/Tektronix, Japan
700000	Tektronix Holland, NV, Heerenveen, The Netherlands

Copyright © Tektronix, Inc., 1987. All rights reserved. Tektronix products are covered by U.S. and foreign patents, issued and pending. TEKTRONIX, TEK, SCOPEMOBILE and  are registered trademarks.

Centronics® is a registered trademark of Data Computer Corporation.

Printed in U.S.A.

## ABOUT THIS MANUAL . . .

***This manual contains:***

- *Instructions for operating the 371 with the front-panel controls or through the GPIB interface*
- *Installation and GPIB configuration instructions*
- *A complete guide to GPIB commands and queries*
- *Detailed functional-check and operator-familiarization procedures*
- *Step-by-step demonstrations of typical measurements*
- *Listings of the specifications and operating characteristics of the 371*
- *A list of all standard accessories, optional accessories, and instrument options.*

## TABLE OF CONTENTS

	Page
About This Manual .....	i
List of Illustrations .....	x
List of Tables .....	xii
Safety Summary .....	xiii

### Section 1 General Information

A more detailed table of contents is given at the beginning of Section 1.

<b>Description</b> .....	<b>1-3</b>
Display Modes .....	1-3
The Collector Supply .....	1-3
The Step Generator .....	1-3
Display Axes .....	1-4
Measurement Modes .....	1-4
Storage .....	1-4
External Interfaces .....	1-5
<b>Installation</b> .....	<b>1-6</b>
Initial Inspection .....	1-6
Power Source Information .....	1-6
Power Cord Information .....	1-9
Operating Temperature .....	1-12
Connecting the Test Fixture .....	1-13
<b>Repackaging for Shipment</b> .....	<b>1-15</b>
<b>Specification</b> .....	<b>1-16</b>
Performance Conditions .....	1-16

**TABLE OF CONTENTS (cont.)**

	<b>Page</b>
<b>Interface Characteristics</b> .....	<b>1-33</b>
Plotter Interface Cable Characteristics .....	1-35
GPIB Interface Functions .....	1-36
<b>Accessories</b> .....	<b>1-37</b>
Standard Accessories .....	1-37
Optional Accessories .....	1-37

**Section 2**  
**Controls, Indicators, and Connectors**

A more detailed table of contents is given at the beginning of Section 2.

<b>Introduction</b> .....	<b>2-5</b>
<b>CRT Controls</b> .....	<b>2-7</b>
Intensity .....	2-7
Focus .....	2-7
Grat Illum .....	2-7
Position .....	2-7
Trace Rotation .....	2-8
<b>Measurement Controls</b> .....	<b>2-9</b>
Repeat .....	2-9
Single .....	2-9
Sweep .....	2-9
<b>Bubble Memory Compartment, Controls, and Indicators</b> .....	<b>2-10</b>
Bubble Memory Index Display .....	2-10
Bubble Memory Compartment .....	2-10

**TABLE OF CONTENTS (cont.)**

	<b>Page</b>
<b>Setup Controls</b> .....	<b>2-11</b>
Save/Erase .....	2-11
Recall/Directory .....	2-11
<b>Display Controls and Indicators</b> .....	<b>2-13</b>
Non Store .....	2-13
Store/Cal Full .....	2-13
Compare/Cal Off .....	2-13
View/Cal Zero .....	2-14
Enter/Text .....	2-15
Horizontal Volts/Div .....	2-16
Vertical Current/Div .....	2-16
Invert .....	2-17
<b>Collector Supply Controls and Indicators</b> .....	<b>2-18</b>
Polarity .....	2-18
Peak Power Watts .....	2-18
Variable .....	2-19
Looping Compensation .....	2-19
<b>Step Generator Controls and Indicators</b> .....	<b>2-20</b>
Invert .....	2-20
Source .....	2-20
Number of Steps .....	2-20
Step/Offset Amplitude .....	2-20
Offset .....	2-21
Step Multi .1X/Disable .....	2-22
<b>Cursor Controls and Indicators</b> .....	<b>2-23</b>
Cursor Selection .....	2-23
Cursor Position Buttons .....	2-24

Revised DEC 1987

**TABLE OF CONTENTS (cont.)**

	<b>Page</b>
<b>GPiB and Plotter Controls and Indicators</b> .....	<b>2-27</b>
Reset to Local/Addr and the Remote Indicator .....	2-27
User Request/ID and the SRQ Indicator .....	2-27
All/Curve and the Busy Indicator .....	2-28
<b>Signal Output Controls, Indicators, and Connectors</b> .....	<b>2-30</b>
Collector Supply Breakers .....	2-30
Test Fixture Connector .....	2-30
Outputs Indicator .....	2-30
<b>Power</b> .....	<b>2-31</b>
Power .....	2-31
Ground Connector .....	2-31
<b>Rear Panel Controls, Indicators, and Connectors</b> .....	<b>2-33</b>
GPiB Terminator and Address Switch .....	2-33
IEEE Std 488 Port .....	2-33
Plotter Interface Port .....	2-33
AC Input .....	2-33
Line Fuse .....	2-34
<b>Test Fixture Unit and Patch Panel Connectors</b> .....	<b>2-35</b>
Collector Supply High Voltage .....	2-37
Collector Supply High Current .....	2-37
Collector Supply High Current Sense .....	2-37
Common .....	2-37
Common Sense .....	2-38
Step Generator Voltage .....	2-38
Step Generator Current .....	2-38
Step Generator Current Sense .....	2-38
Collector/Drain/Anode .....	2-39
Collector/Drain/Anode Sense .....	2-39
Emitter/Source/Cathode .....	2-39

## TABLE OF CONTENTS (cont.)

	<b>Page</b>
Emitter/Source/Cathode Sense .....	2-39
Base/Gate 1 K $\Omega$ .....	2-39
Base/Gate .....	2-39
Base/Gate Sense .....	2-40
Test Adaptor Connector .....	2-40
<b>Readout</b> .....	<b>2-41</b>
Setup Area .....	2-43
Text Area .....	2-43
Error Message Area .....	2-43
Setup/Curve ID Area .....	2-44

## Section 3 Operating Instructions

A more detailed table of contents is given at the beginning of Section 3.

<b>Overview of Instrument Operation</b> .....	<b>3-5</b>
Collector Supply .....	3-5
Step Generator .....	3-5
Detector Amplifier .....	3-5
<b>First-Time Operation</b> .....	<b>3-7</b>
Powering Up the 371 .....	3-8
CRT Controls .....	3-12
Positioning the Display .....	3-13
Making Connections on the Test Fixture Unit Patch Panel .....	3-14
Setting Vertical and Horizontal Sensitivity .....	3-16
Collector Supply High Current Mode .....	3-18
Collector Supply High Voltage Mode .....	3-22
Step Generator .....	3-25
Text Editing .....	3-39



## TABLE OF CONTENTS (cont.)

	<b>Page</b>
Plotting Curves and the Bubble Memory Directory . . .	3-41
Erasing the Bubble Memory Cassette . . . . .	3-44
<b>General Operation . . . . .</b>	<b>3-45</b>
The Display . . . . .	3-45
The Digital Storage and Bubble Memory System . . . .	3-47
Non Store Mode . . . . .	3-50
Cursors . . . . .	3-50
Text Editing . . . . .	3-52
Vertical Axis Measurement and Sensitivity . . . . .	3-54
Horizontal Axis Measurement and Sensitivity . . . . .	3-54
Measurement Modes . . . . .	3-55
The Step Generator . . . . .	3-58
The Collector Supply . . . . .	3-60
The Patch Panel and Test Fixture Unit . . . . .	3-62
Kelvin Sensing . . . . .	3-68
<b>Measurement Examples . . . . .</b>	<b>3-69</b>
Measuring Breakdown Voltage . . . . .	3-70
Measuring Common-Emitter Characteristics . . . . .	3-73
Measuring Saturation Voltage . . . . .	3-76
Measuring MOSFET Characteristics . . . . .	3-78

## Section 4 GPIB

A more detailed table of contents is given at the beginning of Section 4.

<b>Review . . . . .</b>	<b>4-5</b>
Program Development . . . . .	4-6
System Control . . . . .	4-6
Data Processing . . . . .	4-10
Display and Storage . . . . .	4-10

## TABLE OF CONTENTS (cont.)

	Page
<b>Interface Capabilities</b> .....	<b>4-11</b>
Interface Messages .....	4-12
Device-Dependent Messages .....	4-15
<b>Setup</b> .....	<b>4-17</b>
Configuration Switch Settings .....	4-17
Connecting the GPIB Cable .....	4-19
Powering Up .....	4-20
<b>Controlling the 371 Over the Bus</b> .....	<b>4-22</b>
Sending Commands to the 371 .....	4-22
Sending Queries and Receiving Responses .....	4-25
Instrument Setup Over the Bus .....	4-27
Data Storage and Transfer .....	4-30
Moving Waveform Data to the Controller .....	4-32
Loading Data From the Controller .....	4-34
Transferring Other Types of Data .....	4-35
Summary of Data Transfers .....	4-36
<b>Device-Dependent Message Format</b> .....	<b>4-38</b>
Command Message Formats .....	4-39
<b>Front-panel Settings and Corresponding GPIB Commands</b> .....	<b>4-47</b>
<b>Command Reference</b> .....	<b>4-53</b>
Command Index .....	4-55
Collector Supply Commands and Queries .....	4-57
CRT Readout Transfer Commands and Queries .....	4-65
Cursor Commands and Queries .....	4-70
Display Commands and Queries .....	4-78
Instrument Parameter Commands and Queries .....	4-87
Miscellaneous Commands and Queries .....	4-95
Status and Event Commands and Queries .....	4-103

**TABLE OF CONTENTS (cont.)**

	<b>Page</b>
Step Generator Command and Query .....	4-109
Waveform Transfer Commands and Queries .....	4-114
<b>Service Requests .....</b>	<b>4-124</b>
Handling Service Requests .....	4-124
Masking Service Requests .....	4-125
Status Bytes .....	4-127
Event Codes .....	4-129

**Section 5  
Instrument Options**

**Appendix  
Diagnostic Routines and Messages**

A more detailed table of contents is given at the beginning of the appendix.

<b>Diagnostic Routines .....</b>	<b>A-3</b>
Power-Up Diagnostic Routines .....	A-3
User-Initiated Push Button Diagnostic Routine .....	A-7
GPIB Diagnostic Routine .....	A-10
<b>Messages .....</b>	<b>A-11</b>

## LIST OF ILLUSTRATIONS

	<b>Page</b>
Figure 1-1. Location of the Line Voltage Indicator. . . . .	1-7
Figure 1-2. Connection of the 371 and Test Fixture Unit. . . . .	1-14
Figure 1-3. Plotter Interface Port. . . . .	1-33
Figure 2-1. The front-panel controls, indicators, and connectors. . . . .	2-6
Figure 2-2. The rear-panel controls, indicators, and connectors. . . . .	2-32
Figure 2-3. The Test Fixture Unit and Patch Panel connectors. . . . .	2-36
Figure 2-4. The display areas of the 371 CRT. . . . .	2-42
Figure 3-1. Basic 371 block diagram. . . . .	3-6
Figure 3-2. The bubble cassette write-protect key. . . . .	3-10
Figure 3-3. Inserting a bubble cassette. . . . .	3-11
Figure 3-4. Sweep mode display of the forward characteristics of a diode. . . . .	3-20
Figure 3-5. Diode breakdown voltage and current level. . . . .	3-24
Figure 3-6. Display Sweep mode characteristic curves when the Collector Supply is in High Current mode. . . . .	3-29
Figure 3-7. Measuring $H_{FE}$ with the Window cursor. . . . .	3-30
Figure 3-8. Collector current vs. base-emitter voltage characteristic curve for a bipolar transistor. . . . .	3-31
Figure 3-9. Drain current vs. drain source voltage characteristics for a Power MOSFET. . . . .	3-34
Figure 3-10. Compare mode display of drain current vs. drain-source voltage characteristics. . . . .	3-35
Figure 3-11. Forward transfer curve, $I_b = 8$ A. . . . .	3-37

## LIST OF ILLUSTRATIONS (cont.)

	Page
Figure 3-12. Using the $f$ line cursor to measure forward transfer admittance. In this example, $g_{fs} = 5.006$ S. ....	3-38
Figure 3-13. Sample bubble memory directory. ....	3-43
Figure 3-14. Connections for measuring common-emitter characteristic of a transistor and common-source characteristics of a power MOSFET. ....	3-63
Figure 3-15. Test Adapters. ....	3-65
Figure 3-16. Removing the Patch Panel. ....	3-66
Figure 3-17. Connections for measuring the common-source characteristics of a FET. ...	3-67
Figure 3-18. Patch Panel connections for measuring $BV_{CEO}$ of a bipolar transistor. ....	3-71
Figure 3-19. Compare mode display of the $BV_{CEO}$ and $BV_{CES}$ breakdown measurements. ....	3-72
Figure 3-20. Patch Panel connections for measuring the common-emitter characteristics of a bipolar transistor. ....	3-73
Figure 3-21. Typical display of the common-emitter characteristics of a bipolar transistor. ....	3-75
Figure 3-22. $V_{CE(SAT)}$ measurement for a bipolar transistor. ....	3-77
Figure 3-23. Patch Panel connections for measuring the common-source characteristics of a power MOSFET. ....	3-78
Figure 3-24. Typical display of the common-source characteristics of a power MOSFET. ....	3-80
Figure 4-1. GPIB messages. ....	4-8
Figure 4-2. GPIB message types. ....	4-9
Figure 4-3. Rear-panel configuration switch. ....	4-18
Figure 4-4. Bus configurations. ....	4-20
Figure 4-5. Transfer of settings. ....	4-28
Figure 4-6. Transfer of waveforms. ....	4-33
Figure 4-7. Data transfers under GPIB control. ....	4-37

## LIST OF TABLES

		<b>Page</b>
Table 1-1	Line Voltage Ranges .....	1-8
Table 1-2	Power-Cord Color Conductor Identification .....	1-9
Table 1-3	Power-Cord and Plug Identification Information .....	1-11
Table 1-4	Electrical Specification .....	1-17
Table 1-5	Mechanical Specification .....	1-29
Table 1-6	Environmental Specification .....	1-30
Table 1-7	Plotter Interface Port Pin Assignment .....	1-33
Table 1-8	GPIB Functions .....	1-36
Table 2-1	The Cursor SHIFT Button Used With Other Buttons .....	2-25
Table 3-1	Initial State Settings of the 371 .....	3-9
Table 3-2	Test Adapters .....	3-64
Table 4-1	GPIB Interface Specifications .....	4-11
Table 4-2	Controller Output Syntax .....	4-25
Table 4-3	Controller Input Syntax .....	4-26
Table 4-4	Numeric Argument Formats .....	4-42
Table 4-5	Argument Format Examples .....	4-43
Table 4-6	GPIB Commands and Queries for Front Panel Controls .....	4-47
Table 4-7	General Setting Information and Related GPIB Commands .....	4-52
Table 4-8	Command and Query Groups .....	4-54
Table A-1	Power-Up System Error Messages .....	A-5
Table A-2	Key Error—Front Panel Control Identification .....	A-8
Table A-3	Messages .....	A-11

## SAFETY SUMMARY

### SAFETY TERMS

The following terms may be found in this manual or printed on the 371 and its accessories.

#### In This Manual:

**CAUTION** statements identify conditions or practices that could result in damage to the equipment or other property.

**WARNING** statements identify conditions or practices that could result in personal injury or loss of life.

#### As Marked on Equipment:

**CAUTION** indicates a personal injury hazard not immediately accessible as one reads the marking, or a hazard to property including the equipment itself.

**DANGER** indicates a personal injury hazard immediately accessible as one reads the marking.

## **SYMBOLS**

The following symbols may be found in this manual or on the 371 and its accessories.

### **In This Manual:**

 This symbol indicates where applicable cautionary or other information is to be found.

### **As Marked on Equipment:**

 DANGER – High voltage

 Protective ground (earth) terminal

 ATTENTION – Refer to manual



**WARNING**

**Power Source**

This instrument operates from a single-phase power source and has a detachable three-wire power cord with a two pole, three-terminal grounding-type plug. The voltage to ground (earth) from either pole of the power source must not exceed the maximum rated operating voltage (250 volts rms).

**Grounding**

Before making connection to the power source, make sure that the instrument is set for the power source voltage and is equipped with a two-pole, three-terminal, grounding type plug.

This instrument is safety class 1 equipment (IEC1 designation). All accessible conductive parts are directly connected through the grounding conductor of the power cord to the grounding contact of the power plug. Therefore, the power plug must only be inserted in a mating receptacle with a grounding contact. Do not defeat the grounding connection. Any interruption of the grounding connection can create an electric shock hazard.

For electric shock protection, connect the instrument to ground before connecting to the instrument input or output terminals.

**Exposing Dangerous Voltages**

The 371 provides output voltages up to 3 kV, which can be dangerous if the device under test is connected directly to the test fixture connector on the 371, without using the Test Fixture Unit. **Always use the Test Fixture Unit.**

If an item to be tested does not fit under the plastic protective cover, external test fixturing may be required. Refer construction of external test fixtures to a qualified service technician.

## 371 Operators Safety Summary

---

### WARNING

#### Heat

Prolonged use of the 371 at high power settings can make the device under test, Test Fixture Unit, or Protective Cover hot enough to cause injury. Avoid touching any of these items until cooled.

### CAUTION

#### Line Voltage Settings

To prevent damage to the instrument, always check the settings of the Line Voltage Selector on the rear panel of the 371 before connecting the instrument to the power source.

#### Heat

Prolonged use of the 371 can cause high temperatures which may damage the instrument or device under test. When applying current in the 3 kW range of the Peak Power Watts selector, test time should be limited to 4 minutes, followed by at least eleven minutes of cooling.

#### Test Adapter Terminals

To prevent equipment damage, do not short together the collector and emitter terminals on the Test Adapters.

## **SECTION 1**

# **GENERAL INFORMATION**

***This section:***

- *Describes the features of the 371*
- *Provides installation and inspection instructions*
- *Provides repackaging instructions for transporting the 371*
- *Specifies the performance requirements for the 371*

## SECTION 1 CONTENTS

	<b>Page</b>
<b>Description</b> .....	<b>1-3</b>
Display Modes .....	1-3
The Collector Supply .....	1-3
The Step Generator .....	1-3
Display Axes .....	1-4
Measurement Modes .....	1-4
Storage .....	1-4
Characteristic Curves .....	1-5
Text .....	1-5
Setups .....	1-5
External Interfaces .....	1-5
<b>Installation</b> .....	<b>1-6</b>
Initial Inspection .....	1-6
Power Source Information .....	1-6
Power Cord Information .....	1-9
Operating Temperature .....	1-12
Connecting the Test Fixture .....	1-13
<b>Repackaging for Shipment</b> .....	<b>1-15</b>
<b>Specification</b> .....	<b>1-16</b>
Performance Conditions .....	1-16
<b>Interface Characteristics</b> .....	<b>1-33</b>
Plotter Interface Cable Characteristics .....	1-35
GPIB Interface Functions .....	1-36
<b>Accessories</b> .....	<b>1-37</b>
Standard Accessories .....	1-37
Optional Accessories .....	1-37

### DESCRIPTION

The 371 is a high-power curve tracer for measuring static characteristics of semiconductor devices. It enables measurement, display, evaluation, and analysis of characteristics for a variety of devices with two or three leads, including diodes, bipolar transistors, MOSFETs, thyristors, and IGBTs.

#### ■ Display Modes

Characteristic curves can be displayed in Non-Store (real-time) mode or in Store mode from the digital memory. In Store mode, a readout of the cursor position provides the current, voltage, DC and small signal  $\beta$ , and resistance at any point on the characteristic curve. The Non-Store display mode is useful for capturing characteristics viewing rapid variations.

#### ■ The Collector Supply

The 371 is designed for measurement of both high-voltage low-current device characteristics (in High Voltage mode) and low-voltage high-current device characteristics (in High Current mode).

In High Voltage mode, the maximum collector (drain/anode) supply output is 3 kV in the open state, and a minimum of 40 mA (30 W) when the output circuit is closed.

In High Current mode, the corresponding figures are 30 V and 400 A (3 kW).

#### ■ The Step Generator

The step generator that provides the base or gate signal can operate as either a current source or voltage source, supplying

## 371 General Information

---

up to 20 mA or 50 V in High Voltage mode, and up to 20 A pulses or 50 V in High Current mode.

### ■ Display Axes

Collector current is displayed on the vertical axis with a sensitivity range of 10  $\mu$ A/division to 5 mA/division in High Voltage mode and 500 mA/division to 50 A/division in High Current mode.

Collector voltage is displayed on the horizontal axis with sensitivity selectable from 50 V/division to 500 V/division in High Voltage mode and 100 mV/division to 5 V/division in High Current mode.

Base voltage can also be displayed on the horizontal axis, with sensitivity selectable from 100 mV/division to 5 V/division.

### ■ Measurement Modes

In addition to the continuously–displayed Repeat Measurement mode, Single and Sweep modes can be selected.

Single Measurement mode can be used to avoid the device overheating which may occur with Repeat Measurement mode.

Sweep Measurement mode automatically varies the collector voltage or step generator output, displaying a curve formed of a continuous series of dots rather than the single dot normally obtained in High Current mode.

### ■ Storage

The 371 provides storage for characteristic curves, user–entered text, and front–panel settings (setups).

### **Characteristic Curves**

Up to 16 characteristic curves, together with their parameter setups, can be stored in a 128K-byte magnetic bubble memory and recalled for display at any time. A stored characteristic curve can be displayed along with the real-time curve for comparison.

### **Text**

The 371 provides storage for alphanumeric characters and symbols so additional information, such as device names and measurement conditions, can be stored together with characteristic curve data or setups.

### **Setups**

Sixteen independent sets of front-panel settings, called setups, can be stored in the bubble memory and recalled at any time.

### **■ External Interfaces**

The 371 provides a standard GPIB interface for transfer of measurement data and results read by cursor operations, and for remote control of front-panel functions. The GPIB interface may also be used for an HPGL-compatible plotter when the 371 address is set to 31.

Screen displays can be hard-copied directly to an HPGL-compatible plotter via the Plotter Interface Port without using a controller.

Plotters used with the 371 must be equipped with an 8K-byte input buffer.

## 371 General Information

---

### INSTALLATION

The following information explains how to:

- Inspect a new instrument
- Set the 371 Line Voltage Selector to match local power
- Determine which line cord is appropriate
- Determine proper operating temperature
- Connect the Test Fixture Unit to the 371

#### ■ Initial Inspection

The 371 High Power Curve Tracer was thoroughly inspected for mechanical and electrical defects before shipment. It should be free of marks or scratches and meet or exceed all electrical specifications. To confirm this, inspect the instrument for physical damage incurred in transit and test the electrical performance by following the *First-Time Operation* instructions in Section 3, *Operating Instructions*.

For a complete verification of electrical performance, refer a qualified service technician to the *Performance Check* section of the 371 Service manual. If a discrepancy is found, contact your local Tektronix Field Office or representative or refer a qualified service technician to the *Adjustment* section of the 371 Service manual.

#### ■ Power Source Information

This instrument operates from a single-phase power source having a neutral at or near ground (earth) potential. It is not intended for operation from two phases of a multi-phase system, nor across legs of a single-phase, three wire system. This instrument can be operated from either a 100-volt, 120-volt, 200-volt, or 240-volt nominal supply source of 48 to 63 Hz. The line voltage setting of the instrument is indicated by a screw on



## 371 General Information

the rear panel (see Figure 1-1). Table 1-1 contains a listing of line voltage ranges, line frequency range, and power consumption.

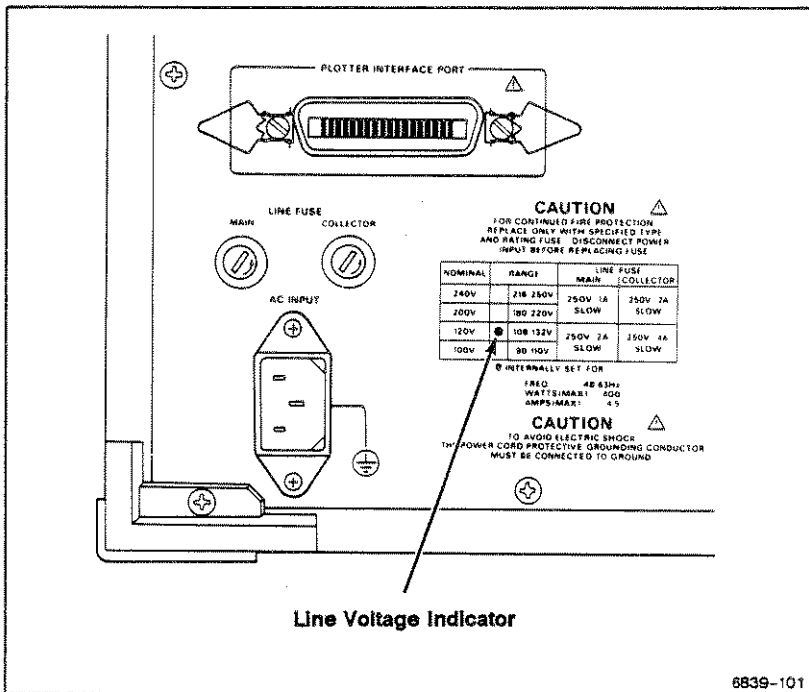

Figure 1-1. Location of the Line Voltage Indicator.

## 371 General Information

**TABLE 1-1**  
**Line Voltage Ranges**

Line Voltage Ranges		Fuses	
Nominal	Range	Main	Collector
240 V	216 V-250 V	250 V, 1 A, slow-blow	250 V, 2 A, slow-blow
200 V	180 V-220 V		
120 V	108 V-132 V	250 V, 2 A, slow-blow	250 V, 4 A, slow-blow
100 V	90 V-110 V		
Line Frequency	48 Hz-63 Hz		
Maximum Power	400 W, 4.5 A		



*To prevent damage to the instrument, always check the position of the line voltage indicator located on the rear panel of the 371 before connecting the instrument to a line voltage source.*

■ Power Cord Information

A power cord with the appropriate plug configuration is supplied with each instrument. The color-coding of the power cord conductors appears in Table 1-2.

TABLE 1-2  
Power-Cord Color Conductor Identification

Conductor	Color	Alternate
Ungrounded (Line)	Brown	Black
Grounded (Neutral)	Light Blue	White
Grounded (Protective Ground)	Green/Yellow	Green/ Yellow

## 371 General Information

---

### WARNING

*This instrument operates from a single-phase power source, and has a detachable three-wire power cord with a two-pole, three-terminal grounding-type plug. The voltage to ground (earth) from either pole of the power source must not exceed the maximum rated operating voltage (250 volts rms).*





*Before making connection to the power source, make sure that the instrument is set for the power source voltage, and is equipped with a suitable plug (two-pole, three-terminal, grounding type).*

*This instrument is safety class 1 equipment (IEC designation). All accessible conductive parts are directly connected through the grounding conductor of the power cord to the grounding contact of the power plug. Therefore, the power plug must only be inserted in a mating receptacle with a grounding contact. Do not defeat the grounding connection. Any interruption of the grounding connection can create an electric shock hazard.*

### 371 General Information

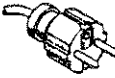
Refer to Table 1-3 if a power-cord plug other than the one supplied is required.

**TABLE 1-3  
Power-Cord and Plug Identification Information**

Plug Configuration	Usage	Nominal AC Line Voltage	Reference Standard	Option Number
	North America 120 V/15 A	120 V	ANSI C73.11 NEMA 5.15-P IEC 83	Standard
	Universal European 220 V/16 A	240 V	CEE (7), II, V, VII IEC 83	A1
	UK 240 V/13 A	240 V	BSI 1363 IEC 83	A2
	Australia 240 V/10 A	240 V	AS C112	A3
	North America 240 V/15 A	240 V	ANSI C73.20 NEMA 6-15-P IEC 83	A4
	Switzerland	220 V	SEV	A5

## 371 General Information

---

### ■ Operating Temperature

The 371 can be operated where the ambient air temperature is between +10°C and +40°C, and can be stored in ambient temperatures from -40°C to +65°C. After storage at temperatures outside the operating limits, allow the chassis temperature to reach the safe operating limits before applying power.

The 371 is cooled by air drawn in through the air filter on the rear panel and blown out through holes in the side panels. For proper instrument cooling, provide adequate clearance of at least two inches on the rear and sides of the instrument to ensure free air flow and dissipation of heat away from the instrument.

#### CAUTION

*Prolonged use of the 371 can cause high temperatures which may damage the instrument or device under test. When applying current in the 3 kW range of the Peak Power Watts selector, test time should be limited to four minutes, followed by at least 11 minutes of cooling.*

#### WARNING

*Prolonged use of the 371 at high power settings can make the device under test, Test Fixture Unit, or Protective Cover hot enough to cause injury. Avoid touching any of these items until cooled.*

### ■ Connecting the Test Fixture

Before switching on the 371, connect it to the Test Fixture Unit as shown in Figure 1-2. Device measurements are performed using this Test Fixture Unit.

**WARNING**

*The 371 provides output voltages up to 3 kV, which can be dangerous if the device under test is connected directly to the test fixture connector on the 371, without using the Test Fixture Unit. Always use the Test Fixture Unit.*

**CAUTION**

*When inserting the Test Fixture Unit plug into the connector on the 371, be certain the plug is parallel to the connector surface so the connecting pins will be inserted straight into the connector.*

## 371 General Information

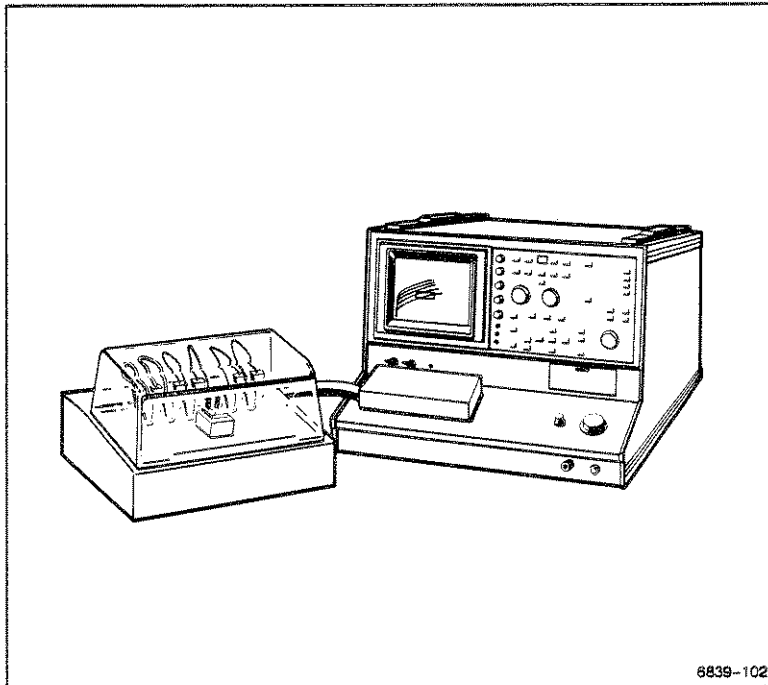

Figure 1-2. Connection of the 371 and Test Fixture Unit

Measurements are made by installing the following Test Adapters on the Patch Panel of the Test Fixture Unit:

A1002	In-line Lead (standard accessory)
A1003	T0-3/T0-66 (standard accessory)
A1004	Offset Lead (optional accessory)
A1005	Axial Lead Diode (optional accessory)

See *The Patch Panel and Test Fixture Unit* in Section 3 for details on making connections on the Patch Panel.

An optional Field Wiring Cable is also available for creating custom test fixtures (see *Accessories*, later in this section).



## REPACKAGING FOR SHIPMENT

If this instrument is shipped long distances, we recommend that the instrument be repackaged the same as when it arrived. The cartons and packaging material in which the instrument was shipped should be saved and used for this purpose.

If the instrument is shipped to a Tektronix Service Center for service or repair, attach a tag to the instrument showing the following:

- Owner of the instrument (with address)
- Name of a person at your firm to contact
- Instrument type and instrument serial number
- Description of the service required.

If the original packaging is unfit for use or not available, package the instrument as follows:

1. Obtain a corrugated cardboard shipping carton with a 375-pound test strength and inside dimensions at least six inches greater than the instrument dimensions.
2. Surround the instrument with polyethylene sheeting to protect the finish.
3. Cushion the instrument on all sides by tightly packing dunnage or urethane foam between the carton and the instrument, allowing three inches on all sides.
4. Seal the carton with shipping tape or with an industrial stapler.
5. Write the address of the Tektronix Service Center and your return address on the carton in one or more prominent locations.

## 371 General Information

---

### SPECIFICATION

This section specifies the electrical, mechanical, and environmental performance requirements of the 371.

#### ■ Performance Conditions

The following electrical and environmental characteristics are valid for instruments operated at ambient temperature between +10°C to +40°C, after an initial warm-up period of 20 minutes and when previously calibrated at a temperature between +15°C to +25°C.

The performance of all stimulus outputs (Collector High Current, Collector High Voltage, Step Gen Current, Step Gen Voltage) should be verified on the Test Fixture Unit, which is provided as a standard accessory.

**371 General Information**

**TABLE 1-4  
Electrical Specification**

<b>Characteristic</b>	<b>Performance Requirement</b>	<b>Supplemental Information</b>
<b>COLLECTOR SUPPLY</b>		
Collector Supply Polarity		Selected by the Collector Supply POLARITY button.
NPN +	Positive pulse for 300 W/3 kW Peak Power Watts.  Positive rectified sine-squared wave for 30 W/3 W Peak Power Watts.	
PNP -	Negative pulse for 300 W/3 kW Peak Power Watts.  Negative rectified sine-squared wave for 30 W/3 W Peak Power Watts.	

### 371 General Information

**TABLE 1-4 (cont.)  
Electrical Specification**

Characteristic	Performance Requirement	Supplemental Information
<b>COLLECTOR SUPPLY (cont.)</b>		
Peak Power Watts Range	3 kW, 300 W, 30 W, 3 W	Selected by the PEAK POWER WATTS buttons. Derived from nominal peak open circuit collector voltages and nominal series resistance value.
Collector Peak Current		With a shorted load in the Test Fixture Unit.
3 kW range	400 A	Pulsed Collector Supply
300 W range	40 A	Pulsed Collector Supply
30 W range	40 mA, -20%, +20%	Sine wave Collector Supply
3 W range	4 mA, -20%, -20%	Sine wave Collector Supply
Maximum Peak Voltage	Peak open circuit voltage	At 100% Collector Supply VARIABLE.
3 kW range	30 V, +10%, -5%	Pulsed Collector Supply

371 General Information

TABLE 1-4 (cont.)  
Electrical Specification

Characteristic	Performance Requirement	Supplemental Information
<b>COLLECTOR SUPPLY (cont.)</b>		
300 W range	30 V, + 10%, -5%	Pulsed Collector Supply
30 W range	3 kV, + 10%, -0%	Rectified sine-squared wave Collector Supply
3 W range	3 kV, + 10%, -0%	Rectified sine-squared wave Collector Supply
Collector Supply Variable	0 to 100.0%.	% of maximum peak voltage value is displayed in the CRT readout area.  Provides uncalibrated variable control of the collector supply amplitude from 0 to 100% in 0.1% increments.
Looping Compensation	Valid for High Voltage mode.	Cancels stray capacitance between the collector terminal and ground at Collector Supply PEAK POWER WATTS 30 W/3 W.
Sweep Start Voltage	Less than + 10%, -10% of peak volt.	Valid for High Voltage mode

### 371 General Information

**TABLE 1-4 (cont.)  
Electrical Specification**

Characteristic	Performance Requirement	Supplemental Information
<b>COLLECTOR SUPPLY (cont.)</b>		
OUTPUTS Indicator		Lights when all outputs (COLLECTOR SUPPLY, STEP GENERATOR output terminals) are enabled.
Pulsed Collector Supply	Pulse amplitude is controlled by the Collector Supply VARIABLE.	Available in High Current mode (PEAK POWER WATTS 3 kW/300 W).
Repetition Rate	One-fourth (.25X) line frequency.	At 3 kW PEAK POWER WATTS.
	One-half (0.5X) line frequency	At 300 W PEAK POWER WATTS.
Pulse Width (Half Amplitude)	250 $\mu$ S + 10%, -10%	More than 30% of the Collector Supply VARIABLE at open circuit.
	150 $\mu$ S to 250 $\mu$ S	5% to 30% of the Collector Supply VARIABLE at open circuit.
Rise Time/ Fall Time	40 $\mu$ S to 120 $\mu$ S	With Collector Supply VARIABLE at 50%.
Overshoot/ Undershoot	Less than 5% of the total output.	More than 5% of the Collector Supply VARIABLE at open circuit.

### 371 General Information

**TABLE 1-4 (cont.)  
Electrical Specification**

Characteristic	Performance Requirement	Supplemental Information
<b>STEP GENERATOR</b>		
Accuracy (Current or Voltage Steps, including Offset)		
Incremental	Within 2% between any two steps.	Without STEP MULTI .1X enabled.
	Within 5% between any two steps.	With STEP MULTI .1X enabled.
Absolute	Within 2% of total output + 3% of STEP/OFFSET AMPLITUDE setting + 10 nA or 2 mV	Without STEP MULTI .1X enabled
	Within 4% of total output + 5% of STEP/OFFSET AMPLITUDE setting + 10 nA or 2 mV	With STEP MULTI .1X enabled
Offset Control Range	Variable, 0 to 5 times STEP/OFFSET AMPLITUDE setting.	Same polarity as step signal. Control resolution is 1%.
Number of Steps	0 to 5	
Step Polarity	Positive, Negative.	Corresponds to the Collector Supply POLARITY when Step Generator INVERT is disabled.

### 371 General Information

**TABLE 1-4 (cont.)  
Electrical Specification**

Characteristic	Performance Requirement	Supplemental Information
<b>STEP GENERATOR (cont.)</b>		
Pulsed Current Steps		When pulsed Collector Supply (PEAK POWER WATTS 3 kW/300 W) is selected, the step current automatically becomes pulsed.
Pulse Width	500 $\mu$ s, + 10%, -10%.	With 1 k $\Omega$ load, 1 mA/step
Rise Time	Less than 40 $\mu$ s	With 1 k $\Omega$ load, 1 mA/step
Fall Time	Less than 40 $\mu$ s	With 1 k $\Omega$ load, 1 mA/step
Overshoot/Undershoot	Less than 10%	With 1 k $\Omega$ load, 1 mA/step and zero COLLECTOR SUPPLY VARIABLE.



### 371 General Information

**TABLE 1-4 (cont.)  
Electrical Specification**

Characteristic	Performance Requirement	Supplemental Information
<b>VERTICAL DEFLECTION SYSTEM</b>		
Collector Current (I <sub>c</sub> )		
Range	1 A/DIV to 50 A/DIV	With PEAK POWER WATTS set to 3 kW
	500 mA/DIV to 5 A/DIV	With PEAK POWER WATTS set to 300 W
	100 μA/DIV to 5 mA/DIV	With PEAK POWER WATTS set to 30 W
	10 μA/DIV to 500 μA/DIV	With PEAK POWER WATTS set to 3 W
Accuracy	Within 0.1 division of the vertical graticule lines.	
Cursor Accuracy	Within 1.5% of the readout + 0.1 division of the CURRENT/DIV setting.	In Store mode (use the DOT cursor).
<b>HORIZONTAL DEFLECTION SYSTEM</b>		
Collector Supply		
Range	Volts (V <sub>CE</sub> ): 100 mV/DIV to 5 V/DIV in a 1-2-5 sequence.	With PEAK POWER WATTS set to 3 kW/300 W
	50 V/DIV to 500 V/DIV in a 1-2-5 sequence.	With PEAK POWER WATTS set to 30 W/3 W

### 371 General Information

**TABLE 1-4 (cont.)  
Electrical Specification**

Characteristic	Performance Requirement	Supplemental Information
----------------	-------------------------	--------------------------

#### **HORIZONTAL DEFLECTION SYSTEM(cont.)**

Step Generator  
Volts (V<sub>ee</sub>)

Range	100 mV/DIV to 5 V/DIV in a 1-2-5 sequence.
-------	---

Accuracy	Within 0.1 division.
----------	----------------------

Cursor Accuracy	Within 1.5% of the readout + 0.1 division of the HORIZONTAL VOLTS/DIV setting.	Checked with the Dot cursor.
-----------------	--	---------------------------------

At 100 mV/DIV COL-  
LECTOR:  
Within 5% of the  
readout + 0.2 division  
of the HORIZONTAL  
VOLTS/DIV setting.

#### **CRT AND READOUT**

CRT

Type	Electrostatic deflection
------	--------------------------

Phosphor	P31
----------	-----

Screen Size	7-inch diagonal, internal graticule and scale factor.
-------------	---

## 371 General Information

**TABLE 1-4 (cont.)  
Electrical Specification**

Characteristic	Performance Requirement	Supplemental Information
<b>CRT (cont.)</b>		
Orthogonality	90°, within 0.6°	
Trace Rotation	At least $\pm 3^\circ$	
Geometry	0.5 minor division or less of tilt or bowing	
	0.75 minor division or less of keystone effect.	
<b>TEXT DISPLAY</b>		
Alphanumeric Character Set (1)	ASCII character set except double quote (") (u is recognized as $\mu$ )	GPIB-accessible with the TEXT command.
Alphanumeric Character Set (2)	space, A, B . . . Z, space, m, $\mu$ , n, p, , 0, 1 . . . 9, -, /, *, (, ), =	Accessible with the VERTICAL CURRENT/DIV and HORIZONTAL VOLTS/DIV controls.
Maximum Text String Length	24 characters.	
Character Size	Approximately 3 mm height, 2 mm width.	

### 371 General Information

TABLE 1-4 (cont.)  
Electrical Specification

Characteristic	Performance Requirement		
<b>POWER SOURCE</b>			
<b>Line Voltage Ranges</b>		<b>Fuses</b>	
<b>Nominal</b>	<b>Range</b>	<b>Main</b>	<b>Collector</b>
240 V	216 V-250 V	250 V, 1 A, slow-blow	250 V, 2 A, slow-blow
200 V	180 V-220 V		
120 V	108 V-132 V	250 V, 2 A, slow-blow	250 V, 4 A, slow-blow
100 V	90 V-110 V		
Line Frequency	48 Hz-63 Hz		
Maximum Power	400 W, 4.5 A		

## 371 General Information

**TABLE 1-5**  
**Mechanical Specification**

<b>Characteristic</b>	<b>Specification</b>
Weight	Approximately 79.3 lbs. (36 kg)
Height	Approximately 13.1 inches (333 mm) With feet and handles removed: Approximately 12.2 inches (310 mm)
Width	Approximately 16.9 inches (429 mm)
Depth	Approximately 24.1 inches (638 mm)

**371 General Information**

**TABLE 1-6  
Environmental Specification**

<b>Characteristic</b>	<b>Performance Requirement</b>
<b>Temperature</b>	
Non-Operating	-40°C to +65°C.
Operating	+10°C to +40°C.
<b>Altitude</b>	
Non-Operating	to 50,000 feet
Operating	to 15,000 feet  Maximum operating temperature decreases 1°C each 1,000 feet above 5,000 feet.
<b>Humidity</b>	
Non-operating/ Operating	MIL-T-28800D paragraph 4.5.5.1.1.2. (5 days humidity with temperature cycling)

## 371 General Information

**TABLE 1-6 (cont.)  
Environmental Specification**

Characteristic	Performance Requirement
EMC <sup>1</sup> (Electromagnetic compatibility)	
Conducted	
Emissions	CE03 MIL-STD-461B Part 4, Curve 1 DIN 57871/VDE 0871/6.78 Class B
Susceptibility	CS06 MIL-STD-461B Part 5 plus additional requirements: CS01 MIL-STD-461B Part 7 CS02 MIL-STD-461B Part 4
Radiated	
Emissions	RE02 MIL-STD-461B Part 7 FCC Part 15, Subpart J, Class A DIN 5781/VDE 1871/6.78 Class B
Susceptibility	RS03 MIL-STD-461B PART 7 Limit to 1 GHz RS01 MIL-STD-461B Part 4 characterization only
Electrostatic Discharge	Mainframe: 15 kV Bubble Cassette: 5 kV Adapter Socket: 5 kV
Safety	UL1244 <sup>1</sup> (Standard for electrical and electronic measuring and testing equipment)  CSA Electrical Bulletin No. 556

<sup>1</sup>Not applicable when the 371 is rackmounted.

**371 General Information**

**TABLE 1-6 (cont.)  
Environmental Specification**

<b>Characteristic</b>	<b>Performance Requirement</b>
Vibration (operating)	MIL-T-28800B Section 4.5.5.3.1
Shock (non-operating)	MIL-T-28800B Section 4.5.5.4.1
Bench Handling	MIL-T-28800B, Section 4.5.5.4.3.
Packaged Transportation Drop	ASTM D775-61 Method 1, Paragraph 5
Package Transportation Vibration	ASTM D999-75 Method A, Paragraph 7.1



## INTERFACE CHARACTERISTICS

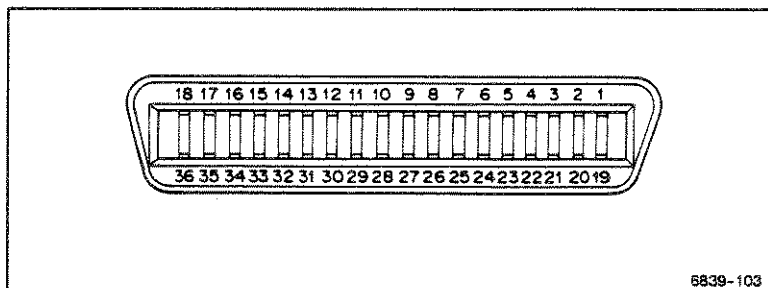

Figure 1-3. Plotter Interface Port.

TABLE 1-7  
Plotter Interface Port Pin Assignment

Signal Pin No.	Return Pin No.	Signal	Direction	Description
1	19	STROBE(L)	OUT	An active low strobe qualifies data. Data may be latched on STROBE low or may be clocked on positive transition of STROBE.
2	20	DATA 1	OUT	INPUT DATA LEVELS: A logic one is represented by a high level.
3	21	DATA 2	OUT	
4	22	DATA 3	OUT	

### 371 General Information

TABLE 1-7 (cont.)  
Plotter Interface Port Pin Assignment

Signal Pin No.	Return Pin No.	Signal	Direction	Description
5	23	DATA 4	OUT	INPUT DATA LEVELS: A logic one is represented by a high level.
6	24	DATA 5	OUT	
7	25	DATA 6	OUT	
8	26	DATA 7	OUT	
9	27	DATA 8	OUT	
10	28	ACKNLG(L)	IN	An active low strobe that flags the host that a transaction is complete.
11	29	BUSY	IN	A high signal indicates that the plotter is not ready for data.
12	30	PE	IN	Paper Empty—A low signal indicates that the paper is not set.
13	-	SLCT	-	Not used.
14	-	NC	-	Not used.
15	-	NC	-	Not used.
16	-	NC	-	Not used.
17	-	FG	-	371 chassis GND. In the 371, the chassis GND and the logic GND are isolated from each other.
18	-	+5V	OUT	+5V
19-30	-	GND	-	Twisted-pair return signal, GND level.

## 371 General Information

**TABLE 1-7 (cont.)  
Plotter Interface Port Pin Assignment**

Signal Pin No.	Return Pin No.	Signal	Direction	Description
31	-	INIT(L)	OUT	Low for Plotter initialize.
32	-	FAULT(L)	IN	The 371 aborts data transmission when the FAULT signal is low.
33	-	NC	-	Not used.
34	-	NC	-	Not used.
35	-	NC	-	Not used.
36	-	NC	-	Not used.

### ■ Plotter Interface Cable Characteristics

The plotter cable is a Centronics-type 36-pin I/F cable.

All input/output signals are TTL-compatible.

(lol = 20 mA)

(loh = -10 mA)

## 371 General Information

### ■ GPIB Interface Functions

The IEEE-488-1978 (GPIB) standard defines the GPIB interface functions and the allowed subsets of those functions. Table 1-8 shows how the standard functions are implemented in the 371.

**TABLE 1-8  
GPIB Functions**

<b>Function</b>	<b>Implemented As</b>
Source handshake	SH1
Acceptor Handshake	AH1
Talker	T6
Listener	L4
Service request	SR1
Remote Local	RL2
Parallel poll	PP0 (Not implemented)
Device clear	DC1
Device trigger	DT0 (Not implemented)
Controller	C0 (Not implemented)

## ACCESSORIES

Standard accessories are shipped with your 371. Optional accessories are available through your nearest Tektronix Field Office or representative.

### ■ Standard Accessories

Test Fixture Unit	016-0908-00
Operators Manual	070-6839-00
Fuses:	
250 V, 1 A, Slow blow	159-0260-00
250 V, 2 A, Slow blow	159-0259-00
250 V, 4 A, Slow blow	159-0291-00
Bubble Cassette	020-1310-00
Power Cord	161-0066-XX
Test Adapters:	
In-line Adapter	A1002
TO-3/TO-66 Adapter	A1003
Patch Cords (with two banana plugs)	198-5621-00
Patch Cords (with one banana plug and one alligator clip)	198-5622-00

### ■ Optional Accessories

Service Manual	070-6840-00
Field Wiring Cable	198-5628-00
Rackmounting Kit	016-0930-00
Centronics Cable	012-0555-00
GPIB Cable	012-0991-00
Test Adapters:	
Blank Adapter	A1001
Offset Lead/Power Adapter	A1004
Axial Lead Adapter	A1005
Camera Adapter, C59AP	016-0244-06
Camera Adapter, C5C opt. 01	016-0357-01
Camera Adapter, C4 opt. 02	016-0357-01

Revised DEC 1987

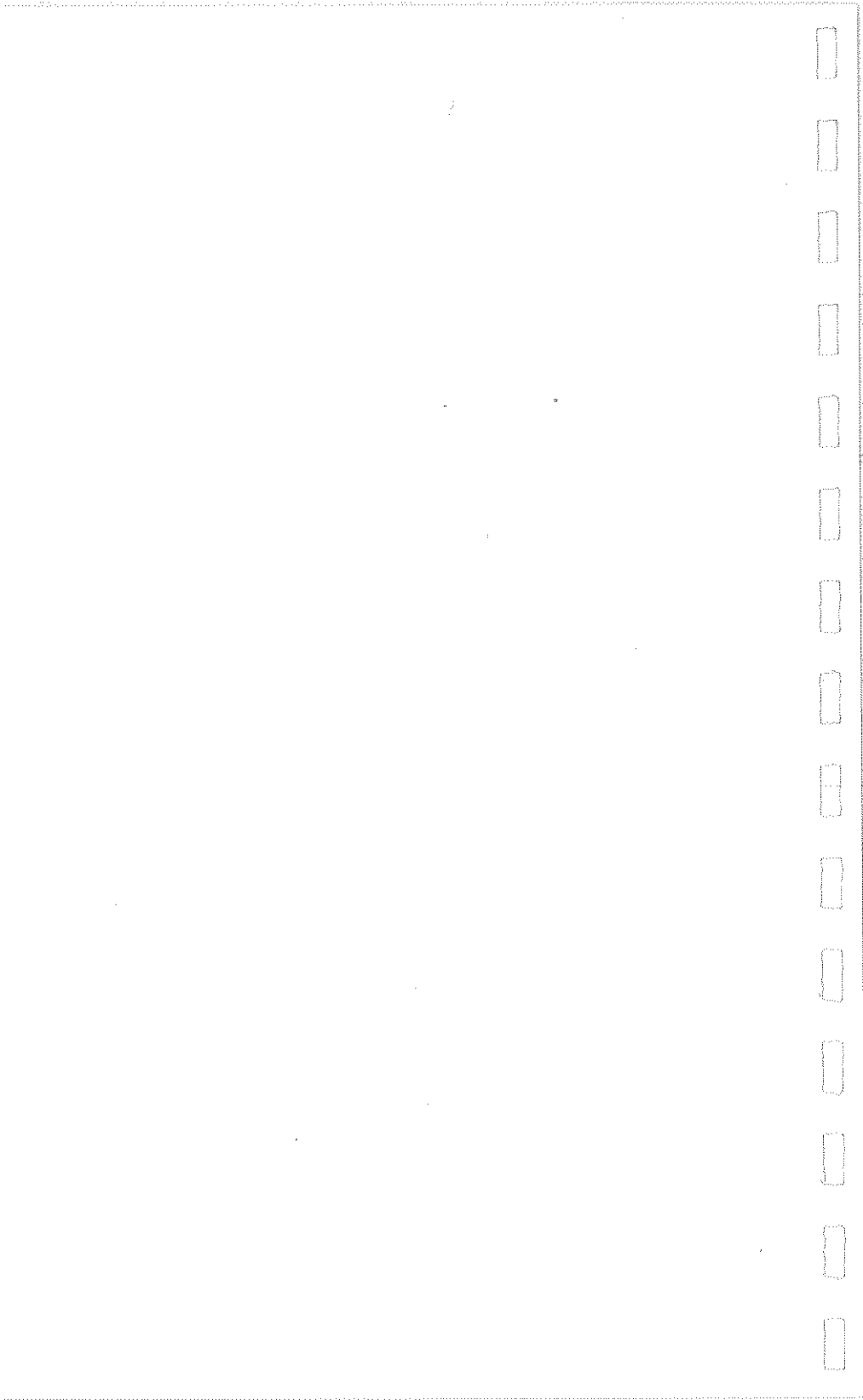

## **SECTION 2**

---

# **CONTROLS, INDICATORS, AND CONNECTORS**

### ***This section:***

- *Describes the function of all controls, indicators, and connectors on the front panel, rear panel, and Test Fixture Unit of the 371*
- *Provides illustrations to help locate front panel, rear panel, and Test Fixture Unit items*
- *Describes the display areas on the 371 CRT*

## SECTION 2 CONTENTS

	Page
<b>Introduction</b> .....	2-5
<b>CRT Controls</b> .....	2-7
Intensity .....	2-7
Focus .....	2-7
Grat Illum .....	2-7
Position .....	2-7
Trace Rotation .....	2-8
<b>Measurement Controls</b> .....	2-9
Repeat .....	2-9
Single .....	2-9
Sweep .....	2-9
<b>Bubble Memory Compartment, Controls, and Indicators</b> .....	2-10
Bubble Memory Index Display .....	2-10
Bubble Memory Compartment .....	2-10
<b>Setup Controls</b> .....	2-11
Save/Erase .....	2-11
Recall/Directory .....	2-11
<b>Display Controls and Indicators</b> .....	2-13
Non Store .....	2-13
Store/Cal Full .....	2-13
Compare/Cal Off .....	2-13
View/Cal Zero .....	2-14
Enter/Text .....	2-15
Horizontal Volts/Div .....	2-16
Vertical Current/Div .....	2-16
Invert .....	2-17

Revised DEC 1987



## INTRODUCTION

The controls, indicators, and connectors for the 371 are located on the front and rear panels. The connectors for the device under test are located on the Patch Panel of the Test Fixture Unit. Setup status and measurement results are indicated in readout areas on the CRT display.

Using the 371 efficiently will require a clear understanding of the functions and meanings of these controls, indicators, connectors, and readout displays.

The front-panel controls, indicators, and connectors are shown in Figure 2-1.

The rear-panel controls, indicators, and connectors are shown in Figure 2-2.

The Patch Panel connectors on the 371 Test Fixture Unit are shown in Figure 2-3.

The display areas of the 371 CRT are shown in Figure 2-4.

The descriptions in this section are preceded by index numbers matching numbers on the fold-out illustrations. The descriptions are presented in numerical order.

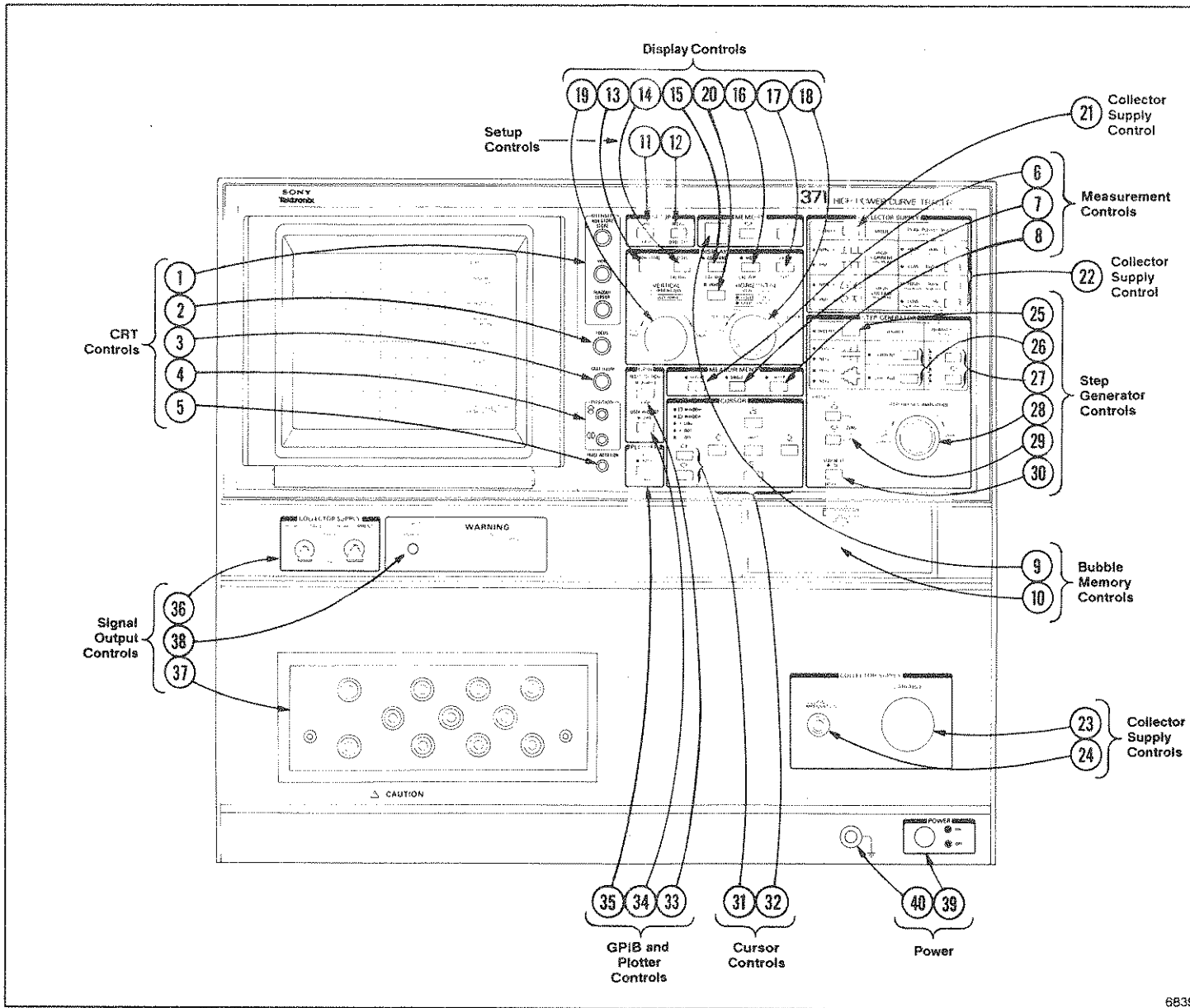

Figure 2-1. The front-panel controls, indicators, and connectors.

## CRT CONTROLS

### ① INTENSITY

#### NON STORE/STORE

The NON STORE/STORE Intensity knob controls the waveform display intensity in Non Store and Store modes.

#### VIEW

The VIEW Intensity knob controls the waveform and Dot cursor display intensity in View mode.

#### READOUT/CURSOR

The READOUT/CURSOR Intensity knob controls the intensity of the readout, *f* Line cursor, and Window cursor on the display.

### ② FOCUS

The FOCUS knob controls the focus of the CRT display.

### ③ GRAT ILLUM

The GRAT ILLUM knob controls the illumination level (brightness) of the CRT graticule.

### ④ POSITION

The POSITION controls are screwdriver adjustments which control the vertical and horizontal position of the display.

**5 TRACE ROTATION**

The TRACE ROTATION control is a screwdriver adjustment which adjusts the slant of the display in reference to the display graticule.

## MEASUREMENT CONTROLS

### 6 REPEAT

Pressing the REPEAT button causes the Step Generator to generate a repeated set of step signals and the measurement is performed repeatedly.

### 7 SINGLE

Each time the SINGLE button is pressed, the Step Generator generates one set of step signals and the measurement is performed once.

### 8 SWEEP

Pressing the SWEEP button causes the Collector Supply (or Step Generator) to automatically sweep the output from the value set by the Collector Supply VARIABLE control (or Step Generator amplitude + offset) to zero.

The measurement is performed as step signals are generated repeatedly over the sweep range.

Sweep mode is available when Display mode is set to Store or Compare.

## BUBBLE MEMORY COMPARTMENT, CONTROLS, AND INDICATORS

In Store and View modes, the characteristic curve displayed on the screen and the front-panel settings can be stored in a magnetic bubble memory cassette.

A bubble memory cassette can store up to 16 curve displays and 16 sets of front-panel settings (setups).

### 9 Bubble Memory Index Display

The Bubble Memory Index Display indicates one of the 16 locations in the bubble memory cassette. When the Enter, View, Save, Recall, and Compare functions are used, data can be stored in or recalled from the indicated location.

The Index number can be increased or decreased by the two arrow buttons (↗, ↘) to the right of the display.

### 10 Bubble Memory Compartment

A bubble memory cassette is inserted into the Bubble Memory Compartment. The cassette is removed by pressing the latch button, located to the left of the cassette, while firmly pulling on the cassette.

## SETUP CONTROLS

Most front-panel settings can be stored in and recalled from bubble memory.

The front-panel settings that cannot be stored are:

- CRT controls:
  - INTENSITY
  - FOCUS
  - GRAT ILLUM
  - POSITION
  - TRACE ROTATION
- LOOPING COMPENSATION
- GPIB
- USER REQUEST/ID
- RESET TO LOCAL/ADDR
- PLOTTER ALL/CURVE

### 11 SAVE/ERASE

Pressing the SAVE button stores the front-panel settings in bubble memory.

Pressing the SAVE button while holding down the Cursor SHIFT button, then pressing the ENTER button changes the button function to ERASE, which erases the entire bubble memory cassette. If the ENTER button is not pressed within a few seconds after pressing the SAVE/ERASE and Cursor SHIFT buttons, the erase operation is canceled.

### 12 RECALL/DIRECTORY

Pressing the RECALL button sets the front-panel settings according to the setup information stored in bubble memory. The location from which the setup

## **371 Controls, Indicators, and Connectors**

is recalled is determined by the setting of the Bubble Memory Index. When a setup is recalled, the bubble memory index number is indicated at the bottom of the 371 display.

Pressing the RECALL button while holding down the Cursor SHIFT button changes the button function to DIRECTORY, which causes a plotter (connected to the rear-panel Plotter Interface Port) to print a directory of the contents of the bubble memory cassette.



## DISPLAY CONTROLS AND INDICATORS

### 13 NON STORE

Pressing the NON STORE button provides a real-time device characteristic display on the 371.

### 14 STORE/CAL FULL

Pressing the STORE button displays a digitized device characteristic curve.

Pressing the STORE button while holding down the Cursor SHIFT button changes the button function to CAL FULL, which displays a dot in the top right corner of the screen. The dot will appear in the lower left corner if Display INVERT is enabled or the Collector Supply POLARITY is set to PNP. If both INVERT and PNP are enabled, they cancel each other's effect and the dot is positioned in its normal position in the upper right corner of the graticule.

The CAL FULL dot provides a reference for checking the CRT deflection at the 10th graticule lines (vertical and horizontal).

While in the calibration mode, "CAL" is displayed in the upper right corner of the display graticule.

### 15 COMPARE/CAL OFF

Pressing the COMPARE button displays the digitized (Store) curve and a curve from bubble memory (View) on the screen. The setup and measurement data of the digitized (Store) curve are displayed in the readout area of the screen.

Pressing the COMPARE button while pressing the Cursor SHIFT button changes the button function to CAL OFF, which cancels the CAL FULL and CAL ZERO functions.

### 16 VIEW/CAL ZERO

Pressing the VIEW button recalls a device characteristic curve from bubble memory and displays it on the screen. An index number is displayed at the bottom of the screen indicating the location in bubble memory from which the curve was recalled.

The Display mode automatically changes to Store if a front-panel setting is changed while the 371 is in View mode.

Pressing the VIEW button while holding down the Cursor SHIFT button changes the button function to CAL ZERO, which displays a dot in the bottom left corner of the screen. The dot will appear in the upper right corner if Display INVERT is enabled or the Collector Supply POLARITY is set to PNP. If both INVERT and PNP are enabled, they cancel each other's effect and the dot is positioned in its normal position in the lower left corner of the graticule.

The CAL ZERO dot provides a reference to check the CRT deflection at the zero point on the vertical and horizontal graticule lines.

While in the calibration mode, "CAL" is displayed in the upper right corner of the display graticule.

17 ENTER/TEXT

Pressing the ENTER button stores the currently displayed device characteristic curve in bubble memory. The display cannot be stored when in the Non Store or Compare modes.

Pressing the ENTER button while holding down the Cursor SHIFT button changes the button function to TEXT, which places the 371 in the Text Edit mode. The Text Edit mode provides text entry to the Text Area of the display and revision of existing text.

To enter text, select the character position in the Text Area with the HORIZONTAL VOLTS/DIV control and select each character from the pre-defined set of characters with the VERTICAL CURRENT/DIV control. The Text Area will display up to 24 characters.

The available characters are listed below in the order in which they are presented by the VERTICAL CURRENT/DIV control:

*space, A, B, . . . Z, space, m,  $\mu$ , n, p, ., 0, 1, . . . 9, -, /, \*, (, )*

To edit text, use the HORIZONTAL VOLTS/DIV control to position the cursor on the character to be changed. Use the VERTICAL CURRENT/DIV control to overwrite the character or the NON STORE button to delete all of the text.

To exit the text edit mode, press the ENTER/TEXT button while holding down the the Cursor SHIFT button.

**18 HORIZONTAL VOLTS/DIV**

The HORIZONTAL VOLTS/DIV knob selects the source (COLLECTOR or STEP GEN) and adjusts the sensitivity (volts/division). The sensitivity is displayed in the HORIZ/DIV readout on the screen.

Rotating the knob clockwise lights the COLLECTOR ( $V_{CE}$ ) indicator, located above the control, to show that the Collector Supply is selected as the source.

COLLECTOR ( $V_{CE}$ ) sensitivity is set in terms of the collector-to-emitter voltage (in a 1-2-5 sequence of steps) on the horizontal axis as follows:

- In High Current mode: 100 mV/division to 5 V/division
- In High Voltage mode: 50 V/division to 500 V/division

Rotating the HORIZONTAL VOLTS/DIV control counterclockwise from the Collector positions lights the STEP GEN ( $V_{BE}$ ) indicator, located above the control, to show that the Step Generator is selected as the source on the horizontal axis.

The STEP GEN ( $V_{BE}$ ) selection sets the base-to-emitter voltage and has selections in the range of 100 mV/division to 5 V/division, in a 1-2-5 sequence of steps.

**19 VERTICAL CURRENT/DIV**

The VERTICAL CURRENT/DIV control sets the sensitivity on the vertical axis.

The selection range depends on the COLLECTOR SUPPLY PEAK POWER WATTS setting as follows:

PEAK POWER WATTS	CURRENT/DIV Range
3 kW	1 A/div to 50 A/div
300 W	500 mA/div to 5 A/div
30 W	100 $\mu$ A/div to 5 mA/div
3 W	10 $\mu$ A/div to 500 $\mu$ A/div

**20** INVERT

Pressing the INVERT button inverts the curve in the horizontal and vertical directions relative to the center point of the internal graticule.

Display INVERT affects both real-time (Non Store) and digitized (Store) displays. In Compare mode, only the digitized (Store) curve is inverted; the curve recalled from memory is not. Supply polarities are not changed when the display is inverted.

## COLLECTOR SUPPLY CONTROLS AND INDICATORS

### 21 POLARITY

Pressing the Collector Supply POLARITY button selects the polarity of the Collector Supply and simultaneously switches the polarity of the Step Generator.

Each polarity setting, NPN+ and PNP- for High Voltage and NPN+ and PNP- for High Current, has an indicator which is illuminated when that setting is selected.

The Collector Supply output automatically goes to 0% when the polarity is switched. The Step Generator output level remains unchanged (except for the reversed polarity).

### 22 PEAK POWER WATTS

The PEAK POWER WATTS buttons select the maximum power output of the Collector Supply. The four Peak Power Watt selections, 3 W, 30 W, 300 W, and 3 kW, are split between two Collector Supply modes: High Current and High Voltage.

Pressing either the 3 kW or 300 W button places the Collector Supply in High Current mode, where the output consists of 250  $\mu$ s pulses and the peak voltage available is 30 V.

Pressing either the 30 W or 3 W buttons places the Collector Supply in High Voltage mode, where the output is a full-wave rectified sine wave and the maximum voltage available is 3 kV.

The Collector Supply output automatically goes to 0% when a PEAK POWER WATTS selection causes the Collector Supply to switch between the High Current and High Voltage modes.

### 23 VARIABLE

Rotating the Collector Supply VARIABLE knob varies the Collector Supply voltage output. The output voltage is indicated in the % OF PEAK VOLTS area of the display as a percent of the peak voltage available.

### 24 LOOPING COMPENSATION

Adjusting the LOOPING COMPENSATION control compensates for stray capacitance in the 371 and Test Fixture Unit when the Collector Supply is in High Voltage mode.

## STEP GENERATOR CONTROLS AND INDICATORS

### 25 INVERT

Pressing the Step Generator INVERT button inverts the polarity of the Step Generator. Because the Step Generator polarity is automatically changed when the Collector Supply polarity is changed, the Step Generator INVERT button is necessary to reverse the polarity change.

The INVERT indicator, located beside the button, is lit to indicate inverted polarity.

### 26 SOURCE

Pressing either the CURRENT or VOLTAGE buttons sets the Step Generator output to either a current step signal or voltage step signal.

### 27 NUMBER OF STEPS

The NUMBER OF STEPS buttons (←, →) select the number of steps produced by the Step Generator. The number of steps is selectable from 0 to 5, and when 0 is selected, the Step Generator output consists of offset only.

### 28 STEP/OFFSET AMPLITUDE

Rotating the STEP/OFFSET control sets the amplitude of the generated steps and the range of the offset.



The step amplitude is selected in a 1-2-5 sequence of steps in the following ranges:

Current steps:

When the Collector Supply is in High Voltage mode:

Step waveform, 1  $\mu$ A/step to 2 mA/step.

When the Collector Supply is in High Current mode:

Pulse waveform, 1 mA/step to 2 A/step.

Voltage steps:

200 mV/step to 5 V/step

Offset amplitude is set by using the STEP/OFFSET AMPLITUDE control together with the OFFSET buttons described next.



## 29 OFFSET

The OFFSET buttons ( $\leftarrow$ ,  $\rightarrow$ ) control the offset added to the step signal. The offset has the same polarity as the step signal and the amount of offset can be selected in 1% steps from 0% to 500% of the step amplitude.

Changing the step amplitude with the STEP/OFFSET AMPLITUDE control causes the offset amplitude to change proportionately. In this way the offset amplitude, as a percentage of step amplitude, remains constant.

When the step signal is a pulse signal, the offset is added as a pulse. The selected amount of offset is displayed in the OFFSET readout area of the CRT.

Holding down the Cursor SHIFT button while pressing either of the OFFSET buttons causes offset changes to be in larger increments.

Simultaneously pressing the OFFSET  and  buttons sets the offset to zero.

**30 STEP MULTI .1X/DISABLE**

Pressing the STEP MULTI .1X button reduces the step signal amplitude by a factor of ten without affecting the offset amplitude. The indicator above the STEP MULTI .1X button lights when the Step Multi function is enabled.

Pressing the STEP MULTI .1X button while holding down the Cursor SHIFT button changes the button function to DISABLE, which disables the output and readout display of the Step Generator.

## CURSOR CONTROLS AND INDICATORS

### 31 Cursor Selection

Pressing the Cursor Selection buttons ( $\leftarrow$ ,  $\rightarrow$ ) selects one of the three types of cursor: DOT, *f* LINE, or WINDOW.

#### DOT Cursor

The Dot cursor is a high-intensity dot displayed on the trace. The voltage, current, and DC  $\beta$  at the Dot cursor position are indicated in the CURSOR readout area. The Dot cursor can be positioned with the four Cursor Position buttons ( $\leftarrow$ ,  $\rightarrow$ ,  $\uparrow$ ,  $\downarrow$ ).

If the Dot cursor is positioned off-screen, the corresponding part of the readout (vertical or horizontal) blinks.

In Compare display mode, the Dot cursor is displayed only on the digitized (Store) curve. In Non Store mode, the Dot cursor is not displayed.

#### *f* LINE Cursor

The *f* Line (functional line) cursor is a straight line which passes through the Dot cursor position at a slope that can be changed by the four Cursor Position buttons ( $\leftarrow$ ,  $\rightarrow$ ,  $\uparrow$ ,  $\downarrow$ ). The slope is indicated in the CURSOR (*f*:1/gradient) area of the readout.

The point at which the *f* Line cursor intercepts the horizontal axis is indicated in the CURSOR (*f*:intercept) area of the readout, giving the horizontal coordinate value.

The  $f$  Line cursor can be used to measure the “on” resistance or horizontal intercept voltage of the device.

The  $f$  Line cursor is not available in Non Store mode and appears only on the digitized (Store mode, or “live”) trace in Compare mode.

### WINDOW Cursor

The Window cursor is displayed as a rectangle and can be used in any display mode as a reference for visual checks. It can also be used to measure small signal  $\beta$  (Hfe).

The Window cursor has two modes, depending on whether the base point is at the top right (□) or bottom left (□) corner. Cursor movement and the cursor readout display are referenced to this base point.

### 32 Cursor Position Buttons

The four Cursor Position buttons (←, →, ↖, ↗) move the cursor or change the slope of the  $f$  Line cursor.

Holding down the Cursor SHIFT button while pressing any of the Cursor Position buttons increases the rate of change (i.e., causes the cursor to move faster).

The Cursor SHIFT button is also used to change the function of other buttons on the 371 front panel. The alternate function is printed in blue below each button .

Table 2-1 shows the buttons with which the SHIFT button operates, and the effect the SHIFT button has on those buttons.

**TABLE 2-1**  
**The Cursor SHIFT Button Used With Other Buttons**

<b>Button</b>	<b>Effect of Pressing the SHIFT button</b>
SAVE	Changes the button function to ERASE, which erases the contents of the bubble memory cassette.
RECALL	Changes the button function to DIRECTORY, which plots a directory of the contents of the bubble memory cassette.
STORE	Changes the button function to CAL FULL, which displays a dot to check the deflection accuracy of the CRT.
COMPARE	Changes the button function to CAL OFF, which turns off the Cal Full or Cal Zero display.
VIEW	Changes the button function to CAL ZERO, which displays a dot to check the deflection accuracy of the CRT.
ENTER	Changes the button function to TEXT, which places the 371 in Text Edit mode for text entry and revision.

TABLE 2-1 (cont.)  
The Cursor SHIFT Button Used With Other Buttons

Button	Effect of Pressing the SHIFT button
Cursor Position (←, →, ↑, ↓)	Increases the rate of cursor movement.
RESET TO LOCAL	Changes the button function to ADDR, which reads in the settings of the rear-panel Configuration Switch Bank and displays them on the CRT.
USER REQUEST	Changes the button function to ID, which displays the firmware version on the CRT.
ALL	Changes the button function to CURVE, which plots only the curve (without the graticule, cursors, text, and readout).
OFFSET (←, →)	Increases the rate of offset increase or decrease.
STEP MULTI .1X	Changes the button function to DISABLE, which disables the Step Generator output.

## GPIB AND PLOTTER CONTROLS AND INDICATORS

### 33 RESET TO LOCAL/ADDR and the REMOTE Indicator

When the 371 is in remote (GPIB controlled) mode, as indicated by the REMOTE indicator, pressing the RESET TO LOCAL button switches the 371 back to local (front-panel) control.

When the Remote Enable (REN) signal has been sent over the GPIB and My Listen Address (MLA) is received, the 371 goes into remote mode and the REMOTE indicator is lit. In remote mode, the 371 executes interface messages and device-dependent messages received via the GPIB.

Pressing the RESET TO LOCAL button while holding down the Cursor SHIFT button changes the button function to ADDR, which causes the 371 to read the GPIB address and message terminator selections on the rear-panel Configuration Switch Bank. Once received by the internal processor, the selections are displayed on the CRT.

### 34 USER REQUEST/ID and the SRQ Indicator

Pressing the USER REQUEST button causes the 371 to send a service request (SRQ) signal over the bus.

The SRQ indicator, located above the USER REQUEST button, lights to indicate that a service request is being sent. The SRQ indicator goes off when a serial poll is executed and the controller acknowledges the service request.

Pressing the USER REQUEST button while holding down the Cursor SHIFT button changes the button function to ID, which displays the 371's firmware version number on the screen.

**35** ALL/CURVE and the BUSY Indicator

Pressing the ALL button in Store or View mode sends the displayed curve, cursor, text, graticule, and setup information to a plotter connected to the PLOTTER INTERFACE PORT or GPIB connector on the 371 rear panel.

The GPIB address switch selects one of the two rear-panel connectors for the output as follows:

Address 0 through 30:	PLOTTER INTERFACE PORT
Address 31:	GPIB connector

The BUSY indicator lights while the data is transferred. When the data transfer is complete, the BUSY indicator goes off and the 371 sends a service request (SRQ) on the GPIB.

Error messages and the bubble memory index number displayed in View mode are not sent to the plotter.

Output to the plotter via the GPIB connector can be halted by pressing the ALL button. However, the ALL button **does not** halt data transfer via the PLOTTER INTERFACE PORT.



Pressing the ALL button while holding down the Cursor SHIFT button changes the button function to CURVE, which sends only the curve (without text, cursor, graticule, and setup information) to the plotter.

## SIGNAL OUTPUT CONTROLS, INDICATORS, AND CONNECTORS

### 36 Collector Supply Breakers

The Collector Supply circuit breakers, HIGH VOLTAGE and HIGH CURRENT, enable or disable Collector Supply output. Overcurrent automatically trips the breakers to disable output.

When the breaker disables the output, the Collector Supply VARIABLE, and therefore the output, is reset to 0%. After re-enabling the output, the Collector Supply VARIABLE must be reset to the desired level.

### 37 Test Fixture Connector

The Test Fixture Connector provides interconnection between the the Test Fixture Unit and the 371.

### 38 OUTPUTS Indicator

The OUTPUTS indicator lights when the Collector Supply and Step Generator outputs are enabled.

The OUTPUTS indicator will go off if one of the following conditions occurs:

- The Test Fixture Unit is not connected
- The Test Fixture Unit protective cover is open
- The Collector Supply peak power is exceeded
- The output is disabled for any other reason

When the OUTPUTS indicator is off, both the output and sense connectors are open circuits.

## POWER

**39** POWER

The POWER switch connects and disconnects the 371 from its power source.

**40** Ground Connector

The front-panel ground connector, located beside the POWER switch, is used to connect the 371 to an external ground level.

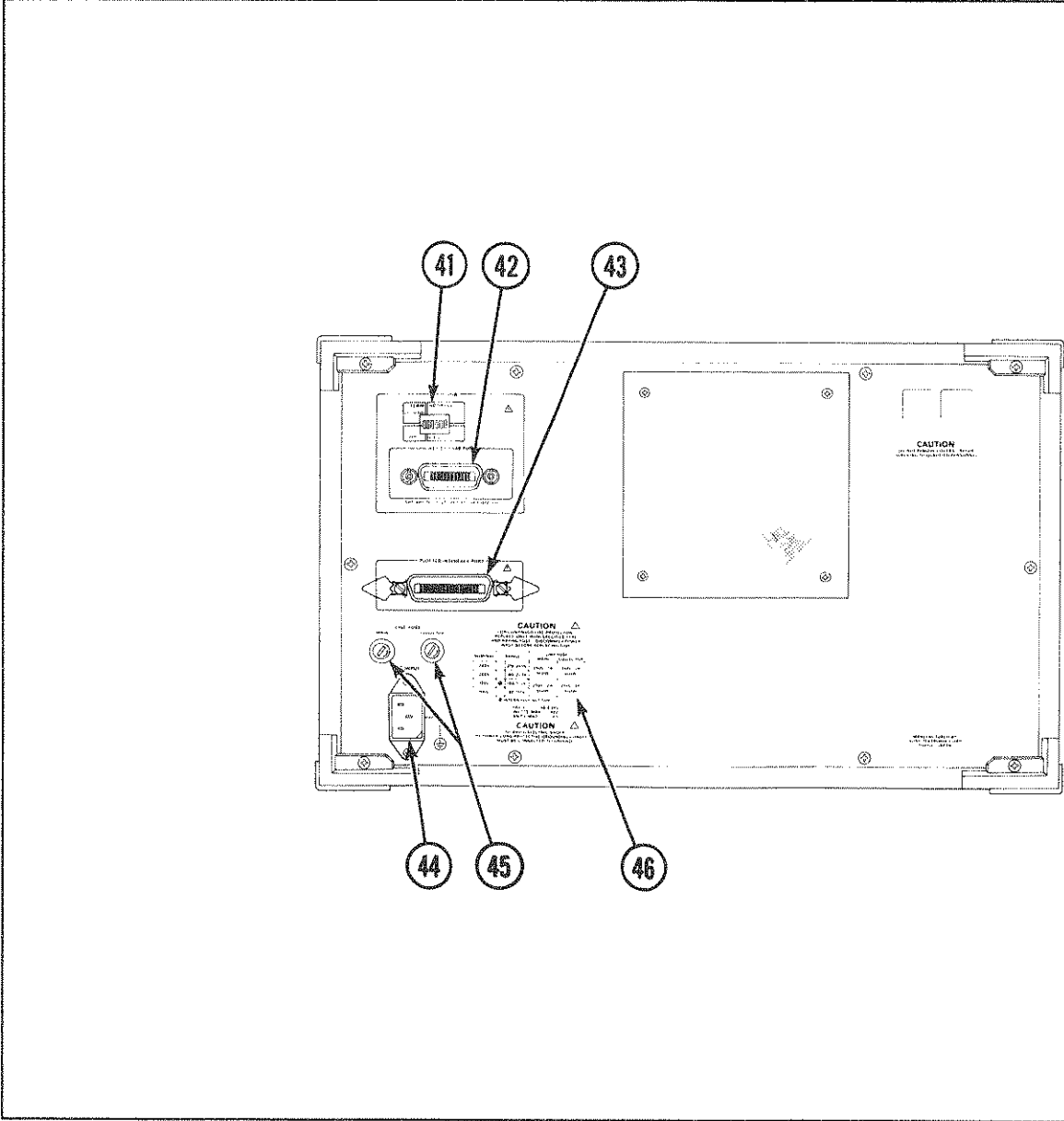

Figure 2-2. The rear-panel controls, indicators, and connectors.

## REAR PANEL CONTROLS, INDICATORS, AND CONNECTORS

### 41 GPIB TERMINATOR and ADDRESS Switch

The GPIB TERMinator and ADDRESS switch sets the 371 GPIB address and selects the message terminator.

The left switch sets the terminator and the other five set the 371's address on the GPIB. New settings become effective when the RESET TO LOCAL/ADDR button is pressed while holding down the Cursor SHIFT button.

### 42 IEEE STD 488 PORT

IEEE STD 488 PORT is the GPIB interface connector.

### 43 PLOTTER INTERFACE PORT

The PLOTTER INTERFACE PORT provides a Centronics-type interface for a plotter.

### 44 AC INPUT

The AC INPUT connector is for the power cord.

**45** **LINE FUSE**

The MAIN fuse receptacle contains the power line fuse and the COLLECTOR fuse receptacle contains the collector supply fuse.

**TEST FIXTURE UNIT AND  
PATCH PANEL CONNECTORS**

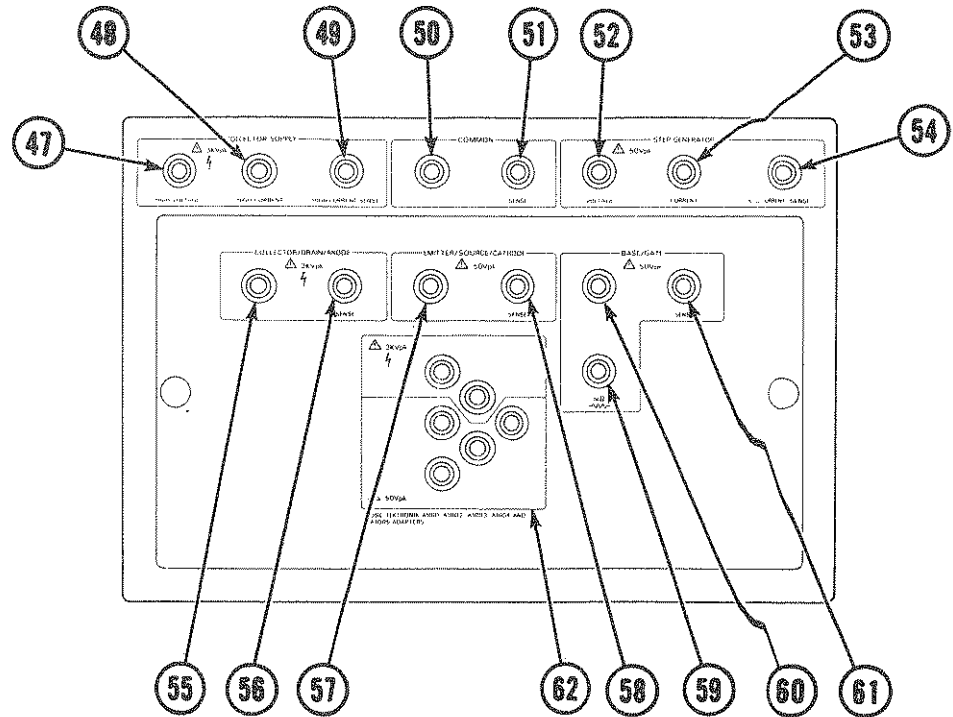

Figure 2-3. The Test Fixture Unit and Patch Panel connectors.



**47** COLLECTOR SUPPLY HIGH VOLTAGE

The COLLECTOR SUPPLY HIGH VOLTAGE connector is the Collector Supply output in High Voltage mode (when the PEAK POWER WATTS setting is 3 W or 30 W).

A rectified sine wave with a maximum amplitude of 3 kV is available at this connector.

**48** COLLECTOR SUPPLY HIGH CURRENT

The COLLECTOR SUPPLY HIGH CURRENT connector is the Collector Supply output in High Current mode (when the PEAK POWER WATTS setting is 300 W or 3 kW).

A voltage pulse with a maximum amplitude of 30 V and a width of 250  $\mu$ s is available at this connector.

**49** COLLECTOR SUPPLY HIGH CURRENT SENSE

The COLLECTOR SUPPLY HIGH CURRENT sense connector is the collector voltage kelvin sense connector in High Current mode (when the PEAK POWER WATTS setting is 300 W or 3 kW).

**50** COMMON

The COMMON connector is the signal common for the COLLECTOR SUPPLY and STEP GENERATOR outputs.

**51** COMMON SENSE

The COMMON SENSE connector is used as the common for kelvin sensing.

**52** STEP GENERATOR VOLTAGE

The STEP GENERATOR VOLTAGE connector is the output for the Step Generator signal in Voltage Source mode.

The maximum output voltage at this connector is 50 V.

**53** STEP GENERATOR CURRENT

The STEP GENERATOR CURRENT connector is the output for the Step Generator signal in Current Source mode.

The output can either be a pulse with a maximum amplitude of 10 A, offset of 10 A, and width of 500  $\mu$ s, or a staircase signal with a maximum amplitude of 10 mA and offset of 10 mA. Which of these two outputs is available depends on whether the Collector Supply is in High Voltage or High Current mode.

**54** STEP GENERATOR CURRENT SENSE

The STEP GENERATOR CURRENT SENSE connector is the kelvin sense input for base voltage ( $V_{BE}$ ) measurements in Current Source mode.

**55** COLLECTOR/DRAIN/ANODE

The COLLECTOR/DRAIN/ANODE connector is connected internally to the Collector (or equivalent) terminal of the Test Adaptor Connector.

**56** COLLECTOR/DRAIN/ANODE SENSE

The COLLECTOR/DRAIN/ANODE connector is connected internally to the Collector Sense terminal of the Test Adaptor Connector.

**57** EMITTER/SOURCE/CATHODE

The EMITTER/SOURCE/CATHODE connector is connected internally to the Emitter (or equivalent) terminal of the Test Adaptor Connector.

**58** EMITTER/SOURCE/CATHODE SENSE

The EMITTER/SOURCE/CATHODE connector is connected internally to the Emitter Sense terminal of the Test Adaptor Connector.

**59** BASE/GATE 1 k $\Omega$

The BASE/GATE 1 k $\Omega$  connector is connected internally through a 1 k $\Omega$  resistor to the Base terminal of the Test Adaptor Connector.

**60** BASE/GATE

The BASE/GATE connector is connected internally to the Base terminal of the Test Adaptor Connector.

**61 BASE/GATE SENSE**

The BASE/GATE SENSE connector is connected internally to the Base Sense terminal of the Test Adaptor Connector.

**62 Test Adapter Connector**

The Test Adaptors plug into the Test Adaptor Connector.

Revised DEC 1987

## READOUT

The display graticule and readout areas, with their titles (VERT/DIV, HORIZ/DIV, etc.), are etched into the 371's CRT faceplate. The illumination (brightness) of these markings is adjusted with the front-panel GRAT ILLUM control.

Figure 2-4 shows the readout areas on the CRT. The information given in each area is described on the following pages.

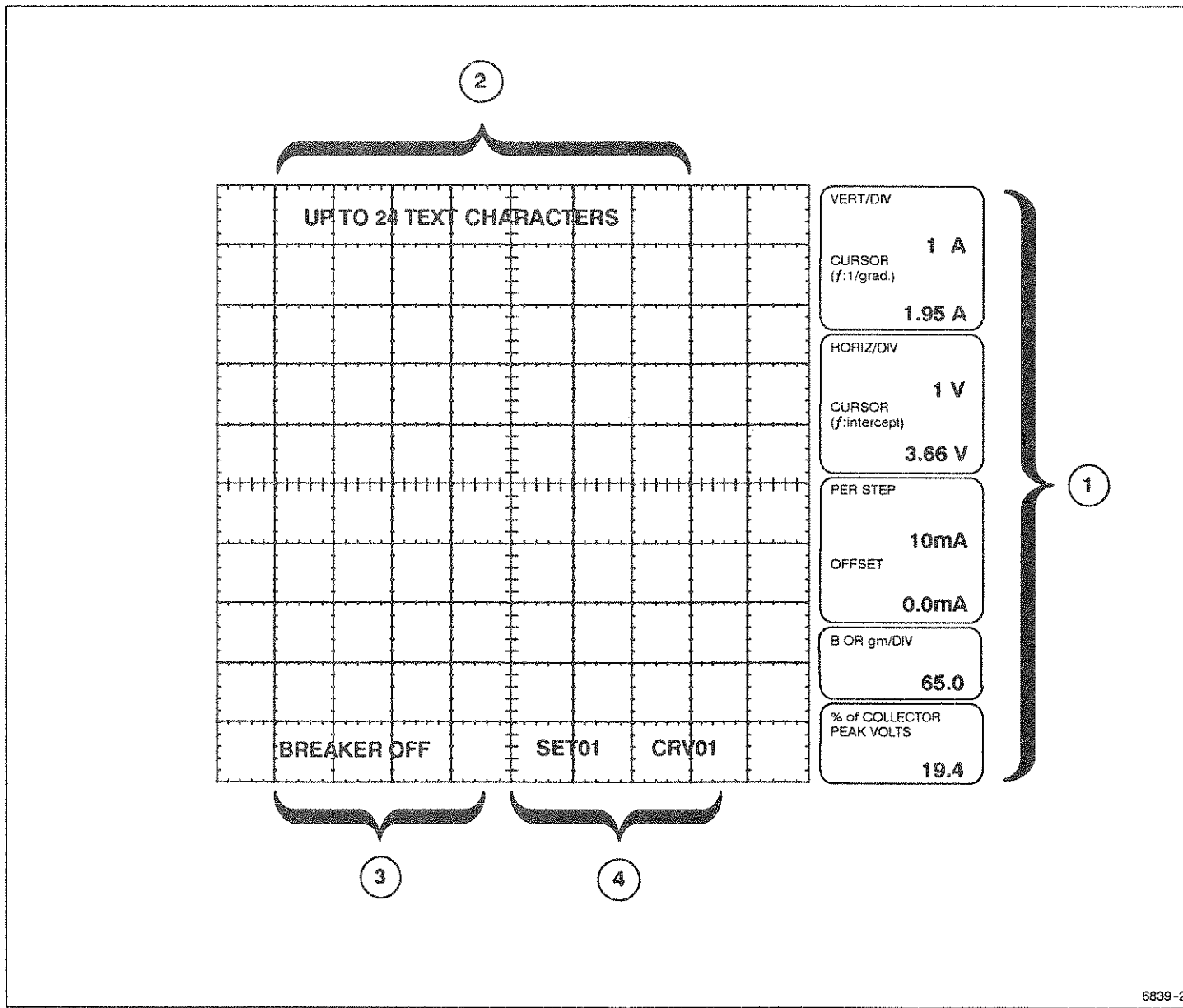

Figure 2-4. The display areas of the 371 CRT.

**1 Setup Area**

The Setup area of the display provides numeric readout under the titles VERT/DIV, HORIZ/DIV, PER STEP, OFFSET, CURSOR (vertical and horizontal coordinate values),  $\beta$  OR gm/DIV, and % OF COLLECTOR PEAK VOLTS.

In View mode, these values are read from bubble memory and displayed.

**2 Text Area**

The Text Area is located within the top graticule division of the display and is provided for user-entered text.

Messages of up to 24 characters in length can be entered for display in the text area. This text can also be stored along with the display in bubble memory.

The 371 recognizes the lower case "u" as the Greek letter " $\mu$ ."

**3 Error Message Area**

This area displays error messages such as "OPERATION ERROR," "I/O ERROR," and "EMERGENCY ERROR."

Error messages are cleared from the display by changing any front-panel setting.

④ Setup/Curve ID Area

The bubble memory location of the curve currently displayed is identified by pressing the VIEW or COMPARE buttons. This bubble memory index number is called the Curve ID.

The bubble memory location of the setup information for the currently displayed curve is identified on the display by pressing the RECALL button. This bubble memory index number is the Setup ID.

The Curve ID and Setup ID are removed from the display when a front-panel setting is changed. ■



## SECTION 3

---

# OPERATING INSTRUCTIONS

***This section:***

- *Provides an overview of 371 operation*
- *Contains detailed procedures to check the functionality of the 371 and to familiarize the first-time user with the controls and features*
- *Includes general operating instructions*
- *Demonstrates typical measurements with step-by-step examples*

## SECTION 3 CONTENTS

<b>Overview of Instrument Operation</b> .....	<b>3-5</b>
Collector Supply .....	3-5
Step Generator .....	3-5
Detector Amplifier .....	3-5
<b>First-Time Operation</b> .....	<b>3-7</b>
Powering Up the 371 .....	3-8
CRT Controls .....	3-12
Positioning the Display .....	3-13
Making Connections on the Test Fixture Unit Patch Panel .....	3-14
Setting Vertical and Horizontal Sensitivity .....	3-16
Collector Supply High Current Mode .....	3-18
Collector Supply High Voltage Mode .....	3-22
Step Generator .....	3-25
Setting Up With a Test Adapter .....	3-25
Setting Up Without a Test Adapter .....	3-26
Making Transistor Measurements in Current Mode .....	3-27
Changing the Test Adapter Setup .....	3-30
Changing the Setup Without a Test Adapter .....	3-32
Making Power MOSFET Measurements in Voltage Mode .....	3-33
Measuring Power MOSFET Forward Admittance .....	3-36
Text Editing .....	3-39
Plotting Curves and the Bubble Memory Directory ...	3-41
Plotting Curves .....	3-41
Plotting a Bubble Memory Directory .....	3-42
Erasing the Bubble Memory Cassette .....	3-44

**SECTION 3 CONTENTS (cont.)**

<b>General Operation</b> .....	<b>3-45</b>
The Display .....	3-45
CRT .....	3-45
Readout .....	3-45
Setting Display Intensity .....	3-46
Setting Display Focus .....	3-47
The Digital Storage and Bubble Memory System ....	3-47
Bubble Memory .....	3-47
Handling of Bubble Memory Cassettes .....	3-48
Saving in Store and View Mode .....	3-48
Saving Data in Sweep Mode .....	3-48
Display and Measurement in Compare Mode ....	3-49
Saving and Recalling Front-Panel Settings .....	3-49
Non Store Mode .....	3-50
Cursors .....	3-50
Using the Window Cursor .....	3-50
Using the Dot Cursor .....	3-51
Using the <i>f</i> Line Cursor .....	3-51
Text Editing .....	3-52
Entering Text Edit Mode .....	3-52
Entering and Editing Text .....	3-52
Erasing Text and Exiting the Text Editor Without Changes .....	3-52
Saving Edited Text .....	3-53
Printing a Directory of Stored Text .....	3-53
Vertical Axis Measurement and Sensitivity .....	3-54
Horizontal Axis Measurement and Sensitivity .....	3-54
Measurement Modes .....	3-55
Repeat .....	3-55
Single .....	3-55
Sweep .....	3-55

## SECTION 3 CONTENTS (cont.)

The Step Generator .....	3-58
Selecting Voltage or Current Output .....	3-58
Selecting the Number of Steps .....	3-58
Setting Step Amplitude .....	3-58
Setting Offset .....	3-59
Setting Polarity .....	3-59
The Collector Supply .....	3-60
Selecting Peak Power .....	3-60
Setting Polarity .....	3-61
Adjusting Looping Compensation .....	3-61
The Patch Panel and Test Fixture Unit .....	3-62
Kelvin Sensing .....	3-68
<b>Measurement Examples .....</b>	<b>3-69</b>
Measuring Breakdown Voltage .....	3-70
Measuring Common-Emitter Characteristics .....	3-73
Measuring Saturation Voltage .....	3-76
Measuring MOSFET Characteristics .....	3-78

## OVERVIEW OF INSTRUMENT OPERATION

The 371 High Power Curve Tracer is a microprocessor-controlled tester for measuring and displaying static characteristics of a variety of high-power semiconductor devices. A collector supply circuit and step generator apply voltage or current to the device under test, and a detector amplifier measures the resulting effect. Measurement results are displayed on a CRT as one or more characteristic curves.

### ■ Collector Supply

The Collector Supply provides a voltage signal with a positively or negatively rectified sine-squared wave, or a pulse waveform. Amplitude is controlled by the Collector Supply VARIABLE knob. This signal is applied to the collector (or equivalent terminal) of the device under test.

### ■ Step Generator

The Step Generator supplies one voltage or current step, or pulse, for each signal cycle from the collector supply. The amplitude of the voltage or current is set by the STEP/OFFSET AMPLITUDE knob and the number of steps by the NUMBER OF STEPS selection buttons. The signal from the Step Generator can be applied to the base or emitter (or an equivalent terminal) of the device under test.

### ■ Detector Amplifier

The Detector Amplifier is connected to the device under test to measure the effect of the application of signals from the Collector Supply and Step Generator. The measurement result is amplified and the voltage obtained is applied to the CRT deflection plates.

## 371 Operating Instructions Overview of Instrument Operation

Sensitivity of the amplifier is set by the VERTICAL CURRENT/DIV and HORIZONTAL VOLTS/DIV knobs.

Figure 3-1 is a block diagram showing how these circuits and the device under test are connected in a general measurement configuration.

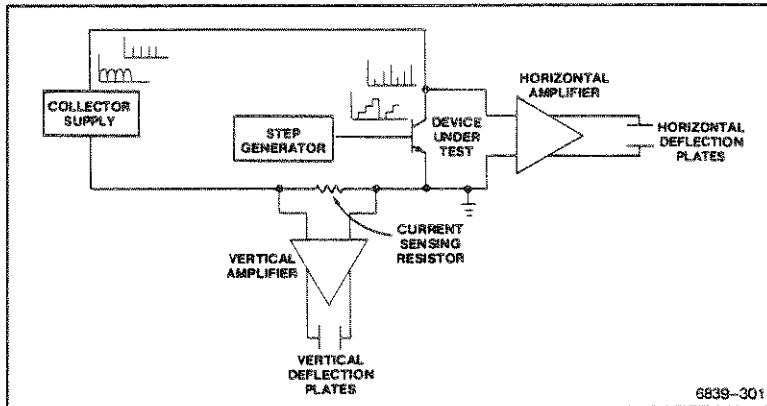

Figure 3-1. Basic 371 block diagram.

## FIRST-TIME OPERATION

The following procedures will familiarize the first-time user with the functions and use of the 371's front-panel controls, and will also provide practice in the display of characteristic curves for transistors and diodes.

These procedures can also be used to check the functionality of the 371. To verify that the 371 satisfies the specifications given in Section 1, refer a qualified service technician to the Performance Check and Adjustment procedure in the 371 Service manual.

### NOTE

*Several illustrations of displayed waveforms are provided in the following procedures. When attempting to duplicated the displays in the course of the procedure, remember that device characteristics differ and the displays depicted herein will likely be different than the ones on your 371 for your device under test.*

## ■ Powering Up the 371

*These steps demonstrate initialization of the front-panel settings and the storage of these settings in bubble memory for future use.*

### NOTE

*See the Installation instructions in Section 1 for power and Test Fixture Unit connections.*

1. Set the Collector Supply HIGH VOLTAGE and HIGH CURRENT breakers to the DISABLED position.
2. Set the 371 POWER switch to ON.

The 371 automatically begins performing a self-test routine. During this routine the front-panel indicators will light in the following sequence:

- (1) The Collector Supply POLARITY indicators light in sequence and the message "SELFTEST START" is displayed at the bottom of the graticule.
- (2) The Collector Supply PEAK POWER WATTS indicators light in sequence. The cycle is repeated four times.

The self test lasts less than ten seconds. If no error is detected, the message "SELFTEST PASS" is displayed and the 371 is set to its initial state. The settings in the initial state are listed in Table 3-1.



**371 Operating Instructions**  
**First-Time Operation**

**TABLE 3-1**  
**Initial State Settings of the 371**

<b>Control</b>	<b>Setting</b>
Measurement Mode	REPEAT
Memory Index	1
Display	
Mode	STORE
VERTICAL CURRENT/DIV	1 A
HORIZONTAL VOLTS/DIV	COLLECTOR ( $V_{CE}$ ), 1 V
INVERT	OFF
Cursor Mode	OFF
Collector Supply	
PEAK POWER WATTS	HIGH CURRENT 300 W
POLARITY	NPN
VARIABLE	0.0%
Step Generator	
SOURCE	CURRENT
AMPLITUDE	1 mA
INVERT	OFF
NUMBER OF STEPS	2
OFFSET	0.00 mA
STEP MULTI .1X	OFF
GPIB	SRQ ON

## 371 Operating Instructions First-Time Operation

---

### NOTE

*The CRT and LOOPING COMPENSATION controls are not initialized.*

3. Let the 371 warm up for several minutes.
4. Take a blank bubble memory cassette from its plastic case and write-enable it (see Figure 3-2).

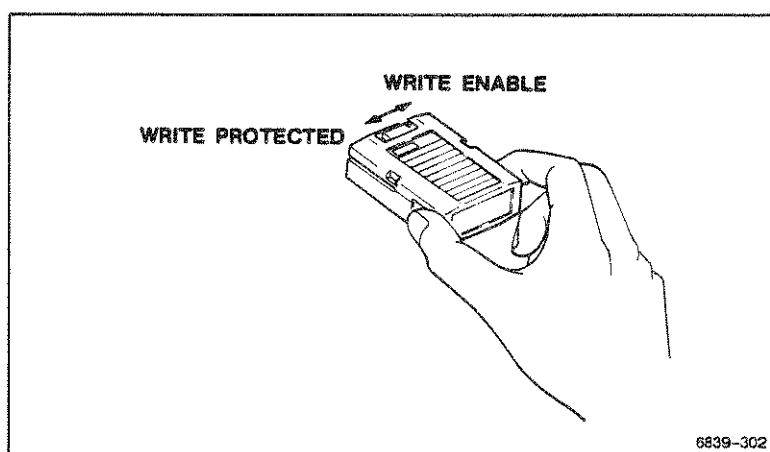
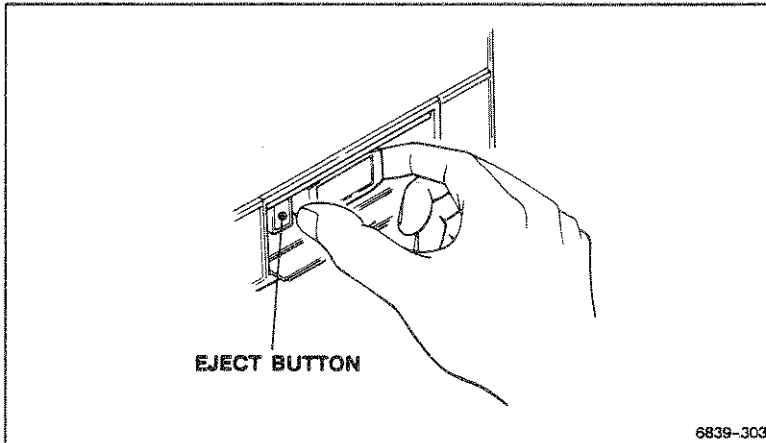

Figure 3-2. The bubble cassette write-protect key.

**371 Operating Instructions**  
**First-Time Operation**

---

5. Open the door of the bubble cassette compartment in the 371. Insert the cassette with the label side up (see Figure 3-3), pushing it in firmly until it clicks into place.



**Figure 3-3. Inserting a bubble cassette.**

6. Press the Setup SAVE button. Observe that "SAVE COMPLETE" is displayed on the screen.

*The 371's front-panel settings have now been stored in bubble memory location 1 and will be recalled for later use.*

*When the Setup SAVE button is pressed, the previous contents of the memory location are replaced by the new front-panel settings.*

## ■ CRT Controls

*These steps demonstrate adjustment of the display for optimum viewing.*

1. Rotate the NON STORE/STORE INTENSITY knob clockwise.

*A dot will be displayed in the lower left corner of the display graticule.*

2. Rotate the FOCUS knob fully counterclockwise and clockwise, then adjust it for optimum dot focus.

3. Rotate the READOUT/CURSOR INTENSITY knob clockwise.

*The readout display will gradually brighten.*

4. Set this knob to the position that provides the easiest to read display.

5. The readout display indicates the following initial values:

VERT/DIV .....	1 A
HORIZ/DIV .....	1 $\mu$ V
PER STEP .....	1 mA
OFFSET .....	0.00 mA
$\beta$ OR gm/DIV .....	1 k
% OF COLLECTOR PEAK VOLTS .....	0.0

6. Rotate the GRAT ILLUM knob clockwise.

*The graticule lines and readout labels on the screen will gradually brighten.*

7. Set the GRAT ILLUM knob to the position that provides most comfortable viewing.

## ■ Positioning the Display

*These steps demonstrate the use of the CAL ZERO and CAL FULL features for display calibration, and the use of the Display Invert mode.*

1. Press the VIEW button while holding down the Cursor SHIFT button. This changes the VIEW button function to CAL ZERO.
2. Rotate the vertical POSITION control to align the displayed dot with the bottom graticule line.
3. Rotate the horizontal POSITION control to align the displayed dot with the left graticule border.
4. Press the STORE button while holding down the Cursor SHIFT button. This changes the STORE button function to CAL FULL.
5. Observe that the dot is displayed at the upper right corner of the display graticule.
6. Press the COMPARE button while holding down the Cursor SHIFT button. This changes the COMPARE button function to CAL OFF.
7. Press the Display INVERT button.
8. Observe that the dot is displayed in the upper right corner of the display graticule.
9. Press the Display INVERT button again to resume normal operation.

## ■ Making Connections on the Test Fixture Unit Patch Panel

*The steps in this procedure contain setup instructions which will be used in the following procedure. These setup instructions demonstrate use of the Patch Panel and Test Adapters.*

*If the optional A1005 Axial Lead Test Adapter is not available, this procedure provides instructions for an alternate setup.*

1. Open the protective cover on the Test Fixture Unit and attach an A1005 Axial Lead Test Adapter (optional accessory) into the Test Adapter connector.
2. Attach a resistor with a rating of 1  $\Omega$  and at least 4 W to the A1005 Axial Lead Test Adapter on the Patch Panel.

### NOTE

*If an A1005 Test Adapter is not available or a resistor cannot be attached, remove the Patch Panel (to provide additional space in the enclosure) and use alligator patch cords instead.*

*For details about the Patch Panel, see the discussion under The Patch Panel and Test Fixture Unit later in this section.*

*Connect the COLLECTOR SUPPLY HIGH CURRENT and COLLECTOR SUPPLY HIGH CURRENT SENSE to one end of the resistor, and the COMMON and COMMON SENSE to the remaining end of the resistor.*

3. Connect the patch cords between connectors on the Test Fixture Patch Panel as follows:
  - COLLECTOR SUPPLY HIGH CURRENT to COLLECTOR/DRAIN/ANODE
  - COLLECTOR SUPPLY HIGH CURRENT SENSE to COLLECTOR/DRAIN/ANODE SENSE
  - COMMON to EMITTER/SOURCE/CATHODE COMMON
  - COMMON SENSE to EMITTER/SOURCE/CATHODE SENSE
  
4. Close the protective cover on the Test Fixture Unit.

### ■ Setting Vertical and Horizontal Sensitivity

*These steps demonstrate the purpose and operation of the vertical and horizontal sensitivity controls. They use the setup made in the preceding procedure.*

1. Set the Collector Supply HIGH CURRENT breaker to the ENABLED position.
2. Slowly rotate the Collector Supply VARIABLE knob clockwise.
3. Observe that the dot on the screen moves along a diagonal line from the bottom left corner to the top right corner of the display graticule.
4. Rotate the Collector Supply VARIABLE knob counterclockwise to move the dot to the center of the display.

*With the present setup, the display center is at 5 A vertical and 5 V horizontal.*

5. Rotate the VERTICAL CURRENT/DIV knob clockwise, increasing vertical sensitivity.
6. Observe that the dot moves upward.
7. Rotate the VERTICAL CURRENT/DIV knob counterclockwise until the sensitivity is set to 5 A/DIV.
8. Observe that the dot moves downward.
9. Return the VERTICAL CURRENT/DIV knob to the 1 A/DIV setting.
10. Rotate the HORIZONTAL VOLTS/DIV knob clockwise, increasing horizontal sensitivity.



11. Observe that the dot moves to the right.
12. Turn the HORIZONTAL VOLTS/DIV knob counterclockwise until the sensitivity is set to 5 V/DIV.
13. Observe that the dot moves to the left.
14. Return the HORIZONTAL VOLTS/DIV knob to the 1 V/DIV setting.
15. Press the Display INVERT button.
16. Observe that the red INVERT indicator is lit and that the dot moves to the upper right corner of the display graticule.
17. Rotate the Collector Supply VARIABLE knob clockwise.
18. Observe that the dot moves toward the lower left when the knob is turned clockwise and toward the upper right when the knob is turned counterclockwise.

*The origin of the graticule is now in the upper right corner and the direction of dot movement is the inverse of normal.*

## ■ Collector Supply High Current Mode

*These steps demonstrate the use of the Dot and f Line cursors to measure the forward resistance characteristics of a diode.*

1. Observe that the Memory Index is set to 1, then press the Setup RECALL button.

*This initializes the 371 settings by reading the settings stored previously in memory location 1. Initialization prevents settings associated with previous measurements from interfering with the present measurement.*

2. Rotate the Collector Supply VARIABLE knob to move the dot to the approximate center of the screen.
3. Press the Collector Supply PEAK POWER WATTS button to select 3 kW.
4. Observe that the dot moves toward the upper right as compared to its previous position for the 300 W (default) setting.
5. Set the Collector Supply HIGH CURRENT breaker to the DISABLED position, then open the protective cover.
6. Remove the 1  $\Omega$  resistor from the Test Adapter and attach a diode with a rating of at least 1 A.
7. Connect the anode lead of the diode to the COLLECTOR connector.
8. Close the protective cover.
9. Observe that the Memory Index is set to 1, then press the Setup RECALL button to initialize the 371.

**371 Operating Instructions**  
**First-Time Operation**

---

10. Set the 371 controls as follows:

VERTICAL CURRENT/DIV and  
HORIZONTAL VOLTS/DIV . . . . . To appropriate values  
(depending on the forward  
current and forward voltage  
rating of the diode).  
STEP GENERATOR . . . . . Disabled

*The Step Generator is disabled by pressing the STEP MULTI  
.1X button while holding down the Cursor SHIFT button.  
(This changes the STEP MULTI .1X button function to  
DISABLE.)*

11. Set the Collector Supply HIGH CURRENT breaker to the  
ENABLED position.

12. Rotate the Collector Supply VARIABLE knob slowly  
clockwise.

*The dot will trace the forward characteristic of the diode.*

### 371 Operating Instructions First-Time Operation

13. Set the Collector Supply VARIABLE knob so that forward current flows through the diode, then press the Measurement SWEEP button.

*The previously-set Collector Supply voltage is reduced to 0%, resulting in a series of dots representing the forward characteristic of the diode (see Figure 3-4).*

14. Use the Cursor selection buttons (↔ or ↔) to select the DOT cursor.

*A high-intensity dot will be displayed on the characteristic curve. If the dot does not appear, adjust the NON STORE/STORE intensity control.*

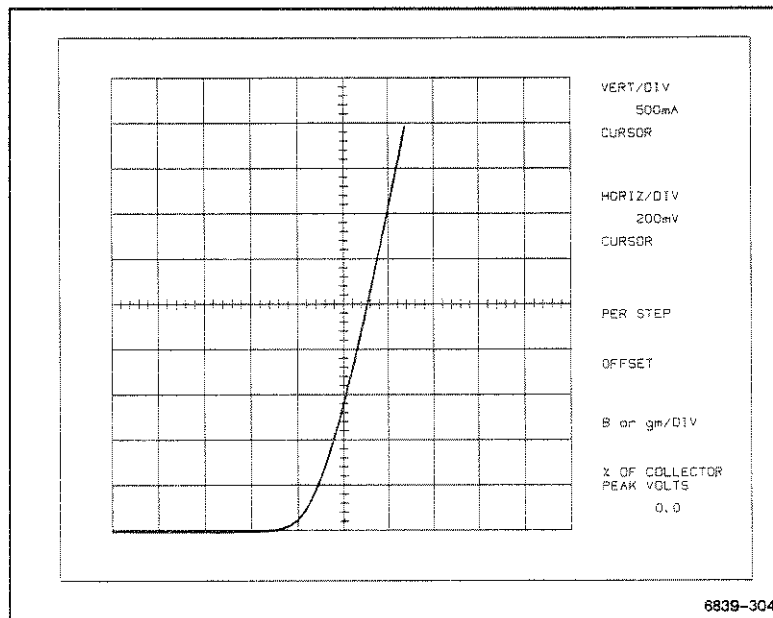

Figure 3-4. Sweep mode display of the forward characteristics of a diode.

371 Operating Instructions  
First-Time Operation

---

15. Use the Cursor position buttons (←, →, ↑, and ↓) to move the dot cursor into the on-state region.
16. Use the Cursor selection buttons (↔ or ↔) to select the *f* LINE cursor.

*If the *f* Line cursor does not appear, adjust the READOUT/CURSOR INTENSITY control.*

17. Use the Cursor position (←, →, ↑, and ↓) buttons to change the slope of the *f* line cursor until it is tangent to the curve.

*The CURSOR (*f*:1/grad) readout indicates the on-state resistance of the diode.*

## 371 Operating Instructions First-Time Operation

10. Rotate the Collector Supply VARIABLE knob farther clockwise to make breakdown current flow.
11. Use the Cursor selection buttons (↔ or ⇄) to select the DOT cursor, and use the Cursor position buttons (←, →, ↓, and ↑) to move the cursor to the desired breakdown current level.

*The vertical CURSOR readout gives the current level and the horizontal CURSOR readout gives the breakdown voltage (see Figure 3-5).*

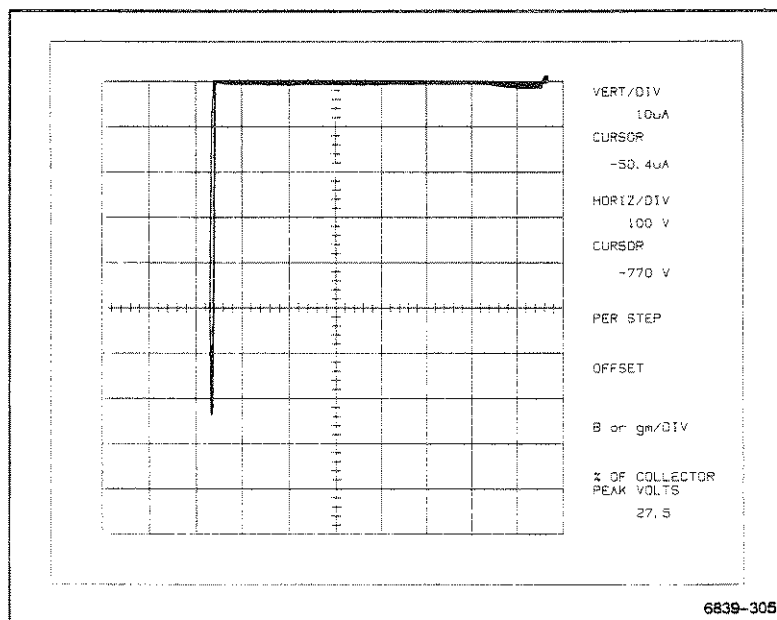

**Figure 3-5. Diode breakdown voltage and current level.**

## ■ Step Generator

*These steps demonstrate the Step Generator modes and how they are used to measure transistor characteristics, as well as how to store data and use the Display modes.*

*Two setups are provided: one requires the use of a Test Adapter and the other requires alligator patch cords.*

### Setting Up With a Test Adapter

1. Obtain a high-power bipolar transistor.
2. Set the Collector Supply HIGH VOLTAGE breaker to the DISABLED position, then open the protective cover.
3. Disconnect the patch cord from the COLLECTOR SUPPLY HIGH VOLTAGE connector and connect it to the COLLECTOR SUPPLY HIGH CURRENT connector.
4. Connect the connectors on the Patch Panel with patch cords as follows:
  - COLLECTOR SUPPLY HIGH CURRENT SENSE to COLLECTOR/DRAIN/ANODE SENSE
  - COMMON SENSE to EMITTER/SOURCE/CATHODE SENSE
  - STEP GENERATOR CURRENT to BASE/GATE
  - STEP GENERATOR CURRENT SENSE to BASE/GATE SENSE
  - COMMON to EMITTER/SOURCE/CATHODE
5. Select the A1002 or A1003 Test Adapter (standard accessory), whichever is suitable for the type of transistor used, and plug it into the Test Adapter connector on the Test Fixture Patch Panel.
6. Insert the transistor into the Test Adapter.

**NOTE**

*If the transistor shape or size does not fit the Test Adapter, remove the Patch Panel to provide more space in the enclosure and perform the instructions for Setting Up Without a Test Adapter.*

**Setting Up Without a Test Adapter**

1. Obtain a high-power bipolar transistor.
2. Using two red alligator patch cords, connect the plug end of one cord to the COLLECTOR SUPPLY HIGH CURRENT connector, and the plug end of the other cord to the COLLECTOR SUPPLY HIGH CURRENT SENSE connector.
3. Connect the alligator ends of both red patch cords to the collector lead of the transistor.
4. Using two black alligator patch cords, connect the plug end of one cord to the COMMON connector and the plug end of the other cord to the COMMON SENSE connector.
5. Connect the alligator ends of both black patch cords to the emitter lead of the transistor.
6. Using two blue alligator patch cords, connect the plug end of one cord to the STEP GENERATOR CURRENT connector and the plug end of the other cord to the STEP GENERATOR CURRENT SENSE connector.
7. Connect the alligator ends of both blue patch cords to the base lead of the transistor.



8. Close the protective cover and check the location of the transistor leads to assure that no short circuits exist to other leads or the inside of the Test Fixture Unit.

### Making Transistor Measurements In Current Mode

*These steps use either of the preceding two setups.*

1. Observe that the Memory Index is set to 1, then press the Setup RECALL button.

*This initializes the 371 settings by reading the settings stored previously in memory location 1. Initialization prevents settings associated with previous measurements from interfering with the present measurement.*

2. Set the 371 controls as follows:

Collector Supply  
POLARITY ..... NPN+ or PNP- (depending  
on the transistor type)  
VERTICAL CURRENT/DIV ..... About 1/10 of the rated  
collector (pulse) current  
Step Generator  
NUMBER OF STEPS ..... 1

3. Observe that the % OF MAX PEAK VOLTS readout is 0, then set the Collector Supply HIGH CURRENT breaker to the ENABLED position.
4. Rotate the Collector Supply VARIABLE knob slowly clockwise until the lowest dot intercepts the horizontal axis at about ten divisions.
5. Rotate the STEP/OFFSET AMPLITUDE knob until the dots are separated by about 1 or 2 divisions.
6. Press the NUMBER OF STEPS  button four times.

### 371 Operating Instructions

#### First-Time Operation

---

7. Observe that the number of dots displayed increases each time the button is pressed.
8. Press the STEP MULTI .1X button and observe that the collector current decreases as the step amplitude is reduced to one-tenth of its previous setting.
9. Press the STEP MULTI .1X button again to resume normal operation.
10. Press the Measurement SWEEP button.

*In about fifteen seconds the collector current vs. collector-emitter voltage characteristic will be displayed (see Figure 3-6).*

11. Change the Memory Index to 2, then press the Display ENTER button.
12. Observe that "ENTER COMPLETE" is displayed on the screen.

*The characteristic curve on the screen is now stored in bubble memory location 2.*

13. Use the Cursor selection buttons (↔, ⇄) to select the □ Window cursor.
14. Use the Cursor position buttons (↔, ⇄, ↕, ⤴) to position the bright dot, in the lower left corner of the cursor window, at any point on the characteristic curve.
15. Use the Cursor selection buttons (↔, ⇄) to select the □ Window cursor.
16. Press the ⤴ Cursor position button to narrow the Cursor window into a straight vertical line.

371 Operating Instructions  
First-Time Operation

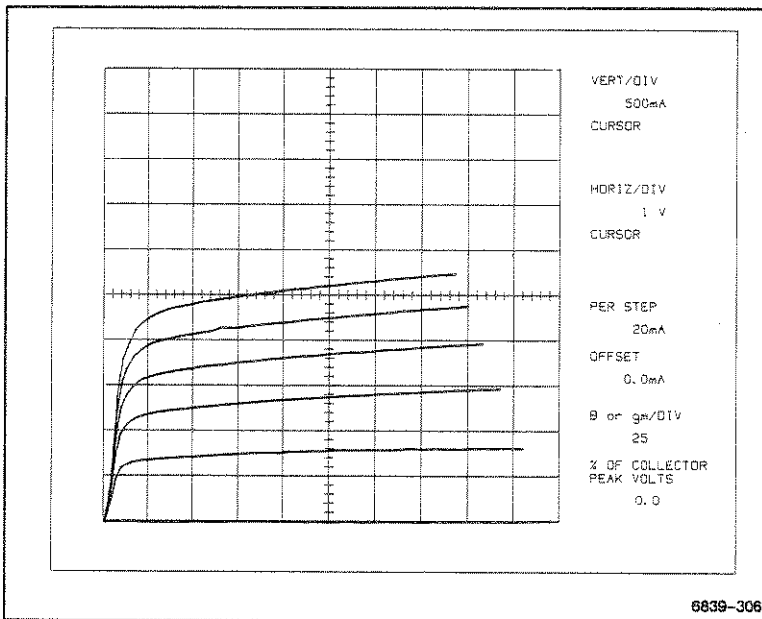

Figure 3-6. Display Sweep mode characteristic curves when the Collector Supply is in High Current mode.

- Use the  $\leftarrow$  or  $\rightarrow$  Cursor position buttons to position the cursor's bright dot on an adjacent characteristic curve (see Figure 3-7).

*The figure now displayed in the  $\beta$  OR gm/DIV readout is the  $H_{FE}$  of the device under test.*

- Change the following 371 settings:

Cursor  
Mode ..... OFF  
HORIZONTAL VOLTS/DIV ..... 100 mV STEP GEN

- Rotate the Collector Supply VARIABLE control until a collector current vs. base-emitter voltage characteristic curve is displayed by dots.

## 371 Operating Instructions First-Time Operation

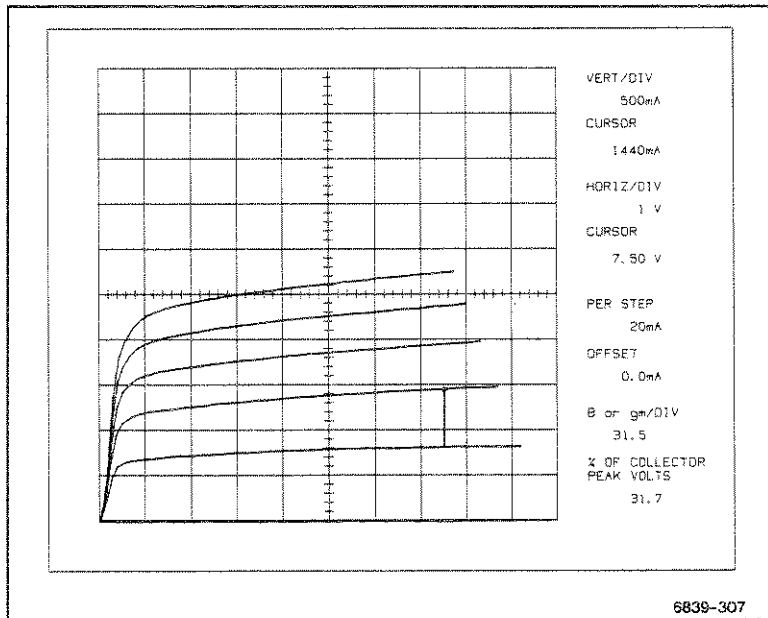

Figure 3-7. Measuring Hfe with the Window cursor.

20. Press the Measurement SWEEP button.

*The 371 will display a characteristic curve of collector current vs. base-emitter voltage (see Figure 3-8).*

### Changing the Test Adapter Setup

*If the Patch Panel was removed and alligator patch cords used earlier, use the instructions, Changing The Setup Without A Test Adapter, which follow these instructions.*

1. Obtain an N-channel enhancement-type power MOSFET.

## 371 Operating Instructions First-Time Operation

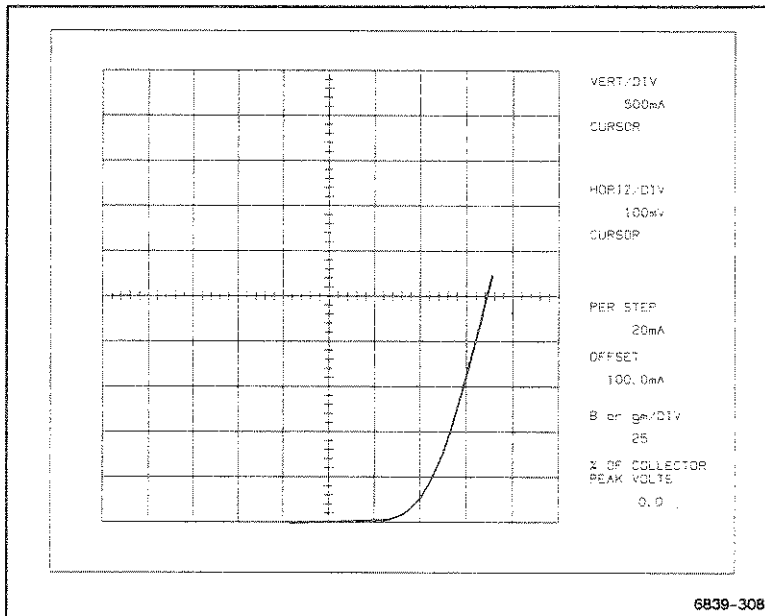

**Figure 3-8. Collector current vs. base-emitter voltage characteristic curve for a bipolar transistor.**

2. Set the Collector Supply HIGH CURRENT breaker to the DISABLED position, then open the protective cover.
3. Remove the patch cord between the STEP GENERATOR CURRENT SENSE and BASE/GATE SENSE connectors.
4. Remove the patch cord between the STEP GENERATOR CURRENT and BASE/GATE connectors, and connect it between the STEP GENERATOR VOLTAGE and BASE/GATE 1 k $\Omega$  connectors.
5. Remove the bipolar transistor and mount the MOSFET in its place.

**Changing the Setup Without a Test Adapter**

1. Obtain an N-channel enhancement-type power MOSFET.
2. Attach the two red alligator patch cords (previously connected to the collector lead of the transistor) to the drain lead of the MOSFET.
3. Attach the two black alligator patch cords (previously connected to the emitter lead of the transistor) to the source lead of the MOSFET.
4. Remove the two alligator patch cords that were connected to the base lead of the transistor.
5. Connect an alligator patch cord between the STEP GENERATOR VOLTAGE connector and the gate lead of the MOSFET.

**Making Power MOSFET Measurements in Voltage Mode**

*These steps use either of the two preceding setup procedures.*

1. Making sure that the Memory Index is set to 1, press the Setup RECALL button to initialize the 371.

2. Set the 371 controls as follows:

Collector Supply

PEAK POWER WATTS . . . 3 kW or 300 W (depending on  
the MOSFET power rating)

Step Generator

SOURCE . . . . . VOLTAGE  
NUMBER OF STEPS . . . . . 0  
STEP MULTI .1X . . . . . On  
STEP/OFFSET AMPLITUDE . . . . . 500 mV  
(with STEP MULTI .1X on)

VERTICAL CURRENT/DIV . . . . About 1/10 of the rated drain  
(pulse) current

HORIZONTAL VOLTS/DIV . . . . . 2 V COLLECTOR

3. Use the Cursor Selection buttons (↔ or ⇄) to select the DOT cursor.
4. Making sure that the % OF MAX PEAK VOLTS readout is 0, set the Collector Supply HIGH CURRENT breaker to the ENABLED position.
5. Rotate the Collector Supply VARIABLE knob slowly clockwise and move the displayed dot about ten divisions to the right.
6. Press the OFFSET ⇄ button until there is a change in the vertical CURSOR readout, indicating the onset of drain current flow.
7. Press the NUMBER OF STEPS ⇄ button five times.

## 371 Operating Instructions

### First-Time Operation

- Observe that the number of dots displayed increases each time the button is pressed.
- Press the Measurement SWEEP button.

*In about fifteen seconds the drain current vs. drain source voltage characteristic will be displayed (see Figure 3-9).*

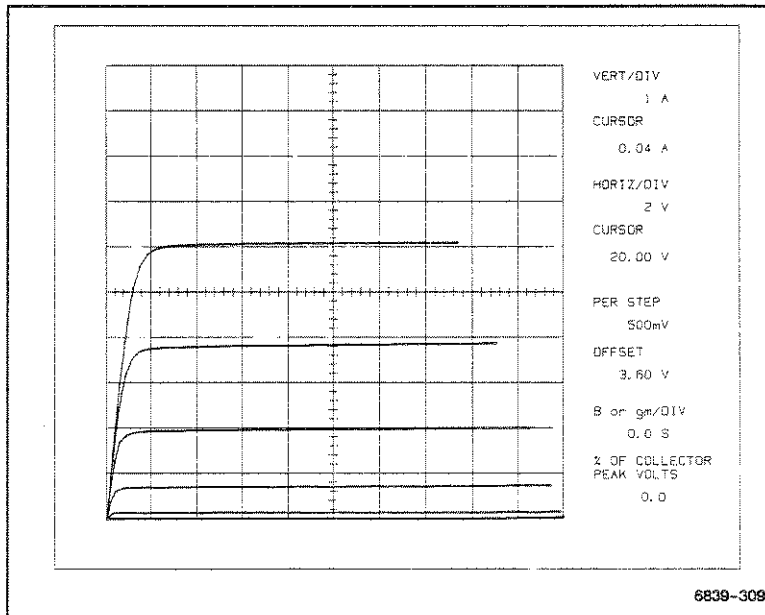

**Figure 3-9. Drain current vs. drain source voltage characteristics for a Power MOSFET.**

- Change the bubble Memory Index setting to 3, then press the Display ENTER button to store the display for later use.
- Press the Display COMPARE button.
- Use the Step Generator OFFSET  $\blacktriangleleft$  button to increase the OFFSET readout value by 250 mV.



371 Operating Instructions  
First-Time Operation

13. Press the Measurement SWEEP button.
14. Increase the Collector Supply VARIABLE setting until the drain current vs. drain-source voltage characteristic curve is displayed (see Figure 3-10).

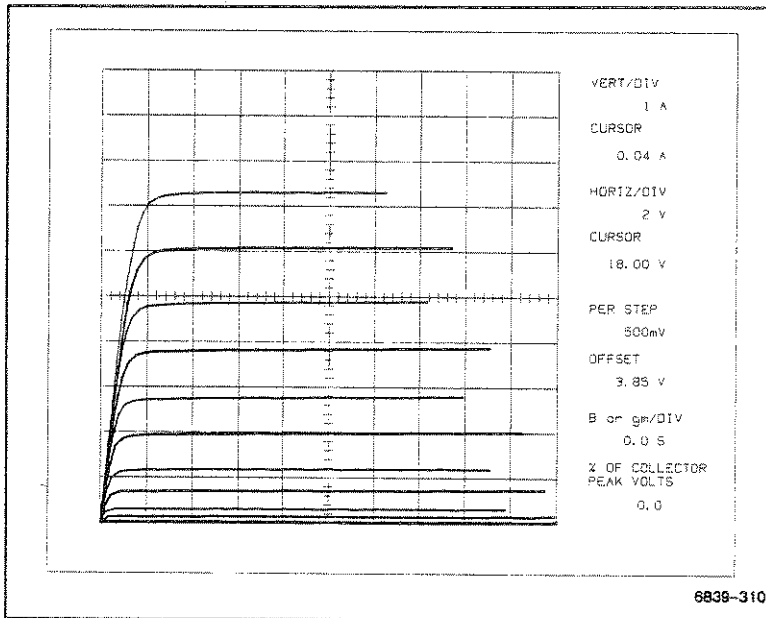

Figure 3-10. Compare mode display of drain current vs. drain-source voltage characteristics.

**Measuring Power MOSFET Forward Admittance**

*These steps use the same patch cord and Patch Panel setup as the previous procedure.*

1. Set the Memory Index to 1, then press the Setup RECALL button to initialize the front-panel settings.

2. Change the following 371 settings:

Collector Supply  
PEAK POWER WATTS ... 3 kW or 300 W (depending on  
the MOSFET power rating)  
HIGH CURRENT Breaker ..... ENABLED  
Step Generator  
SOURCE ..... VOLTAGE  
NUMBER OF STEPS ..... 0  
STEP/OFFSET  
AMPLITUDE ..... 2 V  
VERTICAL CURRENT/DIV .... About 1/10 of the rated drain  
(pulse) current

3. Select the DOT cursor with the Cursor selection buttons.
4. Watching the vertical CURSOR readout, turn the Collector Supply VARIABLE knob and press the Step Generator OFFSET button in turn until the drain-source voltage and drain current attain the forward transfer admittance measurement condition values. If necessary, adjust the VERTICAL CURRENT/DIV and HORIZONTAL VOLTS/DIV controls to change the display sensitivity.
5. Set the HORIZONTAL VOLTS/DIV control to the STEP GEN ( $V_{gs}$ ) range.
6. Press the OFFSET  $\leftarrow$  button to increase the gate-source voltage.
7. Press the Measurement SWEEP button.

### 371 Operating Instructions First-Time Operation

The offset signal automatically sweeps to trace the drain current vs. gate-source voltage characteristic curve (see Figure 3-11).

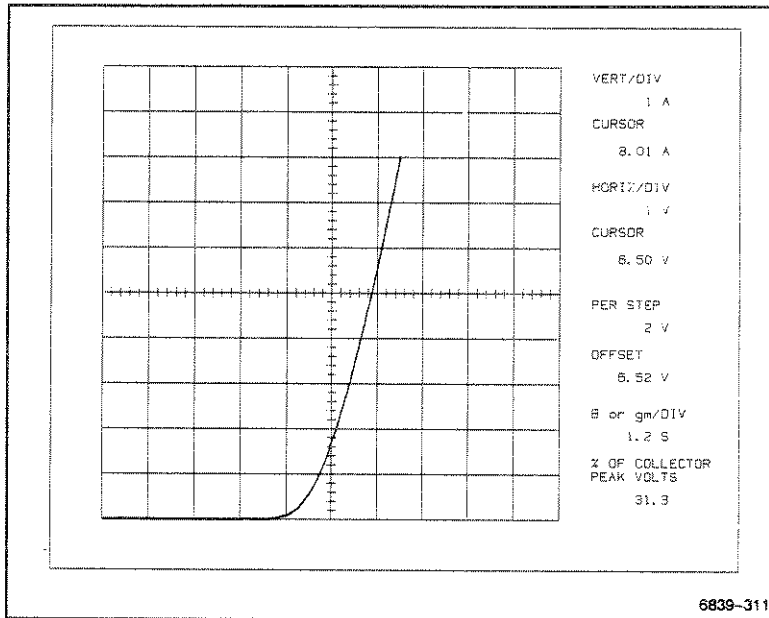

Figure 3-11. Forward transfer curve,  $I_D = 8$  A.

8. Use the Cursor position buttons ( $\leftarrow$ ,  $\rightarrow$ ,  $\uparrow$ ,  $\downarrow$ ) to move the Dot cursor until the drain current readout attains the forward transfer admittance measurement condition value.
9. Use the Cursor Selection buttons ( $\leftarrow$ ,  $\rightarrow$ ) to select the  $f$  LINE cursor.
10. Press the Cursor position buttons ( $\leftarrow$ ,  $\rightarrow$ ,  $\uparrow$ ,  $\downarrow$ ) to adjust the slope of the  $f$  Line cursor until it is tangent to the curve (see Figure 3-12).

371 Operating Instructions  
First-Time Operation

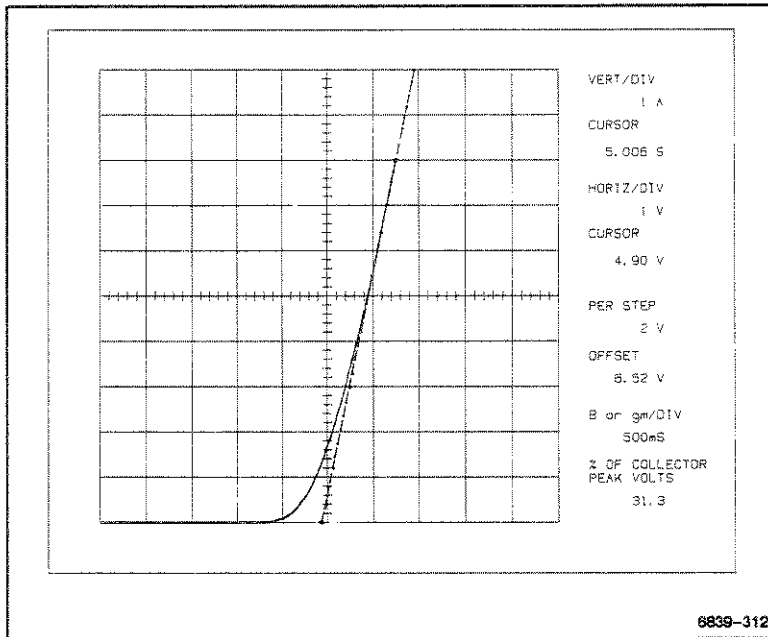

Figure 3-12. Using the  $f$  line cursor to measure forward transfer admittance. In this example,  $g_{fs} = 5.006 \text{ S}$ .

11. The CURSOR ( $f:1/\text{grad}$ ) readout indicates the forward transfer admittance.

## ■ Text Editing

*These steps demonstrate how text is entered and saved in the 371. User-entered text is useful for identification of displays which will be stored in a bubble memory cassette for later use.*

1. Press the ENTER button while holding down the Cursor SHIFT button. This changes the function of the ENTER button to TEXT.

*The message "TEXT EDIT MODE" is displayed at the bottom of the display and the text edit cursor is displayed as a box at the top of the display.*

2. Rotate the VERTICAL CURRENT/DIV knob clockwise and observe that characters are displayed at the cursor position in the following sequence:

space, A, B . . . Z, space, m,  $\mu$ , n, p, ., 0, 1 . . . 9, -, /, \*, (, )

*Once displayed, characters remain in place until written over or erased.*

3. Rotate the HORIZONTAL VOLTS/DIV knob clockwise and counterclockwise, and observe that the cursor moves without altering the display.
4. Use the HORIZONTAL VOLTS/DIV and VERTICAL CURRENT/DIV knobs to enter any desired text, consisting of up to 24 characters.
5. Press the Display NON STORE button and observe that the previously-entered text is erased.
6. Enter another group of text.
7. Press the ENTER button, while holding down the Cursor SHIFT button, to exit the Text Edit mode.

## 371 Operating Instructions

### First-Time Operation

---

*The "TEXT EDIT MODE" message and the text cursor will disappear from the display. The text remains in place.*

8. Change the Memory Index number to 4 and press the Display ENTER button.

*The entered text and the displayed  $I_D$ - $V_{GS}$  characteristic curve are both stored in bubble memory.*

9. Change the Memory Index setting to 1 and press the Setup RECALL button to initialize the 371 settings.
10. Observe that the entered text is cleared from the display.
11. Change the Memory Index number back to 4, then press the Display VIEW button.
12. Observe that the  $I_D$ - $V_{GS}$  curve and previously stored text are displayed.
13. Set the Collector Supply HIGH CURRENT breaker to the DISABLED position, then open the protective cover and remove the MOSFET.

## ■ Plotting Curves and the Bubble Memory Directory

*These steps demonstrate the 371's ability to use a plotter to create a hard copy of its display or a directory of the bubble memory cassette.*

### Plotting Curves

1. Connect a HPGL-compatible plotter (with an input buffer of at least 8K) to the GPIB connector or PLOTTER INTERFACE PORT on the rear panel of the 371. Choose the connector that matches the plotter's interface.
2. Set the GPIB address switch on the rear panel of the 371 as follows, depending on which interface the plotter is connected to:

0 to 30 ..... PLOTTER INTERFACE PORT  
31 ..... GPIB Connector

3. Press the GPIB RESET TO LOCAL button while holding down the Cursor SHIFT button. This changes the RESET TO LOCAL button function to ADDR.

*This loads the selected GPIB address into the 371.*

4. The display can be plotted in two different modes:
  - **To plot the entire display:** Display a characteristic curve, then press the Plotter ALL button on the front panel.
  - **To plot the characteristic curve only:** Display a characteristic curve, then press the Plotter ALL button while holding down the Cursor SHIFT button. This

changes the ALL button function to CURVE.

*Plotter output will begin when the Plotter ALL button is pressed. If the Plotter ALL button is pressed again during data output via the GPIB interface, the output to the plotter will stop.*

*The BUSY indicator on the front panel is on during data output to the plotter.*

#### **Plotting a Bubble Memory Directory**

5. Press the Setup RECALL button while holding down the Cursor SHIFT button. This changes the RECALL button function to DIRECTORY.

*A directory of the text stored in each bubble memory location is produced by the plotter (see Figure 3-13). Space is provided on the directory plot for hand-written comments.*



### 371 Operating Instructions First-Time Operation

*** BUBBLE MEMORY CATALOG ***			NO.
TYPE	INDEX	TEXT	COMMENTS
CURVE	1	ICE (1R530)	
	2	ICE (M15N40)	
	3	IC (1R530)	
	4	VSD (H1211)	
	5	ICSE IC TO 100C	
	6	ICSE BREAKDOWN VOLTAGE	
	7	BUCEO 2N6258	
	8	EMPTY	
	9	EMPTY	
	10	EMPTY	
	11		
	12		
	13		
	14		
	15		
	16		
SET UP	1	INITIAL SETTING	
	2	2N271 BUCEO	
	3	2N6258 VSAT	
	4	TEMP	
	5	2N6258	
	6	1R530 BDS	
	7	EMPTY	
	8	EMPTY	
	9	EMPTY	
	10	EMPTY	
	11	EMPTY	
	12		
	13	EMPTY	
	14		
	15	EMPTY	
	16		

6839-313

**Figure 3-13. Sample bubble memory directory.**

## ■ Erasing the Bubble Memory Cassette



*The following operation ERASES ALL DATA stored in the bubble memory cassette, not just the data under the current index number. Do not perform this operation if there is any important data stored in the bubble memory cassette.*

1. Press the Setup SAVE button while holding down the Cursor SHIFT button. This changes the SAVE button function to ERASE.

*The message "PRESS ENTER" is displayed for about five seconds.*

*If the Display ENTER button is pressed during this interval, the bubble memory cassette is erased and the message "ERASE COMPLETE" is displayed.*

*If the Display ENTER button is not pressed, the erase function is canceled and the message "ERASE CANCELED" is displayed.*

## GENERAL OPERATION

This information describes the features of the 371 and how it performs measurements, stores data, and displays information. These descriptions are general in nature and do not contain detailed demonstrations. The previous portion of this section, *First-Time Operation*, contains procedures to demonstrate these principles in greater detail.

### ■The Display

The 371 display consists of the Cathode-Ray Tube (CRT) and its display areas, which are defined in some cases by readout labels etched on the CRT screen and in others by location within the graticule area.

#### CRT

The CRT of the 371 has graticule markings etched into its inner surface. This internal graticule provides a 10x10 grid, the brightness of which can be controlled by the front-panel GRAT ILLUM knob. A filter mounted on the CRT improves the contrast of the screen.

#### Readout

The readout area of the display (which also gives setup information) is divided into two parts: (1) the readout information itself, consisting of alphanumeric characters; and (2) the readout labels.

The alphanumeric readout information includes numbers and units, such as 5 mA and 2 V, which indicate the state of the front-panel settings. The readout labels define the meaning of

## 371 Operating Instructions

### General Operation

---

the readout information with words such as VERT/DIV and PER STEP etched into the CRT.

The READOUT CURSOR knob controls the intensity of the readout and the GRAT ILLUM knob controls the intensity of the labels. The READOUT CURSOR knob also controls the intensity of other information displayed on the screen, which may include text, error messages, setup IDs, and curve IDs. See *Readout*, in Section 2, for a detailed description of this information.

#### Setting Display Intensity

The intensity of characteristic curves displayed in Non Store or Store mode is controlled by the NON STORE/STORE INTENSITY knob. This knob should be set to the lowest intensity at which the curves can be clearly seen on the screen. Avoid high intensity settings, especially when a dot or spot is displayed on the screen.



*An extremely intense dot can burn the phosphor coating on the CRT screen, causing damage which cannot be repaired, except by replacement of the CRT.*

The intensity of characteristic curves displayed in View mode is controlled by the VIEW INTENSITY knob. The intensity of the cursor and readout information, except for the Dot cursor, is controlled by the READOUT CURSOR INTENSITY knob. The intensity of the DOT cursor is controlled by the NON STORE/STORE INTENSITY knob when in Store or Compare mode, and by the VIEW INTENSITY knob when in View mode.

### Setting Display Focus

CRT focus is adjusted for the sharpest display with the FOCUS knob

### ■The Digital Storage and Bubble Memory System

Characteristic curve data stored in the digital storage (Store) mode is displayed as a bright trace without flicker. The curve is stored in the main internal memory as digital data, then converted to an analog signal and displayed on the CRT. Digital storage mode can be selected by pressing the STORE button, and the intensity of the display is adjusted with the NON STORE/STORE INTENSITY knob.

### Bubble Memory

The 371 has a built-in bubble memory system that can store characteristic curve data, text, front-panel settings, and other information in a bubble memory cassette. A single cassette has a capacity of 128K bytes, enough to hold up to 16 characteristic curves and 16 sets of front-panel setup information. Data stored in bubble memory can be transferred to external devices via the GPIB interface. See Section 4 for more information about GPIB functions.

### NOTE

*Although a single bubble memory cassette can store data from both a 371 and a 370, the 371 cannot read 370 data and vice versa.*

### **Handling of Bubble Memory Cassettes**

Bubble memory cassettes are easy to handle and store, but the following precautions should be taken to protect the cassette and the integrity of the data stored within it.

- Always store bubble memory cassettes in their plastic case, which has been treated to prevent damage from static discharge.
- Do not drop the bubble memory cassette.
- Do not place a bubble memory cassette near a strong magnetic field, or near any strongly ferromagnetic material that can be easily magnetized. A strong magnetic field can destroy the magnetically-stored information in the cassette.

### **Saving in Store and View Mode**

In Store or View mode, pressing the ENTER button stores the characteristic curve, the displayed setting and readout values, and any displayed text in bubble memory. See *Setup Controls*, in Section 2, for a list of information that cannot be stored in bubble memory.

Information stored in bubble memory can be displayed by pressing the VIEW button. The intensity of a characteristic curve displayed from bubble memory is controlled with the VIEW INTENSITY knob.

Curves displayed from bubble memory cannot be inverted by pressing the Display INVERT button.

### **Saving Data in Sweep Mode**

While in Sweep mode, pressing the ENTER button stores all captured data in bubble memory. The stored data can be displayed by pressing the VIEW button.

### Display and Measurement in Compare Mode

Pressing the COMPARE button simultaneously displays the characteristic curve stored in main memory (the Store mode display) and the characteristic curve stored in bubble memory (the View mode display). Measurements in this mode are performed with respect to the characteristic curve stored in main memory (the Store mode, or "live," display); the curve stored in bubble memory is displayed only for comparison. (Changing front-panel settings in View mode removes the stored characteristic curves from the display; this does not happen in Compare mode.)

### Saving and Recalling Front-Panel Settings

Front-panel setting information and user-entered text is saved in bubble memory by pressing the SAVE button. Pressing the RECALL button resets front-panel settings according to the stored information.

Pressing the SAVE button in Sweep mode saves the Sweep mode settings in bubble memory. The initial value of the Collector Supply or Step Generator output is also stored.

All data stored in bubble memory is erased by pressing the Setup SAVE button while holding down the Cursor SHIFT button (changing the button function to ERASE), then pressing the ENTER button.



*Pressing the SAVE button while holding down the Cursor SHIFT button, then pressing the ENTER button, erases*

## 371 Operating Instructions

### General Operation

---

*all data stored in the cassette, not just the data under the current index number.*

*Data stored in any bubble memory location is written over when new data is stored to that location.*

### ■ Non Store Mode

The 371 also has a Non Store display mode. In this mode the characteristic curve data is not stored in main memory but displayed directly on the screen. This mode can be used to observe rapid variations in the waveform.

The intensity of the characteristic curve displayed in Non Store mode is controlled by the NON STORE/STORE INTENSITY knob.

### ■ Cursors

Cursors allow easy, precise measurements. The 371 has three types of cursors: Window, Dot, and *f* Line. Only the Window cursor is available in Non Store mode.

#### Using the Window Cursor

The Window cursor is displayed as a rectangle with a bright dot in either the lower left or upper right corner, as selected by the Cursor mode selection buttons. The current and voltage values at the position of the bright dot are displayed in the CURSOR readout area. The Cursor position buttons move the bright cursor dot and change the size of the window.

Unlike the Dot cursor and *f* Line cursor, the Window cursor can be used in Non Store as well as Store mode, and can be



displayed at any point on the screen. It is typically used to check for characteristics of a device under test to be within a certain range. It can also be used to measure the  $H_{FE}$  on the curve of the collector current vs. collector-emitter voltage characteristics of a transistor. When the vertical side of the cursor is positioned between two adjacent curves, the  $H_{FE}$  value is displayed in the  $\beta$  OR gm/DIV readout area.

#### Using the Dot Cursor

The Dot cursor is a high-intensity spot displayed on the characteristic curve. The current and voltage values at the cursor position are given in the readout area.

#### Using the $f$ Line Cursor

The  $f$  Line cursor is a straight line that passes through the Dot cursor position at a slope that can be varied by the four Cursor position buttons ( $\blacktriangleleft$ ,  $\blacktriangleright$ ,  $\blacklozenge$ , and  $\blacktriangleright$ ).

When COLLECTOR ( $V_{ce}$ ) is displayed on the horizontal axis, the CURSOR ( $f:1/\text{grad}$ ) readout indicates the resistance ( $V_{ce}/I_c$ ), while the CURSOR ( $f:\text{intercept}$ ) readout indicates the voltage value at which the  $f$  Line cursor intercepts the horizontal axis.

When STEP GEN ( $V_{be}$ ) is displayed on the horizontal axis, the CURSOR ( $f:1/\text{grad}$ ) readout indicates the forward transfer admittance ( $I_b/V_{be}$ ), while the CURSOR ( $f:\text{intercept}$ ) readout indicates the voltage value at which the  $f$  Line cursor intercepts the horizontal axis.

The  $f$  LINE cursor is useful for measuring the on-state resistance of a device and for measuring the forward transfer admittance of FETs.

## ■ Text Editing

Text, consisting of letters, numbers, and symbols, can be displayed at the top of the 371 CRT graticule. The text may be used to label characteristic curves with identification information or to note measurement conditions. The text is stored in bubble memory along with the characteristic curve or setup information.

### Entering Text Edit Mode

To enter the Text Edit mode, press the ENTER button while holding down the Cursor SHIFT button. (The Cursor SHIFT button changes the function of the ENTER button to TEXT, as noted in blue below the button.) The "TEXT EDIT MODE" message is displayed at the bottom of the graticule and the Text Edit cursor is displayed at the top, indicating that the 371 is ready for text entry.

### Entering and Editing Text

The character to be entered is selected with the VERTICAL CURRENT/DIV knob, and the position at which it is displayed is selected with the HORIZONTAL VOLTS/DIV knob. Only the functions of these two controls change in the Text Edit mode; the functions of other knobs and buttons remain the same.

A maximum of 24 text characters can be entered. Available text characters (in the order in which they are presented by the VERTICAL CURRENT/DIV knob) are:

space, A, B . . . Z, space, m,  $\mu$ , n, p, ., 0, 1 . . . 9, -, /, \*, (, )

### Erasing Text and Exiting the Text Editor Without Changes

While in Text Edit mode, pressing the NON STORE button erases the text entered up to that point and the edit cursor moves to the

left side of the text area. Pressing the STORE, COMPARE, VIEW, INVERT, or RECALL button in Text Edit mode causes the 371 to exit Text Edit mode, erase the text data entered so far, and display the "TEXT CANCELED" message.

### **Saving Edited Text**

When the text is satisfactorily edited, again press the ENTER button while holding down the Cursor SHIFT button. The Text Edit ends and the 371 returns to normal operation.

Text may be saved in the following ways:

- To save the edited text along with the characteristic curve in bubble memory, press the ENTER button.
- To save the text along with front-panel setup information, press the SAVE button.
- Text is saved automatically when Text Edit mode is exited if the text was entered from View mode.

### **Printing a Directory of Stored Text**

The text stored in bubble memory can be printed on a plotter as a directory table by pressing the RECALL button while holding down the Cursor SHIFT button. The Cursor SHIFT button changes the function of the RECALL button to DIRECTORY, as labeled in blue below the button.

If the stored text describes or otherwise identifies the data stored in each location of the bubble memory cassette, the plotted text will be a directory of the bubble memory contents.

### ■ Vertical Axis Measurement and Sensitivity

The vertical axis on the screen displays the current ( $I_c$ ) flowing at the COLLECTOR/DRAIN/ANODE connector of the Test Fixture Unit. The sensitivity of the display is set by the VERTICAL CURRENT/DIV knob. The range of available settings depends on the setting of the Collector Supply MAXIMUM PEAK POWER as follows:

MAXIMUM PEAK POWER Setting	VERTICAL CURRENT/DIV Setting Range
3 kW	1 A/DIV to 50 A/DIV
300 W	500 mA/DIV to 5 A/DIV
30 W	100 $\mu$ A/DIV to 5 mA/DIV
3 W	10 $\mu$ A/DIV to 500 $\mu$ A/DIV

The selected vertical sensitivity is displayed on the screen in the VERT/DIV field.

### ■ Horizontal Axis Measurement and Sensitivity

The horizontal axis on the screen displays the voltage ( $V_{CE}$ ) between the COLLECTOR/DRAIN/ANODE connector and COMMON connector, or the voltage ( $V_{BE}$ ) between the STEP GENERATOR connector and the COMMON connector.

The selection between the two modes is made with the HORIZONTAL VOLTS/DIV knob. When turned clockwise, this knob selects the COLLECTOR ( $V_{CE}$ ) measurement and sets the sensitivity in one of the following ranges:

MAXIMUM PEAK POWER Setting	HORIZONTAL VOLTS/DIV Setting Range
3 kW/300 W	100 mV/DIV to 5 V/DIV
30 W/3 W	50 V/DIV to 500 V/DIV

When the HORIZONTAL VOLTS/DIV knob is turned counterclockwise, it selects the STEP GEN ( $V_{BE}$ ) measurement

and sets the sensitivity in the range of 100 mV/DIV to 5 V/DIV. The selected horizontal sensitivity is displayed on the CRT in the HORIZ/DIV readout field.

## ■ Measurement Modes

The 371 has three measurement modes: Repeat, Single, and Sweep.

### Repeat

Repeat mode is the measurement mode automatically selected when the 371 is powered up or initialized. In Repeat mode, the Collector Supply and Step Generator output are continuous.

### Single

In Single mode, the Collector Supply and a set of staircase waves, or pulse signal, is output by the Step Generator each time the Measurement SINGLE button is pressed. Single mode is useful when device overheating is a concern.

### Sweep

In Sweep mode, a continuous series of dots is displayed when the Collector Supply is in High Current mode—a situation which would normally produce only a single dot on the display. Two different Sweep mode outputs are available, Collector Supply and Step Generator, depending on the setting of the HORIZONTAL VOLTS/DIV control.

**Collector Supply Sweep** mode sweeps the Collector Supply output from the value selected by the Collector Supply VARIABLE control to 0%, if the SWEEP button is pressed with the 371 set as follows:

## 371 Operating Instructions

### General Operation

---

Collector Supply  
VARIABLE ..... Any setting except 0%  
PEAK POWER WATTS ..... 300 W or 3 kW

Display  
Mode ..... STORE or COMPARE  
HORIZONTAL VOLTS/DIV ..... COLLECTOR ( $V_{ce}$ ) range

The Step Generator output is continuous in Collector Supply Sweep mode.

**Step Generator Sweep** mode sweeps the Step Generator output from its peak value (step amplitude + offset) to 0 A or 0 V when the 371 is set as follows:

Collector Supply  
PEAK POWER WATTS ..... 300 W OR 3 kW

Display  
Mode ..... STORE or COMPARE  
HORIZONTAL VOLTS/DIV ..... STEP GEN ( $V_{ee}$ ) range

Step Generator  
STEP/OFFSET AMPLITUDE ..... Any setting except  
0 V (or A)

The Collector Supply output is continuous in Step Generator Sweep mode.

The Sweep voltage or current is displayed in the OFFSET readout area of the CRT, where the initial value displayed is the sum of the peak amplitude and offset. The Step Generator Number of Steps is automatically set to 0 in Sweep mode, so it must be reset for other measurements.

**Reducing the Distance Between Displayed Dots.** In either Step Generator or Collector Sweep mode, a curve with one-fourth the normal distance between dots may be displayed by pressing the SWEEP button with the Cursor SHIFT button held down. In this mode the sweep time is increased by a factor of four.

**Defeating Sweep Mode.** In Sweep mode, the Measurement mode will automatically revert to Repeat if any front-panel controls are changed except the following:

- Setup
  - SAVE
- Memory
  - Index Selection buttons
- Display
  - ENTER
  - COMPARE
  - STORE
- Cursor
  - Mode selection buttons
  - Position buttons
- GPIB
  - RESET TO LOCAL
  - USER REQUEST
- Plotter
  - ALL

**Saving Sweep Mode Settings.** If Setup SAVE is pressed during the sweep, the Sweep mode settings and the initial value of the Collector Supply or Step Generator are saved in bubble memory. The stored sweep can then be reactivated at any time by pressing the Setup RECALL button (with the Memory Index set to the proper location).

**Saving Data.** If the Display ENTER button is pressed during the sweep, all data captured up to that point is stored in bubble memory and the sweep continues.

## ■ The Step Generator

The Step Generator supplies the current or voltage applied to the base (gate) or emitter of the device under test. The output of the Step Generator is either a staircase current or voltage waveform with fixed increments, or a pulse current waveform. The outputs from the Step Generator and collector supply circuit are applied to the device under test to produce a characteristic curve on the display for a given number of steps.

### Selecting Voltage or Current Output

VOLTAGE output or CURRENT output is selected with the SOURCE buttons. The type of waveform produced by the Step Generator is determined by the SOURCE setting and the Collector Supply PEAK POWER WATTS setting. When the SOURCE is CURRENT and the PEAK POWER WATTS is set to 3 kW or 300 W, the Step Generator output is pulsed. In all other cases the Step Generator output is a staircase waveform.

### Selecting the Number of Steps

The number of steps in the staircase waveform can be selected within the range of 0 to 5 with the NUMBER OF STEPS buttons.

### Setting Step Amplitude

The step amplitude setting is selected by the STEP/OFFSET AMPLITUDE knob. The setting ranges are:

- 1  $\mu$ A to 2 mA for staircase current outputs
- 1 mA to 2 A for pulsed current outputs
- 200 mV to 5 V for voltage outputs.

The selected step amplitude is displayed on the CRT in the PER STEP readout field.



Pressing the STEP MULTI .1X button reduces the step amplitude by a factor of 10.

### Setting Offset

An offset can be added to the step signal by pressing the OFFSET buttons (← or →). The offset is of the same polarity as the Step Generator signal. When the step signal is a staircase waveform, the offset is a DC voltage or DC current. When the step signal is a current pulse, the offset is also a current pulse. The offset amplitude can be set within the range of 0% to 500% of the step amplitude with 1% resolution. The selected offset amplitude is indicated on the CRT in the OFFSET readout field.

### NOTE

*The offset is independent of the STEP MULTI .1X setting and the Measurement mode. The amplitude of the selected offset is always at a constant value.*

### Setting Polarity

The polarity of the Step Generator signal is switched together with the polarity of the Collector Supply, so that when the Collector Supply POLARITY setting is NPN+, the Step Generator polarity is POS+, and when the Collector Supply POLARITY setting is PNP-, the Step Generator polarity is NEG-. To set the polarity of the Step Generator signal to the opposite of the Collector Supply, press the Step Generator INVERT button.

## ■The Collector Supply

The Collector Supply circuit supplies operating voltage to the collector (or drain or anode) of the device under test.

### Selecting Peak Power

The peak power of the Collector Supply can be set to 3 W, 30 W, 300 W, or 3 kW with the PEAK POWER WATTS buttons. These buttons select internal series resistors in the collector supply circuit which limit the available power.

When either the 3 W or 30 W PEAK POWER WATTS button is pressed, the 371 operates in High Voltage mode and a rectified sine-squared voltage output is provided to the COLLECTOR SUPPLY HIGH VOLTAGE connector of the Test Fixture Unit.

When either the 300 W or 3 kW PEAK POWER WATTS button is pressed, the 371 operates in High Current mode and voltage pulses with a width of approximately 250  $\mu$ s are produced at the COLLECTOR SUPPLY HIGH CURRENT connector of the Test Fixture Patch Panel.

The PEAK POWER WATTS setting also determines the maximum peak voltage, which is approximately 3 kV in the open state in the High Voltage mode and approximately 30 V in the open state in the High Current mode.

The output voltage can be varied, within the range determined by the maximum peak voltage, by rotating the Collector Supply VARIABLE knob. The selected value is indicated in the % OF MAX PEAK VOLTS readout area as a percentage of the maximum peak voltage.

If the Collector Supply is switched between the HIGH VOLTAGE mode and HIGH CURRENT mode, the Collector Supply output is automatically reset to zero.

### **Setting Polarity**

The polarity of the output can be selected by the Collector Supply POLARITY button. When POLARITY is switched the output is automatically reset to zero.

### **Adjusting Looping Compensation**

In High Voltage mode, the characteristic curve displayed on the screen occasionally takes the appearance of a loop – a phenomenon known as looping. Looping may occur when the voltage or current is extremely low or extremely high.

The usual cause of looping is the internal floating capacitance of the 371 and Test Fixture Unit, or the capacitance of the device under test, but looping can also result from heat emitted from the device under test. Looping caused by the 371 or Test Fixture Unit can be reduced with the front-panel LOOPING COMPENSATION control. It isn't possible to completely compensate for capacitance in the device under test in this way; however, some compensation can be achieved for floating capacitance in a small diode or voltage-driven three-lead device.

### ■ The Patch Panel and Test Fixture Unit

The row of connectors on the Test Fixture Unit (above the Patch Panel) carry signals to and from the 371. The top row of connectors on the Patch Panel are linked internally to the connectors of the Test Adapter connector. When a measurement is performed, the connectors in the top row must be connected to connectors in the next row with patch cords. Figure 3-14 shows connection examples.



*When making High Voltage measurements, do not make connections between the COLLECTOR SUPPLY HIGH CURRENT SENSE connector and COLLECTOR/DRAIN/ANODE SENSE connector, or between the COMMON SENSE connector and the EMITTER/SOURCE/CATHODE SENSE connector. Resulting voltage and current measurements may be incorrect*

The Test Adapter connector permits use of the Test Adapters listed in Table 3-2 and shown in Figure 3-15. The A1002 and A1003 Test Adapters are provided as standard accessories.

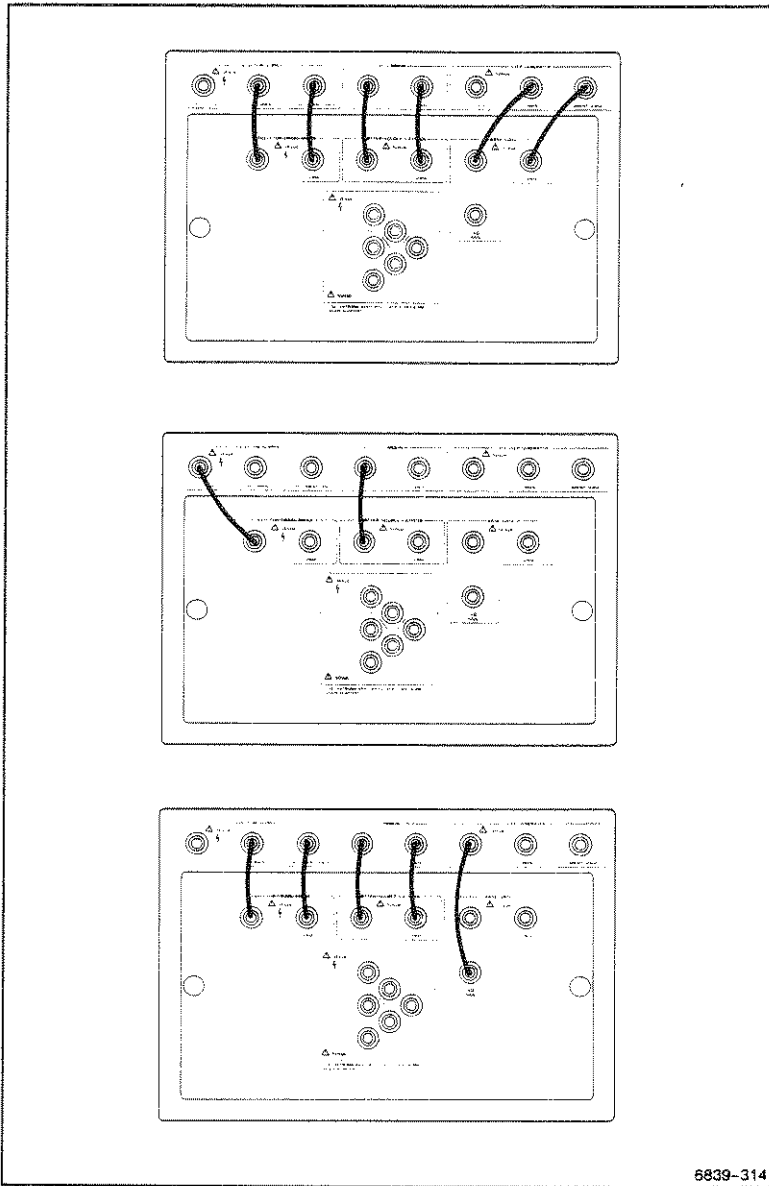

Figure 3-14. Connections for measuring common-emitter characteristic of a transistor and common-source characteristics of a power MOSFET.



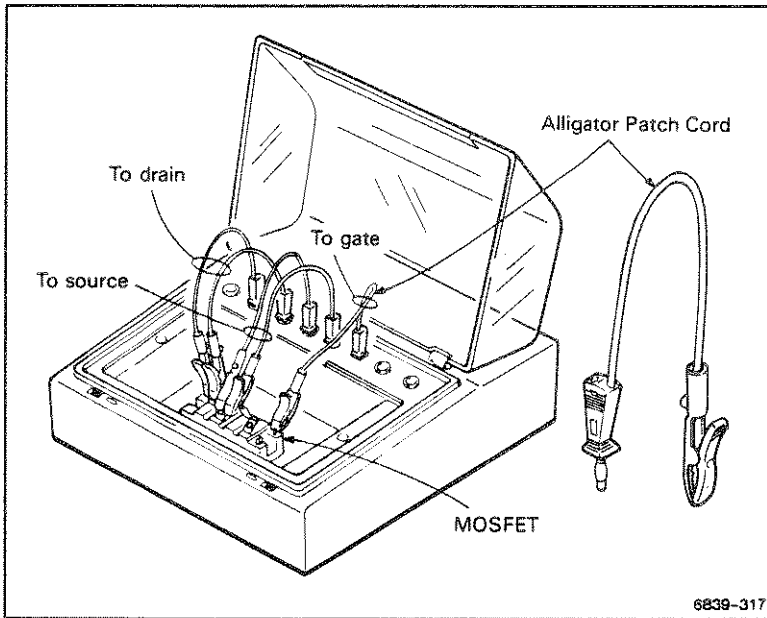

Figure 3-17. Connections for measuring the common-source characteristics of a FET.

### ■ Kelvin Sensing

The SENSE connector on the patch panel is for kelvin sensing of voltage in High Current mode. In kelvin sensing, the voltage-detection connector is independent of the power supply connector. This improves the accuracy of measurements because it eliminates any voltage drop due to contact resistance.

Voltage can be measured without connecting the device to the SENSE connector but, for high precision measurement, the SENSE connector should be used.



## MEASUREMENT EXAMPLES

The following examples will demonstrate how to measure:

- The collector–emitter breakdown voltage of a bipolar transistor with the 371 in High Voltage Mode
- The common–emitter characteristics of a bipolar transistor with the 371 in High Current mode  
The saturation voltage of an NPN bipolar transistor
- The common–source characteristics of a power MOSFET with the 371 in High Current mode

Each of these examples includes a list of all 371 control settings and an illustration of Patch Panel connections. An illustration is also given of a typical 371 display under the same setup.

Connections on the Patch Panel should be made with the patch cords provided as standard accessories to the 371. Connections between the device under test and the Test Adapter connector should be made with a Test Adapter suited to the shape of the device under test.

## ■ Measuring Breakdown Voltage

*This example measures the collector-emitter breakdown voltage of an NPN bipolar transistor with a  $BV_{CEO}$  rating of 1500 V.*

Use the front-panel LOOPING COMPENSATION control to compensate for any displayed looping. See the discussion under *The Collector Supply* earlier in this section for details about looping.

1. Initialize the 371 settings.
2. Use patch cords to make the following Patch Panel connections (see Figure 3-18):
  - Between the COLLECTOR SUPPLY HIGH VOLTAGE and COLLECTOR/DRAIN/ANODE terminals
  - Between the COMMON and EMITTER/SOURCE/CATHODE terminals.
3. Set the 371 controls as follows:
  - Collector Supply
    - PEAK POWER WATTS ..... 3 W
    - HIGH VOLTAGE Breaker ..... ENABLED
  - Display
    - HORIZONTAL VOLTS/DIV ..... 200 V COLLECTOR
4. Slowly increase the Collector Supply VARIABLE until device breakdown is indicated on the 371 display.
5. Set the Memory Index to an empty memory location.
6. Press the Display ENTER button to store the  $BV_{CEO}$  curve.
7. Set the Collector Supply HIGH VOLTAGE breaker to DISABLED.

## 371 Operating Instructions Measurement Examples

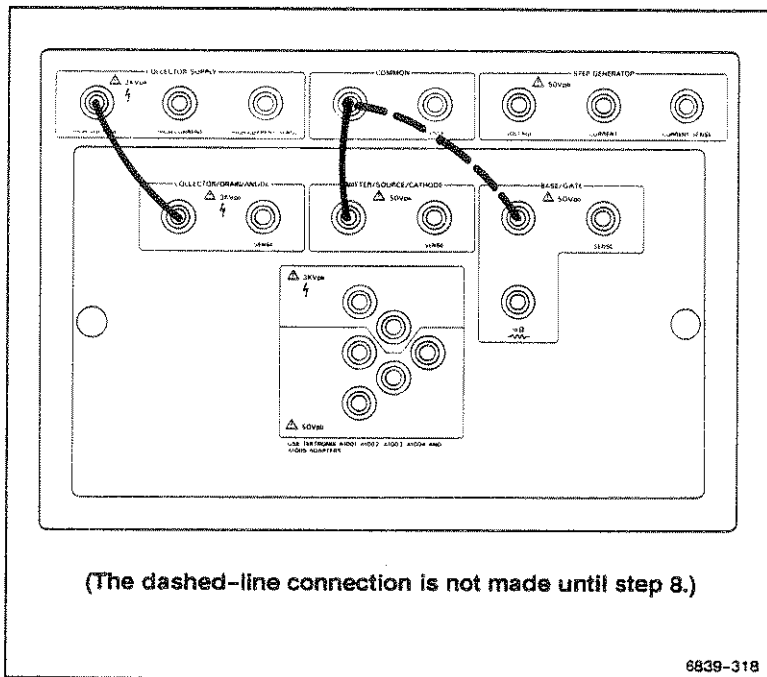

Figure 3-18. Patch Panel connections for measuring  $BV_{CE0}$  of a bipolar transistor.

8. Use a patch cord to connect the COMMON and the BASE/GATE terminals on the Patch Panel, as indicated by the dashed line in Figure 3-18.
9. Set the Collector Supply HIGH VOLTAGE breaker to ENABLED.
10. Slowly increase the Collector Supply VARIABLE until breakdown occurs.
11. Use the Cursor Selection buttons ( $\blacktriangleleft$  or  $\blacktriangleright$ ) to select the DOT cursor.

### 371 Operating Instructions Measurement Examples

12. Use the Cursor Position buttons (←, →, ↓, ↑) to move the Dot cursor into the breakdown region.
13. The breakdown voltage ( $BV_{CES}$ ) is displayed in the HORIZ/DIV CURSOR area of the CRT.
14. Press the Display COMPARE button to include the stored  $BV_{CEO}$  curve in the display, as shown in Figure 3-19.

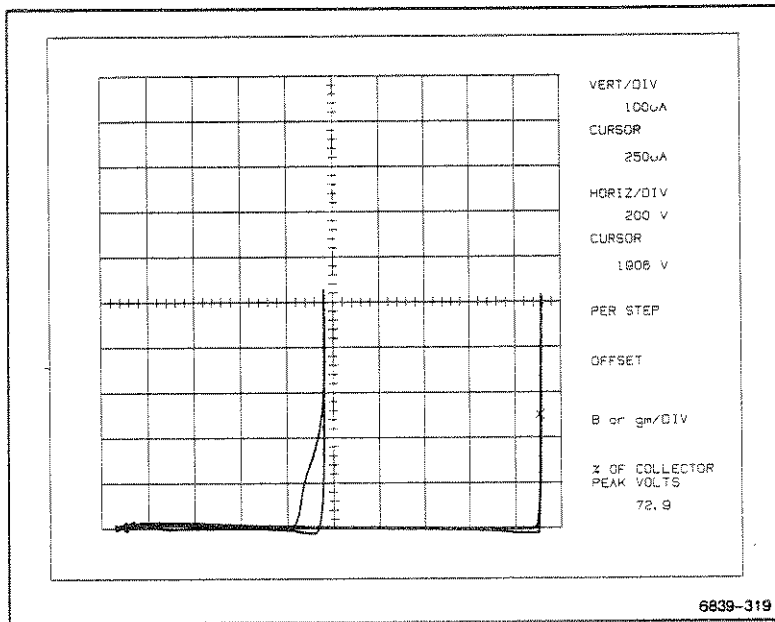

Figure 3-19. Compare mode display of the  $BV_{CEO}$  and  $BV_{CES}$  breakdown measurements.

### ■ Measuring Common-Emitter Characteristics

This example measures the common-emitter characteristics of an NPN bipolar transistor with an  $I_c$  rating of 15 A.

The kelvin sensing feature of the 371 is used in this example to ensure accurate measurement when a large amount of current is flowing to the device under test. For details about the kelvin sense feature, see *Kelvin Sensing* earlier in this section.

1. Initialize the 371 settings.
2. Make the patch cord connections illustrated in Figure 3-20.

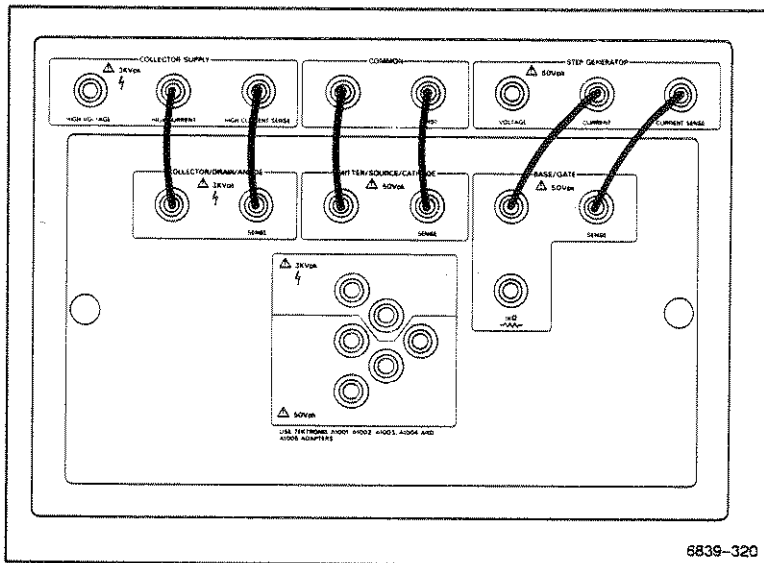



Figure 3-20. Patch Panel connections for measuring the common-emitter characteristics of a bipolar transistor.

### 371 Operating Instructions Measurement Examples

---

3. Set the 371 as follows:

Collector Supply  
HIGH CURRENT ..... ENABLED  
Display  
VERTICAL CURRENT/DIV ..... 2 A  
HORIZONTAL VOLTS/DIV ..... 2 V COLLECTOR

4. Use the Collector Supply VARIABLE to move the dot(s) to the lower right corner of the display ( $20 V_{CE}$ ).
5. Press the Step Generator NUMBER OF STEPS  button for five steps.
6. Increase the STEP/OFFSET AMPLITUDE setting until the dot representing the fifth step is near the 16 A graticule line.
7. Press the Measurement SWEEP button to display a characteristic curve similar to that shown in Figure 3-21.

371 Operating Instructions  
Measurement Examples

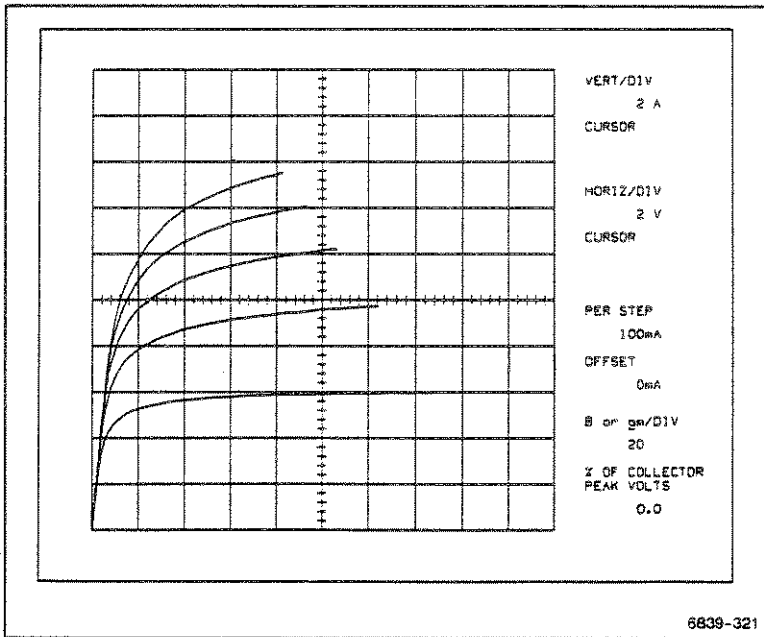

Figure 3-21. Typical display of the common-emitter characteristics of a bipolar transistor.

### ■ Measuring Saturation Voltage

*This example measures the saturation voltage of an NPN bipolar transistor at 10 A  $I_c$  and 2 A  $I_b$ .*

1. Initialize the 371 settings.
2. Use the patch cord connections illustrated in Figure 3-20.
3. Set the 371 as follows:

Collector Supply  
HIGH CURRENT Breaker ..... ENABLED  
Step Generator  
NUMBER OF STEPS ..... 0  
STEP/OFFSET AMPLITUDE ..... 500 mA/STEP  
Display  
VERTICAL CURRENT/DIV ..... 2 A  
HORIZONTAL VOLTS/DIV ..... 200 mV COLLECTOR

4. Use the Step Generator OFFSET buttons ( $\leftarrow$ ,  $\rightarrow$ ) to set the OFFSET readout ( $I_b$ ) to 2000 mA.
5. Increase the Collector Supply VARIABLE setting until the dot rises above the 10 A graticule line, which is the center horizontal graticule line.



### 371 Operating Instructions Measurement Examples

6. Press the Measurement SWEEP button to display a curve similar to that shown in Figure 3-22.

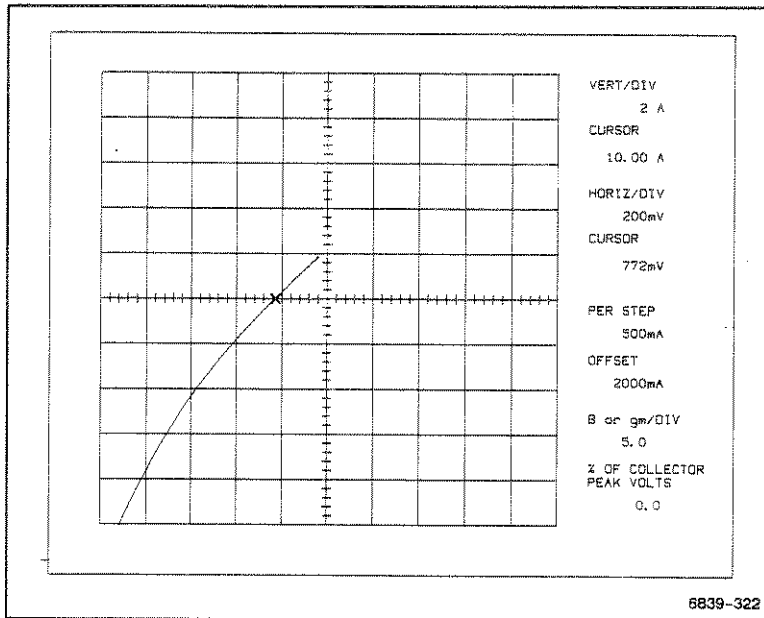

Figure 3-22.  $V_{CE(SAT)}$  measurement for a bipolar transistor.

7. Use the Cursor Selection buttons ( $\leftarrow$ ,  $\rightarrow$ ) to select the DOT cursor.
8. Use the Cursor Position buttons ( $\leftarrow$ ,  $\rightarrow$ ,  $\uparrow$ ,  $\downarrow$ ) to move the Dot cursor to the 10 A level on the curve.
9. Read the  $V_{CE(SAT)}$  value in the HORIZ/DIV CURSOR readout area.

### ■ Measuring MOSFET Characteristics

*This example measures the common-source characteristics of an N-type power MOSFET with an  $I_D$  rating of 10 A.*

As in the previous example using a bipolar transistor, kelvin sensing is used in this measurement because of the high current levels flowing through the device under test. The 1 k $\Omega$  resistor on the Patch Panel is used to prevent oscillation.

1. Initialize the 371 settings.
2. Make the patch cord connections illustrated in Figure 3-23.

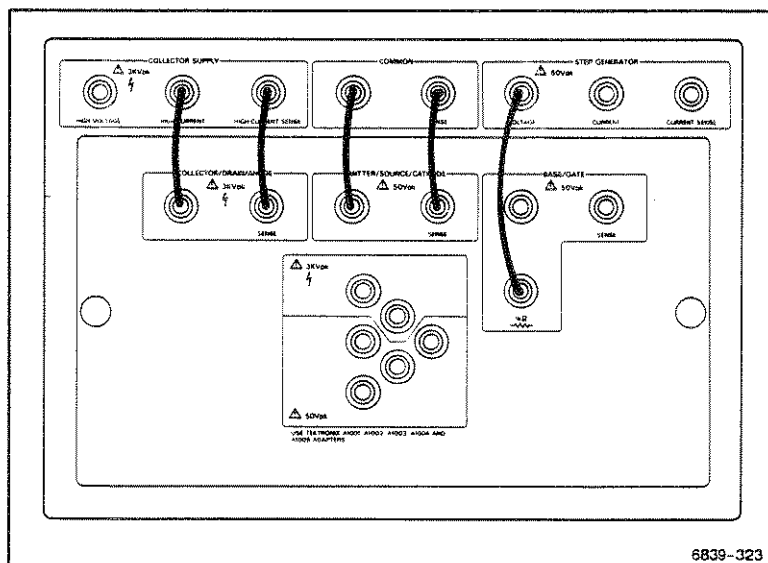

**Figure 3-23. Patch Panel connections for measuring the common-source characteristics of a power MOSFET.**

**371 Operating Instructions**  
**Measurement Examples**

---

3. Set the 371 as follows:

Collector Supply  
HIGH CURRENT breaker ..... ENABLED

Step Generator  
SOURCE ..... VOLTAGE  
STEP MULTI .1X ..... On  
STEP/OFFSET AMPLITUDE ..... 500 mV  
NUMBER OF STEPS ..... 5

Display  
VERTICAL CURRENT/DIV ..... 2 A  
HORIZONTAL VOLTS/DIV ..... 2 V COLLECTOR

4. Use the Collector Supply VARIABLE to move the dot to the mid-point of the bottom graticule line.
5. Use the Step Generator OFFSET  button to increase the gate bias until six dots appear on the display.
6. Increase the OFFSET until the lowest dot begins to move upward.
7. Use the Collector Supply VARIABLE control to move the dots to the right.
8. Press the Measurement SWEEP button to display a curve similar to the one shown in Figure 3-24.

371 Operating Instructions  
Measurement Examples

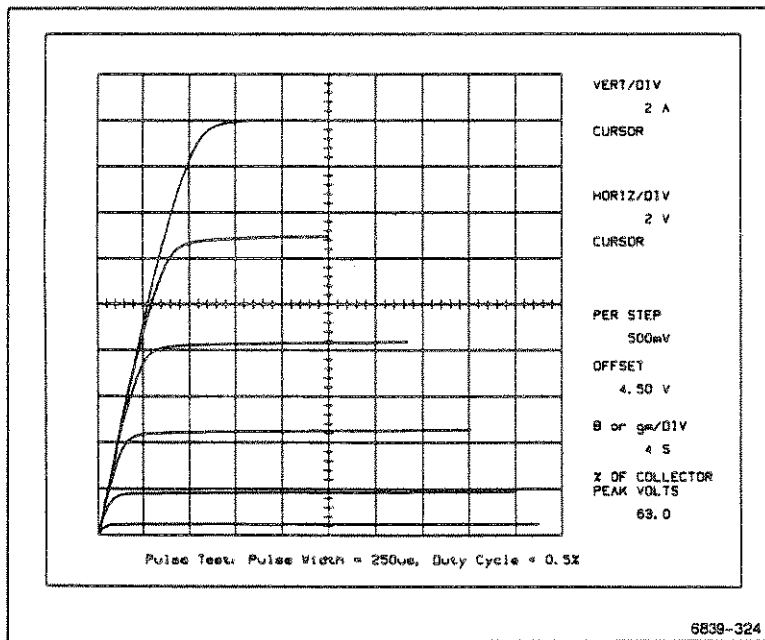

Figure 3-24. Typical display of the common-source characteristics of a power MOSFET.

## SECTION 4

---

# GPIB

***This section:***

- *Reviews GPIB principles*
- *Summarizes the interface capabilities of the 371*
- *Explains how to configure and control the 371 in a GPIB system*
- *Explains device-dependent messages and formats*
- *Provides an alphabetical listing of all 371 commands and queries with definitions and syntax*
- *Explains Service Requests for the 371*

## SECTION 4 CONTENTS

	Page
<b>Review</b> .....	<b>4-5</b>
Hardware .....	4-5
Communication Protocol .....	4-5
Program Development .....	4-6
System Control .....	4-6
Addressing Instruments .....	4-7
Sending Data and Commands .....	4-7
Transmitting And Receiving Data .....	4-9
Handling Interrupts .....	4-10
Data Processing .....	4-10
Display and Storage .....	4-10
<b>Interface Capabilities</b> .....	<b>4-11</b>
Interface Messages .....	4-12
My Listen and My Talk Address (MLA and MTA) ...	4-12
Attention (ATN) .....	4-12
Unlisten (UNL) and Untalk (UNT) .....	4-13
Interface Clear (IFC) .....	4-13
Device Clear (DCL) .....	4-13
Selected Device Clear (SDC) .....	4-13
Go To Local (GTL) .....	4-14
Remote Enable (REN) .....	4-14
Service Request (SRQ) .....	4-14
Serial Poll Enable and Disable (SPE and SPD) ...	4-14
End or Identify (END or EOI) .....	4-14
Local Lockout (LLO) .....	4-15
Device-Dependent Messages .....	4-15
Commands and Queries .....	4-15
Setup Data .....	4-15
Measurement Data .....	4-16

**SECTION 4 CONTENTS (cont.)**

	<b>Page</b>
<b>Setup</b> .....	4-17
Configuration Switch Settings .....	4-17
Setting the Bus Address .....	4-17
Choosing the Message Terminator .....	4-19
Reading in the Switch Settings .....	4-19
Connecting the GPIB Cable .....	4-19
Powering Up .....	4-20
Self Test .....	4-21
Power-Up SRQ .....	4-21
<b>Controlling The 371 Over The Bus</b> .....	4-22
Sending Commands to the 371 .....	4-22
Sending Queries and Receiving Responses .....	4-25
Instrument Setup Over the Bus .....	4-27
Storing Settings for the 371 .....	4-27
Loading Settings Into the 371 .....	4-29
Data Storage and Transfer .....	4-30
Acquiring Data Within the 371 .....	4-31
Data Structure .....	4-31
Moving Waveform Data to the Controller .....	4-32
Transferring the Preamble .....	4-32
Transferring the Curve .....	4-33
Transferring the Waveform to Bubble Memory .....	4-34
Loading Data From the Controller .....	4-34
Loading the Preamble .....	4-34
Loading the Curve .....	4-35
Transferring Other Types of Data .....	4-35
Transferring the Cursor Readout .....	4-35
Transferring Text .....	4-35
Summary of Data Transfers .....	4-36

**SECTION 4 CONTENTS (cont.)**

	<b>Page</b>
<b>Device-Dependent Message Format</b> .....	<b>4-38</b>
Command Message Formats .....	4-39
Headers .....	4-40
Arguments .....	4-40
Linked Arguments .....	4-41
Queries .....	4-41
Multiple Arguments .....	4-41
Numeric Argument Formats .....	4-42
Multiple-Command Messages .....	4-43
Other Messages .....	4-44
Preambles .....	4-45
Curves .....	4-46
<b>Front-Panel Settings and Corresponding GPIB Commands</b> .....	<b>4-47</b>
<b>Command Reference</b> .....	<b>4-53</b>
Command Index .....	4-55
Collector Supply Commands and Queries .....	4-57
CRT Readout Transfer Commands and Queries .....	4-65
Cursor Commands and Queries .....	4-70
Display Commands and Queries .....	4-78
Instrument Parameter Commands and Queries .....	4-87
Miscellaneous Commands and Queries .....	4-95
Status and Event Commands and Queries .....	4-103
Step Generator Command and Query .....	4-109
Waveform Transfer Commands and Queries .....	4-114
<b>Service Requests</b> .....	<b>4-124</b>
Handling Service Requests .....	4-124
Masking Service Requests .....	4-125
Status Bytes .....	4-127
Event Codes .....	4-129



## REVIEW

The General Purpose Interface Bus, or GPIB, is a standardized, digital interface for interconnecting up to 15 self-contained instruments, controllers, and other devices. The instruments may be units such as the 371 High Power Curve Tracer, signal generators, digital multimeters, or digital oscilloscopes. The ANSI<sup>1</sup> and IEEE<sup>2</sup> standards define two aspects of the interface: the hardware and a basic communication protocol.

### Hardware

The hardware consists of a set of interface circuits in each device, along with standard 24-conductor cabling for interconnecting the devices in a system. Sixteen of the 24 wires are used for signaling: eight for addresses or data, three for handshaking during data transfers, and five for interface management. Most data is transferred as a series of eight-bit bytes over the eight data lines.

### Communication Protocol

The basic communication protocol specifies a set of pre-defined interface messages for system organization and housekeeping, but only indicates the basic requirements for communicating other information such as setup commands and measurement results. The protocol does not define the meaning or format of the measurement results, which are termed device-dependent messages.

Meaningful messages for each instrument are specified by the instrument manufacturer and are usually defined in the instrument manual. Tektronix has standardized on a higher level protocol for all its GPIB instruments, called Tektronix Codes and Formats.

<sup>1</sup>ANSI – American National Standards Institute

<sup>2</sup>IEEE – Institute of Electric and Electronic Engineers, Inc.

A typical GPIB system will include a controller and one or more instruments, such as the 371 High Power Curve Tracer. Some instruments are talk-only or listen-only devices while others can both talk and listen. The 371 does both. Linking a controller to the 371, and possibly other instruments, provides operation in four major task areas:

- Program development
- System control
- Data processing
- Display and storage

These four task areas are discussed in the following paragraphs.

### ■ Program Development

Program development includes writing, editing, and debugging the programs needed to control the instruments in the system.

### ■ System Control

While running a program, the controller assigns tasks to instruments in the system, coordinates communication, handles error conditions, and monitors the system's progress.

This instrument control task can be further divided into five functions:

- Addressing instruments
- Sending commands
- Transmitting and receiving data
- Handling interrupts
- Monitoring device status

Each of these system control functions are explained below.

### **Addressing Instruments**

The controller selects an instrument by addressing it. Each instrument on a bus is assigned a unique primary address in the range 0 through 30. The controller uses this address to set an instrument to talk or listen.

### **Sending Data and Commands**

Device-dependent messages carry commands and data from the controller to the 371 and return instrument status information and measurement data. The ATN line (pin 11 of the GPIB) is asserted while interface messages are sent to distinguish them from device-dependent messages (see Fig. 4-1).

Interface messages are commands that control interface functions. The IEEE 488 standard specifies interface messages so that they are the same for all devices.

There are two kinds of interface messages: uni-line and multi-line, where "line" refers to the 16 signal lines within the bus. Multi-line messages can be further subdivided into universal commands, addresses, and addressed commands. Figure 4-2 shows how the different types of GPIB messages are related and indicates the standard three-letter symbols assigned to them.

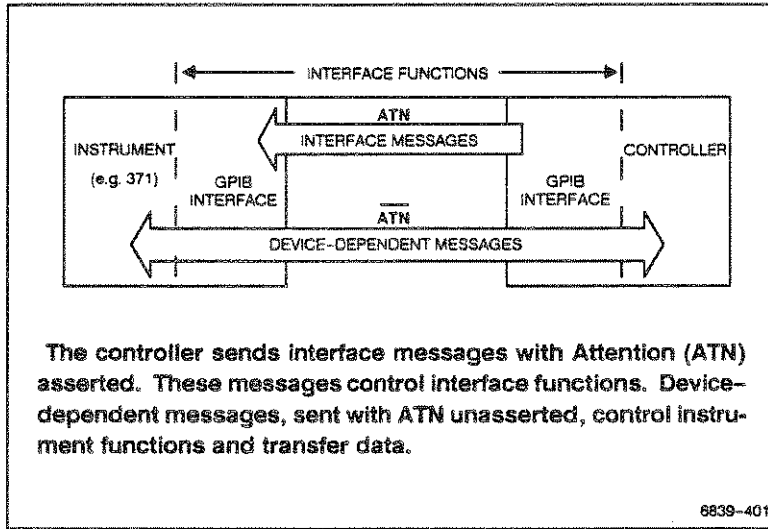

Figure 4-1. GPIB messages.

Multi-line interface messages are sent by placing a byte on the eight data lines of the GPIB and asserting the ATN line. Universal commands affect all devices on the bus while addresses and addressed commands affect only the addressed instruments.

Uni-line interface messages are sent by asserting one of the five individual interface signal lines of the GPIB:

- **SRQ** (service request)
- **ATN** (attention)
- **IFC** (interface clear)
- **REN** (remote enable)
- **END** (EOI, end or identify)

Device-dependent messages consist of commands or data that control instrument function and communicate instrument status, as well as data from measurements and other information. As noted before, the content and format of these messages has

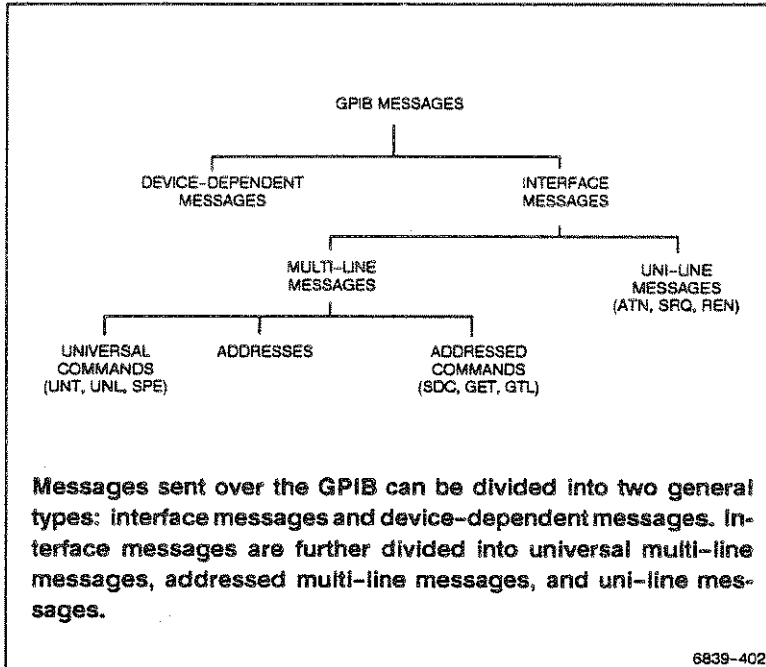

Figure 4-2. GPIB message types.

been addressed with Tektronix Codes and Formats. All of these message types are significant for the 371.

### Transmitting and Receiving Data

Most instruments talk (send data) or listen (receive data) to the system controller. The 371 does both. In fact the 371 sends and receives two classes of data: instrument setups and measurement results. There are various ways of coding such data. The 371, in keeping with Tek Codes and Formats, uses English key-words for setup and status data and a combination of similar key-words and a form of binary-coded numbers for measurement data.

### **Handling Interrupts**

The 371 and other devices in the system can generate interrupts to inform the controller of conditions warranting some sort of attention, such as an error condition or the completion of an operation. The controller polls the devices on the bus to find the source of the interrupt, reads its status, and takes appropriate action.

### **■ Data Processing**

Still another major task of a GPIB system controller is processing the data acquired from instruments. Examples might be extracting key parameters from a family of curves and deciding whether some pass-fail criterion has been exceeded.

### **■ Display and Storage**

Once data has been sent to the controller it can be stored or displayed, as well as processed. The controller console screen is one place data may be displayed.

## INTERFACE CAPABILITIES

IEEE Standard 488 defines a variety of possible interface capabilities for differing needs among various controllers and instruments.

Table 4-1 summarizes the capabilities realized in the 371. The abbreviations are detailed in the IEEE standard.

**TABLE 4-1**  
**GPIB Interface Specifications**

Function	Subset	Note
Source Handshake	SH1	Complete capability
Acceptor Handshake	AH1	Complete capability
Talker	T6	Basic Talker, Serial Poll, Talk Only, Unaddress if MLA
Listener	L4	Basic Listener, Unaddress if MTA
Service Request	SR1	Complete capability
Remote/Local	RL1	Complete capability
Parallel Poll	PP0	No capability
Device Clear	DC1	Complete capability
Device Trigger	DT0	No capability
Controller	C0	No capability

## ■ Interface Messages

The following explains how the curve tracer reacts to standard interface messages. Abbreviations are from IEEE Standard 488. As noted before, a uni-line message is sent over a dedicated line and a multi-line message is sent using the eight data lines while the ATN line is asserted. In the following descriptions, uni-line messages are described as having the appropriate line asserted. Multi-line messages are described with their respective ASCII code and decimal value for the eight-bit byte expressed on the eight data lines.

Due to the set of interface functions required for the 371, not all of the possible interface messages would be meaningful. The 371 does **not** respond to the following:

<b>GET</b>	<b>Group execute trigger</b>
<b>PPC</b>	<b>Parallel poll configure</b>
<b>PPU</b>	<b>Parallel poll unconfigure</b>
<b>TCT</b>	<b>Take control</b>

It does respond to or use the following interface messages, as described.

### **My Listen and My Talk Address (MLA and MTA)**

The 371's address is established by setting the address select switches on the rear panel. When the 371 receives its own address along with either of these commands, it responds by entering the appropriate state: ready to talk or ready to listen.

### **Attention (ATN)**

With the ATN line asserted, data on the eight data lines is interpreted as an address or interface message. With most controller programming languages, operation of the ATN line is transparent to the user.



### **Unlisten (UNL) and Untalk (UNT)**

When the Unlisten (UNL) message (ASCII "?", decimal 63) is received, the 371 listen function is placed in an idle (unaddressed) state. In the idle state, the 371 will not accept messages over the GPIB. The Talk function is placed in an idle state when the curve tracer receives the Untalk (UNT) message (ASCII "\_", decimal 95). In this state the 371 cannot transmit data via the GPIB.

### **Interface Clear (IFC)**

When the Interface Clear (IFC) line is asserted, both the Talk and Listen functions are placed in an idle state. This produces the same effect as receiving both the Untalk and Unlisten commands. It resets the interface only, clearing the input and output buffer, and does not affect any instrument functions. This can be used to restart communication with the 371.

### **Device Clear (DCL)**

The Device Clear (DCL) message (ASCII "Control T," decimal 20) reinitializes communication between the 371 and the controller. In response to Device Clear, the 371 clears any input and output messages as well as any unexecuted control settings. Any errors and events waiting to be reported, except power-up, are also cleared. If the SRQ line has been asserted for any reason other than power-up, it becomes unasserted when DCL is received.

### **Selected Device Clear (SDC)**

The Selected Device Clear (SDC) message (ASCII "Control D," decimal 4) performs the same function as DCL. However, only instruments that have been listen-addressed respond to SDC.

## **371 GPIB Interface Capabilities**

---

### **Go To Local (GTL)**

The Go To Local (GTL) message (ASCII "Control A", decimal 1) takes the 371 "off the bus" and turns off the front-panel REMOTE indicator, just as the front-panel RESET TO LOCAL button does.

### **Remote Enable (REN)**

When the Remote Enable (REN) line is asserted and the instrument receives its listen address (MLA), the 371 is placed in its Remote State (REMS) and the front-panel REMOTE indicator is turned on.

### **Service Request (SRQ)**

The Service Request (SRQ) line is set by the 371 each time it has a change in status to report to the controller, or when an operator presses the front-panel User Request button.

### **Serial Poll Enable and Disable (SPE and SPD)**

The Serial Poll Enable (SPE) message (ASCII Control X, decimal 24) causes the 371 to transmit its serial-poll status byte when it is talk addressed. The Serial Poll Disable (SPD) message (ASCII Control Y, decimal 25) switches the 371 back to normal operation.

### **End or Identify (END or EOI)**

The 371 or controller sets End Or Identify (EOI) simultaneously with the last byte of the command or data if LF (line feed)/EOI is currently selected as the message terminator. If LF alone is selected, the message terminator is LF accompanied by EOI and followed by a CR (carriage return).

### Local Lockout (LLO)

When a Local Lockout (LLO) message (ASCII "Control 0," decimal 21) is received, the 371 enters the Lockout state.

#### NOTE

*The 371 has no front-panel Lockout indicator to indicate when Lockout is set. Once set, all subsequent inputs from front-panel keys with corresponding remote commands will be ignored.*

### ■ Device-Dependent Messages

Device-dependent messages for the 371 are in three categories: Commands and queries, setup data, and measurement data.

#### Commands and Queries

Commands are sent to the 371 to initiate some action or change its settings. Some commands may be as short as three characters. Other more complex commands may be much longer.

A notable subcategory of commands is that of query commands or queries. The 371 responds to a query by sending another device-dependent message back to the controller. This response communicates the appropriate instrument status, settings, or measurement data. These messages may also vary from a few characters to many characters in length.

#### Setup Data

Since most front-panel settings are programmable, a series of commands can set-up the 371 for a particular measurement. In fact, a group of individual settings or an entire front-panel setup can be strung together and sent as a single message.

## **371 GPIB Interface Capabilities**

---

Queries can be used, in turn, to send individual settings or complete front-panel setups back to the controller. This means a setting can be made manually and then stored using the bus controller, providing an alternative to storing the setting in the bubble memory.

### **Measurement Data**

Usually the most significant data available from the 371 are sets of characteristic curves from devices being tested. For any given measurement this data is packaged in two parts: a preamble and a curve. Preambles and curves can be read from the 371 into the controller either separately or combined. Later they can be loaded back into the 371 for further use.

The preamble contains the information needed for interpreting, scaling, and labeling the numeric information in the curve. This preamble is coded in ASCII characters and is readable by the operator without interpretation by the controller.

The curve is a series of binary-coded numbers expressing the X-Y coordinates of the 1024 digitized points representing the displayed curves. These binary-coded numbers are interpreted by the controller.

Two other types of data that can be read out of the 371 are: the coordinates of a cursor located on the curves, and the text shown in the text-display area of the screen.

## SETUP

The first steps in putting the 371 to work in a system are:

- Setting the bus address
- Choosing the message terminator
- Connecting the GPIB cable
- Powering up

These steps are discussed in the following paragraphs.

### ■ Configuration Switch Settings

The 371 has a configuration switch bank on the rear panel which is used to set the bus address and message terminator (see Figure 4-3).

#### Setting the Bus Address

Each instrument connected to the bus must have a unique address. This address is used by the controller to direct the flow of data to and from that specific device.

When choosing a bus address for the instrument, remember:

- The address of the 371 must be unique on the bus.
- Some controllers reserve an address for themselves. For instance, the Tektronix 4041 System Controller has a default address of 30, though it can be changed under program control.
- The 371 enters Talk Only mode when set to address 31. In this mode, information can be sent to the plotter only via the GPIB port by pressing the front-panel PLOTTER button.

## 371 GPIB Setup

- The 371 uses primary addressing only. Sending a secondary address will have no effect.
- The address setting can be verified or changed by examining or setting the address switches located on the rear of the 371 (see Figure 4-3).

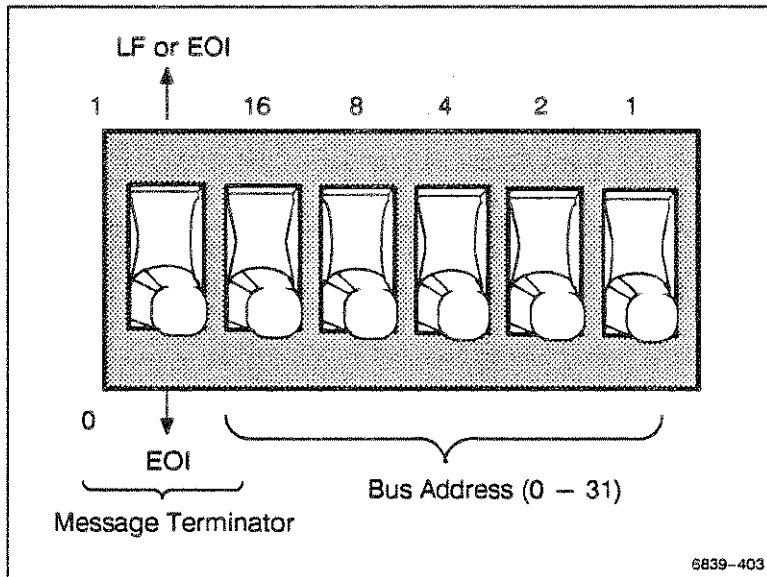

Figure 4-3. Rear-panel configuration switch.

The address can also be verified by simultaneously pressing the front-panel Cursor SHIFT and GPIB ADDR keys. The message terminator and bus address appear in the error message area of the 371 display.

### **Choosing the Message Terminator**

The terminator is used to indicate the end of a message transfer. The two most common terminators are the EOI (end or identify) signal line and the LF (line feed) character.

If EOI is selected, the 371 will assert the EOI line simultaneously with the last data byte when sending a message, and will recognize the EOI line as the terminator when receiving a message. If LF is selected, a CR (carriage return) and LF (line feed) are sent following the last data byte. The EOI line is asserted simultaneously with the LF character.

When receiving a message, the 371 will terminate the message upon receiving either the LF character or the assertion of the EOI line.

The best way to determine which terminator to use is to look at the specifications for the system controller and use the same terminator. For the Tektronix 4041 and the HP 200/300 Series, this would be the EOI terminator.

The terminator can be set with the terminator switch on the rear-panel configuration-switch bank (see Fig. 4-3).

### **Reading In the Switch Settings**

The switch settings are read by the 371's processor only at power-up or when the message terminator and bus address are displayed on the CRT. Therefore, when switches are changed while the power is on, simultaneously press the Cursor SHIFT and GPIB ADDR keys to make the switch change effective.

### **■ Connecting the GPIB Cable**

Attach the 371 to the GPIB with a standard GPIB cable. A GPIB system may be connected in two general configurations: star or line. While the star configuration is recommended, configurations can be mixed as long as the total cable length does not exceed

20 meters and the instruments are distributed on the bus according to a few basic rules (see Fig. 4-4).

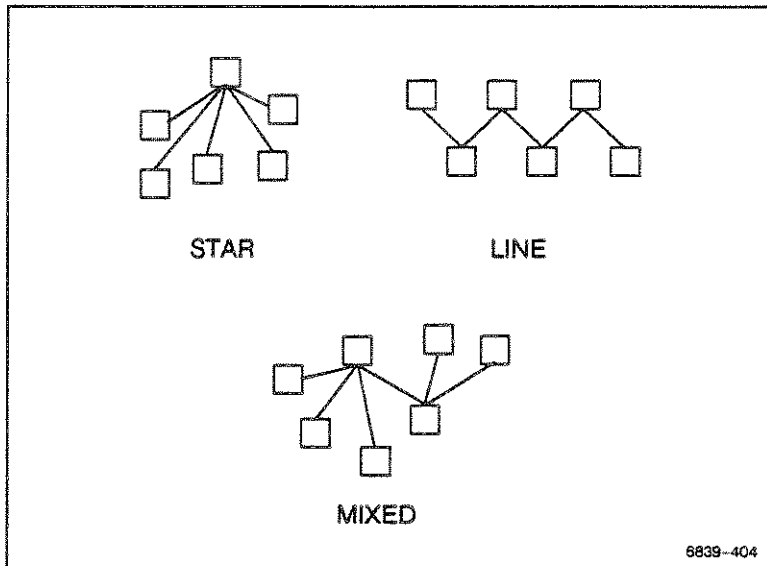

Figure 4-4. Bus configurations.

First, no more than 15 total devices, including the controller, can be included on a single bus. In addition, to maintain proper electrical characteristics, one device load must be connected for every two meters of cable. Generally, each instrument represents one device load on the bus. The 371 represents one device load.

### ■ Powering Up

With the 371 connected by GPIB cable to the system and the address and message terminator has been set, the system is ready to power up. Powering up the 371 as part of a GPIB system involves special considerations, as detailed in the following paragraphs.



Remember, when powering up a system with several GPIB instruments on the bus, at least half of the instruments must be powered up before the controller is brought "on-line".

### Self Test

To turn on the 371, press the front-panel POWER switch. The 371 performs a self-test at power-up and initializes itself to a pre-defined state, after which it's ready to make measurements. For details of the power-up test, see Appendix A, Diagnostic Routines and Messages. The power-up default state for the 371 is the same as for the INIt command described under *Instrument Parameter Commands* in the *Command Reference* portion of this section.

### Power-Up SRQ

When the power-up tests have been completed, the 371 asserts the GPIB line called SRQ. In the interface, the status byte is set to 65.

## CONTROLLING THE 371 OVER THE BUS

As explained in the following discussion, a controller can:

- Send commands to the 371
- Send queries and receive responses
- Control 371 settings
- Store and transfer 371 data
- Move waveform data from the 371
- Load waveform data to the 371
- Transfer cursor and readout data to and from the 371

### ■ Sending Commands to the 371

Most GPIB system controllers and their languages provide high level statements for sending device-dependent messages, such as commands, to any system instrument, including the 371.

These high-level statements usually consist of three parts:

1. A key word (`PRINT`, `OUTPUT`, `WRITE`, etc.) which causes the action (sending the message over the bus) to occur.
2. An address or logical unit number which directs the message to a specific instrument.
3. The device-dependent message which is the actual command, query, or data to be recognized by the instrument. (Most controllers delimit the device-dependent message with double quotes.)

The following examples show command strings for three controllers and a representative language for each. The first is an IBM PC with a Tektronix GURU card (or National Instruments model PC2 or PC2A card) running BASICA. The second is a Tektronix 4041 Instrument Controller running 4041 BASIC. The third is a

Hewlett Packard 200 or 300 Series Scientific Computer running Series 200 or 300 BASIC.

In these examples, the 371 device-dependent command WINdow (abbreviated as WIN) is used to set the window cursor to mid-screen. In the second and third examples, the GPIB address of the 371 is assumed to be "8."

**IBM PC:** (The address is assigned elsewhere in the code.)

```
220 WRT$="WIN 250,250,750,750"      ' Create command
                                     string.
230 CALL IBWRT(DSO%,WRT$)          ' Send command.
```

**Tektronix 4041:**

```
220 Print #8:"WIN 250,250,750,750"  ! Send command to
                                     address 8.
```

**Hewlett Packard 200/300 Series:**

```
220 OUTPUT 708:"WIN 250,250,750,750",END
```

A useful addressing variation assigns the 371 address to a variable and uses that variable in place of the specific numeric address. In the following examples, the address is set to "6." This method works for all three of the example controllers when running BASIC and allows the destination of several commands to be altered by changing only the value of one variable: this is the scheme used in the IBM PC with the GURU card, running BASICA.

**Tektronix 4041:**

```
720 Addr=6
730 Print #addr:"WIN 250,250,750,750"
```

**Hewlett Packard 200/300 Series:**

```
720 DEVICE=706
730 OUTPUT DEVICE:"WIN 250,250,750,750",END
or
```

## 371 GPIB Controlling the 371 Over the Bus

---

```
720 ASSIGN @DEVICE TO 706
730 OUTPUT @DEVICE;"WIN 250,250,750,750",END
```

A third way of addressing the instrument, with further advantages, is to use a logical unit number (LUN). Following is an example using an OPEN statement in 4041 BASIC to set up a LUN associated with a particular 371 GPIB address, instead of using a variable.

Logical unit numbers can conserve programming time, since it is only necessary to specify a list of parameters (a stream specification) once. From then on, in the program, it is only necessary to refer to the logical unit number. In the following example, the LUN is 0 and the instrument bus address is 2. Refer to the Tektronix 4041 Programmer's Reference Manual for more information on logical units.

### **Tektronix 4041:**

```
120 Open #0:"GPIB0(pri=2):"
.
.
400 Print #0:"WIN 250,250,750,750"
```

In this example, note that any of the 371 commands listed in the Command Reference portion of this section may be substituted inside the quotation marks on line 400. Some command strings will be as short as three characters; more elaborate ones can be 250 characters, or even more.

The examples in Table 4-2 show how the syntax of several different controllers can vary. In these examples, the 371 is LUN 10.

**TABLE 4-2**  
**Controller Output Syntax**

Controller Language	Output Command
IBM PC with BASICA	WRT\$="string" CALL IBWRT(DEV%,WRT\$)
Tek 4041 BASIC	Print #10:"string"
HP 200/300 SERIES BASIC	OUTPUT 710;"string",END
HP 9825/200-SERIES HPL	wrt 710,"string"

### ■ Sending Queries and Receiving Responses

Commands with a question mark (?) are query commands which solicit information from the 371. After the controller sends a query command, it must acquire the resulting response from the 371. Examples using the **HOR?** query command follow.

#### IBM PC:

```
150 WRTS="HOR?"
160 CALL IBWRT(DSO%,WRTS)           ' Send query.
170 RDS=SPACES(100)
180 CALL IBRD(DSO%,RDS)           ' Input response.
```

#### Tektronix 4041:

```
150 Dim setS to 100
160 Input #10 prompt "HOR?":setS    ' Query LUN 10 and
                                     input response.
```

## 371 GPIB Controlling the 371 Over the Bus

---

### Hewlett Packard 200/300 Series:

```
150 DIM SET$(100)
160 OUTPUT 710;"HOR?",END
170 ENTER 710;SET$
```

In these examples, a string is dimensioned to 100 characters in order to store the incoming information. The controller sends HOR? over the bus to the 371 located at primary address 10. The controller then assigns the instrument at address 10 to be a talker and inputs the characters into the target variable, SET\$. The following shows a possible response, which is a 29 character string. The variable, SET\$, now contains this string of characters showing the current status of the horizontal controls:

```
HORIZ COLLECT:1E-1
```

Most commands have a corresponding query command. See the *Command Reference* portion of this section for examples. Table 4-3 shows how query responses are input from a variety of controllers.

TABLE 4-3  
Controller Input Syntax

Controller Language	Input Command
IBM PC with BASICA	CALL IBRD\$(DSO%,RD\$)
Tek 4041 BASIC	Input #10:s\$
HP 200/300 SERIES BASIC	INPUT 710;S\$,END
HP 9825/200-SERIES HPL	red 710,S\$

## ■ Instrument Setup Over the Bus

One popular use of the GPIB with the 371 is to store front-panel settings for later recall. These stored settings are then used to set up the curve tracer for repeating specific tests. This is accomplished by using a query command to acquire from the 371 an ASCII string representing the front-panel setup. This string is saved by the controller. Later, this same setup can be restored by sending the stored string back over the bus to the 371.

### Storing Settings for the 371

When a setting is transferred, it must first be moved to the front panel. From there it may be moved to the controller or to bubble memory. Figure 4-5 shows the transfer routes and the commands.

To bring the 371 front-panel setting data into the controller, use the **SET?** query and put the response into a string variable or variables that can hold up to 400 characters. From there it can be stored on any medium available to the controller, such as magnetic tape or disk.

#### IBM PC:

(BASICA is limited to a 255 character maximum string so the IBRD command will have to be executed twice to take in the full possible extent of the settings string.)

```
400 WRTS="SET?"           ^ Set up query
                           command string.
410 RD S=SPACES(200)      ^ Assign space for
                           a 200 character
                           response string.
420 RD2S=SPACES(200)     ^ Assign space for
                           a 200 character
                           response string.
430 CALL IBWRT(DSO%,WRTS) ^ Send query.
```

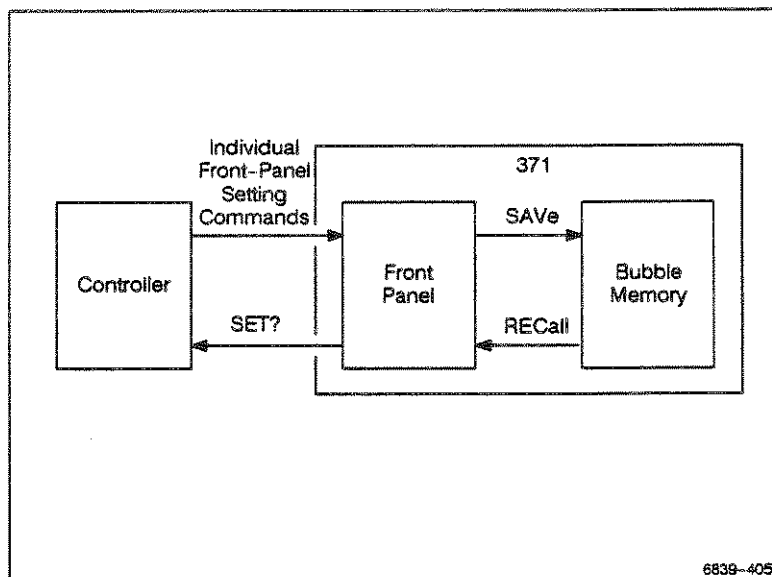

Figure 4-5. Transfer of settings.

```

440 CALL IBRD(DSO%,RDS)           ^ Input response
                                   for first 200
                                   characters.
  
```

```

450 CALL IBRD(DSO%,RD2S)         ^ Input response
                                   for remaining
                                   characters.
  
```

**Tektronix 4041:**

```

400 Dim set$ to 400              ! Dimension string
                                   variable.
410 Input #8 prompt "SET?":set$  ! Send query to
                                   LUN 8 and input
                                   the response.
  
```



**Hewlett Packard 200/300 Series:**

```
400 DIM SET$(400)
410 OUTPUT 710;"SET?",END
420 ENTER 710;SET$
```

A settings string that is stored by the controller can, of course, be modified. Use the appropriate string manipulation commands in the controller language to search for, modify, or replace parts of the string. Be sure that the resulting string meets the syntax requirements of the 11 individual commands making up the whole and that they are in the proper sequence. See the Command Reference portion of this section for details.

To save the current front-panel setting in the bubble memory, choose an appropriate setting storage location number of 1 through 16, then send the command **SAVE <number>**, where <number> identifies the setting storage location.

**Loading Settings Into the 371**

To reverse the above process for settings stored by the controller, simply take the appropriate settings string from wherever it has been stored and send the string back to the 371. There is no need for any preface or other command since the settings string is made up of the very commands that are needed. When it is necessary to break the settings string, as in BASICA, the break should occur where a semicolon would normally appear and that semicolon should be dropped.

The following examples use the settings strings that were saved in the preceding set of examples.

## 371 GPIB Controlling the 371 Over the Bus

---

### IBM PC:

```
700 CALL IBWRT(DEV%,SETAS)  
710 CALL IBWRT(DEV%,SETBS)
```

### Tektronix 4041:

```
700 Print #10;setS
```

### Hewlett Packard 200/300 Series:

```
700 OUTPUT 710;SETS,END
```

If the settings were stored in the bubble memory, it's necessary to know which of the 16 bubble-memory locations was used. Then send the command **RECall <NR1 >**, where the number, **<NR1 >**, identifies bubble memory location.

While these procedures can change settings quickly and without error, the operator may have to make a few manual settings (e.g., the Collector Supply circuit breakers and the position of the protective cover). One way to remind the operator what needs to be done is to send a message using the text display area of the 371 screen. Send an appropriate message of up to 24 characters using the **TEXT <string >** command.

## ■Data Storage and Transfer

Once the 371 has been set up to make a desired measurement, the next step in realizing the advantages of digital storage is to acquire and store the data with the 371. This in turn allows you to plot it, if you have an attached plotter, or copy it into the controller or bubble memory. From the controller you can store it on other media, compare it with other data, calculate with it, or display it. See Figure NO TAG for the possible routes for data transfers.

In most cases, acquiring data with the 371 involves two parts, both done automatically by the instrument. The first is to code the necessary scale factors and other parameters into a series of

words and numbers. The words are English but are standardized so they can also be read by a computer. This part of the data is called the preamble.

The second part of data acquisition is to digitize and code the displayed curves. This converts the curves to a series of binary numbers representing the horizontal and vertical locations of a sequence of points along the curves. This part of the data is called the curve. Together with the preamble it fully describes the displayed curve.

### Acquiring Data Within the 371

To acquire data, set the display function to Store mode. The command to do this over the bus is **DISplay STORE**. At this point the current set of parameters are recorded and the curves being shown are digitized. They can now be copied over the bus to the controller or to an attached plotter.

### Data Structure

The preamble and curve are each a string of eight-bit bytes. The preamble is a string of ASCII letters, numerals, and punctuation. Each character is represented by one byte. The major part of a curve is a sequence of binary-coded numbers, which is prefixed by a 25 character ASCII string identifying the curve.

The curve data string represents the 371 display, where each data point in the display is described as a 10-bit horizontal and 10-bit vertical position. The horizontal and vertical positions are each coded as a pair of bytes in the data string. Thus, there are four bytes for each data point. Since a display can have from 1 to 1024 data points, the curve data can include from 4 to 4096 bytes. In addition, there are two bytes at the start of the string for a byte count and one byte at the end for a checksum value, for a maximum of 4099 bytes.

The numbers are coded in two's-complement binary format. The low-order eight bits are stored in the second byte while the two

high-order bits are stored in the low-order positions of the first byte. The sign bit fills the remaining bits in the high-order byte.

## ■ Moving Waveform Data to the Controller

Waveform data is transferred from the 371 to the controller in two parts, the preamble and the curve data. As explained in the following discussion, these two parts can be transferred together or separately.

### Transferring the Preamble

To receive a waveform preamble from the 371, send the command query `WFMpre?` The response will be a string containing 17 parameters, each shown as a label and value pair. See the Waveform Transfer Commands in the Command Reference portion of this section for details. Follow the command query with an instruction to the controller to input the response, allowing for a string about 410 characters long.

#### Tektronix 4041:

```
300 Dim pream$(410)
310 Input #8 prompt "WFM?":pream$
```

#### Hewlett Packard 200/300 Series:

```
300 DIM PREAMS(410)
310 OUTPUT 718;"WFM?",END
320 ENTER 718;PREAMS
```

### Transferring the Curve

When a waveform is transferred to the controller, it must first be displayed. When a waveform is transferred from the controller it must go directly to the bubble memory. The routes and commands are shown in Figure 4-6.

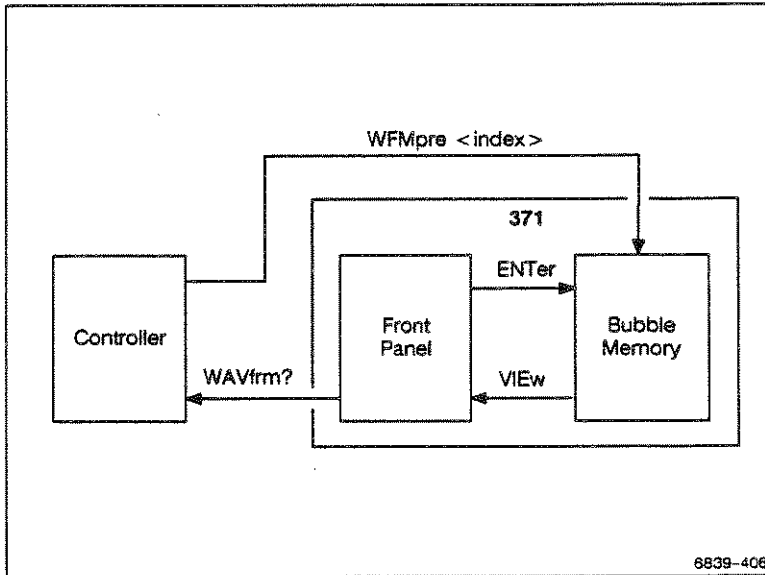

Figure 4-6. Transfer of waveforms.

To copy displayed data in Store or View mode to the controller, first send a **WFMpre?** query to transfer the preamble. Then send a **CURve?** query to transfer the curve.

To copy the data from bubble memory to the controller, first send a **DISplay VIEW: <index>** command to display the curve stored at the index location. Then send a **WFMpre?** query to transfer the preamble from the display. Last, send a **CURve?** query to transfer the curve from that location. Another command, **WAVfrm?**, combines the functions of **WFMpre?** and **CURve?**

and returns the whole display, preamble plus curve, with an ASCII semicolon between them.

For the curve data, in general, provisions will have to be made for a string length of about 4125 bytes. The response will be a short (25 bytes or characters) ASCII string identifying the curve, two bytes giving the number (in binary) of data points to follow, the 4096 bytes representing the actual curve data, and a checksum (one binary byte).

### Transferring the Waveform to Bubble Memory

Another possibility for storing data under control of the bus is to put the waveform into a bubble-memory waveform-storage location. Use the **ENTER** `<NR1>` command, where the number, `<NR1>`, is the storage location index.

### ■ Loading Data From the Controller

Moving display data from the controller to the 371 requires that an unlocked bubble-memory cartridge be in place.

#### NOTE

*Data transferred from the 371 in Store mode cannot be reloaded to the 371.*

### Loading the Preamble

The command **WFMpre** `<string>`, where `<string>` is a waveform preamble, will load that preamble into the 371. The preamble will be stored in the bubble-memory location indicated by the **WFID INDEX** portion of the string (see **WFMpre** in the Command Reference portion of this section for details).

### Loading the Curve

When sending display data to the 371, the target is the bubble-memory location set by the preceding preamble transfer.

To send a curve from the controller to the 371, use the command **CURve <string>**, where <string> consists of a short ASCII string (CURVID) followed by a string of binary bytes. See **WFMpre** in the Command Reference portion of this section for details.

### ■ Transferring Other Types of Data

Although waveforms are the principal data developed with the 371, there are two other types of data: cursor readout and text.

#### Transferring the Cursor Readout

The point at which a dot cursor is located on the display can be expressed in terms of display units. The data is requested with the **REAdout?** command and the response is the word **READOUT** followed by a pair of numbers giving the cursor location in terms of physical units: horizontal location in volts and vertical location in amperes. With the *f* line cursor activated, the response to the **REAdout?** query gives the cursor 1/gradient in ohms abbreviated as "o", and the horizontal intercept in volts. The window cursor can be used similarly but the readout value depends on the last manual setting as to whether it comes from the upper-right or lower-left corner of the rectangular window.

#### Transferring Text

Although it's not data in the same sense, information in the text display area can be read over the bus with the **TEXT?** query command. Text can also be replaced in the display with the **TEXT** command, as described in the Command Reference portion of this section.

## ■ Summary of Data Transfers

There are several kinds of data and, as demonstrated in the previous paragraphs, they differ in content and format. There are a number of ways to move these various kinds of data from place to place, as shown in Figure 4-7.



371 GPIB  
Controlling the 371 Over the Bus

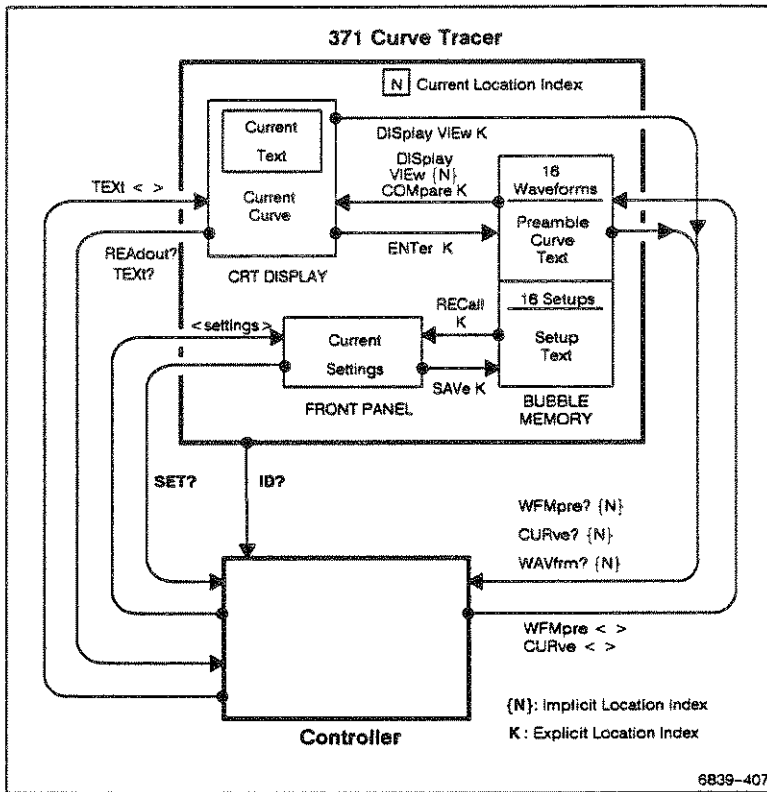

Figure 4-7. Data transfers under GPIB control.

## DEVICE-DEPENDENT MESSAGE FORMAT

**Device-dependent messages** travel both ways between the instrument and controller, and are used to:

- Set instrument controls
- Request and return the instrument status
- Request, return, and send waveforms
- Request and return results of other measurements

Most messages are sent as strings of ASCII characters; however, data representing sets of curves are sent as series of binary-coded numbers.

**Commands** are sent from the controller to the instrument. Each starts with a key word called a header which is usually followed by an argument to further detail the instruction. The key words used for command headers and arguments are mnemonics related to specific instrument controls and functions. Multiple commands can be sent in one message. Many command headers can be issued with an attached question mark (?), identifying them as queries which prompt the instrument for certain information.

**Responses** to queries either contain information about instrument status or measurement data. Generally, status messages are made up of the same key words used for commands. The only device-dependent messages not made up of words or parts of words are those made up of curve data.

Each message ends with the message terminator, which was discussed earlier. In most cases the controller or its language takes care of the message terminator and it is no longer a concern once it has been chosen and set.

## ■ Command Message Formats

Commands for the 371 Curve Tracer, like those for other Tektronix GPIB instruments, follow the conventions of the Tektronix Standard Codes and Formats. Each command starts with a key-word header which is often followed by one or more key-word arguments to further specify the action to be taken. The key words for the commands were chosen to be as understandable as possible, while still allowing a familiar user to shorten most of them to only a few characters. Syntax is also standardized to make the commands easier to learn.

In most of this section, key words for headers and arguments are listed in a combination of uppercase and lowercase letters. The instrument accepts any abbreviated header or argument containing at least all the characters shown in uppercase. We show them as uppercase for emphasis only. **The 371 accepts upper or lower case characters.** In many cases, the commands may be expressed in a variety of valid ways.

The following are all valid versions of the **INIt** command, which resets the 371 to the initial state following power-up.

```
INI
INIT
Ini
Init
ini
init
inIT
```

The Command Reference portion of this section describes all the 371 commands and queries. In the Command Reference, the elements of each command and query are listed in tabular format. The first column lists the header key word. The second column lists arguments that may be associated with the command. A third column, if necessary, lists linked arguments. Brief descriptions and examples are shown in the last column.

## 371 GPIB Device-Dependent Message Format

---

### Headers

Each command consists of at least a header.

<header>

Each command header is unique and in some cases is all that is needed to invoke the command. For example:

INI*t*

### NOTE

*CURSor* can be shortened only to four characters. The three characters *CUR* will be interpreted as *CURve*.

### Arguments

Many commands require the addition of arguments to the header to describe exactly what is to be done. If there is more to the command than just the header, the header must be followed by at least one space. Otherwise, the 371 treats all spaces, line-feeds, and tabs as "white space" and ignores them in analyzing messages from the controller. For example:

<header> <argument>

In some cases, the argument is simply a single word or a number. For example:

CURSor OFF  
RQS on  
PKPower 3000

### Linked Arguments

In other cases, the argument itself requires another argument. When an argument to an argument is required, a colon links the two; hence the second is called a linked argument.

<header> <argument>:<linked argument>

```
DISplay INVert:ON
VERt COLlect:1.0E+0
WFMpre NR.PT:512
```

### Queries

For most commands there is a corresponding query formed by adding a question mark to the header key word. Do not put a space between the last character of the key word and the question mark.

Queries for the 371 need only the header and question mark, though the response will usually be more involved.

<header>?

```
ID?
HOR?
DEB?
STPgen?
```

```
Query:          STP?
Typical Response: STPGEN NUMBER: 5,OFFSET: 0.00,
                  INVERT OFF,MULT:OFF,CURRENT:1.0E-3
```

### Multiple Arguments

Where a header has multiple arguments, the successive arguments (or argument pairs if the arguments have linked arguments) must be separated by commas.

## 371 GPIB Device-Dependent Message Format

---

<header> <first arg>:<link arg>,<second arg>:<link arg>

STP CUR:2E-6,MUL:ON,NUM:5  
DIS VIE:16,INV:ON

### Numeric Argument Formats

Many commands have numeric arguments. The numbers are decimal (base 10) values. They are expressed in three different formats, denoted <NR1>, <NR2>, and <NR3>. These formats are shown in Table 4-4.

TABLE 4-4  
Numeric Argument Formats

Symbol	Number Format	Examples
<NR1>	Integer	+1, 2, -1, -10, 0
<NR2>	Explicit decimal point	-3.2, +5.1, 1.2, .0, 0
<NR3>	Floating point, exponential, or scientific notation	-12.3E-2, .005E-6, 0.000E-3, 6.7E+4, 2.35E-3, 0.E0, 125E-6

Generally:

- An <NR1> argument must be sent to the 371 in that format (i.e., without a decimal point).
- An <NR2> argument may be sent to the 371 in either <NR2> or <NR1> format.

- An <NR3> argument may be sent in <NR3>, <NR2> or <NR1> format.

Examples of these argument formats are shown in Table 4-5.

TABLE 4-5  
Argument Format Examples

Command	Valid Forms
RECall <NR1>	REC 12
DISplay VIEW:<NR1>	DIS VIE:7
VERt COLlect:<NR3>	VER COL:2 VER COL:0.5 VERT COLlect:1.5E-2

### Multiple-Command Messages

Multiple commands may be included in one message by separating individual commands with semicolons. The command examples are shown in different formats to demonstrate the 371's indifference to upper and lower case.

```
<first command>;<second command>;<third command>  
PKPOWER 10;CSPOL NPN;MEASURE SINGLE  
pkpow 10;cspol npn;meas single  
PKP 10;CSP NPN;MEA SIN  
CURSOR OFF;HORIZ STPCEN:1.0E+0;STPCEN NUMBER:3
```

With multiple commands in the message, the message terminator is needed only once, at the end of the message. Again, most controllers and their languages take care of this.

### Other Messages

Besides receiving commands and queries the 371 can receive data and send responses to queries. The data and responses can be quite short (a word and a number) or fairly long (a full set of front-panel settings). Measurement information can also be short (a word and a number) or lengthy (a full display).

**ASCII strings.** As mentioned before, the only device-dependent messages not sent as ASCII strings are the binary data used for curves. All other messages, both to and from the 371, are ASCII strings made up of numbers or key words pertaining to the applicable parameters.

**Key-word messages.** A sample, key-word exchange resulting in a simple response is the following.

```
Query:          PST?
Response:       PSTATUS BUSY
```

Another example follows, this one resulting in a more lengthy response.

```
Query:          STP?
Response:       STPCEN NUMBER: 5, OFFSET: -1.5,
                INVERT: OFF, MULT: OFF, VOLTAGE: 2.0E-3
```

**Number messages.** Numbers other than those representing curves are sent as strings of ASCII characters. Some controllers may require that these be explicitly converted to numeric values for use in calculations. Other controllers or languages may provide a more direct conversion, as the Tektronix 4041 does. For example, if a 4041 is used as the controller, the following exchange may occur:

```
Query:          VCS?
Response:       VCSPLY 50.0
```



The 4041 can handle this either of two ways.

The first method inputs the whole, 12-character response into a string variable, `vcs$`. To extract the numeric part would require use of the `SEG$` function and to convert that to a numeric value would require use of the `VAL` function.

```
210 Input #8 prompt "VCS?":vcs$
```

The second method inputs the numeric value directly into an implicit, short floating-point variable, `vcslev`.

```
210 Input #8 prompt "VCS?":vcslev
```

This requires no additional manipulation, as only the numeric portion of the string is acknowledged.

### Preambles

Preambles are necessary to interpret the numeric information in the curve data that follows them. Within a preamble, 24 parameters are specified. The first eight are unique to the 371 curve tracer and are included as a sub-string linked to the **WFID:** label. The other 16 parameters include ten that have fixed values and six that vary with the particular data sent.

Within the **WFID:** sub-string the parameters are separated by slashes, while the entire sub-string is delimited by a pair of double quote marks. Most of the **WFID:** string is rather strictly defined, with each parameter value being right justified in a fixed length field. An exception is the **BGM** value, which may vary in field length.

The remainder of the preamble uses standard punctuation. A colon links each parameter label with its corresponding value and the individual label and value pairs are separated with commas.

## 371 GPIB Device-Dependent Message Format

---

A complete preamble might look like this:

```
WFMPRE WFID:"INDEX 3/VERT 500mA/HORIZ 1 V/STEP 5 V/  
OFFSET 0.00 V/BGM 100mS/VCS 12.3/TEXT ",ENCDG:BIN,  
NR.PT:3,PT.FMT:XY,XMULT:+1.OE-2,XZERO:0,XOFF:  
12,XUNIT:V,YMULT:+5.OE-3,YZERO:0,YOFF:12,YUNIT:A,BYT/  
NR:2,BN.FMT:RP,BIT/NR:10,CRVCHK:CHKSMO,LN.FMT:DOT
```

### Curves

Curve data sets are usually much longer than any other kind. Typically a set of curve data will be about 4122 bytes long, with most of the bytes being binary-coded numbers. Thus, most of the string of data is not directly readable, but must be interpreted by the controller.

An example might look like this.

```
CURVE CURVID:"INDEX 9",%NNXXYYXXYY . . . XXYYC
```

This example breaks down as follows. It starts with an ASCII string of 25 characters:

```
CURVE CURVID:"INDEX 9",%
```

This is followed by a series of binary bytes. The first of these is two bytes giving the number of data bytes to follow, plus one (typically 4097):

```
NN
```

Then come the 4096 data bytes. Each of the 1024 data points on the curve is represented by four bytes, 2 for the 10 bits of the X coordinate and 2 for the 10 bits of the Y coordinate:

```
XXYYXXYY . . . XXYY
```

And finally there is one byte which is the checksum for the preceding 4098 data bytes.

## FRONT-PANEL SETTINGS AND CORRESPONDING GPIB COMMANDS

Most front-panel controls on the 371 can be set with GPIB commands, and the settings of most front-panel controls can be reported back over the bus to a controller.

Table 4-6 contains a listing of all front-panel controls and the associated commands and queries. The groups listed in the last column of the table are explained in the Command Reference portion of this section.

Table 4-7 contains general setting and command/query information.

**TABLE 4-6  
GPIB Commands and Queries for  
Front Panel Controls**

<b>371 Control</b>	<b>Command</b>	<b>Query</b>	<b>Group</b>
<b>CRT Controls</b>			
NON STORE/STORE Intensity	None	None	None
VIEW Intensity	None	None	None
READOUT Intensity	None	None	None
FOCUS	None	None	None
GRAT ILLUM	None	None	None
POSITION	None	None	None
TRACE ROTATION	None	None	None

**371 GPIB**  
**Front Panel Settings and Corresponding GPIB Commands**

**TABLE 4-6**  
**GPIB Commands and Queries for**  
**Front Panel Controls (cont.)**

<b>371 Control</b>	<b>Command</b>	<b>Query</b>	<b>Group</b>
<b>Measurement Controls</b>			
REPEAT	MEASURE	MEASURE?	Miscellaneous
SINGLE	MEASURE	MEASURE?	Miscellaneous
SWEEP	MEASURE	MEASURE?	Miscellaneous
<b>Bubble Memory</b>			
Bubble Memory Location Index	Selected only as an argument when saving and recalling settings or waveforms.		
<b>Setup Controls</b>			
SAVE	SAVE	—	Miscellaneous
ERASE	None	None	None
RECALL	RECALL	—	Miscellaneous
DIRECTORY	None	None	None
<b>Display Controls</b>			
NON STORE	DISPLAY	DISPLAY?	Display
STORE	DISPLAY	DISPLAY?	Display
	CURVE	CURVE?	Waveform Transfer
	—	WAVEFORM?	Waveform Transfer
CAL FULL	DISPLAY	DISPLAY?	Display
COMPARE	DISPLAY	DISPLAY?	Display

**TABLE 4-6**  
**GPIB Commands and Queries for**  
**Front Panel Controls (cont.)**

371 Control	Command	Query	Group
<b>Display Controls (cont.)</b>			
CAL OFF	DISplay	DISplay?	Display
VIEW	DISplay	DISplay?	Display
CAL ZERO	DISplay	DISplay?	Display
ENTER	DISplay	DISplay?	Display
TEXT	TEXT	TEXT?	CRT Readout Transfer
HORIZONTAL VOLTS/DIV	HORiz	HORiz?	Display
VERTICAL CURRENT/DIV	VERt	VERt?	Display
INVERT	DISplay	DISplay?	Display
<b>Collector Supply Controls</b>			
POLARITY	CSPol	CSPol?	Collector Supply
PEAK POWER WATTS	PKPower	PKPower?	Collector Supply
VARIABLE	VCSpply	VCSpply?	Collector Supply
LOOPING COMPENSATION	None	None	None

Revised DEC 1987

**371 GPIB**  
**Front Panel Settings and Corresponding GPIB Commands**

**TABLE 4-6**  
**GPIB Commands and Queries for**  
**Front Panel Controls (cont.)**

371 Control	Command	Query	Group
<b>Step Generator Controls</b>			
INVERT	STPgen	STPgen?	Step Generator
SOURCE	STPgen	STPgen?	Step Generator
NUMBER OF STEPS	STPgen	STPgen?	Step Generator
STEP/OFFSETS AMPLITUDE	STPgen	STPgen?	Step Generator
OFFSET	STPgen	STPgen?	Step Generator
STEP MULTI .1X	STPgen	STPgen?	Step Generator
DISABLE	None	None	Step Generator
<b>Cursor Controls</b>			
Cursor Mode	CURSor	None	Cursor
	DOT	None	Cursor
	WINdow	None	Cursor
	LINE	None	Cursor

**371 GPIB**  
**Front Panel Settings and Corresponding GPIB Commands**

**TABLE 4-6**  
**GPIB Commands and Queries for**  
**Front Panel Controls (cont.)**

<b>371 Control</b>	<b>Command</b>	<b>Query</b>	<b>Group</b>
<b>Cursor Controls (cont.)</b>			
Cursor Position	—	REAdout?	CRT Readout Transfer
	DOT	DOT?	Cursor
	WINDow	WINDow?	Cursor
	LINE	LINE?	Cursor
<b>GPIB and Plotter Controls</b>			
RESET TO LOCAL	None	None	None
ADDR	None	None	None
USER REQUEST	None	None	None
ID	—	ID?	Instrument Parameters
ALL	PLOt	None	Miscellaneous
CURVE	PLOt	None	Miscellaneous
<b>Signal Output Controls</b>			
Collector Supply Breakers	None	CSOut?	Collector Supply

**371 GPIB**  
**Front Panel Settings and Corresponding GPIB Commands**

---

**TABLE 4-7**  
**General Setting Information and**  
**Related GPIB Commands**

<b>Setting Information</b>	<b>Command or Query</b>	<b>Group</b>
Set the 371 controls to the power-up default settings.	<b>INIt</b>	Instrument Parameters
What are the current 371 settings?	<b>SET?</b>	Instrument Parameters
What are the valid command and query headers?	<b>HElP?</b>	Instrument Parameters



## COMMAND REFERENCE

The 371 has commands and queries in nine functional groups:

- **Collector Supply** – Control and report Collector Supply settings
- **CRT Readout Transfer** – Read and write display text and report the cursor readout
- **Cursor** – Control and report cursor position and set cursor mode
- **Display** – Control and report display settings
- **Instrument Parameter** – Initialization, troubleshooting, and status reporting
- **Miscellaneous** – Control and report measurement mode and plotter output, report output connector status, store and recall front-panel settings
- **Status and Event** – Control and report service requests and event codes
- **Step Generator** – Control and report Step Generator settings
- **Waveform Transfer** – Store and recall waveforms

Table 4-8 shows the nine groups and the commands within each group.

The Command Index (following Table 4-8) lists all commands and queries alphabetically and gives the page on which they are described.

The nine command groups are presented alphabetically in this section, following the Command Index, with their commands and queries presented alphabetically within the group.

TABLE 4-8  
Command and Query Groups

Collector Supply	CRT Readout Transfer	Cursor	Display	Instrument Parameter	Miscellaneous	Status and Event	Step Generator	Waveform Transfer
CSPol? CSPol? CSOut? PKPower? VCSply? VCSply?	BGM? READout? TEXT TEXT?	CHRSor DOT DOT? LINE? LINE? WINDOW WINDOW?	DISplay DISplay? ENTer HORiz HORiz? VERI VERI?	DEBUg DEBUg? HELp? ID? INI SET? TES?	MEASure MEASure? OUTput PLOt PStaus? RECall SAVe	EVEnt? OPC OPC? RQS RQS?	STPgen STPgen?	CURve CURve? WAVform? WEMPie? WEMPie? WFMpie NR.PT WFMpie NR.PT

## ■ Command Index

This index alphabetically lists all command and query headers for the 371. The page number for a full description is also given for each command or query.

Command or Query	Page
BGM?	4-66
CSOut?	4-58
CSPol	4-59
CSPol?	4-60
CURSor	4-71
CURve	4-115
CURve?	4-116
DEBug	4-88
DEBug?	4-89
DISplay	4-79
DISplay?	4-81
DOT	4-72
DOT?	4-73
ENTer	4-82
EVEent?	4-104
HELp?	4-90
HORiz	4-83
HORiz?	4-84
ID?	4-91
INit	4-92
LINE	4-74
LINE?	4-75
MEASURE	4-96
MEASURE?	4-97
OPC	4-105
OPC?	4-106
OUTputs?	4-98

### Command Index (cont.)

Command or Query	Page
PKPower .....	4-61
PKPower? .....	4-62
PLOt .....	4-99
PStatus? .....	4-100
REAdout? .....	4-67
RECall .....	4-101
RQS .....	4-107
RQS? .....	4-108
SAVe .....	4-102
SET? .....	4-93
STPgen .....	4-110
STPgen? .....	4-113
TESt? .....	4-94
TEXt .....	4-68
TEXt? .....	4-69
VERt .....	4-85
VERt? .....	4-86
VCSply .....	4-63
VCSply? .....	4-64
WAVfrm? .....	4-117
WFMpre .....	4-118
WFMpre? .....	4-120
WFMpre NR.PT .....	4-122
WFMpre? NR.PT .....	4-123
WINDow .....	4-76
WINDow? .....	4-77

## ■ Collector Supply Commands and Queries

The Collector Supply group of commands and queries sets and reports the status of the Collector Supply polarity, mode, peak power, and output level. They also query the 371 on the status of the Collector Supply breakers, which are not settable via the GPIB.

The commands and queries in this group include:

CSOut?  
CSPol  
CSPol?  
PKPower  
PKPower?  
VCSply  
VCSply?

An **alphabetical listing** of all command and query headers is given in the Command Index on **page 4-55**.

A **cross reference** for front-panel controls and corresponding GPIB commands and queries is given in Table 4-6 on **page 4-47**.

## CSOut?

**Group:** Collector Supply

**Purpose:** Queries the 371 for the current setting of the Collector Supply High Voltage and High Current breakers.

---

Header	Argument	Definition and Syntax
CSOut?		<p>Respond with the Collector Supply breaker status.</p> <hr/> <p>Response syntax: CSOUT &lt; mode &gt;</p> <p>where: &lt; mode &gt; = BOTH or VOLTAGE or CURRENT or OFF</p> <p>and</p> <p><b>BOTH</b> = Both the High Voltage and High Current breakers are Enabled.</p> <p><b>VOLTAGE</b> = High Voltage breaker is Enabled and High Current breaker is Disabled.</p> <p><b>CURRENT</b> = High Current breaker is Enabled and High Voltage breaker is Disabled.</p> <p><b>OFF</b> = Both the High Voltage and High Current breaker are Disabled.</p>

---

## CSPol

**Group:** Collector Supply

**Purpose:** Sets the Collector Supply polarity and mode.

---

Header	Argument	Definition and Syntax
CSPol	NPN POSitive PNP NEGative	Select the Collector Supply polarity and mode.  Command syntax: CSPol < mode >  where: < mode > = NPN, POSitive, PNP, or NEGative

---

**371 GPIB**  
**Command Reference – Collector Supply Commands**

---

## CSPol?

**Group:** Collector Supply

**Purpose:** Queries the 371 for the current setting of the Collector Supply polarity.

Header	Argument	Definition and Syntax
CSPol?		Respond with the Collector Supply polarity.  Response syntax: CSPOL <mode>  where: <mode> = NPN or PNP



## PKPower

**Group:** Collector Supply

**Purpose:** Selects the Collector Supply Peak Power setting.

---

Header	Argument	Definition and Syntax
PKPower	3000 300 30 3	Set the maximum peak power, in watts.  Command syntax: PKPower < set >  where: < set > = 3000 or 300 or 30 or 3

---

## PKPower?

**Group:** Collector Supply

**Purpose:** Queries the 371 for the current setting of the Collector Supply Peak Power.

---

Header	Argument	Definition and Syntax
PKPower?		Respond with the maximum peak power setting, in watts.  Response syntax: PKPOWER <set>  where: <set> = 3000 or 300 or 30 or 3

---

## VCSpply

**Group:** Collector Supply

**Purpose:** Sets the Collector Supply output level.

---

Header	Argument	Definition and Syntax
VCSpply	<NR2>	Set the Collector Supply output level (Variable). The argument is stated as a percentage with allowed increments of 0.1%. <hr/> <b>Command syntax:</b> VCSpply <data >  <b>where:</b> <data > = 0.0 or 0.1 . . . 99.9 or 100.0

---

**371 GPIB**  
**Command Reference – Collector Supply Commands**

---

## VCSpply?

**Group:** Collector Supply

**Purpose:** Queries the 371 for the current setting of the Collector Supply output level.

---

<b>Header</b>	<b>Argument</b>	<b>Definition and Syntax</b>
VCSpply?		Respond with the Collector Supply output level (Variable) setting.  Response syntax: VCSPPLY < data >  where: < data > = 0.0 or 0.1 . . . 99.9 or 100.0

---

**■ CRT Readout Transfer Commands and Queries**

The CRT Readout Transfer group allows the controller to read horizontal and vertical cursor parameters from the 371, and to read or write text in the text area of the 371 display graticule.

The commands and queries in this group include:

**BGM?**  
**REAdout?**  
**TEXT**  
**TEXT?**

An **alphabetical listing** of all command and query headers is given in the Command Index on **page 4-55**.

A **cross reference** for front-panel controls and corresponding GPIB commands and queries is given in Table 4-6 on **page 4-47**.

## BGM?

**Group:** CRT Readout Transfer

**Purpose:** Queries the 371 for the  $\beta$  OR gm/DIV readout.

---

Header	Argument	Definition and Syntax
BGM?		Respond with the $\beta$ OR gm/DIV readout from the 371 display. <hr/> Response syntax: BGM <para>  where: <para> is <NR1>

---

## REAdout?

**Group:** CRT Readout Transfer

**Purpose:** Queries the 371 for the vertical and horizontal cursor parameter readouts.

Header	Argument	Definition and Syntax
REAdout?	default STRing SCientific	<p>The default argument is STRing.</p> <p>Window cursor values are for the location of the bright dot in the corner of the window, and the Window cursor used depends on the last front-panel Cursor mode setting.</p> <p>The response can be specified to be in either string or scientific notation format.</p> <p>If the cursor is offscreen, the returned values will be preceded by question marks and are not valid.</p> <p>Note also the commands for cursor positioning in the Cursor Commands and Queries group.</p> <hr/> <p>Response syntax: <b>READOUT &lt;xread&gt;, &lt;yread&gt;</b></p> <p>where: &lt;xread&gt; = horizontal reading in volts &lt;yread&gt; = vertical reading in amperes (or ohms for f LINE cursor).</p> <p>When queried with the SCientific argument, the responses &lt;xread&gt; and &lt;yread&gt; are &lt;NR3&gt;.</p>

## TEXT

**Group:** CRT Readout Transfer

**Purpose:** Allows the controller to write text on the 371 display.

---

Header	Argument	Definition and Syntax
TEXT	< string >	Display the text string in the text display area of the 371 CRT graticule.  Command syntax: TEXT "< text >"  where: < text > = A message with a length of no more than 24 characters.

---



## TEXT?

**Group:** CRT Readout Transfer

**Purpose:** Queries the 371 for any text displayed in the text area of the CRT graticule.

Header	Argument	Definition and Syntax
TEXT?		<p>Respond with the text currently displayed in the text area of the CRT graticule.</p> <p>Although text may be stored in bubble memory along with the settings, it can be sent over the bus only with this query.</p> <p>The SET? query does not send text over the bus. Use the TEXT? query for this purpose.</p> <hr/> <p>Response syntax: TEXT "&lt;text&gt;"</p> <p>where: &lt;text&gt; = The message from the CRT text area, with no more than 24 characters.</p>

## ■ Cursor Commands and Queries

The Cursor group selects Cursor mode and positions the selected cursor on the display, or queries the 371 on the position of the cursor.

The commands and queries in this group include:

- CURsor
- DOT
- DOT?
- LINE
- LINE?
- WINdow
- WINdow?

An **alphabetical listing** of all command and query headers is given in the Command Index on **page 4-55**.

A **cross reference** for front-panel controls and corresponding GPIB commands and queries is given in Table 4-6 on **page 4-47**.

## CURSor

**Group:** Cursor

**Purpose:** Sets the 371 Cursor mode to OFF.

---

Header	Argument	Definition and Syntax
CURSor	OFF	Set the Cursor mode to OFF. <hr/> <p>Command syntax: <b>CURSor OFF</b></p> <p>Also see the REAdout? query in the CRT Readout Command Group for extracting data values from the cursor.</p>

---

## DOT

**Group:** Cursor

**Purpose:** Sets the 371 Dot Cursor position to a specific point on the currently displayed curve.

---

Header	Argument	Definition and Syntax
DOT	<NR1>	Set the Dot cursor on the specified data point in the current curve.  Command syntax: DOT <data>  where: <data> = 1 or 2 or 3 . . . 1024 (0 is the beginning of the curve and 1024 is the end.)

---

## DOT?

**Group:** Cursor

**Purpose:** Queries the 371 for the location of the Dot cursor on the currently displayed curve.

---

Header	Argument	Definition and Syntax
DOT?		<p>Respond with the Dot cursor position.</p> <hr/> <p>Response syntax: DOT &lt;NR1 &gt;</p> <p>Where: &lt;NR1 &gt; is a number between 0 and 1024 specifying the location of the Dot cursor on the currently-displayed curve. (0 is the beginning of the curve and 1000 is the end.)</p>

---

## LINE

**Group:** Cursor

**Purpose:** Sets the *f* Line cursor intercept position on the display.

---

Header	Argument	Definition and Syntax
LINE	<NR1>, <NR1>	<p>Set the <i>f</i> Line cursor intercept position. This position must be a point on a square grid whose lower left corner coordinates are 0, 0 and upper right corner coordinates are 1000, 1000.</p> <hr/> <p>Command syntax: LINE &lt;data1&gt;,&lt;data2&gt;</p> <p>where: &lt;data1&gt; = 0 ... 1000 horizontal position &lt;data2&gt; = 0 ... 1000 vertical position</p>

---

## LINE?

**Group:** Cursor

**Purpose:** Queries the 371 for the intercept position of the *f* Line cursor on the display.

Header	Argument	Definition and Syntax
LINE?		<p>Respond with the <i>f</i> Line cursor intercept position. This position is a point on a square grid whose lower left corner coordinates are 0, 0 and upper right corner coordinates are 1000, 1000.</p> <hr/> <p>Response syntax: LINE &lt; data1 &gt; , &lt; data2 &gt;</p> <p>where: &lt; data1 &gt; = 0 . . . 1000 horizontal position &lt; data2 &gt; = 0 . . . 1000 vertical position</p>

## WINDow

**Group:** Cursor

**Purpose:** Positions and sizes the Window cursor on the CRT graticule.

Header	Argument	Definition and Syntax
WINDow	<NR1>, <NR1>, <NR1>, <NR1>	<p>Set the Window cursor to the specified position on the CRT graticule.</p> <p>The cursor window is defined by four points, which are specified in the argument portion of command.</p> <p>Command syntax: WINDow &lt;data1&gt;,&lt;data2&gt;,&lt;data3&gt;, &lt;data4&gt;</p> <p>where: &lt;data1&gt; = 0 ... 1000 Lower left horizontal position &lt;data2&gt; = 0 ... 1000 Lower left vertical position &lt;data3&gt; = 0 ... 1000 Upper right horizontal position &lt;data4&gt; = 0 ... 1000 Upper right vertical position</p>



## WINDow?

**Group:** Cursor

**Purpose:** Queries the 371 for the position and size of the Window cursor on the CRT graticule.

---

Header	Argument	Definition and Syntax
WINDow?		<p>Respond with the Window cursor position. The cursor window is defined by four points, which are specified in the argument portion of the response.</p> <hr/> <p>Response syntax: WINDOW &lt;NR1&gt;, &lt;NR1&gt;, &lt;NR1&gt;, &lt;NR1&gt;</p> <p>where:</p> <ul style="list-style-type: none"><li>&lt;data1&gt; = 0 . . . 1000 Lower left horizontal position</li><li>&lt;data2&gt; = 0 . . . 1000 Lower left vertical position</li><li>&lt;data3&gt; = 0 . . . 1000 Upper right horizontal position</li><li>&lt;data4&gt; = 0 . . . 1000 Upper right vertical position</li></ul>

---

## ■ Display Commands and Queries

The Display group of Commands and Queries controls and reports the status of the 371 display. 371 settings controlled by this group include: mode, polarity, source, sensitivity, and calibration mode. Also included in this group is a command to send Store-mode displays to specified locations in bubble memory.

The commands and queries in this group are:

DISplay  
DISplay?  
ENTer  
HORiz  
HORiz?  
VERt  
VERt?

An **alphabetical listing** of all command and query headers is given in the Command Index on **page 4-55**.

A **cross reference** for front-panel controls and corresponding GPIB commands and queries is given in Table 4-6 on **page 4-47**.

## DISplay

**Group:** Display

**Purpose:** Set and change the 371 Display mode, polarity, and calibration mode.

Header	Argument	Linked Argument	Definition and Syntax
DISplay	NSTore STOre		Select Non-Store mode. Select Store mode.  Command syntax: DISplay < mode >  where: < mode > = NSTore or STOre
	VIEW:	< NR1 >	Select View mode and display a curve from the specified location.  Command syntax: DISplay < mode > : < index >  where: < mode > = VIEW < index > = 1 . . . 16 (Bubble memory index)
	COMpare:	< NR1 >	Select Compare mode and display a curve from the specified location.  Command syntax: DISplay < mode > : < index >  where: < mode > = COMpare < index > = 1 . . . 16 (Bubble memory index)

Revised DEC 1987

## DISplay (cont.)

Header	Argument	Linked Argument	Definition and Syntax
DISplay (cont.)	INVert:	ON OFF	Set the Display invert mode.  Command syntax: DISplay < mode2 > : < status >  where: < mode > = INVert < status > = ON or OFF
	CAL:	ZERo OFF FULI	Set the CRT Calibration mode.  Command syntax: DISplay < mode3 > : < status >  where: < mode > = CAL < status > = ZERo or OFF or FULI

Revised DEC 1987

## DISplay?

**Group:** Display

**Purpose:** Queries the 371 for the current settings of Display mode, polarity, and calibration mode.

---

Header	Argument	Definition and Syntax
DISplay?		<p>Respond with the current Display settings.</p> <hr/> <p>Response syntax: DISPLAY &lt;mode1&gt;, &lt;mode2&gt;,     &lt;mode3&gt;</p> <p>where: &lt;mode1&gt; = NSTORE or           STORE or VIEW: &lt;NR1&gt; or           COMPARE: &lt;NR1&gt; &lt;mode2&gt; = INVERT: OFF or           INVERT: ON &lt;mode3&gt; = CAL: ZERO or           CAL: OFF or CAL: FULL</p>

---

## ENTER

**Group:** Display

**Purpose:** Stores the display in bubble memory.

---

Header	Argument	Definition and Syntax
ENTER	<NR1 >	<p>Store the displayed curve data in the specified bubble memory location</p> <p>This command is valid only in Store or View mode.</p> <hr/> <p>Command syntax: ENTER &lt;index &gt;</p> <p>where: &lt;index &gt; = 1 . . . 16 (bubble memory location)</p>

---

Revised DEC 1987

## HORiz

**Group:** Display

**Purpose:** Sets the 371 horizontal display source and sensitivity.

Header	Argument	Linked Argument	Definition and Syntax
HORiz	STPgen: COLlect:	<NR3 > <NR3 >	Select the horizontal display source and sensitivity (volt/div).  Command syntax: HORiz <source > : <volt >  where: <source > = COLlect or STPgen  When <source > is COLlect: <volt > may be 5.0E-1 to 5.0E+0 if Peak Power Watts is set to 3kW/300 W, and 5.0E+1 to 5.0E+2 if Peak Power Watts is set to 30 W/3 W.  When <source > is STPgen: <volt > may be 1.0E-1 to 5.0E+0.

## HORiz?

**Group:** Display

**Purpose:** Queries the 371 for the current horizontal source and sensitivity settings.

---

Header	Argument	Definition and Syntax
HORiz?		Respond with the horizontal display source and sensitivity.  Response syntax: HORIZ <source>: <volt>  where: <source> = STPGEN or COLLECT <volt> = sensitivity (volt/div) <NR3>

---

Revised DEC 1987



## VERT

**Group:** Display

**Purpose:** Sets the vertical sensitivity of the 371.

Header	Argument	Linked Argument	Definition and Syntax
VERT	COLlect:	<NR3>	<p>Set the vertical sensitivity (A/div).</p> <p>The source, COLlect, is required as the argument.</p> <hr/> <p>Command syntax: VERT COLlect: &lt; amp &gt;</p> <p>where:</p> <ul style="list-style-type: none"><li>&lt; amp &gt; = 1.0E+0 to 5.0E+1 when Peak Power Watts is 3 kW</li><li>&lt; amp &gt; = 500.0E-3 to 5.0E+0 when Peak Power Watts is 300 W</li><li>&lt; amp &gt; = 1.0E-4 to 5.0E-3 when Peak Power Watts is 30 W</li><li>&lt; amp &gt; = 1.0E-5 to 5.0E-4 when Peak Power Watts is 3 W.</li></ul>

## VERT?

**Group:** Display

**Purpose:** Queries the 371 for the vertical sensitivity settings.

Header	Argument	Linked Argument	Definition and Syntax
VERT?			<p>Respond with the vertical display source and sensitivity.</p> <p><b>COLLECT</b> is always given as the source in the argument portion of the query.</p> <hr/> <p>Response syntax: <b>VERT COLLECT: &lt; amp &gt;</b></p> <p>where: <b>&lt; amp &gt;</b> = sensitivity (A/div)</p>

Revised DEC 1987

## ■ Instrument Parameter Commands and Queries

The Instrument Parameter Commands and Queries group is helpful for determining the status of the 371 when problems are encountered. The 371 can be queried for its firmware version, all current settings, a list of all valid command and query headers, and whether debug mode is enabled. A command is included in this group to place the 371 into a known operating condition by initializing most front-panel settings.

For active troubleshooting, the 371 can be placed in debug mode to display the last fifteen characters of a received string. A test routine is available to report back ROM and RAM problems.

The commands and queries in this group are:

DEBUg  
DEBUg?  
HELp?  
ID?  
INIt  
SET?  
TESt?

An **alphabetical listing** of all command and query headers is given in the Command Index on **page 4-55**.

A **cross reference** for front-panel controls and corresponding GPIB commands and queries is given in Table 4-6 on **page 4-47**.

## DEBug

**Group:** Instrument Parameter

**Purpose:** Sets the 371 debug mode.

Header	Argument	Definition and Syntax
DEB <u>u</u> g	ON OFF	Enable or disable the debug feature.  When ON, the 371 momentarily displays the last fifteen characters of the received string in the error message area of the display.  Response syntax: DEB <u>u</u> g < status >  where: < status > = ON or OFF

## DEBug?

**Group:** Instrument Parameter

**Purpose:** Queries the 371 for the status of the debug mode.

---

Header	Argument	Definition and Syntax
DEB <u>u</u> g?		Respond with the status of the debug mode. <hr/> <p>Response syntax: <b>DEBUG &lt;status&gt;</b></p> <p>where: <b>&lt;status&gt; = ON or OFF</b></p>

---

## HELp?

**Group:** Instrument Parameter

**Purpose:** Asks the 371 for a list of all valid command and query headers.

---

Header	Argument	Definition and Syntax
HELp?		Respond with a list of all valid command and query headers.  Response syntax: HELP READOUT, TEXT, LINE, DOT, WINDOW, CURSOR, DISPLAY, HORIZ, VERT, STEPGEN, MEASURE, ENTER, RECALL, SAVE, PLOT, PSTATUS, PKPOWER, CSPOL, CSOUT, VCSPPLY, OUTPUTS, WFMPRE, CURVE, WAVFRM, RQS, OPC, EVENT, TEST, INIT, ID, DEBUG, SET

---

## ID?

**Group:** Instrument Parameter

**Purpose:** Queries the 371 for its firmware version.

---

Header	Argument	Definition and Syntax
ID?		Respond with the 371's ID.  Response syntax: ID SONY_TEK/371, V01.1, F <version >  where: <version > = current firmware version

---

**371 GPIB**  
**Command Reference – Instrument Parameter Commands**

**INIt**

**Group:** Instrument Parameter

**Purpose:** Initializes the 371 settings.

Header	Argument	Definition and Syntax																																						
INIt		Initialize the instrument. Settings are the same as at power-up and are shown below.																																						
		<table border="1"> <thead> <tr> <th>Function</th> <th>INIt Value</th> </tr> </thead> <tbody> <tr> <td>DISplay .....</td> <td>STORE</td> </tr> <tr> <td>CURsor .....</td> <td>OFF</td> </tr> <tr> <td>DISplay CAL: .....</td> <td>OFF</td> </tr> <tr> <td>DISplay INV: .....</td> <td>OFF</td> </tr> <tr> <td>STP CUR: .....</td> <td>1.0E-3</td> </tr> <tr> <td>STP OFF: .....</td> <td>0.00</td> </tr> <tr> <td>STP INV: .....</td> <td>OFF</td> </tr> <tr> <td>PKPower .....</td> <td>300</td> </tr> <tr> <td>CSPol .....</td> <td>NPN</td> </tr> <tr> <td>HORiz COL: .....</td> <td>1.0E+0</td> </tr> <tr> <td>OPC .....</td> <td>OFF</td> </tr> <tr> <td>MEASURE .....</td> <td>REPEAT</td> </tr> <tr> <td>STP NUM: .....</td> <td>2</td> </tr> <tr> <td>STP MUL: .....</td> <td>OFF</td> </tr> <tr> <td>VCSply .....</td> <td>0.0</td> </tr> <tr> <td>VERt COL: .....</td> <td>1.0E+0</td> </tr> <tr> <td>RQS .....</td> <td>ON</td> </tr> <tr> <td>DEBug .....</td> <td>OFF</td> </tr> </tbody> </table>	Function	INIt Value	DISplay .....	STORE	CURsor .....	OFF	DISplay CAL: .....	OFF	DISplay INV: .....	OFF	STP CUR: .....	1.0E-3	STP OFF: .....	0.00	STP INV: .....	OFF	PKPower .....	300	CSPol .....	NPN	HORiz COL: .....	1.0E+0	OPC .....	OFF	MEASURE .....	REPEAT	STP NUM: .....	2	STP MUL: .....	OFF	VCSply .....	0.0	VERt COL: .....	1.0E+0	RQS .....	ON	DEBug .....	OFF
Function	INIt Value																																							
DISplay .....	STORE																																							
CURsor .....	OFF																																							
DISplay CAL: .....	OFF																																							
DISplay INV: .....	OFF																																							
STP CUR: .....	1.0E-3																																							
STP OFF: .....	0.00																																							
STP INV: .....	OFF																																							
PKPower .....	300																																							
CSPol .....	NPN																																							
HORiz COL: .....	1.0E+0																																							
OPC .....	OFF																																							
MEASURE .....	REPEAT																																							
STP NUM: .....	2																																							
STP MUL: .....	OFF																																							
VCSply .....	0.0																																							
VERt COL: .....	1.0E+0																																							
RQS .....	ON																																							
DEBug .....	OFF																																							



## SET?

**Group:** Instrument Parameter

**Purpose:** Queries the 371 for its current front-panel settings.

Header	Argument	Definition
SET?		<p>Respond with the front-panel settings. Text messages are not included.</p> <hr/> <p>Response syntax:                      OPC &lt;mode&gt;;RQS &lt;mode&gt;;                      PKPOWER &lt;watts&gt;;CSPOL &lt;polarity&gt;;                      HORIZ &lt;source:size&gt;;                      VERT COLLECT:&lt;size&gt;;                      STEPGEN OUT:&lt;mode&gt;,                      NUMBER:&lt;number&gt;,                      OFFSET:&lt;offset&gt;,INVERT:&lt;mode&gt;,                      MULT&lt;mode&gt;,&lt;source:size&gt;;                      VCSPPLY &lt;percent&gt;;MEASURE &lt;mode&gt;;                      DISPLAY INVERT:&lt;mode&gt;,                      CAL:&lt;mode&gt;,&lt;display mode&gt;;                      CURSOR &lt;mode&gt;</p> <hr/> <p>Response syntax (when the Measurement mode is SWEEP or SSWEep):                      OPC &lt;mode&gt;;RQS &lt;mode&gt;;                      PKPOWER &lt;watts&gt;;CSPOL &lt;polarity&gt;;                      HORIZ &lt;source:size&gt;;                      VERT COLLECT:&lt;size&gt;;                      STEPGEN OUT:&lt;mode&gt;,                      NUMBER:&lt;number&gt;,                      OFFSET:&lt;offset&gt;,INVERT:&lt;mode&gt;,                      MULT&lt;mode&gt;,&lt;source:size&gt;;                      VCSPPLY &lt;percent&gt;;                      DISPLAY INVERT:&lt;mode&gt;,CAL:&lt;mode&gt;,                      &lt;display mode&gt;;MEASURE SWEEP;                      CURSOR &lt;mode&gt;</p>

**371 GPIB**  
**Command Reference – Instrument Parameter Commands**

---

## TEST?

**Group:** Instrument Parameter

**Purpose:** Performs tests on the ROM and RAM.

Header	Argument	Definition and Syntax
TEST?		<p>Perform ROM and RAM checks and respond with the result.</p> <hr/> <p>Response example (with no error found): TEST ROM:0000, RAM:0000</p> <p><b>NOTE</b> <i>See the Service Manual for codes other than 0000.</i></p>

## ■ Miscellaneous Commands and Queries

The Miscellaneous Commands and Queries group contains queries for the status of the output connectors, measurement mode, and plotter, as well as commands to set the measurement mode, start the plotter, and save and recall sets of front-panel settings.

The commands and queries in this group are:

- MEASURE
- MEASURE?
- OUTPUTS?
- PLOT
- PSTATUS?
- RECALL
- SAVE

An **alphabetical listing** of all command and query headers is given in the Command Index on **page 4-55**.

A **cross reference** for front-panel controls and corresponding GPIB commands and queries is given in Table 4-6 on **page 4-47**.

## MEASURE

**Group:** Miscellaneous

**Purpose:** Selects the 371 Measurement mode.

---

Header	Argument	Definition and Syntax
MEASURE	REPEAT SINGLE SWEEP SSWEEP	Select the Measurement mode.  Command syntax: MEASURE <mode>  where: <mode> = REPEAT or SINGLE or SWEEP or SSWEEP

---

## MEASURE?

**Group:** Miscellaneous

**Purpose:** Queries the 371 for the current Measurement mode setting.

---

Header	Argument	Definition and Syntax
MEASURE?		Respond with the current Measurement mode setting.  Response syntax: MEASURE <mode>  where: <mode> = REPEAT or SINGLE or SWEEP or SSWEEP

---

## OUTputs?

**Group:** Miscellaneous

**Purpose:** Queries the 371 for the status of the output connectors.

---

Header	Argument	Definition and Syntax
OUTputs?		<p>Respond with the status of the output connectors.</p> <hr/> <p>Response syntax: <b>OUTPUTS &lt; status &gt;</b></p> <p>where: <b>&lt; status &gt;</b> = <b>ENABLED</b> or <b>DISABLED</b> and <b>ENABLED</b> = all connector outputs enabled, except interlock <b>DISABLED</b> = all connector outputs disabled except interlock</p>

---

## PLOt

**Group:** Miscellaneous

**Purpose:** Defines which data will be plotted and starts the plot.

---

Header	Argument	Definition and Syntax
PLOt	ALL CURVe	Select the plotter interface mode, curve only or curve plus readout and graticule, and start the output. to the plotter.  Command syntax: PLOt <mode >  where: <mode > = ALL or CURVe and ALL = Curve with readout data and graticule. CUR = Curve only.

---

## PStatus?

**Group:** Miscellaneous

**Purpose:** Queries the 371 for the status of the plotter interface.

---

Header	Argument	Definition and Syntax
PStatus?		<p>Respond with the current status of the plotter.</p> <hr/> <p>Response status: <b>PSTATUS &lt; status &gt;</b></p> <p>where: <b>&lt; status &gt;</b> = <b>READY</b> or <b>BUSY</b> and <b>READY</b> = idle mode <b>BUSY</b> = busy mode</p>

---



## RECall

**Group:** Miscellaneous

**Purpose:** Recalls a set of front-panel settings.

Header	Argument	Definition and Syntax
RECall	<NR1>	Recall the front-panel settings from a specified bubble memory location.  Command syntax: RECall <index>  where: <index> = 1 . . . 16 (bubble memory location)

## SAVe

**Group:** Miscellaneous

**Purpose:** Saves the current set of front-panel settings.

---

Header	Argument	Link Arg	Definition and Syntax
SAVe	<NR1>		Save the current front-panel settings (setup) in the specified bubble memory location.  Command syntax: SAVe <index>  where: <index> = 1 . . . 16 (bubble memory location)

---

## ■ Status and Event Commands and Queries

The Status and Event Reporting group sets and reports the status of Service Requests and Operation Complete Service Requests. A query is also included for the event code of the latest event.

The commands and queries in this group are:

EVEnt?  
OPC  
OPC?  
RQS  
RQS?

An **alphabetical listing** of all command and query headers is given in the Command Index on **page 4-55**.

A **cross reference** for front-panel controls and corresponding GPIB commands and queries is given in Table 4-6 on **page 4-47**.

## EVENT?

**Group:** Status and Event

**Purpose:** Queries the 371 for the event code of the most recent event.

---

Header	Argument	Definition and Syntax
EVENT?		<p>Return the event code for the most recent event.</p> <hr/> <p>Response syntax: EVENT &lt;code&gt;</p> <p>where: &lt;code&gt; = Refer to Table 4-10, Status Bytes and Event Codes, later in this section for a list of event codes and definitions.</p>

---

## OPC

**Group:** Status and Event

**Purpose:** Sets the status of Operation Complete Service Request.

Header	Argument	Definition and Syntax
OPC	ON OFF	Enable or disable assertion of Operation Complete Service Request upon completion of an operation, a change in circuit breaker status, or a change in the status of the interlock system.  Command syntax: OPC < status >  Where: < status > = ON or OFF

**371 GPIB**  
**Command Reference – Status and Event Commands**

---

## OPC?

**Group:** Status and Event

**Purpose:** Queries the 371 for the status of Operation Complete Service Request (OPC).

---

Header	Argument	Definition and Syntax
OPC?		Respond with the current status of the Operation Complete Service Request feature. <hr/> <p>Response syntax: OPC &lt; status &gt;</p> <p>where: &lt; status &gt; = ON for enabled or OFF for disabled</p>

---

## RQS

**Group:** Status and Event

**Purpose:** Sets the status of Service Requests.

---

Header	Argument	Definition and Syntax
RQS	ON OFF	Enable or disable assertion of service requests (SRQs).  Command syntax: RQS < status >  where: < status > = ON or OFF

---

## RQS?

**Group:** Status and Event

**Purpose:** Queries the 371 for the status of Service Request.

---

Header	Argument	Definition and Syntax
RQS?		Respond with the current status of Service Request. <hr/> Response syntax: RQS <status >  where: <status > = ON for enabled or OFF for disabled

---



## ■ Step Generator Command and Query

The Step Generator Command and Query set and ask for the status of the Step Generator settings.

The Step Generator group has one command and one query:

STPgen  
STPgen?

An **alphabetical listing** of all command and query headers is given in the Command Index on **page 4-55**.

A **cross reference** for front-panel controls and corresponding GPIB commands and queries is given in Table 4-6 on **page 4-47**.

## STPgen

**Group:** Step Generator

**Purpose:** Sets the Step Generator source, step size, number of steps, polarity, step multiplication, and offset.

Header	Argument	Linked Argument	Definition and Syntax
STPgen	OUT:	ON OFF	<p>Enable or disable the Step Generator output.</p> <hr/> <p>Command syntax:  <b>STPgen OUT: &lt; mode &gt;</b></p> <p>where:  <b>&lt; mode &gt; = ON or OFF</b></p>
	CURrent: VOLTage:	<NR3> <NR3>	<p>Set the Step Generator to provide current or voltage steps, and set the step size in amperes or volts.</p> <hr/> <p>Command syntax:  <b>STPgen &lt; source &gt;: &lt; val &gt;</b></p> <p>where:  <b>&lt; source &gt; = CUR or VOL</b>  <b>&lt; val &gt; = 1.0E-6 through 2.0E-3</b> when Peak Power Watts is 30 W/3 W and <b>1.0E-3 to 2.0E+0</b> when Peak Power Watts is 3 kW/300 W for current step size (amp/div)  <b>&lt; val &gt; = 2.0E-1 through 5.0E+0</b> in a 1-2-5 sequence for voltage step size (volt/step).</p>

Revised DEC 1987

## STPgen (cont.)

Header	Argument	Linked Argument	Definition and Syntax
STPgen (cont.)			<p>Example:  <b>STPgen CURrent: 1.0E-3</b></p>
	<b>NUMBER:</b>	<b>&lt;NR1&gt;</b>	<p>Set the number of steps to be generated.</p> <hr/> <p>Command syntax:  <b>STPgen NUMBER : &lt;val&gt;</b></p> <p>where:  <b>&lt;val&gt; = 0, 1, 2, . . . 5</b></p>
	<b>INVert:</b>	<b>ON OFF</b>	<p>Set the Step Generator Polarity.</p> <hr/> <p>Command syntax:  <b>STPgen INVert: &lt;mode&gt;</b></p> <p>where:  <b>&lt;mode&gt; = ON or OFF</b></p>
	<b>MULt:</b>	<b>ON OFF</b>	<p>Set the Step Generator Step Multi 0.1X mode.</p> <hr/> <p>Command syntax:  <b>STPgen MULt: &lt;mode&gt;</b></p> <p>where:  <b>&lt;mode&gt; = ON or OFF</b></p>

## STPgen (cont.)

Header	Argument	Linked Argument	Definition and Syntax
STPgen (cont.)	OFFset:	ON OFF	<p>Enable or disable the Step Generator offset.</p> <hr/> <p>Command syntax:            STPgen OFF: &lt;mode&gt;</p> <p>where:            &lt;mode&gt; = ON or OFF</p>
	OFFset:	<NRX>	<p>Set the offset of the Step Generator.</p> <hr/> <p>Command syntax:            STPgen OFFset: &lt;val&gt;</p> <p>&lt;val&gt; = with step Multi On,            0 to 500 times the STEP/OFFSET setting. With Step Multi Off,            0 to 5 times the STEP/OFFSET setting.</p> <p>Resolution is 0.01%.</p>

Revised DEC 1987

## STPgen?

**Group:** Step Generator

**Purpose:** Queries the 371 for the current settings of the Step Generator source, number of steps, step size, polarity, step multiplication, and offset.

---

Header	Argument	Definition and Syntax
STPgen?		<p>Respond with the Step Generator source, amps/step or volt/step, number of steps, offset, polarity, multiplier mode, and output mode.</p> <hr/> <p>Response syntax: <b>STPGEN NUMBER:</b> &lt; num &gt; , <b>OFFSET:</b> &lt; offset &gt; ,<b>INVERT:</b> &lt; invert &gt; , <b>MULT:</b> &lt; mult &gt; , &lt; typ:size &gt; , &lt; mult &gt; , &lt; typ:size &gt; , &lt; output &gt;</p> <p>where: &lt; num &gt; = number of steps, 0-5 &lt; offset &gt; = offset value multiplier &lt; invert &gt; = Invert mode status, ON or OFF &lt; mult &gt; = Step Multi status, ON or OFF &lt; typ:size &gt; = <b>CURRENT:</b> size (A/step)                   or <b>VOLTAGE:</b> size (V/step) &lt; output &gt; = ON or OFF</p>

---

## ■ Waveform Transfer Commands and Queries

The Waveform Transfer group allows curve or preamble data (or both) to be stored in, or recalled from, bubble memory. There is also a command to set the number of curve data points stored and a related query to determine the length of a previously defined waveform.

The commands and queries in this group are:

**CURve**  
**CURve?**  
**WAVfrm?**  
**WFMpre**  
**WFMpre?**  
**WFMpre NR.PT**  
**WFMpre? NR.PT**

An **alphabetical listing** of all command and query headers is given in the Command Index on **page 4-55**.

A **cross reference** for front-panel controls and corresponding GPIB commands and queries is given in Table 4-6 on **page 4-47**.

## CURve

**Group:** Waveform Transfer

**Purpose:** Store a curve.

---

Header	Argument	Definition and Syntax
CURve	<string>	<p>Load the curve into the specified bubble memory location.</p> <hr/> <p>Command syntax: CURve &lt;string&gt;</p> <p>where: &lt;string&gt; = CURVID: &lt;curvid&gt; , % &lt;binary data&gt;</p> <p>where: &lt;curvid&gt; = "INDEX &lt;index&gt;" &lt;binary data&gt; = &lt;count&gt; &lt;first point&gt; ... &lt;last point&gt; &lt;checksum&gt;</p> <p>where: &lt;index&gt; = 1 ... 16 for bubble memory storage location. &lt;count&gt; = two bytes indicating the number of data points plus one. &lt;point&gt; = two bytes indicating the X coordinate and two bytes indicating the Y coordinate for a point (00 through FF). &lt;checksum&gt; = one byte, the 2's complement of the modulo-256 sum of the preceding binary data.</p>

---

## CURve?

**Group:** Waveform Transfer

**Purpose:** Queries the 371 for curve data.

---

Header	Argument	Definition and Syntax
CURve?		<p>Respond with the curve data for the View curve when in View mode, and with the curve data for the current display when in Store mode.</p> <hr/> <p>Response syntax: CURVE CURVID &lt;curvid&gt;, % &lt;binary data&gt;</p> <p>where: &lt;curvid&gt; = "INDEX &lt;index&gt;" &lt;binary data&gt; = &lt;count&gt; &lt;first point&gt; ...&lt;last point&gt; &lt;checksum&gt;</p> <p>where: &lt;index&gt; = for a Store mode curve, 1 . . . 16 for bubble memory storage location. &lt;count&gt; = two bytes indicating the number of data points plus one. &lt;point&gt; = two bytes indicating the X coordinate and two bytes indicating the Y coordinate for a point (00 through FF). &lt;checksum&gt; = one byte, the 2's complement of the modulo 256 sum of the preceding binary data.</p>

---



## WAVfm?

**Group:** Waveform Transfer

**Purpose:** Queries the 371 for the curve and preamble data. This query functions as a combination of the WFMpre? and CURve? queries.

---

Header	Argument	Definition
WAVfm?		Respond with both the preamble and curve data for the current waveform.  See the discussions for WFMpre? and CURve? for details.  The preamble and curve data are separated by a semicolon.

---

## WFMpre

**Group:** Waveform Transfer

**Purpose:** Stores the preamble data for the currently displayed waveform into a specified bubble memory location.

Header	Argument	Definition and Syntax
WFMpre	< string >	<p>Load the waveform preamble into the location indicated by the current content of the memory index display.</p> <p>Command syntax:            WFMpre &lt; string &gt;</p> <p>where:            &lt; string &gt; =            WFID: &lt; wfid &gt; ,ENCDG:BIN,            NR.PT: &lt; point &gt; ,PT.FMT:XY,            XMULT: &lt; x multi &gt; ,XZERO:0,            XOFF: &lt; xoff &gt; ,XUNIT:V,            YMULT: &lt; y multi &gt; ,YZERO:0,            YOFF: &lt; yoff &gt; ,YUNIT:A,            BYT/NR:2,BN.FMT:RP,            BIT/NR:10,CRVCHK:CHKSM0,            LN.FMT: &lt; format &gt;</p> <p>where:            &lt; wfid &gt; = "INDEX &lt; num &gt; /            VERT &lt; amp &gt; /HORIZ &lt; volt &gt; /            STEP &lt; step &gt; / OFFSET &lt; offset &gt; /            BGM &lt; para &gt; / VCS &lt; percent &gt; /            TEXT &lt; txt &gt; /HSNS &lt; mode &gt; "</p> <p>where:            &lt; num &gt; = display address: 0 for CRT, 1 . . . 16            for memory location, &lt; NR1 &gt;            &lt; amp &gt; = sensitivity, A/div &lt; NR3 &gt;</p>

## WFMpre (cont.)

Header	Argument	Definition and Syntax
WFMpre (cont.)		<p>           &lt;volt&gt; = sensitivity, V/div &lt;NR3&gt;            &lt;step&gt; = step amplitude, V or A/step &lt;NR3&gt;            &lt;offset&gt; = step offset, V or A            &lt;para&gt; = beta or gm            &lt;percent&gt; = Collector Supply Variable                      setting, %            &lt;brt&gt; = readout of text area            &lt;mode&gt; = horizontal source, VCE or VBE            &lt;point&gt; = number of points in the curve                      (1 through 1024)            &lt;x multi&gt; = horizontal scale factor, &lt;NR3&gt;            &lt;x off&gt; = horizontal offset, &lt;NR1&gt;            &lt;y multi&gt; = vertical scale factor, &lt;NR3&gt;            &lt;y off&gt; = vertical offset, &lt;NR1&gt;            &lt;format&gt; = VECTOR, DOT, or                      SWEEP &lt;cnt&gt;         </p> <p>           where:            &lt;cnt&gt; = sweep count: 1 . . . 6         </p>

## WFMpre?

**Group:** Waveform Transfer

**Purpose:** Queries the 371 for the preamble data stored in a specified bubble memory location.

Header	Argument	Definition and Syntax
WFMpre?		<p>Respond with the waveform preamble from the specified memory location.</p> <p>Response syntax: WFMPRE WFID: &lt;wfid&gt;, ENCDG: BIN, NR.PT: &lt;point&gt;, PT.FMT:XY, XMULT: &lt;x multi&gt;, XZERO:0, XOFF: &lt;x off&gt;, XUNIT:V, YMULT: &lt;y multi&gt;, YZERO:0, YOFF: &lt;y off&gt;, YUNIT:A, BYT/NR:2, BN.FMT:RP, BIT/NR:10, CRVCHK:CHKSM0, LN.FMT: &lt;format&gt;</p> <p>where: &lt;wfid&gt; = "INDEX &lt;num&gt;/VERT &lt;amp&gt; /HORIZ &lt;volt&gt;/STEP &lt;step&gt; /OFFSET &lt;offset&gt; /BGM &lt;para&gt; /VCS &lt;percent&gt;/TEXT &lt;txt&gt; /HSNS &lt;mode&gt;"</p> <p>where: &lt;num&gt; = display address: 0 for CRT, 1 . . . 16 for memory location &lt;NR1&gt; &lt;amp&gt; = sensitivity, A/div &lt;NR3&gt; &lt;volt&gt; = sensitivity, V/div &lt;NR3&gt; &lt;step&gt; = step amplitude, V or A/step &lt;NR3&gt;</p>

## WFMpre? (cont.)

Header	Argument	Link Arg	Definition and Syntax
WFMpre? (cont)			<p>           &lt;offset&gt; = step offset, V or A            &lt;para&gt; = beta or gm            &lt;percent&gt; = Collector Supply                      Variable setting, %            &lt;txt&gt; = readout of text area            &lt;mode&gt; = horizontal source, VCE or VBE            &lt;points&gt; = number of points in curve                      (1 through 1024)            &lt;x multi&gt; = horizontal scale factor, &lt;NR3&gt;            &lt;x off&gt; = horizontal offset, &lt;NR1&gt;            &lt;y multi&gt; = vertical scale factor, &lt;NR3&gt;            &lt;y off&gt; = vertical offset, &lt;NR1&gt;            &lt;format&gt; = VECTOR, DOT, or                      SWEEP &lt;cnt&gt;         </p> <p>where:            &lt;cnt&gt; = sweep count 1 . . . 6</p> <p>where:            &lt;points&gt; = 1 . . . 1024</p>

## WFMpre NR.PT

**Group:** Waveform Transfer

**Purpose:** Sets the length of the waveform.

---

Header	Argument	Linked Argument	Definition and Syntax
WFMpre	NR.PT:	<NR1>	Set the number of points input for the CURve command.  Command syntax: WFMpre NR.PT: <points>  where: <points> = 1 . . . 1024

---

Revised DEC 1987

## WFMpre? NR.PT

**Group:** Waveform Transfer

**Purpose:** Queries the 371 for the length of a waveform previously defined with the **WFMpre NR.PT** command.

---

Header	Argument	Definition and Syntax
WFMpre?	NR.PT	Respond with the NR.PT waveform preamble data. <hr/> Response syntax: WFMpre? NR.PT: <points >  where: <points > = 1 . . . 1024

---

## SERVICE REQUESTS

The standard GPIB status and error reporting system used by the 371 sends interrupt messages to the bus controller by asserting the Service Request (SRQ) line on the bus. This SRQ message indicates that either an error or a change in status has occurred.

### ■ Handling Service Requests

To service an interrupt, the controller “polls” the instruments on the bus. The instrument asserting SRQ, the 371 in this case, returns a status byte indicating the category of the event causing the Service Request. Each Service Request is automatically cleared after responding to the poll. If there is more than one event to report, the instrument re-asserts SRQ until all pending events have been reported. A complete list of status bytes that can occur is found in Table 4-9.

After polling the 371 for the status byte, the controller can obtain more detailed information about the Service Request event by sending the **EVEnt?** query. The response to an **EVEnt?** query is an event code, which is a **<NR1>** number corresponding to certain conditions that may have occurred. Table 4-10 lists the event codes returned by the 371.

The status byte and event code can be accessed later if they are not read and cleared immediately. In the case of multiple events, only the latest status byte and the one pending are saved. Event codes, however, are kept in a ten-deep Last-In-First-Out (LIFO) buffer for later recall.

The following program segments demonstrate how Service Requests are handled along with the corresponding status byte and event code. The status byte and event code are printed on the controller display to track instrument status.

**IBM PC:** (This is for use with the auto-serial-poll flag disabled in the National Instruments GPIB card configuration file.)

```
800 REM *** SIMPLE SRQ HANDLER FOR 371 ***
```



## 371 GPIB Service Requests

---

```
810 CALL IBRSP(BD%,SPR%)
820 WRT$="EVENT?"
830 CALL IBWRT(BD%,WRT$)
840 RDS=SPACES(100)
850 CALL IBRD(BD%,RDS)
860 PRINT "STATUS=";SPR%,"EVENT=";RDS
```

### Tektronix 4041:

```
800 ! *** Simple SRQ Handler for 371 ***
810 Poll stb,dev ! Poll bus. Store
                status byte in
                "stb."
820 Input #dev prompt "EVENT?":event
                ! Send "EVENT?"
                Input response.
830 Print "STATUS= ";stb;" EVENT= ";event
                ! Show status and
                event.
```

### Hewlett Packard 200/300 Series:

```
800 REM *** SIMPLE SRQ HANDLER FOR 371 ***
810 STB=SPOLL(DEV) ! Poll device
                  previously
                  defined.
820 OUTPUT DEV;"EVENT?",END ! Send "EVENT?"
                              query.
830 ENTER DEV;EVENTS ! Input response.
840 PRINT "STATUS= ";STB;" EVENT= ";EVENTS
                ! Show status and
                event.
```

## Masking Service Requests

The Operation Complete Service Request (OPC SRQ) is a special type of Service Request to communicate that certain instrument processes have been finished. These OPC Service Requests indicate that the 371 has finished one operation and is ready to proceed to the next.

## 371 GPIB Service Requests

---

It may not always be desirable to interrupt the program with Service Requests or OPC Service Requests. Either type of Service Request can be masked so that the 371 will not assert them until the mask is removed. This masking is accomplished with the **RQS** and **OPC** commands.

**RQS ON** enables the 371 to assert an SRQ when it has an event to report. If this feature is turned off (**RQS OFF**), up to ten events are still accumulated and can be retrieved with successive **EVENT?** queries.

**OPC ON** enables the 371 to assert an OPC SRQ upon completion of an operation, a change in circuit breaker status, or a change in the status of the interlock system.

### NOTE

*The response to **RQS?** and **OPC?** queries only indicates whether the function is enabled (**ON**) or disabled (**OFF**). They do not give any other status or event information.*

## Status Bytes

Table 4-9  
Status Byte Responses

8	7	6	5	4	3	2	1	Decimal	Condition
0	0	0	0	0	0	0	0	0	No status to report
0	1	0	0	0	0	0	1	65	Power on
0	1	0	0	0	0	1	1	67	User request
0	1	1	0	0	0	0	1	97	Command error
0	1	1	0	0	0	1	0	98	Execution error
0	1	1	0	0	0	1	1	99	Internal error
1	1	0	0	0	0	0	0	192	Device-dependent error

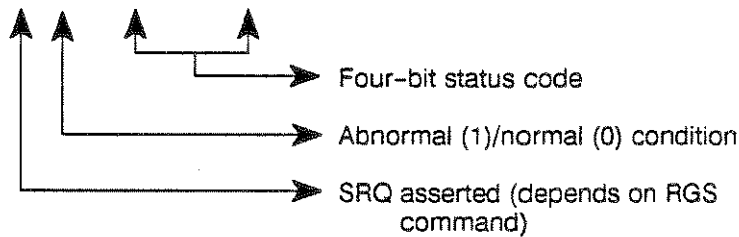

**No status to report** This status byte is set when there are no event or device-dependent events to report.

**Power on** This occurs when the power is turned on, after having been off.

## 371 GPIB Service Requests

---

- User Request** This status byte occurs when the front-panel RQS key is pressed.
- Command Error** This status byte is set when a message cannot be parsed or recognized.
- Execution Error** This status byte is set when a message is parsed and is recognized, but cannot be executed. For example, if the bubble memory cassette is not in place when a SAVE command is received, the 371 registers an execution error.
- Internal Error** This status byte indicates that the 371 micro-computer has discovered a malfunction that could cause the instrument to operate incorrectly.
- Device-dependent events** This status byte is set when there is an event specific to the 371. Primarily, these events signify the completion of a process, such as "PLOTTER OUTPUT COMPLETE."

**Event Codes**

**TABLE 4-10**  
**Status Bytes and Event Codes**

Status Byte	Event Code	Meaning
<b>SYSTEM EVENTS</b>		
0	0	No error
65	401	Power on
67	403	User request (RQS key)
<b>COMMAND ERRORS</b>		
97	101	Command header error
97	103	Command argument error
97	106	Command syntax error
97	108	Checksum error
97	109	Byte count error
<b>EXECUTION ERRORS</b>		
98	201	Command not executable in local mode
98	203	Output buffer overflow; remaining output lost
98	204	Setting conflicts
98	205	Argument out of range
98	206	Bubble I/O error
98	256	Bubble I/O error (UDC: undefined code)
98	257	Bubble I/O error (NHDR: no header)





Table 4-10 (cont.)  
Status Bytes and Event Codes

Status Byte	Event Code	Meaning
<b>DEVICE-DEPENDENT EVENTS (cont.)</b>		
192	752	Sweep measurement operation complete
192	753	Plotter output complete
192	754	Collector Supply recovered
192	755	Interlock system changed

Add DEC 1987

## SECTION 5

# INSTRUMENT OPTIONS

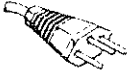
Option Number	Plug Configuration	Usage	Nominal AC Line Voltage	Reference Standard
Standard		North America 120 V/15 A	120 V	ANSI <sup>1</sup> C73.11 NEMA <sup>2</sup> 5.15-P IEC <sup>3</sup> 83
A1		Universal European 220 V/16 A	240 V	CEE <sup>4</sup> (7), II, V, VII IEC 83
A2		UK 240 V/13 A	240 V	BSI <sup>5</sup> 1363 IEC 83
A3		Australia 240 V/10 A	240 V	AS <sup>6</sup> C112
A4		North America 240 V/15 A	240 V	ANSI C73.20 NEMA 6-15-P IEC 83
A5		Switzerland	220 V	SEV <sup>7</sup>

<sup>1</sup>ANSI – American National Standards Institute

<sup>2</sup>NEMA – National Electrical Manufacturer's Association

<sup>3</sup>IEC – International Electrotechnical Commission

<sup>4</sup>CEE – International Commission on Rules for the Approval of Electrical Equipment

<sup>5</sup>BSI – British Standards Institute

<sup>6</sup>AS – Standards Association of Australia

<sup>7</sup>SEV – Schweizerischer Elektrotechnischer Verein





## APPENDIX

---

# DIAGNOSTIC ROUTINES AND MESSAGES

***This appendix:***

- *Explains the four types of diagnostic routines*
- *Lists and explains all messages the 371 may display on its CRT*

## **APPENDIX CONTENTS**

	<b>Page</b>
<b>Diagnostic Routines</b> .....	<b>A-3</b>
Power-Up Diagnostic Routines .....	A-3
System ROM Check .....	A-4
System RAM Check .....	A-4
Display RAM Check .....	A-5
Acquisition RAM Check .....	A-5
LED Check .....	A-6
Display Quality Check .....	A-6
Push Button Test .....	A-6
User-Initiated Push Button Diagnostic Routine .....	A-7
GPIB Diagnostic Routine .....	A-10
<b>Messages</b> .....	<b>A-11</b>

## DIAGNOSTIC ROUTINES

The 371 has four diagnostic routines: Two types of power-up diagnostic routines, a user-initiated diagnostic routine, and a GPIB diagnostic routine.

### ■ Power-Up Diagnostic Routines

At power-up the 371 displays "SELFTEST START" in the error message area of the CRT and runs the power-up diagnostic routine, which executes the following tests:

- System ROM check
- System RAM check
- Display RAM check
- Acquisition RAM check
- Push button stack test
- LED check

After completing the power-up diagnostic routines, the 371 displays a "SELFTEST PASS" message in the error message area of the CRT and sets the front-panel settings to their default (initial) state.

If the 371 POWER switch is turned ON while the Cursor SHIFT button is pressed, a more detailed power-up diagnostic routine occurs in the following sequence:

- System ROM check
- System RAM check
- Display RAM check
- Acquisition RAM check
- LED check
- Display quality check
- Push button stack test

To exit this diagnostic routine, press the Cursor SHIFT button.

## 371 Diagnostic Routines and Messages

### **System ROM Check**

After confirming that the system ROMs are without fault, the 371 diagnoses the system ROMs by checksum. If a fatal error is found in the system ROM (such as mis-insertion), the Memory Index display blinks 0 and 1 alternately.

If a checksum error is found, the error message is displayed in the error message area of the CRT graticule and the 371 does not advance to the next routine.

The message format is as follows:

```
ROM 000X
```

### **System RAM Check**

The 371 checks the system RAM with read/write operations. When a fatal system RAM error is found (such as a shorted bus), the Memory Index display blinks 0 and 2 alternately, and the 371 does not advance to the next routine. When read/write errors are found, the error message is displayed in the error message area of the CRT graticule and the 371 does not advance to the next routine.

The message format is as follows:

```
RAM XXXXX YYYYY
```

**Display RAM Check**

The 371 checks the Display RAM with a read/write operation. When a read/write error is found (such as a shorted bus), the Memory Index display blinks 0 and 3 alternately, and the 371 does not advance to the next routine.

**Acquisition RAM Check**

The 371 checks the Acquisition RAM with a read/write operation. When a read/write error is found (such as a shorted bus), the Memory Index display blinks 0 and 4 alternately, and the 371 does not advance to the next routine.

Table A-1 shows the Power-Up System Error Messages displayed in the Memory Index display.

**TABLE A-1  
Power-Up System Error Messages**

<b>Display</b>	<b>Description</b>
0/1 (blink)	System ROM error (e.g., mis-insertion)
0/2 (blink)	System RAM error (e.g., shorted bus)
0/3 (blink)	Display RAM read/write error (e.g., shorted bus)
0/4 (blink)	Acquisition RAM read/write error (e.g., shorted bus)

## **371 Diagnostic Routines and Messages**

---

### **LED Check**

The 371 sequentially lights all front-panel LED's for a visual check.

### **Display Quality Check**

The 371 displays the SONY/TEKTRONIX logo and a pattern on the CRT for adjustment of the CRT controls. When adjustment is complete, press the Cursor SHIFT button to exit the diagnostics.

### **Push Button Test**

The push button test includes a push button stack test but does not check the functionality of the pushbuttons. The Collector Supply breakers and the Collector Supply VARIABLE control are not tested in this routine.

If an error is found, the error message is displayed in the error message area of the CRT. The error message is in the following format:

KEY ERROR <NUM>

< NUM > identifies the front-panel control as listed in Table A-2.

The following message also appears in the text area of the CRT.

PUSH SHIFT KEY TO GO ON.

The displayed error can be ignored and the test continued by pressing the Cursor SHIFT button, but the front-panel controls may not operate correctly.

■ **User-Initiated Push Button Diagnostic Routine**

Simultaneously pressing the Cursor SHIFT and NON STORE buttons begins the user-initiated diagnostic routine. This routine displays a number or message that corresponds to the last front panel control used. This feature can be used to determine whether a front-panel controls is operating normally.







Table A-2 lists the 371 controls and the corresponding numbers or messages. To exit the routine, press both the Cursor SHIFT button and the NON STORE button again.





## SECTION 5

# INSTRUMENT OPTIONS

Option Number	Plug Configuration	Usage	Nominal AC Line Voltage	Reference Standard
Standard		North America 120 V/15 A	120 V	ANSI <sup>1</sup> C73.11 NEMA <sup>2</sup> 5.15-P IEC <sup>3</sup> 83
A1		Universal European 220 V/16 A	240 V	CEE <sup>4</sup> (7), II, V, VII IEC 83
A2		UK 240 V/13 A	240 V	BSI <sup>5</sup> 1363 IEC 83
A3		Australia 240 V/10 A	240 V	AS <sup>6</sup> C112
A4		North America 240 V/15 A	240 V	ANSI C73.20 NEMA 6-15-P IEC 83
A5		Switzerland	220 V	SEV <sup>7</sup>

<sup>1</sup>ANSI – American National Standards Institute

<sup>2</sup>NEMA – National Electrical Manufacturer's Association

<sup>3</sup>IEC – International Electrotechnical Commission

<sup>4</sup>CEE – International Commission on Rules for the Approval of Electrical Equipment

<sup>5</sup>BSI – British Standards Institute

<sup>6</sup>AS – Standards Association of Australia

<sup>7</sup>SEV – Schweizerischer Elektrotechnischer Verein



## APPENDIX

---

# DIAGNOSTIC ROUTINES AND MESSAGES

***This appendix:***

- *Explains the four types of diagnostic routines*
- *Lists and explains all messages the 371 may display on its CRT*

## APPENDIX CONTENTS

	Page
<b>Diagnostic Routines</b> .....	<b>A-3</b>
Power-Up Diagnostic Routines .....	A-3
System ROM Check .....	A-4
System RAM Check .....	A-4
Display RAM Check .....	A-5
Acquisition RAM Check .....	A-5
LED Check .....	A-6
Display Quality Check .....	A-6
Push Button Test .....	A-6
User-Initiated Push Button Diagnostic Routine .....	A-7
GPIB Diagnostic Routine .....	A-10
<b>Messages</b> .....	<b>A-11</b>

## **DIAGNOSTIC ROUTINES**

The 371 has four diagnostic routines: Two types of power-up diagnostic routines, a user-initiated diagnostic routine, and a GPIB diagnostic routine.

### **■ Power-Up Diagnostic Routines**

At power-up the 371 displays "SELFTEST START" in the error message area of the CRT and runs the power-up diagnostic routine, which executes the following tests:

- System ROM check
- System RAM check
- Display RAM check
- Acquisition RAM check
- Push button stack test
- LED check

After completing the power-up diagnostic routines, the 371 displays a "SELFTEST PASS" message in the error message area of the CRT and sets the front-panel settings to their default (initial) state.

If the 371 POWER switch is turned ON while the Cursor SHIFT button is pressed, a more detailed power-up diagnostic routine occurs in the following sequence:

- System ROM check
- System RAM check
- Display RAM check
- Acquisition RAM check
- LED check
- Display quality check
- Push button stack test

To exit this diagnostic routine, press the Cursor SHIFT button.

## **371 Diagnostic Routines and Messages**

### **System ROM Check**

After confirming that the system ROMs are without fault, the 371 diagnoses the system ROMs by checksum. If a fatal error is found in the system ROM (such as mis-insertion), the Memory Index display blinks 0 and 1 alternately.

If a checksum error is found, the error message is displayed in the error message area of the CRT graticule and the 371 does not advance to the next routine.

The message format is as follows:

```
ROM 000X
```

### **System RAM Check**

The 371 checks the system RAM with read/write operations. When a fatal system RAM error is found (such as a shorted bus), the Memory Index display blinks 0 and 2 alternately, and the 371 does not advance to the next routine. When read/write errors are found, the error message is displayed in the error message area of the CRT graticule and the 371 does not advance to the next routine.

The message format is as follows:

```
RAM XXXXX YYYYY
```

**Display RAM Check**

The 371 checks the Display RAM with a read/write operation. When a read/write error is found (such as a shorted bus), the Memory Index display blinks 0 and 3 alternately, and the 371 does not advance to the next routine.

**Acquisition RAM Check**

The 371 checks the Acquisition RAM with a read/write operation. When a read/write error is found (such as a shorted bus), the Memory Index display blinks 0 and 4 alternately, and the 371 does not advance to the next routine.

Table A-1 shows the Power-Up System Error Messages displayed in the Memory Index display.

**TABLE A-1**  
**Power-Up System Error Messages**

<b>Display</b>	<b>Description</b>
0/1 (blink)	System ROM error (e.g., mis-insertion)
0/2 (blink)	System RAM error (e.g., shorted bus)
0/3 (blink)	Display RAM read/write error (e.g., shorted bus)
0/4 (blink)	Acquisition RAM read/write error (e.g., shorted bus)

## 371 Diagnostic Routines and Messages

### **LED Check**

The 371 sequentially lights all front-panel LED's for a visual check.

### **Display Quality Check**

The 371 displays the SONY/TEKTRONIX logo and a pattern on the CRT for adjustment of the CRT controls. When adjustment is complete, press the Cursor SHIFT button to exit the diagnostics.

### **Push Button Test**

The push button test includes a push button stack test but does not check the functionality of the pushbuttons. The Collector Supply breakers and the Collector Supply VARIABLE control are not tested in this routine.

If an error is found, the error message is displayed in the error message area of the CRT. The error message is in the following format:

KEY ERROR <NUM>

< NUM > identifies the front-panel control as listed in Table A-2.

The following message also appears in the text area of the CRT.

PUSH SHIFT KEY TO GO ON.

The displayed error can be ignored and the test continued by pressing the Cursor SHIFT button, but the front-panel controls may not operate correctly.



**■ User-Initiated Push Button Diagnostic Routine**

Simultaneously pressing the Cursor SHIFT and NON STORE buttons begins the user-initiated diagnostic routine. This routine displays a number or message that corresponds to the last front panel control used. This feature can be used to determine whether a front-panel controls is operating normally.

Table A-2 lists the 371 controls and the corresponding numbers or messages. To exit the routine, press both the Cursor SHIFT button and the NON STORE button again.

TABLE A-2  
Key Error – Front Panel Control Identification

Control	Number
Display SAVE	1
Display RECALL	2
Memory Index ↵	3
Memory Index ↵	4
Display NON STORE	5
Display STORE	6
Display COMPARE	7
Display VIEW	8
Display ENTER	9
Display INVERT	10
Measurement REPEAT	11
Measurement SINGLE	12
Measurement SWEEP	13
GPIB RESET TO LOCAL	14
GPIB USER REQUEST	15
PLOTTER	16
Cursor Mode ↵	17
Cursor Mode ↵	18
⚡	19

TABLE A-2 (cont.)  
Key Error – Front Panel Control Identification

Control	Number
←	20
↓	21
←	22
Cursor SHIFT	23
Collector Supply POLARITY	24
PEAK POWER WATTS 3 kW	25
PEAK POWER WATTS 300 W	26
PEAK POWER WATTS 30 W	27
PEAK POWER WATTS 3 W	28
Step Generator INVERT	29
Step Generator CURRENT Source	30
Step Generator VOLTAGE Source	31
NUMBER OF STEPS ←	32
NUMBER OF STEPS ↙	33
Step Generator OFFSET ←	34
Step Generator OFFSET ↙	35
Step Generator STEP MULTI .1X	36
VERTICAL CURRENT/DIV	VERT SENSE 1-16
HORIZONTAL VOLTS/DIV	HORIZ SENSE 1-16
STEP/OFFSET AMPLITUDE	STEP AMP 1-16

**■ GPIB Diagnostic Routine**

When a controller sends the TEST? query over the GPIB, system ROM and RAM diagnostic routines are run by the 371. The 371 responds to the query by returning system ROM and RAM information to the controller as follows:

TEST ROM:000X, RAM:YYYY

## MESSAGES

Typical messages displayed in the CRT error message area while the 371 is in operation are listed in Table A-3.

**TABLE A-3**  
**Messages**

<b>Message</b>	<b>Description</b>
BREAKER OFF	Collector Supply breaker is off.
COL. DISABLED	Collector Supply is disabled. Wait until the message "COL. RECOVERED" is displayed. If the error persists, contact a qualified service person or the nearest Tektronix Field Service Representative.
COL. FUSE BLOW	The Collector Supply fuse on the rear panel is blown.
COL. OVERHEAT	Series resistor (Collector Supply) overheat. Wait until "COL. RECOVERED" message is displayed.
COL. RECOVERED	The Collector Supply is recovered.
ENTER COMPLETE	The displayed curve is saved in the bubble memory.
ERASE CANCELED	Erasing the bubble memory is canceled.
ERASE COMPLETE	The bubble memory is erased.
OPERATION ERR.	Operation error
PLL UNLOCK	PLL unlock

## 371 Diagnostic Routines and Messages

---

TABLE A-3 (cont.)  
Messages

Message	Description
PLOT ABORTED	Plotter output is aborted.
PLOTTER FAIL	Plotter output I/O error. Confirm that the plotter is properly connected.
SAVE COMPLETE	The current front-panel setting is saved in the bubble memory.
SELFTEST PASS	The 371 power-up diagnostic test is successful.
SELFTEST START	The 371 has initiated the power-up diagnostic routine.
TEXT EDIT MODE	Text can be entered on the CRT using the VERTICAL CURRENT/DIV and HORIZONTAL VOLTS/DIV controls.
TEXT CANCELED	Text Edit mode is canceled; all text entered is lost.
BUBBLE EJECT	The bubble memory cassette is ejected while the 371 is in SAVE/RECALL or ENTER/VIEW operation.
BUBBLE NO DATA	The bubble memory has no data in the location specified by the bubble memory index.
BUBBLE NOMEM	Bubble memory cassette not installed.
BUBBLE WPRTE	Bubble memory cassette "write-protected". Set write-protect key to "write enable" position.

## 371 Diagnostic Routines and Messages

TABLE A-3 (cont.)  
Messages

Message	Description
BUBBLE BUS	Internal bubble memory errors. To determine whether the problem is in the bubble memory cassette or in the cassette drive, try a new bubble memory cassette. Attempt to save or recall a waveform or a setting. If the cassette drive is at fault, contact a Tektronix Field Service Representative. The 371 can still be used, although internal bubble memory functions cannot be used.
BUBBLE BUSY	
BUBBLE MDL	
BUBBLE NHDR	
BUBBLE PARITY	
BUBBLE POVR	
BUBBLE TXMIS	
BUBBLE UCE	
BUBBLE USCE	
BUBBLE UDC	

