

R&S®FSMR

Measuring Receiver

Operating Manual



1313.9723.12 – 02

The Operating Manual describes the following R&S®FSMR models and options:

- R&S FSMR3 1313.9200.03
- R&S FSMR26 1313.9200.26
- R&S FSMR431313.9200.43
- R&S FSMR50 1313.9200.50

The firmware of the instrument makes use of several valuable open source software packages. the most important of them are listed below, together with their corresponding open source license. The verbatimlicense texts are provided on the user documentation CD-ROM (included in delivery).

Package	Link	License
Xitami	http://www.xitami.com	2.5b6
PHP	http://www.php.net	PHP v 3
DOJO-AJAX	http://www.dojotoolkit.org	BSD License
BOOST Library	http://www.boost.org	Boost Software v.1
ONC/RPC	http://www.plt.rwth-aachen.de	SUN
TightVnc	http://www.tightvnc.com	GPL v.3
DemoForgeMirageDriver	http://www.demoforge.com/dfmirage.htm	GPL v.3

Rohde&Schwarz would like to thank the open source community for their valuable contribution to embedded computing.

© 2009 Rohde & Schwarz GmbH & Co. KG

81671 Munich, Germany

Printed in Germany – Subject to change – Data without tolerance limits is not binding.

R&S® is a registered trademark of Rohde & Schwarz GmbH & Co. KG.

Trade names are trademarks of the owners.

The following abbreviations are used throughout this manual:

R&S®FSMR is abbreviated as R&S FSMR.

Tabbed Divider Overview

Contents

Safety Instructions
Certificate of Quality
EU Certificate of Conformity
List of R&S Representatives

Manuals for Measuring Receiver R&S FSMR

Tabbed Divider

1	Chapter 1: Putting into Operation (s. Quick Start Guide)
2	Chapter 2: Getting Started
3	Chapter 3: Menu Overview
4	Chapter 4: Functional Description
5	Chapter 5: Remote Control – Basics
6	Chapter 6: Remote Control – Commands
7	Chapter 7: Remote Control – Program Examples
8	Chapter 8: Maintenance and Hardware Interfaces
9	Chapter 9: Error Messages
10	Index

Basic Safety Instructions

Always read through and comply with the following safety instructions!

All plants and locations of the Rohde & Schwarz group of companies make every effort to keep the safety standards of our products up to date and to offer our customers the highest possible degree of safety. Our products and the auxiliary equipment they require are designed, built and tested in accordance with the safety standards that apply in each case. Compliance with these standards is continuously monitored by our quality assurance system. The product described here has been designed, built and tested in accordance with the EC Certificate of Conformity and has left the manufacturer's plant in a condition fully complying with safety standards. To maintain this condition and to ensure safe operation, you must observe all instructions and warnings provided in this manual. If you have any questions regarding these safety instructions, the Rohde & Schwarz group of companies will be happy to answer them.







Furthermore, it is your responsibility to use the product in an appropriate manner. This product is designed for use solely in industrial and laboratory environments or, if expressly permitted, also in the field and must not be used in any way that may cause personal injury or property damage. You are responsible if the product is used for any purpose other than its designated purpose or in disregard of the manufacturer's instructions. The manufacturer shall assume no responsibility for such use of the product.

The product is used for its designated purpose if it is used in accordance with its product documentation and within its performance limits (see data sheet, documentation, the following safety instructions). Using the product requires technical skills and, in some cases, a basic knowledge of English. It is therefore essential that only skilled and specialized staff or thoroughly trained personnel with the required skills be allowed to use the product. If personal safety gear is required for using Rohde & Schwarz products, this will be indicated at the appropriate place in the product documentation. Keep the basic safety instructions and the product documentation in a safe place and pass them on to the subsequent users.











Observing the safety instructions will help prevent personal injury or damage of any kind caused by dangerous situations. Therefore, carefully read through and adhere to the following safety instructions before and when using the product. It is also absolutely essential to observe the additional safety instructions on personal safety, for example, that appear in relevant parts of the product documentation. In these safety instructions, the word "product" refers to all merchandise sold and distributed by the Rohde & Schwarz group of companies, including instruments, systems and all accessories. For product-specific information, see the data sheet and the product documentation.

Safety labels on products

The following safety labels are used on products to warn against risks and dangers.

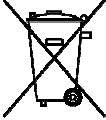
Symbol	Meaning	Symbol	Meaning
	Notice, general danger location Observe product documentation		ON/OFF supply voltage
	Caution when handling heavy equipment		Standby indication
	Danger of electric shock		Direct current (DC)

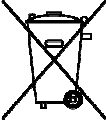
Basic Safety Instructions

Symbol	Meaning	Symbol	Meaning
	Warning! Hot surface		Alternating current (AC)
	Protective conductor terminal		Direct/alternating current (DC/AC)
	Ground		Device fully protected by double (reinforced) insulation
	Ground terminal		EU labeling for batteries and accumulators For additional information, see section "Waste disposal/Environmental protection", item 1.
	Be careful when handling electrostatic sensitive devices		EU labeling for separate collection of electrical and electronic devices For additional information, see section "Waste disposal/Environmental protection", item 2.
	Warning! Laser radiation For additional information, see section "Operation", item 7.		

Signal words and their meaning

The following signal words are used in the product documentation in order to warn the reader about risks and dangers.



Indicates a hazardous situation which, if not avoided, will result in death or serious injury.



Indicates a hazardous situation which, if not avoided, could result in death or serious injury.



Indicates a hazardous situation which, if not avoided, could result in minor or moderate injury.



Indicates information considered important, but not hazard-related, e.g. messages relating to property damage.
In the product documentation, the word ATTENTION is used synonymously.

These signal words are in accordance with the standard definition for civil applications in the European Economic Area. Definitions that deviate from the standard definition may also exist in other economic areas or military applications. It is therefore essential to make sure that the signal words described here are always used only in connection with the related product documentation and the related product. The use of signal words in connection with unrelated products or documentation can result in misinterpretation and in personal injury or material damage.

Basic Safety Instructions

Operating states and operating positions

The product may be operated only under the operating conditions and in the positions specified by the manufacturer, without the product's ventilation being obstructed. If the manufacturer's specifications are not observed, this can result in electric shock, fire and/or serious personal injury or death. Applicable local or national safety regulations and rules for the prevention of accidents must be observed in all work performed.

1. Unless otherwise specified, the following requirements apply to Rohde & Schwarz products: predefined operating position is always with the housing floor facing down, IP protection 2X, use only indoors, max. operating altitude 2000 m above sea level, max. transport altitude 4500 m above sea level. A tolerance of $\pm 10\%$ shall apply to the nominal voltage and $\pm 5\%$ to the nominal frequency, overvoltage category 2, pollution severity 2.
2. Do not place the product on surfaces, vehicles, cabinets or tables that for reasons of weight or stability are unsuitable for this purpose. Always follow the manufacturer's installation instructions when installing the product and fastening it to objects or structures (e.g. walls and shelves). An installation that is not carried out as described in the product documentation could result in personal injury or even death.
3. Do not place the product on heat-generating devices such as radiators or fan heaters. The ambient temperature must not exceed the maximum temperature specified in the product documentation or in the data sheet. Product overheating can cause electric shock, fire and/or serious personal injury or even death.

Electrical safety

If the information on electrical safety is not observed either at all or to the extent necessary, electric shock, fire and/or serious personal injury or death may occur.

1. Prior to switching on the product, always ensure that the nominal voltage setting on the product matches the nominal voltage of the AC supply network. If a different voltage is to be set, the power fuse of the product may have to be changed accordingly.
2. In the case of products of safety class I with movable power cord and connector, operation is permitted only on sockets with a protective conductor contact and protective conductor.
3. Intentionally breaking the protective conductor either in the feed line or in the product itself is not permitted. Doing so can result in the danger of an electric shock from the product. If extension cords or connector strips are implemented, they must be checked on a regular basis to ensure that they are safe to use.
4. If there is no power switch for disconnecting the product from the AC supply network, or if the power switch is not suitable for this purpose, use the plug of the connecting cable to disconnect the product from the AC supply network. In such cases, always ensure that the power plug is easily reachable and accessible at all times. For example, if the power plug is the disconnecting device, the length of the connecting cable must not exceed 3 m. Functional or electronic switches are not suitable for providing disconnection from the AC supply network. If products without power switches are integrated into racks or systems, the disconnecting device must be provided at the system level.
5. Never use the product if the power cable is damaged. Check the power cables on a regular basis to ensure that they are in proper operating condition. By taking appropriate safety measures and carefully laying the power cable, ensure that the cable cannot be damaged and that no one can be hurt by, for example, tripping over the cable or suffering an electric shock.

Basic Safety Instructions

6. The product may be operated only from TN/TT supply networks fuse-protected with max. 16 A (higher fuse only after consulting with the Rohde & Schwarz group of companies).
7. Do not insert the plug into sockets that are dusty or dirty. Insert the plug firmly and all the way into the socket provided for this purpose. Otherwise, sparks that result in fire and/or injuries may occur.
8. Do not overload any sockets, extension cords or connector strips; doing so can cause fire or electric shocks.
9. For measurements in circuits with voltages $V_{rms} > 30$ V, suitable measures (e.g. appropriate measuring equipment, fuse protection, current limiting, electrical separation, insulation) should be taken to avoid any hazards.
10. Ensure that the connections with information technology equipment, e.g. PCs or other industrial computers, comply with the IEC60950-1/EN60950-1 or IEC61010-1/EN 61010-1 standards that apply in each case.
11. Unless expressly permitted, never remove the cover or any part of the housing while the product is in operation. Doing so will expose circuits and components and can lead to injuries, fire or damage to the product.
12. If a product is to be permanently installed, the connection between the protective conductor terminal on site and the product's protective conductor must be made first before any other connection is made. The product may be installed and connected only by a licensed electrician.
13. For permanently installed equipment without built-in fuses, circuit breakers or similar protective devices, the supply circuit must be fuse-protected in such a way that anyone who has access to the product, as well as the product itself, is adequately protected from injury or damage.
14. Use suitable overvoltage protection to ensure that no overvoltage (such as that caused by a bolt of lightning) can reach the product. Otherwise, the person operating the product will be exposed to the danger of an electric shock.
15. Any object that is not designed to be placed in the openings of the housing must not be used for this purpose. Doing so can cause short circuits inside the product and/or electric shocks, fire or injuries.
16. Unless specified otherwise, products are not liquid-proof (see also section "Operating states and operating positions", item 1). Therefore, the equipment must be protected against penetration by liquids. If the necessary precautions are not taken, the user may suffer electric shock or the product itself may be damaged, which can also lead to personal injury.
17. Never use the product under conditions in which condensation has formed or can form in or on the product, e.g. if the product has been moved from a cold to a warm environment. Penetration by water increases the risk of electric shock.
18. Prior to cleaning the product, disconnect it completely from the power supply (e.g. AC supply network or battery). Use a soft, non-linting cloth to clean the product. Never use chemical cleaning agents such as alcohol, acetone or diluents for cellulose lacquers.

Operation

1. Operating the products requires special training and intense concentration. Make sure that persons who use the products are physically, mentally and emotionally fit enough to do so; otherwise, injuries or material damage may occur. It is the responsibility of the employer/operator to select suitable personnel for operating the products.

Basic Safety Instructions

2. Before you move or transport the product, read and observe the section titled "Transport".
3. As with all industrially manufactured goods, the use of substances that induce an allergic reaction (allergens) such as nickel cannot be generally excluded. If you develop an allergic reaction (such as a skin rash, frequent sneezing, red eyes or respiratory difficulties) when using a Rohde & Schwarz product, consult a physician immediately to determine the cause and to prevent health problems or stress.
4. Before you start processing the product mechanically and/or thermally, or before you take it apart, be sure to read and pay special attention to the section titled "Waste disposal/Environmental protection", item 1.
5. Depending on the function, certain products such as RF radio equipment can produce an elevated level of electromagnetic radiation. Considering that unborn babies require increased protection, pregnant women must be protected by appropriate measures. Persons with pacemakers may also be exposed to risks from electromagnetic radiation. The employer/operator must evaluate workplaces where there is a special risk of exposure to radiation and, if necessary, take measures to avert the potential danger.
6. Should a fire occur, the product may release hazardous substances (gases, fluids, etc.) that can cause health problems. Therefore, suitable measures must be taken, e.g. protective masks and protective clothing must be worn.
7. Laser products are given warning labels that are standardized according to their laser class. Lasers can cause biological harm due to the properties of their radiation and due to their extremely concentrated electromagnetic power. If a laser product (e.g. a CD/DVD drive) is integrated into a Rohde & Schwarz product, absolutely no other settings or functions may be used as described in the product documentation. The objective is to prevent personal injury (e.g. due to laser beams).
8. EMC classes (in line with EN 55011/CISPR 11, and analogously with EN 55022/CISPR 22, EN 55032/CISPR 32)
 - Class A equipment:
Equipment suitable for use in all environments except residential environments and environments that are directly connected to a low-voltage supply network that supplies residential buildings
Note: Class A equipment is intended for use in an industrial environment. This equipment may cause radio disturbances in residential environments, due to possible conducted as well as radiated disturbances. In this case, the operator may be required to take appropriate measures to eliminate these disturbances.
 - Class B equipment:
Equipment suitable for use in residential environments and environments that are directly connected to a low-voltage supply network that supplies residential buildings

Repair and service

1. The product may be opened only by authorized, specially trained personnel. Before any work is performed on the product or before the product is opened, it must be disconnected from the AC supply network. Otherwise, personnel will be exposed to the risk of an electric shock.

Basic Safety Instructions

- Adjustments, replacement of parts, maintenance and repair may be performed only by electrical experts authorized by Rohde & Schwarz. Only original parts may be used for replacing parts relevant to safety (e.g. power switches, power transformers, fuses). A safety test must always be performed after parts relevant to safety have been replaced (visual inspection, protective conductor test, insulation resistance measurement, leakage current measurement, functional test). This helps ensure the continued safety of the product.

Batteries and rechargeable batteries/cells

If the information regarding batteries and rechargeable batteries/cells is not observed either at all or to the extent necessary, product users may be exposed to the risk of explosions, fire and/or serious personal injury, and, in some cases, death. Batteries and rechargeable batteries with alkaline electrolytes (e.g. lithium cells) must be handled in accordance with the EN 62133 standard.

- Cells must not be taken apart or crushed.
- Cells or batteries must not be exposed to heat or fire. Storage in direct sunlight must be avoided. Keep cells and batteries clean and dry. Clean soiled connectors using a dry, clean cloth.
- Cells or batteries must not be short-circuited. Cells or batteries must not be stored in a box or in a drawer where they can short-circuit each other, or where they can be short-circuited by other conductive materials. Cells and batteries must not be removed from their original packaging until they are ready to be used.
- Cells and batteries must not be exposed to any mechanical shocks that are stronger than permitted.
- If a cell develops a leak, the fluid must not be allowed to come into contact with the skin or eyes. If contact occurs, wash the affected area with plenty of water and seek medical aid.
- Improperly replacing or charging cells or batteries that contain alkaline electrolytes (e.g. lithium cells) can cause explosions. Replace cells or batteries only with the matching Rohde & Schwarz type (see parts list) in order to ensure the safety of the product.
- Cells and batteries must be recycled and kept separate from residual waste. Rechargeable batteries and normal batteries that contain lead, mercury or cadmium are hazardous waste. Observe the national regulations regarding waste disposal and recycling.

Transport

- The product may be very heavy. Therefore, the product must be handled with care. In some cases, the user may require a suitable means of lifting or moving the product (e.g. with a lift-truck) to avoid back or other physical injuries.
- Handles on the products are designed exclusively to enable personnel to transport the product. It is therefore not permissible to use handles to fasten the product to or on transport equipment such as cranes, fork lifts, wagons, etc. The user is responsible for securely fastening the products to or on the means of transport or lifting. Observe the safety regulations of the manufacturer of the means of transport or lifting. Noncompliance can result in personal injury or material damage.
- If you use the product in a vehicle, it is the sole responsibility of the driver to drive the vehicle safely and properly. The manufacturer assumes no responsibility for accidents or collisions. Never use the product in a moving vehicle if doing so could distract the driver of the vehicle. Adequately secure the product in the vehicle to prevent injuries or other damage in the event of an accident.

Waste disposal/Environmental protection

1. Specially marked equipment has a battery or accumulator that must not be disposed of with unsorted municipal waste, but must be collected separately. It may only be disposed of at a suitable collection point or via a Rohde & Schwarz customer service center.
2. Waste electrical and electronic equipment must not be disposed of with unsorted municipal waste, but must be collected separately.
Rohde & Schwarz GmbH & Co. KG has developed a disposal concept and takes full responsibility for take-back obligations and disposal obligations for manufacturers within the EU. Contact your Rohde & Schwarz customer service center for environmentally responsible disposal of the product.
3. If products or their components are mechanically and/or thermally processed in a manner that goes beyond their intended use, hazardous substances (heavy-metal dust such as lead, beryllium, nickel) may be released. For this reason, the product may only be disassembled by specially trained personnel. Improper disassembly may be hazardous to your health. National waste disposal regulations must be observed.
4. If handling the product releases hazardous substances or fuels that must be disposed of in a special way, e.g. coolants or engine oils that must be replenished regularly, the safety instructions of the manufacturer of the hazardous substances or fuels and the applicable regional waste disposal regulations must be observed. Also observe the relevant safety instructions in the product documentation. The improper disposal of hazardous substances or fuels can cause health problems and lead to environmental damage.

For additional information about environmental protection, visit the Rohde & Schwarz website.

Instrucciones de seguridad elementales

¡Es imprescindible leer y cumplir las siguientes instrucciones e informaciones de seguridad!

El principio del grupo de empresas Rohde & Schwarz consiste en tener nuestros productos siempre al día con los estándares de seguridad y de ofrecer a nuestros clientes el máximo grado de seguridad. Nuestros productos y todos los equipos adicionales son siempre fabricados y examinados según las normas de seguridad vigentes. Nuestro sistema de garantía de calidad controla constantemente que sean cumplidas estas normas. El presente producto ha sido fabricado y examinado según el certificado de conformidad de la UE y ha salido de nuestra planta en estado impecable según los estándares técnicos de seguridad. Para poder preservar este estado y garantizar un funcionamiento libre de peligros, el usuario deberá atenerse a todas las indicaciones, informaciones de seguridad y notas de alerta. El grupo de empresas Rohde & Schwarz está siempre a su disposición en caso de que tengan preguntas referentes a estas informaciones de seguridad.

Además queda en la responsabilidad del usuario utilizar el producto en la forma debida. Este producto está destinado exclusivamente al uso en la industria y el laboratorio o, si ha sido expresamente autorizado, para aplicaciones de campo y de ninguna manera deberá ser utilizado de modo que alguna persona/cosa pueda sufrir daño. El uso del producto fuera de sus fines definidos o sin tener en cuenta las instrucciones del fabricante queda en la responsabilidad del usuario. El fabricante no se hace en ninguna forma responsable de consecuencias a causa del mal uso del producto.













Instrucciones de seguridad elementales

Se parte del uso correcto del producto para los fines definidos si el producto es utilizado conforme a las indicaciones de la correspondiente documentación del producto y dentro del margen de rendimiento definido (ver hoja de datos, documentación, informaciones de seguridad que siguen). El uso del producto hace necesarios conocimientos técnicos y ciertos conocimientos del idioma inglés. Por eso se debe tener en cuenta que el producto solo pueda ser operado por personal especializado o personas instruidas en profundidad con las capacidades correspondientes. Si fuera necesaria indumentaria de seguridad para el uso de productos de Rohde & Schwarz, encontraría la información debida en la documentación del producto en el capítulo correspondiente. Guarde bien las informaciones de seguridad elementales, así como la documentación del producto, y entréguelas a usuarios posteriores.



Tener en cuenta las informaciones de seguridad sirve para evitar en lo posible lesiones o daños por peligros de toda clase. Por eso es imprescindible leer detalladamente y comprender por completo las siguientes informaciones de seguridad antes de usar el producto, y respetarlas durante el uso del producto. Deberán tenerse en cuenta todas las demás informaciones de seguridad, como p. ej. las referentes a la protección de personas, que encontrarán en el capítulo correspondiente de la documentación del producto y que también son de obligado cumplimiento. En las presentes informaciones de seguridad se recogen todos los objetos que distribuye el grupo de empresas Rohde & Schwarz bajo la denominación de "producto", entre ellos también aparatos, instalaciones así como toda clase de accesorios. Los datos específicos del producto figuran en la hoja de datos y en la documentación del producto.

Señalización de seguridad de los productos

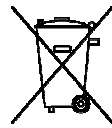
Las siguientes señales de seguridad se utilizan en los productos para advertir sobre riesgos y peligros.

Símbolo	Significado	Símbolo	Significado
	Aviso: punto de peligro general Observar la documentación del producto		Tensión de alimentación de PUESTA EN MARCHA / PARADA
	Atención en el manejo de dispositivos de peso elevado		Indicación de estado de espera (standby)
	Peligro de choque eléctrico		Corriente continua (DC)
	Advertencia: superficie caliente		Corriente alterna (AC)
	Conexión a conductor de protección		Corriente continua / Corriente alterna (DC/AC)
	Conexión a tierra		El aparato está protegido en su totalidad por un aislamiento doble (reforzado)
	Conexión a masa		Distintivo de la UE para baterías y acumuladores Más información en la sección "Eliminación/protección del medio ambiente", punto 1.

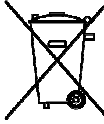
Instrucciones de seguridad elementales

Símbolo	Significado	Símbolo	Significado
	Aviso: Cuidado en el manejo de dispositivos sensibles a la electrostática (ESD)		Distintivo de la UE para la eliminación por separado de dispositivos eléctricos y electrónicos Más información en la sección "Eliminación/protección del medio ambiente", punto 2.
	Advertencia: rayo láser Más información en la sección "Funcionamiento", punto 7.		

Palabras de señal y su significado

En la documentación del producto se utilizan las siguientes palabras de señal con el fin de advertir contra riesgos y peligros.



Indica una situación de peligro que, si no se evita, causa lesiones graves o incluso la muerte.



Indica una situación de peligro que, si no se evita, puede causar lesiones graves o incluso la muerte.



Indica una situación de peligro que, si no se evita, puede causar lesiones leves o moderadas.



Indica información que se considera importante, pero no en relación con situaciones de peligro; p. ej., avisos sobre posibles daños materiales.

En la documentación del producto se emplea de forma sinónima el término CUIDADO.

Las palabras de señal corresponden a la definición habitual para aplicaciones civiles en el área económica europea. Pueden existir definiciones diferentes a esta definición en otras áreas económicas o en aplicaciones militares. Por eso se deberá tener en cuenta que las palabras de señal aquí descritas sean utilizadas siempre solamente en combinación con la correspondiente documentación del producto y solamente en combinación con el producto correspondiente. La utilización de las palabras de señal en combinación con productos o documentaciones que no les correspondan puede llevar a interpretaciones equivocadas y tener por consecuencia daños en personas u objetos.

Estados operativos y posiciones de funcionamiento

El producto solamente debe ser utilizado según lo indicado por el fabricante respecto a los estados operativos y posiciones de funcionamiento sin que se obstruya la ventilación. Si no se siguen las indicaciones del fabricante, pueden producirse choques eléctricos, incendios y/o lesiones graves con posible consecuencia de muerte. En todos los trabajos deberán ser tenidas en cuenta las normas nacionales y locales de seguridad del trabajo y de prevención de accidentes.

Instrucciones de seguridad elementales

1. Si no se convino de otra manera, es para los productos Rohde & Schwarz válido lo que sigue: como posición de funcionamiento se define por principio la posición con el suelo de la caja para abajo, modo de protección IP 2X, uso solamente en estancias interiores, utilización hasta 2000 m sobre el nivel del mar, transporte hasta 4500 m sobre el nivel del mar. Se aplicará una tolerancia de $\pm 10\%$ sobre el voltaje nominal y de $\pm 5\%$ sobre la frecuencia nominal. Categoría de sobrecarga eléctrica 2, índice de suciedad 2.
2. No sitúe el producto encima de superficies, vehículos, estantes o mesas, que por sus características de peso o de estabilidad no sean aptos para él. Siga siempre las instrucciones de instalación del fabricante cuando instale y asegure el producto en objetos o estructuras (p. ej. paredes y estantes). Si se realiza la instalación de modo distinto al indicado en la documentación del producto, se pueden causar lesiones o, en determinadas circunstancias, incluso la muerte.
3. No ponga el producto sobre aparatos que generen calor (p. ej. radiadores o calefactores). La temperatura ambiente no debe superar la temperatura máxima especificada en la documentación del producto o en la hoja de datos. En caso de sobrecalentamiento del producto, pueden producirse choques eléctricos, incendios y/o lesiones graves con posible consecuencia de muerte.

Seguridad eléctrica

Si no se siguen (o se siguen de modo insuficiente) las indicaciones del fabricante en cuanto a seguridad eléctrica, pueden producirse choques eléctricos, incendios y/o lesiones graves con posible consecuencia de muerte.

1. Antes de la puesta en marcha del producto se deberá comprobar siempre que la tensión preseleccionada en el producto coincida con la de la red de alimentación eléctrica. Si es necesario modificar el ajuste de tensión, también se deberán cambiar en caso dado los fusibles correspondientes del producto.
2. Los productos de la clase de protección I con alimentación móvil y enchufe individual solamente podrán enchufarse a tomas de corriente con contacto de seguridad y con conductor de protección conectado.
3. Queda prohibida la interrupción intencionada del conductor de protección, tanto en la toma de corriente como en el mismo producto. La interrupción puede tener como consecuencia el riesgo de que el producto sea fuente de choques eléctricos. Si se utilizan cables alargadores o regletas de enchufe, deberá garantizarse la realización de un examen regular de los mismos en cuanto a su estado técnico de seguridad.
4. Si el producto no está equipado con un interruptor para desconectarlo de la red, o bien si el interruptor existente no resulta apropiado para la desconexión de la red, el enchufe del cable de conexión se deberá considerar como un dispositivo de desconexión. El dispositivo de desconexión se debe poder alcanzar fácilmente y debe estar siempre bien accesible. Si, p. ej., el enchufe de conexión a la red es el dispositivo de desconexión, la longitud del cable de conexión no debe superar 3 m). Los interruptores selectores o electrónicos no son aptos para el corte de la red eléctrica. Si se integran productos sin interruptor en bastidores o instalaciones, se deberá colocar el interruptor en el nivel de la instalación.
5. No utilice nunca el producto si está dañado el cable de conexión a red. Compruebe regularmente el correcto estado de los cables de conexión a red. Asegúrese, mediante las medidas de protección y de instalación adecuadas, de que el cable de conexión a red no pueda ser dañado o de que nadie pueda ser dañado por él, p. ej. al tropezar o por un choque eléctrico.

Instrucciones de seguridad elementales

6. Solamente está permitido el funcionamiento en redes de alimentación TN/TT aseguradas con fusibles de 16 A como máximo (utilización de fusibles de mayor amperaje solo previa consulta con el grupo de empresas Rohde & Schwarz).
7. Nunca conecte el enchufe en tomas de corriente sucias o llenas de polvo. Introduzca el enchufe por completo y fuertemente en la toma de corriente. La no observación de estas medidas puede provocar chispas, fuego y/o lesiones.
8. No sobrecargue las tomas de corriente, los cables alargadores o las regletas de enchufe ya que esto podría causar fuego o choques eléctricos.
9. En las mediciones en circuitos de corriente con una tensión $U_{\text{eff}} > 30 \text{ V}$ se deberán tomar las medidas apropiadas para impedir cualquier peligro (p. ej. medios de medición adecuados, seguros, limitación de tensión, corte protector, aislamiento etc.).
10. Para la conexión con dispositivos informáticos como un PC o un ordenador industrial, debe comprobarse que éstos cumplan los estándares IEC60950-1/EN60950-1 o IEC61010-1/EN 61010-1 válidos en cada caso.
11. A menos que esté permitido expresamente, no retire nunca la tapa ni componentes de la carcasa mientras el producto esté en servicio. Esto pone a descubierto los cables y componentes eléctricos y puede causar lesiones, fuego o daños en el producto.
12. Si un producto se instala en un lugar fijo, se deberá primero conectar el conductor de protección fijo con el conductor de protección del producto antes de hacer cualquier otra conexión. La instalación y la conexión deberán ser efectuadas por un electricista especializado.
13. En el caso de dispositivos fijos que no estén provistos de fusibles, interruptor automático ni otros mecanismos de seguridad similares, el circuito de alimentación debe estar protegido de modo que todas las personas que puedan acceder al producto, así como el producto mismo, estén a salvo de posibles daños.
14. Todo producto debe estar protegido contra sobretensión (debida p. ej. a una caída del rayo) mediante los correspondientes sistemas de protección. Si no, el personal que lo utilice quedará expuesto al peligro de choque eléctrico.
15. No debe introducirse en los orificios de la caja del aparato ningún objeto que no esté destinado a ello. Esto puede producir cortocircuitos en el producto y/o puede causar choques eléctricos, fuego o lesiones.
16. Salvo indicación contraria, los productos no están impermeabilizados (ver también el capítulo "Estados operativos y posiciones de funcionamiento", punto 1). Por eso es necesario tomar las medidas necesarias para evitar la entrada de líquidos. En caso contrario, existe peligro de choque eléctrico para el usuario o de daños en el producto, que también pueden redundar en peligro para las personas.
17. No utilice el producto en condiciones en las que pueda producirse o ya se hayan producido condensaciones sobre el producto o en el interior de éste, como p. ej. al desplazarlo de un lugar frío a otro caliente. La entrada de agua aumenta el riesgo de choque eléctrico.
18. Antes de la limpieza, desconecte por completo el producto de la alimentación de tensión (p. ej. red de alimentación o batería). Realice la limpieza de los aparatos con un paño suave, que no se deshilache. No utilice bajo ningún concepto productos de limpieza químicos como alcohol, acetona o diluyentes para lacas nitrocelulósicas.

Funcionamiento

1. El uso del producto requiere instrucciones especiales y una alta concentración durante el manejo. Debe asegurarse que las personas que manejen el producto estén a la altura de los requerimientos necesarios en cuanto a aptitudes físicas, psíquicas y emocionales, ya que de otra manera no se pueden excluir lesiones o daños de objetos. El empresario u operador es responsable de seleccionar el personal usuario apto para el manejo del producto.
2. Antes de desplazar o transportar el producto, lea y tenga en cuenta el capítulo "Transporte".
3. Como con todo producto de fabricación industrial no puede quedar excluida en general la posibilidad de que se produzcan alergias provocadas por algunos materiales empleados —los llamados alérgenos (p. ej. el níquel)—. Si durante el manejo de productos Rohde & Schwarz se producen reacciones alérgicas, como p. ej. irritaciones cutáneas, estornudos continuos, enrojecimiento de la conjuntiva o dificultades respiratorias, debe avisarse inmediatamente a un médico para investigar las causas y evitar cualquier molestia o daño a la salud.
4. Antes de la manipulación mecánica y/o térmica o el desmontaje del producto, debe tenerse en cuenta imprescindiblemente el capítulo "Eliminación/protección del medio ambiente", punto 1.
5. Ciertos productos, como p. ej. las instalaciones de radiocomunicación RF, pueden a causa de su función natural, emitir una radiación electromagnética aumentada. Deben tomarse todas las medidas necesarias para la protección de las mujeres embarazadas. También las personas con marcapasos pueden correr peligro a causa de la radiación electromagnética. El empresario/operador tiene la obligación de evaluar y señalizar las áreas de trabajo en las que exista un riesgo elevado de exposición a radiaciones.
6. Tenga en cuenta que en caso de incendio pueden desprenderse del producto sustancias tóxicas (gases, líquidos etc.) que pueden generar daños a la salud. Por eso, en caso de incendio deben usarse medidas adecuadas, como p. ej. máscaras antigás e indumentaria de protección.
7. Los productos con láser están provistos de indicaciones de advertencia normalizadas en función de la clase de láser del que se trate. Los rayos láser pueden provocar daños de tipo biológico a causa de las propiedades de su radiación y debido a su concentración extrema de potencia electromagnética. En caso de que un producto Rohde & Schwarz contenga un producto láser (p. ej. un lector de CD/DVD), no debe usarse ninguna otra configuración o función aparte de las descritas en la documentación del producto, a fin de evitar lesiones (p. ej. debidas a irradiación láser).
8. Clases de compatibilidad electromagnética (conforme a EN 55011 / CISPR 11; y en analogía con EN 55022 / CISPR 22, EN 55032 / CISPR 32)
 - Aparato de clase A:
Aparato adecuado para su uso en todos los entornos excepto en los residenciales y en aquellos conectados directamente a una red de distribución de baja tensión que suministra corriente a edificios residenciales.
Nota: Los aparatos de clase A están destinados al uso en entornos industriales. Estos aparatos pueden causar perturbaciones radioeléctricas en entornos residenciales debido a posibles perturbaciones guiadas o radiadas. En este caso, se le podrá solicitar al operador que tome las medidas adecuadas para eliminar estas perturbaciones.
 - Aparato de clase B:
Aparato adecuado para su uso en entornos residenciales, así como en aquellos conectados directamente a una red de distribución de baja tensión que suministra corriente a edificios residenciales.

Reparación y mantenimiento

1. El producto solamente debe ser abierto por personal especializado con autorización para ello. Antes de manipular el producto o abrirlo, es obligatorio desconectarlo de la tensión de alimentación, para evitar toda posibilidad de choque eléctrico.
2. El ajuste, el cambio de partes, el mantenimiento y la reparación deberán ser efectuadas solamente por electricistas autorizados por Rohde & Schwarz. Si se reponen partes con importancia para los aspectos de seguridad (p. ej. el enchufe, los transformadores o los fusibles), solamente podrán ser sustituidos por partes originales. Después de cada cambio de partes relevantes para la seguridad deberá realizarse un control de seguridad (control a primera vista, control del conductor de protección, medición de resistencia de aislamiento, medición de la corriente de fuga, control de funcionamiento). Con esto queda garantizada la seguridad del producto.

Baterías y acumuladores o celdas

Si no se siguen (o se siguen de modo insuficiente) las indicaciones en cuanto a las baterías y acumuladores o celdas, pueden producirse explosiones, incendios y/o lesiones graves con posible consecuencia de muerte. El manejo de baterías y acumuladores con electrolitos alcalinos (p. ej. celdas de litio) debe seguir el estándar EN 62133.

1. No deben desmontarse, abrirse ni triturarse las celdas.
2. Las celdas o baterías no deben someterse a calor ni fuego. Debe evitarse el almacenamiento a la luz directa del sol. Las celdas y baterías deben mantenerse limpias y secas. Limpiar las conexiones sucias con un paño seco y limpio.
3. Las celdas o baterías no deben cortocircuitarse. Es peligroso almacenar las celdas o baterías en estuches o cajones en cuyo interior puedan cortocircuitarse por contacto recíproco o por contacto con otros materiales conductores. No deben extraerse las celdas o baterías de sus embalajes originales hasta el momento en que vayan a utilizarse.
4. Las celdas o baterías no deben someterse a impactos mecánicos fuertes indebidos.
5. En caso de falta de estanqueidad de una celda, el líquido vertido no debe entrar en contacto con la piel ni los ojos. Si se produce contacto, lavar con agua abundante la zona afectada y avisar a un médico.
6. En caso de cambio o recarga inadecuados, las celdas o baterías que contienen electrolitos alcalinos (p. ej. las celdas de litio) pueden explotar. Para garantizar la seguridad del producto, las celdas o baterías solo deben ser sustituidas por el tipo Rohde & Schwarz correspondiente (ver lista de recambios).
7. Las baterías y celdas deben reciclarse y no deben tirarse a la basura doméstica. Las baterías o acumuladores que contienen plomo, mercurio o cadmio deben tratarse como residuos especiales. Respete en esta relación las normas nacionales de eliminación y reciclaje.

Transporte

1. El producto puede tener un peso elevado. Por eso es necesario desplazarlo o transportarlo con precaución y, si es necesario, usando un sistema de elevación adecuado (p. ej. una carretilla elevadora), a fin de evitar lesiones en la espalda u otros daños personales.

Instrucciones de seguridad elementales

2. Las asas instaladas en los productos sirven solamente de ayuda para el transporte del producto por personas. Por eso no está permitido utilizar las asas para la sujeción en o sobre medios de transporte como p. ej. grúas, carretillas elevadoras de horquilla, carros etc. Es responsabilidad suya fijar los productos de manera segura a los medios de transporte o elevación. Para evitar daños personales o daños en el producto, siga las instrucciones de seguridad del fabricante del medio de transporte o elevación utilizado.
3. Si se utiliza el producto dentro de un vehículo, recae de manera exclusiva en el conductor la responsabilidad de conducir el vehículo de manera segura y adecuada. El fabricante no asumirá ninguna responsabilidad por accidentes o colisiones. No utilice nunca el producto dentro de un vehículo en movimiento si esto pudiera distraer al conductor. Asegure el producto dentro del vehículo debidamente para evitar, en caso de un accidente, lesiones u otra clase de daños.

Eliminación/protección del medio ambiente

1. Los dispositivos marcados contienen una batería o un acumulador que no se debe desechar con los residuos domésticos sin clasificar, sino que debe ser recogido por separado. La eliminación se debe efectuar exclusivamente a través de un punto de recogida apropiado o del servicio de atención al cliente de Rohde & Schwarz.
2. Los dispositivos eléctricos usados no se deben desechar con los residuos domésticos sin clasificar, sino que deben ser recogidos por separado.
Rohde & Schwarz GmbH & Co.KG ha elaborado un concepto de eliminación de residuos y asume plenamente los deberes de recogida y eliminación para los fabricantes dentro de la UE. Para desechar el producto de manera respetuosa con el medio ambiente, dirijase a su servicio de atención al cliente de Rohde & Schwarz.
3. Si se trabaja de manera mecánica y/o térmica cualquier producto o componente más allá del funcionamiento previsto, pueden liberarse sustancias peligrosas (povos con contenido de metales pesados como p. ej. plomo, berilio o níquel). Por eso el producto solo debe ser desmontado por personal especializado con formación adecuada. Un desmontaje inadecuado puede ocasionar daños para la salud. Se deben tener en cuenta las directivas nacionales referentes a la eliminación de residuos.
4. En caso de que durante el trato del producto se formen sustancias peligrosas o combustibles que deban tratarse como residuos especiales (p. ej. refrigerantes o aceites de motor con intervalos de cambio definidos), deben tenerse en cuenta las indicaciones de seguridad del fabricante de dichas sustancias y las normas regionales de eliminación de residuos. Tenga en cuenta también en caso necesario las indicaciones de seguridad especiales contenidas en la documentación del producto. La eliminación incorrecta de sustancias peligrosas o combustibles puede causar daños a la salud o daños al medio ambiente.

Se puede encontrar más información sobre la protección del medio ambiente en la página web de Rohde & Schwarz.

Quality management and environmental management

Sehr geehrter Kunde,

Sie haben sich für den Kauf eines Rohde&Schwarz Produktes entschieden. Sie erhalten damit ein nach modernsten Fertigungsmethoden hergestelltes Produkt. Es wurde nach den Regeln unserer Qualitäts- und Umweltmanagementsysteme entwickelt, gefertigt und geprüft. Rohde&Schwarz ist unter anderem nach den Managementsystemen ISO 9001 und ISO 14001 zertifiziert.

Der Umwelt verpflichtet

- Energie-effiziente, RoHS-konforme Produkte
- Kontinuierliche Weiterentwicklung nachhaltiger Umweltkonzepte
- ISO 14001-zertifiziertes Umweltmanagementsystem

Dear customer,

You have decided to buy a Rohde&Schwarz product. This product has been manufactured using the most advanced methods. It was developed, manufactured and tested in compliance with our quality management and environmental management systems. Rohde&Schwarz has been certified, for example, according to the ISO 9001 and ISO 14001 management systems.

Environmental commitment

- Energy-efficient products
- Continuous improvement in environmental sustainability
- ISO 14001-certified environmental management system

Certified Quality System
ISO 9001

Certified Environmental System
ISO 14001

Cher client,

Vous avez choisi d'acheter un produit Rohde&Schwarz. Vous disposez donc d'un produit fabriqué d'après les méthodes les plus avancées. Le développement, la fabrication et les tests de ce produit ont été effectués selon nos systèmes de management de qualité et de management environnemental. La société Rohde&Schwarz a été homologuée, entre autres, conformément aux systèmes de management ISO 9001 et ISO 14001.

Engagement écologique

- Produits à efficience énergétique
- Amélioration continue de la durabilité environnementale
- Système de management environnemental certifié selon ISO 14001

Customer Support

Technical support – where and when you need it

For quick, expert help with any Rohde & Schwarz equipment, contact one of our Customer Support Centers. A team of highly qualified engineers provides telephone support and will work with you to find a solution to your query on any aspect of the operation, programming or applications of Rohde & Schwarz equipment.

Up-to-date information and upgrades

To keep your instrument up-to-date and to be informed about new application notes related to your instrument, please send an e-mail to the Customer Support Center stating your instrument and your wish. We will take care that you will get the right information.

Europe, Africa, Middle East

Phone +49 89 4129 12345
customersupport@rohde-schwarz.com

North America

Phone 1-888-TEST-RSA (1-888-837-8772)
customer.support@rsa.rohde-schwarz.com

Latin America

Phone +1-410-910-7988
customersupport.la@rohde-schwarz.com

Asia/Pacific

Phone +65 65 13 04 88
customersupport.asia@rohde-schwarz.com

China

Phone +86-800-810-8228 /
+86-400-650-5896
customersupport.china@rohde-schwarz.com





Certificate No.: 2004-57

This is to certify that:

Equipment type	Stock No.	Designation
FSMR3	1166.3311.03	Measuring Receiver
FSMR26	1166.3311.26	
FSMR43	1166.3311.43	
FSMR50	1166.3311.50	
FSMR-B2	1157.1903.26/.50	YIG-Preselector
FSMR-B18	1145.0242.06	Removable Harddisc
FSMR-B19	1145.0394.06	Second Harddisc
FSMR-B23	1157.0907.05	Preamplifier
FSMR-B73	1169.5696.02	Vector Signal Analysis
FSMR-B223	1157.1955.26	YIG-Preselector
FSU-B4	1144.9000.02	OCXO 10 MHz
FSU-B9	1142.8994.02	Tracking Generator
FSU-B12	1142.9349.02	Output Attenuator
FSU-B25	1044.9298.02	Electronic Attenuator

complies with the provisions of the Directive of the Council of the European Union on the approximation of the laws of the Member States

- relating to electrical equipment for use within defined voltage limits (73/23/EEC revised by 93/68/EEC)
- relating to electromagnetic compatibility (89/336/EEC revised by 91/263/EEC, 92/31/EEC, 93/68/EEC)

Conformity is proven by compliance with the following standards:

EN61010-1 : 2001-12
EN55011 : 1998 + A1 : 1999
EN61326 : 1997 + A1 : 1998 + A2 : 2001 + A3 : 2003

For the assessment of electromagnetic compatibility, the limits of radio interference for Class B equipment as well as the immunity to interference for operation in industry have been used as a basis.

Affixing the EC conformity mark as from 2004

ROHDE & SCHWARZ GmbH & Co. KG
Mühldorfstr. 15, D-81671 München

Munich, 2006-10-11

Central Quality Management MF-QZ / Radde

Contents of Manuals for Measuring Receiver R&S FSMR

Operating Manual R&S FSMR

The operating manual describes the following models and options of Measuring Receiver R&S FSMR:

- R&S FSMR 3 20 Hz to 3.6 GHz
- R&S FSMR 26 20 Hz to 26.5 GHz
- R&S FSMR 43 20 Hz to 43 GHz
- R&S FSMR 50 20 Hz to 50 GHz

- Option FSMR B2 YIG preselection
- Option R&S FSU-B9 tracking generator
- Option R&S FSMR-B18 removable hard drive

This operating manual contains information about the technical data of the instrument, the setup functions and about how to put the instrument into operation. It informs about the operating concept and controls as well as about the operation of the R&S FSMR via the menus and via remote control. Typical measurement tasks for the R&S FSMR are explained using the functions offered by the menus and a selection of program examples.

Additionally the operating manual includes information about maintenance of the instrument and about error detection listing the error messages which may be output by the instrument. It is subdivided into 9 chapters:

- The data sheet** informs about guaranteed specifications and characteristics of the instrument.
- Chapter 1** describes the control elements and connectors on the front and rear panel as well as all procedures required for putting the R&S FSMR into operation and integration into a test system.
- Chapter 2** gives an introduction to typical measurement tasks of the R&S FSMR which are explained step by step.
- Chapter 3** describes the operating principles, the structure of the graphical interface and offers a menu overview.
- Chapter 4** forms a reference for manual control of the R&S FSMR and contains a detailed description of all instrument functions and their application. The chapter also lists the remote control command corresponding to each instrument function.
- Chapter 5** describes the basics for programming the R&S FSMR, command processing and the status reporting system.
- Chapter 6** lists all the remote-control commands defined for the instrument. At the end of the chapter a alphabetical list of commands and a table of softkeys with command assignment is given.
- Chapter 7** contains program examples for a number of typical applications of the R&S FSMR.
- Chapter 8** describes preventive maintenance and the characteristics of the instrument's interfaces.
- Chapter 8** gives a list of error messages that the R&S FSMR may generate.
- Chapter 9** contains a list of error messages.
- Chapter 10** contains an index for the operating manual.

Service Manual - Instrument

The service manual - instrument informs on how to check compliance with rated specifications, on instrument function, repair, troubleshooting and fault elimination. It contains all information required for the maintenance of R&S FSMR by exchanging modules.

Contents - Chapter 1 " Preparing for Operation "

1 Preparing for Operation.....	1.1
Description of Front and Rear Panel Views.....	1.1
Front View	1.1
Rear View.....	1.11
Getting Started with the Instrument	1.16
Preparing the Instrument for Operation.....	1.16
Setting Up the Instrument.....	1.16
Standalone Operation	1.16
Safety Instruction for Instruments with Tilttable Feet	1.17
Rackmounting	1.17
EMC Safety Precautions	1.18
Connecting the Instrument to the AC Supply	1.18
Switching the Instrument On/Off	1.18
Switching On the Instrument.....	1.19
Startup Menu and Booting	1.19
Switching Off the R&S FSMR	1.19
Operating the R&S FSMR with the Removable Hard Disk Option R&S FSMR-B18 ...	1.19
Power-Save Mode.....	1.20
Recalling the Most Recent Instrument Settings	1.20
Function Test.....	1.20
Properties Specific to Windows XP	1.21
Connecting an External Keyboard.....	1.22
Connecting a Mouse	1.23
Connecting an External Monitor	1.24
Connecting a Printer	1.25
Selecting a Printer	1.25
Installation of Plug&Play Printers	1.28
Installation of Non-Plug&Play Printers.....	1.28
Local Printer	1.30
Configuring a Network Printer	1.34
Connection of USB Devices	1.36
Installing Windows XP Software.....	1.38
Windows XP Software Tested for the Instrument	1.38

1 Preparing for Operation

Chapter 1 describes the controls and connectors of the Spectrum Analyzer R&S FSMR by means of the front and rear view. Then follows all the information that is necessary to put the instrument into operation and connect it to the AC supply and to external devices.

A more detailed description of the hardware connectors and interfaces can be found in chapter 8. Chapter 2 provides an introduction into the operation of the R&S FSMR by means of typical examples of configuration and measurement; for the description of the concept for manual operation and an overview of menus refer to chapter 3.

For a systematic explanation of all menus, functions and parameters and background information refer to the reference part in chapter 4.

For remote control of the R&S FSMR refer to the general description of the SCPI commands, the instrument model, the status reporting system, and command description in chapter 5 and 6.

Description of Front and Rear Panel Views

Front View

1

Display Screen

|| see Chapter 3

2

Softkeys

|| see Chapter 3

3



Keypad for data input

0...9 input numbers

. input decimal point

- change sign

ESC – close input field (for uncompleted or already closed inputs, the original entry is kept)

CANCEL – erase the current entry in input field (beginning of an input)
– close message window (status, error and warning messages)

ENTER close the data input.

BACK – erase last character input for uncompleted input
– restore previous input (undo)

|| see Chapter 3

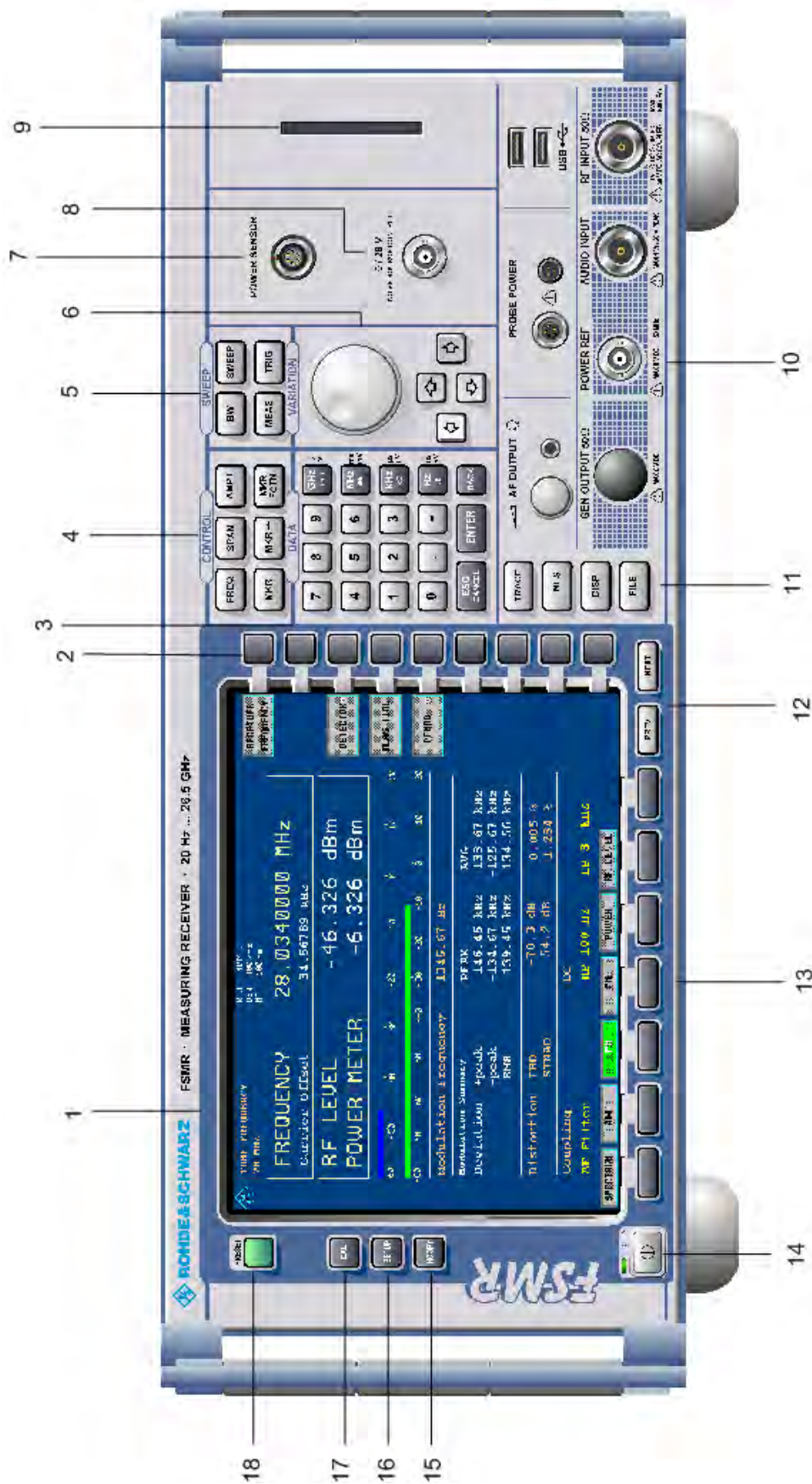

Fig. 1-1 Front View



Keypad for data input

GHz s The units keys close the data input and define the multiplication factor for each basic unit. For dimension-less or alphanumeric inputs, the units keys have weight 1.

-dBm V

MHz ms

dBm mV

kHz μs

dB μV

Hz ns

dB.. nV

see Chapter 3

4



FREQ Set frequency axis

SPAN Set span

AMPT Set level indication and configure RF input.

MKR Select and set standard marker and delta marker functions.

MKR-> Change instrument settings via markers

MKR FCTN Select further marker and delta marker functions

see Chapter 4

5



BW – Set resolution bandwidth, video bandwidth and sweep time, – Set coupling of these parameters

SWEEP Select sweep

MEAS Select and set power measurements

TRIG Set trigger sources

see Chapter 4

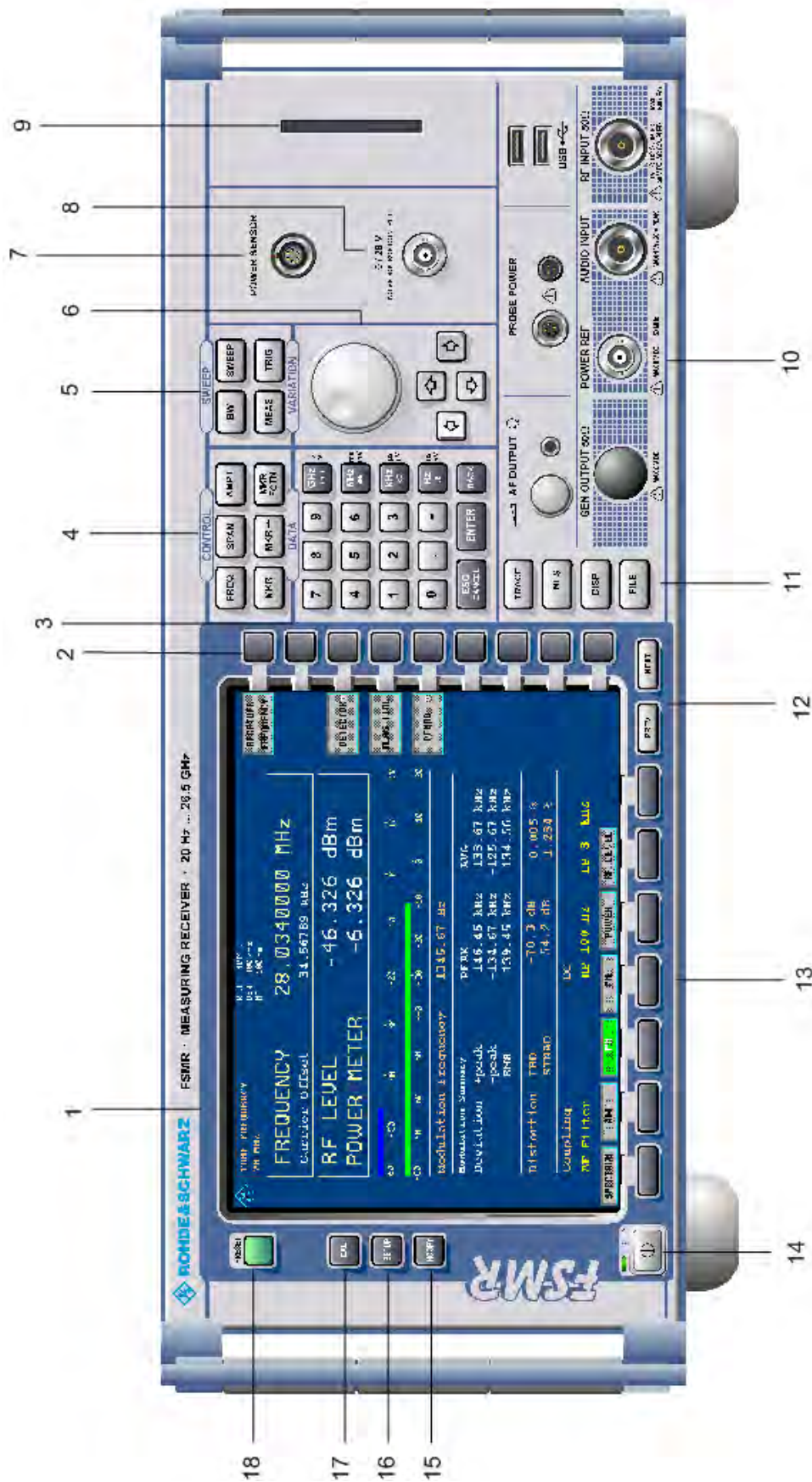
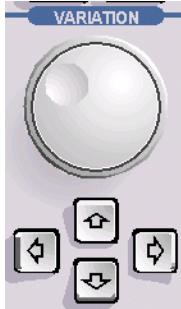

Fig. 1-1 Front View

6



Key group for entering data and for cursor movement

see Chapter 3

- Cursor keys
- Move the cursor within the input fields and tables.
 - Vary the input value.
 - Define the direction of movement for the roll-key.
- Roll-key
- Vary input values.
 - Move markers and limits.
 - Select letters in the help line editor.
 - Move cursor in the tables
 - Close data input (ENTER)

7



Connector for the power sensors NRP-Zx

8



Output connector for an external noise source

s. Chapter 3

9

CF Card option R&S FSU-B18

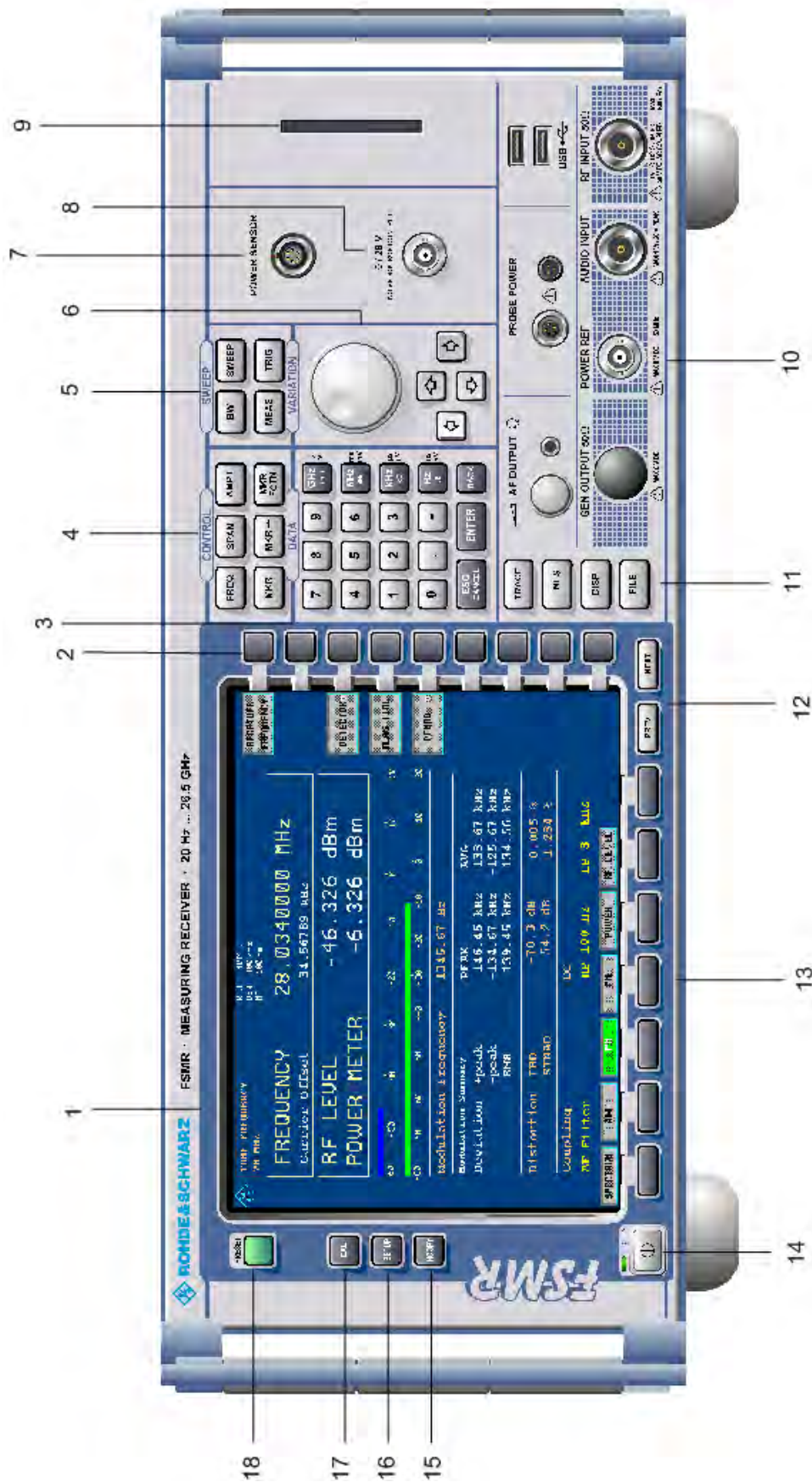

Fig. 1-1 Front View

10



- AF OUTPUT
 - Volume control
 - Head phone connector
- PROBE POWER Power supply and coded socket (+15 V/ -12 V) for accessories
- USB USB interfaces
- RF INPUT RF input

s. Chapter 8

NOTICE!

The maximum DC voltage is 50 V, the maximum power is 1 W (≅ 30 dBm) at ≥ 10 dB attenuation.

- AUDIO INPUT Audio input with 50 Ω or 1 MΩ input impedance

see Chapter 8

NOTICE!

The input can handle a maximum power of 1 W or a peak voltage of 20 V.

- POWER REF Reference source 50 MHz, 1mW

NOTICE!

The maximum DC voltage is 0.

11



- TRACE Select and activate traces and detectors
- LINES Set limit lines
- DISP Configure display
- FILE
 - Save and recall instrument data
 - Configuration of memory media and data

see Chapter 4

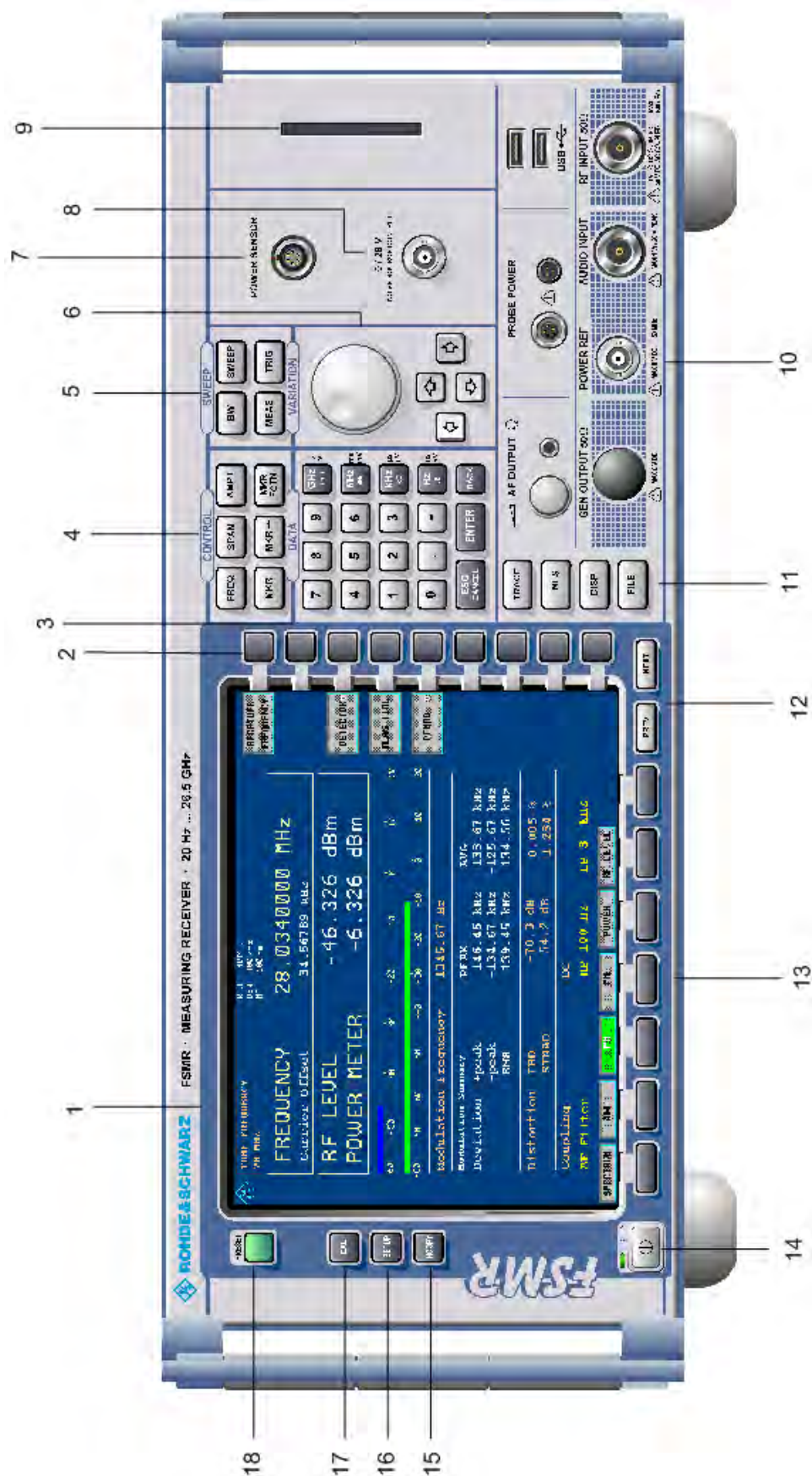

Fig. 1-1 Front View

12



Menu-change keys

see Chapter 3

NEXT Change to side menu

PREV Call main menu

13

Hotkeys

see Chapter 3

14



ON/STANDBY switch

see Chapter 1

15



Configure and start a print job

see Chapters 1 and 4

16



Define general configuration

see Chapter 4

17



Record correction data

see Chapter 4

18



Call default settings

see Chapter 4

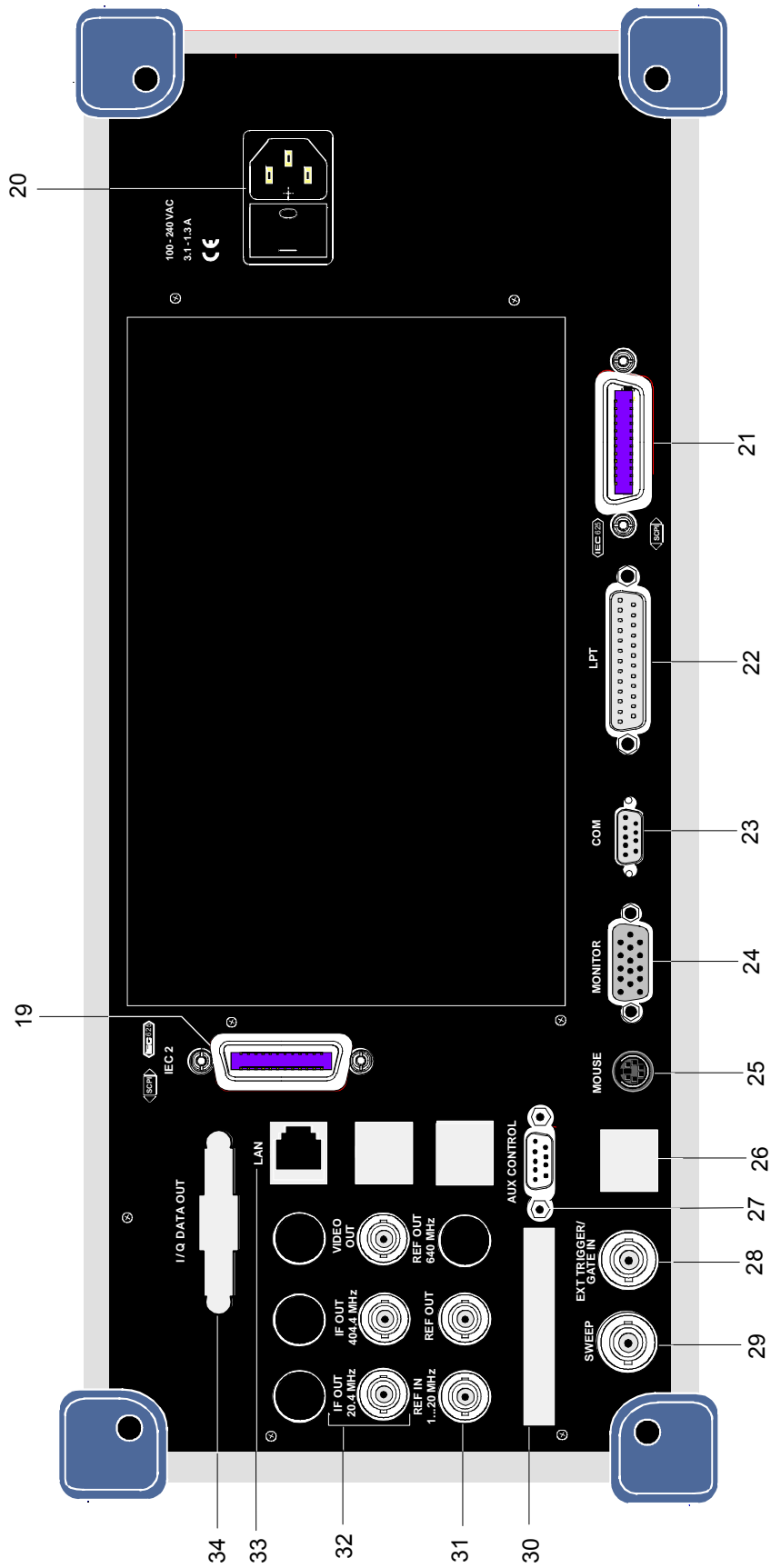

Fig. 1-2 Rear View

Rear View

19

2nd IEC/IEEE bus-connector

see Chapter 8

20

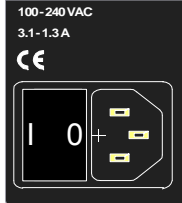

Power switch and AC power connector

see Chapter 1

21

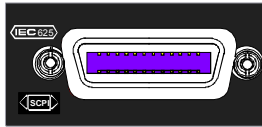

IEC/IEEE bus-connector

see Chapter 8

22

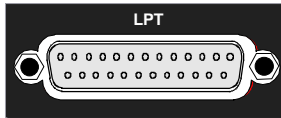

Parallel interface connector
(printer connector)

see Chapter 8

23



Connector for a serial interface
(9-pin socket; COM)

see Chapter 8

24



Connector for an external monitor

see Chapter 8

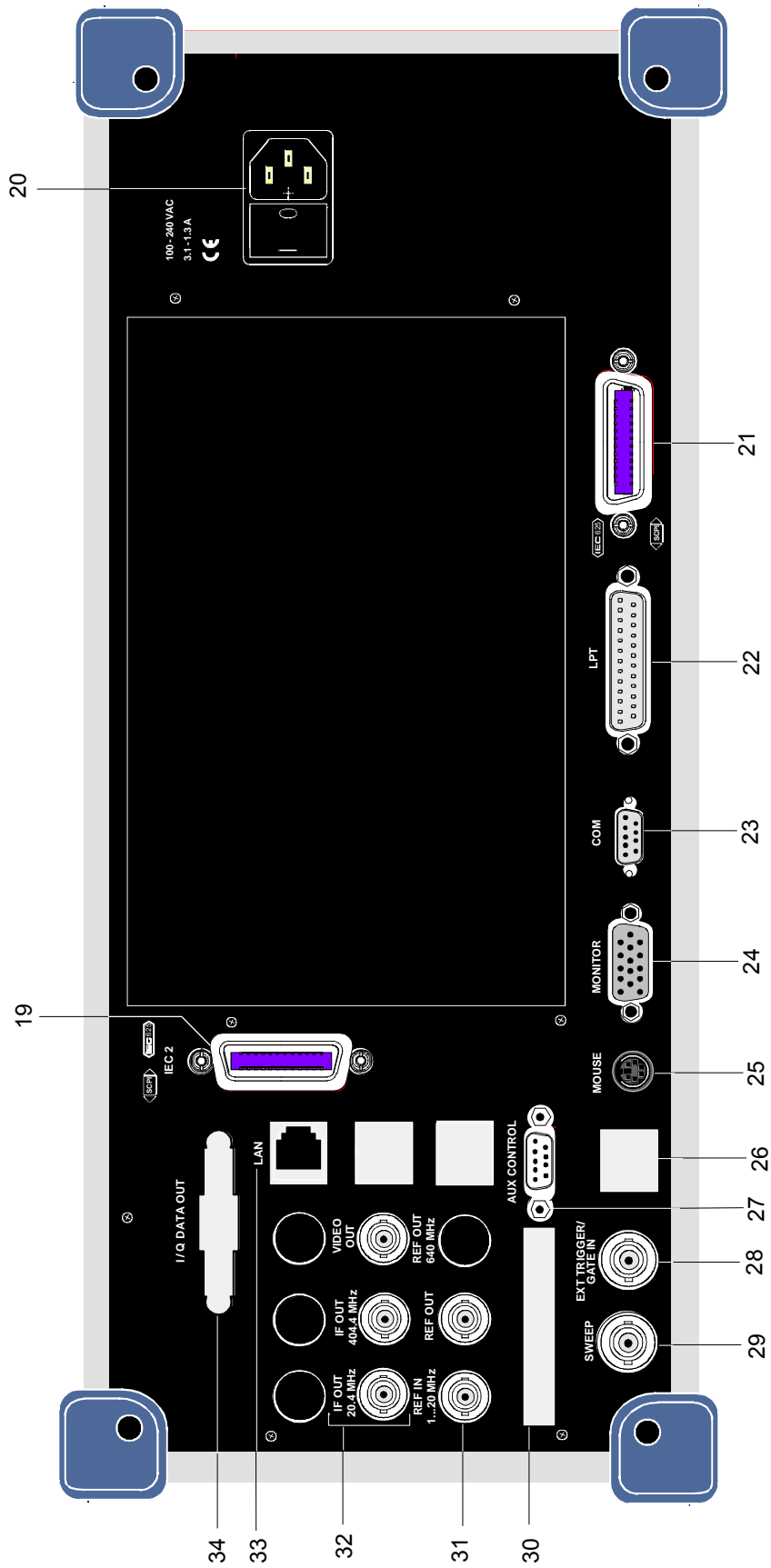

Fig. 1-2 Rear View

25



Connector for a PS/2 mouse

see Chapter 8

26



Connector for USB

see Chapter 8

27



Connector to control an external generator ((only with option FSP-B10)

28



Input connector for an external trigger or an external gate signal

see Chapter 8

29

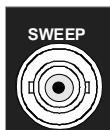

Output connector

During a sweep saw tooth voltage is output which is proportional to frequency

see Chapter 8

30

Reserved for options

31

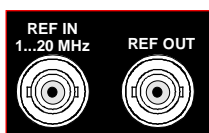

REF IN Input connector for an external reference (1 to 20 MHz)

REF OUT Output connector for an internal reference (10 MHz)

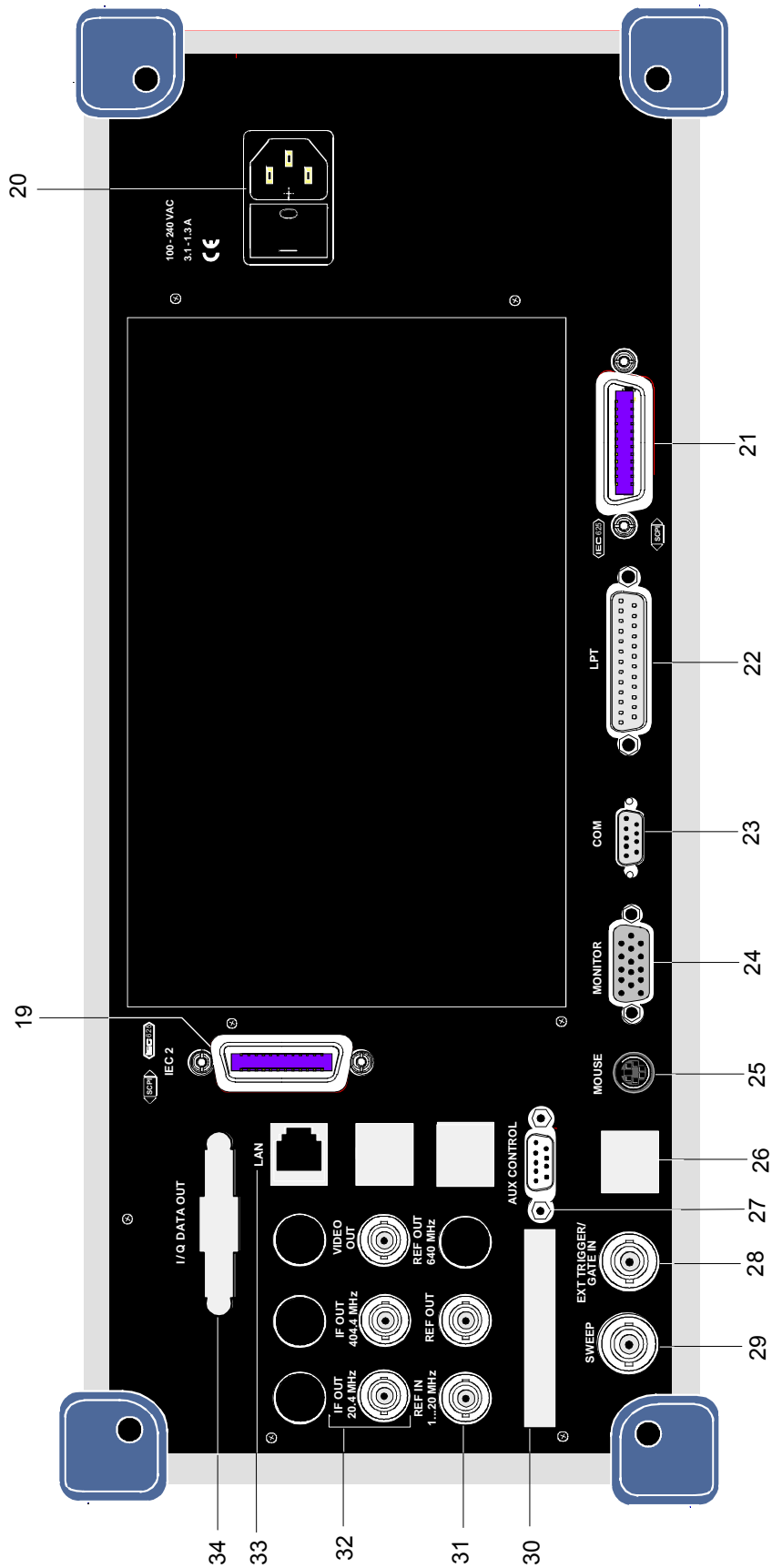
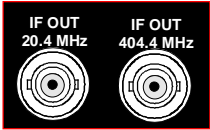

Fig. 1-2 Rear View

32



IF 20.4 MHz OUT Output connector for 20.4 MHz IF
IF 404.4 MHz OUT Output connector for 404.4 MHz IF

see Chapter 8

33



LAN-Interface

34

Reserved for options

Getting Started with the Instrument

The following section describes how to activate the instrument and how to connect external devices such as printer and monitor.

Chapter 2 explains the operation of the instrument using simple measurement examples.

NOTICE

Optional notice heading

Prior to switching on the instrument, make sure that the following conditions are fulfilled:

- The instrument cover is in place and tightly screwed on
- Fan openings are not obstructed
- Signal levels at the inputs are within specified limits
- Signal outputs are connected correctly and not overloaded.

Any non-compliance may cause damage to the instrument

Preparing the Instrument for Operation

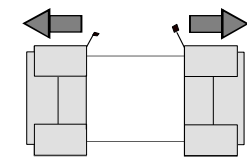

remove protective caps

- Take the instrument out of the packaging and check whether the items listed in the packing list and in the lists of accessories are all included.
- Remove the two protective covers from the front and rear of the R&S FSMR and carefully check the instrument for damage.
- Should the instrument be damaged, immediately notify the carrier and keep the box and packing material.
- For further transport or shipment of the R&S FSMR, the original packing should be used. It is recommended to keep at least the two protective covers of the front and rear panels in order to prevent damage to the controls and connectors.

Setting Up the Instrument

Standalone Operation

The instrument is designed for use under general laboratory conditions. The ambient conditions required at the site of operation are as follows:

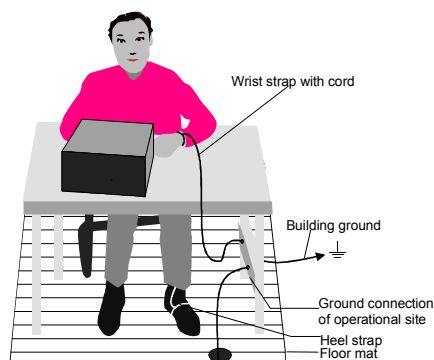

- The ambient temperature must be in the range specified in the data sheet.
- All fan openings must be unobstructed and the air flow at the rear panel and at the side-panel perforations must be unimpeded. The distance to the wall should be at least 10 cm.
- The mounting surface should be flat.
- To avoid damage of electronic components of the DUT due to electrostatic discharge on manual touch, protective measures against electrostatic discharge are recommended.

Safety Instruction for Instruments with Tilttable Feet

⚠ CAUTION

The feet must be fully folded in or out. Only in this way can the stability of the instrument be guaranteed and reliable operation be ensured. With the feet out, the total load for the feet must not exceed 500 N (own weight and additional units put onto the instrument). These units must be secured against slipping (e.g. by locking the feet of the unit at the top side of the enclosure).

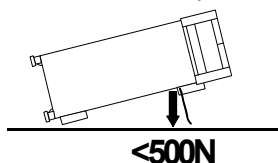

When shifting the instrument with the feet out, the feet might collapse and fold in. To avoid injuries, the instrument must therefore not be shifted with the feet out.

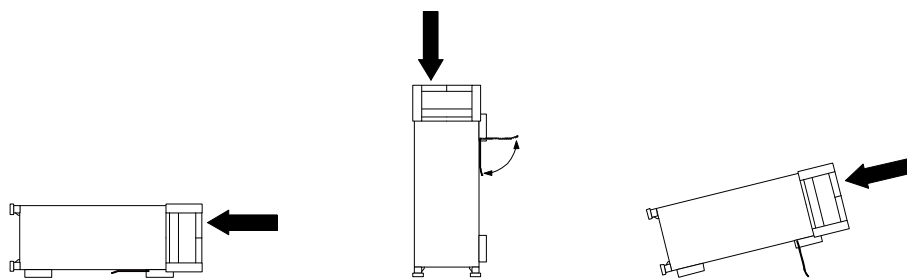

The instrument can be operated in any position.

Rackmounting

NOTICE

For rack installation, ensure that the air flow at the side-panel perforations and the air exhaust at the rear panel are not obstructed.

The instrument may be installed in a 19" rack by using a rack adapter kit (Order No. see data sheet). The installation instructions are part of the adapter kit.

EMC Safety Precautions

In order to avoid electromagnetic interference (EMI), the instrument may be operated only with all covers closed. Only adequately shielded signal and control cables may be used (see recommended accessories).

Connecting the Instrument to the AC Supply

The R&S FSMR is equipped with an AC voltage selection feature and will automatically adapt itself to the applied AC voltage (range: 100 to 240 V AC, 40 to 400 Hz). External voltage selection or adaptation of the fuses are not necessary. The AC power connector is located on the rear panel (see below).

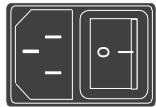

Power connector

- Connect the instrument to the AC power source using the AC power cable delivered with the instrument.

As the instrument is designed according to the regulations for safety class EN61010, it must be connected to a power outlet with earthing contact.

Switching the Instrument On/Off

NOTICE

Do not power down during booting.

Such a switch-off may lead to corruption of the hard disk files

AC power switch on the rear panel

Power switch Power connector

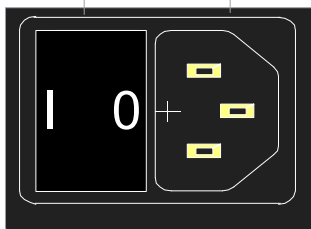

Power switch

Position I = ON

In the I position, the instrument is in standby mode or in operation, depending on the position of the ON/STANDBY key at the front of the instrument.

Note: *The AC power switch may remain ON continuously. Switching to OFF is only required when the instrument must be completely removed from the AC power source.*

Position O = OFF

The 0 position implies an all-pole disconnection of the instrument from the AC power source.

ON/STANDBY switch on the front panel

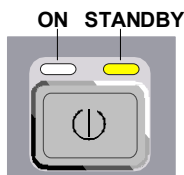

Standby switch

The ON/STANDBY switch activates two different operating modes indicated by coloured LEDs:

Operation ON - ON/STANDBY is depressed

The green LED (ON) is illuminated. The instrument is ready for operation. All modules within the instrument are supplied with power.

⚠ WARNING

Shock hazard

In standby mode, the AC power voltage is present within the instrument

STANDBY - ON/STANDBY switch is not pressed.

The yellow LED (STANDBY) is illuminated. Only the power supply is supplied with power and the quartz oven is maintained at normal operating temperature.

Switching On the Instrument

- In order to switch on the R&S FSMR, set the power switch on the rear panel to position I.
- Set the R&S FSMR to operating mode by pressing the *ON/STANDBY* key on the front panel. The green LED must be illuminated.

Startup Menu and Booting

After switching on the instrument, a message indicating the installed BIOS version (e.g. Analyzer BIOS Rev. 1.2) appears on the screen for a few seconds.

Subsequently Windows XP is booted first and after that the instrument firmware will boot. As soon as the boot process is finished the instrument will start measuring. The settings used will be the one that was active when the instrument was previously switched off, provided no other device configuration than *FACTORY* had been selected with *STARTUP RECALL* in the *FILE* menu.

Switching Off the R&S FSMR

- Switch the *ON/STANDBY* key on the front panel to standby mode by pressing it once.
The R&S FSMR will write the current instrument settings to disk before performing a Windows XP shutdown. At the end of the shutdown procedure the power supply will be switched to *STANDBY* mode.
The yellow LED must be illuminated.

Only when removing the R&S FSMR completely from the AC power source:

- Set the power switch at the rear panel to position 0.

Operating the R&S FSMR with the Removable Hard Disk Option R&S FSMR-B18

The R&S FSMR-B18 option allows the instrument to be operated with differently configured hard disks. Additional hard disks are therefore available as option FSU-B19.

⚠ CAUTION**Type and source of hazardous situation**

Switch off the instrument before you remove and exchange the hard disk. Exchanging the hard disk during operation can produce severe data errors.

Power-Save Mode

Display:

The R&S FSMR offers the possibility of switching on a power-save mode for the screen display. The backlighting will be switched off if no entry is made on the front panel (key, softkey or hotkey as well as spinwheel) during the selected response time.

In order to switch on the power-save mode:

1. Call the *DISPLAY - CONFIG DISPLAY* submenu to configure the screen display:
 - Press *DISP* key
 - Press *CONFIG DISPLAY* softkey
2. Activate the save mode
 - Press *DISPLAY PWR SAVE* softkey.
The softkey is highlighted in colour, thus indicating that the power-save mode is on. At the same time the data entry for the delay time is opened.
3. Define the delay time
 - Enter the required response time in minutes and confirm the entry using the *ENTER* key.
The screen will be blanked out after the selected time period has elapsed.

Hard disk:

A power-save mode is preset for the built-in hard disk which is automatically closed down 15 minutes after the last access.

Recalling the Most Recent Instrument Settings

The R&S FSMR stores its current instrument settings onto the hard disk every time it is switched off via the ON/STANDBY key. After each power-on, the R&S FSMR is reloaded with the operational parameters which were active just prior to the last power-off (STANDBY or AC power OFF) or were set with STARTUP RECALL (see Chapter 4 "Saving and Recalling Data Sets").



Storing the current instrument settings is not possible if the instrument is switched off using the POWER ON switch at the rear panel or when unplugging the mains cord. After power-on the instrument settings stored previously on the hard disk will be loaded in this case.

Function Test

After turning on the AC power, the R&S FSMR will display the following message on the display screen:

Rohde & Schwarz GmbH & Co. KG
Analyzer BIOS Vx.y

After appearance of the above message, a selftest of the controller hardware is performed. Subsequently, the Windows XP controller boots and the measurement screen will appear.

The system self-alignment is activated via *CAL* key, *CAL TOTAL* softkey. The individual results of the self-alignment (PASSED / FAILED) can be displayed in the *CAL* menu (*CAL RESULTS*).

With the aid of the built-in selftest functions (*SETUP* key, *SERVICE*, *SELFTEST* soft keys), the functional integrity of the instrument can be verified and/or defective modules can be localized.

Properties Specific to Windows XP

The instrument contains the Windows XP operating system. To ensure that the instrument software functions properly, certain rules must be adhered to when using the operating system..

NOTICE

Possible impairment of the instrument function

The instrument is equipped with the Windows XP operating system. It is thus possible to install commercial off-the-shelf software on the instrument. The use and installation of commercial software may impair the instrument functions. We recommend that you only execute programs tested by Rohde & Schwarz with regard to their compatibility to the instrument software. The program packages that have been tested are listed in section Windows XP Software Tested for the Instrument.

Install only service packs approved by Rohde & Schwarz to avoid impairment of instrument functions that could lead to the necessity to repair the instrument.

The user is especially warned against using Service Packs of Windows XP Home or of the Professional Edition, since these Service Packs are not compatible with Windows XP Embedded.

The drivers and programs used on the instrument under Windows XP have been adapted to the instrument. Existing instrument software must only be modified with update software released by Rohde & Schwarz.

Login

Windows XP requires that users identify themselves by entering a user name and password in a login window. The instrument provides a factory-installed auto login function, i.e. login is carried out automatically in the background. The ID used for auto login has administrator rights. As user name and password *instrument* (lowercase) are set.

Administrator ID

The ID used by the instrument to perform auto login has administrator rights.

Windows XP Service Packs

The Windows XP operating system on the instrument is supplied with pre-installed XP service packs (SP1 and additional updates/fixes) that are necessary and suitable for operating the instrument.

Opening the Windows XP Start Menu

You can open the Windows XP Start menu by pressing the Windows key () or the key combination **CTRL+ESC**. From the start menu, you can navigate to the submenus by using the mouse or the arrow keys. To return to the measurement screen, activate the *R&S Analyzer Interface* button in the task bar.

You can also open the Windows Start menu with the *OPEN START MENU* softkey in the SETUP menu.

Connecting an External Keyboard

NOTICE

Connect the keyboard only when the instrument is switched off (STANDBY). Otherwise, proper functioning cannot be ensured due to interactions with the firmware.

The R&S FSMR allows an external PC keyboard to be connected to one of the USB interfaces on the front panel or on the rear panel.

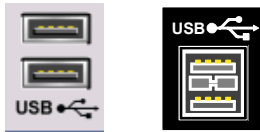

Keyboards and mouse devices conform to USB Standards 1.1 or 2.0 are suitable for connection to the USB interface.

Connecting a Mouse

To make Windows XP operation easier, the R&S FSMR allows a mouse to be connected to one of the USB interfaces interface on te front panel or on the rear panel.



Microsoft and Logitech mouse types are supported.



The recommended keyboard PSP-Z2 is equipped with a trackball for mouse control. Connecting an additional mouse will cause interface conflicts and lead to malfunctions of the instrument.

After connection the mouse is automatically recognized. Special settings such as mouse cursor speed etc, can be performed in the Windows XP menu START - SETTINGS - CONTROL PANEL - MOUSE. Chapter 8 contains the interface description for the connectors.

Connecting an External Monitor

NOTICE

The monitor may only be connected when the instrument is switched off (STANDBY). Otherwise, the monitor may be damaged.

Do not modify the screen driver (display type) and display configuration since this will severely affect instrument operation.

The instrument is equipped with a rear-panel MONITOR connector for the connection of an external monitor.



After connecting the external monitor the instrument needs to be rebooted in order to recognize the monitor. After that the measurement screen is displayed on both the external monitor and the instrument. Further settings are not necessary.

Connecting a Printer

A printer can be connected while the instrument is running.

The R&S FSMR allows two different printer configurations for printing a hardcopy to be created plus switchover between these two configurations. The *DEVICES* table in the *HCOPY* menu shows the available selection of installed printers (see section 4.4 "Documentation of Measurement Results").

The interfaces for connecting printers are on the rear panel:

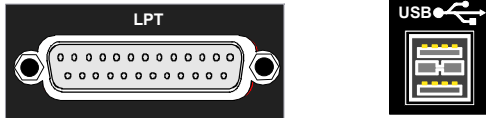

Chapter 8 contains the interface description for the connectors.

Selecting a Printer

Before a hardcopy can be printed, the printer has to be selected from the "*HCOPY*" menu.

In the following example, an HP DeskJet 660C printer that was preinstalled for LPT1 is selected as *DEVICE2* for hardcopies of the screen content.

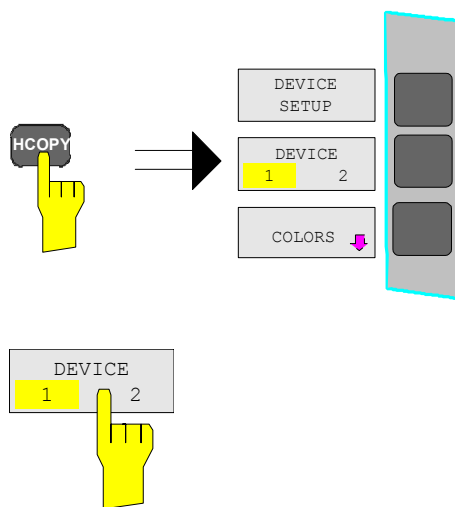

-
- Press the *HCOPY* key.
The *HCOPY* menu will open.

-
- Press the *DEVICE 1/2* softkey.
Device 2 will become the active output unit.

Note:
If the printer is to be operated as device 1, this step can be omitted.

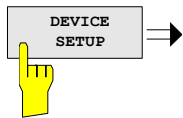

- Press the *DEVICE SETUP* softkey.

The *HARDCOPY SETUP* table opens and displays the selection of output formats. The current selection "*Clipboard*" is highlighted and marked with a dot in the option button.

- Use the cursor key to move the selection bar to "*Printer*" and press *ENTER*.

Windows for selecting a printer (Name), printing to file (Print to File) and selecting printout orientation (Orientation) are displayed.

- Use the cursor key to set the selection bar to "*Name*" and press *ENTER*.

The list of available printer types appears.

- Use the cursor key / or the spinwheel to move the selection bar to the "HP DeskJet 660C" printer and press *ENTER*.

The list closes and the selected printer appears in the "Name" field.

Note:

If the desired printer is not available in the selection list, its driver must first be installed.

For further information, see sections "Installation of Plug&Play Printers", "Installation of Non-Plug&Play Printers" and "Installation of Network Printers".

VARIATION

PRINT
SCREEN



- Press the cursor key  or turn the spinwheel until the “Close” button is reached.

Further settings can still be made:

“Print to File” redirects printing to a file. In this case, the system prompts you for a file name when printing is started.

- The selection is activated by pressing *ENTER* or the spinwheel.

“Orientation” is used to switch between portrait and landscape format.

- To change the selection, open the list by pressing *ENTER* and select the desired orientation with the cursor key  / . To close the list, press *ENTER* again.

The “Close” button is used to complete the setup.

- Press *ENTER* as soon as the “Close” button is available.

The dialog closes. Printing will now be performed according to the selected settings.

Start printing

- Press the *PRINT SCREEN* softkey.

A hardcopy of the screen contents will be printed.

The factory setting for DEVICE 2 is “Clipboard”. In this case, the printout will be copied to the Windows XP clipboard which is supported by most Windows applications. The contents of the clipboard can be pasted directly into a document via EDIT – PASTE.

Table 1-1 shows the factory settings for the two output devices.

Table 1-1 Factory settings for *DEVICE 1* and *DEVICE 2* in the *HCOPY* menu

Setting	Selection in configuration table	Setting for <i>DEVICE 1</i>	Setting for <i>DEVICE 2</i>
Output device	DEVICE	WINDOWS METAFILE	CLIPBOARD
Output	PRINT TO FILE	YES	---
Orientation	ORIENTATION	---	---

Installation of Plug&Play Printers

The installation of Plug&Play printers under Windows XP is quite simple:

After the printer is connected and switched on, Windows XP automatically recognizes it and installs its driver, provided the driver is included in the XP installation.

If the XP printer driver is not found, Windows XP prompts you to enter the path for the corresponding installation files. In addition to pre-installed drivers, a number of other printer drivers can be found in directory D:\I386.



When you install printer drivers that are not pre-installed on the instrument, the installation process will prompt you to specify the path containing the new driver. This can be a memory stick or USB CD-ROM drive (see section “Connection of USB Devices”).

Installation of Non-Plug&Play Printers



The dialogs below can be controlled either from the front panel or via the mouse and keyboard (see sections “Connecting a Mouse” and “Connecting a Keyboard”). Mouse and PC keyboard are absolutely essential for configuring network printers.

A new printer is installed with the *INSTALL PRINTER* softkey in the *HCOPY* menu.

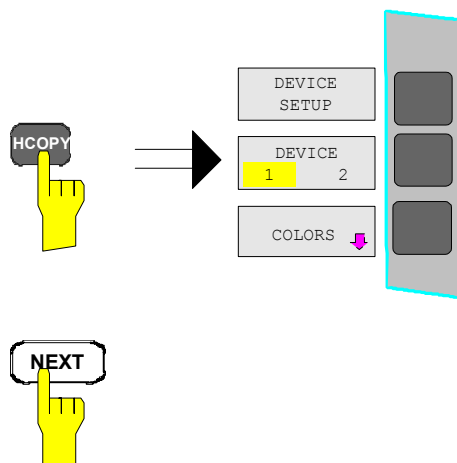

- Press the *HCOPY* key.
The *HCOPY* menu will open.

- Press the *NEXT* key to open the side menu.

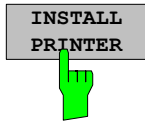

- Press *INSTALL PRINTER* to open the *Printers and Faxes* dialog window.



- Select *Add Printer* in the list using the spinwheel.
 - Highlight the selected item with *CURSOR RIGHT* and press *ENTER* or the spinwheel to confirm the selection.
- The *Add Printer Wizard* is displayed.



- Select *NEXT* with the spinwheel and press the spinwheel for confirmation.
- Local or Network Printer* can be selected.



- To install a local printer, select *Local printer attached to this computer* with the spinwheel. Press the spinwheel for confirmation and continue with the "Local Printer" section.
- To install a network printer, select *A network printer, or a printer attached to another computer*. Press the spinwheel for confirmation and continue with the "Network Printer" section.

Local Printer

In the following example, a Star LC24 printer is connected to the LPT1 interface and configured as *DEVICE2* for hardcopies of screen contents. The Add Printer Wizard has already been opened as described in the section “Starting the Add Printer Wizard” .

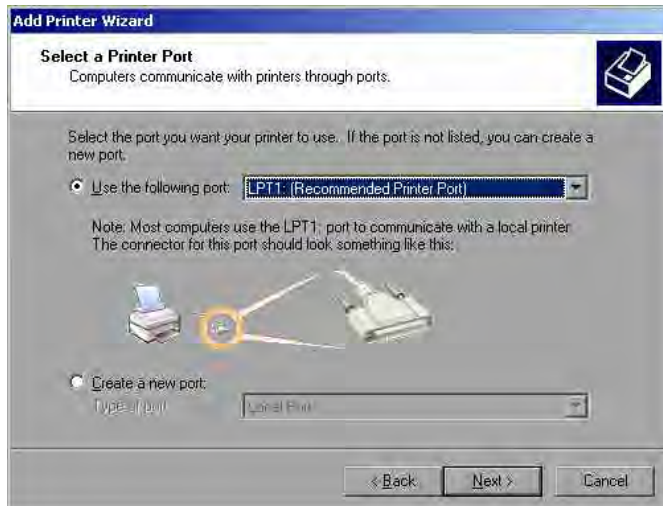

- To select the USB interface, open the list of ports by clicking the spinwheel. Select the printer port with spinwheel/arrow keys and confirm by pressing the spinwheel. The selection list is closed again.
- To select the LPT connector, the selection list need not be opened.
- Place the cursor on the *Next* button and confirm by pressing the spinwheel. The “Install Printer Software” dialog is opened.



- Select the desired manufacturer (“Star”) in the Manufacturer table using the up / down keys.



- Go to the *Printers* list with the spinwheel.
- Select the desired printer type (Star LC24-200 Colour) using the up / down keys and confirm with *ENTER*.

Note:

If the desired printer type is not in the list, the respective driver is not installed yet. In this case click the *HAVE DISK* button with the mouse key. You will be prompted to insert a disk with the corresponding printer driver. Press *OK* and select the desired printer driver.

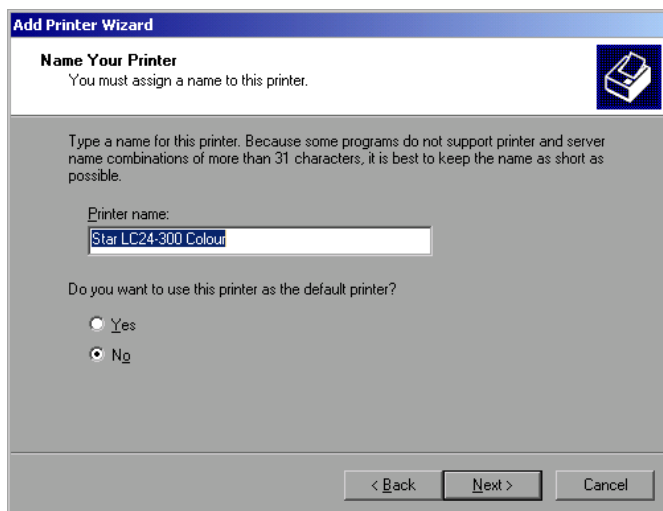

- The printer name can be changed as required in the *Printer name* entry field (max. 60 characters). A PC keyboard is required in this case.
- Use the spinwheel to select *Yes* or *No* for the default printer.
- Choose the desired status with the up /down keys.
- Confirm with *ENTER*.

The *Printer Sharing* dialog is opened.

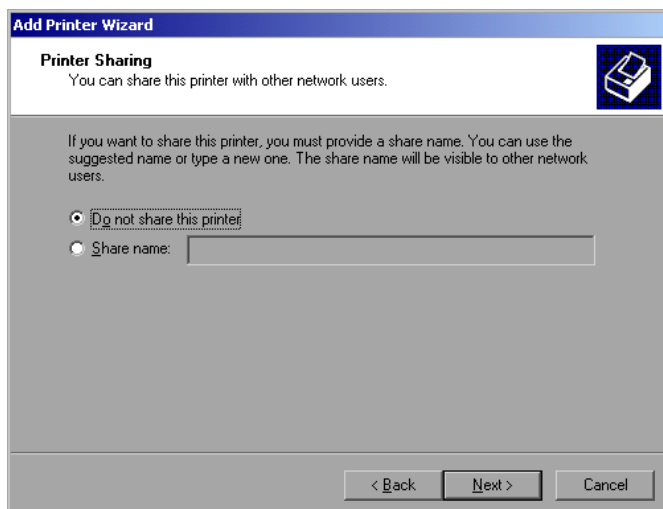

- Exit the dialog with *ENTER*.
- The *Print Test Page* dialog is opened.

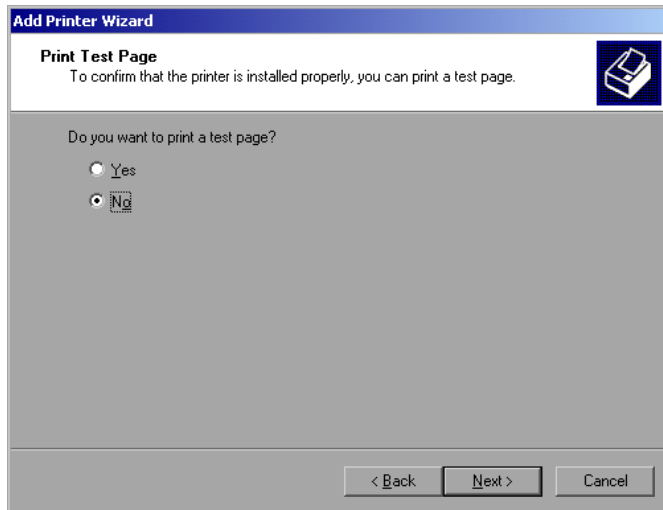

- Exit the dialog with *ENTER*.

The *Completing the Add Printer Wizard* dialog is opened.

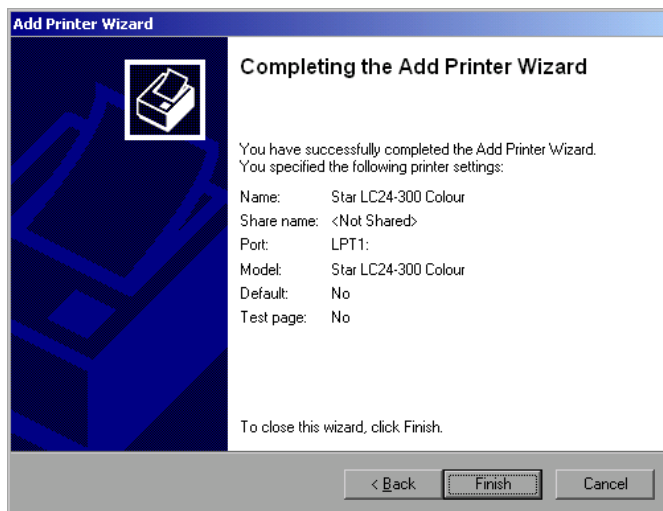

- Check the displayed settings and exit the dialog with *ENTER*.

The printer is installed. If Windows finds the required driver files, the installation is completed without any further queries.

If Windows cannot find the required driver files, a dialog is opened where the path for the files can be entered.

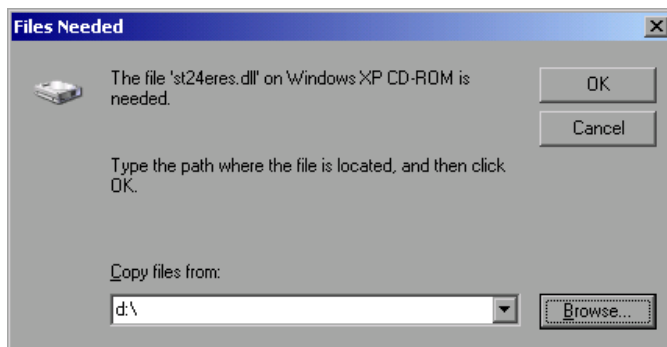

- Select the *Browse* button with the spinwheel and confirm with by pressing the spinwheel.

The *Locate File* dialog is opened.

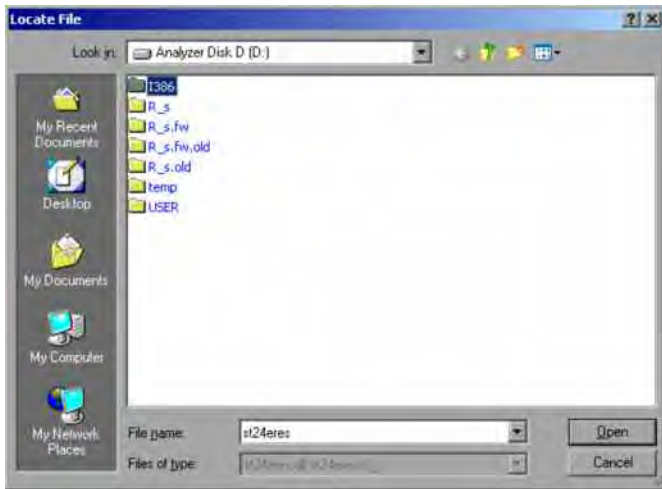

- Turn the spinwheel to select the directory and path D:\I386 and press it to confirm the selection.

If the selected item is not printed on a blue background, it must be marked with the cursor up / down keys before it can be activated by pressing the spinwheel.

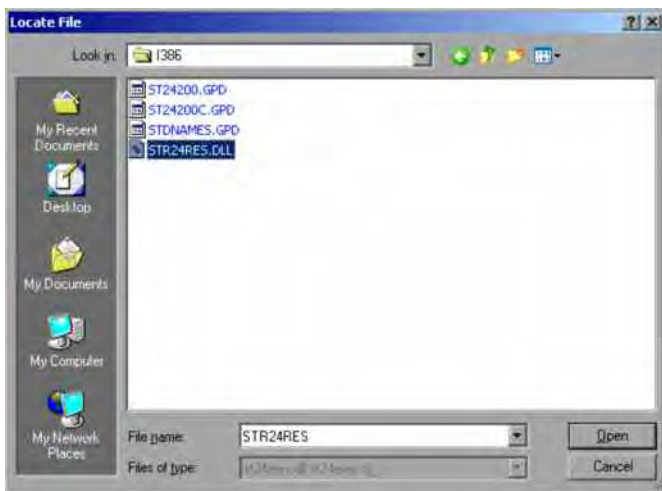

- Select the driver file with the spinwheel and confirm by pressing the spinwheel.

The file is included in the *Files Needed* dialog.

Note:

If the desired file is not in the D:\I386 directory, a disk with the driver file is needed. In this case, exit the dialog with ESC and repeat the selection starting from the "Files needed" dialog.

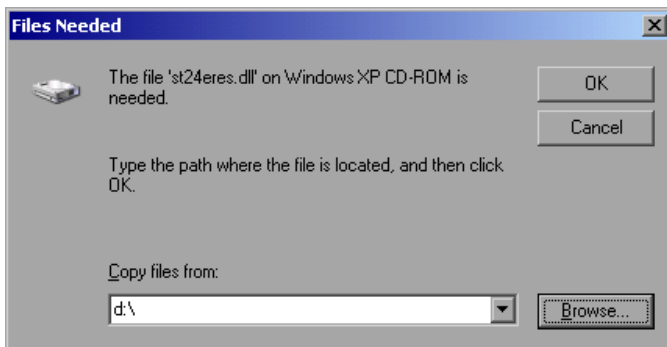

- Select the OK button with the spinwheel and press the spinwheel to confirm.

The installation is completed.

Finally, the instrument must be configured for printout with this printer using the softkeys *DEVICE SETUP* and *DEVICE 1/2* in the hardcopy main menu (see section "Selecting a printer").

Configuring a Network Printer



➤ To select a network printer, click the option "A network printer or a printer attached to another computer".

Continue with *Next*.

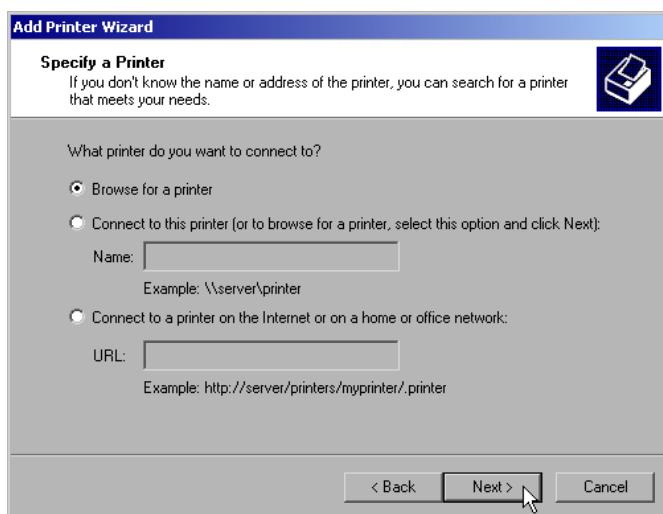

➤ Click *Browse for a printer* and then *Next*.

A list of selectable printers is displayed.

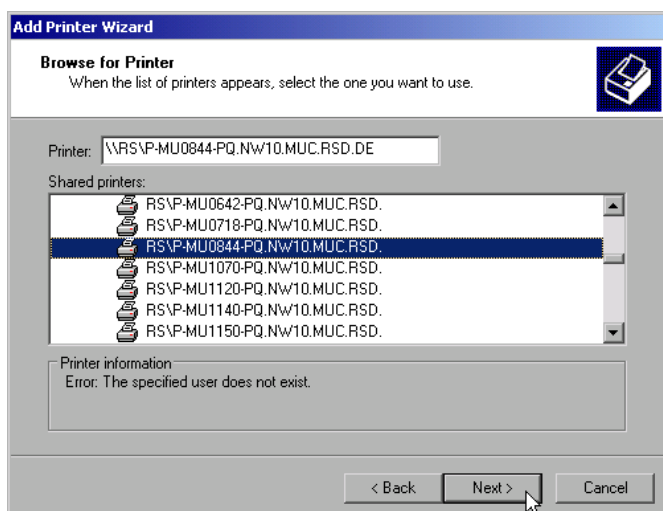

➤ Mark the desired printer and select it with *OK*.

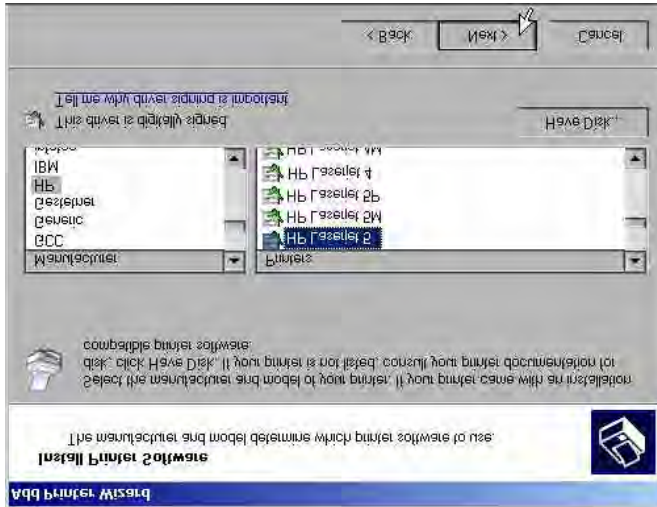

- Confirm the subsequent prompt to install a suitable printer driver with "OK". The list of available printer drivers is displayed. The manufacturers are listed in the left-hand table, the available printer drivers in the right-hand table.
- Select the manufacturer from the *Manufacturers* table and then the printer driver from the *Printers* table.

Note:

If the desired type of output device is not shown in the list, the driver has not yet been installed. In this case, click the "HAVE DISK" button. You will be prompted to insert a disk with the corresponding printer driver. Insert the disk, select "OK" and then choose the desired printer driver.

- Click Next.

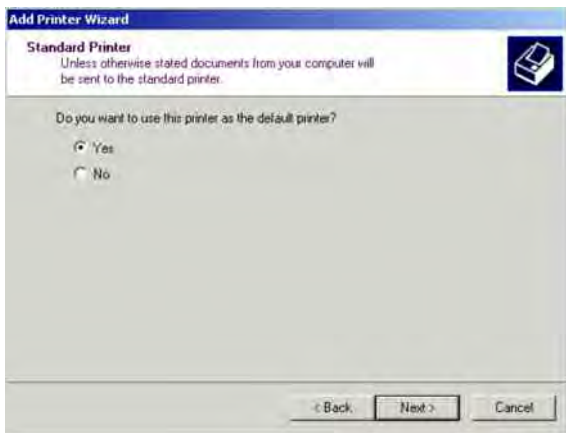

If one or more printers have already been installed, this window queries whether the printer last installed is to be used as the default printer for the Windows XP applications. The default selection is *No*.



- Start the printer driver installation with *Finish*.

Finally, the instrument has to be configured for printout with this printer using the softkeys *DEVICE SETUP* and *DEVICE 1/2* in the hardcopy menu (see section "Selection of a Printer").

Connection of USB Devices

Up to two USB devices can be directly connected to the analyzer via the USB interface on the rear of the R&S FSMR. This number can be increased as required by interconnecting USB hubs.

Owing to the wide variety of available USB devices, the R&S FSMR can be expanded with almost no limitations. The following list shows a selection of USB devices suitable for the R&S FSMR:

- Power Sensor R&S NRP-Z11 or R&S NRP-Z21 (Adapter Cable R&S NRP-Z4 required)
- Pendrive (memory stick) for easy data transfer from/to the PC (e.g. firmware updates)
- CD-ROM drive for easy installation of firmware applications
- PC keyboard for entering comments, file names, etc
- Mouse for easy operation of Windows dialogs
- Printer for documentation of measurement results
- Modem for remote control of the R&S FSMR over great distances

The installation of USB devices is quite simple under Windows XP since all USB devices are Plug&Play. Apart from the keyboard and the mouse, all USB devices can be connected to or disconnected from the R&S FSMR while the instrument is running.

After the instrument is connected to the USB interface, Windows XP automatically searches for a suitable device driver.

If Windows XP does not find a suitable driver, you will be prompted to specify a directory where the driver software can be found. If the driver software is on a CD, a USB CD-ROM should first be connected to drive to the R&S FSMR.

As soon as the connection between the R&S FSMR and the USB device is interrupted, Windows XP will again recognize the modified hardware configuration and will deactivate the corresponding device driver.

Example:

Connecting a pendrive (memory stick) to the R&S FSMR:

1. After the pendrive is connected to the USB interface, Windows XP will recognize the newly connected hardware:

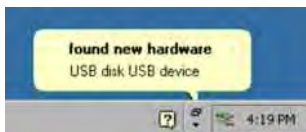

2. Windows XP installs the corresponding driver.
After successful installation, XP signals that the unit is ready for operation:



3. The pendrive is now available as a new drive and is displayed in Windows Explorer:

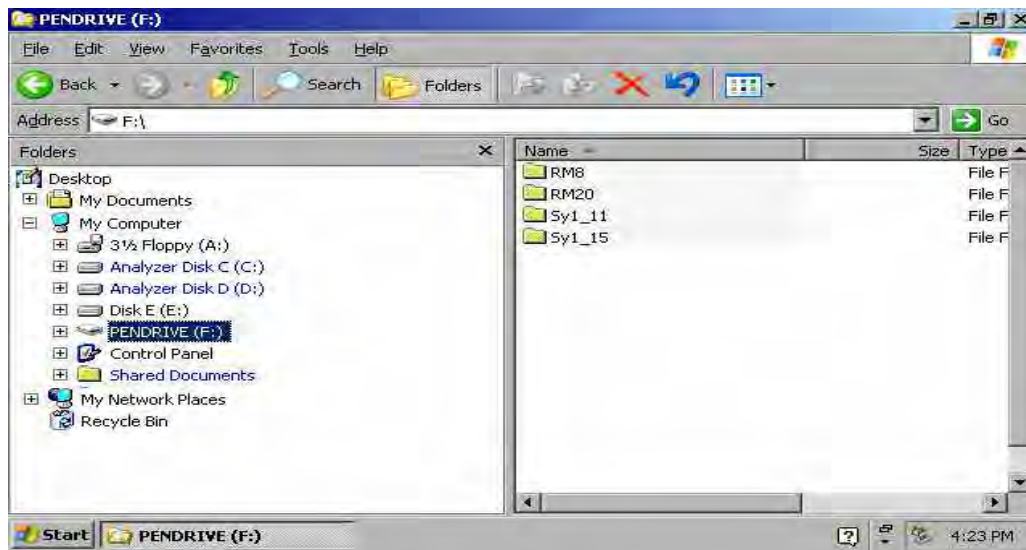

The pendrive can be used as a normal drive to load or save files.

4. If the pendrive is no longer required or if files are to be transferred to another computer, the pendrive is simply disconnected. Windows XP will then deactivate the driver. If the corresponding drive is still selected in Explorer, an error message will be displayed indicating that the drive is no longer available.

Installing Windows XP Software

Windows XP Software Tested for the Instrument

The driver software that is used and the system settings of Windows XP have been fine-tuned to support the measurement functions of the R&S FSUP. Thus, flawless instrument function is ensured only if software and hardware tested or offered by Rohde & Schwarz are used.

Using other software or hardware may cause the functions of the R&S FSMR to perform improperly or fail.

The following program packages have been successfully tested for compatibility with the measurement instrument software:

- R&S FS-K3 – Software for measuring noise factor and gain
- R&S FS-K4 – Software for measuring phase noise
- R&S Power Viewer (virtual power meter for displaying results of the power sensors of the R&S NRP-Zxx series)
- Windows XP Remote Desktop
- FileShredder – For reliable deletion of files on the hard disk
- Symantec Norton AntiVirus – Virus-protection software
- McAfee Virusscan

Contents – Chapter 2 "Getting Started"

1 Getting Started	2.1
Instrument overview	2.1
Setup the instruments.....	2.1
Select the Preset state	2.2
Measurement Examples.....	2.3
Example 1: RF Power Measurements with a Power Sensor	2.4
Measurement	2.4
Main Receiver Functions.....	2.4
Measurement Setup.....	2.4
Measurement Sequence – RF Power Measurements	2.4
Example 2: Low RF Level Measurements with Tuned RF Level Mode	2.7
Measurement	2.7
Main Receiver Functions.....	2.7
Measurement Setup.....	2.7
Measurement Sequence – Tuned RF Level Measurements	2.7
Example 3: AM Modulation and Modulation Distortion Measurements.....	2.13
Measurement	2.13
Main Receiver Functions.....	2.13
Measurement Setup.....	2.13
Measurement Sequence – AM Modulation Measurements	2.13
Example 4: Audio Measurements with the Audio Analyzer mode.....	2.17
Measurement	2.17
Main Receiver Functions.....	2.17
Measurement Setup.....	2.17
Measurement Sequence – Audio Measurements.....	2.17

2 Getting Started

This chapter provides a fast introduction to operation by guiding the user step by step through measurement examples .

Before starting any measurement with the FSMR, please note the instructions given in chapter 1 of the users manual for putting the instrument into operation. In chapter 3 you will find detailed information on customizing the instrument and the display.

For a systematic explanation of all menus, functions and parameters and background information refer to the reference part in chapter 4.

Instrument overview

The R&S FSMR is a very versatile instrument that combines many measurement capabilities required for calibration, troubleshoot and development into a single box instrument. The following functions are included:

- **RF Power Meter**, for highest accuracy RF power measurement.
- **RF Level Meter**, for measurements of low level signals.
- **Modulation Analyzer**, for AM/FM and ϕ M modulated signals.
- **Audio Analyzer**, for Audio Signal level and distortion, using the Audio input.
- **Frequency Counter**, fastest frequency measurements with „mHz“-resolution.
- **Spectrum Analyzer**, for high performance spectral analysis capabilities.

The R&S FSMR still offers an easy-to-use operation which does not require expert knowledge to perform the basic measurements.

This product note is designed to explain the functions and operation of the Measuring Receiver R&S FSMR. In the following descriptions, each step is explained in detail so that the instrument can be immediately used without the need for learning all of the available functions.

Setup the instruments

Most of the following examples use the same test setup. To perform the measurements, in addition to the Measuring Receiver R&S FSMR a signal generator and a power sensor is required. The examples in this paper will require a single, stable RF test signal at lower RF frequencies (for example 100 MHz). The generator shall offer analog modulation capabilities (at least AM modulation) at a variable modulation rate from 1 kHz to 3 kHz and 30 % modulation depth.

For the audio measurement examples a LF generator is required. Most of the R&S signal generators are equipped with a modulation generator which is sufficient for these measurements (for example R&S SML, R&S SMIQ).

The power sensor used in the examples shall be one of the sensors from the R&S NRP series. There are many different sensors available, a terminating average power sensor will best fit to the requirements (for example R&S NRP-Z21)

Select the Preset state

All of the following examples assume the standard settings for the measuring receiver. These are set with the *PRESET* key. The *PRESET* must be set to Factory default values and measuring Receiver Mode.

Check the *PRESET* setting with the following steps:

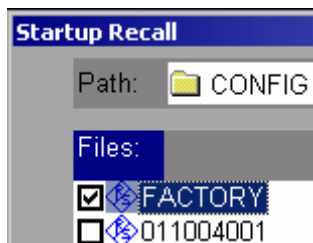
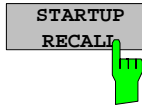
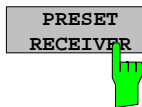
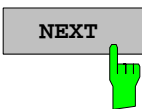
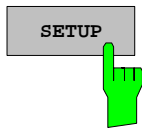

1. Define Preset instrument mode

- Press the *SETUP* key.
The setup menu is opened.
- Press the menu change key *NEXT*.
The submenu is opened.
- Press the *PRESET RECEIVER* softkey.

The following presets will force the instrument into the Measuring Receiver mode.

2. Define the Startup Recall

- Press the *FILE* key.
The file menu is displayed.
- In the *FILE* menu press the *STARTUP RECALL* softkey.

A table with available instrument recall states is displayed.

- In the *STARTUP* table, highlight the entry named "FACTORY" and enable it with the *Enter* key as *STARTUP RECALL*.

3. Reset the instrument.

- Press the *PRESET* key.

The main receiver menu is opened. The receiver mode is set.



Fig.2-1 Display after selecting the default setup in receiver mode

The main default parameters are listed in the following table:

Table 2-1 Default parameters after preset in measuring receiver mode

Parameter	Parameter Name	Value
Receiver frequency	Frequency	100 MHz
Reference Level	Ref Level	Manual -20 dBm
RF attenuation	RF ATT	Auto
Preamplifier	Preamp	Off
Demodulation	Demod	FM
Detector	Det.	+/- peak/2
Measurement time	Meas Time	100 ms
Trigger	Trigger	Free run

Measurement Examples

All of the following examples assume the standard settings for the measuring receiver. These are set with the *PRESET* key

The described measurement applications are:

- Measurement of the RF power of a signal using the Power Meter mode.
- Measurement of low level signals using the Tuned RF Level mode.
- Measurement of AM modulated signals and modulation distortion with the Modulation Analyzer mode.
- Measurement of audio signals with the Audio Analyzer mode.

Example 1: RF Power Measurements with a Power Sensor

Measurement

The FSMR includes a power meter functionality. Measurements of RF Power will be performed in the power meter mode with highest accuracy. The FSMR will automatically handle all required correction factors and compensate the measurements. The FSMR does support the following Rohde&Schwarz power sensors:

- R&S NRP-Z11 10 MHz to 8 GHz / 200 pW to 200 mW
- R&S NRP-Z21 10 MHz to 18 GHz / 200 pW to 200 mW
- R&S NRP-Z51 DC to 18 GHz / 1 uW to 100 mW
- R&S NRP-Z55 DC to 40 GHz / 1 uW to 100 mW

Main Receiver Functions

The power meter functions are available in the Measuring Receiver *POWER METER*-mode. All required settings and evaluations can be reached from the *POWER METER* main menu.

Measurement Setup



Fig.2-2 RF Power measurement setup

The following settings are used on the generator:

1. *PRESET* the generator.
2. Set RF Frequency to 1 GHz.
3. Set the output level to 0 dBm.

Measurement Sequence – RF Power Measurements

Connect the Power sensor with the Signal Generator output and with the Measuring Receiver power sensor connector on the front panel.

The following steps are performed:

1. Zero the power sensor.
2. Connect the power sensor to the DUT.
3. Set the RF frequency.
4. Measure the RF Power

1. Zero the Power Sensor



- **Reset the instrument.**
- *Press the PRESET key.*

The main receiver menu is opened. The receiver mode is set.

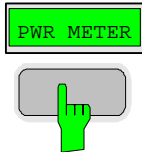

Switching to Power Meter Mode

- *Press the PWR METER hotkey.*

The power meter menu is displayed.



Set the measuring frequency

- Press the *FREQ* key on the front panel.
- In the frequency menu press the *RECEIVER FREQUENCY* softkey.

The measuring receiver frequency menu is displayed.

The frequency entry is displayed. Enter the measuring frequency with the number keys and the appropriate unit key. The frequency will be used by the instrument to calculate the calibration factors for the power sensor head.

- In the *RECEIVER FREQUENCY* entry window key in "1000 MHZ".
-

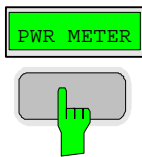

Zero the power sensor

- Press the *PWR METER* hotkey.

The power meter menu is displayed.

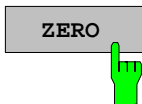

- In the *POWER METER* menu press the *ZERO* softkey.

- In the message box, confirm *CONTINUE* and press *ENTER*.

The zeroing of the sensor will be performed.

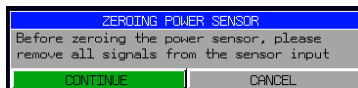

After the zeroing is completed, a message will appear on the screen.



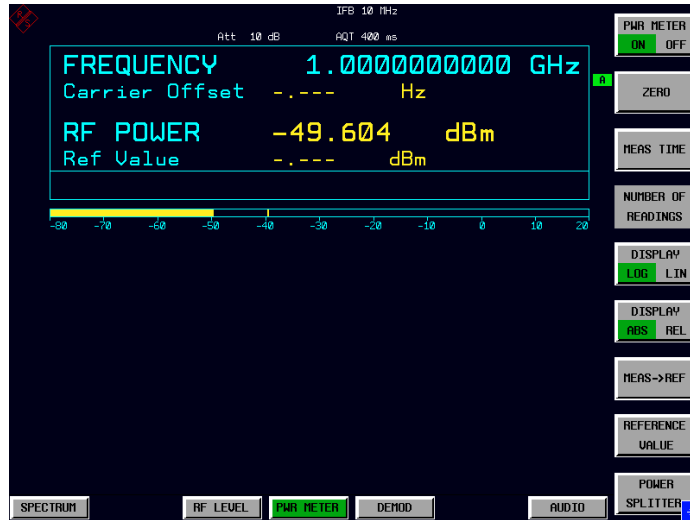

Fig.2-3 RF power measurement after Zeroing



2. Measure the RF power in Watt

Connect the power sensor to the signal generator RF output

Linear display – Change the Unit to Watt

- Press the *PWR METER* hotkey. The POWER METER menu is displayed.
- In the POWER METER menu press the *DISPLAY LOG / LIN* softkey. The RF power unit is changed from dB to Watt.

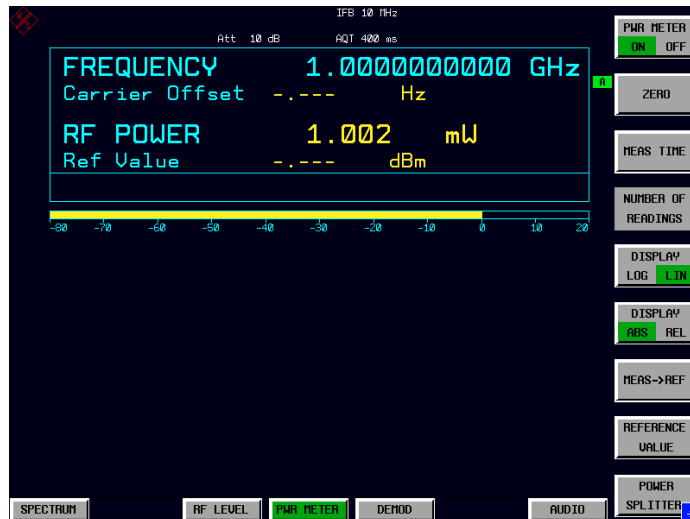
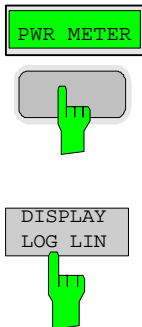

Fig.2-4 RF power measurement in UNIT Watt

Example 2: Low RF Level Measurements with Tuned RF Level Mode

Measurement

The main functionality of a measuring receiver is the RF level measurement. Measurements of low power RF signals will be performed in the Tuned RF Level mode with highest accuracy. The FSMR will automatically handle all required settings.

Main Receiver Functions

The measurement of RF levels over a wide input level range is performed in three different level ranges. To reach the highest possible accuracy, a calibration is performed with a power sensor. The FSMR does offer fully automated calibration procedures in the Tuned RF Level mode. The following example will guide through the calibration steps. All functions for Tuned RF level measurements can be reached from the RF LEVEL main menu.

Measurement Setup

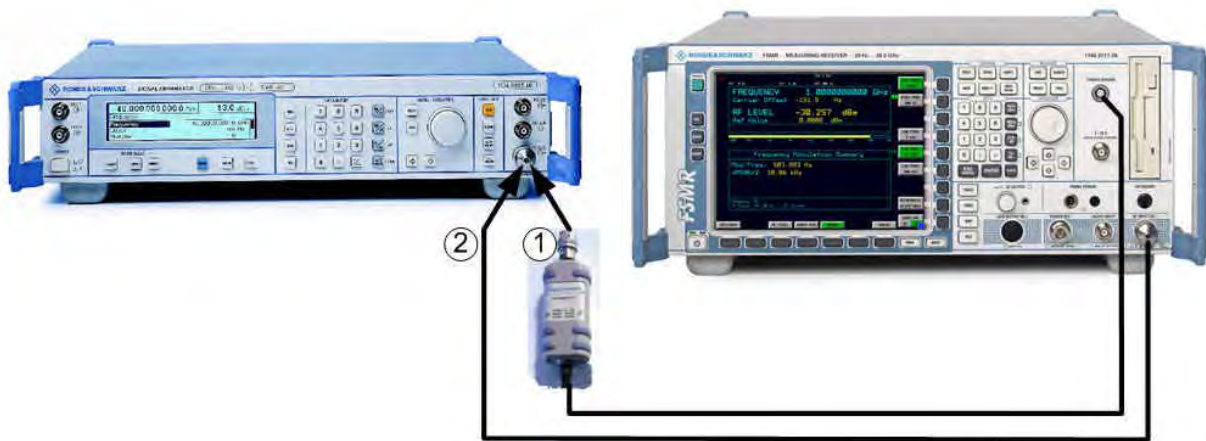

Fig.2-5 Tuned RF Level measurement setup

The following settings are used on the generator:

1. *PRESET* the generator.
2. Set RF Frequency to 300 MHz.
3. Set the output level to 0 dBm.

Measurement Sequence – Tuned RF Level Measurements

Connect the Power sensor with the Signal Generator output and with the Measuring Receiver power sensor connector on the front panel.

The following steps are performed:

1. Calibrate the FSMR with the power meter.
2. Change the output level and perform further Range calibrations.
3. Average the results for enhanced stability.
4. Measure an unstable source (unstable frequency)

1. Calibrate the setup- absolute power calibration



- **Reset the instrument.**
- *Press the PRESET key.*

The main receiver menu is opened. The receiver mode is set.

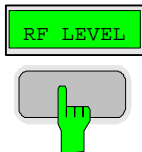

Switching to Tuned RF Level Mode

- *Press the RF LEVEL hotkey.*

The Tuned RF level menu is displayed.



Set the measuring frequency

- Press the *FREQ* key on the front panel.

The measuring receiver frequency menu is displayed.

- In the frequency menu press the *RECEIVER FREQUENCY* softkey.

The frequency entry is displayed. Enter the measuring frequency with the number keys and the appropriate unit key.

- In the *RECEIVER FREQUENCY* entry window key in "300 MHZ".

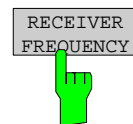

Connect the power sensor to the signal generator RF output

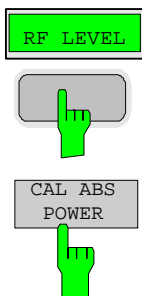

Calibrate the Tuned RF Level – Absolute Power calibration

- Press the *RF LEVEL* hotkey.

The *RF LEVEL* menu is displayed.

- In the *RF LEVEL* menu press the *CAL ABS POWER* softkey.

The calibration of the receiver will be performed. A message box with instructions about the setup appears. The first step is a power measurement with the power sensor connected to the source.

- In the message box, confirm *CONTINUE* and press *ENTER*.

In the next step of the calibration the receiver is connected to the source.

- **Connect FSMR RF input to the signal generator RF output**

- In the next message box, confirm *CONTINUE* and press *ENTER*.

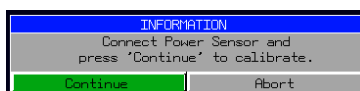

The FSMR is now calibrated in one RF level range (the upper level range does handle RF levels from -10 dBm to +30 dBm). Measurements in this level range can now performed with full accuracy.



Fig.2-6 Tuned RF Level measurement after calibration

2. Range to range calibration- relative calibration

Change the signal generator output level

- The following settings are used on the generator:
 - Change the signal generator RF Level in 1 dB steps down.
 - Observe the FSMR screen for the yellow RECAL message to appear (at levels about -10 dBm). This is the point where the automated Range-to-Range calibration can be performed.

The FSMR is now ready for a RF level range change. The calibration of the level difference due to the range change will be performed.

- Press the *RF LEVEL* hotkey.
 - The RF LEVEL menu is displayed.
- In the RF LEVEL menu press the *RECAL (MANUAL)* softkey.
 - The RECAL procedure is performed. Do not change any signal generator settings at this time.

A message box appears. The instrument will perform a measurement in the calibrated range, then change the RF settings (RF attenuator, IF gain) and then measure again. After the recalibration measurements with high accuracy are available in the RF level range 2 (covers levels from -10 dBm to -50 dBm).

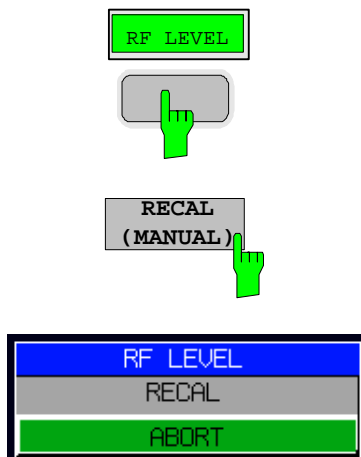



RF LEVEL

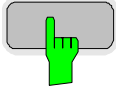

RECAL
(MANUAL)



Change the signal generator output level further down

- The following settings are used on the generator:
Change the signal generator RF Level in 10 dB steps down. Observe the FSMR screen for the yellow RECAL message to re-appear again (at levels about -50 dBm).

As soon as the RECAL flag appears, the FSMR is ready for a next RF level range change. The calibration of the level difference due to the range change will be performed.

- Press the RF LEVEL hotkey.
The RF LEVEL menu is displayed.
- In the RF LEVEL menu press the *RECAL (MANUAL)* softkey.
The RECAL procedure is performed.

A message box appears. The instrument will perform a measurement in the calibrated range, then change the RF settings (RF attenuator, IF gain) and then measure again. After the recalibration measurements with high accuracy are available in the RF level range 3 (covers levels from -50 dBm to noise level).

The FSMR is now calibrated in all RF level ranges (for RF levels from -140 dBm to +30 dBm). Measurements in all level ranges can now be performed with full accuracy. No further calibration is required, the Autorange function will automatically adapt the level setting of the FSMR to the input signal.



Fig.2-7 Tuned RF Level measurement at low levels

3. Average the results for enhanced stability



Change the signal generator output level further down

- The following settings are used on the generator:
Change the signal generator RF Level to -110 dBm).

The FSMR is now performing a calibrated measurement at – 110 dBm. The reading will be flickering due to a low signal to noise ratio. For a more stable reading, the FSMR does offer several functions.

The stability of a low level measurement is mainly depending on the measurement time. A longer acquisition of the signal does allow for a more accurate measurement. The averaging of several single acquisitions will lead to an effective longer measurement time.

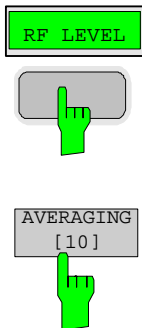

- Press the RF LEVEL hotkey.

The RF LEVEL menu is displayed.

- In the RF LEVEL menu press the *MANUAL AVG* softkey.

The AVERAGE will be switched on. The number of measurements can be entered in the AVERAGING COUNT box which appears on top of the screen. The default value is set to 10 Averages.

The instrument will now perform an averaged measurement. The average function is a floating average over the number of measurements chosen with the Average Count entry (default value: 10).



Fig.2-8 Tuned RF Level measurement with Averaging



4. Measure an unstable source (unstable in frequency)

The simulation of unstable sources requires a signal which is unstable in the frequency domain. This signal can be simulated with active frequency modulation on the signal generator.

- The following settings are used on the generator:
 1. *PRESET* the generator.
 2. Set RF Frequency to 100 MHz.
 3. Set the output level to 0 dBm.
 4. Select FM Modulation, 3 kHz deviation.
 5. Set the Modulation frequency to 1 kHz.



- Reset the instrument.
- Press the PRESET key.

The main receiver menu is opened. The receiver mode is set.

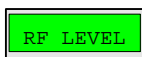

Switching to Tuned RF Level Mode

- Press the RF LEVEL hotkey.

The Tuned RF level menu is displayed.

Set the measuring frequency



- In the RF LEVEL menu press the RECEPTOR FREQUENCY softkey.

The frequency entry is displayed. Enter the measuring frequency with the number keys and the appropriate unit key.

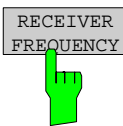

- In the RECEPTOR FREQUENCY entry window key in "100 MHZ".

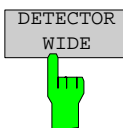

The measurement of an unstable signal requires the measuring receiver to use a wide bandwidth. The FSMR offers a wideband detector mode to acquire wideband signals with high accuracy

- In the RF LEVEL menu press the DETECTOR WIDE softkey.

The wideband detector mode acquire signals with the full acquisition bandwidth. The acquisition bandwidth (DEMOM BW) of the FSMR can be set in the BW menu, the preset value is 12.5 kHz. The bandwidth must be set wide enough to capture the maximum frequency deviation of the input signal. In this example, the frequency deviation is set to 3 kHz and the default bandwidth is 12.5 kHz.

Note: The wideband detection is not only suitable for unstable signals, it can also be used to accurately measure modulated signals

Next steps:

The following steps will be performed as described in the previous example (Tuned RF Level).

Example 3: AM Modulation and Modulation Distortion Measurements

Measurement

The FSMR includes a modulation analyzer. Measurements like AM, FM or PM modulation will be performed in the modulation analyzer mode. The instrument offers standard measurements like modulation depth, deviation and modulation frequency, but also more sophisticated function like modulation distortion or audio frequency response are available.

Main Receiver Functions

The modulation analyzer functions are available in the Measuring Receiver *DEMOD*-mode. All required settings and evaluations can be reached from the DEMOD main menu.

Measurement Setup



Fig.2-9 AM modulation measurement setup

The following settings are used on the generator:

1. *PRESET* the generator.
2. Set RF Frequency to 100 MHz.
3. Set the output level to - 30 dBm.
4. Select the AM Modulation, 30% modulation depth.
5. Set the Modulation frequency to 1 kHz.

Measurement Sequence – AM Modulation Measurements

Connect the Signal Generator output with the Measuring Receiver RF Input.

The following measurement steps are performed:

1. Measure the AM modulation depth.
2. Relative Audio measurements
3. Measure the Total harmonic distortion in %.

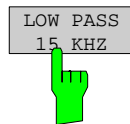
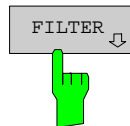
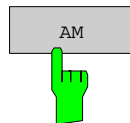
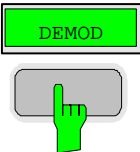

1. Measure the AM modulation depth

- **Reset the instrument.**
- **Press the PRESET key.**

The main receiver menu is opened. The receiver mode is set.

Switching to AM demodulation

- **Press the DEMOD hotkey.**
- **In the DEMOD menu press the AM softkey.**

The modulation frequency and the AM modulation depth with peak detection measurement results are displayed in the lower window of the screen. The upper window shows the RF Frequency and the RF input level.

Limiting the bandwidth - Audio Filters

- **Press the DEMOD hotkey.**
- **In the DEMOD menu press the FILTER softkey.**

The audio filter menu is displayed. To suppress unwanted broadband noise or harmonics of the demodulated signal, the bandwidth of the measurement can be limited with highpass and lowpass filters.

- **In the FILTER menu press the LOW PASS 15 KHZ softkey.**

The following screen is displayed:

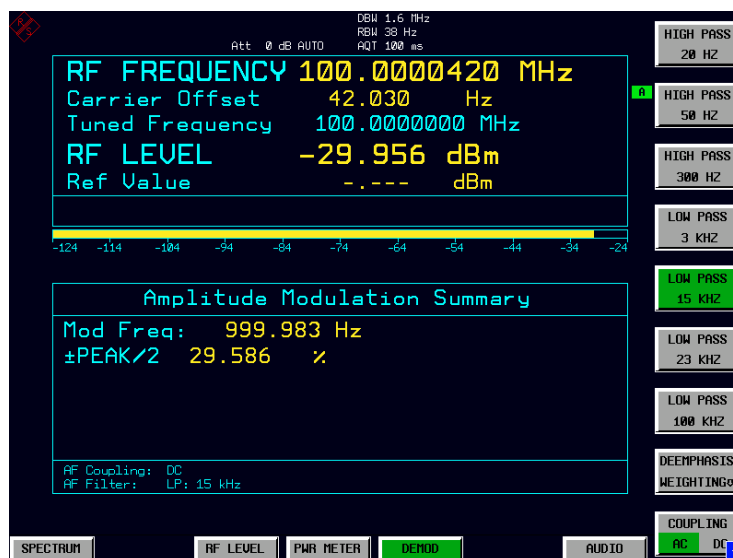
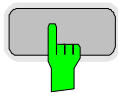

Fig.2-10 AM Modulation measurement in the DEMOD mode

- **In the FILTER menu press the LOW PASS 15 KHZ softkey again to switch the filter off.**

DEMOD



RELATIVE



+/- PEAK/2



RELATIVE



RELATIVE
DB %



2. Relative Audio measurements – audio frequency response

- Press the *DEMOD* hotkey.

The analog demodulation menu is displayed.

- In the DEMOD menu press the *RELATIVE* softkey.

The RELATIVE menu is displayed. In the relative menu, only the detectors which have been switched on in the DETECTOR menu are available for relative measurements.

- In the RELATIVE menu press the +/- *PEAK/2* softkey.

The actual measurement value of the detector will be saved as a reference value and the result display will change to a relative reading (indicated with Δ 0.00 %).

Change the modulation frequency to 50 kHz

- The following settings are used on the generator:

1. Select the AM Modulation, 50 kHz modulation frequency.

Relative display – Change the Unit to dB

- Press the *DEMOD* hotkey.

The analog demodulation menu is displayed.

- In the DEMOD menu press the *RELATIVE* softkey.

The RELATIVE menu is displayed.

- In the RELATIVE menu press the +/- *PEAK/2* softkey.

The actual result display will change from a relative reading indicated in % to a dB reading.

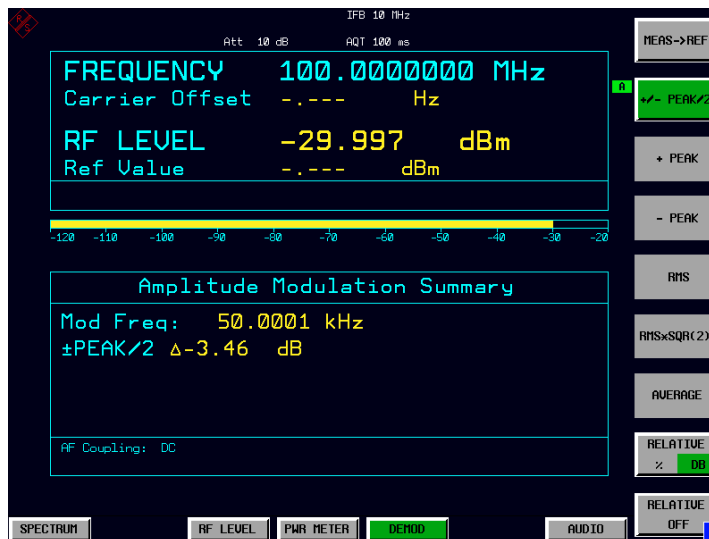
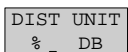
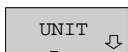
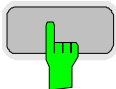
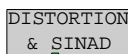
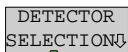

Fig.2-11 Relative measurement in the demod mode



3. Measure the harmonic distortion - Choosing the detector

- Press the *DEMOM* hotkey.
- In the DEMOD menu press the *DETECTOR SELECTION* softkey.

The DETECTOR SELECTION menu is displayed

The instrument is equipped with a wide range of detectors for measuring modulation signals. The peak detectors are a good choice for capturing the highest positive or negative peak within the measurement time, while the RMS and Average detectors are the best choice for measuring noise and residual modulation. The THD & SINAD detector measure the distortion of the demodulated audio signal. All detectors can be used in parallel.

- In the DETECTOR SELECTION menu press the *DISTORTION & SINAD* softkey.

Total Harmonic Distortion – Change the Unit to %

- Press the *AMPT* hardkey on the frontpanel.
- In the AMPLITUDE menu press the *UNIT* softkey.

The measuring receiver UNIT menu is displayed.

- In the UNIT menu press the *DIST UNIT % / DB* softkey.

The actual result display for the THD measurement will change from a “DB” reading to a “%” reading.

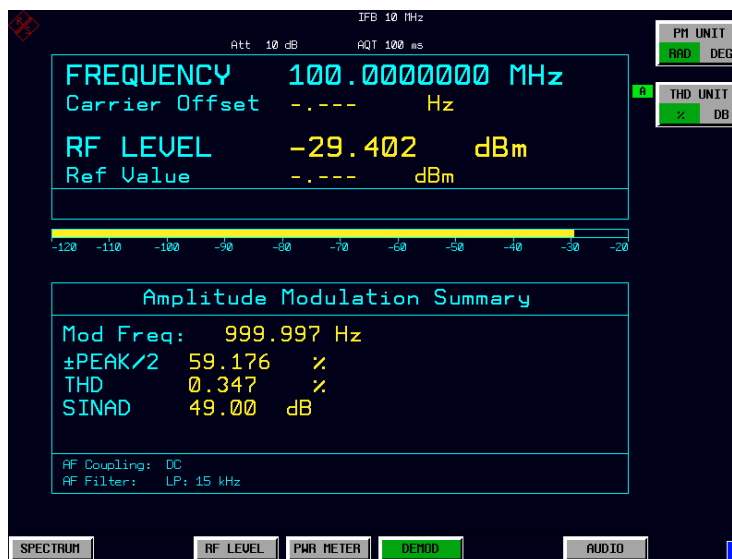

Fig.2-12 THD measurement in UNIT %

Example 4: Audio Measurements with the Audio Analyzer mode

Measurement

The FSMR includes an audio analyzer functionality. Measurements of audio signals will be performed in the audio analyzer mode with highest accuracy. The FSMR will automatically handle all required settings.

Main Receiver Functions

The audio analyzer functions are available in the Measuring Receiver *AUDIO*-mode. All required settings and evaluations can be reached from the AUDIO main menu.

Measurement Setup



Fig.2-13 Audio measurement setup

- **Connect the signal generator LF (low frequency) output with the FSMR Audio input.**

The following settings are used on the generator:

1. *PRESET* the generator.
2. Set LF output to ON .
3. Set the LF output level to 1 volt.
4. Set the LF output frequency to 1 kHz.

Measurement Sequence – Audio Measurements

The following steps are performed:

1. Measure the audio level and frequency.
2. Measure the frequency response of the audio filters.
3. Measure the influence of the input impedance.



- **Reset the instrument.**
- **Press the PRESET key.**

The main receiver menu is opened. The receiver mode is set.

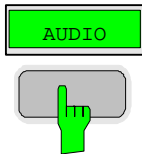

Switching to Audio Mode

- **Press the AUDIO hotkey.**

The audio menu is displayed. The audio measurement results are displayed in parallel, no further settings like frequency is required.

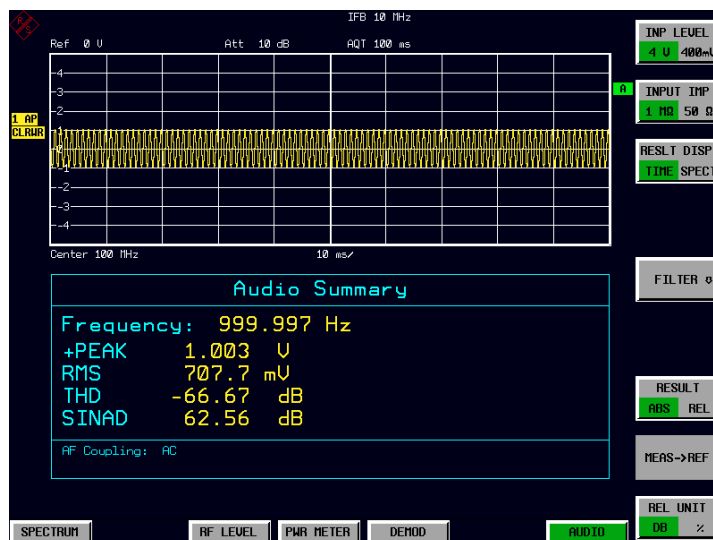
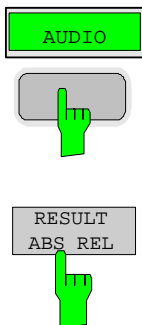

Fig.2-14 Audio measurement after Preset, Mode Audio



4. Relative Audio measurements

- Press the *AUDIO* hotkey.
The audio menu is displayed.
- In the *AUDIO* menu press the *RESULT ABS REL* softkey.

The relative measurement function is enabled.

The actual measurement value of the detector will be saved as a reference value and the result display will change to a relative reading (indicated with Δ 0.00 dB). The unit can be changed with the *REL UNIT DB %* softkey in the audio menu.

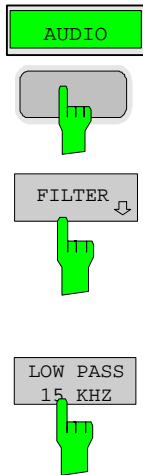

Limiting the bandwidth - Audio Filters

- Press the *AUDIO* hotkey.
The audio menu is displayed.
- In the AUDIO menu press the *FILTER* softkey.
The audio filter menu is displayed. To suppress unwanted broadband noise or harmonics of the signal, the bandwidth of the measurement can be limited with highpass and lowpass filters.
- In the FILTER menu press the *LOW PASS 15 KHZ* softkey.

Change the LF output frequency to 15 kHz

The following settings are used on the generator:

- Set the LF output frequency to 15 kHz.

The audio frequency is now changed to the bandwidth of the active 15 kHz low pass filter. In the following measurement the frequency response of the audio low pass filter is measured.

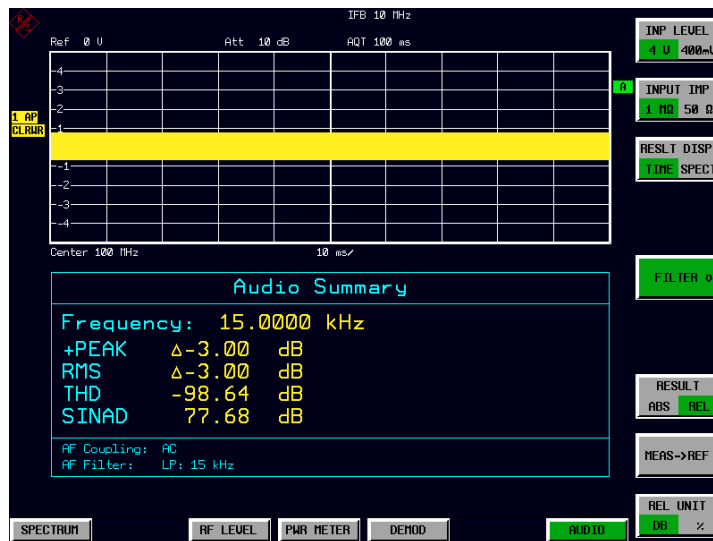

Fig.2-15 Audio measurement in relative mode

Contents - Chapter 3 "Manual Operation"

3 Manual Operation	3.1
The Screen	3.1
Diagram Area	3.2
Indications in the Diagram Area	3.3
Full Screen	3.9
Split Screen	3.9
Softkey Area	3.10
Hotkey Area	3.11
Calling and Changing the Menus	3.11
Setting Parameters	3.12
Numeric Keypad	3.12
Spinwheel and Cursor Keys	3.13
Selection and Setting of Parameters via Keys or Softkeys	3.14
Editing of Numeric Parameters	3.17
Entry of Alphanumeric Parameter	3.20
Editing with External Keyboard	3.20
Editing with Help Line Editor	3.21
Selection and Setting of Parameters via Tables	3.24
Menu Overview Receiver Mode	27
FREQUENCY Key	27
SPAN Key.....	28
AMPT Key	29
BW Key	30
SWEEP/MEAS Keys	31
Hotkey Menus	32
RF LEVEL Key	32
PWR METER Key.....	33
DEMOD Key.....	34
AUDIO Key.....	35
Menu Overview Spectrum Analysis Mode	36
FREQUENCY Key.....	36
SPAN Key.....	37
AMPT Key	38
MEAS Key	39
BW Key	40
SWEEP Key	41
Menu Overview another Keys	42
MKR Key	42
MKR-> Key	43
MKR FCTN Key.....	44
TRIG Key.....	45
TRACE Key	46
LINES Key.....	47

DISP Key.....	48
FILE Key.....	49
CAL Key	50
SETUP Key	51
HCOPY Key.....	52
Hotkey Menu	53
LOCAL Menu.....	53
Menu Overview Ext. Generator Control	54
Menu Overview Option Network Mode.....	55

3 Manual Operation

Chapter 3 provides an overview of the operating concept and the basic steps of manual operation of the R&S FSMR. This includes a description of the screen, of the control of menus and of the setting of parameters. An overview of the menus will be listed at the end of this chapter.

The functions of the menus are described in detail in Chapter 4. Chapter 2 contains a short introduction on step-by-step simple measurements. The remote control of the instrument is described in Chapters 5, 6 and 7

The operation of the spectrum analyzer is menu-controlled via keys, hotkeys and softkeys. The setting of the instrument and test parameters in the menu is made either directly via softkeys or by entry of values in entry fields and by selection in tables. The operating mode and the screen mode is selected via the hotkeys.

If required, data entry windows and tables are superimposed on the screen.

The Screen

The screen informs continuously on the results and parameters of the selected measuring functions. It shows the as signment of the softkeys and menus, which are required for setting the measuring parameters. The display of test results, the softkey labeling and the type of menu depend on the selected measuring function.

The screen is subdivided into three areas:

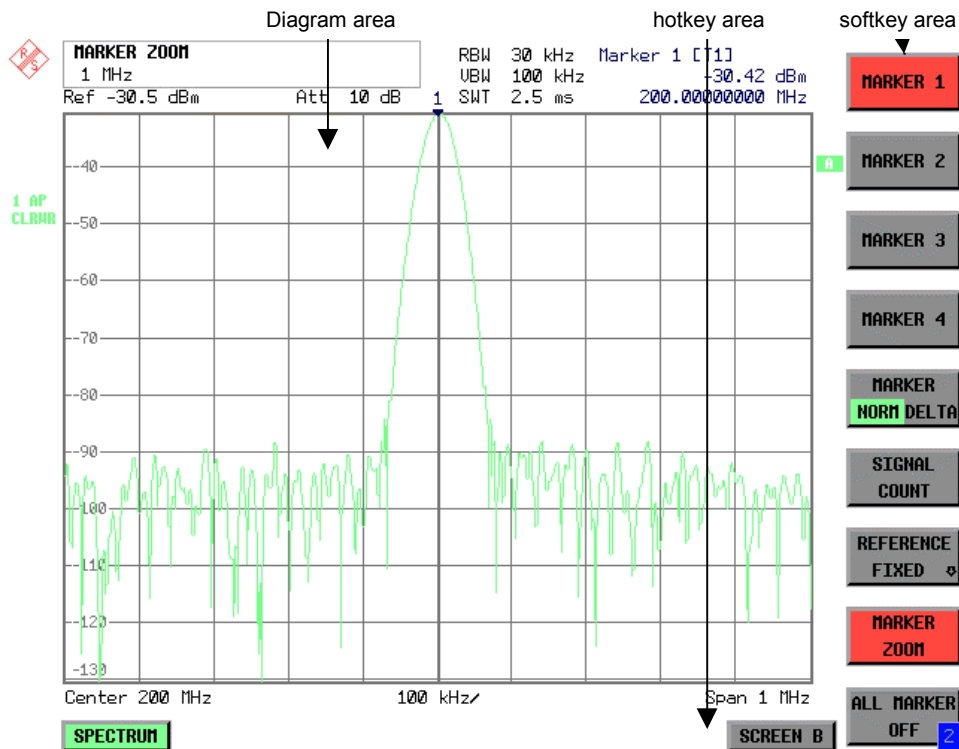

Fig. 3-1 Subdivision of screen

Diagram area This area contains the measuring diagrams and other measured-value information as well as the parameters and status information which are important for analysis of the results. In addition, message fields, entry windows and tables may be shown in this area.

Softkey area This area contains the instrument functions which can be selected via the softkeys. The softkey area is not superimposed by other graphics.

Hotkey area This area contains the available operating modes and screen modes. The hotkey area is not superimposed by other graphics.

Diagram Area

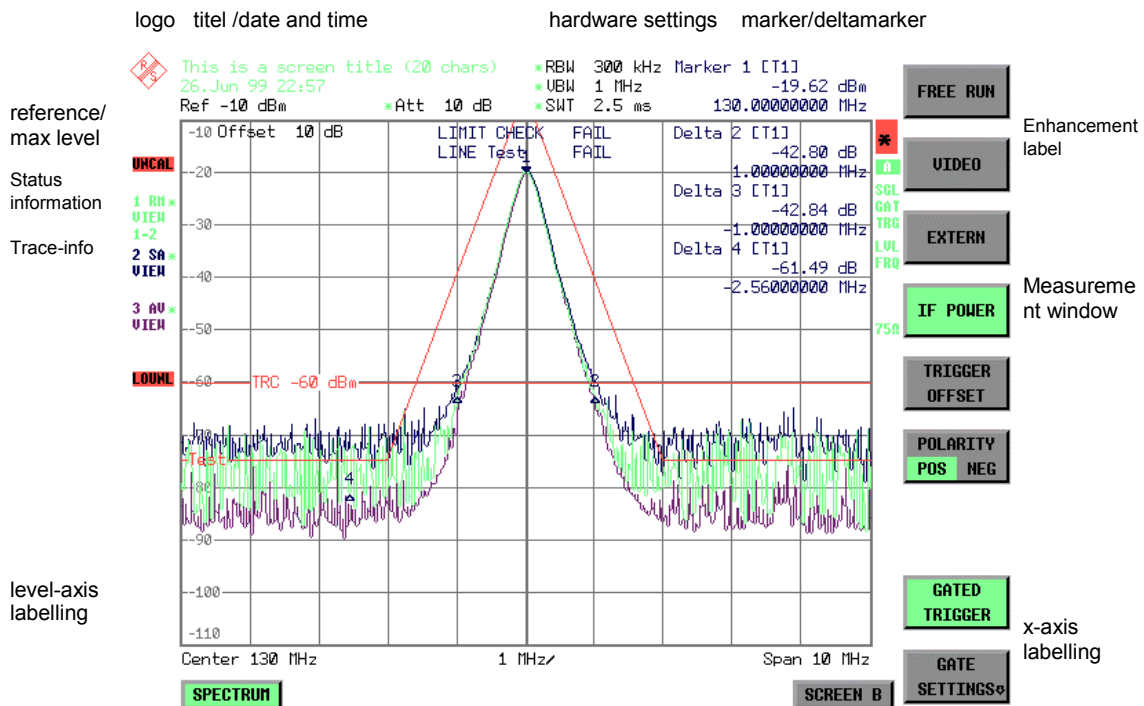

Fig. 3-2 Subdivision of the R&S FSMR screen in analyzer mode (without measuring diagram)

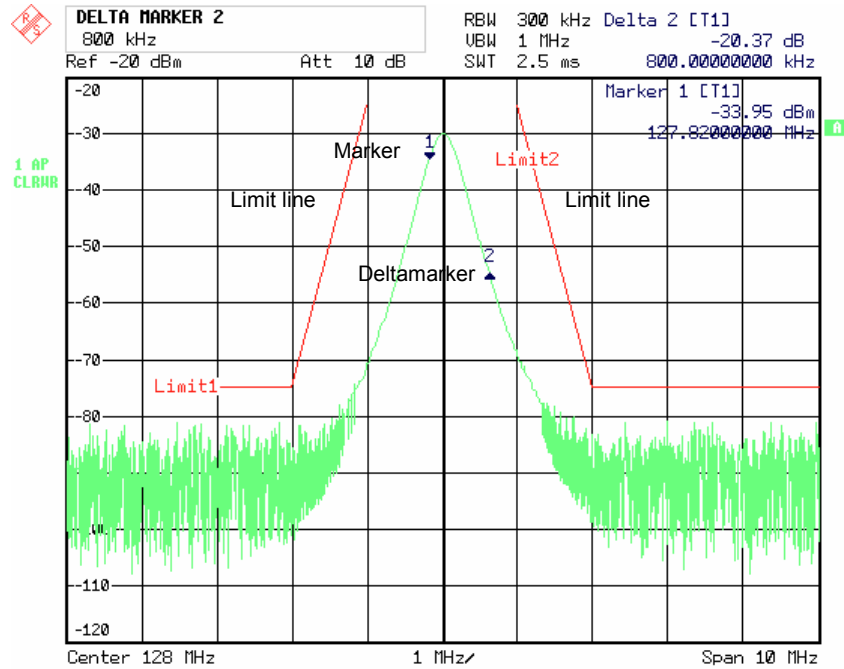

Fig. 3-3 Measuring diagram

Indications in the Diagram Area

The following graphic elements are displayed in the diagram area:

General indications	Indication of the logo
Logo	
Screen title	Indication of selected screen title
Date / time	Indication of date and time
Hardware settings	
Ref	Indication of the reference level
Offset	Indication of the offset of reference level.
Att	Indication of the set RF attenuation.
RBW	Indication of the set resolution bandwidth. If the bandwidth does not correspond to the value of the automatic coupling, a green asterisk "*" is prefixed to the field.
VBW	Indication of the set video bandwidth. If the bandwidth does not correspond to the value of the automatic coupling, a green asterisk "*" is prefixed to the field.
SWT	Indication of the set sweep time. If the sweep time does not correspond to the value of the automatic coupling an asterisk "*" is prefixed to the field. The colour of the asterisk turns red as soon as the sweep time falls below the value of the automatic coupling.

Marker/deltamarker

This label displays the position of the last selected marker or deltamarker in the x and y-directions and the marker/deltamarker index. The square brackets contain the curve which the marker is assigned to and the active measuring function of the marker indicated. The measuring function of the markers in the second field is indicated by the following abbreviations:

- FXD reference fixed active
- PHN phase noise measurement active
- CNT frequency counter active
- TRK signal track active
- NOI noise measurement active
- MOD measurement of AM modulation depth active
- TOI TOI measurement active (3rd order intercept)

Limit check

Indication of the result of the limit check.

X-axis labelling

Display of the x-scaling.

{10 MHz/DIV}

The distance between two grid lines is displayed in this label.

{Center 1.2345678901234 GHz}

The set center frequency or start frequency is displayed in this label depending on whether the keys **FREQ/SPAN** or the softkeys **START/STOP** were last pressed.

{Start 1.2345678901234 GHz}

If span = 0 Hz, the center frequency is always displayed.

{Span 1.2345678901234 GHz}

The set frequency range (*SPAN*) or the stop frequency is displayed, depending on whether the keys **FREQ/SPAN** or the softkeys **START/STOP** were last pressed.

{Stop 1.2345678901234 GHz}

If span = 0 Hz, the trigger moment (*PRETRIGGER*) is displayed.

{Trigger 1.234 ms}

Status information	The status information on the left side of the diagram hint at irregularity (e.g. UNCAL)
#SMPL	"#SMPL" indicates that the relation Span / RBW is higher than 125 while the RMS detector is activated. In this case, a stable signal evaluation is no longer possible due to an insufficient number of A/D converter samples.
UNCAL	<p>⇒ reduce span or increase RBW</p> <p>"UNCAL" is indicated under the following circumstances:</p> <ul style="list-style-type: none"> • correction data are switched off (menu CAL, CAL CORR OFF). ⇒ switch on CAL CORR ON or PRESET • no valid correction data. This may occur after a cold start of the instrument following a firmware update. ⇒ record correction data • Sweep time too short for current instrument settings (span, resolution bandwidth, video bandwidth). ⇒ increase sweep time
OVLD / IFOVL	<p>OVLD is indicated when the input mixer is overloaded. ⇒ Increase input attenuation</p> <p>IFOVL is indicated when overload occurs in the IF signal path after the input mixer. ⇒ Increase reference level</p>
LOUNL / EXREF	<p>LOUNL is indicated when an error occurs in the frequency processing of the instrument.</p> <p>EXREF is indicated when the analyzer is configured for use of an external reference signal, but no reference signal is detected at the corresponding input.</p>
OVEN	OVEN is indicated when the crystal oscillator (option R&S FSMR-B4) has not yet reached its operating temperature. This indication vanishes after a few minutes after switch on.
Trace info:	<p>Every active measurement curve (trace ≠ BLANK) is allocated trace information of two or three lines at the left of the diagram. The trace information has the same colour as the measurement curve.</p> <p>The information on the currently selected trace is displayed in inverse video (see <i>TRACE - SELECT TRACE softkey</i>).</p>

<n> <detector> <*>
 <mode>
 <trace math>

n = trace number (1 ... 3)

detector = selected detector
AP: AUTOPEAK detector
PK: MAX PEAK detector
MI: MIN PEAK detector
SA: SAMPLE detector
AV: AVERAGE detector
RM: RMS detector
QP: QUASIPeAK detector

Example:

1 PK *
 CLRWR
 1-2

* = indicates that the selected detector does not correspond to that of the automatic coupling.

mode = indication of sweep mode
CLRWR: CLEAR/WRITE
MAXH: MAX HOLD
MINH: MIN HOLD
AVG: AVERAGE
VIEW: VIEW

Trace math = trace math active
1 - 2 trace 1 - trace 2
1 - 3: trace 1 - trace 3

Instrument settings
 (Enhancement Labels)

Indication of user instrument settings which influence the measuring result and which are not immediately obvious when viewing the measured values.

- * The current instrument setting does not correspond to the one which applied when one of the displayed curves had been stored. This occurs under the following circumstances:
 - The instrument setting is modified while a measurement is being performed.
 - The instrument setting is modified in SINGLE SWEEP mode subsequent to the end of the sweep and no new sweep is started.
 - The instrument setting is modified after setting the trace to VIEW.

The display is retained until the cause is eliminated by the user. I.e., either a new sweep is started (SINGLE SWEEP mode), or the trace of interest is switched to BLANK.

A / B Identification for screen A / B. When screen A / B is activated for the entry of test parameters, this label is highlighted.

SGL The sweep is set to SINGLE SWEEP.

GAT The frequency sweep is controlled via the *EXT TRIG/GATE* input of the instrument.

TRG The instrument is not triggered in *FREE RUN* mode.

LVL A level offset $\neq 0$ dB has been set.

FRQ A frequency offset $\neq 0$ Hz has been set.

PRN A printer output is active.

75 Ω The input impedance of the instrument is set to 75 Ω .

EXT The instrument is configured for operation with external reference

PA The RF preamplification is switched on (option B23 or B25).

Entry fields:
Entry window

The data entry window is superimposed in the left upper corner of the diagram area, if required. It covers the display of the title and the time. The field is used to enter numeric or alphanumeric device parameters.

Tables

The tables are superimposed in the diagram area, if required. They are used for displaying and configuring device parameters.

Message windows:**Message field**

Message fields provide notes on measurements, e.g. results of the limit check (PASS/FAIL). These notes are no error messages, which are indicated as system messages.

They can be masked out by pressing the *ESC* key.

System messages

System messages indicate warnings and error messages.

Message without action field:

These system messages contain only arbitrary information. They hint at events which are of interest for the user but do not affect the measurement or functioning of the instrument.

They are deleted either automatically after a predefined time has passed (3 seconds) or upon any keystroke or mouse click.

Message with action field:

These system messages require a decision to be taken by the user. They are not deleted until any action has been selected. Deletion of the message initiates the action selected and appropriate measures to be taken. The action field consists of one (OK), two (OK/CANCEL) or three (arbitrary) buttons.

The user may select one of the buttons using the cursor keys and initiate the associated action by means of the unit keys. The *ESC* key is used to acknowledge the message without releasing any action.

Traces:**1 to 3**

Up to 3 traces in each measurement diagram can be displayed simultaneously.

Limit lines

Limit lines are used to mark level curves or spectral distributions which must not be exceeded or dropped below.

The R&S FSMR provides two display modes:

- Full Screen: 1 window, the measurement is performed in the active diagram.
- Split Screen: 2 windows, the measurements are performed in both diagrams.

Full Screen

In the full-screen mode, the settings and measurements are performed in the active visible window. All indications on the screen refer to this window. The designation (SCREEN A or SCREEN B) is inserted as enhancement label A or B on the right diagram margin.

Switching between the windows is by means of *SCREEN A/B* hotkey. The current measurement is terminated when its window is blanked out.

Switching from split-screen to full-screen mode is performed in menu *DISP*.

Split Screen

In Split Screen mode, the screen is divided into two halves.

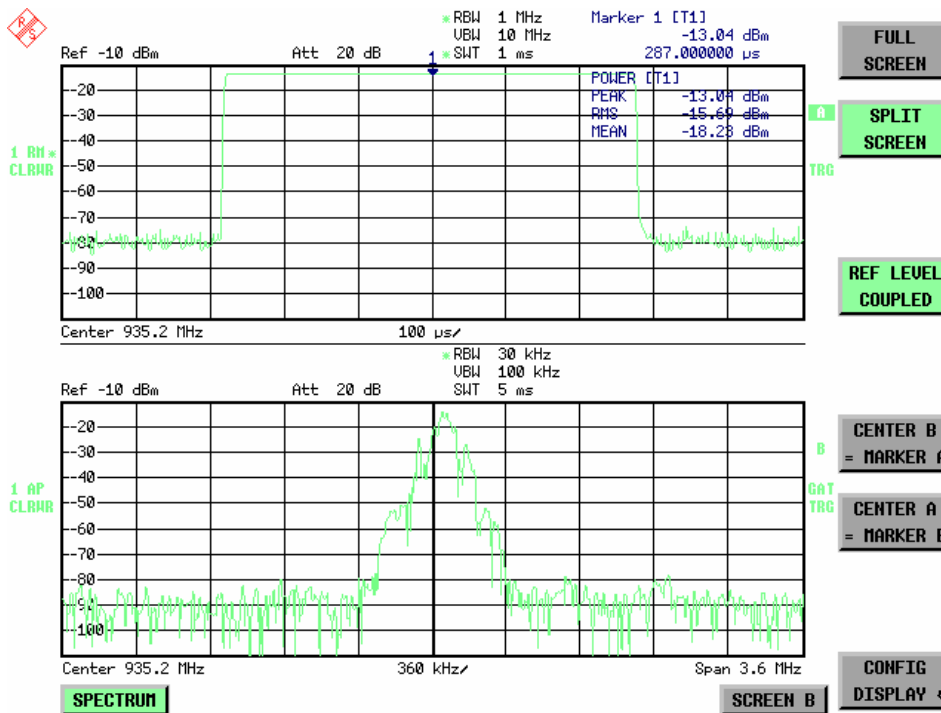

Fig.3-4 Subdivision of the screen in Split Screen mode

The upper half is assigned Screen A, the lower one Screen B. The settings for measurement can be selected independently for both screens. E.g., a spectrum may be displayed in Screen A and a time amplitude in the time range is displayed in Screen B.

The indications which are valid only for one window appear in the margin of the associated diagram. Indications which are valid for the two windows are displayed between the diagrams.

The window for entry of the measuring parameters or the marker operation is selected using the *SCREEN A/B* hotkey. The measurements are simultaneously performed in the two windows irrespective of the currently active one.

Switching from full-screen to split-screen mode is performed in menu *DISP*.

Softkey Area

The softkeys are assigned to the nine keys on the right side of the display. The setup of the softkey area is independent of the operating mode. It consists of the following graphic elements:

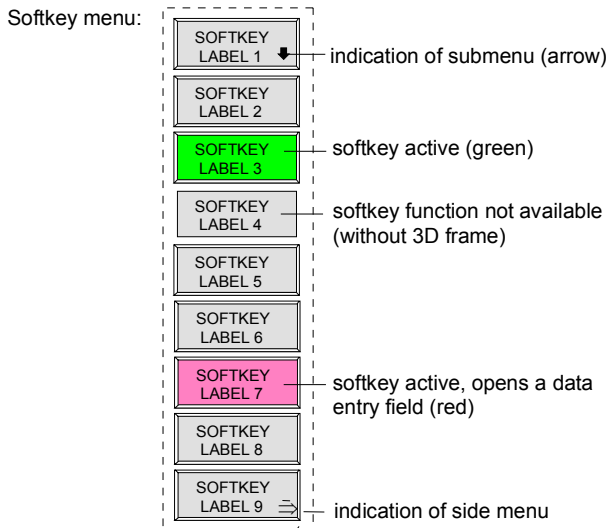

Fig.3-5 Setup of the softkey area

The softkeys have different functions depending on the instrument state. Therefore, their labeling can be varied. The labeling of all softkeys which call a submenu includes a ↓ arrow. The function and current state of the softkeys is indicated in the label by different texts and colors. The color assignment is factory-set as follows:

Table 3-1 Factory-set color assignment of soft keys

Softkey color	Meaning
gray	Softkey switched off
green	Softkey switched on
red	Softkey switched on and data entry active

These colors can be changed by the user as desired in the *DISP - CONFIG DISPLAY* menu.

A softkey is switched on or off by pressing the respective hardkey (see following section "Setting the Parameters").

Softkeys are masked out, too, if the functionality which they represent is not available. A distinction has to be made between two cases:

- If an instrument function depends on an option, and if this option is not fitted, the associated softkey is masked out,.
- If the instrument function is not available temporarily due to specific settings, the softkey is displayed without the 3D frame.

The label  on the right lower corner of the softkey area indicates that a side menu is available. The side menu is called by pressing the *NEXT* key.

Hotkey Area

Hotkeys are allocated to the eight keys on the bottom margin of the screen. They change between modes and the active diagrams.

The menu only shows the hotkeys which are actually used:

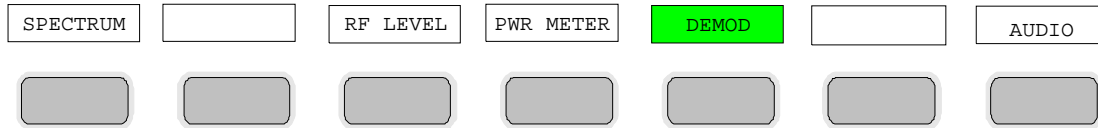

A keystroke activates the associated hotkey. An activated hotkey changes its frame:

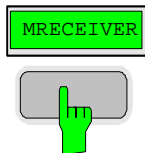

Calling and Changing the Menus

The operation of the spectrum analyzer is menu-controlled via keys and softkeys. Various softkey menus are displayed depending on the instrument status. The individual menus constitute the so-called menu tree. The top menu (the root of the menu tree) is always called by means of a keystroke. Arrows at the lower edge of the softkey area indicate whether a supplementary menu can be entered or not.

Softkeys with an arrow allow for branching into further menus (so-called submenus): The field "↵" at the lower right side of the softkey area indicates that this menu has a side menu.

The menu change keys on the front panel below the softkey area allow for switching between the main menu and the side menus and submenus.

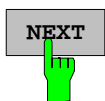

The *NEXT* key calls the side menu.



The *PREVIOUS* key returns to the next higher menu.

Several menus provide for automatic change, i.e., return to the next higher menu is caused automatically after pressing a softkey.

Selection of a submenu is always effected via a softkey.



The labeling of all softkeys which call a submenu includes a ↵ arrow.

Setting Parameters

Parameters are set either by simple selection (selection parameters) or by (alpha)numeric entries in data entry windows or tables.

The numeric keypad on the front panel, an external keyboard (optional), a spinwheel and the cursor keys are provided for the entry of instrument parameters in an entry window or in a table.

The external keyboard is optional. If it is not fitted, the help line editor is called automatically for entry of alphanumeric parameters. The help line editor provides for selection of individual letters and a number of special characters which are copied into the actual entry window.

Numeric Keypad



The numeric keypad is provided for entry of numeric parameters. It contains the following keys:

- Number keys 0 to 9
- Decimal point
Inserts a decimal point "." at the cursor position.
- Sign key
Changes the sign of the mantissa or exponent of a numeric parameter.
A "-" is inserted at the cursor position in case of an alphanumeric parameter.
- Unit keys (*GHz/-dBm*, *MHz/dBm*, *kHz/dB* and *Hz/dB*)
 - Provide the numeric value entered with the selected unit and terminate the entry.
The unit keys are all as signed the value "1" for dimensionless quantities or for level entries (e.g., in dB). The unit keys thus assume the function of an *ENTER* key. The same applies for an alphanumeric entry.
 - Open and close the selection windows of tables.
- *BACK* key
 - Deletes the character left to the cursor with numeric entry.
 - Allows for toggling between the current and the previous values subsequent or prior to entry (*UNDO* function).
- *ESC/CANCEL* key
 - Aborts the entry before it has been terminated. The previous value is restored.
 - Closes the entry field after termination of input.
 - Closes system messages.
- *ENTER* key
 - Terminates the input of dimensionless quantities. The new value is set.

Note: The *ENTER* keys assumes the function of the *Hz* key for frequency input, and the function of the μ s(*kHz*) key for time input.

Spinwheel and Cursor Keys

The spinwheel and the cursor keys are arranged besides the numeric keypad.

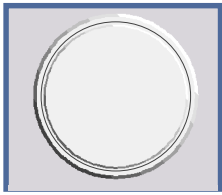

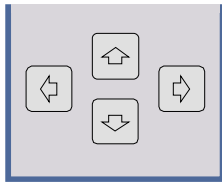

The spinwheel has various functions:

- With numeric entry, the instrument parameter is incremented (turning clockwise) or decremented (turning counterclockwise) at a defined step size.
- In tables, the spinwheel can be used to shift the cursor horizontally or vertically when no entry window is open. The direction (horizontal/ vertical) is switched over using the cursor keys.
- The spinwheel is used with the help-line editor to select the individual letters.
- It can be used to shift markers, display lines, limit lines etc.
- Pressing the spinwheel terminates the input of parameters.



In tables, the cursor keys are used to shift the cursor between the lines and columns of the table.

The keys  and  are used to shift the cursor inside the entry window to reach a particular position in the string.

The keys  and 

- increase or decrease the value of a parameter for numeric input .
- switch between editing line and help line editor for alphanumeric input.

Selection and Setting of Parameters via Keys or Softkeys

The selection of parameters and their settings is effected by means of a key, a softkey or in a table depending on the hierarchical level of the menu they are assigned to. Selection and setting of parameters in tables is described in section "Selection and Setting of Parameters in Tables".

Selection via key

Most keys of the network analyzer are used to enter menus where the selection and the settings are made. Few settings can be made directly by means of a keystroke, only.

Example: Call up of preset settings

- Press *PRESET* key

The spectrum analyzer is brought into a predefined initial state.



Selection via softkey

In most cases the selection is made by pressing the respective softkey. There are various alternatives of making the selection:

1. The softkey is active or inactive.

Example: Switching on/off the frequency counter

- Press *MKR* key.
- Press *SIGNAL COUNT* softkey.

Each time the softkey is pressed, the marker info list is switched on or off. If the softkey is active (= marker info list on), it is illuminated.

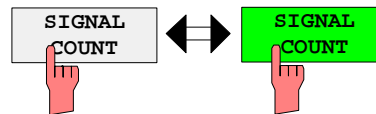

2. The softkey acts like a toggle switch, each pressing changes the active selection.

Example: Selection of the reference (internal or external)

- Press *SETUP* key.
- Press *GENERAL SETUP* softkey, the *GENERAL SETUP* submenu is opened.
- Press *REFERENCE INT/EXT* softkey.

With each pressing, the checkmark on the softkey changes from INT (internal reference) to EXT (external reference) and vice versa. When in the active setting the softkey menu item is illuminated.

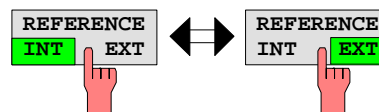

3. Various softkeys act like selection switches. Only one softkey may be active at a time.

Example: sweep setting

- Press *SWEEP* key.
- Press *CONTINUOUS SWEEP* softkey.

The continuous sweep is thus set. The *CONTINUOUS SWEEP* softkey is colored (factory-set: green). The second alternative, a series of *n* sweeps according to the trigger definition, can be selected via the *SINGLE SWEEP* softkey in the same menu. Only one of the two softkeys can be active at a time, the softkeys thus act like selection switches.

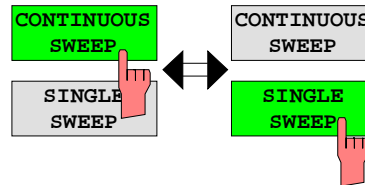

4. The softkey is used to select the parameter, the setting is made in an alphanumeric data entry window.

Example: SWEEP COUNT parameter

- Press *SWEEP* key
- Press *SWEEP COUNT* softkey.

The window for entering the number of sweeps for the *SINGLE SWEEP* mode is opened. The softkey is colored (factory-set: red). (Data entry is described in the next section).

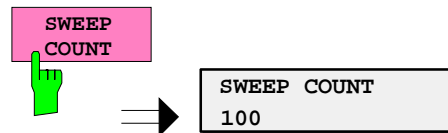

4. The softkey is used to select the parameter, the setting is made in an (alpha)numeric data entry window. The softkey function is switched on. To switch off the function, the softkey has to be pressed again.

Example: parameter MARKER

- Press *MRK* key.
- Press *MARKER 1* softkey.

The window for entering the marker frequency is opened. The softkey is colored (factory set: red). Marker 1 is switched on and the peak search is started.



- Press *MARKER 2* softkey.

The entry window for the marker frequency of marker 2 is opened. The softkey is colored (red), marker 2 is switched on, and the *MARKER 1* softkey turns green.

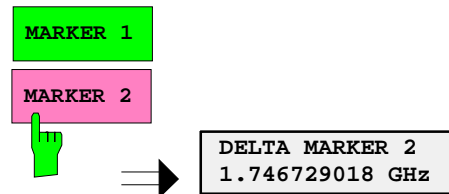

- Press *MARKER 1* softkey again.

Marker 1 is switched off.

5. The softkey selects the parameter, the setting is made in a selection table.

Example: Selection of the sorting criteria of a file list

- Press *FILE* key.
- Press *FILE MANAGER* softkey.
- Press *SORT MODE* softkey.

A selection table is displayed. The softkey is colored (factory-set: red). (operation see below).

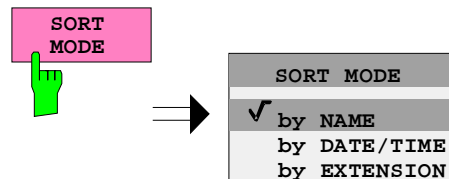

Editing of Numeric Parameters

The entry of numeric values is always made in a data entry window, which is displayed automatically after selection of the parameter.

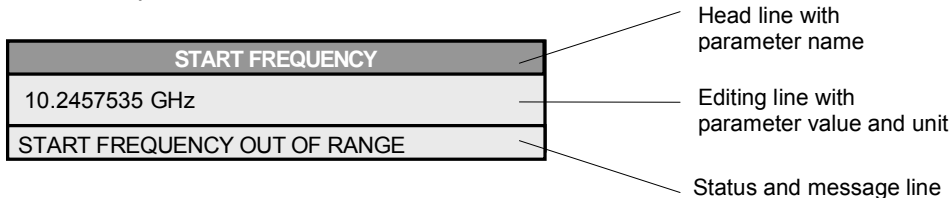

The headline indicates the name of the instrument parameter, which has been selected. The entry is made in the editing line. Subsequent to calling the entry window, the current parameter value including the unit is displayed left-justified in the editing line. Status and error messages which refer to the current entry are displayed in the third and (optionally) fourth line.

Note: Entry windows may be represented transparent (cf. DISPLAY - CONFIG DISPLAY menu)

Entry of a numeric value

- Call data entry window (cf. selection of parameters)
The editing line indicates the current value

Example: center frequency (frequency-sweep mode)

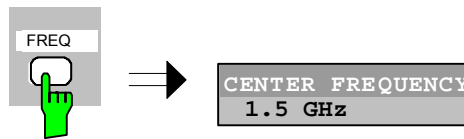

Entry via number keys

- Enter required value via number keys.

Example:

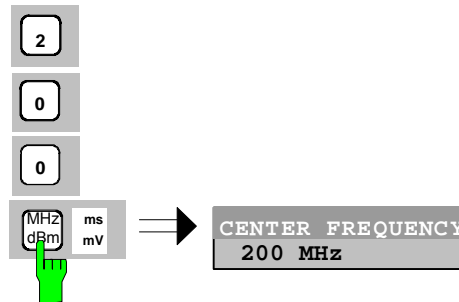

Entry via cursor keys

- Cursor  or  until obtaining the required value.

Example:

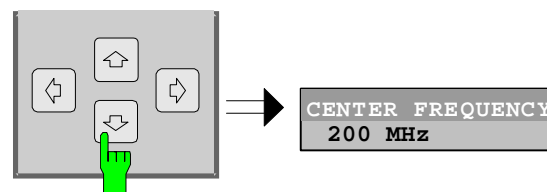

- Entry via spinwheel
- Rotate the spinwheel until reaching the required value.
The variation step size increases with increasing rotational speed.
 - Turning the spinwheel clockwise increases the value, turning it counterclockwise decreases the value.

Example:

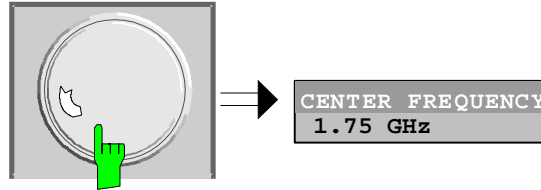

Note: When the value is modified by means of the spinwheel or the cursor keys the new value is immediately set.

Terminating the entry

- Press one of the unit keys
The unit is entered in the entry window and the new setting is accepted by the instrument.

For dimensionless quantities:

- Press the ENTER key or the spinwheel
The new setting is accepted by the instrument.

A few data entry windows close automatically whereas others like the entry window for the start frequency remain open even after termination of the entry. They can be closed by pressing the ESC key.

If an error occurs, a corresponding error message is displayed in the status line of the entry window, e.g., "Out of range", "Value adjusted", etc. In this case, the new value is not accepted for the instrument setting.

Example:

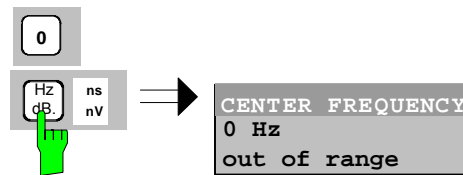

Correcting the entry

Deleting an entry

- Position the cursor beside the digit which is to be deleted using the cursor keys \leftarrow or \rightarrow .
- Press the BACK key. The entry left to the cursor is deleted.
- Enter new numbers. The number is inserted to the left of the cursor, the other numbers are shifted right.

Restoring the original value

- Press the *BACK* key

For numerous parameters, the data administration of the instrument stores the previously valid parameter value in addition to the current value. The *BACK* key can be used to toggle between these two values. This applies for terminated entries as long as the data entry window is displayed.

Aborting the entry

- Press *ESC* key

The original parameter value is restored. The new entry is deleted.

- Press *ESC* key again

The entry window is closed, the original value remains active.

or

- Press any key or any softkey (even the softkey which has opened the entry window).

The entry is aborted and the entry window is closed. The original value remains active.

Entry of Alphanumeric Parameter

A help-line editor or an external keyboard (optional) are provided for the entry of alphanumeric instrument parameters.

The spinwheel and the exponent key have no function with alphanumeric entry. All unit keys assume the function of an ENTER key.

The entry is always made in a data entry window which is displayed automatically upon selection of the parameter. The editing line comprises 60 characters. Up to 256 characters may be entered. If a text exceeds 60 characters the contents is shifted automatically 20 characters left or right when the left or right margin of the editing line is touched by the cursor.

Editing with External Keyboard

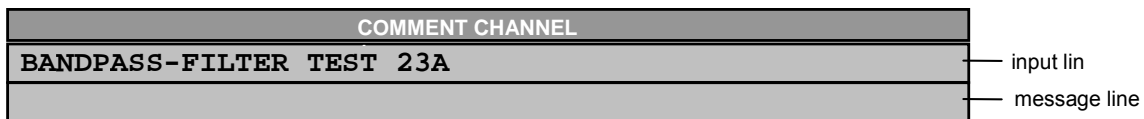

Entry of text

- Select parameter.
The data entry is active automatically upon calling the data entry window. The cursor is positioned at the beginning of the previous entry.
- Press the required character on the keyboard.
The character is inserted prior to the cursor.
- Enter further characters

Correcting the entry

- Delete the entry using the *DELETE* key or *BACKSPACE* key.

Terminating the entry

- Press the *ENTER* key of the external keyboard
The data entry window is closed and the new value is accepted for the instrument.

Aborting the entry

- Press the **ESC** key on the front panel
- or
- any softkey.
- The data entry window is closed, the original value is retained.

Editing with Help Line Editor

If the external keyboard is not fitted, the help line editor is called automatically with entry of alphanumeric parameters. The help line editor is an extension of the alphanumeric entry window. It contains the complete alphabet with uppercase and lowercase letters as well as special characters in two lines of 52 characters, each. Individual letters and a series of special characters can be selected in the help line editor and copied into the entry line.

The help line editor comes in two versions:

Version 1:

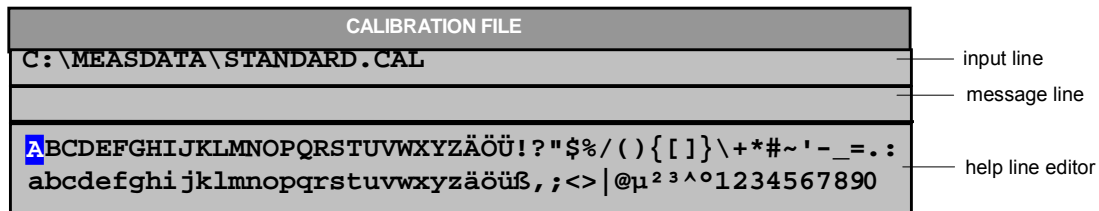

The cursor keys or toggle between entry in the editing line and selection in the help line editor.

Entry of text

- Select parameter.
The data entry is active automatically upon calling the data entry window. The cursor is positioned on the left in the editing line.
- Position the cursor in the help line editor using the cursor key.
The cursor marks the first letter of the editor.
- Locate the cursor on the character which is to be entered into the editing line using the cursor keys or or the spinwheel.
- Press the *ENTER* key or the spinwheel
The character is entered in the editing line.

Correcting the entry

- Locate the cursor in the editing line using the cursor key .
- Position the cursor after the character which is to be deleted using the cursor keys and .
- Press the *BACK* key.
The entry left to the cursor is deleted.

Terminating the entry

- Locate the cursor in the editing line using the cursor key .
- Press any unit key or the spinwheel.
The data entry window is closed, the new entry is accepted by the instrument.

Aborting the entry



- Press the *ESC* key.
The data entry window is closed, the previous entry is retained.

Version 2:





													1	2	3	4	5	6	7	8	9	0
A	B	C	D	E	F	G	H	I	J	K	L	M	:	\	.	/	^	+	-	=	,	
H	O	P	Q	R	S	T	U	V	W	X	Y	Z	<	>	()	{	}	[]	#	~
a	b	c	d	e	f	g	h	i	j	k	l	m	'	@	;		?	!	"	€	\$	%
n	o	p	q	r	s	t	u	v	w	x	y	z	«	»	BACK	EXIT						
SPACE																						

The entry area consists of two parts:

- the editing line
- the character selection field

The cursor keys  or  are used to toggle between entry in the editing line and the character selection field .



Entry of text

- Select parameter.
The data entry is active automatically upon calling the data entry window. In tables, the help line editor is accessed by the cursor key  .
In the editing line, the cursor is positioned at the beginning of the current entry.
- Position the cursor to the character selection field using the cursor key  .
The cursor highlights the first letter of the editor.
- Position the cursor to the character to be entered in the editing line by means of the cursor keys  or  or the spinwheel.
- Press the *ENTER* key or the spinwheel.
The character will be entered in the editing line.

Correcting the entry (Version 1)

- Move to the character << in the character selection field using the spinwheel.
- Position the cursor behind the character to be deleted by moving and pressing the spinwheel on << and >>.
- Move to the *BACK* field using the spinwheel and press the spinwheel.
The entry to the left of the cursor in the editing line will be deleted.

**Correcting the entry
(Version 2)**

- Position the cursor to the editing line by means of the cursor key  .
- Position the cursor after the character to be deleted by means of the cursor keys  and  or with the spinwheel.
- Press the *BACK* key.
The entry to the left of the cursor will be deleted.

**Terminating the entry
(Version 1)**

- Select the EXIT field using the spinwheel and press the spinwheel.
The data entry window will be closed; the new entry will be accepted by the instrument.

**Terminating the entry
(Version 2)**

- Move the cursor to the editing line using the cursor key  .
- Press one of the unit keys or the spinwheel.
The data entry window will be closed; the new entry will be accepted by the instrument.

Interrupting the entry

- Press the *ESC* key.
The data entry window will be closed; the previous entry will be retained.

Selection and Setting of Parameters via Tables

The spectrum analyzer uses numerous tables for display and configuration of instrument parameters.

The tables differ considerably in the number of lines, columns and inscriptions. The basic steps of operation for the selection and setting of parameters are, however, the same for all tables. Shown below is the typical entry of parameters into a table.

Note:

Most of the tables are coupled to a softkey menu which provides further functions for editing table entries such as deletion of tables, copying of lines or columns, marking of table elements, restoring default states.

The definition of individual tables and the operation of particular editing functions can be looked up in the description of the corresponding softkey menu.

1. Activating the table

- If the menu has only one table, the latter is activated automatically subsequent to calling this menu in most cases and the marking cursor is positioned to the top field of the left column.
- If the menu contains various tables, the table of interest must be selected using the softkey which is labeled with the title of the table.

2. Selection of the parameter

LIMIT LINES				
NAME	COMPATIBLE	LIMIT CHECK	TRACE	MARGIN
GSM22UP	✓	off	1	0 dB
✓ LP1GHz		on	2	0 dB
✓ LP1GHz	✓	off	1	0 dB
MIL461A		off	2	-10 dB

marking cursor
↓

Selection of the parameter (or the setting) is made using the marking cursor.

- Press the cursor keys to move to the wanted field.

or

- Rotate the spinwheel until the wanted field is marked. The cursor keys are used to specify the direction of the spinwheel movement (horizontal or vertical)

When shifting the cursor, elements may be skipped which can not be edited. Table elements, which can not be selected are indicated by a different color.

- Press the *ENTER* key or the spinwheel.
The parameter/the setting has been selected.

The selected parameter can be edited the way described below:

3. Editing the marked parameter

LIMIT LINES				
NAME	COMPATIBLE	LIMIT CHECK	TRACE	MARGIN
GSM22UP	✓	off	1	0 dB
✓ LP1GHz		on	2	0 dB
✓ LP1GHz	✓	off	1	0 dB
▲ MIL461A		off	2	-10 dB

checkmark

↑

TRACE

1
✓ 2
3

MARGIN

-10 dB

a) Toggling between two states

If an element of a table can be switched on and off only, the unit keys are used to toggle between these two states.

- Press one of the unit keys.
The table element is switched on and provided with a checkmark. (✓).
- Press one of the unit keys once more.
The table element is switched off.

or

- Press one of the unit keys.
The table element is switched on, "on" is displayed.
- Press one of the unit keys once more.
The table element is switched off, "off" is displayed

b) Opening a data entry window

If a table entry consists of an (alpha-) numeric value, the corresponding entry window will be opened after selecting the numeric value by pressing the *ENTER* key or the spinwheel.

Note 1: For numeric instrument parameters, the editing operation may be started by entering any number or letter on the front panel or on the external keyboard. In this case, the data entry window is opened automatically.

Note 2: For alphanumeric table fields for which the help line editor version 2 is required, the help line editor will be opened by pressing the *CURSOR DOWN* key after *ENTER*.

c) Opening a selection table

If a table entry may have various states (e.g., colors from a color pallet, fixed filter bandwidths, etc.), a table indicating all possible states is displayed with selection. The current state is and marked by a checkmark and by the cursor.

- Set the cursor to the desired setting.
- Press one of the unit keys.
The setting is switched on and marked (✓). The selection table closes and the value is transferred to the original table. The cursor is positioned automatically on the next table element.

Abortion of entry

- Press the *ESC* key.

The current entry/selection is aborted and the original setting is restored.

Scrolling

Some tables contain more entries than can be displayed on one screen page. In this case, a **scrollbar** is displayed at the right margin of the table, whose slider shows the current position in the text.

- Actuate the *PAGE UP* or *PAGE DOWN* softkeys.

The table is paged forward or back by one page.

- Press cursor key  or .

The table is scrolled up or down by one line.

Menu Overview Receiver Mode

The following sections gives a graphical overview of the R&S FSMR menus. Side menus are marked by an arrow directed to the left/right, submenus by an arrow showing upwards.

The menus appear in the order corresponding to the arrangement of keys on the front panel. The available hotkeys and the LOCAL menu appearing during the remote control of the instrument are also displayed.

The functions of menus are described in detail in Chapter 4. The IEC/IEEE-bus command associated with each softkey is indicated. In addition, the softkey list at the of Chapter 6 gives the assignment of IEC/IEEE-bus commands to softkeys.

FREQ Key

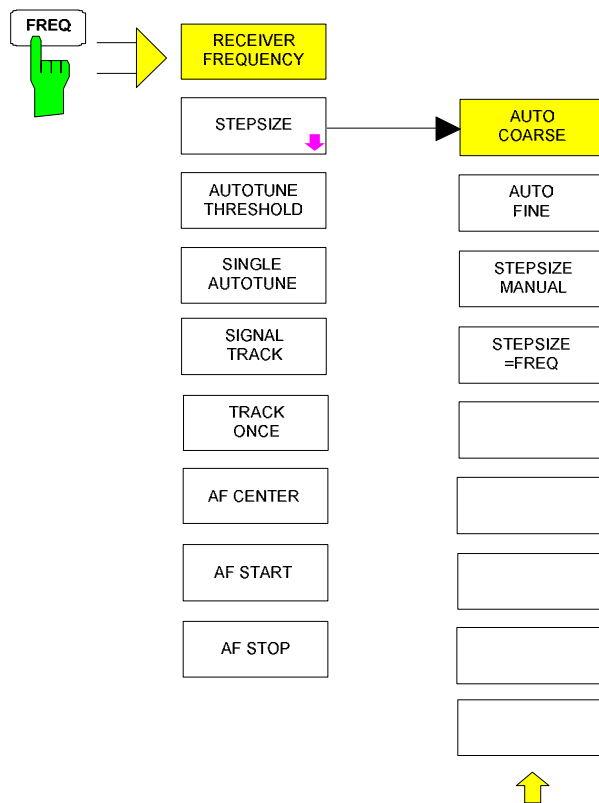

SPAN Key

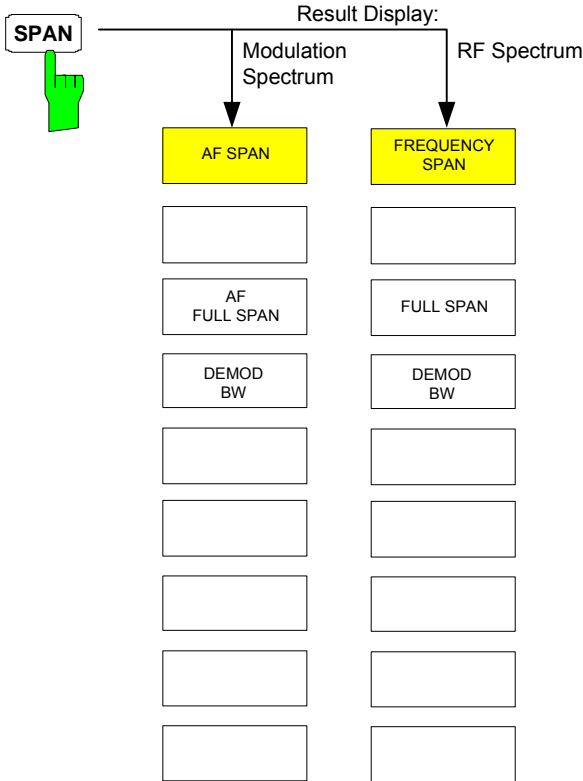

AMPT Key

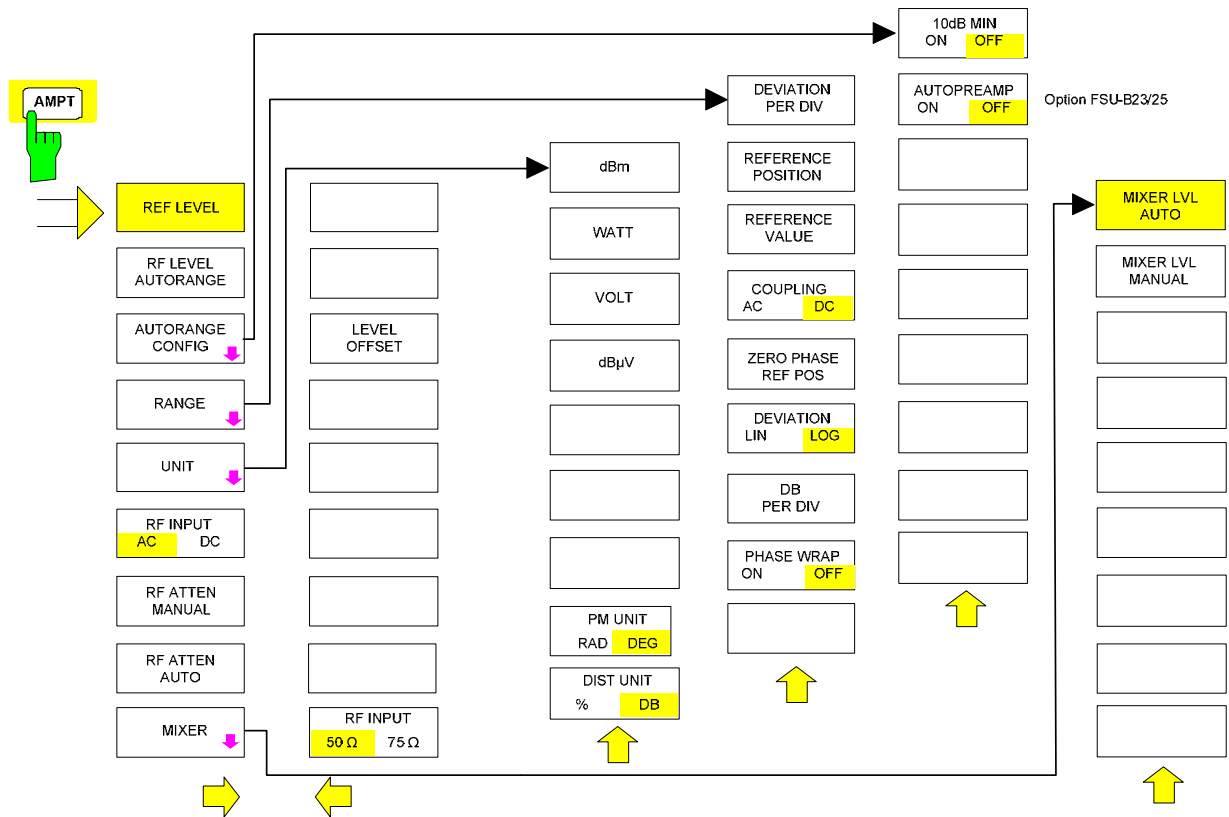

BW Key

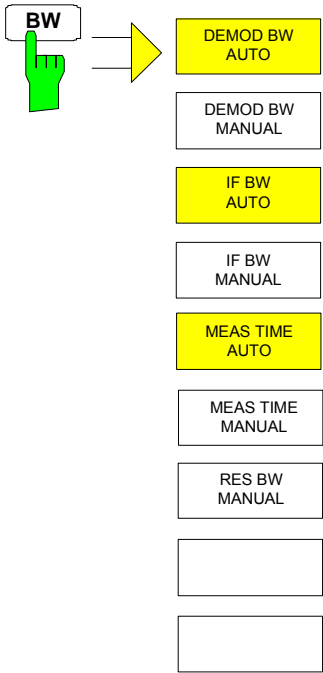

SWEEP/MEAS Keys

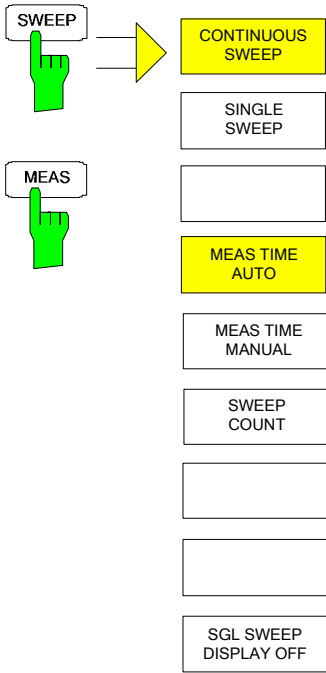

PWR METER Key

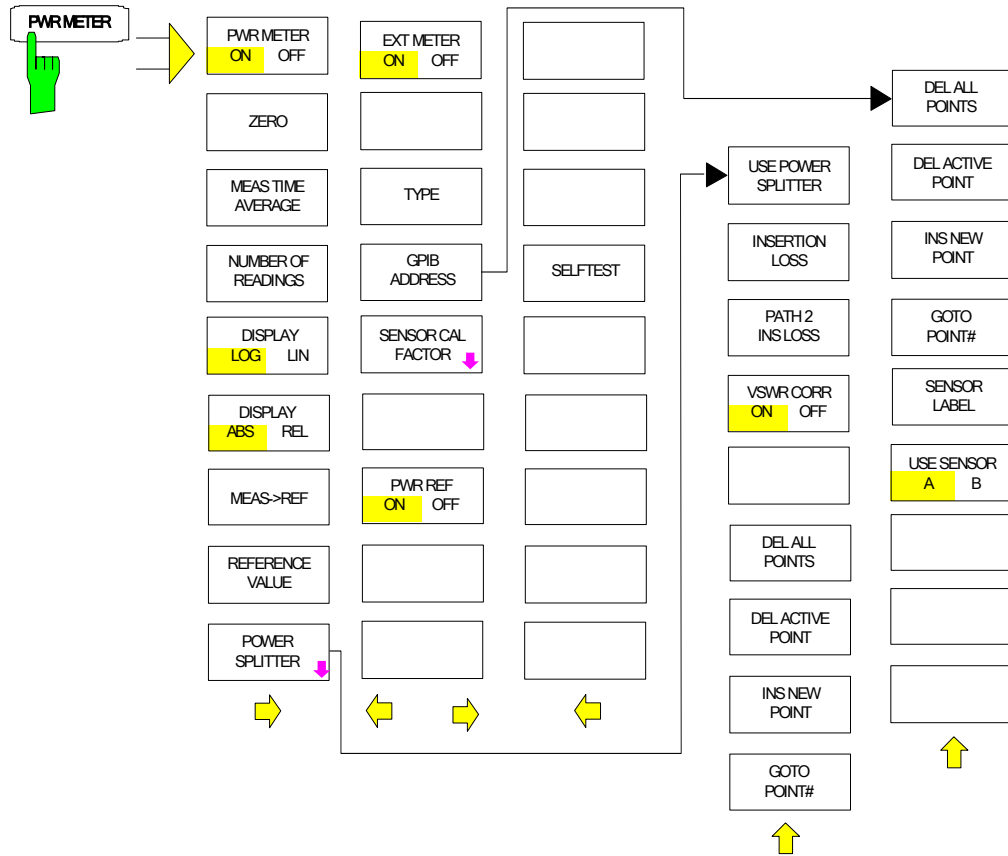

DEMOD Key

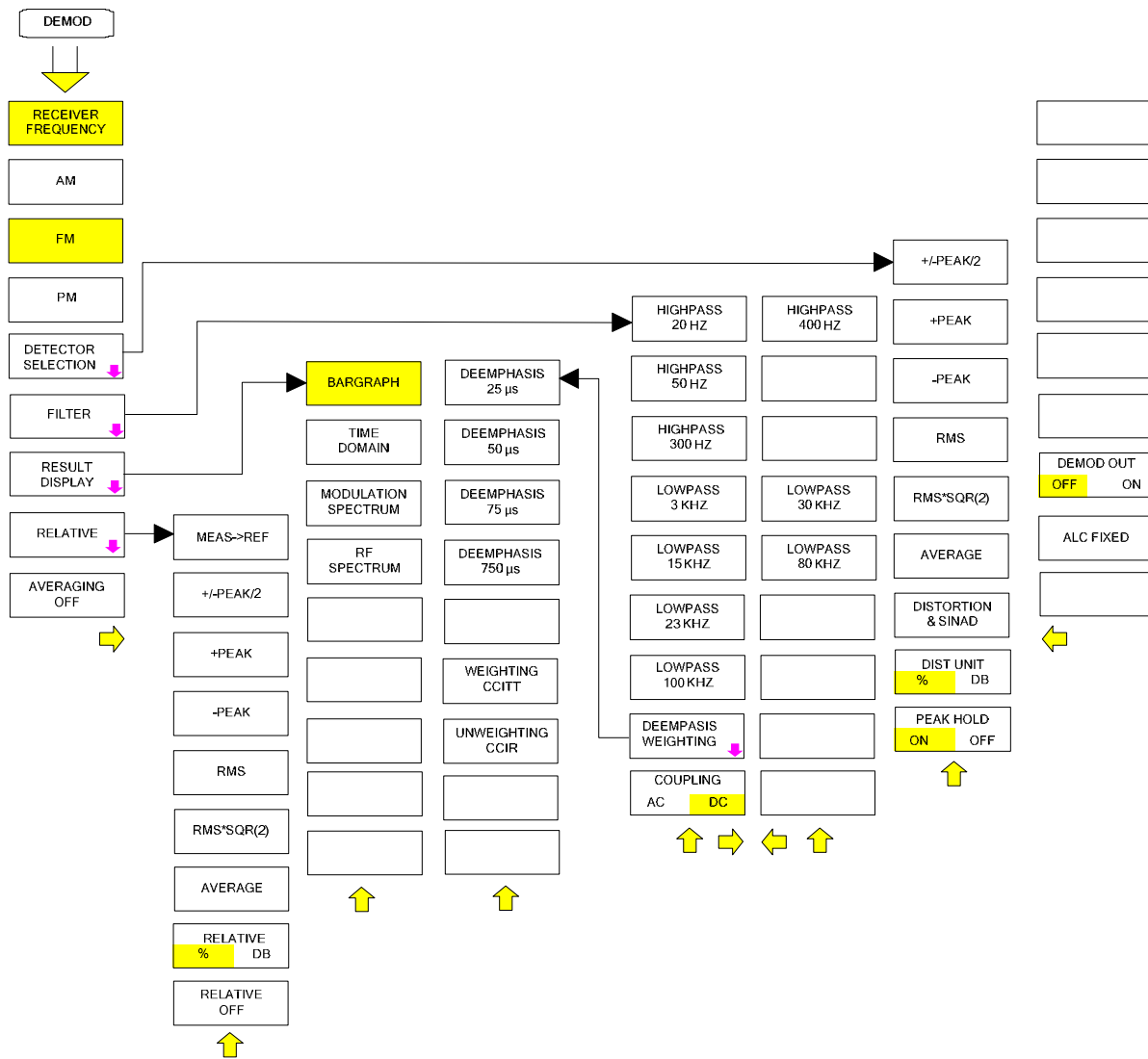

AUDIO Key

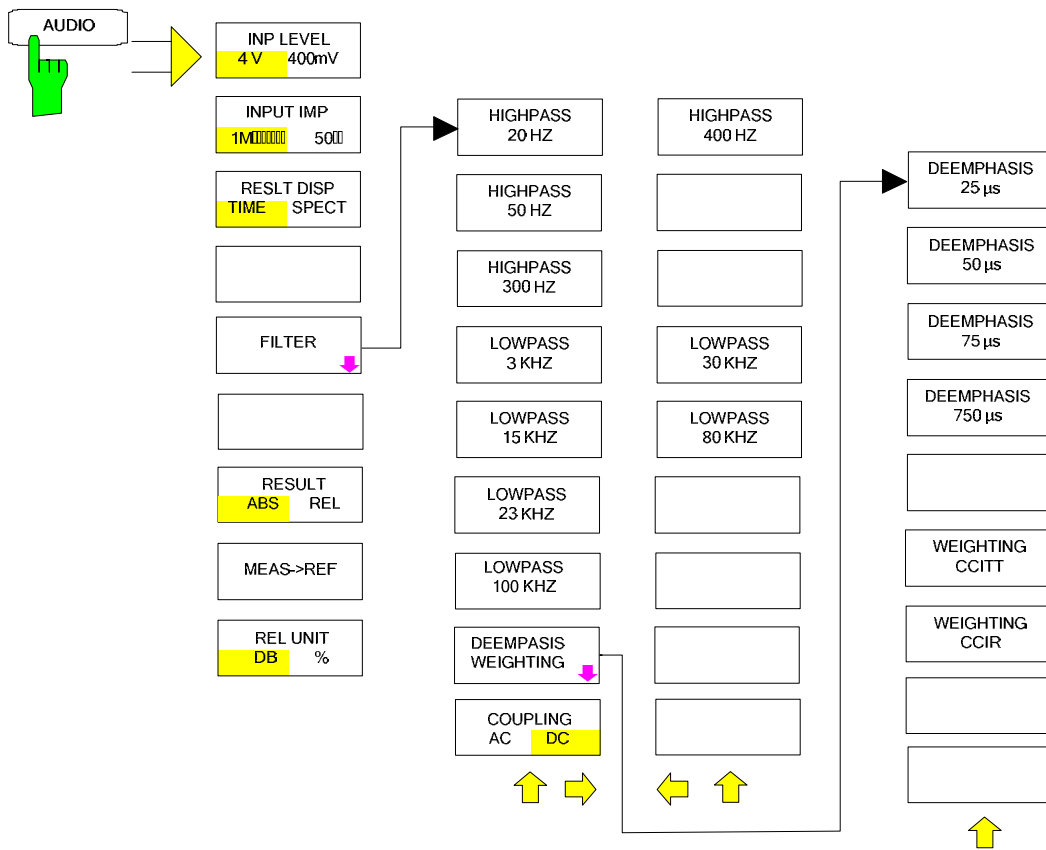

Menu Overview Spectrum Analysis Mode

FREQUENCY Key

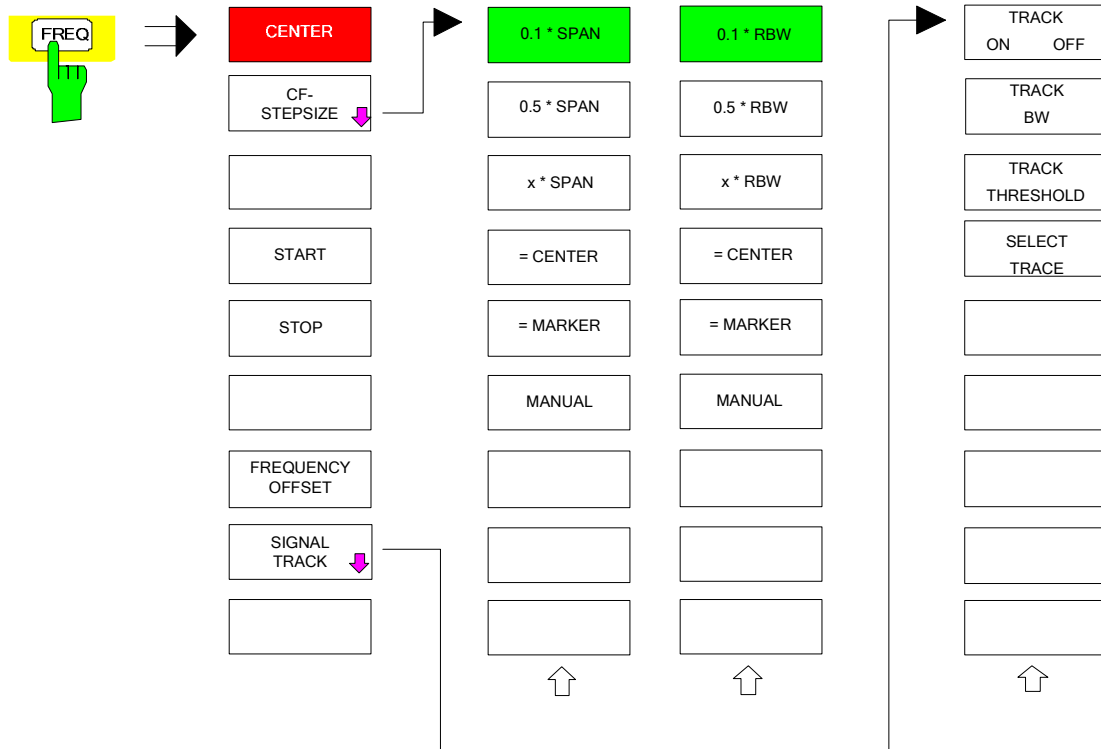

SPAN Key

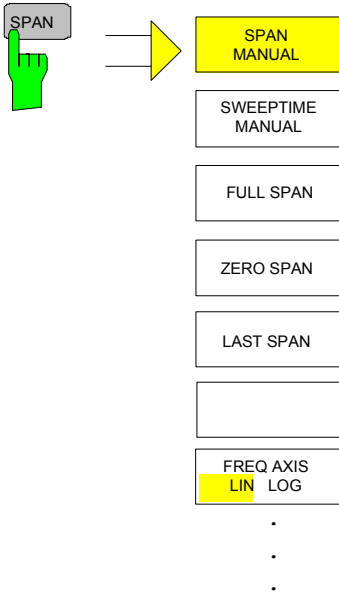

AMPT Key

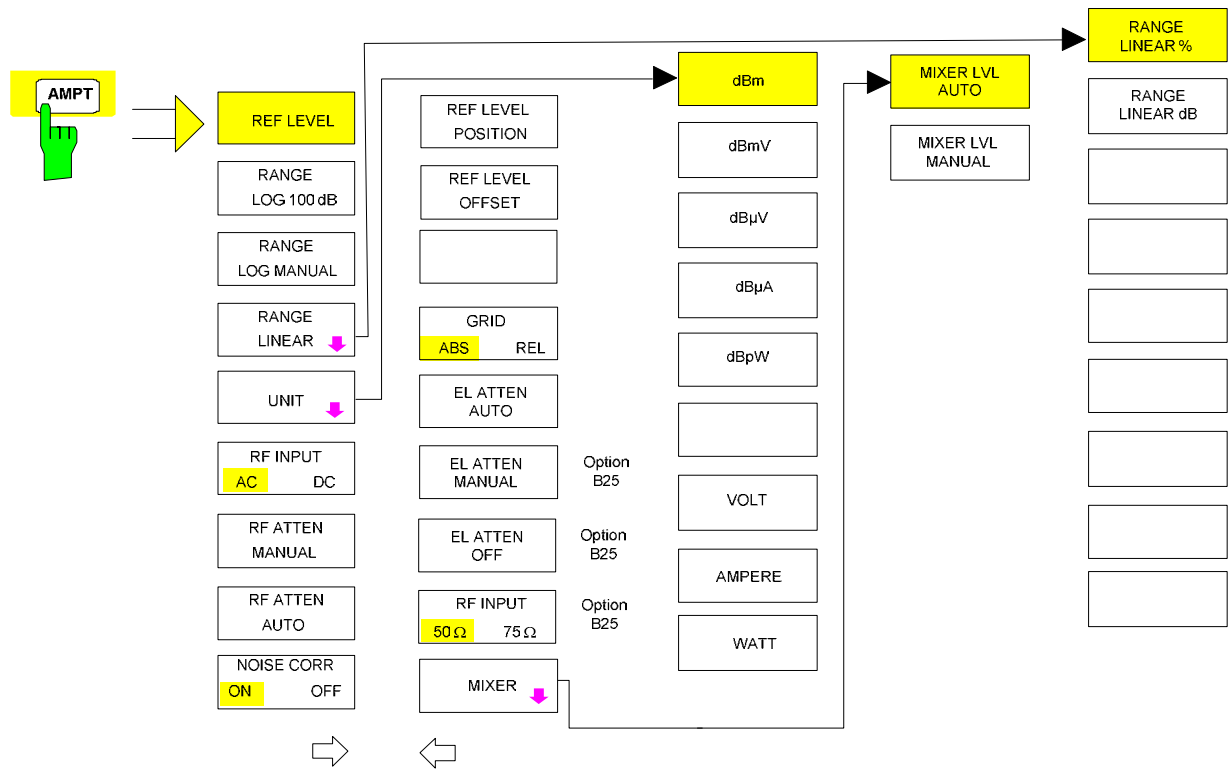

MEAS Key

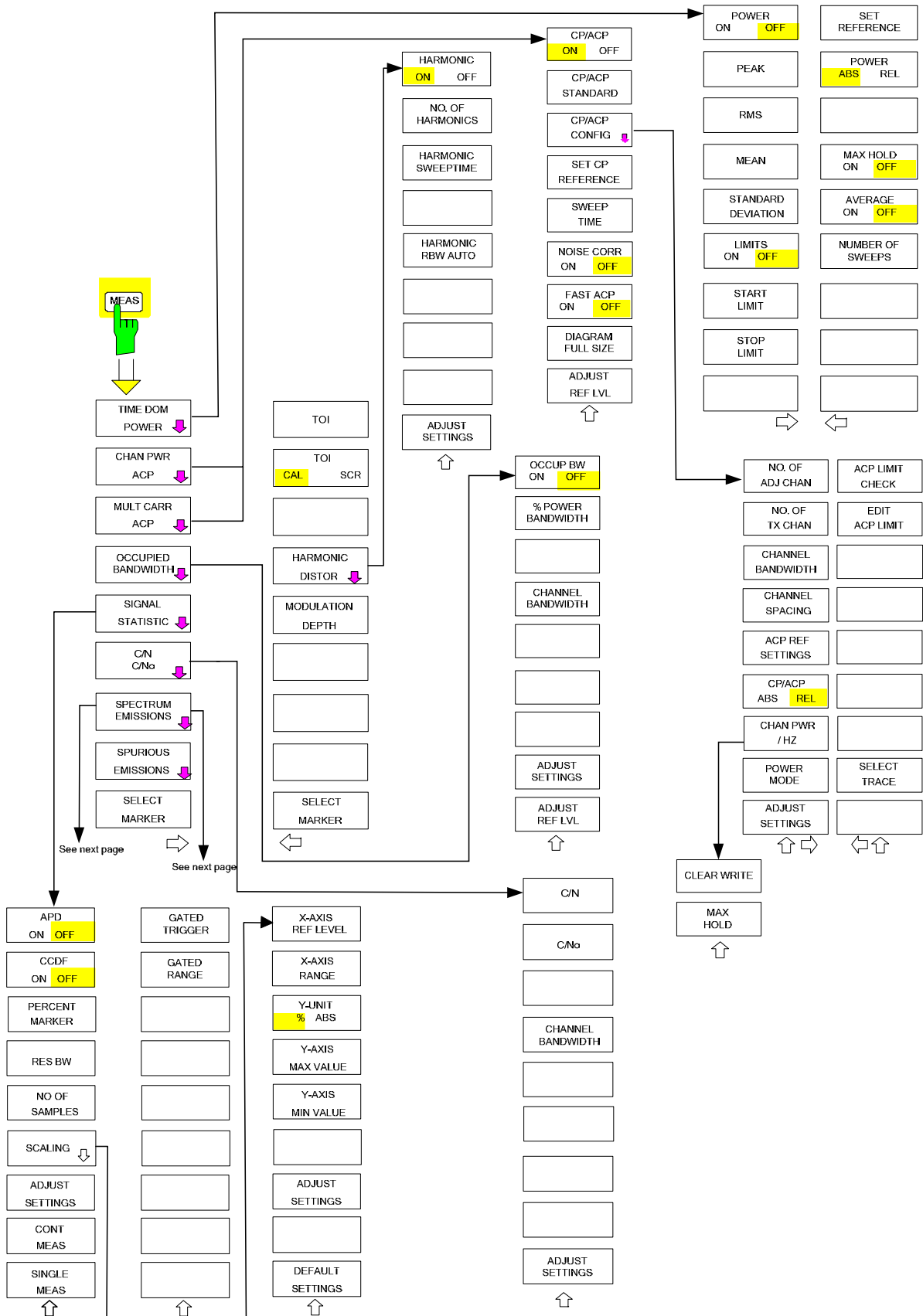

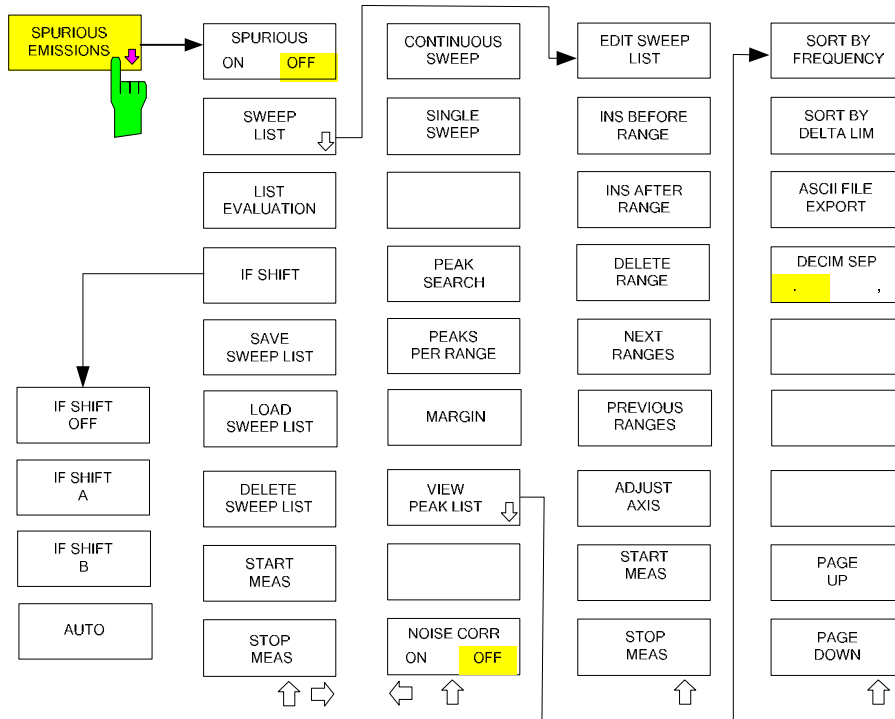
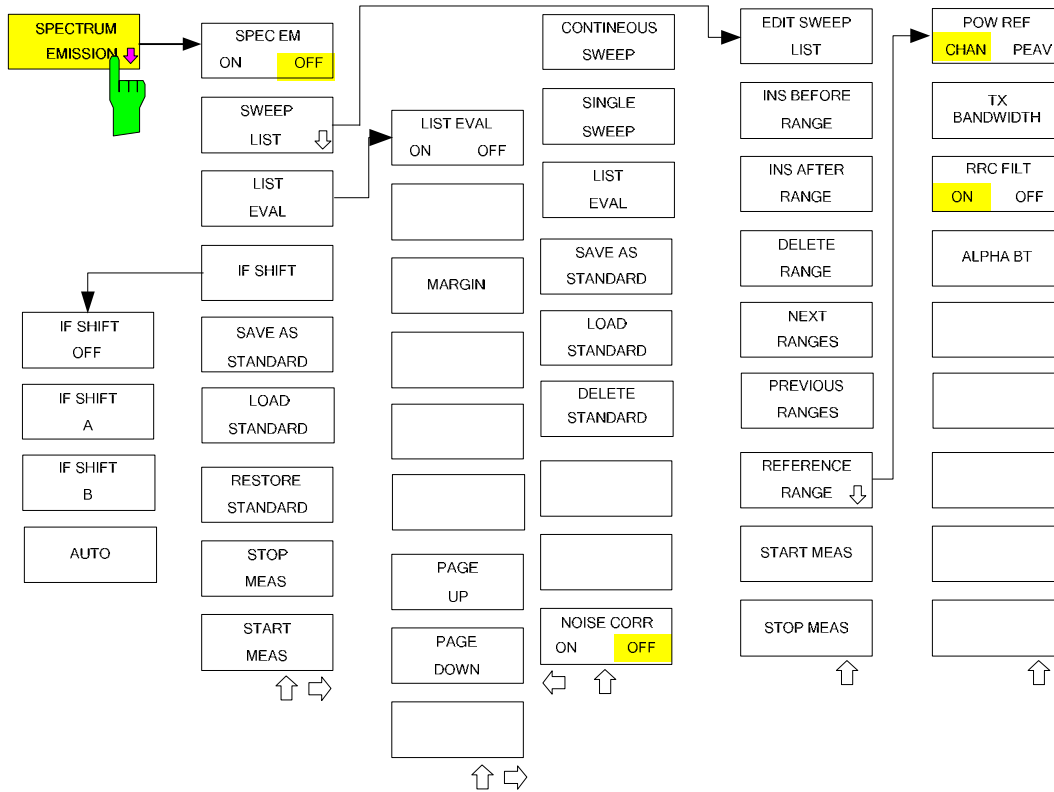

BW Key

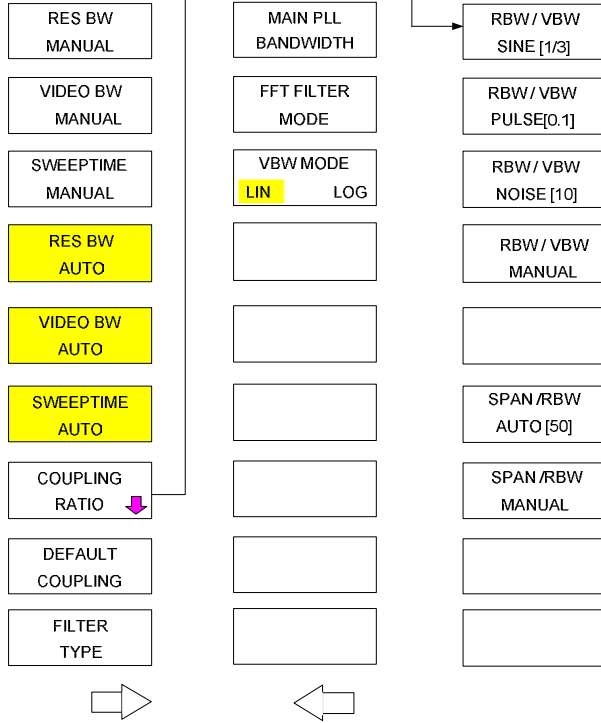
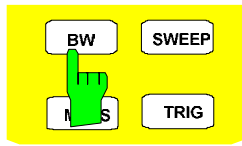

SWEEP Key

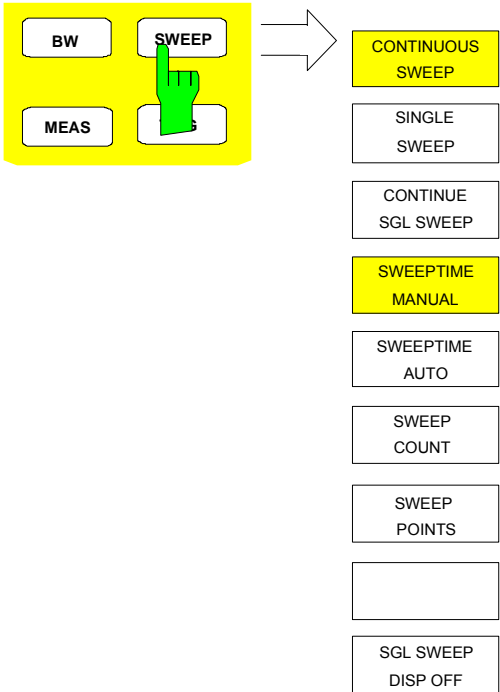

Menu Overview another Keys

MKR Key

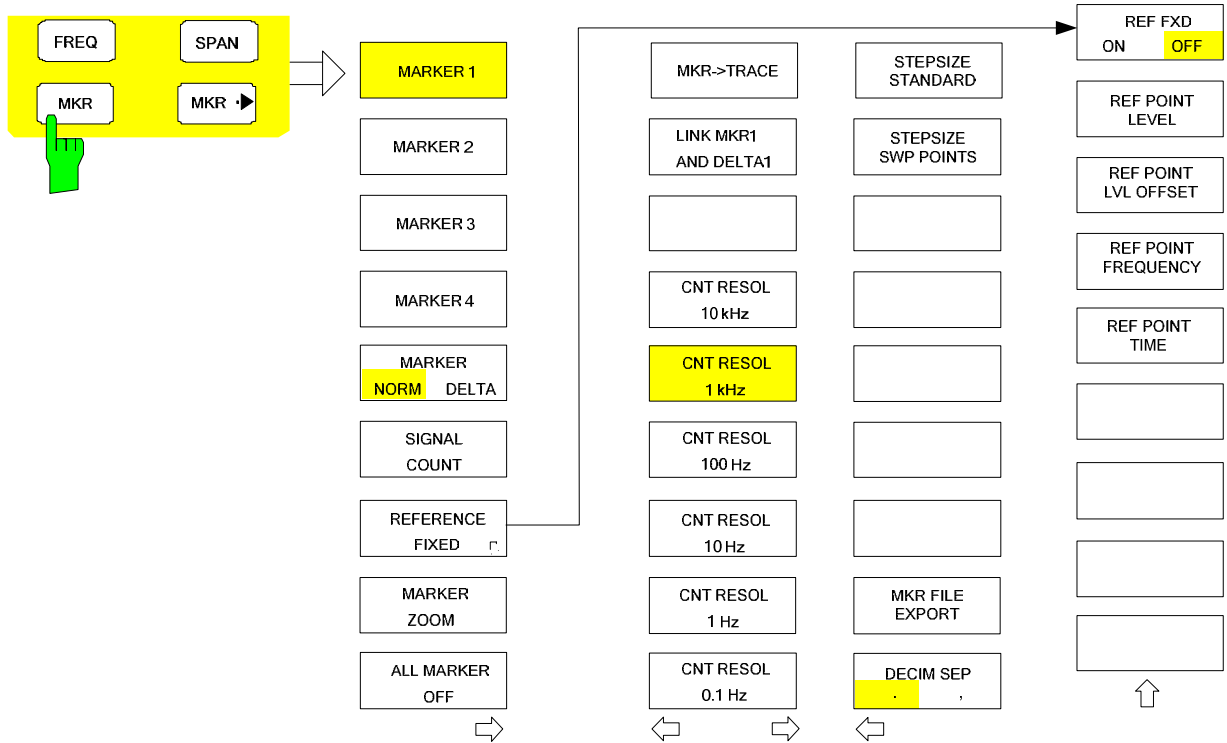

MKR-> Key

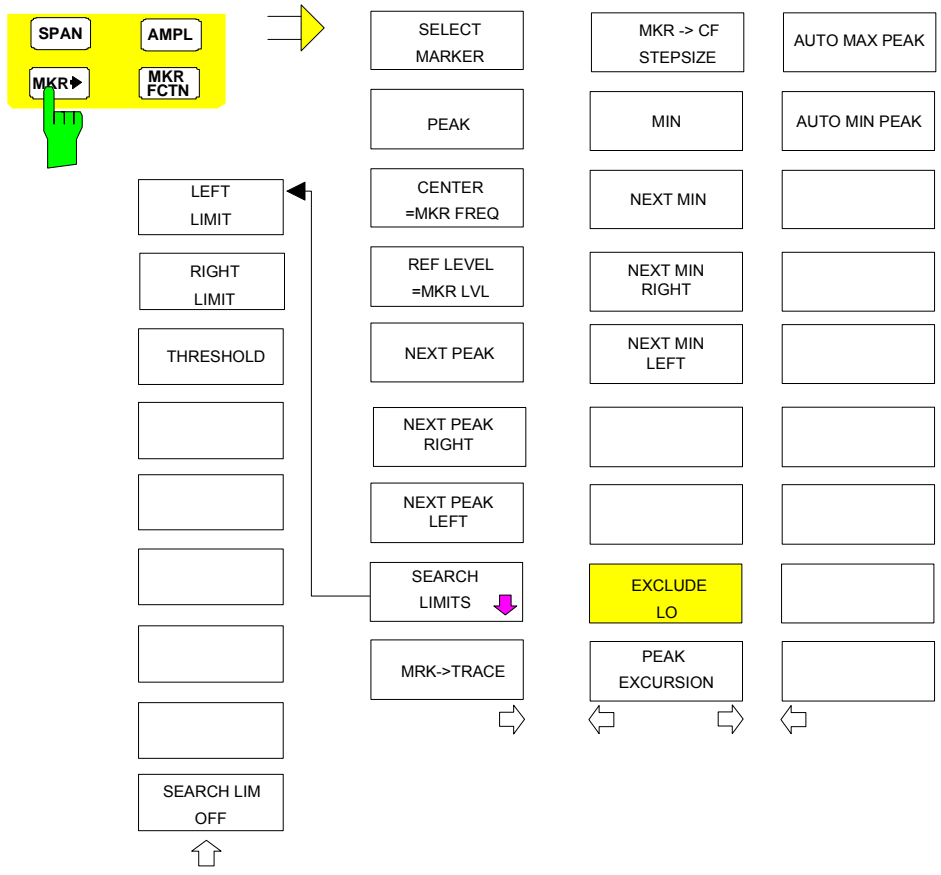

MKR FCTN Key

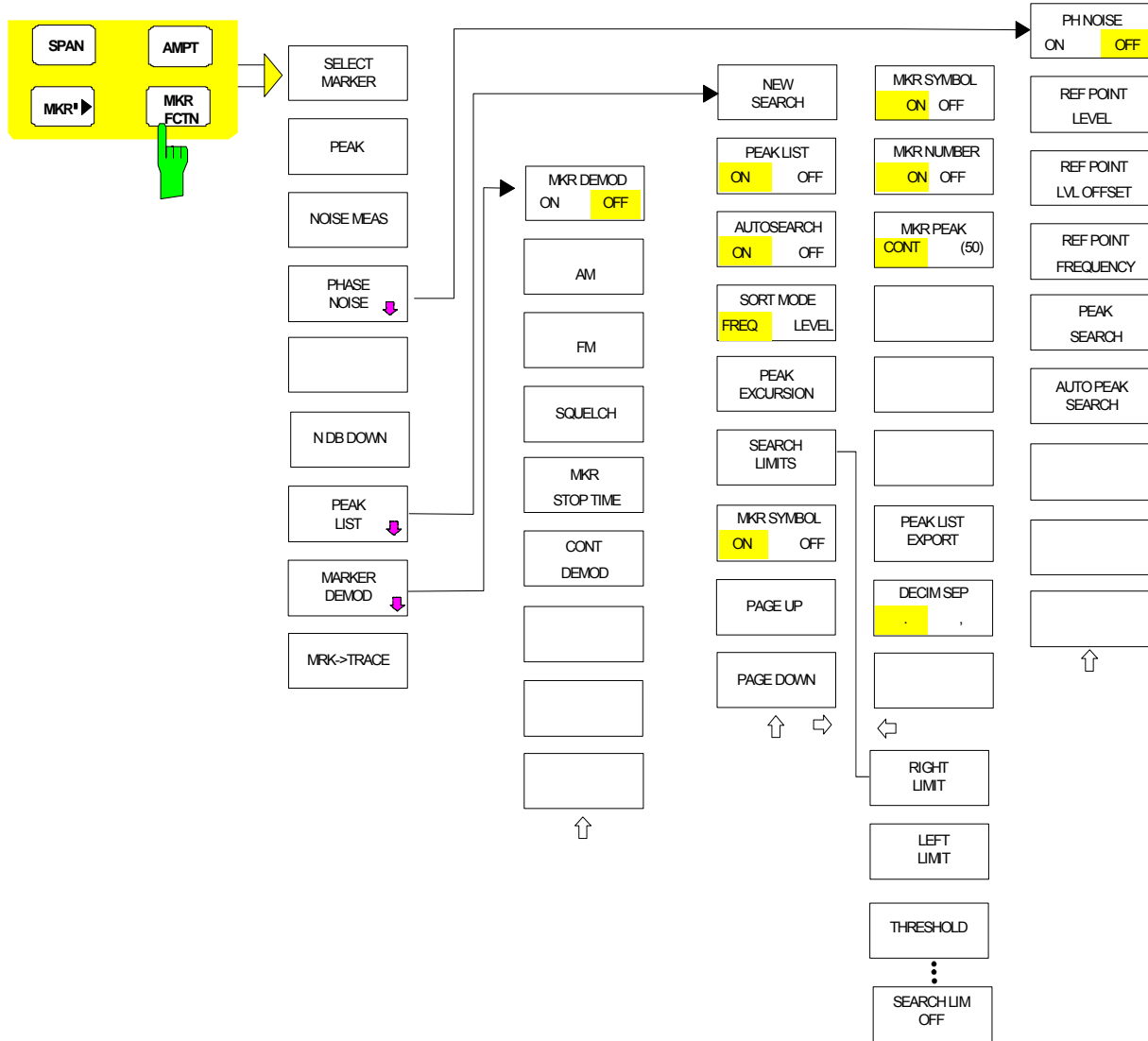

TRIG Key

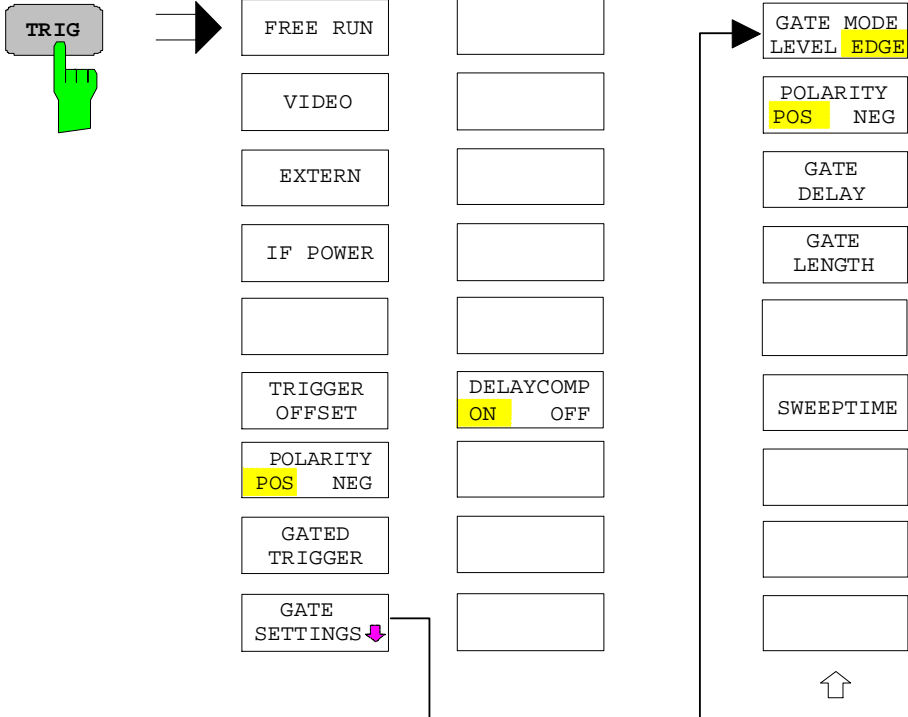

TRACE Key

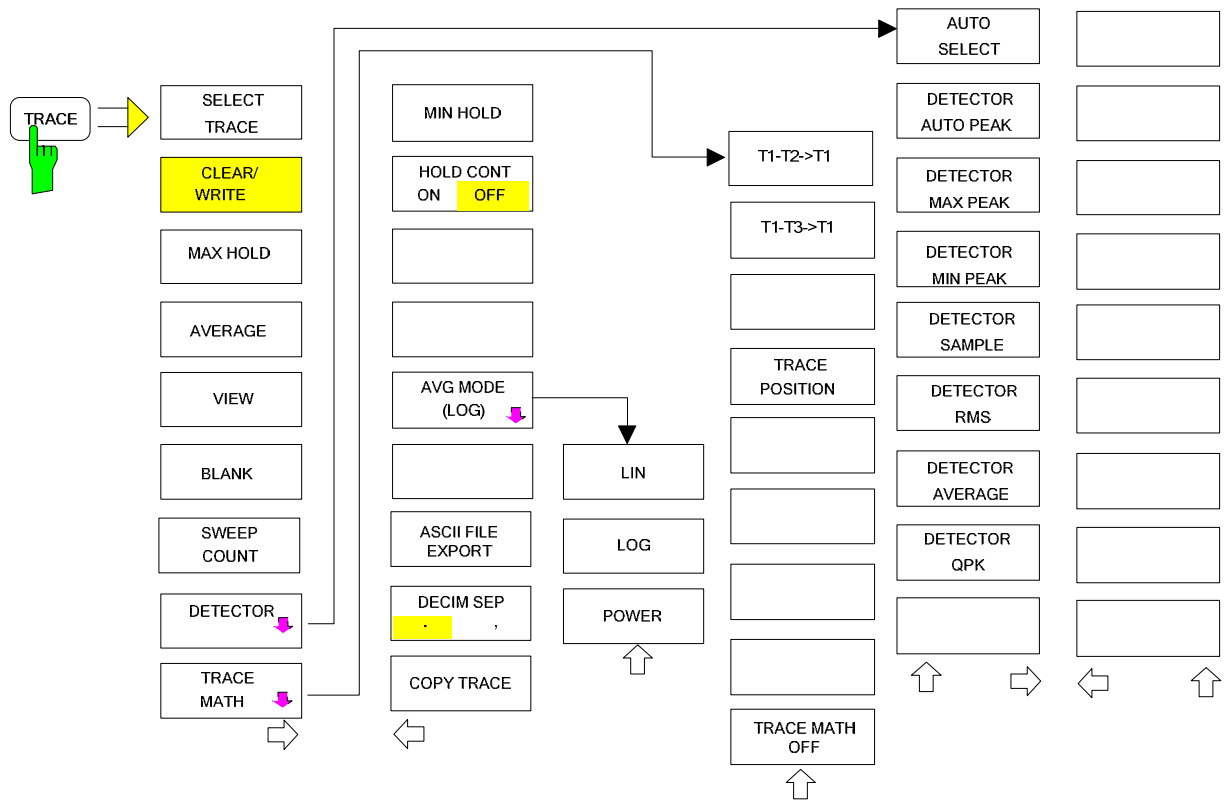

LINES Key

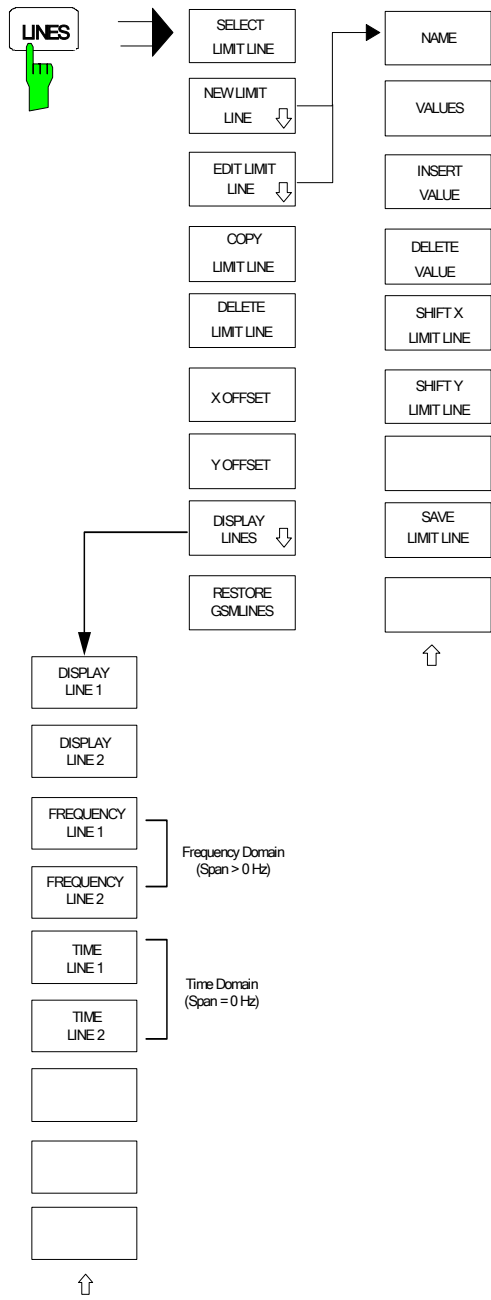

DISP Key

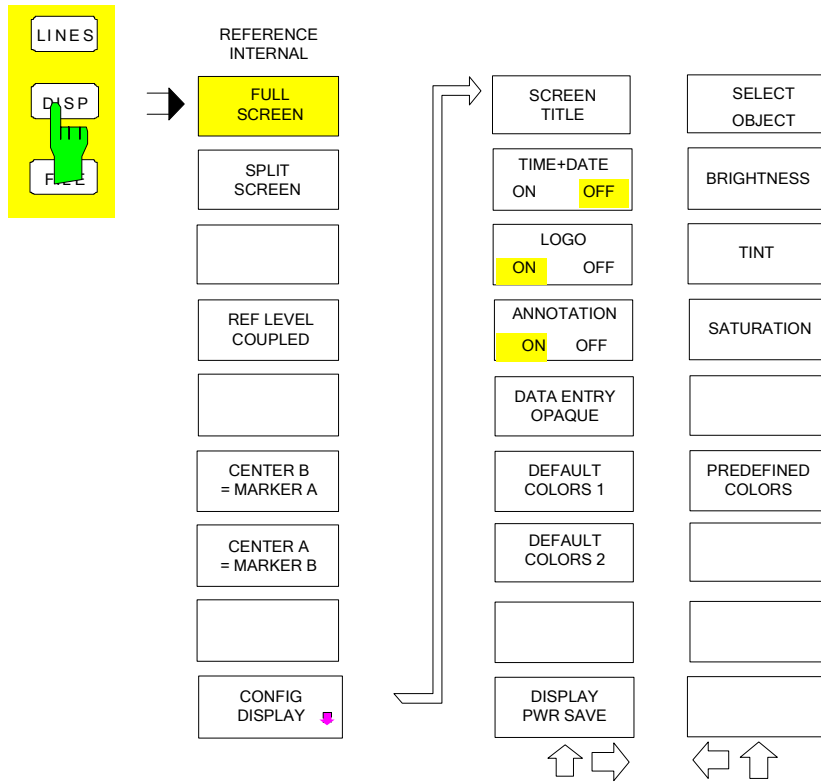

CAL Key

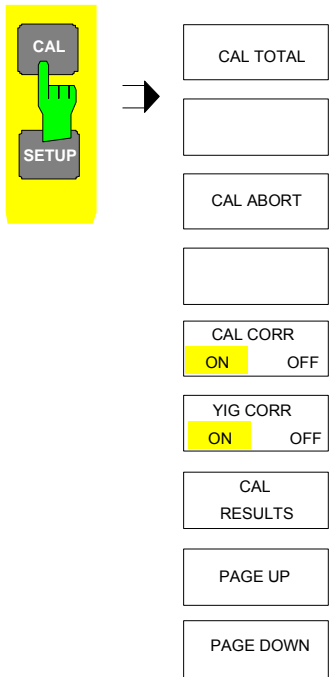

SETUP Key

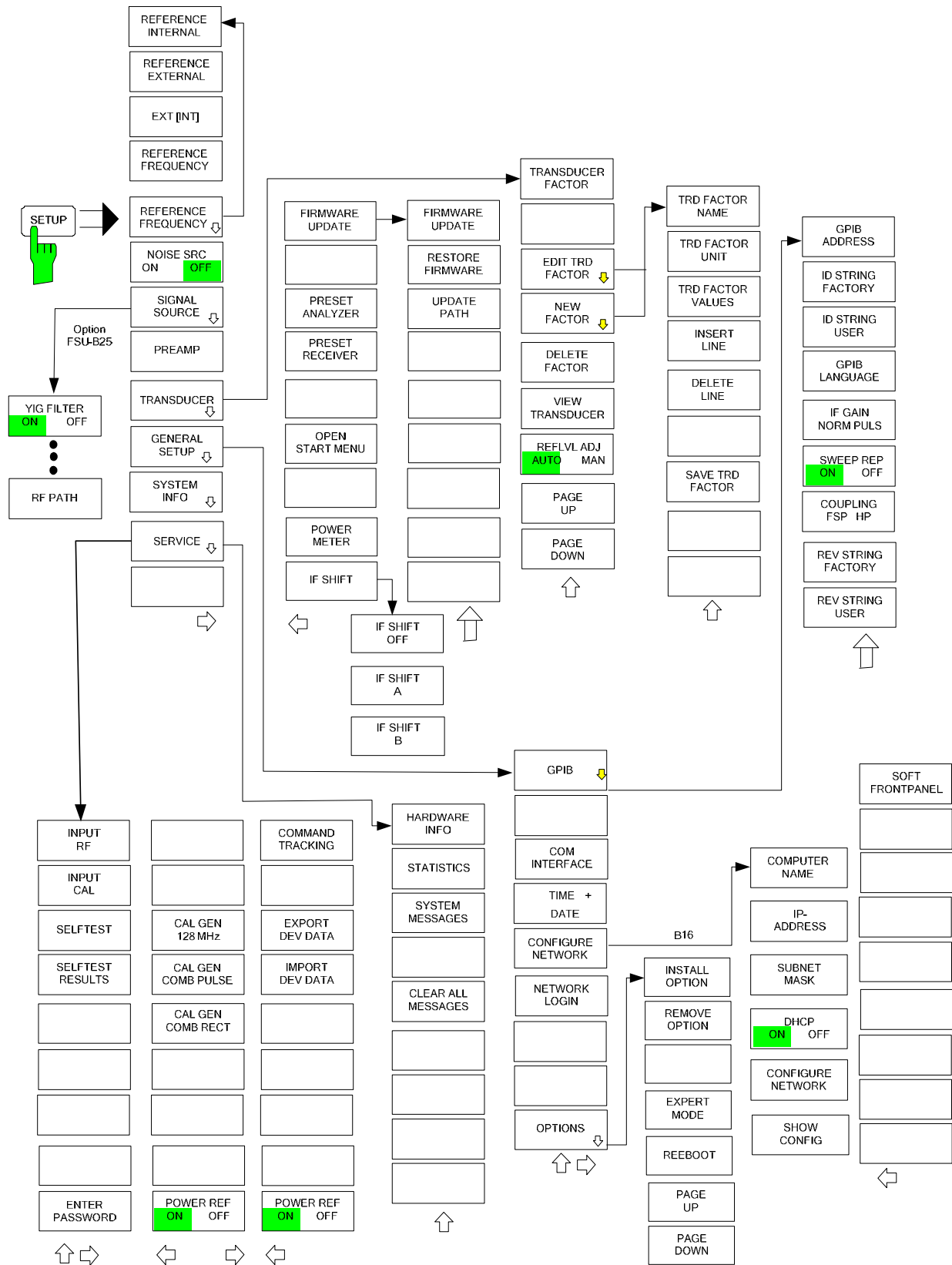

HCOPY Key

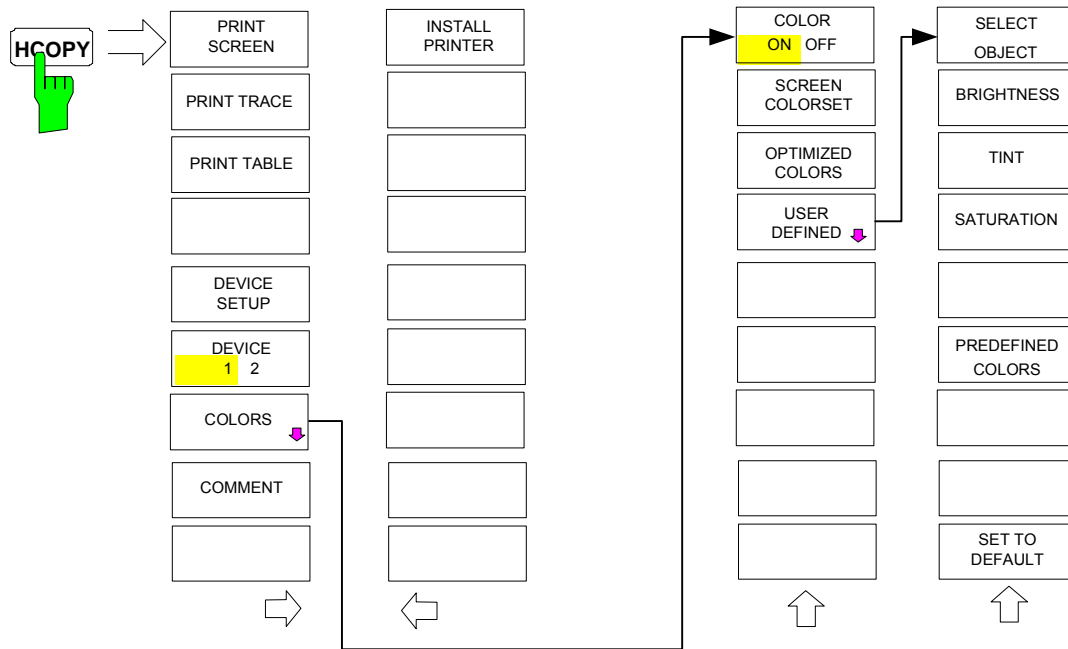

LOCAL Menu

-
-
-
-
-
-
-
-
-
-

Menu Overview Ext. Generator Control

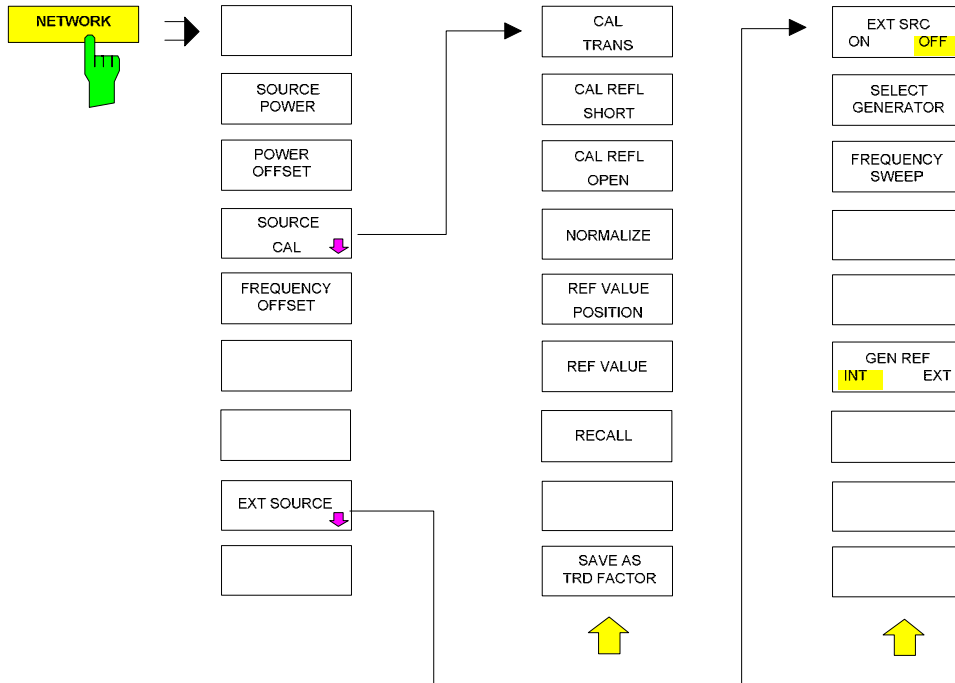

Menu Overview Option Network Mode

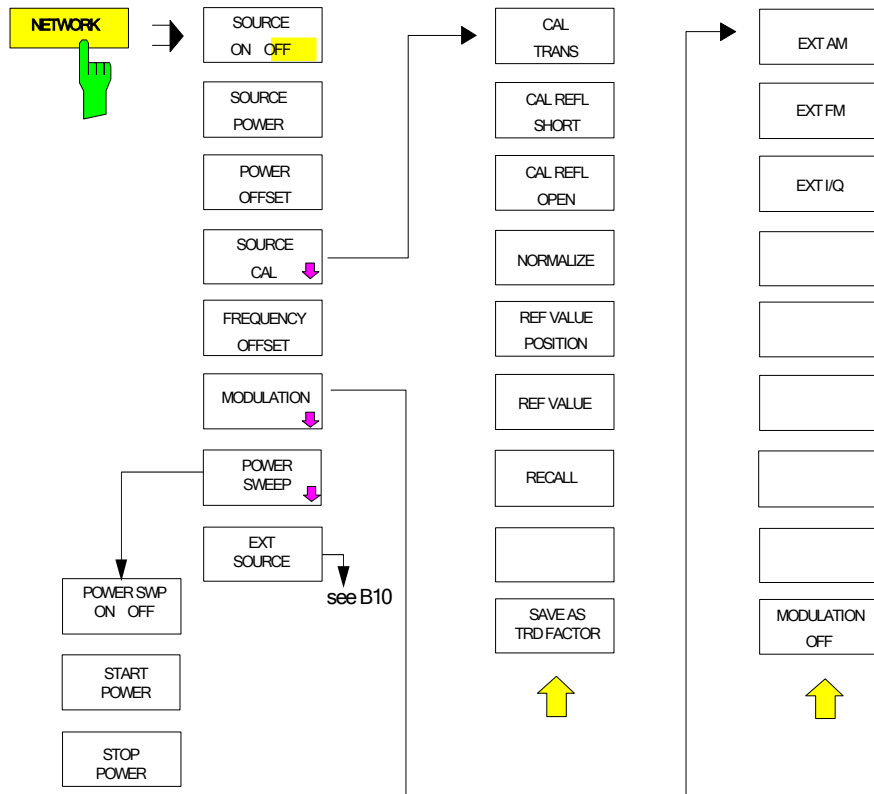

Contents - Chapter 4 "Instrument Functions"

4 Instrument Functions.....	4.1
R&S FSMR Initial Configuration – PRESET Key.....	4.1-1
Selecting the Operating Mode – HOTKEY Bar.....	4.2-1
Return to manual control – LOCAL Menu.....	4.3-1
Measurement Receiver Mode.....	4.4-1
Selective Level Measurement – RF LEVEL Key	4.4-3
Level Measurement with the Power Sensor - PWR METER Key	4.4-18
Modulation Measurements - DEMOD Key	4.4-29
Measurements on the Audio Input – AUDIO Key.....	4.4-47
Setting the Receiver Frequency and the Span - FREQ Key.....	4.4-56
Setting the Level Display and Configuring the RF Input – AMPT Key.....	4.4-61
Setting the Bandwidths and the Measurement Time - BW Key	4.4-68
Setting the Sweep - SWEEP/MEAS Keys	4.4-72
Setting the Span - SPAN Key.....	4.4-76
Spectrum Analyzer Mode.....	4.5.1
Frequency and Span Selection – FREQ Key	4.5.1
Setting the Frequency Span – SPAN Key.....	4.6-1
Level Display Setting and RF Input Configuration – AMPT Key.....	4.7-1
Electronic Attenuator	4.7-4
Setting the Bandwidths and Sweep Time – BW Key	4.8-1
List of available channel filters	4.8-8
Sweep Settings – SWEEP Key	4.9-1
Triggering the Sweep – TRIG Key.....	4.10-1
Menu TRIG - NEXT.....	4.10-11
Selection and Setting of Traces – TRACE Key.....	4.11-1
Selection of Trace Function	4.11-1
Selection of Detector	4.11-8
Mathematical Functions for Traces	4.11-12
Recording the Correction Data of R&S FSMR – CAL Key.....	4.12-1
Markers and Delta Markers – MKR Key.....	4.13-1
Frequency Measurement with the Frequency Counter	4.13-3
Marker Functions – MKR FCTN Key.....	4.14-1
Activating the Markers.....	4.14-2
Measurement of Noise Density	4.14-2
Phase Noise Measurement.....	4.14-4
Measurement of the Filter or Signal Bandwidth	4.14-6
Measurement of a Peak List	4.14-7
AF Demodulation.....	4.14-10
Selecting the Trace	4.14-11
Change of Settings via Markers – MKR ⇒ Key	4.15-1

Power Measurements – MEAS Key	4.16-1
Power Measurement in Time Domain	4.16-4
Channel and Adjacent-Channel Power Measurements	4.16-11
Setting the Channel Configuration	4.16-23
Measurement of Signal Amplitude Statistics.....	4.16-43
Measurement of Carrier/Noise Ratio C/N and C/N ₀	4.16-55
Measurement of the AM Modulation Depth	4.16-58
Spectrum Emission Mask Measurement	4.16-59
Provided XML Files for the Spectrum Emission Mask Measurement.....	4.16-59
Format Description of Spectrum Emission Mask XML files	4.16-64
ASCII File Export Format (Spectrum Emission Mask).....	4.16-69
SPECTRUM EMISSION MASK	4.16-70
Measuring Spurious Emissions.....	4.16-76
Measurement of the Third Order Intercept (TOI).....	4.16-86
Harmonic Measurement.....	4.16-88
Setup of Limit Lines and Display Lines – LINES Key	4.17-1
Selection of Limit Lines	4.17-2
Entry and Editing of Limit Lines	4.17-6
Display Lines	4.17-11
Configuration of Screen Display – DISP Key	4.18-1
Instrument Setup and Interface Configuration – SETUP Key	4.19-1
External Reference.....	4.19-3
External Noise Source.....	4.19-4
YIG Filter On/Off.....	4.19-4
RF Preamplifier	4.19-4
Transducer	4.19-5
Activating Transducer Factors	4.19-5
Entry and Editing of Transducer Factors	4.19-7
Programming the Interface Configuration and Time Setup.....	4.19-11
Selecting the IEC/IEEE-Bus Address.....	4.19-11
Serial Interface Configuration	4.19-14
Setting Date and Time	4.19-16
Network Configuration	4.19-17
Managing Firmware Options.....	4.19-19
Emulation of the Instrument Front Panel	4.19-22
System Information	4.19-23
Display of Module Data	4.19-23
Display of Device Statistics	4.19-24
Display of System Messages.....	4.19-25
Service Menu	4.19-26
General Service Functions.....	4.19-27
Selftest 4.19-28	
Hardware Adjustment	4.19-29
Firmware Update.....	4.19-30
Saving and Recalling Data Sets – FILE Key	1
Overview	1
Storing a Device Configuration.....	2
Storing a Complete Device Configuration.....	2
Storing Parts of a Device Configuration.....	2
Loading a Data Set:.....	3
Automatic Loading of a Data Set during Booting	4
Copying Data Sets to Disk	4

Entering Text with the Help Line Editor	5
Description of the Individual Softkeys	6
Operating Concept of File Managers	11
Measurement Documentation – HCOPIY Key.....	4.21-1
HCOPIY menu:.....	4.21-1
Selecting Printer, Clipboard and File Formats.....	4.21-4
File formats	4.21-4
Clipboard.....	4.21-4
Printer 4.21-5	
Selecting Alternative Printer Configurations.....	4.21-6
Selecting Printer Colours.....	4.21-6
Entering a Text with the Auxiliary Line Editor	4.21-9
Installation of Plug&Play Printers	4.21-10
Installation of Non-Plug&Play Printers.....	4.21-10
Local Printer	4.21-11
Network Printer.....	4.21-15
Tracking Generator - Option R&S FSU-B9.....	4.22-1
Tracking Generator Settings	4.22-2
Transmission Measurement.....	4.22-4
Calibration of Transmission Measurement	4.22-5
Normalization	4.22-7
Reflection Measurement	4.22-11
Calibration of Reflection Measurement.....	4.22-11
Calibration mechanism.....	4.22-12
Frequency-Converting Measurements	4.22-13
External Modulation of the Tracking Generator	4.22-14
Option External Generator Control - FSP-B10.....	4.23-1
External Generator Settings	4.23-2
Transmission Measurement.....	4.23-3
Calibration of Transmission Measurement	4.23-3
Normalization:	4.23-5
Reflection Measurement	4.23-9
Calibration of Reflection Measurement.....	4.23-9
Calibration mechanism.....	4.23-10
Frequency-converting Measurements.....	4.23-11
Configuration of an External Generator	4.23-12
List of Generator Types Supported by the R&S FSMR.....	4.23-14
LAN Interface	4.24-1
Connecting the Instrument to the Network.....	4.24-1
Installing the Software	4.24-1
Installation of Drivers for the Network Card	4.24-1
Configuration of Available Network Protocols (TCP/IP Protocol).....	4.24-3
Installation of Further Network Protocols and Services (e.g. Novell Network Support).....	4.24-6
Examples of Configurations	4.24-8
Subsequent Changing of the Network Configuration (Computer Name, Domain, Workgroup, etc)	4.24-9
Operating the Instrument without a Network.....	4.24-10
Operating the Instrument on the Network	4.24-11
NOVELL Networks.....	4.24-11
MICROSOFT Network	4.24-11

Defining Users	4.24-12
Changing the User Password	4.24-14
Login in the Network	4.24-17
Disabling the Autologin Mechanism	4.24-17
Reenabling the Autologin Mechanism.....	4.24-17
Using Network Drives	4.24-17
Printing on a Network Printer	4.24-19
Remote Monitoring of R&S FSMR via XP Remote Desktop	4.24-24
Introduction	4.24-24
Configuration of R&S FSMR for Using Remote Desktop.....	4.24-25
Configuration of Controller	4.24-27
Setting up the Connection with the R&S FSMR.....	4.24-31
Interruption and Re-setup of Remote Desktop Connection with the R&S FSMR ..	4.24-32
Switching off the R&S FSMR from the Controller	4.24-33
Remote Data Transfer with TCP/IP Services	4.24-33
File Transfer via FTP.....	4.24-33
RSIB Protocol	4.24-35
Remote Control via RSIB Protocol	4.24-35
Windows Environment	4.24-35
UNIX Environment	4.24-36
RSIB Interface Functions.....	4.24-37
Overview of Interface Functions.....	4.24-37
Variables ibsta, iberr, ibcntl.....	4.24-38
Description of Interface Functions	4.24-39
Programming via the RSIB Protocol	4.24-45
Visual Basic.....	4.24-45
Visual Basic for Applications (Winword and Excel)	4.24-48
C / C++	4.24-49

4 Instrument Functions

All functions of the spectrum analyzer and their application are explained in detail in this chapter. The sequence of the described menu groups depends on the procedure selected for the configuration and start of a measurement:

1. Resetting the instrument - *PRESET* key
2. Setting the mode – hotkey bar and *LOCAL* key
3. Setting the measurement parameters - keys *FREQ*, *SPAN*, *AMPT*, *BW*, *SWEEP*, *TRIG*, *TRACE*, *CAL*
4. Selecting and configuring the measurement function - keys *MKR*, *MKR->*, *MKR FCTN*, *MEAS*, *LINES*

The instrument functions for general settings, printout and data management are described at the end of this chapter – keys *DISP*, *SETUP*, *FILE* and *HCOPY*.

The different softkeys of a menu are described from top to bottom and from the left to the right side menu. The submenus are marked by an indentation or displayed in a separate section. The whole path (key - softkey - ...) is indicated in the line above the menu display.

An overview of the menus is given in chapter 3 which also contains the description of the operating concept.

The IEC/IEEE-bus commands (if any) are indicated for each softkey. For a fast overview a list of softkeys with the associated IEC/IEEE-bus commands is given at the end of Chapter 6.

An index at the end of the handbook serves as further help for the user.

R&S FSMR Initial Configuration – PRESET Key

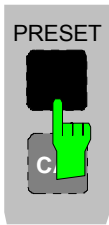

The *PRESET* key sets the R&S FSMR to a predefined default state. You can select between two different default states in the SETUP side menu. PRESET – RECEIVER is selected as standard. PRESET – ANALYZER is compatible with the Spectrum Analyzer R&S FSU and facilitates, for example, the development of a control software to control several of these instrument types.

Notes: *The setting is selected in such a way that the RF input is always protected from overload, provided the signal levels applied are within a range that is permissible for the instrument.*

The default setting performed with PRESET can be adapted to match your requirements by using the STARTUP RECALL function. In this case, the STARTUP RECALL data set is loaded by pressing the Preset key. For more information on STARTUP RECALL, see chapter "Saving and Recalling Data Sets".

After the *PRESET* key has been pressed, the R&S FSMR sets the selected default setting in accordance with table 1 or table 2:

Table 4.1-1 RECEIVER preset default setting

Parameter	Setting
Mode	measurement receiver
Center frequency	100 MHz
Center frequency step size	AUTO COARSE
RF attenuation	auto (10 dB)
Reference level	-20 dBm
Level range	100 dB log
Level unit	dBm
IF bandwidth	10 MHz
Demodulation bandwidth	
Measurement time	100 ms
Averaging	off
Sweep	cont
Trigger	free run
Modulation mode	FM
Detector	+peak/2 (demodulator)
Frequency offset	0 Hz
Reference level offset	0 dB
Reference level position	100%
Grid	abs
Cal correction	on
Noise source	off
Input	RF
Audio input	off
Display	split screen
Tracking generator (only with option R&S FSP-B9)	off
External generator 1/2 (only with option R&S FSP-B10)	off
Preamplifier	off
Preselector (only with option R&S FSMR-B2)	off
Power meter	off

Table 4.1-2 ANALYZER preset default setting

Parameter	Setting	
Mode	spectrum	
Center frequency	1.8 GHz / 13.25 GHz / 21.5 / 25 GHz	(R&S FSMR 3/ 26/ 43 / 50)
Center frequency step size	0.1 * center frequency	
Span	3.6 GHz / 26.5 / 43 / 50 GHz	(R&S FSMR 3/ 26 / 43 / 50)
RF attenuation	auto (10 dB)	
Reference level	-20 dBm	
Level range	100 dB log	
Level unit	dBm	
Sweep time	auto	
Resolution bandwidth (Res BW)	auto (3 MHz)	
Video bandwidth (Video BW)	auto (10 MHz)	
FFT filters	off	
Span / RBW	50	
RBW / VBW	0.33	
Sweep	cont	
Trigger	free run	
Trace 1	clr write	
Trace 2/3	blank	
Detector	auto peak	
Trace math	off	
Frequency offset	0 Hz	
Reference level offset	0 dB	
Reference level position	100%	
Grid	abs	
Cal correction	on	
Noise source	off	
Input	RF	
Display	full screen, active screen A	

Selecting the Operating Mode – *HOTKEY* Bar

For fast mode selection, the R&S FSMR has seven hotkeys below the display which can be differently assigned, depending on the available instrument options and instrument modes.

The keys after instrument preset:

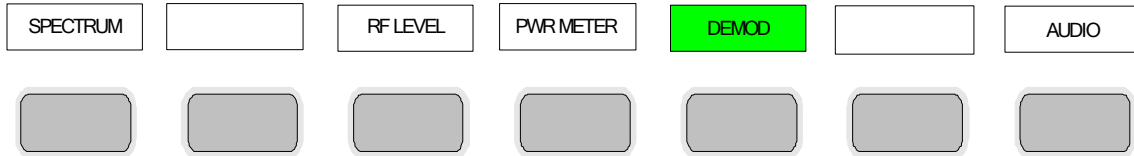

The keys in spectrum analysis mode:

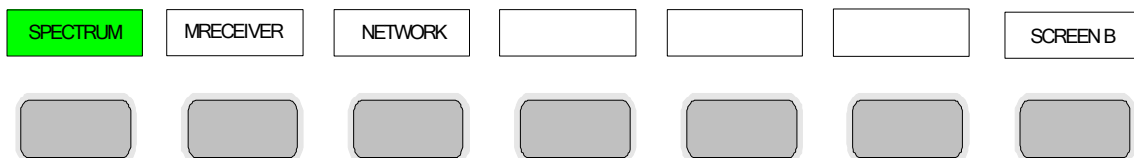

The *SPECTRUM* hotkey sets the R&S FSMR to spectrum analysis mode.

IEC/IEEE bus command: `INST:SEL SAN`

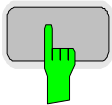

The *RF LEVEL* hotkey sets the R&S FSMR to Tuned RF Level mode.

IEC/IEEE bus command: `SENS:POW:AC:STAT ON`



The *PWR METER* hotkey activates the level measurement with the power sensor or an external power meter.

IEC/IEEE bus command: `SENS:PMET:STAT ON`

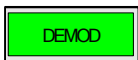
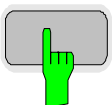

The *DEMOD* hotkey sets the R&S FSMR to modulation measurement mode

IEC/IEEE bus command: `SENS:ADEM:STAT ON`

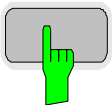



The *AUDIO* hotkey on the R&S FSMR activates the measurement of the signal applied at the audio input.

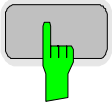

IEC/IEEE bus command: `INP:SEL AUD`



The *MRECEIVER* hotkey sets the R&S FSMR to measurement receiver mode.

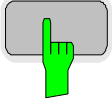

IEC/IEEE bus command: `INST:SEL MREC`



If the option R&S FSU-B9 is installed, the *NETWORK* hotkey activates the tracking generator or the control of an external generator (corresponds to the option R&S FSP-B10).

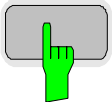

IEC/IEEE bus command: `OUTP:STAT ON`



In FULL SCREEN mode, the *SCREEN A / SCREEN B* hotkey allows you to choose between two different instrument settings.

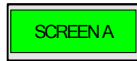

In SPLIT SCREEN mode, the key switches between the active diagrams A and B.

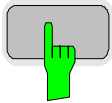

The key caption indicates which of the diagrams can be activated by pressing the key.

The currently active measurement window is specified by the display of **A** or **B** on the right-hand side of the diagram.

IEC/IEEE bus command: `DISP:WIND<1|2>:SEL A`

The meaning of the other keys is described in the chapter describing the various options.

Return to manual control – LOCAL Menu

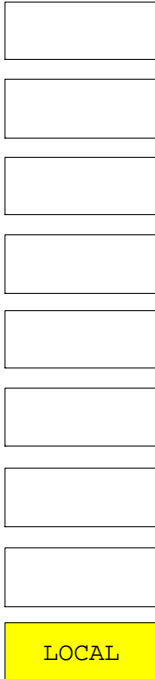

The menu LOCAL is displayed on switching the instrument to remote control mode.

At the same time, the *HOTKEY* bar is blanked out and all keys are disabled except the *PRESET* key. The diagram, traces and display fields are then blanked out (they can be activated using the remote control command `SYSTEM:DISPLAY:UPDATE ON`).

The menu contains only one softkey, the *LOCAL* key. The *LOCAL* key switches the instrument from remote to manual control, with the assumption that the remote controller has not previously set the LOCAL LOCKOUT function.

A change in the control mode consists of:

- **Enabling the Front Panel Keys**

Returning to manual mode enables all inactive keys and turns on the hotkey menu. The soft key menu which is displayed is the main menu of the current mode.

- **Inserting the measurement diagrams**

The blanked diagrams, traces and display fields are inserted.

- **Generating the message OPERATION COMPLETE**

If, at the time of pressing the *LOCAL* softkey, the synchronisation mechanism via `*OPC`, `*OPC?` or `*WAI` is active, the currently running measurement procedure is aborted and synchronisation is achieved by setting the corresponding bits in the registers of the status reporting system.

- **Setting Bit 6 (User Request) of the Event Status Register**

With a corresponding configuration of the status reporting system, this bit immediately causes the generation of a service request (*SRQ*) which is used to inform the control software that the user wishes to return to front-panel control. This information can be used, e.g., to interrupt the control program so that the user can make necessary manual corrections to instrument settings. This bit is set each time the *LOCAL* softkey is pressed.



If the LOCAL LOCKOUT function is active in the remote control mode, the front-panel PRESET key is also disabled. The LOCAL LOCKOUT state is left as soon as the process controller de-activates the REN line or the IEC/IEEE-bus cable is disconnected from the instrument.

Measurement Receiver Mode

Use the *MRECEIVER* hotkey to select this operating mode
See also: Selecting the Operating Mode – Hotkey Bar.

RECEIVER menu:

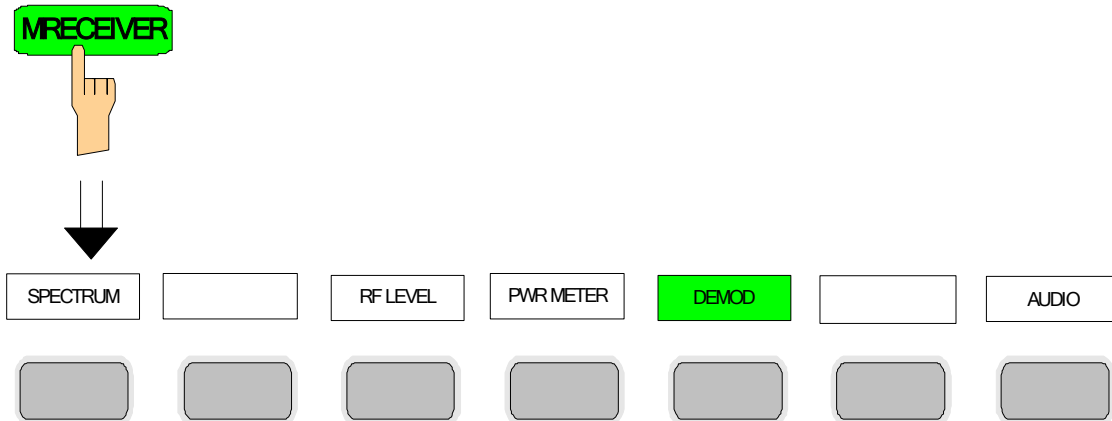

This operating mode corresponds to the instrument's default setting. You can access the spectrum analysis mode using the *SPECTRUM* hotkey.

The *MRECEIVER* (*measurement receiver*) hotkey selects the measurement receiver mode. The hotkey bar is assigned receiver-specific functions. A softkey menu suitable for the currently selected operating mode, i.e. *RF LEVEL*, *PWR METER*, *DEMOD* or *AUDIO*, is simultaneously displayed.

The individual settings are explained in the following menus:

<i>RF LEVEL</i>	Selective Level Measurement, page 4.4-2
<i>PWR METER</i>	Level Measurement with the Power Sensor, page 4.4-10
<i>DEMOD</i>	Modulation Measurements, page 4.4-17
<i>AUDIO</i>	Measurements on the Audio Input, page 4.4-29

IEC/IEEE bus command: INST MREC

In the Receiver mode, the R&S FSMR measures the level on the set frequency with the selected bandwidth and measurement time. Other signal parameters such as modulation depth and frequency deviation can additionally be determined. A whole gamut of AF filters allows you to weight the demodulated signal.

Selective Level Measurement – RF LEVEL Key

For highly accurate level measurements, you can calibrate absolute accuracy using a power meter as a reference and expand the linear measurement range with the aid of further calibrations.

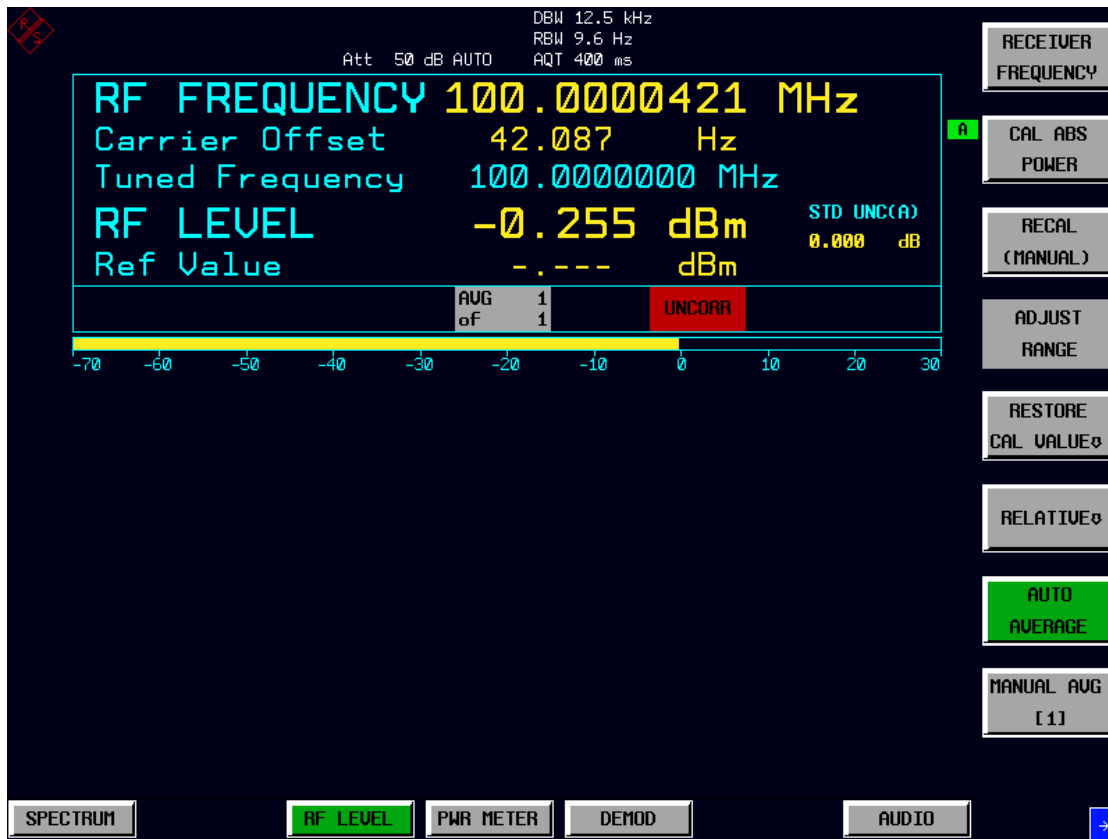

Fig. 4.4-1 RF level display

The RF LEVEL hotkey switches the R&S FSMR to the Tuned RF Level mode (selective level measurement) and opens a menu for configuring and controlling measurements.

IEC/IEEE bus command: SENS:POW:AC:STAT ON

The following commands are used for reading out the individual measured value:

RF LEVEL	CALC:MARK:FUNC:ADEM:CARR?
Carrier Offset	CALC:MARK:FUNC:ADEM:FERR?
Standard uncertainty:	CALC:MARK:FUNC:ADEM:CARR:SUNC?
Reference value:	SENS:POW:AC:REF?

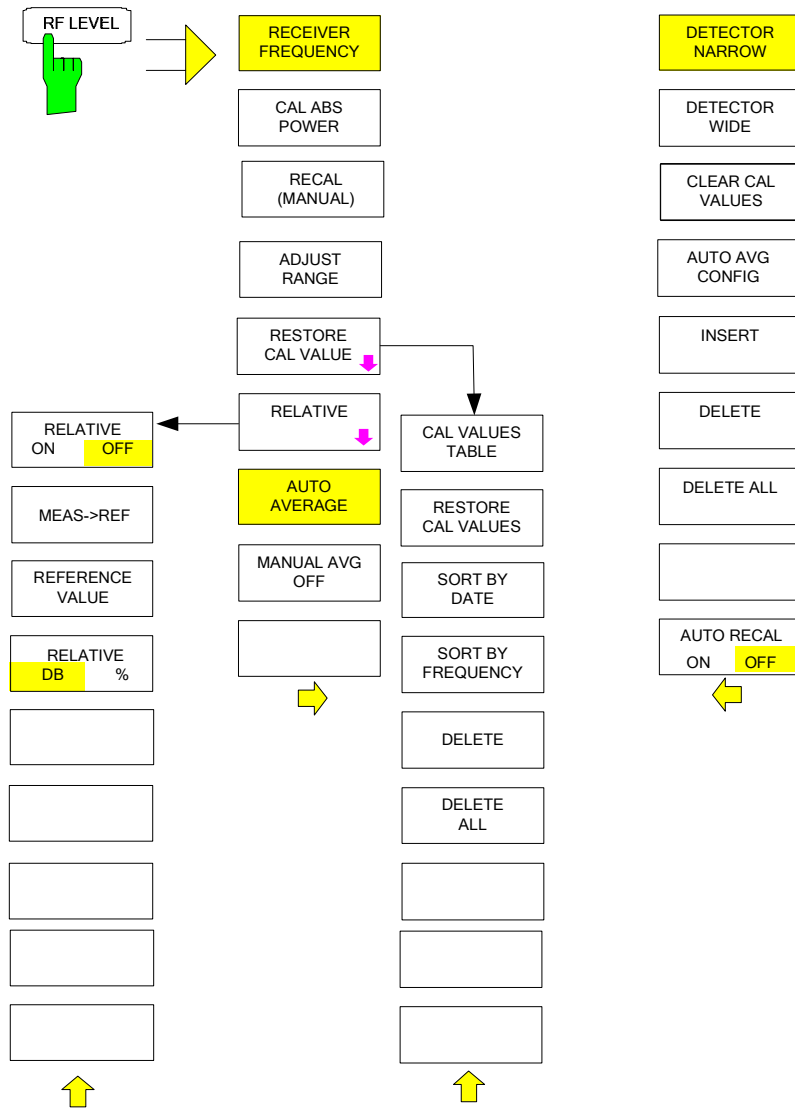

The *RECEIVER FREQUENCY* softkey activates the window for entering the receiver frequency.

The receiver frequency resolution is 0.1 Hz.

Setting range: $20 \text{ Hz} \leq f_{\text{REC}} \leq f_{\text{max}}$

IEC/IEEE bus command: `SENS:FREQ:CENT 300MHZ`



The *CAL ABS POWER* softkey starts the absolute calibration of the measurement path. For this purpose, a power sensor or an external power meter must be connected to the R&S FSMR.

The total calibration process depends on whether a power divider is used (see Level Measurement with the Power Sensor - *PWR METER* Key). If a power divider is used, the reference and comparison values are measured immediately after each other. Since both measurement points are connected to the signal source, no user prompts are output.

If a power divider is not used, the process is different:

Before the absolute calibration, the user is prompted to connect the power sensor to the signal source:

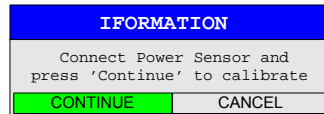

During the reference measurement, the following message appears:

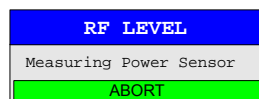

In a second step, the user is prompted to connect the RF input of the R&S FSMR to the signal source:

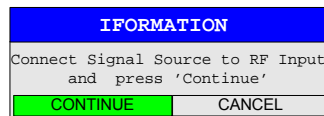

After the second measurement, the absolute calibration is finished.

The reference value is no longer valid if the following parameters are changed:

- Receive frequency
- Preamplification
- RF attenuation
- Coupling of RF input
- Preselection (YIG filter, option R&S FSMR-B2)
- IF bandwidth
- IF gain (*REF LEVEL*)
- Demodulation bandwidth
- Measurement time
- Detector
- Configuration of power splitter
- Total calibration (*CAL TOTAL*)

IEC/IEEE bus commands:

<code>SENS:CORR:COLL PMET</code>	measures the reference level using the power meter
<code>SENS:CORR:COLL INP</code>	measures the reference value on the R&S FSMR RF input, which is then corrected using the reference level
<code>SENS:CORR:COLL PSPL</code>	subsequently measures the reference level and reference value; to do so, power meter and R&S FSMR RF input must be connected to the DUT via a power splitter

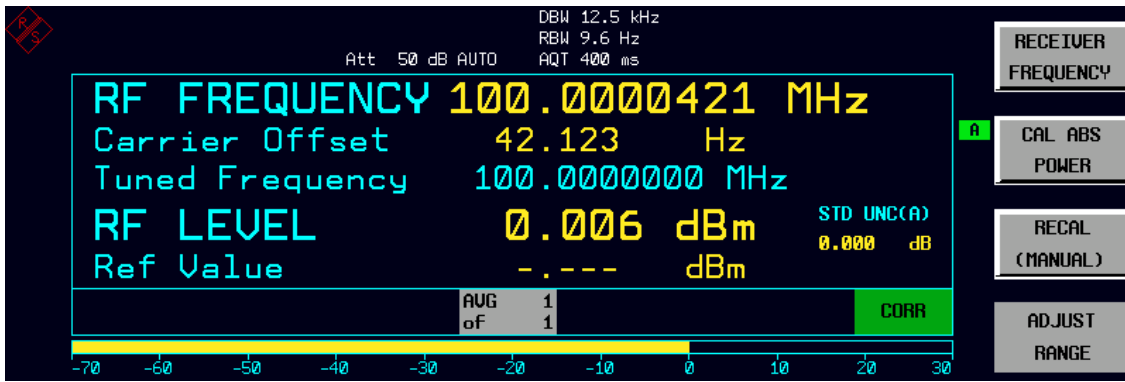
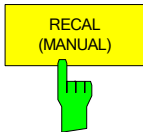

Fig. 4.4-2 CAL ABS POWER sequence



The *RECAL (MANUAL)* softkey starts the subsequent calibration to expand the calibrated measurement range. This function is available whenever the measured level is in the range adjacent to the calibrated range. This is indicated via the RECAL field.

IEC/IEEE bus command: INP:ATT:AUTO REC

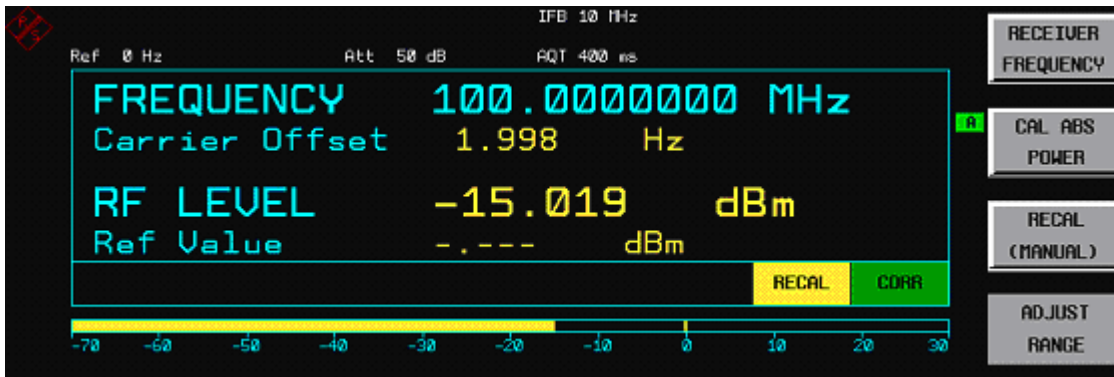
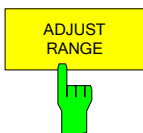

Fig. 4.4-3 RECAL display RF Level

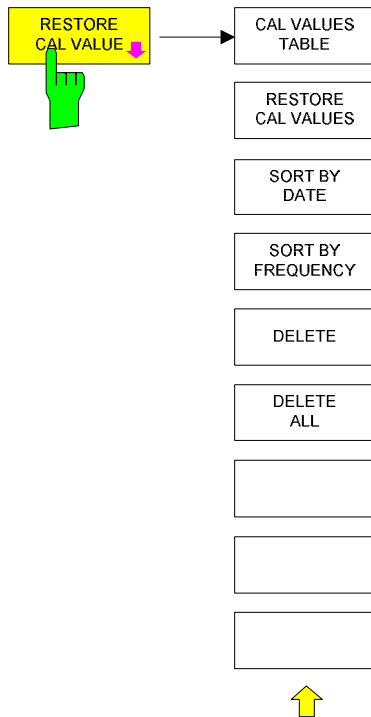

Fig. 4.4-4 Display after RECAL has been completed



The *ADJUST RANGE* softkey starts a single autoranging process. Readjusting RF attenuation, IF gain and, if necessary, preamplification, the R&S FSMR searches for a device status where sensitivity ideally matches the applied signal to be measured.

IEC/IEEE bus command: INP:ATT:AUTO ONCE



The instrument automatically saves the correction data generated by CAL ABS POWER or RECAL. Up to 20 correction sets are stored and can be reloaded e.g. after changing the frequency.

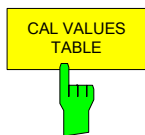

Opens a table with all saved correction sets and the following corresponding settings:

- Frequency in Hz
- Date and time of acquisition
- Used power meter
- Power splitter used

CALIBRATION DATA			
FREQUENCY	DATE	POWER SENSOR	SPLITTER
521.303391900 MHz	31.May 05 16:22	NRP-Z37	√
350.006062100 MHz	31.May 05 16:20	NRP-Z37	√
325.000000000 MHz	31.May 05 16:19	NRP-Z37	√
250.000000000 MHz	31.May 05 16:18	NRP-Z37	√
100.000000000 MHz	31.May 05 16:18	NRP-Z37	√

IEC/IEEE-bus command: MEM:CORR:CAT?



This command activates the selected correction data set.

IEC/IEEE-bus command: MEM:CORR:SEL <name>

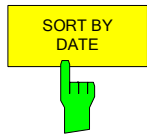

The softkeys sorts the table in a descending order according the entries in the DATE or FREQUENCY column.

IEC/IEEE-bus command: ---

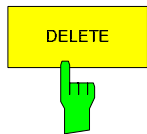
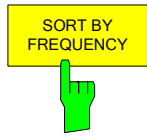

Deletes the selected entry in the AUTO AVG TABLE.

IEC/IEEE-bus command: ---



Deletes all entries in the AUTO AVG TABLE.

IEC/IEEE-bus command: ---

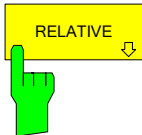

The *RELATIVE* softkey opens a submenu for configuring the relative level measurement. At the same time, the current level measurement value is adopted as the reference value and the relative level measurement is activated.

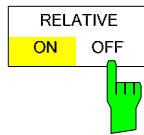

The *RELATIVE ON/OFF* softkey switches the relative level measurement on and off.

IEC/IEEE bus command:
SENS:POW:AC:REF:STAT ON | OFF

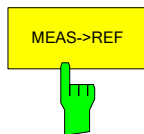

The *MEAS->REF* softkey adopts the current level measurement value as the reference value.

IEC/IEEE bus command: SENS:POW:AC:REF:AUTO ONCE

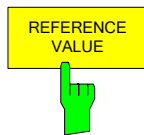

The *REFERENCE VALUE* softkey opens the date entry field for defining the reference value for the relative level measurement.

IEC/IEEE bus command: SENS:POW:AC:REF -30 DBM

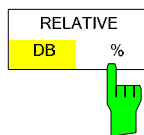

The *RELATIVE DB/%* softkey selects the display mode for the relative level measurement.

IEC/IEEE bus command: UNIT:POW:THD DB | PCT



Fig. 4.4-5 Display mode for the relative level measurement RF Level

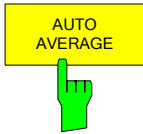

If the current measurement value differs more than a S/N ratio depending threshold from the average value, a restart is performed. The new average count is taken from the Auto AVG table.

IEC/IEEE-bus command: SENS:POW:AC:AVER:AUTO ON



Switches manual averaging on and off. At the same time it opens a data entry field for determining the number of level measurements across which the average value is formed (average count). The permissible range is 0 to 32767. Average count = 0 and 1 indicates no averaging.

IEC/IEEE-bus command: SENS:POW:AC:AVER:AUTO OFF



The *DETECTOR NARROW* softkey activates an FFT in the set demodulation bandwidth. The displayed level value is derived from the FFT peak value. The effective measurement bandwidth for this type of measurement is approx. 4 / measurement time. During the measurement time, the signal must remain in the effective bandwidth. Select *DETECTOR WIDE* if the signal sources are unstable (frequency drift, residual FM).

IEC/IEEE bus command: SENS:DET:FUNC NARROW

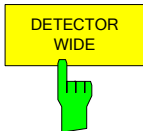

The *DETECTOR WIDE* softkey activates a level measurement in the set demodulation bandwidth. The level is obtained by an RMS (root mean square) computation of all measurement points.

IEC/IEEE bus command: SENS:DET:FUNC WIDE



The *CLEAR CAL VALUES* softkey deletes the active calibration values for the calibrated measurement ranges. This function is available whenever the receiver is using calibration values for the range calibration. This is indicated via the green CORR field.

IEC/IEEE bus command: SENS:CORR:COLL:CLE



Opens a table to define the average counts depending on measured power.

AUTO AVERAGING CONFIG TABLE	
LEVEL RANGE	AVERAGES
<+30dBm	1
<-70 dBm	2
<-80 dBm	4
<-90 dBm	8
<-100 dBm	16
<-110 dBm	32
<-120 dBm	64
<-130 dBm	128

IEC/IEEE-bus command: `SENS:POW:AC:AVER:DATA`
`<lev1>,<count1>,...<levn>,<countn>`

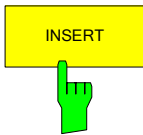

Inserts one entry in the auto config table.

IEC/IEEE-bus command: ---

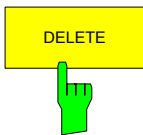

Deletes the selected entry in the auto config table.

IEC/IEEE-bus command: ---



Deletes all entries in the auto config table.

IEC/IEEE-bus command: ---

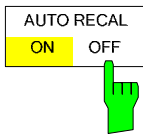

The *AUTO RECAL ON/OFF* softkey activates/deactivates the automatic recalibration. If active, the recalibration is performed automatically as soon as the signal level reaches the appropriate level.

IEC/IEEE-bus command: `INP:ATT:REC:AUTO:STAT ON`

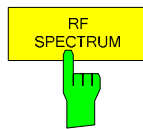

The *RF SPECTRUM* softkey switches the display of the RF spectrum on and off. The spectrum is generated from measured data by means of an FFT.

IEC/IEEE bus commands: `CALC2:FEED `XTIM:SPECTRUM``
`CALC2:FEED `NONE``

Level Measurement with the Power Sensor - *PWR METER* Key

The *PWR METER* hotkey activates the measurement with the power sensor and opens a menu for configuring and controlling the measurements.

IEC/IEEE bus command: SENS : PMET : STAT ON
 READ : PMET?

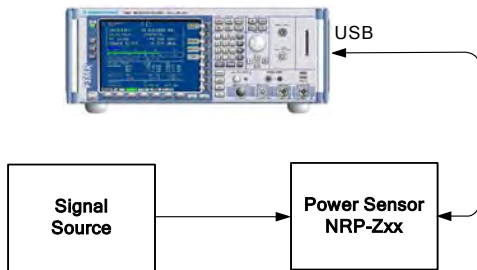
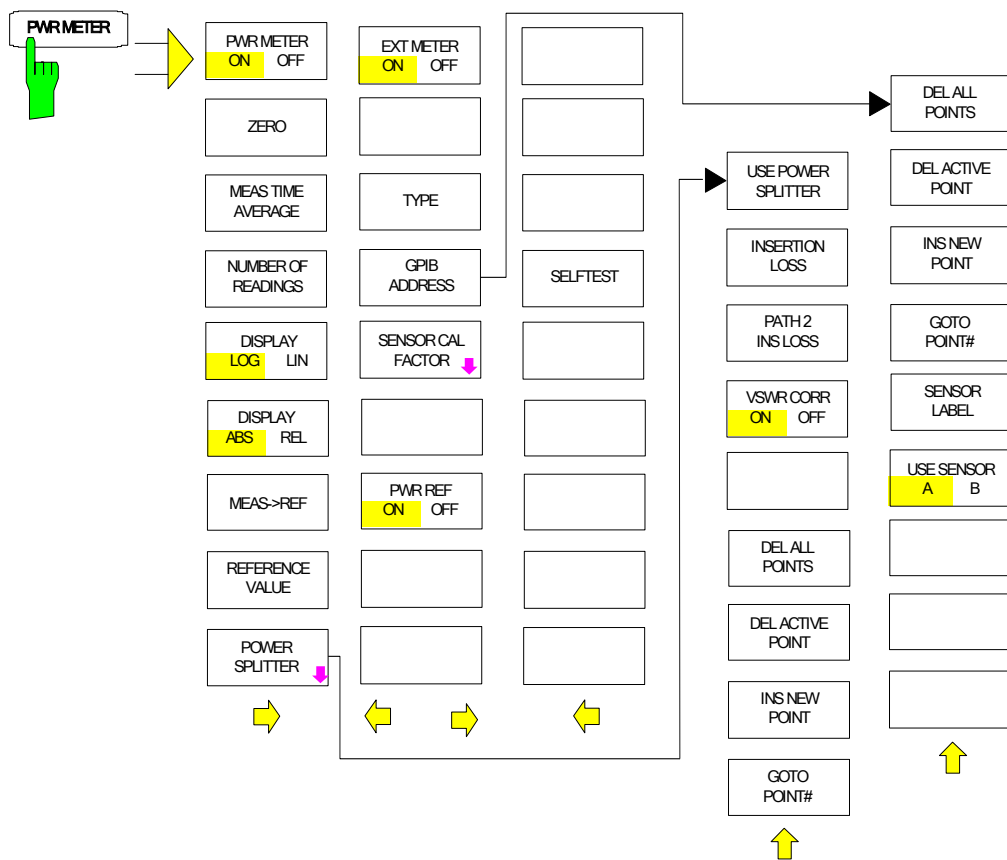

Fig. 4.4-6 Test setup



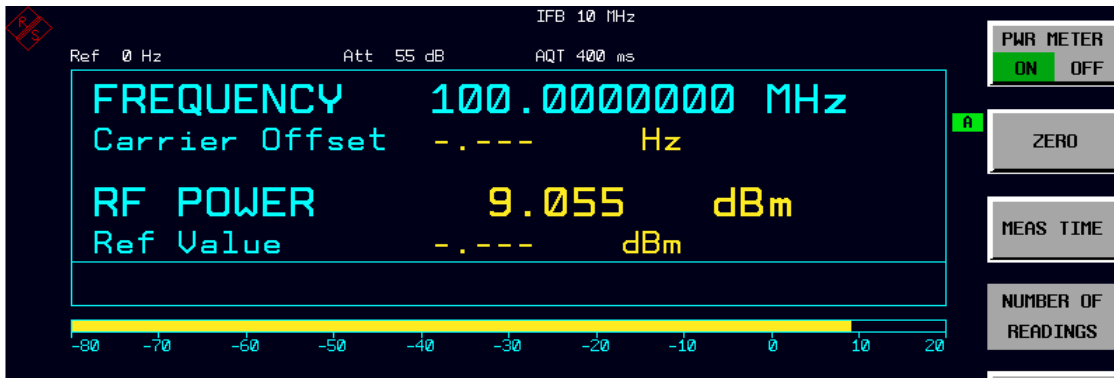
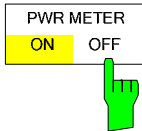

Fig. 4.4-7 Display RF power with power sensor



The *PWR METER ON/OFF* softkey switches the measurement with the power sensor on and off.

IEC/IEEE bus command: `SENS:PMET:STAT ON`

The following command is used for reading out the individual measured value:
`FETCH:PMET?`

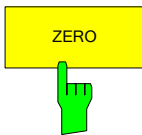

The *ZERO* softkey starts zeroing of the power sensor.

Before zeroing starts, you are prompted to disconnect all signals from the input of the power sensor.

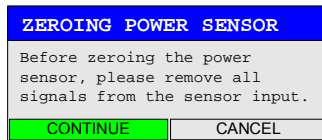

During zeroing, the following message appears:

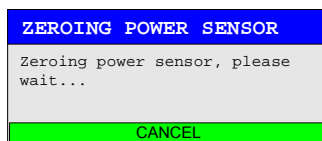

When zeroing is complete, the following message appears:

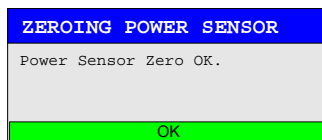

This message is deleted after approx. 3 s.

IEC/IEEE bus command: `CAL:PMET:REL:MAG:AUTO ONCE;*WAI`

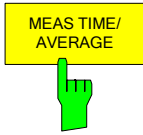

The *MEAS TIME/AVERAGE* softkey opens a list in which the measurement time can be set. Results become more stable with extended measurement time, particularly if signals with low power are measured.

MEAS TIME			
SHORT	(AUTO AVG,	NOISE 0.05 dB,	MAX TIME 1 s)
✓ NORMAL	(AUTO AVG,	NOISE 0.01 dB,	MAX TIME 3 s)
LONG	(AUTO AVG,	NOISE 0.001 dB,	MAX TIME 10 s)
MANUAL	(MAN AVG,	MEAS TIME 100 ms)	

Stationary signals with high power (>-0 dBm) require only a short measurement time to yield stable and exact results. In this case, the *SHORT* setting is recommended because it provides the highest measurement repetition rates. The *NORMAL* setting increases the stability of the displayed results for the measurement of signals with low power or of modulated signals. The *LONG* setting is recommended for signals at the lower end of the measurement range (<-20 dBm). This setting can be used to minimize the influence of noise.

IEC/IEEE bus command: SENS:PMET:MTIM LONG | NORM | SHOR



The *NUMBER OF READINGS* softkey activates the averaging of the power reading. It opens a window for the entry of the number of readings (averagings) to be performed after a single sweep has been started.

The softkey is only available if the MEAS TIME / AVERAGE mode is set to manual average.

The range for the average count is 0 to 256 in binary steps (1 / 2 / 4 / 8 ...). For average count = 0 or 1, one reading is performed.

The averaging and sweep count of the trace menu are not connected.

Results become more stable with extended average, particularly if signals with low power are measured. This setting can be used to minimize the influence of noise in the power meter measurement.

IEC/IEEE bus command: SENS:PMET:MTIM:AVER:STAT ON
SENS:PMET:MTIM:AVER:COUNT
<numeric_value>

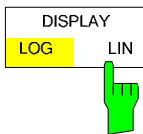

The *DISPLAY LOG/LIN* softkey switches the result display between logarithmic display (units: dBm and dB) and linear display (units: W and %).

IEC/IEEE bus command: UNIT:PMET:POW DBM

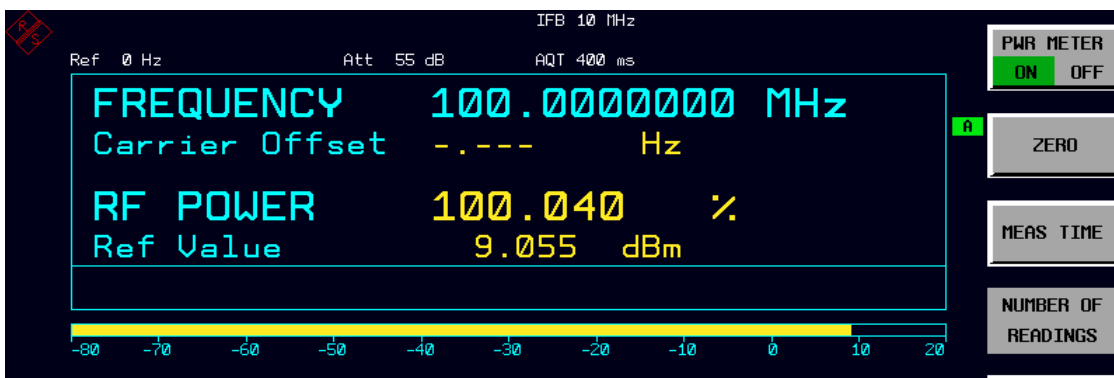
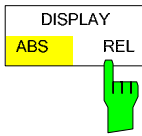
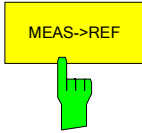

Fig. 4.4-8 Powersensor with relative display



The *DISPLAY ABS/REL* softkey switches the result display between absolute display (units: dBm and W) and relative display (units: dB and %).

IEC/IEEE bus command: `CALC:PMET:REL:STAT ON`
`UNIT:PMET:POW:RAT PCT`



The *MEAS->REF* softkey is used to adopt the currently measured power as a reference value for the relative display.

The reference value can also be set manually via the *REFERENCE VALUE* softkey.

IEC/IEEE bus command: `CALC:PMET:REL:MAG:AUTO ONCE`

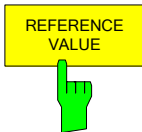

The *REFERENCE VALUE* softkey activates manual entry of a reference value for relative measurements in the unit dBm.

IEC/IEEE bus command: `CALC:PMET:REL:MAG: -30DBM`

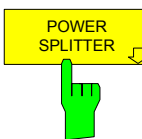

- USE POWER SPLITTER
- INSERTION LOSS
- PATH 2 INS LOSS
- VSWR CORR ON OFF
- DEL ALL POINTS
- DEL ACTIVE POINT
- INS NEW POINT
- GOTO POINT #

The *POWER SPLITTER* softkey opens a submenu for power splitter settings. A table for entering the frequency-dependent insertion loss of the power splitter is opened simultaneously. It is valid for the path between power meter and signal source.

POWER SPLITTER INSERTION LOSS		
POINT	FREQUENCY	INS LOSS
1	20.00000000 MHz	5.40 dB
2	50.00000000 MHz	5.56 dB
3	100.00000000 MHz	5.63 dB
4	200.00000000 MHz	5.78 dB
5	500.00000000 MHz	5.89 dB
6	1.00000000 GHz	6.02 dB
7		
8		
9		
10		
11		
12		
13		
14		
15		
16		
17		
18		
19		
20		

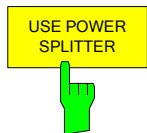

The *USE POWER SPLITTER* softkey activates and deactivates automatic consideration of a power splitter that splits the present RF signal between the power meter and the R&S FSMR RF input.

IEC/IEEE bus command: `SENS:CORR:PLOS:INP:STAT ON`

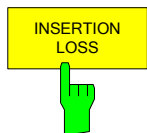

The *INSERTION LOSS* softkey opens the table for entering the frequency-dependent insertion loss of a power splitter.

IEC/IEEE bus command: `SENS:CORR:PLOS:INP 1e6,4.6,2e6,4.85`

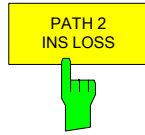

The *PATH 2 INS LOSS* softkey opens a data entry field for defining the insertion loss of the power splitter between the signal source and the R&S FSMR RF input. This value is used only for checking the plausibility during absolute value calibration. The exact value is determined during calibration.

IEC/IEEE bus command:

```
SENS:CORR:PLOS:INP:SPAT2 4 DB
```

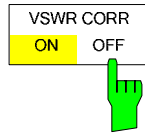

This softkey activates the mismatch correction between the power sensor module R&S NRP-Z27 or R&S NRP-Z37 and the R&S FSMR RF input.

The function is only available under certain conditions:

- The RF attenuation must be 10 dB or 30 dB. The RF attenuation default setting is 30 dB.
- A correction file with VSWR values must be present on the internal memory. If the correction file is not present, the softkey will not be present.

IEC/IEEE bus command: SENS:CORR:VSWR ON



The *DEL ALL POINTS* softkey deletes all values from the table with the frequency-dependent insertion loss of the power splitter.

IEC/IEEE bus command: -



The *DEL ACTIVE POINT* softkey deletes the marked value from the table with the frequency-dependent insertion loss of the power splitter.

IEC/IEEE bus command: -



The *INS NEW POINT* softkey inserts a new line at the spot where the table is marked.

IEC/IEEE bus command: -



The *GOTO POINT #* softkey sets the marking to the specified line within the table.

IEC/IEEE bus command: -

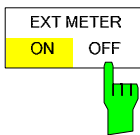

The *EXT METER ON/OFF* softkey switches the measurement with the power sensor on and off.

IEC/IEEE bus command: SENS:PMET:EXT:STAT ON

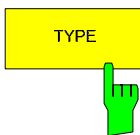

The *TYPE* softkey selects the type of power meter used from a list.

TYPE
EPM441A
HP437B
HP438A
ML2438A
✓NRP
NRU
NRUD
NRUS
MANUAL

The R&S NRVS, R&S NRVD, R&S NRV and R&S NRP power meters from Rohde & Schwarz as well as power meters from other vendors are supported.

IEC/IEEE bus command: `SYST:COMM:RDEV:PMET:TYPE 'NRP'`

When the MANUAL power meter type is selected, a dialog box opens for entry of the signal level when the absolute power calibration is performed in the tuned RF level mode.

IEC/IEEE bus command: `SENS:CORR:COLL:LEV 0dBm`

The *GPIB ADDRESS* softkey opens a data entry field for setting the IEC/IEEE bus address via which the external power meter is addressed for remote-control.

IEC/IEEE bus command: `SYST:COMM:GPIB:RDEV:PMETer:ADDR 5`

GPIB ADDRESS



SENSOR CAL FACTOR



- DEL ALL POINTS
- DEL ACTIVE POINT
- INS NEW POINT
- GOTO POINT #
- SENSOR LABEL
- USE SENSOR
 - A
 - B
-
-
-

The *SENSOR CAL FACTOR* softkey opens a submenu for entering the frequency-dependent calibration factor of the power sensor used.

SENSOR CAL FACTOR		
LABEL	Sensor #35	
POINT	FREQUENCY	CAL FACTOR
1	2.000000000 GHz	99.30 %
2	10.000000000 GHz	98.10 %
3	14.000000000 GHz	97.60 %
4	18.000000000 GHz	97.10 %
5	20.000000000 GHz	97.10 %
6	22.000000000 GHz	96.40 %
7	24.000000000 GHz	96.00 %
8	26.000000000 GHz	96.60 %
9		
10		
11		
12		
13		
14		
15		
16		
17		
18		
19		
20		

Due to mismatch, loss and change of sensitivity of the power sensor used, frequency-dependent errors occur during the power measurement. The calibration factor of a sensor, which is usually specified in percentage, describes which section of the forward power toward the sensor is actually sampled and displayed. Some power sensors, such as the R&S NRV family from Rohde & Schwarz, read in the calibration factor from a memory in the sensor and automatically take this factor into account. With other devices (e.g. HP 436 A), you have to set the calibration factor manually on the device; however, the factor applies only to a specific frequency. In this case, you can enter a table of the calibration factor above the frequency via the *SENSOR CAL FACTOR* menu; when measurements are performed, this factor is taken into account. You then have to set the calibration factor of 100% on the power meter.

You can enter the calibration factor for two different sensors on up to 20 frequency points each. Depending on the setting of the *USE SENSOR A B* softkey, either the *SENSOR A CAL FACTOR LIST* table or the *SENSOR B CAL FACTOR LIST* table is displayed. In the second line, a name for identifying the sensor is displayed; this name can be defined via the *SENSOR LABEL* softkey. The individual frequency points of the list are detailed below, but they can only be entered in ascending frequency order. Next to the number of the frequency point, there are two editable columns.

FREQUENCY – frequency value of the frequency point
 CAL FACTOR – associated calibration factor in percentage

Linear interpolation occurs between the frequency points of the active calibration factor list. The calibration factors of the lower or upper cutoff frequency apply outside the specified frequency range. In the presetting, the table is empty and no correction has been made, i.e. the calibration factor is generally assumed to be 100%. If the list contains only one frequency point, the FREQUENCY field cannot be edited, and CAL FACTOR then applies to all frequencies.

IEC/IEEE bus command:

SYST:COMM:RDEV:PMET:CFAC:ASEN 2GHZ,99PCT,4GHZ,98PCT



The *DEL ALL POINTS* softkey deletes all values from the table with the frequency-dependent insertion loss of the power splitter.

IEC/IEEE bus command: -

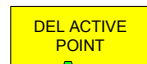

The *DEL ACTIVE POINT* softkey deletes the marked value from the table with the frequency-dependent insertion loss of the power splitter.

IEC/IEEE bus command: -

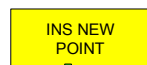

The *INS NEW POINT* softkey inserts a new line where the table is marked.

IEC/IEEE bus command: -

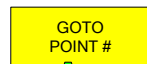

The *GOTO POINT #* softkey sets the marking to the specified line within the table.

IEC/IEEE bus command: -



The *SENSOR LABEL* softkey sets the marking within the table to the LABEL line so that an alphanumeric label can be entered.

IEC/IEEE bus command:

SYST:COMM:RDEV:PMET:CFAC:ASEN:LABEL 'SENSOR1'

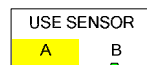

The *USE SENSOR A/B* softkey switches between the calibration factors of the sensors A and B.

Switchover refers both to the table displayed and to the data set used during power calibration.

IEC/IEEE bus command:

SYST:COMM:RDEV:PMET:CFAC:SEL ASEN

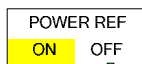

The *POWER REF ON/OFF* softkey switches the POWER REF reference source on the front panel on and off.

IEC/IEEE bus command: OUTP:REF:STAT ON



The *SELFTEST* softkey initiates the selftest of a connected power sensor.

Before starting a selftest do remove any power from the sensors input. The test result (selftest PASSED or FAILED) is output in a message box.

IEC/IEEE-bus command: ---

Modulation Measurements - *DEMODO* Key

The *DEMODO* hotkey switches the R&S FSMR to modulation measurement mode and opens a menu for configuring and controlling measurements.

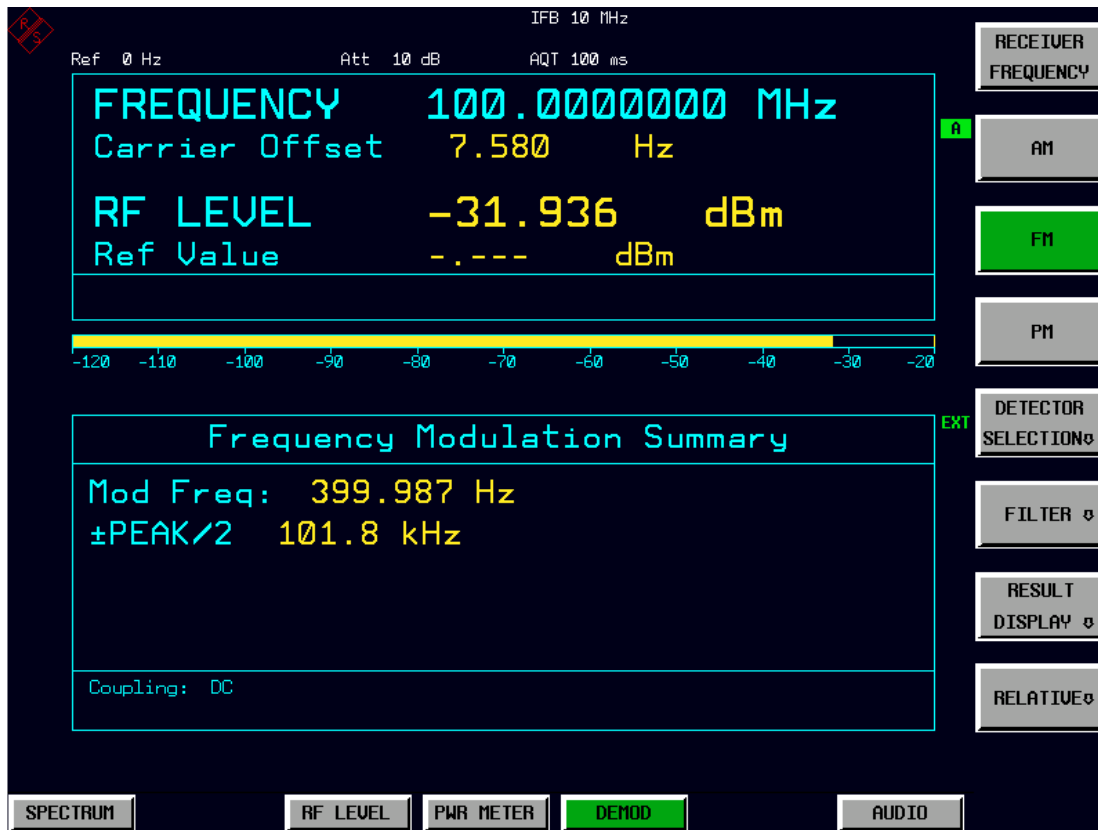

Fig. 4.4-9 Screen display: modulation measurement

IEC/IEEE bus command: SENS:ADEM ON

The following commands are used for reading out the individual measured value:

RF LEVEL CALC:MARK:FUNC:ADEM:CARR?
 Carrier Offset CALC:MARK:FUNC:ADEM:FERR?
 Modulation Frequency CALC:MARK:FUNC:ADEM:AFR?

All other queries are explained with the corresponding softkeys.

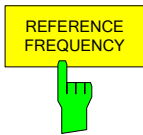
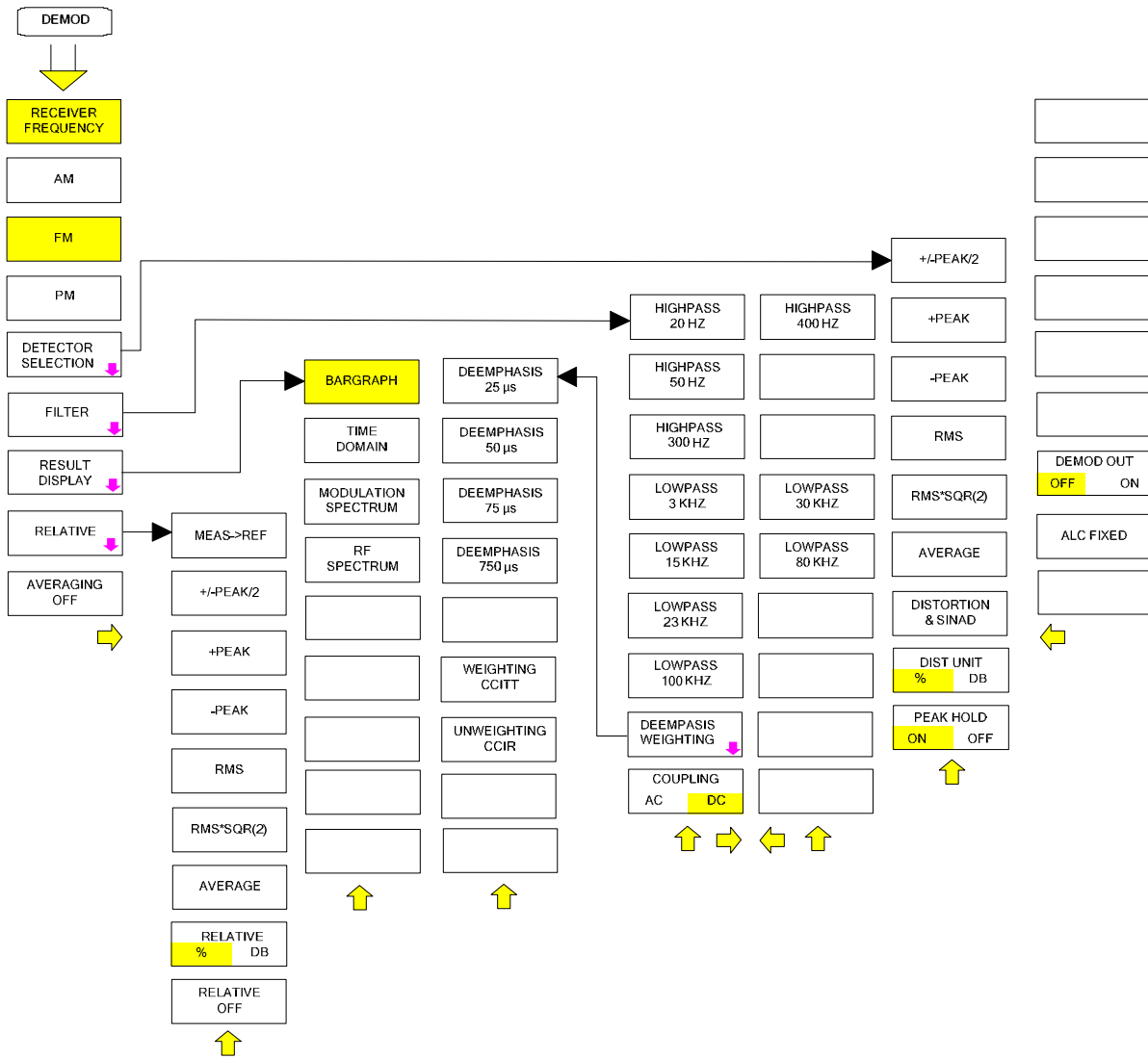

The *RECEIVER FREQUENCY* softkey activates the window for entering the receiver frequency .

The receiver frequency resolution is 0.1 Hz.

Setting range: $20 \text{ Hz} \leq f_{\text{REC}} \leq f_{\text{max}}$

IEC/IEEE bus command: `SENS:FREQ:CENT 300MHZ`

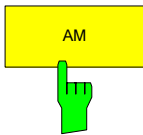

The *AM* softkey activates the amplitude modulation measurement with its result displays.

IEC/IEEE bus command: `CALC2:FEED `XTIM:AM:REL``

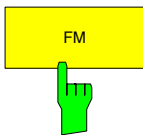

The *FM* softkey activates the frequency modulation measurement with its result displays. In the device default setting of the modulation measurement mode, the FM measurement is active.

IEC/IEEE bus command: `CALC2:FEED `XTIM:FM``

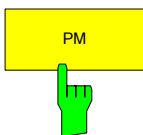

The *PM* softkey activates the phase modulation measurement with its result displays.

IEC/IEEE bus command: `CALC2:FEED `XTIM:PM``

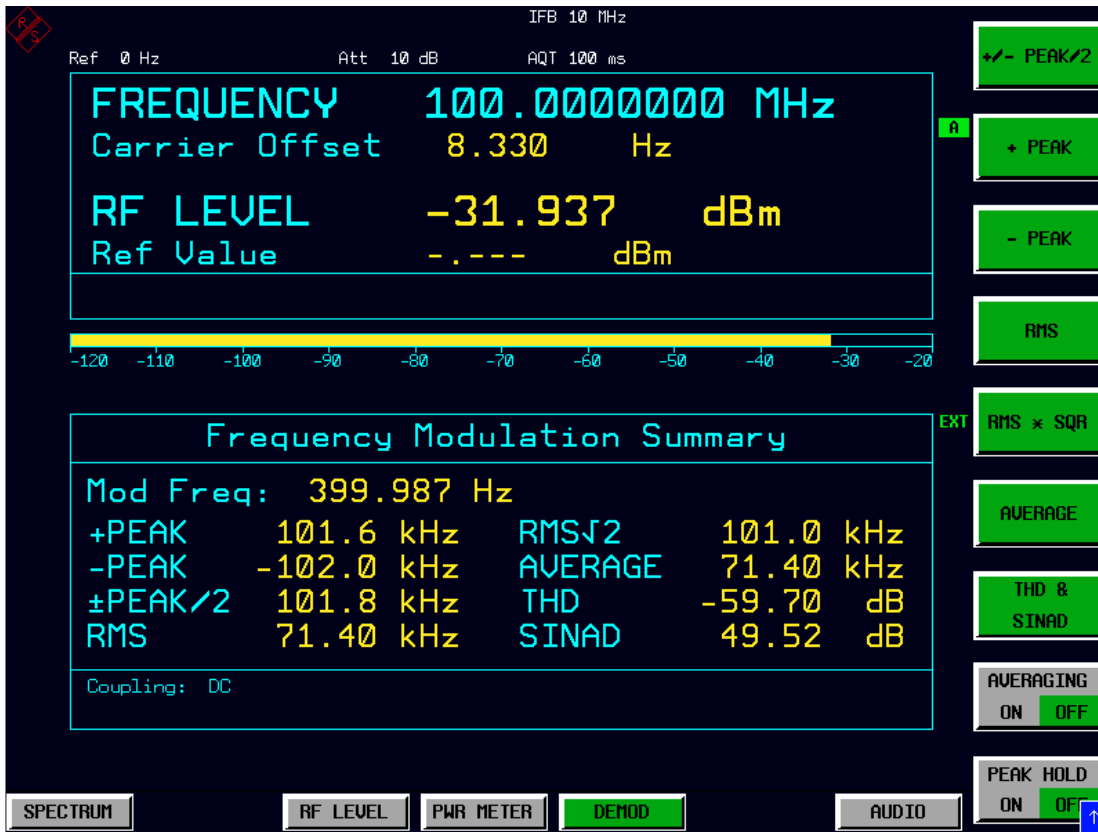
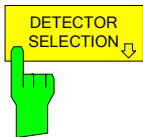
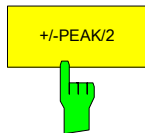

Fig. 4.4-10 Screen display: modulation measurement with detectors



The *DETECTOR SELECTION* softkey opens a submenu for selecting the detectors for the result display.



The *+/-PEAK/2* softkey activates the display of the arithmetic average value from the positive and the negative peak value for the currently active modulation mode.

IEC/IEEE bus command: `ADEM:DET:PAV ON`

The following commands are used for reading out the individual measured value:

```
CALC:MARK:FUNC:ADEM:AM:WRIT:RES? PAV
CALC:MARK:FUNC:ADEM:FM:WRIT:RES? PAV
CALC:MARK:FUNC:ADEM:PM:WRIT:RES? PAV
```

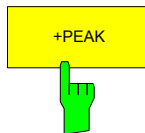

The *+PEAK* softkey activates the display of the positive peak value for the active modulation mode.

IEC/IEEE bus command: `ADEM:DET:PPE ON`

The following commands are used for reading out the individual measured value:

```
CALC:MARK:FUNC:ADEM:AM:WRIT:RES? PPE
CALC:MARK:FUNC:ADEM:FM:WRIT:RES? PPE
CALC:MARK:FUNC:ADEM:PM:WRIT:RES? PPE
```

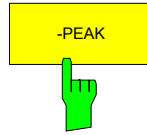

The *-PEAK/2* softkey activates the display of the negative peak value for the active modulation mode.

IEC/IEEE bus command: `SENS:ADEM:DET:MPE ON`

The following commands are used for reading out the individual measured value:

`CALC:MARK:FUNC:ADEM:AM? MPE`
`CALC:MARK:FUNC:ADEM:FM? MPE`
`CALC:MARK:FUNC:ADEM:PM? MPE`

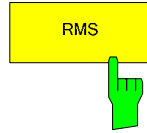

The *RMS* softkey activates the RMS value display for the active modulation mode.

IEC/IEEE bus command: `SENS:ADEM:DET:RMS ON`

The following commands are used for reading out the individual measured value:

`CALC:MARK:FUNC:ADEM:AM? RMS`
`CALC:MARK:FUNC:ADEM:FM? RMS`
`CALC:MARK:FUNC:ADEM:PM? RMS`

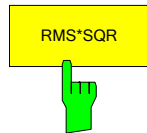

The *RMS*SQR* softkey activates the display of the $RMS \cdot \sqrt{2}$ value for the active modulation mode.

IEC/IEEE bus command: `SENS:ADEM:DET:SRMS ON`

The following commands are used for reading out the individual measured value:

`CALC:MARK:FUNC:ADEM:AM? SRMS`
`CALC:MARK:FUNC:ADEM:FM? SRMS`
`CALC:MARK:FUNC:ADEM:PM? SRMS`

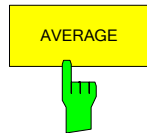

The *AVERAGE* softkey activates the display of the average value for the active modulation mode.

IEC/IEEE bus command: `ADEM:DET:AVER ON`

The following commands are used for reading out the individual measured value:

`CALC:MARK:FUNC:ADEM:AM? AVER`
`CALC:MARK:FUNC:ADEM:FM? AVER`
`CALC:MARK:FUNC:ADEM:PM? AVER`



The *DISTORTION&SINAD* softkey activates the displays of *total harmonic distortion* and *signal, noise and distortion* for the active modulation mode.

IEC/IEEE bus commands: `SENS:ADEM:DET:THD ON`

`SENS:ADEM:DET:SINAD ON`

Each of the IEC/IEEE bus commands switches both displays on or off.

The following commands are used for reading out the individual measured value:

`CALC:MARK:FUNC:ADEM:SINAD?`
`CALC:MARK:FUNC:ADEM:THD?`

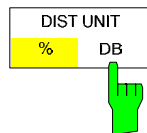

The *DIST UNIT %/DB* softkey selects between % and dB for displaying the distortion unit measurement results.

IEC/IEEE bus commands: `UNIT:THD PCT`

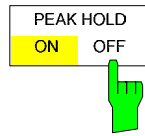

For all selected detectors, the *PEAK HOLD ON/OFF* softkey additionally activates the display of the maximum value from several measurements.

IEC/IEEE bus command: ADEM:PHOL ON

For reading out the individual measured value, PHOL is inserted into the command, e.g.:

CALC:MARK:FUNC:ADEM:AM:PHOL? PAV
 CALC:MARK:FUNC:ADEM:FM:PHOL? PPE
 CALC:MARK:FUNC:ADEM:PM:PHOL? RMS

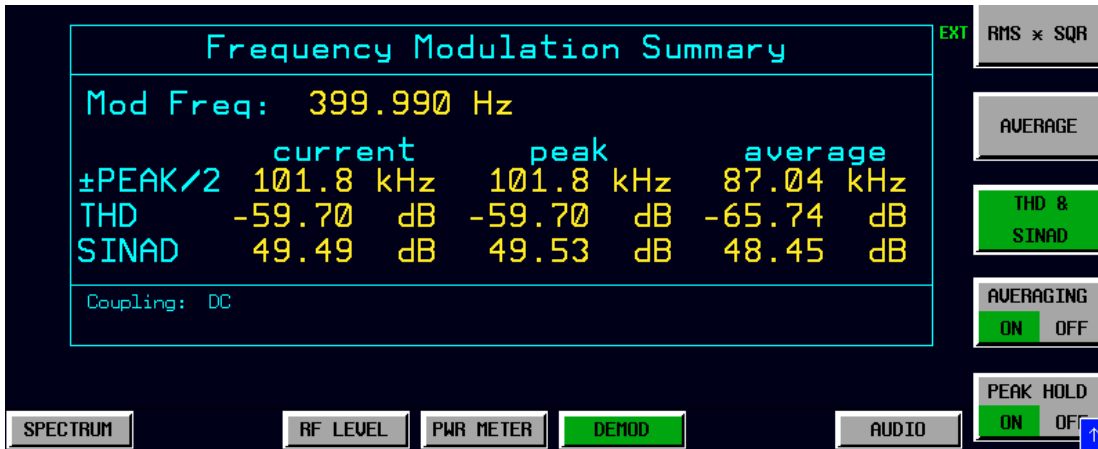

Fig. 4.4-11 Modulation measurement results with Averaging and Peak Hold

If many detectors and result options are active, the measurement results are output in smaller characters.

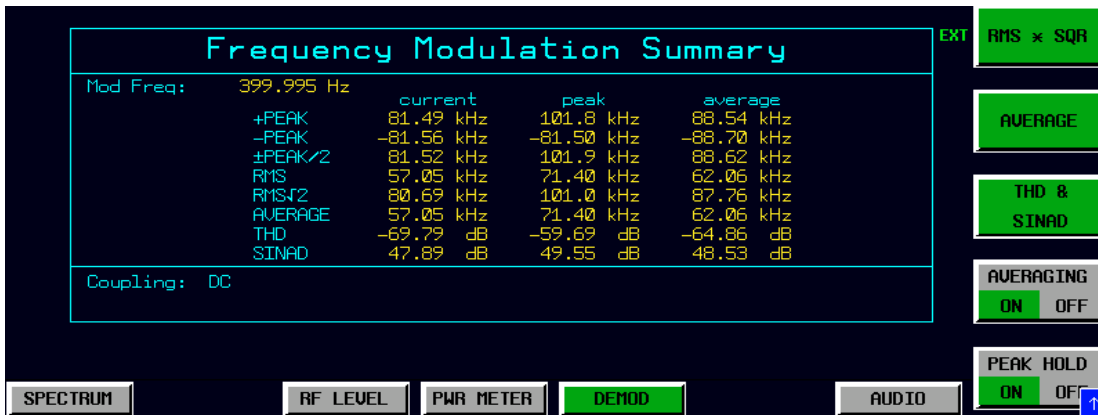
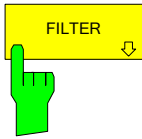
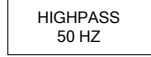
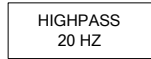

Fig. 4.4-12 All detectors with Averaging and Peak Hold displayed in smaller font



The *FILTER* softkey opens a submenu for setting the AF filters.



The *HIGHPASS 20 HZ*, *50 HZ* and *HIGHPASS 300 HZ* softkeys insert a highpass filter of 20 Hz, 50 Hz or 300 Hz into the audio signal path.

In the default setting, no highpass filter is inserted.

IEC/IEEE bus commands: `SENS:FILT:HPAS ON`
`SENS:FILT:HPAS:FREQ 300 HZ`

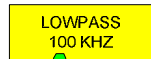
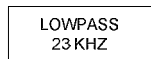
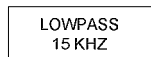
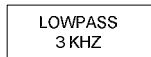

The *LOWPASS 3 KHZ*, *LOWPASS 15 KHZ*, *LOWPASS 23 KHZ* and *LOWPASS 100 KHZ* softkeys insert a lowpass filter of 3 kHz, 15 kHz, 23 kHz or 100 kHz into the audio signal path.

In the default setting, no lowpass filter is inserted.

IEC/IEEE bus commands: `SENS:FILT:LPAS ON`
`SENS:FILT:LPAS:FREQ 100 KHZ`



The *DEEMPHASIS/WEIGHTING* softkey opens a submenu for setting the AF filters.

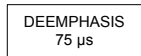
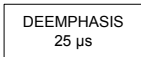

The *DEEMPHASIS 25 μs*, *DEEMPHASIS 50 μs*, *DEEMPHASIS 75 μs* and *DEEMPHASIS 750 μs* softkeys insert a user-selectable deemphasis of either 25 μs, 50 μs, 75 μs or 750 μs into the audio signal path.

In the default setting, no deemphasis is inserted.

IEC/IEEE bus commands:
`SENS:FILT:DEMP ON`
`SENS:FILT:DEMP:TCON 25 us`

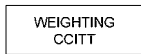

The *WEIGHTING CCITT* (CCITT P.53) and *UNWEIGHTING CCIR* (CCIR unweighted) softkeys switch on a weighting filter. The CCIR unweighted filter is the combination of the 20 Hz highpass and 23 kHz lowpass filter.

The weighting filter are active in the following demodulation bandwidth range:
 CCITT $25 \text{ kHz} \leq \text{demodulation bandwidth} \leq 3 \text{ MHz}$
 CCIR $50 \text{ kHz} \leq \text{demodulation bandwidth} \leq 1.6 \text{ MHz}$

IEC/IEEE bus commands:)
`SENS:FILT:CCIT ON`
`SENS:FFILT:CCIR ON`

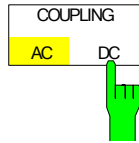

The **COUPLING AC/DC** softkey selects the coupling of the AF path of the analyzer.

IEC/IEEE bus commands: `SENS:ADEM:AF:COUP DC`

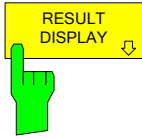

The **RESULT DISPLAY** softkey opens a submenu for configuring the screen display.

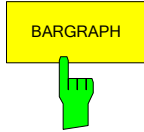

The **BARGRAPH** softkey inserts a numeric frequency and level display in the upper screen half as well as a graphic level display with a bargraph.

IEC/IEEE bus command: `CALC:FEED `XTIM:RFP:BARG``

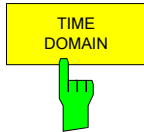

The **TIME DOMAIN** softkey inserts a graphical display with the time characteristics of the demodulated signal in the upper screen half.

IEC/IEEE bus commands:

`CALC:FEED `XTIM:AM:RELAFSP``

`CALC:FEED `XTIM:FMAFSP``

`CALC:FEED `XTIM:PMAFSP``

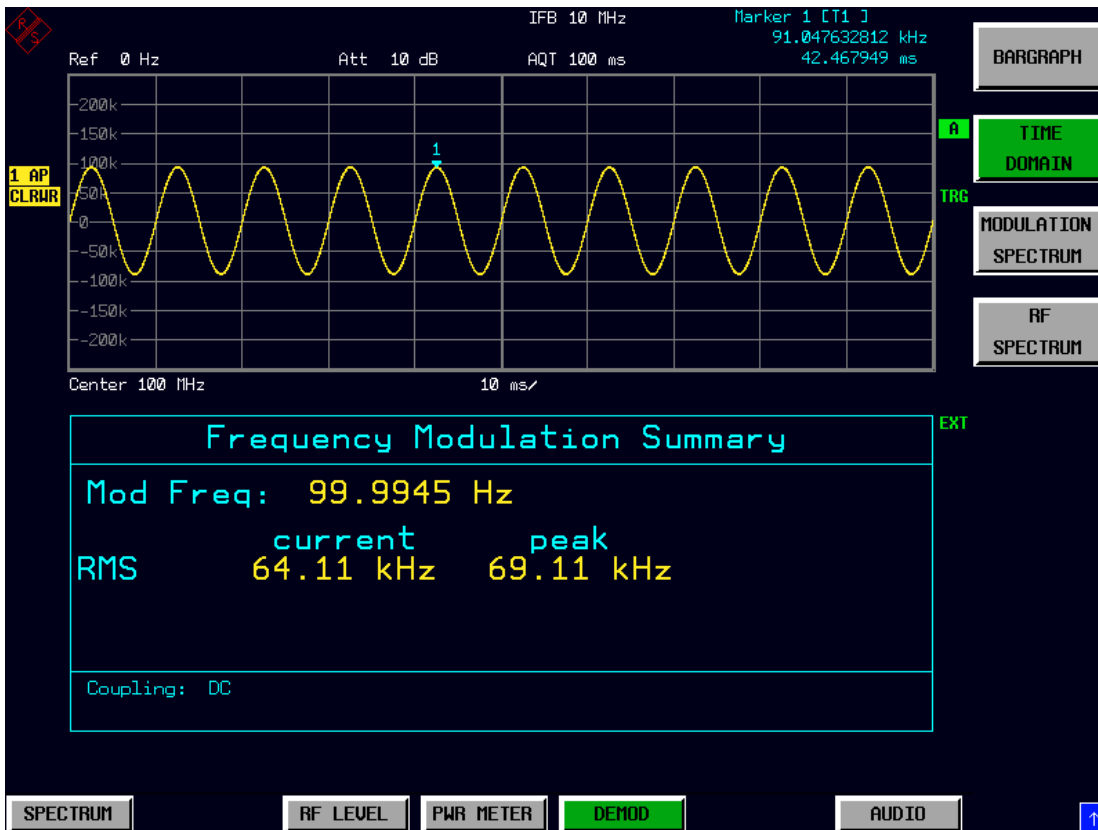
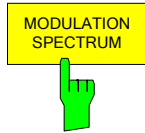

Fig. 4.4-13 Time domain display in upper window



The *MODULATION SPECTRUM* softkey inserts in the upper screen half a graphical display with the AF spectrum of the demodulated signal.

IEC/IEEE bus commands:

```
CALC:FEED `XTIM:AM:REL:AFSP`
CALC:FEED `XTIM:FM:AFSP`
CALC:FEED `XTIM:PM:AFSP`
```

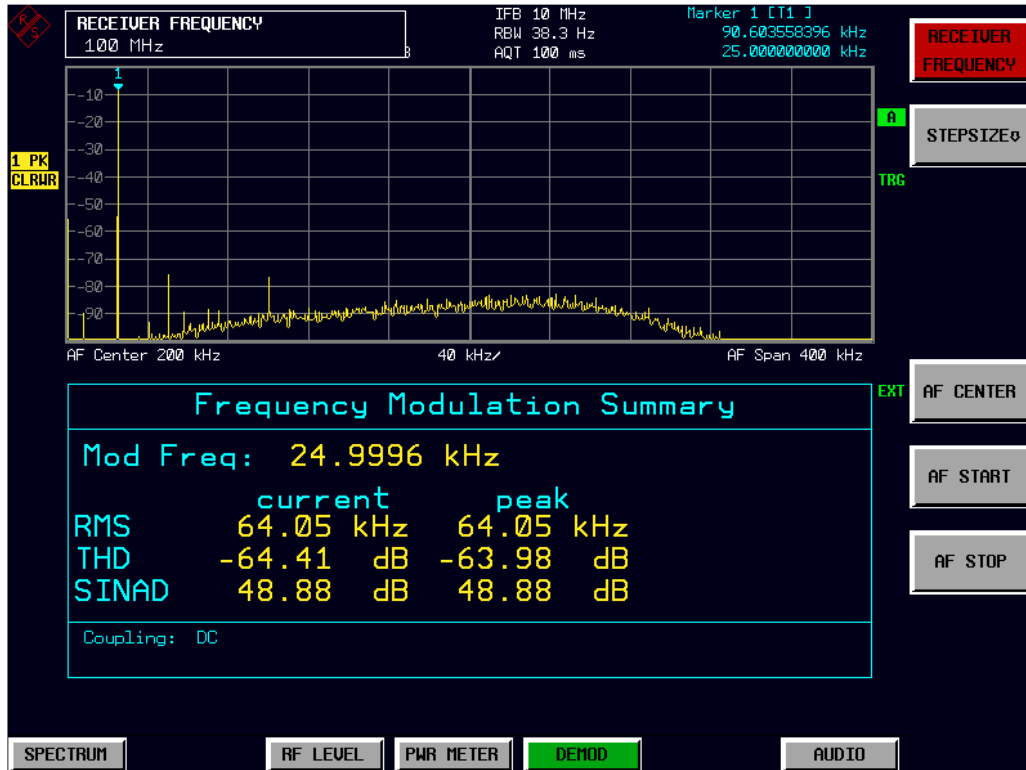
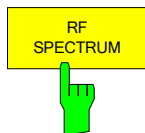

Fig. 4.4-14 Modulation spectrum display in upper window



The *RF SPECTRUM* softkey inserts a graphical display with the RF spectrum of the received signal in the upper screen half.

IEC/IEEE bus command: `CALC:FEED `XTIM:SPEC``

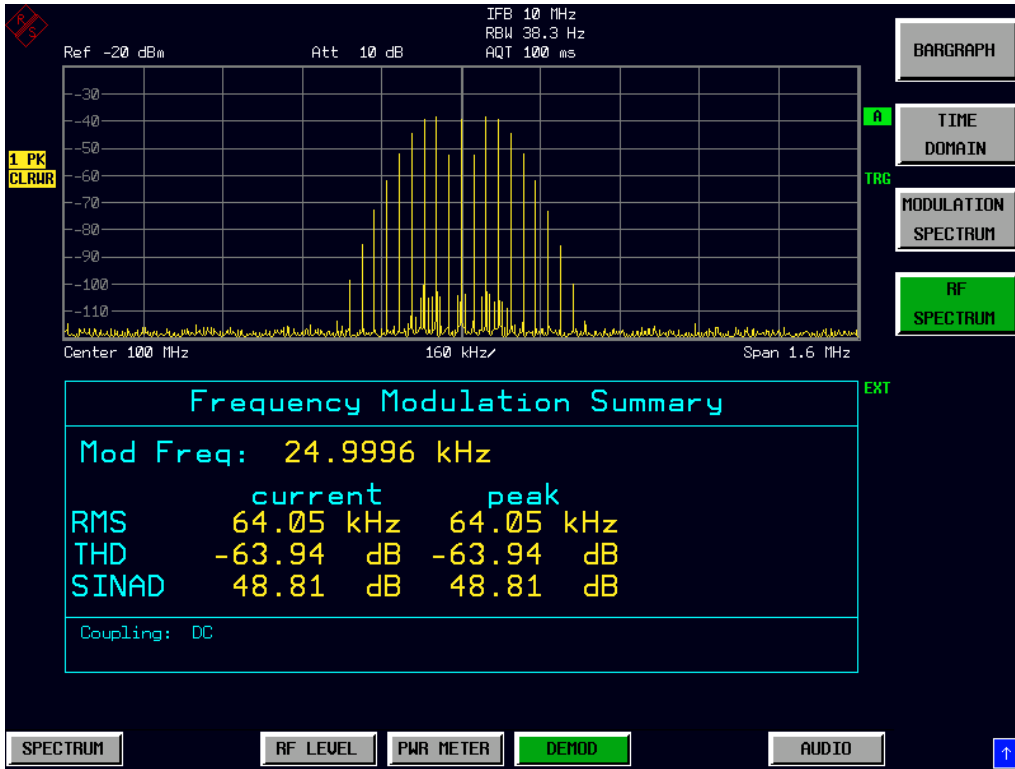
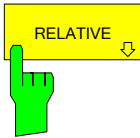
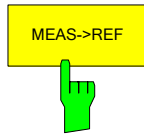

Fig. 4.4-15 RF-spectrum- display in upper window



The *RELATIVE* softkey opens a submenu for configuring the relative display of the modulation measurement results.



The *MEAS->REF* softkey adopts the current modulation measurement values for all active detectors as reference values.

IEC/IEEE bus command:

`SENS:ADEM:DET:REF:AUTO ONCE`

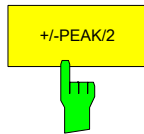

The *+/-PEAK/2* softkey switches the relative display of the arithmetic average value from the positive and the negative peak value for the currently active modulation mode on or off. When the relative display is switched on, the current measured value of this detector is automatically adopted as the reference value.

The softkey opens a data entry field that also allows you to define the reference value manually.

IEC/IEEE bus commands:

`SENS:ADEM:DET:PAV:MOD REL`

`SENS:ADEM:DET:PAV:REF 10`

`SENS:ADEM:DET:PAV:REF:AUTO ONCE`

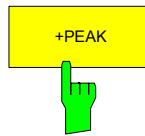

The *+PEAK* softkey switches the relative display of the positive peak value for the active modulation mode on or off. When the relative display is switched on, the current measured value of this detector is automatically adopted as the reference value.

The softkey opens a data entry field that also allows you to define the reference value manually.

IEC/IEEE bus commands:

```
SENS:ADEM:DET:PPE:MOD REL
SENS:ADEM:DET:PPE:REF 10
SENS:ADEM:DET:PPE:REF:AUTO ONCE
```

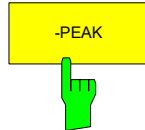

The *-PEAK* softkey switches the relative display of the negative peak value for the active modulation mode on or off. When the relative display is switched on, the current measured value of this detector is automatically adopted as the reference value.

The softkey opens a data entry field that also allows you to define the reference value manually.

IEC/IEEE bus commands:

```
SENS:ADEM:DET:MPE:MOD REL
SENS:ADEM:DET:MPE:REF 10
SENS:ADEM:DET:MPE:REF:AUTO ONCE
```

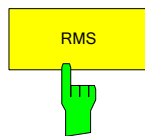

The *RMS* softkey switches the relative display of the RMS detector for the active modulation mode on or off. When the relative display is switched on, the current measured value of this detector is automatically adopted as the reference value. The softkey opens a data entry field that also allows you to define the reference value manually.

IEC/IEEE bus commands:

```
SENS:ADEM:DET:RMS:MOD REL
SENS:ADEM:DET:RMS:REF 10
SENS:ADEM:DET:RMS:REF:AUTO ONCE
```

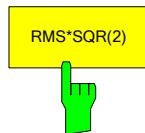

The *RMS*SQR(2)* softkey switches the relative display of the $RMS \cdot \sqrt{2}$ detector for the active modulation mode on or off. When the relative display is switched on, the current measured value of this detector is automatically adopted as the reference value.

The softkey opens a data entry field that also allows you to define the reference value manually.

IEC/IEEE bus commands:

```
SENS:ADEM:DET:SRMS:MOD REL
SENS:ADEM:DET:SRMS:REF 10
SENS:ADEM:DET:SRMS:REF:AUTO ONCE
```

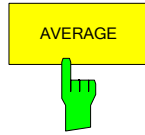

The *AVERAGE* softkey switches the relative display of the average value detector for the active modulation mode on or off. When the relative display is switched on, the current measured value of this detector is automatically adopted as the reference value.

The softkey opens a data entry field that also allows you to define the reference value manually.

IEC/IEEE bus commands:

```
SENS:ADEM:DET:AVER:MOD REL
SENS:ADEM:DET:AVER:REF 10
SENS:ADEM:DET:AVER:REF:AUTO ONCE
```

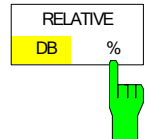

The *RELATIVE DB/%* softkey switches between the units dB and % for the relative display of the modulation measurement results.

IEC/IEEE bus command: UNIT:POW:RAT DB | PCT

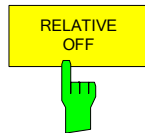

The *RELATIVE OFF* softkey switches all relative displays of the modulation measurement results to absolute display.

IEC/IEEE bus command: SENS:ADEM:DET:REF AOFF

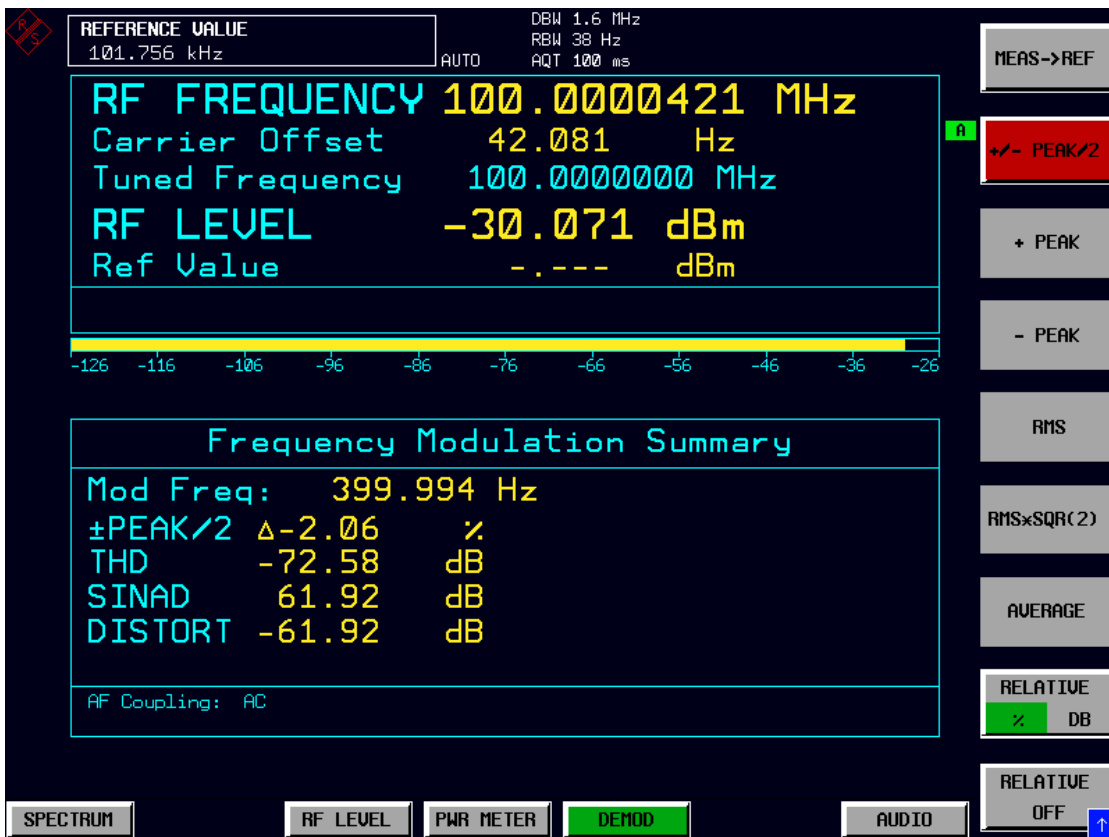
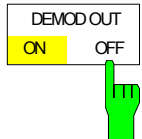

Fig. 4.4-16 Relative displays of the modulation measurement results



This softkey activates the averaging of the modulation summary in the lower screen half. It opens a window for the entry of the number of sweeps (averagings) to be performed after a single sweep has been started. The range for the average count is 0 to 32767. For average count = 0 or 1, one sweep is performed. For averaging in the continuous sweep mode, FSMR performs running averaging over 10 sweeps if average count = 0. If average count = 1, no averaging is performed. The averaging and sweep count of the trace menu are connected.

IEC/IEEE-bus command: SENS:ADEM:AVER:STAT ON | OFF
 SENS:SWE:COUN 0 to 32767



The DEMOD OUT OFF/ON softkey switches the analog output of the demodulator for the active modulation mode on or off. When the demodulation output is switched on, the current modulation signal of the selected demodulator is available on the audio output.

IEC/IEEE bus command: SENS:DEM ON

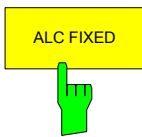

The ALC FIXED softkey enables the AM envelope detector that measures the demodulated baseband signal without normalization to the carrier level. The AM envelope detector measures the envelope RF level of an AM modulated signal. The result of this detector is independent of the RF level of the AM signal. The application of this detector is described in the Performance Test for the Hewlett-Packard 11715A AM/FM Test Source.

IEC/IEEE bus command: SENS:ADEM:DET:ALCF ON

Measurements on the Audio Input – AUDIO Key

The R&S FSMR features an *AUDIO* baseband input for measurements in the audio frequency range. The AUDIO hotkey in the receiver mode switches the audio input to active and opens a menu for configuring and controlling the measurements.

IEC/IEEE bus command: INP AUDIO

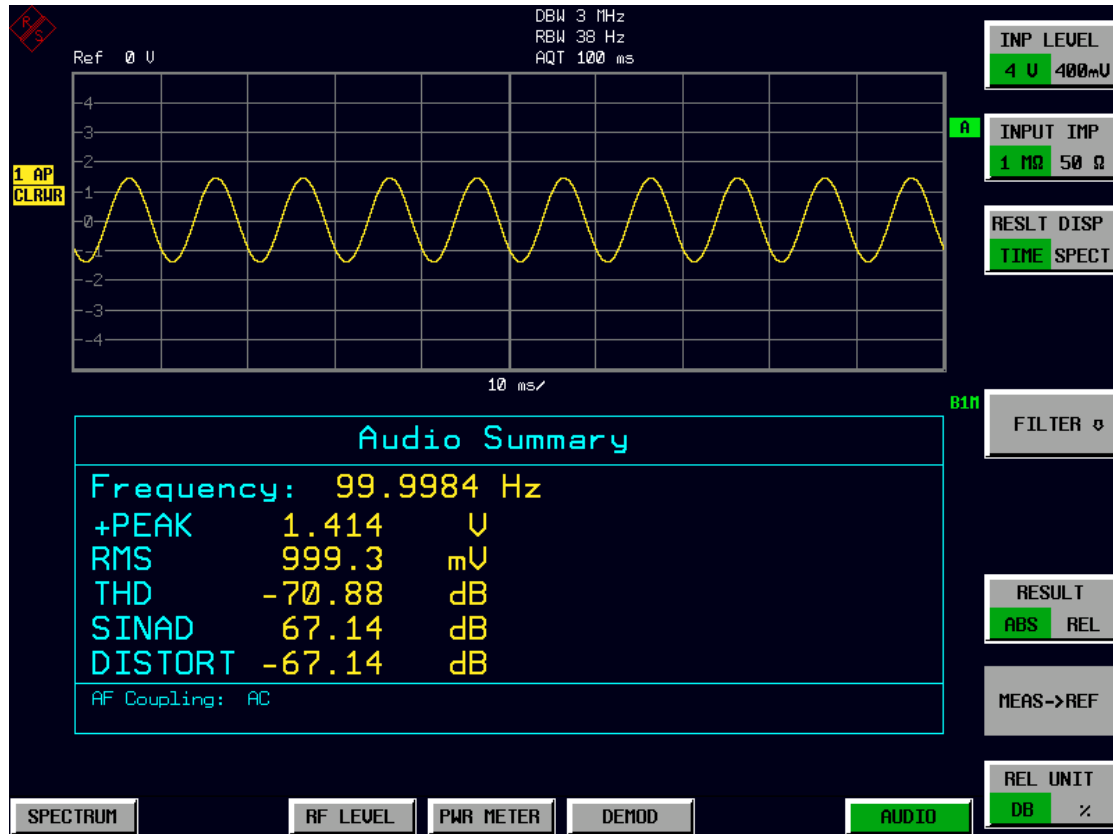
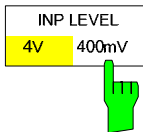
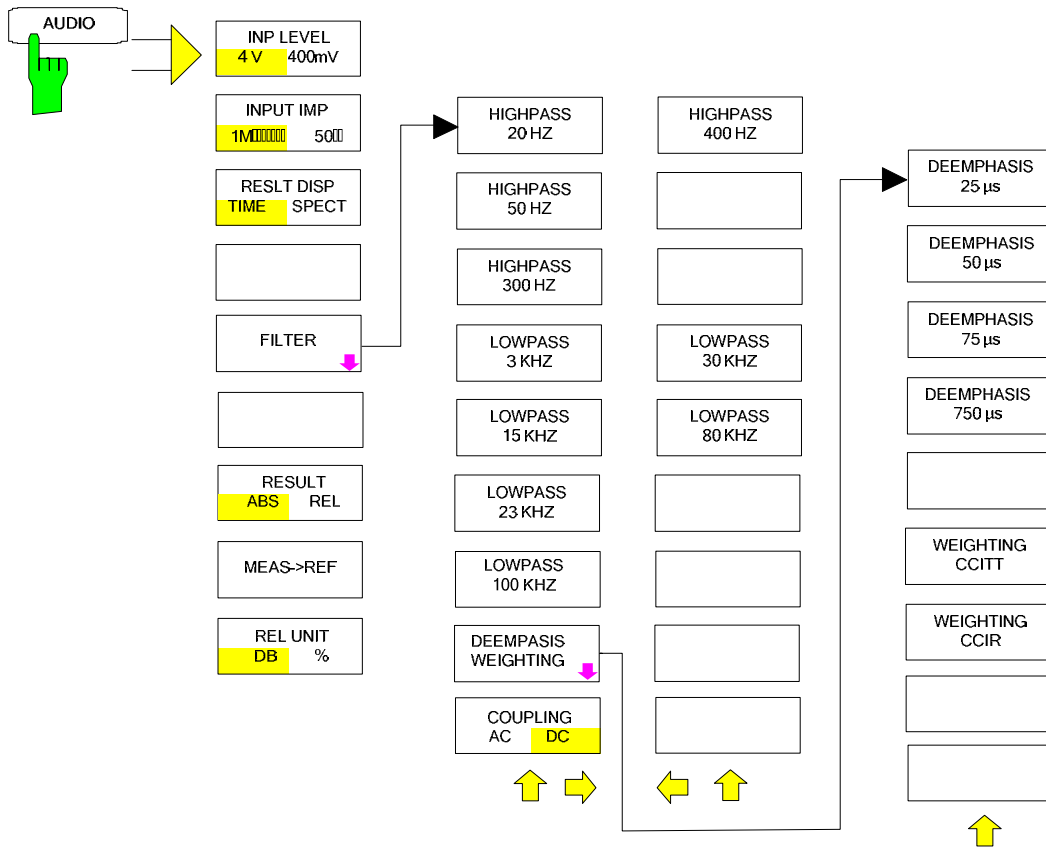

Fig. 4.4-17 Screen display of measurements on the audio input

The following commands are used for reading out the individual measured value:

Modulation Frequency	CALC:MARK:FUNC:ADEM:AFR?
+Peak	CALC:MARK:FUNC:VOLT? PPE
RMS	CALC:MARK:FUNC:VOLT? RMS
THD	CALC:MARK:FUNC:VOLT? THD
SINAD	CALC:MARK:FUNC:VOLT? SIN



The *INP LEVEL 4V/400mV* softkey switches the input voltage range of the audio input between 4 V and 400 mV.

In the default setting, the 4 V range is switched on.

IEC/IEEE bus command: `SENS:VOLT:AC:RANG:UPP 4 V`

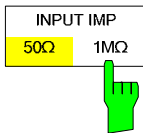

The *INPUT IMP 50Ω/1MΩ* softkey switches the input impedance of the audio input between 50 Ω and 1 MΩ.

In the default setting, an input impedance of 1 MΩ is switched on.

IEC/IEEE bus command: `INP:IMP 50 OHM`

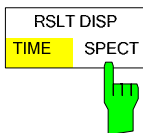

The *RSLT DISP TIME/SPECT* softkey selects the graphical result display in the upper screen half.

In the default setting, the time domain display is switched on.

IEC/IEEE bus commands: `CALC:FEED `XTIM:AC:TDOM``
`CALC:FEED `XTIM:AC:SPEC``

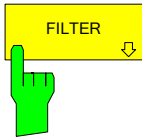

The *FILTER* softkey opens a submenu for setting the AF filters.

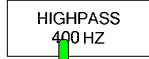
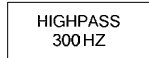
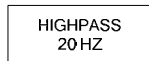

The *HIGHPASS 20 HZ*, *HIGHPASS 50 HZ*, *HIGHPASS 300 HZ* and *HIGHPASS 400 HZ* softkeys insert a highpass filter of 20 Hz, 50 Hz, 300 Hz or 400 Hz into the audio signal path. In the default setting, no highpass filter is inserted.

IEC/IEEE bus commands: `SENS:FILT:HPAS ON`
`SENS:FILT:HPAS:FREQ 300 HZ`

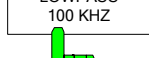
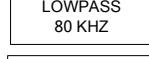
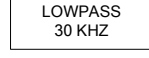
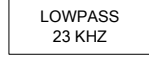
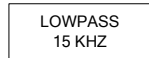
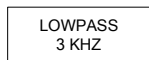

The *LOWPASS 3 KHZ*, *LOWPASS 15 KHZ*, *LOWPASS 23 KHZ*, *LOWPASS 30 KHZ*, *LOWPASS 80 KHZ* and *LOWPASS 100 KHZ* softkeys insert a lowpass filter of 3 kHz, 15 kHz, 23 kHz, 30 kHz, 80kHz or 100 kHz into the audio signal path. In the default setting, no lowpass filter is inserted.

IEC/IEEE bus commands: `SENS:FILT:LPAS ON`
`SENS:FILT:LPAS:FREQ 100 kHz`

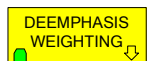

The *DEEMPHASIS/WEIGHTING* softkey opens a submenu for setting the AF filters.

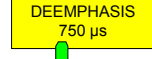
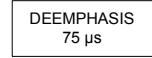
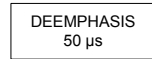
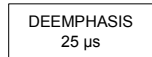

The *DEEMPHASIS 25 μs*, *DEEMPHASIS 50 μs*, *DEEMPHASIS 75 μs* and *DEEMPHASIS 750 μs* softkeys insert a user-selectable deemphasis of either 25 μs, 50 μs, 75 μs or 750 μs into the audio signal path.

In the default setting, no deemphasis is inserted.

IEC/IEEE bus commands:
`SENS:FILT:DEMP ON`
`SENS:FILT:DEMP:TCON 25 us`



WEIGHTING
CCITT

The *WEIGHTING CCITT* and *WEIGHTING CCIR* softkey inserts a weighting filter in line with the CCITT P53 standard into the signal path.



UNWEIGHTING
CCIR

This filter is deactivated in the default setting.

IEC/IEEE bus command: `FILT:CCIT ON`
EC/IEEE bus command: `FILT:CCIR ON`

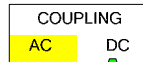

COUPLING
AC DC

The *COUPLING AC/DC* softkey selects the DC coupling of the input signal.

The default setting is the AC coupling.

IEC/IEEE bus command: `SENS:ADEM:AF:COUP DC`

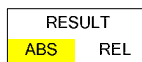

RESULT
ABS REL

The *RESULT ABS/REL* softkey selects the display mode of the measurement results, either absolute or relative in relation to a reference value.

In the default setting, the absolute value display is switched on.

IEC/IEEE bus command: `SENS:VOLT:AC:REF ON`

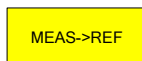

MEAS->REF

The *MEAS->REF* softkey adopts the current level measurement value as the reference value for the display of a relative measured value.

IEC/IEEE bus command: `SENS:VOLT:AC:REF:AUTO ONCE`

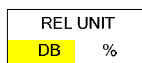

REL UNIT
DB %

The *REL UNIT DB/%* softkey selects the unit for the display of the relative measurement results.

In the default setting, the relative value display in dB is switched on.

IEC/IEEE bus command: `UNIT:POW:RAT DB`

Setting the Receiver Frequency and the Span - *FREQ* Key

Using the *FREQ* key, the receiver frequency is set in manual mode.

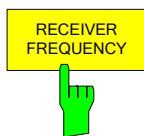
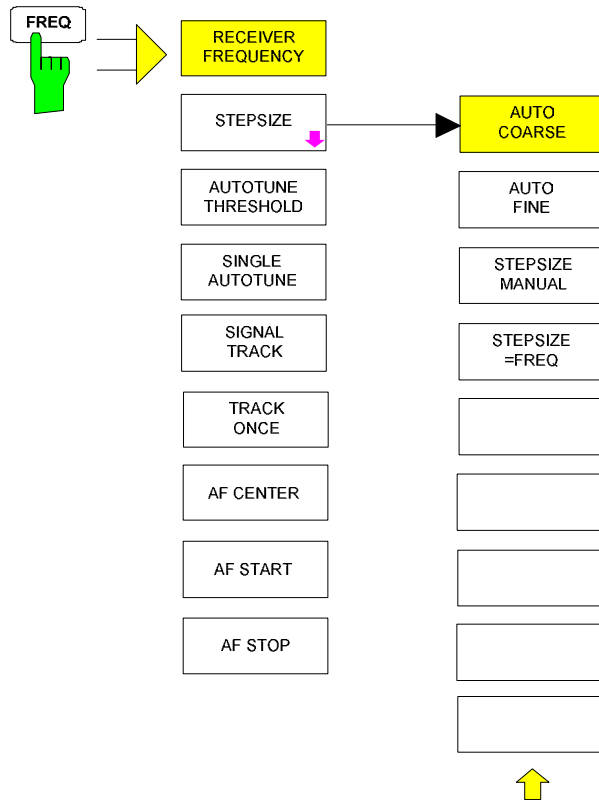

The *RECEPTION FREQUENCY* softkey activates the window for entering the receiver frequency .

The receiver frequency resolution is 0.1 Hz.
 Setting range: $20 \text{ Hz} \leq f_{\text{REC}} \leq f_{\text{max}}$

IEC/IEEE bus command: `SENS:FREQ:CENT 300MHz`

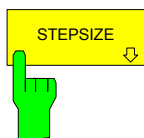

The *STEPSIZE* softkey opens a submenu for setting the step size of the receive frequency. The step size can either be coupled to the set frequency or be manually set to a fixed value. The menu softkeys are selection switches, and only one of them at a time can be active.

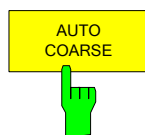

The *AUTO COARSE* softkey sets the step size of the receive frequency to coarse. In this setting, the fourth position of the set frequency is varied.

IEC/IEEE bus command: `--`

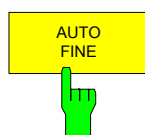

The *AUTO FINE* softkey sets the step size of the receive frequency to fine. In this setting, the seventh position of the set frequency is varied.

IEC/IEEE bus command: `--`



The *STEPSIZE MANUAL* softkey activates the window for entering a fixed value for the step size.

IEC/IEEE bus command: `SENS:FREQ:CENT:STEP 50 kHz`



The *STEPSIZE = FREQ* softkey sets the step size to the receive frequency value. This function is particularly useful for measuring the harmonics of a signal. If the receiver is first tuned to the fundamental, the frequency of another harmonic is set with each frequency variation by using the rotary knob or the *STEP* keys.

IEC/IEEE bus command: `--`



The *AUTOTUNE THRESHOLD* softkey activates the window for entering the threshold level of the autotune function. This function is only available for instrument models up to a maximum frequency of 26.5 GHz

The autotune threshold default setting is -40 dBm.

Setting range: $-50 \text{ dBm} \leq \text{Threshold level} \leq 0 \text{ dBm}$

IEC/IEEE bus command: `SENS:FREQ:CW:AFC:THR`



This softkey activates a single automatic signal search.

IEC/IEEE bus command: `SENS:FREQ:CW:AFC ONCE`

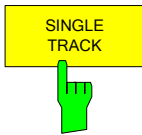

This softkey activates a function to track a drifting signal. If the measured signal frequency is too far away from the tuned center frequency and the level is above the threshold, the center frequency of the receiver will be changed to the new signal frequency.

IEC/IEEE bus command: `SENS:FREQ:CW:AFC ON`



The *AF CENTER* softkey allows you to select the center frequency within the AF spectrum.

IEC/IEEE bus command: `SENS:ADEM:AF:CENT 1MHZ`



The *AF START* softkey allows you to select the start frequency within the AF spectrum.

IEC/IEEE bus command: `SENS:ADEM:AF:STAR 0HZ`

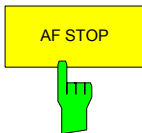

The *AF STOP* softkey allows you to select the stop frequency within the AF spectrum.

The maximum AF stop frequency is half the demodulation bandwidth.

IEC/IEEE bus command: `SENS:ADEM:AF:STOP 2MHZ`

Setting the Level Display and Configuring the RF Input – AMPT Key

Using the *AMPT* key, you can set the RF attenuation, the preamplifier, the autorange function and the display unit.

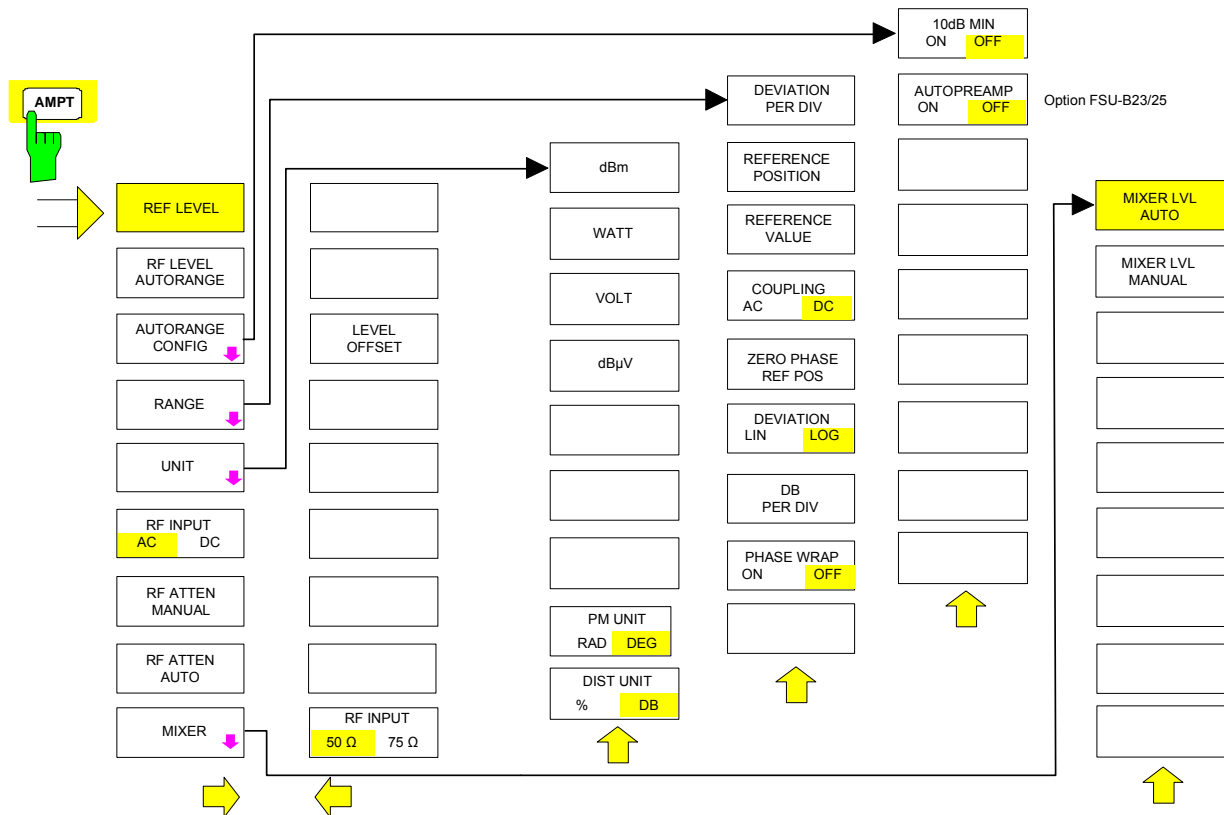

The *REF LEVEL* softkey activates the window for entering the reference level. The entry is made in the currently active unit (dBm, dBµV, etc).

IEC/IEEE bus command: `DISP:WIND:TRAC:SCAL:Y:RLEV -60dBm`



The *RF LEVEL AUTORANGE* softkey activates the autorange function; attenuation, IF gain and, if necessary, preamplification, are automatically matched to the applied RF signal.

IEC/IEEE bus command: `INP:ATT:AUTO ON`

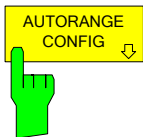

The *AUTORANGE CONFIG* softkey opens a submenu for configuring the automatic setting of attenuation and IF gain and, if necessary, preamplification.

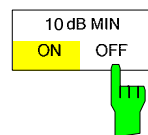

The 10 dB MIN ON/OFF softkey determines whether or not the 0 dB position of the attenuator is used when setting the insertion manually or automatically. The default setting is 10 dB MIN ON. Thus, an RF attenuation of at least 10 dB is always switched on in the R&S FSMR to ensure specific adjustment. Even manually, the 0 dB position cannot be switched on.

IEC/IEEE bus command: `INP:ATT:PROT:STAT ON`

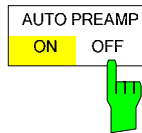

The *AUTO PREAMP ON/OFF* softkey activates the preamplifier for the autorange function.

- ON The autorange function takes the preamplifier into account. The preamplifier is activated only when the attenuation of the attenuator has been reduced to the minimum settable value.
- OFF The autoranging does not take into account the preamplifier.

The softkey is only available with the R&S FSU-B23/B25 *preamplifier* option.

IEC/IEEE bus command: `INP:GAIN:AUTO ON`

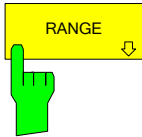

The *RANGE* softkey opens a submenu for configuring the y axis in the graphical display of the modulation measurement results.

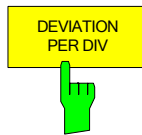

The *DEVIATION PER DIV* softkey allows you to select the phase or frequency deviation that is to be displayed in the range from 1 Hz/div to 1 MHz/div with FM display or from 0.0001 rad/div to 1000 rad/div with PM display. In the AM display, the modulation depth is set in the range from 0.0001%/div to 1000%/div. To ensure that the measurement results are not distorted, select an analyzer IF bandwidth that is larger than the maximum frequency deviation plus modulation frequency (*IF BANDWIDTH* softkey in the *BW* menu).

The softkey is not available in the AF spectrum display because scaling here is effected via the *DB PER DIV* and *REFERENCE VALUE* softkeys.

IEC/IEEE bus command: `DISP:WIND:TRAC:Y:PDIV 50kHz`

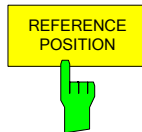

The *REFERENCE POSITION* softkey defines the position of the reference line for the phase or frequency deviation (FM/PM) or the modulation depth (AM) on the y axis of the diagram. In the analyzer's default setting, this line corresponds to a frequency deviation of 0 Hz (FM) or a phase deviation of 0 rad (PM) or a modulation depth of 0% (AM).

The entry is in percentage of the diagram height, where 100% corresponds to the top edge of the diagram. The default setting is 50% (diagram center) for displaying the FM, PM or AM signal, and 100% (top edge of diagram) for displaying the AF spectrum of the signal.

IEC/IEEE bus command: `DISP:WIND:TRAC:Y:RPOS 50PCT`

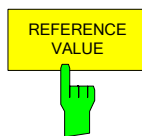

The *REFERENCE VALUE* softkey defines the frequency or phase deviation (FM/PM) or the modulation depth (AM) on the reference line of the y axis. The reference value is set separately both for each FM, PM and AM signal display and for the AF spectrum display of the FM, PM and AM signal.

FM signal display:

The reference value allows you to take into account individual frequency offsets in the trace display (while the *AF COUP AC/DC* softkey permits automatic correction by the average frequency offset of the signal).

The settable value range is 0 MHz to ± 10 MHz. The softkey is not available if the *AF COUP AC* function is active.

AF spectrum display of the FM signal:

In the default setting, the reference value defines the FM deviation at the top edge of the diagram.

The settable value range is 0 MHz to 10 MHz.

PM signal display:

The reference value allows you to take into account individual phase offsets in the trace display (while the *AF COUP AC/DC* softkey permits automatic correction by the average phase offset of the signal).

The settable value range is 0 rad to ± 10000 rad. The softkey is not available if the *AF COUP AC* function is active.

AF spectrum display of the PM signal:

In the default setting, the reference value defines the PM deviation at the top edge of the diagram.

The settable value range is 0 rad to 10000 rad.

AM signal display:

The settable value range is 0% to $\pm 10000\%$.

AF spectrum display of the AM signal:

In the default setting, the reference value defines the modulation depth at the top edge of the diagram.

The settable value range is 0% to 10000%.

IEC/IEEE bus command: `DISP:WIND:TRAC:Y:RVAL 0HZ`

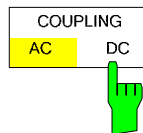

The *COUPLING AC/DC* softkey controls the automatic correction of the frequency offset and the phase offset of the input signal.

FM signal display:

If *DC* is selected, the absolute frequency offset is displayed, i.e. an input signal shifted with respect to the center frequency is displayed as not symmetrical to the zero line.

However, if *AC* is selected, the frequency offset is automatically corrected, i.e. the trace is always displayed as symmetrical to the zero line.

PM signal display:

If *DC* is selected, the phase drifts off, depending on the frequency offset that is present. Moreover, the *DC* signal has a phase offset of $\pm\pi$.

However, if *AC* is selected, the frequency and phase offset is automatically corrected, i.e. the trace is always displayed as symmetrical to the zero line.

The softkey is not available if the FM or PM signal is displayed in the AF spectrum.

IEC/IEEE bus command `SENS:ADEM:AF:COUP DC`



The *ZERO PHASE REF POS* softkey defines the position where the PM-demodulated signal phase is set to 0 rad. Entry is on a time basis. In the default setting, the first measured value is set to 0 rad.

The softkey is only available in the PM display with *DC* coupling.

IEC/IEEE bus command: `SENS:ADEM:PM:RPO:X 10us`

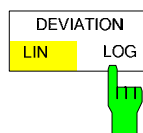

The *DEVIATION LIN/LOG* softkey switches between logarithmic and linear frequency and phase deviation display (FM/PM) or modulation depth display (AM).

The softkey is only available if the FM, PM or AM signal is displayed in the AF spectrum.

IEC/IEEE bus command: `DISP:WIND:TRAC:Y:SPAC LOG`

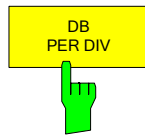

The *DB PER DIV* softkey allows you to select either the FM or PM deviation to be displayed or the modulation depth in the range from 0.1 dB/div to 20 dB/div. The softkey is not available with linear displays.

IEC/IEEE bus command: `DISP:WIND:TRAC:Y:PDIV 5DB`

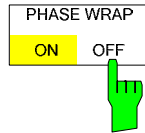

The *PHASE WRAP ON/OFF* softkey activates and deactivates a phase wrap in the graphical display of the phase modulation.

ON The phase is displayed in the $\pm 180^\circ$ ($\pm\pi$) range. If the phase exceeds e.g. $+180^\circ$, 360° are deducted from the phase value resulting in a display of $>-180^\circ$.

OFF The phase is not wrapped.

The softkey is available in the displays of PM signals.

IEC/IEEE bus command: `CALC:FORM PHAS`

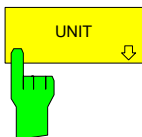

The *UNIT* softkey opens a submenu from which the desired unit for the y axis can be selected.

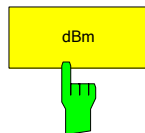

The *dBm* softkey selects the unit dBm for displaying the RF level measurement results.

IEC/IEEE bus command: `CALC:UNIT:POW DBM`

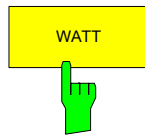

The *WATT* softkey selects the unit Watt for displaying the RF level measurement results.

IEC/IEEE bus command: `CALC:UNIT:POW DBUV`

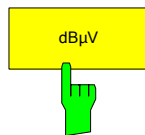

The *dBuV* softkey selects the unit dBuV for displaying the RF level measurement results.

IEC/IEEE bus command: `CALC:UNIT:POW WATT`

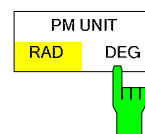

The *PM UNIT RAD/DEG* softkey allows you to select the unit for the PM signal display.

IEC/IEEE bus command: `UNIT:ANGL RAD`

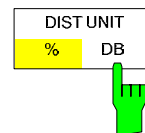

The *DIST UNIT%/DB* softkey selects between % and dB for displaying the THD and SINAD measurement results.

IEC/IEEE bus command: `UNIT:THD PCT`

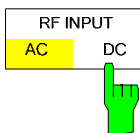

The *RF INPUT AC/DC* softkey switches the analyzer input between AC and DC coupling.

IEC/IEEE bus command: `INP:COUP AC`



The softkey is only available with models 3 and 26.



The *RF ATTEN MANUAL* softkey activates the window for entering attenuation independently of the reference level.

The attenuation can be altered in 5 dB steps between 0 dB and 75 dB. Other entries are rounded down to the next lowest integral value.

If the specified reference level can no longer be set with the specified RF attenuation, the level is adjusted and the "Limit reached" message is displayed.

IEC/IEEE bus command: `INP:ATT 40 DB`



The 0 dB value cannot be switched on unless the 10 dB MIN function is off. This protects the input mixer from overloading by mistake.



The *RF ATTEN AUTO* softkey automatically sets the RF attenuation depending on the set reference level.

This ensures that the optimum RF attenuation is always used.

RF ATTEN AUTO is the default setting.

IEC/IEEE bus command: `INP:ATT:AUTO ON`

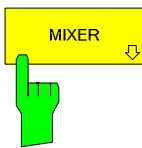

The *MIXER* softkey opens a submenu for changing the mixer level on the input mixer.



The *MIXER LVL AUTO* softkey activates the automatic coupling of the maximum mixer level to the reference level and the RF attenuation.

IEC/IEEE bus command: `INP:MIX:AUTO ON`



The *MIXER LVL MANUAL* softkey activates the window for entering the maximum mixer level that can be achieved with reference levels.

The setting range is 0 dB to -100 dBm with a step size of 10 dB.

IEC/IEEE bus command: `INP:MIX:POS -25DBM`



The *LEVEL OFFSET* softkey allows the arithmetic level offset to be entered. This offset is added to the measured level irrespective of the selected unit.

The setting range is ± 200 dB in 0.1 dB steps.

IEC/IEEE-bus command: `DISP:WIND:TRAC:Y:RLEV:OFFS -10dB`

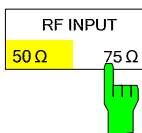

The *RF INPUT 50 Ω / 75 Ω* softkey switches the reference impedance for the measured level values between 50 Ω (= default setting) and 75 Ω.

Select the 75 Ω setting if the 50 Ω input impedance is transformed to the next higher impedance by using a 75 Ω matching pad of the RAZ type (= 25 Ω in series with the input impedance of the analyzer). The correction value used is 1.76 dB = $10 \log(75 \Omega / 50 \Omega)$.

All level specifications in this manual refer to the default setting (50 Ω) of the device.

IEC/IEEE bus command: `INP:IMP 50 OHM`

Setting the Bandwidths and the Measurement Time - *BW* Key

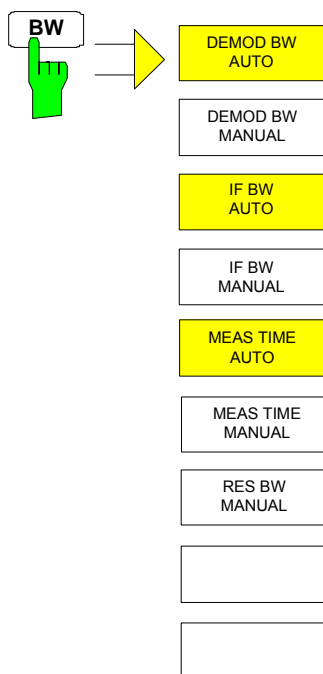

The *BW* key calls up a menu for setting the receiver mode bandwidths and measurement times.



In the default setting, demodulation bandwidth, IF bandwidth and measurement time are automatically selected depending on the selected operating mode. To obtain optimum measurement results, you should keep these settings.

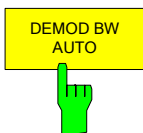

The *DEMOD BW AUTO* softkey activates the automatic setting of the demodulation bandwidth. Depending on the operating mode (Audio, AM, FM, PM, RF Level), the demodulation bandwidth is set in such a way that only the smallest possible measurement error occurs within the specified measurement range.

Mode	Demodulation bandwidth
RF Level	12.5 kHz
Demod	1.6 MHz
AUDIO	3 MHz

IEC/IEEE bus command: SENS : BAND : DEM : AUTO ON

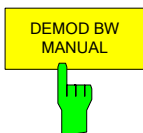

The *DEMOD BW MANUAL* softkey selects a bandwidth between 100 Hz and 10 MHz with which the signal to be measured is sampled.

IEC/IEEE bus command: SENS : BAND : DEM 200 KHZ

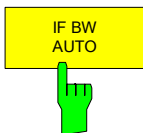

The *IF BW AUTO* softkey couples the IF bandwidth of the R&S FSMR (i.e. the bandwidth of the analog LC filters) to the selected receive frequency.

Receive frequency	IF bandwidth
≥10 MHz	10 MHz
<10 MHz	500 kHz

IEC/IEEE bus command: SENS : BAND : RES : AUTO ON



The *IF BW MANUAL* softkey activates the entry of the IF bandwidth of the R&S FSMR (i.e. the bandwidth of the analog filters). Bandwidths from 300 kHz to 10 MHz can be set.



In most cases, you need not set the IF bandwidth manually. If the IF bandwidth is set more narrowly than specified by the AUTO coupling, the following occurs:

1. In the case of spectrum display, an RF frequency response occurs that equals that of the IF filter.
2. In the case of FM demodulation, an AF frequency response corresponding to a lowpass filter occurs that is equivalent to an IF filter.
3. In the case of level measurement, an additional linearity error occurs.

IEC/IEEE bus command: SENS:BAND:RES 10 MHZ

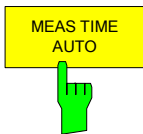

The *MEAS TIME AUTO* softkey activates automatic coupling of the measurement time.

Mode	Demodulation bandwidth
RF Level	12.5 kHz
Demod	1.6 MHz



To obtain a correct result display, at least five periods of the demodulated signal should be monitored. If the modulation frequencies are low, it may be useful to manually prolong the measurement time (= signal monitoring time).

IEC/IEEE bus command: SENS:SWE:TIME:AUTO ON

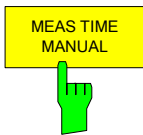

The *MEAS TIME MANUAL* softkey opens the entry field for determining the data acquisition time. The permissible value range depends on the selected demodulation bandwidth.



To obtain a correct result display, at least five periods of the demodulated signal should be monitored.

IEC/IEEE bus command: SENS:SWE:TIME 200 MS



If the spectrum display is active, the *RES BW MANUAL* softkey selects the resolution bandwidth for the displayed signal. Note that these resolution bandwidths are implemented as FFT filters.



The softkey is only available if the RF SPECTRUM or AF SPECTRUM result displays are active. The IF BW MANUAL and IF BW AUTO softkeys help to limit the IF bandwidth via analog LC filters.

IIEC/IEEE bus command: SENS:ADEM:SPEC:BAND 100

Setting the Sweep - SWEEP/MEAS Keys

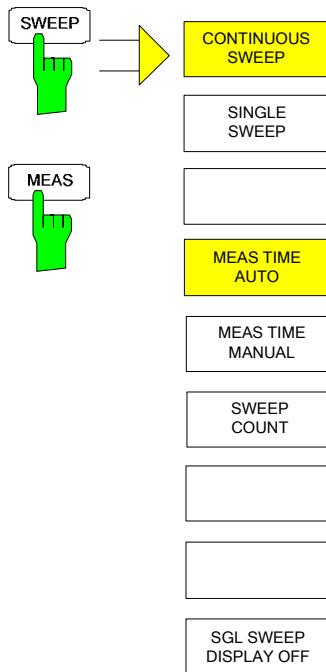

With spectrum displays, the *SPAN* menu allows you to select the frequency range to be displayed.



The *CONTINUOUS SWEEP* softkey sets the continuous sweep triggering, i.e. the sweep occurs continuously in accordance with the trigger setting.

In the case of split-screen display and different settings in both measurement windows, first screen A and then screen B is swept. After pressing the softkey, the sweep is always restarted.

CONTINUOUS SWEEP is the default setting of the R&S FSMR.

IEC/IEEE bus command: `INIT:CONT ON`

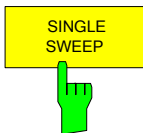

The *SINGLE SWEEP* softkey starts an n-times sweep after the trigger event has occurred. The *SWEEP COUNT* softkey defines the number of sweeps.

In the split-screen display, the frequency ranges of the two windows are subsequently swept.

If a trace is sampled with *TRACE AVERAGE* or *MAXHOLD*, the value set with the *SWEEP COUNT* softkey defines the number of measurements. If the value is 0, a sweep is performed.

IEC/IEEE bus command: `INIT:CONT OFF;:INIT`

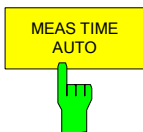

The *MEAS TIME AUTO* softkey activates the automatic coupling of measurement time.

Mode	Measurement time
RF Level	400 ms
Audio	100 ms
Demod	100 ms

IEC/IEEE bus command: `SENS:SWE:TIME:AUTO ON`



To obtain a correct result display, at least five periods of the demodulated signal should be monitored. If the modulation frequencies are low, it may be useful to manually prolong the measurement time (= signal monitoring time).

IEC/IEEE bus command: SENS:SWE:TIME:AUTO ON

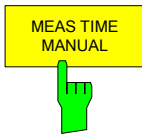

The *MEAS TIME MANUAL* softkey opens the entry field for determining the data acquisition time. The permissible value range depends on the selected demodulation bandwidth:

Demodulation bandwidth	min. measurement time	max. measurement time
10 MHz	31.25 ns	12.5 ms
8 MHz	62.5 ns	25 ms
5 MHz	125 ns	50 ms
3 MHz	250 ns	100 ms
1.6 MHz	500 ns	200 ms
800 kHz	1 μ s	400 ms
400 kHz	2 μ s	800 ms
200 kHz	4 μ s	1.6 s
100 kHz	8 μ s	3.2 s
50 kHz	16 μ s	6.4 s
25 kHz	32 μ s	12.8 s
12.5 kHz	64 μ s	25.6 s
6.4 kHz	128 μ s	51.2 s
3.2 kHz	256 μ s	102.4 s
1.6 kHz	512 μ s	204.8 s
800 Hz	1024 ms	409.6 s
400 Hz	2048 ms	819.2 s
200 Hz	4096 ms	1638.4 s
100 Hz	8192 ms	3276.8 s



To obtain a correct result display, at least five periods of the demodulated signal should be monitored.

IEC/IEEE bus command: SENS:SWE:TIME 200 MS



The *SWEEP COUNT* softkey activates the window for entering the number of sweeps that the R&S FSMR performs after a single sweep has been started. If Trace Average, Max Hold or Min Hold has been activated, the number of averages or maximum value findings is specified as well.

Example: [**TRACE1: MAX HOLD**]
 [**SWEEP: SWEEP COUNT: {10} ENTER**]
 [*SINGLE SWEEP*]

The R&S FSMR performs the Max Hold function across ten sweeps.

The value range permissible for the sweep count is 0 to 32767. If the sweep count is 0 or 1, a sweep is performed. With trace averaging and if the sweep count is 0, the R&S FSMR performs sliding averaging across ten sweeps in continuous sweep mode; if the sweep count is 1, no averaging occurs.

The sweep count is valid for all traces in a diagram.

IEC/IEEE bus command: SENS:SWE:COUN 64



Setting the number of sweeps in the Trace menu is identical with setting them in the Sweep menu.

In the *SINGLE SWEEP* setting, the measurement is stopped once the selected number of sweeps has been reached.



The *SGL SWEEP DISP OFF* softkey starts a sweep and switches off the display during a single sweep. Once the sweep is completed, the display is reactivated and the trace displayed.

IEC/IEEE bus command: INIT:DISP OFF;:INIT

Setting the Span - SPAN Key

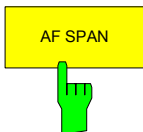
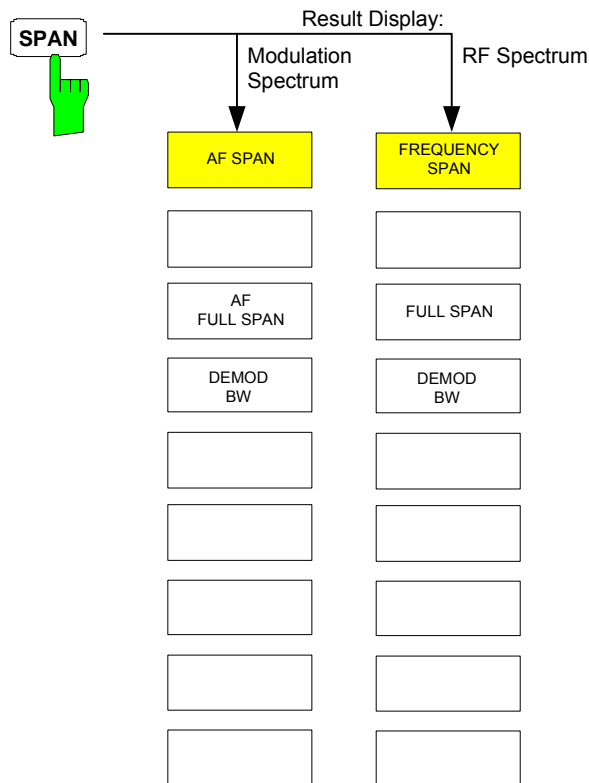

The *AF SPAN* softkey allows you to select the frequency range with AF spectrum displays.

IEC/IEEE bus command: `SENS:ADEM:AF:SPAN 2.5 MHz`

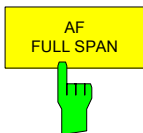

The *AF FULL SPAN* softkey sets the maximum frequency range with AF spectrum displays.

The maximum frequency range is half the demodulation bandwidth.

IEC/IEEE bus command: `SENS:ADEM:AF:SPAN:FULL`

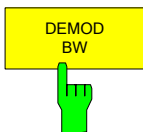

The *DEMOD BW* softkey selects the demodulation bandwidth of the demodulator. This function is identical with the *DEMOD BW* softkey function in the FM DEMOD main menu.

IEC/IEEE bus command: `SENS:BAND:DEM 10MHz`

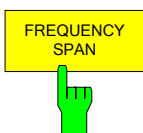

The *FREQUENCY SPAN* softkey allows you to select the frequency range with RF SPECTRUM displays.

IEC/IEEE bus command: `SENS:ADEM:SPEC:SPAN: 5 MHz`

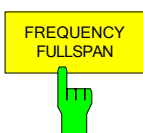

The *FREQUENCY FULL SPAN* softkey sets the maximum frequency range with RF spectrum displays.

The maximum frequency range corresponds to the demodulation bandwidth.

IEC/IEEE bus command: `SENS:ADEM:SPEC:SPAN:ZOOM MAX`

Spectrum Analyzer Mode

The analyzer mode is activated by pressing hotkey *SPECTRUM* (see also Section 'Mode Selection')

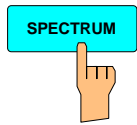

The *SPECTRUM* hotkey selects the *ANALYZER* mode.

This mode is the default setting of the R&S FSMR.

The functions provided correspond to those of a conventional spectrum analyzer. The analyzer measures the frequency spectrum of the test signal over the selected frequency range with the selected resolution and sweep time, or, for a fixed frequency, displays the waveform of the video signal.



If two displays (screen A and screen B) are opened after switch-on of signal analysis, the analyzer mode is only set for the display activated for entry (marked at the top right corner of diagram). For the other display, the previous settings remain valid.

Data acquisition and display of measured values is sequential: first in the upper and then in the lower display.

Frequency and Span Selection – *FREQ* Key

The *FREQ* key is used to specify the frequency axis of the active display window. The frequency axis can be defined either by the start and stop frequency or by the center frequency and the span (*SPAN* key). With two windows (*SPLIT SCREEN*) displayed at the same time, the input data always refer to the window selected in the *SYSTEM-DISPLAY* menu.

After pressing one of the *CENTER*, *START* or *STOP* softkeys, the value of the corresponding parameter can be defined in an input window.

FREQ menu:

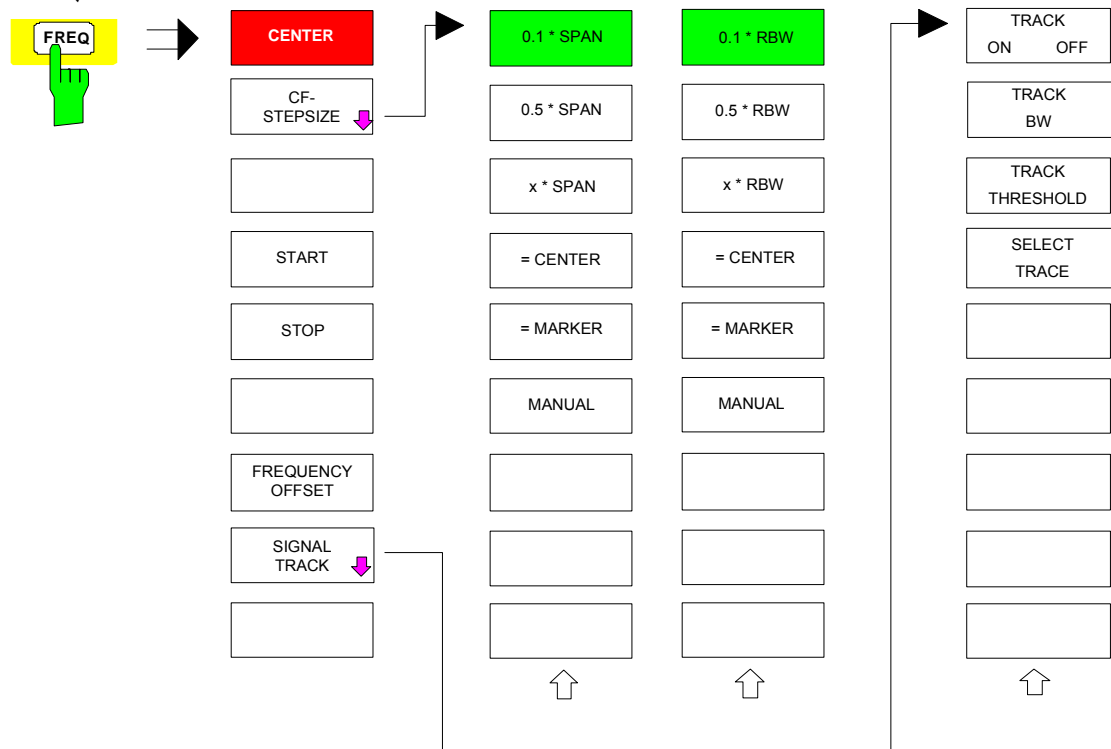

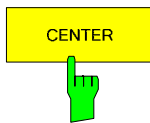

The *CENTER* softkey opens the window for manually entering the center frequency.

The allowed range of values for the center frequency is:

for the frequency domain (span >0):

$$\text{minspan} / 2 \leq f_{\text{center}} \leq f_{\text{max}} - \text{minspan} / 2$$

and for the time domain (span = 0):

$$0 \text{ Hz} \leq f_{\text{center}} \leq f_{\text{max}}$$

f_{center} center frequency
 minspan smallest selectable span > 0 Hz (10 Hz)
 f_{max} max. frequency

IEC/IEEE-bus command: `FREQ:CENT 100MHz`

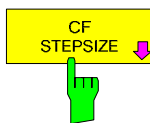

The *CF STEPSIZE* softkey opens a submenu for setting the step size of the center frequency. The step size can be coupled to the span (frequency domain) or the resolution bandwidth (time domain) or it can be manually set to a fixed value. The softkeys are mutually exclusive selection keys.

The softkeys are presented according to the selected domain (frequency or time).

Softkeys in frequency domain:

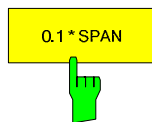

The *0.1 * SPAN* softkey sets the step size for the center frequency entry to 10% of the span.

IEC/IEEE-bus command:
`SENS:FREQ:CENT:STEP:LINK SPAN`
`SENS:FREQ:CENT:STEP:LINK:FACT`
 10PCT

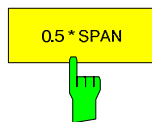

The *0.5 * SPAN* softkey sets the step size for the center frequency entry to 50% of the span.

IEC/IEEE-bus command:
`SENS:FREQ:CENT:STEP:LINK SPAN`
`SENS:FREQ:CENT:STEP:LINK:FACT`
 50PCT

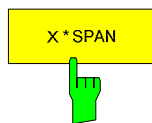

The *X * SPAN* softkey allows the factor defining the center frequency step size to be entered as % of the span.

IEC/IEEE-bus command:
`SENS:FREQ:CENT:STEP:LINK SPAN`
`SENS:FREQ:CENT:STEP:LINK:FACT`
 20PCT

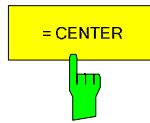

The = *CENTER* softkey sets the step size coupling to *MANUAL* and the step size to the value of the center frequency. This function is especially useful during measurements of the signal harmonic content because by entering the center frequency each stroke of the *STEP* key selects the center frequency of another harmonic.

IEC/IEEE-bus command: --



The = *MARKER* softkey sets the step size coupling to *MANUAL* and the step size to the value of the marker. This function is especially useful during measurements of the signal harmonic content at the marker position because by entering the center frequency each stroke of the *STEP* key selects the center frequency of another harmonic.

IEC/IEEE-bus command: --

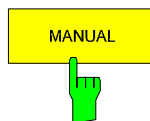

The *MANUAL* softkey activates the window for entering a fixed step size.

IEC/IEEE-bus command:

```
SENS:FREQ:CENT:STEP 120MHz
```

Softkeys in time domain:

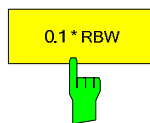

The *0.1 * RBW* softkey sets the step size for the center frequency entry to 10% of the resolution bandwidth.

*AUTO 0.1 * RBW* corresponds to the default setting.

IEC/IEEE-bus command:

```
SENS:FREQ:CENT:STEP:LINK RBW
SENS:FREQ:CENT:STEP:LINK:FACT 10PCT
```

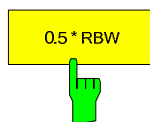

The *0.5 * RBW* softkey sets the step size for the center frequency entry to 50% of the resolution bandwidth.

IEC/IEEE-bus command:

```
SENS:FREQ:CENT:STEP:LINK RBW
SENS:FREQ:CENT:STEP:LINK:FACT 50PCT
```

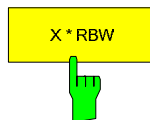

The *X * RBW* softkey allows the factor defining the center frequency step size to be entered as % of the resolution bandwidth.

Values between 1 and 100% in steps of 1% are allowed. The default setting is 10%.

IEC/IEEE-bus command:

```
SENS:FREQ:CENT:STEP:LINK RBW
SENS:FREQ:CENT:STEP:LINK:FACT 20PCT
```

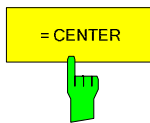

The = *CENTER* softkey sets the step size coupling to *MANUAL* and the step size to the value of the center frequency. This function is especially useful during measurements of the signal harmonic content because by entering the center frequency each stroke of the *STEP* key selects the center frequency of another harmonic.

IEC/IEEE-bus command: --



The = *MARKER* softkey sets the step size coupling to *MANUAL* and the step size to the value of the marker. This function is especially useful during measurements of the signal harmonic content at the marker position because by entering the center frequency each stroke of the *STEP* key selects the center frequency of another harmonic.

IEC/IEEE-bus command: --

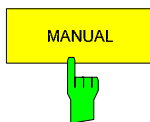

The *MANUAL* softkey activates the window for entering a fixed step size.

IEC/IEEE-bus command:

`SENS:FREQ:CENT:STEP 120MHz`

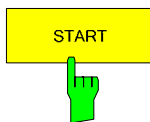

The *START* softkey activates the window for manually entering the start frequency.

The allowed range of values for the start frequency is:

$$0 \text{ Hz} \leq f_{\text{start}} \leq f_{\text{max}} - \text{minspan}$$

f_{start} start frequency
 minspan smallest selectable span (10 Hz)
 f_{max} max. frequency

IEC/IEEE-bus command: `SENS:FREQ:STAR 20MHz`

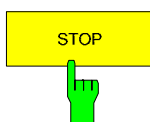

The *STOP* softkey activates the window for entering the stop frequency.

The allowed range of values for the stop frequency is:

$$\text{minspan} \leq f_{\text{stop}} \leq f_{\text{max}}$$

f_{stop} stop frequency
 minspan smallest selectable span (10 Hz)
 f_{max} max. frequency

IEC/IEEE-bus command: `SENS:FREQ:STOP 200MHz`



The *FREQUENCY OFFSET* softkey activates the window for entering an arithmetical frequency offset which is added to the frequency axis labelling. The allowed range of values for the offset is -100 GHz to 100 GHz. The default setting is 0 Hz.

IEC/IEEE-bus command: `SENS:FREQ:OFFS 10 MHz`

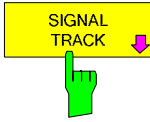

The *SIGNAL TRACK* softkey switches on the tracking of a signal near the center frequency. The signal is tracked as long it is in the search bandwidth around the center frequency defined with *TRACK BW* and above the level threshold defined with *TRACK THRESHOLD*.

For that purpose, the maximum signal is searched (*PEAK SEARCH*) on the screen and the center frequency set to this signal (*MARKER ->CENTER*) after each frequency sweep within the search bandwidth.

If the signal falls below the level threshold or jumps out of the search bandwidth around the center frequency, the center frequency is not varied until a signal is in the search bandwidth above the level threshold. This can be achieved by manually modifying the center frequency, for example.

On switching on, the softkey is highlighted and the search bandwidth and the threshold value are marked on the diagram by two vertical lines and one horizontal line. All these lines are allocated the designation TRK.

At the same time a submenu is opened in which the search bandwidth, the threshold value and the trace can be modified for the maximum search.

The softkey is only available in the frequency domain (span >0).

IEC/IEEE-bus command: `CALC:MARK:FUNC:STR OFF`

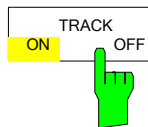

The *TRACK ON/OFF* softkey switches on and off signal tracking.

IEC/IEEE-bus command: `CALC:MARK:FUNC:STR OFF`

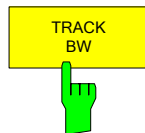

The *TRACK BW* softkey defines the search bandwidth for signal tracking. The frequency range is symmetrical with respect to the center frequency.

IEC/IEEE-bus command:

`CALC:MARK:FUNC:STR:BAND 10KHZ`



The *TRACK THRESHOLD* softkey defines the threshold value for signal detection. The value is always entered as an absolute level value.

IEC/IEEE-bus command:

`CALC:MARK:FUNC:STR:THR -70DBM`



The *SELECT TRACE* softkey selects the trace on which signal tracking is to be performed.

IEC/IEEE-bus command:

`CALC:MARK:FUNC:STR:TRAC 1`

Setting the Frequency Span – SPAN Key

SPAN menu

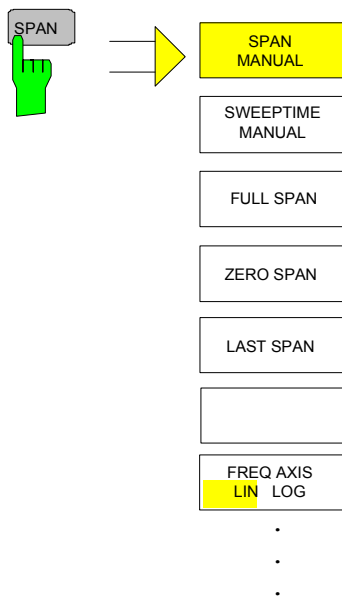

The *SPAN* key opens a menu which offers various options for setting the span.

The entry of the span (*SPAN MANUAL* softkey) is automatically active for span > 0 Hz.

For span = 0 Hz the entry for sweep time (*SWEEPTIME MANUAL*) is automatically active.

With two windows (*SPLIT SCREEN*) displayed at the same time, the input data always refer to the window selected with hotkey *SCREEN A/B*.

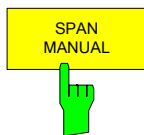

The *SPAN MANUAL* softkey activates the window for manually entering the frequency span. The center frequency is kept constant.

The allowed range of span values is for the time domain (span = 0): 0 Hz and for the frequency domain (span >0): $minspan \leq f_{span} \leq f_{max}$

f_{span}	frequency span
$minspan$	smallest selectable span (10 Hz)
f_{max}	max. frequency

IEC/IEEE-bus command `FREQ:SPAN 2GHz`



The *SWEEPTIME MANUAL* softkey activates the window for entering the sweep time manually with Span = 0 Hz. The softkey is not available for Span > 0 Hz.

IEC/IEEE-bus command: `SWE:TIME 10s`

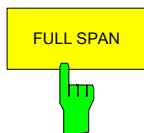

The *FULL SPAN* softkey sets the span to the full frequency range of R&S FSMR.

IEC/IEEE-bus command `FREQ:SPAN:FULL`

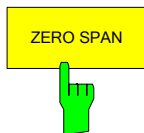

The *ZERO SPAN* softkey sets the span to 0 Hz. The x axis becomes the time axis with the grid lines corresponding to 1/10 of the current sweep time (SWT).

IEC/IEEE-bus command `FREQ:SPAN 0Hz`

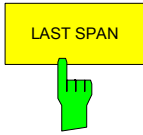

After changing the span setting the *LAST SPAN* softkey activates the previous setting. With this function a fast change between overview measurement (*FULL SPAN*) and detailed measurement (manually set center frequency and span) is possible.

Note:

Only values > 0 Hz are restored, i.e. a transition between time and frequency domain is not possible.

IEC/IEEE-bus command ---

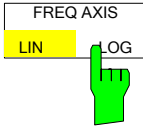

The *FREQ AXIS LIN/LOG* softkey switches between linear and logarithmic scaling of the frequency axis. Switchover is only possible if the stop/start frequency ratio is ≥ 10 .

The default state is LIN.

The logarithmic frequency axis is only available in spectrum mode and it is not available in zero span mode, in external mixer mode, with frequency offset or if the ratio stop frequency / start frequency is below 1.4.

IEC/IEEE-bus command `DISP:WIND<1|2>:TRAC:X:SPAC LIN`

Level Display Setting and RF Input Configuration – AMPT Key

The *AMPT* key is used to set the reference level, the maximum level and the display range of the active window as well as the input impedance and the input attenuation of the RF input.

The *AMPT* key opens a menu for setting the reference level and the input attenuation of the active window. The data entry for the reference level (*REF LEVEL* softkey) is opened automatically.

Further settings regarding level display and attenuation can be made in this menu.

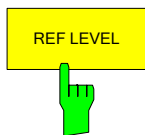
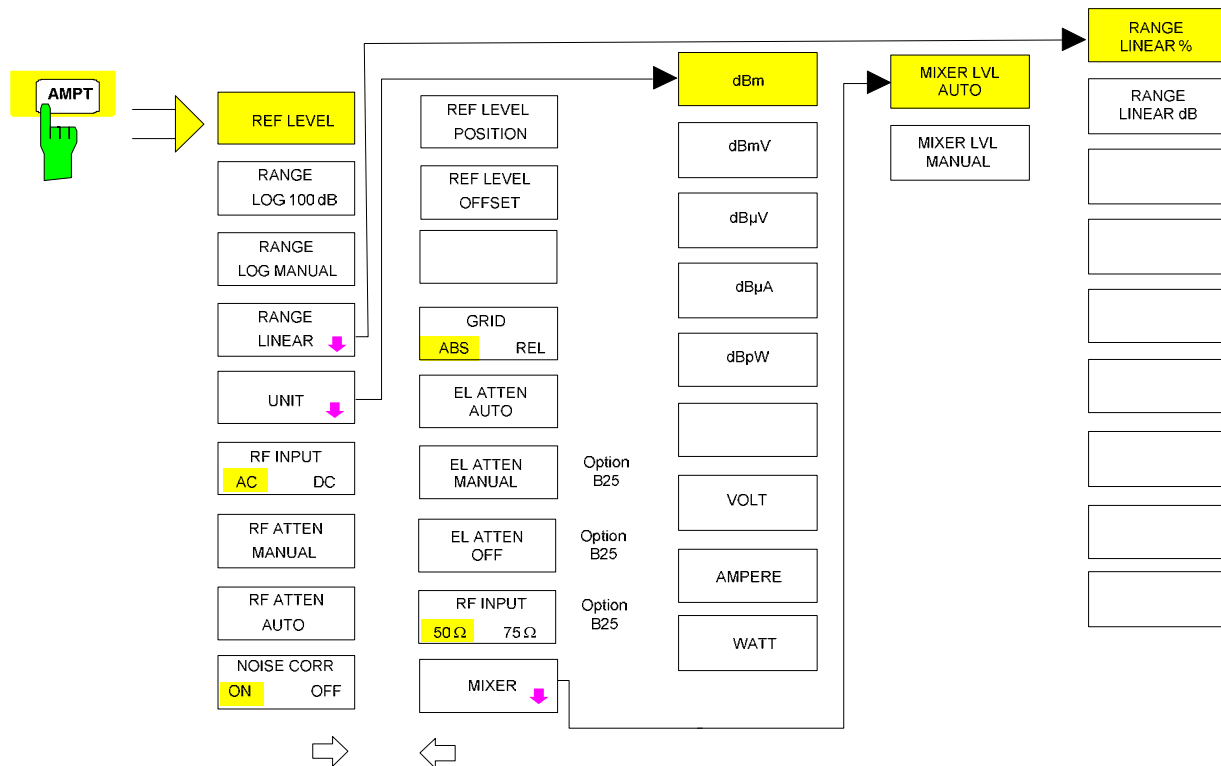

The *REF LEVEL* softkey allows the reference level to be input in the currently active unit (dBm, dBμV, etc).

IEC/IEEE-bus command: `DISP:WIND:TRAC:Y:RLEV -60dBm`

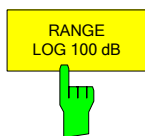

The *RANGE LOG 100 dB* softkey sets the level display range to 100 dB.

IEC/IEEE-bus command: `DISP:WIND:TRAC:Y:SPAC LOG`
`DISP:WIND:TRAC:Y 100DB`



The *RANGE LOG MANUAL* softkey activates the manual entry of the level display range. Display ranges from 10 to 200 dB are allowed in 10 dB steps. Inputs which are not allowed are rounded to the next valid value.

The default setting is 100 dB.

IEC/IEEE-bus command: `DISP:WIND:TRAC:Y:SPAC LOG`
`DISP:WIND:TRAC:Y 120DB`

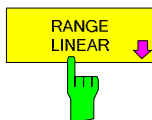

The *RANGE LINEAR* softkey selects linear scaling for the level display range of the analyzer. In addition, it opens a submenu for selecting % or dB for the scaling.

When linear scaling is selected, the % scaling is first activated (see also *RANGE LINEAR dB* softkey).

IEC/IEEE-bus command: `DISP:WIND:TRAC:Y:SPAC LIN`

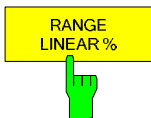

The *RANGE LINEAR %* softkey selects linear scaling in % for the level display range, i.e. the horizontal lines are labelled in %. The grid is divided in decadic steps. Markers are displayed in the selected unit; delta markers are displayed in % referenced to the voltage value at the position of marker 1.

IEC/IEEE-bus command: `DISP:WIND:TRAC:Y:SPAC LIN`

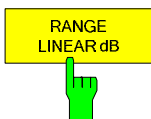

The *RANGE LINEAR dB* softkey selects linear scaling in dB for the level display range, i.e. the horizontal lines are labelled in dB.

Markers are displayed in the selected unit; delta markers are displayed in dB referenced to the power value at the position of marker 1.

IEC/IEEE-bus command: `DISP:WIND:TRAC:Y:SPAC LDB`

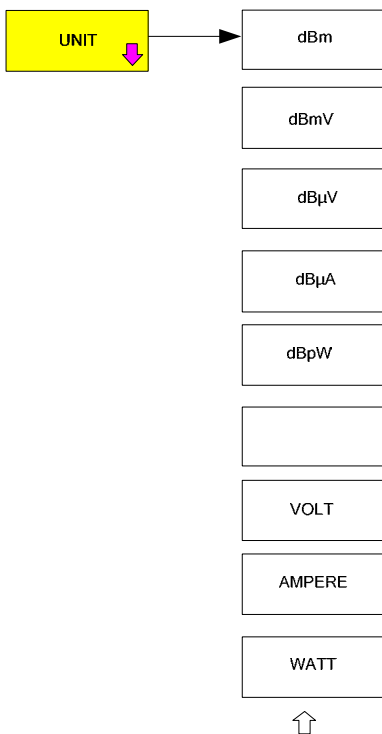

The *UNIT* softkey opens a sub menu allowing to select the unit for the level axis.

The default setting is dBm.

In general, the spectrum analyzer measures the signal voltage at the RF input. The level display is calibrated in rms values of an unmodulated sinewave signal. In the default state, the level is displayed at a power of 1 mW (= dBm). Via the known input resistance of 50 Ω or 75Ω, conversion to other units is possible. The units dBm, dBmV, dBµV, dBµA, dBpW, V, A and W are directly convertible.

IEC/IEEE-bus command: `CALC:UNIT:POW DBM`

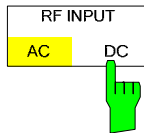

The RF INPUT AC/DC softkey toggles the RF input of the analyzer between AC and DC coupling.

Note:

The softkey is only available for models 3, 8 and 26.

IEC/IEEE-bus command: `INP:COUP AC`



The *RF ATTEN MANUAL* softkey allows the attenuation to be entered irrespective of the reference level.

The attenuation can be set in 5 dB steps between 0 and 75 dB. Other entries will be rounded to the next lower integer value.

If the defined reference level cannot be set for the given RF attenuation, the reference level will be adjusted accordingly and the warning "Limit reached" will be output.

Note:

The 0 dB value can be entered only via the numeric keypad in order to protect the input mixer against overload.

IEC/IEEE-bus command: `INP:ATT 40 DB`



The *RF ATTEN AUTO* softkey sets the RF attenuation automatically as a function of the selected reference level.

This ensures that the optimum RF attenuation desired by the user is always used.

RF ATTEN AUTO is the default setting.

IEC/IEEE-bus command: `INP:ATT:AUTO ON`

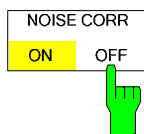

If active, the R&S FSMR corrects the results by its inherent noise. Noise correction increases the dynamic range.

After you activate noise correction, the R&S FSMR performs a reference measurement of its inherent noise. In the actual measurement, the R&S FSMR then subtracts the noise power from the power in the channel that is measured.

The inherent noise depends on the center frequency, resolution bandwidth and level setting. Therefore, the R&S FSMR deactivates noise correction if you change one of these parameters. The R&S FSMR shows a message that noise correction is inactive.

The R&S FSMR also deactivates noise correction after you select another measurement (e.g. channel power, spectrum emission mask etc.).

After the R&S FSMR deactivates noise correction, you have to activate it again manually.

The R&S FSMR performs a new reference measurement.

IEC/IEEE-bus command: `POW:NCOR ON`

AMPT – NEXT menu:

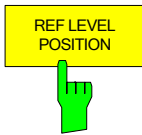

The *REF LEVEL POSITION* softkey allows the reference level position to be entered.

The setting range is from -200 to +200%, 0% corresponding to the lower and 100% to the upper limit of the diagram.

IEC/IEEE-bus command: `DISP:WIND:TRAC:RPOS 100PCT`



The *REF LEVEL OFFSET* softkey allows the arithmetic level offset to be entered. This offset is added to the measured level irrespective of the selected unit. The scaling of the Y axis is changed accordingly.

The setting range is ± 200 dB in 0.1 dB steps.

IEC/IEEE-bus command: `DISP:WIND:TRAC:RLEV:OFFS -10dB`

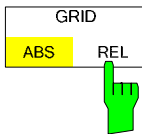

The *GRID ABS/REL* softkey switches between absolute and relative scaling of the level axis.

GRID ABS is the default setting.

ABS The labelling of the level lines refers to the absolute value of the reference level.

REL The upper line of the grid is always at 0 dB.
The scaling is in dB whereas the reference level is always in the set unit (dBm, dB μ V,...).

For setting *RANGE LINEAR* (linear scaling, labelling of axes in %) the softkey is not displayed since the unit % itself implies a relative scale.

IEC/IEEE-bus command: `DISP:WIND:TRAC:Y:MODE ABS`

Electronic Attenuator

Besides the mechanical attenuator at the RF input, the R&S FSMR also offers an electronic attenuation setting (option *ELECTRONIC ATTENUATOR FSU-B25*). The attenuation range is 0 to 30 dB, with the default attenuation being preset by the mechanical attenuator.



The *EL ATTEN MANUAL* softkey switches the electronic attenuator on and allows the attenuation of the electronic attenuator to be set.

The attenuation can be varied in 5 dB steps from 0 to 30 dB. Other entries are rounded to the next lower integer value.

If the defined reference level cannot be set for the given RF attenuation, the reference level will be adjusted accordingly and the warning "Limit reached" will be output.

IEC/IEEE-bus command: `INP:EATT:AUTO OFF`
`INP:EATT 10 DB`

This function is only available with option *ELECTRONIC ATTENUATOR-B25*.



The *EL ATTEN AUTO* softkey switches the electronic attenuator on and automatically sets its attenuation to 0 dB.

The allowed setting range of the reference level ranges from the current reference level on switching on the electronic attenuator to over 30 dB. If a reference level is set outside the allowed 30-dB range, setting is performed by means of the mechanical attenuator. From this new reference level to over 30 dB the setting is again performed with the electronic attenuator.

IEC/IEEE-bus command: `INP:EATT:AUTO ON`

This function is only available with option *ELECTRONIC ATTENUATOR -B25*.



The *EL ATTEN OFF* softkey switches the electronic attenuator off.

IEC/IEEE-bus command: `INP:EATT:STAT OFF`

This function is only available with option *ELECTRONIC ATTENUATOR -B25*.

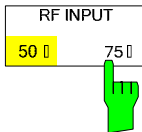

The *RF INPUT 50 Ω / 75 Ω* softkey switches the input impedance of the instrument between 50 Ω (= default setting) and 75 Ω.

The setting 75 Ω should be used if the input impedance (50 Ω) is transformed to 75 Ω using the corresponding adapter unit of type RAZ (= 25 Ω in series to the input impedance of the analyzer). The correction value used for the adaption is 1.76 dB = 10 log (75Ω / 50Ω).

All levels specified in this operating manual refer to the default setting of the instrument (50 Ω).

IEC/IEEE-bus command: `INP:IMP 50OHM`

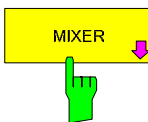

The *MIXER* softkey opens a submenu for defining the maximum mixer level attainable for the selected reference level.



The *MIXER LVL AUTO* softkey activates the automatic calculation of the mixer level dependent on the selected reference level and the selected RF attenuation.

IEC/IEEE-bus command: `INP:MIX:AUTO ON`



The *MIXER LVL MANUAL* softkey allows the maximum mixer level attainable at the reference level to be entered.

The available range is 0 to -100 dBm in 10 dB steps.

IEC/IEEE-bus command: `INP:MIX -25DBM`

Setting the Bandwidths and Sweep Time – *BW*Key

The *BW* key calls a menu for setting the resolution bandwidth (*RBW*), video bandwidth (*VBW*) and sweep time (*SWT*) for the frequency sweep. The parameters may be coupled dependent on the span (stop minus start frequency) or freely set by the user. When working with a split screen display, the settings always refer to the active window.

The R&S FSMR offers resolution bandwidths from 10 Hz to 20 MHz (R&S FSMR43: 10 Hz to 10 MHz) in 1, 2, 3, 5, 10 steps and additionally 50 MHz (not R&S FSMR) as maximum bandwidth.

Resolution bandwidths up to 100 kHz are realized using digital bandpasses with Gaussian characteristics. As far as the attenuation characteristic is concerned they behave like analog filters but have a much higher measurement speed than comparable analog filters. This is due to the fact that the transient response can be compensated as a result of an accurately defined filter behaviour.

Bandwidths above 100 kHz are realized using decoupled 5-circuit LC filters.

As an alternative to the analog filters, FFT filters are available for the bandwidths between 1 Hz and 30 kHz. When working with bandwidths up to 30 kHz, the FFT algorithm offers considerably higher measurement speeds with all the other settings remaining the same. The reason is that with analog filters the sweep time required for a particular span is proportional to $(\text{Span}/\text{RBW}^2)$. When using the FFT algorithm, however, the sweep time is proportional to (Span/RBW) .

The video bandwidths are available in 1, 2, 3, 5, 10 steps between 1 Hz and 10 MHz¹⁾. They can be set in accordance with the resolution bandwidth.

The video filters serve for smoothing the displayed trace. Video bandwidths that are small compared to the resolution bandwidth average out noise peaks and pulsed signals, so that only the signal average is displayed. If pulsed signals are to be measured, it is recommended to use a video bandwidth that is large compared to the resolution bandwidth ($\text{VBW} \geq 10 \times \text{RBW}$) for the amplitudes of pulses to be measured correctly.



For analog and digital filters, the R&S FSMR has overload reserves of different magnitude above the reference level. Due to the LO breakthrough the overload display OVLD responds with digital filters with $\text{RBW} < 100 \text{ kHz}$, as soon as the start frequency is selected $< 6 \times \text{resolution bandwidth}$, for $\text{RBW} = 100 \text{ kHz}$, as soon as the start frequency is below 3 MHz.

¹⁾ to 30 MHz (for resolution bandwidth > 10MHz, not R&S FSMR43)

BW menu:

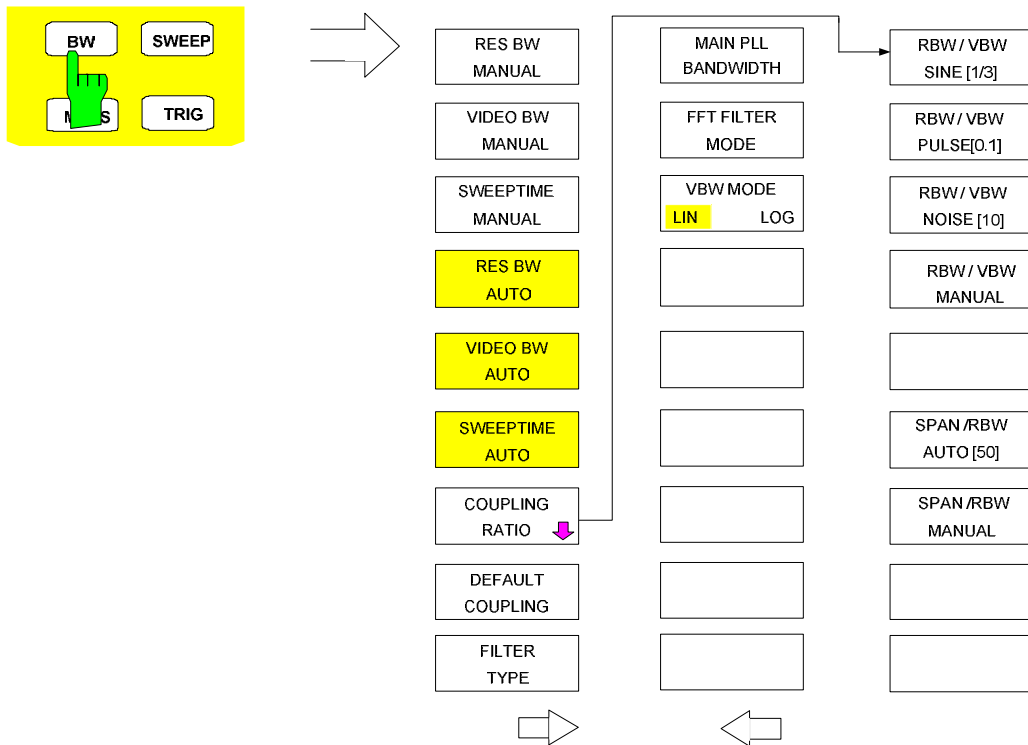

The *BW* key opens a menu for setting the resolution bandwidth, the video bandwidth, the sweep time and their couplings.

The .. *BW AUTO* softkeys are used to couple the functions. The coupling ratios are selected by means of the *COUPLING RATIO* softkey.

The .. *BW MANUAL* softkeys allow a parameter to be entered. This parameter is not coupled to the other parameters.



With the ... *BW AUTO* softkeys the resolution bandwidth, the video bandwidth and the sweep time can be entered separately for the frequency domain (span > 0 Hz) and the time domain (span = 0 Hz).

But with ...*BW MANUAL* softkeys the selected values apply to both the frequency and time domain.



The *RES BW MANUAL* softkey activates the manual data entry for the resolution bandwidth.

The resolution bandwidth can be selected in 1/2/3/5/10 steps in the range between 10 Hz and 20 MHz (R&S FSMR43: between 10 Hz and 10 MHz). Additionally a maximum bandwidth of 50 MHz is available. The nominal resolution bandwidth is the 3 dB bandwidth.

When FFT filters are used, the lower limit of the bandwidth is 1 Hz. FFT filters may be used with bandwidths up to 30 kHz.

For numeric inputs, the values are always rounded to the nearest possible bandwidth. For rollkey or UP/DOWN key inputs, the bandwidth is adjusted in steps either upwards or downwards.

For filter type CHANNEL or RRC the bandwidth is selected from the list of available channel filters given at the end of this chapter. For data entry, the cursor keys \uparrow and \downarrow scroll through this list.

The manual input mode of the resolution bandwidth is indicated by a green terisk (*) on the display.

IEC/IEEE-bus command: `SENS:BAND:AUTO OFF;`
 `SENS:BAND 1MHz`



The *VIDEO BW MANUAL* softkey activates the manual data entry for the video bandwidth.

The video bandwidth can be selected in 1/2/3/5/10 steps in the range between 1 Hz and 10 MHz.

For numeric inputs, the values are always rounded to the nearest possible allowed bandwidth. For rollkey or UP/DOWN key inputs, the bandwidth is adjusted in steps either downwards or upwards.

The manual input mode of the video bandwidth is indicated by a green terisk (*) on the display.

IEC/IEEE-bus command: `SENS:BAND:VID:AUTO OFF;`
 `SENS:BAND:VID 10 kHz`



The *SWEPTIME MANUAL* softkey activates the manual data entry for the sweep time. At the same time, the coupling of the sweep time is cancelled. Other couplings (*VIDEO BW*, *RES BW*) remain effective.

In the frequency domain (span > 0 Hz) and for resolution bandwidths above 1 kHz, the allowed sweep times for spans > 3.2 kHz range from 2.5 ms through to 16000 s. With spans below 3.2 kHz, the maximum allowed sweep time is reduced to 5 s * span/Hz.

If FFT filters are used, the sweep time is fixed by the span and the bandwidth and therefore cannot be set.

In time domain (span = 0 Hz), the range of sweep times is 1 µs to 16000 s is selectable in steps of max. 5% of the sweep time. For numeric inputs, rounding is made to the nearest possible sweep time. For rollkey or UP/DOWN key inputs, the sweep time is adjusted in steps either downwards or upwards.

The manual input mode of the sweep time is indicated by a green asterisk (*) on the display. If the selected sweep time is too short for the selected bandwidth and span, level measurement errors will occur. This happens because the available settling time for the resolution or video filters is too short. In this case, the R&S FSMR outputs *UNCAL* on the display and marks the indicated sweep time with a red asterisk (*).

IEC/IEEE-bus command: `SENS:SWE:TIME:AUTO OFF;`
 `SENS:SWE:TIME 10s`



The *RES BW AUTO* softkey couples the resolution bandwidth to the selected span. Changing the span causes automatic adjustment of the resolution bandwidth.

Automatic coupling of resolution bandwidth to span is always recommended when a favourable setting of the resolution bandwidth in relation to the selected span is desired for the measurement under request.

The coupling ratio is set in the *COUPLING RATIO* submenu.

The *RES BW AUTO* softkey is only available in the frequency domain (span > 0 Hz). The softkey is blanked in the time domain.

IEC/IEEE-bus command: `BAND:AUTO ON`

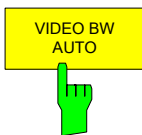

The *VIDEO BW AUTO* softkey couples the video bandwidth to the resolution bandwidth. If the resolution bandwidth is changed, the video bandwidth is automatically adjusted.

The coupling of the video bandwidth is always recommended when the minimum sweep time is required for a selected resolution bandwidth. Narrower video bandwidths require longer sweep times due to the longer settling time. Wider bandwidths reduce the signal/noise ratio.

The coupling ratio is set in the *COUPLING RATIO* submenu.

The coupling of the video bandwidth to the resolution filter is also permitted for the time domain display (span = 0).

IEC/IEEE-bus command: `SENS:BAND:VID:AUTO ON`



The *SWEEPTIME AUTO* softkey couples the sweep time to the span, video bandwidth (VBW) and resolution bandwidth (RBW). The sweep time is automatically adjusted on any change in span, resolution bandwidth or video bandwidth.

The softkey is only available in the frequency domain (span >0 Hz). It is blanked in the time domain.

The R&S FSMR always selects the shortest sweep time possible without falsifying the signal. The maximum level error compared to using a longer sweep time is < 0.1 dB. If additional bandwidth and level errors are to be avoided, the sweep time is to be set to three times the time offered in coupled mode.

IEC/IEEE-bus command: `SWE:TIME:AUTO ON`

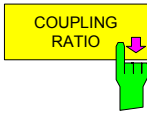

RBW / VBW
SINE [1/3]

The *COUPLING RATIO* softkey opens a sub menu for selection of the coupling ratios.

RBW / VBW
PULSE [.1]

When the default setting is active, i.e. the *COUPLING RATIO* softkey is deactivated (not highlighted), the ratio span/resolution bandwidth (SPAN/RBW) is 50 (this corresponds to SPAN / RBW AUTO [50]) and the ratio resolution bandwidth/video bandwidth (RBW/VBW) is 0.33 (this corresponds to RBW / VBW SINE [1/3]).

RBW / VBW
NOISE [10]

RBW / VBW
MANUAL

If the ratio RBW/VBW or SPAN/RBW is different from the default setting, the *COUPLING RATIO* softkey is highlighted.

SPAN / RBW
AUTO [50]

The softkeys RBW/VBW... are selection keys. Only one softkey can be enabled at any one time. The softkeys are only effective for the *VBW AUTO* selection in the main menu.

SPAN / RBW
MANUAL

The softkeys SPAN/RBW... are also selection keys. They are only effective for the *RBW AUTO* selection in the main menu.

RBW/VBW
SINE [1/3]

The RBW/VBW SINE [1/3] softkey sets the following coupling ratio: video bandwidth = 3 x resolution bandwidth.

This is the default setting for the coupling ratio resolution bandwidth/video bandwidth.

This is the coupling ratio recommended if sinusoidal signals are to be measured.

IEC/IEEE-bus command `SENS:BAND:VID:RAT 3`

This setting is only effective for the *VBW AUTO* selection in the main menu.

RBW / VBW
PULSE [.1]

The *RBW/VBW PULSE [.1]* softkey sets the following coupling ratio: video bandwidth = 10 x resolution bandwidth or video bandwidth = 10 MHz (= max. VBW).

This coupling ratio is recommended whenever the amplitudes of pulsed signals are to be measured correctly. The IF filter is exclusively responsible for pulse shaping. No additional evaluation is performed by the video filter.

IEC/IEEE-bus command `BAND:VID:RAT 10`

This setting is only effective for the *VBW AUTO* selection in the main menu.



The *RBW/VBW NOISE [10]* softkey sets the following coupling ratio:
 video bandwidth = resolution bandwidth/10

At this coupling ratio, noise and pulsed signals are suppressed in the video domain. For noise signals, the average value is displayed.

IEC/IEEE-bus command `BAND:VID:RAT 0.1`

This setting is only effective for the *VBW AUTO* selection in the main menu.

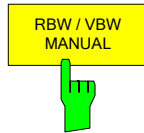

The *RBW/VBW MANUAL* softkey activates the manual input of the coupling ratio.

The resolution bandwidth/video bandwidth ratio can be set in the range 0.001 to 1000.

IEC/IEEE-bus command `BAND:VID:RAT 10`

This setting is only effective for the *VBW AUTO* selection in the main menu.

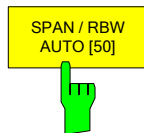

The *SPAN/RBW AUTO [50]* softkey sets the following coupling ratio:
 resolution bandwidth = span/50

This coupling ratio is the default setting of the R&S FSMR

IEC/IEEE-bus command `SENS:BAND:RAT 0.02`

This setting is only effective for the *RBW AUTO* selection in the main menu.



The *SPAN/RBW MANUAL* softkey activates the manual input of the coupling ratio.

The span / resolution bandwidth ratio can be set in the range 1 to 10000.

IEC/IEEE-bus command `SENS:BAND:RAT 0.1`

This setting is only effective for the *RBW AUTO* selection in the main menu.

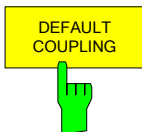

The *DEFAULT COUPLING* softkey sets all coupled functions to the default state (*AUTO*). In addition, the ratio *RBW/VBW* is set to *SINE [1/3]* and the ratio *SPAN/RBW* to 50 in the *COUPLING RATIO* submenu (default setting, *COUPLING RATIO* softkey not highlighted).

IEC/IEEE-bus command `SENS:BAND:AUTO ON`
`SENS:BAND:VID:AUTO ON`
`SENS:SWE:TIME:AUTO ON`

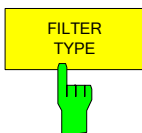

The *FILTER TYPE* softkey opens the selection list for different filter types. In the range up to 30 kHz digital band filters with Gaussian characteristic and filtering with FFT algorithm can be selected.

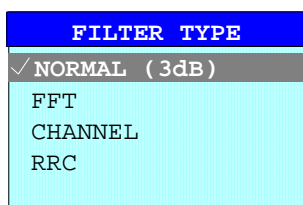

NORMAL(3dB) The resolution bandwidths are implemented by Gaussian filters with the set 3 dB bandwidth and correspond approximately to the noise bandwidth. For bandwidths up to 100 kHz, digital bandpass filters are used.

FFT An FFT is performed. For that purpose, the filtered IF signal is digitized and then transformed into the spectral domain via FFT. The transformation range depends on the selected filter bandwidths and can be set between 4 kHz to 50 kHz. If the span is larger than the transformation range, several transformations are performed and the results are appended to each other in the spectral domain. If the span is smaller than the transformation range, the measurement results are interpolated when the number of measurement points provided by the FFT is smaller than the number of display points in x-direction (625). A flattop window serves as a window in the time domain so that high amplitude precision with good selection is achieved. A flat-top window serves as a window in the time domain so that high amplitude accuracy as well as good selection are achieved.

Sweep time Defined by the selected bandwidth and span (reason: FFT filtering is a block transformation). It cannot be changed (softkey deactivated).

Detector Sample detector and peak detector are available. Peak detector is active when AUTO SELECT is selected.

Video bandwidth Not defined in case of FFT; therefore cannot be set (softkeys deactivated).

Compared to bandpasses, FFT filters lead to significantly reduced sweep times. For a span of 50 kHz and a bandwidth of 100 Hz, for instance, the sweep time is reduced from 5 s to 40 ms. FFT filters are particularly suitable for stationary signals (sinusoidal signals or signals that are continuously modulated in time). For burst signals (TDMA) or pulsed signals, normal filters are preferable.



As soon as the FFT filters are active ($RBW \leq 30$ kHz) the sweep time display field (SWT) is replaced by the acquisition time (AQT) display field.

FFT is a block transformation so the result depends on the time relation between the data set to be transformed and the burst or pulsed signal. A gated sweep measurement for TDMA signals is therefore not provided if FFT filters are used.

Additionally, a number of especially steep-edged channel filters are available for power measurement since firmware version 1.10.

A distinction is made between the following filter types:

- CHANNEL = general, steep-edged channel filters
- RRC = filters with root-raised cosine characteristic (RRC = Root Raised Cosine)

When selecting these filter types, the automatic coupling of the resolution bandwidth to the span is not available. The filters are selected via the *RES BW* softkey.

A list of all available channel filters with their associated applications can be found at the end of this chapter.

IEC/IEEE-bus command: SENS:BAND:TYPE NORM | FFT | CFIL | RRC

List of available channel filters

The channel filters included in the following table are can be activated via the *FILTER TYPE* softkey and are then available as resolution filters (softkey *RES BW*). They available for firmware version 1.10 or higher.



For filters of type RRC (Root Raised Cosine), the filter bandwidth indicated describes the sampling rate of the filter.

For all other filters (CFILter) the filter bandwidth is the 3 dB bandwidth.

Filter Bandwidth	Filter Type	Application
100 Hz 200 Hz 300 Hz 500 Hz	CFILter CFILter CFILter CFILter	A0
1 kHz 1.5 kHz 2 kHz 2.4 kHz 2.7 kHz 3 kHz 3.4 kHz 4 kHz 4.5 kHz 5 kHz 6 kHz 8.5 kHz 9 kHz	CFILter CFILter CFILter CFILter CFILter CFILter CFILter CFILter CFILter CFILter CFILter CFILter CFILter	SSB DAB, Satellite ETTS300 113 (12.5 kHz channels) AM Radio
10 kHz 12.5 kHz 14 kHz 15 kHz 16 kHz 18 kHz, $\alpha=0.35$ 20 kHz 21 kHz 24.3 kHz, $\alpha=0.35$ 25 kHz 30 kHz 50 kHz	CFILter CFILter CFILter CFILter RRC CFILter CFILter RRC CFILter CFILter CFILter	CDMAone ETTS300 113 (20 kHz channels) ETTS300 113 (25 kHz channels) TETRA PDC IS 136 CDPD, CDMAone
100 kHz 150 kHz 192 kHz 200 kHz 300 kHz 500 kHz	CFILter CFILter CFILter CFILter CFILter	FM Radio PHS J.83 (8-VSB DVB, USA)
1.0 MHz 1.2288 MHz 1.5 MHz 2.0 MHz *) 3.0 MHz *) 3.84 MHz, $\alpha=0.22$ *) 4.096 MHz, $\alpha=0.22$ *) 5.0 MHz *)	CFILter CFILter CFILter CFILter CFILter RRC RRC CFILter	CDMAone CDMAone DAB W-CDMA 3GPP W-CDMA NTT DOCoMo

*) This filter is available with hardware index > 2 of the IF filter module (see softkey *SETUP - SYSTEM INFO - HARDWARE INFO*).

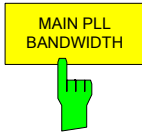

The MAIN PLL BANDWIDTH softkey defines the bandwidth of the main PLL of the analyzer synthesizer and thus influences the phase noise of the analyzer. Three bandwidth settings are possible (WIDE / NORMAL / NARROW); if AUTO is selected, the bandwidth is set automatically (default).

IEC/IEEE-bus command: `SENS:BAND:PLL AUTO`

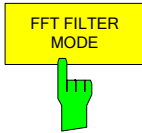

The softkey *FFT FILTER MODE* allows to specify between the following three options for FFT filters:

- WIDE: The FFT filters with the greater partial span (this is the span which is covered with one FFT analysis) are used always.
- AUTO: The firmware decides whether to use wide or narrow filters to achieve the best performance of the measurement.
- NARROW: The FFT filters with the smaller partial span are used, this allows measurements near a carrier with reduced reference level, because of a more narrow analog prefilter.

IEC/IEEE-bus command: `SENS:BWID:FFT:MODE WIDE | AUTO | NARR`

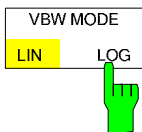

The *VBW MODE LIN/LOG* softkey determines the position of the video filter in the signal path for resolution bandwidths ≤ 100 kHz:

- If LINear is selected, the video filter will be in front of the logarithmic amplifier (default).
- If LOGarithmic is selected, the video filter will be behind the logarithmic amplifier.

The essential difference between the two operating modes relates to the settling in the case of falling signal edges:

With LINear, the falling signal edge will be "flatter" than with LOGarithmic. This is due to the conversion from linear power to logarithmic level units: a reduction of the linear power by 50% reduces the logarithmic signal level by only 3 dB.

IEC/IEEE-bus-command: `SENS:BAND:VID:TYPE LIN`

Sweep Settings – SWEEP Key

The SWEEP key serves for configuring the sweep mode.

SWEEP menu

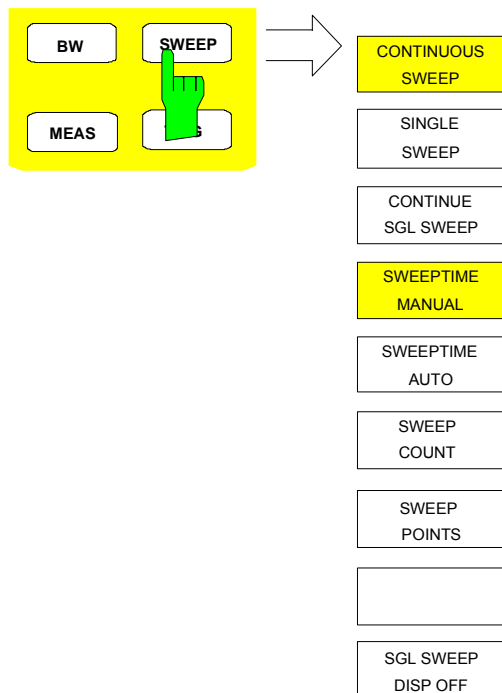

The *SWEEP* key calls a menu in which the sweep mode is defined. In split-screen mode, the entries made are valid for the active window only.

The *CONTINUOUS SWEEP*, *SINGLE SWEEP* and *SGL SWEEP DISP OFF* softkeys are mutually exclusive selection keys.



The *CONTINUOUS SWEEP* softkey activates the continuous sweep mode, which means that the sweep takes place continuously according to the trigger mode set.

When working in the split-screen mode and with different settings in the two windows, screen A is swept first, followed by screen B. When the softkey is pressed, the sweep is restarted.

CONTINUOUS SWEEP is the default setting of R&S FSMR.

IEC/IEEE-bus command: `INIT:CONT ON`

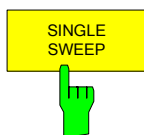

The *SINGLE SWEEP* softkey starts n sweeps after triggering. The number of sweeps is determined by the *SWEEP COUNT* softkey.

When working in the split-screen mode, the frequency ranges of the two windows are swept one after the other.

If a trace is swept using *TRACE AVERAGE* or *MAXHOLD*, the value set via the *SWEEP COUNT* softkey determines the number of sweeps. If 0 has been entered, one sweep is performed.

IEC/IEEE-bus command: `INIT:CONT OFF`



The *CONTINUE SGL SWEEP* softkey repeats the number of sweeps set under *SWEEP COUNT*, however without first deleting the trace.

This is particularly of interest when using the functions *TRACE AVERAGE* and *MAXHOLD*, if previously recorded measurement results are to be taken into consideration for averaging / maximum search.

If *SGL SWEEP DISP OFF* is active, the screen is switched off also during repeated sweeps.

IEC/IEEE-bus command: `INIT:CONM`



The *SWEEPTIME MANUAL* softkey activates the window for entering the sweep time manually (see also BW menu).

IEC/IEEE-bus command: `SWE:TIME 10s`



The *SWEEPTIME AUTO* softkey activates the automatic selection of the sweep time as a function of the bandwidth of the resolution and video filters (see also BW menu).

IEC/IEEE-bus command: `SENS:SWE:TIME:AUTO ON`

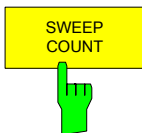

The *SWEEP COUNT* softkey activates the window for the entry of the number of sweeps to be performed by R&S FSMR after a single sweep has been started. If Trace Average, Max Hold or Min Hold is activated, this also determines the number of averaging or maximum search procedures.

Example:

[TRACE1: MAX HOLD]

[SWEEP: SWEEP COUNT: {10} ENTER]

[SINGLE SWEEP]

R&S FSMR performs the Max Hold function over 10 sweeps.

The permissible range for the sweep count is 0 to 32767. For sweep count = 0 or 1, one sweep is performed. For trace averaging in the continuous-sweep mode, R&S FSMR performs running averaging over 10 sweeps if sweep count = 0; if sweep count = 1, no averaging is performed.

The sweep count is valid for all the traces in a diagram.

IEC/IEEE-bus command: `SENS:SWE:COUN 64`



The number of sweeps set in the TRACE menu is the same as that in the SWEEP menu.

If *SINGLE SWEEP* is selected, the measurement stops after the selected number of sweeps has been performed.



The *SWEEP POINTS* softkey selects the number of measurement samples acquired during a sweep.

The following numbers of points per sweep are available: 155, 201, 313, 401, 625 (default), 801, 1251, 1251, 1601, 1999, 2501, 5001, 10001, 20001, 30001

EC/IEEE-bus command: SENS:SWE:POIN 625



The autopeak detector will be disabled while the number of points per sweep is \neq 625.



The *SGL SWEEP DISP OFF* softkey deactivates the display while a single sweep is being performed. Once the sweep has been completed, the trace is shown.

IEC/IEEE-bus command: INIT:DISP OFF;:INIT

Triggering the Sweep – TRIG Key

The *TRIG* key opens a menu for selection of the various trigger sources, trigger polarity and external gate function. The active trigger mode is indicated by highlighting the corresponding softkey.

For video trigger, a trigger threshold can be entered, which is represented in the diagram as a horizontal line.

To indicate that a trigger mode other than *FREE RUN* has been set, the enhancement label **TRG** is displayed on the screen. If two windows are displayed, TRG appears next to the appropriate window.

TRIGGER menu

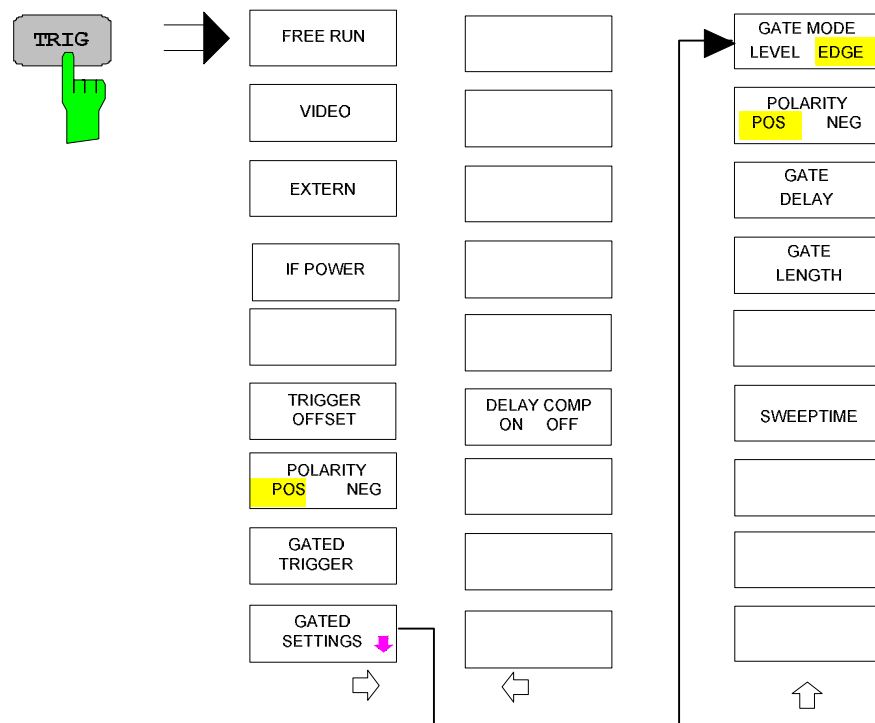

The *FREE RUN* softkey activates the free-run sweep mode, i.e. start of a sweep is not triggered. Once a measurement is completed, another is started immediately.

FREE RUN is the default setting of R&S FSMR.

IEC/IEEE-bus command: `TRIG:SOUR IMM`

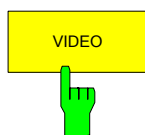

The *VIDEO* softkey activates triggering through the displayed voltage.

For the video triggering mode, a horizontal trigger line is shown in the diagram. It may be used to set the trigger threshold between 0% and 100% of the overall diagram height.

IEC/IEEE-bus command: `TRIG:SOUR VID`
`TRIG:LEV:VID 50 PCT`

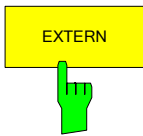

The *EXTERN* softkey activates triggering via a TTL signal at the input connector *EXT TRIGGER/GATE* on the rear panel.

The external trigger level can be adjusted in the range from 0.5 V to 3.5 V. The default value is 1.4 V.

IEC/IEEE-bus command: TRIG:SOUR EXT <numeric_value>
 SWE:EGAT:SOUR EXT

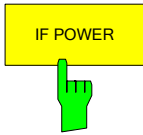

The *IF POWER* softkey activates triggering of the measurement via signals which are outside the measurement channel.

For this purpose, the R&S FSMR uses a level detector at the second intermediate frequency. can be selected in a range between -50 dBm and -10 dBm at the input mixer. The resulting trigger level at the RF input is calculated via the following formula:

$$Mixerlevel_{min} + RFA_{Att} - PreampGain \leq Input\ Signal \leq Mixerlevel_{max} + RFA_{Att} - PreampGain$$

The bandwidth at the intermediate frequency is 50 MHz. The R&S FSMR is triggered as soon as the trigger threshold is exceeded within a 25 MHz range around the selected frequency (= start frequency in the frequency sweep).

Thus, the measurement of spurious emissions, e.g. for pulsed carriers, is possible even when the carrier lies outside the selected frequency span.

IEC/IEEE-bus command: TRIG:SOUR IFP
 SWE:EGAT:SOUR IFP

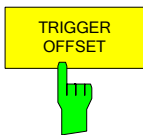

The *TRIGGER OFFSET* softkey activates the window for entering the time offset between the trigger signal and the start of the sweep.

Triggering is delayed by the entered time with respect to the trigger signal (time entered > 0) or is started earlier (time entered < 0). The time may be entered in multiples of 125 ns in the range -100 s to 100 s (default 0 s).



A negative offset (pretrigger) can be set in the time domain only (SPAN = 0 Hz) provided GATED TRIGGER is not active in that domain.

The maximum allowed range and the maximum resolution of the pretrigger is limited by the set sweep time:

max. range = - 499/500 x sweep time

max. resolution = sweep time/500.

Pretriggering is not possible when the rms or the average detector is activated

As a common input signal is used for both trigger and gate when selecting *EXTERN* and *IF POWER*, changes to the gate delay will affect the trigger delay (*TRIGGER OFFSET*) as well.

IEC/IEEE-bus command: TRIG:HOLD 10US

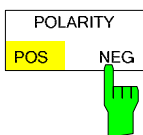

The *POLARITY POS/NEG* softkey selects the polarity of the trigger source.

The sweep starts after a positive or negative edge of the trigger signal. The selected setting is highlighted.

The selection is valid for all trigger modes with the exception of *FREE RUN*; in the gate mode, it also applies to the gate polarity.

The default setting is *POLARITY POS*.

IEC/IEEE-bus command: TRIG:SLOP POS

By using a gate in sweep mode and stopping the measurement while the gate signal is inactive, the spectrum for pulsed RF carriers can be displayed without the superposition of frequency components generated during switching. Similarly, the spectrum can also be examined for an inactive carrier. The sweep can be controlled by an external gate or by the internal power trigger.

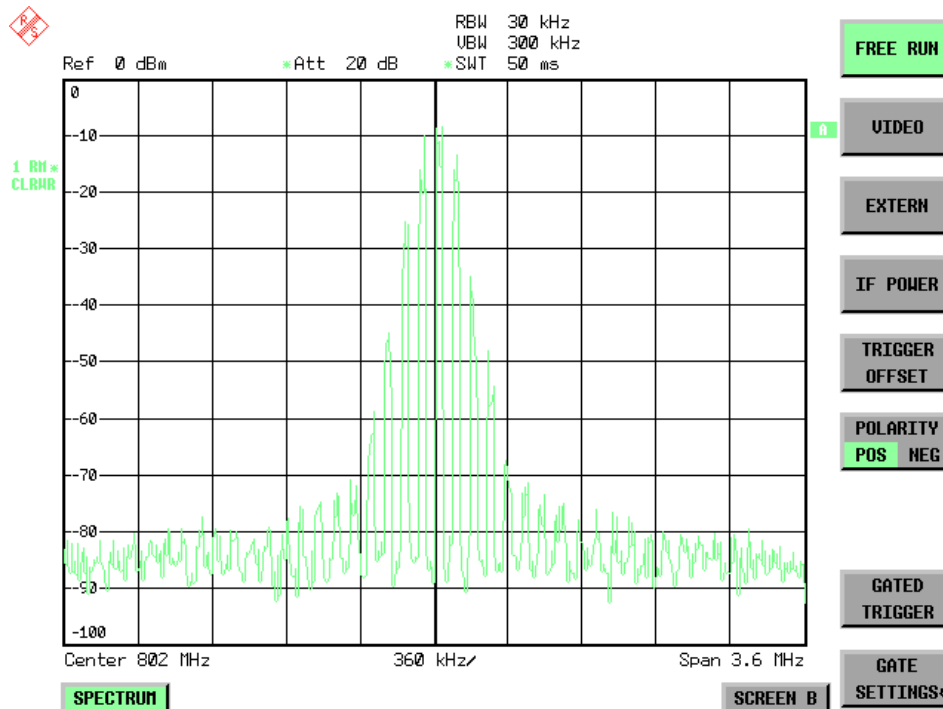

Fig. 4.10-1 Pulsed signal GATE OFF

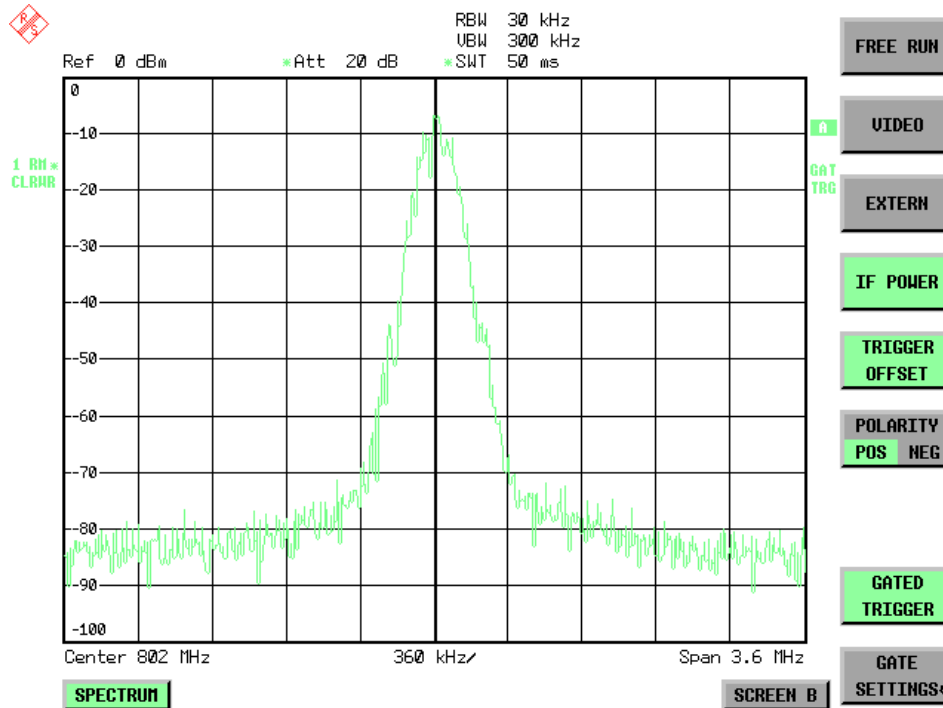
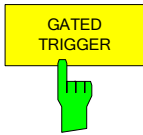

Fig. 4.10-2 TDMA signal with GATE ON

The gated-sweep mode is activated by the *GATED TRIGGER* softkey. The setting of the mode takes place in the *GATE SETTINGS* submenu.



The *GATED TRIGGER* softkey switches the sweep mode with gate on and off.

When gate is switched on, a gate signal applied to the rear panel connector *EXT TRIGGER/GATE* or the internal IF power detector controls the sweep of the analyzer. This selection is made via the *EXTERN* and *IF POWER* softkeys for trigger and gate.

The length of the gate signal defines when the sweep is to be interrupted. Here a differentiation is made between edge-triggered and level-triggered modes: in case of edge triggering the gate length can be set via the *GATE LENGTH* softkey, while in case of level triggering the gate length depends on the length of the gate signal.

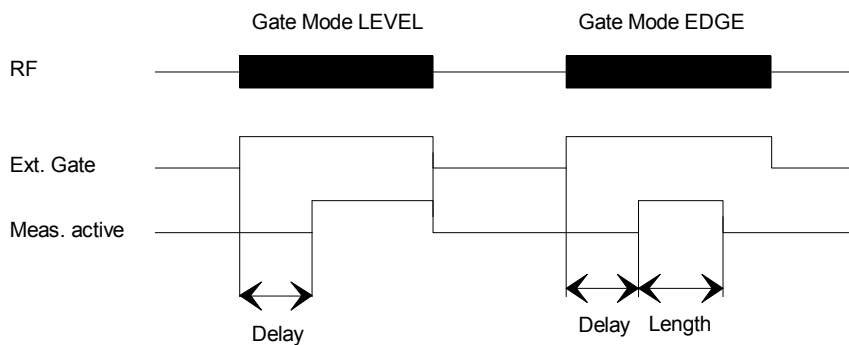

Fig.4.10-3 Timing diagram for GATE, GATE DELAY and GATE LENGTH

This softkey requires the *EXTERN* or *IF POWER* trigger mode. If a different mode is active, *IF POWER* is automatically selected.

Gated-sweep operation is also possible in the time domain. This enables - e.g. in burst signals - level variations of individual slots to be displayed versus time.

To indicate that a gate is used for the sweep, the enhancement label **GAT** is displayed on the screen. This label appears to the right of the window for which the gate is configured.

IEC/IEEE-bus command: SWE:EGAT ON
 SWE:EGAT:SOUR IFP
 OR:
 SWE:EGAT:SOUR EXT

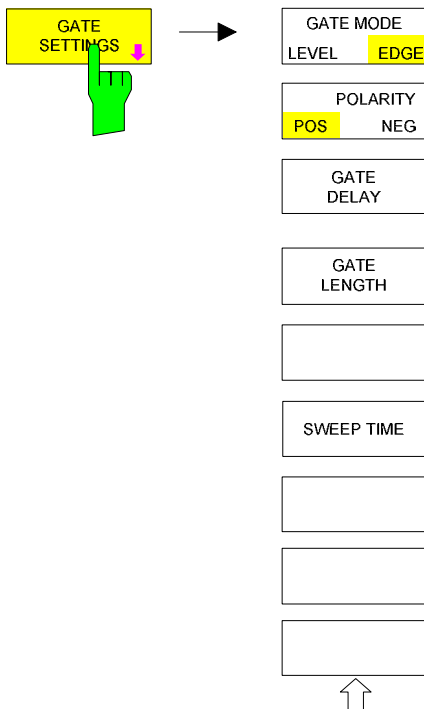

The *GATE SETTINGS* softkey calls a submenu for making all the settings required for gated-sweep operation.

At the same time, a transition is made to the time domain (span = 0) and the time parameters *GATE DELAY* and *GATE LENGTH* are represented as vertical lines. This allows the required gate time parameters to be set easily.

For highly accurate setting of gate delay and gate length, the x axis can be altered using the *SWEEPTIME* softkey in a way that the signal range concerned (e.g. one full burst) is displayed.

Then the sampling time and duration can be set by *GATE DELAY* and *GATE LENGTH* in a way that the desired portion of the signal is shown.

When quitting the submenu, the program will return to the frequency domain provided it was active before. The original span is restored so the desired measurement can now be performed with the accurately set gate.

IEC/IEEE-bus command: --

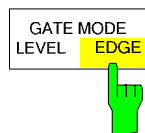

The *GATE MODE LEVEL/EDGE* softkey selects the trigger mode. Gated sweep is possible in the level-triggered as well as in the edge-triggered mode.

If level triggering is selected, the *GATE LENGTH* softkey becomes inactive and cannot be operated.

IEC/IEEE-bus command: SWE:EGAT:TYPE EDGE

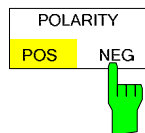

The *POLARITY POS/NEG* softkey controls the polarity of the *EXT TRIGGER/GATE* control line.

In case of level triggering the sweep is stopped by *POLARITY POS* and a logic '0' signal; the signal '1' will restart the sweep after the *GATE DELAY* time has elapsed.

In case of edge triggering the sweep is continued on a '0' to '1' transition for the duration of *GATE LENGTH* after a delay (*GATE DELAY*) has elapsed.

Changing the polarity automatically implies a transition of the trigger-edge polarity (*POLARITY* softkey in the higher menu).

IEC/IEEE-bus command: SWE:EGAT:POL POS



The *GATE DELAY* softkey activates the window for setting the delay time between the gate signal and the continuation of the sweep.

This may be useful for taking into account a delay between the gate signal and the stabilization of an RF carrier for example.

As gate delay, values between 125 ns and 100 s may be set. The position of the delay on the time axis in relation to the sweep is indicated by the line labelled **GD**.

As there is a common input signal for trigger and gate if *EXTERN* or *IF POWER* is selected, changes to the gate delay will affect the trigger delay (*TRIGGER OFFSET*) as well.

IEC/IEEE-bus command: `SWE:EGAT:HOLD 1US`

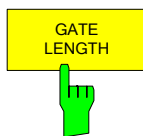

The *GATE LENGTH* softkey activates the window for setting the sweep duration of R&S FSMR in the edge-triggered mode.

Values between 125 ns and 100 s may be set for the gate length. The length of the gate in relation to the sweep is indicated by the line labelled **GL**.

This softkey is only available if *GATE MODE EDGE* (edge triggering) has been selected.

IEC/IEEE-bus command: `SWE:EGAT:LENG 100US`



The *SWEEP TIME* softkey enables the user to change the time axis to obtain a higher resolution for positioning gate delay and gate length.

When this is to be done, the sweep time temporarily changes; the original value is restored when the menu is quit.

IEC/IEEE-bus command: `--`

Measurement example:

The modulation spectrum of a GSM or PCS1900 signal is to be measured using the gated-sweep function. The signal is generated by a Signal Generator SME03 whose RF output is directly connected to the RF input of R&S FSMR.

The modulation spectrum of a GSM 900 signal is to be measured using the gated-sweep function. The signal is generated by a Signal Generator SME03 whose RF output is directly connected to the RF input of R&S FSMR.

Settings on SME03:

FREQ:	802 MHz
Level:	0 dBm: Return
Digital Mod:	Select: GMSK: Select
Source:	Select: PRBS: Select: Return
Level Attenuation:	Select: 60 dB: Return

The SME03 supplies a GMSK-modulated TDMA signal (GSM).

Settings on R&S FSMR:

Conventions: **[KEY]** Menu called by this key. All information between the brackets refers to this menu.
 {Number} Numeric value to be entered for the parameter on hand.
 SOFTKEY Softkey to be used for making a selection or entering a value.

[PRESET]

[FREQ: *CENTER {802} MHz]*
[SPAN *{3.6} MHz]*
[AMPT: *REF LEVEL {0} dBm: RF ATTEN MANUAL: {10} dB]*
[BW: *RES BW MANUAL: {30} kHz]*
[TRACE : *TRACE 1 DETECTOR: RMS]*
[SWEEP: *SWEPTIME MANUAL: {50} ms]*
[TRIG: *EXTERN*
 GATED TRIGGER;
 GATE SETTINGS: GATE MODE EDGE; POLARITY POS
 SWEPTIME MANUAL {1} ms: GATE DELAY {300} μs:
 GATE LENGTH: {250} μs]

The following figure shows the screen display for setting gate parameters. The vertical lines for gate delay (GD) and gate length (GL) can be adjusted to the burst signal by entering numeric values or by means of the rollkey.

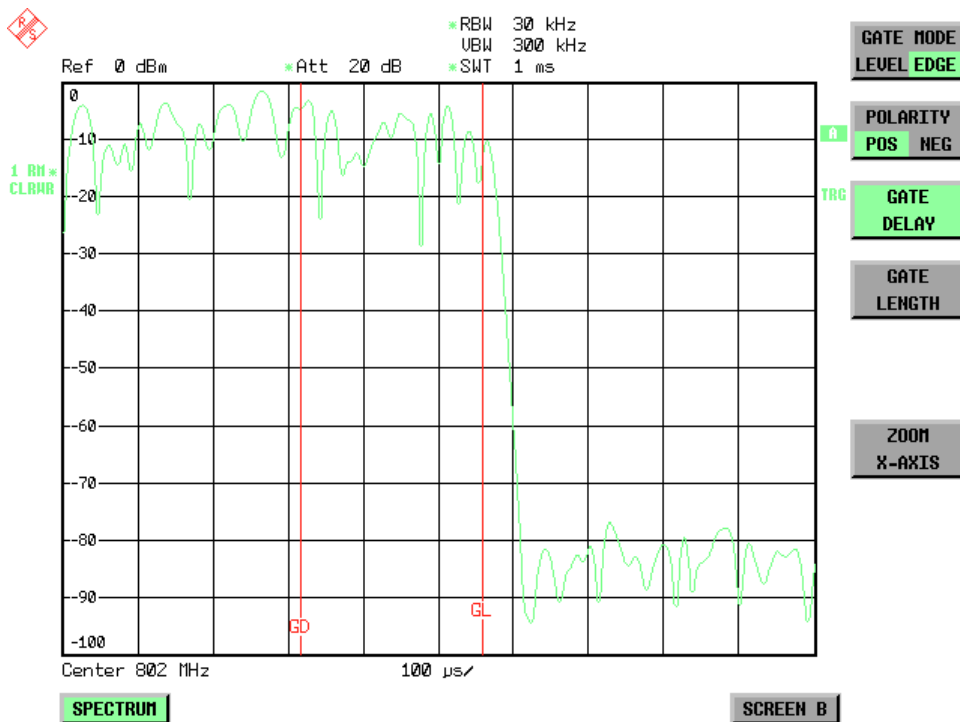
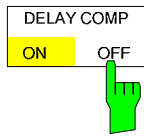

Fig.4.10-4 Setting GATE DELAY and GATE LENGTH in time domain by means of lines GD and GL

On quitting the *GATE SETTINGS* menu, R&S FSMR returns to the previous screen.

Menu TRIG - NEXT

The *DELAY COMP ON/OFF* softkey enables the filter group delay compensation for the external trigger. If a bursted signal is analyzed in zero span and the delay compensation is on, a change of the RBW will not change the rising slope of the signal.
Default is *OFF*.

IEC/IEEE-bus command: TRIG:HOLD:ADJ:AUTO ON|OFF

Selection and Setting of Traces – TRACE Key

The R&S FSMR is capable of displaying up to three different traces at a time in a diagram. A trace consists of a maximum of 625 pixels on the horizontal axis (frequency or time). If more measured values than pixels are available, several measured values are combined in one pixel.

The traces are selected using the *SELECT TRACE* softkey in the menu of the *TRACE* key.

The traces can individually be activated for a measurement or frozen after completion of a measurement. Traces that are not activated are blanked.

The display mode can be selected for each trace. Traces can be overwritten in each measurement (CLEAR/WRITE mode), averaged over several measurements (AVERAGE mode), or a maximum or minimum value can be determined from several measurements and displayed (MAX HOLD or MIN HOLD).

Individual detectors can be selected for the various traces. The autopeak detector displays maximum and minimum values connected by a vertical line. The max peak detector and min peak detector display the maximum and minimum value of the level within a pixel. The sample detector displays the instantaneous value of the level at a pixel. The rms detector displays the power (rms value) of the measured values within a pixel, the average detector the average value.

Selection of Trace Function

The trace functions are subdivided as follows:

- Display mode of trace (CLEAR/WRITE, VIEW and BLANK)
- Evaluation of the trace as a whole (AVERAGE, MAX HOLD and MIN HOLD)
- Evaluation of individual pixels of a trace (AUTOPEAK, MAX PEAK, MIN PEAK, SAMPLE, RMS, AVERAGE and QUASIPEAK)

TRACE menu

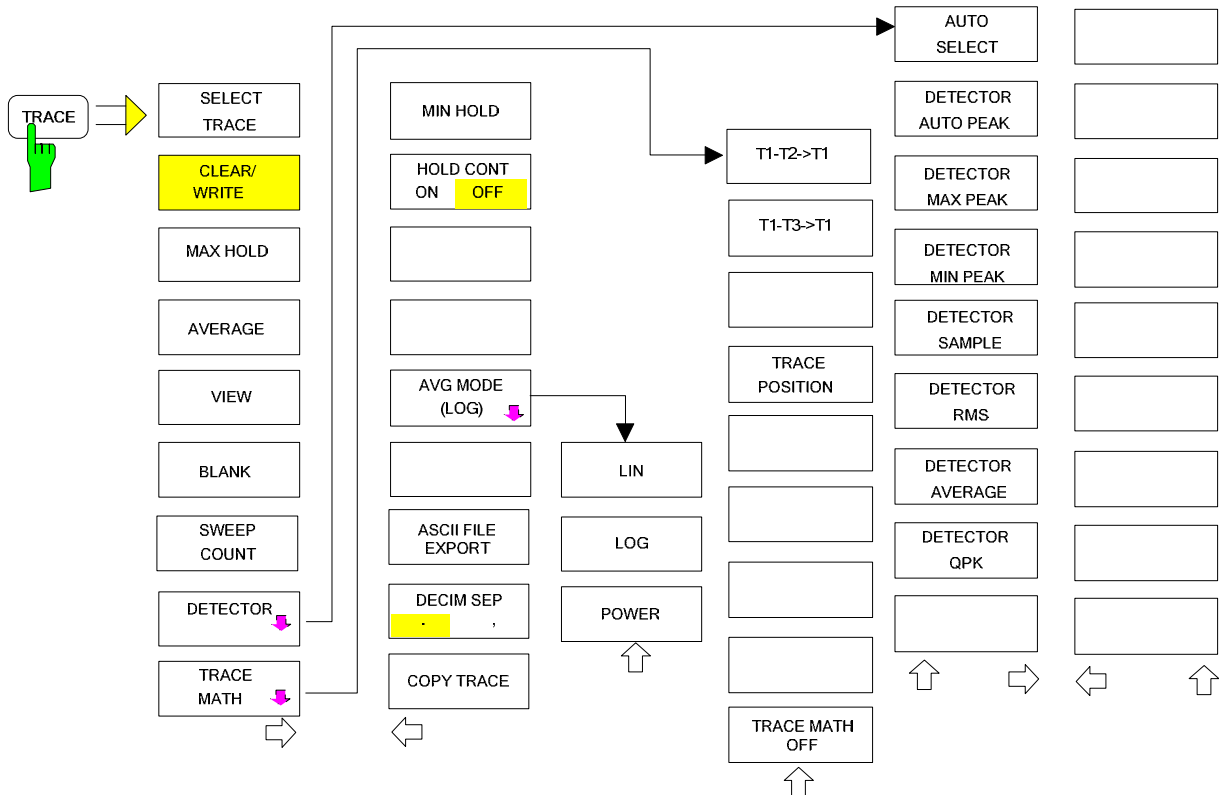

The *TRACE* key opens a menu offering the setting options for the selected trace.

In this menu, the mode of representing the measured data in the frequency or time domain in the 625 pixels of the display is determined. Upon start of the measurement, each trace can be displayed either

completely new or based on the previous results.

Traces can be displayed, blanked and copied. Traces can also be corrected with the aid of mathematical functions.

The measurement detector for the individual display modes can be selected directly by the user or set automatically by R&S FSMR.

The default setting is trace 1 in the overwrite mode (*CLEAR / WRITE*), the other traces 2 and 3 are switched off (*BLANK*).

The *CLEAR/WRITE*, *MAX HOLD*, *MIN HOLD*, *AVERAGE*, *VIEW* and *BLANK* softkeys are mutually exclusive selection keys.



The *SELECT TRACE* softkey activates the entry for the active trace (1, 2, 3).
IEC/IEEE-bus command -- (selected via numeric suffix of :TRACe)



The *CLEAR/WRITE* softkey activates the overwrite mode for the collected measured values, ie the trace is overwritten by each sweep. In the *CLEAR/WRITE* display mode all the available detectors can be selected. In the default mode the autopeak detector (setting *AUTO*) is selected. Each time the *CLEAR/WRITE* softkey is actuated, R&S FSMR clears the selected trace memory and starts the measurement anew.

IEC/IEEE-bus command DISP:WIND:TRAC:MODE WRIT

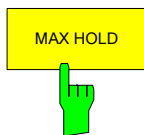

The *MAX HOLD* softkey activates the max peak detector. R&S FSMR saves the sweep result in the trace memory only if the new value is greater than the previous one.

The detector is automatically set to *MAX PEAK*. The maximum value of a signal can thus be determined over several sweeps.

This is especially useful with modulated or impulsive signals. The signal spectrum is filled up upon each sweep until all signal components are detected in a kind of envelope.

Pressing the *MAX HOLD* softkey again clears the trace memory and restarts the max hold mode.

IEC/IEEE-bus command DISP:WIND:TRAC:MODE MAXH

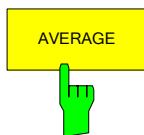

The *AVERAGE* softkey activates the trace averaging function. The average is formed over several sweeps. Averaging can be performed with any of the detectors available. If the detector is automatically selected by R&S FSMR, the sample detector is used.

Depending on the setting of AVG MODE LOG / LIN, the logarithmic level values or the measured power/voltage values are averaged.

Averaging is restarted every time the *AVERAGE* softkey is pressed. The trace memory is always cleared.

IEC/IEEE-bus command DISP:WIND:TRAC:MODE AVER

Description of averaging

Averaging is carried out over the pixels derived from the measurement samples. Several measured values may be combined in a pixel. This means that with linear level display the average is formed over linear amplitude values and with logarithmic level display over levels. For this reason the trace must be measured again when changing between *LIN* and *LOG* display mode. The settings *CONT/SINGLE SWEEP* and running averaging apply to the average display analogously.

There are two methods for calculating the average. For a sweep count = 0, a running average is calculated according to the following formula:

$$\text{TRACE} = \frac{9 * \text{TRACE} + \text{meas. value}}{10}$$

Due to the weighting between the new measured value and the trace average, past values have

practically no influence on the displayed trace after about ten sweeps. With this setting, signal noise is effectively reduced without need for restarting the averaging process after a change of the signal. If the sweep count is >1, averaging takes place over the selected number of sweeps. In this case the displayed trace is determined during averaging according to the following formula:

$$\text{Trace}_n = \frac{1}{n} \left[\sum_{i=1}^{n-1} (T_i) + \text{meas. value}_n \right]$$

where n is the number of the current sweep ($n = 2 \dots \text{SWEEP COUNT}$). No averaging is carried out for the first sweep but the measured value is stored in the trace memory. With increasing n , the displayed trace is increasingly smoothed since there are more single sweeps for averaging.

After the selected number of sweeps the average trace is saved in the trace memory. Until this number of sweeps is reached, a preliminary average is displayed.

After completion of averaging, ie when the averaging length defined by *SWEEP COUNT* is attained, a running averaging is continued with *CONTINUOUS SWEEP* according to the following formula:

$$\text{Trace} = \frac{(N-1) \cdot \text{Trace}_{\text{old}} + \text{meas. value}}{N} \quad \text{where} \quad \begin{array}{l} \text{Trace} = \text{new trace} \\ \text{Trace}_{\text{old}} = \text{old trace} \\ N = \text{SWEEP COUNT} \end{array}$$

The display "Sweep N of N" does not change any more until a new start is triggered.

In the *SINGLE SWEEP* mode, the number of sweeps is triggered with *SWEEP START*. The sweeps are stopped when the selected number of sweeps is attained. The number of the current sweep and the total number of sweeps are shown on the display: "Sweep 3 of 200".

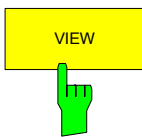

The *VIEW* softkey freezes the current contents of the trace memory and displays it.

If a trace is frozen by *VIEW*, the instrument settings can be changed without the displayed trace being modified (exception: level display range and reference level, see below). The fact that the trace and the current instrument setting do not agree any more is indicated by an enhancement label "*" at the right edge of the grid.

If in the *VIEW* display mode the level display range (*RANGE*) or the reference level (*REF LEVEL*) are changed, R&S FSMR automatically adapts the measured data to the changed display range. This allows an amplitude zoom to be made after the measurement in order to show details of the trace.

IEC/IEEE-bus command `DISP:WIND:TRAC:MODE VIEW`

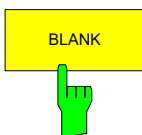

The *BLANK* softkey activates the blanking of the trace on the screen.

IEC/IEEE-bus command `DISP:WIND:TRAC OFF`



The *SWEEP COUNT* softkey activates the entry of the number of sweeps used for averaging. The allowed range of values is 0 to 30000 and the following should be observed:

- Sweep Count = 0 means running averaging
- Sweep Count = 1 means no averaging being carried out
- Sweep Count > 1 means averaging over the selected number of sweeps; in the continuous sweep mode averaging is performed until the set number of sweeps is attained and is then continued as running averaging.

The default setting is running averaging (Sweep Count = 0). The number of sweeps used for averaging is the same for all active traces in the selected diagram.

IEC/IEEE-bus command `SWE:COUN 64`



The setting of the sweep count in the trace menu is equivalent to the setting in the sweep menu.

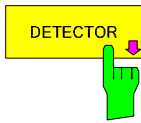

See following Section "Selection of Detector"

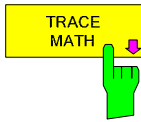

See following Section "Mathematical Functions for Traces"

TRACE - NEXT menu

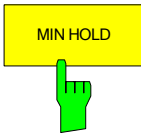

The *MIN HOLD* softkey activates the min peak detector. R&S FSMR saves for each sweep the smallest of the previously stored/currently measured values in the trace memory. The detector is automatically set to *MIN PEAK*. In this way, the minimum value of a signal can be determined over several sweeps.

This function is useful eg for making an unmodulated carrier in a composite signal visible. Noise, interference signals or modulated signals are suppressed by the min hold function whereas a CW signal is recognized by its constant level.

Pressing the *MIN HOLD* softkey again clears the trace memory and restarts the min hold function.

IEC/IEEE-bus command `DISP:WIND:TRAC:MODE MINH`

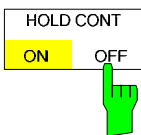

The *HOLD CONT* softkey defines whether the traces in min hold and max hold mode are reset after some specific parameter changes.

OFF The traces are reset after some definite parameter changes (default)

ON This mechanism is switched off.

In general, parameter changes require a restart of the measurement before results are evaluated (e. g. with markers). For those changes that are known to require a new measurement (e. g. modification of the span), the trace is automatically reset so that erroneous evaluations of previous results are avoided.

This mechanism can be switched off for those exceptional cases where the described behavior is unwelcome.

IEC/IEEE-bus command `DISP:WIND1:TRAC4:MODE:HCON ON|OFF`

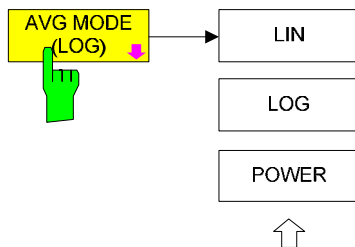

The *AVG MODE LOG/LIN* softkey selects logarithmic or linear averaging for the logarithmic level display mode.

At the same time the difference calculation is switched between linear and logarithmic in submenu *TRACE MATH*.

IEC/IEEE-bus command

`CALC:MATH:AVER:MODE LIN | LOG | POW`

With logarithmic averaging, the dB values of the display voltage are averaged or subtracted from each other with trace mathematical functions. With linear averaging the level values in dB are converted into linear voltages or powers prior to averaging. Voltage or power values are averaged or offset against each other and reconverted into level values.

For stationary signals the two methods yield the same result.

Logarithmic averaging is recommended if sinewave signals are to be clearly visible against noise since with this type of averaging noise suppression is improved while the sinewave signals remain unchanged.

For noise or pseudo-noise signals the positive peak amplitudes are decreased in logarithmic averaging due the characteristic involved and the negative peak values are increased relative to the average value. If the distorted amplitude distribution is averaged, a value is obtained that is smaller than the actual average value. The difference is -2.5 dB.

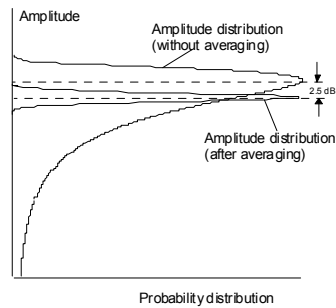

This low average value is usually corrected in noise power measurements by a 2.5 dB factor. Therefore the R&S FSMR offers the selection of linear averaging. The trace data are delogarithmized prior to averaging, then averaged and logarithmized again for display on the screen. The average value is always correctly displayed irrespective of the signal characteristic.

Following selections are available:

LOG: logarithmic averaging
 LIN linear averaging (delogarithmization depends on selected unit)
 For units VOLT and AMPERE the level values are converted into linear voltages prior to averaging.
 POWER linear averaging (delogarithmization to power for all units)



For correct power averaging with units VOLT or AMPERE, selection POWER has to be used.



The *ASCII FILE EXPORT* softkey stores the active trace in ASCII format on a floppy disk.

```
IEC/IEEE command  FORM ASC ;
                   MMEM:STOR:TRAC 1, 'TRACE.DAT'
```

The file consists of the header containing important scaling parameters and a data section containing the trace data.

The data of the file header consist of three columns, each separated by a semicolon:

parameter name; numeric value; basic unit

The data section starts with the keyword " Trace <n> " (<n> = number of stored trace), followed by the measured data in one or several columns (depending on measurement) which are also separated by a semicolon.

This format can be read in from spreadsheet calculation programs, eg MS-Excel. It is necessary to define ';' as a separator.



Different language versions of evaluation programs may require a different handling of the decimal point. It is therefore possible to select between separators '.' (decimal point) and ',' (comma) using softkey DECIM SEP.

Example: File header

File contents	Description
Type;R&S FSMR <model>;	Instrument model
ersion;1.00;	Firmware version
Date;01.Jul 2005;	Date of data set storage
Mode;Spectrum;	Instrument mode
Center Freq;55000;Hz	Center frequency
Freq Offset;0;Hz	Frequency offset
Span;90000;Hz	Frequency range (0 Hz with zero span and statistics measurements)
x-Axis;LIN;	Scaling of x axis linear (LIN) or logarithmic (LOG)
Start;10000;Hz Stop;100000;Hz	Start/stop of the display range. Unit: Hz for span > 0, s for span = 0, dBm/dB for statistics measurements
Ref.Level;-30;dBm	Reference level
Level Offset;0;dB	Level offset
Ref Position;75;%	Position of reference level referred to diagram limits (0% = lower edge)
y-Axis;LOG	Scaling of y axis linear (LIN) or logarithmic (LOG)
Level Range;100;dB	Display range in y direction. Unit: dB with x axis LOG, % with x axis LIN
RF Att;20;dB	Input attenuation
RBW;100000;Hz	Resolution bandwidth
VBW;30000;Hz	Video bandwidth
SWT;0.005;s	Sweep time
Trace Mode;AVERAGE;	Display mode of trace: CLR/WRITE,AVERAGE,MAXHOLD,MINHOLD
Detector;SAMPLE;	Detector set: AUTOPEAK,MAXPEAK,MINPEAK,AVERAGE, RMS,SAMPLE,QUASISPEAK
Sweep Count;20	Number of sweeps set

Example: Data section of the file

File contents	Description
Trace 1.;	Selected trace
x-Unit;Hz	Unit of x values: Hz with span > 0; s with span = 0; dBm/dB with statistics measurements
y-Unit;dBm	Unit of y values: dB*/V/A/W depending on the selected unit with y axis LOG or % with y axis LIN
Values; 625	Number of test points
10000;-10.3;-15.7 10180;-11.5;-16.9 10360;-12.0;-17.4;	Measured values: <x value>, <y1>, <y2> <y2> being available only with detector AUTOPEAK and containing in this case the smallest of the two measured values for a test point.

The following section describes the usage of the instrument's front panel keys using TRACE EXPORT as an example.

- Press the *TRACE* key and then the *NEXT* softkey.
- Press the *ASCII FILE EXPORT* softkey to open the corresponding dialog box.

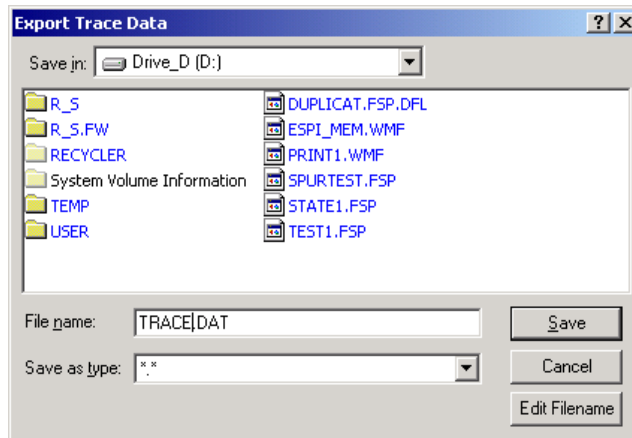

The focus is on the *File Name* field so you can directly edit the file name using the numeric keys, the cursor keys or the *BACK* key.

You can also use alphanumeric characters in the file name.

- To enter alphanumeric characters, select the *EDIT FILENAME* button. Confirm the selection with the ENTER key to open an online keyboard.

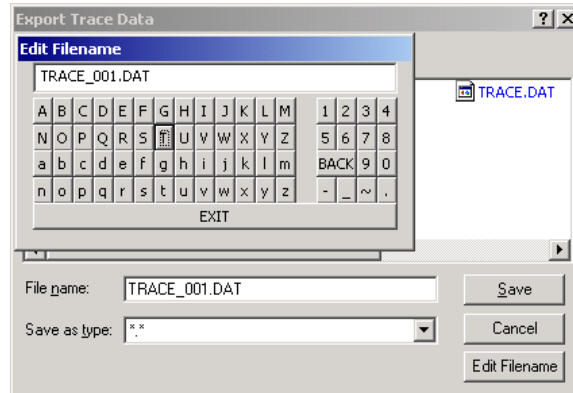

Select the characters with the rotary knob or the cursor keys and confirm with the ENTER key.

- Drive usage is checked according to the following rules:
 - first, the R&S FSMR checks for a connected memory stick
 - if a memory stick is not recognized, then the R&S FSMR uses the internal hard disk.

Note that the path and file name are reset to their default values after an instrument *PRESET*.

- Change the drive by moving the rotary knob until the focus is on the *Save In* field.

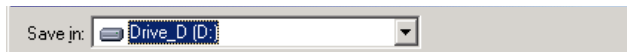

- Press the *CURSOR RIGHT* key to open the dropdown menu and select the drive you want to save the file to with the *CURSOR UP* and *CURSOR DOWN* keys. Confirm your selection by pressing the *ENTER* key.
- Select a subfolder by moving the rotary knob until the file / subfolder list is in focus. The selected file or subfolder in focus is framed by dotted line.

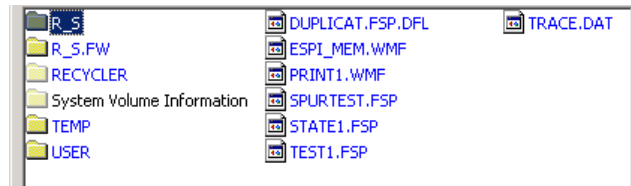

- Use the CURSOR UP or CURSOR DOWN keys to select a specific folder or file. To change the path or select a file, confirm your selection with the ENTER key.

Note that the R&S FSMR overwrites existing files with the new data.

IEC/IEEE command `FORM ASC;`
`MMEM:STOR:TRAC 1, 'TRACE.DAT'`

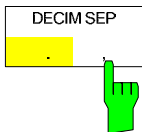

The *DECIM SEP* softkey selects the decimal separator between '.' (decimal point) and ',' (comma) with floating-point numerals for the function ASCII FILE EXPORT. With the selection of the decimal separator different language versions of evaluation programs (eg MS-Excel) can be supported.

IEC/IEEE-bus command `FORM:DEXP:DSEP POIN`

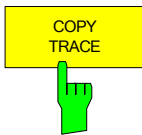

The *COPY TRACE* softkey copies the screen contents of the current trace into another trace memory. The desired memory is selected by entering the number 1, 2 or 3.

Upon copying, the contents of the selected memory is overwritten and the new contents displayed in view mode.

IEC/IEEE-bus command `TRAC:COPY TRACE1,TRACE2`

Selection of Detector

The detectors of the R&S FSMR are implemented as pure digital devices. The detectors available are the peak detectors which determine the maximum and/or the minimum value from a number of samples, the rms detector which measures the power within a pixel, the average, the quasipeak and the sample detector. The sample detector routes through the sampled data without any modification or performs a data reduction by suppressing measured values that cannot be displayed.

The peak detectors compare the current level value with the maximum or minimum level from the previously sampled data. When the number of samples defined by the instrument setting is reached, the samples are combined in displayable pixels. Each of the 625 pixels of the display thus represents 1/625 of the sweep range and contains all single measurements (frequency samples) in this subrange in compressed form. For each trace display mode an optimized detector is selected automatically. Since peak detectors and sample detector are connected in parallel, a single sweep is sufficient for collecting all detector values for 3 traces.

Peak detectors
 (MAX PEAK and MIN PEAK)

Peak detectors are implemented by digital comparators. They determine the largest of all positive (max peak) or the smallest of all negative (min peak) peak values of the levels measured at the individual frequencies which are displayed in one of the 625 pixels. This procedure is repeated for each pixel so that for wide frequency spans and despite the limited resolution of the display a large number of measurements can be taken into consideration for the display of the spectrum.

Autopeak detector

The *AUTOPEAK* detector combines the two peak detectors. The max peak detector and the min peak detector simultaneously determine the maximum and the minimum level within a displayed testpoint and display it as a single measured value. The maximum and minimum levels within a frequency point are connected by a vertical line.

Sample detector	<p>The <i>SAMPLE</i> detector routes through the sampled data without any further evaluation and either displays them directly or, for reasons of speed in case of short sweep times, first writes them into a memory and processes them subsequently.</p> <p>There is no data reduction, ie no summing up of measured values of neighbouring frequencies or time samples. If during a frequency sweep more measured values are obtained than can be displayed, measured values will be lost. This means that discrete signals might be lost.</p> <p>The sample detector therefore can only be recommended for a span-to-resolution bandwidth ratio of up to approx. 250 in order to ensure that no signal will be suppressed (example: span 1 MHz, -> min. bandwidth 5 kHz).</p>
RMS detector	<p>The RMS detector forms the rms value of the measured values within a pixel.</p> <p>To this effect, R&S FSMR uses the linear voltage after envelope detection. The sampled linear values are squared, summed and the sum is divided by the number of samples (= root mean square). For logarithmic display the logarithm is formed from the square sum. For linear display the root mean square value is displayed. Each pixel thus corresponds to the power of the measured values summed up in the pixel.</p> <p>The rms detector supplies the power of the signal irrespective of the waveform (CW carrier, modulated carrier, white noise or impulsive signal). Correction factors as needed for other detectors for measuring the power of the different signal classes are not required.</p>
Average detector	<p>The average detector forms the average value of the measured values within a pixel.</p> <p>To this effect, R&S FSMR uses the linear voltage after envelope detection. The sampled linear values are summed up and the sum is divided by the number of samples (= linear average value). For logarithmic display the logarithm is formed from the average value. For linear display the average value is displayed. Each pixel thus corresponds to the average of the measured values summed up in the pixel.</p> <p>The average detector supplies the average value of the signal irrespective of the waveform (CW carrier, modulated carrier, white noise or impulsive signal).</p>
Quasipeak detector	<p>The quasipeak detector simulates the behaviour of an analog voltmeter by evaluating the measured values in a pixel.</p> <p>The quasipeak detector is especially designed for the requirements of EMC measurements and is used for evaluating pulse-shaped spurious.</p>



During a frequency sweep, R&S FSMR increments the 1st local oscillator in steps that are smaller than approximately 1/10 of the bandwidth. This is to ensure that the signal level is correctly measured. For narrow bandwidths and wide frequency spans a very large number of measured values is thus obtained. The number of frequency steps, however, always is a multiple of 625 (= number of pixels that can be displayed). With the sample detector selected, only every nth value is displayed. The value of n depends on the number of measured values, ie on the frequency span, the resolution bandwidth and the measurement rate.

TRACE-DETECTOR submenu

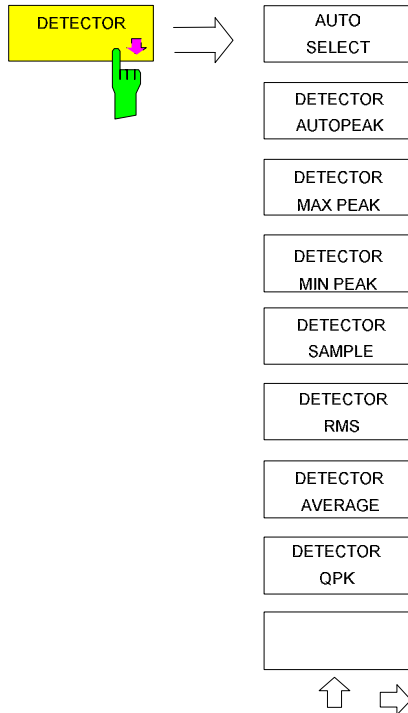

The *DETECTOR* softkey opens a submenu for selecting the detector for the selected trace. The softkey is highlighted if the detector is not selected with *AUTO SELECT*.

The detector can be selected independently for each trace. The *AUTO SELECT* mode selects the optimum detector for each display mode of the trace (Clear/Write, Max Hold or Min Hold).

The softkeys for the detectors are mutually exclusive selection keys.

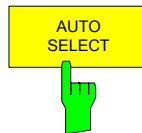

The *AUTO SELECT* softkey (= default setting) selects the optimum detector for the set display mode of the trace (Clear/Write, Max Hold and Min Hold) and the selected filter mode (bandpass/FFT).

Trace display	Detector (bandpass)	Detector (FFT)
Clear/Write	Auto Peak	Max Peak
Average	Sample	Sample
Max Hold	Max Peak	Max Peak
Min Hold	Min Peak	Max Peak

The detector activated for the specific trace is identified in the respective trace display field as follows:

Detector	
Auto Peak	AP
Max Peak	PK
Min Peak	MI
Average	AV
RMS	RM
Sample	SA
Quasipeak	QP

IEC/IEEE-bus command SENS:DET:AUTO ON

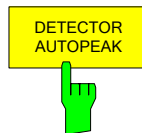

The *DETECTOR AUTOPEAK* softkey activates the autopeak detector.

IEC/IEEE-bus command SENS:DET APE



The *DETECTOR MAX PEAK* softkey activates the max peak detector. It is recommended for measurement of impulsive signals.

IEC/IEEE-bus command SENS:DET POS

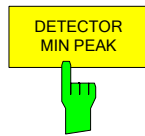

The *DETECTOR MIN PEAK* softkey activates the min peak detector. Weak sinewave signals become clearly visible in noise using this detector. In case of a composite signal made up of sinewave and impulsive signals, the impulsive signals are suppressed.

IEC/IEEE-bus command SENS:DET NEG

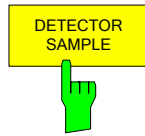

The *DETECTOR SAMPLE* softkey activates the sample detector. It is used for measuring uncorrelated signals such as noise. The power can be determined with the aid of fixed correction factors for evaluation and the logarithmic function.

IEC/IEEE-bus command SENS:DET SAMP

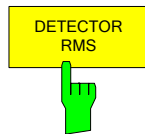

The *DETECTOR RMS* softkey activates the rms detector. The rms detector supplies the power of the signal independent of the waveform. For this effect the root mean square of all sampled level values is formed during the sweep of a pixel. The sweep time thus determines the number of averaged values and with increasing sweep time better averaging is obtained. The rms detector is thus an alternative for averaging over several sweeps (see TRACE AVERAGE).

Since the video bandwidth must be at least 10 times the resolution bandwidth (RBW) to ensure that video filtering does not invalidate the rms values of the signal, this ratio is set automatically upon activating the detector.

IEC/IEEE-bus command DET RMS

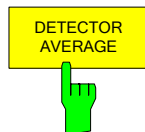

The *DETECTOR AVERAGE* softkey activates the average detector.

In contrast to the rms detector, the average detector supplies the linear average of all sampled level values during the sweep of a pixel.

The same relations as for the rms detector apply (see above).

IEC/IEEE-bus command SENS:DET AVER



The *DETECTOR QPK* softkey activates the quasipeak detector.

This detector evaluates the sampled level values during the sweep of a pixel like an analog voltmeter.

On switching the quasipeak detector on the video bandwidth is automatically set to 10 MHz so as to exclude the influence of the video filter on the signal evaluation.

IEC/IEEE-bus command SENS:DET QPE

Mathematical Functions for Traces

TRACE 1-TRACE MATH submenu:

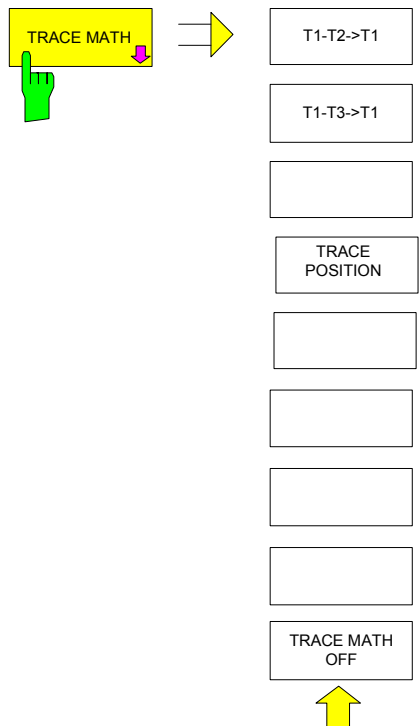

The *TRACE MATH* softkey opens a submenu in which the difference between the selected trace to trace 1 is calculated. The softkey is highlighted if a math function is activated.

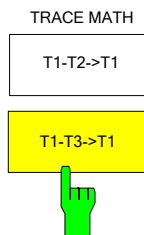

The *T1-T2* and *T1-T3* softkeys subtract the corresponding traces. The result displayed is referred to the zero point defined by *TRACE POSITION*.

To indicate that the trace has been obtained by subtraction, the difference "1 - 2" or "1 - 3" is indicated on the trace info of trace 1 and in the *TRACE* main menu the *TRACE MATH* softkey is highlighted.

IEC/IEEE-bus command `CALC:MATH (TRACE1-TRACE2)`
`CALC:MATH (TRACE1-TRACE3)`



The *TRACE POSITION* softkey activates the entry of the trace position for 0 difference. The position is stated in % of the diagram height.

The range of values extends from -100% to +200%

IEC/IEEE-bus command `DISP:MATH:POS 50PCT`



The *TRACE MATH OFF* softkey switches the math function off.

IEC/IEEE-bus command `CALC:MATH:STAT OFF`

Recording the Correction Data of R&S FSMR – CAL Key

The R&S FSMR obtains its high measurement accuracy through its inbuilt self-alignment method.

The correction data and characteristics required for the alignment are determined by comparison of the results at different settings with the known characteristics of the high-precision calibration signal source of R&S FSMR at 128 MHz. The correction data are then available in the instrument as a file and can be displayed by means of the *CAL RESULTS* softkey.

For service purposes the use of correction data can be deactivated by means of the *CAL CORR ON/OFF* softkey. If the correction data recording is aborted, the last complete correction data set is restored.



The term "Calibration" formerly used for the integrated self alignment was often mistaken for the "true" calibration of the instrument at the test set in production and in service. It is therefore no longer used although it appears in the abbreviated form in the name of keys ("CAL...").

CAL menu:

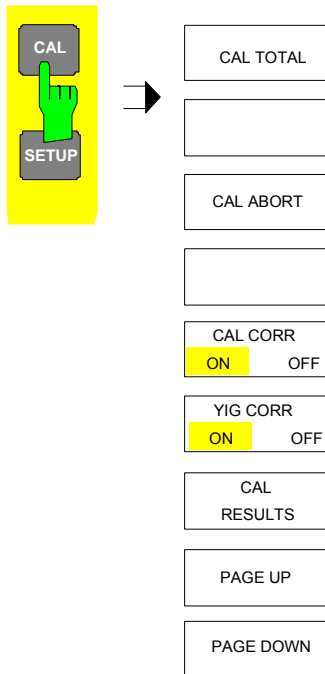

The *CAL* key opens a menu with the available functions for recording, displaying and activating the data for self alignment.



The *CAL TOTAL* softkey starts the recording of correction data of the instrument.

If the correction data recording has failed or if the correction values are deactivated (*CAL CORR = OFF* softkey), the status field indicates

UNCAL

IEC/IEEE-bus command: *CAL?



The *CAL ABORT* softkey interrupts the recording of correction data and restores the last complete correction data set.

IEC/IEEE-bus command: CAL:ABOR

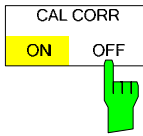

The *CAL CORR ON/OFF* softkey switches the calibration data on/off.

ON The status message depends upon the results of the total calibration.

OFF The message *UNCAL* appears in the status line.

IEC/IEEE-bus command: `CAL:STAT ON`

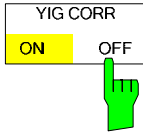

The *YIG CORR ON/OFF* softkey switches on or off the automatic, cyclic correction of the temperature-dependent frequency drift of the YIG filter.

When switched to ON (default setting), it is checked once per minute whether a frequency correction for the YIG filter is required. Frequency correction is performed if the temperature has changed by more than 5K relative to the last instance of correction.



If the instrument is operated in a temperature-controlled environment, the cyclic frequency drift correction can – for time-critical applications – be switched off after an operating period of ≥ 30 minutes.

This function is available only on model R&S FSMR8 and higher.

IEC/IEEE-bus command: `:SENS1:CORR:YIG:TEM:AUTO ON`



The *CAL RESULTS* softkey calls the *CALIBRATION RESULTS* table, which shows the correction data found during calibration.

The *CALIBRATION RESULTS* table contains the following information:

- date and time of last record of correction values
- overall results of correction value record
- list of found correction values according to function/module

The results have the following meaning:

PASSED calibration successful without any restrictions

CHECK deviation of correction value larger than expected, correction could however be performed

FAILED deviations of correction value too large, no correction was possible. The found correction data are not valid.

ABORTED calibration aborted

CALIBRATION RESULTS				
Total Calibration Status: PASSED				
Rohde&Schwarz,FSU-3,823156/001,1.21				
Date (dd/mm/yyyy): 09/10/2000 Time: 13:45:06				
Runtime: 05:28				
Linear Detector Offset [%]				
				-2.81
LC-Centerfrequencies				
LC-Cycle	DAC [%]	Error[kHz]		
0	42.33	-1.60	PASSED	
1	46.04	-1.60	PASSED	
2	45.27	0.00	PASSED	
3	38.88	-1.60	PASSED	
4	39.81	1.60	PASSED	
Bandwidths and Centerfrequencyoffsets				
RBW	DAC [%]	E [RBW %]		

IEC/IEEE-bus command: `CAL:RES?`

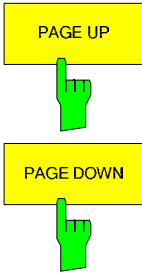

The softkeys *PAGE UP* and *PAGE DOWN* scroll one page forward or backward in the *CALIBRATION RESULTS* table. They have no function when the table is closed.

IEC/IEEE-bus command: --

Markers and Delta Markers – MKR Key

The markers are used for marking points on traces, reading out measurement results and for quickly selecting a display section. R&S FSMR provides four markers per display window. All markers can be used either as markers or delta markers. The availability of marker functions depends on whether the measurement is performed in the frequency, time or level domain.

The marker that can be moved by the user is defined in the following as the **active marker**.

Examples of marker display:

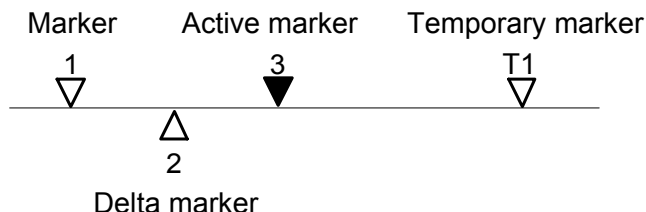

Temporary markers are used in addition to the markers and delta markers to evaluate the measurement results. They disappear when the associated function is deactivated.

The measurement results of the active marker (also called **marker values**) are displayed in the marker field. The marker info field at the upper right of the display shows the marker location (here, frequency), the level and the currently selected trace [T1].

MARKER 1 [T1]
-27.5 dBm
123.4567 MHz

The **MKR** key calls a menu that contains all marker and delta marker standard functions. If no marker is active, **MARKER 1** will be enabled and a peak search on the trace carried out. Otherwise, the data entry for the marker activated last is opened.

MKR menu:

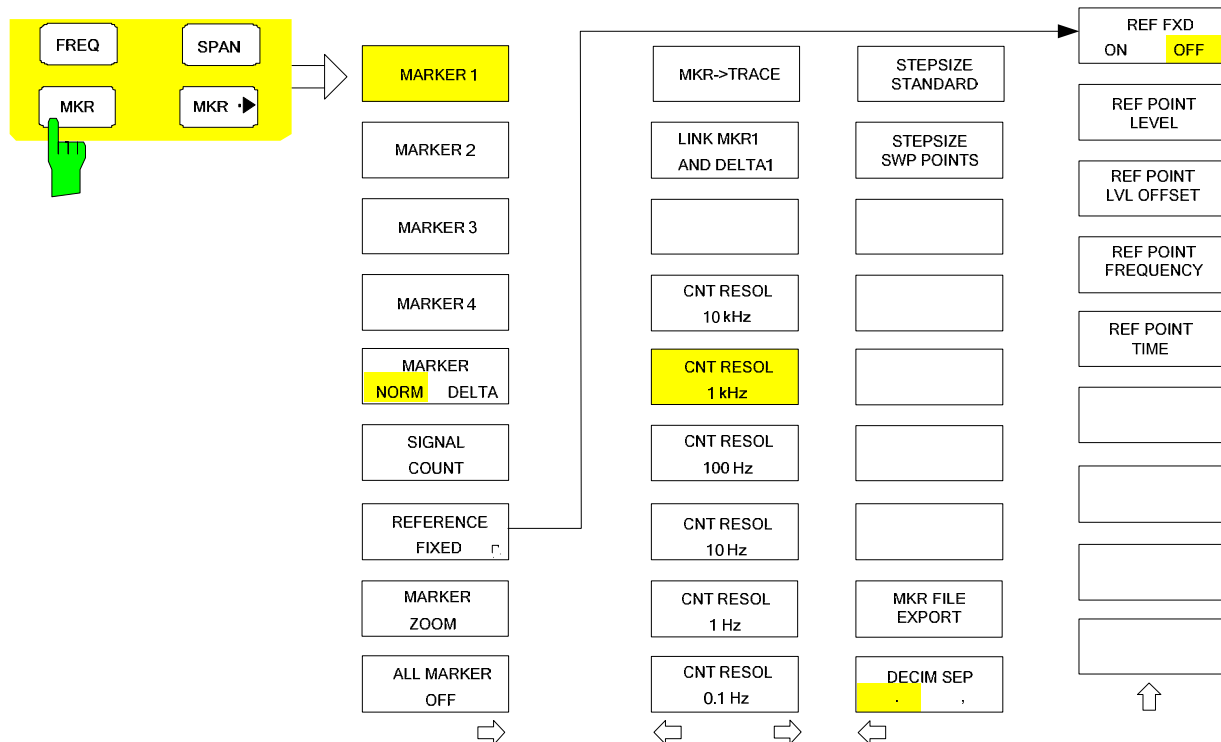

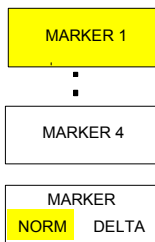

The *MARKER 1/2/3/4* softkey selects the corresponding marker and activates it.

MARKER 1 is always the normal marker. After they have been switched on, *MARKERS 2 to 4* are delta markers that refer to *MARKER 1*. These markers can be converted into markers with absolute value display by means of the *MARKER NORM DELTA* softkey. When *MARKER 1* is the active marker, pressing the *MARKER NORM DELTA* softkey switches on an additional delta marker.

Pressing the *MARKER 1 to 4* softkey again switches off the selected marker.

Example:

[PRESET] R&S FSMR is set to the default setting.

[MKR] On calling the menu, *MARKER 1* is switched on ('1' highlighted in the softkey) and positioned on the maximum value of the trace. It is a normal marker and the *MARKER NORMAL* softkey is highlighted.

[MARKER 2] *MARKER 2* is switched on ('2' highlighted in the softkey). It is automatically defined as a delta marker on switching on so the *DELTA* is highlighted on softkey *MARKER NORM DELTA*. The frequency and level of *MARKER 2* with reference to *MARKER 1* are output in the marker info field.

[MARKER NORM DELTA] The *MARKER NORM DELTA* softkey is highlighted. *MARKER 2* becomes a normal marker. The frequency and level of *MARKER 2* are output as absolute values in the marker info field.

[MARKER 2] *MARKER 2* is switched off. *MARKER 1* is the active marker for entry. The frequency and level of *MARKER 1* are output in the marker info field.

IEC/IEEE-bus command:

```

CALC:MARK ON;
CALC:MARK:X <value>;
CALC:MARK:Y?

CALC:DELT ON;
CALC:DELT:MODE ABS|REL
CALC:DELT:X <value>;
CALC:DELT:X:REL?
CALC:DELT:Y?

```

When several traces are being displayed, the marker is set to the maximum value (peak) of the active trace which has the lowest number (1 to 3). In case a marker is already located there, it will be set to the frequency of the next lowest level (next peak).

When the split-screen display mode is active, the marker will be placed in the active window. A marker can only be enabled when at least one trace in the corresponding window is visible.

If a trace is turned off, the corresponding markers and marker functions are also deactivated. If the trace is switched on again (*VIEW, CLR/WRITE;..*), the markers along with coupled functions will be restored to their original positions provided the markers have not been used on another trace.

Frequency Measurement with the Frequency Counter

In order to accurately determine the frequency of a signal, R&S FSMR is equipped with a frequency counter which measures the frequency of the RF signal at the intermediate frequency. Using the measured IF, R&S FSMR calculates the frequency of the RF input signal by applying the known frequency conversion factors.

The frequency measurement error depends only upon the accuracy of the frequency standard used (external or internal reference). Although R&S FSMR always operates synchronously irrespective of the set span, the frequency counter delivers a more exact result than a measurement performed with a marker. This is due to the following:

- The marker measures only the position of the pixel on the trace and infers the frequency of the signal from this value. The trace, however, contains only a limited number of pixels. Depending upon the selected span, each pixel may contain many measurement values, which therefore limits the frequency resolution.
- The resolution with which the frequency can be measured is proportional to the measurement time. For this reason, the bandwidth is normally made as wide as possible and the sweep time as short as possible. This results in a loss of frequency resolution.

For the measurement with the frequency counter, the sweep is stopped at the reference marker, the frequency is counted with the desired resolution and then the sweep is allowed to continue.

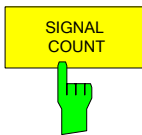

The *SIGNAL COUNT* softkey switches the frequency counter on/off.

The frequency is counted at the position of the reference marker (*MARKER 1*). The sweep stops at the reference marker until the frequency counter has delivered a result. The time required for a frequency measurement depends on the selected frequency resolution. The resolution is set in the side menu.

If no marker is enabled when the *SIGNAL COUNT* softkey is pressed, *MARKER 1* is switched on and set at the largest signal.

In addition, the *SIGNAL COUNT* function is displayed in the marker info field on the screen with [Tx CNT].

```
MARKER 1 [T1 CNT]
-27.5 dBm
23.4567891 MHz
```

Switching the *SIGNAL COUNT* function off is accomplished by pressing the softkey again.

IEC/IEEE-bus command: `CALC:MARK1:COUN ON;`
 `CALC:MARK:COUN:FREQ?`

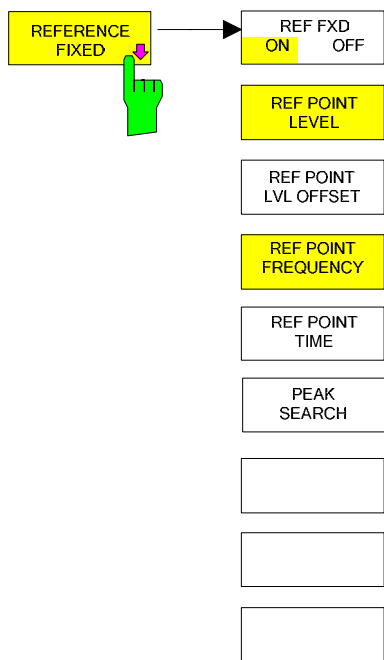

The *REFERENCE FIXED* softkey defines the level and the frequency or time of *MARKER 1* as a reference for one or several delta markers. The measured values for one or several markers displayed in the marker info field are derived from this reference point instead of the current values of the reference marker (*MARKER 1*).

On actuating the softkey, reference fixed is switched on and thus, the level value and the frequency, time or x-level value of *MARKER 1* immediately become the reference point.

Additionally, the *REFERENCE FIXED* softkey opens the submenu where it is possible to determine manually a reference point with level and frequency, time or x-axis level, to define a level offset or deactivate the reference point.

The *REFERENCE FIXED* function is useful for the measurement of the harmonic suppression at small span (fundamental not represented).

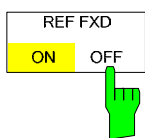

The *REF FXD ON/OFF* softkey switches on or off the relative measurement to a fixed reference value (*REFERENCE POINT*) independent of the trace.

IEC/IEEE-bus command: `CALC:DELT2:FUNC:FIX ON`



The *REF POINT LEVEL* softkey enters a reference level independent of the reference marker level. All relative level values of the delta markers refer to this reference level.

IEC/IEEE-bus command:
`CALC:DELT2:FUNC:FIX:RPO:Y -10dBm`



The *REF POINT LVL OFFSET* softkey specifies a level offset relevant to the reference level. The relative level values of the delta markers refer to the reference point level plus the level offset.

The level offset is set to 0 dB on enabling the *REFERENCE FIXED* or *PHASE NOISE* function.

IEC/IEEE-bus command:
`CALC:DELT2:FUNC:FIX:RPO:Y:OFFS 0dB`

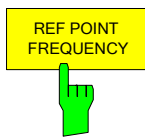

With the *REF POINT FREQUENCY* softkey a reference frequency can be manually activated for the delta markers when the *REFERENCE FIXED* or *PHASE NOISE* function is used.

IEC/IEEE-bus command:
`CALC:DELT2:FUNC:FIX:RPO:X 10.7MHz`

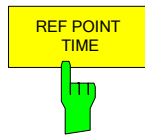

The *REF POINT TIME* softkey activates the entry box for the input of a reference time for the *REFERENCE FIXED* function in the time domain (span = 0 Hz).

IEC/IEEE-bus command:

```
CALC:DELT2:FUNC:FIX:RPO:X 5MS
```

For phase noise measurement, input of reference time is not possible.



The *PEAK SEARCH* softkey defines the maximum of the selected trace as reference level for all delta markers when using the *REFERENCE FIXED* function.

IEC/IEEE-bus command:

```
CALC:DELT2:FUNC:FIX:RPO:MAX
```

Measurement example:

Small-span harmonics measurement to increase sensitivity
CW signal (eg 100 MHz, 0 dBm) with harmonics at the RF input of R&S FSMR.

- | | |
|-------------------|---|
| [PRESET] | R&S FSMR is set to the default setting. |
| [CENTER: 100 MHz] | The center frequency of R&S FSMR is set to 100 MHz. |
| [SPAN: 1 MHz] | The span is set to 1 MHz. |
| [AMPL: 3 dBm] | The reference level is set to 3 dBm (3 dB above the expected RF level). |
| [MKR] | <i>MARKER 1</i> is switched on ('1' highlighted in the softkey) and set to the signal peak. |
| [MARKER 2] | <i>MARKER 2</i> is switched on and automatically defined as the delta marker (<i>DELTA</i> is highlighted on <i>MARKER NORM DELTA</i> softkey). |
| [REFERENCE FIXED] | The frequency and level of <i>MARKER 1</i> are a reference for the delta marker. |
| [CENTER: 200 MHz] | The center frequency is set to 200 MHz (= frequency of the 2nd harmonic). The reference level may have to be reduced to see the 2nd harmonic from the noise. This does not affect the reference level set with <i>REFERENCE FIXED</i> . |
| [MKR->: PEAK] | The delta marker jumps to the 2nd harmonic of the signal. The level spacing of the harmonic to the fundamental is displayed in the marker info field. |



The *MARKER ZOOM* softkey expands the area around MARKER 1. With the zoom function, more details of the spectrum can be seen. The desired display range can be defined in an entry window.

The following sweep is stopped at the position of the reference marker. The frequency of the signal is counted and the measured frequency becomes the new center frequency. The zoomed display range is then configured and the new settings are used by R&S FSMR for further measurements.

As long as switching to the new frequency display range has not yet taken place, pressing the softkey will abort the procedure.

If *MARKER 1* is not active when the softkey is pressed, it is automatically activated and set to the highest peak in the window.

If an instrument setting is changed after selection of *MARKER ZOOM*, the function is aborted.

The *MARKER ZOOM* softkey is only available in the frequency domain (span > 0).

IEC/IEEE-bus command: `CALC:MARK1:FUNC:ZOOM 1kHz`



The *ALL MARKER OFF* softkey switches off all markers (reference and delta markers). It also switches off all functions and displays associated with the markers/delta markers.

IEC/IEEE-bus command: `CALC:MARK:AOFF`

MARKER NEXT menu



The *MKR->TRACE* softkey places the marker on a new trace. The trace is selected via a data entry field. Only those traces can be selected which are visible on the screen in the same window.

Example:

Three traces are presented on the screen. The marker is always on Trace 1 on switching on.

[MKR ->TRACE]
"2"<ENTER>

The marker jumps to Trace 2 but remains on the previous frequency or time.

[MKR ->TRACE]
"3"<ENTER>

The marker jumps to Trace 3. '

IEC/IEEE-bus command: `CALC:MARK1:TRAC 1`
`CALC:DELT:TRAC 1`



With the softkey *LINK MKR1 AND DELTA1* the delta marker1 can be linked to marker1, so if the x-axis value of the marker1 is changed the delta marker1 will follow on the same x-position. The link is default off, and can be switched on.

Example for setup:

- PRESET
- TRACE | MAX HOLD
- TRACE | SELECT TRACE | 2 | AVERAGE
- MKR (Switches marker1 on)
- MARKER NORM DELTA | DELTA (Delta Marker 1 ON)
- MKR-> | MKR->TRACE | 2
- LINK MKR1 AND DELTA1

Now select the Marker1 (by switching MARKER1 from DELTA back to NORM) and when changing the x-axis value (by knob wheel or UP/DOWN keys) the delta marker1 will follow automatically.

The delta marker1 x-value can not be changed away from 0 as long as the link functionality is active.

IEC/IEEE-bus command: `CALC1:DELT1:LINK ON | OFF`

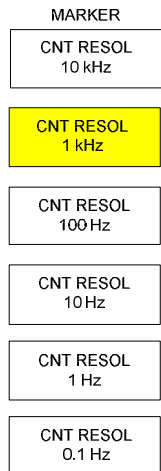

The *CNT RESOL ...* softkeys select the counter resolution. They are selection switches, i.e. only one of the can be active at any one time.

The marker stop time, ie the frequency measurement time, depends on the selected resolution.

IEC/IEEE-bus command: `CALC:MARK1:COUN:RES <value>`

Measurement example:

The frequency of a CW signal is to be determined by means of the frequency counter with a resolution of 10 Hz.

- [PRESET]** R&S FSMR is set to the default setting.
- [MARKER]** *MARKER 1* is switched on and set to the maximum value of the displayed spectrum.

[SIGNAL COUNT] The frequency counter is switched on. R&S FSMR counts the frequency of the signal at the marker position with a resolution of 1 kHz. The counted frequency is indicated in the marker info field.

[NEXT] Changes to the submenu for setting the counter resolution.

[CNT RESOL 10 Hz] The frequency counter resolution is increased to 10 Hz.

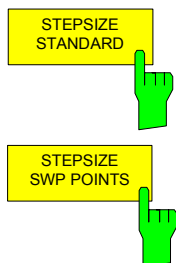

These softkeys control the knob increment/decrement of the marker position. *STEP SIZE STANDARD* uses the grid resolution (span/625), *STEP SIZE SWP POINTS* uses the available sweep points configured in the SWEEP menu.

IEC/IEEE-bus command: `CALC1:MARK:X:SSIZ STAN | POIN`

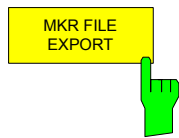

The *MKR FILE EXPORT* softkey stores the content of the active markers in ASCII format to the specified file.

IEC/IEEE-bus command: `MMEM:STOR:MARK 'filename'`

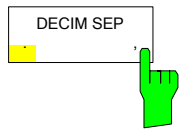

The *DECIM SEP* softkey selects the decimal separator between '.' (decimal point) and ',' (comma) for the function *MKR FILE EXPORT*.

Remote command:

IEC/IEEE-bus command: `FORM:DEXP:DSEP POIN`

Marker Functions – MKR FCTN Key

The MKR FCTN menu offers further measurements with the markers:

- Measurement of noise density (*NOISE MEAS* softkey)
- Measurement of phase noise (*PHASE NOISE* softkey)
- Measurement of filter or signal bandwidth (*N DB DOWN* softkey)
- Activating of AF demodulation (*MARKER DEMOD* softkey)

On calling the menu, the entry for the last active marker is activated (*SELECT MARKER* softkey); if no marker is activated, marker 1 is activated and a maximum search (*PEAK* softkey) is performed. The marker can be set to the desired trace by means of *MKR -> TRACE* softkey.

Menu *MKR FCTN*:

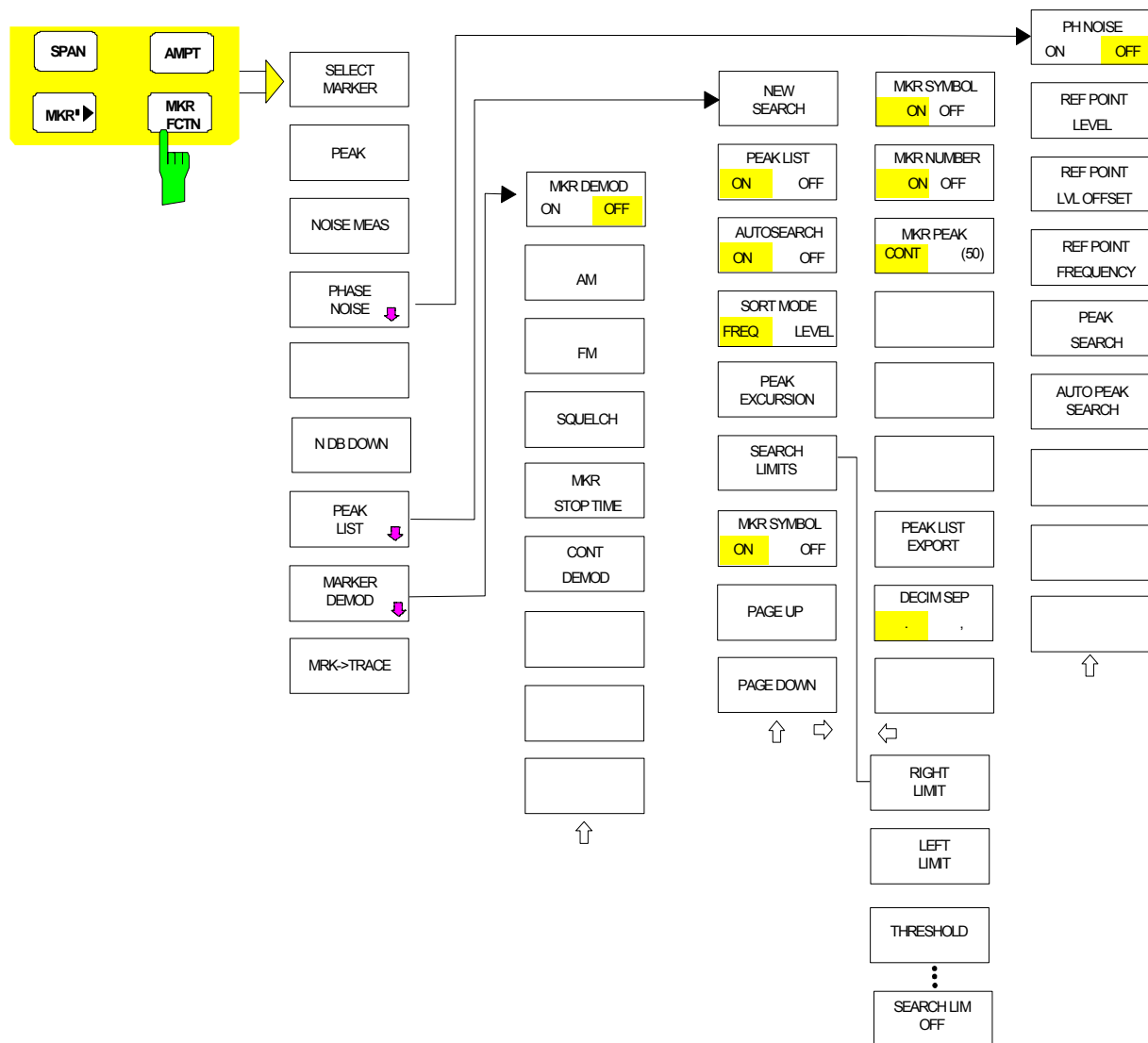

Activating the Markers

Menu *MKR FCTN*:



The *SELECT MARKER* softkey activates the numerical selection of the marker in the data entry field. Delta marker 1 is selected by input of '0'. If the marker is switched off, then it is switched on and can be moved later on.

IEC/IEEE-bus command: `CALC:MARK1 ON;`
 `CALC:MARK1:X <value>;`
 `CALC:MARK1:Y?`

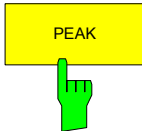

The *PEAK* softkey sets the active marker/delta marker to the peak of the trace.

IEC/IEEE-bus command: `CALC:MARK1:MAX`
 `CALC:DELT1:MAX`

Measurement of Noise Density

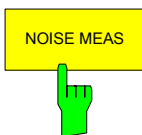

The *NOISE MEAS* softkey switches the noise measurement for the active marker on or off. The corresponding marker becomes the *NORMAL* marker.

During noise measurement, the noise power density is measured at the position of the marker. In the time domain mode, all points of the trace are used to determine the noise power density. When measurements are performed in the frequency domain, two points to the right and left of the marker are used for the measurement to obtain a stable result.

The noise power density is indicated in the marker field. With a logarithmic amplitude units (dBm, dBmV, dBm μ V, dB μ A) the noise power density is output in dBm/Hz i.e. as level in 1 Hz bandwidth with reference to 1 mW. With linear amplitude units (V, A, W) the noise voltage density is evaluated in μ V/ \sqrt Hz, the noise current density in μ A/ \sqrt Hz or the noise power density in μ W/Hz.

The following settings have to be made to ensure that the power density measurement yields correct values:

Detector: Sample or RMS

Video bandwidth:

- ≤ 0.1 x resolution bandwidth with sample detector
(corresponds to RBW / VBW NOISE)
- ≥ 3 x resolution bandwidth with RMS detector
(corresponds to RBW / VBW SINE)

In the default setting, the R&S FSMR uses the sample detector for the noise function.

With the sample detector, the trace can additionally be set to AVERAGE to stabilize the measured values. With RMS detector used, trace averaging must not be used since in this case it produces too low noise levels which cannot be corrected. Instead, the sweep time can be increased to obtain stable measurement results.

The R&S FSMR uses the following correction factors to evaluate the noise density from the marker level:

- Since the noise power is indicated with reference to 1 Hz bandwidth, the bandwidth correction value is deducted from the marker level. It is $10 \times \lg(1 \text{ Hz}/\text{BW}_{\text{Noise}})$, where BW_{Noise} is the noise or power bandwidth of the set resolution filter (RBW).

Sample detector:

- As a result of video filter averaging and trace averaging, 1.05 dB is added to the marker level. This is the difference between the average value and the RMS value of white noise.
- With a logarithmic level axis, 1.45 dB is added additionally. Logarithmic averaging is thus fully taken into account which yields a value that is 1.45 dB lower than that of linear averaging.

RMS detector:

- With the exception of bandwidth correction, no further corrections are required for the RMS detector since it already indicates the power with every point of the trace.

To allow a more stable noise display the adjacent (symmetric to the measurement frequency) points of the trace are averaged.

In time domain mode, the measured values are averaged versus time (after a sweep).

IEC/IEEE-bus command: `CALC:MARK:FUNC:NOIS ON;`
 `CALC:MARK:FUNC:NOIS:RES?`

Example: Measurement of inherent R&S FSMR noise

- [PRESET]** The R&S FSMR is set to default setting.
- [MARKER]** Marker 1 is switched on and set to the maximum value of the displayed spectrum. Set marker to desired frequency using the rotary knob.
- [NOISE]** The R&S FSMR switches the sample detector on and sets the video bandwidth to 300 kHz (0.1 x RBW). The power density level of inherent noise is displayed in dBm/Hz in the marker info field.



The R&S FSMR noise figure can be calculated from the measured power density level. It is calculated by deducting the set RF attenuation (RF Att) from the displayed noise level. 174 is to be added to the result to obtain the R&S FSMR noise figure.

Phase Noise Measurement

Menu MKR FCTN:

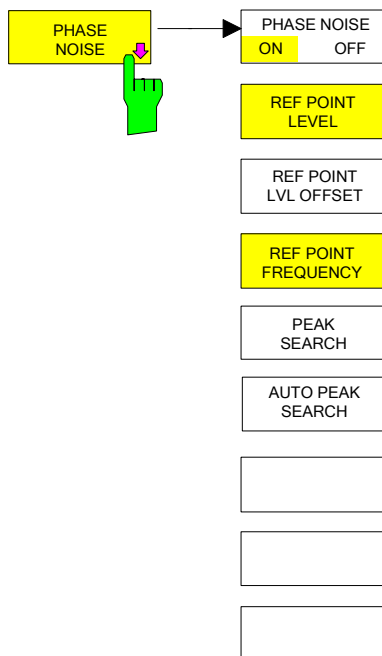

The *PHASE NOISE* softkey switches the *PHASE NOISE* function on/off. Additionally, the softkey opens the submenu for manually setting the reference point. The phase noise measurement can be switched off in the submenu.

MARKER 1 (= reference marker) is used as a reference for the phase noise measurement. The frequency and level of the reference marker are used as fixed reference values, i.e. the *REFERENCE FIXED* function is activated. After switching on the phase noise measurement the reference level or the center frequency can thus be set in a way that the carrier is outside the displayed frequency range, or, for example, a notch filter is switched on to suppress the carrier.

A noise power density measurement is carried out with the delta marker or delta markers. This measurement corresponds to the *NOISE* function in the *MARKER* menu (MKR). The result of the phase noise measurement is the difference in level between the reference point and the noise power density.

The following possibilities can be selected on switching on *PHASE NOISE*:

1. No marker enabled:

[MKR FCTN]

MARKER 1 is enabled and set to peak.

[PHASE NOISE]

MARKER 1 becomes the reference marker, *MARKER 2* the delta marker; frequency = frequency of the reference marker. The delta marker is the active marker, i.e. it can be moved with the rollkey or adjusted by entering numerals.

The *PHASE NOISE* function is switched on and the measured value is output.

2. Markers are enabled:

[MKR FCTN]

The previous marker configuration remains unchanged.

[PHASE NOISE]

MARKER 1 becomes the reference marker. If other markers are enabled, they become delta markers and measure the phase noise at their respective positions.

If further markers are enabled during the phase noise measurement, they automatically become delta markers and measure the phase noise at their respective positions.

When the phase noise measurement is switched off, the marker configuration remains unchanged and the delta markers measure the relative level to the reference marker (*MARKER 1*).

The *PHASE NOISE* function measures the noise power at the delta markers referred to 1 Hz bandwidth. The sample detector is automatically used and the video bandwidth set to 0.1 times the resolution bandwidth (RBW). The two settings are taken into account in the correction values used for the noise power measurement.

To obtain stable results, two pixels on the right and the left of the respective delta marker position are taken for the measurement. The procedure for determining the noise power is identical to the method used for the noise power measurement (see NOISE softkey). The measured noise level referred to 1 Hz bandwidth is subtracted from the carrier level at the reference marker (*MARKER 1*). The measured values are displayed in the delta marker field in dBc/Hz (= spacing in dB of the noise power from the carrier level in 1 Hz bandwidth).

If several delta markers are enabled, only the value read by the active marker is shown in the marker field. If several delta markers are active, their measurement results are shown in the marker info field.

The reference value for the phase noise measurement can be defined with *REF POINT LEVEL*, *REF POINT FREQUENCY* and *REF POINT LVL OFFSET* to differ from that of the reference marker.

IEC/IEEE-bus command: --

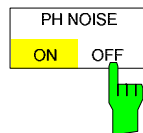

The *PH NOISE ON/OFF* softkey switches on/off the phase noise measurement. Switching on is performed by means of the *PHASE NOISE* softkey and is only necessary when the phase noise measurement has been switched off in the submenu.

IEC/IEEE-bus command: `CALC:DELT1:FUNC:PNO ON`
`CALC:DELT1:FUNC:PNO:RES?`



The *REF POINT LEVEL* softkey activates an entry box for the input of a reference level other than the reference marker level. The function is identical to that of the softkey with the same name in the marker menu (MKR).

IEC/IEEE-bus command: `CALC:DELT1:FUNC:FIX:RPO:Y -10dB`



The *REF POINT LVL OFFSET* softkey activates an entry box for the input of an additional level offset for the phase noise calculation.

This level offset is set to 0 dB on when the *REFERENCE FIXED* or *PHASE NOISE* function is enabled.

IEC/IEEE-bus command: `CALC:DELT:FUNC:FIX:RPO:Y:OFFS 10dB`

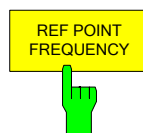

The *REF POINT FREQUENCY* softkey activates an entry box for the manual input of a reference frequency for the *REFERENCE FIXED* or *PHASE NOISE* function.

IEC/IEEE-bus command: `CALC:DELT1:FUNC:FIX:RPO:X 10.7MHz`



The *PEAK SEARCH* sets the reference point level for delta marker 2 in the selected measurement window to the peak of the selected trace.

IEC/IEEE-bus command: `CALC:DELT:FUNC:FIX:RPO:MAX`



The **AUTO PEAK SEARCH** softkey activates an automatic peak search for the reference fixed marker 1 at the end of each particular sweep.

The phase noise **AUTO PEAK SEARCH** adds an automatic peak search action for the reference fixed marker 1 at the end of each particular sweep. This function may be used for tracking of a drifting source whilst phase noise measurement. The delta marker 2 which shows the phase noise measurement result keeps the delta frequency value. Therefore the phase noise measurement in a certain offset is valid although the source is drifting. Only when the marker 2 is reaching the border of the span the delta marker value is adjusted to be within the span. Choose a larger span in such situations.

IEC/IEEE-bus command: `CALC:DELT:FUNC:PNO:AUTO ON | OFF`

Measurement example:

The phase noise of a CW signal at 100 MHz with 0 dBm level is to be measured at 800 kHz from the carrier

[PRESET]	The R&S FSMR is set to the default setting.
[CENTER: 100 MHz]	The center frequency is set to 100 MHz.
[SPAN: 2 MHz]	The span is set to 2 MHz.
[AMPT: 0 dBm]	The reference level is set to 0 dBm.
[MKR FCTN]	MARKER 1 is switched on and positioned at the maximum of the displayed trace.
[PHASE NOISE: 800 kHz]	The phase noise measurement is switched on. The delta marker is positioned on the main marker and the measured phase noise value is displayed in the marker info field. The sample detector is used and the video bandwidth is set to 3 x RBW. When the phase noise measurement function is enabled, the entry of the delta marker frequency is activated. It can be entered directly.

Measurement of the Filter or Signal Bandwidth

Menu **MKR FCTN**:

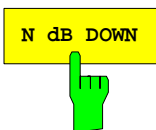

The **N dB DOWN** softkey activates the temporary markers T1 and T2 which are n dB below the active reference marker. Marker T1 is placed to the left and marker T2 at the right of the reference marker. The value n can be input in a window.

The default setting is 3 dB.

Span > 0: The frequency spacing of the two temporary markers is indicated in the marker info field.

Span = 0: The pulse width between the two temporary markers is indicated in the marker info field.

If, for example, it is not possible to form the frequency spacing for the n dB value because of the noise display, dashes are indicated instead of a measured value.

If a negative value is entered than the markers are placed n dB above the active reference marker. This is then a n dB up function which can be used for notch filter measurements,

IEC/IEEE-bus command: `CALC:MARK1:FUNC:NDBD:STAT ON | OFF`
`CALC:MARK1:FUNC:NDBD 3dB`
`CALC:MARK1:FUNC:NDBD:RES?`
`CALC:MARK1:FUNC:NDBD:FREQ? 'Span > 0`
`CALC:MARK1:FUNC:NDBD:TIME? 'Span = 0`

Measurement of a Peak List

Menu MKR FCTN:

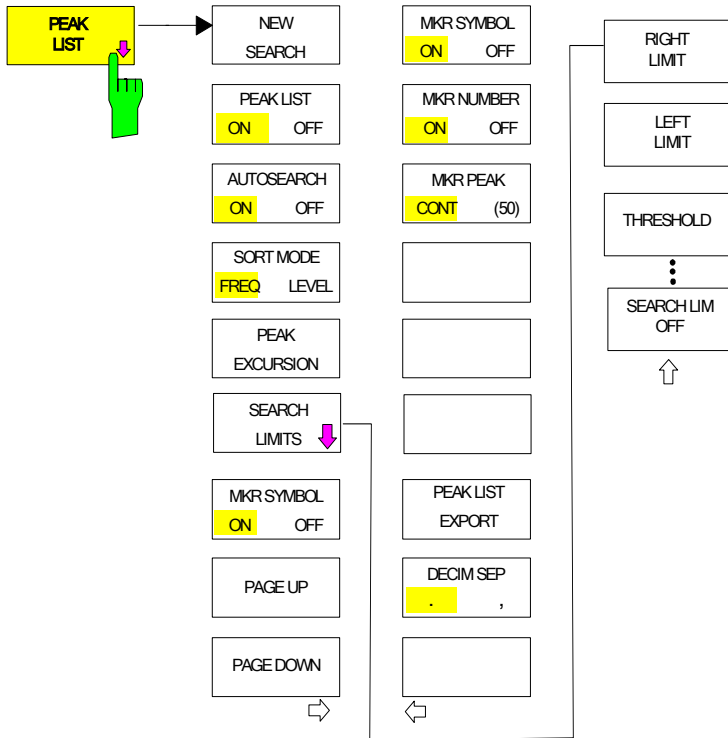

The *PEAK LIST* softkey allows the peak values of the trace to be determined and entered in a list with 50 entries max. The order of the entries is defined by the *SORT MODE*:

- FREQ sorting in ascending order of frequency values (see screenshot); if span = 0, the entries are sorted in ascending order of time values
- LEVEL sorting according to level

PEAK LIST		
#	FREQUENCY	POWER
1	794.871794871 MHz	-55.37 dBm
2	2.397435897 GHz	-74.70 dBm
3	4.012820512 GHz	-38.00 dBm
4	5.615384615 GHz	-26.04 dBm
5	6.435897435 GHz	-38.02 dBm
6	7.217948717 GHz	-55.39 dBm

The search range can be restricted by means of the *LEFT LIMIT*, *RIGHT LIMIT* and *THRESHOLD* softkeys. The definition of the peak values can be modified using the *PEAK EXCURSION* softkey. The *MKR->TRACE* softkey in the main menu is used to select the trace for searching peak values.

Opening the list performs a single search at the end of the sweep. The *NEW SEARCH* softkey triggers a new sweep, determines the peak values of the trace at the end of the sweep and enters them in the list.

Use the *PEAK LIST OFF* key to delete the list from the screen.

```
IEC/IEEE-bus commands: INIT:CONT OFF;
                        CALC:MARK:TRAC 1;
                        CALC:MARK:FUNC:FPE:SORT X;
                        INIT;*WAI;
                        CALC:MARK:FUNC:FPE 10;
                        CALC:MARK:FUNC:FPE:COUN?;
                        CALC:MARK:FUNC:FPE:Y?;
                        CALC:MARK:FUNC:FPE:X?
```



The *NEW SEARCH* softkey starts a new peak search and enters the results in the peak list.

IEC/IEEE-bus commands:

```
INIT; *WAI;
CALC:MARK:FUNC:FPE 10;
CALC:MARK:FUNC:FPE:COUN?;
CALC:MARK:FUNC:FPE:Y?;
CALC:MARK:FUNC:FPE:X?
```

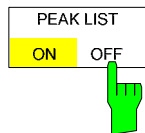

The *SORT MODE FREQ/LEVEL* softkey defines the position of the peak values in the list:

FREQ sorting in ascending order of frequency values (time values if span = 0)
 LEVEL sorting according to level

IEC/IEEE-bus command: `CALC:MARK:FUNC:FPE:SORT X;`

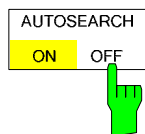

Activates or deactivates an automatic peak search. The R&S FSMR performs the automatic peak search after it has finished a sweep.

If you need an update of the peak list prior to the end of the sweep, perform a new search with the *NEW SEARCH* softkey.

IEC/IEEE-bus commands:

```
CALC:MARK:FUNC:FPE:SEAR:AUTO ON | OFF
```

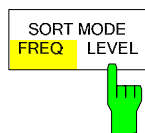

The *SORT MODE FREQ/LEVEL* softkey defines the position of the peak values in the list:

FREQ sorting in ascending order of frequency values (time values if span = 0)
 LEVEL sorting according to level

IEC/IEEE-bus command: `CALC:MARK:FUNC:FPE:SORT X;`



With level measurements, the *PEAK EXCURSION* softkey allows the minimum amount to be entered by which a signal must decrease or increase in order to be recognized as a maximum by the peak search function.

Values between 0 dB and 80 dB may be entered, the resolution being 0.1 dB

IEC/IEEE-bus command: `CALC:MARK:PEXC 6dB`

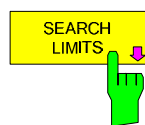

Opens a submenu to define peak search search limits.

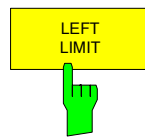

The *LEFT LIMIT* and *RIGHT LIMIT* softkeys define the vertical lines F1/F2 in the frequency domain (span > 0) and T1/T2 in the time domain (span = 0) between which the search is carried out. If only one line is active, the F1/T1 line is used as the lower limit; the upper limit is the stop frequency. If F2/T2 is also active, it defines the upper limit.

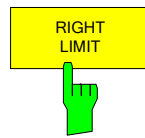

IEC/IEEE-bus commands: `CALC:MARK:X:SLIM:LEFT 1MHZ`
`CALC:MARK:X:SLIM:RIGH 10MHZ`
`CALC:MARK:X:SLIM ON`

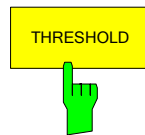

The *THRESHOLD* softkey defines a horizontal threshold line which represents the lower limit of the peak search level range.

IEC/IEEE-bus command: `CALC:THR -20dBm`
`CALC:THR ON`



The *SEARCH LIM OFF* softkey Deactivates peak search limits.

IEC/IEEE-bus command: `-`

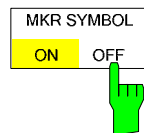

Activates and deactivates the markers symbol (x) that the R&S FSMR places on each peak. The marker symbol is displayed only when the peak list is turned on.

IEC/IEEE-bus command:

`CALC:FUNC:FPE:ANN:MARK:STAT ON | OFF`

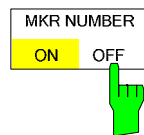

Activates and deactivates the marker label that the R&S FSMR assigns to each peak.

The R&S FSMR ranks the markers according to their power level in descending order, beginning with the strongest peak.

You can activate marker numbers only if the marker symbol is also active. If the peak list is inactive, marker numbers cannot be displayed.

IEC/IEEE-bus command:

`CALC:MARK:FPE:ANN:LAB:STAT ON | OFF`

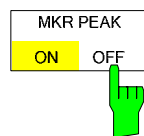

Opens a input field to define the maximum number of peak list entries.

IEC/IEEE-bus command:

`CALC:MARK:FUNC:FPE:LIST:SIZE <number>`



The *PEAK LIST EXPORT* softkey stores the content of the marker peak list in ASCII format to the specified file.

IEC/IEEE-bus command:

`MMEM:STOR:PEAK C\'filename.txt\'`

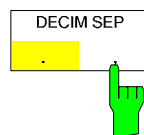

The *DECIM SEP* softkey selects the decimal separator between '.' (decimal point) and ',' (comma) for the function *MKR FILE EXPORT*.

IEC/IEEE-bus command: `FORM:DEXP:DSEP POIN`

AF Demodulation

The R&S FSMR provides demodulators for AM and FM signals. With these demodulators, a displayed signal can be identified acoustically through the use of the internal loudspeaker or with headphones. The frequency at which the demodulation is enabled is coupled to the markers. The sweep stops at the frequency determined by the active marker for the selected time and the RF signal is demodulated. During a measurement in the time domain (span = 0 Hz) the demodulation is continuously on. The threshold line (*MKR->SEARCH LIMITS:THRESHOLD*) performs a squelch function in the demodulator. If the threshold is set, the R&S FSMR LF demodulation is switched on only when the signal to be demodulated exceeds the set threshold.

Menu *MKR FCTN*:

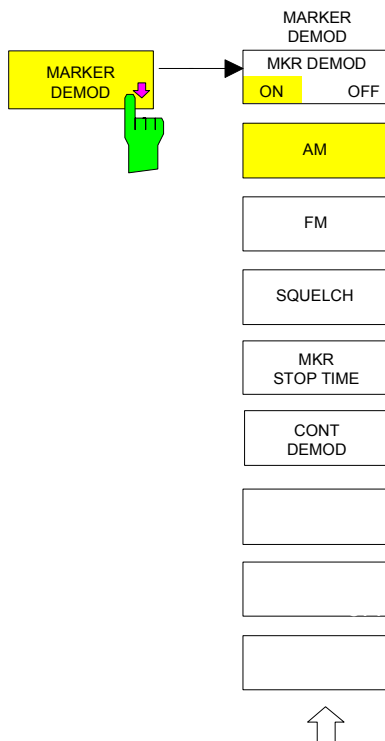

The *MARKER DEMOD* softkey switches on the audio demodulator and calls a submenu in which the demodulation mode and the duration of the demodulation can be selected.

IEC/IEEE-bus command: `CALC:MARK1:FUNC:DEM ON`

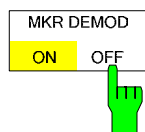

The *MKR DEMOD ON/OFF* softkey switches the demodulation on/off.

In the frequency range (span >0), the frequency scan is stopped at the frequency of the active marker with demodulation switched on – provided that the level is above the threshold line - and the signal is demodulated during the given stop time.

In the time domain (span = 0) demodulation is continuous, i.e. not only active at the marker position.

IEC/IEEE-bus command: `CALC:MARK1:FUNC:DEM ON`

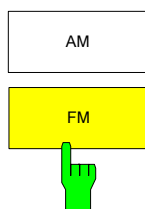

The softkeys *AM and FM* are selector switches one of which only may be active at a time. They set the desired demodulation mode FM or AM. Default setting is AM.

IEC/IEEE-bus command: `CALC:MARK1:FUNC:DEM:SEL AM`
`CALC:MARK1:FUNC:DEM:SEL FM`

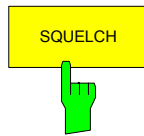

The *SQUELCH* softkey enables the input of a level threshold below which the audible AF is cut off. The squelch function is associated with the internal trigger function (TRIGGER menu), which will be switched on automatically with the squelch. Squelch level and trigger level do have the same value.
The default setting for the squelch is off.

IEC/IEEE-bus command:

```
:CALC:MARK1:FUNC:DEM:SQU ON | OFF
:CALC:MARK1:FUNC:DEM:SQU:LEV 80 PCT
```



The *MKR STOP TIME* softkey defines the stop time for demodulation at the marker(s).
The R&S FSMR interrupts the frequency sweep at the marker position and activates the demodulation for the duration of the stop time (see also *MKR DEMOD ON/OFF*).
In the time domain (span = 0) the demodulation is continuously active irrespective of the stop time set.

IEC/IEEE-bus command: `CALC:MARK1:FUNC:DEM:HOLD 3s`

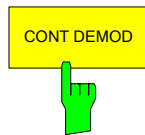

The *CONT DEMOD* softkey switches on the continuous demodulation in the frequency domain. If the sweep time is long enough, the set frequency range can be monitored acoustically.

IEC/IEEE-bus command: `CALC:MARK1:FUNC:DEM:CONT ON`

Selecting the Trace

Menu *MKR FCTN*:



The *MKR→TRACE* softkey sets the active marker to different traces. Only those traces can be selected which are visible on the screen in the same window.

The function of the softkey is identical to that of the softkey with the same name in the MKR-> menu.

Example:

Three traces are displayed on the screen. The marker is always on Trace 1 on switching on.

[MKR ->TRACE]

"1"<ENTER> The marker jumps to Trace 2, but remains at the previous frequency or time.

[MKR ->TRACE]

"3"<ENTER> The marker jumps to Trace 3.

IEC/IEEE-bus command: `CALC:MARK:TRAC 2`

Change of Settings via Markers – MKR ⇒ Key

The *MKR* → menu offers functions through which instrument parameters can be changed with the aid of the currently active marker. The functions can be used on markers and delta markers.

On opening the menu, the entry for the last active marker is activated; if no marker was enabled, *MARKER 1* is activated and a peak search is performed.

MKR → menu

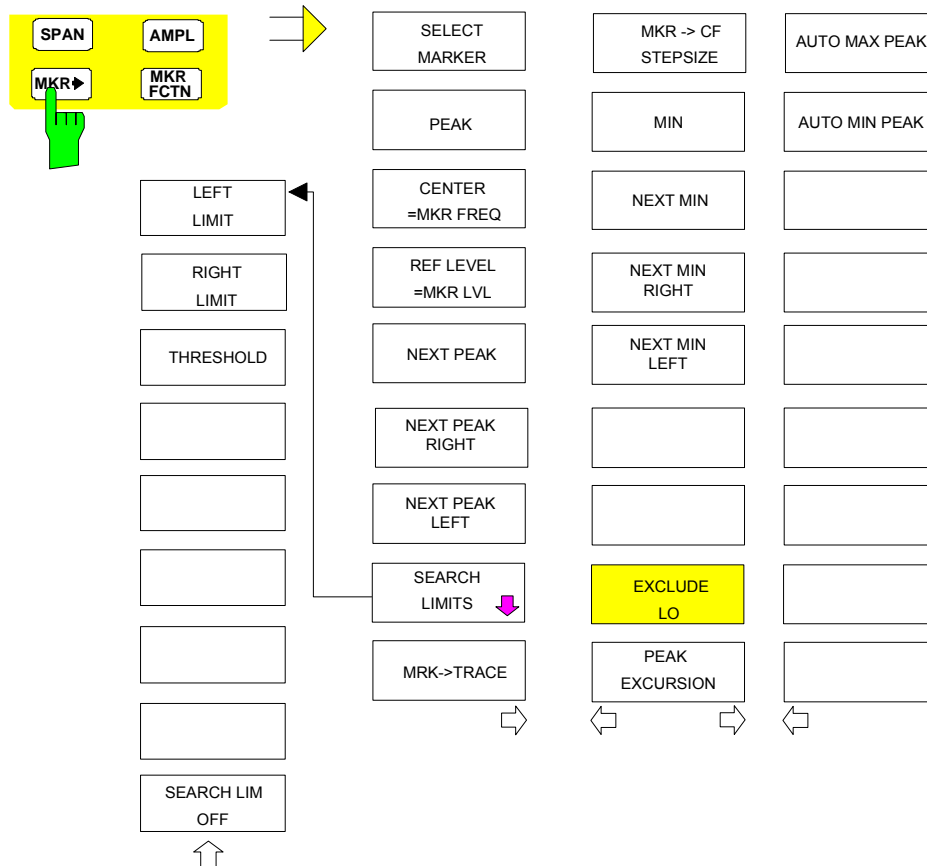

The *SELECT MARKER* softkey activates the numerical selection of the marker in the data entry field. Delta marker 1 is selected by input of '0'.

IEC/IEEE-bus commands: `CALC:MARK1 ON;`
`CALC:MARK1:X <value>;`
`CALC:MARK1:Y?`

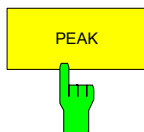

The *PEAK* softkey sets the active marker/delta marker to the peak of the trace.

If no marker is active when **MKR->** menu is called, *MARKER 1* is automatically switched on and the peak search is performed.

IEC/IEEE-bus commands: `CALC:MARK:MAX`
`CALC:DELT:MAX`



The *CENTER = MKR FREQ* softkey sets the center frequency to the current marker or delta marker frequency.

A signal can thus be set to the center of the frequency display range, for example, so that it can then be examined in detail with a smaller span.

The softkey is not available in the time domain (zero span).

IEC/IEEE-bus command: `CALC:MARK:FUNC:CENT`

Example:

A spectrum is displayed with a large span after PRESET. A signal off the center is to be examined in detail:

[PRESET] R&S FSMR is set to the default setting.

[MKR->] *MARKER 1* is switched on and automatically jumps to the largest signal of the trace.

[*CENTER = MKR FREQ*] The center frequency is set to the marker frequency. The span is adapted in such a way that the minimum frequency (= 0 Hz) or the maximum frequency is not exceeded.

[SPAN] The span can, for example, be reduced using the rollkey.

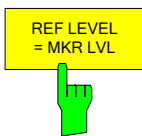

The *REF LEVEL = MKR LVL* softkey sets the reference level to the current marker level.

IEC/IEEE-bus command: `CALC:MARK:FUNC:REF`

Example:

A spectrum is displayed with a large span after PRESET. A signal off the center is to be examined in detail:

[PRESET] R&S FSMR is set to the default setting.

[MKR->] *MARKER 1* is switched on and automatically jumps to the largest signal of the trace.

[*CENTER = MKR FREQ*] The center frequency is set to the marker frequency. The span is adapted in such a way that the minimum frequency (= 0 Hz) or the maximum frequency is not exceeded.

[*REF LEVEL = MKR LVL*] The reference level is set to the measured marker level.

[SPAN] The span can, for example, be reduced using the rollkey.



The *NEXT PEAK* softkey sets the active marker/delta marker to the next lower maximum of the selected trace.

IEC/IEEE-bus commands: `CALC:MARK:MAX:NEXT`
`CALC:DELT:MAX:NEXT`



The *NEXT PEAK RIGHT* softkey sets the active marker/delta marker to the next lower maximum right of the current marker position on the selected trace.

IEC/IEEE-bus commands: `CALC:MARK:MAX:RIGH`
`CALC:DELT:MAX:RIGH`

NEXT PEAK
LEFT



The *NEXT PEAK LEFT* softkey sets the active marker/delta marker to the next lower maximum left of the current marker position the selected trace.

IEC/IEEE-bus commands: `CALC:MARK:MAX:LEFT`
`CALC:DELT:MAX:LEFT`

SEARCH
LIMITS



LEFT
LIMIT

RIGHT
LIMIT

THRESHOLD

SEARCH LIM
OFF

The *SEARCH LIMITS* softkey limits the search range for maximum or minimum search. The softkey switches to a submenu in which the search range limits can be set in the x and y direction.

LEFT
LIMIT



RIGHT
LIMIT



The *LEFT LIMIT* and *RIGHT LIMIT* softkeys define the two vertical lines F1 and F2 in the frequency domain (span > 0) and T1 / T2 in the time domain (span = 0). The search is performed between these lines in the frequency and time domain. If only *LEFT LIMIT* is enabled, line F1/T1 is the lower limit and the upper limit corresponds to the stop frequency. If *RIGHT LIMIT* is also enabled, it determines the upper limit.

IEC/IEEE-bus commands: `CALC:MARK:X:SLIM:LEFT 1MHZ`
`CALC:MARK:X:SLIM:RIGH 10MHZ`
`CALC:MARK:X:SLIM ON`

THRESHOLD



The *THRESHOLD* softkey defines the threshold line. The threshold line represents a limit for the level range of the max. search at the lower end and that of the min. search at the upper end.

IEC/IEEE-bus commands: `CALC:THR -20dBm`
`CALC:THR ON`

SEARCH LIM
OFF



The *SEARCH LIM OFF* softkey disables all limits of the search range.

IEC/IEEE-bus commands: `CALC:MARK:X:SLIM OFF`
`CALC:THR OFF`



The *MKR*→*TRACE* softkey sets the active marker to a new trace. If only one trace is available on the screen, the softkey does not appear. If several traces are available on the screen, only these are offered.

IEC/IEEE-bus command: `CALC:MARK:TRAC 2`

Example:

Three traces are displayed on the screen. The marker is always on Trace 1 after switching on.

[*MKR* ->*TRACE*] "2" <ENTER> The marker jumps to Trace 2 but remains at the previous frequency or time.

[*MKR* ->*TRACE*] "3" <ENTER> The marker jumps to Trace 3.



The *MKR*→*CF STEPSIZE* softkey sets the step size for the center frequency variation to the current marker frequency, and also sets step size adaptation to *MANUAL*. *CF STEPSIZE* remains at this value until the center frequency entry mode in the STEP menu is switched from *MANUAL* to *AUTO* again.

The *MKR*→*CF STEPSIZE* function is, above all, useful in the measurement of harmonics with large dynamic range (narrow bandwidth and narrow span).

The softkey is not available in the time domain (span = 0 Hz).

IEC/IEEE-bus command: `CALC:MARK:FUNC:CST`

Example:

The harmonics levels of a CW carrier are to be measured at 100 MHz.

[**PRESET**] R&S FSMR is set to the default setting.

[**CENTER: 100 MHz**] R&S FSMR sets the center frequency to 100 MHz. The span is set to 200 MHz.

[**SPAN: 1 MHz**] The span is set to 100 MHz.

[**MKR->**] *MARKER 1* is switched on and set to the maximum value of the signal.

[**NEXT**] R&S FSMR switches to the submenu.

[*MKR->CF STEPSIZE*] The step size of the center frequency setting equals the marker frequency (100 MHz).

[**CENTER**] The center frequency entry mode is activated.

[**Right key**] The center frequency is set to 200 MHz. The first harmonic of the test signal is displayed.

[**MKR->: PEAK**] The marker is set to the harmonic and the level of the latter is output in the marker info field.

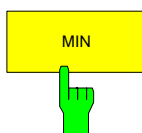

The *MIN* softkey sets the active marker/delta marker to the minimum of the selected trace.

IEC/IEEE-bus commands: `CALC:MARK:MIN`
`CALC:DELT:MIN`

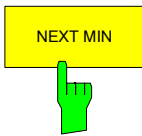

The *NEXT MIN* softkey sets the active marker/delta marker to the next higher minimum of the selected trace. The search direction is defined in the *NEXT MODE* submenu (see above).

IEC/IEEE-bus commands: `CALC:MARK:MIN:NEXT`
`CALC:DELT:MIN:NEXT`



The *NEXT MIN RIGHT* softkey sets the active marker/delta marker to the next higher minimum right of the current marker position on the selected trace.

IEC/IEEE-bus commands: `CALC:MARK:MIN:RIGH`
`CALC:DELT:MIN:RIGH`

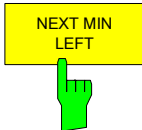

The *NEXT MIN LEFT* softkey sets the active marker/delta marker to the next higher minimum left of the current marker position on the selected trace.

IEC/IEEE-bus commands: `CALC:MARK:MIN:LEFT`
`CALC:DELT:MIN:LEFT`

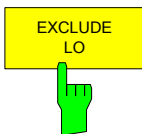

The *EXCLUDE LO* softkey limits the frequency range for the marker search functions or disables the limit.

activated Because of the feedthrough of the first local oscillator to the first intermediate frequency at the input mixer, the LO is represented as a signal at 0 Hz. To avoid the marker jumping to the LO at 0 Hz with the peak function when setting the display range, this frequency is excluded. The minimum frequency to which the marker jumps, is $\geq 6 \times$ resolution bandwidth (RBW).

deactivated No restriction to the search range. The frequency 0 Hz is included in the marker search functions.

IEC/IEEE-bus command: `CALC:MARK:LOEX ON`

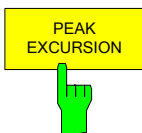

The *PEAK EXCURSION* softkey enables – for level measurements – the entry of a minimum level value by which a signal must rise or fall so that it will be identified as a maximum or a minimum by the *NEXT PEAK* and *NEXT MIN* search functions.

Valid entries are from 0 dB to 80 dB; the resolution is 0.1 dB.

IEC/IEEE-bus command: `CALC:MARK:PEXC 10dB`

The default setting for the peak excursion is 6 dB. This value is sufficient for the *NEXT PEAK* and *NEXT MIN* functions since, in this mode, the next lower maximum or next higher minimum will always be detected.

If *NEXT PEAK LEFT* or *NEXT PEAK RIGHT* is selected, these functions search for the next relative maximum left or right of the current marker position irrespective of the current signal amplitude. *Relative maximum* is understood to mean a decrease of the signal amplitude by a defined value – i.e. the peak excursion – right and left of the amplitude peak.

The 6 dB level change set as a default value may be attained already by the inherent noise of the instrument. In such a case, the R&S FSMR would identify noise peaks as maxima or minima. The value entered for the *PEAK EXCURSION* should therefore be higher than the difference between the highest and the lowest value measured for the displayed inherent noise.

The following example illustrates the effect of different settings of the *PEAK EXCURSION*.

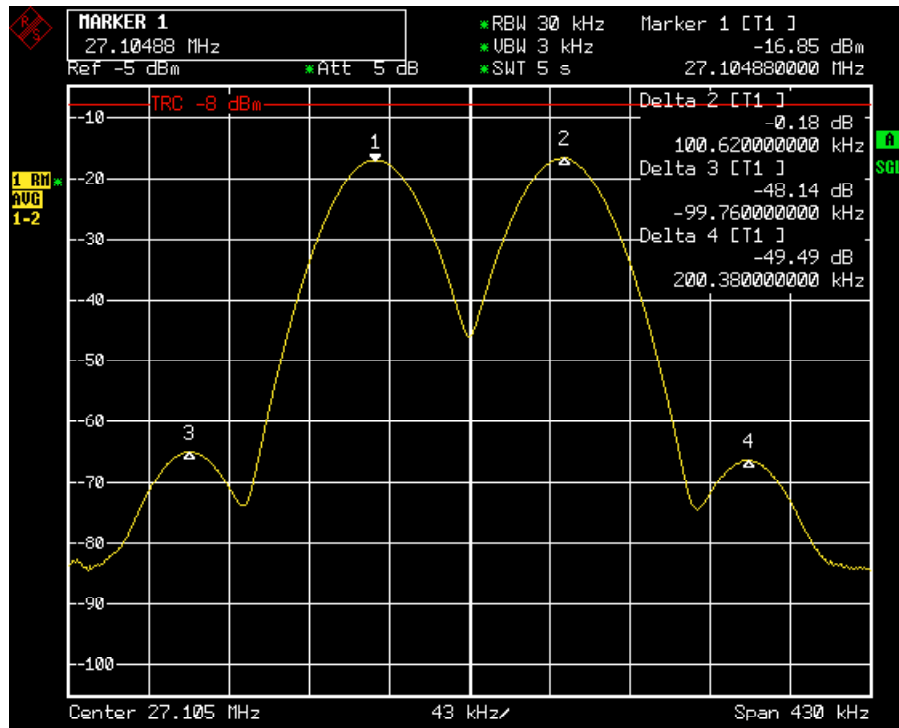

Fig. 14-1 Examples of level measurement with different settings of **PEAK EXCURSION**

The following table lists the signals as indicated by marker numbers in the diagram above, as well as the minimum of the amplitude decrease to both sides of the signal:

signal #	min. amplitude decrease to both sides of the signal
1	30 dB
2	29.85 dB
3	7 dB
4	7 dB

With **40 dB peak excursion**, NEXT PEAK, NEXT PEAK RIGHT and NEXT PEAK LEFT will not find any signal, as the signal level does not decrease by more than 30 dB to either side of any signal.

Order of signals detected:

PEAK: signal 1
 NEXT PEAK: signal 1 (no further signal detected)

or

PEAK: signal 1
 NEXT PEAK LEFT: signal 1 (no further signal detected)
 NEXT PEAK RIGHT: signal 1 (no further signal detected)

With **20 dB peak excursion**, NEXT PEAK and NEXT PEAK RIGHT will also detect signal 2, as the signal level decreases at least by 29.85 dB to either side of this signal, which is now greater than the peak excursion.

Order of signals detected:

PEAK: Signal 1
 NEXT PEAK: Signal 2
 NEXT PEAK: Signal 2 (no further signal detected)

or

PEAK: Signal 1
 NEXT PEAK LEFT: Signal 1 (no further signal detected)
 NEXT PEAK RIGHT: Signal 2
 NEXT PEAK RIGHT: Signal 2 (no further signal detected)

With **6 dB peak excursion**, all signals will be detected with NEXT PEAK and NEXT PEAK RIGHT / NEXT PEAK LEFT.

Order of signals detected:

PEAK: Signal 1
 NEXT PEAK: Signal 2
 NEXT PEAK: Signal 3
 NEXT PEAK: Signal 4

or

PEAK: Signal 1
 NEXT PEAK LEFT: Signal 3
 NEXT PEAK RIGHT: Signal 1
 NEXT PEAK RIGHT: Signal 2
 NEXT PEAK RIGHT: Signal 4

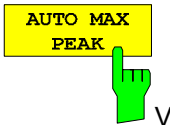

The *AUTO MAX PEAK* softkey adds an automatic peak search action for marker 1 at the end of each particular sweep. This function may be used during adjustments of a device under test to keep track of the current peak marker position and level.

The current marker search limit settings (LEFT LIMIT, RIGHT LIMIT, THRESHOLD, EXCLUDE LO) are taken into account.

IEC/IEEE-bus command: `CALC:MARK:MAX:AUTO ON | OFF`

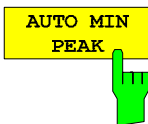

The *AUTO MIN PEAK* softkey adds an automatic peak search action for marker 1 at the end of each particular sweep. This function may be used during adjustments of a device under test to keep track of the current peak marker position and level.

The current marker search limit settings (LEFT LIMIT, RIGHT LIMIT, THRESHOLD, EXCLUDE LO) are taken into account.

IEC/IEEE-bus command: `CALC:MARK:MIN:AUTO ON | OFF`

Power Measurements – MEAS Key

With its power measurement functions the R&S FSMR is able to measure all the necessary parameters with high accuracy in a wide dynamic range.

A modulated carrier is almost always used (except e.g. SSB-AM) for high-frequency transmission of information. Due to the information modulated upon the carrier, the latter covers a spectrum which is defined by the modulation, the transmission data rate and the signal filtering. Within a transmission band each carrier is assigned a channel taking into account these parameters. In order to ensure error-free transmission, each transmitter must be conforming to the specified parameters. These include among others:

- the output power,
- the occupied bandwidth, i.e. the bandwidth which must contain a defined percentage of the power and
- the power dissipation allowed in the adjacent channels.

Additionally the menu contains functions to determine the modulation depth of AM modulated signals and to measure the 3rd order intercept point.

The measurements and the corresponding settings are selected in the *MEAS* menu.

MEAS menu:

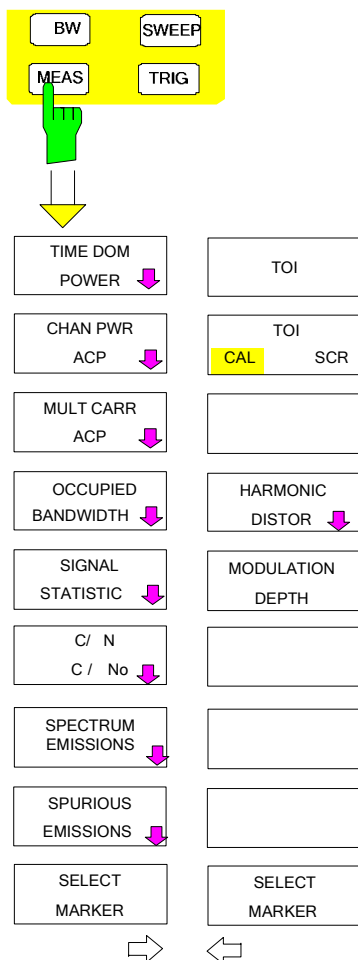

The *MEAS* key opens the menu to select and set the power measurement.

The following measurements can be selected:

- Power in the time domain (*TIME DOM POWER*)
- Channel power and adjacent-channel power in the frequency domain with a single carrier (*CHAN PWR ACP*)
- Channel power and adjacent-channel power in the frequency domain with several carriers (*MULT CARR ACP*)
- Occupied bandwidth (*OCCUPIED BANDWIDTH*)
- Carrier-to-noise ratio (*C/N, C/No*)
- Amplitude probability distribution (*SIGNAL STATISTICS*)
- Modulation depth (*MODULATION DEPTH*)
- SPURIOUS EMISSIONS
- 3rd order intercept (*TOI*)
- Harmonic distortion (*HARMONIC DISTOR*)

The above measurements are carried out alternatively.

Power Measurement in Time Domain

With the aid of the power measurement function, the R&S FSMR determines the power of the signal in the time domain (SPAN = 0 Hz) by summing up the power at the individual pixels and dividing the result by the number of pixels. In this way it is possible to measure for example the power of TDMA signals during transmission or during the muting phase. Both the mean power and the rms power can be measured by means of the individual power values.

The result is displayed in the marker info field.

The measured values are updated after each sweep or averaged over a user-defined number of sweeps (*AVERAGE ON/OFF* and *NUMBER OF SWEEPS*) in order to determine e.g. the mean power over several bursts. For determination of the peak value (*MAX HOLD ON*) the maximum value from several sweeps is displayed.

Example:

Marker info field for: *MEAN* selected, *AVERAGE ON* and *MAX HOLD ON*:

```
MEAN HOLD    -2.33 dBm
MEAN AV      -2.39 dBm
```

If both the on and off phase of a burst signal are displayed, the measurement range can be limited to the transmission or to the muting phase with the aid of vertical lines. The ratio between signal and noise power of a TDMA signal for instance can be measured by using a measurement as a reference value and after that varying the measurement range.

Upon switching on power measurement the sample detector is activated (*TRACE-DETECTOR-SAMPLE*).

Submenu *MEAS - TIME DOM POWER*:

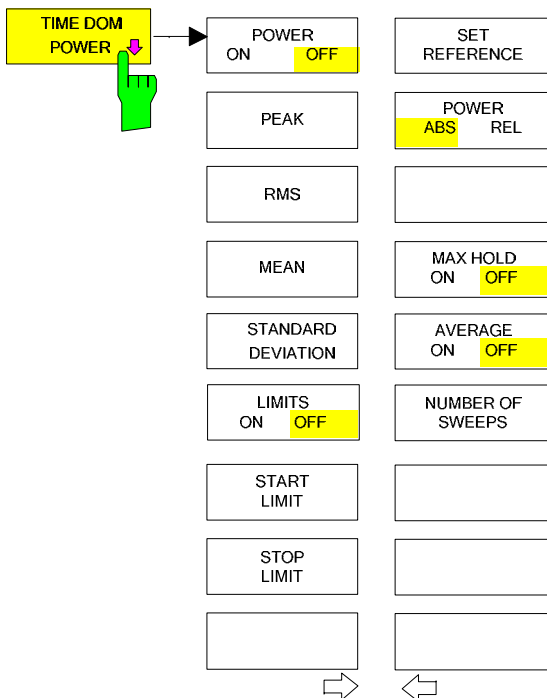

The *TIME DOM POWER* softkey activates the power measurement in the time domain and opens a submenu for configuration of the power measurement.

The submenu allows selection of the type of power measurement (rms or mean power), the settings for max hold and averaging as well as the definition of limits.

The power evaluation range can be limited by input of limit values.

This softkey is only available in time domain (SPAN = 0).

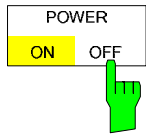

The *POWER ON/OFF* softkey switches the power measurement on and off. When entering the submenu it is *ON* since the power measurement is already switched on with the *TIME DOM POWER* softkey in the main menu.



The measurement is performed on the trace on which marker 1 is placed. To evaluate another trace, marker 1 should be set on another trace using the *SELECT TRACE* softkey in menu *MKR*.

IEC/IEEE-bus command:

```
CALC:MARK:FUNC:SUMM:PPE ON
CALC:MARK:FUNC:SUMM:PPE:RES?
CALC:MARK:FUNC:SUMM:RMS ON
CALC:MARK:FUNC:SUMM:RMS:RES?
CALC:MARK:FUNC:SUMM:MEAN ON
CALC:MARK:FUNC:SUMM:MEAN:RES?
CALC:MARK:FUNC:SUMM:SDEV ON
CALC:MARK:FUNC:SUMM:SDEV:RES?
```

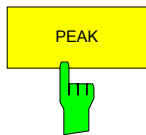

The *PEAK* softkey switches on the calculation of the peak value from the points of the displayed trace or a segment thereof.

For the maximum peak, the largest peak value obtained since the activation of *MAX HOLD ON* is displayed.

With *AVERAGE ON*, the peak values of a trace are averaged over several sweeps and displayed.

The number of sweeps over which the average or the maximum value is calculated is set with the *NUMBER OF SWEEPS* softkey.

IEC/IEEE-bus command:

```
CALC:MARK:FUNC:SUMM:PPE ON
CALC:MARK:FUNC:SUMM:PPE:RES?
```

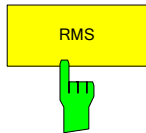

The *RMS* softkey switches on the calculation of the rms value from the points of the displayed trace or a segment of it.

For the maximum peak, the largest rms value obtained since the activation of *MAX HOLD ON* is displayed.

With *AVERAGE ON*, the rms values of a trace are averaged over several sweeps and displayed.

The number of sweeps over which the average or the maximum value is calculated is set with the *NUMBER OF SWEEPS* softkey.

IEC/IEEE-bus command:

```
CALC:MARK:FUNC:SUMM:RMS ON
CALC:MARK:FUNC:SUMM:RMS:RES?
```

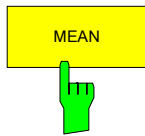

The *MEAN* softkey switches on the calculation of the mean value from the points of the displayed trace or a segment of it. The linear mean value of the equivalent voltages is calculated.

This can be used for instance to measure the mean power during a GSM burst.

For the maximum peak, the largest mean value obtained since the activation of *MAX HOLD ON* is displayed.

With *AVERAGE ON*, the mean values of a trace are averaged over several sweeps and displayed.

The number of sweeps over which the average or the maximum value is calculated is set with the *NUMBER OF SWEEPS* softkey.

IEC/IEEE-bus command: `CALC:MARK:FUNC:SUMM:MEAN ON`
 `CALC:MARK:FUNC:SUMM:MEAN:RES?`



The *STANDARD DEVIATION* softkey switches on the calculation of the standard deviation of trace points from the mean value and outputs them as measured value. The measurement of the mean power is automatically switched on at the same time.

For the maximum peak, the largest standard deviation obtained since the activation of *MAX HOLD ON* is displayed.

With *AVERAGE ON*, the standard deviations of a trace are averaged over several sweeps and displayed.

The number of sweeps over which the average or the maximum value is calculated is set with the *NUMBER OF SWEEPS* softkey.

IEC/IEEE-bus command: `CALC:MARK:FUNC:SUMM:SDEV ON`
 `CALC:MARK:FUNC:SUMM:SDEV:RES?`

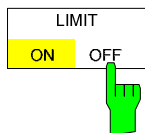

The *LIMIT ON/OFF* softkey selects the limited (*ON*) or non-limited (*OFF*) evaluation range.

The evaluation range is defined by the *START LIMIT* and *STOP LIMIT* softkeys. If *LIMIT = ON*, signals are only searched between the two lines.

If only one limit line is switched on, time line 1 is the lower limit and the upper limit corresponds to the stop frequency. If time line 2 is also switched on, it defines the upper limit.

If no limit line is switched on, the evaluation range is not limited.

The default setting is *LIMIT = OFF*.

IEC/IEEE-bus command: `CALC:MARK:X:SLIM OFF`

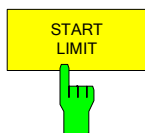

The *START LIMIT* softkey activates the entry of the lower limit of the evaluation range.

IEC/IEEE-bus command: `CALC:MARK:X:SLIM:LEFT <value>`

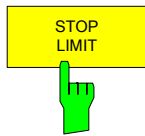

The *STOP LIMIT* softkey activates the entry of the upper limit of the evaluation range.

IEC/IEEE-bus command: `CALC:MARK:X:SLIM:RIGH <value>`

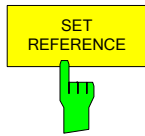

The *SET REFERENCE* softkey sets the power values currently measured as reference values for the calculation of the mean value (*MEAN*) and the rms value (*RMS*). The reference values are used to perform relative measurements.

If the calculation of the mean value (*MEAN*) and rms value (*RMS*) is not switched on, 0 dBm is used as a reference value.

If the average value (*AVERAGE*) or maximum value (*MAX HOLD*) is calculated over several sweeps, the current value is the measured value summed up at the actual time.

IEC/IEEE-bus command: `CALC:MARK:FUNC:SUMM:REF:AUTO ONCE`

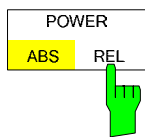

The *POWER ABS/REL* softkey selects the absolute power measurement (default setting) or relative power measurement. The reference value for the relative power is defined by *SET REFERENCE*.

The value 0 dBm is used if the reference value is not defined.

IEC/IEEE-bus command: `CALC:MARK:FUNC:SUMM:MODE ABS`

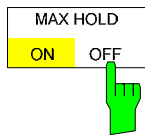

The *MAX HOLD ON/OFF* softkey switches the display of the maximum peak obtained from measurements at successive sweeps on and off.

The displayed maximum peak is only updated at the end of a sweep if a higher value has occurred.

The maximum value can be reset by switching the *MAX HOLD ON / OFF* softkey off and on again.

IEC/IEEE-bus command: `CALC:MARK:FUNC:SUMM:PHOL ON`
`CALC:MARK:FUNC:SUMM:PPE:PHOL:RES?`
`CALC:MARK:FUNC:SUMM:RMS:PHOL:RES?`
`CALC:MARK:FUNC:SUMM:MEAN:PHOL:RES?`
`CALC:MARK:FUNC:SUMM:SDEV:PHOL:RES?`

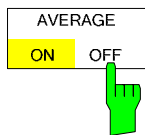

The *AVERAGE ON/OFF* softkey switches averaging over successive sweep measurements on and off.

The measured values can be reset by switching the *AVERAGE ON / OFF* softkey off and on again.

IEC/IEEE-bus command: `CALC:MARK:FUNC:SUMM:AVER ON`
`CALC:MARK:FUNC:SUMM:PPE:AVER:RES?`
`CALC:MARK:FUNC:SUMM:RMS:AVER:RES?`
`CALC:MARK:FUNC:SUMM:MEAN:AVER:RES?`
`CALC:MARK:FUNC:SUMM:SDEV:AVER:RES?`

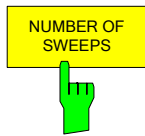

The *NUMBER OF SWEEPS* softkey activates the entry of the number of sweeps for maximum or average value calculation.

NGLE SWEEP mode The R&S FSMR performs sweeps until the selected number of sweeps is reached and stops then.

CONTINUOUS SWEEP mode Averaging is carried out until the selected number of sweeps is reached. After that, averaging is performed in continuous mode. and is then continued as running averaging. Calculation of the maximum peak (*MAX HOLD*) is performed continuously irrespective of the selected number of sweeps.

The valid range values is 0 to 32767.

Depending on the specified number of sweeps, averaging is carried out according to the following rules:

NUMBER OF SWEEPS = 0 Continuous averaging is carried out over 10 measured values.

NUMBER OF SWEEPS = 1 No averaging is carried out.

NUMBER OF SWEEPS > 1 Averaging is carried out over the set number of measured values.

This setting is equivalent to the setting of the sweep count in the TRACE menu.

IEC/IEEE-bus command: `SWE:COUN <value>`

Example:

The mean power of a GSM burst with 0 dBm nominal power at 800 MHz is to be measured.

[PRESET] Set the R&S FSMR to the default setting.

[FREQ: CENTER: 800 MHz] Set the center frequency to 800 MHz.

[SPAN: ZERO SPAN] Select time domain display (span = 0 Hz).

[AMPT: 0 dBm] Set the reference level to 0 dBm.

[BW: RES BW MANUAL: 30 kHz] Set the resolution bandwidth to 30 kHz in line with the requirements of the GSM standard.

[SWEEP: SWEPTIME MANUAL 600 µs] Set the sweep time to 600 µs.

[TRIG: VIDEO: 50 %] Use the video signal as trigger source.

[MEAS] Call the menu for the measurement functions.

[TIME DOM POWER] Select power measurement in the time domain. The R&S FSMR calculates the mean power from the points of the whole trace. The submenu for configuration of the power measurement is opened. *MEAN* is already switched on.

[LIMITS ON] Activate the limitation of the time domain of the power measurement .

[START LIMIT: 250 µs] Set the start of the power measurement at 250 µs.

[STOP LIMIT: 500 µs] Set the end of the power measurement at 500 µs.



The GSM specifications require the power to be measured between 50% and 90% of the TDMA burst. The time limits set above approximately correspond to the required time domain.

Channel and Adjacent-Channel Power Measurements

For all channel and adjacent-channel power measurements a specified channel configuration is assumed which is for instance based on a specific radiocommunication system.

This configuration is defined by the nominal channel frequency (= center frequency of the R&S FSMR if only one carrier is active), the channel bandwidth, the channel spacing, the adjacent-channel bandwidth and the adjacent-channel spacing. The R&S FSMR is able to simultaneously measure the power in up to four transmission channels and up to three adjacent channels (10 channels: 4 transmission channels, 3 lower and 3 upper adjacent channels).

It offers two methods for channel and adjacent-channel power measurement:

- The integrated bandwidth method (IBW method), i.e. the integration of trace pixels within the bandwidth of the channel to be measured to the total power of the channel,
- The measurement in time domain (Fast ACP) by means of steep resolution filters simulating the channel.

The two measurements yield the same results. The measurement in time domain can be performed much faster since the complete signal is measured within a channel at the same time. With the IBW method, the channel is divided into subspectra. This is done by means of a bandwidth which is small compared to the channel bandwidth. These subspectra are then combined by integration of the trace pixels.

With the IBW method, the transmission channels or adjacent channels are marked by vertical lines at a distance of half the channel bandwidth to the left and to the right of the corresponding channel center frequency (see Fig. 4.16-1).

With the time-domain method, the power versus time is shown for each channel. The boundaries of the channels are marked by vertical lines (see Fig. 4.16-2).

For both methods, the results are listed in tables in the lower half of the screen.

The R&S FSMR offers predefined standard settings which can be selected from a table for the common mobile radio standards. Thus, channel configuration is performed automatically without the need to enter the corresponding parameters manually.

For some standards, the channel power and the adjacent-channel power are to be weighted by means of a root-raised cosine filter corresponding to a receive filter. This type of filtering is switched on automatically for both methods on selecting the standard (e.g. NADC, TETRA or 3GPP W-CDMA).

Addition of firmware starting from version 4.3x:

As of firmware version 4.3x it is possible to configure overlapping adjacent channels. Based on a common carrier channel setting, it is now possible to measure with two slightly different ADJ channel settings with one single measurement at the same time.

Example:

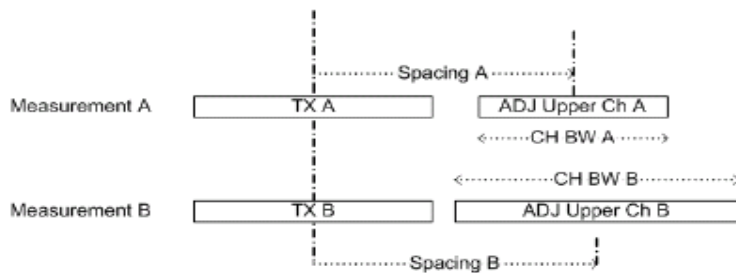

ACP Measurement A and Measurement B are using identical TX channel settings (Channel Bandwidth).

The ADJ settings for Measurement A and measurement B are different.

It is now possible to do both measurements at the same time.

- Configure the ACP measurement with number of ADJ channels = 2.
- Define ADJ settings (bandwidth, spacing) as required for measurement A.
- Define ALT1 settings (bandwidth, spacing) as required for ADJ channel of measurement B
- Perform the ACP measurement
- Read the ACP measurement result:
The Carrier Power belongs to measurement A and B
The ADJ result is the ADJ result of measurement A

The ALT1 result is the ADJ result of measurement B.



This feature is only supported for ACP but not for Multi Carrier ACP measurement.

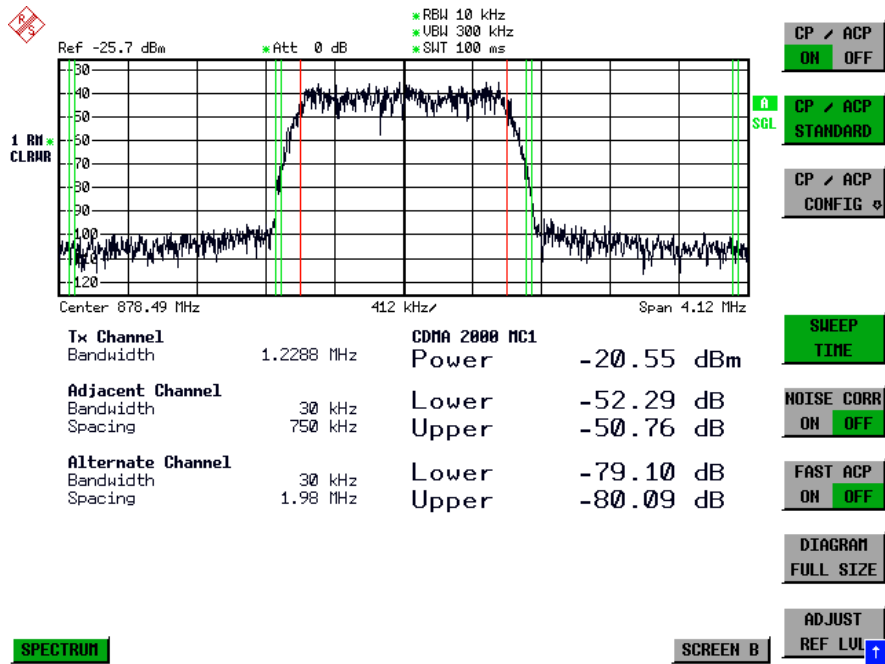

Fig. 4.16-1 Screen display of adjacent-channel power measurement using the IBW method

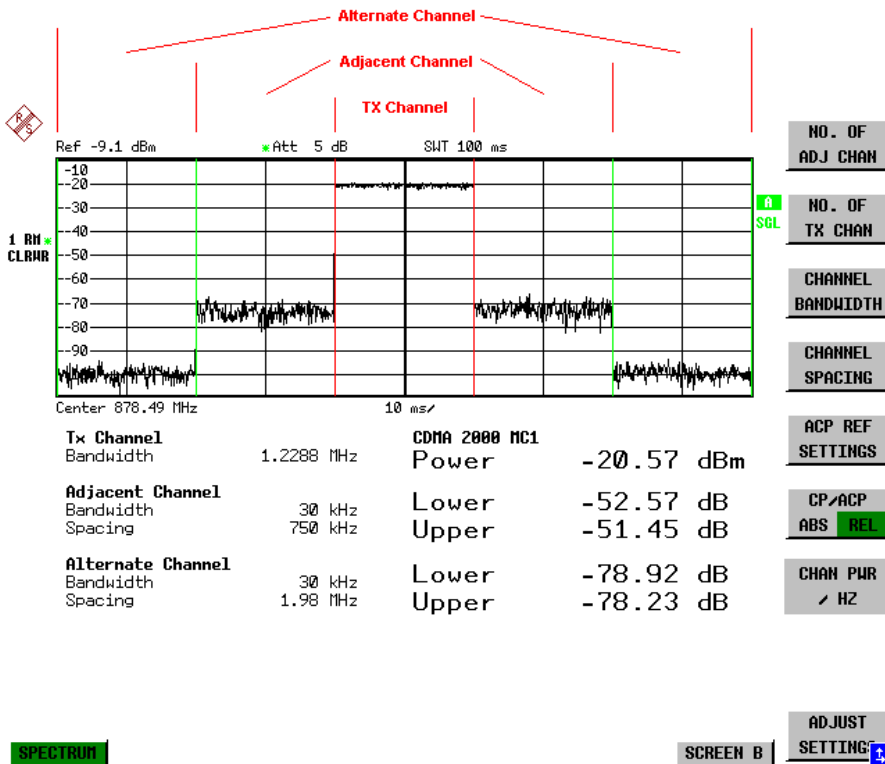

Fig. 4.16-2 Screen display of adjacent-channel power measurement using the time-domain method
 Limit values for the adjacent-channel power can be defined for the measurement. If limit checking is

switched on, a pass/fail information indicating that the power has been exceeded is displayed during the measurement in the table in the lower half of the screen.



With the CP/ACP measurement switched on the functions SPLIT SCREEN and FULL SCREEN are inhibited.

The channel configuration is defined in the *MEAS - CHAN PWR ACP* or the *MEAS - MULT CARR ACP* menu.

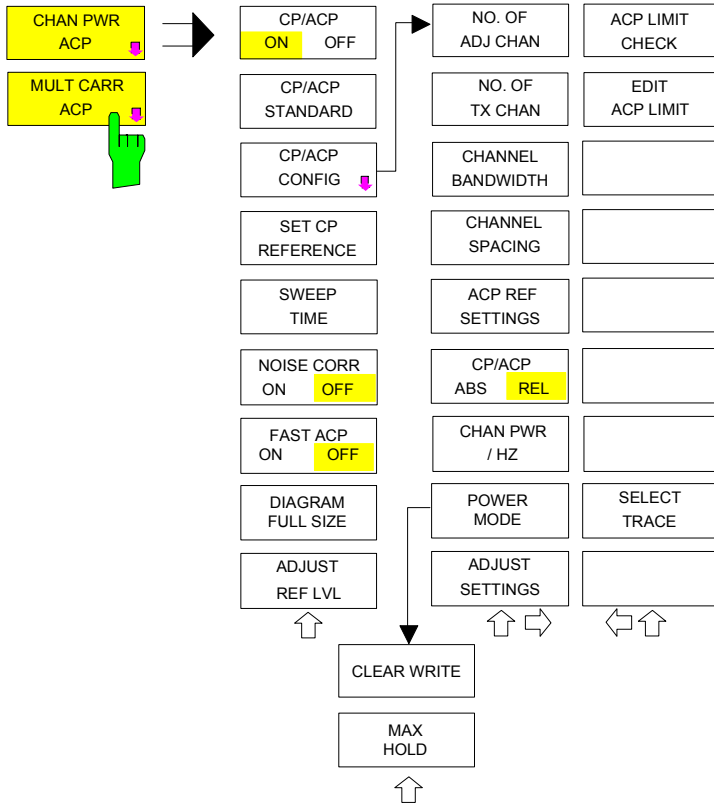

The *CHAN PWR ACP* and *MULT CARR ACP* softkeys activate channel or adjacent-channel power measurement either for a single carrier signal (*CHAN PWR ACP*) or for several carrier signals (*MULT CARR ACP*), depending on the current measurement configuration. In addition, they open a submenu for defining the parameters for channel power measurement. The softkey selected is shown in colour to indicate that a channel or adjacent-channel power measurement is active.



The softkeys are available only for measurements in the frequency domain (span > 0).

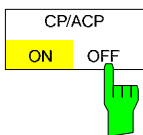

The *CP/ACP ON/OFF* softkey switches calculation of the channel power or adjacent-channel power on and off.

With default settings the measurement is performed by integrating the powers at the display points within the specified channels (IBW method).

The powers of the adjacent channels are measured either as absolute values or as relative values referenced to the power of a transmission channel. The default setting is relative-value measurement (see *CP/ACP ABS/REL* softkey).

When multicarrier ACP measurement is activated, the number of test points is increased to ensure that adjacent-channel powers are measured with adequate accuracy.

IEC/IEEE-bus commands: `CALC:MARK:FUNC:POW:SEL CPOW|ACP|MCAC`
`CALC:MARK:FUNC:POW:RES? CPOW|ACP|MCAC`
`CALC:MARK:FUNC:POW OFF`



The *CPI/ACP STANDARD* softkey opens a table for the selection of the settings according to predefined standards. The test parameters for the channel and adjacent-channel measurements are set according to the mobile radio standard.

ACP STANDARD
√NONE
NADC IS136
TETRA
PDC
PHS
CDPD
CDMA IS95A FWD
CDMA IS95A REV
CDMA IS95C Class 0 FWD
CDMA IS95C Class 0 REV
CDMA J-ST0008 FWD
CDMA J-ST0008 REV
CDMA IS95C Class 1 FWD
CDMA IS95C Class 1 REV
W-CDMA 4.096 FWD
W-CDMA 4.096 REV
W-CDMA 3GPP FWD
W-CDMA 3GPP REV
CDMA 2000 DS
CDMA 2000 MC1
CDMA 2000 MC3
TD-SCDMA
WLAN 802.11A
WLAN 802.11B
WIMAX
WIBRO

The selection of the standard influences the following parameters:

- channel spacing and adjacent-channel spacing
- channel bandwidth, adjacent-channel bandwidth, and type of filtering
- resolution bandwidth
- video bandwidth
- detector
- # of adjacent channels

FAST ACP is not available if a WLAN standard or the WIMAX or WiBro standard is selected. Trace mathematics and trace averaging are switched off. The reference level is not influenced by the selection of a standard.

To achieve an optimum dynamic range, the reference level has to be set in a way that places the signal maximum close to the reference level without forcing an overload message. The default setting is *CPI/ACP STANDARD NONE*.



For the R&S FSMR, the channel spacing is defined as the distance between the center frequency of the adjacent channel and the center frequency of the transmission channel. The definition of the adjacent-channel spacing in standards IS95 B and C, IS97 B and C and IS98 B and C is different. These standards define the adjacent-channel spacing from the center of the transmission channel to the closest border of the adjacent channel. This definition is also used for the R&S FSMR when the following standard settings are selected:

- CDMA IS95 Class 0 FWD
- CDMA IS95 Class 0 REV
- CDMA IS95 Class 1 FWD
- CDMA IS95 Class 1 REV
- FAST ACP is not available if a WiMax or WiBro standard is selected.

IEC/IEEE-bus command: `CALC:MARK:FUNC:POW:PRES <standard>`

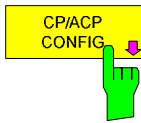

See following section "Setting the Channel Configuration"

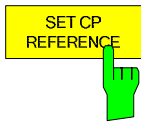

With channel power measurement activated, the *SET CP REFERENCE* softkey defines the currently measured channel power as the reference value. The reference value is displayed in the *CH PWR REF* field; the default value is 0 dBm.

In adjacent-channel power measurement with one or several carrier signals, the power is always referenced to a transmission channel, i.e. no value is displayed for *CH PWR REF*.

IEC/IEEE-bus command: `SENS:POW:ACH:REF:AUTO ONCE`

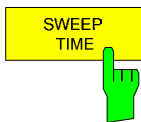

The *SWEEP TIME* softkey activates the entry of the sweep time. With the RMS detector, a longer sweep time increases the stability of the measurement results.

The function of the softkey is identical to the softkey *SWEEP TIME MANUAL* in the menu *BW*.

IEC/IEEE-bus command: `SENS:SWE:TIM <value>`

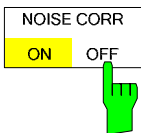

If the *NOISE CORR ON/OFF* softkey is activated, the results will be corrected by the instrument's inherent noise, which increases the dynamic range.

When the function is switched on, a reference measurement of the instrument's inherent noise is carried out. The noise power measured is then subtracted from the power in the channel that is being examined.

The inherent noise of the instrument depends on the selected center frequency, resolution bandwidth and level setting. Therefore, the correction function is disabled whenever one of these parameters is changed. A disable message is displayed on the screen.

To enable the correction function in conjunction with the changed setting, press the softkey once more. A new reference measurement is carried out.

IEC/IEEE-bus command: `SENS:POW:NCOR ON`

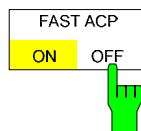

The *FAST ACP* softkey switches between the IBW method (*FAST ACP OFF*) and the time domain method (*FAST ACP ON*).

With *FAST ACP ON* the power measurement is performed in the different channels in the time domain. The R&S FSMR sets the center frequency consecutively to the different channel center frequencies and measures the power with the selected measurement time (= sweep time/number of channels). The RBW filters suitable for the selected standard and frequency offset are automatically used (e.g. root raised cos with IS 136). The list of available channel filters is included in section "Setting of Bandwidths and Sweep Time – *BW* key".

The RMS detector is used for obtaining correct power measurement results. Therefore this requires no software correction factors.

Measured values are output as a list. The powers of the transmission channels are output in dBm, the powers of the adjacent channels in dBm (*CP/ACP ABS*) or dB (*CP/ACP REL*).

The sweep time is selected depending on the desired reproducibility of results. Reproducibility increases with sweep time since power measurement is then performed over a longer time period.

As a general approach, it can be assumed that approx. 500 non-correlated measured values are required for a reproducibility of 0.5 dB (99 % of the measurements are within 0.5 dB of the true measured value). This holds true for white noise. The measured values are considered as non-correlated when their time interval corresponds to the reciprocal of the measured bandwidth.

With IS 136 the measurement bandwidth is approx. 25 kHz, i.e. measured values at an interval of 40 μ s are considered as noncorrelated. A measurement time of 20 ms is thus required per channel for 1000 measured values. This is the default sweep time which the R&S FSMR sets in coupled mode. Approx. 5000 measured values are required for a reproducibility of 0.1 dB (99%), i.e. the measurement time is to be increased to 200 ms.

IEC/IEEE-bus command `SENS:POW:HSP ON`

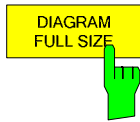

The *FULL SIZE DIAGRAM* softkey switches the diagram to full screen size.

IEC/IEEE-bus command: `DISP:WIND1:SIZE LARG|SMAL`

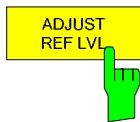

The *ADJUST REF LVL* softkey adjusts the reference level of the R&S FSMR to the measured channel power. This ensures that the settings of the RF attenuation and the reference level are optimally adjusted to the signal level without overloading the R&S FSMR or limiting the dynamic range by a too small S/N ratio.

Since the measurement bandwidth for channel power measurements is significantly lower than the signal bandwidth, the signal path may be overloaded although the trace is still significantly below the reference level.

IEC/IEEE-bus command: `SENS:POW:ACH:PRES:RLEV`

For manual setting of the test parameters different from the settings made with *ADJUST SETTINGS* the following should be observed:

Frequency span The frequency span must at least cover the channels to be measured plus a measurement margin of 10%.
For channel power measurement, the span is 1.1 x channel bandwidth.



If the frequency span is large in comparison with the channel bandwidth (or the adjacent-channel bandwidths) being examined, only a few points on the trace are available per channel. This reduces the accuracy of the waveform calculation for the channel filter used, which has a negative effect on the measurement accuracy.

We therefore strongly recommend that the formulas mentioned be taken into consideration when selecting the frequency span.

Resolution bandwidth (RBW)

To ensure both an acceptable measurement speed and the required selection (to suppress spectral components outside the channel to be measured, especially of the adjacent channels), the resolution bandwidth must not be selected too small or too large. As a general approach, the resolution bandwidth is to be set to values between 1% and 4% of the channel bandwidth.

A larger resolution bandwidth can be selected if the spectrum within the channel to be measured and around it has a flat characteristic. In the standard setting, e.g. for standard IS95A REV at an adjacent channel bandwidth of 30 kHz, a resolution bandwidth of 30 kHz is used. This yields correct results since the spectrum in the neighbourhood of the adjacent channels normally has a constant level. For standard NADC/IS136 this is not possible for example, since the spectrum of the transmit signal penetrates into the adjacent channels and a too large resolution bandwidth causes a too low selection of the channel filter. The adjacent-channel power would thus be measured too high.

With the exception of the IS95 CDMA standards, the *ADJUST SETTINGS* softkey sets the resolution bandwidth (RBW) as a function of the channel bandwidth:

$$RBW \leq 1/40 \text{ of channel bandwidth.}$$

The maximum possible resolution bandwidth (with respect to the requirement $RBW \leq 1/40$) resulting from the available RBW steps (1, 3) is selected .

Video bandwidth (VBW)

For a correct power measurement, the video signal must not be limited in bandwidth. A restricted bandwidth of the logarithmic video signal would cause signal averaging and thus result in a too low indication of the power (-2.51 dB at very low video bandwidths). The video bandwidth should therefore be selected at least three times the resolution bandwidth.

The *ADJUST SETTINGS* softkey sets the video bandwidth (VBW) as a function of the channel bandwidth as follows:

$$VBW \geq 3 \cdot RBW.$$

The smallest possible VBW with regard to the available step size will be selected.

Detector

The *ADJUST SETTINGS* softkey selects the RMS detector.

The RMS detector is selected since it correctly indicates the power irrespective of the characteristics of the signal to be measured. In principle, the sample detector would be possible as well. Due to the limited number of trace pixels used to calculate the power in the channel, the sample detector would yield less stable results. Averaging, which is often performed to stabilize the measurement results, leads to a too low level indication and should therefore be avoided. The reduction in the displayed power depends on the number of averages and the signal characteristics in the channel to be measured.

Setting the Channel Configuration

MEAS - CP/ACP CONFIG submenu:

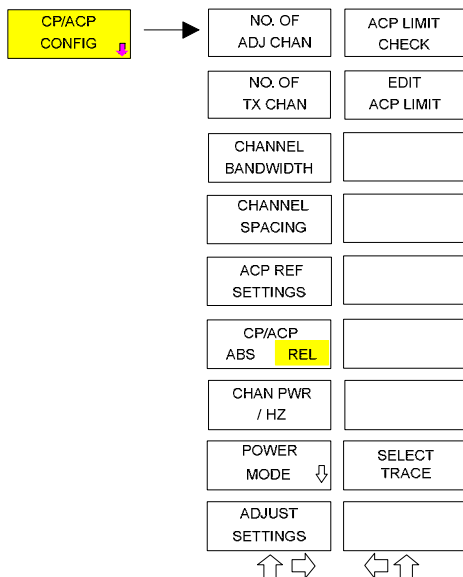

The *CP/ACP CONFIG* softkey opens a submenu for configuration of the channel power and adjacent channel power measurement independently of the offered standards.

The channel configuration includes the number of channels to be measured, the channel bandwidths (*CHANNEL BANDWIDTH*), and the channel spacings (*CHANNEL SPACING*).

Limit values can additionally be specified for the adjacent-channel power (*ACP LIMIT CHECK* and *EDIT ACP LIMITS*) which are checked for compliance during the measurement.

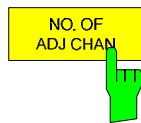

The *NO. OF ADJ CHAN* softkey activates the entry of the number $\pm n$ of adjacent channels to be considered in the adjacent-channel power measurement. Numbers from 0 to 12 can be entered.

The following measurements are performed depending on the number of the channels.

- 0 Only the channel powers are measured.
- 1 The channel powers and the power of the upper and lower adjacent channel are measured.
- 2 The channel powers, the power of the upper and lower adjacent channel and of the next higher and lower channel (alternate channel 1) are measured.
- 3 The channel power, the power of the upper and lower adjacent channel, the power of the next higher and lower channel (alternate channel 1) and of the next but one higher and lower adjacent channel (alternate channel 2) are measured.

With higher numbers the procedure is expanded accordingly.

IEC/IEEE-bus command: `SENS:POW:ACH:ACP 1`

This increased number of adjacent channels is realized all for the relevant settings like:

ACLR LIMIT CHECK

```
:CALC:LIM:ACP:ACH:RES?
:CALC:LIM:ACP:ALT1..11:RES?
```

EDIT ACLR LIMITS

```
:CALC:LIM:ACP:ACH:STAT ON
:CALC:LIM:ACP:ACH:ABS -10dBm,-10dBm
:CALC:LIM:ACP:ACH:ABS:STAT ON
:CALC:LIM:ACP:ALT1..11 0dB,0dB
:CALC:LIM:ACP:ALT1..11:STAT ON
:CALC:LIM:ACP:ALT1..11:ABS -10dBm,-10dBm
:CALC:LIM:ACP:ALT1..11:ABS:STAT ON
```

ADJ CHAN BANDWIDTH

```
:SENS:POW:ACH:BWID:ALT1..11 30kHz
```

ADJ CHAN SPACING

```
:SENS:POW:ACH:SPAC:ALT1..11 4MHz
```

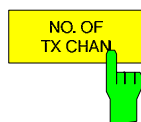

The *NO. OF TX CHAN* softkey enables the entry of the number of carrier signals to be considered in channel and adjacent-channel power measurements.

Numbers from 1 to 12 can be entered.

The softkey is available only for multicarrier ACP measurements.

IEC/IEEE-bus command: `SENS:POW:ACH:TXCH:COUN 12`

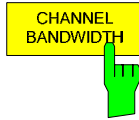

The *CHANNEL BANDWIDTH* softkey opens a table for defining the channel bandwidths for the transmission channels and the adjacent channels.

TX/ACP CHANNEL BW	
CHAN	BANDWIDTH
TX	14 kHz
ADJ	14 kHz
ALT1	14 kHz
ALT2	14 kHz
ALT3	14 kHz
ALT4	14 kHz
ALT5	14 kHz
ALT6	14 kHz
ALT7	14 kHz
ALT8	14 kHz
ALT9	14 kHz
ALT10	14 kHz
ALT11	14 kHz

The transmission-channel bandwidth is normally defined by the transmission standard. The correct bandwidth is set automatically for the selected standard (see *CP/ACP STANDARD* softkey).

With the IBW method (*FAST ACP OFF*), the channel bandwidth limits are marked by two vertical lines right and left of the channel center frequency. It can in this way be visually checked whether the entire power of the signal under test is within the selected channel bandwidth.

Measurements in the time domain (*FAST ACP ON*) are performed in the zero span mode. The channel limits are indicated by vertical lines. For measurements requiring channel bandwidths deviating from those defined in the selected standard the IBW method is to be used.

Refer to section "Setting of Bandwidths and Sweep Time – *BW* key" for a list of available channel filters.

When measuring according to the IBW method (*FAST ACP OFF*) the bandwidths of the different adjacent channels are to be entered numerically. Since all adjacent channels often have the same bandwidth, the other channels Alt1 and Alt2 are set to the bandwidth of the adjacent channel on entering the adjacent-channel bandwidth (*ADJ*). Thus only one value needs to be entered in case of equal adjacent channel bandwidths. The same holds true for the ALT2 channels (alternate channels 2) when the bandwidth of the ALT1 channel (alternate channel 1) is entered.



The channel spacings can be set separately by overwriting the table from top to bottom.

```
IEC/IEEE-bus command: SENS:POW:ACH:BWID:CHAN 14kHz
                      SENS:POW:ACH:BWID:ACH 1kHz
                      SENS:POW:ACH:BWID:ALT1 14kHz
                      SENS:POW:ACH:BWID:ALT2 14kHz
```

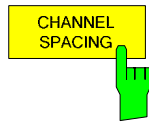

The *CHANNEL SPACING* softkey opens a table for defining the channel bandwidths spacings for the transmissionTX channels as well as for the adjacent channels.



The entry "TX" is only available for the multicarrier ACP measurement.

With the IBW method (*FAST ACP OFF*), the channel bandwidth limits are marked by two vertical lines right and left of the channel center frequency. It can in this way be visually checked whether the entire power of the signal under test is within the selected channel bandwidth.

TX channels

The spacing between every TX channels can be defined separately. Therefore a TX spacing 1-2 for the spacing between the first and the second carrier, a TX spacing 2-3 for the spacing between the second and the third carrier and so on can be defined. In order to allow a convenient setup for the system with equal TX channel spacing, the value of TX spacing 1-2 will be copied in all the spacing below after entry, the TX spacing 2-3 will be copied in all the spacing below after entry and so forth.

Measurements in the time domain (*FAST ACP ON*) are performed in the zero span mode. The channel limits are indicated by vertical lines. For measurements requiring channel bandwidths deviating from those defined in the selected standard the IBW method is to be used.

Refer to section "Setting of Bandwidths and Sweep Time – *BW* key" for a list of available channel filters.



For different spacings a setup from top to bottom is necessary.

When measuring according to the IBW method (*FAST ACP OFF*) the bandwidths if the spacings are not equal the channel distribution according to the center frequency is as follows:

Odd number of the different adjacentTX channels are to be entered numerically. Since all adjacent channels often have the same bandwidth, the other channels Alt1 and Alt2 are set to the bandwidth of the adjacent channel on entering the adjacent-channel bandwidth (ADJ).;

The middle TX channel is centered to center frequency.

Even number of TX channels:

The two TX channels in the middle are used to calculate the frequency between those two channels. This frequency is aligned to the center frequency.

TX/ACP CHANNEL SPACING	
CHAN	SPACING
TX1-2	20 kHz
TX2-3	20 kHz
TX3-4	20 kHz
TX4-5	20 kHz
TX5-6	20 kHz
TX6-7	20 kHz
TX7-8	20 kHz
TX8-9	20 kHz
TX9-10	20 kHz
TX10-11	20 kHz
TX11-12	20 kHz
ADJ	20 kHz
ALT1	40 kHz
ALT2	60 kHz
ALT3	80 kHz
ALT4	100 kHz
ALT5	120 kHz
ALT6	140 kHz
ALT7	160 kHz
ALT8	180 kHz
ALT9	200 kHz
ALT10	220 kHz
ALT11	240 kHz

Adjacent channels

Since all the adjacent channels often have the same distance to each other, the entry of the adjacent-channel spacing (ADJ) causes channel spacing ALT1 to be set to twice and channel spacing ALT2 to three times the adjacent-channel spacing (and so on). Thus only one value needs to be entered in case of equal adjacent channel bandwidths.spacing. The same holds true for the ALT2 channels (alternate channels 2) when the bandwidth of the ALT1 channel (alternate channel 1) is entered.



The channel spacings can be set separately by overwriting the table from top to bottom. If the ACP or MCACP measurement is started all settings according to the standard including the channel bandwidths and channel spacings are set and can be adjusted afterwards.

IEC/IEEE-bus command:

```
SENS:POW:ACH:SPAC:CHAN 14kHz20kHz
:SENS:POW:ACH:SPAC:ACH 1kHz20kHz
:SENS:POW:ACH:SPAC:ALT1 14kHz40kHz
:SENS:POW:ACH:SPAC:ALT2 14kHz60kHz
```

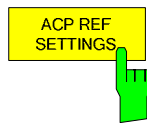

The *ACP REF SETTINGS* softkey opens a table for selecting the transmission channel to which the adjacent-channel relative power values should be referenced.

TX CHANNEL 1 - 4	Selection of one of channels 1 to 4.
MIN POWER TX CHANNEL	The transmission channel with the lowest power is used as a reference channel.
MAX POWER TX CHANNEL	The transmission channel with the highest power is used as a reference channel.
LOWEST & HIGHEST CHANNEL	The outer lefthand transmission channel is the reference channel for the lower adjacent channels, the outer righthand transmission channel that for the upper adjacent channels.



The softkey is only available for the multicarrier ACP measurement.

IEC/IEEE-bus command:

```
SENS:POW:ACH:REF:TXCH:MAN 1
SENS:POW:ACH:REF:TXCH:AUTO MIN
```

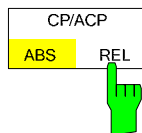

The *CP/ACP ABS/REL* softkey (channel power absolute/ relative) switches between absolute and relative power measurement in the channel.

CP/ACP ABS The absolute power in the transmission channel and in the adjacent channels is displayed in the unit of the Y axis, e.g. in dBm, dB μ V.

CP/ACP REL For adjacent-channel power measurements (*NO. OF ADJ CHAN* > 0), the level of the adjacent channels is displayed relative to the level of the transmission channel in dBc.

For channel power measurements (*NO. OF ADJ CHAN* = 0) with a single carrier, the power of the transmission channel is displayed relative to the power of a reference channel defined by *SET CP REFERENCE*. This means:

1. Declare the power of the currently measured channel as the reference value, using the *SET CP REFERENCE* softkey.
2. Select the channel of interest by varying the channel frequency (R&S FSMR center frequency).

With linear scaling of the Y axis, the power of the new channel relative to the reference channel (CP/CP_{ref}) is displayed. With dB scaling, the logarithmic ratio $10\lg(CP/CP_{ref})$ is displayed.

The relative channel power measurement can thus also be used for universal adjacent-channel power measurements. Each channel can be measured individually.

IEC/IEEE-bus command: `SENS:POW:ACH:MODE ABS`

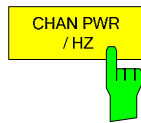

The *CHAN PWR / HZ* softkey toggles between the measurement of the total channel power and the measurement of the channel power referenced to a 1-Hz bandwidth.

The conversion factor is $10 \cdot \lg \frac{1}{\text{Channel} \cdot \text{Bandwidth}}$.

By means of this function it is possible e.g. to measure the signal/noise power density or use the additional functions *CP/ACP REL* and *SET CP REFERENCE* to obtain the signal to noise ratio.

IEC/IEEE-bus command:

`CALC:MARK:FUNC:POW:RES:PHZ ON|OFF`

The *POWER MODE* softkey opens the submenu for selecting the power mode.

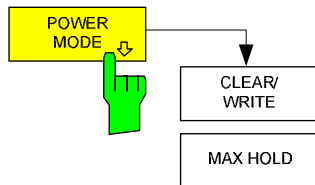

CLEAR/WRITE In the *CLEAR/WRITE* mode the channel power and the adjacent channel powers are calculated directly from the current trace (default mode).

MAX HOLD In *MAX HOLD* mode the power values are still derived from the current trace, but they are compared with the previous power value using a maximum algorithm. The higher value is remained.

IEC/IEEE-bus command:

`:CALC:MARK:FUNC:POW:MODE WRIT|MAXH`

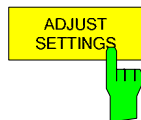

The *ADJUST SETTINGS* softkey automatically optimizes the instrument settings for the selected power measurement (see below).

All instrument settings relevant for a power measurement within a specific frequency range (channel bandwidth) are optimized for the selected channel configuration (channel bandwidth, channel spacing):

- Frequency span:

The frequency span should cover at least all channels to be considered in a measurement.

For channel power measurements, the frequency span is set as follows:

$(\text{No. of transmission channels} - 1) \times \text{transmission channel spacing} + 2 \times \text{transmission channel bandwidth} + \text{measurement margin}$

For adjacent-channel power measurements, the frequency span is set as a function of the number of transmission channels, the transmission channel spacing, the adjacent-channel spacing, and the bandwidth of one of adjacent-channels *ADJ*, *ALT1* or *ALT2*, whichever is furthest away from the transmission channels:

$(\text{No. of transmission channels} - 1) \times \text{transmission channel spacing} + 2 \times (\text{adjacent-channel spacing} + \text{adjacent-channel bandwidth}) + \text{measurement margin}$

The measurement margin is approx. 10% of the value obtained by adding the channel spacing and the channel bandwidth.

- Resolution bandwidth $\text{RBW} \leq 1/40$ of channel bandwidth
- Video bandwidth $\text{VBW} \geq 3 \times \text{RBW}$
- Detector RMS detector

Trace math and trace averaging functions are switched off. The reference level is not influenced by *ADJUST SETTINGS*. It can be separately adjusted with *ADJUST REF LVL*.

The adjustment is carried out only once; if necessary, the instrument settings can be changed later.

IEC/IEEE-bus command:

`SENS:POW:ACH:PRES ACP|CPOW|MCAC|OBW`

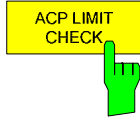

The *ACP LIMIT CHECK* softkey switches the limit check for the ACP measurement on and off.

IEC/IEEE-bus command:

`CALC:LIM:ACP ON`
`CALC:LIM:ACP:ACH:RES?`

`CALC:LIM:ACP:ALT:RES?`

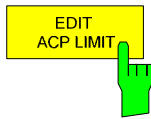

The *EDIT ACP LIMIT* softkey opens a table for defining the limits for the ACP measurement.

ACP LIMITS				
CHAN	RELATIVE LIMIT CHECK		ABSOLUTE LIMIT CHECK	
	VALUE	ON	VALUE	ON
ADJ	-45 dB	✓		
ALT1	-60 dB	✓		
ALT2				

The following rules apply for the limits:

- A separate limit can be defined for each adjacent channel. The limit applies to both the upper and the lower adjacent channel.
- A relative and/or absolute limit can be defined. The check of both limit values can be activated independently.
- The R&S FSMR checks adherence to the limits irrespective of whether the limits are absolute or relative or whether the measurement is carried out with absolute or relative levels. If both limits are active and if the higher of both limit values is exceeded, the measured value is marked accordingly.



Measured values exceeding the limit are marked by a preceding asterisk

IEC/IEEE-bus command:

`CALC:LIM:ACP ON`
`CALC:LIM:ACP:ACH 0dB,0dB`
`CALC:LIM:ACP:ACH:STAT ON`
`CALC:LIM:ACP:ACH:ABS -10dBm,-10dBm`
`CALC:LIM:ACP:ACH:ABS:STAT ON`
`CALC:LIM:ACP:ALT1 0dB,0dB`
`CALC:LIM:ACP:ALT1:STAT ON`
`CALC:LIM:ACP:ALT1:ABS -10dBm,-10dBm`
`CALC:LIM:ACP:ALT1:ABS:STAT ON`
`CALC:LIM:ACP:ALT2 0dB,0dB`
`CALC:LIM:ACP:ALT2:STAT ON`
`CALC:LIM:ACP:ALT2:ABS -10dBm,-10dBm`
`CALC:LIM:ACP:ALT2:ABS:STAT ON`

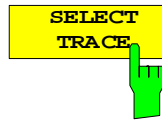

The *SELECT TRACE* softkey selects the trace on which the CP/ACP measurement is to be performed. Only activated traces can be selected, i.e. traces not set to BLANK.

IEC/IEEE-bus command: SENS:POW:TRAC 1

Examples:

1. Measurement of adjacent-channel power for a specific standard:

The adjacent-channel power is to be measured for a signal at 800 MHz with 0 dBm level in line with IS136.

[PRESET]	Set the R&S FSMR to the default setting.
[FREQ: CENTER: 800 MHz]	Set the center frequency to 800 MHz.
[AMPT: 0 dBm]	Set the reference level to 0 dBm.
[MEAS]	Call the menu for the measurement functions.
[CHAN PWR / ACP]	Select the channel and adjacent-channel power measurement function. The measurement is performed with the default settings or a previously defined setting. The submenu for setting the desired new configuration is opened.
[CP/ACP STANDARD: select IS136: ENTER]	Select the NADC (IS136) standard.
[CP/ACP CONFIG]	Call the submenu for configuration of the adjacent-channel power measurement.
[NO. OF ADJ CHAN: 2 ENTER]	Select two adjacent channels for the measurement, i.e. the adjacent channel and the alternate channel are measured.
[ADJUST SETTINGS]	Set the optimum span, resolution bandwidth (RBW), video bandwidth (VBW) and detector automatically for the measurement. The absolute channel power and the relative power of the adjacent channels are displayed on the screen.
	Change to the main menu for channel power measurement.
[ADJUST REF LVL]	Set the reference level equal to the channel power measured.

2. Measurement with user-specific channel configuration:

Measurement of the adjacent-channel power ratio (ACPR) of an IS95 CDMA signal at 800 MHz, level 0 dBm. Similar to example 1, the setting can be simplified by using *CP/ACP STANDARD*.

- [PRESET] Set the R&S FSMR to the default setting.
- [FREQ: CENTER: 800 MHz] Set the center frequency to 800 MHz.
- [AMPT: 0 dBm] Set the reference level to 0 dBm.
- [MEAS] Call the menu for the measurement functions.
- [CHAN PWR / ACP] Select the channel and adjacent-channel power measurement function. The measurement is carried out with the default settings or a previously defined setting. The submenu for setting the desired new configuration is opened.
- [CP/ACP CONFIG] Call the submenu for defining the channel configuration.
- [NO. OF ADJ CHAN: 2 ENTER] Select two adjacent channels for the measurement, i.e. the adjacent channel and the alternate channel are measured.



[CHANNEL BANDWIDTH:

1.23 MHz: : 30 kHz] Set the channel bandwidth to 1.23 MHz in accordance with IS 95. Set the adjacent-channel bandwidth to 30 kHz.

TX/ACP CHANNEL BW	
CHAN	BANDWIDTH
TX	1.23 MHz
ADJ	30 kHz
ALT1	30 kHz
ALT2	30 kHz

Upon entry of 30 kHz for the adjacent channel the alternate channels are also set to 30 kHz.

[CHAN SPACING:

1.25 MHz: 
 885 kHz: 
 -1.98 MHz] 
 2.97 MHz]

Open the list for entering the channel spacings.

TX/ACP CHAN SPACING	
CHAN	SPACING
TX	1.25 MHz
ADJ	885 kHz
ALT1	1.98 MHz
ALT2	2.97 MHz

Upon entry of 885 kHz for the adjacent channel the channels ALT1 and ALT2 are set to 1770 kHz and 2655 kHz. Upon entry of 1.98 MHz for the alternate channel 1 the alternate channel 2 is set to 2.97 MHz.

[ADJUST SETTINGS]

Automatically set the optimum span (= 5 MHz), resolution bandwidth (RBW = 30 kHz), video bandwidth (VBW = 300 kHz) and detector (RMS) for the measurement. The absolute channel power and the relative power of the adjacent channels and alternate channels are displayed on the screen.



Go to the main menu for channel power measurement.

[ADJUST REF LVL]

Set the reference level equal to the channel power measured.

3. Measurement of signal/noise power density (C/No) of an IS95 CDMA signal (frequency 800 MHz, level 0 dBm)

[PRESET]	Set the R&S FSMR to the default setting.
[FREQ: CENTER: 800 MHz]	Set the center frequency to 800 MHz.
[AMPT: 0 dBm]	Set the reference level to 0 dBm.
MEAS]	Call the menu for the measurement functions.
[CHAN PWR / ACP]	Select the channel and adjacent-channel power measurement. The measurement is performed with the default setting or a previously defined setting. The submenu for setting the desired new configuration is opened.
[CP/ACP CONFIG]	Call the submenu for defining the channel configuration.
[NO. OF ADJ CHAN: 0 ENTER]	Do not select an adjacent channel for the measurement, i.e. the measurement is carried out in one channel only.
[CHANNEL BANDWIDTH: 1.23 MHz]	Set the channel bandwidth to 1.23 MHz in line with IS95.
[ADJUST SETTINGS]	Set the optimum span (= 5 MHz), resolution bandwidth (RBW = 30 kHz), video bandwidth (VBW = 300 kHz) and detector (RMS) for the measurement automatically. The absolute channel power and the relative power of the adjacent channels and alternate channels are displayed on the screen.
	Go to the main menu for channel power measurement
[ADJUST REF LVL]	Set the reference level equal to the channel power measured.
[SET CP REFERENCE]	Set the measured channel power as a reference for the subsequent measurements.
[CP/ACP ABS / REL]	Select relative measurement related to the reference power set with SET REFERENCE (result 0 dB).
[CHAN PWR / HZ]	Select power measurement related to 1 Hz bandwidth (result -60.9 dB).
[FREQ: CENTER: 805 MHz]	Set the center frequency to 805 MHz. The R&S FSMR measures the channel power at 1.23 MHz bandwidth and outputs the result in dB relative to the reference power and 1 Hz bandwidth.

Measurement of Occupied Bandwidth

An important characteristics of a modulated signal is its occupied bandwidth. In a radio communications system for instance the occupied bandwidth must be limited to enable distortion-free transmission in adjacent channels. The occupied bandwidth is defined as the bandwidth containing a defined percentage of the total transmitted power. A percentage between 10% and 99.9% can be set on the R&S FSMR.

MEAS OCCUPIED BANDWIDTH menu:

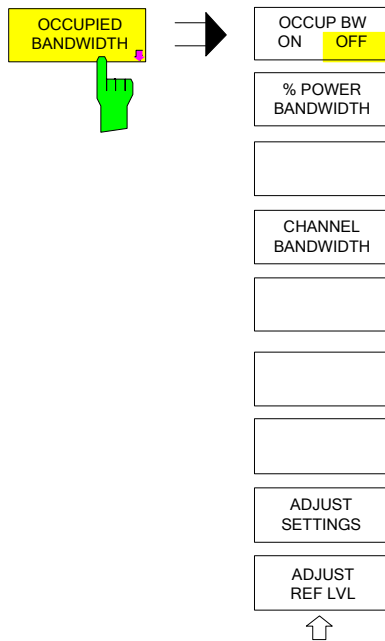

The *OCCUPIED BANDWIDTH* softkey activates measurement of the occupied bandwidth according to the current configuration and opens the submenu for configuring the measurement. The softkey is available only in frequency domain (span > 0) and is highlighted when the measurement is switched on.

In the spectrum display mode, this measurement determines the bandwidth that contains a predefined percentage of the power of the displayed frequency range (*% POWER BANDWIDTH* softkey). The occupied bandwidth is output in the marker display field and marked on the trace by temporary markers.



The softkey is only available in the frequency domain (span > 0).

The measurement is performed on the trace with marker 1. In order to evaluate another trace, marker 1 must be placed on another trace by means of SELECT TRACE in the MKR menu.



The *OCCUP BW ON/OFF* softkey switches measurement of the occupied bandwidth on or off.

IEC/IEEE-bus command: `CALC:MARK:FUNC:POW:SEL OBW`
`CALC:MARK:FUNC:POW:RES? OBW`
`CALC:MARK:FUNC:POW OFF`

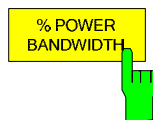

The *% POWER BANDWIDTH* softkey opens the entry of the percentage of power related to the total power in the displayed frequency range which defines the occupied bandwidth (percentage of total power). The valid range of values is 10% to 99.9%.

IEC/IEEE-bus command: `SENS:POW:BWID 99PCT`

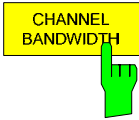

The *CHANNEL BANDWIDTH* softkey opens an input window for defining the channel bandwidth for the transmission channel. For measurements in line with a specific transmission standard, the bandwidth specified by the standard for the transmission channel must be entered.

The default setting is 14 kHz.

The specified channel bandwidth is used for optimization of the test parameters of the R&S FSMR with *ADJUST SETTINGS*.

IEC/IEEE-bus command: `SENS:POW:ACH:BWID 14kHz`

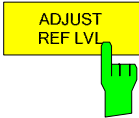

The *ADJUST REF LVL* softkey adjusts the reference level of the R&S FSMR to the measured total power of the signal. The softkey is activated after the first sweep with the measurement of the occupied bandwidth has been completed and the total power of the signal is thus known.

Adjusting the reference level ensures that the signal path of the R&S FSMR will not be overloaded and the dynamic range not limited by too low a reference level.

Since the measurement bandwidth for channel power measurements is significantly lower than the signal bandwidth, the signal path may be overloaded although the trace is distinctly below the reference level. If the measured channel power is equal to the reference level, the signal path cannot be overloaded.

IEC/IEEE-bus command: `SENS:POW:ACH:PRES:RLEV`

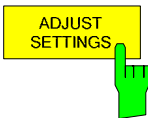

The *ADJUST SETTINGS* softkey optimizes the instrument settings for the measurement of the occupied bandwidth according to the specified channel bandwidth.

All instrument settings relevant for power measurement within a specific frequency range, such as

- frequency span 3 x channel bandwidth
- resolution bandwidth $RBW \leq 1/40$ of channel bandwidth
- video bandwidth $VBW \geq 3 \times RBW$
- detector RMS are optimized.

The reference level is not influenced by *ADJUST SETTINGS*. For an optimum dynamic range it should be selected in a way that the signal maximum is close to the reference level.

The adjustment is carried out only once; if necessary, the instrument settings may be changed later.

IEC/IEEE-bus command: `SENS:POW:PRES OBW`

Measurement principle:

For example, the bandwidth containing 99% of the signal power is to be determined. The routine first calculates the total power of all displayed points of the trace. In the next step, the points from the right edge of the trace are summed up until 0.5% of the total power is reached. Auxiliary marker 1 is positioned at the corresponding frequency. Then the R&S FSMR sums up the points from the left edge of the trace until 0.5% of the power is reached. Auxiliary marker 2 is positioned at this point. 99% of the power is now between the two markers. The distance between the two frequency markers is the occupied bandwidth which is displayed in the marker info field.

A prerequisite for correct measurement is that only the signal to be measured is visible on the screen of the R&S FSMR. An additional signal would invalidate the measurement.

To ensure correct power measurement especially for noise signals and to obtain the correct occupied bandwidth, the following settings should be selected:

RBW	<< occupied bandwidth (approx. 1/20 of occupied bandwidth, for voice communication type. 300 Hz or 1 kHz)
VBW	$\geq 3 \times$ RBW
Detector	RMS or sample
Span	≥ 2 to $3 \times$ occupied bandwidth

Some of the measurement specifications (e.g. PDC, RCR STD-27B) require measurement of the occupied bandwidth using a peak detector. The detector setting of the R&S FSMR has to be changed accordingly then.

Example:

Measurement of occupied bandwidth of a PDC signal at 800 MHz, level 0 dBm

[PRESET]	Set the R&S FSMR to the default setting.
[FREQ: CENTER: 800 MHz]	Set the center frequency to 800 MHz.
[AMPT: 0 dBm]	Set the reference level to 0 dBm.
[MEAS]	Call the menu for the measurement functions.
[OCCUPIED BANDWIDTH]	Select measurement of the occupied bandwidth and open the submenu for configuring the measurement.
[% POWER BANDWIDTH: 99 %]	Select 99% for the bandwidth to be measured.
[CHANNEL BANDWIDTH: 21 kHz]	Enter the channel bandwidth of 21 kHz specified by PDC.
[ADJUST SETTINGS]	Optimize the measurement parameters for the specified channel bandwidth. Allow for a complete frequency sweep so that the R&S FSMR can determine the total signal power.
[ADJUST REF LVL]	Adjust the reference level to the measured signal power.
[TRACE: DETECTOR: DETECTOR MAX PEAK]	PDC requires measurement of the occupied bandwidth using a peak detector. Therefore, switch on the peak detector instead of the RMS detector selected by ADJUST SETTINGS.

Measurement of Signal Amplitude Statistics

Digital modulated signals are similar to white noise within the transmit channel, but are different in their amplitude distribution. In order to transmit the modulated signal without distortion all amplitudes of the signal have to be transmitted linearly, e. g. from the output power amplifier. Most critical are the peak amplitude values, of course.

Degradation in transmit quality caused by a transmitter two port network is dependent on the amplitude of the peak values as well as on their probability.

The probability of amplitude values can be measured with the APD function (Amplitude Probability Distribution). During a selectable measurement time all occurring amplitude values are assigned to an amplitude range. The number of amplitude values in the specific ranges is counted and the result is displayed as a histogram. Each bar of the histogram represents the percentage of measured amplitudes within the specific amplitude range.

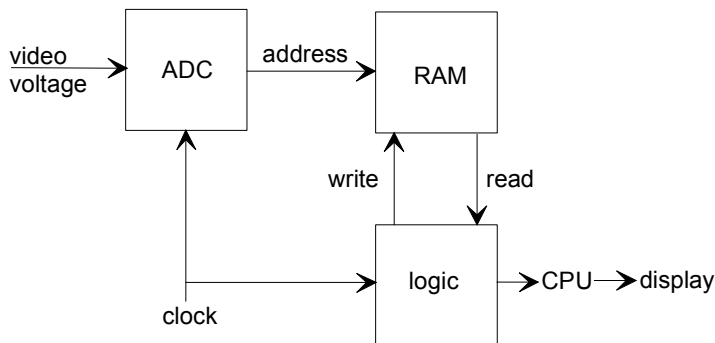

Fig. 4.16-3 Simplified block diagram for APD measurement

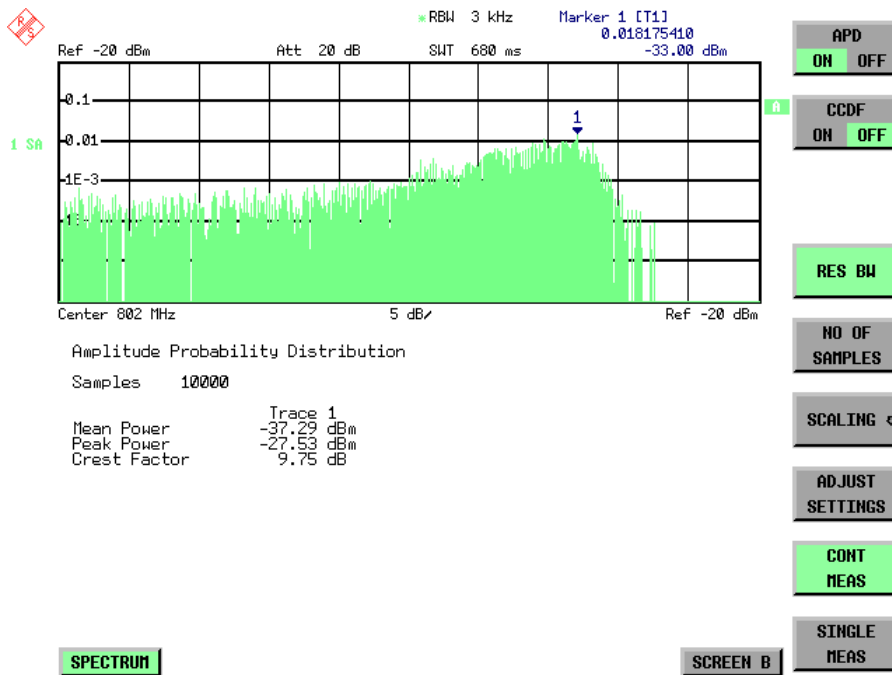

Fig. 4.16-4 Display of the amplitude probability distribution

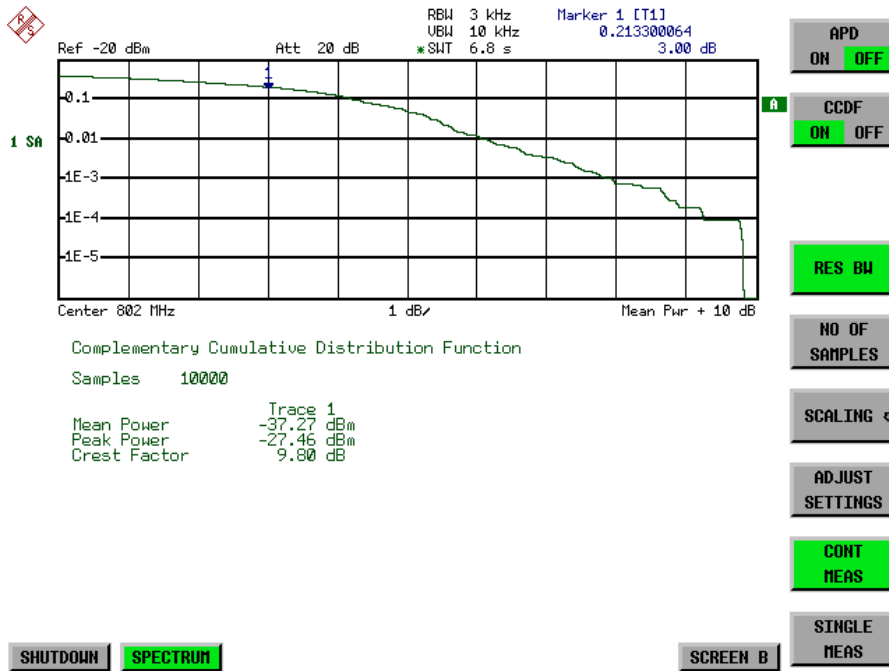

Fig. 4.16-5 Display of the complementary cumulative distribution function (CCDF)

Alternate to the histogram display of the APD the Complementary Cumulative Distribution Function (CCDF) can be displayed. It shows the probability of an amplitude exceeding a specific value. For the APD function the x-axis is scaled in absolute values in dBm, whereas for the CCDF function the x-axis is scaled relative to the MEAN POWER measured.

Definitions:

Crest factor = peak voltage to rms

CCDF = complementary cumulative distribution function



During an active statistic measurement the functions FULL SCREEN, SPLIT SCREEN and selection of the active diagram via SCREEN A / SCREEN B are disabled.

MEAS SIGNAL STATISTIC submenu :

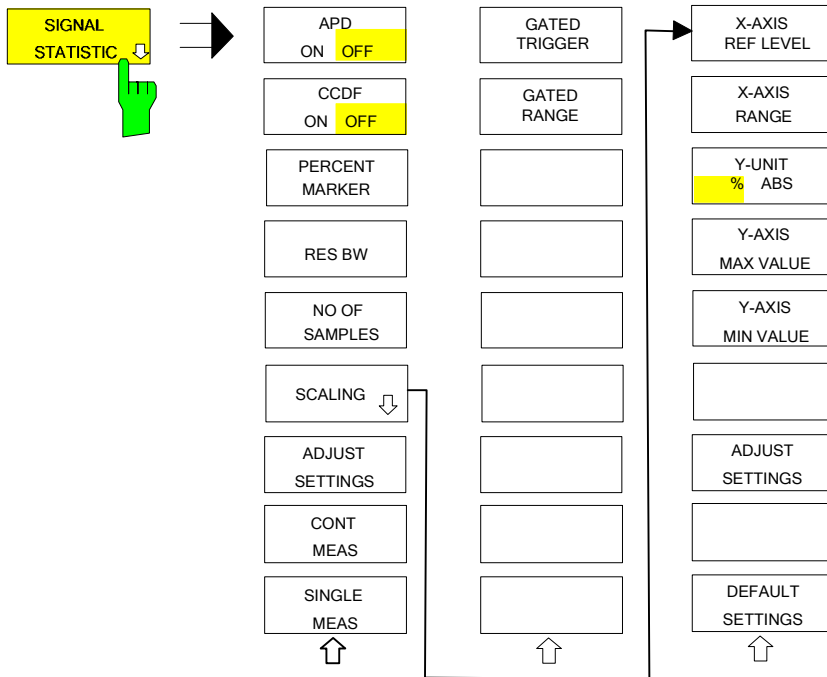

The *SIGNAL STATISTIC* softkey opens a submenu for measurement of signal statistics. In the submenu measurement of amplitude probability density (*APD*) and complementary cumulative distribution (*CCDF*) can be selected alternately. Only one of the signal statistic functions can be switched on at a time.

In default mode all statistic functions are switched off. With a statistic function switched on the R&S FSMR is set into zero span mode automatically.

The R&S FSMR measures the statistics of the signal applied to the RF input with the resolution bandwidth set. In order not to influence the peak amplitudes the video bandwidth is automatically set to 10 times the resolution bandwidth. The sample detector is used for detecting the video voltage.

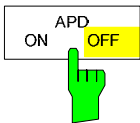

The *APD ON/OFF* softkey switches on or off the amplitude probability distribution function. When the APD function is switched on, the CCDF function is switched off automatically.

IEC/IEEE-bus command: `CALC:STAT:APD ON`

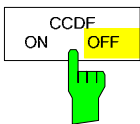

The *CCDF ON/OFF* softkey switches on or off the complementary cumulative distribution function. When the CCDF function is switched on, the APD function is switched off automatically.

IEC/IEEE-bus command: `CALC:STAT:CCDF ON`

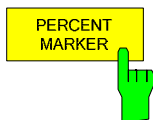

If the CCDF function is active, the *PERCENT MARKER* softkey allows to position marker 1 by entering a probability value. Thus, the power which is exceeded with a given probability can be determined very easily. If marker 1 is in the switched-off state, it will be switched on automatically.

IEC/IEEE-bus command: `CALC:MARK:Y:PERC 0...100%`

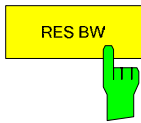

The *RES BW* softkey sets the resolution bandwidth in the menu *STATISTIC FUNCTION* directly without switching to the corresponding menu (*BW*). The function of the softkey is identical to the softkey *RES BW MANUAL* in the menu *BW*.

For correct measurement of the signal statistics the resolution bandwidth has to be wider than the signal bandwidth in order to transmit the actual peaks of the signal amplitude correctly. Video bandwidth is set to 10 MHz automatically with a statistic function switched on.

IEC/IEEE-bus command: `SENS:BAND 3 MHz`

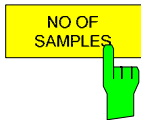

The *NO OF SAMPLES* softkey sets the number of power measurements taken into account for the statistics.

Please note that the overall measurement time is influenced by the number of samples selected as well as by the resolution bandwidth set up for the measurement as the resolution bandwidth directly influences the sampling rate.

IEC/IEEE-bus command: `CALC:STAT:NSAM <value>`

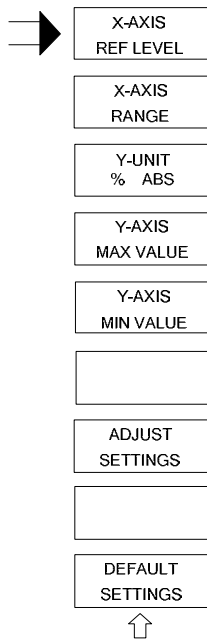
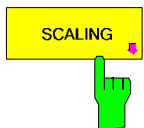

The *SCALING* softkey opens a sub menu that allows changing the scaling parameters for both the x- and the y-axis.

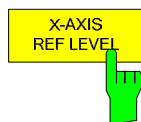

The *X-AXIS REF LEVEL* softkey changes the level settings of the instrument and sets the maximum power to be measured.

The function is identical to softkey *REF LEVEL* in menu *AMPT*. For the *APD* function this value is mapped to the right diagram border. For the *CCDF* function there is no direct representation of this value on the diagram as the x-axis is scaled relatively to the *MEAN POWER* measured.

IEC/IEEE command: `CALC:STAT:SCAL:X:RLEV <value>`

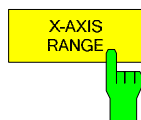

The *X-AXIS RANGE* softkey changes the level range to be covered by the statistics measurement selected.

The function is identical to softkey *RANGE LOG MANUAL* in menu *AMPT*.

IEC/IEEE command: `CALC:STAT:SCAL:X:RANG <value>`

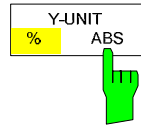

The *Y-UNIT %/ABS* softkey defines the scaling type on the y-axis. The default case are the absolute probability. This can be changed to percent values. The softkeys *Y-AXIS MIN* and *Y-AXIS MAX* are using values based on the *Y-UNIT* setting.

IEC/IEEE command: `CALC:STAT:SCAL:Y:UNIT PCT | ABS`

The 0.01%, 0.1%, 1% and 10% value from the CCDF measurement are shown in the bottom screen half. Those values can also queried via remote:

IEC/IEEE command:

`CALC:STAT:CCDF:X? P0_01 | P0_1 | P1 | P10`

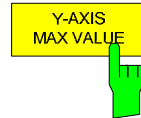

The *Y-AXIS MAX VALUE* softkey defines the upper limit of the displayed probability range.

Values on the y-axis are normalized which means that the maximum value is 1.0. As the y-axis scaling has a logarithmic axis the distance between max and min value must be at least one decade.

IEC/IEEE command: `CALC:STAT:SCAL:Y:UPP <value>`

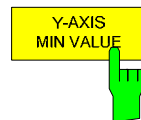

The *Y-AXIS MIN VALUE* softkey defines the lower limit of the displayed probability range.

As the y-axis scaling has a logarithmic axis the distance between max and min value must be at least one decade. Valid values are in the range $0 < \text{value} < 1$.

IEC/IEEE command: `CALC:STAT:SCAL:Y:LOW <value>`

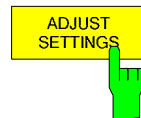

see below

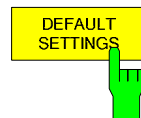

The *DEFAULT SETTINGS* softkey resets the x- and y-axis scalings to their PRESET values.

x-axis ref level: -20 dBm

x-axis range APD: 100 dB

x-axis range CCDF: 20 dB

y-axis upper limit: 1.0

y-axis lower limit: 1E-6

IEC/IEEE-bus command: `CALC:STAT:PRES`

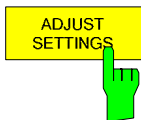

The *ADJUST SETTINGS* softkey optimizes the level settings of the R&S FSMR according to the measured peak power in order to gain maximum sensitivity of the instrument.

The level range is adjusted according to the measured difference between peak and minimum power for APD measurement and peak and mean power for CCDF measurement in order to obtain maximum power resolution.

Additionally the probability scale is adapted to the selected number of samples.

IEC/IEEE-bus command: `CALC:STAT:SCAL:AUTO ONCE`

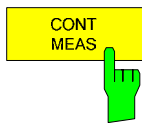

The *CONT MEAS* softkey starts collecting a new sequence of sample data and calculating the APD or CCDF curve depending on the selected measurement. The next measurement is started automatically as soon as the indicated number of samples has been reached ("CONTInuous MEASUrement").

IEC/IEEE-bus command: INIT:CONT ON;
 INIT:IMM

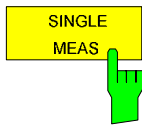

The *SINGLE MEAS* softkey starts collecting a new sequence of sample data and calculating the APD or CCDF curve depending on the selected measurement. At the beginning of the measurement previously obtained measurement results are discarded.

IEC/IEEE-bus command: INIT:CONT OFF;
 INIT:IMM

Hint for usage of the marker functions with measurement of signal statistics:

With the signal statistic measurement level always is displayed on x-axis. Y-axis always is a normalized value between 0 and 1. In contrary to use of marker in frequency or time domain marker is input in level values and the output is in percentage values.

Example:

Measurement of CCDF of a IS95 BTS signal, level 0 dBm, frequency 800 MHz

[PRESET]	Switch on preset settings.
[FREQ: CENTER: 800 MHz]	Set center frequency to 800 MHz.
[AMPT: 10 dBm]	Set reference level to 10 dBm.
[BW: 3 MHz]	Set resolution bandwidth to 3 MHz (resolution bandwidth shall be wider then signal bandwidth (1.25 MHz) in order to have the complete signal within the resolution bandwidth).
[MEAS]	Call the menu for measurement functions.
[SIGNAL STATISTIC]	Call the menu for signal statistics measurement.
[CCDF ON /OFF]	Switch on measurement of the complementary cumulative distribution function. The R&S FSMR switches to zero span mode. The power of the signal and the CCDF is calculated for the number of samples selected. With the CCDF function sample detector and video bandwidth are set automatically.
[NO OF SAMPLES: 10000]	Set the number of measurement samples to 10000.
[SINGLE MEAS]	Start the measurement sequence. At the end the resulting trace will display the CCDF for the measured 10000 samples.

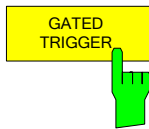

Statistic measurements on pulsed signals can be done using GATED TRIGGER. An external frame trigger is required as a time (frame) reference.

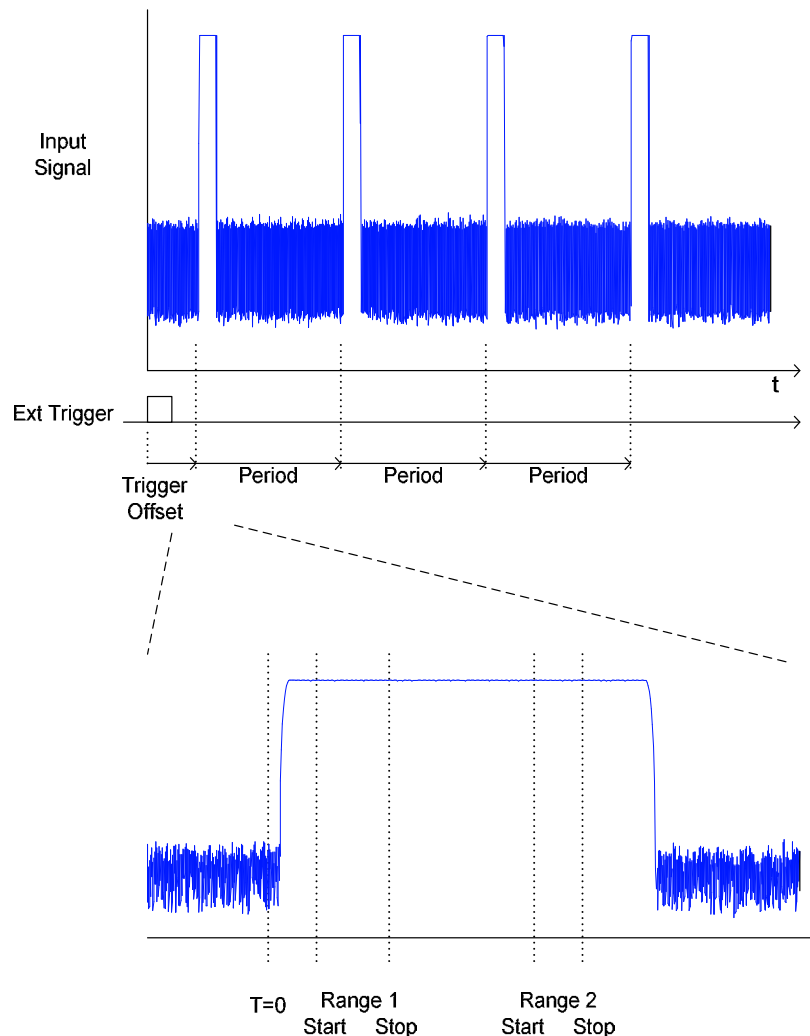

The gate ranges define the part of the I/Q capture data taken into account for the statistics calculation.

These ranges are defined relative to a reference point $T=0$. The gate interval is repeated every period time until the end of the I/Q capture buffer.

The reference point $T=0$ is defined by the external trigger event and the instrument's trigger offset.

GATED TRIGGER activates the gating for statistics functions. The trigger source is changed to EXTERN if this function is switched on.



The I/Q data capturing is repeated until the configured number of valid samples is reached. If the active gate period is outside the I/Q capture buffer or the resulting gate time is zero the measurement will not reach its end. In this case, the range start and stop values have to be checked.

IEC/IEEE-bus command: SENS2:SWE:EGAT ON | OFF

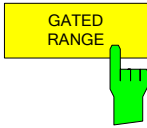

GATED RANGE opens a table to configure up to 3 gate ranges for each trace.

GATE RANGES			
	Trace 1	Trace 2	Trace 3
Comment			
Period	4.615 ms		
Range 1 Start	0 us		
Range 1 Stop	200 us		
Range 1 Use Range	YES		
Range 2 Start			
Range 2 Stop			
Range 2 Use Range			
Range 3 Start			
Range 3 Stop			
Range 3 Use Range			

- Comment: Comment string
- Period: Period of the signal to be measured.
The signal period is common for all ranges.
- Range x Start: Begin of time period to be taken into account.
- Range x Stop: End of time period to be taken into account.
- Use Range: YES / NO: Allows to temporarily disable a range.



The timing values have full numerical resolution and are only rounded for display.

```
IEC/IEEE-bus command:
SENS:SWE:EGAT:TRAC3:COMM
SENSe:SWE:EGAT:TRAC3:STAT ON | OFF
SENS:SWEep:EGAT:TRAC3:STAR2 value
SENS:SWE:EGAT:TRAC3:STOP3 value
SENSe:SWEep:EGATe:TRACe<1...3>: PERiod value
```

Gated statistics configuration example:

A statistics evaluation has to be done over the useful part of the signal between t3 and t4.
The period of the GSM signal is 4.61536 ms

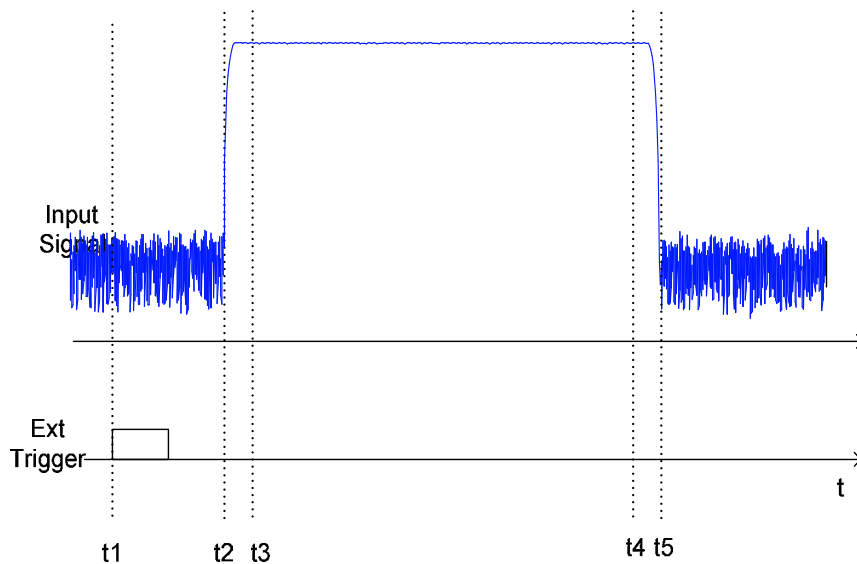

- t1: External positive trigger slope
- t2: Begin of burst (after 25 μs)
- t3: Begin of useful part, to be used for statistics (after 40 μs)
- t4: End of useful part, to be used for statistics (after 578 μs)
- t5: End of burst (after 602 μs)

The instrument has to be configured as follows:

Trigger Offset	$t_2 - t_1 = 25 \mu\text{s}$	now the gate ranges are relative to t2
Range1 Start	$t_3 - t_2 = 15 \mu\text{s}$	start of range 1 relative to t2
Range1 End	$t_4 - t_2 = 553 \mu\text{s}$	end of range 1 relative to t2

Measurement of Carrier/Noise Ratio C/N and C/No

Using the carrier/noise measurement function, the FSP determines the C/N ratio which can also be shown normalized to a 1 Hz bandwidth (function C/No).

To determine the noise power, a channel at the set center frequency is examined. The bandwidth of the channel is fixed by means of the CHANNEL BANDWIDTH function.

The largest signal in the frequency span is the carrier. It is searched when the function is activated and is marked by means of the REFERENCE FIXED marker. The noise power of the channel is subtracted from the signal level obtained (C/N), and in the case of a C/No measurement it is referred to a 1 Hz bandwidth.

There are two methods for measuring the carrier/noise ratio:

1. The carrier is outside the channel examined:

In this case, it is sufficient to switch on the desired measurement function and to set the channel bandwidth. The carrier/noise ratio is displayed on the screen.

2. The carrier is inside the channel examined:

In this case, the measurement must be performed in two steps. First, the reference measurement is performed with the carrier being active. This is done by switching on either the C/N or the C/No measurement and waiting for the end of the next measurement run. Then, the carrier is switched off so that only the noise of the test setup is active in the channel. The carrier/noise ratio is displayed after the subsequent measurement has been completed.

The ADJUST SETTINGS function facilitates the selection of the frequency span appropriate for the channel bandwidth: it automatically sets the SPAN to approx. 4 x channel bandwidth.

The RMS detector is enabled when the power measurement is switched on (TRACE-DETECTOR-RMS).

Submenu MEAS – C/N, C/No:

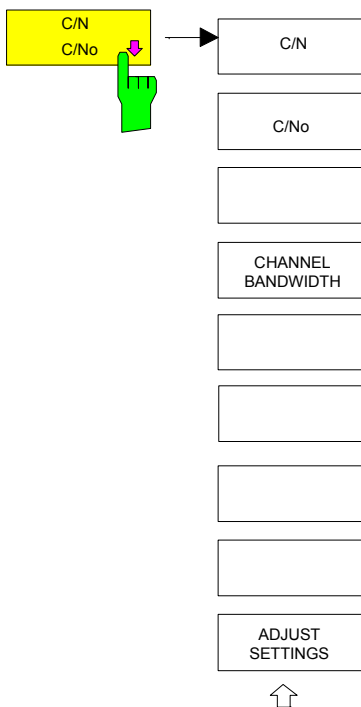

The C/N, C/No softkey opens the submenu for configuring the carrier/noise ratio measurement.

The user can choose between measurement without (C/N) and measurement with reference to the bandwidth (C/No). In addition, it is possible to select the bandwidth of the channel and to adapt the span.



The measurements are only available in the frequency domain (span >0).

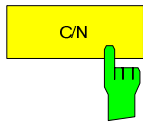

The *C/N* and *C/No* softkeys enable and disable the measurement of the carrier/noise ratio, the *C/No* measurement also being referred to a 1 Hz bandwidth.

The maximum value of the current trace is determined when the function is activated and is marked by means of the *REFERENCE FIXED* marker.

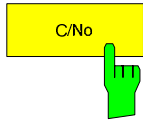

The measurement is performed on the trace where MARKER 1 is located. To measure another trace, MARKER 1 has to be shifted to the trace in question using the SELECT TRACE softkey in the MKR menu.

If no marker is active, MARKER 1 is activated when the function is switched on.

IEC/IEEE-bus command: `CALC:MARK:FUNC:POW:SEL CN`
`CALC:MARK:FUNC:POW:RES? CN`
`CALC:MARK:FUNC:POW:SEL CN0`
`CALC:MARK:FUNC:POW:RES? CN0`
`CALC:MARK:FUNC:POW OFF`

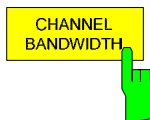

The *CHANNEL BANDWIDTH* softkey opens a window for selecting the measurement channel bandwidth.

The default setting is 14 kHz.

The specified channel bandwidth allows the optimal setting of the measurement parameters of the FSP using *ADJUST SETTINGS*.

IEC/IEEE-bus command: `SENS:POW:ACH:BWID 14kHz`

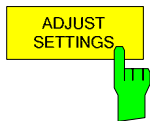

The *ADJUST SETTINGS* softkey adapts the span to the channel bandwidth selected.

For the carrier/noise ratio measurement, the span is set to:

4 x channel bandwidth + measurement margin

The adjustment is performed once; if necessary, the setting can be changed later on.

IEC/IEEE-bus command: `SENS:POW:ACH:PRES CN | CN0`

Measurement of the AM Modulation Depth

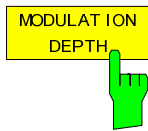

The *MODULATION DEPTH* softkey switches on the measurement of the AM modulation depth. An AM-modulated carrier is required on the screen for ensuring correct operation.

The level value of *MARKER 1* is taken as the carrier level. When this function is activated, *MARKER 2* and *MARKER 3* are automatically set symmetrically to the carrier on the adjacent peak values of the trace as delta markers and *MARKER 2* is activated for the entry.

When the position of *MARKER 2* (delta) is changed, *MARKER 3* (delta) is moved symmetrically with respect to the reference marker (*MARKER 1*).

If the data entry is activated for *MARKER 3* (*MARKER 1 2 3 4* softkey), the latter can be moved for fine adjustment irrespective of *MARKER 2*.

The R&S FSMR calculates the power at the marker positions from the measured levels. The AM modulation depth is calculated from the ratio between the power values at the reference marker and at the delta markers. When the powers of the two AM side bands are unequal, the mean value of the two power values is used for AM modulation depth calculation.

Measurement example:

The AM modulation depth of a carrier modulated with 1 kHz is to be measured at 100 MHz.

[PRESET]	The R&S FSMR is set to the default setting.
[CENTER: 100 MHz]	The center frequency is set to 100 MHz.
[SPAN: 5 kHz]	The span is set to 5 kHz.
[AMPT: 0 dBm]	The reference level is set to 0 dBm.
[MKR FCTN]	<i>MARKER 1</i> is switched on and positioned at the maximum of the displayed trace.
[MODULATION DEPTH: 1 kHz]	The measurement of the AM modulation depth is switched on. <i>MARKERS 2</i> and <i>3</i> (delta markers) are set to the adjacent peak values of the trace and are activated for the frequency entry. The AM modulation depth is output in % in the marker info field. When 1 kHz is entered, <i>MARKER 2</i> can be exactly positioned on 1 kHz and <i>MARKER 3</i> at -1 kHz from the reference marker.

IEC/IEEE-bus command: `CALC:MARK:FUNC:MDEP ON;`
 `CALC:MARK:FUNC:MDEP:RES?`

Spectrum Emission Mask Measurement

The Spectrum Emission Mask (SEM) measurement defines a measurement that monitors compliance with a spectral mask. The SEM measurement of the base unit allows a flexible definition of all parameters in the SEM measurement. The analyzer performs measurements in predefined frequency ranges with settings that can be specified individually for each of these ranges.

For this purpose, the SWEEP LIST settings or the current instrument settings are used. Up to 20 subranges can be defined (they need not directly follow one another) across which the analyzer sweeps in subsequent order. However, the measurement ranges must not overlap. The measurement parameters can be selected independently from each other in every subrange (SWEEP LIST menu, EDIT SWEEP LIST).

In the Spectrum Emission Mask, as in the Spurious Emissions measurement, a range defines a segment, for which you can define the following parameters separately: start and stop frequency, RBW, VBW, sweep time, reference level, attenuator settings, and limit values. Via the sweep list, you define the ranges and their settings (for details on settings refer to the SWEEP LIST softkey).

The following rules apply to ranges:

- The minimum span of a range is 10 Hz.
- The individual ranges must not overlap (but need not directly follow one another).
- The maximum number of ranges is 20.
- A minimum of three ranges is mandatory.
- The reference range cannot be deleted (it is marked in with "Ref").

The frequency range where measurements are actually performed is set by the start and stop frequency parameters of the analyzer; these parameters are independent of the sweep ranges. It is thus possible to define sweep ranges for a measurement task that can be stored and reloaded and to quickly and easily set the frequency range to be actually measured by means of two parameters; complex editing in the sweep table is not necessary.

Provided XML Files for the Spectrum Emission Mask Measurement

You can change the settings manually or via XML files. The XML files offer a quick way to change the configuration. A set of ready-made XML files for different standards is already provided. For details see Table 4.16-1 Provided XML files. You can also create and use your own XML files (for details see Format Description of Spectrum Emission Mask XML files. All XML files are stored under D:\r_s\instr\sem_std. Use the LOAD STANDARD softkey for quick access to the available XML files.

Table 4.16-1 Provided XML files

Path and file name		Displayed standard characteristics*
D:\r_s\instr\sem_std\cdma2000\DL		
	\default0.xml	cmda2000 BC0 DL
	\default1.xml	cmda2000 BC1 DL
D:\r_s\instr\sem_std\cdma2000\UL		
	\default0.xml	cmda2000 BC0 UL
	\default1.xml	cmda2000 BC1 UL
D:\r_s\instr\sem_std\EUTRA-LTE\DL\CategoryA		
	\BW_01_4_MHz__CFhigher1GHz.xml	LTE Category A (Freq. > 1GHz) DL
	\BW_01_4_MHz__CFlower1GHz.xml	LTE Category A (Freq. < 1GHz) DL
	\BW_03_0_MHz__CFhigher1GHz.xml	LTE Category A (Freq. > 1GHz) DL
	\BW_03_0_MHz__CFlow1GHz.xml	LTE Category A (Freq. < 1GHz) DL
	\BW_05_0_MHz__CFhigher1GHz.xml	LTE Category A (Freq. > 1GHz) DL
	\BW_05_0_MHz__CFlower1GHz.xml	LTE Category A (Freq. < 1GHz) DL
	\BW_10_0_MHz__CFhigher1GHz.xml	LTE Category A (Freq. > 1GHz) DL
	\BW_10_0_MHz__CFlower1GHz.xml	LTE Category A (Freq. < 1GHz) DL
	\BW_15_0_MHz__CFhigher1GHz.xml	LTE Category A (Freq. > 1GHz) DL
	\BW_15_0_MHz__CFlower1GHz.xml	LTE Category A (Freq. < 1GHz) DL
	\BW_20_0_MHz__CFhigher1GHz.xml	LTE Category A (Freq. > 1GHz) DL
	\BW_20_0_MHz__CFlower1GHz.xml	LTE Category A (Freq. < 1GHz) DL
D:\r_s\instr\sem_std\EUTRA-LTE\UL\CategoryB		
	\BW_01_4_MHz__CFhigher1GHz.xml	LTE Category B (Freq. > 1GHz) DL
	\BW_01_4_MHz__CFlower1GHz.xml	LTE Category B (Freq. < 1GHz) DL
	\BW_03_0_MHz__CFhigher1GHz.xml	LTE Category B (Freq. > 1GHz) DL
	\BW_03_0_MHz__CFlow1GHz.xml	LTE Category B (Freq. < 1GHz) DL
	\BW_05_0_MHz__CFhigher1GHz.xml	LTE Category B (Freq. > 1GHz) DL
	\BW_05_0_MHz__CFlower1GHz.xml	LTE Category B (Freq. < 1GHz) DL

Path and file name		Displayed standard characteristics*
	\\BW_10_0_MHz_CFhigher1GHz.xml	LTE Category B (Freq. > 1GHz) DL
	\\BW_10_0_MHz_CFflower1GHz.xml	LTE Category B (Freq. < 1GHz) DL
	\\BW_15_0_MHz_CFhigher1GHz.xml	LTE Category B (Freq. > 1GHz) DL
	\\BW_15_0_MHz_CFflower1GHz.xml	LTE Category B (Freq. < 1GHz) DL
	\\BW_20_0_MHz_CFhigher1GHz.xml	LTE Category B (Freq. > 1GHz) DL
	\\BW_20_0_MHz_CFflower1GHz.xml	LTE Category B (Freq. < 1GHz) DL
D:\r_s\instr\sem_std\EUTRA-LTE\UL\Standard		
	\\BW_05_0_MHz.xml	LTE UL
	\\BW_10_0_MHz.xml	LTE UL
	\\BW_15_0_MHz.xml	LTE UL
	\\BW_20_0_MHz.xml	LTE UL
D:\r_s\instr\sem_std\WCDMA\3GPP\DL		
	\\PowerClass_31_39.xml	W.CDMA 3GPP (31,39)dBm DL
	\\PowerClass_39_43.xml	W.CDMA 3GPP (39,43)dBm DL
	\\PowerClass_43_INF.xml	W.CDMA 3GPP (43,INF)dBm DL
	\\PowerClass_negINF_31.xml	W.CDMA 3GPP (-INF,31)dBm DL
D:\r_s\instr\sem_std\WCDMA\3GPP\UL		
	\\3GPP_UL.xml	W.CDMA 3GPP UL
D:\r_s\instr\sem_std\WIBRO\DL		
D:\R_S\instr\sem_std\WIMAX\DL\IEEE		
	\\10MHz.xml	WIMAX 10MHz DL
	\\20MHz.xml	WIMAX 20MHz DL
D:\R_S\instr\sem_std\WIMAX\UL\ETSI ... MHz (1.75 MHz, 2.00 MHz, 3.50 MHz, 7.00 MHz, 14.00 MHz, 28.00 MHz)		
	\\System_Type_E.xml	WIMAX System Type_E UL
	\\System_Type_F.xml	WIMAX System Type_F UL
	\\System_Type_G.xml	WIMAX System Type_G UL
D:\R_S\instr\sem_std\WIMAX\UL\IEEE		

Path and file name		Displayed standard characteristics*
	\\10MHz.xml	WIMAX 10MHz UL
	\\20MHz.xml	WIMAX 20MHz UL
D:\R_S\instr\sem_std\WLAN\802_11		
	\\802_11_highpower_US_4_9GHz_public_safety_band_Mask_M_5MHz.xml	802.11 high-power U.S. 4.9GHz public safety band Mask M 5MHz
	\\802_11_highpower_US_4_9GHz_public_safety_band_Mask_M_10MHz.xml	802.11 high-power U.S. 4.9GHz public safety band Mask M 10MHz
	\\802_11_highpower_US_4_9GHz_public_safety_band_Mask_M_20MHz.xml	802.11 high-power U.S. 4.9GHz public safety band Mask M 20MHz
	\\802_11_lowpower_US_4_9GHz_public_safety_band_Mask_L_5MHz.xml	802.11 low-power U.S. 4.9GHz public safety band Mask L 5MHz
	\\802_11_lowpower_US_4_9GHz_public_safety_band_Mask_L_10MHz.xml	802.11 low-power U.S. 4.9GHz public safety band Mask L 10MHz
	\\802_11_lowpower_US_4_9GHz_public_safety_band_Mask_L_20MHz.xml	802.11 low-power U.S. 4.9GHz public safety band Mask L 20MHz
D:\R_S\instr\sem_std\WLAN\802_11_TURBO		
	\\802_11n_40MHz_5GHz_band.xml	802.11n 40MHz 5GHz band
	\\ETSI.xml	ETSI 5GHz RLAN
D:\R_S\instr\sem_std\WLAN\802_11a		
	\\802_11a_10MHz_5GHz_band.xml	802.11a 10MHz 5GHz band
	\\802_11a_20MHz_5GHz_band.xml	802.11a 20MHz 5GHz band
	\\ETSI.xml	ETSI 5GHz RLAN
D:\R_S\instr\sem_std\WLAN\802_11b		
	\\802_11b.xml	80211b
D:\R_S\instr\sem_std\WLAN\802_11j_10MHz		
	\\802_11j_10MHz_4_9_and_5GHz_band.xml	802.11j 10MHz 4.9 and 5GHz band
D:\R_S\instr\sem_std\WLAN\802_11j_20MHz		
	\\802_11j_20MHz_4_9_and_5GHz_band.xml	802.11j 20MHz 4.9 and 5GHz band
D:\R_S\instr\sem_std\WLAN\802_11n		
	\\802_11n_20MHz_5GHz_band.xml	802.11n 20MHz 5GHz band
	\\802_11n_40MHz_5GHz_band.xml	802.11n 40MHz 5GHz band
D:\R_S\instr\sem_std\WLAN\802_11p		
	\\802_11p_5MHz_US_5GHz_band_power_class_A_0dBm.xml	802.11p 5MHz US 5GHz band power class A 0dBm

Path and file name		Displayed standard characteristics*
	\\802_11p_5MHz_US_5GHz_band_power_class_C_20dBm.xml	802.11p 5MHz US 5GHz band power class C 20dBm
	\\802_11p_5MHz_US_5GHz_band_power_class_B_10dBm.xml	802.11p 5MHz US 5GHz band power class B 10dBm
	\\802_11p_5MHz_US_5GHz_band_power_class_D_28_8dBm.xml	802.11p 5MHz US 5GHz band power class D 28.8dBm
	\\802_11p_10MHz_US_5GHz_band_power_class_A_0dBm.xml	802.11p 10MHz US 5GHz band power class A 0dBm
	\\802_11p_10MHz_US_5GHz_band_power_class_B_10dBm.xml	802.11p 10MHz US 5GHz band power class B 10dBm
	\\802_11p_10MHz_US_5GHz_band_power_class_C_20dBm.xml	802.11p 10MHz US 5GHz band power class C 20dBm
	\\802_11p_10MHz_US_5GHz_band_power_class_D_28_8dBm.xml	802.11p 10MHz US 5GHz band power class D 28.8dBm

*abbreviations:

BC: band class

UL: uplink

DL: downlink

TTA: telecommunications technology association

Format Description of Spectrum Emission Mask XML files

The files for importing range settings are in XML format and therefore obey the rules of the XML standard. Below, the child nodes, attributes, and structure defined for the data import is described. Build your own XML files according to these conventions because the instrument can only interpret XML files of a known structure. For example files look in the *D:\r_s\instr\sem_std* folder.



It is mandatory to follow the structure exactly as shown below or else the analyzer is not able to interpret the XML file and error messages are shown on the screen.

For this reason is it recommended to make a copy of an existing file and edit the copy of the file. The default files can be found in the *D:\r_s\instr\sem_std* folder.

Basically, the file consists of three elements that can be defined.

- The first element of the structure is the BaseFormat element. It carries information about basic settings. In this element only the ReferencePower child node has any effects on the measurement itself. The other attributes and child nodes are used to display information about the Spectrum Emission Mask Standard on the measurement screen. The child nodes and attributes of this element are shown in Table 4.16-2.

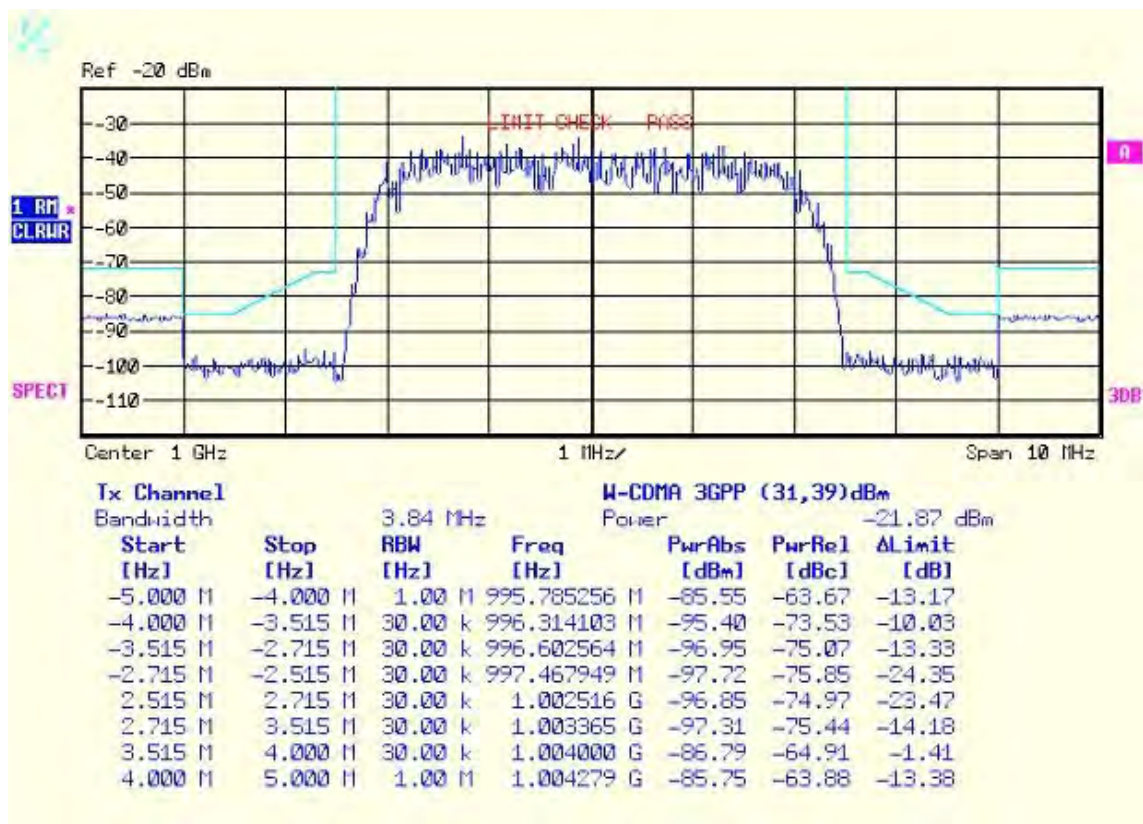

In the example above (PowerClass_31_39.xml under *D:\r_s\instr\sem_std\WCDMA\3GPP*), these attributes are defined as follows:

```
Standard="W-CDMA 3GPP"
LinkDirection="DL"
PowerClass="(31,39)dBm"
```

- The second element is the PowerClass element, which is embedded in the BaseFormat element. It carries settings information about the power classes. The child nodes and attributes of this element are shown in Table 4.16-4.

- The third element is the Range element, which in turn is embedded in the PowerClass element. It carries the settings information of the range. There have to be at least three defined ranges: one reference range and at least one range to either side of the reference range. The maximum number of ranges is twenty.

Note that there are two Limit nodes to be defined: one that gives the limit in absolute values and one in relative values. Make sure units for the Start and Stop nodes are identical for each Limit node. For details refer to the SWEEP LIST softkey and the corresponding parameter description. The child nodes and attributes of this element are shown in Table 4.16-4.

The following tables show the child nodes and attributes of each element and show if a child node or attribute is mandatory for the analyzer to interpret the file or not. Since the hierarchy of the XML can not be seen in the tables, either view one of the default files already stored on the analyzer in the *D:\r_s\instr\sem_std* directory or check the structure as shown below.

Below, a basic example of the structure of the file is shown, containing all mandatory attributes and child nodes. Note that the PowerClass element and the range element are themselves elements of the Base Format element and are to be inserted where noted. The separation is done here simply for reasons of a better overview. Also, no example values are given here to allow a quick reference to the tables above. Italic font shows the placeholders for the values.

- The Base Format element is structured as follows:

```
<RS_SEM_ACP_FileFormat Version="1.0.0.0" Date="2008-02-28T15:21:39Z">
  <Name>Standard</Name>
  <Instrument>
    <Type>Instrument Type</Type>
    <Application>Application</Application>
  </Instrument>
  <MinimumSweepPoints>30001</MinimumSweepPoints>
  <LinkDirection Name="Name">
    <ReferencePower>
      <Method>Method</Method>
    </ReferencePower>
    <PowerClass Index="n">
      <!-- For contents of the PowerClass node see Table 4.16-3 -->
      <!-- Define up to four PowerClass nodes -->
    </PowerClass>
  </LinkDirection>
</RS_SEM_ACP_File>
```

- The PowerClass element is structured as follows:

```
<PowerClass Index="n">
  <StartPower Unit="dBm" InclusiveFlag="true" Value="StartPowerValue"/>
  <StopPower Unit="dBm" InclusiveFlag="false" Value="StopPowerValue"/>
  <DefaultLimitFailMode>Limit Fail Mode</DefaultLimitFailMode>
  <Range Index="n">
    <!-- For contents of the Range node see Table 4.16-3 -->
    <!-- Define up to twenty Range nodes -->
  </Range>
  ...
</PowerClass>
```

- The Range element is structured as follows:

```
<Range Index="n">
  <Name="Name">
```

```

<ChannelType>Channel Type</Channel Type>
<WeightingFilter>
  <Type>FilterType</Type>
  <RollOffFactor>Factor</RollOffFactor>
  <Bandwidth>Bandwidth</Bandwidth>
</WeightingFilter>
<FrequencyRange>
  <Start>RangeStart</Start>
  <Stop>RangeStop</Stop>
</FrequencyRange>
<Limit>
  <Start Unit="Unit" Value="Value"/>
  <Stop Unit="Unit" Value="Value"/>
</Limit>
<Limit>
  <Start Unit="Unit" Value="Value"/>
  <Stop Unit="Unit" Value="Value"/>
</Limit>
<RBW Bandwidth="Bandwidth" Type="FilterType"/>
<VBW Bandwidth="Bandwidth"/>
<Detector>Detector</Detector>
<Sweep Mode="SweepMode" Time="SweepTime"/>
<Amplitude>
  <ReferenceLevel Unit="dBm" Value="Value"/>
  <RFAttenuation Mode="Auto" Unit="dB" Value="Value"/>
  <Preamplifier State="State"/>
</Amplitude>
</Range>

```

Table 4.16-2 Attributes and child nodes of the BaseFormat element

Child Node	Attribute	Value	Parameter Description	Mandatory
	FileFormatVersion	1.0.0.0		Yes
	Date	"YYYY-MM-DD HH:MM:SS"	Date in ISO 8601 format	No
Name	<string>		Name of the standard	Yes
Instrument	Type	FSP Name of the instrument	No	
	Application	SA	Name of the application	No
MinimumSweepPoints	Value	<SweepPoints>	No	
LinkDirection	Name	Downlink Uplink None		Yes
	ShortName	DL UL		No
ReferencePower			Yes	
Method	TX Channel Power TX Channel Peak Power		Yes	
ReferenceChannel	<string>			No

Table 4.16-3 Attributes and child nodes of the PowerClass element

Child Node	Attribute	Value	Parameter Description	Mandatory
	Index	0	Only index 0 is currently supported, others are ignored	Yes
StartPower	Value	<power in dBm>	Start power must equal the stop power of the previous power class. The StartPower value of the first range is -200	No
	Unit	dBm		Yes
	InclusiveFlag	".true"		Yes
StopPower	Value	<power in dBm>	Stop power must equal the start power of the next power class. The StopPower value of the last range is 200	No
	Unit	dBm		
	InclusiveFlag	"false"		Yes
DefaultLimitFailMode		Absolute Relative Absolute and Relative Absolute or Relative		Yes

Table 4.16-4 Attributes and child nodes of the Range element (normal ranges)

Child Node	Attribute	Value	Parameter Description	Mandatory
	Index	0...19	Indexes are continuous and have to start with 0	Yes
	Name	<string>	Name of the range	Only if ReferenceChannel contains a name and range is reference range
	ShortName	<string>	Short name of the range	No
ChannelType		TX Adjacent		Yes
WeightingFilter				Only if ReferenceChannel contains a name and range is reference range
Type		RRC CFILTer	Type of weighting filter	Yes
RollOfffactor		0...1	Excess filter bandwidth	Only if filter type is RRC
Bandwidth		<bandwidth in Hz>	Filter bandwidth	Only if filter type is RRC

Child Node	Attribute	Value	Parameter Description	Mandatory
FrequencyRange				Yes
Start		<frequency in Hz>	Start value of the range	Yes
Stop		<frequency in Hz>	Stop value of the range	Yes
Limit			A Range must contain exactly two limit nodes; one of the limit nodes has to have a relative unit (e.g. dBc), the other one must have an absolute unit (e.g. dBm)	Yes
Start	Value	<numeric value>	Power limit at start frequency	Yes
	Unit	dBm/Hz dBm dBc dBr dB	Sets the unit of start frequency	Yes
Stop	Value	<numeric value>	Power limit at stop frequency	Yes
	Unit	dBm/Hz dBm dBc dBr dB	Sets the unit of stop frequency	Yes
LimitFailMode		Absolute Relative Absolute and Relative Absolute or Relative		No (if specified, it has to be equal to Default-LimitFailMode)
RBW	Bandwidth	<bandwidth in Hz>		Yes
	Type	NORMAL FFT CFILTER RRC PULSE		No
VBW	Bandwidth	<bandwidth in Hz>		Yes
Detector		NEG POS SAMP RMS AVER		No (if specified, it has to be equal in all ranges)
Sweep	Mode	Manual Auto		Yes
	Time	<time in sec>		No
Amplitude				No
ReferenceLevel	Value	<power in dBm>		Yes, if the ReferenceLevel child node is used
	Unit	dBm		Yes, if the ReferenceLevel child node is used
RF Attenuation	Mode	Manual Auto		Yes, if the ReferenceLevel child node is used

ASCII File Export Format (Spectrum Emission Mask)

The first part of the file lists information about the R&S FSMR and the general setup.

File Content	Description
RefType;CPOWER;	Reference range settings
TxBandwidth;9540000M;Hz	
FilterState; ON;	Evaluation list information
Alpha;0.22;	
PeaksPerRange;1;	information about each peak:
Values;4;	
0;-22500000;-9270000;1000000;2986455000;	<range number>;
-74.762840270996094;-10.576210021972656;	<start frequency>
-45.762840270996094;PASS;	<stop frequency>
1;-9270000;-4770000;100000;2991405000;	<resolution bandwidth of range>
-100.17695617675781;-35.990325927734375;	<frequency of peak>
-1.490325927734375;PASS	<absolute power of peak in dBm>
3;4770000;9270000;100000;3005445000;	<relative power of peak in dBc>
-100.17695617675781;-35.990325927734375	(related to the channel power)
;-1.490325927734375;PASS;	<distance to the limit line in dB>
4;9270000;22500000;1000000;3018225000;	(positive value means above the limit line)
-74.762840270996094;-10.576210021972656;	<limit fail> (pass = 0, fail = 1)
-45.762840270996094;PASS;	

SPECTRUM EMISSION MASK

The softkey menu of the Spectrum Emission Mask measurement contains the following softkeys:

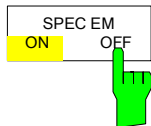
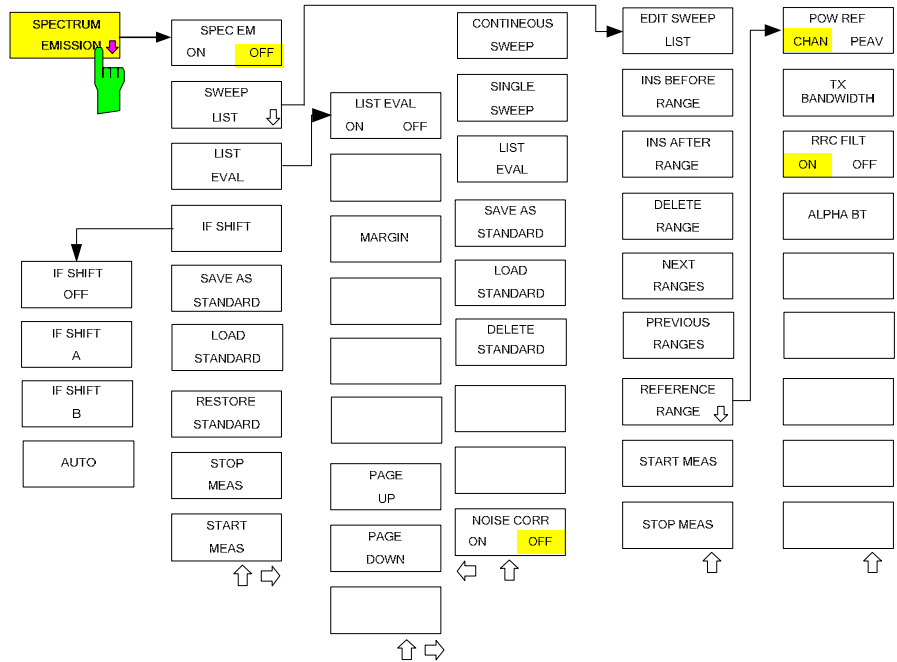

Switches the Spectrum Emission Mask measurement on or off according to the current configuration.

IEC/IEEE bus command: SENS:SWE:MODE ESP
INIT:ESP

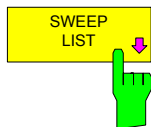

The *SWEEP LIST* softkey opens a submenu to edit the sweep list and displays the *SWEEP LIST* dialog box.

After a preset, the sweep list contains a set of default ranges and parameters. For each range, you can change the parameters listed below. To insert or delete ranges, use the *INS BEFORE RANGE*, *INS AFTER RANGE* and *DELETE RANGE* softkeys.



The *EDIT SWEEP LIST* softkey Configures the sweep list.

SWEEP LIST					
	Range 1	Range 2 Ref	Range 3	Range 4	Range 5
Range Start	-250 MHz	-2.52 MHz	2.52 MHz		
Range Stop	-2.52 MHz	2.52 MHz	250 MHz		
Filter Type	NORMAL (3dB)	NORMAL (3dB)	NORMAL (3dB)		
RBW	30 kHz	30 kHz	30 kHz		
VBW	10 MHz	10 MHz	10 MHz		
Sweep time mode	AUTO	AUTO	AUTO		
Sweep time	270 ms	10 ms	270 ms		
REF-Level	-10 dBm	-10 dBm	-10 dBm		
RF-Att. mode	AUTO	AUTO	AUTO		
RF-Attenuator	15 dB	15 dB	15 dB		
PRE-AMP	OFF	OFF	OFF		
Transd. factor	<NONE>	<NONE>	<NONE>		
Limit check	ABSOLUTE	ABSOLUTE	ABSOLUTE		
Abs Limit Start	-13 dBm	-13 dBm	-13 dBm		
Abs Limit Stop	-13 dBm	-13 dBm	-13 dBm		
Rel Limit Start	-50 dBc	300 dBc	-50 dBc		
Rel Limit Stop	-50 dBc	300 dBc	-50 dBc		

- Range Start
Start frequency of the range (relative to Center Frequency = Carrier Frequency)
IEC/IEEE bus command: SENS:ESP:RANG1:STAR 1000000
- Range Stop
Stop frequency of the range (relative to Center Frequency = Carrier Frequency)
IEC/IEEE bus command: SENS:ESP:RANG1:STOP 10000000
- Filter Type
Normal (3 dB), EMI (6 dB), Channel, RRC
IEC/IEEE bus command: SENS:ESP:RANG1:FILT:TYPE RRC
- RBW
Resolution filter bandwidth
IEC/IEEE bus command: SENS:ESP:RANG1:BAND:RES 5000
- VBW
Video filter bandwidth; not applicable for Channel and RRC filters.
IEC/IEEE bus command: SENS:ESP:RANG1:BAND:VID 5000000
- Sweep Time Mode
AUTO, MANUAL
IEC/IEEE bus command: SENS:ESP:RANG1:SWE:TIME:AUTO ON
- Sweep Time
Shows the current sweep time. The R&S FSMR automatically calculates the sweep time if AUTO mode is selected and displays the corresponding value in this field.
If the field is edited, the sweep time mode is automatically set to MANUAL.
IEC/IEEE bus command: SENS:ESP:RANG1:SWE:TIME 1
- REF Level
Reference level in dBm. The uppermost grid line in the measurement diagram represents the reference level, corrected by the associated transducer factor. The unit depends on the unit selected via the UNIT softkey.
IEC/IEEE bus command: SENS:ESP:RANG1:RLEV 0

- RF Attenuator Mode
AUTO, MANUAL
IEC/IEEE bus command: SENS:ESP:RANG1:INP:ATT:AUTO ON
- RF Attenuator
Shows the current RF attenuation. The R&S FSMR automatically calculates the RF attenuation if AUTO mode is selected and displays the corresponding value in this field. If the field is edited, the RF Attenuator mode is automatically set to MANUAL.
IEC/IEEE bus command: SENS:ESP:RANG1:INP:ATT 10
- PRE AMP
Activates (ON) or deactivates (OFF) the preamplifier if option R&S FSU-B23, R&S FSU-B24 or R&S FSU-B25 is installed.
IEC/IEEE bus command: SENS:ESP:RANG1:INP:GAIN:STAT ON
- Transd. Factor
Shows the name of the transducer factor that is used for the measurement, or NONE if no transducer factor is selected.
To select a transducer factor highlight this field with the rotary knob and press the ENTER key to open the transducer selection list. Select the name of the transducer factor you need with the rotary knob or NONE if you have to work without a transducer factor.
IEC/IEEE bus command: SENS:ESP:RANG1:TRAN <string>
- Limit Check
Sets the type of limit check for all ranges.
ABSOLUTE:
Checks only the defined absolute limits.
RELATIVE:
Checks only the relative limits. Relative limits are defined as relative to the measured power in the reference range.
ABS & REL:
Combines the absolute and relative limit. The limit check fails when both limits are violated.
ABS or REL:
Combines the absolute and relative limit. The limit check fails when one of the limits is violated.
IEC/IEEE bus command: SENS:ESP:RANG1:LIM:STAT ABS | REL | AND | OR
- Abs Limit Start
Sets the absolute limit value at the start frequency of the range. The unit depends on the unit selected via the UNIT softkey.
IEC/IEEE bus command: SENS:ESP:RANG1:LIM:ABS:STAR 10
- Abs Limit Stop
Sets the absolute limit value at the stop frequency of the range. The unit depends on the unit selected via the UNIT softkey.
IEC/IEEE bus command: SENS:ESP:RANG1:LIM:ABS:STOP 20

- Rel Limit Start
Sets the relative limit value at the start frequency of the range. The unit is dBc.
IEC/IEEE bus command: `SENS:ESP:RANG1:LIM:REL:STAR -20`
- Rel Limit Stop
Sets the relative limit value at the stop frequency of the range. The unit is dBc.
IEC/IEEE bus command: `SENS:ESP:RANG1:LIM:REL:STOP -20`

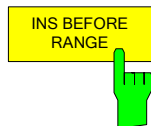

The *INS BEFORE RANGE* softkey inserts a range to the left of the current range / column of the sweep list.

IEC/IEEE bus command: `ESP:RANG1:INS:BEF`

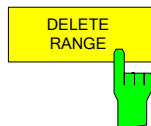

The *DELETE RANGE* softkey deletes the current range / column from the sweep list. All ranges above the deleted one are adjusted by one (e.g. Range 6 turns to Range 5).

IEC/IEEE bus command: `ESP:RANG:DEL`

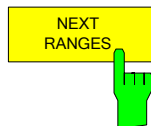

The *NEXT RANGES* softkey scrolls through the sweep list in forward direction if more than 5 ranges are defined. The first page shows Range 1 through 5, the second page shows Range 6 to 11 etc.

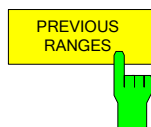

The *PREVIOUS RANGES* softkey scrolls through the sweep list in backwards direction if more than 5 ranges are defined. The first page shows Range 1 through 5, the second page shows Range 6 to 11 etc.

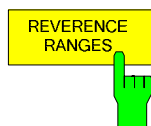

The *REVERENCE RANGES* softkey opens a submenu to define additional parameters for the reference power measurement.

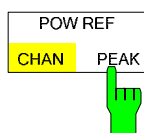

The *POW REF CHAN/PEAK* softkey selects the type of power measurement in the reference range.

Peak Measures the highest peak within the reference range.

Chan Measures the channel power within the reference range (integral bandwidth method).

IEC/IEEE bus command: `SENS:ESP:RTYP PEAK`

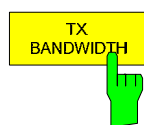

The *TX BANDWIDTH* softkey defines the bandwidth used for measuring the channel power. Possible values are from 20 Hz to the span of the reference range.

IEC/IEEE bus command: `SENS:ESP:BWID 20 HZ`

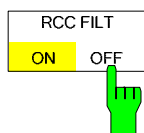

The *RCC FILT ON/OFF* softkey activates or deactivates the RRC filter.

IEC/IEEE bus command: `SENS:ESP:FILT:RRC:STAT ON`

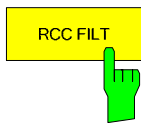

The *RCC FILT* softkey sets the rolloff factor of the RRC filter.

IEC/IEEE bus command: `SENS:ESP:FILT:RRC:ALPH 0.22`

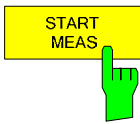

The *START MEAS* softkey starts the Spectrum Emission Mask measurement. In Single Sweep mode, the R&S FSMR automatically stops the measurement.

IEC/IEEE bus command: `INIT:ESP`

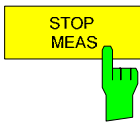

The *STOP MEAS* softkey stops the Spectrum Emission Mask measurement.

IEC/IEEE bus command: `ABOR`

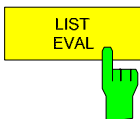

The *LIST EVAL* softkey opens a submenu to edit the list evaluation settings.

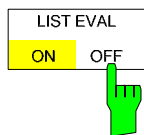

The *LIST EVAL ON/OFF* softkey activates or deactivates the list evaluation.

A peak search evaluation is performed automatically during the measurement. The results are displayed in a table below the measurement diagram.

By default, the list evaluation is active.

The evaluation table shows the following results:

- frequency range
- frequency of the absolute peak power in the corresponding range.
- frequency of the peak power in the corresponding range.
- difference between the limit line and the current power level in dB.
- result of the limit check (color and an asterisk indicate a failed limit check).

The trace, limit line, result of the limit check and the channel power of the reference range are displayed in full screen, too, if the LIST EVALUATION is inactive.

IEC/IEEE bus command: `CALC:ESP:PSE:AUTO ON`

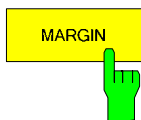

The *MARGIN* softkey opens an edit dialog box to enter the margin used for the limit check/peak search

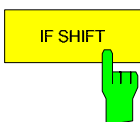

For more information see IF SHIFT.

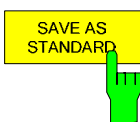

The *SAVE AS STANDARD* softkey opens a dialog box to save customized configurations for spectrum emission mask measurements. The R&S FSMR stores the configurations on its harddisk as an xml file.

IEC/IEEE bus command: `SENS:ESP:STAN:SAVE 'filename'`

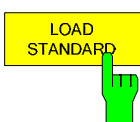

The *LOAD STANDARD* softkey opens a dialog box to select a customized standard in the *.xml file format. Refer to the description of .Provided XML Files for the Spectrum Emission Mask Measurement. and .Format Description of Spectrum Emission Mask XML files for more information on provided standards and customizing standards

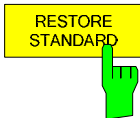

The *RESTORE STANDARD* softkey restores the original *.xml files that came with the R&S FSMR. Note that files of the same name are overwritten.

IEC/IEEE bus command: `SENS:ESP:PRES:REST`

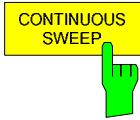

The *CONTINUOUS SWEEP* softkey activates the continuous sweep mode, which means that the sweep takes place continuously according to the trigger mode set. When working in the split-screen mode and with different settings in the two windows, screen A is swept first, followed by screen B. When the softkey is pressed, the sweep is restarted. *CONTINUOUS SWEEP* is the default setting of R&S FSMR.

IEC/IEEE bus command: `INIT:CONT ON`

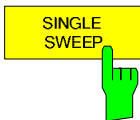

The *SINGLE SWEEP* softkey starts n sweeps after triggering. The number of sweeps is determined by the *SWEEP COUNT* softkey. When working in the split-screen mode, the frequency ranges of the two windows are swept one after the other.

If a trace is swept using *TRACE AVERAGE* or *MAXHOLD*, the value set via the *SWEEP COUNT* softkey determines the number of sweeps. If 0 has been entered, one sweep is performed.

IEC/IEEE bus command: `INIT:CONT OFF`

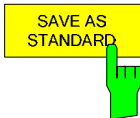
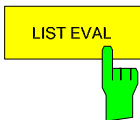

See below

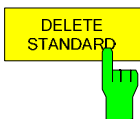
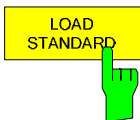

Opens a dialog box to delete a customized spectrum emission mask configuration files.

IEC/IEEE bus command: `ESP:STAN:DEL 'file'`

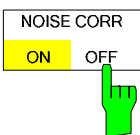

The noise correction for the spectrum emission mask measurement is available only when the measurement is active. For details see NOISE CORR (ON OFF).

Measuring Spurious Emissions

All real amplifiers also generate unwanted RF products outside the assigned frequency band. These spurious emissions are usually measured across a wide frequency range, for example from 9 kHz to 12.75 GHz (ETSI). The spectrum analyzer settings are specified for each frequency range.

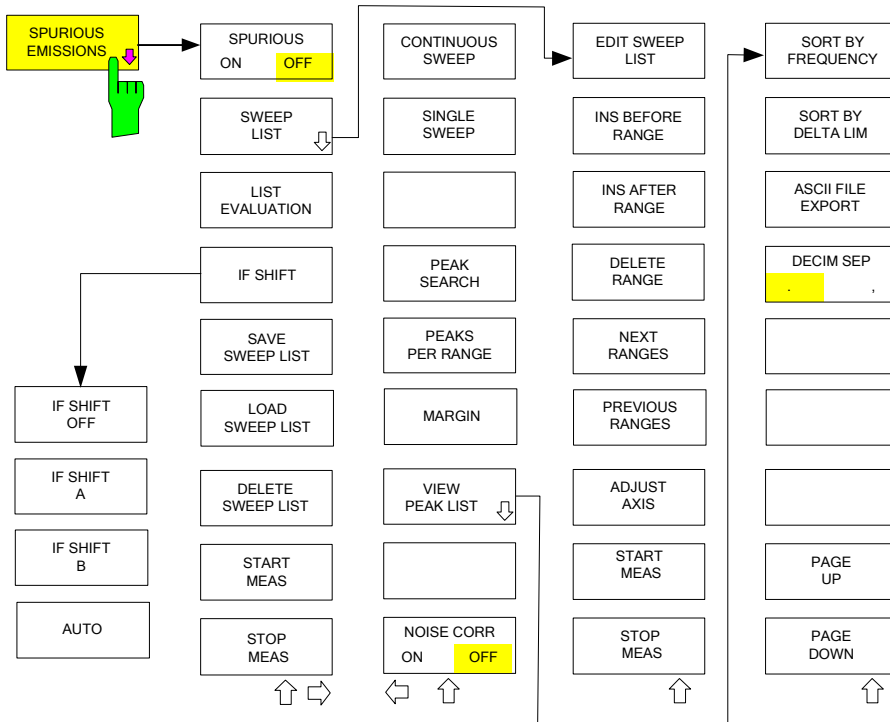

In the Spurious Emissions mode, the R&S FSMR performs measurements in predefined frequency ranges with settings that can be specified individually for each of these ranges. For this purpose, the SWEEP TABLE settings or the current device settings are used. Up to 20 subranges can be defined (they need not directly follow one another) across which the R&S FSMR sweeps in subsequent order. However, the measurement ranges must not overlap. The measurement parameters can be selected independently from each other in every subrange (*SWEEP LIST* menu, *EDIT SWEEP LIST*). Limit lines are defined and displayed irrespective of the sweep ranges, i.e. they are not part of the sweep ranges. The unit of the limit lines is restricted to dB or dBm.

The frequency range where measurements are actually performed is set by the start and stop frequency parameters of the R&S FSMR; these parameters are independent of the sweep ranges. It is thus possible to define sweep ranges for a measurement task that can be stored and reloaded and to quickly and easily set the frequency range to be actually measured by means of two parameters; complex editing in the sweep table is not necessary.



When a limit line is defined in steps, the weaker limit is used at the frequency point with the straight vertical section.

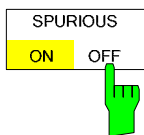

The *SPURIOUS ON OFF* softkey switches the spurious emissions measurement on or off according to the current configuration.

IEC/IEEE bus command: `SWEEP:MODE LIST` switches the spurious list on
`SWEEP:MODE AUTO` switches the spurious list off

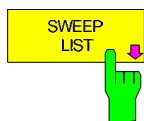

The *SWEEP LIST* softkey opens a submenu where predefined sweep ranges can be edited, or new ranges generated or deleted. A table listing the current sweep ranges is displayed.

IEC/IEEE bus command: --



The EDIT SWEEP LIST softkey opens the table for editing the sweep ranges.

SWEEP LIST					
	RANGE 1	RANGE 2	RANGE 3	RANGE 4	RANGE 5
Range Start	9 kHz	50 MHz	500 MHz		
Range Stop	50 MHz	500 MHz	1 GHz		
Filter Type	NORMAL	CHANNEL	RRC		
RBW	10 kHz	100 kHz	3 MHz		
VBW	30 kHz	300 kHz	10 MHz		
Sweep time mode	AUTO	MANUAL	AUTO		
Sweep time	10 ms	10 ms	100 ms		
Detector	Peak	RMS	Peak		
REF-Level	-20 dBm	-20 dBm	-20 dBm		
RF-Att. mode	AUTO	MANUAL	AUTO		
RF-Attenuator	10 dB	10 dB	5 dB		
PRE-AMP	OFF	OFF	OFF		
Sweep Points	625	625	625		
Stop after sweep	ON	OFF	OFF		
Transd. factor	LOWFREQ	MIDFREQ	MIDFREQ		

In the SWEEP LIST table, the individual sweep ranges are set.

- Range Start: Start frequency of the range
- Range Stop: Stop frequency of the range
- Filter Type: Filter type: NORMAL, CHANNEL, RRC
- RBW: Resolution filter bandwidth
- VBW: Video filter bandwidth; not applicable for CHANNEL and RRC filters
- Sweep Time Mode: AUTO / MANUAL
- Sweep Time: Sweep time; if AUTO is indicated for the sweep time mode, the automatically calculated sweep time is displayed. If the cell is edited, the associated sweep time mode is automatically set to MANUAL.
- Detector: Specifies the range detector: Sample, Average, Max Peak, RMS, Min Peak and Auto Peak
- REF-Level: Reference level in dBm
The upper edge of the displayed screen area is the value of the maximum reference level, corrected by the associated transducer factor.
- RF-Attenuator-Mode: AUTO / MANUAL
- RF-Attenuator: Number; as with Sweep Time
- PRE-AMP: ON/OFF; preamplifier selection (options B23, B25, if available)
- Sweep Points: Number of sweep points per range (sweep segment). The number of sweep points must not exceed **100001**.
- Stop after Sweep: ON / OFF; if ON, the sweep is stopped after the range and continued only if confirmed by you via a message box.
- Transd. factor: NONE or factor (enter via selection list)
- IEC/IEEE bus commands:
 - SENS:LIST:RANGE<1...20>:...
 - LIST:RANG1:STAR
 - LIST:RANG1:STOP
 - LIST:RANG1:FILTER:TYP
 - LIST:RANG1:BANDwidth
 - LIST:RANG1:BANDwidth:VID
 - LIST:RANG1:SWEEP:TIME:AUTO
 - LIST:RANG1:SWEEP:TIME
 - LIST:RANG1:DET
 - LIST:RANG1:RLEV
 - LIST:RANG1:INPUT:ATT:AUTO
 - LIST:RANG1:INPUT:ATT
 - LIST:RANG1:INPUT:GAIN:STAT
 - LIST:RANG1:POINT
 - LIST:RANG1:BREA

LIST:RANG1:TRAN

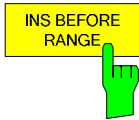

The *INS BEFORE RANGE* softkey inserts a range in front of the marked line.

IEC/IEEE bus command --

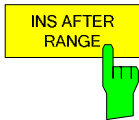

The *INS AFTER RANGE* softkey inserts a range following the marked line.

IEC/IEEE bus command --

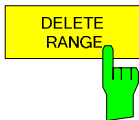

The *DELETE RANGE* softkey deletes the current range. All higher ranges are set back by one.

IEC/IEEE bus command LIST:RANG<1...20>:DEL

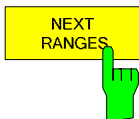

The *NEXT RANGES* softkey activates the displays of the next higher subranges, i.e. 6 to 10, 11 to 15 or 16 to 20.

IEC/IEEE bus command --

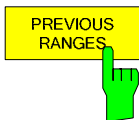

The *PREVIOUS RANGES* softkey activates the displays of the next lower subranges, i.e. 1 to 5, 6 to 10 or 11 to 15.

IEC/IEEE bus command: --

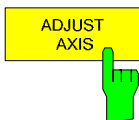

The *ADJUST AXIS* softkey automatically adjusts the frequency axis of measurement diagram so that the start frequency matches the start frequency of the first sweep range, and the stop frequency of the last sweep range.

IEC/IEEE bus command: -- (via `FREQ:STAR <num_value> /`
`FREQ:STOP <num_value>`)

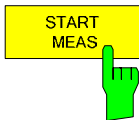

Using the *START MEAS* softkey, you can start the measurement while the submenu is simultaneously exited.

When the measurement is started, the R&S FSMR sets up the measurement diagram in the selected measurement window and starts the measurement in the selected mode.

With *SINGLE*, a single frequency sweep occurs; afterwards the R&S FSMR remains on the stop frequency.

With *CONTINUOUS*, the measurement continues until it is stopped.

You can stop the measurement with *STOP SWEEP*.

If a *STOP AFTER SWEEP* point has been defined in the range, the sweep stops automatically at the end of the respective range to allow you to change the external circuitry, for example. This is indicated in a message box:

SWEEP Range# reached CONTINUE/BREAK

If *CONTINUE* is selected, the sweep is continued in the next range. If *BREAK* is selected, the sweep is stopped.

IEC/IEEE bus command: INIT:SPUR starts the measurement

INIT:CONM starts the measurement after a BREAK has been reached

ABOR stops the measurement after a range has been reached

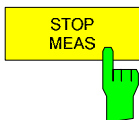

The *STOP MEAS* softkey stops the measurement. The measurement data can be analyzed.

IEC/IEEE bus command: ABOR

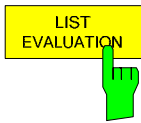

The *LIST EVALUATION* softkey activates or deactivates the spurious emission measurement LIST EVALUATION. The peak search evaluation is automatically done during measurement and the results are displayed in a table in the lower part of the screen.

Following results are listed:

- frequency range
- frequency of the absolute peak power in this range in dBm
- level delta to the limit with margin in dB
- limit check state (by color change and an asterisk at the end of the line if failed)

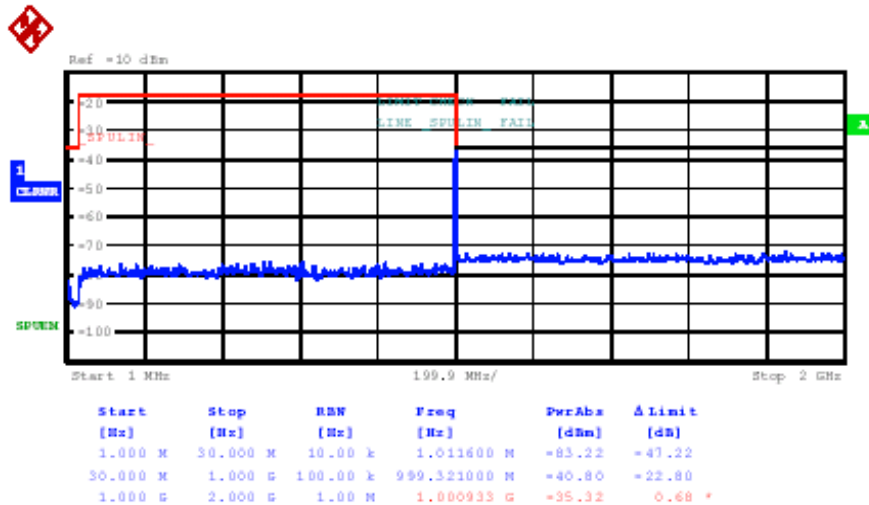

If LIST EVALUATION is switched on, the functions PEAKS PER RANGE, MARGIN, PEAK SEARCH and VIEW PEAK LIST are not available.

IEC/IEEE bus command `CALC:PEAK:AUTO ON|OFF`

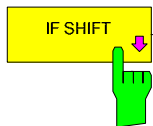

- IF SHIFT OFF
- IF SHIFT A
- IF SHIFT B
- AUTO

Input signals at a frequency of half the 1st IF (in the frequency range of 2270 MHz to 2350 MHz) will reduce the dynamic range of the analyzer. This problem only occurs for low RF attenuation values. It can be overcome by shifting the 1st IF. For signals from 2270MHz to 2310 MHz *IF SHIFT A* is appropriate, for 2310 MHz to 2350 MHz *IF SHIFT B* must be used.



The 1st IF shifting is automatically done for ACP measurements if center frequency (= signal frequency) is in the range of 2270 MHz ...2350 MHz. The IF SHIFT setting is therefore ignored for ACP measurements.

IEC/IEEE-bus command

`SENS2:SWE:IF:SHIF OFF | A | B | AUTO`



The *SAVE SWEEP LIST* softkey opens a dialog box to save customized configurations for spurious emission measurements. The R&S FSMR stores the configurations on its harddisk as an xml file.

IEC/IEEE bus command: `LIST:STAN:SAVE '<filename>'`

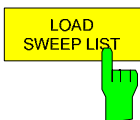

The *LOAD SWEEP LIST* softkey opens a dialog box to load customized spurious emission measurement configurations.

IEC/IEEE bus command: `LIST:PRES '<filename>'`

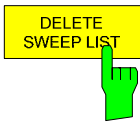

The *DELETE SWEEP LIST* softkey opens a dialog box to delete customized spurious emission measurement configuration files.

IEC/IEEE bus command: `LIST:STAN:DEL '<filename>'`

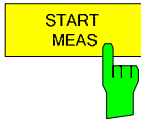

See above.

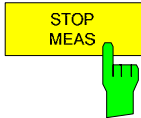

See above.

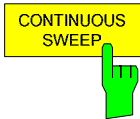

The *CONTINUOUS SWEEP* softkey activates the continuous sweep mode, which means that the sweep takes place continuously according to the trigger mode set. When working in the split-screen mode and with different settings in the two windows, screen A is swept first, followed by screen B. When the softkey is pressed, the sweep is restarted. *CONTINUOUS SWEEP* is the default setting of R&S FSMR.

IEC/IEEE bus command: `INIT:CONT ON`

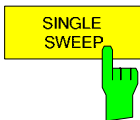

The *SINGLE SWEEP* softkey starts *n* sweeps after triggering. The number of sweeps is determined by the *SWEEP COUNT* softkey.

When working in the split-screen mode, the frequency ranges of the two windows are swept one after the other.

If a trace is swept using *TRACE AVERAGE* or *MAXHOLD*, the value set via the *SWEEP COUNT* softkey determines the number of sweeps. If 0 has been entered, one sweep is performed.

IEC/IEEE bus command: `INIT:CONT OFF`

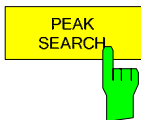

The *PEAK SEARCH* softkey starts the process of determining the list of the subrange maximums from the existing sweep results. This procedure can be repeated as often as desired, e.g. to experiment with the various threshold settings.

It is activated only after a measurement has been performed with *START MEAS*.

IEC/IEEE bus command `CALC:PEAK`

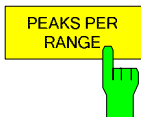

The *PEAKS PER RANGE* softkey activates entry of the number of peaks per range that are stored in the list. The value range extends from 1 to 50. Once the selected number of peaks has been reached, the peak search is stopped in the current range and continued in the next range.

IEC/IEEE bus command: `CALC:PEAK:SUBR 1...50`

Default: 25;

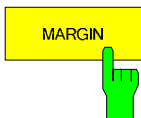

The *MARGIN* softkey activates entry of the margin, i.e. the acceptance threshold for determining the peak list. The limit line is shifted by this value when the maximums are determined. The value range extends from -200 dB to 200 dB.

Default: 6 dB

IEC/IEEE bus command: `CALC:PEAK:MARG -200dB...200dB`

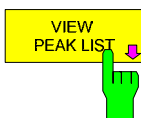

The *VIEW PEAK LIST* softkey opens the submenu for viewing the peak list.

It is activated for display only after a *PEAK SEARCH* has been performed with *PEAK SEARCH*.

A delta limit of +200dB is listed if no limit check is active.

IEC/IEEE bus command: TRAC? SPUR

The table below shows a peak list after a *PEAK SEARCH*:

VIEW PEAK LIST			
TRACE / Detector	FREQUENCY	LEVEL dBm	DELTA LIMIT dB
1 RMS	80.0000 MHz	-36.02	-5.02
1 RMS	80.0001 MHz	-30.07	+0.24
1 RMS	85.1234 MHz	-30.02	-0.02
1 AVERAGE	130.234 MHz	-29.12	-5.12

SORT BY
FREQUENCY



The *SORT BY FREQUENCY* softkey sorts the table according to the entries in the *FREQUENCY* column in descending order.

IEC/IEEE bus command --

SORT BY
DELTA LIM



The *SORT BY DELTA LIM* softkey sorts the table according to the entries in the *DELTA LIM* column (default) in descending order. If no limit line has been specified, an offset of 200 dB is assumed for all peaks.

IEC/IEEE bus command: --

ASCII FILE
EXPORT



The *ASCII FILE EXPORT* softkey stores the peak list in ASCII format to a file on a Memory stick.

The file has a header containing important parameters for scaling, several data sections containing the sweep settings per range and a data section containing the peak list.

The header data is made up of three columns, separated by ';':
parameter name; numeric value; basic unit

The data section for the measurement values starts with the keyword "TRACE <n>:", where <n> includes the number of the used trace. Next comes the peak list with several columns also separated by ';':

Spreadsheet programs such as MS Excel can read this format. Use ';' as the delimiter for the table cells.

Example: File header

File contents	Description
Type;R&S FSMR <model>;	Instrument model
ersion;1.00;	Firmware version
Date;01.Jul 2005;	Date of data set storage
Mode;Spectrum;	Instrument mode
Center Freq;55000;Hz	Center frequency
Freq Offset;0;Hz	Frequency offset
Span;90000;Hz	Frequency range (0 Hz with zero span and statistics measurements)
x-Axis;LIN;	Scaling of x axis linear (LIN) or logarithmic (LOG)
Start;10000;Hz Stop;100000;Hz	Start/stop of the display range. Unit: Hz for span > 0, s for span = 0, dBm/dB for statistics measurements
Ref.Level;-30;dBm	Reference level
Level Offset;0;dB	Level offset
Ref Position;75;%	Position of reference level referred to diagram limits (0% = lower edge)
y-Axis;LOG	Scaling of y axis linear (LIN) or logarithmic (LOG)
Level Range;100;dB	Display range in in y direction. Unit: dB with x axis LOG, % with x axis LIN
RF Att;20;dB	Input attenuation
RBW;100000;Hz	Resolution bandwidth
VBW;30000;Hz	Video bandwidth
SWT;0.005;s	Sweep time
Trace Mode;AVERAGE;	Display mode of trace: CLR/WRITE,AVERAGE,MAXHOLD,MINHOLD
Detector;SAMPLE;	Detector set: AUTOPEAK,MAXPEAK,MINPEAK,AVERAGE, RMS,SAMPLE,QUASISPEAK
Sweep Count;20	Number of sweeps set

Example: Data section of the file

File contents	Description
Trace 1;;	Selected trace
x-Unit;Hz	Unit of x values: Hz with span > 0; s with span = 0; dBm/dB with statistics measurements
y-Unit;dBm	Unit of y values: dB*/V/A/W depending on the selected unit with y axis LOG or % with y axis LIN
Values; 625	Number of test points
10000;-10.3;-15.7 10180;-11.5;-16.9 10360;-12.0;-17.4 ...;...;	Measured values: <x value>, <y1>, <y2> <y2> being available only with detector AUTOPEAK and containing in this case the smallest of the two measured values for a test point.

Spreadsheet programs such as MS Excel can read this format. Use ';' as the delimiter for the table cells.



Different language versions of evaluation programs may require different handling of the decimal point. Using the DECIM SEP softkey, you can thus choose between the delimiters '.' (decimal point) and ',' (comma).

IEC/IEEE bus command: MMEM:STOR:SPUR,'A:\TEST.ASC'

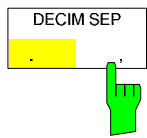

The *DECIM SEP* softkey selects the decimal separator between '.' (decimal point) and ',' (comma) with floating-point numerals for the [ASCII FILE EXPORT](#) function. With the selection of the decimal separator different language versions of evaluation programs (e.g. Microsoft Excel) can be supported.

IEC/IEEE bus command: `FORM:DEXP:DSEP POIN`

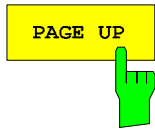

Using PAGE UP and PAGE DOWN, you can scroll forward and backward through the peak list pages.

They are active only as long as a peak list is displayed.

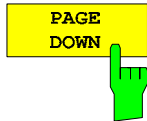

Measurement of the Third Order Intercept (TOI)

If several signals are applied to a transmission twoport device with nonlinear characteristic, intermodulation products appear at its output by the sums and differences of the signals. The nonlinear characteristic produces harmonics of the useful signals which intermodulate at the characteristic. The intermodulation products of lower order have a special effect since their level is largest and they are near the useful signals. The intermodulation product of third order causes the highest interference. It is the intermodulation product generated from one of the useful signals and the 2nd harmonic of the second useful signal in case of two-tone modulation.

The frequencies of the intermodulation products are above and below the useful signals. Fig. 4.16-6 shows intermodulation products P_{I1} and P_{I2} generated by the two useful signals P_{U1} and P_{U2} .

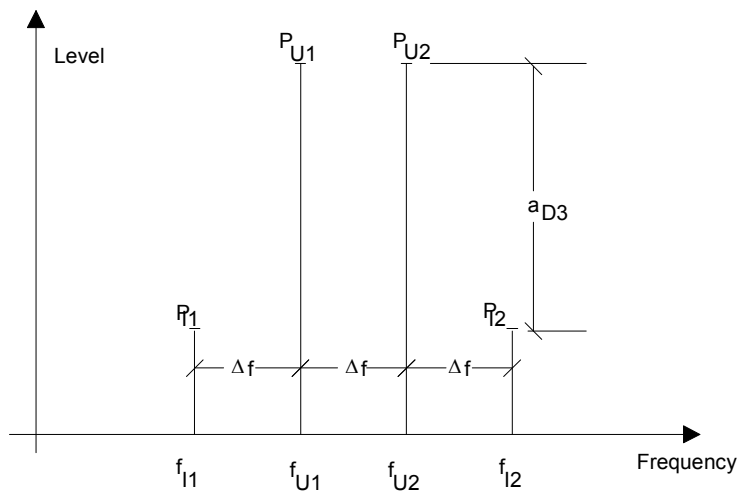

Fig. 4.16-6 Intermodulation products P_{U1} and P_{U2}

The intermodulation product at f_{I2} is generated by mixing the 2nd harmonic of useful signal P_{U2} and signal P_{U1} , the intermodulation product at f_{I1} by mixing the 2nd harmonic of useful signal P_{U1} and signal P_{U2} .

$$f_{I1} = 2 \times f_{U1} - f_{U2} \quad (1)$$

$$f_{I2} = 2 \times f_{U2} - f_{U1} \quad (2)$$

The level of the intermodulation products depends on the level of the useful signals. If the two useful signals are increased by 1 dB, the level of the intermodulation products increases by 3 dB, which

means that spacing a_{D3} between intermodulation signals and useful signals is reduced by 2 dB. This is illustrated in Fig. 4.16-7.

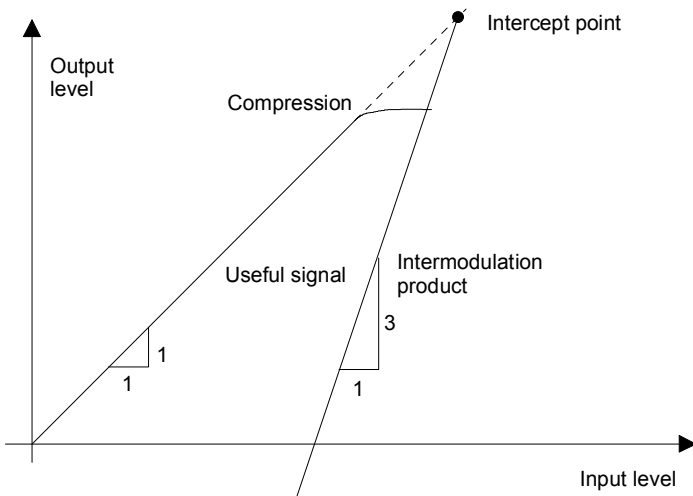

Fig. 4.16-7 Dependence of intermodulation level on useful signal level

The useful signals at the twoport output increase proportionally with the input level as long as the twoport is in the linear range. A level change of 1 dB at the input causes a level change of 1 dB at the output. Beyond a certain input level, the twoport goes into compression and the output level stops increasing. The intermodulation products of the third order increase three times as much as the useful signals. The intercept point is the fictitious level where the two lines intersect. It cannot be measured directly since the useful level is previously limited by the maximum twoport output power. It can be calculated from the known line slopes and the measured spacing a_{D3} at a given level according to the following formula.

$$IP3 = \frac{a_{D3}}{2} + P_N \tag{3}$$

The 3rd order intercept point (TOI), for example, is calculated for an intermodulation of 60 dB and an input level P_U of -20 dBm according to the following formula:

$$IP3 = \frac{60}{2} + (-20dBm) = 10dBm. \tag{4}$$

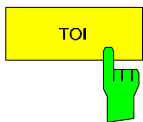

The *TOI* softkey enables the measurement of the 3rd order intercept point. A two-tone signal with equal carrier levels is expected at the R&S FSMR input. *MARKER 1* and *MARKER 2* (both normal markers) are set to the maximum of the two signals. *MARKER 3* and *MARKER 4* (both delta markers) are placed on the intermodulation products. When the function is enabled, the frequency entry is activated for the delta markers. They can be set manually. The R&S FSMR calculates the third order intercept from the level spacing between normal markers and delta markers and outputs it in the marker info field.

IEC/IEEE-bus command: `CALC:MARK:FUNC:TOI ON;`
 `CALC:MARK:FUNC:TOI:RES?`

Example:

A two-tone signal with frequencies of 100 MHz and 101 MHz is applied to the RF input of the R&S FSMR. The level of the two signals is -10 dBm.

- [PRESET]** The R&S FSMR is set to the default setting.
- [CENTER: 100.5 MHz]** The center frequency is set to 100.5 MHz.
- [SPAN: 3 MHz]** The span is set to 3 MHz.

- [AMPT: -10 dBm] The reference level is set to -10 dBm.
- [MKR FCTN] *MARKER 1* is switched on and set to the signal peak.
- [TOI] The R&S FSMR sets the 4 markers to the useful signals and the intermodulation products and calculates the third order intercept. The result is output in the marker info field.

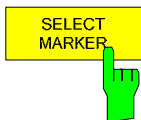

The *SELECT MARKER* softkey activates the selection of a marker for functions *MODULATION DEPTH* and *TOI*. Thus, the markers can be fine-adjusted for these functions.

The markers are numerically selected in a data entry field. Delta marker 1 is selected by entering '0'.

If the marker is in the switch-off state, it will be switched on and can thus be shifted.

IEC/IEEE-bus command: `CALC:MARK1 ON;`
`CALC:MARK1:X <value>;`
`CALC:MARK1:Y?`

Harmonic Measurement

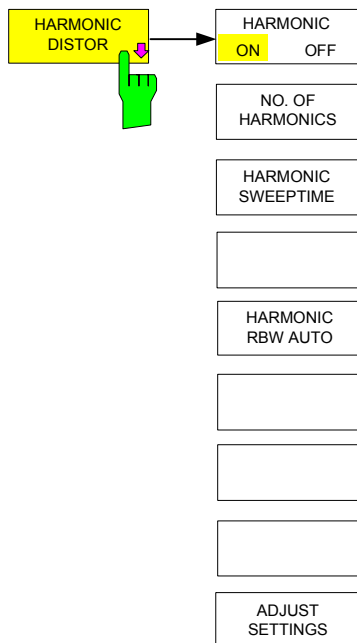

The *HARMONIC DISTOR* softkey opens this submenu and activates the harmonic distortion measurement. With this measurement it is possible to measure easily the harmonics e.g. from a VCO. In addition the THD (total harmonic distortion) is calculated in % and dB.

In the upper screen the zero span sweeps on all harmonics are shown, separated by a grid line. This allows a very good overview about the measurement. In the lower screen the mean RMS results are displayed in numerical values and the THD values can be seen in the marker info field.

The resolution bandwidth will be automatically adjusted: $RBW_n = RBW_1 * n$, if that RBW is not available the next higher value is used.

The results can be obtained via the following remote commands:

Trace read out via the normal trace subsystem. The first harmonic frequency can be read out via the center frequency command.

THD value comma separated in % and dB:

Remote command: `CALC:MARK:FUNC:HARM:DIST? TOT`

Comma separated list of harmonic levels, for each harmonic one value:

Remote command: `CALC:MARK:FUNC:HARM:LIST?`

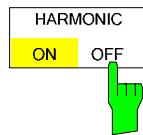

The *HARMONIC DISTORTION* Softkey activates the harmonic distortion measurement. With this measurement it is possible to measure easily the harmonics e.g. from a VCO. In addition the THD (total harmonic distortion) is calculated in % and dB.

There are 2 possible modes within the harmonic measurement. When entering the harmonic measurement from a frequency sweep (span > 0 Hz) an automatic search for the first harmonic is carried out within that given frequency range. Also a level adjust will be carried out. Is the zero span mode active before entering the harmonic measurement, the center frequency is unchanged.

IEC/IEEE-bus command:

```
CALC:MARKer:FUNC:HARM:STAT ON | OFF
```

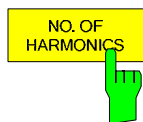

With the softkey *NO. OF HARMONICS* the number of harmonics which shall be measured can be adjusted. The range is from 1 to 26.

IEC/IEEE-bus command:

```
CALC:MARK:FUNC:HARM:NHAR <numerical value>
```

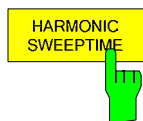

The *HARMONIC SWEPTIME* softkey allows to set the value how long the zero span measurement on each harmonic frequency shall take place. This is an alias softkey to the normal sweep time of the zero span, therefore the same parser command is to be used.

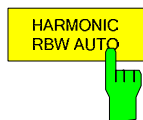

The softkey *HARMONIC RBW AUTO* disabled the resolution bandwidth.

IEC/IEEE-bus command:

```
CALC:MARK:FUNC:HARM:BAND:AUTO ON | OFF
```

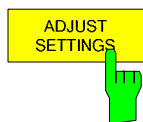

The *ADJUST SETTINGS* softkey activated the frequency search in the frequency range from before starting the harmonic measurement (if harmonic measurement was started from frequency sweep) and the level adjust.

IEC/IEEE-bus command: `CALC:MARK:FUNC:HARM:PRES`

The results can be obtained via IEC/IEEE-bus via the following commands:

Trace read out via the normal trace subsystem. The first harmonic frequency can be read out via the center frequency command.

THD value comma separated in % and dB:

```
CALC:MARK:FUNC:HARM:DIST? TOT
```

Comma separated list of harmonic levels, for each harmonic one value:

```
CALC:MARK:FUNC:HARM:LIST?
```

Setup of Limit Lines and Display Lines – LINES Key

Limit lines are used to define amplitude curves or spectral distribution boundaries on the display screen which are not to be exceeded. They indicate, for example, the upper limits for interference radiation or spurious waves which are allowed from a unit under test (UUT). For transmission of information in TDMA (e.g. GSM), the amplitude of the bursts in a timeslot must adhere to a curve which must fall within a specified tolerance band. The lower and upper limits may each be specified by a limit line. Then, the amplitude curve can be controlled either visually or automatically for any violations of the upper or lower limits (GO/NOGO test).

The instrument supports limit lines with a maximum of 50 data points. 8 of the limit lines stored in the instrument can be used simultaneously and activated in the split-screen mode either in Screen A, Screen B or in the two windows. The number of limit lines stored in the instrument is only limited by the capacity of the flashdisk used.

For each limit line, the following characteristics must be defined:

- The name of the limit line. The limit line data are stored under this name and can be examined in the table *LIMIT LINES*.
- The domain in which the limit line is to be used. Here, a distinction is made between the time domain (span = 0 Hz) and the frequency domain (span > 0 Hz).
- The reference of the interpolation points to the X axis. The limit line may be specified either for absolute frequencies or times or for frequencies which are related to the set center frequency and times related to the time on the left edge of the diagram.
- The reference of the interpolation points to the Y axis. The limit line can be selected either for absolute levels or voltages or referred to the set maximum level (Ref Lvl). The position on the display depends on the *REF LEVEL POSITION*.
- With relative reference values for the Y axis, it is possible to enter an absolute threshold (THRESHOLD) which lowers the relative limit values (see below).
- The type of limit line (upper or lower limit). With this information and the active limit checking function (Table *LIMIT LINES*, *LIMIT CHECK ON*, the R&S FSMR checks for compliance with each limit.
- The limit line units to be used. The units of the limit line must be compatible with the level axis in the active measurement window.
- The measurement curve (trace) to which the limit line is assigned. For the R&S FSMR, this defines the curve to which the limit is to be applied when several traces are simultaneously displayed.
- For each limit line, a margin can be defined which serves as a threshold for automatic evaluation.
- In addition, commentary can be written for each limit line, e.g. a description of the application.

Display lines are exclusively used to optically mark relevant frequencies or points in time (span = 0) as well as constant level values. It is not possible to check automatically whether the marked level values have been underranged or exceeded.

Selection of Limit Lines

The *LINES* key opens the menu for fixing the limit lines and the display lines.

LINES menu

LINES →

SELECTED LIMIT LINE

Name: GSM1900UP x-Axis: LIN
 Domain: FREQUENCY x-Scaling: ABSOLUTE
 Unit: dBm y-Scaling: ABSOLUTE
 Limit: UPPER
 Comment: GSM1900 Transient Spectrum Upper Limit

LIMIT LINES				
NAME	COMPATIBLE	LIMIT CHECK	TRACE	MARGIN
√GSM1900UP	√	on	1	0.000 dB
LP1GHZ	√	off	2	0.000 dB
NFSIG		off	3	0.000 dB

Center 4 GHz 800 MHz/ Span 8 GHz

SPECTRUM **SCREEN B**

Buttons on the right: SELECT LIMIT LINE, NEW LIMIT LINE, EDIT LIMIT LINE, COPY LIMIT LINE, DELETE LIMIT LINE, X OFFSET, Y OFFSET, DISPLAY LINES

The *SELECTED LIMIT LINE* display field provides information concerning the characteristics of the marked limit lines.

In the *LIMIT LINES* table, the limit lines compatible to the settings of the active screen can be enabled.

New limit lines can be specified and edited in the *NEW LIMIT LINE* and *EDIT LIMIT LINE* sub-menus, respectively.

The horizontal and vertical lines of the *DISPLAY LINES* submenu mark individual levels or frequencies (span > 0) or times (span = 0) in the diagram.

The *SELECTED LIMIT LINE* table provides information about the characteristics of the marked limit line :

<i>Name</i>	name
<i>Domain</i>	frequency or time
<i>Unit</i>	vertical scale
<i>X-Axis</i>	interpolation
<i>Limit</i>	upper/lower limit
<i>X-Scaling</i>	absolute or relative frequencies/times
<i>Y-Scaling</i>	absolute or relative Y units
<i>Threshold</i>	absolute limit with relative Y units
<i>Comment</i>	commentary

The characteristics of the limit line are set in the *EDIT LIMIT LINE (=NEW LIMIT LINE)* sub-menu.

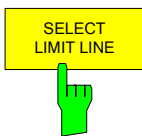

The *SELECT LIMIT LINE* softkey activates the *LIMIT LINES* table and the selection bar jumps to the uppermost name in the table.

The following information is offered in the columns of the table:

<i>Name</i>	Enable the limit line.
<i>Compatible</i>	Indicates if the limit line is compatible with the measurement window of the given trace.
<i>Limit Check</i>	Activate automatic violation check for upper/lower limits.
<i>Trace</i>	Select the measurement curve to which the limit is assigned.
<i>Margin</i>	Define margin.

Name and Compatible - Enabling limit lines

A maximum of 8 limit lines can be enabled at any one time. In split screen mode, they may be assigned to screen A, screen B or to both screens. A check mark at the left edge of a cell indicates that this limit line is enabled.

A limit line can only be enabled when it has a check mark in the *Compatible* column, i.e. only when the horizontal display (time or frequency) and vertical scales are **identical** to those of the display in the measurement window. Lines with the unit dB are compatible to all dB(..) settings of the Y axis.

If the scale of the y axis or the domain (frequency or time axis) are changed, all non-compatible limit lines are automatically switched off in order to avoid misinterpretation. The limit lines must be enabled anew when the original display is re-displayed.

IEC/IEEE-bus command: `CALC:LIM3:NAME "GSM1"`
 `CALC:LIM3:UPP:STAT ON`
 `CALC:LIM4:LOW:STAT ON`

Limit Check - Activate automatic limit violation check

When *LIMIT CHECK ON* is activated, a GO/NOGO test is performed in the active screen. In the center of the diagram, a display window appears which indicates the results of the limit check test:

LIMIT CHECK: PASSED No violations of active limits.

LIMIT CHECK: FAILED One or more active limit lines were violated. The message contains the names of the limit lines which were violated or whose margins were not complied with.

LIMIT CHECK: MARGIN The margin of at least one active limit lines was not complied with, however, no limit line was violated. The message contains the names of the limit lines whose margins were not complied with.

The following example shows two active limit lines:

```
LIMIT CHECK: FAILED
LINE VHF_MASK: Failed
LINE UHF2MASK: Margin
```

A check for violations of limit lines takes place only if the limit line of the assigned measurement curve (trace) is enabled.

If *LIM CHECK* is set to *OFF* for all active limit lines, then the limit line check is not executed and the display window is activated.

IEC/IEEE-bus command: `CALC:LIM:STAT ON`
 `INIT;*WAI`
 `CALC:LIM:FAIL?`

Trace - Select the measurement curve to which the limit line is assigned.

The selection of the measurement curve (trace) takes place in an entry window. Allowed are the integer entries 1, 2 or 3. The default setting is trace 1. If the selected limit line is not compatible with the assigned measurement curve, then the limit line is disabled (display and limit check).

IEC/IEEE-bus command: `CALC:LIM:TRAC 1`

See following Section "Entry and Editing of Limit Lines".

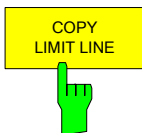
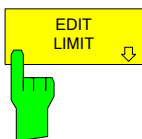
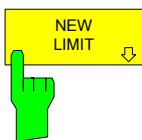

The *COPY LIMIT LINE* softkey copies the data file describing the marked limit line and saves it under a new name. In this way, a new limit line can be easily generated by parallel translation or editing of an existing limit line. The name can be arbitrarily chosen and input via an entry window (max. of 8 characters).

IEC/IEEE-bus command: `CALC:LIM3:COPY 2` or
 `CALC:LIM3:COPY "GSM2"`



The *DELETE LIMIT LINE* softkey erases the selected limit line. Before deletion, a message appears requesting confirmation.

IEC/IEEE-bus command: `CALC:LIM3:DEL`

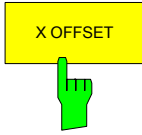

The *X OFFSET* softkey horizontally shifts a limit line, which has been specified for relative frequencies or times (X axis). The softkey opens an entry window, where the value for shifting may be entered numerically or via the rollkey.



This softkey does not have any effect on limit lines that represent absolute values for the X axis.

IEC/IEEE-bus command: `CALC:LIM3:CONT:OFFS 10kHz`

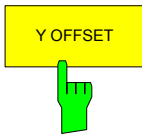

The *Y OFFSET* softkey vertically shifts a limit line, which has relative values for the Y axis (levels or linear units such as volt). The softkey opens an entry window where the value for shifting may be entered numerically or via the rollkey.



This softkey does not have any effect on limit lines that represent absolute values for the Y axis.

IEC/IEEE-bus command: `CALC:LIM3:LOW:OFFS 3dB`
 `CALC:LIM3:UPP:OFFS 3dB`

Entry and Editing of Limit Lines



A limit line is characterized by

- its name
- the assignment of domain (frequency or time)
- the scaling in absolute or relative times or frequencies
- the vertical unit
- the interpolation
- the vertical scaling
- the vertical threshold (only with relative vertical scaling)
- the margin
- the definition of the limit line as either upper or lower limit.
- the data points for frequency/time and level /modulation.

At the time of entry, the R&S FSMR immediately checks that all limit lines are in accordance with certain guidelines. These guidelines must be observed if specified operation is to be guaranteed.

- The frequencies/times for each data point must be entered in ascending order, however, for any single frequency/time, two data points may be input (vertical segment of a limit line).

The data points are allocated in order of ascending frequency/time. Gaps are not allowed. If gaps are desired, two separate limit lines must be defined and then both enabled.

- The entered frequencies/times need not necessarily be selectable in R&S FSMR. A limit line may also exceed the specified frequency or time domains. The minimum frequency for a data point is -200 GHz, the maximum frequency is 200 GHz. For the time domain representation, negative times may also be entered. The valid range is -1000 s to +1000 s.
- The minimum/maximum value for a limit line is -200 dB to +200 dB for the logarithmic or 10^{-20} to 10^{+20} or -99.9% to + 999.9% for the linear amplitude scales.

LINES - EDIT LIMIT LINE menu

The *EDIT LIMIT LINE* and *NEW LIMIT LINE* softkeys both call the *EDIT LIMIT LINE* sub-menu used for editing limit lines. In the table heading, the characteristics of the limit line can be entered. The data points for frequency/time and level values are entered in the columns.

<input type="text" value="NAME"/>	<i>Name</i>	Enter name.
<input type="text" value="VALUES"/>	<i>Domain</i>	Select domain.
<input type="text" value="INSERT VALUE"/>	<i>Unit</i>	Select units.
<input type="text" value="DELETE VALUE"/>	<i>X-Axis</i>	Select interpolation
<input type="text" value="SHIFT X LIMIT LINE"/>	<i>Limit</i>	Select upper and lower limit value.
<input type="text" value="SHIFT Y LIMIT LINE"/>	<i>X-Scaling</i>	Entry of absolute or relative values for the X axis
<input type="text" value="Y-Scaling"/>	<i>Y-Scaling</i>	Entry of absolute or relative values for the Y axis
<input type="text" value="Margin"/>	<i>Margin</i>	Entry of margin.
<input type="text" value="SAVE LIMIT LINE"/>	<i>Threshold</i>	Entry of vertical threshold (only with relative vertical scaling)
<input type="text" value="Comment"/>	<i>Comment</i>	Enter comments.
<input type="text" value="Time/Frequency"/>	<i>Time/Frequency</i>	Enter time/frequency for the data points.
<input type="text" value="Limit/dBm"/>	<i>Limit/dBm</i>	Enter magnitudes for the data points.



Domain, unit, X scaling and Y scaling cannot be modified as soon as reference values have been entered in the data section of the table.

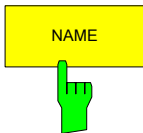

The *NAME* softkey enables the entry of characteristics in the table heading.

Name - Enter name

A maximum of 8 characters is permitted for each name. All names must be compatible with the MS DOS conventions for file names. The instrument stores all limit lines with the .LIM extension.

IEC/IEEE-bus command: `CALC:LIM3:NAME "GSM1"`

Domain - Select time or frequency domain

The default setting is frequency.



A change in domain (frequency/time) is only permitted when the data point table is empty.

IEC/IEEE-bus command: `CALC:LIM3:CONT:DOM FREQ`

X Axis - Select interpolation

Linear or logarithmic interpolation can be carried out between the frequency reference points of the table. The ENTER key toggles between LIN and LOG selection.

IEC/IEEE-bus commands `CALC:LIM3:CONT:SPAC LIN`
 `CALC:LIM3:UPP:SPAC LIN`
 `CALC:LIM3:LOW:SPAC LIN`

Scaling - selection of absolute or relative scaling

The limit line can either be scaled in absolute (frequency or time) or relative units. Any of the unit keys may be used to toggle between *ABSOLUTE* and *RELATIVE*, the cursor must be positioned in the *X Scaling* or the *Y Scaling* line.

X-Scaling ABSOLUTE The frequencies or times are interpreted as absolute physical units.

X-Scaling RELATIVE In the data point table, the frequencies are referred to the currently set center frequency. In time domain mode, the left boundary of the diagram constitutes the reference.

Y-Scaling ABSOLUTE The limit values refer to absolute levels or voltages.

Y-Scaling RELATIVE The limit values refer to the reference level (Ref Level) or, in case a reference line is set, to the reference line.
Limit values with the unit dB are always relative values.

The *RELATIVE* scaling is always suitable, if masks for bursts are to be defined in the time domain, or if masks for modulated signals are required in the frequency domain.

An X offset with half the sweep time may be entered in order to shift the mask in the time domain into the center of screen.

IEC/IEEE-bus command: `CALC:LIM3:CONT:MODE ABS`
 `CALC:LIM3:UPP:MODE ABS`
 `CALC:LIM3:LOW:MODE ABS`

Unit - Select the vertical scale units for the limit line

The selection of units takes place in a selection box. The default setting is dBm.

IEC/IEEE-bus command: `CALC:LIM3:UNIT DBM`

Limit - Select upper/lower limit

A limit line can be defined as either an upper or lower limit.

IEC/IEEE-bus command: `--`
 (defined by key words `:UPPer` or `:LOWer`)

Margin - Setting a margin.

The margin is defined as the signal-level distance to the limit line. When the limit line is defined as an upper limit, the margin means that the level is below the limit line. When the limit line is defined as a lower limit, the margin means that the level is above the limit line. The default setting is 0 dB (i.e. no margin).

IEC/IEEE-bus command: `CALC:LIM3:UPP:MARG 10dB`
 `CALC:LIM3:LOW:MARG 10dB`

Threshold – Selection of the threshold value with relative Y scaling

With relative Y scaling, an absolute threshold value can be defined which lowers the relative limit values. The function is useful especially for mobile radio applications provided the limit values are defined in relation to the carrier power as long as they are above an absolute limit value.

Example:

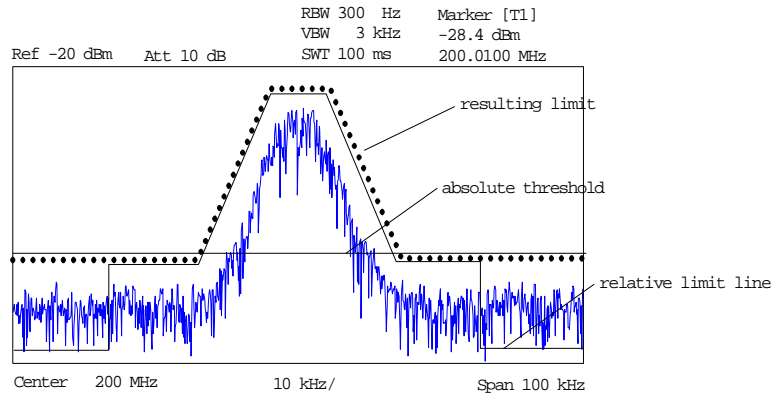

The preset value is at -200 dBm. The field is displayed if the value RELATIVE is entered in the field Y-SCALING.

```
IEC/IEEE-bus command:  CALC:LIM3:UPP:THR -30 dBm
                        OR
                        CALC:LIM3:LOW:THR -30 dBm
```

Comment - Enter comments

Comments are arbitrary, however, they must be less than 41 characters long.

```
IEC/IEEE-bus command:  CALC:LIM3:COMM "Upper limit"
```

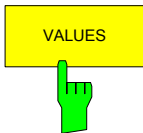

The *VALUES* softkey activates the entry of the data points in the table columns *Time/Frequency* and *Limit/dB*. Which table columns appear depends upon the *Domain* selection in the table heading.

The desired frequency/time data points are entered in ascending order (two repeated frequencies/time values are permitted).

```
IEC/IEEE-bus command:  CALC:LIM3:CONT:DATA 1MHz,3MHz,30MHz
                        CALC:LIM3:UPP:DATA -10,0,0
                        CALC:LIM3:LOW:DATA -30,-40,-40
```

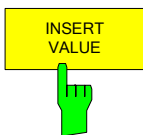

The *INSERT VALUE* softkey creates an empty line above the current cursor position where a new data point may be entered. However, during the entry of new values, it is necessary to observe an ascending order for frequency/time.

```
IEC/IEEE-bus command:  --
```

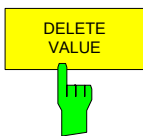

The *DELETE VALUE* softkey erases the data point (complete line) at the cursor position. All succeeding data points are shifted down accordingly.

```
IEC/IEEE-bus command:  --
```

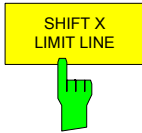

The *SHIFT X LIMIT LINE* softkey calls an entry window where the complete limit line may be shifted parallel in the horizontal direction.

The shift takes place according to the horizontal scale:

- in the frequency domain in Hz, kHz, MHz or GHz
- in the time domain in ns, μ s, ms or s

In this manner, a new limit line can be easily generated based upon an existing limit line which has been shifted horizontally and stored (*SAVE LIMIT LINE* softkey) under a new name (*NAME* softkey).

IEC/IEEE-bus command: `CALC:LIM3:CONT:SHIF 50kHz`



The *SHIFT Y LIMIT LINE* softkey calls an entry window where the complete limit line may be shifted parallel in the vertical direction.

The shift takes place according to the vertical scale:

- for logarithmic units, relative, in dB
- for linear units, as a factor

In this manner, a new limit line can be easily generated based upon an existing limit line which has been shifted vertically and stored (*SAVE LIMIT LINE* softkey) under a new name (*NAME* softkey).

IEC/IEEE-bus command: `CALC:LIM3:CONT:UPP:SHIF 20dB`
 `CALC:LIM3:CONT:LOW:SHIF 20dB`



The *SAVE LIMIT LINE* softkey stores the currently edited limit line. The name can be entered in an input window (max. 8 characters)

IEC/IEEE-bus command: --

Display Lines

Display lines help to evaluate a trace – as do markers. The function of a display line is comparable to that of a ruler that can be shifted on the trace in order to mark absolute values.

The R&S FSMR provides two different types of display lines :

- two horizontal level lines for marking levels – Display Line 1/2,
- two vertical frequency or time lines for marking frequencies or points in time – Frequency/Time Line 1/2.

Each line is identified by one of the following abbreviations:

D1	Display Line 1
D2	Display Line 2
F1	Frequency Line 1
F2	Frequency Line 2
T1	Time Line 1
T2	Time Line 2

The level lines are continuous horizontal lines across the entire width of a diagram and can be shifted in y direction.

The frequency or time lines are continuous vertical lines across the entire height of the diagram and can be shifted in x direction.

The *DISPLAY LINES* submenu for activating and setting the display lines appears different depending on the display mode set in the active measurement window (frequency or time domain).

If the spectrum is shown (span \neq 0) the *TIME LINE 1* and *TIME LINE 2* softkeys are disabled, whereas in the time domain (span = 0) the *FREQUENCY LINE 1* and *FREQUENCY LINE 2* softkeys are not available.



The softkeys for setting and switching the display lines on/off work like triple switches:

Initial situation: The line is off (softkey with gray background)

1st press: The line is switched on (softkey with red background) and the data input function is activated. The position of the display line can be selected by means of the rollkey, the step keys or a numerical entry in the appropriate field. The data input function is disabled if another function is activated. The line, however, remains switched on (softkey with green background).

2nd press: The line is switched off (softkey with gray background).

Initial situation: The line is on (softkey with green background)

1st press: The data input function is activated (softkey with red background). The position of the display line can be selected by means of the rollkey, the step keys or a numerical entry in the appropriate field. The data input function is disabled if another function is activated. The line, however, remains switched on (softkey with green background).

2nd press: The line is switched off (softkey with gray background).

LINES menu

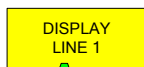
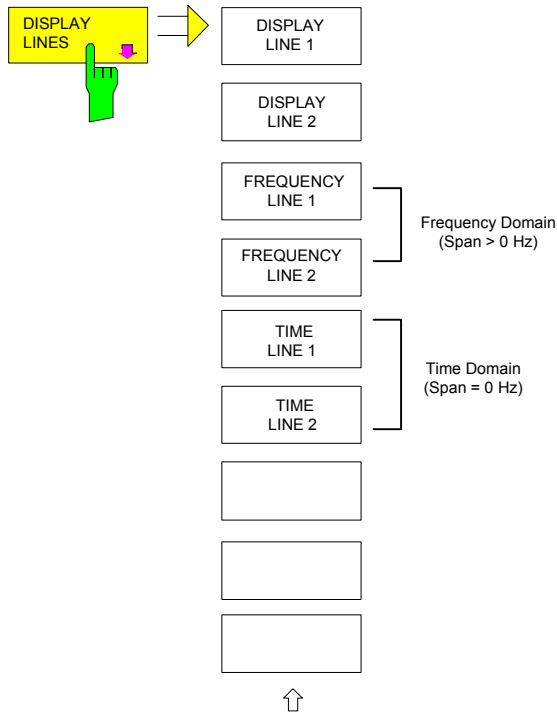

The *DISPLAY LINE 1/2* softkeys enable or disable the level lines and allow the user to enter the position of the lines.

The level lines mark the selected level in the measurement window.

IEC/IEEE-bus command: `CALC:DLIN:STAT ON`
`CALC:DLIN -20dBm`

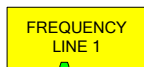
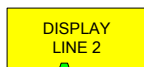

The *FREQUENCY LINE 1/2* softkeys enable or disable the frequency lines 1/2 and allow the user to enter the position of the lines.

The frequency lines mark the selected frequencies in the measurement window.

Note: *The two softkeys cannot be used in the time domain (span = 0).*

IEC/IEEE-bus command: `CALC:FLIN:STAT ON`
`CALC:FLIN 120MHz`

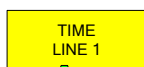
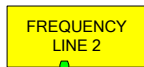

The *TIME LINE 1/2* softkeys enable or disable the time lines 1/ and allow the user to enter the position of the lines.

The time lines mark the selected times or define search ranges (see section "Marker Functions").

Note: *The two softkeys cannot be used in the frequency domain (span > 0).*

IEC/IEEE-bus command: `CALC:TLIN:STAT ON`
`CALC:TLIN 10ms`

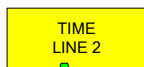

Configuration of Screen Display – DISP Key

The *DISPLAY* menu allows the configuration of the diagram display on the screen and also the selection of the display elements and colors. The *POWER SAVE* mode is also configured in this menu for the display.

The test results are displayed on the screen of the R&S FSMR either in a full-screen window or in two overlapping windows. The two windows are called diagram A and diagram B.

In the default setting, the two windows are completely decoupled from each other, ie they behave like two separate instruments. This is very useful, for example with harmonics measurements or measurements on frequency-converting DUTs, since the input signal and the output signal lie in different frequency ranges.

However, specific settings of the two windows (reference level, center frequency) can be coupled, if required, so that with *CENTER B = MARKER A* for example, the shift of the marker in diagram A causes the frequency range (zoomed in some cases) to be shifted along diagram B.

New settings are performed in the diagram selected via hotkey SCREEN A or SCREEN B. If only one window is displayed, it is the diagram in which the measurements are performed; the diagram not displayed is not active for measurements.

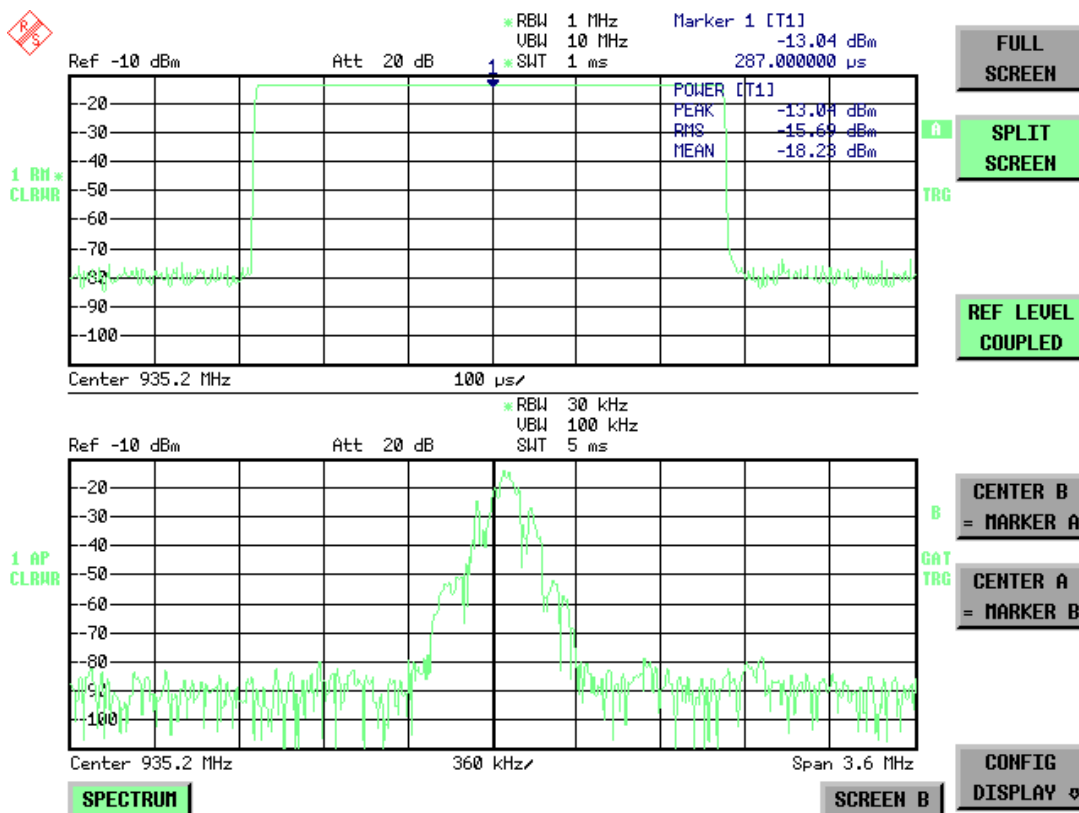
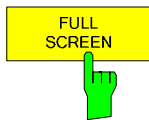
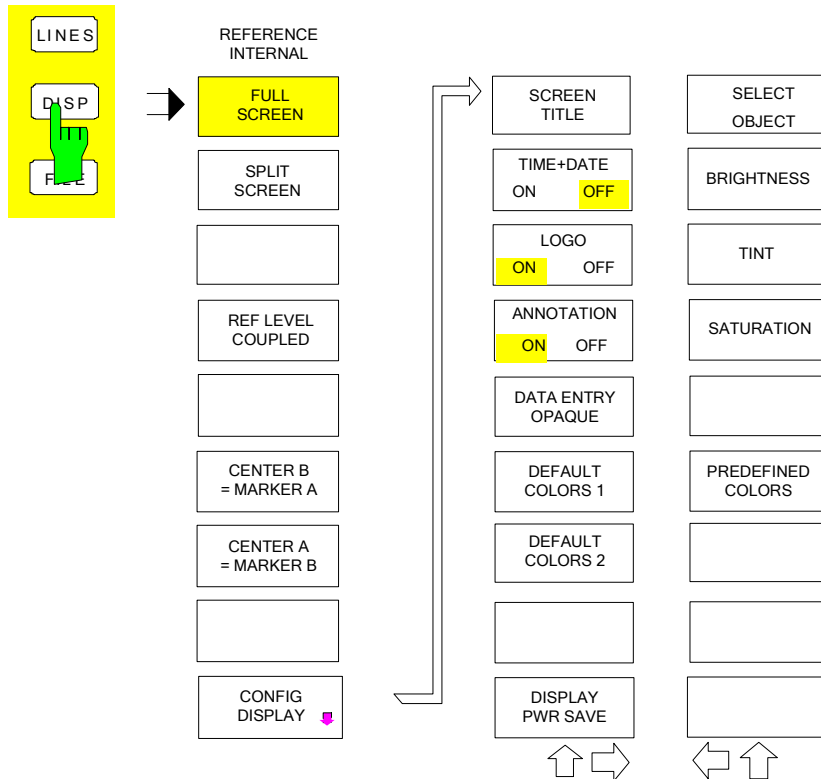

Fig. 4.18-1 Typical split-screen display, settings are uncoupled

The *DISP* key opens the menu for configuring the screen display and selecting the active diagram in SPLIT SCREEN mode.



The *FULL SCREEN* softkey selects the display of one diagram. This corresponds to the default setting of R&S FSMR.

In the *FULL SCREEN* mode it is possible to switch between two different device settings by selecting the active window (screen A or screen B). Switching between *SCREEN A* and *SCREEN B* is performed by means of the corresponding key in the *HOTKEY bar*:

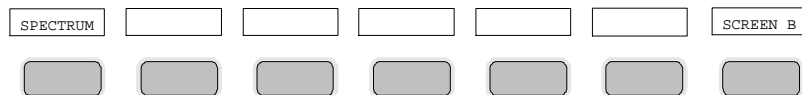

It should be noted that the measurements in the *FULL SCREEN* mode are performed only in the visible (active) window.

The active window is marked by **A** or **B** on the right of the diagram.

IEC/IEEE-bus command: `DISP:FORM SING`
`DISP:WIND<1|2>:SEL`

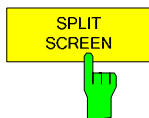

The *SPLIT SCREEN* softkey selects the display of two diagrams. The upper diagram is designated *SCREEN A*, the lower diagram *SCREEN B*.

Switching between *SCREEN A* and *SCREEN B* is performed via the corresponding key in the *HOTKEY bar*. The active window is marked by highlighting fields **A** and **B** on the right of the diagram.

IEC/IEEE-bus command: `DISP:FORM SPL`

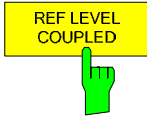

The *REF LEVEL COUPLED* softkey switches the coupling of the reference level on and off. In addition to the reference level, the mixer level and input attenuation are coupled with one another.

For the level measurement, the same reference level and input attenuation must be set for the two diagrams.

IEC/IEEE-bus command `INST:COUP RLEV`



The *CENTER B = MARKER A* and *CENTER A = MARKER B* softkeys couple the center frequency in diagram B with the frequency of marker 1 in diagram A and the center frequency in diagram B with the frequency of marker 1 in diagram B. The two softkeys are mutually exclusive.

This coupling is useful, eg for viewing the signal at the marker position in diagram A with higher frequency resolution or in the time domain in diagram B.

If marker 1 is off, it is switched on and set to the maximum of the trace in the active diagram.

IEC/IEEE-bus command: `INST:COUP CF_B`
`INST:COUP CF_A`

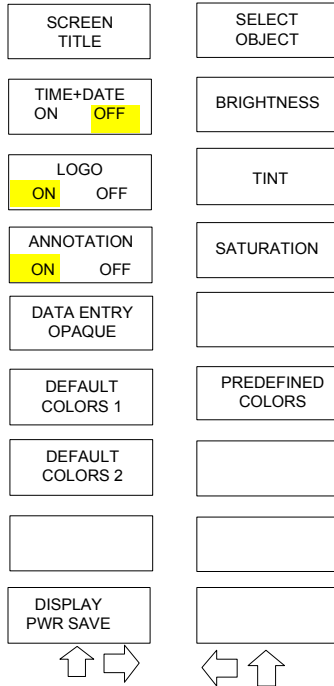
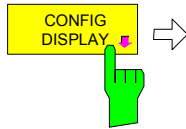

The *CONFIG DISPLAY* softkey opens a submenu allowing additional display items to be added to the screen. In addition, the display power-save mode (*DISPLAY PWR SAVE*) and the colors of the display elements can be set here.

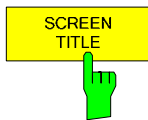

The *SCREEN TITLE* softkey activates the entry of a title for the active diagram A or B. It switches on or off a title that is already input. The length of the title is limited to max. 20 characters.

IEC/IEEE-bus command: `DISP:WIND1:TEXT 'Noise Meas'`
`DISP:WIND1:TEXT:STATE ON`

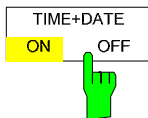

The *TIME+DATE ON/OFF* softkey switches on or off the display of date and time above the diagram.

IEC/IEEE-bus command: `DISP:TIME OFF`

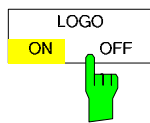

The *LOGO ON/OFF* softkey switches the Rohde & Schwarz company logo displayed in the upper left corner of the display screen on or off.

IEC/IEEE-bus command: `DISP:LOGO ON | OFF`

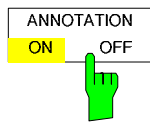

The *ANNOTATION ON/OFF* softkey switches the displaying of frequency information on the screen on and off.

ON Frequency information is displayed.

OFF Frequency information is not outputted to the display. This can be used for example to protect confidential data.

IEC/IEEE-bus command: `DISP:ANN:FREQ ON | OFF`

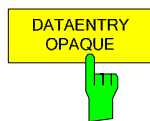

The *DATAENTRY OPAQUE* softkey sets the data entry windows to opaque. This means that entry windows are underlayed with the background color for tables.

IEC/IEEE-bus command: `--`

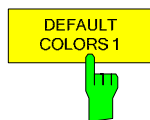

The *DEFAULT COLORS 1 and 2* softkey restores the default settings for brightness, color tint and color saturation for all display screen elements.

The color schemes have been selected to give optimum visibility of all picture elements at an angle of vision from above or below. *DEFAULT COLORS 1* is active in the default setting of the instrument.

IEC/IEEE-bus command: `DISP:CMAP:DEF1`
`DISP:CMAP:DEF2`

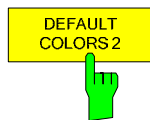

The *DISPLAY PWR SAVE* softkey is used to switch on/off the power-save mode for the display and to enter the time for the power-save function to respond. After the elapse of this time the display is completely switched off, ie including backlighting.



This mode is recommended for saving the TFT display especially when the instrument is exclusively operated in remote control.

The power-save mode is configured as follows:

- The first keystroke activates the power-save mode and opens the editor for the response time (*POWER SAVE TIMEOUT*). The response time is entered in minutes between 1 and 6 minutes and is confirmed by *ENTER*.
- The power-save mode is deactivated by pressing the key again.

On leaving the menu with the power-save mode in the activated state, the softkey is highlighted in color on returning to the menu and opens again the editor for the response time. Pressing again the key switches off the power-save mode.

IEC/IEEE-bus command: `DISP:PSAV ON`
`DISP:PSAV:HOLD 15`

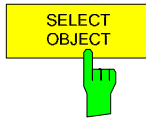

The *SELECT OBJECT* softkey activates the *SELECT DISPLAY OBJECT* table, with which a graphics element can be selected. After selection, the brightness, tint and saturation of the selected element can be changed using the softkeys of the same name. The color changes by means of the *PREDEFINED COLORS* softkey can be seen immediately on the display screen.

SELECT DISPLAY OBJECT	
√ Background	
Grid	
Function field + status field + data entry text	
Function field LED on	
Function field LED warn	
Enhancement label text	
Status field background	
Trace 1	
Trace 2	
Trace 3	
Marker	
Lines	
Measurement status + limit check pass	
Limit check fail	
Table + softkey text	
Table + softkey background	
Table selected field text	
Table selected field background	
Table + data entry field opaq titlebar	
Data entry field opaq text	
Data entry field opaq background	
3D shade bright part	
3D shade dark part	
Softkey state on	
Softkey state data entry	
Logo	



The *BRIGHTNESS* softkey activates entry of the brightness of the selected graphics element. Values between 0 and 100% can be entered.

IEC/IEEE-bus: DISP:CMAP3:HSL< hue>,<sat>,<lum>

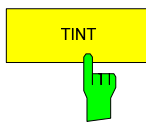

The *TINT* softkey activates the entry of the color tint of the selected element. The entered value is related to a continuous color spectrum ranging from red (0%) to blue (100%).

IEC/IEEE-bus: DISP:CMAP3:HSL <hue>,<sat>,<lum>

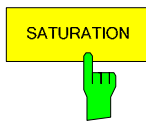

The *SATURATION* softkey activates the entry of the color saturation for the selected element. The range of inputs is from 0 to 100%.

IEC/IEEE-bus: DISP:CMAP3:HSL <hue>,<sat>,<lum>



The *PREDEFINED COLORS* softkey activates a table, with which the predefined colors for the display screen elements can be selected.

COLOR
√ BLACK
BLUE
BROWN
GREEN
CYAN
RED
MAGENTA
YELLOW
WHITE
GRAY
LIGHT GRAY
LIGHT BLUE
LIGHT GREEN
LIGHT CYAN
LIGHT RED
LIGHT MAGENTA

IEC/IEEE-bus command: DISP:CMAP1 to 26:PDEF <color>

Instrument Setup and Interface Configuration – *SETUP* Key

The *SETUP* key opens the menu for configuration of the R&S FSMR:

The following settings can be modified here:

- The *REFERENCE INT/EXT* softkey determines the source of the reference.
- The *NOISE SRC ON/OFF* softkey switches on and off the voltage supply for an external noise source.
- The *PREAMP* softkey switches on the RF preamplifier gain. This softkey is only available with option EL. ATTENUATOR (B25).
- The *TRANSDUCER* softkey opens a submenu for entering the correction characteristics for transducers.
- The *GENERAL SETUP* softkey opens a submenu for all the general settings such as IEC/IEEE-bus address, date and time as well as the configuration of the device interfaces. *FIRMWARE OPTIONS* can be installed under this menu item.
- The *SYSTEM INFO* softkey opens a submenu for displaying the hardware configuration of the instrument, the switching cycle statistics and system messages.
- The *SERVICE* softkey opens a submenu in which special device functions and system information can be selected for servicing. The password required for service functions can be entered in this submenu.
- The *IF SHIFT* softkey opens a submenu to activate or deactivate 1st IF shifting.
- The *RECEIVER PRESET* softkey sets the receiver mode as preset mode.
- The *ANALYZER PRESET* softkey sets the analyzer mode as preset mode.

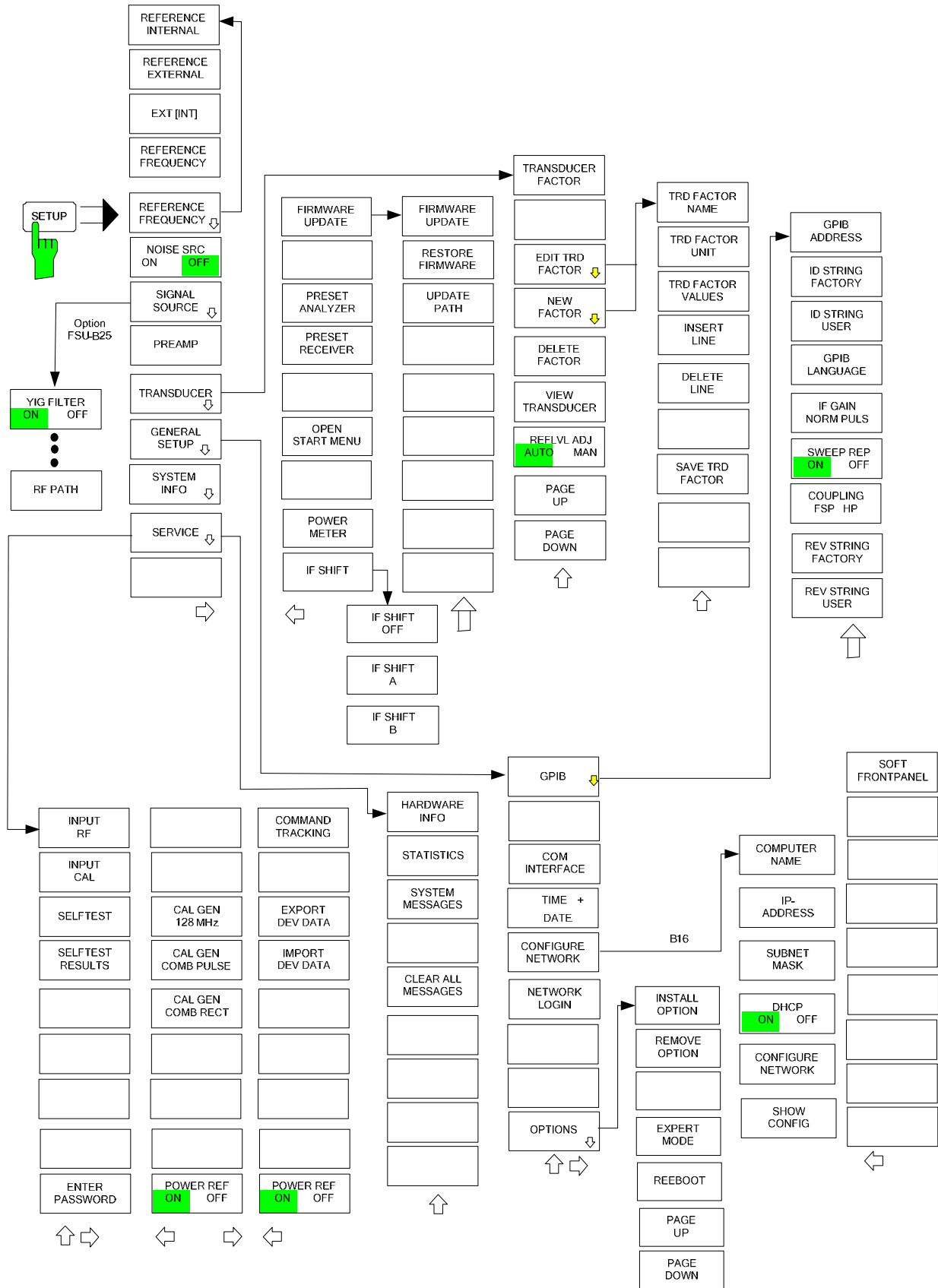

External Reference

The R&S FSMR can use the internal reference source or an external reference source as frequency standard from which all internal oscillators are derived. A 10 MHz crystal oscillator is used as internal reference source. In the default setting (internal reference), this frequency is available as output signal at rear-panel connector REF OUT, e.g. to synchronize other instruments to the reference of the R&S FSMR.

In the setting *REFERENCE EXT*, the connector REF IN is used as input connector for an external frequency standard. In this case all internal oscillators of the R&S FSMR are synchronized to the external reference frequency (also 10 MHz).

SETUP menu:

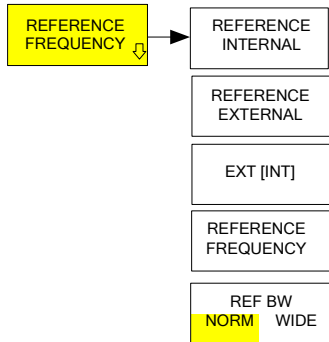

The *REFERENCE FREQUENCY* softkey opens a submenu to configure the reference more precisely.

To maintain the setup of a test system, the reference settings do not change if a preset is performed

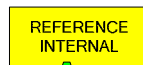

The *REFERENCE INTERNAL / EXTERNAL* softkey activates the internal or external reference.

If the external reference is selected, you can set the frequency of the external reference with the *REFERENCE FREQUENCY* softkey.

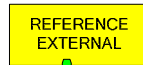

IEC/IEEE-bus command: `ROSC:SOUR INT | EXT`

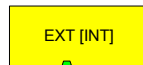

The *EXT [INT]* softkey provides a fail-safe if the external reference signals fails for any reason.

The softkey activates the use of an external reference signal. However, if the R&S FSMR detects an unlock due to a missing external reference signal, the reference signal source automatically switches to use the internal reference signal.

Once the R&S FSMR has switched to the internal reference signal it stays with the internal reference. You have to switch back to the external reference signal manually (press *REFERENCE EXTERNAL* and then activate *EXT [IN]* again). The current source (internal or external) is indicated in the lower part of the softkey.

IEC/IEEE-bus command: `ROSC:SOUR EAUT`

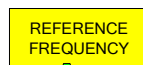

The *REFERENCE FREQUENCY* softkey sets the frequency of the external reference. The range is from 1 MHz to 20 MHz with the default value being 10 MHz.

The reference frequency does not change after a preset to maintain the setup of a test system.

IEC/IEEE-bus command: `RROSC:EXT:FREQ <numeric value>`

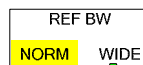

The *REF BW (NORM WIDE)* softkey controls the PLL bandwidth used to synchronize with the external reference signal. Possible settings are *NORM* (PLL bandwidth about 3 Hz) or *WIDE* (PLL bandwidth about 30 Hz). The default setting is *NORM*.

The reference settings do not change after a preset to maintain the

setup of a test system. The softkey is available only if the external reference frequency is 10 MHz. This function requires a synthesizer board revision with hardware code 7 or above. You can check this information in the .HWC. column of the hardware info window.



If the reference signal is missing when switching to external reference, the message "EXREF" appears after a while to indicate that there is no synchronization.

On switching to internal reference please ensure that the external reference signal is de-activated to avoid interactions with the internal reference signal.

```
IEC/IEEE-bus command: ROSC:SOUR INT
                      ROSC:EXT:FREQ <numeric value>
```

External Noise Source

SETUP menu:

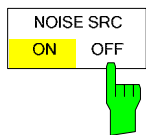

The *NOISE SRC ON/OFF* softkey switches on or off the supply voltage for an external noise source which is connected to the *NOISE SOURCE* connector on the rear panel of the instrument.

```
IEC/IEEE-bus command: DIAG:SERV:NSO ON
```

YIG Filter On/Off

In order to carry out broadband signal analysis, the YIG filter at the input of the R&S FSMR can be removed from the signal path.

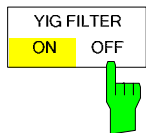

The *YIG FILTER ON / OFF* softkey bypasses the input YIG filter so that broadband signal analysis via the RF is possible. Press the softkey again to re-enable the YIG filter.



The YIG filter operates only if the frequency in the signal path exceeds 3.6 GHz. The command has, therefore, no effect if the frequency is below this threshold. (R&S FSMR-B2).

```
IEC/IEEE-bus command: INP:FILTER:YIG ON|OFF
```

RF Preamp

To improve the noise figure, a low-noise preamplifier with variable gain at the RF input can be switched into the signal path.

SETUP menu:

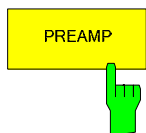

The *PREAMP* softkey switches the preamplifier on and activates the entry of the preamplifier gain. The preamplifier is switched off by pressing the softkey again.

The only possible value with option el. attenuator is 20 dB.

```
IEC/IEEE-bus command: INP:GAIN:STAT ON
```



The *PREAMP* softkey is only available with option EL. ATTENUATOR (R&S FSMR-B25).

Transducer

Activating Transducer Factors

The *TRANSDUCER* softkey opens a submenu enabling the user to activate or deactivate defined transducer factors, to generate new transducer factors or to edit existing ones. A table with the transducer factors defined is displayed.

As soon as a transducer is activated, the unit of the transducer is automatically used for all the level settings and outputs. The unit cannot be changed in the *AMPT* menu since the R&S FSMR and the transducer used are regarded as one measuring instrument. Only if the transducer has the unit dB, will the unit originally set on the R&S FSMR be maintained and can be changed.

If a transducer factor is active, the remark TDF appears in the Enhancement Labels column.

After all transducers have been switched off, the R&S FSMR returns to the unit that was used before a transducer was activated.

In the analyzer mode, an active transducer for a sweep is calculated once in advance for every point displayed and is added to the result of the level measurement during the sweep. If the sweep range changes, the correction values are calculated again. If several measured values are combined, only one value is taken into consideration.

If the active transducer factor is not defined for the entire sweep range, the values missing are replaced by zeroes.

SETUP menu:

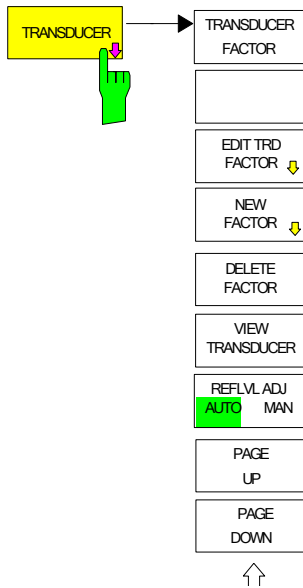

The *TRANSDUCER* softkey opens a submenu where defined transducer factors can be edited or new transducer factors can be entered. A table with the available factors is displayed, and the active transducer can be selected from this list.

TRANSDUCER FACTOR	
Name	Unit
<input checked="" type="checkbox"/> Cable_1	dB
HK116	dBuV/m
HL223	dBuV/m

The *TRANSDUCER FACTOR* table contains all the defined factors with name(max. 8 characters because of MS-DOS) and unit and current status. If the number of transducer factors defined exceeds the number of lines available in the table, the user has to scroll through the table.

Only one factor at a time can be activated. A tick next to the name indicates that the transducer is active.

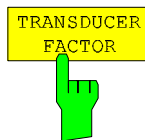

The *TRANSDUCER FACTOR* softkey places the scrollbar on the position of the active transducer factor.

If a transducer factor is not active, the scrollbar is placed on the first line of the table.

IEC/IEEE-bus command: `CORR:TRAN:SEL <name>`
`CORR:TRAN ON | OFF`

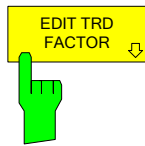

The *NEW* and *EDIT* softkeys give access to the submenu for editing and generating transducer factors.

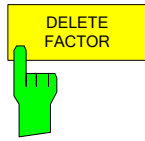
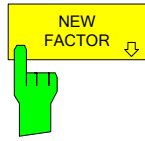

The *DELETE* softkey deletes the factor that is marked. To prevent inadvertent deleting, the instrument outputs a confirmation query.

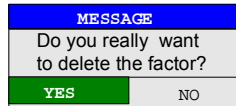

IEC/IEEE-bus command: `CORR:TRAN DEL`

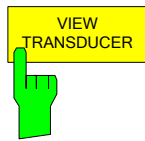

The *VIEW TRANSDUCER* softkey activates the display of the active transducer factor or set. During the measurement, the interpolated characteristic of the active transducer factor or set is shown in the diagram instead of the measured values.

IEC/IEEE-bus command: `CORR:TRAN:VIEW ON`

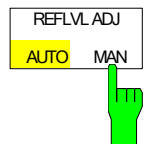

When a transducer factor is used, the trace is moved by a calculated shift. However, an upward shift reduces the dynamic range for the displayed values. With the softkey *REFLVL ADJ* an automatic reference level offset adaptation allows to restore the original dynamic range by also shifting the reference level by the maximum value of the transducer factor.

IEC/IEEE-bus command:

`:SENS1:CORR:TRAN:ADJ:RLEV:STAT ON | OFF`



Command `CORR:TRAN:SEL` has to be sent prior to this command.

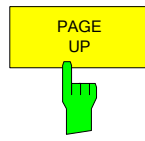

The *PAGE UP* and *PAGE DOWN* softkeys are used to scroll through large tables that cannot completely be displayed on the screen.

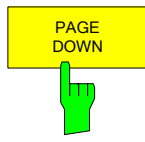

Entry and Editing of Transducer Factors

A transducer factor is characterized by the following:

- Reference values with frequency and factor (*Values*)
- Unit of the factor (*Unit*) and
- Name (*Name*) to distinguish the various factors.

During entry the R&S FSMR checks the transducer factor for compliance with specific rules that must be met to ensure correct operation.

- The frequencies for the reference values must always be entered in ascending order. Otherwise the entry will not be accepted and the following message will appear.

WRONG Frequency Sequence!

- The frequencies entered may exceed the frequency range of the R&S FSMR since only the set frequency range is taken into account for measurements. The minimum frequency of a reference value is 0 Hz, the maximum frequency 200 GHz.
- The value range for the transducer factor is ± 200 dB. If the minimum or maximum value is exceeded, the R&S FSMR outputs the following message:

out of range.

- Gain has to be entered as a negative value, and attenuation as a positive value.



The softkeys in the "UNIT" submenu of the AMPT key cannot be operated if the transducer is on.

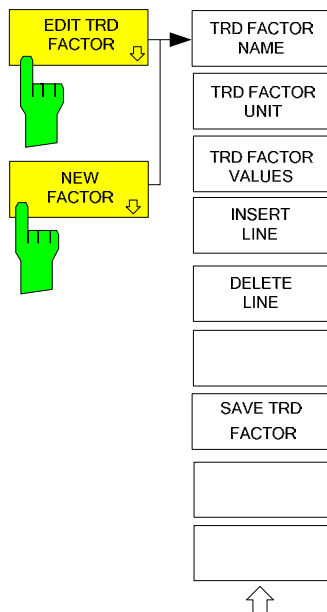

The *EDIT TRD FAKTOR* and *NEW FAKTOR* softkeys give access to the submenu for editing and generating transducer factors.

EDIT TRANSDUCER FACTOR			
Name/Unit/Interpolation:		TDF1	dB LIN
Comment:			
FREQUENCY	TDF/dB..	FREQUENCY	TDF/dB..
10.00000000 MHz	1.000		
500.00000000 MHz	1.250		
1.00000000 GHz	1.500		
1.50000000 GHz	5.000		
2.00000000 GHz	5.500		
3.00000000 GHz	7.500		

Depending on the softkey selected, either the table with the data of the factor marked (softkey *EDIT*) or an empty table (softkey *NEW*) appears. This table is empty except for the following entries:

Unit: dB
 Interpolation: LIN for linear frequency scaling
 LOG for logarithmic frequency scaling

The features of the factor are entered in the header of the table, and the frequency and the transducer factor are entered in the columns.

- Name* Entry of name
- Unit* Selection of unit
- Interpolation* Selection of interpolation
- Comment* Entry of comment
- FREQUENCY* Entry of frequency of reference values
- TDF/dB* Entry of transducer factor.

During editing, a transducer factor remains stored in the background until the factor edited is saved with the *SAVE TRD FACTOR* softkey or until the table is closed. A factor that was edited by mistake can be restored by leaving the entry function.

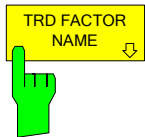

Name – Entry of name

The *TRD FACTOR NAME* softkey is used to enter the name of the transducer factor.

A maximum of 8 characters is permissible for the name. The characters have to comply with the convention of DOS file names. If the name exceeds 8 characters, the name is truncated. The unit automatically stores all transducer factors with the extension .TDF. If an existing name is changed, the factor stored under the previous name is retained and will not be overwritten automatically with the new name. The previous factor can be deleted at a later time, using DELETE. Thus, factors can be copied.

IEC/IEEE-bus command `CORR:TRAN:SEL <name>`

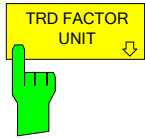

Unit - Selection of unit

The *TRD FACTOR UNIT* softkey gives access to a box for selecting the unit of the transducer factor.

SET UNIT
dB
◀dBm
dBμV
dBmV
dBμA
dBpW
dBμV/m
dBμA/m
dBpT

The default setting is dB.

IEC/IEEE-bus command `CORR:TRAN:UNIT <string>`

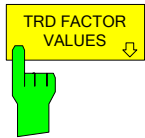

FREQUENCY, TDF/dB – Entry of values

The *TRD FACTOR VALUES* softkey sets the scrollbar on the first reference value. The desired reference values for FREQUENCY and TDF/dB must be entered in ascending order of frequencies. After the frequency has been entered, the scrollbar automatically goes to the associated level value.

The table can be edited after entry of the first value using the *INSERT LINE* and *DELETE LINE* softkeys. To change individual values later on, the value has to be selected and a new one entered.

IEC/IEEE-bus command `CORR:TRAN:DATA <freq>,<level>`.

Interpolation - Selection of interpolation

Linear or logarithmic interpolation can be performed between the frequency reference values of the table. The ENTER key allows the user to select LIN or LOG (toggle function).

IEC/IEEE-bus command `CORR:TRAN:SCAL LIN|LOG`

The following diagrams show the effect that interpolation has on the calculated trace:

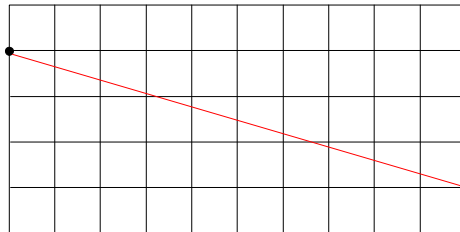

Fig. 4.19-1 Linear frequency axis and linear interpolation

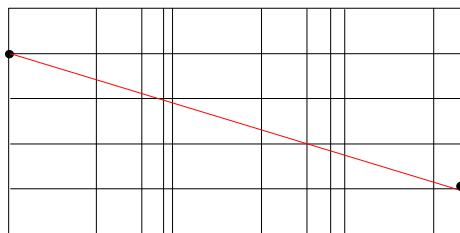
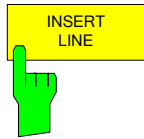

Fig. 4.19-2 Logarithmic frequency axis and interpolation

Comment - Entry of comment

Any comment with a maximum length of 50 characters can be entered.

IEC/IEEE-bus command `CORR:TRAN:COMM <string>`



The *INSERT LINE* softkey inserts an empty line above the marked reference value. When entering a new reference value in the line, the ascending order of frequencies must be taken into consideration, however.

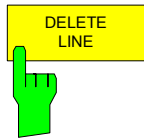

The *DELETE LINE* softkey deletes the marked reference value (complete line). The reference values that follow move one line up.

IEC/IEEE-bus command --

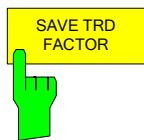

The *SAVE TRD FACTOR* softkey saves the changed table in a file on the internal hard disk.

If there is already a transducer factor that has the same name, a confirmation query is output.

If the new factor is active, the new values become immediately valid.

IEC/IEEE-bus command - (With IEC/IEEE bus operation, the save operation is performed automatically after the definition of the reference values)

Programming the Interface Configuration and Time Setup

The *GENERAL SETUP* softkey opens a submenu in which the general instrument parameters can be set up. In addition to the configuration of the digital interfaces (*IECBUS*, *COM*), the date and time may be entered.

The current settings are displayed in tabular form on the display screen where they may be edited.

SETUP - GENERAL SETUP submenu:

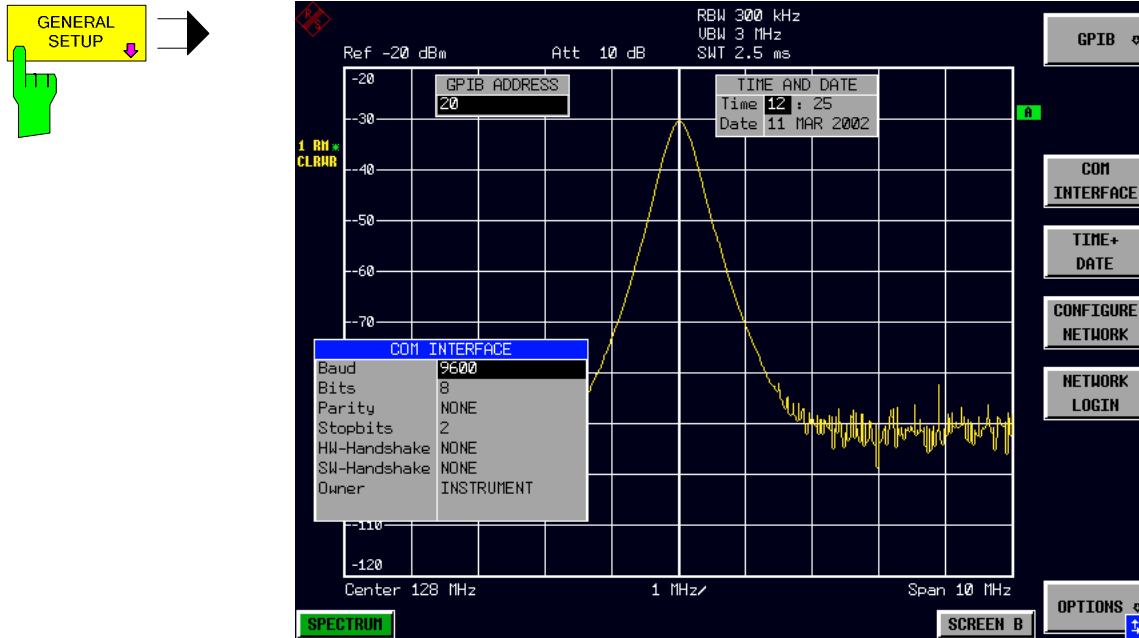

Selecting the IEC/IEEE-Bus Address

SETUP - GENERAL SETUP menu:

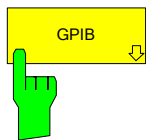

The *GPIB* softkey opens a submenu for setting the parameters of the remote-control interface.

IEC/IEEE-bus command: --



The *GPIB ADDRESS* softkey enables the entry of the IEC/IEEE-bus address.

Valid addresses are 0 through 30. The default address is 20.

IEC/IEEE-bus command: `SYST:COMM:GPIB:ADDR 20`

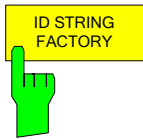

The *ID STRING FACTORY* softkey selects the default response to the *IDN? query.

IEC/IEEE-bus command: --

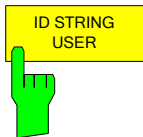

The *ID STRING USER* softkey opens an editor for entering a user-defined response to the *IDN? query.

Max. length of output string: 36 characters

IEC/IEEE-bus command: --

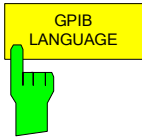

The *GPIB LANGUAGE* softkey opens a list of selectable remote-control languages:

- SCPI
- 71200C
- 8560E
- 8562E
- 8564E
- 8566A
- 8568A
- 8568B
- 8591E
- 71100C
- 71209A
- 8561E
- 8563E
- 8565E
- 8566B
- 8568A_DC
- 8568B_DC
- 8594E



For 8566A/B, 8568A/B and 8594E, command sets A and B are available. Command sets A and B differ in the rules regarding the command structure.

Selecting a language different from "SCPI" will set the GPIB address to 18 if it was 20 before.

Start / stop frequency, reference level and # of sweep points will be adapted to the selected instrument model.

8568A_DC and 8568B_DC are using DC input coupling as default if it is supported by the instrument.

The HP model 8591E is compatible to HP model 8594E, the HP models 71100C, 71200C, and 71209A are compatible to HP models 8566A/B.

On switching between remote-control languages, the following settings or changes will be made:

SCPI:

- The instrument will perform a *PRESET*.

8566A/B, 8568A/B, 8594E:

- The instrument will perform a *PRESET*.
- The following instrument settings will then be changed:

Model	# of Trace Points	Start Freq.	Stop Freq.	Ref Level	Input Coupling
8566A/B	1001	2 GHz	22 GHz	0 dBm	DC (FSU/FSQ) AC (FSP)
8568A/B	1001	0 Hz	1.5 GHz	0 dBm	AC
8560E	601	0 Hz	2.9 GHz	0 dBm	AC
8561E	601	0 Hz	6.5 GHz	0 dBm	AC
8562E	601	0 Hz	13.2 GHz	0 dBm	AC
8563E	601	0 Hz	26.5 GHz	0 dBm	AC
8564E	601	0 Hz	40 GHz	0 dBm	AC
8565E	601	0 Hz	50 GHz	0 dBm	AC
8594E	401	0 Hz	3 GHz	0 dBm	AC



Notes regarding switch over to 8566A/B and 8568A/B on R&S FSMR

The stop frequency indicated in the table may be limited to the corresponding frequency of the R&S FSMR, if required.

```
IEC/IEEE-bus command: SYST:LANG "SCPI" | "8560E" | "8561E" |
                        "8562E" | "8563E" | "8564E" |
                        "8565E" | "8566A" | "8566B" |
                        "8568A" | "8568B" | "8591E" |
                        "8594E" | "71100C" |
                        "71200C" | "71209A"
```

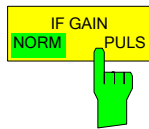

Softkey IF GAIN PULS configures the internal IF gain settings in HP emulation mode due to the application needs. This setting is only taken into account for resolution bandwidth < 300 kHz.

NORMAL Optimized for high dynamic range, overload limit is close to reference level

PULS Optimized for pulsed signals, Overload limit up to 10 dB above reference level

IEC/IEEE bus command: `SYST:IFG:MODE NORM | PULS`

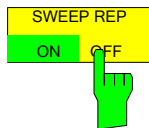

Softkey SWEEP REP ON/OFF controls a repeated sweep of the commands E1 and MKPK HI. If the repeated sweep is OFF, the marker is set without sweeping before.

IEC/IEEE bus command: -



In single sweep mode, switch off this softkey before you set the marker via the E1 and MKPK HI commands in order to avoid sweeping afresh.

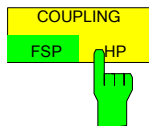

Softkey COUPLING FSP/HP controls the default coupling ratios for span and resolution bandwidth (Span/RBW) and for resolution bandwidth and video bandwidth (RBW/VBW) for the HP emulation mode. In case of FSP the standard parameter coupling of the instrument is used. As a result in most cases a shorter sweeptime is used than in case of HP.

The softkey is only available in HP emulation mode.

IEC/IEEE bus command: `SYST:HPC FSP | HP`

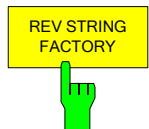

The *REV STRING FACTORY* softkey selects the default response for the .REV? remote command. It is available if a HP language is selected :

IEC/IEEE bus command: `SYST:REV:FACT`

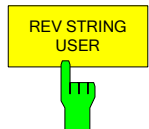

The *REV STRING USER* softkey opens a dialog box to define a customized response for the .REV?. remote command. The maximum length of the output string is 40 characters.

The softkey is available if a HP language is selected:

IEC/IEEE bus command: `SYST:REV <string>`

Serial Interface Configuration

SETUP-GENERAL SETUP submenu:

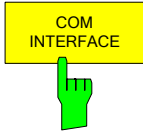

The *COM INTERFACE* softkey activates the *COM INTERFACE* table for entry of the serial interface parameters.

The following parameters can be configured in the table:

<i>Baud rate</i>	data transmission rate
<i>Bits</i>	number of data bits
<i>Parity</i>	bit parity check
<i>Stop bits</i>	number of stop bits
<i>HW-Handshake</i>	hardware handshake protocol
<i>SW-Handshake</i>	software handshake protocol
<i>Owner</i>	assignment to the measuring instrument or computer

COM INTERFACE	
Baud	9600
Bits	8
Parity	NONE
Stopbits	2
HW-Handshake	NONE
SW-Handshake	NONE
Owner	INSTRUMENT

Baud – Data transmission rate

The R&S FSMR supports baud rates between 110 and 19200 baud. The default setting is 9600 baud.

BAUD RATE
19200
✓9600
4800
2400
1200
600
300
110

IEC/IEEE-bus command: SYST:COMM:SER:BAUD 9600

Bits – Number of data bits per word

For the transmission of text without special characters, 7 bits are adequate. For binary data as well as for text with special characters, 8 bits must be selected (default setting).

BITS
?
✓8

IEC/IEEE-bus command: SYST:COMM:SER:BITS 7

Parity – Bit parity check

<i>NONE</i>	no parity check (default setting)
<i>EVEN</i>	even parity check
<i>ODD</i>	odd parity check

PARITY
✓NONE
EVEN
ODD

IEC/IEEE-bus command: SYST:COMM:SER:PAR NONE

Stop bits – Number of stop bits

Available are 1 and 2. The default setting is 1 stop bit.



IEC/IEEE-bus command: `SYST:COMM:SER:SBIT 1`

HW-Handshake – Hardware handshake protocol

The integrity of data transmission can be improved by the use of a hardware handshake mechanism, which effectively prevents uncontrolled transmission of data and the resulting loss of data bytes. For hardware handshake additional interface lines are used to transmit acknowledge signals with which the data transmission can be controlled and, if necessary, stopped until the receiver is ready to receive data again.

A prerequisite for using hardware handshaking is, however, that the interface lines (DTR and RTS) are connected on both transmitter and receiver. For a simple 3-wire connection, this is not the case and hardware handshake cannot be used here.

Default setting is *NONE*.



IEC/IEEE-bus command: `SYST:COMM:SER:CONT:DTR OFF`
`SYST:COMM:SER:CONT:RTS OFF`

SW-Handshake – Software handshake protocol

Besides the hardware handshake mechanism using interface lines, it is also possible to achieve the same effect by using a software handshake protocol. Here, control bytes are transmitted in addition to the normal data bytes. These control bytes can be used, as necessary, to stop data transmission until the receiver is ready to receive data again.

In contrast to hardware handshaking, software handshaking can be realized even for a simple 3-wire connection.

One limitation is, however, that software handshaking cannot be used for the transmission of binary data, since the control characters XON and XOFF require bit combinations that are also used for binary data transmission.

Default setting is *NONE*.



IEC/IEEE-bus command: `SYST:COMM:SER:PACE NONE`

Owner – Assignment of the interface

The serial interface can be assigned alternatively to the measuring instrument section or to the computer section

If the interface is assigned to one section of the instrument, it is not available to the other section.

INSTRUMENT The interface is assigned to the measuring instrument section. Outputs to the interface from the computer section are not possible will get lost.

OS The interface is assigned to the computer section. It

cannot be used by the measuring instrument section. This means that remote control of the instrument via the interface is not possible.



IEC/IEEE-bus command: --

Setting Date and Time

SETUP-GENERAL SETUP submenu:

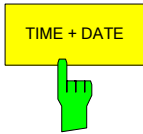

The *TIME+DATE* softkey activates the entry of time and date for the internal realtime clock.

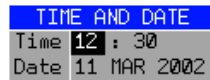

Time - Input of time

In the corresponding dialog box, the time is partitioned into two input fields so that hours and minutes can be entered independently.

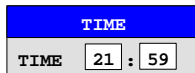

IEC/IEEE-bus command: SYST:TIME 21,59

Date - Input of Date

In the corresponding dialog box, the date is partitioned into 3 input fields so that day, month and year can be input separately.

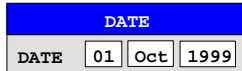

For the selection of the month, pressing a unit key opens a list of abbreviations wherein the desired month can be selected.

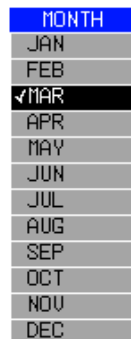

IEC/IEEE-bus command: SYST:DATE 1999,10,01

Network Configuration

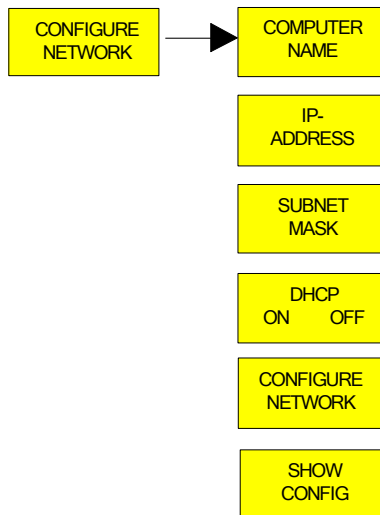

The CONFIGURE NETWORK softkey opens the windows dialog box with the network settings. The most important parameters are accessible by the softkeys COMPUTER NAME, IP ADDRESS, SUBNET MASK and DHCP ON/OFF.



The Network Configuration softkeys above are available from firmware Version 4.3x.

Instruments shipped with Windows XP Service Pack1 require an additional installation package (LXI installer) if the softkeys are not visible. This installation package is available on the R&S instrument's download area.

The configuration via softkeys is only possible if the LAN is connected to the instrument.



Softkey COMPUTERNAME opens a dialog to enter the computer name. The naming conventions of Windows apply. For further details refer to the *Quickstart Guide, Appendix B: LAN Interface*.



Softkey IP ADDRESS opens a dialog to configure the instrument's IP address. The TCP/IP protocol is preinstalled with the IP address 10.0.0.10. If the DHCP server is available (DHCP ON) the softkey is not available. For further details refer to the *Quickstart Guide, Appendix B: LAN Interface*.



Softkey SUBNET MASK opens a dialog to configure the instrument's TCP/IP subnet mask. The TCP/IP protocol is preinstalled with the subnet mask 255.255.255.0.

The subnet mask consists of four number blocks separated by dots. Each block contain 3 numbers in maximum (e.g.100.100.100.100), but also one ore two numbers are allowed in a block (as an example see the preinstalled address).

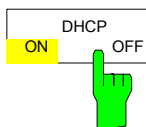

If the *DHCP* softkey is set ON, a new IP address is assigned each time the instrument is restarted. This address must first be determined on the instrument itself.



To avoid problems, use a fixed IP address.

Using a DHCP server is not suitable for remote operation of the R&S FSMR.

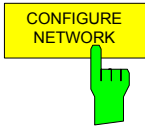

The *CONFIGURE NETWORK* softkey opens the dialog box with the network settings.

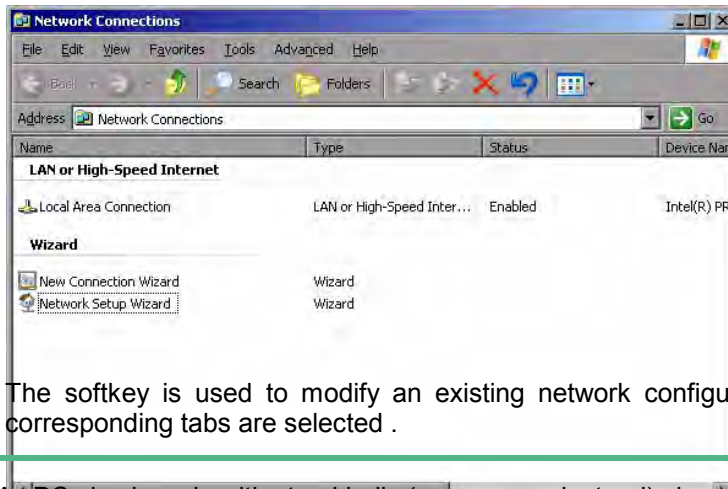

The softkey is used to modify an existing network configuration after the corresponding tabs are selected .



A PC keyboard with trackball (or mouse instead) is required for the installation/configuration of the network support.

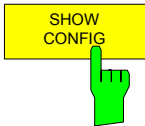

Softkey *SHOW CONFIG* show the current network configuration.

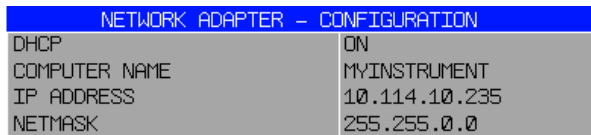

The Network Configuration softkeys above are available since Firmware Version 4.3x.

The configuration via softkeys is only possible if the LAN is connected to the instrument.

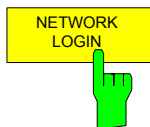

The *NETWORK LOGIN* softkey opens the dialog box with the auto login settings.

Important:

The password was changed to '123456' with firmware version 4.5. For version < 4.5, the password is 'instrument'.

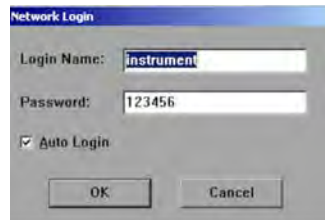

When a network is installed, the preset user name 'instrument' and the password '123456' can be adapted to a new user.

With the 'Auto Login' option active, an automatic registration is performed during booting with the specified user name and password. Otherwise the Windows XP login request is displayed during booting.

IEC/IEEE bus command: -



A PC keyboard with trackball (or mouse instead) is required for the installation/configuration of the network support

Managing Firmware Options

The *OPTIONS* softkey opens a table that shows all available applications and a submenu to manage firmware applications.

FIRMWARE OPTIONS				
DESCRIPTION	NAME	CODE	MIN MEM/MB	MAX MEM/MB
<input checked="" type="checkbox"/> GSM/EDGE Application	K5	3980974966	0.0	22.1
<input checked="" type="checkbox"/> FM Demodulator	K7	2820825824	0.0	25.8
<input checked="" type="checkbox"/> Bluetooth	K8	4263398024	0.0	47.9
<input checked="" type="checkbox"/> Noise Figure	K30	3719832655	16.0	1.1
<input checked="" type="checkbox"/> Phase Noise	K40	3454193305	6.4	3.4
<input checked="" type="checkbox"/> WCDMA BTS			0.0	24.1
WCDMA BTS Analyzer	K72	2887907627	0.0	47.0
WCDMA HSDPA BTS	K74	3704742094		
WCDMA HSPA+ BTS	K74+	2499677638		
Press PAGE UP or PAGE DOWN for further options				
Available Memory			165.9	

The table provides the following information:

- **Description** Application of the firmware option. Active options are check marked.
To activate or deactivate an option move the cursor to the option in question and press the ENTER key. Note that some options can not be deactivated. The cursor will skip those. Note also that some options are combined to groups. You can only activate or deactivate them as a whole.
- **Name**
Name of the firmware option.
- **Code**
License key of the firmware option.

If you have installed several firmware options, the required resources may exceed the available system memory on instruments shipped with a system memory size below 1GByte. Most applications require additional memory space once activated. These resources are not released when you exit the application to allow a fast reactivation of this application for measurement performance reasons.

To avoid memory issues, you can manually activate or deactivate a license key. If the license key is inactive, the application hot key is not visible in the hot key menu.

- **Min Mem/MB**
Shows the additional minimum base system memory required by the application.

This memory remains allocated after you have exited the application. In that case, it is not available for other applications.

- **Max Mem/MB**
Shows the additional maximum base system memory required by the application.

This means that the complete memory requirement for an option is the sum of minimum memory and maximum memory. In the figure above, e.g. 6.4 MB + 3.4 MB for option K40.

The complete instrument memory requirement is the sum of all options. Minimum memory (.Min Mem.) requirements plus the maximum memory (.Max Mem.) requirement of the option that needs the most maximum memory. In the figure above it would be 16 MB + 6.4 MB + 47.9 MB (for option K8).

The complete memory that is required is the sum of all minimum memory values plus the greatest maximum value of all active firmware options. The available system memory is shown in the bottom line. If you can not activate an option you need you can save system memory by

- checking if the option that needs the most memory (Max Mem) is still required. Deactivate this option to reduce maximum memory allocation.
- reducing the base memory allocation. Deactivate all options with a minimum memory unequal to 0.

When you use the *EXPERT MODE*, you can deactivate the memory check.

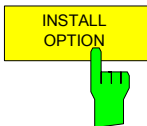
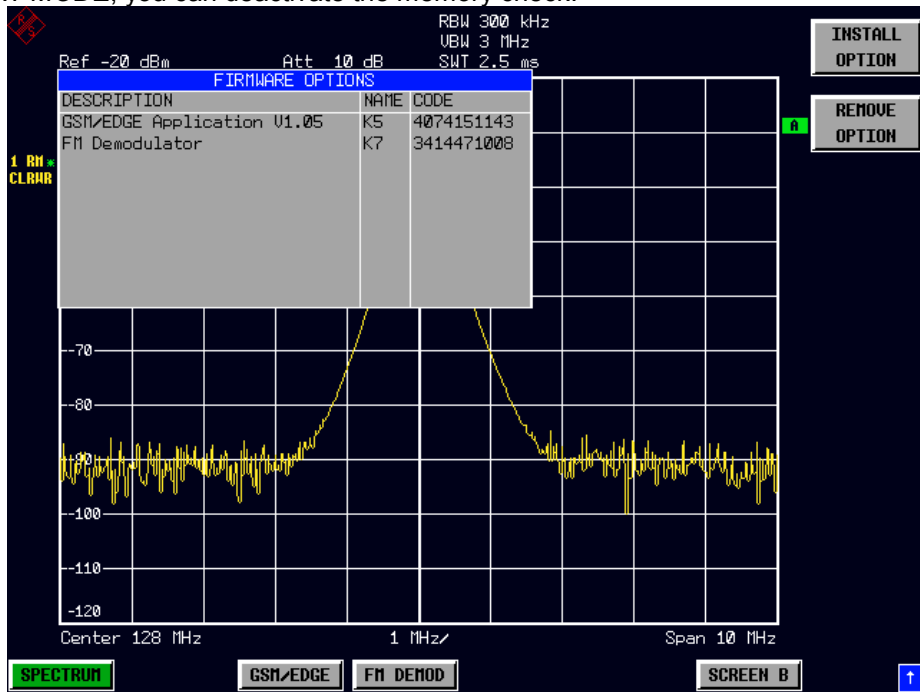
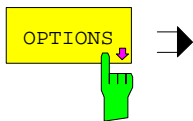

Softkey *INSTALL OPTION* opens the data entry for the license keycode of a firmware option.

On entry of a valid license key the message *OPTION KEY OK* is displayed in the status line and the firmware option appears in table *FIRMWARE OPTIONS*.

On entry of an invalid license key the message *OPTION KEY INVALID* is displayed in the status line.

IEC/IEEE-bus command: --

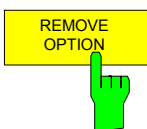

Softkey *REMOVE OPTION* removes all firmware options from the instruments. Execution of this function must be confirmed in a message box in order to avoid removal of the firmware options by mistake.

IEC/IEEE-bus command: --

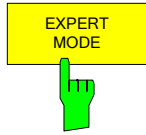

The *EXPERT MODE* softkey switches off the option key memory check. This function is useful if all the required applications do not fit into the available system memory, but the worst case settings (concerning memory usage) of the applications is not required for a certain test case.

Example: An application may only need the maximum memory if a certain function (e.g. FFT calculation) is active. If this function is not used, it is possible to enable an additional application.



The analyzer may crash due to "low memory" conditions if the expert mode is switched on.

IEC/IEEE-bus command: --

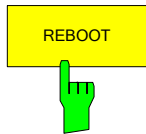

The *REBOOT* softkey performs the shutdown and reboot of the operating system and the analyzer firmware. The reboot will free allocated resources.

IEC/IEEE-bus command: --

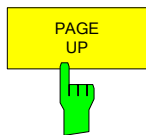

The *PAGE UP* and *PAGE DOWN* softkeys scroll through the Firmware Option List dialog box.

IEC/IEEE-bus command: --

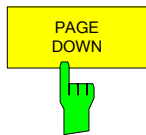

Emulation of the Instrument Front Panel

SETUP - GENERAL SETUP – NEXT menu:

The *SOFT FRONT PANEL* softkey switches the display of the front-panel keys on and off.

When the front-panel keys are displayed on the screen, the instrument can be controlled by clicking the respective button with the mouse. This is especially useful when the instrument in a different site is controlled via a remote-control program, such as, for instance, the remote desktop of Windows XP, and the screen contents are transferred to the controller via remote link (see the section "LAN Interface - Remote Desktop under Windows XP).

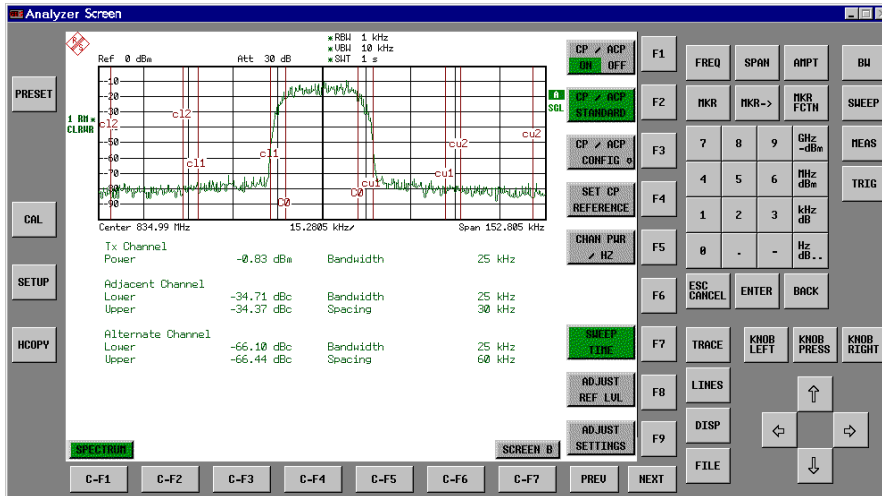

Display resolution:

When the display of the front-panel keys is switched on, the screen resolution of the instrument changes to 1024x768 pixels. Only a section of the total screen is then displayed on the LC display, which will automatically be shifted on mouse moves.

In order to obtain a complete display of the user interface, an external monitor is to be plugged into the corresponding connector at the rear panel. Prior to performing the resolution change the user is prompted for confirmation whether the required monitor is connected.

Switching off the front-panel display restores the original screen resolution.

Key assignment:

Button labels largely correspond to those of the front-panel keys. The rotation function of the rotary knob is assigned to the 'KNOB LEFT' and 'KNOB RIGHT' buttons, the press function (<ENTER>) to 'KNOB PRESS'.

The labels of the softkey buttons (F1 to F9) and of the hotkey buttons (C-F1 to C-F7) indicate that the keys can be operated directly by means of the corresponding function keys F1 to F9 or <CTRL>F1 to <CTRL>F7 of a PS/2 keyboard.

IEC/IEEE-bus command: SYST:DISP:FPAN ON

System Information

The *SYSTEM INFO* softkey opens a submenu in which detailed information on module data, device statistics and system messages is displayed.

SETUP menu:

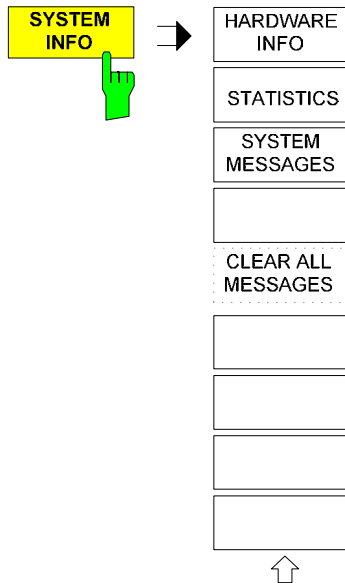

Display of Module Data

SETUP SYSTEM INFO submenu:



The *HARDWARE INFO* softkey opens a table in which the modules (INSTALLED COMPONENTS) installed in the instrument are listed together with the corresponding hardware revisions.

Table *HARDWARE INFO* consists of six columns:

SERIAL #	serial number
COMPONENT	name of module
ORDER #	order number
MODEL	model number of the module
REV	main modification index of the module
SUB REV	secondary modification index of the module

HARDWARE INFO						
COMPONENT	SERIAL #	ORDER #	MODEL	HWC	REV	SUB REV
WB-DETECTOR	000291/072	1130.3086	03	00	03	00
MW CONU UNIT	000291/072	1130.2396	02	00	03	44
CPU-Board	020204/330	1091.2520	00	00	03	02
MOTHERBOARD	100041/003	1130.1960	03	00	05	00
MW CONVERTER	000000	1130.2409	02	00	00	00
DIPLEXER	000000	1132.6501	02	00	00	00
YIG-FILTER	000000	1130.2744	02	00	00	00
FSU	123456/999	1129.9003	00	00	00	00
SYNTHESIZER	100375/002	1130.2096	02	00	05	03
RF-CONVERTER	100113/002	1130.1990	02	00	06	14
IF-FILTER	100302/002	1130.2296	03	05	04	07
RF_ATTEN_L8	100063/002	1137.0599	02	00	25	00
COPX-RELAYS	000000	1137.4788	02	00	00	00

Display of Device Statistics

SETUP SYSTEM INFO submenu:

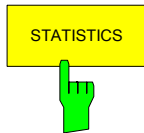

The *STATISTICS* softkey opens the table *STATISTICS*. This table contains the model information, serial number and firmware version, and a list in which the operating time of the instrument, the power-on cycles as well as attenuator switching cycles are displayed.

For recently delivered devices the data sheet version (document of the hardware properties) is shown. For all the device dashes (--.--) are displayed.

IEC/IEEE-bus command: --

Display of System Messages

SETUP SYSTEM INFO submenu:



The *SYSTEM MESSAGES* softkey opens a submenu including a table in which the generated system messages are displayed in the order of their occurrence. The most recent messages are placed at the top of the list. The following information is available:

No	Device-specific error code
MESSAGE	Brief description of the message
COMPONENT	On hardware messages: name of the affected module On software messages: if needed, the name of the affected software components
DATE/TIME	Date and time of the occurrence of the message

Messages that have occurred since the last call to the *SYSTEM MESSAGES* menu are marked with an asterisk '*'.

The *CLEAR ALL MESSAGES* softkey is activated and allows clearing of the error buffer.

If the number of error messages exceeds the capacity of the error buffer, the message appearing first is "Message buffer overflow".

SYSTEM MESSAGES			
NO	MESSAGE	COMP.	DATE/TIME
107	Reference is Unlocked	DDCN	07.MAR.02; 14:03:19
110	Error 110 size of block too big. Block id 10616	CDS	07.MAR.02; 10:38:45
110	Checksum error RF attenuator Block id 10616	CDS	07.MAR.02; 10:38:45

IEC/IEEE-bus command: SYST:ERR?



The *CLEAR ALL MESSAGES* softkey deletes all messages in the table. The softkey is only available when table *SYSTEM INFO* is active.

IEC/IEEE-bus command: SYST:ERR?

Service Menu

The service menu offers a variety of additional functions which are used for maintenance and/or trouble shooting.

NOTICE

The service functions are not necessary for normal measurement operation. However, incorrect use can affect correct operation and/or data integrity of the R&S FSMR.

Therefore, many of the functions can only be used after entering a password. They are described in the instrument service manual.

SETUP menu:

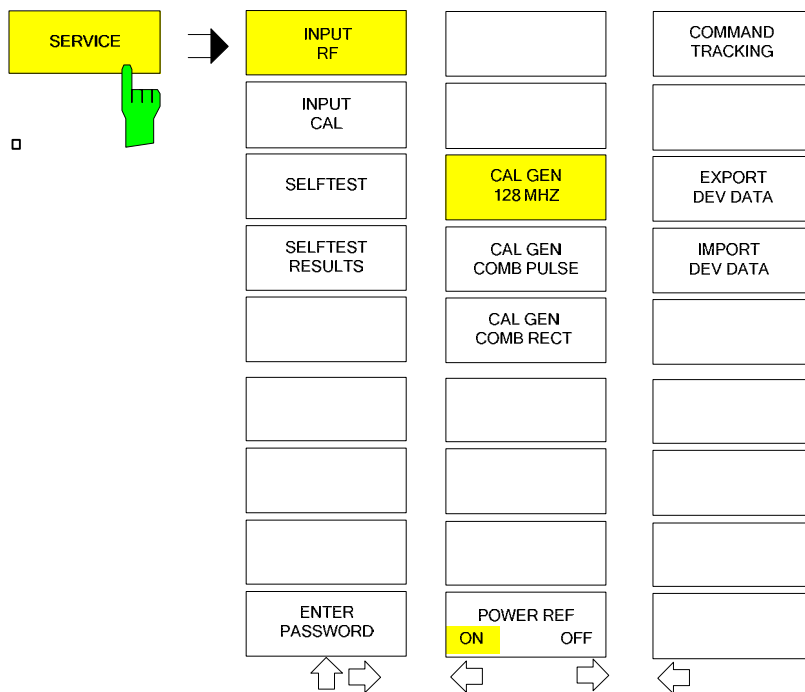

The *SERVICE* softkey opens a submenu for selection of the service function.

The *INPUT RF* and *INPUT CAL* softkeys are mutually exclusive selection switches. Only one switch can be active at any one time.

General Service Functions

SETUP SERVICE submenu:

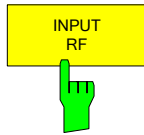

The *INPUT RF* softkey switches the input of the R&S FSMR to the input connector (normal position).

After *PRESET*, *RECALL* or R&S FSMR power on, the *INPUT RF* is always selected.

IEC/IEEE-bus command: `DIAG:SERV:INP RF`

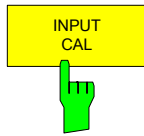

The *INPUT CAL* softkey switches the RF input of the R&S FSMR to the internal calibration source (128 MHz) and activates the data entry of the output level of the calibration source. Possible values are 0 dB and -30 dB.

IEC/IEEE-bus command: `DIAG:SERV:INP CAL;`
`DIAG:SERV:INP:CSO 0 DBM`



The *ENTER PASSWORD* softkey allows the entry of a password.

The R&S FSMR contains a variety of service functions which, if incorrectly used, can affect correct operation of the analyzer. These functions are normally not accessible and are only usable after the entry of a password (see instrument service manual).

IEC/IEEE-bus command: `SYST:PASS "Password"`

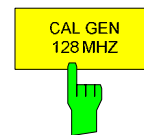

The *CAL GEN 128 MHz* softkey selects a sinusoidal signal at 128 MHz as output signal for the internal calibration source. The internal pulse generator will be switched off.

IEC/IEEE-bus command: `DIAG:SERV:INP:PULS OFF`



The *CAL GEN COMB PULSE* softkey switches the internal pulse generator on and allows the pulse frequency to be entered.

Available pulse frequencies are 10 kHz, 62,5 kHz, 1 MHz, 128 MHz, and 640 MHz.

IEC/IEEE-bus command `DIAG:SERV:INP:PULS ON;`
`DIAG:SERV:INP:PRAT 62.5KHZ`

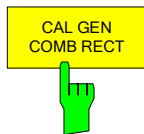

The *CAL GEN COMB RECT* softkey switches the internal pulse generator on and allows the pulse frequency to be entered.

Available pulse frequencies are 5 kHz, 31.25 kHz, 50 kHz, 250 kHz, and 500 kHz.

IEC/IEEE-bus command `DIAG:SERV:INP:RECT ON;`
`DIAG:SERV:INP:RECT:PRAT`

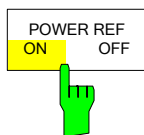

The *POWER REF ON/OFF* softkey switches the POWER REF reference source on the front panel on and off.

IEC/IEEE bus command: `OUTP:REF:STAT ON`



The *COMMAND TRACKING* softkey activates or deactivates the SCPI error log function. All remote control commands received by the R&S FSMR are recorded in the following log file:

`D:\R_S\instr\log\IEC_CMD5.LOG`

Logging the commands may be extremely useful for debug purposes, e.g. in order to find misspelled keywords in control programs.



The *EXPORT DEV DATA* softkey opens a dialog to export device specific data to a memory stick.

The export function automatically creates a sub folder using the instrument name and the serial number, e.g. FSQ40_123000 and copies device specific files to this folder:

- Option license key codes
- Board specific data

IMPORT DEV DATA reads these data back onto the instrument.

Select the folder, where the instrument specific sub folder is located and press *OPEN*. A dialog asks to perform a reboot when the import is done. This function is helpful to backup device specific data, e.g. the option license keys. It is also helpful if you have to use a removable flash disk for more than one device. In this case:

- Export the instrument data of device 1.
- Switch instrument 1 off.
- Remove the flash disk from device 1.
- Insert the flash disk into device 2.
- Switch instrument 2 on
- Import the instrument data of device 2 (saved before).

Note that a new export of the specific instrument data is required whenever:

- A new option key was inserted.
- The Rohde & Schwarz Service refitted a board.

The Rohde & Schwarz Service performed a device calibration.

IEC/IEEE-bus command: ---

Selftest

SETUP SERVICE submenu:



The *SELFTEST* softkey initiates the selftest of the instrument modules.

With this function the instrument is capable of identifying a defective module in case of failure.

During the selftest a message box appears in which the current test and its result is shown. The test sequence can be aborted by pressing ENTER ABORT.

All modules are checked consecutively and the test result (selftest PASSED or FAILED) is output in the message box.

IEC/IEEE-bus command: *TST?



The *SELFTEST RESULTS* softkey calls the *SELFTEST* table in which the results of the module test are displayed. In case of failure a short description of the failed test, the defective module, the associated value range and the corresponding test results are indicated.

SELFTEST RESULTS					
Total Selftest Status: user mode ---PASSED---					
Rohde&Schwarz,FSP-7,123456789,1.40					
Date (dd/mm/yyyy): 07/03/2002 Time: 14:04:29					
Runtime: 01:10					
Supply voltages detector [Volt]					
test description	min	max	result	state	
+6V	5.70	6.60	6.06	PASSED	
+8V	7.60	9.20	8.53	PASSED	
+12V	11.39	13.20	12.45	PASSED	
-12V	-14.27	-10.45	-12.44	PASSED	
+28V	25.74	30.23	28.16	PASSED	
-5V	-5.97	-4.06	-4.98	PASSED	
-6V	-7.18	-4.86	-5.88	PASSED	
Supply & ref. voltages IF-Filter [Volt]					
test description	min	max	result	state	
TEMPERATURE	0.20	70.20	37.80	PASSED	

IEC/IEEE-bus command:DIAG:SERV:STE:RES?

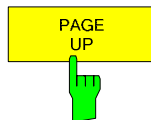

The *PAGE UP* or *PAGE DOWN* softkey sets the *SELFTEST RESULTS* table to the next or previous page.

IEC/IEEE-bus command --

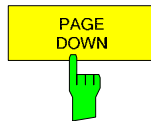

Hardware Adjustment

Some of the R&S FSMR modules can be realigned. This realignment can become necessary after calibration do to temperature drift or aging of components (see service manual instrument).

NOTICE

The realignment should be carried out by qualified personnel since the changes considerably influence the measurement accuracy of the instrument. This is the reason why the softkeys REF FREQUENCY, CAL SIGNAL POWER and SAVE CHANGES can only be accessed after entering a password.

Firmware Update

The installation of a new firmware version can be performed using the built-in disk drive. The firmware update kit contains several disks.

The installation program is called in the *SETUP* menu.

SETUP side menu:



The *FIRMWARE UPDATE* softkey opens the subdirectory for installing/deinstalling new firmware versions.

IEC/IEEE-bus command: --



The *FIRMWARE UPDATE* softkey starts the installation program and leads the user through the remaining steps of the update

IEC/IEEE-bus command: --

The firmware update is started as follows:

Insert disk 1 into the floppy drive.

Call *SETUP* side menu via [*SETUP*][*NEXT*]

Start the update via [*FIRMWARE UPDATE*]



The *RESTORE FIRMWARE* softkey restores the previous firmware version

IEC/IEEE-bus command: --



The *UPDATE PATH* softkey is used to select the drive and directories under which the archive files for the firmware update are stored.

The firmware update can thus also be performed via network drives or USB memory sticks/USB-CD-ROM drives.

IEC/IEEE-bus command:

```
"SYST:FIRM:UPD 'D:\USER\FWUPDATE'"
```

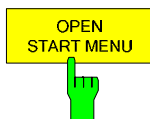

Softkey *OPEN START MENU* opens the windows XP start menu. and provides an easy access to standard windows functions if a mouse is connect.

IEC/IEEE-bus command: -

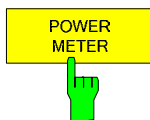

The *POWER METER* softkey opens a submenu for measurements with power sensors. For details refer to the Software Manual of the application firmware R&S FS-K9.

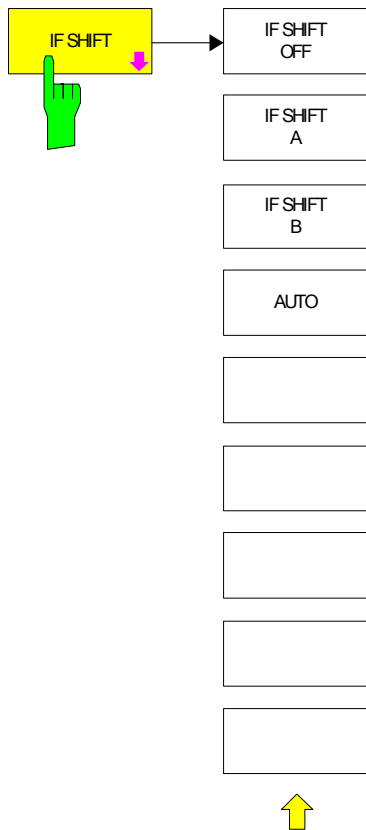

Input signals at a frequency of half the 1st IF (in the frequency range of 2270 MHz to 2350 MHz) will reduce the dynamic range of the analyzer. This problem only occurs for low RF attenuation values. It can be overcome by shifting the 1st IF.

For signals from 2270MHz to 2310 MHz *IF SHIFT A* is appropriate, for 2310 MHz to 2350 MHz *IF SHIFT B* must be used.

IF SHIFT AUTO automatically selects the suitable 1st IF shifting. The Signal Frequency has to be specified for that purpose in the Signal Frequency dialog.

IEC/IEEE-bus command:

```
SENS2:SWE:IF:SHIF:MODE OFF | A | B | AUTO
SENS2:SWE:IF:SHIF:FREQ <numeric value>
```



The 1st IF shifting is automatically done for ACP measurements if center frequency (= signal frequency) is in the range of 2270 MHz ... 2350 MHz. The *IF SHIFT* setting is therefore ignored for ACP measurements.

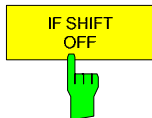

The *IF SHIFT OFF* softkey deactivates the 1st IF shifting.

```
SENS:SWE:IF:SHIF OFF
```

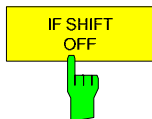

The *IF SHIFT A* softkey is appropriate for input signals in the frequency range of 2270 MHz to 2310 MHz.

```
SENS:SWE:IF:SHIF A
```

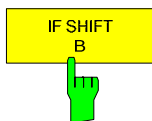

The *IF SHIFT B* softkey is appropriate for input signals in the frequency range of 2310 MHz to 2350 MHz.

```
SENS:SWE:IF:SHIF B
```

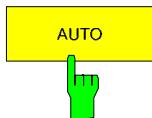

AUTO automatically selects the suitable 1st IF shifting. The Signal Frequency has to be specified for that purpose in the Signal Frequency dialog.

```
SENS:SWE:IF:SHIF AUTO
SENS:SWE:IF:SHIF:FREQ <numeric value>
```

Saving and Recalling Data Sets – FILE Key

Overview

The *FILE* key calls the following functions:

- Storage/loading functions for storing (*SAVE*) instrument settings such as instrument configurations (measurement/display settings, etc) and measurement results from working memory to permanent storage media, or to load (*RECALL*) stored data into working memory.
- Functions for management of storage media (*FILE MANAGER*). Included are among others functions for listing files, formatting storage media, copying, and deleting/renameing files.

The R&S FSMR is capable of internally storing complete instrument settings with instrument configurations and measurement data in the form of data sets. The respective data are stored on the internal hard disk or, if selected, on a floppy. The hard-disk and floppy-disk drives have the following names:

Flash disk F:
 hard disk D: (hard disk C: is reserved for instrument software)

The configuration of the softkeys in the menu is shown in the following figure:

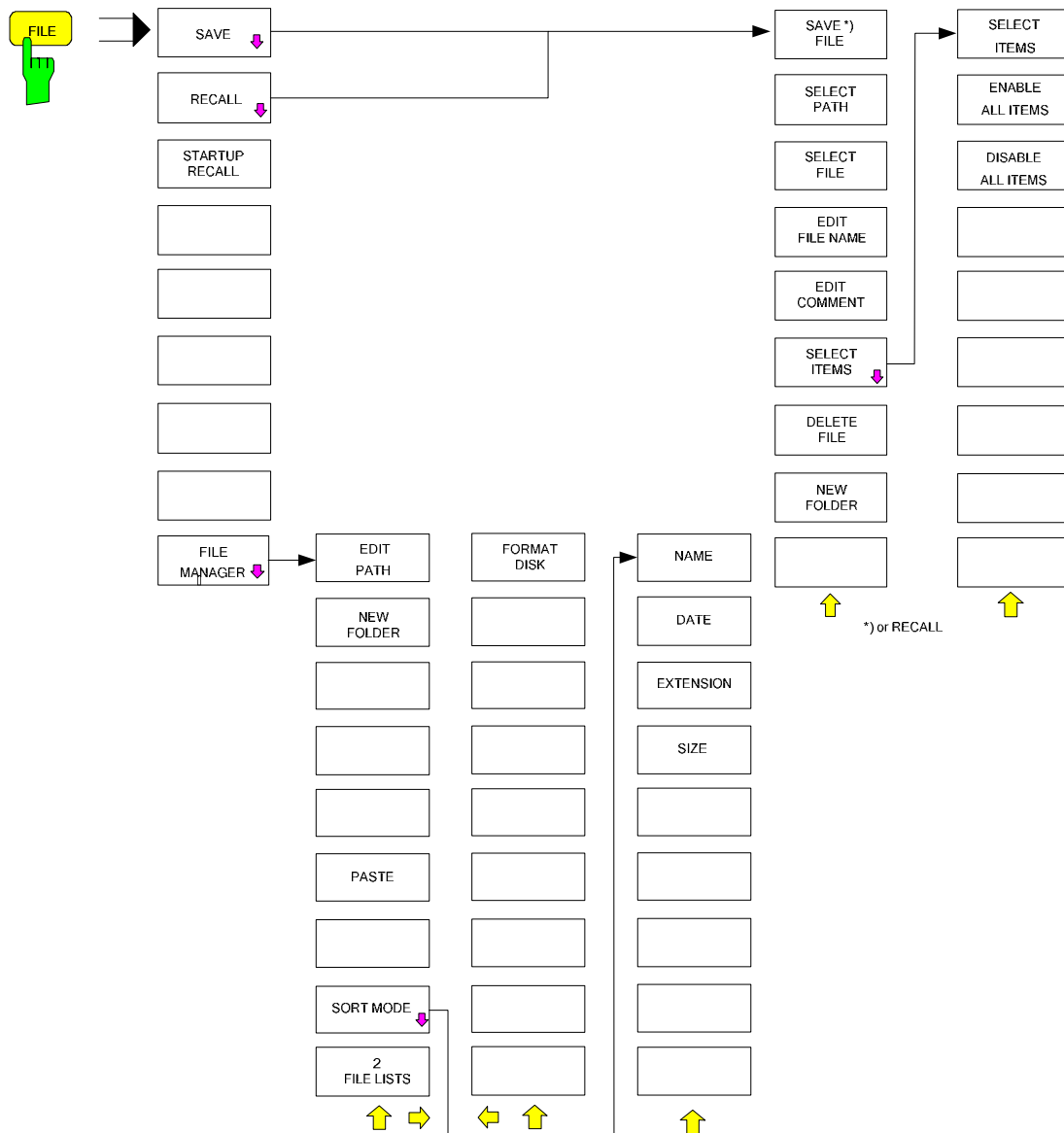



Storing a Device Configuration

Storing a Complete Device Configuration

The following steps are required to store a complete device configuration:

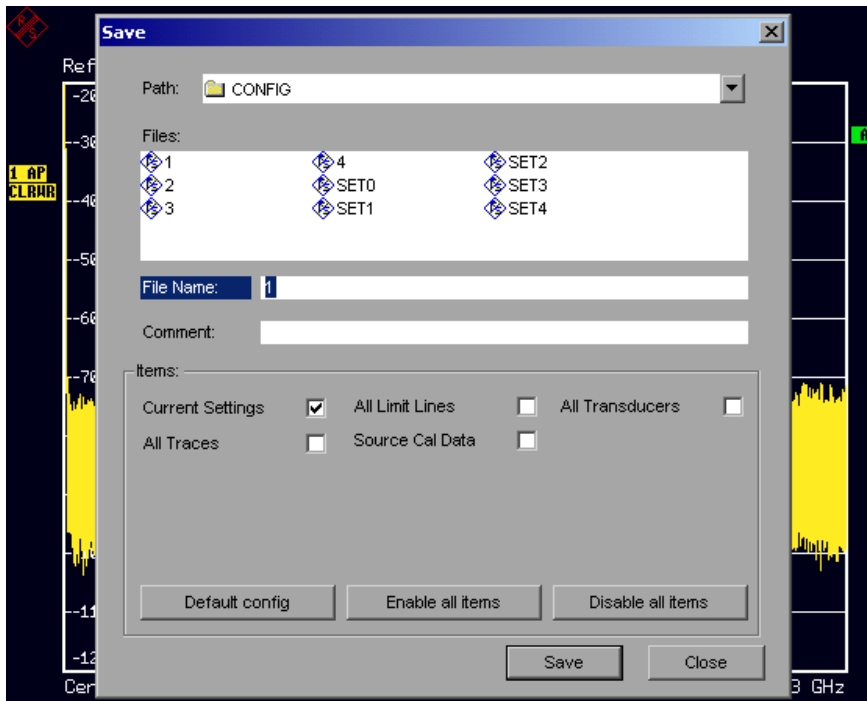
- Press the *FILE* key and then press the *SAVE* softkey.
The selection box for the device configuration will be opened:



- Enter the name of the data set to be stored (in the simplest case, a digit from 0 to 9) and press *ENTER*. The data set will be stored and the dialog window closed.
The name of the data set may comprise letters and digits; if required, the desired directory may precede the name of the data set (the directory will then automatically be used for further *SAVE* and *RECALL* processes).
The help line editor, which can be opened by pressing the *Cursor Down*  key, is available for entering file names via the front-panel keypad.
For further information on the operation of this editor, see section "Entering Text using the Help Line Editor".

How to enter comments, change the path for the file to be stored and select the data set from a list is described under the associated softkeys *EDIT COMMENT*, *EDIT PATH* and *DATA SET LIST*.

The default path for the device configuration is D:\USER\CONFIG. The file names of the data sets have the extension .R&S FSMR.

Storing Parts of a Device Configuration

To store part of a data set (e.g. "All Transducers"), the partial data set has to be selected beforehand. The following steps are required:

- Press the *FILE* key and then the *SAVE* softkey.
- Press the *SELECT ITEM* softkey. The entry focus moves to the first entry in the Items field.
- Use the spinwheel to move the entry focus to the desired entry in the Items field and select the partial data set by pressing the spinwheel or *ENTER*. The selection of already highlighted partial data sets can be cancelled by pressing the spinwheel / *ENTER* again.

Softkeys *ENABLE ALL ITEMS / DISABLE ALL ITEMS* are also available to select all partial data sets or to cancel the selection.

- Move the entry focus to the field *File Name* using the spinwheel and activate the text entry by pressing the spinwheel.
- Enter file names and store the data set with *ENTER*.

Loading a Data Set:

A data set may be loaded in two different ways:

1. Direct entry of data set name:

- Press the *FILE* key and then press the *RECALL* softkey.
- Enter the name of the data set to be stored (in the simplest case, a digit from 0 to 9) and press *ENTER*. The data set will be loaded.

The name of the data set may comprise letters and digits; if required, the desired directory may precede the name of the data set (the directory will then automatically be used for further *SAVE* and *RECALL* processes).

The help line editor, which can be opened by pressing the *Cursor Down*  key, is available for entering file names via the front-panel keypad.

For further information on the operation of this editor, see section "Entering Text using the Help Line Editor".

2. Selection of data set via a selection list:

- Press the *FILE* key and then press the *RECALL* softkey.
- Press the *SELECT ITEM* softkey.

The list of available data sets will be selected:

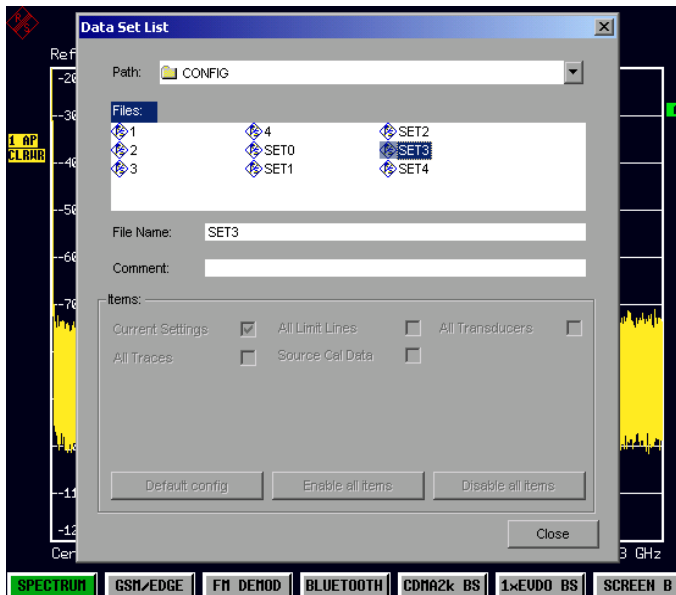

- Select the data set to be loaded with the spinwheel and confirm twice with *ENTER*. The data set will be loaded.

If the path for the device configuration is to be changed, this is done via the *EDIT PATH* softkey. When loading device data, the settings of the unloaded partial data sets will remain unchanged. The R&S FSMR recognizes which parts the loaded data set has and ignores selected but unavailable partial data sets.

Automatic Loading of a Data Set during Booting

When the R&S FSMR is delivered, it will load the device setting last activated when the unit was switched off (provided that the unit was switched off via the *STANDBY* switch at the front panel, see section 1 "Putting the Device Into Operation").

Moreover, the R&S FSMR is also able to automatically load a user-defined data set. The following operating steps are required:

- Press the FILE key and then press the *RECALL* softkey.
- Press the STARTUP RECALL softkey.
The list of available data sets will be selected:

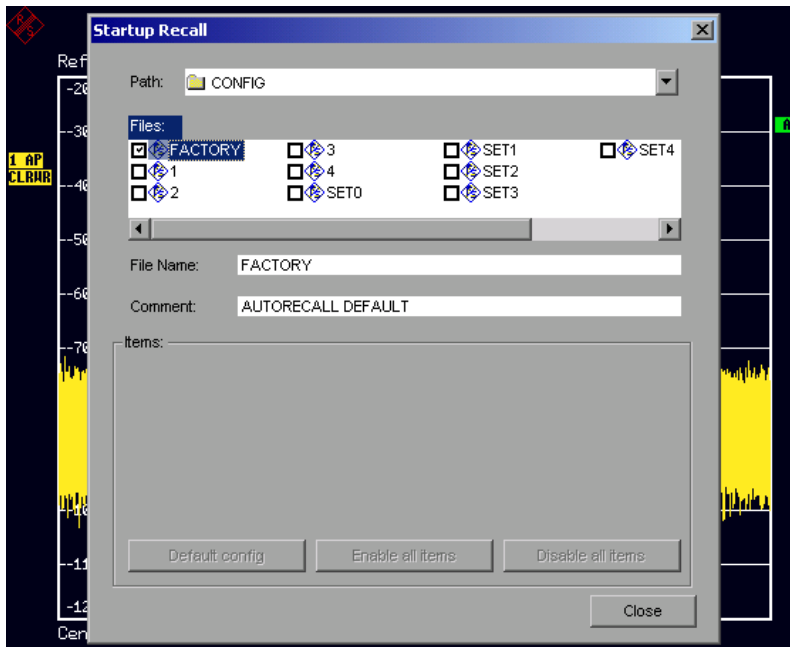

- Select the data set to be loaded using the spinwheel and mark with *ENTER*.



1. The selected data set will also be loaded when pressing the PRESET key.
2. The entry FACTORY will load the last setting that was activated prior to switch-off when the unit is started after delivery.

- Close the dialog window by pressing *ESC* twice.

If the path is to be changed for the device configuration, this is done via the *EDIT PATH* softkey.

Copying Data Sets to Disk

The saved files of the data sets can be copied from one storage medium (e.g. drive D:) to another storage medium (e.g. drive F:) or to another directory using the functions found in the *FILE MANAGER* submenu. The file extension .R&S FSMR must not be changed.

Entering Text with the Help Line Editor





The help line editor is opened as soon as the *CURSOR DOWN*  key is pressed on a text entry field (*File Name, Comment*):

													1	2	3	4	5	6	7	8	9	0
A	B	C	D	E	F	G	H	I	J	K	L	M	:	\	.	/	^	+	-	=	,	
H	O	P	Q	R	S	T	U	V	W	X	Y	Z	<	>	()	{	}	[]	#	~
a	b	c	d	e	f	g	h	i	j	k	l	m	'	@	:		?	!	"	€	\$	%
n	o	p	q	r	s	t	u	v	w	x	y	z	«	»	BACK	EXIT						
SPACE																						

The entry range consists of two parts:

- editing line
- character selection field

The *CURSOR DOWN*  key is used to move from the editing line to the character selection field.

The navigation in the character selection field is by means of the spinwheel or the cursor keys , ,  and .



The desired characters are transferred to the editing line by pressing the spinwheel or by pressing the *ENTER* key:

Default Spectrum													1	2	3	4	5	6	7	8	9	0
A	B	C	D	E	F	G	H	I	J	K	L	M	:	\	.	/	^	+	-	=	,	
H	O	P	Q	R	S	T	U	V	W	X	Y	Z	<	>	()	{	}	[]	#	~
a	b	c	d	e	f	g	h	i	j	k	l	m	'	@	:		?	!	"	€	\$	%
n	o	p	q	r	s	t	u	v	w	x	y	z	«	»	BACK	EXIT						
SPACE																						

The fields of the last line of the character selection field have special functions:

SPACE	adds a space to the editing line
<<	moves the cursor in the editing line by one character towards the left
>>	moves the cursor in the editing line by one character towards the right
BACK	deletes the character in front of the cursor
EXIT	stores the contents of the editing line and closes the help line editor

A return to the editing line is possible via the *CURSOR UP*  key (return from the top line of the character selection field).

Within the editing line, navigation is also performed by means of the spinwheel or the cursor keys  and .

Digits, decimal points and signs are directly entered into the editing line via the keys of the numeric block provided at the front panel. With a PC keyboard connected, letters and special characters can also be entered directly.

Editing is terminated via *ENTER* if the text is to be stored and via *ESC* if the text is to be discarded. The help line editor will be closed in both cases.

Description of the Individual Softkeys



The *SAVE* softkey opens the dialog window for entering the data set to be stored and the Save submenu.

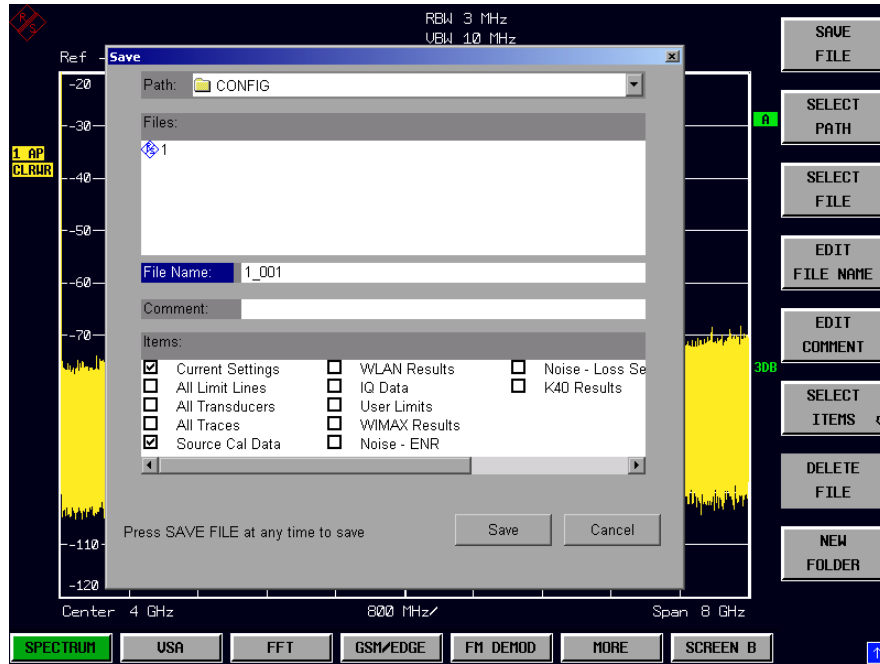

The *SAVE* table contains the entry fields for editing the data set:

- Path* Directory in which the data set is stored.
- Files* List of data sets already stored.
- File Name* Name of data set.
The name can be entered with or without drive name and directory; the drive name and directory, if available, will then appear in the *PATH* field. The extension of the data name is ignored.
- Comment* Comment regarding the data set.
- Items* Selection of settings to be stored.

IEC/IEEE command: `MMEM:STOR:STAT 1,"a:\test02"`



Sets the focus on the File Name field.

In the Save dialog box, the field already contains a suggestion for a new name: the file name used in the last saving process is counted up to the next unused name. For example, if the name last used was "test_004", the new name "test_005" is suggested, but only if this name is not in use. If the name "test_005" is already in use, the next free name is suggested, e.g. "test_006". You can change the suggested name to any name conform to the following naming conventions.

The name of a settings file consists of a base name followed by an underscore and three numbers, e.g. "limit_lines_005". In the example, the base name is "limit_lines". The base name can contain characters, numbers and underscores. The file extension is added automatically and can not be changed.

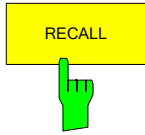

The *RECALL* softkey opens the dialog window for entering the data set set to be loaded and the Recall submenu.

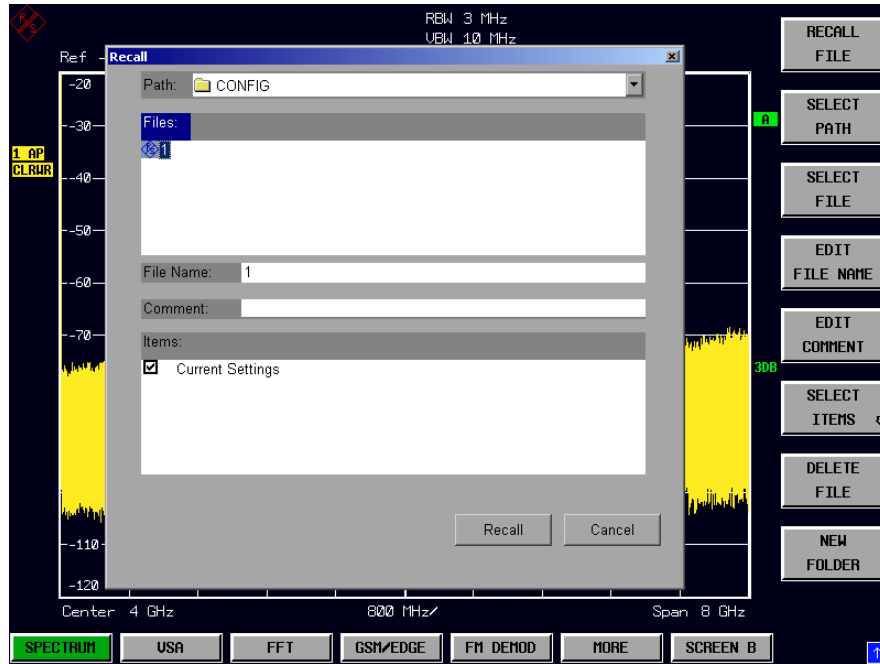

The *RECALL* table shows the current settings regarding the data set:

- Path* Directory in which the data set is stored.
- Files* List of stored data sets
- File Name* Name of data set.
The name can be entered with or without drive name and directory. The drive name and directory will then appear in the Path field. A potential extension of the file name is ignored.
- Comment* Comment regarding data set.

IEC/IEEE command: `MMEM:LOAD:STAT 1,"a:\test02"`



The *RECALL FILE* softkey sets the focus on the Files field to choose a stored file to restore.



The *SELECT PATH* softkey sets the focus on the Path field and opens the pull-down list to choose the correct path to store the file.

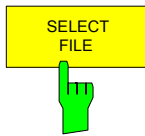

The *SELECT FILE* softkey sets the focus on the Files field to choose a already stored file. In addition, the *DELETE* softkey is displayed. The list Files lists all data sets which are stored in the selected directory.



The *EDIT FILE NAME* softkey sets the focus on the File Name field and. In the Save dialog box, the field already contains a suggestion for a new name: the file name used in the last saving process is counted up to the next unused name. For example, if the name last used was "test_004", the new name "test_005" is suggested, but only if this name is not in use. If the name "test_005" is already in use, the next free name is suggested, e.g. "test_006". You can change the suggested name to any name conform to the following naming conventions. The name of a settings file consists of a base name followed by an underscore and three numbers, e.g. "limit_lines_005". In the example, the base name is "limit_lines". The base name can contain characters, numbers and underscores. The file extension is added automatically and can not be changed.



The *EDIT COMMENT* softkey activates the entry of commentary concerning the current data set. The focus is set on the Comment field and an on-screen keyboard opens.

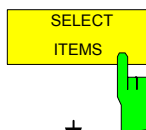

The *SELECT ITEMS* softkey moves the selection bar to the first line, left column of the *Items* field. An entry is selected. Position the entry focus to the corresponding partial data set using the cursor keys and then press the *ENTER* key in the desired line. The selection is cleared by pressing the key again.

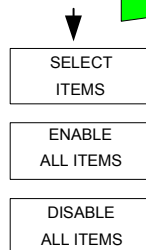

IEC/IEEE command:

Current Settings:	MMEM:SEL:HWS ON
All Limit Lines:	MMEM:SEL:LIN:ALL ON
All Traces:	MMEM:SEL:TRAC ON
Source Cal Data:	MMEM:SEL:SCD ON

Note that the command MMEM:SEL:SCD ON (Source Cal Data) is only available with option R&S FSU-B09 or R&S FSU-B10.

The Dialog *Save* table offers the following selectable data subsets in the *Items* field: *Current Settings* These settings include:

- current configuration of general instrument parameters
- current measurement hardware settings
- active limit lines:
A data set may contain maximum 8 limit lines for each window. It always contain the activated limit lines and the de-activated limit lines used last, if any. Consequently, the combination of the restored de-activated limit lines depends on the sequence of use with command MMEM:LOAD.
- the activated transducer factor
- user-defined colour settings
- configuration for hardcopy output
- settings of tracking generator (only with option tracking generator)
- settings of tracking generator (only with option)

<i>All Limit Lines</i>	all limit lines
<i>All Transducer</i>	all transducer factors
<i>All Traces</i>	all traces which are not blanked
<i>Source Cal Data</i>	correction data for tracking generator (only with options B9 / B10)

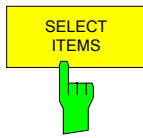

The *SELECT ITEMS* softkey sets the focus on the Items field to select the appropriate item to be stored.

IEC/IEEE command: MMEM:SEL:ALL



The *ENABLE ALL ITEMS* softkey marks all partial data sets.

IEC/IEEE-bus command MMEM:SEL:ALL



The *ENABLE ALL ITEMS* softkey deselects all partial data sets.

IEC/IEEE-bus command MMEM:SEL:NONE



The *DELETE FILE* softkey sets the focus on the File Name field to enter the file name to be deleted. Alternatively the file to be deleted can be chosen from the Files list. A message box opens to confirm the deletion.

IEC/IEEE-bus command MMEM:"test03"

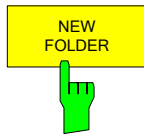

The *NEW FOLDER* softkey opens an on-screen keyboard to enter a new folder name.



The *STARTUP RECALL* softkey activates the selection of a data set which is automatically loaded when the instrument is powered on and after *PRESET*. For this purpose the Dialog *Startup Recall* is opened (analogously to *DATA SET LIST*).

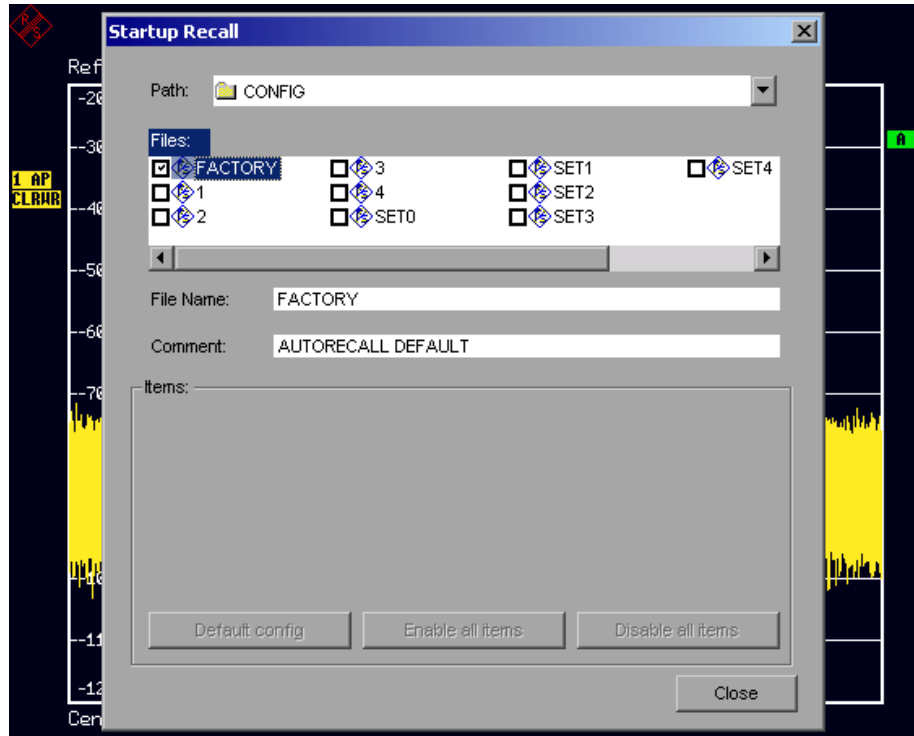

The field *Files* lists all data sets stored in the selected directory. The currently selected data set is checked.

In addition to the data sets stored by the user, the data set *FACTORY*, which specifies the settings of the instrument before it was last switched off (Standby), is always present (when unit is delivered).

To select a data set, the entry focus is set to the corresponding entry by means of the spinwheel and the data set is activated by pressing the spinwheel or the *ENTER* key.

If a data set other than *FACTORY* is chosen, this data set will be loaded when the unit is switched on or after pressing the *PRESET* key. Any settings can be assigned to the *PRESET* key.

IEC/IEEE command: `MMEM:LOAD:AUTO 1, "D:\user\config\test02"`

Operating Concept of File Managers

The *FILE MANAGER* softkey opens a menu for managing storage media and files.

FILE - FILE MANAGER submenu:

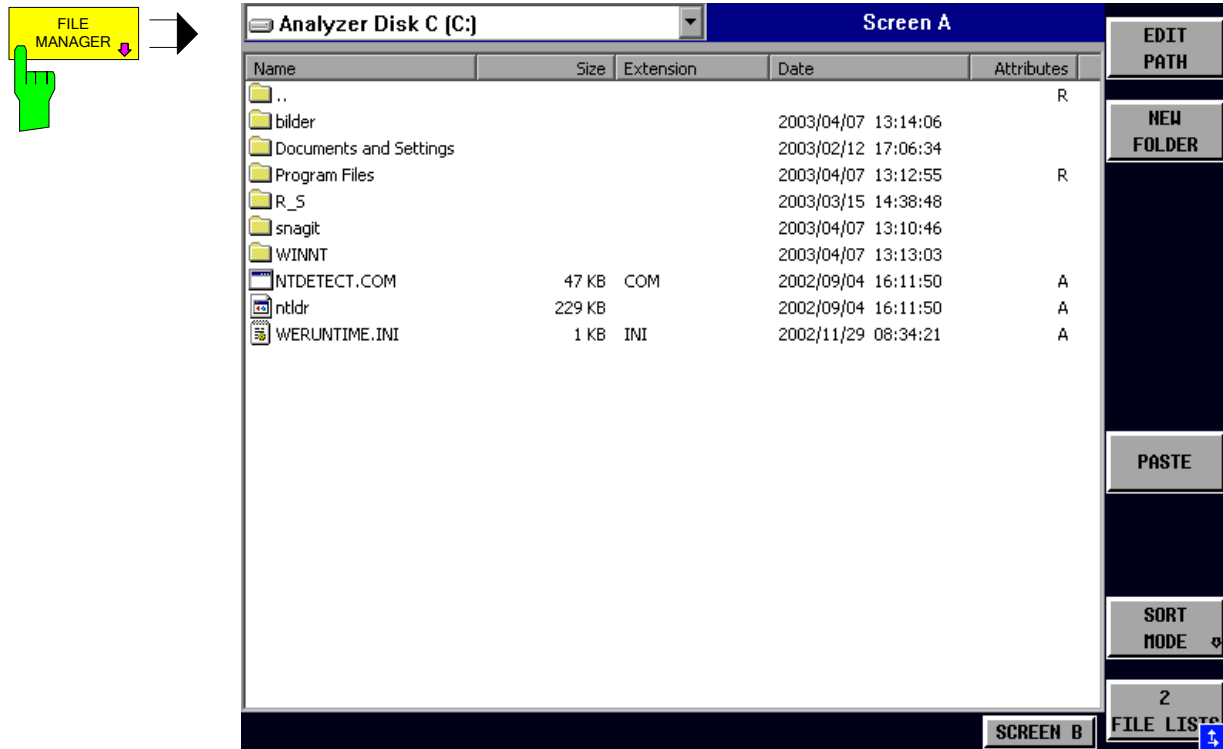

The designation and the letter of the current drive are displayed in the upper left corner of the File Manager dialog.

The table below shows the files of the current directory and potential subdirectories.

A file or a directory in the table is selected via cursor keys. The *ENTER* key is used to switch from one subdirectory to another. The softkeys *COPY*, *RENAME*, *CUT* and *DELETE* are only visible if the entry focus is set to a file and not to a directory.

The dots ".." open up the next higher directory.

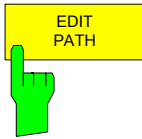

The *EDIT PATH* softkey activates the input of the directory which will be used in subsequent file operations.

The new path is included in the *FILE MANAGEMENT* table.

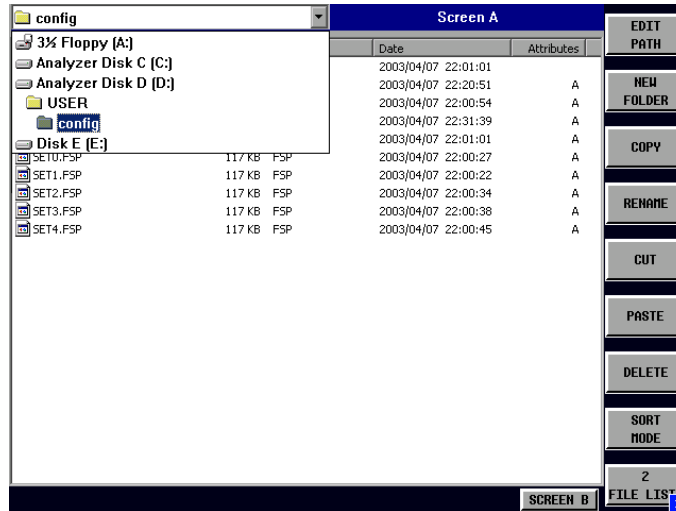

Use *CURSOR UP / DOWN* to select a drive and confirm your selection with *ENTER*.

Open subdirectories by using *CURSOR RIGHT*, and use *CURSOR LEFT* to close them again.

When you have found the subdirectory you looked for, mark it with *ENTER*.

IEC/IEEE command: MMEM:MSIS "a : "
 MMEM:CDIR "D:\user "

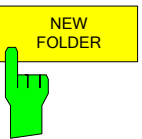

The *NEW FOLDER* softkey creates subdirectories.

The entry of an absolute path name (e.g. "\USERMEAS") as well as the path relative to the current directory (e.g. "..\MEAS") is possible.

IEC/IEEE command: MMEM:MDIR "D:\user\test"

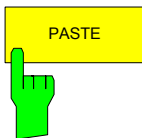

The *PASTE* softkey copies files from the clipboard to the current directory. The directory is changed by means of the cursor keys and subsequent pressing of *ENTER* or via the *EDIT PATH* softkey.

IEC/IEEE-bus command -

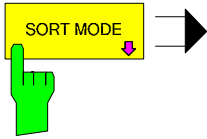

The *SORT MODE* softkey opens the submenu to select the sorting mode for the displayed files.

config					Screen A		NAME
Name	Size	Extension	Date	Attributes			DATE
..			2003/04/07 22:47:33				EXTENSION
autolog.txt	2 KB	txt	2000/09/27 12:14:28	A			SIZE
1.FSP	117 KB	FSP	2003/04/07 22:20:51	A			
2.FSP	117 KB	FSP	2003/04/07 22:00:54	A			
3.FSP	117 KB	FSP	2003/04/07 22:31:39	A			
4.FSP	117 KB	FSP	2003/04/07 22:01:01	A			
SET0.FSP	117 KB	FSP	2003/04/07 22:00:27	A			
SET1.FSP	117 KB	FSP	2003/04/07 22:00:22	A			
SET2.FSP	117 KB	FSP	2003/04/07 22:00:34	A			
SET3.FSP	117 KB	FSP	2003/04/07 22:00:38	A			
SET4.FSP	117 KB	FSP	2003/04/07 22:00:45	A			

Directory names are located at the top of the list after the entry for the next higher directory level ("..").

IEC/IEEE command: --

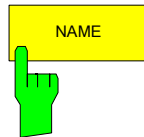

The *NAME* softkey sorts the file list by name.

IEC/IEEE-bus command: --

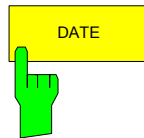

The *DATE* softkey sorts the file list by date.

IEC/IEEE-bus command: --

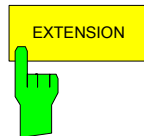

The *EXTENSION* softkey sorts the file list by file extension.

IEC/IEEE-bus command: --

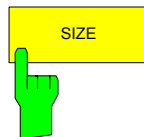

The *SIZE* softkey sorts the file list by size

IEC/IEEE-bus command: --

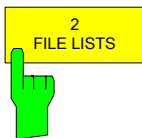

The *2 FILE LISTS* softkey opens a second window for the File Manager. The entry focus can be moved between the two windows by means of hotkeys *SCREEN A* and *SCREEN B*. Files can thus very easily be copied and shifted from one directory to the other.

IEC/IEEE-bus command: -



The second file list can also be opened in the Full Screen mode via hotkey *SCREEN B* or *SCREEN A*.

Measurement Documentation – HCOPY Key



The installation of additional printers is described together with the INSTALL PRINTER softkey.

HCOPY menu:

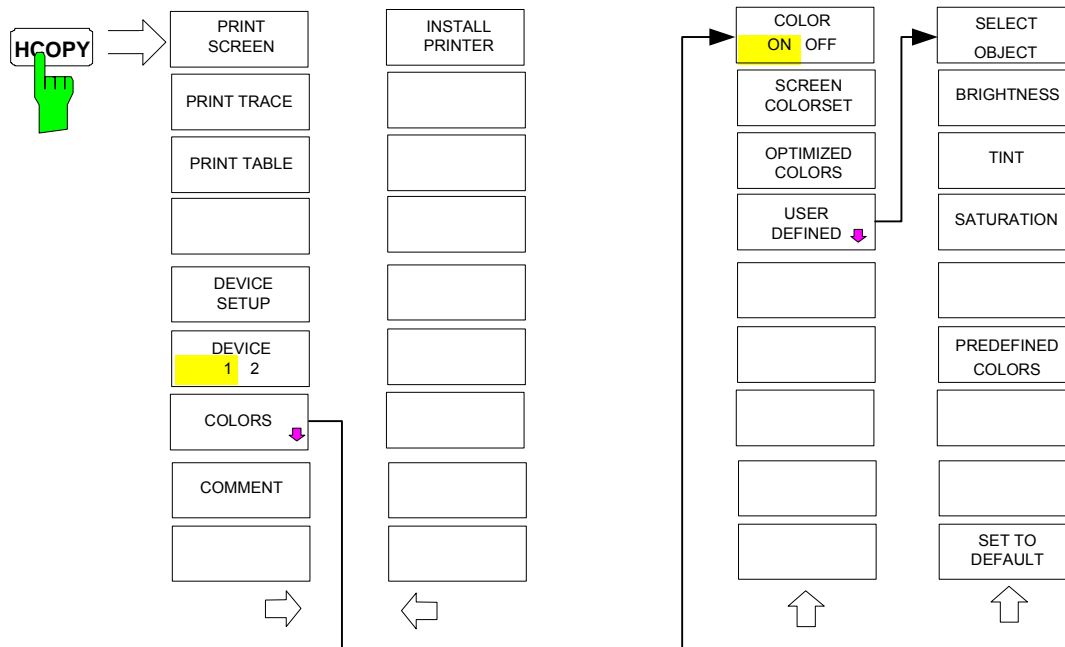

Pressing one of the softkeys *PRINT SCREEN*, *PRINT TRACE* or *PRINT TABLE* in the *HCOPY* menu initiates the print job. The printer parameters defined in the *DEVICE SETTINGS* menu are used for setting up the printer configuration. All of the display items to be printed are written to the printer buffer. Since the printer runs in the background, the instrument may be operated immediately after pressing the *PRINT...* softkey.

With *PRINT SCREEN* selected, all the diagrams with traces and status displays are printed as they occur on the screen. Softkeys, open tables and data entry fields are not printed.

The *PRINT TRACE* function allows individual traces to be printed. With *PRINT TABLE*, tables can be printed. The *DEVICE 1* and *2* softkeys are used for selecting and configuring the output interface.

If the *PRINT TO FILE* option in the *DEVICE SETTINGS* table is selected, the printout is directed to a file. Upon pressing one of the *PRINT...* softkeys, the file name to which the output data is to be written is requested. An entry field is then opened for entering the file name.

The *COLORS* submenu allows switchover between black-and-white and colour printouts (default), provided that the printer connected can produce colour printouts. In addition, the colours are set in this submenu.

- **SCREEN** Output in screen colours.
- **OPTIMIZED (default)** Instead of light colours, dark colours are used for traces and markers: trace 1 blue, trace 1 black, trace 3 green, markers turquoise.
- **USER DEFINED** This option enables the user to change the colours at will. It provides the same setting functions as the *DISPLAY – CONFIG DISPLAY – NEXT* menu.



1. With *SCREEN* and *OPTIMIZED* selected, the background will always be white and the grid black. With *USER DEFINED*, these colours can be selected, too.
2. Upon activation of the submenu, the colour display is switched over to the selected printout colours. When the menu is quit, the original colour setting is restored.

The *COMMENT SCREEN A* and *COMMENT SCREEN B* softkeys allow text to be added to the printout (date and time are inserted automatically).

Use the *INSTALL PRINTER* softkey to install additional printer drivers.

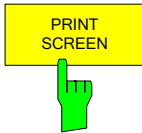

The *PRINT SCREEN* softkey starts the output of test results.

All the diagrams, traces, markers, marker lists, limit lines etc are printed out as long as they are displayed on the screen. All the softkeys, tables and open data entry fields are not printed out. Moreover, comments, title, date, and time are output at the bottom margin of the printout .

IEC/IEEE-bus command: HCOP:ITEM:ALL
 HCOP:IMM

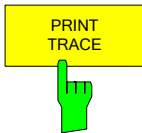

The *PRINT TRACE* softkey starts the output of all curves visible on the display screen without auxiliary information. Specifically, no markers or display lines are printed.

IEC/IEEE-bus command: HCOP:ITEM:WIND:TRAC:STAT ON
 HCOP:IMM

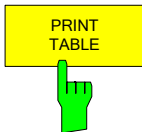

The *PRINT TABLE* softkey starts the output of all tables and info lists visible on the display screen without the measurement diagrams and other information lying behind.

IEC/IEEE-bus command: HCOP:ITEM:WIND:TABL:STAT ON
 HCOP:IMM

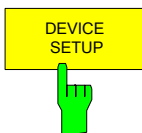

The *DEVICE SETUP* softkey opens the dialog where the file format and the printer can be selected (see section "Selecting Printer, Clipboard and File Formats").

IEC/IEEE-bus commands: HCOP:DEV:LANG GDI;
 SYST:COMM:PRIN:ENUM:FIRS?;
 SYST:COMM:PRIN:ENUM:NEXT?;
 SYST:COMM:PRIN:SEL <Printer>;
 HCOP:PAGE:ORI PORT;
 HCOP:DEST "SYST:COMM:PRIN";
 HCOP:DEST "SYST:COMM:MMEM"

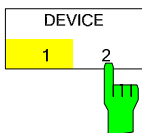

The analyzer is able to manage two hardcopy settings independently of each other. They are selected via the *DEVICE 1 / 2* softkey, which displays also the associated setting if the *DEVICE SETUP* dialog is open.

IEC/IEEE-bus command: --

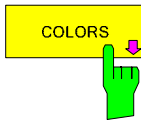

The *COLORS* softkey gives access to the submenu where the colours for the printout can be selected (see section "Selecting Printer Colours").

IEC/IEEE-bus command: -

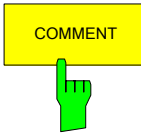

The *COMMENT* softkey opens an entry field in which a comment of two lines (60 characters per line) can be entered for screen A or B.

If the user enters more than 60 characters, the excess characters appear on the second line on the print-out. At any point, a manual line-feed can be forced by entering the @ character.

The comment is printed below the diagram area. The comment text appears on the hardcopy, but not on the display screen.

If a comment should not be printed, it must be cleared.

If the instrument is reset by a click on the PRESET key, all entered comments are cleared.



The *COMMENT* softkey opens the auxiliary line editor where the desired letters can be entered in the text field by means of spinwheel and cursor keys.

After clicking the *COMMENT* softkey, the auxiliary line editor can be reached with the  key. Pressing the spinwheel or the *ENTER* key inserts the selected characters in the text line.

After editing is completed, return to the text line with the  key and confirm the comment text with *ENTER*.

If the entered comment should be aborted, quit the auxiliary line editor with *ESC*.



Only after the auxiliary line editor has been closed with *ESC* can the softkeys and hardkeys be operated again.

A detailed description of the auxiliary line editor can be found in section "Entering a Text with the Auxiliary Line Editor".

IEC/IEEE-bus command: `HCOP:ITEM:WIND2:TEXT 'Comment'`

HCOPY NEXT menu:

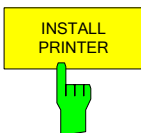

A certain number of printer drivers is already installed on the R&S FSMR. The *INSTALL PRINTER* softkey opens the *Printers and Faxes* dialog where more printer drivers can be installed.

For details refer to sections "Installation of Plug&Play Printers" and "Installation of Non-Plug&Play Printers".

IEC/IEC-bus command: -

Selecting Printer, Clipboard and File Formats

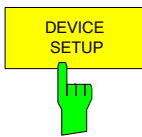

The *DEVICE SETUP* softkey opens the selection dialog for file format and printer.

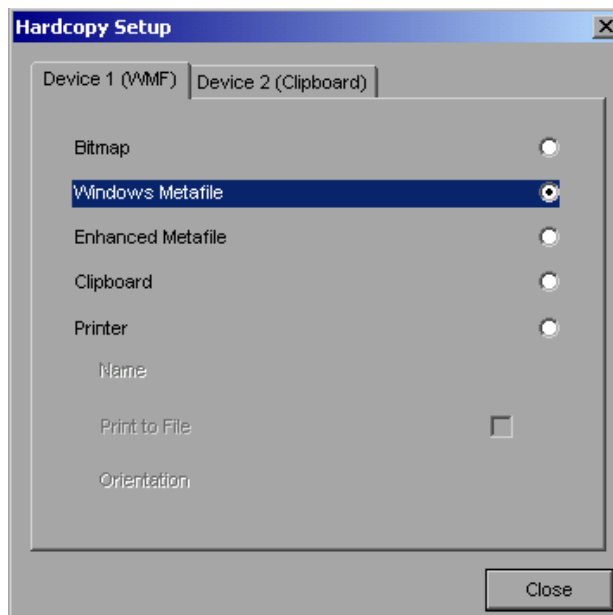

Navigation in the dialog is possible by turning the spinwheel; selection of an item is confirmed by pressing the spinwheel or the *ENTER* key.

The dialog is closed with *ESC* (alternatively, the *Close* button can be selected with the spinwheel and the dialog can be closed by pressing the spinwheel or with *ENTER*).

File formats

A file format is selected by turning the spinwheel and then confirmed by pressing the spinwheel or the *ENTER* key.

The following file formats can be selected:

BITMAP	BMP format (non-compressed)
WINDOWS METAFILE	Vector format, supported as of Windows 3.1
ENHANCED METAFILE	Vector format, supported as of Windows 95/98/ME/NT/XP

When a file format is selected, printing to a file is automatic. The file name is queried when the *PRINT SCREEN*, *PRINT TRACE* and *PRINT TABLE* softkeys are pressed.

Clipboard

A clipboard is also selected with the spinwheel and then confirmed by pressing the spinwheel or *ENTER* key.

After the *PRINT SCREEN*, *PRINT TRACE* or *PRINT TABLE* softkey has been pressed, printout is routed to the clipboard. With the aid of the "Process - Insert" function, the information in the clipboard can then be pasted into other programs, e.g. *Paint*, and subsequently processed.

Printer

A printer (also a preconfigured network printer) is selected by selecting *Printer* with the spinwheel and then confirmed by pressing the spinwheel or the *ENTER* key.

After confirmation, the entries under *Name*, *Print to File* and *Orientation* are available for selection with the spinwheel.

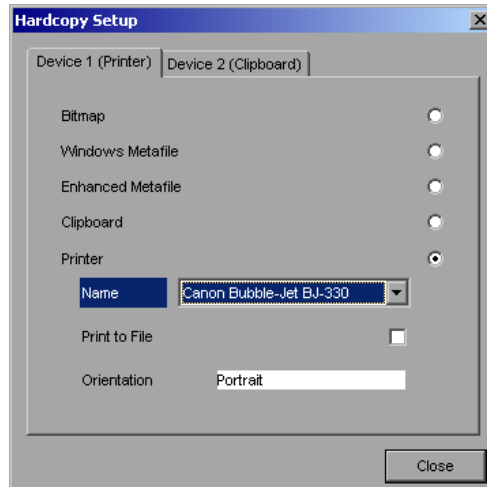

To select the printer type, select *Name* and open the selection list by pressing the spinwheel or *ENTER*.

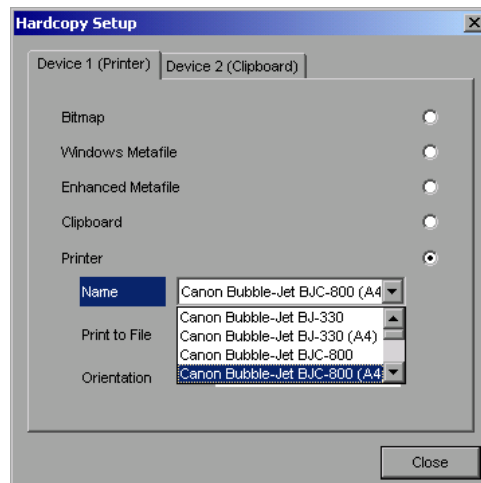

Select the desired printer (in the example "Cannon Bubble-Jet BJC800 (A4)") from the list by means of the spinwheel and confirm by pressing the spinwheel or *ENTER*. This closes the list and the cursor is placed on the *Name* field again.

Printing to a file is also possible. In this case select *Print to File* with the spinwheel and activate or deactivate the associated list by pressing the spinwheel or the *ENTER* key.

The printing format is selected under *Orientation*. In this case, too, pressing the spinwheel or *ENTER* opens the selection list.

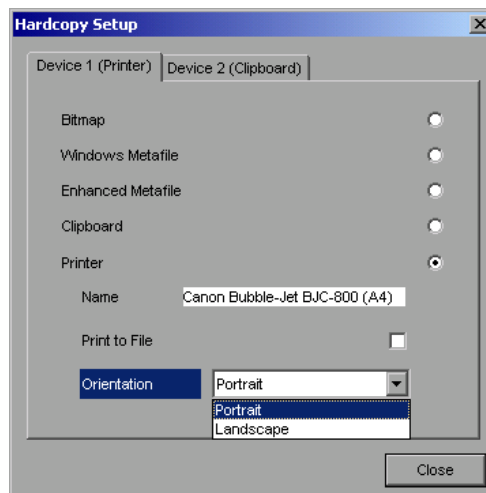

The desired format (here *Portrait*) is selected in the list with the spinwheel and confirmed by pressing the spinwheel or *ENTER*. This closes the list and the cursor is placed again on the *Orientation* field.

The dialog is then closed with *ESC* or by clicking the *Close* button.



The installation of new printer types is described in sections "Local Printer" and "Configuring a Network Printer"

Selecting Alternative Printer Configurations

The analyzer is capable of managing two independent hardcopy settings. This, for instance, permits fast switchover between printing to a file or by a printer.

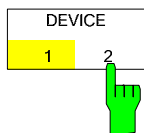

A selection is made with the *DEVICE 1 / 2* softkey which also shows settings when the *DEVICE SETUP* dialog is open.

IEC/IEEE-bus command: --

Selecting Printer Colours

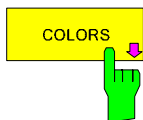

The *COLORS* softkey gives access to the submenu where the colours for the printout can be selected. To facilitate colour selection, the selected colour combination is displayed when the menu is entered. The previous colours are restored when the menu is exited.

IEC/IEEE-bus command: -

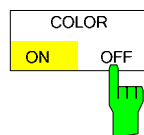

The *COLOR ON OFF* softkey switches over from colour output to black-and-white output. All colour-highlighted areas are printed in white and all colour lines in black. This improves the contrast on the printout. The default setting is *COLOR ON*.

IEC/IEEE-bus command: HCOP:DEV:COL ON

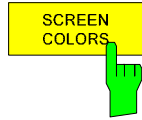

The *SCREEN COLORS* softkey selects the current screen colours for the printout.

IEC/IEEE-bus command: HCOP : CMAP : DEF1



The background is always printed in white and the grid in black.

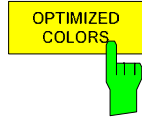

The *OPTIMIZED COLORS* softkey selects an optimized colour setting for the printout to improve the visibility of the colours on the hardcopy.

Trace 1 is blue, trace 2 black, trace 3 green, and the markers are turquoise.

The other colours correspond to the display colours of the *DISP – CONFIG DISPLAY -DEFAULT COLORS 1* softkey.

IEC/IEEE-bus command: HCOP : CMAP : DEF2



The background is always printed in white and the grid in black.

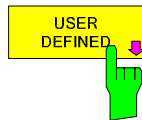

The *USER DEFINED* softkey opens a submenu for user-defined colour selection (see submenu *USER DEFINED COLORS*).

IEC/IEEE-bus command: HCOP : CMAP : DEF3

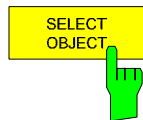

The *SELECT OBJECT* softkey allows picture elements to be selected to change their colour setting. After selection, the *PREDEFINED COLORS*, *BRIGHTNESS*, *TINT* and *SATURATION* softkeys enable the user to change the colours or brightness, the hue and the colour saturation of the element selected.

SELECT DISPLAY OBJECT	
√	Background
	Grid
	Function field + status field + data entry text
	Function field LED on
	Function field LED warn
	Enhancement label text
	Status field background
	Trace 1
	Trace 2
	Trace 3
	Marker
	Lines
	Measurement status + limit check pass
	Limit check fail
	Table + softkey text
	Table + softkey background
	Table selected field text
	Table selected field background
	Table + data entry field opaq titlebar
	Data entry field opaq text
	Data entry field opaq background
	3D shade bright part
	3D shade dark part
	Softkey state on
	Softkey state data entry
	Logo

IEC/IEEE-bus command: -

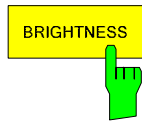

The *BRIGHTNESS* softkey serves for determining the brightness of the graphic element selected.

A value between 0 and 100% can be entered.

IEC/IEEE-bus command:

HCOP:CMAP5:HSL <hue>,<sat>,<lum>

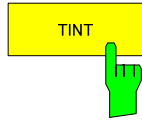

The *TINT* softkey serves for determining the hue of the element selected. The percentage entered refers to a continuous colour spectrum from red (0%) to blue (100%).

IEC/IEEE-bus command:

HCOP:CMAP5:HSL <hue>,<sat>,<lum>

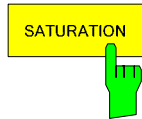

The *SATURATION* softkey serves for determining the saturation of the element selected.

A value between 0 and 100% can be entered.

IEC/IEEE-bus command:

HCOP:CMAP5:HSL <hue>,<sat>,<lum>

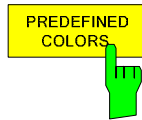

The *PREDEFINED COLORS* softkey opens a list from which predefined colours for the displayed elements can be selected:

COLOR
✓ BLACK
BLUE
BROWN
GREEN
CYAN
RED
MAGENTA
YELLOW
WHITE
GRAY
LIGHT GRAY
LIGHT BLUE
LIGHT GREEN
LIGHT CYAN
LIGHT RED
LIGHT MAGENTA

IEC/IEEE-bus command:

HCOP:CMAP1 ... 26:PDEF <color>

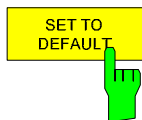

The *SET TO DEFAULT* softkey reactivates the default colour setting (= *OPTIMIZED COLORS*).

IEC/IEEE-bus command: -

Entering a Text with the Auxiliary Line Editor

The auxiliary line editor is opened automatically when the *COMMENT* softkey is clicked.



The entry area consists of two parts:

- the editing line
- the character selection field

Changeover from the editing line to the character selection is performed with the *cursor down* key.

Navigation in the character selection field is possible with the spinwheel or the cursor keys , , and .

Pressing the spinwheel or the *ENTER* key transfers the desired characters to the editing line.



The fields in the last line of the character selection field are assigned special functions.

- SPACE inserts a space in the editing line
 << shifts the cursor in the editing line by one character to the left
 >> shifts the cursor in the editing line by one character to the right
 BACK clears the character before the cursor
 EXIT stores the content of the editing line and closes the auxiliary line editor

Return to the editing line from the first line of the character selection field using the *cursor up* key.

Navigation within the editing line is also performed with the spinwheel or the cursor keys and .

Figures, decimal points and signs are directly entered in the editing line using the keypad on the front panel. When a PC keyboard is connected, letters and special characters can also be directly entered.

Editing is terminated from the editing line with *ENTER* if the text should be stored, and with *ESC* when the entered text should be aborted. In both cases the auxiliary line editor is closed.

Installation of Plug&Play Printers

The installation of Plug&Play printers under Windows XP is quite simple:

After the printer is connected and switched on, Windows XP automatically recognizes it and installs its driver, provided the driver is included in the XP installation.

If the XP printer driver is not found, Windows XP prompts you to enter the path for the corresponding installation files. In addition to pre-installed drivers, a number of other printer drivers can be found in directory D:\I386.



When installing new printer drivers, you will be prompted to indicate the path of the new driver. This path may be on a disk in drive A. Alternatively, the driver can be loaded via a memory stick or USB CD-ROM drive (see section "Connection of USB Devices").

Installation of Non-Plug&Play Printers



The dialogs below can be operated either from the front panel or via mouse and keyboard (see sections "Connecting a Mouse" and "Connecting a Keyboard"). Mouse and PC keyboard are absolutely essential for configuring network printers.

A new printer is installed via the *INSTALL PRINTER* softkey.

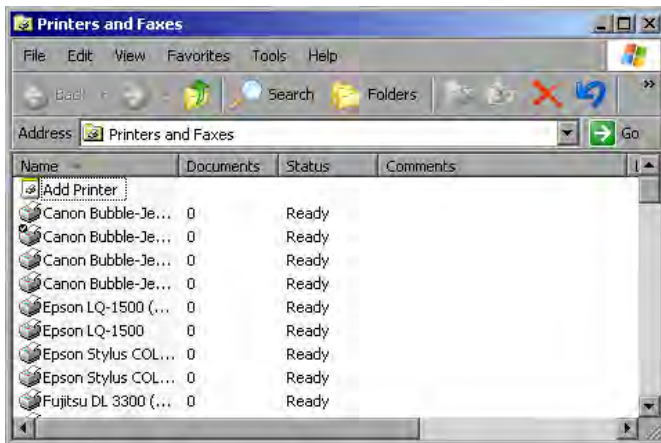

- Select *Add Printer* in the list using the spinwheel.
- Highlight the selected item with *CURSOR RIGHT* and press *ENTER* or the spinwheel to confirm the selection.

The *Add Printer Wizard* is displayed.

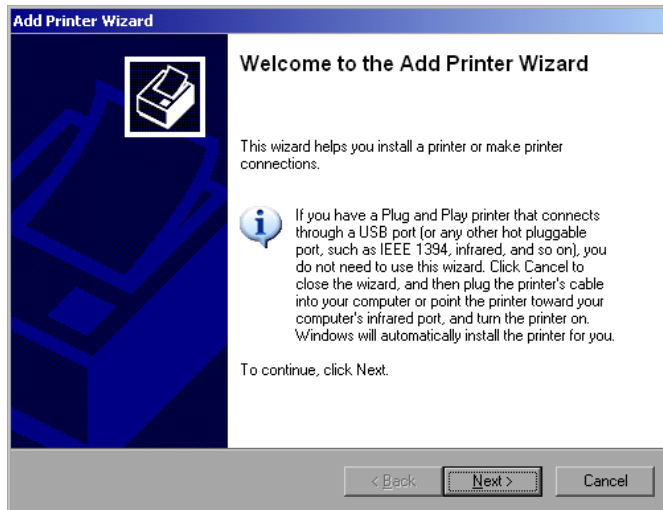

- Select *NEXT* with the spinwheel and press the spinwheel for confirmation.

Local or Network Printer can be selected.

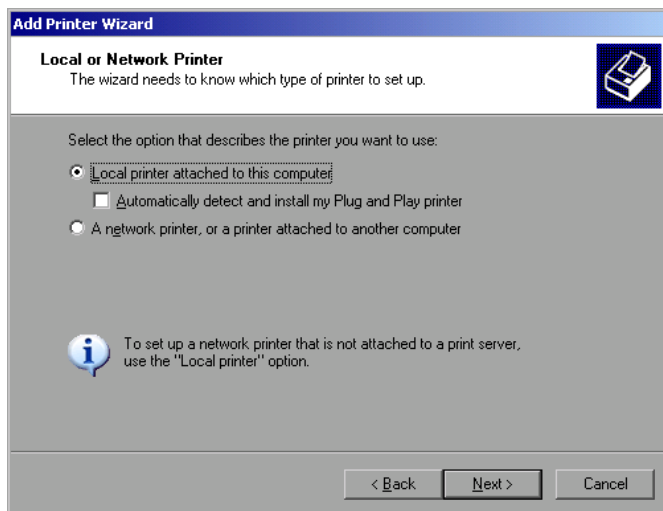

- To install a local printer, select *Local printer attached to this computer* with the spinwheel. Press the spinwheel for confirmation and continue with the "Local Printer" section.

- To install a network printer, select *A network printer, or a printer attached to another computer*. Press the spinwheel for confirmation and continue with the "Network Printer" section.

Local Printer

In the example below, a Star LC24 printer is installed.

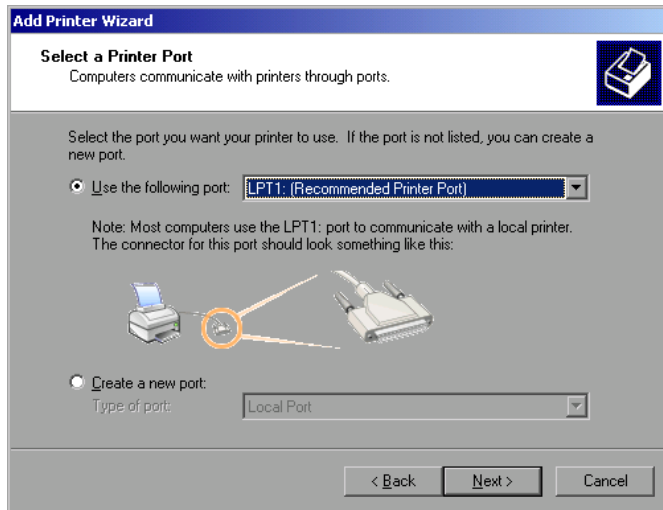

- To select the USB interface, open the list of ports by clicking the spinwheel. Select the printer port with spinwheel/arrow keys and confirm by pressing the spinwheel. The selection list is closed again.
 - To select the LPT connector, the selection list need not be opened.
 - Place the cursor on the *Next* button and confirm by pressing the spinwheel.
- The "Install Printer Software" dialog is opened.

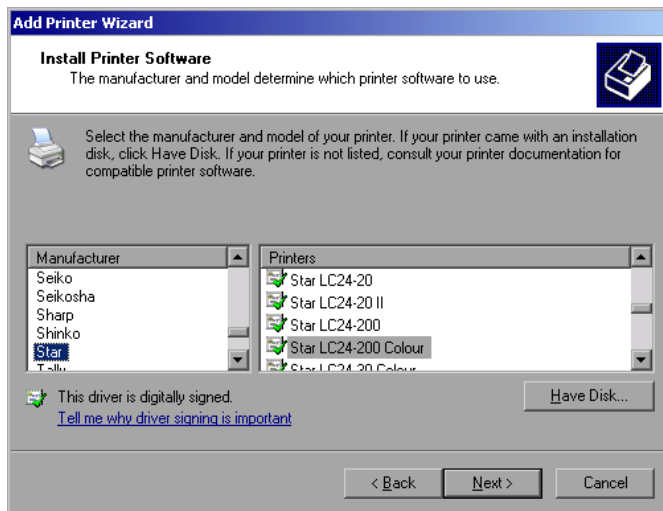

- Select the desired manufacturer ("Star") in the Manufacturer table using the up / down keys.

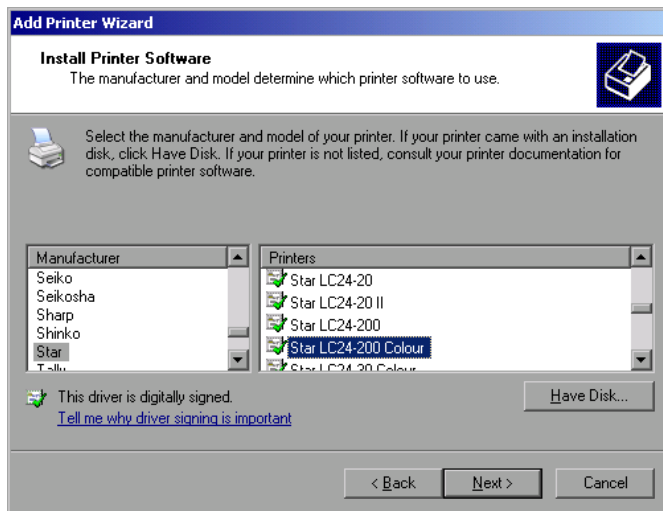

- Go to the *Printers* list with the spinwheel.
- Select the desired printer type (Star LC24-200 Colour) using the up / down keys and confirm with *ENTER*.



If the desired printer type is not in the list, the respective driver is not installed yet. In this case click the HAVE DISK button with the mouse key. You will be prompted to insert a disk with the corresponding printer driver. Press OK and select the desired printer driver.

Add Printer Wizard

Name Your Printer
You must assign a name to this printer.

Type a name for this printer. Because some programs do not support printer and server name combinations of more than 31 characters, it is best to keep the name as short as possible.

Printer name:
Star LC24-300 Colour

Do you want to use this printer as the default printer?

Yes
 No

< Back Next > Cancel

The printer name can be changed as required in the *Printer name* entry field (max. 60 characters). A PC keyboard is required in this case.

- Use the spinwheel to select *Yes* or *No* for the default printer.
- Choose the desired status with the up/down keys.
- Confirm with *ENTER*.

The *Printer Sharing* dialog is opened.

Add Printer Wizard

Printer Sharing
You can share this printer with other network users.

If you want to share this printer, you must provide a share name. You can use the suggested name or type a new one. The share name will be visible to other network users.

Do not share this printer
 Share name: _____

< Back Next > Cancel

- Exit the dialog with *ENTER*.

The *Print Test Page* dialog is opened.

Add Printer Wizard

Print Test Page
To confirm that the printer is installed properly, you can print a test page.

Do you want to print a test page?

Yes
 No

< Back Next > Cancel

- Exit the dialog with *ENTER*.

The *Completing the Add Printer Wizard* dialog is opened.

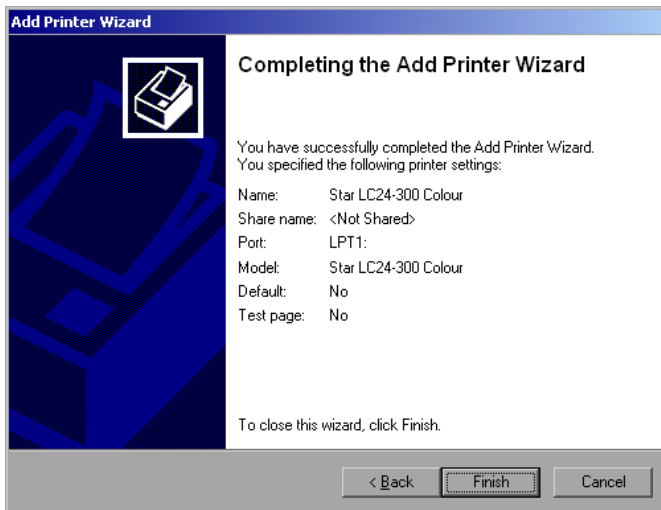

- Check the displayed settings and exit the dialog with *ENTER*.

The printer is installed. If Windows finds the required driver files, the installation is completed without any further queries.

If Windows cannot find the required driver files, a dialog is opened where the path for the files can be entered.

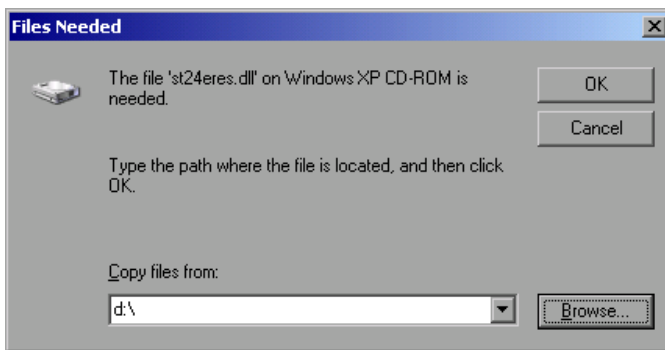

- Select the *Browse* button with the spinwheel and confirm with by pressing the spinwheel.

The *Locate File* dialog is opened.

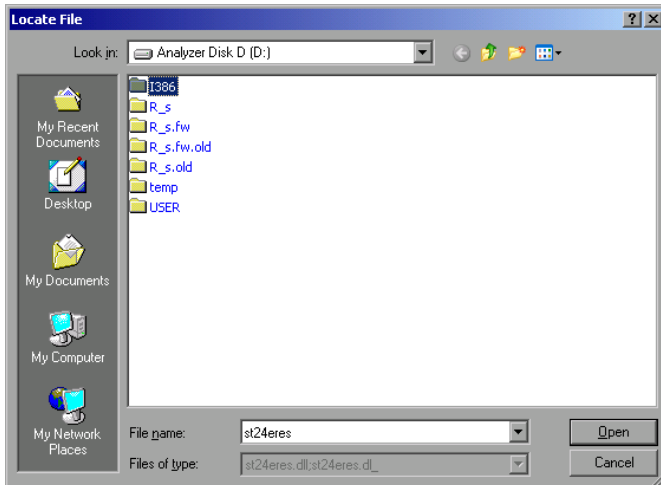

- Turn the spinwheel to select the directory and path D:\1386 and press it to confirm the selection.

If the selected item is not printed on a blue background, it must be marked with the cursor up / down keys before it can be activated by pressing the spinwheel.

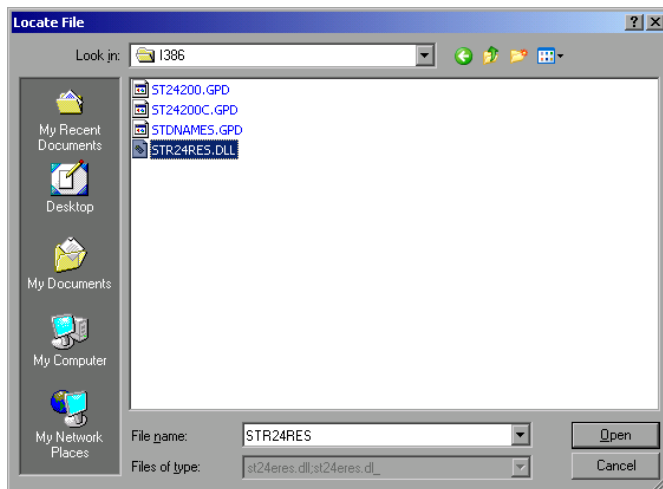

- Select the driver file with the spinwheel and confirm by pressing the spinwheel.

The file is included in the *Files Needed* dialog.



If the desired file is not in the D:\I386 directory, a disk with the driver file is needed. In this case, exit the dialog with ESC and repeat the selection starting from the "Files needed" dialog.

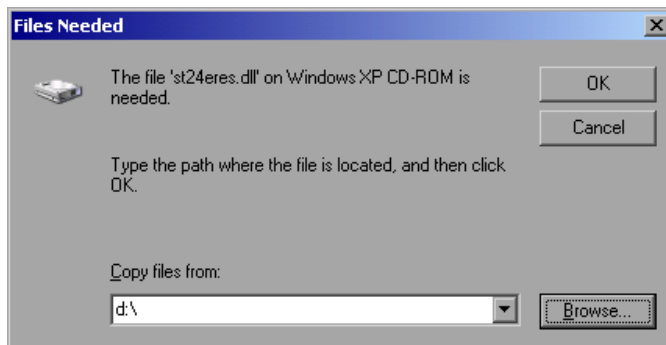

- Select the OK button with the spinwheel and press the spinwheel to confirm.

The installation is completed.

Finally the instrument must be configured for printouts of the measurement screen with this printer. For details please refer to the *DEVICE SETUP* softkey in the hardcopy menu.

Network Printer



For easy operation of the subsequent dialogs, connection of a PS/2 keyboard with trackball to the front panel is recommended. If no trackball is available, a USB mouse should be connected additionally to the rear panel (see section "Connecting a Mouse" and "Connecting a Keyboard")

In the example below, a HP Laserjet 5 printer is installed as network printer. The Add Printer Wizard has already been opened as described in section "Starting the Add Printer Wizard"

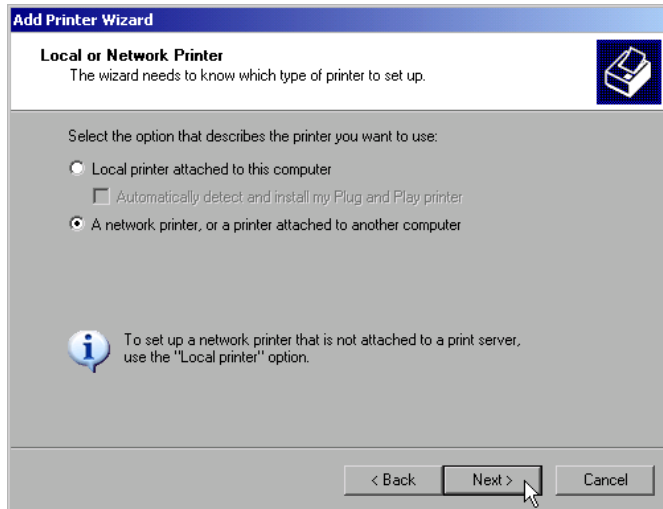

- To select a network printer, click the option "A network printer or a printer attached to another computer".

Continue with *Next*.

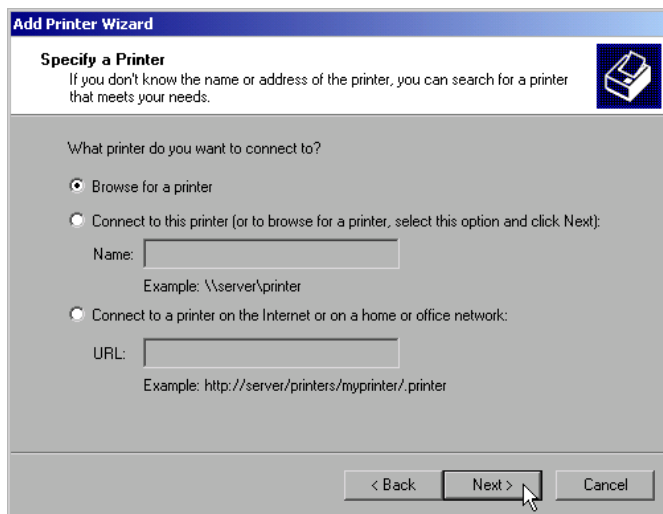

- Click *Browse for a printer* and then *Next*. A list of selectable printers is displayed.

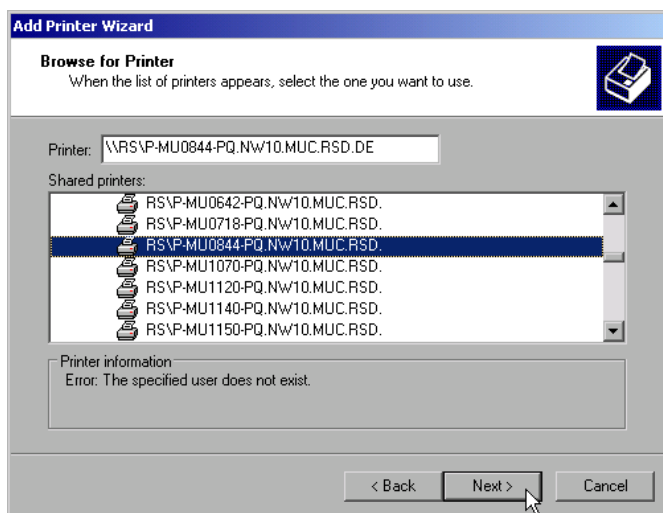

- Mark the desired printer and select it with *OK*.

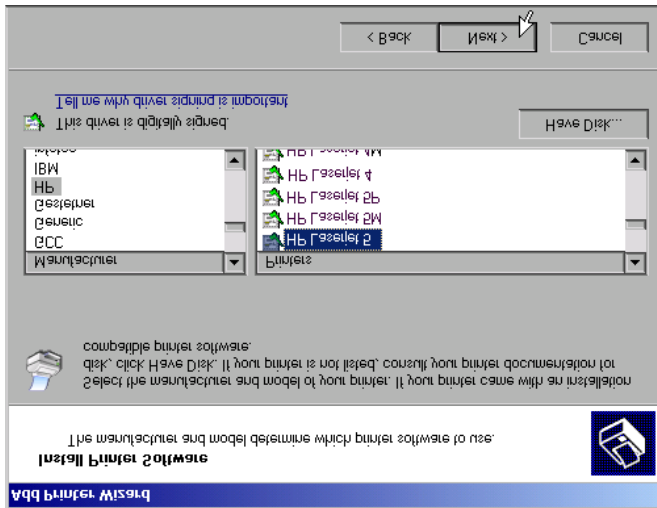

- Confirm the subsequent prompt to install a suitable printer driver with "OK". The list of available printer drivers is displayed. The manufacturers are listed in the left-hand table, the available printer drivers in the right-hand table.
- Select the manufacturer from the *Manufacturers* table and then the printer driver from the *Printers* table.
- Click *Next*.



If the desired type of output device is not shown in the list, the driver has not yet been installed. In this case, click the "HAVE DISK" button. You will be prompted to insert a disk with the corresponding printer driver. Insert the disk, select "OK" and then choose the desired printer driver.

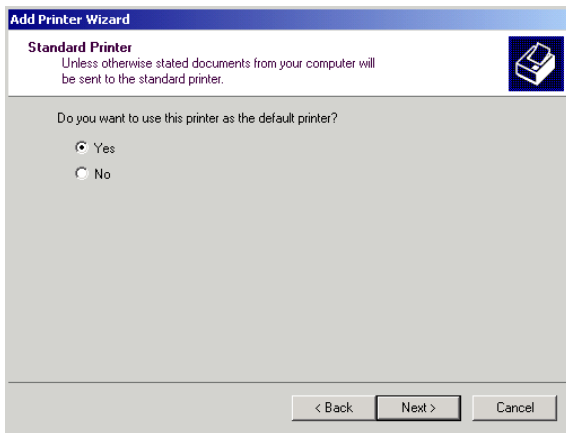

If one or more printers are already installed, a query is displayed whether the printer just installed should be used as the standard printer for the Windows XP applications. Default setting is *No*.

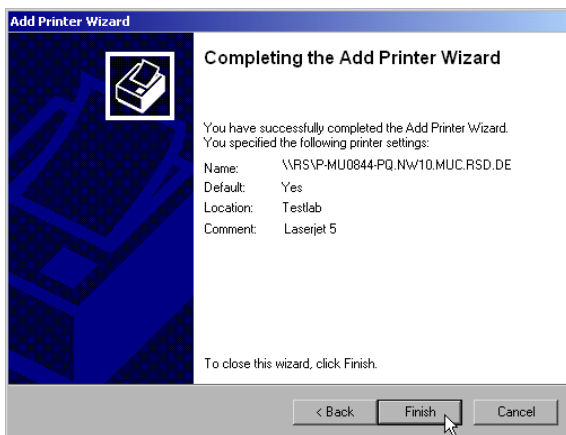

- Start the printer driver installation with *Finish*.

Finally, the instrument has to be configured for printout with this printer using the DEVICE SETUP and DEVICE 1/2 softkeys in the hardcopy main menu (see section "Selection of a Printer").

Tracking Generator - Option R&S FSU-B9

During normal operation (without a frequency offset), the tracking generator emits a signal exactly at the input frequency of the R&S FSMR.

For frequency-converting measurements it is possible to set a constant frequency offset of ± 200 MHz between the receive frequency of the R&S FSMR and the output signal of the tracking generator. Moreover, an I/Q modulation or AM and FM modulation of the output signal can be provided using two analog input signals.

The output power is level-controlled and can be set in 0.1 dB steps in a range from -30 dBm to +5 dBm (-100 to +5 dBm with option FSU-B12).

The tracking generator can be used in all operating modes. Acquisition of test setup calibration values (SOURCE CAL) and normalization using these correction values (*NORMALIZE*) is only possible in the *NETWORK* operating mode.



The RF characteristics of some DUTs is especially sensitive concerning the input VSWR. In such cases insertion of 20 dB attenuation between the DUT and the tracking generator output is highly recommended.

The tracking generator is activated by means of the *NETWORK* hotkey in the hotkey bar at the bottom of the screen:

SPECTRUM

NETWORK

SCREEN B

Tracking Generator Settings

The *NETWORK* hotkey opens a menu for selecting the functions of the tracking generator.

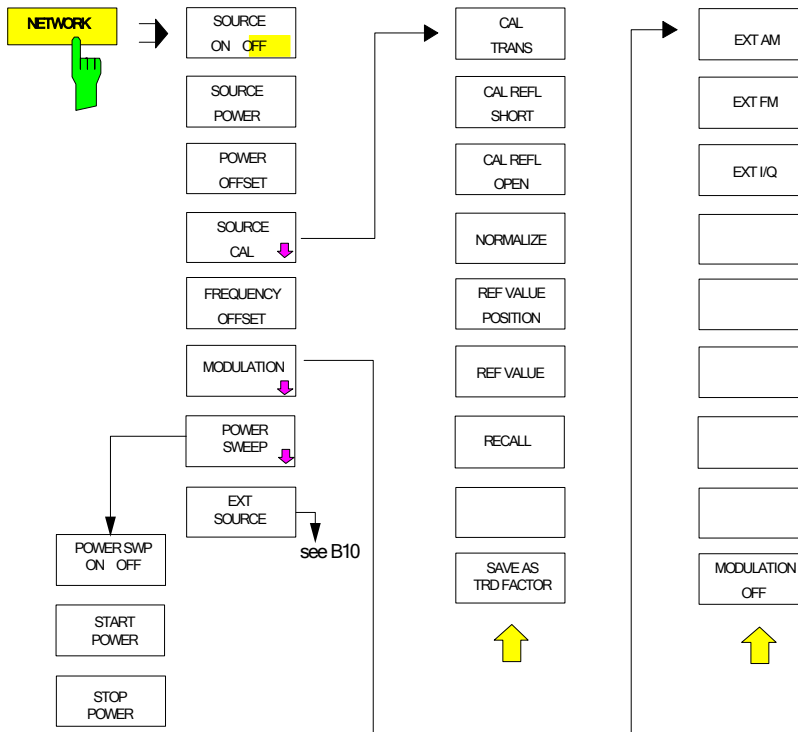

Additional softkeys are available in the displayed menus for controlling an external generator if option External Generator Control FSP-B10 is fitted. For detailed information see section 'External Generator Control Option FSP-B10'.

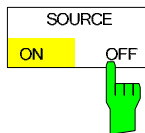

The *SOURCE ON/OFF* softkey switches the tracking generator on or off. Default setting is *OFF*



When the tracking generator is switched on the maximum stop frequency is limited to 3.6 GHz. This upper limit is automatically reduced by a frequency offset set up for the tracking generator.

In order to meet the data sheet accuracy for measurements with active tracing generator the start frequency must be set to $\geq 3 \times$ Resolution Bandwidth.

The minimum sweep time for measurements with data sheet accuracy is 100 ms in frequency domain (span > 0 Hz). Selecting a sweep time below this limit will result in the sweep time indicator field SWT being supplied with a red asterisk and the message UNCAL being displayed.

FFT filters (FILTER TYPE FFT in BW menu) are not available when the tracking generator is active.

IEC/IEEE-bus command: `OUTP:STAT ON`

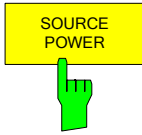

The *SOURCE POWER* softkey allows the tracking generator output power to be selected.

The output power can be set in 0.1 dB steps from -30 dBm to +5 dBm (-100 to +5 dBm with option FSU-B12).

If the tracking generator is off, it is automatically switched on when an output power value is entered.

The default output power is -20 dBm.

IEC/IEEE-bus command: SOUR:POW -20dBm

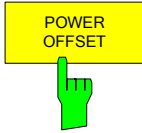

The *POWER OFFSET* softkey allows selection of a constant level offset for the tracking generator.

With this offset for example attenuators or amplifiers at the output connector of the tracking generator can be taken into account for the displayed output power values on screen or during data entry.

The valid range is -200 dB to +200 dB in 0.1 dB steps. Positive offsets apply to an amplifier and negative offsets to an attenuator subsequent to the tracking generator.

The default setting is 0 dB. Offsets \neq 0 will display the enhancement label **LVL**.

IEC/IEEE-bus command: SOUR:POW:OFFS -10dB

Transmission Measurement

This measurement will yield the transmission characteristics of a two-port network. The built-in tracking generator serves as a signal source. It is connected to the input connector of the DUT. The input of the R&S FSMR is fed from the output of the DUT.

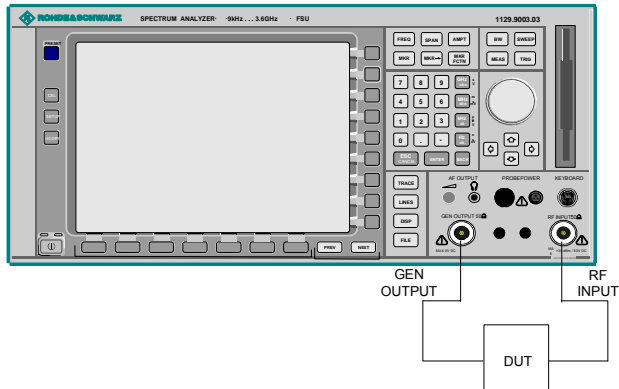
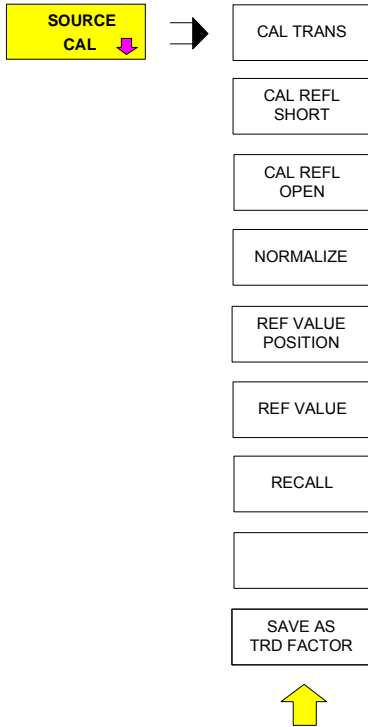

Fig. 4.22-1 Test setup for transmission measurement

A calibration can be carried out to compensate for the effects of the test setup (eg frequency response of connecting cables).

Calibration of Transmission Measurement

NETWORK menu:



The *SOURCE CAL* softkey opens a submenu comprising of the calibration functions for the transmission and reflection measurement.

The calibration of the reflection measurement (*CAL REFL...*) and its mechanisms are described in separate sections.

To carry out a calibration for transmission measurements the whole test setup is through-connected (THRU).

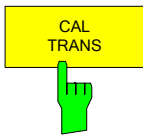

The *CAL TRANS* softkey triggers the calibration of the transmission measurement.

It starts a sweep that records a reference trace. This trace is then used to calculate the difference for the normalized values.

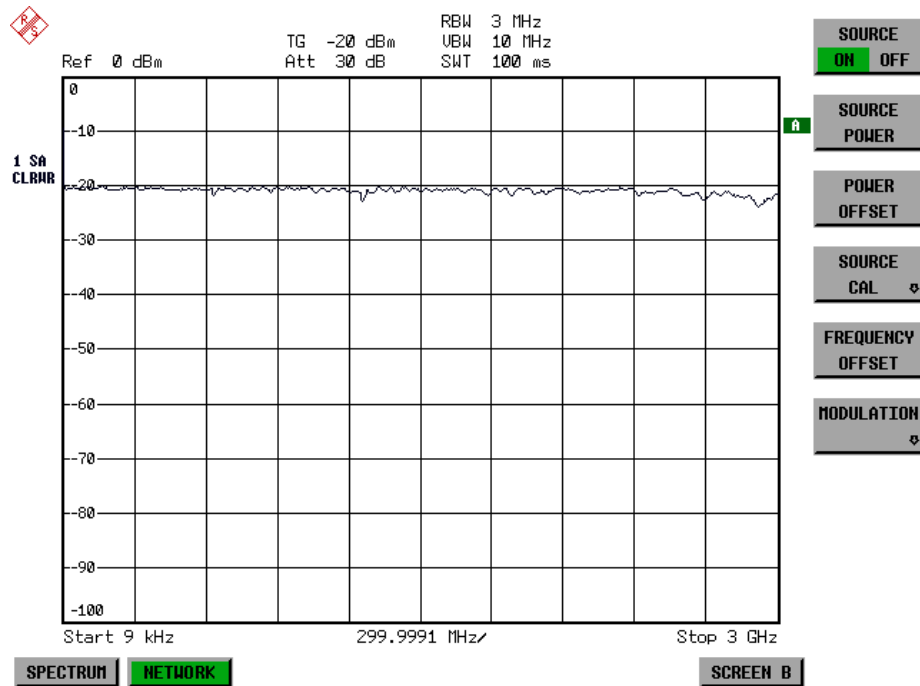
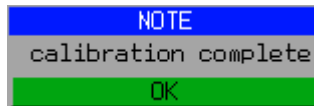

Fig. 4.22-2 Calibration curve for transmission measurement

During the calibration the following message is displayed:



After the calibration the following message is displayed:



This message will be cleared automatically after approx. 3 seconds.

IEC/IEEE-bus command: CORR:METH TRAN

Normalization

NETWORK-SOURCE CAL menu:

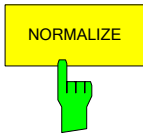

The *NORMALIZE* softkey switches the normalization on or off. The softkey is only available if the memory contains a correction trace.

It is possible to shift the relative reference point within the grid using the *REF VALUE POSITION* softkey. Thus, the trace can be shifted from the upper border of the grid to the vertical center of the grid:

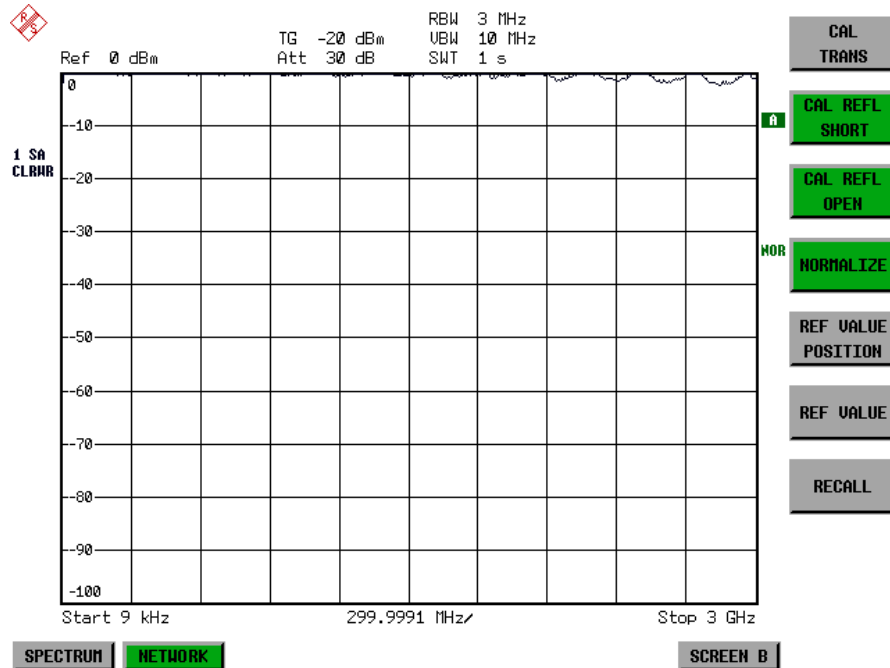

Fig. 4.22-3 Normalized display

In *SPLIT SCREEN* operation, the normalization is switched on in the currently active window. Different types of normalization can be active in the two windows.

Normalization is aborted when the *NETWORK* operating mode is quit.

IEC/IEEE-bus command: CORR ON



The *REF VALUE POSITION* softkey marks a reference position in the active window at which the normalization result (calculated difference with a reference trace) is displayed.

If no reference line is active, the softkey switches on a reference line and activates the input of its position. The line can be moved within the grid boundaries.

The reference line is switched off by pressing the softkey again.

The function of the reference line is explained in the section "Calibration mechanisms".

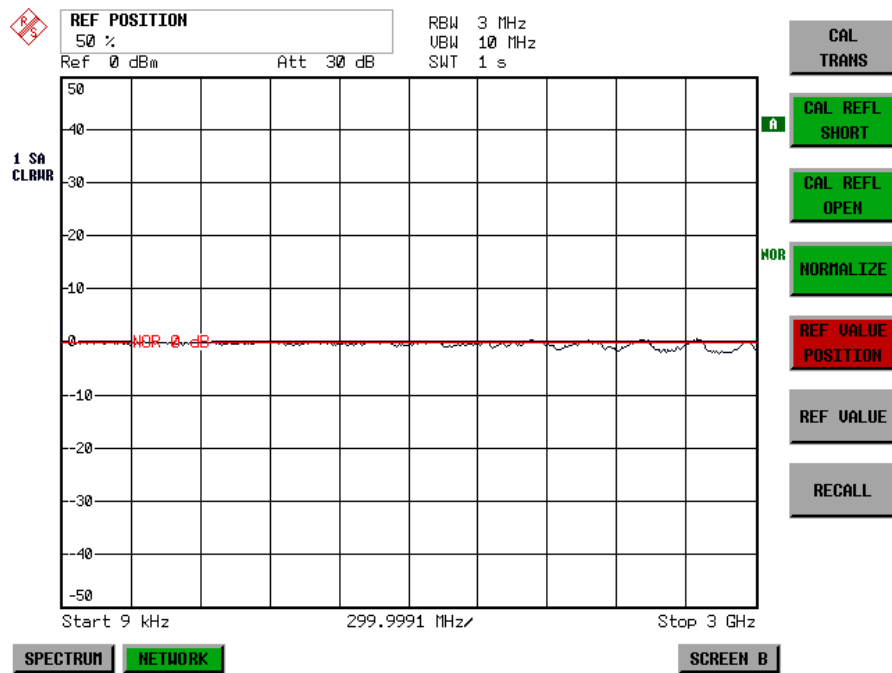
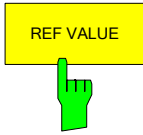

Fig. 4.22-4 Normalized measurement, shifted with *REF VALUE POSITION* 50 %

IEC/IEEE-bus command: DISP:WIND:TRAC:Y:RPOS 10PCT



The *REF VALUE* softkey activates the input of a value which is assigned to the reference line.

With default settings the reference line corresponds to a difference of 0 dB between the currently measured trace and the reference trace. Setting the *REF VALUE* to a different value helps to compensate for changes to the level conditions in the signal path after the calibration data have been recorded. If eg after a source calibration a 10 dB attenuation is inserted into the signal path between DUT and R&S FSMR input, the measurement trace will be moved by 10 dB down. Entering a *REF VALUE* of -10 dB will then result in the reference line for difference calculation being moved by 10 dB down as well. This means that the measured trace will be placed on it, as displayed in figure 4-20.

REF VALUE always refers to the active window.

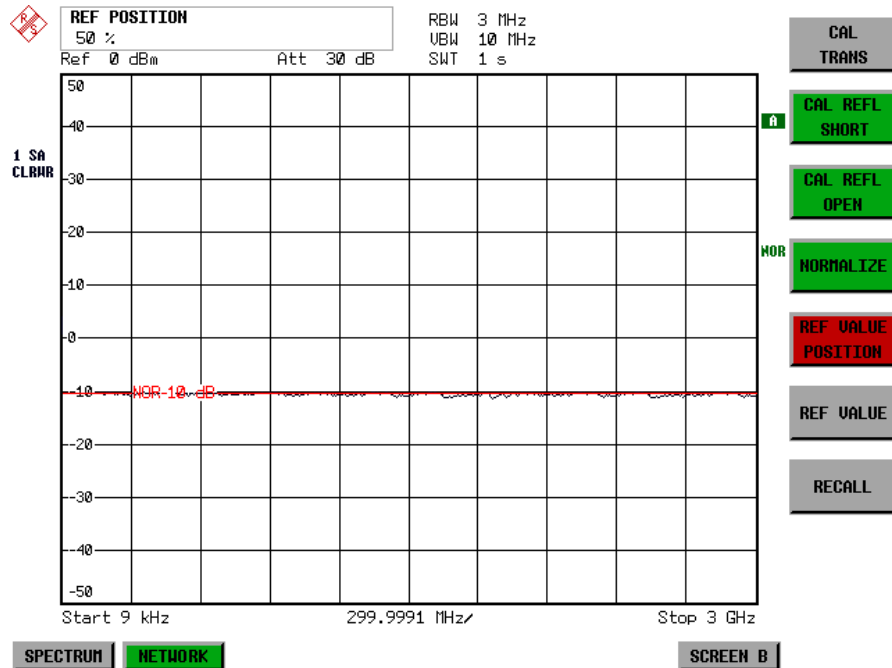

Fig. 4.22-5 Measurement with REF VALUE -10 dB and REF VALUE POSITION 50%

After the reference line has been moved by entering a *REF VALUE* of -10 dB the deviation from the nominal power level can be displayed with high resolution (eg 1 dB/div). The power is still displayed in absolute values, which means that in the above example 1 dB below the nominal power (reference line) = 11 dB attenuation.

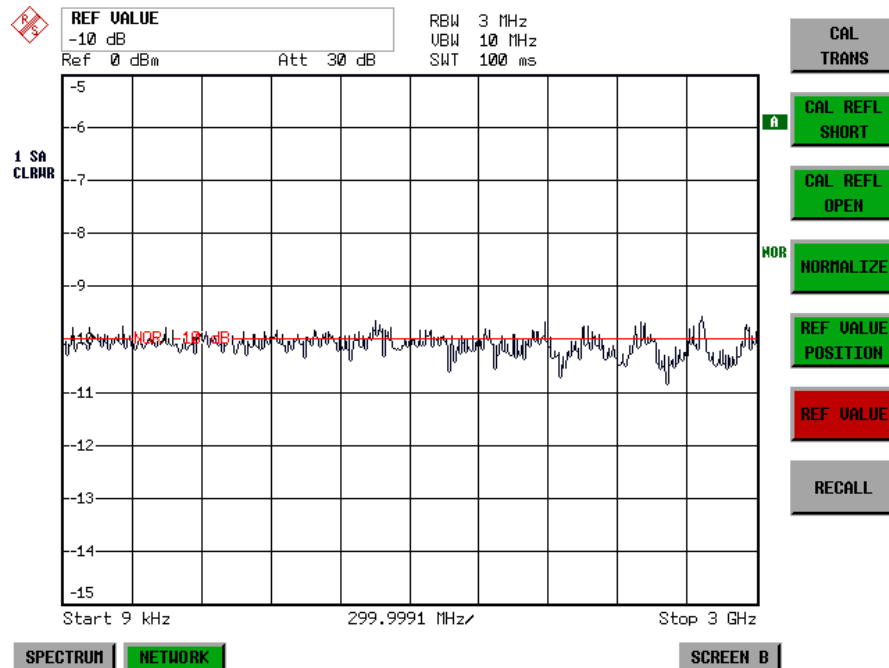
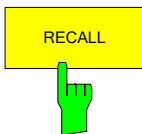

Fig. 4.22-6 Measurement of a 10dB attenuator pad with 1dB/DIV

IEC/IEEE-bus command: `DISP:WIND:TRAC:Y:RVAL -10dB`



The *RECALL* softkey restores the R&S FSMR settings that were used during source calibration.

This can be useful if device settings were changed after calibration (eg center frequency, frequency deviation, reference level, etc).

The softkey is only available if:

- the NETWORK mode has been selected
- the memory contains a calibration dataset.

IEC/IEEE-bus command: `CORR:REC`

Reflection Measurement

Scalar reflection measurements can be carried out by means of a reflection-coefficient measurement bridge.

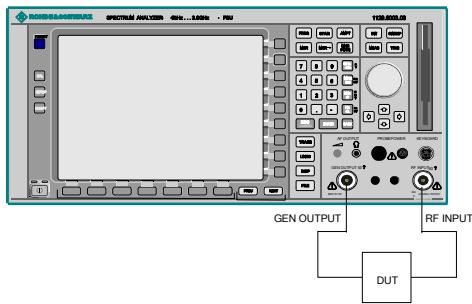

Fig. 4.22-7 Test Setup for Reflection Measurement

Calibration of Reflection Measurement

The calibration mechanism for reflection measurement is basically the same as the one used for transmission measurement.

NETWORK-SOURCE CAL submenu



The *CAL REFL OPEN* softkey starts the open-circuit calibration. During calibration the following message is displayed:



IEC/IEEE-bus command: `CORR:METH REFL`
`CORR:COLL OPEN`



The *CAL REFL SHORT* softkey starts the short-circuit calibration.

If both calibrations (open circuit, short circuit) are carried out, the calibration curve is calculated by averaging the two measurements and stored in the memory. The order of the two calibration measurements is free.

After the calibration the following message is displayed:

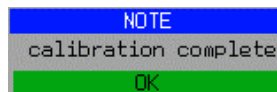

The message is cleared after approx. 3 seconds.

IEC/IEEE-bus command: `CORR:METH REFL`

Calibration mechanism

Calibration means a calculation of the difference between the currently measured power and a reference curve, independent of the selected type of measurement (transmission/reflection). The hardware settings used for measuring the reference curve are included in the reference dataset.

Even with normalization switched on, the device settings can be changed in a wide area without stopping the normalization. This reduces the necessity to carry out a new normalization to a minimum.

For this purpose the reference dataset (trace with 625 measured values) is stored internally as a table of 625 points (frequency/level).

Differences in level settings between the reference curve and the current device settings are taken into account automatically. If the span is reduced, a linear interpolation of the intermediate values is applied. If the span increases, the values at the left or right border of the reference dataset are extrapolated to the current start or stop frequency, ie the reference dataset is extended by constant values.

An enhancement label is used to mark the different levels of measurement accuracy. This enhancement label is displayed at the right diagram border when normalization is switched on and a deviation from the reference setting occurs. Three accuracy levels are defined:

Table 4.22-1 Measurement accuracy levels

Accuracy	Enhancement label	Reason/Limitation
High	NOR	No difference between reference setting and measurement
Medium	APX (approximation)	Change of the following settings: <ul style="list-style-type: none"> • coupling (RBW, VBW, SWT) • reference level, RF attenuation • start or stop frequency • output level of tracking generator • frequency offset of tracking generator • detector (max. peak, min. peak, sample, etc.) Change of frequency: <ul style="list-style-type: none"> • max. 625 points within the set sweep limits (corresponds to a doubling of the span)
-	Aborted normalization	<ul style="list-style-type: none"> • more than 624 extrapolated points within the current sweep limits (in case of span doubling)



At a reference level (REF LEVEL) of -10 dBm and at a tracking generator output level of the same value the R&S FSMR operates without overrange reserve, ie the R&S FSMR is in danger of being overloaded if a signal is applied whose amplitude is higher than the reference line. In this case, either the message "OVLD" for overload is displayed in the status line or the display range is exceeded (clipping of the trace at the upper diagram border = Overrange).

Overloading can be avoided as follows:

- Reducing the output level of the tracking generator (SOURCE POWER, NETWORK menu)
- Increasing the reference level (REF LEVEL, AMPT menu)

Frequency-Converting Measurements

For frequency-converting measurements (eg on converter units) the tracking generator is able to set a constant frequency offset between the output frequency of the tracking generator and the receive frequency of the R&S FSMR.

Up to an output frequency of 200 MHz the measurement can be carried out in both inverted and normal positions.

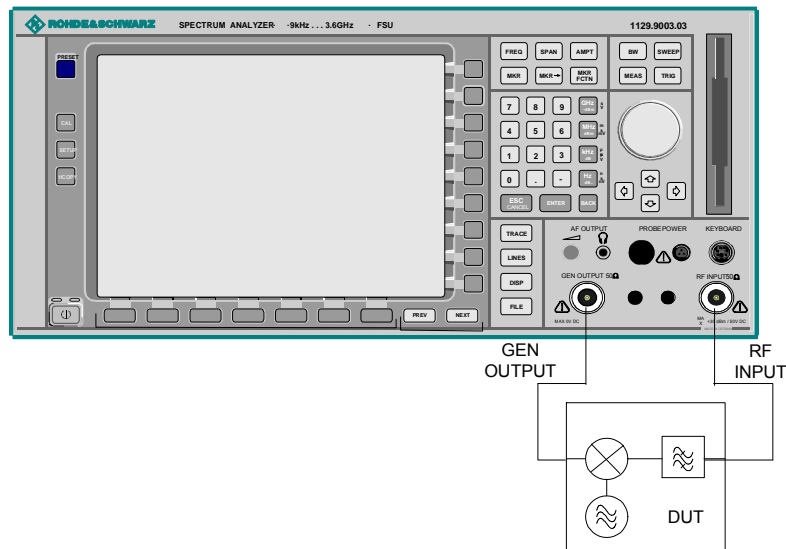
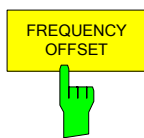

Fig. 4.22-8 Test setup for frequency converting measurements

NETWORK menu



The *FREQUENCY OFFSET* softkey activates the input of the frequency offset between the output signal of the tracking generator and the input frequency of the R&S FSMR. Possible offsets are in a range of ± 200 MHz in 0.1 Hz steps.

The default setting is 0 Hz. Offsets $\neq 0$ Hz are marked with the enhancement label **FRQ**.

If a positive frequency offset is entered, the tracking generator generates an output signal above the receive frequency of the R&S FSMR. In case of a negative frequency offset it generates a signal below the receive frequency of the R&S FSMR. The output frequency of the tracking generator is calculated as follows:

$$\text{Tracking generator frequency} = \text{receive frequency} + \text{frequency offset.}$$

IEC/IEEE-bus command: `SOUR:FREQ:OFFS 50MHz`

External Modulation of the Tracking Generator

NETWORK menu:



The *MODULATION* softkey opens a submenu for selecting different modulation modes.

The time characteristics of the tracking generator output signal can be influenced by means of external signals (input voltage range -1 V to +1 V).

Two BNC connectors at the rear panel are available as signal inputs. Their function changes depending on the selected modulation:

TG IN I / AM and
TG IN Q / FM

The modulation modes can be combined with each other and with the frequency offset function up to a certain degree. The following table shows which modulation modes are possible at the same time and which ones can be combined with the frequency offset function.

Table 4.22-2 Simultaneous modes of modulation (tracking generator)

Modulation	Frequency offset	EXT AM	EXT FM	EXT I/Q
Frequency offset		•	•	•
EXT AM	•		•	
EXT FM	•	•		
EXT I/Q	•			

• = can be combined

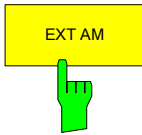

The *EXT AM* softkey activates an AM modulation of the tracking generator output signal.

The modulation signal is applied to the *TG IN I / AM* connector. An input voltage of 1 V corresponds to 100% amplitude modulation.

Switching on an external AM disables the following function:

- active I/Q modulation.

IEC/IEEE-bus command: `SOUR:AM:STAT ON`

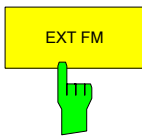

The *EXT FM* softkey activates the FM modulation of the tracking generator output signal.

The modulation frequency range is 1 kHz to 100 kHz, the deviation can be set in 1-decade steps in the range of 100 Hz to 10 MHz at an input voltage of 1 V. The phase deviation η should not exceed the value 100.

$$\text{Phase deviation } \eta = \text{deviation} / \text{modulation frequency}$$

The modulation signal is applied to the *TG IN Q / FM* connector.

Switching on an external FM disables the following function:

- active I/Q modulation.

IEC/IEEE-bus command: `SOUR:FM:STAT ON`
`SOUR:FM:DEV 10MHz`

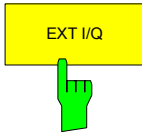

The *EXT I/Q* softkey activates the external I/Q modulation of the tracking generator.

The signals for modulation are applied to the two input connectors *TG IN I* and *TG IN Q* at the rear panel of the unit. The input voltage range is ± 1 V into 50Ω .

Switching on an external I/Q modulation disables the following functions:

- active external AM
- active external FM

Functional description of the quadrature modulator:

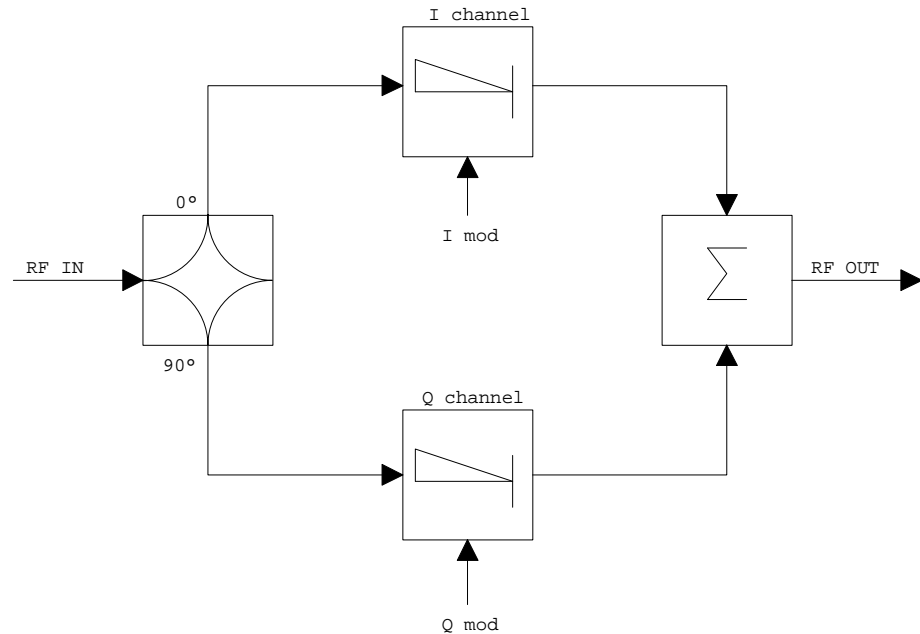
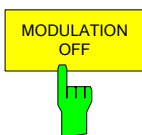

Fig. 4.22-9 I/Q modulation

I/Q modulation is performed by means of the built-in quadrature modulator. The RF signal is divided into two orthogonal I and Q components (inphase and quadrature phase). Amplitude and phase are controlled in each path by the I and Q modulation signal. By adding the two components an RF output signal is generated that can be controlled in amplitude and phase.

IEC/IEEE-bus command: SOUR:DM:STAT ON



The *MODULATION OFF* softkey switches off the modulation of the tracking generator.

IEC/IEEE-bus command: SOUR:AM:STAT OFF
 SOUR:FM:STAT OFF
 SOUR:DM:STAT OFF

The *POWER SWEEP* softkey opens a submenu for activates or deactivates the power sweep.

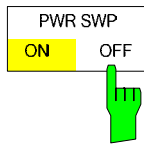
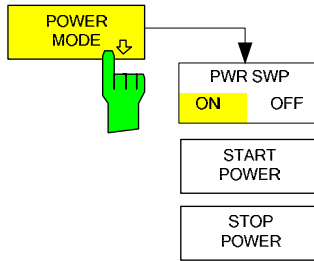

The *POWER SWP ON/OFF* softkey activates or deactivates the power sweep. If the power sweep is ON the enhancement label TGPWR is shown and the Spectrum Analyzer is set in zero span mode (span = 0Hz). During the sweep time of the zero span the power at the internal tracking generator is changed linear from start power to stop power. The start and stop power values are shown on the right side below the diagram.

IEC/IEEE-bus command: SOUR:POW:MODE SWE
 SOUR:POW:MODE FIX

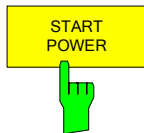

The *START POWER* softkey defines the start power of the power sweep. The start power can be set between -30 dBm and +5 dBm. With the option R&S FSU-B12 the power can be set between -100 and + 5 dBm.

IEC/IEEE-bus command: SOUR:POW:STAR -20dBm

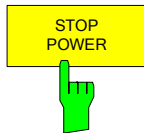

The *STOP POWER* softkey defines the stop power of the power sweep. The start power can be set between -30 dBm and +5 dBm. With the option R&S FSU-B12 the power can be set between -100 and + 5 dBm. The stop value can be smaller than the start value.

IEC/IEEE-bus command: SOUR:POW:STOP -10dBm

Option External Generator Control - FSP-B10

The external generator control option permits to operate a number of commercially available generators as tracking generator on the R&S FSMR. Thus, scalar network analysis with the R&S FSMR is also possible outside the frequency range of the internal tracking generator when the appropriate generators are used.

The R&S FSMR also permits to set a frequency offset for frequency-converting measurements when external generators are used. For harmonics measurements or frequency-converting measurements, it is also possible to enter a factor, by which the generator frequency is increased or reduced compared with the receive frequency of the R&S FSMR. Only make sure that the resulting generator frequencies do not exceed the allowed setting range of the generator.

The settable level range also depends on the generator used.

The generator is controlled via the – optional – second IECBUS interface of the R&S FSMR (= IEC2, supplied with the option) and, with some Rohde & Schwarz generators, additionally via the TTL synchronization interface included in the AUX interface of the R&S FSMR.



The use of the TTL interface enables considerably higher measurement rates as pure IECBUS control, because the frequency stepping of the R&S FSMR is directly coupled with the frequency stepping of the generator.

Therefore, the frequency sweep differs according to the capabilities of the generator used:

- In the case of generators without TTL interface, the generator frequency is first set for each frequency point via IECBUS, then the setting procedure has to be completed before recording of measured values is possible.
- In the case of generators with TTL interface, a list of the frequencies to be set is entered into the generator before the beginning of the first sweep. Then the sweep is started and the next frequency point selected by means of the TTL handshake line TRIGGER. The recording of measured values is only enabled when the generator signals the end of the setting procedure via the BLANK signal. This method is considerably faster than pure IECBUS control.

With the "SELECT GENERATOR" softkey, a list of the supported generators with the frequency and level range as well as the capabilities used is included.

The external generator can be used in all operating modes. Recording of test setup calibration values (*SOURCE CAL*) and normalization with the correction values (*NORMALIZE*) are only possible in the *NETWORK* mode.



In order to enhance measurement accuracy a common reference frequency should be used for both the R&S FSMR and the generator. If no independent 10 MHz reference frequency is available, it is recommended to connect the reference output of the generator with the reference input of the R&S FSMR and to enable usage of the external Reference on the R&S FSMR via SETUP – REFERENCE EXT.

Like the internal tracking generator, the external generator is activated by means of the *NETWORK* hotkey in the hotkey bar at the screen bottom:

**SPECTRUM****NETWORK****SCREEN B**

External Generator Settings

The *NETWORK* hotkey opens the menu for setting the functions of the external generator.

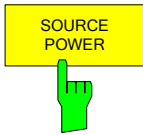
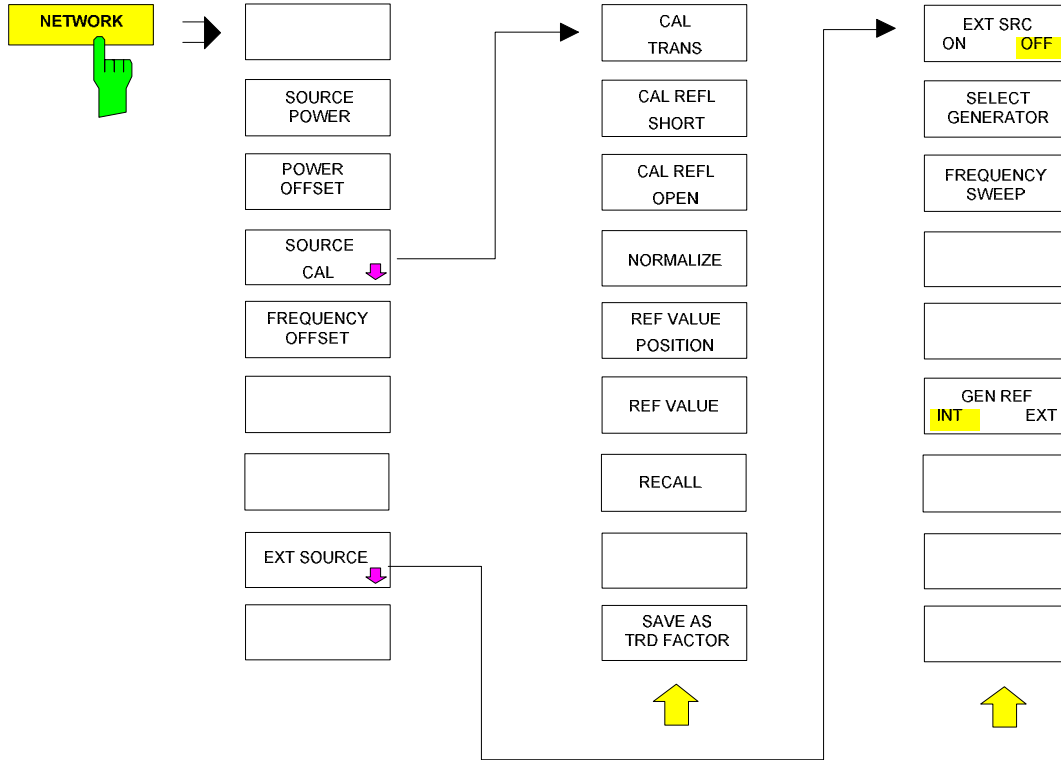

The *SOURCE POWER* softkey activates the entry of the generator output level. The value range depends on the selected generator (See table of chapter "Configuration of the External Generator").

If both option External Generator Control B10 and option Tracking Generator B9 are installed, the softkey will modify the output power of the generator currently in use.

The default output power is -20 dBm.

IEC/IEEE-bus command: `SOUR:EXT:POW -20dBm`

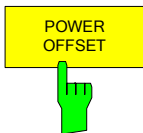

The *POWER OFFSET* softkey activates the entry of a constant level offset of the generator. With this offset, attenuator pads or amplifiers connected to the output connector of the generator can be handled during the input and output of output levels.

The permissible setting range is -200 dB to +200 dB in steps of 0.1 dB. Positive offsets handle a subsequent amplifier and negative offsets an attenuator pad.

The default setting is 0 dB; offsets \neq 0 are marked by the activated enhancement label **LVL**.

IEC/IEEE-bus command `SOUR:POW:OFFS -10dB`

Transmission Measurement

The transmission characteristic of a two-port network is measured. The external generator serves as a signal source. It is connected to the input connector of the DUT. The input of the analyser is fed from the output of the DUT.

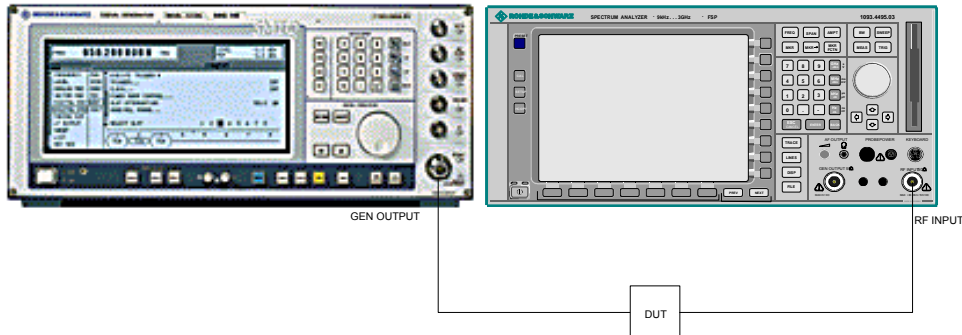
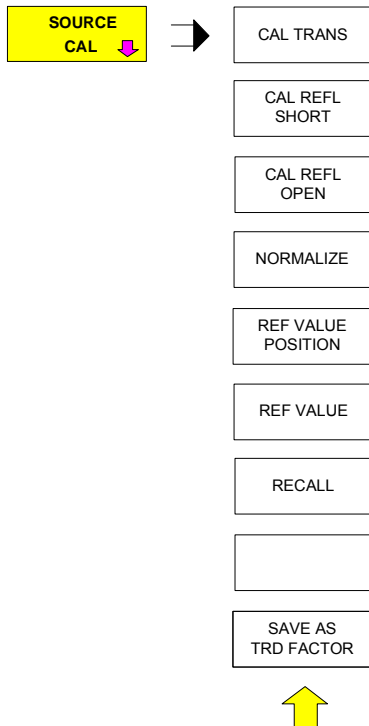

Fig. 4.23-1 Test setup for transmission measurement

A calibration can be carried out to compensate for the effects of the test setup (e.g. frequency response of connecting cables).

Calibration of Transmission Measurement

NETWORK menu:



The *SOURCE CAL* softkey opens a submenu comprising the calibration functions for the transmission and reflection measurement.

The calibration of the reflection measurement (*CAL REFL...*) and its functioning are described in separate sections.

To carry out a calibration for transmission measurements the whole test setup is through-connected (THRU).

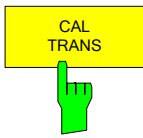

The *CAL TRANS* softkey triggers the calibration of the transmission measurement.

It starts a sweep that records a reference trace. This trace is then used to obtain the differences to the normalized values.

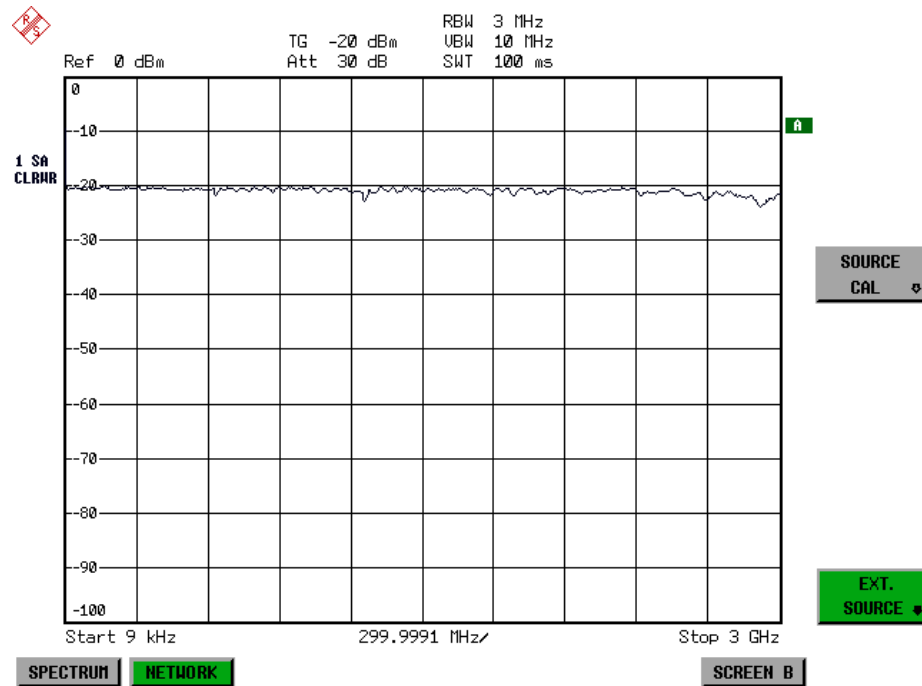
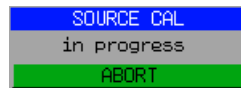
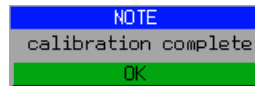

Fig. 4.23-2 Calibration curve for transmission measurement

During the calibration the following message is displayed:



After the calibration sweep the following message is displayed:



This message is cleared after approx. 3 seconds.

IEC/IEEE-bus command CORR:METH TRAN

Normalization:

NETWORK -SOURCE CAL menu:

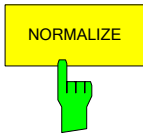

The *NORMALIZE* softkey switches normalization on or off. The softkey is only available if the memory contains a correction trace.

It is possible to shift the relative reference point within the grid using the *REF VALUE POSITION* softkey. Thus, the trace can be shifted from the top grid margin to the middle of the grid:

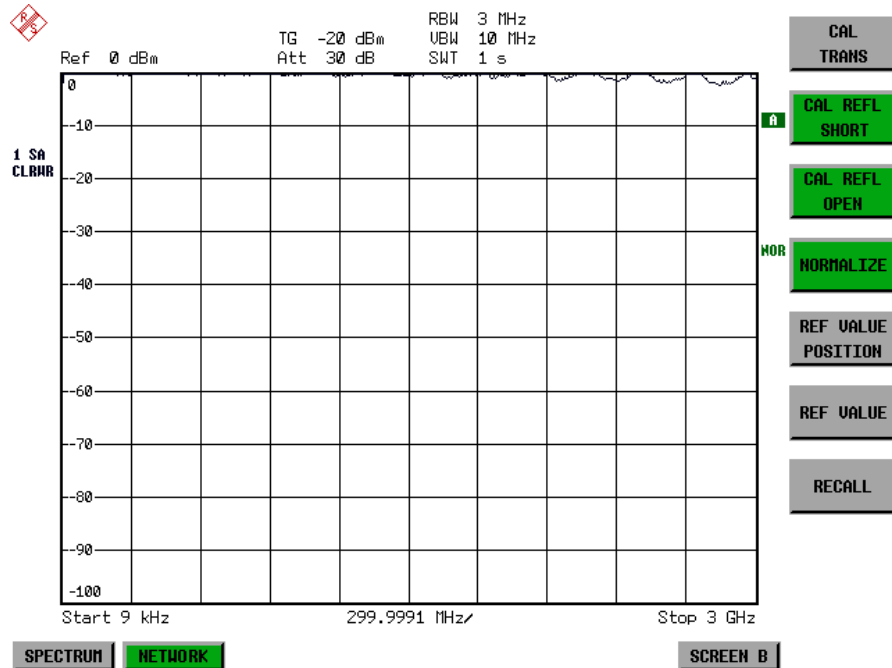
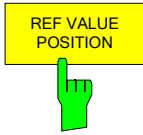

Fig. 4.23-3 Normalized display

In the *SPLIT SCREEN* setting, the normalization is switched on in the current window. Different normalizations can be active in the two windows.

Normalization is aborted when the *NETWORK* mode is quit.

IEC/IEEE-bus command: CORR ON



The *REF VALUE POSITION* softkey (reference position) marks a reference position in the active window on which the normalization (difference formation with a reference curve) is performed.

When pressed for the first time, the softkey switches on the reference line and activates the input of its position. The line can be shifted within the grid limits.

The reference line is switched off by pressing the softkey again.

The function of the reference line is explained in the section "Functioning of Calibration".

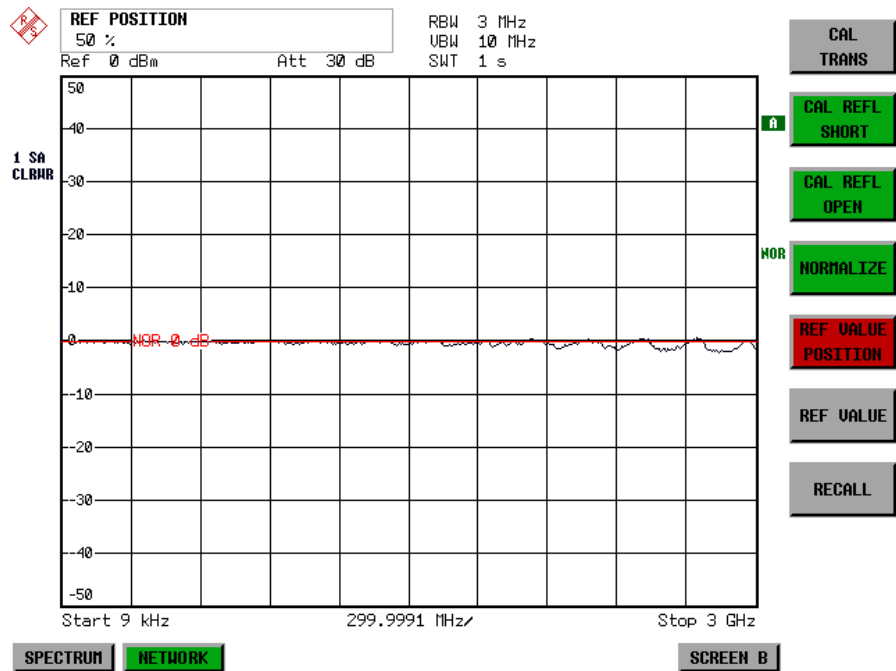
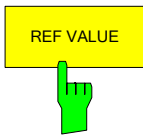

Fig. 4.23-4 Normalized measurement, shifted with *REF VALUE POSITION* 50 %

IEC/IEEE-bus command

DISP:WIND:TRAC:Y:RPOS 10PCT



The *REF VALUE* softkey activates the input of a level difference which is assigned to the reference line.

In the default setting, the reference line corresponds to a level difference of 0 dB. If e.g. a 10-dB attenuator pad is inserted between DUT and analyzer input between recording of the calibration data and normalization, the trace will be shifted down by 10 dB. By entering a *REF VALUE* of -10 dB the reference line for difference formation can also be shifted down by 10 dB so that it will again coincide with the trace (see Fig. 4.22-5).

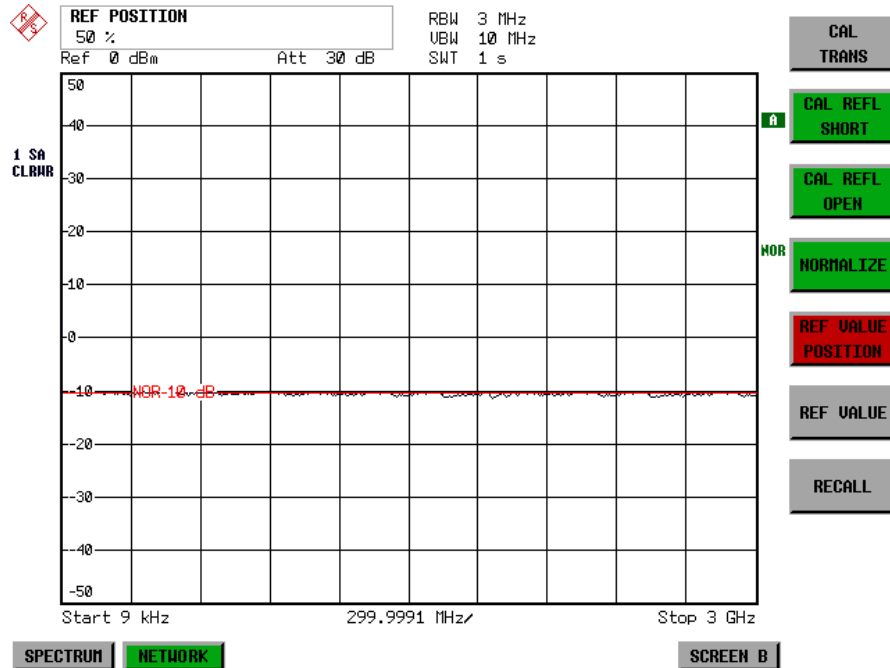

Fig. 4.23-5 Measurement with REF VALUE -10dB and REF VALUE POSITION 50%

After the reference line has been shifted by entering *REF VALUE* -10 dB, departures from the nominal value can be displayed with high resolution (e.g. 1 dB / Div.). The absolute measured values are still displayed, in the above example, 1 dB below nominal value (reference line) = 11 dB attenuation.

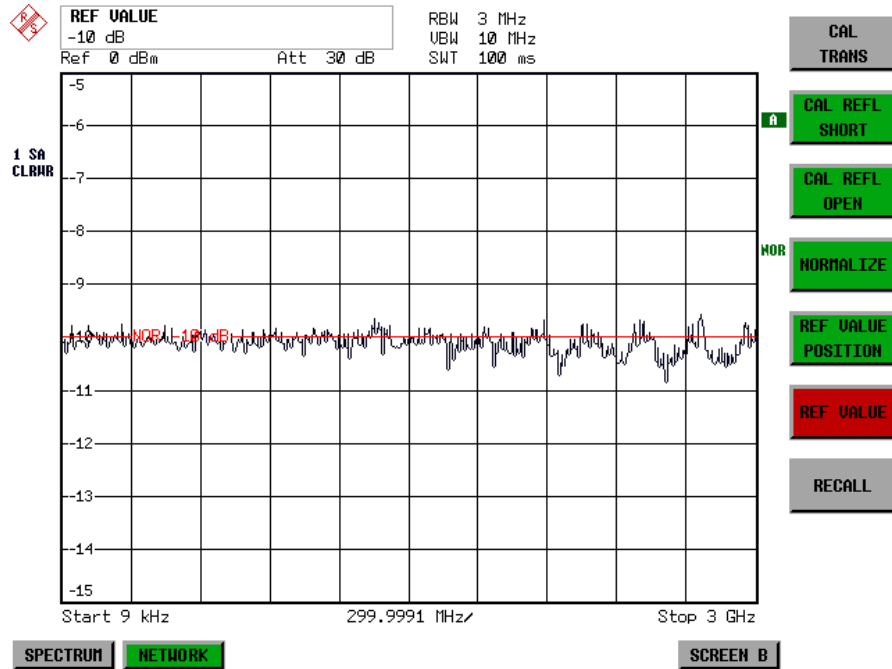
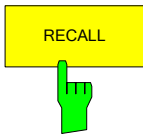

Fig. 4.23-6 Measurement of a 10-dB attenuator pad with 1dB/DIV

IEC/IEEE-bus command `DISP:WIND:TRAC:Y:RVAL -10dB`



The *RECALL* softkey restores the instrument setting with which the calibration was carried out. This can be useful if the device setting was changed after calibration (e.g. center frequency setting, frequency deviation, reference level, etc).

The softkey is only available if:

- the *NETWORK* mode has been selected
- the memory contains a calibration data set.

IEC/IEEE-bus command `CORR:REC`



SAVE AS TRD FACTOR uses the normalized measurement data to generate a transducer factor with up to 625 points. The trace data are converted to a transducer with unit dB after the transducer name has been entered. The number of points is defined by *SWEEP COUNT*. The frequency points are allocated in equidistant steps between start and stop frequency. The generated transducer factor can be further adapted in the menu *SETUP – TRANSDUCER*. *SAVE AS TRD FACTOR* is only available if normalization is switched on.

IEC/IEEE bus command: `CORR:TRAN:GEN <name>`

Calibration mechanism

Calibration means a calculation of the difference between the currently measured power and a reference curve, independent of the selected type of measurement (transmission/reflection). The hardware settings used for measuring the reference curve are included in the reference dataset.

Even with normalization switched on, the device settings can be changed in a wide area without stopping the normalization. This reduces the necessity to carry out a new normalization to a minimum.

For this purpose, the reference dataset (trace with 625 measured values) is stored as a table with 625 points (frequency/level). Differences in level settings between the reference curve and the current device settings are taken into account automatically. If the span is reduced, a linear interpolation of the intermediate values is applied. If the span increases, the values at the left or right border of the reference dataset are extrapolated to the current start or stop frequency, i.e. the reference dataset is extended by constant values.

An enhancement label is used to mark the different levels of measurement accuracy. This enhancement label is displayed at the right diagram border when normalization is switched on and a deviation from the reference setting occurs. Three accuracy levels are defined:

Table 4.23-1 Measurement accuracy levels

Accuracy	Enhancement label	Reason/Limitation
High	NOR	No difference between reference setting and measurement
Medium	APX (approximation)	Change of the following settings: <ul style="list-style-type: none"> • coupling (RBW, VBW, SWT) • reference level, RF attenuation • start or stop frequency • output level of tracking generator • frequency offset of tracking generator • detector (max. peak, min. peak, sample, etc.) Change of frequency: <ul style="list-style-type: none"> • max. 501 points within the set sweep limits (corresponds to a doubling of the span)
-	Aborted normalization	<ul style="list-style-type: none"> • more than 500 extrapolated points within the current sweep limits (in case of span doubling)



At a reference level (REF LEVEL) of -10 dBm and at a tracking generator output level of the same value the analyzer operates without overrange reserve, i.e. the analyzer is in danger of being overloaded if a signal is applied whose amplitude is higher than the reference line. In this case, either the message "OVLD" for overload is displayed in the status line or the display range is exceeded (clipping of the trace at the upper diagram border = Overrange).

Overloading can be avoided as follows:

- Reducing the output level of the tracking generator (SOURCE POWER, NETWORK menu)
- Increasing the reference level (REF LEVEL, AMPT menu)

Frequency-converting Measurements

For frequency-converting measurements (e.g. on converters) the external generator is able to set a constant frequency offset between the output frequency of the generator and the receive frequency of the analyzer and, in addition, the generator frequency as a multiple of the analyzer.

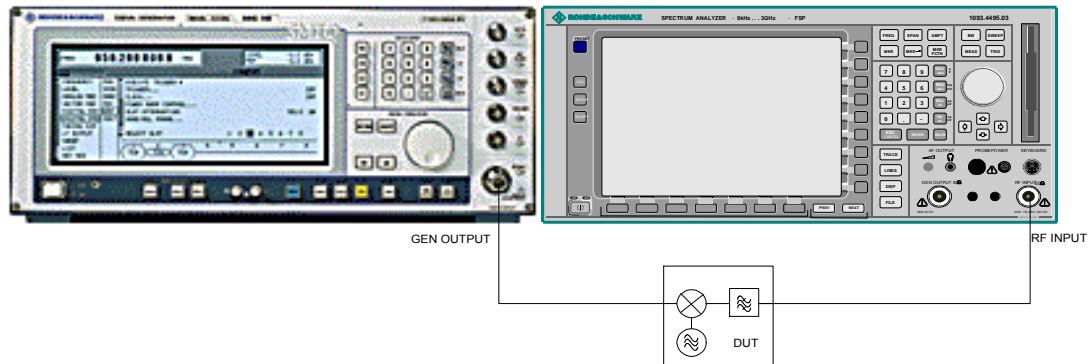
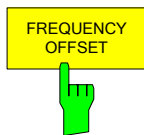

Fig. 4.23-8 Test setup for frequency-converting measurements

NETWORK Menu



The *FREQUENCY OFFSET* softkey activates the input of the frequency offset between the output signal of the generator and the input frequency of the analyzer. The value range depends on the selected generator. The default setting is 0 Hz. Offsets \neq 0 Hz are marked with the enhancement label **FRQ**.

If a positive frequency offset is entered, the tracking generator generates an output signal above the receive frequency of the analyzer. In case of a negative frequency offset it generates a signal below the receive frequency of the analyzer. The output frequency of the generator is calculated as follows:

$$\text{Generator frequency} = \text{receive frequency} + \text{frequency offset}$$

IEC/IEEE-bus command: SOUR:EXT:FREQ:OFFS 1GHZ

Configuration of an External Generator

NETWORK menu:

SELECT GENERATOR							
SRC TYPE	IFC	GPIB ADDR	MODE	F MIN	F MAX	P MIN	P MAX
1	SHF03	TTL 28	REMOTE	5kHz	3GHz	-144dBm	16dBm
2	SHF03	GPIB 28	LOCAL	300kHz	3.3GHz	-140dBm	13dBm

FREQUENCY SWEEP						
SRC	STATE	POWER[dBm]	NUM	DEN	OFFSET	RESULT
1	✓	-30dBm	1	1	0Hz	0Hz..30Hz *
2		-30dBm	1	1	0Hz	0Hz..3.2GHz



The *EXT SOURCE* softkey opens a submenu for configuration of the external generator.
 The R&S FSMR is able to manage two generators, one of which can be active at the time.

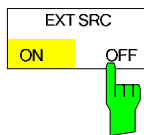

The *EXT SRC ON / OFF* softkey switches the external generator on or off. It can only be switched on successfully if the generator has been selected by means of *SELECT GENERATOR* and configured correctly by means of *FREQUENCY SWEEP*. If one of these conditions is not fulfilled, an error message will be output.



When switching on the external generator by means of *EXT SRC ON*, the R&S FSMR switches off the internal tracking generator and starts programming the generator settings via the IEC/IEEE-bus interface IEC2.

Programming requires takeover of the IEC/IEEE-bus control at this interface by the R&S FSMR. To avoid any access conflicts, ensure that no other controller is connected to the IEC2 interface or the external generator when selecting *EXT SRC ON*.

The maximum stop frequency is limited to the maximum generator frequency. This upper limit is automatically reduced by the set frequency offset of the generator and a set multiplication factor.

With the external generator switched on, the FFT filters (FILTER TYPE FFT in the menu BW) are not available.

If an error occurs on the IEC/IEEE bus when programming the external generator, the generator will automatically be switched off and the following error message will be output:



When the external generator is switched off using *EXT SRC OFF*, the IEC/IEEE-bus control is handed over again at the IEC2 interface, i.e. a different controller will then take over the control of the signal generator.

IEC/IEEE-bus command: SOUR:EXT ON

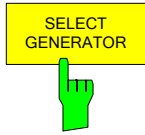

The *SELECT GENERATOR* softkey opens a table for selection of the generator and definition of IECBUS address and control interface. The table permits configuration of two generators so that switching between two different configurations is easily possible.

IEC/IEEE-bus command: SOUR:AM:STAT ON

SELECT GENERATOR								
SRC	TYPE	IFC	GPIB ADDR	MODE	F MIN	F MAX	P MIN	P MAX
1	SME03	TTL	28	REMOTE	5kHz	3GHz	-144dBm	16dBm
2	SMIQ03	GPIB	28	LOCAL	300kHz	3.3GHz	-140dBm	13dBm

The individual fields contain the following settings:

SRC Index of generator selected

TYPE The field opens the list with the available generators:

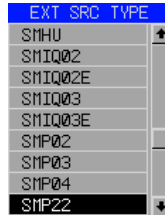

After completion of the selection, the remaining fields of the table are filled with the generator characteristics.

A list of generator types supported by the R&S FSMR is to be found at the end of section "Softkey *SELECT GENERATOR*".

IFC This field selects the interface type of external generator 1 or 2. The following types are available:

GPIB IECBUS only, suitable for all generators of other manufacturers and some Rohde & Schwarz instruments

or

TTL IECBUS and TTL interface for synchronization, for most of the Rohde & Schwarz generators, see table above.

The two operating modes differ in the speed of the control: Whereas, with pure IECBUS operation, each frequency to be set must be individually transferred to the generator, additional use of the TTL interface permits to program a total frequency list at once and subsequently perform the frequency stepping via TTL handshake, which is a big advantage in terms of speed.

Note: Generators equipped with the TTL interface can also be operated with IECBUS (= GPIB) only.

Only one of the two generators can be operated with TTL interface at a time. The other generator must be configured for IECBUS (GPIB).

GPIB ADDR IECBUS address of the respective generator. Addresses from 0 to 30 are possible.

MODE Operating mode of generator. The generator activated using the *FREQUENCY SWEEP* softkey is automatically set to remote mode (REMOTE), the other to manual mode (LOCAL).

F MIN Frequency range of generator. Select the start and stop frequency of the R&S FSMR in a way that the specified range is not exceeded.

If the start frequency lies below F MIN, the generator is only switched on when F MIN is reached.

If the stop frequency lies above F MAX, it is limited to F MAX when the generator is switched on using the EXT SRC ON/OFF softkey.

P MIN Level range of generator. This field defines the allowed input range for the

P MAX POWER column in the *FREQUENCY SWEEP* table.

IEC/IEEE-bus commands SYST:COMM:RDEV:GEN2:TYPE 'SME02'
 SYST:COMM:RDEV:GEN:LINK TTL
 SYST:COMM:GPIB:RDEV:GEN1:ADDR 28

List of Generator Types Supported by the R&S FSMR

Note: The R&S SMA and R&S SMU require the following firmwarversions:

- R&S SMA V2.10 or higher
- R&S SMU V1.10 or higher

Generator	Interface Type	Generator Min Freq	Generator Max Freq	Generator Min Power dBm	Generator Max Power dBm
SMA01	TTL	9 kHz	3 GHz	-145	+30
SME02	TTL	5 kHz	1.5 GHz	-144	+16
SME03	TTL	5 kHz	3.0 GHz	-144	+16
SME06	TTL	5 kHz	6.0 GHz	-144	+16
SMG	GPIB	100 kHz	1.0 GHz	-137	+13
SMGL	GPIB	9 kHz	1.0 GHz	-118	+30
SMGU	GPIB	100 kHz	2.16 GHz	-140	+13
SMH	GPIB	100 kHz	2.0 GHz	-140	+13
SMHU	GPIB	100 kHz	4.32 GHz	-140	+13
SMIQ02B	TTL	300 kHz	2.2 GHz	-144	+13
SMIQ02E	GPIB	300 kHz	2.2 GHz	-144	+13
SMIQ03B	TTL	300 kHz	3.3 GHz	-144	+13
SMIQ03E	GPIB	300 kHz	3.3 GHz	-144	+13
SMIQ04B	TTL	300 kHz	4.4 GHz	-144	+10
SMIQ06B	TTL	300 kHz	6.4 GHz	-144	+10
SML01	GPIB	9 kHz	1.1 GHz	-140	+13
SML02	GPIB	9 kHz	2.2 GHz	-140	+13
SML03	GPIB	9 kHz	3.3 GHz	-140	+13
SMR20	TTL	1 GHz	20 GHz	-130 ²⁾	+11 ²⁾
SMR20B11 ¹⁾	TTL	10 MHz	20 GHz	-130 ²⁾	+13 ²⁾
SMR27	TTL	1 GHz	27 GHz	-130 ²⁾	+11 ²⁾
SMR27B11 ¹⁾	TTL	10 MHz	27 GHz	-130 ²⁾	+12 ²⁾
SMR30	TTL	1 GHz	30 GHz	-130 ²⁾	+11 ²⁾
SMR30B11 ¹⁾	TTL	10 MHz	30 GHz	-130 ²⁾	+12 ²⁾
SMR40	TTL	1 GHz	40 GHz	-130 ²⁾	+9 ²⁾
SMR40B11 ¹⁾	TTL	10 MHz	40 GHz	-130 ²⁾	+12 ²⁾
SMR50	TTL	1 GHz	50 GHz	-130 ²⁾	+9 ²⁾
SMR50B11 ¹⁾	TTL	10 MHz	50 GHz	-130 ²⁾	+12 ²⁾
SMR60	TTL	1 GHz	60 GHz	-130 ²⁾	+9 ²⁾
SMR60B11 ¹⁾	TTL	10 MHz	60 GHz	-130 ²⁾	+12 ²⁾
SMP02	TTL	10 MHz	20 GHz	-130 ³⁾	+17 ³⁾
SMP03	TTL	10 MHz	27 GHz	-130 ³⁾	+13 ³⁾
SMP04	TTL	10 MHz	40 GHz	-130 ³⁾	+12 ³⁾
SMP22	TTL	10 MHz	20 GHz	-130 ³⁾	+20 ³⁾
SMT02	GPIB	5.0 kHz	1.5 GHz	-144	+13
SMT03	GPIB	5.0 kHz	3.0 GHz	-144	+13
SMT06	GPIB	5.0 kHz	6.0 GHz	-144	+13
SMV03	GPIB	9 kHz	3.3 GHz	-140	+13
SMU200A	TTL	100 kHz	2.2 GHz	-145	+13
SMU02B31	TTL	100 kHz	2.2 GHz	-145	+19
SMU03 ⁴⁾	TTL	100 kHz	3 GHz	-145	+13
SMU03B31	TTL	100 kHz	3 GHz	-145	+19
SMU04	TTL	100 kHz	4 GHz	-145	+13
SMU04B31	TTL	100 kHz	4 GHz	-145	+19
SMU06	TTL	100 kHz	6 GHz	-145	+13

Generator	Interface Type	Generator Min Freq	Generator Max Freq	Generator Min Power dBm	Generator Max Power dBm
SMU06B31	TTL	100 kHz	6 GHz	-145	+13
SMX	GPIB	100 kHz	1.0 GHz	-137	+13
SMY01	GPIB	9 kHz	1.04 GHz	-140	+13
SMY02	GPIB	9 kHz	2.08 GHz	-140	+13
HP8340A	GPIB	10 MHz	26.5 GHz	-110	10
HP8648	GPIB	9 kHz	4 GHz	-136	10
HP ESG-A Series 1000A, 2000A, 3000A, 4000A	GPIB	250 kHz	4 GHz	-136	20
HP ESG-D SERIES E4432B	GPIB	250 kHz	3 GHz	-136	+10

- 1) Requires the option SMR-B11 to be fitted.
- 2) Maximum/minimum power depends on presence of Option SMR-B15/-B17 and set frequency range. For more details see SMR data sheet.
- 3) Maximum/minimum power depends on presence of Option SMP-B15/-B17 and set frequency range. For more details see SMP data sheet.



The *FREQUENCY SWEEP* softkey opens a table for setting the generator level as well as the multiplier and the offset used to derive the generator frequency from the analyzer frequency.

This table also permits configuration of two generators so that switching between two different configurations is easily possible.

FREQUENCY SWEEP						
SOURCE FREQ = REC FREQ * NUM/DEN + OFFSET						
SRC	STATE	POWER[dBm]	NUM	DEN	OFFSET	RESULT
1	<input checked="" type="checkbox"/>	-30dBm	1	1	0Hz	0Hz..3GHz *
2	<input type="checkbox"/>	-30dBm	1	1	0Hz	0Hz..3.2GHz

- SRC Index of selected generator
- STATE Selects the active generator. Only one generator can be active at a time. The operating mode of the active generator is set to remote control in the SELECT GENERATOR table.
- POWER Permits to enter the generator level within the limits P MIN to P MAX of the *SELECT GENERATOR* table.
- NUM Numerator,
- DEN Denominator,
- OFFSET Offset, used to derive the generator frequency from the current frequency of the R&S FSMR according to the following formula:

$$F_{Generator} = F_{Analyzer} * \frac{Numerator}{Denominator} + F_{Offset}$$

Note that the frequencies resulting from start and stop frequency of the R&S FSMR do not exceed the allowed generator range:

- If the start frequency lies below F MIN, the generator is only switched on when F MIN is reached.

- If the stop frequency lies above F MAX, the generator is switched off. When the generator is subsequently switched on using the *EXT SRC ON/OFF* softkey, the stop frequency is limited to F MAX.
- If the stop frequency lies below F MIN, the generator is switched off and the following error message output:

```

ERROR
GENERATOR RANGES EXCEEDED; EXT GEN
SWITCHED OFF.

```

- In the time domain (Span = 0 Hz) the generator frequency is derived from the set receive frequency of the R&S FSMR using the calculation formula.

For the sake of clarity, the formula is also displayed in the table.

The offset setting can be used to sweep in the reverse direction. This can be achieved by setting a **negative** offset in the formula above:

Example for reverse sweep:

$$\begin{aligned}
 F_{AnalyzerStart} &= 100 \text{ MHz} \\
 F_{AnalyzerStop} &= 200 \text{ MHz} \\
 F_{Offset} &= -300 \text{ MHz} \\
 \text{Numerator} = \text{Denominator} &= 1 \\
 \rightarrow F_{GeneratorStart} &= 200 \text{ MHz} \\
 \rightarrow F_{GeneratorStop} &= 100 \text{ MHz}
 \end{aligned}$$

If the offset is adjusted in a way that the sweep of the generator crosses the 0 Hz Frequency, it is indicated by the additional statement "via 0 Hz".

Example for reverse sweep via 0 Hz

$$\begin{aligned}
 F_{AnalyzerStart} &= 100 \text{ MHz} \\
 F_{AnalyzerStop} &= 200 \text{ MHz} \\
 F_{Offset} &= -150 \text{ MHz} \\
 \text{Numerator} = \text{Denominator} &= 1 \\
 \rightarrow F_{GeneratorStart} &= 50 \text{ MHz} \\
 \rightarrow F_{GeneratorStop} &= 50 \text{ MHz via 0 Hz}
 \end{aligned}$$

```

IEC/IEEE-bus command: :SOUR:EXT:FREQ:NUM 1
                      :SOUR:EXT:FREQ:DEN 1
                      :SOUR:EXT:FREQ:OFFS -300MHZ

```

RESULT The frequency range of the generator resulting from the calculation formula. An asterisk (*) after the upper limit indicates that the stop frequency of the R&S FSMR must be adapted when the generator is switched on in order not to exceed its maximum frequency. In the following illustration, this is true for the upper generator at a stop frequency of 3.2 GHz of the R&S FSMR, whereas the lower generator does not yet require an adaptation:

SOURCE FREQ = REC FREQ * NUM/DEN + OFFSET				
	NUM	DEN	OFFSET	RESULT
	1	1	0Hz	0Hz..3GHz *
	1	1	0Hz	0Hz..3.2GHz

IEC/IEEE-bus commands `SOUR:EXT:POW -30dBm`
`SOUR:EXT:FREQ:NUM 4`
`SOUR:EXT:FREQ:DEN 3`
`SOUR:EXT:FREQ:OFFS 100MHZ`

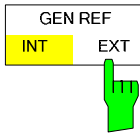

The *GEN REF INT / EXT* softkey switches over the reference oscillator of the generator (switchover between internal and external reference source). Selection *EXT* allows connecting the external generator to an external reference frequency source. The internal reference source is selected as the default setting.

IEC/IEEE-bus command: `SOUR:EXT1:ROSC INT`

LAN Interface

Using the LAN Interface, the instrument can be connected to an Ethernet LAN (Local Area Network). Thus it is possible to transfer data via the network and use network printers. In addition, the instrument can be remote-controlled via network. The network card allows both for a 10 MHz Ethernet IEEE 802.3 and a 100 MHz Ethernet IEEE 802.3u.

Connecting the Instrument to the Network

CAUTION

Before connecting the instrument to the network it is recommended to contact the network administrator, in particular larger LAN installations are affected. Faults in the connection may have a negative effect on the entire network.

The instrument is connected to a network hub of the desired LAN segment via a commercially-available RJ45 cable (not supplied with the instrument) at the instrument rear panel. Since RJ45 provides no bus but a star network topology, no other precautions need to be taken for the connection.

The connection procedure does not produce any disturbances in the network traffic. Disconnection from the network is easily possible provided that there is no more data traffic from and to the instrument.

Installing the Software

The data transfer in the network takes place in data blocks, called packets. In addition to the useful data, further information on the operation, i.e. protocol data (transmitter, receiver, type of data, sequence), is transferred in the packets. For processing the protocol information, suitable drivers must be installed. For the network services (file transfer, directory services, printing in the network) a network operating system needs to be installed.



The WINDOWS files required for the installation of network drivers, protocols or services are included in the directory "D:\1386".

A PC keyboard with trackball (or an additional mouse instead) is required for the installation.

Installation of Drivers for the Network Card

.The network-card drivers do not have to be installed under Windows XP. It is sufficient to connect the network cable to the "LAN-Interface" connector at the rear of the unit. Windows XP will automatically recognize the network link and will activate the required drivers.

Note:

If the original factory setting is required at a later time, i.e. when the unit is to be operated with a different network configuration at a different site, this base configuration can be restored as described below:

- Switch the unit off and on again.
- In the Boot menu, select the entry "Analyzer Firmware Backup" with the cursor keys and confirm with *ENTER*. The device is started from the backup partition and opens a selection window with available device configurations:

```

* * * * *
* INSTRUMENT RESTORE PROCEDURE V 1.4      (c) RSD 2002
*
* Note:
* The presence of the LAN-interface requires
* a restore process different from the standard firmware
* restore (due to the necessary network drivers).
*
* The following 3 selections will NOT destroy user defined
* limit lines and transducer data
*
* Press 1   to perform standard system RESTORE
* press 2   to perform system RESTORE with LAN interface
* press 3   to ABORT system RESTORE
*
* The following selection will DESTROY user defined
* limit lines and transducer data
*
* Press 4   to perform standard system RESTORE
*           (destroys user limit lines and transducers !!!)
* press 5   to perform system RESTORE with LAN interface,
*           (destroys user limit lines and transducers !!!)
*
* * * * *
    
```

- Press 2. Windows XP is newly installed on the analyzer partition of the hard disk with LAN support and device firmware. The device may boot several times. At the end of the installation procedure, the device firmware will be restarted.

The unit is again ready for operation. The configuration of the network protocols then has to be performed according to the following sections.

Configuration of Available Network Protocols (TCP/IP Protocol)

When the unit is delivered, the TCP/IP network protocol is factory-set with the IP address 10.0.0.10 and the subnet mask 255.255.255.0. The steps required to change this configuration and to install further network protocols are described in this and the following sections.

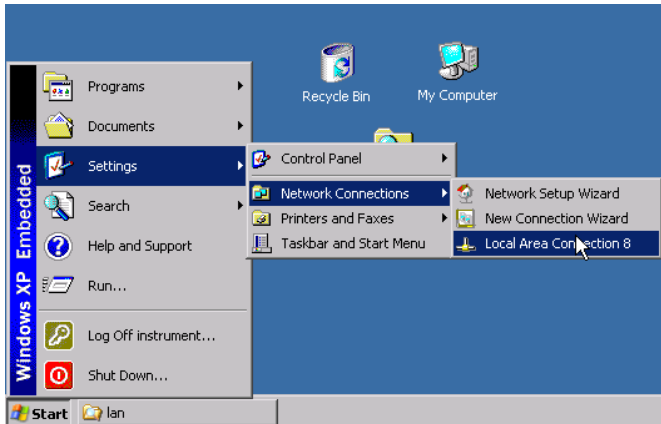

- Open the Windows XP start menu with the Windows key or *CTRL-ESC*.
- Click *Settings - Network Connections - Local Area Connection*.

The *Local Area Connection Status* dialog will be opened.

Note:

Windows XP appends numbers to the name *Local Area Connection Status* (e.g. *Local Area Connection Status 8*) if the configuration is created with the *New Connection Wizard*. These numbers are irrelevant for the following configurations and are therefore not mentioned in the text.

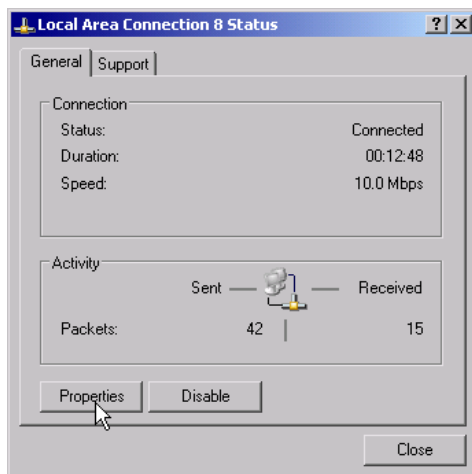

- Click the *Properties* button.
The window with the available network protocols will be opened.

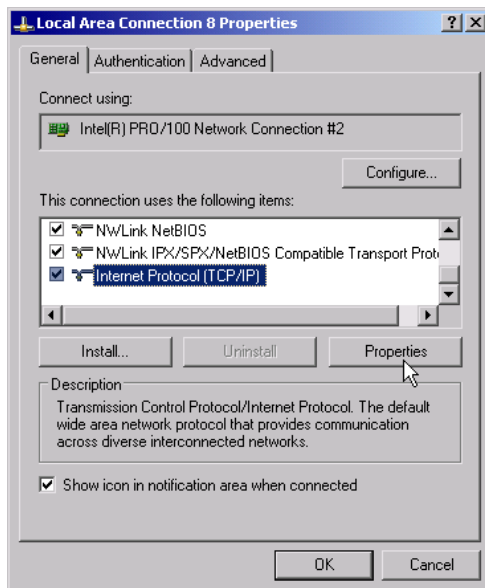

- Click the desired network protocol (in the example: TCP/IP).
- Click the *Properties* button.

The dialog with the settings of the selected network protocol will be opened.

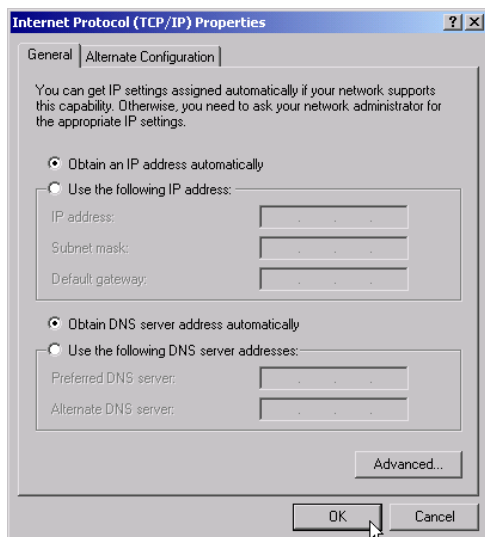

- If the IP address is to be automatically requested by a DHCP server, click the entry *Obtain an IP address automatically*.

Note:

Your network administrator knows whether your network has a DHCP server.

- Click the OK button. Windows will store the configuration.

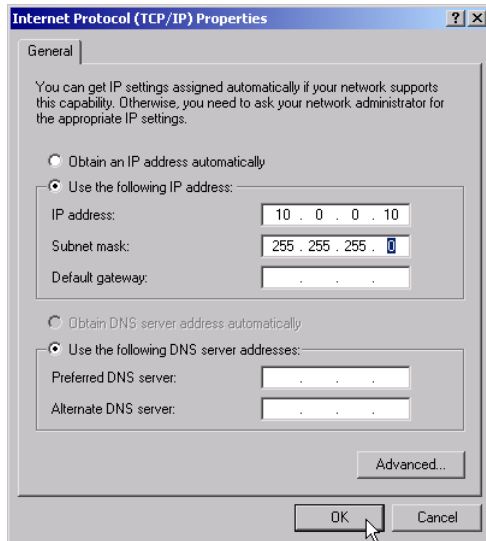

- If a predefined IP address is to be set (since no DHCP server is available in the network), click the entry *Use the following IP address*.
- Click the entry *IP address* and enter the IP address.
- Then click the entry *Subnet mask* and enter the required mask.

Note:

Your network administrator knows which IP addresses and subnet masks are suitable for your network.

- Click the OK button. Windows checks whether the entered settings are correct and stores the configuration.

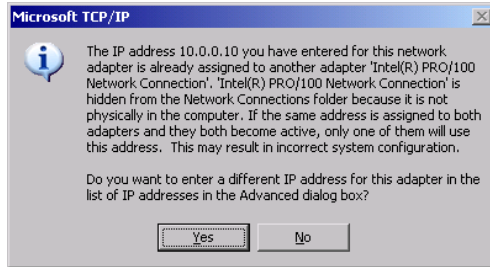

If an invalid IP address or subnet mask was entered, a corresponding error message will be displayed together with a question as whether a different address or mask is to be entered.

- Click the Yes button.
The dialog for entering the TCP/IP parameters will again be opened.

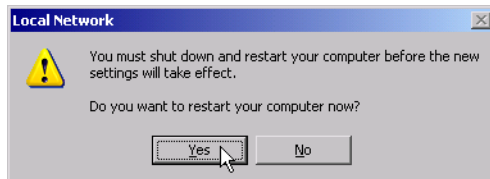

If all settings are correct, the request to start the unit again will be displayed depending on the changed settings.

- Click the Yes button.
Windows will restart the system.

Installation of Further Network Protocols and Services (e.g. Novell Netware Support)



The network administrator knows the protocols to be used. The TCP/IP protocol has to be installed for the RSIB protocol and the VX111 support. The support for the Novell netware is additionally installed in the following example.

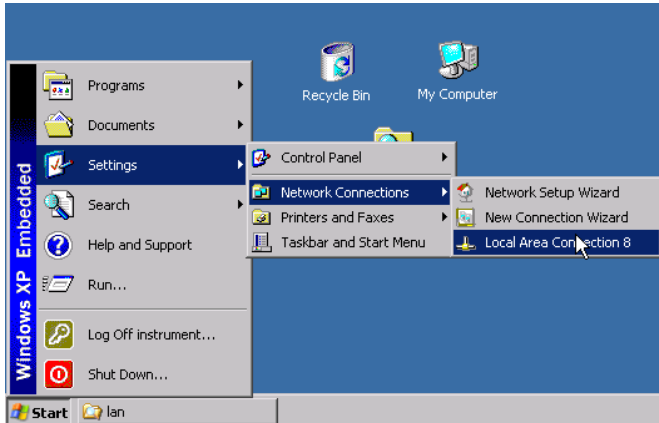

- Open the Windows XP start menu using the Windows key or *CTRL-ESC*.
- Click *Settings - Network Connections - Local Area Connection*.

The *Local Area Connection Status* dialog will be opened.

Note:

Windows XP appends numbers to the name *Local Area Connection Status* (e.g. *Local Area Connection Status 8*) if the configuration is created with the *New Connection Wizard*. These numbers are irrelevant for the following configurations and are therefore not mentioned in the text.

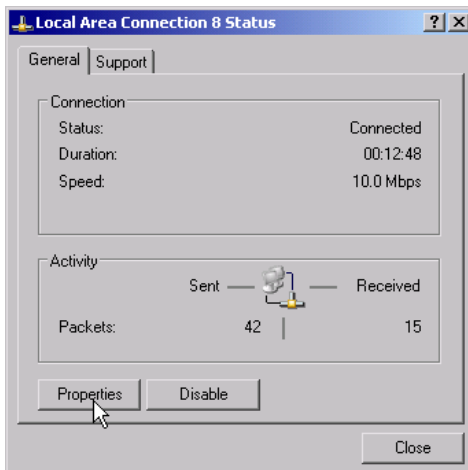

- Press the *Properties* button.
- The window with the available network protocols will be opened.

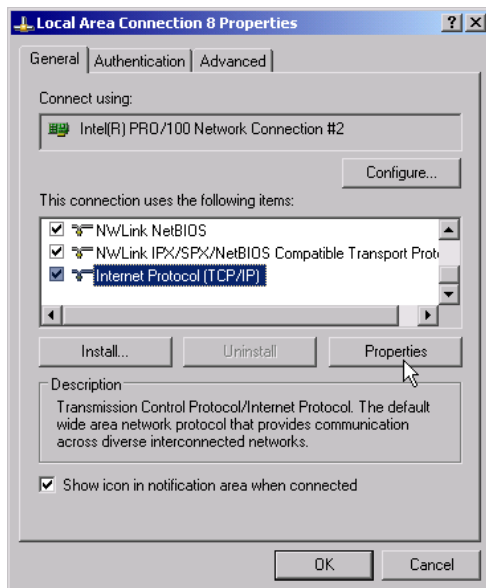

- Click the *Install* button.

The list of installable network components will be opened.

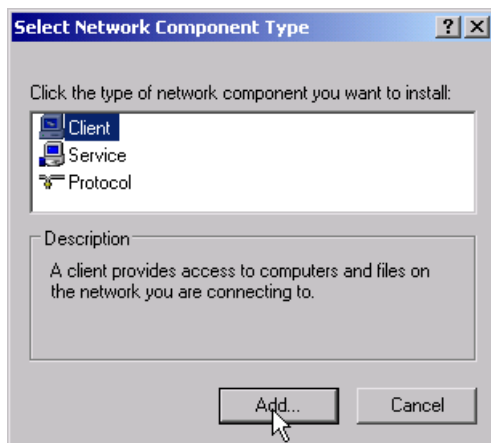

- Select *Client*.
- Click the *Add...* button.

The list of available network protocols will be opened.

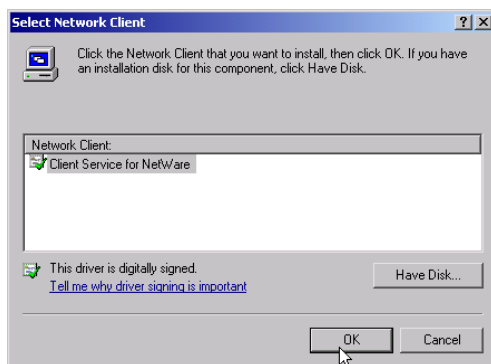

- Select *Client Service for NetWare*.
- Click the *OK* button.

The network driver for Novell Netware is installed.

Note:

- Your network administrator knows which clients, services and protocols have to be installed for your network.
- If network components not contained in D:\1386 are to be installed, a corresponding disk including the drivers has to be prepared (or a CD that can be read via a USB CD-ROM drive).

In this case, click the *Have Disk...* button and indicate the path with the corresponding drivers.

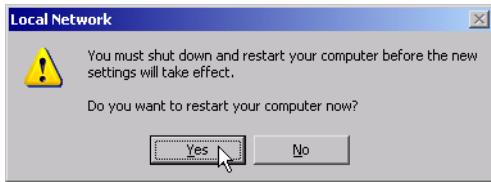

After completion of the installation, the user is requested to restart the unit.
 ➤ Click the Yes button.
 Windows will restart the system.

Examples of Configurations

Network	Protocols	Services	Notes
NOVELL Netware	NWLink IPX/SPX Compatible Transport	Client Service for NetWare	In folder " Protocols - Properties ", the frame type used in the network is to be set.
IP Networks (FTP, TELNET, WWW, GOPHER, etc)	TCP/IP Protocol	Simple TCP/IP Services	In folder " Protocols - Properties ", an IP address that is unique in the network is to be set.
MICROSOFT Network	NetBEUI Protocol or TCP/IP Protocol	Workstation Server	In folder " Identification - Computer Name ", a name that is unique in the network is to be entered.

Subsequent Changing of the Network Configuration (Computer Name, Domain, Workgroup, etc)

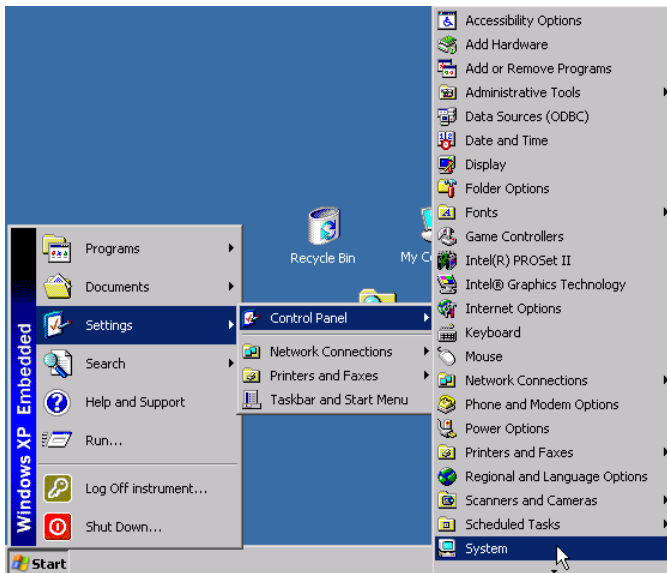

After completion of the installation, the computer name can be adapted as follows:

- Press the Windows key or <CTRL><ESC>.
- The Windows Start menu will be opened.
- Select Settings - Control Panel - System.



- Select the "Computer Name" tab.

Note:

The other settings can be changed after selection of the other tabs. It is strongly recommended to consult the network administrator beforehand.

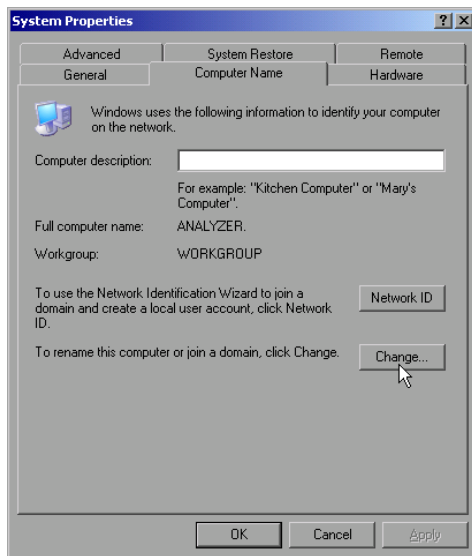

- Click the *Change* button.

The dialog to change the computer name, the domain and workgroup will be opened.

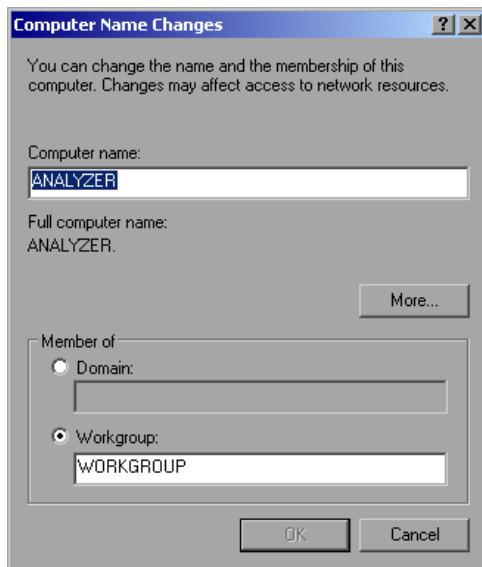

- Enter a new computer name.
- If required, enter the desired domain or workgroup.
- Confirm the changes with *OK*.

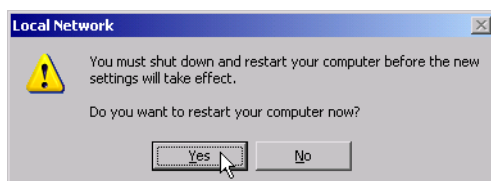

If the request to restart the unit is displayed:

- Click the *Yes* button.
Windows will restart the system.

Operating the Instrument without a Network

If the instrument is to be operated without any network connection for a limited or unlimited period of time, or permanently, no special precautions have to be taken in contrast to Windows NT. Windows XP automatically recognizes the interruption of the network connection and will not carry out any setup when the instrument is switched on.

If the user name and the password are not to be queried, proceed as described in section "Reenabling the Autologin Mechanism".

Operating the Instrument on the Network

After the network support has been installed, it is possible to exchange data between the instrument and other computers and to use printers in the network.

A prerequisite to network operation is having the appropriate access rights for the required network resources. Resources may be file directories of other computers or also central printers.

Access rights can be obtained from the network or server administrator. In that respect it is necessary to obtain the network name of the resource as well as the corresponding access rights.

To prevent misuse, the resources are protected by passwords. Normally, every entitled user of the resources is assigned a user name that is also protected by a password. Resources can then be assigned to this user. It is possible to determine the type of data access, i.e. whether data can only be read or also written, as well as shared data access. Depending on the network operating system, different types of usage are possible.

NOVELL Networks

The operating system NETWARE from NOVELL is a server-based system. Data cannot be exchanged between individual workstations; data transfer takes place between the PC and a server. This server provides memory space and the connection to network printers. On a server, data is organized in directories as under DOS and mapped to the workstation as virtual drives. A virtual drive behaves like an additional hard disk on the workstation, and the data can be edited accordingly. Network printers can also be addressed like normal printers.

There are two versions of the NOVELL network operating system: bindary-based (NETWARE 3) and NDS-based (more recent versions of NETWARE). With the older version (NETWARE 3), each server manages its resources on its own and is independent. A user must be managed on each server separately. In the case of NDS-based versions, all resources in the network are managed together in the NDS (NOVELL DIRECTORY SERVICE). The user must log into the network only once and is given access to the resources according to his/her access rights. The individual resources and users are managed as objects in a hierarchical tree (NDS TREE). The position of the object in the tree is referred to as "CONTEXT" with NETWARE and must be known for access to the resources.

MICROSOFT Network

In case of a MICROSOFT network, data can be exchanged both between workstations (peer to peer) and between workstations and servers. The latter can supply access to files and connection to the printers. On a server, data is organized in directories as under DOS and mapped to the workstation as virtual drives. A virtual drive behaves like an additional hard disk on the workstation, and the data can be edited accordingly. Network printers can also be addressed like normal printers. A connection is possible to DOS, WINDOWS FOR WORKGROUPS, WINDOWS95/98/ME, WINDOWS NT/XP.

Defining Users

After the network driver software has been installed, the instrument will output an error message on the next power-on, as there is no user called "Instrument" (= user name for XP autologin) in the network. It is therefore necessary to define a common user for Windows XP, to adapt the password to the network password and the network and to disable the autologin mechanism subsequently.

The definition of new users in the network is done by the network administrator. For definition of a new user on the instrument, the User Account Assistant is required:

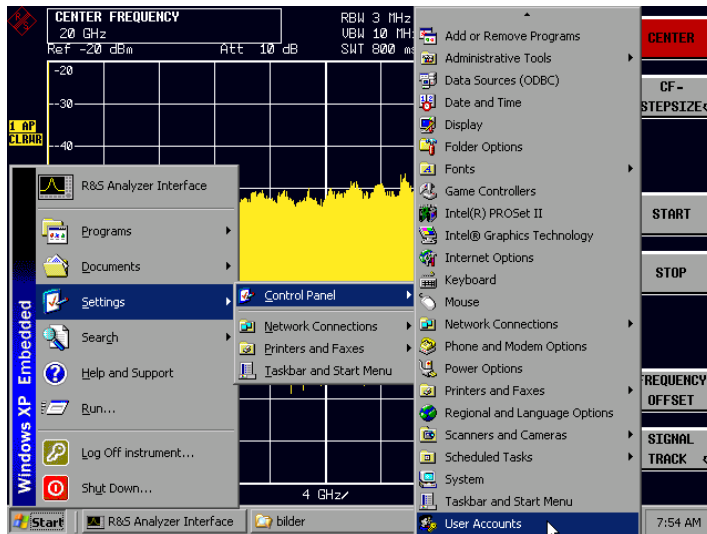

- Call up the Windows XP start menu using the Windows key or the key combination <CTRL> <ESC>.
- Then click "Settings", "Control Panel" and "User Accounts" one after the other.

The User Accounts wizard with the *Pick a task...* dialog will be opened.

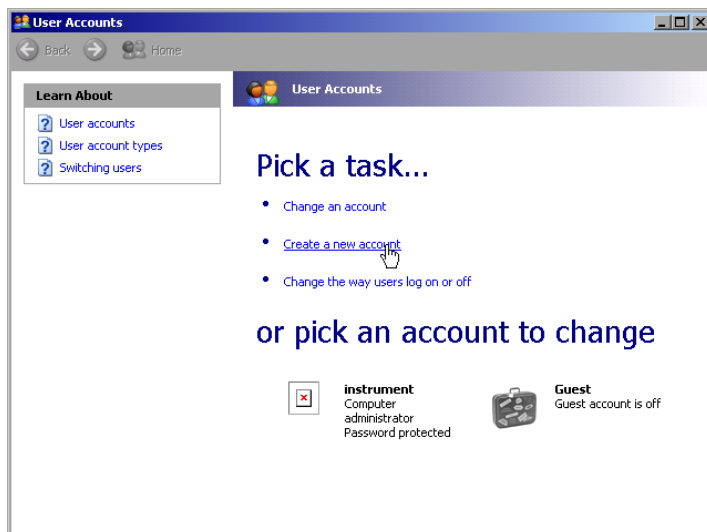

- Select "Create a new account" .

The dialog to enter a new user name will be opened.

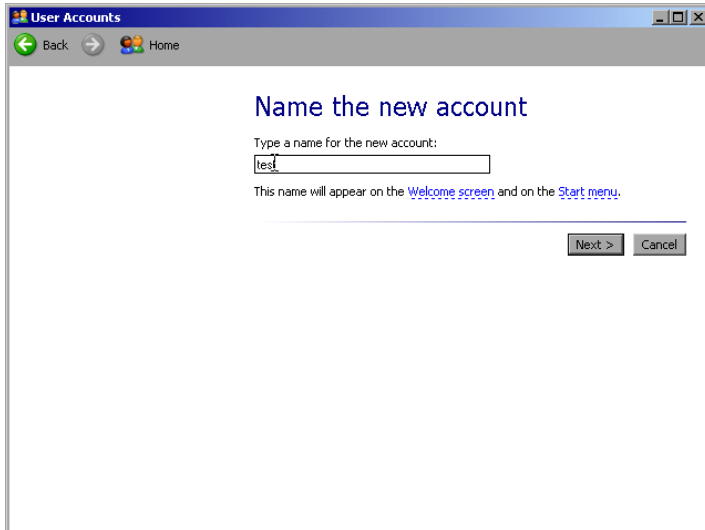

- Enter the name of the new user into the text field and terminate the entry with "Next ->".

The *Pick an account type* dialog to select the user rights will be opened.

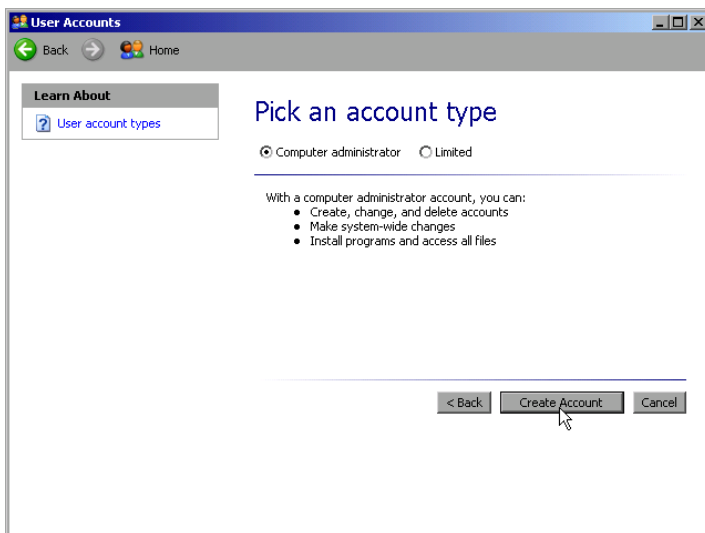

- Select *Computer administrator*.

Note:

Administrator rights are required to ensure trouble-free operation of the firmware.

- Confirm the newly created user with the *Create Account* button.

The new user is created.

Changing the User Password

After the new user has been created, the password has to be adapted to the network password. This is also done via the User Accounts wizard:

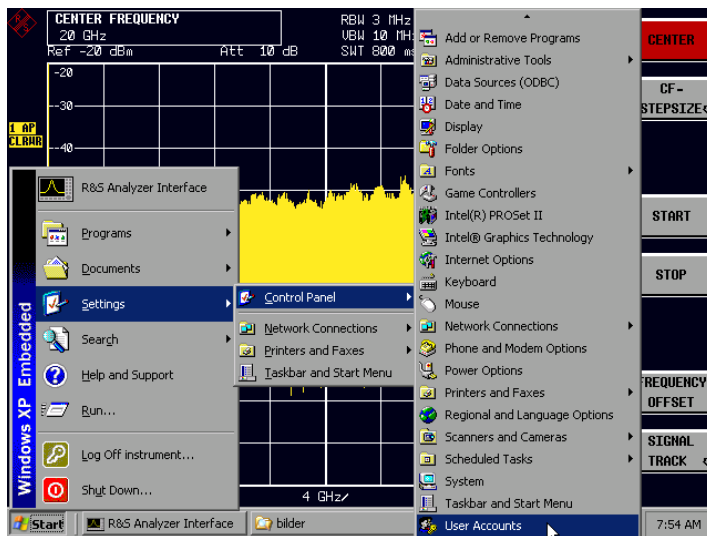

- Call up the Windows XP start menu using the Windows key or the key combination <CTRL> <ESC>.
- Then click "Settings", "Control Panel" and "User Accounts" one after the other.

The User Accounts wizard with the *Pick a task...* dialog will be opened.

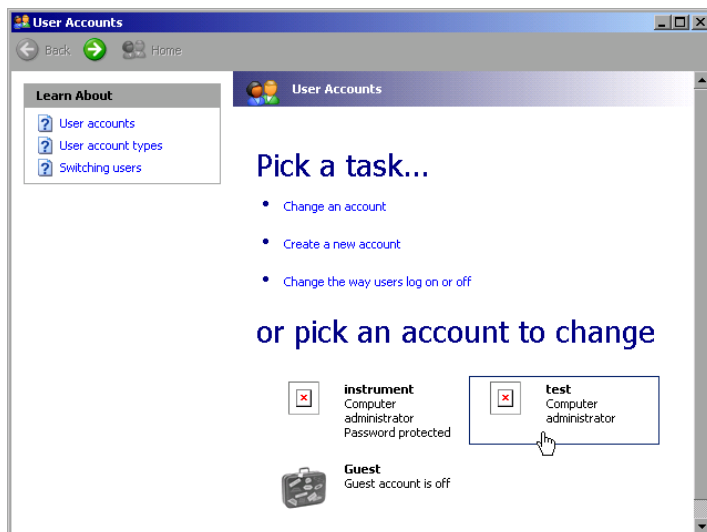

- Click the required user account (in the example: "test"). The dialog to select the desired action will be opened.

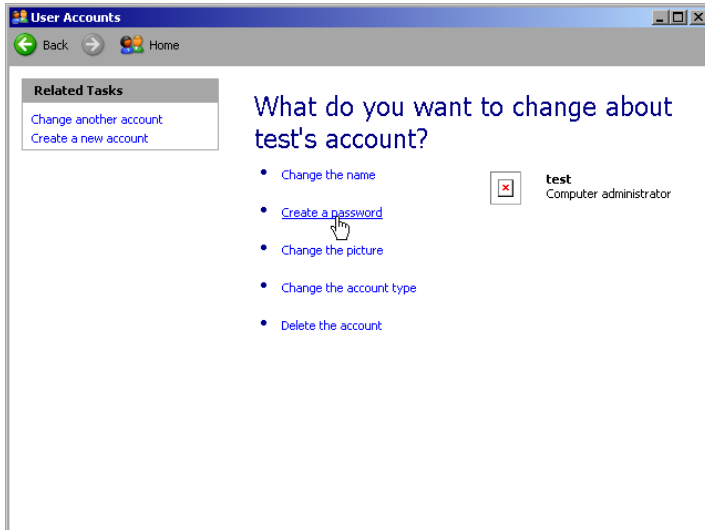

➤ Click *Create a password*.

The dialog to enter a new password will be opened.

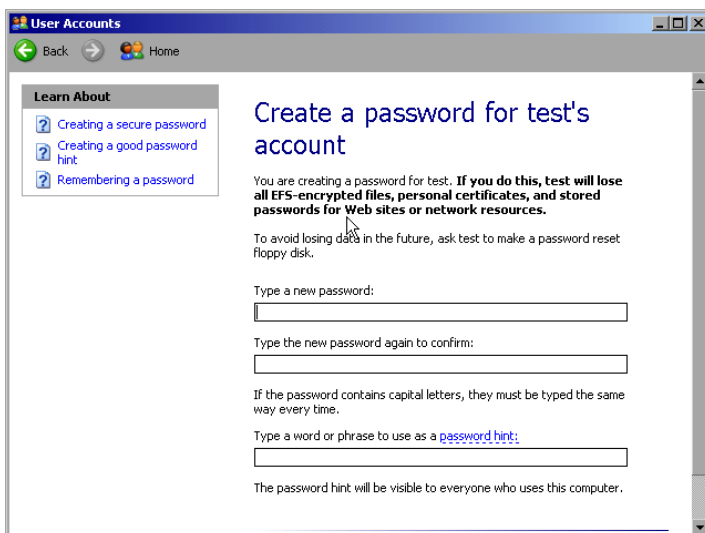

➤ Enter the new password in the upper text line and repeat the entry in the line below.



➤ Scroll the picture contents downwards and terminate the entry with the *Create Password* button.

The new password is activated.

NOVELL network only: Configure NOVELL client

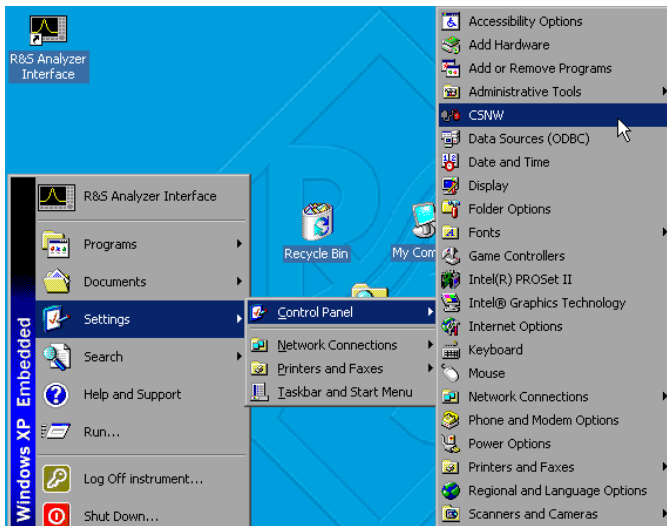

- Call up the Windows XP start menu using the Windows key or the key combination <CTRL> <ESC>.
- Then click "Settings", "Control Panel" and "CSNW" one after the other.

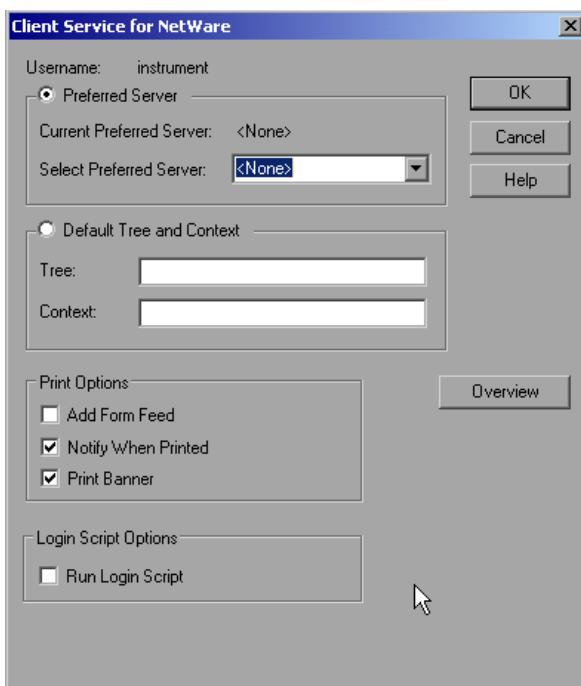

Bindary login (NOVELL 3.x)

- Click "Preferred Server".
- Select the NOVELL server where the user is configured using "Select Preferred Server".

NDS login (more recent NOVELL versions)

- Click "Default Tree and Context".
- Enter the NDS Tree under "Tree" and the hierarchical path where the user is defined under "Context".
- If required, click the "Run Login Script" entry.

Note:

This data can be obtained from the network administrator.

- Terminate the Login configuration with "OK".

Login in the Network

The user automatically logs into the network with the registration in the operating system. As a prerequisite, the user name and the password must be identical under Windows XP and on the network.

Disabling the Autologin Mechanism

Upon delivery, the instrument is configured for automatic login into Windows XP. This mechanism must be disabled if the instrument is operated in a network, since the default user name ("instrument") and the password normally are not identical to those of the network account.

To disable the autologin mechanism, proceed as follows:

- Open the XP start menu by means of <CTRL><ESC>.
- Select the menu item "RUN". A dialog box opens.
- Enter the command "D:\USER\NO_AUTOLOGIN.REG" in the dialog box and confirm with <ENTER>.

The autologin mechanism is disabled. When the instrument is rebooted, a prompt for user name and password will appear before the instrument firmware is started.

Reenabling the Autologin Mechanism

To enable the autologin mechanism again, proceed as follows:

- Open the XP start menu by means of <CTRL><ESC>.
- Select the menu item "RUN". A dialog box opens.
- Enter the command "D:\USER\AUTOLOGIN.REG" in the dialog box and confirm with <ENTER>.

The autologin mechanism is reenabled and is active when the instrument is rebooted the next time.

Using Network Drives

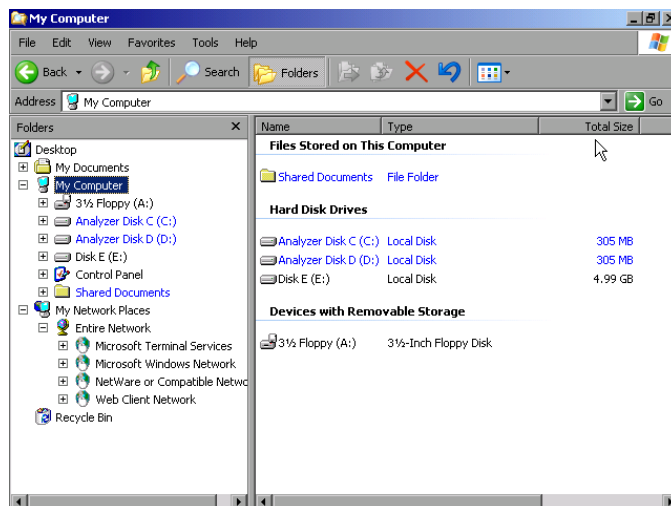

Mapping a network drive:

- Use the Windows key or the key combination <CTRL> <ESC> to call the Windows XP start menu.
- Click "Programs", "Accessories", "Windows Explorer" one after the other.
- Click the line "My Network Places" in the overview "Desktop".

An overview of the available network drives is displayed.

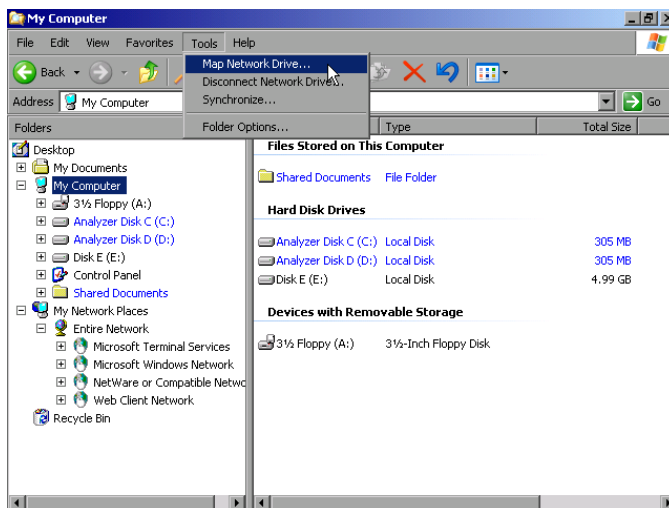

- Click "Tools" and then "Map Network Drive".

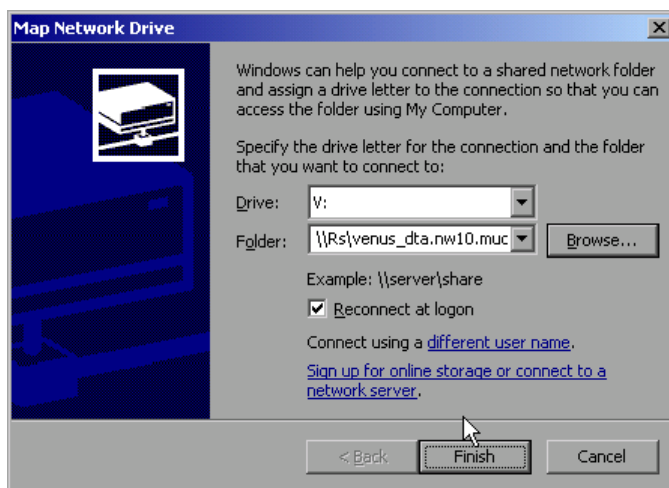

- Select the appropriate drive under "Drive:".
- With "Browse", open the list of available network paths in the network.
- Activate "Reconnect at Logon:" if the connection is to be set up automatically each time the instrument is started.
- Use "Finish" to connect the network path with the selected drive.

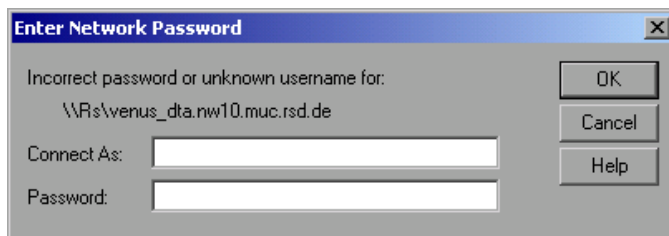

The user name and the password are queried. Then the drive will appear in the "All Directories" overview of the explorer.

Note:

Only those drives in the network for which the user has the appropriate access right can be connected.

Disconnecting a network drive:

- Click "Tools" in the Explorer and then "Disconnect Network Drive".
- Select the drive to be disconnected under "Network Drive:".
- Disconnect the drive using "OK". The security prompt must be answered with "Yes".

Printing on a Network Printer



The following dialogs may be operated both via the front panel and via a mouse and PC keyboard (for further information see the sections "Connection of a Mouse" and "Connection of a Keyboard"). The mouse and the PC keyboard are indispensable for the configuration of network printers.

A new printer is installed via the *INSTALL PRINTER* softkey in the *HCOPY* menu.

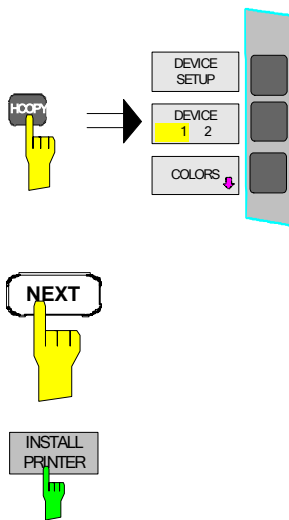

- Press the *HCOPY* key.
The *HCOPY* menu will be opened.

- Call up the lateral menu via the *NEXT* key.

- Open the *Printers and Faxes* dialog with *INSTALL PRINTER*.

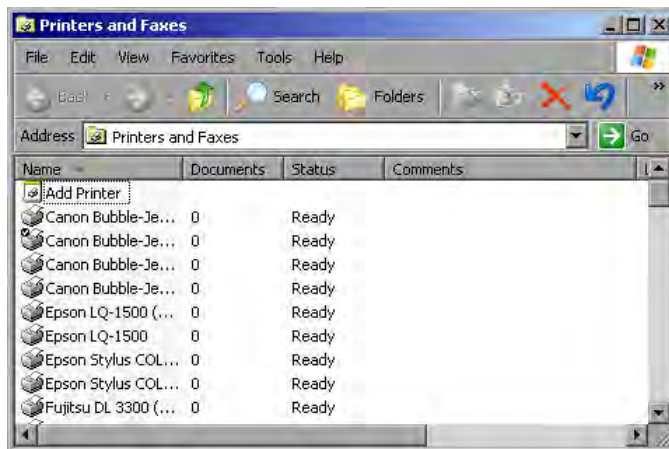

- Select the entry *Add Printer* in the selection list using the spinwheel.
- Highlight the entry with *CURSOR RIGHT* and confirm the selection by pressing *ENTER* or the spinwheel.

The *Add Printer Wizard* will be displayed.

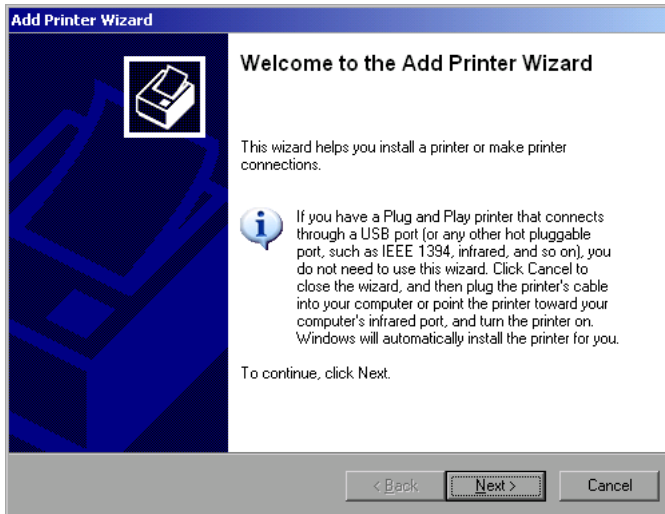

- Select *NEXT* with the spinwheel and confirm by pressing the spinwheel.

The selection *Local or Network Printer* will be displayed.

In the following example, an HP Laserjet 5 printer will be installed as the network printer. The Add Printer Wizard has already been opened according to the information described in the section "Starting the Add Printer Wizard".

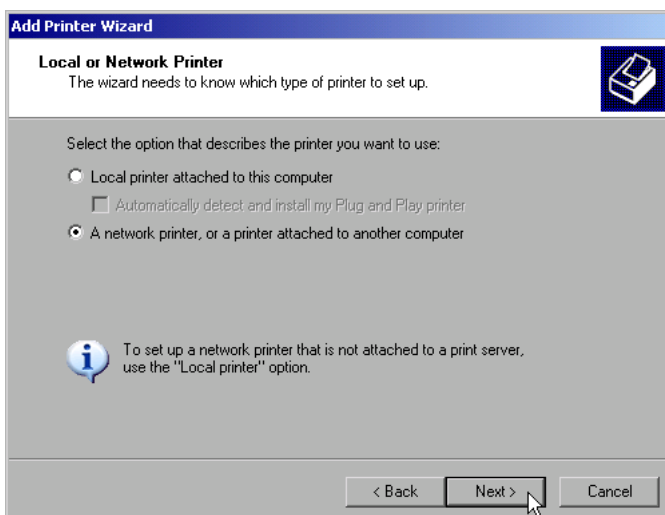

- To select a network printer, click the line "A network printer or a printer attached to another computer".

Then continue with "Next" .

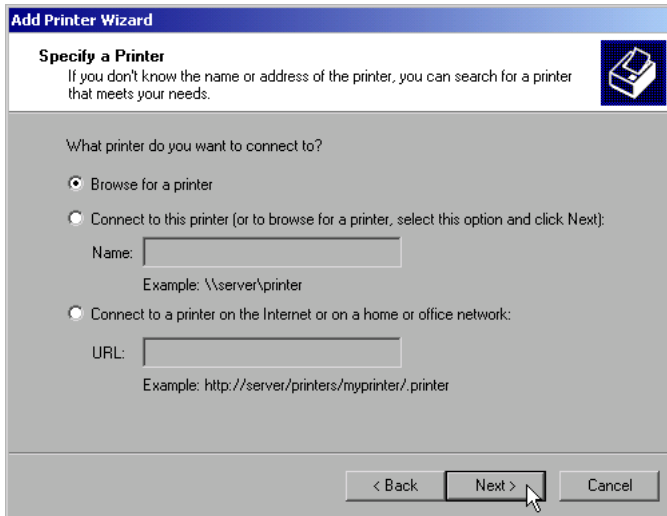

➤ First click "Browse for a printer" and then "Next" .

The selection of shared printers will appear.

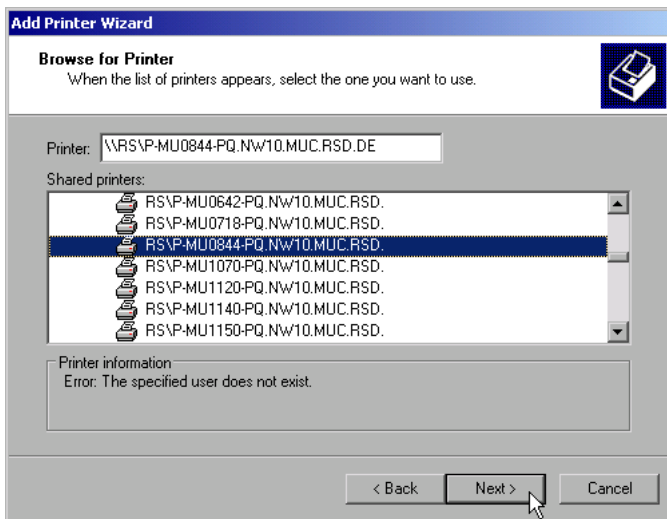

➤ Highlight printer and select with "OK".

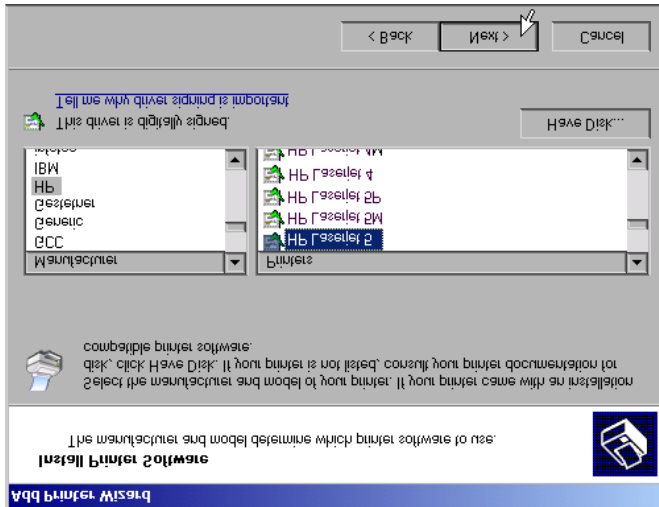

- Confirm the following request to install a suitable printer driver using "OK".

The selection of printer drivers will be displayed.

The manufacturers are displayed in the left-hand table and the available printer drivers in the right-hand table.

- First highlight the manufacturer in the selection list "Manufacturers" and then the printer driver in the selection list "Printers" .

Note:

If the desired printer type does not appear in this list, the driver has not yet been installed in the instrument. In this case, click the "HAVE DISK" button. A request to insert a disk with the corresponding printer driver will appear. Then click "OK" and select the desired printer driver.

- Click "Next".

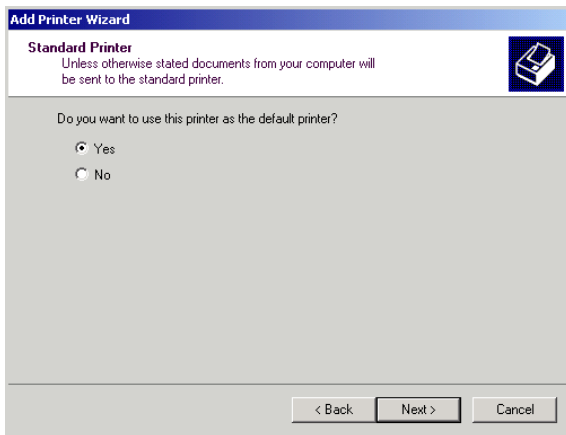

If one or several printers have already been installed, the query of whether the printer installed so far is to be selected as the default printer for the Windows XP applications will be displayed. "No" is preset.

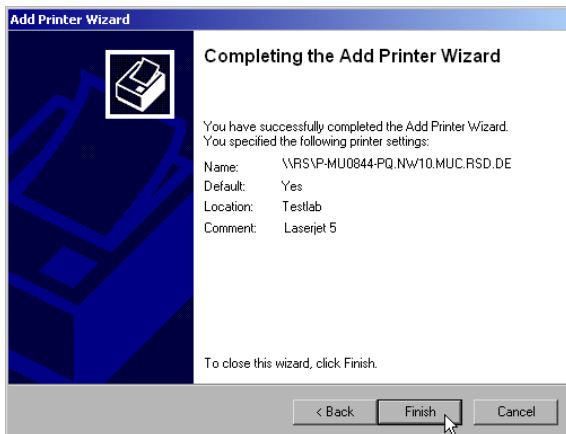

- Start the installation of the printer driver with "Finish".

Finally, the instrument still has to be configured for printout via this printer with the softkeys DEVICE SETUP and DEVICE 1/2 in the main hardcopy menu (see section "Selecting a Printer").

Sharing Directories (only for Microsoft Networks)

Data on the instrument can be made available for other computers if directories are shared. Sharing directories is only possible in the MICROSOFT network.

Sharing is a property of a file or directory. To allow sharing, proceed as follows:

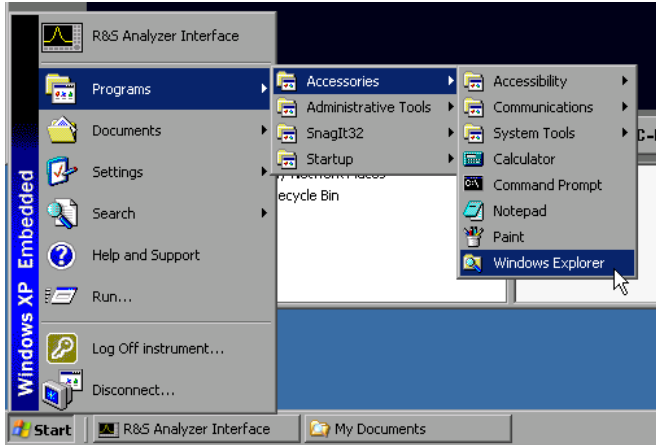

- Open the Windows start menu using the Windows key or <CTRL><ESC>.
- Open the Windows Explorer by clicking Programs - Accessories - Windows Explorer.

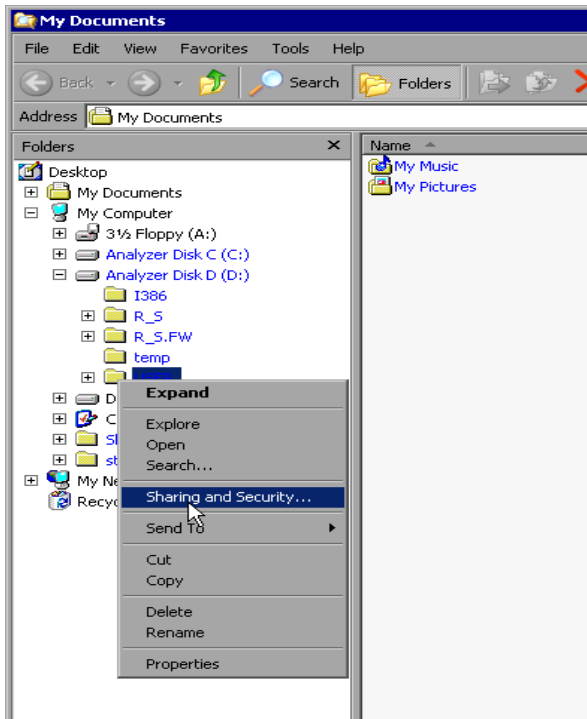

- Click the desired folder with the right mouse key.
- Click Sharing and Security.

The dialog to share the directories will be opened.

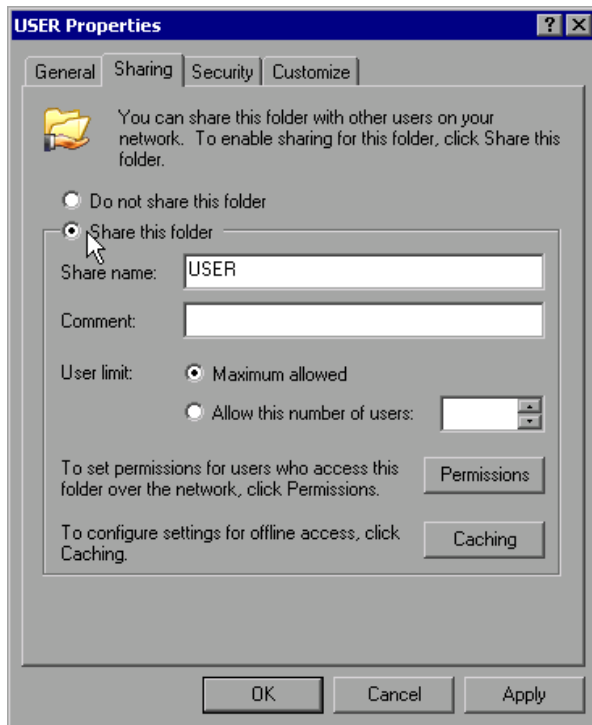

- Click *Share this folder*.
- The following settings can optionally be changed:
 - Share name:**
the name under which the directory appears in the Explorer
 - Comment:**
a comment regarding the shared directory
 - User Limit:**
the number of users that may access the directory at the same time
 - Permissions:**
the rights of the users (read only, read and write, all)
 - Caching:**
local buffering of directory contents for fast access
- Confirm settings with *OK*.

The drive is shared and this is shown in the Explorer by a hand under the directory symbol:



Remote Monitoring of R&S FSMR via XP Remote Desktop

Introduction

In production test and measurements, the question of how to centrally monitor measuring instruments that are used for remote servicing/diagnostics is often arises. With the remote desktop of Windows XP, the new Spectrum Analyzer Family R&S FSMR offers ideal preconditions for use in production:

- Access to operating functions via virtual front panel (*soft front panel*)
- Printout of measurement results directly from the controller
- Storing measurement data to the hard disk of the controller

The analyzer is connected via LAN. XP also supports the connection via data transmission (via modem). This section describes the configuration of R&S FSMR and the remote desktop client of the control PC. For details on setting up the data transmission link, see relevant XP literature.

Configuration of R&S FSMR for Using Remote Desktop

The following steps are required to allow an external PC access to the desktop of the R&S FSMR.

1. Determine the IP configuration of the network link:

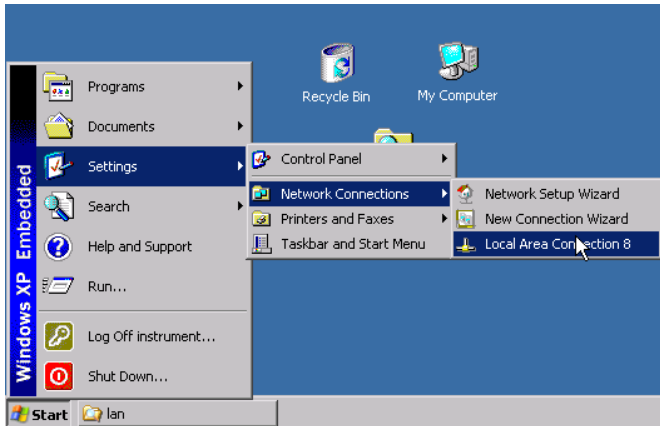

- Open the Windows XP start menu using the Windows key or *CTRL-ESC*.
- Click *Settings - Network Connections - Local Area Connection*.

The *Local Area Connection Status* dialog will be opened.

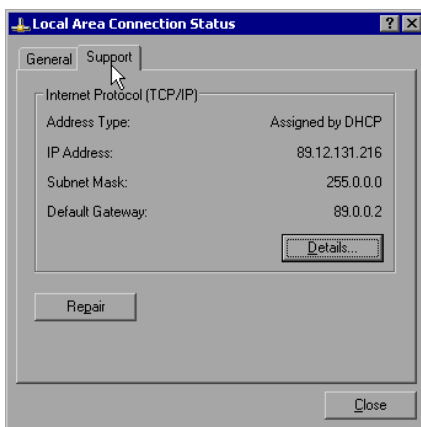

- Click the *Support* tab.

The current TCP/IP configuration will be displayed.

If the entry "Assigned by DHCP" is displayed in the *Address Type* field, continue with step 2 (Installing a fixed IP address...)

It would otherwise be sufficient to note the IP address and to continue with step 3 (Enabling the R&S FSMR...)

2. Install a fixed IP address for the TCP/IP protocol as described in the Section "Configuration of Available Network Protocols (TCP/IP Protocol)".

Note:

Operation with a fixed IP address is strongly recommended.

When a DHCP server is used, a new IP address (which has to be determined first) will be assigned any time the instrument is restarted. For this reason, a DHCP server would not be suitable for use for detached operation of the R&S FSMR.

3. Enable the R&S FSMR for operation with the remote desktop.

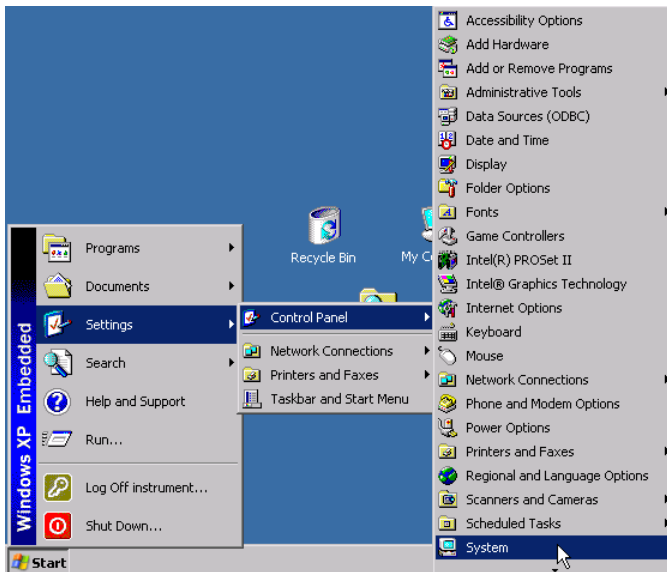

- Press the Windows key or <CTRL><ESC>.
- The Windows start menu will be opened.
- Select Settings - Control Panel - System.

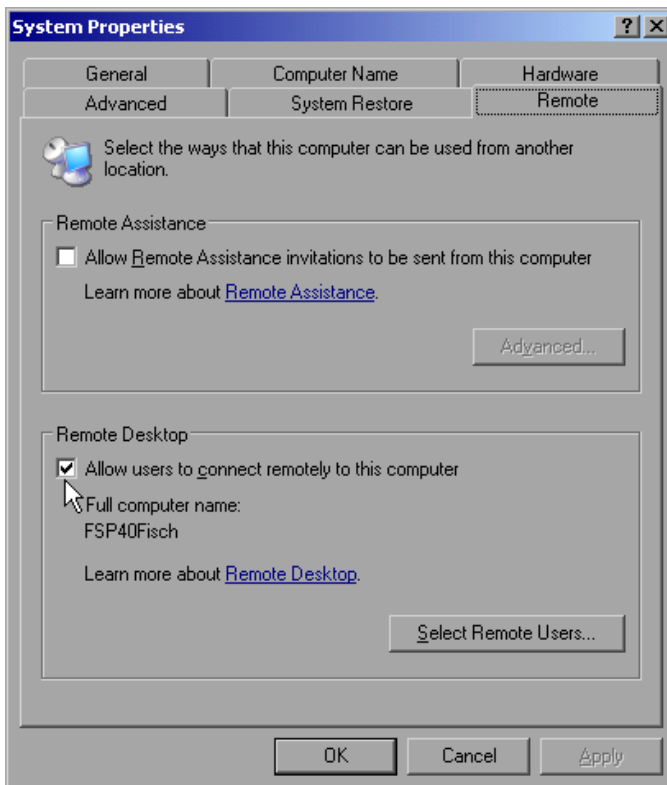

- Select the *Remote* tab.
 - In the *Remote Desktop* field, tick the box in front of *Allow users to connect remotely to this computer*.
 - If required, select the users installed on the R&S FSMR who are to also have access to the R&S FSMR via remote desktop in the *Select Remote Users...* dialog.
- Note:**
The user account under which the configuration is to be performed is automatically enabled for remote desktop.
- Confirm setting with **OK**.

The R&S FSMR is therefore ready for setting up the connection with the remote desktop of the controller.

Configuration of Controller

A precondition for the operation of the remote desktop is the availability of the TCP/IP protocol on the controller and the installation of the remote desktop client.



For Windows XP, the remote desktop client is part of the operating system and available under Start - Programs - Accessories - - Communications - Remote Desktop Connection.

For other Windows versions, Microsoft offers the remote client as a separate program package for subsequent installation.

The settings on the remote desktop client of the controller must be made prior to setting up the connection with the R&S FSMR. The following steps are required:

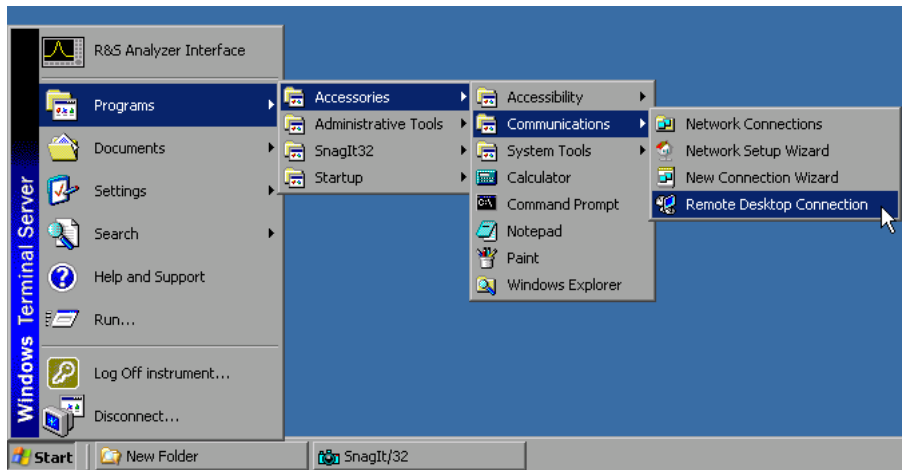

- Press the Windows key or <CTRL><ESC>.
- Select Programs - Accessories - Communications - Remote Desktop Connection.

The Remote Desktop Connection screen will be opened.



- Click the *Options >>* button.

The tabs with the configuration data will be opened.

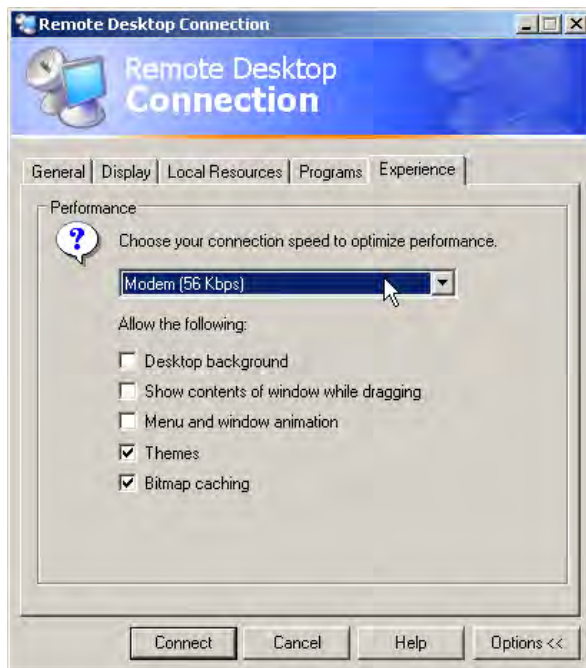

- Select the *Experience* tab.
The speed of setting up the connection will be selected and optimized.
- Click the selection list under *Choose your connection speed to optimize performance*.

The list of available configurations will be opened.

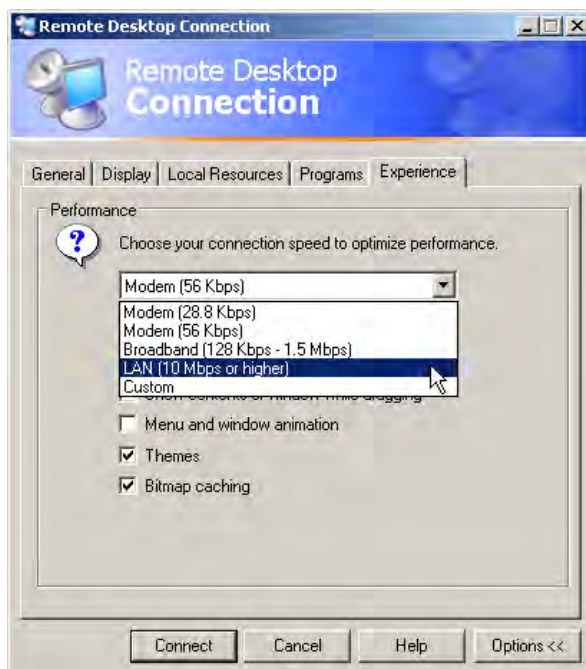

- Select the suitable connection (in the example LAN (10 Mbps or higher)).

Different boxes in the list below are activated depending on the selection and depending on the performance of the connection.

- To improve the performance, the entries "Desktop background", "Show Contents of Window while dragging" and "Menu and Window animation" can be switched off.
- Click the *Local Resources* tab.
The tab to share printers, local drives and serial interfaces will be opened.



- Click the box in front of *Disk drives* if drives of the controller are to be accessed from the R&S FSMR (e.g. to save settings or to copy files from the controller to the R&S FSMR).
Windows XP will then map the drives of the controller like network drives on the R&S FSMR.
- Click the box in front of *Printers* if printers connected to the controller are to be used from the R&S FSMR.
- Do not change the other settings.
- Click the *Display* tab.
The configuration of the representation of the R&S FSMR screen on the controller will be opened.

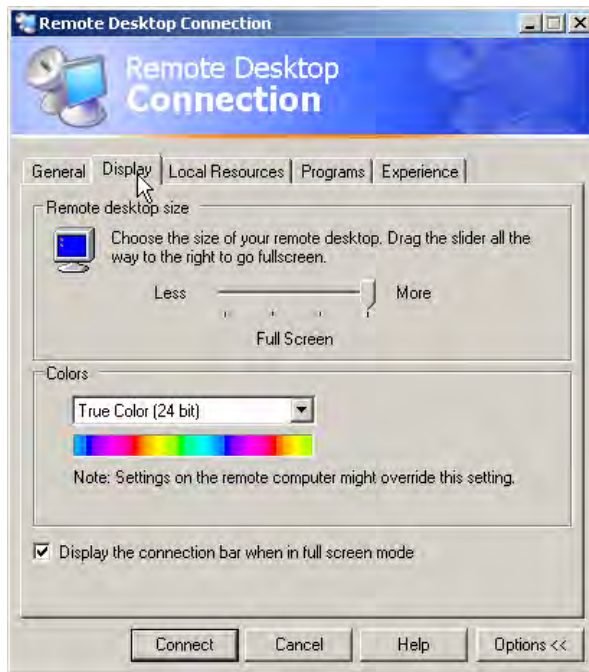

- The size of the R&S FSMR window on the desktop of the controller can be changed by means of the slider. The default setup is full screen.
- Do not change the colour depth.
- *Display the connection bar when in full screen mode:*

If this box is checked, a bar will appear at the top screen margin. This bar displays the network address of the R&S FSMR and can be used to reduce, minimize or to close the window.

If the box is not checked, a return from the R&S FSMR screen to the controller desktop in the full-screen mode is possible only if "Disconnect" is selected in the start menu:

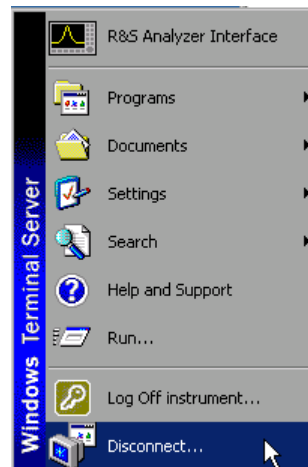

Setting up the Connection with the R&S FSMR

After configuration of the remote desktop client, the connection with the R&S FSMR has to be set up.



- Click the *General* tab. The connection information will be entered.
- Enter the IP address of the R&S FSMR in the *Computer* field.
- The information can be stored via the *Save As...* button for the next time. With the *Open...* button, it is possible to load an existing configuration again.
- Press the *Connect* button. The connection will be set up.

Note:

If the entry *Disk Drives* is active in the *Local Resources* tab, a warning is issued that the drives will be shared for access from the R&S FSMR:



Confirm the warning with OK. The setup will be continued.

The R&S FSMR screen will appear on the controller screen with the request to log in. To allow remote control of the R&S FSMR, the following steps have to be carried out:



- Enter user name "instrument" and password "instrument".

The R&S FSMR screen will be opened in a few moments.

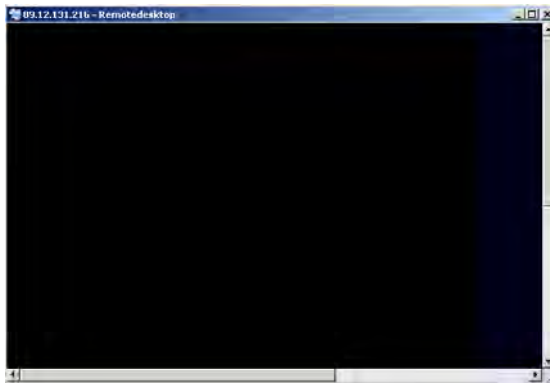

If the screen is dark or if a dark rectangle appears in the upper left corner, the R&S FSMR firmware must be restarted in order to recognize the modified screen resolution. In this case:

- Press <ALT><F4>. The R&S FSMR firmware will be shut down. This may last for several seconds.



- Double-click the entry *R&S Analyzer Interface*.

The firmware will restart and will automatically open the *Soft Frontpanel*, i.e. the user interface in which all front panel buttons and the spinwheel are shown.

- If the R&S FSMR application is directly displayed after setup, shutdown and restart can be omitted.

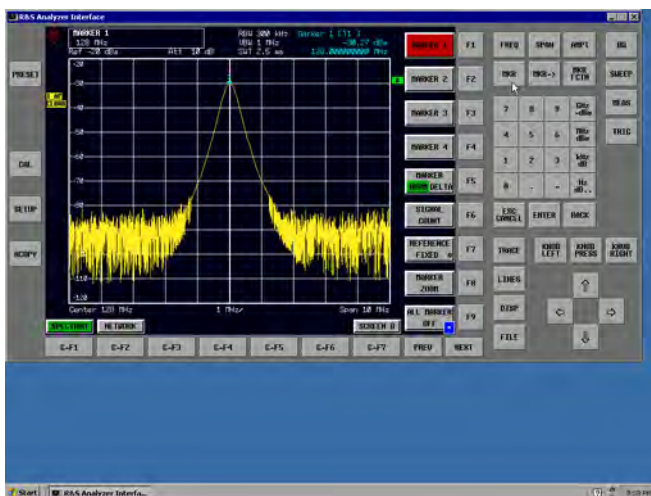

- All hardkeys, softkeys and hotkeys can be operated with the mouse.
- The spinwheel is implemented by *KNOB LEFT*, *KNOB RIGHT* and *KNOB PRESS*.
- The XP start menu is available if the remote desktop window is enlarged to full size.

Interruption and Re-setup of Remote Desktop Connection with the R&S FSMR

The connection to the R&S FSMR can be interrupted any time if the remote desktop window is connected to the controller.

To reestablish the connection, the setup with the R&S FSMR only has to be performed again as described in the section "Setting up the Connection with the R&S FSMR". The R&S FSMR will then maintain its state in case of an interruption with a subsequent re-setup.

When the connection is set up with the controller, the login entry will be displayed on the R&S FSMR screen. If the login procedure is carried out successfully, the message that a different user has assumed control of the instrument and that the connection was therefore cleared will be displayed on the screen of the controller.

Switching off the R&S FSMR from the Controller

The R&S FSMR can be switched off per remote control. For this purpose, proceed as follows:

1. Click the R&S FSMR soft front panel and close the application with <ALT><F4> .
2. Click the desktop and press <ALT><F4>.

A confirmation query with the warning that the instrument cannot be switched on again via remote control is displayed with the query to continue the shutdown process.
3. Answer the confirmation query with YES.

The connection to the controller will then be cleared and the R&S FSMR will be switched off.

Remote Data Transfer with TCP/IP Services

The protocol TCP/IP allows the transfer of files between different computer systems. This requires a program running on the two computers that controls this data transfer. It is not necessary that the same operating or file system is used by both computers. For example, a file transfer between DOS/WINDOWS and UNIX is possible. One of the two partners must be configured as Host and the other one as Client. However, they may change their roles. Usually, the system which is able to perform several processes at the same time will play the host role. The file transfer program usually used under TCP/IP is FTP (File Transfer Protocol). An FTP host is installed as standard on the majority of UNIX systems.

If the TCP/IP services are installed, a terminal connection is possible using "Start" - "Programs" - "Accessories" - "Telnet" or a data transfer via FTP by means of "Start" - "Run" "ftp" - "OK". Thus all computer systems supporting these universal protocols can be addressed (UNIX, VMS, etc).

For further information, refer to the corresponding XP literature.

File Transfer via FTP

The total scope of functions and commands is described in the FTP literature. The following table therefore only contains the major functions:

Setting up the connection

Click "Start" and then "Run" in the task bar.

The DOS command

FTP

starts the program.

The command

OPEN <xx . xx . xx . xx>

sets up the connection.

xx.xx.xx.xx = IP address e.g. 89.0.0.13

Data transfer

The command

PUT <dateiname>

transfers the data to the target system.

The command

GET <dateiname>

transfers the data from the target system.

The command

TYPE B

transfers the data in BINARY format; no conversion takes place.

The command

TYPE A

transfers the data in ASCII format, converting control characters so that text files can also be read on the target system.

Examples:

```
PUT C:\AUTOEXEC.BAT
```

sends the file AUTOEXEC.BAT to the target system.

```
LCD DATA
```

changes the current directory on the local machine to subdirectory DATA

```
CD SETTING
```

changes to the subdirectory SETTING on the target system

dateiname= File name e.g. DATA.TXT

Changing the directories

The command

```
LCD <path>
```

changes the directory on the local machine as with DOS.

The command

```
LDIR
```

shows the directory contents on the local machine.

These commands refer to the file system of the R&S FSMR. If the L is omitted ahead of the commands, they apply to the target system.

RSIB Protocol

The instrument is equipped with an RSIB protocol as standard, which allows the instrument to be controlled by means of Visual C++ and Visual Basic programs, but also by means of the Windows applications WinWord and Excel as well as National Instruments LabView, LabWindows/CVI and Agilent VEE. The control applications run on an external computer in the network.

A UNIX operating system can be installed on an external computer in addition to a Windows operating system. In this case, the control applications are created either in C or C++. The supported UNIX operating systems include:

- Sun Solaris 2.6 Sparc Station
- Sun Solaris 2.6 Intel Platform
- Red Hat Linux 6.2 x86 Processors

Remote Control via RSIB Protocol

Windows Environment

To access the measuring instruments via the RSIB protocol, the file `RSIB32.DLL` must be copied to the Windows `system32` directory or to the directory of the control applications. For 16-bit applications, the file `RSIB.DLL` must be additionally copied to the directories mentioned. The files `RSIB.DLL` and `RSIB32.DLL` are included on the instrument in directory `D:\R_S\Instr\RSIB`.

For the different programming languages, there are files available that contain the declarations of the DLL functions and the definition of the error codes.

Visual Basic (16 bit):	'RSIB.BAS'	(D:\R_S\Instr\RSIB)
Visual Basic (32 bit):	'RSIB32.BAS'	(D:\R_S\Instr\RSIB)
C:/C++:	'RSIB.H'	(D:\R_S\Instr\RSIB)

For C/C++: programs, import libraries are additionally available.

Import library for RSIB.DLL:	RSIB.LIB'	(D:\R_S\Instr\RSIB)
Import library for RSIB32.DLL:	RSIB32.LIB'	(D:\R_S\Instr\RSIB)

The control is performed using the Visual C++ or Visual Basic programs WinWord, Excel, LabView, LabWindows/CVI or Agilent VEE. Every application that can load a DLL is able to use the RSIB protocol. The programs use the IP address of the instrument or its *host name* to set up the connection.

Via VisualBasic: `ud = RSDLLibfind ("82.1.1.200", ibsta, iberr, ibcntl)`

Return to manual operation is possible via the front panel (*LOCAL* key) or via the RSIB protocol:

Via RSIB: `ud = RSDLLibloc (ud, ibsta, iberr, ibcntl);`
 or
 `ud = RSDLLibonl (ud, 0, ibsta, iberr, ibcntl);`

UNIX Environment

To access the measuring equipment via the RSIB interface, copy the `librsib.so.X.Y` file to a directory for which the control application has read rights. `X.Y` in the file name indicates the version number of the library, for example `1.0`.

The `librsib.so.X.Y` library is created as a *shared library*. The applications using the library need not consider its version. They simply link the library with the `lrsib` option. The following instructions have to be observed so that linking can be successfully performed and the library can be found during program execution:

File link:

- Use the operating system command `ln` to create a file with the link name `librsib.so` and pointing to `librsib.so.X.Y` in a directory for which the control application has read rights. Example:

```
$ ln -s /usr/lib/librsib.so.1.0 /usr/lib/librsib.so
```

Linker options for creating applications:

- `-lrsib`: import library
- `-Lxxx`: path information where the import library can be found. This is where the above file link has been created. Example: `-L/usr/lib`.

Additional linker options for creating applications (only under Solaris):

- `-Rxxx`: path information where the library is searched for during the program run:
`-R/usr/lib`.

Run-time environment:

- Set environment variable `LD_RUN_PATH` to the directory in which the file link has been created. This is necessary only if `librsib.so` cannot be found in the default search path of the operating system and the `-R` linker option (only Solaris) was not specified.

For C/C++ programming, the declarations of the library functions and the definition of error codes are contained in:

```
C/C++:          'RSIB.H'          (D:\R_S\Instr\RSIB)
```

RSIB Interface Functions

This chapter lists all functions of the DLL "RSIB.DLL" or "RSIB32.DLL" or "librsib.so", which allow control applications to be produced.

Overview of Interface Functions

The library functions are adapted to the interface functions of National Instruments for GPIB programming. The functions supported by the libraries are listed in the following table.

Function	Description
RSDLLibfind()	Provides a handle for access to a device.
RSDLLibwrt()	Sends a zero-terminated string to a device.
RSDLLilwrt()	Sends a certain number of bytes to a device.
RSDLLibwrtf()	Sends the contents of a file to a device.
RSDLLibrd()	Reads data from a device into a string.
RSDLLilrd()	Reads a certain number of bytes from a device.
RSDLLibrdf()	Reads data from a device into a file.
RSDLLibtmo()	Sets timeout for RSIB functions.
RSDLLibsre()	Switches a device to the local or remote state.
RSDLLibloc()	Temporarily switches a device to the local state.
RSDLLibeot()	Enables/disables the END message for write operations.
RSDLLibrsp()	Performs a serial poll and provides the status byte.
RSDLLibonl()	Sets the device online/offline.
RSDLLTestSrqr()	Checks whether a device has generated an SRQ.
RSDLLWaitSrqr()	Waits until a device generates an SRQ.
RSDLLSwapBytes	Swaps the byte sequence for binary numeric display (only required for non-Intel platforms).

Variables `ibsta`, `iberr`, `ibcntl`

As with the National Instrument interface, the successful execution of a command can be checked by means of the variables `ibsta`, `iberr` and `ibcntl`. For this purpose, all RSIB functions are assigned references to these three variables.

Status word - `ibsta`

The status word `ibsta` provides information on the status of the RSIB interface. The following bits are defined:

Bit designation	Bit	Hex code	Description
ERR	15	8000	Is set when an error has occurred on calling a function. If this bit is set, <code>iberr</code> contains an error code that specifies the error in greater detail.
TIMO	14	4000	Is set when a timeout has occurred on calling a function.
CMPL	8	0100	Is set if the response of the GPIB parser has been read out completely. If a parser response is read out with the function <code>RSDLLlrd()</code> and the length of the buffer is insufficient for the answer, the bit will be cleared.

Error variable - `iberr`

If the ERR bit (8000h) is set in the status word, `iberr` contains an error code which allows the error to be specified in greater detail. Extra error codes are defined for the RSIB protocol, independent of the National Instruments interface.

Error	Error code	Description
IBERR_CONNECT	2	Setup of the connection to the measuring instrument has failed.
IBERR_NO_DEVICE	3	A function of the interface has been called with an illegal device handle.
IBERR_MEM	4	No empty memory available.
IBERR_TIMEOUT	5	Timeout has occurred.
IBERR_BUSY	6	The RSIB protocol is blocked by a function that is still running.
IBERR_FILE	7	Error when reading or writing to a file.
IBERR_SEMA	8	Error upon creating or assigning a semaphore (only under UNIX).

Count variable - `ibcntl`

The variable `ibcntl` is updated with the number of transferred bytes each time a read or write function is called.

Description of Interface Functions

RSDLLibfind()

The function provides a handle for access to the device with the name `udName`.

VB format: Function RSDLLibfind (ByVal udName\$, ibsta%, iberr%, ibcntl&) As Integer

C format: short WINAPI RSDLLibfind(char far *udName, short far *ibsta, short far *iberr, unsigned long far *ibcntl)

C format (UNIX): short RSDLLibfind(char *udName, short *ibsta, short *iberr, unsigned long *ibcntl)

Parameters: udName IP address of device

Example: ud = RSDLLibfind ("89.10.38.97", ibsta, iberr, ibcntl)

The function must be called prior to all other functions of the interface.

As return value, the function provides a handle that must be indicated in all functions for access to the device. If the device with the name `udName` is not found, the handle has a negative value.

RSDLLibwrt

This function sends data to the device with the handle `ud`.

VB format: Function RSDLLibwrt (ByVal ud%, ByVal Wrt\$, ibsta%, iberr%, ibcntl&) As Integer

C format: short WINAPI RSDLLibwrt(short ud, char far *Wrt, short far *ibsta, short far *iberr, unsigned long far *ibcntl)

C format (UNIX): short RSDLLibwrt(short ud, char *Wrt, short *ibsta, short *iberr, unsigned long *ibcntl)

Parameters: ud Device handle
Wrt String sent to the device.

Example: RSDLLibwrt(ud, "SENS:FREQ:STAR?", ibsta, iberr, ibcntl)

This function allows setting and query commands to be sent to the measuring instruments. Whether the data is interpreted as a complete command can be set using the function `RSDLLibeot()`.

RSDLLilwrt

This function sends `Cnt` bytes to a device with the handle `ud`.

VB format: Function RSDLLilwrt (ByVal ud%, ByVal Wrt\$, ByVal Cnt&, ibsta%, iberr%, ibcntl&) As Integer

C format: short WINAPI RSDLLilwrt(short ud, char far *Wrt, unsigned long Cnt, short far *ibsta, short far *iberr, unsigned long far *ibcntl)

C format (UNIX): short RSDLLilwrt(short ud, char *Wrt, unsigned long Cnt, short *ibsta, short *iberr, unsigned long *ibcntl)

Parameters: ud Device handle
Wrt String sent to the GPIB parser.
Cnt Number of bytes sent to the device.

Example: RSDLLilwrt (ud, '.....', 100, ibsta, iberr, ibcntl)

Like `RSDLLibwrt()` this function sends data to a device. The only difference is that binary data can be sent as well. The length of the data is not determined by a zero-terminated string, but by the indication of `Cnt` bytes. If the data is to be terminated with EOS (0Ah), the EOS byte must be appended to the string.

RSDLLibwrtf

This function sends the contents of a file `file$` to the device with the handle `ud`.

VB format: Function RSDLLibwrtf (ByVal ud%, ByVal file\$, ibsta%, iberr%, ibcntl&) As Integer

C format: short WINAPI RSDLLibwrt(short ud, char far *Wrt, short far *ibsta, short far *iberr, unsigned long far *ibcntl)

C format (UNIX): short RSDLLibwrt(short ud, char *Wrt, short *ibsta, short *iberr, unsigned long *ibcntl)

Parameters: ud Device handle
file File whose contents is sent to the device.

Example: RSDLLibwrtf(ud, "C:\db.sav", ibsta, iberr, ibcntl)

This function allows setting and query commands to be sent to the measuring instruments. Whether the data is interpreted as a complete command can be set using the function RSDLLibeot().

RSDLLibrd()

The function reads data from the device with the handle `ud` into the string `Rd`.

VB format: Function RSDLLibrd (ByVal ud%, ByVal Rd\$, ibsta%, iberr%, ibcntl&) As Integer

C format: short WINAPI RSDLLibrd(short ud, char far *Rd, short far *ibsta, short far *iberr, unsigned long far *ibcntl)

C format (UNIX): short RSDLLibrd(short ud, char *Rd, short *ibsta, short *iberr, unsigned long *ibcntl)

Parameters: ud Device handle
Rd String to which the read data is copied.

Example: RSDLLibrd (ud, Rd, ibsta, iberr, ibcntl)

This function fetches the responses of the GPIB parser to a query.

In the case of Visual Basic programming, a string of sufficient length must be generated beforehand. This can be done during the definition of the string or using the command `Space$()`.

Generation of a string of the length 100: - Dim Rd as String * 100
 - Dim Rd as String
 Rd = Space\$(100)

RSDLLilrd

This function reads `Cnt` bytes from the device with the handle `ud`.

VB format: Function RSDLLilrd (ByVal ud%, ByVal Rd\$, ByVal Cnt&, ibsta%, iberr%, ibcntl&) As Integer

C format: short WINAPI RSDLLilrd(short ud, char far *Rd, unsigned long Cnt, short far *ibsta, short far *iberr, unsigned long far *ibcntl)

C format (UNIX): short RSDLLilrd(short ud, char *Rd, unsigned long Cnt, short *ibsta, short *iberr, unsigned long *ibcntl)

Parameters: ud Device handle
cnt Maximum number of bytes copied from the DLL into the target string `Rd`.

Example: RSDLLilrd (ud, RD, 100, ibsta, iberr, ibcntl)

Like the function `RSDLLibrd()`, this function reads data from a device. The only difference is that in this case the maximum number of bytes to be copied to the target string `Rd` can be indicated by means of `Cnt`. This function prevents writing beyond the end of the string.

RSDLLibrdf()

Reads data from the device with the handle `ud` into the file `file`.

VB format: Function RSDLLibrdf (ByVal ud%, ByVal file\$, ibsta%, iberr%, ibcntl&) As Integer

C format: short WINAPI RSDLLibrdf(short ud, char far *file, short far *ibsta, short far *iberr, unsigned long far *ibcntl)

C format (UNIX): short RSDLLibrdf(short ud, char *file, short *ibsta, short *iberr, unsigned long *ibcntl)

Parameters: ud Device handle
file File to which the read data is written.

Example: RSDLLibrdf (ud, "c:\db.sav", ibsta, iberr, ibcntl)

The file name may as well include a drive or path specification.

RSDLLibtmo

This function defines the timeout for a device. The default value for the timeout is set to 5 seconds.

VB format: Function RSDLLibtmo (ByVal ud%, ByVal tmo%, ibsta%, iberr%, ibcntl&) As Integer

C format: void WINAPI RSDLLibtmo(short ud, short tmo, short far *ibsta, short far *iberr, unsigned long far *ibcntl)

C format (UNIX): short RSDLLibtmo(short ud, short tmo, short *ibsta, short *iberr, unsigned long *ibcntl)

Parameters: ud Device handle
tmo Timeout in seconds

Example: RSDLLibtmo (ud, 10, ibsta, iberr, ibcntl)

RSDLLibsre

This function sets the device to the 'LOCAL' or 'REMOTE' state.

VB format: Function RSDLLibsre (ByVal ud%, ByVal v%, ibsta%, iberr%, ibcntl&) As Integer

C format: void WINAPI RSDLLibsre(short ud, short v, short far *ibsta, short far *iberr, unsigned long far *ibcntl)

C format (UNIX): short RSDLLibsre(short ud, short v, short *ibsta, short *iberr, unsigned long *ibcntl)

Parameters: ud Device handle
v State of device

0 - local

1 - remote

Example: RSDLLibsre (ud, 0, ibsta, iberr, ibcntl)

RSDLLibloc

This function temporarily switches the device to the 'LOCAL' state.

VB format: Function RSDLLibloc (ByVal ud%, ibsta%, iberr%, ibcntl&) As Integer

C format: void WINAPI RSDLLibloc(short ud, short far *ibsta, short far *iberr, unsigned long far *ibcntl)

C format (UNIX): short RSDLLibloc(short ud, short *ibsta, short *iberr, unsigned long *ibcntl)

Parameter: ud Device handle

Example: RSDLLibloc (ud, ibsta, iberr, ibcntl)

After switchover to LOCAL state, the instrument can be manually operated via the front panel. On the next access to the instrument by means of one of the functions of the library, the instrument is switched again to the REMOTE state.

RSDLLibeot

This function enables or disables the END message after write operations.

VB format: Function RSDLLibeot (ByVal ud%, ByVal v%, ibsta%, iberr%, ibcntl&) As Integer

C format: void WINAPI RSDLLibeot(short ud, short v, short far *ibsta, short far *iberr, unsigned long far *ibcntl)

C format (UNIX): short RSDLLibeot(short ud, short v, short *ibsta, short *iberr, unsigned long *ibcntl)

Parameters: ud Device handle
v 0 - no END message
1 - send END message

Example: RSDLLibeot (ud, 1, ibsta, iberr, ibcntl)

If the END message is disabled, the data of a command can be sent with several successive calls of write functions. The END message must be enabled again before sending the last data block.

RSDLLibrsp

This function performs a serial poll and provides the status byte of the device.

VB format: Function RSDLLibrsp(ByVal ud%, spr%, ibsta%, iberr%, ibcntl&) As Integer

C format: void WINAPI RSDLLibrsp(short ud, char far* spr, short far *ibsta, short far *iberr, unsigned long far *ibcntl)

C format (UNIX): short RSDLLibrsp(short ud, char *spr, short *ibsta, short *iberr, unsigned long *ibcntl)

Parameters: ud Device handle
spr Pointer to status byte

Example: RSDLLibrsp(ud, spr, ibsta, iberr, ibcntl)

RSDLLibonl

This function switches the device to 'online' or 'offline' mode. When it is switched to 'offline' mode, the interface is released and the device handle becomes invalid. By calling RSDLLibfind again, the communication is set up again.

VB format: Function RSDLLibonl (ByVal ud%, ByVal v%, ibsta%, iberr%,
ibcntl&) As Integer

C format: void WINAPI RSDLLibonl(short ud, short v, short far *ibsta,
short far *iberr, unsigned long far *ibcntl)

C format: short RSDLLibonl(short ud, short v, short *ibsta, short
*iberr, unsigned long *ibcntl)

Parameters: ud Device handle
v Device state
0 - local
1 - remote

Example: RSDLLibonl(ud, 0, ibsta, iberr, ibcntl)

RSDLLTestSRQ

This function checks the status of the SRQ bit.

VB format: Function RSDLLTestSrq (ByVal ud%, Result%, ibsta%, iberr%,
ibcntl&) As Integer

C format: void WINAPI RSDLLTestSrq(short ud, short far *result, short
far *ibsta, short far *iberr, unsigned long far *ibcntl)

C format (UNIX): short RSDLLTestSrq(short ud, short *result, short *ibsta,
short *iberr, unsigned long *ibcntl)

Parameters: ud Device handle
result Reference to an integer value in which the library returns
the status of the SRQ bit
0 - no SRQ
1 - SRQ active, device requests service

Example: RSDLLTestSrq (ud, result%, ibsta, iberr, ibcntl)

This function corresponds to the function RSDLLWaitSrq. The only difference is that RSDLLTestSRQ immediately returns the current status of the SRQ bit, whereas RSDLLWaitSrq waits for an SRQ to occur.

RSDLLWaitSrq

This function waits until the device triggers an SRQ with the handle `ud`.

VB format: Function RSDLLWaitSrq (ByVal ud%, Result%, ibsta%, iberr%, ibcntl&) As Integer

C format: void WINAPI RSDLLWaitSrq(short ud, short far *result, short far *ibsta, short far *iberr, unsigned long far *ibcntl)

C format (UNIX): short RSDLLWaitSrq(short ud, short *result, short *ibsta, short *iberr, unsigned long *ibcntl)

Parameters:

<code>ud</code>	Device handle
<code>result</code>	Reference to an integer value in which the library returns the status of the SRQ bit
	0 - No SRQ occurred during the timeout
	1 - SRQ occurred during the timeout

Example: RSDLLWaitSrq(ud, result, ibsta, iberr, ibcntl);

The function waits until one of the following two events occurs.

- The measuring instrument triggers an SRQ.
- No SRQ occurs during the timeout defined with `RSDLLibtmo()`.

RSDLLSwapBytes

This function changes the display of binary numbers on non-Intel platforms.

VB format: Not provided at present since it is required only on non-Intel platforms.

C format: void WINAPI RSDLLSwapBytes(void far *pArray, const long size, const long count)

C format (UNIX): void RSDLLSwapBytes(void *pArray, const long size, const long count)

Parameters:

<code>pArray</code>	Array in which modifications are made
<code>size</code>	Size of a single element in <code>pArray</code>
<code>count</code>	Number of elements in <code>pArray</code>

Example: RSDLLSwapBytes(Buffer, sizeof(float), ibcntl/sizeof(float))

This function swaps the display of various elements from *Big Endian* to *Little Endian* and vice versa. It is expected that a coherent storage area of elements of the same file type (`size` byte) is transferred to `pArray`. This function has no effect on Intel platforms.

Different types of processor architecture store data in different byte sequences. For example, Intel processors store data in the reverse order of Motorola processors. Comparison of byte sequences:

Byte sequence	Use in	Display in memory	Description
Big Endian	Motorola processors, network standard	Most significant byte at least significant address	The <i>most significant</i> byte is at the left end of the word.
Little Endian	Intel processors	Least significant byte at least significant address	The <i>most significant</i> byte is at the right end of the word.

Example:

```

Dim ibsta As Integer      ' Status variable
Dim iberr As Integer     ' Error variable
Dim ibcntl As Long      ' Count variable
Dim ud As Integer       ' Handle for measuring instrument
Dim Result As String    ' Buffer for simple results
Dim Digits As Byte      ' Number of digits of length indication
Dim TraceBytes As Long  ' Length of trace data in bytes
Dim TraceData(501) As Single ' Buffer for floating point
                          ' Binary data

' Set up connection to instrument
ud = RSDLLibfind("89.10.38.97", ibsta, iberr, ibcntl)

' Query trace data in real format
Call RSDLLibwrt(ud, "FORM:DATA REAL,32", ibsta, iberr, ibcntl)
Call RSDLLibwrt(ud, "TRACE? TRACE1", ibsta, iberr, ibcntl)

'Read number of digits of length indication
Result = Space$(20)
Call RSDLLilrd(ud, Result, 2, ibsta, iberr, ibcntl)
Digits = Val(Mid$(Result, 2, 1))

'Read length indication
Result = Space$(20)
Call RSDLLilrd(ud, Result, Digits, ibsta, iberr, ibcntl)
TraceBytes = Val(Left$(Result, Digits)) 'and store

' Read out trace data
Call RSDLLilrdTraceReal(ud, TraceData(0), TraceBytes, ibsta, iberr, ibcntl)

```

Programming examples:

- In this example, the start frequency of the instrument is queried.

```

Dim ibsta As Integer      ' Status variable
Dim iberr As Integer     ' Error variable
Dim ibcntl As Long      ' Count variable
Dim ud As Integer       ' Handle for measuring instrument
Dim Response As String  ' Response string

' Set up connection to measuring instrument
ud = RSDLLibfind("89.10.38.97", ibsta, iberr, ibcntl)
If (ud < 0) Then
    ' Error treatment
End If

' Send query command
Call RSDLLibwrt(ud, "FREQ:START?", ibsta, iberr, ibcntl)

' Provide space for response
Response = Space$(100)

' Read response from measuring instrument
Call RSDLLibrd(ud, Response, ibsta, iberr, ibcntl)

```

- In this example, a Save/Recall of the instrument setups is performed.

```
Dim ibsta As Integer      ' Status variable
Dim iberr As Integer      ' Error variable
Dim ibcntl As Long        ' Count variable
Dim ud As Integer         ' Handle for measuring instrument
Dim Cmd As String         ' Command string

' Set up connection to measuring instrument
ud = RSDLLibfind("89.10.38.97", ibsta, iberr, ibcntl)
If (ud < 0) Then
    ' Error treatment
End If

' Request instrument settings
Cmd = "SYST:SET?"
Call RSDLLibwrt(ud, Cmd, ibsta, iberr, ibcntl)

' Store instrument response in file
Call RSDLLibrdf(ud, "C:\db.sav", ibsta, iberr, ibcntl)

' Reset instrument
Call RSDLLibwrt(ud, "*RST", ibsta, iberr, ibcntl)

' and restore the previous settings
' to this end disable the END message
Call RSDLLibeot(ud, 0, ibsta, iberr, ibcntl)
' first send off command
Call RSDLLibwrt(ud, "SYST:SET ", ibsta, iberr, ibcntl)
' enable the END message again
Call RSDLLibeot(ud, 1, ibsta, iberr, ibcntl)
' and send the data
Call RSDLLibrwrtf(ud, "C:\db.sav", ibsta, iberr, ibcntl)
```

Visual Basic for Applications (Winword and Excel)

Programming tips:

The programming language Visual Basic for Applications (VBA) is supported as a macro language by various manufacturers. The programs Winword and Excel use this language for the versions Winword 97 or Excel 5.0 and higher.

For macros created with Visual Basic for Applications, the same tips are valid as for Visual Basic Applications.

Programming example:

- Using the macro `QueryMaxPeak`, a single sweep with subsequent query of the maximum peak is performed. The result is entered in a Winword or Excel document.

```
Sub QueryMaxPeak()

    Dim ibsta As Integer      ' Status variable
    Dim iberr As Integer     ' Error variable
    Dim ibcnt1 As Long       ' transferred characters
    Dim ud As Integer        ' Unit Descriptor (handle)for instrument
    Dim Response As String   ' Response string

    ' Set up connection to measuring instrument
    ud = RSDLLibfind("89.10.38.97", ibsta, iberr, ibcnt1)
    If (ud < 0) Then
        Call MsgBox("Device with address 89.10.38.97 could" & _
            "not be found", vbExclamation)
    End
End If

    ' Determine maximum peak in the range 1-2MHZ
    Call RSDLLibwrt(ud, "*RST", ibsta, iberr, ibcnt1)
    Call RSDLLibwrt(ud, "INIT:CONT OFF", ibsta, iberr, ibcnt1)
    Call RSDLLibwrt(ud, "FREQ:START 1MHZ", ibsta, iberr, ibcnt1)
    Call RSDLLibwrt(ud, "FREQ:STOP 2MHZ", ibsta, iberr, ibcnt1)
    Call RSDLLibwrt(ud, "INIT:IMM;*WAI", ibsta, iberr, ibcnt1)
    Call RSDLLibwrt(ud, "CALC:MARK:MAX;Y?", ibsta, iberr, ibcnt1)
    Response = Space$(100)
    Call RSDLLibrd(ud, Response, ibsta, iberr, ibcnt1)
    Response = RTrim(Response) ' Cut off space

    ' Insert value in current document (Winword)
    Selection.InsertBefore (Response)
    Selection.Collapse (wdCollapseEnd)

    ' Terminate connection to measuring instrument
    Call RSDLLibonl(ud, 0, ibsta, iberr, ibcnt1)

End Sub
```

The entry of the peak value in the Winword document can be replaced as follows for Excel:

```
' Insert value in current document (Excel)
ActiveCell.FormulaR1C1 = Response
```

C / C++

Programming tips:

- Access to the functions of the RSIB32.DLL (Windows platforms)

The functions of the `RSIB32.DLL` are declared in the header file `RSIB.H`. The DLL functions can be linked to a C/C++ program in different ways.

1. Enter one of the supplied import libraries (`RSIB.LIB` or `RSIB32.LIB`) into the linker options.
2. Load the library using the function `LoadLibrary()` during runtime and determine the function pointers of the DLL functions using `GetProcAddress()`. Before the end of the program, the `RSIB.DLL` must be unloaded again using the function `FreeLibrary()`.

When import libraries are used, the DLL is automatically loaded immediately before the application is started. At the end of the program, the DLL is unloaded again unless it is still used by other applications.

- Access to `libsib.so` functions (UNIX platforms)

The functions of `libsib.so` are declared in the header file `RSIB.H`. Uppercase/lowercase characters for file names are typically observed under UNIX. The library functions are linked to a C/C++ program by entering the `-libsib` linker option.

The *shared library* `libsib.so` is automatically loaded on starting the application. The accessibility (for example via standard path) of the library must be ensured. Refer to the beginning of this main chapter under "UNIX Environment".

- Query of strings

If instrument responses are to be further processed as strings, a zero termination must be appended.

Example:

```
char buffer[100];
...
RSDLLibrd( ud, buffer, &ibsta, &iberr, &ibcntl );
buffer[ibcntl] = 0;
```

Programming example:

In the following C program example, a single sweep is started on the device with the IP address 89.10.38.97 and subsequently a marker is set to maximum level. Prior to the search for maximum, a synchronization to the end of the sweep is performed. For this purpose the command "*OPC" (Operation complete) is used to create a service request at the end of the sweep, for which the control program waits with the function RSDLLWaitSrq(). Then the maximum is determined ("CALC:MARK:MAX") and the level read out ("Y?").

```
#define MAX_RESP_LEN 100

short          ibsta, iberr;
unsigned long  ibcntl;
short         ud;
short         srq;
char          MaxPegel[MAX_RESP_LEN];
char          spr;

// Determine handle for instrument
ud = RSDLLibfind( "89.10.38.97", &ibsta, &iberr, &ibcntl );

// if instrument exists
if ( ud >= 0 )
{
    // Set timeout for RSDLLWaitSrq() to 10 seconds
    RSDLLibtmo( ud, 10, &ibsta, &iberr, &ibcntl );

    // Activate SRQ generation via event status register (ESR)
    // and enable ESB bit in SRE register
    RSDLLibrwt( ud, "*ESE 1;*SRE 32", &ibsta, &iberr, &ibcntl );

    // Set single sweep, trigger sweep and use "*OPC" to cause
    // the generation of a service request at the end of the sweep
    RSDLLibrwt( ud, "INIT:CONT off;INIT;*OPC", &ibsta, &iberr, &ibcntl );

    // Wait for SRQ (end of sweep)
    RSDLLWaitSrq( ud, &srq, &ibsta, &iberr, &ibcntl );

    // Clear RQS/MSS bit
    RSDLLibrsp( ud, &spr, &ibsta, &iberr, &ibcntl );

    // if sweep is terminated
    if (srq)
    {
        // then set marker to first maximum and query the level
        RSDLLibrwt( ud, "CALC:MARK:MAX;Y?", &ibsta, &iberr, &ibcntl );
        RSDLLilrd( ud, MaxPegel, MAX_RESP_LEN, &ibsta, &iberr, &ibcntl );
        MaxPegel[ibcntl] = 0;
    }
    // End connection to instrument
    RSDLLibonl( ud, 0, &ibsta, &iberr, &ibcntl );
}
else
{
    ; // Error Instrument not found
}
}
```

Contents - Chapter 5 "Remote Control - "Basics"

5 Remote Control - Basics.....	5.1
Introduction.....	5.1
Getting Started.....	5.2
Starting Remote Control Operation.....	5.3
Display Contents during Remote Control	5.3
Remote Control via IEC/IEEE Bus	5.4
Setting the Device Address.....	5.4
Return to Manual Operation.....	5.4
Remote Control via RS-232-Interface	5.5
Setting the Transmission Parameters.....	5.5
Return to Manual Operation.....	5.5
Limitations	5.5
Remote Control in a Network (RSIB Interface)	5.6
Setting the Device Address.....	5.6
Return to Manual Operation.....	5.6
Messages	5.7
IEC/IEEE-Bus Interface Messages	5.7
Device Messages (Commands and Device Responses).....	5.8
Structure and Syntax of the Device Messages.....	5.9
SCPI Introduction	5.9
Structure of a Command.....	5.9
Structure of a Command Line	5.12
Responses to Queries.....	5.12
Parameters.....	5.13
Overview of Syntax Elements	5.14
Instrument Model and Command Processing.....	5.15
Input Unit.....	5.15
Command Recognition.....	5.16
Instrument Data Base and Instrument Hardware.....	5.16
Output Unit	5.17
Command Sequence and Command Synchronization	5.17
Status Reporting System.....	5.18
Structure of an SCPI Status Register.....	5.18
Overview of the Status Registers	5.20
Description of the Status Registers.....	5.21
Status Byte (STB) and Service Request Enable Register (SRE).....	5.21
IST Flag and Parallel Poll Enable Register (PPE)	5.22
Event-Status Register (ESR) and Event-Status-Enable Register (ESE)	5.22
STATus:OPERation Register.....	5.23
STATus:QUEStionable Register	5.24
STATus:QUEStionable:ACPLimit Register.....	5.25
STATus:QUEStionable:FREQuency Register	5.26
STATus:QUEStionable:LIMit<1 2> Register	5.27
STATus:QUEStionable:LMARgin<1 2> Register	5.28
STATus:QUEStionable:POWEr Register	5.29

STATus:QUEStionable:SYNC Register	5.30
Application of the Status Reporting Systems	5.31
Service Request, Making Use of the Hierarchy Structure.....	5.31
Serial Poll	5.31
Parallel Poll	5.32
Query by Means of Commands	5.32
Error-Queue Query	5.32
Resetting Values of the Status Reporting System	5.33

5 Remote Control - Basics

In this chapter you'll find:

- instructions on how to put the R&S FSMR into operation via remote control,
- a general introduction to remote control of programmable instruments. This includes the description of the command structure and syntax according to the SCPI standard, the description of command execution and of the status registers,
- diagrams and tables describing the status registers used in the R&S FSMR.

In chapter 6, all remote control functions are described in detail. The subsystems are listed by alphabetical order according to SCPI. All commands and their parameters are listed by alphabetical order in the command list at the end of chapter 6.

Program examples for the R&S FSMR can be found in chapter 7.

The remote control interfaces and their interface functions are described in Chapter 8.

Introduction

The instrument is equipped with an IEC-bus interface according to standard IEC 625.1/IEEE 488.2 and a RS-232 interface. The connectors are located at the rear of the instrument and permit to connect a controller for remote control. In addition, the instrument can be remotely controlled in a local area network (LAN interface) if option B16 is installed.

The instrument supports the SCPI:version 1997.0 (Standard Commands for Programmable Instruments). The SCPI standard is based on standard IEEE 488.2 and aims at the standardization of device-specific commands, error handling and the status registers (see Section "SCPI Introduction").

The tutorial "Automatic Measurement Control – A tutorial on SCPI and IEEE 488.2" from John M. Pieper (R&S order number 0002.3536.00) offers detailed information on concepts and definitions of SCPI. For remote control in a network, information will be found in the relevant section, "Remote Control in a Network (RSIB Interface)".

This section assumes basic knowledge of IEC/IEEE bus programming and operation of the controller. A description of the interface commands can be obtained from the relevant manuals.

The requirements of the SCPI standard placed on command syntax, error handling and configuration of the status registers are explained in detail in the following sections. Tables provide a fast overview of the bit assignment in the status registers. The tables are supplemented by a comprehensive description of the status registers.

The program examples for IEC-bus programming are all written in VISUAL BASIC.

Getting Started

The short and simple operating sequence given below permits fast putting into operation of the instrument and setting of its basic functions. As a prerequisite, the IEC/IEEE-bus address, which is factory-set to 20, must not have been changed.

1. Connect instrument and controller using IEC/IEEE-bus cable.
2. Write and start the following program on the controller:

```
CALL IBFIND("DEV1", analyzer%)           'Open port to the instrument
CALL IBPAD(analyzer%, 20)                 'Inform controller about instrument address
CALL IBWRT(analyzer%, '*RST;*CLS')        'Reset instrument

CALL IBWRT(analyzer%, 'FREQ:CENT 100MHz') ' Set center frequency to 100 MHz
CALL IBWRT(analyzer%, 'FREQ:SPAN 10MHz')  ' Set span to 10 MHz
CALL IBWRT(analyzer%, 'DISP:TRAC:Y:RLEV -10dBm') ' Set reference level to -10 dBm
```

The instrument now performs a sweep in the frequency range of 95 MHz to 105 MHz .

3. To return to manual control, press the *LOCAL* key at the front panel

Starting Remote Control Operation

On power-on, the instrument is always in the manual operating state ("LOCAL" state) and can be operated via the front panel.

It is switched to remote control ("REMOTE" state)

IEC/IEEE-bus as soon as it receives an addressed command from a controller.

if it is controlled in a network (RSIB interface), as soon as it receives a command from a controller.

RS-232 as soon as it receives the command "@REM" from a controller.

During remote control, operation via the front panel is disabled. The instrument remains in the remote state until it is reset to the manual state via the front panel or via remote control interfaces. Switching from manual operation to remote control and vice versa does not affect the remaining instrument settings.

Display Contents during Remote Control

During remote control, only the LOCAL softkey appears, with which it is possible to return to manual operation.

In addition, the display of diagrams and results can be blanked out with the command "SYSTEM:DISPlay:UPDate OFF" (default in remote control) to obtain optimum performance during remote control operation.

During program execution it is recommended to activate the display of results by means of "SYSTEM:DISPlay:UPDate ON" so that it is possible to follow the changes in the device settings and the recorded measurement curves on the screen.

Note: *If the instrument is exclusively operated in remote control, it is recommended to switch on the power-save mode (POWER SAVE). In this mode, the required display is completely switched off after a preset time.*

Remote Control via IEC/IEEE Bus

Setting the Device Address

In order to operate the instrument via the IEC- bus, it must be addressed using the set IEC/IEEE bus address. The IEC/IEEE bus address of the instrument is factory-set to 20. It can be changed manually in the *SETUP - GENERAL SETUP* menu or via IEC bus. Addresses 0 to 30 are permissible.

Manually:

- Call *SETUP - GENERAL SETUP* menu
- Enter desired address in table *GPIB-ADDRESS*
- Terminate input using the *ENTER* key

Via IEC/IEEE bus:

CALL IBFIND("DEV1", analyzer%)	'Open port to the instrument
CALL IBPAD(analyzer%, 20)	'Inform controller about old address
CALL IBWRT(analyzer%, "SYST:COMM:GPIB:ADDR 18")	'Set instrument to new address
CALL IBPAD(analyzer%, 18)	'Inform controller about new address

Return to Manual Operation

Return to manual operation is possible via the front panel or the IEC/IEEE bus.

Manually:

- Press the *LOCAL* softkey or the *PRESET* key

- Notes:**
- Before the transition, command processing must be completed as otherwise transition to remote control is performed immediately.
 - The keys can be disabled by the universal command *LLO* (see Chapter 8, *IEC/IEEE- Bus Interface – Interface Messages*) in order to prevent unintentional transition. In this case, transition to manual mode is only possible via the IEC/IEEE bus.
 - The keys can be enabled again by deactivating the *REN* line of the IEC/IEEE bus (see Chapter 8, *IEC/IEEE-Bus Interface – Bus Lines*).

Via IEC bus:

...	
CALL IBLOC(analyzer%)	'Set instrument to manual operation
...	

Remote Control via RS-232-Interface

Setting the Transmission Parameters

To enable an error-free and correct data transmission, the parameters of the unit and the controller should have the same setting.

Parameters can be manually changed in menu *SETUP-GENERAL SETUP* in table *COM PORT* or via remote control using the command `SYSTEM:COMMunicate:SERial:....`.

The transmission parameters of the COM interface are factory-set to the following values:

baudrate = 9600, data bits = 8, stop bits = 1, parity = NONE and owner = INSTRUMENT.

For remote control operation, the interface should be allocated to the operating system (owner = OS) so that the control characters including @ can be recognized by the interface.

Manually:

Setting the COM interface

- Call *SETUP-GENERAL SETUP* menu
- Select desired baudrate, bits, stopbit, parity in table *COM PORT*.
- Set owner to OS in table *COM PORT*.
- Terminate input using the *ENTER* key.

Return to Manual Operation

Return to manual operation is possible via the front panel or via RS-232 interface.

Manually:

- Press the *LOCAL* softkey or the *PRESET* key.

Notes:

- Before the transition, command processing must be completed as otherwise transition to remote control is performed immediately
- The keys can be enabled again by sending the control string "@LOC" via RS-232 (see Chapter 8, S-232-C Interface - Control Commands).

Via RS-232:

```
...
v24puts(port, "@LOC");    Set instrument to manual operation..
...
```

Limitations

The following limitations apply if the unit is remote-controlled via the RS-232-C interface:

- No interface messages, only control strings (see interface description in Chapter 8, *RS-232-C Interface – Control Commands*).
- Only the Common Commands *OPC? can be used for command synchronization, *WAI and *OPC are not available.
- Block data cannot be transmitted.

Remote Control in a Network (RSIB Interface)

Setting the Device Address

For control of the instrument in a network, it must be accessed using the preselected IP address. The IP address of the instrument (device address) is defined in the network configuration.

Setting the IP address:

- Call *SETUP - GENERAL SETUP* – CONFIGURE NETWORK menu.
- Select "Protocols" tab.
- Set IP address for TCP/IP protocol under "Properties" (see section on option R&S FSMR-B16).

Return to Manual Operation

Return to manual operation can be made manually via the front panel or remotely via the RSIB interface.

Manually: ➤ Press *LOCAL* softkey or *PRESET* key.

Note:

- *Make sure that the execution of commands is completed prior to switchover since otherwise the instrument will switch back to remote control immediately.*

Via RSIB interface:

```
...  
CALL RSDLLibloc(analyzer%, ibsta%, iberr%, ibcntl&)'Set  
device to manual control  
...
```

Messages

The messages transferred via the data lines of the IEC bus (see Chapter 8, IEC/IEEE-Bus Interface) can be divided into two groups:

- **interface messages and**
- **device messages.**

IEC/IEEE-Bus Interface Messages

Interface messages are transferred on the data lines of the IEC bus, the "ATN" control line being active. They are used for communication between controller and instrument and can only be sent by a controller which has the IEC/IEEE bus control. Interface commands can be subdivided into

- **universal commands and**
- **addressed commands.**

Universal commands act on all devices connected to the IEC/IEEE bus without previous addressing, addressed commands only act on devices previously addressed as listeners. The interface messages relevant to the instrument are listed in Chapter 8, IEC/IEEE-Bus Interface – Interface Functions.

Device Messages (Commands and Device Responses)

Device messages are transferred on the data lines of the IEC bus, the "ATN" control line not being active. ASCII code is used.

A distinction is made according to the direction in which they are sent on the IEC/IEEE bus:

- **Commands** are messages the controller sends to the instrument. They operate the device functions and request informations.
The commands are subdivided according to two criteria:
 1. According to the effect they have on the instrument:
 - Setting commands** cause instrument settings such as reset of the instrument or setting the center frequency.
 - Queries** cause data to be provided for output on the IEC/IEEE bus, e.g. for identification of the device or polling the marker.
 2. According to their definition in standard IEEE 488.2:
 - Common Commands** are exactly defined as to their function and notation in standard IEEE 488.2. They refer to functions such as management of the standardized status registers, reset and selftest.
 - Device-specific commands** refer to functions depending on the features of the instrument such as frequency setting. A majority of these commands has also been standardized by the SCPI committee (cf. Section "SCPI Introduction").
- **Device responses** are messages the instrument sends to the controller after a query. They can contain measurement results, instrument settings and information on the instrument status (cf. Section "Responses to Queries").

Structure and syntax of the device messages are described in the following Section.

Structure and Syntax of the Device Messages

SCPI Introduction

SCPI (Standard Commands for Programmable Instruments) describes a standard command set for programming instruments, irrespective of the type of instrument or manufacturer. The goal of the SCPI consortium is to standardize the device-specific commands to a large extent. For this purpose, a model was developed which defines the same functions inside a device or for different devices. Command systems were generated which are assigned to these functions. Thus it is possible to address the same functions with identical commands. The command systems are of a hierarchical structure.

Fig. 5-1 illustrates this tree structure using a section of command system SENSE, which controls the device-specific settings, that do not refer to the signal characteristics of the measurement signal.

SCPI is based on standard IEEE 488.2, i.e. it uses the same syntactic basic elements as well as the common commands defined in this standard. Part of the syntax of the device responses is defined with greater restrictions than in standard IEEE 488.2 (see Section "Responses to Queries").

Structure of a Command

The commands consist of a so-called header and, in most cases, one or more parameters. Header and parameter are separated by a "white space" (ASCII code 0 to 9, 11 to 32 decimal, e.g. blank). The headers may consist of several key words. Queries are formed by directly appending a question mark to the header.

Note: *The commands used in the following examples are not in every case implemented in the instrument.*

Common commands

Common commands consist of a header preceded by an asterisk "*" and one or several parameters, if any.

Examples: *RST RESET, resets the device
 *ESE 253 EVENT STATUS ENABLE, sets the bits of
 the event status enable register
 *ESR? EVENT STATUS QUERY, queries the
 contents of the event status register.

Device-specific commands

Hierarchy: Device-specific commands are of hierarchical structure (see Fig. 5-1). The different levels are represented by combined headers. Headers of the highest level (root level) have only one key word. This key word denotes a complete command system.

Example: `SENSe` This key word denotes the command system `SENSe`.

For commands of lower levels, the complete path has to be specified, starting on the left with the highest level, the individual key words being separated by a colon ":".

Example: `SENSe:FREQuency:SPAN 10MHZ`

This command lies in the third level of the `SENSe` system. It sets the frequency span.

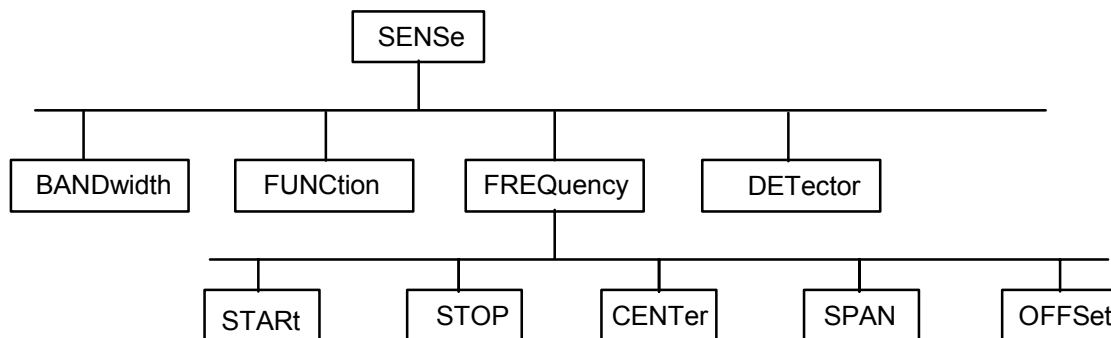

Fig. 5-1 Tree structure the SCPI command systems using the `SENSe` system by way of example

Some key words occur in several levels within one command system. Their effect depends on the structure of the command, that is to say, at which position in the header of a command they are inserted.

Example: `SOURce:FM:POLarity NORMal`

This command contains key word `POLarity` in the third command level. It defines the polarity between modulator and modulation signal.

`SOURce:FM:EXTernal:POLarity NORMal`

This command contains key word `POLarity` in the fourth command level. It defines the polarity between modulation voltage and the resulting direction of the modulation only for the external signal source indicated.

Optional key words: Some command systems permit certain key words to be optionally inserted into the header or omitted. These key words are marked by square brackets in the description. The full command length must be recognized by the instrument for reasons of compatibility with the SCPI standard. Some commands are considerably shortened by these optional key words.

Example: [SENSe]:BANDwidth[:RESolution]:AUTO

This command couples the resolution bandwidth of the instrument to other parameters. The following command has the same effect:

BANDwidth:AUTO

Note: *An optional key word must not be omitted if its effect is specified in detail by a numeric suffix.*

Long and short form: The key words feature a long form and a short form. Either the short form or the long form can be entered, other abbreviations are not permissible.

Beispiel: STATus:QUESTionable:ENABle 1= STAT:QUES:ENAB 1

Note: *The short form is marked by upper-case letters, the long form corresponds to the complete word. Upper-case and lower-case notation only serve the above purpose, the instrument itself does not make any difference between upper-case and lower-case letters.*

Parameter: The parameter must be separated from the header by a "white space". If several parameters are specified in a command, they are separated by a comma ",". A few queries permit the parameters MINimum, MAXimum and DEFault to be entered. For a description of the types of parameter, refer to Section "Parameters".

Example: SENSe:FREQuency:STOP? MAXimum Response: 3.5E9
This query requests the maximal value for the stop frequency.

Numeric suffix: If a device features several functions or features of the same kind, e.g. inputs, the desired function can be selected by a suffix added to the command. Entries without suffix are interpreted like entries with the suffix 1.

Example: SYSTem:COMMunicate:SERial2:BAUD 9600

This command sets the baudrate of a second serial interface.

Parameters

Most commands require a parameter to be specified. The parameters must be separated from the header by a "white space". Permissible parameters are numerical values, Boolean parameters, text, character strings and block data. The type of parameter required for the respective command and the permissible range of values are specified in the command description

Numerical values Numerical values can be entered in any form, i.e. with sign, decimal point and exponent. Values exceeding the resolution of the instrument are rounded up or down. The mantissa may comprise up to 255 characters, the exponent must lie inside the value range -32000 to 32000. The exponent is introduced by an "E" or "e". Entry of the exponent alone is not permissible. In the case of physical quantities, the unit can be entered. Permissible unit prefixes are G (giga), MA (mega), MOHM and MHZ (also permissible), K (kilo), M (milli), U (micro) and N (nano). If the unit is missing, the basic unit is used.

Example:

SENSe:FREQuency:STOP 1.5GHz = SENSe:FREQuency:STOP 1.5E9

Special numerical The texts MINimum, MAXimum, DEFault, UP and DOWN are interpreted as special numerical values.

In the case of a query, the numerical value is provided.

Example: Setting command: SENSe:FREQuency:STOP MAXimum

Query: SENSe:FREQuency:STOP? Response: 3.5E9

MIN/MAX MINimum and MAXimum denote the minimum and maximum value.

DEF DEFault denotes a preset value which has been stored in the EPROM. This value conforms to the default setting, as it is called by the *RST command

UP/DOWN UP, DOWN increases or reduces the numerical value by one step. The step width can be specified via an allocated step command (see annex C, List of Commands) for each parameter which can be set via UP, DOWN.

INF/NINF INFINITY, Negative INFINITY (NINF) Negative INFINITY (NINF) represent the numerical values -9.9E37 or 9.9E37, respectively. INF and NINF are only sent as device responses.

NAN Not A Number (NAN) represents the value 9.91E37. NAN is only sent as device response. This value is not defined. Possible causes are the division of zero by zero, the subtraction of infinite from infinite and the representation of missing values.

Boolean Parameters Boolean parameters represent two states. The ON state (logically true) is represented by ON or a numerical value unequal to 0. The OFF state (logically untrue) is represented by OFF or the numerical value 0. 0 or 1 is provided in a query.

Example: Setting command: DISPlay:WINDow:STATe ON

Query: DISPlay:WINDow:STATe? Response: 1

Text Text parameters observe the syntactic rules for key words, i.e. they can be entered using a short or long form. Like any parameter, they have to be separated from the header by a white space. In the case of a query, the short form of the text is provided.

Example: Setting command: INPut:COUPling GROund
 Query: INPut:COUPling? Response GRO

Strings Strings must always be entered in quotation marks (' or ").

Example: SYSTem:LANGUage "SCPI" or
 SYSTem:LANGUage 'SCPI'

Block data Block data are a transmission format which is suitable for the transmission of large amounts of data. A command using a block data parameter has the following structure:

Example: HEADer:HEADer #45168xxxxxxxx

ASCII character # introduces the data block. The next number indicates how many of the following digits describe the length of the data block. In the example the 4 following digits indicate the length to be 5168 bytes. The data bytes follow. During the transmission of these data bytes all End or other control signs are ignored until all bytes are transmitted.

Overview of Syntax Elements

The following survey offers an overview of the syntax elements.

- :** The colon separates the key words of a command. In a command line the colon after the separating semicolon marks the uppermost command level.
- ;** The semicolon separates two commands of a command line. It does not alter the path.
- ,** The comma separates several parameters of a command.
- ?** The question mark forms a query.
- *** The asterix marks a common command.
- "** Quotation marks introduce a string and terminate it.
- #** The double dagger (#) introduces block data
- A "white space (ASCII-Code 0 to 9, 11 to 32 decimal, e.g. blank) separates header and parameter.

Instrument Model and Command Processing

The instrument model shown in Fig. 5-2 has been made viewed from the standpoint of the servicing of IEC-bus commands. The individual components work independently of each other and simultaneously. They communicate by means of so-called "messages".

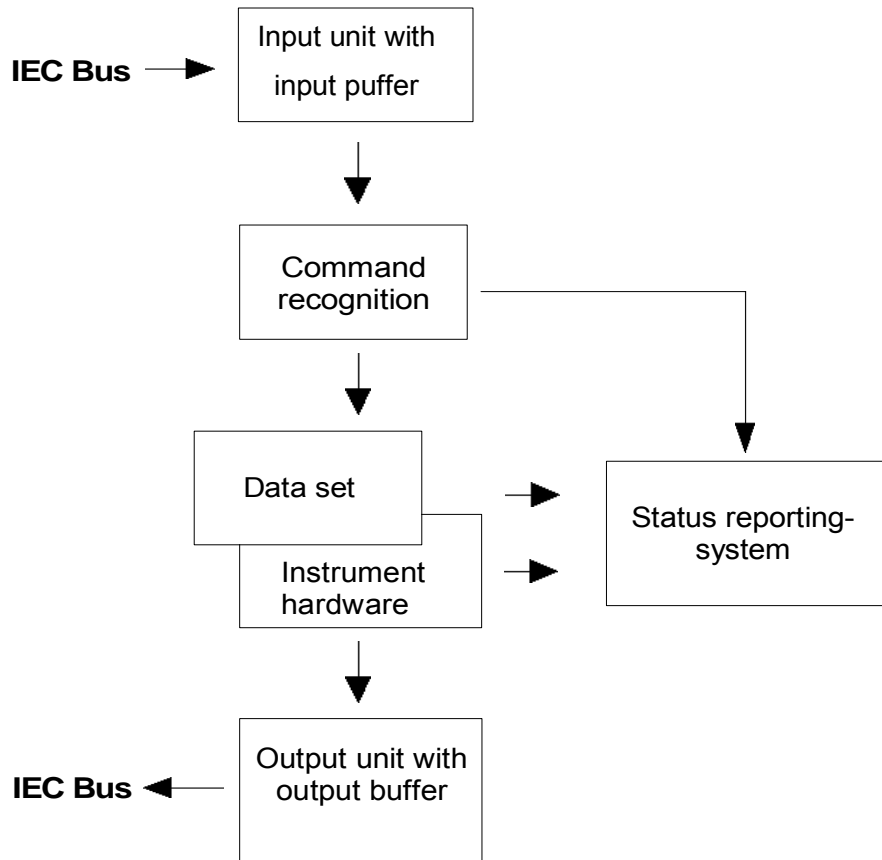

Fig. 5-2 Instrument model in the case of remote control by means of the IEC bus

Input Unit

The input unit receives commands character by character from the IEC bus and collects them in the input buffer. The input unit sends a message to the command recognition as soon as the input buffer is full or as soon as it receives a delimiter, <PROGRAM MESSAGE TERMINATOR>, as defined in IEEE 488.2, or the interface message DCL.

If the input buffer is full, the IEC-bus traffic is stopped and the data received up to then are processed. Subsequently the IEC-bus traffic is continued. If, however, the buffer is not yet full when receiving the delimiter, the input unit can already receive the next command during command recognition and execution. The receipt of a DCL clears the input buffer and immediately initiates a message to the command recognition.

Command Recognition

The command recognition analyses the data received from the input unit. It proceeds in the order in which it receives the data. Only a DCL is serviced with priority, a GET (Group Execute Trigger), e.g., is only executed after the commands received before as well. Each recognized command is immediately transferred to the instrument data base but without being executed there at once.

Syntactical errors in the command are recognized in the command recognition and supplied to the status reporting system. The rest of a command line after a syntax error is analysed further if possible and serviced.

If the command recognition recognizes a delimiter (<PROGRAM MESSAGE SEPARATOR> or <PROGRAM MESSAGE TERMINATOR>) or a DCL, it requests the instrument data base to set the commands in the instrument hardware as well now. Subsequently it is immediately prepared to process commands again. This means for the command servicing that further commands can already be serviced while the hardware is still being set ("overlapping execution").

Instrument Data Base and Instrument Hardware

Here the expression "instrument hardware" denotes the part of the instrument fulfilling the actual instrument function - signal generation, measurement etc. The controller is not included.

The instrument data base is a detailed reproduction of the instrument hardware in the software.

IEC-bus setting commands lead to an alteration in the data set. The data base management enters the new values (e.g. frequency) into the data base, however, only passes them on to the hardware when requested by the command recognition.

The data are only checked for their compatibility among each other and with the instrument hardware immediately before they are transmitted to the instrument hardware. If the detection is made that an execution is not possible, an "execution error" is signalled to the status reporting system. The alteration of the data base are cancelled, the instrument hardware is not reset.

IEC-bus queries induce the data base management to send the desired data to the output unit.

Status Reporting System

The status reporting system collects information on the instrument state and makes it available to the output unit on request. The exact structure and function are described in Section 3.8

Output Unit

The output unit collects the information requested by the controller, which it receives from the data base management. It processes it according to the SCPI rules and makes it available in the output buffer. If the instrument is addressed as a talker without the output buffer containing data or awaiting data from the data base management, the output unit sends error message "Query UNTERMINATED" to the status reporting system. No data are sent on the IEC bus, the controller waits until it has reached its time limit. This behaviour is specified by SCPI.

Command Sequence and Command Synchronization

What has been said above makes clear that all commands can potentially be carried out overlapping.

In order to prevent an overlapping execution of commands, one of commands *OPC, *OPC? or *WAI must be used. All three commands cause a certain action only to be carried out after the hardware has been set and has settled. By a suitable programming, the controller can be forced to wait for the respective action to occur (cf. Table 5-1).

Table 5-1 Synchronisation using *OPC, *OPC? and *WAI

Command	Action after the hardware has settled	Programming the controller
*OPC	Setting the operation-complete bit in the ESR	- Setting bit 0 in the ESE - Setting bit 5 in the SRE - Waiting for service request (SRQ)
*OPC?	Writing a "1" into the output buffer	Addressing the instrument as a talker
*WAI	Continuing the IEC-bus handshake	Sending the next command

An example as to command synchronization can be found in Chapter "Program Examples".

For a couple of commands the synchronization to the end of command execution is mandatory in order to obtain the desired result. The affected commands require either more than one measurement in order to accomplish the desired instrument setting (eg autorange functions), or they require a longer period of time for execution. If a new command is received during execution of the corresponding function this may either lead to either to an aborted measurement or to invalid measurement data.

The following list includes the commands, for which a synchronization via *OPC, *OPC? or *WAI is mandatory:

Table 5-1 Commands with mandatory synchronization (Overlapping Commands)

Command	Purpose
INIT	start measurement
INIT:CONM	continue measurement
CALC:MARK:FUNC:ZOOM	zoom frequency range around marker 1
CALC:STAT:SCAL:AUTO ONCE	optimize level settings for signal statistic measurement functions
[SENS:]POW:ACH:PRES:RLEV	optimize level settings for adjacent channel power measurements

Status Reporting System

The status reporting system (cf. Fig. 5-4) stores all information on the present operating state of the instrument, e.g. that the instrument presently carries out a calibration and on errors which have occurred. This information is stored in the status registers and in the error queue. The status registers and the error queue can be queried via IEC bus.

The information is of a hierarchical structure. The register status byte (STB) defined in IEEE 488.2 and its associated mask register service request enable (SRE) form the uppermost level. The STB receives its information from the standard event status register (ESR) which is also defined in IEEE 488.2 with the associated mask register standard event status enable (ESE) and registers STATUS:OPERation and STATUS:QUESTionable which are defined by SCPI and contain detailed information on the instrument.

The IST flag ("Individual STATUS") and the parallel poll enable register (PPE) allocated to it are also part of the status reporting system. The IST flag, like the SRQ, combines the entire instrument status in a single bit. The PPE fulfills the same function for the IST flag as the SRE for the service request.

The output buffer contains the messages the instrument returns to the controller. It is not part of the status reporting system but determines the value of the MAV bit in the STB and thus is represented in Fig. 5-4.

Structure of an SCPI Status Register

Each SCPI register consists of 5 parts which each have a width of 16 bits and have different functions (cf. Fig. 5-3). The individual bits are independent of each other, i.e. each hardware status is assigned a bit number which is valid for all five parts. For example, bit 3 of the STATUS:OPERation register is assigned to the hardware status "wait for trigger" in all five parts. Bit 15 (the most significant bit) is set to zero for all parts. Thus the contents of the register parts can be processed by the controller as positive integer.

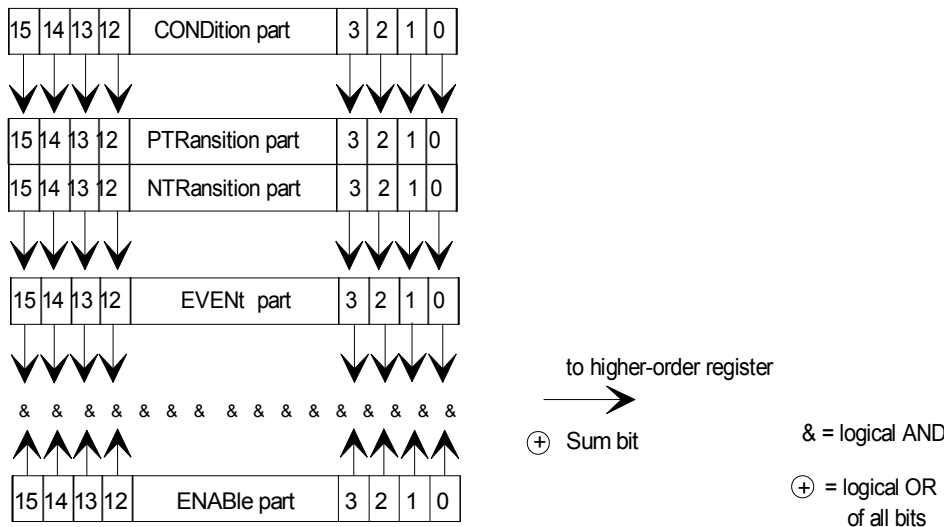

Fig. 5-3 The status-register model

CONDition part	The CONDition part is directly written into by the hardware or the sum bit of the next lower register. Its contents reflects the current instrument status. This register part can only be read, but not written into or cleared. Its contents is not affected by reading.
PTRansition part	The Positive-TRansition part acts as an edge detector. When a bit of the CONDition part is changed from 0 to 1, the associated PTR bit decides whether the EVENT bit is set to 1. PTR bit =1: the EVENT bit is set. PTR bit =0: the EVENT bit is not set. This part can be written into and read at will. Its contents is not affected by reading.
NTRansition part	The Negative-TRansition part also acts as an edge detector. When a bit of the CONDition part is changed from 1 to 0, the associated NTR bit decides whether the EVENT bit is set to 1. NTR-Bit = 1: the EVENT bit is set. NTR-Bit = 0: the EVENT bit is not set. This part can be written into and read at will. Its contents is not affected by reading. With these two edge register parts the user can define which state transition of the condition part (none, 0 to 1, 1 to 0 or both) is stored in the EVENT part.
EVENT part	The EVENT part indicates whether an event has occurred since the last reading, it is the "memory" of the condition part. It only indicates events passed on by the edge filters. It is permanently updated by the instrument. This part can only be read by the user. During reading, its contents is set to zero. In linguistic usage this part is often equated with the entire register.
ENABLE part	The ENABLE part determines whether the associated EVENT bit contributes to the sum bit (cf. below). Each bit of the EVENT part is ANDed with the associated ENABLE bit (symbol '&'). The results of all logical operations of this part are passed on to the sum bit via an OR function (symbol '+'). ENABLE-Bit = 0: the associated EVENT bit does not contribute to the sum bit ENABLE-Bit = 1: if the associated EVENT bit is "1", the sum bit is set to "1" as well. This part can be written into and read by the user at will. Its contents is not affected by reading.
Sum bit	As indicated above, the sum bit is obtained from the EVENT and ENABLE part for each register. The result is then entered into a bit of the CONDition part of the higher-order register. The instrument automatically generates the sum bit for each register. Thus an event, e.g. a PLL that has not locked, can lead to a service request throughout all levels of the hierarchy.

Note: *The service request enable register SRE defined in IEEE 488.2 can be taken as ENABLE part of the STB if the STB is structured according to SCPI. By analogy, the ESE can be taken as the ENABLE part of the ESR.*

Description of the Status Registers

Status Byte (STB) and Service Request Enable Register (SRE)

The STB is already defined in IEEE 488.2. It provides a rough overview of the instrument status by collecting the pieces of information of the lower registers. It can thus be compared with the CONDition part of an SCPI register and assumes the highest level within the SCPI hierarchy. A special feature is that bit 6 acts as the sum bit of the remaining bits of the status byte.

The STATUS BYTE is read out using the command "***STB?**" or a serial poll.

The STB implies the SRE. It corresponds to the ENABLE part of the SCPI registers as to its function. Each bit of the STB is assigned a bit in the SRE. Bit 6 of the SRE is ignored. If a bit is set in the SRE and the associated bit in the STB changes from 0 to 1, a Service Request (SRQ) is generated on the IEC bus, which triggers an interrupt in the controller if this is appropriately configured and can be further processed there.

The SRE can be set using command "***SRE**" and read using "***SRE?**".

Table 5-2 Meaning of the bits in the status byte

Bit No.	Meaning
2	<p>Error Queue not empty</p> <p>The bit is set when an entry is made in the error queue. If this bit is enabled by the SRE, each entry of the error queue generates a Service Request. Thus an error can be recognized and specified in greater detail by polling the error queue. The poll provides an informative error message. This procedure is to be recommended since it considerably reduces the problems involved with IEC-bus control.</p>
3	<p>QUESTIONable status sum bit</p> <p>The bit is set if an EVENT bit is set in the QUESTIONable: status register and the associated ENABLE bit is set to 1. A set bit indicates a questionable instrument status, which can be specified in greater detail by polling the QUESTIONable status register.</p>
4	<p>MAV bit (message available)</p> <p>The bit is set if a message is available in the output buffer which can be read. This bit can be used to enable data to be automatically read from the instrument to the controller (cf. Chapter 7, program examples).</p>
5	<p>ESB bit</p> <p>Sum bit of the event status register. It is set if one of the bits in the event status register is set and enabled in the event status enable register. Setting of this bit implies an error or an event which can be specified in greater detail by polling the event status register.</p>
6	<p>MSS bit (master status summary bit)</p> <p>The bit is set if the instrument triggers a service request. This is the case if one of the other bits of this registers is set together with its mask bit in the service request enable register SRE.</p>
7	<p>OPERation status register sum bit</p> <p>The bit is set if an EVENT bit is set in the OPERation-Status register and the associated ENABLE bit is set to 1. A set bit indicates that the instrument is just performing an action. The type of action can be determined by polling the OPERation-status register.</p>

IST Flag and Parallel Poll Enable Register (PPE)

By analogy with the SRQ, the IST flag combines the entire status information in a single bit. It can be queried by means of a parallel poll (cf. Section 3.8.4.3) or using command `"*IST?"`.

The parallel poll enable register (PPE) determines which bits of the STB contribute to the IST flag. The bits of the STB are ANDed with the corresponding bits of the PPE, with bit 6 being used as well in contrast to the SRE. The Ist flag results from the ORing of all results. The PPE can be set using commands `"*PRE"` and read using command `"*PRE?"`.

Event-Status Register (ESR) and Event-Status-Enable Register (ESE)

The ESR is already defined in IEEE 488.2. It can be compared with the EVENT part of an SCPI register. The event status register can be read out using command `"*ESR?"`.

The ESE is the associated ENABLE part. It can be set using command `"*ESE"` and read using command `"*ESE?"`.

Table 5-3 Meaning of the bits in the event status register

Bit No.	Meaning
0	Operation Complete This bit is set on receipt of the command <code>*OPC</code> exactly when all previous commands have been executed.
1	This bit is not used
2	Query Error This bit is set if either the controller wants to read data from the instrument without having send a query, or if it does not fetch requested data and sends new instructions to the instrument instead. The cause is often a query which is faulty and hence cannot be executed.
3	Device-dependent Error This bit is set if a device-dependent error occurs. An error message with a number between -300 and -399 or a positive error number, which denotes the error in greater detail, is entered into the error queue (cf. Chapter 9, Error Messages).
4	Execution Error This bit is set if a received command is syntactically correct, however, cannot be performed for other reasons. An error message with a number between -200 and -300, which denotes the error in greater detail, is entered into the error queue (cf. Chapter 9, Error Messages).
5	Command Error This bit is set if a command which is undefined or syntactically incorrect is received. An error message with a number between -100 and -200, which denotes the error in greater detail, is entered into the error queue (cf. Chapter 9 "Error Messages").
6	User Request This bit is set on pressing the <i>LOCAL</i> key.
7	Power On (supply voltage on) This bit is set on switching on the instrument.

Table 5-4 Meaning of bits in STATus:OPERation:PCALibration register

Bit No.	Meaning
0	UNCAL This bit is set if there is no valid Power Calibration.
1	CALibrated This bit is set if the measured power values are calibrated.
2	RECAL needed This bit is set if the measured power is not in a valid level range.
3	CAL ABS POWER active This bit is set if the the CAL ABS POWER function is has been activated.
4	Power Sensor Overload This bit is set if Power Sensor is currently overloaded.
5	No Sensor This bit is set if no Power Sensor could be detected.
6	RF Level out of Tolerance This bit is set if the measured power during the power calibration is not in the expected range.
7 to 14	not used
15	This bit is always 0.

STATus:OPERation Register

In the CONDition part, this register contains information on which actions the instrument is being executing or, in the EVENt part, information on which actions the instrument has executed since the last reading. It can be read using commands "STATus:OPERation:CONDition?" or "STATus:OPERation[:EVENT]?".

Table 5-5 Meaning of the bits in the STATus.OPERation register

Bit No.	Meaning
0	CALibrating This bit is set as long as the instrument is performing a calibration.
1 to 7	These bits are not used
8	HardCOPy in progress This bit is set while the instrument is printing a hardcopy.
9	This bit is not used
10	Sweep Break This bit is set when end of sweep range is reached (spurious measurement, mode analyzer). Command "INIT:CONM" has to be used to proceed.
11 to 14	These bits are not used
15	This bit is always 0

STATus:QUEStionable Register

This register comprises information about indefinite states which may occur if the unit is operated without meeting the specifications. It can be queried by commands `STATus:QUEStionable:CONDition?` and `STATus:QUEStionable[:EVENT]?`.

Table 5-6 Meaning of bits in STATus:QUEStionable register

Bit No.	Meaning
0 to 2	These bits are not used
3	POWer This bit is set if a questionable power occurs (cf. also section "STATus:QUEStionable:POWer Register")
4	TEMPerature This bit is set if a questionable temperature occurs.
5	FREQuency The bit is set if a frequency is questionable (cf. section "STATus:QUEStionable:FREQuency Register")
6 to 7	These bits are not used
8	CALibration The bit is set if a measurement is performed uncalibrated ($\hat{=}$ label "UNCAL")
9	LIMit (device-specific) This bit is set if a limit value is violated (see also section STATus:QUEStionable:LIMit Register)
10	LMARgin (device-specific) This bit is set if a margin is violated (see also section STATus:QUEStionable:LMARgin Register)
11	SYNC (device-dependent) This bit is set if, in measurements or premeasurements in GSM MS mode, synchronization to midamble fails or no burst is found. This bit is also set if, in premeasurements in GSM MS mode, the result differs too strongly from the expected value (see also "STATus:QUEStionable:SYNC Register").
12	ACPLimit (device-specific) This bit is set if a limit for the adjacent channel power measurement is violated (see also section "STATus:QUEStionable:ACPLimit Register")
13 to 14	These bits are not used
15	This bit is always 0.

STATus:QUEStionable:ACPLimit Register

This register comprises information about the observance of limits during adjacent power measurements. It can be queried with commands 'STATus:QUEStionable:ACPLimit:CONDition?' and 'STATus:QUEStionable:ACPLimit[:EVENT]?'

Table 5-7 Meaning of bits in STATus:QUEStionable:ACPLimit register

Bit No.	Meaning
0	ADJ UPPer FAIL(Screen A) This bit is set if in screen A. the limit is exceeded in the upper adjacent channel
1	ADJ LOWer FAIL (Screen A) This bit is set if in screen A the limit is exceeded in the lower adjacent channel.
2	ALT1 UPPer FAIL (Screen A) This bit is set if in screen A the limit is exceeded in the upper 1st alternate channel.
3	ALT1 LOWer FAIL (Screen A) This bit is set if in screen A the limit is exceeded in the lower 1st alternate channel.
4	ALT2 UPPer FAIL (Screen A) This bit is set if in screen A the limit is exceeded in the upper 2nd alternate channel.
5	ALT2 LOWer FAIL (Screen A) This bit is set if in screen A the limit is exceeded in the lower 2nd alternate channel.
6	ALT3 ... 11 LOWer/UPPer FAIL (Screen A) This bit is set if in screen A the limit is exceeded in one off the lower or upper alternate channel 3 ... 11
7	not used
8	ADJ UPPer FAIL (Screen B) This bit is set if in screen B the limit is exceeded in the upper adjacent channel.
9	ADJ LOWer FAIL (Screen B) This bit is set if in screen B the limit is exceeded in the lower adjacent channel.
10	ALT1 UPPer FAIL (Screen B) This bit is set if in screen B the limit is exceeded in the upper 1st alternate channel.
11	ALT1 LOWer FAIL (Screen B) This bit is set if in screen B the limit is exceeded in the lower 1st alternate channel.
12	ALT2 UPPer FAIL (Screen B) This bit is set if in screen B the limit is exceeded in the upper 2nd alternate channel.
13	ALT2 LOWer FAIL (Screen B) This bit is set if in screen B the limit is exceeded in the lower 2nd alternate channel.
14	ALT3 ... 11 LOWer/UPPer FAIL (Screen B) This bit is set if in screen B the limit is exceeded in one off the lower or upper alternate channel 3 ... 11
15	This bit is always set to 0.

STATUS:QUESTIONABLE:FREQUENCY Register

This register comprises information about the reference and local oscillator. It can be queried with commands `STATUS:QUESTIONABLE:FREQUENCY:CONDITION?` and `STATUS:QUESTIONABLE:FREQUENCY[:EVENT]?`.

Table 5-8 Meaning of bits in STATUS:QUESTIONABLE:FREQUENCY register

Bit No.	Meaning
0	OVEN COLD This bit is set if the reference oscillator has not yet attained its operating temperature. 'OCXO' will then be displayed.
1	LO UNLocked (Screen A) This bit is set if the local oscillator no longer locks. 'LOUNL' will then be displayed.
2 to 8	not used
9	LO UNLocked (Screen B) This bit is set if the local oscillator no longer locks. 'LOUNL' will then be displayed.
10 to 14	not used
15	This bit is always 0.

STATus:QUEStionable:LIMit<1|2> Register

This register comprises information about the observance of limit lines in the corresponding measurement window (LIMit 1 corresponds to Screen A, LIMit 2 to Screen B). It can be queried with commands `STATus:QUEStionable:LIMit<1|2>:CONDition?` and `STATus:QUEStionable:LIMit<1|2>[:EVENT]?`.

Table 5-9 Meaning of bits in STATus:QUEStionable:LIMit<1|2> register

Bit No.	Meaning
0	LIMit 1 FAIL This bit is set if limit line 1 is violated.
1	LIMit 2 FAIL This bit is set if limit line 2 is violated.
2	LIMit 3 FAIL This bit is set if limit line 3 is violated.
3	LIMit 4 FAIL This bit is set if limit line 4 is violated.
4	LIMit 5 FAIL This bit is set if limit line 5 is violated.
5	LIMit 6 FAIL This bit is set if limit line 6 is violated.
6	LIMit 7 FAIL This bit is set if limit line 7 is violated.
7	LIMit 8 FAIL This bit is set if limit line 8 is violated.
8 to 14	not used
15	This bit is always 0.

STATus:QUEStionable:LMARgin<1|2> Register

This register comprises information about the observance of limit margins in the corresponding measurement window (LMARgin1 corresponds to Screen A, LMARgin2 corresponds to Screen B). It can be queried with commands `STATus:QUEStionable:LMARgin<1|2>:CONDition?` and `"STATus :QUEStionable:LMARgin<1|2>[:EVENT]?"`.

Table 5-10 Meaning of bits in STATus:QUEStionable:LMARgin<1|2> register

Bit No.	Meaning
0	LMARgin 1 FAIL This bit is set if limit margin 1 is violated.
1	LMARgin 2 FAIL This bit is set if limit margin 2 is violated.
2	LMARgin 3 FAIL This bit is set if limit margin 3 is violated.
3	LMARgin 4 FAIL This bit is set if limit margin 4 is violated.
4	LMARgin 5 FAIL This bit is set if limit margin 5 is violated.
5	LMARgin 6 FAIL This bit is set if limit margin 1 is violated.
6	LMARgin 7 FAIL This bit is set if limit margin 7 is violated.
7	LMARgin 8 FAIL This bit is set if limit margin 8 is violated.
8 to 14	not used
15	This bit is always 0.

STATus:QUEStionable:POWer Register

This register comprises all information about possible overloads of the unit. It can be queried with commands `STATus:QUEStionable:POWer:CONDition?` and `"STATus:QUEStionable:POWer[:EVENT]?"`.

Table 5-11 Meaning of bits in STATus:QUEStionable:POWer register

Bit No.	Meaning
0	OVERload (Screen A) This bit is set if the RF input is overloaded. 'OVLD' will then be displayed.
1	UNDerload (Screen A) This bit is set if the RF input is underloaded. 'UNLD' will then be displayed.
2	IF_OVERload (Screen A) This bit is set if the IF path is overloaded. 'IFOVL' will then be displayed.
3 to 7	not used
8	OVERload (Screen B) This bit is set if the RF input is overloaded. 'OVLD' will then be displayed.
9	UNDerload (Screen B) This bit is set if the RF input is underloaded. 'UNLD' will then be displayed.
10	IF_OVERload (Screen B) This bit is set if the IF path is overloaded. 'IFOVL' will then be displayed.
11 to 14	not used
15	This bit is always 0.

STATus:QUEStionable:SYNC Register

This register is used only with GSM MS mode. It contains information about sync and bursts not found, and about premeasurement results exceeding or falling short of expected values.

The bits can be queried with commands "STATus:QUEStionable:SYNC:CONDition?" and "STATus:QUEStionable:SYNC[:EVENT]?".

Table 5-12 Meaning of bits in STATus:QUEStionable:SYNC register

Bit No.	Meaning
0	BURSt not found (screen A) This bit is set if no burst is found in the measurements/premeasurements for phase/frequency error (PFE) or carrier power versus time (PVT) in GSM MS mode. If a burst is found in these measurements/premeasurements, the bit is reset.
1	SYNC not found (screen A) This bit is set if the synchronization sequence (training sequence) of the midamble is not found in the measurements/premeasurements for phase/frequency error (PFE) or carrier power versus time (PVT) in GSM MS mode. If the synchronization sequence (training sequence) of the midamble is found in these measurements/premeasurements, the bit is reset.
2	No carrier (screen A) This bit is set if, in GSM MS mode, the level value determined in the premeasurements for carrier power versus time (PVT) and spectrum due to modulation is too low. The bit is reset at the beginning of the premeasurement (see also Chapter 2, description of the named premeasurements).
3	Carrier overload (screen A) This bit is set if, in GSM MS mode, the level value determined in the premeasurements for carrier versus time (PVT) and spectrum due to modulation is too high. The bit is reset at the beginning of the premeasurement (see also Chapter 2, description of the named premeasurements).
4-14	Not used.
15	This bit is always 0.

Application of the Status Reporting Systems

In order to be able to effectively use the status reporting system, the information contained there must be transmitted to the controller and further processed there. There are several methods which are represented in the following. Detailed program examples are to be found in chapter 7, Program Examples.

Service Request, Making Use of the Hierarchy Structure

Under certain circumstances, the instrument can send a service request (SRQ) to the controller. Usually this service request initiates an interrupt at the controller, to which the control program can react with corresponding actions. As evident from Fig. 5-4, an SRQ is always initiated if one or several of bits 2, 3, 4, 5 or 7 of the status byte are set and enabled in the SRE. Each of these bits combines the information of a further register, the error queue or the output buffer. The corresponding setting of the ENABLE parts of the status registers can achieve that arbitrary bits in an arbitrary status register initiate an SRQ. In order to make use of the possibilities of the service request, all bits should be set to "1" in enable registers SRE and ESE.

Examples (cf. Fig. 5-4 and chapter 7, Program Examples, as well):

Use of command "*OPC" to generate an SRQ at the end of a sweep.

- CALL IBWRT(analyzer%, "*ESE 1") Set bit 0 in the ESE (Operation Complete)
- CALL IBWRT(analyzer%, "*SRE 32") Set bit 5 in the SRE (ESB)?

After its settings have been completed, the instrument generates an SRQ.

The SRQ is the only possibility for the instrument to become active on its own. Each controller program should set the instrument in a way that a service request is initiated in the case of malfunction. The program should react appropriately to the service request. A detailed example for a service request routine is to be found in chapter 7, Program Examples.

Serial Poll

In a serial poll, just as with command "*STB", the status byte of an instrument is queried. However, the query is realized via interface messages and is thus clearly faster. The serial-poll method has already been defined in IEEE 488.1 and used to be the only standard possibility for different instruments to poll the status byte. The method also works with instruments which do not adhere to SCPI or IEEE 488.2.

The VISUAL BASIC command for executing a serial poll is "IBRSP()". Serial poll is mainly used to obtain a fast overview of the state of several instruments connected to the IEC bus.

Parallel Poll

In a parallel poll, up to eight instruments are simultaneously requested by the controller by means of a single command to transmit 1 bit of information each on the data lines, i.e., to set the data line allocated to each instrument to logically "0" or "1". By analogy to the SRE register which determines under which conditions an SRQ is generated, there is a parallel poll enable register (PPE) which is ANDed with the STB bit by bit as well considering bit 6. The results are ORed, the result is then sent (possibly inverted) as a response in the parallel poll of the controller. The result can also be queried without parallel poll by means of command `"*IST"`.

The instrument first has to be set for the parallel poll using quick-BASIC command `"IBPPC()"`. This command allocates a data line to the instrument and determines whether the response is to be inverted. The parallel poll itself is executed using `"IBRPP()"`.

The parallel-poll method is mainly used in order to quickly find out after an SRQ which instrument has sent the service request if there are many instruments connected to the IEC bus. To this effect, SRE and PPE must be set to the same value. A detailed example as to the parallel poll is to be found in chapter 7, Program Examples.

Query by Means of Commands

Each part of every status register can be read by means of queries. The individual commands are indicated in the detailed description of the registers in Section 3.8.3. What is returned is always a number which represents the bit pattern of the register queried. Evaluating this number is effected by the controller program.

Queries are usually used after an SRQ in order to obtain more detailed information on the cause of the SRQ.

Error-Queue Query

Each error state in the instrument leads to an entry in the error queue. The entries of the error queue are detailed plain-text error messages which can be looked at in the ERROR menu via manual control or queried via the IEC bus using command `"SYSTem:ERRor?"`. Each call of `"SYSTem:ERRor?"` provides an entry from the error queue. If no error messages are stored there any more, the instrument responds with 0, "No error".

The error queue should be queried after every SRQ in the controller program as the entries describe the cause of an error more precisely than the status registers. Especially in the test phase of a controller program the error queue should be queried regularly since faulty commands from the controller to the instrument are recorded there as well.

Resetting Values of the Status Reporting System

Table 5-13 comprises the different commands and events causing the status reporting system to be reset. None of the commands, except for *RST and SYSTem:PRESet influences the functional instrument settings. In particular, DCL does not change the instrument settings.

Table 5-13 Resetting instrument functions

Event	Switching on supply voltage		DCL,SDC (Device Clear, Selected Device Clear)	*RST or SYSTem:PRESet	STATus:PRESet	*CLS
	Power-On-Status-Clear					
	0	1				
Clear STB,ESR	—	yes	—	—	—	yes
Clear SRE,ESE	—	yes	—	—	—	—
Clear PPE	—	yes	—	—	—	—
Clear EVENTt parts of the registers	—	yes	—	—	—	yes
Clear Enable parts of all OPERation and QUEStionable registers, Fill Enable parts of all other registers with "1".	—	yes	—	—	yes	—
Fill PTRansition parts with "1", Clear NTRansition parts	—	yes	—	—	yes	—
Clear error queue	yes	yes	—	—	—	yes
Clear output buffer	yes	yes	yes	1)	1)	1)
Clear command processing and input buffer	yes	yes	yes	—	—	—

1) Every command being the first in a command line, i.e., immediately following a <PROGRAM MESSAGE TERMINATOR> clears the output buffer.

Contents - Chapter 6

"Remote Control - Description of Commands"

6 Remote Control - Description of Commands	6.1-1
Notation	6.1-1
Common Commands	6.1-4
ABORt Subsystem	6.1-8
CALCulate Subsystem	6.1-8
CALCulate:DELTa marker Subsystem.....	6.1-9
CALCulate:DLINe Subsystem	6.1-16
CALCulate:FEED Subsystem.....	6.1-17
CALCulate:FLINe Subsystem	6.1-18
CALCulate:FORMat Subsystem.....	6.1-19
CALCulate:LIMit Subsystem	6.1-20
CALCulate:LIMit:ACPower Subsystem	6.1-24
CALCulate:LIMit:CONTRol Subsystem	6.1-32
CALCulate:LIMit:LOWer Subsystem.....	6.1-34
CALCulate:LIMit:UPPer Subsystem.....	6.1-37
CALCulate:MARKer Subsystem.....	6.1-40
CALCulate:MARKer:FUNCTioN Subsystem.....	6.1-48
CALCulate:MARKer:FUNCTioN:ADEMod Subsystem	6.1-59
CALCulate:MARKer:FUNCTioN:HARMonics Subsystem.....	6.1-64
CALCulate:MARKer:FUNCTioN:POWer Subsystem.....	6.1-67
CALCulate:MARKer:FUNCTioN:STRack Subsystem.....	6.1-73
CALCulate:MARKer:FUNCTioN:SUMMary Subsystem.....	6.1-75
CALCulate:MATH Subsystem	6.1-83
CALCulate:PEAKsearch I PSEarch Subsystem.....	6.1-85
CALCulate:PMETER Subsystem	6.1-86
CALCulate:STATistics Subsystem.....	6.1-87
CALCulate:THReshold Subsystem	6.1-91
CALCulate:TLINe Subsystem	6.1-92
CALCulate:UNIT Subsystem.....	6.1-93
CALibration Subsystem	6.1-94
DIAGnostic Subsystem	6.1-96
DISPlay Subsystem	6.1-99
FETCH:PMETER - Subsystem	6.1-107
FORMat Subsystem	6.1-108
HCOPY Subsystem	6.1-109

INITiate Subsystem	6.1-114
INPut Subsystem	6.1-116
INSTRument Subsystem	6.1-120
MEMory - Subsystem	6.1-121
MMEMory Subsystem	6.1-122
OUTPut Subsystem	6.1-132
READ:PMETer Subsystem	6.1-133
SENSE Subsystem	6.1-134
[SENSe:]ADEMod - Subsystem	6.1-135
SENSe:AVERage Subsystem	6.1-149
SENSe:BANDwidth Subsystem	6.1-150
SENSe:CORRection Subsystem.....	6.1-155
SENSe:DETEctor Subsystem.....	6.1-162
SENSe:ESPECTrum Subsystem.....	6.1-164
SENSe:FILTer - Subsystem	6.1-171
SENSe:FREQuency Subsystem	6.1-173
SENSe:LIST Subsystem	6.1-177
SENSe:MPOWer Subsystem.....	6.1-186
SENSe:PMETer Subsystem.....	6.1-190
SENSe:POWer Subsystem.....	6.1-192
SENSe:ROSCillator Subsystem.....	6.1-199
SENSe:SWEep Subsystem	6.1-201
SENSe:VOLTage Subsystem	6.1-206
SOURce Subsystem	6.1-207
Internal Tracking Generator	6.1-207
SOURce:EXTernal Subsystem	6.1-210
STATus Subsystem	6.1-213
SYSTem Subsystem	6.1-220
TRACe Subsystem	6.1-233
General Trace Commands.....	6.1-234
Number and format of the measurement values for the different operating modes	6.1-236
TRACe:IQ Subsystem	6.1-237
TRIGger Subsystem	6.1-245
UNIT Subsystem	6.1-248
IEC/IEEE-Bus Commands of HP Models 856xE, 8566A/B, 8568A/B and 8594E	6.2-1
Introduction.....	6.2-1

Command Set of Models 8560E, 8561E, 8562E, 8563E, 8564E, 8565E, 8566A/B, 8568A/B,
8591E, 8594E, 1100C, 71200C, and 71209A 6.2-1

Special Features of the Syntax Parsing Algorithms for 8566A and 8568A Models 6.2-16

Special Behaviour of Commands 6.2-16

Model-Dependent Default Settings 6.2-18

Data Output Formats..... 6.2-18

Trace Data Output Formats 6.2-18

Trace Data Input Formats 6.2-19

IEC/IEEE-Bus Status Reporting 6.2-19

**Differences in GPIB behavior between the FSQ and the FSE families of
instruments** **6.3-1**

6 Remote Control - Description of Commands

Notation

In the following sections, all commands implemented in the instrument are first listed in tables and then described in detail, arranged according to the command subsystems. The notation is adapted to the SCPI standard. The SCPI conformity information is included in the individual description of the commands.

Table of Commands

- Command: In the command column, the table provides an overview of the commands and their hierarchical arrangement (see indentations).
- Parameter: The parameter column indicates the requested parameters together with their specified range.
- Unit: The unit column indicates the basic unit of the physical parameters.
- Comment: In the comment column an indication is made on:
 - whether the command does not have a query form,
 - whether the command has only one query form
 - whether the command is implemented only with a certain option of the instrument

Indentations

The different levels of the SCPI command hierarchy are represented in the table by means of indentations to the right. The lower the level, the further the indentation to the right. Please note that the complete notation of the command always includes the higher levels as well.

Example: `SENSe:FREQuency:CENTer` is represented in the table as follows:

<code>SENSe</code>	first level
<code>:FREQuency</code>	second level
<code>:CENTer</code>	third level

Individual description

The individual description contains the complete notation of the command. An example for each command, the *RST value and the SCPI information are included as well.

The operating modes for which a command can be used are indicated by the following abbreviations:

- A Spectrum analysis
- A-F Spectrum analysis - frequency domain only
- A-Z Spectrum analysis - time domain only (zero span)



The spectrum analysis (analyzer) mode is implemented in the basic unit. For the other modes, the corresponding options are required.

Upper/lower case notation Upper/lower case letters are used to mark the long or short form of the key words of a command in the description (see Chapter 5). The instrument itself does not distinguish between upper and lower case letters.

Special characters | A selection of key words with an identical effect exists for several commands. These keywords are indicated in the same line; they are separated by a vertical stroke. Only one of these keywords needs to be included in the header of the command. The effect of the command is independent of which of the keywords is used.

Example: `SENSe:FREQuency:CW|:FIXed`

The two following commands with identical meaning can be created. They set the frequency of the fixed frequency signal to 1 kHz:

`SENSe:FREQuency:CW 1E3 = SENSe:FREQuency:FIXed 1E3`

A vertical stroke in parameter indications marks alternative possibilities in the sense of "or". The effect of the command is different, depending on which parameter is used.

Example: Selection of the parameters for the command

`DISPlay:FORMat FULL | SPLit`

If parameter FULL is selected, full screen is displayed, in the case of SPLit, split screen is displayed.

[] Key words in square brackets can be omitted when composing the header (cf. Chapter 5, Optional Keywords). The full command length must be accepted by the instrument for reasons of compatibility with the SCPI standards.

Parameters in square brackets can be incorporated optionally in the command or omitted as well.

{ } Parameters in braces can be incorporated optionally in the command, either not at all, once or several times.

Description of parameters Due to the standardization, the parameter section of SCPI commands consists always of the same syntactical elements. SCPI has therefore specified a series of definitions, which are used in the tables of commands. In the tables, these established definitions are indicated in angled brackets (<...>) and will be briefly explained in the following (see also Chapter 5, Section "Parameters").

<Boolean> This keyword refers to parameters which can adopt two states, "on" and "off". The "off" state may either be indicated by the keyword **OFF** or by the numeric value 0, the "on" state is indicated by **ON** or any numeric value other than zero. Parameter queries are always returned the numeric value 0 or 1.

<numeric_value>
<num>

These keywords mark parameters which may be entered as numeric values or be set using specific keywords (character data).

The following keywords given below are permitted:

MINimum This keyword sets the parameter to the smallest possible value.

MAXimum This keyword sets the parameter to the largest possible value.

DEFault This keyword is used to reset the parameter to its default value.

UP This keyword increments the parameter value.

DOWN This keyword decrements the parameter value.

The numeric values associated to MAXimum/MINimum/DEFault can be queried by adding the corresponding keywords to the command. They must be entered following the quotation mark.

Example: `SENSe:FREQuency:CENTer? MAXimum`

returns the maximum possible numeric value of the center frequency as result.

<arbitrary block program data>

This keyword is provided for commands the parameters of which consist of a binary data block.

Common Commands

The common commands are taken from the IEEE 488.2 (IEC 625-2) standard. A particular command has the same effect on different devices. The headers of these commands consist of an asterisk "*" followed by three letters. Many common commands refer to the status reporting system which is described in detail in Chapter 5.

Command	Parameter	Function	Comment
*CAL?		Calibration Query	query only
*CLS		Clear Status	no query
*ESE	0 to 255	Event Status Enable	
*ESR?		Standard Event Status Query	query only
*IDN?		Identification Query	query only
*IST?		Individual Status Query	query only
*OPC		Operation Complete	
*OPT?		Option Identification Query	query only
*PCB	0 to 30	Pass Control Back	no query
*PRE	0 to 255	Parallel Poll Register Enable	
*PSC	0 1	Power On Status Clear	
*RST		Reset	no query
*SRE	0 to 255	Service Request Enable	
*STB?		Status Byte Query	query only
*TRG		Trigger	no query
*TST?		Self Test Query	query only
*WAI		Wait to continue	no query

***CAL?**

CALIBRATION QUERY initiates a calibration of the instrument and subsequently queries the calibration status. Any responses > 0 indicate errors.

***CLS**

CLEAR STATUS sets the status byte (STB), the standard event register (ESR) and the EVENT-part of the QUESTIONABLE and the OPERATION register to zero. The command does not alter the mask and transition parts of the registers. It clears the output buffer.

***ESE 0 to 255**

EVENT STATUS ENABLE sets the event status enable register to the value indicated. The query form *ESE? returns the contents of the event status enable register in decimal form.

***ESR?**

STANDARD EVENT STATUS QUERY returns the contents of the event status register in decimal form (0 to 255) and subsequently sets the register to zero.

***IDN?**

IDENTIFICATION QUERY queries the instrument identification.

Example: " Rohde&Schwarz, FSMR-3, 123456/789, 1.03"

FSMR-3 = Device name
123456/789 = Serial number of the instrument
1.03 = Firmware version number

***IST?**

INDIVIDUAL STATUS QUERY returns the contents of the IST flag in decimal form (0 | 1). The IST flag is the status bit which is sent during a parallel poll (cf. Chapter 5).

***OPC**

OPERATION COMPLETE sets bit 0 in the event status register when all preceding commands have been executed. This bit can be used to initiate a service request (cf. Chapter 5).

***OPC?**

OPERATION COMPLETE QUERY writes message "1" into the output buffer as soon as all preceding commands have been executed (cf. Chapter 5).

***PSC 0 | 1**

POWER ON STATUS CLEAR determines whether the contents of the ENABLE registers are preserved or reset during power-up.

*PSC = 0 causes the contents of the status registers to be preserved. Thus a service request can be generated when switching on the instrument, if the status registers ESE and SRE are suitably configured.

*PSC ≠ 0 'Resets the registers.

The query form *PSC? reads out the contents of the power-on-status-clear flag. The response can be 0 or 1.

***RST**

RESET sets the instrument to a defined default status. The command essentially corresponds to pressing the *PRESET* key. The default setting is indicated in the description of the commands.

***SRE 0 to 255**

SERVICE REQUEST ENABLE sets the service request enable register to the indicated value. Bit 6 (MSS mask bit) remains 0. This command determines under which conditions a service request is generated. The query form *SRE? reads the contents of the service request enable register in decimal form. Bit 6 is always 0.

***STB?**

READ STATUS BYTE QUERY reads out the contents of the status byte in decimal form.

***TRG**

TRIGGER initiates all actions in the currently active test screen expecting a trigger event. This command corresponds to `INITiate:IMMediate` (cf. Section "TRIGger Subsystem").

***TST?**

SELF TEST QUERY initiates the selftest of the instrument and outputs an error code in decimal form (0 = no error).

***WAI**

WAIT-to-CONTINUE permits servicing of subsequent commands only after all preceding commands have been executed and all signals have settled (cf. Chapter 5 and "**OPC" as well).

ABORt Subsystem

The ABORt subsystem contains the commands for aborting triggered actions. An action can be triggered again immediately after being aborted. All commands trigger events, and therefore they have no *RST value.

COMMAND	PARAMETERS	UNIT	COMMENT
ABORt	-- --	-- --	no query

ABORt

This command aborts a current measurement and resets the trigger system.

Example: "ABOR; INIT: IMM"

Characteristics: *RST value: 0
SCPI: conforming

Mode: A, GSM/EDGE, FM

CALCulate Subsystem

The CALCulate subsystem contains commands for converting instrument data, transforming and carrying out corrections. These functions are carried out subsequent to data acquisition, i.e. following the SENSE subsystem.

The numeric suffix is used in CALCulate to make the distinction between the two measurement windows SCREEN A and SCREEN B:

CALCulate1 = Screen A
CALCulate2 = Screen B.

For commands without suffix, screen A is selected automatically.

Full Screen The settings are valid for the measurement window selected with the numeric suffix. They become effective as soon as the corresponding measurement window has been selected as active measurement window using the command DISPLAY[:WINDow<1|2>]:SElect. Triggering measurements and querying measured values is possible only in the active measurement window.

Split Screen The settings are valid for the measurement window selected by means of the numeric suffix and become effective immediately.

CALCulate<1|2>:DELTamarker<1 to 4>:FUNCTION:FIXed:RPOint:MAXimum[:PEAK] <numeric_value>

This command sets the reference point level for all delta markers in the selected measurement window for a measurement with fixed reference point (CALC:DELT:FUNC:FIX:STAT ON) to the peak of the selected trace.

For phase-noise measurements (CALCulate:DELTamarker:FUNCTION:PNOise:STATE ON), the command defines a new reference point level for delta marker 2 in the selected measurement window.

Example: "CALC:DELT:FUNC:FIX:RPO:MAX"

Characteristics: *RST value: -
SCPI: device-specific

This command is an event and therefore has no *RST value and no query.

CALCulate<1|2>:DELTamarker<1 to 4>:FUNCTION:FIXed:RPOint:X <numeric_value>

This command defines a new reference frequency (span > 0) or time (span = 0) for all delta markers in the selected measurement window for a measurement with fixed reference value (CALCulate:DELTamarker:FUNCTION:FIXed:STATE ON).

For phase-noise measurements (CALCulate:DELTamarker:FUNCTION:PNOise:STATE ON), the command defines a new reference frequency or time for delta marker 2 in the selected measurement window.

Example: "CALC2:DELT:FUNC:FIX:RPO:X 128MHz" 'Sets the reference frequency in 'screen B to 128 MHz.

Characteristics: *RST value: - (FUNCTION:FIXed[:STATE] is set to OFF)
SCPI: device-specific

CALCulate<1|2>:DELTamarker<1 to 4>:FUNCTION:FIXed:RPOint:Y <numeric_value>

This command defines a new reference point level for all delta markers in the selected measurement window for a measurement with fixed reference point.

(CALCulate:DELTamarker:FUNCTION:FIXed:STATE ON).

For phase-noise measurements (CALCulate:DELTamarker:FUNCTION:PNOise:STATE ON), the command defines a new reference point level for delta marker 2 in the selected measurement window.

Example: "CALC:DELT:FUNC:FIX:RPO:Y -10dBm" 'Sets the reference point level for 'delta markers in screen A to -10 'dBm.

Characteristics: *RST value: - (FUNCTION:FIXed[:STATE] is set to OFF)
SCPI: device-specific

CALCulate<1|2>:DELTamarker<1 to 4>:FUNCTION:FIXed:RPOint:Y:OFFSet <numeric_value>

This command defines an additional level offset for the measurement with fixed reference value (CALCulate:DELTamarker:FUNCTION:FIXed:STATE ON). For this measurement, the offset is included in the display of all delta markers of the selected measurement window.

For phase-noise measurements (CALCulate:DELTamarker:FUNCTION:PNOise:STATE ON), the command defines an additional level offset which is included in the display of delta marker 2 in the selected measurement window.

Example: "CALC:DELT:FUNC:FIX:RPO:Y:OFFS 10dB" 'Sets the level offset for the measurement with fixed reference 'value or the phase-noise measurement in screen A to 10 dB.

Characteristics: *RST value: 0 dB
SCPI: device-specific

CALCulate<1|2>:DELTamarker<1 to 4>:FUNCTION:FIXed[:STATe] ON | OFF

This command switches the relative measurement to a fixed reference value on or off. Marker 1 will be activated previously and a peak search will be performed, if necessary. If marker 1 is activated, its position becomes the reference point for the measurement. The reference point can then be modified with commands `CALCulate:DELTamarker:FUNCTION:FIXed:RPOint:X` and `to :RPOint:Y` independently of the position of marker 1 and of a trace. It is valid for all delta markers in the selected measurement window as long as the function is active.

Example:

<code>"CALC2:DELT:FUNC:FIX ON"</code>	'Switches on the measurement with fixed 'reference value for all delta markers in 'screen B.
<code>"CALC2:DELT:FUNC:FIX:RPO:X 128 MHZ"</code>	'Sets the reference frequency 'in screen B to 128 MHz.
<code>"CALC2:DELT:FUNC:FIX:RPO:Y 30 DBM"</code>	'Sets the reference level in 'screen B to +30 dBm

Characteristics: *RST value: OFF
SCPI: device-specific.

CALCulate<1|2>:DELTamarker<1 to 4>:FUNCTION:PNOise:RESult?

This command queries the result of the phase-noise measurement in the selected measurement window. The measurement will be switched on, if necessary.

Example: `"CALC:DELT:FUNC:PNO:RES?"` 'Outputs the result of phase-noise 'measurement of the selected delta marker in 'screen A.

Characteristics: *RST value: -
SCPI: device-specific

This command is only a query and therefore has no *RST value.

CALCulate<1|2>:DELTamarker<1 to 4>:FUNCTION:PNOise[:STATe] ON | OFF

This command switches on or off the phase-noise measurement with all active delta markers in the selected measurement window. The correction values for the bandwidth and the log amplifier are taken into account in the measurement.

Marker 1 will be activated, if necessary, and a peak search will be performed. If marker 1 is activated, its position becomes the reference point for the measurement.

The reference point can then be modified with commands `CALCulate:DELTamarker :FUNCTION:FIXed:RPOint:X` and `...:RPOint:Y` independently of the position of marker 1 and of a trace (the same commands used for the measurement with fixed reference point).

The numeric suffix <1 to 4> with `DELTamarker` is not relevant for this command.

Example:

<code>"CALC:DELT:FUNC:PNO ON"</code>	'Switches on the phase-noise measurement 'with all delta markers in screen A.
<code>"CALC:DELT:FUNC:FIX:RPO:X 128 MHZ"</code>	'Sets the reference frequency 'to 128 MHz.
<code>"CALC:DELT:FUNC:FIX:RPO:Y 30 DBM"</code>	'Sets the reference level to '+30 dBm

Characteristics: *RST value: OFF
SCPI: device-specific

CALCulate<1|2>:DELTAmarker<1 to 4>:LINK ON | OFF

This command switches on and off the delta marker when delta marker 1 is selected. The corresponding marker becomes the delta marker when delta marker 2 to 4 is selected. If the corresponding marker is not activated, it will be activated and positioned on the maximum of the measurement curve. If no numeric suffix is indicated, delta marker 1 is selected automatically.

Example: "CALC:DELT3 ON" 'Switches marker 3 in screen A to delta marker mode.

Characteristics: *RST value: OFF
SCPI: device-specific

This command is an event and therefore has no *RST value and no query.

CALCulate<1|2>:DELTAmarker<1 to 4>:MAXimum:LEFT

This command positions the delta marker to the next smaller maximum value to the left of the current value (i.e. descending X values). The corresponding delta marker will be activated first, if necessary.

Example: "CALC:DELT:MAX:LEFT" 'Sets delta marker 1 in screen A to the next smaller 'maximum value to the left of the 'current value.

Characteristics: *RST value: -
SCPI: device-specific

CALCulate<1|2>:DELTAmarker<1 to 4>:MAXimum:NEXT

This command positions the delta marker to the next smaller maximum value on the measured curve. The corresponding delta marker will be activated first, if necessary.

Example: "CALC1:DELT2:MAX:NEXT" 'Sets delta marker 2 in screen A to the next 'smaller maximum value.

Characteristics: *RST value: -
SCPI: device-specific

This command is an event and therefore has no *RST value and no query.

CALCulate<1|2>:DELTAmarker<1 to 4>:MAXimum[:PEAK]

This command positions the delta marker to the current maximum value on the measured curve. If necessary, the corresponding delta marker will be activated first.

Example: "CALC2:DELT3:MAX" 'Sets delta marker 3 in screen B to the 'maximum value of the associated trace.

Characteristics: *RST value: -
SCPI: device-specific

CALCulate<1|2>:DELTAmarker<1 to 4>:MAXimum:RIGHT

This command positions the delta marker to the next smaller maximum value to the right of the current value (i.e. ascending X values). The corresponding delta marker is activated first, if necessary.

Example: "CALC2:DELT:MAX:RIGHT" 'Sets delta marker 1 in screen B to the next smaller' maximum value to the right of the 'current value.

Characteristics: *RST value: -
SCPI: device-specific

This command is an event and therefore has no *RST value and no query.

CALCulate<1|2>:DELTAmarker<1 to 4>:MINimum:LEFT

This command positions the delta marker to the next higher minimum value to the left of the current value (i.e. descending X values). The corresponding delta marker will be activated first, if necessary.

Example: "CALC:DELT:MIN:LEFT" 'Sets delta marker 1 in screen A to the next 'higher minimum to the left of the current 'value.

Characteristics: *RST value: -
SCPI: device-specific

This command is an event and therefore has no *RST value and no query.

CALCulate<1|2>:DELTAmarker<1 to 4>:MINimum:NEXT

This command positions the delta marker to the next higher minimum value of the measured curve. The corresponding delta marker will be activated first, if necessary.

Example: "CALC1:DELT2:MIN:NEXT" 'Sets delta marker 2 in screen A to the next higher minimum value.

Characteristics: *RST value: -
SCPI: device-specific

This command is an event and therefore has no *RST value and no query.

CALCulate<1|2>:DELTAmarker<1 to 4>:MINimum[:PEAK]

This command positions the delta marker to the current minimum value on the measured curve. The corresponding delta marker will be activated first, if necessary.

Example: "CALC2:DELT3:MIN" 'Sets delta marker 3 in screen B to the 'minimum value of the associated trace.

Characteristics: *RST value: -
SCPI: device-specific

This command is an event and therefore has no *RST value and no query.

CALCulate<1|2>:DELTAmarker<1 to 4>:MINimum:RIGHT

This command positions the delta marker to the next higher minimum value to the right of the current value (i.e. ascending X values). The corresponding delta marker will be activated first, if necessary.

Example: "CALC2:DELT:MIN:RIGH" 'Sets delta marker 1 in screen B to the next 'higher minimum value to the right of the current value.

Characteristics: *RST value: -
SCPI: device-specific

This command is an event and therefore has no *RST value and no query.

ALCulate<1|2>:DELTamarker<1 to 4>:MODE ABSolute | RELative

This command switches between relative and absolute frequency input of the delta marker (or time with span = 0). It affects all delta markers independent of the measurement window.

Example: "CALC:DELT:MODE ABS" 'Switches the frequency/time indication for all delta markers to absolute values.
"CALC:DELT:MODE REL" 'Switches the frequency/time indication for all delta markers to relative to marker 1.

Characteristics: *RST value: REL
SCPI: device-specific

CALCulate<1|2>:DELTamarker<1 to 4>[:STATe] ON | OFF

This command switches on and off the delta marker when delta marker 1 is selected. The corresponding marker becomes the delta marker when delta marker 2 to 4 is selected. If the corresponding marker is not activated, it will be activated and positioned on the maximum of the measurement curve. If no numeric suffix is indicated, delta marker 1 is selected automatically.

Example: "CALC:DELT3 ON" 'Switches marker 3 in screen A to delta marker mode.

Characteristics: *RST value: OFF
SCPI: device-specific

CALCulate<1|2>:DELTamarker<1 to 4>:TRACe 1 to 3

This command assigns the selected delta marker to the indicated measurement curve in the indicated measurement window. The selected measurement curve must be active, i.e. its state must be different from "BLANK".

Example: "CALC:DELT3:TRAC 2" 'Assigns deltamarker 3 to trace 2 in screen A.
"CALC:DELT:TRAC 3" 'Assigns deltamarker 1 to trace 3 in screen B.

Characteristics: *RST value: -
SCPI: device-specific

CALCulate<1|2>:DELTamarker<1 to 4>:X 0 to MAX (frequency | sweep time)

This command positions the selected delta marker in the indicated measurement window to the indicated frequency (span > 0), time (span = 0) or level (APD measurement = ON or CCDF measurement = ON). The input is in absolute values or relative to marker 1 depending on the command

CALCulate:DELTamarker:MODE. If Reference Fixed measurement

(CALCulate:DELTamarker:FUNCTion:FIXed:STATe ON) is active, relative values refer to the reference position are entered. The query always returns absolute values.

Example: "CALC:DELT:MOD REL" 'Switches the input for all delta markers to relative to marker 1.
"CALC:DELT2:X 10.7MHz" 'Positions delta marker 2 in screen A
'10.7 MHz to the right of marker 1.
"CALC2:DELT:X?" 'Outputs the absolute frequency/time of delta marker 1 in screen B
"CALC2:DELT:X:REL?" 'Outputs the relative frequency/time/level of delta marker 1 in screen B

Characteristics: *RST value: -
SCPI: device-specific

CALCulate<1|2>:DELTamarker<1 to 4>:X:RELative?

This command queries the frequency (span > 0) or time (span = 0) of the selected delta marker relative to marker 1 or to the reference position (for CALCulate:DELTamarker:FUNCTion:FIXed:STATe ON). The command activates the corresponding delta marker, if necessary.

Example: "CALC:DELT3:X:REL?" 'Outputs the frequency of delta marker 3 in 'screen B relative to marker 1 or relative to the 'reference position.

Characteristics: *RST value: -
SCPI: device-specific

CALCulate<1|2>:DELTamarker<1 to 4>:Y?

This command queries the measured value of the selected delta marker in the indicated measurement window. The corresponding delta marker will be activated, if necessary. The output is always a relative value referred to marker 1 or to the reference position (reference fixed active). To obtain a valid **query** result, a complete sweep with synchronization to the sweep end must be performed between the activation of the delta marker and the query of the y value. This is only possible in single sweep mode.

Depending on the unit defined with CALC:UNIT or on the activated measuring functions, the query result is output in the units below:

- DBM | DBPW | DBUV | DBMV | DBUA: Output unit DB
- WATT | VOLT | AMPere: Output unit W | V | A
- Statistics function (APD or CCDF) on: Dimensionless output
- FM result display: Hz
- PM result display: rad | deg
- AM result display: %
- RF POWER result display: dB (logarithmic display)
% (linear display)
- RF SPECTRUM result display: dB (logarithmic display)
% (linear display)
- AF SPECTRUM result display: dB (logarithmic display)
Hz | % | rad | deg (linear display)
- AUDIO result display: V
- AUDIO SPECTRUM result display: V

Example: "INIT:CONT OFF" ' Switches to single-sweep mode.
"CALC:DELT2 ON" ' Switches on delta marker 2 in screen A.
"INIT;*WAI" ' Starts a sweep and waits for its end.
"CALC:DELT2:Y?" ' Outputs the measured value of delta marker 2 in 'screen A..

Characteristics: *RST value: -
SCPI: device-specific

CALCulate:DLINe Subsystem

The CALCulate:DLINe subsystem controls the settings for the display lines. The measurement windows are selected by CALCulate 1 (screen A) or 2 (screen B).

Command	Parameter	Unit	Comment
CALCulate<1 2> :DLINe<1 2> :STATe	<numeric_value> <Boolean>	DBM DB DEG RAD S HZ PCT	

CALCulate<1|2>:DLINe<1|2> MINimum .. MAXimum (depending on current unit)

This command defines the position of Display Line 1 or 2. These lines enable the user to mark any levels in the diagram. The unit depends on the setting made with CALC:UNIT.

Example: "CALC:DLIN -20dBm"

Characteristics: *RST value: - (STATe to OFF)
SCPI: device-specific

CALCulate<1|2>:DLINe<1|2>:STATe ON | OFF

This command switches Display Line 1 or 2 (level lines) on or off.

Example: "CALC:DLIN2:STAT OFF"

Characteristics: *RST value: OFF
SCPI: device-specific

CALCulate:FEED Subsystem

The CALCulate:FEED subsystem selects the type of evaluation of the measured data. This corresponds to the selection of the Result Display in manual mode.

If the FM demodulator is active, the selection of the type of evaluation is independent of the measurement window. Therefore, the numeric suffix <1|2> is irrelevant and ignored.

Command	Parameter	Unit	Comment
CALCulate<1 2>: :FEED	<string>		no query

CALCulate<1|2>:FEED <string>

This command selects the type of results to be displayed. The numeric suffix selects screen 1 or screen 2 in the split screen mode. The screen assignment is fixed for the various types of results. For example, if an AM signal is displayed in time domain in screen 1 (top), the numeric AM values are automatically displayed in screen 2 (bottom).

Parameter:

<string>::=

'XTIM:RFPower:BARGraph'	Numeric output of carrier power and frequency error Screen 1: numeric output of measured values Screen 2: not possible
'XTIM:AM:RELative[:TDOMain]'	Demodulated AM signal Screen 1: graphic time-domain display Screen 2: numeric output of measured values
'XTIM:AM:RELative:AFSPectrum<1 to 3>'	AF spectrum of demodulated AM signal (normalized display) for trace 1, 2 or 3 Screen 1: graphic spectrum display Screen 2: not possible
'XTIM:FM[:TDOMain]'	Demodulated FM signal Screen 1: graphic time-domain display Screen 2: numeric output of measured values
'XTIM:FM:AFSPectrum<1 to 3>'	AF spectrum of demodulated FM signal for trace 1, 2 or 3 Screen 1: graphic spectrum display Screen 2: not possible
'XTIM:PM[:TDOMain]'	Demodulated PM signal Screen 1: graphic time-domain display Screen 2: numeric output of measured values
'XTIM:PM:AFSPectrum<1 to 3>'	AF spectrum of demodulated PM signal Screen 1: graphic spectrum display Screen 2: not possible
'XTIM:AC[:TDOMain]'	Audio signal in <i>AUDIO</i> mode Screen 1: graphic time-domain display Screen 2: not possible
'XTIM:AC:AFSPectrum<1 to 3>'	AF spectrum of audio signal in <i>AUDIO</i> mode Screen 1: graphic spectrum display Screen 2: not possible
'XTIM:SPECTrum'	RF spectrum of signal generated from measured data by means of an FFT Screen 1: graphic spectrum display Screen 2: not possible
'NONE'	RF spectrum in the receiver mode RF LEVEL switched off.

Example: "CALC:FEED 'XTIM:FM' " ' Selects display of the FM signal.

Characteristics: *RST value: 'XTIM:FM'
SCPI: conforming

CALCulate:FLINE Subsystem

The CALCulate:FLINE subsystem controls the settings for the frequency limit lines. The measurement windows are selected by CALCulate 1 (screen A) or 2 (screen B).

COMMAND	PARAMETERS	UNIT	COMMENT
CALCulate<1 2> :FLINE<1 2> :STATe	<numeric_value> <Boolean>	HZ	

CALCulate<1|2>:FLINE<1|2> 0...f_{max}

This command defines the position of the frequency lines.

The frequency lines mark the frequencies specified in the measurement window. Frequency lines are only available with SPAN > 0.

Example: "CALC:FLIN2 120MHz"

Characteristics: *RST value: - (STATe to OFF)
SCPI: device-specific

CALCulate<1|2>:FLINE<1|2>:STATe ON | OFF

This command switches the frequency line on or off.

Example: "CALC:FLIN2:STAT ON"

Characteristics: *RST value: OFF
SCPI: device-specific

CALCulate:FORMat Subsystem

The CALCulate:FORMat subsystem determines further processing and conversion of measured data. The measurement windows are assigned to CALCulate 1 (screen A) or 2 (screen B).

COMMAND	PARAMETERS	UNIT	COMMENT
CALCulate<1 2> :FORMat	PHASe UPHase	-	

CALCulate<1|2>:FORMat PHASe | UPHase

This command limits the display of the measured phase deviation to $\pm 180^\circ$.

Parameters: PHASe: Limitation of phase display to $\pm 180^\circ$.
 UPHase: No limitation of phase display (unwrapped).

Example: " :CALC:FORM PHAS" ' Activates limitation of the phase display to $\pm 180^\circ$.

Characteristics: *RST value: UPAS
 SCPI: conforming

CALCulate:LIMit Subsystem

The CALCulate:LIMit subsystem consists of the limit lines and the corresponding limit checks. Limit lines can be defined as upper or lower limit lines. The individual Y values of the limit lines correspond to the values of the X axis (CONTRol). The number of X and Y values must be identical.

8 limit lines can be active at the same time (marked by LIMIT1 to LIMIT8) in screen A and/or screen B. The measurement windows is selected via CALCulate 1 (screen A) or 2 (screen B).

The limit check can be switched on separately for each measurement screen and limit line. WINDow1 corresponds to screen A, WINDow2 to screen B.

Each limit line can be assigned a name (max. 8 letters) under which the line is stored in the instrument. An explanatory comment can also be given for each line (max. 40 characters).

Example (analyzer mode):

Definition and use of a new limit line 5 for trace 2 in screen A and trace 1 in screen B with the following features:

- upper limit line
- absolute X axis in the frequency domain
- 5 ref. values: 126 MHz/-40 dB, 127 MHz/-40 dB, 128 MHz/-20 dB, 129 MHz/-40 dB, 130 MHz/-40 dB
- relative Y axis with unit dB
- absolute threshold value at -35 dBm
- no safety margin

Definition of the line:

1. Defining the name: `CALC:LIM5:NAME 'TEST1'`
2. Entering the comment: `CALC:LIM5:COMM 'Upper limit line'`
3. Associated trace in screen A: `CALC1:LIM5:TRAC 2`
4. Associated trace in screen B: `CALC2:LIM5:TRAC 1`
5. Defining the X axis range: `CALC:LIM5:CONT:DOM FREQ`
6. Defining the X axis scaling: `CALC:LIM5:CONT:MODE ABS`
7. Defining the Y axis unit: `CALC:LIM5:UNIT DB`
8. Defining the Y axis scaling: `CALC:LIM5:UPP:MODE REL`
9. Defining the X axis values: `CALC:LIM5:CONT 126MHZ, 127MHZ, 128MHZ, 129 MHZ, 130MHZ`
10. Defining the y values: `CALC:LIM5:UPP -40, -40, -30, -40, -40`
11. Defining the y threshold value: `CALC:LIM5:UPP:THR -35DBM`

The definition of the safety margin and shifting in X and/or Y direction can take place as from here (see commands below).

Switching on and evaluating the line in screen A:

1. Switching on the line in screen A: `CALC1:LIM5:UPP:STAT ON`
2. Switching on the limit check in screen A: `CALC1:LIM5:STAT ON`
3. Starting a new measurement with synchronization: `INIT;*WAI`
4. Querying the limit check result: `CALC1:LIM5:FAIL?`

Switching on and evaluating the line in screen B is performed in the same way by using `CALC2` instead of `CALC1`.

COMMAND	PARAMETERS	UNIT	COMMENT
CALCulate<1 2> :LIMit<1 to 8> .ACTive? .CATalog? :CLEar [IMMEDIATE] :COPY :COMMent :DELeTe :FAIL? :NAME :STATe :TRACe :UNIT	1 to 8 < name> <string> DBM DBPW WATT DBUV DBMV VOLT DBUA AMPere DB DBUV_M DBUA_M DEG RAD S HZ PCT UNITLESS <string> <Boolean> <numeric_value>		query only no query query only

CALCulate<1|2>:LIMit<1...8>:ACTive?

This commands queries the names of all active limit lines. The numeric suffixes at CALCulate and LIMit are ignored. The list is sorted in alphabetic order. Any empty string is returned, if no limit line is active.

Example: "CALC:LIM:ACT?"
Characteristics: *RST value : -
 SCPI: device-specific

CALCulate:LIMit:CATalog?

This command reads out the names of all limit lines stored on the hard disk.

Example: "CALC:LIM:CAT?"
Feature: *RST value: -
 SCPI: device-specific

CALCulate<1|2>:LIMit<1 to 8>:CLEar[:IMMEDIATE]

This command deletes the result of the current limit check for all limit lines in the selected measurement window.

Example: "CALC:LIM:CLE" 'Deletes the result of the limit check in screen A
Characteristics: *RST value: -
 SCPI: conforming

This command is an event and therefore has no *RST value.

Example: "CALC:LIM1:NAME 'GSM1'" 'Assigns the name 'GSM1' to limit line 1.

Characteristics: *RST value: 'REM1' to 'REM8' for lines 1 to 8
SCPI: device-specific

CALCulate<1|2>:LIMit<1 to 8>:STATe ON | OFF

This command switches on or off the limit check for the selected limit line in the selected measurement window.

The result of the limit check can be queried with CALCulate:LIMit<1 to 8>:FAIL?.

Example: "CALC:LIM:STAT ON" 'Switches on the limit check for limit line 1 in 'screen A.
"CALC2:LIM:STAT OFF" 'Switches off the limit check for limit line 1 in 'screen B.

Characteristics: *RST value: OFF
SCPI: conforming

CALCulate<1|2>:LIMit<1 to 8>:TRACe 1 to 3

This command assigns a limit line to a trace in the indicated measurement window.

Examples: "CALC:LIM2:TRAC 3" 'Assigns limit line 2 to trace 3 in screen A.
"CALC2:LIM2:TRAC 1" 'Assigns limit line 2 to trace 1 in screen B at the same time.

Characteristics: *RST value: 1
SCPI: device-specific

CALCulate<1|2>:LIMit<1 to 8>:UNIT DBM | DBPW | WATT | DBUV | DBMV | VOLT | DBUA | AMPere | DB | DEG | RAD | S | HZ | PCT | UNITLESS

This command defines the unit of the selected limit line.

The definition is valid independently of the measurement window.

Upon selection of the unit DB the limit line is automatically switched to the relative mode. For units different from DB the limit line is automatically switched to absolute mode.

The units DEG, RAD, S, HZ, PCT are not available in *SPECTRUM* mode.

Example: "CALC:LIM4:UNIT DBUV" 'Sets the unit of limit line 4 to dB μ V.

Characteristics: *RST value: DBM
SCPI: device-specific

CALCulate:LIMit:ACPower Subsystem

The CALCulate:LIMit:ACPower subsystem defines the limit check for adjacent channel power measurement.

COMMAND	PARAMETERS	UNIT	COMMENT
CALCulate<1 2> LIMit<1 to 8> :ACPower :ACHannel :ABSolute :STATe [:RELative] :STATe :RESult? :ALTerminate<1 2> :ABSolute :STATe [:RELative] :STATe :RESult? [:STATe]	<numeric_value>, <numeric_value> <Boolean> <numeric_value>, <numeric_value> <Boolean> <numeric_value>, <numeric_value> <Boolean> <numeric_value>, <numeric_value> <Boolean> <Boolean>	DBM, DBM DB, DB DBM, DBM DB, DB query only query only	

CALCulate<1|2>:LIMit<1 to 8>:ACPower:ACHannel:ABSolute -200DBM to 200DBM,
-200DBM to 200DBM

This command defines the absolute limit value for the lower/upper adjacent channel during adjacent-channel power measurement (Adjacent Channel Power) in the selected measurement window. It should be noted that the absolute limit value has no effect on the limit check as soon as it is below the relative limit value defined with CALCulate:LIMit:ACPower:ACHannel:RELative. This mechanism allows automatic checking of the absolute basic values of adjacent channel power as defined in mobile radio standards.

The numeric suffixes <1 to 8> in LIMit are irrelevant for this command.

Parameter: The first value is the limit for the lower and the upper adjacent channel. The second limit value is ignored but must be indicated for reasons of compatibility with the FSE family.

Example: "CALC:LIM:ACP:ACH:ABS -35DBM, -35DBM"
'Sets the absolute limit value in 'screen A for the power in the lower 'and upper adjacent channel to '-35 dBm.

Characteristics: *RST value: -200DBM
SCPI: device-specific

CALCulate<1|2>:LIMit<1 to 8>:ACPower:ACHannel:ABSolute:STATe ON | OFF

This command activates the limit check for the adjacent channel when adjacent-channel power measurement (Adjacent Channel Power) is performed. Before the command, the limit check for the channel/adjacent-channel measurement must be globally switched on using CALC:LIM:ACP ON. The result can be queried with CALCulate:LIMit:ACPower:ACHannel:RESult?. It should be noted that a complete measurement must be performed between switching on the limit check and the result query, since otherwise no valid results are available.

The numeric suffixes <1 to 8> in LIMit are irrelevant for this command.

Example: "CALC:LIM:ACP:ACH 30DB, 30DB"
'Sets the relative limit value in screen A for 'the power in the lower and upper adjacent 'channel to 30 dB below the channel power.

"CALC:LIM:ACP:ACH:ABS -35DBM, -35DBM"	'Sets the absolute limit value in screen A 'for the power in the lower and upper 'adjacent channel to -35 dBm.
"CALC:LIM:ACP ON"	'Switches on globally the limit check for the 'channel/adjacent channel measurement in 'screen A.
"CALC:LIM:ACP:ACH:REL:STAT ON"	'Switches on the check of the relative limit 'values for adjacent channels in screen A.
"CALC:LIM:ACP:ACH:ABS:STAT ON"	'Switches on the check of absolute limit values 'for the adjacent channels in screen 'A.
"INIT;*WAI"	'Starts a new measurement and waits for 'the sweep end.
"CALC:LIM:ACP:ACH:RES?"	'Queries the limit check result in the 'adjacent channels in screen A.

Characteristics: *RST value: OFF
SCPI: device-specific

CALCulate<1|2>:LIMit<1 to 8>:ACPower:ACHannel[:RELative] 0 to 100dB, 0 to 100dB

This command defines the relative limit of the upper/lower adjacent channel for adjacent channel power measurements in the selected measurement window. The reference value for the relative limit value is the measured channel power.

It should be noted that the relative limit value has no effect on the limit check as soon as it is below the absolute limit value defined with `CALCulate:LIMit:ACPower:ACHannel:ABSolute`. This mechanism allows automatic checking of the absolute basic values of adjacent channel power as defined in mobile radio standards.

The numeric suffixes <1 to 8> are irrelevant for this command.

Parameter: The first numeric value is the limit for the upper (lower) adjacent channel. The second value is ignored but must be indicated for reasons of compatibility with the FSE family.

Example: "CALC:LIM:ACP:ACH 30DB, 30DB" 'Sets the relative limit value in
'screen A for the power in the lower
'and upper adjacent channel to
'30 dB below the channel power.

Characteristics: *RST value: 0 dB
SCPI: device-specific

CALCulate<1|2>:LIMit<1 to 8>:ACPpower:ACHannel[:RELative]:STATe ON | OFF

This command activates the limit check for the relative limit value of the adjacent channel when adjacent channel power measurement is performed. Before the command, the limit check must be activated using `CALCulate:LIMit:ACPpower:STATe ON`.

The result can be queried with `CALCulate:LIMit:ACPpower:ACHannel:RESult?`. It should be noted that a complete measurement must be performed between switching on the limit check and the result query, since otherwise no valid results are available.

The numeric suffixes <1 to 8> are irrelevant for this command.

Example:

```
"CALC:LIM:ACP:ACH 30DB, 30DB" 'Sets the relative limit value in screen A for
                               'the power in the lower and upper adjacent
                               'channel to 30 dB below the channel 'power.
"CALC:LIM:ACP:ACH:ABS -35DBM, -35DBM"
                               'Sets the absolute limit value in screen A
                               'for the power in the lower and upper
                               'adjacent channel to -35 dBm.
"CALC:LIM:ACP ON"
                               'Switches on globally the limit check for the
                               'channel/adjacent channel measurement in
                               'screen A.
"CALC:LIM:ACP:ACH:REL:STAT ON" 'Switches on the check of the relative limit
                               'values for adjacent channels in 'screen A.
"CALC:LIM:ACP:ACH:ABS:STAT ON" 'Switches on the check of absolute 'limit
                               'values for the adjacent channels in 'screen A.
"INIT;*WAI"
                               'Starts a new measurement and waits for
                               'the sweep end.
"CALC:LIM:ACP:ACH:RES?"
                               'Queries the limit check result in the
                               'adjacent channels in screen A.
```

Characteristics: *RST value: OFF
SCPI: device-specific

CALCulate<1|2>:LIMit<1 to 8>:ACPpower:ACHannel:RESult?

This command queries the result of the limit check for the upper/lower adjacent channel in the selected measurement window when adjacent channel power measurement is performed.

If the power measurement of the adjacent channel is switched off, the command produces a query error.

The numeric suffixes <1 to 8> are irrelevant for this command.

Parameter: The result is returned in the form <result>, <result> where <result> = PASSED | FAILED, and where the first returned value denotes the lower, the second denotes the upper adjacent channel.

Example:

```
"CALC:LIM:ACP:ACH 30DB, 30DB"
                               'Sets the relative limit value in screen A for the
                               'power in the lower and upper adjacent
                               'channel to 30 dB below the channel power.
"CALC:LIM:ACP:ACH:ABS -35DBM, -35DBM"
                               Sets the absolute limit value in screen A
                               'for the power in the lower and upper
                               'adjacent channel to -35 dB.
"CALC:LIM:ACP ON"
                               'Switches on globally the limit check for the
                               'channel/adjacent channel measurement in
                               'screen A.
"CALC:LIM:ACP:ACH:STAT ON" 'Switches on the limit check for the adjacent
                               'channels in screen A.
"INIT;*WAI"
                               'Starts a new measurement and waits for
                               'the 'sweep end.
```

"CALC:LIM:ACP:ACH:RES?" 'Queries the limit check result in the adjacent
'channels in screen A.

Characteristics: *RST value: --
SCPI: device-specific

This command is a query and therefore has no *RST value.

CALCulate<1|2>:LIMit<1 to 8>:ACPpower:ALternate<1 to 11>:ABSolute -200DBM to 200DBM,
-200DBM to .200DBM

This command defines the absolute limit value for the lower/upper alternate adjacent channel power measurement (Adjacent Channel Power) in the selected measurement window.

The numeric suffix after ALternate<1 to 11> denotes the alternate channel. The numeric suffixes <1 to 8> are irrelevant for this command.

It should be noted that the absolute limit value for the limit check has no effect as soon as it is below the relative limit value defined with CALCulate:LIMit:ACPpower:ALternate<1 to 11>:RELative. This mechanism allows automatic checking of the absolute basic values defined in mobile radio standards for the power in adjacent channels.

Parameter: The first value is the limit for the lower and the upper alternate adjacent channel. The second limit value is ignored but must be indicated for reasons of compatibility with the FSE family.

Example: "CALC:LIM:ACP:ALT2:ABS -35DBM, -35DBM"
'Sets the absolute limit value in
'screen A for the power in the lower
'and upper second alternate
'adjacent channel to -35 dBm.

Characteristics: *RST value: -200DBM
SCPI: device-specific

CALCulate<1|2>:LIMit<1 to 8>:ACPpower:ALternate<1 to 11>:ABSolute:STATe ON | OFF

This command activates the limit check for the alternate adjacent channels in the selected measurement window for adjacent channel power measurement (Adjacent Channel Power).

Before the command, the limit check must be globally switched on for the channel/adjacent channel power with the command `CALCulate:LIMit:ACPpower:STATe ON`.

The numeric suffix after `ALternate<1 to 11>` denotes the alternate channel. The numeric suffixes <1 to 8> are irrelevant for this command.

The result can be queried with `CALCulate:LIMit:ACPpower:ALternate<1 to 11>:RESult?`. It should be noted that a complete measurement must be performed between switching on the limit check and the result query, since otherwise no valid results are available.

Example:	" <code>CALC:LIM:ACP:ALT2 30DB, 30DB</code> "	'Sets the relative limit value in screen A for the power in the lower and upper second alternate adjacent channel to 30 dB below the channel power.'
	" <code>CALC:LIM:ACP:ALT2:ABS -35DBM, -35DBM</code> "	'Sets the absolute limit value in screen A for the power in the lower and upper second alternate adjacent channel to -35 dBm.'
	" <code>CALC:LIM:ACP ON</code> "	'Switches on globally the limit check for the channel/adjacent channel measurement in screen A.'
	" <code>CALC:LIM:ACP:ACH:REL:STAT ON</code> "	Switches on the check of the relative limit values for the alternative adjacent channels in screen A.'
	" <code>CALC:LIM:ACP:ACH:ABS:STAT ON</code> "	'Switches on the check of absolute limit values for the alternative adjacent channels in screen A.'
	" <code>INIT;*WAI</code> "	'Starts a new measurement and waits for the sweep end.'
	" <code>CALC:LIM:ACP:ACH:RES?</code> "	'Queries the limit check result in the second alternate adjacent channels in screen A.'

Characteristics: *RST value: OFF
SCPI: device-specific

CALCulate<1|2>:LIMit<1 to 8>:ACPower:ALTernate<1 to 11>[:RELative] 0 to 100dB, 0 to 100dB.

This command defines the limit for the alternate adjacent channels in the selected measurement window for adjacent channel power measurements. The reference value for the relative limit value is the measured channel power.

The numeric suffix after **ALTernate<1 to 11>** denotes the alternate channel. The numeric suffixes <1 to 8> are irrelevant for this command.

It should be noted that the relative limit value has no effect on the limit check as soon as it is below the absolute limit defined with **CALCulate:LIMit:ACPower:ALTernate<1 to 11>:ABSolute**. This mechanism allows automatic checking of the absolute basic values of adjacent channel power as defined in mobile radio standards.

Parameter: The first value is the limit for the lower and the upper alternate adjacent channel. The second limit value is ignored but must be indicated for reasons of compatibility with the FSE family.

Example: "CALC:LIM:ACP:ALT2 30DB, 30DB" 'Sets the relative limit value in 'screen A for the power in the lower 'and upper alternate adjacent 'channel to 30 dB below the channel 'power.

Characteristics: *RST value: 0DB
SCPI: device-specific

CALCulate<1|2>:LIMit<1 to 8>:ACPpower:ALternate<1 to 11>[:RELative]:STATe ON | OFF

This command activates the limit check for the alternate adjacent channels in the selected measurement window for adjacent channel power measurements. Before the command, the limit check must be activated using `CALCulate:LIMit:ACPpower:STATe ON`.

The numeric suffix after `ALternate<1 to 11>` denotes the alternate channel. The numeric suffixes <1 to 8> are irrelevant for this command.

The result can be queried with `CALCulate:LIMit:ACPpower:ALternate<1 to 11>:RESult?`. It should be noted that a complete measurement must be performed between switching on the limit check and the result query, since otherwise no valid results are obtained.

Example:

<code>"CALC:LIM:ACP:ALT2 30DB, 30DB"</code>	'Sets the relative limit value in screen A for the power in the lower and upper second alternate adjacent channel to 30 dB below the channel power.'
<code>"CALC:LIM:ACP:ALT2:ABS -35DBM, -35DBM"</code>	'Sets the absolute limit value in screen A for the power in the lower and upper second alternate adjacent channel to -35 dBm.'
<code>"CALC:LIM:ACP ON"</code>	'Switches on globally the limit check for the channel/adjacent channel measurement in screen A.'
<code>"CALC:LIM:ACP:ACH:REL:STAT ON"</code>	'Switches on the check of the relative limit values for the alternate adjacent channels in screen A.'
<code>"CALC:LIM:ACP:ACH:ABS:STAT ON"</code>	'Switches on the check of absolute limit values for the alternate adjacent channels in screen A.'
<code>"INIT;*WAI"</code>	'Starts a new measurement and waits for the sweep end.'
<code>"CALC:LIM:ACP:ACH:RES?"</code>	'Queries the limit check result in the second alternate adjacent channels in screen A.'

Characteristics:

*RST value:	OFF
SCPI:	device-specific

CALCulate<1|2>:LIMit<1 to 8>:ACPpower:ALternate<1 to 11>:RESult?

This command queries the result of the limit check for the alternate adjacent channels in the selected measurement window for adjacent channel power measurements.

The numeric suffix after `ALternate<1 to 11>` denotes the alternate channel. The numeric suffixes `<1 to 8>` are irrelevant for this command.

If the power measurement of the adjacent channel is switched off, the command produces a query error.

Parameter: The result is returned in the form `<result>`, `<result>` where `<result>` = PASSED | FAILED and where the first (second) returned value denotes the lower (upper) alternate adjacent channel.

Example:

<code>"CALC:LIM:ACP:ALT2 30DB, 30DB"</code>	'Sets the relative limit value in screen A for the power in the lower and upper second alternate adjacent channel to 30 dB below the channel power.'
<code>"CALC:LIM:ACP:ALT2:ABS -35DBM, -35DBM"</code>	'Sets the absolute limit value in screen A for the power in the lower and upper second alternate adjacent channel to -35 dBm.'
<code>"CALC:LIM:ACP ON"</code>	'Switches on globally the limit check for the channel/adjacent channel measurement in screen A.'
<code>"CALC:LIM:ACP:ALT:STAT ON"</code>	'Switches on the limit check for the adjacent channels in screen A.'
<code>"INIT;*WAI"</code>	'Starts a new measurement and waits for the sweep end.'
<code>"CALC:LIM:ACP:ALT:RES?"</code>	'Queries the limit check result in the second alternate adjacent channels in screen A.'

Characteristics: *RST value: --
SCPI: device-specific

This command is a query and therefore has no *RST value.

CALCulate<1|2>:LIMit<1 to 8>:ACPpower[:STATe] ON | OFF

This command switches on and off the limit check for adjacent channel power measurements in the selected measurement window. The commands `CALCulate:LIMit:ACPpower:ACHannel:STATe` or `CALCulate:LIMit:ACPpower:ALternate:STATe` must be used in addition to specify whether the limit check is to be performed for the upper/lower adjacent channel or for the alternate adjacent channels. The numeric suffixes `<1 to 8>` are irrelevant for this command.

Example: `"CALC:LIM:ACP ON"` 'Switches on the ACP limit check in screen A.'

Characteristics: *RST value: OFF
SCPI: device-specific

CALCulate:LIMit:CONTRol Subsystem

The CALCulate:LIMit:CONTRol subsystem defines the x axis (CONTRol-axis).

COMMAND	PARAMETERS	UNIT	COMMENT
CALCulate<1 2> :LIMit<1...8> :CONTRol [:DATA] :DOMain :MODE :OFFSet :SHIFt :SPACing	<numeric_value>,<numeric_value>.. FREQUency TIME RELative ABSolute <numeric_value> <numeric_value> LINear LOGarithmic	HZ S HZ S HZ S	

CALCulate<1|2>:LIMit<1 to 8>:CONTRol[:DATA] <numeric_value>,<numeric_value>..

This command defines the X axis values (frequencies or times) of the upper or lower limit lines. The values are defined independently of the measurement window.

Example: "CALC:LIM2:CONT 1MHz,30MHz,100MHz, 300MHz,1GHz" 'Defines 5 reference values for the X axis of 'limit line 2
"CALC:LIM2:CONT?" 'Outputs the reference values for the X axis of 'limit line 2 separated by a comma.

Characteristics: *RST value: - (LIMit:STATe is set to OFF)
SCPI: conforming

CALCulate<1|2>:LIMit<1 to 8>:CONTRol:DOMain FREQUency | TIME

This command defines the frequency or time domain for the x axis values.

Example: "CALC:LIM2:CONT:DOM TIME" 'Defines the time domain for the X axis of limit 'line 2.

Characteristics: *RST value: FREQUency
SCPI: device-specific

CALCulate<1|2>:LIMit<1 to 8>:CONTRol:MODE RELative | ABSolute

This command selects the relative or absolute scaling for the X axis of the selected limit line. The definition is independent of the measurement window.

Example: "CALC:LIM2:CONT:MODE REL" 'Defines the X axis of limit line 2 as relatively 'scaled.

Characteristics: *RST value: ABSolute
SCPI: device-specific

CALCulate<1|2>:LIMit<1 to 8>:CONTRol:OFFSet <numeric_value>

This command defines an offset for the X axis value of the selected relative limit line in the frequency or time domain.

The unit of values depends on the frequency or time domain of the X axis, i.e. it is HZ with `CALC:LIM:CONT:DOM FREQ` and S with `CALC:LIM:CONT:DOM TIME`.

Example: `"CALC:LIM2:CONT:OFFS 100us"` 'Sets the X offset for limit line 2 (defined in 'the time domain) to 100µs.

Characteristics: *RST value: 0
SCPI: device-specific

CALCulate<1|2>:LIMit<1 to 8>:CONTRol:SHIFt <numeric_value>

This command moves a limit line by the indicated value in x direction. In contrast to `CALC:LIM:CONT:OFFS`, the line is shifted by modifying the individual x values and not by means of an additive offset. The shift is independent of the measurement window.

Example: `"CALC:LIM2:CONT:SHIF 50KHZ"` 'Shifts all reference values of limit line 2 by '50 kHz.

Characteristics: *RST value: --
SCPI: device-specific

This command is an event and therefore has no *RST value and no query.

CALCulate<1|2>:LIMit<1 to 8>:CONTRol:SPACing LINear | LOGarithmic

This command selects linear or logarithmic interpolation for the calculation of limit lines from frequency points.

Example: `"CALC:LIM:CONT:SPAC LIN"`

Characteristics: *RST value: LIN
SCPI: device-specific

CALCulate:LIMit:LOWer Subsystem

The CALCulate:LIMit:LOWer subsystem defines the lower limit line. This subsystem is not available in receiver mode.

COMMAND	PARAMETERS	UNIT	COMMENT
CALCulate<1 2> :LIMit<1 to 8> :LOWer [:DATA]	<numeric_value>,<numeric_value>..	DBM DB DEG RAD S HZ PCT	
:MARGin	umeric_value>	DB DEG RAD S HZ PCT	
:MODE	RELative ABSolute		
:OFFSet	<n<numeric_value>	DB DEG RAD S HZ PCT	
:SHIFt	<numeric_value>		
:SPACing	LINear LOGarithmic	DB DEG RAD S HZ PCT	
:STATe	<Boolean>		
:THReshold	<numeric_value>	DBM DB DEG RAD S HZ PCT	

CALCulate<1|2>:LIMit<1 to 8>:LOWer[:DATA] <numeric_value>,<numeric_value>..

This command defines the values for the selected lower limit line independently of the measurement window.

The unit must be identical with the unit selected by CALC:LIM:UNIT. If no unit is indicated, the unit defined with CALC:LIM:UNIT is automatically used.

If the measured values are smaller than the LOWER limit line, the limit check signals errors.

The units DEG, RAD, S, HZ, PCT are not available in the SPECTRUM mode.

Example: "CALC:LIM2:LOW -30,-40,-10,-40,-30" 'Defines 5 lower limit values for limit line 2 in 'the preset unit.
"CALC:LIM2:LOW?" 'Outputs the lower limit values of limit line 2 'separated by a comma.

Characteristics: *RST value: - (LIMit:STATe is set to OFF)
SCPI: conforming

CALCulate<1|2>:LIMit<1 to 8>:LOWer:MARGin <numeric_value>

This command defines a margin to a lower limit line, at which out-of-limit values are signaled (if the limit check is active), but not handled as a violation of the limit value. The margin is independent of the measurement window.

Example: "CALC:LIM:LOW:MARG 10dB"

Characteristics: *RST value: 0
SCPI: device-specific

CALCulate<1|2>:LIMit<1 to 8>:LOWer:MODE RELative | ABSolute

This command selects the relative or absolute scaling for the Y axis of the selected lower limit line. The setting is independent of the measurement window.

Selecting RELative causes the unit to be switched to DB.

Example: "CALC:LIM:LOW:MODE REL" 'Defines the Y axis of limit line 2 as relative
'scaled.

Characteristics: *RST value: ABSolute
SCPI: device-specific

CALCulate<1|2>:LIMit<1 to 8>:LOWer:OFFSet <numeric_value>

This command defines an offset for the Y axis of the selected relative lower limit line. In contrast to CALC:LIM:LOW:SHIFT, the line is not shifted by modifying the individual Y values but by means of an additive offset. The offset is independent of the measurement window.

Example: "CALC:LIM2:LOW:OFFS 3dB" 'Shifts limit line 2 in the corresponding
'measurement windows by 3 dB upwards.

Characteristics: *RST value: 0
SCPI: device-specific

Mode: A, GSM/EDGE, FM

CALCulate<1|2>:LIMit<1 to 8>:UPPer:MARGin <numeric_value>

This command defines a margin to an upper limit line, at which out-of-limit values are signaled (if the limit check is active), but not handled as a violation of the limit value. The margin is independent of the measurement window.

Example: "CALC:LIM2:UPP:MARG 10dB" 'Defines the margin of limit line 2 to 10 dB
'below the limit value.

Characteristics: *RST value: 0
SCPI: device-specific

CALCulate<1|2>:LIMit<1 to 8>:UPPer:MODE RELative | ABSolute

This command selects the relative or absolute scaling for the Y axis of the selected upper limit line. The setting is independent of the measurement window.

Selecting RELative causes the unit to be switched to DB.

Example: "CALC:LIM2:UPP:MODE REL" 'Defines the Y axis of limit line 2 as relative
'scaled.

Characteristics: *RST value: ABSolute
SCPI: device-specific

CALCulate<1|2>:LIMit<1 to 8>:UPPer:OFFSet <numeric_value>

This command defines an offset for the Y axis of the selected relative upper limit line. In contrast to CALC:LIM:UPP:SHIFt, the line is not shifted by modifying the individual Y values but by means of an additive offset. The offset is independent of the measurement window.

Example: "CALC:LIM2:UPP:OFFS 3dB" 'Shifts limit line 2 by 3 dB upwards in the
'corresponding measurement windows.

Characteristics: *RST value: 0
SCPI: device-specific

CALCulate<1|2>:LIMit<1 to 8>:UPPer:SHIFt <numeric_value>

This command moves a limit line by the indicated value in Y direction. In contrast to CALC:LIM:UPP:OFFS, the line is shifted by modifying the individual Y values and not by means of an additive offset. The shift is independent of the measurement window.

Example: "CALC:LIM3:UPP:SHIF 20DB" 'Shifts all Y values of limit line 3 by 20 dB.

Characteristics: *RST value: --
SCPI: device-specific

This command is an event and therefore has no *RST value and no query.

CALCulate<1|2>:LIMit<1 to 8>:UPPer:SPACing LINear | LOGarithmic

This command selects linear or logarithmic interpolation for the upper limit line.

Example: "CALC:LIM:UPP:SPAC LIN"

Characteristics: *RST value: LIN
SCPI: device-specific

CALCulate<1|2>:LIMit<1 to 8>:UPPer:STATe ON | OFF

This command switches on or off the indicated limit line in the selected measurement window. The limit check is activated separately with `CALC:LIM:STAT ON`.

Example: `"CALC1:LIM4:UPP:STAT ON"` 'Switches on limit line 4 (upper limit) in 'screen A.

`"CALC2:LIM4:UPP:STAT ON"` 'Switches on limit line 4 (upper limit) in 'screen B.

Characteristics: *RST value: OFF
 SCPI: conforming

CALCulate<1|2>:LIMit<1 to 8>:UPPer:THReshold <numeric_value>

This command defines an absolute threshold value for limit lines with relative Y axis scaling independently of the measurement window. The absolute threshold value is used in the limit check as soon as it exceeds the relative limit value.

The unit must correspond to the unit selected with `CALC:LIM:UNIT` (except dB which is not possible). If no unit is indicated, the unit defined with `CALC:LIM:UNIT` is automatically used (exception: dBm instead of dB).

The units DEG, RAD, S, HZ, PCT are not available in the *SPECTRUM* mode.

Example: `"CALC:LIM2:UPP:THR -35DBM"` 'Defines an absolute threshold value 'for limit line 2.

Characteristics: *RST value: -200 dBm
 SCPI: device-specific

CALCulate:MARKer Subsystem

The CALCulate:MARKer subsystem checks the marker functions in the instrument. The measurement windows are assigned to CALCulate 1 (screen A) or 2 (screen B).

COMMAND	PARAMETERS	UNIT	COMMENT
CALCulate<1 2>			
:MARKer<1 to 4>			
:AOFF	<Boolean>		no query
:COUNT	<Boolean>		
:FREQuency?			query only
:RESolution	<numeric_value>	HZ	
:LOEXclude	<Boolean>		
:MAXimum			
:AUTO	<Boolean>		
:LEFT			no query
:NEXT			no query
[:PEAK]			no query
:RIGHT			no query
:MINimum			
:AUTO	<Boolean>		
:LEFT			no query
:NEXT			no query
[:PEAK]			no query
:RIGHT			no query
:PEXCursion	<numeric_value>	DB DEG RAD HZ PCT	
[:STATe]			
:TRACe	<numeric_value>		
:X?	<numeric_value>	HZ S DBM DB	
:SLIMits			
:LEFT	<numeric_value>	HZ S	
:RIGHT	<numeric_value>	HZ S	
[:STATe]	<Boolean>		
:SSIZe	STANdard POINTs		
:Y?	--	--	query only
:PERCent	<numeric_value>	PCT	

CALCulate<1|2>:MARKer<1 to 4>:AOFF

This command switches off all active markers in the selected measurement window. All delta markers and active marker/delta marker measurement functions are switched off.

Example: "CALC:MARK:AOFF" Switches off all markers in screen A.

Characteristics: *RST value: -
SCPI: device-specific

This command is an event and therefore has no *RST value and no query.

CALCulate<1|2>:MARKer<1 to 4>:COUNT ON | OFF

This command switches on or off the frequency counter at the marker position in the selected measurement window. The count result is queried with

CALCulate:MARKer:COUNT:FREQuency?.

Frequency counting is possible only for one marker at a time for each measurement window. If it is activated for another marker, it is automatically de-activated for the previous marker.

It should be noted that a complete sweep must be performed after switching on the frequency counter to ensure that the frequency to be measured is actually reached. The synchronization to the sweep end required for this is possible only in single-sweep mode.

This command is not available for GSM/EDGE measurements modulation accuracy (MAC), phase/frequency error (PFE) and power versus time (PVT).

Example:

"INIT:CONT OFF"	'Switches to single-sweep mode.
"CALC:MARK ON"	'Switches on marker 1 in screen A.
"CALC:MARK:COUN ON"	'Switches on the frequency counter for marker 1.
"INIT;*WAI"	'Starts a sweep and waits for the end.
"CALC:MARK:COUN:FREQ?"	'Outputs the measured value in screen A.

Characteristics: *RST value: OFF
SCPI: device-specific

CALCulate<1|2>:MARKer:COUNT:FREQuency?

This command queries the result of the frequency counter for the indicated marker in the selected measurement window. Before the command, the frequency counter should be switched on and a complete measurement performed to obtain a valid count result. Therefore, a single sweep with synchronization must be performed between switching on the frequency counter and querying the count result.



This command is not available for GSM/EDGE measurements modulation accuracy (MAC), phase/frequency error (PFE) and power versus time (PVT)

Example:

"INIT:CONT OFF"	'Switches to single-sweep mode.
"CALC:MARK ON"	'Switches marker in screen A.
"CALC:MARK:COUN ON"	'Switches the frequency counter for marker.
"INIT;*WAI"	'Starts a sweep and waits for the end.
"CALC:MARK:COUN:FREQ?"	'Outputs the measured value of marker in 'screen A.

Characteristics: *RST value: -
SCPI: device-specific

This command is only a query and therefore has no *RST value.

CALCulate<1|2>:MARKer<1 to 4>:COUNT:RESolution 0.1 | 1 | 10 | 100 | 1000 | 10000 Hz

This command specifies the resolution of the frequency counter in the selected measurement window. The setting is independent of the selected marker, i.e. the numeric suffix in MARKer<1 to 4> is irrelevant.



This command is not available for GSM/EDGE measurements modulation accuracy (MAC), phase/frequency error (PFE) and power versus time (PVT).

Example:

"CALC:MARK:COUN:RES 1kHz"	'Sets the resolution of the frequency counter to 1 kHz.
---------------------------	---

Characteristics: *RST value: 1kHz
SCPI: device-specific

CALCulate<1|2>:MARKer<1 to 4>:LOEXclude ON | OFF

This command switches the local oscillator suppression for peak search on or off. This setting is valid for all markers and delta markers in all measurement windows.

Example: "CALC:MARK:LOEX ON"

Characteristics: *RST value: ON
SCPI: device-specific

The numeric suffixes 1|2 and 1 to 4 are irrelevant.

CALCulate<1|2>:MARKer<1 to 4>:MAXimum:AUTO ON | OFF

This command switches an automatic maximum peak search for marker 1 at the end of each particular sweep on and off. The current marker search limit settings (LEFT LIMIT, RIGHT LIMIT, THRESHOLD, EXCLUDE LO) are taken into account. The numeric suffix at MARKer<1 to 4> is irrelevant.

Example: "CALC:MARK:MAX:AUTO ON" Activates the auto search function for marker 1.

Characteristics: *RST value: OFF
SCPI: device-specific

CALCulate<1|2>:MARKer<1 to 4>:MAXimum:LEFT

This command positions the marker to the next smaller maximum value to the left of the current value (i.e. in descending X values) on the trace in the selected measurement window.



If no next smaller maximum value is found on the trace (level spacing to adjacent values < peak excursion), an execution error (error code: -200) is produced.

Example: "CALC:MARK2:MAX:LEFT" 'Positions marker 2 in screen A to the next 'lower maximum value to the left of the current 'value.

Characteristics: *RST value: -
SCPI: device-specific

This command is an event and therefore has no *RST value and no query.

CALCulate<1|2>:MARKer<1 to 4>:MAXimum:NEXT

This command positions the marker to the next smaller maximum value of the corresponding trace in the selected measurement window.

If no next smaller maximum value is found on the trace (level spacing to adjacent values < peak excursion), an execution error (error code: -200) is produced.

Example: "CALC:MARK2:MAX:NEXT" 'Positions marker 2 in screen A to the next 'lower maximum value.

Characteristics: *RST value: -
SCPI: device-specific

This command is an event and therefore has no *RST value and no query.

CALCulate<1|2>:MARKer<1 to 4>:MAXimum[:PEAK]

This command positions the marker to the current maximum value of the corresponding trace in the selected measurement window. The corresponding marker is activated first or switched to the marker mode.

If no maximum value is found on the trace (level spacing to adjacent values < peak excursion), an execution error (error code: -200) is produced.

Example: "CALC:MARK2:MAX" 'Positions marker 2 in screen A to the maximum value of the trace.

Characteristics: *RST value: -
 SCPI: device-specific

This command is an event and therefore has no *RST value and no query.

CALCulate<1|2>:MARKer<1 to 4>:MAXimum:RIGHT

This command positions the marker to the next smaller maximum value to the right of the current value (i.e. in ascending X values) on the corresponding trace in the selected measurement window.



If no next smaller maximum value is found on the trace (level spacing to adjacent values < peak excursion), an execution error (error code: -200) is produced.

Example: "CALC:MARK2:MAX:RIGHT" 'Positions marker 2 in screen A to the next lower maximum value to the right of the current value.

Characteristics: *RST value: -
 SCPI: device-specific

This command is an event and therefore has no *RST value and no query.

CALCulate<1|2>:MARKer<1 to 4>:MINimum:AUTO ON | OFF

This command switches an automatic minimum peak search for marker 1 at the end of each particular sweep on and off. The current marker search limit settings (LEFT LIMIT, RIGHT LIMIT, THRESHOLD, EXCLUDE LO) are taken into account. The numeric suffix at MARKer<1 to 4> is irrelevant.

Example: "CALC:MARK:MIN:AUTO ON" Activates the auto search function for marker 1.

Characteristics: *RST value: OFF
 SCPI: device-specific

CALCulate<1|2>:MARKer<1 to 4>:MINimum:LEFT

This command positions the marker to the next higher minimum value to the left of the current value (i.e. in descending X direction) on the corresponding trace in the selected measurement window.

If no next higher minimum value is found on the trace (level spacing to adjacent values < peak excursion), an execution error (error code: -200) is produced.

Example: "CALC:MARK2:MIN:LEFT" 'Positions marker 2 in screen A to the next higher minimum value to the left of the current value.

Characteristics: *RST value: -
 SCPI: device-specific

CALCulate<1|2>:MARKer<1 to 4>:MINimum:NEXT

This command positions the marker to the next higher minimum value of the corresponding trace in the selected measurement window.

If no next higher minimum value is found on the trace (level spacing to adjacent values < peak excursion), an execution error (error code: -200) is produced.

Example: "CALC:MARK2:MIN:NEXT" 'Positions marker 2 in screen A to the next higher maximum value.'

Characteristics: *RST value: -
SCPI: device-specific

This command is an event and therefore has no *RST value and no query.

CALCulate<1|2>:MARKer<1 to 4>:MINimum[:PEAK]

This command positions the marker to the current minimum value of the corresponding trace in the selected measurement window. The corresponding marker is activated first or switched to marker mode, if necessary.

If no minimum value is found on the trace (level spacing to adjacent values < peak excursion), an execution error (error code: -200) is produced.

Example: "CALC:MARK2:MIN" 'Positions marker 2 in screen A to the minimum value of the trace.'

Characteristics: *RST value: -
SCPI: device-specific

This command is an event and therefore has no *RST value and no query.

CALCulate<1|2>:MARKer<1 to 4>:MINimum:RIGHT

This command positions the marker to the next higher minimum value to the right of the current value (i.e. in ascending X direction) on the corresponding trace in the selected measurement window.

If no next higher minimum value is found on the trace (level spacing to adjacent values < peak excursion), an execution error (error code: -200) is produced.

Example: "CALC:MARK2:MIN:RIGHT" 'Positions marker 2 in screen A to the next higher minimum value to the right of the current value.'

Characteristics: *RST value: -
SCPI: device-specific

This command is an event and therefore has no *RST value and no query.

CALCulate<1|2>:MARKer<1 to 4>:PEXCursion <numeric_value>

This command defines the peak excursion, i.e. the spacing below a trace maximum which must be attained before a new maximum is recognized, or the spacing above a trace minimum which must be attained before a new minimum is recognized. The set value is valid for all markers and delta markers. The unit depends on the selected operating mode.

Example: "CALC:MARK:PEXC 10dB" 'Defines peak excursion 10 dB in 'SPECTRUM mode
 "CALC:MARK:PEXC 100 HZ" 'Defines peak excursion 100 Hz in 'FM DEMOD mode

Characteristics: *RST value: 6dB
SCPI: device-specific

The numeric suffix in MARKer<1 to 4> is irrelevant.

CALCulate<1|2>:MARKer<1 to 4>:STATe] ON | OFF

This command switches on or off the currently selected marker in the selected measurement window. If no indication is made, marker 1 is selected automatically. If marker 2, 3 or 4 is selected and used as a delta marker, it is switched to marker mode.

Example: "CALC:MARK3 ON" 'Switches marker 3 in screen A on or to marker mode.

Characteristics: *RST value: OFF
SCPI: device-specific

CALCulate<1|2>:MARKer<1 to 4>:TRACe 1 to 3

This command assigns the selected marker (1 to 4) to the indicated measurement curve in the selected measurement window. The corresponding trace must be active, i.e. its status must be different from "BLANK".

If necessary the corresponding marker is switched on prior to the assignment.

Example: "CALC:MARK3:TRAC 2" 'Assigns marker 3 in screen A to trace 2.

"CALC2:MARK:TRAC 3" 'Assigns marker 1 in screen B to trace 3.

Characteristics: *RST value -
SCPI: device-specific

CALCulate<1|2>:MARKer<1 to 4>:X 0 to MAX (frequency | sweep time)

This command positions the selected marker to the indicated frequency (span > 0), time (span = 0) or level (APD measurement or CCDF measurement ON) in the selected measurement window. If marker 2, 3 or 4 is selected and used as delta marker, it is switched to marker mode.

Example: "CALC1:MARK2:X 10.7MHz" 'Positions marker 2 in screen A to frequency '10.7 MHz.

Characteristics: *RST value: -
SCPI: device-specific

CALCulate<1|2>:MARKer<1 to 4>:X:SLIMits:LEFT 0 to MAX (frequency | sweep time)

This command sets the left limit of the search range for markers and delta markers in the selected measurement window. Depending on the x axis domain the indicated value defines a frequency (span > 0) or time (span = 0). The function is independent of the selection of a marker, i.e. the numeric suffix in MARKer<1 to 4> is irrelevant.

If the time domain power measurement is active, this command limits the evaluation range to the trace.



The function is only available if the search limit for marker and delta marker is switched on (CALC:MARK:X:SLIM ON).

Example: "CALC:MARK:X:SLIM ON" 'Switches the search limit function on for screen A.

"CALC:MARK:X:SLIM:LEFT 10MHz" 'Sets the left limit of the search range in screen A to 10 MHz.

Characteristics: *RST value: - (is set to the left diagram border on switching on search limits)
SCPI: device-specific

CALCulate<1|2>:MARKer<1 to 4>:X:SLIMits:RIGHT 0 to MAX (frequency | sweep time)

This command sets the right limit of the search range for markers and delta markers in the selected measurement window. Depending on the x axis domain the indicated value defines a frequency (span > 0) or time (span = 0). The function is independent of the selection of a marker, i.e. the numeric suffix in MARKer<1 to 4> is irrelevant.

If the time domain power measurement is active, this command limits the evaluation range to the trace.

The function is only available if the search limit for marker and delta marker is switched on (CALC:MARK:X:SLIM ON).

Example: "CALC:MARK:X:SLIM ON" 'Switches the search limit function on
'for screen A.
"CALC:MARK:X:SLIM:RIGH 20MHz" 'Sets the right limit of the search range
'in screen A to 20 MHz.

Characteristics: *RST value: - is set to the right diagram border on switching on search
limits)
SCPI: device-specific

CALCulate<1|2>:MARKer<1 to 4>:X:SLIMits[:STATe] ON | OFF

This command switches between a limited (ON) and unlimited (OFF) search range in the selected measurement window. The function is independent of the selection of a marker, i.e. the numeric suffix MARKer<1 to 4> is irrelevant.

If the time domain power measurement is active, this command limits the evaluation range on the trace.

Example: "CALC:MARK:X:SLIM ON" 'Switches on search limitation in screen A.

Characteristics: *RST value: OFF
SCPI: device-specific

CALCulate<1|2>:MARKer<1 to 4>:X:SSIZe STANdard| POINTs

This command control the knob increment/decrement of the marker position. STEPSIZE STANDARD uses the grid resolution (span/625), STEPSIZE SWP POINTS uses the available sweep points configured in the SWEEP menu.

Example: "CALC:MARK:X:SSIZ POIN"

Characteristics: *RST value: STANdard
SCPI: device-specific

CALCulate<1|2>:MARKer<1 to 4>:Y?

This command queries the measured value of the selected marker in the selected measurement window. The corresponding marker is activated before or switched to marker mode, if necessary.

To obtain a valid query result, a complete sweep with synchronization to the sweep end must be performed between the activation of the marker and the query of the y value. This is only possible in single sweep mode.

The query result is output in the unit determined with `CALCulate:UNIT`.

In the default setting, the output is made depending on the unit determined with `CALC:UNIT`; only with linear level scaling is the output in %.

If the FM Demodulator (FS-K7) is activated, the query result is output in the following units:

- Result display FM: Hz
- Result display RF POWER LOG: dBm
- Result display RF POWER LIN: %
- Result display SPECTRUM LOG: dBm
- Result display SPECTRUM LIN: %

Example:

"INIT:CONT OFF"	'Switches to single-sweep mode.
"CALC:MARK2 ON"	'Switches marker 2 in screen A.
"INIT;*WAI"	'Starts a sweep and waits for the end.
"CALC:MARK2:Y?"	'Outputs the measured value of marker 2 in screen A.

Characteristics: *RST value: -
SCPI: device-specific

CALCulate<1|2>:MARKer<1 to 4>:Y:PERCent 0 to100%

This command positions the selected marker in the selected window to the given probability. If marker 2, 3 or 4 is selected and used as a delta marker, it is switched to marker mode.



The command is only available with the CCDF measurement switched on. The associated level value can be determined with the CALC:MARK:X? command.

Example: "CALC1:MARK:Y:PERC 95PCT" 'Positions marker 1 in screen A to a 'probability of 95%.

Characteristics: *RST value: -
SCPI: device-specific

CALCulate<1|2>:MARKer<1 to 4>:FUNCtion:CSTep

This command sets the step width of the center frequency in the selected measurement window to the X value of the current marker. If marker 2, 3 or 4 is selected and used as delta marker, it is switched to the marker mode.

Example: "CALC2:MARK3:FUNC:CST" 'Sets the center frequency of screen B to the same value as the frequency of marker 3.

Characteristics: *RST value: -
SCPI: device-specific

This command is an event and therefore has no *RST value and no query.

CALCulate<1|2>:MARKer<1 to 4>:FUNCtion:DEModulation:CONTinuous ON | OFF

This command switches on or off the continuous demodulation in the frequency domain (span >0) in the selected measurement window. Thus acoustic monitoring of the signals can be performed in the frequency domain. The function does not depend on the selected marker, i.e. the numeric suffix <1 to 4> is irrelevant.

Example: "CALC2:MARK3:FUNC:DEM:CONT ON" 'Switches on the continuous demodulation in screen B.

Characteristics: *RST value: OFF
SCPI: device-specific

CALCulate<1|2>:MARKer<1 to 4>:FUNCtion:DEModulation:HOLDoff 10ms to 1000s

This command defines the hold time at the marker position for the demodulation in the frequency domain (span > 0). The setting is independent of the measurement window and the selected marker, i.e. the suffixes <1|2> and <1 to 4> are irrelevant

Example: "CALC:MARK:FUNC:DEM:HOLD 3s"

Characteristics: *RST value: - (DEModulation is set to OFF)
SCPI: device-specific

CALCulate<1|2>:MARKer<1 to 4>:FUNCtion:DEModulation:SELEct AM | FM

This command selects the demodulation type for the audio demodulator. The command is independent of the measurement window and of the selected marker, i.e. suffixes 1|2 and 1 to 4 are irrelevant.

Example: "CALC:MARK:FUNC:DEM:SEL FM"

Characteristics: *RST value: AM
SCPI: device-specific

CALCulate<1|2>:MARKer<1 to 4>:FUNCtion:DEModulation:SQUelch:LEVel 0 to 100 PCT

This command sets the trigger level for the squelch function.

Example: "CALC:MARK:FUNC:DEM:SQU:LEV 80 PCT"

Characteristics: *RST value: 50PTC
SCPI: device-specific

CALCulate<1|2>:MARKer<1 to 4>:FUNCtion:DEModulation:SQUelch[:STATe] ON | OFF

This command enables or disables the squelch function for the audio output.

Example: "CALC:MARK:FUNC:DEM:SQU ON"

Characteristics: *RST value: OFF
SCPI: device-specific

CALCulate<1|2>:MARKer<1 to 4>:FUNction:DEModulation[:STATe] ON | OFF

This command switches on or off the audio demodulator when the indicated marker is reached in the selected measurement window. In the frequency domain (span > 0) the hold time can be defined at the corresponding marker position with `CALCulate:MARKer:FUNction:DEModulation:HOLD`. In the time domain (span = 0) the demodulation is permanently active.

Example: `"CALC2:MARK3:FUNC:DEM ON"` 'Switches on the demodulation for marker 3 in 'screen B.

Characteristics: *RST value: OFF
SCPI: device-specific

CALCulate<1j2>:MARKer<1...4>:FUNction:FPEaks:ANNotation:LABel[:STATe] ON | OFF

This command activates and deactivates the peak list marker label.

Note that the peak list marker symbols have to active in order for the labels to appear. You can activate them with `CALCulate<1|2> MARKer<1...4> FUNction FPEaks ANNotation MARKer[STATe]`.

The numeric suffix at MARKer is irrelevant.

Example: `"INIT:CONT OFF"` 'activates single sweep mode.
`"CALC:MARK:FUNC:FPE ON"` 'turns the peak list on.
`"CALC:MARK:FUNC:FPE:SEAR:AUTO ON"` 'makes the R&S FSU perform a peak search after the sweep.
`"CALC:MARK:FUNC:FPE:LIST:SIZE 5"` 'adds five peaks to the list.
`"CALC:MARK:FUNC:FPE:SORT Y"` 'sorts the list by y values in decreasing order.
`"CALC:MARK:FUNC:FPE:ANN:MARK ON"` 'activates peak list markers.
`"CALC:MARK:FUNC:FPE:ANN:LAB ON"` 'activates peak list marker labels.
`"INIT;*WAI"` 'starts the measurement and synchronizes to end.
`"CALC:MARK:FUNC:FPE:COUN?"` 'returns the number of detected peaks.
`"CALC:MARK:FUNK:FPE:Y?"` 'returns the level of the peaks,
e.g. -37.5, -58.3, -59.6 .
`"CALC:MARK:FUNC:FPE:X?"` 'returns the horizontal position of the peaks,
e.g. 107.5E6, 153.8E6, 187,9E6 .
`"TRAC? FPE"` 'returns the peak list.

Characteristics: *RST value ON
SCPI device-specific

CALCulate<1j2>:MARKer<1...4>:FUNction:FPEaks:ANNotation:MARKer[:STATe] ON | OFF

This command activates and deactivates the peak list markers (visualized as crosses). The numeric suffix at MARKer is irrelevant.

Example: `"CALC:MARK:FUNC:FPE ON"` 'turns the peak list on.
`"CALC:MARK:FUNC:FPE:ANN:MARK ON"` 'activates peak list markers.

Characteristics: *RST value ON
SCPI device-specific

CALCulate<1|2>:MARKer<1 to 4>:FUNction:FPEaks:COUNT?

This query reads out the number of maxima found during the search. If no search for maxima has been performed, 0 is returned.

Example: `"CALC:MARK:FUNC:FPE 3"` 'searches the 3 highest maxima for trace 1
`"CALC:MARK:FUNC:FPE:COUN?"` 'queries the number of maxima found

Characteristics: *RST value: --
SCPI: device-specific

CALCulate<1j2>:MARKer<1...4>:FUNCTION:FPEaks:LIST:SIZE 1 to 50

This command sets the maximum length of the peak list. Alternately to this command you can use `CALCulate<1j2> MARKer<1...4> FUNCtion FPEaks[IMMEDIATE]` to set the number of peaks. The number of maxima found depends on the waveform and value set for the Peak Excursion parameter (`CALC:MARK:PEXC`), however, a maximum number of 50 maxima are determined. Only the signals which exceed their surrounding values at least by the value indicated by the peak excursion parameter will be recognized as maxima. Therefore, the number of maxima found is not automatically the same as the number of maxima desired. The numeric suffix at `MARKer` is irrelevant.

Example: `"CALC:MARK:FUNC:FPE:LIST:SIZE 12"` 'searches for 12 peaks.

Characteristics: *RST value -
SCPI device-specific

CALCulate<1j2>:MARKer<1 to 4>:FUNCTION:FPEaks[:IMMEDIATE] <numeric_value>

This command searches the selected trace for the indicated number of maxima. The results are entered in a list and can be queried with commands `CALC:MARK:FUNC:FPEaks:X?` and `CALC:MARK:FUNC:FPEaks:Y?`. The number of maxima found can be queried with `CALC:MARK:FUNC:FPEaks:COUNT?`. The trace to be examined is selected with `CALC:MARK:TRACE`. The order of the results in the list can be defined with `CALC:MARK:FUNC:FPEaks:SORT`.

The number of maxima found depends on the waveform and value set for the Peak Excursion parameter (`CALC:MARK:PEXC`), however, a maximum number of 50 maxima are determined. Only the signals which exceed their surrounding values at least by the value indicated by the peak excursion parameter will be recognized as maxima. Therefore, the number of maxima found is not automatically the same as the number of maxima desired.

Example:

<code>"INIT:CONT OFF"</code>	'switches to single-sweep mode
<code>"INIT;*WAI"</code>	'starts measurement and synchronizes to end
<code>"CALC:MARK:TRAC 1"</code>	'sets marker 1 in screen A to trace 1
<code>"CALC:MARK:FUNC:FPE:SORT X"</code>	'sets the sort mode to increasing X values
<code>"CALC:MARK:FUNC:FPE 3"</code>	'searches the 3 highest maxima for trace 1
<code>"CALC:MARK:FUNC:COUN?"</code>	'queries the number of maxima found
<code>"CALC:MARK:FUNC:Y?"</code>	'queries the level of maxima found
<code>"CALC:MARK:FUNC:X?"</code>	'queries the frequencies (span <> 0) or time (span = 0) of maxima found.

Characteristics: *RST value: --
SCPI: device-specific

CALCulate<1j2>:MARKer<1 to 4>:FUNCTION:FPEaks:SORT X|Y

This command sets the sort mode for the search for maxima:

X the maxima are sorted in the list of responses according to increasing X values
Y the maxima are sorted in the list of responses according to decreasing Y values

Example: `"CALC:MARK:FUNC:FPE:SORT Y"` 'sets the sort mode to decreasing y values

Characteristics: *RST value: --
SCPI: device-specific

CALCulate<1|2>:MARKer<1 to 4>:FUNCTION:FPEaks:X?

This query reads out the list of X values of the maxima found. The number of available values can be queried with `CALC:MARK:FUNC:FPEaks:COUNt?`.

With sort mode X, the X values are in increasing order; with sort mode Y the order corresponds to the decreasing order of the Y values.

Example:

<code>"CALC:MARK:FUNC:FPE: SORT Y"</code>	'sets the sort mode to decreasing y values
<code>"CALC:MARK:FUNC:FPE 3"</code>	searches the 3 highest maxima for trace 1
<code>"CALC:MARK:FUNC:FPE:COUN?"</code>	'queries the number of maxima found
<code>"CALC:MARK:FPE:FUNC:X?"</code>	'queries the frequencies (span <> 0) or. 'time (span = 0) of the maxima found.

Returned values:

`"107.5E6,153.8E6,187.9E6"` 'frequencies in increasing order

`"2.05E-3,2.37E-3, 3.71e-3"` 'times in increasing order

Characteristics: *RST value: --
SCPI: device-specific

CALCulate<1|2>:MARKer<1 to 4>:FUNCTION:FPEaks:Y?

This query reads out the list of X values of the maxima found. The number of available values can be queried with `CALC:MARK:FUNC:FPEaks:COUNt?`.

With sort mode X, the X values are in increasing order; with sort mode Y the order corresponds to the decreasing order of the Y values.

Example:

<code>"CALC:MARK:FUNC:FPE: SORT Y"</code>	'sets the sort mode to decreasing y values
<code>"CALC:MARK:FUNC:FPE 3"</code>	'searches the 3 highest maxima for trace 1
<code>"CALC:MARK:FUNC:FPE:COUN?"</code>	'queries the number of maxima found
<code>"CALC:MARK:FUNC:FPE:Y?"</code>	'queries the levels of the maxima found.

Return value:

`"-37.5,-58.3,-59.6"` 'level in decreasing order

Characteristics: *RST value: --
SCPI: device-specific

Mode: A

CALCulate<1|2>:MARKer<1 to 4>:FUNCTION:MDEPth:RESult?

This command queries the AM modulation depth in the indicated measurement window. A complete sweep with synchronization to sweep end must be performed between switching on the function and querying the measured value to obtain a valid query result. This is only possible in single sweep mode.

The numeric suffix <1 to 4> of :MARKer is irrelevant for this command.

Example:

<code>"INIT:CONT OFF"</code>	'Switches to single-sweep mode.
<code>"CALC:MARK:X 10MHZ"</code>	'Sets the reference marker (marker 1) to 'the carrier signal at 10 MHz.
<code>"CALC:MARK:FUNC:MDEP ON"</code>	'Switches on the modulation depth 'measurement in screen A.
<code>"INIT;*WAI"</code>	'Starts a sweep and waits for the end.
<code>"CALC:MARK:FUNC:MDEP:RES?"</code>	'Outputs the measured value of screen A.

Characteristics: *RST value: -
SCPI: device-specific

This command is only a query and therefore has no *RST value.

CALCulate<1|2>:MARKer<1 to 4>:FUNCtion:MDEPth[:STATe]

This command switches on the measurement of the AM modulation depth. An AM-modulated carrier is required on the screen for correct operation. If necessary, marker 1 is previously activated and set to the largest signal available.

The level value of marker 1 is regarded as the carrier level. On activating the function, marker 2 and marker 3 are automatically set as delta markers symmetrically to the carrier to the adjacent maxima of the trace.

If the position of delta marker 2 is changed, delta marker 3 is moved symmetrically with respect to the reference marker (marker 1). If the position of delta marker 3 is changed, fine adjustment can be performed independently of delta marker 2.

The R&S FSMR calculates the power at the marker positions from the measured levels.

The AM modulation depth is calculated from the ratio of power values at the reference marker and the delta markers. If the two AM sidebands differ in power, the average value of the two power values is used for calculating the AM modulation depth.

The numeric suffix <1 to 4> of :MARKer is irrelevant with this command.

Example:	"CALC:MARK:X 10MHZ"	'Sets the reference marker (marker 1) to 'the carrier signal at 10 MHz
	"CALC:MARK:FUNC:MDEP ON"	'Switches on the modulation depth 'measurement in screen A.
	"CALC:DELT2:X 10KHZ"	'Sets delta markers 2 and 3 to the signals 'at 10 kHz from the carrier signal
	"CALC:DELT3:X 9.999KHZ"	'Corrects the position of delta marker 3 'relative to delta marker 2.

Characteristics:	*RST value:	OFF
	SCPI:	device-specific

CALCulate<1|2>:MARKer<1 to 4>:FUNCTION:MSUMmary? <time offset of first pulse>, <measurement time>, <period>, < # of pulses to measure>

The commands of this subsystem are used to determine the power of a sequence of signal pulses having the same interval, as are typical for the slots of a GSM signal, for example. The number of pulses to be measured as well as the measurement time and the period can be set. To define the position of the first pulse in the trace, a suitable offset can be entered.

The evaluation is performed on the measurement data of a previously recorded trace. The data recorded during the set measurement time is combined to a measured value for each pulse according to the detector specified and the indicated number of results is output as a list.

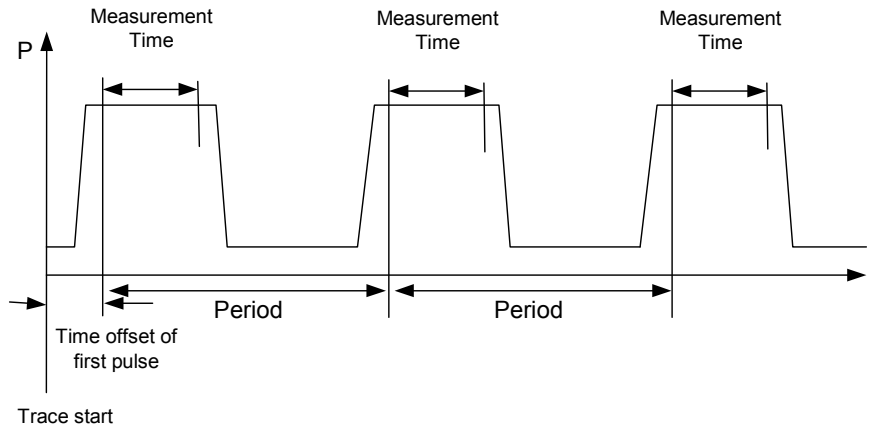

TRACE 1 of the selected screen is always used by the function. The suffix of MARKer will be ignored.

Example:	<pre>"DISP:WIND:TRAC:Y:RLEV -10dBm" "INP:ATT 30 dB" "FREQ:CENT 935.2MHz;SPAN 0Hz" "BAND:RES 1MHz;VID 3MHz" "DET RMS" "TRIG:SOUR VID;LEV:VID 50 PCT" "SWE:TIME 50ms" "INIT;*WAI" "CALC:MARK:FUNC:MSUM? 50US,450US,576.9US,8"</pre>	<pre>'Sets the reference level to 10 dB 'Sets the input attenuation to 30 dB 'Sets the receive frequency to 935.2 MHz 'and the span to 0 Hz 'Sets the resolution bandwidth to 1 MHz 'and the video bandwidth to 3 MHz 'Sets the RMS detector 'Selects the trigger source VIDEo and sets the level of the video trigger source to 50 PCT 'Sets the sweep time to 50 ms 'Starts the measurement with synchronization 'Queries 8 bursts with an offset of 50 μs, a 'test time of 450 μs and a period of 576.9 μs</pre>
-----------------	---	---

Characteristics: *RST value: -
SCPI: device-specific

CALCulate<1|2>:MARKer<1 to 4>:FUNction:NDBDown <numeric_value>

This command defines the level spacing of the two delta markers to the right and left of marker 1 in the selected measurement window. Marker 1 is always used as the reference marker. The numeric suffix <1 to 4> is irrelevant for this command.

The temporary markers T1 and T2 are positioned by n dB below the active reference marker. The frequency spacing of these markers can be queried with `CALCulate:MARKer:FUNction:NDBDown:RESult?`.

Example: `"CALC:MARK:FUNC:NDBD 3dB"` 'Sets the level spacing in screen A to 3 dB.

Characteristics: *RST value: 6dB
SCPI: device-specific

CALCulate<1|2>:MARKer<1 to 4>:FUNction:NDBDown:FREQuency?

This command queries the two frequencies of the N-dB-down marker in the selected measurement window. The numeric suffix <1 to 4> is irrelevant for this command. The two frequency values are separated by comma and output in ascending order.

A complete sweep with synchronization to sweep end must be performed between switching on the function and querying the measured value to obtain a valid query result. This is only possible in single sweep mode.

Example:

<code>"INIT:CONT OFF"</code>	'Switches to single-sweep mode.
<code>"CALC:MARK:FUNC:NDBD ON"</code>	'Switches on the n-dB-down function in screen A.
<code>"INIT;*WAI"</code>	'Starts a sweep and waits for the end.
<code>"CALC:MARK:FUNC:NDBD:FREQ?"</code>	'Outputs the frequencies of the temporary markers in screen A.

Characteristics: *RST value: -
SCPI: device-specific

This command is only a query and therefore has no *RST value.

CALCulate<1|2>:MARKer<1 to 4>:FUNction:NDBDown:RESult?

This command queries the frequency spacing (bandwidth) of the N-dB-down markers in the selected measurement window. The numeric suffix <1 to 4> is irrelevant for this command.

A complete sweep with synchronization to sweep end must be performed between switching on the function and querying the measured value in order to obtain a valid query result. This is only possible in single sweep mode.



This command is not available for GSM/EDGE measurements modulation accuracy (MAC), phase/frequency error (PFE) and power versus time (PVT).

Example:

<code>"INIT:CONT OFF"</code>	'Switches to single-sweep mode.
<code>"CALC:MARK:FUNC:NDBD ON"</code>	'Switches on the n-dB-down function in screen A.
<code>"INIT;*WAI"</code>	'Starts a sweep and waits for the end.
<code>"CALC:MARK:FUNC:NDBD:RES?"</code>	'Outputs the measured value of screen A.

Characteristics: *RST value: -
SCPI: device-specific

This command is only a query and therefore has no *RST value.

CALCulate<1|2>:MARKer<1 to 4>:FUNCtion:NDBDown:STATe ON | OFF

This command switches the "N dB Down" function on or off in the selected measurement window. Marker 1 is activated first, if necessary. The numeric suffix <1 to 4> is irrelevant for this command.

Example: "CALC:MARK:FUNC:NDBD:STAT ON" 'Switches on the N-dB-down function in 'screen A.

Characteristics: *RST value: OFF
SCPI: device-specific

CALCulate<1|2>:MARKer<1 to 4>:FUNCtion:NDBDown:TIME?

This command queries the two time values of the "N dB Down" markers in the specified measurement window. The suffix <1 to 4> has no meaning with this command. The two time values are output in ascending order, separated by commas.

To obtain a valid query response, a complete sweep with synchronization to the sweep end must have been performed in between activating the function and querying the measurement results. This is possible only in single-sweep mode.

Example: "INIT:CONT OFF" 'Switches to single-sweep mode.
"CALC:MARK:FUNC:NDBD ON" 'Switches on the "N dB Down" function in screen A.
"INIT;*WAI" 'Starts a sweep and waits for the end.
"CALC:MARK:FUNC:NDBD:TIME?" 'Outputs the time values of the temporary markers in screen A.

Characteristics: *RST value: -
SCPI: device-specific

CALCulate<1|2>:MARKer<1 to 4>:FUNCtion:NOISe:RESult?

This command queries the result of the noise measurement.

A complete sweep with synchronization to the sweep end must be performed between switching on the function and querying the measured value in order to obtain a valid query result. This is only possible in single sweep mode.

Example: "INIT:CONT OFF" 'Switches to single-sweep mode.
"CALC:MARK2 ON" 'Switches on marker 2 in screen A.
"CALC:MARK:FUNC:NOIS ON" 'Switches on noise measurement in screen A.
"INIT;*WAI" 'Starts a sweep and waits for the end.
"CALC:MARK2:NOIS:RES?" 'Outputs the noise result of marker 2 in 'screen A.

Characteristics: *RST value: -
SCPI: device-specific

This command is an event and therefore has no *RST value and no query.

CALCulate<1|2>:MARKer<1 to 4>:FUNCtion:NOISe[:STATe] ON | OFF

This command switches the noise measurement on or off for all markers of the indicated measurement window. The noise power density is measured at the position of the markers. The result can be queried with CALCulate:MARKer:FUNCtion:NOISe:RESult?.

Example: "CALC2:MARK:FUNC:NOIS ON" 'Switches on the noise measurement for 'screen B.

Characteristics: *RST value: OFF
SCPI: device-specific

CALCulate<1|2>:MARKer<1 to 4>:FUNCtion:REFerence

This command sets the reference level in the selected measurement window to the power measured by the indicated marker. If marker 2, 3 or 4 is selected and used as delta marker, it is switched to marker mode.

Example: "CALC:MARK2:FUNC:REF" 'Sets the reference level of screen A to the level of marker 2.

Characteristics: *RST value: -
SCPI: device-specific

This command is an event and therefore has no *RST value and no query.

CALCulate<1|2>:MARKer<1...4>:FUNCtion:TOI:MARKer CALCulate | SEARch

This command controls the positioning of the intercept markers 3 and 4 for TOI measurement, based on the two carrier signals.

CALCulate Calculates the intermodulation product frequencies.

SEARch Performs a local peak search near the expected intermodulation product frequencies.

Example: "CALC:MARK:FUNC:TOI:MARK SEAR" 'selects TOI marker search mode

Characteristics: *RST value: CALC
SCPI: device-specific

CALCulate<1|2>:MARKer<1 to 4>:FUNCtion:TOI:RESult?

This command queries the third-order intercept point measurement in the indicated measurement window.

A complete sweep with synchronization to sweep end must be performed between switching on the function and querying the measured value to obtain a valid query result. This is only possible in single sweep mode.

The numeric suffix <1 to 4> of :MARKer is irrelevant of this command.



This command is not available during GSM measurements modulation accuracy (MAC), phase-frequency error (PFE), power vs. time (PVT) and carrier power (CPW).

Example: "INIT:CONT OFF" 'Switches to single-sweep mode.
 "CALC:MARK:FUNC:TOI ON" 'Switches the intercept measurement in screen A.
 "INIT;*WAI" 'Starts a sweep and waits for the end.
 "CALC:MARK:FUNC:TOI:RES?" 'Outputs the measured value of screen A.

Characteristics: *RST value: -
SCPI: device-specific

This command is only a query and therefore has no *RST value.

CALCulate<1|2>:MARKer<1 to 4>:FUNCtion:TOI[:STATe] ON | OFF

This command initiates the measurement of the third-order intercept point.

A two-tone signal with equal carrier levels is expected at the RF input of the instrument. Marker 1 and marker 2 (both normal markers) are set to the maximum of the two signals. Delta marker 3 and delta marker 4 are positioned to the intermodulation products. The delta markers can be modified sperately afterwards with the commands CALCulate:DELTamarker3:X and

CALCulate:DELTamarker4:X.

The third-order intercept is calculated from the level spacing between the normal markers and the delta markers.

The numeric suffix <1 to 4> of :MARKer is irrelevant for this command.



This command is not available during GSM measurements modulation accuracy (MAC), phase-frequency error (PFE), power vs. time (PVT) and carrier power (CPW).

Example:	"CALC:MARK:FUNC:TOI ON"	'Switches on the measurement of the third-order intercept in screen A.
Characteristics:	*RST value: OFF SCPI: device-specific	

CALCulate:MARKer:FUNCTION:VOLTage[:WRITE][:RESULT]? PPEak | RMS | THD | SINad

This command queries the results of the audio measurement.

PPEak	Result of measurement with +PK detector
RMS	Result of measurement with RMS detector
THD	Total harmonic distortion
SINad	Signal, noise and distortion

Example:	"INP:SEL AUD"	'Switches on the audio measurement.
	"CALC:MARK:FUNC:VOLT? PPE"	'Queries the peak value.
Characteristics:	*RST value: - SCPI: device-specific	

CALCulate<1|2>:MARKer<1 to 4>:FUNCTION:ZOOM <numeric_value>

This command defines the range to be zoomed around marker 1 in the selected measurement window. Marker 1 is activated first, if necessary.

The subsequent frequency sweep is stopped at the marker position and the frequency of the signal is counted. This frequency becomes the new center frequency, and the zoomed span is set. In order to recognize the end of the operation the synchronization to the sweep end should be activated. This is only possible in single sweep mode.

Example:	"INIT:CONT OFF"	'Switches to single-sweep mode
	"CALC:MARK:FUNC:ZOOM 1kHz;*WAI"	'Activates zooming in screen A and 'waits for its end.
Characteristics:	*RST value: - SCPI: device-specific	

This command is an event and therefore has no *RST value and no query.

CALCulate<1|2>:MARKer<1 to 4>:FUNCtion:ADEMod:AFRequency[:RESult]?

This command queries the audio frequency with analog demodulation.

Example: "ADEM ON" "Switches on the demodulator.
 "CALC:FEED 'XTIM:FM:TDOM" "Switches on the FM result display.
 "CALC:MARK:FUNC:ADEM:AFR?" "Queries the audio frequency.

Characteristics: *RST value: -
 SCPI: device-specific

CALCulate:MARKer:FUNCtion:ADEMod:AM:AVERage[:RESult]? PPEak| MPEak| PAverage| AVERage | RMS | SRMS

This command queries the averaged results of the AM modulation measurement.
 For this, a suitable result display mode must have been selected before with CALC:FEED.

PPEak Result of measurement with +PK detector
 MPEak Result of measurement with -PK detector
 PAverage Result of averaging \pm PK/2, i.e. (plus peak + minus peak)/2
 AVERage Result of measurement with average detector
 RMS Result of measurement with RMS detector
 SRMS Result of measurement with $\sqrt{2}$ RMS detector

Example: "ADEM ON" 'Switches on the modulation measurement.
 "CALC2:FEED 'XTIM:AM:REL:TDOM" 'Switches on the AM result display.
 "ADEM:AVER ON" "Switches on the averaging function.
 "CALC:MARK:FUNC:ADEM:AM:AVER? PPE" 'Queries the averaged peak value.

Characteristics: *RST value: -
 SCPI: device-specific

CALCulate:MARKer:FUNCtion:ADEMod:AM:PHOLd[:RESult]? PPEak| MPEak| PAverage| AVERage | RMS | SRMS

This command queries the highest values obtained in the AM modulation measurement.
 For this, a suitable result display mode must have been selected before with CALC:FEED.

PPEak Result of measurement with +PK detector
 MPEak Result of measurement with -PK detector
 PAverage Result of averaging \pm PK/2, i.e. (plus peak + minus peak)/2
 AVERage Result of measurement with average detector
 RMS Result of measurement with RMS detector
 SRMS Result of measurement with $\sqrt{2}$ RMS detector

Example: "ADEM ON" 'Switches on the modulation measurement.
 "CALC2:FEED 'XTIM:AM:REL:TDOM" 'Switches on the AM result display.
 "ADEM:PHOL ON" 'Switches on the Peak Hold function.
 "CALC:MARK:FUNC:ADEM:AM:PHOL? PPE" 'Queries the highest peak value.

Characteristics: *RST value: -
 SCPI: device-specific

CALCulate:MARKer:FUNCTION:ADEMod:AM[:WRITEj]:RESult]? PPEak| MPEak| PAverage| AVERage | RMS | SRMS

This command queries the current results of the AM modulation measurement.
For this, a suitable result display mode must have been selected before with CALC:FEED.

PPEak	Result of measurement with +PK detector
MPEak	Result of measurement with -PK detector
PAverage	Result of averaging \pm PK/2, i.e. (plus peak + minus peak)/2
AVERage	Result of measurement with average detector (this is <i>not</i> an average over several measured values)
RMS	Result of measurement with RMS detector
SRMS	Result of measurement with $\sqrt{2}$ RMS detector

Example: "ADEM ON" 'Switches on the modulation measurement.
"CALC2:FEED 'XTIM:AM:REL:TDOM" 'Switches on the AM result display.
"CALC:MARK:FUNC:ADEM:AM? PPE" 'Queries the current peak value.

Characteristics: *RST value: -
SCPI: device-specific

CALCulate<1|2>:MARKer<1 to 4>:FUNCTION:ADEMod:CARRier[:RESult]?

This command queries the measured value of the carrier power.

Example: "ADEM ON" 'Switches on the FM demodulator.
"CALC:MARK:FUNC:ADEM:CARR?" 'Queries the carrier power.

Characteristics: *RST value: -
SCPI: device-specific

CALCulate<1|2>:MARKer<1...4>:FUNCTION:ADEMod:CARRier:SUNCertainty?

This command queries the standard uncertainty of the carrier power.

Example: "CALC:MARK:FUNC:ADEM:CARR:SUNC?"

Characteristics: *RST value: --
SCPI: device dependent

CALCulate<1|2>:MARKer<1...4>:FUNCTION:ADEMod:DISToRTion:RESult?

This command queries the distortion value of DEMOD and AUDIO mode of measurement receiver if DISTORTION & SINAD detectors are switched on.

Example: "CALC:MARK:FUNC:ADEM:DIST:RES?"

Characteristics: *RST value: --
SCPI: device dependent

CALCulate<1|2>:MARKer<1 to 4>:FUNCTION:ADEMod:FERRor[:RESult]?

This command queries the frequency error of the carrier signal.

Example: "ADEM ON" 'Switches on the demodulator.
"CALC:FEED 'XTIM:FM:TDOM" 'Switches the FM result display on.
"CALC:MARK:FUNC:ADEM:FERR? " 'Queries the frequency error.

Characteristics: *RST value: -
SCPI: device-specific

CALCulate<1|2>:MARKer<1 to 4>:FUNCtion:ADEMod:SINad:AVERage:RESult?

This command queries the SINAD value averaged over several measurements.

Example:

"ADEM ON"	'Switches on the demodulator.
"CALC:FEED XTIM:FM:AFSP"	'Switches on the AF spectrum of the FM.
"ADEM:AVER ON"	'Switches on the averaging function.
"CALC:MARK:FUNC:ADEM:SIN:AVER:RES?"	'Queries the averaged SINAD value.

Characteristics: *RST value: -
SCPI: device-specific

CALCulate<1|2>:MARKer<1 to 4>:FUNCtion:ADEMod:SINad:PHOLd:RESult?

This command queries the highest value obtained in the SINAD measurement.

Example:

"ADEM ON"	'Switches on the demodulator.
"CALC:FEED XTIM:FM:AFSP"	'Switches on the AF spectrum of the FM.
"ADEM:PHOL ON"	'Switches on the Peak Hold function.
"CALC:MARK:FUNC:ADEM:SIN:PHOL:RES?"	'Queries the highest SINAD value.

Characteristics: *RST value: -
SCPI: device-specific

CALCulate<1|2>:MARKer<1 to 4>:FUNCtion:ADEMod:SINad[:WRITe]:RESult?

This command queries the current result of the SINAD measurement.

Example:

"ADEM ON"	'Switches on the demodulator.
"CALC:FEED XTIM:FM:AFSP"	'Switches on the AF spectrum of the FM.
"CALC:MARK:FUNC:ADEM:SIN:RES?"	'Queries the current SINAD value.

Characteristics: *RST value: -
SCPI: device-specific

CALCulate<1|2>:MARKer<1 to 4>:FUNCtion:ADEMod:THD:AVERage:RESult?

This command queries the THD value averaged over several measurements.

Example:

"ADEM ON"	'Switches on the demodulator.
"CALC:FEED XTIM:FM:AFSP"	'Switches on the AF spectrum of the FM.
"ADEM:AVER ON"	'Switches on the averaging function.
"CALC:MARK:FUNC:ADEM:SIN:AVER:RES?"	'Queries the averaged THD value.

Characteristics: *RST value: -
SCPI: device-specific

CALCulate<1|2>:MARKer<1 to 4>:FUNCtion:ADEMod:THD:PHOLd:RESult?

This command queries the highest value obtained in the THD measurement.

Example:

"ADEM ON"	'Switches on the demodulator.
"CALC:FEED XTIM:FM:AFSP"	'Switches on the AF spectrum of the FM.
"ADEM:PHOL ON"	'Switches on the Peak Hold function.
"CALC:MARK:FUNC:ADEM:SIN:PHOL:RES?"	'Queries the highest THD value.

Characteristics: *RST value: -
SCPI: device-specific

CALCulate<1|2>:MARKer<1 to 4>:FUNCtion:ADEMod:THD[:WRITE]:RESult?

This command queries the current result of the THD measurement.

Example:

"ADEM ON"	'Switches on the demodulator.
"CALC:FEED XTIM:FM:AFSP"	'Switches on the AF spectrum of the FM.
"CALC:MARK:FUNC:ADEM:THD:RES?"	'Queries the current THD value.

Characteristics: *RST value: -
SCPI: device-specific

CALCulate:MARKer:FUNcTion:HARMonics Subsystem

The CALCulate:MARKer:FUNcTion:HARMonics subsystem contains the commands for Harmonic Distortion measurement.

COMMAND	PARAMETERS	UNIT	COMMENT
CALCulate<1 2> :MARKer<1...4> :FUNcTion :HARMonics :BANDwidth :AUTO [:LIST]? :DISTortion? :LIST? :NHARmonics :PRESet [:STATe]	<Boolean> TOTal <numeric_value> <Boolean>		 query only query only no query

CALCulate<1|2>:MARKer<1 to 4>:FUNcTion:HARMonics:BANDwidth:AUTO ON | OFF

This command specifies whether the resolution bandwidth of the 2nd to the nth harmonic should be identical to the bandwidth of the first harmonic (OFF) or to the next largest bandwidth (corresponding to the harmonic) of the multiple of the bandwidth of the first harmonic (ON).

Example: "CALC:MARK:FUNC:HARM:BAND:AUTO OFF" 'Switches automatic bandwidth expansion off

Characteristics: *RST value: ON
SCPI: device-specific

CALCulate<1|2>:MARKer<1...4>:FUNcTion:HARMonics:BANDwidth[:LIST]?

This command returns the resolution bandwidth values used by the harmonic measurement. A separate value for every harmonic frequency is automatically calculated. It is possible to query the calculated values with this command.

The function is independent of the marker selection, i.e. the suffix <1|2> or <1...4> of CALCulate or MARKer is irrelevant.

Example: "CALC:MARK:FUNC:HARM:BAND?"
'Returns the used bandwidth values of the harmonics measurement.

Characteristics: *RST value: -
SCPI: device-specific

This command is a query and therefore has no *RST value.

CALCulate<1|2>:MARKer<1 to 4>:FUNCtion:HARMonics:DISToRTion? TOTal

This command queries the results of the total harmonic distortion (THD).

A complete sweep with synchronization to sweep end should be performed between switching on the function and querying the measured value to obtain a valid query result. This is only possible in the single-sweep mode.

The function is independent of the marker selection, i.e. the suffix <1|2> or <1 to 4> of CALCulate or MARKer is irrelevant.

Example:

"INIT:CONT OFF"	'Switches to single-sweep mode.
"CALC:MARK:FUNC:HARM:NHAR 3"	'Sets the number of harmonics to 3.
"CALC:MARK:FUNC:HARM ON"	'Switches on the measurement of harmonics.
"INIT;*WAI"	'Starts a sweep and waits for the end.
"CALC:MARK:FUNC:HARM:DIS? TOT"	'Outputs the total harmonic distortion in % and dB.

Characteristics: *RST value: --
SCPI: device-specific

CALCulate<1|2>:MARKer<1 to 4>:FUNCtion:HARMonics:LIST?

This command reads out the list of harmonics. The first value is the absolute power of the first harmonic in the unit set via UNIT. The other values are relative to the carrier signal and are output in dB.

The numeric values are output, separated by commas. The number corresponds to that of the harmonics to be measured, which are defined with CALC:MARK:FUNC:HARM:NHAR.

A complete sweep with synchronization to sweep end should be performed between switching on the function and querying the measured value to obtain a valid query result. This is only possible in the single-sweep mode.

The function is independent of the marker selection, i.e. the suffix <1|2> or <1 to 4> of CALCulate or MARKer is irrelevant.

Example:

"INIT:CONT OFF"	'Switches to single-sweep mode.
"CALC:MARK:FUNC:HARM:NHAR 3"	'Sets the number of harmonics to 3.
"CALC:MARK:FUNC:HARM ON"	'Switches on the measurement of harmonics.
"INIT;*WAI"	'Starts a sweep and waits for the end.
"CALC:MARK:FUNC:HARM:LIST?"	'Outputs the three measured harmonics, separated by commas.

Characteristics: *RST value: --
SCPI: device-specific

CALCulate<1|2>:MARKer<1 to 4>:FUNCtion:HARMonics:NHARmonics 1 to 10

This command defines the number of harmonics of a carrier signal to be measured. The function is independent of the marker selection, i.e. the suffix <1|2> or <1 to 4> of CALCulate or MARKer is irrelevant.

Example:

"CALC:MARK:FUNC:HARM:NHAR 3"	'Sets the number of harmonics to be measured to 3.
------------------------------	--

Characteristics: *RST value: OFF
SCPI: device-specific

CALCulate<1|2>:MARKer<1 to 4>:FUNCtion:HARMonics:PRESet

This command optimizes the device settings depending on the mode in which the harmonic measurement was started:

If the harmonic measurement was started in the frequency domain (span > 0), the frequency and the level of the first harmonic are calculated, from which the measurement list is set up.

If the measurement was started in the time domain (span = 0), the frequency of the first harmonic is not changed. The level, however, is not calculated.

The function is independent of the marker selection, i.e. the suffix <1|2> or <1 to 4> of CALCulate or MARKer is irrelevant.

Example: "CALC:MARK:FUNC:HARM:PRES" Optimizes the device setting for the measurement of harmonics.

Characteristics: *RST value: --
SCPI: device-specific

This command is an event and therefore has no *RST value and no query.

CALCulate<1|2>:MARKer<1 to 4>:FUNCtion:HARMonics[:STATe] ON | OFF

This command switches on or off the measurement of the harmonics of a carrier signal. The carrier signal is the first harmonic. The function is independent of the marker selection, i.e. the suffix <1|2> or <1 to 4> of CALCulate or MARKer is irrelevant. It is only available in the frequency domain (span > 0).

If the measurement is started in the frequency domain (span > 0), the last span will define the search range for the first harmonic. The level for the first harmonic will also be calculated in the frequency domain. However, the measurement can also be started in the time domain (span = 0), in which case the center frequency and the level used will remain unchanged.

Example: "CALC:MARK:FUNC:HARM ON" 'Switches on the measurement of harmonics.

Characteristics: *RST value: OFF
SCPI: device-specific

CALCulate:MARKer:FUNCTION:POWER Subsystem

The CALCulate:MARKer:FUNCTION:POWER subsystem contains the commands for control of power measurement.

COMMAND	PARAMETERS	UNIT	COMMENT
CALCulate<1 2> :MARKer :FUNCTION :POWER :MODE :PRESet :RESult? :PHZ :SElect [::STATe]	WRITe MAXHold NADC TETRA PDC PHS CDPD FWCDma RWCDma F8CDma R8CDma F19CDma R19CDma FW3Gppcdma RW3Gppcdma D2CDma S2CDma M2CDma FIS95A RIS95A FIS95C0 RIS95C0 FIS95C1 RIS95C1 FJ008 RJ008 TCDMa NONE ACPower CPOWer MCACpower OBANdwidth OBWidth CN CN0 <Boolean> ACPower CPOWer MCACpower OBANdwidth OBWidth CN CN0 OFF		query only no query

CALCulate<1|2>:MARKer<1 to 4>:FUNCTION:POWER:MODE WRITe | MAXHold

This command selects the Clear Write or Maxhold for Channel Power values.

Example: "CALC:MARK:FUNC:POW:MODE MAXH" Maxhold for Channel Power values

Characteristics: *RST value: WRITe
SCPI: device-specific

CALCulate<1|2>:MARKer<1 to 4>:FUNCTION:POWER:PRESet

NADC | TETRA | PDC | PHS | CDPD | FWCDma | RWCDma | F8CDma | R8CDma | F19CDma | R19CDma | FW3Gppcdma | RW3Gppcdma | D2CDma | S2CDma | M2CDma | FIS95A | RIS95A | FIS95C0 | RIS95C0 | FJ008 | RJ008 | FIS95C1 | RIS95C1 | TCDMa | NONE | AWLan | BWLan | WIMax | WIBro

This command selects the power measurement setting for a standard in the indicated measurement window and previously switches on the corresponding measurement, if required. The function is independent of the marker selection, i.e. the numeric suffix <1 to 4> of MARKer is irrelevant.

The configuration for a standard comprises of the parameters weighting filter, channel bandwidth and spacing, resolution and video bandwidth, as well as detector and sweep time.

Meaning of the CDMA standard abbreviations:

- FIS95A, F8CDma CDMA IS95A forward
- RIS95A, R8CDma CDMA IS95A reverse
- FJ008, F19CDma CDMA J-STD008 forward
- RJ008, R19CDma CDMA J-STD008 reverse
- FIS95C0 CDMA IS95C Class 0 forward
- RIS95C0 CDMA IS95C Class 0 reverse
- FIS95C1 CDMA IS95C Class 1 forward
- RIS95C1 CDMA IS95C Class 1 reverse
- FWCDma W-CDMA 4.096 MHz forward
- RWCDma W-CDMA 4.096 MHz reverse
- FW3Gppcdma W-CDMA 3.84 MHz forward

RW3Gppcdma	W-CDMA 3.84 MHz reverse
D2CDma	CDMA 2000 direct sequence
S2CDma	CDMA 2000 MC1 multi carrier with 1 carrier
M2CDma	CDMA 2000 MC3 multi carrier with 3 carriers
TCDMa	TD-SCDMA
AWLan	WLAN 802.11a
BWLan	WLAN 802.11b
WIMax	WiMAX (Worldwide Interoperability for Microwave Access) IEEE 802.16-2004/Cor1-2005
WIBro	WiMAX WiBro (Wireless Broadband) IEEE 802.16-2004/Cor1-2005



The settings for standards IS95A and C differ as far as the calculation method of channel spacings is concerned. For IS95A and J-STD008 the spacing is calculated from the center of the main channel to the center of the corresponding adjacent channel, for IS95C from the center of the main channel to the nearest border of the adjacent channel.

This command is not available during active GSM measurements.

Example: "CALC2:MARK:FUNC:POW:PRES NADC" 'Selects the standard setting for 'NADC in screen B

Characteristics: *RST value: -
SCPI: device-specific

CALCulate<1|2>:MARKer<1...4>:FUNCTION:POWER:RESult? ACPower | CPOwer | MCACpower | OBANdwidth | OBWidth | CN | CN0

This command queries the result of the power measurement performed in the selected window. If necessary, the measurement is switched on prior to the query.

The channel spacings and channel bandwidths are configured in the `SENSe:POWer:ACHannel` subsystem.

To obtain a valid result, a complete sweep with synchronization to the end of the sweep must be performed before a query is output. Synchronization is possible only in the single-sweep mode.

Parameters:

ACPower: Adjacent-channel power measurement
Results are output in the following sequence, separated by commas:

1. Power of transmission channel
2. Power of lower adjacent channel
3. Power of upper adjacent channel
4. Power of lower alternate channel 1
5. Power of upper alternate channel 1
6. Power of lower alternate channel 2
7. Power of upper alternate channel 2

The number of measured values returned depends on the number of adjacent/alternate channels selected with `SENSe:POWer:ACHannel:ACPairs`.

With logarithmic scaling (RANGE LOG), the power is output in the currently selected level unit; with linear scaling (RANGE LIN dB or LIN %), the power is output in W. If `SENSe:POWer:ACHannel:MODE REL` is selected, the adjacent/alternate-channel power is output in dB.

AOBandwidth | AOWidth Measurement of occupied bandwidth, all results. The results include the left and right frequency/level information

Results are output in the following sequence, separated by commas:

1. Occupied bandwidth in Hz
2. T1 marker position in Hz (left marker)
3. T1 marker level
4. T2 marker position in Hz (right marker)
5. T2 marker level

CPOWer	Channel power measurement With logarithmic scaling (RANGE LOG), the channel power is output in the currently selected level unit; with linear scaling (RANGE LIN dB or LIN %), the channel power is output in W.
MCACpower:	<p>Channel/adjacent-channel power measurement with several carrier signals Results are output in the following sequence, separated by commas:</p> <ol style="list-style-type: none"> 1. Power of carrier signal 1 2. Power of carrier signal 2 3. Power of carrier signal 3 4. Power of carrier signal 4 5. Power of carrier signal 5 6. Power of carrier signal 6 7. Power of carrier signal 7 8. Power of carrier signal 8 9. Power of carrier signal 9 10. Power of carrier signal 10 11. Power of carrier signal 11 12. Power of carrier signal 12 13. Total power of all carrier signals 14. Power of lower adjacent channel 15. Power of upper adjacent channel 16. Power of lower alternate channel 1 17. Power of upper alternate channel 1 18. Power of lower alternate channel 2 19. Power of upper alternate channel 2 <p>The number of measured values returned depends on the number of carrier signals and adjacent/alternate channels selected with SENSe:POWer:ACHannel:TXChannel:COUNT and SENSe:POWer:ACHannel:ACPairs.</p> <p>If only one carrier signal is measured, the total value of all carrier signals will not be output.</p> <p>With logarithmic scaling (RANGE LOG), the power is output in dBm; with linear scaling (RANGE LIN dB or LIN %), the power is output in W. If SENSe:POWer:ACHannel:MODE REL is selected, the adjacent/alternate-channel power is output in dB.</p>
OBANdwidth OBWidth	<p>Measurement of occupied bandwidth , all results. The results include the left and The occupied bandwidth in Hz is returned.</p>
CN	<p>Measurement of carrier-to-noise ratio The carrier-to-noise ratio in dB is returned.</p>
CN0	<p>Measurement of carrier-to-noise ratio referenced to 1 Hz bandwidth. The carrier-to-noise ratio in dB/Hz is returned.</p>

Example of channel/adjacent-channel power measurement:

"SENS2:POW:ACH:ACP 3"	'Sets the number of adjacent/alternate channels in screen B to 3.
"SENS2:POW:ACH:BAND 30KHZ"	'Sets the bandwidth of the transmission channel to 30 kHz.
"SENS2:POW:ACH:BAND:ACH 40KHZ"	'Sets the bandwidth of each adjacent channel to 40 kHz.
"SENS2:POW:ACH:BAND:ALT1 50KHZ"	'Sets the bandwidth of each alternate channel to 50 kHz.

"SENS2:POW:ACH:BAND:ALT2 60KHZ"	'Sets the bandwidth of alternate channel 2 to 60 kHz.
"SENS2:POW:ACH:SPAC 30KHZ"	'Sets the spacing between the transmission channel and the adjacent channel to 30 kHz, the spacing between the transmission channel and alternate channel 1 to 60 kHz, and the spacing between the transmission channel and alternate channel 2 to 90 kHz.
"SENS2:POW:ACH:SPAC:ALT1 100KHZ"	'Sets the spacing between the transmission channel and alternate channel 1 to 100 kHz, and the spacing between the transmission channel and alternate channel 2 to 150 kHz.
"SENS2:POW:ACH:SPAC:ALT2 140KHZ"	'Sets the spacing between the transmission channel and alternate channel 2 to 140 kHz.
"SENS2:POW:ACH:MODE ABS"	'Switches on absolute power measurement.
"CALC2:MARK:FUNC:POW:SEL ACP"	'Switches on the adjacent-channel power measurement in screen B.
"INIT:CONT OFF"	'Switches over to single-sweep mode.
"INIT;*WAI"	'Starts a sweep and waits for the end of the sweep.
"CALC2:MARK:FUNC:POW:RES? ACP"	'Queries the result of adjacent-channel power measurement in screen B.
"SENS2:POW:ACH:REF:AUTO ONCE"	'Defines the measured channel power as the reference value for relative power measurements.

If the **channel power only** is to be measured, all commands relating to adjacent/alternate channel bandwidth and channel spacings are omitted. The number of adjacent/alternate channels is set to 0 with `SENS2:POW:ACH:ACP 0`.

Example of occupied bandwidth measurement:

"SENS2:POW:BAND 90PCT"	'	'Defines 90% as the percentage of the power to be contained in the bandwidth range to be measured.
"INIT:CONT OFF"	'	'Switches over to single-sweep mode.
"INIT;*WAI"	'	'Starts a sweep and waits for the end of the sweep.
"CALC2:MARK:FUNC:POW:RES? OBW"	'	'Queries the occupied bandwidth measured in screen B.

Characteristics: *RST value: -
SCPI: device-specific

This command is a query and therefore has no *RST value.

CALCulate<1|2>:MARKer<1 to 4>:FUNCtion:POWer:RESult:PHZ ON | OFF

This command switches the query response of the power measurement results in the indicated measurement window between output of absolute values (OFF) and output referred to the measurement bandwidth (ON).

The measurement results are output with `CALCulate:MARKer:FUNCtion:POWer:RESult?`



This command is not available during active GSM measurements.

Parameter:

ON: Results output referred to measurement bandwidth.

OFF: Results output in absolute values.

Example of channel/adjacent channel measurement:

"SENS2:POW:ACH:ACP 3"	'Sets the number of adjacent channels in 'screen B to 3.
"SENS2:POW:ACH:BAND 30KHZ"	'Sets the bandwidth of the main channel to 30 kHz.
"SENS2:POW:ACH:BAND:ACH 40KHZ"	'Sets the bandwidth of all adjacent 'channels to 40 kHz.
"SENS2:POW:ACH:BAND:ALT1 50KHZ"	'Sets the bandwidth of all alternate 'adjacent channels to 50 kHz.
"SENS2:POW:ACH:BAND:ALT2 60KHZ"	'Sets the bandwidth of alternate adjacent 'channel 2 to 60 kHz.
"SENS2:POW:ACH:SPAC 30KHZ"	'Sets the spacing between channel and 'adjacent channel as well as between all 'adjacent channels to 30 kHz.
"SENS2:POW:ACH:SPAC:ALT1 40KHZ"	'Sets the spacing between adjacent 'channel and alternate adjacent channel as 'well as between all alternate adjacent 'channels to 40 kHz.
"SENS2:POW:ACH:SPAC:ALT2 50KHZ"	'Sets the spacing between alternate 'adjacent channel 1 and alternate adjacent 'channel 2 to 50 kHz.
"SENS2:POW:ACH:MODE ABS"	'Switches on absolute power 'measurement.
"CALC2:MARK:FUNC:POW:SEL ACP"	'Switches the adjacent channel power 'measurement in screen B.
"INIT:CONT OFF"	'Switches to single-sweep mode.
"INIT;*WAI"	'Starts a sweep and waits for the end.
"CALC2:MARK:FUNC:POW:RES:PHZ ON"	'Output of results referred to the channel 'bandwidth.
"CALC2:MARK:FUNC:POW:RES? ACP"	'Queries the result of the adjacent channel 'power measurement in screen B referred 'to the channel bandwidth.

If only the **channel power** is to be measured, all commands for defining the bandwidths of adjacent channels as well as the channel spacings are not necessary. The number of adjacent channels is set to 0 with `SENS2:POW:ACH:ACP 0`.

Characteristics: *RST value: -
SCPI: device-specific

CALCulate<1|2>:MARKer<1...4>:FUNCTION:POWer:SElect ACPower | CPOWer | MCACpower | OBANdwidth | OBWidth | CN | CN0

This command selects – and switches on – one of the above types of power measurement in the selected measurement window. This function is independent of the selected marker, i.e. the numerical suffix <1...4> appended to MARKer has no effect.

The channel spacings and channel bandwidths are configured in the `SENSe:POWer:ACHannel` subsystem. Please note the following:

If CPOWer is selected, the number of adjacent channels (command:

`[SENSe:]POWer:ACHannel:ACPairs`) is set to 0. If ACPower is selected, the number of adjacent channels is set to 1, unless adjacent-channel power measurement is switched on already.

With respect to the above two settings, the behaviour of the FSMR differs from that of the FSE family.



The channel/adjacent-channel power measurement is performed for the trace selected with `SENSe:POWer:TRACe 1|2|3`.

This command is not available during an active GSM measurement.

The occupied bandwidth measurement is performed for the trace on which marker 1 is positioned. To select another trace for the measurement, marker 1 is to be positioned on the desired trace by means of `CALC:MARK:TRAC 1|2|3`.

Parameters:

ACPower	Adjacent-channel power measurement with a single carrier signal
CPOWer	Channel power measurement with a single carrier signal (equivalent to adjacent-channel power measurement with <i>NO. OF ADJ CHAN</i> = 0)
MCACpower	Channel/adjacent-channel power measurement with several carrier signals
OBANdwidth OBWidth	Measurement of occupied bandwidth
CN	Measurement of carrier-to-noise ratio
CN0	Measurement of carrier-to-noise ratio referenced to 1 Hz bandwidth

Example: `"CALC:MARK:FUNC:POW:SEL ACP"` 'Switches on adjacent-channel power measurement in window A.

Characteristics: *RST value: -
SCPI: device-specific

CALCulate<1|2>:MARKer<1 to 4>:FUNCTION:POWer[:STATe] OFF

This command switches off the power measurement in the selected measurement window.



This command is not available during active GSM measurements.

Example: `"CALC:MARK:FUNC:POW OFF"` 'Switches off the power measurement in screen B.

Characteristics: *RST value: -
SCPI: device-specific

This command is an event and therefore has no *RST value.

CALCulate:MARKer:FUNcTion:STRack Subsystem

The CALCulate:MARKer:FUNcTion:STRack subsystem defines the settings of the signal track.

COMMAND	PARAMETERS	UNIT	COMMENT
CALCulate<1 2> :MARKer :FUNcTion :STRack			
:BANDwidth	<numeric_value>	HZ	
:BWIDth	<numeric_value>	HZ	
[:STATe]	<Boolean>		
:THReshold	<numeric_value>	DBM	
:TRACe	<numeric_value>		

CALCulate<1|2>:MARKer<1 to 4>:FUNcTion:STRack:BANDwidth 10Hz to MAX(SPAN)

CALCulate<1|2>:MARKer<1 to 4>:FUNcTion:STRack:BWIDth 10Hz to MAX(SPAN)

These commands have the same function. For the selected measurement window they define the bandwidth around the center frequency within which the largest signal is searched. The function is independent of the selected marker, i.e. the numeric suffix <1 to 4> of MARKer is irrelevant. It is only available in the frequency domain (span > 0).

The entry of the search bandwidth is only possible if the Signal Track function is switched on (CALC:MARK:FUNC:STR ON).

Example: "CALC:MARK:FUNC:STR:BAND 1MHZ"
Sets the search bandwidth for screen 'A to 1 MHz.

"CALC:MARK:FUNC:STR:BWID 1MHZ" 'Alternative command for the same function.

Characteristics: *RST value: -- (= span/10 on activating the function)
SCPI: device-specific

CALCulate<1|2>:MARKer<1 to 4>:FUNcTion:STRack[:STATe] ON | OFF

This command switches the signal-track function on or off for the selected measurement window. The function is independent of the selected marker, i.e. the numeric suffix <1 to 4> of MARKer is irrelevant.

With signal track activated, the maximum signal is determined after each frequency sweep and the center frequency is set to the frequency of this signal. Thus with drifting signals the center frequency follows the signal.

Example: "CALC:MARK:FUNC:STR ON" 'Switches on the signal track function for screen A.

Characteristics: *RST value: OFF
SCPI: device-specific

CALCulate<1|2>:MARKer<1 to 4>:FUNCtion:STRack:THReshold -330dBm to +30dBm

This command defines the threshold above which the largest signal is searched for in the selected measurement window. The function is independent of the selected marker, i.e. the numeric suffix <1 to 4> of MARKer is irrelevant. It is only available in the frequency domain (span > 0)..

The entry of the search bandwidth is only possible if the Signal Track function is switched on (CALC:MARK:FUNC:STR ON).

Example: "CALC:MARK:FUNC:STR:THR -50DBM" 'Sets the threshold for signal tracking
'in screen A to -50 dBm.

Characteristics: *RST value: -120 dBm
SCPI: device-specific

CALCulate<1|2>:MARKer<1 to 4>:FUNCtion:STRack:TRACe 1 to 3

This command defines the trace on which the largest signal is searched for in the selected measurement window. The function is independent of the selected marker, i.e. the numeric suffix <1 to 4> of MARKer is irrelevant. It is only available in the frequency domain (span > 0).

Example: "CALC2:MARK:FUNC:STR:TRAC 3" 'Defines trace 3 in screen B as the
'trace for signal tracking.

Characteristics: *RST value: 1
SCPI: device-specific

CALCulate<1|2>:MARKer<1 to 4>:FUNCTion:SUMMary:AVERage ON | OFF

This command switches on or off averaging for the active time domain power measurement in the indicated window. The function is independent of the marker selection, i.e. the numeric suffix <1 to 4> of :MARKer is irrelevant. It is only available in the time domain (span = 0).

Averaging is reset by switching it off and on again.

The number of results required for the calculation of average is defined with SENS<1|2>:AVER:COUN.

It should be noted that synchronization to the end of averaging is only possible in single sweep mode.

Example:

"INIT:CONT OFF"	'Switches to single-sweep mode.
"CALC2:MARK:FUNC:SUMM:AVER ON"	'Switches on the calculation of average 'in screen B.
"AVER:COUN 200"	'Sets the measurement counter to 200.
"INIT;*WAI"	'Starts a sweep and waits for the end.

Characteristics: *RST value: OFF
SCPI: device-specific

CALCulate<1|2>:MARKer<1 to 4>:FUNCTion:SUMMary:MEAN:AVERage:RESult?

This command queries the result of the measurement of the averaged mean value in the selected measurement window. The query is only possible if averaging has been activated previously using CALCulate<1|2>:MARKer<1 to 4>:FUNCTion:SUMMary:AVERage.

The function is independent of the marker selection, i.e. the numeric suffix <1 to 4> of :MARKer is irrelevant. It is only available in the time domain (span = 0).

A complete sweep with synchronization to sweep end must be performed between switching on the function and querying the measured value to obtain a valid query result. This is only possible in single sweep mode.

Example:

"INIT:CONT OFF"	'Switches to single-sweep mode.
"CALC:MARK:FUNC:SUMM:MEAN ON"	'Switches on the function in screen A.
"CALC:MARK:FUNC:SUMM:AVER ON"	'Switches on the average value 'calculation in screen A.
"INIT;*WAI"	'Starts a sweep and waits for the end.
"CALC:MARK:FUNC:SUMM:MEAN:AVER:RES?"	'Outputs the result of screen A.

Characteristics: *RST- value: -
SCPI: device-specific

This command is only a query and therefore has no *RST value.

CALCulate<1|2>:MARKer<1 to 4>:FUNCTion:SUMMary:MEAN:PHOLd:RESult?

This command queries the result of the measurement of the mean value with active peak hold in the selected measurement window. The query is only possible if the peak hold function has been switched on previously using CALCulate<1|2>:MARKer<1 to 4>:FUNCTion:SUMMary:PHOLd.

The query is possible only if the peak hold function is active. The function is independent of the marker selection, i.e. the numeric suffix <1 to 4> of :MARKer is irrelevant. It is only available in the time domain (span = 0).

A complete sweep with synchronization to sweep end must be performed between switching on the function and querying the measured value to obtain a valid query result. This is only possible in single sweep mode.

Example:

"INIT:CONT OFF"	'Switches to single-sweep mode
"CALC:MARK:FUNC:SUMM:MEAN ON"	'Switches on the function in screen A
"CALC:MARK:FUNC:SUMM:PHOL ON"	'Switches on the peak value 'measurement in screen A
"INIT;*WAI"	'Starts a sweep and waits for the end
"CALC:MARK:FUNC:SUMM:MEAN:PHOL:RES?"	'Outputs the result of screen A.

Characteristics: *RST- value: -
SCPI: device-specific

This command is only a query and therefore has no *RST value.

CALCulate<1|2>:MARKer<1 to 4>:FUNCtion:SUMMary:MEAN:RESult?

This command queries the result of the measurement of the mean value in the selected measurement window. The function is independent of the marker selection, i.e. the numeric suffix <1 to 4> of :MARKer is irrelevant. It is only available in the time domain (span = 0). A complete sweep with synchronization to sweep end must be performed between switching on the function and querying the measured value to obtain a valid query result. This is only possible in single sweep mode.

Example:

"INIT:CONT OFF"	'Switches to single-sweep mode.
"CALC:MARK:FUNC:SUMM:MEAN ON"	'Switches on the function in screen A.
"INIT;*WAI"	'Starts a sweep and waits for the end.
"CALC:MARK:FUNC:SUMM:MEAN:RES?"	'Outputs the result of screen A.

Characteristics: *RST- value: -
SCPI: device-specific

Mode: A-T, GSM/EDGE

This command is only a query and therefore has no *RST value.

CALCulate<1|2>:MARKer<1 to 4>:FUNCtion:SUMMary:MEAN[:STATe] ON | OFF

This command switches on or off the measurement of the mean value in the selected measurement window.

The function is independent of the marker selection, i.e. the numeric suffix <1 to 4> of :MARKer is irrelevant. It is only available in the time domain (span = 0).



The measurement is performed on the trace on which marker 1 is positioned. In order to evaluate another trace, marker 1 must be positioned on another trace with CALC:MARK:TRAC 1|2|3.

Example: "CALC:MARK:FUNC:SUMM:MEAN ON" 'Switches on the function in screen A.

Characteristics: *RST value: OFF
SCPI: device-specific

CALCulate<1|2>:MARKer<1 to 4>:FUNCtion:SUMMary:MODE ABSolute | RELative

This command selects absolute or relative time domain power measurement in the indicated measurement window. The function is independent of the marker selection, i.e. the numeric suffix <1 to 4> of :MARKer is irrelevant. It is only available in the time domain (span = 0).

The reference power for relative measurement is defined with CALCulate:MARKer:FUNCtion:SUMMary:REFerence:AUTO ONCE. If the reference power is not defined, the value 0 dBm is used.



This command is not available for GSM/EDGE measurements modulation accuracy (MAC) and phase/frequency error (PFE).

Example: "CALC:MARK:FUNC:SUMM:MODE REL" 'Switches the time domain power measurement to relative.

Characteristics: *RST value: ABSolute
SCPI: device-specific

CALCulate<1|2>:MARKer<1 to 4>:FUNCtion:SUMMary:PHOLd ON | OFF

This command switches on or off the peak-hold function for the active time domain power measurement in the indicated measurement window. The function is independent of the marker selection, i.e. the numeric suffix <1 to 4> of :MARKer is irrelevant. It is only available in the time domain (span = 0).

The peak-hold function is reset by switching it off and on again.

Example: "CALC:MARK:FUNC:SUMM:PHOL ON" 'Switches on the function in screen A.

Characteristics: *RST value: OFF
SCPI: device-specific

The peak-hold function is reset by switching off and on, again.

CALCulate<1|2>:MARKer<1 to 4>:FUNCtion:SUMMary:PPEak:AVERage:RESult?

This command is used to query the result of the measurement of the averaged positive peak value in the selected measurement window. The query is only possible if averaging has been activated previously using CALCulate<1|2>:MARKer<1 to 4>:FUNCtion:SUMMary:AVERage.

The function is independent of the marker selection, i.e. the numeric suffix <1 to 4> in MARKer is irrelevant. It is only available in the time domain (span = 0).

A complete sweep with synchronization to sweep end must be performed between switching on the function and querying the measured value to obtain a valid query result. This is only possible in single sweep mode.

Example: "INIT:CONT OFF" 'Switches to single-sweep mode.
"CALC:MARK:FUNC:SUMM:PPE ON" 'Switches on the function in screen A.
"CALC:MARK:FUNC:SUMM:AVER ON" 'Switches on the calculation of average
'in screen A.
"INIT;*WAI" 'Starts a sweep and waits for the end.
"CALC:MARK:FUNC:SUMM:PPE:AVER:RES?" 'Outputs the result of screen A.

Characteristics: *RST value: -
SCPI: device-specific

This command is only a query and therefore has no *RST value.

CALCulate<1|2>:MARKer<1 to 4>:FUNCtion:SUMMary:PPEak:PHOLd:RESult?

This command is used to query the result of the measurement of the positive peak value with active peak hold function. The query is only possible if the peak hold function has been activated previously using CALCulate<1|2>:MARKer<1 to 4>:FUNCtion:SUMMary:PHOLd.

The function is independent of the marker selection, i.e. the numeric suffix <1 to 4> of :MARKer is irrelevant. It is only available in the time domain (span = 0).

A complete sweep with synchronization to sweep end must be performed between switching on the function and querying the measured value to obtain a valid query result. This is only possible in single sweep mode.

Example: "INIT:CONT OFF" 'Switches to single-sweep mode.
"CALC:MARK:FUNC:SUMM:PPE ON" 'Switches on the function in screen A.
"CALC:MARK:FUNC:SUMM:PHOL ON" 'Switches on the measurement of the
'peak value in screen A.
"INIT;*WAI" 'Starts a sweep and waits for the end.
"CALC:MARK:FUNC:SUMM:PPE:PHOL:RES?" 'Outputs the result of screen A.

Characteristics: *RST value: -
SCPI: device-specific

This command is only a query and therefore has no *RST value.

CALCulate<1|2>:MARKer<1 to 4>:FUNCtion:SUMMary:PPEak:RESult?

This command is used to query the result of the measurement of the positive peak value in the selected measurement window. The measurement may have to be switched on previously.

The function is independent of the marker selection, i.e. the numeric suffix <1 to 4> of MARKer is irrelevant. It is only available in the time domain (span = 0).

A complete sweep with synchronization to sweep end must be performed between switching on the function and querying the measured value to obtain a valid query result. This is only possible in single sweep mode.

Example:

"INIT:CONT OFF"	'Switches to single-sweep mode.
"CALC:MARK:FUNC:SUMM:PPE ON"	'Switches on the function in screen A.
"INIT;*WAI"	'Starts a sweep and waits for the end.
"CALC:MARK:FUNC:SUMM:PPE:RES?"	'Outputs the result of screen A.

Characteristics: *RST value: -
SCPI: device-specific

This command is only a query and therefore has no *RST value.

CALCulate<1|2>:MARKer<1 to 4>:FUNCtion:SUMMary:PPEak[:STATe] ON | OFF

This command switches on or off the measurement of the positive peak value in the selected measurement window.

The function is independent of the marker selection, i.e. the numeric suffix <1 to 4> of MARKer is irrelevant. It is only available in the time domain (span = 0).

Example: "CALC:MARK:FUNC:SUMM:PPE ON" 'Switches on the function in screen A.

Characteristics: *RST value: OFF
SCPI: device-specific

CALCulate<1|2>:MARKer<1 to 4>:FUNCtion:SUMMary:REFerence:AUTO ONCE

With this command the currently measured average value (. . . :SUMMary:MEAN) and RMS value (. . . :SUMMary:RMS) are declared as reference values for relative measurements in the indicated measurement window. The function is independent of the marker selection, i.e. the numeric suffix <1 to 4> of :MARKer is irrelevant. It is only available in the time domain (span = 0).

If the measurement of RMS value and average is not activated, the reference value 0 dBm is used.

If the function . . . :SUMMary:AVErAge or . . . :SUMMary:PHOLd is switched on, the current value is the accumulated measurement value at the time considered.



This command is not available for GSM/EDGE measurements modulation accuracy (MAC) and phase/frequency error (PFE).

Example: "CALC:MARK:FUNC:SUMM:REF:AUTO ONCE"
' Takes the currently measured power in
'screen A as reference value for the relative
'time domain power measurement.

Characteristics: *RST value: -
SCPI: device-specific

This command is an event and therefore has no *RST value and no query.

CALCulate<1|2>:MARKer<1 to 4>:FUNction:SUMMary:RMS:AVERage:RESult?

This command queries the result of the measurement of the averaged RMS value in the selected measurement window. The query is only possible if averaging has been activated previously using CALCulate<1|2>:MARKer<1 to 4>:FUNction:SUMMary:AVERage.

The function is independent of the marker selection, i.e. the numeric suffix <1 to 4> of :MARKer is irrelevant. It is only available in the time domain (span = 0).

A complete sweep with synchronization to sweep end must be performed between switching on the function and querying the measured value to obtain a valid query result. This is only possible in single sweep mode.

Example:

"INIT:CONT OFF"	'Switches to single-sweep mode.
"CALC:MARK:FUNC:SUMM:RMS ON"	'Switches on the function in screen A.
"CALC:MARK:FUNC:SUMM:AVER ON"	'Switches on the average value calculation in screen A.
"INIT;*WAI"	'Starts a sweep and waits for the end.
"CALC:MARK:FUNC:SUMM:RMS:AVER:RES?"	'Outputs the result of screen A.

Characteristics: *RST- value: -
SCPI: device-specific

This command is only a query and therefore has no *RST value.

CALCulate<1|2>:MARKer<1 to 4>:FUNction:SUMMary:RMS:PHOLd:RESult?

This command queries the result of the measurement of the RMS value with active peak hold in the selected measurement window. The query is only possible only if the peak hold function has been activated previously using CALCulate<1|2>:MARKer<1 to 4>:FUNction:SUMMary:PHOLd.

The function is independent of the marker selection, i.e. the numeric suffix <1 to 4> of :MARKer is irrelevant. It is only available in the time domain (span = 0).

A complete sweep with synchronization to sweep end must be performed between switching on the function and querying the measured value to obtain a valid query result. This is only possible in single sweep mode.

Example:

"INIT:CONT OFF"	'Switches to single-sweep mode.
"CALC:MARK:FUNC:SUMM:RMS ON"	'Switches on the function in screen A.
"CALC:MARK:FUNC:SUMM:PHOL ON"	'Switches on the peak value measurement in screen A.
"INIT;*WAI"	'Starts a sweep and waits for the end.
"CALC:MARK:FUNC:SUMM:RMS:PHOL:RES?"	'Outputs the result of screen A.

Characteristics: *RST- value: -
SCPI: device-specific

This command is only a query and therefore has no *RST value.

CALCulate<1|2>:MARKer<1 to 4>:FUNction:SUMMary:RMS:RESult?

This command queries the result of the measurement of the RMS power value in the selected measurement window.

The function is independent of the marker selection, i.e. the numeric suffix <1 to 4> of :MARKer is irrelevant. It is only available in the time domain (span = 0).

A complete sweep with synchronization to sweep end must be performed between switching on the function and querying the measured value to obtain a valid query result. This is only possible in single sweep mode.

Example:

"INIT:CONT OFF"	'Switches to single-sweep mode.
"CALC:MARK:FUNC:SUMM:RMS ON"	'Switches on the function in screen A.
"INIT;*WAI"	'Starts a sweep and waits for the end.
"CALC:MARK:FUNC:SUMM:RMS:RES?"	'Outputs the result of screen A.

Characteristics: *RST- value: -
SCPI: device-specific

This command is only a query and therefore has no *RST value.

CALCulate<1|2>:MARKer<1 to 4>:FUNCTION:SUMMARY:RMS[:STATe] ON | OFF

This command switches on or off the measurement of the effective (RMS) power in the selected measurement window. If necessary the function is switched on previously. The function is independent of the marker selection, i.e. the numeric suffix <1 to 4> of :MARKer is irrelevant. It is only available in the time domain (span = 0).

Example: "CALC2:MARK:FUNC:SUM:RMS ON" 'Switches on the function in screen B.

Characteristics: *RST value: OFF
SCPI: device-specific

CALCulate<1|2>:MARKer<1 to 4>:FUNCTION:SUMMARY:SDEVIation:AVERage:RESult?

This command queries the result of the averaged standard deviation determined in several sweeps in the selected measurement window. The query is possible only if averaging is active. The function is independent of the marker selection, i.e. the numeric suffix <1 to 4> of :MARKer is irrelevant. It is only available in the time domain (span = 0).

A complete sweep with synchronization to sweep end must be performed between switching on the function and querying the measured value to obtain a valid query result. This is only possible in single sweep mode.

Example: "INIT:CONT OFF" 'Switches to single-sweep mode.
"CALC:MARK:FUNC:SUMM:SDEV ON" 'Switches on the function in screen A.
"CALC:MARK:FUNC:SUMM:AVER ON" 'Switches on the calculation of average
'in screen A.
"INIT;*WAI" 'Starts a sweep and waits for the end.
"CALC:MARK:FUNC:SUMM:MEAN:SDEV:RES?" 'Outputs the result of screen A.

Characteristics: *RST value: -
SCPI: device-specific

This command is only a query and therefore has no *RST value.

CALCulate<1|2>:MARKer<1 to 4>:FUNCTION:SUMMARY:SDEVIation:PHOLd:RESult?

This command queries the maximum standard deviation value determined in several sweeps in the selected measurement window. The query is possible only if the peak hold function is active.

The function is independent of the marker selection, i.e. the numeric suffix <1 to 4> of :MARKer is irrelevant. It is only available in the time domain (span = 0).

A complete sweep with synchronization to sweep end must be performed between switching on the function and querying the measured value to obtain a valid query result. This is only possible in single sweep mode.

Example: "INIT:CONT OFF" 'Switches to single-sweep mode.
"CALC:MARK:FUNC:SUMM:SDEV ON" 'Switches on the function in screen A.
"CALC:MARK:FUNC:SUMM:PHOL ON" 'Switches on the peak value
'measurement in screen A.
"INIT;*WAI" 'Starts a sweep and waits for the end.
"CALC:MARK:FUNC:SUMM:SDEV:PHOL:RES?" 'Outputs the result of screen A.

Characteristics: *RST value: -
SCPI: device-specific

This command is only a query and therefore has no *RST value.

CALCulate<1|2>:MARKer<1 to 4>:FUNCtion:SUMMary:SDEVIation:RESult?

This command queries the results of the standard deviation measurement. The function is independent of the marker selection, i.e. the numeric suffix <1 to 4> of :MARKer is irrelevant. It is only available in the time domain (span = 0).

A complete sweep with synchronization to sweep end must be performed between switching on the function and querying the measured value to obtain a valid query result. This is only possible in single sweep mode.

Example:

"INIT:CONT OFF"	'Switches to single-sweep mode.
"CALC:MARK:FUNC:SUMM:SDEV ON"	'Switches on the function in screen A.
"INIT;*WAI"	'Starts a sweep and waits for the end.
"CALC:MARK:FUNC:SUMM:SDEV:RES?"	'Outputs the result of screen A.

Characteristics: *RST value: -
SCPI: device-specific

This command is only a query and therefore has no *RST value.

CALCulate<1|2>:MARKer<1 to 4>:FUNCtion:SUMMary:SDEVIation[:STATe] ON | OFF

This command switches on or off the measurement of the standard deviation in the selected measurement window. The function is independent of the marker selection, i.e. the numeric suffix <1 to 4> of :MARKer is irrelevant. It is only available in the time domain (span = 0)..

On switching on the measurement, the mean power measurement is switched on as well.

Example:

"CALC2:MARK:FUNC:SUMM:SDEV ON"	'Switches on the measurement of 'the standard deviation in screen B.
--------------------------------	---

Characteristics: *RST value: OFF
SCPI: device-specific

CALCulate<1|2>:MARKer<1 to 4>:FUNCtion:SUMMary[:STATe] ON | OFF

This command switches on or off the previously selected time domain power measurements. Thus one or several measurements can be first selected and then switched on and off together with CALC:MARK:FUNC:SUMMary:STATe.

The function is independent of the marker selection, i.e. the suffix of MARKer is irrelevant. It is only available in the time domain (span = 0).

Example: "CALC:MARK:FUNC:SUMM:STAT ON"

Characteristics: *RST value: OFF
SCPI: device-specific

CALCulate:MATH Subsystem

The CALCulate:MATH subsystem allows to process data from the SENSE-subsystem in numeric expressions. The measurement windows are selected by CALCulate1 (screen A) or CALCulate2 (screen B).

COMMAND	PARAMETERS	UNIT	COMMENT
CALCulate<1 2> :MATH [:EXPRession] [:DEFine] :MODE :POSition :STATe	<expr> LINear LOGarithmic POWer <numeric_value> <Boolean>	PCT	

CALCulate<1|2>:MATH[:EXPRession][:DEFine] <expr>

This command defines the mathematical expression for relating traces to trace1.

The zero point of the result display can be defined with CALC:MATH:POS. Command CALCulate:MATH:STATe switches the mathematical relation of traces on or off.

Parameter: <expr> ::= 'OP1 - OP2'
 OP1 ::= TRACE1
 OP2 ::= TRACE2 | TRACE3

Example: "CALC1:MATH (TRACE1 - TRACE2)" 'Selects the subtraction of trace 1
 'from trace 2 in screen A.
"CALC2:MATH (TRACE1 - TRACE3)" 'Selects the subtraction of trace 1
 'from trace 3 in screen B.

Characteristics: *RST value: -
SCPI: conforming

CALCulate<1|2>:MATH:MODE LINear | LOGarithmic | POWer

This command selects linear or logarithmic (= video) calculation of the mathematical functions related to the traces. The calculation of the average is one of the affected functions. The setting is valid for all measurement windows, i.e. the numeric suffix <1|2> of CALCulate is irrelevant.

Example: "CALC:MATH:MODE LIN" 'Switches on the linear calculation.

Characteristics: *RST value: LOG
SCPI: device-specific

CALCulate<1|2>:MATH:POSition -100PCT to 200PCT

This command defines the position of the result of the trace mathematics in the selected measurement window. The indication is in % of the screen height, with 100% corresponding to the upper diagram border.

Example: "CALC:MATH:POS 50PCT" 'Sets the position in screen A to the
 'horizontal diagram center.

Characteristics: *RST value: 50 %
SCPI: device-specific

CALCulate<1|2>:MATH:STATe ON | OFF

This command switches the mathematical relation of traces on or off.

Example: "CALC:MATH:STAT ON" 'Switches on the trace mathematics in 'screen A.

Characteristics: *RST value: OFF
SCPI: conforming

CALCulate:PEAKsearch | PSEarch Subsystem

CALCulate<1|2>:PEAKsearch|PSEarch:AUTO ON | OFF

By using this command, the peak list in the spurious measurement is calculated automatically after a measurement. For each range, exactly one peak value is calculated.
The SENSE suffix is unused.

Example: "CALC:PEAK:AUTO ON" Switches the automatic peak search on.

Characteristics: *RST value: OFF
SCPI: device-specific

CALCulate<1|2>:PEAKsearch|PSEarch[:IMMEDIATE]

This command activates the generation of a peak list.
The numeric suffix in CALCULATE<1|2> is not significant.

Example: "CALC:PEAK"

Characteristics: *RST value: -
SCPI: device-specific

This command is an event and therefore has no *RST value and no query.

CALCulate<1|2>:PEAKsearch|PSEarch:MARGIN MINimum .. MAXimum

This command defines the margin for the peak search.
The numeric suffix in CALCULATE<1|2> is not significant.

Example: "CALC:PEAK:MARG 5 dB"

Characteristics: *RST value: 6 dB
SCPI: device-specific

CALCulate<1|2>:PEAKsearch|PSEarch:SUBRANGES 1 to 500

This command defines the number of subranges for the peak search.
The numeric suffix in CALCULATE<1|2> is not significant.

Example: "CALC:PEAK:SUBR 10"

Characteristics: *RST value: 25
SCPI: device-specific

CALCulate:PMETER Subsystem

This subsystem controls the settings of the instrument for measurements with a power sensor. The measurement window is selected via CALCulate1 (SCREEN A) and CALCulate2 (SCREEN B).

COMMAND	PARAMETERS	UNIT	COMMENT
CALCulate<1 2> :PMETER :RELative [:MAGNitude] :AUTO :STATe	<numeric_value> ONCE <Boolean>	dBm	Option K9

CALCulate<1|2>:PMETER:RELative[:MAGNitude] <numeric_value>

This command sets the reference value for relative measurements.

Example: ":CALC:PMET:REL -30" ' sets the reference value for relative measurements to -30 dBm

Properties: *RST value: 0
 SCPI: device-specific

CALCulate<1|2>:PMETER:RELative[:MAGNitude]:AUTO ONCE

This command accepts the current result as a reference value for relative measurements.

Example: ":CALC:PMET:REL:AUTO ONCE" ' accepts the current result as a reference value for relative measurements

Properties: *RST value: -
 SCPI: device-specific

CALCulate<1|2>:PMETER:RELative:STATe ON | OFF

This command switches between relative and absolute display of the result.

Example: ":CALC:PMET:REL:STAT ON" ' activates relative display of the result

Properties: *RST value: OFF
 SCPI: device-specific

CALCulate:STATistics Subsystem

The CALCulate:STATistics subsystem controls the statistical measurement functions in the instrument. The measurement window cannot be selected with these functions. The numeric suffix in CALCulate is therefore ignored.



The commands of this subsystem are not available during GSM measurements.

COMMAND	PARAMETERS	UNIT	COMMENT
CALCulate			
:STATistics			
:APD			
[:STATe]	<Boolean>	--	
:CCDF			
[:STATe]	<Boolean>	--	
:X<1...3>?	P0_01 P0_1 P1 P10		
:NSAMples	<numeric_value>		
:PRESet			
:RESult<1 to 3>?	MEAN PEAK CFACtor ALL		query only
:SCALE			
:AUTO	ONCE		
:X			
:RANGe	<numeric_value>	DB	
:RLEVel	<numeric_value>	DBM	
:Y			
:LOWer	<numeric_value>		
:UNIT	PCT ABSolute		
:UPPer	<numeric_value>		

CALCulate:STATistics:APD[:STATe] ON | OFF

This command switches on or off the measurement of amplitude distribution (APD). On activating this function, the CCDF measurement is switched off.

Example: "CALC:STAT:APD ON" 'Switches on the APD measurement.

Characteristics: *RST value: OFF
SCPI: device-specific

CALCulate:STATistics:CCDF[:STATe] ON | OFF

This command switches on or off the measurement of the complementary cumulative distribution function (CCDF). On activating this function, the APD measurement is switched off.

Example: "CALC:STAT:CCDF ON" 'Switches on the CCDF measurement.

Characteristics: *RST value: OFF
SCPI: device-specific

CALCulate:STATistics:CCDF:X<1 to 3>? P0_1 | P1 | P10

This command reads out the level values for the probabilities 0.1%, 1% and 10%. The trace is selected by means of the numeric suffix <1 to 3>.

Parameters: The desired result is selected by means of the following parameters:

P0_1 Level value for 0.1% probability
 P1 Level value for 1% probability
 P10 Level value for 10% probability

Example: "CALC:STAT:CCDF:X? P1" 'Reads out the level values for 1% probability.

Characteristics: *RST value: --
 SCPI: device-specific

CALCulate:STATistics:NSAMples 100 to 1E9

This command sets the number of measurement points to be acquired for the statistical measurement functions.

Example: "CALC:STAT:NSAM 500" 'Sets the number of measurement points to be acquired to 500.

Characteristics: *RST value: 100000
 SCPI: device-specific

CALCulate:STATistics:PRESet

This command resets the scaling of the X and Y axes in a statistical measurement. The following values are set:

X axis ref level: -20 dBm
 X axis range APD: 100 dB
 X axis range CCDF: 20 dB
 Y axis upper limit: 1.0
 Y axis lower limit: 1E-6

Example: "CALC:STAT:PRES" ' Resets the scaling for statistical functions

Characteristics: *RST value: --
 SCPI: device-specific

This command is an event and therefore has no *RST value and no query.

CALCulate:STATistics:RESult<1 to 3>? MEAN | PEAK | CFACtor | ALL

This command reads out the results of statistical measurements of a recorded trace. The trace is selected with the numeric suffix <1 to 3> attached to RESULT.

Parameter: The required result is selected via the following parameters:

MEAN Average (=RMS) power in dBm measured during the measurement time.
 PEAK Peak power in dBm measured during the measurement time.
 CFACtor Determined CREST factor (= ratio of peak power to average power) in dB.
 ALL Results of all three measurements mentioned before, separated by comm.as:
 <mean power>,<peak power>,<crest factor>

Example: "CALC:STAT:RES2? ALL" 'Reads out the three measurement results of 'trace 2.
 Example of answer string: '5.56,19.25,13.69 'i.e. mean power: 5.56 dBm, peak power 19.25 'dBm, CREST factor 13.69 dB

Characteristics: *RST value: --
 SCPI: device-specific

CALCulate:STATistics:SCALE:AUTO ONCE

This command optimizes the level setting of the instrument depending on the measured peak power, in order to obtain maximum instrument sensitivity.

To obtain maximum resolution, the level range is set as a function of the measured spacing between peak power and the minimum power for the APD measurement and of the spacing between peak power and mean power for the CCDF measurement. In addition, the probability scale for the number of test points is adapted.



Subsequent commands have to be synchronized with *WAI, *OPC or *OPC? to the end of the autorange process which would otherwise be aborted.

Example: "CALC:STAT:SCAL:AUTO ONCE;*WAI" 'Adapts the level setting for
'statistical measurements.'

Characteristics: *RST value: --
SCPI: device-specific

This command is an event and therefore has no *RST value and no query.

CALCulate:STATistics:SCALE:X:RANGe 10dB to 200dB

This command defines the level range for the X axis of the measurement diagram. The setting is identical to the level range setting defined with the command DISPLAY:WINDOW:TRACE:Y:SCALE.

Example: "CALC:STAT:SCAL:X:RANG 20dB"

Characteristics: *RST value: 100dB
SCPI: device-specific

CALCulate:STATistics:SCALE:X:RLEVel -130dBm to 30dBm

This command defines the reference level for the X axis of the measurement diagram. The setting is identical to the reference level setting using the command DISPLAY:WINDOW:TRACE:Y:RLEVel. With the reference level offset <> 0 the indicated value range of the reference level is modified by the offset.

The unit depends on the setting performed with CALC:UNIT.

Example: "CALC:STAT:SCAL:X:RLEV -60dBm"

Characteristics: *RST value: -20dBm
SCPI: device-specific

CALCulate<1|2>:STATistics:SCALE:Y:LOWer 1E-9 to 0.1

This command defines the lower limit for the y-axis of the diagram in statistical measurements. Since probabilities are specified on the y-axis, the entered numerical values are dimensionless.

Example: "CALC:STAT:SCAL:Y:LOW 0.001"

Characteristics: *RST value: 1E-6
SCPI: device-specific

CALCulate:STATistics:SCALE:Y:UNIT PCT | ABS

This command toggles the scaling of Y axis between percentage und absolute.

Example: "CALC:STAT:SCAL:Y:UNIT PCT" 'toggle to percentage

Characteristics: *RST value ABS
SCPI: device-specific

CALCulate:STATistics:SCALe:Y:UPPer 1E-8 to 1.0

This command defines the upper limit for the Y axis of the diagram in statistical measurements. Since probabilities are specified on the Y axis, the entered numerical values are dimensionless.

Example: "CALC:STAT:Y:UPP 0.01"

Characteristics: *RST value: 1.0
SCPI: device-specific

CALCulate:STATistics:SCALe:Y:LOWer 1E-9 to 0.1

This command defines the lower limit for the Y axis of the diagram in statistical measurements. Since probabilities are specified on the Y axis, the entered numerical values are dimensionless.

Example: "CALC:STAT:SCAL:Y:LOW 0.001"

Characteristics: *RST value: 1E-6
SCPI: device-specific

CALCulate:THReshold Subsystem

The CALCulate:THReshold subsystem controls the threshold value for the maximum/minimum search of markers. The measurement windows are selected by CALCulate 1 (screen A) or 2 (screen B).

COMMAND	PARAMETERS	UNIT	COMMENT
CALCulate<1 2> :THReshold :STATe	<numeric_value> <Boolean>	DBM DB	

CALCulate<1|2>:THReshold MINimum to MAXimum (depending on current unit)

This command defines the threshold value for the maximum/minimum search of markers with marker search functions MAX PEAK, NEXT PEAK, etc in the selected measurement window. The associated display line is automatically switched on.

Example: "CALC:THR -82DBM" 'Sets the threshold value for screen A to -82 dBm.

Characteristics: *RST value: - (STATe to OFF)
SCPI: device-specific

CALCulate<1|2>:THReshold:STATe ON | OFF

This command switches on or off the threshold line in the selected measurement window. The unit depends on the setting performed with CALC:UNIT.

Example: "CALC2:THR:STAT ON" 'Switches on the threshold line in screen B.

Characteristics: *RST value: OFF
SCPI: device-specific

CALCulate:TLINe Subsystem

COMMAND	PARAMETERS	UNIT	COMMENT
:TLINe<1 2> :STATe	<numeric_value> <Boolean>	S	

CALCulate<1|2>:TLINe<1|2> 0 to 1000s

This command defines the position of the time lines.

The time lines mark the times specified in the measurement window. Time lines are only available with SPAN = 0.

Example: "CALC:TLIN 10ms"

Characteristics: *RST value: - (STATe to OFF)
SCPI: device-specific

CALCulate<1|2>:TLINe<1|2>:STATe ON | OFF

This command switches the time line on or off.

Example: "CALC:TLIN2:STAT ON"

Characteristics: *RST value: OFF
SCPI: device-specific

CALCulate:UNIT Subsystem

The CALCulate:Unit subsystem defines the units for power measurement settings.

COMMAND	PARAMETERS	UNIT	COMMENT
CALCulate<1 2> :UNIT :POWer	DBM V A W DB PCT UNITLESS DBPW WATT DBUV DBMV VOLT DBPT DBUA AMPere DBUV_M DBUA_M		

CALCulate<1|2>:UNIT:POWer DBM | V | A | W | DB | PCT | UNITLESS |DBPW | WATT | DBUV |
DBMV | DBPT | VOLT | DBUA | AMPere | DBUV_M | DBUA_M

This command selects the unit for power in the selected measurement window.

In receiver mode, only the units DBUV, DBUV_M, DBUA, DBUA_M, DBPW, DBPT and DBMV are available



During GSM measurements the unit is either dBm (power measurements) or deg (phase error measurements).

Example: "CALC:UNIT:POW DBM" 'Sets the power unit for screen A to dBm.

Characteristics: *RST value: dBm
SCPI: device-specific

CALibration Subsystem

The commands of the CALibration subsystem determine the data for system error correction in the instrument.

COMMAND	PARAMETERS	UNIT	COMMENT
CALibration :ABORt [:ALL]? :RESult? :STATe	<Boolean>		no query query only query only

CALibration:ABORt

This command aborts the acquisition of correction data and restores the last complete correction data set.

Example: "CAL:ABOR"

Characteristics: *RST value: -
SCPI: device-specific

This command is an event and therefore has no *RST value and no query.

CALibration[:ALL]?

This command initiates the acquisition of system error correction data. A "0" is returned if the acquisition was successful.



During the acquisition of correction data the instrument does not accept any remote control commands, except

*RST
CALibration:ABORt

In order to recognize when the acquisition of correction data is completed, the MAV bit in the status byte can be used. If the associated bit is set in the Service Request Enable Register, the instrument generates a service request after the acquisition of correction data has been completed.

Example: "*CLS" ' Resets the status management.
"*SRE 16" ' Enables MAV bit in the Service Request Enable Register.
"*CAL?" ' Starts the correction data recording and then a service request is generated.

Characteristics: *RST value: -
SCPI: conforming

CALibration:PMETer:ZERO:AUTO ONCE

This command starts zeroing of the power sensor.

Example: "CAL:PMET:ZERO:AUTO ONCE;*WAI"

Characteristics: *RST value: -
SCPI: conforming

CALibration:RESult?

This command outputs the results of the correction data acquisition. The lines of the result table (see section "Recording the correction data of R&S FSMR – CAL key") are output as string data separated by commas:

```
"Total Calibration Status: PASSED", "Date (dd/mm/yyyy): 12/07/1999",  
"Time: 16:24:54", "Runtime:00.06"
```

Example: "CAL:RES?"

Characteristics: *RST value: --
SCPI: device-specific

CALibration:STATe ON | OFF

This command determines whether the current calibration data are taken into account by the instrument (ON) or not (OFF).

Example: "CAL:STAT OFF" 'Sets up the instrument to ignore the calibration data.

Characteristics: *RST value: -
SCPI: conforming

DIAGnostic Subsystem

The DIAGnostic subsystem contains the commands which support instrument diagnostics for maintenance, service and repair. In accordance with the SCPI standard, all of these commands are device-specific.

The measurement windows are selected by DIAGnostic1 (screen A) or DIAGnostic2 (screen B) .

COMMAND	PARAMETERS	UNIT	COMMENT
DIAGnostic<1 2> :SERVice :CSOurce :HWINfo? :INPut :PULSed :PRATe [:STATe] :RECTangle :PRATe [:STATe] [:SElect] :NSOurce :SFUNction [:POWer] :STEST :RESult?	<numeric_value> <Boolean> <numeric_value> <Boolean> CALibration RF <Boolean> <string>	Hz Hz	query only no query query only

DIAGnostic<1|2>:SERVice:CSOource[:POWer] <numeric_value>

This command switches the level of the 128 MHz reference signal source between 0 dBm and -30 dBm in the selected measurement window.

Example: "DIAG:SERV:CSO 0DBM"

Characteristics: *RST value: -30 dBm
SCPI: device-specific

DIAGnostic<1|2>:SERVice:HWINfo?

This command queries the contents of the module info table. Table lines are output as string data and are separated by commas.

"<component 1>|<serial #>|<order #>|<model>|<HWC>|<rev>|<sub rev>",
"<component 2>|<serial #>|<order #>|<model>|<HWC>|<rev>|<sub rev>",...

The individual columns of the table are separated from each other by '|'.
The numeric suffix <1|2> is ignored with this command.

Example: "DIAG:SERV:HWIN?"

Result (shortened):

"RF_ATTEN_7|650551/007|1067.7684|02|00|20|04",
"IF-FILTER|648158/037|1093.5540|03|01|07|05",
...

Characteristics: *RST value: --
SCPI: device-specific

DIAGnostic<1|2>:SERVice:INPut:PULSed:PRATe 10 kHz | 62.5 kHz | 1 MHz | 128 MHz | 640 MHz

This command selects the pulse rate for the pulsed calibration signal in the selected measurement window. Available pulse frequencies are 10 kHz, 62.5 kHz, 100 kHz, 1 MHz, 128 MHz and 640 MHz.

Example: "DIAG:SERV:INP:PRAT 128 MHz"

Characteristics: *RST value: 128 MHz
SCPI: device-specific

DIAGnostic<1|2>:SERVice:INPut:PULSed[:STATe] ON | OFF

This command toggles the calibration signal in the selected measurement window between pulsed and non-pulsed. The selection takes effect only if the RF input has been set to the internal reference signal using `DIAG:SERV:INP CAL`.

Example: "DIAG:SERV:INP CAL;
DIAG:SERV:INP:PULS ON"

Characteristics: *RST value: OFF
SCPI: device-specific

DIAGnostic<1|2>:SERVice:INPut:RECTangle:PRATe <numeric_value>

This command sets the frequency of the rectangle calibration signal in the selected measurement window (suffix <1|2>).

5 kHz | 31.25 kHz | 50 kHz | 250 kHz | 500 kHz can be set.

Example: "DIAG:SERV:INP:RECT:PRAT 128 MHz"

Characteristics: *RST value: 5 kHz
SCPI: device-specific

DIAGnostic<1|2>:SERVice:INPut[:SELEct] CALibration | RF

This command toggles between the RF input on the front panel and the internal 128-MHz reference signal in the selected measurement window. The level of the 128-MHz signals can be selected by command `DIAG:SERV:CSourCe`.

Example: "DIAG:SERV:INP CAL"

Characteristics: *RST value: RF
SCPI: device-specific

DIAGnostic<1|2>:SERVice:INPut:RECTangle[:STATe] ON | OFF

This command switches the rectangle calibration signal on or off in the selected measurement window (suffix <1|2>). The setting takes effect only if the RF input is set to the internal reference signal (`DIAG:SERV:INP CAL` command).



If the rectangle calibration signal is switched on, the pulsed calibration signal is switched off.

Example: "DIAG:SERV:INP CAL;
DIAG:SERV:INP:RECT ON"

Characteristics: *RST value: OFF
SCPI: device-specific

DIAGnostic<1|2>:SERVice:SFUNction <string>...

This command activates a service function which can be selected by indicating the five parameters: function group number, board number, function number, parameter 1 and parameter 2 (see service manual). The contents of the parameter string is identical to the code to be entered in the data entry field of manual operation. The entry of a service function is accepted only if the system password Level 1 or Level 2 has been entered previously (command: `SYSTem:SECurity`). The numeric suffix <1|2> is ignored with this command.



The service functions of the instrument are not identical to those of the FSE family. That is why the IEC/IEEE-bus command differs in syntax and data format.

Example: `"DIAG:SERV:SFUN '2.0.2.12.1'"`

Characteristics: *RST value: -
SCPI: device-specific

DIAGnostic<1|2>:SERVice:NSOource ON | OFF

This command switches the 28-V supply of the noise source at the rear panel on or off. The numeric suffix <1|2> is ignored with this command.

Example: `"DIAG:SERV:NSO ON"`

Characteristics: *RST value: OFF
SCPI: device-specific

DIAGnostic<1|2>:SERVice:STES:RESult?

This command reads the results of the selftest out of the instrument. The lines of the result table are output as string data separated by commas:

```
"Total Selftest Status: PASSED", "Date (dd/mm/yyyy): 09/07/1999  
TIME: 16:24:54", "Runtime: 00:06", "..."
```

The numeric suffix <1|2> is ignored with this command.

Example: `"DIAG:SERV:STES:RES?"`

Characteristics: *RST value: --
SCPI: device-specific

DISPlay Subsystem

The DISPlay subsystem controls the selection and presentation of textual and graphic information as well as of measurement data on the display.

The measurement windows are selected by WINDow1 (screen A) or WINDow2 (screen B) .

COMMAND	PARAMETERS	UNIT	COMMENT
DISPlay			
:ANNotation			
:FREQuency	<Boolean>		
:CMAp<1...26>			
:DEFault<1 2>			
:HSL	0..1,0..1,0..1		
:PDEFined	BLACK BLUE BROWn GREen CYAN RED MAGenta YELLow WHITe DGRAY LGRAY LBLUe LGREen LCYan LRED LMAGenta		
:FORMat	SINGLE SPLIT		
:LOGO	<Boolean>		
:PSAVe			
:HOLDoff	1...60		
[:STATe]	<Boolean>		
[:WINDow<1 2>]			
:ACTive?			no query
:SElect			
:SIZE	LARGE SMALL		
:TEXT			
[:DATA]	<string>		
:STATe	<Boolean>		
:TIME	<Boolean>		
:MODE	WRITE VIEW AVERAGE MAXHold MINHold RMS	--	
[:STATe]	<Boolean>	--	
:TRACe<1...3>		--	
:MODE	WRITE VIEW AVERAGE MAXHold MINHold RMS	--	
[:STATe]	<Boolean>		
:X			
:Y			
[:SCALE]	<numeric_value>	DB	
:MODE	ABSolute RELative		
:PDIVision	<numeric_value>	DBM DB HZ	Option FM demodulator
:RLEVel	<numeric_value>	DBM	
:OFFSet	<numeric_value>	DB	
:RPOSition	<numeric_value>	PCT	
:RVALue	<numeric_value>	DB HZ	
:SPACing	LINear LOGarithmic LDB		
:UNIT?			

DISPlay:ANNotation:FREQuency ON | OFF

This command switches the X axis annotation on or off.

Example: "DISP:ANN:FREQ OFF"

Characteristics: *RST value: ON
SCPI: conforming

DISPlay:CMAP<1 to 26>:DEFault<1|2>

This command resets the screen colors of all display items to their default settings. Two default settings DEFault1 and DEFault2 are available. The numeric suffix of CMAP is irrelevant.

Example: "DISP:CMAP:DEF2" 'Selects default setting 2 for setting the colors.

Characteristics: *RST value: --
SCPI: conforming

This command is an event and therefore has no query and no *RST value .

DISPlay:CMAP<1 to 26>:HSL <hue>,<sat>,<lum>

This command defines the color table of the instrument.

Each numeric suffix of CMAP is assigned one or several graphical elements which can be modified by varying the corresponding color setting. The following assignment applies:

CMAP1	Background
CMAP2	Grid
CMAP3	Function field + status field + data entry text
CMAP4	Function field LED on
CMAP5	Function field LED warn
CMAP6	Enhancement label text
CMAP7	Status field background
CMAP8	Trace 1
CMAP9	Trace 2
CMAP10	Trace 3
CMAP11	Marker
CMAP12	Lines
CMAP13	Measurement status + limit check pass
CMAP14	Limit check fail
CMAP15	Table + softkey background
CMAP16	Table + softkey text
CMAP17	Table selected field text
CMAP18	Table selected field background
CMAP19	Table + data entry field opaq titlebar
CMAP20	Data entry field opaq text
CMAP21	Data entry field opaq background
CMAP22	3D shade bright part
CMAP23	3D shade dark part
CMAP24	Softkey state on
CMAP25	Softkey state data entry
CMAP26	Logo

Parameter: hue = TINT
sat = SATURATION
lum = BRIGHTNESS

The value range is 0 to 1 for all parameters.

Example: "DISP:CMAP2:HSL 0.3,0.8,1.0" Changes the grid color.

Characteristics: *RST value: --
SCPI: conforming

The values set are not changed by *RST.

DISPlay:CMAP<1 to 26>:PDEFined BLACK | BLUE | BROWn | GREEn | CYAN | RED | MAGenta |
 YELLOW | WHITE | DGRAY | LGRAY | LBLUe | LGREen | LCYan
 | LRED | LMAGenta

This command defines the color table of the instrument using predefined color values. Each numeric suffix of CMAP is assigned one or several graphical elements which can be modified by varying the corresponding color setting.

The same assignment as for `DISPlay:CMAP<1 to 26>:HSL` applies.

Example: `"DISP:CMAP2:PDEF GRE"`

Characteristics: *RST value: --
 SCPI: conforming

The values set are not changed by *RST.

DISPlay:FORMat SINGLE | SPLit

This command switches the measurement result display between FULL SCREEN and SPLIT SCREEN. The coupling of settings between screen A and screen B can be selected with the command `INSTRument:COUPle`.

In full-screen display the active measurement window can be selected with

`DISPlay:WINDow<1|2>:SElect`.

For GSM/EDGE mode, the display is always set to FULL SCREEN.

Example: `"DISP:FORM SPL"` Switches the display to 2 measurement windows.

Characteristics: *RST value: SINGLE
 SCPI: device-specific

DISPlay:LOGO ON | OFF

This command switches the company logo on the screen on or off.

Example: `"DISP:LOGO OFF"`

Characteristics: *RST value: ON
 SCPI: device-specific

DISPlay:PSAVe[:STATe] ON | OFF

This command switches on or off the power-save mode of the display. With the power-save mode activated the display including backlight is completely switched off after the elapse of the response time (see command `DISPlay:PSAVe:HOLDoff`).

This mode is recommended for preserving the display especially if the instrument is exclusively operated via remote control.

Example: `"DISP:PSAVe ON"` Switches on the power-save mode.

Characteristics: *RST value: OFF
 SCPI: device-specific

DISPlay:PSAVe:HOLDoff 1 to 60

This command sets the holdoff time for the power-save mode of the display. The available value range is 1 to 60 minutes, the resolution 1 minute. The entry is dimensionless.

Example: `"DISP:PSAV:HOLD 30"`

Characteristics: *RST value: 15
 SCPI: device-specific

Characteristics: *RST value: "" (empty)
SCPI: conforming

DISPlay[:WINDow<1|2>]:TEXT:STATe ON | OFF

This command switches on or off the display of the comment (screen title) in the selected measurement window.

Example: "DISP:TEXT:STAT ON" 'Switches on the title of screen B.

Characteristics: *RST value: OFF
SCPI: conforming

DISPlay[:WINDow<1|2>]:TIME ON | OFF

This command switches on or off the screen display of date and time. The numeric suffix in WINDow<1|2> is irrelevant.

Example: "DISP:TIME ON"

Characteristics: *RST value: OFF
SCPI: device-specific

DISPlay[:WINDow<1|2>]:TRACe<1 to 3>:MODE WRITe | VIEW | AVERAge | MAXHold | MINHold

This command defines the type of display and the evaluation of the traces in the selected measurement window. WRITE corresponds to the Clr/Write mode of manual operation. The trace is switched off (= BLANK in manual operation) with DISP:WIND:TRAC:STAT OFF.

The number of measurements for AVERAge, MAXHold and MINHold is defined with the command SENSE:AVERAge:COUNT or SENSE:SWEp:COUNT. It should be noted that synchronization to the end of the indicated number of measurements is only possible in single sweep mode.

If calculation of average values is active, selection between logarithmic and linear averaging is possible. For more detail see command SENSE:AVERAge:TYPE.

Example: "SWE:CONT OFF" Switching to single-sweep mode.
"SWE:COUN 16" 'Sets the number of measurements to 16.
"DISP:WIND1:TRAC3:MODE MAXH" 'Switches on the calculation of the for
'trace 3 in screen A.
"INIT;*WAI" 'Starts the measurement and waits for the end of the
'16 sweeps.

Characteristics: *RST value: WRITe for TRACe1, STATe OFF for TRACe2/3
SCPI: device-specific

DISPlay[:WINDow<1|2>]:TRACe<1 to 3>:MODE:HCONtinuous ON | OFF

This command specifies whether or not the traces with peak or minimum value detection are reset after specific parameter changes.

Usually the measurement must be restarted after a parameter change, before an evaluation of the measurement results is performed (e.g. with a marker). In cases in which a change causes a compulsory new measurement, the trace is automatically reset in order to prevent erroneous measurements of previous measurement results (e.g. when the span changes). For applications in which this behavior is not desired, this mechanism can be switched off.

OFF The traces are reset after specific parameter changes.

ON The reset mechanism is switched off.

Example: "DISP:WIND1:TRAC3:MODE:HCON ON" The reset mechanism is switched off for measurement window 1.

Characteristics: *RST value: OFF
SCPI: device-specific

DISPlay[:WINDow<1|2>]:TRACe<1 to 3>[:STATe] ON | OFF

This command switches on or off the display of the corresponding trace in the selected measurement window.

Example: "DISP:WIND1:TRAC3 ON"

Characteristics: *RST value: ON for TRACe1, OFF for TRACe2 to 4
SCPI: conforming

DISPlay[:WINDow<1|2>]:TRACe<1 to 3>:Y[:SCALe] 10dB to 200dB

This command defines the display range of the Y axis (level axis) in the selected measurement window with logarithmic scaling (DISP:TRAC:Y:SPAC LOG).

For linear scaling, (DISP:TRAC:Y:SPAC LIN | PERC) the display range is fixed and cannot be modified. The numeric suffix in TRACe<1 to 3> is irrelevant.

Example: "DISP:TRAC:Y 110dB"

Characteristics: *RST value: 100dB
SCPI: device-specific

DISPlay[:WINDow<1|2>]:TRACe<1 to 3>:Y[:SCALe]:MODE ABSolute | RELative

This command defines the scale type of the Y axis (absolute or relative) in the selected measurement window.

When SYSTem:DISPlay is set to OFF, this command has no immediate effect on the screen. The numeric suffix in TRACe<1 to 3> is irrelevant.

Example: "DISP:TRAC:Y:MODE REL"

Characteristics: *RST value: ABS
SCPI: device-specific

DISPlay[:WINDow<1|2>]:TRACe<1 to 3>:Y[:SCALe]:PDIVision <numeric_value>

This command defines the scaling of the Y axis in the current unit.

Example: "DISP:TRAC:Y:PDIV +1.20"

Characteristics: *RST value: -
SCPI: conforming

DISPlay[:WINDow<1|2>]:TRACe<1 to 3>:Y[:SCALe]:RLEVel -130dBm to 30dBm

This command defines the reference level in the selected measurement window. Depending on the coupling of the measurement windows, it is valid for both screens (INSTrument:COUPlE ALL) or only for the selected measurement window (INSTrument:COUPlE NONE).

With the reference level offset <> 0 the indicated value range of the reference level is modified by the offset. The unit depends on the setting defined with CALCulate:UNIT. The numeric suffix in TRACe<1 to 3> is irrelevant.

Example: "DISP:TRAC:Y:RLEV -60dBm"

Characteristics: *RST value: -20dBm
SCPI: conforming

DISPlay[:WINDow<1|2>]:TRACe<1 to 3>:Y[:SCALe]:RLEVel:OFFSet -200dB to 200dB

This command defines the offset of the reference level in the selected measurement window. Depending on the coupling of the measurement windows, it is valid for both screens (INSTRument:COUPLe ALL) or only for the selected measurement window (INSTRument:COUPLe NONE).

The numeric suffix at TRACe<1 to 3> is irrelevant.

Example: "DISP:TRAC:Y:RLEV:OFFS -10dB"

Characteristics: *RST value: 0dB
SCPI: conforming

DISPlay[:WINDow<1|2>]:TRACe<1 to 3>:Y[:SCALe]:RPOSition 0 to 100PCT

This command defines the position of the reference value in the selected measurement window. The numeric suffix in TRACe<1 to 3> is irrelevant.

With the FM demodulator (FS-K7) switched on, the reference position for result display RF POWER and SPECTRUM is kept separate from that for result display FM.

In operating mode NETWORK (Ext. Generator Option FSP-B10) with active normalization, RPOSition defines the reference point for the output of the normalized measurement results.

Example: "DISP:TRAC:Y:RPOS 50PCT"

Characteristics: *RST value: 100PCT(SPECTRUM mode)
50 PCT (NETWORK and FM DEMOD mode)
50 PCT (Mode FM-DEMOM with FM display)
100 PCT(Mode FM-DEMOM with AF spectrum display of FM)
SCPI: conforming

DISPlay[:WINDow<1|2>]:TRACe<1 to 3>:Y[:SCALe]:RVALue <numeric_value>

If the external generator control option (FSP-B10) is mounted and the normalization in the NETWORK mode is activated, this value defines the power value assigned to the reference position in the selected measurement window. This value corresponds to the parameter REFERENCE VALUE in manual operation.

The numeric suffix at TRACe<1 to 3> is irrelevant.

Example: "DISP:TRAC:Y:RVAL -20dBm" (spectrum analysis)
"DISP:TRAC:Y:RVAL 0" Sets the power value assigned to the reference position to 0 dB (Tracking Generator /Ext. Generator Control option) or 0 Hz (FM demodulator option).

Characteristics: *RST value: 0 dB (Mode NETWORK)
0 Hz (FM demodulator mode with FM display)
2.5MHz (FM demodulator mode with AF spectrum display of FM)
- coupled to reference level
0 dB
SCPI: device specific

DISPlay[:WINDow<1|2>]:TRACe<1 to 3>:Y:SPACing LINear | LOGarithmic| LDB

This command toggles between linear and logarithmic display in the selected measurement window. On a linear scale, switchover between the unit % (command `DISP:WIND:TRAC:Y:SPAC LIN`) and the unit dB (command `DISP:WIND:TRAC:Y:SPAC LDB`) is also possible.

If the FM demodulator (FS-K7) is active and result display AF spectrum of FM is selected, only the parameters LINear and LOGarithmic are permissible.

The numeric suffix in TRACe<1 to 3> is irrelevant.

Example: `"DISP:TRAC:Y:SPAC LIN"`

Characteristics: *RST value: LOGarithmic
SCPI: conforming

DISPlay[:WINDow<1|2>]:TRACe<1 to 3>:Y:UNIT?

This command returns the Y unit that has been set.

This command is only a query and has the *RST value from the UNIT:POWer command.

The numeric suffix in TRACe<1 to 3> has no significance.

Example: `"DISP:WIND1:TRAC:Y:UNIT?"`

Characteristics: *RST value: DBM
SCPI: device-specific

FETCh:PMETer - Subsystem

This subsystem contains the commands for outputting the results of the measurements with a power sensor without starting the measurement itself.

COMMAND	PARAMETERS	UNIT	COMMENT
FETCh<1 2> :PMETer?	--	--	query only

FETCh<1|2>:PMETer?

This command outputs the result of the power sensor.

Example: "FETC:PMET?" 'outputs the result of the power sensor

Characteristics: *RST value: -
SCPI: device-specific

If no measurement has been carried out yet, a query error is triggered. This command is strictly a query and thus does not have a *RST value.

FORMat Subsystem

The FORMat subsystem specifies the data format of the data transmitted from and to the instrument.

COMMAND	PARAMETERS	UNIT	COMMENT
FORMat [:DATA] :DEXPort :DSEParator	ASCIi REAL UINT[,<numeric_value>] POINT COMMa	-	

FORMat[:DATA] ASCii | REAL| UINT [, 8 | 32]

This command specifies the data format for the data transmitted from the instrument to the control PC.

The format settings below are valid for the binary transmission of trace data(see also TRACE:DATA?):

Mode SPECTRUM: REAL, 32
 Mode 3G FDD: UINT, 8 with bit stream measurement
 REAL, 32 otherwise

Example: "FORM REAL, 32"
 "FORM ASC"
 "FORM UINT, 8"

Characteristics: *RST value: ASCII
 SCPI: conforming

The data format is either ASCII or one of the formats REAL . ASCII data are transmitted in plain text, separated by commas. REAL data are transmitted as 32-bit IEEE 754 floating-point numbers in the "definite length block format".

The FORMat command is valid for the transmission of trace data. The data format of trace data received by the instrument is automatically recognized, regardless of the format which is programmed.

Format setting for the binary transmission of trace data (see also TRACE:DATA?):

Analyzer mode: REAL, 32

FORMat:DEXPort:DSEParator POINT|COMMA

This command defines which decimal separator (decimal point or comma) is to be used for outputting measurement data to the file in ASCII format. Different languages of evaluation programs (e.g. MS-Excel) can thus be supported.

Example: "FORM:DEXP:DSEP POIN 'Sets the decimal point as separator.

Characteristics: *RST value: -- (factory setting is POINT; *RST does not affect setting)
 SCPI: device-specific

HCOPY Subsystem

The HCOpy subsystem controls the output of display information for documentation purposes on output devices or files. The instrument allows two independent printer configurations which can be set separately with the numeric suffix <1|2>.

COMMAND	PARAMETERS	UNIT	COMMENT
HCOPY			
:ABORT	--	--	no query
:CMAP<1 to 26>			
:DEFault<1 2 3>			
:HSL	0..1,0..1,0..1		
:PDEFined	BLACK BLUE BROWN GREEN CYAN RED MAGenta YELLOW WHITE DGRAY LGRAY LBLUE LGREEN LCYan LRED LMAGenta		
:DESTination<1 2>	<string>		no query
:DEvice			
:COLor	<Boolean>		
:LANGuage<1 2>	WMF GDI EWMF BMP HTML PDF RTF		
[:IMMediate<1 2>]	--	--	no query
:ITEM			
:ALL			no query
:WINDow<1 2>			
:TABLE			
:STATe	<Boolean>		
:TEXT	<string>		
:TRACe			
:STATe	<Boolean>		
:PAGE			
:ORientation<1 2>	LANDscape PORTrait		

HCOPY:ABORT

This command aborts a running hardcopy output.

Example: "HCOPY:ABORT"

Characteristics: *RST value: -
SCPI: conforming

This command is an event and therefore has no *RST value and no query.

HCOPY:CMAP<1 to 26>:DEFault1|2|3

This command resets the colors for a hardcopy to the selected default settings. DEFault1 (SCREEN COLORS, but background white), DEFault2 (OPTIMIZED COLOR SET) and DEFault3 (USER DEFINED). The numeric suffix in CMAP is not significant.

Example: "HCOPY:CMAP:DEF2" 'selects OPTIMIZED COLOR SET for the color settings of a hardcopy.

Characteristics: *RST value: --
SCPI: conforming

This command is an event and therefore has no query and no *RST value.

HCOPy:CMAP<1 to 26>:HSL <hue>,<sat>,<lum>

This command defines the color table in USER DEFINED COLORS mode. To each numeric suffix of CMAP is assigned one or several picture elements which can be modified by varying the corresponding color setting. The following assignment applies:

- CMAP1 Background
- CMAP2 Grid
- CMAP3 Function field + status field + data entry text
- CMAP4 Function field LED on
- CMAP5 Function field LED warn
- CMAP6 Enhancement label text
- CMAP7 Status field background
- CMAP8 Trace 1
- CMAP9 Trace 2
- CMAP10 Trace 3
- CMAP11 Marker
- CMAP12 Lines
- CMAP13 Measurement status + Limit check pass
- CMAP14 Limit check fail
- CMAP15 Table + softkey background
- CMAP16 Table + softkey text
- CMAP17 Table selected field text
- CMAP18 Table selected field background
- CMAP19 Table + data entry field opaque titlebar
- CMAP20 Data entry field opaque text
- CMAP21 Data entry field opaque background
- CMAP22 3D shade bright part
- CMAP23 3D shade dark part
- CMAP24 Softkey state on
- CMAP25 Softkey state data entry
- CMAP26 Logo

Parameter: hue = tint
 sat = saturation
 lum = brightness
 The value range is 0 to 1 for all parameters

Example: "HCOP:CMAP2:HSL 0.3,0.8,1.0" ' changes the grid color

Characteristics: *RST value: --
 SCPI: conforming

The values set are not changed by *RST.

HCOPy:CMAP<1 to 26>:PDEFined BLACK | BLUE | BROWn | GREen | CYAN | RED | MAGenta |
 YELLow | WHITe | DGRAY | LGRAY | LBLUe | LGREen | LCYan
 | LRED | LMAGenta

This command defines the color table in USER DEFINED COLORS using predefined color values. To each numeric suffix of CMAP is assigned one or several picture elements which can be modified by varying the corresponding color setting. The same assignment as for :HCPOy:CMAP<1 to 26>:HSL applies

Example: "HCOP:CMAP2:PDEF GRE"

Characteristics: *RST value: --
 SCPI: conforming

The values set are not changed by *RST.

HCOPY:DESTination<1|2> <string>

This command selects the printer output medium (Disk, Printer or Clipboard) associated with configuration 1 or 2.

The type of instrument is selected with `SYSTEM:COMMunicate:PRINter:SElect`, which will automatically select a default output medium. Therefore the command `HCOPY:DESTination` should always be sent after setting the device type.

Parameter:	<code><string>::=</code>	<code>'MMEM' </code> <code>'SYST:COMM:PRIN' </code> <code>'SYST:COMM:CLIP'</code>
	<code>'MMEM'</code>	'Directs the hardcopy to a file. Command <code>MMEM:NAME</code> <code><file_name></code> defines the file name. All formats can be selected for <code>HCOPY:DEVIce:LANGuage</code> .
	<code>'SYST:COMM:PRIN'</code>	'Directs the hardcopy to the printer. The printer is selected with command <code>SYSTEM:COMMunicate:PRINter:SElect</code> . <code>GDI</code> should be selected for <code>HCOPY:DEVIce:LANGuage</code> .
	<code>'SYST:COMM:CLIP'</code>	'Directs the hardcopy to the clipboard. <code>EWMMF</code> should be selected for <code>HCOPY:DEVIce:LANGuage</code> .

Example: `"SYST:COMM:PRIN:SEL2 'LASER on LPT1'"` 'Selects the printer and output medium for device 2
`"HCOP:DEST2 'SYST:COMM:PRIN'"` 'Selects the printer interface as device 2.

Characteristics: *RST value: -
 SCPI: conforming

This command is an event and therefore has no *RST value and no query.

HCOPY:DEVIce:COLor ON|OFF

This command selects between color and monochrome hardcopy of the screen.

Example: `"HCOP:DEV:COL ON"`

Characteristics: *RST value: OFF
 SCPI: conforming

HCOPY:DEVIce:LANGUage<1|2> GDI | WMF | EWMF | BMP | HTML | PDF | RTF | HTML 4.0

This command determines the data format of the printout.

Parameter:	GDI	Graphics Device Interface: Default format for the output to a printer configured under Windows. Must be selected for the output to the printer interface (HCOPY:DEVIce 'SYST:COMM:PRIN'). Can be used for the output to a file (HCOPY:DEVIce 'SYST:COMM:MMEM'). The printer driver configured under Windows is used in this case and a printer-specific file format is thus generated.
	WMF and EWMF	WINDOWS Metafile and Enhanced Metafile Format: Data formats for output files which can be integrated in corresponding programs for documentation purposes at a later time. WMF can only be used for output to a file (HCOPY:DEVIce 'SYST:COMM:MMEM') and EWMF also for the output to the clipboard (HCOPY:DEVIce 'SYST:COMM:CLIP').
	BMP	Bitmap. Data format for output to files only (HCOPY:DEVIce 'SYST:COMM:MMEM').
	HTML 4.0	Hypertext Markup Language: Test reports can be exported to files in HTML format. It is then possible to view these files using a web browser. HTML is available only for HCOPI:MODE TREPort.
	PDF	PDF is available only for HCOPI:MODE TREPort. Adobe Acrobat (Portable Document Format). Test reports can be exported to files in PDF format. These files can then be opened using a PDF reader such as Adobe Acrobat.
	RTF	Rich Text Format: Test reports can be exported to files in RTF format. It is then possible to open these files for further processing using word processing software such as Microsoft Word. RTF is available only for HCOPI:MODE TREPort.

Example: "HCOP:DEV:LANG WMF"

Characteristics: *RST value: -
SCPI: conforming

HCOPY[:IMMEDIATE<1|2>]

This command starts a hardcopy output. The numeric suffix selects which printer configuration (1 or 2) is to be used for the hardcopy output. If there is no suffix, configuration 1 is automatically selected.

HCOPY:IMM[1] 'Starts the hardcopy output to device 1 (default).
HCOPY:IMM2 'Starts the output to device 2.

Example: "HCOP"

Characteristics: *RST value: -
SCPI: conforming

This command is an event and therefore has no *RST value and no query.

HCOPY:ITEM:ALL

This command selects the complete screen to be output.

Example: "HCOP:ITEM:ALL"

Characteristics: *RST value: OFF
SCPI: conforming

The hardcopy output is always provided with comments, title, time and date. As an alternative to the whole screen, only traces (commands 'HCOPY:ITEM:WINDOW:TRACE:STATE ON') or tables (command 'HCOPY:ITEM:WINDOW:TABLE:STATE ON') can be output.

HCOPY:ITEM:WINDOW<1|2>:TABLE:STATE ON | OFF

This command selects the output of the currently displayed tables.

Example: "HCOP:ITEM:WIND:TABLE:STAT ON"

Characteristics: *RST value: OFF
SCPI: device-specific

The command `HCOPY:DEVICE:ITEM:WINDOW<1|2>:TABLE:STATE OFF` as well as command `HCOPY:DEVICE:ITEM:ALL` enables the output of the whole screen.

HCOPY:ITEM:WINDOW<1|2>:TEXT <string>

This command defines the comment text for measurement window 1 or 2 for printout, with a maximum of 100 characters; line feed by means of character @).

Example: "HCOP:ITEM:WIND2:TEXT 'comment' "

Characteristics: *RST value: -
SCPI: device-specific

HCOPY:ITEM:WINDOW<1|2>:TRACE:STATE ON | OFF

This command selects the output of the currently displayed trace.

Example: "HCOP:ITEM:WIND:TRACE:STAT ON"

Characteristics: *RST value: OFF
SCPI: device-specific

The command `HCOPY:ITEM:WINDOW<1|2>:TRACE:STATE OFF` as well as command `HCOPY:ITEM:ALL` enables the output of the whole screen.

HCOPY:PAGE:ORIENTATION<1|2> LANDscape | PORTRait

The command selects the format of the output (portrait and landscape) (hardcopy unit 1 or 2).



The command is only available provided that the output device "printer" (`HCOP:DEST 'SYST:COMM:PRIN'`) has been selected.

Example: "HCOP:PAGE:ORI LAND"

Characteristics: *RST value: -
SCPI: conforming

INITiate Subsystem

The INITiate subsystem is used to control the init-measurement function in the selected measurement window. The measurement windows are assigned to INITiate1 (screen A) and INITiate2 (screen B).

COMMAND	PARAMETERS	UNIT	COMMENT
INITiate<1 2>			
:CONTinuous	<Boolean>	--	
:CONMeas	--	--	no query
:ESPectrum	--	--	
[:IMMediate]	--	--	no query
:DISPlay	<Boolean>		
:SPURious			no query

INITiate<1|2>:CONTinuous ON | OFF

This command determines whether the trigger system is continuously initiated (continuous) or performs single measurements (single). In the spectrum analysis mode, this setting refers to the sweep sequence (switching between continuous/single sweep).

"INIT2:CONT ON" 'Switches the sequence to continuous sweep.

Characteristics: *RST value: ON
 SCPI: conforming

INITiate<1|2>:CONMeas

This command continues a stopped measurement at the current position in single sweep mode. The function is useful especially for trace functions MAXHold, MINHold and AVERage if the previous results are not to be cleared with Sweep Count > 0 or Average Count > 0 on restarting the measurement (INIT:IMMediate resets the previous results on restarting the measurement). The single-sweep mode is automatically switched on. Synchronization to the end of the indicated number of measurements can then be performed with the command *OPC, *OPC? or *WAI. In the continuous-sweep mode, synchronization to the sweep end is not possible since the overall measurement "never" ends.

Example: "INIT:CONT OFF" 'Switches to single-sweep mode.
 "DISP:WIND:TRAC:MODE AVER" 'Switches on trace averaging.
 "SWE:COUN 20" 'Setting the sweep counter to 20 sweeps.
 "INIT;*WAI" 'Starts the measurement and waits for the
 'end of the 20 sweeps.
 "INIT:CONM;*WAI" 'Continues the measurement (next 20
 'sequences) and waits for the end.

Characteristics: *RST value: -
 SCPI: device-specific

This command is an event and therefore has no *RST value and no query.

INITiate<1|2>:ESPectrum

This command starts a Spectrum Emission Mask measurement. The measurement can be stopped in continuous sweep mode with ABORT.

Example: "SENS:SWE:MODE ESP" ' activates the SEM measurement
 "INIT:CONT OFF" ' Set to Single Sweep
 "INIT:ESP" ' Starts a SEM measurement

Characteristics: *RST value:-
 SCPI: device-specific

INITiate<1|2>[:IMMediate]

The command initiates a new sweep in the indicated measurement window.

With Sweep Count > 0 or Average Count > 0, this means a restart of the indicated number of measurements. With trace functions MAXHold, MINHold and AVERage, the previous results are reset on restarting the measurement.

In single sweep mode, synchronization to the end of the indicated number of measurements can be achieved with the command *OPC, *OPC? or *WAI. In continuous-sweep mode, synchronization to the sweep end is not possible since the overall measurement never ends.

Example:

"INIT:CONT OFF"	'Switches to single-sweep mode.
"DISP:WIND:TRAC:MODE AVER"	'Switches on trace averaging.
"SWE:COUN 20"	Setting the sweep counter to 20 sweeps.
"INIT;*WAI"	'Starts the measurement and waits for the end of the 20 sweeps.

Characteristics: *RST value: -
SCPI: conforming

This command is an event and therefore has no *RST value and no query.

INITiate<1|2>:DISPlay ON | OFF

This command configures the behavior of the display during a single sweep.

INITiate:DISPlay OFF means that the display is switched off during the measurement,

INITiate:DISPlay ON means that the display is switched on during the measurement.

The numeric suffix of INITiate is irrelevant with this command.

Example:

"INIT:CONT OFF"	'Switches to single-sweep mode
"INIT:DISP OFF"	'Sets the display behavior to OFF
"INIT;*WAI"	'Starts the measurement with display switched off.

Characteristics: *RST value: ON
SCPI: device-specific

INITiate<1|2>:SPURious

This command starts a new spurious measurement.

Example:

"INIT:CONT OFF"	'switches to single sweep mode
"INIT:SPUR;*WAI"	'starts the measurement by waiting for the end of the 20 measurements

Characteristics: *RST value: -
SCPI: device-specific

INPut Subsystem

The INPut subsystem controls the input characteristics of the RF inputs of the instrument. The measurement windows are assigned to INPut1 (screen A) and INPut2 (screen B).

COMMAND	PARAMETERS	UNIT	COMMENT
INPut<1 2>			
:ATTenuation	<numeric_value>	DB	
:AUTO	ON OFF ONCE RECaL	--	
:PROTection			no query
[:STATe]	ON OFF	DB	with option B25 only
:RESet		--	with option B25 only
.RECaL			
:AUTO			
[:STATe]	ON OFF		
:COUPling	AC DC		
:GAIN			with option B23 or B25 only
:STATe	ON OFF		
:EATT	<numeric_value>	DB	with option B25 only
:AUTO	ON OFF	--	
:STATe	ON OFF		
:FILTer		OHM	
:YIG	ON OFF		with option B2 only
:IMPedance	50 75 1000	DBM	
:MIXer			
:AUTO	ON OFF		
[:POWeR]	<numeric_value>		
SElect	AUDio RF		

INPut<1|2>:ATTenuation 0 ... 75dB

This command programs the input attenuator. To protect the input mixer against damage from overloads, the setting 0 dB can be obtained by entering numerals, not by using the command DEC. The step width is 5 dB, the range is 0 dB to..75 dB.

The step width is 10 dB without the option electronic attenuator, the range 0 dB to 70 dB.

The input attenuation can be set in 5 dB steps between 0 dB and 75 dB with the option electronic attenuator.

In the default state with analyzer mode, the attenuation set on the step attenuator is coupled to the reference level of the instrument. If the attenuation is programmed directly, the coupling to the reference level is switched off.

Example: "`INP:ATT 40dB`" 'Sets the attenuation on the attenuator to 40 dB and switches off the coupling to the reference level.

Characteristics: *RST value: 10 dB (AUTO is set to ON)
SCPI: conforming

INPut<1|2>:ATTenuation:AUTO ON | OFF | ONCE | RECaL

This command automatically couples the input attenuation to the reference level (ON state) or switches the input attenuation to manual control (OFF state).

The ONCE parameter starts a single autoranging procedure. The input attenuation, IF gain and, if a preamplifier is installed, the preamplification are adjusted in order to optimally match the receiver sensitivity to the input signal to be measured.

The RECAL parameter starts a calibration of the adjacent range in order to extend the calibrated measurement range. The RECAL function is available if the measured level is in the range adjacent to the calibrated range. This condition is indicated by the STATus:OPERation:PCALibration register.

Example: "`INP:ATT:AUTO REC`" 'Starts calibration of the adjacent range.

Characteristics: *RST value: ON
SCPI: conforming

INPut<1|2>:ATTenuation:PROTection[:STATe] ON | OFF

This command determines whether the attenuator may be switched to 0 dB in manual or automatic attenuation control.

Example:

Characteristics: *RST value: OFF
SCPI: device-specific

INPut<1|2>:ATTenuation:PROTection:RESet

The FSMR is equipped with an overload protection mechanism. This mechanism becomes active as soon as the power at the input mixer exceeds a value of 27 dBm. It ensures that the connection between RF input and input mixer is cut off.

The command resets the attenuator into the state that it had before the overload condition was detected. It re-connects the RF input with the input mixer.



This command comes into effect only if the reason for the overload condition has been eliminated. Otherwise the connection between RF input and input mixer is left open.

Example: "INP:ATT:PROT:PRES"

Characteristics: *RST value: --
SCPI: device-specific

This command is an event and therefore has no query and no *RST value.

INPut<1|2>:ATTenuation:RECal:AUTO[:STATe] ON | OFF

This command specifies whether the auto recal function in the rf level mode of the measurement receiver is switched on. If active, a recal operation is performed automatically if the signal level reaches a recal range.

Example: "INP:ATT:REC:AUTO OFF" 'Switches off automatic recal

Characteristics: *RST value: OFF
SCPI: device-specific

INPut:COUpling AC | DC

This command switches the input coupling of the RF input between AC and DC.

Example: "INP:COUP DC"

Characteristics: *RST value: AC
SCPI: conforming

INPut<1|2>:EATT 0 to 30dB

This command programs the attenuation of the electronic input attenuator. The attenuation can be varied in 5 dB steps from 0 to 30 dB. Other entries are rounded to the next lower integer value. If the attenuation is programmed directly, the coupling to the reference level is switched off.

If the defined reference level cannot be set with the given RF attenuation, this level is adapted to the maximum possible value.

The electronic attenuator is switched off in the default state.

Example: "INP:EATT:STAT ON" 'Switches the electronic attenuator into the signal path.

"INP:EATT 15dB" 'Sets the attenuation of the electronic attenuator to '15 dB and switches off the coupling to the reference level.

Characteristics: *RST value: 0 dB (state is set to OFF)
SCPI: device-specific

The command is only available with the electronic attenuator option B25.

INPut<1|2>:EATT:AUTO ON | OFF

This command automatically couples the electronic input attenuation to the reference level and the attenuation of the mechanical attenuator (state ON) or switches the input attenuation to manual entry (state OFF).

Example: "INP:EATT:STAT ON" 'Switches the electronic attenuator into the signal path.
 "INP:EATT:AUTO ON" 'Couples the attenuation of the electronic attenuator to the reference level.

Characteristics: *RST value: ON
 SCPI: device-specific

The command is only available with the electronic attenuator option B25.

INPut<1|2>:EATT:STATe ON | OFF

This command switches the electronic input attenuation into the signal path (state ON) or removes it from the signal path (state OFF).

Example: "INP:EATT:STAT ON" 'Switches the electronic attenuator into the signal path.

Characteristics: *RST value: OFF
 SCPI: device-specific

The command is only available with the option electronic attenuator B25.

INPut<1|2>:FILTer:YIG[:STATe] ON | OFF

This command switches the YIG filter for image rejection into the signal path (ON) or removes it from the signal path (OFF).

Example: "INP:FILT:YIG OFF" 'YIG filter switch off

Characteristics: *RST value: ON
 SCPI: device-specific

The command is only available with the YIG preselection option B2.

INPut<1|2>:GAIN:STATe ON | OFF

This command switches on the preamplifier for the instrument. The switchable gain is fixed to 20 dB..

Example: "INP:GAIN ON" 'Switches on 20 dB preamplification

Characteristics: *RST value: OFF
 SCPI: conforming

The command is only available with the option electronic attenuator B25.

INPut<1|2>:IMPedance 50 | 75 | 1000

In the analyzer mode, this command sets the nominal input impedance of the instrument. The set impedance is taken into account in all level indications of results. .

The setting 75 Ω should be selected, if the 50 Ω input impedance is transformed to a higher impedance using a 75 Ω adapter of the RAZ type (= 25 Ω in series to the input impedance of the instrument). The correction value in this case is 1.76 dB = 10 log (75 Ω / 50 Ω).

In the receiver mode, this command, switches the input impedance of the audio input between 50 Ω and 1 M Ω .

Example: "INP:IMP 75"

Characteristics: *RST value: 50 Ω
 SCPI: conforming

INPut<1|2>:MIXer:AUTO ON | OFF

This command enables/disables the automatic setup of the mixer level.

Example: "INP:MIX:AUTO ON"

Characteristics: *RST value: ON
SCPI: device-specific

INPut<1|2>:MIXer[:POWer] <numeric value>

This command defines the desired power at the input mixer of the analyzer. On any change to the reference level the RF attenuation will be adjusted in a way that makes the difference between reference level and RF attenuation come as close to the desired mixer level as possible.

Example: "INP:MIX -30"

Characteristics: *RST value: - 25 dBm
SCPI: device-specific

INPut<1|2>:SELEct AUDio | RF

This command switches the audio input – and thus the *AUDIO* mode – on (*AUDIO*) or off (*RF*).

The numeric suffix <1|2> has no meaning with this command.

Example: "INP:SEL AUD" 'Switches on the *AUDIO* mode.

Characteristics: *RST value: RF
SCPI: device-specific

INSTrument Subsystem

The INSTrument subsystem selects the operating mode of the unit either via text parameters or fixed numbers.

COMMAND	PARAMETERS	UNIT	COMMENT
INSTrument :COUPle :NSElect [:SElect]	NONE RLEVel CF_B CF_A <numeric_value> SANalyzer MRECeiver ADEMod		no query

INSTrument:COUPle NONE | RLEVel | CF_B | CF_A

In operating mode *SPECTRUM* this command selects the parameter coupling between the two measurement windows screen A and B.

- Parameter:**
- NONE No coupling. The two measurement windows are operated like two independent "virtual" devices.
 - RLEVel The reference levels of the two measurement windows are coupled.
 - CF_B The center frequency of screen B is coupled to the frequency of marker 1 in screen A.
 - CF_A The center frequency of screen A is coupled to the frequency of marker 1 in screen B.

Example: "INST:COUP NONE" 'Switches off the coupling of measurement windows. This leads to two independent "virtual" devices.'

Characteristics: *RST value: NONE
SCPI: device specific

INSTrument:NSElect <numeric value>

This command switches between the operating modes by means of numbers.

- Parameter:**
- 1: Spectrum analysis
 - 21: Measuring receiver
 - 3: ADEMode

Example: "INST:NSEL 1" 'Switches the instrument to *SPECTRUM*.'

Characteristics: *RST value: 21
SCPI: conforming

INSTrument[:SElect] SANalyzer | MRECeiver | ADEMod |

This command switches between the operating modes by means of text parameters.

- Parameter:**
- SANalyzer: Spectrum analysis
 - MRECeiver Measuring receiver
 - ADEMod: FM demodulator (see manual FS-K7)

Example: "INST SAN" 'Switches the instrument to *SPECTRUM*.'

Characteristics: *RST value: MRECeiver
SCPI: conforming

MEMory Subsystem

MEMory:CORRection enables the administration of automatically saved correction sets in operating mode Tuned RF Level.

BEFEHL	PARAMETER	EINHEIT	KOMMENTAR
MEMory [:CORRection]			
:CATalog?			Query only
:DElete			
:ALL			No query
[:NAME]	<setup_name>	--	No query
:SElect	<setup_name>	--	No query

MEMory[:CORRection]:CATalog?

This command returns the names of all saved correction sets and the corresponding settings.

Hint:

The correction sets are named by the frequency. A possible response could be:
 '100000000','23.Feb 05 08:45','NRP-Z11',1, '200000000.33','23.Feb 05 12:34','NRP-Z22',0,
 '2350000035.683','23 Feb 05 14:59','0

Ordering of data:

- Frequency in Hz
- Date and time of acquisition
- Used Power meter
- Power splitter use

The order of the data sets is as it is set in manual operation. All data are strings except Power splitter use.

Example: "MEM:CAT?"

MEMory[:CORRection]:DElete:ALL

This command deletes all correction data sets for Tuned RF Level of FSMR.

Example: "MEM:DEL:ALL

This command is an event and therefore has no *RST value and no query.

MEMory[:CORRection]:DElete[:NAME] <name>

This command deletes a correction data set with the given name for Tuned RF Level of FSMR.

Example: "MEM:DEL '100000000' 'correction set 100MHz
 "MEM:DEL '200E6' 'correction set 200MHz

Hint: *The correction sets are named by the frequency.*

This command is an event and therefore has no *RST value and no query.

MEMory[:CORRection]:SElect <name>

This command activates a correction data set with the given name for Tuned RF Level of FSMR.

Example: "MEM:SEL '100000000'

Hint: *The correction sets are named by the frequency.*

This command is an event and therefore has no *RST value and no query.

MMEemory Subsystem

The MMEemory (mass memory) subsystem provides commands which allow for access to the storage media of the instrument and for storing and loading various instrument settings. The various drives can be addressed via the "mass storage unit specifier" <msus> using the conventional DOS syntax. The internal hard disk is addressed by "D:", the flash disk drive by "F:".



For reasons of compatibility with the FSE instruments, addressing the hard disk by "C:" is also accepted. Since hard disk "C:" is reserved for instrument software, all read and write operations are rerouted to hard disk "D:" in normal operation (service level 0).

The file names <file_name> are indicated as string parameters with the commands being enclosed in quotation marks. They also comply with DOS conventions.

DOS file names consist of max. 8 ASCII characters and an extension of up to three characters separated from the file name by a dot "." Both, the dot and the extension are optional. The dot is not part of the file name. DOS file names do not distinguish between uppercase and lowercase notation. All letters and digits are permitted as well as the special characters "_", "^", "\$", "~", "!", "#", "%", "&", "-", "{", "}", "(", ")", "@", and "'". Reserved file names are CLOCK\$, CON, AUX, COM1 to COM4, LPT1 to LPT3, NUL and PRN.

The two characters "*" and "?" have the function of so-called "wildcards", i.e., they are variables for selection of several files. The question mark "?" replaces exactly one character, the asterisk means any of the remaining characters in the file name. "*.*" thus means all files in a directory.

COMMAND	PARAMETERS	UNIT	COMMENT
MMEemory			
:CATalog?	<path>		
:LONG?	<path>		
:CDIRectory	<directory_name>		
:CLEar			
:ALL			no query
:STATe	1,<file_name>		no query
:COMMent	<string>		
:COPY	<file_name>,<file_name>		no query
:DATA	<file_name>[,<block>]		
:DELeTe	<file_name>		no query
:IMMediate	<file_name>		no query
:INITialize	<msus>		no query
:LOAD			
:AUTO	1,<file_name>		no query
:STATe	1,<file_name>		no query
:MDIRectory	<directory_name>		no query
:MOVE	<file_name>,<file_name>		no query
:MSIS	<msus>		
:NAME	<file_name>		
:RDIRectory	<directory_name>		no query
:SELeCt			
[:ITEM]			
:ALL	--		no query
:DEFault	--		no query
:HWSettings	<Boolean>		
:LINes			
:ALL	<Boolean>		
:NONE	--		no query
:SCData	<Boolean>		Tracking generator option
:TRACe			
[:ACTive]	<Boolean>		
:STORe<1 2>			
:MARKer	<file_name>		no query
:PEAKlist	<file_name>		
:SPURious	<file_name>		
:STATe	1,<file_name>		no query
:TRACe	<numeric_value>, <file_name>		

MMEMory:CATalog? <path>

This command reads the indicated directory. According to DOS convention, wild card characters can be entered in order to query e.g. a list of all files of a certain type. The path name should be in conformance with DOS conventions and may also include the drive name.

Parameter: <path>::= DOS Path name

Example: "MEM:CAT:LONG? 'D:\USER\DATA'" 'queries the contents of directory
D:\USER\DATA directory
"MEM:CAT? 'D:\USER\DATA*.LOG'" 'Returns all files in D:\USER\DATA
'with extension ".LOG"
"MEM:CAT? 'D:\USER\DATA\SPOOL?.WMF'"
'Returns all files in D:\USER\DATA whose 'names start with
SPOOL, have 6 letters 'and the extension ".WMF".'

Return value: <used_bytes_in_this_directory>,<free_bytes_on_this_disk>,
"<file_name>,<file_type>,<filesize_in_bytes>";
"<file_name>,<file_type>,<filesize_in_bytes>"; ...
with
<file_name> name of file or directory
<file_type> file type: DIR (directory), ASCII (ASCII file),
BINary (binary file) and STATE (file with device settings)
<filesize_in_bytes> size of file, 0 for directories

Response value: List of file names in the form of strings separated by commas, i.e.
'SPOOL1.WMF', 'SPOOL2.WMF', 'SPOOL3.WMF'

Characteristics: *RST value: -
SCPI: conform

MMEMory:CATalog:LONG? <path>

This command queries the directories and files in the given path.

Example: "MEM:CAT:LONG? 'D:\USER\DATA'" 'queries the contents of directory
D:\USER\DATA

Return value: <used_bytes_in_this_directory>,<free_bytes_on_this_disk>,
"<file_name>,<file_type>,<filesize_in_bytes>";
"<file_name>,<file_type>,<filesize_in_bytes>"; ...
with
<file_name>: name of file or directory
<file_type>: DIR (directory), ASCII (ASCII file), BINary (binary file) and STATE
(file with device settings)
<filesize_in_bytes>: size of file, 0 for directories

Characteristics: *RST value: -
SCPI: conform

MMEMory:CDIRectory <directory_name>

This command changes the current directory.

In addition to the path name, the indication of the directory may contain the drive name. The path name complies with the DOS conventions.

Parameter: <directory_name>::= DOS path name

Example: "MEM:CDIR 'D:\USER\DATA'" 'Returns the list of files in directory
'D:\USER\DATA.

Characteristics: *RST value: -
SCPI: conforming

MMEMory:CLEar:ALL

This command deletes all device settings in the current directory. The current directory can be selected with `MMEM:CDIR`. The default directory is D:.

Example: `"MMEM:CLE:ALL"`

Characteristics: *RST value: -
SCPI: device-specific

This command is an event and therefore has no *RST value and no query.

MMEMory:CLEar:STATe 1,<file_name>

This command deletes the instrument setting selected by <file_name>. All associated files on the mass memory storage are cleared. A list of the extensions used is included under `MMEMory:LOAD:STATe`. The file name includes indication of the path and may also include the drive. The path name complies with DOS conventions.

Parameter: <file_name> ::= DOS file name without extension

Example: `"MMEM:CLE:STAT 1, 'TEST'"`

Characteristics: *RST value: -
SCPI: device-specific

This command is an event and therefore has no *RST value and no query.

MMEMory:COMMeNT <string>

This command defines a comment (max. 60 characters) for a device setting to be stored.

Example: `"MMEM:COMM 'Setup for GSM measurement'"`

Characteristics: *RST value: blank comment
SCPI: device-specific

MMEMory:COpy <file_source>,<file_destination>

This command copies the files indicated in <file_source> to the destination directory indicated with <file_destination> or to the destination file indicated by <file_destination> when <file_source> is just a file. The indication of the file name may include the path and the drive name. The file names and path information must be in accordance with the DOS conventions.

Parameter: <file_source>,<file_destination> ::= <file_name>
<file_name> ::= DOS file name

Example: `"MMEM:COpy 'D:\USER\DATA\SETUP.CFG', 'A:'"`

Characteristics: *RST value: -
SCPI conforming

This command is an event and therefore has no *RST value and no query.

MMEMory:DATA <file_name>[,<block data>]

This command writes the block data contained in <block> into the file characterized by <file_name>. The IEC/IEEE-bus delimiter must be set to EOI to obtain error-free data transfer.

The associated query command reads the indicated file from the mass memory and transfers it to the control computer via the IEC/IEEE bus. It should be noted that the buffer memory of the control computer should be large enough to store the file. The setting of the IEC/IEEE-bus delimiter is irrelevant in this case.

The command is useful for reading stored device settings or trace data from the instrument or for transferring them to the instrument.

<file_name>,<block data> Data transfer from control computer to instrument.

DATA? <file_name> Data transfer from instrument to control computer.
<file_name> selects the file to be transferred.

The binary data block <block> has the following structure:

- it always begins with the character '#',
- followed by a digit for the length of the length information,
- followed by the indicated number of digits as length information (number of bytes) for the binary data themselves,
- finally the binary data with the indicated number of bytes

Example: "MMEM:DATA 'TEST01.HCP', #217This is the file"
' means:
'#2: the next 2 characters are the length indication
'17: number of subsequent binary data bytes
'This is the file:
'17 bytes stored as binary data in the file
'TEST01.HCP.
"MMEM:DATA? 'TEST01.HCP' " 'Transfers the file TEST01.HCP from the
'instrument to the control computer.

Characteristics: *RST value: -
SCPI: conforming

MMEMory:DELeTe <file_name>

This command deletes the indicated files.

The indication of the file name contains the path and, optionally, the drive name. Indication of the path complies with DOS conventions.

Parameter: <file_name> ::= DOS file name

Example: "MMEM:DEL 'TEST01.HCP' " 'The file TEST01.HCP is deleted.

Characteristics: *RST value: -
SCPI: conforming

This command is an event and therefore has no *RST value and no query.

MMEMory:DELeTe:IMMEdiate <file_name>

This command deletes the indicated files. Any .read only. labels are ignored.

The indication of the file name contains the path and, optionally, the drive name. Indication of the path complies with DOS conventions.

Parameter: <file_name> ::= DOS file name

Example: "MMEM:DEL:IMM 'TEST01.HCP' " "The file TEST01.HCP is deleted.

Characteristics: *RST value: -
SCPI: device-specific

This command is an event and therefore has no *RST value and no query.

MMEMory:LOAD:AUTO 1,<file_name>

This command defines which device setting is automatically loaded after the device is switched on. The contents of the file are read after switching on the device and used to define the new device state. The file name includes indication of the path and may also include the drive. The path name complies with DOS conventions.



The data set defined as auto recall set will also be restored by a *RST-command.

Parameter: <file_name> ::= DOS file name without extension;
 FACTORY denotes the data set previously in the instrument

Example: "MMEM:LOAD:AUTO 1, 'D:\USER\DATA\TEST' "

Characteristics: *RST value: FACTORY
 SCPI: device-specific

This command is an event and therefore has no *RST value and no query.

MMEMory:LOAD:STATe 1,<file_name>

This command loads device settings from files. The contents of the file are loaded and set as the new device state. The device automatically recognizes the files that are required for the whole setup from the list of file extensions:

Contents	Extension
Current setting of measurement hardware and associated title, if indicated	.SET
Activated limit lines	.LIN
Current configuration of general device parameters	.CFG
Configuration for the hardcopy output	.HCS
User-defined color setting	.COL
All defined limit lines	.LIA
Measured data trace 1 to trace 3 screen A	.TR1 to 3
Measured data trace 1 to trace 3 screen B	.TR4 to 6
Tracking generator settings (only with Option Ext. Generator Control B10)	.TCi
Setting for source calibration (only with Option Ext. Generator Control B10)	.TS1 .TS2
Correction data for source calibration (only with Tracking Generator Option B9 or Ext. Generator Control B10)	.TC1 .TC2
Correction data for source calibration (only with Option Ext. Generator Control B10)	
Activated transducer factors	.TF

The file name includes indication of the path and may also include the drive name. The path name complies with DOS conventions.

Parameter: <file_name> ::= DOS file name without extension, extensions see table

Example: "MMEM:LOAD:STAT 1, 'A:TEST' "

Characteristics: *RST value: -
 SCPI: conforming

This command is an event and therefore has no *RST value and no query.

MMEMory:MDIRectory <directory_name>

This command creates a new directory. The file name includes indication of the path and may also include the drive name. The path name complies with DOS conventions.

Parameter: <directory_name> ::= DOS path name

Example: "MMEM:MDIR 'D:\USER\DATA' "

Characteristics: *RST value: -
SCPI: device-specific

This command is an event and therefore has no *RST value and no query.

MMEMory:MOVE <file_source>,<file_destination>

This command renames existing files, if <file_destination> contains no path indication. Otherwise the file is moved to the indicated path and stored under the file name specified there, if any. The file name includes indication of the path and may also include the drive. The path name complies with DOS conventions.

Parameter: <file_source>,<file_destination> ::= <file_name>
<file_name> ::= DOS file name

Example: "MMEM:MOVE 'D:\TEST01.CFG', 'SETUP.CFG' "
' Renames TEST01.CFG in SETUP.CFG 'in directory D:\.
"MMEM:MOVE 'D:\TEST01.CFG', 'D:\USER\DATA' "
' Moves TEST01.CFG from D:\ to 'D:\USER\DATA.
"MMEM:MOVE 'D:\TEST01.CFG', 'D:\USER\DATA\SETUP.CFG' "
' Moves TEST01.CFG from D:\ to 'D:\USER\DATA and renames the file
in 'SETUP.CFG.

Characteristics: *RST value: -
SCPI: conforming

This command is an event and therefore has no *RST value and no query.

MMEMory:MSIS <device>

This command changes to the drive indicated. The drive may be the internal hard disk D: or the flash disk drive F:.

Example: "MMEM:MSIS 'A:' "

Characteristics: *RST value: "D:"
SCPI: conforming

MMEMory:NAME <file_name>

This command defines a destination file for the printout started with the command `HCOPY:IMMEDIATE`. In this case the printer output must be routed to destination *FILE* using the command "HCOP:DEST 'MMEM' ". The file name includes indication of the path and may also include the drive name. The file name and path information comply with DOS conventions.

Parameter: <file_name> ::= DOS file name

Example: "HCOP:DEV:LANG BMP" Selection of data format.
"HCOP:DEST 'MMEM' " Selection of the output device
"MMEM:NAME 'PRINT1.BMP' " Selection of file name.
"HCOP:IMM" Start of the printout.

Characteristics: *RST value: -
SCPI: conforming

This command is an event and therefore has no *RST value and no query.

MMEMory:RDIRectory <directory_name>

This command deletes the indicated directory. The directory name includes indication of the path and may also include the drive name. The path name complies with DOS conventions.

Parameter: <directory_name>:= DOS path name

Example: "MMEM:RDIR 'D:\TEST'"

Characteristics: *RST value: -
SCPI: device-specific

This command is an event and therefore has no *RST value and no query.

MMEMory:SElect[:ITEM]:ALL

This command includes all data subsets in the list device settings to be stored/loaded.

Example: "MMEM:SEL:ALL"

Characteristics: *RST value: --
SCPI: device-specific

MMEMory:SElect[:ITEM]:DEfault

This command sets the default list of device settings to be stored/loaded. The latter includes:

- current configuration of general device parameters (general setup)
- current setting of the measurement hardware including markers
- activated limit lines
- user-defined color setting
- configuration for the hardcopy output
- Tracking generator settings
(only in conjunction with option Tracking Generator B9 or External Generator Control B10)
- Correction data for source calibration
(only in conjunction with option Tracking Generator B9 or External Generator Control B10)

Trace data and non-used limit lines are not included.

Example: "MMEM:SEL:DEfault"

Characteristics: *RST value: --
SCPI: device-specific

This command is an event and therefore has no *RST value.

MMEMory:SElect[:ITEM]:HwSettings ON | OFF

This command includes the hardware settings in the list of data subsets of a device setting to be stored/loaded. The hardware settings include:

- current configuration of general device parameters (general setup)
- current setting of the measurement hardware including markers
- activated limit lines:
A data set may include 8 limit lines at maximum in each measurement window. This number includes the activated limit lines and, if available, the de-activated limit lines last used. Therefore the combination of the non-activated restored limit lines depends on the sequence of use with the command `MMEM:LOAD`.
- user-defined color setting
- configuration for the hardcopy output
- Tracking generator settings
(only in conjunction with option External Generator Control B10)
- Correction data for source calibration
(only in conjunction with option External Generator Control B10)

Example: "MMEM:SEL:HWS ON"
Characteristics: *RST value: ON
 SCPI: device-specific

MMEMory:SElect[:ITEM]:LINEs:ALL ON | OFF

This command adds all limit lines (activated and de-activated) to the list of device settings to be stored/loaded.

Example: "MMEM:SEL:LIN:ALL ON"
Characteristics: *RST value: ON
 SCPI: device-specific

MMEMory:SElect[:ITEM]:NONE

This command deletes all data subsets from the list of device settings to be stored/loaded.

Example: "MMEM:SEL:NONE"
Characteristics: *RST value: --
 SCPI: device-specific

This command is an event and therefore has no *RST value.

MMEMory:SElect[:ITEM]:SCData ON | OFF

This command adds the tracking generator calibration data to the list of device settings to be stored/loaded.

Example: "MMEM:SEL:SCD ON" 'Inserts the tracking generator correction data
 'in the list of data subsets'
Characteristics: *RST value: OFF
 SCPI: device-specific

MMEMory:SElect[:ITEM]:TRACe[:ACTive] ON | OFF

This command adds the active traces to the list of data subsets of a save/recall device setting. Active traces are all traces whose state is not blank.

Example: "MMEM:SEL:TRAC ON"
Characteristics: *RST value: OFF, i.e. no traces will be stored
 SCPI: device-specific

MMEMory:SElect[:ITEM]:TRANsducer:ALL ON | OFF

This command includes all transducer factors and sets in the list of data subsets of a device setting to be stored/loaded.

Example: "MMEM:SEL:TRAN:ALL ON"
Characteristics: *RST value: ON
 SCPI: device-specific

This command is an event and therefore has no *RST value.

MMEMory:STORe<1|2>:MARKer <file_name>

This command saves the data of active markers to a file < file_name >.

Example: " :MMEM:STOR:MARK
 'Generates a *MARKER.TXT* file that contains all data of the active markers in screen A.
 If in screen A two markers are active, the generated *MARKER.TXT* file
 includes the following:
 Marker;1;T1

-25.87;dBm
 19.920000000;GHz
 Delta;2;T1
 -21.90;dB
 -5.920000000;GHz

Characteristics: *RST-Wert: -
 SCPI: device-specific

This command is an event and therefore has no *RST value and no query.

MMEMory:STORe<1|2>:PEAKlist <file_name>

This command stores the content of the marker peak list in ASCII format to the specified file.

Parameter: <file_name> := DOS file name

Example: "MMEM:STOR:PEAK 'D:\TEST.ASC'"

Characteristics: *RST value: -
 SCPI: device-specific

MMEMory:STORe:SPURious <file_name>

This command stores the peak list in an ASCII file to a file on a disk. The file has a header containing important parameters for scaling, several data sections containing the sweep settings per range and a data section containing the peak list. The header data is made up of three columns, separated by ';':
 parameter name; numeric value; basic unit
 The data section for the measurement values starts with the key word "TRACE <n>:", where <n> includes the number of the used trace. Next comes the peak list with several columns also separated by ';'. Spreadsheet programs such as MS Excel can read this format. Use ';' as the delimiter for the tablecells.



Different language versions of evaluation programs may require different handling of the decimal point. Using the DECIM SEP softkey, you can thus choose between the delimiters '.' (decimal point) and ',' (comma).

Parameter: <file_name> := DOS file name

Example: ":MMEM:STOR:SPUR 'D:\TEST.ASC'"

Characteristics: *RST value: -
 SCPI: device-specific

This command is an event and therefore has no *RST value and no query.

MMEMory:STORe<1|2>:STATe 1,<file_name>

This command stores the current device settings in a series of files which have the indicated file name, but different extensions. The file name includes indication of the path and may also include the drive name. The path name complies with DOS conventions. The numeric suffix in STORe<1|2> is irrelevant with this command.

A list of the extensions used is contained under MMEMory:LOAD:STATe.

Parameter: <file_name> := DOS file name without extension

Example: "MMEM:STOR:STAT 1, 'TEST'"

Characteristics: *RST value: -
 SCPI: conforming

This command is an event and therefore has no *RST value and no query.

MMEMory:STORe<1|2>:TRACe 1 to 3,<file_name>

This command stores the selected trace (1 to 3) in the measurement window indicated by STORe<1|2> (screen A or B) in a file with ASCII format. The file format is described in chapter 4 in the TRACE menu under the *ASCII-FILE EXPORT* softkey.

The decimal separator (decimal point or comma) for floating-point numerals contained in the file is defined with the command *FORMat:DEXPort:DSEParator*.

The file name includes indication of the path and the drive name. Indication of the path complies with DOS conventions.

Parameter: 1 to 3 := selected measurement curve Trace 1 to 3
 <file_name> := DOS file name

Example: "MMEM:STOR2:TRAC 3, 'A:\TEST.ASC'"
 ' Stores trace 3 from screen B in the file
 'TEST.ASC on a disk.

Characteristics: *RST value: -
 SCPI: device-specific

This command is an event and therefore has no *RST value and no query.
 For Spurious Measurement in analyzer mode, an extended file format is used:

	File contents	Explanation
File header	Type; R&S FSMR;	Model
	Version;4.1x;	Firmware version
	Date;02.Nov. 2007;	Storage date of data set
	Mode;ANALYZER;SPURIOUS ;	Operating mode of the device Format for Spurious Emissions measurement
	Start;9000.000000;Hz Stop;8000000000.000000;Hz	Start/stop of the span Unit: Hz
	x-Axis;LIN;	Linear (LIN) or logarithmic (LOG) (future feature) scaling of the x-axis
	Sweep Count;1;	Selected number of sweeps
	Range 1:	Loop across all defined sweep ranges (1 to 20)
	Start; 9000.000000;Hz	Range start frequency in Hz
	Stop; 150000.000000;Hz	Range stop frequency in Hz
	Filter Type;NORMAL;	Range filter type: NORMAL, RRC or CFILTER
	RBW;10000.000000;Hz	Resolution bandwidth of the measurement filter
	VBW;30000.000000;Hz	Resolution bandwidth of the video filter
	Auto Sweep time;ON	
	Sweep time; 0.145000;s	Selected sweep time in the current range
	Detector;RMS;	Detector: MAX PEAK, MIN PEAK, RAVERAGE
	REF-Level; -10.000000;dBm	Setting of the reference level in the current range
	Auto RF-Attenuator; OFF;	Manual (OFF) or automatic (ON) setting of the RF attenuator
	RF Att;15.000000;dB	Range input attenuation
	Sweep Points; 625;	Number of sweep points in the current range
	Preamp; 0.000000;dB	Range preamplifier, on (20 dB) or off (0 dB)
	Stop after range;OFF;	Stop after range, switched on (ON) or off (OFF) for the current range
	Transducer;TRD1;	Transducer name (if activated) repeated for all sweep list ranges
File data section	TRACE 1:	Selected trace
	x-Unit;Hz;	Unit of x values:
	y-Unit;dBm;	Unit of y values:
	Values;2500;	Number of measurement points
	9000.000000;-99.619965; 9225.961538;-105.416908; 9451.923077;-100.938057; 9677.884615;-99.483894; 9903.846154;-106.879539; 10129.807692;-108.772316;	Measurement values: <x value>; <y value>

OUTPut Subsystem

The OUTPut subsystem controls the output features of the instrument. In conjunction with the tracking generator option, a distinction is made between OUTPut1 (screen A) and OUTPut2 (screen B).

COMMAND	PARAMETERS	UNIT	COMMENT
OUTPut<1 2> REFerence: STATe [:STATe]	ON OFF ON OFF	-- --	Tracking generator option

OUTPut:REFerence:STATe ON | OFF

This command switches on or off the POWER REF reference source on the front panel.

Example: "OUTP:REF:STAT ON"

Characteristics: *RST value: OFF
SCPI: device-specific

OUTPut<1|2>[:STATe] ON | OFF

This command switches the tracking generator on or off.

With the tracking generator switched on, the maximum stop frequency is limited to 3 GHz. This upper limit is automatically modified by the set frequency offset of the generator.

If measurements in compliance with specs are to be performed with the tracking generator, the start frequency has to be $\geq 3 \times$ resolution bandwidth.

The minimum sweep time for measurements in compliance with the data sheet is 100 ms in the frequency domain (span >0). If a shorter sweep time is selected, the sweep time indicator SWT on the screen is marked with a red asterisk and the message UNCAL is also displayed.

With the tracking generator switched on, the FFT filters (BAND:MODE:FFT) are not available.

Example: "OUTP ON" 'Switches on the tracking generator in screen A.

Characteristics: *RST value: -
SCPI: conforming

This command is only valid in conjunction with option tracking generator.

READ:PMETer Subsystem

This subsystem contains the commands for starting measurements with a power sensor and outputting the results.

COMMAND	PARAMETERS	UNIT	COMMENT
READ<1 2> :PMETer?	--	--	query only

READ<1|2>:PMETer?

This command triggers a measurement with the power sensor and then outputs the result.

Example: "READ:PMET? " ' starts a measurement and output the result

Characteristics: *RST value: -
SCPI: device-specific

This command is strictly a query and thus does not have a *RST value.

SENSe Subsystem

The SENSe subsystem is organized in several subsystems. The commands of these subsystems directly control device-specific settings, they do not refer to the signal characteristics of the measurement signal.

The SENSe subsystem controls the essential parameters of the analyzer. In accordance with the SCPI standard, the keyword "SENSe" is optional for this reason, which means that it is not necessary to include the SENSe node in command sequences.

The measurement windows are selected by SENSe1 and SENSe2:

SENSe1 = Modification of screen A settings

SENSe2 = Modification of screen B settings.

Screen A is automatically selected if 1 or 2 is missing.

SENSe:ADEMod - Subsystem

This subsystem provides commands for measurement of analog modulation parameters.

COMMAND	PARAMETERS	UNIT	COMMENT
[SENSe<1 2>] :ADEMod :AF :CENTer :COUPling :SPAN :FULL :STARt :STOP :BANDwidth :DEModulation :BWIDth :DEModulation :DETEctor :ALCFixed [:STATe] :AVERage :MODE :REFerence :AUTO [:STATe] :MPEak :MODE :REFerence :AUTO [:STATe] :PAverage :MODE :REFerence :AUTO [:STATe] :PPEak :MODE :REFerence :AUTO [:STATe] :REFerence :AUTO ONCE :RMS :MODE :REFerence :AUTO [:STATe] :SINad :MODE :REFerence :AUTO [:STATe]	<numeric_value> AC DC <numeric_value> -- <numeric_value> <numeric_value> <numeric_value> <numeric_value> PPEak MPEak PAverage RMS AVERage SRMS THD SINad [[.PPEak MPEak PAverage RMS AVERage SRMS THD SINad],...] <Boolean> ABSolute RELative <numeric_value> ONCE <Boolean> ABSolute RELative <numeric_value> ONCE ON OFF O N OFF ABSolute RELative <numeric_value> ONCE <Boolean> ABSolute RELative <numeric_value> ONCE ON OFF AOFF ONCE ABSolute RELative <numeric_value> ONCE <Boolean> AOFF ONCE <Boolean>ABSolute RELative <numeric_value>	HZ HZ -- HZ HZ HZ HZ DBM DBM DBM DBM DBM DBM DBM	

COMMAND	PARAMETERS	UNIT	COMMENT
[SENSe<1 2>] :ADEMod :DETEctor :SRMS :MODE :REFerence :AUTO [:STATe] :THD :MODE :REFerence :AUTO [:STATe] :MTIME PHOLD [:STATe] :PM :RPOint [:X] :SPECtrum :BANDwidth [:RESolution] :BWIDth [:RESolution] :RESult? :SPAN [:TYPE] [:STATe]	ABSolute RELative <numeric_value> ONCE <Boolean> ABSolute RELative <numeric_value> ONCE <Boolean> <numeric_value> <Boolean> <numeric_value> <numeric_value> WRITe AVERAge MAXHold MINHold <numeric_value> WRITe AVERAge MAXHold MINHold VIEW OFF, WRITe AVERAge MAXHold MINHold VIEW OFF, WRITe AVERAge MAXHold MINHold VIEW OFF <Boolean>	DBM DBM S HZ HZ HZ HZ	

[SENSe:]ADEMod:AF:CENTer <numeric_value>

This command sets the center frequency for result display AF spectrum.

Example: "ADEM ON" 'Switches on the FM demodulator
"CALC:FEED XTIM:FM:AFSP' 'Switches on result display AF spectrum of FM
or
"CALC:FEED XTIM:RFP:AFSP' 'Switches on result display AF spectrum of
'RF power signal
"ADEM:BAND 5 MHz" 'Sets the measurement bandwidth to 5 MHz
"ADEM:AF:CENT 500kHz" 'Sets the AF center frequency to 500 kHz
"ADEM:AF:SPAN 200kHz" 'Sets the AF span to 200 kHz

Characteristics: *RST value: 1.25 MHz
SCPI: device-specific

[SENSe:]ADEMod:AF:COUPling AC | DC

This command selects the coupling of the AF path of the analyzer.

Example: "ADEM:AF:COUP DC" 'Switches on DC coupling.

Characteristics: *RST value: AC
SCPI: device-specific

Mode: A

[SENSe:]ADEMod:AF:SPAN <numeric_value>

This command sets the span for result display AF spectrum.

The span is limited to half the measurement bandwidth of analog demodulation (SENS:ADEM:BAND).

Example: "ADEM ON" 'Switches on the FM demodulator
 "CALC:FEED 'XTIM:FM:AFSP' 'Switches on result display AF spectrum of FM
 or
 "CALC:FEED 'XTIM:RFP:AFSP' 'Switches on result display AF spectrum of
 'RF power signal
 "ADEM:BAND 5 MHz" 'Sets the measurement bandwidth to 5 MHz
 "ADEM:AF:CENT 500kHz" 'Sets the AF center frequency to 500 kHz
 "ADEM:AF:SPAN 200kHz" 'Sets the AF span to 200 kHz

Characteristics: *RST value: 2.5 MHz
 SCPI: device-specific

[SENSe:]ADEMod:AF:SPAN:FULL

This command sets the maximum span for result display AF spectrum.

The maximum span corresponds to half the measurement bandwidth of analog demodulation (SENS:ADEM:BAND).

Example: "ADEM ON" 'Switches on the FM demodulator
 "CALC:FEED 'XTIM:FM:AFSP' 'Switches on result display AF spectrum of
 'FM
 or
 "CALC:FEED 'XTIM:RFP:AFSP' 'Switches on result display AF spectrum of
 'RF power signals
 "ADEM:BAND 5 MHz" 'Sets the measurement bandwidth to 5 MHz
 "ADEM:AF:SPAN:FULL" 'Sets the AF span to 2.5 MHz

Characteristics: *RST value: -
 SCPI: device-specific

[SENSe:]ADEMod:AF:START <numeric_value>

This command sets the start frequency for result display AF spectrum.

Example: "ADEM ON" 'Switches on FM demodulator
 "CALC:FEED 'XTIM:FM:AFSP' 'Switches on result display AF spectrum of FM
 or
 "CALC:FEED 'XTIM:RFP:AFSP' 'Switches on result display AF spectrum of
 'RF power signal
 "ADEM:BAND 5 MHz" 'Sets the measurement bandwidth to 5 MHz
 "ADEM:AF:STAR 0kHz" 'Sets the AF start frequency to 0 kHz
 "ADEM:AF:STOP 500kHz" 'Sets the AF stop frequency to 500 kHz

Characteristics: *RST value: 0 MHz
 SCPI: device-specific

[SENSe:]ADEMod:AF:STOP <numeric_value>

This command sets the stop frequency for result display AF spectrum.

The stop frequency is limited to half the measurement bandwidth of analog demodulation (SENS:ADEM:BAND).

Example: "ADEM ON" 'Switches on the FM demodulator
 "CALC:FEED 'XTIM:FM:AFSP' 'Switches on result display AF spectrum of FM

or

```
"CALC:FEED 'XTIM:RFP:AFSP'"Switches on result display AF spectrum of
                                'RF power signal
"ADEM:BAND 5 MHz" 'Sets the measurement bandwidth to 5 MHz
"ADEM:AF:STAR 0kHz" 'Sets the AF start frequency to 0 kHz
"ADEM:AF:STOP 500kHz" 'Sets the AF stop frequency to 500 kHz
```

Characteristics: *RST value: 2.5 MHz
 SCPI: device-specific

[SENSe:]ADEMod[:STATe] ON | OFF

This command switches on the FM demodulator of the instrument. The instrument will be set to time-domain measurement (span = 0) at the current center frequency. The measurement is always performed in screen A. Split-screen operation will be switched off as soon as the demodulator is activated.

Example: "ADEM ON" Switch on the FM demodulator

Characteristics: *RST value: OFF
 SCPI: device-specific

[SENSe:]ADEMod:BANDwidth | BWIDth:DEModulation <numeric_value>

This command defines the demodulation bandwidth used for analog demodulation. The required sampling rate is automatically set depending on the selected demodulation bandwidth. The available demodulation bandwidths are determined by the existing sampling rates.

Rounded demodulation bandwidth	Sampling rate
10 MHz	32 MHz
8 MHz	16 MHz
5 MHz	8 MHz
3 MHz	4 MHz
1.6 MHz	2 MHz
800 kHz	1 MHz
400 kHz	500 kHz
200 kHz	250 kHz
100 kHz	125 kHz
50 kHz	62.5 kHz
25 kHz	31.25 kHz
12.5 kHz	15.625 kHz
6.4 kHz	7.8125 kHz
3.2 kHz	3.90625 kHz
1.6 kHz	1.953125 kHz
800 Hz	976.5625 Hz
400 Hz	488.28125 Hz
200 Hz	244.140625 Hz
100 Hz	122.0703125 Hz

Example: "ADEM:BAND:DEM 1MHz" 'Sets the demodulation bandwidth to 1 MHz.

Characteristics: *RST value: 5 MHz
 SCPI: device-specific

[SENSe:]ADEMod:DETECTOR PPEak|MPEak|PAverage|RMS | AVERage | SRMS | THD | SINad | ALCF

This command switches on the detectors whose results are to be displayed in the modulation summary.

PPEak	Result of measurement with +PK detector
MPEak	Result of measurement with -PK detector
PAverage	Result of averaging \pm PK/2, i.e. (plus peak + minus peak)/2
AVERage	Result of measurement with average detector
RMS	Result of measurement with RMS detector
SRMS	Result of measurement with $\sqrt{2}$ RMS detector
THD	Total harmonic distortion
SINad	Signal, noise and distortion
ALCF	Enables the AM envelope detector



THD and SINad are always displayed together. The above command can be used to activate any combination of detectors. For the detailed configuration of the individual detectors, including relative measurements, see the commands below.

Example: "ADEM:DET PPE, RMS, THD" 'The peak and RMS detectors are switched on together with the THD and the SINAD display.'

Characteristics: *RST value: PPE
SCPI: device-specific

[SENSe:]ADEMod:DETECTOR:ALCFixed[:STATE] ON | OFF

This command enables the AM envelope detector that measures the demodulated baseband signal without normalization to the carrier level. The AM envelope detector measures the envelope RF level of an AM modulated signal. The result of this detector is independent of the RF level of the AM signal.

Example: "ADEM:DET:AVER:MODE REL" 'Switches on the relative measurement for the average detector.'

Characteristics: *RST value: OFF
SCPI: device-specific

[SENSe:]ADEMod:DETECTOR:AVERAGE:MODE ABSolute | RELative

This command switches on absolute or relative measurement for the average detector in the modulation summary. Each time the relative measurement mode is switched on, the current measured value is taken as a reference for the subsequent relative measurements. The command is executed independently of the settings for the other detectors.

Example: "ADEM:DET:AVER:MODE REL" 'Switches on the relative measurement for the average detector.'

Characteristics: *RST value: ABS
SCPI: device-specific

[SENSe:]ADEMod:DETECTOR:AVERAGE:REFERENCE <numeric_value>

This command sets or queries the reference value for the relative measurement for the average detector in the modulation summary.

Example: "ADEM ON" 'Switches on the demodulator.
"CALC2:FEED 'XTIM:FM:TDOM'" 'Switches on the FM modulation summary.
"ADEM:DET:AVER ON" 'Switches on the average detector.
"ADEM:DET:AVER:MODE REL" 'Switches on the relative measurement for the average detector.
"ADEM:DET:AVER:REF 20 kHz" 'Sets the reference value.'

Characteristics: *RST value: 0
SCPI: device-specific

[SENSe:]ADEMod:DETECTOR:AVERAge:REFerence:AUTO ONCE

This command uses the current measured value as a reference for the relative measurement for the average detector in the modulation summary.

Example: " ADEM:DET:AVER:REF:AUTO ONCE" 'Uses the current measured value as a reference for the relative measurement.'

Characteristics: *RST value -
SCPI: device-specific

This command is an event and therefore has no *RST value and no query.

[SENSe:]ADEMod:DETECTOR:AVERAge[:STATe] ON | OFF

This command switches on or off the average detector in the modulation summary. The command is executed independently of the settings for the other detectors.

Example: "ADEM ON" 'Switches on the demodulator.
"CALC2:FEED 'XTIM:FM:TDOM" 'Switches on the FM modulation summary.
"ADEM:DET:AVER ON" 'Switches on the average detector.'

Characteristics: *RST value: OFF
SCPI: device-specific

[SENSe:]ADEMod:DETECTOR:MPEak:MODE ABSolute | RELative

This command switches on absolute or relative measurement for the minus peak detector in the modulation summary. Each time the relative measurement mode is switched on, the current measured value is taken as a reference for the subsequent relative measurements. The command is executed independently of the settings for the other detectors.

Example: "ADEM:DET:MPE:MODE REL" 'Switches on the relative measurement for the minus peak detector.'

Characteristics: *RST value: ABS
SCPI: device-specific

[SENSe:]ADEMod:DETECTOR:MPEak:REFerence <numeric_value>

This command sets or queries the reference value for the relative measurement for the minus peak detector in the modulation summary.

Example: "ADEM ON" 'Switches on the demodulator.
"CALC2:FEED 'XTIM:FM:TDOM'" 'Switches on the FM modulation summary.
"ADEM:DET:MPE ON" 'Switches on the minus peak detector.
"ADEM:DET:MPE:MODE REL" 'Switches on the relative measurement for the minus peak detector.
"ADEM:DET:MPE:REF 20 kHz" 'Sets the reference value.'

Characteristics: *RST value: 0
SCPI: device-specific

[SENSe:]ADEMod:DETECTOR:MPEak:REFerence:AUTO ONCE

This command uses the current measured value as a reference for the relative measurement for the minus peak detector in the modulation summary.

Example: " ADEM:DET:MPE:REF:AUTO ONCE" 'Uses the current measured value as a reference for the relative measurement.'

Characteristics: *RST value: -
SCPI: device-specific

This command is an event and therefore has no *RST value and no query.

SENSe:]ADEMod:DETECTOR:MPEAK[:STATe] ON | OFF

This command switches on or off the minus peak detector in the modulation summary. The command is executed independently of the settings for the other detectors.

Example:

"ADEM ON"	'Switches on the demodulator.
"CALC2:FEED 'XTIM:FM:TDOM'"	'Switches on the FM modulation summary.
"ADEM:DET:MPE ON"	'Switches on the minus peak detector.

Characteristics: *RST value: OFF
SCPI: device-specific

[SENSe:]ADEMod:DETECTOR:PAVERAGE:MODE ABSolute | RELative

This command switches on absolute or relative measurement for the (plus peak + minus peak)/2 (\pm PK/2) detector in the modulation summary. Each time the relative measurement mode is switched on, the current measured value is taken as a reference for the subsequent relative measurements. The command is executed independently of the settings for the other detectors.

Example:

"ADEM:DET:PAV:MODE REL"	'Switches on the relative measurement 'for the (plus peak + minus peak)/2 detector.
-------------------------	--

Characteristics: *RST value: ABS
SCPI: device-specific

[SENSe:]ADEMod:DETECTOR:PAVERAGE:REFERENCE <numeric_value>

This command sets or queries the reference value for the relative measurement for the (plus peak + minus peak)/2 (\pm PK/2) detector in the modulation summary.

Example:

"ADEM ON"	'Switches on the demodulator.
"CALC2:FEED 'XTIM:FM:TDOM'"	'Switches on the FM modulation summary.
"ADEM:DET:PAV ON"	'Switches on the (plus peak + minus peak)/2 'detector.
"ADEM:DET:PAV:MODE REL"	'Switches on the relative measurement 'for the (plus peak + minus peak)/2 detector.
"ADEM:DET:PAV:REF 20 kHz"	'Sets the reference value.

Characteristics: *RST value: 0
SCPI: device-specific

[SENSe:]ADEMod:DETECTOR:PAVERAGE:REFERENCE:AUTO ONCE

This command uses the current measured value as a reference for the relative measurement for the (plus peak + minus peak)/2 (\pm PK/2) detector in the modulation summary.

Example:

" ADEM:DET:PAV:REF:AUTO ONCE"	'Uses the current measured value 'as a reference for the relative 'measurement.
-------------------------------	---

Characteristics: *RST value: -
SCPI: device-specific

This command is an event and therefore has no *RST value and no query.

[SENSe:]ADEMod:DETECTOR:PAVERAGE[:STATe] ON | OFF

This command switches on or off the (plus peak + minus peak)/2 (\pm PK/2) detector in the modulation summary. The command is executed independently of the settings for the other detectors.2

Example:

"ADEM ON"	'Switches on the demodulator.
"CALC2:FEED 'XTIM:FM:TDOM'"	'Switches on the FM modulation summary.

"ADEM:DET:PAV ON" 'Switches on the (plus peak + minus peak)/2
'detector.

Characteristics: *RST value: OFF
SCPI: device-specific

[SENSe:]ADEMod:DETECTOR:PPEAK:MODE ABSolute | RELative

This command switches on absolute or relative measurement for the plus peak detector in the modulation summary. Each time the relative measurement mode is switched on, the current measured value is taken as a reference for the subsequent relative measurements. This command is executed independently of the settings for the other detectors.

Example: "ADEM:DET:PPE:MODE REL" 'Switches on the relative measurement
for the plus peak detector.

Characteristics: *RST value: ABS
SCPI: device-specific

[SENSe:]ADEMod:DETECTOR:PPEAK:REFERENCE <numeric_value>

This command sets or queries the reference value for the relative measurement for the plus peak detector in the modulation summary.

Example: "ADEM ON" 'Switches on the demodulator.
"CALC2:FEED 'XTIM:FM:TDOM'" 'Switches on the FM modulation summary.
"ADEM:DET:PPE ON" 'Switches on the plus peak detector.
"ADEM:DET:PPE:MOD REL" 'Switches on the relative measurement
for the plus peak detector.
"ADEM:DET:PPE:REF 20 kHz" 'Sets the reference value.

Characteristics: *RST value: 0
SCPI: device-specific

[SENSe:]ADEMod:DETECTOR:PPEAK:REFERENCE:AUTO ONCE

This command uses the current measured value as a reference for the relative measurement for the plus peak detector in the modulation summary.

Example: " ADEM:DET:PPE:REF:AUTO ONCE" 'Uses the current measured value
as a reference for the relative
measurement.

Characteristics: *RST value: -
SCPI: device-specific

This command is an event and therefore has no *RST value and no query.

[SENSe:]ADEMod:DETECTOR:PPEAK[:STATE] ON | OFF

This command switches on or off the plus peak detector in the modulation summary. The command is executed independently of the settings for the other detectors.

Example: "ADEM ON" 'Switches on the demodulator.
"CALC2:FEED 'XTIM:FM:TDOM'" 'Switches on the FM modulation summary.
"ADEM:DET:PPE ON" 'Switches on the plus peak detector.

Characteristics: *RST value: ON
SCPI: device-specific

[SENSe:]ADEMod:DETECTOR:RMS[:STATe] ON | OFF

This command switches on or off the RMS detector in the modulation summary. The command is executed independently of the settings for the other detectors.

Example:

"ADEM ON"	'Switches on the demodulator.
"CALC2:FEED 'XTIM:FM:TDOM'"	'Switches on the FM modulation summary.
"ADEM:DET:RMS ON"	'Switches on the RMS detector.

Characteristics: *RST value: OFF
SCPI: device-specific

[SENSe:]ADEMod:DETECTOR:SRMS:MODE ABSolute | RELative

This command switches on absolute or relative measurement for the $\sqrt{2}$ RMS detector in the modulation summary. Each time the relative measurement mode is switched on, the current measured value is taken as a reference for the subsequent relative measurements. The command is executed independently of the settings for the other detectors.

Example:

"ADEM:DET:SRMS:MODE REL"	'Switches on the relative measurement for the $\sqrt{2}$ RMS detector.
--------------------------	--

Characteristics: *RST value: ABS
SCPI: device-specific

[SENSe:]ADEMod:DETECTOR:SRMS:REFERENCE <numeric_value>

This command sets or queries the reference value for the relative measurement for the $\sqrt{2}$ RMS detector in the modulation summary.

Example:

"ADEM ON"	'Switches on the demodulator.
"CALC2:FEED 'XTIM:FM:TDOM'"	'Switches on the FM modulation summary.
"ADEM:DET:SRMS ON"	'Switches on the $\sqrt{2}$ RMS detector.
"ADEM:DET:SRMS:MODE REL"	'Switches on the relative measurement for the $\sqrt{2}$ RMS detector.
"ADEM:DET:SRMS:REF 20 kHz"	'Sets the reference value.

Characteristics: *RST value: 0
SCPI: device-specific

[SENSe:]ADEMod:DETECTOR:SRMS:REFERENCE:AUTO ONCE

This command uses the current measured value as a reference for the relative measurement for the $\sqrt{2}$ RMS detector in the modulation summary.

Example:

" ADEM:DET:SRMS:REF:AUTO ONCE"	'Uses the current measured value as a reference for the relative measurement.
--------------------------------	---

Characteristics: *RST value: -
SCPI: device-specific

This command is an event and therefore has no *RST value and no query.

[SENSe:]ADEMod:DETECTOR:SRMS[:STATe] ON | OFF

This command switches on or off the $\sqrt{2}$ RMS detector in the modulation summary. The command is executed independently of the settings for the other detectors.

Example:

"ADEM ON"	'Switches on the demodulator.
"CALC2:FEED 'XTIM:FM:TDOM'"	'Switches on the FM modulation summary.
"ADEM:DET:SRMS ON"	'Switches on the $\sqrt{2}$ RMS detector.

Characteristics: *RST value: OFF
SCPI: device-specific

SENSe:]ADEMod:DETECTOR:SINAd:MODE ABSolute | RELative

This command switches between absolute and relative measurement for the SINAD display in the modulation summary. Each time the relative measurement mode is switched on, the current measured value is taken as a reference for the subsequent relative measurements. The command is executed independently of the settings for the other detectors.

Example: "ADEM:DET:SIN:MODE REL" 'Switches on the relative measurement
'for the SINAD display.

Characteristics: *RST value: ABS
SCPI: device-specific

[SENSe:]ADEMod:DETECTOR:SINAd:REFerence <numeric_value>

This command sets or queries the reference value for the relative measurement for the SINAD display in the modulation summary.

Example: "ADEM ON" 'Switches on the demodulator.
"CALC2:FEED 'XTIM:FM:TDOM'" 'Switches on the FM modulation summary.
"ADEM:DET:SIN ON" 'Switches on the SINAD display.
"ADEM:DET:SIN:MODE REL" 'Switches on the relative measurement
for the SINAD display.
"ADEM:DET:SIN:REF 20 kHz" 'Sets the reference value.

Characteristics: *RST value: 0
SCPI: device-specific

[SENSe:]ADEMod:DETECTOR:SINAd:REFerence:AUTO ONCE

This command uses the current measured value as a reference for the relative measurement for the SINAD display in the modulation summary.

Example: "ADEM:DET:SIN:REF:AUTO ONCE" 'Uses the current measured value
as a reference for the relative
measurement.

Characteristics: *RST value: -
SCPI: device-specific

This command is an event and therefore has no *RST value and no query.

[SENSe:]ADEMod:DETECTOR:SINAd[:STATe] ON | OFF

This command switches on or off the SINAD display in the modulation summary. The command is executed independently of the settings for the other detectors.

Example: "ADEM ON" 'Switches on the demodulator.
"CALC2:FEED 'XTIM:FM:TDOM'" 'Switches on the FM modulation summary.
"ADEM:DET:SIN ON" 'Switches on the SINAD display.

Characteristics: *RST value: OFF
SCPI: device-specific

[SENSe<1|2>:]ADEMod:DETECTOR:THD:MODE ABSolute | RELative]

This command switches on absolute or relative measurement for the *harmonic distortion*. Each time the relative measurement mode is switched on, the current measured value is taken as a reference for the subsequent relative measurements. The command is executed independently of the settings for the other detectors.

Example: ADEM:DET:THD:MODE REL . Switches on the demodulator

Characteristics: *RST value: ABS
SCPI: device-specific

[SENSe<1|2>:]ADEMod:DETECTOR:THD:REFERENCE <numeric_value>

This command sets or queries the reference value for the relative measurement for the *harmonic distortion* in the modulation summary.

Example: "ADEM ON" Switches on the demodulator
"CALC:FEED 'XTIM:FM:TDOM" Switches on the FM modulation summary
"ADEM:DET:THD ON" Switches on the harmonic distortion display
"ADEM:DET:THD:MODE REL" Switches on the relative measurement for THD
"ADEM:DET:THD:REF 20 kHz" Sets the reference value

Characteristics: *RST value: 0
SCPI: device-specific

[SENSe<1|2>:]ADEMod:DETECTOR:THD:REFERENCE:AUTO ONCE

This command uses the current measured value as a reference for the relative measurement for the harmonic distortion in the modulation summary.

Example: ADEM:DET:THD:REF:AUTO ONCE

Characteristics: *RST value: -
SCPI: device-specific

This command is an event and therefore has no *RST value and no query.

[SENSe<1|2>:]ADEMod:DETECTOR:THD[:STATE] ON | OFF

This command switches the displays of *total harmonic distortion* and *signal, noise and distortion* for the active modulation mode.

Example: "ADEM ON" Switches on the demodulator
"CALC:FEED 'XTIM:FM:TDOM" Switches on the FM modulation summary.
"ADEM:DET:THD ON" Switches on the harmonic distortion display

Characteristics: *RST value: OFF
SCPI: device-specific

[SENSe:]ADEMod:MTIME <numeric_value>

This command defines the measurement time for analog demodulation.

Example: "ADEM:MTIM 62.625us" 'Sets the measurement time to 62.625 μ s.

Characteristics: *RST value: 62.625us
SCPI: device-specific

[SENSe:]ADEMod:PHOLd[:STATe] ON | OFF

This command switches on or off the display of the highest results obtained in the modulation summary. The highest results are displayed in addition to the current results.
 If the average-value measurement is switched on, the relative-value display is referenced to the average values rather than to the current measured values.
 If the Peak Hold display is active, this display has priority, and the relative-value display is referenced to the Peak Hold values.

Example:

"ADEM ON"	'Switches on the demodulator.
"CALC2:FEED 'XTIM:FM:TDOM"	'Switches on the FM modulation summary.
"ADEM:PHOL ON"	'Switches on the display of the highest results obtained.

Characteristics: *RST value: OFF
 SCPI: device-specific

[SENSe:]ADEMod:PM:RPOint[:X] 0s to measurement time

This command determines the position where the phase of the PM-demodulated signal is set to 0 rad. The maximum possible value depends on the measurement time selected in the instrument; this value is output in response to the query ADEM:PM:RPO:X? MAX.

Example:

"ADEM:PM:RPO:X 500us"	Set the position where the phase to 0 rad setting to 500 μ s.
-----------------------	---

Characteristics: *RST value 0 s
 SCPI: conforming

[SENSe:]ADEMod:SPECTrum:BANDwidth|BWIDth[:RESolution] 1 Hz to 10 MHz

This command sets the resolution bandwidth for spectrum representation that was determined from the analog demodulation data.

The recording time required is calculated from the and the sampling rate indirectly set via ADEM:SPEC:SPAN:MAX or ADEM:BAND. If the available recording time is not sufficient for the given bandwidth, the recording time is set to its maximum and the resolution bandwidth is enlarged to the resulting bandwidth.

Example:

"ADEM ON"	' Switches on the FM demodulator
"CALC:FEED 'XTIM:SPEC'	' Switches on the result display RF spectrum
or	
"CALC:FEED 'XTIM:FM:AFSP'	' Switches on the result display AF spectrum
or	'of FM
"CALC:FEED 'XTIM:RFP:AFSP'	' Switches on the result display AF spectrum
	'of RF power signal
"ADEM:BAND:RES 61.2kHz"	' Sets the resolution bandwidth to 61.2 kHz.

Characteristics: *RST value: 61.2 kHz
 SCPI: device-specific

[SENSe:]ADEMod:SPECTrum:SPAN[:MAXimum] <numeric_value>

This command sets the maximum frequency range for displaying the RF spectrum that was determined from the FM demodulation data. The maximum span corresponds to the measurement bandwidth of analog demodulation (SENS:ADEM:BAND). Only discrete values are possible for the span since the available sampling rates are discrete.

Demodulation bandwidth	Sampling rate
10 MHz	32 MHz
8 MHz	16 MHz
5 MHz	8 MHz
3 MHz	4 MHz
1,6 MHz	2 MHz
800 kHz	1 MHz
400 kHz	500 kHz
200 kHz	250 kHz
100 kHz	125 kHz
50 kHz	62.5 kHz
25 kHz	31.25 kHz
12.5 kHz	15.625 kHz
6.4 kHz	7.8125 kHz
3.2 kHz	3.90625 kHz
1.6 kHz	1.953125 kHz
800 Hz	976.5625 Hz
400 Hz	488.28125 Hz
200 Hz	244.140625 Hz
100 Hz	122.0703125 Hz

Example:

```
"ADEM ON"           'Switches on the FM demodulator
"CALC:FEED XTIM:SPEC' 'Switches on result display RF spectrum
"ADEM:SPEC:SPAN:MAX 5 MHz" 'Sets the max. span to 5 MHz
"ADEM:SPEC:SPAN:ZOOM 1 MHz" 'Sets the displayed span to 1 MHz
```

Characteristics: *RST value: 5 MHz
SCPI: device-specific

[SENSe:]ADEMod:SPECTrum:SPAN:ZOOM <numeric_value>

This command sets the frequency range for result display of RF spectrum determined from FM demodulation data. The frequency range for result display is limited to the maximum span (SENS:ADEM:SPEC:SPAN:MAX) or to the measurement bandwidth of analog demodulation (SENS:ADEM:BAND).

Example:

```
"ADEM ON"           'Switches on the FM demodulator
"CALC:FEED XTIM:SPEC' 'Switches on result display RF spectrum"
"ADEM:SPEC:SPAN:MAX 5 MHz" 'Sets the maximum span to 5 MHz
"ADEM:SPEC:SPAN:ZOOM 1 MHz" 'Sets displayed span to 1 MHz
```

Characteristics: *RST value: 5 MHz
SCPI: device-specific

[SENSe:]ADEMod[:STATe] ON | OFF

This command activates the FM demodulator of the instrument. The instrument will be set to time domain measurement (span = 0) at the current center frequency.

Example: "ADEM ON" 'Switches the AM/FM demodulator on

Characteristics: *RST value: OFF
SCPI: device-specific

SENSe:AVERage Subsystem

The SENSe:AVERage subsystem calculates the average of the acquired data. A new test result is obtained from several successive measurements.

There are two types of average calculation: logarithmic and linear. In case of logarithmic average calculation (denoted with VIDEo), the average value of the measured logarithmic power is calculated and in case of linear average calculation, the linear power is averaged before the logarithm is applied.

The measurement windows are selected by SENSe1 (screen A) and SENSe2 (screen B).

COMMAND	PARAMETERS	UNIT	COMMENT
[SENSe<1 2>] :AVERage :COUNT [:STATe<1 to 3>] :TYPE	<numeric_value> <Boolean> VIDeO LINear	-- -- --	

[SENSe<1|2>:]AVERage:COUNT 0 to 32767

This command defines the number of measurements which contribute to the average value. It should be noted that continuous averaging will be performed after the indicated number has been reached in continuous sweep mode.

In single sweep mode, the sweep is stopped as soon as the indicated number of measurements (sweeps) is reached. Synchronization to the end of the indicated number of measurements is only possible in single sweep mode.

The command [SENSe<1|2>:]AVERage:COUNT is the same as command

[SENSe<1|2>:]SWEep:COUNT. In both cases, the number of measurements is defined whether the average calculation is active or not.

The number of measurements is valid for all traces in the indicated measurement window.

Example:

```
"SWE:CONT OFF" 'Switching to single-sweep mode.
"AVER:COUN 16" 'Sets the number of measurements to 16.
"AVER:STAT ON" 'Switches on the calculation of average.
"INIT;*WAI" 'Starts the measurement and waits for the end of the 16 sweeps.
```

Characteristics: *RST value: 0
SCPI: conforming

[SENSe<1|2>:]AVERage[:STATe<1 to 3>] ON | OFF

This command switches on or off the average calculation for the selected trace (STATe<1 to 3>) in the selected measurement window.

Example:

```
"AVER OFF" 'Switches off the average calculation for trace 1 in screen A.
"SENS2:AVER:STAT3 ON" 'Switches on the average calculation for trace 3
'in screen B.
```

Characteristics: *RST value: OFF
SCPI: conforming

[SENSe<1|2>:]AVERage:TYPE VIDEo | LINear

This command selects the type of average function. If VIDEo is selected, the logarithmic power is averaged and, if LINear is selected, the power values are averaged before they are converted to logarithmic values.

The type of average calculation is equally set for all traces in one measurement window.

Example: "AVER:TYPE LIN" 'Switches screen A to linear average calculation.

Characteristics: *RST value: VIDEo
SCPI: device-specific

SENSe:BANDwidth Subsystem

This subsystem controls the setting of the instrument's filter bandwidths. Both groups of commands (BANDwidth and BWIDth) perform the same functions. The measurement windows are selected by SENSe1 (screen A) and SENSe2 (screen B).

COMMAND	PARAMETERS	UNIT	COMMENT
[SENSe<1 2>] :BANDwidth			
:DEMod	<numeric_value>	HZ	
:AUTO	<Boolean>		
FFT	AUTO WIDE NARRow		
:PLL	AUTO HIGH MEDium LOW		
[:RESolution]	<numeric_value>	HZ	
:AUTO	<Boolean>		
:RATio	<numeric_value>		
:TYPE	NORMal FFT CFILter RRC		
:VIDeo	<numeric_value>	HZ	
:AUTO	<Boolean>		
:RATio	<numeric_value>		
:TYPE	LINear LOGarithmic		
:BWIDth			
:DEMod	<numeric_value>	HZ	
:AUTO	<Boolean>		
FFT	AUTO WIDE NARRow		
:PLL	AUTO HIGH MEDium LOW		
[:RESolution]	<numeric_value>	HZ	
:AUTO	<Boolean>		
:RATio	<numeric_value>		
:TYPE	NORMal FFT CFILter RRC		
:VIDeo	<numeric_value>	HZ	
:AUTO	<Boolean>	--	
:RATio	<numeric_value>	--	
:TYPE	LINear LOGarithmic		

[SENSe<1|2>:]BANDwidth|BWIDth:DEMod <numeric-value>

This command defines the demodulation bandwidth of the instrument for analog demodulation. The required sampling rate is automatically set depending on the selected demodulation bandwidth. The available demodulation bandwidths are determined by the existing sampling rates.

Rounded off demodulation bandwidth	Sampling rate
10 MHz	32 MHz
8 MHz	16 MHz
5 MHz	8 MHz
3 MHz	4 MHz
1.6 MHz	2 MHz
800 kHz	1 MHz
400 kHz	500 kHz
200 kHz	250 kHz
100 kHz	125 kHz
50 kHz	62.5 kHz
25 kHz	31.25 kHz
12.5 kHz	15.625 kHz
6.4 kHz	7.8125 kHz
3.2 kHz	3.90625 kHz
1.6 kHz	1.953125 kHz
800 Hz	976.5625 Hz
400 Hz	488.28125 Hz
200 Hz	244.140625 Hz
100 Hz	122.0703125 Hz

Example: "ADEM:BAND:DEM 5MHz" 'Sets demodulation bandwidth to 5 MHz.

Characteristics: *RST value: 1.6 MHz
SCPI: device specific

[SENSe<1|2>:]BANDwidth|BWIDth:DEMod:AUTO ON | OFF

This command activates automatic setting of the demodulation bandwidth. The demodulation bandwidth is set as a function of the operating mode (audio, AM, FM, PM, RF Level) in order to minimize the measurement error in the specified measurement range.

Example: "BAND:DEM:AUTO OFF"

Characteristics: *RST value: ON
SCPI: device-specific

[SENSe<1|2>:]BANDwidth|BWIDth:FFT AUTO | WIDE | NARROW

This command allows to specify between the following three options for FFT filters.

AUTO: The firmware decides whether to use wide or narrow filters to achieve the best performance of the measurement.

WIDE: The FFT filters with the greater partial span (this is the span which is covered with one FFT analysis) are used always.

NARROW: The FFT filters with the smaller partial span are used, this allows measurements near a carrier with reduced reference level, because of a more narrow analog prefilter.

Example: "BWID:FFT:MODE WIDE"

Characteristics: *RST value: AUTO
SCPI: device-specific

[SENSe<1|2>:]BANDwidth|BWIDth:PLL AUTO | HIGH | MEDium | LOW

This command defines the bandwidth of the main PLL of the instrument synthesizer and thus affects the phase noise of the Spectrum Analyzer. You can set the bandwidth in three stages (high/medium/low); if you select AUTO, it is automatically set.

Example: "BWID:PLL HIGH"

Characteristics: *RST value: AUTO
SCPI: device-specific

[SENSe<1|2>:]BANDwidth|BWIDth[:RESolution] 10 Hz to max

This command defines the analyzer's resolution bandwidth. This corresponds to the IF bandwidth of the demodulator in FM demodulator mode.

Analog resolution filters of 10 Hz to 20 MHz in 1, 2, 3, 5, 10 steps are available. Additionally there is a 50 MHz (FSMR43: 10 Hz to 10 MHz) resolution bandwidth. These filters are implemented as 5-circuit LC filters in the range from 300 kHz to 10 MHz and as digital filters with analog characteristic in the range of 10 Hz to 100 kHz.

In addition, the EMI bandwidths 200 Hz, 9 kHz and 120 kHz are available (6 dB bandwidths each). These bandwidths can only be obtained by entering numeric values and not with the commands INCRement and DECReMENT.

FFT filters from 1 Hz to 30 kHz (3 dB bandwidth each) are also available in the frequency domain (span > 0) for fast measurements on periodic signals. The instrument automatically switches to analog filters above 30 kHz.

A number of especially steep-edged channel filters can be selected from firmware version 1.10 or higher provided that parameters CFILter or RRC are selected using the BAND:TYPE command.

The possible combinations of filter type and filter bandwidth are listed in the table "List of available channel filters" of chapter 4, section "Setting Bandwidths and Sweep Time– Key BW".

If the resolution bandwidth is modified in SPECTRUM mode, the coupling to the span is automatically switched off.

If the resolution bandwidth is modified in FM DEMOD mode, the coupling to the demodulation bandwidth is automatically switched off.



This command is not available for GSM/EDGE measurements modulation accuracy (MAC), phase/frequency error (PFE) and power versus time (PVT). During these measurements the bandwidth is selected due to GSM standard.

Example: "BAND 1MHz" 'Sets the resolution bandwidth to 1 MHz

Characteristics: *RST value: - (AUTO is set to ON)
SCPI: conforming

[SENSe<1|2>:]BANDwidth|BWIDth[:RESolution]:AUTO ON | OFF

In SPECTRUM mode, this command either automatically couples the resolution bandwidth of the instrument to the span or cancels the coupling. In FM DEMOD mode, this command either automatically couples the IF bandwidth of the instrument to the demodulation bandwidth or cancels the coupling ($BW_{RBW} = 10 * BW_{Demod}$).

In FM DEMOD mode, the coupling refers to the demodulation bandwidth ($BW_{RBW} = 10 * BW_{Demod}$).

The automatic coupling adapts the resolution bandwidth to the currently set frequency span according to the relationship between frequency span and resolution bandwidth. The 6 dB bandwidths 200 Hz, 9 kHz and 120 kHz and the channel filters available from Version 1.10 are not set by the automatic coupling.

The ratio resolution bandwidth/span can be modified with the command

[SENSe<1|2>:]BANDwidth[:RESolution]:RATio.



This command is not available for GSM/EDGE measurements modulation accuracy (MAC), phase/frequency error (PFE) and power versus time (PVT).

Example: "BAND:AUTO OFF" 'Switches off the coupling of the resolution bandwidth to the span (analyzer mode).
'Switches off the coupling of the IF bandwidth to the demodulation bandwidth (FM demod mode).

Characteristics: *RST value: ON
SCPI: conforming

[SENSe<1|2>:]BANDwidth|BWIDTH[:RESolution]:RATio 0.0001 to 1

This command defines the ratio resolution bandwidth (Hz) / span (Hz). The ratio to be entered is reciprocal to the ratio span/RBW used in manual control.

Example: "BAND:RAT 0.1"

Characteristics: *RST value: 0.02 with BAND:TYPE NORMal or RBW > 30 kHz
0.01 with BAND:TYPE FFT for RBW ≤ 30 kHz
SCPI: conforming

[SENSe<1|2>:]BANDwidth|BWIDTH[:RESolution]:TYPE NORMal | FFT | CFILter | RRC

This command switches the filter type for the resolution bandwidth between "normal" analog or FIR filters in 1, 3, 10 steps and the FFT filtering for bandwidths <100 kHz.

The advantage of FFT filtering is the higher measurement speed compared to digital filters with analog filter characteristic. However, FFT filters are only suitable for periodic signals, and they are only available for span > 0 Hz.

From firmware version 1.10 onwards, steep-edged channel filters and filters with RRC (Root Raised Cosine) characteristic are available. The possible combinations of filter type and filter bandwidth are listed in the table "List of available channel filters" in chapter 4, section "Setting Bandwidths and Sweep Time— Key BW".



When changing the filter type, the next larger filter bandwidth is selected if the same filter bandwidth is not available for the new filter type.

This command is not available for GSM/EDGE measurements modulation accuracy (MAC), phase/frequency error (PFE), power versus time (PVT) and carrier power (CPW).

Example: "BAND:TYPE NORM"

Characteristics: *RST value: NORMal
SCPI: device-specific

[SENSe<1|2>:]BANDwidth|BWIDTH:VIDeo 1Hz to 10MHz

This command defines the instrument's video bandwidth. Bandwidths from 10 Hz to 10 MHz in 1, 2, 3, 5, 10 steps are available. The command is not available if FFT filtering is switched on and the set bandwidth is ≤ 30 kHz or if the quasi-peak detector is switched on.



This command is not available for GSM/EDGE measurements modulation accuracy (MAC), phase/frequency error (PFE) and power versus time (PVT).

Example: "BAND:VID 10kHz"

Characteristics: *RST value: - (AUTO is set to ON)
SCPI: conforming

[SENSe<1|2>:]BANDwidth|BWIDth:VIDeo:AUTO ON | OFF

This command either automatically couples the instrument's video bandwidth to the resolution bandwidth or cancels the coupling.

The ratio video bandwidth/resolution bandwidth can be modified with the command

[SENSe<1|2>:]BANDwidth:VIDeo:RATio.



This command is not available for GSM/EDGE measurements modulation accuracy (MAC), phase/frequency error (PFE) and power versus time (PVT).

Example: "BAND:VID:AUTO OFF"

Characteristics: *RST value: ON
SCPI: conforming

[SENSe<1|2>:]BANDwidth|BWIDth:VIDeo:RATio 0.01 to 1000

This command defines the ratio video bandwidth (Hz) / resolution bandwidth (Hz). The ratio to be entered is reciprocal to the ratio RBW/VBW used in manual control.



This command is not available for GSM/EDGE measurements modulation accuracy (MAC), phase/frequency error (PFE) and power versus time (PVT).

Example: "BAND:VID:RAT 3" 'Sets the coupling of video bandwidth to video
'bandwidth = 3*resolution bandwidth

Characteristics: *RST value: 3
SCPI: conforming

[SENSe<1|2>:]BANDwidth|BWIDth:VIDeo:TYPE LINear | LOGarithmic

This command selects the position of the video filter in the signal path, provided that the resolution bandwidth is ≤ 100 kHz:

- If LINear is selected, the video filter is connected ahead of the logarithmic amplifier (default)
- If LOGarithmic is selected, the video filter follows the logarithmic amplifier

The essential difference between the two modes is the transient response at falling signal edges: If LINear is selected, the measurement with logarithmic level scaling yields a much "flatter" falling edge than LOGarithmic.

This behaviour is due to the conversion of linear power into logarithmic level. If the linear power is halved, the level decreases by only 3 dB.

Example: "BAND:VID:TYPE LIN" 'Video filter ahead of the logarithmic amplifier

Characteristics: *RST value: LIN
SCPI: device-specific

SENSe:CORRection Subsystem

The SENSe:CORRection subsystem controls the correction of measured results by means of frequency-dependent correction factors (e. g. for antenna or cable attenuation). This subsystem also controls calibration and normalization during operation with the external generator control option (B10). The measurement windows are selected by SENSe1 (screen A) and SENSe2 (screen B).



The commands of this subsystem are not available during GSM measurements.

COMMAND	PARAMETERS	UNIT	COMMENT
[SENSe<1 2>] :CORRection :COLlect [ACQuire] :CLEar [:IMMEDIATE]	INPut PMeter PSPLitter THROugh OPEN		no query
:LEVel	<numeric_value>		
:METHod	TRANsmiSSion REFLExion		
:PMETer :CALibration [:DATA] :OPERator :FLASh	<freq> , <level> .. <string>	HZ, PCT	
:PLOSs :INPut :SPATH :STATe	<freq>,<level>.. <numeric_value> <Boolean>	DB	
:RECall	<Boolean>		no query
[:STATe] :TRANsducer :ACTive? :ADJust :RLEVel [:STATe]	<Boolean>		query only
:CATalog?			query only
:COMMent :DATA :DELeTe :GENerate :SCALing :SELeCt [:STATe] :UNIT :VIEW	<string> <freq> , <level> ... <name> LINear LOGarithmic <name> <Boolean> <string> <Boolean>	HZ	no query
:VSWR [:STATe]	ON OFF		
:YIG :TEMPerature [:AUTO]	<Boolean>		

[SENSe<1|2>]:CORRection:COLlect[:ACQuire] INPut | PMETer | PSPLitter | THROugh | OPEN

- This command carries out the various steps of absolute level calibration in the *Tuned RF Level* mode.
- PMETer Measures the reference level with a power meter.
- INPut Measures the comparison value at the receiver's RF input and corrects it to the reference level.
- PSPLitter Measures the reference level and then the comparison value.
For this measurement, the power meter and the receiver's RF input must be connected to the DUT via a power splitter.
- THROugh "TRANsmiSSion" mode: calibration with direct connection between tracking generator and device input.
"REFLExion" mode: calibration with short circuit at the input
- OPEN only valid in "REFLExion" mode: calibration with open input

Example: "CORR:COLL PSPL;*WAI" 'Starts the reference measurement and the comparison measurement one after the other and waits for the operation to be completed.'

Characteristics: *RST value: --
SCPI: device-specific

This command is an event and therefore has no *RST value and no query.

[SENSe<1|2>:]CORRection:COLLect[:ACQuire]:CLEar:IMMediate

This command does reset the current level correction in *Tuned RF Level* mode.

Example: "CORR:COLL:CLE:IMM" 'Reset the level correction.'

Characteristics: *RST value: --
SCPI: device-specific

This command is an event and therefore has no *RST value and no query.

[SENSe<1|2>:]CORRection:COLLect[:ACQuire]:LEVEl <numeric_value>

This command defines the level measured with an external power meter when SYSTem:COMMunicate:RDEvice:PMETer:TYPE is set to 'MANUAL'

Example: "CORR:COLL:LEV -53 DBM" A level of -53 dBm was measured with an external power meter and is used for subsequent level corrections.

Characteristics: *RST value: --
SCPI: device-specific

[SENSe<1|2>:]CORRection:COLLect[:ACQuire]:LEVEl <numeric_value>

This command defines the level measured with an external power meter when SYSTem:COMMunicate:RDEvice:PMETer:TYPE is set to 'MANUAL'

Example: "CORR:COLL:LEV -53 DBM" A level of -53 dBm was measured with an external power meter and is used for subsequent level corrections.

Characteristics: *RST value: --
SCPI: device-specific

[SENSe<1|2>:]CORRection:METhod TRANsmission | REFLEction

This command selects the type of measurement with active tracking generator (transmission/reflection).

Example: "CORR:METH TRAN" 'Sets the type of measurement in screen A to "transmission".'

Characteristics: *RST value: TRANsmission
SCPI: device specific

This command is only valid in conjunction with the ext. generator control option (B10).

[SENSe<1|2>:]CORRection:PLOs:INPut <freq>,<level>..

This command defines the interpolation points for the frequency response correction for the power splitter on the path between the signal source and the power meter. The points are to be entered as a sequence of frequency/level pairs, with the frequencies to be specified in ascending order.

Example: "CORR:PLOS:INP 10MHZ,-4.2,20MHZ,-4.6"

Characteristics: *RST value: -
SCPI: device-specific

[SENSe:]CORRection:PLOs:INPut:SPATh <numeric_value>

This command defines the insertion loss of the power splitter between the signal source and the RF input of the receiver. The value entered here only serves for plausibility checking during absolute value calibration. The correct value is then determined during absolute value calibration. *Softkey: PATH 2 INS LOSS*

Example: "CORR:PLOS:INP:SPAT 4 dB" Defines a 4 dB insertion loss.

Characteristics: *RST value: 0
SCPI: device-specific

[SENSe:]CORRection:PLOs:INPut[:STATe] ON | OFF

This command switches on or off automatic correction of the insertion loss of the power splitter, which distributes the incoming RF signal to the power meter and the RF input of the receiver.

Example: "CORR:PLOS:INP ON" 'Corrects the insertion loss of the power splitter.

Characteristics: *RST value: OFF
SCPI: device-specific

[SENSe<1|2>:]CORRection:RECall

This command restores the instrument setting that was valid for the measurement of the reference data, provided that the tracking generator is active.

Example: "CORR:REC"

Characteristics: *RST value: -
SCPI: conforming

This command is an event and therefore has no *RST value and no query.

It is only valid in conjunction with the ext. generator control option (B10).

[SENSe<1|2>:]CORRection[:STATe] ON | OFF

This command activates/deactivates the normalization of the measurement results in the selected window provided that the tracking generator is active. The command is available only after acquisition of a reference trace for the selected type of measurement (transmission/reflection, see command [SENSe<1|2>:]CORRection:COLLect[:ACQire]).

Example: "CORR ON " 'Activates normalization in screen A.

Characteristics: *RST value: OFF
SCPI: conforming

This command is only valid in conjunction with the ext. generator control option (B10).

[SENSe<1|2>:]CORRection:TRANsdUcer:ACTive?

This command queries the active transducer factor. Any empty string is returned, if no transducer factor is active.

Example: ":CORR:TRAN:ACT?"

Characteristics: *RST value: -
SCPI: device-specific

[SENSe<1|2>:]CORRection:TRANsdUcer:ADJust:RLEVel[:STATe] ON | OFF

This command switches the automatic adjustment of the reference level to the selected transducer factor on or off.



The command `SENS:CORR:TRAN:SEL` must have been sent prior to this command.

Example: `"CORR:TRAN:ADJ:RLEV ON"`

Characteristics: *RST value: OFF
SCPI: device-specific

[SENSe<1|2>:]CORRection:TRANsdUcer:CATalog?

This command reads out the names of all transducer factors stored on the harddisk.

Example: `"CORR:TRAN:CAT?"`

Feature: *RST value: -
SCPI: device-specific

[SENSe<1|2>:]CORRection:TRANsdUcer:COMMeNt <string>

This command defines the comment for the selected transducer factor.



Prior to this command, the command `SENS:CORR:TRAN:SEL` must be sent.

Example: `":CORR:TRAN:COMM 'FACTOR FOR ANTENNA'"`

Characteristics: *RST value " (empty comment)
SCPI: device specific

[SENSe<1|2>:]CORRection:TRANsdUcer:DATA <freq>,<level>..

This command defines the reference values of the transducer factor selected. These values are entered as a sequence of frequency/level pairs. The frequencies must be sent in ascending order.



Prior to this command, the command `SENS:CORR:TRAN:SEL` must be sent. The level values are sent as dimensionless numbers; the unit is specified by means of the command `SENS:CORR:TRAN:UNIT`.

Example: `":CORR:TRAN:TRANsdUcer:DATA 1MHZ,-30,2MHZ,-40"`

Characteristics: *RST value: -
SCPI: device-specific

[SENSe<1|2>:]CORRection:TRANsdUcer:DELeTe

This command deletes the selected transducer factor.



Prior to this command, the command `SENS:CORR:TRAN:SEL` must be sent.

Example: `":CORR:TRAN:DEL"`

Characteristics: *RST value: -
SCPI: device-specific

This command is an event and therefore has no *RST value.

[SENSe<1|2>:]CORRection:TRANsdUcer:GENerate <name>

This command generates a transducer factor <name> using normalized trace data. The function is only available when normalization is switched on.

Parameter: <name>::= Name of the transducer factors as string data with up to 8 characters.

Example: `"CORR:TRAN:GEN 'FACTOR1'"`

Characteristics: *RST value: -
SCPI: device-specific

[SENSe<1|2>:]CORRection:TRANsdUcer:SCALing LINear | LOGarithmic

This command defines whether the frequency scaling of the transducer factor is linear or logarithmic.



Prior to this command, the command `SENS:CORR:TRAN:SEL` must be sent.

Example: `":CORR:TRAN:SCAL LOG"`

Characteristics: *RST value: LINear
SCPI: device-specific

[SENSe<1|2>:]CORRection:TRANsdUcer:SELeCt <name>

This command selects the transducer factor designated by <name>. If <name> does not exist yet, a new transducer factor is created.



This command must be sent prior to the subsequent commands for modifying/activating transducer factors.

Parameter: <name>::= Name of the transducer factor in string data form with a maximum of 8 characters.

Example: ":CORR:TRAN:SEL 'FACTOR1'"

Characteristics: *RST value: -
SCPI: device-specific

[SENSe<1|2>:]CORRection:TRANsdUcer[:STATe] ON | OFF

This command switches the selected transducer factor on or off.

Note:

Prior to this command, the command `SENS:CORR:TRAN:SEL` must be sent.

Example: ":CORR:TRAN ON"

Characteristics: *RST value: OFF
SCPI: device-specific

[SENSe<1|2>:]CORRection:TRANsdUcer:UNIT <string>

This command defines the unit of the transducer factor selected.



Prior to this command, the command `SENS:CORR:TRAN:SEL` must be sent.

Parameter: <string>::= 'DB' | 'DBM' | 'DBMV' | 'DBUV' | 'DBUV/M' | 'DBUA' | 'DBUA/M' | 'DBPW' | 'DBPT'

Example: ":CORR:TRAN:UNIT 'DBUV'"

Characteristics: *RST value: 'DB'
SCPI: device-specific

[SENSe<1|2>:]CORRection:TRANsdUcer:VIEW ON | OFF

This command switches on the display of the active transducer factor or set.



Prior to this command, the command `SENS:CORR:TRAN:SEL` must be sent.

Example: "CORR:TRAN:VIEW ON"

Characteristics: *RST value: OFF
SCPI: device-specific

[SENSe<1|2>:]CORRection:VSWR[:STATe] ON | OFF

This command activates/deactivates the mismatch correction between the power sensor module NRP-Z27 or NRP-Z37 and the FSMR RF input.

Example: "CORR:VSWR ON"

Characteristics: *RST value: OFF
SCPI: device dependent

[SENSe<1|2>:]CORRection:YIG:TEMPerature:AUTO ON | OFF

This command switches on or off the automatic correction of the YIG filter frequency drift.

When correction is switched on, it is checked once per minute whether the temperature on the YIG filter has changed by more than 5K relative to the last instance of correction. If this is the case, the frequency of the YIG filter is – at the end of the next measurement – adjusted as required for the new temperature. For time-critical applications, the correction function can be switched off after an operating period of ≥ 30 minutes.

Example: "CORR:YIG:TEMP OFF" 'Switches off automatic correction of the YIG filter frequency drift.

Characteristics: *RST value: ON
SCPI: device-specific

The ON parameter is available only if the MW CONV UNIT module has one of the following modification states:

Order No.	Rev	SubRev
1130.2396	≥ 02	≥ 01
1130.2544	≥ 02	≥ 01
1093.8249	≥ 08	≥ 01
1093.8584	≥ 02	≥ 01
1130.3240	≥ 02	≥ 01

The option Presalektor must be installed.

SENSe:DETECTOR Subsystem

The SENSe:DETECTOR subsystem controls the acquisition of measurement data via the selection of the detector for the corresponding trace. The measurement windows are selected by SENSe1 (screen A) and SENSe2 (screen B).

COMMAND	PARAMETERS	UNIT	COMMENT
[SENSe<1 2>] :DETECTOR<1..3> [:FUNCTION] :AUTO	APEAK NEGATIVE POSITIVE SAMPLE RMS AVERAGE QPEAK NARROW WIDE <Boolean>	--	

[SENSe<1|2>]:DETECTOR<1..3>[:FUNCTION] APEAK | NEGATIVE | POSITIVE | SAMPLE | RMS | AVERAGE | QPEAK | NARROW | WIDE

This command switches on the detector for the data acquisition in the selected trace and the indicated measurement window.

- The APEAK detector (AutoPeak) displays the positive and also the negative peak value of the noise floor. If a signal is detected, only the positive peak value is displayed.
- The POSITIVE or NEGATIVE detector only displays the positive or the negative peak value.
- With the Sample detector the value measured at the sampling time is displayed, whereas the RMS value of the power measured at each test point is displayed with the RMS detector.
- The AVERAGE detector displays the power average value at each test point.
- The QPEAK detector performs a signal evaluation for EMC measurements.

If QPEAK is selected, the video filter is automatically switched off. The couplings between span and RBW as well as between RBW and sweep time are also switched off and restored on selecting another detector. A long sweep time should be selected so that the quasi-peak detector can fully settle at each test point.

The trace is indicated as numeric suffix in DETECTOR.



APEAK and QPEAK are not available during GSM measurements modulation accuracy (MAC), phase-frequency error (PFE) and power vs. time (PVT).

Example: "DET POS" 'Sets the detector in screen A to "positive peak".

Characteristics: *RST value: APEAK
SCPI: conforming

SENSe<1|2>:DETECTOR[:FUNCTION] NARROW | WIDE

This command selects between different detector functions. *DETECTOR NARROW* activates an FFT in the set demodulation bandwidth. The displayed level value is derived from the FFT peak value. The effective measurement bandwidth for this type of measurement is approx. 4 / measurement time. During the measurement time, the signal must remain in the effective bandwidth. *DETECTOR WIDE* activates a level measurement in the set demodulation bandwidth. The level is obtained by an RMS (root mean square) computation of all measurement points. Select *DETECTOR WIDE* if the signal sources are unstable (frequency drift, residual FM).

Example: "DET NARR"

Characteristics: *RST value: NARROW
SCPI: device dependent

[SENSe<1|2>:]DETECTOR<1 to 3>[:FUNCTION]:AUTO ON | OFF

This command either couples the detector in the selected measurement window to the current trace setting or turns coupling off. The trace is selected by the numeric suffix at DETECTOR.

Example: "DET:AUTO OFF"

Characteristics: *RST value: ON
SCPI: conforming

SENSe:ESpectrum Subsystem

This chapter describes all remote control commands available to configure Spectrum Emission Mask measurements.

COMMAND	PARAMETER	UNIT	
[SENSe<1 2>]			
:ESpectrum			
:BWID	<numeric_value>		
:FILTer			
[:RRC]			
:ALPHa	<numeric_value>		
[:STATe]	<Boolean>		
:PRESet			
:REStore			
[:STANdard]	<string>		
:RANGe<1...20>			
:BANDwidth	<numeric_value>	HZ	
[:RESolution]	<numeric_value>	HZ	
:VIDeo			
:COUNt?			
:DELete			
:FILTer			
:TYPE	NORMal FFT CFILTer RRC P5Digital P5 NOISe PULSe		
[:FREQuency]			
:START	<numeric_value>	HZ	
:STOP	<numeric_value>	HZ	
:INPut			
:ATTenuation	<numeric_value>	DB	
:AUTO	<Boolean>	--	
:GAIN			
:STATe	<Boolean>	--	
:RLEVel	<numeric_value>	DBM	
:SWEep			
:TIME	<numeric_value>	S	
:AUTO	<Boolean>	-	
:INSert	AFTer BEFore		
:LIMit			
:ABSolute			
:START	<numeric_value>	DBM	
:STOP	<numeric_value>	DBM	
:RELative			
:START	<numeric_value>	DBC	
:STOP	<numeric_value>	DBC	
:STATe	ABSolute RELative AND OR		
:TRANsducer	<string>	HZ	
:RRANge?			
:RTYPE	PEAK CPOWer		
:STANdard			
:DELete	<file_name>		
:SAVE	<file_name>		

[SENSe<1|2>:]ESpectrum:BWIDth numeric_value

This command defines the bandwidth used for measuring the channel power in the Spectrum Emission Mask measurement. Allowed range: 20 Hz .span of reference range.
The numeric suffix at SENSe<1|2> is irrelevant.

Example: "SENS:ESP:BWID 3.84MHz" sets the channel bandwidth to 3.84MHz

Characteristics: *RST value: 3.84 MHz
SCPI: device-specific

[SENSe<1|2>:]ESpectrum:FILTer:RRC:ALPHa 0.1

This command sets the alpha value of the RRC filter for measuring the channel power in the Spectrum Emission Mask measurement if the RRC filter is switched on.
The numeric suffix at SENSe<1|2> is irrelevant.

Example: "SENS:ESP:FILT:RRC:ALPH ON" 'RRC filter switched on

Characteristics: *RST value: 0.22
SCPI: device-specific

[SENSe<1|2>:]ESpectrum:FILTer:RRC[:STATe] ON | OFF

This command activates or deactivates the use of a RRC filter for measuring the channel power in the Spectrum Emission Mask measurement.
The numeric suffix at SENSe<1|2> is irrelevant.

Example: "SENS:ESP:FILT:RRC ON" 'RRC filter switched on

Characteristics: *RST value: ON
SCPI: device-specific

[SENSe<1|2>:]ESpectrum:PRESet:RESTore

This command copies the XML files from the D:\R_S\FW\instr\sem_backup folder to the D:\R_S\instr\sem_std folder. Files of the same name are overwritten.
This command is an event and therefore has no *RST value and no query.
The numeric suffix at SENSe<1|2> is irrelevant.

Example: "SENS:ESP:PRES:REST" 'Restores the originally provided XML files.

Characteristics: *RST value:-
SCPI: device-specific

[SENSe<1|2>:]ESpectrum:PRESet[:STANdard] 'xml_file'

This command selects the specified XML file under D:\r_s\instr\sem_std. If the file is stored in a subdirectory, include the relative path.
The query returns information about the selected standard, the power class and the link direction. If no standard has been selected, the query returns ".
The numeric suffix at SENSe<1|2> is irrelevant.

Example: "SENS:ESP:PRES 'WCDMA\3GPP\DL\PowerClass_31_39.xml"
'Selects the PowerClass_31_39.xml XML file in the folder
.D:\R_S\instr\sem_std\WCDMA\3GPP\DL.
"SENS:ESP:PRES?" 'Returns 'W-CDMA 3GPP (31,39)dBm DL

Characteristics: *RST value:
SCPI: device-specific

[SENSe<1|2>:]ESpectrum:RANGe<1...20>:BANDwidth[:RESolution] <numeric_value>

This command selects the resolution bandwidth (RBW) of a range in the Spectrum Emission Mask measurement.

The numeric suffixes <1...20> specify the range. The numeric suffix at SENSe<1|2> is irrelevant.

Example: "SENS:ESP:RANG2: BAND 10E3" 'sets the RBW to 10 KHz

Characteristics: *RST value: 10 kHz
SCPI: device-specific

[SENSe<1|2>:]ESpectrum:RANGe<1...20>:BANDwidth:VIDeo <numeric_value>

This command selects the video bandwidth (VBW) of a range in the Spectrum Emission Mask measurement.

The numeric suffixes <1...20> specify the range. The numeric suffix at SENSe<1|2> is irrelevant.

Example: "SENS:ESP:RANG2: BAND:VID 100E3"'sets the VBW to 100 KHz

Characteristics: *RST value: 30 kHz
SCPI: device-specific

[SENSe<1|2>:]ESpectrum:RANGe<1...20>:COUNt?

This command indicates the number of defined ranges of the Spectrum Emission Mask measurement.

The numeric suffixes <1|2> at SENSe and <1...20> at RANGE are irrelevant for this command.

Example: "SENS:ESP:RANG:COUN?" 'indicates the number of ranges

Characteristics: *RST value: OFF
SCPI: device-specific

[SENSe<1|2>:]ESpectrum:RANGe<1...20>:DELete

This command deletes a range of the Spectrum Emission Mask measurement configuration.

The numeric suffixes <1...20> specify the range. The numeric suffix at SENSe<1|2> is irrelevant.

Example: "SENS:ESP:RANG2: DEL"'deletes range 2

Characteristics: *RST value:-
SCPI: device-specific

[SENSe<1|2>:]ESpectrum:RANGe<1...20>:FILTer:TYPE NORMAl | CFILter | RRC | PULSe

This command sets the filter in the Spectrum Emission Mask measurement. For details on filter type refer to .Filter Types.

The numeric suffixes <1...20> specify the range. The numeric suffix at SENSe<1|2> is irrelevant.

Example: "SENS:ESP:RANG2: FILT:TYPE RRC" 'RRC filter

Characteristics: *RST value: NORMAl
SCPI: device-specific

[SENSe<1|2>:]ESpectrum:RANGe<1...20>[:FREQuency]:STARt <numeric_value>

This command sets the relative start frequency of a range in the Spectrum Emission Mask measurement.

The numeric suffixes <1...20> specify the range. The numeric suffix at SENSe<1|2> is irrelevant.

Example: "SENS:ESP:RANG2: STAR -2.52MHz" 'start frequency of range 2 to -2.52 MHz

Characteristics: *RST value:-
SCPI: device-specific

[SENSe<1|2>]:ESpectrum:RANGe<1...20>[:FREQUENCY]:STOP <numeric_value>

This command sets the relative stop frequency of a range in the Spectrum Emission Mask measurement. The numeric suffixes <1...20> specify the range. The numeric suffix at SENSe<1|2> is irrelevant.

Example: "SENS:ESP:RANG2:STOP 2.52MHZ" 'stop frequency of range 2 to +2.52MHz

Characteristics: *RST value:-
SCPI: device-specific

[SENSe<1|2>]:ESpectrum:RANGe<1...20>:INPut:ATTenuation <numeric_value>

This command defines the RF attenuation of a range in the Spectrum Emission Mask measurement. The numeric suffixes <1...20> specify the range. The numeric suffix at SENSe<1|2> is irrelevant.

Example: "SENS:ESP:RANG2:INP:ATT 30db" 'RF attenuation of range 2 to 30 dB

Characteristics: *RST value:-
SCPI: device-specific

[SENSe<1|2>]:ESpectrum:RANGe<1...20>:INPut:ATTenuation:AUTO ON | OFF

This command switches the attenuation mode of a range in the Spectrum Emission Mask measurement to AUTO (ON) or MANUAL (OFF). The numeric suffixes <1...20> specify the range. The numeric suffix at SENSe<1|2> is irrelevant.

Example: "SENS:ESP:RANG2:INP:ATT:AUTO ON"
'attenuation mode is AUTO for range 2

Characteristics: *RST value: ON
SCPI: device-specific

[SENSe<1|2>]:ESpectrum:RANGe<1...20>:INPut:GAIN:STATe ON | OFF

This command switches the preamplifier of a range in the Spectrum Emission Mask measurement on or off. The numeric suffixes <1...20> specify the range. The numeric suffix at SENSe<1|2> is irrelevant.

Example: "SENS:ESP:RANG2:INP:GAIN:STAT ON"
'activates the preamplifier for range 2

Characteristics: *RST value: OFF
SCPI: device-specific

[SENSe<1|2>]:ESpectrum:RANGe<1...20>[:FREQUENCY]:STOP <numeric_value>

This command sets the relative stop frequency of a range in the Spectrum Emission Mask measurement. The numeric suffixes <1...20> specify the range. The numeric suffix at SENSe<1|2> is irrelevant.

Example: "SENS:ESP:RANG2:STOP 2.52MHZ" 'stop frequency of range 2 to +2.52MHz

Characteristics: *RST value:-
SCPI: device-specific

[SENSe<1|2>]:ESpectrum:RANGe<1...20>:INPut:ATTenuation <numeric_value>

This command defines the RF attenuation of a range in the Spectrum Emission Mask measurement. The numeric suffixes <1...20> specify the range. The numeric suffix at SENSe<1|2> is irrelevant.

Example: "SENS:ESP:RANG2:INP:ATT 30db" 'RF attenuation of range 2 to 30 dB

Characteristics: *RST value:-
SCPI: device-specific

[SENSe<1|2>]:ESpectrum:RANGe<1...20>:INPut:ATTenuation:AUTO ON | OFF

This command switches the attenuation mode of a range in the Spectrum Emission Mask measurement to AUTO (ON) or MANUAL (OFF).

The numeric suffixes <1...20> specify the range. The numeric suffix at SENSE<1|2> is irrelevant.

Example: "SENS:ESP:RANG2:INP:ATT:AUTO ON"
'attenuation mode is AUTO for range 2

Characteristics: *RST value: ON
SCPI: device-specific

[SENSe<1|2>]:ESpectrum:RANGe<1...20>:INPut:GAIN:STATe ON | OFF

This command switches the preamplifier of a range in the Spectrum Emission Mask measurement on or off.

The numeric suffixes <1...20> specify the range. The numeric suffix at SENSE<1|2> is irrelevant.

Example: "SENS:ESP:RANG2:INP:GAIN:STAT ON"
'activates the preamplifier for range 2

Characteristics: *RST value: OFF
SCPI: device-specific

Characteristics: *RST value: depends on range
SCPI: device-specific

[SENSe<1|2>]:ESpectrum:RANGe<1..20>:LIMit:RELative:STOP <numeric_value>

This command defines the relative limit at the stop frequency of the range for the Spectrum Emission Mask measurement.

The numeric suffixes <1...20> specify the range. The numeric suffix at SENSE<1|2> is irrelevant.

Parameter: -400 to +400 dBc

Example: "SENS:ESP:RANG5:LIM:REL:STOP -40"
'Relative limit at stop frequency in range 5 is -40 dBc

Characteristics: *RST value: depends on range
SCPI: device-specific

[SENSe<1|2>]:ESpectrum:RANGe<1..20>:LIMit:STATe ABSolute | RELative | AND | OR

This command sets the type of limit check for all ranges of Spectrum Emission Mask measurement.

ABSolute Checks only the absolute limits defined

RELative: Checks only the relative limits. Relative limits are defined as relative to the measured power in the reference range.

AND Combines the absolute and relative limit. The limit check fails when both limits are violated.

OR Combines the absolute and relative limit. The limit check fails when one of the limits is violated.

The numeric suffixes at SENSE<1|2> and the numeric suffix at RANGe<1..20> are irrelevant.

Example: "SENS:ESP:RANG5:LIM -40" 'limit in range 5 is -40 dBc
"SENS:ESP:RANG7:LIM -20" 'limit in range 7 is -20 dBc
"SENS:ESP:RANG:LIM:STAT ABS" 'activates relative limit check

Characteristics: *RST value: Limit check is OFF
SCPI: device-specific

[SENSe<1|2>:]ESpectrum:RANGe<1...20>:RLEVel <numeric_value>

This command defines the reference level of a range in the Spectrum Emission Mask measurement. The numeric suffixes <1...20> specify the range. The numeric suffix at SENSe<1|2> is irrelevant.

Example: "SENS:ESP:RANG2:RLEV -30" sets the reference level in range 2 to -30 dBm

Characteristics: *RST value:-20 dBm
SCPI: device-specific

[SENSe<1|2>:]ESpectrum:RANGe<1...20>:SWEep:TIME <numeric_value>

This command defines the sweep duration of a range in the Spectrum Emission Mask measurement. The numeric suffixes <1...20> specify the range.

Example: "SENS:ESP:RANG2:SWE:TIME 1MS" sets the sweep time in range 2 to 1 ms

Characteristics: *RST value:depends on range
SCPI: device-specific

[SENSe<1|2>:]ESpectrum:RANGe<1...20>:SWEep:TIME:AUTO ON | OFF

This command controls the automatic coupling of the sweep duration on the frequency span and the bandwidth settings in a Spectrum Emission Mask measurement range. The numeric suffixes <1...20> specify the range. The numeric suffix at SENSe<1|2> is irrelevant.

Example: "SENS:ESP:RANG2:SWE:TIME:AUTO ON"
'activates the coupling of frequency range and bandwidths in range 2

Characteristics: *RST value: ON
SCPI: device-specific

[SENSe<1|2>:]ESpectrum:RANGe<1...20>:TRANsducer <string>

This command sets the transducer factor for a range in the Spectrum Emission Mask measurement. The numeric suffixes <1...20> specify the range. The numeric suffix at SENSe<1|2> is irrelevant.

Example: "SENS:ESP:RANG2:TRAN 'fac_1'"
'sets the transducer factor fac_1 in range 2

Characteristics: *RST value:-
SCPI: device-specific

[SENSe<1|2>:]ESpectrum:RRANGe?

This command returns the number of the reference range of the Spectrum Emission Mask measurement. The numeric suffixes <1...20> specify the range. The numeric suffix at SENSe<1|2> is irrelevant.

Example: "SENS:ESP:RRAN?"

Characteristics: *RST value:-
SCPI: device-specific

[SENSe<1|2>:]ESpectrum:RTYPE PEAK | CPOWER

This command sets selects the type of power measurement in the reference range: The numeric suffixes <1...20> specify the range. The numeric suffix at SENSe<1|2> is irrelevant.

PEAK: Measures the highest peak within the reference range.
CPOWER Measures the channel power within the reference range (integral bandwidth method).

Example: "SENS:ESP:RTYP PEAK" selects highest peak

Characteristics: *RST value: CPOW
SCPI: device-specific

[SENSe<1|2>:]ESpectrum:STANdard:DELeTe <filename>

This command deletes a file that contains a spectrum emission mask measurement configuration.

The default path to the file is "D:\R_S\INSTR\SPURS_STD". The file name has to be specified without the *.xml file extension.

The numeric suffix at SENSe<1|2> is irrelevant.

This command is an event and therefore has no RST value and no query.

Example: "SENS:ESP:STAN:DEL 'custom_standard'"
 'deletes the file called custom_standard.xml'

Characteristics: *RST value: -
 SCPI: device-specific

[SENSe<1|2>:]ESpectrum:STANdard:SAVE <filename>

This command stores the current spectrum emission mask configuration to a file in the R&S FSMR memory.

The file format is *.xml. The default path is "D:\R_S\INSTR\SPURS_STD".

The numeric suffix at SENSe<1|2> is irrelevant.

This command is an event and therefore has no RST value and no query.

Example: "SENS:ESP:STAN:SAVE 'custom_standard'"
 'saves the configuration to a file called custom_standard.xml'

Characteristics: *RST value: -
 SCPI: device-specific

SENSe:FILTer - Subsystem

COMMAND	PARAMETERS	UNIT	COMMENT
[SENSe<1 2>] FILTer :CCIR [:UNWeighted] [:STATe]	<Boolean>		
:CCITt [:STATe]	<Boolean>		
DEEMPhasis [:STATe] TCOMstant	<Boolean> <numeric_value>	-- µs	
HPASs [:STATe] FREQuency	<Boolean> <numeric_value>	-- Hz	
LPASs [:STATe] FREQuency	<Boolean> <numeric_value>	-- Hz	

[SENSe:]FILTer:CCIR[:STATe] ON | OFF

This command activates den Bewertungsfilter CCIR.
The weighting filter is active in the following demodulation bandwidth range:
50 kHz ≤ demodulation bandwidth ≤ 1.6 MHz

The CCIR unweighted filter is the combination of the 20 Hz highpass and 23 kHz lowpass filter.

Example: "SENS:FILT:CCIR:STAT ON"

Characteristics: *RST value: NONE
SCPI: device specific

[SENSe:]FILTer:CCITt[:STATe] ON | OFF

This command activates den Bewertungsfilter CCITT (CCITT P.53).
The weighting filter is active in the following demodulation bandwidth range:
25 kHz ≤ demodulation bandwidth ≤ 3 MHz

Example: "SENS:FILT:CCIT:STAT ON"

Characteristics: *RST value: NONE
SCPI: device specific

[SENSe:]FILTer:DEMPHasis[:STATe] ON | OFF

This command switches on or off a deemphasis in the audio signal path.



Audio filters can be used in the Demodulation and Audio modes.

Example: "FILT:DEMP ON" 'Switches on the deemphasis.

Characteristics: *RST value: OFF
SCPI: conforming

[SENSe:]FILTer:DEMPHasis:TCONstant 25 µs | 50 µs | 75 µs | 750 µs

This command defines the time constant for the deemphasis.



Audio filters can be used in the Demodulation and Audio modes.

Example: "FILT:DEMP:TCON 25 μ s" Selects the time constant.

Characteristics: *RST value: -- (STATE OFF)
SCPI: conforming

[SENSe:]FILTer:HPASs[:STATe] ON | OFF

This command switches on or off a highpass filter in the audio signal path.



Audio filters can be used in the Demodulation and Audio modes.

Example: "FILT:HPAS ON" Switches on the highpass filter.

Characteristics: *RST value: OFF
SCPI: conforming

[SENSe:]FILTer:HPASs:FREQuency 20 | 50 Hz | 300 Hz

This command defines the cutoff frequency of the highpass filter in the AF path.



Audio filters can be used in the Demodulation and Audio modes.

Example: "FILT:HPAS:FREQ 300 Hz" Selects the highpass filter.

Characteristics: *RST value: -- (STATE OFF)
SCPI: conforming

[SENSe:]FILTer:LPASs[:STATe] ON | OFF

This command switches on or off a lowpass filter in the audio signal path.



Audio filters can be used in the Demodulation and Audio modes.

Example: "FILT:LPAS ON" Switches on the lowpass filter.

Characteristics: *RST value: OFF
SCPI: conforming

[SENSe:]FILTer:LPASs:FREQuency 3 kHz | 15 kHz | 23 kHz | 80 kHz | 100 kHz

This command defines the cutoff frequency of the lowpass filter in the AF path.



Audio filters can be used in the Demodulation and Audio modes.

Example: "FILT:LPAS:FREQ 100 kHz" Selects the lowpass filter.

Characteristics: *RST value: -- (STATE OFF)
SCPI: conforming

SENSe:FREQUENCY Subsystem

The SENSe:FREQUENCY subsystem defines the frequency axis of the active display. The frequency axis can either be defined via the start/stop frequency or via the center frequency and span. The measurement windows are selected by SENSe1 (screen A) and SENSe2 (screen B).

COMMAND	PARAMETERS	UNIT	COMMENT
[SENSe<1 2>] :FREQUENCY			
:CENTer	<numeric_value>	HZ	
:STEP	<numeric_value>	HZ	
:LINK	SPAN RBW OFF		
:FACTor	<numeric_value>	PCT	
:CW:	<numeric_value>	HZ	
:AFC	<Boolean> ONCE		
:STRack	ONCE		
:THReshold	<numeric_value>		
:MODE	CW FIXed SWEep		
:OFFSet	<numeric_value>	HZ	
:SPAN	<numeric_value>	HZ	
:FULL			
:START	<numeric_value>	HZ	
:STOP	<numeric_value>	HZ	

[SENSe<1|2>]:FREQUENCY:CENTer 0 to f_{max}

This command defines the center frequency of the analyzer or the measuring frequency for span = 0.

Example: "FREQ:CENT 100MHz"

Characteristics: *RST value: $f_{max}/2$ with f_{max} = maximum frequency
SCPI: conforming

[SENSe<1|2>]:FREQUENCY:CENTer:STEP 0 to f_{max}

This command defines the step width of the center frequency.

Example: "FREQ:CENT:STEP 120MHz"

Characteristics: *RST value: - (AUTO 0.1 × SPAN is switched on)
SCPI: conforming

[SENSe<1|2>]:FREQUENCY:CENTer:STEP:LINK SPAN | RBW | OFF

This command couples the step width of the center frequency to span (span > 0) or to the resolution bandwidth (span = 0) or cancels the couplings.

Parameters:

SPAN = Coupling to frequency display range (for span > 0)
RBW = Coupling to resolution bandwidth (for span = 0)
OFF = manual input, no coupling.



This command is not available for GSM/EDGE measurements modulation accuracy (MAC), phase/frequency error (PFE) and power versus time (PVT).

Example: "FREQ:CENT:STEP:LINK SPAN"

Characteristics: *RST value: SPAN
SCPI: device-specific

[SENSe<1|2>]:FREQuency:CENTer:STEP:LINK:FACTor 1 to 100 PCT

This command couples the step width of the center frequency with a factor to the span (span >0) or to the resolution bandwidth (span = 0).



This command is not available for GSM/EDGE measurements modulation accuracy (MAC), phase/frequency error (PFE) and power versus time (PVT).

Example: "FREQ:CENT:STEP:LINK:FACT 20PCT"

Characteristics: *RST value: - (AUTO 0.1 × SPAN is switched on)
SCPI: device-specific

[SENSe<1|2>]:FREQuency:CW:AFC <Boolean> | ONCE | THR

This command executes an automatic signal search and activates a function to track a drifting signal. If the measured signal frequency is too far away from the tuned center frequency and the level is above the threshold, the center frequency of the receiver will be changed to the new signal frequency.

Example: "FREQ:CW:AFC ONCE"

Characteristics: *RST value: -
SCPI: conforming

This command is an event and therefore has no *RST value and no query.

[SENSe<1|2>]:FREQuency:CW:AFC:THReshold <numeric_value>

This command defines a level threshold for automatic signal search.

Example: "FREQ:CW:AFC:THR -40 DBM"

Characteristics: *RST value: -40
SCPI: device-specific

[SENSe<1|2>]:FREQuency:CW:AFC:STRack ONCE

This command sets the tunes frequency to the currently measured frequency.

Example: "FREQ:CW:AFC:STR ONCE"

Characteristics: *RST value: -
SCPI: device-specific

This command is an event and therefore has no *RST value and no query.

[SENSe<1|2>]:FREQuency:MODE CW | FIXEd | SWEep

This command switches between frequency domain (SWEep) and time domain (CW | FIXEd) in the analyzer mode.

For CW and FIXEd, the frequency setting is via command FREQuency:CENTer. In the SWEep mode, the setting is via commands FREQuency:START, STOP, CENTer and SPAN.



This command is not available for GSM/EDGE measurements modulation accuracy (MAC), phase/frequency error (PFE), power versus time (PVT), carrier power (CPW) and spurious (SPU).

Example: "FREQ:MODE SWE"

Characteristics: *RST value: SWEep
SCPI: conforming

[SENSe<1|2>:]FREQUENCY:OFFSet <numeric_value>

This command defines the frequency offset of the instrument.

Example: "FREQ:OFFS 1GHZ"

Characteristics: *RST value: 0 Hz
SCPI: conforming

[SENSe<1|2>:]FREQuency:SPAN 0 to f_{\max}

This command defines the frequency span in the analyzer mode.



This command is not available for GSM/EDGE measurements modulation accuracy (MAC), phase/frequency error (PFE) and power versus time (PVT).

Example: "FREQ:SPAN 10MHz"

Characteristics: *RST value: f_{\max} with f_{\max} = maximum frequency
SCPI: conforming

[SENSe<1|2>:]FREQuency:SPAN:FULL

This command sets the frequency span in the analyzer mode to its maximum.



This command is not available for GSM/EDGE measurements modulation accuracy (MAC), phase/frequency error (PFE), power versus time (PVT) and carrier power (CPW).

Example: "FREQ:SPAN:FULL"

Characteristics: *RST value: -
SCPI: conforming

[SENSe<1|2>:]FREQuency:STARt 0 to f_{\max}

This command defines the start frequency of the analyzer. This command is only available in the frequency domain (span >0).



This command is not available for GSM/EDGE measurements modulation accuracy (MAC), phase/frequency error (PFE), power versus time (PVT) and carrier power (CPW).

Example: "FREQ:STAR 20MHz"

Characteristics: *RST value: 0
SCPI: conforming

[SENSe<1|2>:]FREQuency:STOP 0 to f_{\max}

This command defines the stop frequency of the analyzer. This command is only available in the frequency domain (span >0).



This command is not available for GSM/EDGE measurements modulation accuracy (MAC), phase/frequency error (PFE), power versus time (PVT) and carrier power (CPW).

Example: "FREQ:STOP 2000MHz"

Characteristics: *RST value: f_{\max}
SCPI: conforming

SENSe:LIST Subsystem

The commands of this subsystem are used for measuring the power at a list of frequency points with different device settings. The measurement is always performed in the time domain (span = 0 Hz).

A new trigger event is required for each test point (exception: Trigger FREE RUN).

The results are output as a list in the order of the entered frequency points. The number of results per test point depends on the number of concurrently active measurements (peak/RMS/average).

Selection of concurrently active measurements and setting of parameters that are constant for the whole measurement is via a configuration command (SENSe:LIST:POWer:SET). This also includes the setting for trigger and gate parameters.

The following setting parameters can be selected independently for each frequency point:

- Analyzer frequency
- Reference level
- RF attenuation of attenuator (only with option B25)
- Resolution filter
- Resolution bandwidth
- Video bandwidth
- Measurement time
- Detector

The number of frequencies is limited to 100 entries.

The commands of this subsystem can be used in two different ways:

1. Instrument setup, measurement and querying of the results in a single command:
With this method, there is the least delay between the measurement and the result output. However, it requires the control computer to wait for the response from the instrument.
2. Instrument setup and querying of the result list at the end of the measurement:
With this method, the control computer may be used for other activities while the measurement is being performed. However, more time is needed for synchronization via service request.



Settings that are not directly included in commands of this subsystem can be configured by sending the corresponding commands prior to the SENSe:LIST-commands.

Please note that changes to the trigger level have to be executed in time domain (span = 0 Hz) in order to take effect for the SENSe:LIST-commands.

The commands of this subsystem are not available for GSM/EDGE measurements modulation accuracy (MAC), phase/frequency error (PFE) and power versus time (PVT).

COMMAND	PARAMETER	UNIT	COMMENT
[SENSe<1 2>] :LIST :POWer :RESult? [:SEQuence]	<numeric_value>, <numeric_value>, <numeric_value>, <numeric_value> OFF, NORMal CFILter RRC, <numeric_value>, <numeric_value>, <numeric_value>, <numeric_value>	HZ, DBM, DB, DB, --, HZ, HZ, S, PCT DBM	query only
:SET	<Boolean>, <Boolean>, <Boolean>, IMMediate EXTernal VIDeo IFPower, POSitive NEGative, <numeric_value>, <numeric_value>	--, --, --, --, --, S, S	
:AVERage :TYPE	LINear LOGarithmic		
:STATe	OFF		
:RANGe<1...20> :BANDwidth [:RESolution]	<numeric_value> <numeric_value>	HZ HZ	
:VIDeo	<Boolean>	HZ	
:BREak :COUNT? :DELete :DETector	APEak NEGative POSitive SAMPlE RMS AVERage		
:FILTer :TYPE	NORMal CHANnel RRC P5 NOISe PULSe		
[:FREQuency] :START :STOP	<numeric_value> <numeric_value>	HZ HZ	
:INPut :ATTenuation :AUTO :GAIN [:STATe]	<numeric_value> <Boolean> <Boolean> <numeric_value>	DB	
:LIMit :STATe	<numeric_value> <Boolean>		
:POINTs :RLEVel	<numeric_value>	DBM	
:SWEep :TIME :AUTO	<numeric_value> <Boolean> <string>	S	
:TRANsducer	<numeric_value>		

[SENSe<1|2>:]LIST:POWer:RESult?

This command queries the result of a previous list measurement as configured and initiated with `SENSe:LIST:POWer[:SEQuence]`. The measured results are output in a list of floating point values separated by commas. The unit of the results depends on the setting made with the `CALC:UNIT` command.

This command may be used to obtain measurement results in an asynchronous way, using the service request mechanism for synchronization with the end of the measurement.

If no measurement results are available, the command will return a query error.



This command is not available for GSM/EDGE measurements modulation accuracy (MAC), phase/frequency error (PFE) and power versus time (PVT).

Example: 'Configuration of the status reporting system for the generation of an SRQ on operation complete

```
*ESE 1
*SRE 32      'Configuring and starting the measurement
"SENSe:LIST:POWer      935.2MHz,-20dBm,10dB,OFF,NORM,1MHz,3MHz,434us,0,
                    935.4MHz,-20dBm,10dB,10dB,NORM,30kHz,100kHz,434us,0,
                    935.6MHz,-20dBm,10dB,20dB,NORM,30kHz,100kHz,434us,0;
                    *OPC"
'Further actions of the control computer during measurement
to          'Response to service request
On SRQ:
SENSe:LIST:POWer:RESult?
```

Characteristics: *RST value: --
SCPI: device-specific

[SENSe<1|2>:]LIST:POWer[:SEQuence] <analyzer freq>,<ref level>,<rf att>,<el att>,<filter type>,<rbw>,<vbw>,<meas time>,<trigger level>,...

This command configures the list of settings (max. 100 entries) for the multiple power measurement and starts a measurement sequence. When synchronizing the command with *OPC, a service request is generated as soon as all frequency points are processed and the defined number of individual measurements is reached.

To reduce the setting time, all indicated parameters are set up simultaneously at each test point.

The query form of the command processes the list and immediately returns the list of results. The number of results per test point depends on the setting of the `"SENSe:LIST:POWer:SET"` command.

Parameter:

The following parameters are the settings for an individual frequency point. They are repeated for every other frequency point.

<analyzer freq>: Receive frequency for the signal to be measured
(= center frequency in manual operation)
Range of values: 0 Hz to max. frequency, depending
on the instrument model.

<ref level>:	Reference level Range of values: +30 dBm to -70 dBm in 10 dB steps +30 dBm to -75 dBm in 5 dB steps with El. Attenuator option B25 Range of values: 0 dB to 70 dB in 10 dB steps 0 dB to 75 dB in 5 dB steps with El. Attenuator Option B25
<el att>:	RF input attenuation of electronic attenuator Range of values: 0 dB to 30 dB in 10 dB steps OFF electronic attenuator not in signal path If option B25 is missing, OFF is to be used.
<filter type>:	NORMAL: normal resolution filter CFILter: channel filter. These are especially steep-edged filters, which are used for example in Fast ACP measurement to ensure the band-limiting of a transmission channel in the time domain. RRC: Root Raised Cosine filter. This special filter form is used to determine the channel power for some mobile radio standards.
<rbw>:	Resolution bandwidth Range of values: 10 Hz to 10 MHz in 1, 3, 10 steps and 50 MHz (R&S FSMR43: 10Hz to 10MHz) for <filter type> = NORMAL.
<vbw>:	Video bandwidth Range of values: 1 Hz to 10 MHz in 1, 2, 3, 5, 10 steps. (30 MHz for RBW > 10 MHz, not R&S FSMR) The value is ignored for <filter type> = CFILter or RRC
<meas time>:	Measurement time Range of values: 1us to 30s
<trigger level>:	Reserved. Must be set to 0.

Returned values:

The query command returns a list of comma-separated values (CSV) which contains the power measurement results in floating-point format. The unit depends on the setting with `CALC:UNIT`.

Command

```
"SENSe:LIST:POWer? 935.2MHz,-20dBm,10dB,OFF,NORM,1MHz,3MHz,434us,0,
935.4MHz,-20dBm,10dB,10dB,NORM,30kHz,100kHz,434us,0,
935.6MHz,-20dBm,10dB,20dB,NORM,30kHz,100kHz,434us,0"
```

thus returns the following list, for example:

```
-28.3,-30.6,-38.1
```

If the command sequence is extended to

```
"SENSe:LIST:POWer:SET ON,ON,ON,IMM,POS,0,0"
```

```
"SENSe:LIST:POWer? 935.2MHz,-20dBm,10dB,OFF,NORM,1MHz,3MHz,434us,0,
935.4MHz,-20dBm,10dB,10dB,NORM,30kHz,100kHz,434us,0,
935.6MHz,-20dBm,10dB,20dB,NORM,30kHz,100kHz,434us,0"
```

the result list is extended to 3 results per frequency point (peak, RMS and average):

```
-28.3, -29.6, 1.5, -30.6, -31.9, 0.9, -38.1, -40.0, 2.3
```

Examples:

```
"SENSe:LIST:POWer 935.2MHz,-20dBm,10dB,OFF,NORM,1MHz,3MHz,434us,0,
935.4MHz,-20dBm,10dB,10dB,CFIL,30kHz,100kHz,434us,0,
935.6MHz,-20dBm,10dB,20dB,CFIL,30kHz,100kHz,434us,0"
```

performs a measurement sequence with the following settings:

Step	Freq. [MHz]	Ref Level	RF Att	el Att	Filter type	RBW	VBW	Meas Time	TRG Level (reserved)
1	935.2	-20 dBm	10 dB	OFF	Normal	1 MHz	3 MHz	434 us	0
2	935.4	-20 dBm	10 dB	10dB	Channel	30 kHz	100 kHz	434 us	0
3	935.6	-20 dBm	10 dB	20dB	Channel	30 kHz	100 kHz	434 us	0

```
"SENSe:LIST:POWer? 935.2MHz,-20dBm,10dB,OFF,NORM,1MHz,3MHz,434us,0,
935.4MHz,-20dBm,10dB,10dB,CFIL,30kHz,100kHz,434us,0,
935.6MHz,-20dBm,10dB,20dB,CFIL,30kHz,100kHz,434us,0"
```

performs the same measurement and returns the result list immediately after the last frequency point.



The measurement is performed in the time domain and therefore the span is set to 0 Hz. If the time domain is abandoned, the function is automatically switched off.

The measurement is not compatible with other measurements, especially as far as marker, adjacent channel power measurement or statistics are concerned. The corresponding commands thus automatically deactivate the function.

The function is only available in REMOTE operation. It is deactivated when switching the instrument back to LOCAL.

This command is not available for GSM/EDGE measurements modulation accuracy (MAC), phase/frequency error (PFE) and power versus time (PVT).

Characteristics: *RST value: --
SCPI: device-specific

```
[SENSe<1|2>:]LIST:POWer:SET <PEAK meas>,<RMS meas>,<AVG meas>,
<trigger mode>,<trigger slope>,<trigger offset>,<gate length>
```

This command defines the constant settings for the list during multiple power measurement.

Parameters <PEAK meas>, <RMS meas> and <AVG meas> define, which measurements are to be performed at the same time at the frequency point. Correspondingly, one, two or three results per frequency point are returned for the `SENSe:LIST:POWer?` command. If all three parameters are set to OFF, the command generates an execution error.

Parameter:

<PEAK meas>: ON activates the measurement of the peak power (peak detector).
OFF deactivates the measurement of the peak power.

<RMS meas>: ON activates the measurement of the RMS power (RMS detector).
OFF deactivates the measurement of the RMS power.

<AVG meas>: ON activates the measurement of the average power (average detector).
OFF deactivates the measurement of the average power.

<trigger mode>: Selection of the trigger source used for the list measurement.
Possible values:
IMMediate | VIdEO | EXTeRnal | IFFoWer

<trigger slope>: Used trigger slope.

	Possible values: POSitive NEGative
<trigger offset>:	Offset between the detection of the trigger signal and the start of the measurement at the next frequency point. Range of values: 0 s, 125 ns to 100s
<gate length>:	Gate length with Gated Sweep. Range of values: 0 s, 125 ns to 100s



The value 0 s deactivates the use of GATED TRIGGER; other values activate the GATED TRIGGER function.

Values <> 0 s are only possible if <trigger mode> is different from IMMEDIATE. Otherwise, an execution error is triggered.

Returned values:

The query command returns a list of comma-separated values (CSV) of the settings, i.e.

```
ON, ON, ON, IMM, POS, 0, 0
```

if the configuration has been set with the command

```
"SENSe:LIST:POWer:SET ON, ON, ON, IMM, POS, 0, 0"
```



This command is not available for GSM/EDGE measurements modulation accuracy (MAC), phase/frequency error (PFE) and power versus time (PVT).

Examples:

```
"SENSe:LIST:POWer:SET ON, OFF, OFF, EXT, POS, 10US, 434US"
```

```
"SENSe:LIST:POWer:SET ON, ON, ON, VID, NEG, 10US, 0"
```

Characteristics:

*RST values: ON, OFF, OFF, IMM, POS, 0S, 0S

SCPI: device-specific

[SENSe<1|2>:]LIST:POWer:SET:AVERAge:TYPE LINear | LOGarithmic

With this command the average type of the sense list measurement can be set either to linear (default) or logarithmic. In linear mode voltages are averaged in logarithmic mode levels.

Example: "LIST:POW:SET:AVER LOG"

Characteristics:

*RST value: LIN

SCPI: device-specific

[SENSe<1|2>:]LIST:POWer:STATe OFF

This command deactivates the list measurement.



This command is not available for GSM/EDGE measurements modulation accuracy (MAC), phase/frequency error (PFE) and power versus time (PVT).

Example:

```
"SENSe:LIST:POWer:STATe OFF"
```

Characteristics:

*RST value: --

SCPI: device-specific

[SENSe<1|2>:]LIST:RANGe<1...20>:BANDwidth[:RESolution] <numeric_value>

This command selects the resolution bandwidth (RBW) of a range in the spurious measurement.

Example: "LIST:RANG2:BAND 10E3" 'sets the RBW to 10 KHz

Characteristics: *RST value: 10 kHz
SCPI: device-specific

[SENSe<1|2>:]LIST:RANGe<1...20>:BANDwidth:VIDeo <numeric_value>

This command selects the video bandwidth (VBW) of a range in the spurious measurement.

Example: "LIST:RANG2:BAND:VIDeo 40E3" 'sets the VBW to 40 KHz

Characteristics: *RST value: 30 kHz
SCPI: device-specific

[SENSe<1|2>:]LIST:RANGe<1...20>:BREak ON | OFF

This command determines whether a sweep is stopped in the spurious measurement when a range is changed.

Example: "LIST:RANG2:BRE ON" 'sweep stops if the range is changed from range 2 to 3

Characteristics: *RST value: OFF
SCPI: device-specific

[SENSe<1|2>:]LIST:RANGe<1.20>:COUNT?

This command indicates the number of defined ranges of the spurious measurement. The numeric suffix <1 to 20> with RANGE is not relevant for this command.

Example: "LIST:RANG:COUNT?" 'Indicates the number of ranges

Characteristics: *RST value: --
SCPI: device-specific

[SENSe<1|2>:]LIST:RANGe<1.20>:DELeTe

This command deletes a range.

Example: "LIST:RANG2:DEL" 'deletes range 2

Characteristics: *RST value: --
SCPI: device-specific

[SENSe<1|2>:]LIST:RANGe<1.20>:DETEctor APEak | NEGative | POSitive | SAMPlE | RMS | AVERAge

This command sets the detector in the spurious measurement.

Example: "LIST:RANG2:DET APE" 'autopeak detector

Characteristics: *RST value: POS
SCPI: device-specific

[SENSe<1|2>:]LIST:RANGe<1.20>:FILTer:TYPE NORMAl | CHANnel | RRC | P5 | NOISe | PULSe

This command sets the filter in the spurious measurement.

Example: "LIST:RANG2:FILT:TYPE RRC" RRC filter

Characteristics: *RST value: NORMal
SCPI: device-specific

[SENSe<1|2>:]LIST:RANGe<1..20>[:FREQUency]:START <numeric_value>

This command sets the start frequency of a range in the spurious measurement.

Example: "LIST:RANG2:STAR 1GHZ" 'start frequency of range 2 to 1 GHz

Characteristics: *RST value: --
SCPI: device-specific

[SENSe<1|2>:]LIST:RANGe<1..20>[:FREQUency]:STOP <numeric_value>

This command sets the stop frequency of a range in the spurious measurement.

Example: "LIST:RANG2:STOP 2GHZ" 'stop frequency of range 2 to 2 GHz

Characteristics: *RST value: --
SCPI: device-specific

[SENSe<1|2>:]LIST:RANGe<1..20>:INPut:ATTenuation <numeric_value>

This command defines the RF attenuation of a range in the spurious measurement.

Example: "LIST:RANG2:INP:ATT 30dB" 'RF attenuation of range 2 to 30 dB

Characteristics: *RST value: --
SCPI: device-specific

[SENSe<1|2>:]LIST:RANGe<1..20>:INPut:ATTenuation:AUTO ON | OFF

This command switches the autoranging of a range in the spurious measurement on or off.

Example: "LIST:RANG2:INP:ATT:AUTO ON" 'activates autorange for range 2

Characteristics: *RST value: ON
SCPI: device-specific

[SENSe<1|2>:]LIST:RANGe<1..20>:INPut:GAIN[:STATE] ON | OFF

This command switches the preamplifier of a range in the spurious measurement on or off.

Example: "LIST:RANG2:INP:GAIN:STAT ON" 'activates the preamplifier for range 2

Characteristics: *RST value: OFF
SCPI: device-specific

[SENSe<1|2>:]LIST:RANGe<1...20>:LIMit <numeric_value>

Using this command, you can specify a limit line for each of the 20 ranges in the spurious measurement.

The SENSe suffix is unused.

Example: "LIST:RANG5:LIM -40"Limit line in range 5 of .40 dB

Characteristics: *RST value: 13dB
SCPI: device-specific

[SENSe<1|2>:]LIST:RANGe<1...20>:LIMit:STATe ON | OFF

This command switches all limit lines of the spurious measurement on or off.
The SENSe and RANGe suffix is unused.

Example: "LIST:RANG5:LIM -40" Limit line in range 5 of .40 dB
 "LIST:RANG7:LIM -20" Limit line in range 7 of .20 dB
 "LIST:RANG:LIM:STAT ON" Switches both limit lines on

Characteristics: *RST value: ON
 SCPI: device-specific

[SENSe<1|2>:]LIST:RANGe<1.20>:POINts <numeric_value>

This command defines the number of sweep points of a range in the spurious measurement.

Example: "LIST:RANG2:POIN 300" sets 300 sweep points in range 2

Characteristics: *RST value: 625
 SCPI: device-specific

[SENSe<1|2>:]LIST:RANGe<1.20>:RLEVel <numeric_value>

This command defines the reference level of a range in the spurious measurement.

Example: "LIST:RANG2:RLEV -30" 'sets the reference level in range 2 to -30 dBm

Characteristics: *RST value: --
 SCPI: device-specific

[SENSe<1|2>:]LIST:RANGe<1.20>:SWEep:TIME <numeric_value>

This command defines the sweep duration of a range in the spurious measurement.

Example: "LIST:RANG2:SWE:TIME 1MS" 'sets the sweep time in range 2 to 1 ms

Characteristics: *RST value: --
 SCPI: device-specific

[SENSe<1|2>:]LIST:RANGe<1.20>:SWEep:TIME:AUTO ON | OFF

This command controls the automatic coupling of the sweep duration on the frequency span and the bandwidth settings in a spurious measurement range.

Example: "LIST:RANG2:SWE:TIME:AUTO ON" 'activates the coupling of frequency range and bandwidths in range 2

Characteristics: *RST value: ON
 SCPI: device-specific

[SENSe<1|2>:]LIST:RANGe<1.20>:TRANsducer <string>

This command sets the transducer factor for a range in the spurious measurement.

Example: "LIST:RANG2:TRAN ON 'fac_1'" 'sets the transducer factor fac_1 in range 2

Characteristics: *RST value: --
 SCPI: device-specific

SENSe:MPOWER Subsystem

The commands of this subsystem are used to determine the mean burst power or peak burst power for a given number of signal bursts, and for outputting the results in a list. Since all the settings required for a measurement are combined in a single command, the measurement speed is considerably higher than when using individual commands.

For measuring the signal bursts, the GATED SWEEP function is used in the time domain. The gate is controlled either by an external trigger signal or by the video signal. An individual trigger event is required for each burst to be measured. If an external trigger signal is used, the threshold is fixed to TTL level, while with a video signal the threshold can be set as desired.

The following graphics shows the relation between trigger time, trigger offset (for delayed gate opening) and measurement time.

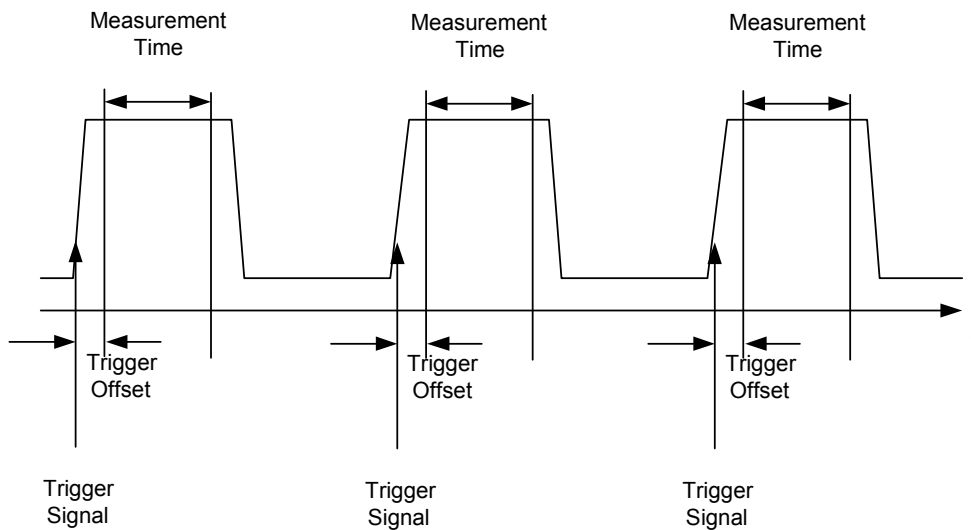

Depending on the settings made, the measurements are performed with the RMS detector for RMS power or the PEAK detector for peak power. For all these measurements, TRACE 1 of the selected system is used.

The setting parameters for this measurement are:

- analyzer frequency
- resolution bandwidth
- measurement time used for a single burst
- trigger source
- trigger level
- trigger offset
- type of power measurement (PEAK, MEAN)
- number of bursts to be measured

The commands of this subsystem can be used in two different ways:

1. Setting up the instrument and at the same time querying the result list: This method ensures the smallest delay between measurement and the output of the measured values, but requires the control computer to wait actively for the response of the instrument.
2. Setting up the instrument and querying the result list after synchronization to the end of measurement: With this method the control computer can be used for other activities while the instrument is performing the measurement at the cost of additional time needed for synchronization via service request.

COMMAND	PARAMETER	UNIT	COMMENT
[SENSe<1 2>] :MPOWer :RESult [:LIST]? :MIN? [:SEQuence]	<numeric_value>, <numeric_value>, <numeric_value>, EXTErnal VIDEo, <numeric_value>, <numeric_value>, MEAN PEAK, <numeric_value>	HZ, HZ, S, --, PCT, S, --, --	Query only Query only

[SENSe:MPOWer:RESult[:LIST]?

This command queries the results of a multiple burst power measurement as configured and initiated with `SENSe:MPOWer[:SEQuence]`. The results are output in a comma-separated list of floating point values. The unit used for the return values is always dBm.

This command may be used to obtain measurement results in an asynchronous way using the service request mechanism for synchronization with the end of the measurement.

If no measurement results are available, the command will return a query error.



This command is not available for GSM/EDGE measurements modulation accuracy (MAC), phase/frequency error (PFE) and power versus time (PVT).

Example:

```
*ESE 1           'Configuration of status reporting systems for the
*SRE 32         'generation of an SRQ on operation complete
SENSe:MPOWer
935.2MHz,1MHz,434us,VIDEO,50PCT,5us,MEAN,20;*OPC
                'Configuring and starting the measurement
...            'Further actions of the control computer during
                'measurement
On SRQ:        'Response to service request
SENSe:MPOWer:RESult?
```

Characteristics:

```
*RST value:    --
SCPI:         instrument-specific
```

SENSe:MPOWer:RESult:MIN?

This command queries the minimum power value in a multiple burst power measurement as configured and initiated with `SENSe:MPOWer[:SEQuence]`. The unit used for the return values is always dBm.

If no measurement result is available, the command will return a query error.



This command is not available for GSM/EDGE measurements modulation accuracy (MAC), phase/frequency error (PFE) and power versus time (PVT).

Example:

```
*ESE 1           'Configuration of status reporting systems for the
*SRE 32         'generation of an SRQ on operation complete
SENSe:MPOWer
935.2MHz,1MHz,434us,VIDEO,50PCT,5us,MEAN,20;*OPC
                'Configuring and starting the measurement
...            'Further actions of the control computer during
                'measurement
On SRQ:        'Response to service request
SENSe:MPOWer:RESult:MIN?
```

Characteristics: *RST value: --
SCPI: instrument-specific

SENSe<1|2>:MPOWer[:SEQUence] <analyzer freq>,<rbw>,<meas time>,<trigger source>,<trigger level>,<trigger offset>,<type of meas>,<# of meas>

This command configures the instrument setup for multiple burst power measurement and starts a measurement sequence. When synchronizing the command with *OPC, a service request is generated as soon as the defined number of individual measurements (# of meas) is reached.

To reduce the setting time, the setup is performed simultaneously for all selected parameters.

The command in the form of a query makes the instrument settings, performs the defined number of measurements and outputs the measurement results list.

Parameters:

<analyzer freq>: Receive frequency for the burst signals to be measured (= center frequency in manual operation)
Range: 0 Hz to max. frequency, depending on instrument model

<rbw>: resolution bandwidth for the measurement
Range: 10 Hz to 10 MHz in steps of 1, 3, 10

<meas time>: Time span during which measurement samples are sampled for RMS / peak measurement The type of measurement is selected by <type of meas>.
Range: 1us to 30s

<trigger source>: trigger signal source. Possible settings:
EXTernal The trigger signal is fed from the "Ext. Trigger/Gate" input on the rear of the unit.
VIDeo The internal video signal is used as trigger signal.

<trigger level>: Signal level at which the trigger becomes active. For <trigger source> = VIDeo this is the level of the video signal as a percentage of the diagram height. If <trigger source> = EXTernal is selected, the value entered here is ignored, as in this case the trigger input uses TTL levels.
Range: 0 – 100PCT (<trigger source> = VIDeo)

<trigger offset>: Offset between the detection of the trigger signal and the start of the measurement.
Range: 125 ns to 100s

<type of meas>: Determines whether mean power (RMS) or peak power (PEAK) is to be measured. The detector is selected accordingly.
Possible values: MEAN, PEAK

<# of meas>: Number of individual bursts to be measured.
Range: 1 to 625

Return values:

The query command returns a list separated by commas (comma separated values = CSV), which contains the power measurement results in floating-point format. The unit used for the return values is always dBm.

The command "SENSe:MPOWer? 935.2MHz,1MHz,434us,VIDEO,50PCT,5us,MEAN,20" may, for instance, cause the following list to be returned:
18.3,18.6,18.1,18.0,17.9,18.3,18.6,18.1,18.0,17.9,18.3,18.6,18.1,18.0,17.9,18.3,18.6,18.1,18.0,17.9



This command is not available for GSM/EDGE measurements modulation accuracy (MAC), phase/frequency error (PFE) and power versus time (PVT).

Examples:

```
"SENSe:MPOWer 935.2MHz,1MHz,434us,VIDEO,50PCT,5us,MEAN,20"
```

performs a measurement sequence with the following settings:

```
Frequency           = 935.2 MHz,
Resolution bandwidth = 1 MHz
Measurement time    = 434 μs
Trigger source      = VIDEO
Trigger threshold   = 50%
Trigger offset      = 5 μs
Type of measurement = MEAN power
No. of measurements = 20
```

```
"SENSe:MPOWer? 935.2MHz,1MHz,434us,VIDEO,50PCT,5us,MEAN,20"
```

performs the same measurement and in addition returns the results list immediately after completion of the last measurement.



The measurement function always uses trace 1 in the selected screen, and activates the selected screen.

Repeated use of the command without changes to its parameters (i.e. using the same settings again) will speed up the measurement since the previous hardware settings will be cached and therefore additional hardware settling times will be avoided. This also holds true if only part of the parameters (e.g. only the trigger delay) are changed, as in this case the rest of the parameters will be cached.

This measurement is not compatible with other measurements, especially as far as marker functions, adjacent-channel measurement or statistics are concerned. The corresponding functions are therefore automatically switched off. In return incompatible commands will automatically deactivate the multi burst power function.

The function is only available in the REMOTE operation. It is deactivated on switching back to LOCAL.

Characteristics: *RST value: --
SCPI: instrument-specific

SENSe:PMETer Subsystem

This subsystem controls the settings of the instrument for measurements with a power sensor. The measurement window is selected via SENSe1 (SCREEN A) and SENSe2 (SCREEN B).

COMMAND	PARAMETERS	UNIT	COMMENT
[SENSe<1 2>] :PMETer :EXTern [:STATe] :FREQuency :LINK :MTIME AVERage COUNT [:STATe] [:STATe]	<Boolean> <numeric_value> CENTer MARKer1 OFF SHORT NORMAL LONG <numeric_value> ON OFF <Boolean>	Hz	

[SENSe<1|2>]:PMETer:EXTern[:STATe] ON | OFF

This command switches on or off the measurements with an external power meter.

Example: "PMET:EXT ON" 'Switches on the measurements with an external power meter.

Characteristics: *RST value: OFF
 SCPI: device-specific

[SENSe<1|2>]:PMETer:FREQuency f_{min} to f_{max}

This command sets the frequency of the power sensor. The limit values f_{min} and f_{max} are set by the power sensor that is connected.

Example: "PMET:FREQ 1GHZ" 'sets the frequency of the power sensor to 1 GHz

Characteristics: *RST value: 50 MHz
 SCPI: device-specific

[SENSe<1|2>]:PMETer:FREQuency:LINK CENTer | MARKer1 | OFF

This command sets the coupling for the frequency of the power sensor.

Parameter: CENTer couples the frequency to the center frequency of the analyzer
 MARKer1 couples the frequency to the position of marker 1
 OFF deactivates the coupling of the frequency

Example: "PMET:FREQ:LINK CENT" ' couples the frequency to the center frequency of the analyzer

Characteristics: *RST value: CENT
 SCPI: device-specific

[SENSe<1|2>:]PMETer:MTIME SHORT | NORMAl | LONG

This command determines the measurement time of the power sensor.

The *SHORT* setting is recommended because it provides the highest measurement repetition rates.

The *NORMAL* setting increases the stability of the displayed results for the measurement of signals with low power or of modulated signals.

The *LONG* setting is recommended for signals at the lower end of the measurement range (<- 20 dBm). This setting can be used to minimize the influence of noise.

Example: "PMET:MTIM SHOR" ' selects the short time for the measurement of stationary signals with high power

Properties: *RST value: NORM
SCPI: device-specific

[SENSe<1|2>:]PMETer:MTIME:AVERAge:COUNT <numeric_value>

This command defines the number of averages for the manual average mode of the power meter.

Example: "PMET:MTIM:AVER:COUN 8"

Characteristics: *RST value: ?
SCPI: device dependent

[SENSe<1|2>:]PMETer:MTIME:AVERAge[:STATe] ON | OFF

This command activates/deactivates the auto average mode of the power meter.

Example: "PMET:MTIM:AVER ON"

Characteristics: *RST value: ON
SCPI: device dependent

[SENSe<1|2>:]<1|2>:]PMETer[:STATe] ON | OFF

This command switches measurements with an external power sensor on or off.

Example: "PMET:EXT ON" ' witches measurements with an external power sensor on

Properties: *RST value: OFF
SCPI: device-specific

[SENSe<1|2>:]POWer:AC:AVERage:AUTO ON|OFF

This command activates/deactivates the auto average mode of the RF Level Mode.

Example: "POW:AC:AVER:AUTO ON"

Characteristics: *RST value: ON
SCPI: conforming

[SENSe:]POWer:AC:AVERage:COUNT <numeric_value>

This command defines, in the *RF LEVEL* mode, the number of measurements that are to be started as "single measurements" and used to form an average. The value "0" causes a sliding average to be generated over ten measurements.

Example: "POW:AC:AVER:COUN 40" Sets 40 measurements to be included in the averaging process.

Characteristics: *RST value: 10
SCPI: device-specific

[SENSe<1|2>:]POWer:AC:AVERage:DATA <level 1>, <count 1>,.....,<level n>, <count n>

This command defines the entries of the auto averaging config table. The entries are defined in pairs of level and average count. Up to 20 entries are allowed in descending order of level values.

Example: "POW:AC:AVER:DATA 30.0,1,-70.0,2,-80.0,4"

[SENSe:]POWer:AC:AVERage[:STATE] ON | OFF

This command switches on or off averaging of the measured level values in the *RF LEVEL* mode.

Example: "POW:AC:AVER ON" Switches on the averaging function.

Characteristics: *RST value: OFF
SCPI: device-specific

[SENSe:]POWer:AC:REFerence <numeric_value>

This command defines the reference value for the relative measured-value display in the *RF LEVEL* mode.

Example: "POW:AC:REF -28 dBm" Sets the reference value to -28 dBm.

Characteristics: *RST value: 0
SCPI: device-specific

[SENSe:]POWer:AC:REFerence:AUTO ONCE

This command uses the current measured value as a reference for the relative measured-level display in the *RF LEVEL* mode.

Example: "POW:AC:REF:AUTO ONCE" Uses the current measured value as a reference for the relative measured-level display.

Characteristics: *RST value: -
SCPI: device-specific

This command is an event and therefore has no *RST value and no query.

[SENSe:]POWer:AC:REFerence[:STATe] ON | OFF

This command switches on absolute or relative measured-value display in the *RF LEVEL* mode.

Example: "POW:AC:STAT ON" 'Switches on the *RF LEVEL* mode.
 "POW:AC:REF ON" 'Switches on relative measured-value display.

Characteristics: *RST value: OFF
 SCPI: device-specific

[SENSe:]POWer:AC[:STATe] ON | OFF

This command switches on or off the *RF LEVEL* mode.

Example: "POW:AC:STATE ON" 'Switches on the *RF LEVEL* mode.
 "POW:AC:REF:STAT ON" 'Switches on relative measured-value display.

Characteristics: *RST value: OFF
 SCPI: device-specific

[SENSe<1|2>:]POWer:ACHannel:ACPairs 0 to 12

This command sets the number of adjacent channels (upper and lower channel in pairs). The figure 0 stands for pure channel power measurement.

The command is only available in the frequency domain (span > 0).

Example: "POW:ACH:ACP 3" 'Sets the number of adjacent channels to 3, i.e. the 'adjacent channel and alternate adjacent channels 1 and '2 are switched on.

Characteristics: *RST value: 1
 SCPI: device-specific

[SENSe<1|2>:]POWer:ACHannel:BANDwidth|BWIDth:ACHannel 100 Hz to 1000 MHz

This command defines the channel bandwidth of the adjacent channel of the radio transmission system. If the bandwidth of the adjacent channel is changed, the bandwidths of all alternate adjacent channels are automatically set to the same value.

With *SENS:POW:HSP ON* the steep-edged channel filters from the table "List of available channel filters" in Section "Setting Bandwidths and Sweep Time – Key *BW*" are available.

Example: "POW:ACH:BWID:ACH 30kHz" 'Sets the bandwidth of all adjacent channels to '30 kHz.

Characteristics: *RST value: 14 kHz
 SCPI: device-specific

[SENSe<1|2>:]POWer:ACHannel:BANDwidth|BWIDth:ALternate<1 to 11> 100 Hz to 1000 MHz

This command defines the channel bandwidth of the alternate adjacent channels of the radio transmission system. If the channel bandwidth of an alternate adjacent channel (e.g. channel no. 1) is changed, the bandwidth of all the following alternate adjacent channels (e.g. channels no. 2 to 11) is automatically set to the same value.

With *SENS:POW:HSP ON* the steep-edged channel filters from the table "List of available channel filters" in Section "Setting Bandwidths and Sweep Time – Key *BW*" are available.

Example: "POW:ACH:BWID:ALT2 30kHz"

Characteristics: *RST value: 14 kHz
 SCPI: device-specific

[SENSe<1|2>:]POWer:ACHannel:BANDwidth|BWIDTH[:CHANnel] 100 Hz to 1000 MHz

This command sets the channel bandwidth of the radio communication system. The bandwidths of adjacent channels are not influenced by this modification (in contrast to the FSE family).

With `SENSe:POW:HSP ON` the steep-edged channel filters from the table "List of available channel filters" in Section "Setting Bandwidths and Sweep Time – Key *BW*" are available.

Example: `"POW:ACH:BWID 30kHz"` 'Sets the bandwidth of the TX channel to 30 kHz.

Characteristics: *RST value: 14 kHz
SCPI: device-specific

[SENSe<1|2>:]POWer:ACHannel:MODE ABSolute | RELative

This command toggles between absolute and relative adjacent channel measurement.

For the relative measurement the reference value is set to the currently measured channel power by command `SENSe:POWer:ACHannel:REFeRence:AUTO ONCE`.

The command is only available in the frequency domain (span > 0).

Example: `"POW:ACH:MODE REL"`

Characteristics: *RST value: ABSolute
SCPI: device-specific

[SENSe<1|2>:]POWer:ACHannel:PRESet ACPower | CPOWer | MCACpower | OBANdwidth | OBWidth | CN | CN0

This command adjusts the frequency span, the measurement bandwidths and the detector as required for the number of channels, the channel bandwidths and the channel spacings selected in the active power measurement. If necessary, adjacent-channel power measurement is switched on prior to the adjustment.

To obtain valid results, a complete sweep with synchronization to the end of the sweep must be performed after the adjustment. Synchronization is possible only in the single-sweep mode.

The result is queried with the command `CALCulate:MARKer:FUNction:POWer:RESult?`.

The command is available only for measurements in the frequency domain (span > 0).

Example: `"POW:ACH:PRESet ACP"` 'Sets the frequency span, the measurement bandwidths and the detector as required for the ACP measurement in screen A.
 `"INIT:CONT OFF"` 'Switches over to single-sweep mode.
 `"INIT;*WAI"` 'Starts a sweep and waits for the end of the sweep.
 `"CALC:MARK:FUNC:POW:RES? ACP"` 'Queries the result of the adjacent-channel power measurement.

Characteristics: *RST value: -
SCPI: device-specific

[SENSe<1|2>:]POWer:ACHannel:PRESet:RLEVel

This command adapts the reference level to the measured channel power and – if required - switches on previously the adjacent channel power measurement. This ensures that the signal path of the instrument is not overloaded. Since the measurement bandwidth is significantly smaller than the signal bandwidth in channel power measurements, the signal path can be overloaded although the trace is still significantly below the reference level. If the measured channel power equals the reference level, the signal path is not overloaded.

The command is only available in the frequency domain (span > 0).



Subsequent commands have to be synchronized with *WAI, *OPC or *OPC? to the end of the autorange process which would otherwise be aborted.

Example: "POW:ACH:PRESet:RLEV;*WAI" 'Adapts the reference level to the measured channel power.'

Characteristics: *RST value: -
SCPI: device-specific

[SENSe<1|2>:]POWer:ACHannel:REFerence:AUTO ONCE

This command sets the reference value for the relative measurement to the currently measured channel power.

The command is only available in the frequency domain (span > 0).

Example: "POW:ACH:REF:AUTO ONCE"

Characteristics: *RST value: -
SCPI: device-specific

This command is an event and therefore has no *RST value and no query.

[SENSe<1|2>:]POWer:ACHannel:REFerence:TXCHannel:AUTO MINimum | MAXimum | LHIGHest | OFF

This command activates the automatic selection of a transmission channel to be used as a reference channel in relative adjacent-channel power measurements.

The transmission channel with the highest power, the transmission channel with the lowest power, or the transmission channel nearest to the adjacent channels can be defined as a reference channel. The command is available only for multicarrier channel and adjacent-channel power measurements (CALC:MARK:FUNC:POW:SEL MCAC) in the frequency domain (span > 0).

Parameters: MINimum Transmission channel with the lowest power
MAXimum Transmission channel with the highest power
LHIGhest Lowermost transmission channel for the lower adjacent channels, uppermost transmission channel for the upper adjacent channels
OFF: Deactivates the automatic transmission channel selection.

Example: "POW:ACH:REF:TXCH:AUTO MAX" 'The transmission channel with the highest power is used as a reference channel.'

Characteristics: *RST value: -
SCPI: device-specific

[SENSe<1|2>]:POWer:ACHannel:REference:TXChannel:MANual 1 to 12

This command selects a transmission channel to be used as a reference channel in relative adjacent-channel power measurements.

The command is available only for multicarrier channel and adjacent-channel power measurements (CALC:MARK:FUNC:POW:SEL MCAC) in the frequency domain (span > 0).

Example: "POW:ACH:REF:TXCH:MAN 3" 'Transmission channel 3 is used as a reference channel.'

Characteristics: *RST value: 1
SCPI: device-specific

[SENSe<1|2>]:POWer:ACHannel:SPACing:ACHannel 100 Hz to 2000 MHz

This command defines the channel spacing of the adjacent channel to the TX channel. At the same time, the spacing of alternate adjacent channels 1 to 11 is set to the double or triple etc. of the entered value. The command is only available in the frequency domain (span > 0).

Example: "POW:ACH:SPAC:ACH 33kHz" 'Sets the spacing between the carrier signal and
'- the adjacent channel to 33 kHz
'- the alternate adjacent channel 1 to 66 kHz
'- the alternate adjacent channel 2 to 99 kHz

Characteristics: *RST value: 14 kHz
SCPI: device-specific

[SENSe<1|2>]:POWer:ACHannel:SPACing:ALTErnate<1 to 11> 100 Hz to 2000 MHz

This command defines the spacing between the alternate adjacent channels and the TX channel. If the spacing to an alternate adjacent channel ALTErnate<k> is modified, the spacing to all the following alternate adjacent channels ALTErnate<n> is set to (<n> + 1) / (<k> + 1) times the entered value. This command is only available in the frequency domain (span > 0).

Example: "POW:ACH:SPAC:ALT1 100kHz" 'Sets the spacing between TX channel and alternate adjacent channel 1 to 100 kHz and
'between TX channel and alternate adjacent channel 2 to 150 kHz.

Characteristics: *RST value: 40 kHz (ALT1)
60 kHz (ALT2)
80 kHz (ALT3)
100 kHz (ALT4)
120 kHz (ALT5)
140 kHz (ALT6)
160 kHz (ALT7)
180 kHz (ALT8)
200 kHz (ALT9)
220 kHz (ALT10)
240 kHz (ALT11)
SCPI: device-specific

[SENSe<1|2>]:POWer:ACHannel:SPACing:CHANnel 100 Hz to 2000 MHz

This command defines the channel spacing for the carrier signals.

The command is available only for measurements in the frequency domain (span > 0).

Example: "POW:ACH:SPAC:CHAN 25kHz" Sets the spacing between all carriers to 25 kHz

Characteristics: *RST value: 20 kHz
SCPI: device-specific

[SENSe<1|2>:]POWer:ACHannel:TXChannel:COUNT 1 to 12

This command selects the number of carrier signals.
The command is available only for multicarrier channel and adjacent-channel power measurements (CALC:MARK:FUNC:POW:SEL MCAC) in the frequency domain (span > 0).

Example: "POW:ACH:TXCH:COUN 3"

Characteristics: *RST value: 4
SCPI: device-specific

[SENSe<1|2>:]POWer:BANDwidth|BWIDth 10 to 99.9PCT

This command defines the percentage of the power with respect to the total power. This value is the basis for the occupied bandwidth measurement (command: POWer:ACHannel:PRESet OBW).
The command is only available in the frequency domain (span > 0).

Example: "POW:BWID 95PCT"

Characteristics: *RST value: 99PCT
SCPI: device-specific

[SENSe<1|2>:]POWer:HSPeed ON | OFF

This command switches on or off the high-speed channel/adjacent channel power measurement. The measurement itself is performed in the time domain on the center frequencies of the individual channels. The command automatically switches to the time domain and back.
Depending on the selected mobile radio standard, weighting filters with $\sqrt{\cos}$ characteristic or very steep-sided channel filters are used for band limitation.
The command is only available in the frequency domain (span > 0).

Example: "POW:HSP ON"

Characteristics: *RST value: OFF
SCPI: device-specific

[SENSe<1|2>:]POWer:NCORrection ON | OFF

This command switches on or off the correction of the instrument inherent noise for channel power measurement. On activating this function, a reference measurement of the instrument inherent noise is performed. The measured noise power is then subtracted from the power in the examined channel.
The instrument inherent noise is then re-determined after any change of the center frequency, resolution bandwidth, sweep time and level setting by repeating the reference measurement in the new instrument setting.

Example: "POW:NCOR ON"

Characteristics: *RST value: OFF
SCPI: device-specific

[SENSe<1|2>:]POWer:TRACe 1 to 3

This command assigns the channel/adjacent channel power measurement to the indicated trace in the selected measurement window. The corresponding trace must be active, i.e. its state must be different from blank.
The measurement of the occupied bandwidth (OBW) is performed on the trace on which marker 1 is positioned. To evaluate another trace, marker 1 must be positioned to another trace with CALCulate:MARKer:TRACe.

Example: "POW:TRAC 2" 'Assigns the measurement in screen A to trace 2.
"SENS2:POW:TRAC 3" 'Assigns the measurement in screen B to trace 3.

Characteristics: *RST value: -
SCPI: device-specific

SENSe:ROSCillator Subsystem

This subsystem controls the reference oscillator. The numeric suffix in SENSe is irrelevant for the commands of this subsystem.

COMMAND	PARAMETERS	UNIT	COMMENT
[SENSe<1 2>] :ROSCillator :EXTernal :FREQuency [:INTernal] :TUNE :SAVe :SOURce	<numeric_value> <numeric_value> INTernal EXTernal EAUTO	 HZ	 no query

[SENSe<1|2>]:ROSCillator:EXTernal:FREQuency 1MHz to 20MHz

This command informs the instrument on the frequency of the external reference oscillator. This frequency is used as starting point for the synchronization of the internal reference frequencies. The value of the external reference frequency (1 MHz to 20 MHz) is rounded in steps of 1 Hz.

Example: "ROSC:EXT:FREQ 5MHz"

Characteristics: *RST value: -
SCPI: conforming

[SENSe<1|2>]:ROSCillator[:INTernal]:TUNE 0 to 4095

This command defines the value for the tuning of the internal reference oscillator.

The reference oscillator should be tuned only if an error has been detected in the frequency accuracy check. After rebooting the instrument, the factory-set reference frequency or the previously saved reference frequency is restored.



This command is only available at service level 1.

Example: "ROSC:TUNE 128"

Characteristics: *RST value: -
SCPI: device-specific

[SENSe<1|2>]:ROSCillator[:INTernal]:TUNE:SAVe

This command saves the new value for the tuning of the internal reference oscillator. The factory-set value in the EEPROM is overwritten.



This command is only available at service level 1.

Example: "ROSC:TUNE:SAV"

Characteristics: *RST value: -
SCPI: device-specific

[SENSe<1|2>:]ROSCillator:SOURce INTernal | EXTernal | EAUTo

This command controls selection of the reference oscillator.

INTernal Uses the internal reference signal.

EXTernal Uses the external reference signal.

EAUTo Uses the external reference signal, but automatically switches to the internal reference signal, if no external reference signal is detected. Note that you have to change the reference source back to EXT and EAUT once the connection to the external reference is reestablished.

You can query the current status with [SENSe<1|2>]ROSCillator SOURceEAUTo?

If the external reference oscillator is selected, the reference signal must be connected to the rear panel of the instrument.

As of firmware version 4.4x, you can you also select EAUTo. This paramater selects an external reference signal, but switches to the internal reference signal if no external reference is detected. If the external reference oscillator is selected (EXT | EAUT), the reference signal must be connected to the rear panel of the instrument.

The reference settings are not changed after a preset. **Example:** "ROSC:SOUR EXT"

Characteristics: *RST value: –
SCPI: conforming

SENSe:SWEep Subsystem

This subsystem controls the sweep parameters. The measurement windows are selected by SENSe1 (screen A) and SENSe2 (screen B).

COMMAND	PARAMETERS	UNIT	COMMENT
[SENSe<1 2>] :SWEep			
:COUNT	<numeric_value>		query only
:CURRENT?			
:EGATe	<Boolean>		
:HOLDoff	<numeric_value>	S	
:LENGth	<numeric_value>	S	
:POLarity	POSitive NEGative		
:SOURce	EXTernal RFPower IFPower		
:TYPE	LEVEl EDGE		
:IF			
:SHIFT			
:FREQuency	<numeric_value>		
[:MODE]	OFF A B AUTO		
:MODE	AUTO ESPectrum ESYNchroize LIST		
:POINTs	<numeric_value>		
:TIME	<numeric_value>	S	
:AUTO	<Boolean>		

[SENSe<1|2>:]SWEep:COUNT 0 to 32767

This command defines the number of sweeps started with single sweep, which are used for calculating the average or maximum value. In average mode, the value 0 defines a continuous averaging of measurement data over 10 sweeps.

Example:

```
"SWE:COUN 64"           'Sets the number of sweeps to 64.
"INIT:CONT OFF"        'Switches to single-sweep mode.
"INIT;*WAI"            'Starts a sweep and waits for its end.
```

Characteristics: *RST value: 0
SCPI: conforming

[SENSe<1|2>:]SWEep:COUNT:CURRENT?

This query command returns the current number of started sweeps. A sweep count value should be set and the device should be in single sweep mode. This command is a query and therefore has no *RST value.

Example:

```
"SWE:COUNT 64"        'sets sweep count to 64
"INIT:CONT OFF"        'switches to single sweep mode
"INIT"                  'starts a sweep (without waiting for the sweep end!)
"SWE:COUN:CURR?"       'queries the number of started sweeps
```

Characteristics: *RST value: 0
SCPI: conforming

[SENSe<1|2>:]SWEep:EGATe ON | OFF

This command switches on/off the sweep control by an external gate signal. If the external gate is selected the trigger source is automatically switched to EXTERNAL as well. In case of measurement with external gate, the measured values are recorded as long as the gate is opened. There are two possibilities:

1. The gate is edge-triggered ("SWEep:EGATe:TYPE EDGE"):

After detection of the set gate signal edge, the gate remains open until the gate delay (SWEep:EGATe:HOLDoff) has expired.
2. The gate is level-triggered ("SWEep:EGATe:TYPE LEVEL"):

After detection of the gate signal, the gate remains open until the gate signal disappears.

A delay between applying the gate signal and the start of recording measured values can be defined with SWEep:EGATe:HOLDoff.

During a sweep the gate can be opened and closed several times. The synchronization mechanisms with *OPC, *OPC? and *WAI remain completely unaffected.

The sweep end is detected when the required number of measurement points (625 in analyzer mode) has been recorded.



This command is not available for GSM/EDGE measurements modulation accuracy (MAC), phase/frequency error (PFE), power versus time (PVT), carrier power (CPW), spectrum due to switching (TRA) and spurious emissions (SPU).

Example:	"SWE:EGAT ON"	'Switches on the external gate mode.
	"SWE:EGAT:TYPE EDGE"	'Switches on the edge-triggered mode.
	"SWE:EGAT:HOLD 100US"	'Sets the gate delay to 100 µs.
	"SWE:EGAT:LEN 500US"	'Sets the gate opening time to 500 µs.
	"INIT;*WAI"	'Starts a sweep and waits for its end.

Characteristics: *RST value: OFF
SCPI: device-specific

[SENSe<1|2>:]SWEep:EGATe:HOLDoff 125 ns to 100 s

This command defines the delay time between the external gate signal and the continuation of the sweep.

Note: This command is not available for GSM/EDGE measurements modulation accuracy (MAC), phase/frequency error (PFE), power versus time (PVT), carrier power (CPW), spectrum due to switching (TRA) and spurious emissions (SPU).

Example: "SWE:EGAT:HOLD 100us"

Characteristics: *RST value: 0s
SCPI: device-specific

[SENSe<1|2>:]SWEep:EGATe:LENGth 0 to 100 s

In case of edge triggering, this command determines the time interval during which the instrument sweeps.



This command is not available for GSM/EDGE measurements modulation accuracy (MAC), phase/frequency error (PFE), power versus time (PVT), carrier power (CPW), spectrum due to switching (TRA) and spurious emissions (SPU).

Example: "SWE:EGAT:LENG 10ms"

Characteristics: *RST value: 0s
SCPI: device-specific

[SENSe<1|2>:]SWEep:EGATe:POLarity POSitive | NEGative

This command determines the polarity of the external gate signal. The setting is valid both for the edge of an edge-triggered signal and the level of a level-triggered signal.



This command is not available for GSM/EDGE measurements modulation accuracy (MAC), phase/frequency error (PFE), power versus time (PVT), carrier power (CPW), spectrum due to switching (TRA) and spurious emissions (SPU).

Example: "SWE:EGAT:POL POS"

Characteristics: *RST value: POSitive
SCPI: device-specific

[SENSe<1|2>:]SWEep:EGATe:SOURce EXTernal | IFPower

This command toggles between external gate signal and IF power signal as a signal source for the gate mode. If an IF power signal is used, the gate is opened as soon as a signal at > -20 dBm is detected within the IF path bandwidth (50 MHz).



Selection RFPower is only available with option FSP-B6 (TV and RF Trigger). This command is not available for GSM/EDGE measurements modulation accuracy (MAC), phase/frequency error (PFE), power versus time (PVT), carrier power (CPW), spectrum due to switching (TRA) and spurious emissions (SPU).

Example: "SWE:EGAT:SOUR IFP" 'Switches the gate source to IF power.

Characteristics: *RST value: IFPower
SCPI: device-specific

[SENSe<1|2>:]SWEep:EGATe:TYPE LEVel | EDGE

This command sets the type of triggering (level or edge) by the external gate signal.

The gate opening time cannot be defined with the parameter EGATe:LENGth in case of level triggering. The gate is closed when the gate signal disappears.



This command is not available for GSM/EDGE measurements modulation accuracy (MAC), phase/frequency error (PFE), power versus time (PVT), carrier power (CPW), spectrum due to switching (TRA) and spurious emissions (SPU).

Example: "SWE:EGAT:TYPE EDGE"

Characteristics: *RST value: EDGE
SCPI: device-specific

[SENSe<1|2>:]SWEep:IF:SHIFt:FREQuency <numeric value>

This command defines the signal frequency to automatically select the suitable 1st IF shifting for mode IF SHIFT AUTO (SENS:SWE:IF:SHIFT:MODE AUTO).



The 1st IF shifting is automatically done for ACP measurements if center frequency (= signal frequency) is in the range of 2270 MHz ... 2350 MHz. The IF SHIFT setting is therefore ignored for ACP measurements.

Example: "SENS:SWE:IF:MODE AUTO" 'activates IF SHIFT AUTO
"SENS:SWE:IF:SHIF:FREQ 2GHz" 'carrier signal at 2 GHz"

Characteristics: *RST value: 1 GHz
SCPI: device-specific

[SENSe<1|2>:]SWEep:IF:SHIFt[:MODE] OFF | A | B | AUTO

Input signals at a frequency of half the 1st IF (in the frequency range of 2270 MHz to 2350 MHz) will reduce the dynamic range of the analyzer. This problem only occurs for low RF attenuation values. It can be overcome by shifting the 1st IF.

- OFF: Normal operation.
 A: For signals from 2270MHz to 2310 MHz.
 B: For signals from 2310 MHz to 2350 MHz.
 AUTO: Automatically selects the suitable 1st IF shifting.
 The signal frequency has to be specified with SWE:IF:SHIFT:FREQ.



The 1st IF shifting is automatically done for ACP measurements if center frequency (= signal frequency) is in the range of 2270 MHz ... 2350 MHz. The IF SHIFT setting is therefore ignored for ACP measurements.

Example: "SENS:SWE:IF:SHIF A" 'activates IF SHIFT A

Characteristics: *RST value: OFF
 SCPI: device-specific

[SENSe<1|2>:]SWEep:MODE AUTO | ESpectrum | | ESYNchroize | LIST

This command controls the sweep continuation.

- AUTO free running sweep
 ESYNchroize external synchronization of sweep steps via the signal of the AUX PORT interface
 ESpectrum activates the Spectrum Emission Mask measurement
 LIST Activates the spurious emissions measurement, the sweep list is defined using the SENS:LIST:RANGE commands.



AUX-Port interface, requires option FSP-B10.

Example: "SWE:MODE ESYNC" 'enables external synchronization sweep mode.

Characteristics: *RST value: AUTO
 SCPI: device-specific

[SENSe<1|2>:]SWEep:POINts 625, 1251, 1999, 2501,5001,10001,20001,30001

This command defines the number of measurement points for one sweep run.

Parameter: SENSe<1|2>:]SWEep:POINts <numeric_value>

Characteristics: *RST value: 625
 SCPI: conforming

[SENSe<1|2>:]SWEep:TIME 2,5ms to 16000s (frequency domain) | 1 μ s to 16000s (time domain)

This command defines the sweep time. The available time values are different in the frequency domain (2.5 ms to 16000s with span > 0) and in the time domain (1 μ s to 16000s with span = 0). If SWEep:TIME is directly programmed, automatic coupling to resolution bandwidth and video bandwidth is switched off.



This command is not available for GSM/EDGE measurements modulation accuracy (MAC), phase/frequency error (PFE), power versus time (PVT) and carrier power (CPW).

Example: "SWE:TIME 10s"

Characteristics: *RST value - (AUTO is set to ON)
SCPI: conforming

[SENSe<1|2>:]SWEep:TIME:AUTO ON | OFF

This command controls the automatic coupling of the sweep time to the frequency span and bandwidth settings.

If SWEep:TIME is directly programmed, automatic coupling is switched off.



This command is not available for GSM/EDGE measurements modulation accuracy (MAC), phase/frequency error (PFE), power versus time (PVT) and carrier power (CPW).

Example: "SWE:TIME:AUTO ON"

'Switches on the coupling to frequency span and bandwidths.

Characteristics: *RST value: ON
SCPI: conforming

SENSe:VOLTage Subsystem

COMMAND	PARAMETERS	UNIT	COMMENT
[SENSe<1 2>] VOLTage :AC :RANGe [:UPPer] :REFerence :AUTO [:STATe]	<numeric_value> <numeric_value> ONCE	V	

[SENSe:]VOLTage:AC:RANGe[:UPPer] <numeric_value>

This command selects 4 V or 400 mV as the input voltage range for the audio input.

Example: "INP AUD" 'Switches on the *AUDIO* mode.
"VOLT:AC:RANG 0.4 V" 'Selects 400 mV as the input voltage range.

Characteristics: *RST value: 4 V
SCPI: device-specific

[SENSe:]VOLTage:AC:REFerence:AUTO ONCE

This command uses the current measured values as reference values for the relative measured-value display for all detectors shown in the audio summary.

Example: "VOLT:AC:REF:AUTO ONCE" 'Uses the current measured values as reference values for the relative measurement for all detectors displayed.

Characteristics: *RST value: -
SCPI: device-specific

This command is an event and therefore has no *RST value and no query.

[SENSe:]VOLTage:AC:REFerence[:STATe] ON | OFF

This command switches on absolute or relative measured-value display in the *AUDIO* mode.

Example: "" INP AUD" 'Switches on the *AUDIO* mode.
"VOLT:AC:REF ON" 'Switches on relative measured-value display.

Characteristics: *RST value: OFF
SCPI: device-specific

SOURce Subsystem

The SOURce subsystem controls the output signals of the instrument if the options tracking generator (B9) or External Generator Control (B10) are installed. The measurement window is selected by SOURce1 (screen A) and SOURce2 (screen B).

The SOURce subsystem controls the output signals of the analyzer if the option External Generator Control (FSP-B10) is installed. The measurement window is selected by SOURce1 (screen A) and SOURce2 (screen B).

Internal Tracking Generator

COMMAND	PARAMETERS	UNIT	COMMENT
SOURce<1 2>			Tracking generator option
:AM			
:STATe	<Boolean>		
:DM			
:STATe	<Boolean>		
:FM			
:DEVIation	<numeric_value>	HZ	
:STATe	<Boolean>		
:FREQuency			
:MODE	FIXed SWEEp	HZ	
:OFFSet	<numeric_value>		
:POWer			
[:LEVel]			
[:IMMediate]		DBM	
[:AMPLitude]	<numeric_value>	DB	
:OFFSet	<numeric_value>		
:START	<numeric_value>	DBM	
:STOP	<numeric_value>	DBM	

SOURce<1|2>:AM:STATe ON | OFF

This command switches on or off the external amplitude modulation of the tracking generator in the selected measurement window.

External I/Q modulation is switched off, if active. This command is only valid in conjunction with the tracking generator option B9.

Example: "SOUR:AM:STAT ON " 'Switches on the external amplitude modulation of the tracking generator for screen A.

Characteristics: *RST value: OFF
SCPI: conforming

SOURce<1|2>:DM:STATe ON | OFF

This command switches on or off the external I/Q modulation of the tracking generator in the selected measurement window.

External AM and external FM are switched off, if active. This command is only valid in conjunction with the tracking generator option B9.

Example: "SOUR2:DM:STAT ON "'Switches on the external I/Q modulation of the tracking generator for screen B.

Characteristics: *RST- value: OFF
SCPI: conforming

SOURce<1|2>:POWer[:LEVel][:IMMediate][:AMPLitude] <numeric_value>

This command defines the output level of the tracking generator in the current measurement window. This command is only valid in conjunction with the tracking generator option B9.

Parameter: <numeric value>::= -30 dBm to 5 dBm. (-100 dBm to + 5dBm with option B12)

Example: "SOUR:POW -20dBm" 'Sets the tracking generator level in screen A to -20 dBm.

Characteristics: *RST value: -20 dBm
SCPI: conforming

SOURce<1|2>:POWer[:LEVel][:IMMediate]:OFFSet -200dB to +200dB

This command defines a level offset for the tracking generator level. Thus, for example, attenuators or amplifiers at the output of the tracking generator can be taken into account for the setting.

This command is only valid in conjunction with the tracking generator option FSP-B9.

Example: "SOUR:POW:OFFS -10dB" 'Sets the level offset of the tracking generator in 'screen A to - 20 dBm.

Characteristics: *RST- value: 0dB
SCPI: conforming

SOURce<1|2>:POWer:MODE FIXed | SWEep

This command activates or deactivates the power sweep. If the power sweep is ON the enhancement label TGPWR is shown and the analyzer is set in zero span mode (span = 0Hz). During the sweep time of the zero span the power at the internal tracking generator is changed linear from start power to stop power. The start and stop power values are shown on the right side below the diagram

Example: "SOUR:POW:MODE SWE" 'switches on the level sweep in screen A.

Characteristics: *RST value: FIX
SCPI: conforming

SOURce<1|2>:POWer:STARt -30 dBm to 0 dBm

This command defines the start power of the power sweep. start power can be set between -30 dBm and +5 dBm for the R&S FSQ. With the option FSU-B12 the power can be set between -100 and + 5 dBm.

Example: "SOUR:POW:STAR -20dBm" 'sets the start level to -20 dBm in screen A.

Characteristics: *RST-Wert: - 30 dBm
SCPI: conforming

SOURce<1|2>:POWer:STOP -30 dBm to 0 dBm

This command defines the stop power of the power sweep. The stop power can be set between -30 dBm and +5 dBm for the R&S FSQ. With the option FSU-B12 the power can be set between -100 and + 5 dBm. The stop value can be smaller than the start value.

Example: "SOUR:POW:STOP 0dBm" 'sets the end level to 0 dBm in screen A.

Characteristics: *RST value: 0 dBm
SCPI: conforming

SOURce:EXTernal Subsystem

The SOURce:EXTernal subsystem controls the operation of the unit with option Ext. Generator Control (B10). The commands are only valid for the selected window, with SOURce1 changing the setting in screen A and SOURce2 the setting in screen B.

The selection of the external generator 1 or 2 is via EXTernal<1|2>.



The commands of the SOURce:EXTernal subsystem assume that the addressed generator was correctly configured with the commands of subsystem *SYSTem:COMMunicate:GPIB:RDEvice:GENerator*.

If no external generator is selected, if the IEC bus address is not correct or the generator is not ready for operation, an execution error will be generated.

COMMAND	PARAMETER	UNIT	COMMENT
SOURce<1 2> :EXTernal<1 2> :FREQuency [:FACTor] :DENominator :NUMerator :OFFSet :SWEep [:STATe] :POWer [:LEVel] :ROSCillator [:SOURce] [:STATe]	<numeric_value> <numeric_value> <numeric_value> <Boolean>	HZ DBM	Ext. generator option

SOURce<1|2>:EXTernal<1|2>:FREQuency[:FACTor]:DENominator <numeric_value>

This command defines the denominator of the factor with which the analyzer frequency is multiplied in order to obtain the transmit frequency of the selected generator 1 or 2 in the selected window.

Select the frequency offset of the generator so that the frequency range of the generator is not exceeded with the following formula:

$$F_{Generator} = F_{Analyzer} * \frac{Numerator}{Denominator} + F_{Offset}$$

applied to the start and stop frequency of the analyzer.

Example: "SOUR:EXT:FREQ:NUM 4"

"SOUR:EXT:FREQ:DEN 3"

'Sets a multiplication factor of 4/3, i.e. the 'transmit frequency of the generator is '4/3 times the analyzer frequency.

Characteristics: *RST value: 1
SCPI: device-specific

This command is only valid in combination with option Ext. Generator Control B10.

SOURce<1|2>:EXTernal<1|2>:FREQUENCY[:FACTOR]:NUMerator <numeric_value>

This command defines the numerator of the factor with which the analyzer frequency is multiplied to obtain the transmit frequency of the selected generator 1 or 2 in the selected window.

Select the frequency offset of the generator so that the frequency range of the generator is not exceeded with the following formula:

$$F_{Generator} = F_{Analyzer} * \frac{Numerator}{Denominator} + F_{Offset}$$

applied to the start and stop frequency of the analyzer.

Example: "SOUR:EXT:FREQ:NUM 4"

"SOUR:EXT:FREQ:DEN 3"

'Sets a multiplication factor of 4/3, i.e. the 'transmit frequency of the generator is '4/3 times the analyzer frequency.

Characteristics: *RST value: 1
SCPI: device-specific

This command is only valid in combination with option Ext. Generator Control B10.

SOURce<1|2>:EXTernal<1|2>:FREQUENCY:OFFSet <numeric_value>

This command defines the frequency offset of the selected generator 1 or 2 with reference to the receive frequency in the selected window.

Select the frequency offset of the generator so that the frequency range of the generator is not exceeded with the following formula:

$$F_{Generator} = F_{Analyzer} * \frac{Numerator}{Denominator} + F_{Offset}$$

applied to the start and stop frequency of the analyzer.

Example: "SOUR:EXT:FREQ:OFFS 1GHZ"

'Sets a frequency offset of the 'generator transmit frequency 'compared to the analyzer receive 'frequency of 1 GHz.

Characteristics: *RST value: 0 Hz
SCPI: device-specific

This command is only valid in combination with option Ext. Generator Control B10.

SOURce<1|2>:EXTernal<1|2>:FREQUENCY:SWEep[:STATe] ON | OFF

This command activates or deactivates the frequency sweep for generator 1 or 2 in the selected window.

Example: "SOUR:EXT1:FREQ:SWE ON"

'Activates the frequency sweep for ext. generator 1.

Characteristics: *RST value: OFF
SCPI: device-specific

This command is only valid in combination with option Ext. Generator Control B10.

SOURce<1|2>:EXTernal<1|2>:POWer[:LEVel] <numeric_value>

This command sets the output power of the selected generator 1 or 2 in the selected window.

Example: "SOUR:EXT:POW -30dBm" 'Sets the generator level to -30 dBm

Characteristics: *RST value: -20 dBm
 SCPI: device-specific

This command is only valid in combination with option Ext. Generator Control B10.

SOURce<1|2>:EXTernal<1|2>:ROSCillator[:SOURce] INTernal | EXTernal

This command switches between external and internal reference oscillator for the frequency processing of external generator 1 and 2.

The command always works on both generators. Therefore, the numeric suffix in EXTernal<1|2> is not significant.

This command is only valid in combination with option Ext. Generator Control B10.

Example: "SOUR:EXT:ROSC EXT" 'switches to external reference oscillator

Characteristics: *RST value: INT
 SCPI: device-specific

SOURce<1|2>:EXTernal<1|2>[:STATe] ON | OFF

This command activates or deactivates the external generator selected with SOUR:EXT<1|2>:FREQ:SWE ON in the selected window.

The suffix behind EXTernal is irrelevant for this command.

This command is only available in connection with option Ext. Generator Control B10.

Example: "SYST:COMM:RDEV:GEN1:TYPE 'SMP02'" 'Selects SMP02 as generator 1.
 "SYST:COMM:RDEV:GEN1:LINK TTL" 'Selects IECBUS + TTL link as interface.
 "SYST:COMM:RDEV:GEN1:ADDR 28" 'Sets the generator address to 28.
 "SOUR:EXT1:FREQ:SWE ON" 'Activates the frequency sweep for generator 1.
 "SOUR:EXT ON" 'Activates the external generator

Characteristics: *RST value: OFF
 SCPI: device-specific

STATus Subsystem

The STATus subsystem contains the commands for the status reporting system (see Chapter 5, Status Reporting System"). *RST does not influence the status registers.

COMMAND	PARAMETERS	UNIT	COMMENT
STATus			
:OPERation			
:CONDition?	--	--	
:ENABle	0 to 65535	--	
[:EVENT?]	--	--	
:NTRansition	0 to 65535	--	
:PTRansition	0 to 65535	--	
:PRESet	--	--	
:QUEStionable			
:ACPLimit			
:CONDition?	--		
[:EVENT?]	--		
:ENABle	0 to 65535		
:NTRansition	0 to 65535		
:PTRansition	0 to 65535		
:CONDition?			
:ENABle	0 to 65535		
[:EVENT?]			
:FREQuency			
:CONDition?	--		
[:EVENT?]	--		
:ENABle	0 to 65535		
:NTRansition	0 to 65535		
:PTRansition	0 to 65535		
:LMARgin<1 2>			
:CONDition?	--		
[:EVENT?]	--		
:ENABle	0 to 65535		
:NTRansition	0 to 65535		
:PTRansition	0 to 65535		
:LIMit<1 2>			
:CONDition?	--		
[:EVENT?]	--		
:ENABle	0 to 65535		
:NTRansition	0 to 65535		
:PTRansition	0 to 65535		
[:NEXT?]	--	--	
:NTRansition	0 to 65535		
:POWer			
[:EVENT?]	--		
:CONDition?	--		
:ENABle	0 to 65535		
:PTRansition	0 to 65535		
:NTRansition	0 to 65535		
:PTRansition	0 to 65535		

STATus:OPERation:CONDition?

This command queries the CONDition section of the STATus:OPERation register. Readout does not delete the contents of the CONDition section. The value returned reflects the current hardware status.

Example: "STAT:OPER:COND?"

Characteristics: *RST value: –
SCPI: conforming

STATus:OPERation:ENABLE 0 to 65535

This command sets the bits of the ENABLE section of the STATus:OPERation register. The ENABLE register selectively enables the individual events of the associated EVENT section for the summary bit in the status byte.

Example: "STAT:OPER:ENAB 65535"

Characteristics: *RST value: –
SCPI: conforming

STATus:OPERation[:EVENT]?

This command queries the contents of the EVENT section of the STATus:OPERation register. The contents of the EVENT section are deleted after readout.

Example: "STAT:OPER?"

Characteristics: *RST value: –
SCPI: conforming

STATus:OPERation:NTRansition 0 to 65535

This command sets the edge detectors of all bits of the STATus:OPERation register from 1 to 0 for the transitions of the CONDition bit.

Example: "STAT:OPER:NTR 65535"

Characteristics: *RST value: –
SCPI: conforming

STATus:OPERation:PTRansition 0 to 65535

This command sets the edge detectors of all bits of the STATus:OPERation register from 0 to 1 for the transitions of the CONDition bit.

Example: "STAT:OPER:PTR 65535"

Characteristics: *RST value: –
SCPI: conforming

STATus:PRESet

This command resets the edge detectors and ENABLE parts of all registers to a defined value. All PTRansition parts are set to FFFFh, i.e. all transitions from 0 to 1 are detected. All NTRansition parts are set to 0, i.e. a transition from 1 to 0 in a CONDition bit is not detected. The ENABLE part of the STATus:OPERation and STATus:QUESTionable registers are set to 0, i.e. all events in these registers are not passed on.

Example: "STAT:PRES"

Characteristics: *RST value: –
SCPI: conforming

STATus:QUEStionable:ACPLimit[:EVENT]?

This command queries the contents of the EVENT section of the STATus:QUEStionable:ACPLimit register. Readout deletes the contents of the EVENT section.

Example: "STAT:QUES:ACPL?"

Characteristics: *RST value: –
SCPI: device-specific

STATus:QUEStionable:ACPLimit:NTRansition 0 to 65535

This command sets the edge detectors of all bits of the STATus:QUEStionable: ACPLimit register from 1 to 0 for the transitions of the CONDition bit.

Example: "STAT:QUES:ACPL:NTR 65535"

Characteristics: *RST value: –
SCPI: device-specific

STATus:QUEStionable:ACPLimit:PTRansition 0 to 65535

This command sets the edge detectors of all bits of the STATus:QUEStionable: ACPLimit register from 0 to 1 for the transitions of the CONDition bit.

Example: "STAT:QUES:ACPL:PTR 65535"

Characteristics: *RST value: –
SCPI: device-specific

STATus:QUEStionable:CONDition?

This command queries the CONDition section of the STATus:QUEStionable register. Readout does not delete the contents of the CONDition section.

Example: "STAT:QUES:COND?"

Characteristics: *RST value: –
SCPI: conforming

STATus:QUEStionable:ENABLE 0 to 65535

This command sets the bits of the ENABLE section of the STATus-QUEStionable register. The ENABLE register selectively enables the individual events of the associated EVENT section for the summary bit in the status byte.

Example: "STAT:QUES:ENAB 65535"

Characteristics: *RST value: –
SCPI: conforming

STATus:QUEStionable[:EVENT]?

This command queries the contents of the EVENT section of the STATus:QUEStionable register. The contents of the EVENT section are deleted after the readout.

Example: "STAT:QUES?"

Characteristics: *RST value: –
SCPI: conforming

STATus:QUESTionable:FREQuency:CONDition?

This command queries the contents of the CONDition section of the STATus:QUESTionable:FREQuency register. Readout does not delete the contents of the CONDition section.

Example: "STAT:QUES:FREQ:COND?"

Characteristics: *RST value: –
SCPI: device-specific

STATus:QUESTionable:FREQuency:ENABle 0 to 65535

This command sets the bits of the ENABle section of the STATus:QUESTionable:FREQuency register. The ENABle register selectively enables the individual events of the associated EVENT section for the summary bit.

Example: "STAT:QUES:FREQ:ENAB 65535"

Characteristics: *RST value: –
SCPI: device-specific

STATus:QUESTionable:FREQuency[:EVENT]?

This command queries the contents of the EVENT section of the STATus:QUESTionable: FREQuency register.

Example: "STAT:QUES:FREQ?"

Characteristics: *RST value: –
SCPI: device-specific

Readout deletes the contents of the EVENT section.

STATus:QUESTionable:FREQuency:NTRansition 0 to 65535

This command sets the edge detectors of all bits of the STATus:QUESTionable:FREQuency register from 1 to 0 for the transitions of the CONDition bit.

Example: "STAT:QUES:FREQ:NTR 65535"

Characteristics: *RST value: –
SCPI: device-specific

STATus:QUESTionable:FREQuency:PTRansition 0 to 65535

This command sets the edge detectors of all bits of the STATus:QUESTionable:FREQuency register from 0 to 1 for the transitions of the CONDition bit.

Example: "STAT:QUES:FREQ:PTR 65535"

Characteristics: *RST value: –
SCPI: device-specific

STATus:QUESTionable:LMARgin<1|2>:CONDition?

This command queries the contents of the CONDition section of the STATus:QUESTionable:LMARgin register. Readout does not delete the contents of the CONDition section.

Example: "STAT:QUES:LMAR:COND?"

Characteristics: *RST value: –
SCPI: device-specific

STATus:QUESTionable:LMARgin<1|2>:ENABLE 0 to 65535

This command sets the bits of the ENABLE section of the STATus:QUESTionable:LMARgin register. The ENABLE register selectively enables the individual events of the associated EVENT section for the summary bit.

Example: "STAT:QUES:LMAR:ENAB 65535"

Characteristics: *RST value: –
SCPI: device-specific

STATus:QUESTionable:LMARgin<1|2> [:EVENT]?

This command queries the contents of the EVENT section of the STATus:QUESTionable:LMARgin register. Readout deletes the contents of the EVENT section.

Example: "STAT:QUES:LMAR?"

Characteristics: *RST value: –
SCPI: device-specific

STATus:QUESTionable:LMARgin<1|2>:NTRansition 0 to 65535

This command sets the edge detectors of all bits of the STATus:QUESTionable:LMARgin register from 1 to 0 for the transitions of the CONDition bit.

Example: "STAT:QUES:LMAR:NTR 65535"

Characteristics: *RST value: –
SCPI: device-specific

STATus:QUESTionable:LMARgin<1|2>:PTRansition 0 to 65535

This command sets the edge detectors of all bits of the STATus:QUESTionable:LMARgin register from 0 to 1 for the transitions of the CONDition bit.

Example: "STAT:QUES:LMAR:PTR 65535"

Characteristics: *RST value: –
SCPI: device-specific

STATus:QUESTionable:LIMit<1|2>:CONDition?

This command queries the contents of the CONDition section of the STATus:QUESTionable:LIMit register.

Readout does not delete the contents of the CONDition section.

Example: "STAT:QUES:LIM:COND?"

Characteristics: *RST value: –
SCPI: device-specific

STATus:QUESTionable:LIMit<1|2>:ENABLE 0 to 65535

This command sets the bits of the ENABLE section of the STATus:QUESTionable register. The ENABLE register selectively enables the individual events of the associated EVENT section for the summary bit.

Example: "STAT:QUES:ENAB 65535"

Characteristics: *RST value: –
SCPI: device-specific

STATus:QUEStionable:LIMit<1|2>[:EVENT]?

This command queries the contents of the EVENT section of the STATus:QUEStionable:LIMit register. Readout deletes the contents of the EVENT section.

Example: "STAT:QUES?"

Characteristics: *RST value: –
SCPI: device-specific

STATus:QUEStionable:LIMit<1|2>:NTRansition 0 to 65535

This command sets the edge detectors of all bits of the STATus:QUEStionable:LIMit register from 1 to 0 for the transitions of the CONDition bit.

Example: "STAT:QUES:NTR 65535"

Characteristics: *RST value: –
SCPI: device-specific

STATus:QUEStionable:LIMit<1|2>:PTRansition 0 to 65535

This command sets the edge detectors of all bits of the STATus:QUEStionable:LIMit register from 0 to 1 for the transitions of the CONDition bit.

Example: "STAT:QUES:PTR 65535"

Characteristics: *RST value: –
SCPI: device-specific

STATus:QUEue[:NEXT]?

This command returns the earliest entry to the error queue and deletes it.

Positive error numbers indicate device-specific errors, negative error numbers are error messages defined by SCPI (cf. Chapter 9). If the error queue is empty, the error number 0, "no error", is returned. This command is identical with the command SYSTem:ERRor.

Example: "STAT:QUE?"

Characteristics: *RST value: –
SCPI: conforming

STATus:QUEStionable:NTRansition 0 to 65535

This command sets the edge detectors of all bits of the STATus:OPERation register from 1 to 0 for the transitions of the CONDition bit.

Example: "STAT:QUES:NTR 65535"

Characteristics: *RST value: –
SCPI: conforming

STATus:QUEStionable:PTRansition 0 to 65535

This command sets the edge detectors of all bits of the STATus:QUEStionable register from 0 to 1 for the transitions of the CONDition bit.

Example: "STAT:QUES:PTR 65535"

Characteristics: *RST value: –
SCPI: conforming

STATus:QUEStionable:POWer:CONDition?

This command queries the contents of the CONDition section of the STATus:QUEStionable:POWer register. Readout does not delete the contents of the CONDition section.

Example: "STAT:QUES:COND?"

Characteristics: *RST value: –
SCPI: conforming

STATus:QUEStionable:POWer:ENABle 0 to 65535

This command sets the bits of the ENABle section of the STATus:QUEStionable:POWer register. The ENABle register selectively enables the individual events of the associated EVENt section for the summary bit.

Example: "STAT:QUES:ENAB 65535"

Characteristics: *RST value: –
SCPI: conforming

STATus:QUEStionable:POWer[:EVENt]?

This command queries the contents of the EVENt section of the STATus:QUEStionable:POWer register. Readout deletes the contents of the EVENt section.

Example: "STAT:QUES?"

Characteristics: *RST value: –
SCPI: conforming

STATus:QUEStionable:POWer:PTRansition 0 to 65535

This command sets the edge detectors of all bits of the STATus:QUEStionable:POWer register from 0 to 1 for the transitions of the CONDition bit.

Example: "STAT:QUES:PTR 65535"

Characteristics: *RST value: –
SCPI: conforming

STATus:QUEStionable:POWer:NTRansition 0 to 65535

This command sets the edge detectors of all bits of the STATus:QUEStionable:POWer register from 1 to 0 for the transitions of the CONDition bit.

Example: "STAT:QUES:NTR 65535"

Characteristics: *RST value: –
SCPI: conforming

COMMAND	PARAMETERS	UNIT	COMMENT
SYSTem :IDENtify :FACTory :IFGain :MODE :LANGuage :MSIZe? :PASSword [:CENable] :PRESet :RSWeep :SET :SPEaker :VOLume :TIME :VERSion?	NORMal PULSe <string> MBOard B100 <string> <Boolean> 0 to 1 <numeric_value>		query only no query query only no query no query no query query only

SYSTEM:COMMunicate:GPIB:RDEvice:COMManD 0..30,<command string>

This command sends a command or query string to the device using the GPIB interface FSP-B10. Usually an external generator is connected to this interface.

Only basic I/O is possible with this device. The first parameter is the GPIB address of the device connected with GPIB interface of option FSP-B10.

Example:

```
" :SYST:COMM:GPIB:RDEF:COMM 18, '*RST' "
'generator reset; gen. frequency 2 GHz

" :SYST:COMM:GPIB:RDEF:COMM 18, 'SOURCE:FREQ:CW 2E9' "
'gen. power 0dBm

" :SYST:COMM:GPIB:RDEF:COMM 18, 'SOUR:POW 0' "

" :SYST:COMM:GPIB:RDEF:COMM? 18, 'SENS:POW?' "
'queries the generator power
```

Characteristics: *RST value: -
SCPI: device-specific

SYSTEM:COMMunicate:GPIB:RDEvice:GENerator<1|2>:ADDRess 0 to 30

This command changes the IEC/IEEE-bus address of the device selected as external generator 1 or 2.



If two generators are connected at the same time to IECBUS 2 their addresses must be different.

Example:

```
"SYST:COMM:GPIB:RDEV:GEN1:ADDR 19" 'Changes the IECBUS address
'of generator 1 to 19
```

Characteristics: *RST value: 28
SCPI: device-specific

Hinweis: dieses Kommando fehlt, ist aber im FSU-Handbuch!!!!

SYSTEM:COMMunicate:RDEvice:GENerator<1|2>:TYPE <name>

SYSTem:COMMunicate:GPIB:RDEvice:PMETer:ADDRess 0 ... 30

This command sets the IEC/IEEE bus address via which the external power meter is addressed for remote-control.

Example: "SYST:COMM:GPIB:RDEV:PMET:ADDR 5"
 'Changes the IECBUS address 'of power sensor to 5

Characteristics: *RST value:
 SCPI: device-specific

SYSTem:COMMunicate:RDEvice:PMETer:TYPE 'NRVD' | 'NRVS' | 'EPM' | '437B' | '437A' | 'MANUAL'

This command selects the type of external power meter. The R&S NRVS, R&S NRVD power meters from Rohde & Schwarz as well as EPM, 437B and 438A from Hewlett-Packard/Agilent are supported. When MANUAL is selected measurement values have to be entered manually.

Example:"YST:COMM:RDEV:PMET:TYPE 'NRVS'"

Characteristics:*RST value:
 SCPI:device-specific

SYSTem:COMMunicate:GPIB[:SELF]:ADDRess 0 to 30

This command changes the IEC/IEEE-bus address of the unit.

Example: "SYST:COMM:GPIB:ADDR 18"

Characteristics: *RST value: - (no influence on this parameter, factory default 20)
 SCPI: conforming

SYSTem:COMMunicate:GPIB[:SELF]:RTERminator LFEOI | EOI

This command changes the GPIB receive terminator.
 According to the standard the terminator in ASCII is <LF> and/or <EOI>. For binary data transfers (e.g. trace data) from the control computer to the instrument, the binary code (0AH) used for <LF> might be included in the binary data block, and therefore should not be interpreted as a terminator in this particular case. This can be avoided by changing the receive terminator to EOI.
 Output of binary data from the instrument to the control computer does not require such a terminator change.

Example: "SYST:COMM:GPIB:RTER EOI"

Characteristics: *RST value: -- (no influence on this parameter, factory default LFEOI)
 SCPI: device-specific

SYSTem:COMMunicate:PRINter:ENUMerate:FIRSt?

This command queries the name of the first printer (in the list of printers) available under Windows NT. The names of other installed printers can be queried with command SYSTem:COMMunicate:PRINter:ENUMerate:NEXT?. If no printer is configured an empty string is output.

Example: "SYST:COMM:PRIN:ENUM:FIRS?"

Characteristics: *RST value: NONE
 SCPI: device-specific

SYSTem:COMMunicate:PRINter:ENUMerate:NEXT?

This command queries the name of the next printer installed under Windows NT. The command SYSTem:COMMunicate:PRINter:ENUMerate:FIRSt? should be sent previously to return to the beginning of the printer list and query the name of the first printer.

The names of other printers can then be queried with NEXT?. After all available printer names have been output, an empty string enclosed by quotation marks (") is output for the next query. Further queries are answered by a Query Error.

Example: "SYST:COMM:PRIN:ENUM:NEXT?"

Characteristics: *RST value: NONE
SCPI: device-specific

SYSTEM:COMMunicate:PRINter:SElect <1|2> <printer_name>

This command selects one of the printers configured under Windows NT including the associated output destination.

The specified printer name must be a string as returned by the commands

SYSTEM:COMMunicate :PRINter:ENUMerate:FIRSt? or
 SYSTEM:COMMunicate :PRINter:ENUMerate:NEXT?

Command HCOpy:DESTination is used to select an output medium other than the default one.

Example: "SYST:COMM:PRIN:SEL 'LASER on LPT1'"

Characteristics: *RST value: NONE
 SCPI: device-specific

SYSTEM:COMMunicate:RDEvice:GENerator<1|2>:LINK GPIB | TTL

This command selects the interface type of the external generator 1 or 2.

The following types are available

- IECBUS alone (= GPIB, for all the generators of other manufacturers and some Rohde & Schwarz units)
- IECBUS and TTL interface for synchronization (= TTL, for most of the Rohde & Schwarz generators, see table in command SYSTEM:COMMunicate:RDEvice:GENerator:TYPE).

The difference between the two operating modes is the execution speed. While, during IECBUS operation, each settable frequency is transmitted separately to the generator, a whole frequency list can be programmed in one go if the TTL interface is also used. Frequency switching can then be performed per TTL handshake which results in considerable speed advantages.

Only one of the two generators can be operated via the TTL interface at a time. The other generator must be configured for IECBUS (GPIB).

Example: "SYST:COMM:RDEV:GEN:LINK TTL" 'Selects IECBUS + TTL interface 'for generator operation

Characteristics: *RST value: GPIB
 SCPI: device-specific

SYSTEM:COMMunicate:RDEvice:GENERator<1|2>:TYPE <name>

This command selects the type of external generator 1 or 2. The following table shows the available generator types including the associated interface:

Generator	Interface Type	Generator Min Freq	Generator Max Freq	Generator Min Power dBm	Generator Max Power dBm
SME02	TTL	5 kHz	1.5 GHz	-144	+16
SME03	TTL	5 kHz	3.0 GHz	-144	+16
SME06	TTL	5 kHz	6.0 GHz	-144	+16
SMG	GPIB	100 kHz	1.0 GHz	-137	+13
SMGL	GPIB	9 kHz	1.0 GHz	-118	+30
SMGU	GPIB	100 kHz	2.16 GHz	-140	+13
SMH	GPIB	100 kHz	2.0 GHz	-140	+13
SMHU	GPIB	100 kHz	4.32 GHz	-140	+13
SMIQ02B	TTL	300 kHz	2.2 GHz	-144	+13
SMIQ02E	GPIB	300 kHz	2.2 GHz	-144	+13
SMIQ03B	TTL	300 kHz	3.3 GHz	-144	+13
SMIQ03E	GPIB	300 kHz	3.3 GHz	-144	+13
SMIQ04B	TTL	300 kHz	4.4 GHz	-144	+10
SMIQ06B	TTL	300 kHz	6.4 GHz	-144	+10
SML01	GPIB	9 kHz	1.1 GHz	-140	+13
SML02	GPIB	9 kHz	2.2 GHz	-140	+13
SML03	GPIB	9 kHz	3.3 GHz	-140	+13
SMR20	TTL	1 GHz	20 GHz	-130 ²⁾	+11 ²⁾
SMR20B11 ¹⁾	TTL	10 MHz	20 GHz	-130 ²⁾	+13 ²⁾
SMR27	TTL	1 GHz	27 GHz	-130 ²⁾	+11 ²⁾
SMR27B11 ¹⁾	TTL	10 MHz	27 GHz	-130 ²⁾	+12 ²⁾
SMR30	TTL	1 GHz	30 GHz	-130 ²⁾	+11 ²⁾
SMR30B11 ¹⁾	TTL	10 MHz	30 GHz	-130 ²⁾	+12 ²⁾
SMR40	TTL	1 GHz	40 GHz	-130 ²⁾	+9 ²⁾
SMR40B11 ¹⁾	TTL	10 MHz	40 GHz	-130 ²⁾	+12 ²⁾
SMP02	TTL	10 MHz	20 GHz	-130 ³⁾	+17 ³⁾
SMP03	TTL	10 MHz	27 GHz	-130 ³⁾	+13 ³⁾
SMP04	TTL	10 MHz	40 GHz	-130 ³⁾	+12 ³⁾
SMP22	TTL	10 MHz	20 GHz	-130 ³⁾	+20 ³⁾
SMT02	GPIB	5.0 kHz	1.5 GHz	-144	+13
SMT03	GPIB	5.0 kHz	3.0 GHz	-144	+13
SMT06	GPIB	5.0 kHz	6.0 GHz	-144	+13
SMV03	GPIB	9 kHz	3.3 GHz	-140	+13
SMX	GPIB	100 kHz	1.0 GHz	-137	+13
SMY01	GPIB	9 kHz	1.04 GHz	-140	+13
SMY02	GPIB	9 kHz	2.08 GHz	-140	+13
HP8340A	GPIB	10 MHz	26.5 GHz	-110	10
HP8648	GPIB	9 kHz	4 GHz	-136	10
HP ESG-A Series 1000A, 2000A, 3000A, 4000A	GPIB	250 kHz	4 GHz	-136	20
HP ESG-D SERIES E4432B	GPIB	250 kHz	3 GHz	-136	+10

¹⁾ Requires mounting of option SMR-B11.

²⁾ Maximum/Minimum Power depends on the presence of option SMR-B15/-B17 and of the selected frequency range. For details please consult the SMR datasheet.

³⁾ Maximum/Minimum Power depends on the presence of option SMP-B15/-B17 and of the selected frequency range. For details please consult the SMP datasheet.

Generators with TTL interface can also be operated via IECBUS (= GPIB) alone.

With NONE selected, the corresponding generator 1 or 2 is deactivated.

Example: "SYST:COMM:RDEV:GEN2:TYPE 'SME02'" Selects SME02 as generator 2.

Characteristics: *RST value: NONE
SCPI: device-specific

SYSTEM:COMMunicate:RDEvice:PMETer:CFACtor:ASENsor <numeric_value>,<numeric_value>..

This command defines the interpolation points for the frequency response correction for the external power meter. The points are to be entered as a sequence of frequency/factor pairs, with the frequencies to be specified in ascending order. The correction factors are percentage values.

The receiver can store two correction tables; the values defined here are stored in correction table A.

Example: "SYST:COMM:RDEV:PMET:CFAC:ASEN 10MHz,99,20MHZ,98"

Characteristics: *RST value: -
SCPI: device-specific

SYSTEM:COMMunicate:RDEvice:PMETer:CFACtor:ASENsor:LABel <name>

This command defines a name for correction table A for the external power meter. This name may designate a specific power sensor, for example.

Example: "SYST:COMM:RDEV:PMET:CFAC:ASEN:LAB 'SN 317'"

Characteristics: *RST value: -
SCPI: device-specific

SYSTEM:COMMunicate:RDEvice:PMETer:CFACtor:BSENsor <numeric_value>,<numeric_value>..

This command defines the interpolation points for the frequency response correction for the external power meter. The points are to be entered as a sequence of frequency/factor pairs, with the frequencies to be specified in ascending order. The correction factors are percentage values.

The receiver can store two correction tables; the values defined here are stored in correction table B.

Example: "SYST:COMM:RDEV:PMET:CFAC:BSEN 10MHz,99,20MHZ,98"

Characteristics: *RST value: -
SCPI: device-specific

SYSTEM:COMMunicate:RDEvice:PMETer:CFACtor:BSENsor:LABel <name>

This command defines a name for correction table B for the external power meter. This name may designate a specific power sensor, for example.

Example: "SYST:COMM:RDEV:PMET:CFAC:BSEN:LAB 'SN 319'"

Characteristics: *RST value: -
SCPI: device-specific

SYSTEM:COMMunicate:RDEvice:PMETer:CFACtor[:SElect] ASENsor | BSENsor

This command selects correction table A or B for the external power meter.

Example: "SYST:COMM:RDEV:PMET:CFAC:SEL ASEN" 'Selects correction table A.

Characteristics: *RST value: BSENsor
SCPI: device-specific

SYSTEM:COMMunicate:RDEvice:PMETer:TYPE <name>

This command selects the type of external power meter.

Example: "SYST:COMM:RDEV:PMET:TYPE 'NRVD'" 'Selects a type NRVD external power meter.

Characteristics: *RST value: " "
SCPI: device-specific

SYSTEM:COMMunicate:SERial:CONTRol:DTR IBFull | OFF

SYSTEM:COMMunicate:SERial:CONTRol:RTS IBFull | OFF

These commands switch the hardware handshake procedure for the serial interface off (OFF) or on (IBFull). The two commands are equivalent.

Examples: "SYST:COMM:SER:CONT:DTR OFF"
"SYST:COMM:SER:CONT:RTS IBF"

Characteristics: *RST value: -- (no influence on this parameter, factory default OFF)
SCPI: conforming

SYSTEM:COMMunicate:SERial[:RECeive]:BAUD 110 | 300 | 600 | 1200 | 2400 | 9600 | 19200

This command sets the transmission speed for the serial interface (COM).

Example: "SYST:COMM:SER:BAUD 2400"

Characteristics: *RST value: -- (no influence on this parameter, factory default 9600)
SCPI: conforming

SYSTEM:COMMunicate:SERial[:RECeive]:BITS 7 | 8

This command defines the number of data bits per data word for the serial interface (COM).

Example: "SYST:COMM:SER:BITS 7"

Characteristics: *RST value: -- (no influence on this parameter, factory default 8)
SCPI: conforming

SYSTEM:COMMunicate:SERial[:RECeive]:PACE XON | NONE

This command switches on or off the software handshake for the serial interface.

Example: "SYST:COMM:SER:PACE XON"

Characteristics: *RST value: -- (no influence on this parameter, factory default NONE)
SCPI: conforming

SYSTEM:COMMunicate:SERial[:RECeive]:PARity[:TYPE] EVEN | ODD | NONE

This command defines the parity check for the serial interface (COM).

Possible values are:
EVEN even parity
ODD odd parity
NONE no parity check.

Example: "SYST:COMM:SER:PAR EVEN"

Characteristics: *RST value: -- (no influence on this parameter, factory default NONE)
SCPI: conforming

SYSTEM:COMMunicate:SERial[:RECeive]:SBITs 1|2

This command defines the number of stop bits per data word for the serial interface (COM).

Example: "SYST:COMM:SER:SBITs 2"

Characteristics: *RST value: -- (no influence on this parameter, factory default 1)
SCPI: conforming

SYSTEM:DATE 1980 to 2099, 1 to 12, 1 to 31

This command is used to enter the date for the internal calendar. The sequence of entry is year, month, day.

Example: " SYST:DATE 2000,6,1"

Characteristics: *RST value: --
SCPI: conforming

SYSTEM:DISPlay:FPANel ON | OFF

This command activates or deactivates the display of the front panel keys on the screen. With the display activated, the instrument can be operated on the screen using the mouse by pressing the corresponding buttons. This may be useful if the instrument is operated in a detached station by means of a remote program such as PCANYWHERE.



With the display of the front panel keys activated, the screen resolution of the unit is set to 1024x768. Thus, only a section of the whole screen is visible on the internal LCD display, which will be moved by mouse moves.

For a full display of the user interface, an external monitor has to be connected to the rear panel.

When the front panel display is deactivated, the original screen resolution is restored.

Example: "SYST:DISP:FPAN ON"

Characteristics: *RST value: OFF
SCPI: device-specific

SYSTEM:DISPlay:UPDate ON | OFF

This command switches on or off the update of all display elements during remote control.



The best performance is obtained when the display output is switched off during remote control.

Example: " SYST:DISP:UPD ON"

Characteristics: *RST value: OFF
SCPI: device specific

SYSTEM:ERRor?

This command queries the earliest entry in the error queue, and deletes it after the readout. Positive error numbers indicate device-specific errors, negative error numbers are error messages defined by SCPI (cf. Chapter 9). If the error queue is empty, the error number 0, "no error", is returned. This command is identical with the command `STATus:QUEue:NEXT?`. This command is a query and therefore has no *RST value.

Example: "SYST:ERR?"

Characteristics: *RST value: –
SCPI: conforming

SYSTEM:ERRor:CLEar:ALL

This command deletes all entries in the table SYSTEM MESSAGES. This command is an event and therefore has no query and no *RST value.

Example: "SYST:ERR:CLE:ALL?"

Characteristics: *RST value: –
SCPI: device specific

SYSTEM:ERRor:LIST?

This command reads all system messages and returns a list of comma separated strings. Each string corresponds to an entry in the table SYSTEM MESSAGES.
If the error list is empty, an empty string "" will be returned.
This command is a query and therefore has no *RST value.

Example: "SYST:ERR:LIST?"

Characteristics: *RST value: –
SCPI: device specific

SYSTEM:FIRMware:UPDate <path>

This command starts a firmware update using the data set in the selected directory. Beforehand, the update files have to be stored in the following subdirectories using command `MMEM:DATA:`

Directory	Contents					
DISK1	_inst32i.ex_	_isdell.exe	_setup.dll	_sys1.cab	_user1.cab	
	data.tag	data1.cab	id.txt	lang.dat	layout.bin	
	os.dat	Setup.exe	Setup.ini	setup.ins	setup.lid	
DISK2	data2.cab					
DISK3	data3.cab					
DISK4	data4.cab					
DISK5	data5.cab					

Example: "SYST:FIRM:UPD 'D:\USER\FWUPDATE'"
'Starts the firmware update
'from directory
'D:\USER\FWUPDATE using the
'files of subdirectories DISK1
'to DISK5

Characteristics: *RST value: –
SCPI: device specific

This command is an 'event' and therefore has no query and no *RST value.

SYSTEM:IDENTify:FACTory

This command resets the *IDN string to the factory default (softkey: ID STRING FACTORY).

Return value: "1" for the factory default state
"0" for a changed *IDN string

Example: "SYST:IDEN:FACT" sets the ID string to the factory default

Characteristics: *RST value: –
SCPI: device specific

SYSTEM:IFGain:MODE NORMal | PULSe

This command switches the 10 dB overload reserve on or off.
This command can only be selected in the HP emulation mode.

NORM: switches the overload reserve off
PULSe: switches the overload reserve on

Example: "SYST:LANG '8566B'" switches the HP emulation on
"SYST:IFG:MODE PULS" switches the overload reserve on

Characteristics: *RST value: –
 SCPI: device specific

SYSTEM:LANGUage SCPI | '8561E' | '8560E' | '8566A' | '8566B' | '8591E' | '8568A' | '8568B' | '8594E' | '71100C' | '71200C' | '71209A' | 8562E | 8563E | 8564E | 8565E | 8568B

This command activates the emulation of various spectrum analyzers. The analyzer default command set is SCPI. The following remote-control languages are available:

- SCPI, '8561E, 8560E, 8566A, 8566B, 8591E, 8568A, 8568B, 8594E, 71100C, 71200C, 71209A, 8562E, 8563E, 8564E, 8565E, 8568B



When SCPI is selected, the 8566B/8568B/8594E command set is available in addition. When 8566A, 8566B, 8568A or 8568B is selected, both command sets A and B are available, as far as they are supported.

The HP model 8591E is compatible to HP model 8594E, the HP models 71100C, 71200C, and 71209A are compatible to HP models 8566A/B.

On switching between remote-control languages, the following settings or changes will be made:

SCPI:

The instrument will perform a PRESET.

8566A/B, 8568A/B, 8594E:

The instrument will perform a PRESET.

The following instrument settings will then be changed:

Model	# of Trace Points	Start Freq.	Stop Freq.	Input Coupling
8566A/B	1001	2 GHz	22 GHz	DC (FSU) AC (FSP)
8568A/B	1001	0 Hz	1.5 GHz	AC
8594E	625 (FSU) 501 (FSP)	0 Hz	3 GHz	AC

Notes regarding switchover to 8566A/B and 8568A/B:

- Commands *IP* and *KST*, too, will perform the settings for the "# of Trace Points", "Start Freq.", "Stop Freq." and "Input Coupling".
- Switchover of the "# of Trace Points" will not take place until the instrument is switched to the *REMOTE* mode. For manual operation (selected with *LOCAL* softkey), the number of sweep points (trace points) will always be set to 1251.
- In the remote mode, the screen area for the measurement will be reduced. The *LOCAL* softkey (lowermost softkey) will be shifted slightly towards the center of the screen.

Example: "SYST:LANG 'SCPI'"

Characteristics: *RST value: 'SCPI'
 SCPI: conforming

There is no query for this command.

SYSTEM:MSIZe? MBOard

This command returns the memory size installed on related boards. This information is listed in table SETUP - SYSTEM INFO - STATISTICS.

Parameter: MBOard Mainboard

Example: "SYST:MSIZ? MBO" Outputs the memory size of the mainboard.

Characteristics: *RST value: –
SCPI: device specific

SYSTEM:PASSword[:CENable] 'password'

This command enables access to the service functions by means of the password.

Example: "SYST:PASS 'XXXX'"

Characteristics: *RST value: –
SCPI: conforming

This command is an event and therefore has no *RST value and no query.

SYSTEM:PRESet

This command initiates an instrument reset. The effect of this command corresponds to that of the *PRESET* key with manual control or to the *RST command.

Example: "SYST:PRES"

Characteristics: *RST value: –
SCPI: conforming

SYSTEM:RSWeep ON | OFF

This command controls a repeated sweep of the E1 and MKPK HI HP model commands. If the repeated sweep is OFF, the marker is set without sweeping before.

Example: "SYST:RSW:ON"
'Sets the repeated sweep on.'

Characteristics: *RST value: –
SCPI: device specific

SYSTEM:SET <block>

The query *SYSTEM:SET?* causes the data of the current instrument setting to be transmitted to the control computer in binary format (SAVE function). The data can be read back into the instrument (RECALL function) by means of command *SYSTEM:SET <block>*. Whilst the data records are stored on the instrument hard disk with SAVE/RECALL (*MMEMory:STORe* bzw. *MMEMory:LOAD*), it is possible to store the data in an external computer by means of *SYSTEM:SET*.

The receive terminator has to be set to EOI to ensure reliable transfer of data (setting *SYST:COMM:PIB:RTER* EOI).

Example: "SYST:SET "

Characteristics: *RST value: –
SCPI: conforming

SYSTem:SPEaker:VOLume 0 to 1

This command sets the volume of the built-in loudspeaker for demodulated signals. Minimum volume is set by 0 and maximum volume by 1.

The value 0 is the lowest volume, the value 1 the highest volume.

Example: "SYST:SPE:VOL 0.5"

Characteristics: *RST value: 0
SCPI: device-specific

SYSTem:TIME 0 to 23, 0 to 59, 0 to 59

This command sets the internal clock. The sequence of entry is hour, minute, second.

Example: "SYST:TIME 12,30,30"

Characteristics: *RST value: –
SCPI: conforming

SYSTem:VERSion?

This command queries the number of the SCPI version, which is relevant for the instrument.

Example: "SYST:VERS?"

Characteristics: *RST value: –
SCPI: conforming

This command is a query and therefore has no *RST value.

General Trace Commands

TRACe<1|2>[:DATA] TRACE1 | TRACE2 | TRACE3 | SPURious | PHOLd | ABITstream | PWCDp | CTABle, <block> | <numeric_value>

This command transfers trace data from the control computer to the instrument, the query reads trace data out of the instrument. The associated measurement window is selected with the numeric suffix of TRACe<1|2>.

SPURious reads the peak list in the spurious measurement. As results a list of frequency, level and delta to limit line values is returned. A delta limit of +200dB indicates no limit check is active

Example: "TRAC TRACE1,"+A\$ (A\$: data list in the current format)
 "TRAC? TRACE1"

Characteristics: *RST value: -
 SCPI: conforming

Return values:

The returned values are scaled in the current level unit. Returned FM-modulated measurement values (activated option FS-K7) are scaled in Hz. For information on the LIST parameter, see TRACe<1|2> :IQ:DATA? below.

ASCII format (FORMat ASCII):

In ASCII format, a list of values separated by commas is returned (Comma Separated Values = CSV).

The number of measurement points is 625.

Binary format (FORMat REAL,32):

If the transmission takes place using the binary format (REAL,32), the data are transferred in block format (Definite Length Block Data according to IEEE 488.2). They are arranged in succeeding lists of I and Q data of 32 Bit IEEE 754 floating point numbers. General structure of return string:

#42500<meas value 1><meas value value2>...<meas value 625>

with

#4 digits of the subsequent number of data bytes (4 in the example)

2500 Number of subsequent data bytes (2500 in the example))

<meas value x> 4 byte floating point measurement values

Saving and recalling:

Saving and recalling trace data together with the device settings to/from the device-internal hard disk or on an external storage device (e.g. a memory stick) is controlled via the commands "MMEMory:STORe:STATe" and "MMEMory:LOAD:STATe" respectively. Trace data are selected with "MMEMory:SELEct[:ITEM]:ALL" or "MMEMory:SELEct[:ITEM]:TRACe". Trace data in ASCII format (ASCII FILE EXPORT) are exported with the command "MMEM:STORe:TRACe".

Transfer format:

The trace data are transferred in the current format (corresponding to the command FORMat ASCII|REAL). The device-internal trace memory is addressed using the trace names 'TRACE1' to 'TRACE3'.

The transfer of trace data from the control computer to the instrument takes place by indicating the trace name and then the data to be transferred. In ASCII format, these data are values separated by commas. If the transfer takes place using the format real (REAL,32), the data are transferred in block format.

The parameter of the query is the trace name TRACE1 to TRACE3, it indicates which trace memory will be read out.

The command "MMEMory:STORE:STATE" or "MMEMory:LOAD:STATE" controls the storage or loading of measured data, including the device settings, on or from the internal hard disk or on an external storage device (e.g. a memory stick). The trace data is selected via "MMEMory:SElect[:ITEM]:ALL" or "MMEMory:SElect[:ITEM]:TRACe". The trace data in ASCII format (ASCII FILE EXPORT) is exported via the "MMEM:STORE:TRACe" command.

TRACe<1|2>:DATA? LIST

This command reads the resulting peak list of the spurious emission measurement LIST EVALUATION (CALC:PEAK:AUTO ON).

The output format of the result is:

<result of range 1>,< result of range 2>,...< result of range n>

Every single range has following format:

<No>,<Start>,<Stop>,<rbw>,<freq>,<Levelabs>,<Levelrel>,<Delta>,<Limitcheck>,<unused1>,<unused2>

Where:

No	: Range number
Start	: Range start frequency
Stop	: Range stop frequency
Rbw	: Resolution bandwidth
Freq	: Frequency of the peak in the range
Levelabs	: Absolute peak power of the range in dBm
Levelrel	: reserved (0.0)
Delta	: Delta of the peak power to the limit line in dB
Limitcheck	: Limit check state (0 = PASSED, 1 = FAILED)
Unused1	: reserved (0.0)
Unused2	: reserved (0.0)

The number of ranges correspond to the number of ranges define in the spurious sweep list.

The numeric suffix at TRACe<1|2> is irrelevant.

Example: "TRAC:DATA? LIST" Read LIST EVALUATION result

Characteristics: *RST value: --
SCPI: device-specific

Number and format of the measurement values for the different operating modes

The number of measurement values depends on the instrument setting:

SPECTRUM mode (span > 0 and zero span):

625 results are output in the unit selected for display.

For spurious emissions measurement the number of results is the sum of all sweep points, specified in the sweep list configuration.



*With AUTO PEAK detector, only positive peak values can be read out.
Trace data can be written into the instrument with logarithmic display only in dBm, with linear display only in volts.*

FORMat REAL,32 is to be used as format for binary transmission, and FORMat ASCii for ASCII transmission.

SPURious reads the peak list in the spurious measurement. As results a list of frequency, level and delta to limit line values is returned. A delta limit of +200dB indicates no limit check is active.

TRACe<1|2>:COPY TRACE1| TRACE2| TRACE3|

This command copies data from one trace to another. The second operand describes the source, the first operand the destination of the data to be copied. The associated measurement window is selected with the numeric suffix of TRACe<1|2>.

Example: "TRAC: COPY TRACE1, TRACE2"

Characteristics: *RST value:
SCPI: conforming

TRACe<1|2>:IMMEDIATE:LEVEL?

This query returns the current Y results of the sweep. During a sweep the last measured value is read out.

Example: "INIT:CONT OFF" 'switches to single sweep mode
"INIT" 'starts a sweep (without waiting for the sweep end!)
"TRAC1:IMM:LEV?" 'queries the level of the last measured measurement point

Characteristics: *RST value:
SCPI: conforming

TRACe<1|2>:IMMEDIATE:RESULT?

This query returns the current X and Y results of the sweep. During a sweep the last measured values are read out.

Example: "INIT:CONT OFF" 'switches to single sweep mode
"INIT" 'starts a sweep (without waiting for the sweep end!)
"TRAC:IMM:RES?" 'queries the X and Y values of the last measured measurement point

Characteristics: *RST value:
SCPI: conforming

TRACe:IQ Subsystem

The commands of this subsystem are used for collection and output of measured IQ data. A special memory is therefore available in the instrument with 512k words for the I and Q data. The measurement is always performed in the time domain (span = 0 Hz) at the selected center frequency. The number of samples to be collected can be set. The sample rate can be set in the range from 15.625 kHz to 32 MHz. Prior to being stored in memory or output via GPIB, the measurement data are corrected in terms of frequency response.

Depending on the sample rate, the following maximum bandwidths can be obtained during the measurement.

Sample rate	Max. bandwidth	Notes
32 MHz	9.6 MHz	
16 MHz	7.72 MHz	
8 MHz	4.8 MHz	Signals outside the given bandwidth are folded back into the useful band due to the anti-aliasing filter.
4 MHz	2.8 MHz	
2 MHz	1.6 MHz	max. bandwidth = 0.8 * sample rate for sample rate ≤ 2 MHz
1 MHz	800 kHz	
500 kHz	400 kHz	
250 kHz	200 kHz	
125 kHz	100 kHz	
62.5 kHz	50 kHz	
31.25 kHz	25 kHz	
15.625 kHz	12.5 kHz	

Due to the sampling concept (21.4 MHz IF, 32 MHz Sampling rate), the image frequency is suppressed only by the 10 MHz analog IF filter. When applying an input signal at the edge of the 10 MHz band (+5 MHz from center), the image frequency appears 800 kHz above the input signal.

The image frequency in MHz is calculated as follows:

$$f_{\text{image}} = 2 \cdot (f_{\text{center}} + 5.4 \text{ MHz}) - f_{\text{signal}}$$

where

f_{image} = image frequency in MHz

f_{center} = center frequency in MHz

f_{signal} = frequency of the signal to be measured in MHz

For correct operation the RF input signal shall be limited in bandwidth. Signals more than 5.4 MHz above the center frequency will be mirrored into the 10 MHz pass band.

For additional bandwidth limitation of the measurement data the analog filters (RBW ≥ 300 kHz) are available.

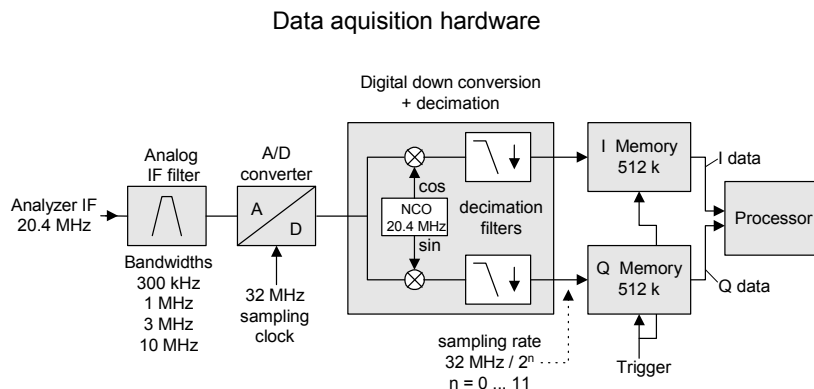

Fig. 6.1-1 Block diagram illustrating signal processing in analyzer

Maximum useful bandwidth		
Sample rate from	Sample rate to	Maximum bandwidth
> 81.6 MHz	<163.2 MHz	0.68 sample rate
163.2 MHz	326.4 MHz	120 MHz

All trigger sources except for VIDEO can be used for triggering. The number of test points to be recorded prior to the trigger time can be selected for all of the available trigger sources except for FREE RUN, where this parameter is always to be assigned the value 0). Measurement results are output in the form of a list, with the Q values following immediately after the list of I values in the output buffer. The FORMAT command can be used to select between binary output (32 bit IEEE 754 floating-point values) and output in ASCII format.

The commands of this subsystem can be used in two ways:

1. Measurement and result query with one command:
This method causes the least delay between measurement and output of the result data, but it requires the control computer to wait actively for the response data.
2. Setting up the instrument, start of the measurement via "INIT" and query of the result list at the end of the measurement:
With this method the control computer can be used for other activities during the measurement. In this case the additional time needed for synchronization via service request must be taken into account.

It is possible to combine I/Q data measurement with gated trigger function for following settings:

- Sample Rate 81.6 MHz
- Gate Source EXTERN

The gate parameter (gate mode, gate polarity, gate delay and gate length) are configured by the subsystem SENSE:SWEep:EGATE, when TRACE:IQ:STATE is set to ON.

TRACe<1|2>:IQ:AVERAge:COUNT 0 to 32767

This command defines the number of I/Q data sets that are to serve as a basis for averaging.

Example:

```

TRAC:IQ ON 'Switches on acquisition of I/Q data.
TRAC:IQ:SYNC ON 'Switches on synchronization of the aquisition of I/Q
measurement data with the trigger time.
TRAC:IQ:SET NORM,10MHz,32MHz,EXT,POS,0,2048
'Reads 2048 I/Q values from the moment of
triggering.
'Filter type: NORMAL (analogue)
'RBW: 10 MHz
'Sample Rate: 32 MHz
'Trigger: external
'Slope: positive

TRAC:IQ:AVER ON 'Enables averaging of the I/Q measurement data
TRAC:IQ:AVER:COUN 10 'Selects averaging over 10 data sets
TRAC:IQ:DATA? 'Starts the measurement and reads out the averaged
data.
```

Characteristics: *RST value: 0
SCPI: conforming

TRACe<1|2>:IQ:AVERAge[:STATe] ON|OFF

The command enables averaging of the recorded I/Q data provided that I/Q data acquisition was previously enabled with TRAC:IQ ON and the sampling rate was set to 32 MHz.



Averaging is not supported at sampling rates \neq 32 MHz or for a trigger offset < 0 .

Example:	TRAC:IQ ON	'Switches on acquisition of I/Q data.
	TRAC:IQ:SYNC ON	'Switches on synchronization of the acquisition of I/Q measurement data with the trigger time.
	TRAC:IQ:SET NORM,10MHz,32MHz,EXT,POS,0,2048	'Reads 2048 I/Q values starting at the time of trigger. 'Filter type: NORMAL (analogue) 'RBW: 10 MHz 'Sample Rate: 32 MHz 'Trigger: external 'Slope: positive
	TRAC:IQ:AVER ON	'Enables averaging of the recorded I/Q data..
	TRAC:IQ:AVER:COUN 10	'Selects averaging over 10 data sets..
	TRAC:IQ:DATA?	'Starts the measurement and reads out the averaged data.
Characteristics:	*RST value: OFF	
	SCPI: device-specific	

TRACe<1|2>:IQ:DATA?

This command starts a measurement with the settings defined via TRACe:IQ:SET and returns the list of measurement results immediately after they are corrected in terms of frequency response. The number of measurement results depends on the settings defined with TRACe:IQ:SET, the output format depends on the settings of the FORMat – subsystem.



The command requires that all response data are read out completely before the instrument accepts further commands.

Parameter:	none	
Example:	"TRAC:IQ:STAT ON"	'Enables acquisition of I/Q data
	"TRAC:IQ:SET NORM,10MHz,32MHz,EXT,POS,0,4096"	'Measurement configuration:'Filtertype:Normal 'RBW:10 MHz 'Sample Rate:32 MHz 'Trigger Source:External 'Trigger Slope:Positive 'Pretrigger Samples:0 '# of Samples:4096
	"FORMat REAL,32"	'Selects format of response data
	"TRAC:IQ:DATA?"	'Starts measurement and reads results

Return values:

The result values are scaled linear in unit *Volt* and correspond to the voltage at the RF input of the instrument.

ASCII Format (FORMat ASCII):

In this case the command returns a comma separated list of the measured voltage values in floating point format (Comma Separated Values = CSV). The number of values returned is 2 * number of samples, the first half being the I-values, the second half the Q-values.

Binary Format (FORMat REAL,32):

In this case the command returns binary data (Definite Length Block Data according to IEEE 488.2), with the lists of I- and Q-data being arranged one after the other in 32 Bit IEEE 754 floating point data. The scheme of the response string is as follows:

```
#44096<I-value1><I-value2>...<I-value512><Q-value1><Q-value2>...<Q-value512>
```

with

#4 digits of the subsequent number of data bytes (4 in the example)
 4096 number of subsequent data bytes (# of DataBytes, 4096 in the example)
 <I-value x> 4-Byte-Floating Point I-value
 <Q-value y> 4-Byte-Floating Point Q-value

The number of I- and Q-data can be calculated as follows:

$$\# \text{ of } I\text{-Data} = \# \text{ of } Q\text{-Data} = \frac{\# \text{ of } DataBytes}{8}$$

The offset of Q-data in the output buffer can be calculated as follows:

$$Q\text{-Data-Offset} = \frac{(\# \text{ of } DataBytes)}{2} + LengthIndicatorDigits$$

with LengthIndicatorDigits being the number of digits of the length indicator including the '#'. In the example above (#44096...) this results in a value of 6 for LengthIndicatorDigits and the offset for the Q-data will result in 2048 + 6 = 2054.

Characteristics: *RST value: --

Note:

Using the command with the *RST values for command TRAC:IQ:SET the following minimum buffer sizes for the response data are recommended:

ASCII format: 10 kBytes

Binary format: 2 kBytes

SCPI: device specific



The command requires that all response data are read out completely before the instrument accepts further commands.

TRACe<1|2>:IQ:DATA:FORMat COMPatible | IQBLock | IQPair

This command sets the data output formatting (using the TRAC:IQ:DATA? command):

COMPatible 512k I data and 512k Q data is alternately transferred
 IQBLock First, all I and then all Q data is transferred
 IQPair I/Q data is transferred in pairs

Example: "TRAC:IQ:DATA:FORM IQP"

Features: *RST value: COMP
 SCPI: device-specific

TRACe<1|2>:IQ:DATA:MEMory[:RF]? <offset samples>,<# of samples>

This command permits the readout of previously acquired (and frequency response corrected) I/Q data from the memory, with indication of the offset related to the start of measurement and with indication of the number of measurement values. Therefore a previously acquired data set can be read out in smaller portions. The maximum amount of available data depends on the settings of command TRACe:IQ:SET, the output format on the settings in the FORMat – subsystem.



The command requires that all requested measurement data be completely retrieved before the device accepts any further commands.

If no baseband IQ data is available in the memory because the associated measurement has not yet been started, the command generates a query error.

Parameter:	<code><offset samples></code>	Offset of the values to be output, referenced to the start of the sampled data. Value range: 0 ... <code><# of samples></code> - 1, where <code><# of samples></code> is the value specified with the TRACe:IQ:SET command
	<code><# of samples></code>	Value range: 1 ... <code><# of samples></code> - <code><offset samples></code> where <code><# of samples></code> is the value specified with the TRACe:IQ:SET command.

Examples:

<code>"TRAC:IQ:STAT ON"</code>	'activates the I/Q data sampling
<code>"TRAC:IQ:SET NORM,10MHz,32MHz,EXT,POS,100,4096"</code>	'configures the measurement: 'Filter type:Normal 'RBW:10 MHz 'Sample Rate:32 MHz 'Trigger Source:External 'Trigger Slope:Positive 'Pretrigger Samples:100 '# of Samples:4096
<code>"INIT;*WAI"</code>	'starts the measurement and waits for its end
<code>"FORMat REAL,32"</code>	'specifies the format of the response data'
results:	
<code>"TRAC:IQ:DATA:MEM? 0,2048"</code>	"reads in 2048 I/Q values starting with the beginning of the sampling
<code>"TRAC:IQ:DATA:MEM? 2048,1024"</code>	'reads in 2048 I/Q values starting with the beginning of the sampling
<code>"TRAC:IQ:DATA:MEM? 100,512"</code>	'reads in 512 I/Q values starting with the trigger time (<Pretrigger Samples> was 100))

Return values

Irrespective of the output format selected, the data is scaled linearly with 'V' as the unit and corresponds to the voltage at the RF input of the device.

The return buffer is similarly configured to the return buffer with the TRACe:IQ:DATA? command where all I data has the value 0.

Characteristics: *RST value: --
SCPI: device-specific

Examples:

"TRAC:IQ:SET NORM,10MHz,32MHz,EXT,POS,0,2048" 'Reads 2048 I/Q-values starting at the trigger point.
'Filtertype: NORMAL (analog)
'RBW: 10 MHz
'Sample Rate:32 MHz
'Trigger: External
'Slope: Positive

"TRAC:IQ:SET NORM,1MHz,4MHz,EXT,POS,1024,512" 'Reads 512 I/Q-values from 1024 measurement points before the trigger point.
'Filtertype: NORMAL (analog)
'RBW: 1 MHz
'Sample Rate:4 MHz
'Trigger: External
'Slope: Positive

Characteristics: *RST values: NORM,3MHz,32MHz,IMM,POS,0,128



*For using these default settings with command TRAC:IQ:DATA? the following minimum buffer sizes for the response data are recommended:
ASCII format:10 kBytes
Binary format:2 kBytes!*

SCPI: device specific

TRACe<1|2>:IQ:SRATe 15.625kHz to 32MHz

This command sets the sampling rate for the I/Q data acquisition. Thus the sample rate can be modified without affecting the other settings.

Example: "TRAC:IQ:SRAT 4MHZ"

Characteristics: *RST value: 32 MHz
SCPI: device specific

TRACe<1|2>:IQ:STATe] ON | OFF

This command switches the I/Q data acquisition on or off.



The I/Q data acquisition is not compatible with other measurement functions. Therefore all other measurement functions will be switched off as soon as the I/Q measurement function is switched on. Additionally a trace display is not possible in this operating mode. Therefore all traces are set to "BLANK". Finally split screen operation will automatically be stopped.

Example: TRAC:IQ ON 'Switches on I/Q data acquisition

Characteristics: *RST value: OFF
SCPI: device specific

TRACe<1|2>:IQ:SYNChronize[:STATe] ON | OFF

This command switches on or off the synchronization of the start of I/Q data acquisition to the trigger event. Prior to this command, I/Q data acquisition has to be switched. The sampling rate must be 32 MHz. The synchronization ensures the correct calculation of I/Q average values as the data acquisition is always started with the same phase reference in relation to the trigger event.



This command is not supported for sampling rates other than 32 MHz.

Example:

```
"TRAC:IQ ON"           'Switches on I/Q data acquisition
"TRAC:IQ:SYNC ON ON"  'Switches on synchronization of I/Q data acquisition
                        to the trigger event
"TRAC:IQ:SET NORM,10MHz,32MHz,EXT,POS,0,2048"
                        'Reads 2048 I/Q-values starting at the 'trigger point.
                        'Filtertype:NORMAL (analog)
                        'RBW: 10 MHz
                        'Sample Rate:32 MHz
                        'Trigger:External
                        'Slope: Positive
TRAC:IQ:AVER ON        'Enables averaging of the I/Q measurement data
TRAC:IQ:AVER:COUN 10  'Selects averaging over 10 data sets
TRAC:IQ:DATA?         "Starts the measurement and reads out the
                        averaged 'data.
```

Characteristics: *RST value: ON
SCPI: device specific

TRIGger Subsystem

The TRIGger subsystem is used to synchronize instrument actions with events. It is thus possible to control and synchronize the start of a sweep. An external trigger signal can be applied to the connector at the rear panel of the instrument. A distinction is made between TRIGger1 (screen A) and TRIGger2 (screen B).

COMMAND	PARAMETERS	UNIT	COMMENT
TRIGger<1 2> [:SEquence] :HOLDoff :ADJUST :AUTO [:TIME] :LEVel :AM :AUDio [:EXTeRnal] :FM :IFPower :PM :VIDeo :SLOPe :SOURce	<Boolean> <numeric_value> <numeric_value> <numeric_value> <numeric_value> <numeric_value> <numeric_value> <numeric_value> POSitive NEGativ	S PTC V V MV UV PCT HZ DBM RAD PCT	IMMediate EXTeRnal VIDeo IFPower AUDio TV AF AM FM PM AUDio

TRIGger<1|2>[:SEquence]:HOLDoff:ADJust:AUTO ON|OFF

This command defines whether the group delay of the bandwidth filters for the external trigger is compensated (ON) or not (OFF). If a burst signal is analyzed in the time domain mode, the rising edge will remain at the same time position if compensation is on and the bandwidth changes.

Example: "TRIG:HOLD:ADJ:AUTO ON"

Characteristics: *RST value: OFF
SCPI: device-specific

TRIGger<1|2>[:SEquence]:HOLDoff -100 to 100s

This command defines the length of the trigger delay. A negative delay time (pretrigger) can be set in the time domain (span = 0 Hz) only.

Example: "TRIG:HOLD 500us"

Characteristics: *RST value: 0s
SCPI: conforming

TRIGger<1|2>[:SEquence]:LEVel:AM -100 to +100PTC

The command sets the level when AM-modulated signals are used as a trigger source.



To ensure successful triggering with trigger sources AF, AM and FM, the measurement time should include at least 5 periods of the audio signal.

Example: "TRIG:LEV:AM 20 PTC" 'Sets the AM trigger threshold to 20 % deviation

Characteristics: *RST value: 0 Hz
SCPI: device-specific

TRIGger<1|2>[:SEQUENCE]:LEVel:AF -10 to +10MHz

TRIGger<1|2>[:SEQUENCE]:LEVel:FM -10 to +10MHz

The command sets the level when FM-modulated signals are used as a trigger source.



To ensure successful triggering with trigger sources AF, AM and FM, the measurement time should include at least 5 periods of the audio signal.

Example: "TRIG:LEV:FM 10 kHz" 'Sets the FM trigger threshold to 10 kHz

Characteristics: *RST value: 0 Hz
SCPI: device-specific

TRIGger<1|2>[:SEQUENCE]:LEVel:AUDio -4 to +4 V

This command sets the trigger threshold for audio signals.



For successful triggering, the audio signal has to be measured over at least five periods.

Example: "TRIG:LEV:AUD 0.5 V" 'Sets the trigger threshold to 500 mV.

Characteristics: *RST value: 0 V
SCPI: device-specific

TRIGger<1|2>[:SEQUENCE]:LEVel[:EXTernal] 0.5 to +3.5V

This command sets the level of the external trigger source.

Example: "TRIG:LEV 2V"

Characteristics: *RST value: 1.4 V
SCPI: device-specific

TRIGger<1|2>[:SEQUENCE]:LEVel:IFPower -70 to +30DBM

This command sets the level of the IF power trigger source.

Example: "TRIG:LEV:IFP .20DBM"

Characteristics: *RST value: -20 dBm
SCPI: device-specific

TRIGger<1|2>[:SEQUENCE]:LEVel:PM -1000...+1000RAD

The command sets the level when PM-modulated signals are used as a trigger source.



To ensure successful triggering with trigger sources AF, AM, FM and PM, the measurement time should include at least 5 periods of the audio signal.

Example: "TRIG:LEV:PM 1.2 RAD" 'Sets the PM trigger threshold to 1.2 rad

Characteristics: *RST value: 0 Hz
SCPI: device-specific

TRIGger<1|2>[:SEQUENCE]:LEVel:VIDeo 0 to 100PCT

This command sets the level of the video trigger source.

Example: "TRIG:LEV:VID 50PCT"

Characteristics: *RST value: 50 PCT
SCPI: device-specific

TRIGger<1|2>[:SEQuence]:SLOPe POSitive | NEGative

This command selects the slope of the trigger signal. The selected trigger slope applies to all trigger signal sources .

Example: "TRIG:SLOP NEG"

Characteristics: *RST value: POSitive
SCPI: conforming

TRIGger<1|2>[:SEQuence]:SOURce IMMEDIATE | EXTernal | VIDeo | IFPower | RFPower | AF | FM | AM | PM

This command selects the trigger source for the start of a sweep.



This command is not available during GSM measurements. The trigger source selection has to be done with the command TRIGger<1|2>[:SEQuence]:SYNChronize:ADJust.

Parameter:	<p>IMMEDIATE = automatic triggering the next measurement at the end of the previous one. The value IMMEDIATE corresponds to the FREE RUN setting.</p> <p>EXTernal = the next measurement is triggered by the signal at the external trigger input.</p> <p>VIDeo = the next measurement is triggered by the detection of a signal at the video filter output (not available for FM DEMOD mode).</p> <p>IFPower = the next measurement is triggered by the detection of a signal at the instrument IF (10 MHz bandwidth)</p> <p>RFPower = the next measurement is triggered by the detection of a signal at the instrument RF (80 MHz bandwidth)</p> <p>TV = the next measurement is triggered by the detection of a TV signal according to the settings of the TRIGger:SEQuence:VIDeo-subsystem (not available for FM DEMOD mode)</p> <p>AF FM = the next measurement is triggered by the detection of a FM modulated signal (AF is synonymous with FM)</p> <p>AM = the next measurement is triggered by the detection of a audio signal after AM demodulation</p> <p>PM = the next measurement is triggered by the detection of a audio signal after PM demodulation</p>
-------------------	--



To ensure successful triggering with trigger sources AF, AM, FM, and PM the measurement time should include at least 5 periods of the audio signal.

Example: "TRIG:SOUR EXT" 'Selects the external trigger input as source of the trigger 'signal

Characteristics: *RST value: IMMEDIATE
SCPI: conforming

UNIT Subsystem

The UNIT subsystem is used to switch the basic unit of setting parameters. A distinction is made between UNIT1 (screen A) and UNIT2 (screen B).

COMMAND	PARAMETERS	UNIT	COMMENT
UNIT<1 2> :ANGLE :DDM :PMETer: :POWer :RATio :POWer :THD	DEG RAD UNITless PCT DBM WATT W DB PCT DBM V A W DBPW WATT DBUV DBMV VOLT DBUA AMPere DB PCT		

UNIT:ANGLE DEG | RAD

This command selects the unit for angles.

Example: "UNIT:ANGL DEG"

Characteristics: *RST value: RAD
SCPI: conforming

UNIT<1|2>:DDM UNITless | PCT

This command selects the unit for ILS DDM reading.

Example: "UNIT:DDM PCT"

Characteristics: *RST value: UNITless
SCPI: compliant

UNIT<1|2>:PMETer:POWer DBM | WATT | W

This command selects the unit for absolute measurements with a power sensor.

Example: "UNIT:PMET:POW DBM"

Characteristics: *RST value: DBM
SCPI: compliant

UNIT<1|2>:PMETer:POWer:RATio DB | PCT

This command selects the unit for relative measurements with a power sensor.

Example: "UNIT:PMET:POW DB"

Characteristics: *RST value: DB
SCPI: compliant

UNIT<1|2>:POWER DBM | DBPW | WATT | DBUV | DBMV | VOLT | DBUA | AMPere | V | A | W

This command selects the default unit for the selected measurement window.

DBxx_MHZ indicates the units dBxx/MHz and DBxx_MMHZ indicates the units dBxx/mMHz (the measured level is referenced to a 1 MHz bandwidth).



This command is not available in GSM/EDGE mode. In GSM/EDGE mode, the unit is fixed, i.e. dBm (for power measurements) or deg (for phase error measurements).

Example: "UNIT:POW DBUV" 'Sets the power unit for screen A to dBm.

Characteristics: *RST value: DBM
SCPI: conforming

UNIT<1|2>:THD DB | PCT

Selects the unit for THD measurements.

Example: "UNIT:THD PCT"

Characteristics: *RST value: DB
SCPI: device-specific

IEC/IEEE-Bus Commands of HP Models 856xE, 8566A/B, 8568A/B and 8594E

Introduction

The R&S FSMR analyzer family supports a subset of the IEC/IEEE-bus commands of HP models 8560E, 8561E, 8562E, 8563E, 8564E, 8565E, 8566A, 8566B, 8568A, 8568B and 8594E.

Despite the differences in system architecture and device features, the supported commands have been implemented in a way to ensure a sufficiently high degree of correspondence with the original.

This includes the support of syntax rules for not only newer device families (B and E models) but for the previous A family as well.

In many cases the selection of commands supported by the R&S FSMR is sufficient to run an existing IEC/IEEE-bus program without adaptation.

The device model to be emulated is selected manually by means of the key sequence *SETUP - GENERAL SETUP - GPIB - GPIB LANGUAGE* via the IEC/IEEE bus using the *SYSTEM:LANGUage* command.

To make it possible to also emulate device models that are not part of the selection list of the GPIB LANGUAGE softkey, the identification string received in response to the ID command can be modified (key sequence *SETUP - GENERAL SETUP - GPIB - ID STRING USER*). This allows any device model to be emulated whose command set is compatible with one of the supported device models.

Command Set of Models 8560E, 8561E, 8562E, 8563E, 8564E, 8565E, 8566A/B, 8568A/B and 8594E

Supported in addition to the manual:

85xx - command	Modification	Description
DA	1)	Display address
DISPOSE	ONEOS TRMATH ONSWP ALL <numeric_value> 1)	
DW	1)	Write to display and increment address
KSg		CRT beam off
KSh		CRT beam on
KSn	1)	Grid on
MKDR?		Delta marker reverse query
PA	1)	Plot absolute
PD	1)	Pen down
PLOTORG	1)	Plot origin
PLOTSRC	1)	Plot source
RCLTHRU		Recall the thru-reference trace into trace B, set instrument to stored thru-reference state.
TACL?, TBCL?, TCCL?		Returns instantaneous measurement results. See TRACe<trace #>:IMMediate: LEVel? for full description.
TACR?, TBCR?, TCCR?		Returns instantaneous measurement results. See TRACe<trace #>:IMMediate: RESult? for full description.
TDF	Parameters: P Meas Unit, like dBm, V etc. (already supported) M Display Unit B Binary A Binary with length I Binary without length	Trace data format

85xx - command	Modification	Description
TRA/TRB	Trace input in the following format: B Binary data without header A Binary data with length I Binary data without length	Transfer A Transfer B

¹⁾ Command accepted, but ignored

As with the original units, the R&S FSMR includes the command set of the A models in the command set of the B models.

Command	Supported subset	Function	Corresponding HP-Models	Status
A1	A1	Clear/Write A	HP 8566A/ HP 8568A	available
A2	A2	Max Hold A	HP 8566A/ HP 8568A	available
A3	A3	View A	HP 8566A/ HP 8568A	available
A4	A4	Blank A	HP 8566A/ HP 8568A	available
ABORT ¹⁾	ABORT	Stop previous function	HP 856xE / HP 8566B / HP 8568B / HP 8594E	available
ADD		Add	HP 8566B / HP 8568B / HP 8594E	available in V4.1x and above
ADJALL	ADJALL	Adjust all	HP 856xE / HP 8566B / HP 8568B / HP 8594E	available in V3.2x and above
ADJCRT ²⁾	ADJCRT	Adjust CRT	HP 856xE / HP 8566B / HP 8568B / HP 8594E	available in V3.2x and above
ADJIF ²⁾	ADJIF	Auto adjust IF	HP 856xE / HP 8566B / HP 8568B / HP 8594E	available in V3.2x and above
AMB	AMB ON OFF AMB 1 0 AMB?	Trace A - B -> Trace A	HP 856xE / HP 8594E	available in V3.3x and above
AMBPL	AMBPL ON OFF AMBPL 1 0 AMBPL?		HP 856xE / HP 8566B / HP 8568B / HP 8594E	available
ANNOT	ANNOT ON OFF ANNOT 1 0 ANNOT?	Annotation	HP 856xE / HP 8566B / HP 8568B / HP 8594E	available
APB	APB	Trace A + B -> Trace A	HP 856xE / HP 8566B / HP 8568B / HP 8594E	available in V3.3x and above
AT	AT <numeric_value> DB DM AT DN AT UP AT AUTO AT?	Attenuation	HP 8566A/ HP 8568A/ HP 856xE / HP 8566B / HP 8568B / HP 8594E	available

Command	Supported subset	Function	Corresponding HP-Models	Status
AUNITS	AUNITS DBM DBMV DBUV AUNITS?	Amplitude Units	HP 856xE / HP 8566B / HP 8568B / HP 8594E	available
AUTOCPPL	AUTOCPPL	Coupling default	HP 856xE / HP 8566B / HP 8568B / HP 8594E	available in V3.2x and above
AXB	AXB	Exchange trace A and B	HP 856xE / HP 8566B / HP 8568B / HP 8594E	available in V3.2x and above
B1	B1	Clear/Write B	HP 8566A/ HP 8568A	available
B2	B2	Max Hold B	HP 8566A/ HP 8568A	available
B3	B3	View B	HP 8566A/ HP 8568A	available
B4	B4	Blank B	HP 8566A/ HP 8568A	available
BL	BL	Trace B - Display Line -> Trace B	HP 8566A/ HP 8568A	available in V3.3x and above
BML	BML	Trace B - Display Line -> Trace B	HP 856xE/ HP8594E	available in V3.3x and above
BTC	BTC	Transfer Trace B - > C	HP 856xE / HP 8566B / HP 8568B / HP 8594E	available in V3.3x and above
BXC	BXC	Exchange Trace B and C	HP 856xE / HP 8566B / HP 8568B / HP 8594E	available in V3.3x and above
BLANK	BLANK TRA TRB TRC	Blank Trace	HP 856xE / HP 8566B / HP 8568B / HP 8594E	available
C1	C1	A-B off	HP 8566A/ HP 8568A	available
C2	C2	A-B -> A	HP 8566A/ HP 8568A	available
CA	CA	Couple Attenuation	HP 8566A/ HP 8568A	available
CAL ¹⁾	CAL ALL CAL ON CAL OFF	Start analyzer self alignment	HP 856xE / HP 8566B / HP 8568B / HP 8594E	available
CF	CF <numeric_value> HZ KHZ MHZ GHZ CF UP CF DN CF?	Center Frequency	HP 8566A/ HP 8568A/ HP 856xE / HP 8566B / HP 8568B / HP 8594E	available
CHANPWR	CHANPWR TRA TRB, <numeric_value>, ?	Channel Power Measurement	HP 856xE / HP 8594E	available in V3.4x and above
CHPWRBW	CHPWRBW <numeric_value> HZ KHZ MHZ GHZ	Channel Power Bandwidth	HP 856xE / HP 8594E	available in V3.4x and above

Command	Supported subset	Function	Corresponding HP-Models	Status
CLRW	CLRW TRA TRB TRC	Clear/Write Trace	HP 856xE / HP 8566B / HP 8568B / HP 8594E	available
CLS ¹⁾	CLS	Clear all status bits	HP 856xE / HP 8566B / HP 8568B / HP 8594E	available
CONTS	CONTS		HP 856xE / HP 8566B / HP 8568B / HP 8594E	available
COUPLE	COUPLE AC DC	Input coupling	HP 856xE / HP 8566B / HP 8568B / HP 8594E	available in V3.2x and above
CR	CR	Couple RBW	HP 8566A/ HP 8568A	available
CS	CS	Couple Step Size	HP 8566A/ HP 8568A	available
CT	CT	Couple SWT	HP 8566A/ HP 8568A	available
CTA		Convert to absolute units	HP 8566B / HP 8568B / HP 8594E	available in V4.1x and above
CV	CV	Couple VBW	HP 8566A/ HP 8568A	available
D1 ²⁾	D1	Display Size normal	HP 8566A/ HP 8568A	available in V3.3x and above
DEMOM ¹⁾	DEMOM ON OFF AM FM	AF Demodulator	HP 856xE / HP 8566B / HP 8568B / HP 8594E	available
DEMOMAGC ²⁾	DEMOMAGC ON OFF 1 0 DEMOMAGC?	Demodulation AGC	HP 856xE / HP 8566B / HP 8568B / HP 8594E	available in V3.2x and above
DEMOMT	DEMOMT <numeric_value> S MS US SC DEMOMT UP DN DEMOMT?	Demodulation time	HP 856xE / HP 8566B / HP 8568B / HP 8594E	available in V3.3x and above
DET	DET POS SMP NEG DET?	Detector	HP 856xE / HP 8566B / HP 8568B / HP 8594E	available
DIV		Divide	HP 8566B / HP 8568B / HP 8594E	available in V4.1x and above
DL	DL <numeric_value> DB DM DL DN DL UP DL ON DL OFF DL?	Display Line	HP 856xE / HP 8566B / HP 8568B / HP 8594E	available
DLE	DLE ON OFF	Display Line enable	HP 856xE / HP 8566B / HP 8568B /	available in V3.3x and above

Command	Supported subset	Function	Corresponding HP-Models	Status
			HP 8594E	
DONE	DONE DONE?	Done query	HP 856xE / HP 8566B / HP 8568B / HP 8594E	available
E1	E1	Peak Search	HP 8566A/ HP 8568A	available
E2	E2	Marker to Center Freq.	HP 8566A/ HP 8568A	available
E3	E3	Deltamarker Step Size	HP 8566A/ HP 8568A	available
E4	E4	Marker to Ref. Level	HP 8566A/ HP 8568A	available
ERR?	ERR?	Error queue query	HP 856xE / HP 8566B / HP 8568B / HP 8594E	available
EX	EX	Exchange trace A and B	HP 8566A / HP 8568A	available in V3.2x and above
FA	FA <numeric_value> HZ KHZ MHZ GHZ FA UP FA DN FA?	Start Frequency	HP 8566A/ HP 8568A/ HP 856xE / HP 8566B / HP 8568B / HP 8594E	available
FB	FB <numeric_value> HZ KHZ MHZ GHZ FB UP FB DN FB?	Stop Frequency	HP 8566A/ HP 8568A/ HP 856xE / HP 8566B / HP 8568B / HP 8594E	available
FOFFSET ¹⁾	FOFFSET <numeric_value> HZ KHZ MHZ GHZ FOFFSET?	Frequency Offset	HP 856xE / HP 8566B / HP 8568B / HP 8594E	available
FREF	FREF INT EXT	Reference Frequency	HP 856xE / HP 8566B / HP 8568B / HP 8594E	available in V3.2x and above
FS	FS	Full Span	HP 8566A/ HP 8568A	available
GATE ¹⁾	GATE ON OFF GATE 1 0		HP 856xE / HP 8566B / HP 8568B / HP 8594E	available
GATECTL ¹⁾	GATECTL EDGE LEVEL GATECTL?		HP 856xE / HP 8566B / HP 8568B / HP 8594E	available
GD ¹⁾	GD <numeric_value> US MS SC GD DN GD UP GD?		HP 856xE / HP 8566B / HP 8568B / HP 8594E	available
GL ¹⁾	GL <numeric_value> US MS SC GL DN GL UP GL?		HP 856xE / HP 8566B / HP 8568B / HP 8594E	available

Command	Supported subset	Function	Corresponding HP-Models	Status
GP ¹⁾	GP POS NEG GP?		HP 856xE / HP 8566B / HP 8568B / HP 8594E	available
GRAT ²⁾	GRAT ON OFF	Graticule	HP 856xE / HP 8566B / HP 8568B / HP 8594E	available in V3.2x and above
I1	I1		HP 8566A/ HP 8568A	available
I2	I2		HP 8566A/ HP 8568A	available
ID	ID ID?	Identify	HP 8566A/ HP 8568A/ HP 856xE / HP 8566B / HP 8568B / HP 8594E	available
INZ ¹⁾	INZ 75 INZ 50 INZ?	Input Impedance	HP 856xE / HP 8566B / HP 8568B / HP 8594E	available
IP	IP	Instrument preset	HP 8566A/ HP 8568A	available
KS=	KS= <numeric_value> HZ KHZ MHZ GHZ KS= DN KS= UP KS=?	Marker Frequency Counter Resolution	HP 8566A/ HP 8568A	available
KS/	KS/	Manual Peaking	HP 8566A/ HP 8568A	available in V3.2x and above
KS(KS(Lock register	HP 8566A/ HP 8568A	available in V3.4x and above
KS)	KS)	Unlock register	HP 8566A/ HP 8568A	available in V3.4x and above
KS91	KS91	Read Amplitude Error	HP 8566A/ HP 8568A	available in V3.4x and above
KSA	KSA	Amplitude Units in dBm	HP 8566A/ HP 8568A	available
KSB	KSB	Amplitude Units in dBmV	HP 8566A/ HP 8568A	available
KSC	KSC	Amplitude Units in dBuV	HP 8566A/ HP 8568A	available
KSD	KSD	Amplitude Units in V	HP 8566A/ HP 8568A	available
KSE	KSE <numeric_value> <char data>@	Title mode	HP 8566A/ HP 8568A	available
KSG	KSG KSG ON KSG <numeric_value>	Video Averaging on	HP 8566A/ HP 8568A	available
KSH	KSH	Video Averaging Off	HP 8566A/ HP 8568A	available
KSK		Marker to Next Peak	HP 8566A/ HP 8568A	available

Command	Supported subset	Function	Corresponding HP-Models	Status
KSL		Marker Noise off	HP 8566A/ HP 8568A	available
KSM		Marker Noise on	HP 8566A/ HP 8568A	available
KSO	KSO	Deltamarker to span	HP 8566A/ HP 8568A	available in V3.2x and above
KSP	KSP <numeric_value>	HPIB address	HP 8566A/ HP 8568A	available
KSQ ²⁾	KSQ	Band lock off	HP 8566A/ HP 8568A	available in V3.2x and above
KST	KST	Fast Preset	HP 8566A/ HP 8568A	available
KSV	KSV <numeric_value> HZ KHZ MHZ GHZ KSV?	Frequency Offset	HP 8566A/ HP 8568A	available
KSW	KSW	Error Correction Routine	HP 8566A/ HP 8568A	available
KSX	KSX	Correction Values On	HP 8566A/ HP 8568A	available
KSY	KSY	Correction Values Off	HP 8566A/ HP 8568A	available
KSZ	KSZ <numeric_value> DB KSZ?	Reference Value Offset	HP 8566A/ HP 8568A	available
KSa	KSa	Normal Detection	HP 8566A/ HP 8568A	available
KSb	KSb	Pos Peak Detection	HP 8566A/ HP 8568A	available
KSc	KSc	Neg Peak Detection	HP 8566A/ HP 8568A	available
KSe	KSe	Sample Detection	HP 8566A/ HP 8568A	available
KSj	KSj	View Trace C	HP 8566A/ HP 8568A	available
KSk	KSk	Blank Trace C	HP 8566A/ HP 8568A	available
KSl	KSl	Transfer B to C	HP 8566A/ HP 8568A	available
KSm	KSm	Graticule off	HP 8566A/ HP 8568A	available
KSn	KSn	Grid on	HP 8566A/ HP 8568A	available in V3.2x and above
KSo	KSn	Character display off	HP 8566A/ HP 8568A	available in V3.2x and above
KSp	KSp	Character display on	HP 8566A/ HP 8568A	available in V3.2x and above
KSr	KSr	Create service request	HP 8566A/ HP 8568A	available in V3.2x and above
KSt ²⁾	KSt	Band lock on	HP 8566A/ HP 8568A	available in V3.2x and above
KSv ²⁾	KSv	Signal ident on	HP 8566A/ HP 8568A	available in V3.2x and above

Command	Supported subset	Function	Corresponding HP-Models	Status
L0	L0	Display line off	HP 8566A/ HP 8568A	available in V3.2x and above
LB	LB <numeric_value> <char data>@	Label	HP 8566A/ HP 8568A	available in V3.2x and above
LF	LF	Low frequency band preset	HP 8566A/ HP 8568A	available in V3.2x and above
LG	LG <numeric_value> DB DM LG?	Amplitude Scale Log	HP 856xE / HP 8566B / HP 8568B / HP 8594E	available
LL ²⁾	LL	Plot command	HP 8566A/ HP 8568A	available in V3.2x and above
LN	LN	Amplitude Scale Lin	HP 856xE / HP 8566B / HP 8568B / HP 8594E	available
M1	M1	Marker Off	HP 8566A/ HP 8568A	available
M2	M2 M2 <numeric_value> HZ KHZ MHZ GHZ M2 DN M2 UP M2?	Marker Normal	HP 8566A/ HP 8568A	available
M3	M3 M3 <numeric_value> HZ KHZ MHZ GHZ M3 DN M3 UP M3?	Delta Marker	HP 8566A/ HP 8568A	available
M4	M4 <numeric_value> HZ KHZ MHZ GHZ	Marker Zoom	HP 8566A/ HP 8568A	available
MA	MA	Marker Amplitude	HP 8566A/ HP 8568A	available
MC0	MC0	Marker Count off	HP 8566A/ HP 8568A	available
MC1	MC1	Marker Count on	HP 8566A/ HP 8568A	available
MF	MF MF?	Marker Frequency	HP 8566A/ HP 8568A/ HP 856xE / HP 8566B / HP 8568B / HP 8594E	available
MINH ¹⁾	MINH TRC	Minimum Hold	HP 856xE / HP 8566B / HP 8568B / HP 8594E	available
MKA	MKA <numeric_value> MKA?	Marker Amplitude	HP 856xE / HP 8566B / HP 8568B / HP 8594E	MKA <numeric_value> available in V3.4x and above query always available
MKACT	MKACT 1 MKACT?	Select the active marker	HP 856xE / HP 8566B / HP 8568B / HP 8594E	available

Command	Supported subset	Function	Corresponding HP-Models	Status
MKBW ¹⁾	MKBW <numeric_value> MKBW ON MKBW OFF	N dB Down	HP 856xE / HP 8566B / HP 8568B / HP 8594E	available
MKD	MKD MKD <numeric_value> HZ KHZ MHZ GHZ MKD DN MKD UP MKD ON MKD OFF MKD?	Delta Marker	HP 856xE / HP 8566B / HP 8568B / HP 8594E	available
MKDR	MKDR <numeric_value> HZ KHZ MHZ GHZ S SC MS MSEC USMKD R?	Delta Marker reverse	HP 856xE / HP 8566B / HP 8568B / HP 8594E	query available in V3.2x and above, completely available in V3.3x and above
MKF	MKF <numeric_value> HZ KHZ MHZ GHZ MKF?	Set Marker Frequency	HP 856xE / HP 8566B / HP 8568B / HP 8594E	available
		Marker On		hidden
MKFC	MKFC ON OFF	Frequency Counter on/off	HP 856xE / HP 8566B / HP 8568B / HP 8594E	available in V3.2x and above
MKFCR ¹⁾	MKFCR <numeric_value>HZ KHZ MHZ GHZ MKFCR DN MKFCR UP MKFCR?	Frequency Counter Resolution	HP 856xE / HP 8566B / HP 8568B / HP 8594E	available
MKMIN	MKMIN	Marker -> Min	HP 856xE / HP 8566B / HP 8568B / HP 8594E	available
MKN	MKN MKN <numeric_value> HZ KHZ MHZ GHZ MKN DN MKN UP MKN ON MKN OFF MKN?	Normal Marker	HP 856xE / HP 8566B / HP 8568B / HP 8594E	available
MKNOISE	MKNOISE ON OFF MKNOISE 1 0 MKNOISE?	Noise Measurement	HP 856xE / HP 8566B / HP 8568B / HP 8594E	available
MKOFF	MKOFF MKOFF ALL	Marker off	HP 856xE / HP 8566B / HP 8568B / HP 8594E	available
MKP	MKP <numeric_value> MKP?	Marker position	HP 856xE / HP 8566B / HP 8568B / HP 8594E	available in V3.4x and above

Command	Supported subset	Function	Corresponding HP-Models	Status
MKPK	MKPK MKPK HI MKPK NH MKPK NR MKPK NL	Marker Search	HP 856xE / HP 8566B / HP 8568B / HP 8594E	available
MKPT	MKPT MKPT HI MKPT NH MKPT NR MKPT NL	Marker Peak Threshold	HP 856xE / HP 8566B / HP 8568B / HP 8594E	available
MKPX	MKPX <numeric_value> DB MKPX DN MKPX UP MKPX?	Peak Excursion	HP 856xE / HP 8566B / HP 8568B / HP 8594E	available
MPY		Multiply	HP 8566B / HP 8568B HP 8594E	available in V4.1x and above
MKRL	MKRL	Ref Level = Marker Level	HP 856xE / HP 8566B / HP 8568B / HP 8594E	available
MKSP	MKSP	Deltamarker to span	HP 856xE / HP 8566B / HP 8568B / HP 8594E	available in V3.2x and above
MKSS	MKSS	CF Stepsize = Marker Freq	HP 856xE / HP 8566B / HP 8568B / HP 8594E	available
MKT	MKT <numeric_value> S MS US SC MKT?	MKF = fstart + MKT/SWT*Span	HP 856xE / HP 8594E	available in V3.3x and above
MKTRACE	MKTRACE TRA TRB TRC	Marker to Trace	HP 856xE / HP 8566B / HP 8568B / HP 8594E	available
MKTRACK	MKTRACK ON OFF MKTRACK 1 0 MKTRACK?	Signal Track	HP 856xE / HP 8566B / HP 8568B / HP 8594E	available
MKTYPE	MKTYPE AMP MKTYPE?	Marker type	HP 856xE / HP 8566B / HP 8568B / HP 8594E	available in V3.4x and above
MOV	MOV TRA TRB TRC,TRA TRB TRC	Move Trace Contents	HP 856xE / HP 8566B / HP 8568B / HP 8594E	available
MT0	MT0	Marker Track Off	HP 8566A/ HP 8568A	available
MT1	MT1	Marker Track On	HP 8566A/ HP 8568A	available
MXMH	MXMH TRA TRB	Maximum Hold	HP 856xE / HP 8566B / HP 8568B / HP 8594E	available
NORMALIZE	NORMALIZE	Normalize trace	HP 856xE /	available in V4.1x and above

Command	Supported subset	Function	Corresponding HP-Models	Status
			HP 8566B / HP 8568B / HP 8594E	
NRL ¹⁾	NRL <numeric_value> DB DM NRL?	Normalized Reference Level	HP 856xE / HP 8566B / HP 8568B / HP 8594E	available
NRPOS	NRPOS <numeric_value> NRL?	Normalize position	HP 856xE / HP 8566B / HP 8568B / HP 8594E	available in V3.2x and above
O1	O1	Format ASCII, Values 0 to 4095	HP 8566A/ HP 8568A	available
O2	O2	Format Binary, Values 0 to 4095	HP 8566A/ HP 8568A	available in V3.3x and above
O3	O3	Format ASCII	HP 8566A/ HP 8568A	available
OA	OA	Output All	HP 8566A/ HP 8568A	available
OL	OL <80 characters> OL?	Output Learn String	HP 8566A/ HP 8568A	available
OT	OT	Output Trace Annotations	HP 8566A/ HP 8568A	available
PA ²⁾	PA <numeric_value>, <numeric_value	Plot command	HP 8566A/ HP 8568A	available in V3.2x and above
PD ²⁾	PD <numeric_value>, <numeric_value	Plot command	HP 8566A/ HP 8568A	available in V3.2x and above
PLOTORG ²⁾	PLOTORG DSP GRT	Plot command	HP 856xE / HP 8566B / HP 8568B / HP 8594E	available in V3.2x and above
PLOTSRC ²⁾	PLOTSRC ANNT GRT TRB TRA ALLDSP GRT	Plot command	HP 856xE / HP 8566B / HP 8568B / HP 8594E	available in V3.2x and above
PP	PP	Preselector Peaking	HP 8566A/ HP 8568A	available
PRINT ¹⁾	PRINT PRINT 1 0	Hardcopy	HP 856xE / HP 8566B / HP 8568B / HP 8594E	available
PSDAC ²⁾	PSDAC <numeric_value> PSDAC UP DN	Preselector DAC value	HP 856xE / HP 8566B / HP 8568B / HP 8594E	available in V3.2x and above
PSTATE ²⁾	PSTATE ON OFF 1 0	Protect State	HP 856xE / HP 8566B / HP 8568B / HP 8594E	available in V3.2x and above
PU ²⁾	PU	Pen Up	HP 8566A/ HP 8568A	available in V3.3x and above
R1	R1	Set Status Bit Enable	HP 8566A/ HP 8568A	available
R2	R2	Set Status Bit Enable	HP 8566A/ HP 8568A	available

Command	Supported subset	Function	Corresponding HP-Models	Status
R3	R3	Set Status Bit Enable	HP 8566A/ HP 8568A	available
R4	R4	Set Status Bit Enable	HP 8566A/ HP 8568A	available
RB	RB <numeric_value> HZ KHZ MHZ GHZ RB DN RB UP RB AUTO RB?	Resolution Bandwidth	HP 856xE / HP 8566B / HP 8568B / HP 8594E	available
RBR	RBR <numeric_value> RBR DN RBR UP RBR?	Resolution Bandwidth Ratio	HP 856xE / HP 8566B / HP 8568B / HP 8594E	available in V3.2x and above
RC1...6	RC1...6	Recall Last State	HP 8566A/ HP 8568A	available
RCLS	RCLS <numeric_value>	Recall State Register	HP 856xE / HP 8566B / HP 8568B / HP 8594E	available
RCLT	RCLT TRA TRB,<number>	Recall Trace	HP856xE / HP8594E	available in V3.3x and above
RESET	RESET	Instrument preset	HP 856xE / HP 8566B / HP 8568B / HP 8594E	available
REV	REV REV?	Firmware revision	HP 856xE / HP 8566B / HP 8568B / HP 8594E	available
RL	RL <numeric_value> DB DM RL DN RL UP RL?	Reference Level	HP 856xE / HP 8566B / HP 8568B / HP 8594E	available
RLCAL	RLCAL <numeric_value> RL?	Reference Level Calibration	HP 856xE / HP 8566B / HP 8568B / HP 8594E	available in V3.2x and above
RCLOSCAL	RCLOSCAL	Recall Open/Short Average	HP 856xE / HP 8594E	available in V3.3x and above
RCLTHRU	RCLTHRU	Recall Thru	HP 856xE / HP 8594E	available in V3.3x and above
RLPOS ¹⁾	RLPOS <numeric_value> RLPOS DN RLPOS UP RLPOS?	Reference Level Position	HP 856xE / HP 8566B / HP 8568B / HP 8594E	available
ROFFSET	ROFFSET <numeric_value> DB DM ROFFSET?	Reference Level Offset	HP 856xE / HP 8566B / HP 8568B / HP 8594E	available
RQS	RQS	Service Request Bit mask	HP 856xE / HP 8566B / HP 8568B / HP 8594E	available
S1	S1	Continuous Sweep	HP 8566A/ HP 8568A	available

Command	Supported subset	Function	Corresponding HP-Models	Status
S2	S2	Single Sweep	HP 8566A/ HP 8568A	available
SAVES	SAVES <numeric_value>	Save State Register	HP 856xE / HP 8566B / HP 8568B / HP 8594E	available
SAVET	SAVET TRA TRB,<number>	Save Trace	HP856xE / HP8594E	available in V3.3x and above
SMOOTH	SMOOTH TRA TRB TRC, <number of points>	Smooth Trace	HP 856xE / HP 8566B / HP 8568B / HP 8594E	available in V3.4x and above
SNGLS	SNGLS	Single Sweep	HP 856xE / HP 8566B / HP 8568B / HP 8594E	available
SQUELCH ²⁾	SQUELCH <numeric_value> DM DB SQUELCH UP DN SQUELCH ON OFF	Squelch	HP 856xE / HP 8566B / HP 8568B / HP 8594E	available in V3.3x and above
SP	SP <numeric_value> HZ KHZ MHZ GHZ SP DN SP UP SP?	Span	HP 8566A/ HP 8568A/ HP 856xE / HP 8566B / HP 8568B / HP 8594E	available
SRCNORM ¹⁾	SRCNORM ON OFF SRCNORM 1 0	Source Normalization	HP 856xE / HP 8566B / HP 8568B / HP 8594E	available
SRCPOFS ¹⁾	SRCPOFS <numeric_value> DB DM SRCPOFS DN SRCPOFS UP SRCPOFS?	Source Power Offset	HP 856xE / HP 8566B / HP 8568B / HP 8594E	available
SRCPWR ¹⁾	SRCPWR <numeric_value> DB DM SRCPWR DN SRCPWR UP SRCPWR ON SRCPWR OFF SRCPWR?	Source Power	HP 856xE / HP 8566B / HP 8568B / HP 8594E	available
SS	SS <numeric_value> HZ KHZ MHZ GHZ SS DN SS UP SS AUTO SS?	CF Step Size	HP 8566A/ HP 8568A/ HP 856xE / HP 8566B / HP 8568B / HP 8594E	available
ST	ST <numeric_value> US MS SC ST DN ST UP ST AUTO ST?	Sweep Time	HP 8566A/ HP 8568A/ HP 856xE / HP 8566B / HP 8568B / HP 8594E	available
STB	STB	Status byte query	HP 856xE / HP 8566B / HP 8568B / HP 8594E	available
STOREOPEN	STOREOPEN	Store Open	HP 856xE /	available in V3.3x and above

Command	Supported subset	Function	Corresponding HP-Models	Status
			HP 8594E	
STORESHORT	STORESHORT	Store Short	HP 856xE / HP 8594E	available in V3.3x and above
STORETHRU	STORETHRU	Store Thru	HP 856xE / HP 8594E	available in V3.3x and above
SUB		Subtract	HP 8566B / HP 8568B / HP 8594E	available in V4.1x and above
SV1...6	SV1...6	Save State	HP 8566A/ HP 8568A	available
SWPCPL ²⁾	SWPCPL SA SR SWPCPL?	Sweep Couple	HP 856xE / HP 8566B / HP 8568B / HP 8594E	available in V3.3x and above
SWPOUT ²⁾	SWPOUT FAV FAVA RAMP SWPOUT?	Sweep Output	HP 856xE / HP 8566B / HP 8568B / HP 8594E	available in V3.2x and above
T0	T0	Threshold off	HP 8566A/ HP 8568A	available
T1	T1	Free Run Trigger	HP 8566A/ HP 8568A	available
T2 ²⁾	T2	Line Trigger	HP 8566A/ HP 8568A	available
T3	T3	External Trigger	HP 8566A/ HP 8568A	available
T4	T4	Video Trigger	HP 8566A/ HP 8568A	available
TA	TA	Transfer A	HP 8566A/ HP 8568A	available
TB	TB	Transfer B	HP 8566A/ HP 8568A	available
TDF	TDF P TDF?	Trace Data Format	HP 856xE / HP 8566B / HP 8568B / HP 8594E	available
TH	TH <numeric_value> DB DM TH DN TH UP TH ON TH OFF TH AUTO TH?	Threshold	HP 856xE / HP 8566B / HP 8568B / HP 8594E	available
THE	THE ON OFF	Threshold Line enable	HP 856xE / HP 8566B / HP 8568B / HP 8594E	available in V3.3x and above
TIMEDSP ¹⁾	TIMEDSP ON OFF TIMEDSP 1 0 TIMEDSP?	Time Display	HP 856xE / HP 8566B / HP 8568B / HP 8594E	available
TM	TM FREE VID EXT LINE ²⁾ TM?	Trigger Mode	HP 856xE / HP 8566B / HP 8568B / HP 8594E	available

Command	Supported subset	Function	Corresponding HP-Models	Status
TRA	TRA?	Transfer A	HP 856xE / HP 8566B / HP 8568B / HP 8594E	available
TRB	TRB?	Transfer B	HP 856xE / HP 8566B / HP 8568B / HP 8594E	available
TRSTAT	TRSTAT?	Trace State Query	HP 856xE / HP 8566B / HP 8568B / HP 8594E	available in V3.3x and above
TS	TS	Take Sweep	HP 856xE / HP 8566B / HP 8568B / HP 8594E	available
UR ²⁾	UR	Plot Command	HP 8566A/ HP 8568A	available in V3.2x and above
VARDEF		Variable definition arrays are not supported	HP 8566B / HP 8568B / HP 8594E	available in V4.1x and above, ignored in earlier versions
VAVG	VAVG VAVG TRA TRB TRC	Video Averaging	HP 856xE / HP 8566B / HP 8568B / HP 8594E	available
VB	VB <numeric_value> HZ KHZ MHZ GHZ VB DN VB UP VB AUTO VB?	Video Bandwidth	HP 856xE / HP 8566B / HP 8568B / HP 8594E	available
VBR ¹⁾	VBR <numeric_value> VBR DN VBR UP VBR?	Video Bandwidth Ratio	HP 856xE / HP 8566B / HP 8568B / HP 8594E	available
VIEW	VIEW TRA TRB TRC		HP 856xE / HP 8566B / HP 8568B / HP 8594E	available
VTL	VTL <numeric_value> DB DM VTL DN VTL UP VTL?	Video Trigger Level	HP 856xE / HP 8594E	available in V3.3x and above

¹⁾ HP 8594E only

²⁾ Command will be accepted without error message, but will be ignored

856x: Emulation of the Spurious Response Measurement Utility 85672A

General commands for Spurious

Command	Supported subset	Function	Corresponding HP-Models	Status
---------	------------------	----------	-------------------------	--------

SP_OK		A value of 1 denotes a successful measurement	HP 856xE	available in V4.1x and above
SP_RMT		A value of 1 means, that the instrument settings are saved to register 9	HP 856xE	available in V4.1x and above
SP_EXTREF		0: use internal reference, 1: use external reference	HP 856xE	available in V4.1x and above
SP_EXIT		Quits spurious	HP 856xE	available in V4.1x and above

Commands for TOI-Measurement

Command	Supported subset	Function	Corresponding HP-Models	Status
SP_TOI		Executes TOI measurement	HP 856xE	available in V4.1x and above
SP_TOIFA		Lower primary signal frequency in Hz	HP 856xE	available in V4.1x and above
SP_TOIFB		Upper primary signal frequency in Hz	HP 856xE	available in V4.1x and above
SP_TOIFS		Primary signal frequency spacing in Hz	HP 856xE	available in V4.1x and above
SP_TOI_SL		Lower signal amplitude in dBm	HP 856xE	available in V4.1x and above
SP_TOI_SU		Upper signal amplitude in dBm	HP 856xE	available in V4.1x and above
SP_TOI_PL		Lower distortion product amplitude in dBm	HP 856xE	available in V4.1x and above
SP_TOI_PU		Upper distortion product amplitude in dBm	HP 856xE	available in V4.1x and above
SP_TOI_A, SP_TOI_B		Third order intercept point in dBm	HP 856xE	available in V4.1x and above
SP_TOINA, SP_TOINB		The flag = 0 indicates a good measurement	HP 856xE	available in V4.1x and above

Commands for Harmonic Distortion

Command	Supported subset	Function	Corresponding HP-Models	Status
SP_HARM		Executes harmonic distortion measurement	HP 856xE	available in V4.1x and above
SP_H_MAX		Maximum harmonic to be measured, range is from 2 to 10	HP 856xE	available in V4.1x and above
SP_H_FFLAG		Displays or hides harmonics	HP 856xE	available in V4.1x and above
SP_HBWMIN		Min resolution bandwidth	HP 856xE	available in V4.1x and above
SP_H_LVL[1..10]		Array of amplitudes for each harmonic in dBc relative to the fundamental. SP_H_LVL[1] = 0 (the level of the fundamental in dBc). The index is the number of the harmonic	HP 856xE	available in V4.1x and above
SP_THD		Total harmonic distortion in percent	HP 856xE	available in V4.1x and above
SP_H_NS[1..10]		Array of flags corresponding to each measurement in the SP_H_LVL array. A value of 0 denotes a good measurement	HP 856xE	available in V4.1x and above
SP_H_FRQ		Frequency of the fundamental in Hz	HP 856xE	available in V4.1x and above
SP_H_AMP		Amplitude of the fundamental in dBm	HP 856xE	available in V4.1x and above

Commands for Spurious

Command	Supported subset	Function	Corresponding HP-Models	Status
SP_TIME		Calculates an estimated time for the spurious search	HP 856xE	available in V4.1x and above
SP_GEN		Executes the spurious search	HP 856xE	available in V4.1x and above
SP_SR_FL		Lower search limit in Hz	HP 856xE	available in V4.1x and above
SP_SR_FU		Upper search limit in Hz	HP 856xE	available in V4.1x and above
SP_DBCFLG		Values in dBm (SP_DBCFLG = 0) or dBc (SP_DBCFLG=1)	HP 856xE	available in V4.1x and above
SP_SR_TH		Lower search amplitude limit in dBm or dBc	HP 856xE	available in V4.1x and above
SP_SR_TG		Upper search amplitude limit in dBm or dBc	HP 856xE	available in V4.1x and above
SP_SRTFLG		Sort flag, 0 = sort output by frequencies, 1 = sort output by amplitudes	HP 856xE	available in V4.1x and above
SP_SR_TM		Estimated search time in seconds	HP 856xE	available in V4.1x and above
SP_NUMSP		Number of spurious signals found	HP 856xE	available in V4.1x and above

				above
SP_SR_F[1..50]		Array of frequencies in Hz for spurious signals found	HP 856xE	available in V4.1x and above
SP_SR_A[1..50]		Array of amplitudes of the spurious signals found in dBm or dBc	HP 856xE	available in V4.1x and above
SP_SR_CF		Reference frequency in Hz for dBc mode	HP 856xE	available in V4.1x and above
SP_SR_CP		Reference amplitude in dBm for dBc mode	HP 856xE	available in V4.1x and above

856x: Emulation of the Phase Noise Utility 85671A

The following commands require option FS-K40 installed and enabled.

Command	Supported subset	Function	Corresponding HP-Models	Status
PH_MKF		Spot frequency in Hz	HP 856xE	available in V4.1x and above
PH_FMIN		Min offset frequency to be measured	HP 856xE	available in V4.1x and above
PH_FMAX		Max offset frequency to be measured	HP 856xE	available in V4.1x and above
PH_MKA		Queries amplitude at the spot frequency	HP 856xE	available in V4.1x and above
PH_DRIFT		0: for stable signals, 1: for drifty	HP 856xE	available in V4.1x and above
PH_RLVL		Reference level for the log plot	HP 856xE	available in V4.1x and above
PH_SMTHV		Trace smoothing	HP 856xE	available in V4.1x and above
PH_VBR		Filtering	HP 856xE	available in V4.1x and above
PH_RMSPT		Amount of data points to skip when doing the integration	HP 856xE	available in V4.1x and above
PH_RMSFL		Lower integration frequency in Hz	HP 856xE	available in V4.1x and above
PH_RMSFU		Upper integration frequency in Hz	HP 856xE	available in V4.1x and above
PH_EXIT		Quits phase noise	HP 856xE	available in V4.1x and above
PH_F_UDT		Updates internal frequency variables	HP 856xE	available in V4.1x and above
PH_LMT_L		Apply limits to PH_FMIN and PH_FMAX	HP 856xE	available in V4.1x and above
PH_MEAS		Generates log frequency plot	HP 856xE	available in V4.1x and above
PH_MKF_D		Updates the spot frequency	HP 856xE	available in V4.1x and above

Command	Supported subset	Function	Corresponding HP-Models	Status
PH_RMS		Requests the rms phase noise	HP 856xE	available in V4.1x and above
PH_RMSFT		Updates internal frequency variables	HP 856xE	available in V4.1x and above
PH_RMSX		Calculates the rms phase noise	HP 856xE	available in V4.1x and above
PH_SPOTF		Executes the spot frequency measurement	HP 856xE	available in V4.1x and above

Special Features of the Syntax Parsing Algorithms for 8566A and 8568A Models

The command syntax is very different for models A and B. Different names are assigned to identical instrument functions, and the command structure likewise differs considerably between models A and models B.

The command structure for models A is as follows:

<command> ::=

<command code> [<SPC>] [<data> | <step>] [<SPC>] [<delimiter>] [<command code>] ... <delimiter>

<data> ::=

<value> [<SPC>] [<units code>] [<SPC>] [<delimiter>] [<SPC>] [<data>] ...

<step> ::=

UP|DN

where

<command code> = see Table "Supported Commands"

<value> = integer or floating-point numerical value

<units code> = DM | -DM | DB | HZ | KZ | MZ | GZ | MV | UV | SC | MS | US

<delimiter> = <CR> | <LF> | <,> | <;> | <ETX>

<SPC> = 32₁₀

<ETX> = 3₁₀

Command sections given in [] are optional.

The R&S FSMR IEC/IEEE-bus hardware differs from that used in the HP analyzers. Therefore, the following constraint exists:

<LF> | <EOI> are still used as delimiters since the IEC/IEEE-bus hardware is able to identify them. The other delimiters are identified and evaluated during syntax analysis.

Special Behaviour of Commands

Command	Known Differences
ABORT	Does not automatically set the command complete bit (bit 4) in the status byte. An additional DONE is required for that purpose.
ANNOT	Only frequency axis annotation is affected.
AT	AT DN/UP: Step size
CAL	The CAL commands do not automatically set the command complete bit (bit 4) in the status byte. An additional DONE command is required for that purpose.
CF	Default value, range, step size
CR	Default ratio Span / RBW
CT	Formula for coupled sweeptime
CV	Default ratio RBW / VBW
DEMOD	on R&S FSMR: requires option FSP-B3
DET	DET? returns SAMP instead of SMP on the R&S FSMR. DET not automatically set the command complete bit (bit 4) in the status byte. An additional DONE is required for that purpose.
ERR?	Deletes the error bit in the status register but always returns a '0' in response.
FA	Default value, range, step size
FB	Default value, range, step size
ID	Query of instrument type. The instrument type entered with <i>SETUP - GENERAL SETUP - GPIB - ID STRING USER</i> will be returned.
M2	Default value, range, step size

Command	Known Differences
M3	Default value, range, step size
MKACT	Only marker 1 is supported as the active marker.
MKBW	Default value
MKPT	Step size
MKPX	Step size
NRL	
OL?	Storage of instrument settings: 80 characters are returned as information on the instrument settings. The contents of the 80 characters returned does not correspond to the original data contents of the 8566A / 8568A family.
OL	Readout of instrument settings: The 80 characters read by means of OL? are accepted as information on the corresponding instrument settings. The contents of the 80 characters read does not correspond to the original data contents of the 8566A / 8568A family.
RB	Default value, range, step size
RL	Default value, step size
RLPOS	Adapts the position of the reference level even if the tracking generator normalization is not active.
RQS	Supported bits: 1 (Units key pressed) 2 (End of Sweep) 3 (Device error) 4 (Command complete) 5 (Illegal command)
SRCNORM	
SRCPWR	
SP	Default value, range, step size
SS	Default value, range, step size
ST	Default value, range, step size
STB	The status bits are mapped as described with command RQS. <i>Note:</i> <i>Bit 2 and 4 are always set in parallel if "Command Complete" or "End of Sweep" are recognized. The R&S FSMR cannot distinguish between these conditions. Additionally these bits are not suitable for synchronization on the end of sweep in continuous sweep operation.</i>
TA	Output of 1001 trace points of trace A in O1 or O3 format.
TB	Output of 1001 trace points of trace B in O1 or O3 format.
TH	Default value
VB	Range
VBR	Default value

Model-Dependent Default Settings

When the IEC/IEEE-bus language is switched over to an 85xx model, the IEC/IEEE-bus address will automatically be switched over to 18 provided that the default address of the R&S FSMR (20) is still set. If a different value is set, this value will be maintained. Upon return to SCPI, this address will remain unchanged.

The following table shows the default settings obtained after a change of the IEC/IEEE-bus language and for the commands IP, KST and RESET:

Model	# of Trace Points	Start Freq.	Stop Freq.	Ref Level	Input Coupling
8566A/B	1001	2 GHz	22 GHz	0 dBm	DC (FSU) AC (FSP)
8568A/B	1001	0 Hz	1.5 GHz	0 dBm	AC
8560E	601	0 Hz	2.9 GHz	0 dBm	AC
8561E	601	0 Hz	6.5 GHz	0 dBm	AC
8562E	601	0 Hz	13.2 GHz	0 dBm	AC
8563E	601	0 Hz	26.5 GHz	0 dBm	AC
8564E	601	0 Hz	40 GHz	0 dBm	AC
8565E	601	0 Hz	50 GHz	0 dBm	AC
8594E	401	0 Hz	3 GHz	0 dBm	AC

Notes regarding the set stop frequency:

The stop frequency given in the table may be limited to the corresponding frequency range of the R&S FSMR.

Command LF sets the stop frequency for 8566A/B to a maximum value of 2 GHz.

Note regarding the number of test points (trace points):

The # of trace points is switched over only upon transition to the REMOTE state.

Data Output Formats

In the case of the SCPI and IEEE488.2 standards, the output formats for numerical data are flexible to a large extent. The output format for the HP units, by contrast, is accurately defined with respect to the number of digits. The memory areas for reading instrument data have therefore been adapted accordingly in the remote-control programs for instruments of this series.

Therefore, in response to a query, the R&S FSMR returns data of the same structure as that used by the original instruments; this applies in particular to the number of characters returned.

Two formats are currently supported when trace data is output: Display Units (command O1) and physical values (command O2, O3 or TDF P). As to the "Display Units" format, the level data of the R&S FSMR is converted to match the value range and the resolution of the 8566/8568 series. Upon transition to the REMOTE state, the R&S FSMR is reconfigured such that the number of test points (trace points) corresponds to that of the 85xx families (1001 for 8566A/B and 8568A/B, 601 for 8560E to 8565E, 401 for 8594E).

IEC/IEEE-Bus Status Reporting

The assignment of status bits by commands R1, R2, R3, R4, RQS is supported starting at firmware version 1.80. The STB command and the serial poll respond with an 8-bit value having the following assignment:

The return value of a serial poll is to use the STB command in order to identify the reason for the service request. The bits returned by the STB command are mapped in the same way as for the RQS command.

Bit enabled by RQS
1 (Units key pressed)
2 (End of Sweep)
3 (Device Error)
4 (Command Complete)
5 (Illegal Command)
6 (Service Request)

Bits 0 and 7 are not used and always have the value 0.

It should be noted that the R&S FSMR will report any key pressed on the front panel (if bit 1 was enabled) rather than only the unit keys.

Additionally there is a difference in the handling of bit 6. This bit reflects the status of the SRQ line of the GPIB bus on the HP 8590 analyzers. With the R&S FSMR this is not possible. Therefore this bit will be set as soon as any of the bits 1 to 5 is set, but it will not be cleared on a serial poll.

Differences in GPIB behavior between the R&S FSMR and the FSE families of instruments

The following list of commands contains the differences in syntax and behavior between the GPIB command set of the R&S FSMR and the FSE families of instruments. Firmware options like FS-K5 or FSE-K10 are not described in this operating manual as the related commands are not available in the basic instrument. FSE alone in column "Devices" denotes the instrument families FSE, FSIQ, FSET and ESIB, unless otherwise noted in column "Notes".

Devices	Command	Parameter	Notes
R&S FSMR + FSE	*CAL?		R&S FSMR: executes total calibration FSE: executes short calibration
R&S FSMR + FSE	*CLS		
R&S FSMR + FSE	*ESE		
R&S FSMR + FSE	*ESR?		
R&S FSMR + FSE	*IDN?		model indicator and version index is different for R&S FSMR and FSE
R&S FSMR + FSE	*IST?		
R&S FSMR + FSE	*OPC?		
R&S FSMR + FSE	*OPT?		list of available options is slightly different for R&S FSMR and FSE, but equally available options have equal names
R&S FSMR + FSE	*PCB		
R&S FSMR + FSE	*PRE		
R&S FSMR + FSE	*PSC		
R&S FSMR + FSE	*RST		instrument settings are slightly different for R&S FSMR and FSE due to different instrument specs
R&S FSMR + FSE	*SRE		
R&S FSMR + FSE	*STB?		
R&S FSMR + FSE	*TRG		R&S FSMR starts measurement in active screen FSE: starts measurement in both screens (split screen mode)
R&S FSMR + FSE	*TST?		
R&S FSMR + FSE	*WAI		
R&S FSMR + FSE	ABORt		
R&S FSMR	CALCulate:STATistics:APD[:STATe]	ON OFF	new function for R&S FSMR
R&S FSMR	CALCulate:STATistics:CCDF[:STATe]	ON OFF	new function for R&S FSMR
R&S FSMR	CALCulate:STATistics:NSAMples	100 to 1E9	new function for R&S FSMR
R&S FSMR	CALCulate:STATistics:PRESet		new function for R&S FSMR
R&S FSMR	CALCulate:STATistics:Result<1...3>?	MEAN PEAK CFACtor ALL	new function for R&S FSMR
R&S FSMR	CALCulate:STATistics:SCALE:AUTO	ONCE	new function for R&S FSMR
R&S FSMR	CALCulate:STATistics:X:RANGe	-10dB to 200dB	new function for R&S FSMR
R&S FSMR	CALCulate:STATistics:X:RLEVel	-130dBm to 30dBm	new function for R&S FSMR
R&S FSMR	CALCulate:STATistics:Y:LOWer	-1E-9 to 0.1	new function for R&S FSMR

Devices	Command	Parameter	Notes
R&S FSMR	CALCulate:STATistics:Y:UPPer	-1E-8 to 1.0	new function for R&S FSMR
FSE	CALCulate<1 2>:CTHReshold	MIN to MAX	not available in R&S FSMR
FSE	CALCulate<1 2>:CTHReshold:STATe	ON OFF	not available in R&S FSMR
R&S FSMR	CALCulate<1 2>:DELTaMarker<1...4>:AOFF		markers 2...4 are either normal or delta markers; marker 1 always serves as the reference marker for all deltamarkers
FSE	CALCulate<1 2>:DELTaMarker<1...4>:AOFF		there are 4 markers and 4 deltamarkers; the most recently used marker serves as the reference marker for all deltamarkers
R&S FSMR + FSE	CALCulate<1 2>:DELTaMarker<1...4>:FUNCTION:FIXed:RPOint:X	<numeric_value>	R&S FSMR: marker 1 can be moved independently from the reference point FSE: the marker and the reference point are linked to each other
R&S FSMR + FSE	CALCulate<1 2>:DELTaMarker<1...4>:FUNCTION:FIXed:RPOint:Y	<numeric_value>	R&S FSMR: marker 1 can be moved independently from the reference point; FSE: the marker and the reference point are linked to each other
R&S FSMR + FSE	CALCulate<1 2>:DELTaMarker<1...4>:FUNCTION:FIXed:RPOint:Y:OFFSet	<numeric_value>	
R&S FSMR	CALCulate<1 2>:DELTaMarker<1...4>:FUNCTION:FIXed:RPOint:MAX:PEAK		new function for R&S FSMR
R&S FSMR + FSE	CALCulate<1 2>:DELTaMarker<1...4>:FUNCTION:FIXed[:STATe]	ON OFF	
R&S FSMR + FSE	CALCulate<1 2>:DELTaMarker<1...4>:FUNCTION:PNOise:RESult?		
R&S FSMR + FSE	CALCulate<1 2>:DELTaMarker<1...4>:FUNCTION:PNOise[:STATe]	ON OFF	
FSE	CALCulate<1 2>:DELTaMarker<1...4>:MAXimum:APEak		not available for R&S FSMR
R&S FSMR + FSE	CALCulate<1 2>:DELTaMarker<1...4>:MAXimum:LEFT		
R&S FSMR + FSE	CALCulate<1 2>:DELTaMarker<1...4>:MAXimum:NEXT		
R&S FSMR + FSE	CALCulate<1 2>:DELTaMarker<1...4>:MAXimum:RIGHT		
R&S FSMR + FSE	CALCulate<1 2>:DELTaMarker<1...4>:MAXimum[:PEAK]		
R&S FSMR + FSE	CALCulate<1 2>:DELTaMarker<1...4>:MINimum:LEFT		
R&S FSMR + FSE	CALCulate<1 2>:DELTaMarker<1...4>:MINimum:NEXT		
R&S FSMR + FSE	CALCulate<1 2>:DELTaMarker<1...4>:MINimum:RIGHT		
R&S FSMR + FSE	CALCulate<1 2>:DELTaMarker<1...4>:MINimum[:PEAK]		
R&S FSMR + FSE	CALCulate<1 2>:DELTaMarker<1...4>:MODE	ABSolute RELative	
FSE	CALCulate<1 2>:DELTaMarker<1...4>:STEP:AUTO	ON OFF	not available for R&S FSMR
FSE	CALCulate<1 2>:DELTaMarker<1...4>:STEP[:INCRement]	<numeric_value>	not available for R&S FSMR
R&S FSMR + FSE	CALCulate<1 2>:DELTaMarker<1...4>:TRACe	1 to 3	R&S FSMR: 3 traces are available per screen; FSE: 4 traces are available in full screen mode and 2 traces per screen in split screen mode
R&S FSMR + FSE	CALCulate<1 2>:DELTaMarker<1...4>:X	0 to MAX (frequency sweep time)	unit 'SYM' is not available for R&S FSMR
R&S FSMR + FSE	CALCulate<1 2>:DELTaMarker<1...4>:X:RELative		
R&S FSMR + FSE	CALCulate<1 2>:DELTaMarker<1...4>:Y?		
R&S FSMR + FSE	CALCulate<1 2>:DELTaMarker<1...4>[:STATe]	ON OFF	
R&S FSMR + FSE	CALCulate<1 2>:DLINe<1 2>	MIN to MAX	

Devices	Command	Parameter	Notes
R&S FSMR + FSE	CALCulate<1 2>:DLINe<1 2>:STATe	ON OFF	
FSE	CALCulate<1 2>:FEED	'XTIM:DDEM:MEAS' 'XTIM:DDEM:REF' 'XTIM:DDEM:ERR:MPH' 'XTIM:DDEM:ERR:VECT' 'XTIM:DDEM:SYMB' 'XTIM:AM' 'XTIM:FM' 'XTIM:PM' 'XTIM:AMSummary' 'XTIM:FMSummary' 'XTIM:PMSummary' 'TCAP'	not available for R&S FSMR
FSET	CALCulate<1 2>:FEED	'XTIM:DDEM:MEAS' 'XTIM:DDEM:REF' 'XTIM:DDEM:ERR:MPH' 'XTIM:DDEM:ERR:VECT' 'XTIM:DDEM:SYMB' 'TCAP'	not available for R&S FSMR
R&S FSMR + FSE	CALCulate<1 2>:FLINe<1 2>	0 to fmax	
R&S FSMR + FSE	CALCulate<1 2>:FLINe<1 2>:STATe	ON OFF	
FSE	CALCulate<1 2>:FORMat	MAGNitude PHASe UPHase RIMag FREQuency IEYE QEYE TEYE FEYE COMP CONS	not available for R&S FSMR
FSE	CALCulate<1 2>:FSK:DEViation:REFerence	<numeric value>	not available for R&S FSMR
FSE	CALCulate<1 2>:LIMit<1...8>:ACPowEr:ACHannel	0 to 100 DB, 0 to 100 DB	compatible to CALCulate<1 2>:LIMit<1...8>: ACPowEr:ACHannel [:RELative] of R&S FSMR not available for FSET
R&S FSMR	CALCulate<1 2>:LIMit<1...8>:ACPowEr:ACHannel:ABSolute	-200 to 200 DBM, -200 to 200 DBM	new function for R&S FSMR
R&S FSMR	CALCulate<1 2>:LIMit<1...8>:ACPowEr:ACHannel:ABSolute:STATe	ON OFF	new function for R&S FSMR
R&S FSMR + FSE	CALCulate<1 2>:LIMit<1...8>:ACPowEr:ACHannel:RESult?		
FSE	CALCulate<1 2>:LIMit<1...8>:ACPowEr:ACHannel:STATe	ON OFF	compatible to CALCulate<1 2>:LIMit<1...8>: ACPowEr:ACHannel[:RELativ e]:STATe of R&S FSMR not available for FSET
R&S FSMR	CALCulate<1 2>:LIMit<1...8>:ACPowEr:ACHannel[:RELative]	0 to 100 DB, 0 to 100 DB	compatible to CALCulate<1 2>:LIMit<1...8>: ACPowEr:ACHannel of FSE
R&S FSMR	CALCulate<1 2>:LIMit<1...8>:ACPowEr:ACHannel[:RELative]:STATe	ON OFF	compatible to CALCulate<1 2>:LIMit<1...8>: ACPowEr:ACHannel:STATe of FSE
FSE	CALCulate<1 2>:LIMit<1...8>:ACPowEr:ALTernatE<1 2>	0 to 100 DB, 0 to 100 DB	compatible to CALCulate<1 2>:LIMit<1...8>: ACPowEr:ALTernatE<1 2> [:RELative] of R&S FSMR not available for FSET
R&S FSMR	CALCulate<1 2>:LIMit<1...8>:ACPowEr:ALTernatE<1 2>:ABSolute	-200 to 200 DBM, -200 to 200 DBM	new function for R&S FSMR
R&S FSMR	CALCulate<1 2>:LIMit<1...8>:ACPowEr:ALTernatE<1 2>:ABSolute:STATe	ON OFF	new function for R&S FSMR
R&S FSMR + FSE	CALCulate<1 2>:LIMit<1...8>:ACPowEr:ALTernatE<1 2>:RESult?		
FSE	CALCulate<1 2>:LIMit<1...8>:ACPowEr:ALTernatE<1 2>:STATe	ON OFF	compatible to CALCulate<1 2>:LIMit<1...8>: ACPowEr:ALTernatE<1 2> [:RELative]:STATe of R&S FSMR not available for FSET
R&S FSMR	CALCulate<1 2>:LIMit<1...8>:ACPowEr:ALTernatE<1 2>[:RELative]	0 to 100 DB, 0 to 100 DB	compatible to CALCulate<1 2>:LIMit<1...8>: ACPowEr:ALTernatE<1 2> of FSE

Devices	Command	Parameter	Notes
R&S FSMR	CALCulate<1 2>:LIMit<1...8>:ACPowEr:ALTErnate<1 2>	ON OFF	compatible to CALCulate<1 2>:LIMit<1...8>: ACPowEr:ALTErnate<1 2>: STATe of FSE
R&S FSMR + FSE	CALCulate<1 2>:LIMit<1...8>:ACPowEr[:STATe]	ON OFF	
FSE	CALCulate<1 2>:LIMit<1...8>:BURSt:POWEr?		not available for R&S FSMR, FSET and ESI
FSE	CALCulate<1 2>:LIMit<1...8>:BURSt:PTEmplate?		not available for R&S FSMR, FSET and ESI
FSE	CALCulate:LIMit:CATalog?		not available in R&S FSMR
R&S FSMR + FSE	CALCulate<1 2>:LIMit<1...8>:CLEAr[:IMMediate]		
R&S FSMR + FSE	CALCulate<1 2>:LIMit<1...8>:COMMeNt	<string>	
R&S FSMR + FSE	CALCulate<1 2>:LIMit<1...8>:CONTRol:DOMain	FREQuency TIME	
R&S FSMR + FSE	CALCulate<1 2>:LIMit<1...8>:CONTRol:MODE	RELative ABSolute	
R&S FSMR + FSE	CALCulate<1 2>:LIMit<1...8>:CONTRol:OFFset	<numeric value>	
R&S FSMR + FSE	CALCulate<1 2>:LIMit<1...8>:CONTRol:SHIFt	<numeric_value>	
R&S FSMR + FSE	CALCulate<1 2>:LIMit<1...8>:CONTRol:SPACing	LINear LOGarithmic	
FSE	CALCulate<1 2>:LIMit<1...8>:CONTRol:UNIT[:TIME]	S SYM	not available for R&S FSMR
R&S FSMR + FSE	CALCulate<1 2>:LIMit<1...8>:CONTRol[:DATA]	<numeric value>, <numeric value>	
R&S FSMR + FSE	CALCulate<1 2>:LIMit<1...8>:COPY	1 to 8 <name>	
R&S FSMR + FSE	CALCulate<1 2>:LIMit<1...8>:DELeTe		
R&S FSMR + FSE	CALCulate<1 2>:LIMit<1...8>:FAIL?		
R&S FSMR + FSE	CALCulate<1 2>:LIMit<1...8>:LOWer:MARGin	<numeric value>	
R&S FSMR + FSE	CALCulate<1 2>:LIMit<1...8>:LOWer:MODE	RELative ABSolute	
R&S FSMR + FSE	CALCulate<1 2>:LIMit<1...8>:LOWer:OFFset	<numeric value>	
R&S FSMR + FSE	CALCulate<1 2>:LIMit<1...8>:LOWer:SHIFt	<numeric_value>	
R&S FSMR + FSE	CALCulate<1 2>:LIMit<1...8>:LOWer:SPACing	LINear LOGarithmic	
R&S FSMR + FSE	CALCulate<1 2>:LIMit<1...8>:LOWer:STATe	ON OFF	
R&S FSMR	CALCulate<1 2>:LIMit<1...8>:LOWer:THREshold	<numeric value>	new function for R&S FSMR
R&S FSMR + FSE	CALCulate<1 2>:LIMit<1...8>:LOWer[:DATA]	<numeric value>	
FSE	CALCulate<1 2>:LIMit<1...8>:MARGin	0 to 100DB	not available for R&S FSMR, FSET and ESI
R&S FSMR + FSE	CALCulate<1 2>:LIMit<1...8>:NAME	1 to 8 <string>	
FSE	CALCulate<1 2>:LIMit<1...8>:SPECTrum:MODulation:EXCeptions?	ARFCn TXBand RXBand COMBined DCSRx1800	not available for R&S FSMR, FSET and ESI
FSE	CALCulate<1 2>:LIMit<1...8>:SPECTrum:MODulation:FAILs?	ARFCn TXBand RXBand COMBined DCSRx1800	not available for R&S FSMR, FSET and ESI
FSE	CALCulate<1 2>:LIMit<1...8>:SPECTrum:MODulation?	ARFCn TXBand RXBand COMBined DCSRx1800	not available for R&S FSMR, FSET and ESI
FSE	CALCulate<1 2>:LIMit<1...8>:SPECTrum:SWITChing:FAILs?		not available for R&S FSMR, FSET and ESI
FSE	CALCulate<1 2>:LIMit<1...8>:SPECTrum:SWITChing?		not available for R&S FSMR, FSET and ESI
FSE	CALCulate<1 2>:LIMit<1...8>:SPURious:FAILs?	TXBand OTXBand RXBand IDLeband	not available for R&S FSMR, FSET and ESI
FSE	CALCulate<1 2>:LIMit<1...8>:SPURious?	TXBand OTXBand RXBand IDLeband	not available for R&S FSMR, FSET and ESI

Devices	Command	Parameter	Notes
R&S FSMR + FSE	CALCulate<1 2>:LIMit<1...8>:STATe	ON OFF	
R&S FSMR + FSE	CALCulate<1 2>:LIMit<1...8>:TRACe	1 to 3	R&S FSMR: 3 traces are available per screen FSE: 4 traces are available in full screen mode and 2 traces per screen in split screen mode
R&S FSMR	CALCulate<1 2>:LIMit<1...8>:UNIT	DBM DBPW WATT DBUV DBMV VOLT DBUA AMPere DB DBUV_M DBUA_M DEG RAD S HZ PCT UNITLESS	Available units are compatible to the FSE
FSE/FSIQ	CALCulate<1 2>:LIMit<1...8>:UNIT	DBM DBPW WATT DBUV DBMV VOLT DBUA AMPere DB DBUV_MHZ DBMV_MHZ DBUA_MHZ DBUV_M DBUA_M DBUV_MHZ DBUA_MHZ DEG RAD S HZ PCT UNITLESS	only the following units are available for the R&S FSMR: DBM DBPW WATT DBUV DBMV VOLT DBUA AMPere DB DBUV_M DBUA_M DEG RAD S HZ PCT UNITLESS
FSET/ESI	CALCulate<1 2>:LIMit<1...8>:UNIT	DBM DBPW WATT DBUV DBMV VOLT DBUA AMPere DB DBUV_MHZ DBMV_MHZ DBUA_MHZ DBUV_M DBUA_M DBUV_MHZ DBUA_MHZ DEG RAD S HZ PCT UNITLESS	only the following units are available for the R&S FSMR: DBM DBPW WATT DBUV DBMV VOLT DBUA AMPere DB DBUV_M DBUA_M DEG RAD S HZ PCT UNITLESS
R&S FSMR + FSE	CALCulate<1 2>:LIMit<1...8>:UPPer:MARGin	<numeric value>	
R&S FSMR + FSE	CALCulate<1 2>:LIMit<1...8>:UPPer:MODE	RELative ABSolute	
R&S FSMR + FSE	CALCulate<1 2>:LIMit<1...8>:UPPer:OFFset	<numeric value>	
R&S FSMR + FSE	CALCulate<1 2>:LIMit<1...8>:UPPer:SHIFt	<numeric_value>	
R&S FSMR + FSE	CALCulate<1 2>:LIMit<1...8>:UPPer:SPACing	LINear LOGarithmic	
R&S FSMR + FSE	CALCulate<1 2>:LIMit<1...8>:UPPer:STATe	ON OFF	
R&S FSMR	CALCulate<1 2>:LIMit<1...8>:UPPer:THReshold	<numeric value>	new function for R&S FSMR
R&S FSMR + FSE	CALCulate<1 2>:LIMit<1...8>:UPPer[:DATA]	<numeric value>	
R&S FSMR + FSE	CALCulate<1 2>:MARKer<1...4>:AOFF		
R&S FSMR + FSE	CALCulate<1 2>:MARKer<1...4>:COUNT	ON OFF	
R&S FSMR + FSE	CALCulate<1 2>:MARKer<1...4>:COUNT:FREQuency?		
R&S FSMR + FSE	CALCulate<1 2>:MARKer<1...4>:COUNT:RESolution	0.1 1 10 100 1000 10000 Hz	
FSE	CALCulate<1 2>:MARKer<1...4>:COUPled[STATe]	ON OFF	not available for R&S FSMR
FSE	CALCulate<1 2>:MARKer<1...4>:FUNCTion:ADEMod		not available for R&S FSMR and FSET
FSE	CALCulate<1 2>:MARKer<1...4>:FUNCTion:ADEMod:AM[:RESult]?	PPEak MPEak MIDDLE RMS	not available for R&S FSMR and FSET
FSE	CALCulate<1 2>:MARKer<1...4>:FUNCTion:ADEMod:CARRier		not available for R&S FSMR and FSET
FSE	CALCulate<1 2>:MARKer<1...4>:FUNCTion:ADEMod:FERRor		not available for R&S FSMR and FSET
FSE	CALCulate<1 2>:MARKer<1...4>:FUNCTion:ADEMod:FM	PPEak MPEak MIDDLE RMS RDEV	not available for R&S FSMR and FSET
FSE	CALCulate<1 2>:MARKer<1...4>:FUNCTion:ADEMod:PM	PPEak MPEak MIDDLE RMS	not available for R&S FSMR and FSET
FSE	CALCulate<1 2>:MARKer<1...4>:FUNCTion:ADEMod:SiNad:RESult?		not available for R&S FSMR and FSET
FSE	CALCulate<1 2>:MARKer<1...4>:FUNCTion:ADEMod:SiNad	ON OFF	not available for R&S FSMR and FSET
R&S FSMR + FSE	CALCulate<1 2>:MARKer<1...4>:FUNCTion:CENTer		

Devices	Command	Parameter	Notes
R&S FSMR + FSE	CALCulate<1 2>:MARKer<1...4>:FUNctIon:CSTep		
FSE	CALCulate<1 2>:MARKer<1...4>:FUNctIon:DDEMod:RESult?	MERM MEPK MEPS PERM PEPK PEPS EVRM EVPK EVPS IQOF IQIM ADR FERR FEPK RHO DEV FSRM R&S FSMRK R&S FSMRS DTTS	not available for R&S FSMR
R&S FSMR	CALCulate<1 2>:MARKer<1...4>:FUNctIon:DEModulation:CONTInuous		new function for R&S FSMR
R&S FSMR + FSE	CALCulate<1 2>:MARKer<1...4>:FUNctIon:DEModulation:HOLDoff	10ms to 1000s	
R&S FSMR + FSE	CALCulate<1 2>:MARKer<1...4>:FUNctIon:DEModulation:SElect	AM FM	
R&S FSMR + FSE	CALCulate<1 2>:MARKer<1...4>:FUNctIon:DEModulation[:STATe]	ON OFF	
R&S FSMR	CALCulate<1 2>:MARKer<1...4>:FUNctIon:FPEaks[:IMMediate]	<numeric value>	new function for R&S FSMR
R&S FSMR	CALCulate<1 2>:MARKer<1...4>:FUNctIon:FPEaks:COUNT?		new function for R&S FSMR
R&S FSMR	CALCulate<1 2>:MARKer<1...4>:FUNctIon:FPEaks:X?		new function for R&S FSMR
R&S FSMR	CALCulate<1 2>:MARKer<1...4>:FUNctIon:FPEaks:Y?		new function for R&S FSMR
R&S FSMR	CALCulate<1 2>:MARKer<1...4>:FUNctIon:FPEaks:SORT	X Y	new function for R&S FSMR
R&S FSMR	CALCulate<1 2>:MARKer<1...4>:FUNctIon:MDEPth:RESult?		new function for R&S FSMR
R&S FSMR	CALCulate<1 2>:MARKer<1...4>:FUNctIon:MDEPth[:STATe]		new function for R&S FSMR
R&S FSMR	CALCulate<1 2>:MARKer<1...4>:FUNctIon:MSUMmary?	<numeric value>, <numeric value>, <numeric value>, <numeric value>	new function for R&S FSMR
FSE	CALCulate<1 2>:MARKer<1...4>:FUNctIon:MSTep		not available for R&S FSMR
R&S FSMR + FSE	CALCulate<1 2>:MARKer<1...4>:FUNctIon:NDBDown	<numeric value>	
R&S FSMR + FSE	CALCulate<1 2>:MARKer<1...4>:FUNctIon:NDBDown:FREQuency?		
R&S FSMR + FSE	CALCulate<1 2>:MARKer<1...4>:FUNctIon:NDBDown:RESult?		
R&S FSMR + FSE	CALCulate<1 2>:MARKer<1...4>:FUNctIon:NDBDown:STATe	ON OFF	
R&S FSMR + FSE	CALCulate<1 2>:MARKer<1...4>:FUNctIon:NOISe:RESult?		
R&S FSMR + FSE	CALCulate<1 2>:MARKer<1...4>:FUNctIon:NOISe:STATe	ON OFF	
FSE	CALCulate<1 2>:MARKer<1...4>:FUNctIon:POWer:CFILter	ON OFF	not available for R&S FSMR
R&S FSMR + FSE	CALCulate<1 2>:MARKer<1...4>:FUNctIon:POWer:PRESet	NADC TETRA PDC PHS CDPD FWCDma RWCDma F8CDma R8CDma F19Cdma R19Cdma FW3Gppcdma RW3Gppcdma D2CDma S2CDma M2CDma NONE	available standards are compatible to the FSE
R&S FSMR	CALCulate<1 2>:MARKer<1...4>:FUNctIon:POWer:RESult:PHZ	ON OFF	new function for R&S FSMR
R&S FSMR + FSE	CALCulate<1 2>:MARKer<1...4>:FUNctIon:POWer:RESult?	ACPower CPower OBANdwidth OBWidth MCACpower	MCACpower is not available on the FSE MCACpower, ACPower and CPower are not available on the FSET
R&S FSMR + FSE	CALCulate<1 2>:MARKer<1...4>:FUNctIon:POWer:SElect?	ACPower CPower OBANdwidth OBWidth CN CN0 MCACpower	MCACpower is not available on the FSE MCACpower, ACPower and CPower are not available on the FSET
R&S FSMR + FSE	CALCulate<1 2>:MARKer<1...4>:FUNctIon:POWer[:STATe]	OFF	
R&S FSMR + FSE	CALCulate<1 2>:MARKer<1...4>:FUNctIon:REFerence		
FSE	CALCulate<1 2>:MARKer<1...4>:FUNctIon:SFACTor	(60dB/3dB) (60dB/6dB)	not available for R&S FSMR
FSE	CALCulate<1 2>:MARKer<1...4>:FUNctIon:SFACTor:FREQuency?		not available for R&S FSMR
FSE	CALCulate<1 2>:MARKer<1...4>:FUNctIon:SFACTor:RESult?		not available for R&S FSMR
FSE	CALCulate<1 2>:MARKer<1...4>:FUNctIon:SFACTor:STATe	ON OFF	not available for R&S FSMR
FSE	CALCulate<1 2>:MARKer<1...4>:FUNctIon:STARt		not available for R&S FSMR
FSE	CALCulate<1 2>:MARKer<1...4>:FUNctIon:STOP		not available for R&S FSMR

Devices	Command	Parameter	Notes
R&S FSMR	CALCulate<1 2>:MARKer<1...4>:FUNction:STRack: BANDwidth BWIDth	10 Hz to MAX(span)	new function for R&S FSMR. Replaces DISP:FLINE of the FSE.
R&S FSMR	CALCulate<1 2>:MARKer<1...4>:FUNction:STRack:THReshold	-330 to +30 dBm	new function for R&S FSMR
R&S FSMR	CALCulate<1 2>:MARKer<1...4>:FUNction:STRack:TRACe	1 to 3	new function for R&S FSMR
R&S FSMR + FSE	CALCulate<1 2>:MARKer<1...4>:FUNction:STRack[:STATe]	ON OFF	
R&S FSMR + FSE	CALCulate<1 2>:MARKer<1...4>:FUNction:SUMMARY:AOFF		
R&S FSMR + FSE	CALCulate<1 2>:MARKer<1...4>:FUNction:SUMMARY:AVERAge	ON OFF	
FSE	CALCulate<1 2>:MARKer<1...4>:FUNction:SUMMARY:MAXimum: AVERAge:RESult?		not available for R&S FSMR
FSE	CALCulate<1 2>:MARKer<1...4>:FUNction:SUMMARY:MAXimum: PHOLd:RESult?		not available for R&S FSMR
FSE	CALCulate<1 2>:MARKer<1...4>:FUNction:SUMMARY:MAXimum: RESult?		not available for R&S FSMR
FSE	CALCulate<1 2>:MARKer<1...4>:FUNction:SUMMARY:MAXimum [:STATe]	ON OFF	not available for R&S FSMR
R&S FSMR + FSE	CALCulate<1 2>:MARKer<1...4>:FUNction:SUMMARY:MEAN: AVERAge:RESult?		
R&S FSMR + FSE	CALCulate<1 2>:MARKer<1...4>:FUNction:SUMMARY:MEAN:PHOLd:RESult?		
R&S FSMR + FSE	CALCulate<1 2>:MARKer<1...4>:FUNction:SUMMARY:MEAN:RESult?		
R&S FSMR + FSE	CALCulate<1 2>:MARKer<1...4>:FUNction:SUMMARY:MEAN[:STATe]	ON OFF	
FSE	CALCulate<1 2>:MARKer<1...4>:FUNction:SUMMARY:MIDDLE: AVERAge:RESult?		not available for R&S FSMR
FSE	CALCulate<1 2>:MARKer<1...4>:FUNction:SUMMARY:MIDDLE: PHOLd:RESult?		not available for R&S FSMR
FSE	CALCulate<1 2>:MARKer<1...4>:FUNction:SUMMARY:MIDDLE: RESult?		not available for R&S FSMR
FSE	CALCulate<1 2>:MARKer<1...4>:FUNction:SUMMARY:MIDDLE [:STATe]	ON OFF	not available for R&S FSMR
R&S FSMR	CALCulate<1 2>:MARKer<1...4>:FUNction:SUMMARY:MODE	ABSolute RELative	new function for R&S FSMR
FSE	CALCulate<1 2>:MARKer<1...4>:FUNction:SUMMARY:MPEAk: AVERAge:RESult?		not available for R&S FSMR
FSE	CALCulate<1 2>:MARKer<1...4>:FUNction:SUMMARY:MPEAk: PHOLd:RESult?		not available for R&S FSMR
FSE	CALCulate<1 2>:MARKer<1...4>:FUNction:SUMMARY:MPEAk: RESult?		not available for R&S FSMR
FSE	CALCulate<1 2>:MARKer<1...4>:FUNction:SUMMARY:MPEAk [:STATe]	ON OFF	not available for R&S FSMR
R&S FSMR + FSE	CALCulate<1 2>:MARKer<1...4>:FUNction:SUMMARY:PHOLd	ON OFF	
R&S FSMR + FSE	CALCulate<1 2>:MARKer<1...4>:FUNction:SUMMARY:PPEAk: AVERAge:RESult?		
R&S FSMR + FSE	CALCulate<1 2>:MARKer<1...4>:FUNction:SUMMARY:PPEAk:PHOLd:RESult?		
R&S FSMR + FSE	CALCulate<1 2>:MARKer<1...4>:FUNction:SUMMARY:PPEAk:RESult?		
R&S FSMR + FSE	CALCulate<1 2>:MARKer<1...4>:FUNction:SUMMARY:PPEAk[:STATe]	ON OFF	
R&S FSMR	CALCulate<1 2>:MARKer<1...4>:FUNction:SUMMARY:REFerence: AUTO	ONCE	new function for R&S FSMR
R&S FSMR + FSE	CALCulate<1 2>:MARKer<1...4>:FUNction:SUMMARY:RMS:AVERAge:RESult?		
R&S FSMR + FSE	CALCulate<1 2>:MARKer<1...4>:FUNction:SUMMARY:RMS:PHOLd:RESult?		
R&S FSMR + FSE	CALCulate<1 2>:MARKer<1...4>:FUNction:SUMMARY:RMS:RESult?		
R&S FSMR + FSE	CALCulate<1 2>:MARKer<1...4>:FUNction:SUMMARY:RMS[:STATe]	ON OFF	
R&S FSMR	CALCulate<1 2>:MARKer<1...4>:FUNction:SUMMARY:SDEVIation: RESult?		new function for R&S FSMR
R&S FSMR	CALCulate<1 2>:MARKer<1...4>:FUNction:SUMMARY:SDEVIation: AVERAge:RESult?		new function for R&S FSMR
R&S FSMR	CALCulate<1 2>:MARKer<1...4>:FUNction:SUMMARY:SDEVIation: PHOLd:RESult?		new function for R&S FSMR
R&S FSMR	CALCulate<1 2>:MARKer<1...4>:FUNction:SUMMARY:SDEVIation [:STATe]	ON OFF	new function for R&S FSMR
R&S FSMR + FSE	CALCulate<1 2>:MARKer<1...4>:FUNction:SUMMARY[:STATe]	ON OFF	

Devices	Command	Parameter	Notes
R&S FSMR	CALCulate<1 2>:MARKer<1...4>:FUNctIon:TOI:RESult?		new function for R&S FSMR
R&S FSMR	CALCulate<1 2>:MARKer<1...4>:FUNctIon:TOI[:STATe]	ON OFF	new function for R&S FSMR
R&S FSMR + FSE	CALCulate<1 2>:MARKer<1...4>:FUNctIon:ZOOM	<numeric value>	R&S FSMR: function uses always marker 1 as its reference marker; FSE: all available markers can be used as a reference marker
R&S FSMR + FSE	CALCulate<1 2>:MARKer<1...4>:LOEXclude	ON OFF	
FSE	CALCulate<1 2>:MARKer<1...4>:MAXimum:APEak		not available for R&S FSMR
R&S FSMR + FSE	CALCulate<1 2>:MARKer<1...4>:MAXimum:LEFT		
R&S FSMR + FSE	CALCulate<1 2>:MARKer<1...4>:MAXimum:NEXT		
R&S FSMR + FSE	CALCulate<1 2>:MARKer<1...4>:MAXimum:RIGHT		
R&S FSMR + FSE	CALCulate<1 2>:MARKer<1...4>:MAXimum[:PEAK]		
R&S FSMR + FSE	CALCulate<1 2>:MARKer<1...4>:MINimum:LEFT		
R&S FSMR + FSE	CALCulate<1 2>:MARKer<1...4>:MINimum:NEXT		
R&S FSMR + FSE	CALCulate<1 2>:MARKer<1...4>:MINimum:RIGHT		
R&S FSMR + FSE	CALCulate<1 2>:MARKer<1...4>:MINimum[:PEAK]		
R&S FSMR + FSE	CALCulate<1 2>:MARKer<1...4>:PEXCursion	<numeric value>	
FSE	CALCulate<1 2>:MARKer<1...4>:READout	MPHase RIMaginary	not available for R&S FSMR
FSE	CALCulate<1 2>:MARKer<1...4>:SCOupled[STATe]	ON OFF	not available for R&S FSMR
FSE	CALCulate<1 2>:MARKer<1...4>:STEP:AUTO	ON OFF	not available for R&S FSMR
FSE	CALCulate<1 2>:MARKer<1...4>:STEP[:INCRement]	<numeric_value>	not available for R&S FSMR
R&S FSMR + FSE	CALCulate<1 2>:MARKer<1...4>:TRACe	1 to 3	R&S FSMR: 3 traces are available per screen FSE: 4 traces are available in full screen mode and 2 traces per screen in split screen mode
R&S FSMR + FSE	CALCulate<1 2>:MARKer<1...4>:X	0 to MAX (frequency sweep time)	additional unit SYM is available for FSE
R&S FSMR	CALCulate<1 2>:MARKer<1...4>:X:SLIMits:LEFT	0 to MAX (frequency sweep time)	new function for R&S FSMR. Replaces DISP:FLIN and DISP:TLIN commands of the FSE
R&S FSMR	CALCulate<1 2>:MARKer<1...4>:X:SLIMits:RIGHT	0 to MAX (frequency sweep time)	new function for R&S FSMR. Replaces DISP:FLIN and DISP:TLIN commands of the FSE
R&S FSMR + FSE	CALCulate<1 2>:MARKer<1...4>:X:SLIMits[:STATe]	ON OFF	
R&S FSMR + FSE	CALCulate<1 2>:MARKer<1...4>:Y?		
R&S FSMR	CALCulate<1 2>:MARKer<1...4>:Y:PERCent	<numeric_value>	new function for R&S FSMR
R&S FSMR + FSE	CALCulate<1 2>:MARKer<1...4>[:STATe]	ON OFF	
R&S FSMR	CALCulate<1 2>:MATH:MODE	LINear LOGarithmic	affects all traces on the R&S FSMR; therefore the numeric suffix :MATH<1...4> is not allowed for the R&S FSMR
FSE	CALCulate<1 2>:MATH<1...4>:MODE	LINear LOGarithmic	for FSE, only the trace indicated by a numeric suffix is affected
R&S FSMR	CALCulate<1 2>:MATH:POS	-100PCT to 200PCT	new function for R&S FSMR; replacement for CALC:RLINE of the FSE

Devices	Command	Parameter	Notes
R&S FSMR + FSE	CALCulate<1 2>:MATH:STATe	ON OFF	for R&S FSMR, traces can only be subtracted from trace 1; therefore there is no numeric suffix behind :MATH
R&S FSMR + FSE	CALCulate<1 2>:MATH[:EXPRession][:DEFine]	<expr>	for R&S FSMR, traces can only be subtracted from trace 1; therefore there is no numeric suffix behind :MATH and <expr> may only consist of (TRACE1-TRACE2) or (TRACE1-TRACE3)
FSE	CALCulate<1 2>:RLINe	MIN to MAX	not available for R&S FSMR (replaced by CALC:MATH:POS)
FSE	CALCulate<1 2>:RLINe:STATe	ON OFF	not available for R&S FSMR (replaced by CALC:MATH:POS)
R&S FSMR + FSE	CALCulate<1 2>:THReshold	MIN to MAX	
R&S FSMR + FSE	CALCulate<1 2>:THReshold:STATe	ON OFF	
FSE	CALCulate<1 2>:TLINe<1 2>	0 to 1000s	not available on the R&S FSMR; replaced by CALC:SLIMits:LEFT and CALC:SLIMits:RIGHT
FSE	CALCulate<1 2>:TLINe<1 2>:STATe	ON OFF	not available on the R&S FSMR; replaced by CALC:SLIMits:LEFT and CALC:SLIMits:RIGHT
FSE	CALCulate<1 2>:UNIT:ANGLe	DEG RAD	not available for R&S FSMR
R&S FSMR	CALCulate<1 2>:UNIT:POWer	DBM V A W DBPW WATT DBUV DBMV VOLT DBUA AMPere	available units are compatible to the FSE
FSET/ ESI	CALCulate<1 2>:UNIT:POWer	DBM V W DB PCT UNITLESS DBPW WATT DBUV DBMV VOLT DBUA AMPere DBPT DBUV_MHZ DBMV_MHZ DBUA_MHZ DBUV_M DBUA_M DBUV_MMHZ DBUA_MMHZ	the R&S FSMR supports the following units:DBM V A W DBPW WATT DBUV DBMV VOLT DBUA AMPere
FSE/ FSIQ	CALCulate<1 2>:UNIT:POWer	DBM V W DB PCT UNITLESS DBPW WATT DBUV DBMV VOLT DBUA AMPere DBUV_MHZ DBMV_MHZ DBUA_MHZ DBUV_M DBUA_M DBUV_MMHZ DBUA_MMHZ	the R&S FSMR supports the following units:DBM V A W DBPW WATT DBUV DBMV VOLT DBUA AMPere
FSE	CALCulate<1 2>:X:UNIT:TIME	S SYM	not available for R&S FSMR
R&S FSMR	CALibration:ABORt		new function for R&S FSMR
FSE	CALibration:BANDwidth BWIDth[:RESolution]?		not available for R&S FSMR
FSE	CALibration:IQ?		not available for R&S FSMR
FSE	CALibration:LDETEctor?		not available for R&S FSMR
FSE	CALibration:LOSuppression?		not available for R&S FSMR
FSE	CALibration:PPEak?		not available for R&S FSMR
ESI	CALibration:PRESelector?		not available for R&S FSMR
R&S FSMR	CALibration:RESult?		new function for R&S FSMR
FSE	CALibration:SHORT?		not available for R&S FSMR
R&S FSMR + FSE	CALibration:STATe	ON OFF	
R&S FSMR + FSE	CALibration[:ALL]?		
FSE	CONFigure:BURSt:PFERror:COUNT	1 to 1000	not available for R&S FSMR and FSET
FSE	CONFigure:BURSt:PFERror[IMMediate]		not available for R&S FSMR and FSET
FSE	CONFigure:BURSt:POWer:CONDition	NORMal EXTReme	not available for R&S FSMR and FSET
FSE	CONFigure:BURSt:POWer:COUNT	1 to 1000	not available for R&S FSMR and FSET

Devices	Command	Parameter	Notes
FSE	CONFigure:BURSt:POWer[IMMediate]		not available for R&S FSMR and FSET
FSE	CONFigure:BURSt:PTEmplate:[IMMediate]		not available for R&S FSMR and FSET
FSE	CONFigure:BURSt:PTEmplate:COUnT	1 to 1000	not available for R&S FSMR and FSET
FSE	CONFigure:BURSt:PTEmplate:SElect	FULL TOP RISing FALLing	not available for R&S FSMR and FSET
FSE	CONFigure:BURSt:REFerence:AUTO	ON OFF	not available for R&S FSMR and FSET
FSE	CONFigure:SPECTrum:MODulation:COUnT	1 to 1000	not available for R&S FSMR and FSET
FSE	CONFigure:SPECTrum:MODulation:RANGe	ARFCn TXBand RXBand COMBined DCSRx1800	not available for R&S FSMR and FSET
FSE	CONFigure:SPECTrum:MODulation:TGATe	ON OFF	not available for R&S FSMR and FSET
FSE	CONFigure:SPECTrum:MODulation[:IMMediate]		not available for R&S FSMR and FSET
FSE	CONFigure:SPECTrum:SWITChing:COUnT	1 to 1000	not available for R&S FSMR and FSET
FSE	CONFigure:SPECTrum:SWITChing[:IMMediate]		not available for R&S FSMR and FSET
FSE	CONFigure:SPURious:ANTenna	CONDUCTed RADiated	not available for R&S FSMR and FSET
FSE	CONFigure:SPURious:COUn:RXBandt	1 to 1000	not available for R&S FSMR and FSET
FSE	CONFigure:SPURious:COUnT	1 to 1000	not available for R&S FSMR and FSET
FSE	CONFigure:SPURious:RANGe	TXBand OTXBand RXBand IDLeband COMBined	not available for R&S FSMR and FSET
FSE	CONFigure:SPURious:STEP:COUnT?		not available for R&S FSMR and FSET
FSE	CONFigure:SPURious:STEP<1..26>	ON OFF	not available for R&S FSMR and FSET
FSE	CONFigure:SPURious[:IMMediate]		not available for R&S FSMR and FSET
FSE	CONFigure[:BTS]:ARFCn	<numeric_value>	not available for R&S FSMR and FSET
FSE	CONFigure[:BTS]:ARFCn:AUTO	ONCE	not available for R&S FSMR and FSET
FSE	CONFigure[:BTS]:CHANnel:SFH	ON OFF	not available for R&S FSMR and FSET
FSE	CONFigure[:BTS]:CHANnel:SLOT	0 to 7	not available for R&S FSMR and FSET
FSE	CONFigure[:BTS]:CHANnel:SLOT:AUTO	ONCE	not available for R&S FSMR and FSET
FSE	CONFigure[:BTS]:CHANnel:TSC	0 to 7	not available for R&S FSMR and FSET
FSE	CONFigure[:BTS]:CHANnel:TSC:AUTO	ON OFF	not available for R&S FSMR and FSET
FSE	CONFigure[:BTS]:COSiting	ON OFF	not available for R&S FSMR and FSET
FSE	CONFigure[:BTS]:LIMit:FREQuency	<numeric_value>	not available for R&S FSMR and FSET
FSE	CONFigure[:BTS]:LIMit:PPEak	<numeric_value>	not available for R&S FSMR and FSET
FSE	CONFigure[:BTS]:LIMit:PRMS	<numeric_value>	not available for R&S FSMR and FSET
FSE	CONFigure[:BTS]:LIMit:STANdard	ON OFF	not available for R&S FSMR and FSET
FSE	CONFigure[:BTS]:NETWork:PHASe	1 2[,PLUS]	not available for R&S FSMR and FSET
FSE	CONFigure[:BTS]:NETWork[:TYPE]	PGSM PGSM900 EGSM EGSM900 DCS GSM1800 PCS GSM1900 RGSM RGSM900	not available for R&S FSMR and FSET
FSE	CONFigure[:BTS]:POWer:CLASs	1 to 8 1 to 4 M1 M2 M3	not available for R&S FSMR and FSET

Devices	Command	Parameter	Notes
FSE	CONFigure[:BTS]:POWer:COUPled	ON OFF	not available for R&S FSMR and FSET
FSE	CONFigure[:BTS]:POWer:DYNamic	0 to 15	not available for R&S FSMR and FSET
FSE	CONFigure[:BTS]:POWer:EXPEcted	<numeric_value>	not available for R&S FSMR and FSET
FSE	CONFigure[:BTS]:POWer:LIMit	<numeric_value>	not available for R&S FSMR and FSET
FSE	CONFigure[:BTS]:POWer:SINGle:CLEar		not available for R&S FSMR and FSET
FSE	CONFigure[:BTS]:POWer:SINGle[:STATe]	ON OFF	not available for R&S FSMR and FSET
FSE	CONFigure[:BTS]:POWer:STATic	0 to 6	not available for R&S FSMR and FSET
FSE	CONFigure[:BTS]:PRESet		not available for R&S FSMR and FSET
FSE	CONFigure[:BTS]:SWEeptime	STANdard AUTO	not available for R&S FSMR and FSET
FSE	CONFigure[:BTS]:TXSupp	ON OFF	not available for R&S FSMR and FSET
FSE	CONFigure[:BTS]MEASurement?		not available for R&S FSMR and FSET
FSE	CONFigure[:MS]:ARFCn	<numeric_value>	not available for R&S FSMR and FSET
FSE	CONFigure[:MS]:ARFCn:AUTO	ONCE	not available for R&S FSMR and FSET
FSE	CONFigure[:MS]:CHANnel:SFH	ON OFF	not available for R&S FSMR and FSET
FSE	CONFigure[:MS]:CHANnel:TSC	0 to 7	not available for R&S FSMR and FSET
FSE	CONFigure[:MS]:LIMit:FREQuency	<numeric_value>	not available for R&S FSMR and FSET
FSE	CONFigure[:MS]:LIMit:PPEak	<numeric_value>	not available for R&S FSMR and FSET
FSE	CONFigure[:MS]:LIMit:PRMS	<numeric_value>	not available for R&S FSMR and FSET
FSE	CONFigure[:MS]:LIMit:STANdard	ON OFF	not available for R&S FSMR and FSET
FSE	CONFigure[:MS]:NETWork:PHASe	1 2[,PLUS]	not available for R&S FSMR and FSET
FSE	CONFigure[:MS]:NETWork[:TYPE]	PGSM PGSM900 EGSM EGSM900 DCS GSM1800 PCS GSM1900 RGSM RGSM900	not available for R&S FSMR and FSET
FSE	CONFigure[:MS]:POWer:CLASs	<numeric_value>	not available for R&S FSMR and FSET
FSE	CONFigure[:MS]:POWer:COUPled	ON OFF	not available for R&S FSMR and FSET
FSE	CONFigure[:MS]:POWer:EXPEcted	<numeric_value>	not available for R&S FSMR and FSET
FSE	CONFigure[:MS]:POWer:LEVel	0 to 31	not available for R&S FSMR and FSET
FSE	CONFigure[:MS]:POWer:LIMit	<numeric_value>	not available for R&S FSMR and FSET
FSE	CONFigure[:MS]:POWer:SINGle:CLEar		not available for R&S FSMR and FSET
FSE	CONFigure[:MS]:POWer:SINGle[:STATe]	ON OFF	not available for R&S FSMR and FSET
FSE	CONFigure[:MS]:POWer:SMALI	ON OFF	not available for R&S FSMR and FSET
FSE	CONFigure[:MS]:PRESet		not available for R&S FSMR and FSET
FSE	CONFigure[:MS]:SWEeptime	STANdard AUTO	not available for R&S FSMR and FSET
FSE	CONFigure[:MS]:TXSupp	ON OFF	not available for R&S FSMR and FSET
FSE	CONFigure[:MS]MEASurement?		not available for R&S FSMR and FSET
FSET	DIAGnostic:INFO:CCOunt:ATTenuation?		not available for R&S FSMR

Devices	Command	Parameter	Notes
FSE	DIAGnostic:INFO:CCOunt:ATTenuation<1 10>?		not available for R&S FSMR
FSIQ	DIAGnostic:INFO:CCOunt:ATTenuation<1 2 3>?		not available for R&S FSMR
ESI	DIAGnostic:INFO:CCOunt:ATTenuation<1 2 4>?		not available for R&S FSMR
FSE	DIAGnostic:INFO:CCOunt:PRESelector<1..6>?		not available for R&S FSMR
R&S FSMR	DIAGnostic:SERVice:CSOource[:POWer]	<numeric_value>	new function for R&S FSMR
FSE	DIAGnostic:SERVice:FUNcTion	<numeric_value>, <numeric_value> to	not available for R&S FSMR. Replaced by DIAG:SERV:SFUNcTion
FSET	DIAGnostic:SERVice:HGENerator	OFF 10 kHz 100 kHz BALanced	not available for R&S FSMR
R&S FSMR	DIAGnostic:SERVice:HWINfo?		new function for R&S FSMR
R&S FSMR + FSE	DIAGnostic:SERVice:INPut[:SElect]	CALibration RF	
R&S FSMR	DIAGnostic:SERVice:INPut:PULSed[:STATe]	ON OFF	new command for R&S FSMR
R&S FSMR	DIAGnostic:SERVice:INPut:PULSed:PRATe	<numeric value>	new command for R&S FSMR
R&S FSMR	DIAGnostic:SERVice:INPut:PULSed[:STATe]		new function for R&S FSMR
R&S FSMR	DIAGnostic:SERVice:INPut:PULSed:PRATe	<numeric_value>	new function for R&S FSMR
R&S FSMR + FSE	DIAGnostic:SERVice:NSOource	ON OFF	
R&S FSMR	DIAGnostic:SERVice:SFUNcTion	<string> to	replacement for DIAG:SERV:FUNC of R&S FSMR; necessary due to different parameter formats needed on the R&S FSMR
R&S FSMR	DIAGnostic:SERVice:STESt:RESult?		new function for R&S FSMR
R&S FSMR + FSE	DISPlay:ANNotation:FREQuency	ON OFF	
	DISPlay:BARGraph:LEVel:LOWer		not available for R&S FSMR
	DISPlay:BARGraph:LEVel:UPPer		not available for R&S FSMR
R&S FSMR + FSE	DISPlay:CMAP<1...26>:DEFault<1 2>		larger selection of independently configurable items (1 to 26)
R&S FSMR + FSE	DISPlay:CMAP<1...26>:HSL	0 to 1,0 to 1,0 to 1	larger selection of independently configurable items (1 to 26)
R&S FSMR + FSE	DISPlay:CMAP<1...26>:PDEFined	<color>	larger selection of independently configurable items (1 to 26)
R&S FSMR + FSE	DISPlay:FORmat	SINGle SPLit	
R&S FSMR + FSE	DISPlay:LOGO	ON OFF	
FSE	DISPlay:PROGram[:MODE]	ON OFF	not available for R&S FSMR
R&S FSMR + FSE	DISPlay:PSAVe:HOLDoff	0 to 60	
R&S FSMR + FSE	DISPlay:PSAVe[:STATe]	ON OFF	
FSE	DISPlay[:WINDow<1 2>]:FEED	'AF' 'VIDeo'	not available for R&S FSMR
FSE	DISPlay[:WINDow<1 2>]:MINFo	ON OFF	not available for R&S FSMR
R&S FSMR	DISPlay[:WINDow<1 2>]:SElect		new function for R&S FSMR
R&S FSMR	DISPlay[:WINDow<1 2>]:SIZE	LARGe SMALl	new function for R&S FSMR
R&S FSMR + FSE	DISPlay[:WINDow<1 2>]:TEXT:STATe	ON OFF	
R&S FSMR + FSE	DISPlay[:WINDow<1 2>]:TEXT[:DATA]	<string>	
R&S FSMR + FSE	DISPlay[:WINDow<1 2>]:TIME	ON OFF	
R&S FSMR + FSE	DISPlay[:WINDow<1 2>]:TRACe<1...3>:MODE	WRITe VIEW AVERAge MAXHold MINHold	R&S FSMR: 3 traces are available per screen FSE: 4 traces are available in full screen mode and 2 traces per screen in split screen mode
FSE	DISPlay[:WINDow<1 2>]:TRACe<1...4>:EYE:COUnT	1 to Result Length	not available for R&S FSMR
FSE	DISPlay[:WINDow<1 2>]:TRACe<1...4>:MODE:ANALog	ON OFF	not available for R&S FSMR
FSE	DISPlay[:WINDow<1 2>]:TRACe<1...4>:MODE:CWRITe	ON OFF	not available for R&S FSMR
FSE	DISPlay[:WINDow<1 2>]:TRACe<1...4>:MODE:HCONtinuous	ON OFF	not available for R&S FSMR

Devices	Command	Parameter	Notes
FSE	DISPlay[:WINDow<1 2>]:TRACe<1...4>:SYMBOL	DOTS BARS OFF	not available for R&S FSMR
FSE	DISPlay[:WINDow<1 2>]:TRACe<1...4>:X:SPACing	LINear LOGarithmic	not available for R&S FSMR
FSE	DISPlay[:WINDow<1 2>]:TRACe<1...4>:X[:SCALe]:RVALue	<numeric value>	not available for R&S FSMR
FSE	DISPlay[:WINDow<1 2>]:TRACe<1...4>:X[:SCALe]:ZOOM	ON OFF	not available for R&S FSMR
FSE	DISPlay[:WINDow<1 2>]:TRACe<1...4>:X[:SCALe]:ZOOM [:FREQuency]:CENTer	<numeric_value>	not available for R&S FSMR
FSE	DISPlay[:WINDow<1 2>]:TRACe<1...4>:X[:SCALe]:ZOOM [:FREQuency]:	<numeric_value>	not available for R&S FSMR
FSE	DISPlay[:WINDow<1 2>]:TRACe<1...4>:X[:SCALe]:ZOOM [:FREQuency]:	<numeric_value>	not available for R&S FSMR
R&S FSMR	DISPlay[:WINDow<1 2>]:TRACe<1...3>:Y:SPACing	LINear LOGarithmic LDB	R&S FSMR: TRACe<1...3> LDB is not available for FSE
FSE	DISPlay[:WINDow<1 2>]:TRACe<1...4>:Y:SPACing	LINear LOGarithmic PERCent	PERCent is not available for R&S FSMR FSE: TRACE<1...4>
R&S FSMR + FSE	DISPlay[:WINDow<1 2>]:TRACe<1...3>:Y[:SCALe]	10dB to 200dB	R&S FSMR: TRACe<1...3> FSE: TRACE<1...4>
FSET/ESI	DISPlay[:WINDow<1 2>]:TRACe<1...4>:Y[:SCALe]:BOTTom	<numeric value>	not available for R&S FSMR
R&S FSMR + FSE	DISPlay[:WINDow<1 2>]:TRACe<1...3>:Y[:SCALe]:MODE	ABSolute RELative	R&S FSMR: TRACe<1...3> FSE: TRACE<1...4>
FSE	DISPlay[:WINDow<1 2>]:TRACe<1...4>:Y[:SCALe]:PDIVision		not available for R&S FSMR
R&S FSMR + FSE	DISPlay[:WINDow<1 2>]:TRACe<1...3>:Y[:SCALe]:RLEVel	-130dBm to 30dBm	R&S FSMR: TRACe<1...3> FSE: TRACE<1...4>
R&S FSMR + FSE	DISPlay[:WINDow<1 2>]:TRACe<1...3>:Y[:SCALe]:RLEVel:OFFSet	-200dB to 200dB	R&S FSMR: TRACe<1...3> FSE: TRACE<1...4>
R&S FSMR + FSE	DISPlay[:WINDow<1 2>]:TRACe<1...3>:Y[:SCALe]:RPOSition	0 to 100 PCT	R&S FSMR: TRACe<1...3> FSE: TRACE<1...4>
R&S FSMR + FSE	DISPlay[:WINDow<1 2>]:TRACe<1...3>:Y[:SCALe]:RVALue	<numeric value>	R&S FSMR: TRACe<1...3> FSE: TRACE<1...4>
FSE	DISPlay[:WINDow<1 2>]:TRACe<1...4>:Y[:SCALe]:RVALue:AUTO	ON OFF	not available for R&S FSMR
FSET/ESI	DISPlay[:WINDow<1 2>]:TRACe<1...4>:Y[:SCALe]:TOP	<numeric value>	not available for R&S FSMR
R&S FSMR	DISPlay[:WINDow<1 2>]:TRACe<1...3>[:STATe]	ON OFF	R&S FSMR: TRACe<1...3> FSE: TRACE<1...4>
FSE	FETCh:BURSt:FERRor:AVERAge?		not available for R&S FSMR and FSET
FSE	FETCh:BURSt:FERRor:MAXimum?		not available for R&S FSMR and FSET
FSE	FETCh:BURSt:FERRor:STATus?		not available for R&S FSMR and FSET
FSE	FETCh:BURSt:PERRor:PEAK:AVERAge?		not available for R&S FSMR and FSET
FSE	FETCh:BURSt:PERRor:PEAK:MAXimum?		not available for R&S FSMR and FSET
FSE	FETCh:BURSt:PERRor:PEAK:STATus?		not available for R&S FSMR and FSET
FSE	FETCh:BURSt:PERRor:RMS:AVERAge?		not available for R&S FSMR and FSET
FSE	FETCh:BURSt:PERRor:RMS:MAXimum?		not available for R&S FSMR and FSET
FSE	FETCh:BURSt:PERRor:RMS:STATus?		not available for R&S FSMR and FSET
FSE	FETCh:BURSt:POWEr[:IMMediate]?		not available for R&S FSMR and FSET
FSE	FETCh:MODulation[:ALL]?	ARFCn TXBand RXBand COMBined DCSRx1800	not available for R&S FSMR and FSET
FSE	FETCh:PTEMPlate:REFerence?	TXBand	not available for R&S FSMR and FSET
FSE	FETCh:SPECTrum:MODulation:REFerence?	TXBand	not available for R&S FSMR and FSET
FSE	FETCh:SPECTrum:SWITChing:REFerence?	TXBand	not available for R&S FSMR and FSET
FSE	FETCh:SPECTrum:SWITChing[:ALL]?		not available for R&S FSMR and FSET
FSE	FETCh:SPURious:STEP?		not available for R&S FSMR and FSET

Devices	Command	Parameter	Notes
FSE	FETCh:SPURious[:ALL]?	TXBand OTXBand RXBand IDLeband	not available for R&S FSMR and FSET
FSE	FORMat:DEXPort:APPend[:STATe] ON OFF[,32]		not available for R&S FSMR
R&S FSMR + FSE	FORMat:DEXPort:DSEParator	POINt COMMa	
FSE	FORMat:DEXPort:HEADer[:STATe] ON OFF[,32]		not available for R&S FSMR
R&S FSMR	FORMat[:DATA]	ASCIi REAL[,32]	
FSE	FORMat[:DATA]	ASCIi REAL UINt [,32]	UINt is not available for R&S FSMR
R&S FSMR + FSE	HCOPy:ABORt		
R&S FSMR	HCOPy:CMAP:DEFault		new function for R&S FSMR
R&S FSMR	HCOPy:CMAP:HSL	<numeric value>, <numeric value>, <numeric value>	new function for R&S FSMR
R&S FSMR	HCOPy:CMAP:PDEFined	<char data>	new function for R&S FSMR
R&S FSMR	HCOPy:DESTination<1 2>	'MMEM' 'SYST:COMM:PRIN' 'SYST:COMM:CLIP'	
FSE/	HCOPy:DESTination<1 2>	'SYST:COMM:GPIB' 'SYST:COMM:SER1' 'SYST:COMM:SER2' 'SYST:COMM:CENt' 'MMEM' 'SYST:COMM:PRIN' 'SYST:COMM:CLIP'	SYST:COMM:GPIB/SER1/SE R2 is not available for R&S FSMR
FSIQ/ ESI	HCOPy:DESTination<1 2>	"MMEM" 'SYST:COMM:PRIN' 'SYST:COMM:CLIP'	
R&S FSMR + FSE	HCOPy:DEVice:COLor	ON OFF	
R&S FSMR	HCOPy:DEVice:LANGUage<1 2>	GDI WMF EWMF BMP	
FSE/	HCOPy:DEVice:LANGUage<1 2>	HPGL PCL4 PCL5 POSTscript ESCP WMF PCX HP7470 to	
FSIQ/ ESI	HCOPy:DEVice:LANGUage<1 2>	WMF GDI EWMF BMP to	
FSE/	HCOPy:DEVice:PRESet<1 2>	ON OFF	not available for R&S FSMR
FSE/	HCOPy:DEVice:RESolution<1 2>	150 300	not available for R&S FSMR
R&S FSMR + FSE	HCOPy:ITEM:ALL		
FSE	HCOPy:ITEM:FFEed<1 2>:STATe	ON OFF	not available for R&S FSMR
FSE	HCOPy:ITEM:LABel:TEXT	<string>	not available for R&S FSMR
FSE	HCOPy:ITEM:PFEEed<1 2>:STATe	ON OFF	not available for R&S FSMR
R&S FSMR + FSE	HCOPy:ITEM:WINDow<1 2>:TABLe:STATe	ON OFF	
R&S FSMR + FSE	HCOPy:ITEM:WINDow<1 2>:TEXT	<string>	
FSE	HCOPy:ITEM:WINDow<1 2>:TRACe:CAINcrement	ON OFF	not available for R&S FSMR
R&S FSMR + FSE	HCOPy:ITEM:WINDow<1 2>:TRACe:STATe	ON OFF	
FSE	HCOPy:PAGE:DIMensions:FULL		not available for R&S FSMR
FSE	HCOPy:PAGE:DIMensions:QUADrant<1...4>		not available for R&S FSMR
R&S FSMR + FSE	HCOPy:PAGE:ORientation<1 2>	LANDscape PORtrait	
R&S FSMR + FSE	HCOPy[:IMMediate]		
FSET/ ESI	HOLD		not available for R&S FSMR
R&S FSMR + FSE	INITiate<1 2>:CONMeas	ON OFF	
R&S FSMR + FSE	INITiate<1 2>:CONTInuous	ON OFF	
R&S FSMR + FSE	INITiate<1 2>:DISPlay	ON OFF	
R&S FSMR + FSE	INITiate<1 2>[:IMMediate]		
FSET	INPut:PRESelection:CATalog?		not available for R&S FSMR

Devices	Command	Parameter	Notes
FSET	INPut:PRESelection:USET:NAME	'name of user defined preselector set (to edit existing set or to create new set)'	not available for R&S FSMR
FSET	INPut:PRESelection:USET:CLear		not available for R&S FSMR
FSET	INPut:PRESelection:USET:COMMeNt	'comment for preselector-set'	not available for R&S FSMR
FSET	INPut:PRESelection:USET:LRANge[:DATA]	<numeric value>, <numeric value>, <numeric_value>	not available for R&S FSMR
FSET	INPut:PRESelection:USET:MRANge[:DATA]	<numeric value>, <numeric value>, <numeric_value>	not available for R&S FSMR
R&S FSMR + FSE	INPut<1 2>:ATTenuation	0 to 70dB	
FSET	INPut<1 2>:ATTenuation	0 to 70 80dB	80 dB not available for R&S FSMR
R&S FSMR + FSE	INPut<1 2>:ATTenuation:AUTO	ON OFF	
R&S FSMR + FSE	INPut<1 2>:ATTenuation:AUTO:MODE	NORMal LNOise LDISTorsion	not available for models 3 and 7; not available for R&S FSMR
FSET/ESI	INPut<1 2>:ATTenuation:PROTection	ON OFF	not available for R&S FSMR
R&S FSMR	INPut<1 2>:ATTenuation:PROTection:PRESet		new function for R&S FSMR
INPut<1 2>:PRESelection[:STATe]	INPut<1 2>:ATTenuation:PROTection:PRESet		new function for R&S FSMR
FSET	INPut<1 2>:ATTenuation:STEPsize	1dB 10dB	not available for R&S FSMR
FSET	INPut<1 2>:BIMPedance	150OHM 600OHM 10kOHM	not available for R&S FSMR
FSET	INPut<1 2>:COUPLing	AC DC	only available for R&S FSMR models 3, 8, 26
R&S FSMR	INPut<1 2>:EATT	0 to 30dB	new function for R&S FSMR
R&S FSMR	INPut<1 2>:EATT:AUTO	ON OFF	new function for R&S FSMR
R&S FSMR	INPut<1 2>:EATT:STATe	ON OFF	new function for R&S FSMR
FSET	INPut<1 2>:GAIN	0 to 30dB	not available for R&S FSMR
FSET/ESI	INPut<1 2>:GAIN:AUTO	ON OFF	not available for R&S FSMR
R&S FSMR + FSE	INPut<1 2>:GAIN:STATe	ON OFF	
R&S FSMR + FSE	INPut<1 2>:IMPedance	50 75	
FSE	INPut<1 2>:IMPedance:CORRection	RAM RAZ	not available for R&S FSMR
FSET	INPut<1 2>:LISN:PEARth	GROunded FLOating	not available for R&S FSMR
FSET	INPut<1 2>:LISN:PHASe	L1 L2 L3 N	not available for R&S FSMR
FSET	INPut<1 2>:LISN[:TYPE]	TWOphase FOURphase OFF	not available for R&S FSMR
R&S FSMR	INPut<1 2>:MIXer:AUTO	ON OFF	new function for FSU/FSQ
R&S FSMR	INPut<1 2>:MIXer[:POWER]	<numeric value>	new function for FSU/FSQ
R&S FSMR + FSE	INPut<1 2>:MIXer	<numeric value>	not available for R&S FSMR
R&S FSMR	INPut<1 2>:MIXer[:POWER]:AUTO	ON OFF	new function for R&S FSMR
FSET	INPut<1 2>:PRESelection:COUPLing	ON OFF	not available for R&S FSMR
FSET	INPut<1 2>:PRESelection:COUPLing:HIGH:FREQUency	5MHz to 500MHz	not available for R&S FSMR
FSET	INPut<1 2>:PRESelection:COUPLing:HIGH:SET	'name of preselector set for high RBW'	not available for R&S FSMR
FSET	INPut<1 2>:PRESelection:COUPLing:LOW:FREQUency	10Hz to 5MHz	not available for R&S FSMR
FSET	INPut<1 2>:PRESelection:COUPLing:LOW:SET	"name of preselector set for low RBW"	not available for R&S FSMR
FSET	INPut<1 2>:PRESelection:COUPLing:MID:SET	"name of preselector set for medium RBW"	not available for R&S FSMR
FSET	INPut<1 2>:PRESelection:FILTer:HPASS[:FREQUency]	100Hz to 5MHz	not available for R&S FSMR
FSET	INPut<1 2>:PRESelection:FILTer:LPASS[:FREQUency]	20KHz to 40MHz	not available for R&S FSMR
FSET	INPut<1 2>:PRESelection:FILTer[:STATe]	ON OFF	not available for R&S FSMR
FSET	INPut<1 2>:PRESelection:SET	NARRow NORMal WIDE	not available for R&S FSMR
FSET	INPut<1 2>:PRESelection:USET[:SElect]	"name of user defined preselector set"	not available for R&S FSMR
FSET	INPut<1 2>:PRESelection[:STATe]	ON OFF	not available for R&S FSMR
FSET	INPut<1 2>:TYPE	RF BALanced	not available for R&S FSMR

Devices	Command	Parameter	Notes
ESI	INPut<1 2>:TYPE	INPUT1 INPUT2	not available for R&S FSMR
FSE	INPut<1 2>:UPORt<1 2>:STATe	ON OFF	not available for R&S FSMR
FSE	INPut<1 2>:UPORt<1 2>[:VALue]?		not available for R&S FSMR
ESI	INPut2:COUPling	AC DC	not available for R&S FSMR
R&S FSMR	INSTrument:COUPlE	NONE RLEVel CF_B CF_A	available coupling modes between Screen A and Screen B have been changed between FSE and R&S FSMR
FSE	INSTrument:COUPlE	NONE MODE X Y CONTRol XY XCONTRol YCONTRol ALL	Available coupling modes between screen A and screen B have been changed between FSE and R&S FSMR
R&S FSMR	INSTrument<1 2>:NSElect	1	currently only parameter value 1 available
ESI	INSTrument<1 2>:NSElect	1 to 3 6	4 parameter values are available
FSE/ FSIQ	INSTrument<1 2>:NSElect	1 to 5	5 parameter values are available
FSET	INSTrument<1 2>:NSElect	1 2 6	3 parameter values are available
R&S FSMR	INSTrument<1 2>[:SElect]	SANalyzer	Currently only SANalyzer available
FSE/ FSIQ	INSTrument<1 2>[:SElect]	SANalyzer DDEMod ADEMod BGSM MGSM	5 parameters are available.
ESI	INSTrument<1 2>[:SElect]	RECeiver SANalyzer DDEMod ADEMod	4 parameters are available.
FSET	INSTrument<1 2>[:SElect]	ANalyzer DDEMod RECeiver	3 parameters are available.
R&S FSMR + FSE	MMEMemory:CATalog?	string	
R&S FSMR + FSE	MMEMemory:CDIRectory	directory name	
R&S FSMR + FSE	MMEMemory:CLear:ALL		
R&S FSMR + FSE	MMEMemory:CLear:STATe	1,path	
R&S FSMR + FSE	MMEMemory:COMMent	<string>	
R&S FSMR + FSE	MMEMemory:COPY	path\file, path\file	
R&S FSMR + FSE	MMEMemory:DATA	filename [, <block data>]	
R&S FSMR + FSE	MMEMemory:DELeTe	path\filename	
R&S FSMR + FSE	MMEMemory:LOAD:AUTO	1,path	
R&S FSMR + FSE	MMEMemory:LOAD:STATe	1,path	
R&S FSMR + FSE	MMEMemory:MDIRectory	path	
R&S FSMR + FSE	MMEMemory:MOVE	path	
R&S FSMR + FSE	MMEMemory:MSIS	'A:' 'D:'	R&S FSMR: valid drives are A: and D: FSE: valid drives are A: and C:
R&S FSMR + FSE	MMEMemory:NAME	path\filename	
R&S FSMR + FSE	MMEMemory:RDIRectory	directory	
R&S FSMR + FSE	MMEMemory:SElect[:ITEM]:ALL		
FSE	MMEMemory:SElect[:ITEM]:CSEtup	ON OFF	not available for R&S FSMR (default setting on the R&S FSMR)
FSE	MMEMemory:SElect[:ITEM]:CVL:ALL	ON OFF	not available for R&S FSMR and FSET
FSE	MMEMemory:SElect[:ITEM]:CVL[:ACTive]	ON OFF	not available for R&S FSMR and FSET

Devices	Command	Parameter	Notes
R&S FSMR + FSE	MMEMemory:SElect[:ITEM]:DEFault		
FSE	MMEMemory:SElect[:ITEM]:GSEtUp	ON OFF	not available for R&S FSMR (default setting on the R&S FSMR)
FSE	MMEMemory:SElect[:ITEM]:HCOPy	ON OFF	not available for R&S FSMR (default setting on the R&S FSMR)
R&S FSMR + FSE	MMEMemory:SElect[:ITEM]:HWSettings	ON OFF	
R&S FSMR + FSE	MMEMemory:SElect[:ITEM]:LINES:ALL	ON OFF	
FSE	MMEMemory:SElect[:ITEM]:LINES:ALL	ON OFF	
FSE	MMEMemory:SElect[:ITEM]:LINES[:ACTive]	ON OFF	not available for R&S FSMR (default setting on the R&S FSMR)
FSE	MMEMemory:SElect[:ITEM]:MACROs	ON OFF	not available for R&S FSMR
R&S FSMR + FSE	MMEMemory:SElect[:ITEM]:NONE		
R&S FSMR + FSE	MMEMemory:SElect[:ITEM]:SCData	ON OFF	
R&S FSMR	MMEMemory:SElect[:ITEM]:TRACe[:ACTive]	ON OFF	no numeric suffixes behind TRACe
FSE	MMEMemory:SElect[:ITEM]:TRACe<1...4>	ON OFF	numeric suffixes behind TRACe
FSE	MMEMemory:SElect[:ITEM]:TRANsducer:ALL	ON OFF	not available for R&S FSMR
FSE	MMEMemory:SElect[:ITEM]:TRANsducer[:ACTive]	ON OFF	not available for R&S FSMR
R&S FSMR + FSE	MMEMemory:STORE:STATe	1,path	
R&S FSMR + FSE	MMEMemory:STORE:TRACe	1 to 3,path	
FSE	OUTPut:AF:SENSitivity	<numeric_value>	not available for R&S FSMR and FSET
FSE	OUTPut:UPOrT<1 2>:STATe	ON OFF	not available for R&S FSMR
FSE	OUTPut:UPOrT<1 2>[:VALue]	#B00000000 to #B11111111	not available for R&S FSMR
R&S FSMR + FSE	OUTPut<1 2>[:STATe]	ON OFF	
FSE	READ:BURSt:FERRor:AVERAge?		not available for R&S FSMR and FSET
FSE	READ:BURSt:FERRor:MAXimum?		not available for R&S FSMR and FSET
FSE	READ:BURSt:FERRor:STATus?		not available for R&S FSMR and FSET
FSE	READ:BURSt:PERRor:PEAK:AVERAge?		not available for R&S FSMR and FSET
FSE	READ:BURSt:PERRor:PEAK:MAXimum?		not available for R&S FSMR and FSET
FSE	READ:BURSt:PERRor:PEAK:STATus?		not available for R&S FSMR and FSET
FSE	READ:BURSt:PERRor:RMS:AVERAge?		not available for R&S FSMR and FSET
FSE	READ:BURSt:PERRor:RMS:MAXimum?		not available for R&S FSMR and FSET
FSE	READ:BURSt:PERRor:RMS:STATus?		not available for R&S FSMR and FSET
FSE	READ:BURSt:POWEr:DYNamic?		not available for R&S FSMR and FSET
FSE	READ:BURSt:POWEr:LEVel?		not available for R&S FSMR and FSET
FSE	READ:BURSt:POWEr:STATic?		not available for R&S FSMR and FSET
FSE	READ:BURSt:POWEr?		not available for R&S FSMR and FSET
FSE	READ:BURSt:REFerence[:IMMediate?]		not available for R&S FSMR and FSET
FSE	READ:SPEctrum:MODulation[:ALL]?		not available for R&S FSMR and FSET
FSE	READ:SPEctrum:SWITChing[:ALL]?		not available for R&S FSMR and FSET

Devices	Command	Parameter	Notes
FSE	READ:SPURious:STEP?		not available for R&S FSMR and FSET
FSE	READ:SPURious[:ALL]?		not available for R&S FSMR and FSET
FSE	[SENSe<1 2>:]ADEMod:AF:COUPling	AC DC	not available for R&S FSMR and FSET
FSE	[SENSe<1 2>:]ADEMod:RTIME	ON OFF	not available for R&S FSMR and FSET
FSE	[SENSe<1 2>:]ADEMod:SBANd	NORMal INVerse	not available for R&S FSMR and FSET
FSE	[SENSe<1 2>:]ADEMod:SQUelch:LEVel	30 to 150 dBm	not available for R&S FSMR and FSET
FSE	[SENSe<1 2>:]ADEMod:SQUelch[:STATe]	ON OFF	not available for R&S FSMR and FSET
FSET	[SENSe<1 2>:]AM:RANGe[:UPPer]	3PCT 10 PCT 100PCT	not available for R&S FSMR
FSE	[SENSe<1 2>:]AVERAge:AUTO	ON OFF	not available for R&S FSMR
R&S FSMR + FSE	[SENSe<1 2>:]AVERAge:COUNT	0 to 32767	
FSE	[SENSe<1 2>:]AVERAge:COUNT	0 to 32767	
R&S FSMR	[SENSe<1 2>:]AVERAge:TYPE	VIDeo LINear	command is used to select logarithmic or linear averaging on the R&S FSMR; therefore parameters are incompatible to the FSE
FSE	[SENSe<1 2>:]AVERAge:TYPE	MAXimum MINimum SCALar	command is used to select logarithmic or linear averaging on the R&S FSMR; therefore parameters are incompatible to the FSE
R&S FSMR + FSE	[SENSe<1 2>:]AVERAge[:STATe<1...3>]	ON OFF	
FSE	[SENSe<1 2>:]BANDwidth BWIDth:DEMod	<numeric_value>	not available for R&S FSMR and FSET
R&S FSMR	[SENSe<1 2>:]BANDwidth BWIDth:PLL	WIDE NORMal NARRow	new function for R&S FSMR
FSE	[SENSe<1 2>:]BANDwidth BWIDth:PLL	AUTO HIGH MEDium LOW	not available for R&S FSMR
R&S FSMR	[SENSe<1 2>:]BANDwidth BWIDth:PLL	AUTO HIGH MEDium NARRow	new function for R&S FSMR
R&S FSMR + FSE	[SENSe<1 2>:]BANDwidth BWIDth:VIDeo	1Hz to 10MHz	R&S FSMR
FSET	[SENSe<1 2>:]BANDwidth BWIDth:VIDeo	1Hz to 500MHz	
R&S FSMR + FSE	[SENSe<1 2>:]BANDwidth BWIDth:VIDeo:AUTO	ON OFF	
FSET	[SENSe<1 2>:]BANDwidth BWIDth:VIDeo:EXTernal[:STATe]	ON OFF	not available for R&S FSMR
R&S FSMR	[SENSe<1 2>:]BANDwidth BWIDth:VIDeo:RATio	0.0001 to 1	only numeric values available. Parameter ranges differ between R&S FSMR and FSE
FSE	[SENSe<1 2>:]BANDwidth BWIDth:VIDeo:RATio	0.001 to 1000 SINE PULSE NOISE	also text parameters are available. Parameter ranges differ between R&S FSMR and FSE not available for FSET
R&S FSMR + FSE	[SENSe<1 2>:]BANDwidth BWIDth[:RESolution]	10Hz to 10MHz (anal. filter) 1Hz to 10MHz (FFT filter)	FSE: 10Hz to 10MHz (models 20) 1Hz to 10MHz (models 30)
FSET	[SENSe<1 2>:]BANDwidth BWIDth[:RESolution]	10 Hz to 500MHz	
R&S FSMR + FSE	[SENSe<1 2>:]BANDwidth BWIDth[:RESolution]:AUTO	ON OFF	
FSE	[SENSe<1 2>:]BANDwidth BWIDth[:RESolution]:MODE	ANALog DIGital	not available for R&S FSMR and FSET
R&S FSMR + FSE	[SENSe<1 2>:]BANDwidth BWIDth[:RESolution]:MODE:FFT	ON OFF	old command that is still supported, but has been replaced on the R&S FSMR by [SENSe<1 2>:]BANDwidth BWIDth[:RESolution]:TYPE
R&S FSMR + FSE	[SENSe<1 2>:]BANDwidth BWIDth[:RESolution]:RATio	0.0001 to 1	
R&S FSMR	[SENSe<1 2>:]BANDwidth BWIDth[:RESolution]:TYPE	NORMal FFT CFILter RRC	new function for R&S FSMR

Devices	Command	Parameter	Notes
R&S FSMR	[SENSe<1 2>:]BANDwidth BWIDTH:VIdeo:TYPE	LINear LOGarithmic	new function for R&S FSMR
R&S FSMR + FSE	[SENSe<1 2>:]CORRection:COLLect[:ACQuire]	THRough OPEN	
FSE	[SENSe<1 2>:]CORRection:CVL:Band	A Q U V E W F D G Y J	not available for R&S FSMR and FSET
FSE	[SENSe<1 2>:]CORRection:CVL:BIAS	<numeric_value>	not available for R&S FSMR and FSET
FSE	[SENSe<1 2>:]CORRection:CVL:CATalog?		not available for R&S FSMR and FSET
FSE	[SENSe<1 2>:]CORRection:CVL:CLear		not available for R&S FSMR and FSET
FSE	[SENSe<1 2>:]CORRection:CVL:COMment	<string>	not available for R&S FSMR and FSET
FSE	[SENSe<1 2>:]CORRection:CVL:DATA	<freq>, <level> to	not available for R&S FSMR and FSET
FSE	[SENSe<1 2>:]CORRection:CVL:MIxer	<string>	not available for R&S FSMR and FSET
FSE	[SENSe<1 2>:]CORRection:CVL:PORTs	2 3	not available for R&S FSMR and FSET
FSE	[SENSe<1 2>:]CORRection:CVL:SElect	<file_name>	not available for R&S FSMR and FSET
FSE	[SENSe<1 2>:]CORRection:CVL:SNUMber	<string>	not available for R&S FSMR and FSET
FSE	[SENSe<1 2>:]CORRection:CVL:TYPE	ODD EVEN EODD	not available for R&S FSMR and FSET
FSE/FSIQ	[SENSe<1 2>:]CORRection:LOSS:INPut[:MAGNitude]	<numeric_value>	not available for R&S FSMR
R&S FSMR + FSE	[SENSe<1 2>:]CORRection:METhod	TRANsmission REFLEXion	
R&S FSMR + FSE	[SENSe<1 2>:]CORRection:RECall		
FSE	[SENSe<1 2>:]CORRection:RXGain:INPut[:MAGNitude]	<numeric_value>	not available for R&S FSMR, FSET and ESI
R&S FSMR + FSE	[SENSe<1 2>:]CORRection[:STATe]	ON OFF	
R&S FSMR + FSE	[SENSe<1 2>:]CORRection:TRANsdUcer:ACTive?		
R&S FSMR + FSE	[SENSe<1 2>:]CORRection:TRANsdUcer:CATalog?		
R&S FSMR + FSE	[SENSe<1 2>:]CORRection:TRANsdUcer:COMment	<string>	
R&S FSMR + FSE	[SENSe<1 2>:]CORRection:TRANsdUcer:DATA	<freq>, <level> to	
R&S FSMR + FSE	[SENSe<1 2>:]CORRection:TRANsdUcer:DELeTe		
R&S FSMR + FSE	[SENSe<1 2>:]CORRection:TRANsdUcer:SCALing	LINear LOGarithmic	
R&S FSMR + FSE	[SENSe<1 2>:]CORRection:TRANsdUcer:SElect	<name>	
R&S FSMR + FSE	[SENSe<1 2>:]CORRection:TRANsdUcer:UNIT	<string>	
R&S FSMR + FSE	[SENSe<1 2>:]CORRection:TRANsdUcer[:STATe]	ON OFF	
FSE	[SENSe<1 2>:]CORRection:TSET:ACTive?		not available for R&S FSMR
FSE	[SENSe<1 2>:]CORRection:TSET:BREak	ON OFF	not available for R&S FSMR
FSE	[SENSe<1 2>:]CORRection:TSET:CATalog?		not available for R&S FSMR
FSE	[SENSe<1 2>:]CORRection:TSET:COMment	<string>	not available for R&S FSMR
FSE	[SENSe<1 2>:]CORRection:TSET:DELeTe		not available for R&S FSMR
FSE	[SENSe<1 2>:]CORRection:TSET:RANGe<1...10>	<freq>, <freq>, <name> to	not available for R&S FSMR
FSE	[SENSe<1 2>:]CORRection:TSET:SElect	<name>	not available for R&S FSMR
FSE	[SENSe<1 2>:]CORRection:TSET:UNIT	<string>	not available for R&S FSMR
FSE	[SENSe<1 2>:]CORRection:TSET[:STATe]	ON OFF	not available for R&S FSMR
R&S FSMR + FSE	[SENSe<1 2>:]CORRection:YIG:TEMPerature:AUTO	ON OFF	new function for R&S FSMR
FSE	[SENSe<1 2>:]DDEMod:FILTer:ALPHA	0.2 to 1	not available for R&S FSMR

Devices	Command	Parameter	Notes
FSE	[SENSe<1 2>:]DDEMod:FILTer:MEASurement	OFF RCOSine RRCosine GAUSSian B22 B25 B44 QFM QFR QRM QRR A25Fm EMES EREF	not available for R&S FSMR
FSE	[SENSe<1 2>:]DDEMod:FILTer:REFErence	RCOSine RRCosine GAUSSian B22 B25 B44 QFM QFR QRM QRR A25Fm EMES EREF	not available for R&S FSMR
FSE	[SENSe<1 2>:]DDEMod:FORMat	QPSK PSK MSK QAM FSK	not available for R&S FSMR
FSE	[SENSe<1 2>:]DDEMod:FSK:NState	2 4	not available for R&S FSMR
FSE	[SENSe<1 2>:]DDEMod:MSK:FORMat	TYPE1 TYPE2 NORMal DIFFerential	not available for R&S FSMR
FSE	[SENSe<1 2>:]DDEMod:NORMalize	ON OFF	not available for R&S FSMR
FSE	[SENSe<1 2>:]DDEMod:PRATe	1 2 4 8 16	not available for R&S FSMR
FSE/ ESI	[SENSe<1 2>:]DDEMod:PRESet	GSM EDGe NADC TETRa DCS1800 PCS1900 PHS PDCup PDCDown APCO25CQPSK APCO25C4FM CDPD DECT CT2 ERMes MODacom PWT TFTS F16 F322 F324 F64 FQCDma RQCDma FNADc RNADc BPSK18 GMSK18 QPSK18 GMSK36	not available for R&S FSMR
FSIQ	[SENSe<1 2>:]DDEMod:PRESet	GSM EDGe NADC TETRa PHS PDCup PDCDown APCO25CQPSK APCO25C4FM CDPD DECT CT2 ERMes MODacom PWT TFTS F16 F322 F324 F64 FWCDma RWCDma FW3Gppcdma RW3Gppcdma BPSK18 GMSK18 QPSK18 GMSK36	not available for R&S FSMR
FSET	[SENSe<1 2>:]DDEMod:PRESet	GSM EDGe NADC TETRa DCS1800 PCS1900 PHS PDCup PDCDown APCO25CQPSK APCO25C4FM CDPD DECT CT2 ERMes MODacom PWT TFTS F16 F322 F324 F64 FQCDma RQCDma FNADc RNADc BPSK18 GMSK18 QPSK18 GMSK36	not available for R&S FSMR
FSE	[SENSe<1 2>:]DDEMod:PSK:FORMat	NORMal DIFFerential N3Pi8	not available for R&S FSMR
FSE	[SENSe<1 2>:]DDEMod:PSK:NState	2 8	not available for R&S FSMR
FSE	[SENSe<1 2>:]DDEMod:QAM:NState	16	not available for R&S FSMR
FSE	[SENSe<1 2>:]DDEMod:QPSK:FORMat	NORMal DIFFerential OFFSet DPI4	not available for R&S FSMR
FSE	[SENSe<1 2>:]DDEMod:SBANd	NORMal INVerse	not available for R&S FSMR
FSE	[SENSe<1 2>:]DDEMod:SEARch:PULSe:STATe	ON OFF	not available for R&S FSMR
FSE	[SENSe<1 2>:]DDEMod:SEARch:SYNC:CATalog?		not available for R&S FSMR
FSE	[SENSe<1 2>:]DDEMod:SEARch:SYNC:COMMeNT	<string>	not available for R&S FSMR
FSE	[SENSe<1 2>:]DDEMod:SEARch:SYNC:DATA	<string>	not available for R&S FSMR
FSE	[SENSe<1 2>:]DDEMod:SEARch:SYNC:NAME	<string>	not available for R&S FSMR
FSE	[SENSe<1 2>:]DDEMod:SEARch:SYNC:OFFSet	<numeric_value>	not available for R&S FSMR
FSE	[SENSe<1 2>:]DDEMod:SEARch:SYNC:PATTern	<string>	not available for R&S FSMR
FSE	[SENSe<1 2>:]DDEMod:SEARch:SYNC:SELEct	<string>	not available for R&S FSMR
FSE	[SENSe<1 2>:]DDEMod:SEARch:SYNC:STATe	ON OFF	not available for R&S FSMR
FSE	[SENSe<1 2>:]DDEMod:SEARch:TIME	100 to 1600	not available for R&S FSMR

Devices	Command	Parameter	Notes
FSE	[SENSe<1 2>:]DDEMod:SRATe	160 Hz to 1,6 MHz	not available for R&S FSMR
FSIQ	[SENSe<1 2>:]DDEMod:SRATe	160 Hz to 7 MHz	not available for R&S FSMR
	[SENSe<1 2>:]DDEMod:TIME	1 to Frame Length	not available for R&S FSMR
FSET	[SENSe<1 2>:]DEMod	OFF AM AMVideo FM PM	not available for R&S FSMR
ESI	[SENSe<1 2>:]DEMod	OFF AM FM	not available for R&S FSMR
FSET	[SENSe<1 2>:]DEMod:FILTer:HPASs:FREQuency	0 Hz 10 Hz 100 Hz 1 kHz	not available for R&S FSMR
FSET	[SENSe<1 2>:]DEMod:FILTer[:LPASs]:AUTo	ON OFF	not available for R&S FSMR
FSET	[SENSe<1 2>:]DEMod:FILTer[:LPASs]:FREQuency	<numeric_value>	not available for R&S FSMR
FSE	[SENSe<1 2>:]DETEctor<1...4>:CMEM[:STATe]	ON OFF	not available for R&S FSMR
R&S FSMR	[SENSe<1 2>:]DETEctor<1...3>[:FUNCTion]	APEak NEGative POSitive SAMPlE RMS AVERAge QPEak	R&S FSMR: number of traces restricted to 3; detector settings correspond to selected screen FSE: Qpeak not available
ESI	[SENSe<1 2>:]DETEctor<1..4>[:FUNCTion]	APEak NEGative POSitive SAMPlE RMS AVERAge QPEak	
R&S FSMR + FSE	[SENSe<1 2>:]DETEctor<1...3>[:FUNCTion]:AUTo	ON OFF	number of traces restricted to 3
FSET	[SENSe<1 2>:]DETEctor<1...4>:PSTRetch:AUTo	ON OFF	not available for R&S FSMR
FSET	[SENSe<1 2>:]DETEcto<1...4>r:PSTRetch[:STATe]	ON OFF	not available for R&S FSMR
ESI	[SENSe<1 2>:]DETEctor<1...4>:RECEiver[:FUNCTion]	POSitive NEGative RMS AVERAge QPEak	not available for R&S FSMR
FSET	[SENSe<1 2>:]DETEctor<1...4>:RECEiver[:FUNCTion]	POSitive NEGative RMS AVERAge	not available for R&S FSMR
FSE	[SENSe<1 2>:]FILTer:CCIT[:STATe]	ON OFF	not available for R&S FSMR and FSET
FSE	[SENSe<1 2>:]FILTer:CMESsage[:STATe]	ON OFF	not available for R&S FSMR and FSET
FSE	[SENSe<1 2>:]FILTer:DEMPHasis:LINK	DISPlay AUDio	not available for R&S FSMR and FSET
FSE	[SENSe<1 2>:]FILTer:DEMPHasis:TCONstant	<numeric_value>	not available for R&S FSMR and FSET
FSE	[SENSe<1 2>:]FILTer:DEMPHasis[:STATe]	ON OFF	not available for R&S FSMR and FSET
FSE	[SENSe<1 2>:]FILTer:HPASs:FREQuency	30 Hz 300 HZ	not available for R&S FSMR and FSET
FSET	[SENSe<1 2>:]FILTer:HPASs:FREQuency	10 kHz 1 kHz 100 Hz	not available for R&S FSMR
FSE	[SENSe<1 2>:]FILTer:HPASs[:STATe]	ON OFF	not available for R&S FSMR
FSE	[SENSe<1 2>:]FILTer:LPASs:FREQuency	3 kHz 15 kHz	not available for R&S FSMR and FSET
FSE	[SENSe<1 2>:]FILTer:LPASs[:STATe]	ON OFF	not available for R&S FSMR and FSET
FSET	[SENSe<1 2>:]FILTer:NOTCh[:STATe]	ON OFF	not available for R&S FSMR
FSET	[SENSe<1 2>:]FM[:DEViation]:RANGe:UPPer	ON OFF	not available for R&S FSMR
FSET	[SENSe<1 2>:]FM[:DEViation]:RANGe[:UPPer]	<numeric_value>	not available for R&S FSMR
R&S FSMR + FSE	[SENSe<1 2>:]FREQuency:CENTer	0 to f_{max}	frequency ranges are different for R&S FSMR and FSE
FSE	[SENSe<1 2>:]FREQuency:CENTer:LINK	STARt STOP SPAN	not available for R&S FSMR
R&S FSMR + FSE	[SENSe<1 2>:]FREQuency:CENTer:STEP	0 to f_{max}	frequency ranges are different for R&S FSMR and FSE
R&S FSMR + FSE	[SENSe<1 2>:]FREQuency:CENTer:STEP:LINK	SPAN RBW OFF	
R&S FSMR + FSE	[SENSe<1 2>:]FREQuency:CENTer:STEP:LINK:FACTor	1 to 100 PCT	
R&S FSMR + FSE	[SENSe<1 2>:]FREQuency:MODE	CW FIXed SWEep	
R&S FSMR + FSE	[SENSe<1 2>:]FREQuency:OFFSet	<numeric_value>	
FSET	[SENSe<1 2>:]FREQuency:RANGe	2 GHz 22 GHz	not available for R&S FSMR
R&S FSMR + FSE	[SENSe<1 2>:]FREQuency:SPAN	0 to f_{max}	frequency ranges are different for R&S FSMR and FSE
R&S FSMR + FSE	[SENSe<1 2>:]FREQuency:SPAN:FULL		
FSE	[SENSe<1 2>:]FREQuency:SPAN:LINK	CENTer STOP SPAN	not available for R&S FSMR
R&S FSMR + FSE	[SENSe<1 2>:]FREQuency:STARt	0 to f_{max}	frequency ranges are different for R&S FSMR and FSE

Devices	Command	Parameter	Notes
FSET	[SENSe<1 2>:]FREQuency:START:FLINe[:STATe]	ON OFF	not available for R&S FSMR. Replaced by CALC:MARK:FUNC:SLIMits
FSE	[SENSe<1 2>:]FREQuency:START:LINK	CENTer STOP SPAN	not available for R&S FSMR
R&S FSMR + FSE	[SENSe<1 2>:]FREQuency:STOP	0 to f_{max}	frequency ranges are different for R&S FSMR and FSE
FSET	[SENSe<1 2>:]FREQuency:STOP:FLINe[:STATe]	ON OFF	not available for R&S FSMR; replaced by CALC:MARK:FUNC:SLIMits.
FSE	[SENSe<1 2>:]FREQuency:STOP:LINK	CENTer START SPAN	not available for R&S FSMR
FSET/ ESI	[SENSe<1 2>:]FREQuency[:CW]:FIXed]	f_{min} to f_{max}	not available for R&S FSMR
FSET/ ESI	[SENSe<1 2>:]FREQuency[:CW]:FIXed]:STEP	f_{min} to f_{max}	not available for R&S FSMR
R&S FSMR	[SENSe<1 2>:]LIST:POWer:RESult?		new function for R&S FSMR
R&S FSMR	[SENSe<1 2>:]LIST:POWer[:SEQuence]	<analyzer freq>, <ref level>, <rf att>, <el att>, <filter type>, <rbw>, <vbw>, <meas time>, <trigger level>,...	new function for R&S FSMR
R&S FSMR	[SENSe<1 2>:]LIST:POWer:SET	<PEAK meas>, <RMS meas>, <AVG meas>, <trigger mode>, <trigger slope>, <trigger offset>, <gate length>	new function for R&S FSMR
R&S FSMR	[SENSe<1 2>:]LIST:POWer:STATe	ON OFF	new function for R&S FSMR
FSE	[SENSe<1 2>:]MIXer:BIAS	<numeric_value>	not available for R&S FSMR
FSE	[SENSe<1 2>:]MIXer:BIAS:LIMit:MIN	<numeric_value>	not available for R&S FSMR
FSE	[SENSe<1 2>:]MIXer:BIAS:LIMit[:MAX]	<numeric_value>	not available for R&S FSMR
FSE	[SENSe<1 2>:]MIXer:BLOCK	ON OFF	not available for R&S FSMR
FSE	[SENSe<1 2>:]MIXer:HARMonic	<numeric_value>	not available for R&S FSMR
FSE	[SENSe<1 2>:]MIXer:HARMonic:BAND	A Q U V E W F D G Y J	not available for R&S FSMR
FSE	[SENSe<1 2>:]MIXer:HARMonic:TYPE	ODD EVEN EODD	not available for R&S FSMR
FSE	[SENSe<1 2>:]MIXer:LOSS:HIGH	<numeric_value>	not available for R&S FSMR
FSE	[SENSe<1 2>:]MIXer:LOSS:TABLE	<file_name>	not available for R&S FSMR
FSE	[SENSe<1 2>:]MIXer:LOSS[:LOW]	<numeric_value>	not available for R&S FSMR
FSE	[SENSe<1 2>:]MIXer:PORTs	2 3	not available for R&S FSMR
FSE	[SENSe<1 2>:]MIXer:SIGNal	2 3	not available for R&S FSMR
FSE	[SENSe<1 2>:]MIXer:THReshold	0.1 to 100 dB	not available for R&S FSMR
FSE	[SENSe<1 2>:]MIXer[:STATe]	ON OFF	not available for R&S FSMR
R&S FSMR	[SENSe<1 2>:]MPOWer[:SEQuence]	<analyzer freq>, <rbw>, <meas time>, <trigger source>, <trigger level>, <trigger offset>, <type of meas>, <# of meas>	new function for R&S FSMR
R&S FSMR	[SENSe<1 2>:]MPOWer:RESult[:LIST]?		new function for R&S FSMR
R&S FSMR	[SENSe<1 2>:]MPOWer:RESult:MIN?		new function for R&S FSMR
FSE	[SENSe<1 2>:]MSUMmary:AHOLd[:STATe]	ON OFF	not available for R&S FSMR and FSET
FSE	[SENSe<1 2>:]MSUMmary:MODE	ABSolute RELative	not available for R&S FSMR and FSET
FSE	[SENSe<1 2>:]MSUMmary:MTIME	0.1S 1S	not available for R&S FSMR and FSET
FSE	[SENSe<1 2>:]MSUMmary:REFerence	<numeric_value>	not available for R&S FSMR and FSET
FSE	[SENSe<1 2>:]MSUMmary:REFerence:AUTO	ONCE	not available for R&S FSMR and FSET
FSE	[SENSe<1 2>:]MSUMmary:RUNit	PCT DB	not available for R&S FSMR and FSET
FSET	[SENSe<1 2>:]PM[:DEViation]:RANGe[:UPPer]	<numeric_value>	not available for R&S FSMR
R&S FSMR + FSE	[SENSe<1 2>:]POWer:ACHannel:ACPairs	0 to 3	R&S FSMR: new parameter value 0 for channel power measurement

Devices	Command	Parameter	Notes
R&S FSMR + FSE	[SENSe<1 2>:]POWer:ACHannel:BANDwidth BWIDth:ACHannel	100 to 1000MHz	R&S FSMR: parameter range starts at 100Hz FSE: parameter range starts at 0 Hz
R&S FSMR + FSE	[SENSe<1 2>:]POWer:ACHannel:BANDwidth BWIDth:ALTErnate<1 2>	100 to 1000MHz	R&S FSMR: parameter range starts at 100Hz FSE: parameter range starts at 0 Hz
R&S FSMR + FSE	[SENSe<1 2>:]POWer:ACHannel:BANDwidth BWIDth[:CHANnel]	100 to 1000MHz	R&S FSMR: parameter range starts at 100Hz FSE: parameter range starts at 0 Hz
R&S FSMR + FSE	[SENSe<1 2>:]POWer:ACHannel:MODE	ABSolute RELative	
R&S FSMR + FSE	[SENSe<1 2>:]POWer:ACHannel:PRESet	ACPowEr CPOWEr OBANdwidth OBWIDth CN CN0 MCACpower	MCACpower not available for FSE
R&S FSMR	[SENSe<1 2>:]POWer:ACHannel:PRESet:RLEVel		new function for R&S FSMR
R&S FSMR + FSE	[SENSe<1 2>:]POWer:ACHannel:REFerence:AUTO	ONCE	
R&S FSMR + FSE	[SENSe<1 2>:]POWer:ACHannel:SPACing[:ACHannel]	100Hz to 2000MHz	different parameter range
R&S FSMR	[SENSe<1 2>:]POWer:CHannel:SPACing:CHANnel	100Hz to 2000MHz	new function for R&S FSMR
FSE	[SENSe<1 2>:]POWer:ACHannel:SPACing[:UPPER]	0 to 1000MHz	not available for R&S FSMR and FSET
R&S FSMR + FSE	[SENSe<1 2>:]POWer:ACHannel:SPACing:ALTErnate<1 2>	100Hz to 2000MHz	different parameter range
R&S FSMR	[SENSe<1 2>:]POWer:ACHannel:TXCHannel:COUNT	1 2 3 4	new function for R&S FSMR
R&S FSMR	[SENSe<1 2>:]POWer:ACHannel:REFerence:TXCHannel:AUTO	MINimum MAXimum LHIGhest	new function for R&S FSMR
R&S FSMR	[SENSe<1 2>:]POWer:ACHannel:REFerence:TXCHannel:MANual	1 2 3 4	new function for R&S FSMR
R&S FSMR + FSE	[SENSe<1 2>:]POWer:BANDwidth BWIDth	10 to 99.9PCT	different parameter range
R&S FSMR	[SENSe<1 2>:]POWer:HSPeed	ON OFF	new function for R&S FSMR
R&S FSMR	[SENSe<1 2>:]POWer:NCORrection	ON OFF	new function for R&S FSMR
R&S FSMR	[SENSe<1 2>:]POWer:TRACe	1 to 3	new function for R&S FSMR
R&S FSMR + FSE	[SENSe<1 2>:]ROSCillator:[INTernal:]TUNE	0 to 4095	
R&S FSMR + FSE	[SENSe<1 2>:]ROSCillator:[INTernal:]TUNE:SAVE		
FSE	[SENSe<1 2>:]ROSCillator:EXTernal:FREQuency	1MHz to 16MHz	not available for R&S FSMR
R&S FSMR + FSE	[SENSe<1 2>:]ROSCillator:SOURce	INTernal EXTernal	
FSET/ESI	[SENSe<1 2>:]SCAN<:RANGes[COUNT]	1 to 10	not available for R&S FSMR
FSE/ESI	[SENSe<1 2>:]SCAN<1...10>:BANDwidth:RESolution	f_{min} to f_{max}	not available for R&S FSMR
FSET/ESI	[SENSe<1 2>:]SCAN<1...10>:INPut:ATTenuation	dB_{min} to dB_{max}	not available for R&S FSMR
FSET/ESI	[SENSe<1 2>:]SCAN<1...10>:INPut:ATTenuation:AUTO	ON OFF	not available for R&S FSMR
FSET	[SENSe<1 2>:]SCAN<1...10>:INPut:BIMPedance	150OHM 600OHM 10kOHM	not available for R&S FSMR
FSET	[SENSe<1 2>:]SCAN<1...10>:INPut:GAIN	0dB to 30dB	not available for R&S FSMR
FSET/ESI	[SENSe<1 2>:]SCAN<1...10>:INPut:GAIN:AUTO	ON OFF	not available for R&S FSMR
ESI	[SENSe<1 2>:]SCAN<1...10>:INPut:GAIN:STATe	ON OFF	not available for R&S FSMR
ESI	[SENSe<1 2>:]SCAN<1...10>:INPut:TYPE	INPUT1 INPUT2	not available for R&S FSMR
FSET	[SENSe<1 2>:]SCAN<1...10>:INPut:TYPE	RF BALanced	not available for R&S FSMR
FSET/ESI	[SENSe<1 2>:]SCAN<1...10>:START	f_{min} to f_{max}	not available for R&S FSMR
FSET/ESI	[SENSe<1 2>:]SCAN<1...10>:STEP	f_{min} to f_{max}	not available for R&S FSMR
FSET/ESI	[SENSe<1 2>:]SCAN<1...10>:STOP	f_{min} to f_{max}	not available for R&S FSMR
FSET/ESI	[SENSe<1 2>:]SCAN<1...10>:TIME	100 μ s to 100 s	not available for R&S FSMR
R&S FSMR + FSE	[SENSe<1 2>:]SWEep:COUNT	0 to 32767	

Devices	Command	Parameter	Notes
R&S FSMR + FSE	[SENSe<1 2>:]SWEep:EGATe	ON OFF	
R&S FSMR + FSE	[SENSe<1 2>:]SWEep:EGATe:HOLDoff	0 to 100s	
R&S FSMR + FSE	[SENSe<1 2>:]SWEep:EGATe:LENGth	0 to 100s	
FSE	[SENSe<1 2>:]SWEep:EGATe:LENGth	0 to 100s	
FSE	[SENSe<1 2>:]SWEep:EGATe:LEVel	-5V to +5V	not available for R&S FSMR
R&S FSMR + FSE	[SENSe<1 2>:]SWEep:EGATe:POLarity	POSitive NEGative	
R&S FSMR + FSE	[SENSe<1 2>:]SWEep:EGATe:SOURce	EXTernal IFPower RFPower	
R&S FSMR + FSE	[SENSe<1 2>:]SWEep:EGATe:TYPE	LEVel EDGE	
FSE	[SENSe<1 2>:]SWEep:GAP	ON OFF	not available for R&S FSMR
FSE	[SENSe<1 2>:]SWEep:GAP:LENGth	0 to 100s	not available for R&S FSMR
FSE	[SENSe<1 2>:]SWEep:GAP:PRETrigger	0 to 100s	not available for R&S FSMR
FSE	[SENSe<1 2>:]SWEep:GAP:TRGTogap	0 to 100s	not available for R&S FSMR
R&S FSMR	[SENSe<1 2>:]SWEep:POINts	<numeric value>	not available for FSE
FSET/ESI	[SENSe<1 2>:]SWEep:SPACing	LINear LOGarithmic AUTO	not available for R&S FSMR
FSE/FSIQ	[SENSe<1 2>:]SWEep:SPACing	LINear LOGarithmic	not available for R&S FSMR
R&S FSMR + FSE	[SENSe<1 2>:]SWEep:TIME	2.5ms to 1000s 1 μ s to 16000s	different parameter ranges for R&S FSMR and FSE
R&S FSMR + FSE	[SENSe<1 2>:]SWEep:TIME:AUTO	ON OFF	
FSE	[SENSe<1 2>:]TCAPture:LENGth	1024 2048 4096 8192 16384	not available for R&S FSMR
FSE	[SENSe<1 2>:]TV:PSOFFset	0 to 6.5 MHz	not available for R&S FSMR and FSET
R&S FSMR	[SENSe<1 2>:]TV:CCVS	INTernal EXTernal	new function for R&S FSMR
R&S FSMR + FSE	[SENSe<1 2>:]TV[:STATe]	ON OFF	
R&S FSMR + FSE	SOURce:AM:STATe	ON OFF	
R&S FSMR + FSE	SOURce:DM:STATe	ON OFF	
R&S FSMR	SOURce:EXTernal[:STATe]	ON OFF	new command for R&S FSMR
R&S FSMR	SOURce:EXTernal:FREQUency:OFFset	<numeric_value>	new command for R&S FSMR
R&S FSMR	SOURce:EXTernal:FREQUency[:FACTOR]:NUMerator	<numeric_value>	new command for R&S FSMR
R&S FSMR	SOURce:EXTernal:FREQUency[:FACTOR]:DENominator	<numeric_value>	new command for R&S FSMR
R&S FSMR	SOURce:EXTernal:FREQUency:SWEep[:STATe]	ON OFF	new command for R&S FSMR
R&S FSMR	SOURce:EXTernal:POWer[:LEVel]	<numeric_value>	new command for R&S FSMR
R&S FSMR + FSE	SOURce:FM:STATe	ON OFF	
R&S FSMR + FSE	SOURce:FREQUency:OFFSet	-150Hz to 150MHz	different value ranges for R&S FSMR and FSE
FSE	SOURce:POWer:ALC:SOURce	INTernal EXTernal	not available for R&S FSMR and FSET
R&S FSMR + FSE	SOURce:POWer[:LEVel][:IMMediate]:OFFSet	-200dB to +200dB	
R&S FSMR + FSE	SOURce:POWer[:LEVel][:IMMediate][:AMPLitude]	-30dBm to 0dBm	different value ranges for R&S FSMR and FSE
R&S FSMR + FSE	STATus:OPERation:CONDition?		
FSE	STATus:OPERation:CONDition?		
R&S FSMR + FSE	STATus:OPERation:ENABLE	0 to 65535	
R&S FSMR + FSE	STATus:OPERation:NTRansition	0 to 65535	
R&S FSMR + FSE	STATus:OPERation:PTRansition	0 to 65535	

Devices	Command	Parameter	Notes
R&S FSMR + FSE	STATus:OPERation[:EVENT?]		
R&S FSMR + FSE	STATus:PRESet		
R&S FSMR + FSE	STATus:QUEStionable:ACPLimit:CONDition?		
R&S FSMR + FSE	STATus:QUEStionable:ACPLimit:ENABle	0 to 65535	
R&S FSMR + FSE	STATus:QUEStionable:ACPLimit:NTRansition	0 to 65535	
R&S FSMR + FSE	STATus:QUEStionable:ACPLimit:PTRansition	0 to 65535	
R&S FSMR + FSE	STATus:QUEStionable:ACPLimit[:EVENT]?		
R&S FSMR + FSE	STATus:QUEStionable:CONDition?		
R&S FSMR + FSE	STATus:QUEStionable:ENABle	0 to 65535	
R&S FSMR + FSE	STATus:QUEStionable:FREQuency:CONDition?		
R&S FSMR + FSE	STATus:QUEStionable:FREQuency:ENABle	0 to 65535	
R&S FSMR + FSE	STATus:QUEStionable:FREQuency:NTRansition	0 to 65535	
R&S FSMR + FSE	STATus:QUEStionable:FREQuency:PTRansition	0 to 65535	
R&S FSMR + FSE	STATus:QUEStionable:FREQuency[:EVENT]?		
R&S FSMR + FSE	STATus:QUEStionable:LIMit<1 2>:CONDition?		R&S FSMR: individual registers for screen A and B
R&S FSMR + FSE	STATus:QUEStionable:LIMit<1 2>:ENABle	0 to 65535	R&S FSMR: individual registers for screen A and B
R&S FSMR + FSE	STATus:QUEStionable:LIMit<1 2>:NTRansition	0 to 65535	R&S FSMR: individual registers for screen A and B
R&S FSMR + FSE	STATus:QUEStionable:LIMit<1 2>:PTRansition	0 to 65535	R&S FSMR: individual registers for screen A and B
R&S FSMR + FSE	STATus:QUEStionable:LIMit<1 2>[:EVENT]?		R&S FSMR: individual registers for screen A and B
R&S FSMR + FSE	STATus:QUEStionable:LMARgin<1 2>:CONDition?		R&S FSMR: individual registers for screen A and B
R&S FSMR + FSE	STATus:QUEStionable:LMARgin<1 2>:ENABle	0 to 65535	R&S FSMR: individual registers for screen A and B
R&S FSMR + FSE	STATus:QUEStionable:LMARgin<1 2>:NTRansition	0 to 65535	R&S FSMR: individual registers for screen A and B
R&S FSMR + FSE	STATus:QUEStionable:LMARgin<1 2>:PTRansition	0 to 65535	R&S FSMR: individual registers for screen A and B
R&S FSMR + FSE	STATus:QUEStionable:LMARgin<1 2>[:EVENT]?		R&S FSMR: individual registers for screen A and B
R&S FSMR + FSE	STATus:QUEStionable:NTRansition	0 to 65535	
R&S FSMR + FSE	STATus:QUEStionable:POWer:CONDition?		
R&S FSMR + FSE	STATus:QUEStionable:POWer:ENABle	0 to 65535	
R&S FSMR + FSE	STATus:QUEStionable:POWer:NTRansition	0 to 65535	
R&S FSMR + FSE	STATus:QUEStionable:POWer:PTRansition	0 to 65535	
R&S FSMR + FSE	STATus:QUEStionable:POWer[:EVENT]?		
R&S FSMR + FSE	STATus:QUEStionable:PTRansition	0 to 65535	
R&S FSMR + FSE	STATus:QUEStionable:SYNC:CONDition?		
R&S FSMR + FSE	STATus:QUEStionable:SYNC:ENABle	0 to 65535	
R&S FSMR + FSE	STATus:QUEStionable:SYNC:NTRansition	0 to 65535	
R&S FSMR + FSE	STATus:QUEStionable:SYNC:PTRansition	0 to 65535	

Devices	Command	Parameter	Notes
R&S FSMR + FSE	STATus:QUEStionable:SYNC[:EVENT]?		
FSE	STATus:QUEStionable:TRANsducer:CONDition?		not available for R&S FSMR
FSE	STATus:QUEStionable:TRANsducer:ENABle	0 to 65535	not available for R&S FSMR
FSE	STATus:QUEStionable:TRANsducer:NTRansition	0 to 65535	not available for R&S FSMR
FSE	STATus:QUEStionable:TRANsducer:PTRansition	0 to 65535	not available for R&S FSMR
FSE	STATus:QUEStionable:TRANsducer[:EVENT]?		not available for R&S FSMR
R&S FSMR + FSE	STATus:QUEStionable[:EVENT]?		
R&S FSMR + FSE	STATus:QUEue[:NEXT?]		
FSE	SYSTem:BINFo?		not available for R&S FSMR
R&S FSMR	SYSTem:COMMunicate:GPIB:RDEvice:GENerator<1 2>:ADDReSS	0 to 30	new command for R&S FSMR
FSE	SYSTem:COMMunicate:GPIB:RDEvice<1 2>:ADDReSS	0 to 30	not available for R&S FSMR
R&S FSMR + FSE	SYSTem:COMMunicate:GPIB[:SELF]:ADDReSS	0 to 30	
R&S FSMR + FSE	SYSTem:COMMunicate:GPIB[:SELF]:RTERminator	LFE0I EOI	
R&S FSMR + FSE	SYSTem:COMMunicate:PRINter:ENUMerate:FIRSt?		
R&S FSMR + FSE	SYSTem:COMMunicate:PRINter:ENUMerate:NEXt?		
R&S FSMR	SYSTem:COMMunicate:PRINter:SElect<1 2>	<printer_name>	numeric suffix behind SElect
FSIQ/ ESI	SYSTem:COMMunicate:PRINter<1 2>:SElect	<printer_name>	numeric suffix behind PRINters
R&S FSMR	SYSTem:COMMunicate:RDEvice:GENerator<1 2>:LINK	GPIB TTL	new function for R&S FSMR
R&S FSMR	SYSTem:COMMunicate:RDEvice:GENerator<1 2>:TYPE	<name>	new function for R&S FSMR
R&S FSMR + FSE	SYSTem:COMMunicate:SERial:CONTRol:DTR	IBFull OFF	only SERial1 available for R&S FSMR
R&S FSMR + FSE	SYSTem:COMMunicate:SERial:CONTRol:RTS	IBFull OFF	only SERial1 available for R&S FSMR
R&S FSMR + FSE	SYSTem:COMMunicate:SERial[:RECeive]:BAUD	110 300 600 1200 2400 9600 19200	only SERial1 available for R&S FSMR
R&S FSMR + FSE	SYSTem:COMMunicate:SERial[:RECeive]:BITS	7 8	only SERial1 available for R&S FSMR
R&S FSMR + FSE	SYSTem:COMMunicate:SERial[:RECeive]:PACE	XON NONE	only SERial1 available for R&S FSMR
R&S FSMR + FSE	SYSTem:COMMunicate:SERial[:RECeive]:PARity[:TYPE]	EVEN ODD NONE	only SERial1 available for R&S FSMR
R&S FSMR + FSE	SYSTem:COMMunicate:SERial[:RECeive]:SBITs	1 2	only SERial1 available for R&S FSMR
R&S FSMR + FSE	SYSTem:DATE	1980 to 2099, 1 to 12, 1 to 31	
R&S FSMR	SYSTem:DISPlay:FPANel	ON OFF	new function for R&S FSMR
R&S FSMR + FSE	SYSTem:DISPlay:UPDate	ON OFF	
R&S FSMR + FSE	SYSTem:ERRor[:NEXT]?		new function for R&S FSMR, but compatible to SYSTem:ERRor? on the FSE
R&S FSMR	SYSTem:ERRor:LIST?		new function for R&S FSMR
R&S FSMR	SYSTem:ERRor:CLEar:ALL		new command for R&S FSMR
R&S FSMR + FSE	SYSTem:FIRMware:UPDate	<path>	
R&S FSMR	SYSTem:LANGUage	'SCP' '8560E' '8561E' '8562E' '8563E' '8564E' '8565E' '8566A' '8566B' '8568A' '8568B' '8594E'	new command for R&S FSMR
R&S FSMR + FSE	SYSTem:PASSword[:CENable]	'pass word	
R&S FSMR + FSE	SYSTem:PRESet		
ESI/ FSIQ	SYSTem:PRESet:COMPAtible	FSE OFF	not available for R&S FSMR
R&S FSMR + FSE	SYSTem:SET		
R&S FSMR + FSE	SYSTem:SPEaker:VOLume	0 to 1	

Devices	Command	Parameter	Notes
R&S FSMR + FSE	SYSTem:TIME	0 to 23, 0 to 59, 0 to 59	
R&S FSMR + FSE	SYSTem:VERSion?		
R&S FSMR + FSE	TRACe:COpy	TRACE1 TRACE2 TRACE3 , TRACE1 TRACE2 TRACE3	only TRACE1...TRACE3 available for R&S FSMR
FSET/ ESI	TRACe:FEED:CONTRol<1...4>	ALWays NEVer	not available for R&S FSMR
R&S FSMR + FSE	TRACe[:DATA]	TRACE1 TRACE2 TRACE3 , <block> <numeric_value>	only TRACE1...TRACE3 available for R&S FSMR
FSET/ ESI	TRACe[:DATA]	TRACE1 TRACE2 TRACE3 TRACE4 SINGle SCAN STATus, <block> <numeric_value>	
R&S FSMR	TRACe:IQ:DATA?		new function for R&S FSMR
R&S FSMR			new function for R&S FSMR
R&S FSMR	TRACe:IQ:SET	<filter type>, <rbw>, <sample rate>, <trigger source>, <trigger slope>, <pretrigger samples>, <# of samples>	new function for R&S FSMR
R&S FSMR	TRACe:IQ:AVERAge[:STATe]	ON OFF	new function for R&S FSMR
R&S FSMR	TRACe:IQ:AVERAge:COUNT	<numeric value>	new function for R&S FSMR
R&S FSMR	TRACe:IQ:SRATe	16kHz to 32MHz	new function for R&S FSMR
R&S FSMR	TRACe:IQ:STATe]	ON OFF	new function for R&S FSMR
R&S FSMR + FSE	TRIGGer<1 2>[:SEQuence]:HOLDoff	0 to 100s	
FSE	TRIGGer<1 2>[:SEQuence]:LEVel:AF	-120 to +120PCT	not available for R&S FSMR
FSE	TRIGGer<1 2>[:SEQuence]:LEVel:VIDeo	0 to 100PCT	not available for R&S FSMR; replaced by TRIGGer:SEQuence:SOURce:VIDeo
FSE	TRIGGer<1 2>[:SEQuence]:LEVel[:EXTernal]	-5.0 to +5.0V	not available for R&S FSMR
R&S FSMR	TRIGGer<1 2>[:SEQuence]:LEVel:IFPower	<numeric value>	new command for R&S FSMR
R&S FSMR + FSE	TRIGGer<1 2>[:SEQuence]:SLOPe	POSitive NEGative	
R&S FSMR	TRIGGer<1 2>[:SEQuence]:SOURce	IMMediate LINE EXTernal VIDeo IFPower	
FSE/ ESI	TRIGGer<1 2>[:SEQuence]:SOURce	IMMediate LINE EXTernal VIDeo RFPower TV AF	
FSIQ	TRIGGer<1 2>[:SEQuence]:SOURce	IMMediate LINE EXTernal VIDeo RFPower AF	
FSET	TRIGGer<1 2>[:SEQuence]:SOURce	IMMediate LINE EXTernal VIDeo	
R&S FSMR + FSE	TRIGGer<1 2>[:SEQuence]:SOURce:VIDeo:FORMat:LPFrame	525 625	requires option B6 on FSP
R&S FSMR + FSE	TRIGGer<1 2>[:SEQuence]:SOURce:VIDeo:FIELD:SElect	ALL ODD EVEN	requires option B6 on FSP
R&S FSMR + FSE	TRIGGer<1 2>[:SEQuence]:SOURce:VIDeo:LINE:NUMBer	<numeric value>	requires option B6 on FSP
R&S FSMR + FSE	TRIGGer<1 2>[:SEQuence]:SOURce:VIDeo:SSIGnal:POLarity	NEGative POSitive	requires option B6 on FSP
FSE/ ESI	TRIGGer<1 2>[:SEQuence]:SYNChronize:ADJust:FRAMe	0 to 100s	not available for R&S FSMR
FSE	TRIGGer<1 2>[:SEQuence]:SYNChronize:ADJust:FRAMe:AUTO	ONCE	not available for R&S FSMR and FSET
FSE	TRIGGer<1 2>[:SEQuence]:SYNChronize:ADJust:SLOT	0 to 100s	not available for R&S FSMR and FSET
FSE	TRIGGer<1 2>[:SEQuence]:SYNChronize:ADJust:SLOT:AUTO	ONCE	not available for R&S FSMR and FSET
FSE	TRIGGer<1 2>[:SEQuence]:SYNChronize:SOURce	FRAMe TSC	not available for R&S FSMR and FSET

Devices	Command	Parameter	Notes
R&S FSMR	UNIT<1 2>:POWer	DBM DBPW WATT DBUV DBMV VOLT DBUA AMP V A W	available units are compatible to the FSE.
FSE/ FSIQ	UNIT<1 2>:POWer	DBM DBPW WATT DBUV DBMV VOLT DBUA AMP DB PCT UNITLESS DBUV_MHZ DBMV_MHZ DBUA_MHZ DBUV_M DBIA_M DBUV_MMHZ DBUA_MMHZ	for R&S FSMR, the following units apply:DBM DBPW WATT DBUV DBMV VOLT DBUA AMP V A W
FSET/ ESI	UNIT<1 2>:POWer	DBM DBPW DBPT WATT DBUV DBMV VOLT DBUA AMPere V W DB PCT UNITLESS DBUV_MHZ DBMV_MHZ DBUA_MHZ DBUV_M DBIA_M DBUV_MMHZ DBUA_MMHZ	for R&S FSMR, the following units apply:DBM DBPW WATT DBUV DBMV VOLT DBUA AMP V A W
FSE	UNIT<1 2>:PROBe	ON OFF	not available for R&S FSMR

Table of Softkeys with IEC/IEEE-Bus Command Assignment - Spectrum analyzer Mode

FREQUENCY Key

FREQ	
CENTER	[SENSe:]FREQuency:CENTer <num_value>
CF-SREPSIZE	
0.1 * SPAN	[SENSe:]FREQuency:CENTer:STEP:LINK SPAN; [SENSe:]FREQuency:CENTer:STEP:LINK:FACTor 10PCT
0.5 * SPAN	[SENSe:]FREQuency:CENTer:STEP:LINK SPAN; [SENSe:]FREQuency:CENTer:STEP:LINK:FACTor 50PCT
X * SPAN	[SENSe:]FREQuency:CENTer:STEP:LINK SPAN; [SENSe:]FREQuency:CENTer:STEP:LINK:FACTor <num_value>
0.1 * RBW	[SENSe:]FREQuency:CENTer:STEP:LINK RBW; [SENSe:]FREQuency:CENTer:STEP:LINK:FACTor 10PCT
0.5 * RBW	[SENSe:]FREQuency:CENTer:STEP:LINK RBW; [SENSe:]FREQuency:CENTer:STEP:LINK:FACTor 50PCT
X * RBW	[SENSe:]FREQuency:CENTer:STEP:LINK RBW; [SENSe:]FREQuency:CENTer:STEP:LINK:FACTor <num_value>
= CENTER	no corresponding IEC/IEEE-bus command
= MARKER	no corresponding IEC/IEEE-bus command
MANUAL	[SENSe:]FREQuency:CENTer:STEP <num_value>
START	[SENSe:]FREQuency:START <num_value>
STOP	[SENSe:]FREQuency:STOP <num_value>
FREQUENCY OFFSET	[SENSe:]FREQuency:OFFSet <num_value>
SIGNAL TRACK	

TRACK ON OFF	CALCulate<1 2>:MARKer<1...4>:FUNction:STRack[:STATe] ON OFF
TRACK BW	CALCulate<1 2>:MARKer<1...4>:FUNction:STRack:BANDwidth <num_value>
TRACK THRESHOLD	CALCulate<1 2>:MARKer<1...4>:FUNction:STRack:THReshold <num_value>
SELECT TRACE	CALCulate<1 2>:MARKer<1...4>:FUNction:STRack:TRACe 1 2 3

SPAN Key

SPAN	
SPAN MANUAL	[SENSe:]FREQuency:SPAN <num_value>
SWEETIME MANUAL	[SENSe:]SWEeptime <num_value>
FULL SPAN	[SENSe:]FREQuency:SPAN:FULL
ZERO SPAN	[SENSe:]FREQuency:SPAN 0HZ or [SENSe:]FREQuency:MODE CW FIXed
LAST SPAN	no corresponding IEC/IEEE-bus command

AMPT Key

AMPT	
REF LEVEL	DISPlay[:WINDow<1 2>]:TRACe<1...3>:Y[:SCALe]:RLEVel <num_value>
RANGE LOG 100 dB	DISPlay[:WINDow<1 2>]:TRACe<1...3>:Y:SPACing LOGarithmic; DISPlay[:WINDow<1 2>]:TRACe<1...3>:Y[:SCALe] 100 dB
RANGE LOG MANUAL	DISPlay[:WINDow<1 2>]:TRACe<1...3>:Y:SPACing LOGarithmic; DISPlay[:WINDow<1 2>]:TRACe<1...3>:Y[:SCALe] <num_value>
RANGE LINEAR	DISPlay[:WINDow<1 2>]:TRACe<1...3>:Y:SPACing LINear
RANGE LINEAR %	DISPlay[:WINDow<1 2>]:TRACe<1...3>:Y:SPACing LINear %
RANGE LINEAR dB	DISPlay[:WINDow<1 2>]:TRACe<1...3>:Y:SPACing LINear dB

UNIT	
dBm	CALCulate<1 2>:UNIT:POWER DBM
dBmV	CALCulate<1 2>:UNIT:POWER DBMV
dBμV	CALCulate<1 2>:UNIT:POWER DBUV
dBμA	CALCulate<1 2>:UNIT:POWER DBUA
dBpW	CALCulate<1 2>:UNIT:POWER DBPW
VOLT	CALCulate<1 2>:UNIT:POWER VOLT
AMPERE	CALCulate<1 2>:UNIT:POWER AMPere
WATT	CALCulate<1 2>:UNIT:POWER WATT
RF ATTEN MANUAL	INPut:ATTenuation <num_value>
RF ATTEN AUTO	INPut:ATTenuation:AUTO ON
MIXER	
MIXER LVL AUTO	INPut<1 2>:MIXer:AUTO ON
MIXER LVL MANUAL	INPut<1 2>[:POWER]:MIXer <num_value>
MIXER LOW NOISE	INPut:ATTenuation:MODE NORMAL LNOIse
REF LEVEL POSITION	DISPlay[:WINDow<1 2>]:TRACe<1...3>:Y[:SCALE]:RPOSITION <num_value>
REF LEVEL OFFSET	DISPlay[:WINDow<1 2>]:TRACe<1...3>:Y[:SCALE]:RLEVEL:OFFSet <num_value>
GRID ABS/REL	DISPlay[:WINDow<1 2>]:TRACe<1...3>:Y[:SCALE]:MODE ABSolute RELative
EL ATTEN AUTO	INPut:EATT:AUTO ON (with option B25 only)
EL ATTEN MANUAL	INPut:EATT <num_value> (with option B25 only)
EL ATTEN OFF	INPut:EATT:STATE OFF (with option B25 only)
RF INPUT 50Ω 75Ω	INPut:IMPedance 50 75

MKR Key

MKR	
MARKER 1..4	CALCulate<1 2>:MARKer<1...4>[:STATE] ON OFF; CALCulate<1 2>:MARKer<1...4>:X <numeric value>; CALCulate<1 2>:MARKer<1...4>:Y? CALCulate<1 2>:DELTamarker1[:STATE] ON OFF; CALCulate<1 2>:DELTamarker<1...4>:X <numeric value>; CALCulate<1 2>:DELTamarker<1...4>:Y?
MARKER NORM DELTA	CALCulate<1 2>:DELTamarker<1...4>[:STATE] ON OFF;
SIGNAL COUNT	CALCulate<1 2>:MARKer<1...4>:COUNT ON OFF; CALCulate<1 2>:MARKer<1...4>:COUNT:FREQuency?
REFERENCE FIXED	
REF FXD FREQUENCY	CALCulate<1 2>:DELTamarker<1...4>:FUNctIon:FIXed[:STATE] ON OFF
REF POINT LEVEL	CALCulate<1 2>:DELTamarker<1..4>:FUNctIon:FIXed:RPoint:Y <num_value>
REF POINT LVL OFFSET	CALCulate<1 2>:DELTamarker<1..4>:FUNctIon:FIXed:RPoint:Y:OFFSet <num_value>
REF POINT FREQUENCY	CALCulate<1 2>:DELTamarker<1..4>:FUNctIon:FIXed:RPoint:X <num_value>
Or: REF POINT TIME	CALCulate<1 2>:DELTamarker<1..4>:FUNctIon:FIXed:RPoint:X <num_value>
PEAK SEARCH	CALCulate<1 2>:DELTamarker<1..4>:FUNctIon:FIXed:RPoint: MAX
MARKER ZOOM	CALCulate<1 2>:MARKer<1...4>:FUNctIon:ZOOM <num_value>
ALL MARKER OFF	CALCulate<1 2>:MARKer<1...4>:AOFF CALCulate<1 2>:DELTamarker<1...4>:AOFF
MKR-> TRACE	CALCulate<1 2>:MARKer<1...4>:TRACe <num_value> CALCulate<1 2>:DELTamarker<1...4>:TRACe <num_value>
CNT RESOL ...	CALCulate<1 2>:MARKer<1...4>:COUNT:RESOLution <numeric value>

MKR-> Key

MKR->	
SELECT MARKER	no corresponding IEC/IEEE-bus command
PEAK	CALCulate<1 2>:MARKer<1...4>:MAXimum[:PEAK] CALCulate<1 2>:DELTamarker<1...4>:MAXimum[:PEAK]
CENTER = MKR FREQ	CALCulate<1 2>:MARKer<1...4>:FUNction:CENTer
REF LEVEL = MKR LVL	CALCulate<1 2>:MARKer<1...4>:FUNction:REFerence
NEXT PEAK	CALCulate<1 2>:MARKer<1...4>:MAXimum:NEXT CALCulate<1 2>:DELTamarker<1...4>:MAXimum:NEXT
NEXT PEAK RIGHT	CALCulate<1 2>:MARKer<1...4>:MAXimum:RIGHT CALCulate<1 2>:DELTamarker<1...4>:MAXimum:LEFT
NEXT PEAK LEFT	CALCulate<1 2>:MARKer<1...4>:MAXimum:NEXT CALCulate<1 2>:DELTamarker<1...4>:MAXimum:NEXT
SEARCH LIMITS	
LEFT LIMIT	CALCulate<1 2>:MARKer<1...4>:X:SLIMits[:STATE] ON OFF CALCulate<1 2>:MARKer<1...4>:X:SLIMits:LEFT <num_value>
RIGHT LIMIT	CALCulate<1 2>:MARKer<1...4>:X:SLIMits[:STATE] ON OFF CALCulate<1 2>:MARKer<1...4>:X:SLIMits:RIGHT <num_value>
THRESHOLD	CALCulate<1 2>:THReshold[:STATE] ON OFF CALCulate<1 2>:THReshold <num_value>
SEARCH LIM OFF	CALCulate<1 2>:MARKer<1...4>:X:SLIMits[:STATE] OFF CALCulate<1 2>:THReshold[:STATE] ON OFF
MKR-> TRACE	CALCulate<1 2>:MARKer<1...4>:TRACe <numeric value> CALCulate<1 2>:DELTamarker<1...4>:TRACe <numeric value>
MKR-> CF STEPSIZE	CALCulate<1 2>:MARKer<1...4>:FUNction:CSTep
MIN	CALCulate<1 2>:MARKer<1...4>:MINimum[:PEAK] CALCulate<1 2>:DELTamarker<1...4>:MINimum[:PEAK]
NEXT MIN	CALCulate<1 2>:MARKer<1...4>:MINimum:NEXT CALCulate<1 2>:DELTamarker<1...4>:MINimum:NEXT
PEAK EXCURSION	CALCulate<1 2>:MARKer<1...4>:PEXCursion <num_value>
NEXT MODE	see above
EXCLUDE LO	CALCulate<1 2>:MARKer<1...4>:LOEXclude ON OFF

MKR FCTN Key

MKR	
FUNC	
SELECT MARKER	no corresponding IEC/IEEE-bus command
PEAK	CALCulate<1 2>:MARKer<1...4>:MAXimum[:PEAK] CALCulate<1 2>:DELTamarker<1...4>:MAXimum[:PEAK]
NOISE MEAS	CALCulate<1 2>:MARKer<1...4>:FUNction:NOISE[:STATe] ON OFF; CALCulate<1 2>:MARKer<1...4>:FUNction:NOISE:RESult?
PHASE NOISE	
PH NOISE ON OFF	CALCulate<1 2>:DELTamarker<1...4>:FUNction:PNOise[:STATe] ON OFF CALCulate<1 2>:DELTamarker<1...4>:FUNction:PNOise:RESult?
REF POINT LEVEL	CALCulate<1 2>:DELTamarker<1..4>:FUNction:FIXed:RPOint:Y <num_value>
REF POINT LVL OFFSET	CALCulate<1 2>:DELTamarker<1..4>:FUNction:FIXed:RPOint:Y:OFFSet <num_value>
REF POINT FREQUENCY	CALCulate<1 2>:DELTamarker<1..4>:FUNction:FIXed:RPOint:X <num_value>
PEAK SEARCH	CALCulate<1 2>:DELTamarker<1..4>:FUNction:FIXed:RPOint: MAX
N dB DOWN	CALCulate<1 2>:MARKer<1...4>:FUNction:NDBDown[:STATe] ON OFF CALCulate<1 2>:MARKer<1...4>:FUNction:NDBDown <num_value> CALCulate<1 2>:MARKer<1...4>:FUNction:NDBDown:RESult? CALCulate<1 2>:MARKer<1...4>:FUNction:NDBDown:FREQuency
PEAK LIST	
NEW SEARCH	INIT;*WAI; CALCulate<1 2>:MARKer<1...4>:FUNction:FPEaks 10; CALCulate<1 2>:MARKer<1...4>:FUNction:FPEaks:COUNT?; CALCulate<1 2>:MARKer<1...4>:FUNction:FPEaks:Y?; CALCulate<1 2>:MARKer<1...4>:FUNction:FPEaks:X?;
SORT MODE FREQ LEVEL	CALCulate<1 2>:MARKer<1...4>:FUNction:FPEaks:SORT X Y
PEAK EXCURSION	CALCulate<1 2>:MARKer<1...4>:PEXCursion <num_value>
LEFT LIMIT	CALCulate<1 2>:MARKer<1...4>:X:SLIMits[:STATe] ON OFF CALCulate<1 2>:MARKer<1...4>:X:SLIMits:LEFT <num_value>
RIGHT LIMIT	CALCulate<1 2>:MARKer<1...4>:X:SLIMits[:STATe] ON OFF CALCulate<1 2>:MARKer<1...4>:X:SLIMits:RIGHT <num_value>

THRESHOLD	CALCulate<1 2>:THReshold[:STATe] ON OFF CALCulate<1 2>:THReshold <num_value>
PEAK LIST	
OFF	
MARKER	
DEMODO	
MKR DEMOD	
ON/OFF	CALCulate<1 2>:MARKer<1...4>:FUNCTion:DEModulation[:STATe] ON OFF
AM	CALCulate<1 2>:MARKer<1...4>:FUNCTion:DEModulation:SElect AM
FM	CALCulate<1 2>:MARKer<1...4>:FUNCTion:DEModulation:SElect FM
MKR	
STOP TIME	CALCulate<1 2>:MARKer<1..4>:FUNCTion:DEModulation:HOLDoff <num_value>
MKR->	
TRACE	CALCulate<1 2>:MARKer<1...4>:TRACe <numeric value> CALCulate<1 2>:DELTAmarker<1...4>:TRACe <numeric value>

BW Key

BW	
RES BW MANUAL	[SENSe:]BANDwidth BWIDth:AUTO OFF [SENSe:]BANDwidth BWIDth[:RESolution] <num_value>
VIDEO BW MANUAL	[SENSe:]BANDwidth BWIDth:VIDeo:AUTO OFF [SENSe:]BANDwidth BWIDth:VIDeo <num_value>
SWEEP TIME MANUAL	[SENSe:]SWEep:TIME:AUTO OFF [SENSe:]SWEep:TIME <num_value>
RES BW AUTO	[SENSe:]BANDwidth BWIDth[:RESolution]:AUTO ON
VIDEO BW AUTO	[SENSe:]BANDwidth BWIDth:VIDeo:AUTO ON
SWEEP TIME AUTO	[SENSe:]SWEep:TIME:AUTO ON
COUPLING RATIO	--
RBW / VBW SINE [1/3]	[SENSe:]BANDwidth BWIDth:VIDeo:RATio 3
RBW / VBW PULSE [.1]	[SENSe:]BANDwidth BWIDth:VIDeo:RATio 10
RBW / VBW NOISE [10]	[SENSe:]BANDwidth BWIDth:VIDeo:RATio 0.1
RBW / VBW MANUAL	[SENSe:]BANDwidth BWIDth:VIDeo:RATio <num_value>
SPAN / RBW AUTO [50]	[SENSe:]BANDwidth BWIDth[:RESolution]:RATio 0.02
SPAN / RBW MANUAL	[SENSe:]BANDwidth BWIDth[:RESolution]:RATio <num_value>
COUPLING DEFAULT	[SENSe:]BANDwidth BWIDth[:RESolution]:AUTO ON; [SENSe:]BANDwidth BWIDth:VIDeo:AUTO ON; [SENSe:]SWEep:TIME:AUTO ON
FILTER TYPE	[SENSe:]BANDwidth BWIDth[:RESolution]:TYPE NORMAl FFT CFILter RRC
MAIN PLL BANDWIDTH	[SENSe:]BANDwidth BWIDth:PLL AUTO HIGH MEDIum LOW
VBW MODE LIN LOG	[SENSe:]BANDwidth BWIDth:VIDeo:TYPE LINear LOGarithmic

SWEEP Key

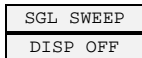
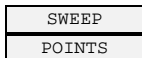
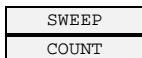
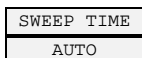
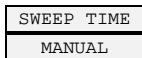
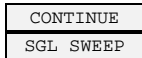
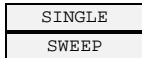
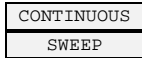
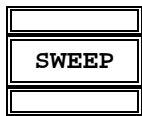

INITiate:CONTInuous ON

INITiate:CONTInuous OFF;
INITiate:IMMediate

INITiate:CONMeasure

[SENSe:]SWEep:TIME <num_value>

[SENSe:]SWEep:TIME:AUTO ON | OFF

[SENSe:]SWEep:COUNT <num_value>

[SENSe:]SWEep:POINTs <num_value>

INITiate:DISPlay OFF
INITiate:IMMediate

MEAS Key

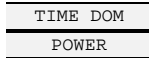
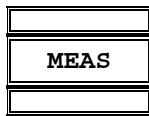

```
CALCulate<1 | 2>:MARKer<1...4>:FUNction:SUMMary:RMS[:STATE] ON
CALCulate<1 | 2>:MARKer<1...4>:FUNction:SUMMary:PPEak[:STATE] (
CALCulate<1 | 2>:MARKer<1...4>:FUNction:SUMMary:MEAN[:STATE]
ON
CALCulate<1 | 2>:MARKer<1...4>:FUNction:SUMMary:SDEVIation
[:STATE] ON
```

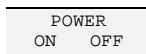

```
CALCulate<1 | 2>:MARKer<1...4>:FUNction:SUMMary:RMS[:STATE]
ON|OFF
CALCulate<1 | 2>:MARKer<1...4>:FUNction:SUMMary:PPEak[:STATE]
ON|OFF
CALCulate<1 | 2>:MARKer<1...4>:FUNction:SUMMary:MEAN[:STATE]
ON|OFF
CALCulate<1 | 2>:MARKer<1...4>:FUNction:SUMMary:SDEVIation
[:STATE] ON|OFF
```

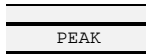

```
CALCulate<1 | 2>:MARKer<1...4>:FUNction:SUMMary:PPEak[:STATE]
ON | OFF
CALCulate<1 | 2>:MARKer<1...4>:FUNction:SUMMary:PPEak:RESult?
```

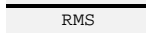

```
CALCulate<1 | 2>:MARKer<1...4>:FUNction:SUMMary:RMS[:STATE]
ON | OFF
CALCulate<1 | 2>:MARKer<1...4>:FUNction:SUMMary:RMS:RESult?
```

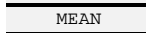

```
CALCulate<1 | 2>:MARKer<1...4>:FUNction:SUMMary:MEAN[:STATE]
ON | OFF
CALCulate<1 | 2>:MARKer<1...4>:FUNction:SUMMary:MEAN:RESult?
```

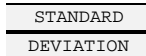

```
CALCulate<1 | 2>:MARKer<1...4>:FUNction:SUMMary:SDEVIation
[:STATE] ON|OFF
CALCulate<1 | 2>:MARKer<1...4>:FUNction:SUMMary:SDEVIation:
RESult?
```

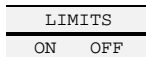

```
CALCulate<1 | 2>:MARKer<1...4>:SLIMits ON | OFF
```

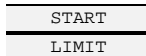

```
CALCulate<1 | 2>:MARKer<1...4>:SLIMits:LEFT <num_value>
```

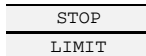

```
CALCulate<1 | 2>:MARKer<1...4>:SLIMits:RIGHT <num_value>
```

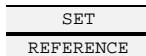

```
CALCulate<1 | 2>:MARKer<1...4>:FUNction:SUMMary:REFerence:A
UTO ONCE
```

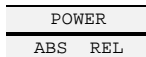

```
CALCulate<1 | 2>:MARKer<1...4>:FUNction:SUMMary:MODE ABS |
REL
```

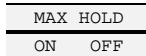

```
CALCulate<1 | 2>:MARKer<1...4>:FUNction:SUMMary:PHOLD
ON | OFF
CALCulate<1 | 2>:MARKer<1...4>:FUNction:SUMMary:PPEak:PHOLD
:RESult?
CALCulate<1 | 2>:MARKer<1...4>:FUNction:SUMMary:RMS:PHOLD:
RESult?
CALCulate<1 | 2>:MARKer<1...4>:FUNction:SUMMar:MEAN:PHOLD:
RESult?
CALCulate<1 | 2>:MARKer<1...4>:FUNction:SUMMary:SDEVIation:
PHOLD:RESult?
```

AVERAGE	CALCulate<1 2>:MARKer<1...4>:FUNction:SUMMary:AVERage
ON OFF	ON OFF
	CALCulate<1 2>:MARKer<1...4>:FUNction:SUMMary:PPEak:AVERage:RESult?
	CALCulate<1 2>:MARKer<1...4>:FUNction:SUMMary:RMS:AVERage:RESult?
	CALCulate<1 2>:MARKer<1...4>:FUNction:SUMMar:MEAN:AVERage:RESult?
	CALCulate<1 2>:MARKer<1...4>:FUNction:SUMMary:SDEVIation:AVERage:RES?
NUMBER OF SWEEPS	[SENSe:]SWEep:COUNT <num_value>
CHAN PWR	--
ACP	
CP / ACP	CALCulate<1 2>:MARKer<1...4>:FUNction:POWER:SElect CPOWER ACPower;
ON OFF	CALCulate<1 2>:MARKer<1...4>:FUNction:POWER:RESult?
	CPOWER ACPower;
	CALCulate<1 2>:MARKer<1...4>:FUNction:POWER[:STATe] OFF
CP / ACP	CALCulate<1 2>:MARKer<1...4>:FUNction:POWER:PRESet
STANDARD	<standard>
CP / ACP	--
CONFIG	
NO. OF ADJ CHAN	[SENSe:]POWER:ACHannel:ACPairs <num_value>
CHANNEL BANDWIDTH	[SENSe:]POWER:ACHannel:BANDwidth BWIDth[:CHANnel] <num_value>
	[SENSe:]POWER:ACHannel:BANDwidth BWIDth:ACHannel <num_value>
	[SENSe:]POWER:ACHannel:BANDwidth BWIDth:ALternate <1 2> <num_value>
CHANNEL SPACING	[SENSe:]POWER:ACHannel:SPACing:ACHannel <num_value>
	[SENSe:]POWER:ACHannel:SPACing:ALternate<1 2> <num_value>
ACP REF SETTINGS	[SENSe:]POWER:ACHannel:REFerence:TXCHannel:MAN 1
	[SENSe:]POWER:ACHannel:REFerence:TXCHannel:Auto MIN
CP/ACP ABS/REL	[SENSe:]POWER:ACHannel:MODE ABSolute RELative
CHAN PWR /HZ	CALCulate<1 2>:MARKer<1...4>:FUNction:POWER:RESult:PHZ ON OFF
ADJUST SETTINGS	[SENSe:]POWER:ACHannel:PRESet ACPower CPOWER OBANDwidth OBwidth
ACP LIMIT CHECK	CALCulate<1 2>:LIMit<1...8>:ACPPower[:STATe] ON OFF
	CALCulate<1 2>:LIMit<1...8>:ACPPower:ACHannel:RESult?
	CALCulate<1 2>:LIMit<1...8>:ACPPower:ALternate<1 2>:RESult?

EDIT	CALCulate<1 2>:LIMit<1...8>:ACPoweR[:STATe] ON OFF
ACP LIMITS	CALCulate<1 2>:LIMit<1...8>:ACPoweR:ACHannel[:RELative]:S TATe ON OFF
	CALCulate<1 2>:LIMit<1...8>:ACPoweR:ACHannel[:RELative] <num_val>, <num_val>
	CALCulate<1 2>:LIMit<1...8>:ACPoweR:ACHannel:ABSolute:STATe ON OFF
	CALCulate<1 2>:LIMit<1...8>:ACPoweR:ACHannel:ABSolute <num_value>, <num_value>
	CALCulate<1 2>:LIMit<1...8>:ACPoweR:ALternate[:RELative]: STATe ON OFF
	CALCulate<1 2>:LIMit<1...8>:ACPoweR:ALternate[:RELative] <num_value>, <num_value>
	CALCulate<1 2>:LIMit<1...8>:ACPoweR:ALternate:ABSolute:STATe ON OFF
	CALCulate<1 2>:LIMit<1...8>:ACPoweR:ALternate:ABSolute <num_value>, <num_value>
SELECT	[SENSe:]POWer:TRACe 1 2 3
TRACE	
SET CP	[SENSe:]POWer:ACHannel:REFerence:AUTO ONCE
REFERENCE	
SWEEP	[SENSe:]SWEep:TIME <num_value>
TIME	
FAST ACP	[SENSe:]POWer:HSPeed ON OFF
ON OFF	
NOISE CORR	[SENSe:]POWer:NCORrection ON OFF
ON OFF	
FULL SIZE	
DIAGRAM	
ADJUST	[SENSe:]POWer:ACHannel:PRESet:RLEVel
REF LVL	
MULT CARR	--
ACP	
CP / ACP	CALCulate<1 2>:MARKer<1...4>:FUNctioN:POWer:SElect CPOWer ACPoweR;
ON OFF	CALCulate<1 2>:MARKer<1...4>:FUNctioN:POWer:RESult? CPOWer ACPoweR;
	CALCulate<1 2>:MARKer<1...4>:FUNctioN:POWer[:STATe] OFF
CP / ACP	CALCulate<1 2>:MARKer<1...4>:FUNctioN:POWer:PRESet
STANDARD	<standard>
CP / ACP	--
CONFIG	
NO. OF	[SENSe:]POWer:ACHannel:ACPairs <num_value>
ADJ CHAN	
NO. OF	[SENSe:]POWer:ACHannel:TXChannel:COUNT <num_value>
TX CHAN	
CHANNEL	[SENSe:]POWer:ACHannel:BANDwidth BWIDth[:CHANnel]
BANDWIDTH	<num_value>
	[SENSe:]POWer:ACHannel:BANDwidth BWIDth:ACHannel <num_value>
	[SENSe:]POWer:ACHannel:BANDwidth BWIDth:ALternate <1 2> <num_value>

CHANNEL	[SENSe:]POWER:ACHannel:SPACing:CHANnel <num_value>
SPACING	[SENSe:]POWER:ACHannel:SPACing:ACHannel <num_value> [SENSe:]POWER:ACHannel:SPACing:ALternate<1 2> <num_value>
ACP REF SETTINGS	[SENSe:]POWER:ACHannel:REFErence:TXCHannel:MAN 1 [SENSe:]POWER:ACHannel:REFErence:TXCHannel:Auto MIN
CP/ACP ABS/REL	[SENSe:]POWER:ACHannel:MODE ABSolute RELative
CHAN PWR /HZ	CALCulate<1 2>:MARKer<1...4>:FUNction:POWER:RESult:PHZ ON OFF
ADJUST SETTINGS	[SENSe:]POWER:ACHannel:PRESet ACPower CPower MCACpower OBANdwidth OBwidth
ACP LIMIT CHECK	CALCulate<1 2>:LIMit<1...8>:ACPower[:STATE] ON OFF CALCulate<1 2>:LIMit<1...8>:ACPower:ACHannel:RESult? CALCulate<1 2>:LIMit<1...8>:ACPower:ALternate<1 2>:RESult?
EDIT ACP LIMITS	CALCulate<1 2>:LIMit<1...8>:ACPower[:STATE] ON OFF CALCulate<1 2>:LIMit<1...8>:ACPower:ACHannel[:RELative]:S TATe ON OFF CALCulate<1 2>:LIMit<1...8>:ACPower:ACHannel[:RELative] <num_val>, <num_val> CALCulate<1 2>:LIMit<1...8>:ACPower:ACHannel:ABSolute:STATE ON OFF CALCulate<1 2>:LIMit<1...8>:ACPower:ACHannel:ABSolute <num_value>, <num_value> CALCulate<1 2>:LIMit<1...8>:ACPower:ALternate[:RELative]: STATE ON OFF CALCulate<1 2>:LIMit<1...8>:ACPower:ALternate[:RELative] <num_value>, <num_value> CALCulate<1 2>:LIMit<1...8>:ACPower:ALternate:ABSolute:STATE ON OFF CALCulate<1 2>:LIMit<1...8>:ACPower:ALternate:ABSolute <num_value>, <num_value>
SELECT TRACE	[SENSe:]POWER:TRACe 1 2 3
SET CP REFERENCE	[SENSe:]POWER:ACHannel:REFErence:AUTO ONCE
SWEEP TIME	[SENSe:]SWEep:TIME <num_value>
FAST ACP ON OFF	[SENSe:]POWER:HSPeed ON OFF
NOISE CORR ON OFF	[SENSe:]POWER:NCORrection ON OFF
FULL SIZE DIAGRAM	
ADJUST REF LVL	[SENSe:]POWER:ACHannel:PRESet:RLEVel
OCCUPIED PWR BANDW	

OCCUP BW ON OFF	CALCulate<1 2>:MARKer<1...4>:FUNction:POWer:SElect OBANdwidth OBWidth CALCulate<1 2>:MARKer<1...4>:FUNction:POWer:RESult? OBANdwidth OBWidth CALCulate<1 2>:MARKer<1...4>:FUNction:POWer[:STATe] OFF
% POWER BANDWIDTH	[SENSe:]POWer:BANDwidth BWIDth <num_value>
CHANNEL BANDWIDTH	[SENSe:]POWer:ACHannel:BANDwidth BWIDth <num_value>
NOISE CORR ON OFF	[SENSe:]POWer:NCORrection ON OFF
ADJUST REF LVL	[SENSe:]POWer:ACHannel:PRESet:RLEVel
ADJUST SETTINGS	[SENSe:]POWer:PRESet ACPower CPOWer OBANdwidth OBWidth
ADJUST REV LVL	[SENSe:]POWer:PRESet ACPower:RLEVel

SIGNAL STATISTIC	
APD ON OFF	CALCulate:STATistics:APD[:STATe] ON OFF CALCulate:STATistics:RESult<1...3>? MEAN PEAK CFACTOR ALL
CCDF ON OFF	CALCulate:STATistics:CCDF[:STATe] ON OFF CALCulate:STATistics:RESult<1...3>? MEAN PEAK CFACTOR ALL
PERCENT MARKER	CALC:MARK:Y:PERC 0...100%
RES BW	[SENSe:]BANDwidth[:RESolution]:AUTO OFF [SENSe:]BANDwidth[:RESolution] <num_value>
NO OF SAMPLES	CALCulate:STATistics:NSAMples <num_value>
SCALING	--
X-AXIS REF LEVEL	CALCulate:STATistics:X:RLEVel <num_value>
X-AXIS RANGE	CALCulate:STATistics:X:RANGE <num_value>
Y-AXIS MAX VALUE	CALCulate:STATistics:Y:UPPER <num_value>
Y-AXIS MIN VALUE	CALCulate:STATistics:Y:LOWer <num_value>
ADJUST SETTINGS	CALCulate:STATistics:SCALE:AUTO ONCE
DEFAULT SETTINGS	CALCulate:STATistics:PRESet
ADJUST SETTINGS	CALCulate:STATistics:SCALE:AUTO ONCE
SINGLE MEAS	INITiate:CONTinuous OFF; INITiate:IMMediate
COUNT MEAS	INITiate:CONTinuous ON; INITiate:IMMediate
C/N	
C/N	CALCulate:MARKer:FUNCTion:POWER:SElect CN CALCulate:MARKer:FUNCTion:POWER:RESult? CN CALCulate:MARKer:FUNCTion:POWER:SElect CN0 CALCulate:MARKer:FUNCTion:POWER:RESult? CN0 CALCulate:MARKer:FUNCTion:POWER OFF
C/No	
CHANNEL BANDWIDTH	[SENSe:]POWER:ACHannel:BANDwidth BWIDth <num_value>
ADJUST SETTINGS	[SENSe:]POWER:ACHannel:PRESet CN CN0
MODULATION DEPTH	CALCulate<1 2>:MARKer<1...4>:FUNCTion:MDEPTH[:STATe] ON OFF CALCulate<1 2>:MARKer<1...4>:FUNCTion:MDEPTH:RESult?

TOI

CALCulate<1 | 2>:MARKer<1...4>:FUNctioN:TOI[:STATe] ON | OFF
CALCulate<1 | 2>:MARKer<1...4>:FUNctioN:TOI:RESult?

SELECT
MARKER

no corresponding IEC/IEEE-bus command

TRIG Key

TRIG	
FREE RUN	TRIGger[:SEquence]:SOURce IMMEDIATE
VIDEO	TRIGger[:SEquence]:SOURce VIDEO TRIGger[:SEquence]:LEVel:VIDeo <numeric value>
EXTERN	TRIGger[:SEquence]:SOURce EXTERNAL [SENSe:]SWEep:EGATe:SOURce EXTERNAL
IF POWER	TRIGger[:SEquence]:SOURce IFPower TRIGger[:SEquence]:LEVel:IFPower <numeric value> [SENSe:]SWEep:EGATe:SOURce IFPower
TRIGGER OFFSET	TRIGger[:SEquence]:HOLDoff <num_value>
POLARITY POS/NEG	TRIGger[:SEquence]:SLOPe POSitive NEGative or [SENSe:]SWEep:EGATe:POLarity POSitive NEGative
GATED TRIGGER	[SENSe:]SWEep:EGATe ON OFF [SENSe:]SWEep:EGATe:SOURce IFPower EXTERNAL
GATE SETTINGS	--
GATE MODE LEVEL/EDGE	[SENSe:]SWEep:EGATe:TYPE LEVel EDGE
POLARITY POS/NEG	[SENSe:]SWEep:EGATe:POLarity POSitive NEGative
GATE DELAY	[SENSe:]SWEep:EGATe:HOLDoff <num_value>
GATE LENGTH	[SENSe:]SWEep:EGATe:LENGTh <num_value>
SWEEP TIME	--
PRINT SCREEN	--

TRACE Key

TRACE	
SELECT TRACE	--
CLEAR/ WRITE	DISPlay[:WINDow<1 2>]:TRACe<1...3>:MODE WRITe
MAX HOLD	DISPlay[:WINDow<1 2>]:TRACe<1...3>:MODE MAXHold
AVERAGE	DISPlay[:WINDow<1 2>]:TRACe<1...3>:MODE AVERAge or: [SENSe:]AVERAge[:STATe<1...3>] ON
VIEW	DISPlay[:WINDow<1 2>]:TRACe<1...3>:MODE VIEW
BLANK	DISPlay[:WINDow<1 2>]:TRACe<1...3>[:STATe] OFF
SWEEP COUNT	[SENSe:]SWEep:COUNT <num_value> or: [SENSe:]AVERAge:COUNT <num_value>
DETECTOR	--
AUTO SELECT	[SENSe:]DETEctor[:FUNCTION]:AUTO ON OFF
DETECTOR AUTOPEAK	[SENSe:]DETEctor[:FUNCTION] APEak
DETECTOR MAX PEAK	[SENSe:]DETEctor[:FUNCTION] POSitive
DETECTOR MIN PEAK	[SENSe:]DETEctor[:FUNCTION] NEGative
DETECTOR SAMPLE	[SENSe:]DETEctor[:FUNCTION] SAMPlE
DETECTOR RMS	[SENSe:]DETEctor[:FUNCTION] RMS
DETECTOR AVERAGE	[SENSe:]DETEctor[:FUNCTION] AVERAge
DETECTOR QPK	[SENSe:]DETEctor[:FUNCTION] QPEak
TRACE MATH	--

T1-T2->T1	CALCulate<1 2>:MATH:STATE ON CALCulate<1 2>:MATH[:EXPRession][:DEFine] (TRACE1 - TRACE2)
T1-T3->T1	CALCulate<1 2>:MATH:STATE ON CALCulate<1 2>:MATH[:EXPRession][:DEFine] (TRACE1 - TRACE3)
TRACE POSITION	CALCulate<1 2>:MATH:POSition <num_value>
TRACE MATH OFF	CALCulate<1 2>:MATH:STATE OFF
MIN HOLD	DISPlay[:WINDow<1 2>]:TRACe<1...3>:MODE MINHold
AVG MODE LOG LIN	CALCulate<1 2>:MATH:MODE LINear LOGarithmic or: [SENSe:]AVERage:TYPE VIDEO LINear
ASCII FILE EXPORT	FORMat[:DATA] ASCii MMEMory:STORE<1 2>:TRACe 1, 'TRACE.DAT'
DECIM SEP . ,	FORMat:DEXPort:DSEPARATOR POINT COMMa
COPY TRACE	TRACe:COPY TRACE1 TRACE2 TRACE3, TRACE1 TRACE2 TRACE3

LINES Key

LINES

SELECT
LIMIT LINE

selection:

```
CALCulate<1|2>:LIMit<1...8>:NAME <string>;
CALCulate<1|2>:LIMit<1...8>:UPPer:STATe ON | OFF
CALCulate<1|2>:LIMit<1...8>:LOWer:STATe ON | OFF
```

limit check:

```
CALCulate<1|2>:LIMit<1...8>:STATe ON | OFF
INITiate[:IMMediate]; WAI*
CALCulate<1|2>:LIMit<1...8>:FAIL?
```

trace assignment:

```
CALCulate<1|2>:LIMit<1...8>:TRACe 1|2|3
```

NEW
LIMIT LINE

NAME

name:

```
CALCulate<1|2>:LIMit<1...8>:NAME <string>;
```

domain:

```
CALCulate<1|2>:LIMit<1...8>:CONTRol:DOMain FREQuency|TIME
```

scaling:

```
CALCulate<1|2>:LIMit<1...8>:CONTRol:MODE RELative | ABSolute
CALCulate<1|2>:LIMit<1...8>:UPPer:MODE RELative | ABSolute
CALCulate<1|2>:LIMit<1...8>:LOWer:MODE RELative | ABSolute
```

unit:

```
CALCulate<1|2>:LIMit<1...8>:UNIT DBM|DBPW|WATT|DBUV|
VOLT|DBUA|AMPere|DB|DBUV_MHZ|DBUA_MHZ|DEG|RAD|S|HZ|PCT
```

margin:

```
CALCulate<1|2>:LIMit<1...8>:UPPer:MARGin <num_value>
CALCulate<1|2>:LIMit<1...8>:LOWer:MARGin <num_value>
```

threshold for relative y-scaling:

```
CALCulate<1|2>:LIMit<1...8>:UPPer:THReshold <num_value>
CALCulate<1|2>:LIMit<1...8>:LOWer:THReshold <num_value>
```

comment:

```
CALCulate<1|2>:LIMit<1...8>:COMMeNt <string>
```

VALUES

```
CALCulate<1|2>:LIMit<1...8>:CONTRol[:DATA]
<num_value>, <num_value>..
CALCulate<1|2>:LIMit<1...8>:UPPer[:DATA]
<num_value>, <num_value>..
CALCulate<1|2>:LIMit<1...8>:LOWer[:DATA]
<num_value>, <num_value>..
```

INSERT
VALUE

no corresponding IEC/IEEE-bus command

DELETE
VALUE

no corresponding IEC/IEEE-bus command

SHIFT X
LIMIT LINE

```
CALCulate<1|2>:LIMit<1...8>:CONTRol:SHIFt <num_value>
```

SHIFT Y
LIMIT LINE

```
CALCulate<1|2>:LIMit<1...8>:UPPer:SHIFt <num_value>
CALCulate<1|2>:LIMit<1...8>:LOWer:SHIFt <num_value>
```

SAVE
LIMIT LINE

automatically executed during IEC/IEEE-bus operation

EDIT LIMIT
LINE

s. EDIT LIMIT LINE

COPY LIMIT LINE	CALCulate<1 2>:LIMit<1...8>:COPY 1...8 <name>
DELETE LIMIT LINE	CALCulate<1 2>:LIMit<1...8>:DELeTe
X OFFSET	CALCulate<1 2>:LIMit<1...8>:CONTRol:OFFset <num_value>
Y OFFSET	CALCulate<1 2>:LIMit<1...8>:UPPer:OFFset <num_value>
DISPLAY LINES	CALCulate<1 2>:LIMit<1...8>:LOWer:OFFset <num_value>
DISPLAY LINE 1	CALCulate<1 2>:DLINe1:STATe ON OFF CALCulate<1 2>:DLINe1 -30 dBm
DISPLAY LINE 2	CALCulate<1 2>:DLINe2:STATe ON OFF CALCulate<1 2>:DLINe2 -30 dBm
FREQUENCY LINE 1	CALCulate<1 2>:FLINe1:STATe ON OFF CALCulate<1 2>:FLINe1 0 HZ
FREQUENCY LINE 2	CALCulate<1 2>:FLINe2:STATe ON OFF CALCulate<1 2>:FLINe2 3 GHZ
TIME LINE 1	CALCulate<1 2>:TLINe1:STATe ON OFF CALCulate<1 2>:TLINe1 0 S
TIME LINE 2	CALCulate<1 2>:TLINe2:STATe ON OFF CALCulate<1 2>:TLINe2 2.5 MS

DISP Key

DISP	
FULL SCREEN	DISPlay:FORmat SINGLE DISPlay[:WINDow<1 2>]:SElect
SPLIT SCREEN	DISPlay:FORmat SPLit
REF LEVEL COUPLED	INSTRument:COUple RLEVel NONE
CENTER B = MARKER A	INSTRument:COUple CF_B NONE
CENTER A = MARKER B	INSTRument:COUple CF_A NONE
CONFIG DISPLAY	--
SCREEN	DISPlay[:WINDow<1 2>]:TEXT[:DATA] <string>
TITLE	DISPlay[:WINDow<1 2>]:TEXT:STATE ON OFF
TIME/DATE	DISPlay[:WINDow<1 2>]:TIME ON OFF
ON OFF	
LOGO	DISPlay:LOGO ON OFF
ON/OFF	
ANNOTATION	DISPlay:ANNotation:FREQuency ON OFF
ON/OFF	
DATAENTRY	no corresponding IEC/IEEE-bus command
OPAQUE	
DEFAULT COLORS 1	DISPlay:CMAP<1...13>:DEFault1
DEFAULT COLORS 2	DISPlay:CMAP<1...13>:DEFault2
DISPLAY PWR SAVE	DISPlay:PSAVE[:STATE] ON OFF DISPlay:PSAVe:HOLDoff <num_value>
SELECT OBJECT	--
BRIGHTNESS	DISPlay:CMAP:HSL <hue>,<sat>,<lum>
TINT	DISPlay:CMAP<1...13>:HSL <hue>,<sat>,<lum>
SATURATION	DISPlay:CMAP<1...13>:HSL <hue>,<sat>,<lum>
PREDEFINED COLORS	DISPlay:CMAP<1...13>:PDEFined BLACK BLUE BROWN GREEN MAGenta YELLOW WHITE DGRAY LGRAY LBLUE LGREEN LCYan LRED MAGenta

FILE Key

FILE	
SAVE	MMEemory:STORE:STATE 1,<file_name>
RECALL	MMEemory:LOAD:STATE 1,<file_name>
EDIT PATH	--
EDIT COMMENT	MMEemory:COMMENT <string>
ITEMS TO SAVE/RCL	
SELECT ITEMS	MMEemory:SElect[:ITEM]:HWSettings ON OFF MMEemory:SElect[:ITEM]:TRACe[:ACTIVE] ON OFF MMEemory:SElect[:ITEM]:LINES:ALL ON OFF MMEemory:SElect[:ITEM]:NONE
DEFAULT CONFIG	MMEemory:SElect[:ITEM]:DEFault
DISABLE ALL ITEMS	MMEemory:SElect[:ITEM]:NONE
ENABLE ALL ITEMS	MMEemory:SElect[:ITEM]:ALL
DATA SET LIST	--
DATA SET CLEAR	MMEemory:CLEar:STATE 1,<file_name>
STARTUP RECALL	MMEemory:LOAD:AUTO 1,<file_name>
FILE MANAGER	
EDIT PATH	MMEemory:MSIS <device> MMEemory:CDIRectory <directory_name>
NEW FOLDER	MMEemory:MDIRectory <directory_name>
COPY	MMEemory:COPY <file_source>,<file_destination>
RENAME	MMEemory:MOVE <file_source>,<file_destination>

CUT	MMEemory:DELeTe <file_name> MMEemory:RDIRECTory <directory_name>
PASTE	no corresponding IEC/IEEE-bus command
DELETE	MMEemory:DELeTe <file_name> MMEemory:RDIRECTory <directory_name>
SORT MODE	no corresponding IEC/IEEE-bus command
2 FILE LISTS	no corresponding IEC/IEEE-bus command
FORMAT DISK	MMEemory:INITialize <msus>
ASCII FILE EXPORT	FORMat[:DATA] ASCii MMEemory:STORe<1 2>:TRACe 1, 'TRACE.DAT'
DECIM SEP .	FORMat:DEXPort:DSEParator POINT COMMa
DATA SET CLEAR ALL	MMEemory:CLEAr:ALL

CAL Key

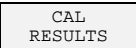
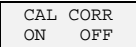
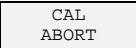
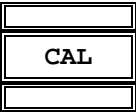

CALibration[:ALL]?

CALibration:ABORT

CALibration:STATE ON | OFF

CALibration:RESuLts?

SETUP Key

REFERENCE INT/EXT	[SENSe:]ROSCillator:SOURce INTernal EXTernal
NOISE SCR ON OFF	DIAGnostic:SERVice:NSource ON OFF <num_value>
PREAMP ON OFF	INPut:GAIN: [STATe]e ON OFF <num_value> (with option Electronic Attenuator - B25 only)
SIGNAL SOURCE	
YIG FILTER ON OFF	
TRANSDUCER	--
TRANSDUCER FACTOR	CORRection:TRANSmision:SElect <name> CORRection:TRANSmision ON OFF
EDIT TRD FACTOR	CORRection:TRANSmision:COMMunicate <string> CORRection:TRANSmision:SCALE LIN LOG
NEW FACTOR	
TRD FACTOR NAME	--
TRD FACTOR UNIT	--
TRD FACTOR VALUES	--
INSERT LINE	--
DELETE LINE	--
SAVE TRD FACTOR	--
DELETE	CORRection:TRANSmision DELeTe
PAGE UP	--
PAGE DOWN	--
GENERAL SETUP	--
GPIB	--
GPIB ADDRESS	SYSTem:COMMunicate:GPIB[:SELF]:ADDRess 0...30
ID STRING FACTORY	--

LD STRING	--
USER	
GPIB	SYSTem: LANGUage "SCPI" "8560E" "8561E" "8562E"
LANGUAGE	"8563E" "8564E" "8566A" "8566B"
	"8568A" "8568B" "8594E"
COM INTERFACE	SYSTem: COMMunicate: SERIAL[:RECeive:]BAUD <num_value> SYSTem: COMMunicate: SERIAL[:RECeive:]BITS 7 8 SYSTem: COMMunicate: SERIAL:RECeive:PARity[:TYPE] EVEN ODD NONE SYSTem: COMMunicate: SERIAL[:RECeive:]SBITS 1 2 SYSTem: COMMunicate: SERIAL:CONTrol:DTR IBFull OFF SYSTem: COMMunicate: SERIAL:CONTrol:RTS IBFull OFF SYSTem: COMMunicate: SERIAL[:RECeive:]PACE XON NONE
TIME+DATE	SYSTem: TIME 0...23, 0...59, 0...59 SYSTem: DATE <num>, <num>, <num>
CONFIGURE NETWORK	With option LAN-Interface B16 only --
NETWORK LOGIN	With option LAN-Interface B16 only --
OPTIONS	--
INSTALL	--
OPTION	
REMOVE	--
OPTION	
SOFT FRONTPANEL	SYSTem: DISPlay: FPANel ON OFF
SYSTEM INFO	--
HARDWARE INFO	DIAGnostic: SERvice: HWINfo?
STATISTICS	--
SYSTEM MESSAGES	SYSTem: ERRor? SYSTem: ERRor: LIST?
CLEAR ALL MESSAGES	SYSTem: ERRor?
SERVICE	--
INPUT RF	DIAGnostic: SERvice: INPut[:SElect] RF
INPUT CAL	DIAGnostic: SERvice: INPut[:SElect] CALibration DIAGnostic: SERvice: CSourc[:POWER] <num_value>
SELFTTEST	*TST?
SELFTTEST RESULTS	DIAGnostic: SERvice: STESt: RESult?
ENTER PASSWORD	SYSTem: PASSword[:CENable] <string>

CAL GEN 128 MHz	DIAGnostic:SERVice:INPut:PULSed OFF
CAL GEN COMB	DIAGnostic:SERVice:INPut:PULSed ON DIAGnostic:SERVice:INPut:PULSed:PRATe 128 MHz
SERVICE FUNCTION	DIAGnostic:SERVice:SFUNction <string>
FIRMWARE UPDATE	--
RESTORE FIRMWARE	--

HCOPY Key

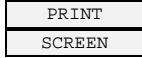
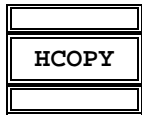

HCOPY:ITEM:ALL
 HCOpy:IMMediate

for printout into file add MMEMory:NAME <file_name>

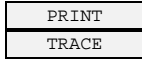

HCOPY:ITEM:WINDow<1|2>:TRACe:STATe ON | OFF
 HCOpy:IMMediate

for printout into file add MMEMory:NAME <file_name>

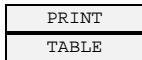

HCOPY:ITEM:WINDow<1|2>:TABLe:STATe ON | OFF
 HCOpy:IMMediate

for printout into file add MMEMory:NAME <file_name>

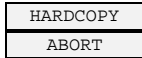

HCOpy:ABORt



SYSTem:COMMunicate:PRINter:ENUMerate:FIRSt?
 SYSTem:COMMunicate:PRINter:ENUMerate:NEXt?
 SYSTem:COMMunicate:PRINter:SELEct <string>
 HCOpy:DESTination <string>
 HCOpy:DEvIce:LANGuage GDI | WMF | EWMF | BMP
 HCOpy:PAGE:ORientation<1|2> LANDscape | PORTRait



HCOpy:DEvIce:COLor ON | OFF
 HCOpy:CMAP:DEFault1



HCOpy:ITEM:WINDow:TEXT <string>

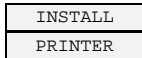

Hotkeys

SPECTRUM	INSTRument[:SElect] SANalyzer INSTRument:NSElect 1
NETWORK	With option tracking generator B9 or option ext. Generator control B10 --
SCREEN A/B	FULL SCREEN: Selection of the active window: DISPLAY[:WINDow<1 2> The window valid for the setting is selected by the numeric. suffix in the command, eg SENSE<1 2> SPLIT SCREEN: The two measurement windows are active. The window valid for the setting is selected by the numeric suffix in the command, eg SENSE<1 2>

Hotkey NETWORK

NETWORK	with option internal tracking generator FSP-B9 or option external generator control FSP-B10 only: --
SOURCE ON / OFF	OUTPut:STATE ON OFF
SOURCE POWER	SOURce:POWer <num_value>
POWER OFFSET	SOURce:POWer:OFFSet <num_value>
SOURCE CAL	with option internal tracking generator FSP-B9 or option external generator control FSP-B10 only:
CAL TRANS	[SENSe:]CORRection:METhod TRANsmission [SENSe:]CORRection:COLLect[:ACQuire] THRUgh
CAL REFL SHORT	[SENSe:]CORRection:METhod REFLeXion [SENSe:]CORRection:COLLect[:ACQuire] THRUgh
CAL REFL OPEN	[SENSe:]CORRection:METhod REFLeXion [SENSe:]CORRection:COLLect[:ACQuire] OPEN
NORMALIZE	[SENSe:]CORRection[:STATE] ON OFF
REF VALUE POSITION	DISP:WIND:TRAC:Y:RPOS <num_value>
REF VALUE	DISP:WIND:TRAC:Y:RVAL <num_value>
RECALL	[SENSe:]CORRection:RECall
FREQUENCY OFFSET	with option internal tracking generator FSP-B9 only: SOURce:FREQuency:OFFSet <num_value>

MODULATION

with option internal tracking generator FSP-B9 only:

EXT AM

SOURce:AM:STATE ON|OFF

EXT FM

SOURce:FM:STATE ON|OFF
 SOURce:FM:DEVIation <num_value>

EXT I/Q

SOURce:DM:STATE ON|OFF

MODULATION
OFF

--

EXT
SOURCE

with option external generator control FSP-B10 only:

EXT SRC
ON / OFF

SOURce:EXTErnal[:STATE] ON | OFF

SELECT
GENERATOR

SYSTem:COMMunicate:RDEvice:GENErator:TYPE 'SME02'
 SYSTem:COMMunicate:RDEvice:GENErator:LINK TTL
 SYSTem:COMMunicate:GPIB:RDEvice:GENErator:ADDRESS 28

FREQUENCY
SWEEP

SOURce:EXTErnal:POWEr -30dBm
 SOURce:EXTErnal:FREQuency:NUMerator 4
 SOURce:EXTErnal:FREQuency:DENominator 3
 SOURce:EXTErnal:FREQuency:OFFSet 100MHZ

Table of Softkeys with IEC/IEEE-Bus Command Assignment - Receiver Mode

FREQUENCY Key

FREQ	
RECEIVER FREQUENCY	[SENSe:]FREQuency:CENTer <num_value>
SREPSIZE	
AUTO COARSE	--
AUTO FINE	--
STEPSize MANUAL	--
STEPSize =FREQ	--
SINGLE AUTOTUNE	[SENSe<1 2>:]FREQuency:CW:AFC ONCE
SIGNAL TRACK	[SENSe<1 2>:]FREQuency:CW:AFC <Boolean>
AF CENTER	[SENSe:]ADEMod:AF:CENTer <numeric_value>
AF START	[SENSe:]ADEMod:AF:START <numeric_value>
AF STOP	[SENSe:]ADEMod:AF:STOP <numeric_value>

SPAN Key

SPAN	
AF SPAN	[SENSe:]ADEMod:AF:SPAN <numeric_value>
AF FULL SPAN	SENSe:]ADEMod:AF:SPAN:FULL
DEMOD BW	[SENSe<1 2>:]BANDwidth BWIDTH:DEMod <numeric_value>
FREQUENCY SPAN	[SENSe:]ADEMod:SPECTrum:SPAN[:MAXimum] <numeric_value>
FULL SPAN	[SENSe:]ADEMod:SPECTrum:SPAN:ZOOM MAX

AMPT Key

AMPT	
REFLEVEL	DISPlay[:WINDow<1 2>]:TRACe<1...3>:Y[:SCALE]:RLEVel <num_value>
RF LEVEL AUTORANGE	INPut<1 2>:ATTenuation:AUTO ON OFF
AUTORANGE CONFIG	DISPlay[:WINDow<1 2>]:TRACe<1...3>:Y:SPACing LINear
10 dB MIN ON OFF	INPut<1 2>:ATTenuation:PROTection[:STATE] ON OFF
AUTOPREAM ON OFF	INPut<1 2>:GAIN:STATE ON OFF
RANGE	
DEVIATION PER DIV	DISPlay[:WINDow<1 2>]:TRACe<1 to 3>:Y[:SCALE]:PDIVision <numeric_value>
REFERENC POSITION	DISPlay[:WINDow<1 2>]:TRACe<1 to 3>:Y[:SCALE]:RPOSITion 0 to 100PCT
REFERENCE VALUE	DISPlay[:WINDow<1 2>]:TRACe<1 to 3>:Y[:SCALE]:RVALue <numeric_value>
COUPLING AC DC	[SENSe:]ADEMod:AF:COUpling AC DC
ZERO PHASE REF POS	
DEVIATION LIN LOG	DISPlay[:WINDow<1 2>]:TRACe<1 to 3>:Y:SPACing LINear LOGarithmic
DB PER DIV	DISPlay[:WINDow<1 2>]:TRACe<1 to 3>:Y[:SCALE]:PDIVision <numeric_value>
PHASE WRAP ON OFF	CALCulate<1 2>:FORMat PHASE UPHase
UNIT	SENS:ADEM:PM:RPO:X 10us
PM UNIT RAD DEG	UNIT:ANGLE DEG RAD
THD UNIT % DB	UNIT<1 2>:THD DB PCT
RF INPUT AC DC	INPut:COUpling AC DC
RF ATTEN MANUAL	INPut:ATTenuation <num_value>
RF ATTEN AUTO	INPut:ATTenuation:AUTO ON
MIXER	
MIXER LVL AUTO	INPut<1 2>:MIXer:AUTO ON

MIXER LVL
MANUAL

INPut<1|2>[:POWER]:MIXer <num_value>

RF INPUT
50Ω 75Ω

INPut:IMPedance 50 | 75

BW Key

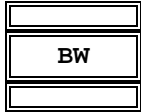

DEMODO BW
AUTO

[SENSe<1|2>:]BANDwidth|BWIDth:DEMod:AUTO ON | OFF

DEMODO BW
MANUAL

[SENSe<1|2>:]BANDwidth|BWIDth:DEMod <numeric-value>

IF BW
AUTO

[SENSe<1|2>:]BANDwidth|BWIDth[:RESolution]:AUTO ON | OFF

MEAS TIME
AUTO

MEAS TIME
MANUAL

[SENSe<1|2>:]SWEep:TIME 2,5ms to 16000s (frequency domain)

RES BW
MANUAL

[SENSe:]BANDwidth|BWIDth:AUTO OFF
[SENSe:]BANDwidth|BWIDth[:RESolution] <num_value>

SWEEP/MEAS Key

SWEEP	INITiate:CONTInuous ON
CONTINUOUS SWEEP	
SINGLE SWEEP	INITiate:CONTInuous OFF; INITiate:IMMEDIATE
MEAS TIME AUTO	[SENSE:]SWEep:TIME:AUTO ON OFF
MEAS TIME MANUAL	[SENSE:]SWEep:TIME <num_value>
SWEEP COUNT	[SENSE:]SWEep:COUNT <num_value>
SGL SWEEP DISP OFF	INITiate:DISPlay OFF INITiate:IMMEDIATE

DISP Key

DISP	
RF SPECTRUM	CALC2:FEED 'XTIM:SPECTRUM' CALC2:FEED 'NONE'

Hotkey *RF LEVEL* Key

RF LEVEL	[SENSE:]POWer:AC:AVERAge[:STATe] ON OFF The following commands are used for reading out the individual measured value: RF LEVEL CALC:MARK:FUNC:ADEM:CARR? Carrier Offset CALC:MARK:FUNC:ADEM:FERR? Standard uncertainty: CALC:MARK:FUNC:ADEM:CARR:SUNC? Reference value: SENS:POW:AC:REF?
RECEIVER FREQUENCY	[SENSE<1 2>:]FREQUency:CENTer 0 to f_{max}
CAL ABS PAWER	[SENSE<1 2>:]CORRection:COLLect[:ACQuire] INPut PMETer PSPLitter THROugh OPEN
RECAL (MANUAL)	INPut<1 2>:ATTenuation:AUTO ON OFF ONCE RECal
RESTORE CAL VALUE	--
CAL VALUES TABLE	MEMory[:CORRection]:CATalog?
RESTORE CAL VALUES	MEMory[:CORRection]:SElect <name>
SORT BY DATE	--

SORT BY FREQUENCY	--
DELETE	--
DELETE ALL	--
RELATIVE	--
RELATIVE ON OFF	[SENSE:]POWER:AC:AVERAGE[:STATE] ON OFF
MEAS ->REF	[SENSE:]POWER:AC:REFERENCE[:STATE].AUTO ONCE
REFERENCE VALUE	[SENSE:]POWER:AC:REFERENCE <numeric_value>
RELATIVE DB %	UNIT<1 2>:THD DB PCT
AUTO AVERAGE	[SENSE<1 2>:]POWER:AC:AVERAGE:AUTO ON OFF
MANUAL AVG OFF	
DETECTOR NARROW	SENSE<1 2>:]DETECTOR[:FUNCTION] NARROW WIDE
DETECTOR WIDE	
AUTO AVG CONFIG	[SENSE<1 2>:]POWER:AC:AVERAGE:DATA <level 1>, <count 1>,.....,<level n>, <count n>
INSERT	--
DELETE	--
DELETE ALL	--
AUTO RECAL ON OFF	INPut<1 2>:ATTenuation:PROTection[:STATE] ON OFF

Hotkey PWR METER

PWR METER	--
PWR METER ON OFF	[SENSE<1 2>:]PMETER:STATE ON OFF
ZERO	CALCulate<1 2>:PMETER:RELative[:MAGNitude]:AUTO ONCE
MEAS TIME/ AVERAGE	[SENSE<1 2>:]PMETER:MTIME SHORT NORMAl LONG
NUMBER OF READING	[SENSE<1 2>:]PMETER:MTIME:AVERAge[:STATE] ON OFF [SENSE<1 2>:]PMETER:MTIME:AVERAge:COUNTt <numeric_value>
DISPLAY LOG LIN	UNIT<1 2>:PMETER:POWer DBM V A W DBPW WATT DBUV DBMV VOLT DBUA AMPere
DISPLAY ABS REL	CALCulate<1 2>:PMETER:RELative:STATE ON OFF UNIT<1 2>:PMETER:POWer:RATio DB PCT
MEAS→REF	CALCulate<1 2>:PMETER:RELative[:MAGNitude]:AUTO ONCE
REFERENCE VALUE	CALCulate<1 2>:PMETER:RELative[:MAGNitude] <numeric_value>
POWER SPLITTER	---
USE POWER SPLITTER	[SENSE:]CORrection:PLOSS:INPut[:STATE] ON OFF
INSERTION LOSS	[SENSE<1 2>:]CORrection:PLOSS:INPut <freq>,<level>..
PATH 2 INS LOSS	[SENSE:]CORrection:PLOSS:INPut:SPATH <numeric_value>
VSWR CORR ON OFF	[SENSE<1 2>:]CORrection:VSWR[:STATE] ON OFF
DEL ALL POINTS	---
INS NEW POINT	---
GOTO POINT #	---
EXT METER ON/OFF	[SENSE<1 2>:]PMETER:EXTern[:STATE] ON OFF
TYPE	SYSTEM:COMMunicate:RDEvice:PMETER:TYPE <name>
GPIB ADDRESS	SYSTEM:COMMunicate:GPIB:RDEvice:PMETER:ADDRESS 0 ... 30
SENSOR CAL FACTOR	SYSTEM:COMMunicate:RDEvice:PMETER:CFACTOR:ASENSor <numeric_value>,<numeric_value>..

DEL ALL POINTS	---
DEL ACTIVE POINT	---
INS NEW POINT	---
GOTO POINT #	---
SENSOR LABEL	SYSTem:COMMunicate:RDEvice:PMETer:CFACTOR:ASENsor:LABel <name>
USE SENSOR A/B	SYSTem:COMMunicate:RDEvice:PMETer:CFACTOR:SElect ASENsor BSENsor
POWER REF ON OFF	OUTPut:REFerence:STATE ON OFF

Hotkey DEMOD

DEMOD	--
RECEIVER FREQUENCY	SENSe<1 2>:]FREQuency:CENTer 0 to f_{max}
AM	CALCulate<1 2>:FEED `XTIM:AM:REL`
FM	CALCulate<1 2>:FEED `XTIM:FM`
PM	CALCulate<1 2>:FEED `XTIM:PM`
DETECTOR SELECTION	--
+/-PEAK/2	<p>[SENSe:]ADEMod:DETEctor:PAverage[:STATE] ON OFF</p> <p>The following commands are used for reading out the individual measured value:</p> <p>CALCulate<1 2>:MARKer:FUNCTion:ADEMod:AM[:WRITE][:RESult]? PAV</p> <p>CALCulate<1 2>:MARKer:FUNCTion:ADEMod:FM[:WRITE][:RESult]? PAV</p> <p>CALCulate<1 2>:MARKer:FUNCTion:ADEMod:PM[:WRITE][:RESult]? PAV</p>
+PEAK	<p>[SENSe:]ADEMod:DETEctor:PPEak[:STATE] ON OFF</p> <p>The following commands are used for reading out the individual measured value:</p> <p>CALCulate<1 2>:MARKer:FUNCTion:ADEMod:AM[:WRITE][:RESult]? PPE</p> <p>CALCulate<1 2>:MARKer:FUNCTion:ADEMod:FM[:WRITE][:RESult]? PPE</p> <p>CALCulate<1 2>:MARKer:FUNCTion:ADEMod:PM[:WRITE][:RESult]? PPE</p>
-PEAK	<p>[SENSe:]ADEMod:DETEctor:MPEak[:STATE] ON OFF</p> <p>The following commands are used for reading out the individual measured value:</p> <p>CALCulate<1 2>:MARKer:FUNCTion:ADEMod:AM[:WRITE][:RESult]? MPE</p> <p>CALCulate<1 2>:MARKer:FUNCTion:ADEMod:FM[:WRITE][:RESult]? MPE</p> <p>CALCulate<1 2>:MARKer:FUNCTion:ADEMod:PM[:WRITE][:RESult]? MPE</p>
RMS	<p>[SENSe:]ADEMod:DETEctor:RMS[:STATE] ON OFF</p> <p>The following commands are used for reading out the individual measured value:</p> <p>CALCulate<1 2>:MARKer:FUNCTion:ADEMod:AM[:WRITE][:RESult]? RMS</p> <p>CALCulate<1 2>:MARKer:FUNCTion:ADEMod:FM[:WRITE][:RESult]? RMS</p> <p>CALCulate<1 2>:MARKer:FUNCTion:ADEMod:PM[:WRITE][:RESult]? RMS</p>
RMS*SQR	<p>[SENSe:]ADEMod:DETEctor:SRMS[:STATE] ON OFF</p> <p>The following commands are used for reading out the individual measured value:</p> <p>CALCulate<1 2>:MARKer:FUNCTion:ADEMod:AM[:WRITE][:RESult]? RMS</p> <p>CALCulate<1 2>:MARKer:FUNCTion:ADEMod:FM[:WRITE][:RESult]? RMS</p> <p>CCALCulate<1 2>:MARKer:FUNCTion:ADEMod:PM[:WRITE][:RESult]? RMS</p>
AVERAGE	<p>[SENSe:]ADEMod:DETEctor:AVERage[:STATE] ON OFF</p> <p>The following commands are used for reading out the individual measured value:</p> <p>CALCulate<1 2>:MARKer:FUNCTion:ADEMod:AM[:WRITE][:RESult]? AVER</p> <p>CALCulate<1 2>:MARKer:FUNCTion:ADEMod:FM[:WRITE][:RESult]? AVER</p> <p>CALCulate<1 2>:MARKer:FUNCTion:ADEMod:PM[:WRITE][:RESult]? AVER</p>
DISTORTION & SINAD	<p>[SENSe:]ADEMod:DETEctor:THD[:STATE] ON OFF</p> <p>[SENSe:]ADEMod:DETEctor:SINad[:STATE] ON OFF</p> <p>The following commands are used for reading out the individual measured value:</p> <p>CALCulate<1 2>:MARKer:FUNCTion:ADEMod:SINAD?</p> <p>CALCulate<1 2>:MARKer:FUNCTion:ADEMod:THD?</p>

DIST UNIT % dB	UNIT<1 2>:THD DB PCT
PEAK HOLD ON OFF	[SENSe:]ADEMod:PHOLd[:STATE] ON OFF For reading out the individual measured value, PHOL is inserted into the command, e.g.: CALCulate<1 2>:MARKer:FUNCTion:ADEMod:AM:PHOL? PAV CALCulate<1 2>:MARKer:FUNCTion:ADEMod:FM:PHOL? PPE CALCulate<1 2>:MARKer:FUNCTion:ADEMod:PM:PHOL? RMS
FILTER	--
HIGHPASS 20 HZ	
HIGHPASS 50 HZ	[SENSe:]FILTer:HPAs[:STATE] ON OFF [SENSe:]FILTer:HPASs:FREQuency 50 Hz 300 Hz
HIGHPASS 300 HZ	
LOWPASS 3 KHZ	
LOWPASS 15 KHZ	[SENSe:]FILTer:LPASs ON [SENSe:]FILTer:LPASs:FREQuency 100 KHZ
LOWPASS 23 KHZ	
LOWPASS 100 KHZ	
DEEMPHAS S WEIGHTING	--
DEEMPHAS IS 25 µs	[SENSe:]FILTer:DEMPhasis[:STATE] ON OFF
DEEMPHAS IS 50 µs	[SENSe:]FILTer:DEMPhasis:TCONstant 25 µs 50 µs 75 µs 750 µs
DEEMPHAS IS 75 µs	
DEEMPHAS IS 750 µs	
WEIGHTIN G CCITT	[SENSe<1 2>:]FILTer:CCITt[:STATE] ON OFF [SENSe:]FILTer:CCIR[:UNWeighted][:STATE] ON OFF
UNWEIGHTIN G CCIR	
COUPLING AC DC	[SENSe:]ADEM:AF:AF:COUPling AC DC
RESULT DISPLAY	--
BARGRAPH	CALC:FEED `XTIM:RFP:BARG`
TIME DOMAIN	CALCulate<1 2>:FEED `XTIM:AM:RELAFSP` CALCulate<1 2>:FEED `XTIM:FMAFSP` CALCulate<1 2>:FEED `XTIM:PMAFSP`

MODULATION SPECTRUM	CALCulate<1 2>:FEED `XTIM:AM:REL:AFSP` CALCulate<1 2>:FEED `XTIM:FM:AFSP` CALCulate<1 2>:FEED `XTIM:PM:AFSP`
RF SPECTRUM	CALCulate<1 2>:FEED `XTIM:SPEC`
RELATIVE	--
MEAS ->REF	[SENSe:]ADEMod:DET:REF:AUTO ONCE
+/-PEAK/2	[SENSe:]ADEMod:DETECTOR:PAverage:MODE ABSolute RELative [SENSe:]ADEMod:DETECTOR:PAverage:REFerence <numeric_value> [SENSe:]ADEMod:DETECTOR:PAverage:REF:AUTO ONCE
+PEAK	[SENSe:]ADEMod:DETECTOR:PPE:MOD REL [SENSe:]ADEMod:DETECTOR:PPE:REF 10 [SENSe:]ADEMod:DETECTOR:PPE:REF:AUTO ONCE
-PEAK	[SENSe:]ADEMod:DETECTOR:MPE:MOD REL [SENSe:]ADEMod:DETECTOR:MPE:REFerence <numeric_value> [SENSe:]ADEMod:DETECTOR:MPE:REFerence:AUTO ONCE
RMS	[SENSe:]ADEMod:DETECTOR:RMS:MODE ABSolute RELative [SENSe:]ADEMod:DETECTOR:RMS:REFerence <numeric_value> [SENSe:]ADEMod:DETECTOR:RMS:REF:AUTO ONCE
RMS*SQR	[SENSe:]ADEMod:DETECTOR:SRMS:MODE ABSolute RELative [SENSe:]ADEMod:DETECTOR:SRMS:REFerence <numeric_value> [SENSe:]ADEMod:DETECTOR:SRMS:REFerence:AUTO ONCE
RELATIVE DB %	UNIT:POWer:THD DB PCT
RELATIVE OFF	[SENSe:]ADEMod:DETECTOR:REFerence AOFF
AVERING OFF	[SENSe:]ADEMod:AVERage:[STATE] ON OFF [SENSe:]SWEep:COUNT <numeric_value>

Hotkey AUDIO

AUDIO	--
INP LEVEL 4V/400mV	[SENSe:]VOLTage:AC:RANGe[:UPPer] <numeric_value>
INPUT IMP 50Ω/1MΩ	INPut<1 2>:IMPedance 50 75 1000
RSLT DISP TIME/SPECT	CALCulate<1 2>:FEED `XTIM:AC:TDOM` CALCulate<1 2>:FEED `XTIM:AC:SPEC`

FILTER	--
HIGHPASS 20 HZ	[SENSe:]FILTer:HPASs[:STATE] ON OFF
HIGHPASS 50 HZ	[SENSe:]FILTer:HPASs:FREQuency 20 Hz 50 Hz 300 Hz
HIGHPASS 300 HZ	
LOWPASS 3 KHZ	
LOWPASS 15 KHZ	[SENSe:]FILTer:LPASs[:STATE] ON OFF
LOWPASS 23 KHZ	[SENSe:]FILTer:LPASs:FREQuency 3 kHz 15 kHz 23 kHz 100 kHz
LOWPASS 100 KHZ	
DEEMPHASIS WEIGHTING	--
DEEMPHASIS 25 μ s	
DEEMPHASIS 50 μ s	[SENSe:]FILTer:DEMPHasis:TCONstant 25 μ s 50 μ s 75 μ s 750 μ s
DEEMPHASIS 75 μ s	
DEEMPHASIS 750 μ s	
WEIGHTING CCITT	[SENSe:]FILTer:CCITt[:STATE] ON OFF
UNWEIGHTING CCIR	[SENSe:]FILTer:CCIR[:STATE] ON OFF
COUPLING AC DC	[SENSe:]ADEMod:AF:COUPLing AC DC
RESULT ABS/REL	[SENSe:]VOLTage:AC:REFerence[:STATE] ON OFF
MEAS->REF	[SENSe:]VOLTage:AC:REFerence:AUTO ONCE
REL UNIT DB %	UNIT<1 2>:PMETer:POWEr:RATio DB PCT

Contents - Chapter 7 "Remote Control - Programming Examples"

7 Remote Control - Programming Examples	7.1
Basic Steps of IEC/IEEE-Bus Programming	7.1
Including IEC-Bus Library for VisualBasic	7.1
Initialization and Default Status	7.2
Creating Global Variables	7.2
Initiate Controller	7.2
Initiate Instrument	7.3
Switching the Display On/Off	7.3
Configuring Power Save Function (Display Permanently Switched Off)	7.4
Transmission of Simple Instrument Setting Commands	7.4
Return to Manual Control	7.4
Reading Out Instrument Settings	7.5
Positioning Markers and Displaying Values	7.5
Command Synchronization	7.6
Service Request	7.7
Initiate Service Request	7.7
Waiting for the Arrival of a Service Request	7.8
Waiting Without Blocking the Keyboard and Mouse	7.9
Service Request Routine	7.10
Reading Out the Output Buffer	7.10
Reading Out Error Messages	7.11
Evaluation of SCPI Status Registers	7.11
Evaluation of Event Status Register	7.12
More Complex Programming Examples	7.13
Default Setting of the R&S FSMR	7.13
Setting the IEC/IEEE Bus Status Register	7.13
Default Setting for Measurements	7.14
Using Marker and Delta Marker	7.15
Marker Search Functions, Limitation of Search Range	7.15
Measuring Spurious Emissions	7.17
Frequency Counting	7.18
Operation with Fixed Reference Point (Reference Fixed)	7.19
Phase and Phase Noise Measurement	7.20
Shape Factor Measurement (using n dB down)	7.21
Measuring the Third Order Intercept Point	7.22
Measuring the AM Modulation Depth	7.23
Limit Lines and Limit Test	7.24
Measuring the Channel and Adjacent Channel Power	7.26
Occupied Bandwidth Measurement	7.28
Time Domain Power Measurement	7.29
Fast Power Measurement on Power Ramps	7.30
Power Measurement with Multi-Summary Marker	7.30
Multi-Burst Power Measurement	7.32
Fast Level Measurement Using Frequency Lists	7.34
Level Correction of Transducers (Definition of Transducer Factors)	7.36
Reading Trace Data	7.37

Measuring the Magnitude and Phase of a Signal (I/Q Data Acquisition)	7.39
Averaging I/Q Data	7.42
Storing and Loading Device Settings	7.43
Storing Instrument Settings.....	7.43
Loading Device Settings	7.44
Setting the Data Set for Startup Recall	7.44
Reading and Writing Files	7.45
Reading a File from the Instrument.....	7.45
Creating a File on the Instrument.....	7.46
Configuring and Starting a Printout	7.47

7 Remote Control - Programming Examples

The following programming examples have a hierarchical structure, i.e. subsequent examples are based on previous ones. It is thus possible to compile very easily an operational program from the modules of the given examples.

Basic Steps of IEC/IEEE-Bus Programming

The examples explain the programming of the instrument and can serve as a basis to solve more complex programming tasks.

VISUAL BASIC has been used as programming language. However, the programs can be translated into other languages.

Including IEC-Bus Library for VisualBasic

Programming hints:

- **Output of texts using the "Print" function**

The following programming examples are based on the assumption that all subroutines are part of a form (file extension: .FRM). In this case the syntax

```
Print "Text"
```

is allowed.

If however the subroutines are stored as a so-called module (file extension: .BAS), the print instruction should be preceded by the name of a form which has the required print method. If, for example, there is a form with the name "Main", the associated print instruction is as follows:

```
Main.Print "Text".
```

- **Access to functions of GPIB.DLL**

To create Visual Basic control applications, the file GPIB.BAS (as from VB 6.0 VBIB-32.BAS) is added to a project so that the functions of the RSIB.DLL can be called. In addition, the file NIGLOBAL.BAS is added to the project. This file contains constants and definitions for the processing of errors, timeout values, etc.

- **Declaration of DLL functions as procedures**

Since the functions all return an integer value, the functions in the file GPIB.BAS are all declared as follows:

```
Declare Function xxx Lib "gplib.dll" ( ... ) As Integer
```

The function value with the status variables `ibsta` should be allocated a variable when it is called up. Since this value is also returned via a reference parameter of the functions, the functions can be declared as procedures as follows:

```
Declare Sub xxx Lib "rsib.dll" ( ... )
```

- **Generating a response buffer**

Since the DLL returns zero-terminated strings in case of responses, a string of sufficient length should be generated prior to calling the functions `ibrd()` and `ilrd()`, since Visual Basic prefixes a length value to the strings which is not updated by the DLL.

The following two possibilities are available to generate a length value for a string:

```
- Dim Rd as String * 100
- Dim Rd as String
  Rd = Space$(100)
```

Initialization and Default Status

Variables used by all subroutines should be stored at the beginning of every program.

Then the IEC/IEEE bus as well as the settings of the instrument are brought into a defined default status at the beginning of every program. Subroutines `"InitController"` and `"InitDevice"` are used to this effect.

Creating Global Variables

Global variables are placed in so-called "modules" (file extension: .BAS) in Visual Basic. Therefore, at least one module (e.g. "GLOBALS.BAS) should be created which contains the variables used by all subroutines, such as the device addresses used by the IEC/IEEE-bus driver.

The file should contain the following instructions for the programming examples below:

```
Global analyzer As Integer
Global boardId As Integer
```

Initiate Controller

```
REM ----- Initiate controller -----
Public SUB InitController()

ieaddress% = 20                                'IEC/IEEE-bus address of the
                                              'instrument

CALL IBFIND("GPIB0", boardId%)                'Open port to the controller
CALL IBFIND("DEV1", analyzer%)                'Open port to the instrument
CALL IBPAD(analyzer%, ieaddress%)             'Inform controller on instrument
                                              'address

CALL IBTMO(analyzer%, 11)                     'Response time to 1 sec

END SUB
REM *****
```

Initiate Instrument

The IEC-bus status registers and instrument settings of the instrument are brought to the default status.

```

REM ----- Initiate instrument -----
Public SUB InitDevice()

CALL IBWRT(analyzer%, "*CLS")           'Reset status registers
CALL IBWRT(analyzer%, "*RST")           'Reset instrument

END SUB
REM*****

```

Switching the Display On/Off

In the default status, all remote control commands are executed with the display switched off to achieve maximum measurement speed. During the generation of remote control programs, however, the display is often needed to check the settings programmed as well as the test results.

The functions shown below are examples of how the display can be switched on or off by remote control::

```

REM ----- Switch display on -----
Public SUB DisplayOn()
CALL IBWRT(analyzer%, "SYST:DISP:UPD ON")   'Switch display on
END SUB
REM*****

REM ----- Switch display off -----
Public SUB DisplayOff()
CALL IBWRT(analyzer%, "SYST:DISP:UPD OFF")  'Switch display off
END SUB
REM*****

```

Configuring Power Save Function (Display Permanently Switched Off)

The results on the screen are often not required during IEC/IEEE-bus operation. Although the command "SYSTEM:DISPlay:UPDate OFF" switches off the display of results, which brings considerable advantages in terms of speed in the remote control mode, the display itself and in particular the backlighting remain switched on.

To switch the display off use the power save function, the response time having to be set in minutes prior to activation.

Note: *The display is switched on as soon as a key is pressed on the instrument front panel.*

```
REM ----- Configure power save function -----
Public SUB PowerSave()

CALL IBWRT(analyzer%, "SYSTEM:PSAVE:HOLDoff 1") 'Set holdoff to 1 minute
CALL IBWRT(analyzer%, "SYSTEM:PSAVE ON")      'Power save function on
END SUB
REM*****
```

Transmission of Simple Instrument Setting Commands

Center frequency, span, and reference level of the instrument are set in this example.

```
REM ----- Instrument setting commands -----
PUBLIC SUB SimpleSettings()

CALL IBWRT(analyzer%, "FREQUENCY:CENTER 128MHZ") 'Center frequency 128 MHz
CALL IBWRT(analyzer%, "FREQUENCY:SPAN 10MHZ")   'Span 10 MHz
CALL IBWRT(analyzer%, "DISPLAY:TRACE:Y:RLEVEL -10dBm")
                                                    'Reference level -10dBm
END SUB
REM *****
```

Return to Manual Control

```
REM ----- Switch instrument over to manual control -----
CALL IBLOC(analyzer%) 'Set instrument to Local state
REM *****
```

Reading Out Instrument Settings

The settings made in the above example are read out using the abbreviated commands.

```

REM ----- Reading out instrument settings -----
PUBLIC SUB ReadSettings()

CFfrequency$ = SPACE$(20)           'Provide text variables (20 characters)
CALL IBWRT(analyzer%, "FREQ:CENT?") 'Request center frequency
CALL IBRD(analyzer%, CFfrequency$)  'Read value

CFspan$ = SPACE$(20)                'Provide text variables (20 characters)
CALL IBWRT(analyzer%, "FREQ:SPAN?") 'Query span
CALL IBRD(analyzer%, CFspan$)       'Read value

RLevel$ = SPACE$(20)                'Provide text variables (20 characters)
CALL IBWRT(analyzer%, "DISP:TRAC:Y:RLEV?")
                                     'Query reference level
CALL IBRD(analyzer%, RLevel$)       'Read value

REM ----- Display values on the screen -----
PRINT "Center frequency: "; CFfrequency$,
PRINT "Span:           "; CFspan$,
PRINT "Reference level: "; RLevel$,
REM*****

```

Positioning Markers and Displaying Values

```

REM ----- Examples of marker functions -----
PUBLIC SUB ReadMarker()

CALL IBWRT(analyzer%, "CALC:MARKER ON;MARKER:MAX")
                                     'Activate marker1 and start peak search
MKmark$ = SPACE$(30)                'Provide text variables (30 characters)
CALL IBWRT(analyzer%, "CALC:MARK:X?;Y?") 'Query frequency and level
CALL IBRD(analyzer%, MKmark$)         'Read value

REM ----- Display values on the screen -----
PRINT "Center frequency / level "; MKmark$,
REM *****

```

Command Synchronization

The possibilities for synchronization implemented in the following example are described in Chapter 5, Section "Command Order and Command Synchronization".

```

REM ----- Examples of command synchronization -----
PUBLIC SUB SweepSync()

REM The command INITiate[:IMMediate] starts a single sweep if the command
REM INIT:CONT OFF was previously sent. It has to be ensured that the next
REM command is only executed when the entire sweep is complete.

CALL IBWRT(analyzer%, "INIT:CONT OFF")

REM ----- First possibility: Use of *WAI -----
CALL IBWRT(analyzer%, "ABOR;INIT:IMM; *WAI")

REM ----- Second possibility: Use of *OPC? -----
OpcOk$ = SPACE$(2)                'Space for *OPC? - Provide response
CALL IBWRT(analyzer%, "ABOR;INIT:IMM; *OPC?")

REM ----- The controller can operate other instruments -----
CALL IBRD(analyzer%, OpcOk$)      'Wait for "1" from *OPC?

REM ----- Third possibility: Use of *OPC -----
REM In order to be able to use the service request function in conjunction
REM with a National Instruments GPIB driver, the setting "Disable
REM Auto Serial Poll" must be changed to "yes" by means of IBCONF!
CALL IBWRT(analyzer%, "*SRE 32")  'Permit service request for ESR
CALL IBWRT(analyzer%, "*ESE 1")  'Set event enable bit for
                                'operation complete bit
CALL IBWRT(analyzer%, "ABOR;INIT:IMM; *OPC") 'Start sweep and
                                'synchronize to OPC
CALL WaitSRQ(boardID%,result%)   'Wait for service request
REM Continue main program.

END SUB
REM *****

```

Service Request

The service request routine requires an extended initialization of the instrument in which the relevant bits of the transition and enable registers are set.

In order to use the service request function in conjunction with a National Instruments GPIB driver, the setting "Disable Auto Serial Poll" must be changed to "yes" by means of IBCONF.

Initiate Service Request

REM ---- Example of initialization of the SRQ in the case of errors -----

PUBLIC SUB SetupSRQ()

```
CALL IBWRT(analyzer%, "*CLS")           'Reset status reporting system
CALL IBWRT(analyzer%, "*SRE 168")      'Permit service request for
                                        'STAT:OPER,STAT:QUES and ESR
                                        'register
CALL IBWRT(analyzer%, "*ESE 60")      'Set event enable bit for
                                        'command, execution, device-
                                        'dependent and query error
CALL IBWRT(analyzer%, "STAT:OPER:ENAB 32767") 'Set OPERation enable bit for
                                        'all events
CALL IBWRT(analyzer%, "STAT:OPER:PTR 32767") 'Set appropriate OPERation
                                        'Ptransition bits
CALL IBWRT(analyzer%, "STAT:QUES:ENAB 32767") 'Set questionable enable bits
                                        'for all events
CALL IBWRT(analyzer%, "STAT:QUES:PTR 32767") 'Set appropriate questionable
                                        'Ptransition bits
```

END SUB

REM *****

Waiting for the Arrival of a Service Request

There are basically two methods of waiting for the arrival of a service request:

1. Blocking (user inputs not possible):

This method is appropriate if the waiting time until the event to be signalled by an SRQ is short (shorter than the selected timeout), if no response to user inputs is required during the waiting time, and if – as the main criterion – the event is absolutely certain to occur.

Reason:

From the time the WaitSRQ() function is called until the occurrence of the expected event, it does not allow the program to respond to mouse clicks or key entries during the waiting time. Moreover, it causes program abort if the SRQ event does not occur within the predefined timeout period.

The method is, therefore, in many cases not suitable for waiting for measurement results, especially with triggered measurements.

The following function calls are required:

```
CALL WaitSRQ(boardID%,result%)      'Wait for service request
                                     'User inputs are not possible
                                     'during the waiting time!

IF (result% = 1) THEN CALL Srq      'If SRQ is recognized =>
                                     'subroutine for evaluation
```

2. Non-blocking (user inputs possible):

This method is recommended if the waiting time until the event to be signalled by an SRQ is long (longer than the selected timeout), and user inputs should be possible during the waiting time, or if the event is not certain to occur. This method is, therefore, the preferable choice for waiting for the end of measurements, i.e. the output of results, especially in the case of triggered measurements.

The method necessitates a waiting loop that checks the status of the SRQ line at regular intervals and returns control to the operating system during the time the expected event has not yet occurred. In this way, the system can respond to user inputs (mouse clicks, key entries) during the waiting time.

It is advisable to employ the Hold() auxiliary function, which returns control to the operating system for a selectable waiting time (see section "Waiting Without Blocking the Keyboard or Mouse"), so enabling user inputs during the waiting time.

```
result% = 0

For i = 1 To 10                      'Abort after max. 10 loop
                                     'iterations

    CALL TestSRQ(boardID%,result%)  'Check service request line

    If (result% <> 0) Then
        CALL Srq                    'If SRQ is recognized =>
                                     'subroutine for evaluation
    Else
        Call Hold(20)               'Call hold function with
                                     '20 ms waiting time.
                                     'User inputs are possible.
    Endif

Next i

If result% = 0 Then
    PRINT "Timeout Error; Program aborted" ' Output error message
    STOP                               'Stop software
Endif
```

Waiting Without Blocking the Keyboard and Mouse

A frequent problem with remote control programs using Visual Basic is to insert waiting times without blocking the keyboard and the mouse.

If the program is to respond to user inputs also during a waiting time, control over the program events during this time must be returned to the operating system. In Visual Basic, this is done by calling the *DoEvents* function. This function causes keyboard- or mouse-triggered events to be executed by the associated elements. For example, it allows the operation of buttons and input fields while the user waits for an instrument setting to be completed.

The following programming example describes the *Hold()* function, which returns control to the operating system for the period of the waiting time selectable in milliseconds.

```

Rem *****
Rem The waiting function below expects the transfer of the desired
Rem waiting time in milliseconds. The keyboard and the mouse remain
Rem operative during the waiting period, thus allowing desired elements
Rem to be controlled
Rem *****
Public Sub Hold(delayTime As Single)
    Start = Timer          'Save timer count on calling the function
    Do While Timer < Start + delayTime / 1000    'Check timer count
        DoEvents          'Return control to operating system
                          'to enable control of desired elements as long as
                          'timer has not elapsed
    Loop
End Sub
Rem *****

```

The waiting procedure is activated simply by calling *Hold(<Waiting time in milliseconds>)*.

Service Request Routine

A service request is processed in the service request routine.

Note: the variables userN% and userM% must be pre-assigned usefully!

```

REM ----- Service request routine -----
Public SUB Srq()

ON ERROR GOTO noDevice           'No user existing
CALL IBRSP(analyzer%, STB%)      'Serial poll, read status byte
IF STB% > 0 THEN                  'This instrument has bits set
                                  'in the STB

    SRQFOUND% = 1
    IF (STB% AND 16) > 0 THEN CALL Outputqueue
    IF (STB% AND 4) > 0 THEN CALL ErrorQueueHandler
    IF (STB% AND 8) > 0 THEN CALL Questionablestatus
    IF (STB% AND 128) > 0 THEN CALL Operationstatus
    IF (STB% AND 32) > 0 THEN CALL Esrread
END IF

noDevice:
END SUB                          'End of SRQ routine

```

```

REM *****
Reading out the status event registers, the output buffer and the error/event queue is effected in
subroutines.

```

Reading Out the Output Buffer

```

REM ----- Subroutine for the individual STB bits -----
Public SUB Outputqueue()         'Reading the output buffer

result$ = SPACE$(100)           'Make space for response
CALL IBRD(analyzer%, result$)
PRINT "Contents of Output Queue : "; result$
END SUB

REM *****

```

Reading Out Error Messages

```

REM ----- Subroutine for reading the error queue -----
Public SUB ErrorQueueHandler()
ERROR$ = SPACE$(100)           'Make space for error variable
CALL IBWRT(analyzer%, "SYSTEM:ERROR?")
CALL IBRD(analyzer%, ERROR$)
PRINT "Error Description : "; ERROR$
END SUB
REM *****

```

Evaluation of SCPI Status Registers

```

REM ----- Subroutine for evaluating Questionable Status Register -----
Public SUB Questionablestatus()
Ques$ = SPACE$(20)             'Preallocate blanks to text variable
CALL IBWRT(analyzer%, "STATUS:QUESTIONABLE:EVENT?")
CALL IBRD(analyzer%, Ques$)
PRINT "Questionable Status: "; Ques$
END SUB
REM *****

```

```

REM ----- Subroutine for evaluating Operation Status Register -----
Public SUB Operationstatus()
Oper$ = SPACE$(20)             'Preallocate blanks to text variable
CALL IBWRT(analyzer%, "STATUS:OPERATION:EVENT?")
CALL IBRD(analyzer%, Oper$)
PRINT "Operation Status: "; Oper$
END SUB
REM *****

```

Evaluation of Event Status Register

```
REM ----- Subroutine for evaluating the Event Status Register -----
Public SUB Esrread()
Esr$ = SPACE$(20)           'Preallocate blanks to text variable
CALL IBWRT(analyzer%, "*ESR?")           'Read ESR
CALL IBRD(analyzer%, Esr$)
IF (VAL(Esr$) AND 1) > 0 THEN PRINT "Operation complete"
IF (VAL(Esr$) AND 2) > 0 THEN PRINT "Request Control"
IF (VAL(Esr$) AND 4) > 0 THEN PRINT "Query Error"
IF (VAL(Esr$) AND 8) > 0 THEN PRINT "Device dependent error"
IF (VAL(Esr$) AND 16) > 0 THEN
    PRINT "Execution Error; Program aborted" ' Output error message
    STOP                                     'Stop software
    END IF
IF (VAL(Esr$) AND 32) > 0 THEN
    PRINT "Command Error; Program aborted" ' Output error message
    STOP                                     'Stop software
    END IF
IF (VAL(Esr$) AND 64) > 0 THEN PRINT "User request"
IF (VAL(Esr$) AND 128) > 0 THEN PRINT "Power on"
END SUB
REM *****
```

More Complex Programming Examples

Default Setting of the R&S FSMR

The following settings are an example of how to modify the default setting of the R&S FSMR. It should be noted that only some settings are necessary depending on the example of application. In particular, the settings for resolution bandwidth, video bandwidth and sweep time are often not needed since these parameters are automatically calculated in the default setting on modifying the frequency range (span). The insertion loss is also automatically calculated depending on the reference level. The level detectors are coupled to the selected trace mode in the default setting. The settings which are automatically calculated in the default setting are marked by (*) in the following programming example.

Setting the IEC/IEEE Bus Status Register

```

REM *****
Public Sub SetupStatusReg()

'----- IEEE 488.2 status register -----
CALL IBWRT(analyzer%,"*CLS")           'Reset Status Registers
CALL IBWRT(analyzer%,"*SRE 168")      'Enable service request
                                       'for STAT:OPER-,STAT:QUES- and
                                       'ESR registers
CALL IBWRT(analyzer%,"*ESE 61")      'Set Event Enable bit for:
                                       'Operation Complete
                                       'Command-, Execution-,Device
                                       'Dependent- and Query Error

'----- SCPI status register -----
CALL IBWRT(analyzer%,"STAT:OPER:ENAB 0") 'Disable OPERATION Status Reg
CALL IBWRT(analyzer%,"STAT:QUES:ENAB 0") 'Disable Questionable Status
                                       'Register

End Sub
REM *****

```

Default Setting for Measurements

```

REM *****
Public Sub SetupInstrument()

'----- R&S FSMR default setting -----
-----
CALL SetupStatusReg           'Set status registers
CALL IBWRT(analyzer%,"*RST")  'Reset instrument
CALL IBWRT(analyzer%,"SYST:DISP:UPD ON") 'ON: display on
                                   'OFF: off(improved
                                   '      performance)

CALL IBWRT(analyzer%,"DISP:FORM SINGLE") 'Full screen
CALL IBWRT(analyzer%,"DISP:WIND1:SEL")  'Active screen A
CALL IBWRT(analyzer%,"INIT:CONT OFF")   'Single sweep

'----- Set frequency -----
CALL IBWRT(analyzer%,"FREQUENCY:CENTER 100MHz") 'Center frequency
CALL IBWRT(analyzer%,"FREQ:SPAN 1 MHz")        'Span

'----- Set level -----
CALL IBWRT(analyzer%,"DISP:WIND:TRAC:Y:RLEV -20dBm") 'Reference level
CALL IBWRT(analyzer%,"INP:ATT 10dB")                'Input attenuation (*)

'----- Scale y axis -----
CALL IBWRT(analyzer%,"DISP:WIND:TRAC:Y:SPAC LOG")    'Log level axis
CALL IBWRT(analyzer%,"DISP:WIND:TRAC:Y:SCAL 100dB")  'Level range
CALL IBWRT(analyzer%,"DISP:WIND:TRAC:Y:SCAL:MODE ABS") 'Absolute scaling
CALL IBWRT(analyzer%,"CALC:UNIT:POW DBM")           'Unit of y axis

'----- Trace and detector settings -----
CALL IBWRT(analyzer%,"DISP:WIND:TRAC1:MODE AVER")    'Trace1 average
CALL IBWRT(analyzer%,"AVER:TYPE VID")               'Average mode video;
                                                    ' "LIN" for linear

CALL IBWRT(analyzer%,"SWE:COUN 10")                 'Sweep count
CALL IBWRT(analyzer%,"DISP:WIND:TRAC2:STAT OFF")    'Trace2 blank
CALL IBWRT(analyzer%,"DISP:WIND:TRAC3:STAT OFF")    'Trace3 blank
CALL IBWRT(analyzer%,"CALC:MATH:STAT OFF")          'Trace mathematics off

CALL IBWRT(analyzer%,"DETECTOR1 RMS")               'Detector Trace1  (*)
CALL IBWRT(analyzer%,"DET2:AUTO ON")                'Detector Trace2  (*)
CALL IBWRT(analyzer%,"DET3:AUTO ON")                'Detector Trace3  (*)

'----- Band width and sweep time -----
CALL IBWRT(analyzer%,"BAND:RES 100KHz")             'Resolution BW (*)
CALL IBWRT(analyzer%,"BAND:VID 1MHz")               'Video bandwidth  (*)
CALL IBWRT(analyzer%,"SWE:TIM 100ms")              'Sweep time        (*)

END SUB

REM *****

```

Using Marker and Delta Marker

Marker Search Functions, Limitation of Search Range

The example below is based on an AM-modulated signal at 100 MHz with the following characteristics:

- Carrier signal level: -30 dBm
- AF frequency: 100 kHz
- Modulation depth: 50 %

Marker 1 and delta marker 2 are set one after the other to the highest maxima of the measurement curve and then the frequency and level are read out. The default setting of the R&S FSMR can be used for the following measurements (SetupInstrument).

```

REM *****
Public Sub MarkerSearch()

result$ = Space$(100)
CALL SetupInstrument           'Default setting
'----- Peak search without search limit -----
CALL IBWRT(analyzer%,"INIT:CONT OFF")           'Switch to single sweep
CALL IBWRT(analyzer%,"CALC:MARK:PEXC 6DB")      'Define peak excursion
CALL IBWRT(analyzer%,"CALC:MARK:STAT ON")       'Switch on Marker 1
CALL IBWRT(analyzer%,"CALC:MARK:TRAC 1")       'Assign Marker 1 to Trace 1
CALL IBWRT(analyzer%,"INIT;*WAI")              'Perform sweep with sync
CALL IBWRT(analyzer%,"CALC:MARK:MAX;X?;Y?")    'Marker to peak; read out
CALL IBRD(analyzer%, result$)                  'frequency and level
Print "Marker 1: ";result$

CALL IBWRT(analyzer%,"CALC:DELT2:STAT ON;MAX;MAX:LEFT")
                                                    'Switch on delta marker 2
                                                    'Peak and then Next Peak Left

CALL IBWRT(analyzer%,"CALC:DELT:MODE ABS")      'Delta marker2 frequency output
                                                    'absolute

CALL IBWRT(analyzer%,"CALC:DELT2:X?;Y?")       'Delta marker 2 - read out
                                                    'frequency and level

CALL IBRD(analyzer%, result$)

Print "Delta 2: ";result$

'----- Peak search with search limit in x direction -----
CALL IBWRT(analyzer%,"CALC:MARK:X:SLIM:STAT ON;LEFT 0Hz;RIGHT 100.05MHz")
                                                    'Search limit on and set below
                                                    'LF on the right side

CALL IBWRT(analyzer%,"CALC:DELT3:STAT ON;MAX;MAX:RIGHT")
                                                    'Delta marker 3 on
                                                    'Peak and then Next Peak Right
CALL IBWRT(analyzer%,"CALC:DELT3:X?;Y?")       'Delta marker 3; Read out
                                                    'frequency and level, both must
                                                    'have the value 0

CALL IBRD(analyzer%, result$)

Print "Delta 3: ";result$

```



```
'----- Peak search with search limit in y direction -----
CALL IBWRT(analyzer%,"CALC:THR:STAT ON")
CALL IBWRT(analyzer%,"CALC:THR -35DBM")           'Threshold on and set above LF
CALL IBWRT(analyzer%,"CALC:DELT3:STAT ON;MAX;MAX:NEXT")
                                           'Delta marker 3 on
                                           'Peak and then Next Peak
                                           ' => is not found

CALL IBWRT(analyzer%,"CALC:DELT3:X:REL?;:CALC:DELT3:Y?")
CALL IBRD(analyzer%, result$)                 'Delta marker 3; read out
                                           'frequency and level, both must
                                           'have the value 0

Print "Delta 3: ";result$

'---- Set center frequency and reference level by means of markers -----
CALL IBWRT(analyzer%,"CALC:MARK2:FUNC:CENT") 'Delta marker 2 -> Marker and
                                           'center frequency = Marker 2

CALL IBWRT(analyzer%,"CALC:MARK2:FUNC:REF") 'Ref level = Marker 2
Call ibwrt(analyzer%,"INIT;*WAI")           'Perform sweep with sync

END SUB
REM *****
```

Measuring Spurious Emissions

In transmission measurements, it is often necessary to search a large frequency range for unwanted spurious emissions.

This can be done by means of the R&S FSMR's LIST PEAKS function, which finds up to 50 peaks in a preselected frequency range and outputs them as a list. The search range can be defined both in terms of frequency and level, and the number of peaks to be found is selectable as well.

In the following example, the 10 highest peaks are to be found in a preselected frequency range. Only signals >-60 dBm in a range ± 400 kHz about the center frequency are of interest, so the search range is limited accordingly. The signals found are output in the order of ascending frequency.

```

REM *****
Public Sub SpuriousSearch()

powerlist$ = Space$(1000)
freqlist$ = Space$(1000)
count$ = Space$(30)

'----- R&S FSMR default setting -----
CALL SetupInstrument           'Default setting
CALL IBWRT(analyzer%,"INIT:CONT OFF") 'Default setting

'----- Definition of search range -----
CALL IBWRT(analyzer%,"CALC:MARK:X:SLIM:STAT ON")
CALL IBWRT(analyzer%,"CALC:MARK:X:SLIM:LEFT 99.6MHz;RIGHT 100.4MHz")
                                'Activate search limit and
                                'set to  $\pm 400$  kHz about
                                'center frequency

CALL IBWRT(analyzer%,"CALC:THR:STAT ON")
CALL IBWRT(analyzer%,"CALC:THR -60DBM")
                                'Activate threshold and
                                'set to -60 dBm

'----- Activate search for spurious -----
CALL IBWRT(analyzer%,"CALC:MARK:FUNC:FPE:SORT X")
                                'Sort according to
                                'frequency
CALL IBWRT(analyzer%,"INIT;*WAI")
                                'Perform sweep with sync
CALL IBWRT(analyzer%,"CALC:MARK:FUNC:FPE 10")
                                'Search for
                                '10 highest peaks
CALL IBWRT(analyzer%,"CALC:MARK:FUNC:FPE:COUN?")
                                'Call number of
                                'peaks, check it,
CALL IBRD(analyzer%, count$)
                                'and read it in
CALL IBWRT(analyzer%,"CALC:MARK:FUNC:FPE:X?")
                                'Query and read
CALL IBRD(analyzer%, freqlist$)
                                'frequency list
CALL IBWRT(analyzer%,"CALC:MARK:FUNC:FPE:Y?")
                                'Query and read
CALL IBRD(analyzer%, powerlist$)
                                'level list
Print "# of spurious: ";count$
                                'Output number of results
Print "Frequencies: ";freqlist$
                                'Output frequency list
Print "Power: ";powerlist$
                                'Output level list

END SUB
REM *****

```

Frequency Counting

The following example is based on a signal with a level of -30 dBm at 100 MHz. The default setting of the R&S FSMR can also be used for this measurement (SetupInstrument). The objective of frequency counting is to determine the exact frequency of the signal at 100 MHz.

```

REM *****
Public Sub MarkerCount()

result$ = Space$(100)
CALL SetupInstrument           'Default setting
'----- Measure signal frequency with frequency counter -----
CALL IBWRT(analyzer%,"INIT:CONT OFF")           'Single sweep on
CALL IBWRT(analyzer%,"CALC:MARK:PEXC 6DB")      'Peak excursion
CALL IBWRT(analyzer%,"CALC:MARK:STAT ON")       'Marker 1 on
CALL IBWRT(analyzer%,"CALC:MARK:TRAC 1")       'Assign marker 1 to trace 1
CALL IBWRT(analyzer%,"CALC:MARK:X 100MHZ")     'Set marker 1 to 100 MHz
CALL IBWRT(analyzer%,"CALC:MARK:COUNT:RES 1HZ") 'Frequency counter 1 Hz
CALL IBWRT(analyzer%,"CALC:MARK:COUNT ON")    'frequency counter on
CALL IBWRT(analyzer%,"INIT;*WAI")             'Perform sweep with sync
CALL IBWRT(analyzer%,"CALC:MARK:COUNT:FREQ?") 'Query measured frequency
CALL IBRD(analyzer%, result$)                 'and read it out

Print "Marker Count Freq: ";result$

END SUB
REM *****

```

Operation with Fixed Reference Point (Reference Fixed)

The following example is based on a signal with a level of -20 dBm at 100 MHz. The harmonics of the signal lie at 200 MHz, 300 MHz, etc. In the presence of high-quality signal sources these harmonics may be outside the dynamic range of the R&S FSMR. In order to measure harmonic suppression, however, the level must be set to higher sensitivity for measuring the harmonics; the carrier has to be suppressed by a notch filter to avoid overloading the R&S FSMR RF input.

In the following example, two measurements are therefore performed with different level settings, first with a high reference level at the carrier frequency and then with a low reference level at the frequency of the 3rd harmonic.

The default setting of the R&S FSMR for measurements (SetupInstrument) is used as starting point and adaptations are then made for the measurement.

```

REM *****
Public Sub RefFixed()

result$ = Space$(100)
CALL SetupInstrument           'Default setting

'----- Measure the reference point -----
CALL IBWRT(analyzer%,"INIT:CONT OFF")           'Single sweep
CALL IBWRT(analyzer%,"CALC:MARK:PEXC 6DB")      'Peak Excursion
CALL IBWRT(analyzer%,"CALC:MARK:STAT ON")       'Marker1 on
CALL IBWRT(analyzer%,"CALC:MARK:TRAC 1")       'Assign Marker 1 to Trace 1
CALL IBWRT(analyzer%,"INIT;*WAI")              'Perform sweep with sync
CALL IBWRT(analyzer%,"CALC:MARK:MAX")          'Set Marker1 to 100 MHz
CALL IBWRT(analyzer%,"CALC:DELT:FUNC:FIX ON")   'Reference fixed

'-----Setting frequency, level and bandwidth for harmonic measurement -----
CALL IBWRT(analyzer%,"FREQ:CENT 400MHz;Span 1MHz") 'Set freq. of 3rd harmonic
CALL IBWRT(analyzer%,"BAND:RES 1kHz")           'and appropriate RBW
CALL IBWRT(analyzer%,"SWEEP:TIME:AUTO ON")      'Couple sweep time
CALL IBWRT(analyzer%,"INP:ATT:AUTO ON")        'Optimize level
CALL IBWRT(analyzer%,"DISP:WIND:TRAC:Y:RLEV -50dBm")
CALL IBWRT(analyzer%,"INIT;*WAI")              'Perform sweep with sync
CALL IBWRT(analyzer%,"CALC:DELT:MODE REL")      'Delta marker frequency
                                           'relative
CALL IBWRT(analyzer%,"CALC:DELT:MAX;X?;Y?")    'Read out delta marker
Call ibrd(analyzer%, result$)                  'Read out frequency and level

Print "Deltamarker 1: "; result$

END SUB

REM *****

```

Phase and Phase Noise Measurement

During phase noise measurement the noise power referred to 1 Hz is brought into proportion to the power of an adjacent carrier signal. The spacing often used between the measured frequency and the carrier frequency is 10 kHz.

For the noise measurement the measured absolute level is referred to a bandwidth of 1 Hz.

The following example is again based on a signal with a level of -30 dBm at 100 MHz. Two markers are used to determine the noise and the phase noise at an offset of 10 kHz from the carrier signal.

```

REM *****
Public Sub Noise()

result$ = Space$(100)

'----- R&S FSMR default setting -----
----
CALL SetupStatusReg           'Configure status register
CALL IBWRT(analyzer%,"*RST")  'Reset instrument
CALL IBWRT(analyzer%,"INIT:CONT OFF") 'Single sweep

'----- Set frequency -----
CALL IBWRT(analyzer%,"FREQUENCY:CENTER 100MHz") 'Center frequency
CALL IBWRT(analyzer%,"FREQ:SPAN 100 kHz")       'Span

'----- Set level -----
CALL IBWRT(analyzer%,"DISP:WIND:TRAC:Y:RLEV -20dBm") 'Reference level
CALL IBWRT(analyzer%,"INIT;*WAI")                   'Perform sweep with sync

'----- Set reference point -----
CALL IBWRT(analyzer%,"CALC:MARK:PEXC 6DB")          'Peak excursion
CALL IBWRT(analyzer%,"CALC:MARK:STAT ON")           'Marker 1 on
CALL IBWRT(analyzer%,"CALC:MARK:TRAC 1")           'Assign marker1 to trace1
CALL IBWRT(analyzer%,"CALC:MARK:MAX")              'Set marker1 to 100 MHz
CALL IBWRT(analyzer%,"CALC:DELT:FUNC:PNO ON")       'Define phase noise
                                                    'reference point

'----- Measure phase noise -----
CALL IBWRT(analyzer%,"CALC:DELT:X 10kHz")           'Set delta marker
CALL IBWRT(analyzer%,"CALC:DELT:FUNC:PNO:RES?")    'Read out result of
Call ibrd(analyzer%, result$)                       'phase noise meas.
Print "Phase Noise [dBc/Hz]: "; result$

'----- Measure noise -----
CALL IBWRT(analyzer%,"CALC:MARK:X 99.96MHz")        'Set Marker 1
CALL IBWRT(analyzer%,"CALC:MARK:FUNC:NOIS:RES?")    'Read out result
Call ibrd(analyzer%, result$)
Print "Noise [dBm/Hz]: "; result$

END SUB

REM *****

```

Shape Factor Measurement (using n dB down)

The n-dB-down function of the R&S FSMR is used twice to determine the shape factor of a filter (ratio of bandwidths at 60 dB and 3 dB below the filter maximum).

The following example is again based on a signal with a level of -30 dBm at 100 MHz. The shape factor is determined for the 30 k Hz resolution bandwidth. The default setting of the R&S F SMR is used for measurements (SetupInstrument).

```

REM *****
Public Sub ShapeFactor()

result$ = Space$(100)

'----- R&S FSMR default setting -----
-
CALL SetupInstrument                'Default setting
CALL IBWRT(analyzer%,"INIT:CONT OFF")  'Single sweep

'----- Set frequency -----
CALL IBWRT(analyzer%,"FREQ:SPAN 1MHz")  'Span
CALL IBWRT(analyzer%,"BAND:RES 30kHz")  'Resolution bandwidth
CALL IBWRT(analyzer%,"INIT;*WAI")      'Perform sweep with sync

'----- Measure 60 dB value -----
CALL IBWRT(analyzer%,"CALC:MARK:PEXC 6DB")  'Peak excursion
CALL IBWRT(analyzer%,"CALC:MARK:STAT ON")  'Marker1 on
CALL IBWRT(analyzer%,"CALC:MARK:TRAC 1")  'Assign marker1 to trace1
CALL IBWRT(analyzer%,"CALC:MARK:MAX")      'Set marker1 to 100 MHz

CALL IBWRT(analyzer%,"CALC:MARK:FUNC:NDBD 60dB")'Read out bandwidth measured
CALL IBWRT(analyzer%,"CALC:MARK:FUNC:NDBD:RES?")'at 60 dB
CALL IBRD(analyzer%,result$)

result60 = Val(result$)

'----- Measure 3 dB Down value -----
CALL IBWRT(analyzer%,"CALC:MARK:FUNC:NDBD 3dB")'Read out bandwidth measured
CALL IBWRT(analyzer%,"CALC:MARK:FUNC:NDBD:RES?")'at 60 dB
CALL IBRD(analyzer%,result$)

result3 = Val(result$)

'----- Read out shape factor-----
Print "Shapefaktor 60dB/3dB: ";result60/result3

END SUB

REM *****

```

Measuring the Third Order Intercept Point

The third order intercept point (TOI) is the (virtual) level of two adjacent useful signals at which the intermodulation products of third order have the same level as the useful signals.

The intermodulation product at f_{S2} is obtained by mixing the first harmonic of the useful signal P_{N2} with signal P_{N1} , the intermodulation product at f_{S1} by mixing the first harmonic of the useful signal P_{N1} with signal P_{N2} .

$$f_{S1} = 2 \times f_{n1} - f_{n2}(1)$$

$$f_{S2} = 2 \times f_{n2} - f_{n1}(2)$$

The following example is based on two adjacent signals with a level of -30 dBm at 100 MHz and 110 MHz. The intermodulation products lie at 90 MHz and 120 MHz according to the above formula. The frequency is set so that the examined mixture products are displayed in the diagram. Otherwise, the default setting of the R&S FSMR is used for measurements (SetupInstrument).

```

REM *****
Public Sub TOI()

result$ = Space$(100)

'----- R&S FSMR default setting -----
----
CALL SetupStatusReg           'Set status registers
CALL IBWRT(analyzer%,"*RST")  'Reset instrument
CALL IBWRT(analyzer%,"INIT:CONT OFF") 'Single sweep
CALL IBWRT(analyzer%,"SYST:DISP:UPD ON") 'ON: display on
                                      'OFF: off

'----- Set frequency -----
CALL IBWRT(analyzer%,"FREQ:START 85MHz;STOP 125 MHz") 'Span

'----- Set level -----
CALL IBWRT(analyzer%,"DISP:WIND:TRAC:Y:RLEV -20dBm") 'Reference level
CALL IBWRT(analyzer%,"INIT;*WAI") 'Perform sweep with sync

'----- TOI measurement -----
CALL IBWRT(analyzer%,"CALC:MARK:PEXC 6DB") 'Peak excursion
CALL IBWRT(analyzer%,"CALC:MARK:FUNC:TOI ON") 'Switch on TOI measurement
CALL IBWRT(analyzer%,"CALC:MARK:FUNC:TOI:RES?") 'and read out results
CALL IBRD(analyzer%,result$)

'----- Read out result -----
Print "TOI [dBm]: ";result$

END SUB

REM *****

```

Measuring the AM Modulation Depth

The example below is based on an AM-modulated signal at 100 MHz with the following characteristics:

- Carrier signal level: -30 dBm
- AF frequency: 100 kHz
- Modulation depth: 50 %

The default setting of the analyzer for measurements can be used for the measurements described below (SetupInstrument).

```

REM *****
Public Sub AMMod()

result$ = Space$(100)
CALL SetupInstrument           'Default setting

'----- Peak search -----
CALL IBWRT(analyzer%,"INIT:CONT OFF")      'Single sweep
CALL IBWRT(analyzer%,"INIT;*WAI")         'Perform sweep with sync

CALL IBWRT(analyzer%,"CALC:MARK:PEXC 6DB")  'Peak excursion
CALL IBWRT(analyzer%,"CALC:MARK:STAT ON")   'Marker 1 on
CALL IBWRT(analyzer%,"CALC:MARK:TRAC 1")    'Assign marker1 to tracen

'----- Measure modulation depth-----
CALL IBWRT(analyzer%,"CALC:MARK:MAX;FUNC:MDEP ON") 'Marker to Peak;
CALL IBWRT(analyzer%,"CALC:MARK:FUNC:MDEP:RES?")  'Measure mod. depth
CALL IBRD(analyzer%, result$)                   'Read out result

'----- Read out result -----
Print "AM Mod Depth [%]: ";result$

END SUB
REM *****

```

Limit Lines and Limit Test

The example below shows the definition and use of a new limit line 5 for trace 1 on screen A and trace 2 on screen B with the following characteristics:

- Upper limit line
- Absolute x axis in the frequency range
- 5 reference values: 120 MHz / -70 dB, 126 MHz/-40 dB, 127 MHz/-40 dB, 128 MHz/-10 dB, 129 MHz/-40 dB, 130 MHz/-40 dB, 136 MHz / -70 dB
- Relative y axis with unit dB
- Absolute threshold at -75 dBm
- No margin

The signal of the integrated calibration source (128 MHz, -30 dBm) is used to check the limit test.

```

REM *****
Public Sub LimitLine()

result$ = Space$(100)

'----- R&S FSMR default setting -----
----

CALL SetupInstrument                'Default setting
CALL IBWRT(analyzer%,"FREQUENCY:CENTER 128MHZ;Span 10MHz")'Span
Call ibwrt(analyzer%,"Diag:Serv:Inp Cal;CSO -30dBm")  'Cal signal on

'----- Definition of limit lines -----
CALL IBWRT(analyzer%,"CALC:LIM5:NAME 'TEST1'")        'Define name
CALL IBWRT(analyzer%,"CALC:LIM5:COMM 'Upper limit'")  'Define comment
CALL IBWRT(analyzer%,"CALC1:LIM5:TRAC 1")            'Assign trace in screen A
CALL IBWRT(analyzer%,"CALC2:LIM5:TRAC 2")            'Assign trace in screen B
CALL IBWRT(analyzer%,"CALC:LIM5:CONT:DOM FREQ")      'Define x axis range
CALL IBWRT(analyzer%,"CALC:LIM5:CONT:MODE ABS")      'Define x axis scaling
CALL IBWRT(analyzer%,"CALC:LIM5:UNIT DB")            'Define y axis unit
CALL IBWRT(analyzer%,"CALC:LIM5:UPP:MODE REL")       'Define y axis scaling

'----- Definition of data points and threshold -----
xlimit$ = "CALC:LIM5:CONT 120MHZ,126MHZ,127MHZ,128MHZ,129MHZ,130MHZ,136MHZ"
CALL IBWRT(analyzer% , xlimit$)                      'Set values for x axis
CALL IBWRT(analyzer%,"CALC:LIM5:UPP -70,-40,-40,-20,-40,-40,-70")
                                                    'Set values for y axis

CALL IBWRT(analyzer%,"CALC:LIM5:UPP:THR -75DBM")      'Set y threshold (only
                                                    'possible for relative
                                                    'y axis)

'-----

'A margin or an x /y offset can be defined here.

'----- Activate and evaluate the limit line in screen A -----
CALL IBWRT(analyzer%,"CALC1:LIM5:UPP:STAT ON")      'Activate line 5 in screen A
CALL IBWRT(analyzer%,"CALC1:LIM5:STAT ON")          'Activate limit check in
                                                    'screen A

CALL IBWRT(analyzer%,"INIT;*WAI")                  'Perform sweep with sync

```

```

CALL IBWRT(analyzer%,"CALC1:LIM5:FAIL?")      'Query result of limit
                                              'check
CALL IBRD(analyzer%, result$)                'Result: 1 (= FAIL)
'----- Read out result -----
Print "Limit Result Line 5: ";result$

'----- Evaluate limit line in screen A by means of status register -----
CALL IBWRT(analyzer%,"*CLS")                  'Reset status register
'----- Measure -----
CALL IBWRT(analyzer%,"INIT;*OPC")            'Perform sweep with sync
CALL WaitSRQ(boardID%,status%)              'Wait for service request
'----- Read out result -----
IF (status% = 1) THEN
    CALL IBWRT(analyzer%,"STAT:QUES:LIM1:COND?") 'Read out STAT:QUES:LIMit
    CALL IBRD(analyzer%, result$)              'register
    IF ((Val(result$) And 16) <> 0) THEN
        Print "Limit5 failed"
    ELSE
        Print "Limit5 passed"
    END IF
END IF
END SUB
REM *****

```

Measuring the Channel and Adjacent Channel Power

In the following example, the channel and adjacent channel power is first measured on a signal with a level of 0 dBm at 800 MHz to IS95. Then the channel and adjacent channel power is measured on a GSM signal at 935.2 MHz with fast ACP measurement (FAST ACP).

In addition, the limit test is activated.

```

REM *****
Public Sub ACP()

result$ = Space$(100)

'----- R&S FSMR default setting -----
----

CALL SetupStatusReg           'Set status register
CALL IBWRT(analyzer%,"*RST")  'Reset instrument
CALL IBWRT(analyzer%,"INIT:CONT OFF") 'Single sweep
CALL IBWRT(analyzer%,"SYST:DISP:UPD ON") 'ON: display on
                                   'OFF: off

'----- Set frequency -----
CALL IBWRT(analyzer%,"FREQ:CENT 800MHz") 'Set frequency

'----- Set level -----
CALL IBWRT(analyzer%,"DISP:WIND:TRAC:Y:RLEV 10dBm") 'Reference level

'----- Example 1: Configure CP/ACP for CDMA -----
CALL IBWRT(analyzer%,"CALC2:MARK:FUNC:POW:SEL ACP") 'ACP measurement on
CALL IBWRT(analyzer%,"CALC:MARK:FUNC:POW:PRES F8CDMA") 'Select CDMA800 FWD
CALL IBWRT(analyzer%,"SENS:POW:ACH:ACP 2") 'Select 2 adjacent channels
CALL IBWRT(analyzer%,"SENS:POW:ACH:PRES ACP") 'Optimize settings
CALL IBWRT(analyzer%,"SENS:POW:ACH:PRES:RLEV") 'Optimize reference level
CALL IBWRT(analyzer%,"SENS:POW:ACH:MODE ABS") 'Absolute measurement
CALL IBWRT(analyzer%,"SENS:POW:HSP ON") 'Fast ACP measurement

'----- Perform measurement and query results -----
CALL IBWRT(analyzer%,"INIT;*WAI") 'Perform sweep with sync
CALL IBWRT(analyzer%,"CALC2:MARK:FUNC:POW:RES? ACP") 'Query result
CALL IBRD(analyzer%, result$)

'----- Read out result -----
Print "Result (CP, ACP low, ACP up, Alt low, Alt up): "
Print result$

```

```

'----- Example 2: Configure CP/ACP manually for GSM -----
result$ = Space$(100)
CALL IBWRT(analyzer%,"FREQ:CENT 935.2MHz")      'Set frequency
CALL IBWRT(analyzer%,"CALC:MARK:FUNC:POW:SEL ACP") 'ACP measurement on
CALL IBWRT(analyzer%,"SENS:POW:ACH:ACP 1")      '1 adjacent channel
CALL IBWRT(analyzer%,"SENS:POW:ACH:BAND 200KHZ") 'Channel bandw. 200 kHz
CALL IBWRT(analyzer%,"SENS:POW:ACH:BAND:ACH 200KHZ") 'Adjacent channel band-
                                                    'width 200 kHz
CALL IBWRT(analyzer%,"SENS:POW:ACH:SPAC 200KHZ") 'Channel spacing 200 kHz
CALL IBWRT(analyzer%,"SENS:POW:ACH:PRES ACP")   'Optimize settings
CALL IBWRT(analyzer%,"SENS:POW:ACH:PRES:RLEV") 'Optimize reference level
CALL IBWRT(analyzer%,"SENS:POW:ACH:MODE ABS")  'Absolute measurement

'----- Start measurement and query result -----
CALL IBWRT(analyzer%,"INIT;*WAI")              'Perform sweep with sync
CALL IBWRT(analyzer%,"CALC:MARK:FUNC:POW:RES? ACP") 'Query result
CALL IBRD(analyzer%, result$)

'----- Read out result -----
Print "Result (CP, ACP low, ACP up): "
Print result$

'----- Active limit check -----
result$ = Space$(100)
CALL IBWRT(analyzer%,"CALC:LIM:ACP:ACH 30DB, 30DB") 'Set relative limit
CALL IBWRT(analyzer%,"CALC:LIM:ACP:ACH:ABS -35DBM,-35DBM")
                                                    'Set absolute limit
CALL IBWRT(analyzer%,"CALC:LIM:ACP:ACH:STAT ON")   'Rel. limit check on
CALL IBWRT(analyzer%,"CALC:LIM:ACP:ACH:ABS:STAT ON") 'Abs. limit check on
CALL IBWRT(analyzer%,"CALC:LIM:ACP ON")            'Limit check on

'----- Start measurement and query result -----
CALL IBWRT(analyzer%,"INIT;*WAI")              'Perform sweep with
sync
CALL IBWRT(analyzer%,"CALC:LIM:ACP:ACH:RES?")     'Query result of
CALL IBRD(analyzer%, result$)                   'limit check

'----- Read out result -----
Print "Result Limit Check: ";result$

END SUB
REM *****

```

Occupied Bandwidth Measurement

In the following example, the bandwidth is to be found in which 95% of the power of a GSM signal is contained. Signal frequency is 935,2 MHz; channel bandwidth is 200 kHz.

```

REM *****
Public Sub OBW()

result$ = Space$(100)

'----- R&S FSMR default setting -----
-----
CALL SetupStatusReg           'Set status register
CALL IBWRT(analyzer%,"*RST")  'Reset instrument
CALL IBWRT(analyzer%,"INIT:CONT OFF") 'Single sweep
CALL IBWRT(analyzer%,"SYST:DISP:UPD ON") 'ON: display on
                                      'OFF: off

'----- Configure R&S FSMR for OBW for GSM -----
CALL IBWRT(analyzer%,"FREQ:CENT 935.2MHz")           'Set frequency
CALL IBWRT(analyzer%,"CALC:MARK:FUNC:POW:SEL OBW")  'OBW measurement on
CALL IBWRT(analyzer%,"SENS:POW:ACH:BAND 200KHZ")    'Channel bandw. 200 kHz
CALL IBWRT(analyzer%,"SENS:POW:BWID 95PCT")         'Percentage of power
CALL IBWRT(analyzer%,"SENS:POW:ACH:PRES OBW")       'Set frequency and
CALL IBWRT(analyzer%,"SENS:POW:ACH:PRES:RLEV")     'optimize reference level
CALL IBWRT(analyzer%,"SENS:POW:NCOR OFF")           'Noise correction
                                      'OFF: switch off
                                      'ON:  switch on

'----- Perform measurement and query results -----
CALL IBWRT(analyzer%,"INIT;*WAI")                   'Perform sweep with sync
CALL IBWRT(analyzer%,"CALC:MARK:FUNC:POW:RES? OBW") 'Query result
CALL IBRD(analyzer%, result$)

Print result$

END SUB

REM *****

```

Time Domain Power Measurement

In the following example, the mean carrier power of a signal with 300 kHz bandwidth at 100 MHz is to be determined. In addition, the peak power, the rms value and the standard deviation are measured. To do this, the time-domain-power measurement functions are used.

```

REM *****
Public Sub TimeDomainPower()

result$ = Space$(100)

'----- R&S FSMR default setting -----
----

CALL SetupStatusReg           'Set status register
CALL IBWRT(analyzer%,"*RST")  'Reset instrument
CALL IBWRT(analyzer%,"INIT:CONT OFF") 'Single sweep
CALL IBWRT(analyzer%,"SYST:DISP:UPD ON") 'ON: display on
                                      'OFF: off

'----- Configure R&S FSMR for time domain power measurement -----

CALL IBWRT(analyzer%,"FREQ:CENT 100MHz;SPAN 0Hz") 'Set frequency
CALL IBWRT(analyzer%,"BAND:RES 300kHz")           'Resolution bandwidth
CALL IBWRT(analyzer%,"SWE:TIME 200US")           'Sweep time

CALL IBWRT(analyzer%,"CALC:MARK:FUNC:SUMM:PPE ON") 'Peak measurement on
CALL IBWRT(analyzer%,"CALC:MARK:FUNC:SUMM:MEAN ON") 'Mean measurement on
CALL IBWRT(analyzer%,"CALC:MARK:FUNC:SUMM:RMS ON") 'RMS measurement on
CALL IBWRT(analyzer%,"CALC:MARK:FUNC:SUMM:SDEV ON") 'Standard deviation on

'----- Perform measurement and query results -----

CALL IBWRT(analyzer%,"INIT;*WAI")                'Perform sweep with sync

query$ =          " CALC:MARK:FUNC:SUMM:PPE:RES?;" 'Query results:
query$ = query$ + ":CALC:MARK:FUNC:SUMM:MEAN:RES?;" 'Peak measurement
query$ = query$ + ":CALC:MARK:FUNC:SUMM:RMS:RES?;"  'Mean measurement
query$ = query$ + ":CALC:MARK:FUNC:SUMM:SDEV:RES?;" 'RMS measurement
Call IBWRT(analyzer%, query$)                    'Standard deviation

CALL IBRD(analyzer%, result$)

Print result$

END SUB

REM *****

```

Fast Power Measurement on Power Ramps

A frequent task in mobile radio tests is measurement of a DUT at various power control levels at the highest possible speed. The R&S FSMR offers two test functions for this task, which can be used depending on the signal characteristics.

In the following, the two methods are presented by means of two examples.

Power Measurement with Multi-Summary Marker

The multi-summary marker function is suitable for measuring the power of a sequence of pulses with the following characteristics:

- The pulses occur at identical time intervals, which is typical of GSM transmission in slots, for example.
- The level of the first signal is reliably above threshold.
- The subsequent pulses may have any levels.

The function uses the first pulse as a trigger signal. The power of the subsequent pulses is determined exclusively via the timing pattern selected for the pulse sequence. The function is, therefore, suitable for adjustments where the DUT output power varies considerably and is not reliably above the trigger threshold.

The measurement accuracy is determined by the ratio of pulse duration to total measurement time; this should not be below 1:50.

The function always uses TRACE 1 of the selected screen.

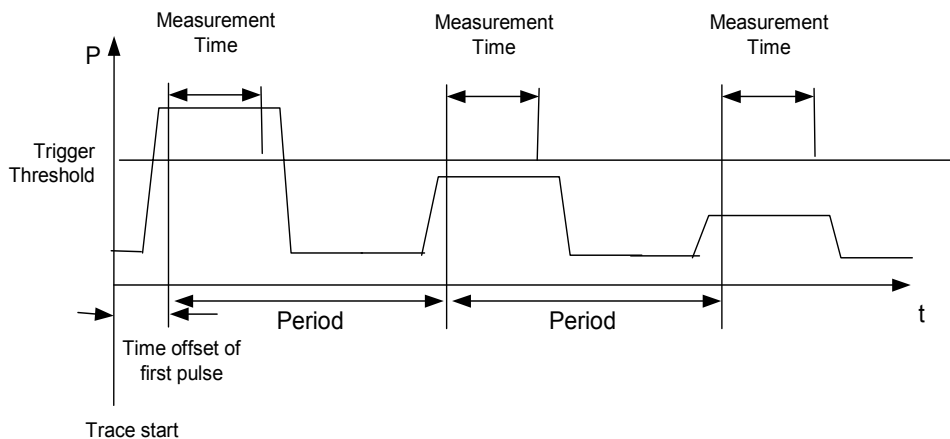

Fig. 7-1 Block diagram illustrating signal processing in analyzer

In the example below, a sequence of 8 pulses is measured with an offset of $50 \mu\text{s}$ of the first pulse, $450 \mu\text{s}$ measurement time/pulse and $576.9 \mu\text{s}$ pulse period.

```

REM *****
Public Sub MultiSumMarker()

result$ = Space$(200)

'----- R&S FSMR default setting-----
CALL SetupStatusReg           'Configure status register
CALL IBWRT(analyzer%,"*RST")  'Reset instrument
CALL IBWRT(analyzer%,"INIT:CONT OFF") 'Single sweep mode
CALL IBWRT(analyzer%,"SYST:DISP:UPD ON") 'ON: switch display on
                                         'OFF: switch display off

'----- Configure R&S FSMR for power measurement in time domain -----
-----
CALL IBWRT(analyzer%,"FREQ:CENT 935.2MHz;SPAN 0Hz") 'Frequency setting
CALL IBWRT(analyzer%,"DISP:WIND:TRAC:Y:RLEV 10dBm") 'Set reference level
                                                         'to 10 dB

CALL IBWRT(analyzer%,"INP:ATT 30 dB") 'Set input attenuation
                                         'to 30 dB

CALL IBWRT(analyzer%,"BAND:RES 1MHz;VID 3MHz") 'Bandwidth setting
CALL IBWRT(analyzer%,"DET RMS") 'Select RMS detector
CALL IBWRT(analyzer%,"TRIG:SOUR VID") 'Trigger source: video
CALL IBWRT(analyzer%,"TRIG:LEV:VID 50 PCT") 'Trigger threshold: 50%
CALL IBWRT(analyzer%,"SWE:TIME 50ms") 'Sweep time ≥ 1 frame

'----- Perform measurement and query results -----
CALL IBWRT(analyzer%,"INIT;*WAI") 'Perform sweep with sync
                                         'Query results:

cmd$ = "CALC:MARK:FUNC:MSUM? "
cmd$ = cmd$ + "50US," 'Offset of first pulse
cmd$ = cmd$ + "450US," 'Measurement time
cmd$ = cmd$ + "576.9US," 'Pulse period
cmd$ = cmd$ + "8" 'Number of bursts
CALL IBWRT(analyzer%,cmd$)
CALL IBRD(analyzer%, result$) 'Read results

Print result$

END SUB
REM *****

```

Multi-Burst Power Measurement

The multi-burst power measurement function is suitable for measuring the power of a sequence of pulses with the following characteristics:

- The pulses occur at variable time intervals.
- The levels of all pulses of the sequence are reliably above the trigger threshold, or an external trigger signal is used.

The function requires one trigger event per pulse. This means that if the video trigger or the IF power trigger is used, the levels of all pulses must be above the trigger threshold.

The function is, therefore, particularly suitable for re-measuring DUTs already adjusted and whose output power is within the specified range. The measurement is optimized for minimum overhead relative to the actual measurement time.

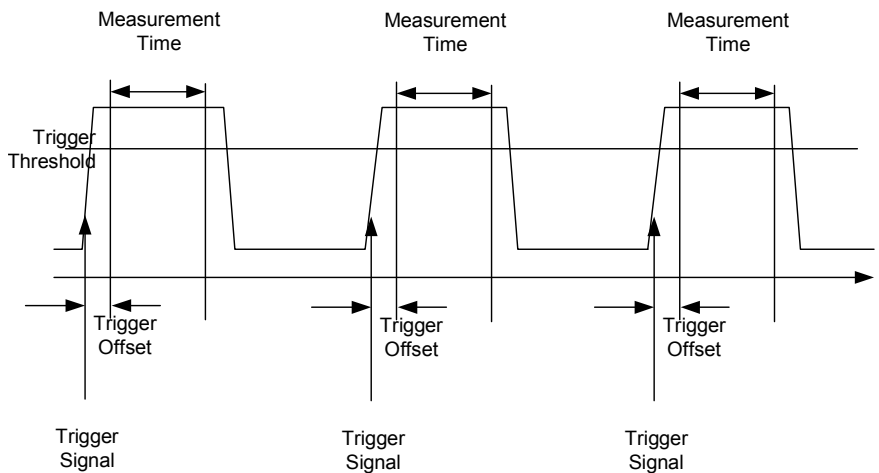

Fig. 7-2 Block diagram illustrating signal processing in analyzer

Either the root-mean-square power or the peak power is measured, depending on whether the RMS detector or the PEAK detector is selected. The function always uses TRACE 1 of the selected screen.

The following parameters are to be set for this measurement:

- Analyzer frequency
- Resolution bandwidth
- Measurement time per single pulse
- Trigger source
- Trigger threshold
- Trigger offset
- Type of power measurement (PEAK, MEAN)
- Number of pulses to be measured

During the measurement, each pulse is mapped into a pixel of the screen, i.e. any change of the trace can be detected only at the left-hand edge of the screen. Maximum measurement speed is as usual achieved with the display switched off.

In the example below, a GSM pulse sequence of 8 pulses is measured with 5 μs trigger offset, 434 μs measurement time/pulse, video trigger with 50% trigger threshold, and peak detection:

```

REM *****
Public Sub MultiBurstPower()

result$ = Space$(200)

'----- R&S FSMR default setting -----
----

CALL SetupStatusReg           'Configure status register
CALL IBWRT(analyzer%,"*RST")  'Reset instrument
CALL IBWRT(analyzer%,"INIT:CONT OFF") 'Single sweep mode
CALL IBWRT(analyzer%,"SYST:DISP:UPD OFF") 'OFF: display off

'----- Perform measurement and query results -----

cmd$ = "MPOW? "
cmd$ = cmd$ + "935.2 MHZ,"      'Center frequency
cmd$ = cmd$ + "1MHZ,"          'Resolution bandwidth
cmd$ = cmd$ + "434US,"         'Measurement time
cmd$ = cmd$ + "VID,"           'Trigger source
cmd$ = cmd$ + "50PCT,"         'Trigger threshold
cmd$ = cmd$ + "1US,"           'Trigger offset, must be > 125 ns
cmd$ = cmd$ + "PEAK,"          'Peak detector
cmd$ = cmd$ + "8"              'Number of bursts
CALL IBWRT(analyzer%, cmd$)
CALL IBRD(analyzer%, result$)  'Read results
Print result$

END SUB
REM *****

```

Fast Level Measurement Using Frequency Lists

A typical task for the R&S FSMR is power measurement at a number of frequency points, e.g. at multiples of the fundamental (harmonics measurement), or at frequencies defined by a mobile radio standard (e.g. spectrum due to transients at ± 200 kHz, ± 400 kHz, etc about the carrier frequency of a GSM signal). In many cases, different level and/or bandwidth settings are required for the different frequency points to match the channel spacing and meet the requirements of dynamic range.

Especially for this application, the R&S FSMR offers a number of remote-control functions (commands available in SENSE:LIST subsystem) that allow level measurement based on a frequency list with different instrument settings assigned to different frequencies. Not only the frequency list can be programmed, but also the measurement types (PEAK, RMS, AVG) to be performed simultaneously can be selected.

The example below describes a harmonics measurement on a dual-band amplifier. The harmonics level in general decreases as the frequency increases. To boost measurement sensitivity, therefore, the reference level is lowered by 10 dB from the third harmonic.

The following settings are used:

Reference level: 10.00 dBm up to 2nd harmonic, 0 dBm from 3rd harmonic
 RF attenuation: 20 dB
 Electronic attenuation: 0 dB
 RBW: 1 MHz
 VBW: 3 MHz
 Filter type: NORMal
 Measurement time: 300 μ s
 Trigger delay: 100 μ s
 Trigger: video, 45 %

Frequency	Type
935.2 MHz	GSM 900 fundamental
1805.2 MHz	GSM 1800 fundamental
1870.4 MHz	GSM 900 2nd harmonic
2805.6 MHz	GSM 900 3rd harmonic
3610.4 MHz	GSM 1800 2nd harmonic
3740.8 MHz	GSM 900 4th harmonic
5815.6 MHz	GSM 1800 3rd Harmonic

The frequencies are selected in ascending order to minimize system-inherent waiting times resulting from frequency changes.

At each frequency point the peak power and the rms power are measured. The peak power and the rms power values are stored alternately in the results memory.

```

REM *****
Public Sub FrequencyList()

result$ = Space$(500)

'----- R&S FSMR default setting -----
---

CALL SetupStatusReg           'Configure status register
CALL IBWRT(analyzer%,"*RST")  'Reset instrument
CALL IBWRT(analyzer%,"INIT:CONT OFF") 'Single sweep mode
CALL IBWRT(analyzer%,"SYST:DISP:UPD OFF") 'Display off

'-----Configure R&S FSMR for power measurement based on frequency list -
-----

Call IBWRT(analyzer%, "TRIG:LEV:VID 45PCT") 'Video trigger threshold
Call IBWRT(analyzer%, "LIST:POWer:SET ON,ON,OFF,VID,POS,100us,0")

'----- Perform measurement and query results -----

cmd$ = "LIST:POWer? "
cmd$ = cmd$ + "935.2MHZ,10dBm,20dB,OFF,NORM,1MHz,3MHz,300us,0,"
cmd$ = cmd$ + "1805.2MHZ,10dBm,20dB,OFF,NORM,1MHz,3MHz,300us,0,"
cmd$ = cmd$ + "1870.4MHZ,10dBm,20dB,OFF,NORM,1MHz,3MHz,300us,0,"
cmd$ = cmd$ + "2805.6MHZ,0dBm,20dB,OFF,NORM,1MHz,3MHz,300us,0,"
cmd$ = cmd$ + "3610.4MHz,10dBm,20dB,OFF,NORM,1MHz,3MHz,300us,0,"
cmd$ = cmd$ + "3740.8MHz,0dBm,20dB,OFF,NORM,1MHz,3MHz,300us,0,"
cmd$ = cmd$ + "5815.6MHz,0dBm,20dB,OFF,NORM,1MHz,3MHz,300us,0"
Call IBWRT(analyzer%, cmd$)
Call IBRD(analyzer%, result$)
Print result$

END SUB
REM *****

```

Level Correction of Transducers (Definition of Transducer Factors)

In more complex test systems, the frequency response of the test setup must be taken into account in all power measurements to avoid any measurement errors being introduced from sources other than the DUT.

The R&S FSMR offers the possibility of defining a frequency-dependent attenuation correction factor (transducer factor).

In the example below, a factor with the following characteristics is defined:

Name: Transtest
 Unit: dB
 Scaling: lin
 Comment: simulated cable correction

Frequency	Level
10 MHz	0 dB
100 MHz	3 dB
1 GHz	7 dB
3 GHz	10 dB

The factor is defined and can be activated as required.

```

REM *****
Public Sub TransducerFactor()

'----- Define transducer factor -----
CALL IBWRT(analyzer%,"CORR:TRAN:SEL 'TRANSTEST'")
                                     'Define "Transtest"
                                     'transducer factor

CALL IBWRT(analyzer%,"CORR:TRAN:UNIT 'DB'") 'Unit 'dB'
CALL IBWRT(analyzer%,"CORR:TRAN:SCAL LIN")  'Linear frequency axis
CALL IBWRT(analyzer%,"CORR:TRAN:COMM 'Simulated cable correction'")

cmd$ = "CORR:TRAN:DATA "                'Enter frequency and level
cmd$ = cmd$ + "10MHz, 0,"                'values. Level values without
cmd$ = cmd$ + "100MHz, 3,"              'unit!
cmd$ = cmd$ + "1GHz, 7,"
cmd$ = cmd$ + "3GHz, 10"

CALL IBWRT(analyzer%,cmd$)                'Enter frequency and level values

'----- Activate transducer -----
CALL IBWRT(analyzer%,"CORR:TRAN:STAT ON") 'Activate transducer factor

END SUB
REM *****

```

Reading Trace Data

In the following example, the trace data recorded together at the default setting is read out and displayed on the screen in the form of a list. Reading is performed consecutively in the binary format and in the ASCII format, at span > 0 and also at span = 0.

In the binary format the message header is evaluated with the length information and used to calculate the x axis values.

In the ASCII format only the list of level values is output.

The binary data is read out in 3 steps:

1. Reading the number of digits of the length information
2. Reading the length information
3. Reading trace data

This procedure is necessary with programming languages that support only structures with similar data types (arrays) (such as Visual Basic) since the data types of header and data differ in binary data.

```

REM *****
Public Sub ReadTrace()

'----- Define variables -----
Dim traceData(1250) As Single           'Buffer for floating point
                                        'binary data
Dim digits As Byte                     'Number of digits of
                                        'length information
Dim traceBytes As Integer              'Length of trace data in bytes
Dim traceValues As Integer             'Number of values in buffer
asciiResult$ = Space$(25000)          'Buffer for ASCII trace data
result$ = Space$(100)                  'Buffer for simple results
startFreq$ = Space$(100)               'Buffer for start frequency
span$ = Space$(100)                    'Buffer for span

'----- R&S FSMR default setting -----
---
CALL SetupInstrument                   'Default setting
CALL IBWRT(analyzer%,"INIT:CONT OFF")  'Single sweep
CALL IBWRT(analyzer%,"INIT;*WAI")      'Perform sweep with sync

'----- Define span for read out -----
Call ibwrt(analyzer%,"FREQ:START?")    'Read out start frequency
Call ibrd(analyzer%,startFreq$)
startFreq = Val(startFreq$)

Call ibwrt(analyzer%,"FREQ:SPAN?")     'Read out span
Call ibrd(analyzer%,span$)
span = Val(span$)

```

```

'----- Read out in binary format -----
Call ibwrt(analyzer%, "FORMAT REAL,32")      'Select binary format
Call ibwrt(analyzer%, "TRAC1? TRACE1")      'Read out trace 1
Call ilrd(analyzer%, result$, 2)            'Read out and store
digits = Val(Mid$(result$, 2, 1))           'number of digits of
                                             'length information
result$ = Space$(100)                       'Initialize buffer again
Call ilrd(analyzer%, result$, digits)        'Read out
traceBytes = Val(Left$(result$, digits))     'and store length information
Call ibrd32(analyzer%, traceData(0), traceBytes) 'Read trace data into buffer
Call ilrd(analyzer%, result$, 1)           'Read the terminator <NL>
'----- Read out binary data as pairs of frequency/level values -----
traceValues = traceBytes/4                  'Single precision = 4 bytes
stepsize = span/traceValues                 'Calculate frequency step width
For i = 0 To traceValues - 1
    Print "Value["; i; "] = "; startFreq+stepsize*i; ", "; traceData(i)
Next i
'----- Time domain default setting -----
Call ibwrt(analyzer%, "FREQ:SPAN 0Hz")      Switchover to time domain
CALL IBWRT(analyzer%, "INIT;*WAI")          'Perform sweep with sync
'----- Read out in ASCII format -----
Call ibwrt(analyzer%, "FORMAT ASCII")       'Select ASCII format
CALL ibwrt(analyzer%, "TRAC1? TRACE1")     'Read out Trace 1
CALL ibrd(analyzer%, asciiResult$)
Print "Contents of Trace1: ",asciiResult$   'Output
END SUB
REM *****

```

Measuring the Magnitude and Phase of a Signal (I/Q Data Acquisition)

Due to the R&S F SMR's internal architecture, it is capable of measuring and outputting the magnitude and phase of a signal in addition to its power values. This opens up a variety of possibilities for more in-depth analysis (FFT, demodulation, etc).

I/Q data is stored in memory areas each containing 128 k words. Hardware triggering controls the memory.

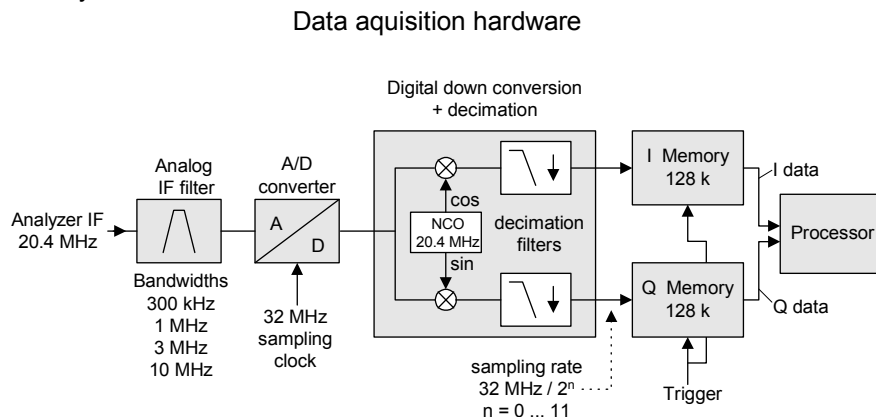

Fig. 7-3 Block diagram illustrating signal processing in the analyzer

The following maximum bandwidths are possible in this measurement depending on the selected sampling rate:

Sampling rate	Max. bandwidth	Remarks
32 MHz	9.6 MHz	
16 MHz	7.72 MHz	
8 MHz	4.8 MHz	Signals outside the specified bandwidth may be deconvoluted to the useful band due to the characteristics of the anti-aliasing filter.
4 MHz	2.8 MHz	
2 MHz	1.6 MHz	
1 MHz	800 kHz	
500 kHz	400 kHz	
250 kHz	200 kHz	
125 kHz	100 kHz	
62.5 kHz	50 kHz	
31.25 kHz	25 kHz	
15.625 kHz	12.5 kHz	

Due to the instrument's sampling concept (21.4 MHz IF, 32 MHz sampling rate), the image frequency is band-limited only by the analog 10 MHz filter. For an input signal at the limit of the 10 MHz band (+ 5 MHz above center frequency), an image-frequency signal 800 kHz above the input signal would be obtained.

The image frequency in MHz is calculated as follows:

$$f_{\text{image}} = 2 \cdot (f_{\text{center}} + 5.4 \text{ MHz}) - f_{\text{signal}}$$

where

f_{image} = image frequency in MHz

f_{center} = center frequency in MHz

f_{signal} = frequency in MHz of signal measured

For correct measurements, the RF input signal must be band-limited. Signals spaced more than 5.4 MHz from the center frequency are reflected into the passband of the 10 MHz filter.

Analog prefilters (bandwidth ≥ 300 kHz) are available to provide additional band-limiting of the signal measured.

The following example shows the steps necessary to collect data at a predefined sampling rate and read it from the I/Q memory.

Data is output in the form of voltage values referred to the analyzer input. Data can be read in binary or ASCII format.

In binary format, the length information carried in the message header is evaluated and used for calculating the x axis values.

In ASCII format, only a list of voltage values is output.

Binary data is read in three steps:

1. The number of digits carrying the length information is read.
2. The length information itself is read.
3. The trace data is read.

This procedure is necessary with programming languages like Visual Basic which support only structures of identical data types (arrays), whereas the binary data format uses different data types in the header and the data section.

```
REM *****
```

```
Public Sub ReadIQData()
```

```
'----- Create variables -----
```

```
Dim IData(131072) As Single           'Buffer for floating-point
                                       'I data (= 128*1024 bytes)

Dim QData(131072) As Single           'Buffer for floating-point
                                       'Q data (= 128*1024 bytes)

                                       'Note:
                                       'Visual Basic cannot read in
                                       'data volumes larger than
                                       '128k words!

Dim digits As Byte                    'No. of digits as length
Dim IQBytes As Long                   'Length of trace data in bytes
Dim IQValues As Long                  'No. of meas. values in buffer

asciiResult$ = Space$(6553600)        'Buffer for ASCII I/Q data
                                       '(= 25*2*1024 bytes)

result$ = Space$(100)                 'Buffer for simple results
```

```
'----- Default setting -----
```

```
CALL SetupInstrument                   'Default setting

CALL IBWRT(analyzer%, "TRAC:IQ:STAT ON") 'Activate I/Q data
                                       'acquisition mode; must be
                                       'done before TRAC:IQ:SET !
```

```

'Select number of test points (= 128 * 1024 - 512) at RBW 10 MHz,
'sample rate 32 MHz, trigger free run, pos. trigger edge and 0 s trigger
'delay.
CALL IBWRT(analyzer%,"TRAC:IQ:SET NORM,10MHz,32MHz,IMM,POS,0,130560")

'----- Read-out in binary format-----
Call ibwrt(analyzer%, "FORMAT REAL,32")           'Set binary format
Call ibwrt(analyzer%, "TRAC:IQ:DATA?")           'Measure + read out I/Q data
Call ilrd(analyzer%, result$, 2)                  'Read and store length for
digits = Val(Mid$(result$, 2, 1))                 'number of digits
result$ = Space$(100)                             'Re-initialize buffer
Call ilrd(analyzer%, result$, digits)             'Read and store length
IQBytes = Val(Left$(result$, digits))             '
IQBytes = IQBytes / 2                             'Divide no. per buffer in
half
Call ibrd32(analyzer%, IData(0), IQBytes)         'Read I data in buffer
Call ibrd32(analyzer%, QData(0), IQBytes)         'Read Q data in buffer
Call ilrd(analyzer%, result$, 1)                'Read in end character <NL>
'----- Output of binary data as frequency/level pair -----
IQValues = IQBytes/4                             'Single Precision = 4 Bytes
For i = 0 To IQValues - 1
  Print "I-Value["; i; "] = "; IData(i)
  Print "Q-Value["; i; "] = "; QData(i)
Next i
'----- Auslesen im ASCII-Format -----
Call ibwrt(analyzer%,"FORMAT ASCII")             'Set ASCII format
Call ibwrt(analyzer%, "TRAC:IQ:DATA?")           'Re-measure and read out
'I/Q data
CALL ibrd(analyzer%, asciiResult$)
CALL IBWRT(analyzer%,"TRAC:IQ:STAT OFF")         'Stop I/Q data aquisition
'mode if no further
'measurements are to be
'done

END SUB
REM *****

```

Averaging I/Q Data

The R&S FSMR has averaging capability also for I/Q measurements, i.e. I/Q data can be averaged over several test runs. This is subject to the following conditions:

1. An external trigger signal must be available for data measurement, and the trigger signal must be phase-locked to the signal measured.
2. The same reference-frequency signal must be used for the DUT and the R&S FSMR.
3. The sampling rate must be 32 MHz, since only with this sampling frequency will the measurement be performed phase-synchronous with the trigger signal.

If all of the above conditions are fulfilled, no phase shift will occur between consecutive test runs. Phase shift may invalidate the measured average so that in extreme cases a value of 0 is obtained.

The default setting of the instrument for data measurement without averaging has to be changed as follows:

```
'----- R&S FSMR default setting -----
--
CALL SetupInstrument           'Default setting
CALL IBWRT(analyzer%,"TRAC:IQ:STAT ON")  'Activate I/Q data acquisition
                                         'mode; this must be
                                         'done before TRAC:IQ:SET!

'Select max. number of test points (= 128 * 1024 - 512) at 10 MHz RBW,
'S32 MHz sampling rate, external trigger, pos. trigger edge and 0 s trigger
'delay.

CALL IBWRT(analyzer%,"TRAC:IQ:SET NORM,10MHz,32MHz,EXT,POS,0,130560")
CALL IBWRT(analyzer%,"TRAC:IQ:AVER ON")   'Switch on I/Q averaging
CALL IBWRT(analyzer%,"TRAC:IQ:AVER:COUN 10") 'Set 10 test runs

'----- Read data in binary format -----
...

```

Storing and Loading Device Settings

Storing Instrument Settings

In the following example, the settings/measurement data to be stored are determined; only the hardware settings are stored. The selection commands for the other settings are indicated with the status OFF for the sake of completeness.

```

REM *****
Public Sub StoreSettings()

' This subroutine selects the settings to be stored and creates
' the data set "TEST1" in directory D:\USER\DATA. It uses
' the default setting and resets the instrument after storage
' of the setting.

'----- R&S FSMR default setting -----
-----
Call SetupInstrument
CALL IBWRT(analyzer%,"INIT:CONT OFF")           'Single sweep
CALL IBWRT(analyzer%,"INIT;*WAI")             'Perform sweep with sync

'----- Select items to be stored -----
CALL IBWRT(analyzer%,"MMEM:SEL:HWS ON")        'Save hardware settings
CALL IBWRT(analyzer%,"MMEM:SEL:TRAC OFF")     'No storing of traces
CALL IBWRT(analyzer%,"MMEM:SEL:LIN:ALL OFF")  'Save only active limit lines

'----- Define comment -----
CALL IBWRT(analyzer%,"MMEM:COMM 'Test Setup'")

'----- Store selected items -----
CALL IBWRT(analyzer%,"MMEM:STOR:STAT 1,'D:\USER\DATA\TEST1'")

'----- Reset instrument -----
CALL IBWRT(analyzer%,"*RST")

END SUB
REM *****

```

Loading Device Settings

In the following example, data set TEST1 stored under D:\USER\DATA is reloaded into the instrument:

```

REM *****
Public Sub LoadSettings()

'----- Default setting of status register -----
Call SetupStatusReg           'Configure status register
'----- Load data set -----
CALL IBWRT(analyzer%,"MMEM:LOAD:STAT 1,'D:\USER\DATA\TEST1'")
'----Start measurement using the data set loaded ----
CALL IBWRT(analyzer%,"DISP:TRAC1:MODE WRITE") 'Set trace to Clr/Write
CALL IBWRT(analyzer%,"INIT;*WAI")           'Start the sweep
END SUB
REM *****

```

Setting the Data Set for Startup Recall

In the following example, the R&S SMR is first reset. Then the data set TEST1 stored under D:\USER\DATA is selected for the STARTUP RECALL function, i.e. the data set is set for every *RST, PRESET and every device startup. For illustration, the command *RST is executed again.

```

REM *****
Public Sub StartupRecallSettings()
'----- Reset R&S FSMR -----
'-----
CALL IBWRT(analyzer%,"*RST")
'----- Default setting of status register -----
Call SetupStatusReg           'Configure status register
'----- Select startup recall data set-----
CALL IBWRT(analyzer%,"MMEM:LOAD:AUTO 1,'D:\USER\DATA\TEST1'")
'----- Activate startup recall data set -----
CALL IBWRT(analyzer%,"*RST")
END SUB
REM *****

```

Reading and Writing Files

Reading a File from the Instrument

In the following example, file TEST1.SET stored under D:\USER\DATA is read from the instrument and stored in the controller.

```

REM *****
Public Sub ReadFile()
  '----- Generate variables -----
  Dim digits As Byte           'Number of digits of
                               'length information
  Dim fileBytes As Long       'Length of file with trace data
                               'in bytes
  result$ = Space$(100)      'Buffer for simple results
  '----- Default setting of status register -----
  Call SetupStatusReg        'Configure status register
  '----- Read out file -----
  Call ibwrt(analyzer%, "MMEM:DATA? 'D:\USER\DATA\TEST1.SET'")
                               'Select file
  Call ilrd(analyzer%, result$, 2) 'Read and store number of
  digits = Val(Mid$(result$, 2, 1)) 'digits of length information
  Call ilrd(analyzer%, result$, digits) 'Read and store length
  fileBytes = Val(Left$(result$, digits)) 'information
  FileBuffer$ = Space$(fileBytes) 'Buffer for file
  Call ilrd(analyzer%, FileBuffer, fileBytes) 'Read file into buffer
  Call ilrd(analyzer%, result$, 1) 'Read terminator <NL>
  '----- Store file to controller -----
  Open "TEST1.SET" For Output As #1
  Print #1, FileBuffer;      ' ; to avoid linefeed at
                               ' end of file

  Close #1
END SUB
REM *****

```

Creating a File on the Instrument

In the following example, the TEST1.SET file available on the controller is stored in the instrument under D:\USER\DATA\DUPLICAT.SET.

```

REM *****
Public Sub WriteFile()
  '----- Generate variables -----
  FileBuffer$ = Space$(100000)           'Buffer for file
  Dim digits As Long                    'Number of digits of
                                        'length information
  Dim fileBytes As Long                 'Length of file in bytes
  fileSize$ = Space$(100)              'Length of file as a string
  result$ = Space$(100)                'Buffer for simple results

  '----- Default setting of status register -----
  Call SetupStatusReg                  'Configure status register

  '----- Prepare the definite length block data -----
  fileBytes = FileLen("H:\work\vb\test1.set") 'Determine length of file
  fileSize$ = Str$(fileBytes)
  digits = Len(fileSize$) - 1           'Determine number of digits of
  fileSize$ = Right$(fileSize$, digits) 'length information
  FileBuffer$ = "#" + Right$(Str$(digits), 1) + fileSize$
                                        'Store length information in
                                        'file buffer

  '----- Read file from controller -----
  Open "H:\work\vb\TEST1.SET" For Binary As #1
  FileBuffer$ = FileBuffer$ + Left$(Input(fileBytes, #1), fileBytes)
  Close #1

  '----- Write file -----
  -
  Call ibwrt(analyzer%, "SYST:COMM:GPIB:RTER EOI") 'Set receive
                                                    'terminator on the
                                                    'instrument

  Call ibwrt(analyzer%, "MMEM:DATA 'D:\USER\DATA\DUPLICAT.SET', " +
                FileBuffer$) 'Select file

END SUB
REM *****

```

Configuring and Starting a Printout

The following example shows the configuration of the output format and output device for printing out the measurement screen.

Proceed in the following order:

1. Set the measurement required for the printout
2. Query available output devices
3. Select an output device
4. Select the output interface
5. Configure the output format
6. Start printout with synchronization to the end

It is assumed that the setting required is a signal with a power of -20 dBm at 100 MHz and that the printer required is the No. 6 of the printers available. The data is first output on the selected printer, then to a file.

```

REM *****
Public Sub HCopy()

DIM Devices(100) as string           'Buffer for printer name
FOR i = 0 TO 49
    Devices$(i) = Space$(50)         'Preallocate buffer for
                                     'printer name
NEXT i

'----- R&S FSMR default setting -----
-----
CALL SetupStatusReg                 'Configure status register
CALL IBWRT(analyzer%,"*RST")        'Reset instrument
CALL IBWRT(analyzer%,"INIT:CONT OFF") 'Single sweep
CALL IBWRT(analyzer%,"SYST:DISP:UPD ON") 'Display on

'----- Configure measurement -----
CALL IBWRT(analyzer%,"FREQ:CENT 100MHz;SPAN 10MHz") 'Set frequency
CALL IBWRT(analyzer%,"DISP:WIND:TRAC:Y:RLEV -10dBm") 'Reference level
CALL IBWRT(analyzer%,"INIT;*WAI") 'Perform measurement

'----- Query regarding available output devices -----
CALL IBWRT(analyzer%,"SYST:COMM:PRIN:ENUM:FIRSt?") 'Read out first output
CALL IBRD(analyzer%,Devices$(0)) 'device and indicate
PRINT "Printer 0: "+Devices$(0) 'name

For i = 1 to 99
    CALL IBWRT(analyzer%,"SYST:COMM:PRIN:ENUM:NEXT?") 'Read out the next
    CALL IBRD(analyzer%,Devices$(i)) 'printer name
    IF Left$(Devices$(i),2) = "" THEN GOTO SelectDevice 'Abort at end of
                                                         'list
    PRINT "Printer"+Str$(i)+" : " Devices$(i) 'Indicate printer name
NEXT i

```

SelectDevice:

```
'----- Select device, printer language and output interface -----
CALL IBWRT(analyzer%,"SYST:COMM:PRIN:SEL "+ Devices(6))'Select printer #6
8 CALL IBWRT(analyzer%,"HCOP:DEST 'SYST:COMM:PRIN'") 'Configuration:
'Output to
'printer interface"

CALL IBWRT(analyzer%,"HCOP:DEV:LANG GDI") 'Output language 'GDI'
'----- Select orientation (portrait/landscape) and colour/BW -----
CALL IBWRT(analyzer%,"HCOP:PAGE:ORI PORTRait") 'Portrait
CALL IBWRT(analyzer%,"HCOP:DEV:COL OFF") 'Black and white

'----- Configure and start print out -----
CALL IBWRT (analyzer%,"HCOP:ITEM:ALL") 'Select complete screen
'CALL IBWRT (analyzer%,"HCOP:ITEM:WIND1:TRAC:STAT ON") 'alternative: only
'CALL IBWRT (analyzer%,"HCOP:ITEM:WIND2:TRAC:STAT ON") 'traces in
' screen A/B

CALL IBWRT (analyzer%,"*CLS") 'Reset status registers
CALL IBWRT (analyzer%,"HCOP:IMMediate;*OPC") 'Start print out

CALL WaitSRQ(boardID%,result%) 'Wait for service request
IF (result% = 1) THEN CALL Srq 'If SRQ is recognized =>
'Subroutine for evaluation

'---- Print out into file in WMF format (BMP format) -----
CALL IBWRT(analyzer%,"HCOP:DEST 'MMEM'") 'Configuration:
'"Print to file"

CALL IBWRT(analyzer%,"HCOP:DEV:LANG WMF") 'File format WMF
'CALL IBWRT(analyzer%,"HCOP:DEV:LANG BMP") 'File format BMP

CALL IBWRT(analyzer%,"MMEM:NAME 'D:\USER\DATA\PRINT1.WMF'") 'Determine
'file name

CALL IBWRT (analyzer%,"*CLS") 'Reset status registers
CALL IBWRT (analyzer%,"HCOP:IMMediate;*OPC") 'Start print out

CALL WaitSRQ(boardID%,result%) 'Wait for service request
IF (result% = 1) THEN CALL Srq 'If SRQ is recognized =>
'Subroutines for evaluation

END SUB

REM *****
```

Contents - Chapter 8 "Maintenance and Instrument Interfaces"

8 Maintenance and Instrument Interfaces.....	8.1
Maintenance.....	8.1
Mechanical and Electrical Maintenance	8.1
Storing and Packing	8.1
List of Power Cables Available	8.1
Instrument Interfaces	8.2
AF Output	8.2
Probe Connector (PROBE POWER)	8.2
External Keyboard (KEYBOARD).....	8.2
IEC Bus Interface	8.3
Interface Characteristics	8.3
Bus Lines	8.3
Interface Functions	8.4
IEC Bus Messages	8.4
Interface Messages.....	8.5
Instrument Messages.....	8.5
Printer Interface (LPT).....	8.6
RS-232-C Interface (COM)	8.7
Interface Characteristics	8.7
Signal Lines.....	8.7
Transmission Parameters.....	8.8
Control Characters.....	8.9
Handshake.....	8.9
Monitor Connector (MONITOR)	8.10
Noise Source Control (NOISE SOURCE)	8.10
External Trigger Input (EXT TRIG/GATE).....	8.11
Mouse Connector (MOUSE)	8.11
USB Connector (USB 	8.11
Reference Output/Input (REF IN and REF OUT).....	8.11
IF Output 20.4 MHz (20.4 MHz OUT).....	8.12
IEC 2 Interface (Option FSP-B10).....	8.12
AUX CONTROL Interface (Option FSP-B10).....	8.13
LAN Interface	8.13

8 Maintenance and Instrument Interfaces

The R&S FSMR following chapter contains information on the maintenance of the R&S FSMR and on the instrument interfaces.

Please follow the instructions in the service manual when exchanging modules or ordering spares. The order no. for spare parts can be found in the service manual.

The address of our support center and a list of all Rohde & Schwarz service centers can be found at the beginning of this manual.

The service manual includes further information particularly on troubleshooting, repair, exchange of modules (including battery exchange, adjustment of the OCXO oscillator) and calibration.

Maintenance

Mechanical and Electrical Maintenance

The R&S FSMR does not require any special maintenance. Remove any contamination on the instrument by means of a soft cloth. Make sure that the air vents are not obstructed.

Storing and Packing

The R&S FSMR can be stored at a temperature of -5°C to $+60^{\circ}\text{C}$. When stored for an extended period of time the instrument should be protected against dust.

The original packing should be used, particularly the protective covers at the front and rear, when the instrument is to be transported or dispatched. If the original packing is no longer available, use a sturdy cardboard box of suitable size and carefully wrap the instrument to protect it against mechanical damage.

List of Power Cables Available

Table 8-1 List of power cables available

Stock No.	Earthed-contact connector	Preferably used in
DS 006.7013	BS1363: 1967' complying with IEC 83: 1975 standard B2	Great Britain
DS 006.7020	Type 12 complying with SEV-regulation 1011.1059, standard sheet S 24 507	Switzerland
DS 006.7036	Type 498/13 complying with US-regulation UL 498, or with IEC 83	USA/Canada
DS 006.7107	Type SAA3 10 A, 250 V, complying with AS C112-1964 Ap.	Australia
DS 0025.2365 DS 0099.1456	DIN 49 441, 10 A, 250 V, angular DIN 49 441, 10 A, 250 V, straight	Europe (except Switzerland)

Instrument Interfaces

AF Output

A miniature telephone jack can be used at the AF OUTPUT connector to connect an external loudspeaker, a headphone set or, e.g., a LF voltmeter. The internal resistance is 10 ohms and the output voltage can be controlled with the volume controller on the left side to the connector. When a jack is plugged in, the internal loudspeaker is automatically turned off.



Probe Connector (PROBE POWER)

To allow the connection of probes, the R&S FSMR provides the PROBE POWER power connector. It delivers the power supply voltages +15 V and -12,6 V and ground.

The connector is also suited for powering the high-impedance probes from Hewlett Packard.

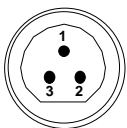

Pin	Signal
1	GND
2	-12.6 V; max 150 mA
3	+15 V; max 150 mA

Fig. 8-1 Pin assignments of PROBE POWER connector

External Keyboard (KEYBOARD)

A 6-pin PS/2 connector is provided on the front panel to allow connecting an external keyboard. The PSP-Z1 keyboard (Order No. 1091.4000.02, German) or the PSP-Z2 (Order No. 1091.4100.02, English) is recommended (Order No. 1009.5001.31). Also they include a trackball for mouse control. However, any other multifunction keyboard may also be used.

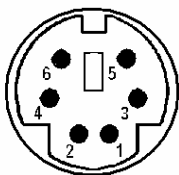

Pin	Signal
1	KEYBOARDDATA
2	MOUSEDATA
3	GND
4	5V, KEYBOARD
5	KEYBOARDCLK
6	MOUSECLK

Fig 8-2 Pin assignments of the KEYBOARD connector.

IEC Bus Interface

The standard instrument is equipped with an IEC/IEEE Bus connector. An IEEE 488 interface connector is located on the rear panel of the R&S FSMR. An external controller for remote control of the instrument can be connected via the IEEE 488 interface connector using a shielded cable.

Interface Characteristics

- 8-bit parallel data transfer
- bi-directional data transfer
- three-line handshake
- high data transfer rate of max. 350 kbyte/s
- up to 15 instruments can be connected
- maximal length of the interconnecting cables 15 m (single connection, 2m)
- wired-OR connection if several instruments are connected in parallel.

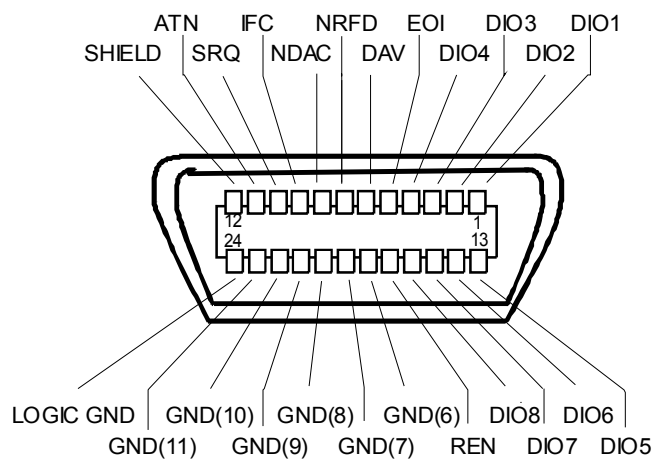

Fig. 8-3 Pin assignment of IEC-Bus interface

Bus Lines

1. Data bus with 8 lines DIO 1 to DIO 8.

The transmission is bit-parallel and byte-serial in the ASCII/ISO code. DIO1 is the least significant, DIO8 the most significant bit.

2. Control bus with 5 lines.

IFC (Interface Clear),

active low resets the interfaces of the devices connected to the default setting.

ATN (Attention),

active low signals the transmission of interface messages

inactive high signals the transmission of device messages.

SRQ (Service Request),

active low enables a device connected to send a service request to the controller.

REN (Remote Enable),

active low permits the switch over to remote control.

EOI (End or Identify),

has two functions in connection with ATN:

active low marks the end of data transmission when ATN=high

active low triggers a parallel poll when ATN=low.

3. Handshake bus with three lines.

DAV (Data Valid),

active low signals a valid data byte on the data bus.

NRFD (Not Ready For Data),

active low signals that one of the devices connected is not ready for data transfer .

NDAC (Not Data Accepted),

active low as long as the device connected is accepting the data present on the data bus.

Interface Functions

Instruments which can be remote controlled via the IEC bus can be equipped with different interface functions. Table 8-2 lists the interface functions appropriate for the instrument.

Table 8-2 Interface functions

Control character	Interface function
SH1	Handshake source function (source handshake), full capability
AH1	Handshake sink function (acceptor handshake), full capability
L4	Listener function, full capability, unaddress if MTA.
T6	Talker function, full capability, ability to respond to serial poll, unaddress if MLA
SR1	Service request function (Service Request), full capability
PP1	Parallel poll function, full capability
RL1	Remote/Local switch over function, full capability
DC1	Reset function (Device Clear), full capability
DT1	Trigger function (Device Trigger), full capability
C0	No controller function

IEC Bus Messages

The messages transferred via the data lines of the IEC bus can be divided into two groups:

- **interface messages** and
- **instrument messages.**

Interface Messages

Interface messages are transferred on the data lines of the IEC Bus when the "ATN" control line is active (LOW). They are used for communication between controller and instruments and can only be sent by the controller which currently has control of the IEC Bus.

Universal Commands

The universal commands are encoded 10 - 1F hex. They affect all instruments connected to the bus without addressing.

Table 8-3 Universal Commands

Command	QuickBASIC command	Effect on the instrument
DCL (Device Clear)	IBCMD (controller%, CHR\$(20))	Aborts the processing of the commands just received and sets the command processing software to a defined initial state. Does not change the instrument settings.
IFC (Interface Clear)	IBSIC (controller%)	Resets the interfaces to the default setting.
LLO (Local Lockout)	IBCMD (controller%, CHR\$(17))	The LOC/IEC ADDR key is disabled.
SPE (Serial Poll Enable)	IBCMD (controller%, CHR\$(24))	Ready for serial poll.
SPD (Serial Poll Disable)	IBCMD (controller%, CHR\$(25))	End of serial poll.
PPU (Parallel Poll Unconfigure)	IBCMD (controller%, CHR\$(21))	End of the parallel-poll state.

Addressed Commands

The addressed commands are encoded 00 - 0F hex. They are only effective for instruments addressed as listeners.

Table 8-4 Addressed Commands

Command	QuickBASIC command	Effect on the instrument
SDC (Selected Device Clear)	IBCLR (device%)	Aborts the processing of the commands just received and sets the command processing software to a defined initial state. Does not change the instrument setting.
GTL (Go to Local)	IBLOC (device%)	Transition to the "Local" state (manual control).
PPC (Parallel Poll Configure)	IBPPC (device%, data%)	Configure instrument for parallel poll. Additionally, the QuickBASIC command executes PPE/PPD.

Instrument Messages

Instrument messages are transferred on the data lines of the IEC bus when the "ATN" control line is not active. ASCII code is used.

Structure and syntax of the instrument messages are described in Chapter 5. The commands are listed and explained in detail in Chapter 6.

Printer Interface (LPT)

The 25-pin LPT connector on the rear panel of the Fig. 8-4 is provided for the connection of a printer. The LPT interface is compatible with the CENTRONICS printer interface.

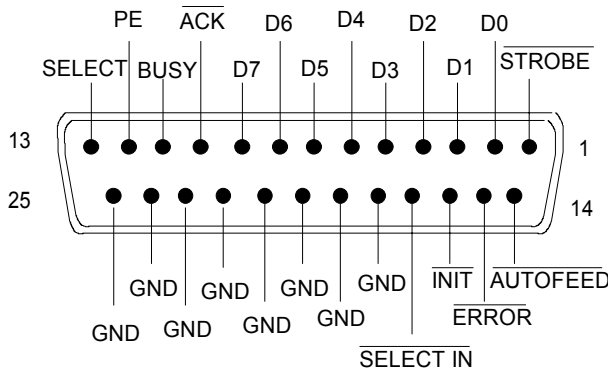

Pin	Signal	Input (I) Output (O)	Description
1	STROBE	O	Pulse for transmitting a data byte, min. 1µs pulse width (active LOW)
2	D0	O	Data Line 0
3	D1	O	Data Line 1
4	D2	O	Data Line 2
5	D3	O	Data Line 3
6	D4	O	Data Line 4
7	D5	O	Data Line 5
8	D6	O	Data Line 6
9	D7	O	Data Line 7
10	ACK	I	Indicates that the printer is ready to receive the next byte. (active LOW)
11	BUSY	I	Signal is active when the printer cannot accept data. (active HIGH)
12	PE	I	Signal is active when the paper tray is empty. (active HIGH)
13	SELECT	I	Signal is active when the printer is selected. (active HIGH)
14	AUTOFEED	O	When signal is active, the printer automatically performs a linefeed after each line. (active LOW)
15	ERROR	I	This signal is high when the printer has no paper, is not selected or has an error status. (active LOW)
16	INIT	O	Initialize the printer. (active LOW)
17	SELECT IN	O	If signal is active, the codes DC1/DC3 are ignored by the printer. (active LOW).
18 - 25	GND		Ground connection.

Fig. 8-4 Pin assignments for the LPT connector.

RS-232-C Interface (COM)

The standard R&S FSMR is equipped with a serial interfaces (RS-232-C; COM connector at the rear of the instrument). The interface can be set up and activated manually in the *SETUP-GENERAL SETUP* menu in the *COM PORT* table (Selection *OWNER = INSTRUMENT*).

Interface Characteristics

- Serial data transmission in asynchronous mode
- Bi-directional data transfer via two separate lines
- Transmission rate selectable from 110 to 19200 baud
- Logic '0' signal from +3 V to +15 V
- Logic '1' signal from -15 V to -3 V
- An external instrument (controller) can be connected.

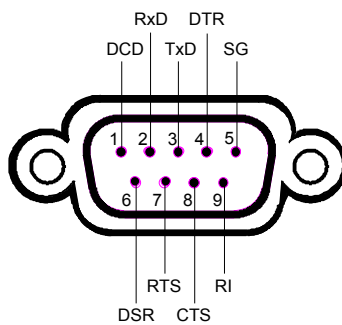

Fig. 8-5 Pin assignment of the RS-232-C interface

Signal Lines

DCD (Data Carrier Detect),

Not used in R&S FSMR.

Input; active LOW.

Using this signal, the local terminal recognizes that the modem of the remote station receives valid signals with sufficient level. DCD is used to disable the receiver in the local terminal and prevent reading of false data if the modem cannot interpret the signals of the remote station.

RxD (Receive Data)

Input, LOW = logic '1', HIGH = logic '0'.

Data line, local terminal receives data from remote station.

TxD (Transmit Data)

Output, LOW = logic '1', HIGH = logic '0'.

Data line, local terminal transmits data to remote station.

DTR (Data Terminal Ready),

Output, active LOW,

Indicates that the local terminal is ready to receive data.

GND

Interface ground, connected to instrument ground

DSR (Data Set Ready),
Input, active LOW,
Indicates that the remote station is ready to receive data.

RTS (Request To Send),
Output, active LOW.
Indicates that the local terminal wants to transmit data.

CTS (Clear To Send),
Input, active LOW.
Used to tell the local terminal that the remote station is ready to receive data.

RI (Ring Indicator),
Not used in R&S FSMR.
Input, active LOW.
Used by a modem to indicate that a remote station wants to establish a connection.

Transmission Parameters

To ensure error-free data transmission, the parameters of the instrument and the controller must have the same settings. The parameters are defined in the *SETUP-GENERAL SETUP* menu.

Transmission rate (baud rate)	the following transmission rates can be set in the instrument: 110, 300, 600, 1200, 2400, 4800, 9600, 19200.
Data bits	Data transmission is in 7- or 8-bit ASCII code. The first bit transmitted is the LSB (least significant bit).
Start bit	Each data byte starts with a start bit. The falling edge of the start bit indicates the beginning of the data byte.
Parity bit	In order to detect errors, a parity bit may be transmitted. No parity, even parity or odd parity may be selected. In addition, the parity bit can be set to logic '0' or to logic '1'.
Stop bits	The transmission of a data byte is terminated by 1, 1,5 or 2 stop bits.

Example:

Transmission of character 'A' (41 hex) in 7-bit ASCII code,
with even parity and 2 stop bits:

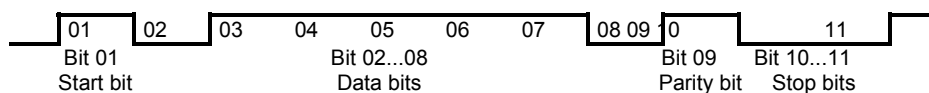

Control Characters

For interface control, several strings are defined and control characters are reserved which are based upon IEC Bus control.

Table 8-5 Control strings or control characters of the RS-232 interface

Control string or character	Function
'@REM'	Switch over to remote
'@LOC'	Switch over to local
'@SRQ'	Service Request SRQ (SRQ is sent by the instrument)
'@GET'	Group Execute Trigger (GET)
'@DCL'	Reset instrument (Device Clear DCL)
<Ctrl Q> 11 Hex	Enables character output / XON
<Ctrl S> 13 Hex	Inhibits character output / XOFF
0D Hex, 0A Hex	Terminator <CR>, <LF>

Handshake

Software handshake

In the software handshake mode of operation, the data transfer is controlled using the two control characters XON / XOFF.

The instrument uses the control character XON to indicate that it is ready to receive data. If the receive buffer is full, it sends the XOFF character via the interface to the controller. The controller then interrupts the data output until it receives another XON from the instrument. The controller indicates to the instrument that it is ready to receive data in the same way.

Cable required for software handshake

The connection of the instrument with a controller for software handshake is made by crossing the data lines. The following wiring diagram applies to a controller with a 9-pin or 25-pin configuration.

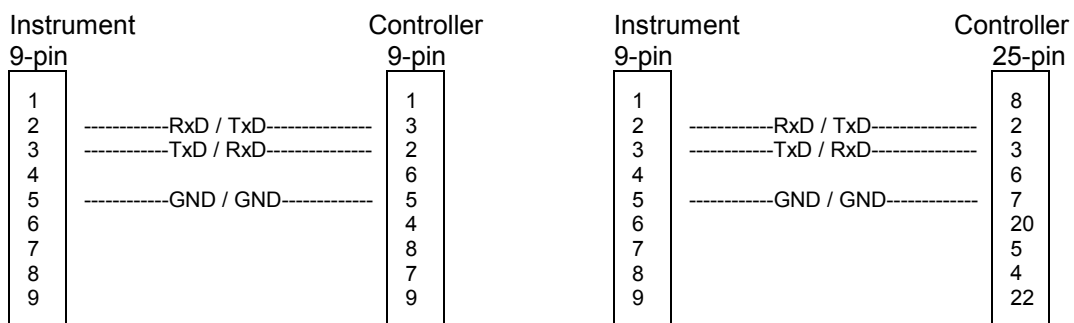

Fig. 8-6 Wiring of the data lines for software handshake

Hardware handshake

For hardware handshake, the instrument indicates that it is ready to receive data via the lines DTR and RTS. A logic '0' on both lines means 'ready' and a logic '1' means 'not ready'. The RTS line is always active (logic '0') as long as the serial interface is switched on. The DTR line thus controls the readiness of the instrument to receive data.

The readiness of the remote station to receive data is reported to the instrument via the CTS and DSR line. A logic '0' on both lines activates the data output and a logic '1' on both lines stops the data output of the instrument. The data output takes place via the TxD line.

Cable for hardware handshake

The connection of the instrument to a controller is made with a so-called zero modem cable. Here, the data, control and acknowledge lines must be crossed. The following wiring diagram applies to a controller with a 9-pin or 25-pin configuration.

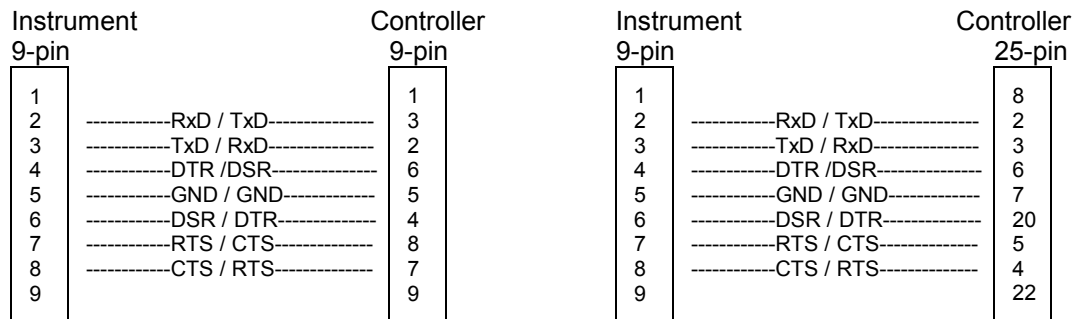

Fig. 8-7 Wiring of the data, control and acknowledge lines for hardware handshake

The configuration of the user ports takes place in the *SETUP* menu (SETUP key) in the *GENERAL SETUP* sub-menu.

Monitor Connector (MONITOR)

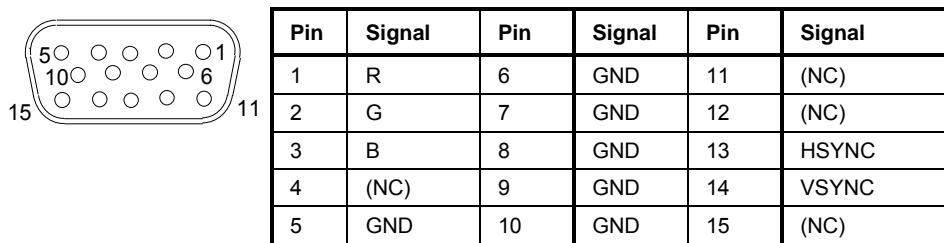

Fig. 8-8 Pin assignments of the MONITOR connector.

Noise Source Control (NOISE SOURCE)

Using the NOISE SOURCE connector, an external noise source can be switched on/off, in order, e.g., to measure the noise figure of units under test (UUTs). Usual noise sources require a +28 V signal to be turned on. At 0 V, they are turned off. These supply voltages are delivered by the connector. Maximum current is 100 mA..

External Trigger Input (EXT TRIG/GATE)

The EXT TRIG/GATE connector is used for controlling the measurement via an external signal. The trigger voltages are TTL level (Low < 0.7 V, High > 1.4 V), typ. input impedance is 10 kOhm

Mouse Connector (MOUSE)

A PS/2 connector is provided at the rear panel to connect a PS/2 mouse:

Pin	Signal
1	MOUSEDATA
2	KEYBOARDDATA
3	MOUSEGND
4	MOUSEVD5
5	MOUSECLK
6	KEYBOARDCLK

Fig 8-9 Pin assignments for the MOUSE connector.

USB Connector (USB)

A USB connector is provided at the rear panel of the R&S FSMR. This USB connector is used to connect two USB devices (USB 1.1):

Pin	Signal
1	+ 5 V USB0
2	USBDATA0 -
3	USBDATA0 +
4	GND
5	+ 5 V USB1
6	USBDATA1 -
7	USBDATA1 +
8	GND

Fig. 8-10 USB connector assignment

Note: *Passive USB connection cables should not be longer than 1 m.*

Reference Output/Input (REF IN and REF OUT)

For operation with an external reference, the internal reference oscillator is then synchronized to the 10-MHz reference applied to the connector. The necessary level is > 0 dBm.

The internal 10 MHz reference signal is also available at the REF OUT connector and thus provides the capability of, e.g., synchronization of external instruments to the R&S FSMR. The output level is 0 dBm.

Selection between internal and external reference is possible in the *SETUP* menu.

IF Output 20.4 MHz (20.4 MHz OUT)

The 20.4 MHz IF signal of the R&S FSMR is available at the 20.4 MHz OUT BNC connector. The bandwidth corresponds to the selected bandwidth for a resolution bandwidth between 100 kHz and 10 MHz. For a resolution bandwidth below 100 kHz, the bandwidth of the output is 2.6 times the resolution bandwidth with a minimum of 2.6 kHz.

The signal level at the IF output is 0 dBm for resolution bandwidth \geq 100 kHz, and -10 dBm for resolution bandwidth $<$ 100 kHz (mixer level \geq 60 dBm).

IEC 2 Interface (Option B16)

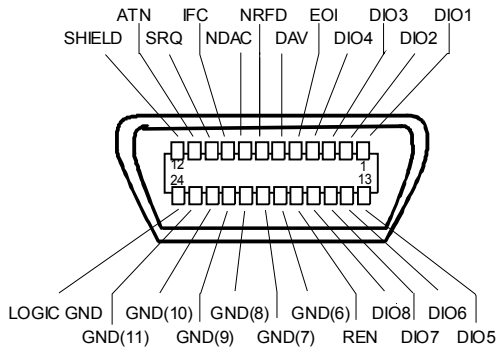

Fig. 8-11 Pin assignment of IEC 2 interface

AUX CONTROL Interface (Option FSP-B10)

The voltage levels are of the TTL type (low < 0.4 V, high > 2 V).

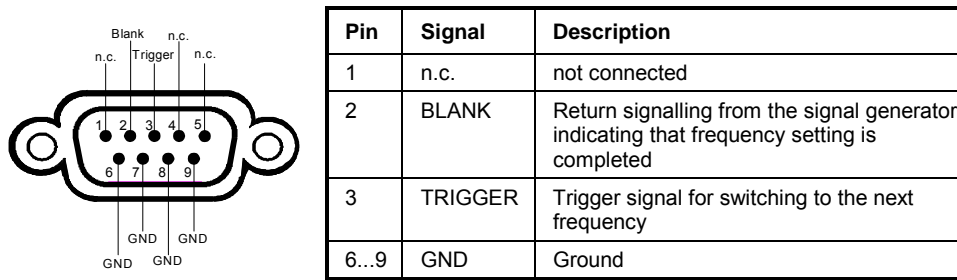

Fig. 8-12 Pin assignment of AUX CONTROL connector

LAN Interface

The LAN interface allows the instrument to be connected to local networks. The pin assignment of the RJ45 connector supports double-paired category 5 UTP/STP cables in star configuration. (UTP means unshielded twisted pair, and STP stands for shielded twisted pair).

Contents - Chapter 9 "Error Messages"

- 9 Error Messages**
 - SCPI-Specific Error Messages9.2
 - Device-Specific Messages.....9.8

10 Index



All softkeys are listed alphabetically under keyword "Softkey" with their names. The page numbers 4.xxx refer to the detailed description of the softkeys in chapter 4. Generally, the number of the page in chapter 6 containing the equivalent remote control command is given in addition.

A list of softkeys and equivalent remote control commands or command sequences is given in chapter 6, section "Table of Softkeys with IEC/IEEE-Bus Command Assignment".

Chapter 6 also contains an alphabetical list of all remote control commands.

*	
* (enhancement label)	4.11-3
1	
1 - 2 (trace info)	4.11-12
1 - 3 (trace info)	4.11-12
2	
20.4 MHz Out	8.12
A	
Abort	
recording of correction data	4.12-2
ACP measurement	4.16-7
Addressed command	8.5
Adjacent-channel power	
number of channels	4.16-14
AF demodulation	4.14-9
AF OUTPUT	8.2
AM	4.4-19
AM demodulation	4.14-10
AM modulation	4.22-17
AM modulation depth	4.16-39
Amplitude	4.7-1
Amplitude probability distribution function	4.16-30
Amplitude statistics	4.16-28
Analyzer mode	4.5.1
Annotation	4.18-4
APD function	4.16-30
Ascii #	5.14
Attenuation	4.7-3
Mechanical	4.4-39
AUDIO	4.4-29
Autoppeak detector	4.11-10
AUX CONTROL	
interface	8.13
AUX CONTROL connector	8.13
Average detector	4.11-9, 4.11-11
Averaging	4.11-2, 4.16-5
continuous sweep	4.11-3
lin/log	4.11-4
single sweep	4.11-3
sweep count	4.11-2
B	
Band filter, digital	4.8-7
Bandwidth	4.4-40
occupied	4.16-25
resolution	4.8-3
video	4.8-3
Baud rate	4.19-13
Befehl	
Zuordnung Softkey	6.4-1, 6.4-32
Block data	5.14
Boolean parameter	5.13
Brightness	4.18-5
Brightness, Screen	4.21-8
C	
Calibration	
functioning	4.22-13, 4.23-10
reflection measurement	4.23-9
reflexion measurement	4.22-12
transmission measurement	4.22-5, 4.23-3
Calibration results	4.12-3
CCDF function	4.16-30
CCIR 473-4	4.10-8
CCVS signal	4.10-8
Center frequency	4.5-2
Step size	4.5-2
Channel	
power	4.16-18
bandwidth	4.16-15, 4.16-26, 4.16-38
number	4.16-14
spacing	4.16-16
Channel filters	4.8-9
Channel power measurement	4.16-9
Characters, special	6.1-2
Clear/Write mode	4.11-2
Colon	5.14
Color	4.18-5, 4.21-6
Color printout	4.21-6
COM interface	4.19-13, 8.7
Comma	5.14
Command	
#	5.14
addressed	8.5
colon	5.14
comma	5.14
description	6.1-1
header	5.10
line	5.12
long form	5.11

- overlapping execution 5.17
 - programming examples 7.1
 - query 5.12
 - question mark 5.12, 5.14
 - quotation mark 5.14
 - recognition 5.16
 - sequence 5.17
 - short form 5.11
 - structure 5.9
 - suffix 5.11
 - syntax elements 5.14
 - universal 8.5
 - white space 5.14
 - Common commands 6.1-4
 - CONDition register part 5.19
 - Configuration 4.19-1
 - save 20-1
 - Continue single sweep 4.9-2
 - Continuous sweep 4.9-1
 - Control
 - output level 4.22-3
 - Control characters 8.9
 - Copy
 - limit line 4.17-4
 - trace 4.11-8
 - Correction
 - inherent noise 4.16-11
 - Correction data 4.12-1
 - Correction values
 - normalization 4.22-1, 4.23-1
 - Counter resolution 4.13-7
 - Coupling
 - bandwidths 4.8-1
 - default settings 4.8-5, 4.8-7
 - frequency of diagrams 4.18-3
 - reference level of diagrams 4.18-3
 - resolution bandwidth 4.8-4
 - sweep time 4.8-5
 - video bandwidth 4.8-4
 - Create directory 20-12
 - Cumulative distribution function 4.16-30
- D**
- Date 4.18-3
 - input 4.19-15
 - DCL 5.16
 - Default
 - coupling ratios 4.8-5
 - Device Setting 4.1-1
 - display settings 4.18-4
 - scalings of x- and y-axis 4.16-32
 - Default Setting
 - Device 4.1-1
 - Delay, gate signal 4.10-6
 - Delete
 - limit line 4.17-5
 - DEM0D 4.4-18
 - Demodulation 4.14-9
 - Detector
 - autopeak 4.11-8
 - average 4.11-9
 - max peak 4.11-8
 - min peak 4.11-8
 - quasipeak 4.11-9
 - RMS 4.11-9
 - sample 4.11-9
 - Display
 - brightness 4.18-5
 - color 4.18-5
 - date 4.18-3
 - deactivation during single sweep 4.9-3
 - power-save mode 4.18-4
 - saturation 4.18-5
 - time 4.18-3
 - tint 4.18-5
 - title 4.18-3
 - Display line 4.17-11
 - Display mode
 - full screen 4.18-2
 - split screen 4.18-2
 - Display range
 - frequency 4.5-2
 - level 4.7-1
 - span 4.6-1
 - Distortion 4.16-49
 - Distribution function 4.16-30
 - Double dagger 5.14
- E**
- Editing
 - limit line 4.17-6
 - ENABle register part 5.19
 - Enabling the front panel keys 4.3-1
 - Error messages 4.19-22, 9.1
 - Error variable - iberr 4.24-38
 - Error-queue query 5.33
 - ESE (event status enable register) 5.22
 - ESR (event status register) 5.22
 - EVENT register part 5.19
 - Event status enable register (ESE) 5.22
 - Event status register (ESR) 5.22
 - EXT TRIGGER/GATE input 4.10-2, 8.11
 - External generator 4.23-1
 - External noise source 4.19-2
- F**
- Fast power measurement 4.16-11
 - FFT filter 4.8-7
 - Field, first or second 4.10-8
 - File
 - sort 4.20-13
 - Filter
 - band filter 4.8-7
 - FFT 4.8-7
 - Firmware update 4.19-26
 - Firmware version 4.19-21
 - Fixed filter 4.8-7
 - FM 4.4-19
 - FM demodulation 4.14-10
 - FM modulation 4.22-17
 - Free-run sweep 4.10-1
 - Frequency 4.5.1
 - center 4.5-2
 - counter 4.13-3
 - coupling of diagrams 4.18-3
 - display window 4.5.1, 4.6-1
 - Line 4.17-12
 - offset 4.5-4
 - Offset (ext. generator) 4.23-11
 - offset (tracking generator) 4.22-14
 - Receiver 4.4-3, 4.4-19, 4.4-33
 - span 4.6-1
 - start 4.5-4
 - stop 4.5-4
 - switching off display 4.18-4
 - Frequency-converting measurements 4.22-14, 4.23-11

Full screen 4.18-2
 Full span 4.6-1

G

Gate
 delay 4.10-6
 external/internal 4.10-4
 length 4.10-6
 GET (Group Execute Trigger) 5.16

H

Hardcopy
 screen 4.21-2
 Hardware Adjustment 4.19-26
 Harmonic distortion 4.16-49
 4.16-48, 4.16-49
 Header 5.10
 Horizontal sync signal 4.10-8
 Hotkey
 AUDIO 4.2-1
 DEMOD 4.2-1
 MRECEIVER 4.2-2
 NETWORK 4.2-2
 NETWORK 4.22-1
 PWR METER 4.2-1
 PWR METER 6.1-88
 PWR METER 6.1-184
 RECEIVER 4.4-1
 RF LEVEL 4.2-1
 SCREEN A/B 4.2-2, 6.1-104
 SPECTRUM 4.2-1, 4.5.1, 6.1-122
 Softkey
 MEAS TIME/ AVERAGE 4.4-12
 Hue, Screen 4.21-8

I

I/Q modulation 4.22-18
 IEC Bus
 Interface 8.12
 IEC/IEEE bus
 address 4.19-10
 command description 6.1-1
 interface 8.3
 interface functions 8.4
 programming examples 7.1
 4.4-40
 Impedance of input 4.7-4
 Inherent noise, Correction 4.16-11
 Initial configuration 4.1-1
 Input
 EXT TRIGGER/GATE 4.10-2, 8.11
 REF IN 8.11
 Input impedance 4.7-4
 Instrument functions 4.1
 Interface functions
 IEC/IEEE bus 8.4
 Interfaces 8.2
 Intermodulation product 4.16-47
 Interrupt 5.32
 IST flag 5.22

K

Key

AMPT 4.4-35, 4.7-1
 BW 4.8-2
 CAL 4.12-1
 DISP 4.18-1
 ESC 6.1-21
 FILE 20-1
 FREQ 4.5.1
 LINES 4.17-2, 4.17-11
 MEAS 4.16-1
 MKR 4.13-1
 MKR FCTN 4.14-1
 MKR to 4.15-1
 PRESET 4.1-1, 6.1-7, 6.1-224
 SETUP 4.19-1
 SPAN 4.6-1
 SWEEP 4.9-1
 TRACE 4.11-1
 TRIG 4.10-1
 Keyboard
 connector 8.2

L

LAN Interface 4.24-1
 LAN-Interface 4.24-1
 Level 4.4-35, 4.7-1
 display range 4.7-1
 offset (phase noise) 4.14-5
 offset (tracking generator) 4.22-3
 range 4.7-1
 reference 4.7-1
 Limit
 ACP measurement 4.16-21
 evaluation range 4.16-4
 probability range 4.16-32
 Limit check 4.17-4
 ACP measurement 4.16-20
 Limit Check 4.17-4
 Limit line
 copy 4.17-4
 delete 4.17-5
 domain 4.17-7
 edit 4.17-6
 limit check 4.17-4
 offset 4.17-5
 save 4.17-10
 scaling 4.17-8
 select 4.17-3
 shift 4.17-10
 unit 4.17-8
 value 4.17-9
 Line
 Frequency (Frequency Line 1, 2) 4.17-12
 limit 4.17-3
 reference (tracking generator) 4.22-8, 4.23-6
 threshold 4.15-3
 Time (Time Line 1, 2) 4.17-12
 Line system 4.10-8
 Lines 4.17-12
 LO exclude 4.15-5, 4.15-7
 Logo 4.18-4
 Lower case 6.1-2
 LPT interface 8.6

M

Maintenance	8.1
Manual operation	
return to	5.4, 5.6
switch to	4.3-1
Marker	4.13-1
center frequency to	4.15-2
CF stepsize to	4.15-4
N dB Down	4.14-6, 4.14-10
normal	4.13-1
peak	4.14-2, 4.15-1
reference level to	4.15-2
search limit	4.15-3
signal track	4.5-5
to trace	4.13-6, 4.14-10
zoom	4.13-6
Max hold	4.11-2
Max peak detector	4.11-10
Maximum peak value	4.16-5
Maximum search	4.15-1
Maximum value	4.16-3
Mean power (GSM burst)	4.16-4
Mean value	4.16-4
Measurement	
examples	2.1
frequency-converting	4.22-14, 4.23-11
reflection	4.23-9
reflexion	4.22-11
transmission	4.22-4, 4.23-3
Measurement data	
storing (ASCII format)	4.16-45
Measurement example	
ACP with user-specific channel configuration	4.16-23
adjacent-channel power for a specific standard	4.16-22
CCDF of a IS95 BTS signal	4.16-33
occupied bandwidth of a PDC signal	4.16-27
signal/noise power density (C/No) of an IS95 CDMA signal	4.16-24
Measurement of Carrier/Noise Ratio C/N and C/No	4.16-37
Measurement Receiver	4.4-1
Measurement Time	4.4-12
Measurement, save	20-1
Messages	4.19-22
Min hold	4.11-4
Min peak detector	4.11-11
Minimum search	4.15-4
Mobile radio standard	4.16-10
Mode	
analyzer	4.5.1
Receiver	4.4-1
Modulation	
external (tracking generator)	4.22-16
Modulation depth	4.16-39
Monitor	
connector	8.10
Mouse	8.11
connector	8.11
Mouse connection	8.11
Mouse connector	8.2

N

Network	4.22-1
Noise	
source, external	4.19-2
Noise measurement	4.14-2
NOISE SOURCE	8.10
Noise, Correction	4.16-11
Normalization	4.22-7, 4.23-5

NTRansition register part	5.19
Numerical values (command)	5.13

O

Occupied bandwidth	4.16-25
Offset	
frequency	4.5-4
frequency (ext. generator)	4.23-11
gate signal	4.10-6
level (tracking generator)	4.22-3
limit line	4.17-5
phase noise	4.14-5
reference level	4.7-4
trigger	4.10-2
Operating mode	
analyzer	4.5.1
Operating Mode	
Receiver	4.4-1
Operating time	4.19-21
Option	
FSP-B10 – External Generator	4.23-1
FSP-B6 – TV and RF Trigger	4.10-8
FSP-B9 – Tracking Generator	4.22-1
FSP-B16 - LAN Interface	4.24-1, 8.13
Order number	4.19-20
Output	
AF OUTPUT	8.2
IF 20.4 MHz Out	8.12
noise source control	8.10
REF OUT	8.11
Output level	
control	4.22-3
Overwrite mode	4.11-2
OVLd	4.22-13, 4.23-10

P

Packing	8.1
Parallel poll	5.33
Parallel poll enable register (PPE)	5.22
Parameter	
block data	5.14
boolean	5.13
numerical values	5.13
string	5.14
text	5.14
Password	
service functions	4.19-24
Path	4.20-12
Peak search	4.14-2, 4.15-1
Phase noise measurement	4.14-4
PM	4.4-19
Polarity	
external trigger/gate	4.10-5
trigger edge	4.10-2
video	4.10-8
Power bandwidth percentage	4.16-25
Power cables	8.1
Power measurement	4.16-1
CP/ACP	4.16-7
Fast	4.16-11
occupied bandwidth	4.16-25
signal amplitude statistics	4.16-28
Time domain	4.16-2
trace	4.16-21
Power Meter	4.4-4
Power, mean	4.16-4
PPE (parallel poll enable register)	5.22

Preamplifier..... 4.19-3
 Preset 4.1-1
 Pretrigger 4.10-2
 Print
 start..... 4.21-2
 Printer
 configuration 4.21-1
 connection 4.21-3, 8.6
 interface 8.6
 Probe Power connector..... 8.2
 PTRansition register part..... 5.19

Q

Quasipeak detector 4.11-9
 Query 5.12, 5.33
 Question mark 5.12, 5.14
 Quotation mark..... 5.14

R

Receive Frequency
 Step Width 4.4-33
 Receiver..... 4.4-1
 Receiver Frequency 4.4-3, 4.4-19, 4.4-33
 Recording the correction data 4.12-1
 Reference
 dataset (tracking generator) 4.22-13
 external 4.19-2
 fixed 4.13-4
 frequency 4.13-4
 level to marker level 4.15-2
 line (tracking generator) 4.22-8, 4.23-6
 position for normalization 4.23-6
 Reference level 4.7-1
 channel power..... 4.16-12
 coupling of diagrams 4.18-3
 offset..... 4.7-4
 position 4.7-4
 to marker level 4.15-2
 Reference point
 frequency 4.13-4
 frequency (phase noise)..... 4.14-5
 level 4.13-4
 offset..... 4.13-4
 level (phase noise)..... 4.14-5
 offset..... 4.14-5
 time..... 4.13-5
 Reference value
 channel power..... 4.16-11
 time domain power..... 4.16-5
 Reference Value 4.4-13
 Referenz
 Datensatz (Mitlaufgenerator) 4.23-10
 Reflection measurement..... 4.22-11, 4.23-9
 Remote control
 basics 5.1
 IEC/IEEE bus..... 5.4
 RS-232-C..... 5.5
 switch over..... 5.3
 Reset
 status reporting system..... 5.34
 Resetting
 Device..... 4.1-1
 Resolution bandwidth 4.8-3
 Resolution counter 4.13-7
 RF ATTEN MANUAL..... 4.7-5
 RF attenuation..... 4.7-3
 RF Attenuation

Mechanical 4.4-39
 RF LEVEL..... 4.4-2, 4.4-10
 RMS detector..... 4.11-9, 4.11-11
 RMS value 4.16-3
 RS-232-C
 configuration 4.19-13
 interface 8.7
 transmission parameters..... 8.8

S

Sample detector..... 4.11-11
 Sample number..... 4.16-31
 Saturation 4.18-5
 Saturation, Screen 4.21-8
 Save
 configuration 4.20-1
 limit line 4.17-10
 measurement 4.20-1
 Scalar reflection measurement..... 4.22-11, 4.23-9
 Scaling..... 4.7-2
 level axis 4.7-4
 limit line 4.17-8
 x- and y-axis (signal statistic)..... 4.16-31
 SCPI
 conformity information 6.1-1
 introduction 5.9
 version 5.1
 Screen
 brightness 4.21-8
 full screen 4.18-2
 hue 4.21-8
 Saturation 4.21-8
 split screen 4.18-2
 Search
 bandwidth 4.5-5
 minimum 4.15-4
 peak 4.14-2, 4.15-1
 PEAK EXCURSION..... 4.14-8, 4.15-5
 range 4.15-3
 Selftest 4.19-25
 Sensitivity
 APD measurement 4.16-32
 CCDF measurement 4.16-32
 Serial interface..... 8.7
 configuration 4.19-13
 Serial number 4.19-20
 Serial poll..... 5.32
 Service functions 4.19-23
 Service request (SRQ)..... 5.21, 5.32
 Service request enable register (SRE)..... 5.21
 Setup 4.19-1
 general 4.19-10
 Signal amplitude statistics..... 4.16-28
 Signal count..... 4.13-3
 Signal tracking 4.5-5
 search bandwidth 4.5-5
 Single sweep 4.9-1
 Softkey
 % POWER BANDWIDTH 4.16-25, 6.1-192
 +/-PEAK/24.4-20, 4.4-26, 6.1-144, 6.4-38, 6.4-39, 6.4-40,
 6.4-41
 +PEAK..... 4.4-26
 +PEAK/2..... 4.4-20, 6.1-145
 = CENTER..... 4.5-3, 4.5-4
 = MARKER 4.5-3, 4.5-4
 0.1 * RBW 4.5-3, 6.1-168, 6.1-169
 0.1 * SPAN 4.5-2, 6.1-168, 6.1-169
 0.5 * RBW..... 4.5-3, 6.1-168, 6.1-169
 0.5 * SPAN 4.5-2, 6.1-168, 6.1-169

- 10 dB MIN ON/OFF 4.4-36, 6.1-119
- ABSOLUTE PEAK/MIN 6.1-12, 6.1-13
- ACP LIMIT CHECK 4.16-20, 6.1-31
- ACP REF SETTINGS 4.16-18, 6.1-190, 6.1-191
- ADJ CHAN BANDWIDTH 4.16-15, 6.1-188
- ADJ CHAN SPACING 4.16-16, 6.1-191
- ADJUST AXIS 4.16-42
- ADJUST RANGE 4.4-5, 6.1-118
- ADJUST REF LVL 4.16-12, 4.16-26, 6.1-190
- ADJUST SETTINGS .. 4.16-32, 4.16-38, 6.1-91, 6.1-189
- ADJUST SETTINGS (occupied bandwidth)..... 4.16-26
- ADJUST SETTINGS (power measurements)..... 4.16-20
- AF CENTER 4.4-34, 6.1-139
- AF FULL SPAN 4.4-45, 6.1-140
- AF SPAN 4.4-45, 6.1-140
- AF START 4.4-34, 6.1-140
- AF STOP 4.4-34, 6.1-140
- ALL MARKER OFF 4.4-19, 4.13-6, 4.14-10,
..... 6.1-9, 6.1-40
- AMPERE 4.7-2, 6.1-95
- ANNOTATION ON/OFF 4.18-4, 6.1-101
- APD ON/OFF 4.16-30, 6.1-89, 6.1-90
- ASCII FILE EXPORT 4.11-5, 4.16-45, 6.1-110,
..... 6.1-131, 6.1-134
- AUTO AVERAGE 4.4-8, 6.1-187
- AUTO COARSE 4.4-33
- AUTO FINE 4.4-34
- AUTO PREAMP ON/OFF 4.4-36, 6.1-120
- AUTO RECAL ON/OFF 4.4-9, 6.1-119
- AUTO SELECT 4.11-10, 6.1-165
- AUTORANGE CONFIG 4.4-35
- AVERAGE 4.4-21, 4.4-27, 4.11-2, 6.1-105,
..... 6.1-143, 6.1-152, 6.1-164
- AVERAGE ON/OFF 4.16-5, 6.1-78, 6.1-80, 6.1-82,
..... 6.1-83
- AVG MODE LOG/LIN 4.11-4, 6.1-85, 6.1-152
- BARGRAPH 4.4-24, 6.1-17
- BLANK 4.11-3, 6.1-106
- BRIGHTNESS 4.18-5, 4.21-8, 6.1-102, 6.1-112
- C/N 4.16-37, 4.16-38
- C/No 4.16-38
- CAL ABORT 4.12-2, 6.1-96
- CAL ABS POWER 4.4-4, 6.1-158
- CAL CORR ON/OFF 4.12-2, 6.1-97
- CAL GEN 128 MHZ 4.19-24, 6.1-99
- CAL GEN COMB PULSE 4.19-24, 6.1-99
- CAL REFL OPEN 4.22-12, 4.23-9, 6.1-159
- CAL REFL SHORT 4.22-12, 4.23-9, 6.1-159
- CAL RESULTS 4.12-3, 6.1-97
- CAL TOTAL 4.12-1, 6.1-96
- CAL TRANS 4.22-6, 4.23-4, 6.1-159
- CAL VALUES TABLE 4.4-6, 6.1-123
- CARRIER FREQUENCY 4.16-49
- CCDF ON/OFF 4.16-30, 6.1-89, 6.1-90
- CCVS INT / EXT 4.10-8
- CENTER 4.5-2, 6.1-168
- CENTER = MKR FREQ 4.15-2, 6.1-48
- CENTER A = MARKER B 4.18-3, 6.1-122
- CENTER B = MARKER A 4.18-3, 6.1-122
- CHAN PWR / HZ 4.16-19, 6.1-73
- CHAN PWR ACP 4.16-9
- CHANNEL BANDWIDTH 4.16-26, 4.16-38, 6.1-189
- CLEAR ALL MESSAGES 4.19-22, 6.1-221, 6.1-222
- CLEAR/WRITE 4.11-2, 4.16-19, 6.1-105
- CNT RESOL 4.13-7, 6.1-41
- COLOR ON/ OFF 4.21-6, 6.1-113
- COM INTERFACE 4.19-13, 6.1-220
- CONT DEMOD 4.14-10, 6.1-49
- CONT MEAS 4.16-33, 6.1-116, 6.1-117
- CONTINUE SGL SWEEP 4.9-2, 6.1-116, 6.1-117
- CONTINUOUS SWEEP .. 4.4-42, 4.8-10, 4.9-1, 6.1-116,
..... 6.1-117
- COPY 20-12, 20-13, 6.1-126
- COPY LIMIT LINE 4.17-4, 6.1-22
- COPY TRACE 4.11-8, 6.1-229
- COUPLING AC/DC 4.4-32, 6.1-139
- COUPLING DEFAULT 4.8-7, 6.1-155, 6.1-199
- COUPLING RATIO 4.8-5, 6.1-156
- COUPLING AC/DC 4.4-37
- CP/ACP ABS/REL 4.16-18, 6.1-189
- CP/ACP CONFIG 4.16-13, 6.1-31, 6.1-191
- CP/ACP ON/OFF 4.16-9, 6.1-70, 6.1-74
- CP/ACP STANDARD 4.16-10, 6.1-69
- DATAENTRY OPAQUE 4.18-4
- DB PER DIV 4.4-38, 6.1-106
- dBm 4.7-2, 6.1-95
- dBmV 4.7-2, 6.1-95
- dBpW 4.7-2, 6.1-95
- dB μ A 4.7-2, 6.1-95
- dB μ V 4.7-2, 6.1-95
- DECIM SEP 4.11-8, 4.13-8, 4.14-8, 6.1-110
- DEEMPHASIS 25 μ s 4.4-23, 4.4-31, 6.1-166
- DEEMPHASIS 50 μ s 4.4-23, 4.4-31, 6.1-166
- DEEMPHASIS 75 μ s 4.4-23, 4.4-31, 6.1-166
- DEEMPHASIS 750 μ s 4.4-23, 4.4-31, 6.1-166
- DEEMPHASIS/WEIGHTING 4.4-23, 4.4-31
- DEFAULT COLORS 4.18-4, 6.1-102, 6.1-111
- DEFAULT SETTINGS 4.16-32, 6.1-90
- DEL ACTIVE POINT 4.4-14, 4.4-16
- DEL ALL POINTS 4.4-14, 4.4-16
- DEL CHAN CONF TABLE 6.1-97
- DELAY COMP ON/OFF 6.1-238
- DELETE 4.19-5, 6.1-130, 6.1-161
- DELETE LIMIT LINE 4.17-5, 6.1-22
- DELETE LINE 4.19-9
- DELETE RANGE 4.16-42
- DELETE VALUE 4.17-10
- DEMODO BW AUTO 4.4-40
- DEMODO BW MANUAL 4.4-40, 6.1-154
- DETECTOR 4.11-10, 6.1-164
- DETECTOR AUTOPEAK 4.11-10, 6.1-164
- DETECTOR AVERAGE 4.11-11, 6.1-164
- DETECTOR MAX PEAK 4.11-10, 6.1-164
- DETECTOR MIN PEAK 4.11-11, 6.1-164
- DETECTOR NARROW 4.4-8, 6.1-164
- DETECTOR QPK 4.11-11, 6.1-164
- DETECTOR RMS 4.11-11, 6.1-164
- DETECTOR SAMPLE 4.11-11, 6.1-164
- DETECTOR SELECTION 4.4-20
- DETECTOR WIDE 4.4-8, 6.1-164
- DEVIATION LIN/LOG 4.4-38
- DEVIATION PER DIV 4.4-36
- DEVICE 1/2 4.21-2, 6.1-113, 6.1-114, 6.1-115,
..... 6.1-130, 6.1-216
- DISPLAY ABS/REL 4.4-13, 6.1-241
- DISPLAY LINE 1 4.17-12
- DISPLAY LOG/LIN 4.4-12, 6.1-241
- DISPLAY PWR SAVE 4.18-4, 6.1-103
- DIST UNIT %/DB 4.4-21
- DISTORTION&SINAD 4.4-21, 6.1-149
- EDIT 4.19-4, 6.1-161, 6.1-162
- EDIT ACP LIMITS 4.16-21, 6.1-24, 6.1-25, 6.1-26,
..... 6.1-27, 6.1-28, 6.1-29, 6.1-30, 6.1-31
- EDIT LIMIT LINE 4.17-7, 6.1-23, 6.1-32, 6.1-33,
..... 6.1-35, 6.1-36, 6.1-37, 6.1-38
- EDIT PATH 4.20-12, 6.1-125, 6.1-130
- EDIT PEAK LIST 4.16-44
- EDIT SWEEP LIST 4.16-41
- EDIT TRD FAKTOR 4.19-6
- ENABLE ALL ITEMS 4.20-9, 6.1-131
- ENTER PASSWORD 4.19-24, 6.1-224
- EXCLUDE LO 4.15-5, 4.15-7, 6.1-42

EXT METER ON/OFF	4.4-15, 6.1-185
EXT SRC ON/OFF	4.23-12, 6.1-206
EXTERN	4.10-2, 6.1-197, 6.1-240
FAST ACP ON/OFF	4.16-11, 6.1-192
FILE MANAGER	4.20-11, 6.1-125
FILTER	4.4-22, 4.4-31
FILTER TYPE	4.8-7, 6.1-156
FIRMWARE UPDATE	4.19-26, 6.1-222
FM	4.4-19, 4.14-10, 6.1-17, 6.1-49, 6.1-240
FREE RUN	4.10-1, 6.1-240
FREQUENCY LINE 1/2	4.17-12
FREQUENCY OFFSET	4.5-4, 4.22-15, 4.23-11, 6.1-169
FREQUENCY SPAN	4.4-45, 6.1-151
FREQUENCY SWEEP	4.23-15, 6.1-204, 6.1-205
FULL SCREEN	4.18-2, 6.1-103
FULL SIZE DIAGRAM	4.16-12
FULL SPAN	4.4-45, 4.6-1, 6.1-151, 6.1-170
GATE DELAY	4.10-6, 6.1-196
GATE LENGTH	4.10-6, 6.1-196
GATE MODE LEVEL/EDGE	4.10-5, 6.1-197
GATE SETTINGS	4.10-5, 6.1-196
GATED TRIGGER	4.10-4, 6.1-196, 6.1-197
GEN REF INT/EXT	4.23-17
GENERAL SETUP	4.19-10
GOTO POINT #	4.4-14, 4.4-17, 6.4-37, 6.4-38
GPIB	4.19-10
GPIB ADDRESS	4.4-15, 6.1-216
GPIB LANGUAGE	4.19-11
GRID ABS/REL	4.7-4, 6.1-106
HARDWARE INFO	4.19-20, 6.1-6, 6.1-98
HARM MEAS ON/OFF	4.16-49
HARMONICS	4.16-49
HARMONICS RBW AUTO	6.1-66
HIGHPASS 300 HZ	4.4-23, 4.4-31, 6.1-167
HIGHPASS 50 HZ	4.4-23, 4.4-31, 6.1-167
HOR SYNC	4.10-8, 6.1-240
ID STRING FACTORY	4.19-10
ID STRING USER	4.19-10
IF BW AUTO	4.4-41
IF BW MANUAL	4.4-41, 6.1-155
IF GAIN	4.19-12
IF POWER	4.10-2, 6.1-197, 6.1-239, 6.1-240
INP LEVEL 4V/400mV	4.4-30, 6.1-200
INPUT CAL	4.19-23, 4.19-24, 6.1-98, 6.1-99
INPUT IMP 50Ω/1MΩ	4.4-30, 6.1-17, 6.1-120
INPUT RF	4.19-23, 4.19-24, 6.1-99
INS NEW POINT	4.4-14, 4.4-16, 6.4-38
INSERT RANGE	4.16-42
INSERT VALUE	4.17-10
INSERTION LOSS	4.4-14, 6.1-159
INSTALL OPTION	4.19-18
LAST SPAN	4.6-2
LEFT LIMIT	4.14-8, 4.15-3, 6.1-45, 6.1-46
LIMIT ON/OFF	4.16-4, 6.1-46
LINES 625 / 525	4.10-8, 6.1-240
LOCAL	4.3-1, 5.6
LOGO ON/OFF	4.18-4, 6.1-103
LOWPASS 100 KHZ	4.4-23, 4.4-31, 6.1-167
LOWPASS 15 KHZ	4.4-23, 4.4-31, 6.1-167
LOWPASS 3 KHZ	4.4-23, 4.4-31, 6.1-167
MAIN PLL BANDWIDTH	4.8-10
MAKE DIRECTORY	4.20-12, 6.1-129
MANUAL	4.5-3
MANUAL AVG OFF	4.4-8, 6.1-187
MARGIN	4.16-44
MARKER 1 to 4	4.13-2, 6.1-14, 6.1-15, 6.1-45, 6.1-47
MARKER DEMOD	4.14-9, 6.1-49
MARKER NORM/DELTA	4.13-2, 6.1-12, 6.1-14
MARKER ZOOM	4.13-6, 6.1-107
MAX HOLD	4.11-2, 4.16-19, 6.1-105
MAX HOLD ON/OFF	4.16-5, 6.1-78, 6.1-80, 6.1-82, 6.1-83
MEAN	4.16-4, 6.1-79
MEAS TIME AUTO	4.4-41, 4.4-43, 6.1-199
MEAS TIME MANUAL	4.4-41, 4.4-43, 6.1-199
MEAS→REF	4.4-13, 6.1-88
MEAS→REF	4.4-7, 4.4-26, 4.4-32, 6.1-187, 6.1-200
MIN	4.15-4, 6.1-13, 6.1-44
MIN HOLD	4.11-4, 6.1-105
MIXER	4.4-39
MIXER LOW NOISE	4.7-3
MKR -> CF STEPSIZE	4.15-4, 6.1-49
MKR -> TRACE	4.13-6, 4.14-10, 4.15-4, 6.1-14, 6.1-45
MKR DEMOD ON/OFF	4.14-9, 6.1-50
MKR FILE EXPORT	4.13-8
MKR STOP TIME	4.14-10, 6.1-49
MODULATION	4.22-16
MODULATION DEPTH	4.16-39, 6.1-52
MODULATION SPECTRUM	4.4-24, 6.1-17
MULT CARR ACP	4.16-9
N dB DOWN	4.14-6, 4.14-10, 6.1-54, 6.1-55
NAME	4.17-7, 6.1-22, 6.1-23, 6.1-32, 6.1-36, 6.1-38
NETWORK	4.23-1, 4.23-2
NEW	4.19-4
NEW FAKTOR	4.19-6
NEW LIMIT LINE	4.17-7, 6.1-22, 6.1-23, 6.1-32, 6.1-35, 6.1-37
NEXT MIN	4.15-5, 6.1-13, 6.1-43, 6.1-44
NEXT MIN LEFT	4.15-5
NEXT MIN RIGHT	4.15-5
NEXT PEAK	4.15-2, 6.1-12, 6.1-13, 6.1-42, 6.1-43
NEXT PEAK LEFT	4.15-3
NEXT PEAK RIGHT	4.15-2
NO OF SAMPLES	4.16-31, 6.1-90
NO. OF ADJ CHAN	4.16-14, 6.1-188
NO. OF HARMONICS	4.16-50, 6.1-67
NO. OF TX CHAN	4.16-14, 6.1-192
NOISE CORR ON/OFF	4.16-11, 6.1-192
NOISE MEAS	4.14-2, 6.1-55
NOISE SRC ON/OFF	4.19-2, 6.1-100
NORMALIZE	4.22-7, 4.23-5, 6.1-160
NUMBER OF SWEEPS	4.16-6, 6.1-195
OCCUP BW ON/OFF	4.16-25, 6.1-70, 6.1-74
OCCUPIED BANDWIDTH	4.16-25, 6.1-74, 6.1-97
OPTIMIZED COLORS	4.21-7
OPTIONS	4.19-18
PATH 2 INS LOSS	4.4-14
-PEAK	4.4-26, 6.1-143
PEAK	4.14-2, 4.15-1, 4.16-3, 6.1-12, 6.1-43, 6.1-81, 6.1-84
PEAK EXCURSION	4.14-8, 4.15-5, 6.1-44
PEAK HOLD ON/OFF	4.4-22, 6.1-149
PEAK LIST	4.14-7, 6.1-50
PEAK LIST OFF	4.14-8, 6.1-50
PEAK SEARCH	4.13-5, 4.14-5, 4.14-8, 4.16-44
-PEAK/2	4.4-21, 6.1-143
PEAKS PER PEAKS	4.16-44
PERCENT MARKER	4.16-30, 6.1-47
PH NOISE ON/OFF	4.14-5, 6.1-11
PHASE NOISE	4.14-4, 6.1-11
PHASE WRAP ON/OFF	4.4-38, 6.1-19
PM	4.4-19, 6.1-17
PM UNIT RAD/DEG	4.4-38, 6.1-241
POLARITY POS/NEG	4.10-2, 4.10-5, 6.1-197, 6.1-240
POWER ABS/REL	4.16-5, 6.1-79
POWER MODE	4.16-19, 6.1-69
POWER ON/OFF	4.16-3, 6.1-77, 6.1-79, 6.1-81, 6.1-84
POWER REF ON/OFF	4.4-17, 6.1-135, 6.4-38
POWER SPLITTER	4.4-13, 6.1-159
PREAMP	4.19-3, 6.1-120
PREDEFINED COLORS	4.18-5, 4.21-8, 6.1-103, 6.1-112
PRINT SCREEN	4.21-2, 6.1-114, 6.1-115, 6.1-130
PRINT TABLE	4.21-2, 6.1-114, 6.1-115, 6.1-130
PRINT TRACE	4.21-2, 6.1-114, 6.1-115, 6.1-130

- PWR METER ON/OFF 4.4-11, 6.1-185
 PWR OFFSET 4.22-3, 4.23-2
 RANGE 4.4-36
 RANGE LINEAR 4.7-2, 6.1-108
 RANGE LINEAR % 4.7-2
 RANGE LINEAR dB 4.7-2
 RANGE LOG 100 dB 4.7-1, 6.1-108
 RANGE LOG MANUAL 4.7-1, 6.1-108
 RBW / VBW MANUAL 4.8-6, 6.1-157
 RBW / VBW NOISE [10] 4.8-6, 6.1-157
 RBW / VBW PULSE [1] 4.8-6, 6.1-157
 RBW / VBW SINE [1/3] 4.8-5, 6.1-157
 RECAL (MANUAL) 4.4-5, 6.1-118
 RECALL 20-7, 4.23-8, 6.1-129, 6.1-159
 RECEIVER FREQUENCY 4.4-3, 4.4-19, 4.4-33, 6.1-168
 REF FXD ON/OFF 4.13-4, 6.1-11
 REF LEVEL 4.4-35, 4.7-1, 6.1-106, 6.1-107
 REF LEVEL = MKR LVL 4.15-2, 6.1-56
 REF LEVEL COUPLED 4.18-3, 6.1-122
 REF LEVEL OFFSET 4.7-4, 6.1-107
 REF LEVEL POSITION 4.7-4, 6.1-107
 REF POINT FREQUENCY 4.13-4, 4.14-5, 6.1-10
 REF POINT LEVEL 4.13-4, 4.14-5, 6.1-10
 REF POINT LVL OFFSET 4.13-4, 4.14-5, 6.1-10
 REF POINT TIME 4.13-5, 6.1-10
 REF VALUE 4.22-9, 4.23-7, 6.1-108
 REF VALUE POSITION 4.22-8, 4.23-6, 6.1-107
 REFERENCE FIXED 4.13-4, 6.1-11
 REFERENCE INT/EXT 4.19-2, 6.1-194
 REFERENCE POSITION 4.4-36, 6.1-107
 REFERENCE VALUE 4.4-7, 6.1-187
 REFERENCE VALUE ... 4.4-13, 4.4-37, 6.1-88, 6.1-108, 6.1-184
 REL UNIT DB/% 4.4-32, 6.1-241
 RELATIVE 4.4-7, 4.4-26
 RELATIVE DB/% 4.4-7, 4.4-27, 6.1-242
 RELATIVE OFF 4.4-27
 RELATIVE ON/OFF 4.4-7
 REMOVE OPTION 4.19-18
 RES BW 4.16-31, 6.1-155
 RES BW AUTO 4.8-4, 6.1-155
 RES BW MANUAL 4.4-41, 4.8-3, 6.1-97, 6.1-150, 6.1-155
 RESTORE CAL VALUES TABLE 4.4-7, 6.1-123
 RESTORE FIRMWARE 4.19-26
 RESULT ABS/REL 4.4-32, 6.1-200, 6.4-42
 RESULT DISPLAY 4.4-24
 RF ATTEN AUTO 4.4-39, 4.7-3, 6.1-118, 6.1-119
 RF ATTEN MANUAL 4.4-39, 4.7-3, 4.7-5, 6.1-118
 RF INPUT 50 Ω / 75 Ω 4.4-39, 4.7-4, 6.1-120
 RF INPUT AC/DC 4.4-39, 4.7-3, 6.1-119
 RF LEVEL AUTORANGE 4.4-35, 6.1-118
 RF POWER 4.10-8, 6.1-239, 6.1-240
 RF SPECTRUM 4.4-9, 4.4-25, 6.1-17
 RIGHT LIMIT 4.14-8, 4.15-3, 6.1-46
 RMS 4.4-21, 4.4-27, 4.16-3, 6.1-82, 6.1-146
 RMS*SQR 4.4-21, 6.1-147
 RMS*SQR(2) 4.4-27
 SATURATION 4.18-5, 4.21-8, 6.1-102, 6.1-112
 SAVE 4.20-6, 6.1-133
 SAVE AS TDD FACTOR 6.1-161
 SAVE LIMIT LINE 4.17-10
 SAVE TRD FACTOR 4.19-9
 SCALING 4.16-31, 6.1-91
 SCREEN COLORS 4.21-7
 SCREEN TITLE 4.18-3, 6.1-104, 6.1-105
 SEARCH LIM OFF 4.15-3, 6.1-46
 SEARCH LIMITS 4.15-3, 6.1-46
 SELECT GENERATOR 4.23-13, 6.1-215, 6.1-217
 SELECT ITEMS 20-8, 6.1-131, 6.1-132
 SELECT LIMIT LINE 4.17-3, 6.1-22, 6.1-23, 6.1-36, 6.1-39
 SELECT MARKER 4.14-2, 4.15-1, 4.16-48, 6.1-45
 SELECT OBJECT 4.18-5, 4.21-7
 SELECT TRACE 4.5-5, 4.11-2, 4.16-21, 6.1-76, 6.1-192
 SELFTTEST 4.19-25, 6.1-7
 SELFTTEST RESULTS 4.19-25, 6.1-100
 SENSOR CAL FACTOR 4.4-15, 6.1-219
 SENSOR LABEL 4.4-17, 6.4-38
 SERVICE 4.19-23, 6.1-99
 SET CP REFERENCE 4.16-11, 6.1-190
 SET REFERENCE 4.16-5, 6.1-81
 SET TO DEFAULT 4.21-8
 SGL SWEEP DISP OFF 4.4-44, 4.9-3, 6.1-116, 6.1-117
 SHIFT X LIMIT LINE 4.17-10, 6.1-33
 SHIFT Y LIMIT LINE 4.17-10, 6.1-38
 SIGNAL COUNT 4.13-3, 6.1-41
 SIGNAL STATISTIC 4.16-30
 SIGNAL TRACK 4.5-5, 6.1-75
 SINGLE MEAS 4.16-33, 6.1-116, 6.1-117
 SINGLE SWEEP 4.4-42, 4.9-1, 6.1-116, 6.1-117
 SOFT FRONT PANEL 4.19-19
 SORT BY DATE 4.4-7
 SORT BY DELTA LIMIT 4.16-44
 SORT BY FREQUENCY 4.16-44
 SORT BY TABLE 4.4-7
 SORT MODE 4.20-13
 SORT MODE FREQ/LEVEL 4.14-8
 SOURCE CAL 4.22-5, 4.23-3
 SOURCE ON/OFF 4.22-2
 SOURCE POWER 4.22-3, 4.23-2, 6.1-203, 6.1-206
 SPAN MANUAL 4.6-1, 6.1-169
 SPAN/RBW AUTO [50] 4.8-6, 6.1-156
 SPAN/RBW MANUAL 4.8-7, 6.1-156
 SPLIT SCREEN 4.18-2, 6.1-103
 SPURIOUS 4.16-40, 6.1-198
 SQUELCH 6.1-50, 6.1-49
 STANDARD DEVIATION 4.16-4, 6.1-84
 START 4.5-4, 6.1-170
 START LIMIT 4.16-4, 4.16-5, 6.1-45, 6.1-46
 START MEAS 4.16-42, 6.1-117
 STARTUP RECALL 4.1-1, 20-10, 6.1-128
 STATISTICS 4.19-21, 6.1-5
 STEPSIZE 4.4-33
 STEPSIZE = FREQ 4.4-34, 6.1-168
 STEPSIZE MANUAL 4.4-34, 4.5-4
 STEPSIZE STANDARD 4.13-7
 STEPSIZE SWP POINTS 4.13-7
 STOP 4.5-4, 6.1-170
 STOP LIMIT 4.16-4, 4.16-5, 6.1-46
 STOP MEAS 4.16-42
 SWEEP COUNT 4.4-44, 4.9-2, 4.11-3, 6.1-195
 SWEEP LIST 4.16-40, 6.1-177
 SWEEP POINTS 4.9-3, 6.1-198
 SWEPTIME AUTO 4.8-5, 4.9-2, 6.1-199
 SWEPTIME MANUAL 4.6-1, 4.8-4, 4.9-2, 6.1-199
 SYSTEM INFO 4.19-20
 SYSTEM MESSAGES 4.19-22, 6.1-221, 6.1-222
 T1-T2 4.11-12, 6.1-85
 T1-T3 4.11-12, 6.1-85
 THD UNIT %/DB 4.4-38, 6.1-242
 THRESHOLD 4.14-8, 4.15-3, 6.1-93
 TIME DOM POWER 4.16-2, 6.1-79, 6.1-81, 6.1-84
 TIME DOMAIN 4.4-24, 6.1-17
 TIME LINE 1/2 4.17-12
 TIME+DATE 4.19-15, 6.1-221, 6.1-225
 TIME+DATE ON/OFF 4.18-3, 6.1-105
 TINT 4.18-5, 4.21-8, 6.1-102, 6.1-112
 TOI 4.16-48, 6.1-56
 TRACE MATH 4.11-12, 6.1-85
 TRACE MATH OFF 4.11-12, 6.1-86
 TRACE POSITION 4.11-12, 6.1-85
 TRACK BW 4.5-5, 6.1-75

TRACK ON/OFF	4.5-5, 6.1-75
TRACK THRESHOLD	4.5-5, 6.1-76
TRACKING	4.22-2
TRANSDUCER	4.19-4, 6.1-162
TRANSDUCER FACTOR	4.19-4, 6.1-162
TRIGGER OFFSET	4.10-2, 6.1-239
TV TRIG SETTINGS	4.10-8
TV TRIGGER ON/OFF	4.10-8
TYPE	4.4-15, 6.1-219
UNIT	4.4-38, 4.7-2, 6.1-95
USE POWER SPLITTER	4.4-13
USE SENSOR A/B	4.4-17, 6.1-219
USER DEFINED	4.21-7
VALUES	4.17-9, 6.1-32, 6.1-34, 6.1-37
VBW LIN LOG	4.8-10, 6.1-157
VERT SYNC	4.10-8, 6.1-240
VERT SYNC EVEN FIELD	4.10-8, 6.1-240
VERT SYNC ODD FIELD	4.10-8, 6.1-240
VIDEO	4.10-1, 6.1-239, 6.1-240
VIDEO BW AUTO	4.8-4, 6.1-157
VIDEO BW MANUAL	4.8-3, 6.1-156
VIDEO POL POS / NEG	4.10-8, 6.1-240
VIEW	4.11-3, 6.1-105
VOLT	4.7-2, 6.1-95
WATT	4.7-2, 6.1-95
WEIGHTING AF FILTER	4.4-23, 4.4-32, 6.1-166
WEIGHTING CCITT	4.4-23, 4.4-32, 6.1-166
X * RBW	4.5-3, 6.1-168, 6.1-169
X * SPAN	4.5-2, 6.1-168, 6.1-169
X OFFSET	4.17-5, 6.1-33
X-AXIS RANGE	4.16-31, 6.1-91
X-AXIS REF LEVEL	4.16-31, 6.1-91
Y OFFSET	4.17-5, 6.1-35, 6.1-38
Y-AXIS MAX VALUE	4.16-32, 6.1-92
Y-AXIS MIN VALUE	4.16-32, 6.1-92
YIG CORR ON/OFF	4.12-2
YIG FILTER ON/OFF	4.19-3
ZERO	4.4-11, 6.1-88
ZERO PHASE REF POS	4.4-38, 6.1-150
ZERO SPAN	4.6-1, 6.1-169
ZOOM x-AXIS	4.10-6
Special characters	6.1-2
Spectrum analyzer mode	4.5.1
Split screen	4.18-2
Squelch	4.14-9
SRE (service request enable register)	5.21
SRQ (service request)	5.21, 5.32
Standard deviation	4.16-4
Standard, mobile radio	4.16-10
Start frequency	4.5-4
Statistics	4.16-28
Status byte (STB)	5.21
STATus OPERation register	5.24
STATus QUEStionable register	5.25
ACPLimit register	5.26
FREQuency register	5.27
LIMit register	5.28
LMARgin register	5.29
POWer register	5.30
SYNC	5.31
TRANsducerESPI	5.31
Status register	
CONDition part	5.19
ENABle part	5.19
ESE	5.22
ESR	5.22
EVENT part	5.19
NTRansition part	5.19
overView	5.20
PPE	5.22
PTRansition part	5.19
SRE	5.21
STATus OPERation	5.24
STATus QUEStionable ACPLimit	5.26
STATus QUEStionable FREQuency	5.27
STATus QUEStionable LIMit	5.28
STATus QUEStionable LMARgin	5.29
STATus QUEStionable POWer	5.30
STATus QUEStionable SYNC	5.31
STATus QUEStionable TRANsducerESPI	5.31
STB	5.21
structure	5.18
sum bit	5.19
Status reporting system	5.18
resetting values	5.34
STB (status byte)	5.21
Step Width Receive Frequency	4.4-33
Stepsize	4.5-4
center frequency	4.5-2
coupling	4.5-4
Stop frequency	4.5-4
Storing	8.1
Trace	4.16-45
String	5.14
Subsequent Calibration	4.4-5
Suffix	5.11
Sum bit	5.19
Supply voltage, external noise source	4.19-2
continue single sweep	4.9-2
continuous	4.9-1
count	4.4-44
count	4.9-2
coupling	4.8-1
free run	4.10-1
gated	4.10-3, 4.10-4
kontinuierlich	4.4-42
n-times	4.4-42
Number	4.4-44
settings	4.9-1
single	4.9-1
Single	4.4-42
time	4.6-1, 4.9-2
coupling	4.8-5
SWEEP RANGES	4.16-41
Switching cycles	4.19-21
Sync signal	4.10-8
Syntax elements of commands	5.14
System messages	4.19-22
T	
Test	
selftest	4.19-25
Text parameter	5.14
Third Order Intercept	4.16-47
Threshold	
line	4.15-3
signal tracking	4.5-5
Time	4.18-3
input	4.19-15
Line	4.17-12
Time axis	4.6-1
Tint	4.18-5
Title for the active diagram	4.18-3
TOI	4.16-47
Trace	4.11-1, 4.11-2
average	4.11-2
averaging	4.11-4
blank	4.11-3
Clear/Write	4.11-2
copy	4.11-8
freeze	4.11-3

<i>math</i>	4.11-12
<i>max hold</i>	4.11-2
<i>min hold</i>	4.11-4
<i>position for 0 difference</i>	4.11-12
<i>power measurement</i>	4.16-21
<i>select</i>	4.11-1
<i>signal tracking</i>	4.5-5
<i>storing (ASCII format)</i>	4.16-45
<i>Tracking generator</i>	4.22-1
<i>Transducer</i>	
<i>Activating</i>	4.19-3
<i>Entry</i>	4.19-6
<i>Transmission measurement</i>	4.22-4, 4.23-3
<i>Transmission parameters RS-232-C/COM</i>	8.8
<i>Trigger</i>	
<i>external</i>	4.10-2
<i>external gate</i>	4.10-4
<i>free run</i>	4.10-1
<i>gated sweep</i>	4.10-5
<i>IF power</i>	4.10-2
<i>offset</i>	4.10-2
<i>RF power</i>	4.10-8
<i>slope</i>	4.10-2
<i>sweep</i>	4.10-1
<i>video</i>	4.10-1
<i>TV trigger</i>	4.10-8

U

<i>Unit</i>	
<i>level axis</i>	4.7-2
<i>limit line</i>	4.17-8
<i>Universal command</i>	8.5
<i>Upper case</i>	6.1-2
<i>USB connection</i>	8.11
<i>User Interface</i>	8.10

V

<i>Vertical sync signal</i>	4.10-8
<i>Video bandwidth</i>	4.8-3
<i>Video polarity</i>	4.10-8
<i>Video triggering</i>	4.10-1
<i>View trace</i>	4.11-3

W

<i>White space</i>	5.14
--------------------------	------

Z

<i>Zero span</i>	4.6-1
<i>Zeroing</i>	4.4-11
<i>Zoom</i>	4.13-6
<i>amplitude</i>	4.11-3
<i>x-AXIS (gate signal)</i>	4.10-6

9 Error Messages

Error messages are entered in the error/event queue of the status reporting system in the remote control mode and can be queried with the command `SYSTem:ERRor?`. The answer format of R&S FSMR to the command is as follows:

```
<error code>, "<error text with queue query>;  
<remote control command concerned>"
```

The indication of the remote control command with prefixed semicolon is optional.

Example:

The command `"TEST:COMMAND"` generates the following answer to the query `SYSTem:ERRor?` :

```
-113,"Undefined header;TEST:COMMAND"
```

The subsequent list contains the description of error texts displayed on the instrument.

Distinction is made between error messages defined by SCPI, which are marked by negative error codes, and the device-specific error messages for which positive error codes are used.

The right-hand column in the following tables contains the error text in bold which is entered in the error/event queue and can be read out by means of query `SYSTem:ERRor?`. A short explanation of the error cause is given below. The left-hand column contains the associated error code.

SCPI-Specific Error Messages

No Error

Error code	Error text in the case of queue poll Error explanation
0	No error This message is output if the error queue does not contain any entries.

Command Error - Faulty command; sets bit 5 in the ESR register.

Error code	Error text in the case of queue poll Error explanation
-100	Command Error The command is faulty or invalid.
-101	Invalid Character The command contains an invalid sign. Example: A header contains an ampersand, " SENSe& ".
-102	Syntax error The command is invalid. Example: The command contains block data the instrument does not accept.
-103	Invalid separator The command contains an imallowed sign instead of a separator. Example: A semicolon is missing after the command.
-104	Data type error The command contains an invalid value indication. Example: ON is indicated instead of a numeric value for frequency setting.
-105	GET not allowed A Group Execute Trigger (GET) is within a command line.
-108	Parameter not allowed The command contains too many parameters. Example: Command SENSe:FREQuency:CENTer permits only one frequency indication.

Continuation: Command Error

Error code	Error text in the case of queue poll Error explanation
-109	Missing parameter The command contains too few parameters. Example: The command <code>SENSe:FREQuency:CENTer</code> requires a frequency indication.
-110	Command header error The header of the command is faulty.
-111	Header separator error The header contains an imallowed separator. Example: the header is not followed by a "White Space", " <code>*ESE255</code> "
-112	Program mnemonic too long The header contains more than 12 characters.
-113	Undefined header The header is not defined for the instrument. Example: <code>*XYZ</code> is undefined for every instrument.
-114	Header suffix out of range The header contains an imallowed numeric suffix. Example: <code>SENSe3</code> does not exist in the instrument.
-120	Numeric data error The command contains a faulty numeric parameter.
-121	Invalid character in number A number contains an invalid character. Example: An "A" in a decimal number or a "9" in an octal number.
-123	Exponent too large The absolute value of the exponent is greater than 32000.
-124	Too many digits The number includes too many digits.
-128	Numeric data not allowed The command includes a number which is not allowed at this position. Example: The command <code>INPut:COUPLing</code> requires indication of a text parameter.
-130	Suffix error The command contains a faulty suffix.
-131	Invalid suffix The suffix is invalid for this instrument. Example: nHz is not defined.
-134	Suffix too long The suffix contains more than 12 characters.
-138	Suffix not allowed A suffix is not allowed for this command or at this position of the command. Example: The command <code>*RCL</code> does not permit a suffix to be indicated.
-140	Character data error The command contains a faulty text parameter
-141	Invalid character data The text parameter either contains an invalid character or it is invalid for this command. Example: Write error with parameter indication; <code>INPut:COUPLing XC</code> .

Continuation: Command Error

Error code	Error text in the case of queue poll Error explanation
-144	Character data too long The text parameter contains more than 12 characters.
-148	Character data not allowed The text parameter is not allowed for this command or at this position of the command. Example: The command *RCL requires a number to be indicated.
-150	String data error The command contains a faulty string.
-151	Invalid string data The command contains a faulty string. Example: An END message has been received prior to the terminating apostrophe.
-158	String data not allowed The command contains a valid string at a position which is not allowed. Example: A text parameter is set in quotation marks, INPut:COUPLing "DC"
-160	Block data error The command contains faulty block data.
-161	Invalid block data The command contains faulty block data. Example: An END message was received prior to reception of the expected number of data.
-168	Block data not allowed The command contains valid block data at an imallowed position. Example: The command *RCL requires a number to be indicated.
-170	Expression error The command contains an invalid mathematical expression.
-171	Invalid expression The command contains an invalid mathematical expression. Example: The expression contains mismatching parentheses.
-178	Expression data not allowed The command contains a mathematical expression at an imallowed position.

Execution Error - Error on execution of a command; sets bit 4 in the ESR register

Error code	Error text in the case of queue poll Error explanation
-200	Execution error Error on execution of the command.
-201	Invalid while in local The command is not executable while the device is in local due to a hard local control. Example: The device receives a command which would change the rotary knob state, but the device is in local so the command can not be executed.
-202	Settings lost due to rtl A setting associated with hard local control was lost when the device changed to LOCS from REMS or to LWLS from RWLS.
-210	Trigger error Error on triggering the device.
-211	Trigger ignored The trigger (GET, *TRG or trigger signal) was ignored because of device timing considerations. Example: The device was not ready to respond.
-212	Arm ignored An arming signal was ignored by the device.
-213	Init ignored Measurement initialisation was ignored as another measurement was already in progress.
-214	Trigger deadlock The trigger source for the initiation of measurement is set to GET and subsequent measurement is received. The measurement cannot be started until a GET is received, but the GET would cause an interrupted-error)
-215	Arm deadlock The trigger source for the initiation of measurement is set to GET and subsequent measurement is received. The measurement cannot be started until a GET is received, but the GET would cause an interrupted-error.
-220	Parameter error The command contains a faulty or invalid parameter.
-221	Settings conflict There is a conflict between setting of parameter value and instrument state.
-222	Data out of range The parameter value lies out of the allowed range of the instrument.
-223	Too much data The command contains too many data. Example: The instrument does not have sufficient storage space.
-224	Illegal parameter value The parameter value is invalid. Example: The text parameter is invalid , TRIGger : SWEep : SOURce TASTe

Continuation: Execution Error

Error code	Error text in the case of queue poll Error explanation
-230	Data corrupt or stale The data are incomplete or invalid. Example: The instrument has aborted a measurement.
-231	Data questionable The measurement accuracy is suspect.
-240	Hardware error The command cannot be executed due to problems with the instrument hardware.
-241	Hardware missing Hardware is missing. Example: An option is not fitted.
-250	Mass storage error A mass storage error occurred.
-251	Missing mass storage The mass storage is missing. Example: An option is not installed.
-252	Missing media The media is missing. Example: There is no floppy in the floppy disk drive.
-253	Corrupt media The media is corrupt. Example: The floppy is bad or has the wrong format.
-254	Media full The media is full. Example: There is no room on the floppy.
-255	Directory full The media directory is full.
-256	File name not found The file name cannot be found on the media.
-257	File name error The file name is wrong. Example: An attempt is made to copy to a duplicate file name.
-258	Media protected The media is protected. Example: The write-protect tab on the floppy is present.
-260	Expression error The expression contains an error.

Device Specific Error; sets bit 3 in the ESR register

Error code	Error test in the case of queue poll Error explanation
-300	Device-specific error R&S FSMR-specific error not defined in greater detail.
-310	System error This error message suggests an error within the instrument. Please inform the R&S Service.
-313	Calibration memory lost Loss of the non-volatile data stored using the *CAL? command. This error occurs when the correction data recording has failed.
-330	Self-test failed The selftest could not be executed.
-350	Queue overflow This error code is entered in the queue instead of the actual error code if the queue is full. It indicates that an error has occurred but not been accepted. The queue can accept 5 entries.

Query Error - Error in data request; sets bit 2 in the ESR register

Error code	Error text in the case of queue poll Error explanation
-400	Query error General error occurring when data are requested by a query.
-410	Query INTERRUPTED The query has been interrupted. Example: After a query, the instrument receives new data before the response has been sent completely.
-420	Query UNTERMINATED The query is incomplete. Example: The instrument is addressed as a talker and receives incomplete data.
-430	Query DEADLOCKED The query cannot be processed. Example: The input and output buffers are full, the instrument cannot continue operation.
-440	Query UNTERMINATED after indefinite response A query is in the same command line after a query which requests an indefinite response.

Device-Specific Messages

Error code	Error text in the case of queue poll Error explanation
1036	MS: The correction table based amplifier gain exceeds the amplifier range for CALAMP1 and CALAMP2 on IF board This message is output when the setting range of the calibration amplifier is not sufficient for the required correction. The error occurs only with modules which are not correctly adjusted or defective.
1052	Frontend LO is Unlocked This message is output when the phase regulation of the local oscillator fails in the RF frontend.
1060	Trigger-Block Gate Delay Error- gate length < Gate Delay This message is output when the gate signal length is not sufficient for the pull-in delay with a predefined gate delay.
1064	Tracking LO is Unlocked This message is output when the phase regulation of the local oscillator fails on the tracking generator module.

Error code	Error text in the case of queue poll Error explanation
2022	OPTIONS.INI invalid This message is output when an error has been recognized in the file OPTIONS.INI which contains the clearing codes for retrofitable firmware applications. If this file is not correctly recognized, all firmware applications are blocked for this instrument.
2028	Hardcopy not possible during measurement sequence This message is output when a printout is started during scan sequences that cannot be interrupted. Such sequences are for example: <ul style="list-style-type: none"> • Recording the system error correction data (calibration) • Instrument selftest In such cases a synchronization to the end of the scan sequence should be performed prior to starting the printout.
2033	Printer Not Available This message is output when the selected printer is not included in the list of available output devices. A possible cause is that the required printer driver is missing or incorrectly installed.
2034	CPU Temperature is too high This message is output when the temperature of the processor exceeds 70 °C.