

# R&S® DVMS4

## DTV Monitoring System

### Getting Started



2113.7625.02 – 05

© 2013 Rohde & Schwarz GmbH & Co. KG  
Mühlhofstr. 15, 81671 München, Germany  
Phone: +49 89 41 29 - 0  
Fax: +49 89 41 29 12 164  
E-mail: [info@rohde-schwarz.com](mailto:info@rohde-schwarz.com)  
Internet: [www.rohde-schwarz.com](http://www.rohde-schwarz.com)

Subject to change – Data without tolerance limits is not binding.

R&S® is a registered trademark of Rohde & Schwarz GmbH & Co. KG.

Trade names are trademarks of the owners.

The following abbreviations are used throughout this manual: R&S®XYZ1234 is abbreviated as R&S XYZ1234.

# Basic Safety Instructions

## Always read through and comply with the following safety instructions!

All plants and locations of the Rohde & Schwarz group of companies make every effort to keep the safety standards of our products up to date and to offer our customers the highest possible degree of safety. Our products and the auxiliary equipment they require are designed, built and tested in accordance with the safety standards that apply in each case. Compliance with these standards is continuously monitored by our quality assurance system. The product described here has been designed, built and tested in accordance with the EC Certificate of Conformity and has left the manufacturer's plant in a condition fully complying with safety standards. To maintain this condition and to ensure safe operation, you must observe all instructions and warnings provided in this manual. If you have any questions regarding these safety instructions, the Rohde & Schwarz group of companies will be happy to answer them.







Furthermore, it is your responsibility to use the product in an appropriate manner. This product is designed for use solely in industrial and laboratory environments or, if expressly permitted, also in the field and must not be used in any way that may cause personal injury or property damage. You are responsible if the product is used for any purpose other than its designated purpose or in disregard of the manufacturer's instructions. The manufacturer shall assume no responsibility for such use of the product.

The product is used for its designated purpose if it is used in accordance with its product documentation and within its performance limits (see data sheet, documentation, the following safety instructions). Using the product requires technical skills and, in some cases, a basic knowledge of English. It is therefore essential that only skilled and specialized staff or thoroughly trained personnel with the required skills be allowed to use the product. If personal safety gear is required for using Rohde & Schwarz products, this will be indicated at the appropriate place in the product documentation. Keep the basic safety instructions and the product documentation in a safe place and pass them on to the subsequent users.











Observing the safety instructions will help prevent personal injury or damage of any kind caused by dangerous situations. Therefore, carefully read through and adhere to the following safety instructions before and when using the product. It is also absolutely essential to observe the additional safety instructions on personal safety, for example, that appear in relevant parts of the product documentation. In these safety instructions, the word "product" refers to all merchandise sold and distributed by the Rohde & Schwarz group of companies, including instruments, systems and all accessories. For product-specific information, see the data sheet and the product documentation.

## Safety labels on products

The following safety labels are used on products to warn against risks and dangers.

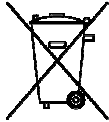
Symbol	Meaning	Symbol	Meaning
	Notice, general danger location Observe product documentation		ON/OFF supply voltage
	Caution when handling heavy equipment		Standby indication
	Danger of electric shock		Direct current (DC)

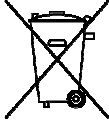
## Basic Safety Instructions

Symbol	Meaning	Symbol	Meaning
	Warning! Hot surface		Alternating current (AC)
	Protective conductor terminal		Direct/alternating current (DC/AC)
	Ground		Device fully protected by double (reinforced) insulation
	Ground terminal		EU labeling for batteries and accumulators For additional information, see section "Waste disposal/Environmental protection", item 1.
	Be careful when handling electrostatic sensitive devices		EU labeling for separate collection of electrical and electronic devices For additional information, see section "Waste disposal/Environmental protection", item 2.
	Warning! Laser radiation For additional information, see section "Operation", item 7.		

### Signal words and their meaning

The following signal words are used in the product documentation in order to warn the reader about risks and dangers.



Indicates a hazardous situation which, if not avoided, will result in death or serious injury.



Indicates a hazardous situation which, if not avoided, could result in death or serious injury.



Indicates a hazardous situation which, if not avoided, could result in minor or moderate injury.



Indicates information considered important, but not hazard-related, e.g. messages relating to property damage.  
In the product documentation, the word ATTENTION is used synonymously.

These signal words are in accordance with the standard definition for civil applications in the European Economic Area. Definitions that deviate from the standard definition may also exist in other economic areas or military applications. It is therefore essential to make sure that the signal words described here are always used only in connection with the related product documentation and the related product. The use of signal words in connection with unrelated products or documentation can result in misinterpretation and in personal injury or material damage.

## Basic Safety Instructions

### Operating states and operating positions

*The product may be operated only under the operating conditions and in the positions specified by the manufacturer, without the product's ventilation being obstructed. If the manufacturer's specifications are not observed, this can result in electric shock, fire and/or serious personal injury or death. Applicable local or national safety regulations and rules for the prevention of accidents must be observed in all work performed.*

1. Unless otherwise specified, the following requirements apply to Rohde & Schwarz products: predefined operating position is always with the housing floor facing down, IP protection 2X, use only indoors, max. operating altitude 2000 m above sea level, max. transport altitude 4500 m above sea level. A tolerance of  $\pm 10\%$  shall apply to the nominal voltage and  $\pm 5\%$  to the nominal frequency, overvoltage category 2, pollution severity 2.
2. Do not place the product on surfaces, vehicles, cabinets or tables that for reasons of weight or stability are unsuitable for this purpose. Always follow the manufacturer's installation instructions when installing the product and fastening it to objects or structures (e.g. walls and shelves). An installation that is not carried out as described in the product documentation could result in personal injury or even death.
3. Do not place the product on heat-generating devices such as radiators or fan heaters. The ambient temperature must not exceed the maximum temperature specified in the product documentation or in the data sheet. Product overheating can cause electric shock, fire and/or serious personal injury or even death.

### Electrical safety

*If the information on electrical safety is not observed either at all or to the extent necessary, electric shock, fire and/or serious personal injury or death may occur.*

1. Prior to switching on the product, always ensure that the nominal voltage setting on the product matches the nominal voltage of the AC supply network. If a different voltage is to be set, the power fuse of the product may have to be changed accordingly.
2. In the case of products of safety class I with movable power cord and connector, operation is permitted only on sockets with a protective conductor contact and protective conductor.
3. Intentionally breaking the protective conductor either in the feed line or in the product itself is not permitted. Doing so can result in the danger of an electric shock from the product. If extension cords or connector strips are implemented, they must be checked on a regular basis to ensure that they are safe to use.
4. If there is no power switch for disconnecting the product from the AC supply network, or if the power switch is not suitable for this purpose, use the plug of the connecting cable to disconnect the product from the AC supply network. In such cases, always ensure that the power plug is easily reachable and accessible at all times. For example, if the power plug is the disconnecting device, the length of the connecting cable must not exceed 3 m. Functional or electronic switches are not suitable for providing disconnection from the AC supply network. If products without power switches are integrated into racks or systems, the disconnecting device must be provided at the system level.
5. Never use the product if the power cable is damaged. Check the power cables on a regular basis to ensure that they are in proper operating condition. By taking appropriate safety measures and carefully laying the power cable, ensure that the cable cannot be damaged and that no one can be hurt by, for example, tripping over the cable or suffering an electric shock.

## Basic Safety Instructions

6. The product may be operated only from TN/TT supply networks fuse-protected with max. 16 A (higher fuse only after consulting with the Rohde & Schwarz group of companies).
7. Do not insert the plug into sockets that are dusty or dirty. Insert the plug firmly and all the way into the socket provided for this purpose. Otherwise, sparks that result in fire and/or injuries may occur.
8. Do not overload any sockets, extension cords or connector strips; doing so can cause fire or electric shocks.
9. For measurements in circuits with voltages  $V_{rms} > 30$  V, suitable measures (e.g. appropriate measuring equipment, fuse protection, current limiting, electrical separation, insulation) should be taken to avoid any hazards.
10. Ensure that the connections with information technology equipment, e.g. PCs or other industrial computers, comply with the IEC60950-1/EN60950-1 or IEC61010-1/EN 61010-1 standards that apply in each case.
11. Unless expressly permitted, never remove the cover or any part of the housing while the product is in operation. Doing so will expose circuits and components and can lead to injuries, fire or damage to the product.
12. If a product is to be permanently installed, the connection between the protective conductor terminal on site and the product's protective conductor must be made first before any other connection is made. The product may be installed and connected only by a licensed electrician.
13. For permanently installed equipment without built-in fuses, circuit breakers or similar protective devices, the supply circuit must be fuse-protected in such a way that anyone who has access to the product, as well as the product itself, is adequately protected from injury or damage.
14. Use suitable overvoltage protection to ensure that no overvoltage (such as that caused by a bolt of lightning) can reach the product. Otherwise, the person operating the product will be exposed to the danger of an electric shock.
15. Any object that is not designed to be placed in the openings of the housing must not be used for this purpose. Doing so can cause short circuits inside the product and/or electric shocks, fire or injuries.
16. Unless specified otherwise, products are not liquid-proof (see also section "Operating states and operating positions", item 1). Therefore, the equipment must be protected against penetration by liquids. If the necessary precautions are not taken, the user may suffer electric shock or the product itself may be damaged, which can also lead to personal injury.
17. Never use the product under conditions in which condensation has formed or can form in or on the product, e.g. if the product has been moved from a cold to a warm environment. Penetration by water increases the risk of electric shock.
18. Prior to cleaning the product, disconnect it completely from the power supply (e.g. AC supply network or battery). Use a soft, non-linting cloth to clean the product. Never use chemical cleaning agents such as alcohol, acetone or diluents for cellulose lacquers.

## Operation

1. Operating the products requires special training and intense concentration. Make sure that persons who use the products are physically, mentally and emotionally fit enough to do so; otherwise, injuries or material damage may occur. It is the responsibility of the employer/operator to select suitable personnel for operating the products.

## Basic Safety Instructions

2. Before you move or transport the product, read and observe the section titled "Transport".
3. As with all industrially manufactured goods, the use of substances that induce an allergic reaction (allergens) such as nickel cannot be generally excluded. If you develop an allergic reaction (such as a skin rash, frequent sneezing, red eyes or respiratory difficulties) when using a Rohde & Schwarz product, consult a physician immediately to determine the cause and to prevent health problems or stress.
4. Before you start processing the product mechanically and/or thermally, or before you take it apart, be sure to read and pay special attention to the section titled "Waste disposal/Environmental protection", item 1.
5. Depending on the function, certain products such as RF radio equipment can produce an elevated level of electromagnetic radiation. Considering that unborn babies require increased protection, pregnant women must be protected by appropriate measures. Persons with pacemakers may also be exposed to risks from electromagnetic radiation. The employer/operator must evaluate workplaces where there is a special risk of exposure to radiation and, if necessary, take measures to avert the potential danger.
6. Should a fire occur, the product may release hazardous substances (gases, fluids, etc.) that can cause health problems. Therefore, suitable measures must be taken, e.g. protective masks and protective clothing must be worn.
7. Laser products are given warning labels that are standardized according to their laser class. Lasers can cause biological harm due to the properties of their radiation and due to their extremely concentrated electromagnetic power. If a laser product (e.g. a CD/DVD drive) is integrated into a Rohde & Schwarz product, absolutely no other settings or functions may be used as described in the product documentation. The objective is to prevent personal injury (e.g. due to laser beams).
8. EMC classes (in line with EN 55011/CISPR 11, and analogously with EN 55022/CISPR 22, EN 55032/CISPR 32)
  - Class A equipment:  
Equipment suitable for use in all environments except residential environments and environments that are directly connected to a low-voltage supply network that supplies residential buildings  
Note: Class A equipment is intended for use in an industrial environment. This equipment may cause radio disturbances in residential environments, due to possible conducted as well as radiated disturbances. In this case, the operator may be required to take appropriate measures to eliminate these disturbances.
  - Class B equipment:  
Equipment suitable for use in residential environments and environments that are directly connected to a low-voltage supply network that supplies residential buildings

### Repair and service

1. The product may be opened only by authorized, specially trained personnel. Before any work is performed on the product or before the product is opened, it must be disconnected from the AC supply network. Otherwise, personnel will be exposed to the risk of an electric shock.

## Basic Safety Instructions

- Adjustments, replacement of parts, maintenance and repair may be performed only by electrical experts authorized by Rohde & Schwarz. Only original parts may be used for replacing parts relevant to safety (e.g. power switches, power transformers, fuses). A safety test must always be performed after parts relevant to safety have been replaced (visual inspection, protective conductor test, insulation resistance measurement, leakage current measurement, functional test). This helps ensure the continued safety of the product.

### Batteries and rechargeable batteries/cells

*If the information regarding batteries and rechargeable batteries/cells is not observed either at all or to the extent necessary, product users may be exposed to the risk of explosions, fire and/or serious personal injury, and, in some cases, death. Batteries and rechargeable batteries with alkaline electrolytes (e.g. lithium cells) must be handled in accordance with the EN 62133 standard.*

- Cells must not be taken apart or crushed.
- Cells or batteries must not be exposed to heat or fire. Storage in direct sunlight must be avoided. Keep cells and batteries clean and dry. Clean soiled connectors using a dry, clean cloth.
- Cells or batteries must not be short-circuited. Cells or batteries must not be stored in a box or in a drawer where they can short-circuit each other, or where they can be short-circuited by other conductive materials. Cells and batteries must not be removed from their original packaging until they are ready to be used.
- Cells and batteries must not be exposed to any mechanical shocks that are stronger than permitted.
- If a cell develops a leak, the fluid must not be allowed to come into contact with the skin or eyes. If contact occurs, wash the affected area with plenty of water and seek medical aid.
- Improperly replacing or charging cells or batteries that contain alkaline electrolytes (e.g. lithium cells) can cause explosions. Replace cells or batteries only with the matching Rohde & Schwarz type (see parts list) in order to ensure the safety of the product.
- Cells and batteries must be recycled and kept separate from residual waste. Rechargeable batteries and normal batteries that contain lead, mercury or cadmium are hazardous waste. Observe the national regulations regarding waste disposal and recycling.

### Transport

- The product may be very heavy. Therefore, the product must be handled with care. In some cases, the user may require a suitable means of lifting or moving the product (e.g. with a lift-truck) to avoid back or other physical injuries.
- Handles on the products are designed exclusively to enable personnel to transport the product. It is therefore not permissible to use handles to fasten the product to or on transport equipment such as cranes, fork lifts, wagons, etc. The user is responsible for securely fastening the products to or on the means of transport or lifting. Observe the safety regulations of the manufacturer of the means of transport or lifting. Noncompliance can result in personal injury or material damage.
- If you use the product in a vehicle, it is the sole responsibility of the driver to drive the vehicle safely and properly. The manufacturer assumes no responsibility for accidents or collisions. Never use the product in a moving vehicle if doing so could distract the driver of the vehicle. Adequately secure the product in the vehicle to prevent injuries or other damage in the event of an accident.



## Instrucciones de seguridad elementales

### Waste disposal/Environmental protection

1. Specially marked equipment has a battery or accumulator that must not be disposed of with unsorted municipal waste, but must be collected separately. It may only be disposed of at a suitable collection point or via a Rohde & Schwarz customer service center.
2. Waste electrical and electronic equipment must not be disposed of with unsorted municipal waste, but must be collected separately.  
Rohde & Schwarz GmbH & Co. KG has developed a disposal concept and takes full responsibility for take-back obligations and disposal obligations for manufacturers within the EU. Contact your Rohde & Schwarz customer service center for environmentally responsible disposal of the product.
3. If products or their components are mechanically and/or thermally processed in a manner that goes beyond their intended use, hazardous substances (heavy-metal dust such as lead, beryllium, nickel) may be released. For this reason, the product may only be disassembled by specially trained personnel. Improper disassembly may be hazardous to your health. National waste disposal regulations must be observed.
4. If handling the product releases hazardous substances or fuels that must be disposed of in a special way, e.g. coolants or engine oils that must be replenished regularly, the safety instructions of the manufacturer of the hazardous substances or fuels and the applicable regional waste disposal regulations must be observed. Also observe the relevant safety instructions in the product documentation. The improper disposal of hazardous substances or fuels can cause health problems and lead to environmental damage.

For additional information about environmental protection, visit the Rohde & Schwarz website.

## Instrucciones de seguridad elementales

### ¡Es imprescindible leer y cumplir las siguientes instrucciones e informaciones de seguridad!

El principio del grupo de empresas Rohde & Schwarz consiste en tener nuestros productos siempre al día con los estándares de seguridad y de ofrecer a nuestros clientes el máximo grado de seguridad. Nuestros productos y todos los equipos adicionales son siempre fabricados y examinados según las normas de seguridad vigentes. Nuestro sistema de garantía de calidad controla constantemente que sean cumplidas estas normas. El presente producto ha sido fabricado y examinado según el certificado de conformidad de la UE y ha salido de nuestra planta en estado impecable según los estándares técnicos de seguridad. Para poder preservar este estado y garantizar un funcionamiento libre de peligros, el usuario deberá atenerse a todas las indicaciones, informaciones de seguridad y notas de alerta. El grupo de empresas Rohde & Schwarz está siempre a su disposición en caso de que tengan preguntas referentes a estas informaciones de seguridad.

Además queda en la responsabilidad del usuario utilizar el producto en la forma debida. Este producto está destinado exclusivamente al uso en la industria y el laboratorio o, si ha sido expresamente autorizado, para aplicaciones de campo y de ninguna manera deberá ser utilizado de modo que alguna persona/cosa pueda sufrir daño. El uso del producto fuera de sus fines definidos o sin tener en cuenta las instrucciones del fabricante queda en la responsabilidad del usuario. El fabricante no se hace en ninguna forma responsable de consecuencias a causa del mal uso del producto.















## Instrucciones de seguridad elementales

Se parte del uso correcto del producto para los fines definidos si el producto es utilizado conforme a las indicaciones de la correspondiente documentación del producto y dentro del margen de rendimiento definido (ver hoja de datos, documentación, informaciones de seguridad que siguen). El uso del producto hace necesarios conocimientos técnicos y ciertos conocimientos del idioma inglés. Por eso se debe tener en cuenta que el producto solo pueda ser operado por personal especializado o personas instruidas en profundidad con las capacidades correspondientes. Si fuera necesaria indumentaria de seguridad para el uso de productos de Rohde & Schwarz, encontraría la información debida en la documentación del producto en el capítulo correspondiente. Guarde bien las informaciones de seguridad elementales, así como la documentación del producto, y entréguelas a usuarios posteriores.



Tener en cuenta las informaciones de seguridad sirve para evitar en lo posible lesiones o daños por peligros de toda clase. Por eso es imprescindible leer detalladamente y comprender por completo las siguientes informaciones de seguridad antes de usar el producto, y respetarlas durante el uso del producto. Deberán tenerse en cuenta todas las demás informaciones de seguridad, como p. ej. las referentes a la protección de personas, que encontrarán en el capítulo correspondiente de la documentación del producto y que también son de obligado cumplimiento. En las presentes informaciones de seguridad se recogen todos los objetos que distribuye el grupo de empresas Rohde & Schwarz bajo la denominación de "producto", entre ellos también aparatos, instalaciones así como toda clase de accesorios. Los datos específicos del producto figuran en la hoja de datos y en la documentación del producto.

### Señalización de seguridad de los productos

Las siguientes señales de seguridad se utilizan en los productos para advertir sobre riesgos y peligros.

Símbolo	Significado	Símbolo	Significado
	Aviso: punto de peligro general Observar la documentación del producto		Tensión de alimentación de PUESTA EN MARCHA / PARADA
	Atención en el manejo de dispositivos de peso elevado		Indicación de estado de espera (standby)
	Peligro de choque eléctrico		Corriente continua (DC)
	Advertencia: superficie caliente		Corriente alterna (AC)
	Conexión a conductor de protección		Corriente continua / Corriente alterna (DC/AC)
	Conexión a tierra		El aparato está protegido en su totalidad por un aislamiento doble (reforzado)
	Conexión a masa		Distintivo de la UE para baterías y acumuladores Más información en la sección "Eliminación/protección del medio ambiente", punto 1.

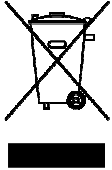
## Instrucciones de seguridad elementales

Símbolo	Significado	Símbolo	Significado
	Aviso: Cuidado en el manejo de dispositivos sensibles a la electrostática (ESD)		Distintivo de la UE para la eliminación por separado de dispositivos eléctricos y electrónicos  Más información en la sección "Eliminación/protección del medio ambiente", punto 2.
	Advertencia: rayo láser  Más información en la sección "Funcionamiento", punto 7.		

### Palabras de señal y su significado

En la documentación del producto se utilizan las siguientes palabras de señal con el fin de advertir contra riesgos y peligros.



Indica una situación de peligro que, si no se evita, causa lesiones graves o incluso la muerte.



Indica una situación de peligro que, si no se evita, puede causar lesiones graves o incluso la muerte.



Indica una situación de peligro que, si no se evita, puede causar lesiones leves o moderadas.



Indica información que se considera importante, pero no en relación con situaciones de peligro; p. ej., avisos sobre posibles daños materiales.

En la documentación del producto se emplea de forma sinónima el término CUIDADO.

Las palabras de señal corresponden a la definición habitual para aplicaciones civiles en el área económica europea. Pueden existir definiciones diferentes a esta definición en otras áreas económicas o en aplicaciones militares. Por eso se deberá tener en cuenta que las palabras de señal aquí descritas sean utilizadas siempre solamente en combinación con la correspondiente documentación del producto y solamente en combinación con el producto correspondiente. La utilización de las palabras de señal en combinación con productos o documentaciones que no les correspondan puede llevar a interpretaciones equivocadas y tener por consecuencia daños en personas u objetos.

### Estados operativos y posiciones de funcionamiento

*El producto solamente debe ser utilizado según lo indicado por el fabricante respecto a los estados operativos y posiciones de funcionamiento sin que se obstruya la ventilación. Si no se siguen las indicaciones del fabricante, pueden producirse choques eléctricos, incendios y/o lesiones graves con posible consecuencia de muerte. En todos los trabajos deberán ser tenidas en cuenta las normas nacionales y locales de seguridad del trabajo y de prevención de accidentes.*

## Instrucciones de seguridad elementales

1. Si no se convino de otra manera, es para los productos Rohde & Schwarz válido lo que sigue: como posición de funcionamiento se define por principio la posición con el suelo de la caja para abajo, modo de protección IP 2X, uso solamente en estancias interiores, utilización hasta 2000 m sobre el nivel del mar, transporte hasta 4500 m sobre el nivel del mar. Se aplicará una tolerancia de  $\pm 10\%$  sobre el voltaje nominal y de  $\pm 5\%$  sobre la frecuencia nominal. Categoría de sobrecarga eléctrica 2, índice de suciedad 2.
2. No sitúe el producto encima de superficies, vehículos, estantes o mesas, que por sus características de peso o de estabilidad no sean aptos para él. Siga siempre las instrucciones de instalación del fabricante cuando instale y asegure el producto en objetos o estructuras (p. ej. paredes y estantes). Si se realiza la instalación de modo distinto al indicado en la documentación del producto, se pueden causar lesiones o, en determinadas circunstancias, incluso la muerte.
3. No ponga el producto sobre aparatos que generen calor (p. ej. radiadores o calefactores). La temperatura ambiente no debe superar la temperatura máxima especificada en la documentación del producto o en la hoja de datos. En caso de sobrecalentamiento del producto, pueden producirse choques eléctricos, incendios y/o lesiones graves con posible consecuencia de muerte.

### Seguridad eléctrica

*Si no se siguen (o se siguen de modo insuficiente) las indicaciones del fabricante en cuanto a seguridad eléctrica, pueden producirse choques eléctricos, incendios y/o lesiones graves con posible consecuencia de muerte.*

1. Antes de la puesta en marcha del producto se deberá comprobar siempre que la tensión preseleccionada en el producto coincida con la de la red de alimentación eléctrica. Si es necesario modificar el ajuste de tensión, también se deberán cambiar en caso dado los fusibles correspondientes del producto.
2. Los productos de la clase de protección I con alimentación móvil y enchufe individual solamente podrán enchufarse a tomas de corriente con contacto de seguridad y con conductor de protección conectado.
3. Queda prohibida la interrupción intencionada del conductor de protección, tanto en la toma de corriente como en el mismo producto. La interrupción puede tener como consecuencia el riesgo de que el producto sea fuente de choques eléctricos. Si se utilizan cables alargadores o regletas de enchufe, deberá garantizarse la realización de un examen regular de los mismos en cuanto a su estado técnico de seguridad.
4. Si el producto no está equipado con un interruptor para desconectarlo de la red, o bien si el interruptor existente no resulta apropiado para la desconexión de la red, el enchufe del cable de conexión se deberá considerar como un dispositivo de desconexión. El dispositivo de desconexión se debe poder alcanzar fácilmente y debe estar siempre bien accesible. Si, p. ej., el enchufe de conexión a la red es el dispositivo de desconexión, la longitud del cable de conexión no debe superar 3 m). Los interruptores selectores o electrónicos no son aptos para el corte de la red eléctrica. Si se integran productos sin interruptor en bastidores o instalaciones, se deberá colocar el interruptor en el nivel de la instalación.
5. No utilice nunca el producto si está dañado el cable de conexión a red. Compruebe regularmente el correcto estado de los cables de conexión a red. Asegúrese, mediante las medidas de protección y de instalación adecuadas, de que el cable de conexión a red no pueda ser dañado o de que nadie pueda ser dañado por él, p. ej. al tropezar o por un choque eléctrico.

## Instrucciones de seguridad elementales

6. Solamente está permitido el funcionamiento en redes de alimentación TN/TT aseguradas con fusibles de 16 A como máximo (utilización de fusibles de mayor amperaje solo previa consulta con el grupo de empresas Rohde & Schwarz).
7. Nunca conecte el enchufe en tomas de corriente sucias o llenas de polvo. Introduzca el enchufe por completo y fuertemente en la toma de corriente. La no observación de estas medidas puede provocar chispas, fuego y/o lesiones.
8. No sobrecargue las tomas de corriente, los cables alargadores o las regletas de enchufe ya que esto podría causar fuego o choques eléctricos.
9. En las mediciones en circuitos de corriente con una tensión  $U_{\text{eff}} > 30 \text{ V}$  se deberán tomar las medidas apropiadas para impedir cualquier peligro (p. ej. medios de medición adecuados, seguros, limitación de tensión, corte protector, aislamiento etc.).
10. Para la conexión con dispositivos informáticos como un PC o un ordenador industrial, debe comprobarse que éstos cumplan los estándares IEC60950-1/EN60950-1 o IEC61010-1/EN 61010-1 válidos en cada caso.
11. A menos que esté permitido expresamente, no retire nunca la tapa ni componentes de la carcasa mientras el producto esté en servicio. Esto pone a descubierto los cables y componentes eléctricos y puede causar lesiones, fuego o daños en el producto.
12. Si un producto se instala en un lugar fijo, se deberá primero conectar el conductor de protección fijo con el conductor de protección del producto antes de hacer cualquier otra conexión. La instalación y la conexión deberán ser efectuadas por un electricista especializado.
13. En el caso de dispositivos fijos que no estén provistos de fusibles, interruptor automático ni otros mecanismos de seguridad similares, el circuito de alimentación debe estar protegido de modo que todas las personas que puedan acceder al producto, así como el producto mismo, estén a salvo de posibles daños.
14. Todo producto debe estar protegido contra sobretensión (debida p. ej. a una caída del rayo) mediante los correspondientes sistemas de protección. Si no, el personal que lo utilice quedará expuesto al peligro de choque eléctrico.
15. No debe introducirse en los orificios de la caja del aparato ningún objeto que no esté destinado a ello. Esto puede producir cortocircuitos en el producto y/o puede causar choques eléctricos, fuego o lesiones.
16. Salvo indicación contraria, los productos no están impermeabilizados (ver también el capítulo "Estados operativos y posiciones de funcionamiento", punto 1). Por eso es necesario tomar las medidas necesarias para evitar la entrada de líquidos. En caso contrario, existe peligro de choque eléctrico para el usuario o de daños en el producto, que también pueden redundar en peligro para las personas.
17. No utilice el producto en condiciones en las que pueda producirse o ya se hayan producido condensaciones sobre el producto o en el interior de éste, como p. ej. al desplazarlo de un lugar frío a otro caliente. La entrada de agua aumenta el riesgo de choque eléctrico.
18. Antes de la limpieza, desconecte por completo el producto de la alimentación de tensión (p. ej. red de alimentación o batería). Realice la limpieza de los aparatos con un paño suave, que no se deshilache. No utilice bajo ningún concepto productos de limpieza químicos como alcohol, acetona o diluyentes para lacas nitrocelulósicas.

## Instrucciones de seguridad elementales

### Funcionamiento

1. El uso del producto requiere instrucciones especiales y una alta concentración durante el manejo. Debe asegurarse que las personas que manejen el producto estén a la altura de los requerimientos necesarios en cuanto a aptitudes físicas, psíquicas y emocionales, ya que de otra manera no se pueden excluir lesiones o daños de objetos. El empresario u operador es responsable de seleccionar el personal usuario apto para el manejo del producto.
2. Antes de desplazar o transportar el producto, lea y tenga en cuenta el capítulo "Transporte".
3. Como con todo producto de fabricación industrial no puede quedar excluida en general la posibilidad de que se produzcan alergias provocadas por algunos materiales empleados —los llamados alérgenos (p. ej. el níquel)—. Si durante el manejo de productos Rohde & Schwarz se producen reacciones alérgicas, como p. ej. irritaciones cutáneas, estornudos continuos, enrojecimiento de la conjuntiva o dificultades respiratorias, debe avisarse inmediatamente a un médico para investigar las causas y evitar cualquier molestia o daño a la salud.
4. Antes de la manipulación mecánica y/o térmica o el desmontaje del producto, debe tenerse en cuenta imprescindiblemente el capítulo "Eliminación/protección del medio ambiente", punto 1.
5. Ciertos productos, como p. ej. las instalaciones de radiocomunicación RF, pueden a causa de su función natural, emitir una radiación electromagnética aumentada. Deben tomarse todas las medidas necesarias para la protección de las mujeres embarazadas. También las personas con marcapasos pueden correr peligro a causa de la radiación electromagnética. El empresario/operador tiene la obligación de evaluar y señalizar las áreas de trabajo en las que exista un riesgo elevado de exposición a radiaciones.
6. Tenga en cuenta que en caso de incendio pueden desprenderse del producto sustancias tóxicas (gases, líquidos etc.) que pueden generar daños a la salud. Por eso, en caso de incendio deben usarse medidas adecuadas, como p. ej. máscaras antigás e indumentaria de protección.
7. Los productos con láser están provistos de indicaciones de advertencia normalizadas en función de la clase de láser del que se trate. Los rayos láser pueden provocar daños de tipo biológico a causa de las propiedades de su radiación y debido a su concentración extrema de potencia electromagnética. En caso de que un producto Rohde & Schwarz contenga un producto láser (p. ej. un lector de CD/DVD), no debe usarse ninguna otra configuración o función aparte de las descritas en la documentación del producto, a fin de evitar lesiones (p. ej. debidas a irradiación láser).
8. Clases de compatibilidad electromagnética (conforme a EN 55011 / CISPR 11; y en analogía con EN 55022 / CISPR 22, EN 55032 / CISPR 32)
  - Aparato de clase A:  
Aparato adecuado para su uso en todos los entornos excepto en los residenciales y en aquellos conectados directamente a una red de distribución de baja tensión que suministra corriente a edificios residenciales.  
Nota: Los aparatos de clase A están destinados al uso en entornos industriales. Estos aparatos pueden causar perturbaciones radioeléctricas en entornos residenciales debido a posibles perturbaciones guiadas o radiadas. En este caso, se le podrá solicitar al operador que tome las medidas adecuadas para eliminar estas perturbaciones.
  - Aparato de clase B:  
Aparato adecuado para su uso en entornos residenciales, así como en aquellos conectados directamente a una red de distribución de baja tensión que suministra corriente a edificios residenciales.

## Instrucciones de seguridad elementales

### Reparación y mantenimiento

1. El producto solamente debe ser abierto por personal especializado con autorización para ello. Antes de manipular el producto o abrirlo, es obligatorio desconectarlo de la tensión de alimentación, para evitar toda posibilidad de choque eléctrico.
2. El ajuste, el cambio de partes, el mantenimiento y la reparación deberán ser efectuadas solamente por electricistas autorizados por Rohde & Schwarz. Si se reponen partes con importancia para los aspectos de seguridad (p. ej. el enchufe, los transformadores o los fusibles), solamente podrán ser sustituidos por partes originales. Después de cada cambio de partes relevantes para la seguridad deberá realizarse un control de seguridad (control a primera vista, control del conductor de protección, medición de resistencia de aislamiento, medición de la corriente de fuga, control de funcionamiento). Con esto queda garantizada la seguridad del producto.

### Baterías y acumuladores o celdas

*Si no se siguen (o se siguen de modo insuficiente) las indicaciones en cuanto a las baterías y acumuladores o celdas, pueden producirse explosiones, incendios y/o lesiones graves con posible consecuencia de muerte. El manejo de baterías y acumuladores con electrolitos alcalinos (p. ej. celdas de litio) debe seguir el estándar EN 62133.*

1. No deben desmontarse, abrirse ni triturarse las celdas.
2. Las celdas o baterías no deben someterse a calor ni fuego. Debe evitarse el almacenamiento a la luz directa del sol. Las celdas y baterías deben mantenerse limpias y secas. Limpiar las conexiones sucias con un paño seco y limpio.
3. Las celdas o baterías no deben cortocircuitarse. Es peligroso almacenar las celdas o baterías en estuches o cajones en cuyo interior puedan cortocircuitarse por contacto recíproco o por contacto con otros materiales conductores. No deben extraerse las celdas o baterías de sus embalajes originales hasta el momento en que vayan a utilizarse.
4. Las celdas o baterías no deben someterse a impactos mecánicos fuertes indebidos.
5. En caso de falta de estanqueidad de una celda, el líquido vertido no debe entrar en contacto con la piel ni los ojos. Si se produce contacto, lavar con agua abundante la zona afectada y avisar a un médico.
6. En caso de cambio o recarga inadecuados, las celdas o baterías que contienen electrolitos alcalinos (p. ej. las celdas de litio) pueden explotar. Para garantizar la seguridad del producto, las celdas o baterías solo deben ser sustituidas por el tipo Rohde & Schwarz correspondiente (ver lista de recambios).
7. Las baterías y celdas deben reciclarse y no deben tirarse a la basura doméstica. Las baterías o acumuladores que contienen plomo, mercurio o cadmio deben tratarse como residuos especiales. Respete en esta relación las normas nacionales de eliminación y reciclaje.

### Transporte

1. El producto puede tener un peso elevado. Por eso es necesario desplazarlo o transportarlo con precaución y, si es necesario, usando un sistema de elevación adecuado (p. ej. una carretilla elevadora), a fin de evitar lesiones en la espalda u otros daños personales.

## Instrucciones de seguridad elementales

2. Las asas instaladas en los productos sirven solamente de ayuda para el transporte del producto por personas. Por eso no está permitido utilizar las asas para la sujeción en o sobre medios de transporte como p. ej. grúas, carretillas elevadoras de horquilla, carros etc. Es responsabilidad suya fijar los productos de manera segura a los medios de transporte o elevación. Para evitar daños personales o daños en el producto, siga las instrucciones de seguridad del fabricante del medio de transporte o elevación utilizado.
3. Si se utiliza el producto dentro de un vehículo, recae de manera exclusiva en el conductor la responsabilidad de conducir el vehículo de manera segura y adecuada. El fabricante no asumirá ninguna responsabilidad por accidentes o colisiones. No utilice nunca el producto dentro de un vehículo en movimiento si esto pudiera distraer al conductor. Asegure el producto dentro del vehículo debidamente para evitar, en caso de un accidente, lesiones u otra clase de daños.

### Eliminación/protección del medio ambiente

1. Los dispositivos marcados contienen una batería o un acumulador que no se debe desechar con los residuos domésticos sin clasificar, sino que debe ser recogido por separado. La eliminación se debe efectuar exclusivamente a través de un punto de recogida apropiado o del servicio de atención al cliente de Rohde & Schwarz.
2. Los dispositivos eléctricos usados no se deben desechar con los residuos domésticos sin clasificar, sino que deben ser recogidos por separado.  
Rohde & Schwarz GmbH & Co.KG ha elaborado un concepto de eliminación de residuos y asume plenamente los deberes de recogida y eliminación para los fabricantes dentro de la UE. Para desechar el producto de manera respetuosa con el medio ambiente, dirijase a su servicio de atención al cliente de Rohde & Schwarz.
3. Si se trabaja de manera mecánica y/o térmica cualquier producto o componente más allá del funcionamiento previsto, pueden liberarse sustancias peligrosas (polvos con contenido de metales pesados como p. ej. plomo, berilio o níquel). Por eso el producto solo debe ser desmontado por personal especializado con formación adecuada. Un desmontaje inadecuado puede ocasionar daños para la salud. Se deben tener en cuenta las directivas nacionales referentes a la eliminación de residuos.
4. En caso de que durante el trato del producto se formen sustancias peligrosas o combustibles que deban tratarse como residuos especiales (p. ej. refrigerantes o aceites de motor con intervalos de cambio definidos), deben tenerse en cuenta las indicaciones de seguridad del fabricante de dichas sustancias y las normas regionales de eliminación de residuos. Tenga en cuenta también en caso necesario las indicaciones de seguridad especiales contenidas en la documentación del producto. La eliminación incorrecta de sustancias peligrosas o combustibles puede causar daños a la salud o daños al medio ambiente.

Se puede encontrar más información sobre la protección del medio ambiente en la página web de Rohde & Schwarz.



## Safety Instructions for Stacking Instruments

**⚠ WARNING**

### Danger of injury

Instruments may slip if they are stacked on top of each other.

Place the instrument on a stable, even surface. Stack the instruments according to their size, with the largest instrument on the bottom. Do not stack more than three instruments directly on top of each other. Instruments may only be stacked if their feet and housing allow horizontal stacking. If these conditions are not met, the instruments must be installed in a rack in order to avoid the risk of personal injury and material damage.

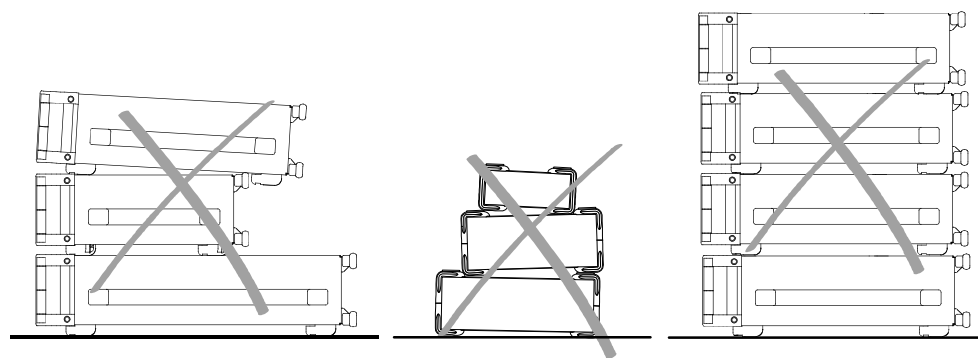
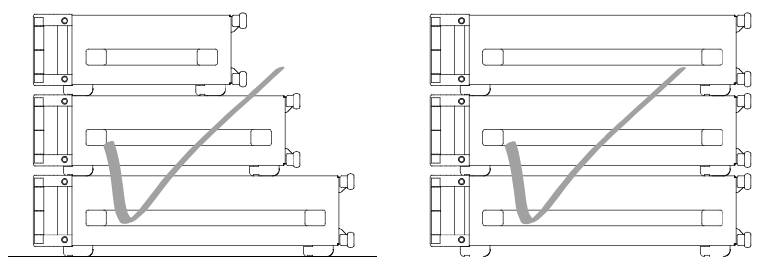

Incorrect order

Incompatible feet

Too many instruments stacked

## Informaciones de seguridad para el amontonamiento de aparatos

### **⚠ ADVERTENCIA**

#### **Peligro de heridas**

Los aparatos pueden desplazarse al ser amontonados.

Posicionar los aparatos sobre una superficie estable y lisa. Amontonar los aparatos por orden de su tamaño. No amontonar nunca más de tres aparatos uno sobre el otro. Los aparatos solamente deberán ser amontonados, si los piés y la caja del aparato correspondiente hacen posible amontonarlos de forma horizontal. Si no se cumplen estas condiciones, deberán ser montados los aparatos en una caja apta para este propósito. De esta manera evitarán el riesgo de daños en personas y daños en el aparato.

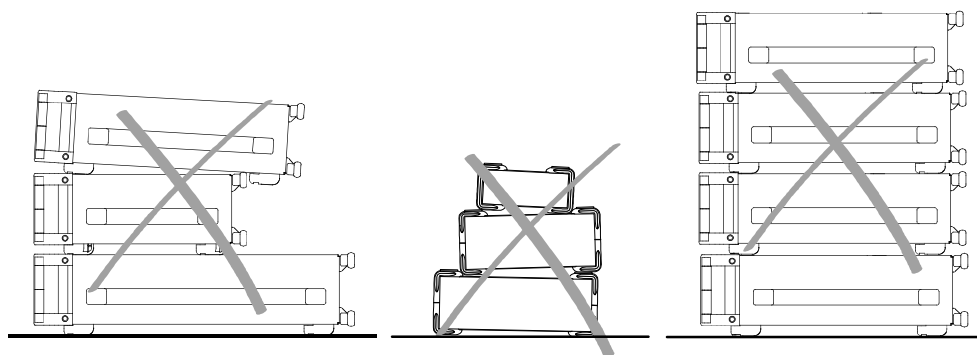
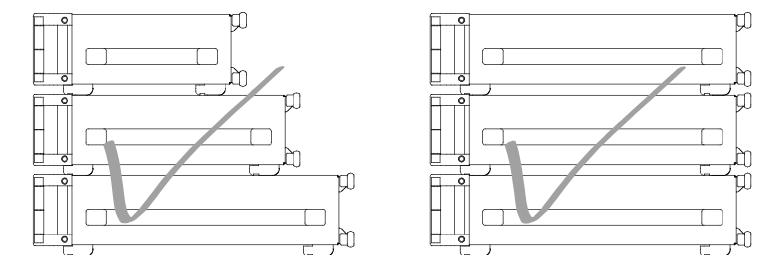

orden no permitido

piés incompatibles

demasiados aparatos  
amontonados

# Customer Support

## Technical support – where and when you need it

For quick, expert help with any Rohde & Schwarz equipment, contact one of our Customer Support Centers. A team of highly qualified engineers provides telephone support and will work with you to find a solution to your query on any aspect of the operation, programming or applications of Rohde & Schwarz equipment.

## Up-to-date information and upgrades

To keep your instrument up-to-date and to be informed about new application notes related to your instrument, please send an e-mail to the Customer Support Center stating your instrument and your wish. We will take care that you will get the right information.

### Europe, Africa, Middle East

Phone +49 89 4129 12345  
[customersupport@rohde-schwarz.com](mailto:customersupport@rohde-schwarz.com)

### North America

Phone 1-888-TEST-RSA (1-888-837-8772)  
[customer.support@rsa.rohde-schwarz.com](mailto:customer.support@rsa.rohde-schwarz.com)

### Latin America

Phone +1-410-910-7988  
[customersupport.la@rohde-schwarz.com](mailto:customersupport.la@rohde-schwarz.com)

### Asia/Pacific

Phone +65 65 13 04 88  
[customersupport.asia@rohde-schwarz.com](mailto:customersupport.asia@rohde-schwarz.com)

### China

Phone +86-800-810-8228 /  
+86-400-650-5896  
[customersupport.china@rohde-schwarz.com](mailto:customersupport.china@rohde-schwarz.com)



# Quality management and environmental management

Certified Quality System  
**ISO 9001**

Certified Environmental System  
**ISO 14001**

## Sehr geehrter Kunde,

Sie haben sich für den Kauf eines Rohde&Schwarz Produktes entschieden. Sie erhalten damit ein nach modernsten Fertigungsmethoden hergestelltes Produkt. Es wurde nach den Regeln unserer Qualitäts- und Umweltmanagementsysteme entwickelt, gefertigt und geprüft. Rohde&Schwarz ist unter anderem nach den Managementsystemen ISO9001 und ISO 14001 zertifiziert.

## Der Umwelt verpflichtet

- Energie-effiziente, RoHS-konforme Produkte
- Kontinuierliche Weiterentwicklung nachhaltiger Umweltkonzepte
- ISO 14001-zertifiziertes Umweltmanagementsystem

## Dear customer,

You have decided to buy a Rohde&Schwarz product. This product has been manufactured using the most advanced methods. It was developed, manufactured and tested in compliance with our quality management and environmental management systems. Rohde&Schwarz has been certified, for example, according to the ISO9001 and ISO 14001 management systems.

## Environmental commitment

- Energy-efficient products
- Continuous improvement in environmental sustainability
- ISO 14001-certified environmental management system

## Cher client,

Vous avez choisi d'acheter un produit Rohde&Schwarz. Vous disposez donc d'un produit fabriqué d'après les méthodes les plus avancées. Le développement, la fabrication et les tests de ce produit ont été effectués selon nos systèmes de management de qualité et de management environnemental. La société Rohde&Schwarz a été homologuée, entre autres, conformément aux systèmes de management ISO9001 et ISO 14001.

## Engagement écologique

- Produits à efficience énergétique
- Amélioration continue de la durabilité environnementale
- Système de management environnemental certifié selon ISO 14001



# Contents

<b>1</b>	<b>Preface</b> .....	<b>7</b>
1.1	Documentation Overview.....	7
1.2	Conventions Used in the Documentation.....	7
<b>2</b>	<b>Setting Up the Instrument</b> .....	<b>9</b>
2.1	Unpacking the Instrument.....	9
2.1.1	Inspecting for Shipping Damage.....	9
2.1.2	Unpacking the Cardboard Box.....	9
2.1.3	Checking the Accessories.....	10
2.1.4	Warranty Conditions.....	10
2.2	Putting Up the Instrument.....	10
2.2.1	Placing the Instrument on a Bench Top.....	10
2.2.2	Mounting the Instrument in a Rack.....	11
<b>3</b>	<b>Interfaces and Connectors</b> .....	<b>12</b>
3.1	Front Panel.....	12
3.1.1	Display.....	12
3.1.2	Keys.....	12
3.1.3	Status Display LEDs.....	13
3.2	Rear Panel.....	13
3.2.1	AC Power Supply Connector.....	14
3.2.2	LAN Interface.....	14
3.2.3	USB Interfaces.....	14
3.2.4	TS Interface.....	15
3.2.5	DVB-T/H Receiver Module (R&S DVMS-B53).....	16
3.2.6	DVB-T / DVB-T2 Receiver Module (R&S DVMS-B55).....	17
3.2.7	DVB-T2 Receiver Module (R&S DVMS-B54).....	19
3.2.8	S/S2 Receiver Module (R&S DVMS-B51).....	20
3.2.9	TS/IP Interface Module (R&S DVMS-B40).....	21
<b>4</b>	<b>Connecting the Instrument</b> .....	<b>23</b>
4.1	Connecting to the AC Power Supply.....	23
4.2	Connecting External Devices.....	23

<b>5</b>	<b>Switching On or Off the Instrument.....</b>	<b>25</b>
5.1	Switching On the Instrument.....	25
5.2	Switching Off the Instrument.....	26
5.3	Checking the Provided Software Options.....	26
<b>6</b>	<b>Sample Application.....</b>	<b>27</b>
6.1	Requirements.....	27
6.2	Setting Up the R&S DVMS.....	27
6.3	Creating a Basic Configuration.....	28
6.4	Checking the TS Synchronization.....	28
6.5	Performing the Measurement.....	29
6.5.1	Checking the Gross Bit Rate of the Connected TS.....	30
6.5.2	Checking the Net Bit Rate of the Connected TS.....	30
6.5.3	Activating the Monitoring Error for TS Bit Rate Monitoring.....	32
6.5.4	Checking the Content of the PSI Table PAT.....	34
<b>7</b>	<b>Operating the Instrument in a LAN.....</b>	<b>35</b>
7.1	Connecting the Instrument to the Network.....	35
7.2	Configuring the Network Card.....	36
7.3	Firewall Settings.....	36
7.4	Configuring the Simple Network Management (SNMP) Agent.....	37
<b>8</b>	<b>Installed Software.....</b>	<b>38</b>
8.1	Operating System.....	38
8.1.1	Login.....	38
8.1.2	Windows XP Start Menu.....	39
8.2	Additional Software.....	39
8.3	Windows XP Recovery and Backup Partition.....	39
8.3.1	Prerequisite for the Recovery and Backup.....	40
8.3.2	Displaying the Windows XP Recovery and Backup Partition Dialog.....	42
8.3.3	Backing Up the Current System Partition.....	43
8.3.4	Recovering the Selected Version of System Partition.....	44
8.3.5	Recovering the Factory Default.....	45
8.3.6	Deleting Backups.....	46
<b>9</b>	<b>Maintenance.....</b>	<b>48</b>

9.1 Cleaning the Instrument.....48

9.2 Replacing the Fuses.....48

9.3 Storing the Instrument.....49

Index.....50





# 1 Preface

This chapter gives an overview of the user documentation and the conventions used in the documentation.

## 1.1 Documentation Overview

### Getting Started

This manual is delivered with the instrument in printed form. It is an excerpt from the user manual (see below) and provides the information needed to set up the instrument and start working with it. Also a sample application is described. For instructions on installation, refer to the release notes. The printed Getting Started manual also includes general information, e.g. the Basic Safety Instructions. In PDF format, it is included in the user manual to allow quick access to the information needed.

### User Manual

This manual is part of the firmware ("Help" menu) and is also delivered with the instrument on CD-ROM. It provides the necessary information to work with the instrument. For additional information on default settings and parameters, refer to the data sheet.

### Help

The help is context-sensitive and provides a quick access to the complete description. To avoid crowding the screen, the screenshots are omitted.

For detailed information on how to use the help, refer to the chapter "Operating Concepts".

## 1.2 Conventions Used in the Documentation

The following conventions are used throughout this documentation.

### Typographical conventions

Convention	Description
"Graphical user interface elements"	All names of graphical user interface elements on the screen, such as dialogs, menus, options, buttons, and softkeys are enclosed by parentheses.
KEYS	Key names are written in capital letters.
File names, commands, program code	File names, commands, coding samples and screen output are distinguished by their font.
<i>Input</i>	Input to be entered by the user is displayed in italics.

Convention	Description
<a href="#">Links</a>	Links are displayed in blue font.
"References"	References to other parts of the documentation are enclosed by parentheses.

### Conventions for procedure descriptions

When describing how to operate the R&S DVMS, several alternative methods may be available to perform the same task. If possible, the procedure using an additionally connected mouse and an external keyboard is described.

The terms "select" and "press" may refer to any of the described methods, i.e. using a key on the R&S DVMS or on a keyboard, or a mouse pointer in the display.

## 2 Setting Up the Instrument

### **WARNING**

#### **Risk of injuries**

To avoid injuries to yourself or others, always follow the instructions provided in the following sections. Furthermore, observe the general safety instructions at the beginning of this manual.

### 2.1 Unpacking the Instrument

The R&S DVMS is shipped together with its mandatory accessories in a cardboard box.

#### 2.1.1 Inspecting for Shipping Damage

Check the following. If anything is damaged, immediately notify the carrier.

1. Check the shipping container and cushioning material for damage.
2. Unpack the cardboard box (see [chapter 2.1.2, "Unpacking the Cardboard Box"](#), on page 9) and check the housing and handle for visible damages or loose parts.

#### 2.1.2 Unpacking the Cardboard Box

Proceed as follows:

1. Open the cardboard box.
2. Remove the accessories packed into the box.
3. Take the instrument out of the packaging.
4. Remove the shock protectors attached to the instrument.



Retain the original packing material. If the instrument needs to be transported or shipped at a later date, you can use the material to prevent control elements and connectors from being damaged. Rohde & Schwarz will only accept claims of warranty if the instrument is shipped with sufficient packaging.

### 2.1.3 Checking the Accessories

The instrument comes with the following accessories:

- Power cable
- Getting Started manual
- CD-ROM containing the complete user documentation
- 4 rubber feet

### 2.1.4 Warranty Conditions

For information on warranty conditions for the R&S DVMS refer to the terms of the delivery documents.

## 2.2 Putting Up the Instrument

The instrument can be used in standalone operation or can be installed in a rack.

---

### NOTICE

#### Risk of material damage

Make sure that the following conditions are met at the operation site:

- The ambient temperature does not exceed the range specified in the data sheet.
- All fan openings are unobstructed and the airflow perforations are unimpeded. The minimum distance from the wall is at least 10 cm.

Failure to meet these conditions may cause damage to the instrument or other devices in the test setup.

If necessary, use proper protective equipment to protect DUTs against electrostatic discharge in the event of human contact.

---

### 2.2.1 Placing the Instrument on a Bench Top

The R&S DVMS may be used under general laboratory conditions.

- ▶ To prevent sliding on the bench, stick four rubber feet onto the provided recesses at the bottom of the R&S DVMS. These rubber feet are delivered as part of the accessories (see [chapter 2.1.3, "Checking the Accessories"](#), on page 10).

---

**⚠ WARNING****Risk of injuries**

If the instrument is not set up securely, you or others can be injured.

Place the instrument on a stable and level surface. Do not place anything on top of the instrument, if the instrument is not in a level position.

Before folding out the feet at the instrument bottom, read the safety instructions for instruments with fold-out feet at the beginning of this manual carefully.

---

### 2.2.2 Mounting the Instrument in a Rack

The R&S DVMS is designed for installation in a 19" rack mount. The rack adapter is already integrated in the cabinet of the R&S DVMS.

## 3 Interfaces and Connectors

This chapter describes the front panel and the rear panel of the instrument, including all status displays and connectors.



Some connectors may warm up slightly when high voltages are applied. As long as maximum input levels are not exceeded, warm-up should not affect normal operation.

### 3.1 Front Panel

This section gives a short overview of the status displays and connectors on the front panel.

The inscriptions on your R&S DVMS match the captions of the connector descriptions.



Fig. 3-1: Front panel view

#### 3.1.1 Display

For information on the graphical user interface see the user manual or the help system.

#### 3.1.2 Keys

Key	Description
Arrow keys	UPARROW / DNARROW keys: <ul style="list-style-type: none"> <li>In a list in editing mode, increase or decrease the parameter value.</li> <li>In a list, table, window or dialog box, scroll vertically to select a parameter.</li> </ul> LEFTARROW / RIGHTARROW keys: <ul style="list-style-type: none"> <li>In editing mode, move the cursor in the input fields forward and back.</li> <li>In a list, table, window or dialog box, scroll horizontally to select a parameter.</li> </ul>
BACK	<ul style="list-style-type: none"> <li>Deletes the character to the left of the cursor.</li> <li>Navigates back in the tree pane.</li> </ul>
OK	<ul style="list-style-type: none"> <li>Displays the next menu level.</li> <li>Activates the editing mode for the selected numeric/alphanumeric parameter.</li> <li>Completes the data entry.</li> <li>The new value is accepted. For numeric parameters, the unit is also displayed.</li> <li>Switches the marked status parameters on/off (State On/Off).</li> <li>Confirms (OK) and closes message windows.</li> </ul>

### 3.1.3 Status Display LEDs

The basic status is indicated by LEDs.

#### 3.1.3.1 POWER

Displays the power supply status.

- LED off: No power is supplied. R&S DVMS is switched off.
- LED green: Power is supplied.

For further information:

- See [chapter 3.2.1, "AC Power Supply Connector"](#), on page 14

#### 3.1.3.2 REMOTE

Displays the remote control status within the last second.

- LED off: R&S DVMS is not used for remote control.
- LED yellow: R&S DVMS is remote controlled or is sending SNMP traps.

#### 3.1.3.3 FAULT

Displays the error status within the last second.

- LED green: No error detected.
- LED red (flashing): Failure of fan.  
To rectify this failure, switch the R&S DVMS off and on again. If the fan still does not work, shut down the R&S DVMS to prevent overheating of the R&S DVMS and contact one of our customer support centers.

## 3.2 Rear Panel

This section gives a short overview of the connectors on the rear panel.

The R&S DVMS provides 4 slots for the installation of modules. The slots are not preassigned to a certain module. The modules can be installed in any slot in any combination. Refer to the R&S DVMS datasheet for an overview of the currently available modules.

The MODULE INDEX shows how the slots are assigned by the R&S DVMS firmware.

For information on the instrument configuration see the user manual or the help system.



Fig. 3-2: Rear panel view (example)

### 3.2.1 AC Power Supply Connector

For further information:

- See [chapter 4.1, "Connecting to the AC Power Supply"](#), on page 23
- See [chapter 5, "Switching On or Off the Instrument"](#), on page 25
- See [chapter 9.2, "Replacing the Fuses"](#), on page 48

### 3.2.2 LAN Interface

The 1 Gigabit LAN interface (1000 Base-T) can be used to connect the R&S DVMS to a local network for remote control, printouts and data transfer. The assignment of the RJ45 connector supports twisted pair category 7 STP cables in a star configuration (STP stands for shielded twisted pair).



Two LEDs indicate the current status of the LAN connection.

- Green LED
  - LED off: No connection
  - LED on (steady): Connection is established.
  - LED blinking: Connection is established, communication line is in a busy state.
- Yellow LED
  - LED off: Connection speed is 10 Mbit/s or 100 Mbit/s.
  - LED on (steady): Connection speed is 1000 Mbit/s.



Do not connect or disconnect the network cable until the instrument is switched off. Otherwise, the network connection cannot be reliably detected.

Electromagnetic interference (EMI) can affect the measurement results. To avoid any impact, use category 7 cables.

For further information:

- See [chapter 7, "Operating the Instrument in a LAN"](#), on page 35

### 3.2.3 USB Interfaces

Two USB 2.0 interfaces of the type A (host USB) are provided (USB = universal serial bus). Use the interfaces to connect external devices like a keyboard, mouse, printer, or memory stick.





For further information:

- See [chapter 4.2, "Connecting External Devices"](#), on page 23



Electromagnetic interference (EMI) can affect the measurement results. To avoid any impact, make sure that the following conditions are met:

- Use suitable double-shielded cables.
- Do not use USB connecting cables exceeding 1 m in length.
- Use only USB devices that remain within the permissible EMI limits.

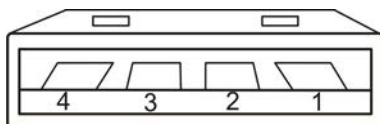
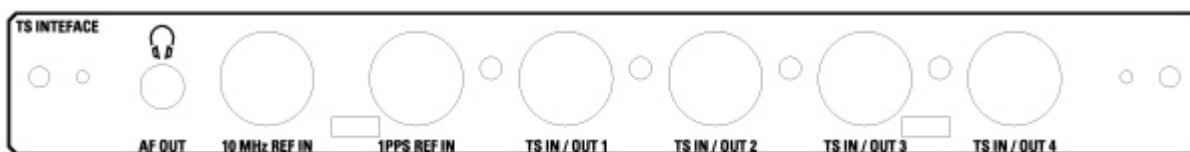

**Table 3-1: Pin assignment**

Pin	Abbreviation	Signal
1	PWR	+ 0.5 A max!
2	D-	Data -
3	D+	Data +
4	GND SHIELD	Shielding

### 3.2.4 TS Interface

The TS interface module is an inherent part of the base unit.



**Fig. 3-3: TS interface module**

#### 3.2.4.1 TS IN/OUT 1 ... 4

Each of these sockets can be used either as input or output for MPEG2 transport streams. If used as an input, this BNC socket is used to feed in an MPEG2 transport stream signal conforming to the DVB-ASI (EN 50083-9 (2002)) or SMPTE (SMPTE 310M) interface standards. If used as an output, this BNC socket provides an MPEG2 transport stream

signal conforming to the DVB-ASI (EN 50083-9 (2002)) interface standard. The output can be used as a loop output for any transport stream input signal available.

To select the input or output, in the toolbar, click "Instrument Configuration" and then select "Signal Interface". For details see for details see the user manual or help system.

### 3.2.4.2 AF OUT (Headphones)

The jack socket for the L/R analog audio output provides the decoded audio stream of the VLC software decoder as a stereo signal.

The socket is intended for connecting headphones or an active loudspeaker.

### 3.2.4.3 10 MHz REF IN

This BNC jack is used as input for the 10 MHz reference frequency. The reference frequency input of the R&S DVMS is used for high accuracy measurements such as RF frequency offset, TS bit rate or PCR drift/offset. To activate this input, use the "Setup" menu.

For details refer to the user manual or help system.

### 3.2.4.4 1 PPS REF IN

This BNC jack is used as input for the 1PPS (1 pulse per second) reference pulse. The 1PPS reference pulse input of the R&S DVMS is used for measurement of network delay in DVB-T distribution networks. The signal should be derived from an external GPS receiver and provides short pulses at exactly 1 second distance. This input is activated, if one of the SFN synchronization monitoring subparameters "SFN Sync Network Delay" is activated.

For details refer to the user manual or help system.

## 3.2.5 DVB-T/H Receiver Module (R&S DVMS-B53)

The DVB-T/H receiver module is optional (R&S DVMS-B53).

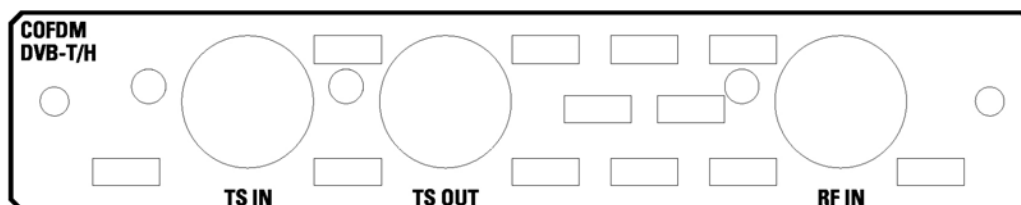

Fig. 3-4: DVB-T/H receiver module

The status of the connectors is indicated by LEDs. Before showing a new state, each LED holds the current state for at least one second, if the current state is not "off" or "flashing".

To select the input, in the toolbar, click "Instrument Configuration" and then select "Signal Interface". For details see for details see the user manual or help system.



To help locating a connector socket, you can let its status LED flash blue ("Instrument Configuration" dialog, "Signal Interfaces" tab; for details see the user manual or help system).

### RF IN

This BNC socket (female Connector @DVMS) is used to feed in a RF signal conforming to the DVB-T (EN 300 744) or DVB-H (EN 302 304) standards.

An LED indicates the RF IN status:

- LED off: Input is currently not used for monitoring.
- LED green: Input is used for monitoring. Synchronization state is valid for both RF signal and related transport stream.
- LED yellow: Input is used for monitoring but synchronization cannot be achieved.

### TS IN

This BNC socket is used to feed in an MPEG2 transport stream signal conforming to the DVB-ASI (EN 50083-9 (2002)) or SMPTE (SMPTE 310M) interface standards.

An LED indicates the TS IN status:

- LED off: Input is currently not used for monitoring.
- LED green: Input is used for monitoring. Synchronization state is valid for the transport stream signal.
- LED yellow: Input is used for monitoring but synchronization cannot be achieved.

### TS OUT

This BNC socket provides an MPEG2 transport stream signal conforming to the DVB-ASI (EN 50083-9 (2002)) interface standard.

The interface is used as a loop output for any transport stream input signal available.

An LED indicates the TS OUT status:

- LED off: Output is currently not used.
- LED blue: Output is used as loop output.

## 3.2.6 DVB-T / DVB-T2 Receiver Module (R&S DVMS-B55)

The T/T2 receiver module is optional (R&S DVMS-B55).

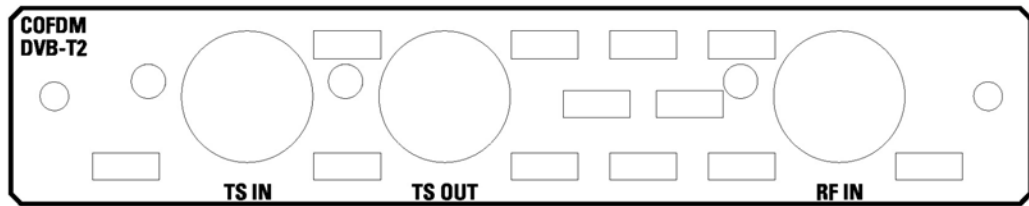

Fig. 3-5: DVB-T/T2 receiver module

The status of the connectors is indicated by LEDs. Before showing a new state, each LED holds the current state for at least one second, if the current state is not "off" or "flashing".

To select the input, in the toolbar, click "Instrument Configuration" and then select "Signal Interface". For details see for details see the user manual or help system.



To help locating a connector socket, you can let its status LED flash blue ("Instrument Configuration" dialog, "Signal Interfaces" tab; for details see the user manual or help system).

### RF IN

This BNC socket (female Connector @DVMS) is used to feed in a RF signal conforming to the DVB-T2 (ETSI EN 302 755) standard.

An LED indicates the RF IN status:

- LED off: Input is currently not used for monitoring.
- LED green: Input is used for monitoring. Synchronization state is valid for both RF signal and related transport stream.
- LED yellow: Input is used for monitoring but synchronization cannot be achieved.

### TS IN

This BNC socket is used to feed in an MPEG2 transport stream signal conforming to the DVB-ASI (EN 50083-9 (2002)) or SMPTE (SMPTE 310M) interface standards.

An LED indicates the TS IN status:

- LED off: Input is currently not used for monitoring.
- LED green: Input is used for monitoring. Synchronization state is valid for the transport stream signal.
- LED yellow: Input is used for monitoring but synchronization cannot be achieved.

### TS OUT

This BNC socket provides an MPEG2 transport stream signal conforming to the DVB-ASI (EN 50083-9 (2002)) interface standard.

The interface is used as a loop output for any transport stream input signal available.

An LED indicates the TS OUT status:

- LED off: Output is currently not used.

- LED blue: Output is used as loop output.

### 3.2.7 DVB-T2 Receiver Module (R&S DVMS-B54)

The T2 receiver module is optional (R&S DVMS-B54).

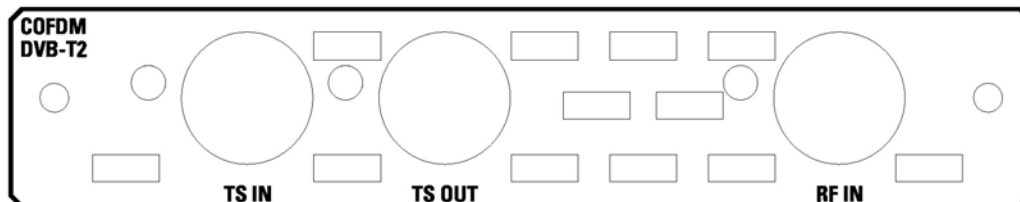

Fig. 3-6: DVB-T2 receiver module

The status of the connectors is indicated by LEDs. Before showing a new state, each LED holds the current state for at least one second, if the current state is not "off" or "flashing".

To select the input, in the toolbar, click "Instrument Configuration" and then select "Signal Interface". For details see for details see the user manual or help system.



To help locating a connector socket, you can let its status LED flash blue ("Instrument Configuration" dialog, "Signal Interfaces" tab; for details see the user manual or help system).

#### RF IN

This BNC socket (female Connector @DVMS) is used to feed in a RF signal conforming to the DVB-T2 (ETSI EN 302 755) standard.

An LED indicates the RF IN status:

- LED off: Input is currently not used for monitoring.
- LED green: Input is used for monitoring. Synchronization state is valid for both RF signal and related transport stream.
- LED yellow: Input is used for monitoring but synchronization cannot be achieved.

#### TS IN

This BNC socket is used to feed in an MPEG2 transport stream signal conforming to the DVB-ASI (EN 50083-9 (2002)) or SMPTE (SMPTE 310M) interface standards.

An LED indicates the TS IN status:

- LED off: Input is currently not used for monitoring.
- LED green: Input is used for monitoring. Synchronization state is valid for the transport stream signal.
- LED yellow: Input is used for monitoring but synchronization cannot be achieved.

### TS OUT

This BNC socket provides an MPEG2 transport stream signal conforming to the DVB-ASI (EN 50083-9 (2002)) interface standard.

The interface is used as a loop output for any transport stream input signal available.

An LED indicates the TS OUT status:

- LED off: Output is currently not used.
- LED blue: Output is used as loop output.

### 3.2.8 S/S2 Receiver Module (R&S DVMS-B51)

The S/S2 receiver module is optional (R&S DVMS-B51).

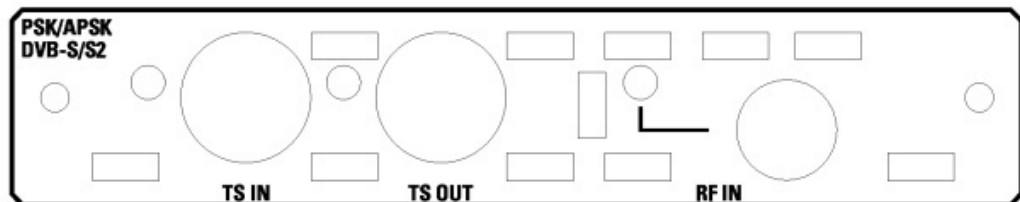

*Fig. 3-7: S/S2 receiver module*

The status of the connectors is indicated by LEDs. Before showing a new state, each LED holds the current state for at least one second, if the current state is not "off" or "flashing".



To help locating a connector socket, you can let its status LED flash blue ("Instrument Configuration" dialog, "Signal Interfaces" tab; for details see the user manual or help system).

### RF IN

This F socket (female Connector @DVMS) is used to feed in a RF signal conforming to the DVB-S (EN 300421), DVB-S2 (EN 302307) or DIRECTV legacy modulation standards.

An LED indicates the RF IN status:

- LED off: Input is currently not used for monitoring.
- LED green: Input is used for monitoring. Synchronization state is valid for both RF signal and related transport stream.
- LED yellow: Input is used for monitoring but synchronization cannot be achieved.

### TS IN

This BNC socket is used to feed in an MPEG2 transport stream signal conforming to the DVB-ASI (EN 50083-9 (2002)) or SMPTE (SMPTE 310M) interface standards.

An LED indicates the TS IN status:

- LED off: Input is currently not used for monitoring.
- LED green: Input is used for monitoring. Synchronization state is valid for the transport stream signal.
- LED yellow: Input is used for monitoring but synchronization cannot be achieved.

### TS OUT

This BNC socket provides an MPEG2 transport stream signal conforming to the DVB-ASI (EN 50083-9 (2002)) interface standard.

The interface is used as a loop output for any transport stream input signal available.

To select the input, in the toolbar, click "Instrument Configuration" and then select "Signal Interface". For details see for details see the user manual or help system.

An LED indicates the TS OUT status:

- LED off: Output is currently not used.
- LED blue: Output is used as loop output.

### 3.2.9 TS/IP Interface Module (R&S DVMS-B40)

The TS/IP module is optional (R&S DVMS-B40).

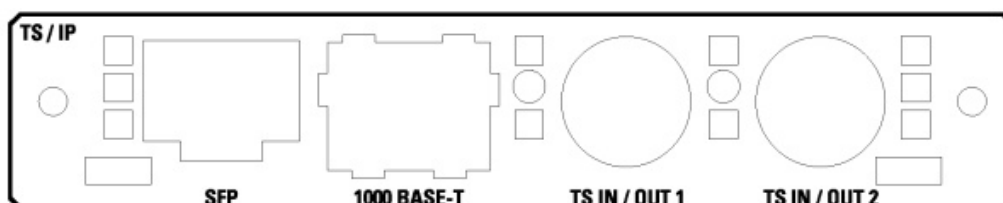

Fig. 3-8: TS/IP interface module

#### TS IN/OUT 1 and TS IN/OUT 2

Each of these two sockets is used either as input or output for MPEG2 transport streams. If used as an input, this BNC socket feeds in an MPEG2 transport stream signal conforming to the DVB-ASI (EN 50083-9 (2002)) or SMPTE (SMPTE310M) interface standards. If used as an output, this BNC socket provides an MPEG2 transport stream signal conforming to the DVB-ASI (EN 50083-9 (2002)) interface standard. The output can be used as a loop output for any transport stream input signal available.

To select the input or output, in the toolbar, click "Instrument Configuration" and then select "Signal Interface". For details see for details see the user manual or help system.

The status of the connectors is indicated by LEDs. Before showing a new status, each LED holds the current status for at least one second, if the current status is not "off" or "flashing".

- LED off: Connector is currently not used.

- LED blue: Connector is used as a loop output for any MPEG2 transport stream input signal.
- LED green: Connector is used as an input for monitoring. Synchronization state is valid for the transport stream signal.
- LED yellow: Connector is used as an input for monitoring but synchronization cannot be achieved.



To help locating a connector socket, you can let its status LED flash ("Instrument Configuration" dialog, "Signal Interfaces" tab; for details see the user manual or help system).

### 1000 BASE-T

This 1000 Base-T Gigabit interface socket is used either as an input for IP and TS monitoring (IP in flow) or as IP loop output (IP out flow) for encapsulated MPEG2 transport streams conforming to the Pro-MPEG code of practice #3 (release 2).

To select and configure the IP in flows and IP out flows, in the toolbar, click "Instrument Configuration" and then select "Signal Interface". For details see for details see the user manual or help system.

The assignment of the RJ45 connector supports twisted pair category 7 STP cables in a star configuration (STP stands for shielded twisted pair).

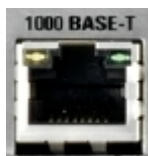

Two LEDs indicate the current status of the LAN connection.

- Yellow LED (left)
  - LED off: Connection speed is 10 Mbit/s or 100 Mbit/s.
  - LED on (steady): Connection speed is 1000 Mbit/s.
- Green LED (right)
  - LED off: No connection
  - LED on (steady): Connection is established.
  - LED blinking: Connection is established, communication line is in a busy state.

### SFP

This SFP (small formfactor pluggable) module socket is used to add an additional IP interface by insertion of an optical Gigabit SFP module (1000BASE-X). If inserted, the additional SFP IP connector is used and configured in the same manner as the built-in 1000 BASE-T connector (see "1000 BASE-T" on page 22).

The SFP module is not part of the R&S DVMS-B40 option.



## 4 Connecting the Instrument

This chapter describes how to connect the instrument to the power supply and external devices.



### Preventing electromagnetic interference

Use only suitable and shielded signal/control cables. These cables should have at least 80 dB to 1 GHz shielding. This is usually achieved by means of double-shielded cables. In particular cables that are connected to the ASI inputs and outputs can cause EMC problems. Depending on the data rate and the packet timing of the transport stream, high levels may occur sporadically within the signal spectrum.

### 4.1 Connecting to the AC Power Supply

The R&S DVMS can be used with different AC power voltages and adapts itself automatically to it. Adjusting the instrument to a particular AC supply voltage is therefore not required. Refer to the datasheet for the requirements of voltage and frequency.

#### **WARNING**

##### Shock hazard

Observe the basic safety instructions at the beginning of this manual, especially the instructions on electrical safety.

1. If you use the S/S2 receiver module (R&S DVMS-B51), connect this module before switching on the R&S DVMS (see [chapter 3.2.8, "S/S2 Receiver Module \(R&S DVMS-B51\)"](#), on page 20).
2. Connect the R&S DVMS to the AC power supply, using the power cable that is supplied. The AC power connector is located on the rear panel of the instrument. Since the R&S DVMS complies with safety class EN61010-1, it should only be connected to a socket with a ground contact.



The R&S DVMS has no AC power switch. Therefore the R&S DVMS starts operating as soon as it is connected to the AC power supply. For further details see [chapter 5.1, "Switching On the Instrument"](#), on page 25.

### 4.2 Connecting External Devices

Using the USB interfaces, you can directly connect USB devices to the R&S DVMS. This number can be increased as necessary by using USB hubs.

Due to the large number of available USB devices, there is almost no limit to the possible expansions. In the following, USB devices that can be useful are listed.

- Keyboard for entering comments, file names, etc.
- Mouse for easy operation of Windows dialogs.
- Memory stick for easy transfer of data to/from a computer (e.g. firmware updates).
- CD-ROM drives for easy installation of firmware applications.
- Printer for printing out measurement results.

#### To install a USB device

1. Connect the USB device to the R&S DVMS. You can do this during operation because all USB devices are Plug and Play.

Windows XP automatically searches for a suitable device driver.

2. If Windows XP does not find a suitable driver, it will prompt you to specify a directory that contains the driver software. If the driver software is on a CD-ROM, connect a USB CD-ROM drive to the R&S DVMS before proceeding.



Before connecting an external device that is not a USB device, e.g. a monitor, make sure that the R&S DVMS is switched off. Otherwise, correct operation cannot be assured.

---

#### To uninstall a USB device

- ▶ Disconnect the USB device from the R&S DVMS. You can do this during operation. Windows XP immediately detects the change in the hardware configuration and deactivates the corresponding driver.

## 5 Switching On or Off the Instrument

### **WARNING**

#### **Shock hazard**

Observe the basic safety instructions at the beginning of this manual, especially the instructions on electrical safety.

### 5.1 Switching On the Instrument

#### **NOTICE**

#### **Risk of instrument damage**

Before switching on the instrument, make sure that the following conditions are met:

- The instrument is set up as described in [chapter 2.2, "Putting Up the Instrument"](#), on page 10.
- Signal levels at the input connectors are all within the specified ranges.
- Signal outputs are correctly connected and are not overloaded.

Failure to meet these conditions may cause damage to the instrument or other devices in the test setup.

#### **To switch on the R&S DVMS**

- ▶ Connect the R&S DVMS to the AC power supply as described in [chapter 4.1, "Connecting to the AC Power Supply"](#), on page 23).

The LED under POWER changes to green.

The R&S DVMS starts booting. The front panel display shows the boot screen with a progress bar that indicates the status of the startup process. As soon as the R&S DVMS main application is running, the boot screen disappears and the R&S DVMS application screen is displayed. The R&S DVMS is now ready for operation.

The configuration settings that were active before the R&S DVMS was last switched off are automatically restored.

## 5.2 Switching Off the Instrument

### NOTICE

#### Risk of losing data

If you switch off the running instrument by disconnecting the power cord before shutting it down, the instrument loses its current settings. Furthermore, program data may be lost.

Always shut down the R&S DVMS first.

#### To switch off the R&S DVMS

1. Check the status displays on the front panel of the R&S DVMS. If the REMOTE status display on the front panel is on, do not switch off the R&S DVMS. Someone else is using the R&S DVMS by means of remote operation (see also [chapter 3.1.3, "Status Display LEDs"](#), on page 13).
2. Shut down the R&S DVMS.  
The current configuration settings are automatically stored.  
The R&S DVMS starts booting again.
3. As soon as the front panel display shows the boot screen, disconnect the R&S DVMS from the AC power supply.  
All LEDs on the front panel should go out.

## 5.3 Checking the Provided Software Options

The R&S DVMS may be equipped with software options. In order to check whether the installed options correspond to the options indicated on the delivery note, proceed as follows.

1. In the "Help" menu, select "Option Management".  
A list with the software options is displayed.
2. Check the options enabled via license keys as indicated in the delivery note.  
  
▶ Check the availability of the hardware options as indicated in the delivery note.

For an overview of the all options available for the instrument refer to the Rohde & Schwarz Homepage.

## 6 Sample Application

Follow the instructions in this chapter to perform your first measurement with the R&S DVMS.

For an expanded selection of measurement examples and background information refer to the user manual or the help system.

In this measurement, the R&S DVMS is used for basic compliance checks of one single MPEG2 transport stream (TS) signal.

Since the R&S DVMS base unit provides 4 baseband transport stream inputs (TS IN/OUT 1...4, see [chapter 3.2.4.1, "TS IN/OUT 1 ... 4"](#), on page 15), you can perform the described measurement with every R&S DVMS independently of the number of installed modules.

### 6.1 Requirements

The DVB TS-ASI input signal used in this measurement should be generated by either a TS generator (i.e. R&S DVSG) or by any other DVB-compliant TS-ASI source.

The R&S DVMS is locally operated by using a LCD monitor (DVI input required, at least 1024 x 768 pixels) and an USB mouse.

### 6.2 Setting Up the R&S DVMS

The required connectors are on the rear side of the R&S DVMS. For details on the connectors refer to [chapter 3, "Interfaces and Connectors"](#), on page 12.

1. Connect the TS ASI output of the TS generator to the TS IN/OUT 2 baseband input (BNC connector) of the R&S DVMS base unit.
2. Plug the USB connector of the USB mouse in one of the two USB2.0 interfaces.
3. Switch on the R&S DVMS and wait until the TS analyzer monitoring application is running.

The application window showing the default start screen is displayed.

## 6.3 Creating a Basic Configuration

In the TS Analyzer monitoring application, create the basic configuration.

1. In the toolbar, select "Instrument Configuration" to open the "Instrument Configuration" dialog.
2. On the "Signal Interface" tab, select the following:
  - a) In the "Interface Settings" column of the base unit, activate the "TS In 2" option.
  - b) Deactivate all other input options.

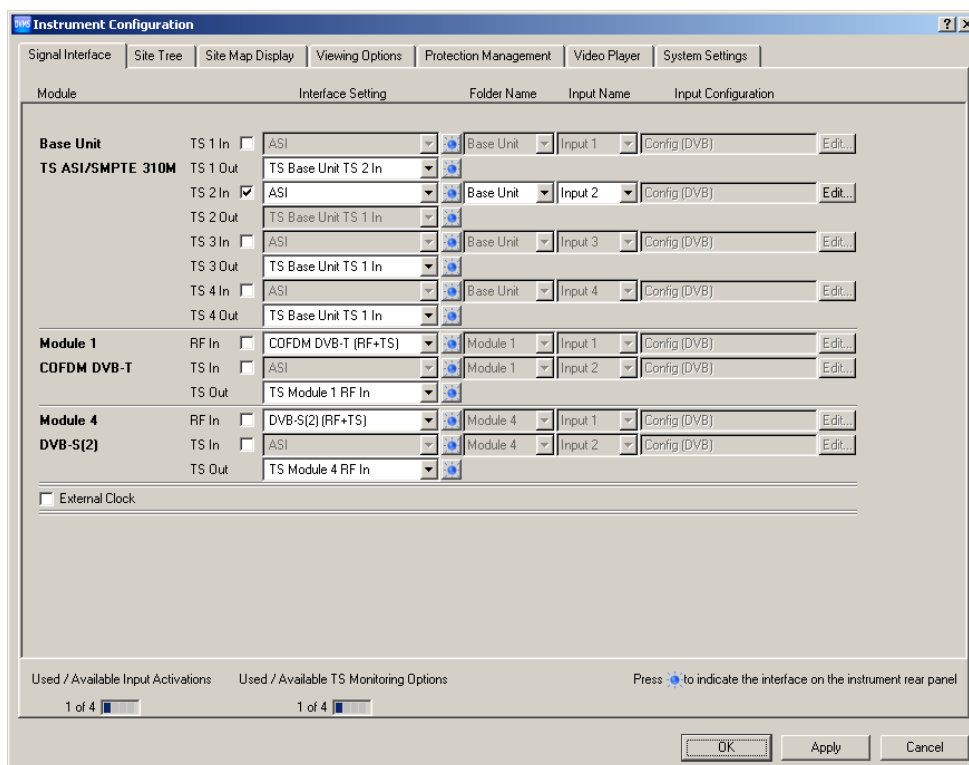

3. Click "OK".
4. In the toolbar, select "Input Configuration" to open the "Input Configuration Assignment" dialog.
5. Under "Monitoring Configuration", select "Config (DVB)".

## 6.4 Checking the TS Synchronization

Before any measurement can be performed, the TS Synchronization within the R&S DVMS TS Analyzer must achieve the "Locked" state. To check the current state, perform the following steps.

1. In the toolbar, click "View Selector".

2. In the "View Selector" dialog, click the icon for the Statistics & Log measurement.
3. Click "Control" and select "Clear Statistics & Log".
4. Under "1st Priority Error", check the "TS Sync" statistics counter.

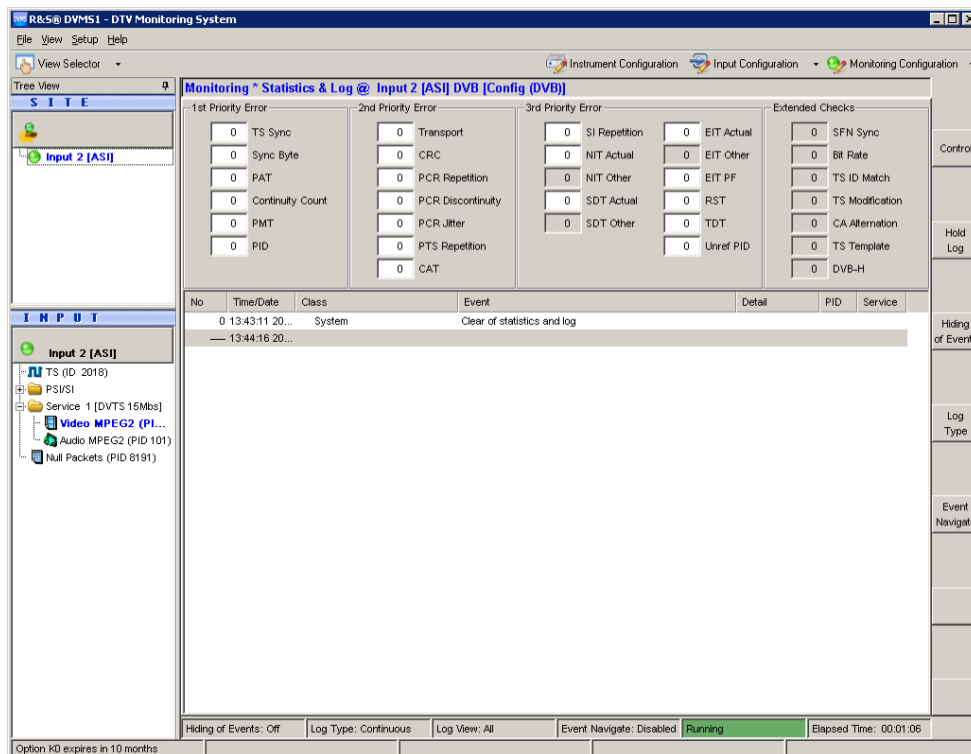

- In the "Locked" state, the value is "0".  
Under "SITE", the LED symbol is green. At the rear panel, the LED corresponding to the TS IN input is switched to green.
- In the "Unlocked" state, the value is > 0, continuously incrementing (every second).  
Under "SITE", the LED symbol shows the  icon for TS synch loss. At the rear panel, the LED corresponding to the TS IN input is switched to yellow.



The following measurements can only be performed, if TS synchronization is in the "Locked" state.

## 6.5 Performing the Measurement

Since the measurement results strongly depend on the content of the used TS input signal, the following examples use basic parameters and measurements which are valid for all kind of MPEG2 TS signals.

### 6.5.1 Checking the Gross Bit Rate of the Connected TS

1. In the toolbar, click "View Selector".
2. In the "View Selector" dialog, click the icon for the Bit Rate measurement.
3. Read the current bit rate of the connected TS from the TS elements table.

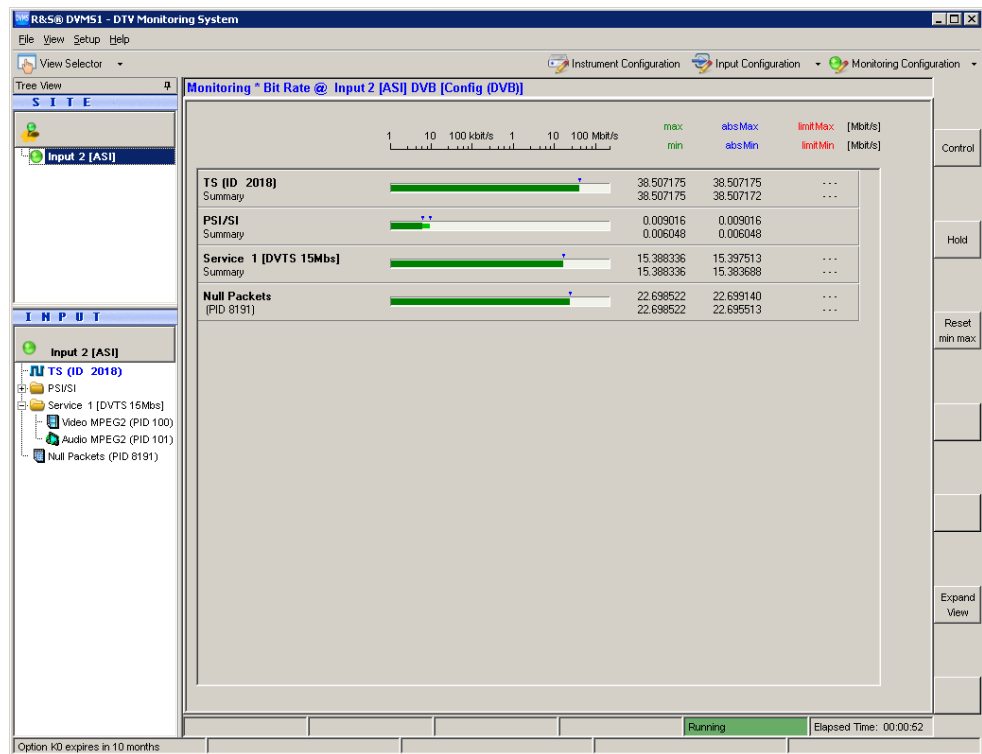

The value is given in units of Megabits per Second (Mbit/s). The value shown is the gross value of all transport stream packets per second, including TS packet header and TS packet payload.

### 6.5.2 Checking the Net Bit Rate of the Connected TS

In order to check the net bit rate value of the TS, you have to change the calculation method for the TS bit rate DV measurement from gross to net values.

1. In the toolbar, select "Monitoring Configuration".
2. Select the "Extended Checks I" tab.  
On this tab, you can see all settings for bit rate measurements.



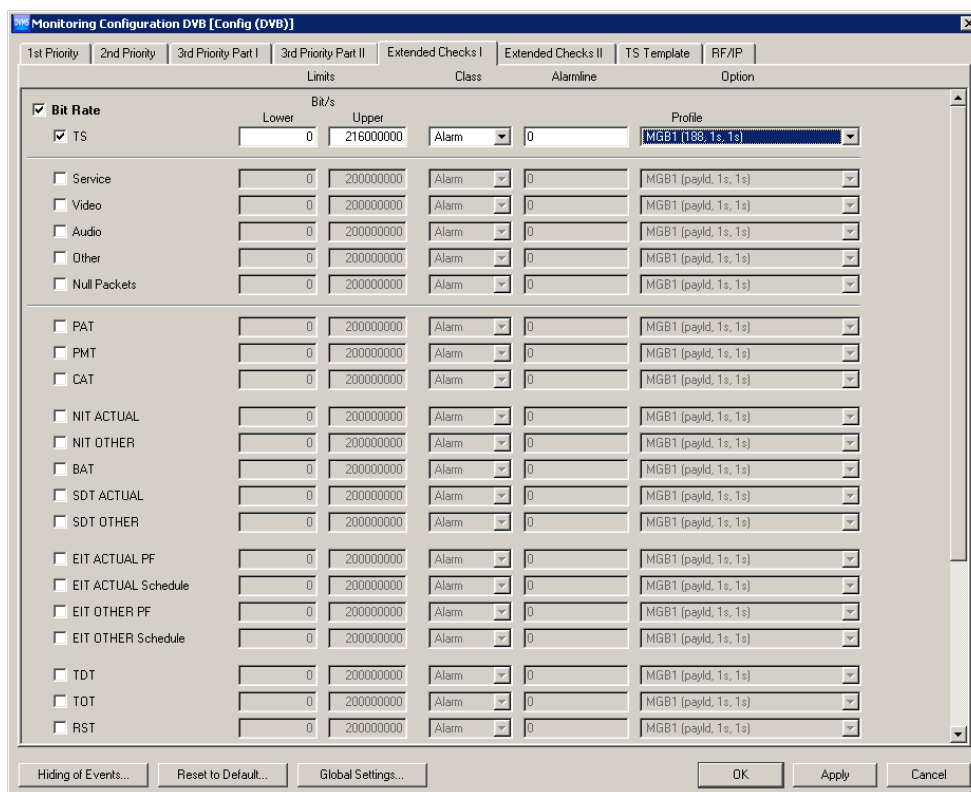

Fig. 6-1: Extended Checks I tab

3. In the first line, activate the "Bit Rate" option for overall bit rate limits monitoring.
4. The second line shows the current (default) settings for the monitoring TS bit rate. To modify the calculation method, do the following:
  - a) Activate the "TS" option.
  - b) Open the "Profile" list and select the "MGB1(payload,1,1)" predefined setting.
5. Click "OK" to close the configuration dialog.  
The monitoring view is displayed.
6. In the "TS (ID XXXX)" line, "max/min" column, read the current net bit rate of the connected TS (in this example, [figure 6-2](#), XXXX = 2018).

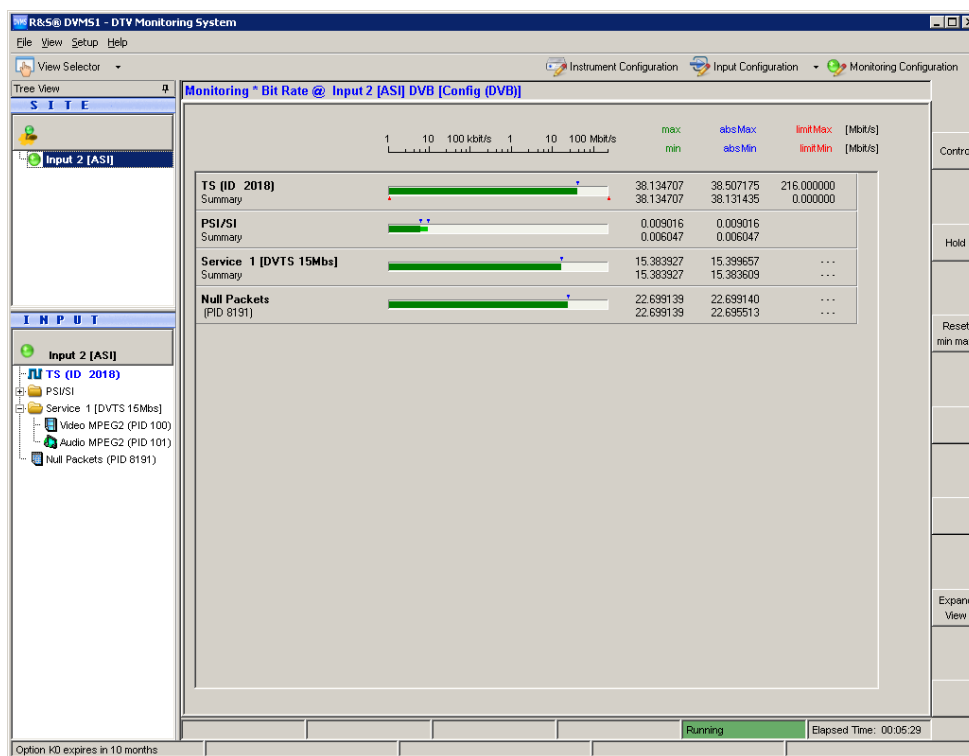

Fig. 6-2: Monitoring view

7. Compare this value to the gross value from before (see [chapter 6.5.1, "Checking the Gross Bit Rate of the Connected TS"](#), on page 30).  
Since only the packet payload of all TS packets is examined for net bit rate calculation, the net value should be lower by a factor of approximately 184/188.

### 6.5.3 Activating the Monitoring Error for TS Bit Rate Monitoring

Now you activate monitoring errors by changing the monitoring limit of the parameter TS bit rate.

1. In the toolbar, select "Monitoring Configuration".
2. Select the "Extended Checks I" tab (see [figure 6-1](#)).  
In the second line, in the "Upper Bit Rate" field, set the limit from the default value of 200 Mbit/s to a value of approx. 1 Mbit/s below the current TS bit rate as checked in [chapter 6.5.2, "Checking the Net Bit Rate of the Connected TS"](#), on page 30.
3. Click "OK" to close the configuration dialog.
4. In the toolbar, click "View Selector".
5. In the "View Selector" dialog, click the icon for the Statistics & Log measurement.
6. Click "Control" and select "Clear Statistics & Log".

## 7. Check the monitoring log.

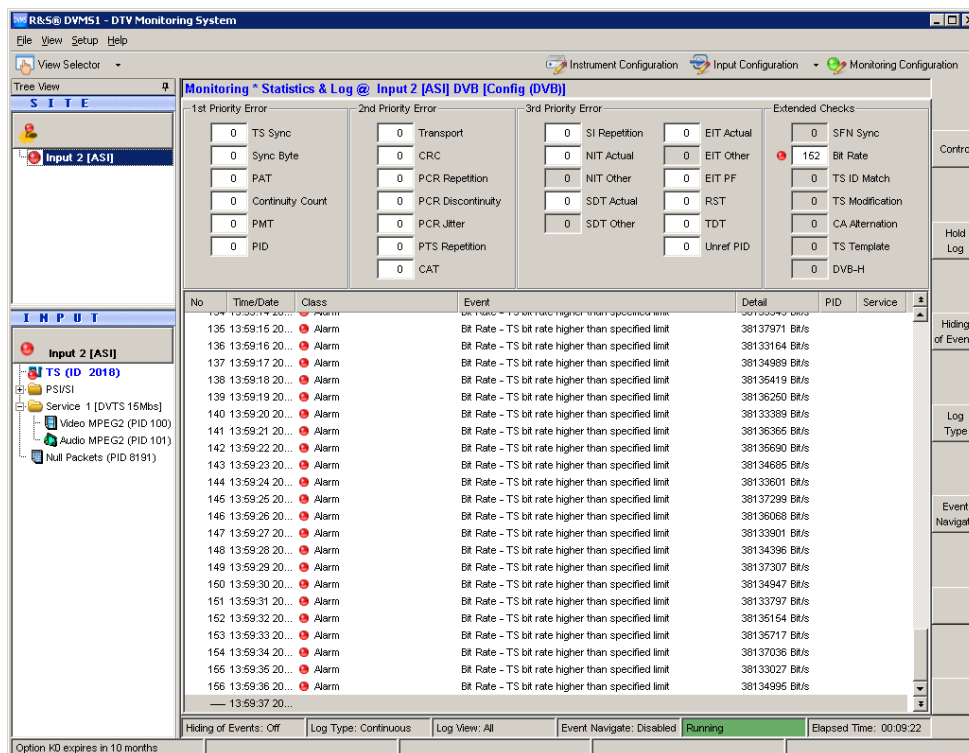

Every second, "Bite Rate - TS bit rate higher than specified limit" log entries are inserted at the end of the log. In addition, the "Bit Rate" statistics counter is incremented every second. Also, under "INPUT", a red LED symbol at the selected input indicates an active monitoring fault.

## 8. To simplify the monitoring log, click "Log Type" and then select "Transition" to change the log type.

Only at the moment when the monitoring error is detected, one single entry is inserted. As long as the error is present, no new log entries are added, but the "Statistics Counter" is incremented. As soon as the monitoring error disappears, a new log entry is inserted informing you that the error has disappeared and how long the error has lasted.

For further details see the user manual or help system.

## 9. Stop reporting the monitoring faults by deactivating the TS bit rate monitoring:

- In the toolbar, select "Monitoring Configuration".
- Select the "Extended Checks I" tab.
- In the second line, deactivate the "TS" option for TS bit rate monitoring.

## 10. Click "OK" to close the configuration dialog.

## 11. Click "Control" and select "Clear Statistics &amp; Log".

### 6.5.4 Checking the Content of the PSI Table PAT

PAT is used as abbreviation for Program Association Table as specified in the associated MPEG2 standard ISO/IEC13818-1.

1. In the toolbar, click "View Selector".
2. In the "View Selector" dialog, click the icon for the Table/PES interpreter.
3. Under "INPUT", expand the PSI/SI node and select the PAT element.

The screenshot shows the R&S DVMS4 - DTV Monitoring System interface. The 'Tree View' on the left shows the hierarchy: SITE > DVMS1 > Input 2 [ASI] > INPUT > Input 2 [ASI] > TS (ID 2018) > PSIS > PAT (PID 0). The main pane displays the 'Program Association Section' with the following fields:

Field	Bit Length	Value	Notes
Table id	8 bit	0x00	
Section syntax indicator	1 bit	1	
Section syntax indicator	1 bit	0	
reserved	2 bit	0x3	
Section length	12 bit	17	
Transport Stream Id	16 bit	0x07E2 (2018)	
reserved	2 bit	0x3	
Version number	5 bit	1	
Current/next indicator	1 bit	1	sub_table is currently applicab
Section number	8 bit	0	
Last section number	8 bit	0	
<b>Reference Loop</b>			
<b>1st Reference</b>			
Program number	16 bit	0x0000 (0)	1
reserved	3 bit	0x7	
Network PID	13 bit	0x0010 (16)	
<b>2nd Reference</b>			
Program number	16 bit	0x0001 (1)	
reserved	3 bit	0x7	
Program map PID	13 bit	0x0080 (128)	2
CRC-32	32 bit	0xB958F29E	CRC ok

The toolbar on the right includes buttons for Start, Stop, Update, and Filter. The status bar at the bottom shows 'Option ID expires in 8 months', 'Snapshot', 'Stopped', 'History Indicator: Unlimited', and 'Active User Level: Administrator'.

1 = Network PID (NIT) referenced by program number = 0

2 = Program map PID (PMT) referenced by program number  $\geq 1$

The results pane shows the content of the PAT in tabular form.

For details see user manual or help system, "Program Association Table (PAT)".

## 7 Operating the Instrument in a LAN

The R&S DVMS is equipped with a network interface and can be connected to an Ethernet LAN (local area network). Provided the appropriate rights have been assigned and the Windows XP firewall configuration is adapted accordingly, the interface can be used e.g. for transferring data, printing on network printers, operating the R&S DVMS from a remote computer.

To use network resources, access must be granted. To share files on the R&S DVMS with other network users, access to instrument resources, e.g. the hard drives, must also be granted. All these administration tasks are normally performed by a network administrator using the Windows XP Start menu (for details refer to the Windows XP help system). Contact your network administrator for access authorizations.

User name and password of the R&S DVMS are factory-set. The user name is used for auto login, access authorization and remote operation.

For further information:

- See [chapter 8.1.1, "Login"](#), on page 38
- See [chapter 3.2.2, "LAN Interface"](#), on page 14
- See the user manual or help system for details on remote operation.

### 7.1 Connecting the Instrument to the Network

---

#### **NOTICE**

##### **Risk of network failure/virus infection**

Before connecting the R&S DVMS to the network or configuring the network, do the following:

- Consult your network administrator.
- If your network does not support DHCP or if you choose to disable dynamic TCP/IP configuration, you must assign valid address information before connecting the R&S DVMS to the LAN.

Errors may affect the entire network.

Efficient virus protection is a prerequisite for secure operation in the network. Never connect the R&S DVMS to a network without proper protection against a virus infection, as doing so may cause damage to the instrument software.

---

##### **To connect the R&S DVMS to the network**

1. Fulfill all prerequisites mentioned above.

2. Make sure that the R&S DVMS is switched off. This is the only way to ensure that the network connection is reliably detected and any disruptions during the operation of the R&S DVMS are avoided.
3. Connect the R&S DVMS to the network using a CAT-7 RJ-45 cable.

**To disconnect the R&S DVMS from the network**

1. Make sure that the R&S DVMS is switched off.
2. Disconnect the R&S DVMS from the network.

## 7.2 Configuring the Network Card

Under Windows XP, network card drivers do not need to be installed separately. If the R&S DVMS is connected to the LAN, Windows XP automatically detects the network connection and activates the required drivers.

The configuration tasks depend on whether your network has a DHCP server or not. If necessary, ask your network administrator.

**Networks with DHCP Server**

The instrument is preconfigured for networks using the dynamic host configuration protocol (DHCP). In such networks, the instrument is automatically assigned a free IP address. Identification in the network is based on the use of a unique computer name.

Every instrument is assigned an individual computer name at the factory. It is displayed as part of the window title of the application.

If necessary, you can change the computer name using the Windows XP Start menu. For details refer to the Windows XP help system.

**Networks without DHCP Server**

In networks that assign fixed IP addresses, the network administrator usually configures the network card. Contact your network administrator. The IP address is set using the Windows XP Start menu. For details refer to the Windows XP help system.

## 7.3 Firewall Settings

By default, the Windows Firewall is activated to protect the R&S DVMS from an attack of hostile users and programs. The Windows Firewall suppresses all network communication which is not initialized by the R&S DVMS itself or which is not defined as an exception.

To enable data transfer or to allow access to the R&S DVMS, define exceptions using the Windows XP Start menu. For details refer to the Windows XP help system or contact your network administrator for support.

## 7.4 Configuring the Simple Network Management (SNMP) Agent

The "Instrument Configuration" dialog, "System Settings" tab gives access to the SNMP configuration settings.

For details refer to the user manual or help system, chapter "Configurations".

## 8 Installed Software

The firmware and the operating system are already installed on the R&S DVMS.

For further information:

- Performing a firmware update: see the Release Notes.
- Installing software options: see the user manual or the help system.

### 8.1 Operating System

The R&S DVMS is equipped with the Windows XP Embedded operating system. When the R&S DVMS is delivered, the operating system is configured for optimum operation. Changes to the system settings are required only if you install peripherals such as a keyboard and printer or if you configure the network and the settings do not conform to the default settings.

#### NOTICE

##### Risk of causing instrument unusability

To prevent malfunctions and to avoid instrument repair, only install service packs approved by Rohde & Schwarz.

In particular, do not use service packs for Windows XP Home Edition or Professional Edition.

#### 8.1.1 Login

Windows XP requires that you identify yourself by entering a user name and password in a login window. The R&S DVMS provides a factory-installed auto login function, i.e. login is carried out automatically in the background. The ID used for auto login has administrator rights.



As user name and password, *instrument* are factory-set.

If the R&S DVMS is connected to a network and if the user name and the password are identical under Windows XP and on the network, you log on to operating system and the network at the same time.



### 8.1.2 Windows XP Start Menu

The Windows XP Start menu provides access to the Windows XP functionality and installed programs. Under "Control Panel", the system settings are grouped. For details refer to the Windows XP help system.

To access to the operating system, connect an external keyboard. If you want more convenient access to Windows XP, connect a mouse. To change to the user interface of the R&S DVMS, in the taskbar, double-click the R&S DVMS entry.

For details on connecting external devices see [chapter 4.2, "Connecting External Devices"](#), on page 23.

## 8.2 Additional Software

---

### NOTICE

#### Risk of causing instrument unusability

The instrument is equipped with the Windows XP operating system. Additional software can therefore be installed on the instrument. The use and installation of additional software may impair instrument function. Thus, run only programs that Rohde & Schwarz has tested for compatibility with the instrument software.

The drivers and programs used on the instrument under Windows XP have been adapted to the instrument. Existing instrument software must always be modified using only update software released by Rohde & Schwarz.

---

## 8.3 Windows XP Recovery and Backup Partition

The R&S DVMS provides a backup and recovery partition. A backup of the factory system partition (C:\) is stored per default and can be recovered in case of a system crash.

In addition, backups of up to 5 firmware versions can be stored on this partition. For example, it is possible to backup the current system partition prior to a firmware update or to provide different system configurations for different environments. When recovered, the system partition (C:/) is deleted, formatted and written newly. The data partition (D:\) is not affected.



If the following message is displayed during backup or recovery, ignore it and do not restart your instrument. Select "No".



### 8.3.1 Prerequisite for the Recovery and Backup

As a prerequisite for a backup/restore process, in the BIOS settings, the hardware watchdog must be disabled. Otherwise the backup/restore process (which normally lasts about 10 to 15 minutes) will be terminated and fail due to a reboot issued by the watchdog after about 4 minutes.

#### To disable the hardware watchdog

1. Connect an external keyboard to the USB interface.
2. Switch the R&S DVMS off and on again.
3. Boot into the BIOS settings by pressing the DEL key of the external keyboard in the early boot phase when prompted at the bottom of the screen.

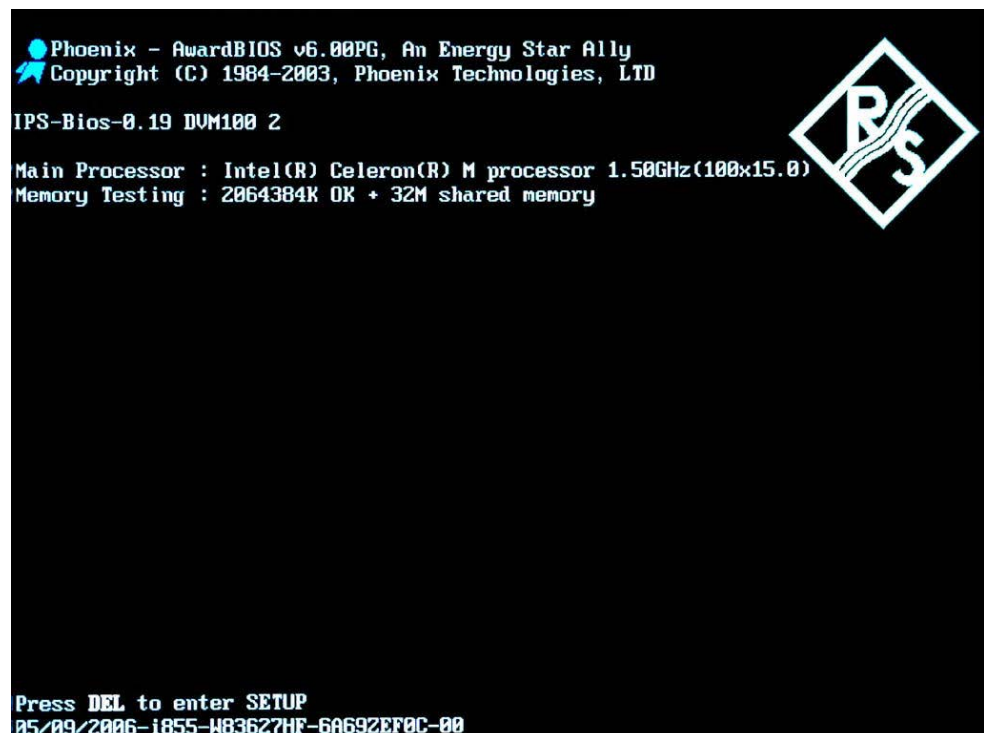

4. In the BIOS settings, select "Integrated Peripherals" using the UPARROW/DNARROW keys of the external keyboard and open the following page by pressing ENTER.

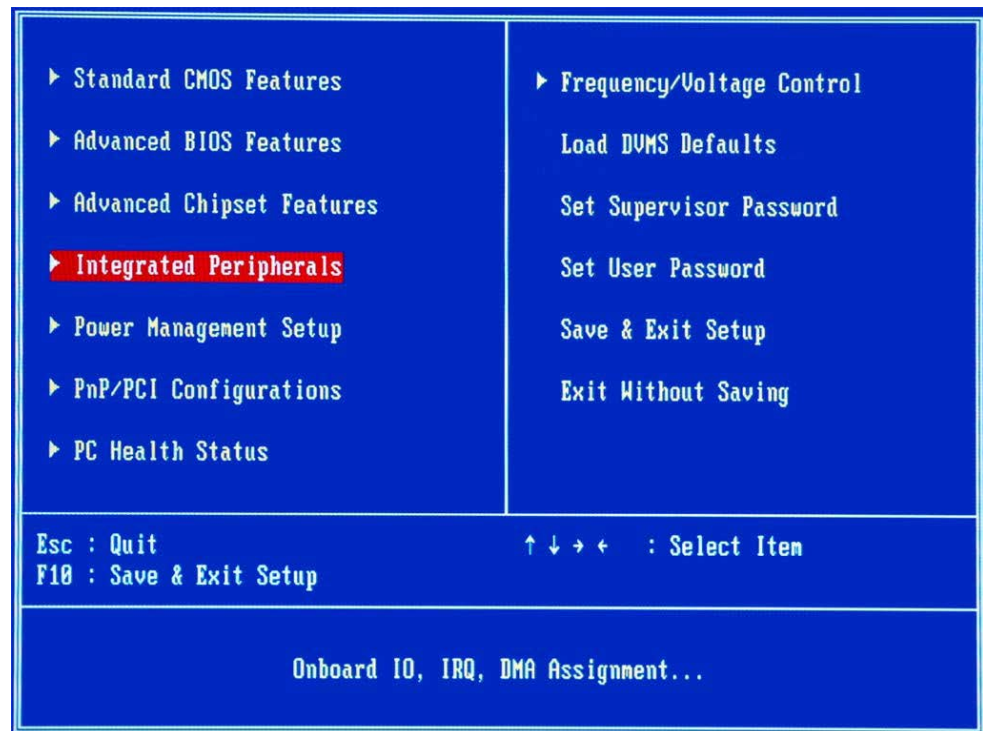

5. In "Integrated Peripherals", change the "Watch Dog Timer Select" setting to "Disabled".

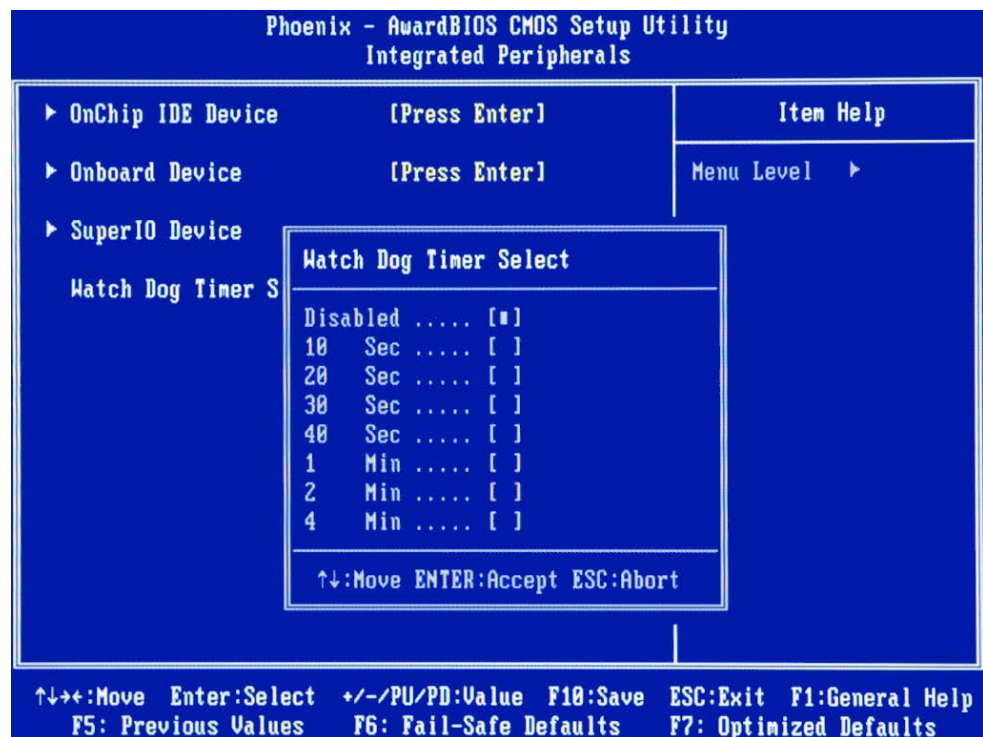

6. Return to the main page and select "Save & Exit Setup" to store the changes and proceed with the system boot.
7. Continue as described in [chapter 8.3.2, "Displaying the Windows XP Recovery and Backup Partition Dialog"](#), on page 42.



After a successful boot with the default option "Firmware" in the boot dialog or a restored backup, the hardware watchdog will automatically be re-enabled by the R&S DVMS system software. Make sure that the required sequence as described above is not interrupted for some reason. Otherwise restart at step 2.

### 8.3.2 Displaying the Windows XP Recovery and Backup Partition Dialog



Before you perform a backup or recovery, make sure that the hardware watchdog is disabled. For details see [chapter 8.3.1, "Prerequisite for the Recovery and Backup"](#), on page 40.

1. In the boot screen, select "Backup/Recovery" and press ENTER.

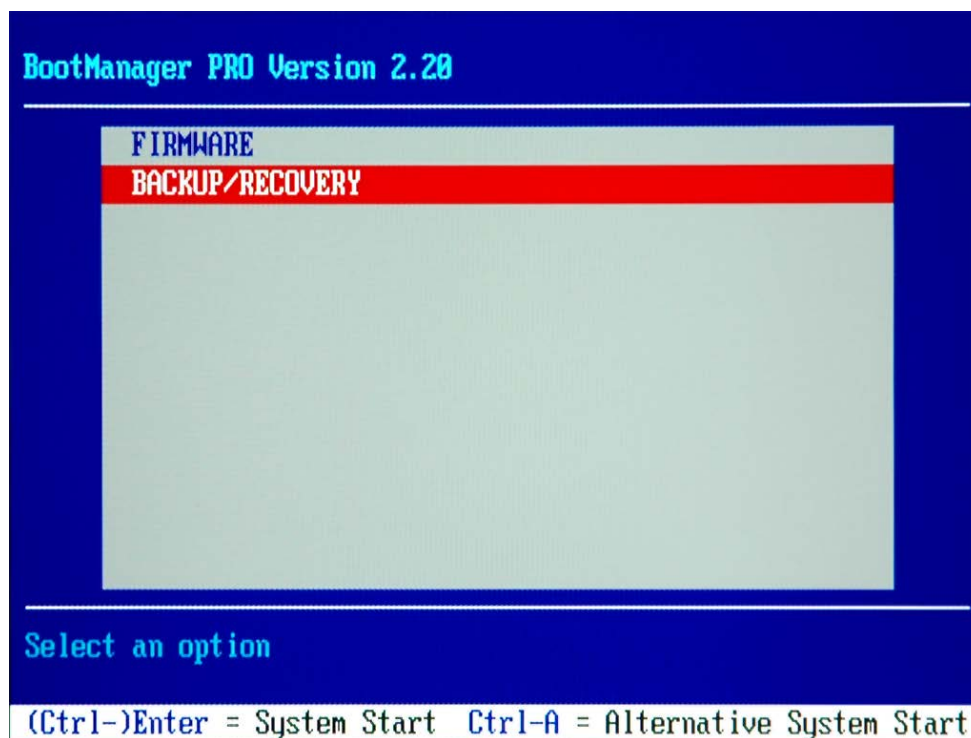

2. Press ENTER to open the "Windows XP Embedded Recovery and Backup Partition" dialog.

The dialog shows the available selections for the recovery and backup partition.

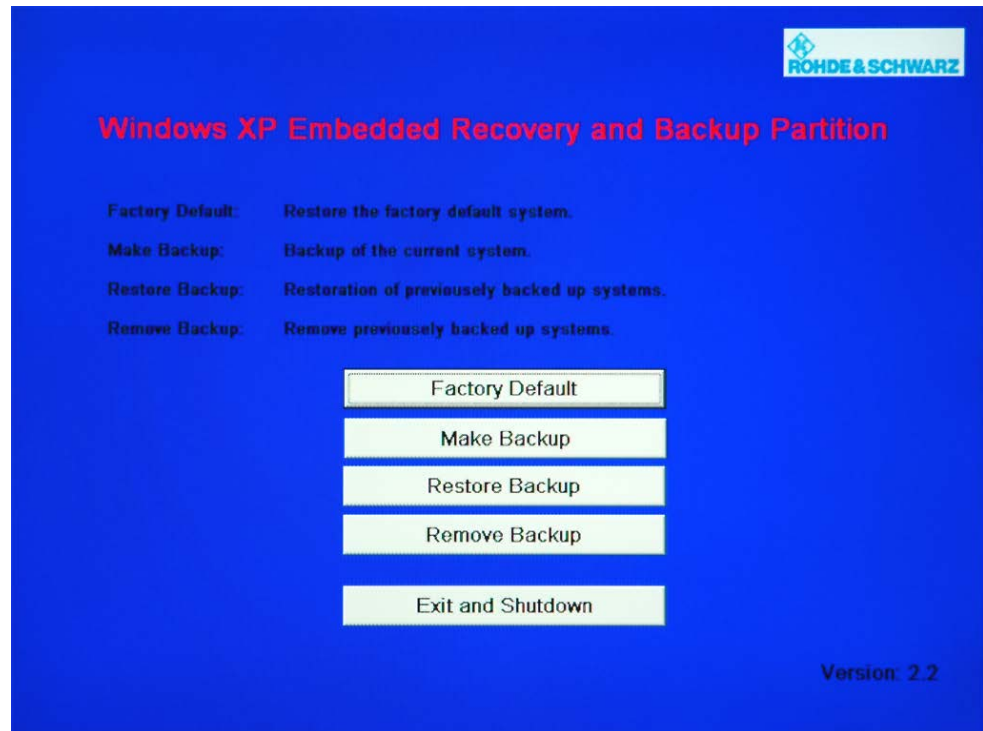

To continue see one of the following chapters:

- The [chapter 8.3.3, "Backing Up the Current System Partition"](#), on page 43
- The [chapter 8.3.4, "Recovering the Selected Version of System Partition"](#), on page 44
- The [chapter 8.3.5, "Recovering the Factory Default"](#), on page 45
- The [chapter 8.3.6, "Deleting Backups"](#), on page 46



In the "Windows XP Embedded Recovery and Backup Partition" dialog and all successive dialogs, you need a mouse to work with.

### 8.3.3 Backing Up the Current System Partition

1. Make sure that the hardware watchdog is disabled. For details see [chapter 8.3.1, "Prerequisite for the Recovery and Backup"](#), on page 40.
2. In the "Windows XP Embedded Recovery and Backup Partition" dialog (see [chapter 8.3.2, "Displaying the Windows XP Recovery and Backup Partition Dialog"](#), on page 42), click "Make Backup".

The "Make Backup" dialog is displayed. It shows the current versions of the firmware and the software platform.

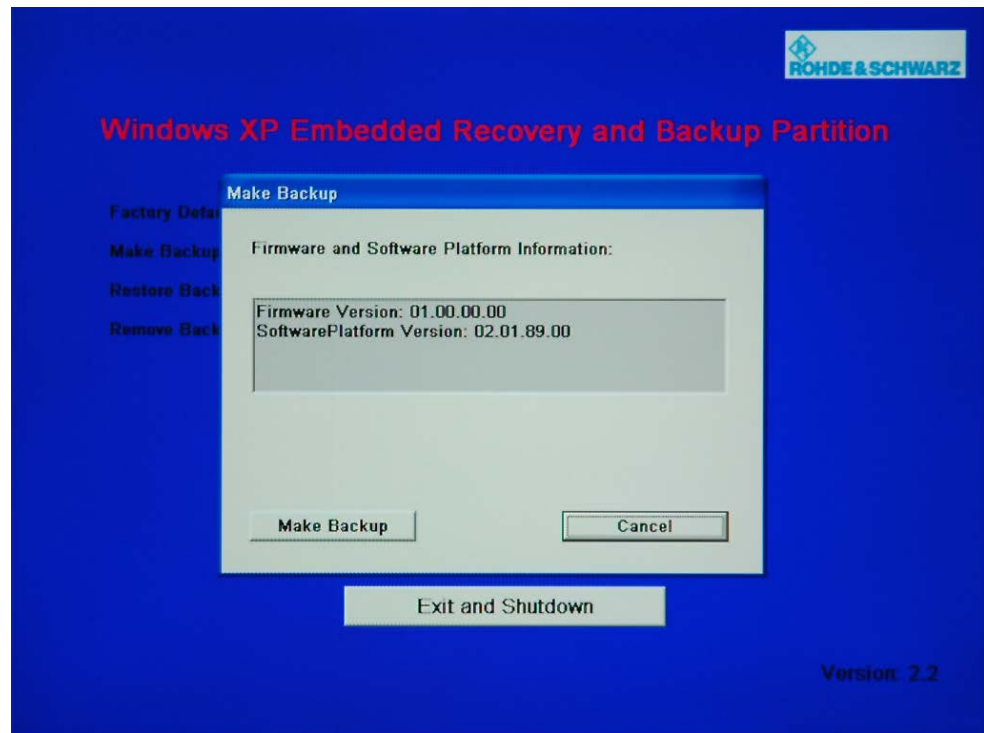

3. Click "Make Backup".

After the backup, the "Windows XP Embedded Recovery and Backup Partition" dialog is displayed again.

4. Click "Exit and Shutdown".
5. Turn off/on the R&S DVMS manually.

### 8.3.4 Recovering the Selected Version of System Partition

1. Make sure that the hardware watchdog is disabled. For details see [chapter 8.3.1, "Prerequisite for the Recovery and Backup"](#), on page 40.
2. In the "Windows XP Embedded Recovery and Backup Partition" dialog (see [chapter 8.3.2, "Displaying the Windows XP Recovery and Backup Partition Dialog"](#), on page 42), click "Restore Backup" to recover a selected version of the system partition.

The "Restore Backup" dialog is displayed. It shows the versions of the firmware and the software platform of the backup displayed under "Select Backup".



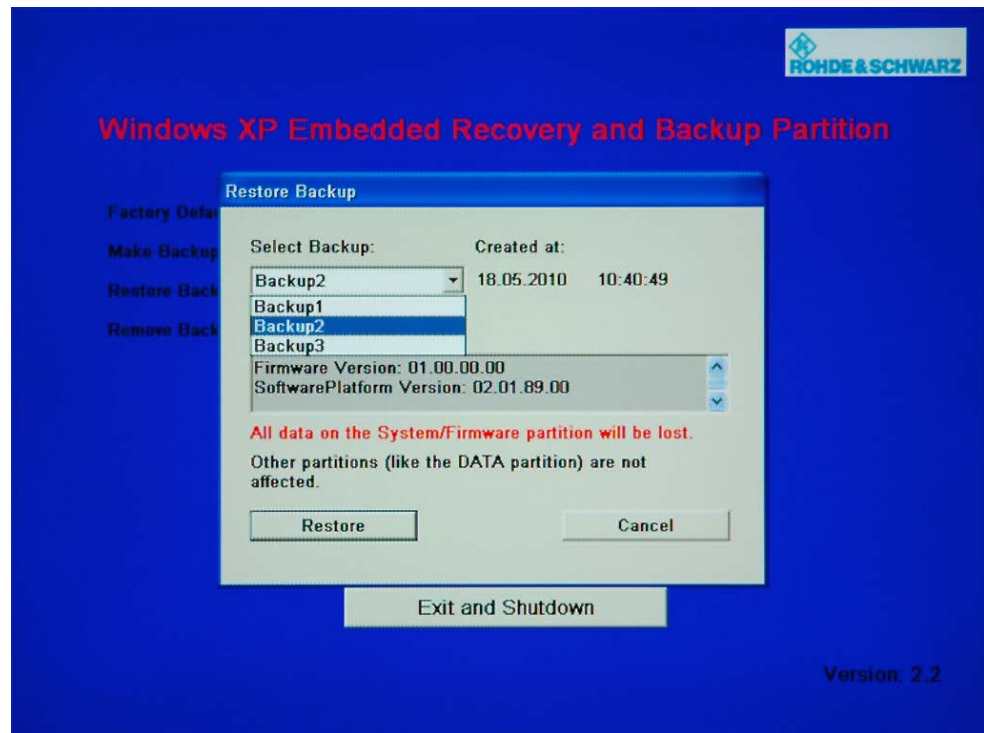

3. Under "Select Backup", select the backup to be restored.
4. Click "Restore" and follow the instructions.
5. After the recovery, turn off/on the R&S DVMS manually.

### 8.3.5 Recovering the Factory Default

1. Make sure that the hardware watchdog is disabled. For details see [chapter 8.3.1, "Prerequisite for the Recovery and Backup"](#), on page 40.
2. In the "Windows XP Embedded Recovery and Backup Partition" dialog (see [chapter 8.3.2, "Displaying the Windows XP Recovery and Backup Partition Dialog"](#), on page 42), click "Factory Default" to recover the factory version of the system partition.

The "Factory Default" dialog is displayed. It shows the versions of the firmware and the software platform on delivery.

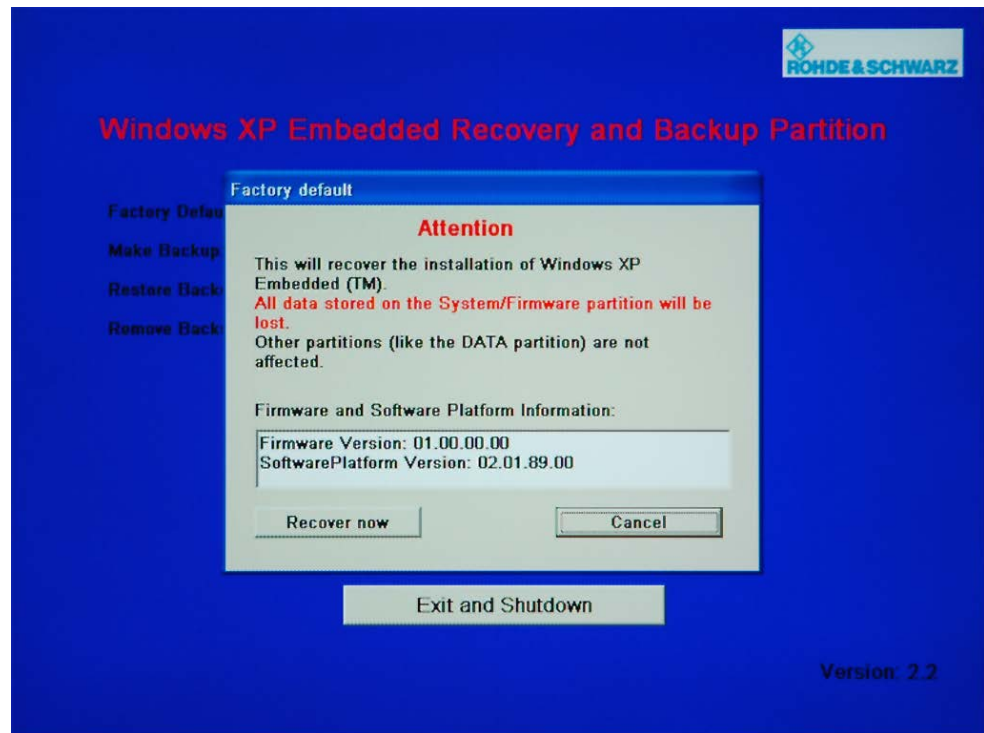

3. Click "Recover now" and follow the instructions.
4. After the recovery, turn off/on the R&S DVMS manually.

### 8.3.6 Deleting Backups

On the recovery partition, you can store up to five backups in addition to the factory default. To provide space for new backups, you may need to remove older backups. The factory default cannot be deleted.

1. Make sure that the hardware watchdog is disabled. For details see [chapter 8.3.1, "Prerequisite for the Recovery and Backup"](#), on page 40.
2. In the "Windows XP Embedded Recovery and Backup Partition" dialog (see [chapter 8.3.2, "Displaying the Windows XP Recovery and Backup Partition Dialog"](#), on page 42), click "Remove Backup" to delete a selected backup.

The "Remove Backup" dialog is displayed. It shows the versions of the firmware and the software platform of the selected backup.



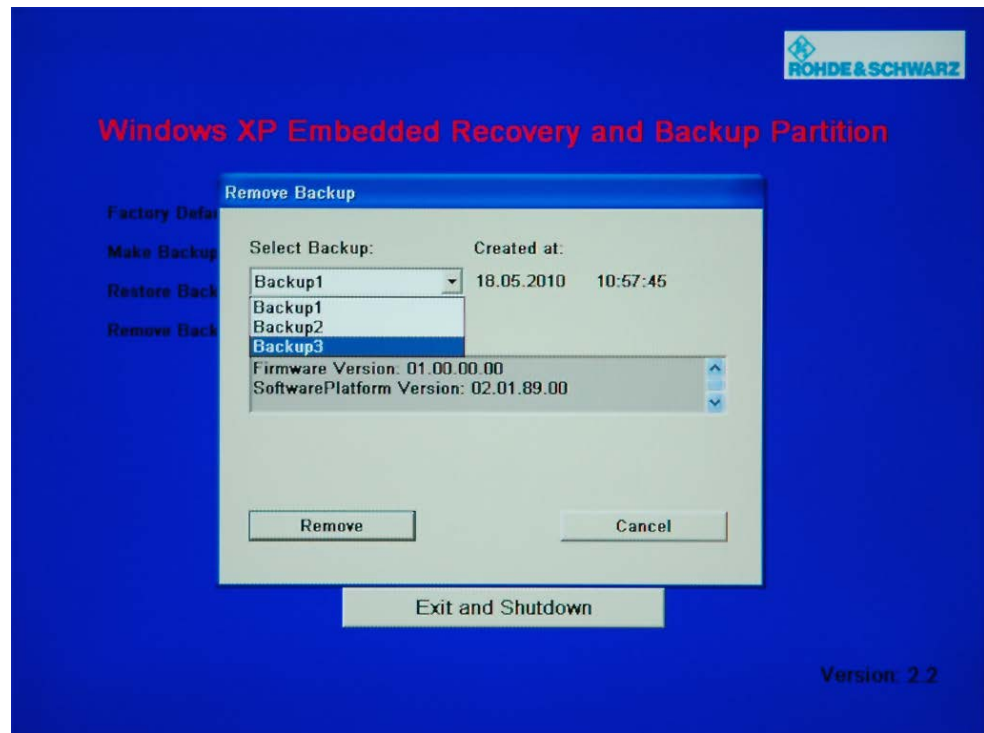

3. Under "Select Backup", select the backup to be deleted.

4. Click "Remove".

After the deletion, the R&S DVMS returns to the "Remove Backup" dialog as long as backups are still available. If the last backup is deleted, the "Windows XP Recovery and Backup Partition" dialog is displayed again.

5. Click "Cancel" to return the "Windows XP Embedded Recovery and Backup Partition" dialog.

6. Click "Exit and Shutdown".

7. Turn off/on the R&S DVMS manually.

## 9 Maintenance

The R&S DVMS does not need a periodic maintenance. Clean the outside of the instrument when necessary and check the rated data from time to time.

If any problem arises, contact one of our customer support centers. The addresses of our customer support centers are provided at the beginning of this manual.

### 9.1 Cleaning the Instrument

#### **WARNING**

##### **Shock hazard**

Before cleaning the R&S DVMS, make sure that the R&S DVMS is disconnected from all power supplies.

1. Clean the outside of the R&S DVMS using a soft, lint-free dust cloth.
2. Make sure that vents are not obstructed.

#### **NOTICE**

##### **Instrument damage caused by cleaning agents**

Cleaning agents contain substances that may damage the R&S DVMS, e.g. cleaning agents that contain a solvent may damage the front panel labeling or plastic parts.

Never use cleaning agents such as solvents (thinners, acetone, etc), acids, bases, or other substances.

### 9.2 Replacing the Fuses

The R&S DVMS is protected by two fuses (IEC 127 – T 3.15 H / 250 V) that are an integral part of the AC power connector.

#### **WARNING**

##### **Shock hazard**

Before replacing a fuse, make sure that the R&S DVMS is disconnected from all power supplies.

Always use fuses supplied by Rohde & Schwarz as spare parts, or fuses of the same type and rating.

**To replace the fuses**

1. Open the lid of the AC power connector.
2. Lift the fuse holder out of its slot.
3. Exchange the two fuses.
4. Put the fuse holder back in its slot and close the lid.

## 9.3 Storing the Instrument

The storage temperature range of the R&S DVMS is given in the data sheet. If the R&S DVMS is to be stored for a longer period of time, it must be protected against dust.

Repack the R&S DVMS as it was originally packed when transporting or shipping. The two protective foam plastic parts prevent the control elements and connectors from being damaged. The antistatic packing foil avoids any undesired electrostatic charging to occur.

If you do not use the original packaging, provide for sufficient padding to prevent the R&S DVMS from slipping inside the package. Wrap antistatic packing foil around the R&S DVMS to protect it from electrostatic charging.

# Index

## Symbols

1 PPS REF IN connector .....	16
10 MHz REF IN connector .....	16

## A

AC power supply connector .....	14
AC power switch .....	14
Activating the TS bit rate monitoring (example) .....	32
Administrator ID .....	38
AF OUT connector .....	16
Arrow keys .....	12

## B

Backing up system partition .....	39, 43
prerequisite .....	40
BACK key .....	12
Bench operation .....	10

## C

Checking	
accessories .....	10
provided options .....	26
Checking the gross bit rate (example) .....	30
Checking the net bit rate (example) .....	30
Checking the PSI table PAT (example) .....	34
Checking the TS synchronization (example) .....	28
Connecting	
external devices .....	23
power supply .....	23
Connector	
1 PPS REF IN .....	16
10 MHz REF IN .....	16
AC power supply .....	14
AF OUT (headphones) .....	16
Local area network (LAN) .....	14
USB .....	14
Conventions .....	7
Creating a basic configuration (example) .....	28
Cursor keys .....	12

## D

Deleting system partition backups .....	46
DNARROW key .....	12
Documentation overview .....	7
DVB-T/H receiver module .....	16
DVB-T/T2 receiver module .....	17
DVB-T2 receiver module .....	19

## E

Electromagnetic interference .....	23
External devices .....	23

## F

FAULT status display .....	13
Firewall settings .....	36

Firmware	
options .....	26
update .....	38
Front panel .....	12
Fuse	
replacing .....	48

## G

Getting started manual .....	7
------------------------------	---

## H

Help system .....	7
-------------------	---

## I

IP address	
changing .....	36

## K

Key	
BACK .....	12
DNARROW .....	12
LEFTARROW .....	12
OK .....	12
RIGHTARROW .....	12
UPARROW .....	12

## L

LEFTARROW key .....	12
Local area network (LAN) .....	35
Local area network (LAN) connector .....	14
Login	
Windows XP .....	38

## M

Maintenance .....	48
-------------------	----

### Manual

Getting started .....	7
User manual .....	7

Measurement example .....	27
activating the TS bit rate monitoring .....	32
checking the gross bit rate .....	30
checking the net bit rate .....	30
checking the PSI table PAT .....	34
checking the TS synchronization .....	28
creating a basic configuration .....	28
requirements .....	27
setup .....	27

### Module

DVB-T/H receiver .....	16
DVB-T/T2 receiver .....	17
DVB-T2 receiver .....	19
S/S2 receiver .....	20
TS/IP interface .....	21
TS interface .....	15

## N

Navigation keys .....	12
-----------------------	----

Network		
configuring card .....	36	
connecting to .....	35	
disconnecting from .....	35	
Non-volatile RAM .....	26	
<b>O</b>		
OK key .....	12	
Operating system .....	38	
Options		
checking .....	26	
firmware .....	26	
<b>P</b>		
Packing the instrument .....	49	
Password		
Windows XP .....	38	
POWER status display .....	13	
Power supply		
connecting to .....	23	
Provided options		
checking .....	26	
Putting up the instrument .....	10	
<b>R</b>		
Rack mounting .....	11	
RAM		
non-volatile .....	26	
Rear panel .....	13	
Recovering system partition .....	39	
factory default .....	45	
prerequisite .....	40	
selected version .....	44	
Recovery/backup partition dialog .....	42	
REMOTE status display .....	13	
Replacing fuses .....	48	
RIGHTARROW key .....	12	
<b>S</b>		
S/S2 receiver module .....	20	
Sample application .....	27	
activating the TS bit rate monitoring .....	32	
checking the gross bit rate .....	30	
checking the net bit rate .....	30	
checking the PSI table PAT .....	34	
checking the TS synchronization .....	28	
creating a basic configuration .....	28	
requirements .....	27	
setup .....	27	
Shipping damage inspection .....	9	
Software		
installing .....	39	
Software options		
installing .....	38	
Start menu .....	39	
Status display		
FAULT .....	13	
POWER .....	13	
REMOTE .....	13	
Storing the instrument .....	49	
Switching off the instrument .....	26	
Switching on the instrument .....	25	
<b>T</b>		
TCP/IP protocol		
configuring .....	36	
TS/IP interface module .....	21	
TS interface module .....	15	
<b>U</b>		
Unpacking the cardboard box .....	9	
UPARROW key .....	12	
USB connector .....	14	
external devices .....	23	
User manual .....	7	
User name		
Windows XP .....	38	
<b>W</b>		
Warranty .....	10	
Windows XP .....	38	
administrator ID .....	38	
backing up system partition .....	43	
deleting system partition backups .....	46	
login .....	38	
password .....	38	
prerequisite for recovering/backing up system partition .		
.....	40	
recovering/backing up system partition .....	39	
recovering system partition .....	44, 45	
recovery/backup partition dialog .....	42	
Start menu .....	39	
user name .....	38	