

CDMA2000

WCDMA

Bluetooth



GSM

1xEV-DO

Analog

TDMA

Version
07.00February
2006

Universal Radio Communication Tester R&S® CMU 200

THE multiprotocol tester for current and future mobile radio networks

- ◆ Extremely high-speed testing
- ◆ Highly accurate measurements
- ◆ Modular future-proof design
- ◆ Comprehensive spectrum analyzer
- ◆ Fast switching between networks

**ROHDE & SCHWARZ**

Testing the 3rd generation

Low cost of ownership

For more than 70 years, Rohde & Schwarz has always been at the forefront of mobile radio technology. We continue this tradition of RF test and measurement with the Universal Radio Communication Tester R&S®CMU 200. The R&S®CMU 200 is a third-generation-platform design that offers true scalable multimode functionality.

The R&S®CMU 200 reflects the many years of expertise Rohde & Schwarz has gained in the world of mobile radio. In recent years, the company has helped to launch overwhelmingly successful mobile radio systems.

Rohde & Schwarz is a preferred supplier to many of the leading mobile equipment manufacturers and is the market leader for mobile radio test sets.

The R&S®CMU 200 is part of a complete range of mobile radio test equipment, encompassing everything from conformance test systems to system simulators, turnkey functional board test / final test systems and simple sales-counter Go/NoGo testers.

The base unit with its standard-independent module test provides many general-purpose measurement facilities for the development of all kinds of standards within its wide and continuous frequency range. If extended by the appropriate options, the R&S®CMU 200 offers the hardware and software necessary to handle your 3G, 2.5G and previous-generation testing applications, including analog.

Selecting the R&S®CMU 200 is a decision for the future and results in a total cost of ownership that is sure to be among the lowest due to the following factors:

- ◆ The completely modular design of hardware and software components eliminates unnecessary investments right from the start merely because a feature might be needed at some point in the future. You only pay for what you need
- ◆ Maximum production output in a compact 4-rack-unit-high package with minimum power dissipation allows compact production space layout
- ◆ If an expansion becomes necessary because your needs grow, the modularity of the R&S®CMU 200 concept will make this easy. Many expansions may be installed on site. You pay for them only when you need them
- ◆ With the intuitive R&S®CMU 200 user interface, even less experienced users do not require extensive training
- ◆ A new remote interface syntax reflects the inherent modularity of this real multimode tester

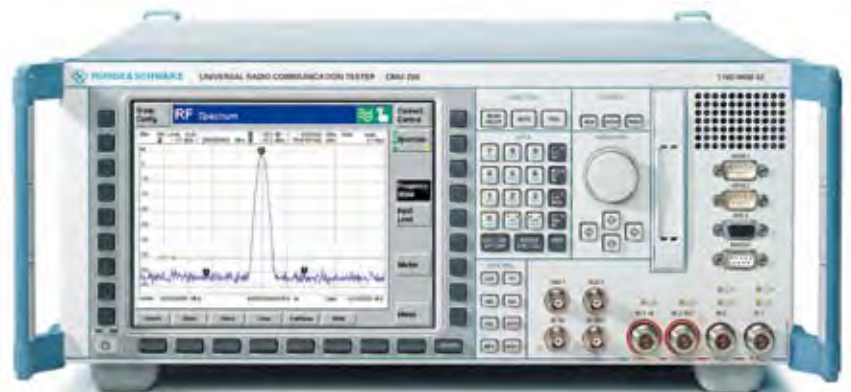

The R&S®CMU 200 targets a wide range of applications but is primarily optimized for the high accuracy and speed demanded in increasingly quality-conscious manufacturing processes. The picture shows the front panel for desktop use.

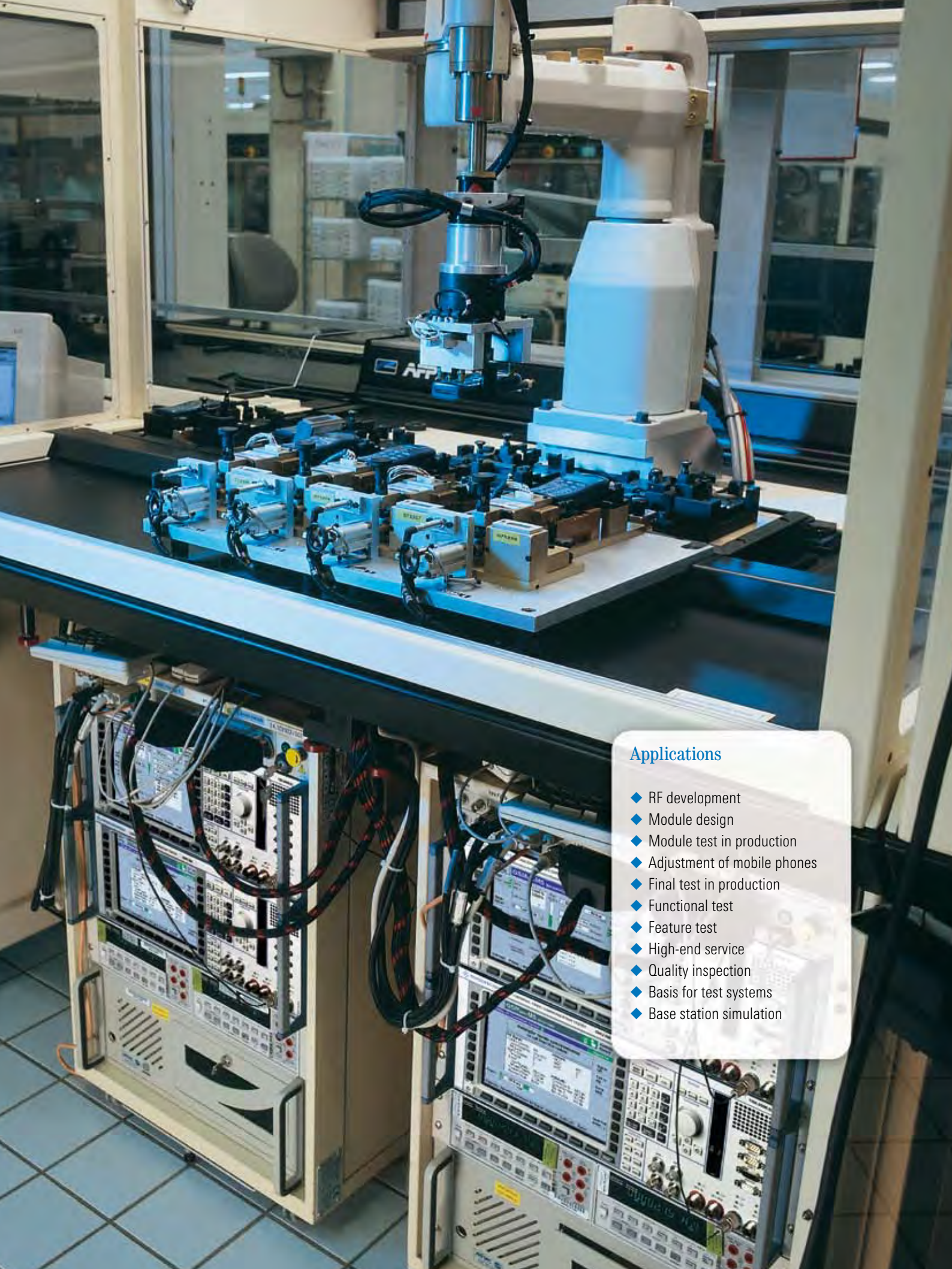

Applications

- ◆ RF development
- ◆ Module design
- ◆ Module test in production
- ◆ Adjustment of mobile phones
- ◆ Final test in production
- ◆ Functional test
- ◆ Feature test
- ◆ High-end service
- ◆ Quality inspection
- ◆ Basis for test systems
- ◆ Base station simulation

Usability

The R&S®CMU 200 key strengths

The Radio Communication Tester R&S®CMU 200 brings premium cost-effectiveness through a variety of features, with extremely fast measurement speed and very high accuracy being the two most important ones. In addition, the secondary remote addressing of the tester's modular architecture makes for intelligent and autonomous processing of complete measurement tasks and fast control program design.

Maximum accuracy

In a production environment, the tester's high accuracy allows devices under test (DUTs) to be trimmed for maximum battery lifetime without compromising quality. In the lab, the R&S®CMU 200 enables the development engineer to partly replace conventional, dedicated premium-quality instruments and save desktop space at the same time. High-precision measurement correction over the entire frequency and dynamic range as well as compensation for temperature effects in realtime are critical factors for achieving the R&S®CMU 200's excellent accuracy.

The globally standardized Rohde & Schwarz calibration system can check the R&S®CMU 200's accuracy at a service center close to you or, in some cases, on your premises. A worldwide network of these standardized automatic calibration systems has been implemented in our service centers. Highly accurate and repeatable calibration can be performed wherever you are. Your local Rohde & Schwarz representative offers customized service contracts. For large-scale users of the R&S®CMU 200, a compact level verification system is available in addition.

Owing to the high resolution of the extremely bright high-contrast TFT display, even the finest details can be displayed

Direct branching to all associated menus makes for a uniquely flat menu structure

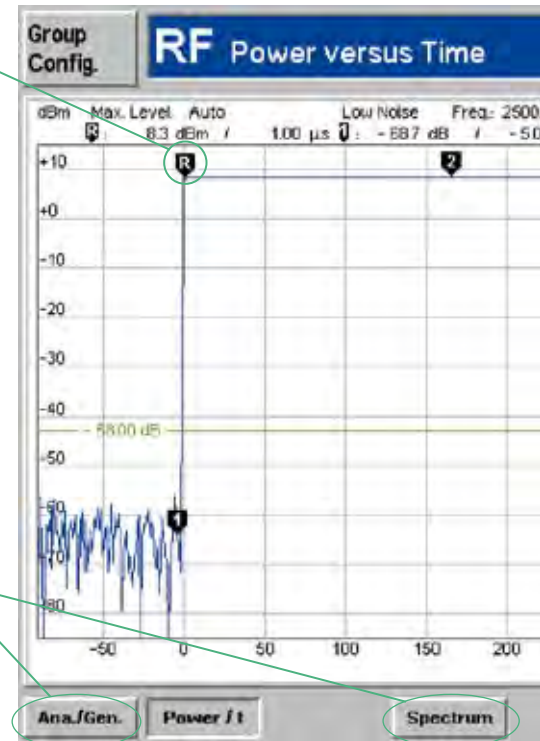

Top speed

The high processing speed is due to extensive use of ProbeDSP™ technology, parallel measurements and innovative remote command processing.

- ◆ ProbeDSP™ technology
The modular architecture relies on decentralized ProbeDSP™ processing coordinated by a powerful central processor. Like an oscilloscope probe, DSPs dedicated to a specific local data acquisition and evaluation workload help to keep subsystem performance at a maximum even if additional modules are fitted to the R&S®CMU 200 mainframe
- ◆ Parallel measurements
Several RX and TX measurements can be performed in parallel. This is achieved by the fast response of the R&S®CMU 200's modular hardware as well as the high overall processing power of the instrument and the avoidance of bottlenecks by dedicated operation of the

ProbeDSP™ technology. Examples of parallel operation are measurements of BER and simultaneous phase/frequency error, error vector magnitude (EVM), magnitude error and audio, or the various spectrum measurements

- ◆ Innovative remote processing
The novel secondary addressing mode can address similar functions of each of the R&S®CMU 200 subsystems (i.e. different mobile radio standards) in an almost identical way. Using this type of addressing, new remote test sequences can be programmed by a simple cut-and-paste operation followed by the editing of specific commands to adapt the control program to the new application. Secondary addressing is fully SCPI-compliant, which means that a subsystem address, for example WCDMA, can be replaced by a string denoting a different subsystem, i.e. another mobile radio standard

As the R&S®CMU 200 offers many of its measurements in signaling and non-signaling mode, this simple visual indication of the signaling state is provided as part of the status line

This symbol shows the instrument status, i.e. remote or manual operation

For increased speed, measurements not required can be switched off to free resources for the measurements you want to focus on

Measurements are configured by twice pressing the softkey marked with the yellow triangle

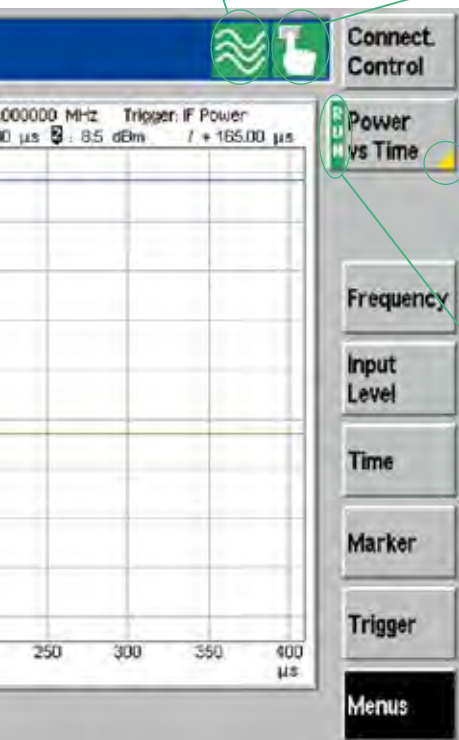

Exceptional reliability

The R&S®CMU 200 employs ultra-effective heat management between housing and individual components as well as between heat sinks and air flow. Together with the independent cooling cycles for different modules, this adds up to an optimized cooling system.

The base unit

The base unit without any options installed can be used for testing general parameters of 1st, 2nd or 3rd generation mobile phones. The R&S®CMU 200 base unit is the ideal solution for tasks at the module level, i.e. at the early production stages of all cellular standards.

Integral parts of the R&S®CMU 200 base unit are the RF generator and RF analyzer, which are complemented by a versatile, network-independent time domain menu and a comprehensive spectrum analyzer. The illustration above shows a power versus time measurement as an example.

By combining graphical and numeric overview menus, the user can select the optimal view when the R&S®CMU 200 is in manual mode.

The menu structure of the R&S®CMU 200 is very flat and uses context-sensitive selection, entry and configuration pop-up menus.

Advanced operational ergonomics have been incorporated into a highly compact and lightweight, 4-rack-unit-high package.

Key advantages of the R&S®CMU 200

Speed

- ◆ Unrivaled speed of single measurements

Accuracy

- ◆ Incomparable accuracy
- ◆ Excellent result repeatability

Modularity

- ◆ Modular hardware and software concept provides easy expansion to further functionality

Reliability

- ◆ Extremely low power consumption and effective heat conduction result in unparalleled reliability

Future-proof

- ◆ Easy migration to emerging standards

Optimized solutions for your production test requirements

Rohde & Schwarz supports R&S®CMU 200-based production test solutions through a comprehensive network of application engineering sites. The backbone of this network consists of the four system integration centers located in Asia, North America and Europe.

System integration services

Regional center project teams offer local system integration, service and support. A team of experts is ready to provide turnkey solutions, including test case programming. Custom-tailored project solutions and site process optimization are major aspects of our services.

Time to market

The key to commercial success is the time required to get a new product to market in large numbers. The crucial point is the fast transition from product development to mass production. The Cellular Phone Production Test Platform R&S®TS7180 featuring the R&S®CMU 200 meets this challenge.

R&S®TS7180 description in brief

The R&S®TS7180 test platform can test two mobile phones simultaneously. It essentially consists of two Radio Communication Testers R&S®CMU 200, two Dual-Channel Analyzers/Power Supplies R&S®NGM02, two Shielded RF Test Fixtures R&S®TS7110 for holding the DUT, and an industrial PC. The modular RF Test Fixture R&S®TS7110 can be expanded from a bed-of-nails PCB test fixture up to a fully configured test fixture for final testing, including an antenna for RF tests, a loudspeaker and microphone for acoustic tests, a camera for LC display

tests, a test pattern for the camera of the DUT, and pneumatic fingers for keypad tests.

The Shielded RF Test Fixture R&S®TS7110 for mobile phones can be adjusted by means of swap kits to accommodate several types of DUTs. It can be used for the following tests:

- ◆ RF (antenna)
- ◆ Audio
- ◆ LC display
- ◆ DUT camera and keypad and other DUT interfaces



The Shielded RF Test Fixture R&S®TS7110.

Sequence editor

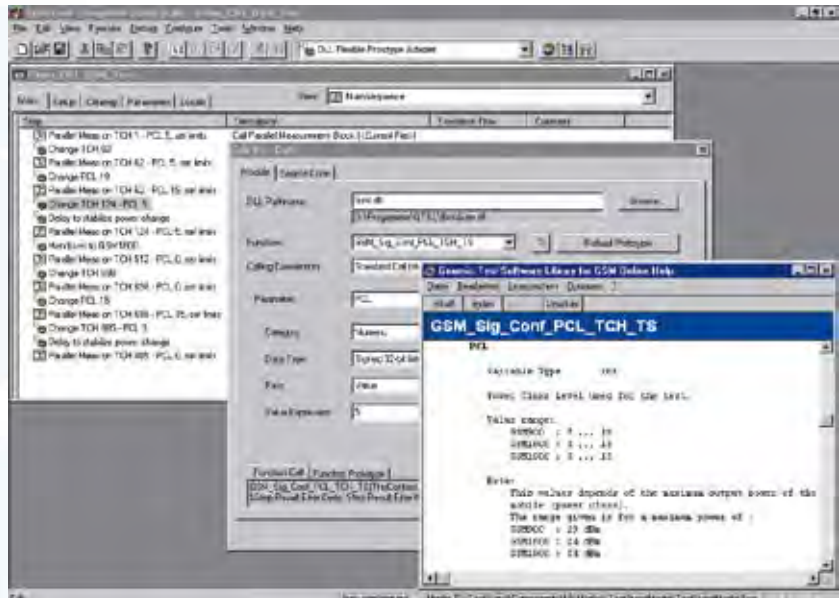

The R&S®TS7180 supports common mobile radio standards such as GSM, GPRS, CDMA2000® and WCDMA by means of ready-to-run test sequences supplied with the platform. The test sequences can be extended and modified by means of a flexible sequence editor.

The software can thus simultaneously use the resources of the parallel equipment to maximize speed in highly automated production. We can offer optimally configured test systems customized to your production environment.

Test executive and generic test software library features

The parallel hardware is fully supported by TestStand, the industry-wide test executive from National Instruments. A user-friendly connection to the available device drivers has been created to provide faster use of the test executive. This connection is established by the generic test software library (GTSL). At the same time, the toolkit concept provides ready-to-run test cases, which can be customized by the user as required.

CDMA2000® is a registered trademark of the Telecommunications Industry Association (TIA -USA).

R&S® TS 7180/7110 features in brief

- ◆ High throughput by parallel testing of mobile phones
- ◆ One system for functional board test, phone calibration and final test
- ◆ One system for all major mobile phone standards
- ◆ Easy expansion to 3rd generation technologies
- ◆ Ready-to-run Rohde & Schwarz GTSL test library for immediate use or customization
- ◆ Modular and versatile hardware/software platform
- ◆ Reduced costs due to generic concept
- ◆ Swap kit

For detailed information, see separate data sheets:

R&S® TS 7110 (PD 0757.7723)

R&S® TS 7180 (PD 0757.7469)

R&S® TS7180:
example of a
two-channel
system with one
R&S® TS 7110
fixture.



Software concept in brief

- ◆ Software platform based on LabWindows/CVI and TestStand from National Instruments
- ◆ GTSL includes ready-to-run test cases for the standards supported by the R&S® CMU 200
- ◆ Functional test sequences for RF test, calibration, signaling test, audio and acoustic test of mobile phones are supported
- ◆ Transparent and open library can be expanded by the user
- ◆ Operator interface (GTOP) and test cases can be easily customized
- ◆ Parallel test of multiple mobile phones is fully supported
- ◆ GTSL supports multithreading and instrument sharing if needed
- ◆ Test development time is reduced by as much as 80 %

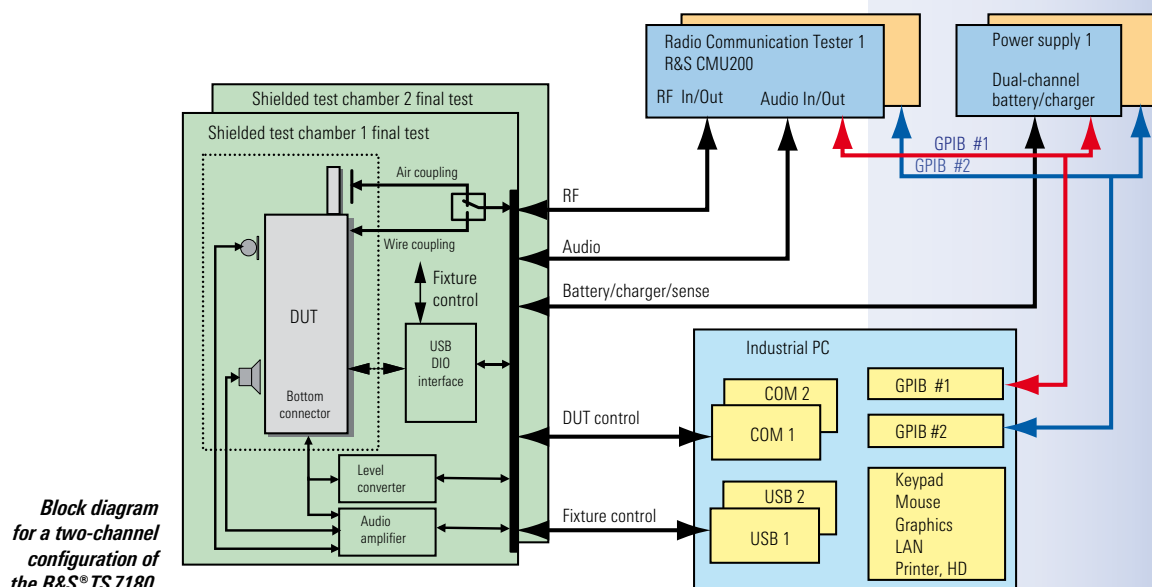

Ready for today's networks ...

GSM today

Since its introduction in the early nineties, the GSM system has won acceptance and undergone an evolution that no one could have foreseen.

Currently, the following GSM systems are deployed in support of numerous applications worldwide:

- ◆ GSM400
- ◆ GSM850
- ◆ GSM900 including
 - P-GSM (primary GSM)
 - E-GSM (extended GSM)
 - R-GSM (railway GSM)
- ◆ GSM1800 (DCS)
- ◆ GSM1900 (PCS)

Whether the application is in production, service or development, the flexible concept of the R&S®CMU 200 can handle practically all requirements: from basic RF signal generation, frequency, power and spectrum analyzer measurements for the alignment of modules in production or development, to full GSM-specific signaling in any of the above-mentioned bands, as well as module tests on frequencies anywhere in the range from 10 MHz to 2.7 GHz.

Signaling mode

The R&S®CMU 200 simulates a GSM base station RF interface, providing the signaling flexibility necessary to test the performance of a mobile phone under the influence of different signaling parameters. These parameters are normally set by the network operator but can be reproduced by the R&S®CMU 200 for test purposes. The instrument supports the latest fast location update and direct paging features.

Reduced signaling synchronized mode

The R&S®CMU 200 provides the same functionality as in the signaling mode but discards any signaling response from the mobile phone connected. This mode of operation enables testing of modules that only have layer 1 capabilities as well as very fast RF testing in production environments. It can also skip the location update procedure in order to save time.

Non-signaling mode

This mode is used to generate a signal with GSM-specific midambles and modulation in the entire frequency range from 10 MHz to 2.7 GHz. The analyzer offers the same flexibility for GSM-specific transmitter measurements such as

- ◆ Modulation analysis
- ◆ Average and peak burst power
- ◆ Power versus time, power versus slot, power versus frame
- ◆ Spectrum due to switching/modulation

GSM development

As a tool for GSM development engineers, the R&S®CMU 200 is an unsurpassed solution. The RF interface provides four input and output connectors offering a wide range of signal levels for the generation and analysis of RF signals. Input-only connectors, as well as combined input/output connectors, can analyze mobile phones or modules with a sensitivity down to -80 dBm and up to +47 dBm for the power meter. RF signals can be generated with levels from -130 dBm up to +13 dBm, depending on the selected connector.

All measurement tolerances are set by default in line with the 3GPP TS 51.010 and 3GPP TS 45.005 recommendations but may be altered to suit individual needs.

Production of mobile phones

Production is a process that calls for cost effectiveness. The R&S®CMU 200 concept is optimized for IEC/IEEE bus speed, measurement accuracy and reproducibility as well as cost of ownership. Owing to multitasking capability and parallel measurements, previously unobtainable test times can be achieved.

The flexible R&S®CMU 200 hardware concept allows the latest DSP technologies to be used in measurements, e.g. to speed up transmitter measurements (spectrum due to switching/modulation) to the extent that measurements virtually in realtime are possible.

The ability to process BER data and perform transmitter measurements at the same time allows phase/frequency error, power versus time and average power (PCL accuracy) to be measured during the time-consuming receiver test.

The accuracy and reproducibility ensure correct and stable measurement results and thus contribute to the quality and reliability of the end product.

GSM speech evolution – AMR

Maintaining good voice quality even under extremely poor transmission conditions is now possible with the innovative adaptive multirate (AMR) voice coding algorithm, which opens up new possibilities for GSM. The new algorithm allows voice quality to be gradually reduced in favor of improved error correction by

The GSM-specific non-signaling test provides generation and analysis of RF signals (GMSK or 8PSK modulated) for testing RX/TX modules or mobile phones in service mode.

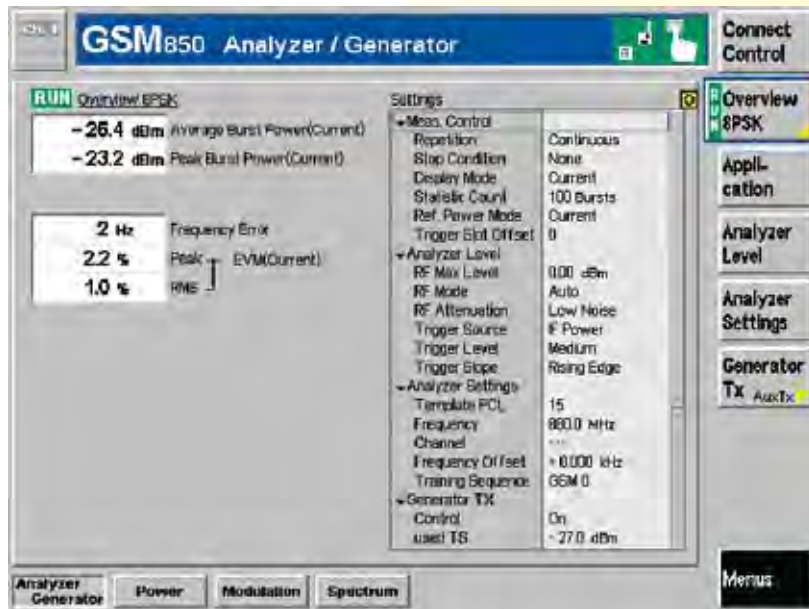

For an AMR full-rate or AMR half-rate link, a rate set of up to four combinations of voice and channel codings (codecs) can be selected from the eight full-rate and the six half-rate codecs. During a call, it is possible to switch between the rates of the rate set.

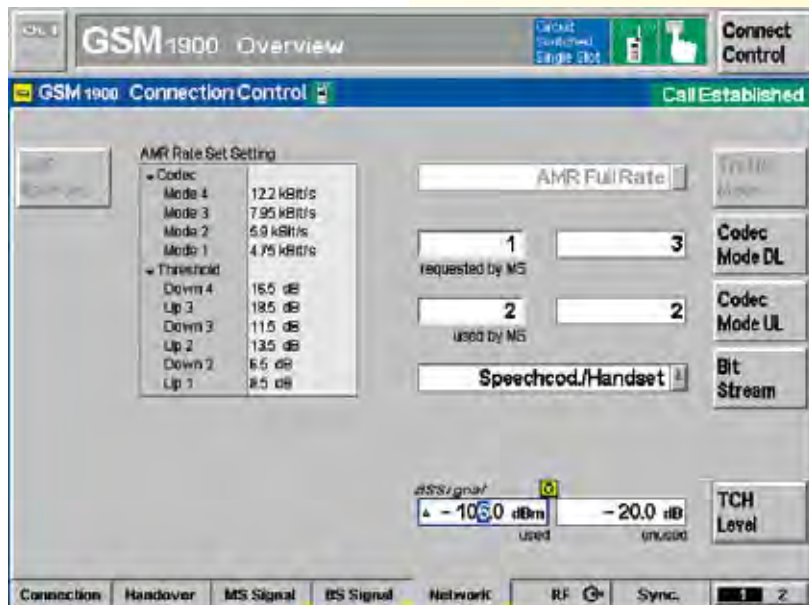

The overview menu provides fast comprehensive information on the mobile phone's RF performance; the hotkeys at the bottom of the screen provide immediate access to specific and detailed GSM measurements.

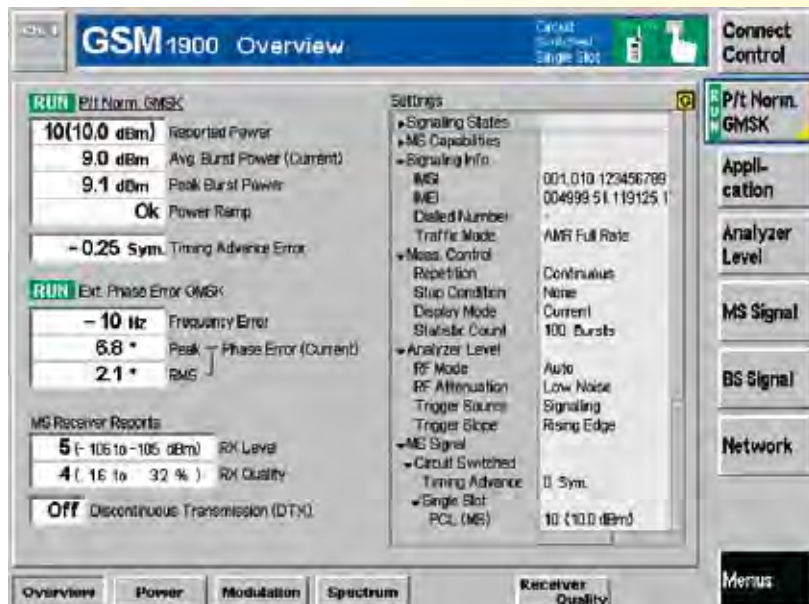

dynamically adapting the data rate. Interruptions of voice transmission can thus be avoided by allowing a barely perceptible reduction in audio quality. The R&S®CMU 200 provides all eight combinations of voice and channel coding (codecs) for full-rate and six combinations for half-rate transmission. For call set-up, a set of four rates (codecs) is selected from the eight full-rate and the six half-rate codecs. Then additional test parameters (thresholds) are selected for the mobile phone. Dynamic switchover between the selected rates is effected by AMR in-band signaling. In the uplink, the mobile phone informs the base station about the quality of the established link and proposes the optimal rate for the selected rate set to the base station.

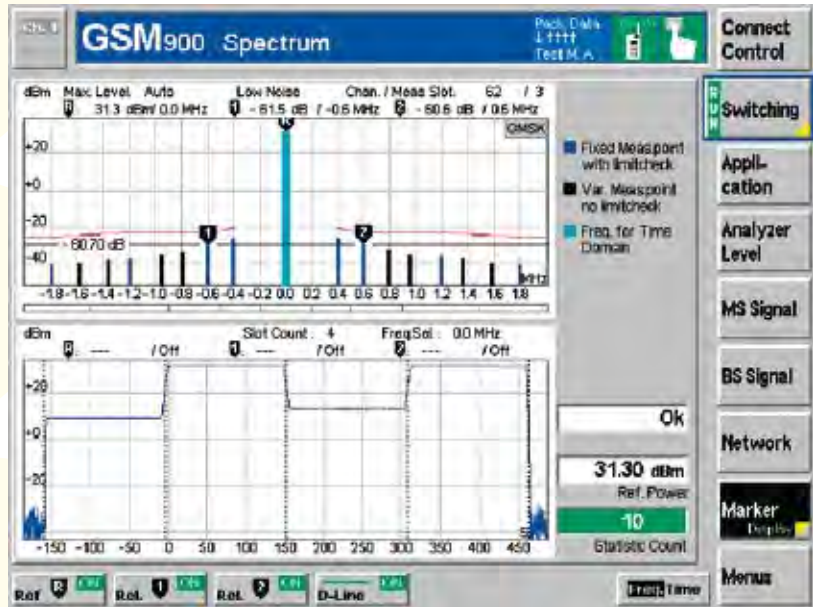

The newly designed spectrum application allows the simultaneous measurement of spectra due to switching and modulation in realtime. Moreover, the user can select a frequency offset (spectral line) by means of a marker and display it in the time domain. Transient characteristics in spectrum-due-to-switching measurements can thus be shown as a function of time.

GSM data evolution – 2.5G

The amount of data traffic in GSM networks is growing rapidly. Multislot applications such as HSCSD, GPRS and the innovative 8PSK modulation scheme EDGE are needed to support the increase in data traffic. The R&S®CMU 200 platform is not only able to handle today's standards and systems but is also designed for the needs of tomorrow.

Multislot

In the future, mobile phones will be able to use several timeslots simultaneously for data transmission and reception to further increase the data rate. The simultaneous transmission and reception of several timeslots (multislot) is the main technological challenge for circuit-switched and packet-switched applications. The following expansions of the GSM single-slot measurements enable maximum flexibility in development, and, with reduced measurement times, maximum throughput in production.

- ◆ Individual levels for all timeslots used in the downlink (DL). The R&S®CMU generates up to eight timeslots per frame in the downlink; each timeslot can be assigned a separate level. The excellent level stability of the R&S®CMU 200 generator is not impaired by multislot transmission using different levels, and allows highly accurate receiver sensitivity measurements (BER/BLER)
- ◆ Transmitter and receiver measurements are possible on every timeslot used. The new multislot concept allows independent measurements on any timeslot (TS 0 to 7) and thus covers the current and future multislot combinations without restrictions
- ◆ The R&S®CMU 200 combines high flexibility with great operating convenience. Based on the multislot capability information from the mobile phone, the R&S®CMU 200 selects the maximum possible number of timeslots for a specific application and, when changing between transmitter and receiver tests, automatically adapts the timeslot allocation
- ◆ Power-versus-time measurement (graphical display) for up to four timeslots in the uplink (UL). The templates of this application are evaluated independently for each timeslot – in line with standards and recommendations. Both GMSK- and 8PSK-modulated signals are recognized, and the templates of the relevant timeslot, depending on the modulation scheme used, are set in realtime

Multislot measurements are required for HSCSD technologies as well as for GPRS and EGPRS.

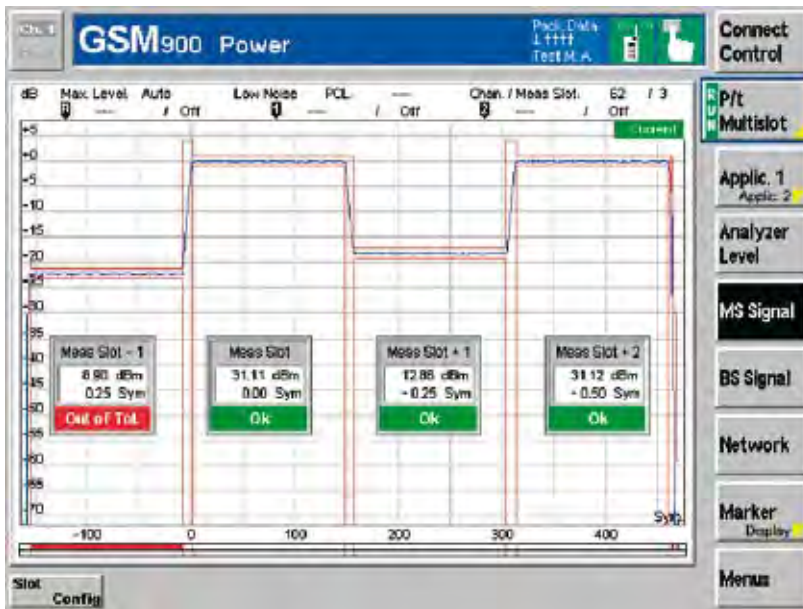

The power-versus-time multislot application can graphically display up to 4 adjacent timeslots, automatically detect GMSK- and 8PSK-modulated signals and activate the associated templates in realtime. A new zoom function allows full-screen display of up to four slots. Moreover, the user can zoom in anywhere along the time or power axis.

8PSK modulation – EDGE

In addition to multislot, a further step toward increasing the mobile radio data rate is 8PSK. By using the available GSM frame structure, the gross data rate is three times that obtained with GMSK. Error vector magnitude and magnitude error have been added to the range of modulation measurements. New templates for power-versus-time measurements ensure compliance with the specifications, as do the modified tolerance for spectrum measurements. As with all measurements provided by the R&S®CMU 200, special attention has been given to achieving maximum measurement accuracy and speed for EDGE.

GPRS/EGPRS

With newer, future-oriented methods of packet data transmission, the radio resources of existing GSM mobile radio networks can be utilized efficiently for data services. As with circuit-switched services, GPRS will also use a combination of several timeslots (multislots) and higher-level modulation in the form of 8PSK (EGPRS) to increase the data rate. The introduction of packet-oriented transmission and the associated temporary assignment of radio resources require new test concepts. The R&S®CMU 200 provides the following test modes:

3GPP test mode A (GPRS/EGPRS)

In this mode, the mobile phone continuously transmits the associated UL timeslots. The R&S®CMU 200 can carry out all TX multislot measurements available, such as the power ramp measurement of up to four adjacent timeslots simultaneously, or modulation and spectrum measurements.

Selecting the coding scheme determines whether the mobile phone is to transmit GMSK- or 8PSK-modulated data. With GPRS/EGPRS, transmission resources are usually allocated temporarily. The uplink state flag (USF) transmitted in the downlink informs the mobile phone that uplink resources have been allocated for the next block and that these resources have to be used. Correct decoding of the highly protected USF sequence is an essential prerequisite for the “dynamic allocation” and “extended dynamic allocation” modes to work properly, and is verified by the R&S®CMU 200 by means of the USF BLER test (test modes A and B). Various routines, e.g. USF BLER and false USF detection, are available.

3GPP test mode B (GPRS/EGPRS)

This mode creates a loopback in the mobile phone so that the mobile phone retransmits data blocks received from the R&S®CMU 200. To achieve maximum measurement speed, the test mode does not employ the backward error correction function used in packet data transmission, which enables the acknowledgement-based (acknowledged/not acknowledged) retransmission of erroneous data blocks. The transmitter and the receiver are active at the same time. The mobile phone returns the received data blocks to the R&S®CMU 200 unchanged, comparable to the loopback mode in circuit-switched operation. The data is looped back after channel coding, which means that the mobile phone’s coder and decoder functions are tested as well.

In addition to the measurements available in the 3GPP test mode A, test mode B enables very fast receiver test, bit error ratio and Rohde & Schwarz-proprietary block error ratio measurements in parallel to transmitter tests (BER/DBLER)

3GPP EGPRS symmetrical and non-symmetrical loopback mode (EGPRS only)

Unlike in test mode B, the data blocks are looped back before they undergo channel coding, i.e. the coders are bypassed in favor of increased measurement speed. In the symmetrical (E)GPRS loopback mode, 8PSK-modulated data blocks are received in the downlink and returned unchanged in the uplink. In the non-symmetrical mode, 8PSK data blocks are received in the downlink and returned in the uplink as GMSK-modulated data spread over the next three data blocks. Similar to test mode B, the (E)GPRS loopback mode allows simultaneous transmitter and receiver tests to be performed at an even higher data throughput.

3GPP BLER measurements – acknowledge mode (GPRS/(E)GPRS)

The BLER measurement mode employs GPRS/(E)GPRS backward error correction. The R&S®CMU 200 sends data blocks in allocated timeslots in the downlink. The mobile phone checks the data blocks for errors (CRC check) and, instead of returning the data blocks, returns only the block acknowledgements in the uplink. The mobile phone transmitter is thus only temporarily active for sending uplink acknowledgements, which means that transmitter measurements are possible only to a limited extent in the BLER mode.

For R&D requirements, the BLER menu opens up a wide range of options to determine receiver characteristics even beyond the scope of the 3GPP test scenarios. The R&S®CMU 200 furnishes an average result over all timeslots used, as well as the BLER and the actual data throughput for each timeslot. The downlink transmitter level can be varied separately for each timeslot and is displayed as an important test parameter together with the data throughput and the resulting BLER. The (E)GPRS BLER measurement is based on a new retransmission algorithm referred to as "incremental redundancy".

Incremental redundancy means that errored blocks are retransmitted using a different puncturing scheme. The R&S®CMU 200 can cycle through the puncturing schemes as specified by the 3GPP standard, or start with a specific puncturing scheme, or use the same puncturing scheme throughout (incremental redundancy OFF).

Fast production test mode for test modes A, B and (E)GPRS loop (GPRS/(E)GPRS)

Extremely fast adjustment and testing of RF parameters during mobile phone production is ensured by deactivating the GPRS/(E)GPRS protocol stack. Without using all functions on the higher protocol layer (RLC/MAC layer), the R&S®CMU 200 synchronizes the mobile phone (camping), and the data channel (PDCH) is then set up directly without executing the time-consuming routines of location update and GPRS/(E)GPRS attach. Any signaling for reconfiguring the test setup is likewise omitted. The fast production test mode developed by Rohde & Schwarz provides test conditions comparable to those defined for the 3GPP test modes. The R&S®CMU 200 performs all transmitter and receiver measurements described by 3GPP, but at a considerably higher speed.



...making the right connections.

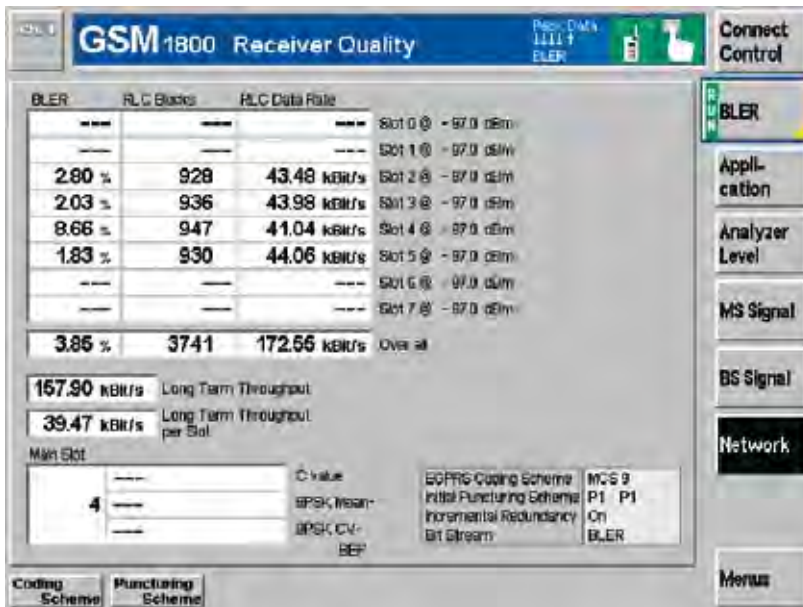

For GPRS/EGPRS, BLER measurements can be performed simultaneously on up to four downlink timeslots. The actual data throughput, the BLER and the resulting data rate (RLC/MAC layer) are displayed separately for each timeslot and as an average for all timeslots used. Furthermore an incremental redundancy performance test is performed, and the channel quality is indicated.

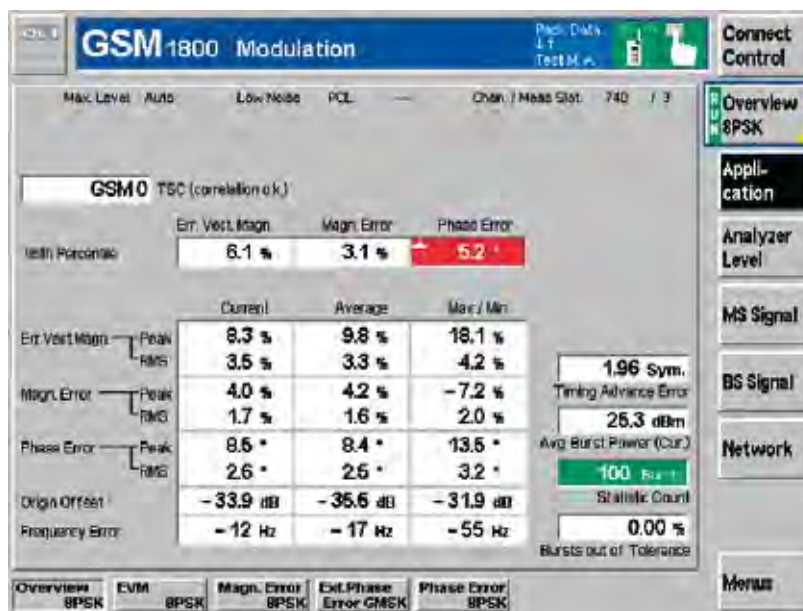

In the 8PSK mode, the modulation analysis is subdivided. The error vector magnitude (EMV), the magnitude error and the phase error can be displayed both numerically as shown above, or graphically.

GSM highlights of the R&S®CMU 200

Benchmark-breaking IEC/IEEE bus speed due to

- ◆ Optimized processing power and fast modulation spectrum measurement using latest DSP generations
- ◆ Statistical BER test based on confidence evaluation

High flexibility for R&D

- ◆ Assignment on up to 8 UL and DL slots (TS 0 to 7)
- ◆ TX/RX on any transmit slot
- ◆ Individual level generation on any DL slot used
- ◆ 3GPP packet data test mode supporting modes A, B and (E)GPRS loop
- ◆ GPRS/(E)GPRS TBF reconfiguration during established link
- ◆ GPRS/(E)GPRS intra-band handover

GMSK/8PSK measurements

- ◆ Phase/frequency error, EVM, magnitude error, origin offset, I/Q imbalance GMSK for I/Q modulator tuning
- ◆ Power versus time
 - On up to 4 UL slots
 - Normal/access
 - Peak power/average, power versus frame, power versus slot
- ◆ High-speed ACP measurement (switching and modulation measurement in parallel) with additional time domain view
- ◆ Timing error
- ◆ BER/DBLER, RBER/FER, FastBER BLER@4DL (GPRS/EGPRS)
- ◆ Incremental redundancy support ((E)GPRS)
- ◆ Power versus PCL (on 3 or 7 channels)

WCDMA in the R&S®CMU 200

The need for higher data rates is the consequence of an information-oriented society in the new millennium. The enhancement of mobile devices takes this need into account. Third-generation wireless communication poses new challenges as a consequence. Driven by ideas of the first and second generation (SIM, global roaming, CDMA technology, data services), WCDMA takes all fundamentals to unprecedented levels and adds new application fields as well as application-tailored data security. Derived from Asian, American and European ideas, 3G networks are the mobile solution for future needs as well as the current mainstream.

WCDMA FDD functionality

The tests provided by the R&S®CMU 200 are currently based on the 3GPP/FDD Release 99 WCDMA radio link standards. Regular adaptations to new releases and baselines will be made available as the standard evolves; thus the R&S®CMU 200 today supports Release 5 and is already prepared for Release 6. Most of the measurements offered comply with the 3GPP specification TS 34.121, chapter 5 (Transmitter Characteristics), chapter 6 (Receiver Characteristics), and chapter 7 (Performance Tests) and chapter 9 (Performance Requirements for HSDPA)¹⁾. The R&S®CMU 200 can be fitted with an FDD transmitter tester, an additional FDD generator, and FDD signaling hardware. Depending on the application, only the first or the first two might be needed, allowing T&M budgets to be optimized. The three parts allow the R&S®CMU 200 to be configured for non-signaling TX, TX/RX or signaling TX/RX measurements and functional testing on the UE (user equipment)

¹⁾ More about the HSDPA capabilities in the following section.

in line with the 3GPP specification. Due to the highly user-friendly menu concept, the R&S®CMU 200 provides quick access to all required measurements and optimizes the handling and thus the efficiency of complex measurement tasks with appropriate status messages and built-in statistical functions. Different handover capabilities within WCDMA/FDD such as inter-frequency handover are available in the R&S®CMU 200 WCDMA solution. Moreover, handover to other cellular networks such as GSM, i.e. inter-RAT handovers – blind or in compressed mode – are implemented and will also be expanded depending on the specification progress.

Non-signaling mode

The non-signaling mode is for generating and analyzing WCDMA (3GPP/FDD) signals in the full frequency range of the R&S®CMU 200 base unit. The R&S®CMU 200 provides WCDMA-specific TX measurements on signals with up to six DPDCHs such as:

- ◆ ACLR (adjacent channel leakage power ratio): two measurement modes, filter (bar graph) and FFT (cont. spectrum) method; absolute or relative readout
- ◆ OBW (occupied bandwidth)
- ◆ SEM (spectrum emission mask)
- ◆ CDP (code domain power): CDP vs all codes, CDP vs DCH channels, RHO vs all codes, RHO vs DCH channels; all measurements in relative or absolute readout
- ◆ Modulation (for 3GPP or general QPSK): EVM (error vector magnitude), magnitude error, phase error, frequency error, I/Q offset, I/Q imbalance, peak code domain error, RHO (waveform quality), I/Q constellation/vector/eye diagram

- ◆ Power: MAX, MIN, OFF (UE test mode)
- ◆ Power versus slot, innerloop power
- ◆ Phase discontinuity

The non-signaling mode allows tests of all essential RF parameters of the connected UE, where autoranging for the received UE signal is also applied. The measurements are performed in unsynchronized mode. No call is set up to evaluate UE performance using this mode. No 3GPP FDD generator option is needed. The capability to use different 3G dedicated triggers such as signaling trigger, IF, TPC, frame or slot trigger, HSDPCCH etc, together with the flexible trigger settings such as delay and delay offset make this an interesting tool for R&D applications where a protocol stack is not available. Dedicated level service facilities can also be supported.

Reduced signaling synchronized mode

This mode requires the 3GPP FDD generator option to be installed. This generator for the R&S®CMU 200 provides all necessary forward link channels and 3GPP-conforming orthogonal noise signals. 16 channels of OCNS can be added and their power levels changed.

The generated channels and available functions include

- ◆ P-CPICH/P-SCH/S-SCH/P-CCPCH/S-CCPCH/PICH/DPCCCH/DPDCH
- ◆ Flexible adjustments of physical parameters such as power, code, etc for physical channels, including the generation of data (pseudo noise sequences)
- ◆ TPC profiles (three predefined, one user-defined setting, seven user-selectable, five definable TPC setups)

WCDMA in the R&S®CMU 200

- ◆ OCNS (16 orthogonal channels)
OCNS/Rel. 99 and OCNS/Rel. 5
- ◆ AWGN

The R&S®CMU 200 generator can also provide non-channel coded data on the physical layer and allow slot formats from 0 through 16 to be selected. Synchronization of the UE (but still no call setup) is mandatory for RX evaluation, synchronized TX measurements and additional TX measurements such as inner-loop power control with TPC commands:

- ◆ TPC stepping measurement (UE receives TPC commands from the R&S®CMU 200 generator)
- ◆ Receiver quality: BER, BLER and DBLER (two modes, UE-assisted evaluation or RF loopback (realtime receiver option needed))

In conjunction with the Baseband Fading Simulator R&S®ABFS and the R&S®CMU 200 with optional VQ/IF interface, conditions of fading may be simulated and the results evaluated with the R&S®CMU 200. In contrast to RF fading, a baseband fading scenario allows the extremely high downlink accuracy provided by the R&S®CMU 200 3GPP FDD generator to be maintained. In addition, baseband-faded testing usually comes at a much lower cost than an RF fading solution. All fading tests are possible in synchronized or signaling mode. The optional VQ/IF interface can also be used for baseband testing when no RF section of the UE is available in R&D.

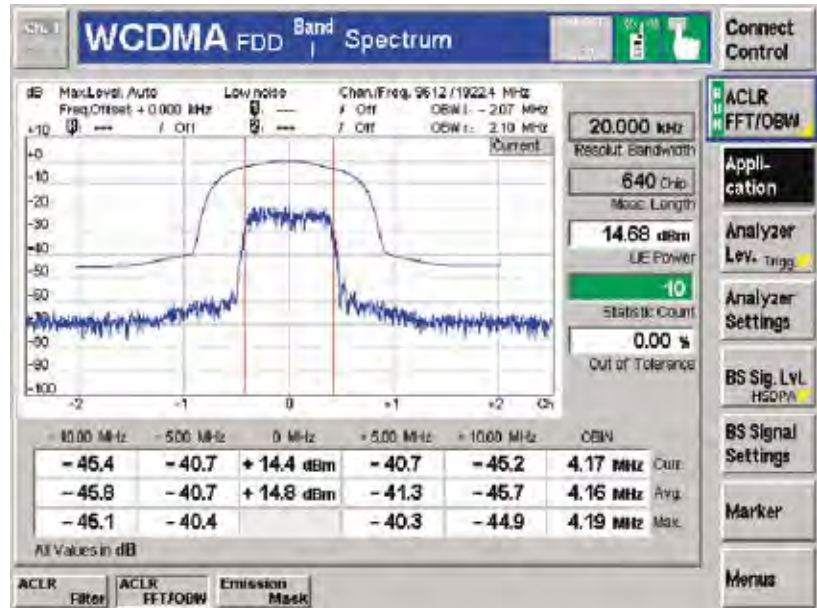

The ACLR menu shows all adjacent-channel-related information in graphical as well as in scalar numeric form. Since the ACLR FFT and OBW measurement methods are closely related, results for occupied bandwidth are displayed simultaneously. The scalar display excluding the center channel (0 MHz) may be switched to absolute readout as well.

FDD signaling mode

Signaling tests are tests in an environment closer to a true live network. 3GPP currently specifies six different operating bands for FDD (bands 1 through 6). All six bands are optionally supported by the R&S®CMU 200.

The measurements offered are largely the same as performed in synchronized mode. In signaling mode, the R&S®CMU 200 simulates one WCDMA base-station RF interface including the signaling protocol so that an FDD UE can be tested with regard to various signaling parameters. All necessary network and Node B (base station) parameters such as control and data channel configurations can be set. In addition to the non-signaling tests, R&S®CMU 200 provides features such as:

- ◆ Dynamic setting of signaling parameters
- ◆ RRC connection setup
- ◆ Readout of UE capabilities
- ◆ Authentication and security (integrity)
- ◆ Call setup (MOC, MTC)
- ◆ Call release (NIR, MIR)
- ◆ Measurements from non-signaling section
- ◆ Open-loop power control (on/off time mask for RACH preambles)
- ◆ Modulation quality measurements during the random access procedure (PRACH preambles)
- ◆ Phase discontinuity in line with 3GPP TS 31.121 chapter 5.3.13
- ◆ Innerloop power control (traffic power commands, TPC patterns A to H)

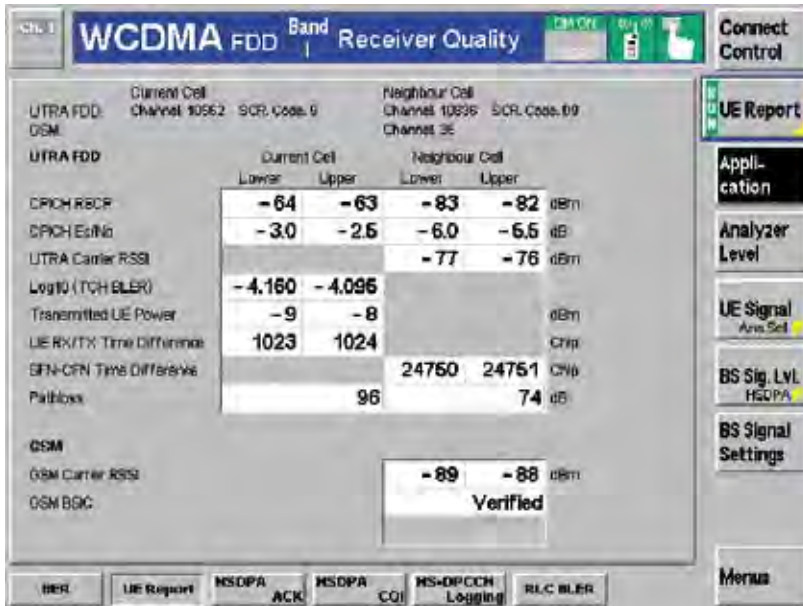

The UE reports for the current and neighbor FDD cell (can be obtained from an existing FDD cell on the air, for example) and from a neighbor GSM cell can be requested by activating the compressed mode patterns. Four predefined compressed mode patterns can be combined. The R&S® CMU 200 also provides full flexibility with user-defined patterns.

- ◆ Packet-switched connection at fixed data rate of UL/64 kbit/s, DL/384 kbit/s or 64 kbit/s UL DL

An optional AMR speech codec for WCDMA that supports the above-listed data rates is also available. It allows audio measurements to be performed with the R&S® CMU 200 audio board (option) or on an external audio analyzer, e.g. the R&S® UPL16.

The high flexibility of the signaling stack allows various parameters in the R&S® CMU 200 MMI to be changed or different Node B configurations to be simulated via remote control.

Quality assurance

Due to its high measurement repeatability and accuracy, the R&S® CMU 200 is the right choice to help ensure a consistently high level of quality. WCDMA-specific measurements such as BER/BLER and EVM, plus the full implementation of complementary (i.e. ACLR and OBW) measurements provide an excellent test platform for high-quality products. Unrivalled AF/audio and RF/fading performance allows test setups at a low price and compact size with high test depth.

- ◆ Test mode/test loop activation command (test loop mode 1 transparent and test loop mode 2 with and without uplink CRC)
 - ◆ BTFD (blind transport format detection) with false transmit format detection ratio (FDR) and transport format indicator (UL TFCI)
 - ◆ Receiver quality: BER, BLER and DBLER (RF loopback)
 - ◆ Readout of UE measurement reports on current and neighbor cell (UTRA/GSM) (with activated compressed mode (CM))
 - ◆ Several possibilities for handovers: from WCDMA to GSM (blind and compressed mode), and back from GSM to WCDMA (blind handover), including neighbor cell measurement
- The measurements can be performed on different radio access bearers (RAB) such as:
- ◆ SRB at 2.5 kbit/s, 3.4 kbit/s and 13.6 kbit/s
 - ◆ AMR at 12.2 kbit/s, 10.2 kbit/s, 7.95 kbit/s, 7.4 kbit/s, 6.7 kbit/s, 5.9 kbit/s, 5.15 kbit/s, 4.75 kbit/s (codec set A to H, M) with selectable audio loopback
 - ◆ RMC at 12.2 kbit/s, 64 kbit/s, 144 kbit/s, 384 kbit/s
 - ◆ Asymmetric RMC at UL/144 kbit/s DL/64 kbit/s UL/384 kbit/s DL/64 kbit/s UL/384 kbit/s DL/144 kbit/s UL
 - ◆ Video call in loopback mode at 64 kbit/s fixed data rate UL, DL

WCDMA in the R&S®CMU 200

WCDMA development

The well-structured, user-friendly menu design and the clear-cut screen layout provide quick access to all features and ensures trouble-free monitoring of the device under test (DUT). The tester can be switched between 3GPP and general QPSK modes to increase the usability with DUTs under development. For analysis of the signaling messages between the UE and the R&S®CMU 200, an optional message analyzer is available.

Production of mobile phones

The production of mobile phones requires time-efficient and cost-effective measures that simultaneously ensure both high throughput and high yield. Owing to market-leading accuracy and to the unique IEC/IEEE bus concept of the R&S®CMU 200, these two goals can be easily achieved in production environments.

Repair applications (manufacturing and service centers)

With its outstanding versatility, the R&S®CMU 200 is also a suitable tool for mobile phone troubleshooting. Four configurable RF ports and a built-in RF connector switch matrix (standard unit) are provided to enable flexible signal level ranges and switching. Since each R&S®CMU 200 measurement menu allows an independent setting for the input and output ports, a phone fixture and spectrum analyzer probe can remain permanently connected to the R&S®CMU 200.

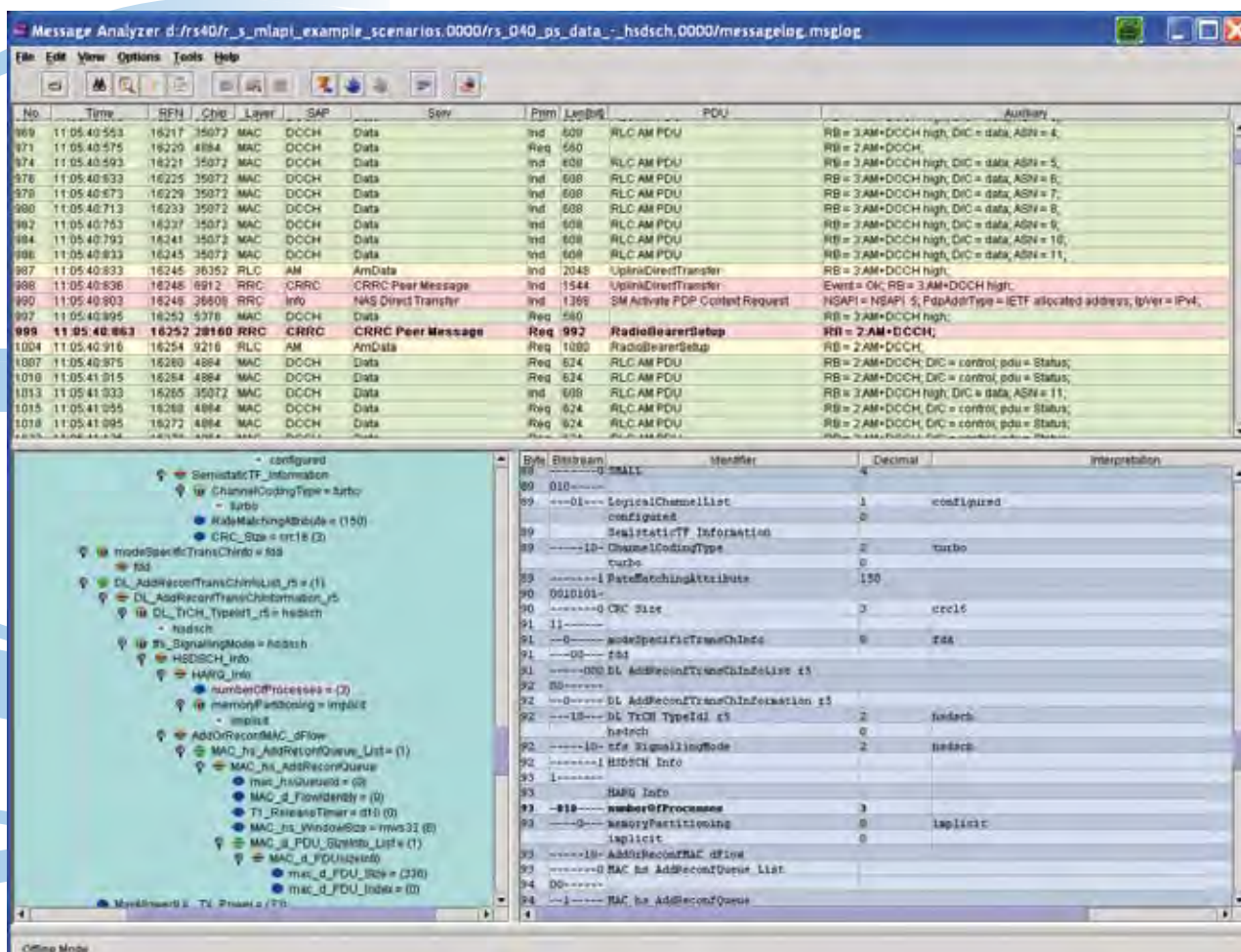

After the software has been ported to the mobile phone, users often want to record protocols to optimize internal processes or to perform an error analysis that may be necessary. The R&S®CMU-Z46 WCDMA message analyzer and recorder option allows all universal terrestrial radio access network (UTRAN) protocol layers to be recorded, which can then be used for more detailed analysis. When installed on an external PC and communicated to the R&S®CMU 200 via an Ethernet connection, this powerful tool permits in-depth analyses, including transport layer analyses.

WCDMA highlights of the R&S®CMU 200

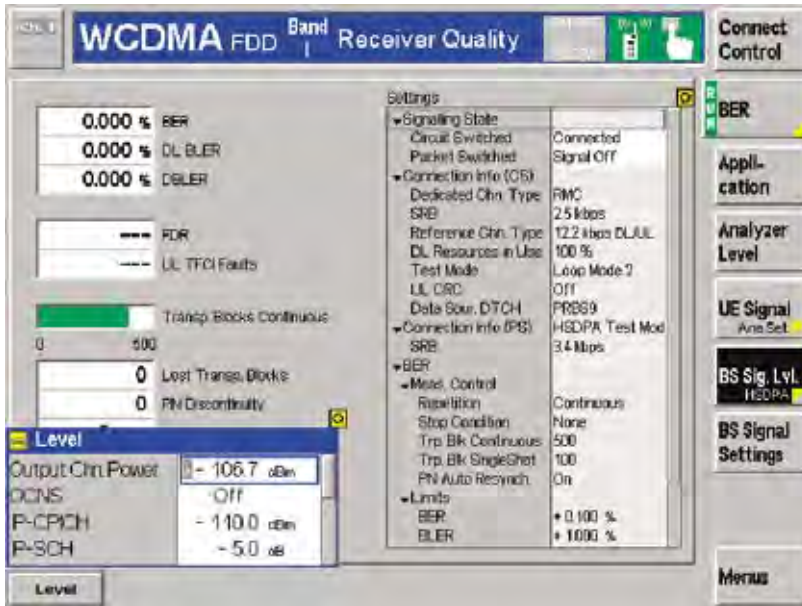

This measurement shows the receiver sensitivity measurement on a UE at -110 dBm P-CPICH in test-loop mode 2. In addition to the minimum DL power condition, the compressed mode can be selected to see if the same sensitivity is maintained with compressed mode. The R&S®CMU 200 also provides a "lost transport blocks" counter for easier troubleshooting.

Switching standards

Fast switching between 3GPP FDD and any of the other numerous standards supported by the R&S®CMU 200 is part of the standard instrument and can be achieved by simply pressing a button.

Versatile production test layouts are possible and true multimode test bays that utilize the flexibility and throughput of the R&S®CMU 200 are no longer a concept of the future.

Multimode UE applications are possible using the handover capabilities of the R&S®CMU 200 such as blind and compressed mode handover to GSM as well as blind handover from GSM back to WCDMA.

- ◆ Benchmark-breaking ICE/IEEE bus speed (see highlights of base unit)
- ◆ Combined measurements, many different measurement mode
- ◆ Multiband/multimode testing
- ◆ Powerful signaling capabilities available: MOC, MTC, MIR, NIR, inter-frequency handover, inter-RAT handover, cell reselection
- ◆ Display of UE capabilities
- ◆ Large selection of radio access bearers (RABs) with various data rates including video call in loopback mode
- ◆ Up to 384 kbit/s reference measurement channels (symmetrical and asymmetrical)
- ◆ 3GPP-conforming generation of OCNS (orthogonal channel noise simulation) and AWGN
- ◆ Separate and highly accurate level setting for individual DL code channels
- ◆ Simple voice test using AB/echo by tester; dedicated audio tests available (option)
- ◆ User-defined settings of RF-relevant signaling parameters
- ◆ On/off time mask for open loop power measurements including the system info settings
- ◆ Power vs slot menu for realtime measurement of RMS UE transmit power in up to 100 consecutive slots
- ◆ 3G dedicated trigger options such as IF power, signaling, slot, frame, preamble, PRACH message part, TPC, compressed mode and change of TFC trigger
- ◆ External message analyzer for reading signaling message log files (option)
- ◆ Simple interactive operation in manual MMI
- ◆ Configuration of compressed mode for neighbor cell reports
- ◆ Handover and BER/BLER procedures during compressed mode

WCDMA evolution – High speed downlink packet access

High speed downlink packet access

Fast, high-quality data services are already possible with WCDMA FDD Rel. 99 (frequency division duplex). As an extension of this functionality, 3GPP Rel. 5 (HSDPA) increases the data rate up to 14.4 Mbit/s by implementing new data transfer techniques. The increased data rate is made possible for two reasons: Both communicating entities (Node B and UE) implement complex data transfer principles in layer 1, and, even more important, up to 15 new transport channels (HS-DSCHs) have been introduced in the downlink signal.

The R&S®CMU 200 takes part in this evolutionary trend by offering the software option for HSDPA in the signaling and non-signaling modes. All you need to do is install the option – no extra hardware is needed. The only requirement for the HSDPA software option is existing WCDMA functionality in the R&S®CMU 200.

HSDPA functionality

The HSDPA software option enables the R&S®CMU 200 to generate up to four HS-SCCHs and up to five HS-DSCHs in the downlink signal. Thus, the R&S®CMU 200 can handle HSDPA categories 1 to 6 plus 11 and 12 or up to the 3.6 Mbit/s class, which corresponds to a maximum data rate of 4.6 Mbit/s. Furthermore, the R&S®CMU 200 hardware is already prepared for the next step, which supports HSDPA categories with up to 15 HS-DSCHs (7 Mbit/s/10 Mbit/s class) and HSUPA as well.

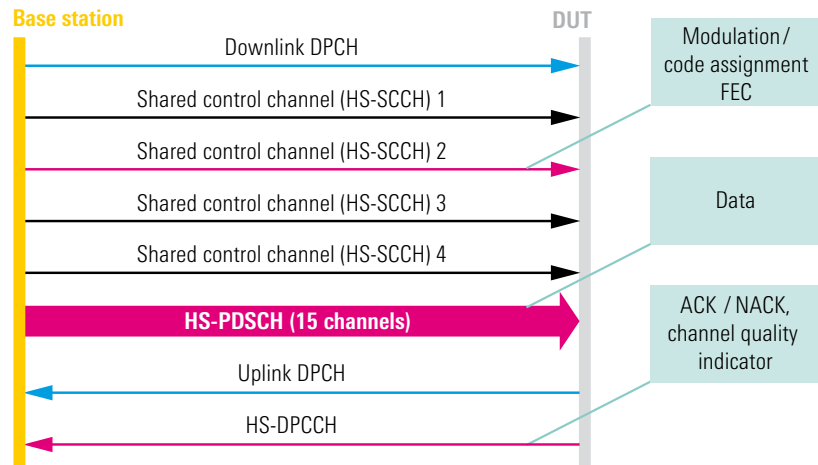

Channel structure of the physical channels with HSDPA.

Configuring the HSDPA channels

The R&S®CMU 200 downlink signal can be configured in various ways, depending on the test purpose. This yields maximum flexibility. Each of the four HS-SCCH can be configured in power or channelization code, or they can be disabled. The HS-DSCH can also be changed with respect to power code, channelization code, and data pattern, and it can be configured in three ways:

- ◆ In accordance with the fixed reference channels (H sets). You can select any of the fixed reference channel configurations defined by 3GPP that use QPSK and 16QAM modulation for five HS-DSCHs
- ◆ In accordance with the CQI mapping table. Here, it is possible to use either a setting that corresponds to a fixed CQI value (1 to 30) or automatically change the setting between the corresponding parameters for a minimum and maximum CQI value in every TTI. You can also configure the R&S®CMU 200 downlink signal in accordance with the received CQI in the uplink signal (the follow CQI feature)

- ◆ User-defined configuration. Any of the following parameters can be adjusted individually: configuration of the downlink (HS-DSCH) channels including TTI distance, number of HARQ processes (1 to 8), transport block size, number of HS-DSCHs, modulation, redundancy versions (0 to 7), etc.

Non-signaling and signaling mode

Since HSDPA is primarily implemented in layer 1, interaction can already be provided between the UE and the tester in the non-signaling mode. The downlink signals (HS-DSCH) are configured in accordance with the responses in the uplink signal HS-DPCCH (CQI, ACKs and NACKs).

All the described functionalities in the non-signaling mode are also provided in the signaling mode.

This screenshot shows the ACK report menu, which counts the ACKs, NACKs, and DTXs for a specific HARQ process or for all HARQ processes. The throughput is calculated from the number of ACKs and the size of the transport blocks transmitted.

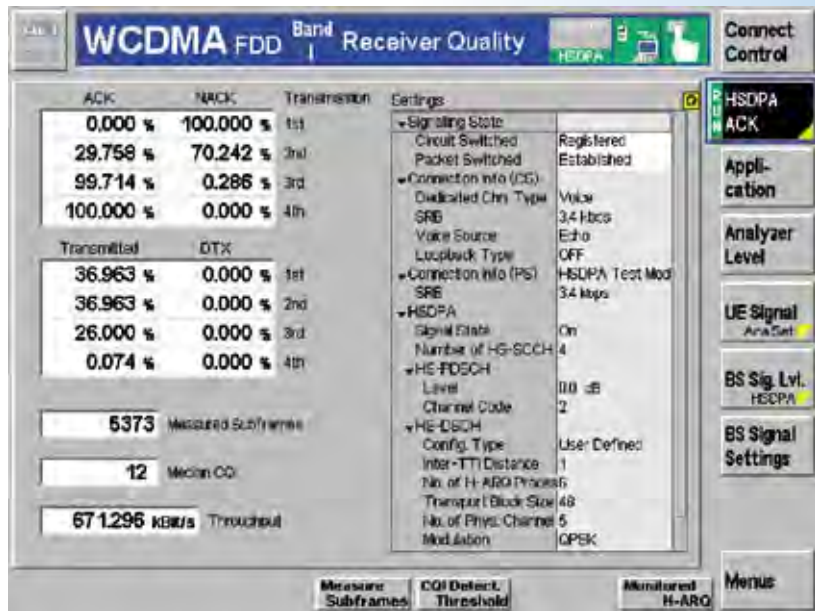

The HS-DPCCH logging application of the receiver quality measurement provides the ACK/NACK messages and reported CQI values that the UE returns in a sequence of 60 consecutive HS-DPCCH subframes (12 WCDMA frames).

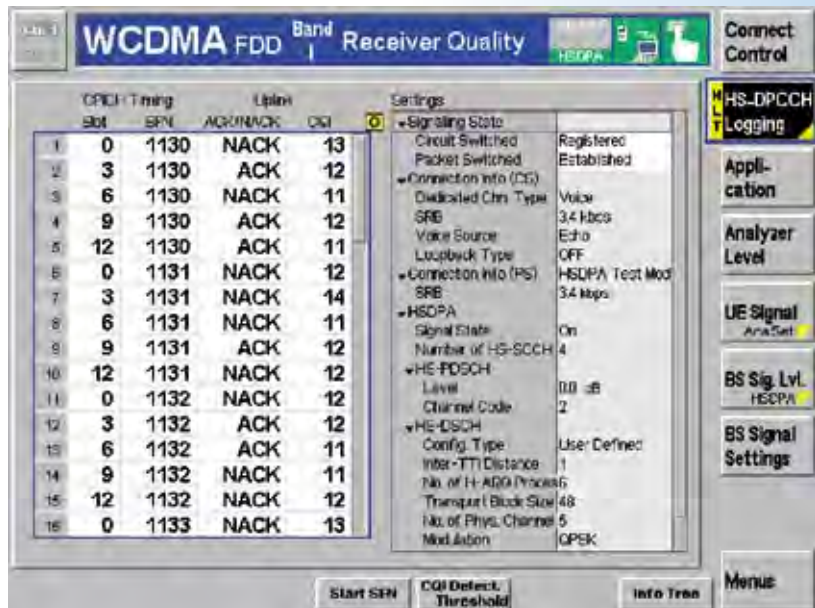

This screenshot shows the reporting of the CQI and testing for two cases: whether more than 90% of the reported CQIs (except DTX) are in the interval [median CQI - 2, median CQI + 2] and whether the HS-PDSCH BLER on the median CQI is less than or greater than 10%.

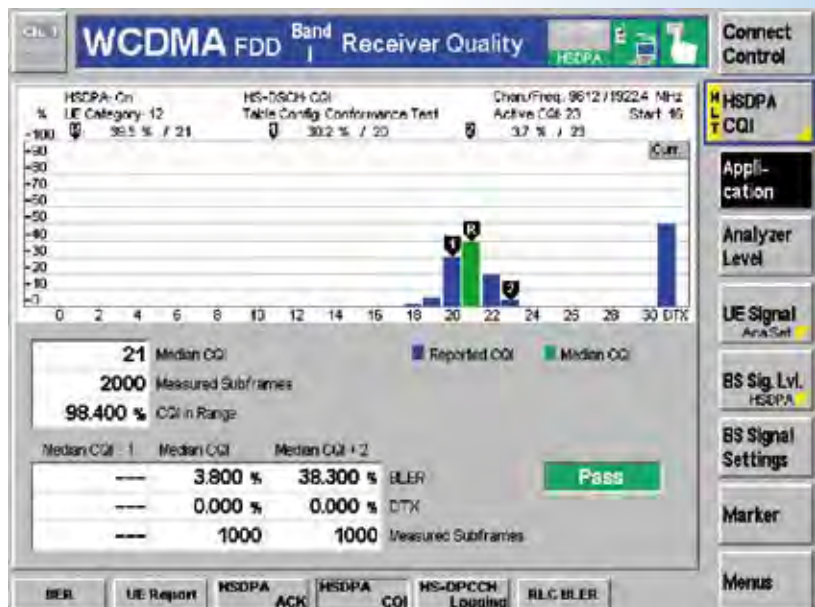

WCDMA evolution – High speed downlink packet access

New required measurements

In Rel. 99, the measurements that are defined in chapter 5 (transmitter characteristics) of TS 34.121 are performed using a 12.2 kbit/s reference measurement channel (RMC). This RMC defines one code channel on the I branch (D-DCH) and one code channel on the Q branch (DPCCH); both are continuously transmitted (except compressed mode cases). With Rel. 5, there is an additional code channel for the uplink, the HS-DPCCH. This code channel is on the Q branch in the case of the 12.2 kbit/s RMC and in the case of a signaling radio bearer (SRB). This code channel is continuously transmitted, thus resulting in power transients that are not due to inner loop power control. Furthermore, the HS-DPCCH slot boundaries are not necessarily aligned with the slot boundaries of the DPCH, which means that power transients may occur within the inner loop power control period.

The following properties of the HS-DPCCH pose new challenges for UE transmitter design:

- ◆ The HS-DPCCH channel is switched on and off as a function of the dynamic time scheduling in the downlink, i.e. it is switched on or off each time an HSDPA HARQ process is active and scheduled
- ◆ The beginning and end of the channel are not synchronized with the timeslot pattern of the other uplink channels, but may be shifted by $n \times 256$ chips relative to this pattern

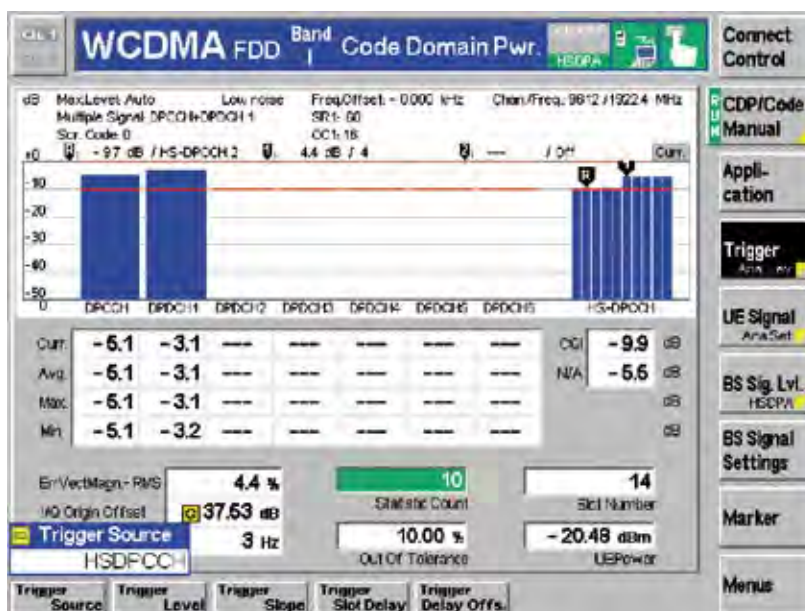

The measurement diagram in code domain power measurement shows the DPCCH, the DPDCCH and the HS-DPCCH. The measurement for the HS-DPCCH is divided into ten bars which represent the powers of the ten HS-DPCCH symbols in the DPCH slot. Since the power of the HS-DPCCH changes in accordance with its content, the timing offset between the HS-DPCCH and the downlink DPCH can be set to 50% alignment. Thus, the power change between two slots transmitting different data can be shown. The first one transmits ACKs or NACKs and the next one contains CQIs, for example.

Transmitter measurements

The characteristics mentioned above place new demands on the RF functionality of DUTs, which in turn calls for an expansion of 3GPP TS34.121 RF test definitions. For example, an HS-DPCCH that is out of tolerance may produce undesired spectral components, which may affect results both in modulation and spectral (ACLR, SEM) measurements. The power setting of the UE in limit ranges and transitional regions, for example at maximum power, must correspond to a predefined nominal behavior. The R&S®CMU 200 can start measurements (modulation, spectrum, power, etc) using a time-variable HS-DPCCH trigger. By means of this trigger, the additional RF component introduced by the HS-DPCCH uplink signal can be included or omitted in measurements. Moreover, nominal beta factors can be set on the R&S®CMU 200 for determining the code power of each uplink code channel (DPCCH, DPDCCH and HS-DPCCH).

Performance measurements

In addition to the transmitter characteristics, items defined in chapter 9 of 3GPP TS 34.121 related to performance tests are also covered in the R&S®CMU 200.

In the throughput measurement, the R&S®CMU 200 provides a receiver sensitivity measurement by counting the ACKs, NACKs and DTXs for a specific HARQ process or for all HARQ processes. The throughput is calculated from the number of ACKs and the size of the transport blocks transmitted.

The R&S®CMU 200 can be configured in such a manner that its downlink channels (HS-DSCH) correspond to the UE category and to the CQI returned from the UE (the follow CQI feature).

Depending on the feedback from the UE (ACKs, NACKs, or DTX), the R&S®CMU 200

HSDPA highlights of the R&S®CMU 200

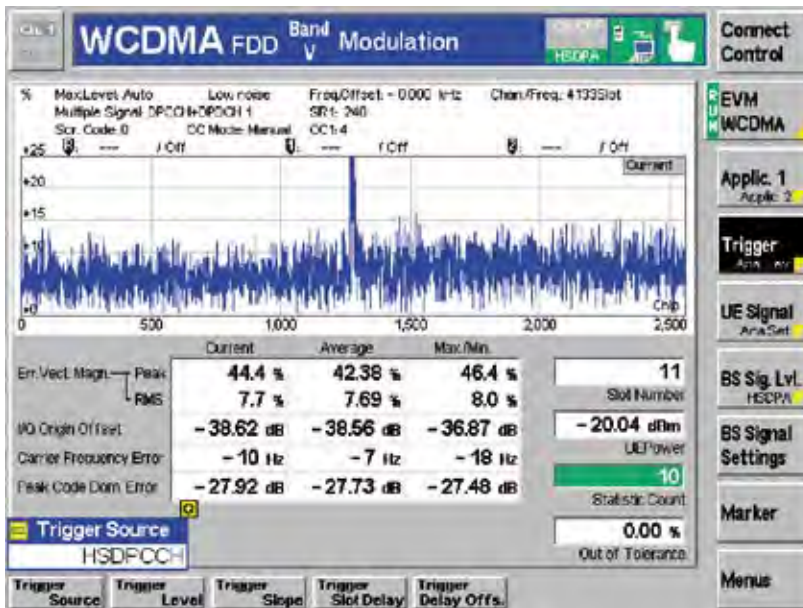

This screenshot shows the effect of a power rise after the first five SF256 symbols in the slot. An EVM, magnitude and phase error surge appears. The HS-DPCCH trigger in the case of the modulation measurements always marks the DPCCH slot that contains the start of an HS-DPCCH sub-frame in which a valid ACK or NACK is expected.

can send a different redundancy version of the data package, repeat the package with the same redundancy version or continue with a new package. During this scenario, several measurements or reports are performed in parallel:

- ◆ Percentage of transmissions that were transmitted or retransmitted (ACKs and NACKs) or not answered at all (discontinuous transmission, DTX)
- ◆ Values are specified for the 1st, 2nd, 3rd, and 4th redundancy versions
- ◆ Median of the CQI values reported by the UE
- ◆ Throughput measurement

Furthermore, chapter 9 of 3GPP TS 34.121 defines various tests for checking the reporting of CQI under AWGN propagation conditions or under fading propagation conditions.

These measurements can be performed in the R&S®CMU 200 by means of the CQI reporting test. The measurement is performed in two stages:

In the first stage, the R&S®CMU 200 checks whether more than 90 % of the reported CQIs (except DTX) are in the interval (median CQI - 2, median CQI + 2) and whether the HS-PDSCH on the median CQI is greater than or less than 10 %. If the BLER on the median CQI is < 0.1, the test is repeated at (median CQI + 2); otherwise, it is repeated at (median CQI - 1). The BLER at (median CQI + 2) must be > 0.1, the BLER at (median CQI - 1) must be < 0.1.

The R&S®CMU 200 also provides an additional HS-DPCCH logging function. This function can be used to track the HS-DPCCH in order to verify the response to the HARQ process scheduled by the R&S®CMU 200. The logged HS-DPCCH data may also be compared to logging data from the UE. The log contains the ACK/NACK and CQI data for 60 consecutive HS-DPCCH subframes. The log starts with subframe 0 of the next system frame or with the starting system frame number (SNF).

- ◆ Generation of up to four HS-SCCHs and up to five HS-DSCHs. The configuration of downlink HS-DSCHs can be performed in three different ways:
 - 3GPP-compliant fixed reference channels (H sets for QPSK or 16QAM)
 - In accordance with the CQI mapping table (1 to 30)
 - User-defined (providing full flexibility)
- ◆ Force NACK function to test the performance of the UE by sending a corrupted block in the downlink
- ◆ CQI interaction, in which the R&S®CMU 200 generates the downlink signal (HS-DSCH) in accordance with the received uplink CQI (follow CQI setting)
- ◆ Transmitter measurements by means of the power, modulation, code domain power and spectrum measurements in the presence of an HSDPA (dedicated HS-DPCCH trigger) in accordance with chapters 5 and 6 of 3GPP TS 34.121
- ◆ Receiver measurements by counting ACKs, NACKs, DTXs for a specific HARQ process or all HARQ processes and the data throughput
- ◆ CQI reporting test and HS-DPCCH logging tool
- ◆ Configuration capabilities for the power offset parameters Δ ACK, Δ NACK and Δ CQI to control the power of the HS-DPCCH
- ◆ DPCH timing offset between the DPCH and the HS-DPCCH.
- ◆ Code domain power vs time measurement
- ◆ Two RAB types:
 - 12.2 kbit/s RMC + HSDPA (with closed loop mode 1 RLC TM and loop mode 2)
 - 3.4 kbit/s SRB RAB + HSDPA

TDMA in the R&S® CMU 200

TDMA overview

The broad acceptance of TDMA (IS-136) is based on its very flexible and powerful technology as well as on its compatibility with AMPS, which is widespread. Derived from analog AMPS, the TDMA standard is ready for step-by-step evolution to the third generation of mobile radio technology. This fact shows the need for a test instrument that is flexible enough to cover all future needs as well as the current standards.

For TDMA (IS-136) signaling functionality, the R&S® CMU 200 requires the universal signaling unit (R&S® CMU-B21) as well as the software option R&S® CMU-K27 for the cellular band or R&S® CMU-K28 for the PCS band.

Due to the highly user-friendly menu concept, the R&S® CMU 200 provides quick access to all required measurements, optimizing handling and thus efficiency.

Signaling mode

The R&S® CMU 200 simulates a TDMA base-station RF interface including the signaling protocol so that a mobile phone can be tested with regard to different signaling parameters. All necessary network and base-station parameters can be set, such as control and traffic channel configuration, neighboring channels setup, etc. A MAHO report can also be generated.

Non-signaling mode

The non-signaling mode is for generating and analyzing TDMA (IS-136) signals in the frequency range from 10 MHz to 2.7 GHz. The R&S® CMU 200 provides TDMA-specific measurements such as:

- ◆ Power
- ◆ Modulation
- ◆ Spectrum
- ◆ Power versus time
- ◆ BER

TDMA (IS-136) development

With its superb versatility, the R&S® CMU 200 is the most suitable tool for the development of mobile phones. Four configurable RF connectors are provided to enable flexible signal generation and analysis. The power meter can evaluate signals in a range from -80 dBm to +47 dBm, whereas the generator outputs signals from -130 dBm to +13 dBm. The clearly structured and user-friendly menu together with the clear-cut screen layout provide quick access to all features and ensure trouble-free monitoring of the device under test.

Quality assurance

Due to its high measurement repeatability and accuracy, the R&S® CMU 200 is the right choice to ensure a consistently high level of quality in production. TDMA-specific measurements such as BER, error vector magnitude (EVM) and EVM10, where only the first 10 symbols are taken into account, provide an excellent test platform to ensure the production of high-quality devices.

Production of mobile phones

The production of mobile phones requires time-efficient and cost-effective means that ensure both high throughput and state-of-the-art accuracy. Owing to the unique IEC/IEEE bus concept of the R&S® CMU 200, these two goals can be easily achieved in production lines. The intelligent handling of the received GPIB commands optimizes the measurement speed for all TDMA-specific measurements. In practice, this will mean significantly shorter test time and enhanced test yield.

Acoustic measurements

The implemented ACELP speech coder is able to encode and decode real audio signals and allows the R&S® CMU 200 to be used also in real acoustic measurement applications. This is equivalent to the CDMA2000® and GSM implementation of the R&S® CMU 200. The TDMA speech coder provides analog inputs and outputs and a connector for an external handset. It requires the hardware option R&S® CMU-B52 and can also be combined with the internal Audio Analyzer/Generator R&S® CMU-B41.

The mobile phone reports the received signal strength (RSSI) of the observed channels back to the R&S® CMU200 where the RSSI is displayed in the MAHO report list. It is possible to configure the neighboring channels in the network set-up. The reported BER can also be monitored.

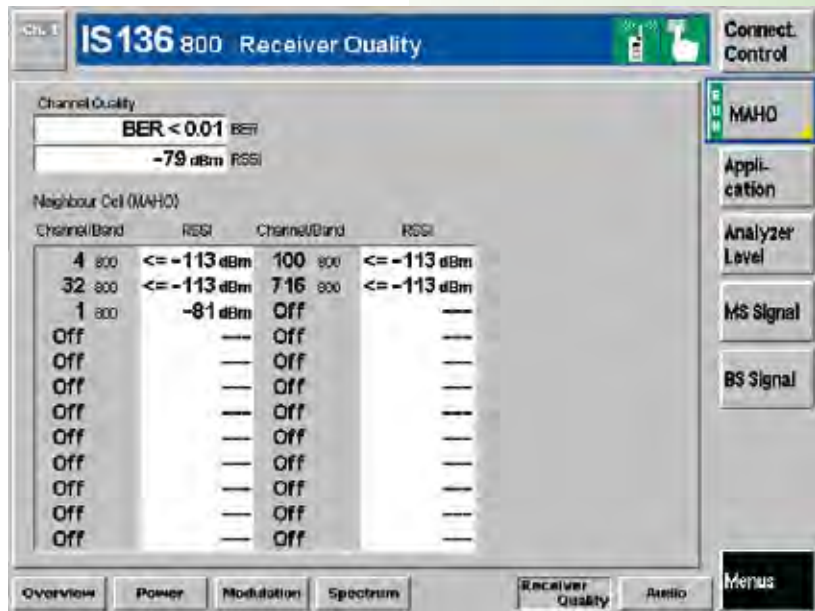

The modulation menu allows the phase error, frequency error and the error vector magnitude to be measured. The measurement results are displayed graphically. Additional measurements such as amplitude droop and timing error are taken as well and displayed numerically in the same screen.

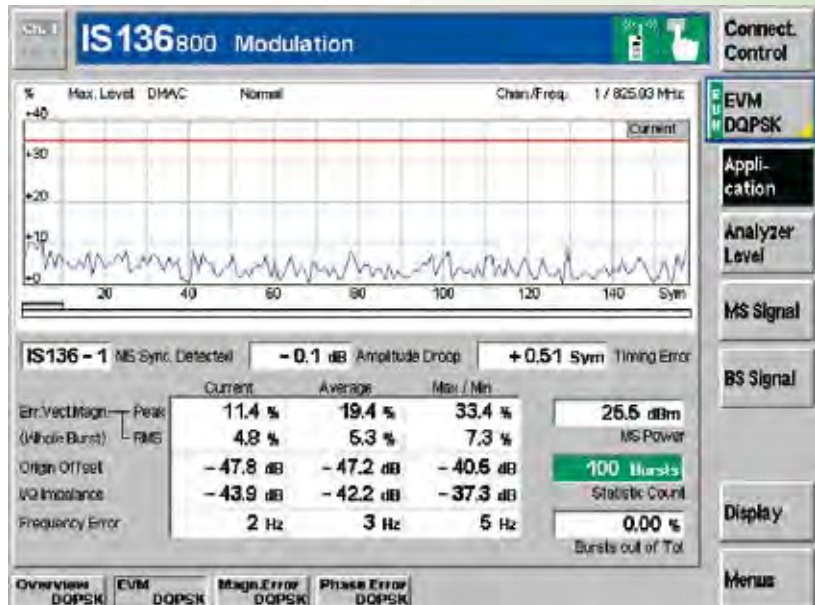

In the power menu, the mobile phone output power of the short burst or the normal burst is displayed. The R&S® CMU200 also enables leakage power measurements which indicate the mobile phone power output in timeslots not used.

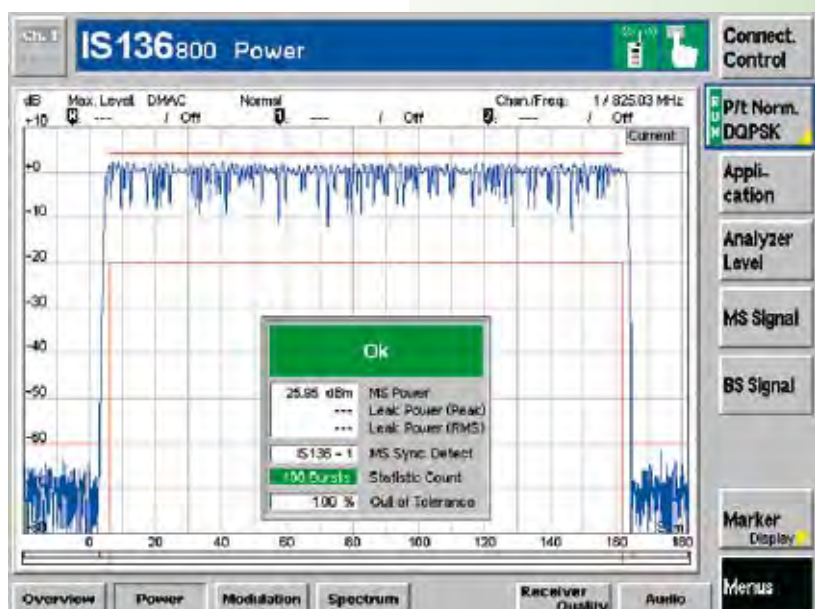

Handoffs

Handoffs are part of the IS-136 specification. Handoffs between PCS and cellular bands as well as from and to AMPS are defined and have to be tested. The R&S® CMU 200 supports IS-136 handoffs from 800 MHz to 1900 MHz (interband handoff) and vice versa. Handoffs from 1900 MHz or 800 MHz to AMPS and vice versa are also possible (intermode handoff) with the R&S® CMU 200.

Switching standards

The flexibility of the R&S® CMU 200 makes for quick and simple switching between two different standards. This is very important for IS-136, which is a dual-mode standard containing a digital (TDMA) and an analog mode (AMPS). The handoff between TDMA and AMPS can be achieved by simply pressing a button. This results in a very versatile test concept to improve the flexibility and throughput of production lines.

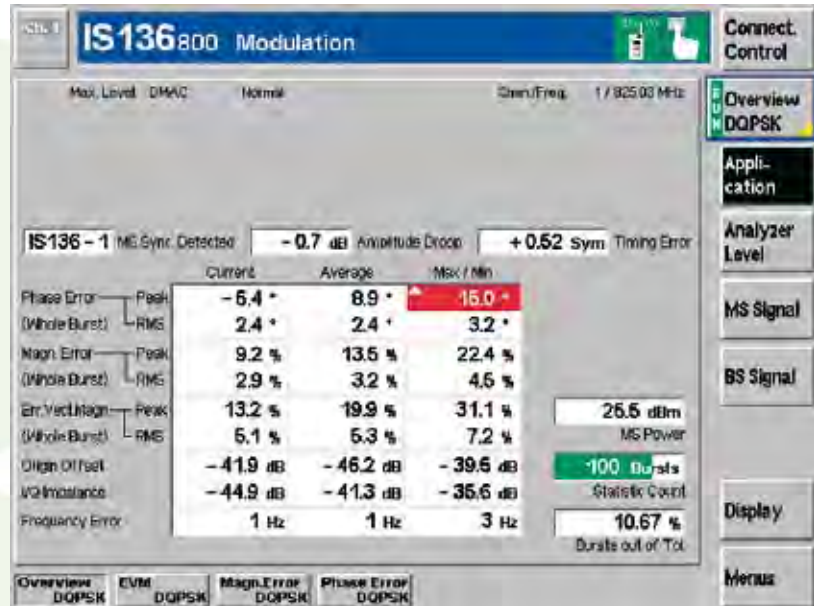

In the modulation overview menu, error vector magnitude (EVM), phase error and magnitude error are measured simultaneously and displayed in a numeric table. The user can choose either EVM, where the entire burst is considered, or EVM10, where only the first ten symbols are taken into account.



Handoffs from cellular band (800 MHz) to PCS band (1900 MHz) can be tested as well as to and from AMPS. Before handoff to a new network, the parameters for the target network can be set. This results in a large variety of different test scenarios.

TDMA highlights of the R&S®CMU 200

Basic features

- ◆ Call to or from mobile phone
- ◆ Handoff to AMPS
- ◆ Dual-band handoff

Signaling measurements

- ◆ MAHO report
- ◆ Power versus time
 - Short burst
 - Normal burst
- ◆ Modulation
 - Phase error
 - Magnitude error
 - EVM/EVM10
 - Overview of phase/magnitude and EVM simultaneously
- ◆ Spectrum
 - Adjacent channel power due to switching or modulation
- ◆ Overview
 - Signaling information

Non-signaling measurements

- ◆ Modulation
- ◆ Spectrum
- ◆ Power versus time
- ◆ BER

AMPS in the R&S® CMU 200

AMPS overview

Analog AMPS (advanced mobile phone system) is a standard system for analog mobile phone service in the United States and is also used in other countries. It is based on the frequency spectrum allocation for cellular service established by the Federal Communications Commission (FCC) in 1970. Introduced by AT&T in 1983, AMPS became the most widely deployed cellular system in the United States.

AMPS options

Although AMPS is a first generation analog standard, a substantial demand for mobile radio testers covering this standard will continue to exist in the future. Especially in the United States, dual-mode CDMA2000®/AMPS and TDMA/AMPS phones are very common.

By combining the digital standards with analog AMPS, the network operators offer their customers the advantages of the digital standards and ensure nearly 100% coverage in North America. As a consequence, Rohde & Schwarz is offering analog AMPS in addition to the digital standards TDMA and CDMA2000®. These options add analog AMPS functionality to the R&S® CMU 200 base unit:

- ◆ R&S® CMU-B21 (universal signaling unit)
- ◆ R&S® CMU-B41 (audio generator/analyzer)
- ◆ R&S® CMU-K29 (AMPS test software)

The hardware options R&S® CMU-B21 and R&S® CMU-B41 are suitable for other standards as well.

AMPS measurements and features

As for other standards, there are two categories of AMPS measurements:

- ◆ Transmitter tests for verifying the transmit part of a mobile phone
- ◆ Receiver tests for verifying the receive part of a mobile phone

AF level search routine

The AF level search routine in the TX test menu allows the user to set the desired frequency deviation of the mobile phone transmitter at a keystroke, the level of the R&S® CMU 200 modulation generator being automatically corrected.

Sensitivity search routine

The sensitivity search routine in the RX test menu automatically searches for the receiver input level at which a selectable SINAD of the demodulated signal can still be attained.

The following lists provide an overview of the most important tests implemented in the R&S® CMU-K29 option.

Transmitter measurements

- ◆ Carrier power
- ◆ Carrier frequency error
- ◆ SAT frequency error/peak deviation
- ◆ ST frequency error/peak deviation
- ◆ Modulation noise and distortion
- ◆ Hum and noise
- ◆ Electrical AF response
- ◆ Modulation distortion
- ◆ Residual AM

Receiver measurements

- ◆ Sensitivity
- ◆ Hum and noise
- ◆ SINAD
- ◆ Distortion
- ◆ AF voltage
- ◆ Electrical AF response
- ◆ Residual AM
- ◆ Audio deviation

AMPS highlights of the R&S®CMU 200

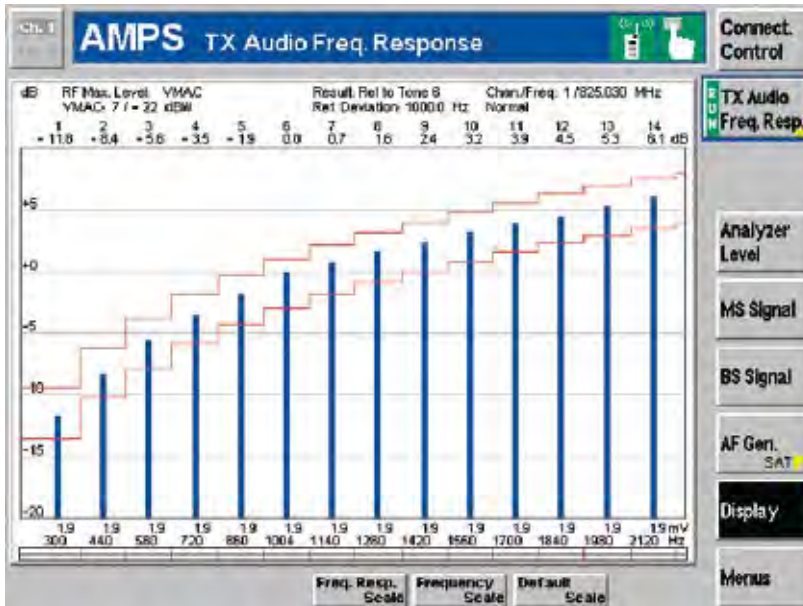

TX AF response measurement: the pre-emphasis characteristic of the mobile phone transmitter is verified by a single-shot measurement.

All the filters required for the measurements are of course preconfigured in line with specifications, but their settings can be modified for individual measurements. The RX and TX electrical AF response measurements in AMPS are usually defined as frequency sweep versus AF range. The R&S®CMU 200 offers a much faster and more modern alternative.

Using the TX and RX AF response menus of the R&S®CMU 200, the AF response is measured simultaneously at 20 test points with user-programmable level and frequency and then checked against specified tolerances (see screenshot above).

Benefits of base unit

- ◆ Platform supporting CDMA2000®, TDMA and AMPS in one box
- ◆ Wide frequency range allowing dual-mode/dual-band testing required for CDMA2000® and TDMA
- ◆ See base unit section

AMPS features

- ◆ Powerful signaling capabilities
- ◆ Base station simulation
- ◆ Mobile or base station originated call connect/disconnect
- ◆ Short measurement time ensuring high throughput
- ◆ Combined measurements
- ◆ Benchmark-breaking IEC/IEEE bus speed
- ◆ Simple interactive operation, standardized MMI
- ◆ No specialized network knowledge required
- ◆ Various handoffs from CDMA2000®/TDMA and to TDMA supported

CDMA2000® 1X in the R&S® CMU 200

CDMA2000® overview

CDMA2000® arose from the further development of cdmaOne (TIA/EIA-95) and is an enormous step toward 3G. Besides higher data rates and considerably improved efficiency, CDMA2000® is particularly noteworthy for its downward compatibility with cdmaOne. Nine different configurations (radio configurations RC1 to RC9) in the forward link and six radio configurations in the reverse link define the different connections which are specified in the IS-2000 standard.

- ◆ RC1 and RC2 define cdmaOne connections for rate set 1 and rate set 2
- ◆ RC3 to RC5 in the forward link (or RC3 to RC4 in the reverse link) define CDMA2000® connections for spreading rate 1 (CDMA2000® 1X)
- ◆ RC6 to RC9 in the forward link (or RC5 to RC6 in the reverse link) are CDMA2000® connections for spreading rate 3 (CDMA2000® 3X) only

Compared to cdmaOne, CDMA2000® 1X doubles the capacity for pure voice transmission and provides a maximum packet data rate of 307 kbit/s on a single 1.25 MHz carrier. CDMA2000® 1X is a recognized IMT-2000 3G standard, already successfully deployed in multiple networks over several continents.

R&S® CMU CDMA2000® 1X options

The CDMA2000® standard within the R&S® CMU 200 was launched in December 2001. By supporting the CDMA2000® standard, Rohde & Schwarz is enhancing the CDMA2000® 1X functionality to meet customer needs today as well as in the future.

The central component of the CDMA2000® 1X option is the Signaling Unit R&S® CMU-B83, which is a prerequisite for enabling CDMA2000® 1X functionality in the R&S® CMU 200. The R&S® CMU-B83 is designed for maximum conformance to the standard. The R&S® CMU-B83, of course, not only supports pure CDMA2000® 1X high-speed data links, but also enables the links of the previous TIA/EIA-95A/B standards.

CDMA2000® 1X is used in various frequency ranges. The standard currently defines more than ten different band classes, all of which can be supported by the R&S® CMU 200 with its universal hardware concept.¹⁾

The following options are available for CDMA2000® 1X:

- ◆ R&S® CMU-B83: CDMA2000® signaling unit (essential)
- ◆ R&S® CMU-K83: CDMA2000® 1X software for the 450 MHz band (band class 5)
- ◆ R&S® CMU-K84: CDMA2000® 1X software for cellular bands
- ◆ R&S® CMU-K85: CDMA2000® 1X software for PCS bands
- ◆ R&S® CMU-K86: CDMA2000® 1X software for IMT2000 band (band class 6)
- ◆ R&S® CMU-B85: 8k QCELP, 8k EVRC, 13k QCELP speech coder
- ◆ R&S® CMU-B87: layer 3 message monitor software
- ◆ R&S® CMU-U80: gpsOne trigger output connector

The universal hardware and software concept of the R&S® CMU 200 represents the optimum solution for the development and challenges of the CDMA2000® standard over the next few years.

CDMA2000® 1X functionality

Similarity in physical conditions and downward compatibility make the CDMA2000® 1X T & M concept very similar to that of cdmaOne. There are, however, major differences in the protocols.

The R&S® CMU 200 supports connections in all radio configurations defined for CDMA2000® 1X, i.e. TIA/EIA-95 connections as well as the usual CDMA2000® 1X high-speed connections.

Code domain power is a new and highly important measurement for mobile phones in CDMA2000®. Since several code channels are now transmitted simultaneously in the reverse link, it is necessary to check whether the power distribution of the different channels complies with the test specification (TIA/EIA-IS-98-E) for CDMA2000®. The measurement concept in the R&S® CMU 200 is based on ProbeDSF™ technology, which permits high-speed measurement of the code domain power. The emphasis is on fast measurements and clear and concise representation.

Of course, the R&S® CMU 200 also supports the requirements placed on the gpsOne test application; the R&S® CMU 200 meets the high demands for frequency and phase accuracy.

The CDMA2000® 1X implementation in the R&S® CMU 200 is based on the TIA/EIA IS-2000 Rev. 0 standard. However, features of Rev. A are partly implemented. The R&S® CMU 200 currently supports, for example, FER measurements on two supplemental channels (SCH0 and SCH1).

¹⁾ The R&S® CMU 200 already supports band classes BC0 to BC10. Additional band classes can be integrated easily if there is a market requirement.

Within a TDS0 (SO 32) connection, the frame error ratio (FER) on the fundamental channel (FCH) as well as on the supplemental channels SCH0 and SCH1 can be evaluated (as soon as CDMA2000® handsets support SCH1).

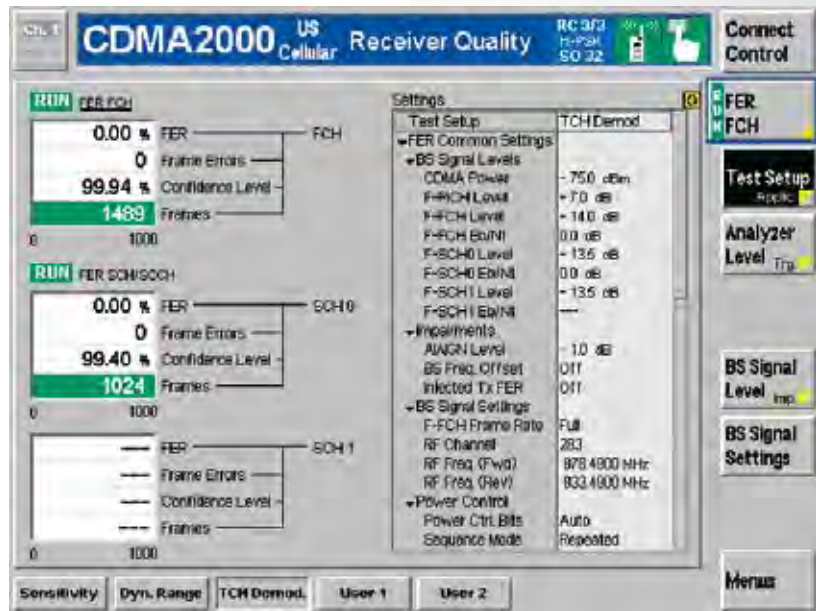

Code domain power is a highly important measurement for mobile phones in CDMA2000®. Since several code channels are transmitted simultaneously in the reverse link, it is necessary to check whether the power distribution of the different channels complies with the test specification (TIA/EIA-IS-98-E).

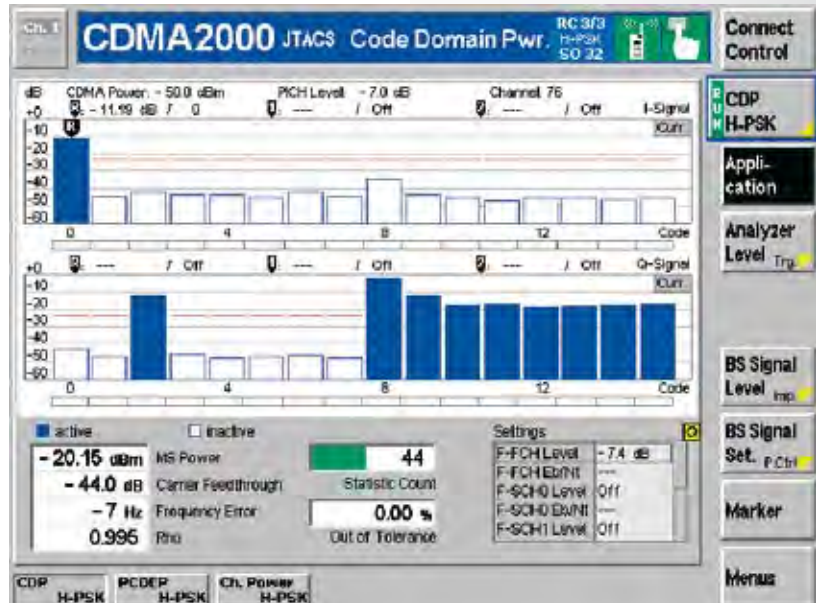

The spectrum measurement provides comprehensive ACPR measurements at four different user-definable frequencies in a ± 2 MHz range.

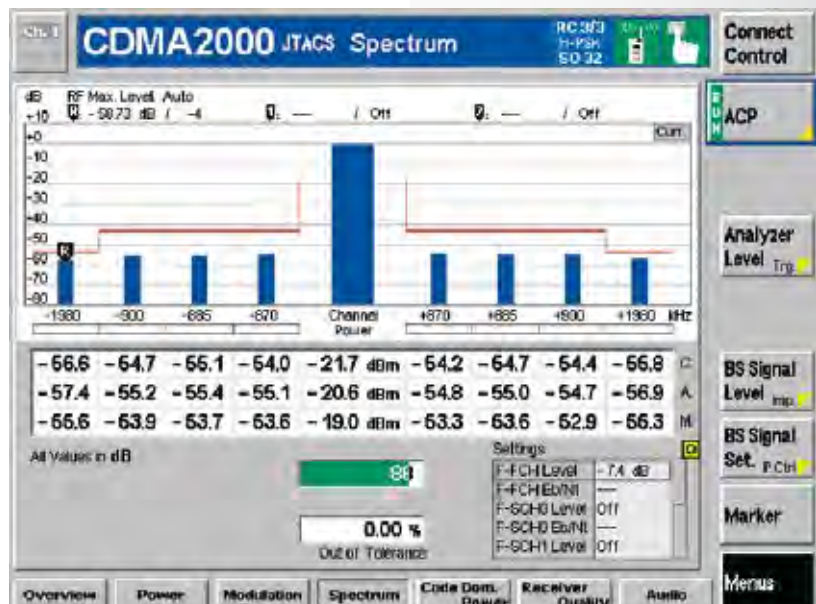

CDMA2000® 1X in the R&S® CMU 200

The R&S® CMU 200 provides a large set of different connection types (service options), making the tester ideal for R&D purposes. The following are currently possible:

- ◆ Test loop service options: SO 2, SO 9, SO 55
- ◆ Speech service options: SO 1, SO 3, SO 17, SO 0x8000
- ◆ Test data service option: SO 32
- ◆ IP end-to-end data connection: SO 33
- ◆ Short message service (SMS): SO 6, SO 14

The R&S® CMU-B85 speech coder option is a unique feature within the R&S® CMU 200. The capability to encode external audio signals and to decode digital CDMA2000® signals to analog audio makes the R&S® CMU 200, in combination with an external audio analyzer such as the R&S® UPL16, suitable for high-precision acoustic measurements on CDMA2000® mobile phones.

The layer 3 message monitor (option R&S® CMU-B87) is an extremely helpful tool for analyzing and verifying the correct implementation of the protocol stack. This Windows-based software displays and stores single messages or complete test sessions. Analysis can be performed offline, online or via the local area network (LAN).

All relevant base station parameters and connection settings can be configured in user-friendly menus.

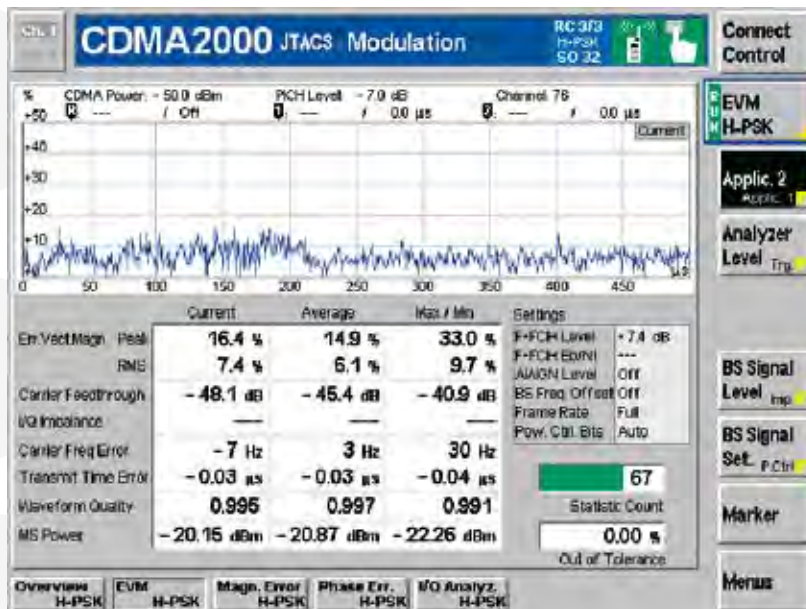

Modulation measurements allow users to check the MS transmitter. Parameters such as EVM, phase error and frequency error are displayed graphically.

As with all mobile radio networks supported by the R&S® CMU 200, two different measurement modes are available:

On the one hand, there are tests in the non-signaling mode, which permit analysis of the mobile phone without registration in the base station and without actual call setup. For this purpose, the R&S® CMU 200 generates a base station signal with all the physical channels required, which are user-configurable. This measurement mode complies in particular with requirements for high measurement speed in production lines.

On the other hand, there are tests with complete signaling.

Signaling mode

The range of functions is as follows:

- ◆ Power measurements
 - Minimum/maximum output power
 - High-speed channel power
 - Gated output power
 - Open-loop time response
 - Access probe power
 - Standby power
 - Range tests by using user-configurable power control bit patterns
- ◆ Receiver quality measurements
 - Frame error ratio (FER) on FCH, SCH0 and SCH1
 - Dynamic range, sensitivity and other user-selectable test environments:
 - FER injection
 - Forward power control measurement

CDMA2000® highlights of the R&S® CMU 200

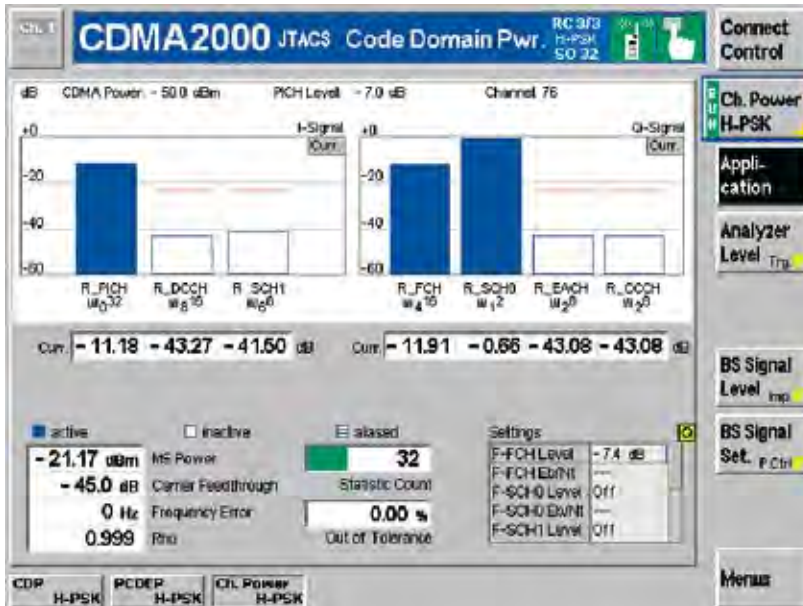

The channel power measurement displays the power in the channels used by the reverse link, separated into I and Q signals.

- ◆ Modulation (both RC1/2 and RC3/4)
 - Error vector magnitude (EVM), magnitude error, phase error, waveform quality, carrier feedthrough, frequency error, eye diagram, constellation/vector diagram
- ◆ Code domain power
 - Code domain power
 - Peak code domain error power, channel power
- ◆ Handoffs
 - Implicit handoffs (RF channel, Walsh code, PN offset, frame offset)
 - Interband handoff
 - Handoff to AMPS
- ◆ Sideband suppression

Non-signaling mode

- ◆ High-speed power measurement
- ◆ Frequency error
- ◆ Waveform quality (both RC1/2 and RC3/4)
- ◆ Carrier feedthrough
- ◆ Transmit time error
- ◆ Sideband suppression

- ◆ CDMA2000® speech coder for high-precision acoustic measurements
- ◆ Multiple connection types to cover most important test requirements in R&D, production and high-level service labs
- ◆ Forward closed-loop power control tests as specified in IS-98E sections 3.4.7, 3.4.8, 3.4.9 supported
- ◆ Quick paging channel implemented
- ◆ Handoffs possible between service options and between CDMA2000® and IS-95 connection types during an established call
- ◆ Measurements under fading conditions supported (baseband fading; requires option R&S® CMU-B17 in combination with a fading generator such as the R&S® ABFS)
- ◆ Voice loopback and comprehensive testing of mobile phones
- ◆ Full support of RC1/RC2 (cdmaOne measurements) and RC3/RC4 (CDMA2000®)
- ◆ Support of all band classes specified in IS-2000
- ◆ Innovative measurement of code domain power, code domain peak error power, channel power
- ◆ Parallel RX/TX measurements ensuring high throughput in production environments
- ◆ Graphical representation of measurement results best suited for R&D labs
- ◆ Readout and display of many mobile-phone-specific parameters (ESN, slot cycle index, etc)
- ◆ Extremely fast measurements
- ◆ Non-signaling and signaling mode
- ◆ Various handoffs supported (e.g. handoff to AMPS, interband handoff)

1xEV-DO in the R&S® CMU 200

1xEV-DO overview

CDMA2000® 1xEV-DO (TIA/EIA/IS-856), officially recognized by the ITU as an IMT-2000 3G standard, is the latest step in CDMA2000® evolution. The new standard provides a “data only” mode (no voice traffic) with data rates up to 2.4 Mbit/s in the forward link and up to 153.7 kbit/s in the reverse link.

1xEV-DO uses a dedicated carrier with the same 1.25 MHz bandwidth per carrier as CDMA2000® 1X and is optimized for the delivery of high-speed wireless data to mobile terminals as well as fixed wireless devices. Due to the compatibility with existing CDMA2000®/IS-95 networks (same cell sites, towers and antennas can be used), more and more CDMA2000®/IS-95 operators worldwide will to upgrade their networks to 1xEV-DO service.

1xEV-DO test concept

Recent production measurement trends have been moving away from “call established” based or “signaling” based testing toward a “module” or “non-signaling” strategy. The main advantage of this approach is reduced test time in comparison to full signaling tests. It is possible to implement vendor-specific tests/procedures and easier to add new test scenarios as the DUT matures. In addition, lack of symmetry between forward and reverse links makes traditional loopback testing less effective.

With the 1xEV-DO option, the R&S® CMU 200 now offers a very flexible all-in-one solution including a 1xEV-DO generator for receiver measurements of 1xEV-DO access terminals as well as an extensive list of transmitter measurements. The test concept is based on the factory test mode (FTM) which provides direct control of the DUT without complete signaling. The FTM is implemented via the serial diagnostic monitor interface which is already present in most 1xEV-DO terminal designs. The factory test mode minimizes test configuration and transition time between tests and allows simultaneous testing of different DUTs. Enhanced measurement times and optimized test sequences are a special benefit especially in production environments, yielding higher throughput.

1xEV-DO options

The 1xEV-DO option of the R&S® CMU 200 is based on the CDMA2000® 1X Signaling Unit R&S® CMU-B83. To upgrade the R&S® CMU 200 with 1xEV-DO functionality, the following options are required:

- ◆ R&S® CMU-B83
CDMA2000® 1X signaling unit
- ◆ R&S® CMU-B88
CDMA2000® 1xEV-DO generator for CDMA2000® Signaling Unit R&S® CMU-B83
- ◆ R&S® CMU-K88
CDMA2000® 1xEV-DO test software

1xEV-DO generator

The extremely flexible 1xEV-DO generator (option R&S® CMU-B88) was designed to provide not only a limited live control channel but also traffic for up to four different access terminals simultaneously. This allows receiver measurements for up to four separate access terminals at the same time.¹⁾

Each of the four different traffic channels can be configured independently. The user-specific parameter set includes

- ◆ MACIndex
- ◆ MACLevel
- ◆ Data rate
- ◆ Data pattern
- ◆ Transmission interval
- ◆ Power level
- ◆ DRCLock mode
- ◆ Reverse power control mode

The reverse power control system that is implemented allows extensive range tests to be performed (independently for each user) by sending a series of specific power-control bit patterns to the access terminal or by using an external power control bit source.

The access network also supports a complete set of parameter settings: PN offset, reverse activity bit state, AWGN, power and channel, which can be configured easily. To simulate different conditions in a real network, up to 55 other users (comparable to OCNS in CDMA2000®) are supported by the 1xEV-DO generator.

¹⁾ Multiple-user support depends on the data multiplexing mode used.

Test setup: A test system using a factory test mode (FTM) is virtually identical to most protocol-based production test setups. It consists of a test controller, a radiocommunications tester with 1xEV-DO option and the actual device under test. The primary difference is that the device under test operates in the FTM mode while the test sequence is performed.

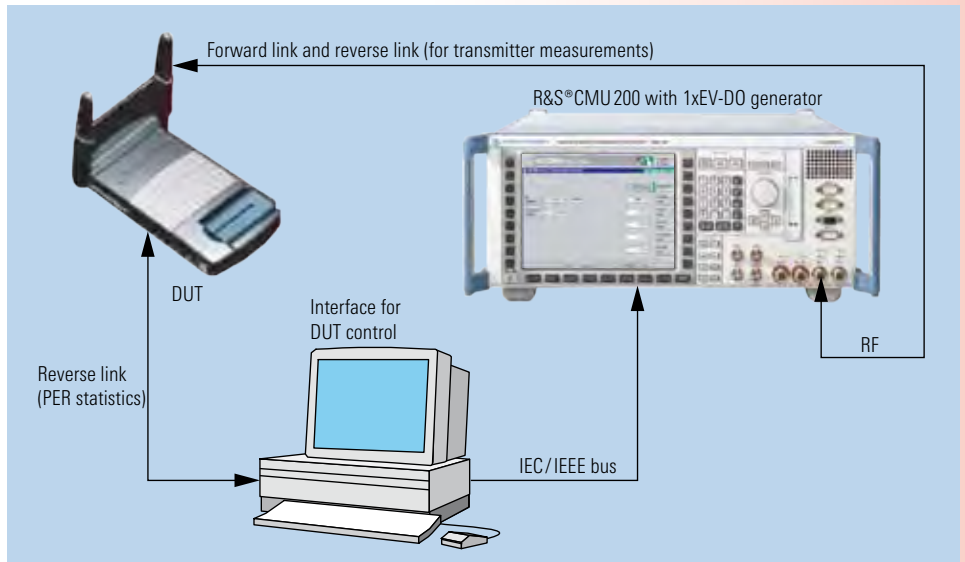

Channel filters: Three different channel filters allow the reverse link signal to be analyzed in eight different signaling states. Users may select whether or not to measure the signal at the time when ACK, DATA or DRC channel is transmitted (ON or OFF).

All modulation measurements as well as the code domain power measurement support the channel filters.

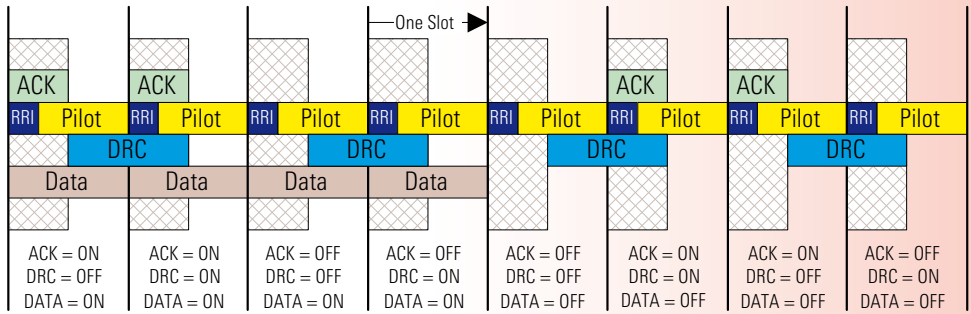

Notes: DRCLength = 2
DRCGating = ON
Measurement window

The spectrum measurement provides comprehensive ACPR measurements at four different user-definable frequencies in a ± 2 MHz range.

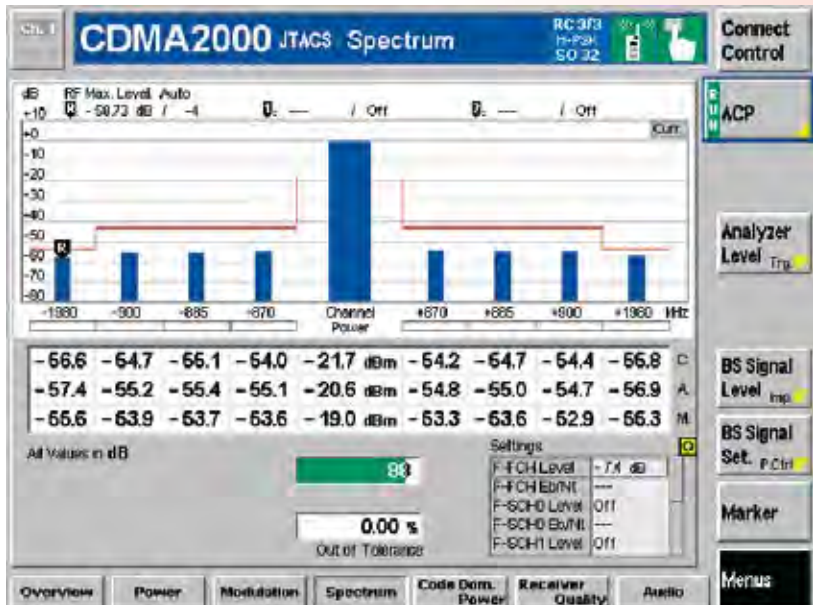

1xEV-DO in the R&S®CMU 200

1xEV-DO measurements

The R&S®CMU 200 provides a complete set of extremely fast transmitter measurements. Most of the measurements are presented in graphical form which makes the test solution ideal for R&D. The modulation analyzer allows the reverse link signal to be evaluated in eight different states (DATA on/off, DRC on/off, ACK on/off)

Since receiver testing can be performed in parallel by the access terminals, the R&S®CMU 200 is the perfect solution for the production of 1xEV-DO access terminals.

The list below shows the implemented 1xEV-DO measurements:

Power measurements

- ◆ General power measurement (e.g. for fast power phasing)

Code domain power

- ◆ Code domain power
- ◆ Code domain error power
- ◆ Channel power

Modulation measurements

- ◆ Error vector magnitude (EVM)
- ◆ Magnitude error
- ◆ Phase error
- ◆ I/Q analyzer

Spectrum measurements

- ◆ 30 kHz spectrum analyzer filter at four frequency offsets (user-configurable); max. frequency offset 2 MHz

Receiver measurements

- ◆ Via DUT control interface in test controller – RF signal data for up to four ATs may be generated in parallel by the R&S®CMU 200

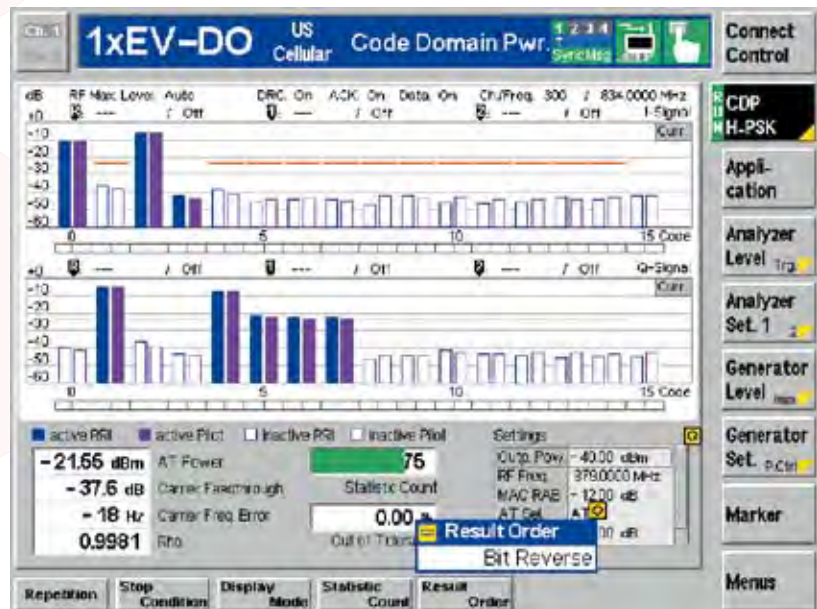

Code domain power measurement:

The code domain power (CDP) includes the time-switching component between RRI and pilot channel. The "blue" bar displays the CDP for the time the RRI channel is up. The "purple" bar shows the CDP value for the time the pilot channel is up.

1xEV-DO highlights of the R&S® CMU 200

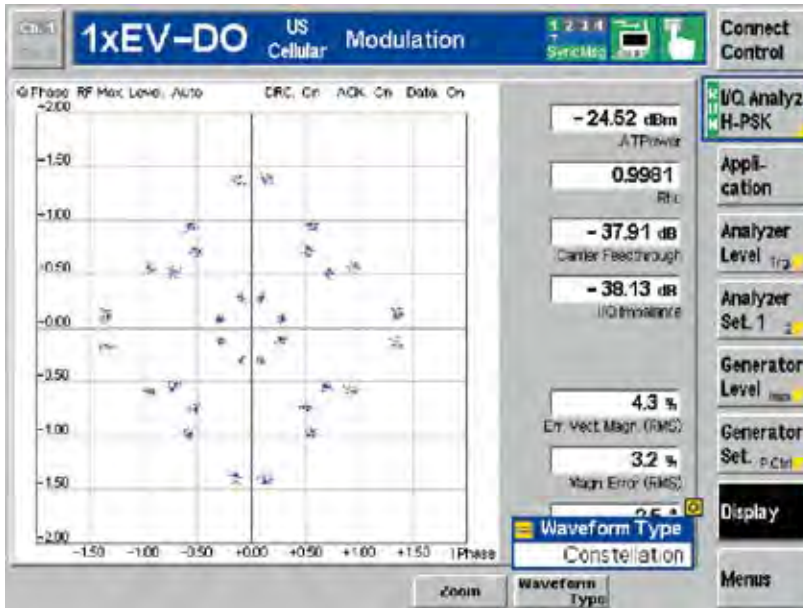

The I/Q analyzer provides a constellation diagram as well as an eye pattern for the I and Q component.

- ◆ Simultaneous testing of up to four access terminals
- ◆ Reduced test times in comparison to full signaling tests
- ◆ Extremely flexible 1xEV-DO generator allows vendor-specific tests and new test scenarios
- ◆ Channel filters allow the reverse link signal to be evaluated in eight different states
- ◆ Combines 1xEV-DO with CDMA2000® test applications in one box for dual-mode CDMA2000®/1xEV-DO testing
- ◆ All band classes used are supported
- ◆ Code domain power includes time switching between RRI and pilot channel
- ◆ Different network conditions can be simulated by a user-definable number of additional users in the forward link

Bluetooth® measurements in the R&S® CMU 200

General

The R&S® CMU 200 was the first Bluetooth® test set on the market. It is the only radiocommunications tester worldwide to offer Bluetooth® as well as all important mobile radio standards in a single instrument.

Applications

The R&S® CMU 200 with the Bluetooth® option is the ideal instrument for the production, development and maintenance of any kind of device with an integrated Bluetooth® interface.

Due to its modular platform concept, the R&S® CMU 200 is the ideal solution for all cellular-standard mobile-phone production lines.

Parallel operation for high measurement speed

Due to the high measurement speed and large memory capacity of the R&S® CMU 200, transmitter and receiver measurements can be carried out simultaneously. When measurements are performed in frequency hopping mode, a significant test depth is rapidly attained. Only a few seconds are required between call setup, transmitter and receiver measurements and call detach. Fast test cycles ensure a fast return on investment.

Many convenient measurement functions

The R&S® CMU 200 offers a large number of statistical monitoring and measurement functions. It is possible, for instance, to define individual tolerances for each measured value and to stop a

measurement sequence after a certain number of measurements or when a tolerance has been exceeded. Besides the common traces for power and modulation versus time, averaged minimum or maximum traces can also be displayed over a user-defined number of packets.

Signaling

Setting up a Bluetooth® connection

The R&S® CMU 200 acts as the master of a Bluetooth® piconet, the DUT as a slave. The R&S® CMU 200 is able to perform the inquiry procedure for the identification of all Bluetooth® devices within range of the R&S® CMU 200. All devices found are listed on the display and one of them can be selected for the paging procedure. The R&S® CMU 200 then establishes the connection to the DUT and switches it to test mode operation.

The inquiry procedure can be skipped if the Bluetooth® device address of the DUT is already known. In this case, a shorter setup time for the connection can be achieved. This is important for production tests of Bluetooth® devices to increase the maximum throughput of a production line. In line with the Bluetooth® test mode specification, the DUT has to be locally enabled for test mode operation.

After a Bluetooth® link is established, the R&S® CMU 200 sends test control commands to the DUT to switch it to the desired test mode. The R&S® CMU 200 is then able to perform a number of transmitter and receiver measurements.

The R&S® CMU 200 is also capable of setting up a normal Bluetooth® asynchronous connectionless (ACL) link without activating the test mode. Via this normal link, the power and frequency accuracy of every DUT can be measured,

regardless of whether the DUT has been locally enabled for the test mode.

If a normal (ACL) link is used, the R&S® CMU 200 can switch the DUT to the audio, hold, park and sniff modes.

Audio mode

In the audio mode, the R&S® CMU 200 establishes a synchronous connection-oriented (SCO) link to the DUT in addition to the ACL link. The R&S® CMU 200's built-in Bluetooth® audio codec supports CVSD as well as A-law and μ -law coding. External audio generators and analyzers can be connected by means of one analog input and output each on the R&S® CMU 200 front panel. A much more convenient alternative is the R&S® CMU-B41 audio option. This option, in conjunction with the Bluetooth® audio codec, makes it very easy to carry out basic audio measurements on Bluetooth® DUTs.

Park, hold and sniff modes

The power consumption of a Bluetooth® chipset is considerably reduced in these three modes, making them particularly important in all battery-powered Bluetooth® devices. The R&S® CMU 200 can switch the DUT to the park, hold or sniff mode, making it possible to check the reduced power consumption by means of external test equipment.

Signaling information from the DUT

The R&S® CMU 200 is able to display a variety of information that is received from the DUT (e.g. device name, version numbers, service class, supported features).

Compliance with existing Bluetooth® standards

The R&S®CMU 200 is compliant with the Bluetooth® Core Specifications Version 1.1. The Bluetooth® test mode (Core Spec. Part 1:1) is implemented with all commands needed to perform the TX/RX measurements. In addition, the R&S®CMU 200 is capable of testing all DUTs that support the new Bluetooth® Core Specifications Version 1.2, since the test mode specified in the new version does not include any changes relevant to the R&S®CMU 200.

The Bluetooth® RF Test Specification describes RF test cases for the Bluetooth® qualification process. Although the R&S®CMU 200 was not designed for qualification tests, the RF test specification was taken as a guideline for the implementation of the R&S®CMU 200's Bluetooth® measurements. All TX measurements are implemented in line with the RF test specification Version 1.2.

In connection with the R&S®CMU 200, the R&S®CMUGo application software allows the evaluation of the following Bluetooth® test purposes:

- ◆ TRM/CA/01/C (output power)
- ◆ TRM/CA/03/C (power control)
- ◆ TRM/CA/05/C (TX output spectrum – 20 dB bandwidth)
- ◆ TRM/CA/06/C (TX output spectrum – adjacent channel power)
- ◆ TRM/CA/07/C (modulation characteristics)
- ◆ TRM/CA/08/C (initial carrier frequency tolerance)
- ◆ TRM/CA/09/C (carrier frequency drift)
- ◆ RCV/CA/01/C (sensitivity – single-slot packets)¹⁾
- ◆ RCV/CA/02/C (sensitivity – multislot packets)¹⁾
- ◆ RCV/CA/06/C (maximum input level)

¹⁾ Dirty transmitter with static settings for frequency offset and modulation index.

The Connection Control menu allows the DUT to be inquired and paged. After link setup, the R&S®CMU 200 can switch the DUT to one of five submodes.

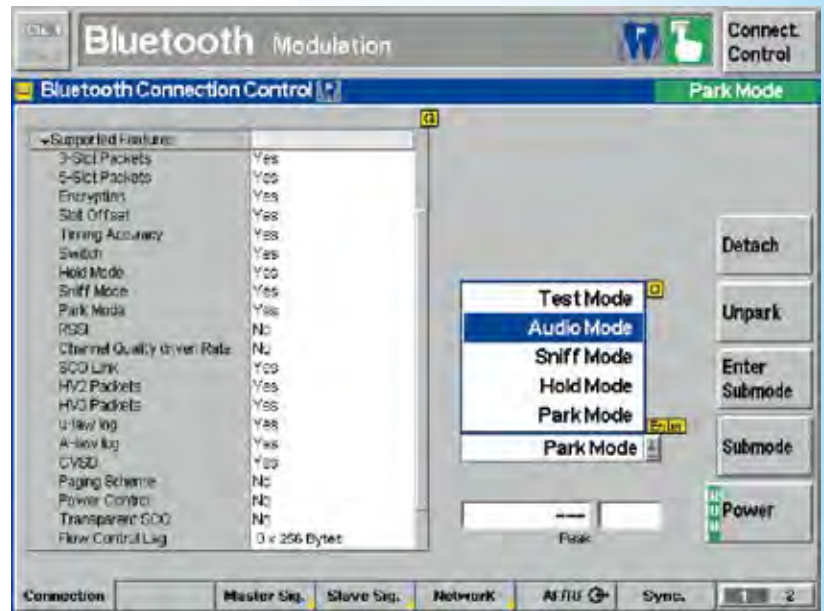

The Power menu shows the results in graphical and scalar form. Statistical functions as well as convenient markers facilitate further evaluation. The DUT power can be varied in stages using the up and down keys.

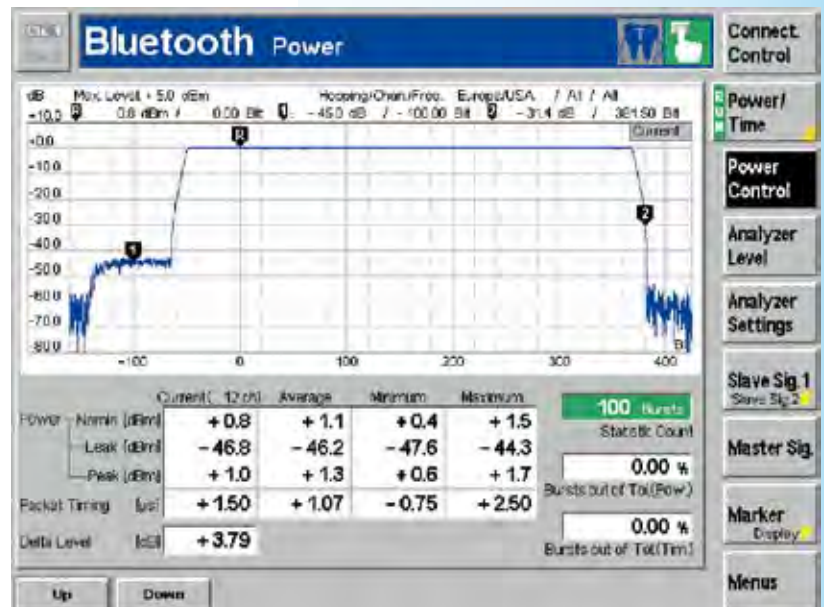

The graphical display of modulation results may be spread between 1/1 and 1/16 of a burst for in-depth analysis. The "Max. Freq. Dev." and "Min. Freq. Dev." results allow the highest and lowest values of a payload to be evaluated individually.

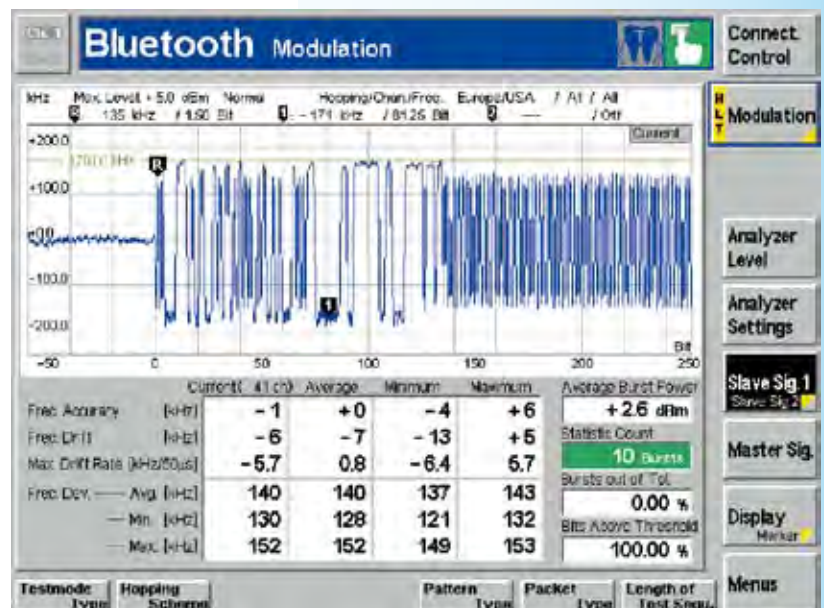

Bluetooth® measurements in the R&S® CMU 200

TX measurements

The current measurement values for each parameter are displayed on the R&S® CMU 200 screen. Additionally, average, maximum and minimum values are displayed as a result of a statistical evaluation of a definable number of Bluetooth® packets (bursts).

Power measurements (output power)

Measurement parameters:

- ◆ Nominal power (measured as the part of the burst starting at the detected first bit of the preamble (bit 0) to the last bit of the burst)
- ◆ Peak power (shows the highest power level within a burst)
- ◆ Leakage power (measured within defined areas before and after the burst)

Power control

The Power menu enables the power control function of a Bluetooth® DUT to be checked. In this mode, the R&S® CMU 200 can send the "Power up" and "Power down" commands to the DUT. The user has two keys for manual power control. After each keystroke, the R&S® CMU 200 displays in a measurement window the difference level as compared to each previous power level. In compliance with the Bluetooth® specifications, all difference values must be in the 2 dB to 8 dB range. When the maximum or minimum power level is reached, the DUT sends a message which is displayed on the R&S® CMU 200.

Timing measurements (packet timing error)

Measurement parameter:

- ◆ Packet alignment (distance between ideal master receiver slot and detected bit 0 of the received burst)

This measurement is displayed on the Power screen.



The DUT can be connected to the R&S® CMU 200 via an RF coupler (antenna) or a cable.

Modulation measurements

(modulation characteristics/quality)

Measurement parameters:

- ◆ Frequency accuracy/initial carrier frequency tolerance (ICFT) (difference between measured frequency and intended transmitted frequency, measured in the preamble at the beginning of a packet)
- ◆ Carrier frequency drift (difference between the frequency at the start of the packet and the frequency in the payload)
- ◆ Maximum drift rate (maximum drift rate anywhere within the packet payload)
- ◆ Average, maximum and minimum frequency deviation (calculated over the packet payload)

In compliance with the Bluetooth® RF test specifications, a minimum of 99.9% of all measured bits must have a frequency deviation of at least 115 kHz. The R&S® CMU 200 shows the measurement results in an additional window in the modulation display.

Spectrum measurements

20 dB bandwidth (occupied bandwidth)

The detection level for determining the occupied bandwidth is adjustable. It is used as a reference for determining the lowest frequency below the transmit frequency of the DUT (f_L) and the highest frequency above the transmit frequency of the DUT (f_H)

Measurement parameters:

- ◆ Emission peak
- ◆ f_L , f_H and the difference ($f_H - f_L$) for the Current, Average and Maximum display modes

Adjacent channel power (ACP)

The center channel as well as the three higher and the three lower adjacent channels for the measurement are user-configurable.

Measurement parameters:

- ◆ Power of the center channel (for Current display mode)
- ◆ Power of the selected adjacent channels (for Current, Average and Maximum display modes)

The spectrum measurements are particularly important for the continuously growing market share of Bluetooth® power class 1 equipment (+20 dBm). In this power class, instruments with impure RF can significantly impair signals for users of adjacent frequencies.

RX measurements

For RX measurements, the built-in signal generator generates a selectable bit sequence, which is looped back in the DUT and demodulated and processed by the R&S® CMU 200 again. The TX level of the R&S® CMU 200 can be adjusted for this measurement.

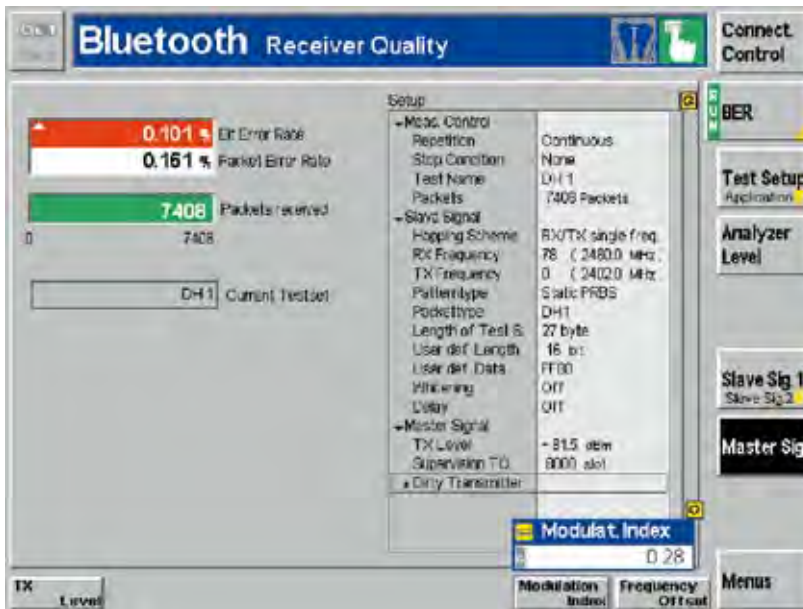

The receiver quality measurement includes the output of BER and PER values. It supports three modes, i.e. single shot, continuous and search of a target BER value, by automatic variation of the R&S® CMU 200 output level. The modulation index and the frequency offset of the R&S® CMU 200 transmitter signal can be set in any combination ("dirty signal").

Sensitivity (single slot packets/multi-slot packets)

Measurement parameters:

- ◆ BER (percentage of bit errors that have occurred within the current statistical cycle)
- ◆ BER search function (sensitivity level for a predefined BER level)
- ◆ PER (percentage of packet errors that have occurred within the current statistical cycle)

Definable dirty transmitter parameters

The Bluetooth® RF test specifications stipulate a "dirty transmitter" for measuring receiver sensitivity. Its two main parameters, i.e. modulation index and frequency offset, can be continuously adjusted on the R&S® CMU 200 and set in any combination. The R&S® CMU 200 can use dirty transmitter settings even during link setup (inquiry, connect), thus enabling a wide variety of tests that far exceed test specification requirements.

Control commands to the DUT

The R&S® CMU 200 can send control commands with user-specific contents to the DUT via the normal ACL link. This application, which is very useful in production,

allows the control of specific DUT functions via the RF interface, e.g. switching a headset LED on and off.

Channel display in frequency-hopping mode

The R&S® CMU 200 enables the convenient determination of all RF channels in which the DUT exceeds specified tolerances. If "on limit failure" is set as a stop condition in frequency-hopping measurements, the R&S® CMU 200 automatically stops the measurement when a measured value exceeds the definable limit values.

The R&S® CMU 200 in addition displays the number of the channel in which the out-of-tolerance condition occurred – a very helpful function for laboratory measurements.

Measurements without link setup

Many Bluetooth® DUTs can be locally switched to the transmitter test mode via the HCI interface. The R&S® CMU 200 can carry out power, frequency and modulation measurements on such DUTs without previously establishing a Bluetooth® link.

Bluetooth® wireless technology highlights of the R&S® CMU 200

- ◆ Measurements in Bluetooth® test mode, non-test mode or without a connection
- ◆ Selectable channels and stop conditions for in-depth signal analysis
- ◆ Spectrum measurements (ACP and 20 dB bandwidth)
- ◆ Park, hold and sniff modes for power consumption tests
- ◆ Audio codec integrated (CVSD, A-law, μ -law) for test of audio equipment
- ◆ High measurement accuracy and speed
- ◆ Parallel TX and RX measurement of the RF interface in loopback mode
- ◆ Output of Bluetooth®-specific clock signal
- ◆ IF signal output

Supported standards

- ◆ Bluetooth® Core Specifications Version 1.1 (DUTs in line with 1.2 can also be measured)
- ◆ Bluetooth® Test Specification V1.2, vol. 2, Radio Frequency

The Bluetooth word mark and logos are owned by the Bluetooth SIG, Inc. and any use of such marks by Rohde & Schwarz is under license.

Testing applications in mobile radiocommunications

R&S®CMU 200 goes Internet: testing data applications

The highly successful Universal Radio Communication Tester R&S®CMU 200, which was originally designed as a pure RF tester for the various mobile radio standards used around the world, now enables additional user groups to test video telephony and data applications.

Appealing compact solution

Both developing and providing data applications for mobile radio present a multitude of new challenges. Most applications in data communications are based on the Internet protocol (IP), which in turn is based on the client-server principle. This means that a client uses a mobile phone to request services that are provided by a server in the communications network.

The software for these applications is usually developed on PCs; after its implementation and extensive computer simulations, the software is ported to the mobile phone. To perform further tests on the mobile phone itself, a public mobile radio network or the simulation of such a network is required.

Up to now, radio networks could usually be simulated only with the aid of complex setups. This is remedied by the R&S®CMU 200, which is a very interesting alternative for such tasks.

Test setup

Application test setups basically consist of a mobile phone, the R&S®CMU 200 and a PC. The mobile radio tester, which is connected to the mobile phone via the radio interface, simulates the mobile radio network. Via an Ethernet connection, it accesses the IP-based computer world, which can be either a local area network

(LAN), the Internet or, at its simplest, a controller, where the servers providing the communications services can be accessed. The user usually accesses these services from the mobile phone via mobile originated calls.

The R&S®CMU 200 bridges the gap between wired data communications and radiocommunications across various protocol layers.

When the R&S®CMU 200 is combined with the Fading Simulator R&S®ABFS, the operation of a mobile telephone under various fading scenarios such as in an automobile at various speeds and reception conditions can be simulated. Thus, the reliability of data exchange can be tested and evaluated.

TCP/IP services

The clients on the mobile phone require suitable servers at the controller end as a counterpart for application tests.

The R&S®CMU-K96 WCDMA application testing option allows IP-based data applications to be tested on a mobile phone; in addition, it includes several TCP/IP servers, for example an HTTP server, which allows you to start a web browser on a mobile phone. Another server is the MMS center (MMSC) with basic functionality, which can be used to test the transmission and reception of multimedia messages on a mobile phone.

Future prospects

Application tests are becoming more and more important in mobile radio. Rohde & Schwarz is meeting this trend by continuously developing new solutions in this field. The licensing authorities have responded to changes in the way mobile communications are used: By developing test scenarios with exact specifications, they define appropriate tests at the application level that will ensure that mobile radio networks will also operate smoothly in the future.

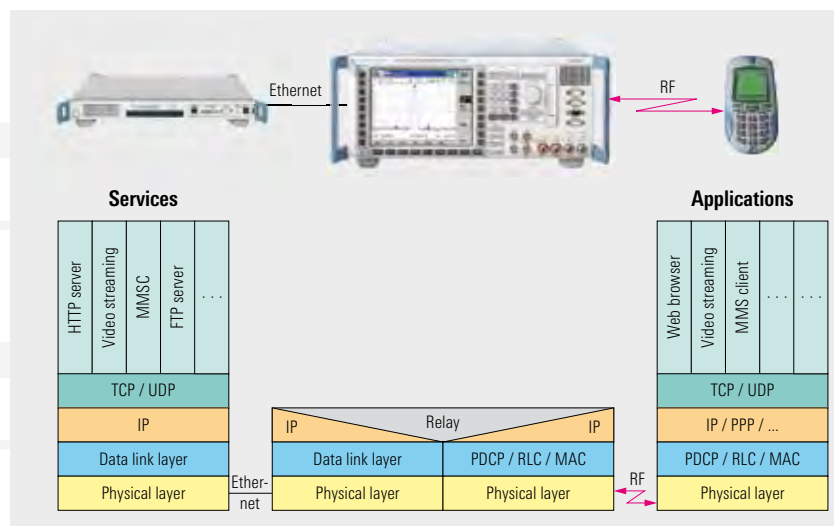

Versatile application tests in (E)GPRS mobile radio

The R&S®CMU-K92 software option allows you to test applications for 2.5G mobile phones. For example, you can now test the transmission or reception of multimedia message services (MMS), Internet browsing or video streaming within a simulated (E)GPRS network environment. In addition to measuring the known RF parameters of power, spectrum or modulation, you can now also perform such tasks as displaying data throughput or analyzing protocols.

(E)GPRS application tests with the R&S®CMU 200

Owing to significant protocol stack extensions, the R&S®CMU 200 now also allows you to test applications via GPRS and EGPRS(EDGE) mobile phones simply by activating a new software option.

The new software option makes it possible to test almost any IP-based applications in packet-oriented mode via an IP gateway.

You can simply test proper functioning, but also check whether different applications that are simultaneously activated on a mobile phone run smoothly.

In addition to displaying the current data throughput of the IP packets exchanged between mobile phone and server, the R&S®CMU 200 also records various transmission protocols.

Regardless of these activities, it is still possible to measure and analyze the RF signals transmitted by GPRS or EGPRS mobile phones on the R&S®CMU 200 with respect to power, spectrum or modulation. Unlike the previous transmitter test, the measurement is now performed as part of the application data transmis-

sion and no longer on the basis of pseudo-random binary sequences (PRBS). If two R&S®CMU 200 testers are available, the application tests can be expanded to accommodate data end-to-end tests, for example for checking the exchange of an MMS message between two mobile phones. If only one R&S®CMU 200 is available, the transmission and slightly delayed reception of an MMS message with one mobile phone can also be implemented using the loopback setting in the MMSC.

Powerful aid in the development lab

The new R&S®CMU-K92 software option for the R&S®CMU 200 for the first time allows application design engineers to test their work in the lab on mobile phones in a simulated radio network. In this case, the main focus is on proving that the application runs smoothly on the mobile phone under normal operating and radio conditions.

Recording of all exchanged IP data packets with time stamp and display of the data transmission rate achieved.

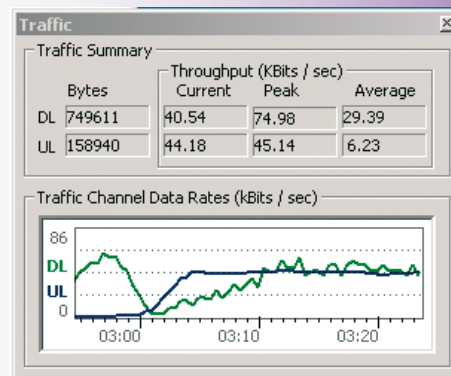

Throughput of IP data exchanged between mobile phone and radio network in uplink (UL) and downlink (DL).

Future prospects

Option R&S®CMU-K92 is the platform for further application tests. It is required in order to run validated MMS test cases or to test complex applications such as push to talk over cellular (PoC). In the forthcoming configurations, data applications can also be tested while voice transmission is in progress. If feasible with the mobile phone, both applications (circuit-switched/packet-switched) can then be operated and tested simultaneously in the dual transfer mode.

Testing applications in mobile radiocommunications

WCDMA: data applications and video telephony test

Option R&S®CMU-K96 makes it possible to test data applications on WCDMA mobile phones.

Settings and measurement results

The configuration of the RF parameters of a WCDMA radio network can be dynamically adjusted on the R&S®CMU 200 during application testing.

Changing the channel numbers triggers an intracell handover, for example. Since a reduced transmit level increases the bit error probability at the receiver end, an application function on a mobile phone can also be tested under adverse receive conditions.

If the application test is performed in compressed mode, the mobile phone is subjected to additional stress, which allows you to check the quality of the UE report transmitted from the mobile phone to the tester. While an application is running on the mobile phone, the known transmitter measurements such as power, code domain power, spectrum and modulation can still be performed. The block error ratio (BLER) determined by the R&S®CMU 200 is used to evaluate the receiver in the mobile phone.

An inner loop power measurement can be used during the application test, for example, to test the accuracy of a mobile phone's amplifier when traffic power commands (TPC) are being carried out.

Remote control and automation

To remote-control the R&S®CMU 200 during application tests, an IEC/IEEE bus interface is available; it can be used, for example, to automatically obtain measurement results and measurement values – a prerequisite for program-controlled sequences. Such automatically running tests can be repeated at any time and as often as necessary without staff intervention, thus helping to increase the system's efficiency.

Protocol analysis

After the software has been ported to the mobile phone, users often want to record protocols to optimize internal processes or to perform an error analysis that may be necessary. The R&S®CMU-Z46 WCDMA message analyzer and recorder option allows all universal terrestrial radio access network

(UTRAN) protocol layers to be recorded, which can then be used for more detailed analysis. This powerful tool permits in-depth analyses, including transport layer analyses.

Video telephony

In all likelihood, video telephony is the most spectacular new WCDMA application. It is unique in that it is circuit-switched, and not IP-based like the previously described applications. The WCDMA firmware checks this functionality without requiring optional extensions. The test is performed in echo mode, where the transmission and reception of video and audio signals can be checked with just one mobile phone. The video telephony signals transmitted by the phone to the R&S®CMU 200 are looped back by the radio tester and displayed by the phone as would-be video and audio signals of a called station.

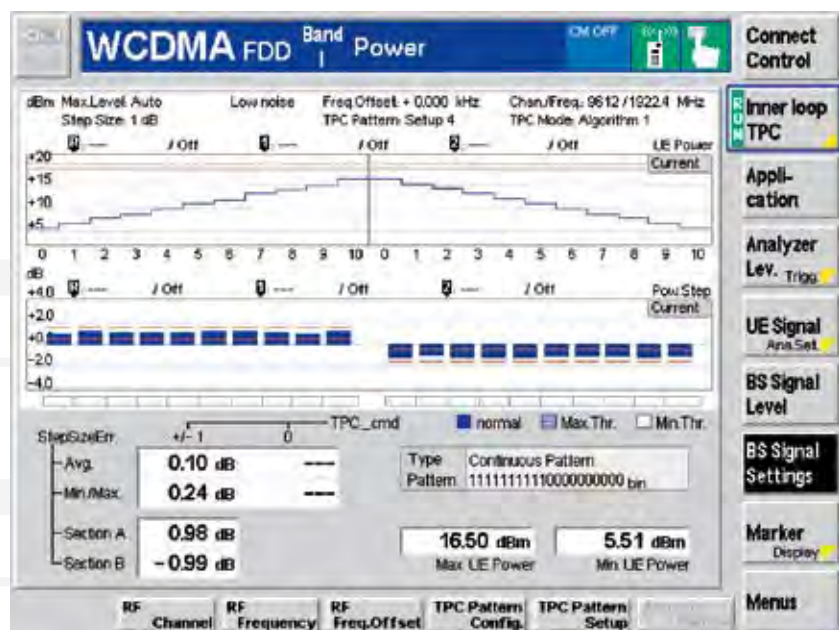

Testing CDMA2000® data applications

Standard CDMA2000® mobile radio networks have already been in commercial use since 2000 in many Asian countries (e.g. Japan and South Korea), the Americas (e.g. the USA and Canada), as well as in Eastern Europe. With the options R&S®CMU-B87 and R&S®CMU-K87 the R&S®CMU 200 now offers extensive test capabilities for data applications for this important global 3G standard.

Extensive test capabilities

The CDMA2000® 1X mobile radio standard, which was developed by the 3GPP2 standardization body, is officially recognized by the ITU as an IMT-2000 standard for the third mobile radio generation (3G). Revision 0 (or A), which is now in commercial use, allows data rates of up to 307.2 kbit/s in a 1.25 MHz frequency channel. Once further optimization stages have been completed, Revision A (also known as 1xEV-DO) will allow a maximum data rate of 3.1 Mbit/s in the forward link (base station to mobile station) and 1.8 Mbit/s in the reverse link (mobile station to base station).

In these networks, data links based on the Internet protocol are playing a more and more significant role. This calls for new test procedures designed to verify the functionality of IP-based links. For example, the TIA/EIA standard TIA-898 specifies data rate measurements for FTP links.

Service Option 33

In its Service Option 33, the TIA/EIA standard IS-707-A-1 specifies IP-based data links for the CDMA2000® standard. The R&S®CMU 200 provides all parameters required for this service option, ranging from traffic channel configuration (data rates of up to 153.6 kbit/s can be set for the supplemental channel

Rr	Rr Total	Tx	Tx Total	RLP Frame Type
0	5	0	6	Data (Unsegmented)
7	20	0	0	Data (Segmented)
4	38	0	3121	Fill
36	3330	0	0	Idle
2	18	0	0	NAK
0	9	0	0	SYNC
0	10	0	0	ACK
0	0	0	9	SYNCAK
0	96	60	463	B_Data
0	464	400	3503	C_Data
33	165	0	34	D_Data
0	0	0	0	Reassembly
6	85	0	25359	Blank
0	0	0	0	Invalid
88	4239	460	32496	Summary

Summary Statistics:

13607	5.2 kBit/s	Rr	79291	70.0 kBit/s	Tx
PPP Total Bytes	Data Rate		PPP Total Bytes	Data Rate	

Statistical evaluation of data transfer between the R&S®CMU 200 and the mobile phone during the application test. After the RLP (radio link protocol type 3) and IP data packets are exchanged, the transmitted and received packets are evaluated using different criteria.

(SCH) both for the forward and the reverse link) through to the parameters for mobile IP and authentication.

PPP authentication

For setting up a point-to-point protocol (PPP) link, the R&S®CMU 200 can be configured to request PPP authentication from the mobile phone. The R&S®CMU 200 supports two methods of authentication: CHAP (challenge handshake authentication protocol) and PAP (password authentication protocol).

Mobile IP

Mobile IP is an addition to the conventional Internet protocol. It makes the movements of a mobile computer (mobile node, i.e. in this case a mobile phone) transparent for data applications and the higher protocol layers.

PPP link status

During periods in which the mobile phone is not transmitting or receiving data, it switches to an idle state referred to as dormant mode. In this

mode, the PPP link is maintained, but no traffic channel connections are set up in the CDMA2000® network. The R&S®CMU 200 indicates the various PPP states the mobile phone can assume.

TX/RX RLP frame and IP packet statistics

A statistical evaluation based on counts of the different parameters makes it possible to track the data flow through the base station, i.e. the R&S®CMU 200. The following types of data are counted separately for the TX and RX directions.

Application scenarios

The R&S®CMU 200 allows different test setups to be implemented for different application scenarios. In the simplest case, you can operate the tester in the standalone mode to perform data rate measurements on the mobile phone under test.

I/Q and IF interfaces for the R&S®CMU 200

Functionality

The R&S®CMU-B17 option allows access to analog I/Q and IF signals in both communication directions (uplink and downlink). Once a radio link has been established, complex I/Q signals can be applied or transmitted for further analysis. This solution will allow the R&S®CMU 200 to be used for new tasks in the development and testing of mobile phones and their modules.

Technical concept

The selectable I/Q and IF interface module is looped between the RF module (modulator, demodulator) and the digital module (test DSP, signaling unit) of the R&S®CMU 200. During normal operation without access to I/Q or IF signals, the interface module can be set to the bypass mode. This eliminates any further influence on the transmit and receive signal, and the original data of the instrument is retained. In addition to pre-configured default settings for constantly recurring T&M tasks (e.g. fading of the transmit signal), all types of customized signal path combinations can be set.

Receiver tests under fading conditions

A fading simulator is used to test the receiver characteristics of mobile phones under practical conditions. An RF channel that is ideal if the tester and the DUT are connected by means of a cable is provided with fading effects that also occur under real field conditions.

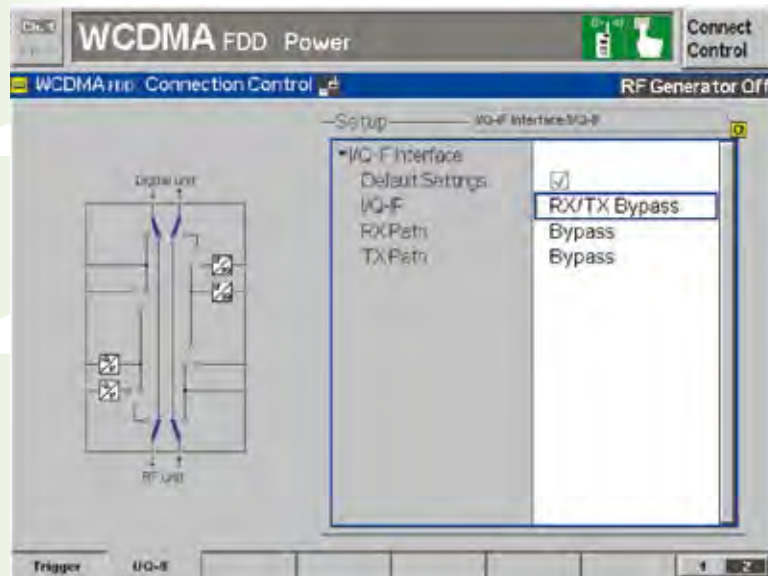

Fitted with the R&S®CMU-B17 option, the R&S®CMU 200, together with the Fading Simulator R&S®ABFS, provides a cost-effective solution for the specified measurement task. Optionally, the Signal Generator R&S®SMIQ with the option R&S®SMIQB14 can be used; the transmit module of the generator can also provide a faded RF signal.

Testing of mobile radio modules

Another major application is the generation and analysis of I/Q signals. Most mobile radio modules include an RF module and a baseband module that communicate with each other via an analog I/Q interface. The I/Q and IF interface can now be used to access the RF modules from both sides.

Quite often, different teams in development departments are responsible for the RF and the baseband modules. Testing via the I/Q interfaces allows space- and time-independent development.

I/Q signal analysis

If I/Q signals are applied to the receive path of the R&S®CMU 200, they can be analyzed analogously to the RF signals. In addition to more complex modulation parameters (error vector magnitude (EVM), peak code domain error power), direct I/Q parameters such as I/Q offset or I/Q imbalance can be analyzed.

Your local Rohde & Schwarz representative will gladly provide you with further information about the R&S®CMU-B17 option.

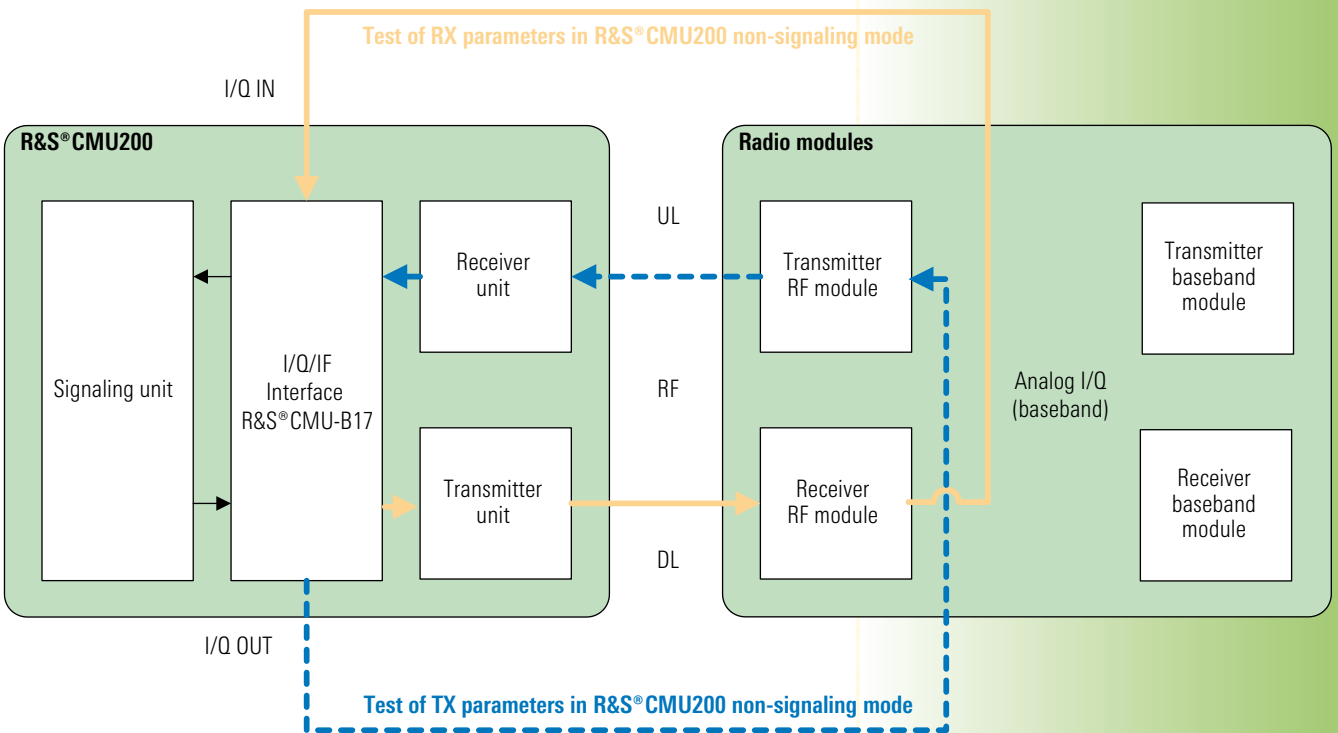
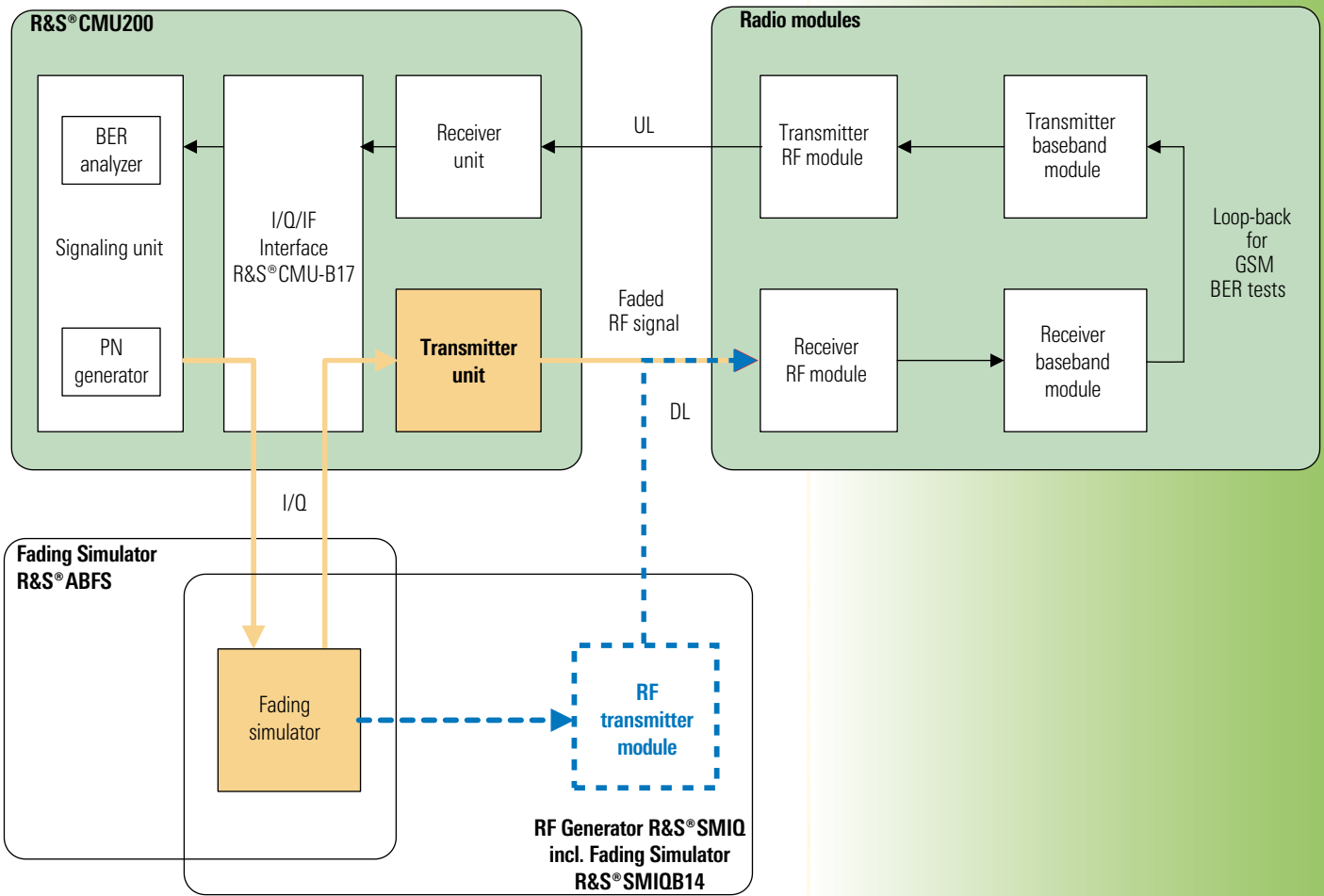

R&S® CMU 200 options and accessories

Type	Description	GSM/GPRS/EDGE	TDMA	AMPS	CDMA2000®	WCDMA/HSDPA	Bluetooth®	Order No.
R&S® CMU 200	Base unit with following accessories: power cord, operating and service manual for instrument	☑	☑	☑	☑	☑	☑	
R&S® CMU-B11 ¹⁾	Reference OCXO, aging 2×10^{-7} /year	☺	☺	☺	☺	☺	☺	1100.5000.02
R&S® CMU-B12 ¹⁾	High-stability OCXO, aging 3.5×10^{-9} /year; oven crystal with highest long-term stability	☺	☺	☺	☺	☺	☺	1100.5100.02
R&S® CMU-B17	Analog I/Q IF interface	☺	☺	–	☺	☺	☺	1100.6906.02
R&S® CMU-B21	Universal signaling unit; includes signaling module for AMPS, TDMA, GSM/GPRS/EGPRS	☑	☑	☑	–	☑	☑	1100.5200.54
R&S® CMU-B41	Audio generator and analyzer; includes audio frequency (AF) generator, voltmeter, distortion meter	☺	☺	☑	☺	☺	☺	1100.5300.02
R&S® CMU-B52	Internal versatile multimode speech coder/decoder; R&S® CMU-B21 necessary	☺	☺	–	–	☺	☺	1100.5400.14
R&S® CMU-B53	Bluetooth® extension; R&S® CMU-B21 necessary	–	–	–	–	–	☺	1100.5700.14
R&S® CMU-B55	HD option for (E)GPRS application testing with more than 2 UL slots	☺	–	–	–	–	–	1159.4000.14
R&S® CMU-B56	WCDMA (3GPP FDD) signaling module for R&S® CMU-B21 model 14	☺	–	–	–	☑	–	1150.1850.14
R&S® CMU-B68	Versatile baseband board for WCDMA (3GPP FDD) Layer 1, DL and UL, non-signaling	–	–	–	–	☑	–	1149.9809.02
R&S® CMU-B83	CDMA2000® 1X signaling unit	–	–	–	☑	–	–	1150.0301.12
R&S® CMU-B85	8 k/13 k QCELP, 8k EVRC speech codec for CDMA2000® Signaling Unit R&S® CMU-B83	–	–	–	☺	–	–	1100.7002.12
R&S® CMU-B87	Interface for CDMA2000® data test for R&S® CMU-B83	–	–	–	☺	–	–	1150.2404.02
R&S® CMU-B88	CDMA2000® 1xEV-DO (HDR) generator for CDMA2000® 1X Signaling Unit R&S® CMUB83	–	–	–	☺	–	–	1158.9908.02
R&S® CMU-B95	2nd Tx RF channel, covering the requirements of present BCCH by GSM/GPRS/EGPRS and application testing for (E)GPRS	☺	–	–	–	☺	–	1159.0504.02
R&S® CMU-B96	2nd Tx RF channel with full functionality, for generation of small band signal (GSM BCCH, channel A) or for generation of a wideband signal (WCDMA BCCH, channel B)	☺	–	–	–	☺	–	1159.1600.02
R&S® CMU-B99	RF1 level range identical to RF2	☺	☺	☺	☺	☺	☺	1150.1250.02
R&S® CMU-U80	Trigger output connector for gpsOne	–	–	–	☺	–	–	1150.1750.02
R&S® CMU-K20	GSM400 mobile station signaling/non-signaling test software	✓	–	–	–	–	–	1115.5900.02
R&S® CMU-K21	GSM900, R-GSM and E-GSM mobile station signaling/non-signaling test software	✓	–	–	–	–	–	1115.6007.02
R&S® CMU-K22	GSM1800 (DCS) mobile station signaling/non-signaling test software	✓	–	–	–	–	–	1115.6107.02
R&S® CMU-K23	GSM1900 (PCS) mobile station signaling/non-signaling test software	✓	–	–	–	–	–	1115.6207.02
R&S® CMU-K24	GSM850 mobile station signaling/non-signaling test software	✓	–	–	–	–	–	1115.6307.02
R&S® CMU-K26	GT800 mobile station signaling/non-signaling test software	✓	–	–	–	–	–	1115.6507.02
R&S® CMU-K27	IS-136/cellular (800 MHz band) mobile station signaling/non-signaling test software	–	✓	–	–	–	–	1115.6607.02
R&S® CMU-K28	IS-136/PCS (1900 MHz band) mobile station signaling/non-signaling test software	–	✓	–	–	–	–	1115.6707.02
R&S® CMU-K29	AMPS mobile station signaling/non-signaling test software	–	–	☑	–	–	–	1115.6807.02
R&S® CMU-K42	GPRS test software extension for all GSM test software packages	☺	–	–	–	–	–	1115.4691.02
R&S® CMU-K43	EGPRS classic (EDGE) signaling test software for all GSM test software packages	☺	–	–	–	–	–	1115.6907.02
R&S® CMU-K44	Dual transfer mode: simultaneous CS and PS connection for all GSM packages	☺	–	–	–	–	–	1157.4277.02
R&S® CMU-K45	AMR test software extension for all GSM test software packages	☺	–	–	–	–	–	1150.3100.02
R&S® CMU-K47	Smart alignment for all GSM packages	☺	–	–	–	–	–	1157.4477.02
R&S® CMU-K48	I/Q versus slot measurement for adjustment of polar modulators	☺	–	–	–	–	–	1157.5309.02
R&S® CMU-K53	Bluetooth® test software	–	–	–	–	–	☑	1115.5000.02
R&S® CMU-K61	WCDMA (3GPP FDD) band 4, UE test signaling software	–	–	–	–	✓	–	1157.3670.02
R&S® CMU-K62	WCDMA (3GPP FDD) band 5, UE test signaling software	–	–	–	–	✓	–	1157.3770.02
R&S® CMU-K63	WCDMA (3GPP FDD) band 6, UE test signaling software	–	–	–	–	✓	–	1157.3870.02
R&S® CMU-K64	3.6 Mbit/s HSDPA	–	–	–	–	☺	–	1157.3970.02
R&S® CMU-K65	WCDMA (3GPP FDD) UL user equipment TX test, non-signaling test software	–	–	–	–	☑	–	1115.4891.02
R&S® CMU-K66	WCDMA (3GPP FDD) DL generator, non-signaling test software	–	–	–	–	☑	–	1115.5100.02
R&S® CMU-K67	WCDMA (3GPP FDD) band 3, UE test signaling software	–	–	–	–	✓	–	1150.3000.02
R&S® CMU-K68	WCDMA (3GPP FDD) band 1, UE test signaling software	–	–	–	–	✓	–	1115.5300.02

Type	Description	GSM/GPRS /EDGE	TDMA	AMPS	CDMA2000®	WCDMA/HSDPA	Bluetooth®	Order No.
R&S®CMU-K69	WCDMA (3GPP FDD) band 2, UE test signaling software	–	–	–	–	✓	–	1115.5400.02
R&S®CMU-K83	CDMA2000® 1X (450 MHz band) cellphone signaling/non-signaling test software	–	–	–	✓	–	–	1150.3500.02
R&S®CMU-K84	CDMA2000® 1X (800 MHz band) cellphone signaling/non-signaling test software	–	–	–	✓	–	–	1150.3600.02
R&S®CMU-K85	CDMA2000® 1X (1900 MHz band) cellphone signaling/non-signaling test software	–	–	–	✓	–	–	1150.3700.02
R&S®CMU-K86	CDMA2000® 1X (2200 MHz band) cellphone signaling/non-signaling test software	–	–	–	✓	–	–	1150.3800.02
R&S®CMU-K87	CDMA2000® application testing, Interface for CDMA2000® Data Test R&S®CMU-B87 required	–	–	–	☺	–	–	1150.4007.02
R&S®CMU-K88	CDMA2000® 1xEV-DO (HDR) test software extension	–	–	–	☺	–	–	1150.3900.02
R&S®CMU-K92	(E)GPRS application testing; external PC, Windows XP/2000, GPRS or EGPRS software option and auxiliary generator R&S®CMU-B95 plus power PC required	☺	–	–	–	–	–	1157.4077.02
R&S®CMU-K96	WCDMA application testing; at least one WCDMA signaling band necessary	–	–	–	–	☺	–	1157.4177.02
R&S®CMU-PK20 ²⁾	Software package for R&S®CMU 200 including GSM850 + 900 + 1800 + 1900 + GPRS signaling (R&S®CMU-K21, -K22, -K23, -K24, -K42)	☺	–	–	–	–	–	1159.3303.02
R&S®CMU-PK60 ²⁾	Software package for R&S®CMU 200 including WCDMA signaling: 3GPP/FDD/UE, TX test, DL generator, band 1+2+3+4+5+6 (R&S®CMU-K61, -K62, -K63, -K65, -K66, -K67, -K68, -K69)	–	–	–	–	☺	–	1159.3355.02
R&S®CMU-PK80 ²⁾	Software package for R&S®CMU 200 including CDMA2000® band 450 MHz + PCS + cellular + IMT2000; analog AMPS (R&S®CMU-K83, -K84, -K85, -K86, -K29)	–	–	☺	☺	–	–	1159.3403.02
R&S®CMU-PK100 ²⁾	Software package for R&S®CMU 200 including GSM/GPRS/EGPRS + WCDMA + CDMA2000® + 1xEV-DO + AMPS + IS-136 (R&S®CMU-PK20, -PK60, -PK80, -K27, -K28, -K43, -K88)	☺	☺	☺	☺	☺	–	1159.3455.02
R&S®CMU-DCV	Documentation of calibration values	☺	☺	☺	☺	☺	☺	0240.2193.08
R&S®CRT-Z2	GSM/GPRS test SIM for GSM900 and DCS1800 for loopback mode; required for BER and other applications	☺	–	–	–	–	–	1039.9005.02
R&S®CRT-Z12	GSM/GPRS test SIM for GSM850 and PCS1900 for loopback mode; required for BER and other applications	☺	–	–	–	–	–	1139.1205.02
R&S®CRT-Z3	3G UICC/USIM test card for UMTS	–	–	–	–	☺	–	1139.1005.02
R&S®CMU-Z1	256 Mbyte memory card for use with PCMCIA interface; flash ATA formatted, also named PC Card ATA	☺	☺	☺	☺	☺	☺	1100.7490.04
R&S®CRT-Z6	Enhancement of wideband modulation (WCDMA 3GPP FDD) analyzer accuracy	–	–	–	–	☺	–	1150.0001.02
R&S®CMU-Z10	Antenna coupler 900 MHz/1700 MHz to 2200 MHz	☺	☺	☺	☺	☺	☺	1150.0801.10
R&S®CMU-Z11	RF shielded cover, extension for R&S®CMU-Z10	☺	☺	☺	☺	☺	☺	1150.1008.02
R&S®CMU-Z12	Bluetooth® antenna, extension for R&S®CMU-Z10	–	–	–	–	–	☺	1150.1043.02
R&S®CMU-Z13	USB feedthrough for R&S®CMU-Z10	☺	☺	☺	☺	☺	☺	1159.1200.02
R&S®CMU-Z46	WCDMA (3GPP FDD) message analyzer and recorder	–	–	–	–	☺	–	1159.0804.02
R&S®CMU-Z49	GSM message viewer	☺	–	–	–	–	–	1150.2704.02
R&S®CMU-Z50	Handset for R&S®CMU 200	☺	☺	☺	☺	☺	☺	1159.0104.02
R&S®ZZA-411	19" rack adapter	☺	☺	☺	☺	☺	☺	1069.3283.00

¹⁾ R&S®CMU-B11 or R&S®CMU-B12 possible. One of two OCXOs should be installed to ensure high frequency accuracy, or an external frequency reference may be used, if available.

²⁾ When ordering one of the R&S®CMU-PK20 to -PK100 software packages, the signaling software included in these packages does not have to be ordered separately.

Comments on table

- ☑ mandatory
- ✓ signaling Option (At least one is mandatory)
- ☺ optional
- not applicable

Value-added services

- ◆ Rohde & Schwarz offers a wide range of training programs not only on products but also on new technical developments
- ◆ Rohde & Schwarz application engineers help to optimize the use of the R&S® CMU 200 and the overall performance of your local environment
- ◆ Over 70 representative offices and a worldwide network of service and calibration centers ensure Rohde & Schwarz support where you need it

Quality management at Rohde & Schwarz

Lasting customer satisfaction is our primary objective. The quality management system of Rohde & Schwarz meets the requirements of ISO 9001 and encompasses virtually all fields of activity of the company.



For specifications, see PD 0758.0039.22
and www.rohde-schwarz.com
(search term: CMU200)



www.rohde-schwarz.com

Europe: +49 1805 12 4242, customersupport@rohde-schwarz.com
USA and Canada: 1-888-837-8772, customer.support@rsa.rohde-schwarz.com
Asia: +65 65130488, customersupport.asia@rohde-schwarz.com