

5700A/5720A Series II

Multi-Function Calibrator

Getting Started

LIMITED WARRANTY & LIMITATION OF LIABILITY

Each Fluke product is warranted to be free from defects in material and workmanship under normal use and service. The warranty period is one year and begins on the date of shipment. Parts, product repairs and services are warranted for 90 days. This warranty extends only to the original buyer or end-user customer of a Fluke authorized reseller, and does not apply to fuses, disposable batteries or to any product which, in Fluke's opinion, has been misused, altered, neglected or damaged by accident or abnormal conditions of operation or handling. Fluke warrants that software will operate substantially in accordance with its functional specifications for 90 days and that it has been properly recorded on non-defective media. Fluke does not warrant that software will be error free or operate without interruption.

Fluke authorized resellers shall extend this warranty on new and unused products to end-user customers only but have no authority to extend a greater or different warranty on behalf of Fluke. Warranty support is available if product is purchased through a Fluke authorized sales outlet or Buyer has paid the applicable international price. Fluke reserves the right to invoice Buyer for importation costs of repair/replacement parts when product purchased in one country is submitted for repair in another country.

Fluke's warranty obligation is limited, at Fluke's option, to refund of the purchase price, free of charge repair, or replacement of a defective product which is returned to a Fluke authorized service center within the warranty period.

To obtain warranty service, contact your nearest Fluke authorized service center or send the product, with a description of the difficulty, postage and insurance prepaid (FOB Destination), to the nearest Fluke authorized service center. Fluke assumes no risk for damage in transit. Following warranty repair, the product will be returned to Buyer, transportation prepaid (FOB Destination). If Fluke determines that the failure was caused by misuse, alteration, accident or abnormal condition of operation or handling, Fluke will provide an estimate of repair costs and obtain authorization before commencing the work. Following repair, the product will be returned to the Buyer transportation prepaid and the Buyer will be billed for the repair and return transportation charges (FOB Shipping Point).

THIS WARRANTY IS BUYER'S SOLE AND EXCLUSIVE REMEDY AND IS IN LIEU OF ALL OTHER WARRANTIES, EXPRESS OR IMPLIED, INCLUDING BUT NOT LIMITED TO ANY IMPLIED WARRANTY OF MERCHANTABILITY OR FITNESS FOR A PARTICULAR PURPOSE. FLUKE SHALL NOT BE LIABLE FOR ANY SPECIAL, INDIRECT, INCIDENTAL OR CONSEQUENTIAL DAMAGES OR LOSSES, INCLUDING LOSS OF DATA, WHETHER ARISING FROM BREACH OF WARRANTY OR BASED ON CONTRACT, TORT, RELIANCE OR ANY OTHER THEORY.

Since some countries or states do not allow limitation of the term of an implied warranty, or exclusion or limitation of incidental or consequential damages, the limitations and exclusions of this warranty may not apply to every buyer. If any provision of this Warranty is held invalid or unenforceable by a court of competent jurisdiction, such holding will not affect the validity or enforceability of any other provision.

Fluke Corporation
P.O. Box 9090
Everett, WA 98206-9090
U.S.A.

Fluke Europe B.V.
P.O. Box 1186
5602 BD Eindhoven
The Netherlands

Claims

Immediately upon arrival, purchaser shall check the packing container against the enclosed packing list and shall, within thirty (30) days of arrival, give Fluke notice of shortages or any nonconformity with the terms of the order. If purchaser fails to give notice, the delivery shall be deemed to conform with the terms of the order.

The purchaser assumes all risk of loss or damage to instruments upon delivery by Fluke to the carrier. If an instrument is damaged in transit, PURCHASER MUST FILE ALL CLAIMS FOR DAMAGE WITH THE CARRIER to obtain compensation. Upon request by purchaser, Fluke will submit an estimate of the cost to repair shipment damage.

Fluke will be happy to answer all questions to enhance the use of this instrument. Please address your requests or correspondence to: Fluke Corporation, P.O. Box 9090, Everett, WA 98206-9090.

Declaration of the Manufacturer or Importer

We hereby certify that the Fluke Models 5700A Series II and 5720A Series II are in compliance with Postal Regulation Vfg. 1046 and is RFI suppressed. The marketing and sale of the equipment was reported to the German Postal Service. The right to retest this equipment to verify compliance with the regulation was given to the German Postal Service.

Bescheinigung des Herstellers/Importeurs

Hiermit wird bescheinigt, daß Fluke Models 5700A Series II und 5720A Series II in Übereinstimmung mit den Bestimmungen der Amtsblattverfügung Vfg. 1046 funk-entstört ist, Der Deutschen Bundespost wurde das Inverkehrbringen dieses Gerätes angezeigt und die Berechtigung zur Überprüfung der Seire auf Einhaltung der Bestimmungen eingeräumt.

Fluke Corporation

Interference Information

This equipment generates and uses radio frequency energy and if not installed and used in strict accordance with the manufacturer's instructions, may cause interference to radio and television reception. It has been type tested and found to comply with the limits for a Class B computing device in accordance with the specifications in Subpart J of Part 15 of FCC Rules, which are designed to provide reasonable protection against such interference in a residential installation. However, there is no guarantee that interference will not occur in a particular installation. If this equipment does cause interference to radio or television reception, which can be determined by turning the equipment off and on, the user is encouraged to try to correct the interference by one of more of the following measures:

- Reorient the receiving antenna
- Relocate the equipment with respect to the receiver
- Move the equipment away from the receiver
- Plug the equipment into a different outlet so that the computer and receiver are on different branch circuits

If necessary, the user should consult the dealer or an experienced radio/television technician for additional suggestions. The user may find the following booklet prepared by the Federal Communications Commission helpful: How to Identify and Resolve Radio-TV Interference Problems. This booklet is available from the U.S. Government Printing Office, Washington, D.C. 20402. Stock No. 004-000-00345-4.

OPERATOR SAFETY SUMMARY

WARNING



HIGH VOLTAGE

is used in the operation of this equipment

LETHAL VOLTAGE

may be present on the terminals, observe all safety precautions!

To avoid electrical shock hazard, the operator should not electrically contact the output hi or sense hi binding posts. During operation, lethal voltages of up to 1100V ac or dc may be present on these terminals.

Whenever the nature of the operation permits, keep one hand away from equipment to reduce the hazard of current flowing through vital organs of the body.

Terms in this Manual

This instrument has been designed and tested in accordance with the safety standards listed in the General Specifications. This manual contains information and warnings which have to be followed by the user to ensure safe operation and to retain the instrument in safe condition.

WARNING statements identify conditions or practices that could result in personal injury or loss of life.

CAUTION statements identify conditions or practices that could result in damage to the equipment or other property.

Symbols Marked on Equipment



DANGER — High Voltage



Protective ground (earth) terminal



Attention — refer to the manual. This symbol indicates that information about the usage of a feature is contained in the manual.

Power Source

The 5700A Series II and 5720A Series II are intended to operate from a power source that will not apply more than 264V ac rms between the supply conductors or between either supply conductor and ground. A protective ground connection by way of the grounding conductor in the power cord is essential for safe operation.

Use the Proper Fuse

To avoid fire hazard, use only the fuse specified on the line voltage selection switch label, and which is identical in type voltage rating, and current rating.

Grounding the 5700A Series II or 5720A Series II

The 5700A Series II and 5720A Series II are Safety Class I (grounded enclosure) instruments as defined in IEC 348. The enclosure is grounded through the grounding conductor of the power cord. To avoid electrical shock, plug the power cord into a properly wired earth grounded receptacle before connecting anything to any of the 5700A Series II or 5720A Series II terminals. A protective ground connection by way of the grounding conductor in the power cord is essential for safe operation.

Use the Proper Power Cord

Always use the power (line) cord and connector appropriate for the voltage and outlet of the country or location in which you are working.

Always match the line cord to the instrument.

- Use the AC line cord supplied with this instrument with this instrument only.
- Do not use this line cord with any other instruments.
- Do not use any other line cords with this instrument.

Use only the power cord and connector appropriate for proper operation of a 5700A Series II or 5720A Series II in your country.

Use only a power cord that is in good condition.

For detailed information on power cords, refer to Figure 24.

Refer cord and connector changes to qualified service personnel.

Do Not Operate in Explosive Atmospheres

To avoid explosion, do not operate the 5700A Series II or 5720A Series II in an atmosphere of explosive gas.

Do Not Remove Cover

To avoid personal injury, do not remove the cover from the 5700A Series II or 5720A Series II. Do not operate the 5700A Series II or 5720A Series II without the cover properly installed. There are no user-serviceable parts inside the 5700A Series II or the 5720A Series II, so there is no need for the operator to ever remove the cover.



FIRST AID FOR ELECTRIC SHOCK

Free the Victim From the Live Conductor

Shut off high voltage at once and ground the circuit. If high voltage cannot be turned off quickly, ground the circuit.

Get Help!

Call loudly for help. Call an emergency number. Request medical assistance.

Never Accept Ordinary and General Tests for Death

Symptoms of electric shock may include unconsciousness, failure to breathe, absence of pulse, pallor, and stiffness, and well as severe burns.

Treat the Victim

If the victim is not breathing, begin CPR or mouth-to-mouth resuscitation if you are certified.

Table of Contents

Title	Page
Introduction.....	1
Instruction Manuals	2
Wideband AC Voltage Module (Option 5700A-03).....	3
Auxiliary Amplifier	3
5725A Amplifier	3
Support Equipment and Services	4
732B Direct Voltage Reference Standard	4
732B-200 Direct Volt Maintenance Program (U.S.A. Only)	4
742A Series Resistance Standards.....	4
Wideband AC Module (Option 5700A-03) Calibration Support	5
Service Centers.....	5
The Components of the 5700A/5720A Series II Calibrator	6
Calibrating the 5700A/5720A Series II Calibrator	6
The Calibration Process.....	7
Establishing Traceability	8
Calibration Reports.....	8
Calibration Check	9
Developing a Performance History.....	9
Range Calibration	9
DC Zeros Calibration.....	9
Specifications.....	10
Specification Confidence Levels	10
Using Absolute and Relative Uncertainty Specifications.....	10
Using Secondary Performance Specifications.....	10
General Specifications	11
Electrical Specifications	13
DC Voltage Specifications	13
AC Voltage Specifications	16
Resistance Specifications	27
DC Current Specifications.....	31
AC Current Specifications.....	34
Wideband AC Voltage (Option 5700-03) Specifications.....	39
Auxiliary Amplifier Specifications	40
Service Information	41
Contacting Fluke.....	42
Placement and Rack Mounting	42

Cooling Considerations.....	42
Accessing the Fuse.....	43
Selecting Line Voltage.....	44
Connecting to Line Power	46
Connecting a 5725A Amplifier.....	46
Selecting Output Binding Posts	46
Front Panel Features	47
Display Screen Saver.....	47
Rear Panel Features	56
Softkey Menu Tree	58

List of Tables

Table	Title	Page
1.	Auxiliary Amplifier Data	3
2.	Standard Equipment	41
3.	Line Power Cord Types Available from Fluke	44
4.	Front Panel Features	48
5.	Rear Panel Features	56

List of Figures

Figure	Title	Page
1.	Time and Costs: Calibrator Calibration	7
2.	Accessing the Fuse	43
3.	Line Power Cord Types Available from Fluke	44
4.	Line Power Label and Switch Location	45
5.	Front Panel Features	49
6.	Rear Panel Features	57
7.	Softkey Menu Tree	59

Getting Started

Introduction

The Fluke Model 5700A/5720A Series II Calibrators are precise instruments that calibrate a wide variety of electrical measuring instruments. These calibrators maintain high accuracy over a wide ambient temperature range, allowing them to test instruments in any environment, eliminating the restrictions to calibrate only in a temperature-controlled standards laboratory. With a 5700A/5720A Series II, you can calibrate precision multimeters that measure ac or dc voltage, ac or dc current, and resistance. The 5720A Series II operates in a similar manner to the 5700A Series II, the difference is that the 5720A Series II has a considerably higher specified accuracy. Option 5700A-03 Wideband AC Voltage, which is available for both the 5700A Series II and the 5720A Series II, extends this workload to include rf voltmeters.

The calibrator is a fully-programmable precision source of the following:

- DC voltage to 1100 V
- AC voltage to 1100 V, with output available from 10 Hz to 1.2 MHz
- AC and DC current to 2.2 A, with output available from 10 Hz to 10 kHz
- Resistance in values of 1×10^n and 1.9×10^n from 1 Ω to 100 M Ω , plus a short
- Optional wideband ac voltage from 300 μ V to 3.5 V into 50 Ω (-57 dBm to +24 dBm), 10 Hz to 30 MHz

Features of the calibrator include the following:

- Internal environmentally-controlled references allowing the calibrator to maintain full performance over a wide ambient temperature range
- Automatic meter error calculation obtained through using a simple output adjust knob; the display shows linearity, offset, and scale errors
- Keys that multiply and divide the output value by 10 to simplify work on meters with calibration points at decade multiples of a fraction of full-scale
- Programmable entry limits used for restricting the levels that can be keyed into the calibrator, preventing access to levels that may be harmful to equipment or personnel
- A SPEC key that provides the capability of displaying the instrument's specification at the selected operating point, calibration interval, and specification confidence level

- An auxiliary current binding post that allows you to calibrate meters with separate current inputs without moving cables
- Real-time clock and calendar for date stamping reports
- Offset and scaling modes that simplify linearity testing of multimeters
- Variable phase reference signal output and phase-lock input
- Interface for the Fluke 5725A Amplifier
- Standard IEEE-488 (GPIB) interface, complying with ANSI/IEEE Standards 488.1-1987 and 488.2-1987
- Selectable normal remote mode or emulation of the Fluke 5100B and 5200A Series calibrators in functions and response to system controller software
- EIA Standard RS-232C serial data interface for printing, displaying, or transferring internally-stored calibration constants, and for remote control of the calibrator
- Extensive internal self-testing and diagnostics of analog and digital functions
- A traceable calibration procedure for all modes and ranges that requires only 10 V, 1 Ω , and 10 k Ω external standards, with only occasional independent verification
- Fast, simple, automated calibration check providing added confidence between calibration recalls, and data that can be used to document and characterize the calibrator's performance between calibration recalls

Instruction Manuals

The 5700A/5720A Series II Calibrators ship with a complete manual set that contains information for the operator and service or maintenance technicians. The set includes:

- *5700A/5720A Series II Getting Started Manual* (PN 1668111)
- *5700A/5720A Series II Operator Reference Guide* (PN 601648)
- *5700A/5720A Series II Remote Programming Reference Guide* (PN 601655)
- *5700A/5720A Series II Operator Manual* (provided on CD-ROM, PN 1668127, or a printed copy is available for purchase through the Fluke Service Department under PN 601622)
- *5700A/5720A Series II Service Manual* (provided on CD-ROM, PN 1668127, or a printed copy is available for purchase through the Fluke Service Department under PN 105798)

Order additional copies of these instruction manuals separately using the part numbers provided. For ordering instructions, refer to the Fluke Catalog or contact a Fluke sales representative.

Wideband AC Voltage Module (Option 5700A-03)

The Wideband AC Voltage Module (Option 5700A-03) can be installed in both the 5700A and 5720A Series II Calibrators. The module is a high-accuracy, low-noise, extremely flat ac voltage source for calibrating rf voltmeters, with a frequency range of 10 Hz to 30 MHz. Output is in seven ranges from 300 μ V (-57 dBm) to 3.5 V (+24 dBm) through a Type-N coaxial connector into a 50 Ω load. The output level is selected in volts or dBm through either the front panel controls or under remote control.

The wideband module also functions with the calibrator's output adjust controls that let display the error of a wideband meter in either percentage of output or in decibels.

Included with the wideband module is a Type-N output cable and a 50 Ω terminator. The wideband module is calibrated to the end of its standard-equipment output cable.

Auxiliary Amplifier

The Fluke Model 5725A Amplifier is available to extend the high voltage performance and current range of the calibrator:

Interface connectors on the calibrator's rear panel accept cables to directly operate a 5725A. Three amplifiers can be connected to the calibrator at the same time, but only one output can be active at a time. Once you have connected the amplifiers and configured the calibrator in a setup menu, amplifier operation is controlled by the calibrator.

Operating instructions for the 5725A are provided in Chapter 4 of the Operators Manual. The General Specifications include specifications for operating the calibrator with the 5725A. For other amplifier specifications, refer to their instruction manuals. Table 1 summarizes the extended capabilities offered by the 5725A. Brief descriptions of the extended capabilities follow.

Table 1. Auxiliary Amplifier Data

Model	Mode	Range
5725A Amplifier	AC V	20 to 1100 V rms up to 70 mA, 40 Hz to 30 kHz (50 mA < 5 kHz)
		220 to 750 V rms up to 70 mA, 30 kHz to 100 kHz
	DC Amps	0 to \pm 11 A
	DC Amps	1 to 11 A rms, 40 Hz to 10 kHz

5725A Amplifier

The Fluke 5725A Amplifier is an external unit operating under calibrator control to extend ac voltage drive capabilities and both ac and dc current output range. The amplifier adds the following capabilities to the calibrator's 1100 V AC range with no compromise in accuracy:

- Frequency limits at higher voltage increase to 100 kHz at 750 V, 30 kHz at 1100 V.
- Load limit increases to 70 mA for frequencies above 5 kHz.
- Capacitive drive increases to 1000 pF, subject to the maximum output current.

Extended-performance voltage is available at the calibrator's front or rear binding posts, eliminating the need to change cables during a procedure.

A separate set of binding posts on the front panel of the 5725A supplies extended-range ac and dc current outputs. Since most meters have a separate input terminal for the high current ranges, this eliminates the need to change cables during a procedure. The 5725A can also be configured to source all current (both standard calibrator-generated current and its own current) through the 5725A binding posts.

Support Equipment and Services

Fluke supports your calibration needs with precision, high-quality equipment and a wide range of services. Depending on your needs, location, and capabilities, you may decide to support your 5700A/5720A Series II Calibrator independently or use Fluke services for part, or all, of your support needs. The following paragraphs describe the support equipment and services offered by Fluke for the calibrator. For specifications and ordering instructions for this support equipment and other Fluke instruments, refer to the Fluke catalog, or contact a representative at a Fluke Sales and Service Center.

732B Direct Voltage Reference Standard

The Fluke 732B is a rugged, easily transported solid state direct voltage reference standard with a highly predictable 10 V output. This predictability allows the Fluke Standards Laboratory, as well as many Fluke customers, to completely eliminate fragile, saturated standard cells. Laboratories still maintain standard cells using the 732A and 732B as a transportable voltage standard, eliminating the need to transport their standard cells. The 732B can be short-circuited, even for extended periods of time, without damage or loss of stability. It maintains full specified stability over a temperature span of 18 to 28 °C.

The calibrator uses a 10 V reference standard such as the Fluke 732B in its semi-automated calibration procedure to establish external voltage traceability. Chapter 7 of the Operators Manual describes this procedure.

732B-200 Direct Volt Maintenance Program (U.S.A. Only)

The Fluke 732B-200 Direct Volt Maintenance Program provides your laboratory with NIST-traceable 10 V calibration uncertainty as low as 0.6 parts per million.

The program maintains the 732B that you keep in your laboratory. To accomplish this, the following occurs:

1. Fluke sends you a calibrated Fluke-owned 732B standard, together with all-necessary connecting cables and instructions for comparison with your 10 V reference standard.
2. You take a series of readings over a five-day period, and return the results to the Fluke Standards Laboratory.
3. The Fluke Standards Laboratory assigns a value to your 10 V standard relative to the NIST legal volt and sends you a report of calibration.

742A Series Resistance Standards

The calibrator uses 1 Ω and 10 k Ω resistor standards such as the 742A Series in its semi-automated calibration procedure to establish external traceability of resistance and current. Chapter 7 of the Operators Manual describes this procedure.

The 742A Resistance Standards, which are constructed of arrays of Fluke wirewound precision resistors, are ideally suited as support standards for the calibrator. Stability of the resistance transfer standards and their temperature coefficients make them ideal for easy transport to and operation in the calibrator's working environment.

Wideband AC Module (Option 5700A-03) Calibration Support

The Wideband AC Module (Option 5700A-03) requires two kinds of calibration: gain and flatness. Gain constants are checked and recalibrated as a part of the normal calibrator semi-automated calibration process.

Since frequency flatness is determined by such stable parameters as circuit geometry and dielectric constants, flatness of the Wideband AC module has excellent long-term stability. This stability gives the Wideband AC Module a two-year calibration cycle for flatness calibration. Flatness calibration is required only infrequently, and can be done when the calibrator is returned to a standards laboratory for periodic verification. The *5700A/5720A Series II Service Manual* contains the wideband flatness calibration procedure. Chapter 7 of the Operators Manual contains the wideband gain calibration procedure.

Service Centers

A worldwide network of Fluke service centers supports Fluke instruments and assists customers in many ways. Most service centers have standards and calibration laboratories certified by local national standards organizations. The following is a partial list of the services provided by most service centers:

- Repair and certified traceable calibration of all Fluke products.
- Certified traceable calibration of many non-Fluke standards and calibrators.
- Worldwide exchange of calibrator internal modules. Delivery inside the U.S.A. is typically within 48 hours.
- Service agreements with the flexibility to suit your needs. These can be a simple warranty extension or an agreement that includes on-site support. Calibration service agreements are also available in many areas.
- Training programs and seminars, including laboratory metrology, system applications, and product maintenance.
- Application help and consulting, including system design, hardware selection, custom software, site evaluation and installation.
- Replacement parts inventory, including recommended spare parts and module kits.

Visit www.fluke.com for locations and phone numbers of authorized Fluke service centers.

The Components of the 5700A/5720A Series II Calibrator

The calibrator is configured internally as an automated calibration system, with process controls and consistent procedures. Internal microprocessors control all functions and monitor performance, using a switching matrix to route signals between modules. Complete automatic internal diagnostics, both analog and digital, confirm operational integrity.

Reference amplifiers maintain dc accuracy and stability. Of all technologies available, reference amplifiers have the lowest noise and best stability. Reference amplifiers in the calibrator go through special selection processes including long-term aging to ensure high reliability and performance well within specifications.

The calibrator achieves its exceptional ac voltage accuracy by using a patented Fluke rms sensor to make real-time AC/DC comparison measurements. The Fluke rms sensor is similar in principle to the traditional thermal voltage converter, but has a shorter time constant, virtually no reversal error, higher signal-to-noise ratio, and better frequency response. In the calibrator, one Fluke rms sensor serves as an AC/DC transfer standard to develop gain and flatness correction constants during calibration. The second Fluke rms sensor continuously monitors and corrects output voltage during operation.

A patented 26-bit digital-to-analog converter (dac) provides the calibrator with the ability to precisely vary its output. This is a pulse-width-modulated dac with linearity typically better than 0.2 ppm of full scale. As with the other internal functions, the linearity of the dac is automatically checked during calibration and analog diagnostics.

Calibrating the 5700A/5720A Series II Calibrator

The traditional practice of returning a calibrator to a standards laboratory at regular intervals for a full calibration is time consuming, expensive, and disruptive to the task to which the calibrator is being applied. Moreover, it leaves gaps in confidence. You must rely on manufacturer's specifications to determine if a calibrator will perform acceptably in an operating environment outside the lab. Also, you must assume that drift is predictable enough so that performance is within limits between recalls.

The 5700A/5720A Series II Calibrator makes use of Fluke design breakthroughs in the use of internal check standards and measurement systems. As a result, it can be completely calibrated in place to full specifications using a small number of convenient, portable, environmentally tolerant standards available from Fluke. As you will see below, this procedure is traceable to military standard requirements.

When manufactured, each calibrator is calibrated and thoroughly verified with process metrology and calibration standards traceable to the U.S. National Bureau of Standards. A certificate of calibration is included.

A calibration verification procedure described in the *5700A/5720A Series II Service Manual* is recommended every two years or as required by your established policies. This procedure involves no adjustments. It simply ensures internal processes are in control, and establishes parallel external traceability paths for internal functions such as ac transfers that are never adjusted or corrected.

Figure 1 illustrates the time and money that can be saved by using the 5700A/5720A Series II calibration support plan recommended by Fluke. Depending on your policies, you may initially decide to perform calibration verification more often. The calibrator makes this unnecessary and offers you a practical way to collect data unavailable with a traditional calibrator design about performance between calibrations.

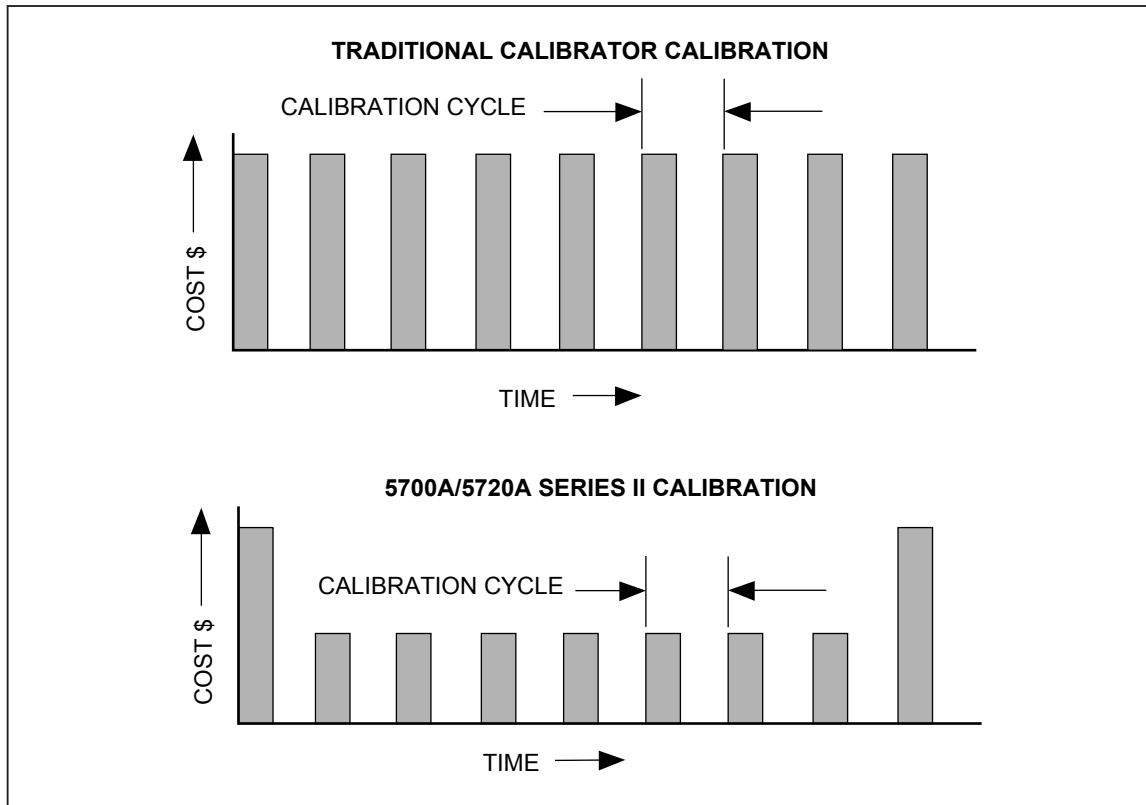

alh1.eps

Figure 1. Time and Costs: Calibrator Calibration

The Calibration Process

Calibration requires only three external standards: 10 V, 1 Ω , and 10 k Ω . Environmentally-controlled internal check standards provide the primary reference points. A stored table of calibration constants defines additional reference points for controlling the output. Traceable calibration and adjustment to the specified level of performance is accomplished in a semi-automated process that revises this table.

When you finish calibration, but before you save the new constants, the calibrator presents you with the proposed adjustments as +/- ppm of range and percentage change in specification for each range and function. You can print a list of changes through the serial (RS-232C) port, or send them to a computer through either the serial port or the IEEE-488 port. Also on completion of calibration, the calibrator displays the largest proposed change.

Calibration can be completed as far as deriving and printing the proposed adjustments without changing the setting of the rear panel CALIBRATION switch; however, the switch must be set to ENABLE to store the changes in nonvolatile memory and make them effective. The switch is recessed to allow the metrologist to cover it with a calibration sticker to guarantee calibrator integrity.

Establishing Traceability

Traceability to national standards is established as follows:

- Except for the internal AC/DC transfer standard, the internal check standards are directly calibrated by traceable external standards every time the 5700A/5720A Series II is calibrated.
- The internal AC/DC transfer standard is never adjusted, so its traceability is not disturbed by calibration. Infrequent verification is done in the traditional way, by comparing selected ac voltage outputs with an external dc voltage standard through an external ac/dc transfer standard. Fluke recommends this is done every two years or as determined by the policy of your organization.
- Infrequent independent verification is also performed on stable parameters, such as frequency flatness, determined more by circuit geometry and dielectric constants than time.

Calibration Reports

The calibrator stores two sets of calibration constants: the set currently in use and the old set from the previous calibration. This gives the calibrator the ability at any time to produce a calibration report of the differences between the present settings and the settings that were in effect before the last calibration. The report shows changes for each range and function in +/- ppm of range and in percentage of specification limit. You can print the report or send it to a host computer through either the RS-232-C or IEEE-488 interface.

If you request a calibration report after doing calibration but before saving the new constants, the report shows proposed changes to the calibration constants relative to the previously stored settings.

Calibration Check

Checking the calibration takes about an hour, and provides you with a means of documenting the calibrator's performance of a between calibrations. Calibration checking is similar to calibration, except internal check standards are used as primary references (no external standards are needed), and changes cannot be stored. The process produces a report similar to normal calibration, showing drift relative to internal check standards. Because cal check does not change stored calibration constants, there is no need to enable the rear panel CALIBRATION switch. Therefore, an external computer can do the procedure unattended.

Developing a Performance History

A Fluke specification is a set of performance limits that all products must meet. To maintain consistent quality, Fluke calibrators are specified with enough margin to include temperature, line, and load extremes, plus additional margin for production. This means that a typical 5700A/5720A Series II calibrator in a typical environment operates inside 50 % of specification limits. For some exacting applications, it can be helpful to know just how accurately a particular calibrator operates. The proper way to do this is to accumulate a performance history by calibrating regularly and recording results on a control chart.

Calibrating regularly and recording the results on a control chart is tedious and requires a large array of equipment. The calibrator's calibration check feature is an alternative with some distinct advantages:

- Calibrated check standards are already programmed into the unit. You do not have to use external standards.
- The process is consistent and automatic: it does not require an operator's assistance.

Each calibration check produces a new set of data points for accumulating a historical record. When this process is externally automated, significant history can be accumulated much faster than with a manual calibration.

Range Calibration

After calibration, you can make further fine adjustments to each range. Range adjustments are optional; they are not necessary to meet total uncertainty specifications. However, they do allow you to align your calibrator closer to your standards.

Before you do range calibration, you must first use the calibrator's semi-automated calibration procedure. This is to calibrate the ranges that will not be adjusted. It also performs an initial adjustment for each range, and supplies flatness corrections for ac functions.

DC Zeros Calibration

To ensure the validity of the specifications, a dc zeros calibration must be performed at least every 30 days. If more than 30 days elapse without a dc zeros calibration a warning message appears. This procedure does not require any external equipment or connections and takes approximately 2.5 minutes to complete.

Specifications

The 5700A/5720A Series II Calibrators are verified and calibrated at the factory prior to shipment to ensure they meet the accuracy standards required for all certified calibration laboratories. By calibrating to the specifications in this manual, you can maintain the high performance level throughout the life of your calibrator.

Specifications are valid after a warm-up period of twice the time the calibrator has been turned off, up to a maximum of 30 minutes. For example, if the calibrator has been turned off for five minutes, the warm-up period is ten minutes.

Specification Confidence Levels

Your calibrator's performance level is ensured by regular calibration to the primary performance specifications, which are provided at both the 99 % and 95 % confidence levels. The 95 % confidence level will provide an accuracy that will often surpass the accuracy requirements for meeting Tag 4 standards, or a coverage factor of 2. Calibration at the 99 % confidence level is also available for those applications that require a confidence factor for the specifications that is higher than 95 %. For information on selecting the confidence level, refer to Chapter 4 of the Operators Manual.

The specification tables in this manual provide specifications at both the 95 % and 99 % confidence levels for the 5700A/5720A Series II Calibrators. Included with these tables are operating specifications for using the calibrator with the Wideband AC Module (Option 5700A-03) and the 5725A Amplifier.

Using Absolute and Relative Uncertainty Specifications

To evaluate the 5700A/5720A Series II coverage of your calibration workload, use the Absolute Uncertainty specifications. Absolute uncertainty includes stability, temperature coefficient, linearity, line and load regulation, and the traceability to external standards. You do not need to add anything to absolute uncertainty to determine the ratios between the calibrator's uncertainties and the uncertainties of your calibration workload.

Relative uncertainty specifications are provided for enhanced accuracy applications. These specifications apply when range constants are adjusted (see "Range Calibration"). To calculate absolute uncertainty, you must combine the uncertainties of your external standards and techniques with relative uncertainty.

Using Secondary Performance Specifications

Secondary performance specifications and operating characteristics are included in uncertainty specifications. They are provided for special calibration requirements such as stability or linearity testing.

General Specifications

Warm-Up Time	Twice the time since last warmed up, to a maximum of 30 minutes.
System Installation	Rear output configuration and rack-mount kit available.
Standard Interfaces	IEEE-488, RS-232, 5725A, 5205A or 5215A, 5220A, phase lock in (BNC), phase reference out (BNC).
Temperature Performance	
Operating	0 °C to 50 °C
Calibration	15 °C to 35 °C
Storage	-40 °C to 75 °C
Relative Humidity	
Operating	<80 % to 30 °C, <70 % to 40 °C, <40 % to 50 °C
Storage	<95 %, non-condensing. A power stabilization period of four days may be required after extended storage at high temperature and humidity.
Safety	Designed to comply with UL3111; EN61010; CSA C22.2 No. 1010; ANSI/ISA S82.01-1994
Guard Isolation	20 V
EMI/RFI	Designed to comply with FCC Rules Part 15, Subpart B, Class B; EN50081-1, EN50082-1
ElectroStatic Discharge	This instrument meets criteria C for ESD requirements per EN61326
Line Power	
Line Frequency	47 to 63 Hz; ± 10 % 100 V, 110 V, 115 V, 120 V, 200 V, 220 V, 230 V, 240 V
Maximum Power	
5700A/5720A	300 VA
5725A	750 VA
Weight	
5700A/5720A	27kg (62 lbs)
5725A	32kg (70 lbs)
Size	
5700A/5720A	
Height	17.8 cm (7 in), standard rack increment, plus 1.5 cm (0.6 in) for feet
Width	43.2 cm (17 in), standard rack width
Depth	63.0 cm (24.8 in), overall; 57.8 cm (22.7 in), rack depth
5725A	
Height	13.3 cm, (5.25 in)
Width and Depth	Same as 5700A/5720A. Both units project 5.1 cm, (2 in) from rack front.

5700A/5720A Series II
Getting Started

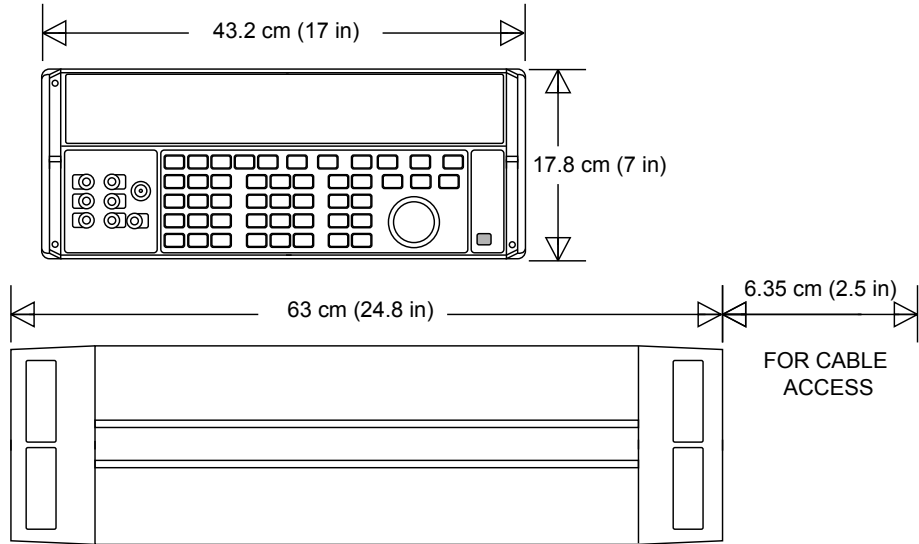

Electrical Specifications

Note

Fluke guarantees performance verification using specifications stated to 99% confidence level.

DC Voltage Specifications

5720A Series II DC Voltage Specifications

Range	Resolution	Absolute Uncertainty ± 5 °C from calibration temperature ^[1]				Relative Uncertainty ± 1 °C	
		24 Hours	90 Days	180 Days	1 Year	24 Hours	90 Days
		± (ppm output + μV)					
99 % Confidence Level							
220 mV	10 nV	5 + 0.5	7 + 0.5	8 + 0.5	9 + 0.5	2 + 0.4	2.5 + 0.4
2.2 V	100 nV	3.5 + 0.8	4 + 0.8	4.5 + 0.8	6 + 0.8	2 + 0.8	2.5 + 0.8
11 V	1 μV	2.5 + 3	3 + 3	3.5 + 3	4 + 3	1 + 3	1.5 + 3
22 V	1 μV	2.5 + 5	3 + 5	3.5 + 5	4 + 5	1 + 5	1.5 + 5
220 V	10 μV	3.5 + 50	4 + 50	5 + 50	6 + 50	2 + 50	2.5 + 50
1100 V	100 μV	5 + 500	6 + 500	7 + 500	8 + 500	2.5 + 400	3 + 400
95 % Confidence Level							
220 mV	10 nV	4 + 0.4	6 + 0.4	6.5 + 0.4	7.5 + 0.4	1.6 + 0.4	2 + 0.4
2.2 V	100 nV	3 + 0.7	3.5 + 0.7	4 + 0.7	5 + 0.7	1.6 + 0.7	2 + 0.7
11 V	1 μV	2 + 2.5	2.5 + 2.5	3 + 2.5	3.5 + 2.5	0.8 + 2.5	1.2 + 2.5
22 V	1 μV	2 + 4	2.5 + 4	3 + 4	3.5 + 4	0.8 + 4	1.2 + 4
220 V	10 μV	3 + 40	3.5 + 40	4 + 40	5 + 40	1.6 + 40	2 + 40
1100 V	100 μV	4 + 400	4.5 + 400	6 + 400	6.5 + 400	2 + 400	2.4 + 400
Notes:							
DC Zeros calibration required every 30 days.							
1. For fields strengths >1 V/m but ≤3 V/m, add 0.01 % of range.							

5700A Series II DC Voltage Specifications

Range	Resolution	Absolute Uncertainty ± 5 °C from calibration temperature ^[1]				Relative Uncertainty ± 1 °C	
		24 Hours	90 Days	180 Days	1 Year	24 Hours	90 Days
		± (ppm output + μV)					
99 % Confidence Level							
220 mV	10 nV	6.5 + .75	7 + .75	8 + .75	9 + .8	2.5 + .5	4 + .5
2.2 V	100 nV	3.5 + 1.2	6 + 1.2	7 + 1.2	8 + 1.2	2.5 + 1.2	4 + 1.2
11 V	1 μV	3.5 + 3	5 + 4	7 + 4	8 + 4	1.5 + 3	3.5 + 4
22 V	1 μV	3.5 + 6	5 + 8	7 + 8	8 + 8	1.5 + 6	3.5 + 8
220 V	10 μV	5 + 100	6 + 100	8 + 100	9 + 100	2.5 + 100	4 + 100
1100 V	100 μV	7 + 600	8 + 600	10 + 600	11 + 600	3 + 600	4.5 + 600
95 % Confidence Level							
220 mV	10 nV	5.5 + 0.6	6 + 0.6	7 + 0.6	8 + 0.6	2 + 0.4	3.5 + 0.4
2.2 V	100 nV	3.5 + 1	5 + 1	6 + 1	7 + 1	2 + 1	3.5 + 1
11 V	1 μV	3 + 3.5	4 + 3.5	6 + 3.5	7 + 3.5	1.2 + 3	3 + 3.5
22 V	1 μV	3 + 6.5	4 + 6.5	6 + 6.5	7 + 6.5	1.2 + 6	3 + 7
220 V	10 μV	4 + 80	5 + 80	7 + 80	8 + 80	2 + 80	3.5 + 80
1100 V	100 μV	6 + 500	7 + 500	8 + 500	9 + 500	2.4 + 500	4 + 500
Notes:							
DC Zeros calibration required every 30 days.							
1. For fields strengths >1 V/m but ≤ 3 V/m, add 0.01 % of range.							

DC Voltage Secondary Performance Specifications and Operating Characteristics

Range	Stability ^[1] ± 1 °C 24 Hours	Temperature Coefficient Adder ^[2]		Linearity ± 1 °C	Noise	
		10 - 40 °C	0 - 10 °C and 40 - 50 °C		Bandwidth 0.1-10 Hz pk-pk	Bandwidth 10 Hz-10 kHz RMS
	± (ppm output + μV)	± (ppm output + μV) / °C	± (ppm output + μV)	μV		
220 mV	0.3 + 0.3	0.4 + 0.1	1.5 + 0.5	1 + 0.2	0.15 + 0.1	5
2.2 V	0.3 + 1	0.3 + 0.1	1.5 + 2	1 + 0.6	0.15 + 0.4	15
11 V	0.3 + 2.5	0.15 + 0.2	1 + 1.5	0.3 + 2	0.15 + 2	50
22 V	0.4 + 5	0.2 + 0.4	1.5 + 3	0.3 + 4	0.15 + 4	50
220 V	0.5 + 40	0.3 + 5	1.5 + 40	1 + 40	0.15 + 60	150
1100 V	0.5 + 200	0.5 + 10	3 + 200	1 + 200	0.15 + 300	500

Notes:

1. Stability specifications are included in the Absolute Uncertainty values in the primary specification tables.
2. Temperature coefficient is an adder to uncertainty specifications that does *not* apply unless operating more than ±5 °C from calibration temperature.

Minimum Output	0 V for all ranges, except 100 V for 1100 V range
Maximum Load	50 mA for 2.2 V through 220 V ranges; 20 mA for 1100 V range; 50 Ω output impedance on 220 mV range; all ranges <1000 pF, >25 Ω
Load Regulation	<(0.2 ppm of output + 0.1 ppm of range), full load to no load
Line Regulation	<0.1 ppm change, ± 10 % of selected nominal line
Settling Time	3 seconds to full accuracy; + 1 second for range or polarity change; + 1 second for 1100 V range
Overshoot	<5 %
Common Mode Rejection	140 dB, DC to 400 Hz
Remote Sensing	Available 0 V to ±1100 V, on 2.2 V through 1100 V ranges

AC Voltage Specifications

5720A Series II AC Voltage Specifications: 99% Confidence Level

Range	Resolution	Frequency (Hz)	Absolute Uncertainty ± 5 °C from calibration temperature				Relative Uncertainty ± 1 °C	
			24 Hours	90 Days	180 Days	1 Year	24 Hours	90 Days
			± (ppm output + μV)					
2.2 mV	1 nV	10 - 20	250 + 5	270 + 5	290 + 5	300 + 5	250 + 5	270 + 5
		20 - 40	100 + 5	105 + 5	110 + 5	115 + 5	100 + 5	105 + 5
		40 - 20 k	85 + 5	90 + 5	95 + 5	100 + 5	60 + 5	65 + 5
		20 k - 50 k	220 + 5	230 + 5	240 + 5	250 + 5	85 + 5	95 + 5
		50 k - 100 k	500 + 6	540 + 6	570 + 6	600 + 6	200 + 6	220 + 6
		100 k - 300 k	1000 + 12	1200 + 12	1250 + 12	1300 + 12	350 + 12	400 + 12
		300 k - 500 k	1400 + 25	1500 + 25	1600 + 25	1700 + 25	800 + 25	1000 + 25
500 k - 1 M	2900 + 25	3100 + 25	3250 + 25	3400 + 25	2700 + 25	3000 + 25		
22 mV	10 nV	10 - 20	250 + 5	270 + 5	290 + 5	300 + 5	250 + 5	270 + 5
		20 - 40	100 + 5	105 + 5	110 + 5	115 + 5	100 + 5	105 + 5
		40 - 20 k	85 + 5	90 + 5	95 + 5	100 + 5	60 + 5	65 + 5
		20 k - 50 k	220 + 5	230 + 5	240 + 5	250 + 5	85 + 5	95 + 5
		50 k - 100 k	500 + 6	540 + 6	570 + 6	600 + 6	200 + 6	220 + 6
		100 k - 300 k	1000 + 12	1200 + 12	1250 + 12	1300 + 12	350 + 12	400 + 12
		300 k - 500 k	1400 + 25	1500 + 25	1600 + 25	1700 + 25	800 + 25	1000 + 25
500 k - 1 M	2900 + 25	3100 + 25	3250 + 25	3400 + 25	2700 + 25	3000 + 25		
220 mV	100 nV	10 - 20	250 + 15	270 + 15	290 + 15	300 + 15	250 + 15	270 + 15
		20 - 40	100 + 8	105 + 8	110 + 8	115 + 8	100 + 8	105 + 8
		40 - 20 k	85 + 8	90 + 8	95 + 8	100 + 8	60 + 8	65 + 8
		20 k - 50 k	220 + 8	230 + 8	240 + 8	250 + 8	85 + 8	95 + 8
		50 k - 100 k	500 + 20	540 + 20	570 + 20	600 + 20	200 + 20	220 + 20
		100 k - 300 k	850 + 25	900 + 25	1000 + 25	1100 + 25	350 + 25	400 + 25
		300 k - 500 k	1400 + 30	1500 + 30	1600 + 30	1700 + 30	800 + 30	1000 + 30
500 k - 1 M	2700 + 60	2900 + 60	3100 + 60	3300 + 60	2600 + 60	2800 + 60		
2.2 V	1 μV	10 - 20	250 + 50	270 + 50	290 + 50	300 + 50	250 + 50	270 + 50
		20 - 40	95 + 20	100 + 20	105 + 20	110 + 20	95 + 20	100 + 20
		40 - 20 k	45 + 10	47 + 10	50 + 10	52 + 10	30 + 10	40 + 10
		20 k - 50 k	80 + 12	85 + 12	87 + 12	90 + 12	70 + 12	75 + 12
		50 k - 100 k	120 + 40	125 + 40	127 + 40	130 + 40	100 + 40	105 + 40
		100 k - 300 k	380 + 100	420 + 100	460 + 100	500 + 100	270 + 100	290 + 100
		300 k - 500 k	1000 + 250	1100 + 250	1150 + 250	1200 + 250	900 + 250	1000 + 250
500 k - 1 M	1600 + 400	1800 + 600	1900 + 400	2000 + 400	1200 + 400	1300 + 400		
22 V	10 μV	10 - 20	250 + 500	270 + 500	290 + 500	300 + 500	250 + 500	270 + 500
		20 - 40	95 + 200	100 + 200	105 + 200	110 + 200	95 + 200	100 + 200
		40 - 20 k	45 + 70	47 + 70	50 + 70	52 + 70	30 + 70	40 + 70
		20 k - 50 k	80 + 120	85 + 120	87 + 120	90 + 120	70 + 120	75 + 120
		50 k - 100 k	110 + 250	115 + 250	117 + 250	120 + 250	100 + 250	105 + 250
		100 k - 300 k	300 + 800	310 + 800	320 + 800	325 + 800	270 + 800	290 + 800
		300 k - 500 k	1000 + 2500	1100 + 2500	1150 + 2500	1200 + 2500	900 + 2500	1000 + 2500
500 k - 1 M	1500 + 4000	1600 + 4000	1700 + 4000	1800 + 4000	1300 + 4000	1400 + 4000		
± (ppm output + mV)								
220 V ^[2]	100 μV	10 - 20	250 + 5	270 + 5	290 + 5	300 + 5	250 + 5	270 + 5
		20 - 40	95 + 2	100 + 2	105 + 2	110 + 2	95 + 2	100 + 2
		40 - 20 k	57 + 0.7	60 + 0.7	62 + 0.7	65 + 0.7	45 + 0.7	50 + 0.7
		20 k - 50 k	90 + 1.2	95 + 1.2	97 + 1.2	100 + 1.2	75 + 1.2	80 + 1.2
		50 k - 100 k	160 + 3	170 + 3	175 + 3	180 + 3	140 + 3	150 + 3
		100 k - 300 k	900 + 20	1000 + 20	1050 + 20	1100 + 20	600 + 20	700 + 20
		300 k - 500 k	5000 + 50	5200 + 50	5300 + 50	5400 + 50	4500 + 50	4700 + 50
500 k - 1 M	8000 + 100	9000 + 100	9500 + 100	10,000 + 100	8000 + 100	8500 + 100		
1100 V ^[1]	1 mV	15 - 50	300 + 20	320 + 20	340 + 20	360 + 20	300 + 20	320 + 20
		50 - 1 k	70 + 4	75 + 4	80 + 4	85 + 4	50 + 4	55 + 4

5725A Amplifier:								
1100 V	1 mV	40 - 1 k	75 + 4	80 + 4	85 + 4	90 + 4	50 + 4	55 + 4
		1 k - 20 k	105 + 6	125 + 6	135 + 6	165 + 6	85 + 6	105 + 6
		20 k - 30 k	230 + 11	360 + 11	440 + 11	600 + 11	160 + 11	320 + 11
750 V		30 k - 50 k	230 + 11	360 + 11	440 + 11	600 + 11	160 + 11	320 + 11
		50 k - 100k	600 + 45	1300 + 45	1600 + 45	2300 + 45	380 + 45	1200 + 45
Notes: 1. Maximum output 250 V from 15-50 Hz. 2. See Volt-Hertz capability in Figure A.								

5720A Series II AC Voltage Specifications: 95 % Confidence Level

Range	Resolution	Frequency (Hz)	Absolute Uncertainty ± 5 °C from calibration temperature				Relative Uncertainty ± 1 °C	
			24 Hours	90 Days	180 Days	1 Year	24 Hours	90 Days
			± (ppm output + μV)					
2.2 mV	1 nV	10 - 20	200 + 4	220 + 4	230 + 4	240 + 4	200 + 4	220 + 4
		20 - 40	80 + 4	85 + 4	87 + 4	90 + 4	80 + 4	85 + 4
		40 - 20 k	70 + 4	75 + 4	77 + 4	80 + 4	50 + 4	55 + 4
		20 k - 50 k	170 + 4	180 + 4	190 + 4	200 + 4	70 + 4	80 + 4
		50 k - 100 k	400 + 5	460 + 5	480 + 5	500 + 5	160 + 5	180 + 5
		100 k - 300 k	300 + 10	900 + 10	1000 + 10	1050 + 10	280 + 10	320 + 10
		300 k - 500 k	1100 + 20	1200 + 20	1300 + 20	1400 + 20	650 + 20	800 + 20
		500 k - 1 M	2400 + 20	2500 + 20	2600 + 20	2700 + 20	2100 + 20	2400 + 20
22 mV	10 nV	10 - 20	200 + 4	220 + 4	230 + 4	240 + 4	200 + 4	220 + 4
		20 - 40	80 + 4	85 + 4	87 + 4	90 + 4	80 + 4	85 + 4
		40 - 20 k	70 + 4	75 + 4	77 + 4	80 + 4	50 + 4	55 + 4
		20 k - 50 k	170 + 4	180 + 4	190 + 4	200 + 4	70 + 4	80 + 4
		50 k - 100 k	400 + 5	460 + 5	480 + 5	500 + 5	160 + 5	180 + 5
		100 k - 300 k	300 + 10	900 + 10	1000 + 10	1050 + 10	280 + 10	320 + 10
		300 k - 500 k	1100 + 20	1200 + 20	1300 + 20	1400 + 20	650 + 20	800 + 20
		500 k - 1 M	2400 + 20	2500 + 20	2600 + 20	2700 + 20	2100 + 20	2400 + 20
220 mV	100 nV	10 - 20	200 + 12	220 + 12	230 + 12	240 + 12	200 + 12	220 + 12
		20 - 40	80 + 7	85 + 7	87 + 7	90 + 7	80 + 7	85 + 7
		40 - 20 k	70 + 7	75 + 7	77 + 7	80 + 7	50 + 7	55 + 7
		20 k - 50 k	170 + 7	180 + 7	190 + 7	200 + 7	70 + 7	80 + 7
		50 k - 100 k	400 + 17	420 + 17	440 + 17	460 + 17	160 + 17	180 + 17
		100 k - 300 k	700 + 20	750 + 20	800 + 20	900 + 20	280 + 20	320 + 20
		300 k - 500 k	1100 + 25	1200 + 25	1300 + 25	1400 + 25	650 + 25	800 + 25
		500 k - 1 M	2400 + 45	2500 + 45	2600 + 45	2700 + 45	2100 + 45	2400 + 45
2.2 V	1 mV	10 - 20	200 + 40	220 + 40	230 + 40	240 + 40	200 + 40	220 + 40
		20 - 40	75 + 15	80 + 15	85 + 15	90 + 15	75 + 15	80 + 15
		40 - 20 k	37 + 8	40 + 8	42 + 8	45 + 8	25 + 8	35 + 8
		20 k - 50 k	65 + 10	70 + 10	73 + 10	75 + 10	55 + 10	60 + 10
		50 k - 100 k	100 + 30	105 + 30	107 + 30	110 + 30	80 + 30	85 + 30
		100 k - 300 k	300 + 80	340 + 80	380 + 80	420 + 80	230 + 80	250 + 80
		300 k - 500 k	800 + 200	900 + 200	950 + 200	1000 + 200	700 + 200	800 + 200
		500 k - 1 M	1300 + 300	1500 + 300	1600 + 300	1700 + 300	1000 + 300	1100 + 300
22 V	10 mV	10 - 20	200 + 400	220 + 400	230 + 400	240 + 400	200 + 400	220 + 400
		20 - 40	75 + 150	80 + 150	85 + 150	90 + 150	75 + 150	80 + 150
		40 - 20k	37 + 50	40 + 50	42 + 50	45 + 50	25 + 50	35 + 50
		20k - 50k	65 + 100	70 + 100	73 + 100	75 + 100	55 + 100	60 + 100
		50k - 100k	90 + 200	95 + 200	97 + 200	100 + 200	80 + 200	85 + 200
		100k - 300k	250 + 600	260 + 600	270 + 600	275 + 600	250 + 600	270 + 600
		300k - 500k	800 + 2000	900 + 2000	900 + 2000	1000 + 2000	700 + 2000	800 + 2000
		500k - 1M	1200 + 3200	1300 + 3200	1400 + 3200	1500 + 3200	1100 + 3200	1200 + 3200
± (ppm output + mV)								
220 V ^[2]	100 mV	10 - 20	200 + 4	220 + 4	230 + 4	240 + 4	200 + 4	220 + 4
		20 - 40	75 + 1.5	80 + 1.5	85 + 1.5	90 + 1.5	75 + 1.5	80 + 1.5
		40 - 20 k	45 + 0.6	47 + 0.6	50 + 0.6	52 + 0.6	35 + 0.6	40 + 0.6
		20 k - 50 k	70 + 1	75 + 1	77 + 1	80 + 1	60 + 1	65 + 1
		50 k - 100 k	120 + 2.5	130 + 2.5	140 + 2.5	150 + 2.5	110 + 2.5	120 + 2.5
		100 k - 300 k	700 + 16	800 + 16	850 + 16	900 + 16	500 + 16	600 + 16
		300 k - 500 k	4000 + 40	4200 + 40	4300 + 40	4400 + 40	3600 + 40	3800 + 40
		500 k - 1 M	6000 + 80	7000 + 80	7500 + 80	8000 + 80	6500 + 80	7000 + 80
1100 V ^[1]	1 mV	15 - 50	240 + 16	260 + 16	280 + 16	300 + 16	240 + 16	260 + 16
		50 - 1 k	55 + 3.5	60 + 3.5	65 + 3.5	70 + 3.5	40 + 3.5	45 + 3.5

5725A Amplifier:

1100 V	1 mV	40 - 1 k	75 + 4	80 + 4	85 + 4	90 + 4	50 + 4	55 + 4
		1 k - 20 k	105 + 6	125 + 6	135 + 6	165 + 6	85 + 6	105 + 6
		20 k - 30 k	230 + 11	360 + 11	440 + 11	600 + 11	160 + 11	320 + 11
750 V		30 k - 50 k	230 + 11	360 + 11	440 + 11	600 + 11	160 + 11	320 + 11
		50 k - 100 k	600 + 45	1300 + 45	1600 + 45	2300 + 45	380 + 45	1200 + 45
Notes: 1. Maximum output 250 V from 15-50 Hz. 2. See Volt-Hertz capability in Figure A.								

5700A Series II AC Voltage Specifications: 99 % Confidence Level

Range	Resolution	Frequency (Hz)	Absolute Uncertainty ± 5 °C from calibration temperature				Relative Uncertainty ± 1 °C	
			24 Hours	90 Days	180 Days	1 Year	24 Hours	90 Days
			± (ppm output + μV)					
2.2 mV	1 nV	10 - 20	500 + 5	550 + 5	600 + 5	600 + 5	500 + 5	550 + 5
		20 - 40	200 + 5	220 + 5	230 + 5	240 + 5	200 + 5	220 + 5
		40 - 20 k	100 + 5	110 + 5	120 + 5	120 + 5	60 + 5	65 + 5
		20 k - 50 k	340 + 5	370 + 5	390 + 5	410 + 5	100 + 5	110 + 5
		50 k - 100 k	800 + 8	900 + 8	950 + 8	950 + 8	220 + 8	240 + 8
		100 k - 300 k	1100 + 15	1200 + 15	1300 + 15	1300 + 15	400 + 15	440 + 15
		300 k - 500 k	1500 + 30	1700 + 30	1700 + 30	1800 + 30	1000 + 30	1100 + 30
		500 k - 1 M	4000 + 40	4400 + 40	4700 + 40	4800 + 40	400 + 30	4400 + 30
22 mV	10 nV	10 - 20	500 + 6	550 + 6	600 + 6	600 + 6	500 + 6	550 + 6
		20 - 40	200 + 6	220 + 6	230 + 6	240 + 6	200 + 6	220 + 6
		40 - 20 k	100 + 6	110 + 6	120 + 6	120 + 6	60 + 6	65 + 6
		20 k - 50 k	340 + 6	370 + 6	390 + 6	410 + 6	100 + 6	110 + 6
		50 k - 100 k	800 + 8	900 + 8	950 + 8	950 + 8	220 + 8	240 + 8
		100 k - 300 k	1100 + 15	1200 + 15	1300 + 15	1300 + 15	400 + 15	440 + 15
		300 k - 500 k	1500 + 30	1700 + 30	1700 + 30	1800 + 30	1000 + 30	1100 + 30
		500 k - 1 M	4000 + 40	4400 + 40	4700 + 40	4800 + 40	4000 + 30	4400 + 30
220 mV	100 nV	10 - 20	500 + 16	550 + 16	600 + 16	600 + 16	500 + 16	550 + 16
		20 - 40	200 + 10	220 + 10	230 + 10	240 + 10	200 + 10	220 + 10
		40 - 20 k	95 + 10	100 + 10	110 + 10	110 + 10	60 + 10	65 + 10
		20 k - 50 k	300 + 10	330 + 10	350 + 10	360 + 10	100 + 10	110 + 10
		50 k - 100 k	750 + 30	800 + 30	850 + 30	900 + 30	220 + 30	240 + 30
		100 k - 300 k	940 + 30	1000 + 30	1100 + 30	1100 + 30	400 + 30	440 + 30
		300 k - 500 k	1500 + 40	1700 + 40	1700 + 40	1800 + 40	1000 + 40	1100 + 40
		500 k - 1 M	3000 + 100	3300 + 100	3500 + 100	3600 + 100	3000 + 100	3300 + 100
2.2 V	1 mV	10 - 20	500 + 100	550 + 100	600 + 100	600 + 100	500 + 100	550 + 100
		20 - 40	150 + 30	170 + 30	170 + 30	180 + 30	150 + 30	170 + 30
		40 - 20 k	70 + 7	75 + 7	80 + 7	85 + 7	40 + 7	45 + 7
		20 k - 50 k	120 + 20	130 + 20	140 + 20	140 + 20	100 + 20	110 + 20
		50 k - 100 k	230 + 80	250 + 80	270 + 80	280 + 80	200 + 80	220 + 80
		100 k - 300 k	400 + 150	440 + 150	470 + 150	480 + 150	400 + 150	440 + 150
		300 k - 500 k	1000 + 400	1100 + 400	1200 + 400	1200 + 400	1000 + 400	1100 + 400
		500 k - 1 M	2000 + 1000	2200 + 1000	2300 + 1000	2400 + 1000	2000 + 1000	2200 + 1000
22 V	10 mV	10 - 20	500 + 1000	550 + 1000	600 + 1000	600 + 1000	500 + 1000	550 + 1000
		20 - 40	150 + 300	170 + 300	170 + 300	180 + 300	150 + 300	170 + 300
		40 - 20 k	70 + 70	75 + 70	80 + 70	85 + 70	40 + 70	45 + 70
		20 k - 50 k	120 + 200	130 + 200	140 + 200	140 + 200	100 + 200	110 + 200
		50 k - 100 k	230 + 400	250 + 400	270 + 400	280 + 400	200 + 400	220 + 400
		100 k - 300 k	500 + 1700	550 + 1700	550 + 1700	600 + 1700	500 + 1700	550 + 1700
		300 k - 500 k	1200 + 5000	1300 + 5000	1300 + 5000	1400 + 5000	1200 + 5000	1300 + 5000
		500 k - 1 M	2600 + 9000	2800 + 9000	2900 + 9000	3000 + 9000	2600 + 9000	2800 + 9000
± (ppm output + mV)								
220 V ^[2]	100 mV	10 - 20	500 + 10	550 + 10	600 + 10	600 + 10	500 + 10	550 + 10
		20 - 40	150 + 3	170 + 3	170 + 3	180 + 3	150 + 3	170 + 3
		40 - 20 k	75 + 1	80 + 1	85 + 1	90 + 1	45 + 1	50 + 1
		20 k - 50 k	200 + 4	220 + 4	240 + 4	250 + 4	100 + 1	110 + 1
		50 k - 100 k	500 + 10	550 + 10	600 + 10	600 + 10	300 + 10	330 + 10
		100 k - 300 k	1500 + 110	1500 + 110	1600 + 110	1600 + 110	1500 + 110	1500 + 110
		300 k - 500 k	5000 + 110	5200 + 110	5300 + 110	5400 + 110	5000 + 110	5200 + 110
		500 k - 1 M	12,000 + 220	12,500 + 220	12,500 + 220	13,000 + 220	12,000 + 220	12,000 + 220
1100 V ^[1]	1 mV	15 - 50	400 + 20	420 + 20	440 + 20	460 + 20	400 + 20	420 + 20
		50 - 1 k	75 + 4	80 + 4	85 + 4	90 + 4	50 + 4	55 + 4

5725A Amplifier:								
1100 V	1 mV	40 - 1 k	75 + 4	80 + 4	85 + 4	90 + 4	50 + 4	55 + 4
		1 k - 20 k	105 + 6	125 + 6	135 + 6	165 + 6	85 + 6	105 + 6
		20 k - 30 k	230 + 11	360 + 11	440 + 11	600 + 11	160 + 11	320 + 11
750 V		30 k - 50 k	230 + 11	360 + 11	440 + 11	600 + 11	160 + 11	320 + 11
		50 k - 100 k	600 + 45	1300 + 45	1600 + 45	2300 + 45	380 + 45	1200 + 45
Notes:								
1. Maximum output 250 V from 15-50 Hz.								
2. See Volt-Hertz capability in Figure A.								

5700A Series II AC Voltage Specifications: 95 % Confidence Level

Range	Resolution	Frequency (Hz)	Absolute Uncertainty $\pm 5^\circ\text{C}$ from calibration temperature				Relative Uncertainty $\pm 1^\circ\text{C}$	
			24 Hours	90 Days	180 Days	1 Year	24 Hours	90 Days
			\pm (ppm output + μV)					
2.2 mV	1 nV	10 - 20	400 + 4.5	500 + 4.5	530 + 4.5	550 + 4.5	400 + 4.5	500 + 4.5
		20 - 40	170 + 4.5	190 + 4.5	200 + 4.5	210 + 4.5	170 + 4.5	190 + 4.5
		40 - 20 k	85 + 4.5	95 + 4.5	100 + 4.5	105 + 4.5	55 + 4.5	60 + 4.5
		20 k - 50 k	300 + 4.5	330 + 4.5	350 + 4.5	370 + 4.5	90 + 4.5	100 + 4.5
		50 k - 100 k	700 + 7	750 + 7	800 + 7	850 + 7	210 + 7	230 + 7
		100 k - 300 k	900 + 13	1000 + 13	1050 + 13	1100 + 13	380 + 13	420 + 13
		300 k - 500 k	1300 + 25	1500 + 25	1600 + 25	1700 + 25	900 + 25	1000 + 25
		500 k - 1 M	2800 + 25	3100 + 25	3300 + 25	3400 + 25	2900 + 25	3200 + 25
22 mV	10 nV	10 - 20	400 + 5	500 + 5	530 + 5	550 + 5	400 + 5	500 + 5
		20 - 40	170 + 5	190 + 5	200 + 5	210 + 5	170 + 5	190 + 5
		40 - 20 k	85 + 5	95 + 5	100 + 5	105 + 5	55 + 5	60 + 5
		20 k - 50 k	300 + 5	330 + 5	350 + 5	370 + 5	90 + 5	100 + 5
		50 k - 100 k	700 + 7	750 + 7	800 + 7	850 + 7	210 + 7	230 + 7
		100 k - 300 k	900 + 12	1000 + 12	1050 + 12	1100 + 12	380 + 12	420 + 12
		300 k - 500 k	1300 + 25	1500 + 25	1600 + 25	1700 + 25	900 + 25	1000 + 25
		500 k - 1 M	2800 + 25	3100 + 25	3300 + 25	3400 + 25	2900 + 25	3200 + 25
220 mV	100 nV	10 - 20	400 + 13	500 + 13	530 + 13	550 + 13	400 + 13	500 + 13
		20 - 40	170 + 8	190 + 8	200 + 8	210 + 8	170 + 8	190 + 8
		40 - 20 k	85 + 8	95 + 8	100 + 8	105 + 8	55 + 8	60 + 8
		20 k - 50 k	250 + 8	280 + 8	300 + 8	320 + 8	90 + 8	100 + 8
		50 k - 100 k	700 + 25	750 + 25	800 + 25	850 + 25	210 + 25	230 + 25
		100 k - 300 k	900 + 25	1000 + 25	1050 + 25	1100 + 25	380 + 25	420 + 25
		300 k - 500 k	1300 + 35	1500 + 35	1600 + 35	1700 + 35	900 + 35	1000 + 35
		500 k - 1 M	2800 + 80	3100 + 80	3300 + 80	3400 + 80	2900 + 80	3200 + 80
2.2 V	1 mV	10 - 20	400 + 80	450 + 80	480 + 80	500 + 80	400 + 80	450 + 80
		20 - 40	130 + 25	140 + 25	150 + 25	160 + 25	130 + 25	140 + 25
		40 - 20 k	60 + 6	65 + 6	70 + 6	75 + 6	35 + 6	40 + 6
		20 k - 50 k	105 + 16	110 + 16	115 + 16	120 + 16	85 + 16	95 + 16
		50 k - 100 k	190 + 70	210 + 70	230 + 70	250 + 70	170 + 70	190 + 70
		100 k - 300 k	350 + 130	390 + 130	420 + 130	430 + 130	340 + 130	380 + 130
		300 k - 500 k	850 + 350	950 + 350	1000 + 350	1050 + 350	850 + 350	950 + 350
		500 k - 1 M	1700 + 850	1900 + 850	2100 + 850	2200 + 850	1700 + 850	1900 + 850
22 V	10 mV	10 - 20	400 + 800	450 + 800	480 + 800	500 + 800	400 + 800	450 + 800
		20 - 40	130 + 250	140 + 250	150 + 250	160 + 250	130 + 250	140 + 250
		40 - 20 k	60 + 60	65 + 60	70 + 60	75 + 60	35 + 60	40 + 60
		20 k - 50 k	105 + 160	110 + 160	115 + 160	120 + 160	85 + 160	95 + 160
		50 k - 100 k	190 + 350	210 + 350	230 + 350	250 + 350	170 + 350	190 + 350
		100 k - 300 k	400 + 1500	450 + 1500	470 + 1500	500 + 1500	400 + 1500	450 + 1500
		300 k - 500 k	1050 + 4300	1150 + 4300	1200 + 4300	1250 + 4300	1000 + 4300	1100 + 4300
		500 k - 1 M	2300 + 8500	2500 + 8500	2600 + 8500	2700 + 8500	2200 + 8500	2400 + 8500
\pm (ppm output + mV)								
220 V ^[2]	100 mV	10 - 20	400 + 8	450 + 8	480 + 8	500 + 8	400 + 8	450 + 8
		20 - 40	130 + 2.5	140 + 2.5	150 + 2.5	160 + 2.5	130 + 2.5	140 + 2.5
		40 - 20 k	65 + 0.8	70 + 0.8	75 + 0.8	80 + 0.8	40 + 0.8	45 + 0.8
		20 k - 50 k	170 + 3.5	190 + 3.5	210 + 3.5	220 + 3.5	85 + 3.5	95 + 3.5
		50 k - 100 k	400 + 8	450 + 8	480 + 8	500 + 8	270 + 8	300 + 8
		100 k - 300 k	1300 + 90	1400 + 90	1450 + 90	1500 + 90	1200 + 90	1300 + 90
		300 k - 500 k	4300 + 90	4500 + 90	4600 + 90	4700 + 90	4200 + 90	4500 + 90
		500 k - 1 M	10,500 + 190	11,000 + 190	11,300 + 190	11,500 + 190	10,500 + 190	11,000 + 190
1100 V ^[1]	1 mV	15 - 50	340 + 16	360 + 16	380 + 16	400 + 16	340 + 16	360 + 16
		50 - 1 k	65 + 3.5	70 + 3.5	75 + 3.5	80 + 3.5	45 + 3.5	50 + 3.5

5725A Amplifier:								
1100 V	1 mV	40 - 1 k	75 + 4	80 + 4	85 + 4	90 + 4	50 + 4	55 + 4
		1 k - 20 k	105 + 6	125 + 6	135 + 6	165 + 6	85 + 6	105 + 6
		20 k - 30 k	230 + 11	360 + 11	440 + 11	600 + 11	160 + 11	320 + 11
750 V		30 k - 50 k	230 + 11	360 + 11	440 + 11	600 + 11	160 + 11	320 + 11
		50 k - 100 k	600 + 45	1300 + 45	1600 + 45	2300 + 45	380 + 45	1200 + 45
Notes: 1. Maximum output 250 V from 15-50 Hz. 2. See Volt-Hertz capability in Figure A.								

AC Voltage Secondary Performance Specifications and Operating Characteristics

Range	Frequency (Hz)	Stability $\pm 1\text{ }^\circ\text{C}$ [1] 24 Hours	Temperature Coefficient		Output Impedance (Ω)	Maximum Distortion Bandwidth 10 Hz-10 MHz \pm (% output + μV)
			10 - 40 $^\circ\text{C}$	0 - 10 $^\circ\text{C}$ and 40 - 50 $^\circ\text{C}$		
			$\pm\mu\text{V} / ^\circ\text{C}$			
2.2 mV	10 - 20	5	0.05	0.05	50	0.05 + 10
	20 - 40	5	0.05	0.05		0.035 + 10
	40 - 20 k	2	0.05	0.05		0.035 + 10
	20 k - 50 k	2	0.1	0.1		0.035 + 10
	50 k - 100 k	3	0.2	0.2		0.035 + 30
	100 k - 300 k	3	0.3	0.3		0.3 + 30
	300 k - 500 k 500 k - 1 M	5 5	0.4 0.5	0.4 0.5		0.3 + 30 2 + 50
22 mV	10 - 20	5	0.2	0.3	50	0.05 + 11
	20 - 40	5	0.2	0.3		0.035 + 11
	40 - 20 k	2	0.2	0.3		0.035 + 11
	20 k - 50 k	2	0.4	0.5		0.035 + 11
	50 k - 100 k	3	0.5	0.5		0.035 + 30
	100 k - 300 k	5	0.6	0.6		0.3 + 30
	300 k - 500 k 500 k - 1 M	10 15	1 1	1 1		0.3 + 30 2 + 30
		\pm (ppm output + μV)	\pm (ppm output μV) / $^\circ\text{C}$			
220 mV	10 - 20	150 + 20	2 + 1	2 + 1	50	0.05 + 16
	20 - 40	80 + 15	2 + 1	2 + 1		0.035 + 16
	40 - 20 k	12 + 2	2 + 1	2 + 1		0.035 + 16
	20 k - 50 k	10 + 2	15 + 2	15 + 2		0.035 + 16
	50 k - 100 k	10 + 2	15 + 4	15 + 4		0.035 + 30
	100 k - 300 k	20 + 4	80 + 5	80 + 5		0.3 + 30
	300 k - 500 k 500 k - 1 M	100 + 10 200 + 20	80 + 5 80 + 5	80 + 5 80 + 5		0.3 + 30 1 + 30
					Load Regulation \pm (ppm output+ μV)	
2.2 V	10 - 20	150 + 20	50 + 10	50 + 10	10 + 2	0.05 + 80
	20 - 40	80 + 15	15 + 5	15 + 5	10 + 2	0.035 + 80
	40 - 20 k	12 + 4	2 + 1	5 + 2	10 + 4	0.035 + 80
	20 k - 50 k	15 + 5	10 + 2	15 + 4	30 + 10	0.035 + 80
	50 k - 100 k	15 + 5	10 + 4	20 + 4	120 + 16	0.035 + 110
	100 k - 300 k	30 + 10	80 + 15	80 + 15	300 ppm	0.3 + 110
	300 k - 500 k 500 k - 1 M	70 + 20 150 + 50	80 + 40 80 + 100	80 + 40 80 + 100	600 ppm 1200 ppm	0.5 + 110 1 + 110
22 V	10 - 20	150 + 20	50 + 100	50 + 100	10 + 20	0.05 + 700
	20 - 40	80 + 15	15 + 30	15 + 40	10 + 20	0.035 + 700
	40 - 20 k	12 + 8	2 + 10	4 + 15	10 + 30	0.035 + 700
	20 k - 50 k	15 + 10	10 + 20	20 + 20	30 + 50	0.035 + 700
	50 k - 100 k	15 + 10	10 + 40	20 + 40	80 + 80	0.05 + 800
	100 k - 300 k	30 + 15	80 + 150	80 + 150	100 + 700	0.3 + 800
	300 k - 500 k 500 k - 1 M	70 + 100 150 + 100	80 + 300 80 + 500	80 + 300 80 + 500	200 + 1100 600 + 3000	0.3 + 800 2 + 800
220 V	10 - 20	150 + 200	50 + 1000	50 + 1000	10 + 200	0.05 + 10,000
	20 - 40	80 + 150	15 + 300	15 + 300	10 + 200	0.05 + 10,000
	40 - 20 k	12 + 80	2 + 80	4 + 80	10 + 300	0.05 + 10,000
	20 k - 50 k	15 + 100	10 + 100	20 + 100	30 + 600	0.05 + 10,000
	50 k - 100 k	15 + 100	10 + 500	20 + 500	80 + 3,000	0.2 + 50,000
	100 k - 300 k	30 + 400	80 + 600	80 + 600	250 + 25,000	1.5 + 50,000
	300 k - 500 k 500 k - 1 M	100 + 10,000 200 + 20,000	80 + 800 80 + 1000	80 + 800 80 + 1000	500 + 50,000 1000 + 110,000	1.5 + 50,000 3.5 + 100,000
		\pm (ppm output + mV)	\pm (ppm output) / $^\circ\text{C}$		\pm (ppm output + mV)	\pm (% output)
1100 V	15 - 50	150 + 0.5	50	50	10 + 2	0.15
	50 - 1 k	20 + 0.5	2	5	10 + 1	0.07

5725A Amplifier:							
Range	Frequency (Hz)	Stability ± 1 °C ^[1] 24 Hours	Temperature Coefficient Adder		Load Regulation ^[2]	Distortion Bandwidth 10 Hz -10 MHz ±(% output)	
			10 - 40 °C	0 - 10 °C and 40 - 50 °C		150 pF	1000 pF
		±(ppm output + mV)	±(ppm output) / °C		±(ppm output + mV)		
1100 V	40 - 1 k	10 + .5	5	5	10 + 1	0.10	0.10
	1 k - 20 k	15 + 2	5	5	90 + 6	0.10	0.15
	20 k - 50 k	40 + 2	10	10	275 + 11	0.30	0.30
	50 k - 100 k	130 + 2	30	30	500 + 30	0.40	0.40

Notes:

- Stability specifications are included in Absolute Uncertainty values for the primary specifications.
- The 5725A will drive up to 1000 pF of load capacitance. Uncertainty specifications include loads to 300 pF and 150 pF as shown under "Load Limits." For capacitances up to the maximum of 1000 pF, add "Load Regulation."

Voltage Range	Maximum Current Limits	Load Limits
2.2 V ^[2]		
22 V	50 mA, 0 °C-40 °C	>50 Ω,
220 V	20 mA, 40 °C-50 °C	1000 pF
1100 V	6 mA	600 pF
5725A Amplifier:		
1100 V	40 Hz-5 kHz	50 mA
	5 kHz-30 kHz	70 mA
	30 kHz-100 kHz	70 mA ^[3]
		1000 pF ^[1]
		300 pF
		150 pF

Notes:

- The 5725A will drive up to 1000 pF of load capacitance. Uncertainty specifications include loads to 300 pF and 150 pF as shown under "Load Limits." For capacitances up to the maximum of 1000 pF, add "Load Regulation."
- 2.2 V Range, 100 kHz-1.2 MHz only: uncertainty specifications cover loads to 10 mA or 1000 pF. For higher loads, load regulation is added.
- Applies from 0 °C to 40 °C.

Output Display Formats Voltage or dBm, dBm reference 600 Ω.
Minimum Output 10 % on each range
External Sense Selectable for 2.2 V, 22 V, 220 V, and 1100 V ranges; 5700A/5720A <100 kHz, 5725A <30 kHz

Settling Time to Full Accuracy

Frequency (Hz)	Settling Time (seconds)
<20	7
120-120 k	5
>120 k	2

Notes:

- Plus 1 second for amplitude or frequency range change
- Plus 2 seconds for 5700A/5720A 1100 V range
- Plus 4 seconds for 5725A 1100 V range

Overshoot	<10 %
Common Mode Rejection	140 dB, DC to 400 Hz
Frequency	
Ranges (Hz).....	10.000 - 119.99
	0.1200 k - 1.1999 k
	1.200 k - 11.999 k
	12.00 k - 119.99 k
	120.0 k - 1.1999 M
Uncertainty.....	±0.01 %
Resolution.....	11.999 counts
Phase Lock (Selectable Rear Panel BNC Input)	
Phase Uncertainty (except 1100 V range).....	>30 Hz: $\pm 1^\circ + 0.05^\circ/\text{kHz}$, <30 Hz: $\pm 3^\circ$
Input Voltage.....	1 V to 10 V rms sine wave (do not exceed 1 V for mV ranges)
Frequency Range	10 Hz to 1.1999 MHz
Lock Range.....	±2 % of frequency
Lock-In Time	Larger of 10/frequency or 10 msec
Phase Reference (Selectable Rear Panel BNC Output)	
Range	±180 °
Phase Uncertainty (except 1100 V range).....	±1 ° at quadrature points (0 °, ±90 °, ±180 °) elsewhere ±2 °
Stability	±0.1 °
Resolution.....	1 °
Output Level	2.5 V rms ±0.2 V
Frequency Range	50 kHz to 1 kHz, usable 10 Hz to 1.1999 MHz

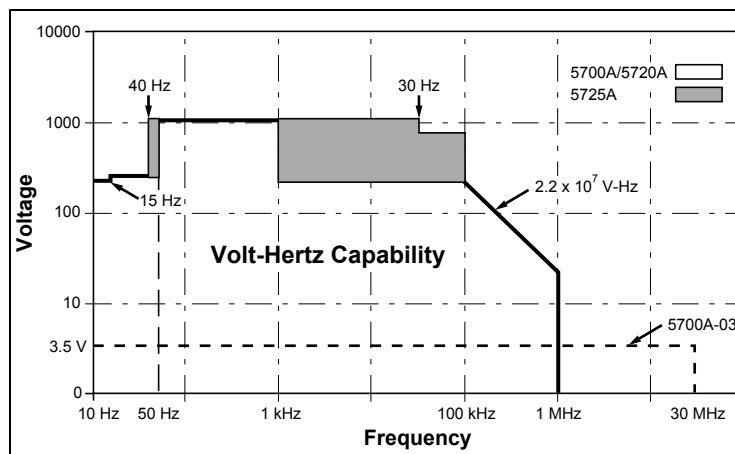

Figure A.

Resistance Specifications

5720A Series II Resistance Specifications

Nominal Value (Ω)	Absolute Uncertainty of Characterized Value $\pm 5^\circ\text{C}$ from calibration temperature ^[1]				Relative Uncertainty $\pm 1^\circ\text{C}$	
	24 Hours	90 Days	180 Days	1 Year	24 Hours	90 Days
	$\pm\text{ppm}$					
99 % Confidence Level						
0	50 $\mu\Omega$	50 $\mu\Omega$	50 $\mu\Omega$	50 $\mu\Omega$	50 $\mu\Omega$	50 $\mu\Omega$
1	85	95	100	110	32	40
1.9	85	95	100	110	25	33
10	23	25	26	27	5	8
19	23	25	26	27	4	7
100	10	11	11.5	12	2	4
190	10	11	11.5	12	2	4
1 k	8	9	9.5	10	2	3
1.9 k	8	9	9.5	10	2	3
10 k	8	9	9.5	10	2	3
19 k	9	9	9.5	10	2	3
100 k	9	11	12	13	2	3
190 k	9	11	12	13	2	3
1 M	16	18	20	23	2.5	5
1.9 M	17	19	21	24	3	6
10 M	33	37	40	46	10	14
19 M	43	47	50	55	20	24
100 M	100	110	115	120	50	60
95 % Confidence Level						
0	40 $\mu\Omega$	40 $\mu\Omega$	40 $\mu\Omega$	40 $\mu\Omega$	40 $\mu\Omega$	40 $\mu\Omega$
1	70	80	85	95	27	35
1.9	70	80	85	95	20	26
10	20	21	22	23	4	7
19	20	21	22	23	3.5	6
100	8	9	9.5	10	1.6	3.5
190	8	9	9.5	10	1.6	3.5
1 k	6.5	7.5	8	8.5	1.6	2.5
1.9 k	6.5	7.5	8	8.5	1.6	2.5
10 k	6.5	7.5	8	8.5	1.6	2.5
19 k	7.5	7.5	8	8.5	1.6	2.5
100 k	7.5	9	10	11	1.6	2.5
190 k	7.5	9	10	11	1.6	2.5
1 M	13	15	17	20	2	4
1.9 M	14	16	18	21	2.5	4
10 M	27	31	34	40	8	12
19 M	35	39	42	47	16	20
100 M	85	95	100	100	40	50
Note:						
1. Specifications apply to displayed value. 4-wire connections, except 100 M Ω .						

5700A Series II Resistance Specifications

Nominal Value (Ω)	Absolute Uncertainty of Characterized Value $\pm 5^\circ\text{C}$ from calibration temperature ^[1]				Relative Uncertainty $\pm 1^\circ\text{C}$	
	24 Hours	90 Days	180 Days	1 Year	24 Hours	90 Days
	$\pm\text{ppm}$					
99 % Confidence Level						
0	50 $\mu\Omega$	50 $\mu\Omega$	50 $\mu\Omega$	50 $\mu\Omega$	50 $\mu\Omega$	50 $\mu\Omega$
1	85	95	100	110	32	40
1.9	85	95	100	110	25	33
10	26	28	30	33	5	8
19	24	26	28	31	4	7
100	15	17	18	20	2	4
190	15	17	18	20	2	4
1 k	11	12	13	15	2	3.5
1.9 k	11	12	13	15	2	3.5
10 k	9	11	12	14	2	3.5
19 k	9	11	12	14	2	3.5
100 k	11	13	14	16	2	3.5
190 k	11	13	14	16	2	3.5
1 M	16	18	20	23	2.5	5
1.9 M	17	19	21	24	3.5	6
10 M	33	37	40	46	10	14
19 M	43	47	50	55	20	24
100 M	110	120	125	130	50	60
95 % Confidence Level						
0	50 $\mu\Omega$	50 $\mu\Omega$	50 $\mu\Omega$	50 $\mu\Omega$	50 $\mu\Omega$	50 $\mu\Omega$
1	70	80	85	95	32	40
1.9	70	80	85	95	25	33
10	21	23	27	28	5	8
19	20	22	24	27	4	7
100	13	14	15	17	2	4
190	13	14	15	17	2	4
1 k	9	10	11	13	2	3.5
1.9 k	9	10	11	13	2	3.5
10 k	7.5	9.5	10.5	12	2	3.5
19 k	7.5	9.5	10.5	12	2	3.5
100 k	9	11	12	14	2	3.5
190 k	9	11	12	14	2	3.5
1 M	13	15	17	20	2.5	5
1.9 M	14	16	18	21	3	6
10 M	27	31	34	40	10	14
19 M	35	39	42	47	20	24
100 M	90	100	105	110	50	60
Note:						
1. Specifications apply to displayed value. 4-wire connections, except 100 M Ω .						

Resistance Secondary Performance Specifications and Operating Characteristics

Nominal Value (Ω)	Stability $\pm 1\text{ }^\circ\text{C}$ ^[1] 24 Hours	Temperature Coefficient Adder ^[2]		Full Spec Load Range ^[3] $I_L - I_U$ (mA)	Maximum Peak Current I_{MAX} (mA)	Maximum Difference of Characterized to Nominal Value	Two-Wire Adder Active Compensation ^[4]	
		10 - 40 $^\circ\text{C}$	0 - 10 $^\circ\text{C}$ and 40 - 50 $^\circ\text{C}$				Lead Resistance	
		$\pm\text{ppm}/^\circ\text{C}$					0.1 Ω	1 Ω
						$\pm\text{ppm}$	$\pm\text{m}\Omega$	
0	—	—	—	8 - 500	500	—	$2 + \frac{4\mu\text{V}}{I_m}$	$4 + \frac{4\mu\text{V}}{I_m}$
1	32	4	5	8 - 100	700	500	$2 + \frac{4\mu\text{V}}{I_m}$	$4 + \frac{4\mu\text{V}}{I_m}$
1.9	25	6	7	8 - 100	500	500	$2 + \frac{4\mu\text{V}}{I_m}$	$4 + \frac{4\mu\text{V}}{I_m}$
10	5	2	3	8 - 11	220	300	$2 + \frac{4\mu\text{V}}{I_m}$	$4 + \frac{4\mu\text{V}}{I_m}$
19	4	2	3	8 - 11	160	300	$2 + \frac{4\mu\text{V}}{I_m}$	$4 + \frac{4\mu\text{V}}{I_m}$
100	2	2	3	8 - 11	70	150	$2 + \frac{4\mu\text{V}}{I_m}$	$4 + \frac{4\mu\text{V}}{I_m}$
190	2	2	3	8 - 11	50	150	$2 + \frac{4\mu\text{V}}{I_m}$	$4 + \frac{4\mu\text{V}}{I_m}$
1 k	2	2	3	1 - 2	22	150	10	15
1.9 k	2	2	3	1 - 1.5	16	150	10	15
10 k	2	2	3	100 - 500 μA	7	150	50	60
19 k	2	2	3	50 - 250 μA	5	150	100	120
100 k	2	2	3	10 - 100 μA	1	150	I_m = Current produced by Ohmmeter (A)	
190 k	2	2	3	5 - 50 μA	500 μA	150		
1 M	2.5	2.5	6	5 - 20 μA	100 μA	200		
1.9 M	3.5	3	10	2.5 - 10 μA	50 μA	200		
10 M	10	5	20	0.5 - 2 μA	10 μA	300		
19 M	20	8	40	0.25 - 1 μA	5 μA	300		
100 M	50	12	100	50 - 200 nA	1 μA	500		

Notes:

1. Stability specifications are included in the Absolute Uncertainty values in the primary specification tables.
2. Temperature coefficient is an adder to uncertainty specifications that does not apply unless operated more than 5 $^\circ\text{C}$ from calibration temperature, or calibrated outside the range 19 $^\circ\text{C}$ to 24 $^\circ\text{C}$. Two examples:
 - Calibrate at 20 $^\circ\text{C}$: Temperature coefficient adder is not required unless operated below 15 $^\circ\text{C}$ or above 25 $^\circ\text{C}$.
 - Calibrate at 26 $^\circ\text{C}$: Add 2 $^\circ\text{C}$ temperature coefficient adder. Additional temperature coefficient adder is not required unless operated below 21 $^\circ\text{C}$ or above 31 $^\circ\text{C}$.
3. Refer to current derating factors table for loads outside of this range.
4. Active two-wire compensation may be selected for values less than 100 k Ω , with either the front panel or the meter input terminals as reference plane. Active compensation is limited to 11 mA load, and to 2 V burden. Two-wire compensation can be used only with Ω -meters that source continuous (not pulsed) dc current.

Current Derating Factors

Nominal Value (Ω)	Value of Derating Factor K for Over or Under Current		
	Two-Wire Comp $I < I_L$ ^[1]	Four-Wire $I < I_L$ ^[1]	Four-Wire $I_U < I < I_{MAX}$ ^[2]
SHORT	4.4	0.3	—
1	4.4	300	4×10^{-5}
1.9	4.4	160	1.5×10^{-4}
10	4.4	30	1.6×10^{-3}
19	4.4	16	3×10^{-3}
100	4.4	3.5	1×10^{-2}
190	4.4	2.5	1.9×10^{-2}
1 k	4.4	0.4	0.1
1.9 k	4.4	0.4	0.19
10 k	5000	50	2.0
19 k	5000	50	3.8
100 k	—	7.5	2×10^{-5}
190 k	—	4.0	3.8×10^{-5}
1 M	—	1.0	1.5×10^{-4}
1.9 M	—	0.53	2.9×10^{-4}
10 M	—	0.2	1×10^{-3}
19 M	—	0.53	1.9×10^{-3}
100 M	—	0.1	—

Notes:

- For $I < I_L$, errors occur due to thermally generated voltages within the 5720A. Use the following equation to determine the error, and add this error to the corresponding uncertainty or stability specification.

$$\text{Error} = K(I_L - I) / (I_L \times I)$$
 Where: Error is in m Ω for all two-wire comp values and four-wire short, and in ppm for the remaining four-wire values.
 K is the constant from the above table;
 I and I_L are expressed in mA for short to 1.9 k Ω ;
 I and I_L are expressed in μ A for 10 k Ω to 100 M Ω
- For $I_U < I < I_{MAX}$ errors occur due to self-heating of the resistors in the calibrator. Use the following equation to determine the error in ppm and add this error to the corresponding uncertainty or stability specification.

$$\text{Error in ppm} = K(I^2 - I_U^2)$$
 Where: K is the constant from the above table;
 I and I_U are expressed in mA for short to 19 k Ω ;
 I and I_U are expressed in μ A for 100 k Ω to 100 M Ω

DC Current Specifications

5720A Series II DC Current Specifications

Range	Resolution	Absolute Uncertainty ± 5 °C from calibration temperature ^[2]				Relative Uncertainty ± 1 °C	
		24 Hours	90 Days	180 Days	1 Year	24 Hours	90 Days
	nA	± (ppm output + nA)					
99 % Confidence Level							
220 µA	0.1	40 + 7	42 + 7	45 + 7	50 + 7	24 + 2	26 + 2
2.2 mA	1	30 + 8	35 + 8	37 + 8	40 + 8	24 + 5	26 + 5
22 mA	10	30 + 50	35 + 50	37 + 50	40 + 50	24 + 50	26 + 50
	µA	± (ppm output + µA)					
220 mA ^[1]	0.1	40 + 0.8	45 + 0.8	47 + 0.8	50 + 0.8	26 + 0.3	30 + 0.3
2.2 A ^[1]	1	60 + 15	70 + 15	80 + 15	90 + 15	40 + 7	45 + 7
5725A Amplifier:							
11 A	10	330 + 470	340 + 480	350 + 480	360 + 480	100 + 130	110 + 130
95 % Confidence Level							
	nA	± (ppm output + nA)					
220 µA	0.1	32 + 6	35 + 6	37 + 6	40 + 6	20 + 1.6	22 + 1.6
2.2 mA	1	25 + 7	30 + 7	33 + 7	35 + 7	20 + 4	22 + 4
22 mA	10	25 + 40	30 + 40	33 + 40	35 + 40	20 + 40	22 + 40
	µA	± (ppm output + µA)					
220 mA ^[1]	0.1	35 + 0.7	40 + 0.7	42 + 0.7	45 + 0.7	22 + 0.25	25 + 0.25
2.2 A ^[1]	1	50 + 12	60 + 12	70 + 12	80 + 12	32 + 6	40 + 6
5725A Amplifier:							
11 A	10	330 + 470	340 + 480	350 + 480	360 + 480	100 + 130	110 + 130
<p>Note:</p> <p>Maximum output from the calibrator's terminals is 2.2 A. Uncertainty specifications for 220 mA and 2.2 mA ranges are increased by a factor of 1.3 when supplied through 5725A terminals.</p> <p>Specifications are otherwise identical for all output locations.</p> <ol style="list-style-type: none"> Add to uncertainty specifications: <ul style="list-style-type: none"> ±200 x I² ppm for >100 mA on 220 mA range ±10 x I² ppm for >1 A on 2.2 A range For fields strengths >0.4 V/m but ≤3 V/m, add 1 % of range. 							

5700A Series II DC Current Specifications

Range	Resolution	Absolute Uncertainty $\pm 5\text{ }^\circ\text{C}$ from calibration temperature ^[2]				Relative Uncertainty $\pm 1\text{ }^\circ\text{C}$	
		24 Hours	90 Days	180 Days	1 Year	24 Hours	90 Days
	nA	\pm (ppm output + nA)					
99 % Confidence Level							
220 μA	0.1	45 + 10	50 + 10	55 + 10	60 + 10	24 + 2	26 + 2
2.2 mA	1	45 + 10	50 + 10	55 + 10	60 + 10	24 + 5	26 + 5
22 mA	10	45 + 100	50 + 100	55 + 100	60 + 100	24 + 50	26 + 50
	μA	\pm (ppm output + μA)					
220 mA ^[1]	0.1	55 + 1	60 + 1	65 + 1	70 + 1	26 + 0.3	30 + 0.3
2.2 A ^[1]	1	75 + 30	80 + 30	90 + 30	95 + 30	40 + 7	45 + 7
5725A Amplifier:							
11 A	10	330 + 470	340 + 480	350 + 480	360 + 480	100 + 130	110 + 130
95 % Confidence Level							
	nA	\pm (ppm output + nA)					
220 μA	0.1	35 + 8	40 + 8	45 + 8	50 + 8	20 + 1.6	22 + 1.6
2.2 mA	1	35 + 8	40 + 8	45 + 8	50 + 8	20 + 4	22 + 4
22 mA	10	35 + 80	40 + 80	45 + 80	50 + 80	20 + 40	22 + 40
	μA	\pm (ppm output + μA)					
220 mA ^[1]	0.1	45 + 0.8	50 + 0.8	55 + 0.8	60 + 0.8	22 + 0.25	25 + 0.25
2.2 A ^[1]	1	60 + 25	65 + 25	75 + 25	80 + 25	35 + 6	40 + 6
5725A Amplifier:							
11 A	10	330 + 470	340 + 480	350 + 480	360 + 480	100 + 130	110 + 130
<p>Note:</p> <p>Maximum output from the calibrator's terminals is 2.2 A. Uncertainty specifications for 220 mA and 2.2 mA ranges are increased by a factor of 1.3 when supplied through 5725A terminals.</p> <p>Specifications are otherwise identical for all output locations.</p> <ol style="list-style-type: none"> Add to uncertainty specifications: <ul style="list-style-type: none"> $\pm 200 \times I^2$ ppm for >100 mA on 220 mA range $\pm 10 \times I^2$ ppm for >1 A on 2.2 A range For fields strengths >0.4 V/m but ≤ 3 V/m, add 1 % of range. 							

DC Current Secondary Performance Specifications and Operating Characteristics

Range	Stability ± 1 °C ^[1] 24 Hours	Temperature Coefficient ^[2]		Compliance Limits	Burden Voltage Adder ^[3] (±nA/V)	Maximum Load for Full Accuracy ^[4] (Ω)	Noise	
		10 - 40 °C	0 - 10 °C and 40 - 50 °C				Bandwidth 0.1-10 Hz	Bandwidth 10 Hz-10 kHz
	± (ppm output + nA)	± (ppm output + nA) / °C					pk-pk ppm output + nA	RMS nA
220 µA	5 + 1	1 + 0.40	3 + 1	10	0.2	20k	6 + .9	10
2.2 mA	5 + 5	1 + 2	3 + 10	10	0.2	2k	6 + 5	10
22 mA	5 + 50	1 + 20	3 + 100	10	10	200	6 + 50	50
220 mA	8 + 300	1 + 200	3 + 1 µA	10	100	20	9 + 300	500
2.2 A	9 + 7 µA	1 + 2.5 µA	3 + 10 µA	3 ^[5]	2 µA	2	12 + 1.5 µA	20 µA
5725A	± (ppm output + µA)	± (ppm output + µA) / °C					ppm output + µA	µA
11 A	25 + 100	20 + 75	30 + 120	4	0	4	15 + 70	175

Notes:

Maximum output from the calibrator's terminals is 2.2 A. Uncertainty specifications for 220 mA and 2.2 mA ranges are increased by a factor of 1.3 when supplied through 5725A terminals.

- Stability specifications are included in the Absolute Uncertainty values for the primary specifications.
- Temperature coefficient is an adder to uncertainty specifications. It does not apply unless operating more than ±5 °C from calibration temperature.
- Burden voltage adder is an adder to uncertainty specifications that does not apply unless burden voltage is greater than 0.5 V.
- For higher loads, multiply uncertainty specification by: $1 + \frac{0.1 \times \text{actual load}}{\text{maximum load for full accuracy}}$
- The calibrator's compliance limit is 2 V for outputs from 1 A to 2.2 A. 5725A Amplifier may be used in range-lock mode down to 0 A.

Minimum Output: 0 for all ranges, including 5725A.

Settling Time: 1 second for mA and mA ranges; 3 seconds for 2.2 A range; 6 seconds for 11 range; + 1 second for range or polarity change

Overshoot: <5 %

AC Current Specifications

5720A Series II AC Current Specifications: 99 % Confidence Level

Range	Resolution	Frequency (Hz)	Absolute Uncertainty ± 5 °C from calibration temperature ^[1]				Relative Uncertainty ± 1 °C	
			24 Hours	90 Days	180 Days	1 Year	24 Hours	90 Days
			± (ppm output + nA)					
220 µA	1 nA	10 - 20	260 + 20	280 + 20	290 + 20	300 + 20	260 + 20	280 + 20
		20 - 40	170 + 12	180 + 12	190 + 12	200 + 12	130 + 12	150 + 12
		40 - 1 k	120 + 10	130 + 10	135 + 10	140 + 10	100 + 10	110 + 10
		1k - 5 k	300 + 15	320 + 15	340 + 15	350 + 15	250 + 15	280 + 15
		5k - 10 k	1000 + 80	1100 + 80	1200 + 80	1300 + 80	900 + 80	1000 + 80
2.2 mA	10 nA	10 - 20	260 + 50	280 + 50	290 + 50	300 + 50	260 + 50	280 + 50
		20 - 40	170 + 40	180 + 40	190 + 40	200 + 40	130 + 40	150 + 40
		40 - 1 k	120 + 40	130 + 40	135 + 40	140 + 40	100 + 40	110 + 40
		1k - 5 k	210 + 130	220 + 130	230 + 130	240 + 130	250 + 130	280 + 130
		5k - 10 k	1000 + 800	1100 + 800	1200 + 800	1300 + 800	900 + 800	1000 + 800
22 mA	100 nA	10 - 20	260 + 500	280 + 500	290 + 500	300 + 500	260 + 500	280 + 500
		20 - 40	170 + 400	180 + 400	190 + 400	200 + 400	130 + 400	150 + 400
		40 - 1 k	120 + 400	130 + 400	135 + 400	140 + 400	100 + 400	110 + 400
		1k - 5 k	210 + 700	220 + 700	230 + 700	240 + 700	250 + 700	280 + 700
		5k - 10 k	1000 + 6000	1100 + 6000	1200 + 6000	1300 + 6000	900 + 6000	1000 + 6000
			± (ppm output + µA)					
220 mA	1 µA	10 - 20	260 + 5	280 + 5	290 + 5	300 + 5	260 + 5	280 + 5
		20 - 40	170 + 4	180 + 4	190 + 4	200 + 4	130 + 4	150 + 4
		40 - 1 k	120 + 3	130 + 3	135 + 3	140 + 3	100 + 3	110 + 3
		1k - 5 k	210 + 4	220 + 4	230 + 4	240 + 4	250 + 4	280 + 4
		5k - 10 k	1000 + 12	1100 + 12	1200 + 12	1300 + 12	900 + 12	1000 + 12
2.2 A	10 µA	20 - 1 k	290 + 40	300 + 40	310 + 40	320 + 40	300 + 40	350 + 40
		1 k - 5 k	440 + 100	460 + 100	480 + 100	500 + 100	500 + 100	520 + 100
		5 k - 10 k	6000 + 200	7000 + 200	7500 + 200	8000 + 200	6000 + 200	7000 + 200
5725A Amplifier:								
11 A	100 µA	40 - 1 k	370 + 170	400 + 170	440 + 170	460 + 170	300 + 170	330 + 170
		1 k - 5 k	800 + 380	850 + 380	900 + 380	950 + 380	700 + 380	800 + 380
		5 k - 10 k	3000 + 750	3300 + 750	3500 + 750	3600 + 750	2800 + 750	3200 + 750
<p>Note:</p> <p>Maximum output from the calibrator's terminals is 2.2 A. Uncertainty specifications for 220 µA and 2.2 mA ranges are increased by a factor of 1.3 plus 2 µA when supplied through 5725A terminals. For the 5720A 220 µA range, 1 kHz through 5 kHz and 5 kHz through 10 kHz, when the output is coming from the AUX current terminal, use the 5700A Absolute Uncertainty Specifications. Specifications are otherwise identical for all output locations.</p> <p>1. For fields strengths >0.4 V/m but ≤3 V/m, add 1 % of range.</p>								

5720A Series II AC Current Specifications: 95% Confidence Level

Range	Resolution	Frequency (Hz)	Absolute Uncertainty ± 5 °C from calibration temperature ^[1]				Relative Uncertainty ± 1 °C	
			24 Hours	90 Days	180 Days	1 Year	24 Hours	90 Days
			± (ppm output + nA)					
220 µA	1 nA	10 - 20	210 + 16	230 + 16	240 + 16	250 + 16	210 + 16	230 + 16
		20 - 40	130 + 10	140 + 10	150 + 10	160 + 10	110 + 10	130 + 10
		40 - 1 k	100 + 8	110 + 8	115 + 8	120 + 8	80 + 8	90 + 8
		1k - 5 k	240 + 12	250 + 12	270 + 12	280 + 12	200 + 12	230 + 12
		5k - 10 k	800 + 65	900 + 65	1000 + 65	1100 + 65	700 + 65	800 + 65
2.2 mA	10 nA	10 - 20	210 + 40	230 + 40	240 + 40	250 + 40	210 + 40	230 + 40
		20 - 40	140 + 35	140 + 35	150 + 35	160 + 35	110 + 35	130 + 35
		40 - 1 k	100 + 35	110 + 35	115 + 35	120 + 35	80 + 35	90 + 35
		1k - 5 k	170 + 110	180 + 110	190 + 110	200 + 110	200 + 110	230 + 110
		5k - 10 k	800 + 650	900 + 650	1000 + 650	1100 + 650	700 + 650	800 + 650
22 mA	100 nA	10 - 20	210 + 400	230 + 400	240 + 400	250 + 400	210 + 400	230 + 400
		20 - 40	130 + 350	140 + 350	150 + 350	160 + 350	110 + 350	130 + 350
		40 - 1 k	100 + 350	110 + 350	115 + 350	120 + 350	80 + 350	90 + 350
		1k - 5 k	170 + 550	180 + 550	190 + 550	200 + 550	200 + 550	230 + 550
		5k - 10 k	800 + 5000	900 + 5000	1000 + 5000	1100 + 5000	700 + 5000	800 + 5000
			± (ppm output + µA)					
220 mA	1 µA	10 - 20	210 + 4	230 + 4	240 + 4	250 + 4	210 + 4	230 + 4
		20 - 40	130 + 3.5	140 + 3.5	150 + 3.5	160 + 3.5	110 + 3.5	130 + 3.5
		40 - 1 k	100 + 2.5	110 + 2.5	115 + 2.5	120 + 2.5	80 + 2.5	90 + 2.5
		1k - 5 k	170 + 3.5	180 + 3.5	190 + 3.5	200 + 3.5	200 + 3.5	230 + 3.5
		5k - 10 k	800 + 10	900 + 10	1000 + 10	1100 + 10	700 + 10	800 + 10
2.2 A	10 µA	20 - 1 k	230 + 35	240 + 35	250 + 35	260 + 35	250 + 35	300 + 35
		1 k - 5 k	350 + 80	390 + 80	420 + 80	450 + 80	400 + 80	440 + 80
		5 k - 10 k	5000 + 160	6000 + 160	6500 + 160	7000 + 160	5000 + 160	6000 + 160
5725A Amplifier:								
11 A	100 µA	40 - 1 k	370 + 170	400 + 170	440 + 170	460 + 170	300 + 170	330 + 170
		1 k - 5 k	800 + 380	850 + 380	900 + 380	950 + 380	700 + 380	800 + 38
		5 k - 10 k	3000 + 750	3300 + 750	3500 + 750	3600 + 750	2800 + 750	3200 + 750
<p>Note:</p> <p>Maximum output from the calibrator's terminals is 2.2 A. Uncertainty specifications for 220 µA and 2.2 mA ranges are increased by 1.3 plus 2 µA when supplied through 5725A terminals. For the 5720A 220 µA range, 1 kHz through 5 kHz and 5 kHz through 10 kHz, when the output is coming from the AUX current terminal, use the 5700A Absolute Uncertainty Specifications. Specifications are otherwise identical for all output locations.</p> <p>1. For fields strengths >0.4 V/m but ≤3 V/m, add 1 % of range.</p>								

5700A Series II AC Current Specifications: 99 % Confidence Level

Range	Resolution	Frequency (Hz)	Absolute Uncertainty ± 5 °C from calibration temperature ^[1]				Relative Uncertainty ± 1 °C	
			24 Hours	90 Days	180 Days	1 Year	24 Hours	90 Days
			± (ppm output + nA)					
220 µA	1 nA	10 - 20	650 + 30	700 + 30	750 + 30	800 + 30	450 + 30	500 + 30
		20 - 40	350 + 25	380 + 25	410 + 25	420 + 25	270 + 25	300 + 25
		40 - 1 k	120 + 20	140 + 20	150 + 20	160 + 20	110 + 20	120 + 20
		1k - 5 k	500 + 50	600 + 50	650 + 50	700 + 50	450 + 50	500 + 50
		5k - 10 k	1500 + 100	1600 + 100	1700 + 100	1800 + 100	1400 + 100	1500 + 100
2.2 mA	10 nA	10 - 20	650 + 50	700 + 50	750 + 50	800 + 50	450 + 50	500 + 50
		20 - 40	350 + 40	380 + 40	410 + 40	420 + 40	270 + 40	300 + 40
		40 - 1 k	120 + 40	140 + 40	150 + 40	160 + 40	110 + 40	120 + 40
		1k - 5 k	500 + 500	600 + 500	650 + 500	700 + 500	450 + 500	500 + 500
		5k - 10 k	1500 + 1000	1600 + 1000	1700 + 1000	1800 + 1000	1400 + 1000	1500 + 1000
22 mA	100 nA	10 - 20	650 + 500	700 + 500	750 + 500	800 + 500	450 + 500	500 + 500
		20 - 40	350 + 400	380 + 400	410 + 400	420 + 400	270 + 400	300 + 400
		40 - 1 k	120 + 400	140 + 400	150 + 400	160 + 400	110 + 400	120 + 400
		1k - 5 k	500 + 5000	600 + 5000	650 + 5000	700 + 5000	450 + 5000	500 + 5000
		5k - 10 k	1500 + 10,000	1600 + 10,000	1700 + 10,000	1800 + 10,000	1400 + 10,000	1500 + 10,000
			± (ppm output + µA)					
220 mA	1 µA	10 - 20	650 + 5	700 + 5	750 + 5	800 + 5	450 + 5	500 + 5
		20 - 40	350 + 4	380 + 4	410 + 4	420 + 4	280 + 4	300 + 4
		40 - 1 k	120 + 4	150 + 4	170 + 4	180 + 4	110 + 4	130 + 4
		1k - 5 k	500 + 50	600 + 50	650 + 50	700 + 50	450 + 50	500 + 50
		5k - 10 k	1500 + 100	1600 + 100	1700 + 100	1800 + 100	1400 + 100	1500 + 100
2.2 A	10 µA	20 - 1 k	600 + 40	650 + 40	700 + 40	750 + 40	600 + 40	650 + 40
		1 k - 5 k	700 + 100	750 + 100	800 + 100	850 + 100	650 + 100	750 + 100
		5 k - 10 k	8000 + 200	9000 + 200	9500 + 200	10,000 + 200	7500 + 200	8500 + 200
5725A Amplifier:								
11 A	100 µA	40 - 1 k	370 + 170	400 + 170	440 + 170	460 + 170	300 + 170	330 + 170
		1 k - 5 k	800 + 380	850 + 380	900 + 380	950 + 380	700 + 380	800 + 380
		5 k - 10 k	3000 + 750	3300 + 750	3500 + 750	3600 + 750	2800 + 750	3200 + 750
<p>Note:</p> <p>Maximum output from the calibrator's terminals is 2.2 A. Uncertainty specifications for 220 µA and 2.2 mA ranges are increased by a factor of 1.3 plus 2 µA when supplied through 5725A terminals. Specifications are otherwise identical for all output locations.</p> <p>1. For field strengths >0.4 V/m but ≤3 V/m, add 1 % of range.</p>								

5700A Series II AC Current Specifications: 95 % Confidence Level

Range	Resolution	Frequency (Hz)	Absolute Uncertainty ± 5 °C from calibration temperature ^[1]				Relative Uncertainty ± 1 °C	
			24 Hours	90 Days	180 Days	1 Year	24 Hours	90 Days
			± (ppm output + nA)					
220 µA	1 nA	10 - 20	550 + 25	600 + 25	650 + 25	700 + 25	375 + 25	400 + 25
		20 - 40	280 + 20	310 + 20	330 + 20	350 + 20	220 + 20	250 + 20
		40 - 1 k	100 + 16	120 + 16	130 + 16	140 + 16	90 + 16	100 + 16
		1k - 5 k	400 + 40	500 + 40	550 + 40	600 + 40	375 + 40	400 + 40
		5k - 10 k	1300 + 80	1400 + 80	1500 + 80	1600 + 80	1200 + 80	1200 + 80
2.2 mA	10 nA	10 - 20	550 + 40	600 + 40	650 + 40	700 + 40	375 + 40	400 + 40
		20 - 40	280 + 35	310 + 35	330 + 35	350 + 35	220 + 35	250 + 35
		40 - 1 k	100 + 35	120 + 35	130 + 35	140 + 35	090 + 35	100 + 35
		1k - 5 k	400 + 400	500 + 400	550 + 400	600 + 400	375 + 400	400 + 400
		5k - 10 k	1300 + 800	1400 + 800	1500 + 800	1600 + 800	1200 + 800	1200 + 800
22 mA	100 nA	10 - 20	550 + 400	600 + 400	650 + 400	700 + 400	375 + 400	400 + 400
		20 - 40	280 + 350	310 + 350	330 + 350	350 + 350	220 + 350	250 + 350
		40 - 1 k	100 + 350	120 + 350	130 + 350	140 + 350	090 + 350	100 + 350
		1k - 5 k	400 + 4000	500 + 4000	550 + 4000	600 + 4000	375 + 4000	400 + 4000
		5k - 10 k	1300 + 8000	1400 + 8000	1500 + 8000	1600 + 8000	1200 + 8000	1200 + 8000
			± (ppm output + µA)					
220 mA	1 µA	10 - 20	550 + 4	600 + 4	650 + 4	700 + 4	375 + 4	400 + 4
		20 - 40	280 + 3.5	310 + 3.5	330 + 3.5	350 + 3.5	220 + 3.5	250 + 3.5
		40 - 1 k	100 + 3.5	120 + 3.5	130 + 3.5	140 + 3.5	90 + 3.5	100 + 3.5
		1k - 5 k	400 + 40	500 + 40	550 + 40	600 + 40	375 + 40	400 + 40
		5k - 10 k	1300 + 80	1400 + 80	1500 + 80	1600 + 80	1200 + 80	1200 + 80
2.2 A	10 µA	20 - 1 k	500 + 35	550 + 35	600 + 35	650 + 35	500 + 35	550 + 35
		1 k - 5 k	600 + 80	650 + 80	700 + 80	750 + 80	550 + 80	650 + 80
		5 k - 10 k	6500 + 160	7500 + 160	8000 + 1600	8500 + 160	6000 + 160	7000 + 160
5725A Amplifier:								
11 A	100 µA	40 - 1 k	370 + 170	400 + 170	440 + 170	460 + 170	300 + 170	330 + 170
		1 k - 5 k	800 + 380	850 + 380	900 + 380	950 + 380	700 + 380	800 + 380
		5 k - 10 k	3000 + 750	3300 + 750	3500 + 750	3600 + 750	2800 + 750	3200 + 750
<p>Note:</p> <p>Maximum output from the calibrator's terminals is 2.2 A. Uncertainty specifications for 220 A and 2.2 mA ranges are increased by a factor of 1.3 plus 2 µA when supplied through 5725A terminals. Specifications are otherwise identical for all output locations.</p> <p>1. For fields strengths >0.4 V/m but ≤3 V/m, add 1 % of range.</p>								

AC Current Secondary Performance Specifications and Operating Characteristics

Range	Frequency (Hz)	Stability $\pm 1^\circ\text{C}$ ^[1] 24 Hours	Temperature Coefficient ^[2]		Compliance Limits (V rms)	Maximum Resistive Load For Full Accuracy ^[3] (Ω)	Noise and Distortion (Bandwidth 10 Hz - 50 kHz <0.5V Burden)
			10 - 40 $^\circ\text{C}$	0 - 10 $^\circ\text{C}$ and 40 - 50 $^\circ\text{C}$			
		\pm (ppm output + nA)	\pm (ppm output + nA)/ $^\circ\text{C}$				\pm (% output + μA)
220 μA	10 - 20	150 + 5	50 + 5	50 + 5	7	2 k ^[6]	0.05 + 0.1
	20 - 40	80 + 5	20 + 5	20 + 5			0.05 + 0.1
	40 - 1 k	30 + 3	4 + 0.5	10 + 0.5			0.05 + 0.1
	1 k - 5 k	50 + 20	10 + 1	20 + 1			0.25 + 0.5
	5 k - 10 k	400 + 100	20 + 100	20 + 100			0.05 + 1
2.2 mA	10 - 20	150 + 5	50 + 5	50 + 5	7	500	0.05 + 0.1
	20 - 40	80 + 5	20 + 4	20 + 4			0.05 + 0.1
	40 - 1 k	30 + 3	4 + 1	10 + 2			0.05 + 0.1
	1 k - 5 k	50 + 20	10 + 100	20 + 100			0.25 + 0.5
	5 k - 10 k	400 + 100	50 + 400	50 + 400			0.05 + 1
22 mA	10 - 20	150 + 50	50 + 10	50 + 10	7	150	0.05 + 0.1
	20 - 40	80 + 50	20 + 10	20 + 10			0.05 + 0.1
	40 - 1 k	30 + 30	4 + 10	10 + 20			0.05 + 0.1
	1 k - 5 k	50 + 500	10 + 500	20 + 400			0.25 + 0.5
	5 k - 10 k	400 + 1000	50 + 1000	50 + 1000			0.05 + 1
	Hz	\pm (ppm output + μA)	\pm (ppm output + μA) / $^\circ\text{C}$				
220 mA	10 - 20	150 + 0.5	50 + 0.05	50 + 0.05	7	15	0.05 + 10
	20 - 40	80 + 0.5	20 + 0.05	20 + 0.05			0.05 + 10
	40 - 1 k	30 + 0.3	4 + 0.1	10 + 0.1			0.05 + 10
	1 k - 5 k	50 + 3	10 + 2	20 + 2			0.25 + 50
	5 k - 10 k	400 + 5	50 + 5	50 + 5			0.05 + 100
2.2 A	20 - 1 k	50 + 5	4 + 1	10 + 1	1.4 ^[4]	0.5	0.5 + 100
	1 k - 5 k	80 + 20	10 + 5	20 + 5			0.3 + 500
	5 k - 10 k	800 + 50	50 + 10	50 + 10			0.1 + 1 mA
5725A Amplifier:							\pm (% output)
11 A	40 - 1 k	75 + 100	20 + 75	30 + 75	3	3	0.05 ^[5]
	1 k - 5 k	100 + 150	40 + 75	50 + 75			0.12 ^[5]
	5 k - 10 k	200 + 300	100 + 75	100 + 75			0.5 ^[5]

Notes:

Maximum output from 5720A terminals is 2.2 A. Uncertainty specifications for 220 μA and 2.2 mA ranges are increased by a factor of 1.3, plus 2 μA when supplied through 5725A terminals. Specifications are otherwise identical for all output locations.

- Stability specifications are included in the Absolute Uncertainty values for the primary specifications.
- Temperature coefficient is an adder to uncertainty specifications that does not apply unless operating more than $\pm 5^\circ\text{C}$ from calibration temperature.
- For larger resistive loads multiply uncertainty specifications by: $\left(\frac{\text{actual load}}{\text{maximum load for full accuracy}}\right)^2$
- 1.5 V compliance limit above 1 A. 5725A Amplifier may be used in range-lock mode down to 1 A.
- For resistive loads within rated compliance voltage limits.
- For outputs from the Aux Current terminals, the maximum resistive load for full accuracy is 1 k Ω . For larger resistive loads, multiply the uncertainty as described in Note 3.

Minimum Output 9 μA for 220 μA range, 10 % on all other ranges. 1 A minimum for 5725A.

Inductive Load Limits 400 μH (5700A/5720A, or 5725A). 20 μH for 5700A/5720A output >1 A.

Power Factors 5700A/5720A, 0.9 to 1; 5725A, 0.1 to 1. Subject to compliance voltage limits.

Frequency:

Range (Hz) 10.000 - 11.999, 12.00 - 119.99, 120.0 - 1199.9, 1.200 k - 10.000 k

Uncertainty ± 0.01 %

Resolution 11,999 counts

Settling Time 5 seconds for 5700A/5720A ranges; 6 seconds for 5725A 11 A range; +1 second for amplitude or frequency range change.

Overshoot <10 %

Wideband AC Voltage (Option 5700-03) Specifications

Specifications apply to the end of the cable and 50 Ω termination used for calibration.

Range		Resolution	Absolute Uncertainty ± 5 °C from calibration temperature 30 Hz - 500 kHz			
			24 Hours	90 Days	180 Days	1 Year
Volts	dBm		± (% output + μV)			
1.1 mV	-46	10 nV	0.4 + 0.4	0.5 + 0.4	0.6 + 0.4	0.8 + 2
3 mV	-37	10 nV	0.4 + 1	0.45 + 1	0.5 + 1	0.7 + 3
11 mV	-26	100 nV	0.2 + 4	0.35 + 4	0.5 + 4	0.7 + 8
33 mV	-17	100 nV	0.2 + 10	0.3 + 10	0.45 + 10	0.6 + 16
110 mV	-6.2	1 μV	0.2 + 40	0.3 + 40	0.45 + 40	0.6 + 40
330 mV	+3.4	1 μV	0.2 + 100	0.25 + 100	0.35 + 100	0.5 + 100
1.1 V	+14	10 μV	0.2 + 400	0.25 + 400	0.35 + 400	0.5 + 400
3.5 V	+24	10 μV	0.15 + 500	0.2 + 500	0.3 + 500	0.4 + 500

Frequency (Hz)	Frequency Resolution (Hz)	Amplitude Flatness, 1 kHz Reference Voltage Range			Temperature Coefficient ± ppm/°C	Settling Time To Full Accuracy (Seconds)	Harmonic Distortion (dB)
		1.1 mV	3 mV	> 3 mV			
		± (% output + floor indicated)					
10 - 30	0.01	0.3	0.3	0.3	100	7	-40
30 - 120	0.01	0.1	0.1	0.1	100	7	-40
120 - 1.2 k	0.1	0.1	0.1	0.1	100	5	-40
1.2 k - 12 k	1	0.1	0.1	0.1	100	5	-40
12 k - 120 k	10	0.1	0.1	0.1	100	5	-40
120 k - 1.2 M	100	0.2 + 3 μV	0.1 + 3 μV	0.1 + 3 μV	100	5	-40
1.2 M - 2 M ^[1]	100 k	0.2 + 3 μV	0.1 + 3 μV	0.1 + 3 μV	100	0.5	-40
2 M - 10 M	100 k	0.4 + 3 μV	0.3 + 3 μV	0.2 + 3 μV	100	0.5	-40
10 M - 20 M	1 M	0.6 + 3 μV	0.5 + 3 μV	0.4 + 3 μV	150	0.5	-34
20 M - 30 M	1 M	1.5 + 15 μV	1.5 + 3 μV	1 + 3 μV	300	0.5	-34

Note:

[1] For output voltages < 50 % of full range in the 33 mV, 110 mV, 330 mV, 1.1 V, and 3.5 V ranges, add 0.1 % to the amplitude flatness specification.

Additional Operating Information:

dBm reference = 50 Ω

Range boundaries are at voltage points, dBm levels are approximate.

$$\text{dBm} = 10 \log \left(\frac{\text{Power}}{1 \text{ mW}} \right); 0.22361 \text{ V across } 50 \Omega = 1 \text{ mW or } 0 \text{ dBm}$$

Minimum Output	300 μV (-57 dBm)
Frequency Uncertainty	± 0.01 %
Frequency Resolution	11,999 counts to 1.1999 MHz, 119 counts to 30 MHz
Overload Protection	A short circuit on the wideband output will not result in damage. After settling time, normal operation is restored upon removal.

Auxiliary Amplifier Specifications

For complete specifications, see the 5205A and 5220A Operators Manuals.

5205A (220V - 1100 V ac, 0 V - 1100 V dc)

Overshoot: < 10 %

Distortion (bandwidth 10 Hz - 1 MHz):

- 10 Hz - 20 kHz 0.07 %
- 20 kHz - 50 kHz 0.2 %
- 50 kHz - 100 kHz 0.25 %

Frequency (Hz)	90 Day Accuracy at 23 ± 5 °C ± (% output + % range)	Temperature Coefficient for 0 - 18 °C and 28 - 50 °C ± (ppm output + ppm range) / °C
0 dc	0.05 + 0.005	15 + 3
10 - 40	0.15 + 0.005	45 + 3
40 - 20 k	0.04 + 0.004	15 + 3
20 k - 50 k	0.08 + 0.006	50 + 10
50 k - 100 k	0.1 + 0.01	70 + 20

5220A (AC Current, 180-day specifications):

Accuracy:

- 20 Hz - 1 kHz 0.07 % + 1 mA
- 1 kHz - 5 kHz (0.07 % + 1mA) x frequency in kHz

Temperature Coefficient (0 - 18 °C and 28 - 50 °C):

(0.003 % + 100A) / °C

Distortion (bandwidth 300 kHz):

- 20 Hz - 1 kHz 0.1% + 1 mA
- 1 kHz - 5 kHz (0.1% + 1 mA) x frequency in kHz

Note: 5700A/5720A combined with 5220A is not specified for inductive loads.

Table 2. Standard Equipment

Item	Model or Part Number
Calibrator	5700A/5720A Series II
Line Power Cord	See Table 3 and Figure 3
5700A/5720A Series II Manual Set	1668111
5700A/5720A Series II Operators Reference Guide	601648
5700A/5720A Series II Remote Programming Reference Guide	601655
5700A/5720A Series II Getting Started	1668111
5700A/5720A Series II Manual CD	1668127
Certificate of Calibration	No part number

Service Information

Each calibrator is warranted to the original purchaser for a period of one year beginning on the date received. The warranty is located at the front of this manual.

Service and technical advice for the calibrator is available at Fluke Service Centers. For a complete list of Fluke Service Centers, visit **www.fluke.com**.

After-warranty service is available, but you may choose to repair the calibrator using the information in the Troubleshooting Chapter of the *5700A/5720A Series II Service Manual* and the Module Exchange Program. Refer to the Fluke catalog or contact a Service Center representative for the module exchange procedure.

Contacting Fluke

To order accessories, receive operating assistance, or get the location of the nearest Fluke distributor or Service Center, call:

USA: 1-888-44-FLUKE (1-888-443-5853)

Canada: 1-800-36-FLUKE (1-800-363-5853)

Europe: +31 402-675-200

Japan: +81-3-3434-0181

Singapore: +65-738-5655

Anywhere in the world: +1-425-446-5500

Or, visit Fluke's Web site at www.fluke.com.

Placement and Rack Mounting

Place the calibrator on top of a bench or mounted in a standard-width, 24-inch (61-cm) deep equipment rack. For bench-top use, the calibrator is equipped with non-slipping, non-marring feet. To mount the calibrator in an equipment rack, use the Rack Mount Kit, Model Y-5737, instructions are included with the kit. For convenience, the rack mount instruction sheet can be stored in the binder of this manual.

Cooling Considerations

⚠Caution

Damage caused by overheating may occur if the area around the air intake is restricted, the intake air is too warm, or the air filter becomes clogged.

A hidden but important feature of the calibrator is its internal cooling system. Baffles direct cooling air from the fans throughout the chassis to internally dissipate heat during operation. The accuracy and dependability of all internal parts of the calibrator are enhanced by maintaining the coolest possible internal temperature. By observing the following rules, you can lengthen the life of the calibrator and enhance its performance:

- The area around the air filter must be at least 3 inches from nearby walls or rack enclosures.
- The exhaust perforations on the sides of the calibrator must be clear of obstructions.
- The air entering the instrument must be room temperature. Make sure that exhaust from another instrument is not directed into the fan inlet.
- Clean the air filter every 30 days or more frequently if the calibrator is operated in a dusty environment. (Instructions for cleaning the air filter are in Chapter 7 of the Operators Manual.)

Accessing the Fuse

⚠ Caution

To prevent instrument damage, verify that the correct fuse is installed for the line voltage setting.

The line power fuse is accessible on the rear panel. The fuse rating label to the right of the fuse holder (labeled F1) shows the correct replacement fuse rating for each line voltage setting. To check or replace the fuse, refer to Figure 2 and proceed as follows:

1. Disconnect line power.
2. Using a standard screwdriver, loosen the fuse holder by turning the slot labeled F1 until the cap and fuse pop free.
3. Replace the fuse and holder.

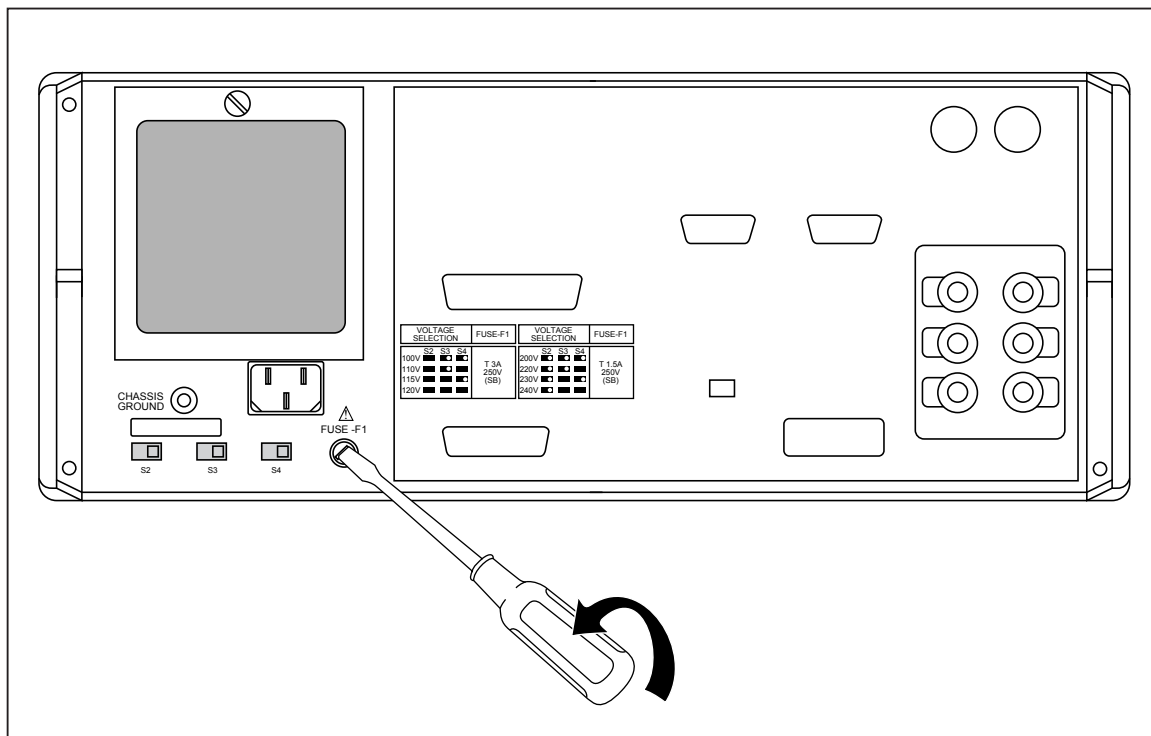

Figure 2. Accessing the Fuse

alh2.eps

Selecting Line Voltage

The calibrator arrives from the factory configured for the line voltage normally appropriate for the country of purchase, or as specified at the time of your purchase order. The calibrator also comes with the appropriate line power plug for the country of purchase. If you need a different type, refer to Table 3 and Figure 3. They list and illustrate the line power plug types available from Fluke.

Check the line power label on the rear panel of the calibrator to verify that the line voltage matches local line power. Figure 4 shows the location of the line power label.

You can set the calibrator to operate from eight different nominal line voltages; each voltage setting has a voltage tolerance of $\pm 10\%$, and frequency range of 47 to 63 Hz. The line voltage switches are located on the bottom left side of the rear panel.

To change the line voltage setting, set the line voltage selection switches to the correct setting shown in Figure 4.

Table 3. Line Power Cord Types Available from Fluke

Type	Voltage/Current	Fluke Option Number
North America	120V/15A	LC-1
North America	240V/15A	LC-2
Universal Euro	220V/16A	LC-3
United Kingdom	240V/13A	LC-4
Switzerland	220V/10A	LC-5
Australia	240V/10A	LC-6
South Africa	240V/5A	LC-7

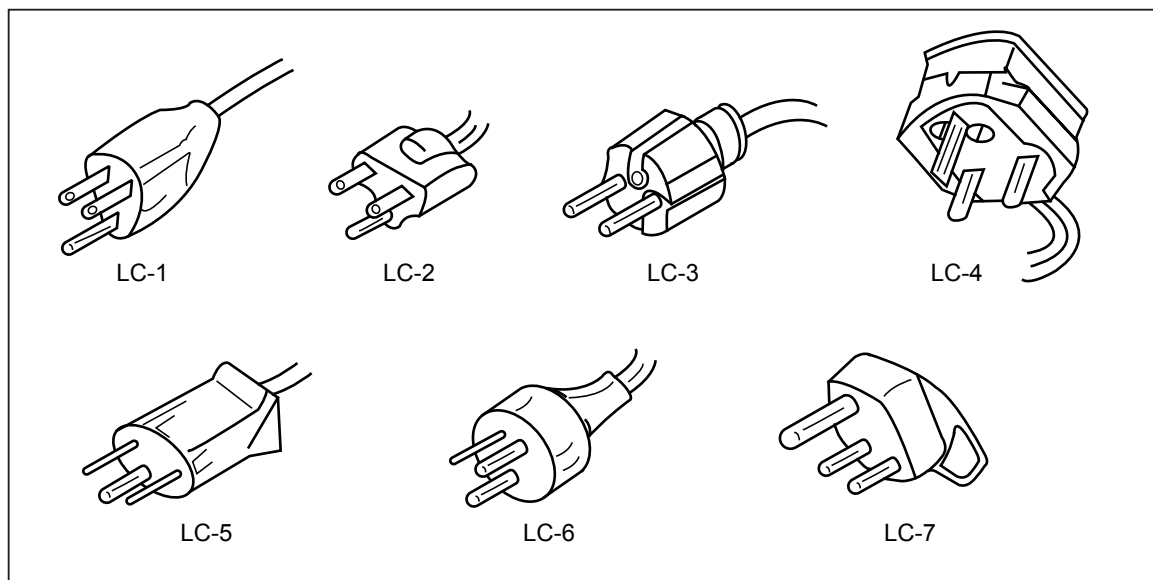
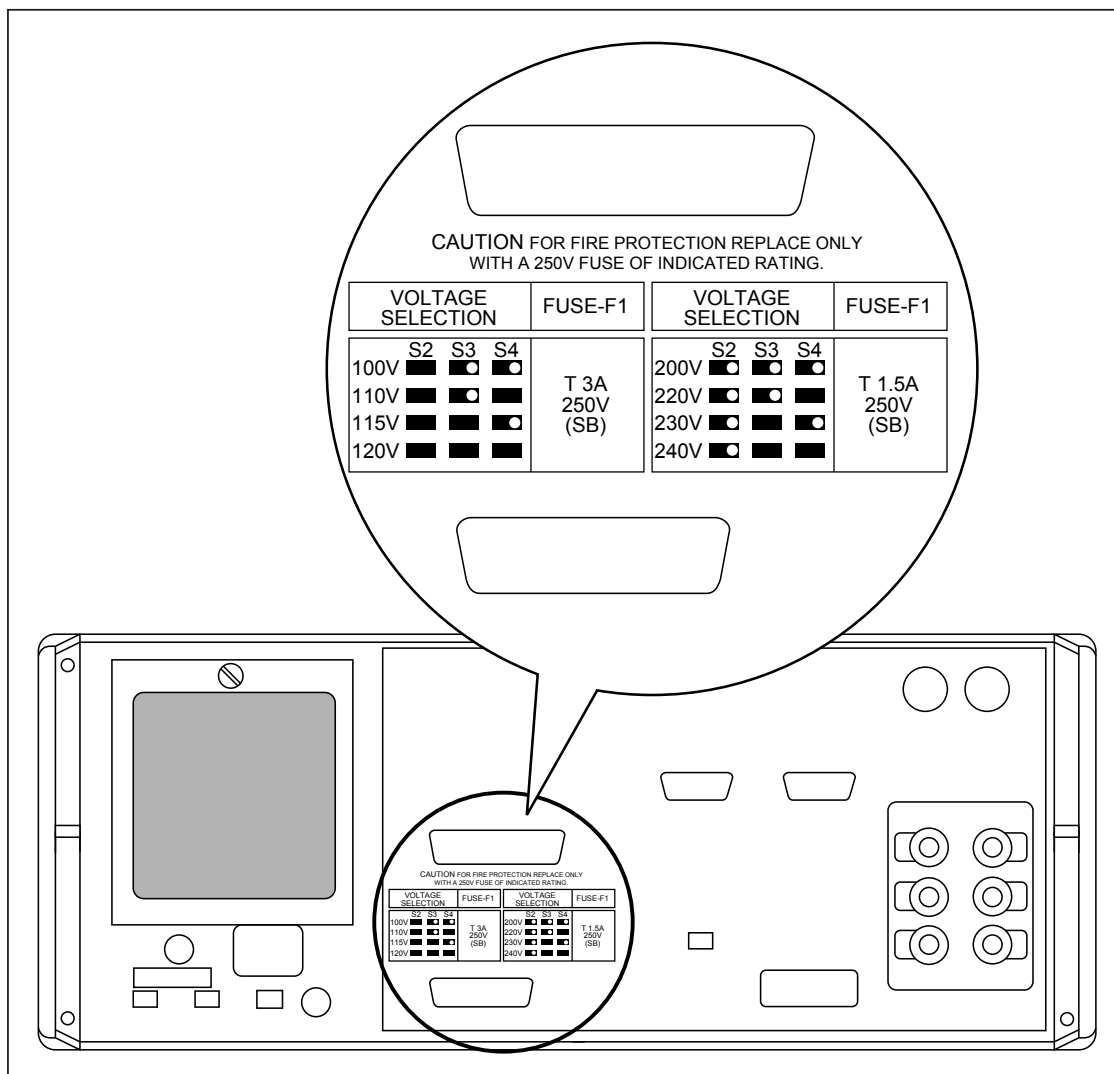

Figure 3. Line Power Cord Types Available from Fluke

alh3.eps



alh4.eps

Figure 4. Line Power Label and Switch Location

Connecting to Line Power

Warning

To avoid shock hazard, connect the factory supplied three-conductor line power cord to a properly grounded power outlet. Do not use a two-conductor adapter or extension cord; this will break the protective ground connection. If a two-conductor power cord must be used, a protective grounding wire must be connected between the ground terminal and earth ground before connecting the power cord or operating the instrument.

After you verify that the line voltage selection switches are set to the correct positions, verify that the correct fuse for that line voltage is installed. Connect the calibrator to a properly grounded three-prong outlet.

Connecting a 5725A Amplifier

The calibrator provides an interface connector for the Fluke 5725A amplifier. You designate the active amplifier for voltage and current boost in a setup menu. That procedure is located in the beginning of Chapter 4 of the Operators Manual. Refer to the *5725A Instruction Manual* for the installation procedure.

Selecting Output Binding Posts

The calibrator is equipped with binding posts for OUTPUT, SENSE, and V GUARD (Voltage Guard) on the front and rear panels. Only one set of binding posts can be enabled at the same time. (GND binding posts on both front and rear are always connected to chassis ground.) The calibrator is shipped with the front panel binding posts enabled. The procedure to enable the rear panel binding posts involves opening the case of the calibrator, and repositioning a cable. This procedure is described in Chapter 4 of the *5700A/5720A Series II Service Manual*.

Note

A Type "N" connector for output from the Option 5700-03 Wideband AC Voltage Module is available only on the calibrator's front panel. A terminal for I GUARD is available only on the rear panel. (Connection to the I GUARD terminal is normally required only at low current levels in calibration systems with long cable runs.) Chapters 3 and 4 of the Operators Manual contain detailed information about the function and use of all binding posts.

Front Panel Features

Front panel features (including all controls, displays, indicators, and terminals) are shown in Figure 5. Each front panel feature is briefly described in Table 4.

Display Screen Saver

The Control Display (described in Table 4) is equipped with a screen saver that lengthens the display's life when the front panel is not being used. The display becomes blank after 30 minutes of inactivity, unless it is one of the operating states that override the screen saver.

If the screen saver is in effect, you can restore the display by pressing CE. Pressing another key, or turning the knob, will also restore the display in addition to performing the command selected by the key or knob.

The screen saver will *not* go into effect after 30 minutes of inactivity if:

- the Setup Menu or any of its submenus are displayed
- the calibrator is being operated under remote control
- the calibrator is undergoing calibration or diagnostics
- an error message is displayed

Table 4. Front Panel Features







<p>① Output Display</p>	<p>A two-line vacuum-fluorescent display that shows output amplitude and frequency. The top line shows the active output value (or potential output value if in standby) using up to eight digits plus a polarity sign. The bottom line shows output frequency (or potential output frequency if the calibrator is in standby) using five digits. Following the digits on both lines of the Output Display are four unit annunciators. (Examples of units are: mV, μA, and kHz.) Annunciators below the amplitude line on the Output Display indicate the following active conditions:</p> <p>OPERATE Lit when an output is active at the binding posts or auxiliary amplifier</p> <p>STANDBY Lit when the calibrator is in standby</p> <p>ADDR Lit when the calibrator is addressed over the IEEE-488 interface</p> <p>∅-LCK Lit when the calibrator's output is phase locked to a signal at the rear panel PHASE LOCK IN connector</p> <p>∅-SHF Lit when the calibrator's output has a programmed phase difference with a signal at the rear panel VARIABLE PHASE OUT connector</p> <p>U (Unsettled.) When you change the output, this annunciator lights briefly until the output settles to within specification.</p>
<p>② Control Display</p>	<p>An alphanumeric vacuum-fluorescent display that shows data entries, UUT error adjustments, menus, and other prompts and messages. Each menu contains a set of softkey labels that identify the functions of the softkeys directly below them. The changing menus provide access to many different functions through the five softkeys plus the  key. (See Figure 7, Softkey Menu Tree.)</p>
<p>③  (Operate/Standby)</p>	<p>Toggles the calibrator between operate and standby modes. In standby mode, the OUTPUT binding posts are internally disconnected from the calibrator. The calibrator normally starts up in standby. Status is indicated by the lighted OPERATE or STANDBY annunciator above the OUTPUT binding posts. Pressing the  key does not change any other aspect of the calibrator's status. The calibrator automatically switches to standby when any of the following events occur:</p> <ul style="list-style-type: none"> • The  key is pressed. • A voltage ≥ 22V is selected when the previous output voltage was less than 22V. • The output location changes (e.g., an amplifier is selected). The exception to this is when the 5725A is selected for ac voltage or current, provided the calibrator's current output location is set to "5725A". In this case, the mode does not toggle. • The output function changes to voltage <22V, ac voltage >22V, dc voltage >22V, dc current, ac current, or resistance. The exception is when switching between dc and ac current in 5100B emulation mode.
<p>④  (External Sense)</p>	<p>Opens and closes an internal connection between the SENSE and OUTPUT binding posts. The calibrator powers up with SENSE and OUTPUT connected internally (the SENSE binding posts are open circuited), with  off. Pressing  disconnects the sense lines from the OUTPUT binding posts, and connects them to the SENSE binding posts internally.</p>

Table 4. Front Panel Features (continued)

	<p>External Sensing should be used in the dc voltage function when the UUT draws enough current to produce a significant voltage drop in the cables, and in the resistance function when the UUT has a four-wire ohms input and the calibrator is set to 100 kΩ or less. External sensing can also be used in conjunction with the two-wire compensation circuit to compensate for lead resistance at the UUT terminals. Refer to "When to use External Sensing," "Four-Wire vs. Two-Wire Resistance Connections," and "Cable Connections" in Chapter 4 of the Operators Manual for external sensing instructions.</p>
<p>5 EX GRD (External Guard)</p>	<p>Opens and closes an internal connection between V GUARD (voltage guard) and OUTPUT LO. The calibrator powers up with the voltage guard internally connected to OUTPUT LO and the EX GRD indicator off. Toggling EX GRD on disconnects OUTPUT LO from the voltage guard.</p> <p>The V GUARD binding post provides an external connection point for the voltage internal guard. For a UUT with floating inputs, the V GUARD should be connected to LO internally. (EX GRD is off.) For a UUT with a grounded input, the GUARD may be externally connected to the grounded UUT input. (EX GRD is on.) See Chapter 4 of the Operators Manual for instructions.</p>
<p>6 W BND (Wideband)</p>	<p>Toggles the Wideband AC Voltage Module (Option 5700A-03) and sets the calibrator to standby. When enabled, the ac voltage output from 10 Hz to 30 MHz is available at the front-panel coaxial connector. Wideband is disabled whenever W BND is toggled off or when another function (such as current) is selected. Chapter 4 of the Operators Manual contains more information.</p>

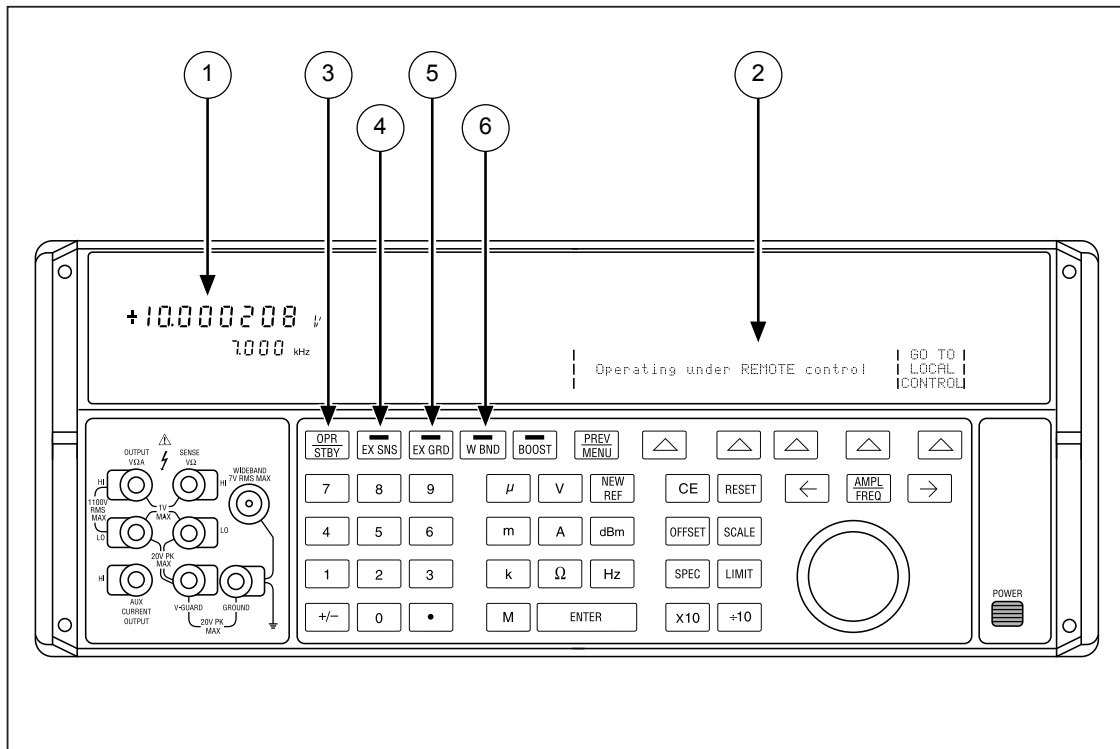

Figure 5. Front Panel Features

aih6.eps

Table 4. Front Panel Features (continued)













<p>7</p> 	<p>Enables or disables output from an amplifier, when it would not otherwise be automatically selected. Sets the calibrator to standby if this selection moves the output location.</p> <p>When available, an amplifier is automatically selected for output settings that exceed the calibrator's capabilities but fall within the limits of the selected amplifier. The  key is only needed to activate an amplifier for an output setting that is available from either the calibrator or the amplifier. This allows you to take advantage of amplifier capabilities besides extended range, such as higher compliance voltage.</p> <p>For both voltage and current, the amplifier is assumed to be a 5725A unless another model is designated in the setup menus.</p>
<p>8</p>  (Previous Menu)	<p>The  softkey aborts the current operational state of the calibrator and recalls the previous set of menu choices. Some menus display a more specific label for this key, such as "DONE Setting Up".</p>
<p>9</p> <p>Softkeys</p>	<p>The functions of the five unlabeled softkeys are identified by labels on the Control Display directly above each key. The functions change during operation so that many different functions are accessible through these keys. A group of softkey labels is called a menu. A group of interconnected menus is called a menu tree. Figure 7 shows the menu tree for the calibrator.</p>
<p>10</p> <p>Power Switch</p>	<p>Turns the power on and off. The switch remains locked inwards when the power is on. Pushing the switch again unlocks it and turns the power off.</p>
<p>11</p>   	<p>The output adjustment controls. If any of these keys are pressed or the knob is rotated, a digit on the Output Display becomes highlighted and the output increments or decrements as the knob is rotated. If a digit rolls past 0 or 9, the digit to its left or right is carried. An error display appears on the Control Display, showing the difference between the original (reference) output and the new (adjusted) output.</p> <p>The  and  keys adjust the magnitude of changes by moving the highlighted digit. In the ac functions, the  key toggles between voltage or current to frequency. For voltage and current outputs, the knob and arrow keys are used to adjust output until the UUT reads correctly. The error display then displays UUT deviation from the reference.</p> <p>Since resistances are not adjustable, the knob and arrow keys adjust a value on the Control Display to equal the UUT reading. Refer to "Error Mode Operation" in Chapter 4 of the Operators Manual for details of entering, operating, and exiting Error Mode.</p> <p>The rotary knob is also used to adjust the phase of the ac output signal with respect to a signal at the VARIABLE PHASE OUT connector after the "Phase Ctrls Menu" softkey is pressed.</p>
<p>12</p> 	<p>Aborts the current operating state of the calibrator and returns it to its power-up default state.  has no effect when operating under remote control.</p>

Table 4. Front Panel Features (continued)

<p>13</p> <p>SCALE</p>	<p>Identifies a UUT full-scale endpoint for checking linearity and does not change the output. If the output was adjusted with the rotary knob, subsequent keyed-in output values are multiplied by a scale factor. Scaling is deactivated by pressing SCALE again, or by selecting another function. Scaling is not available for resistance outputs. See "Linearity Checking Using Offset and Scale" in Chapter 4 of the Operators Manual for details.</p>
<p>14</p> <p>LIMIT</p>	<p>Calls up a menu that allows you to specify limits beyond which the calibrator will not operate, to protect your test equipment and personnel.</p>
<p>15</p> <p>+10</p>	<p>Immediately changes the output to one tenth the reference value (not necessarily the present output value) if the value is within performance limits.</p>
<p>16</p> <p>X10</p>	<p>Immediately changes the output to ten times the reference value (not necessarily the present output value) if the value is within performance limits. This key sets the calibrator to standby if this change is from below 22V to 22V or more.</p>

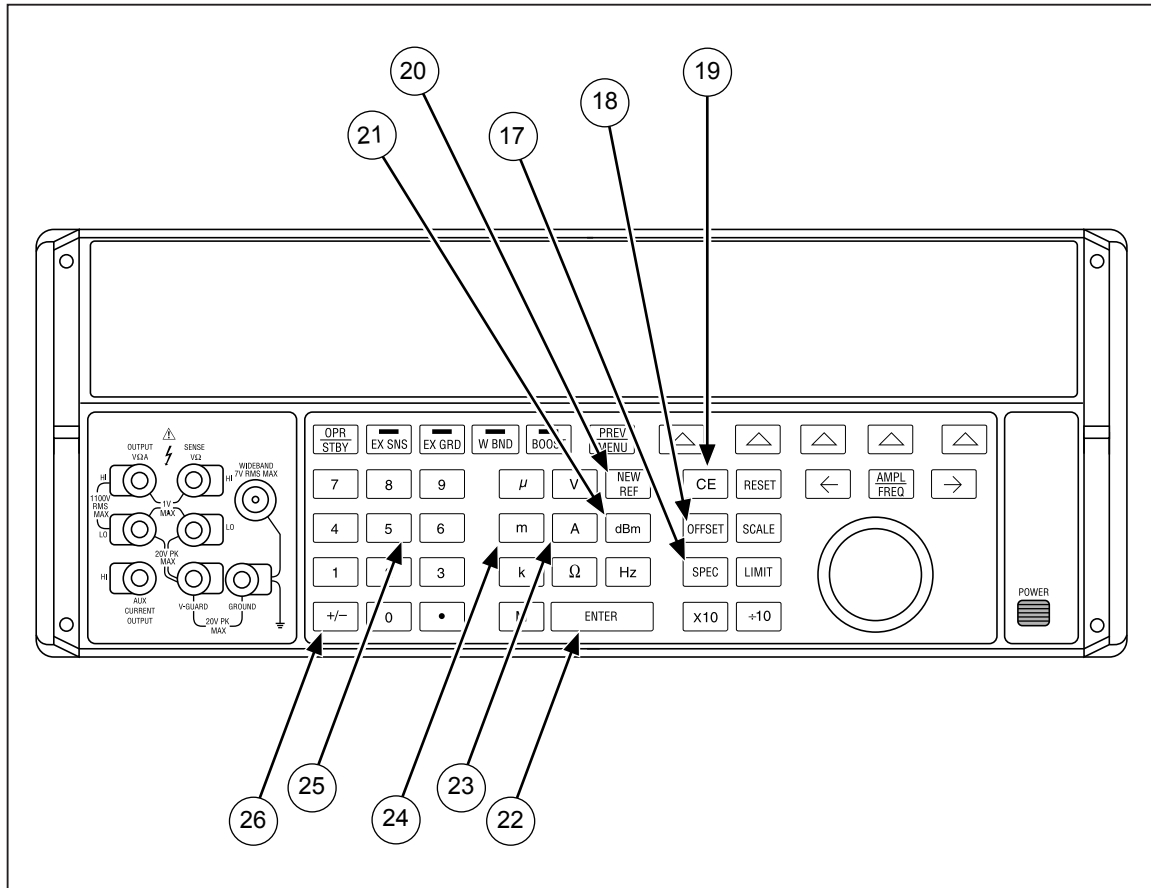

alh7.eps

Figure 5. Front Panel Features (continued)

Table 4. Front Panel Features (continued)

<p>17</p> <p>SPEC (Specification)</p>	<p>Causes the calibrator to compute and display its absolute uncertainty for the present output setting for the calibration interval selected in the setup menus.</p>
<p>18</p> <p>OFFSET</p>	<p>Identifies a UUT zero-scale endpoint and does not change the output. Subsequent keyed-in output values have the offset value (the calibrator's output value when OFFSET was pressed) added to them. Offset mode is deactivated by pressing OFFSET again or by selecting another function. Offsets are available for dc outputs only. See "Programming an OFFSET" in Chapter 4 of the Operators Manual for details.</p>
<p>19</p> <p>CE (Clear Entry)</p>	<p>Clears a partially completed keypad entry from the Control Display or clears an error message that requires acknowledgement. If there is a partially completed entry when CE is pressed, the output is unaffected.</p>
<p>20</p> <p>NEW REF</p>	<p>Only active during error mode operation, the NEW REF key establishes the present output value as a new reference for meter error computation.</p>
<p>21</p> <p>dBm</p>	<p>When in the ac volts or wideband function, and if no entry is in progress, the dBm key shows the equivalent dBm output on the Control Display. For the ac voltage function, dBm is calculated for a 600Ω load. For the wideband function, dBm is calculated for a 50Ω resistive termination at the end of a 3-foot 50Ω coaxial cable.</p> <p>The formula for computing dBm is: $10 * \log(\text{power in mW})$</p> <p>Examples:</p> <p>For 3.0V into a 600Ω load, $\text{dBm} = 10 \log(15.000) = 11.7609 \text{ dBm}$</p> <p>For 3.0V into a 50Ω load, $\text{dBm} = 10 \log(180.000) = 22.5527 \text{ dBm}$</p>
<p>22</p> <p>ENTER</p>	<p>The ENTER key loads an output value that was entered into the Control Display into the calibrator. If you press ENTER without identifying the units for the entry, the calibrator keeps the most recently used units. The multipliers are not saved. For example, if the most recently entered value was 1 mV, then simply entering 10 produces an output of 10V. (The "V" units were saved from the last entry, but not the multiplier, "m".)</p> <p>Another function of the ENTER key is to recall the currently-programmed reference value during error mode operation. Refer to "Error Mode Operation" in Chapter 4 of the Operators Manual for details.</p>
<p>23</p> <p>Output Function Keys</p>	<p>Select the output function. The output functions are:</p> <ul style="list-style-type: none"> dBm Decibels relative to 1 mW V Voltage A Current Ω Resistance Hz Frequency <p>When Hz is entered, the calibrator automatically switches to ac. When a new signed (+ or -) output value is entered without specifying Hz, the calibrator automatically switches back to dc.</p>

Table 4. Front Panel Features (continued)

<p>24</p> <p>Multiplier Keys</p>	<p>Select output value multipliers. For example, if you enter $\boxed{3} \boxed{3} \boxed{m} \boxed{V}$, then $\boxed{\text{ENTER}}$, the calibrator output value is 33 mV. The multiplier keys are:</p> <p>$\boxed{\mu}$ micro (10^{-6})</p> <p>\boxed{m} milli (10^{-3})</p> <p>\boxed{k} kilo (10^3)</p> <p>\boxed{M} mega (10^6)</p>
<p>25</p> <p>Numeric Keypad</p>	<p>Contains number keys for keying in the output amplitude and frequency, as well as other data such as the time and date. To enter a value, press the digits of the output value, a multiplier key if necessary, and an output function key; then press $\boxed{\text{ENTER}}$. For example, for an output of 20 mV, press $\boxed{2} \boxed{0} \boxed{m} \boxed{V}$, then $\boxed{\text{ENTER}}$.</p>
<p>26</p> <p>$\boxed{+/-}$</p>	<p>If the output function is dc voltage, current, ac voltage entered in dBm, or a wideband output entered in dBm, pressing $\boxed{+/-} \boxed{\text{ENTER}}$ toggles the polarity of the output. If the output function is ac voltage or current, pressing $\boxed{+/-}$; then $\boxed{\text{ENTER}}$ changes the output to dc.</p>

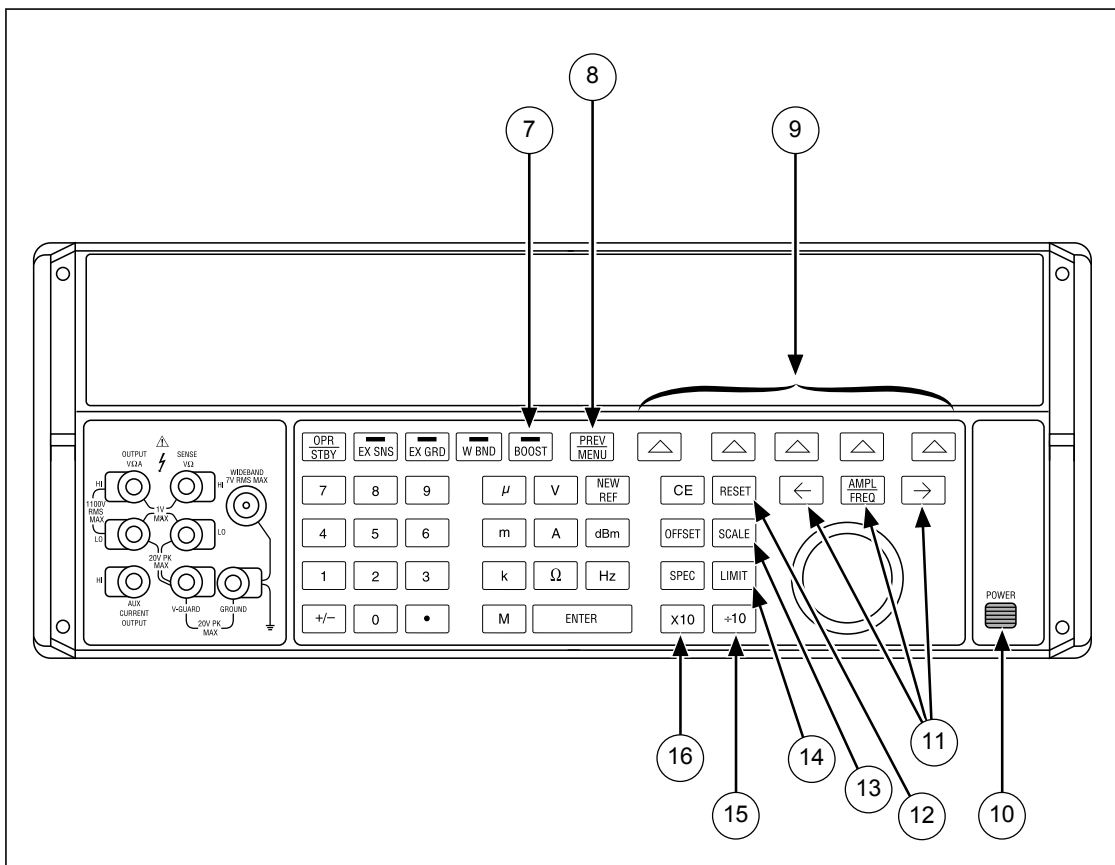

aih8.eps

Figure 5. Front Panel Features (continued)

Table 4. Front Panel Features (continued)

<p>②⑦ WIDEBAND Connector</p>	<p>A Type "N" connector that provides a connection point for output from the Option 5700A-03 Wideband AC Module. Wideband output specifications are stated for output levels present at the end of its 3-foot 50Ω coaxial cable terminated into a 50Ω purely resistive load. The connector shell is connected to chassis ground. Refer to Chapter 4 of the Operators Manual for connecting and operating instructions for the wideband module.</p>
<p>②⑧ GND Binding Post</p>	<p>If the calibrator is the location of the ground reference point in a system, the GND binding post can be used for connecting other instruments to earth ground. (The chassis is normally connected to earth ground through the three-conductor line cord instead of through the earth ground binding post.) Refer to "Cable Connections" in Chapter 4 of the Operators Manual for details. Included with the calibrator is a brass strap that connects GND to V GUARD.</p>
<p>②⑨ V GUARD Binding Post</p>	<p>Provides an external connection point for the internal voltage guard. For a UUT with floating (ungrounded) inputs, the V GUARD should be connected to LO internally (<input type="checkbox"/> EX GRD off). For a UUT with a grounded input, the V GUARD must be externally connected to the grounded UUT input (<input type="checkbox"/> EX GRD on). The maximum allowable potential between the V GUARD connector and chassis ground is 20V peak. Refer to "When to use External Voltage Guard" and "Cable Connections" in Chapter 4 of the Operators Manual for details.</p>
<p>③① SENSE Binding Posts</p>	<p>Used in the resistance and voltage functions for sensing at the UUT after you have selected external sense by pressing <input type="checkbox"/> EX SNS or by remote command.</p> <p>External Sensing should be used in the dc voltage function when the UUT draws enough current to produce a significant voltage drop in the cables, and in the resistance function when the UUT has a four-wire ohms input and the calibrator is set to 100 kΩ or less. External sensing can also be used in the two-wire ohms function to allow the two-wire compensation circuitry to the UUT terminals. Refer to "When to use External Sensing," "Four-Wire vs. Two-Wire Resistance Connections," and "Cable Connections" in Chapter 4 of the Operators Manual for external sensing instructions and illustrations of SENSE connections.</p>
<p>③② OUTPUT Binding Posts</p>	<p>Provide connection points for ac and dc current and voltage output, as well as resistance. The function of each OUTPUT binding post is defined below:</p> <p>LO The common binding post for all output functions including 5725A amplified voltage output, but not Option 5700A-03 Wideband AC or other auxiliary amplifier output.</p> <p>HI The active binding post for all output functions including 5725A amplified voltage output, but not Option 5700A-03 Wideband AC or other auxiliary amplifier output.</p> <p>AUX CURRENT OUTPUT An optional active binding post for current. It is convenient to use the AUX CURRENT OUTPUT binding post when calibrating a UUT with a separate current input terminal. Refer to "Connecting the calibrator to the UUT" in Chapter 4 of the Operators Manual for instructions for using this binding post.</p>

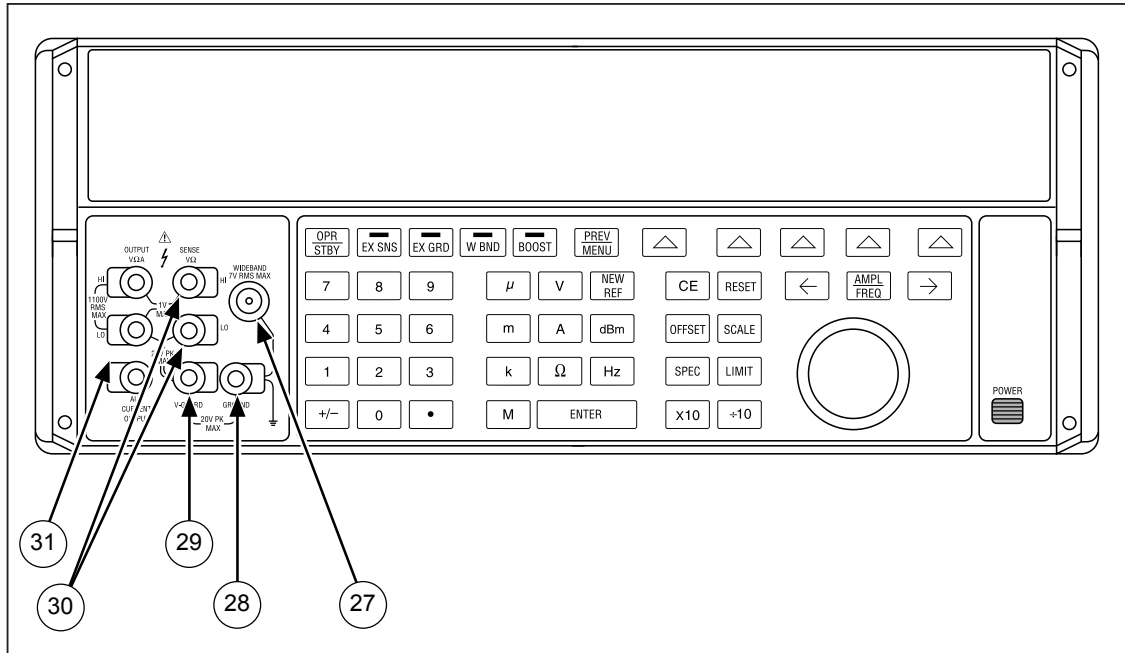

alh9.eps

Figure 5. Front Panel Features (continued)

Rear Panel Features

Rear panel features (including all terminals, sockets, and connectors) are shown in Figure 6. Each rear panel feature is briefly described in Table 5.

Table 5. Rear Panel Features

<p>① Fan Filter</p>	<p>The filter covers the air intake to keep dust and debris out of chassis air baffles. Fans inside the calibrator provide a constant cooling air flow throughout the chassis. Circuitry inside the calibrator monitors correct operation of the internal fans.</p>
<p>② 5725A AMPLIFIER Connector</p>	<p>Provides the analog and digital interface for the Fluke 5725A Amplifier. After connecting the 5725A to the 5725A AMPLIFIER connector, you control the 5725A from the calibrator's front panel or by remote commands. Refer to "Using an Auxiliary Amplifier" in Chapter 4 of the Operators Manual for details.</p>
<p>③ VARIABLE PHASE OUT BNC Connector</p>	<p>Provides access to a variable-phase nominal 2.5V rms sine-wave signal, intended for a 3 kΩ load. The phase of this signal can be adjusted using the arrow keys and rotary knob (or by remote commands) to lead or lag the main calibrator output signal by up to 180 degrees. The connector shell is not connected directly to chassis ground. It is connected internally to the OUTPUT LO binding post. The maximum allowable potential between the connector shell and chassis ground is 20V peak. Refer to "Variable Phase Output" in Chapter 4 of the Operators Manual for details.</p>
<p>④ PHASE LOCK IN BNC Connector</p>	<p>Provides the input for an external signal onto which the calibrator can be phase locked. (1 to 10V rms, 10 kΩ input impedance.) The connector shell is not connected directly to chassis ground. It is connected internally to the OUTPUT LO binding post. The maximum allowable potential between the connector shell and chassis ground is 20V peak. Refer to "Phase Locking to an External Signal," in Chapter 4 of the Operators Manual for details.</p>
<p>⑤ Rear Panel Binding Posts</p>	<p>The rear-panel OUTPUT, SENSE, and V GUARD and I GUARD binding posts are alternative connections to the UUT. An internal cable enables either the front or rear binding posts. The procedure to disable the front panel binding posts and enable the rear panel binding posts involves opening the cover of the calibrator and is described in Chapter 4 of the Operators Manual of the <i>5700A/5720A Series II Service Manual</i>.</p> <p>The I GUARD binding post provides an external connection point for the internal current guard. The current guard is used when the calibrator is supplying low-level ac current through a long cable to remove errors introduced by leakage through the cable capacitance. The I GUARD binding post is available on the rear panel where it is convenient for system applications. Refer to "When to use the Current Guard" in Chapter 4 of the Operators Manual for details.</p> <p>AUX CURRENT OUTPUT is not available on the rear panel binding posts.</p>

Table 5. Rear Panel Features (continued)

<p>⑥ IEEE-488 Connector</p>	<p>A standard interface connector for operating the calibrator in remote control as a Talker or Listener on the IEEE-488 Bus. Refer to Chapter 5 of the Operators Manual for bus connection and remote programming instructions.</p>
<p>⑦ CALIBRATION Switch</p>	<p>A slide switch that write enables and disables the nonvolatile memory that stores calibration constants, dates, and setup parameter settings. Switching to ENABLE write enables the memory, and switching to NORMAL protects data in memory from being overwritten. The switch must be in the ENABLE position to set the clock. The switch is recessed to allow the metrologist to cover it with a calibration sticker to guarantee calibrator integrity.</p>
<p>⑧ RS 232C Connector</p>	<p>A male (DTE) serial port connector for transmitting internal calibration constant data to a printer, monitor, or host computer, and for remote control of the calibrator. Chapter 6 of the Operators Manual describes proper cabling, how to set up the serial interface, and how to transmit data from the calibrator. Chapter 5 of the Operators Manual how to use the serial interface for remote control.</p>

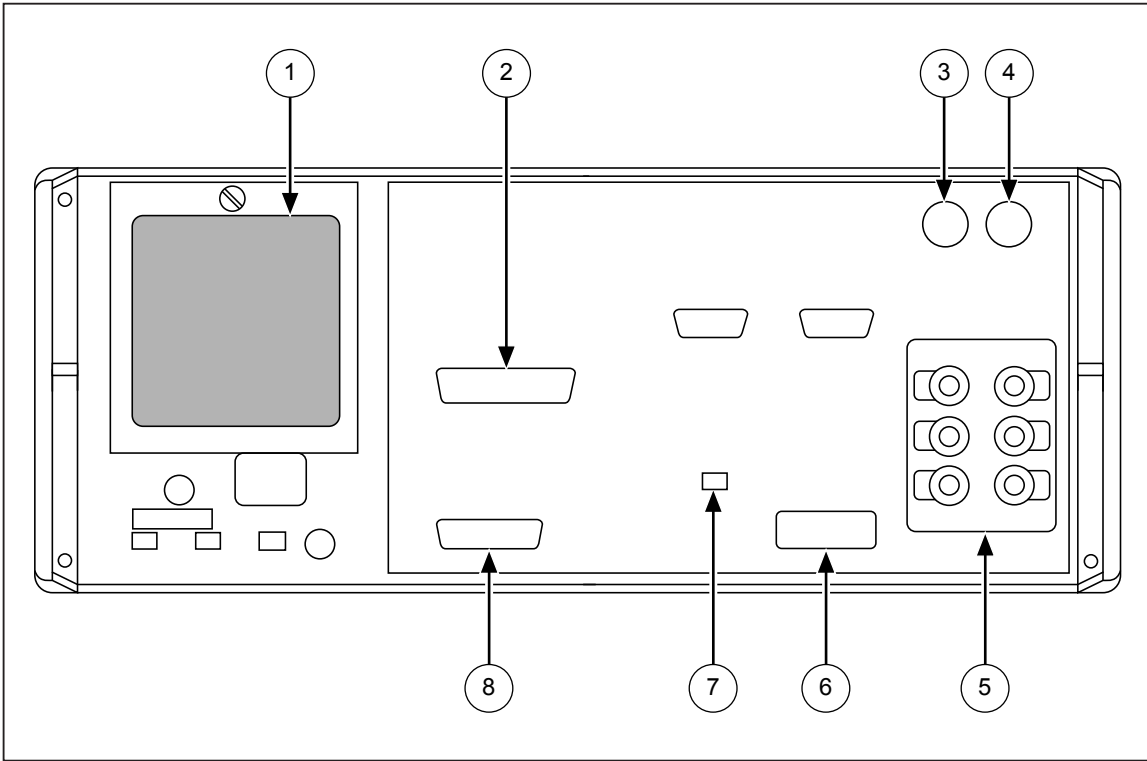

alh10.eps

Figure 6. Rear Panel Features

Table 5. Rear Panel Features (continued)

<p>⑨ Line Voltage Switch and Fuse Rating Label</p>	<p>Shows the various settings of the line voltage switches, and the correct replacement fuse ratings for fuse F1 for operating voltages of 110 (90-132) and 220 (180-264) V ac. Refer to "Accessing the Fuse" in Chapter 2 of the Operators Manual for the fuse replacement procedure.</p>
<p>⑩ F1 Fuseholder</p>	<p>The line power fuse. Refer to "Accessing the Fuse" in Chapter 2 of the Operators Manual for fuse rating information and the fuse replacement procedure.</p>
<p>⑪ AC PWR INPUT Connector</p>	<p>A grounded male three-prong connector that accepts the line power cord.</p>
<p>⑫ Line Voltage Selection Switches</p>	<p>Select the operating line voltage. Refer to "Selecting Line Voltage" in Chapter 2 of the Operators Manual for how to select operating line voltage.</p>
<p>⑬ CHASSIS GROUND Binding Post</p>	<p>A binding post that is internally grounded to the chassis. If the calibrator is the location of the ground reference point in a system, this binding post can be used for connecting other instruments to earth ground. (The chassis is normally connected to earth ground through the three-conductor line cord instead of through the earth ground binding post.) Refer to "Connecting to the UUT" in Chapter 4 of the Operators Manual for details.</p>

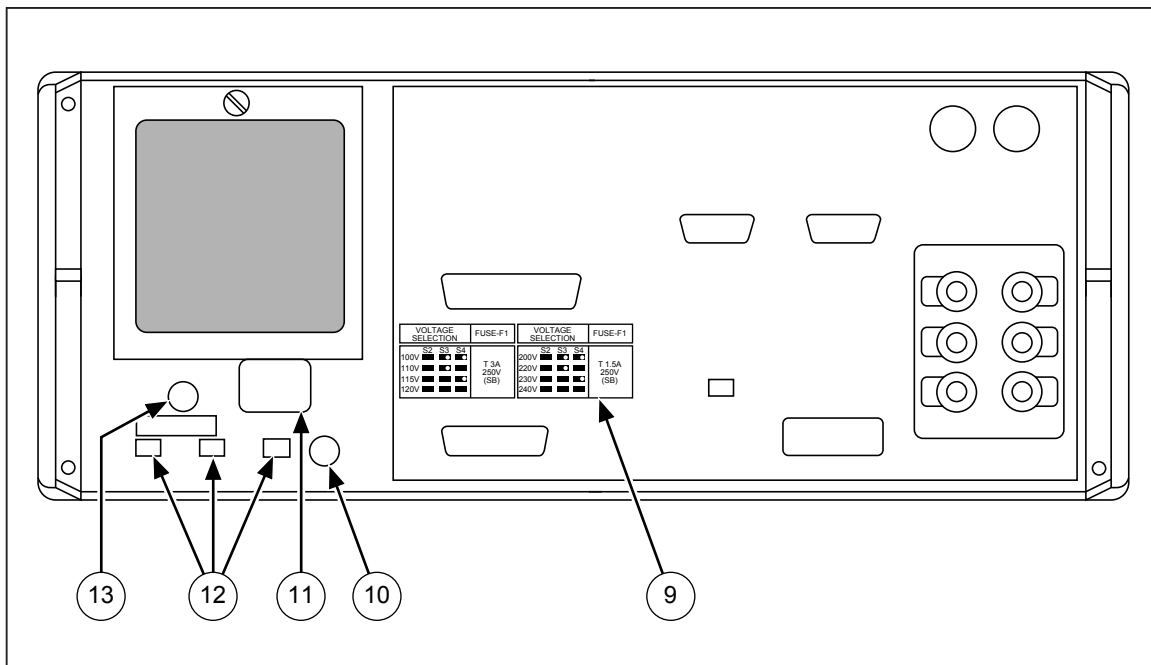

alh11.eps

Figure 6. Rear Panel Features (continued)

Softkey Menu Tree

The functions of the six softkeys described under “Front Panel Features”, are represented by menus containing labels displayed directly above each key. These functions change whenever you access a new menu. Figure 7 shows the hierarchy of all the menus available for the calibrator.

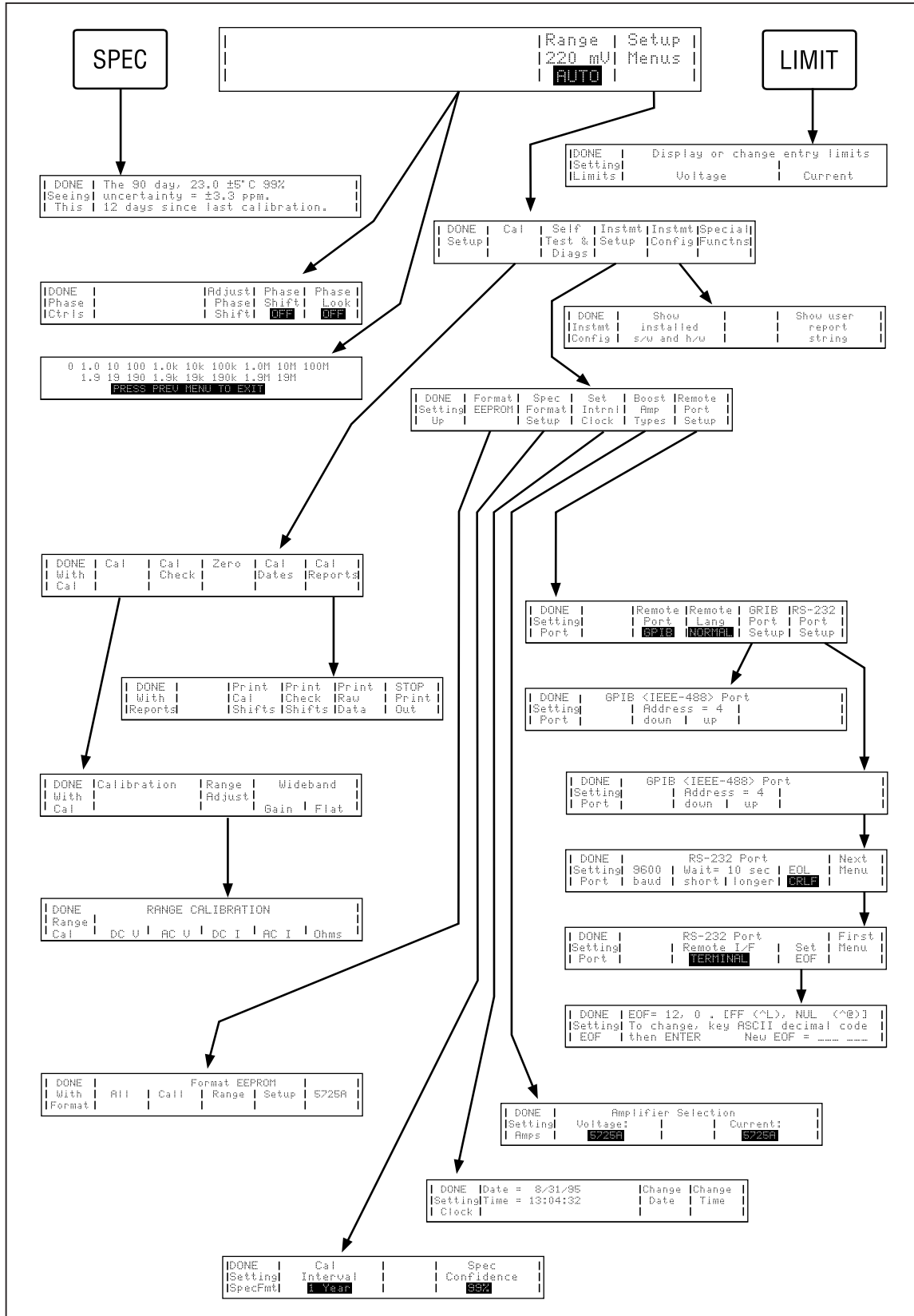

ah12.eps

Figure 7. Softkey Menu Tree

