

FLUKE®

DSP-100/2000

LAN CableMeter®/Cable Analyzer

Users Manual

PN 642964

January 1997

© 1997 Fluke Corporation. All rights reserved. Printed in U.S.A.
All product names are trademarks of their respective companies.

LIMITED WARRANTY & LIMITATION OF LIABILITY

Each Fluke product is warranted to be free from defects in material and workmanship under normal use and service. The warranty period is one year and begins on the date of shipment. Parts, product repairs and services are warranted for 90 days. This warranty extends only to the original buyer or end-user customer of a Fluke authorized reseller, and does not apply to fuses, disposable batteries or to any product which, in Fluke's opinion, has been misused, altered, neglected or damaged by accident or abnormal conditions of operation or handling. Fluke warrants that software will operate substantially in accordance with its functional specifications for 90 days and that it has been properly recorded on non-defective media. Fluke does not warrant that software will be error free or operate without interruption.

Fluke authorized resellers shall extend this warranty on new and unused products to end-user customers only but have no authority to extend a greater or different warranty on behalf of Fluke. Warranty support is available if product is purchased through a Fluke authorized sales outlet or Buyer has paid the applicable international price. Fluke reserves the right to invoice Buyer for importation costs of repair/replacement parts when product purchased in one country is submitted for repair in another country.

Fluke's warranty obligation is limited, at Fluke's option, to refund of the purchase price, free of charge repair, or replacement of a defective product which is returned to a Fluke authorized service center within the warranty period.

To obtain warranty service, contact your nearest Fluke authorized service center or send the product, with a description of the difficulty, postage and insurance prepaid (FOB Destination), to the nearest Fluke authorized service center. Fluke assumes no risk for damage in transit. Following warranty repair, the product will be returned to Buyer, transportation prepaid (FOB Destination). If Fluke determines that the failure was caused by misuse, alteration, accident or abnormal condition of operation or handling, Fluke will provide an estimate of repair costs and obtain authorization before commencing the work. Following repair, the product will be returned to the Buyer transportation prepaid and the Buyer will be billed for the repair and return transportation charges (FOB Shipping Point).

THIS WARRANTY IS BUYER'S SOLE AND EXCLUSIVE REMEDY AND IS IN LIEU OF ALL OTHER WARRANTIES, EXPRESS OR IMPLIED, INCLUDING BUT NOT LIMITED TO ANY IMPLIED WARRANTY OF MERCHANTABILITY OR FITNESS FOR A PARTICULAR PURPOSE. FLUKE SHALL NOT BE LIABLE FOR ANY SPECIAL, INDIRECT, INCIDENTAL OR CONSEQUENTIAL DAMAGES OR LOSSES, INCLUDING LOSS OF DATA, WHETHER ARISING FROM BREACH OF WARRANTY OR BASED ON CONTRACT, TORT, RELIANCE OR ANY OTHER THEORY.

Since some countries or states do not allow limitation of the term of an implied warranty, or exclusion or limitation of incidental or consequential damages, the limitations and exclusions of this warranty may not apply to every buyer. If any provision of this Warranty is held invalid or unenforceable by a court of competent jurisdiction, such holding will not affect the validity or enforceability of any other provision.

Fluke Corporation
P.O. Box 9090
Everett, WA 98206-9090
U.S.A.

Fluke Europe B.V.
P.O. Box 1186
5602 BD Eindhoven
The Netherlands

Table of Contents

Chapter		Page
1	Introduction	1-1
	Overview of Features	1-1
	Standard Accessories	1-3
	Using This Manual	1-5
2	Getting Started	2-1
	Δ Safety and Operational Information	2-1
	Quick Start	2-3
	Quick Configuration	2-4
	Results within Accuracy Range	2-6
	Autotest on Twisted Pair Cable	2-7
	Autotest on Coaxial Cable	2-10
	Main Unit Features	2-12
	Remote Features	2-14
	Strap and Bail	2-16
	Rotary Switch	2-16
	Turning On the Test Tool	2-20
	Configuring the Test Tool	2-22
	Remote Lights, Messages, and Audible Tones	2-29
	Remote End Testing	2-30
	Remote Communication Error	2-31
	Battery Status	2-31
3	Autotest	3-1
	Autotest Softkeys	3-1
	Autotest on Twisted Pair Cable	3-2
	Link Performance Grade Result (Headroom)	3-4
	Automatic Diagnostics (Model DSP-2000)	3-4
	Autotest Results for Twisted Pair Cable	3-6

	Autotest on Coaxial Cable	3-19
	Autotest Results for Coaxial Cable	3-21
	Saving Autotest Results	3-23
	The Autotest Report.....	3-25
4	Running Individual Tests	4-1
	Single Tests for Twisted Pair Cable	4-1
	Scanning Function	4-2
	When to Use a Remote Unit	4-2
	The TDX Analyzer	4-6
	The TDR Test	4-9
	Single Test Results for Twisted Pair Cable	4-12
	Single Tests for Coaxial Cable	4-14
	Monitoring Network Activity	4-16
	Identifying Hub Port Connections	4-20
	Monitoring Impulse Noise.....	4-20
	Determining Hub Port Capabilities (Model DSP-2000).....	4-23
	Using the Tone Generator (Model DSP-2000).....	4-24
5	Viewing and Printing Saved Reports.....	5-1
	Printing Test Reports	5-1
	Viewing, Renaming, and Deleting Test Reports	5-6
6	Calibrations and Custom Test Standards.....	6-1
	Calibrating the Test Tool.....	6-1
	NVP Calibration	6-3
	Configuring a Custom Cable	6-4
7	Basic Cable Testing.....	7-1
	LAN Cable Construction	7-1
	Attenuation	7-5
	Noise	7-6
	Characteristic Impedance.....	7-7
	Crosstalk and Near-End Crosstalk (NEXT)	7-9
	Nominal Velocity of Propagation (NVP)	7-14
	Time Domain Reflectometry (TDR).....	7-15
	ACR	7-19
	RL	7-20
	Troubleshooting Basics	7-21
8	Maintenance and Specifications.....	8-1
	Maintenance.....	8-1
	If the Test Tool Fails	8-4
	Specifications.....	8-7

Appendices

A	Using DSP-LINK	A-1
B	Glossary.....	B-1
C	Tests Run per Test Standard During an Autotest.....	C-1

Index

List of Tables

Table		Page
2-1.	International Electrical Symbols.....	2-1
2-2.	Key Functions for the Menu System	2-3
2-3.	Quick Configuration Settings	2-4
2-4.	Main Unit Features	2-13
2-5.	Remote Connectors and Features	2-15
2-6.	Status Indications from Remotes	2-29
2-7.	Battery Status Messages	2-31
3-1.	Wire Map Displays	3-6
3-2.	Items on the Attenuation Results Screen	3-10
3-3.	Items on the Attenuation Plot Screen	3-11
3-4.	Items on the NEXT Results Screen	3-12
3-5.	Items on the NEXT Plot Screen.....	3-13
3-6.	Items on the ACR Results Screen.....	3-15
3-7.	Items on the ACR Plot Screen	3-16
3-8.	Items on the RL Results Screen	3-17
3-9.	Items on the RL Plot Screen	3-18
3-10.	Items on the Autotest Save Screen.....	3-24
4-1.	Remote Requirements for Cable Tests	4-3
4-2.	Items on the TDX Analyzer Results Screen	4-7
4-3.	Items on a TDX Analyzer Plot.....	4-8
4-4.	Effects of Termination on TDR Results	4-9
4-5.	Items on the TDR Results Screen (Twisted Pair Results)	4-11
4-6.	Items on the TDR Plot (Twisted Pair Results)	4-12
4-7.	Items on the Traffic Monitor Screen.....	4-19
4-8.	Items on the Noise Monitor Screen	4-23
7-1.	Identifying Cable Faults.....	7-22
8-1.	Troubleshooting the Test Tool.....	8-5
8-2.	Replacement Parts.....	8-6
8-3.	Characteristic Impedance Test Specifications	8-8
8-4.	Length Test Specifications	8-9
8-5.	Length Test Specifications	8-9

8-6.	Distance Specifications for TDR Test.....	8-11
8-7.	PC Interface Cable Connections.....	8-13
8-8.	9-to 25-pin Adapter	8-13
8-9.	Certifications	8-16
A-1.	Summary of DSP-LINK Functions	A-5
A-2.	Special Terms Used in DSP-LINK.....	A-6
A-3.	Formats for Uploaded Reports	A-7
C-1.	Tests Run per Test Standard During an Autotest.....	C-2

List of Figures

Figure		Page
1-1.	Standard Accessories	1-4
2-1.	The Asterisk and Test Tool Accuracy	2-6
2-2.	Autotest Connections for Twisted Pair Cable (Channel)	2-8
2-3.	Autotest Connections for Coaxial Cable	2-11
2-4.	Main Unit Features	2-12
2-5.	Standard and Smart Remote Features	2-14
2-6.	Attaching the Strap and Opening the Bail	2-16
3-1.	Autotest Connections for Twisted Pair Cable (Basic Link)	3-2
3-2.	Examples of Automatic Diagnostics Displays.....	3-5
3-3.	The Attenuation Plot Screen.....	3-11
3-4.	The NEXT Plot Screen	3-13
3-5.	The ACR Plot Screen.....	3-16
3-6.	The RL Plot Screen.....	3-18
3-7.	Autotest Connections for Coaxial Cable	3-21
3-8.	Screen for Saving Autotest Results	3-24
3-9.	Part of an Autotest Report for Twisted Pair	3-26
3-10.	Autotest Report for Coaxial Cable	3-27
3-11.	Autotest Report Summary.....	3-27
4-1.	Single Test Connections for Twisted Pair Cable.....	4-4
4-3.	Example of a TDX Analyzer Plot for a Good Twisted Pair Cable Run	4-8
4-3.	Example of a TDR Plot (Twisted Pair Results).....	4-12
4-4.	Single Test Connections for Coaxial Cable.....	4-15
4-5.	Connections for Monitoring Network Traffic	4-17
4-6.	Connections for Monitoring Impulse Noise	4-21
5-1.	Connections for Printing Test Reports	5-3
6-1.	Connections for Self-Calibration (Smart Remote Shown)	6-2
7-1.	Twisted Pair Cable Construction	7-2
7-2.	EIA/TIA RJ45 Connections.....	7-3
7-3.	Coaxial Cable Construction.....	7-4
7-4.	Attenuation of a Signal	7-5
7-5.	Sources of Electrical Noise.....	7-6

7-6.	A TDX Analyzer Plot.....	7-10
7-7.	Split Pair Wiring.....	7-12
7-8.	How NVP is Calculated	7-14
7-9.	Signals Reflected from an Open, Shorted, and Terminated Cable.....	7-16
7-10.	Example of a TDR Plot	7-18
7-11.	A Plot of NEXT, Attenuation, and the Resulting ACR	7-20
8-1.	Removing the Battery in the Standard Remote	8-2
8-2.	Removing the NiCad Battery Pack.....	8-3
8-3.	Operating Environment Specifications	8-15
A-1.	Connecting the Test Tool to a PC	A-3

Chapter 1

Introduction

Chapter 1 provides the following information:

- Features of the DSP-100 and DSP-2000 test tools.
- A list of equipment included with the test tools.
- A guide to using this manual.

Overview of Features

The Fluke DSP-100 LAN CableMeter[®] and DSP-2000 LAN Cable Analyzer test tools (hereafter referred to collectively as “the test tool”) are hand-held instruments used to certify cable and to test and troubleshoot coaxial and twisted pair cable in local area network (LAN) installations. The test tool features new measurement technology that combines test pulses with digital signal processing to provide fast, accurate results and advanced testing capabilities.

The test tool includes the following features:

- Checks LAN cable performance against IEEE, ANSI, TIA, and ISO/IEC standards.
- Presents test options and results in a simple menu system.
- Presents displays and printed reports in English, German, French, Spanish, or Italian.
- Runs all critical tests automatically.

- Produces 2-way Autotest results in approximately 20 seconds.
- Includes a stored library of common test standards and cable types.
- Allows for configuration of up to 4 custom test standards.
- Time Domain Crosstalk (TDX™) analyzer locates the position of crosstalk (NEXT) problems on a cable.
- Tests for return loss (RL).
- Produces plots of NEXT, attenuation, ACR, and RL. Shows NEXT, ACR, and attenuation results up to 155 MHz.
- Stores at least 500 cable test results in nonvolatile memory.
- Monitors impulse noise and network traffic on Ethernet systems. Hub port locator helps you identify port connections.
- Sends stored test reports to a host computer or directly to a serial printer.
- Flash EPROM accepts test standard and software upgrades.
- Tests fiber optic cable when used with a Fluke DSP Fiber Optic Meter.

Model DSP-2000 includes the following additional features:

- Monitors 100BaseTX network traffic.
- Diagnostic routine provides specific information about the location and cause of an Autotest failure.
- Tests for remote return loss (RL@REMOTE) and power sum NEXT (PSNEXT).
- Determines which standards are supported by a hub port connection.
- Tone generator lets you use an inductive pickup device to identify cables in a LAN installation.

Standard Accessories

The test tool comes with the following accessories, which are shown in Figure 1-1. If the test tool is damaged or something is missing, contact the place of purchase immediately.

- 1 AC/adaptor/charger (2 with smart remote package) 120V (US only) or universal adapter/charger and line cord (outside North America)
- 2 RJ45 2m (6.6 ft), 100 Ω , straight-through patch cables
- 1 RJ45 15 cm (6"), 100 Ω , straight-through patch cable
- 1 50 Ω BNC coaxial cable
- 1 RJ45 to BNC adapter (Model DSP-2000 only)
- 1 PC serial interface (EIA-232C) cable
- 1 Carrying strap (2 with smart remote package)
- 1 3.5" DSP-LINK utility diskette
- 1 Users manual (not shown)
- 1 Warranty registration card (not shown)
- 1 Soft carrying case for Model DSP-100 (2 with smart remote package, not shown. Discard loose foam pieces.)
- 1 Smart remote unit with Model DSP-2000 (not shown)
- 1 Hard carrying case with Model DSP-2000 (not shown)

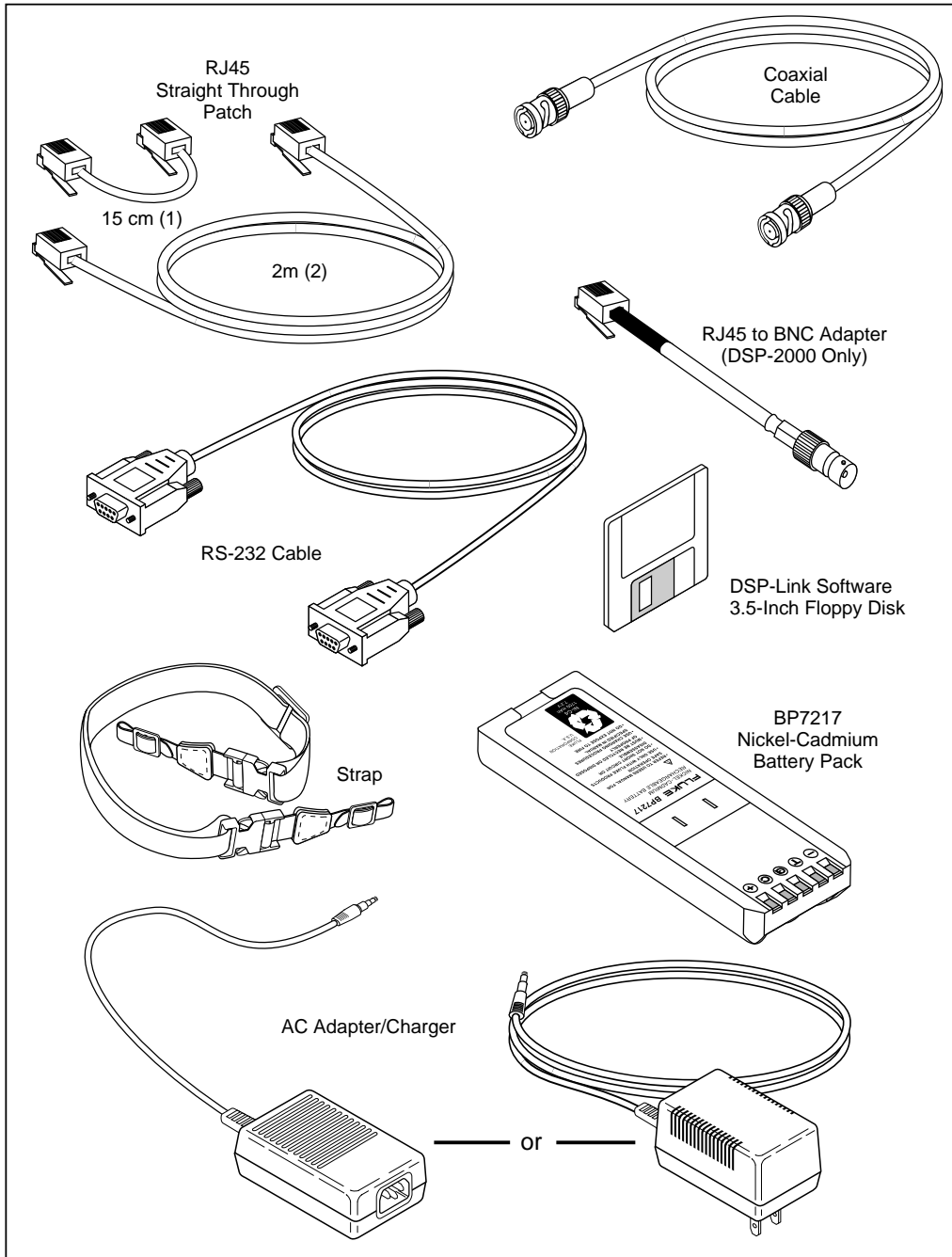

gc01f.eps

Figure 1-1. Standard Accessories

Using This Manual

⚠Warning

Before using the test tool, carefully read "Safety and Operational Information" at the beginning of Chapter 2.

If you are familiar with the general features, functions, and operation of LAN cable testers and want to start testing cables immediately, proceed as follows:

1. Read "Quick Start" in Chapter 2 to prepare the test tool for operation, access the test tool's functions, and run an Autotest.
2. Refer to the test and setup features listed under "Rotary Switch" in Chapter 2 to locate functions in the test tool's menu structure.
3. Refer to Appendix B, "Glossary," to find definitions for unfamiliar terms.

If you have never used a LAN cable tester, but want to start testing cables immediately and learn as you work, proceed as follows:

1. Read "Quick Start" in Chapter 2 to prepare the test tool for operation, access the test tool's functions, and run an Autotest.
2. Refer to Appendix B, "Glossary," to find definitions for unfamiliar terms.
3. Refer to the test and setup features listed under "Rotary Switch" in Chapter 2 to locate functions in the test tool's menu structure.
4. Refer to Chapter 3, "Autotest," to find more detailed information about cable tests and test results."
5. Read Chapter 4, "Running Individual Tests," to learn how to run individual tests and monitor network traffic and impulse noise.
6. Read Chapter 7, "Basic Cable Testing," to add to your cable testing and troubleshooting knowledge.

If you have never used a LAN cable tester and want to learn about cable testing and troubleshooting before you use the test tool, proceed as follows:

1. Read Chapter 7, “Basic Cable Testing,” to learn the basics of LAN cable characteristics, testing, and interpreting test results.
2. Read “Features” in Chapter 2 to familiarize yourself with the test tool.
3. Read “Getting Started” in Chapter 2 to learn how to prepare the test tool for use.
4. Read Chapter 3, “Autotest,” to learn how to run the most commonly used cable test and interpret the test results.
5. Read Chapter 4, “Running Individual Tests,” to learn how to run individual tests and monitor network traffic and impulse noise.
6. Refer to the test and setup features listed under “Rotary Switch” in Chapter 2 to locate functions in the test tool’s menu structure.
7. Refer to Appendix B, “Glossary,” to find definitions for unfamiliar terms.

Chapter 2

Getting Started





Chapter 2 provides the following information:

- Safety and cautions to observe when using the test tool.
- Instructions for getting started quickly with the test tool.
- Detailed information on the test tool's features.
- Detailed instructions on configuring the test tool.

Safety and Operational Information

The international electrical symbols used on the instrument or in this manual are described in Table 2-1.

Table 2-1. International Electrical Symbols

	Warning: Risk of electric shock.
	Warning or Caution: Risk of damage or destruction to equipment or software. See explanations in the manual.
	Equipment is protected by double insulation or reinforced insulation to protect the user against electric shock.
	Do not connect this terminal to public communications networks, such as telephone systems.
 Ni-Cd	Battery should be recycled. Refer to "Replacing the NiCad Battery Pack" in Chapter 8.

⚠ Warning

To avoid possible fire or electric shock when charging the battery or powering the test tool with ac power, use only the ac adapter/charger provided with the test tool.

⚠ Caution

Never connect the test tool to telephone lines of any type, including ISDN lines. Doing so can damage the test tool.

- Always turn on the test tool before connecting it to a cable. Turning the test tool on activates the tool's input protection circuitry.
- Except when monitoring network activity, never connect the test tool to an active network. Doing so may disrupt network operation.
- When using a coaxial T-connector to connect the test tool to a network, never allow the T-connector to touch a conductive surface. Such contact may disrupt network operation.
- Never attempt to insert any connector other than an RJ45 connector into the RJ45 jack. Inserting other connectors, such as RJ11 (telephone) connectors, can permanently damage the jack.
- Never attempt to send data from a PC to the test tool while running a cable test. Doing so may cause erroneous test results.
- Never operate portable transmitting devices during a cable test. Doing so may cause erroneous test results.
- Never run tests with cables connected to both test connectors. Doing so may cause erroneous test results.
- To ensure maximum accuracy of test results, perform the self-calibration procedure as described in "Calibrating the Test Tool" in Chapter 6.

Quick Start

This section is for users who want to start using the test tool immediately with minimal instruction. For suggestions on additional reading that may be helpful to you, see “Using this Manual” in Chapter 1.

Powering the Test Tool

Before powering the test tool or smart remote with the NiCad battery pack, charge the battery for about 3 hours. To charge the battery, connect the ac adapter/charger to the test tool or smart remote and to ac line power. You can operate the unit on ac power while the battery charges. A fully-charged battery typically lasts 10-12 hours. See “Battery Status” on page 2-31 for information on battery status messages.

Note





The ac adapter/charger will not power the test tool when the battery pack is removed.

The standard remote unit is powered by a 9V alkaline battery. The test tool monitors the remote unit and alerts you when the battery voltage is low.

Using the Menus

The test tool’s setup configuration, test selections, and test results are presented in a menu system. Table 2-2 shows the keys used to select items and move between screens in the menu system.

Table 2-2. Key Functions for the Menu System

Key	Function
	Allow up, down, left, and right movement on the display.
	Selects the highlighted item.
	Starts the highlighted test.
	Exits the current screen.
	Softkeys select the function displayed on the screen area above the key. Softkey functions depend on the screen displayed.

Quick Configuration

The settings listed in Table 2-3 affect either the display format or the accuracy of your test results. Following the table are instructions for changing the settings. For a complete list of the test tool's adjustable settings, refer to the later section "Setup."

Table 2-3. Quick Configuration Settings

SETUP Setting	Description
Test Standard and Cable Type	Select the test standard and cable type you are using. Your selection determines which test specifications are used and which tests are run during cable testing. Fiber optic cable testing requires a Fluke DSP Fiber Optic Meter.
Average Cable Temperature	Select the cable temperature range that includes the average temperature where the cable is installed. Cable temperature is not applicable to all test standards.
Conduit Setting	The conduit setting is not applicable to all test standards.
Remote End Testing	Enables execution of the REMOTE tests. Select Disable or Auto Detect when using a standard remote.
Length Units	Select meters or feet as the unit for length measurements.
Numeric Format	Select a format (0.00 or 0,00) for display of decimal fractions.
Display and Report Language	Select English, German, French, Spanish, or Italian.
Power Line Noise Filter Frequency	Select the frequency of the ac power in your area. The test tool filters out 50 or 60 Hz noise from measurements.

To change any of the settings shown in Table 2-3, proceed as follows:

1. Turn the rotary switch to SETUP.
2. If the setting you want to change is not on the first Setup screen, press **Page Down** to see additional Setup screens.
3. Use to highlight the setting you want to change.
4. Press **Choice**.
5. Use to highlight the setting you want.
6. Press to store the highlighted setting.
7. Repeat steps 2 through 6 to change additional settings.

Results within Accuracy Range

An asterisk following a test result value indicates that the value is within the test tool's range of accuracy, as shown in Figure 2-1. All tests except the wire map test may produce results with an asterisk when the asterisk is required by the selected test standard.

The asterisk appears on displayed and printed test results, but does not appear in comma separated variable (CSV) data uploaded to a PC.

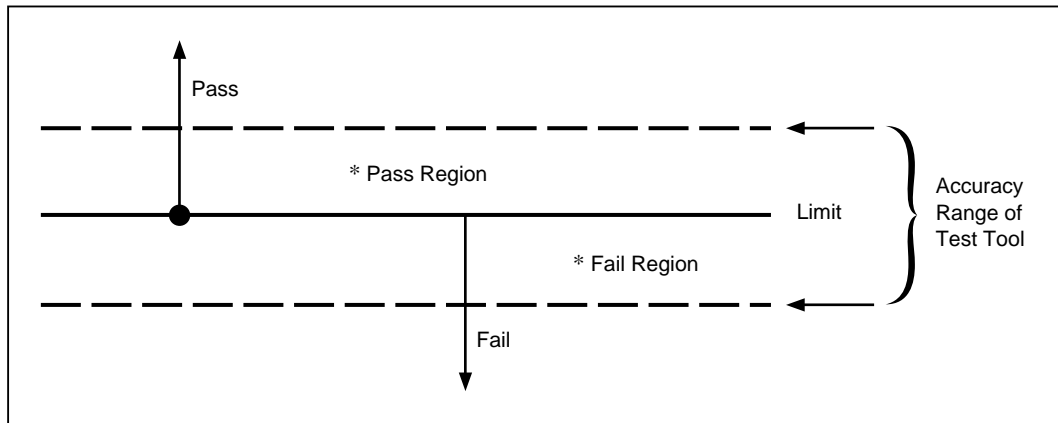

gc02f.eps

Figure 2-1. The Asterisk and Test Tool Accuracy

Autotest on Twisted Pair Cable

Autotest performs all of the tests necessary to determine if the cable you are testing meets the test standards specified for your LAN installation.

The following tests apply to twisted pair cable:

- Wire Map
- Resistance
- Length
- Propagation Delay
- Delay Skew
- Impedance
- NEXT (Near-end Crosstalk)
- Attenuation
- ACR (Attenuation to Crosstalk Ratio)
- RL (Return Loss)
- PSNEXT (Power Sum NEXT; Model DSP-2000 only)

Some test standards require a NEXT measurement from both ends of the cable. If you are using another main unit (Model DSP-100 only) or a smart remote as the remote unit, and you enable remote end testing on the main unit, the Autotest runs the REMOTE tests supported by the test tool if those tests apply to the selected test standard.

To Autotest twisted pair cable, refer to Figure 2-2 on the next page and proceed as follows:

Note

Standard remote units do not support remote end testing.

Note

If the calibration message appears after you start the Autotest, refer to “Calibrating the Test Tool” in Chapter 6 for complete calibration instructions.

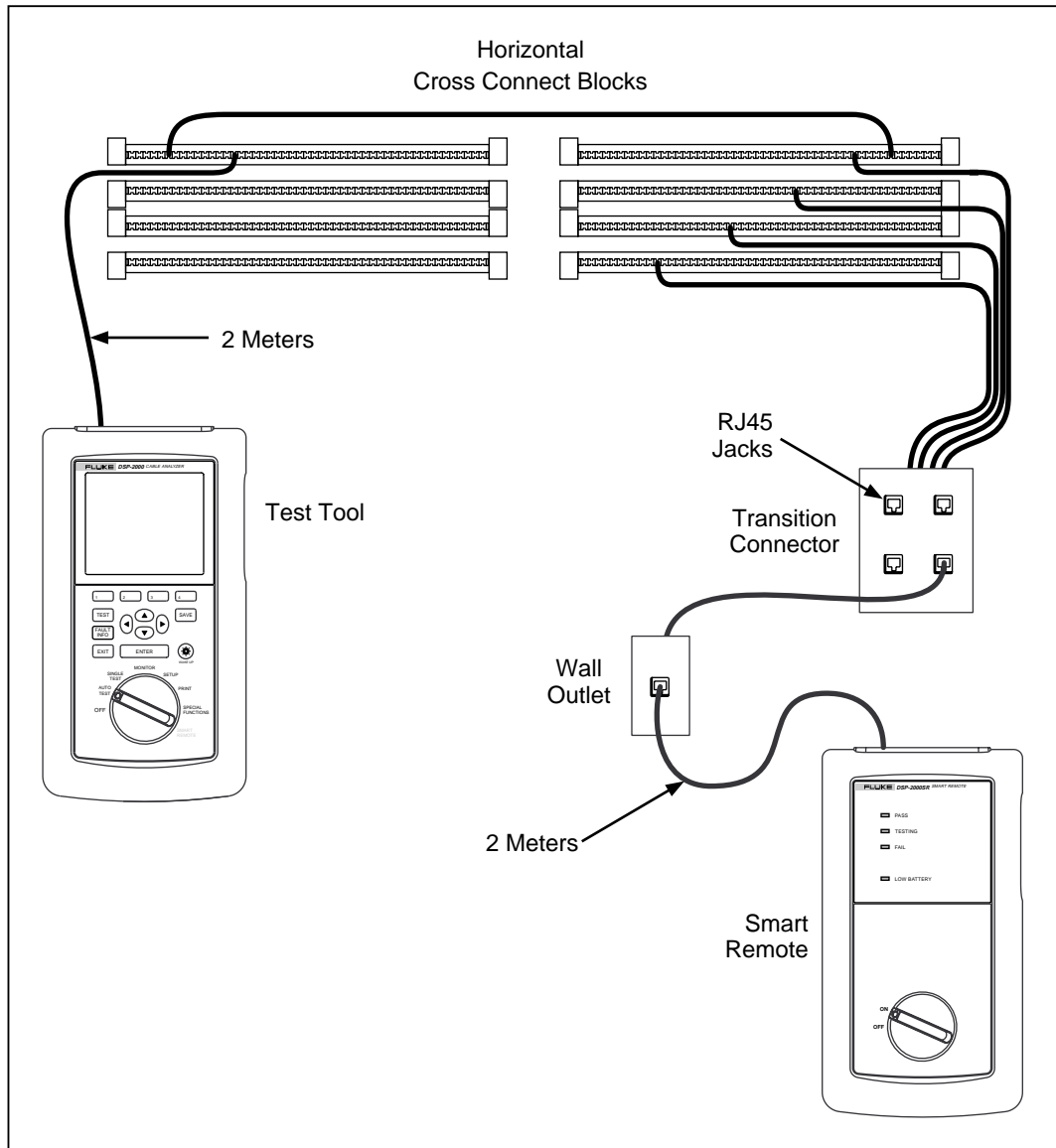

gc03f.eps

Figure 2-2. Autotest Connections for Twisted Pair Cable (Channel Configuration and Model DSP-2000 Shown)

1. If you are using a DSP-100 main unit as the remote, turn the remote unit's rotary switch to SMART REMOTE. If you are using a smart remote unit, turn its rotary switch to ON.
2. Use a 2m patch cable of the correct impedance to connect the remote to the far end of the cable link.
3. On Model DSP-100, remove any cable connected to the test tool's BNC connector.
4. Turn the rotary switch on the main unit to AUTOTEST.
5. Verify that the settings displayed are correct. You can change these settings in the SETUP mode.
6. Use a 2m patch cable of the correct impedance to connect the test tool to the near end of the cable link. On Model DSP-2000, connect to the CABLE TEST jack.
7. Press to start the Autotest.

Autotest on Coaxial Cable

The following tests are run during an Autotest on coaxial cable:

- Impedance
- Resistance
- Length
- Anomaly detection (Results shown only if anomalies are detected.)

To run an Autotest on coaxial cable, refer to Figure 2-3 and proceed as follows:

1. Turn off any PC nodes connected to the cable you are testing.
2. If you want the Autotest to report cable length, remove the terminator from the far end of the cable.
3. Turn the rotary switch to AUTOTEST.
4. Verify that the test standard and cable type displayed are correct. You can change these settings in the SETUP mode.
5. Remove any cable connected to the test tool's unused RJ45 connector.
6. Remove the terminator from the near end of the coaxial cable and connect the cable to the BNC connector on the test tool. On Model DSP-2000, use the RJ45 to BNC adapter to connect the cable to the CABLE TEST jack.
7. Press to start the Autotest.

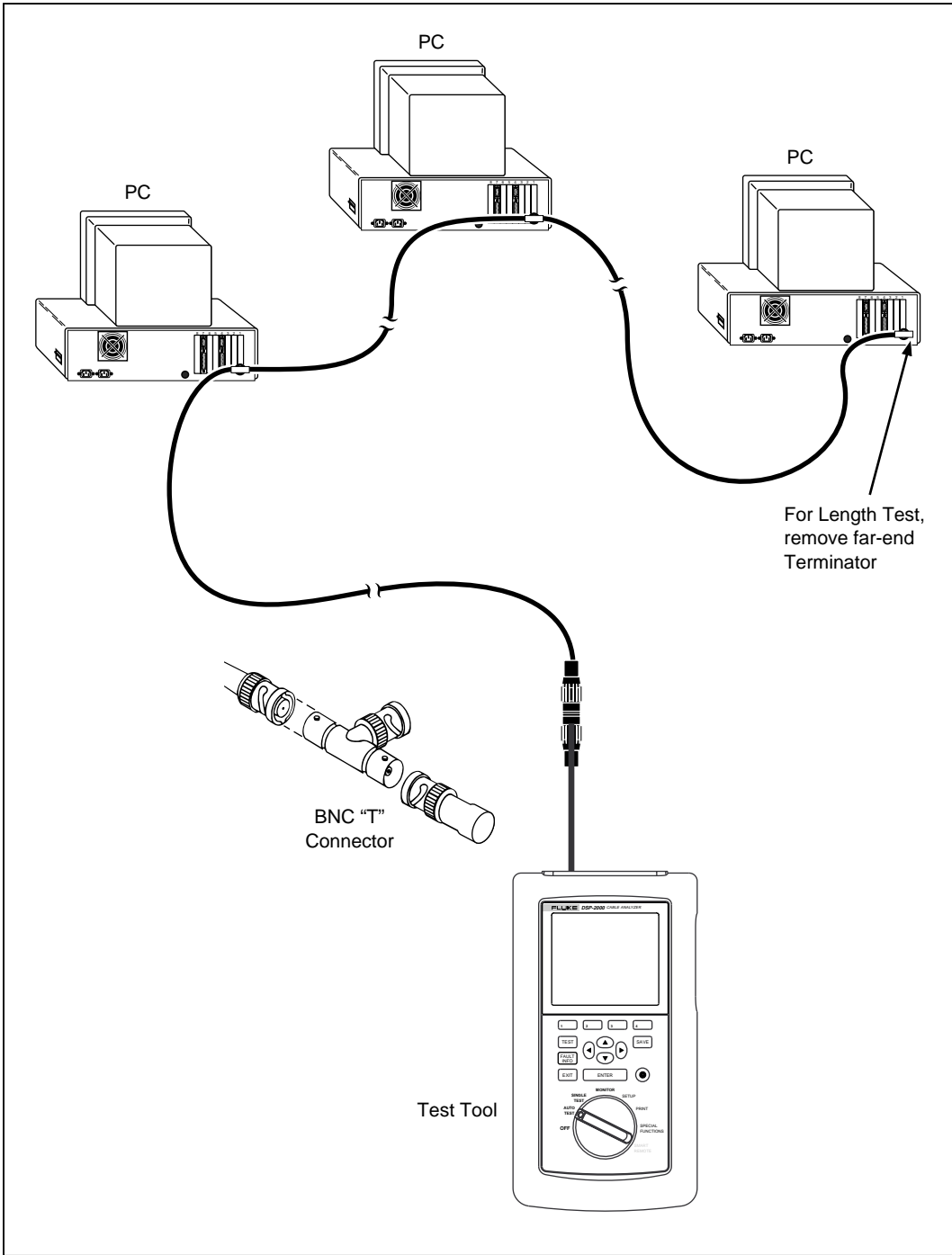

gc04f.epc

Figure 2-3. Autotest Connections for Coaxial Cable (Model DSP-2000 Shown)

Main Unit Features



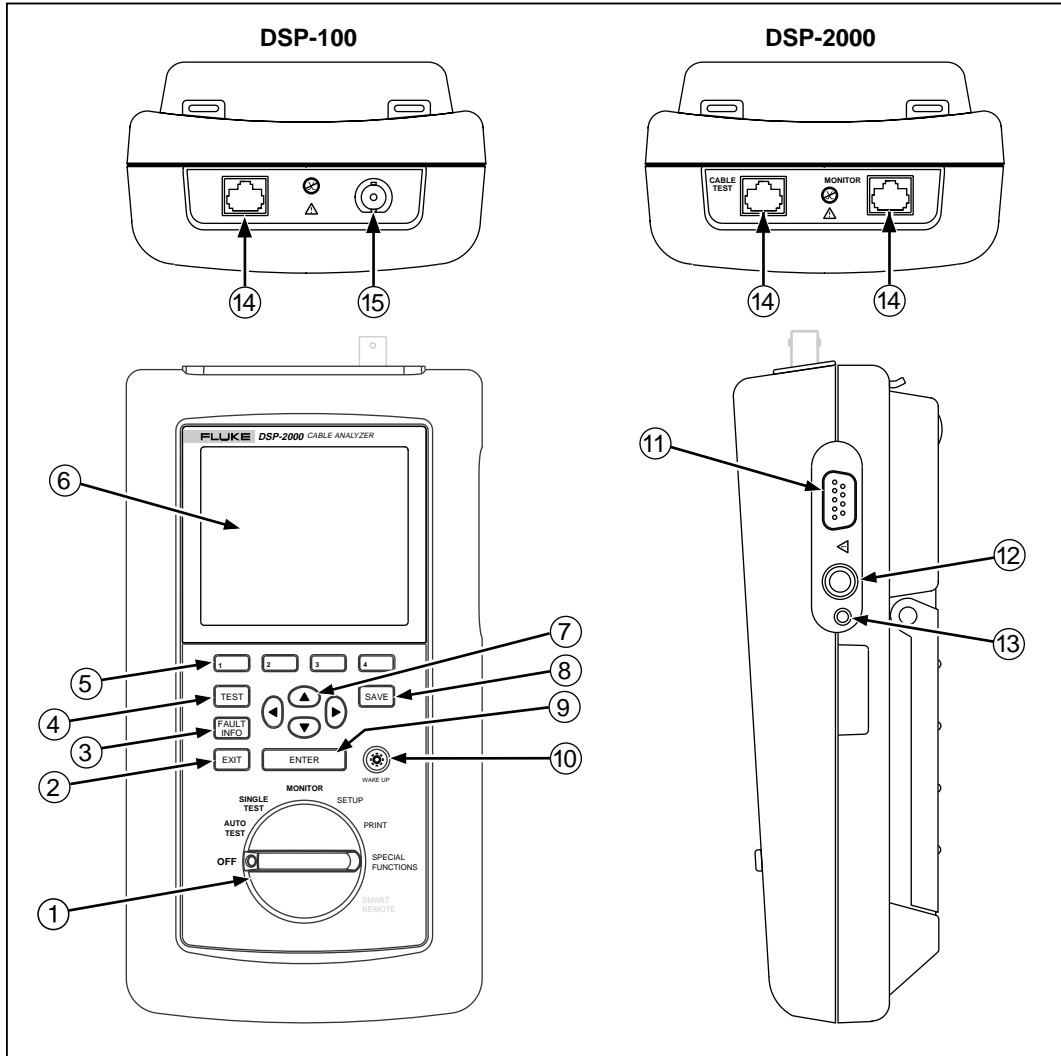
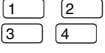



Figure 2-4 shows the features on the main unit and Table 2-4 explains their functions. Features shown in light gray are found on Model DSP-100 only.



gc05f.eps

Figure 2-4. Main Unit Features

Table 2-4. Main Unit Features

Item	Feature	Description
①	Rotary Switch	Selects the test tool's modes.
②		Exits the current screen.
③		Model DSP-2000 only. Automatically provides more specific information on the cause of an Autotest failure.
④		Starts the highlighted test or restarts the test last run.
⑤		Provide functions related to the concurrent display. Softkey functions are shown in the display area above the keys.
⑥	Display	A LCD display with backlight and adjustable contrast.
⑦		Allow left, right, up, and down movement on the display. Increase or decrease the numerical values of user-definable parameters.
⑧		Saves Autotest results and parameter changes in memory.
⑨		Selects the highlighted item from a menu.
⑩	 WAKE UP	Controls the display backlight. Pressing for 1 second allows adjustment of the display contrast. Reactivates the test tool when the tool is in power down mode.
⑪	RS-232C serial port	A 9-pin connector for interfacing with a printer or host computer via a standard IBM-AT EIA RS-232C serial cable.
⑫	AC adapter/charger jack	Connection for the ac adapter/charger supplied with the test tool.
⑬	AC power indicator	LED Style 1: A green LED that turns on when the test tool is powered with the ac adapter/charger. LED Style 2: A multicolor LED with four states: Off: AC adapter/charger is not connected, or is connected without the battery pack installed. Blinking Red: The ac adapter/charger is trickle charging the battery in preparation for fast charging. This mode indicates an extremely low battery voltage. The test tool may not operate. Steady Red: The ac adapter/charger is fast charging the battery. Steady Green: Fast charging is complete. The ac adapter/charger continues to trickle charge the battery.
⑭	RJ45 connector(s)	A shielded 8-pin jack for shielded and unshielded twisted pair cable. On Model DSP-2000, this jack is labeled CABLE TEST. Model DSP-2000 has an additional RJ45 jack labeled MONITOR, which is used for 10/100BaseTX traffic and hub tests.
⑮	BNC connector	Model DSP-100 only. A connector for coaxial cable.

Remote Features

Figure 2-5 shows the features on the standard and smart remote units. Table 2-5 explains the functions of these items.

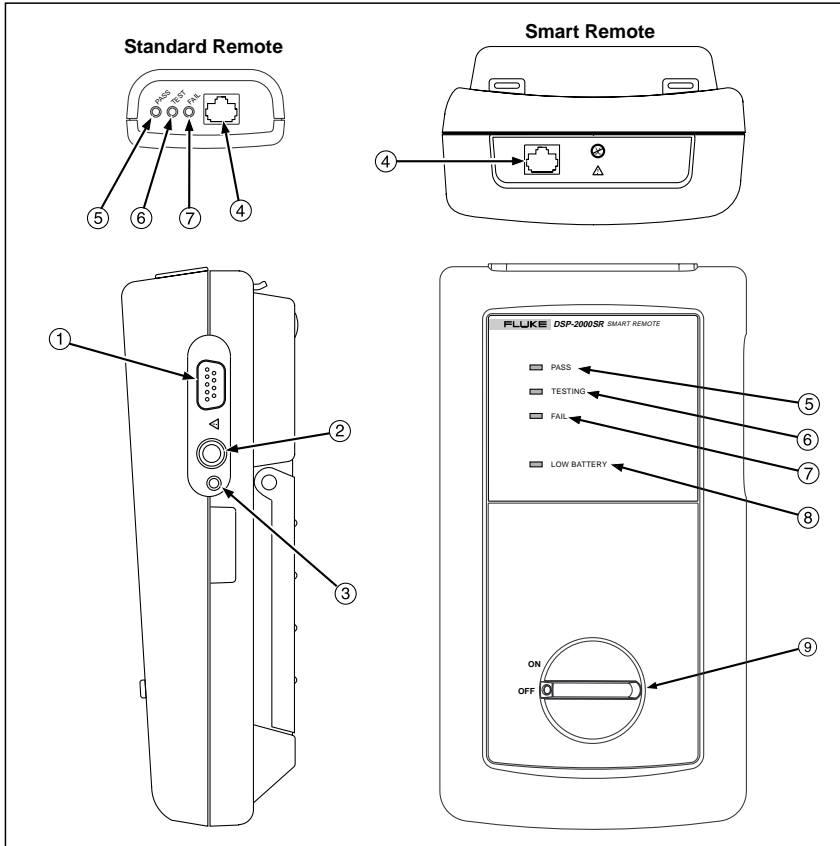

Figure 2-5. Standard and Smart Remote Features

gc06f.eps

Table 2-5. Remote Connectors and Features

Item	Feature	Description
①	RS-232C serial port	A DB9P connector for loading software updates.
②	AC adapter/charger jack	Connection for the ac adapter/charger supplied with the test tool.
③	AC power indicator	<p>LED Style 1: A green LED that turns on when the test tool is powered with the ac adapter/charger.</p> <p>LED Style 2: A multicolor LED with four states:</p> <p>Off: AC adapter/charger is not connected, or is connected without the battery pack installed.</p> <p>Blinking Red: The ac adapter/charger is trickle charging the battery in preparation for fast charging. This mode indicates an extremely low battery voltage. The test tool may not operate.</p> <p>Steady Red: The ac adapter/charger is fast charging the battery.</p> <p>Steady Green: Fast charging is complete. The ac adapter/charger continues to trickle charge the battery.</p>
④	RJ45 connector	A shielded 8-pin jack for shielded and unshielded twisted pair cable.
⑤	Pass LED	A green LED that turns on at the end of a test if no faults were detected.
⑥	Test LED	A yellow LED that turns on when a test is in progress.
⑦	Fail LED	A red LED that turns on at the end of a test if one or more faults were detected.
⑧	Low-battery LED	A LED that turns on when the smart remote battery voltage is low.
⑨	Rotary switch	On/off switch for smart remote.

Strap and Bail

The test tool and the smart remote have a strap and a bail. Figure 2-6 shows how to attach the strap and open the bail.

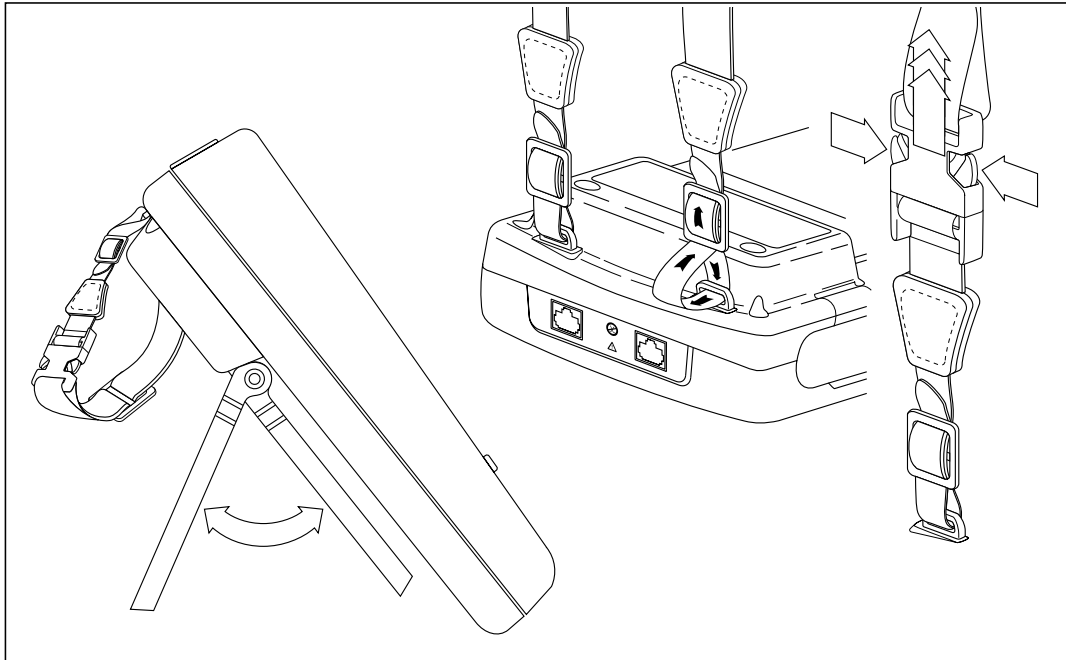

gc07f.eps

Figure 2-6. Attaching the Strap and Opening the Bail

Rotary Switch

The following paragraphs summarize the modes you can select with the rotary switch on the main unit.

Off

Turns the test tool off. Setup information and test results that were saved via the SAVE key are stored in nonvolatile memory.

Autotest

Autotest is the most frequently used function in LAN cable testing. Autotest performs all of the tests necessary to qualify the cable you are testing. When the Autotest is complete, the tests that were run are listed with the overall result for each test. You can also view detailed results for each test. Results from at least 500 Autotests can be saved for printing or transmission to a host computer.

The following tests apply to twisted pair cable:

Note

The tests run during an Autotest on twisted pair cable depend on the test standard selected. Tests not applicable to the selected test standard are not run or displayed. For a list of tests applicable to various test standards, see Table C-1 in Appendix C.

- **Wire Map:** Tests for opens, shorts, crossed pairs, reversed wires, and split pairs.
- **NEXT:** Tests twisted pair cable for near-end crosstalk (NEXT).
- **Length:** Displays the length of twisted pairs in feet or meters.
- **Propagation Delay:** Measures the times taken for a signal to travel the length of each cable pair.
- **Delay Skew:** Calculates the differences in propagation delays between the cable pairs.
- **Impedance:** Measures the impedance of each cable pair. If impedance anomalies are detected, the test reports the largest anomaly detected on each cable pair.
- **Attenuation:** Measures the attenuation of each cable pair.
- **Resistance:** Measures the loop resistance of each cable pair.
- **ACR:** Calculates the ratio of attenuation to crosstalk for all combinations of cable pairs.
- **RL (Return Loss):** Measures signal loss due to signal reflections in the cable.
- **PSNEXT (Power Sum Next; Model DSP-2000 only):** For each cable pair, PSNEXT is calculated as the sum of the NEXT from all other pairs.

The following tests apply to coaxial cable:

- Impedance: Measures the impedance of the cable.
- Resistance: Measures the loop resistance of the cable, shield, and terminator.
- Length: Measures the length of unterminated cables.
- Anomaly Detection: During a coaxial cable test, the test tool also detects and reports the position of the largest impedance anomaly (if any are present) on the cable.

Single Test

The SINGLE TEST mode provides access to the individual tests defined by the selected test standard, except for the ACR test. This mode also allows execution of TDR and TDX™ analyzer tests. A scanning function, which continuously repeats the test, is available for the wire map, resistance, TDR, and TDX analyzer tests.

Monitor

The MONITOR mode allows you to continuously monitor impulse noise on network cables or network activity on Ethernet systems. Network activity is monitored for collisions, jabber, and percentage of system utilization.

The MONITOR mode also includes a hub port locator, which helps you determine port connections at a hub. Model DSP-2000 includes a hub port capabilities feature that determines the standards supported by a port.

Setup

Allows you to do the following:

- Select a test standard and cable type.
- Select an average cable temperature when temperature is required by the selected test standard.
- Set the test tool to test cable installed in conduit when a conduit setting is required by the selected test standard.
- Enable remote testing or automatic remote detection when you use a second main unit or a smart remote as a remote unit.
- Set the cable identification number to increment automatically each time you save Autotest results.
- Set the backlight timer to turn off the backlight after a specified period of inactivity.
- Set the power-down timer to switch the test tool to a low-power mode after a specified period of inactivity.
- Set the fault threshold for the impulse noise test.
- Select interface parameters for the serial port.
- Enable or disable the test tool's beeper.
- Set the date and time.
- Select a format for the date and time.
- Select a unit for length measurements.
- Select a format for displaying decimal fractions.
- Select a language for the display and printed reports.
- Select a frequency for the power line noise filter.
- Enable or disable the shield continuity test.
- Modify test standards for custom cable configurations.
- Select 100 MHz or 155 MHz as the maximum frequency for NEXT, ACR, and attenuation tests.

Print

Allows you to send saved reports or report summaries to a serial printer. You can print the results from previously stored Autotests. Also allows editing of the report identification information.

Special Functions

Allows you to do the following:

- View or delete test reports saved in memory.
- Generate a tone to use with an inductive pickup to identify cable runs (Model DSP-2000 only).
- Determine the cable NVP to ensure maximum accuracy of length and resistance results.
- View the status of the NiCad battery in the main unit or smart remote.
- Calibrate the test tool to work with a new remote unit.
- Run a self-test to verify proper operation of the test tool and the remote.

Smart Remote (Model DSP-100)

The SMART REMOTE mode causes the test tool to function as a smart remote. In the SMART REMOTE mode, when remote testing is enabled on the main unit, the remote unit sends results from REMOTE tests to the main unit.

Turning On the Test Tool

To turn on the test tool, turn the rotary switch from OFF to any one of the available modes. The power-up screen, which appears for about 3 seconds, shows the software, hardware, and test standards versions for your main and remote units.

During this time, the test tool also performs a self-test. If a fault is detected during the self-test, the following message appears:

INTERNAL FAULT DETECTED. REFER TO MANUAL. For information, see “If the Test Tool Fails” in Chapter 8.

Selecting a Language for Displays and Reports

The test tool displays results and prints reports in English, German, French, Spanish, and Italian.

To select a language for displays and reports, proceed as follows:

1. Turn the rotary switch to SETUP.
2. Press **Page Down** four times.
3. Use to highlight the currently selected language.
4. Press **Choice**.
5. Use to highlight the language you want.
6. Press to accept the highlighted language. The test tool's display now appears in the selected language.

Performing a Self-Test

The self-test verifies that the test tool and the remote are operating properly. To run the self-test, proceed as follows:

1. Turn the rotary switch to SPECIAL FUNCTIONS.
2. Use to highlight **Self Test**.
3. Press .
4. Use the 2m Cat5 patch cable provided to connect the test tool to the remote as described on the display.
5. Press to start the self-test.
6. When the self-test is complete, you can either return to the main Special Functions menu by pressing or start a new operation by turning the rotary switch to a new position.

If the self-test fails, refer to “If the Test Tool Fails” in Chapter 8.

Overvoltage Test

The test tool periodically checks for dc voltages on the cable connected to the RJ45 jack. A dc voltage means that the test tool is connected to an active telephone cable or other power source. If voltage is detected, the following message appears:

WARNING! EXCESSIVE VOLTAGE DETECTED AT INPUT.

Voltage on the cable can damage the test tool or cause errors in measurements. Voltage must be removed before you can run any tests.

Noise Test

The test tool periodically checks for excessive electrical noise on the cable under test. If excessive noise is detected, the following message appears:

WARNING Excessive noise detected.

Measurement accuracy may be degraded. To continue the test, press . If you continue the test and then save the test results, the test report will include the warning given above.

To stop the test and return to the first screen of the selected test mode, press .

Configuring the Test Tool

Controlling the Backlight

To turn on the display backlight, press on the keypad. Press the key again to turn off the backlight. On Model DSP-2000, the backlight key toggles the backlight between two levels of brightness.





You can set the backlight timer to automatically turn off the backlight after a specified period of inactivity. You can also disable the backlight timer.

To set the backlight timer or disable the timer, proceed as follows:

1. Turn the rotary switch to SETUP.
2. Press **Page Down** once.
3. Use to highlight the backlight time-out setting.
4. Press **Choice**.
5. Use to highlight the desired time-out period or the disable status.
6. Press to accept the highlighted selection.

When the backlight time-out is enabled, the backlight timer starts counting down after all tests are complete or after the last key entry or movement of the rotary switch. To restart the backlight timer while the backlight is on, press any key (except the backlight key) or turn the rotary switch to a new mode.







Adjusting the Display Contrast

To adjust the display contrast, hold down  for 1 second or longer. The following message appears: **USE   KEYS TO ADJUST CONTRAST.** Adjust the contrast to the desired level then press  to accept the new level. The display contrast setting is saved in memory when you turn off the test tool.

Selecting a Power Line Filter Frequency

The test tool has a noise filter to keep ac noise (50 or 60 Hz) from affecting resistance measurements.

To set the frequency of the noise filter to the frequency of your ac power, proceed as follows:

1. Turn the rotary switch to SETUP.
2. Press  **Page Down** four times.
3. Use  to highlight the power line frequency.
4. Press  **Choice**.
5. Use   to highlight the frequency you want.
6. Press  to accept the highlighted frequency.

Selecting a Test Standard and Cable Type

The test standard and cable type you select determine which standards are used and which tests are run during cable testing. The test tool is equipped with information for all the common test standards and cable types.

Several of the test standards for twisted pair cable are defined for both a channel and a basic link configuration. The test limits for a channel are looser than those for a basic link because the channel limits allow for the effects of two connections at a horizontal cross-connect and a transition connector near the telecommunications outlet in the work area. Figure 2-2 shows the connections involved in a channel; Figure 3-1 shows the connections involved in a basic link.

To select a test standard and cable type, proceed as follows:

1. Turn the rotary switch to SETUP.
2. Press **Choice**.
3. Use to highlight the test standard you want.
4. Press to accept the highlighted test standard. The test tool displays a menu of the cable types that are valid for the selected test standard.
5. Use to select the cable type you want; then press .

If you select a shielded cable type, you can enable or disable the shield continuity test on page 6 of the SETUP screens.

You can test cables for NEXT, attenuation, and ACR up to 100 MHz or 155 MHz. Because no industry standards specify cable performance beyond 100 MHz, there are no test limits for these measurements.

The maximum frequency selection is on page 6 of the SETUP screens.





Selecting an Average Cable Temperature

Some test standards require you to select an average temperature for the cable you are testing. The selected temperature appears on the display when you turn the rotary switch to AUTOTEST. If the test standard has no temperature-dependent limits, **N/A** is displayed.

If you select a test standard that has temperature-dependent limits, the test tool uses a default value of below 21°C (69°F) for the average cable temperature.

An increase in cable temperature causes an increase in attenuation. To compensate for this increase, the test tool uses the temperature you select to modify the attenuation test limits. To avoid passing faulty cables or failing good cables, select the temperature that is closest to the cable's average temperature.

To select an average cable temperature, proceed as follows:





1. Turn the rotary switch to **SETUP**.
2. Use  to highlight the average cable temperature.
3. Press  **Choice**.
4. Use   to highlight the temperature range you want.
5. Press  to select the highlighted temperature range.

Selecting a Conduit Setting

Some test standards require you to specify whether or not the cable is installed inside conduit. If the test standard requires a conduit setting, the current setting (yes or no) appears on the display when you turn the rotary switch to **AUTOTEST**. If the test standard does not require a conduit setting, **N/A** is displayed.

Metal conduit slightly increases a cable's attenuation. To compensate for this increase, the test tool's attenuation test limits are raised when the conduit setting is set to "yes."

To change the conduit setting, proceed as follows:

1. Turn the rotary switch to **SETUP**.
2. Use  to highlight the conduit setting.
3. Press  **Choice**.
4. Use   to highlight the setting you want.
5. Press  to accept the highlighted setting.

Selecting a Length Unit

The test tool displays length measurements in meters or feet.

To change the unit of measurement, proceed as follows:

1. Turn the rotary switch to SETUP.
2. Press **Page Down** four times.
3. Press **Choice**.
4. Use to highlight the desired unit.
5. Press to accept the highlighted unit.

Selecting a Numeric Format

The test tool displays decimal fractions with a decimal point separator (0.00) or a comma separator (0,00).

To change the numeric format, proceed as follows:

1. Turn the rotary switch to SETUP.
2. Press **Page Down** four times.
3. Use to highlight the numeric format.
4. Press **Choice**.
5. Use to highlight the desired format.
6. Press to accept the highlighted format.

Setting the Date and Time

The test tool has a clock that records the date and time for saved test results.

To change the date or time or the format for the date or time, proceed as follows:

1. Turn the rotary switch to **SETUP**.
2. Press **Page Down** three times.
3. Use to highlight the date or time parameter you want to change.
4. Press **Choice**. The display you see next depends on which parameter you are changing.

If you are changing the date or time, use **INC** or **DEC** to increment or decrement the highlighted number. Use to move the highlighted area from one number to another number.

If you are changing the date or time format, use to highlight the format you want.







5. Press to accept the highlighted date, time, or format.

Setting the Power-Down Timer

To extend battery life, you can set the power-down timer to automatically switch the test tool to a low-power mode after a selected period of inactivity. You can also disable the power-down timer.

When the test tool switches to low-power mode, the display goes blank. To reactivate the display, press .







To set the power-down timer or enable/disable the timer, proceed as follows:

1. Turn the rotary switch to SETUP.
2. Press  **Page Down** once.
3. Use  to highlight the power-down timer status.
4. Press  **Choice**.
5. Use   to highlight the desired time-out period or the enable/disable status.
6. Press  to accept your selection.

Model DSP-2000 turns itself off if not used for 30 minutes after power-down. When this happens, pressing  turns on the test tool. The test tool then goes through its power-on sequence as though it were turned on with the rotary switch.

Enabling or Disabling the Audible Tones

To enable or disable the test tool's audible tones, proceed as follows:

1. Turn the rotary switch to SETUP.
2. Press  **Page Down** twice.
3. Use  to highlight the audible tone status.
4. Press  **Choice**.
5. Use   to highlight the desired enable or disable status.
6. Press  to accept your selection.

Remote Lights, Messages, and Audible Tones

The standard and smart remotes indicate various states by flashing light-emitting diodes (LEDs) and emitting audible tones, as described in Table 2-6.

Table 2-6. Status Indications from Remotes

Status	Standard Remote Indications	Smart Remote Indications
Power on self-test passed.	The unit beeps and all LEDs flash in sequence.	The unit beeps and all LEDs flash in sequence.
Power on self-test failed.	The unit beeps and the fail LED flashes continuously.	The unit beeps and the fail LED flashes continuously.
Main unit is running a test.	Test LED is on. Pass and fail LEDs flash as tests pass or fail.	Testing LED is on. Pass and fail LEDs flash as tests pass or fail.
Previous test passed.	Pass LED turns on for 15 seconds.	Pass LED turns on for 15 seconds.
Previous test failed.	Fail LED turns on for 15 seconds.	Fail LED turns on for 15 seconds.
Battery voltage is low.	Message appears on main unit.	The unit beeps and the low-battery LED flashes continuously.
Battery voltage is too low to operate.	Message appears on main unit.	The unit beeps and the low-battery LED is on continuously.
Overvoltage condition detected on cable under test.	Message appears on main unit.	The unit beeps and all LEDs flash continuously.





Remote End Testing

If you have a second test tool or a smart remote, you can perform remote end testing. The remote end testing feature allows you to run the near-end crosstalk (NEXT) test at the far end of the cable and get the attenuation to crosstalk ratio (ACR) from the far end of the cable without switching the positions of the main and remote units.

When you enable remote testing the NEXT@REMOTE and ACR@REMOTE tests appear in the AUTOTEST and SINGLE TEST modes if the selected test standard requires the tests. Model DSP-2000 also includes RL@REMOTE and PSNEXT@REMOTE tests.

Selecting Auto Detect allows the test tool to identify the remote as a standard or smart remote and run the REMOTE tests as appropriate.

To enable remote end testing, proceed as follows:

1. Turn the rotary switch on the main unit to SETUP.
2. Use  to highlight the remote end testing status.
3. Press  **Choice**.
4. Use  to highlight **Enable** or **Auto Detect**; then press .

If you use a DSP-100 unit as a remote, the remote unit displays the following status messages:

SMART REMOTE READY: The remote unit is waiting for the main unit to start a test.

SMART REMOTE TESTING: The main unit is running a test.

SMART REMOTE PASS or **FAIL:** Pass or fail is the overall result of the test just completed. This message is displayed for about 3 seconds after a test is completed.

SMART REMOTE READY

PREVIOUS TEST: PASS or **PREVIOUS TEST: FAIL:** The remote is waiting for the main unit to start another test. Pass or fail is the overall result of the previous test.

Remote Communication Error

If you are running the NEXT@REMOTE or RL@REMOTE test, and the main unit detects a communication problem with the remote, the following message appears on the main unit: **REMOTE communication error**. This message means that the REMOTE data cannot be transmitted to the main unit, usually because the cable is defective. To verify proper remote operation, run a self-test as described in the earlier section “Performing a Self-Test.”

Battery Status

The test tool displays a message when its battery voltage or the remote battery voltage is low. Table 2-7 shows the battery status messages and what you should do if a battery message appears.

Note

*To ensure continued operation while charging the battery, always connect the ac adapter/charger when the message **WARNING RECHARGEABLE BATTERY VOLTAGE IS LOW** appears.*

Table 2-7. Battery Status Messages

Message Displayed	What You Should Do
WARNING RECHARGEABLE BATTERY VOLTAGE IS LOW.	Connect the ac adapter/charger.
RECHARGEABLE BATTERY VOLTAGE IS TOO LOW TO OPERATE.	Turn the test tool off and connect the ac adapter/charger. If the tool does not operate when you turn it on, turn it off again and allow the battery to charge for about 30 minutes.
WARNING REMOTE BATTERY VOLTAGE IS LOW.	For a standard remote, have a 9V alkaline battery available. For a smart remote or second main unit, connect the ac adapter/charger.
WARNING REMOTE BATTERY VOLTAGE IS TOO LOW TO OPERATE.	Replace the alkaline battery in standard remote. Charge the NiCad battery in a second main unit or smart remote.
INTERNAL DATA STORAGE BATTERY VOLTAGE IS LOW.	Have the lithium battery replaced at a Fluke Service Center.

Battery Status Display

To see the charge level of the main unit's NiCad battery, turn the rotary switch to SPECIAL FUNCTIONS; then select **Battery Status**. To see the charge level of the smart remote's battery, connect the smart remote to the main unit (use the CABLE TEST jack on Model DSP-2000); then use to toggle the display.

Note

Connecting the battery charger can change the readings displayed on the battery status screen. These changes are due to the charger's effect on the test tool's charging circuit.

Chapter 3

Autotest

Chapter 3 provides the following information:

- Instructions and test result descriptions for an Autotest on twisted pair cable.
- Instructions and test result descriptions for an Autotest on coaxial cable.
- Instructions for saving Autotest results.

Autotest Softkeys

The following softkey functions are active on the Autotest screens noted. The PSNEXT screen is available on Model DSP-2000 only.

or **View Result:** shows the results of the last Autotest run. Active on the first Autotest screen. shows detailed test results regarding the highlighted cable pair or pairs. Active on the first screens for the NEXT, attenuation, ACR, RL, and PSNEXT tests.

View Plot: Press to see a frequency response plot of the test results. Active on the first screen and the results screen for the NEXT, attenuation, ACR, RL, and PSNEXT tests.

Next Pair, **Next Pairs:** Press to see the detailed results or the plot for the next cable pair or pairs tested. Active on the results and plot screens for the NEXT, attenuation, ACR, and RL tests.

155 MHz: Press to see NEXT, ACR, or attenuation results plotted up to 155 MHz. This key is available only if the frequency option under SETUP is set to 155 MHz.

Autotest on Twisted Pair Cable

The procedures for an Autotest on shielded and unshielded twisted pair cable are the same. When shielded cable is selected, the test tool performs an additional test for shield continuity if the shield test is enabled in SETUP.

To run the Autotest on twisted pair cable, refer to Figure 3-1 and proceed as follows:

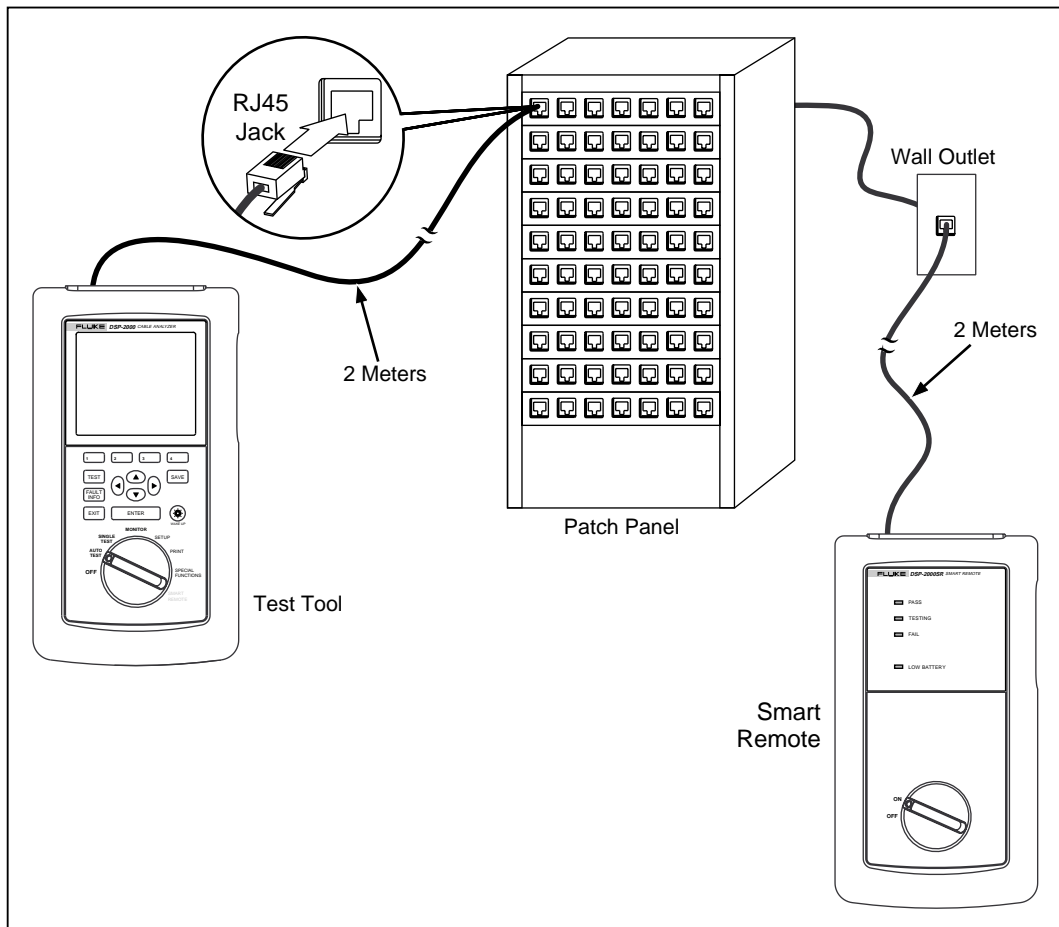

gc08f.eps

Figure 3-1. Autotest Connections for Twisted Pair Cable (Basic Link Configuration and DSP-2000 Shown)

Note

The REMOTE tests will run only if the remote is a smart remote or a DSP-100 with the SMART REMOTE mode selected.

1. If you are using a DSP-100 main unit as the remote, turn the remote unit's rotary switch to SMART REMOTE. If you are using a smart remote unit, turn its rotary switch to ON.
2. Use a 2m patch cable of the correct impedance to connect the remote to the far end of the cable link.
3. On Model DSP-100, remove any cable connected to the test tool's BNC connector.
4. Turn the rotary switch on the main unit to AUTOTEST.
5. Verify that the settings displayed are correct. You can change these settings in the SETUP mode.
6. Use a 2m patch cable of the correct impedance to connect the test tool to the near end of the cable link. On Model DSP-2000, connect to the CABLE TEST jack.
7. Press **TEST** to start the Autotest.

Notes

*Pressing **TEST** when the previous Autotest was not saved causes the test tool to display a warning message. In this case, you can either save the results of the previous test by pressing **SAVE** or delete the results and start a new Autotest by pressing **TEST**.*

*If a remote is not connected, the test tool displays the message **SCANNING FOR REMOTE** and does not run the Autotest until a remote is connected.*

If the calibration message appears, refer to "Calibrating the Test Tool" in Chapter 6 for complete calibration instructions.

Link Performance Grade Result (Headroom)

When an Autotest is complete, the display shows the overall result (pass or fail) and the worst-case NEXT margin, or headroom. Headroom is the smallest difference found between the measured NEXT value and the limit. This number serves as a figure of merit that reflects the overall performance of the link.

Automatic Diagnostics (Model DSP-2000)

If an Autotest fails, you can press the FAULT INFO key to see more specific information on the cause of the failure. Figure 3-2 shows examples of automatic diagnostics displays for a NEXT failure and an open pin failure.

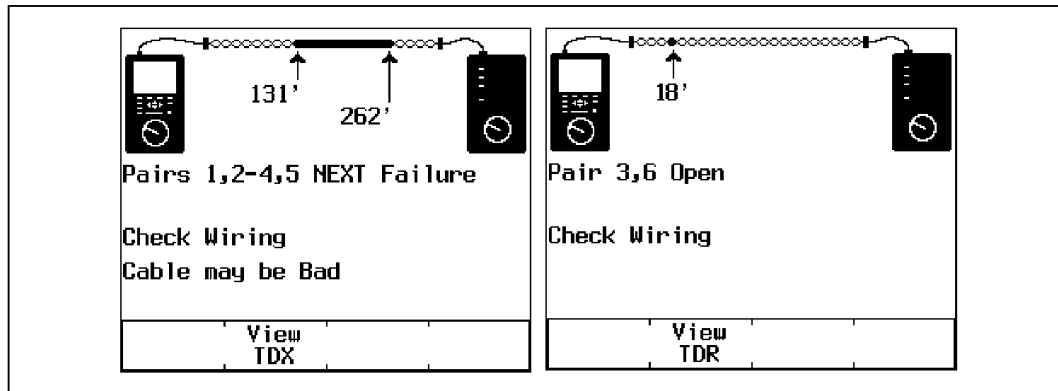

The arrow in the diagram at the top of the display shows the location of the failure. The bottom half of the display describes the failure and suggests ways to fix the fault. When appropriate, softkeys let you see the plot or plots relevant to the failure. If more than one fault was found, you can use the **4** **Next Fault** and **3** **Prev Fault** softkeys to scroll through the diagnostics displays.



gc09c.eps

Figure 3-2. Examples of Automatic Diagnostics Displays

Autotest Results for Twisted Pair Cable

To see detailed results from a test, use   to highlight the test on the main Autotest menu; then press .

Note

The tests run during an Autotest on twisted pair cable depend on the test standard selected. Tests not applicable to the selected test standard are not run or displayed. For a list of tests applicable to various test standards, see Table C-1 in Appendix C.

Wire Map Test

The wire map test tests and displays the wire connections between the near and far ends of the cable on all four pairs. Shield continuity is also tested if a shielded cable type is selected and you have not disabled shield testing in SETUP. The pairs tested are those defined by the selected test standard. Table 3-1 shows examples of wire map displays.



If the wire map test passes, the Autotest continues. You can view the wire map test results when the Autotest is complete. If the wire map test fails, the Autotest halts and the wire map screen appears with the word **FAIL**. You can then save the wire map results by pressing . To continue the Autotest, press  **Continue Test**.

Table 3-1. Wire Map Displays

Wire Map Condition	Display	Schematic (only affected pairs shown)	Description
Correct wiring (Top row represents near-end connector.)	<p style="text-align: center;">WIRE MAP</p> <pre> RJ45 PIN: 1 2 3 4 5 6 7 8 5 RJ45 PIN: 1 2 3 4 5 6 7 8 5 PASS </pre> <p style="text-align: right;"><small>gc42i.eps</small></p>	 <p style="text-align: right;"><small>gc43i.eps</small></p>	Cable wiring is correct. Shield (S) shown only if required by selected test standard.

Table 3-1. Wire Map Displays (continued)

Wire Map Condition	Display	Schematic (only affected pairs shown)	Description
Crossed wires	<p style="text-align: center;">WIRE MAP</p> <p>RJ45 PIN: 1 2 3 4 5 6 7 8 5 x x RJ45 PIN: 1 3 2 4 5 6 7 8 5 FAIL</p> <p style="text-align: right;"><small>gc44i.eps</small></p>	 <p style="text-align: right;"><small>gc45i.eps</small></p>	A wire in the 1,2 pair is crossed with a wire in the 3,6 pair. Wiring does not form a recognizable circuit.
Reversed pairs	<p style="text-align: center;">WIRE MAP</p> <p>RJ45 PIN: 1 2 3 4 5 6 7 8 5 x x RJ45 PIN: 2 1 3 4 5 6 7 8 5 FAIL</p> <p style="text-align: right;"><small>gc46i.eps</small></p>	 <p style="text-align: right;"><small>gc47i.eps</small></p>	Wires 1 and 2 are crossed.
Crossed pairs	<p style="text-align: center;">WIRE MAP</p> <p>RJ45 PIN: 1 2 3 4 5 6 7 8 5 x x x x RJ45 PIN: 3 6 1 4 5 2 7 8 5 FAIL</p> <p style="text-align: right;"><small>gc48i.eps</small></p>	 <p style="text-align: right;"><small>gc49i.eps</small></p>	Pairs 1,2 and 3,6 are crossed.
Short	<p style="text-align: center;">WIRE MAP</p> <p>RJ45 PIN: 1 2 3 4 5 6 7 8 5 s s RJ45 PIN: 1 2 3 4 5 6 7 8 5 FAIL</p> <p style="text-align: right;"><small>gc50i.eps</small></p>	 <p style="text-align: right;"><small>gc51i.eps</small></p>	Wires 1 and 3 are shorted. You can use the TDR test to locate the short.
Open	<p style="text-align: center;">WIRE MAP</p> <p>RJ45 PIN: 1 2 3 4 5 6 7 8 5 o RJ45 PIN: 1 2 3 4 5 6 7 8 5 FAIL</p> <p style="text-align: right;"><small>gc52i.eps</small></p>	 <p style="text-align: right;"><small>gc53i.eps</small></p>	Wire 1 is open. You can use the TDR test to locate the open.
Split pair	<p style="text-align: center;">WIRE MAP</p> <p>RJ45 PIN: 1 2 3 4 5 6 7 8 5 RJ45 PIN: 1 2 3 4 5 6 7 8 FAIL</p> <p>Split pairs detected: 1,2-3,6</p> <p style="text-align: right;"><small>gc54i.eps</small></p>	 <p style="text-align: right;"><small>gc55i.eps</small></p>	A wire in the 1,2 pair is twisted with a wire in the 3,6 pair. You can use the TDX analyzer to locate the split pair.

Resistance

The resistance test measures the dc loop resistance for each cable pair. The resistance results screen displays the resistance, limit, and pass/fail result for each cable pair. A **PASS** result means that the measured resistance is less than the limit. A **FAIL** result means that the measured resistance exceeds the limit.

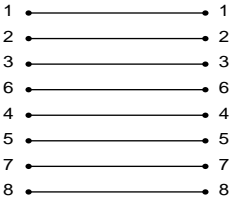
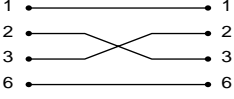
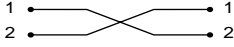
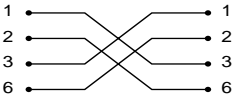
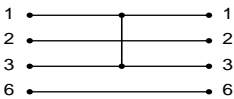
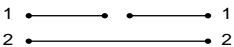
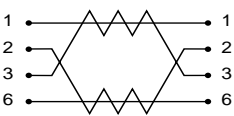
Length

The length test measures the length of each cable pair tested. The main Autotest results screen shows the length of the cable pair having the shortest electrical delay. Length is displayed in meters or feet. The length results screen displays the length, limit, and pass/fail result for each cable pair. You can change the length units in the SETUP mode, as described in “Selecting a Length Unit” in Chapter 2.

Notes

A 2 to 5 percent difference in measured length between twisted pairs is typical. This difference is due to differences in the number of twists in the cable pairs.

Differences between measured and actual values of cable length can be caused by variations in the cable's NVP value. To ensure maximum accuracy of length measurements, perform an NVP calibration as described in Chapter 6.

The length test limits include an extra 10% to account for variations in NVP.

A **PASS** result means that the measured length is within the specified limit for the selected test standard. A **FAIL** result means that the measured length exceeds the limit.

Propagation Delay and Delay Skew

Propagation delays are the times taken in nanoseconds for a test pulse to travel the length of each cable pair.

Delay skews are the differences in propagation delays between the shortest delay, which is displayed as 0 ns, and the delays of the other cable pairs.

The propagation delay and delay skew results show a limit if the test is required by the selected test standard. If the test is not required, the results always show **PASS**.

Characteristic Impedance

The characteristic impedance test determines the approximate characteristic impedance of each cable pair.

Note

Impedance measurements require a cable at least 5m (16 ft) long.

Cables shorter than this length will always pass the impedance test.

A **PASS** result means that the measured impedance is within the specified limit for the selected test standard. A **FAIL** result means that the measured impedance exceeds the specified limit, or an impedance anomaly is detected.

A **Warning** result means that the measured impedance exceeds test limits, but the characteristic impedance test is not required by the selected test standard. The warning result causes a warning to appear as the test summary result in printed reports.

If an impedance anomaly is detected on a cable pair, the display shows the distance to the anomaly (in meters or feet) and the result is displayed as **FAIL**. The test tool reports an anomaly if 15% or more of the test signal is reflected. If more than one anomaly is detected on a cable pair, the distance to the largest anomaly is displayed. You can use the TDR test to plot the locations and sizes of impedance anomalies on the cable.

Attenuation

Note

Incorrect conduit or temperature settings can cause false attenuation results. You can change these settings in the SETUP mode, as described in “Configuring the Test Tool” in Chapter 2.

The attenuation test measures the loss of signal strength over the length of the cable.

The first attenuation results screen shows the cable pairs tested, the worst-case attenuation margin found, and a **PASS** or **FAIL** result for each pair.



To see detailed results for the cable pairs, use   to highlight a cable pair, then press  **View Result**. Table 3-2 describes the items on the attenuation results screen.

Table 3-2. Items on the Attenuation Results Screen

Item	Description
Pair	The cable pair relevant to the results.
Result	The overall result for the test. A PASS result means that measured attenuation is lower than the specified limit for the selected test standard. A FAIL result means that the measured attenuation is higher than the specified limit.
Attenuation	If the test passed, this value is the highest measured attenuation. If the test failed, this value is the highest measured attenuation that exceeds the test limits.
Frequency	If the test passed, this frequency is where the highest measured attenuation occurred. If the test failed, this is where the highest failing value of attenuation occurred.
Limit	The highest attenuation value acceptable at the frequency shown. This value is based on the maximum allowable cable length.
Margin	The difference between the worst-case attenuation and the limit. A positive number means that the measured attenuation value is lower than the limit. A negative number means that the attenuation is higher than the limit.

Pressing **2** **View Plot** produces the attenuation plot screen. Figure 3-3 shows an example of the screen and Table 3-3 describes the items on the screen.

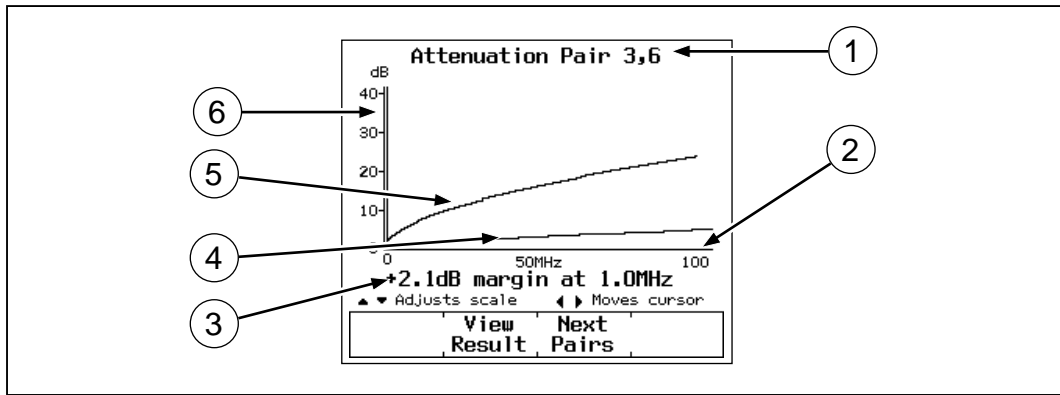

gc10c.eps

Figure 3-3. The Attenuation Plot Screen

Table 3-3. Items on the Attenuation Plot Screen

Item	Description
①	The cable pair relevant to the plot.
②	Frequency range in MHz of the attenuation test.
③	Margin is the difference between the limit and measured values plotted at the cursor's position. Use 4 ▶ to move the cursor left or right. If you move the cursor beyond the highest test frequency specified by the selected test standard, the readout shows the attenuation value at the cursor's position.
④	The measured attenuation for the cable pair.
⑤	The attenuation limits, as defined by the selected test standard. A crosshair is shown if the limit is defined for only one frequency.
⑥	Decibels of attenuation.

NEXT Test

The NEXT test measures the crosstalk between cable pairs. This crosstalk value is expressed as the difference in amplitude (in dB) between the test signal and the crosstalk signal. NEXT is measured from the main-unit end of the cable over a frequency range defined by the selected test standard.

If the NEXT test fails, you can use the TDX analyzer to locate the source of the crosstalk on the cable.

The first NEXT screen displays the cable pairs tested, the worst-case NEXT margin, and the test result for each set of pairs.



To see detailed results for the cable pairs, use   to highlight the pairs; then press  **View Result**. Table 3-4 describes the items on the NEXT results screen.

Table 3-4. Items on the NEXT Results Screen

Item	Description
Pairs	The cable pairs relevant to the results.
Result	The overall result for the NEXT test. A PASS result indicates that the NEXT between the cable pairs was higher than the specified NEXT for the selected test standard. A FAIL result indicates that the NEXT was lower than specifications.
NEXT	The worst-case NEXT. Worst-case NEXT is the measured NEXT value that is closest to falling below specifications. If the NEXT falls below specifications, the value displayed is the value that falls the farthest below specifications.
Frequency	The frequency where the worst-case NEXT value is measured.
Limit	The lowest NEXT value acceptable for the worst-case frequency.
Margin	The difference between the worst-case NEXT value and the limit. A positive number means that the measured NEXT value is higher than the limit (PASS). A negative number means that the NEXT is lower than the limit (FAIL).

Pressing **2** **View Plot** produces the NEXT plot screen. Figure 3-4 shows an example of the screen and Table 3-5 describes the items on the screen.

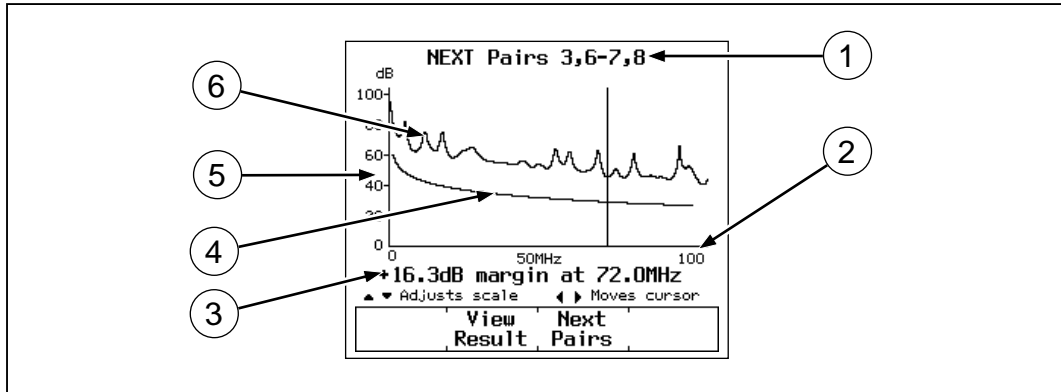

gc11c.eps

Figure 3-4. The NEXT Plot Screen

Table 3-5. Items on the NEXT Plot Screen

Item	Description
①	The cable pairs relevant to the plot.
②	Frequency range in MHz of the NEXT test.
③	Margin is the difference between the limit and measured values plotted at the cursor's position. Use 4 ▶ to move the cursor left or right. If you move the cursor beyond the highest test frequency specified by the selected test standard, the readout shows the NEXT value at the cursor's position.
④	The limits for NEXT, as defined by the selected test standard. A crosshair is shown if the limit is defined for only one frequency.
⑤	Decibels of crosstalk attenuation (NEXT) between the cable pairs.
⑥	The measured NEXT for the cable pairs.

NEXT@REMOTE Results

The NEXT@REMOTE test and its results are identical to the NEXT test described above, except that the NEXT@REMOTE measurements are taken from the remote end of the cable and sent to the main unit.

ACR

The ACR test calculates the ratio of attenuation to crosstalk (ACR) for each combination of cable pairs. ACR is expressed as the difference (in dB) between the measured NEXT and attenuation values. ACR is calculated using values obtained from the NEXT and attenuation tests.

ACR Results

The first ACR results screen shows the NEXT pairs and attenuation pair used to calculate the ACR result, the worst-case ACR margin, and a **PASS** or **FAIL** result for each set of pairs.



To see detailed results for the cable pairs, use   to highlight the pairs; then press **View Result**. Table 3-6 describes the items on the ACR results screen.

Table 3-6. Items on the ACR Results Screen

Item	Description
NEXT Pairs	The pairs that produced the crosstalk value used in calculating the ACR result.
Atten. Pair	The pair that produced the attenuation value used in calculating the ACR result.
Result	The overall result for the ACR test. A PASS result means that the calculated ACR is higher than the value specified for the selected test standard. A FAIL result means that the calculated ACR is lower than the specified value.
ACR (dB)	The worst-case ACR. Worst-case ACR is the calculated ACR value that is closest to exceeding specifications. If the ACR exceeded specifications, the value displayed is the ACR value that exceeded specifications by the greatest amount.
Frequency	The frequency where the worst-case ACR value is calculated.
Limit	The specified limit for the ACR at the worst-case frequency. The limit is defined by the test standard selected.
Margin	The difference between the worst-case ACR and the limit. A positive number means that the worst-case ACR is higher than the limit. A negative number means that the worst-case ACR is lower than the limit.

Pressing **2** **View Plot** produces the ACR plot screen. Figure 3-5 shows an example of the screen and Table 3-7 describes the items on the screen.

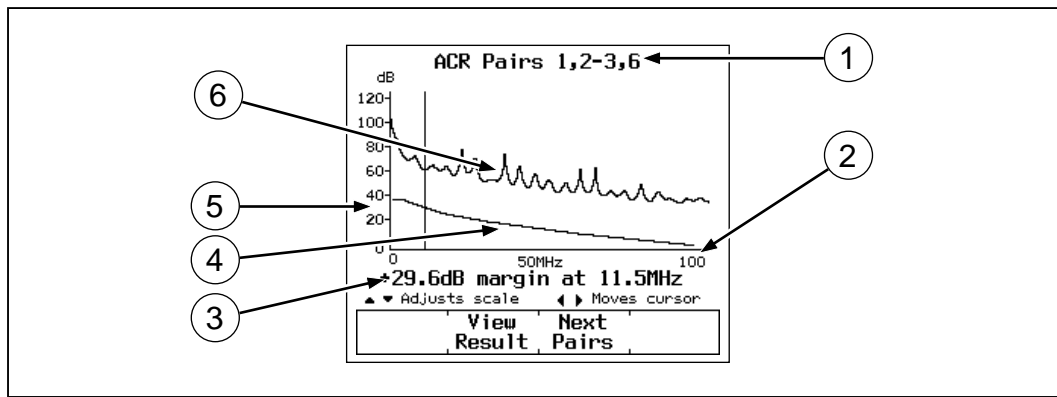

gc12c.eps

Figure 3-5. The ACR Plot Screen

Table 3-7. Items on the ACR Plot Screen

Item	Description
①	The cable pairs relevant to the plot.
②	Frequency range in MHz of the ACR test.
③	Margin is the difference between the limit and measured values plotted at the cursor's position. Use 4 ▶ to move the cursor left or right. If you move the cursor beyond the highest test frequency specified by the selected test standard, the readout shows the ACR value at the cursor's position.
④	The ACR limits, as defined by the selected test standard.
⑤	Decibels of ACR for the cable pair.
⑥	The measured ACR for the cable pairs.

ACR@REMOTE

The ACR@REMOTE test is identical to the ACR test, except that the ACR values are calculated using NEXT@REMOTE values.

Return Loss (RL)

The RL test measures the difference between a test signal's amplitude and the amplitude of signal reflections returned by the cable. The results of the RL test indicate how well the cable's characteristic impedance matches its rated impedance over a range of frequencies.



The first RL results screen shows the cable pairs tested, the worst-case RL margin, and a **PASS** or **FAIL** result for each pair. To see detailed results for the cable pairs, use   to highlight a pair; then press **View Result**. Table 3-8 describes the items on the RL results screen.

Table 3-8. Items on the RL Results Screen

Item	Description
Pair	The cable pair relevant to the results.
Result	The overall result for the RL test. A PASS result means that the measured RL is lower than the specified limit for the selected test standard. A FAIL result means that the measured RL is higher than specified limit.
RL	The worst-case return loss. Worst-case RL is the measured RL value that is closest to exceeding specifications. If the RL exceeds specifications, the value displayed is the value that exceeds specifications by the greatest amount.
Frequency	The frequency where the worst-case RL occurred.
Limit	The specified limit for RL at the worst-case frequency. The limit is defined by the test standard selected.
Margin	The difference between the worst-case RL and the Limit. A positive number means that the worst-case RL is better than the limit. A negative number means that the worst-case RL exceeds the limit.

Pressing **2** **View Plot** produces the RL plot screen. Figure 3-6 shows an example of the screen and Table 3-9 describes the items on the screen.

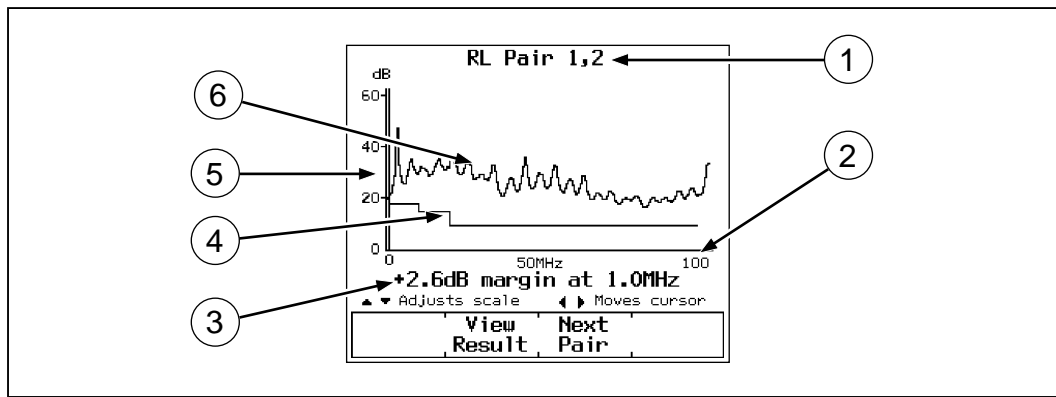

gc13c.eps

Figure 3-6. The RL Plot Screen

Table 3-9. Items on the RL Plot Screen

Item	Description
①	The cable pair relevant to the plot.
②	Frequency range in MHz of the RL test.
③	Margin is the difference between the limit and measured values plotted at the cursor's position. Use 4 ▷ to move the cursor left or right. If you move the cursor beyond the highest test frequency specified by the selected test standard, the readout shows the RL value at the cursor's position.
④	The limits for RL, as defined by the selected test standard.
⑤	Decibels of RL for the cable pair.
⑥	The measured RL for the cable pair.

RL@REMOTE (Model DSP-2000)

The RL@REMOTE test is identical to the RL test, except that the RL values are measured from the remote end of the cable.

PSNEXT (Power Sum NEXT; Model DSP-2000)

The PSNEXT results show how much each cable pair is affected by the combined NEXT from the other pairs. PSNEXT is expressed as the difference in amplitude (in dB) between the crosstalk received on a cable pair and a test signal transmitted on the other pairs.

PSNEXT is calculated from NEXT values. The descriptions of the results are the same as for NEXT results, except that they show the sum effect of NEXT on a cable pair.

Autotest on Coaxial Cable

To run an Autotest on coaxial cable, refer to Figure 3-7 and proceed as follows:

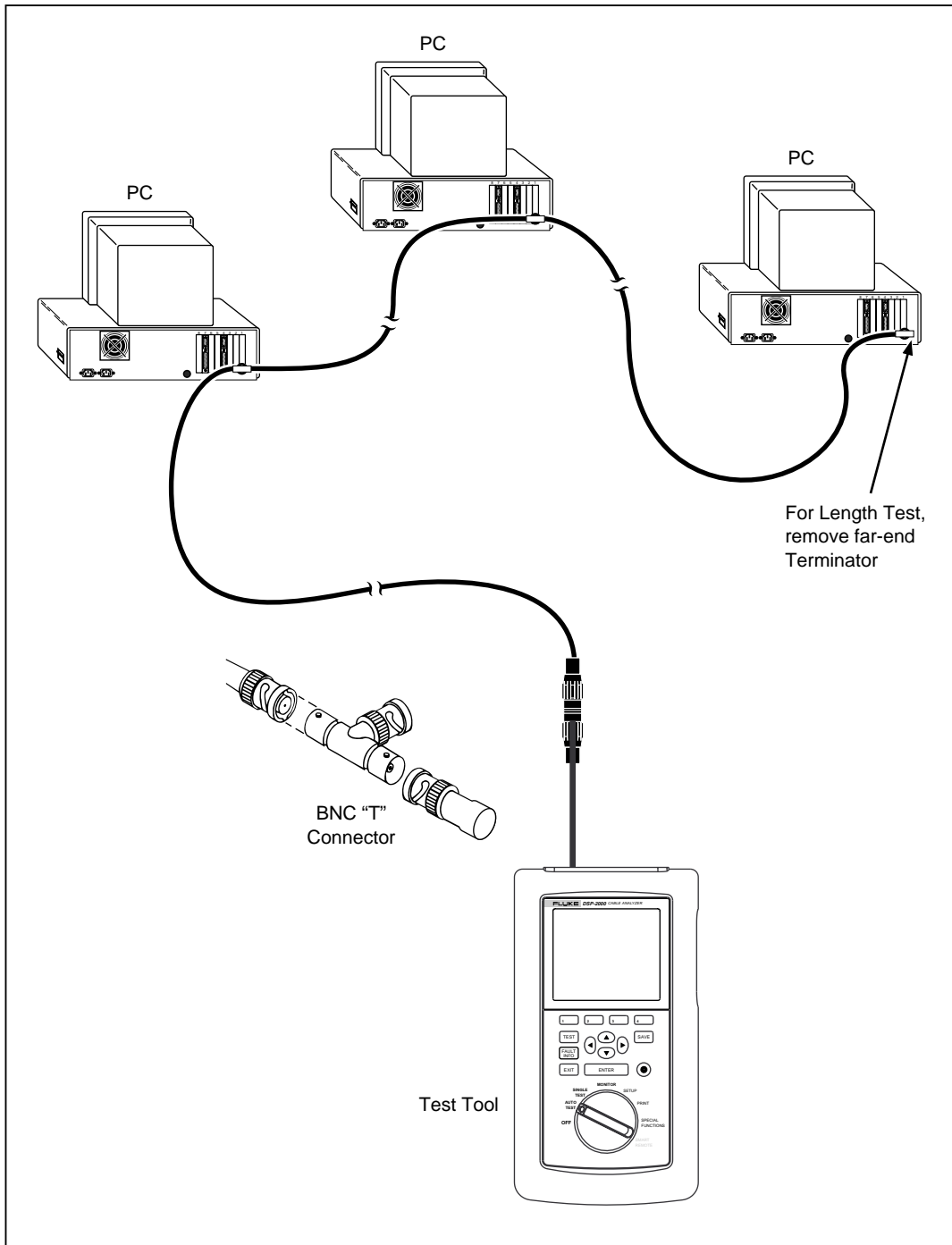

gc04f.eps

Figure 3-7. Autotest Connections for Coaxial Cable (Model DSP-2000 Shown)

1. Turn off any PC nodes connected to the cable you are testing.
2. If you want the Autotest to report cable length, remove the terminator from the far end of the cable.
3. Turn the rotary switch to AUTOTEST.
4. Verify that the test standard and cable type displayed are correct. You can change these settings in the SETUP mode.
5. On Model DSP-100, remove any cable connected to the test tool's RJ45 connector.
6. Remove the terminator from the near end of the coaxial cable and connect the cable to the BNC connector on the test tool. On Model DSP-2000, use the RJ45 to coaxial adapter to connect the cable to the CABLE TEST jack.
7. Press TEST to start the Autotest.

Autotest Results for Coaxial Cable

An Autotest on coaxial cable performs the following tests:

Characteristic Impedance

Note

Impedance measurements require a cable at least 5m (16 ft) long. Terminated cables shorter than this length will always pass the impedance test. Unterminated cables shorter than this length will always fail the impedance test.

The characteristic impedance test determines the approximate characteristic impedance for the cable. A **PASS** result means that the impedance is within the limit specified by the selected test standard. A **FAIL** result means that the impedance exceeds the limit. You can use the TDR test to plot the locations and sizes of all impedance anomalies on the cable.

Resistance

The resistance test measures the loop resistance of the cable and the terminator. If a terminator is not connected or if the cable is open, the resistance value is reported as **OPEN**. If the cable or the terminator is shorted, the resistance value is reported as near 0Ω . Resistance values over 400Ω are reported as **OPEN**.

Length

Note

Because a cable terminator eliminates signal reflections in coaxial cable, the test tool cannot measure the length of a terminated coaxial cable.

The length test measures the length of the cable when a terminator is not connected. If a terminator is connected, the result of the length test is reported as **NO REFLECTION**.

A **PASS** result means that the measured length is within the limit specified by the selected test standard. A **FAIL** result means that the measured length exceeds the limit.

Notes

Differences between measured and actual values of cable length can be caused by variations in the cable's NVP value. To ensure maximum accuracy of length measurements, perform an NVP calibration as described in Chapter 6.

The length test limits include an extra 10% to account for variations in NVP.

Anomaly

This result is shown at the bottom of the screen only if an impedance anomaly is detected. The test tool reports an anomaly if 10% or more of the test signal is reflected. The result shows the distance to the largest anomaly detected.

Saving Autotest Results

The test tool's memory can store the results of 500 or more Autotests, depending on the software version and test standard used. You can save the results from an Autotest anytime after the Autotest is complete, but before another Autotest or a Single Test is started.

To save Autotest results, proceed as follows:

1. After an Autotest is complete, press **[SAVE]**. The test save screen appears, as shown in Figure 3-8. Table 3-10 describes the items on the screen.
2. Use the appropriate editing keys to enter a cable identification name for the test results you are saving.

To delete the character left of the cursor, press **[4] Delete**. To add characters to the name, use the **[4] [5]** and **[6] [7]** keys to highlight characters in the list, then enter the highlighted character in the cable identification by pressing **[ENTER]**. To edit characters in the middle of a name, use **[1] ←** to move the cursor into the name.

Model DSP-2000 allows you to increment or decrement an alphanumeric character anywhere in the cable identification. Use **[1] ←** to highlight the desired character; then press **[2] INC** or **[3] DEC**. To move the cursor back to the right-most character, press **[1] ←** until the cursor wraps back to the right.

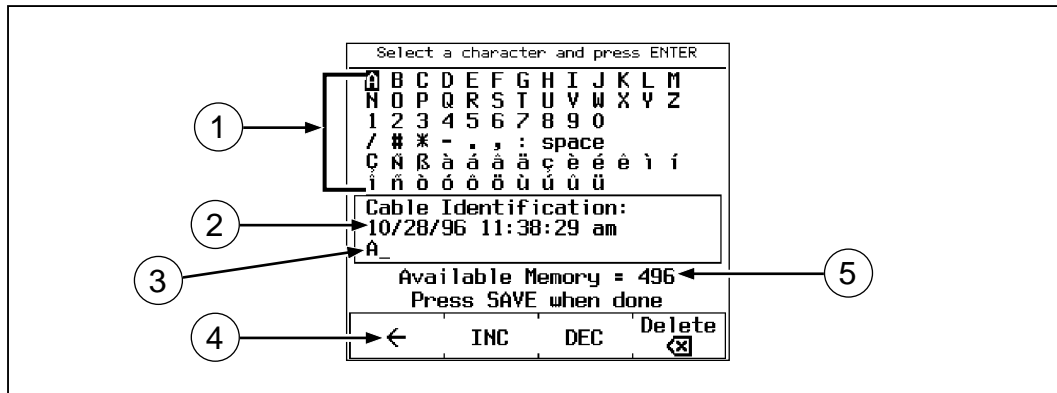

3. Press **[SAVE]** to store the test results with the cable identification displayed. A confirmation screen appears for about 2 seconds.



gc15c.eps

Figure 3-8. Screen for Saving Autotest Results

Table 3-10. Items on the Autotest Save Screen

Item	Description
①	The characters you can use to make a name for the test results you are saving.
②	The date and time when the Autotest was saved.
③	The default name assigned to the results from the most recently completed test.
④	Softkey for moving the cursor to edit characters in the middle of the cable identification. On Model DSP-100 with software versions 3.0 and earlier, use the  softkey to move the cursor back to the right. On Model DSP-2000, press  until the cursor wraps back to the right.
⑤	The remaining number of locations available for storing Autotest results.

Automatically Incrementing the Cable Identification Name

The test tool's auto increment function increments the last alphanumeric character of the cable identification name each time you save Autotest results.

To enable or disable the auto increment function, proceed as follows:

1. Turn the rotary switch to SETUP.
2. Press **Page Down** once.
3. Press **Choice**.
4. Use to highlight the status you want.
5. Press to select the highlighted status.

If Memory is Full

If the Autotest results you save fill the last available memory location, the following message appears:

WARNING! TEST RESULT MEMORY IS NOW FULL. If you try to save additional test results after the memory has been filled, the following message appears:

UNABLE TO SAVE TEST RESULTS. MEMORY IS FULL.

To save additional test results, you must first delete one or more test reports from memory. You can delete test reports in the SPECIAL FUNCTIONS mode. For complete instructions, see Chapter 5, "Viewing and Printing Saved Reports."

You can see how many memory spaces are available by pressing the **Memory** softkey, which appears on several Autotest displays.

Note

The test tool can store the results from more than 500 Autotests. The exact number of memory spaces available depends on the number of tests run by the selected test standard.

The Autotest Report

Figures 3-9, 3-10, and 3-11 on the following pages show how Autotest results appear in printed reports. You can print Autotest reports or edit the report's identification information in the PRINT mode. See Chapter 5, "Viewing and Printing Saved Reports," for complete instructions.

The result printed on a report summary can be a pass or fail, or warning. A failure of any test required by the selected test standard produces a fail result on the report summary. A warning appears on reports for twisted pair cable if a length, impedance, propagation delay, or delay skew test produced a warning. The table in Appendix C shows which test standards can produce a warning result for these tests.

Mukilteo Cable Co.							Test Summary: FAIL				
SITE: Westshore Business Park							Cable ID: Bldg7Rm9Cb13				
OPERATOR: Kim Nguyen							Date / Time: 01/07/97 10:01:05am				
NVP: 69.0% FAULT ANOMALY THRESHOLD: 15%							Test Standard: TIA Cat 5 Channel				
FLUKE DSP-2000 S/N: 6680915							Cable Type: UTP 100 Ohm Cat 5				
HEADROOM: -20.4							Software Version: 3.29				
							Standards Version: 3.06				
Wire Map FAIL	Result	RJ45 PIN:	1	2	3	4	5	6	7	8	S
Split pairs detected: 1,2-3,6											
Patch Cable BAD or Patch Cable too short		RJ45 PIN:	1	2	3	4	5	6	7	8	
Pair		1,2	3,6	4,5	7,8						
Impedance (ohms), Limit 80-120		107	105 W	106	108						
Anomaly (ft)			71								
Length (ft), Limit 328		75	77	74	74						
Prop. Delay (ns)		110	113	109	109						
Delay Skew (ns), Limit 50		1	4	0	0						
Resistance (ohms)		4.6	4.9	4.9	4.6						
Attenuation (dB)		5.1	6.7	5.2	4.9						
Limit (dB)		24.0	22.5	24.0	24.0						
Margin (dB)		18.9	15.8	18.8	19.1						
Frequency (MHz)		100.0	88.3	100.0	100.0						
Pairs		1,2-3,6	1,2-4,5	1,2-7,8	3,6-4,5	3,6-7,8	4,5-7,8				
NEXT (dB)		36.6 F	43.5*F	40.2	26.1 F	31.8 F	50.1*F				
Limit (dB)		49.2	44.6	34.9	46.5	45.6	50.8				
Margin (dB)		-12.6	-1.1	5.3	-20.4	-13.8	-.7				
Frequency (MHz)		4.9	9.3	35.4	7.1	8.1	3.9				
* Measurement is within the accuracy limits of the instrument.											

Figure 3-9. Part of an Autotest Report for Twisted Pair

gc16f.eps

Mukilteo Cable Co. SITE: World Technology Ctr. OPERATOR: Mike Marshall NVP: 80.0% FAULT ANOMALY THRESHOLD: 10% FLUKE DSP-2000 S/N: 6680915	Test Summary: PASS Cable ID: Rml6COAX34 Date / Time: 01/07/97 10:50:12am Test Standard: Coax Cables Cable Type: 10Base2 (50 Ohms) Software Version: 3.29 Standards Version: 3.06
Impedance (ohms), Limit 42-58	49
Length (ft), Limit 607 Prop. Delay (ns)	No Reflection No Reflection
Resistance (ohms), Limit 48.0-65.0	50.5

gc17f.eps

Figure 3-10. Autotest Report for Coaxial Cable

MUKILTEO CABLE CO.					
Cable ID:	Date / Time:		SITE:	Length(ft):	
RM1CBL1	01/06/97	09:51:46am	MOUNTAIN REAL ESTATE	77	PASS
RM1CBL2	01/06/97	09:56:53am	MOUNTAIN REAL ESTATE	98	FAIL
RM2CBL1	01/06/97	10:00:44am	MOUNTAIN REAL ESTATE	77	PASS
RM2CBL2	01/06/97	10:01:50am	MOUNTAIN REAL ESTATE	120	PASS
RM2CBL3	01/06/97	10:04:16am	MOUNTAIN REAL ESTATE	99	PASS
Total Length:				471	

gc18f.eps

Figure 3-11. Autotest Report Summary

Chapter 4

Running Individual Tests

Chapter 4 provides the following information:

- Descriptions of the test results produced by the TDX™ analyzer and TDR test.
- Instructions for running Single Tests on twisted pair cable.
- Instructions for running Single Tests on coaxial cable.
- Instructions for using the tests available in the MONITOR mode.
- Instructions for using the tone generator (Model DSP-2000).

Single Tests for Twisted Pair Cable

The SINGLE TEST mode on the rotary switch allows individual execution of the tests available in the Autotest mode, except the ACR test. SINGLE TEST mode features two additional tests: the TDX analyzer and the TDR test.

Scanning Function

The Single Test versions of the wire map, resistance, TDR, and TDX analyzer tests include a scanning function, which you can activate by pressing the **3** **Scanning ON** softkey. The scanning function runs the test repeatedly and updates the display each time a test is complete. This function is useful for finding intermittent problems on a cable.

Note

To extend battery life, connect the ac adapter/charger when using the scanning function for more than 1 minute.

When to Use a Remote Unit

A remote unit is required only when testing twisted pair cable. Table 4-1 shows which cable tests require a remote and which remotes support each test.

If a remote unit is detected at the start of a Single Test, the test tool runs a wire map test before running the selected test. If the wire map test fails, the test tool stops the test and displays the wire map. Press **4** **Continue Test** to run the selected test.

Note

*Model DSP-2000 is compatible only with Model DSP-2000SR units.
Model DSP-100 is not compatible with Model DSP-2000SR units.*

Table 4-1. Remote Requirements for Cable Tests

Test	Remote Unit
Autotest	Required. Supported by all remotes.
Wire Map	Required. Supported by all remotes.
NEXT	Required. Supported by all remotes.
NEXT@REMOTE	Required. Supported by smart remotes and DSP-100 main units used as remotes. With a standard remote, results can be obtained by switching the positions of the remote and main unit and retesting.
Length	Optional. Supported by all remotes. Without a remote, the limit and pass/fail result are not shown.
Impedance	Optional. Supported by all remotes.
Attenuation	Required. Supported by all remotes.
Resistance	Optional. Supported by all remotes. Without a remote, the resistance of cable pairs is reported as "open," assuming the cable pair is not shorted.
RL	Required. Supported by all remotes.
RL@REMOTE	Required. Supported by DSP-2000 smart remote.
ACR	Required. Supported by all remotes. Test available only in Autotest mode.
ACR@REMOTE	Required. Supported by smart remotes and DSP-100 main units used as remotes. With a standard remote, results can be obtained by switching the positions of the remote and main unit and retesting. Test is available only in Autotest mode.
PSNEXT PSNEXT@REMOTE	Required. Supported by DSP-2000 smart remote. Test is available only in Autotest mode.
TDR	Optional. Supported by all remotes. Without a remote, the end of the cable is not identified.
TDX Analyzer	Recommended. Supported by all remotes. Without a remote, results from tests on short cables may be unreliable.
Impulse Noise	Recommended. Supported by all remotes. Without a remote, test results may not represent the level of noise present on a terminated cable.
Traffic Monitor	Never used.

Running a Single Test on Twisted Pair Cable

To run a test as a Single Test, refer to Figure 4-1 and proceed as follows:

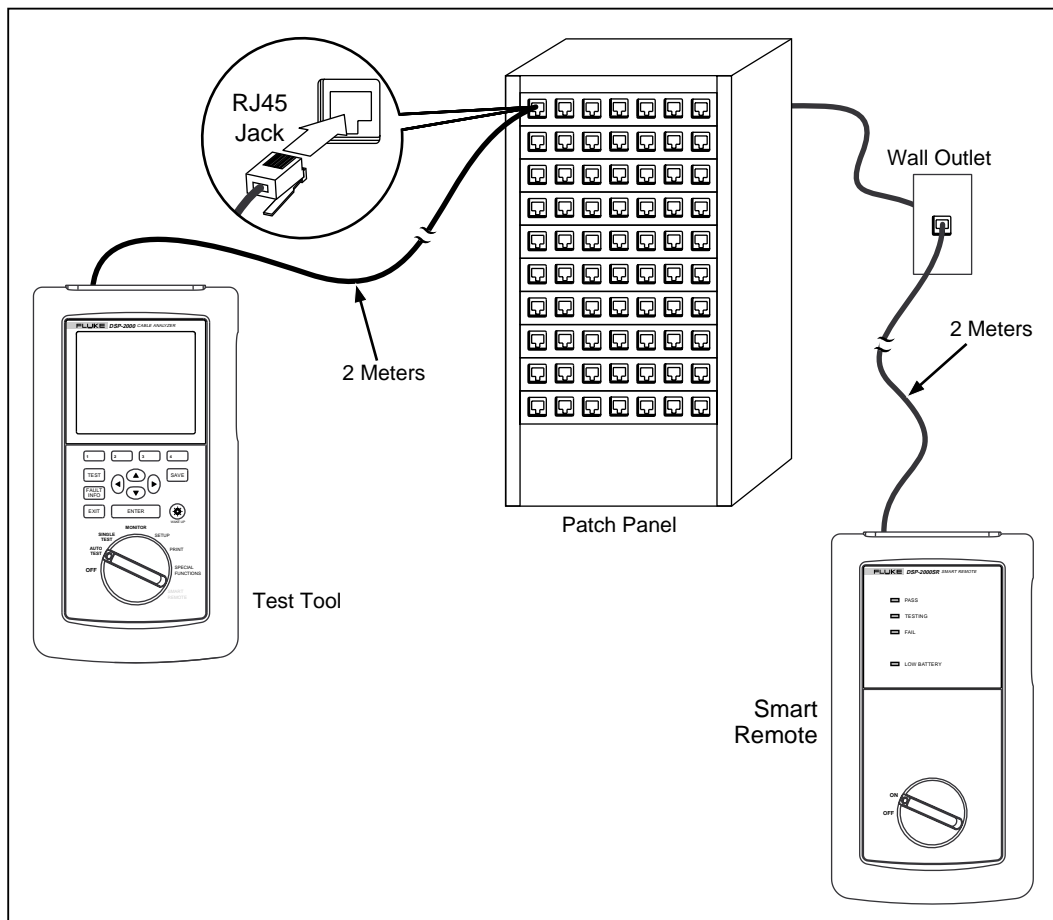

gc19f.eps



Figure 4-1. Single Test Connections for Twisted Pair Cable (Model DSP-2000 Shown)

Note

For instructions on running the TDR test or TDX analyzer, or running tests from the MONITOR mode, see the later sections on those topics in this chapter.

Note

The standard remote does not support remote end testing.

1. If you are using a DSP-100 main unit as the remote, turn the remote unit's rotary switch to SMART REMOTE. If you are using a smart remote unit, turn its rotary switch to ON.
2. Use a 2m patch cable of the correct impedance to connect the remote to the far end of the cable link.
3. On Model DSP-100, remove any cable connected to the test tool's BNC connector.
4. Turn the rotary switch on the main unit to SINGLE TEST.
5. Use a 2m patch cable of the correct impedance to connect the test tool to the near end of the cable link. On Model DSP-2000, connect to the CABLE TEST jack.
6. Use   to highlight the test you want to run.
7. Press  to start the highlighted test.

Note

*If a remote is required for the test, but is not connected, the test tool displays the message **SCANNING FOR REMOTE** and does not run the test until a remote is connected.*

If the calibration message appears, refer to “Calibrating the Test Tool” in Chapter 6 for complete calibration instructions.

The TDX Analyzer

The TDX (Time Domain Crosstalk) analyzer displays the locations where crosstalk is occurring on the cable. You can view the test results in a list or plot format. The list format shows the largest crosstalk value detected on the cable. The plot shows all of the crosstalk detected.

The crosstalk values displayed are adjusted to compensate for cable attenuation. The values represent the approximate levels of crosstalk as they appear at the sources of the crosstalk. A level over 50 represents a crosstalk magnitude that exceeds the limit specified by the selected test standard.



The TDX analyzer results are not intended for use in determining if a cable meets specifications; the results are intended to help you locate the sources of crosstalk on a cable. To determine if a cable meets specifications for crosstalk, run the NEXT test.

Running the TDX Analyzer

Note

You can run the TDX analyzer with or without a remote. If you run the analyzer without a remote, the results may be unreliable.

To run the TDX analyzer, proceed as follows:

1. Turn off any PCs connected to the link you are testing.
2. If you are using a DSP-100 main unit as a remote, turn the remote unit's rotary switch to SMART REMOTE. If you are using a smart remote unit, turn its rotary switch to ON.
3. If you are testing with a remote, connect the remote to the far end of the cable link.
4. Turn the rotary switch on the main unit to SINGLE TEST.
5. Verify that the test standard and cable type displayed are correct.
6. On Model DSP-100, remove any cable connected to the test tool's BNC connector.
7. Connect the test tool to the near end of the cable link. On Model DSP-2000, connect to the CABLE TEST jack.
8. Use  to highlight **TDX Analyzer**.
9. Press  to run the TDX analyzer.

If the test tool does not detect a remote, the following message appears:
NO REMOTE DETECTED. To run the TDX analyzer, press . To restart the analyzer and scan for the remote again, press . To return to the first Single Test screen, press .

TDX Analyzer Results

When the TDX analyzer test is complete, the TDX analyzer results screen appears. Table 4-2 describes the items on the analyzer screen.

Table 4-2. Items on the TDX Analyzer Results Screen

Item	Description
Pairs	The cable pairs relevant to the results.
Peak	The highest magnitude of crosstalk measured on the cable pair. A peak over 50 indicates a crosstalk level that exceeds the limit specified by the selected test standard. Crosstalk levels are adjusted to compensate for cable attenuation.
Distance	The measured distance from the main unit to the peak crosstalk value.
<input type="button" value="3"/> View Plot	Press to see a plot that shows where crosstalk is detected on the cable.

TDX Analyzer Plot

To view a TDX analyzer plot for a set of cable pairs, use \blacktriangledown \blacktriangleup to highlight the pairs, then press $\boxed{3}$ **View Plot** to see the plot screen for the pairs. Figure 4-2 shows an example of a TDX analyzer plot and Table 4-3 describes the items on the screen.

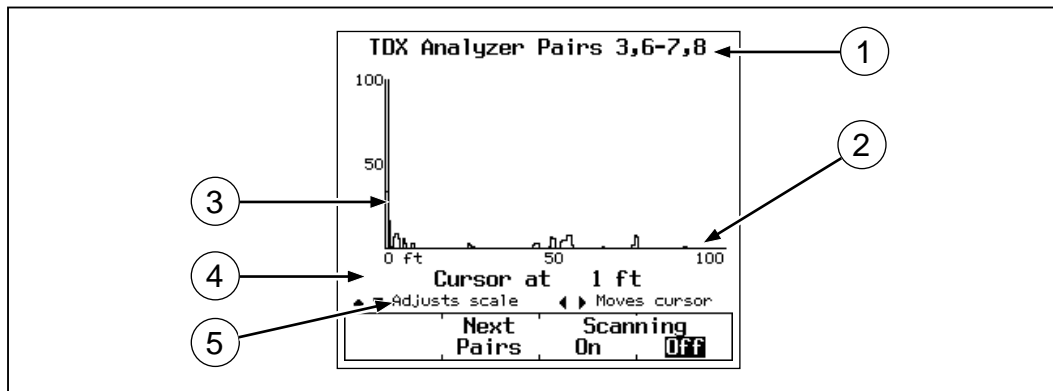

gc20c.eps

Figure 4-2. Example of a TDX Analyzer Plot for a Good Twisted Pair Cable Run

Table 4-3. Items on a TDX Analyzer Plot

Item	Description
①	The cable pairs relevant to the results.
②	The distance along the cable under test. The 0 at the left of the scale represents the location of the main test tool.
③	Magnitude of crosstalk on the cable pair. A peak over 50 indicates a crosstalk level that exceeds the limit specified by the selected test standard. Crosstalk levels are adjusted to compensate for cable attenuation.
④	The Cursor Readout shows the distance to the crosstalk source at the cursor's position. Use \blacktriangleleft \blacktriangleright to move the cursor left or right.
⑤	Use \blacktriangledown \blacktriangleup to change the maximum distance of the horizontal scale.

The TDR Test

The TDR (Time Domain Reflectometry) test helps you locate impedance anomalies on a cable by reporting the locations of signal reflections caused by the anomalies.

The test locates anomalies caused by problems such as shorts, opens, poor connections, and mismatches in cable types. You can view the location and size of the anomalies in a list or plot format.

The reflection values displayed are adjusted to compensate for cable attenuation. The values represent the approximate size of the reflections as they appear at the anomalies.

How to Terminate the Cable



You can run the TDR test on twisted pair cable with or without a remote unit, and on coaxial cable with or without a terminator. Table 4-4 describes how termination devices affect the results reported for twisted pair and coaxial cable.

Table 4-4. Effects of Termination on TDR Results

Cable Type and Termination	Listed Results Show the Following:	Plotted Results Show the Following:
Twisted pair with no termination	Displays the message No Remote Detected . Results show the two largest reflections greater than or equal to 15%. The largest reflection probably comes from the end of the cable, but is not identified as the end.	All reflections are shown.
Twisted pair with remote	Two largest reflections greater than or equal to 15%. Largest reflection is identified as the end of the cable.	All reflections are shown.
Coaxial cable with no terminator	Two largest reflections greater than or equal to 10%. The largest reflection comes from the end of the cable, but is not identified as the end.	All reflections are shown. The largest reflection comes from the end of the cable.
Coaxial Cable with terminator	No Reflection reported for a good cable. On a faulty cable, the test reports the two largest reflections, but does not identify end of cable.	All reflections are shown. The plot will not show a reflection from the terminated end.



Running the TDR Test on Twisted Pair Cable

To run the TDR test on twisted pair cable, proceed as follows:

1. Disconnect any PCs from the link you are testing.
2. If you are using a DSP-100 main unit as a remote, turn the remote unit's rotary switch to SMART REMOTE. If you are using a smart remote unit, turn its rotary switch to ON.
3. If you are testing with a remote, connect the remote to the far end of the cable link.
4. Turn the rotary switch on the main unit to SINGLE TEST.
5. Verify that the test standard and cable type displayed are correct.
6. On Model DSP-100, remove any cable connected to the test tool's BNC connector.
7. Connect the test tool to the near end of the cable link. On Model DSP-2000, connect to the CABLE TEST jack.
8. Use  to highlight **TDR**.
9. Press  to run the TDR test.

Running the TDR Test on Coaxial Cable

To run the TDR test on coaxial cable, proceed as follows:

1. Turn off any PC nodes connected to the cable you are testing.
2. If desired, remove the terminator from the far end of the cable.
3. Turn the rotary switch to SINGLE TEST.
4. Verify that the test standard and cable type displayed are correct.
5. Remove any cable connected to the test tool's unused RJ45 connector.
6. Remove the terminator from the near end of the coaxial cable and connect the cable to the BNC connector on the test tool. On Model DSP-2000, use the RJ45 to BNC adapter to connect the cable to the CABLE TEST jack.
7. Use  to highlight **TDR**.
8. Press  to run the TDR test.

TDR Results Screen

When the TDR test is complete, the TDR results screen appears. Table 4-5 describes the items on the screen.



Table 4-5. Items on a TDR Results Screen (Twisted Pair Results)

Item	Description
Pair	The cable pair relevant to the results. Not shown for coaxial cable results.
Distance	The first distance is the measured distance from the test tool to the end of the cable. The second distance, if shown, is the distance from the test tool to the beginning of the largest anomaly that caused a reflection greater than the limit defined by the selected test standard.
Peak	The percentage of the test signal reflected at the peak of the anomaly.
<input type="checkbox"/> View Plot	Press to see a plot of the locations and reflection percentages of the impedance anomalies detected.

Note

It is possible for impedance anomalies to be detected when testing from one end of the cable, but not from the other end. This discrepancy is caused by attenuation of the signal reflections returning from the anomaly.

TDR Plot Screen

To view the TDR plot for a cable pair, use   to highlight one of the pairs; then press **View Plot** to see the plot screen for that pair. Figure 4-3 shows an example of a TDR plot and Table 4-6 describes the items on the plot.

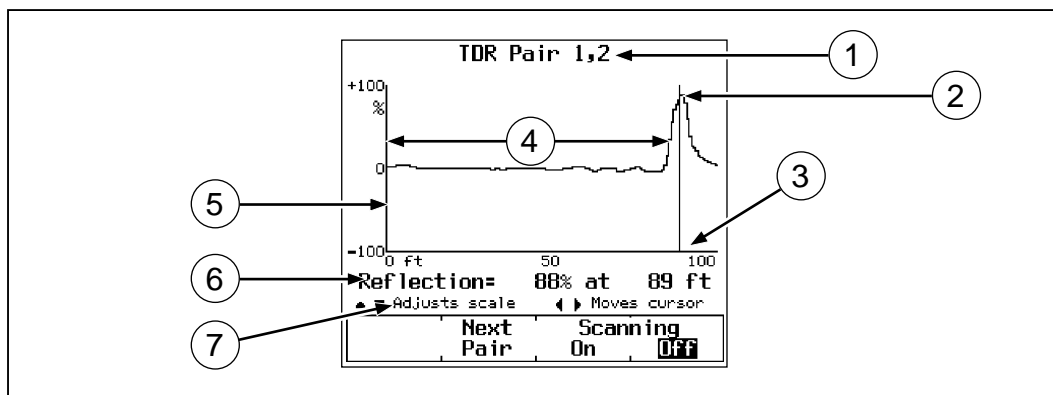

gc21c.eps

Figure 4-3. Example of a TDR Plot (Twisted Pair Results)

Table 4-6. Items on a TDR Plot (Twisted Pair Results)

Item	Description
①	The cable pair relevant to the results.
②	The peak value as reported on the results screen.
③	The distance along the cable under test. The 0 at the left of the scale represents the location of the main test tool.
④	The distance to the end of the cable as reported on the results screen.
⑤	The percentage of reflected signal relative to the size of the TDR test signal. Positive values indicate locations on the cable where the impedance is higher than the cable's characteristic impedance. Negative values indicate locations on the cable where the impedance is lower than the cable's characteristic impedance.
⑥	The Cursor Readout shows the location and the reflection percentage at the cursor's position. Use ◀ ▶ to move the cursor left or right.
⑦	Use ⏪ ⏩ to change the maximum distance of the horizontal scale.

Single Test Results for Twisted Pair Cable

The Single Test results for twisted pair cable are identical to those displayed by an Autotest, with exceptions noted in the following paragraphs.

Tests not required by the selected test standard produce a **Warning** result when measured values exceed the test's limits.

Wire Map

Wire map results are identical to the Autotest version. See “Wire Map” in Chapter 3 for details. The Single Test version of the wire map test includes the scanning function.

Length

If a remote is connected, the length test and results are identical to the Autotest version. See “Length” in Chapter 3 for details.

If a remote is not connected, the test tool displays the message **NO REMOTE DETECTED**, and the limit and result columns are not shown. If the length of a cable pair cannot be determined, the length value on the display is blank and **WARNING** appears in the result column.

NEXT and NEXT@REMOTE

The NEXT test and results are identical to the Autotest version. See “NEXT” in Chapter 3 for details.

The NEXT@REMOTE test is available only when using a second main DSP-100 unit or a smart remote as a remote unit. Remote end testing must be enabled on the main unit. The NEXT@REMOTE test and results are identical to the Autotest version. See “NEXT@REMOTE” in Chapter 3 for details.

Impedance

The impedance test and results are identical to the Autotest version. See “Impedance” in Chapter 3 for details.

Attenuation

The attenuation test and results are identical to the Autotest version. See “Attenuation” in Chapter 3 for details.

Resistance

If a remote is connected, the results displayed are identical to the display in Autotest. See “Resistance” in Chapter 3 for details.

If a remote is not connected, the test tool displays the message **NO REMOTE DETECTED** and all pair resistances are reported as **OPEN**. A cable pair with a resistance greater than 400Ω is also reported as **OPEN**.

Return Loss (RL) and RL@REMOTE

The RL test is identical to the Autotest version. See “Return Loss” in Chapter 3 for details.

The RL@REMOTE test is available only when using a DSP-2000 with a DSP-2000 smart remote. Remote end testing must be enabled on the main unit. See "RL@REMOTE" in Chapter 3 for details.

Single Tests for Coaxial Cable

The Single Test mode on the rotary switch allows individual execution of the coaxial cable tests available in the Autotest mode. The TDR test is also available as a Single Test for coaxial cable.



The coaxial cable tests available as Single Tests produce results displayed in the same format as displayed in the Autotest mode.

Running a Single Test on Coaxial Cable

Note

For instructions on running the TDR test, see the earlier section “The TDR Test.” For instructions on running tests in the MONITOR mode, see the later section “Monitoring Network Activity.”

To run a Single Test on coaxial cable, refer to Figure 4-4 and proceed as follows:

1. Turn off any PC nodes connected to the cable you are testing.
2. If you want to measure cable length, remove the terminator from the far end of the cable you are testing.
3. Turn the rotary switch to SINGLE TEST.
4. Verify that the test standard and cable type are correct. You can change these settings in the SETUP mode.
5. Remove any cable connected to the test tool’s unused RJ45 connector.
6. Remove the terminator from the near end of the coaxial cable and connect this end of the cable to the BNC connector on the test tool. On Model DSP-2000, use the RJ45 to BNC adapter to connect the cable to the CABLE TEST jack.
7. Use   to highlight the test you want to run.
8. Press  to start the highlighted test.

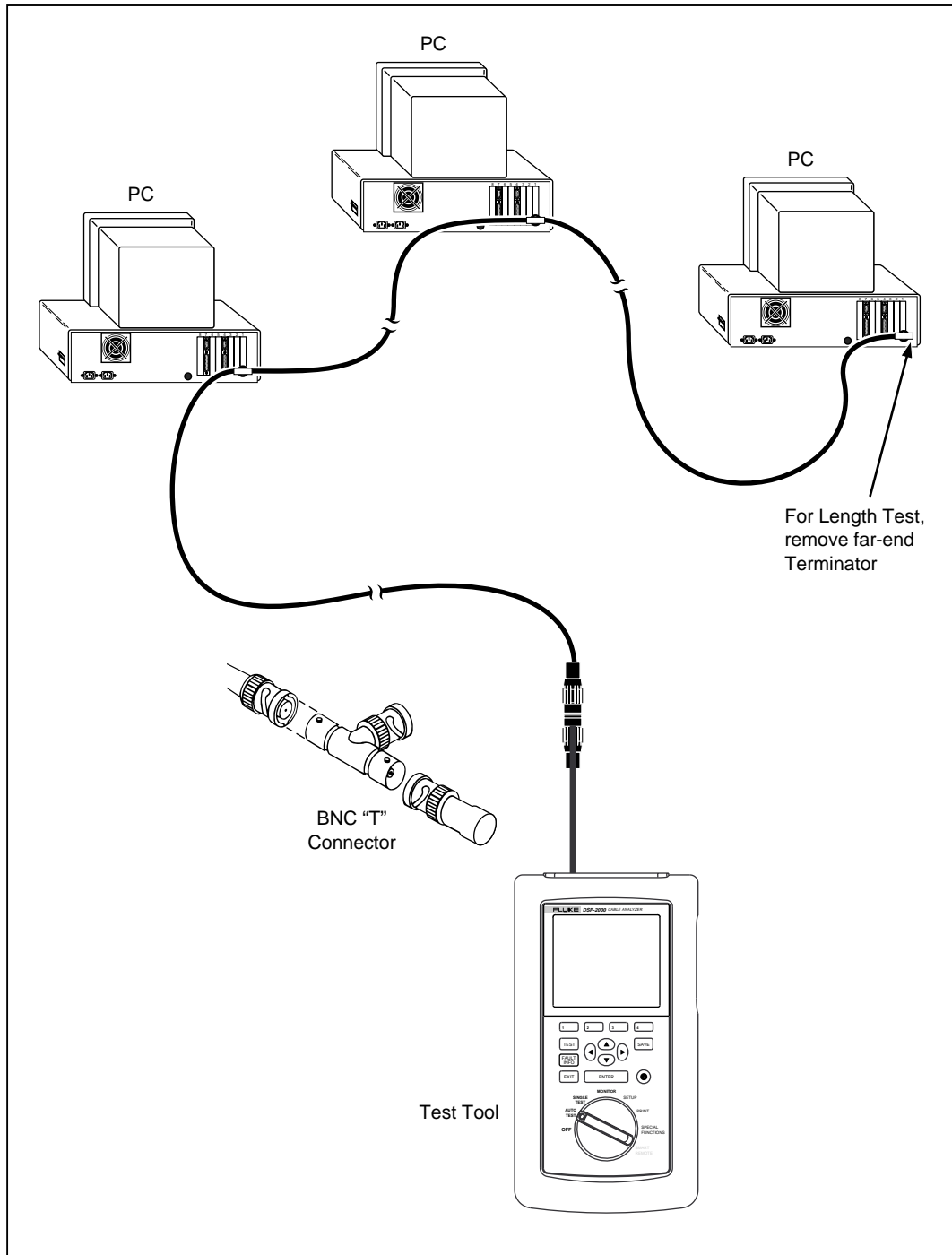

Figure 4-4. Single Test Connections for Coaxial Cable (Model DSP-2000 Shown)

gc22f.eps

Single Test Results for Coaxial Cable

The Single Test results for coaxial cable are identical to those displayed by an Autotest, with exceptions noted as follows.

Impedance

Identical to Autotest version. See “Impedance” in Chapter 3 for details.

Resistance

Identical to Autotest version. See “Resistance” in Chapter 3 for details. The Single Test version of the resistance test includes the scanning function.

Length

Identical to Autotest version. See “Length” in Chapter 3 for details.

TDR for Coaxial Cable

The TDR test is described for both twisted pair and coaxial cable in the earlier section “The TDR Test.”

Monitoring Network Activity

The MONITOR mode on the rotary switch allows you to monitor Ethernet traffic for collisions, jabber, peak traffic and percentage of network utilization. You can monitor traffic on 10BaseT twisted pair or 10Base2 coaxial cable. Model DSP-2000 can monitor traffic on 10/100BaseTX cable as well.

This feature allows you to identify active cables and provides some information on network activity. If you want to troubleshoot active networks, contact your Fluke representative for information on LAN diagnostic tools.

When connected to a network, the test tool automatically generates link pulses to activate the hub. Model DSP-2000 uses Auto-Negotiation when attempting to link to monitor 10/100BaseTX traffic. If a link state with the hub does not occur, the test tool displays the warning message **NO LINK PULSE**.

To monitor network traffic on a twisted pair or coaxial Ethernet network, refer to Figure 4-5 and proceed as follows:

⚠ Caution

When using a coaxial T-connector to connect the test tool to a network, never allow the T-connector to touch a conductive surface. Such contact could disrupt network operation by creating a ground loop.



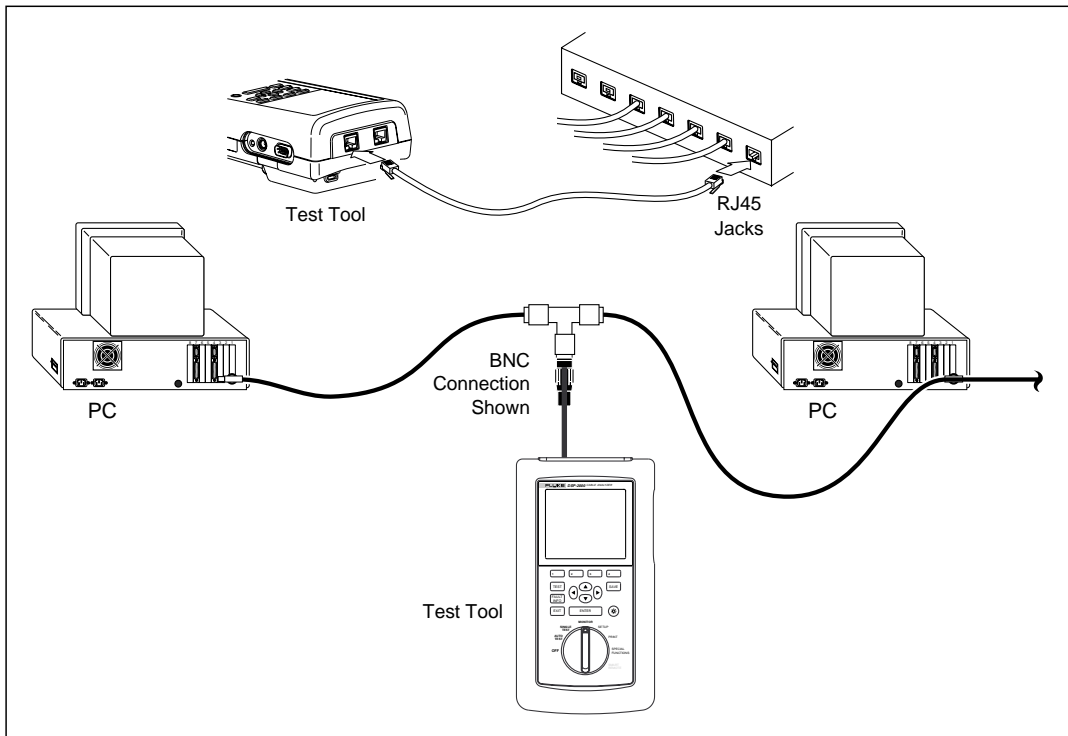

Note

To extend battery life, use the ac adapter/charger when monitoring network traffic for extended periods. While monitoring network traffic, the test tool's automatic power-down function is disabled.



gc23f.eps

Figure 4-5. Connections for Monitoring Network Traffic (Model DSP-2000 Shown)

1. Turn the rotary switch to MONITOR.
2. Use  to highlight either **10BaseT Traffic on RJ45** (**10/100BaseTX Traffic on RJ45** on Model DSP-2000) or **10Base2 Traffic on BNC**.
3. Remove any cable connected to the test tool's unused test connector.
4. Use a patch cable of the correct impedance to connect the test tool to the network as shown in Figure 4-5. On Model DSP-2000, connect to the jack indicated by the arrow at the top of the display. Use the RJ45 to BNC adapter if necessary.
5. Press  to start the traffic test.
6. When using Model DSP-2000, use the  **10T Only** or  **100TX Only** softkey to select traffic monitoring at 10 Mb/s or 100 Mb/s.

If you don't know which speed to use, and the test tool is not already trying to link using Auto-Negotiation, press  until the display reads **Auto-Negotiation**. This causes the test tool to select the proper speed to match the hub.

As the traffic test runs, the results shown on the test tool's display are updated every second. Table 4-7 describes the items on the screen.



Table 4-7. Items on the Traffic Monitor Screen

Item	Description
Utilization Last 1 second	Percentage of the network's transmission bandwidth used over the last 1 second. Utilization includes correct frames, collisions, and jabber. The percentage indicates the current traffic density.
Utilization Average	The average of all the 1-second utilization percentages since the start of the test.
Utilization Peak	The highest 1-second utilization percentage recorded since the start of the test.
Collisions Last 1 second	The percentage of collision frames as compared to the total number of frames detected in the last 1 second. Collisions are counted when runt packets are detected.
Collisions Average	The average of all the 1-second collision percentages since the start of the test.
Collisions Peak	The highest 1-second collision percentage recorded since the start of the test.
Bottom of screen	If jabber is detected, the message Jabber Detected appears in this space. A jabber is reported if a frame is detected to be larger than the maximum legal size. If no link pulse is detected, the message NO LINK PULSE appears in this space.
<input type="checkbox"/> Sound On <input type="checkbox"/> Sound Off	Activates and deactivates a sound that represents network activity.
<input type="checkbox"/> Stop Test	Stops the traffic test and freezes the screen. To restart the traffic test, press <input type="button" value="TEST"/> .

Identifying Hub Port Connections

The hub port locator helps you determine which port a cable is connected to at a hub. The locator sends a link pulse to the hub, causing the port's LED to blink.

To identify a hub port connection, proceed as follows:

1. On Model DSP-100, remove any cable connected to the test tool's BNC connector.
2. Use a patch cable of the correct impedance to connect the test tool to the network connection. On Model DSP-2000, connect to the MONITOR jack.
3. Turn the rotary switch to MONITOR.
4. Use  to highlight the hub port locator selection; then press .
5. Locate the connected port by finding the flashing LED on the hub's LED panel.

Monitoring Impulse Noise







The Monitor Impulse Noise function allows you to monitor electrical noise on inactive twisted pair cable. Pair 3, 6 is monitored.

The noise test takes noise voltage samples every second. Voltages that exceed the impulse noise threshold are regarded as noise "hits." If the 10BaseT standard is selected, the noise test results include a pass or fail indication. A fail result is displayed if more than two noise hits are detected in a 10-second interval.

Changing the Impulse Noise Threshold

You can set the impulse noise threshold to a value from 100 to 500 mV in increments of 10 mV. The default noise threshold value is 270 mV.

To change the noise threshold, proceed as follows:

1. Turn the rotary switch to SETUP.
2. Press  **Page Down** once.
3. Use  to highlight the impulse noise threshold setting.
4. Press  **Choice**.
5. Use  **DEC** or  **INC** to change the threshold.
6. Press  to store the threshold setting.

Running the Impulse Noise Test

The connector type for the noise test is always RJ45. The noise test is not valid for coaxial cable because the level of noise on coaxial cable is negligible.

To monitor impulse noise, refer to Figure 4-6 and proceed as follows:

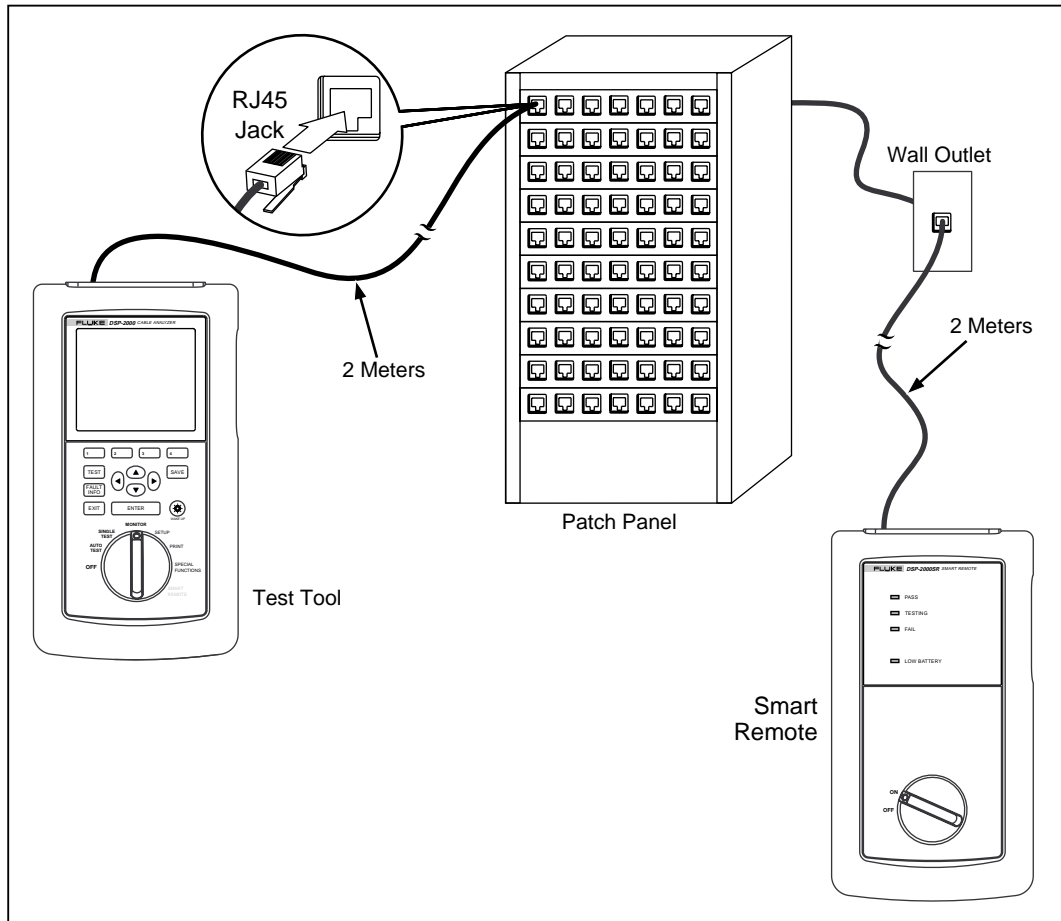

gc24f.eps



Figure 4-6. Connections for Monitoring Impulse Noise (Model DSP-2000 Shown)

Note

To extend battery life, use the ac adapter/charger when monitoring impulse noise for extended periods. While monitoring impulse noise, the test tool's automatic power-down function is disabled.

Note

Monitoring impulse noise without a remote connected may produce unreliable test results.

1. If you are using another main unit as the remote, turn the remote unit's rotary switch to SMART REMOTE. If you are using a smart remote unit, turn its rotary switch to ON.
2. Use a 2m patch cable of the correct impedance to connect the remote to the far end of the cable link.
3. On Model DSP-100, remove any cable connected to the test tool's BNC connector.
4. Turn the rotary switch to MONITOR.
5. Use  to highlight **Impulse Noise on RJ45**.
6. Use a 2m patch cable of the correct impedance to connect the test tool to the near end of the cable link. On Model DSP-2000, connect to the CABLE TEST jack.
7. Press  to start the noise test.

Noise Test Results

As the noise test runs, the displayed test results are updated every second after the first 10-second sample period. Table 4-8 describes the items on the screen.

Table 4-8. Items on the Noise Monitor Screen

Item	Description
Impulse Noise Threshold	The minimum level of noise that is considered to be a noise hit. The default threshold is 270 mV. If you want to change the fault threshold, see the earlier section "Changing the Impulse Noise Threshold."
Noise Test	The overall result of the noise test. Displayed only when 10BaseT is selected. A PASS result means that no 10-second intervals included more than two noise hits. A FAIL result means that more than two noise hits were detected during a 10-second interval.
Average	The average number of noise hits per second since the start of the test.
Peak	The highest number of noise hits per second and the time at which the peak was recorded.
<input type="checkbox"/> Stop Test	Stops the noise test and freezes the screen. To restart the noise test, press <input type="button" value="TEST"/> .

Determining Hub Port Capabilities (Model DSP-2000)

This test determines if a hub supports the following standards:

- Auto-Negotiation
- 10BaseT
- 100BaseTX
- 100BaseT4
- 100BaseTX Full Duplex
- 10BaseT Full Duplex



To determine hub port capabilities, proceed as follows:

1. Use a patch cable of the correct impedance to connect the network connection to the test tool's MONITOR jack.
2. Turn the rotary switch to MONITOR.
3. Use to highlight **HUB Port Capabilities**; then press .

Using the Tone Generator (Model DSP-2000)

If you have an inductive pickup device, you can use the test tool's tone generator to identify cable runs and connections. The tone generator produces a signal on the cable under test. You can hear the signal as an audible tone when you place an inductive pickup device near the cable or one of the cable's connectors.

To use the tone generator, proceed as follows:

1. Turn the rotary switch to **SPECIAL FUNCTIONS**.
2. Use a patch cable of the correct impedance to connect the test tool to the **CABLE TEST** jack.
3. Use  to highlight **Tone Generator**; then press .
4. Use an inductive pickup device along the cable run or at far end connectors to determine which cable is connected to the test tool.

Chapter 5

Viewing and Printing Saved Reports

Chapter 5 provides the following information:

- Instructions for sending saved test reports to a serial printer.
- Instructions for editing the report identification information.
- Instructions for viewing, deleting, and renaming test reports saved in the test tool's memory.

Printing Test Reports

This section describes how to send reports directly to a printer. If you want to send reports to a computer, use the DSP-LINK software provided with the test tool. See Appendix A for instructions on running DSP-LINK.

The PRINT mode on the rotary switch allows you to send saved Autotest reports or report summaries to a serial printer or a PC through the test tool's EIA-232C serial port. You can also edit the header, operator name, and site name that appear at the top of reports. Examples of printed Autotest reports are shown in "The Autotest Report" in Chapter 3.

Configuring the Serial Port

Before you send a report to a printer, set the test tool's serial port settings to match the printer's serial port settings. The serial port settings include baud rate, flow control, and printer type. For the type of printer, you can select Hewlett-Packard, Epson, or Text Only. The Text Only setting, which omits formatting commands for the printer, is suitable for sending Autotest reports to a terminal emulator or to a printer other than a Hewlett-Packard or Epson.

To configure the test tool's serial port, proceed as follows:

1. Turn the rotary switch to **SETUP**.
2. Press **Page Down** twice.
3. Use to highlight the parameter you want to change.
4. Press **Choice**.
5. Use to highlight the setting you want.
6. Press to select the highlighted setting.
7. Repeat steps 2 through 6 to change additional serial port settings.

Printer Interface Cable

The interface cable provided with the test tool is configured for serial communication with a PC. To communicate with a serial printer, you will probably need a different cable or an adapter for the cable provided. The pin configuration for the cable provided and for Fluke's 9-to 25-pin adapter is given in "Specifications" in Chapter 8. Refer to your printer's manual for specifications on your printer's serial port.

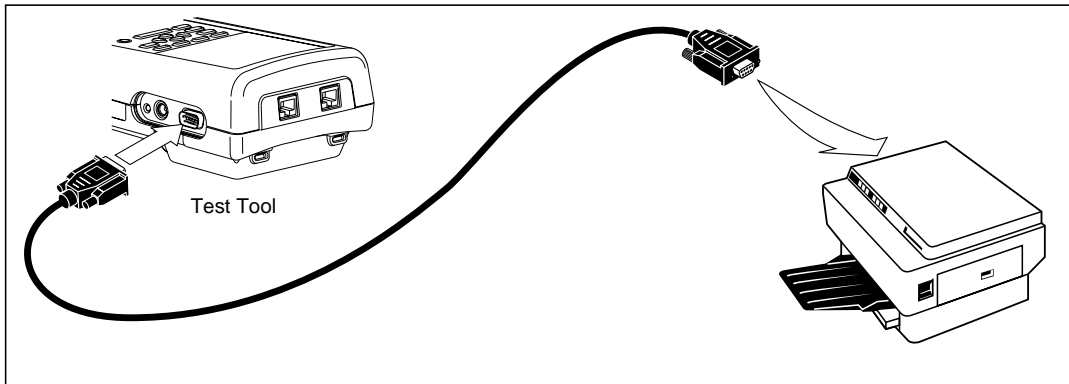

Printing

To send a report through the test tool's serial port directly to a serial printer, refer to Figure 5-1 and proceed as follows:





gc25f.eps

Figure 5-1. Connections for Printing Test Reports

1. Remove any cables connected to the connectors at the top of the test tool.
2. Configure the test tool's serial port, as described in the previous section.
3. Use an appropriate cable to connect the test tool to the printer.
4. Turn the rotary switch to PRINT.
5. Use   to highlight the print function you want.
6. Press  to select the highlighted function.

The results of selecting each function are as follows:

- **All Autotest Reports:** Prints all of the reports stored in the test tool's memory. Before printing, the test tool's baud rate, printer type, and flow control are displayed. You can change these settings in the SETUP mode, as described in the earlier section "Configuring the Serial Port."

Press  to start printing. To stop printing and return to the main print screen, press .

- **Selected Autotest Reports:** Displays the SELECT AUTOTEST REPORTS screen where you can select the reports you want to print, as follows:
 1. Use **Page Up**, **Page Down**, and/or to highlight a report label.
 2. Press to select the highlighted report. An asterisk appears on the label to show that the report is selected for printing. To select several consecutive reports, hold down . To remove an asterisk, highlight the report label; then press .
 3. To print the selected reports, press **Start Print**. To stop printing and return to the main Print menu, press .
- **All Report Summary:** Same as All Autotest Reports, except that reports are printed in summary form. The summaries give the date and time each report was saved, the cable identification entered for each report, and an overall test result for each report.
- **Selected Report Summary:** Same as Selected Autotest Reports, except that reports are printed in summary form.
- **Edit Report Identification:** Displays the REPORT IDENTIFICATION screen, where you can edit the Custom Header, Operator Name, or Site Name, as follows:
 1. Turn the rotary switch to PRINT.
 2. Use to highlight **Edit Report Identification**; then press .
 3. Use to highlight the information you want to edit; then press .

If you are editing an operator or site name, you can press **New** to add a new name. The **New** softkey appears only if less than 20 names have been entered.

To rename or delete an existing operator or site name, press **Edit**, select the desired name; then press **Rename** or **Delete**. Changes to names preceded by a "\$" appear on printed test reports. You cannot delete a name that is used on a saved report.

4. To delete characters in the name, press **Delete**. To add a character to the name, use and to highlight a character in the list; then press .
5. To store the name, press .
6. When printing is complete, the test tool displays the following message:
Delete All Printed Reports? To delete the printed reports from memory, press **Yes** twice. To exit without deleting the printed reports, press **No** or .

If the Printer Does Not Respond

If the printer does not respond correctly to the test tool, the message **Serial Port Error** appears. In this case, check the following:

- Verify that the printer indicates an online condition.
- Verify that the baud rate and flow control settings are the same for the test tool and the printer.
- Verify that the printer type in Setup matches the type of printer connected to the test tool.
- Verify that the interface cable is securely connected to the printer and the test tool.
- Verify that the cable or adapter you are using is compatible with your printer. Pin assignments for the test tool's serial port are given in "Specifications" in Chapter 8. Refer to your printer's manual for specifications on your printer's serial port.

Viewing, Renaming, and Deleting Test Reports

To view, rename, or delete test reports, proceed as follows:

1. Turn the rotary switch to SPECIAL FUNCTIONS.
2. Press to select **View/Delete Test Reports**. The VIEW/DELETE TEST REPORTS screen appears showing the first screen of test record labels. The reports are listed in the order saved, starting with the oldest report in memory. Each test report label shows the date and time the report was saved, the cable identification name, and an overall test result (pass, fail, or warning).
3. Use **Page Up**, **Page Down**, and/or to highlight the record you want to view, rename, or delete.
4. Press the softkey labeled with the function you want. The softkeys function as follows:
 - **Delete Report**: Allows you to delete the highlighted report from memory.
 - **View Result**: Displays the list of tests stored in the highlighted report. An overall result is given for each test. This softkey also gives access to the **Rename Report** softkey.

To delete all of the Autotest reports stored in memory, select **Delete All Test Reports** from the main SPECIAL FUNCTIONS menu.

Chapter 6

Calibrations and Custom Test Standards

Chapter 6 provides the following information:

- Instructions for calibrating the test tool.
- Instructions for determining a cable's NVP value.
- Instructions for defining a custom test standard.

Calibrating the Test Tool

Before shipment, each test tool is calibrated to work with the remote unit shipped in the same package. If you want to use your test tool with a different remote, you must perform a self-calibration to store the new remote's calibration parameters in the test tool. You must also recalibrate after replacing the battery in a standard remote.

Calibrating the test tool also ensures maximum accuracy of cable test results.

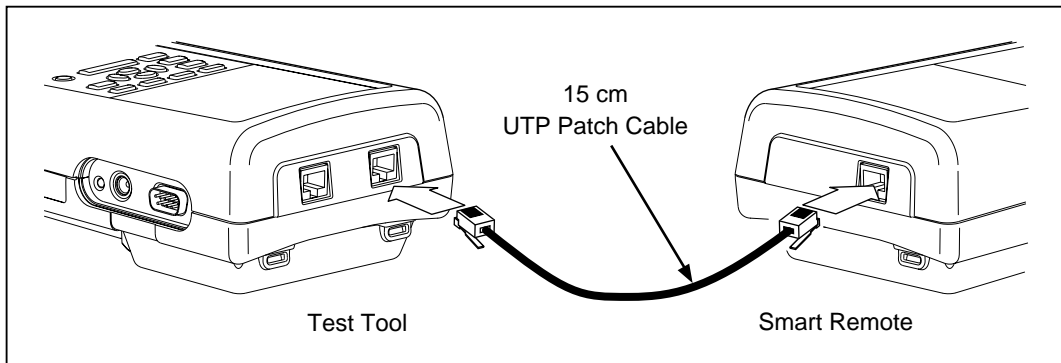

The test tool stores the remote's calibration data in non-volatile memory. You can calibrate your test tool to work with two different remotes.

To recalibrate the test tool, refer to Figure 6-1 and proceed as follows:



gc26f.eps

Figure 6-1. Connections for Self-Calibration (DSP-2000 Shown)

1. Turn the rotary switch to SPECIAL FUNCTIONS.
2. Use  to highlight **Self Calibration**.
3. Press .
4. On Model DSP-100, remove any cable connected to the test tool's BNC connector.
5. Connect the test tool to the remote as directed by the displayed messages. On Model DSP-2000, connect the cable to the CABLE TEST jack.
6. Press  to start the calibration.

When the calibration is complete, the calibration data and the remote's serial number are automatically stored in the test tool's calibration library.

If the message **SELF CALIBRATION FAIL** appears, check the following:

- Verify that the main test tool and the remote are connected with the patch cable described on the test tool's display.
- Check the patch cable for breaks or damaged connectors.
- Check the connectors on the main and remote units for damage.

If the self calibration continues to fail, send both the main and remote units to the nearest Fluke service center. See "Service Center Repair" in Chapter 8 for details.

NVP Calibration







The Determine Cable NVP function allows you to determine the NVP (nominal velocity of propagation) for a known length of cable and save the value for additional measurements of unknown lengths of the same type of cable. The calibrated NVP value applies only to the selected test standard. You can also enter a known NVP value or use the **Set to Default** softkey to set the NVP to the default value, which is the NVP for a typical sample of the selected cable type.

To determine a cable's NVP value, proceed as follows:

Notes

To determine a cable's NVP, you should use a cable at least 15m (50 ft) long. The recommended length is 30m (100 ft).

NVP is determined for the cable pair with the shortest electrical delay.

1. Turn the rotary switch to SPECIAL FUNCTIONS.
2. Use  to highlight **Determine Cable NVP**.
3. Press .
4. As prompted by the display, connect a known length of the appropriate cable to the test tool. On Model DSP-2000, connect the cable to the CABLE TEST jack.
5. Verify that no cables are connected to the unused cable connector or DB9 connector on the test tool.
6. Press .
7. Use  or  to change the displayed length to the known length of the attached cable. As you adjust the length measurement, the NVP value changes automatically. The range for NVP values is 50.0% to 99.9%.
8. When the displayed length matches the known length of the cable, press  to store the new NVP value and return to the main Special Functions menu. To exit the screen without saving the new NVP value, press .

If the message **CABLE FAULT DETECTED** appears, verify that the selected cable type is correct, check the cable for proper pin connections, or calibrate with a different cable.

Configuring a Custom Cable

The Configure Custom Cable function allows you to define custom test standards for up to four custom cables. You can change the following parameters for your custom configuration:

- Baseline standard for cable definition
- NVP (Nominal Velocity of Propagation)
- Maximum cable length
- Fault threshold for impedance anomalies
- Active pair assignments for cable pairs
- Resistance
- Characteristic impedance test enabled or disabled
- Attenuation test enabled or disabled
- NEXT and NEXT@REMOTE tests enabled or disabled
- RL test enabled or disabled
- ACR and ACR@REMOTE tests enabled or disabled
- PSNEXT and PSNEXT@REMOTE tests enabled or disabled (Model DSP-2000)

Note

To determine the NVP for a custom cable configuration refer to the previous section, “NVP Calibration.”

During the configuration process, you can abandon the changes you have made by pressing **1** **Abort**. To reset a parameter back to the default value, highlight the parameter; then press **2** **Set to Default**. To reset all of the parameters back to default values, highlight the test standard on Page 1 of 6 of the configuration screens; then press **2** **Set to Default**.

To configure a custom cable, proceed as follows:

1. Turn the rotary switch to SETUP.
2. Press **4** **Page Down** five times.
3. Highlight the custom cable configuration; then press **ENTER** to see the menu of custom cable names. The default cable names are ***Custom Cable 1*** through ***Custom Cable 4***. You can change the cable name after configuring the test parameters. An asterisk always precedes and follows the name of a custom cable configuration.
4. Use **▼** **▲** to highlight the custom cable name you want to configure; then press **ENTER**.
5. To select a new baseline test standard, press **ENTER**. Highlight the desired test standard; then press **ENTER**.
6. To change the parameters of the test standard shown on Page 1 of 6, use **3** **Page Up**, **4** **Page Down**, and **▼** **▲** to highlight the parameter you want to change; then press **ENTER**.
7. Use the appropriate keys to select the value you want; then press **ENTER**.

If you selected to change the custom cable name or the cable type, the alphanumeric entry screen appears. Use the appropriate keys to enter a name up to 27 characters long. When you are finished entering characters, press **SAVE**.

8. Repeat steps 6 and 7 to change additional parameters.
9. When you are finished configuring test parameters, press **SAVE** to store the custom configuration.

Chapter 7

Basic Cable Testing

Chapter 7 provides the following information:

- A description of LAN cable construction.
- Definitions and explanations of attenuation, noise, characteristic impedance, crosstalk, near-end crosstalk (NEXT), NVP, ACR, and RL.
- Explanations of the TDR and TDX™ analyzer tests and plots.
- Basic troubleshooting procedures for LAN cable.

LAN Cable Construction

LAN cables have a number of characteristics in common with other types of electrical cables. All electrical cables have continuity, which means that they serve as a complete path for electrical current flow. Each end of a cable has some type of connector for connecting the cable to the appropriate electrical device. Cables with multiple wires usually have a pin assignment that describes how the wires are arranged in the connectors.

Cables are designed to perform best in specific applications. For example, power cables are designed to minimize power losses at frequencies of 50 or 60 Hz. LAN cables are designed to minimize signal distortion at higher frequencies.

Two types of cables are designed for use with LAN systems: twisted pair cable and coaxial cable.

Twisted Pair Cable

Twisted pair cable consists of wire pairs that are twisted together, as shown in Figure 7-1. The wires are twisted to minimize crosstalk between the cable pairs.

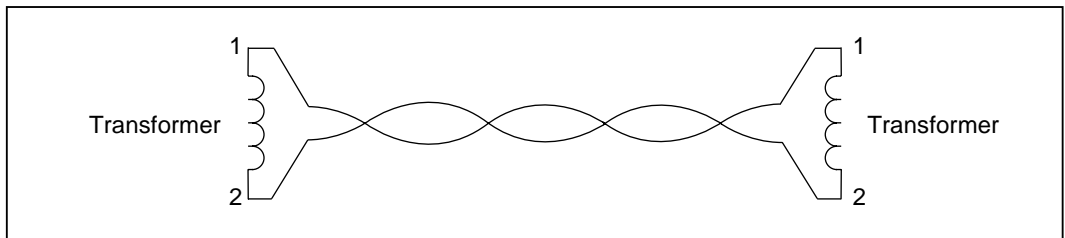

gc27f.eps

Figure 7-1. Twisted Pair Cable Construction

Each cable pair forms a complete electrical path for signal transmission. The currents flowing through the wires in each pair are equal, but flow in opposite directions. These currents produce electromagnetic fields that could transmit electrical noise to nearby wires. However, the fields surrounding the two wires have opposite polarities. Twisting the wires together causes the fields to cancel out, which minimizes the electrical noise, or crosstalk, generated by each cable pair.

There are two types of twisted pair cable: shielded twisted pair (STP) and unshielded twisted pair (UTP). STP cable, which may also be referred to as ScTP (screened twisted pair) or FTP (foil-screened twisted pair), contains a conductive shield that is electrically grounded to protect the wires inside from electrical noise. STP cable is more expensive and more difficult to install than UTP.

Figure 7-2 shows the pin connections and wire colors for correct wiring on standard 568A and 568B RJ45 connectors.

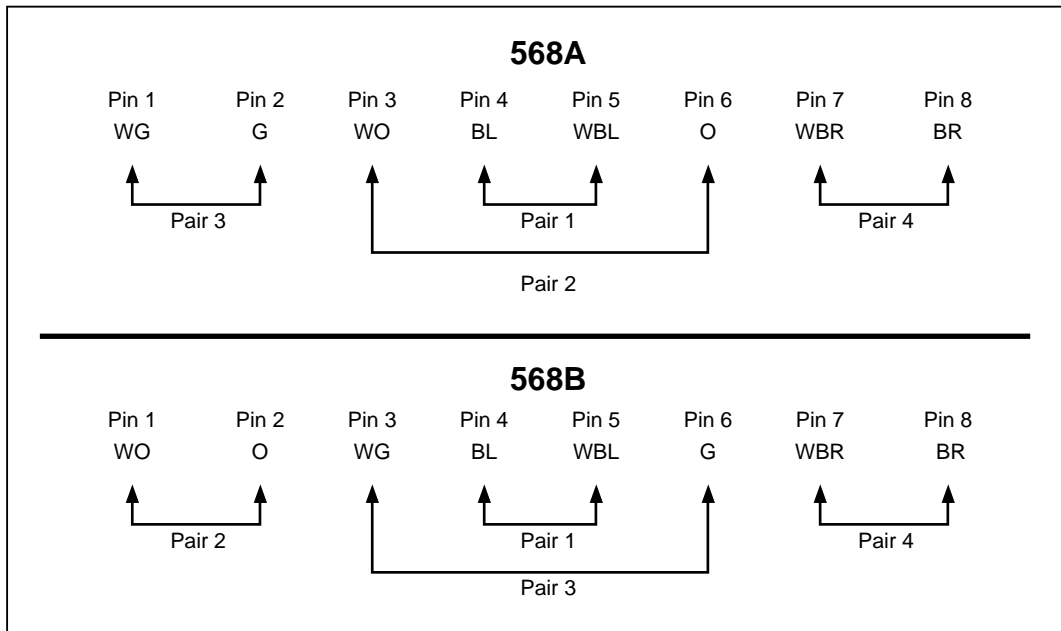

gc28f.eps

Figure 7-2. EIA/TIA RJ45 Connections

Coaxial Cable

Coaxial cable consists of a conductor surrounded first by an insulating material, then by a braided conductive sheath, as shown in Figure 7-3. In LAN applications, the sheath is electrically grounded and serves as a shield that protects the inner conductor from electrical noise. The shield also helps eliminate signal loss by keeping the transmitted signal confined to cable.

Coaxial cable can carry a wider range of frequencies and can be used in greater lengths than twisted pair cable. However, coaxial cable is more expensive than twisted pair.

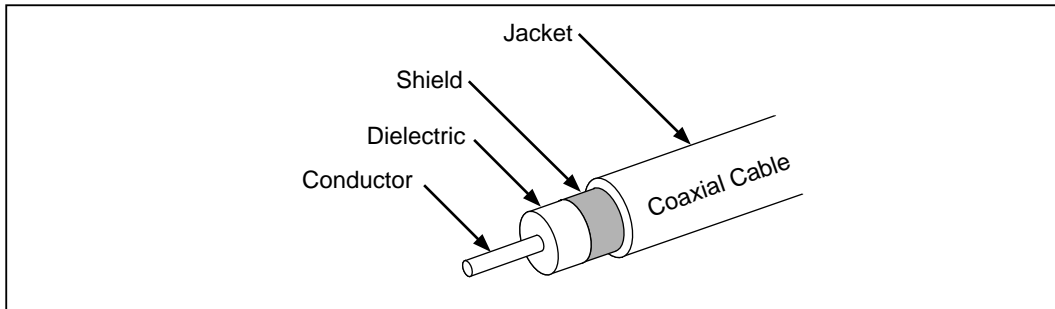

gc29f.eps

Figure 7-3. Coaxial Cable Construction

Attenuation

Attenuation is a decrease in the strength of a signal over the length of a cable, as shown in Figure 7-4.

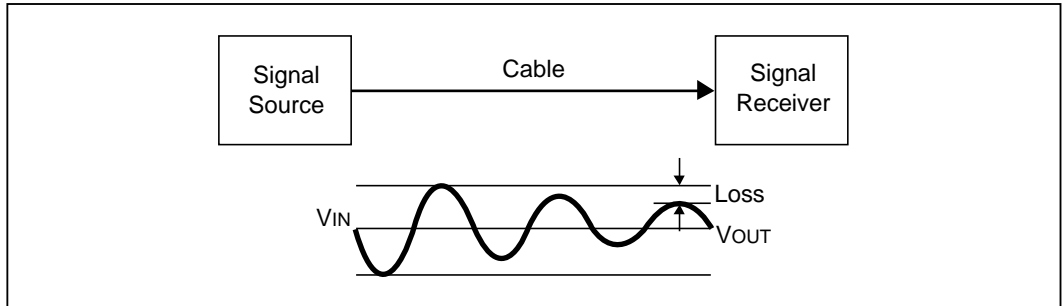

gc30f.eps

Figure 7-4. Attenuation of a Signal

Attenuation is caused by a loss of electrical energy in the resistance of the cable wire and by leakage of energy through the cable's insulating material. This loss of energy is expressed in decibels. Lower attenuation values correspond to better cable performance. For example, when comparing the performance of two cables at a particular frequency, a cable with an attenuation of 10 dB performs better than a cable with an attenuation of 20 dB.

Cable attenuation is determined by the cable's construction, length, and the frequencies of the signals sent through the cable. At higher frequencies, the skin effect and the cable's inductance and capacitance cause attenuation to increase.

Noise

Electrical noise is unwanted electrical signals that alter the shape of the signals transmitted on a LAN cable. Figure 7-5 shows an example of how noise affects the shape of an electrical signal known as a sine wave. Signals that are severely distorted by noise can cause communication errors in a LAN.

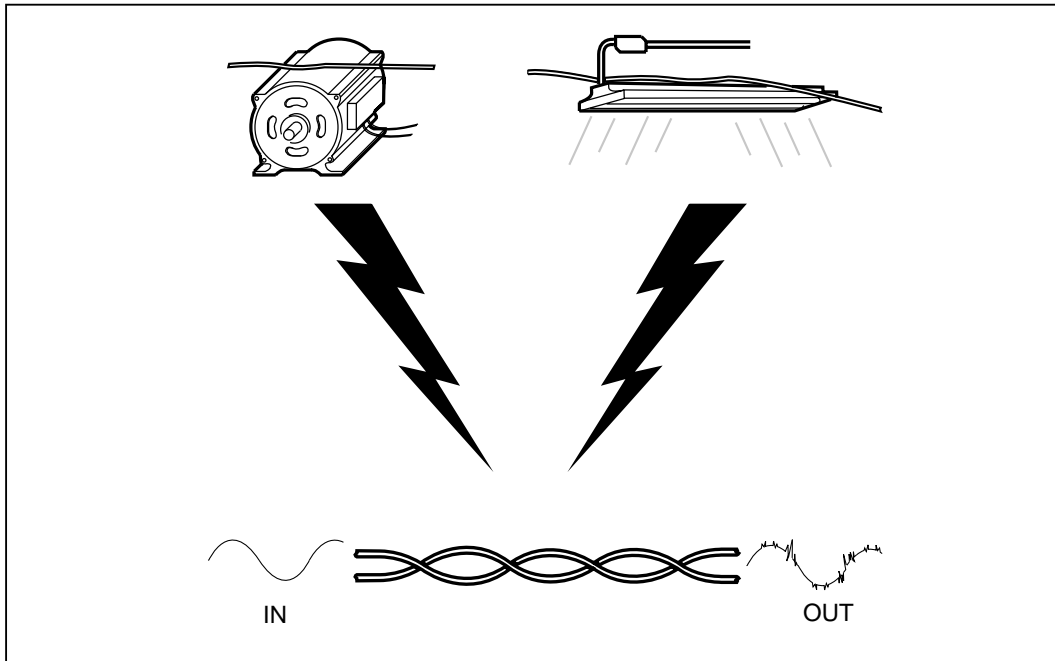

Figure 7-5. Sources of Electrical Noise

Electrical noise is generated by any device that uses or generates voltages that vary over time. Varying voltage generates a varying electromagnetic field, which transmits noise to nearby devices in the same way that a radio transmitter transmits signals to your radio. For example, fluorescent lights, which use 50 or 60 Hz ac (alternating current) power, continuously radiate a 50 or 60 Hz signal that can be received by nearby devices as electrical noise.

LAN cables act as antennas that can pick up noise from fluorescent lights, electric motors, electric heaters, photocopiers, refrigerators, elevators, and other electronic devices. Coaxial cable is far less susceptible to noise than twisted pair cable because it is shielded by a conductive sheath. The sheath is electrically grounded to prevent noise from reaching the inner conductor.

The test tool measures impulse noise on the cable under test. Impulse noise is abrupt “spikes” of interference. This noise is caused by electronic devices that run intermittently, such as elevators, photocopiers, and microwave ovens. You can monitor impulse noise in the test tool’s MONITOR mode. The test tool counts impulse noise spikes that have an amplitude greater than the selected impulse noise threshold.

Characteristic Impedance

Characteristic impedance is the impedance that a cable would have if the cable were infinitely long. Impedance is a type of resistance that opposes the flow of alternating current (ac). A cable’s characteristic impedance is a complex property resulting from the combined effects of the cable’s inductive, capacitive, and resistive values. These values are determined by physical parameters such as the size of the conductors, distance between conductors, and the properties of the cable’s insulation material.

Proper network operation depends on a constant characteristic impedance throughout the system’s cables and connectors. Abrupt changes in characteristic impedance, called impedance discontinuities or impedance anomalies, cause signals reflections, which can distort signals transmitted through LAN cables and cause network faults.

Minimizing Impedance Discontinuities

Characteristic impedance is usually altered slightly by cable connections and terminations. Sharp bends or kinks in LAN cable can also alter the cable's characteristic impedance. Networks can operate with small discontinuities because the resulting signal reflections are small and are attenuated in the cable. Larger impedance discontinuities can interfere with data transmission. Such discontinuities are caused by poor electrical contacts, improper cable terminations, mismatched cable or connector types, and by disturbances in the twisting pattern of twisted pair cable.

You can avoid problems with impedance discontinuities by observing the following precautions during installation:

- Never mix cables with different characteristic impedances (unless you use special impedance-matching circuitry).
- Always terminate coaxial cables with a resistance equal to the cable's characteristic impedance. The terminating resistance prevents signal reflections by absorbing the signal's energy.
- When untwisting cable pairs to install connectors or make connections at punch-down blocks, make the untwisted sections as short as possible.
- Do not make sharp bends or kinks in the cable. The radius of bends in a cable should be larger than 1 inch (2.54 cm).
- Handle LAN cable carefully during installation. Do not step on the cable or pinch it with tight cable ties.

Crosstalk and Near-End Crosstalk (NEXT)

Crosstalk is undesirable signal transmission from one cable pair to another nearby pair. Like electrical noise from outside sources, crosstalk can cause communication problems in networks. Of all the characteristics of LAN cable operation, crosstalk has the greatest effect on network performance.

The test tool measures crosstalk by applying a test signal to one cable pair and measuring the amplitude of the crosstalk signals received by the other cable pairs. The crosstalk value is computed as the difference in amplitude between the test signal and the crosstalk signal when measured from the same end of the cable. This difference is called near-end crosstalk (NEXT) and is expressed in decibels. Higher NEXT values correspond to less crosstalk and better cable performance.

All signals transmitted through a cable are affected by attenuation. Because of attenuation, crosstalk occurring at the far end of a cable contributes less to NEXT than crosstalk occurring at the near end of a cable. To verify proper cable performance, you should measure NEXT from both ends of the cable.

Locating NEXT Problems

If the test tool reports a NEXT failure on a cable pair, you can use the TDX analyzer to locate the source of the crosstalk problem.

Like the TDR results, the TDX analyzer results are presented in both a list and a plot format. The list format shows the cable pairs tested, the peak magnitude of crosstalk detected on the pairs, and the distance to the peak magnitude.

The TDX analyzer plot shows the location and magnitude of all crosstalk sources detected on the cable. An example of a TDX analyzer plot from a test on a good twisted pair cable is shown in Figure 7-6.

The plot's horizontal scale represents the distance along the cable under test. In the above example, the cursor is placed at a small crosstalk source caused by a connector 77 ft (23.5m) from the test tool.

The vertical scale represents the magnitude of the crosstalk detected. The crosstalk levels shown on the plot are adjusted to compensate for cable attenuation. Without this adjustment, the peak on the right side of the plot (farther from the test tool) would appear much smaller. The adjusted plot makes it easier for you identify crosstalk sources because you can use the scale on the vertical scale to measure crosstalk magnitudes plotted at any distance from the test tool. You can also compare the relative magnitudes of crosstalk peaks to determine the largest sources of crosstalk on the cable.

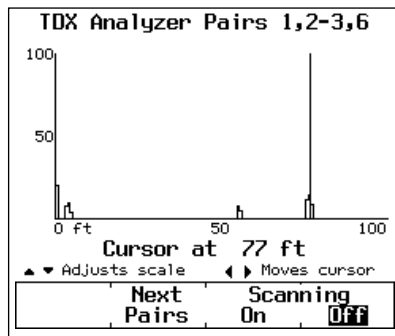

gc32c.eps

Figure 7-6. A TDx Analyzer Plot

The scale of the vertical scale increases logarithmically. The scale units are arbitrary. A level of 50 represents a crosstalk magnitude that is close to causing a cable failure. The level of 100 is approximately 20 times greater than the level of 50. A level of 100 represents an extremely high level of crosstalk that is typically due to split pairs. Cables or other hardware that cause crosstalk levels of 100 or above are considered unusable. Crosstalk levels near 0 are considered to be inconsequential.

The TDX plot from a cable that failed a NEXT test may show one or more peaks of crosstalk greater than a level of 50. A failure can also be caused by a crosstalk level less than 50 if the level is sustained over a substantial distance of the cable.

Split Pairs and NEXT

A split pair occurs when one wire from a cable pair is twisted together with a wire from a different cable pair. Split pairs most frequently result from miswires at punchdown blocks and cable connectors. Figure 7-7 shows an example of split pair wiring. Notice that the pin-to-pin connections across the cable are correct, but the pairs twisted together do not form a complete circuit.

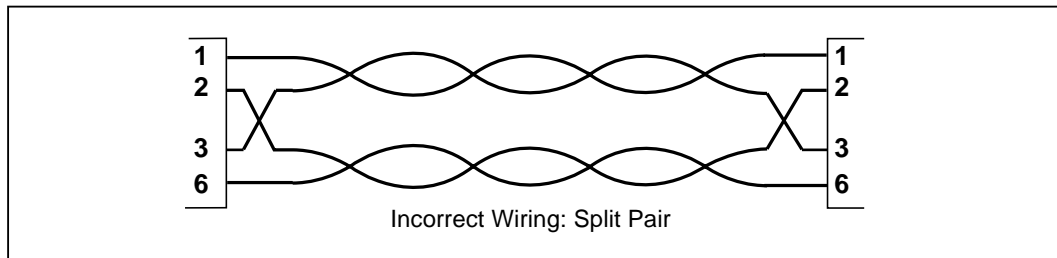

gc33f.eps

Figure 7-7. Split Pair Wiring

Split pairs cause severe crosstalk because the signals in the twisted pairs come from different circuits. The high crosstalk levels produced by split pairs cause low NEXT values during cable tests. If the NEXT value is low enough, the test tool reports a split pair during the wire map test.

The tool may also report split pairs if you test untwisted cable, such as ribbon cable or untwisted telephone line.

If the tool reports split pairs when you are testing a cable made of multiple segments, you can determine which segment has the split pair by running the TDX analyzer. The TDX analyzer plot will show a large value of crosstalk starting at a distance that corresponds to the beginning of the segment with the split pair.

Minimizing Crosstalk

Crosstalk problems are minimized by twisting together the two wires in each cable pair. Twisting the two wires together causes the electromagnetic fields around the wires to cancel out, leaving virtually no external field to transmit signals to nearby cable pairs.

You can avoid problems with crosstalk by observing the following precautions during installation:

- When untwisting cable pairs to install connectors or make connections at punch-down blocks, make the untwisted sections as short as possible.
- Be attentive when making wiring connections. Wiring errors that cause split pairs create severe crosstalk problems.
- Do not make sharp bends or kinks in the cable. The radius of bends in a cable should be larger than 1 inch (2.54 cm).
- Handle LAN cable carefully during installation. Do not step on the cable or pinch it with tight cable ties.

Nominal Velocity of Propagation (NVP)

NVP is the speed of a signal through a cable relative to the speed of light. In a vacuum, electrical signals travel at the speed of light. In a cable, signals travel slower than the speed of light. Typically, the speed of an electrical signal in a cable is between 60% and 80% of the speed of light. Figure 7-8 shows how the NVP percentage is calculated.

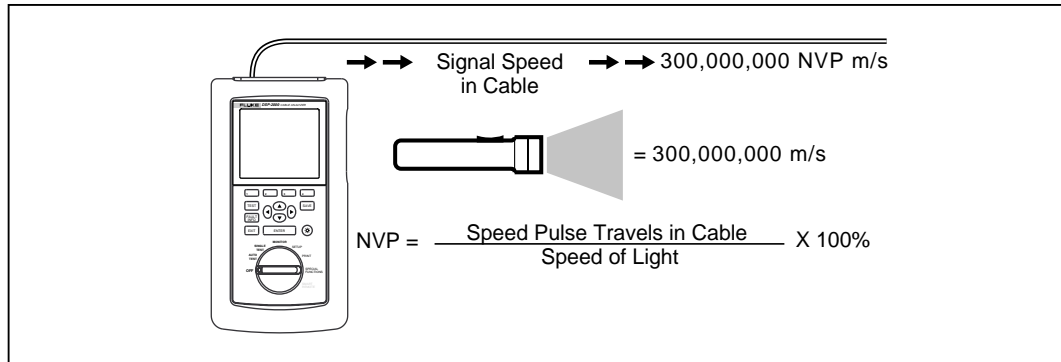

gc34f.eps

Figure 7-8. How NVP is Calculated

NVP values affect the limits on cable length for Ethernet systems because Ethernet operation depends on the system's ability to detect collisions in a specified amount of time. If a cable's NVP is too low or the cable is too long, signals are delayed and the system cannot detect collisions soon enough to prevent serious problems in the network.

NVP and Length Measurements

Length measurements depend directly on the NVP value entered for the selected cable type. To measure length, the test tool first measures the time it takes for a test pulse to travel the length of the cable. The test tool then calculates cable length by multiplying the travel time by the signal speed in the cable.

Because the test tool uses the length measurement to determine cable resistance limits, the NVP value also affects the accuracy of resistance measurements.

NVP Calibration

The NVP values specified for standard cables are included in the cable specifications stored in the test tool. These values are accurate enough for most length measurements. However, the actual NVP for one cable type can vary up to 20% between batches because of variations in the manufacturing process.

Therefore, if accurate length measurements are critical to your installation or testing process, you should determine the actual NVP value for each spool of cable. Determining the NVP value involves measuring a known length of cable and adjusting the test tool's length measurement to match the known length. As you adjust the length measurement, the NVP value changes accordingly. The calibration procedure is explained in "NVP Calibration" in Chapter 6.

Time Domain Reflectometry (TDR)

TDR is a measurement technique used to determine a cable's length and characteristic impedance and locate faults along the cable. TDR is sometimes referred to as cable radar because it involves analyzing signal reflections in the cable.

If a signal traveling through a cable encounters an abrupt change in the cable's impedance, some or all of the signal is reflected back to the source. The timing, size, and polarity of the reflected signals indicate the location and nature of impedance discontinuities in the cable.

Reflections from Opens

An open, or break, in the cable represents an abrupt increase in the cable's impedance. The impedance of an open is nearly infinite. In an open cable, a signal's energy is not dissipated by a terminating impedance, so the signal bounces back towards the source. This reflection appears at the source with the same amplitude and polarity as the original signal, as shown on the next page in Figure 7-9. By measuring the amount of time taken for the reflected pulse to return, the test tool can determine the location of the open in the cable.

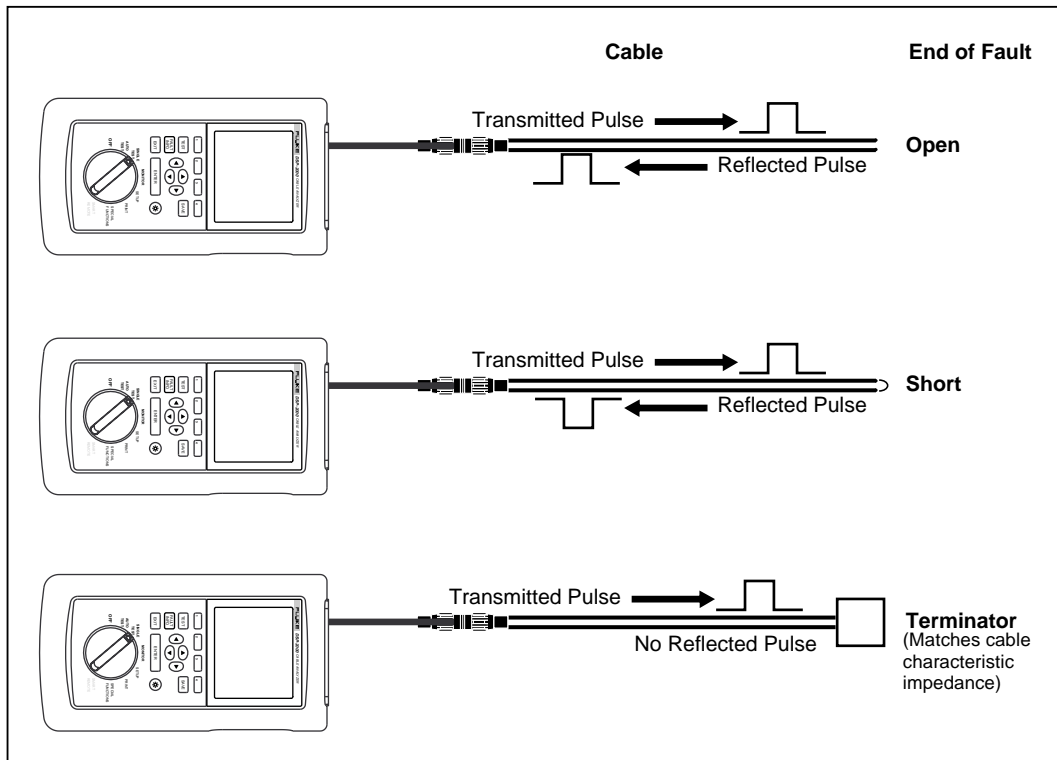

gc35f.eps

Figure 7-9. Signals Reflected from an Open, Shorted, and Terminated Cable

Reflections from Shorts

A short represents an abrupt decrease in the impedance between the two conductors in a cable. A short is caused when the insulation surrounding a cable's wires is damaged, allowing the wires to touch each other. The result is a near-zero impedance connection between the conductors.

A short also causes signal reflections, but in a manner opposite of an open. In a shorted cable, the signal's energy is not dissipated because the short's impedance is close to zero. The signal is reflected back to the source, where it appears with the same amplitude but a polarity opposite of the original signal, as shown in Figure 7-9.

Reflections from Other Discontinuities

Reflections are also caused by impedance discontinuities that measure somewhere between infinite and zero impedance. These discontinuities can be caused by mechanical stress that damages cable wire or insulation without causing a complete open or short. They can also be caused by cable mismatches and faulty contacts at connectors or punch-down blocks.

A cable fault that has an impedance higher than the cable's characteristic impedance reflects a signal that has the same polarity as the original signal. If the fault is not a complete open, the amplitude of the reflected signal will be less than the original signal.

If the fault's impedance is lower than the cable's characteristic impedance, but is not a complete short, the reflected signal will have the opposite polarity and less amplitude than the original signal.

Cable Termination

Because signal reflections can distort the shape of communication signals, the unused ends of cable segments must be terminated to prevent reflections. The terminating device is a resistor with a value equal to the cable's characteristic impedance. A signal reaching the terminator is neither reflected nor passed: the signal is absorbed and dissipated by the terminating resistance.

Because the test tool relies on signal reflections to determine cable length, the tool cannot measure the length of properly terminated cables.

Interpreting the TDR Plot

The TDR plot has a horizontal scale that represents distance and a vertical scale that represents the percentage of reflection relative to the original signal, as shown in Figure 7-10.

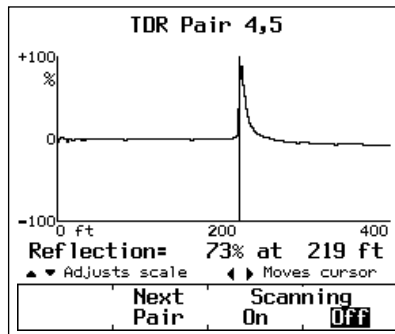

gc36c.eps

Figure 7-10. A TDR Plot

Notice that the reflection percentages can be positive or negative. A positive value indicates that the polarity of the reflection is the same as the polarity of the original signal. As discussed earlier, positive reflections are caused by abrupt increases in the cable's impedance, such as those caused by mismatches in cable types, poor connections, or breaks in the cable.

A negative reflection percentage indicates that the polarity of the reflection is the opposite of the original signal. Negative reflections are caused by abrupt decreases in the cable's impedance, such as those caused by mismatches in cable types or shorts on the cable.

The results plotted in Figure 7-10 are the results from a TDR test on pair 4,5 in a good twisted pair cable. The results show a positive anomaly caused by the open end of the cable at about 219 feet. Note that the left edge of a TDR reflection represents the location of the anomaly on the cable, while the peak of the reflection represents the size of the anomaly.

The test tool's TDR plot includes a movable cursor with a readout that displays the cursor's position and the reflection percentage of the anomaly at the cursor's position. You can move the cursor left and right by pressing the (←) (→) keys on the test tool. Figure 7-10 shows the cursor positioned near the beginning of an anomaly.

ACR

ACR (attenuation to crosstalk ratio) is the difference between NEXT in dB and attenuation in dB. The ACR value indicates how the amplitude of signals received from a far-end transmitter compares to the amplitude of crosstalk produced by near-end transmissions. A high ACR value means that the received signals are much larger than the crosstalk. In terms of NEXT and attenuation values, a high ACR value corresponds to high NEXT and low attenuation.

Figure 7-11 shows a plot of NEXT and attenuation limits, along with the resulting ACR plot. Notice that the ACR is lower where NEXT and attenuation values are near each other.

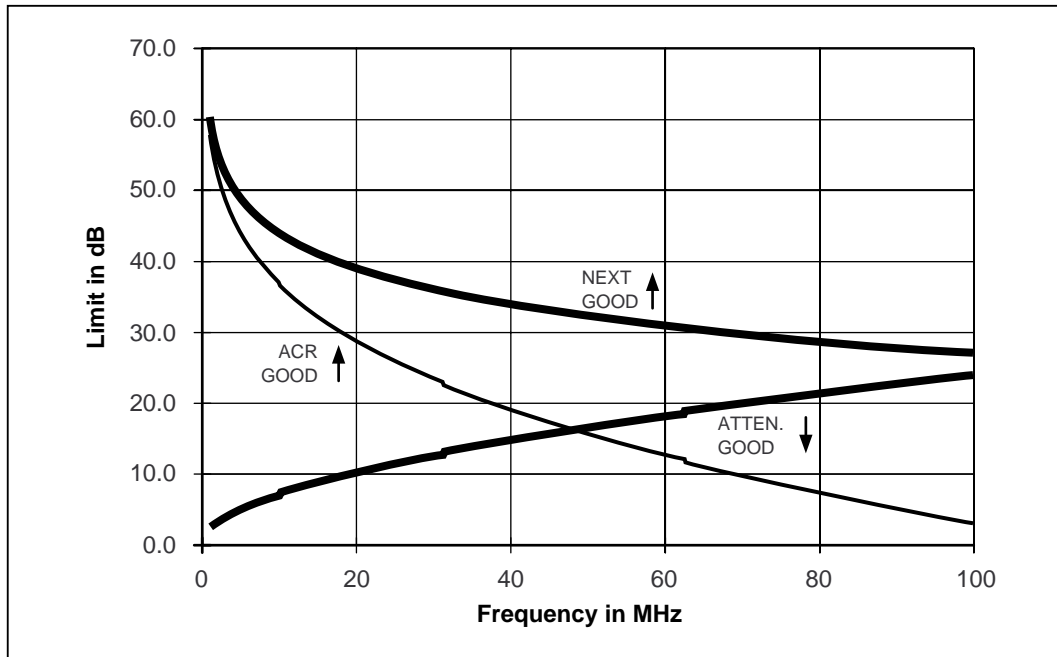

gc37f.eps

Figure 7-11. A Plot of NEXT, Attenuation, and the Resulting ACR

RL

RL (return loss) is the difference between the power of a transmitted signal and the power of the signal reflections caused by variations in the cable's impedance. A RL plot indicates how well a cable's impedance matches its rated impedance over a range of frequencies. High RL values mean a close impedance match, which results in a large difference between the powers of transmitted and reflected signals. Cables with high RL values are more efficient at transmitting LAN signals because little of the signal is lost in reflections.

Troubleshooting Basics

Troubleshooting LAN cable installations is most often required during cable installation or modification. When cable is handled carefully and installed correctly, it usually operates trouble-free for years.

Finding Cable Faults

A general rule for finding cable faults is as follows: *With very few exceptions, faults occur at cable connections.* Cable connections include telecommunication outlets, patch panels, punchdown blocks, and transition connectors.

Connections are the most likely places for faults for at least three reasons: (1) Connections always alter the impedance of the transmission path, (2) connections are likely places for faults caused by wiring errors and faulty or incompatible hardware installation, and (3) connections always cause some crosstalk due to the untwisting of cable pairs.

When cable is handled carelessly, faults can occur in the middle of the cable. These faults can happen when the cable is stepped on, sharply bent, pinched by cable ties or other hardware, or otherwise stressed.

A general procedure for finding cable faults (excluding sources of noise and traffic faults) involves the following steps:

1. Run an Autotest on the cable.
2. Analyze the results of failed tests and determine a probable cause for the failure. If you are using Model DSP-2000, press  for specific information on the fault.
3. If the Autotest results do not indicate the location of the fault, run an additional test (such as TDR or TDX analyzer) that will help you locate the fault. Model DSP-2000 provides these test results on its diagnostics displays.
4. Visually inspect the cable at the location indicated by the tests.
5. Repair the fault and retest the cable.

Table 7-1 on the next four pages shows possible causes for test failures and shows examples of displays from tests that can help you locate the cause of a failure.

Table 7-1. Identifying Cable Faults

Test Failure	Likely Causes of Failure
Wire map: open	Wires connected to wrong pins at connector or punchdown blocks. Faulty connections. Cables routed to the wrong location. Wires broken by stress at connections. Damaged connector. Cuts or breaks in cable.
Wire map: split pair	Wires connected to wrong pins at connector or punchdown blocks.
Wire map: reversed pairs	Wires connected to wrong pins at connector or punchdown blocks.
Wire map: crossed pairs	Wires connected to wrong pins at connectors or punchdown blocks.

Table 7-1. Identifying Cable Faults (continued)

Examples of Test Displays and Plots																	
<p style="text-align: center;">WIRE MAP</p> <pre> RJ45 PIN: 1 2 3 4 5 6 7 8 5 0 RJ45 PIN: 2 3 4 5 6 7 8 5 FAIL </pre> <p style="text-align: right;"><small>gc52i.eps</small></p> <p>Wire map display showing an open on pair 1,2.</p>	<p style="text-align: center;">TDR</p> <table border="1"> <thead> <tr> <th>Pair</th> <th>Distance</th> <th>Peak</th> </tr> </thead> <tbody> <tr> <td>1,2</td> <td>27 ft</td> <td>72%</td> </tr> <tr> <td>3,6</td> <td>138 ft</td> <td>End</td> </tr> <tr> <td>4,5</td> <td>136 ft</td> <td>End</td> </tr> <tr> <td>7,8</td> <td>134 ft</td> <td>End</td> </tr> </tbody> </table> <p style="text-align: center;">▲ ▼ to select pair</p> <div style="border: 1px solid black; padding: 2px; text-align: center;">View Plot</div> <p style="text-align: right;"><small>gc57i.eps</small></p> <p>TDR results showing open on pair 1,2 at near-end connector.</p>	Pair	Distance	Peak	1,2	27 ft	72%	3,6	138 ft	End	4,5	136 ft	End	7,8	134 ft	End	<p style="text-align: center;">TDR Pair 1,2</p> <p style="text-align: right;"><small>gc58i.eps</small></p> <p>TDR plot of results shown at left.</p>
Pair	Distance	Peak															
1,2	27 ft	72%															
3,6	138 ft	End															
4,5	136 ft	End															
7,8	134 ft	End															
<p style="text-align: center;">WIRE MAP</p> <pre> RJ45 PIN: 1 2 3 4 5 6 7 8 5 RJ45 PIN: 1 2 3 4 5 6 7 8 FAIL </pre> <p>Split pairs detected: 1,2-3,6</p> <p style="text-align: right;"><small>gc59i.eps</small></p> <p>Wire map display showing a split pair on pairs 1,2 and 3,6.</p>	<p style="text-align: center;">TDX Analyzer Pairs 1,2-3,6</p> <p style="text-align: right;"><small>gc60i.eps</small></p> <p>TDX plot showing split pair in a short cable segment that starts about 100 ft from test tool.</p>																
<p style="text-align: center;">WIRE MAP</p> <pre> RJ45 PIN: 1 2 3 4 5 6 7 8 5 x x RJ45 PIN: 2 1 3 4 5 6 7 8 5 FAIL </pre> <p style="text-align: right;"><small>gc61i.eps</small></p> <p>Wire map display showing reversed pair on pair 1,2.</p>	<p style="text-align: center;">Inspect the cable connectors for reversed pairs.</p>																
<p style="text-align: center;">WIRE MAP</p> <pre> RJ45 PIN: 1 2 3 4 5 6 7 8 5 x x x x RJ45 PIN: 3 6 1 4 5 2 7 8 5 FAIL </pre> <p style="text-align: right;"><small>gc62i.eps</small></p> <p>Wire map display showing crossed pairs on 1,2 and 3,6.</p>	<p style="text-align: center;">Inspect the cable connectors for crossed pairs.</p>																

Table 7-1. Identifying Cable Faults (continued)

Test Failure	Likely Causes of Failure
Wire map: short	<p>Wires connected to wrong pins at connector or punchdown blocks.</p> <p>Conductive material stuck between pins at a connection.</p> <p>Damage to cable insulation.</p>
NEXT	<p>Excessive untwisting of pairs at connection.</p> <p>Insufficient quality of connecting hardware.</p> <p>Damage to cable (pinches, kinks, etc.)</p> <p>Damaged connector</p> <p>Insufficient cable quality.</p>
Impedance anomaly detected	<p>Poor connection between two lengths of cable.</p> <p>Damage to cable (pinches, kinks, etc.)</p> <p>Taps into wire pair. (Twisted pair cable should never be tapped.)</p> <p>Excessive loading at coaxial cable tap.</p> <p>Mismatch of cable types.</p> <p>Incorrect terminator value.</p>

Table 7-1. Identifying Cable Faults (continued)

Examples of Test Displays and Plots																	
<p style="text-align: center;">WIRE MAP</p> <pre> RJ45 PIN: 1 2 3 4 5 6 7 8 5 s s RJ45 PIN: 3 4 5 6 7 8 5 FAIL </pre> <p style="text-align: right; font-size: small;">gc63i.eps</p> <p>Wire map display showing short between pins 1 and 2.</p>	<p style="text-align: center;">TDR</p> <table border="1" style="width: 100%; border-collapse: collapse;"> <thead> <tr> <th>Pair</th> <th>Distance</th> <th>Peak</th> </tr> </thead> <tbody> <tr> <td>1,2</td> <td>78 ft</td> <td>-99%</td> </tr> <tr> <td>3,6</td> <td>86 ft</td> <td>End</td> </tr> <tr> <td>4,5</td> <td>86 ft</td> <td>End</td> </tr> <tr> <td>7,8</td> <td>84 ft</td> <td>End</td> </tr> </tbody> </table> <p style="text-align: center;">▲ ▼ to select pair</p> <div style="border: 1px solid black; padding: 2px; text-align: center;">View Plot</div> <p style="text-align: right; font-size: small;">gc64i.eps</p> <p>TDR results showing short 78 ft from test tool.</p>	Pair	Distance	Peak	1,2	78 ft	-99%	3,6	86 ft	End	4,5	86 ft	End	7,8	84 ft	End	<p style="text-align: center;">TDR Pair 1,2</p> <p>Reflection= -11% at 78 ft</p> <p style="font-size: small;">▲ ▼ Adjusts scale ◀ ▶ Moves cursor</p> <div style="border: 1px solid black; padding: 2px; text-align: center;"> Next Pair Scanning On Off </div> <p style="text-align: right; font-size: small;">gc65i.eps</p> <p>TDR plot of results shown at left.</p>
Pair	Distance	Peak															
1,2	78 ft	-99%															
3,6	86 ft	End															
4,5	86 ft	End															
7,8	84 ft	End															
<p>NEXT test fails.</p>	<p style="text-align: center;">TDX Analyzer Pairs 1,2-3,6</p> <p style="text-align: center;">Cursor at 79 ft</p> <p style="font-size: small;">▲ ▼ Adjusts scale ◀ ▶ Moves cursor</p> <div style="border: 1px solid black; padding: 2px; text-align: center;"> Next Pairs Scanning On Off </div> <p style="text-align: right; font-size: small;">gc66i.eps</p> <p>TDX plot showing NEXT caused by excessive untwisting of cable pair at far-end connector.</p>																
<p>Impedance anomaly is detected.</p>	<p style="text-align: center;">TDR Pair 4,5</p> <p>Reflection= 14% at 59 ft</p> <p style="font-size: small;">▲ ▼ Adjusts scale ◀ ▶ Moves cursor</p> <div style="border: 1px solid black; padding: 2px; text-align: center;"> Next Pair Scanning On Off </div> <p style="text-align: right; font-size: small;">gc67i.eps</p> <p>TDR plot showing impedance anomaly caused by a 150Ω cable segment in a 100Ω run.</p>																

Chapter 8

Maintenance and Specifications

Chapter 8 provides the following information:

- Instructions for cleaning and storing the test tool.
- Instructions for replacing batteries.
- A troubleshooting guide to use when the test tool is not operating correctly.
- Instructions for returning the unit for repair.
- A list of replacement parts.
- Electrical and mechanical specifications.

Maintenance

Cleaning and Storage

Clean the test tool and remote with a soft cloth dampened with water or water and a mild soap.

⚠ Caution

To avoid damaging the display or the case, do not use solvents or abrasive cleansers.

If you are storing the test tool or the smart remote for an extended period of time, charge the NiCad battery pack before storing. Do not remove the battery pack. Removing the battery pack for extended periods shortens the life of the backup lithium battery.

Before storing the standard remote for an extended period of time, remove the alkaline battery to prevent damage from battery leakage. Figure 8-1 shows how to remove the remote battery.

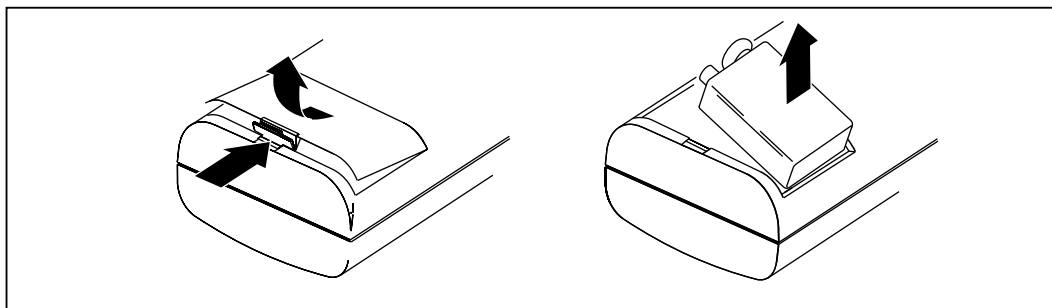

gc38f.eps

Figure 8-1. Removing the Battery in the Standard Remote

Replacing the NiCad Battery Pack

Replace the NiCad battery pack when its life between full charges becomes noticeably shorter. The battery is normally good for up to 1,000 charge/discharge cycles. Figure 8-2 shows how to remove the battery pack.



Note

This instrument contains a Nickel-Cadmium battery. Used batteries should be disposed of by a qualified recycler or hazardous materials handler. Contact your authorized Fluke Service Center for recycling information.

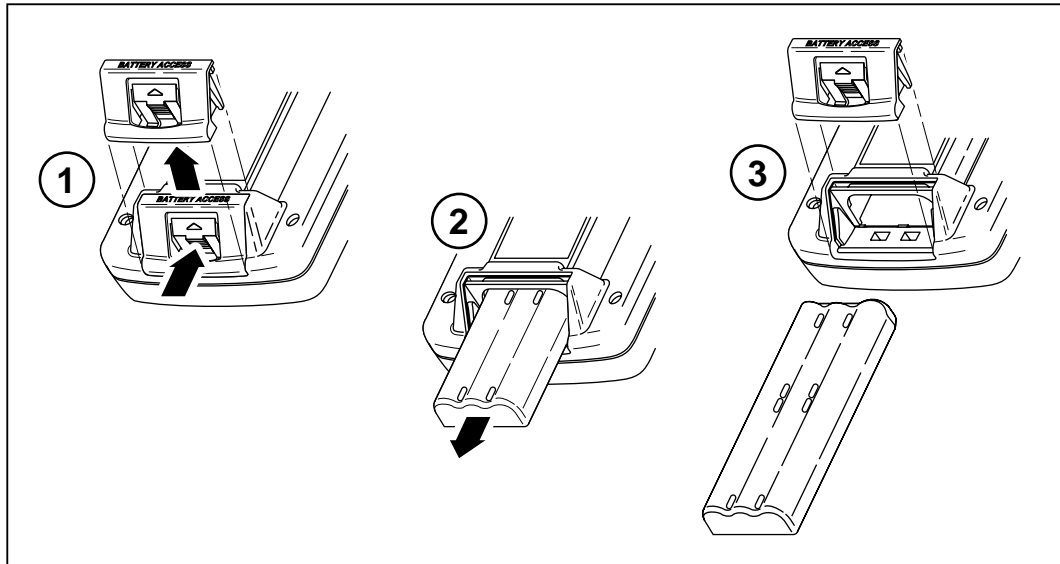

gc39f.eps

Figure 8-2. Removing the NiCad Battery Pack

Note

The ac adapter/charger will not power the test tool when the battery pack is removed.

Internal Lithium Backup Battery

A lithium battery maintains the test tool's memory contents when you remove the NiCad battery pack. The memory contents maintained are the stored Autotest reports, all SETUP settings, self-calibration and NVP calibration data, custom cable configurations, and the report identification information.

The lithium battery lasts about five years if you always keep the main battery installed. Removing the main battery pack for extended periods shortens the life of the lithium battery.

When the lithium battery voltage is low, have the battery replaced at a Fluke Service Center. See the later section “Service Center Repair” for shipping and warranty information.

If the Test Tool Fails

If the test tool does not operate properly, refer to Table 8-1 on the next page for troubleshooting procedures. If the self-test fails, return the unit for service as described in “Service Center Repair.”

Service Center Repair

If the test tool requires service, pack it in the original shipping container and send it, postage paid and insured, to the nearest Fluke Service Center. Include a written description of the problem. Fluke assumes no responsibility for shipping damage.

A test tool covered under warranty will be promptly repaired or replaced (at Fluke’s option) and returned to you, postage paid, at no charge. See the registration card for warranty terms. If the warranty has lapsed, Fluke will repair the test tool for a fixed fee and return it to you postage paid. Contact the nearest Service Center for information and repair prices.

For application or operation assistance or information on Fluke products, call:





800-44-FLUKE (800-443-5853) in U.S.A. and Canada

31-40-267 8200 in Europe

206-356-5500 from other countries

For service information in the U.S.A., call 1-800-825-9810. Outside the U.S.A., contact the nearest Fluke Service Center.

Table 8-1. Troubleshooting the Test Tool

<p>Symptom 1: Display is blank</p> <p>Press . The test tool may have switched to low-power mode.</p> <p>Connect the ac adapter/charger. The NiCad battery pack may need charging.</p> <p>Hold down  for 2 seconds, then hold down  for 5 seconds. The display contrast may be too low.</p> <p>Hold down  for 2 seconds, then hold down  for 5 seconds. The display contrast may be too high.</p>
<p>Symptom 2: Remote unit is not detected.</p> <p>Charge or replace the battery in the remote.</p> <p>Verify that the cable is securely connected to the main and remote units.</p> <p>Connect the remote with a different cable. The cable you are using may be defective.</p> <p>Check the connectors on the main and remote units for damage.</p>
<p>Symptom 3: Test results appear to be incorrect.</p> <p>Perform a self-test to verify correct operation. See “Performing a Self-Test” in Chapter 2 for details.</p> <p>Verify that the test standard, cable type, temperature, conduit setting, and power line frequency (all in SETUP) are correctly set. See Chapter 2 for details.</p> <p>Perform a self-calibration. See “Calibrating the Test Tool” in Chapter 6 for details.</p> <p>Perform a NVP calibration. See “Calibrating the NVP Value” in Chapter 6 for details.</p>
<p>Symptom 4: Internal fault detected.</p> <p>Note any error number displayed. Turn the unit off, then turn it on again. Stored data may be lost.</p> <p>If the error occurs again, contact a Fluke Service Center for assistance.</p>
<p>Symptom 5: Test tool does not operate with ac adapter/charger connected.</p> <p>Verify that the NiCad battery pack is installed. The ac adapter/charger will not power the test tool if the battery is removed.</p> <p>Turn off the test tool; then charge the battery for about 30 minutes before resuming operation.</p> <p>Replace the NiCad battery pack.</p>
<p>Symptom 6: Self calibration fails.</p> <p>See “Calibrating the Test Tool” in Chapter 6 for details.</p>
<p>Symptom 7: Test tool is locked in the power-on sequence.</p> <p>Turn off the test tool; then charge the battery for about 30 minutes before resuming operation.</p>

Replacement Parts

Table 8-2 lists the replacement parts for the test tool, the standard remote, and the smart remote. To order replacement parts in the USA and Canada, call Fluke Service Parts at 1-800-526-4731. Outside the USA and Canada, call 1-206-356-5500.

Table 8-2. Replacement Parts

Description	Part Number
NiCad battery pack	938170
9V alkaline battery	614487
AC adapter/charger, North America version	106200
AC adapter/charger, international version	944223
Battery door, main unit and smart remote	938357
Battery door, standard remote	116183
Cable, 100 Ω RJ45, 2m (6.56')	107109
Cable, 100 Ω RJ45, 15 cm (6")	107117
Cable, 50 Ω BNC coaxial, 1m (3')	927876
Cable, 9-pin PC interface	944806
Adapter, RJ45 to BNC	642402
Conductive case, bottom, CE, DSP-100	625415
Conductive case, bottom, CE, DSP-2000	625423
Conductive case, top, CE, DSP-100	621364
Conductive case, top, CE, DSP-2000	625431
Conductive case, smart remote top, CE, DSP-100	621398
Conductive case, smart remote top, CE, DSP-2000	625434
Side connector plate, conductive	100435
Case, standard remote top	116160
Case, standard remote bottom	100385

Table 8-2. Replacement Parts (continued)

Description	Part Number
Bail	938340
Strap	946769
Soft carrying case	948992
Hard carrying case	625407
Users manual, English	642964
Users manual, French	603719
Users manual, Spanish	604477
Users manual, German	604451
Users manual, Italian	604469
DSP-LINK software	116145

Specifications

Service Center Calibration Period

One year.

Self-Calibration Period

To ensure maximum accuracy of test results, perform the self-calibration procedure, as described in “Calibrating the Test Tool” in Chapter 6, every 30 days.

Note

All specifications for tests on twisted pair cable apply to cable with 100Ω of characteristic impedance.

Compatibility with Remote Units

Model DSP-100 is compatible with DSP-R and DSP-SR units and with other DSP-100 test tools set to the SMART REMOTE mode. It can store calibration data for eight different remotes.

Model DSP-2000 is compatible with DSP-2000SR units. It can store calibration data for two different smart remotes.

Cable Types Tested

Unshielded twisted pair LAN cables of all categories (UTP category 3, category 4, and category 5).

Foil-screened twisted pair cables (ScTP): category 3, category 4, and category 5.

Shielded twisted pair cables (STP) (IBM Type 1, 6, and 9; adapter required).

Coaxial cables: Thicknet (10Base5; adapter required), Thinnet (10Base2), RG-58, RG-58 foam, RG-59, RG-59 foam, RG-8, RG-8A/U, and RG-62.

Test Standards

TIA category 3, 4, and 5, basic link or channel, and TIA TP-PMD.

IEEE 802.3 10Base5, 10Base2, and 10BaseT.

IEEE 802.5 Token Ring 4 Mb/s or 16 Mb/s.

IEEE 100BaseTX, 100BaseT4, IEEE 802.12 (100BaseVG).

ISO Class A, B, C, and D.

ANSI TP-PMD

Time for Autotest

Full 2-way Autotest of category 5 UTP cable in approximately 20 seconds.

Characteristic Impedance

Table 8-3 shows the specifications for the characteristic impedance test.

Table 8-3. Characteristic Impedance Test Specifications

	Twisted Pair cable	Coax
Range	70 - 180 Ω	35 - 100 Ω
Accuracy	$\pm (5\Omega + 5\% \text{Nominal} - \text{Measured})$	$\pm (5\Omega + 5\% \text{Nominal} - \text{Measured})$
Anomaly Threshold	15% Reflection	10% Reflection
Resolution	1 Ω	1 Ω

Length Test

Table 8-4 shows the specifications for the length test.

Table 8-4. Length Test Specifications

	Twisted Pair cable	Coax
Range	0 to 328 ft (100m)	0 to 328 ft (100m)
Resolution	1 ft or 0.1m	1 ft or 0.1m
Accuracy	$\pm (1 \text{ ft } (.3\text{m}) + 2\% \text{ of reading})$	$\pm (1 \text{ ft } (.3\text{m}) + 2\% \text{ of reading})$
Range	328 to 2500 ft (762m)	328 to 4000 ft (1219m)
Resolution	1 ft or 0.1m	1 ft or 0.1m
Accuracy	$\pm (1 \text{ ft } (.3\text{m}) + 4\% \text{ of reading})$	$\pm (1 \text{ ft } (.3\text{m}) + 4\% \text{ of reading})$

Note

Specifications are relative to calibrated value using a representative reference cable. Variations occur because of variations in the cable manufacturing process.

Propagation Delay Test

Table 8-5 shows the specifications for the propagation delay test.

Table 8-5. Propagation Delay Test Specifications

	Twisted Pair cable	Coax
Range	0 to 500 ns	0 to 500 ns
Resolution	1 ns	1 ns
Accuracy	$\pm(2 \text{ ns} + 2\% \text{ of reading})$	$\pm(2 \text{ ns} + 2\% \text{ of reading})$
Range	500 to 3800 ns	500 to 6000 ns
Resolution	1 ns	1 ns
Accuracy	$\pm(2 \text{ ns} + 4\% \text{ of reading})$	$\pm(2 \text{ ns} + 4\% \text{ of reading})$

DC Loop Resistance

Range: 0 to 400 Ω

DSP-100 accuracy: $\pm(500 \text{ m}\Omega + 1\% \text{ of reading})$

DSP-2000 accuracy: $\pm(2\Omega + 2\% \text{ of reading})$

Resolution: 0.1 Ω

Overload recovery time: Less than 10 minutes to rated accuracy following an overvoltage. Self-calibration is required after repeated or prolonged overvoltage.

Attenuation

The following attenuation specifications are defined per TIA TSB-67.

Frequency Range: 100 kHz to 105 MHz in 100 kHz steps. Range is determined by the selected test standard.

Amplitude Range: 0 to >30 dB (random noise floor for NEXT: 30 dB)

Resolution: 0.1 dB

Return Loss: Better than 15 dB from 1 MHz to 100 MHz. Typically better than 20 dB.

Dynamic Accuracy: Better than ± 0.75 dB from 1 MHz to 100 MHz. Typically better than ± 0.25 dB at 30 dB of attenuation from 1 MHz to 100 MHz.

Measurement Accuracy (calculated from above parameters): Better than ± 1.0 dB from 1 MHz to 100 MHz. Typically better than ± 0.3 dB at 30 dB of attenuation from 1 MHz to 100 MHz.

NEXT

The following NEXT specifications are defined per TIA TSB-67.

Frequency Range: 100 kHz to 105 MHz in 100 kHz steps. Range is determined by the selected test standard.

Amplitude Range: 85 dB at 1 MHz to 65 dB at 100 MHz (residual NEXT: 10 dB)

Resolution: 0.1 dB

Return Loss: Better than 15 dB from 1 MHz to 100 MHz. Typically better than 20 dB.

Dynamic Accuracy: Better than ± 0.75 dB from 1 MHz to 100 MHz. Typically better than ± 0.6 dB.

Residual NEXT Loss (after connector compensation): Better than 55 dB at 100 MHz.

Random Noise Floor: Better than 65 dB at 100 MHz. Typically better than 75 dB at 100 MHz.

Output Signal Balance: Better than 37 dB at 100 MHz.

Common Mode Rejection: Better than 37 dB at 100 MHz.

Measurement Accuracy (calculated from above parameters): Better than ± 1.5 dB from 1 MHz to 100 MHz. Typically better than ± 1.25 dB.

TDX™ Analyzer Specifications for Cables <100m (328 ft)

The following performance is typical for cables less than 100m (328 ft):

Distance accuracy: $\pm(1 \text{ ft (0.3m)} + 2\% \text{ distance})$

Distance resolution: 1 ft or 0.1m

TDR Specifications for Cables <100m (328 ft)

Table 8-6 shows the distance specifications for TDR tests on cables less than 100m (328 ft) long.

Table 8-6. Distance Specifications for TDR Test

	Twisted Pair	Coaxial
Distance accuracy	$\pm(1 \text{ ft (0.3m)} + 2\% \text{ distance})$	$\pm(1 \text{ ft (0.3m)} + 2\% \text{ distance})$
Distance resolution	1 ft or 0.1m	1 ft or 0.1m

Return Loss

Return loss range: 0 to 30 dB

Accuracy: ± 3 dB over the following ranges:

0 to 18 dB from 1 to 10 MHz

0 to 15 dB from 10.1 to 20 MHz

0 to 10 dB from 20.1 to 100 MHz

Impulse Noise

Adjustable from 100 mV to 500 mV in 10 mV steps. The default threshold is 270 mV.

Monitors either polarity of noise on pair 3, 6.

Minimum detectable impulse width: 10 ns

Model DSP-100 LAN Traffic

Monitors 10 Mb/s Ethernet only; UTP or coaxial cable.

Monitors pair 3, 6 for either polarity of data.

Generates a positive polarity link pulse on pair 1, 2.

Model DSP-2000 LAN Traffic

Monitors 10BaseT traffic using the MONITOR RJ45 jack. Monitors pair 3, 6 for either polarity of traffic. Generates a positive polarity link pulse on pair 1,2.

Monitors 100BaseTX traffic Ethernet traffic using the MONITOR RJ45 jack.

Monitors pair 3, 6 for either polarity of traffic. Generates 100BaseTX link signals on pair 1, 2.

Auto-negotiates between 10BaseT and 100BaseTX using the MONITOR RJ45 jack. Monitors pair 3, 6 for 10BaseT or 100BaseTX link pulses. Generates Auto-Negotiation signals on pair 1, 2.

Monitors 10 Mb/s Ethernet traffic using the COAX jack with the RJ45 to BNC adapter provided.

Serial Interface

Connector: DB9 (DTE male)

Baud rate: 1200 to 38,400 baud

Flow control: hardware, XON/XOFF, or none

Data format: 8 data bits, 1 stop bit, no parity

Printer formats: Epson, HP LaserJet, or Text Only

PC Interface Cable

Table 8-7 shows the pin connections for the PC interface cable provided with the test tool. Table 8-8 shows the pin connections for the 9-to 25-pin adapter available from Fluke (part number 929187).

Table 8-7. PC Interface Cable Connections

Test Tool End DB9S (female)	Pin	Direction	PC End DB9S (female)
Data Carrier Detect	1	<-----	4
Receive Data	2	<-----	3
Transmit Data	3	----->	2
Data Terminal Ready (always true)	4	----->	1
Signal Ground	5	<---->	5
Not connected	6		6
Request To Send (used only with hardware flow control)	7	----->	8
Clear To Send	8	<-----	7
Not connected	9		9

Table 8-8. 9-to 25-pin Adapter (available from Fluke)

9-pin Connector	25-pin Connector
3	2
2	3
7	4
8	5
6	6
5	7
1	8
4	20
9	22
Shell	Shell

Power

Main unit and smart remote: NiCad battery pack, 7.2V, 1700 mA hr

Typical NiCad battery life for DSP-100: 10 to 12 hours

Typical NiCad battery life for DSP-2000: 8 to 11 hours

AC adapter/charger, USA version: Linear power supply; 108 to 132V ac input; 15V dc, 1A output

AC adapter/charger, international version: Switching power supply; 90 to 264V ac input; 15V dc; 1A output

Remote unit: 9V alkaline battery

Typical life of alkaline battery in remote: 6 months

Memory backup power in main unit: Lithium battery

Typical life of lithium battery: 5 years

Environmental Requirements

Operating temperature: 32 to 113°F (0 to 45°C)

Storage temperature: -4 to 140°F (-20 to 60°C)

Pollution degree: 2

Altitude: 9843 ft (3000m)

Avoid use outside the operating boundaries shown in Figure 8-3.

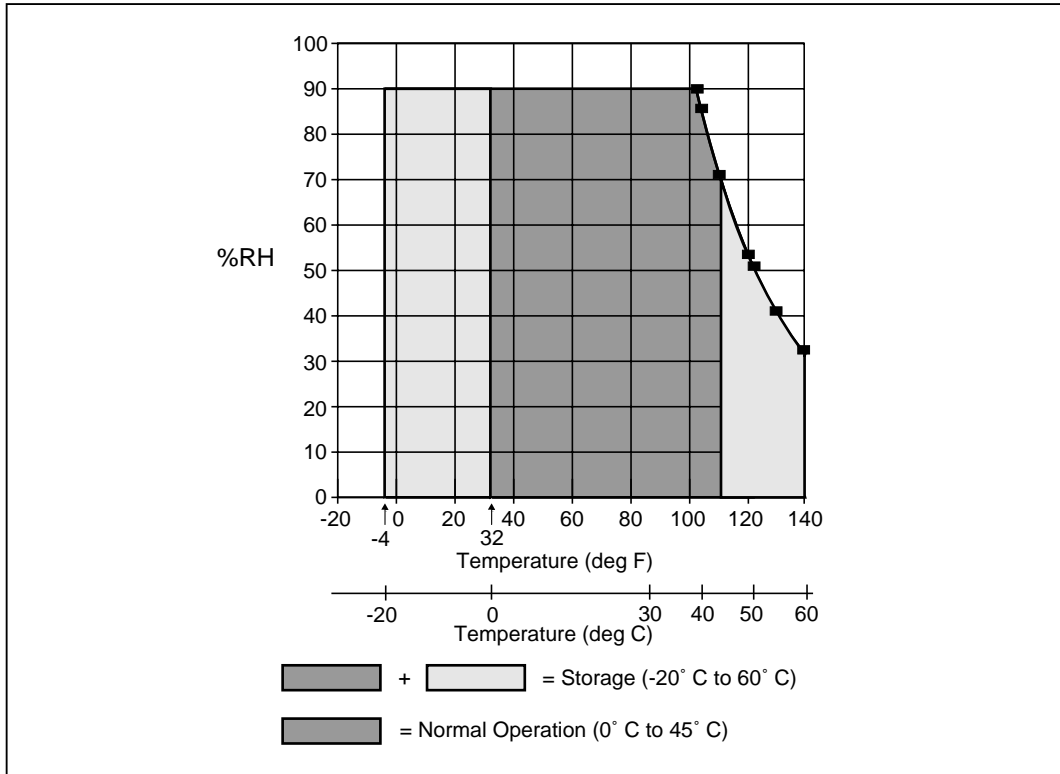

gc40f.eps

Figure 8-3. Operating Environment Specifications

Input Ratings



Models DSP-100 and DSP-2000 are designed to measure unpowered cables. The inputs are protected against continuous, current-limited telco voltages (<100 mA).

Model DSP-2000 can withstand occasional overvoltages of less than 30V rms (42V peak, 60V dc).

Certifications

Table 8-9 shows the certifications that apply to the test tool.

Table 8-9. Certifications

Symbol	Description
	Conforms to relevant European Union directives.
	Safety listed by UL. The control number of the Fluke Corporation is 950Z.
TIA TSB-67 ACCURACY BASIC LINK:LEVEL II CHANNEL:LEVEL II	This instrument meets the requirements of Telecommunications Industry Association (TIA) Technical System Bulletin (TSB) 67 Accuracy Level II performance for both basic link and channel test configurations.
	Listed by Canadian Standards Association. NRTL: Instrument has been tested by CSA for compliance with UL safety standards.

Memory

512K-byte nonvolatile RAM stores results from at least 500 Autotests. More storage may be available depending on the software version used and the number of tests run by the selected test standard.

1 M-byte Flash EPROM for firmware and test standard updates.

Dimensions

Main unit and smart remote: 9.25" x 5" x 3" (23.5 cm x 12.7 cm x 7.6 cm)

Standard remote: 6" x 3" x 1.5" (15.2 cm x 7.6 cm x 3.8 cm)

Weight

Main unit: 3 lbs, 4 oz (1.5 kg)

Smart remote: 3 lbs, 1 oz (1.4 kg)

Standard remote: 8.5 oz (241g)

Display

Type: Graphic bit-mapped LCD with backlight and adjustable contrast.

Size and resolution: 2.8" x 2.4" (7.1 cm x 6.1 cm), 15 lines, 30 characters per line, 240 x 200 bits.

RJ45 Connector

Typical life: > 5000 cycles

Warranty

One year from date of purchase.

Appendices

Appendix		Page
A	Using DSP-LINK	A-1
B	Glossary.....	B-1
C	Tests Run per Test Standard During an Autotest.....	C-1

Appendix A

Using DSP-LINK

Introduction

DSP-LINK is a Windows[®] program that allows you to do the following:

- Configure a PC's serial port for communication with the test tool.
- Transfer saved Autotest reports and report summaries from the test tool to a PC.
- View and print saved Autotest reports and summaries.
- Transfer test data in CSV format from the test tool to a PC.
- View and print plots from the last test run.
- Transfer software updates and new test standards from a PC to the test tool.

The minimum requirements for running DSP-LINK are an 80386 microprocessor system with 4 M-bytes of RAM, Windows 3.1 software, and a VGA monitor.

Installing DSP-LINK

The DSP-LINK installation program copies the DSP-LINK files from the diskette provided to the drive of your choice. The program creates a \DSPLINK directory for storing the files. The installation program also allows you to change the name and path of this directory.

To install DSP-LINK on your computer, proceed as follows:

1. Put the DSP-LINK diskette in either the A: or B: floppy disk drive.
2. From Windows, use the Program Manager or the File Manager to run the file SETUP.EXE from the DSP-LINK diskette.
3. Follow the instructions given by the SETUP program.

Preparing for Data Transfer

For all data transfer operations, you must connect the test tool to the PC with the appropriate interface cable and set the test tool's and PC's serial ports to the same configuration.

Connecting to a PC

To connect the test tool to a PC, use the 9-pin serial interface cable provided with the test tool. Refer to Figure A-1. If your PC has a 25-pin serial port, you can use a Fluke 25-pin adapter, Fluke P/N 929187.

To verify the pin assignments for a different 25-pin adapter or a different cable, refer to the pin assignments for the serial interface cable given in "Specifications" in Chapter 8.

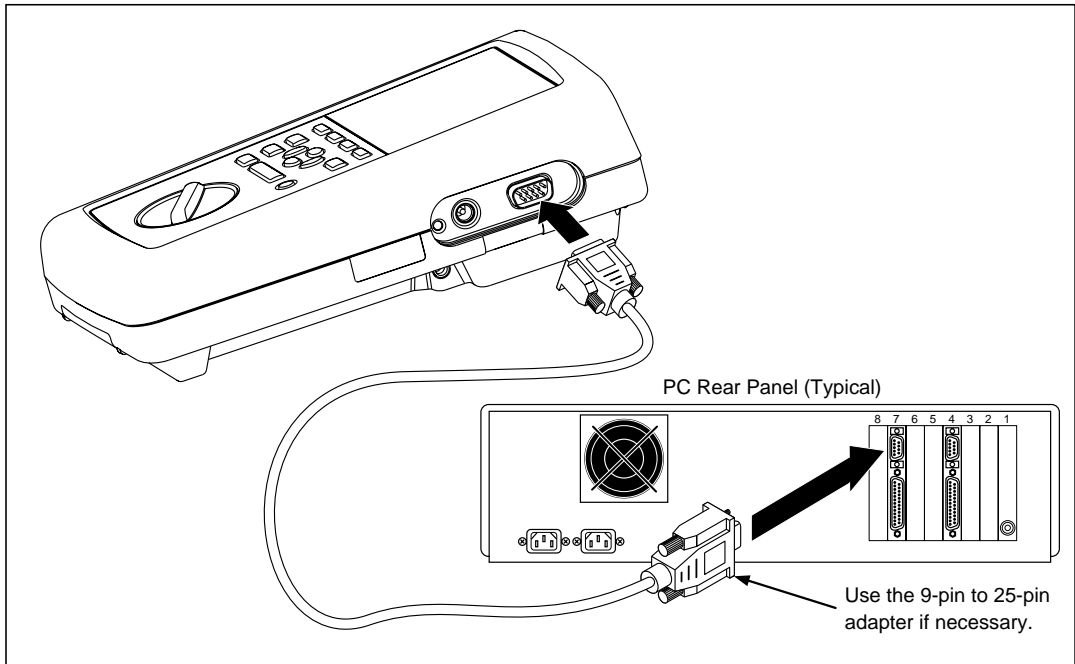

gc41f.eps

Figure A-1. Connecting the Test Tool to a PC

Configuring the Serial Ports

Transferring data requires the serial ports on the test tool and the PC to have the same interface configurations.

You can view or change the test tool's serial port configuration in the SETUP mode. For complete instructions, refer to Chapter 5, "Viewing and Printing Saved Reports."

The DSP-LINK software allows you to configure a PC's serial port. The PC serial port configuration includes baud rate, flow control protocol, and a port number selection.

To use DSP-LINK to configure a PC's serial port and establish communications, proceed as follows:

1. Use the serial interface cable provided to connect the test tool to the PC.
2. Start the DSP-LINK program on the PC.
3. Click on Setup.
4. Select the following:
 - (a) the baud rate that matches the test tool's baud rate setting;
 - (b) the PC serial port number that is connected to the test tool;
 - (c) and the flow control that matches the test tool's flow control setting.
5. Click on Connect.

When communication is established, the Setup menu closes and the bottom of the main DSP-LINK menu shows which COM port and baud rate are in use.

Communication Problems

If DSP-LINK cannot connect to the test tool, check the following:

- Verify that the baud rates and flow control protocols are the same for the test tool and the PC.
- Verify that the test tool is connected to the COM port selected on the DSP-LINK Setup menu. If you are not sure which port number you are connected to, change the COM number on the Setup menu and try again.
- Verify that the interface cable is securely connected to the test tool and to the selected serial port on the PC.
- If you are not using the cable provided, verify that the cable's pin assignment matches the pin assignment given for the serial PC interface cable given in "Specifications" in Chapter 8.
- If the PC still can't connect, set the test tool and the PC to a lower baud rate and try again.

DSP-LINK Functions

Table A-1 summarizes the functions available in DSP-LINK. Table A-2 defines some of the special functions and terms used in DSP-LINK. For additional information, see the online help in DSP-LINK.

Table A-1. Summary of DSP-LINK Functions

DSP-LINK Function	What You Can Save on a PC	What You Can View on a PC	What You Can Print
Autotest Reports	Autotest reports and report summaries saved in the test tool can be saved as CSV or TXT file types.	Autotest reports saved in the test tool. Use a database program, such as Fluke Cable Manager*, to work with CSV data saved on the PC.	Autotest reports and report summaries saved in the test tool.
Detailed Test Data	CSV data from the last test run.	NA. Use Quick Plot to create plots of data from the last test run. Or, save the CSV data; then use a spreadsheet program to work with the data.	NA. Use Quick Plot to create and print plots of data from the last test run. Or, save the CSV data; then use a spreadsheet program to work with the data.
Quick Plot	NA. Use the Detailed Test Data function to save CSV data for plots.	Plots from the last test run.	Plots from the last test run.
<p>* Fluke Cable Manager software lets you organize, sort, edit, print, and save Autotest reports generated by a DSP-100 or DSP-2000 test tool. To purchase Cable Manager, contact your local Fluke distributor.</p>			

Table A-2. Special Terms Used in DSP-LINK

DSP-LINK Function	Description of Related Function or Term
<p>Autotest Reports Detailed Test Data</p>	<p>Summary Data: Summary data are the cable identification name, date and time of the test, cable length, test result summary (pass, fail, or warning), total length, and site name for the selected summaries, as shown in the Autotest Reports window.</p> <p>Save File as Type .CSV: Comma-separated values are test data formatted for use in spreadsheet and database applications. The test data are uploaded as a list of values separated by commas. When you open the data file in another application, the application places each comma-separated value in a separate cell. You can then use the data to create plots of NEXT, attenuation, ACR, and RL. See your spreadsheet or database manual or help file for instructions on using CSV data.</p> <p>If your test tool's numeric format is set to use a comma as the decimal separator, the test tool automatically uses a semicolon as the data separator in CSV files.</p> <p>Save File as Type .TXT: Text files uploaded to a PC can be edited and printed using a word processor.</p> <p>Data from the Last Test Run: This data, which is temporarily stored in a block of the test tool's memory, include 1550 measurement points for each cable pair for each test that produces a plot. Only data from tests specified by the selected test standards are available. The data remain memory until you save the test, run another test, or turn the rotary switch to a new position. When you save an Autotest, the test tool saves only the worst-case point for each test.</p>
<p>Quick Plot</p>	<p>Find Worst Margin: Worst Margin is the margin that comes closest to exceeding the limit, or the margin that exceeds the limit by the greatest amount. Worst margin is reported for the cable pair selected with the cursor.</p> <p>Find Worst Pair: Worst Pair is the pair having the worst margin of all the cable pairs. Quick Plot finds the worst pair even if all of the pairs are not shown on the plot.</p> <p>The Find menu does not appear with TDR and TDX™ plots.</p>

Table A-2. Special Terms Used in DSP-LINK (continued)

DSP-LINK Function	Description of Related Function or Term
Quick Plot	<p>Using a Mouse to Control the Cursor: When the pointing hand is shown on the plot, you can move the cursor by sliding the mouse from side to side. To freeze the cursor at a point on the line, click the mouse. Click again to move the cursor. To move the cursor to a different plotted line, click on a cable pair listed near the lower-right side of the plot.</p> <p>Using a Keyboard to Control the Cursor: Use the left and right arrow keys to move the cursor in 100 kHz increments. Use the shift key with the arrow keys to move the cursor in 1 MHz increments. To move the cursor to a different plotted line, use the up and down arrow keys to move the cursor up and down among the cable pairs on the plot.</p> <p>To View Pairs One at a Time in Forward or Reverse Sequence: Use the tab and shift-tab keys, respectively. The cursor moves to the worst margin for each pair. You can also view the next pair by selecting Next Pair(s) from the Pair(s) menu.</p>

Formatting Hints for Uploaded Reports

To fit an uploaded Autotest report on one 8.5" x 11" or A4 page, use a word processor to set the font and margins as shown in Table A-3.

Table A-3. Formats for Uploaded Reports

Courier Point Size	Maximum Left and Right Margins for 8.5" x 11" Page	Maximum Left and Right Margins for 210 mm x 297 mm (A4) Page
8-point	1.3"	3.0 cm
9-point	0.9"	2.1 cm
10-point	0.5"	1.1 cm

Getting Software Updates from Fluke

The Fluke bulletin board system (BBS) and the LAN Products web site give you access to new versions of software and test standards for your test tool.

Using the BBS requires a modem and a communication software package.

Following is the phone number for Fluke's LAN Products BBS:

(206) 353-5966

(8 data bits, 1 stop bit, no parity)

If you require assistance in using the BBS, call the Fluke Applications Help Line at 1-800-44-Fluke. Or, send email to lans@fluke.com.

Using the web site requires internet access and a web browser. Following is the address for Fluke's LAN Products page:

<http://www.fluke.com/nettools/>

Downloading New Test Standards

When new test standards are available, you can download the standards from Fluke's LAN Products BBS or web site to your PC, then use DSP-LINK to download the standards to your test tool.

⚠ Cautions

Downloading new test standards erases all test result data stored in the test tool's memory. To save stored Autotest or Single Test results, upload the results to a PC.

To prevent an unexpected loss of battery power to the test tool, connect the battery charger to the test tool during the downloading process.

To download cable standards from the BBS or web site to your test tool, proceed as follows:

1. Copy the test standards file from the BBS or web site to a PC. The file is compressed and self-executing.
2. Execute the file to expand the data. Expanding the file creates a file with a .SDB extension.
3. Connect the test tool to the PC and configure the serial ports as described in the earlier section "Preparing for Data Transfer."
4. In the DSP-LINK window, click on Test Standards Update.
5. If you want to save the Autotest reports stored in memory, click on no in response to the next dialog box. Save the reports by uploading them to the PC.
If you do not want to save the stored reports, click on yes.
6. Enter the path and file name of the expanded (.SDB) test standards file.
7. Click on OK.

Downloading New Software

When a software update becomes available from Fluke, you can download the software from Fluke's LAN Products BBS or web site to your PC, then use DSP-LINK to download the software to your test tool.

⚠ Cautions

Downloading new software overwrites the existing test software in your test tool. You will not have access to the old version of the software.

Downloading new software erases all data stored in the test tool's memory. To save stored Autotest or Single Test results, use DSP-link to upload the results to a PC. To save Setup data, write down the settings shown on the displays in the test tool's SETUP mode.

To prevent an unexpected loss of battery power to the test tool, connect the battery charger to the test tool during the downloading process.

To download new software from the BBS or web site to your test tool, proceed as follows:

1. Copy the software update file from the BBS or web site to a PC. The file is compressed and self-executing.
2. Execute the file to expand the data. Expanding the file creates files with the extensions .SDB or .DSP. More than one file may be created.
3. Connect the test tool to the PC and configure the serial ports as described in the earlier section "Preparing for Data Transfer."
4. In the DSP-LINK window, click on Software Update.
5. If you want to save the Autotest reports stored in memory, click on no in response to the next dialog box. Save the reports by uploading them to the PC.
If you do not want to save the stored reports, click on yes.
6. Enter the path and file name of the expanded software update file (.DSP or .SDB).
7. Click on OK.
8. Repeat steps 4 through 6 for all files created by the expansion process.

Appendix B

Glossary

10Base2

An IEEE Standard for Thin Coax Ethernet networks: 10 Mb/s transmission, baseband signaling, 185 meters per coax segment. Also known as Thinlan, Thinnet, or Cheapernet.

10BaseT

An IEEE Standard for unshielded twisted pair Ethernet networks: 10 Mb/s transmission, baseband signaling, unshielded twisted pair cable. Maximum cable length is 100 meters.

100BaseTX

An IEEE Standard for twisted pair Ethernet networks: 100 Mb/s transmission; baseband signaling; two-pair, category 5 twisted pair cable. Maximum cable length is 100 meters.

ACR

Attenuation to crosstalk ratio. The difference between NEXT in dB and attenuation in dB. Good cable performance corresponds to high ACR values (in negative dB), which result when NEXT is much higher than attenuation.

Anomaly

A location on a network cable where the cable's impedance changes abruptly.

Attenuation

A reduction in the strength of a signal. Attenuation is usually expressed in decibels.

Auto-Negotiation

The ability of a network device to determine the capabilities of a far end device, then select settings for optimal communication.

Bandwidth

A measure of the information capacity of a transmission medium. The measurement is expressed in hertz (Hz) and is the difference between the highest and lowest frequencies that the medium will pass without significant attenuation.

Baseband Signaling

A method of signal transmission where the entire bandwidth of the medium is used to send a single signal. Compare with *broadband signaling*.

Basic Link

A network connection consisting of (1) a patch cable to a patch panel, (2) one connection at the patch panel, (3) a horizontal cable segment up to 90m (295 ft), (4) a telecommunications outlet or transition connector, and (5) a patch cable from the outlet or transition connector. Cable test limits for a link are tighter than those for a channel because the channel limits allow for additional connections at the horizontal cross-connect and near the telecommunications outlet.

BNC

A coaxial cable connector used with Thin-wire (10Base2) Ethernet networks.

Broadband Signaling

A method of signal transmission where the bandwidth of the medium is shared by multiple signals. The signals are separated into channels carried on different frequencies within the bandwidth. This transmission method is often used to transmit voice, data, and video signals over a single medium. Compare with *baseband signaling*.

Cable Pair

Two wires, usually twisted together, that form a complete circuit for signal transmission.

Capacitance

A measurement of the capacity to store electrical charge across conductive elements that are separated by an insulating material (dielectric). Undesirable capacitance that occurs between conducting wires in a network cable results in capacitive coupling, which causes crosstalk between cable pairs.

Channel

A network connection consisting of (1) a patch cable to a horizontal cross-connect, (2) two connections at the cross-connect, (3) a horizontal cable segment up to 90m (295 ft), (4) a transition connector near the telecommunications outlet, and (5) a telecommunications outlet. Cable test limits for a channel are looser than those for a basic link because the channel limits allow for the effects of two connections at the cross-connect and an extra connector near the telecommunications outlet.

Characteristic Impedance

The total opposition (dc resistance and ac reactance) to the flow of ac current that a network cable would have if the cable were infinitely long.

Coaxial Cable

A type of transmission cable in which an inner conductor is surrounded first by an insulating layer, then by a braided, conductive sheath. The braided sheath acts as a shield that protects the inner conductor from electrical noise. Coaxial cables typically have a wide bandwidth. Two types of coaxial cable are used with Ethernet networks: Thicknet (10Base5 standard) and Thinnet (10Base2 standard).

Collision

The result of two stations simultaneously attempting to transmit data on a shared network transmission medium (such as Ethernet).

Crossed Pair

A wiring error in twisted pair cabling where a pair on one end of the cable is wired to a different pair in the connector on the other end of the cable.

Crosstalk

Unwanted signal transfer between adjacent cable pairs. Crosstalk occurs because electrical signals passing through a cable pair create an electromagnetic field that transmits the signal to nearby pairs.

CSV Data

Abbreviation for comma-separated variable. A list of data separated by commas. When CSV data is loaded into a spreadsheet application, the application puts each comma-separated value into a separate cell.

dB

Abbreviation for decibel. A logarithmic unit used for expressing the loss or gain of signal strength.

Download

To transfer data from a computer to a remote device.

EIA 568A

Electronic Industries Association Commercial Building Telecommunications wiring standard. Specifies maximum cable lengths, installation practices, and performance specifications for generic building wiring.

Ethernet

A local area network protocol using Carrier Sense Multiple Access with Collision Detection (CSMA/CD). Ethernet is available with four cabling alternatives: thin coaxial, standard (thick) coaxial, twisted pair, and fiber optic. This protocol uses 10 Mb/s baseband transmission and is defined by the IEEE standard 802.3.

Flash Memory

Computer memory that requires no power to maintain its contents, yet, unlike ROM, can be reprogrammed while installed in a system.

Foil-Screened Twisted Pair (FTP)

See *Screened Twisted Pair*.

Hardware Flow Control

A hardware method of controlling data flow between two devices. The receiving device tells the sending device to start or stop data transmission by sending control signals on a cable wire that is dedicated to flow control signals.

Horizontal Cabling

The cabling between a telecommunications outlet and a horizontal cross-connect.

Horizontal Cross-Connect

A group of connectors, such as a patch panel or punch-down block, that allows equipment to be cross-connected with patch cords or jumpers. The horizontal cross-connect is usually located in a wiring closet.

Impedance

Opposition to the flow of ac (alternating current) signals. Impedance is caused by inductance and capacitance. Unlike resistance, impedance varies with the frequency of the applied ac signal.

Impedance Discontinuity

An abrupt change in a cable's characteristic impedance. Impedance discontinuities can be caused by faulty connections, mismatched cable types, and untwisted sections on twisted pair cable. Also called an anomaly.

Inductance

A property of a device that tends to oppose changes in current. Inductance is an undesirable characteristic of cables because it causes signal attenuation.

Inductive Pickup

A device that emits sound when placed near a source of electromagnetic emissions.

Jabber

A network fault condition where a frame longer than 1518 bytes is detected. Network protocols specify a maximum packet length that one station may transmit before other stations are allowed to transmit.

Link Pulse

A single-bit, 100 ns test pulse that is transmitted at least every 50 ms during idle periods on 10BaseT link segments to verify link integrity.

Near-End Crosstalk (NEXT)

The amount of coupling loss (in decibels) occurring when a signal sent on one cable pair is received as crosstalk by another cable pair. Higher NEXT levels correspond to better cable performance.

NVP

Nominal Velocity of Propagation. The speed of a signal through a cable, expressed as a percentage of the speed of light. Typically, the speed of a signal through a cable is between 60% and 80% of the speed of light.

Packet

A group of bits in a specific format, containing a data message that is sent over a network.

Plenum Cable

Cable certified for installation in air ducts and open spaces over suspended ceilings without conduit. Plenum cable is fire resistant and does not emit toxic fumes when burned.

Propagation Delay

The time required for an electrical signal to travel the length of a cable.

PSNEXT

Power-sum NEXT. The combined NEXT received by a cable pair from the other pairs.

Resistor

An electronic component that resists the flow of electrical current. Resistors are used in the *terminators* that are connected to the ends of coaxial cable.

Return Loss (RL)

The loss of signal strength in a cable due to signal reflections. A cable's RL value indicates how well the cable's characteristic impedance matches its rated impedance over a range of frequencies.

Reversed Pair

A wiring error in twisted pair cabling where the pins on a cable pair are reversed between connectors on each end of the cable.

RJ45

An 8-pin modular connector used with twisted pair cable. The RJ45 connector resembles a telephone connector (RJ11).

ROM

Read-only memory. A device used for permanent storage of data or programs. A ROM does not require power to maintain its contents. Once a ROM is programmed, its contents cannot be altered.

Runt Packet

An Ethernet data packet that is shorter than the valid minimum packet length of 64 bytes. Runt packets are usually caused by a collision.

Screened Twisted Pair (ScTP)

Twisted pair cable wrapped in a metallic sheath. The sheath, which is grounded at a single location in the network, acts as a shield that protects the cable pairs from crosstalk and other sources of electrical noise.

Serial Data Transmission

The transmission of data over a single wire.

Segment

A network cable terminated at both ends.

Shielded Twisted Pair

Refers to shielded twisted pair IBM[®] cable with an impedance of 150Ω.

Skin Effect

The tendency of current to flow only near the surface of a conductor. This effect becomes more pronounced at higher frequencies.

Split Pair

A wiring error in twisted pair cable where a wire from one cable pair is twisted with a wire from another cable pair. Though the pin-to-pin connections may be correct, splitting the cable pairs causes excessive crosstalk because the electromagnetic fields around the wires cannot cancel properly.

TDR

Time domain reflectometry. A technique used for finding cable faults and measuring cable length and characteristic impedance. A test pulse applied to the cable is reflected by impedance discontinuities along the cable (such as a short or an open). The cable's characteristics are determined by timing the duration between the test pulse and the reflection and analyzing the shape of the reflected pulse.

TDX™

Time domain crosstalk. The TDX analyzer locates sources of NEXT along a cable. This measurement technique is patented by Fluke corporation.

Terminator

A resistor connected to the end of a coaxial cable. The terminator, which is intended to match the characteristic impedance of the cable, eliminates signal reflections by dissipating signals in the cable.

Token Ring

A local area network that is arranged in a ring or star topology and uses token passing to control access.

Twisted Pair

A cable pair made of two wires that are twisted together to minimize crosstalk to other cable pairs. The twisting minimizes crosstalk because it causes cancellation of the electromagnetic fields generated by each wire in the twisted pair.

Unshielded Twisted Pair (UTP)

Twisted pair cable that is not shielded. UTP cable is more susceptible to crosstalk than shielded twisted pair (STP) cable.

XON/XOFF Flow Control

Transmitter ON/transmitter OFF. A software method of controlling data flow between two devices. The receiving device tells the sending device to start or stop data transmission by sending commands over the data transmission line.

***Appendix C
Tests Run per Test Standard During
an Autotest***

Table C-1. Tests Run per Test Standard During an Autotest

Test Standard ¹	Wire Map	Resistance ²	Length	Impedance	NEXT
TIA Cat 5 Channel	■ 4 pair		■*	□	■* 1-100 MHz
TIA Cat 5 Basic Link	■ 4 pair		■*	□	■* 1-100 MHz
TIA Cat 4 Channel	■ 4 pair		■*	□	■* 1-20 MHz
TIA Cat 4 Basic Link	■ 4 pair		■*	□	■* 1-20 MHz
TIA Cat 3 Channel	■ 4 pair		■*	□	■* 1-16 MHz
TIA Cat 3 Basic Link	■ 4 pair		■*	□	■* 1-16 MHz
Fiber Optic					
ISO11801 EN50173 Class A	■ 4 pair	■	□		■ 0.1 MHz
ISO11801 EN50173 Class B	■ 4 pair	■	□	■	■ 0.1-1 MHz
ISO/IEC11801 Class C	■ 4 pair	■	□	■	■ 1-16 MHz
ISO/IEC11801 Class D	■ 4 pair	■	□	■	■ 1-100 MHz
ISO 11801 Class D - No RL	■ 4 pair	■	□	■	■ 1-100 MHz
EN 50173 Class C	■ 4 pair	■	□	■	■ 1-16 MHz
EN 50173 Class D	■ 4 pair	■	□	■	■ 1-100 MHz
EN 50173 Class D - No RL	■ 4 pair	■	□	■	■ 1-100 MHz
IEEE 10Base2		■	■	■	
IEEE 10Base5		■	■	■	

Table C-1. Tests Run per Test Standard During an Autotest (continued)

Test Standard ¹	Attenuation	ACR	Return Loss	Prop. Delay ²	Delay Skew ²
TIA Cat 5 Channel	■* 1-100 MHz				□
TIA Cat 5 Basic Link	■* 1-100 MHz				□
TIA Cat 4 Channel	■* 1-20 MHz				□
TIA Cat 4 Basic Link	■* 1-20 MHz				□
TIA Cat 3 Channel	■* 1-16 MHz				□
TIA Cat 3 Basic Link	■* 1-16 MHz				□
Fiber Optic	■ (Loss)				
ISO11801 EN50173 Class A	■ 0.1 MHz			■	
ISO11801 EN50173 Class B	■ 0.1-1 MHz			■	
ISO/IEC11801 Class C	■ 1-16 MHz		■ 1-16 MHz	■	□
ISO/IEC11801 Class D	■ 1-100 MHz	■ 1-100 MHz	■ 1-100 MHz	■	□
ISO 11801 Class D - No RL	■ 1-100 MHz	■ 1-100 MHz		■	□
EN 50173 Class C	■ 1-16 MHz		■ 1-16 MHz	■	□
EN 50173 Class D	■ 1-100 MHz	■ 1-100 MHz	■ 1-100 MHz	■	□
EN 50173 Class D - No RL	■ 1-100 MHz	■ 1-100 MHz		■	□
IEEE 10Base2					
IEEE 10Base5					
<p>1. Test standards version 4.0.</p> <p>2. Resistance, propagation delay, and delay skew are always measured; results appear on printed test reports.</p> <p>■ Pass/Fail result given.</p> <p>□ Pass/Warning result given.</p> <p>* Results within the accuracy specifications of the test tool are marked with an asterisk.</p> <p>⊕ NEXT test is run but not displayed. Results are used to calculate ACR.</p>					

Table C-1. Tests Run per Test Standard During an Autotest (continued)

Test Standard ¹	Wire Map	Resistance ²	Length	Impedance	NEXT
Coax Cables		■	■	■	
IEEE 10BaseT	■ 2 pair		■	□	■ 5-10 MHz
100BaseTX	■ 2 pair		■	■	■ 1-80 MHz
100BaseT4	■ 4 pair		■	■	■ 12.5 MHz
IEEE 802.12 4-UTP	■ 4 pair		■	■	■ 1-15 MHz
IEEE 802.12 STP	■ 2 pair	■	■	■	■ 1-100 MHz
TokenRing, 4 Mb/s	■ 2 pair		■	■	+4 MHz
TokenRing, 16 Mb/s, Passive	■ 2 pair		■	■	+ 16 MHz
TokenRing, 16 Mb/s, Active	■ 2 pair		■	■	+ 16 MHz
TP-PMD	■ 2 pair		■	■	■ 1-80 MHz
Twin-Ax: RJ45 pins 4,5,S	■ 1 pair		■	■	
ARCnet		■	■	■	
Aus/NZ Class C Channel	■ 4 pair		■*	□	■* 1-16 MHz
Aus/NZ Class D Channel	■ 4 pair		■*	□	■* 1-100 MHz
Aus/NZ Class C Basic Link	■ 4 pair		■*	□	■* 1-16 MHz
Aus/NZ Class D Basic Link	■ 4 pair		■*	□	■* 1-100 MHz
All Tests	■ 4 pair	■	■	□	■ 1-100 MHz

Table C-1. Tests Run per Test Standard During an Autotest (continued)

Test Standard ¹	Attenuation	ACR	Return Loss	Prop. Delay ²	Delay Skew ²
Coax Cables					
IEEE 10BaseT	■ 5-10 MHz				
100BaseTX	■ 16 MHz	■ 1-80 MHz			
100BaseT4	■ 2-12.5 MHz			■	■
IEEE 802.12 4-UTP	■ 1-15 MHz			■	■
IEEE 802.12 STP	■ 1-100 MHz	■ 1-100 MHz		■	
TokenRing, 4 Mb/s	■ 4 MHz	■ 1-12 MHz			
TokenRing, 16 Mb/s, Passive	■ 16 MHz	■ 1-25 MHz			
TokenRing, 16 Mb/s, Active	■ 16 MHz	■ 1-25 MHz			
TP-PMD	■ 16 MHz	■ 1-80 MHz			
Twin-Ax: RJ45 pins 4, 5, S					
ARCnet					
Aus/NZ Class C Channel	■* 1-16 MHz				□
Aus/NZ Class D Channel	■* 1-100 MHz	■ 1-100 MHz			□
Aus/NZ Class C Basic Link	■* 1-16 MHz				□
Aus/NZ Class D Basic Link	■* 1-100 MHz	■ 1-100 MHz			□
All Tests	■ 1-100 MHz	■ 1-100 MHz	■ 1-100 MHz	□	□
<p>1. Test standards version 4.0.</p> <p>2. Resistance, propagation delay, and delay skew are always measured; results appear on printed test reports.</p> <p>■ Pass/Fail result given.</p> <p>□ Pass/Warning result given.</p> <p>* Results within the accuracy specifications of the test tool are marked with an asterisk.</p> <p>* NEXT test is run but not displayed. Results are used to calculate ACR.</p>					

Index

—A—

- AC adapter/charger, 2-3
- Accessories
 - standard accessories, 1-3
- Accuracy range, 2-6
- ACR
 - ACR@Remote test, 3-17
 - explanation of ACR, 7-19
 - plot description, 3-16
 - results screen items, 3-15
 - test for twisted pair, 3-14
- Anomaly. See Impedance anomaly
- Asterisk
 - in test results, 2-6
 - on custom configurations, 6-5
 - on selected report, 5-4
- Attenuation
 - explanation of attenuation, 7-5
 - plot description, 3-11
 - results screen items, 3-10
 - test for twisted pair, 3-10
- Audible tones, enabling/disabling, 2-28
- Auto increment, 3-25
- Automatic diagnostics, 3-4
- Auto-Negotiation
 - traffic test, 4-16
- Autotest
 - coaxial cable, 3-19
 - connections, 2-11, 3-19
 - descriptions of tests and results, 3-21
 - list of tests, 2-18
 - quick start, 2-10

- organizing reports on a PC, A-5
- printing reports, 5-1
 - print options, 5-3
 - serial port error, 5-5
- report samples, 3-25
- saving results, 3-23
- twisted pair, 3-2
 - connections, 3-2
 - connections for basic link, 3-2
 - connections for channel, 2-8
 - descriptions of tests and results, 3-6
 - list of tests, 2-17
 - quick start, 2-7

—B—

- Backlight, 2-22
- Bail, 2-16
- Basic link
 - configuration diagram, 3-2
 - test standard selection, 2-24
- Battery
 - charging, 2-3
 - lithium, 8-3
 - NiCad
 - removal and replacement, 8-2
 - when to replace, 8-2
 - remote battery removal and replacement, 8-2
 - status messages, 2-31
- Beeper, enabling/disabling, 2-28
- BNC connector, 2-13
- Bulletin board system, A-8

—C—

Cable

- basic troubleshooting, 7-21
- configuring a custom cable, 6-4
- construction, coaxial and twisted pair, 7-1
- identifying hub port connections, 4-20
- interface for PC, 8-13
- interface for printing, 5-2
- pin connections for 568 standard, 7-3

Cable temperature

- effect on test results, 2-25
- selecting, 2-24
- selecting, quick start, 2-4

Cable type

- selecting, 2-24
- selecting, quick start, 2-4

Calibrating the test tool, 6-1

Certifications, 8-16

Channel

- configuration diagram, 2-8
- test standard selection, 2-24

Characteristic impedance. *See* Impedance

Communicating with a PC, A-2

- downloading software updates, A-10
- downloading test standards, A-9
- problems with communications, A-4

Conduit setting

- effect on test results, 2-25
- selecting, 2-25
- selecting, quick start, 2-4

Configure custom cable, 6-4

Connectors

- main unit, 2-13
- remote, 2-15
- RJ11 (telephone), 2-2

Crossed pair

- wire map display, 3-7

Crossed wires

- wire map display, 3-7

Custom cable configuration, 6-4

—D—

Date, 2-27

Delay skew test, 3-9

Display

- adjusting contrast, 2-23
- size, 8-17

DSP-LINK

- hardware requirements, A-1
- installing, A-2
- summary of functions, A-5

—E—

Email address for Fluke, A-8

—F—

False test results, 8-5

Fault anomaly threshold (twisted pair), 3-9

Fault info key, 3-4

Fiber optic cable testing, 2-4

Frequency, 155 MHz, 2-24

Front panel

- main unit, 2-13
- remote, 2-14

—H—

Headroom, 3-4

Hub port capabilities, 4-23

Hub port locator, 4-20

—I—

Impedance

- anomaly on coaxial cable, 3-22
- anomaly on twisted pair, 3-12
- explanation of characteristic impedance, 7-7
- minimizing impedance discontinuities, 7-8
- test for coaxial cable, 3-21
- test for twisted pair, 3-9
- warning result, 3-9

Impulse noise threshold, 4-20

Inductive pickup device, 4-24

Installing DSP-LINK, A-2

Internal fault detected (error message), 8-5

ISDN lines, 2-2

—K—

Keys

- for moving around screens, 2-3
- functions, 2-13

—L—

Language

- selecting a language, 2-21
- selecting, quick start, 2-4

LED functions, 2-15, 2-29

Length

- test for coaxial cable, 3-22
- test for twisted pair, 3-8
- variations between cable pairs, 3-8
- variations between measured and actual, 7-14

Length units

- selecting, 2-26
- selecting, quick start, 2-4

Link. *See* Basic link

Link performance grade, 3-4

—M—

Maintenance, 8-1

Memory

- capacity and type, 8-16
- full, 3-25
- maintained by lithium battery, 8-3
- space available, 3-25

Monitor

- hub port capabilities, 4-23
- monitoring impulse noise, 4-20
 - changing the noise threshold, 4-20
 - connections, 4-21
 - screen items, 4-23
- monitoring network activity, 4-16
 - connections, 4-17
 - screen items, 4-18

—N—

NEXT

- explanation of NEXT, 7-9
- minimizing NEXT, 7-13

NEXT@Remote test results, 3-14

- plot description, 3-13
- results screen items, 3-12

Noise

- causes of electrical noise, 7-6
- changing the impulse noise threshold, 4-20
- monitoring impulse noise, 4-20

Noise test, 2-22

Numeric format

- selecting, 2-26
- selecting, quick start, 2-4

NVP

- determining cable NVP, 6-3
- explanation of NVP, 7-14

—O—

Open

- wire map display, 3-7

Overvoltage test, 2-22

—P—

PC interface cable, 8-13

Power line filter frequency

- selecting, 2-23
- selecting, quick start, 2-4

Power sum NEXT test, 3-19

Power-down timer, 2-28

Power-off timer, 2-28

Printing

- configuring the serial port, 5-2
- connections for printing, 5-3
- error, 5-5
- options, 5-3
- printer interface cable, 5-2

Problems

- with the test tool, 8-5

Propagation delay test, 3-9

PSNEXT test, 3-19

—Q—

Quick configuration, 2-4

Quick start, 2-3

—R—

Reflection

- causes of reflections, 7-15
- length test result message, 3-22

Remote

- calibrating for a new remote, 6-1
- communication error, 2-31
- compatibility between models, 8-7
- effects on TDR test, 4-9
- lights, messages, and audible tones, 2-29
- messages displayed on remote, 2-30
- smart remote features, 2-14
- standard remote features, 2-14
- when to use a remote unit, 4-2

Remote end test

- how to enable/disable, 2-30
- quick start, 2-4

Replacement parts, 8-6

Reports

- formatting uploaded reports, A-7
- organizing reports on a PC, A-5
- printing reports, 5-1
- samples of Autotest reports, 3-25
- viewing, deleting, and renaming reports, 5-6

Resistance

- test for coaxial cable, 3-22
- test for twisted pair, 3-8

Reversed pairs

- wire map display, 3-7

RJ11 connector, 2-2

RJ45 connector, 2-13

RL

- explanation of RL, 7-20
- plot description, 3-18
- results screen items, 3-17
- test for twisted pair, 3-17

Rotary switch modes, 2-16

—S—

Safety and operational information, 2-2

Saving Autotest results, 3-23

Scanning, 4-2

Self test

- failure, 8-4

- how to run, 2-21

Self-calibration, 6-1

Serial port

- cable for printer interface, 5-2
- configuring a PC serial port, A-3
- configuring for PC communications, A-3
- configuring for printing, 5-2
- connection for printing, 5-3
- error, printing, 5-5
- interface description, 8-12
- problems with PC communications, A-4

Servicing, 8-4

Setup

- configuring the test tool, 2-22
- list of settings, 2-19
- quick setup, 2-4

Shield test, 2-24

Short

- wire map display, 3-7

Single test

- tests for coaxial cable, 4-14
- tests for twisted pair, 4-1

Smart remote. *See* Remote

- mode on rotary switch, 2-20

Softkeys

- description, 2-13
- on Autotest screens, 3-1

Software update, A-10

Special Functions

- list of functions, 2-20

Split pair

- explanation of split pair, 7-12
- wire map display, 3-7

Standard remote. *See* Remote

Storage, 8-2

Strap, 2-16

Switch modes, 2-16

—T—

TDR (Time Domain Reflectometry)

- effects of termination results, 4-9
- example plots, 7-23
- explanation of TDR, 7-15
- interpreting the plot, 7-18

- plot description, 4-11
- results screen items, 4-11
- test for twisted pair and coaxial cable, 4-9
- TDX analyzer
 - example plots, 7-23
 - interpreting the plot, 7-9
 - plot description, 4-8
 - results screen items, 4-7
 - running the analyzer, 4-6
- Terminator
 - connection during length test, 3-22
 - connection during resistance test, 3-22
 - effects on TDR test, 4-9
- Test standard
 - selecting, 2-24
 - selecting, quick start, 2-4
- Test standards updates, A-9
- Time, 2-27
- Tone generator, 4-24
- Troubleshooting
 - finding cable faults, 7-21
 - troubleshooting the test tool, 8-4

—U—

Using this manual, 1-5

—V—

Version

- hardware, 2-20
- software, 2-20
- test standards, 2-20

—W—

Warning messages

- battery voltage messages, 2-31
- characteristic impedance warning, 3-9
- excessive noise detected, 2-22
- excessive voltage detected, 2-22
- printed reports, 3-26
- test result memory is now full, 3-25
- test summary result, 3-9
- the previous test results have not been saved, 3-3
- unable to save test results, 3-25
- warning in test results, 4-12

Web site address for Fluke, A-8

Wire map

- description of test, 3-6
- displays, 3-6
- pin connections for 568 standard, 7-3

Manual Supplement

Manual Title:	DSP-100,DSP-2000 Users	Supplement Issue:	4
Part Number:	642964	Issue Date:	7/00
Print Date:	January 1997	Page Count:	5
Revision/Date:	---		

This supplement contains information necessary to ensure the accuracy of the above manual.

Change #1

On page 6-1, under **Calibrating the Test Tool**, add the following note after the first paragraph:

Note

Allow a 1 minute warm-up time prior to performing self-calibration (see Chapter 6). Self-calibration should be performed only after the test tool and remote unit have warmed up to an ambient temperature between 10°C and 40°C (50°F and 104°F).

On page 8-11, replace the **Return Loss** specification with:

Return Loss (RL)

Return Loss range: 0 to 30 dB

Accuracy: ± 3 dB over the following ranges:

0 to 18 dB from 5 to 10 MHz

0 to 15 dB from 10.1 to 20 MHz

0 to 10 dB from 20.1 to 100 MHz

Change #2

On pages 3-6 and 3-7, replace Table 3-1 with the following:

Table 3-1. Wire Map Displays

Wire Map Condition	Displayed Schematic	Description
<p>Correct wiring (Left side of display represents near-end connector.)</p>		<p>Cable wiring is correct. Shield(s) shown only if required by selected test standard.</p>
<p>Crossed wires</p>		<p>A wire in the 1,2 pair is crossed with a wire in the 3,6 pair.</p>
<p>Reversed pairs</p>		<p>Wires 1 and 2 are crossed.</p>
<p>Transposed pairs</p>		<p>The wire pair connected to pins 1 & 2 at one end is connected to pins 3 & 6 at the other end.</p>

Table 3-1. Wire Map Displays (continued)

<p>Short</p>	 <p style="text-align: right; font-size: small;">gc51i.eps</p>	<p>Wires 1 and 2 are shorted. You can use the TDR test to locate the short.</p>
<p>Open</p>	 <p style="text-align: right; font-size: small;">gc53i.eps</p>	<p>Wire 1 is not connected from end to end or "open". You can use the TDR test to locate the open.</p>
<p>Split pair</p>	 <p style="text-align: right; font-size: small;">gc55i.eps</p>	<p>A wire in the 3,6 pair is twisted with a wire in the 4,5 pair. You can use the TDX analyzer to locate the split pair.</p>

On page 7-23, Table 7-1, replace the entire first column and the bottom two cells of the second column with the following:

 <p style="text-align: right; font-size: small;">gc53i.eps</p> <p>Wire map display showing an open on pair 1, 2.</p>	Empty cell
---	------------

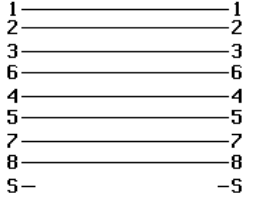
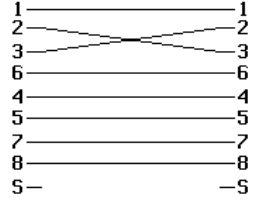
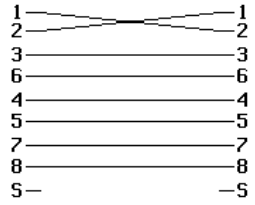
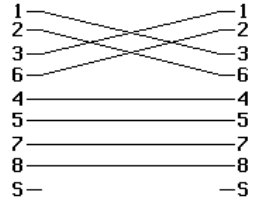
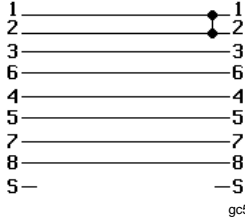
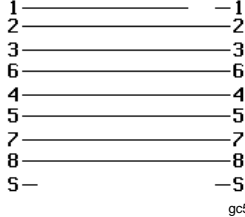
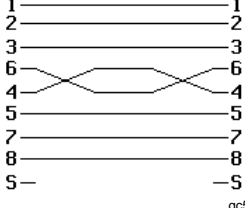
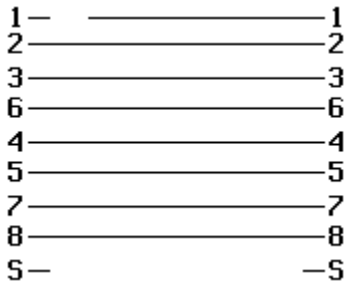
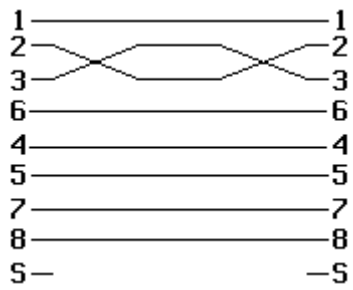
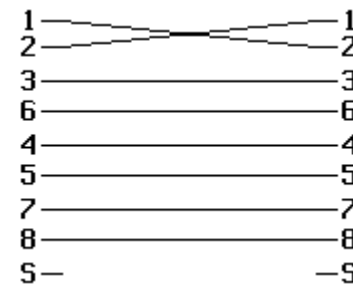
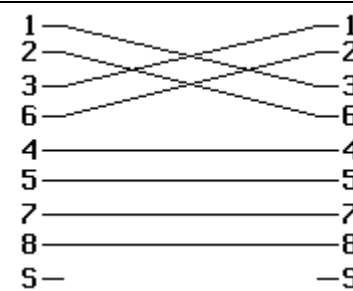
 <p>gc59i.eps</p> <p>Wire map display showing a split pair on pairs 1, 2 and 3, 6.</p>	
 <p>gc47i.eps</p> <p>Wire map display showing reversed pair on pair 1, 2.</p>	<p>Inspect the color code at each connection/termination.</p>
 <p>gc49i.eps</p> <p>Wire map display showing transposed pairs on 1, 2 and 3, 6.</p>	<p>Inspect the color codes of the wires at each connection/termination.</p>

On page 7-25, replace the wire map display at the top of the first column with the following:

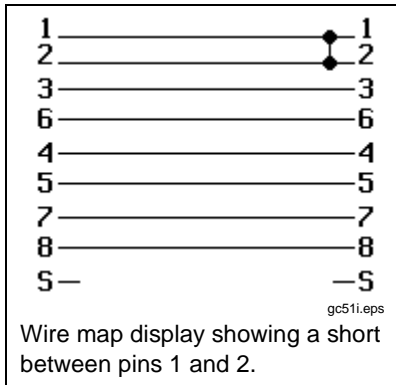

Change #3

On page 6-1, under Calibrating the Test Tool add the following note:

Note

The test tool requires a traceable calibration once a year to make sure that it meets or exceeds the published accuracy specifications. Send it to an authorized Fluke service center for a complete traceable calibration once a year.

On page 8-7, change Service Center Calibration Period,

To: Traceable Calibration Period

Change #4

On page 8-2, under Replacing the NiCad Battery Pack, add the following note:

Note

Do not use a NiMH battery pack in place of the NiCad battey pack. The test tool will not charge properly with a NiMH battery pack.