

# **Agilent 8494/95/96A/B Attenuators**

## **Operating and Service Manual**



**Agilent Technologies**

# Notices

© Agilent Technologies, Inc. 2011

No part of this manual may be reproduced in any form or by any means (including electronic storage and retrieval or translation into a foreign language) without prior agreement and written consent from Agilent Technologies, Inc. as governed by United States and international copyright laws.

## Manual Part Number

08494-90008

## Edition

Third Edition, January 2011

Printed in Malaysia

Agilent Technologies, Inc.

Phase 3 Bayan Lepas Free Industrial Zone  
Bayan Lepas, Penang 11900 Malaysia

## Warranty

**The material contained in this document is provided “as is,” and is subject to being changed, without notice, in future editions. Further, to the maximum extent permitted by applicable law, Agilent disclaims all warranties, either express or implied, with regard to this manual and any information contained herein, including but not limited to the implied warranties of merchantability and fitness for a particular purpose. Agilent shall not be liable for errors or for incidental or consequential damages in connection with the furnishing, use, or performance of this document or of any information contained herein. Should Agilent and the user have a separate written agreement with warranty terms covering the material in this document that conflict with these terms, the warranty terms in the separate agreement shall control.**

## Technology Licenses

The hardware and/or software described in this document are furnished under a license and may be used or copied only in accordance with the terms of such license.

## Restricted Rights Legend

U.S. Government Restricted Rights. Software and technical data rights granted to the federal government include only those rights customarily provided to end user customers. Agilent provides this customary commercial license in Software and technical data pursuant to FAR 12.211 (Technical Data) and 12.212 (Computer Software) and, for the Department of Defense, DFARS 252.227-7015 (Technical Data - Commercial Items) and DFARS 227.7202-3 (Rights in Commercial Computer Software or Computer Software Documentation).

## Safety Notices

### CAUTION

A **CAUTION** notice denotes a hazard. It calls attention to an operating procedure, practice, or the likes of that, if not correctly performed or adhered to, could result in damage to the product or loss of important data. Do not proceed beyond a **CAUTION** notice until the indicated conditions are fully understood and met.

---

### WARNING

A **WARNING** notice denotes a hazard. It calls attention to an operating procedure, practice, or the likes of that, if not correctly performed or adhered to, could result in personal injury or death. Do not proceed beyond a **WARNING** notice until the indicated conditions are fully understood and met.

---

## Certification

Agilent Technologies certifies that this product met its published specifications at the time of shipment from the factory. Agilent Technologies further certifies that its calibration measurements are traceable to the United States National Institute of Standards and Technology (NIST, formerly NBS), to the extent allowed by the Institute's calibration facility, and to the calibration facilities of the other International Standards Organization members.

## WEEE Compliance





This product complies with the WEEE Directive (2002/96/EC) marking requirements. The affixed label indicates that you must not discard this electrical/electronic product in domestic household waste.

Product Category: With reference to the equipment types in the WEEE Directive Annex I, this product is classed as a "Monitoring and Control Instrumentation" product.

Do not dispose in domestic household waste.

To return unwanted products, contact your local Agilent office, or see [www.agilent.com](http://www.agilent.com) for more information.

## Regulatory Markings

	The CE mark is a registered trademark of the European Community. If it is accompanied by a year, it indicates the year the design was proven.
	The CSA mark is a registered trademark of the Canadian Standards Association.
<b>ICES/NMB-001</b>	This text indicates that this ISM device complies with Canadian ICES-001. Cet appareil ISM est conforme a la norme NMB-001 du Canada.
<b>ISM 1-A</b>	This text indicates that the instrument is an Industrial Scientific and Medical Group 1 Class A product (CISPER 11, Clause 4).
	This symbol indicates the time period during which no hazardous or toxic substance elements are expected to leak or deteriorate during normal use. Forty years is the expected useful life of the product.

## Contacting Agilent

For more information, please contact your nearest Agilent office.

### Americas

Canada	(877) 894-4414
Latin America	305 269 7500
United States	(800) 829-4444

### Asia Pacific

Australia	1 800 629 485
China	800 810 0189
Hong Kong	800 938 693
India	1 800 112 929
Japan	81 426 56 7832
Korea	080 769 0800
Malaysia	1 800 888 848
Singapore	1 800 375 8100
Taiwan	0800 047 866
Thailand	1 800 226 008

### Europe

Austria	0820 87 44 11
Belgium	32 (0) 2 404 93 40
Denmark	45 70 13 15 15
Finland	358 (0) 10 855 2100
France	0825 010 700
Germany	01805 24 6333
Ireland	1890 924 204
Italy	39 02 92 60 8484
Netherlands	31 (0) 20 547 2111
Spain	34 (91) 631 3300
Sweden	0200-88 22 55
Switzerland(French)	41 (21) 8113811 (Opt 2)
Switzerland(German)	0800 80 53 53 (Opt 1)
United Kingdom	44 (0) 118 9276201
Other European Countries:	<a href="http://www.agilent.com/find/contactus">www.agilent.com/find/contactus</a>

Or, go to [www.agilent.com/find/assist](http://www.agilent.com/find/assist) for more information.

**This page is intentionally left blank.**

# Contents

<b>1</b>	<b>Introduction</b>	<b>9</b>
	Product Overview	10
	Instrument Options	11
	Specifications	12
	Frequency Range and Attenuation	12
	Attenuation Accuracy	12
	Maximum SWR	13
	Maximum Residual Attenuation	13
	Attenuation Repeatability	13
	RF Power Handling Capability	14
	Operating Life	14
<b>2</b>	<b>Environmental Specifications &amp; Physical Dimensions</b>	<b>15</b>
	Environmental Specifications	16
	Physical Dimensions	17
<b>3</b>	<b>Operating Guides</b>	<b>19</b>
	Installation	20
	Initial Inspection	20
	Mating Connectors	21
	Installation Instructions	21
	Operating Instructions	22
	Operator's Check	23
	Performance Tests	25
	Service Instructions	25

**This page is intentionally left blank.**



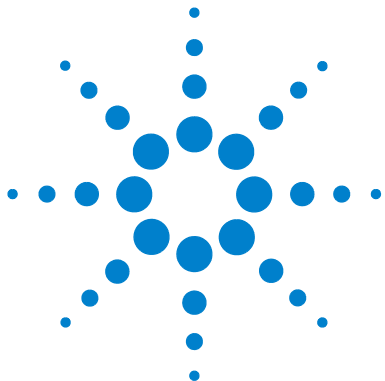

# 1 Introduction

Product Overview	10
Instrument Options	11
Specifications	12
Frequency Range and Attenuation	12
Attenuation Accuracy	12
Maximum SWR	13
Maximum Residual Attenuation	13
Attenuation Repeatability	13
RF Power Handling Capability	14
Operating Life	14

This manual contains operating instructions for the Agilent 8494/95/96A/B Attenuators. Included in the manual is information required to install and test these attenuators.



## Product Overview

Agilent 8494A/B, 8495A/B, and 8496A/B are 50-ohm coaxial step attenuators.

For the 8494A/B, the attenuation can be varied in 1 dB steps, or 10 dB steps for the 8495A/B and 8496A/B. The attenuation shown on the control knob is the additional attenuation added in the signal path over the insertion loss of the attenuator in the 0 dB position.

- Agilent 8494A/B instruments are four-section attenuators with a range of 0 dB to 11 dB in 1 dB steps.
- The 8495A/B is a three-section attenuator with a range of 0 dB to 70 dB in 10 dB steps.
- The 8496A/B is a four-section attenuator with a range of 0 dB to 110 dB in 10 dB steps.

The attenuator sections are connected in cascade. Each section consists of a precision, thin-film attenuator card, a lossless thru-line and a ganged pair of edge line transmission lines. The edge lines are flexed to make contact with either the attenuator card or the thru-line. The edge line contacts are gold-plated leaf springs which ensure long life and high repeatability. Low-torque cams flex the edge lines. [Table 8](#), “Attenuator Switching Order,” on page 22 shows the switching arrangements.

### CAUTION

Do not exceed the RF power rating of 1 W average or 100 W peak with a maximum pulse width of 10  $\mu$ s. Do not connect an attenuator RF input or output connector to greater than  $\pm 7$  Vdc. If the attenuator must be connected to a device with a potential greater than  $\pm 7$  Vdc, use a blocking capacitor.

---

## Instrument Options

Each instrument is specified with an option number which denotes the configuration of the input and output connectors.

**Table 1** Instrument Options

<b>Option</b>	<b>Connector Description</b>
001	Both connectors type-N female
002	Both connectors SMA female
003 <sup>[1]</sup>	Both connectors APC-7

[1] Option 003 is not available with the 8494A, 8495A, and 8496A.

# Specifications

## Frequency Range and Attenuation

**Table 2** Frequency Range and Attenuation

Product	8494A	8494B	8495A	8495B	8496A	8496B
Frequency Range	dc to 4 GHz	dc to 18 GHz	dc to 4 GHz	dc to 18 GHz	dc to 4 GHz	dc to 18 GHz
Attenuation	0 dB to 11 dB	0 dB to 11 dB	0 dB to 70 dB	0 dB to 70 dB	0 dB to 110 dB	0 dB to 110 dB
Steps	1 dB	1 dB	10 dB	10 dB	10 dB	10 dB

## Attenuation Accuracy

(±dB): (Referenced from 0 dB)

**Table 3** Attenuation Accuracy

8494A/B		8495A/B 8496A/B		8494A			8494B			8495A			8495B			8496A			8496B		
Attenuation Selection (dB)		dc-4 GHz		dc-12.4 GHz		12.4-18 GHz		dc-4 GHz		dc-12.4 GHz		12.4-18 GHz		dc-4 GHz		dc-12.4 GHz		12.4-18 GHz			
1	10	0.2	0.3	0.7	0.2	0.5	0.6	0.2	0.5	0.6	0.2	0.5	0.6	0.2	0.5	0.6	0.2	0.5	0.6		
2	20	0.2	0.3	0.7	0.4	0.7	0.8	0.4	0.7	0.8	0.4	0.7	0.8	0.4	0.7	0.8	0.4	0.7	0.8		
3	30	0.3	0.4	0.7	0.5	0.9	1.2	0.5	0.9	1.2	0.5	0.9	1.2	0.5	0.9	1.2	0.5	0.9	1.2		
4	40	0.3	0.4	0.7	0.7	1.2	1.6	0.7	1.2	1.6	0.7	1.2	1.6	0.7	1.2	1.6	0.7	1.2	1.6		
5	50	0.3	0.5	0.7	0.8	1.5	2.0	0.8	1.5	2.0	0.8	1.5	2.0	0.8	1.5	2.0	0.8	1.5	2.0		
6	60	0.3	0.5	0.8	1.0	1.8	2.4	1.0	1.8	2.4	1.0	1.8	2.4	1.0	1.8	2.4	1.0	1.8	2.4		
7	70	0.4	0.6	0.8	1.2	2.1	2.8	1.2	2.1	2.8	1.2	2.1	2.8	1.2	2.1	2.8	1.2	2.1	2.8		
8	80	0.4	0.6	0.8	–	–	–	–	1.3	2.4	3.2	1.3	2.4	3.2	1.3	2.4	3.2	1.3	2.4	3.2	
9	90	0.4	0.6	0.8	–	–	–	–	1.5	2.7	3.6	1.5	2.7	3.6	1.5	2.7	3.6	1.5	2.7	3.6	
10	100	0.4	0.6	0.9	–	–	–	–	1.6	3.0	4.0	1.6	3.0	4.0	1.6	3.0	4.0	1.6	3.0	4.0	
11	110	0.5	0.7	0.9	–	–	–	–	1.8	3.3	4.4	1.8	3.3	4.4	1.8	3.3	4.4	1.8	3.3	4.4	

## Maximum SWR

**Table 4** Maximum SWR

Instrument	Frequency Range (GHz)	Maximum SWR
8495A	dc to 4	1.35
8495B	dc to 8	1.35
	8 to 12.4	1.5
	12.4 to 18	1.7
8494A, 8496A	dc to 4	1.5
8494B, 8496B	dc to 8	1.5
	8 to 12.4	1.6
	12.4 to 18	1.9

## Maximum Residual Attenuation

**Table 5** Maximum Residual Attenuation

Instrument	Maximum Residual Attenuation
8494A, 8494B	0.6 dB + 0.09 dB/GHz
8495A, 8495B	0.4 dB + 0.07 dB/GHz
8496A, 8496B	0.6 dB + 0.09 dB/GHz

## Attenuation Repeatability

±0.03 dB max (5 million cycles per section).

## **RF Power Handling Capability**

1 W average, 100 W peak with maximum pulse width of 10 microseconds (all models).

## **Operating Life**

5 million cycles per section.

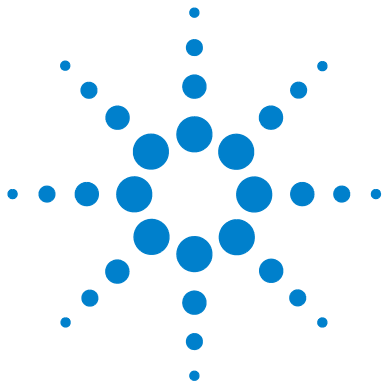

## 2 Environmental Specifications & Physical Dimensions

Environmental Specifications 16

Physical Dimensions 17

This chapter contains the environmental tests on the Agilent 8494/95/96A/B Attenuators that fully comply with Agilent Technologies' product operating environmental specifications. The physical dimensions are illustrated in the later section.



## Environmental Specifications

The Agilent 8494/95/96A/B Attenuators are designed to fully comply with Agilent Technologies' product operating environmental specifications as shown in [Table 6](#).

**Table 6** Environmental Specifications

Temperature:	
• Operating	0 °C to +55 °C
• Storage	-40 °C to +75 °C
Humidity:	
• Operating	<95% relative
• Storage	<95% relative
Altitude:	
• Operating	<4600 m (15000 ft)
• Storage	<7600 m (25000 ft)
Shock:	
• Operating	10 Gs, six ms, on six sides, three blows
• Non-operating	500 Gs, 1.8 ms, in six directions
Vibration:	
• Operating	5 Gs, 34 Hz to 2000 Hz
EMC	Radiated interference is within the requirements of MIL-STD-461, RE02



## Physical Dimensions

Table 7 shows the physical dimensions of the Agilent 8494/95/96A/B Attenuators.

**Table 7** Physical Dimensions

Instrument	Dimensions <sup>[1]</sup>	Weight <sup>[2]</sup>
8494A/B	Per <a href="#">Figure 1</a>	15 oz 425 g
8495A/B	Per <a href="#">Figure 1</a>	11 oz 312 g
8496A/B	Per <a href="#">Figure 1</a>	15 oz 425 g

[1] Dimensions are for general information only. If dimensions are required for building special enclosures, contact your Agilent field engineer.

[2] Weight and width of the instrument varies with the option selected due to the type of connectors.

## 2 Environmental Specifications & Physical Dimensions

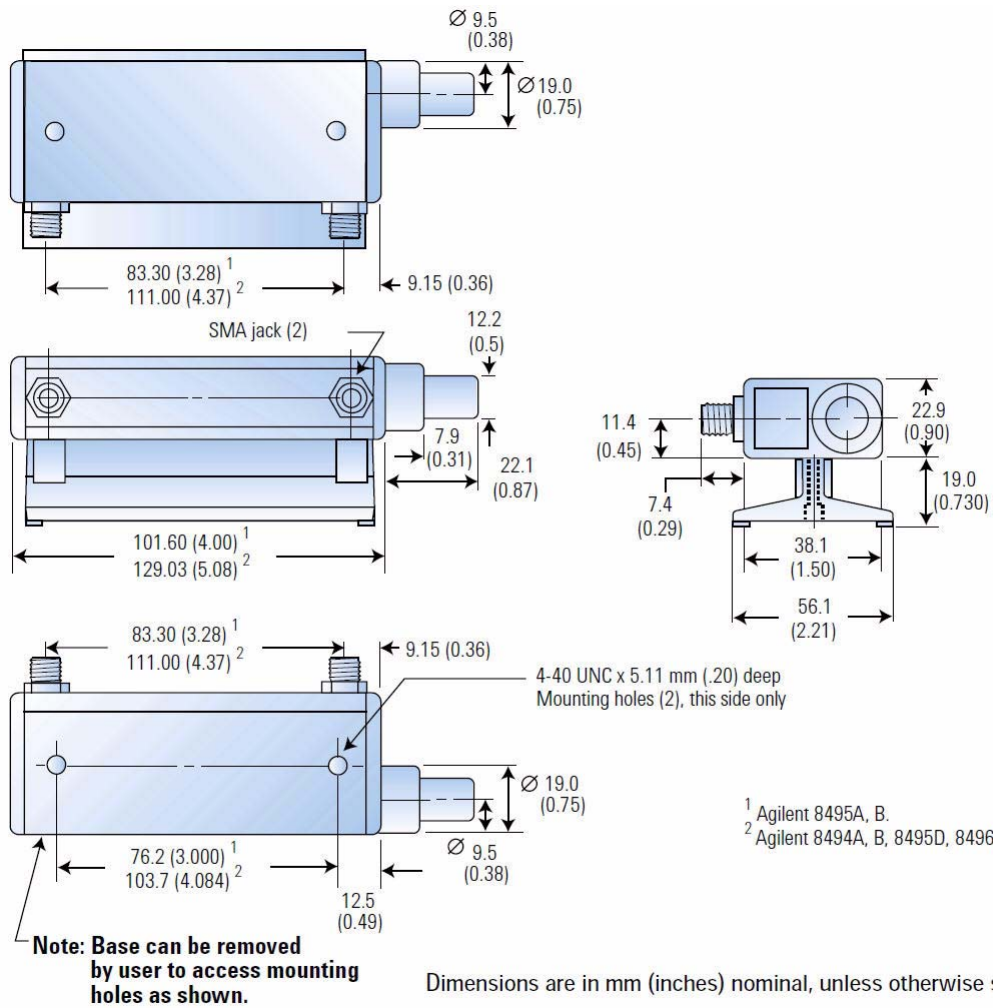

**Figure 1** Dimensions of Agilent 8494/95/96A/B Attenuators

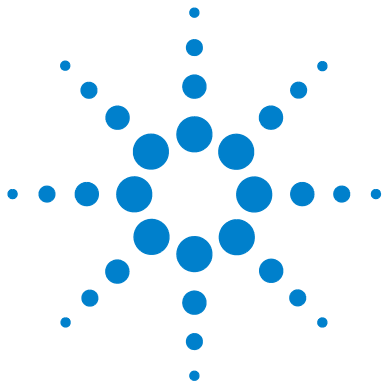

## 3 Operating Guides

Installation	20
Initial Inspection	20
Mating Connectors	21
Installation Instructions	21
Operating Instructions	22
Operator's Check	23
Performance Tests	25
Service Instructions	25

This chapter describes the installation of the Agilent 8494/95/96A/B Attenuators. The operating instruction quick-check procedure is included for verification test prior to usage. Service instructions on the repair and maintenance of the Agilent 8494/95/96A/B Attenuators are also included in this chapter.



# Installation

## Initial Inspection

- 1 Inspect the shipping container for damage. If the shipping container or cushioning material is damaged, it should be kept until the contents of the shipment have been checked for completeness and the instrument has been checked both mechanically and electrically.
  - Check for mechanical damage such as scratches or dents.
  - Procedures for checking electrical performance are given under “Operator’s Check” on page 23 or “Performance Tests” on page 25.
- 2 If the contents are incomplete, if there is mechanical damage or defect, or if the instrument does not pass the electrical performance test, contact the nearest Agilent Technologies Sales and Service office. Refer to the Service and Support information in the front matter of this manual. Agilent Technologies will arrange for repair or replacement of the damaged or defective equipment. Keep the shipping materials for the carrier's inspection.
- 3 If you are returning the instrument under warranty or for service, repackaging the instrument requires original shipping containers and materials or their equivalents. Agilent Technologies can provide packaging materials identical to the original materials. Refer to Service and Support information in the front matter of this manual for the Agilent Technologies nearest to you. Attach a tag indicating the type of service required, return address, model number and serial number. Mark the container **FRAGILE** to insure careful handling. In any correspondence, refer to the instrument by model number and serial number.

## Mating Connectors

Mating RF connectors used with the Option 001 must be type-N male connectors, which comply with U.S. military standard MIL-C-39012. For Option 002, male SMA connectors must be used. For Option 003, APC-7 mating connectors must be used.

### CAUTION

When installing the instrument, make sure that the connectors do not support weight or bear torque. The preferred procedure is to set up all equipment in position before connecting the instrument. Either connector may be used as the input or output connector.

---

## Installation Instructions

The attenuators may be installed with or without the base. The base is removed by unscrewing the two fillister head screws from the bottom of the base. The attenuator may be mounted without the base by inserting two 4-40 screws into the screw holes in the bottom of the attenuator. Removing the base and mounting the attenuator does not affect the performance of the attenuator.

## Operating Instructions

**CAUTION**

Do not apply RF power greater than 1 W average, or 100 W peak with a maximum pulse width of 10 microseconds. If these limits are exceeded, the attenuators may be damaged.

After the instrument is connected, the attenuation may be selected. Turn counterclockwise to increase attenuation or clockwise to decrease attenuation. Either connector may be used as the input or output. [Table 8](#) lists the attenuator switching order.

**Table 8** Attenuator Switching Order

8494A/B Attenuator Sections					8495A/B Attenuator Sections				8496A/B Attenuator Sections				
Atten (dB)	1 1 dB	2 2 dB	3 4 dB	4 4 dB	Atten (dB)	1 10 dB	2 20 dB	3 40 dB	Atten (dB)	1 10 dB	2 20 dB	3 40 dB	4 40 dB
0					0				0				
1	×				10	×			10	×			
2		×			20		×		20		×		
3	×	×			30	×	×		30	×	×		
4				×	40			×	40				×
5	×		×		50	×		×	50	×		×	
6		×	×		60		×	×	60		×	×	
7	×	×	×		70	×	×	×	70	×	×	×	
8			×	×					80			×	×
9	×		×	×					90	×		×	×
10		×	×	×					100		×	×	×
11	×	×	×	×					110	×	×	×	×

**CAUTION**

Do not attempt to force the switch between 0 and the highest value position as there is a stop between these switch positions.

## Operator's Check

The operator's check allows the operator to make a quick check of the instrument prior to use or if a failure is suspected.

### Description

The attenuator is driven from a 50-ohm signal source at 1 kHz. The output level from the attenuator is detected by a narrow-bandwidth voltmeter. The attenuator and detector range switches are stepped together and the variations in level noted. This verifies that each attenuator section is being properly switched and checks the low-frequency accuracy of the attenuator.

**NOTE**

The SWR meter used in this check is calibrated for a square-law detector. Therefore, the range changes and errors (read in dB) are twice that indicated by the meter.

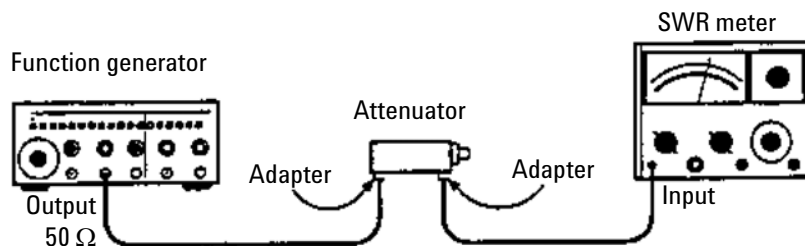

**Figure 2** Operator's Check Setup

**Procedure**

- 1 Connect equipment as shown in [Figure 2](#) on [page 23](#) with the attenuator set to 0 dB attenuation.
- 2 Set the test oscillator to 0.3 Vrms at 1 kHz.
- 3 Set SWR meter range to 2 dB (expanded) [or for the 8494A/B to 10 dB (expanded)] and adjust its bandwidth to the center of the adjustment range. Fine-tune the oscillator frequency to obtain maximum meter indication.
- 4 Set attenuator and SWR meter range switch as listed in [Table 9](#) and verify that the SWR meter indicates within the limits shown.

**Table 9** Attenuator and SWR Settings

SWR Meter Range (dB)		Attenuation (dB)			Meter Indication (dB)					
					Minimum		Actual		Maximum	
8494A/B	8495A/B 8496A/B	8494A/B	8495A/B	8496A/B	8494A/B	8495A/B 8496A/B	8494A/B	8495A/B 8496A/B	8494A/B	8495A/B 8496A/B
10	2	0	0	0	–	–	Set to 0.0	Set to 0.5	–	–
10	6	1	10	10	0.40	1.40	–	–	0.60	1.60
10	12	2	20	20	0.90	0.30	–	–	1.10	0.70
10	16	3	30	30	1.35	1.25	–	–	1.65	1.75
10 <sup>[1]</sup>	22	4	40	40	1.85	0.15	–	–	2.15	0.85
12	26	5	50	50	0.35	1.10	–	–	0.65	1.90
12	32	6	60	60	0.85	0.00	–	–	1.15	1.00
12	36 <sup>[1]</sup>	7	70	70	1.30	0.90	–	–	1.70	2.10
12 <sup>[1]</sup>	42 <sup>[1]</sup>	8	–	80	1.80	–0.15	–	–	2.20	1.15
14	46 <sup>[1]</sup>	9	–	90	0.30	0.75	–	–	0.70	2.25
14	52 <sup>[1]</sup>	10	–	100	0.80	–0.30	–	–	1.20	1.30
14	56 <sup>[1]</sup>	11	–	110	1.75	0.60	–	–	1.75	2.40

[1] Adjust range by 2 dB, if needed, to obtain an on-scale indication.



## Performance Tests

The Agilent 8494/95/96A/B Attenuators can be tested to the accuracy of the specifications with a network analyzer or equivalent equipment of suitable accuracy. If a network analyzer is available, test instrument using the procedure in the analyzer's operating manual.

## Service Instructions

### Adjustment

The Agilent 8494/95/96A/B Attenuators do not have internal adjustments and should not be opened.

### Repair

The Agilent 8494/95/96A/B Attenuators are not recommended for repair as most components are not easily removed.

### Maintenance

The connectors, particularly the connector faces, must be kept clean. For instruction on connecting and care of your connectors, refer to Microwave Connector Care Quick Reference Card (08510-90360).

**This page is intentionally left blank.**