ADVANTEST®

ADVANTEST CORPORATION

R3267 Series

Spectrum Analyzer

Operation Manual (Vol.1)

MANUAL NUMBER FOE-8335033H00

Applicable models

R3264

R3267

R3273

Safety Summary

To ensure thorough understanding of all functions and to ensure efficient use of this instrument, please read the manual carefully before using. Note that Advantest bears absolutely no responsibility for the result of operations caused due to incorrect or inappropriate use of this instrument.

If the equipment is used in a manner not specified by Advantest, the protection provided by the equipment may be impaired.

- **Warning Labels**

Warning labels are applied to Advantest products in locations where specific dangers exist. Pay careful attention to these labels during handling. Do not remove or tear these labels. If you have any questions regarding warning labels, please ask your nearest Advantest dealer. Our address and phone number are listed at the end of this manual.

Symbols of those warning labels are shown below together with their meaning.

DANGER: Indicates an imminently hazardous situation which will result in death or serious personal injury.

WARNING: Indicates a potentially hazardous situation which will result in death or serious personal injury.

CAUTION: Indicates a potentially hazardous situation which will result in personal injury or a damage to property including the product.

- **Basic Precautions**

Please observe the following precautions to prevent fire, burn, electric shock, and personal injury.

- Use a power cable rated for the voltage in question. Be sure however to use a power cable conforming to safety standards of your nation when using a product overseas.
- When inserting the plug into the electrical outlet, first turn the power switch OFF and then insert the plug as far as it will go.
- When removing the plug from the electrical outlet, first turn the power switch OFF and then pull it out by gripping the plug. Do not pull on the power cable itself. Make sure your hands are dry at this time.
- Before turning on the power, be sure to check that the supply voltage matches the voltage requirements of the instrument.
- Be sure to plug the power cable into an electrical outlet which has a safety ground terminal. Grounding will be defeated if you use an extension cord which does not include a safety ground terminal.
- Be sure to use fuses rated for the voltage in question.
- Do not use this instrument with the case open.
- Do not place objects on top of this product. Also, do not place flower pots or other containers containing liquid such as chemicals near this product.

Safety Summary

- When the product has ventilation outlets, do not stick or drop metal or easily flammable objects into the ventilation outlets.
- When using the product on a cart, fix it with belts to avoid its drop.
- When connecting the product to peripheral equipment, turn the power off.

- **Caution Symbols Used Within this Manual**

Symbols indicating items requiring caution which are used in this manual are shown below together with their meaning.

DANGER: Indicates an item where there is a danger of serious personal injury (death or serious injury).

WARNING: Indicates an item relating to personal safety or health.

CAUTION: Indicates an item relating to possible damage to the product or instrument or relating to a restriction on operation.

- **Safety Marks on the Product**

The following safety marks can be found on Advantest products.



: ATTENTION - Refer to manual.



: Protective ground (earth) terminal.



: DANGER - High voltage.



: CAUTION - Risk of electric shock.

- **Replacing Parts with Limited Life**

The following parts used in the instrument are main parts with limited life.

Replace the parts listed below before their expected lifespan has expired to maintain the performance and function of the instrument.

Note that the estimated lifespan for the parts listed below may be shortened by factors such as the environment where the instrument is stored or used, and how often the instrument is used.

The parts inside are not user-replaceable. For a part replacement, please contact the Advantest sales office for servicing.

There is a possibility that each product uses different parts with limited life. For more information, refer to Chapter 1.

Main Parts with Limited Life

Part name	Life
Unit power supply	5 years
Fan motor	5 years
Electrolytic capacitor	5 years
LCD display	6 years
LCD backlight	2.5 years
Floppy disk drive	5 years
Memory backup battery	5 years

• **Hard Disk Mounted Products**

The operational warnings are listed below.

- Do not move, shock and vibrate the product while the power is turned on. Reading or writing data in the hard disk unit is performed with the memory disk turning at a high speed. It is a very delicate process.
- Store and operate the products under the following environmental conditions.
 - An area with no sudden temperature changes.
 - An area away from shock or vibrations.
 - An area free from moisture, dirt, or dust.
 - An area away from magnets or an instrument which generates a magnetic field.
- Make back-ups of important data.
 - The data stored in the disk may become damaged if the product is mishandled. The hard disc has a limited life span which depends on the operational conditions. Note that there is no guarantee for any loss of data.

• **Precautions when Disposing of this Instrument**

When disposing of harmful substances, be sure dispose of them properly with abiding by the state-provided law.

Harmful substances: (1) PCB (polycarbon biphenyl)
 (2) Mercury
 (3) Ni-Cd (nickel cadmium)
 (4) Other
 Items possessing cyan, organic phosphorous and hexadic chromium and items which may leak cadmium or arsenic (excluding lead in solder).

Example: fluorescent tubes, batteries

Environmental Conditions

This instrument should be only be used in an area which satisfies the following conditions:

- An area free from corrosive gas
- An area away from direct sunlight
- A dust-free area
- An area free from vibrations

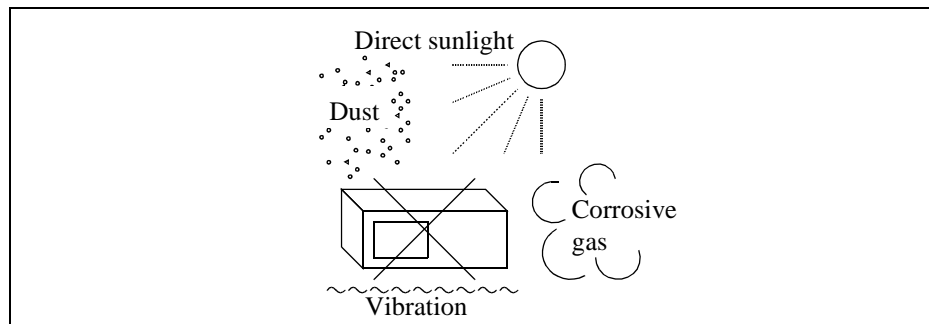

Figure-1 Environmental Conditions

- Operating position

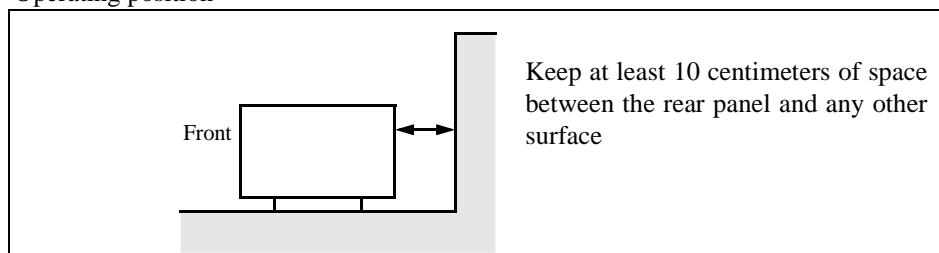

Figure-2 Operating Position

- Storage position

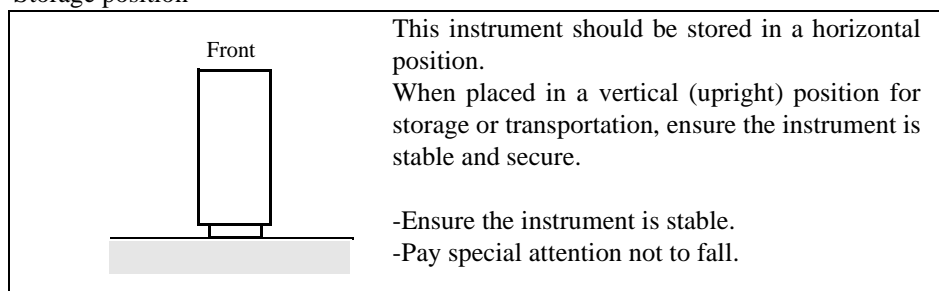

Figure-3 Storage Position

This instrument can be used safely under the following conditions:

- Altitude of up to 2000 m
- Installation Categories II
- Pollution Degree 2

Other Information for the R3267 Series

Flip Down Stand

The metal flip down stand beneath the front panel can be used to provide a better viewing angle. Use the instrument with the flip down stand opened all the way.

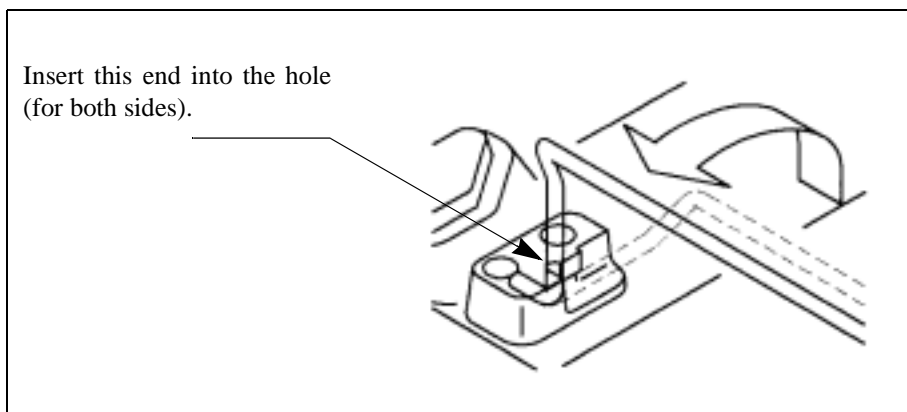

Be sure to support the analyzer firmly with one hand when opening or closing the stand.

Note the following when using the flip down stand:

Use the analyzer on flat surfaces so that the weight of the analyzer is evenly distributed.

- Do not put any objects on the analyzer.
- Do not lean on the analyzer.
- Do not place anything under the analyzer.
- Do not slide the analyzer.
- Do not use excessive force when pressing keys.
- Do not use the analyzer on a slippery place.
- Do not use the wire flip down stand as a carry handle.
- Never drag the instrument or push it from behind when the flip down stand is opened because the stand may close shut and jar the instrument..

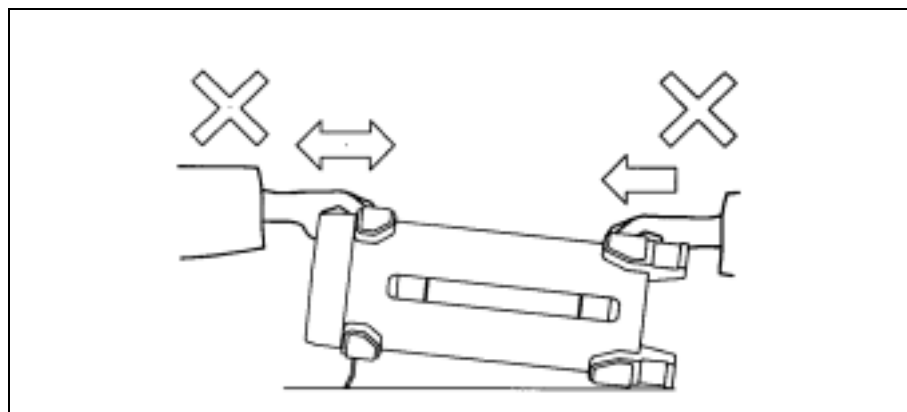

Make sure the flip down stand is folded shut when:

- The spectrum analyzer is not in use.
- Connecting or disconnecting cables
- Using the analyzer on a cart

CAUTION:

1. *Make sure that the flip down stand is in the normal position when the instrument is used with the flip down stand swung open.*
 2. *Make sure that the instrument is used according to the instructions presented in this section and be careful not to catch your fingers when opening or closing the stand.*
-

Memory Cards

There is a possibility that writing, reading or formatting memory cards, which comply with the JEIDA standard, may fail when used with this instrument. In particular, a memory card with no attribute memory or the one whose attribute memory is not defined cannot be used with the instrument, even if it is normally used with personal computers.

The following are the restrictions on the memory cards that can be used with the instrument.

(1) Memory Cards Compliant with the Instrument

SRAM Cards

- The ones that have a memory space of 64 KB or more and are compliant with JEIDA 4.0 (PCMCIA 2.0) or later
- The ones with or without the attribute memory
- For the ones without attribute memory or with an empty attribute memory, the following must be met:
 1. Writing, reading, and physically and logically formatting the media are possible.
 2. Sectors are arranged from the head of common memory in a single partition without ECC (Error Check Code).
- For the ones with Level 1 device information as attribute information, the following must be met:
 1. Writing, reading, and physically and logically formatting the media are possible.
 2. Sectors are arranged from the head of common memory in a single partition without ECC.
- For the ones with Level 2 device information as attribute information, the following must be met:
 1. Physically formatting the media is not possible.
 2. Reading or writing the media is possible depending on whether it has ECC or not.
Without ECC: Reading, writing and logically formatting the media are possible.
With ECC: Reading the media only is possible.
- For the ones with plural partitions, the partitions written in the first format information can be

used (the partitions, however, must be according to the basic DOS partitions).

Disk Cards compliant with the PCard-ATA standard

- I/O cards compliant with JEIDA4.2 (PCMCIA2.1) or later under the PCMCIA-ATA standard
- For flash disk cards and hard disk cards, the following must be met:
 1. Logically and physically formatting the media is not possible.
 2. For the ones with plural partitions, the partitions written in the first format information can be used (the partitions, however, must be according to the basic DOS partitions).

EPROM cards and plane flash memory cards

- Reading only is possible when data is written in the same format as SRAM cards.

(2) Cards that cannot be used with the instrument

DRAM cards

I/O cards

Certificate of Conformity

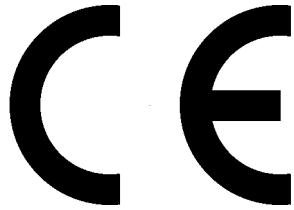

This is to certify, that

Spectrum Analyzer

R3264 / R3267 / R3273 Series

instrument, type, designation

complies with the provisions of the EMC Directive 89/336/EEC in accordance with EN61326 and Low Voltage Directive 73/23/EEC in accordance with EN61010.

ADVANTEST Corp.

Tokyo, Japan

ROHDE&SCHWARZ

Engineering and Sales GmbH
Munich, Germany

PREFACE

This manual(Vol.1) provides the information necessary to check functionality, operate and program the R3267 Series.

The procedure for conducting the performance test is described in a separate volume (Vol.2).

(1) Organization of this manual

This manual consists of the following chapters:

Safety Summary	To use the analyzer safely, be sure to read this manual first.
1. Introduction <ul style="list-style-type: none"> • Product Description • Standard Accessories and Power Cable Options • Operating Environment • Operation Check • Cleaning, Storing and Transporting 	Includes a description of the analyzer and its' parts along with information on its' operating environment and how to perform a system checkout.
2. Operation <ul style="list-style-type: none"> • Controls and Connectors on the Front and Rear Panels • Screen Annotation • Basic Operation • Measurement Examples 	Describes the names, functions and annotations of each part on the panels. You can learn the basic operations of the analyzer through the examples shown in this chapter.
3. Reference <ul style="list-style-type: none"> • Menu Index • Menu Map • Functional Description 	Shows a list of operation keys, and describes the function of each key.
4. Principle of measurement <ul style="list-style-type: none"> • Input saturation • ACP measurements (internal processing and setting the Root Nyquist filter for both the Full screen and Separate screen modes) • Operation of the gated sweep 	Describes the principle of operation necessary for taking measurements more accurately.
5. Remote Control <ul style="list-style-type: none"> • GPIB • RS-232 	Gives an outline of the GPIB and RS-232 interfaces, and how to connect and set them up. Also included are a list of commands necessary for programming and using the program examples.
6. Specifications	Shows the specifications of the analyzer.
APPENDIX A.1 Before Contacting ADVANTEST with a problem	Refer to this section when you have any problems.

APPENDIX A.2 Error Messages	If an error occurs during operation, an error number and its corresponding error message are displayed. The meaning of each error is explained in this section.
APPENDIX A.3 Glossary	Terminology related to the spectrum analyzer is explained in this section.
APPENDIX A.4 dB Conversion Formulas	

(2) Typeface conventions used in this manual

- Panel keys and soft keys are printed in a contrasting typeface to make them stand out from the text as follows:

Panel keys: Boldface type

Example: **FREQ, FORMAT**

Soft keys: Boldface and italic type

Example: ***Center, Trace Detector***

- When a series of key operations are described using a comma between two keys.
- There are various soft menus used to switch between two states such as ON/OFF and AUTO/MNL. For example, when turning off the ***Display ON/OFF*** function, the annotation "***Display ON/OFF(OFF)***" is used. When switching the ***RBW AUTO/MNL*** function to MNL, the annotation "***RBW AUTO/MNL(MNL)***" is used.

(3) Trademarks

- Epson is a registered trademark of EPSON Corp.
- Hewlett Packard is a registered trademarks of Hewlett-Packard Company.

TABLE OF CONTENTS

1	INTRODUCTION	1-1
1.1	Product Description	1-1
1.2	Accessories	1-2
1.3	Operating Environment	1-4
1.3.1	Environmental Conditions	1-4
1.3.2	Power Supply Specifications	1-5
1.3.3	Power Fuse	1-5
1.3.4	Power Cable	1-7
1.4	Precautions in Use	1-8
1.5	System Checkout	1-10
1.6	Cleaning, Storing and Transporting the R3267 Series	1-13
1.6.1	Cleaning	1-13
1.6.2	Storing	1-14
1.6.3	Transporting	1-14
1.7	About Calibration	1-15
1.8	Concerning Limited-life Parts	1-15
2	OPERATION	2-1
2.1	Panel Description	2-1
2.1.1	Front Panel	2-1
2.1.1.1	Display Section	2-2
2.1.1.2	Power Switch/Connector Section	2-3
2.1.1.3	Floppy Disk Drive Section	2-4
2.1.1.4	MEASUREMENT Section	2-4
2.1.1.5	MARKER Section	2-5
2.1.1.6	Save/Recall Section	2-5
2.1.1.7	DISPLAY CONTROL Section	2-6
2.1.1.8	ENTRY Section	2-7
2.1.1.9	REMOTE Section	2-8
2.1.1.10	Control Section	2-9
2.1.1.11	Option Section	2-9
2.1.2	Screen Annotation	2-10
2.1.3	Rear Panel	2-12
2.2	Basic Operation	2-14
2.2.1	Operating Menus and Entering Data	2-14
2.2.2	Displaying Spectrums and Operating the Markers	2-18
2.2.3	Measuring Frequency Using Counter	2-23
2.2.4	Display Line and Measuring Window	2-26
2.2.5	Entering Level Correction Data	2-29
2.2.6	Separating Two Signals	2-33
2.2.7	Dynamic Range	2-36

Table of Contents

2.2.8	UNCAL Message	2-39
2.2.9	Zooming the Frequency Domain	2-41
2.2.10	Zooming the Time Domain	2-44
2.2.11	Measurement Using the F/T Function	2-49
2.2.12	Measuring Dual Parameters	2-53
2.2.12.1	Measuring Dual Parameters in the Frequency Domain	2-53
2.2.12.2	Measuring Dual Parameters in the Time Domain	2-57
2.2.13	Calibration	2-61
2.2.13.1	Cal All	2-62
2.2.13.2	Total Gain	2-63
2.2.13.3	Cal Each Item	2-64
2.2.14	Pass/Fail Judgments Using the Limit line Function	2-65
2.3	Measurement Examples	2-71
2.3.1	Measuring Average Power of Digital Modulation Signal	2-71
2.3.2	Measuring CDMA Wave's Total Power	2-75
2.3.3	Measuring the Power Density of Wide Band Digital Modulation Signal	2-78
2.3.4	Measuring CDMA Channel Power	2-81
2.3.5	Measuring the Occupied Bandwidth (OBW)	2-84
2.3.6	Measuring Adjacent Channel Leakage Power (ACP)	2-87
2.3.6.1	Full Screen Mode	2-87
2.3.6.2	SEPARATE Display	2-93
2.3.7	Measuring Burst Signals Using the Gated Sweep	2-97
2.3.8	Measuring Burst signals in the Time Domain	2-101
2.3.9	Harmonic Distortion Measurements	2-105
2.3.9.1	Using the Normal and Delta Markers	2-105
2.3.9.2	Using the Peak List	2-108
2.3.9.3	Using the Fixed Marker Function	2-111
2.3.10	Third Order Intermodulation Distortion	2-114
2.3.11	AM Modulation Frequency and Modulation Factor of AM Signals	2-117
2.3.12	Measuring Frequency deviation of FM Signals	2-120
2.3.13	Measuring Modulation Index of FM Signals	2-123
2.3.14	Carrier Frequency and Power Measurements Using Pulsed RF Signals	2-125
2.4	Expanded Functions	2-130
2.4.1	Saving/Recalling Measurement Conditions	2-130
2.4.1.1	Saving/Recalling Basic Measurement Conditions	2-130
2.4.1.2	Saving/Recalling OBW Measurement Conditions	2-137
2.4.1.3	Saving/Recalling ACP Measurement Conditions	2-137
2.4.2	Saving Screen Data	2-138
2.4.3	Obtaining a Hard Copy of screen data	2-140
2.4.4	Formatting Media	2-142
2.4.4.1	Formatting a Floppy Disk	2-142
2.4.4.2	Formatting the Memory Card (Option)	2-143
2.4.5	Setting Date and Time	2-146
2.4.6	Setting the Screen Label	2-147

3	REFERENCE	3-1
3.1	Menu Index	3-1
3.2	Menu Map	3-7
3.3	Functional Description	3-20
3.3.1	A Key (Trace A)	3-20
3.3.2	ATT Key (Attenuator)	3-24
3.3.3	B Key (Trace B)	3-25
3.3.4	CAL Key (Calibration)	3-28
3.3.5	CONFIG Key (Configuration)	3-30
3.3.6	COPY Key (Copy)	3-36
3.3.7	COUPLE Key (Couple Function)	3-37
3.3.8	FORMAT Key (Display format)	3-40
3.3.9	FREQ Key (Frequency)	3-45
3.3.10	LCL Key (GPIB Remote Control)	3-48
3.3.11	LEVEL Key (Level)	3-49
3.3.12	MEAS Key (Measurement)	3-51
3.3.13	MKR Key (Marker)	3-53
3.3.14	MKR → Key (Marker →)	3-56
3.3.15	OFF Key (Marker off)	3-57
3.3.16	POWER Key (Power Measurement)	3-58
3.3.17	PRESET Key (Initialization)	3-63
3.3.18	RCL Key (Data Readout)	3-64
3.3.19	REPEAT Key (Continuous Sweep)	3-65
3.3.20	SAVE Key (Saving Data)	3-66
3.3.21	SINGLE Key (Single Sweep)	3-70
3.3.22	SPAN Key (Frequency Span)	3-71
3.3.23	SRCH Key (Peak Search)	3-72
3.3.24	SWP Key (Sweep Time)	3-75
3.3.25	UTIL Key (Utility)	3-78
3.3.26	WINDOW Key	3-84
3.4	List of Settings	3-86
3.4.1	Set Resolution	3-86
3.4.2	Set Values for RBW, VBW and Sweep-Time	3-86
3.4.3	Factory Defaults	3-87
3.4.4	Defaults Configuration Values	3-87
3.4.5	Parameters Range	3-90
4	PRINCIPLE OF MEASUREMENT	4-1
4.1	Input Saturation	4-1
4.2	Measuring Adjacent Channel Leakage Power (ACP)	4-3
4.2.1	Differences between Full Screen and Separate Screen Operation Processes	4-3
4.2.2	Root Nyquist Filter	4-6
4.2.3	Noise Correction Function	4-7

Table of Contents

4.3	Operation of the Gated Sweep	4-8
4.4	Eye Opening Calculation	4-10
4.4.1	Calculation Using No Measurement Window	4-10
4.4.2	Calculation using the Measurement Window	4-11
4.5	Phase Jitter Measurement	4-12
4.5.1	Additional Functions	4-12
5	REMOTE PROGRAMMING	5-1
5.1	GPIB Command Index	5-1
5.2	GPIB Remote Programming	5-7
5.2.1	GPIB	5-7
5.2.2	GPIB Setup	5-8
5.2.3	GPIB Interface Functions	5-9
5.2.4	Responses to Interface Messages	5-10
5.2.5	Message Exchange Protocol	5-11
5.2.6	Command Syntax	5-12
5.2.7	Data Formats	5-13
5.2.8	Status Bytes	5-14
5.2.9	GPIB Command Codes	5-21
5.2.10	Example Programs	5-45
5.2.10.1	Sample Programs for Setting or Reading Measurement Conditions	5-45
5.2.10.2	Sample Programs for Reading Data	5-47
5.2.10.3	Sample Programs for Inputting or Outputting Trace Data	5-52
5.2.10.4	Program Examples Using the Status Byte	5-56
5.3	RS-232 Remote Control Function	5-59
5.3.1	GPIB and RS-232 Compatibility	5-59
5.3.2	Features of RS-232 Remote Control	5-59
5.3.3	Parameter Setup Window	5-59
5.3.4	Interface connection	5-60
5.3.5	Data Format	5-61
5.3.6	Differences Between RS-232 and GPIB	5-62
5.3.7	Panel Control	5-62
5.3.8	Remote Control Usage Examples	5-63
6	SPECIFICATIONS	6-1
6.1	R3264 Specifications	6-1
6.2	R3267 Specifications	6-7
6.3	R3273 Specifications	6-14
6.4	Specifications for the Memory Card (Option)	6-21
	APPENDIX	A-1
A.1	Before Contacting with a Problem	A-1
A.2	Error Message	A-3

A.3	Glossary	A-9
A.4	dB Conversion Formulas	A-16
	DIMENSIONAL OUTLINE DRAWING	EXT-1
	ALPHABETICAL INDEX	I-1

LIST OF ILLUSTRATIONS

No.	Title	Page
1-1	Operating Environment	1-4
1-2	Replacing the Power Fuse	1-6
1-3	Power Cable	1-7
1-4	Human body	1-9
1-5	Floor in the work area	1-9
1-6	Benchboard	1-9
1-7	Connecting the Power Supply Cable	1-10
1-8	Start-up Screen	1-11
1-9	Config Menu	1-11
1-10	Selftest Menu	1-12
1-11	Selftest Result	1-12
1-12	Removing the Display Filter	1-13
2-1	Front Panel	2-1
2-2	Display Section	2-2
2-3	Power Switch/Connector Section	2-3
2-4	Floppy Disk Drive Section	2-4
2-5	MEASUREMENT Section	2-4
2-6	MARKER Section	2-5
2-7	Save/Recall Section	2-5
2-8	DISPLAY CONTROL Section	2-6
2-9	ENTRY Section	2-7
2-10	REMOTE Section	2-8
2-11	Control Section	2-9
2-12	Option Section	2-9
2-13	Screen Annotation	2-10
2-14	Display Area Names	2-11
2-15	Rear Panel	2-12
2-16	Span Menu	2-14
2-17	Soft Menu Configuration (CONFIG Key)	2-16
2-18	Factory Defaults	2-19
2-19	Calibration Output	2-19
2-20	Frequency Menu	2-20
2-21	Setting the Center Frequency	2-20
2-22	Setting Measurement Conditions	2-21
2-23	Peak Search	2-21
2-24	Frequency Difference Between the Peak Point and a Point 3 dB Levels Down	2-22
2-25	Frequency Difference Between the Peak Point and a Point 60 dB Levels Down	2-22
2-26	Setting Measurement Conditions	2-24
2-27	Frequency Counter Measurement	2-24
2-28	Frequency Counter Measurement (Resolution: 10 Hz)	2-25
2-29	The Display Line	2-27
2-30	Measuring the Values Relative to the Display Line	2-27
2-31	The Measuring Window	2-28
2-32	Setting Measurement Conditions	2-30
2-33	Displaying the Correction Table	2-30

List of Illustrations

No.	Title	Page
2-34	Entering Frequency Data	2-31
2-35	Showing a Trace Whose Level Is Corrected	2-31
2-36	Corrected Compensation Data	2-32
2-37	Setup for Measuring Two Signals Separately	2-33
2-38	Two Superimposed Peaks	2-34
2-39	Two Discernible Peaks	2-34
2-40	Two Distinct Peaks Can Now Be Seen	2-35
2-41	Setup for Verifying the Dynamic Range	2-36
2-42	Trace Prior to Changing the RBW	2-37
2-43	Trace After Changing the RBW	2-37
2-44	Trace After Changing the VBW	2-38
2-45	The Trace after Averaging	2-38
2-46	Measuring AM Signal in Separate Screen Mode	2-39
2-47	Screen with UNCAL Message	2-40
2-48	UNCAL Message Removed	2-40
2-49	Measuring AM Signal in Separate Screen Mode	2-41
2-50	Displaying the Trace in Full Screen Mode	2-42
2-51	Displaying the Trace in Separate Screen Mode	2-42
2-52	Displaying the Magnified Lower Screen	2-43
2-53	Measuring Burst Signal in Separate Screen Mode	2-44
2-54	Trace of a Burst Signal	2-45
2-55	Burst Signal in the Zero Span	2-46
2-56	Displaying the Trace in the Separate Screen Mode	2-46
2-57	Observing the Leading Edge in the Separate Screen Mode	2-47
2-58	Observing the Trailing Edge in Separate Screen Mode	2-47
2-59	Setup to Measure Pulse Signal Using 2 Screens	2-49
2-60	Trace of a Burst Signal	2-50
2-61	F/T Function Displayed in Separate Screen Mode	2-51
2-62	F/T Mode in Zoom Display	2-51
2-63	Setup to Measure Dual Parameters	2-53
2-64	Displaying in Separate Screen Mode	2-54
2-65	Setting for the Upper Screen in Separate Screen Mode	2-55
2-66	Setting for the Lower Screen in Separate Screen Mode	2-55
2-67	Magnified Trace for the Lower Screen	2-56
2-68	Setup to Measure Pulse Signals with Different Frequencies Using 2 Screens	2-57
2-69	Upper Screen in Sync with the Trigger Signal	2-58
2-70	Displaying the Traces of 900 MHz and 1800 MHz in the Separate Screen Mode	2-59
2-71	Displaying the Trace of 1800 MHz for the Lower Screen	2-60
2-72	Cal Menu	2-62
2-73	Editing the Limit Line 1	2-66
2-74	Screen Displayed after Limit Line 1 Data Has Been Entered	2-67
2-75	Screen Displayed after Limit Line 2 Data Has Been Entered	2-67
2-76	Setting Limit Line PASS/FAIL	2-68
2-77	PASS/FAIL Result using Limit Line 1	2-68
2-78	PASS/FAIL Result using Limit Lines 1 and 2	2-69
2-79	Judgment Result after the Offset Has Been Changed	2-70
2-80	Setup for the Average Power Measurement	2-71
2-81	Checking the Input Signal	2-73

No.	Title	Page
2-82	Setting Measurement Conditions for Average Power Measurement	2-73
2-83	Result of an Average Power Measurement	2-74
2-84	Moving the Measurement Result	2-74
2-85	Setup for Measuring the Total Power	2-75
2-86	Setting Conditions for the Total Power Measurement	2-77
2-87	Result of Total Power Measurement	2-77
2-88	Setup for Measuring the Total Power	2-78
2-89	Displaying the Measuring Window	2-80
2-90	Power Density Measurement	2-80
2-91	Setup for Measuring the Channel Power	2-81
2-92	Result of Channel Power Measurement	2-83
2-93	Setup for Measuring the Occupied Bandwidth	2-84
2-94	OBW Measurement Results	2-86
2-95	Setup Measuring Adjacent Channel Leakage Power	2-88
2-96	PDC trace	2-89
2-97	CS/BS Setup dialog box	2-90
2-98	Root Nyquist Filter dialog box	2-91
2-99	ACP Measurement Display in Full Screen Mode	2-91
2-100	Measurement Using ACP GRAPH	2-92
2-101	ACP at the 100 kHz	2-92
2-102	Setup Measuring Adjacent Channel Leakage Power	2-93
2-103	PHS Trace	2-94
2-104	CS/BS Setup dialog box	2-95
2-105	Measurement Result in ACP Separate Screen Mode	2-96
2-106	Setup for Measuring a Burst Signal	2-97
2-107	Burst Signal Displayed in Split Screen Mode	2-98
2-108	Trigger Setup	2-98
2-109	Burst Signal by Use of the Gated Sweep (Separate Screen Mode)	2-99
2-110	Burst Signal by Use of the Gated Sweep (Full Screen Mode)	2-100
2-111	Setup for Measuring a Burst wave signal	2-101
2-112	Burst signal in the frequency domain	2-102
2-113	Burst Signal in the Time Domain	2-102
2-114	Burst Signal in Synchronization with the Trigger Signal	2-103
2-115	Measuring Burst Signal Leading Edge	2-104
2-116	Measuring Burst Signal Trailing Edge	2-104
2-117	Setup for Measuring the Harmonic Distortion	2-105
2-118	Trace of Harmonics	2-106
2-119	Secondary Harmonics	2-107
2-120	Tertiary Harmonics	2-107
2-121	Setup for Measuring the Harmonic Distortion	2-108
2-122	Trace of Harmonics	2-109
2-123	Peak List Display	2-110
2-124	Setup for Measuring the Harmonic Distortion	2-111
2-125	Trace of Harmonics	2-112
2-126	Secondary Harmonics	2-113
2-127	Tertiary Harmonics	2-113
2-128	Setup for Measuring the Third Order Intermodulation Distortion	2-114
2-129	Third Order Intermodulation Distortion	2-115

List of Illustrations

No.	Title	Page
2-130	Third Order Intermodulation Distortion (Peak Δ Ref)	2-116
2-131	Measurement Result of the Third Order Intermodulation Distortion	2-116
2-132	Setup for Measuring AM Signal	2-117
2-133	AM Signal with Low Modulation Factor	2-118
2-134	Relationship between DLevel (dB) and Modulation Factor m(%)	2-119
2-135	Setup for Measuring FM Signal	2-120
2-136	Trace of an FM Signal	2-121
2-137	Measuring a frequency deviation	2-121
2-138	Modulation Frequency of the FM Signal	2-122
2-139	Setup for Measuring Modulation Index	2-123
2-140	FM Signal with Low Modulation Index	2-124
2-141	Setup for Measuring Pulsed RF Signal	2-125
2-142	Spectrum of a Pulsed Signal	2-127
2-143	Measuring Peak Power	2-127
2-144	Measuring the pulse repetition frequency	2-129
2-145	Selecting Destination Device	2-131
2-146	Save Item Setup dialog box	2-131
2-147	File Saved	2-132
2-148	File Protection Enabled	2-133
2-149	Selected File	2-135
2-150	Read Data	2-135
2-151	File to Be Deleted	2-136
2-152	File Already Deleted	2-136
2-153	Specifying	2-138
2-154	File Dialog Box	2-139
2-155	Printer dialog box	2-141
2-156	Floppy Disk Write Protection	2-142
2-157	Media Menu	2-143
2-158	Slots in the Memory Card Drive	2-144
2-159	Date/Time Dialog Box	2-146
2-160	Dialog Box Used to Enter Labels	2-147
2-161	Displaying the Screen Label	2-148
4-1	Input Section Block Diagram	4-1
4-2	Relationship between the Input and Output of the Mixer	4-1
4-3	Full Screen Mode	4-3
4-4	Separate Screen Mode	4-4
4-5	Characteristics of the Root Nyquist Filter	4-6
4-6	Internal Block Diagram	4-8
4-7	Generating the Internal Gate Signal	4-9
4-8	Eye Opening Ratio Calculation (Using No Measurement Window)	4-10
4-9	Eye Opening Calculation (Using the Measurement Window)	4-11
4-10	RMS Phase Jitter Measurement Method	4-12
5-1	Arrangement of the Three Status Registers	5-15
5-2	Details of the Three Status Registers	5-16
5-3	Structure of the Status Byte Register	5-18
5-4	Relationship between Screen Graticule and Trace Data	5-52

No.	Title	Page
5-5	Parameter Setup	5-59
5-6	Connection Between the Controller and the analyzer	5-60
5-7	Cable Wiring Diagram	5-61
5-8	Data Format	5-61
A-1	Bandwidth Selectivity	A-9
A-2	Bandwidth Switching Uncertainty	A-10
A-3	IF Gain Uncertainty	A-10
A-4	Noise Sidebands	A-11
A-5	Occupied Bandwidth	A-12
A-6	Resolution Bandwidth	A-13
A-7	Spurious Response	A-14
A-8	V.S.W.R	A-14

LIST OF TABLES

No.	Title	Page
1-1	Standard Accessories List	1-2
1-2	Power Cable Options	1-3
1-3	Power Supply Specifications	1-5
2-1	Correction	2-29
2-2	Calibration Items	2-61
2-3	Setting Limit Line 1	2-66
2-4	Setting Limit Line 2	2-66
2-5	Recommended Printers	2-140
3-1	Center Frequency Set Resolution vs. Frequency Span	3-86
3-2	Values for RBW, VBW and Sweep-Time (using AUTO)	3-86
3-3	Factory Defaults	3-87
3-4	Default Settings (1 of 3)	3-87
3-5	Parameters Range	3-90
5-1	A Key/B Key (Trace A/Trace B) (1 of 3)	5-21
5-2	ATT Key (Attenuator)	5-23
5-3	CAL Key (Calibration)	5-24
5-4	CONFIG Key (Configuration)	5-25
5-5	COUPLE Key (Couple Function)	5-26
5-6	FORMAT Key (Display Format) (1 of 2)	5-27
5-7	FREQ Key (Frequency)	5-29
5-8	LEVEL Key	5-30
5-9	MEAS Key	5-31
5-10	MKR key (1 of 2)	5-32
5-11	MKR → Key (Maker →)	5-34
5-12	POWER Key (Power measurement) (1 of 2)	5-34
5-13	PRESET Key (Initialization)	5-36
5-14	RCL Key (Reading Data)	5-36
5-15	SAVE Key (Saving Data)	5-36
5-16	SPAN Key (Frequency Span)	5-36
5-17	SRCH Key (Peak Search)	5-37
5-18	SWP/SINGLE Key (Sweep Time)	5-38
5-19	UTIL Key (Utility) (1 of 3)	5-39
5-20	WINDOW Key (Window)	5-42
5-21	Numeric keys/Step keys/Data knob/Unit keys (Entering data)	5-43
5-22	Miscellaneous	5-44
5-23	Trace Accuracy Specification Codes	5-52
5-24	I/O formatI	5-53

1 INTRODUCTION

This chapter includes the accessories along with information on the analyzers' operating environment, and information on how to perform a system checkout for users who operate the analyzer for the first time.

1.1 Product Description

The R3267 Series spectrum analyzers are high-performance and multi-featured analyzers (with basic functions) that respond to customer demands for the Future Public Land Mobile Telecommunication System and have a high ratio of C/N (carrier to noise).

The key features of the analyzer are listed below:

- Wide frequency ranges:

R3264	9 kHz to 3.5 GHz
R3267	100 Hz to 8 GHz
R3273	100 Hz to 26.5 GHz
- Excellent signal purity: -110 dBc/Hz 10 kHz offset
- Low noise level:

R3264	-146 dBm/Hz or less (at 2 GHz)
R3267/73	-148 dBm/Hz or less (at 2 GHz)
- High-speed zero span sweep: 1 μ sec
- Precision level measurements
- High-speed measurements with 20 traces/sec
- Various types of interface that permit an easy systematization: GPIB, parallel and RS232 interfaces
- A 3.5-inch floppy disk drive equipped as standard (Compatible with MS-DOS)

1.2 Accessories

Table 1-1 lists the standard accessories shipped with the analyzer. If any of the accessories are damaged or missing, contact a sales representative. Order new accessories by type name.

Table 1-1 Standard Accessories List

Name of accessory	Type name	Quantity	Remarks
Power cable	A01413	1	*1
Input cable	A01036-0150	1	
N-BNC through connector	JUG-201A/U	1	
Power fuse	T6.3A/250V	1	
Front cover		1	*2
R3267 Series Operation manual	ER3267/73	1	English

* 1: Depends on the type specified when purchasing the R3267 Series (see Table 1-2).

*2: The front cover does not come with the analyzer when OPT 85 (JIS Rack Mount Set) or OPT 86 (EIA Rack Mount Set) is specified in a purchase order.

Table 1-2 Power Cable Options

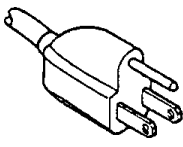
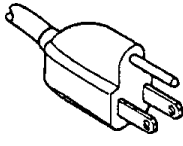
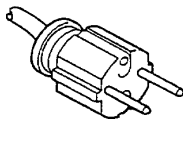
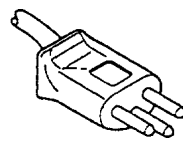
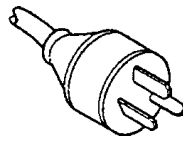
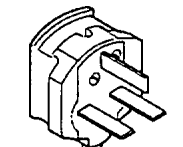
Plug configuration	Standards	Rating, color and length	Model number (Option number)
	JIS: Japan Law on Electrical Appliances	125 V at 7 A Black 2 m (6 ft)	Straight: A01402 Angled: A01412
	UL: United States of America CSA: Canada	125 V at 7 A Black 2 m (6 ft)	Straight: A01403 (Option 95) Angled: A01413
	CEE: Europe DEMKO: Denmark NEMKO: Norway VDE: Germany KEMA: The Netherlands CEBEC: Belgium OVE: Austria FIMKO: Finland SEMKO: Sweden	250 V at 6 A Gray 2 m (6 ft)	Straight: A01404 (Option 96) Angled: A01414
	SEV: Switzerland	250 V at 6 A Gray 2 m (6 ft)	Straight: A01405 (Option 97) Angled: A01415
	SAA: Australia, New Zealand	250 V at 6 A Gray 2 m (6 ft)	Straight: A01406 (Option 98) Angled: -----
	BS: United Kingdom	250 V at 6 A Black 2 m (6 ft)	Straight: A01407 (Option 99) Angled: A01417

1.3 Operating Environment

1.3 Operating Environment

This section describes the environmental conditions and power requirements necessary to use the R3267 Series.

1.3.1 Environmental Conditions

The R3267 Series should be only be used in an area which satisfies the following conditions:

- Ambient temperature: 0°C to +50°C (operating temperature)
- Relative humidity: 85% or less (without condensation)
- An area free from corrosive gas
- An area away from direct sunlight
- A dust-free area
- An area free from vibrations
- A low noise area

Although the R3267 Series has been designed to withstand a certain amount of noise riding on the AC power line, it should be used in an area of low noise. Use a noise cut filter when ambient noise is unavoidable.

- An area allowing unobstructed air flow

There is an exhaust cooling fan on the rear panel and exhaust vents on both sides and the bottom (toward the front) of the R3267 Series. Never block the fan and these vents.

Keep the rear panel 10 centimeters away from the wall. In addition, do not use the R3267 Series upright turned the rear panel side down. The resulting internal temperature rise will affect measurement accuracy.

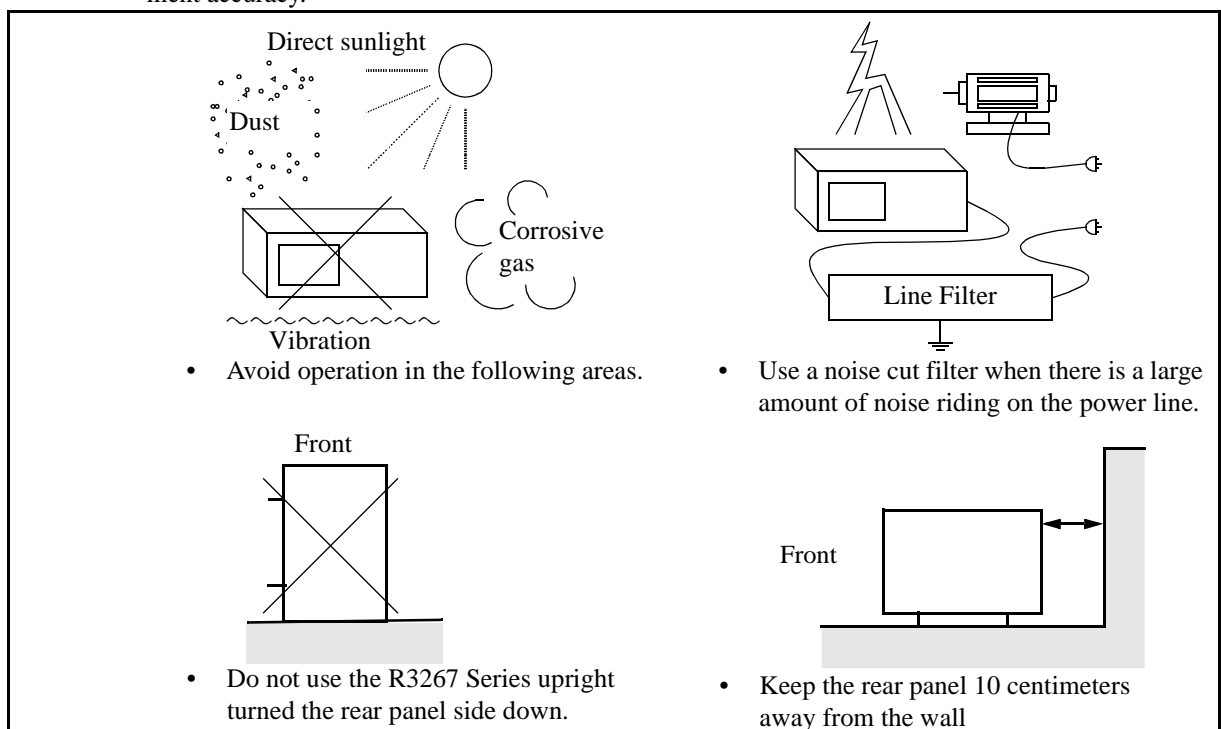

Figure 1-1 Operating Environment

The R3267 Series can be used safely under the following conditions:

- Altitude of up to 2000 m
- Installation Categories II
- Pollution Degree 2

1.3.2 Power Supply Specifications

The power supply specifications of the R3267 Series are listed in Table 1-3.

Table 1-3 Power Supply Specifications

	100 VAC Operation	220 VAC Operation	Remarks
Input voltage range	90 V to 132 V	198 V to 250 V	Automatically switches between input levels of 100 VAC and 220 VAC.
Frequency range	48Hz to 66Hz		
Power consumption	300 VA or below		

CAUTION *To prevent damage, operate the R3267 Series within the specified input voltage and frequency ranges.*

1.3.3 Power Fuse

CAUTION:

1. *When a fuse blows, there may be some problem with the R3267 Series. Contact a sales representative before replacing the fuse.*
 2. *For fire prevention, use only fuses with the same rating and same type.*
-

The power fuse is placed in the fuse holder which is mounted on the rear panel. A spare fuse is located in the fuse holder.

To check or replace the power fuse, use the following procedure:

1. Press the **POWER** switch (on the front panel) to the OFF position.
2. Press the **MAIN POWER** switch (on the rear panel) to the OFF position.
3. Disconnect the power cable from the AC power outlet.
4. Remove the fuse holder on the rear panel (See Figure 1-2).
5. Check (and replace if necessary) the power fuse and put it back in the fuse holder.

1.3.3 Power Fuse

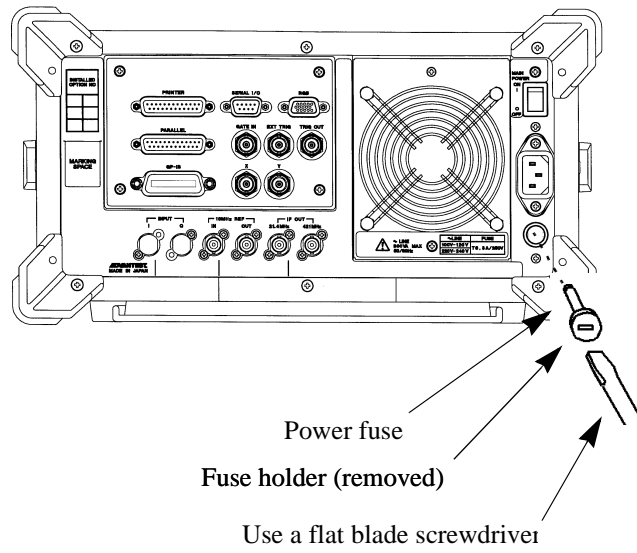

Figure 1-2 Replacing the Power Fuse

1.3.4 Power Cable

CAUTION:

1. *Use a power cable rated for the voltage in question. Be sure however to use a power cable conforming to safety standards of your nation when using a product overseas (See Table 1-2).*
 2. *Be sure to plug the power cable into an electrical outlet which has a safety ground terminal. Grounding will be defeated if you use an extension cord which dose not include a safety ground terminal.*
 3. *Turn the MAIN POWER switch (on the rear panel) and the POWER switch (on the front panel) off prior to connecting the power cable.*
-

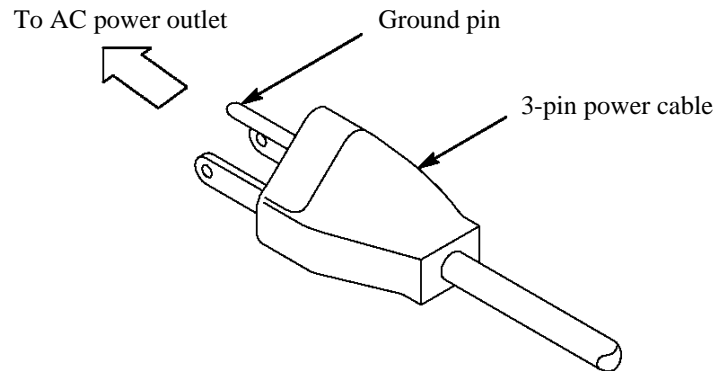

Figure 1-3 Power Cable

1.4 Precautions in Use

- (1) Before starting the measurement

When turning on the power, don't connect DUT.

Before starting the measurement, check to see the output power level.

- (2) Removing of case

Do not open the case to one except service man of our company.

The R3267 Series has a high temperature part and a high pressure part.

- (3) When abnormality occurs

When smoke rises from the R3267 Series, smell nastily, or rear unusual sound feel, turn off the power switch. Pull out power cable from the outlet. And contact to our company.

The address and the telephone number of our company are in the end of this manual.

- (4) Electromagnetic interference.

Electromagnetic interference may be caused to the television or the radio.

If the R3267 Series power is turned off and the electromagnetic interference is reduced, then the R3267 Series has caused the problem.

Prevent electromagnetic interference by the following procedure.

- Change the direction of antenna of the television or the radio.
- Place the R3267 Series the other side of the television or the radio.
- Place the R3267 Series away from the television or the radio.
- Use another line of power source for the television or the radio than the R3267 Series.

- (5) Prevention of Electrostatic Buildup

To prevent damages to semiconductor parts from electrostatic discharge (ESD), the precautions shown below should be taken. We recommend that two or more measures be combined to provide adequate protection from ESD. (Static electricity can easily be built up when a person moves or an insulator is rubbed.)

Countermeasure example

Human body: Use of a wrist strap (see Figure 1-4).

Floor in the work area: Installation of a conductive mat, the use of conductive shoes, and grounding (see Figure 1-5).

Benchboard: Installation of a conductive mat and grounding (see Figure 1-6).

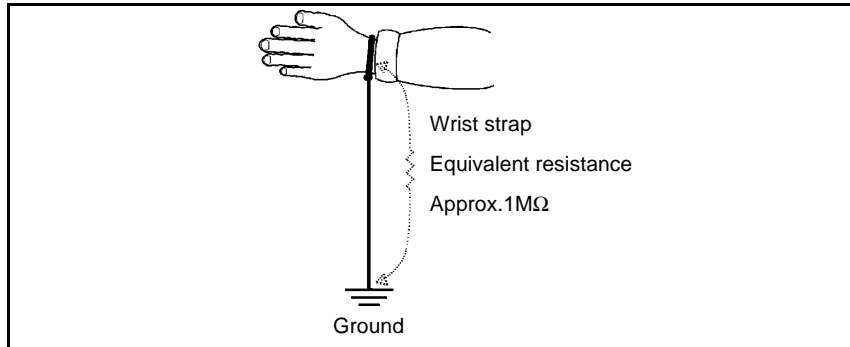

Figure 1-4 Human body

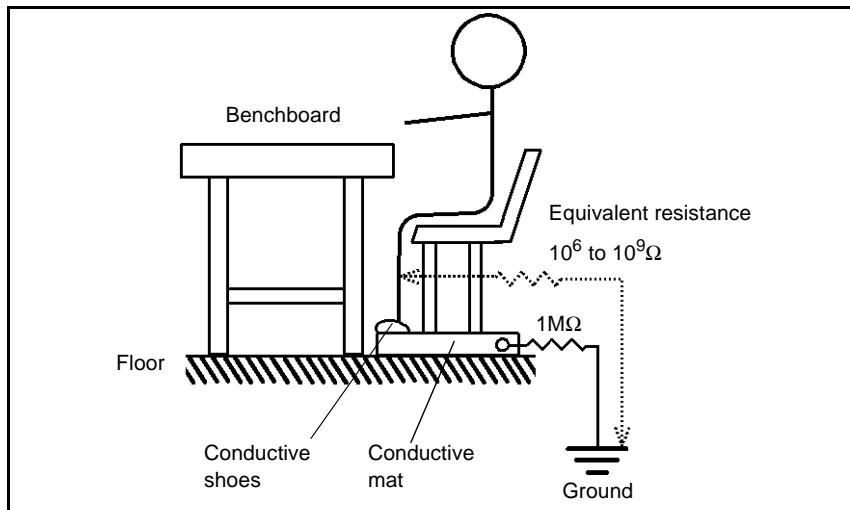

Figure 1-5 Floor in the work area

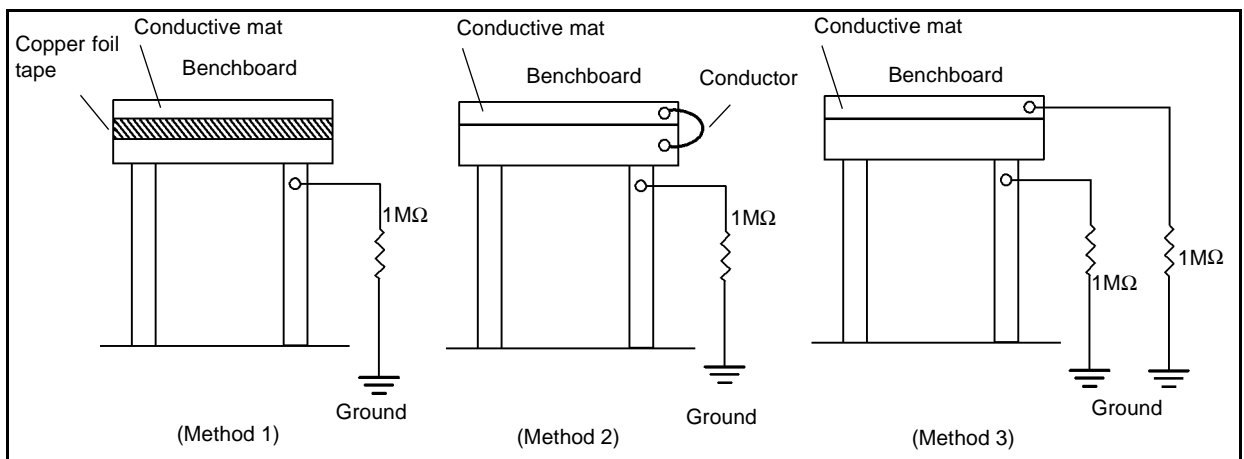

Figure 1-6 Benchboard

1.5 System Checkout

This section describes the Selftest which must be performed when operating the R3267 Series for the first time. Follow the procedure below:

1. Check to see that the **POWER** switch (on the front panel) and the **MAIN POWER** switch (on the rear panel) are turned off.
2. Connect the power cable provided to the AC power supply connector on the rear panel.

CAUTION: To prevent damage, operate the R3267 Series within specified input voltage and frequency ranges.

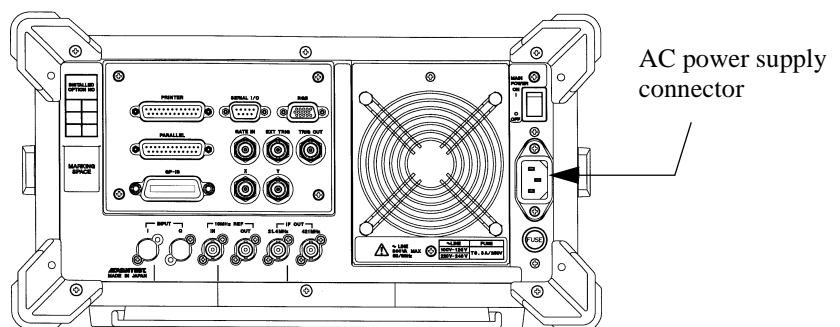

Figure 1-7 Connecting the Power Supply Cable

3. Connect the power cable to the outlet.
4. Turn on the **MAIN POWER** switch (on the rear panel).
5. Turn on the **POWER** switch (on the front panel).
The R3267 Series performs the Initial test (processing time: approximately 10 seconds). The start-up screen is displayed as shown in Figure 1-8.

NOTE:

1. There is a possibility that the screen display is different from the one shown in Figure 1-8, depending on previously saved conditions.
 2. An error message will be displayed when an abnormal condition is detected. Refer to the list of error messages to solve the problem (Refer to Section A.2).
-

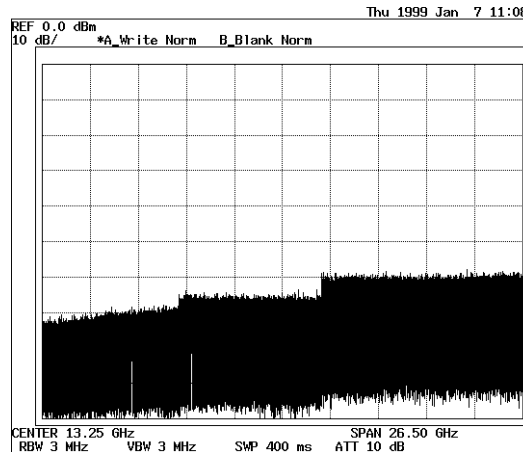

Figure 1-8 Start-up Screen

6. Attach the N-BNC adapter to the **INPUT** connector on the front panel and connect the Input cable from the **CAL OUT** connector to the **INPUT** connector.
7. Press **SHIFT**.
The SHIFT lamp lights.
8. Press **CONFIG(PRESET)**.
The default settings have now been reset.
The start-up screen is displayed as shown in Figure 1-8.
9. Press **CONFIG**.
The Config menu is displayed.

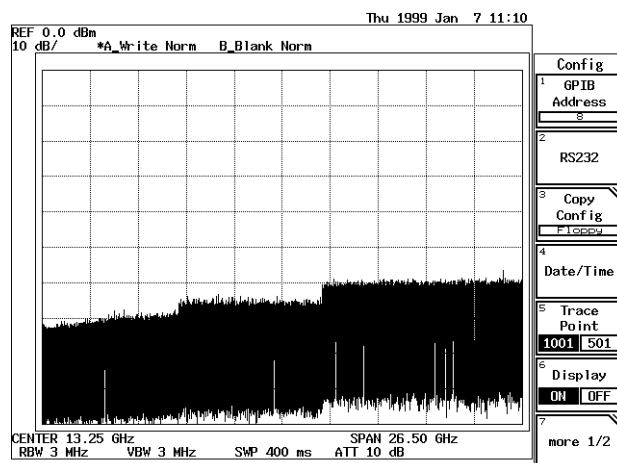

Figure 1-9 Config Menu

10. Press *more 1/2* and *Selftest*.
The Selftest menu is displayed.

1.5 System Checkout

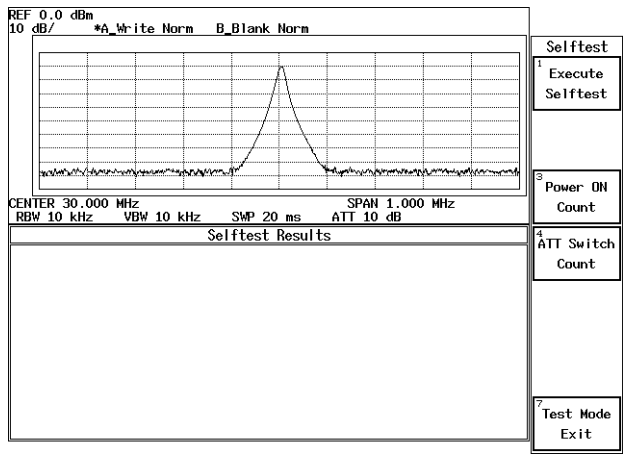

Figure 1-10 Selftest Menu

11. Press *Execute Selftest*.
The selftest consisting of following items is executed in sequence and the result is displayed.

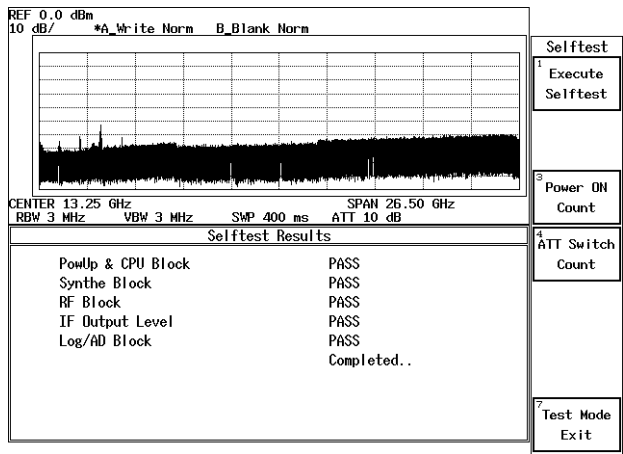

Figure 1-11 Selftest Result

NOTE: *If the Selftest detects any errors, do not attempt to use the R3267 Series any further. Contact a sales representative as soon as possible. If the selftest is executed without a calibration signal, it fails, so make sure to supply the calibration signal.*

12. Press **RETURN**.
This completes the system checkout.

1.6 Cleaning, Storing and Transporting the R3267 Series

1.6.1 Cleaning

Remove dust from the outside of the R3267 Series by wiping or brushing the surface with a soft cloth or small brush. Use a brush to remove dust from around the panel keys. Hardened dirt can be removed by using a cloth which has been dampened in water containing a mild detergent.

CAUTION:

1. *Do not allow water to get inside the R3267 Series.*
 2. *Do not use organic cleaning solvents, such as benzene, toluene, xylene, acetone or similar compounds, since these solvents may damage the plastic parts.*
 3. *Do not use abrasive cleaners.*
-

- Removing the Display Filter

Normally cleaning the display filter from the front should be sufficient. However, if the inside of the filter or the LCD surface is dirty, you can detach the screen filter from the R3267 Series by removing the two screws on the front and pulling the right-hand part of the filter forward. Clean the filter with a piece of soft close.

CAUTION *Do not touch the LCD display with your finger when the filter has been removed.*

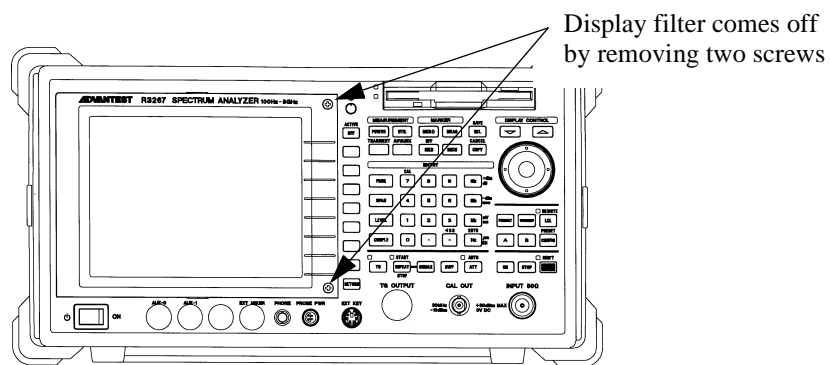

Figure 1-12 Removing the Display Filter

1.6.2 Storing

1.6.2 Storing

Store the R3267 Series in an area which has a temperature from -20°C to $+60^{\circ}\text{C}$. If you plan to store the R3267 Series for a long period (more than 90 days), put the R3267 Series in a vapor-barrier bag with a drying agent and store the R3267 Series in a dust-free location out of direct sunlight.

1.6.3 Transporting

When you ship the R3267 Series, use the original container and packing material. If the original packaging is not available, use the following repackaging guidelines:

1. To allow for cushioning, use a corrugated cardboard container that is at least 15 centimeters larger than those of the R3267 Series.
2. Surround the R3267 Series with protective sheeting.
3. Cushion the R3267 Series on all sides with packing material.
4. Seal the corrugated cardboard container with shipping tape or an industrial stapler.

If you are shipping the R3267 Series to a sales representative for service or repair, attach a tag to the R3267 Series that shows the following information:

- Owner and address
- Name of a contact person at your location
- Serial number of the R3267 Series (located on the rear panel)
- Description of the service requested

1.7 About Calibration

When you want to calibrate the R3267 Series, please contact a sales representative.

Desirable Period	One year
------------------	----------

1.8 Concerning Limited-life Parts

The R3267 Series uses the following parts with limited life that are not listed in Safety Summary.

Replace the parts listed below after their expected lifespan has expired.

Part Name	Life	Description
Input attenuator	R3264: 1 million times	When the error message "Input ATT Cal failed" (under the message code "400") is displayed, run the user selftest. If the RF BLOCK error occurred during the user selftest, contact a sales representative.
	R3267: 2 million times	
	R3273: 5 million times	
Mechanical relays	100,000 times	Applicable to the relays used with Opt01 only.

2 OPERATION

This chapter describes the following.

- Description on the front and rear panels
- Screen annotation
- Basic operation
- Measurement examples
- Expanded functions

2.1 Panel Description

This section describes the names, functions and screen annotations of the front and rear panels.

2.1.1 Front Panel

The panel keys and connectors are described below for each section of the front panel.

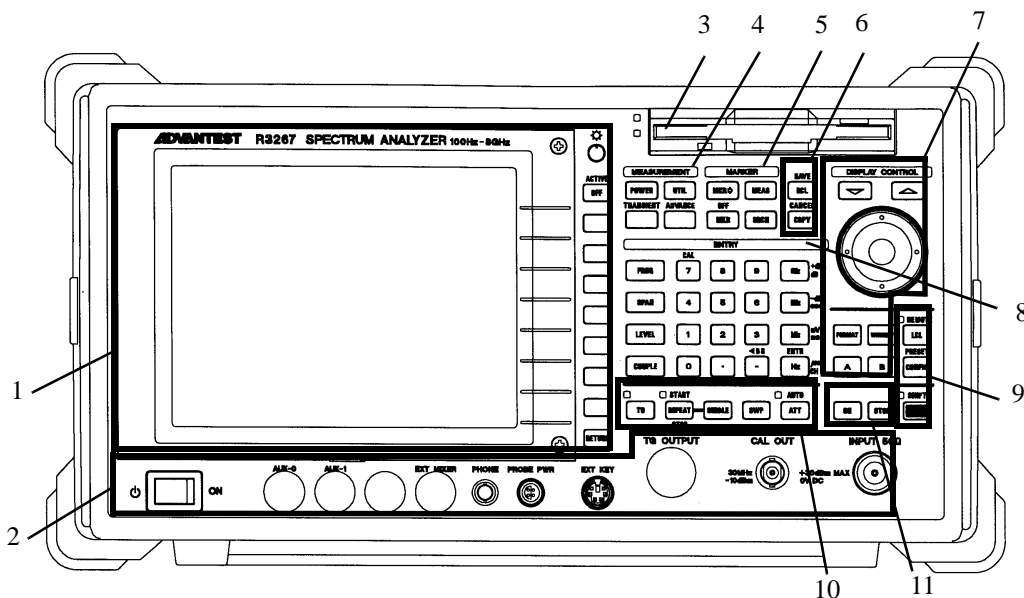

Figure 2-1 Front Panel

The front panel consists of 11 sections as shown below.

1. Display Section
2. **POWER** Switch/Connector Section
3. Floppy Disk Drive Section
4. MEASUREMENT Section
5. MARKER Section
6. Save/Recall Section
7. DISPLAY CONTROL Section
8. ENTRY Section
9. REMOTE Section
10. Control Section
11. Option Section

2.1.1 Front Panel

2.1.1.1 Display Section

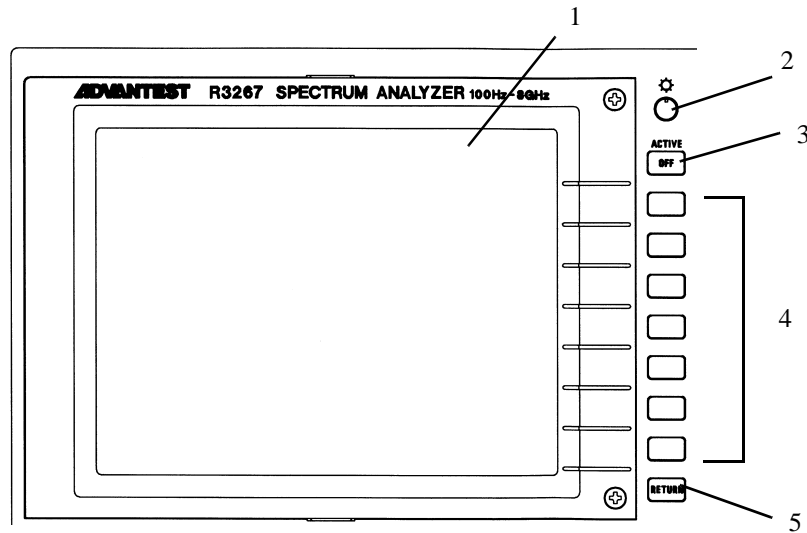

Figure 2-2 Display Section

- | | |
|---------------------------------|---|
| 1. Liquid crystal display (LCD) | Displays trace and measured data. |
| 2. Contrast control | Adjusts the display contrast. |
| 3. ACTIVE OFF key | Turns off the active area removing any displayed information. |
| 4. Soft keys | Seven keys corresponding to the soft-menu display on the left; pressing a soft key selects the corresponding menu item. |
| 5. RETURN key | Used to return the screen display to the previous level of the hierarchical soft-menu structure. |

2.1.1.2 Power Switch/Connector Section

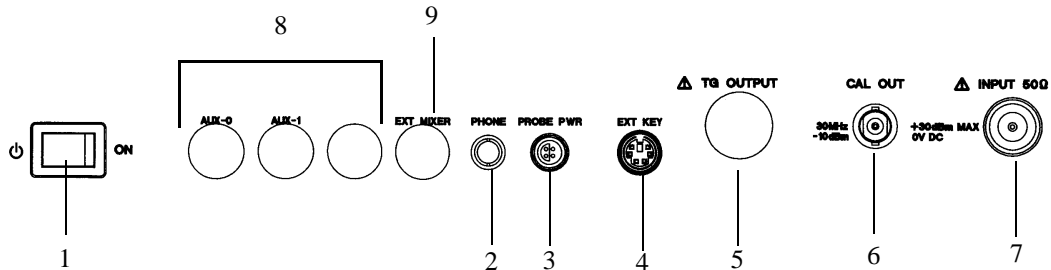
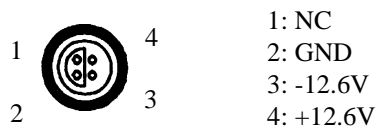

Figure 2-3 Power Switch/Connector Section

- | | |
|------------------------|----------------------------|
| 1. POWER Switch | Turns the power on or off. |
|------------------------|----------------------------|

CAUTION: To turn the analyzer power on, turn on the Main Power switch (on the rear panel) and then turn this **POWER** switch on.

- | | |
|-------------------------------|--|
| 2. PHONE connector | Unused |
| 3. PROBE PWR connector | Power supply for accessories such as the active probe. |



(Not available when OPT 22 or OPT23 is installed.)

- | | |
|-------------------------------|-----------------------------------|
| 4. EXT KEY connector | Unused |
| 5. TG OUTPUT connector | Outputs the TG signal. (option) |
| 6. CAL OUT connector | Outputs the calibration signal. |
| 7. INPUT connector | Inputs the signal to be measured. |

CAUTION: Do not apply signals whose RF level and DC voltage exceed the values prescribed by the specification.

- | | |
|-------------------------------|--|
| 8. | Unused |
| 9. EXT MIXER connector | Used to connect an external mixer to widen measurable frequency range. |

CAUTION: The external mixer can be used only for the R3273.

2.1.1 Front Panel

2.1.1.3 Floppy Disk Drive Section

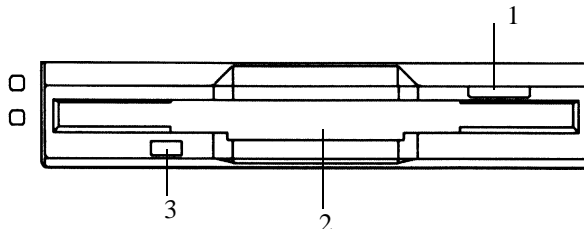

Figure 2-4 Floppy Disk Drive Section

- | | |
|---------------------------|---|
| 1. Eject button | Used to eject floppy disks from the drive. |
| 2. Floppy disk drive door | Insert floppy disks here. |
| 3. Access lamp | Turns on when the floppy disk in the drive is being accessed. |

2.1.1.4 MEASUREMENT Section

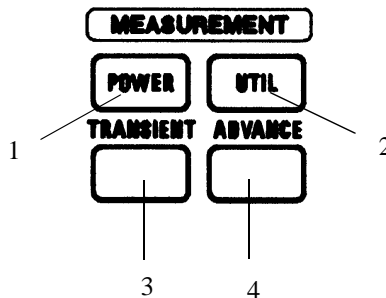

Figure 2-5 MEASUREMENT Section

- | | |
|-------------------------|--|
| 1. POWER key | Used to measure power. |
| 2. UTIL key | Used to measure the occupied bandwidth (OBW), harmonics and so on. |
| 3. TRANSIENT key | Unused (option) |
| 4. ADVANCE key | Unused (option) |

2.1.1.5 MARKER Section

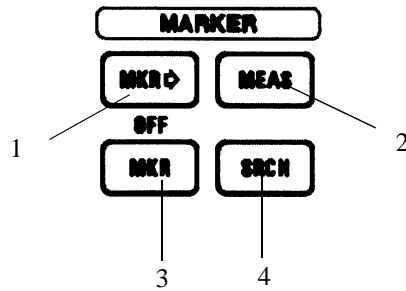

Figure 2-6 MARKER Section

- | | |
|--------------------------------------|--|
| 1. MKR→ key | Used to obtain marker values so that they can be used as data for other functions. |
| 2. MEAS key | Used to set the measurement mode. |
| 3. MKR key | Used to display the marker. |
| OFF key (SHIFT, MKR) | Used to turn the marker off. |
| 4. SRCH key | Used to search for the peak point on the trace. |

2.1.1.6 Save/Recall Section

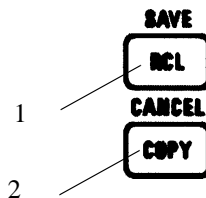

Figure 2-7 Save/Recall Section

- | | |
|--|---|
| 1. RCL key | Used to recall set conditions and traces previously saved. |
| SAVE key (SHIFT, RCL) | Used to save measurement conditions and traces. |
| 2. COPY key | Used to output the displayed data to the printer or save it to a floppy disk. |
| CANCEL key (SHIFT, COPY) | Used to cancel the copy operation in progress. |

2.1.1.7 DISPLAY CONTROL Section

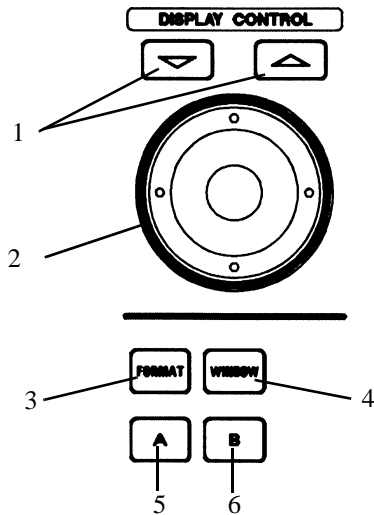

Figure 2-8 DISPLAY CONTROL Section

- | | |
|----------------------|---|
| 1. Step keys | Used to enter data in predefined steps. |
| 2. Data knob | Used to finely adjust input data by turning the data knob clockwise or counterclockwise.
In the dialog box, turn the data knob, select the items to be set and press the knob. |
| 3. FORMAT key | Used to set up display lines and limit lines, and to enter labels. |
| 4. WINDOW key | Used to set up measuring windows and separate windows. |
| 5. A key | Used to set trace A. |
| 6. B key | Used to set trace B. |

2.1.1.8 ENTRY Section

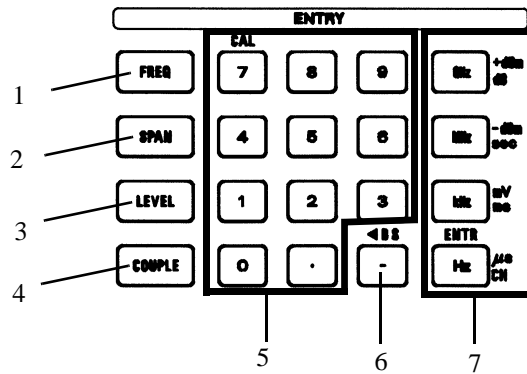

Figure 2-9 ENTRY Section

- | | | |
|----|------------------------------------|---|
| 1. | FREQ key | Used to set center, start or stop frequency. |
| 2. | SPAN key | Used to set the frequency span, full span or zero span. |
| 3. | LEVEL key | Used to set the reference level, vertical axis scale or unit. |
| 4. | COUPLE key | Use to set the resolution bandwidth (RBW), video bandwidth (VBW) and sweep time. |
| 5. | Numeric keys | Used to enter numeric values.
There are ten number keys (0 through 9) and a decimal point-key (.). |
| | CAL key (SHIFT , 7) | Used to execute calibrations for the analyzer. |
| 6. | -(BS) key | Used to remove data you have entered or to enter a minus (-) sign. |
| 7. | Units keys | These are used to select a unit and enter a numeric value. |
| | GHz key | Sets GHz, +dBm or dB. |
| | MHz key | Sets MHz, -dBm or sec. |
| | kHz key | Sets kHz, mV or msec. |
| | Hz (ENTR) key | Sets Hz or μ sec.
This key is also used to confirm data. |

2.1.1.9 REMOTE Section

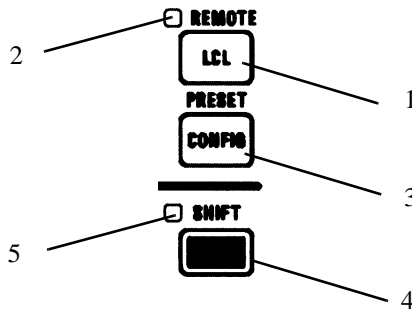

Figure 2-10 REMOTE Section

- | | | |
|----|--|--|
| 1. | LCL key | Turns off the GPIB remote control mode (this applies only when the REMOTE lamp is lit). |
| 2. | REMOTE lamp | Lit when in the remote state. |
| 3. | CONFIG key | Sets interface operation conditions, etc. |
| | PRESET key (SHIFT , CONFIG) | Resets all analyzer settings to the factory defaults, or to the user-defined presets. |
| 4. | SHIFT key | SHIFT is used to select the secondary functions that are labeled in blue above the panel keys. |
| 5. | SHIFT lamp | The LED is lit when the shift key has been pressed. |

2.1.1.10 Control Section

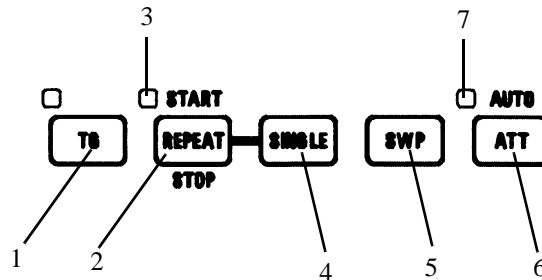

Figure 2-11 Control Section

- | | |
|-----------------------------------|--|
| 1. TG key | Unused (TG option) |
| 2. REPEAT (START/STOP) key | Starts a continuous sweep or resets the sweep in progress. |
| 3. Sweep indicator | Lit while sweeping. |
| 4. SINGLE key | Executes a single sweep or resets the sweep in progress. |
| 5. SWP key | Sets the sweep time. |
| 6. ATT key | Sets the input attenuator. |
| 7. AUTO lamp | Lit when the input attenuator is set to AUTO. |

2.1.1.11 Option Section

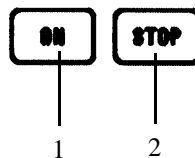

Figure 2-12 Option Section

- | | |
|--------------------|-----------------|
| 1. ON key | Unused (option) |
| 2. STOP key | Unused (option) |

2.1.2 Screen Annotation

2.1.2 Screen Annotation

This section describes both the annotation and display areas of the screen.

(1) Screen Annotation

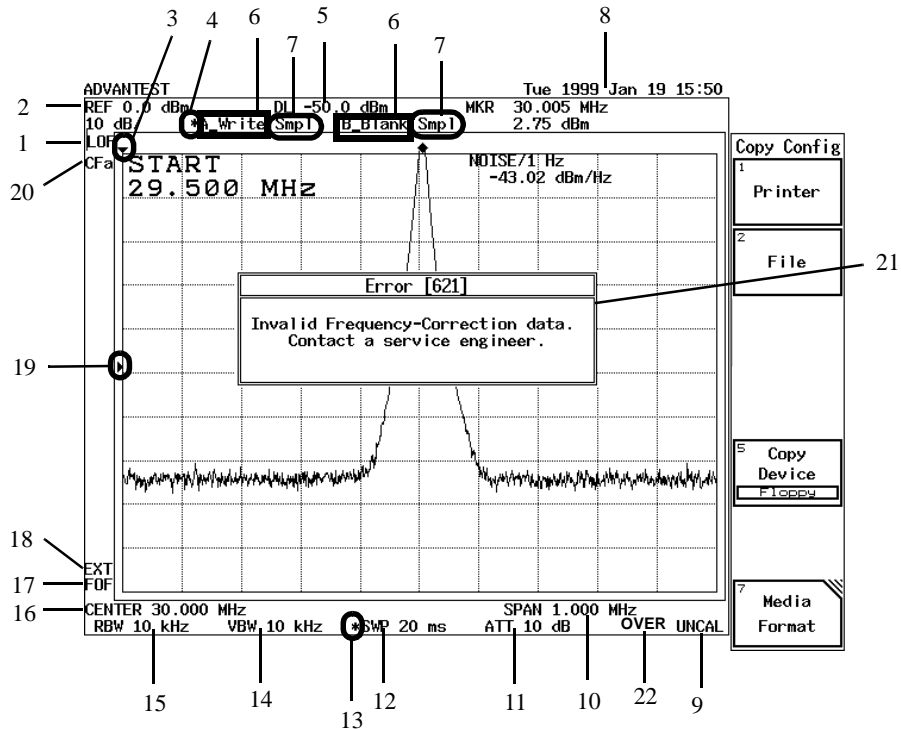

Figure 2-13 Screen Annotation

1. Level offset mark
2. Reference level
3. Trigger position mark (only for Zero span)
4. Trace active mark
5. Display line set-up display
6. Trace mode
7. Detector mode
8. Date
9. UNCAL message
10. Frequency span/Stop frequency
11. Attenuator
12. Sweep time
13. Manual mark
14. Video bandwidth (VBW)
15. Resolution bandwidth (RBW)
16. Center frequency/Start frequency
17. Frequency offset mark
18. External 10 MHz reference mark
19. Trigger level mark
20. Correction factor mark
21. Error message
22. IF/ADC overrange message (Only for digital filters)

(2) Display Area

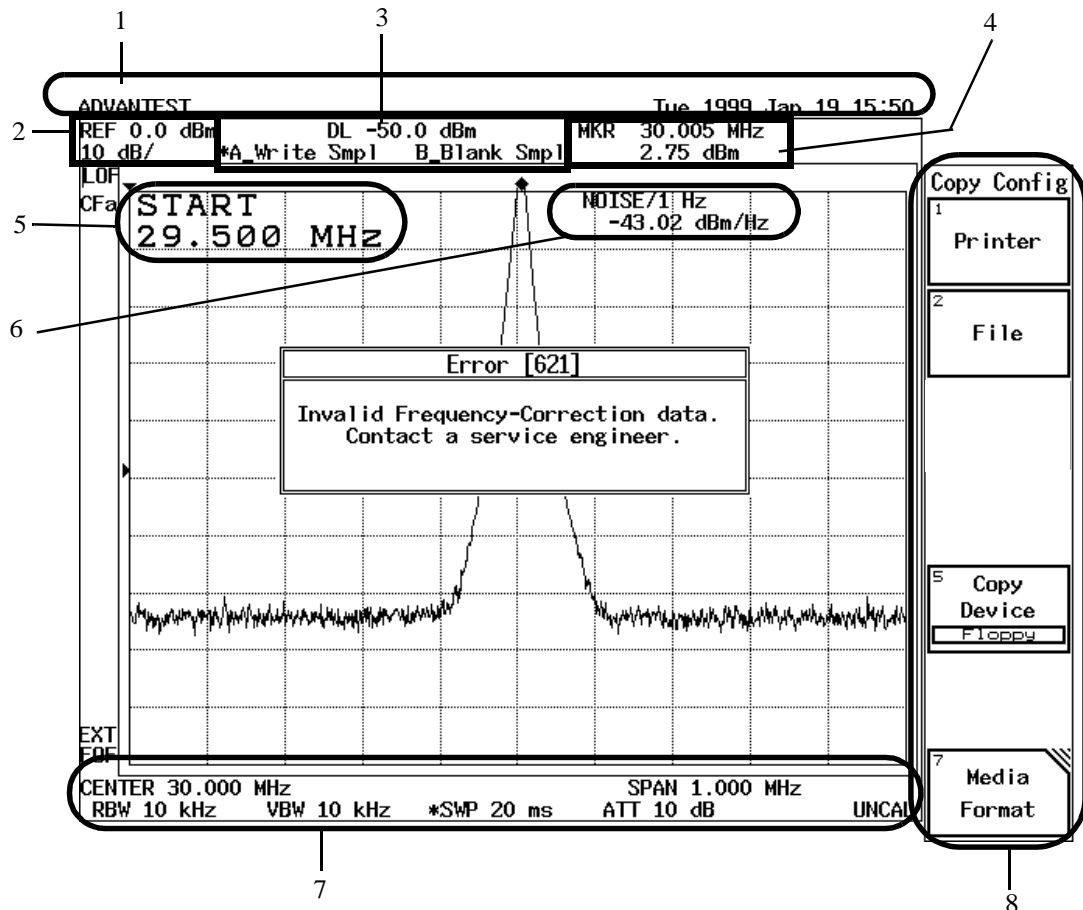

Figure 2-14 Display Area Names

1. Title area
2. Reference area
3. Trace status area
4. Marker area
5. Active area
6. Result area
7. Frequency area
8. Soft menu display area

2.1.3 Rear Panel

2.1.3 Rear Panel

This subsection shows the rear panel and describes its terminals and connectors.

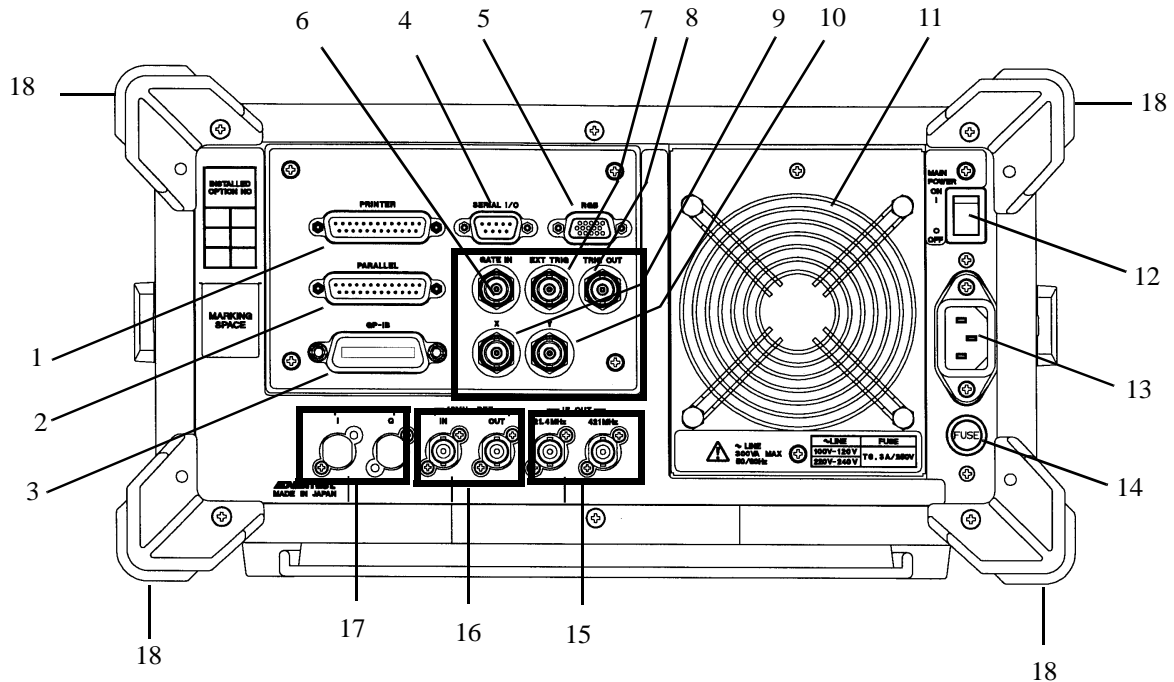

Figure 2-15 Rear Panel

- | | |
|--------------------------------|---|
| 1. PRINTER connector | Connector for a printer |
| 2. PARALLEL connector | Unused |
| 3. GPIB connector | Connector for an external controller used when set to remote control through GPIB interface. |
| 4. SERIAL I/O connector | Connector for an external controller used when set to remote control through RS232 interface. |
| 5. RGB connector | Connector for an external monitor compatible with VGA specifications. |
| 6. GATE IN terminal | Connector for inputting the gate signal of the gated sweep. |
| 7. EXT TRIG terminal | Connector for inputting not only the external trigger signal but the gate timing signal of the gated sweep. |
| 8. TRIG OUT terminal | Connector for outputting a signal in synchronization with the trigger signal. |
| 9. X-OUT terminal | Connector for outputting the ramp voltage proportional to sweep. |
| 10. Y-OUT terminal | Connector for outputting the signal proportional to power level. |
| 11. Exhaust vent | Cooling fan |

CAUTION: Do not block the vent.

-
- | | |
|-------------------------------------|---|
| 12. MAIN POWER switch | Used to turn the Main power on or off. |
| 13. AC power connector | Connect the input power cable from the analyzer to the outlet of the AC power source. |
| 14. Fuse holder | Used to hold a power fuse to protect the analyzer from an overcurrent. |
| 15. IF OUT 21.4 MHz terminal | Connector for outputting the 3rd IF (21.4 MHz) signal. |
| IF OUT 421 MHz terminal | Connector for outputting the 2nd IF (421 MHz) signal. |
| 16. 10 MHz REF IN terminal | Connector for inputting the 10 MHz reference signal. |
| 10 MHz REF OUT terminal | Connector for outputting the 10 MHz reference signal. |
| 17. INPUT I terminal | Unused (option) |
| INPUT Q terminal | Unused (option) |
| 18. Rear feet | This is to protect the projections such as the fan and connectors. |

CAUTION: *Never use the analyzer upright with the rear panel to the bottom.*

2.2 Basic Operation

2.2 Basic Operation

This section describes the method of how to go through the menus and use the measurement functions.

2.2.1 Operating Menus and Entering Data

This section explains how the panel keys and soft keys are used.

- (1) Selecting the menu

If you press a panel key, the soft menu associated with that key is displayed in the soft menu area on the screen.

To make a soft menu selection, press the soft key next to the menu item.

When a soft menu is selected and any item corresponding to this soft menu has previously been set, the titles and values which are currently set are displayed in the active area (Refer to (2) Entering data). In addition, if there is an associated menus are also displayed (Refer to (3) Soft menu configuration).

For example, the following soft menu will be displayed when you press SPAN.

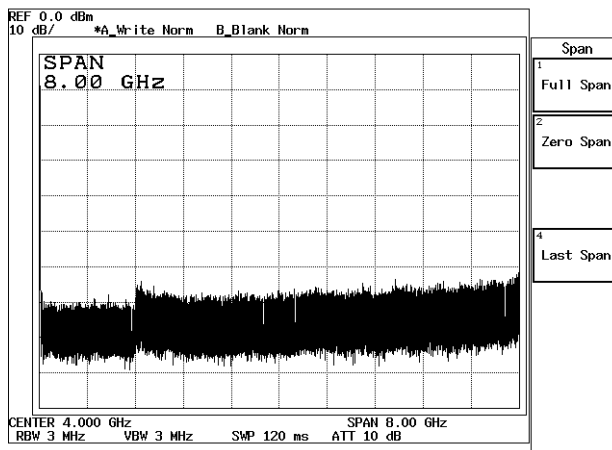

Figure 2-16 Span Menu

When selecting an item from the soft menu, press the corresponding soft key on the right.

(2) Entering data

When a value is displayed in the active area, you can change it using the numeric keys, the step keys or the data knob.

- Entering Data Using the Numeric Keys

You use the following keys to enter data: the number keys (0 through 9), the decimal point key, the **backspace** (BS) or minus (-) key. If you make a mistake when using the numeric keys, you can use the **backspace** (BS) key to delete the last digit entered. If you have not entered any data, pressing the **BS** key enters a minus (-) sign. After entering the data, pressing the **ENTR** key or one of the other unit keys completes the operation.

CAUTION: *Data entered with the numeric keys that is not terminated with a units terminator is aborted when you press any panel key.*

Example 1: The following example sets the reference level to -20 dBm using the numeric keys:
Press **LEVEL, -, 2, 0** and **GHz(+dBm)** or **LEVEL, 2, 0** and **MHz(-dBm)**.

- Entering Data Using the Step Keys

The step keys are used to enter data in a predefined step size. Press the ∇ step key to decrease the value and the Δ step key to increase the value. You can enter data while looking at the active area and the trace on the screen using the step keys. You can also define the step size manually.

Example 2: The following example sets the reference level to 0 dBm using the step keys:
Press the Δ step key following Example 1. This sets the reference level to -10.0 dBm. If you press the Δ step key once more, the level is set to 0.0 dBm.

- Entering Data Using the Data Knob

The data knob is used to set data in increments smaller than the step size. This is convenient when making fine adjustments to data already entered.

Example 3: The following example sets the reference level to 0.5 dBm using the data knob.
Turning the data knob clockwise increases the reference level in increments of 0.1 dB. Continue to turn it until the active area shows a setting of 0.5 dBm.
Turning the data knob counter clockwise decreases the reference level by 0.1 dB.

(3) Soft menu configuration

Menus consist of the main menu, associated submenus and dialog boxes.

In addition, there are some soft keys with which you can switch the setting each time you press them.

In this section, the menus associated with the **CONFIG** key are shown as an example of a typical menu configuration (See Figure 2-17).

2.2.1 Operating Menus and Entering Data

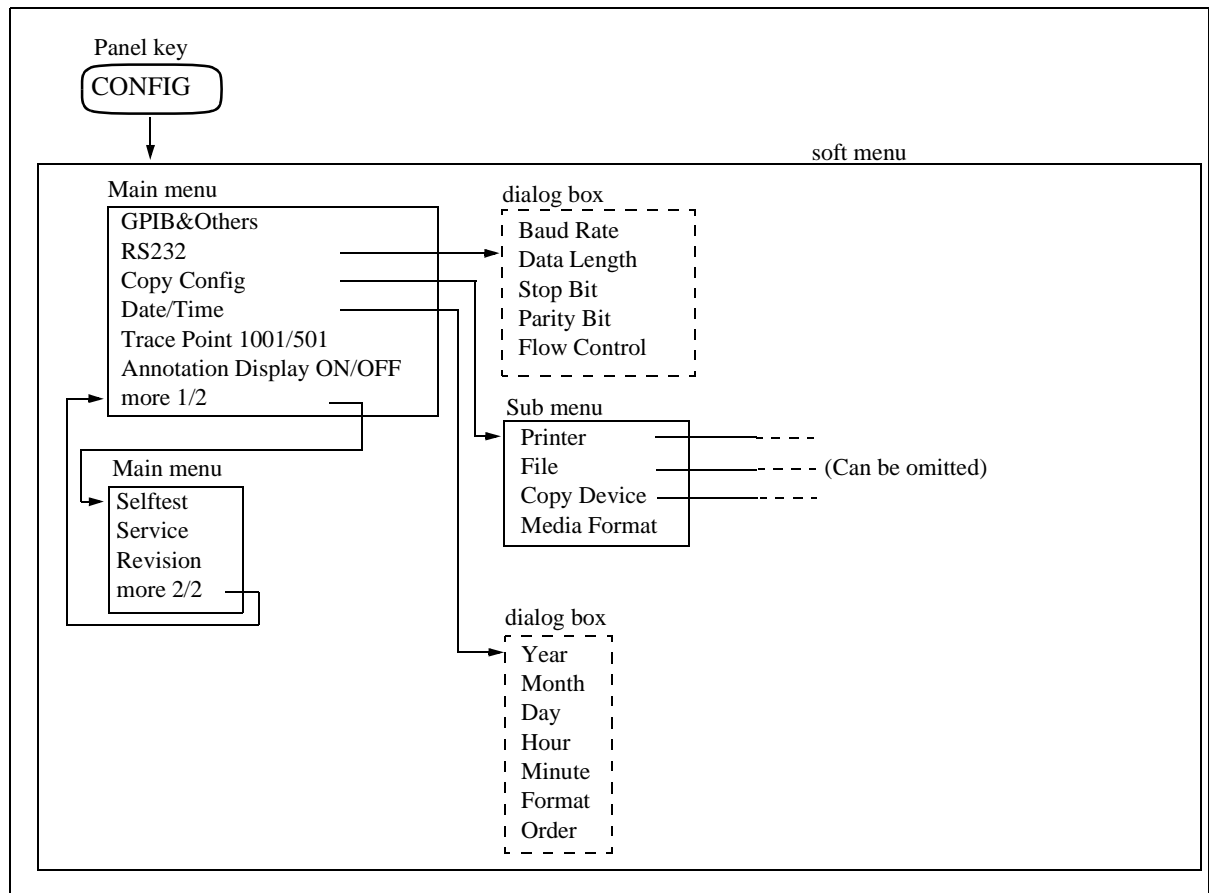

Figure 2-17 Soft Menu Configuration (CONFIG Key)

(4) Main menu and sub menu

- Displaying the main menu
Pressing a panel key displays the main menu.
- Displaying the second screen of the main menu (the same level as the main menu)
Pressing *more 1/2* in the main menu displays the rest of the main menu. Pressing *more 2/2* on the second page returns to the first page.
- Displaying the submenu
Pressing a soft key in the soft menu with a mark in the right-hand corner will display the next or previous submenu.
- Switching between settings on a toggle button.
Press the soft key under the soft menu with switching capability to toggle between settings for ON/OFF, AUTO/MNL and similar switches each time you press the soft key.

(5) Displaying a dialog box

Some soft key menu items display a dialog box when pressed.

- How to select a setting
To select a setting, use the step keys Δ (to move the cursor upwards) and ∇ (to move the cursor downwards).
- Choosing the contents from the selected setting
Turn the data knob to select the desired setting and press the data knob to set the data.
- Entering numeric values
Use the numeric and unit keys to set the data.
- Exiting from the dialog box
Press the **RETURN** key or the same key that you pressed to display the dialog box again.

(6) ACTIVE OFF

Pressing **ACTIVE OFF** removes all information from the active area. Data cannot be entered if this is done. To turn the active area again, press the panel or soft key whose function you wish to use.

(7) RETURN key

Press the **RETURN** key to return to the previous menu.

(8) SHIFT key

SHIFT is used to select the functions that are labeled in blue above the panel keys. There are five such functions:

- CAL
- CANCEL
- OFF
- PRESET
- SAVE

To select one of these functions, press **SHIFT** and the appropriate panel key.

Pressing **SHIFT** lights the green LED (on the left side above the key) to indicate that the Shift function is active.

To cancel the shift function, press **SHIFT** a second time before selecting other blue-labeled functions.

The LED goes off indicating that the Shift function is no longer active.

2.2.2 Displaying Spectrums and Operating the Markers

2.2.2 Displaying Spectrums and Operating the Markers

The following example measures the frequency difference between the peak point and a point 3 dB levels lower, and the frequency difference between the peak point and a point 60 dB levels lower.

Use the CAL signal of the analyzer as an input signal.

Power on

NOTE: *To take accurate measurements, use the analyzer within the specified temperature range, and wait at least 60 minutes after turning on the power before performing the Calibrations. In this exercise example, the warm-up and calibration are omitted.*

1. Check to see if the **POWER** switch (on the front panel) and **MAIN POWER** switch (on the rear panel) are turned off.
2. Connect the power cable provided to the AC power supply connector on the rear panel.

CAUTION: *To avoid damage to the analyzer, operate the analyzer within the specified input voltage and frequency ranges.*

3. Connect the power cable to the outlet.
4. Turn on the **MAIN POWER** switch (on the rear panel).
5. Turn on the **POWER** switch (on the front panel).
When the self-test has completed, the start-up screen is displayed.

NOTE: *The screen displayed after the power is turned on may differ from the one shown here depending on the current settings.*

Initialization

This resets the current settings to the factory defaults or user-defined presets.

6. Press **SHIFT** and **CONFIG(PRESET)**.
This sets the analyzer to its presets values.

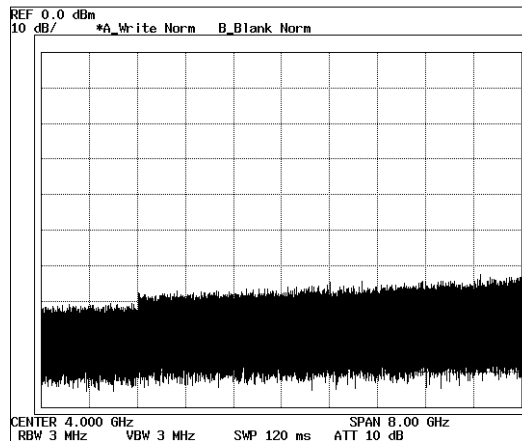

Figure 2-18 Factory Defaults

Connecting calibration signal

Connect the calibration signal used in the measurement.

7. Attach the N-BNC adapter to the **INPUT** connector on the front panel.
8. Connect the Input cable from the **CAL OUT** connector to the **INPUT** connector.

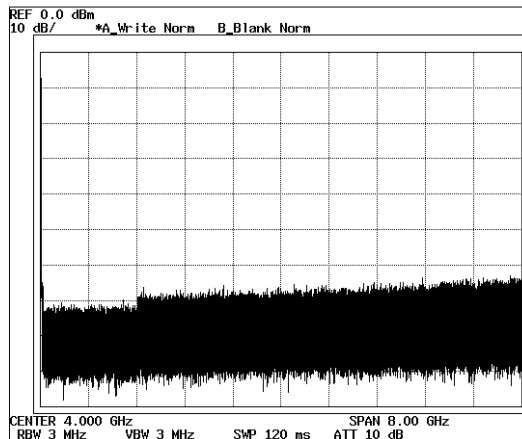

Figure 2-19 Calibration Output

Setting the measurement conditions

This changes the analyzer settings so that the input signal is displayed more clearly.

9. Press **FREQ**.
The current center frequency is displayed in the active area, and the Freq menu used to select the frequency type appears on the right.

2.2.2 Displaying Spectrums and Operating the Markers

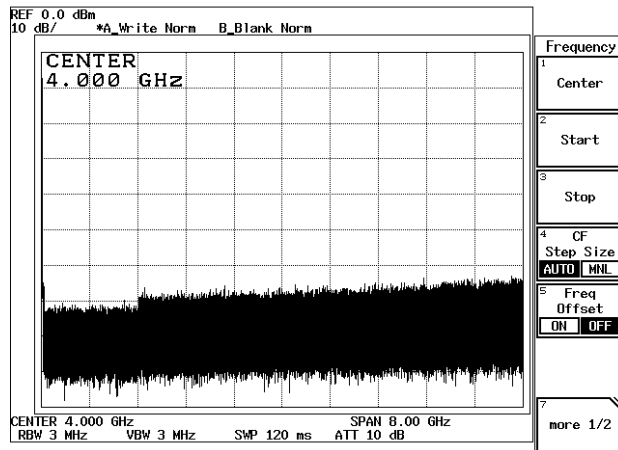

Figure 2-20 Frequency Menu

10. Press **3, 0** and **MHz**.
A center frequency of 30 MHz is set.

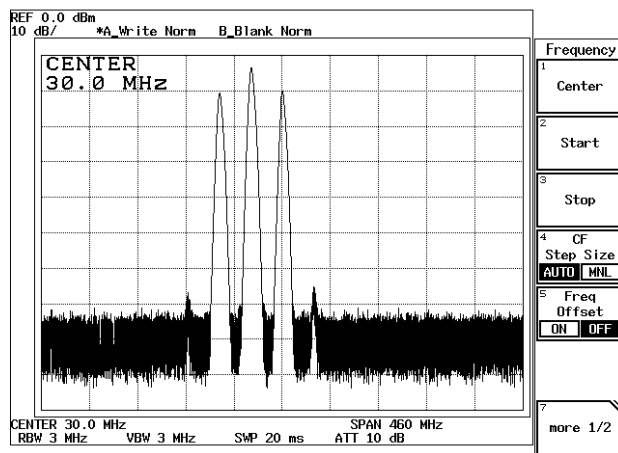

Figure 2-21 Setting the Center Frequency

11. Press **SPAN**.
The current frequency span is displayed in the active area, and the Span menu used for setting the frequency span appears on the right.
12. Press **2, 0** and **MHz**.
A frequency span of 20 MHz is set.
13. Press **LEVEL**.
The current reference level is displayed in the active area, and the Level menu used for setting the level appears on the right.

14. Press **1, 0, MHz(-dBm)**.
A reference level of -10 dBm is set.

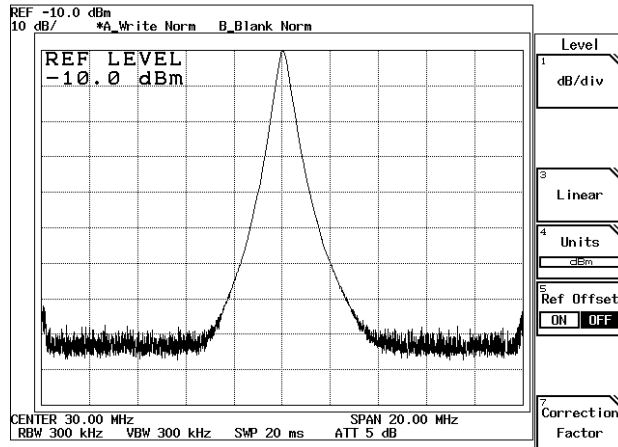

Figure 2-22 Setting Measurement Conditions

Displaying the normal marker on the trace peak

15. Press **SRCH**.
The normal marker is displayed on the trace peak, and the marker frequency (approximately 30 MHz) and level (approximately -10 dBm) are displayed in the marker area.

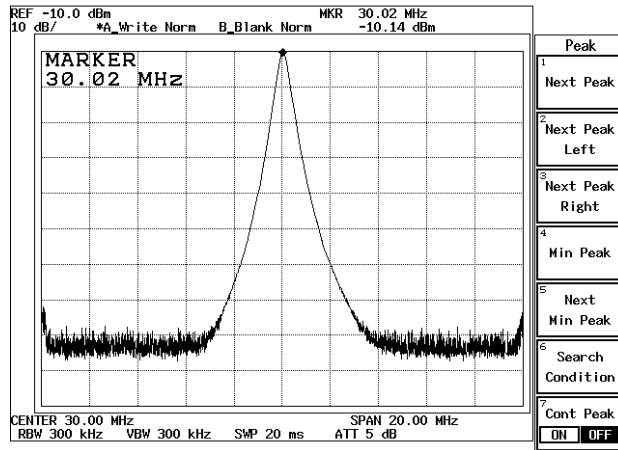

Figure 2-23 Peak Search

Displaying the delta marker

This measures the frequency difference between a point 3 dB levels down and a point 60 dB levels down from the peak.

16. Press **MKR**.
The Marker (1) menu used with the marker function is displayed.

2.2.2 Displaying Spectrums and Operating the Markers

17. Press **Delta Marker**.
The delta marker is displayed, and the differences (relative values) between the normal marker and delta marker frequency and level are displayed
18. Move the marker to the -3 dB point using the data knob while looking at the level indication in the marker area and set it as precisely as possible (an exact setting may not be possible due to resolution limitations).
The frequency difference (relative value) between the peak point and a point 3 dB levels lower is displayed in the marker area.

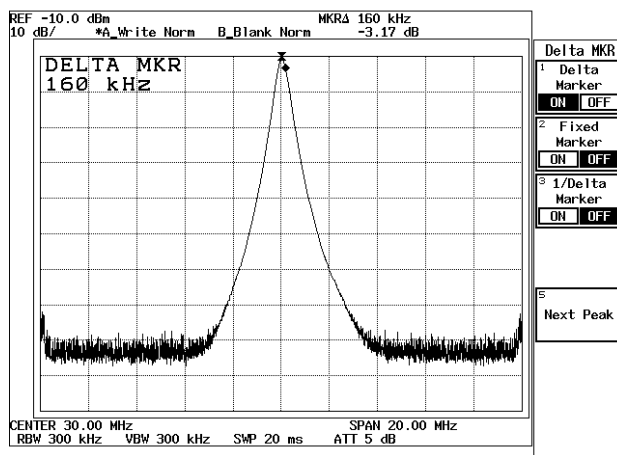

Figure 2-24 Frequency Difference Between the Peak Point and a Point 3 dB Levels Down

19. Next, move the marker to a point 60 dB levels down from the peak using the data knob.
The display in the marker area is the frequency difference between the peak point and a point 60 dB levels down from the peak.

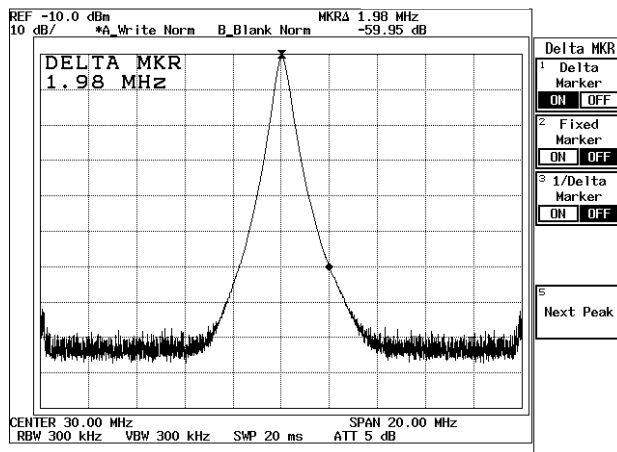

Figure 2-25 Frequency Difference Between the Peak Point and a Point 60 dB Levels Down

2.2.3 Measuring Frequency Using Counter

Frequencies are measured using the counter function. Use the CAL signal of the analyzer as input signal. The counter function measures the signal frequency at the marker with high accuracy. The value of an amplitude indicates the amplitude at the marker point. The maximum resolution possible for the counter function display is 1 Hz. As you increase the resolution, you will have to increase the gate time to compensate.

CAUTION:

1. *The counter function may not work normally if the span is greater than 1 GHz or the difference between the marker and the noise level is 25 dB or less.*
 2. *The signal track mode cannot be used with this function.*
-

Power on

1. Turn the analyzer power on.

Initialization

This resets the current settings to the factory defaults or user-defined presets.

2. Press **SHIFT** and **CONFIG(PRESET)**.
This sets the analyzer to its presets values.

Connecting calibration signal

Connect the calibration signal used in the measurement.

3. Attach the N-BNC adapter to the **INPUT** connector on the front panel.
4. Connect the Input cable from the **CAL OUT** connector to the **INPUT** connector.

Setting the measurement conditions

This changes the analyzer settings so that the input signal is displayed more clearly.

5. Press **FREQ, 3, 0** and **MHz**.
A center frequency of 30 MHz is set.
6. Press **SPAN, 5, 0** and **MHz**.
A frequency span of 50 MHz is set.

2.2.3 Measuring Frequency Using Counter

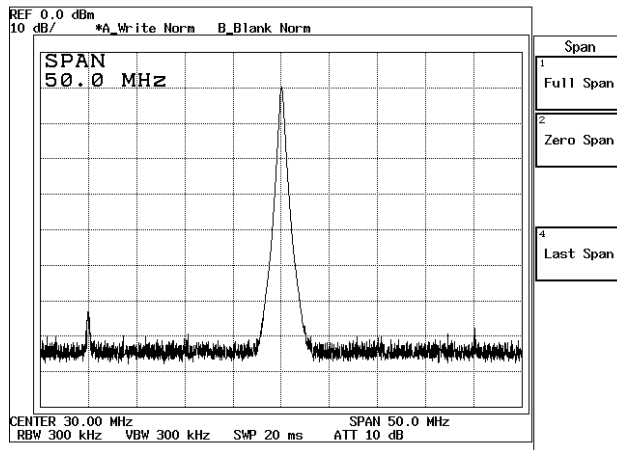

Figure 2-26 Setting Measurement Conditions

Measuring frequency by counter

This measures the frequency using the counter function.

7. Press **MEAS** and *Counter*.
The Counter menu used to set the frequency counter resolution is displayed and the frequency measurement by the frequency counter is started.

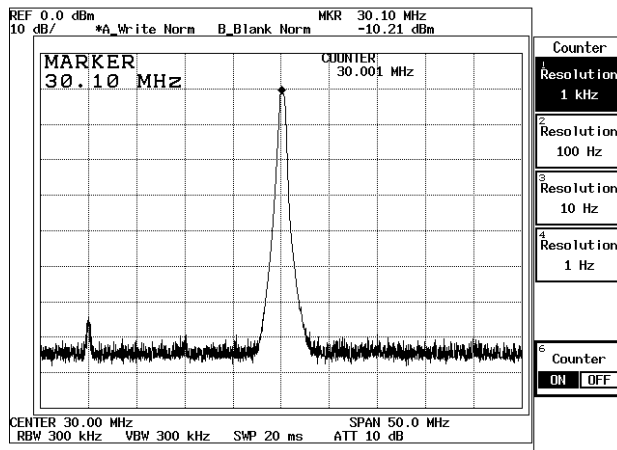

Figure 2-27 Frequency Counter Measurement

8. Press *Resolution 10 Hz*.
The frequency counter resolution is set to 10 Hz and is displayed in the Result area.

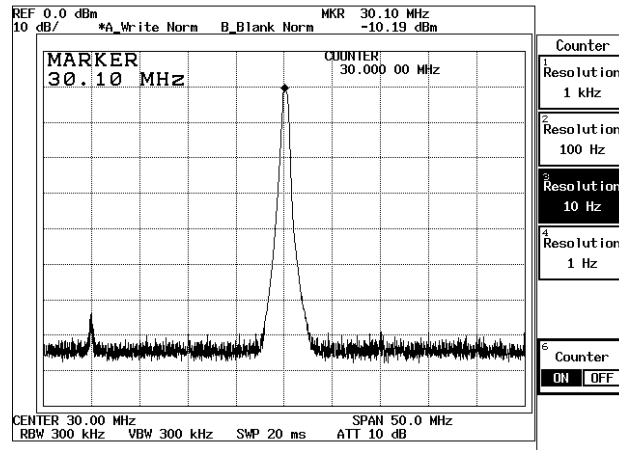

Figure 2-28 Frequency Counter Measurement (Resolution: 10 Hz)

9. Press **Counter ON/OFF**(OFF).
The counter function is turned off.

2.2.4 Display Line and Measuring Window

2.2.4 Display Line and Measuring Window

This section describes the display line used to compare the levels between traces and the measuring window used to take measurements within a limited area.

Power on

1. Turn the analyzer power on.

Initialization

This resets the current settings to the factory defaults or user-defined presets.

2. Press **SHIFT** and **CONFIG(PRESET)**.
This sets the analyzer to its presets values.

Connecting the calibration signal

Connect the calibration signal used in the measurement.

3. Attach the N-BNC adapter to the **INPUT** connector on the front panel.
4. Connect the Input cable from the **CAL OUT** connector to the **INPUT** connector.

Setting the measurement conditions

This changes the analyzer settings so that the input signal is displayed more clearly.

5. Press **FREQ, 3, 0** and **MHz**.
A center frequency of 30 MHz is set.
6. Press **SPAN, 8, 0** and **MHz**.
A frequency span of 80 MHz is set.

Turning on the display line

7. Press **FORMAT** and **Display Line ON/OFF(ON)**.
The display line is displayed.

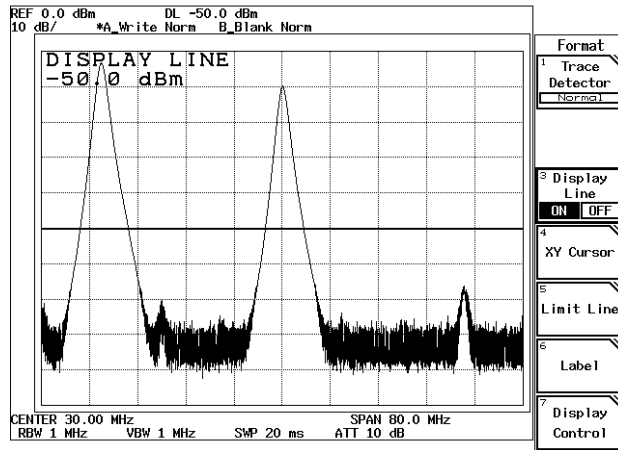

Figure 2-29 The Display Line

8. Align the Display line to a peak on the right.
9. Press **SRCH**.
A marker is displayed on the trace peak.
10. Press **MKR**, *Reference Object* and *Display Line*.
The values shown by the marker are the values relative to the Display line.

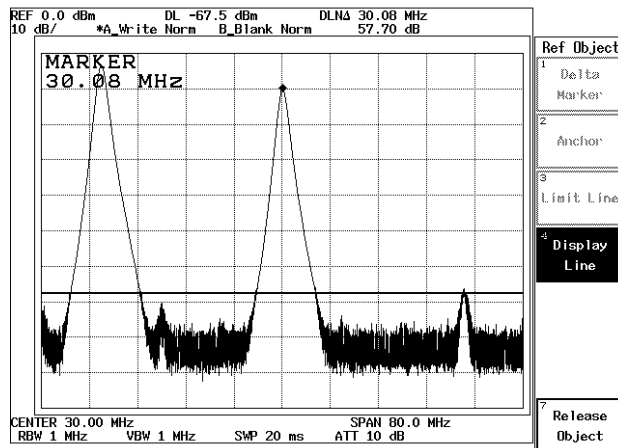

Figure 2-30 Measuring the Values Relative to the Display Line

Removing the Display line

11. Press **FORMAT**, *Display Line ON/OFF*(ON) and *Display Line ON/OFF*(OFF).
The Display line and the values relative are removed.

2.2.4 Display Line and Measuring Window

Using the measuring window

12. Press **WINDOW** and *Measuring Window*.
A measuring window is opened, and the Measuring Window menu is displayed. In the active area, the frequency in the center of the window is displayed.
13. Press *Window position* and move the measuring window by turning the data knob until the right-hand peak is in the center of the measuring window (See Figure 2-31).

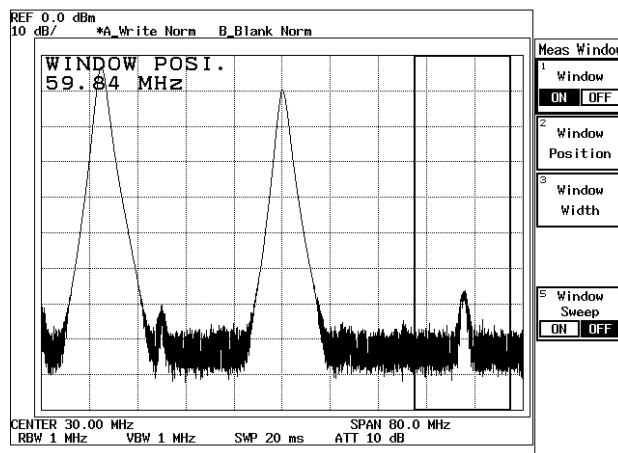

Figure 2-31 The Measuring Window

14. Press *Window width, 1, 0* and **MHz**.
The width of the measuring window is set to 10 MHz.

Removing the measuring window

15. Press *Window ON/OFF(OFF)*.
The measuring window is removed.

2.2.5 Entering Level Correction Data

Measurement objects (such as input cables, antennas and adapters used with amplifiers), which have proper frequency characteristics, can be measured by using correction tables on a measurement object basis.

The frequency characteristics of the instruments used are listed in Table 2-1. This section describes how to enter data into the correction table and use it.

Table 2-1 Correction Table

	Frequency	Correction Value
1	660 MHz	-20 dB
2	670 MHz	-10 dB
3	690 MHz	+10 dB
4	730 MHz	+20 dB
5	740 MHz	-30 dB

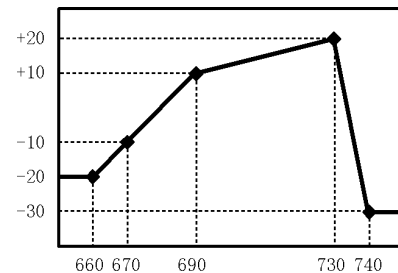

Power on

1. Turn the analyzer power on.

Initialization

This resets the current settings to the factory defaults or user-defined presets.

2. Press **SHIFT** and **CONFIG(PRESET)**.
This sets the analyzer to its presets values.

Setting the measurement conditions

This changes the analyzer settings so that the correction signal is reflected more clearly.

3. Press **FREQ, 7, 0, 0** and **MHz**.
A center frequency of 700 MHz is set.
4. Press **SPAN, 1, 0, 0** and **MHz**.
A frequency span of 100 MHz is set.
5. Press **LEVEL, 4, 0** and **MHz(-dBm)**.
The reference level is set to -40 dBm.

2.2.5 Entering Level Correction Data

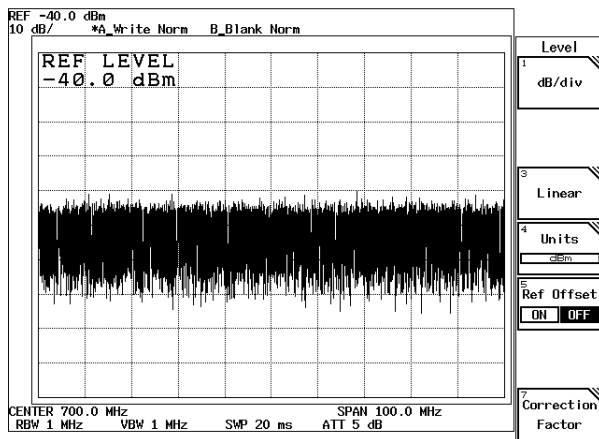

Figure 2-32 Setting Measurement Conditions

Entering the correction data

The correction table is composed of frequency and level columns, and is used to set a maximum of 50 sets of data. The interpolation method is applicable between correction data.

6. Press **LEVEL**, **Correction Factor** and **Correction Edit**.
The Correction Edit menu and the correction table are displayed and you are allowed to enter frequency data (See Figure 2-33).

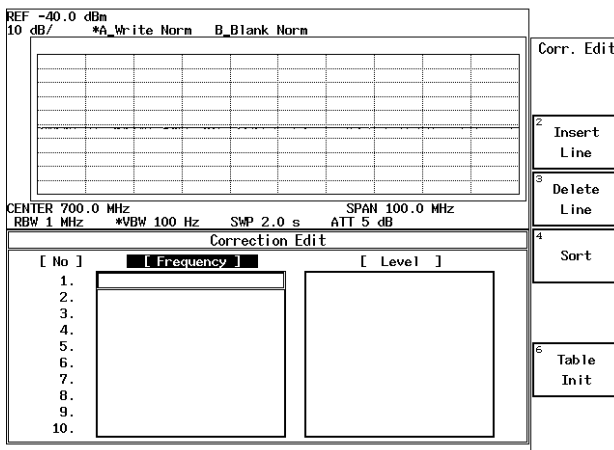

Figure 2-33 Displaying the Correction Table

7. Press **6**, **6**, **0** and **MHz**.
A frequency of 660 MHz is displayed in the first frequency item, and the cursor moves to the level item (See Figure 2-34).

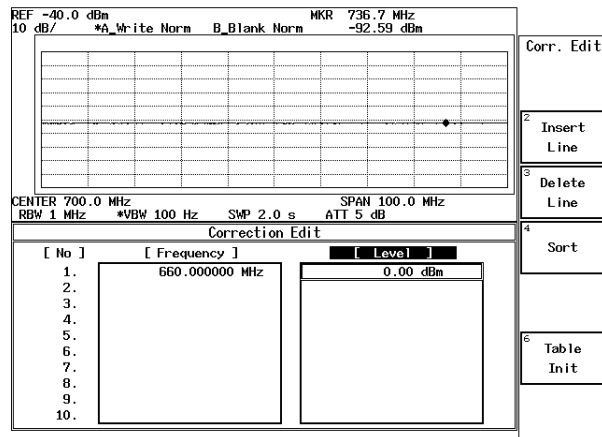

Figure 2-34 Entering Frequency Data

8. Press **2, 0** and **MHz(-dBm)**.
A level of -20 dBm is displayed in the level item and the cursor moves to the frequency item on the second line.
9. Enter the correction data one by one according to Table 2-1.
10. Press **RETURN**.
The correction table is removed.

Reflecting the level correction data

11. Press **Correction ON/OFF(ON)**.
The trace, whose noise level was corrected using the data previously entered, is displayed.

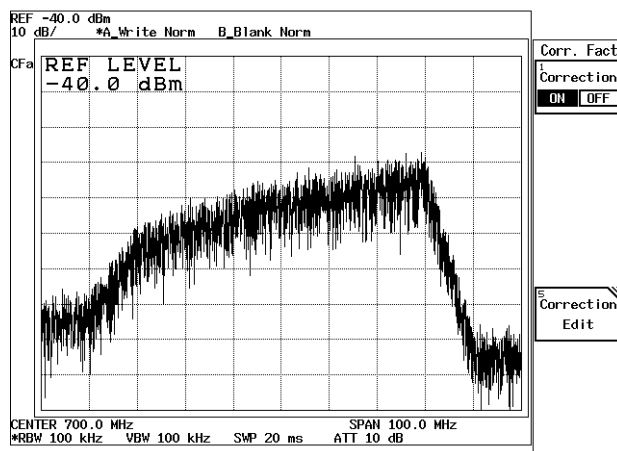

Figure 2-35 Showing a Trace Whose Level Is Corrected

2.2.5 Entering Level Correction Data

12. Press **Correction ON/OFF**(OFF).
The level correction function is turned off.

Correcting the entered data

The data you entered can be corrected using the step keys or the data knob. In this example, the level data on the second line is changed from -10 dBm to 0 dBm.

1. Move the cursor to the level data on the second line using the step keys or the data knob.
2. Press **0** and **MHz(-dBm)**.
The level data on the second line is changed to 0 dBm.

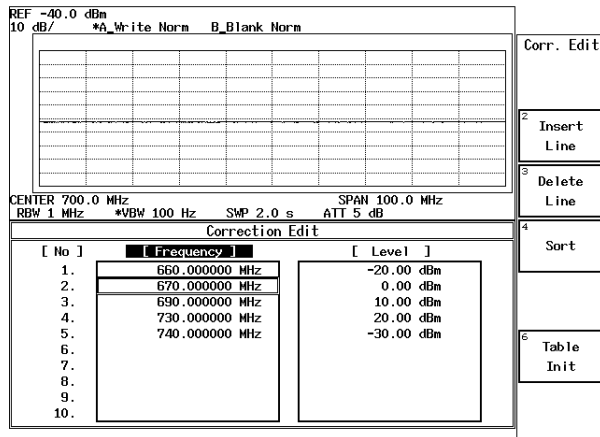

Figure 2-36 Corrected Compensation Data

3. Press **RETURN**.
The correction table is removed.

2.2.6 Separating Two Signals

This section describes how RBW should be set to properly observe adjacent signals using the analyzer.

Measurement conditions: The two signals used are as follows.

Signal 1: A frequency of 200.00 MHz and a Level of -10 dBm

Signal 2: A frequency 200.25 MHz and a Level of -40 dBm

Setup

1. Connect the signal generators as shown in Figure 2-37.

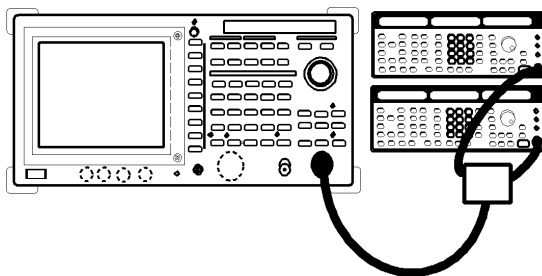

Figure 2-37 Setup for Measuring Two Signals Separately

Power on

2. Turn the analyzer and the signal generators power on.

Setting the signal generators

This prepares the signal generators for output.

3. For Signal generator 1, set the frequency to 200.00 MHz; the level to -10 dBm; and the output to the ON position.
4. For Signal generator 2, set the frequency to 200.25 MHz; level to -40 dBm; and the output to the ON position.

Initialization

This resets the current settings to the factory defaults or user-defined presets.

5. Press **SHIFT** and **CONFIG(PRESET)**.
This sets the analyzer to its presets values.

Setting the measurement conditions

This changes the analyzer settings so that the input signal is displayed more clearly.

6. Press **FREQ, 2, 0, 0** and **MHz**.
A center frequency of 200 MHz is set.

2.2.6 Separating Two Signals

7. Press **SPAN, 2, 0** and **MHz**.
A frequency span of 20 MHz is set.
8. Press **LEVEL, 1, 0** and **MHz(-dBm)**.
The reference level of -10 dBm is set.
The spectrums are not fully separated because the RBW default setting is 300 kHz. As a result, the display shows only one input signal even though there are actually two.

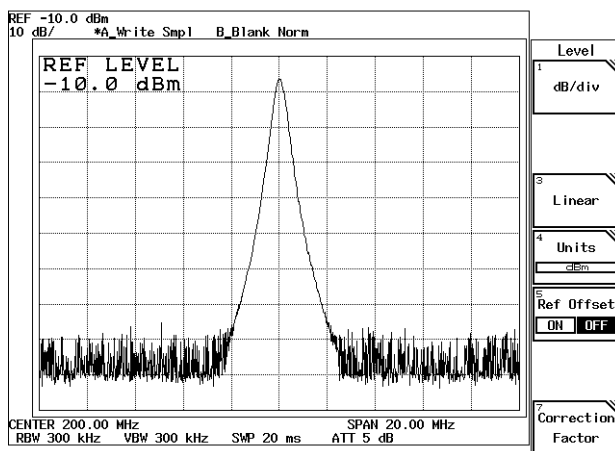

Figure 2-38 Two Superimposed Peaks

9. Press **COUPLE, RBW AUTO/MNL(MNL), 3, 0** and **kHz**.
The RBW is set to 30 kHz.
Two peaks are now discernible but they are still not clearly separated.

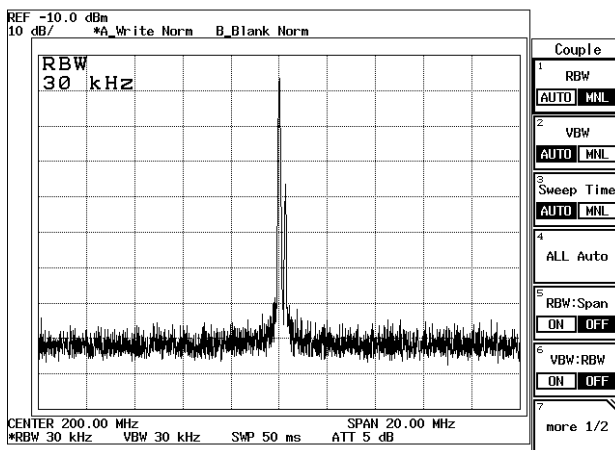

Figure 2-39 Two Discernible Peaks

10. Press **1, 0** and **kHz**.
The RBW is set to 10 kHz.
Two peaks can now be distinctly seen.

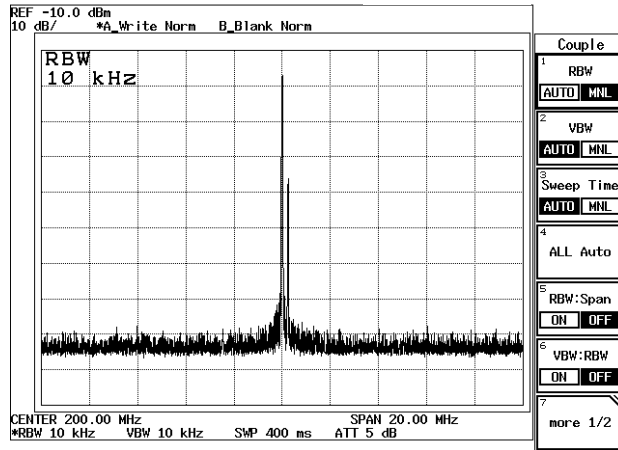

Figure 2-40 Two Distinct Peaks Can Now Be Seen

2.2.7 Dynamic Range

2.2.7 Dynamic Range

The dynamic range can be increased by reducing the noise level, which is accomplished by making the resolution bandwidth narrower. The noise level can be further reduced by setting the video bandwidth (VBW) to approximately 1/10 of the resolution bandwidth (RBW). In addition, noise level can be reduced in a short time using the average function.

Setup

1. Connect the signal generator as shown in Figure 2-41.

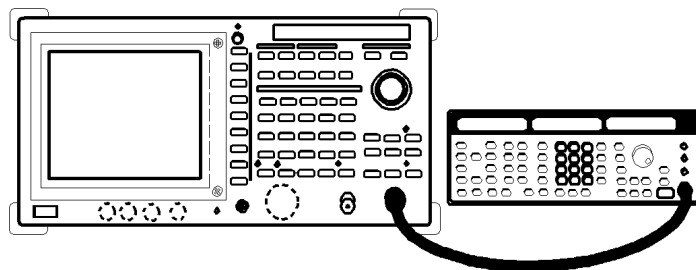

Figure 2-41 Setup for Verifying the Dynamic Range

Power on

2. Turn the analyzer and the signal generator power on.

Setting the signal generator

This prepares the signal generators for output.

3. For Signal generator, set the frequency to 200 MHz; the level to -50 dBm; and the output to the ON position.

Initialization

This resets the current settings to the factory defaults or user-defined presets.

4. Press **SHIFT** and **CONFIG(PRESET)**.
This sets the analyzer to its presets values.

Setting the measurement conditions

This changes the analyzer settings so that the input signal is displayed more clearly.

5. Press **FREQ, 2, 0, 0** and **MHz**.
A center frequency of 200 MHz is set.
6. Press **SPAN, 1, 0, 0** and **MHz**.
A frequency span of 100 MHz is set.

7. Press **LEVEL, 4, 0** and **MHz(-dBm)**.
The reference level is set to -40 dBm.

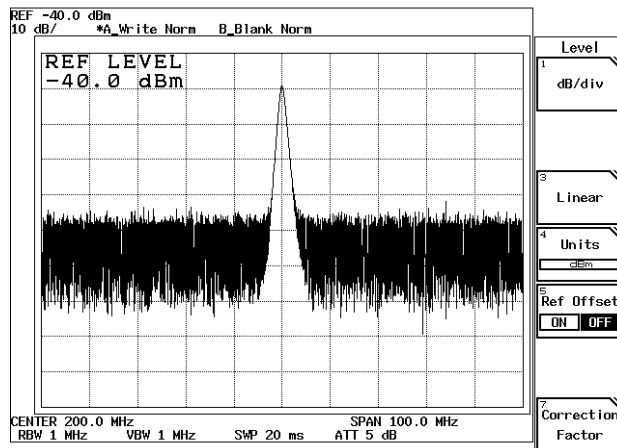

Figure 2-42 Trace Prior to Changing the RBW

Changing the RBW

The RBW is set to 1 MHz according to the current center frequency and frequency span. The noise can be reduced by making this value smaller.

8. Press **COUPLE, RBW AUTO/MNL(MNL), 1, 0, 0** and **kHz**.
An RBW of 100 kHz is set. Check that the noise level is reduced by 10 dB and the dynamic range is widened.

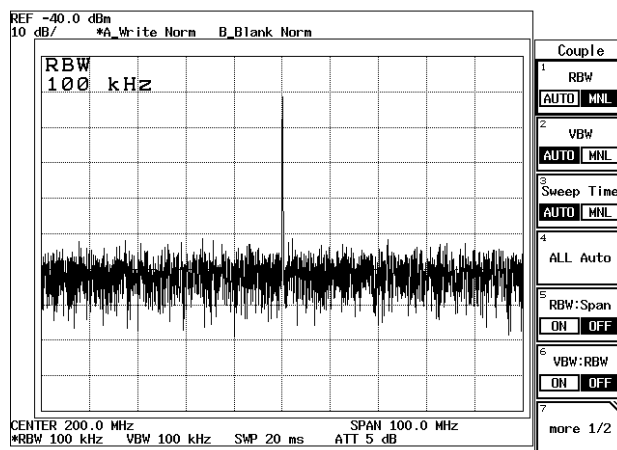

Figure 2-43 Trace After Changing the RBW

Changing the VBW

The noise width can be further reduced by setting the VBW to 1/10 of the RBW.

2.2.7 Dynamic Range

9. Press **VBW AUTO/MNL(MNL)**, **1, 0** and **kHz**.
A VBW of 10 kHz is set. Check that the noise level is reduced more.

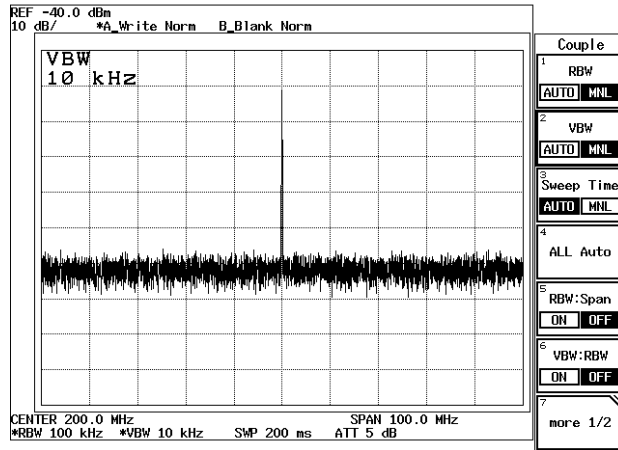

Figure 2-44 Trace After Changing the VBW

Performing the averaging function

This function can improve the S/N ratio faster than the VBW method shown above. This function makes it possible to quantify random components and measure signals buried in the noise.

10. Press **A** and **Average A**.
Average A (with a default setting of 20) has reduced the noise level considerably.

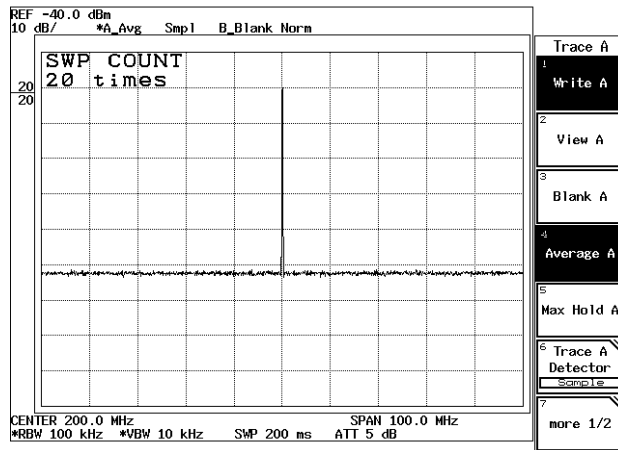

Figure 2-45 The Trace after Averaging

2.2.8 UNCAL Message

The settings of the resolution bandwidth (RBW), video bandwidth (VBW), frequency span (SPAN) and sweep time (SWP) are interrelated. The message UNCAL is displayed in the frequency area when any item is inappropriately set. If this happens, proceed as follows to remove the UNCAL message.

- Make the resolution bandwidth (RBW) wider.
- Make the video bandwidth (VBW) wider.
- Make the sweep time (SWP) longer.
- Make the frequency span (SPAN) narrower when the RBW or VBW cannot be changed.

CAUTION: *Measured data may be inaccurate if you take measurements while the UNCAL message is displayed.*

In this section, the following example shows how to remove an UNCAL message, which was caused by making the sweep time shorter, by changing the RBW setting.

Setup

1. Connect the unit under test as shown in Figure 2-46.

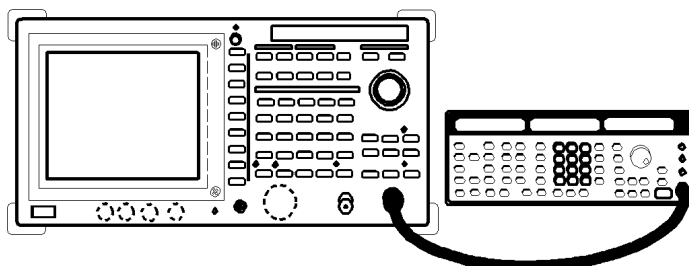

Figure 2-46 Measuring AM Signal in Separate Screen Mode

Power on

2. Turn the analyzer and the signal generator power on.

Initialization

This resets the current settings to the factory defaults or user-defined presets.

3. Press **SHIFT** and **CONFIG(PRESET)**.
This sets the analyzer to its presets values.

Setting the measurement conditions

This changes the analyzer settings so that the input signal is displayed more clearly.

4. Press **FREQ, 1** and **GHz**.
A center frequency of 1 GHz is set.

2.2.8 UNCAL Message

5. Press **SPAN, 5, 0** and **kHz**.
A frequency span of 50 kHz is set.
The following are automatically set:
RBW = 1 kHz, VBW = 1 kHz, Sweep time = 100 ms.
6. Press **SWP, Sweep Time AUTO/MNL(MNL), 2, 0** and **kHz(ms)**.
Sweep time is set to 20 ms and UNCAL is displayed in the lower right hand frequency area on the screen.
A Sweep time of 20 msec is too short.

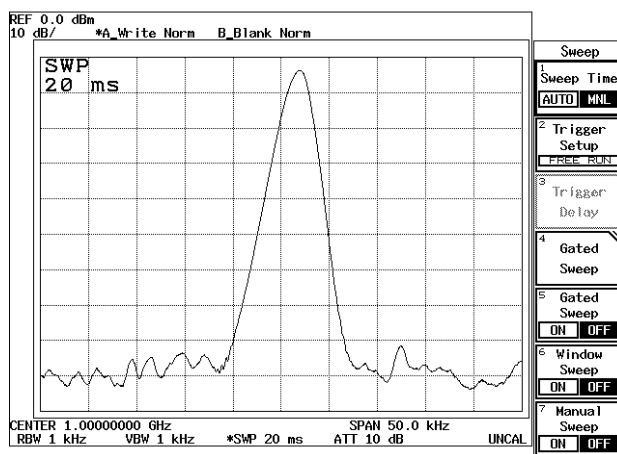

Figure 2-47 Screen with UNCAL Message

Coping with the UNCAL message

7. Press **COUPLE, RBW AUTO/MNL(MNL), 1, 0** and **kHz**.
Once the RBW is set to 10 kHz, the UNCAL message will disappear because a sweep time of 20 msec meets the required condition.

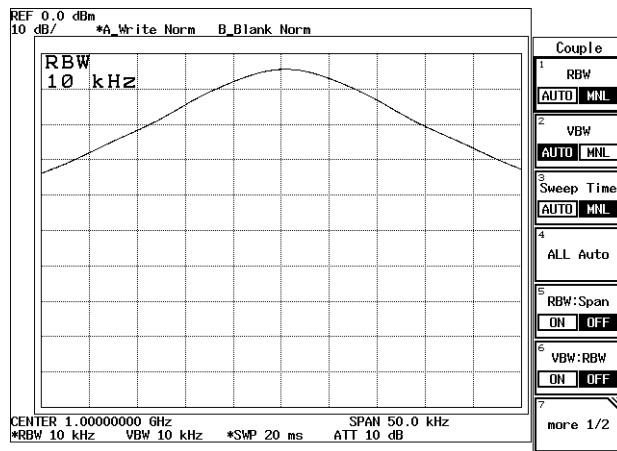

Figure 2-48 UNCAL Message Removed

2.2.9 Zooming the Frequency Domain

The analyzer has a function that allows you to display a part of magnified upper screen trace on the lower screen in the frequency domain.

This section describes the zoom function in the frequency domain.

Measurement conditions: The target of the measurement below is a signal whose characteristics consist of an output frequency of 100 MHz, a level of -10 dBm, a modulation frequency of 10 kHz and an AM modulation factor of 3%.

Use appropriate parameter values when making the measurements in the example shown below.

Setup

1. Connect the unit under test as shown in Figure 2-49.

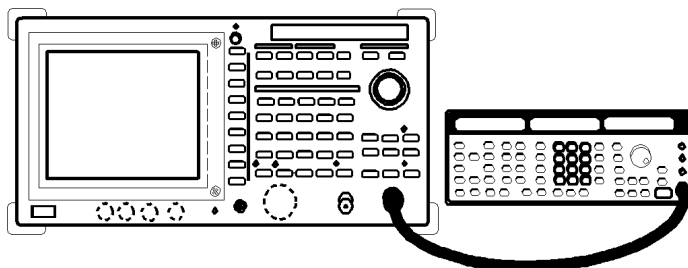

Figure 2-49 Measuring AM Signal in Separate Screen Mode

Power on

2. Turn the analyzer and the signal generator power on.

Setting the signal generator

This prepares the signal generator for output.

3. Set the frequency to 100 MHz; the level to -10 dBm; the modulation frequency to 10 kHz; AM modulation factor to 3% and the output to the ON position.

Initialization

This resets the current settings to the factory defaults or user-defined presets.

4. Press **SHIFT** and **CONFIG(PRESET)**.
This sets the analyzer to its presets values.

Setting the measurement conditions

This changes the analyzer settings so the input signal is displayed more clearly.

5. Press **FREQ,1, 0, 0** and **MHz**.
A center frequency of 100 MHz is set.

2.2.9 Zooming the Frequency Domain

6. Press **SPAN, 2, 5** and **kHz**.
A frequency span of 25 kHz is set.

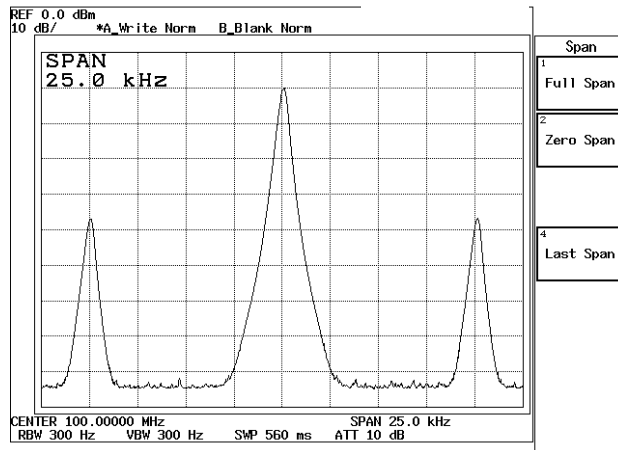

Figure 2-50 Displaying the Trace in Full Screen Mode

Separate screen mode

7. Press **WINDOW** and **Zoom**.
The screen display is in Separate screen mode and the Zoom menu is displayed. The cursor for the zoom position and the cursors for the zoom width are displayed on the upper screen.

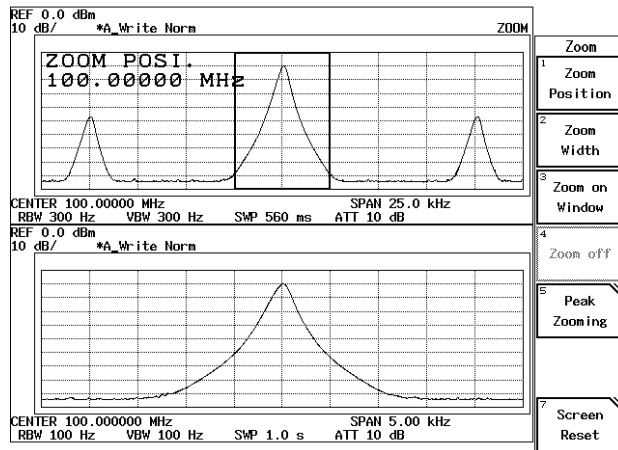

Figure 2-51 Displaying the Trace in Separate Screen Mode

8. Press **Zoom Width, 1** and **kHz**.
A frequency span of the lower screen is set to 1 kHz.
9. Press **Zoom Position** and move the cursor to the peak on the modulating signal using the data knob.
The center frequency on the lower screen moves to the peak on the modulating signal.

Displaying a magnified lower screen in Full screen mode

10. Press **Zoom on Window**.

The lower screen is magnified and displayed in Full screen mode.
The spectrum can be analyzed using this magnified display.

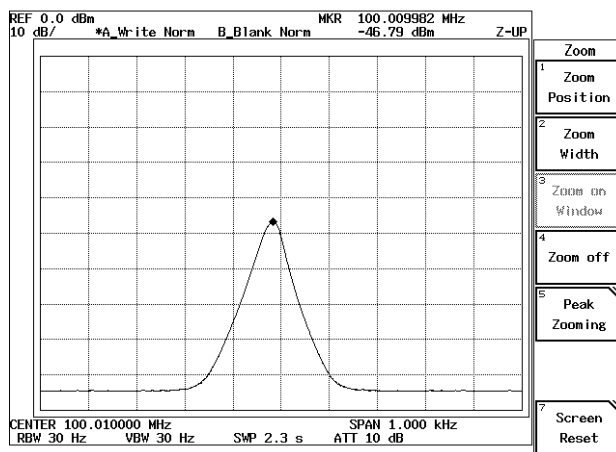

Figure 2-52 Displaying the Magnified Lower Screen

Turning off the magnified display

11. Press **Zoom off**.

The screen display returns to Separate screen mode from the magnified lower screen mode.

Turning off the Separate screen mode

12. Press **Screen Reset**.

The screen display returns to Full screen mode for displaying only the upper screen.

2.2.10 Zooming the Time Domain

2.2.10 Zooming the Time Domain

The analyzer has a function that allows you to display a part of magnified upper screen trace on the lower screen in the time domain. This section describes the zoom function in the time domain.

Measurement conditions: The target of the measurement below is a signal whose characteristics consist of an output frequency of 1 GHz, a level of -10 dBm, a pulse width of 0.8 msec and a pulse period of 10 msec.

Use appropriate parameter values when making the measurements in the example shown below.

Setup

1. Connect the unit under test as shown in Figure 2-53.

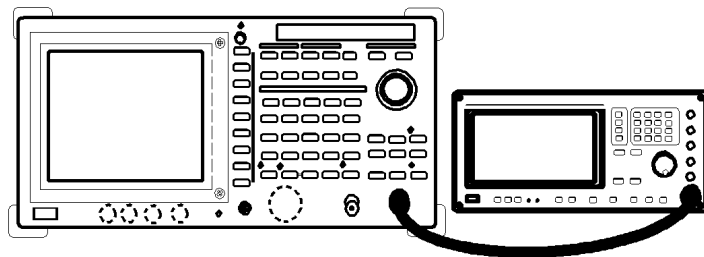

Figure 2-53 Measuring Burst Signal in Separate Screen Mode

Power on

2. Turn the analyzer and the signal generator power on.

Setting the signal generator

This prepares the signal generator for output.

3. Set the frequency to 1 GHz; the level to -10 dBm; the pulse width to 0.8 msec; pulse period to 10 msec and the output to the ON position.

Initialization

This resets the current settings to the factory defaults or user-defined presets.

4. Press **SHIFT** and **CONFIG(PRESET)**.
This sets the analyzer to its presets values.

Setting the measurement conditions

This changes the analyzer settings so the input signal is displayed more clearly.

5. Press **FREQ, 1** and **GHz**.
A center frequency of 1 GHz is set.

6. Press **SPAN**, **5, 0** and **MHz**.
A frequency span of 50 MHz is set.
7. Press **SWP**, **Sweep Time AUTO/MNL(MNL)**, **1, 0, 0** and **kHz(ms)**.
A sweep time of 100 msec is set.
8. Press **COUPLE**, **RBW AUTO/MNL(MNL)**, **3** and **MHz**.
A resolution bandwidth of 3 MHz is set. The burst signal can be identified.

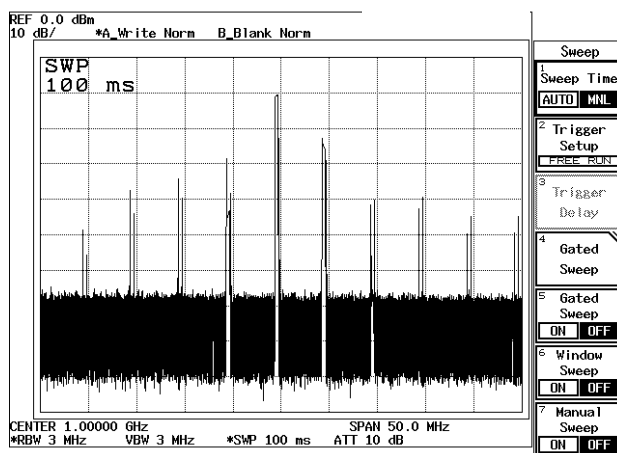

Figure 2-54 Trace of a Burst Signal

9. Press **SPAN** and **Zero Span**.
The frequency span is set to zero span.
10. Press **SWP** and **Trigger Setup**.
The Trigger Setup dialog box is displayed.
11. Set **Source** to **VIDEO**.
The trigger source is set to VIDEO. The cursor moves to Slope. The trigger level mark "→" is displayed on the left-hand side of the scale.
12. Press **Hz(ENTER)**.
The trigger slope is set to "+" and the cursor moves to Trigger Level.
13. Adjust the trigger level.
Adjust the trigger level to the middle of the burst signal turning the data knob. A stably triggered display is obtained.
14. Press **RETURN**.
The Trigger Setup dialog box is removed.

2.2.10 Zooming the Time Domain

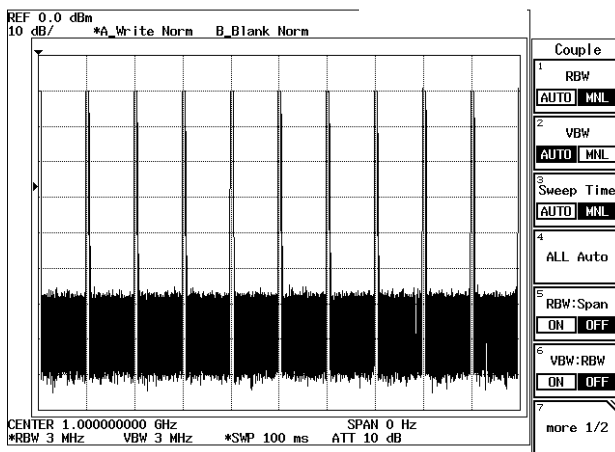

Figure 2-55 Burst Signal in the Zero Span

Separate screen mode

15. Press **WINDOW** and **Zoom**.
The screen display is in Separate screen mode and the Zoom menu is displayed. The cursor for the zoom position and the cursors for the zoom width are displayed on the upper screen.

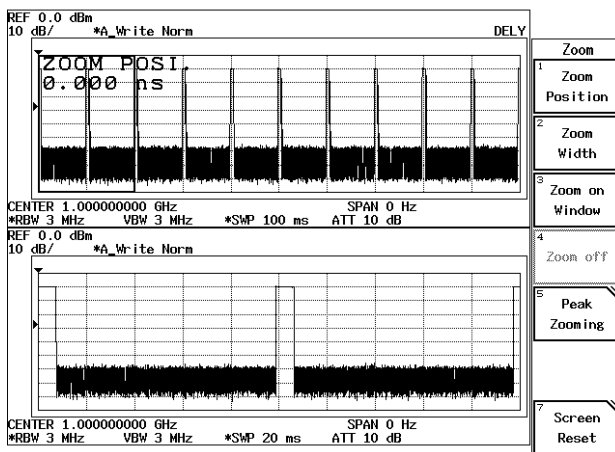

Figure 2-56 Displaying the Trace in the Separate Screen Mode

Observing the leading edge

16. Press **Zoom Position** and move the cursor to the leading edge of the signal using the data knob.
The leading edge of the signal is displayed on the lower screen.
17. Press **Zoom Width** and move the zoom width to the leading edge of the signal.
The leading edge is magnified on the lower screen.

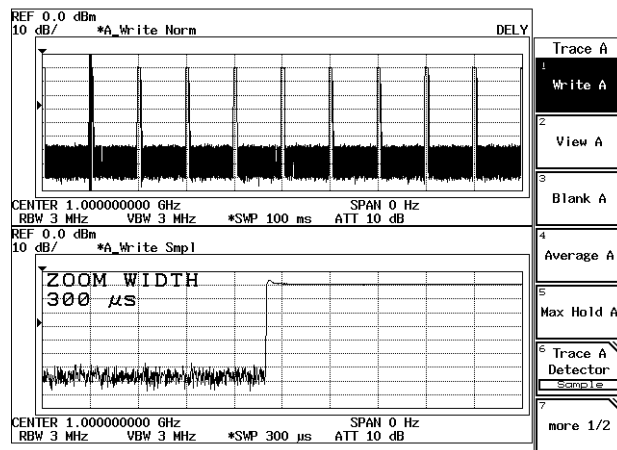

Figure 2-57 Observing the Leading Edge in the Separate Screen Mode

Observing the trailing edge

18. Press **Zoom Position**. Move the cursor to the trailing edge of the signal using the data knob.
The trailing edge of the signal is displayed on the lower screen.

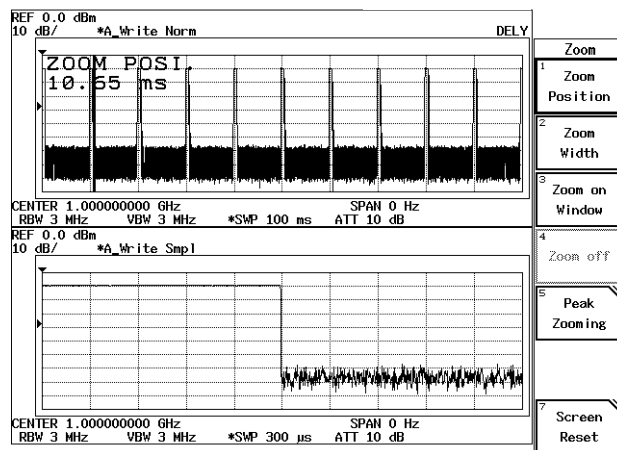

Figure 2-58 Observing the Trailing Edge in Separate Screen Mode

Displaying the lower screen in Full screen mode

19. Press **Zoom on Window**.
The leading edge is magnified on the lower screen.
You can analyze the time axis using this magnified display.

2.2.10 Zooming the Time Domain

Returning to Separate screen mode from the magnified lower screen

20. Press ***Zoom off***.
The screen display returns to Separate screen mode from the magnified lower screen.

Entering Full screen mode

21. Press ***Screen Reset***.
The screen display now returns to Full screen mode (displaying the trace on the upper screen).

2.2.11 Measurement Using the F/T Function

The analyzer provides the F/T function that allows you to measure using two screens (one is in the frequency domain; and the other is in the time domain) simultaneously.

Measurement conditions: The target of the measurement below is a signal whose characteristics consist of an output frequency of 1 GHz, a level of -10 dBm, a pulse width of 4 msec and a pulse period of 10 msec.

Use appropriate parameter values when making the measurements in the example shown below.

Setup

1. Connect the unit under test as shown in Figure 2-59.

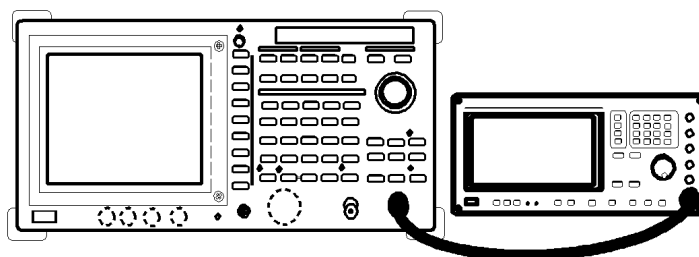

Figure 2-59 Setup to Measure Pulse Signal Using 2 Screens

Power on

2. Turn the analyzer and the signal generator power on.

Setting the signal generator

This prepares the signal generator for output.

3. Set the frequency to 1 GHz; the level to -10 dBm; the pulse width to 4 msec; pulse period to 10 msec and the output to the ON position.

Initialization

This resets the current settings to the factory defaults or user-defined presets.

4. Press **SHIFT** and **CONFIG(PRESET)**.
This sets the analyzer to its presets values.

Setting the measurement conditions

This changes the analyzer settings so that the input signal is displayed more clearly.

5. Press **FREQ, 1** and **GHz**.
A center frequency of 1 GHz is set.

2.2.11 Measurement Using the F/T Function

6. Press **SPAN**, **8**, **0** and **MHz**.
A frequency span of 80 MHz is set.

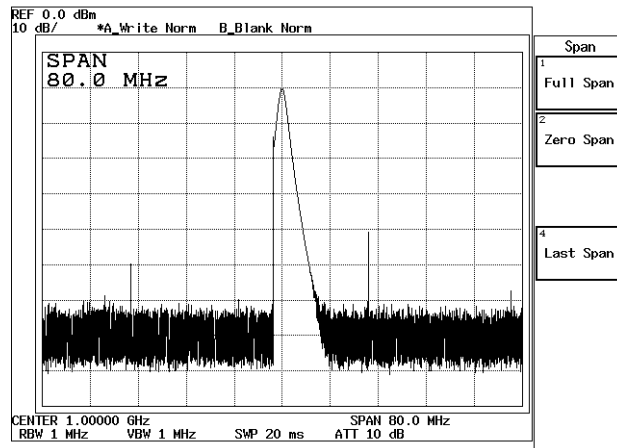

Figure 2-60 Trace of a Burst Signal

Separate screen mode

7. Press **WINDOW** and **F/T**.
The display is now in the Separate screen mode. The frequency domain is displayed on the upper screen, and the time domain is displayed on the lower screen.
8. Press **B**.
The lower screen is active.
9. Press **SWP**, *Sweep Time AUTO/MNL(MNL)*, **1**, **0** and **kHz(ms)**.
The sweep time for the lower screen is set to 10 msec.
10. Press **Trigger Setup**.
The Trigger Setup dialog box is displayed.
11. Set **Source** to **VIDEO**.
The trigger source is set to VIDEO. The cursor moves to Slope. The trigger level mark "→" is displayed on the left-hand side of the scale.
12. Press **Hz(ENTER)**.
The trigger slope is set to "+" and the cursor moves to Trigger Level.
13. Adjust the trigger level.
Adjust the trigger level to the middle of the burst signal turning the data knob. A stably triggered display is obtained.
14. Press **RETURN**.
The Trigger Setup dialog box is removed.

15. Press **SRCH**.

The marker is displayed on the lower screen.

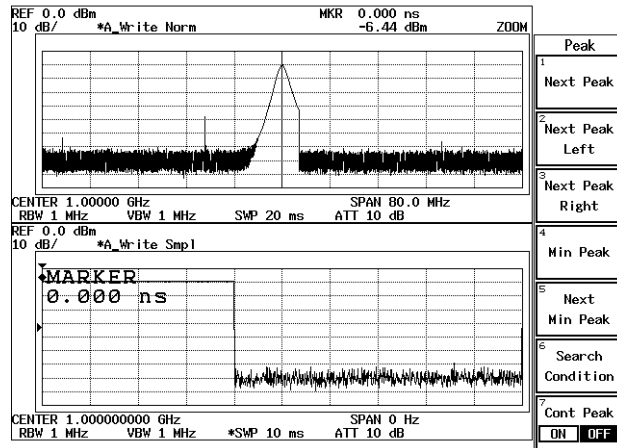

Figure 2-61 F/T Function Displayed in Separate Screen Mode

Displaying the lower trace in Full screen mode

16. Press **WINDOW** and *Zoom on Window*.

The leading edge is magnified on the lower screen.

You can analyze the time axis using this magnified display.

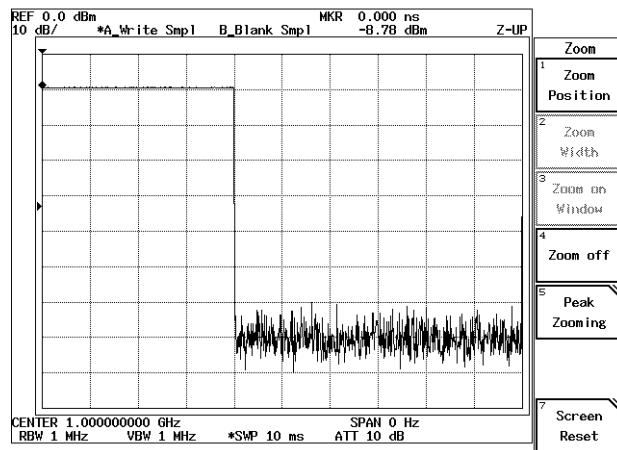

Figure 2-62 F/T Mode in Zoom Display

Entering Separate screen mode

17. Press *Zoom off*.

The screen display changes from the magnified mode (of the lower screen) to Separate screen mode.

2.2.11 Measurement Using the F/T Function

Entering Full screen mode

18. Press **Screen Reset**.
The screen display now returns to Full screen mode (displaying the trace on the upper screen).

2.2.12 Measuring Dual Parameters

The analyzer is capable of displaying traces using two screens simultaneously with different measurement conditions to each other.

2.2.12.1 Measuring Dual Parameters in the Frequency Domain

This section describes how to set the center frequency for each screen and display them.

Measurement conditions: The two signals used are as follows.

Signal 1: A center frequency of 100 MHz and a level of -10 dBm.

Signal 2: A center frequency of 650 MHz and a level of -10 dBm.

Use appropriate parameter values when making the measurements in the example shown below.

Setup

1. Connect the unit under test as shown in Figure 2-63.

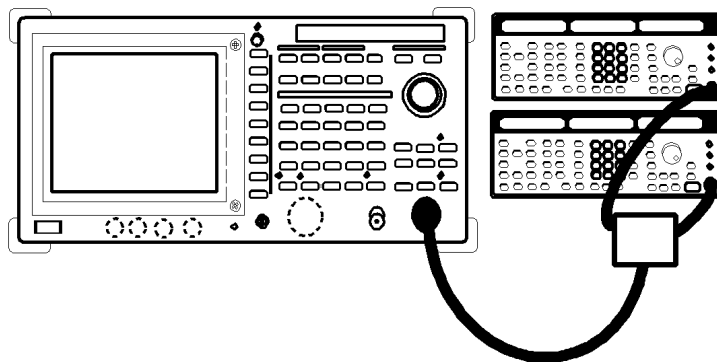

Figure 2-63 Setup to Measure Dual Parameters

Power on

2. Turn the analyzer and the signal generators power on.

Setting the signal generators

This prepares the signal generators for output.

3. For signal generator 1, set the frequency to 100 MHz; the level to -10 dBm and the output to the ON position.
4. For signal generator 2, set the frequency to 650 MHz; the level to -10 dBm and the output to the ON position.

Initialization

This resets the current settings to the factory defaults or user-defined presets.

2.2.12 Measuring Dual Parameters

5. Press **SHIFT** and **CONFIG(PRESET)**.
This sets the analyzer to its presets values.

Setting the measurement conditions

This changes the analyzer settings so that the input signal is displayed more clearly.

6. Press **WINDOW** and **Zoom**.
The Zoom menu is displayed and the screen display is changed to Separate screen mode.

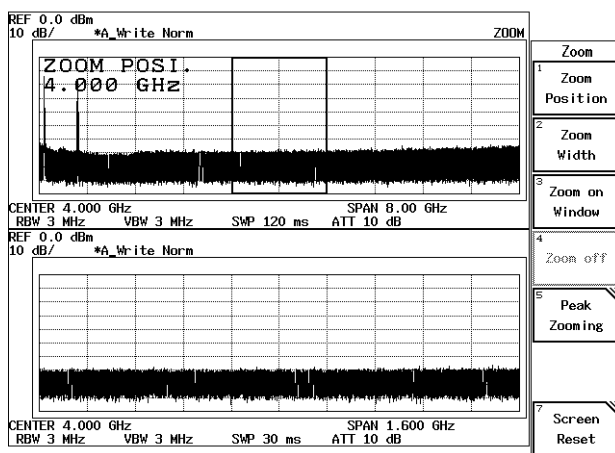

Figure 2-64 Displaying in Separate Screen Mode

Setting for the upper screen

7. Press **FREQ, 1, 0, 0** and **MHz**.
A center frequency of 100 MHz is set for the upper screen.
8. Press **SPAN, 1, 0** and **MHz**.
A frequency span of 10 MHz is set for the upper screen.
Trace 1 is displayed on the upper screen.

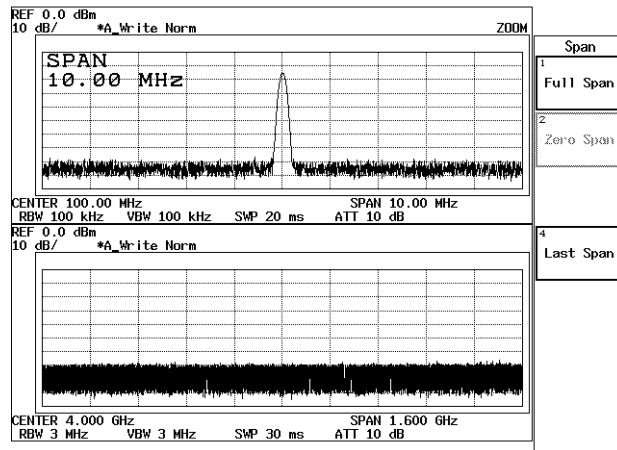

Figure 2-65 Setting for the Upper Screen in Separate Screen Mode

Setting for the lower screen

9. Press **B**.
The lower screen is active.
10. Press **FREQ, 6, 5, 0** and **MHz**.
A center frequency of 650 MHz is set for the lower screen.
11. Press **SPAN, 5** and **MHz**.
A frequency span of 5 MHz is set for the lower screen.

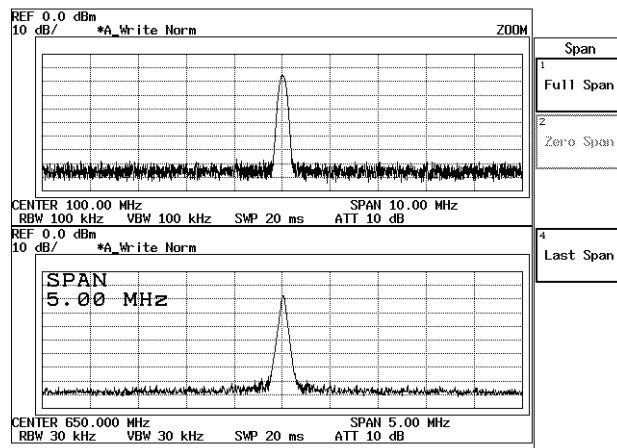

Figure 2-66 Setting for the Lower Screen in Separate Screen Mode

2.2.12 Measuring Dual Parameters

Magnified display for the lower screen

12. Press **WINDOW** and *Zoom on Window*.
The trace for the lower screen is now displayed in Full screen mode.

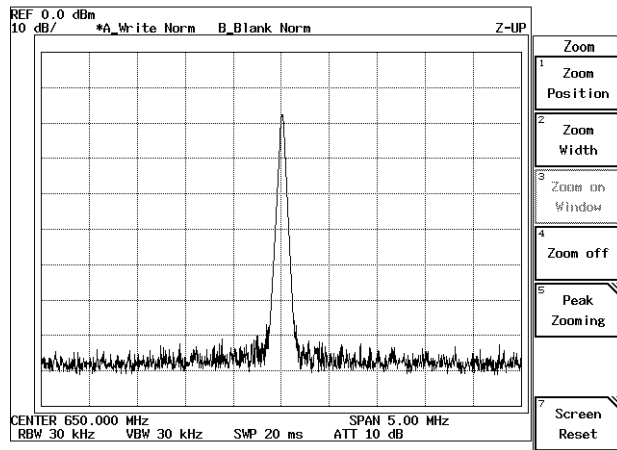

Figure 2-67 Magnified Trace for the Lower Screen

Changing the screen display to Separate screen mode

13. Press *Zoom off*.
The screen display is changed from the magnified mode (of the lower trace) to Separate screen mode.

Changing the screen display to Full screen mode (for displaying the upper screen)

14. Press *Screen Reset*.
The screen display is changed to Full screen mode for displaying the upper screen.

2.2.12.2 Measuring Dual Parameters in the Time Domain

This section describes how to set the center frequency for each screen and analyze them in the time domain.

Measurement conditions: The signal to be measured consists of the signal specified below.

Signal 1: A frequency of 900 MHz, a Level of 0 dBm, a pulse width of 1 msec and a pulse period of 10 msec.

Signal 2: A frequency of 1800 MHz, a Level of 0 dBm, a pulse width of 1 msec and a pulse period of 10 msec.

Use appropriate parameter values when making the measurements in the example shown below.

Setup

1. Connect the unit under test as shown in Figure 2-68.

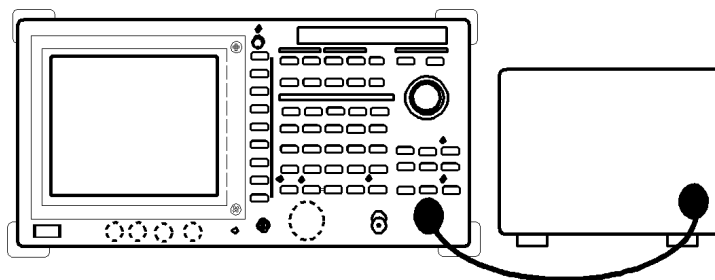

Figure 2-68 Setup to Measure Pulse Signals with Different Frequencies Using 2 Screens

Power on

2. Turn the analyzer and the unit under test power on.

Setting the unit under test

3. Couples Signal 1 with Signal 2 and outputs the total signal.

Initialization

This resets the current settings to the factory defaults or user-defined presets.

4. Press **SHIFT** and **CONFIG(PRESET)**.
This sets the analyzer to its presets values.

Setting the measurement conditions

This changes the analyzer settings so that the input signal is displayed more clearly.

5. Press **WINDOW** and **T/T**.
Both screens are set to Zero span in the Separate screen.

2.2.12 Measuring Dual Parameters

Setting for the upper screen

6. Press **FREQ, 9, 0, 0** and **MHz**.
A center frequency of 900 MHz is set for the upper screen.
7. Press **COUPLE, RBW AUTO/MNL(MNL), 3** and **MHz**.
A resolution bandwidth of 3 MHz is set for the upper screen.
8. Press **SWP, Sweep Time AUTO/MNL(MNL), 1, 0** and **kHz(ms)**.
A sweep time of 10 msec is set for the upper screen.
9. Press **Trigger Setup**.
The Trigger Setup dialog box is displayed.
10. Set **Source** to **VIDEO**.
The trigger source is set to VIDEO. The cursor moves to Slope. The trigger level mark " \rightarrow " is displayed on the left-hand side of the scale.
11. Press **Hz(ENTER)**.
The trigger slope is set to "+" and the cursor moves to Trigger Level.
12. Adjust the trigger level.
Adjust the trigger level to the middle of the burst signal turning the data knob. A stably triggered display is obtained.
13. Press **RETURN**.
The Trigger Setup dialog box is removed.

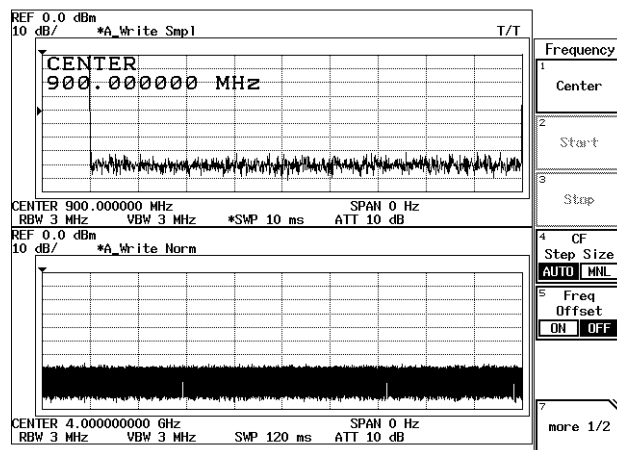

Figure 2-69 Upper Screen in Sync with the Trigger Signal

Setting for the lower screen

14. Press **B**.
The lower screen is active.

15. Press **FREQ, 1, 8, 0, 0** and **MHz**.
A center frequency of 1800 MHz is set for the lower screen.
16. Press **COUPLE, VBW AUTO/MNL, 1, 0, 0** and **kHz**.
A VBW of 100 kHz is set for the lower screen.
17. Press **SWP** and **Trigger Setup**.
The Trigger Setup dialog box is displayed.
18. Set **Source** to **VIDEO**.
The trigger source is set to VIDEO. The cursor moves to Slope. The trigger level mark " \rightarrow " is displayed on the left-hand side of the scale.
19. Press **Hz(ENTER)**.
The trigger slope is set to "+" and the cursor moves to Trigger Level.
20. Adjust the trigger level.
Adjust the trigger level to the middle of the burst signal turning the data knob. A stably triggered display is obtained.
21. Press **RETURN**.
The Trigger Setup dialog box is removed.
22. Press **Sweep Time AUTO/MNL(MNL), 5** and **kHz(ms)**.
A sweep time of 5 msec is set for the lower screen.

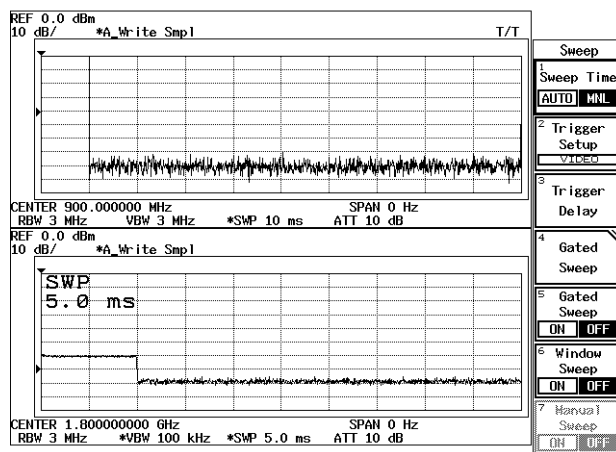

Figure 2-70 Displaying the Traces of 900 MHz and 1800 MHz in the Separate Screen Mode

23. Press **SRCH**.
The level on the lower screen can be measured using the marker.

2.2.12 Measuring Dual Parameters

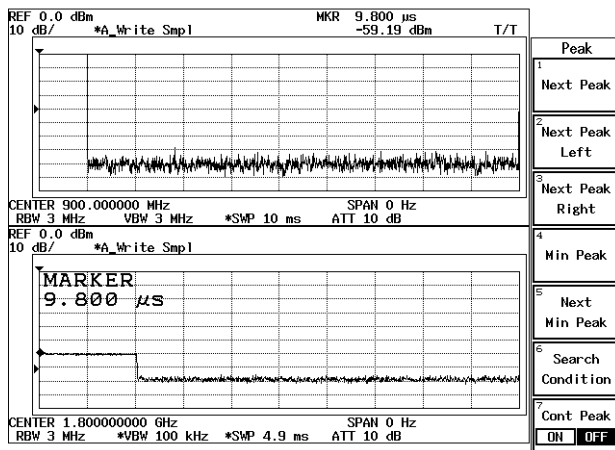

Figure 2-71 Displaying the Trace of 1800 MHz for the Lower Screen

Changing the screen display to Full screen mode for displaying only the upper screen.

24. Press **WINDOW** and *Screen Reset*.
The screen display returns to Full screen mode for displaying only the upper screen.

2.2.13 Calibration

Calibrations are required to take measurements within the specifications of the analyzer.

CAUTION:

1. *Wait 60 minutes after turning the power on before performing the calibrations.*
 2. *If a calibration is performed during the first 10 minutes after the power is turned on, spectrum analyzers with OPT 23 installed may occasionally display error messages since the reference frequency source is not stable.*
-

There are three methods to calibrate the analyzer as shown below.

- **Cal All**
Performs calibrations for all items to see if they meet the specifications.
Perform them before taking measurements. Processing time: Approximately 9 minutes.
- **Total Gain**
Performs calibrations with more accuracy than Cal All, because user-defined measurement conditions are used. Set the conditions first before the calibrations. Processing time: Approximately 1 minute.
- **Cal Each Item**
Performs calibration on only one item.

Table 2-2 Calibration Items

Input ATT
IF Step AMP
RBW Switching
Log Linearity
Amplitude MAG
PBW

NOTE: *You may hear some clicking noises during calibration. This is normal.*

2.2.13 Calibration

2.2.13.1 Cal All

Setup

Connect the calibration signal.

1. Connect the N-BNC adapter to the **INPUT** connector on the front panel.
2. Connect the Input cable between the **CAL OUT** and **INPUT** connectors on the front panel.

Performing the calibration

3. Press **SHIFT** and **7(CAL)**.
The menu used for calibration appears (See Figure 2-72).

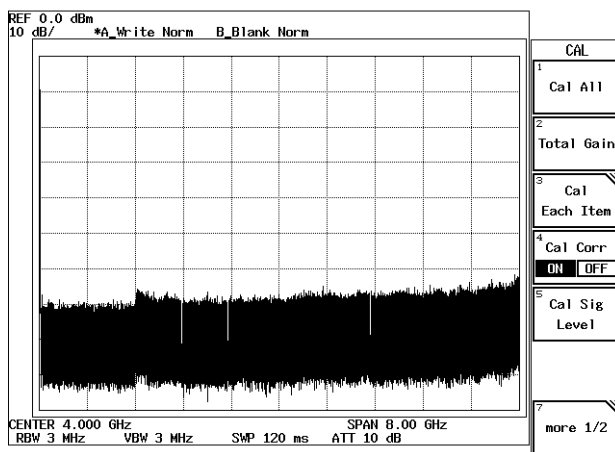

Figure 2-72 Cal Menu

4. Press **Cal All**.
All calibration items are performed.

2.2.13.2 Total Gain

Prior to performing this calibration, be sure to set the RBW, dB/div and reference level as the measurement conditions.

Setup

Connect the calibration signal.

1. Connect the N-BNC adapter to the **INPUT** connector on the front panel.
2. Connect the Input cable between the **CAL OUT** and **INPUT** connectors on the front panel.

Setting measurement conditions

3. Set the RBW, dB/div and the reference level to the values which are actually used in measurements.

Performing the calibration

4. Press **SHIFT** and **7(CAL)**.
The menu used for calibration appears (See Figure 2-72).
5. Press **Total Gain**.
Calibration is performed using the current measurement conditions.

CAUTION: *Perform the Total Gain calibration again if you have changed the RBW, dB/div and reference level after completing the Total Gain calibration.*

2.2.13 Calibration

2.2.13.3 Cal Each Item

Performs one Cal Each Item though Cal All performs all calibration item.

This section describes the PBW calibration.

Setup

Connect the calibration signal.

1. Connect the N-BNC adapter to the **INPUT** connector on the front panel.
2. Connect the Input cable between **CAL OUT** and **INPUT** connectors on the front panel.

Performing the calibration

3. Press **SHIFT** and **7(CAL)**.
The Cal menu used for calibration appears (See Figure 2-72).
4. Press **Cal Each Item** and **PBW**.
PBW (noise power bandwidth) calibration is performed.

2.2.14 Pass/Fail Judgments Using the Limit line Function

Pass/fail judgments for traces on the screen can easily be made by storing the upper and lower limit values using the limit line function.

Power on

1. Turn the power on.

Connecting the input signal cable

Connect the calibration signal used in the measurement.

2. Connect the N-BNC adapter to the **INPUT** connector on the front panel.
3. Connect the Input cable between the **CAL OUT** and **INPUT** connectors on the front panel.

Initialization

This resets the current settings to the factory defaults or user-defined presets.

4. Press **SHIFT** and **CONFIG(PRESET)**.
This sets the analyzer to its presets values.

Setting the measurement conditions

This changes the analyzer settings so that the input signal is displayed more clearly.

5. Press **FREQ, 3, 0** and **MHz**.
The center frequency is set to 30 MHz.
6. Press **SPAN, 2, 0** and **MHz**.
A frequency span of 20 MHz is set.
7. Press **LEVEL, 0** and **GHz(+dBm)**.
The reference level is set to 0 dBm.

2.2.14 Pass/Fail Judgments Using the Limit line Function

Setting the limit line

Each limit line uses the data in the table.

Table 2-3 Setting Limit Line 1

	Frequency	Level
1	20 MHz	-70 dBm
2	26 MHz	-70 dBm
3	28 MHz	-5 dBm
4	32 MHz	-5 dBm
5	34 MHz	-70 dBm
6	40 MHz	-70 dBm

Table 2-4 Setting Limit Line 2

	Frequency	Level
1	20 MHz	-95 dBm
2	28 MHz	-95 dBm
3	29 MHz	-60 dBm
4	31 MHz	-60 dBm
5	32 MHz	-95 dBm
6	40 MHz	-95 dBm

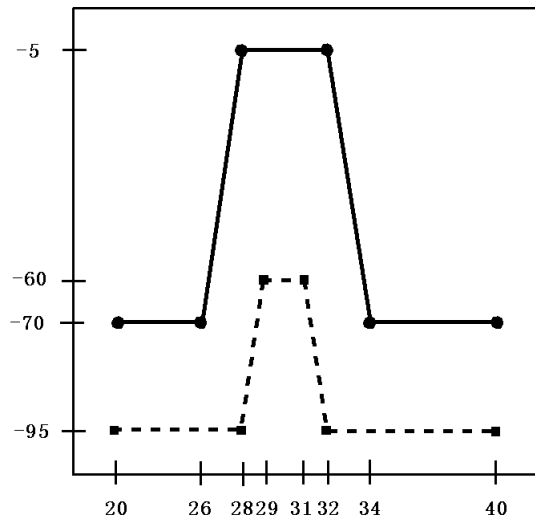

- Press **FORMAT**, *Limit Line* and *Limit Line Edit*.
The Edit menu and editor used for Limit Line 1 are displayed.

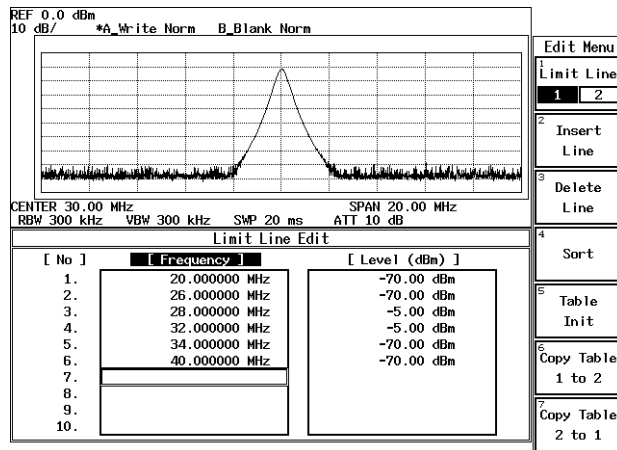

Figure 2-73 Editing the Limit Line 1

- Press **2, 0** and **MHz**.
20 MHz is set in the first frequency entry, and the cursor moves to the level entry.
- Press **7, 0** and **MHz(-dBm)**.
-70 dBm is set in the first level entry, and the cursor moves to the second row.

11. Continue entering data into Table 2-3, repeating steps 9 and 10.

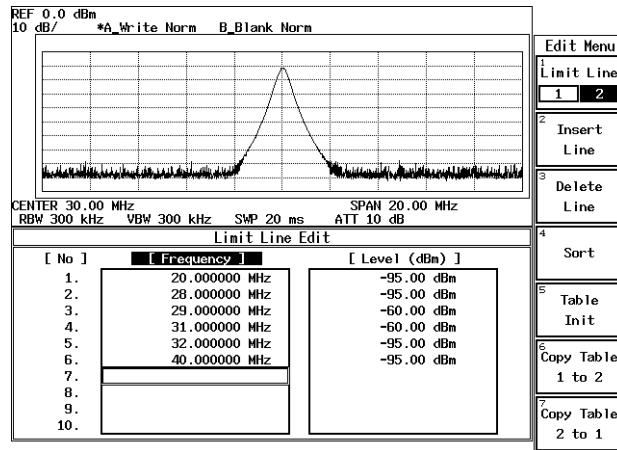

Figure 2-74 Screen Displayed after Limit Line 1 Data Has Been Entered

12. Press *Limit Line 1/2*.
The editor is changed from the Limit line 1 mode to the Limit line 2 mode.
13. Press **2, 0** and **MHz**.
A frequency of 20 MHz is set in the frequency entry used for Limit Line 2. The cursor moves to the level entry.
14. Press **9, 5** and **MHz(-dBm)**.
A level of -95 dBm is set in the first level entry.
15. Continue entering data into Table 2-4, repeating steps 13 and 14.

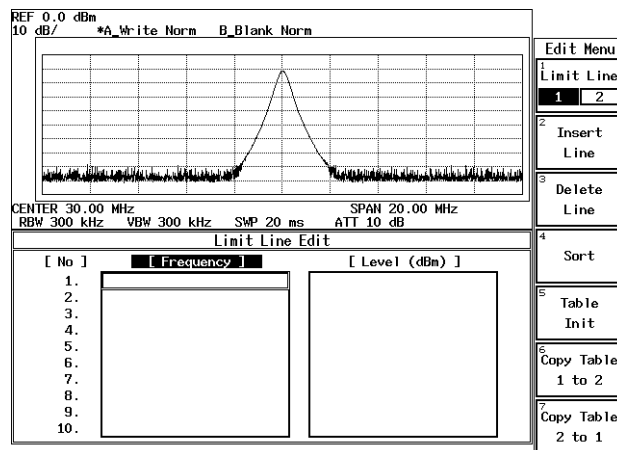

Figure 2-75 Screen Displayed after Limit Line 2 Data Has Been Entered

2.2.14 Pass/Fail Judgments Using the Limit line Function

16. Press **RETURN**.
The editor for Limit line 2 is closed and the Limit Line menu is displayed.

Displaying the Limit Line 1 and setting the Pass/Fail criteria

17. Press **Limit Line Setup**.
The Limit Line Setup dialog box is used to set the Limit Line 1 conditions.

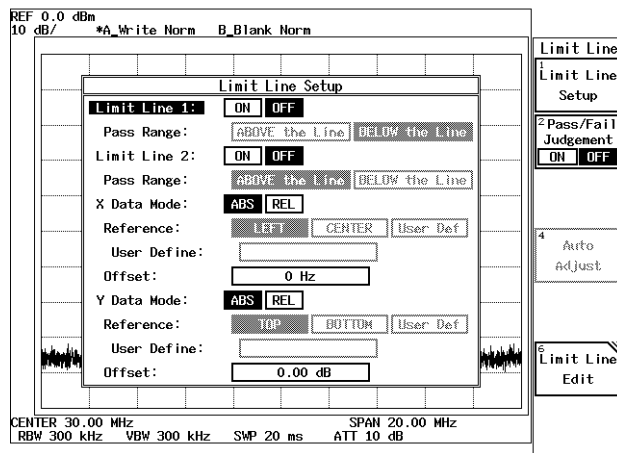

Figure 2-76 Setting Limit Line PASS/FAIL

18. Select ON used with Limit Line 1.
19. Select 'BELOW the Line' in Pass Range for the Limit Line 1.
This setting causes data in the area below Limit Line 1 to be considered a pass.
20. Press **Limit Line Setup**.
The Limit Line Setup dialog box is closed and message PASS is displayed on the screen after the relationships between Limit Line 1 and the trace data have been judged as pass.

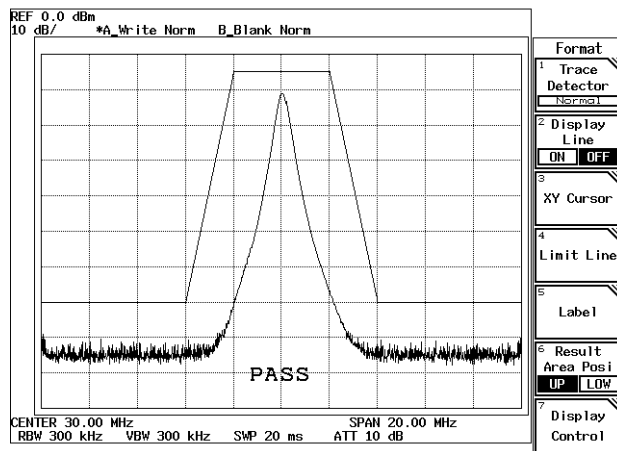

Figure 2-77 PASS/FAIL Result using Limit Line 1

Displaying the Limit Line 2 and setting the Pass/Fail criteria

21. Press **Limit Line Setup**.
The Limit Line Setup dialog box is used to set the Limit Line 2 conditions.
22. Select ON used with Limit line 2.
23. Select 'ABOVE the Line' on the Pass Range for the Limit Line 2.
This setting causes data in the area above Limit Line 2 to be considered a pass.
24. Press **Limit Line Setup**.
The Limit Line Setup dialog box is closed and the judgment result on the limit lines is displayed.

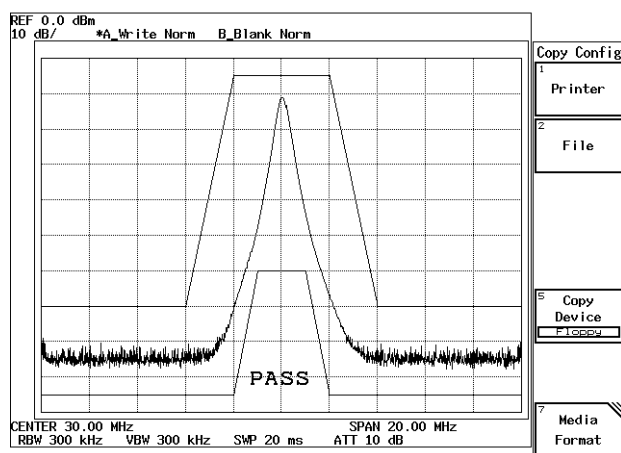

Figure 2-78 PASS/FAIL Result using Limit Lines 1 and 2

Setting an offset for the limit line

25. Press **Limit Line Setup**.
The Limit Line Setup dialog box is displayed.
26. Press the step key Δ .
The input cursor moves to Offset of Y Data Mode.
27. Press **1, 0** and **MHz(-dBm)**.
The Limit lines 1 and 2 that have previously been specified are moved downwards by 10 dB.

2.2.14 Pass/Fail Judgments Using the Limit line Function

28. Press **RETURN**.
The Limit Line Setup dialog box is closed and the judgment result on the limit lines is displayed.

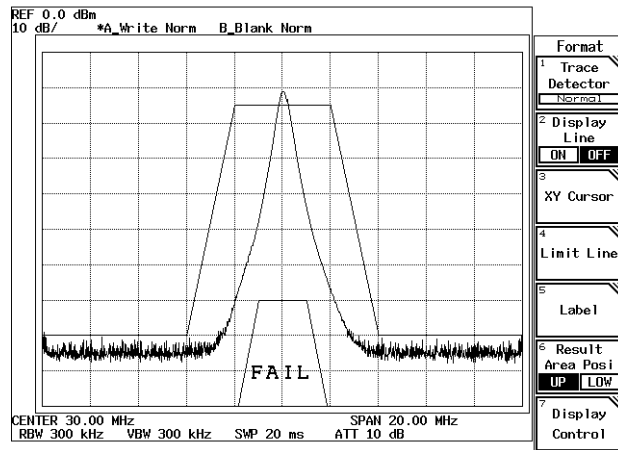

Figure 2-79 Judgment Result after the Offset Has Been Changed

2.3 Measurement Examples

This section describes how the analyzer through practical examples.

2.3.1 Measuring Average Power of Digital Modulation Signal

This section describes the method for measuring the average power of digital modulation signal used in PHS and so on.

Measurement conditions: The unit used in this measurement must comply with the PHS system and output a frequency of 1917.950 MHz and a level of 10 dBm. The signal used must be continuous.

Use appropriate parameter values to make the measurements shown below.

CAUTION: *The maximum amount of power that can be input to the analyzer is 30 dBm (1 W). When measuring a signal power whose value exceeds this limit, connect an external attenuator so the power cannot exceed 30 dBm.*

Setup

1. Connect the unit under test as shown in Figure 2-80.

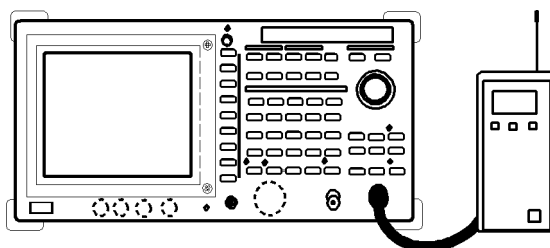

Figure 2-80 Setup for the Average Power Measurement

Power on

2. Turn the analyzer and the unit under test power on.

Setting the unit under test

3. Activate the signal output for the unit under test.

Initialization

This resets the current settings to the factory defaults or user-defined presets.

4. Press **SHIFT** and **CONFIG(PRESET)**.
This sets the analyzer to its presets values.

2.3.1 Measuring Average Power of Digital Modulation Signal

Setting the measurement conditions

This changes the analyzer settings so that the input signal is displayed more clearly.

5. Press **FREQ, 1, 9, 1, 7, ,, 9, 5** and **MHz**.
A center frequency of 1917.95 MHz is set.
6. Press **SPAN, 2, 0** and **MHz**.
A span frequency of 20 MHz is set.
7. Press **COUPLE, RBW AUTO/MNL(MNL), 1** and **MHz**.
An RBW of 1 MHz is set.
8. Press **VBW AUTO/MNL(MNL), 1, 0** and **MHz**.
A VBW of 10 MHz is set.

NOTE: *To reduce measurement errors, make sure that VBW is greater than the RBW.*
VBW > RBW

9. Press **LEVEL, 1, 5** and **GHz(+dBm)**.
The reference level is set to +15 dBm.
10. Press **A, Trace A Detector** and **Sample**.
The trace detector is set to sample detector mode.

NOTE: *Sample detector mode is used to keep measurement errors to a minimum.*

11. Press **LEVEL** and adjust the reference level using the data knob.
When the signal peak is one or more divisions away from the reference level, adjust the signal peak using the data knob so they are as close as possible.

2.3.1 Measuring Average Power of Digital Modulation Signal

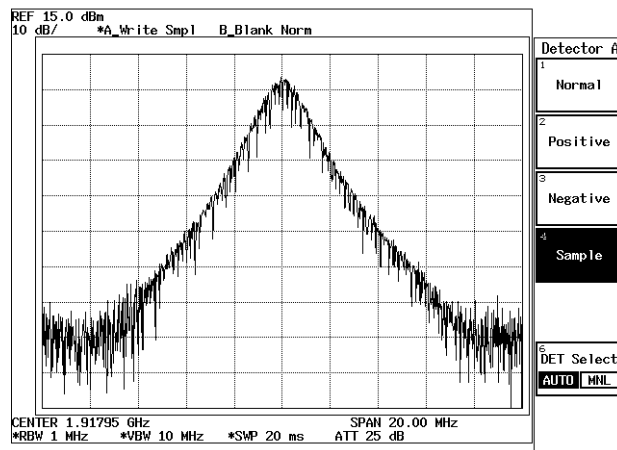

Figure 2-81 Checking the Input Signal

12. Press **SPAN** and *Zero Span*.
The frequency span is set to zero (See Figure 2-82).

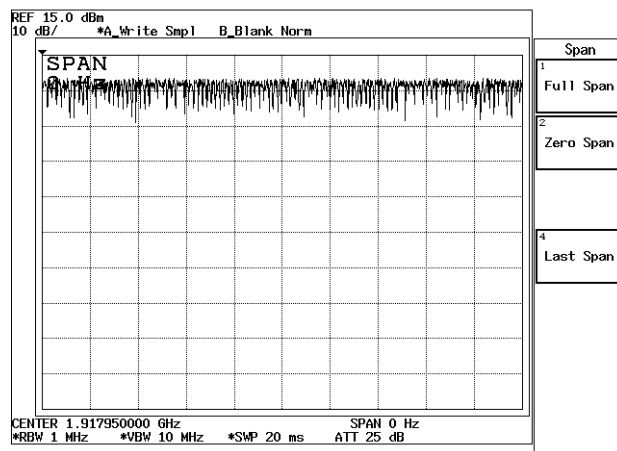

Figure 2-82 Setting Measurement Conditions for Average Power Measurement

Measuring average power

13. Press **POWER** and *Average Power*.
Measures the power averaged over the object range and displays the result.
Allows you to set the averaging count.
14. Press **1, 0** and **Hz(ENTR)**.
An averaging count of 10 is set.
The average power and averaging count set are displayed in the result area (See Figure 2-83).

2.3.1 Measuring Average Power of Digital Modulation Signal

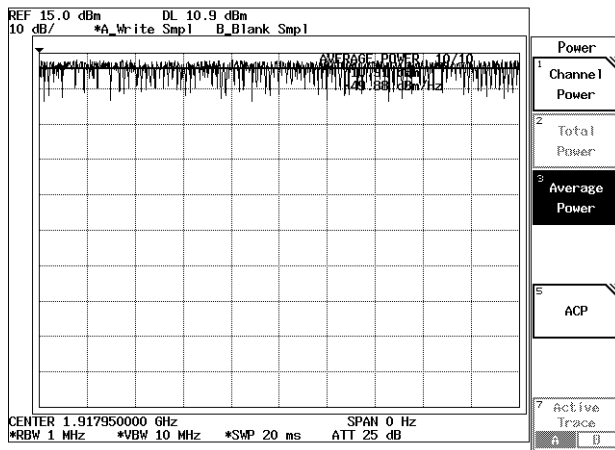

Figure 2-83 Result of an Average Power Measurement

When it is difficult for you to see the measurement result

15. Press **FORMAT** and *Result Area Posi UP/LOW*(LOW). The measurement result is moved downwards.

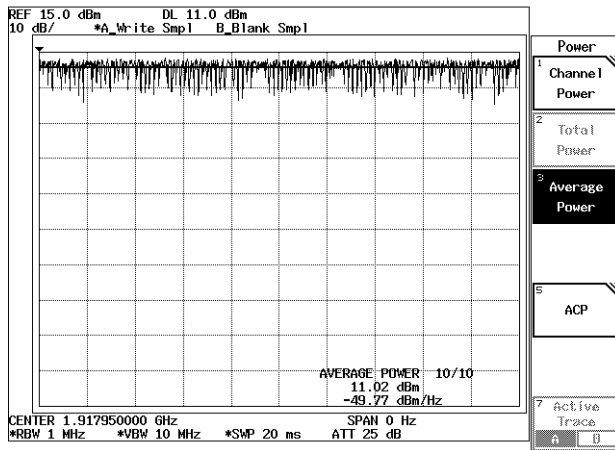

Figure 2-84 Moving the Measurement Result

2.3.2 Measuring CDMA Wave's Total Power

This section describes the method of measuring the total power of CDMA signal.

Measurement conditions: The unit used in this measurement must be usable with CDMA and output a frequency of 916.25 MHz and a level of +10 dBm.

Use appropriate parameter values to make the measurements shown below.

CAUTION: *The maximum amount of power that can be input to the analyzer is 30 dBm (1 W). When measuring a signal power whose value exceeds this limit, connect an external attenuator so the power cannot exceed 30 dBm.*

Setup

1. Connect the unit as shown in Figure 2-85.

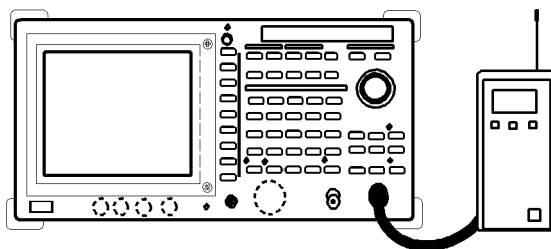

Figure 2-85 Setup for Measuring the Total Power

Power on

2. Turn the analyzer and the unit under test power on.

Setting the unit under test

3. Activate the signal output for the unit under test.

Initialization

This resets the current settings to the factory defaults or user-defined presets.

4. Press **SHIFT** and **CONFIG(PRESET)**.
This sets the analyzer to its presets values.

Setting the measurement conditions

This changes the analyzer settings so that the input signal is displayed more clearly.

5. Press **FREQ, 9, 1, 6, ,, 2, 5** and **MHz**.
A center frequency of 916.25 MHz is set.

2.3.2 Measuring CDMA Wave's Total Power

6. Press **SPAN, 1, 0** and **MHz**.
A frequency span of 10 MHz is set.

NOTE: *When setting the frequency span, make sure it is wider than the span of the displayed spectrum being measured.*

7. Press **LEVEL, 1, 0** and **GHz(+dBm)**.
The reference level is set to +10 dBm.
8. Press **ATT, ATT AUTO/MNL(MNL), 3, 0** and **GHz(dB)**.
The attenuator is set to 30 dB.

NOTE: *Set the attenuator to 'input level + 10 dB' or more to avoid the saturation at the input mixer.*

9. Press **COUPLE, RBW AUTO/MNL(MNL), 3, 0** and **kHz**.
An RBW of 30 kHz is set.
10. Press **VBW AUTO/MNL(MNL), 3, 0, 0** and **kHz**.
A VBW of 300 kHz is set.

NOTE: *To reduce measurement errors, make sure that VBW is greater than the RBW.*
VBW > RBW

11. Press **A, Trace A Detector** and **Sample**.
The trace detector is set to the sample detector mode.

NOTE: *Sample detector mode is used to keep measurement errors to a minimum.*

12. Press **LEVEL** and adjust the reference level using the data knob.
When the signal peak is one or more divisions away from the reference level adjust the signal peak using the data knob so that they are close as much as possible.

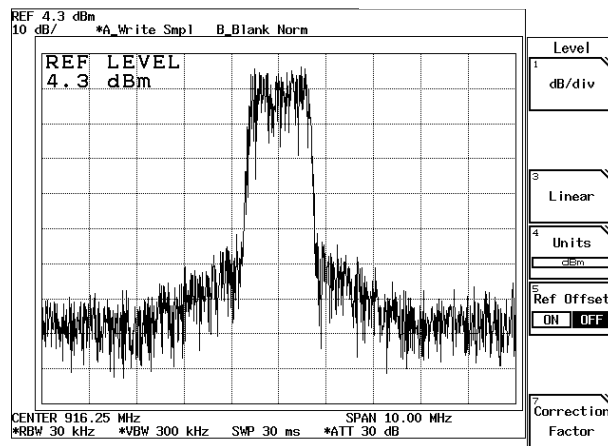

Figure 2-86 Setting Conditions for the Total Power Measurement

Measuring the total power

13. Press **POWER** and **Total Power**.
The total power within the displayed screen area is measured.
Allows you to set the averaging count.
14. Press **1, 0** and **Hz(ENTR)**.
An averaging count of 10 is set.
The total power and averaging count set are displayed in the result area (See Figure 2-87).

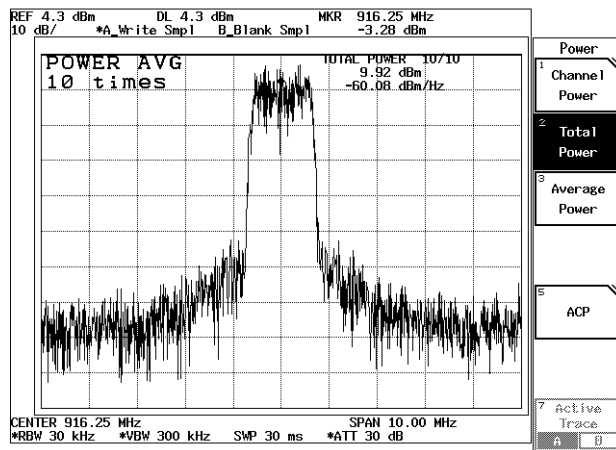

Figure 2-87 Result of Total Power Measurement

2.3.3 Measuring the Power Density of Wide Band Digital Modulation Signal

2.3.3 Measuring the Power Density of Wide Band Digital Modulation Signal

This section describes how to measure the power density of a medium-speed radio frequency LAN in a frequency band of 1 MHz.

Measurement conditions: The wide band digital modulation signal(16bps, BPSK) to be measured has a frequency of 2.45 GHz and a level of +10 dBm.

Use appropriate parameter values to make the measurements shown below.

CAUTION: *The maximum amount of power that can be input to the analyzer is 30 dBm (1 W). When measuring a signal power whose value exceeds this limit, connect an external attenuator so the power cannot exceed 30 dBm.*

Setup

1. Connect the unit as shown in Figure 2-88.

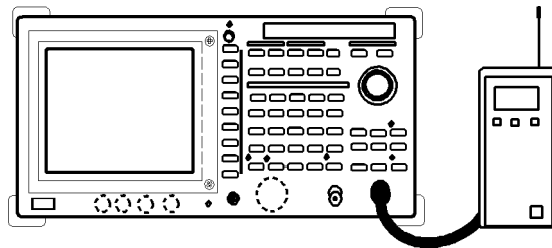

Figure 2-88 Setup for Measuring the Total Power

Power on

2. Turn the analyzer and the unit under test power on.

Setting the unit under test

3. Activate the signal output for the unit under test.

Initialization

This resets the current settings to the factory defaults or user-defined presets.

4. Press **SHIFT** and **CONFIG(PRESET)**.
This sets the analyzer to its presets values.

Setting the measurement conditions

This changes the analyzer settings so that the input signal is displayed more clearly.

5. Press **FREQ, 2, ,, 4, 5** and **GHz**.
A center frequency of 2.45 GHz is set.

2.3.3 Measuring the Power Density of Wide Band Digital Modulation Signal

6. Press **SPAN, 1, 0** and **MHz**.
A frequency span of 10 MHz is set.

NOTE: *When setting the frequency span, make sure it is wider than the span of the displayed spectrum being measured.*

7. Press **LEVEL, 1, 0** and **GHz(+dBm)**.
The reference level is set to +10 dBm.
8. Press **ATT, ATT AUTO/MNL(MNL), 3, 0** and **GHz(dB)**.
The attenuator is set to 30 dB.

NOTE: *Set the attenuator to 'input level + 10 dB' or more to avoid the saturation at the input mixer.*

9. Press **COUPLE, RBW AUTO/MNL(MNL), 3, 0, 0** and **kHz**.
An RBW of 300 kHz is set.
10. Press **VBW AUTO/MNL(MNL), 3** and **MHz**.
A VBW of 3 MHz is set.

NOTE: *To reduce measurement errors, make sure that VBW is greater than the RBW.*
VBW > RBW

11. Press **A, Trace A Detector** and **Sample**.
The trace detector is set to the sample detector mode.

NOTE: *Sample detector mode is used to keep measurement errors to a minimum.*

12. Press **LEVEL** and adjust the reference level using the data knob.
When the signal peak is one or more divisions away from the reference level adjust the signal peak using the data knob so that they are close as much as possible.

Setting the window

13. Press **WINDOW** and **Measuring Window**.
The measuring window is displayed.
14. Press **Window Width, 1** and **MHz**.
A window width of 1 MHz is set (See Figure 2-89).

2.3.3 Measuring the Power Density of Wide Band Digital Modulation Signal

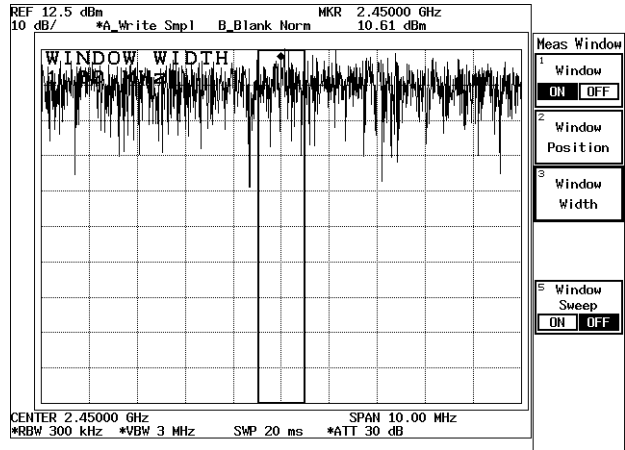

Figure 2-89 Displaying the Measuring Window

Measuring the power density

15. Press **POWER, Channel Power, 1, 0** and **Hz(ENTR)**.
 The power density of 1 MHz band is measured and displayed.
 An averaging count of 10 is set.
 The power density of 1 MHz band and the averaging count are displayed in the result area (See Figure 2-90).

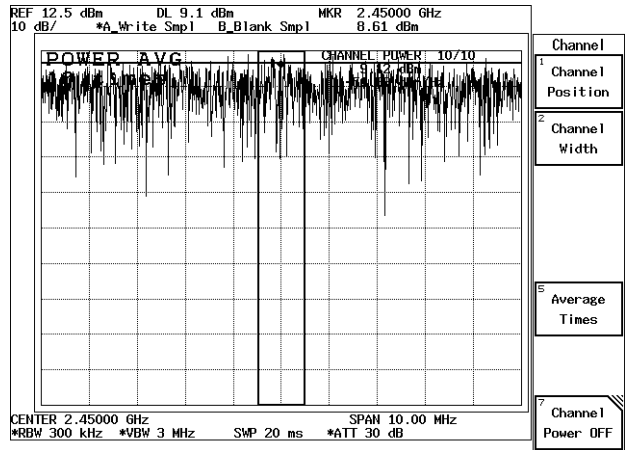

Figure 2-90 Power Density Measurement

2.3.4 Measuring CDMA Channel Power

This section describes how to measure the CDMA channel power.

Measurement conditions: The unit used for the measurement must comply with CDMA and must output a frequency of 916.25 MHz and a level of +10 dBm.

Use appropriate parameter values to make the measurements shown below.

CAUTION: *The maximum amount of power that can be input to the analyzer is 30 dBm (1 W). When measuring a signal power whose value exceeds this limit, connect an external attenuator so the power cannot exceed 30 dBm.*

Setup

1. Connect the unit as shown in Figure 2-91.

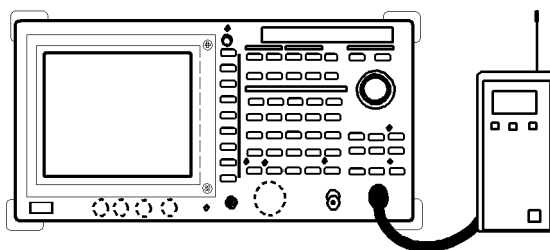

Figure 2-91 Setup for Measuring the Channel Power

Power on

2. Turn the analyzer and the unit under test power on.

Setting the unit under test

3. Activate the signal output for the unit under test.

Initialization

This resets the current settings to the factory defaults or user-defined presets.

4. Press **SHIFT** and **CONFIG(PRESET)**.
This sets the analyzer to its presets values.

Setting the measurement conditions

This changes the analyzer settings so that the input signal is displayed more clearly.

5. Press **FREQ, 9, 1, 6, ,, 2, 5** and **MHz**.
A center frequency of 916.25 MHz is set.

2.3.4 Measuring CDMA Channel Power

6. Press **SPAN, 2** and **MHz**.
A frequency span of 2 MHz is set.

NOTE: *When setting the frequency span, make sure it is wider than the span of the displayed spectrum being measured.*

7. Press **LEVEL, 1, 0** and **GHz(+dBm)**.
The reference level is set to +10 dBm.
8. Press **ATT, ATT AUTO/MNL(MNL), 2, 0** and **GHz(dB)**.
The attenuator is set to 20 dB.

NOTE: *Set the attenuator to 'input level + 10 dB' or more to avoid the saturation at the input mixer.*

9. Press **COUPLE, RBW AUTO/MNL(MNL), 3, 0** and **kHz**.
An RBW of 30 kHz is set.
10. Press **VBW AUTO/MNL(MNL), 3, 0, 0** and **kHz**.
A VBW of 300 kHz is set.

NOTE: *To reduce measurement errors, make sure that VBW is greater than the RBW.*
VBW > RBW

11. Press **A, Trace A Detector** and **Sample**.
The trace detector is set to the sample detector mode.

NOTE: *Sample detector mode is used to keep measurement errors to a minimum.*

12. Press **LEVEL** and adjust the reference level using the data knob.
When the signal peak is one or more divisions away from the reference level adjust the signal peak using the data knob so that they are close as much as possible.

Setting the channel space and bandwidth

13. Press **POWER** and **Channel power**.
Allows you to set the measuring window. The channel menu is displayed.
14. Press **Channel Position, 9, 1, 6, ,, 2, 5** and **MHz**.
The center of the measuring window is set to 916.25 MHz.

15. Press **Channel Width, 1, ,, 2, 2, 8** and **MHz**.
The width of the measuring window is set to 1.228 MHz.
16. Press **Average Times, 1, 0** and **Hz**.
An averaging count of 10 is set.
The channel power and the averaging count are displayed in the result area (See Figure 2-92).

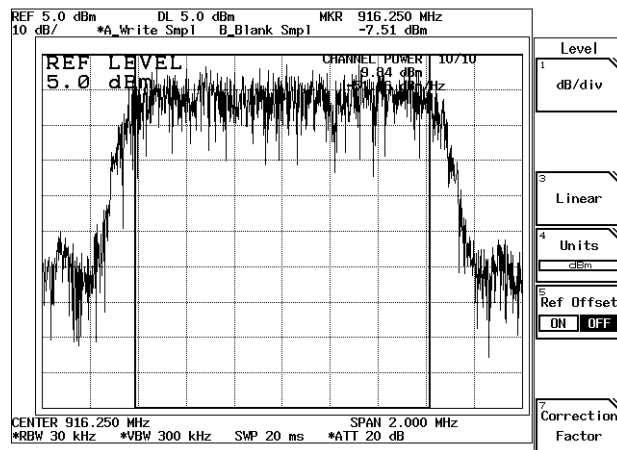

Figure 2-92 Result of Channel Power Measurement

2.3.5 Measuring the Occupied Bandwidth (OBW)

2.3.5 Measuring the Occupied Bandwidth (OBW)

This section describes how the occupied bandwidth of the digital modulation signal used in PDC and so on is measured.

This function allows you to set the ratio (of the occupied bandwidth to the total power) to a range between 10.0% and 99.9%. The factory default is 99%.

Measurement conditions: The unit used for the measurement must be usable with PDC and must output a frequency of 940.05 MHz, a level of +10 dBm and a specified bandwidth of 26 kHz.

Use appropriate parameter values to make the measurements shown below.

CAUTION:

1. *The maximum amount of power that can be input to the analyzer is 30 dBm (1 W). When measuring a signal power whose value exceeds this limit, connect an external attenuator so the power cannot exceed 30 dBm.*
 2. *To reduce occupied bandwidth measurement error, use the instrument under the following conditions.*
 - *Set the reference level so that the modulation signal level is 50 dB higher than the noise level of the spectrum analyzer.*
 - *The optimum span is approximately three times the occupied bandwidth.*
 - *Set the resolution bandwidth to less than 3% of the specified bandwidth.*
 - *The trace detector must be set up according to the specifications of the measurement object.*
-

Setup

1. Connect the unit under test as shown in Figure 2-93.

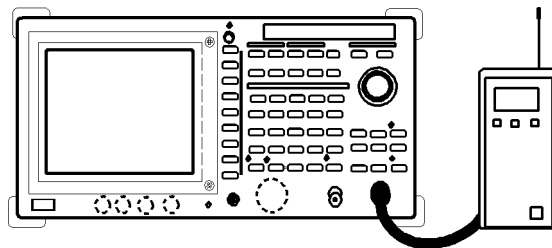

Figure 2-93 Setup for Measuring the Occupied Bandwidth

Power on

2. Turn the analyzer and the unit under test power on.

Setting the unit under test

3. Activate the signal output for the unit under test.

Initialization

This resets the current settings to the factory defaults or user-defined presets.

4. Press **SHIFT** and **CONFIG(PRESET)**.
This sets the analyzer to its presets values.

Setting the measurement conditions

This changes the analyzer settings so that the input signal is displayed more clearly.

5. Press **FREQ, 9, 4, 0, ., 0, 5** and **MHz**.
A center frequency of 940.05 MHz is set.
6. Press **SPAN, 1, 0, 0** and **kHz**.
A frequency span of 100 kHz is set.

NOTE: *The optimum span is approximately three times the occupied bandwidth.*

7. Press **ATT, ATT AUTO/MNL(MNL), 3, 0** and **GHz(dB)**.
The attenuator is set to 30 dB.

NOTE: *Set the attenuator to 'input level + 10 dB' or more to avoid saturation at the input mixer.*

8. Press **LEVEL, 5** and **MHz(-dBm)**.
The reference level is set to -5 dBm.
9. Press **COUPLE, RBW AUTO/MNL(MNL), 3, 0, 0** and **Hz**.
An RBW is set to 300 Hz.
10. Press **A, Trace A Detector** and **Positive**.
The trace detector is set to the positive detector mode.
11. Press **LEVEL** and adjust the reference level using the data knob.
When the signal peak is one or more divisions away from the reference level, adjust the signal peak using the data knob so that they are close as much as possible.
12. Press **SWP, Sweep Time AUTO/MNL(MNL), 2, 0** and **MHz(sec)**.
A sweep time of 20 seconds is set.

NOTE: *Set the sweep time equal to or greater than the number of data points (1001) multiplied by the burst repetition time.*

2.3.5 Measuring the Occupied Bandwidth (OBW)

Measuring the OBW

13. Press **UTIL** and **OBW**.

An occupied bandwidth at an occupancy ratio of 99% is calculated on a sweep basis. When the measurement has been completed, width (occupied bandwidth) and center (carrier frequency (Fc: the center of the occupied bandwidth)) are displayed, and two markers are placed at either end of the occupied bandwidth.

Changing the ratio to the total power

14. Press **OBW%**, **9**, **9**, **.**, **5** and **Hz(ENTR)**.

The occupancy ratio is changed to 99.5%.

After the sweep, the measurement results are displayed.

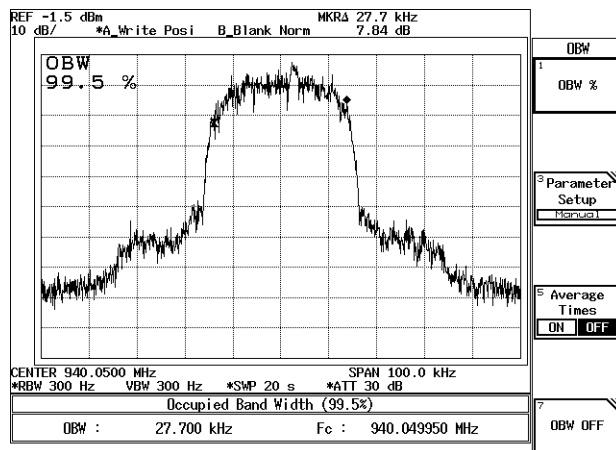

Figure 2-94 OBW Measurement Results

2.3.6 Measuring Adjacent Channel Leakage Power (ACP)

One of the most important items to be measured of the digital modulating signal, which is used in the Personal Handy Phone and so on, is the adjacent channel leakage power (ACP).

In this section, the following two modes are explained: PDC digital modulating signal measurements in Full screen mode using the Root Nyquist filter, the adjacent (or the second adjacent) channel leakage power measurements for PHS in Separate screen mode.

Full screen mode: Calculates the total power using the data on the entire screen, calculates the channel leakage power of the upper and lower adjacent channels by integration to the specified bandwidth (BS), and calculates the ratio of the previously obtained values. The time required for taking measurements using this mode is shorter than the other mode since all necessary data is collected in a single sweep. In addition, a graphic function, which permits you to display the power at a point by integrating the leakage power over the specified bandwidth with respect to this point, is available.

Separate screen mode: Automatically sets the frequency span to the specified bandwidth, measures Carrier wave power (on the upper screen), measures the adjacent channel leakage powers (on the lower screens) (or the second adjacent leakage powers on the lower screens), and calculates the ratios separately. Using this mode, a higher accuracy is obtained when the channel spacing is large enough in relation to the specified bandwidth.

CAUTION:

1. *Set the values to meet the following unless otherwise specified.*

$$RBW \leq \frac{1}{40} \times \text{Specified bandwidth}$$

Detection mode: Sample

Trace Average function: OFF

2. *The VBW must meet the following.*

$$VBW \geq RBW$$

2.3.6.1 Full Screen Mode

This section describes how to measure PDC digital modulating signal using the Root Nyquist Filter in Full screen mode.

Measurement conditions: The unit used in this measurement must output a PDC signal with a frequency of 917.950 MHz and a level of +10 dBm.

Use appropriate parameter values to make the measurements shown below.

ACP Measurement Setup

1. Connect the unit under test as shown in Figure 2-95.

2.3.6 Measuring Adjacent Channel Leakage Power (ACP)

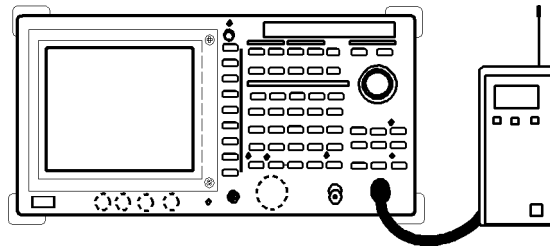

Figure 2-95 Setup Measuring Adjacent Channel Leakage Power

Power on

2. Turn the analyzer and the unit under test power on.

Setting the unit under test

3. Activate the signal output for the unit under test.

Initialization

This resets the current settings to the factory defaults or user-defined presets.

4. Press **SHIFT** and **CONFIG(PRESET)**.
This sets the analyzer to its presets values.

Setting the measuring conditions

This changes the analyzer settings so that the input signal is displayed more clearly.

5. Press **FREQ, 9, 1, 7, ., 9, 5, 0** and **MHz**.
A center frequency of 917.950 MHz is set.
6. Press **SPAN, 2, 5, 0** and **kHz**.
A frequency span of 250 kHz is set.

CAUTION: *The frequency span must meet the conditions shown below.*
 $SPAN \geq 2 \times \text{Channel spacing} + X$
When specifying a Root Nyquist Filter:
 $X = (1 + \text{Rolloff factor}) \times \text{Symbol rate}$
When not specifying a Root Nyquist Filter:
 $X = \text{Specified bandwidth}$

7. Press **COUPLE, RBW AUTO/MNL(MNL), 1** and **kHz**.
The RBW is set to 1 kHz.
8. Press **VBW AUTO/MNL(MNL), 3** and **kHz**.
The VBW is set to 3 kHz.

9. Press **ATT**, **ATT AUTO/MNL**(MNL), **3, 0** and **GHz(dB)**.
The attenuator is set to 30 dB.
10. Press **LEVEL**, **0** and **GHz(+dBm)**.
The reference level of 0 dBm is set.
11. Press **A**, **Trace A Detector** and **Positive**.
This sets the trace detector to the Positive mode.
12. Press **LEVEL** and adjust the trace using the data knob so that the trace peak can be within 1 graduation in relation to the reference level.

NOTE: *Measurement errors increase when the signal level is much lower than the reference level.*

13. Press **SWP**, **Sweep Time AUTO/MNL**(MNL), **2, 1** and **MHz(sec)**.
A sweep time of 21 seconds is set.

NOTE: *The sweep time must meet the following.
Sweep time \geq Number of trace points \times Period of the burst signal*

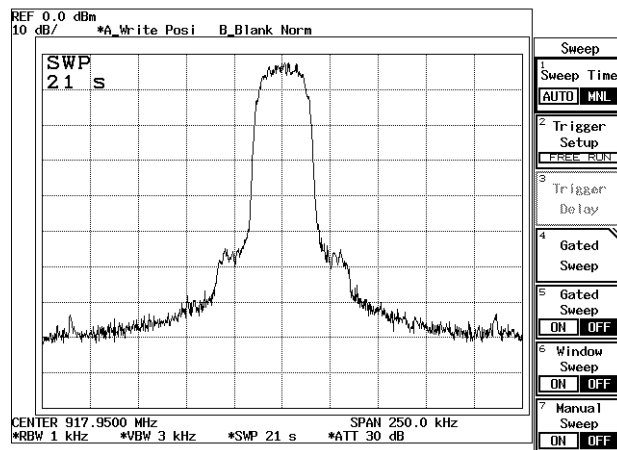

Figure 2-96 PDC trace

Channel spacing and specified bandwidth

Channel spacing and channel bandwidth are specified in PDC mode.

14. Press **POWER**, **ACP** and **CS/BS Setup**.
The dialog box for setting the channel spacing and specified bandwidth is displayed.

2.3.6 Measuring Adjacent Channel Leakage Power (ACP)

15. Press **5, 0** and **kHz**.
The channel spacing for channel 1 is set to 50 kHz. The cursor moves to the specified bandwidth.
16. Press **2, 1** and **kHz**.
The specified bandwidth for channel 1 is set to 21 kHz. The cursor moves to the channel spacing for channel 2.
17. Press **1, 0, 0** and **kHz**.
The channel spacing for the channel 2 is set to 100 kHz. The cursor moves to the specified bandwidth for channel 2.
18. Press **2, 1** and **kHz**.
The specified bandwidth for channel 2 is set to 21 kHz.

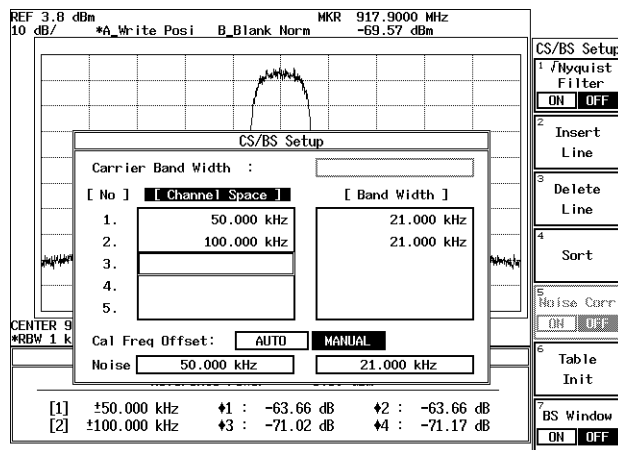

Figure 2-97 CS/BS Setup dialog box

19. Press **RETURN**.
This closes the CS/BS Setup dialog box.

NOTE: An ACP measurement cannot be carried out if the frequency span for the specified bandwidth and channel spacing is inappropriately set or not set.

Setting the Root Nyquist filter's correction function

20. Press **√Nyquist Filter Setup**.
The dialog box used to set Root Nyquist Filter parameters is displayed.
21. Move the cursor to **Symbol Rate 1/T** using the step keys and press **2, 1** and **kHz**.
A symbol rate of 21 kHz is set, and the cursor is moved to Rolloff Factor.
22. Press **0, ., 5** and **HZ(ENTR)**.
A rolloff factor of 0.5 is set.

23. Set $\sqrt{\text{Nyquist Filter ON/OFF}}$ (ON).
Allows you to set parameters and displays the data enter.

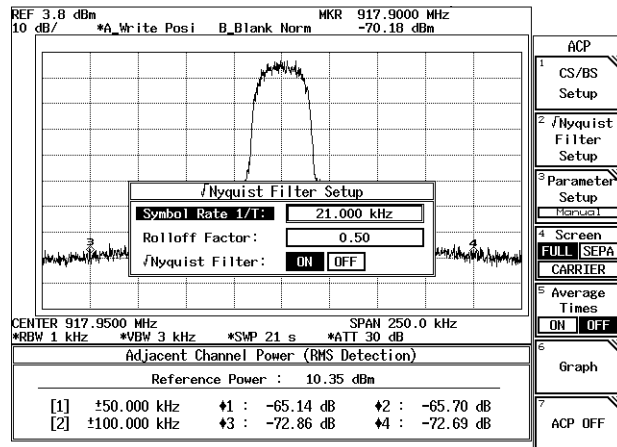

Figure 2-98 Root Nyquist Filter dialog box

24. Press $\sqrt{\text{Nyquist Filter Setup}}$.
This closes the dialog box used for setting Root Nyquist Filter parameters.

Performing ACP

25. One marker is displayed in each of the upper and lower adjacent channels each time a sweep is performed, and the lower adjacent channel leakage power as well as the upper adjacent channel leakage power is displayed.
When you press **SINGLE**, only one measurement is taken.

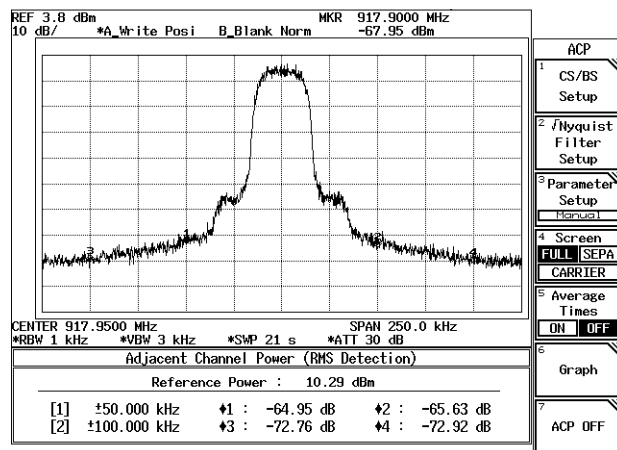

Figure 2-99 ACP Measurement Display in Full Screen Mode

2.3.6 Measuring Adjacent Channel Leakage Power (ACP)

Making observations using ACP GRAPH

26. Press **Graph** and **Graph ON/OFF(ON)**.

The calculation result of the adjacent channel leakage power and the delta marker are displayed. (See Figure 2-100).

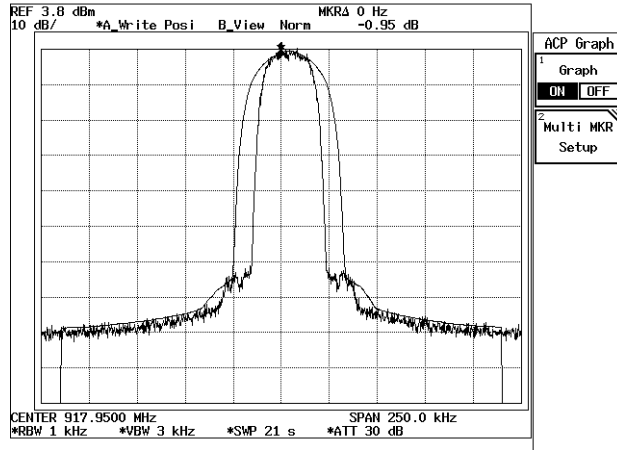

Figure 2-100 Measurement Using ACP GRAPH

Specifying measurement points

Moving the marker to another channel.

27. Press **MKR** and move the marker to 100 kHz using the data knob. The adjacent channel leakage power at 100 kHz is displayed in the result area.

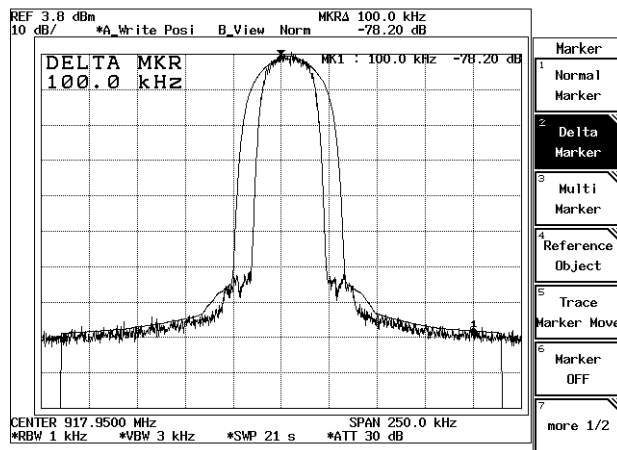

Figure 2-101 ACP at the 100 kHz

2.3.6.2 SEPARATE Display

This section describes how to measure PHS digital modulating signal in Separate screen mode.

Measurement conditions: The unit used in this measurement must output a PHS signal with a frequency of 1917.950 MHz and a level of +10 dBm.

Use appropriate parameter values to make the measurements shown below.

ACP Measurement Setup

1. Connect the unit under test as shown in Figure 2-102.

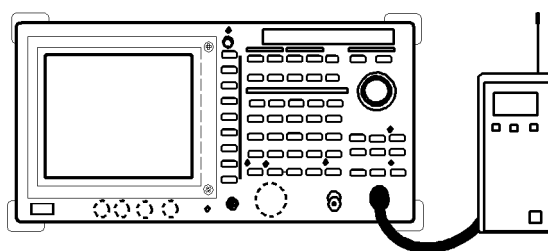

Figure 2-102 Setup Measuring Adjacent Channel Leakage Power

Power on

2. Turn the analyzer and the unit under test power on.

Setting the unit under test

3. Activate the signal output for the unit under test.

Initialization

This resets the current settings to the factory defaults or user-defined presets.

4. Press **SHIFT** and **CONFIG(PRESET)**.
This sets the analyzer to its presets values.

Setting the measuring conditions

This changes the analyzer settings so that the input signal is displayed more clearly.

5. Press **FREQ, 1, 9, 1, 7, ., 9, 5, 0** and **MHz**.
A center frequency of 1917.950 MHz is set.
6. Press **SPAN, 3** and **MHz**.
A frequency span of 3 MHz is set.
7. Press **ATT, ATT AUTO/MNL(MNL), 3, 0** and **GHz(dB)**.
The attenuator is set to 30 dB.
8. Press **LEVEL, 0** and **GHz(+dBm)**.
The reference level of 0 dBm is set.

2.3.6 Measuring Adjacent Channel Leakage Power (ACP)

9. Press **COUPLE**, **RBW AUTO/MNL(MNL)**, **3** and **kHz**.
The RBW is set to 3 kHz.
10. Press **VBW AUTO/MNL(MNL)**, **1, 0** and **kHz**.
The VBW is set to 10 kHz.
11. Press **A**, **Trace A Detector** and **Positive**.
This sets the trace detector to the Positive mode.
12. Press **LEVEL** and adjust the trace using the data knob so that the trace peak can be within 1 graduation in relation to the reference level.

NOTE: *Measurement errors increase when the signal level is much lower than the reference level.*

13. Press **SWP**, **Sweep Time AUTO/MNL(MNL)**, **5** and **MHz(sec)**.
A sweep time of 5 seconds is set.

NOTE: *The sweep time must meet the following.
Sweep time \geq Number of trace points \times Period of the burst signal*

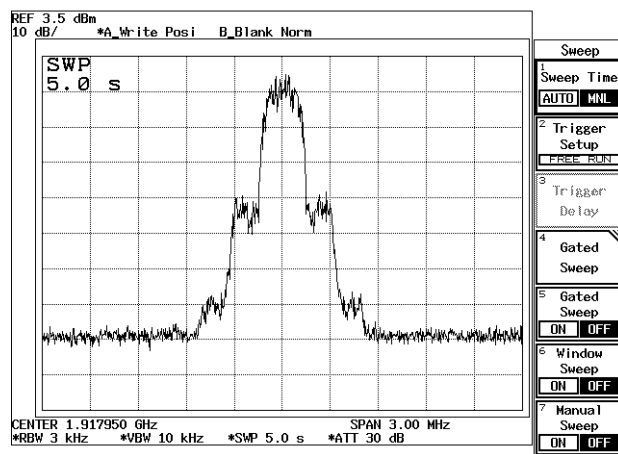

Figure 2-103 PHS Trace

Setting the Channel spacing and Specified Bandwidth

Channel spacing and channel bandwidth are specified in PHS.

14. Press **POWER**, **ACP**, **Screen FULL/SEPA/CARRIER(SEPA)**.
The screen mode is set to the separate.
15. Press **CS/BS Setup**.
The dialog box for setting the channel spacing and specified bandwidth is displayed.

16. Press **1, 9, 2** and **kHz**.
The specified bandwidth of the carrier frequency is set to 192 kHz. The cursor moves to the channel spacing for channel 1.
17. Press **6, 0, 0** and **kHz**.
The channel spacing for channel 1 is set to 600 kHz. The cursor moves to the specified bandwidth.
18. Press **1, 9, 2** and **kHz**.
The specified bandwidth for channel 1 is set to 192 kHz. The cursor moves to the channel spacing for channel 2.
19. Press **9, 0, 0** and **kHz**.
The channel spacing for the channel 2 is set to 900 kHz. The cursor moves to the specified bandwidth for channel 2.
20. Press **1, 9, 2** and **kHz**.
The specified bandwidth for channel 2 is set to 192 kHz.

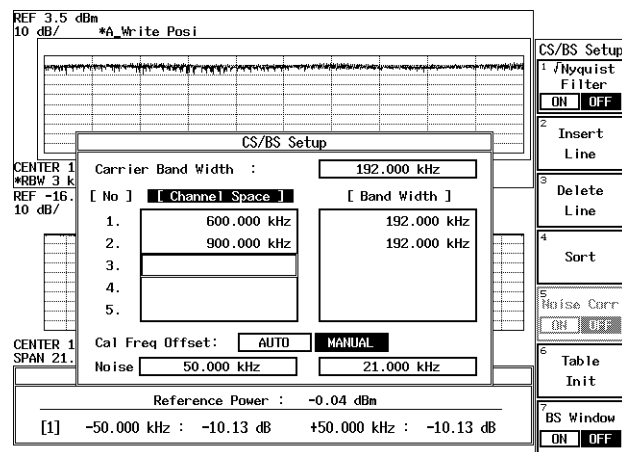

Figure 2-104 CS/BS Setup dialog box

21. Press **RETURN**.
This closes the CS/BS Setup dialog box.

NOTE: This operation will not function correctly when the specified bandwidth is inappropriate or not set.

2.3.6 Measuring Adjacent Channel Leakage Power (ACP)

Performing ACP using Separate screen

- 22. Each time a sweep is performed, the trace of a carrier signal is displayed on the upper screen, and the upper and lower adjacent channel traces are displayed on each of the two lower screens. The ACP values for both adjacent channels are displayed once every 5 sweeps. When you press **SINGLE**, only five measurements are taken.

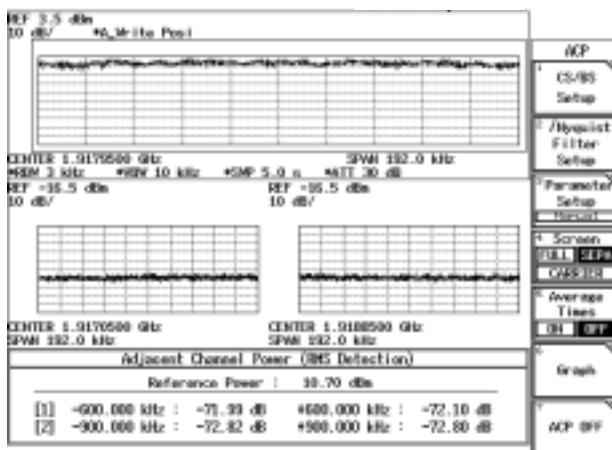

Figure 2-105 Measurement Result in ACP Separate Screen Mode

2.3.7 Measuring Burst Signals Using the Gated Sweep

This section describes how pulse modulation signals are measured using the gated sweep function.

Measurement conditions: The signal used in this measurement has an output frequency of 1 GHz, a level of 0 dBm, a pulse width of 1 msec and a period of 10 msec.

Use appropriate parameter values to make the measurements shown below.

Setup

1. Connect the unit as shown in Figure 2-106.

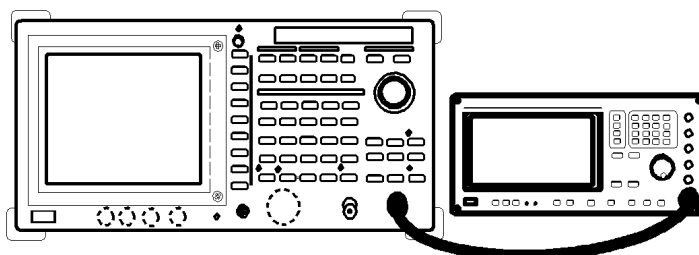

Figure 2-106 Setup for Measuring a Burst Signal

Power on

2. Turn the analyzer and the signal generator power on.

Setting the signal generator

This prepares the signal generator for output.

3. Set the frequency to 1 GHz; the level to 0 dBm; the pulse width to 1 msec; the period to 10 msec; and output to ON.

Initialization

This resets the current settings to the factory defaults or user-defined presets.

4. Press **SHIFT** and **CONFIG(PRESET)**.
This sets the analyzer to its presets values.

Setting the measurement conditions

This changes the analyzer settings so that the input signal is displayed more clearly.

5. Press **FREQ, 1** and **GHz**.
A center frequency of 1 GHz is set.
6. Press **SPAN, 5, 0, 0** and **kHz**.
A frequency span of 500 kHz is set.

2.3.7 Measuring Burst Signals Using the Gated Sweep

7. Press **LEVEL, 5** and **GHz(+dBm)**.
The reference level is set to +5 dBm.
8. Press **COUPLE, RBW AUTO/MNL(MNL), 3** and **kHz**.
An RBW of 3 kHz is set.

Setting the gated sweep

This sets the conditions of the gated sweep to bring the gated sweep into sync with the input signal.

9. Press **SWP** and **Gated Sweep**.
The Gated Sweep menu is displayed, and the gated sweep mode is set.
The upper screen displays the spectrum and the lower screen displays the waveform in the time domain in Split screen mode (See Figure 2-107).

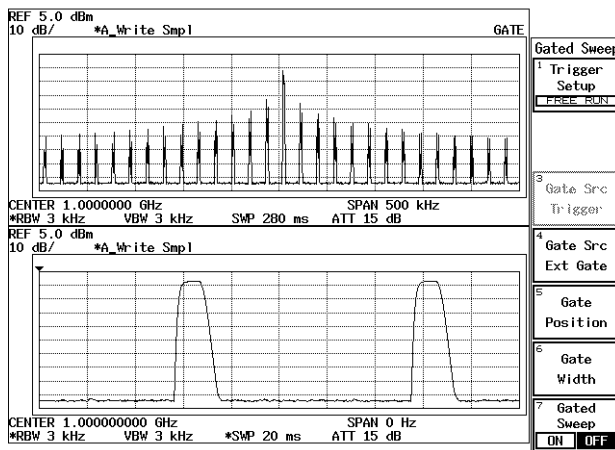

Figure 2-107 Burst Signal Displayed in Split Screen Mode

10. Press **SWP, 2** and **kHz(ms)**.
A sweep time of 2 msec for the lower screen is set (See Figure 2-108).

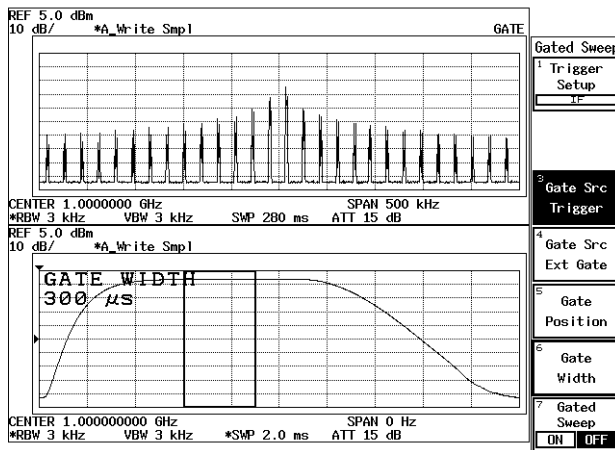

Figure 2-108 Trigger Setup

11. Press **Gated Sweep**.
The Gated Sweep menu is displayed.
12. Press **Trigger Setup**.
The Trigger Setup dialog box is displayed.
13. Set **Source** to **IF**.
Starts to sweep in synchronization with IF signal.
14. Select **Trigger Level** and set it to the middle of the burst signal waveform.
15. Press **Gate Src Trigger, Gate Position, 0, ,, 6** and **kHz(ms)**.
The gate start position is set to 0.6 msec.
16. Press **Gate Width, 0, ,, 3** and **kHz(ms)**.
A gate width of 0.3 msec is set.
17. Press **Gate Sweep ON/OFF(ON)**.
A spectrum without the effect caused by a burst signal will be displayed on the upper part of the screen (See Figure 2-109).

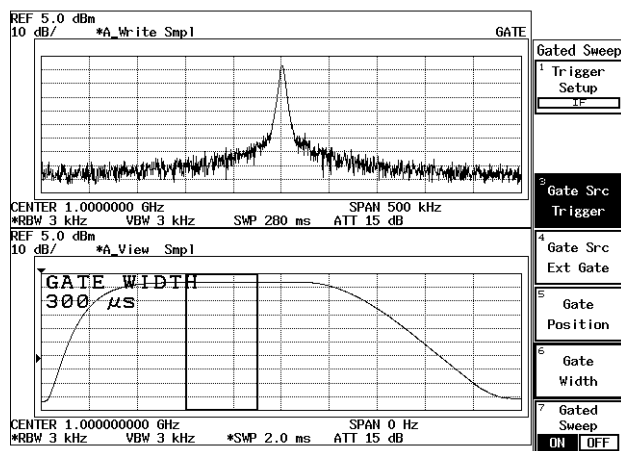

Figure 2-109 Burst Signal by Use of the Gated Sweep (Separate Screen Mode)

18. Press **RETURN**.
The display shows the gated sweep trace in Full screen mode. You can now change the frequency span and reference level if desired.

NOTE: Check the gated sweep for its settings after you have changed the resolution bandwidth and video bandwidth of the spectrum (displayed on the upper screen) when measuring a burst signal using the gated sweep.

2.3.7 Measuring Burst Signals Using the Gated Sweep

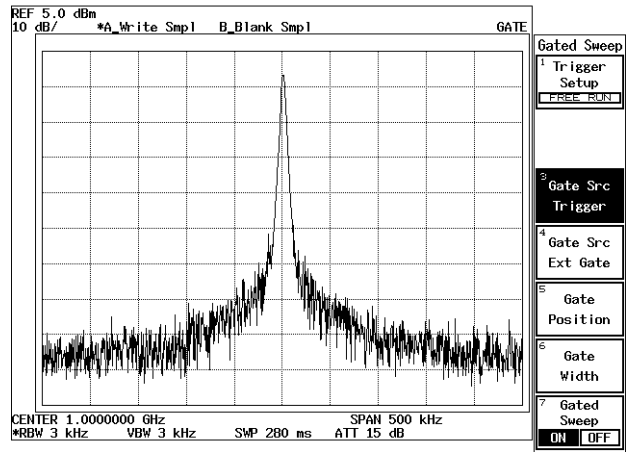

Figure 2-110 Burst Signal by Use of the Gated Sweep (Full Screen Mode)

2.3.8 Measuring Burst signals in the Time Domain

This section describes how to measure the leading and trailing edges of the TDMA signal used in PHS and so on, using the time domain function.

Measurement conditions: The signal used in this measurement has an output frequency of 1917.950 MHz, a level of 0 dBm, a pulse width of 600 μ sec, a pulse period of 5 msec, a leading time of 13 μ sec, a trailing time of 13 μ sec of the burst signal.
Use appropriate parameter values to make the measurements shown below.

Setup

1. Connect the unit as shown in Figure 2-111.

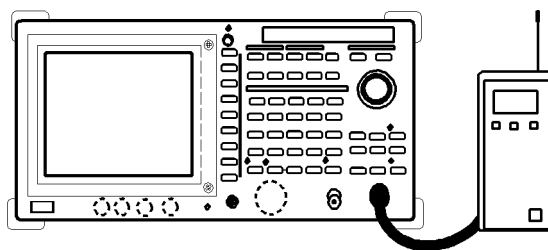

Figure 2-111 Setup for Measuring a Burst wave signal

Power on

2. Turn the analyzer and the unit under test power on.

Setting the unit under test

3. This prepares the unit under test for signal output.

Initialization

This resets the current settings to the factory defaults or user-defined presets.

4. Press **SHIFT** and **CONFIG(PRESET)**.
This sets the analyzer to its presets values.

Setting the measurement conditions

This changes the analyzer settings so that the input signal is displayed more clearly.

5. Press **FREQ, 1, 9, 1, 7, ., 9, 5** and **MHz**.
A center frequency of 1917.95 MHz is set.
6. Press **SPAN, 5, 0** and **MHz**.
The frequency span of 50 MHz is set.

2.3.8 Measuring Burst signals in the Time Domain

7. Press **LEVEL, 5** and **GHz(+dBm)**.
The reference level is set to +5 dBm.
8. Press **COUPLE, RBW AUTO/MNL(MNL), 3** and **MHz**.
An RBW of 3 MHz is set.
The burst signal used with TDMA can be checked.

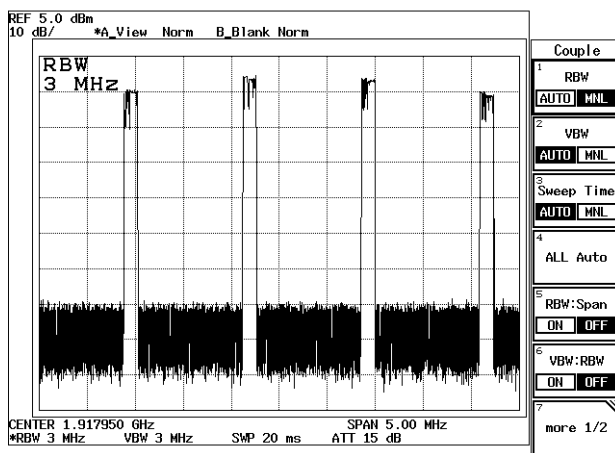

Figure 2-112 Burst signal in the frequency domain

9. Press **SPAN** and **Zero Span**.
The frequency span is set to zero span.
10. Press **SWP, Sweep Time AUTO/MNL(MNL), 5** and **kHz(ms)**.
A sweep time of 5 msec is set.

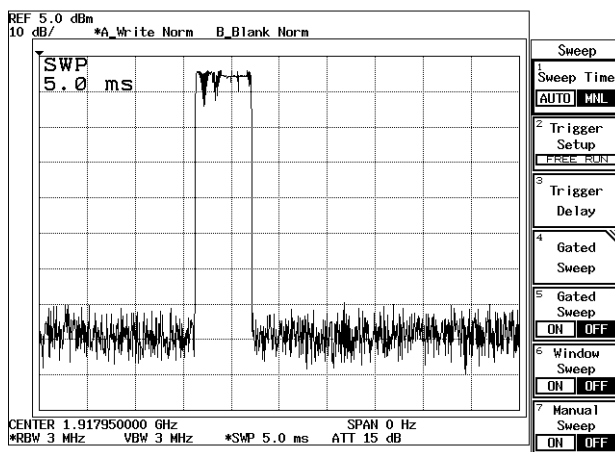

Figure 2-113 Burst Signal in the Time Domain

Setting the video trigger

11. Press **Trigger Setup**.
The Trigger Setup dialog box is displayed.

12. Set **Source** to **VIDEO**.
VIDEO is selected and the cursor moves to Slope. The trigger level mark (→) is displayed on the left edge vertical axis.
13. Press **H_z(ENTER)**.
The trigger slope is set to "+" and the cursor moves to Trigger Level.
14. Adjust the trigger level.
Adjust the trigger level approximately to the midpoint of the burst signal, turning the data knob. A stable trace is displayed in synchronization with the signal.
15. Press **RETURN**.
The Trigger Setup dialog box is closed.

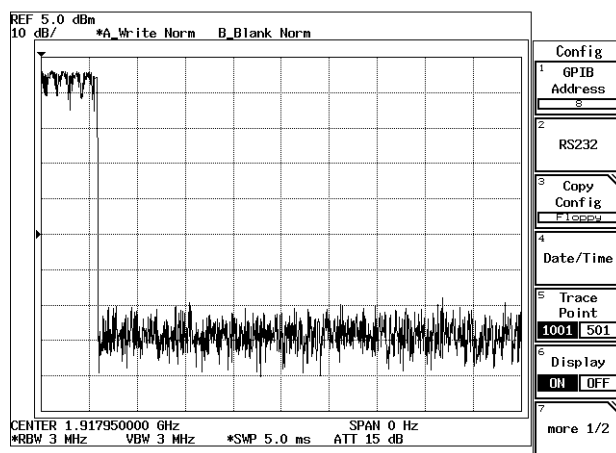

Figure 2-114 Burst Signal in Synchronization with the Trigger Signal

Setting the leading edge of a waveform

16. Press **SWP, 5, 0** and **H_z(μs)**.
A Sweep time of 50 μsec is set.
17. Press **Trigger Delay, -, 2, 5** and **H_z(μs)**.
The waveform is displayed 25 μsec before the triggering point so you can observe the leading edge of the burst signal.

2.3.8 Measuring Burst signals in the Time Domain

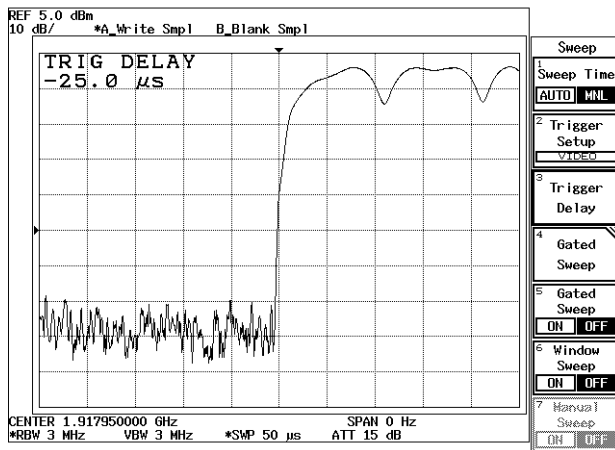

Figure 2-115 Measuring Burst Signal Leading Edge

Setting the trailing edge of a waveform

18. Press **Trigger Delay, 5, 7, 5** and **Hz(μs)**.
The waveform is displayed 575 μsec after the triggering point so you can observe the trailing edge of the burst signal.

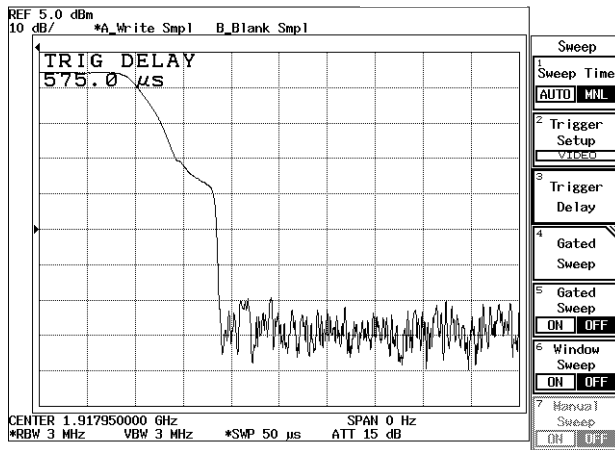

Figure 2-116 Measuring Burst Signal Trailing Edge

2.3.9 Harmonic Distortion Measurements

This section describes how harmonic distortion is measured using either of the following three methods: the Normal/Delta marker, peak list or Delta marker fixed function.

2.3.9.1 Using the Normal and Delta Markers

This section describes the basic technique of how to measure harmonic distortion using the normal and delta markers.

Measurement conditions: The target of the measurement below is a signal that has an output frequency of 100 MHz and a level of -10 dBm.

Use appropriate parameter values when making the measurements in the example shown below.

Setup

1. Connect the unit under test as shown in Figure 2-117.

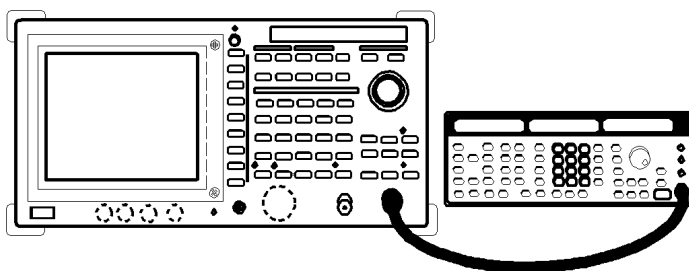

Figure 2-117 Setup for Measuring the Harmonic Distortion

Power on

2. Turn the analyzer and the signal generator power on.

Setting the signal generator

This prepares the signal generator for output.

3. Set the frequency to 1 GHz; the level to -10 dBm; and output to ON.

Initialization

This resets the current settings to the factory defaults or user-defined presets.

4. Press **SHIFT** and **CONFIG(PRESET)**.
This sets the analyzer to its presets values.

Setting the measurement conditions

This changes the analyzer settings so that the input signal is displayed more clearly.

5. Press **FREQ, Start, 5, 0** and **MHz**.
The start frequency is set to 50 MHz.

2.3.9 Harmonic Distortion Measurements

6. Press **Stop, 3, 5, 0** and **MHz**.
The stop frequency is set to 350 MHz.
7. Press **COUPLE, VBW AUTO/MNL(MNL), 1, 0, 0** and **kHz**.
A VBW of 100 kHz is set.
The noise level is now low enough to observe the trace.
8. Press **SRCH**.
The normal marker is displayed on the peak of the fundamental wave.
9. Press **MKR →** and **Marker → Ref**.
The reference level is set to the peak of the trace.
To improve measurement accuracy, the level of the fundamental wave is set to the reference level (See Figure 2-118).

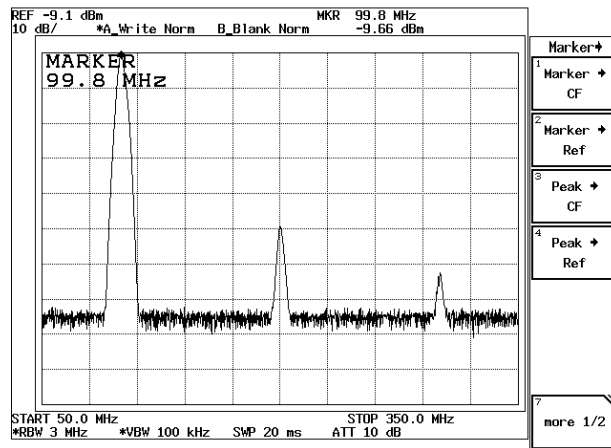

Figure 2-118 Trace of Harmonics

10. Press **SRCH**.
The normal marker is displayed on the peak of the trace.

Measuring the secondary harmonics

11. Press **MKR** and **Delta Marker**.
The delta marker is displayed.
12. Press **SRCH** and **Next peak Right**.
The delta marker is moved to the secondary harmonics.
The difference in level between the fundamental wave and secondary harmonics is displayed in the marker area (See Figure 2-119).

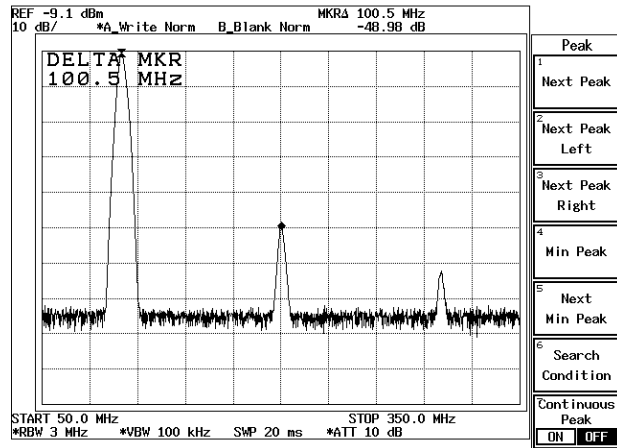

Figure 2-119 Secondary Harmonics

Measuring tertiary harmonics

13. Press *Next Peak Right*.

The delta marker is moved to the tertiary harmonics.

The difference in level between the fundamental wave and tertiary harmonics is displayed in the marker area (See Figure 2-120).

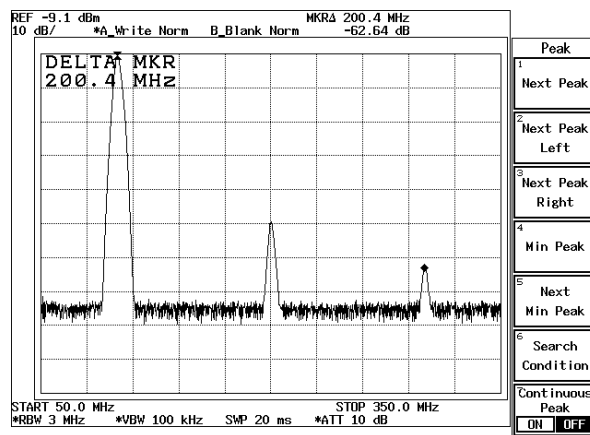

Figure 2-120 Tertiary Harmonics

2.3.9.2 Using the Peak List

This section describes a method on how to measure harmonic distortion using the peak list.

Measurement conditions: The target of the measurement below is a signal that has an output frequency of 100 MHz and a level of -10 dBm.

Use appropriate parameter values when making the measurements in the example shown below.

Setup

1. Connect the unit under test as shown in Figure 2-121.

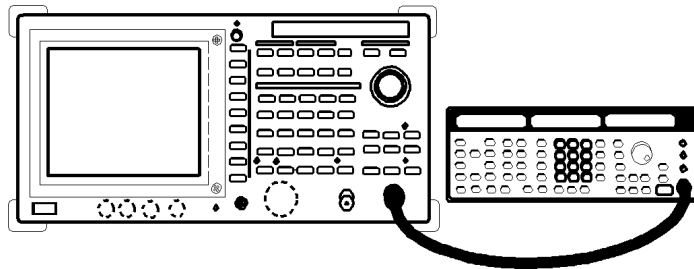

Figure 2-121 Setup for Measuring the Harmonic Distortion

Power on

2. Turn the analyzer and the signal generator power on.

Setting the signal generator

This prepares the signal generator for output.

3. Set the frequency to 100 MHz; the level to -10 dBm; and output to ON.

Initialization

This resets the current settings to the factory defaults or user-defined presets.

4. Press **SHIFT** and **CONFIG(PRESET)**.
This sets the analyzer to its presets values.

Setting the measurement conditions

This changes the analyzer settings so that the input signal is displayed more clearly.

5. Press **FREQ, Start, 5, 0** and **MHz**.
The start frequency is set to 50 MHz.
6. Press **Stop, 3, 5, 0** and **MHz**.
The stop frequency is set to 350 MHz.

7. Press **COUPLE**, **VBW AUTO/MNL(MNL)**, **1, 0, 0** and **kHz**.
A VBW of 100 kHz is set.
The noise level is now low enough to observe the trace.

Specifying the fundamental wave

8. Press **SRCH**.
The normal marker is displayed on the peak of the fundamental wave.
9. Press **MKR →** and **Marker → Ref**.
The reference level is set to the peak of the trace.
To improve measurement accuracy, set the level of the fundamental wave to the reference level (See Figure 2-122).

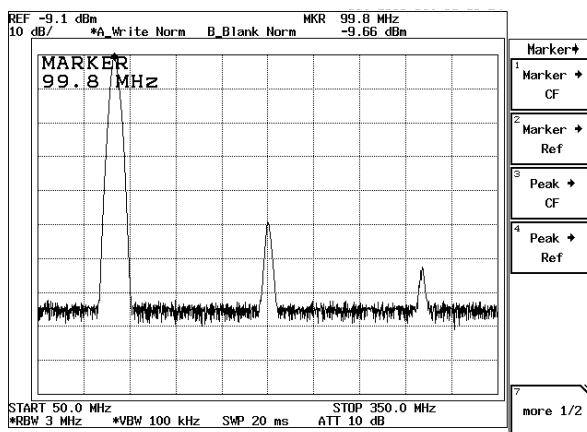

Figure 2-122 Trace of Harmonics

10. Press **MEAS**, **Peak List** and **Peak List Freq**.
Changes to the split screen display. The peak list is displayed on the lower part of the screen and the spectrum is displayed on the upper part of the screen.
11. Press **MKR** and **Delta Marker**.
The list which shows frequency and level differences between the fundamental wave and the secondary/tertiary harmonics is shown (See Figure 2-123).

2.3.9 Harmonic Distortion Measurements

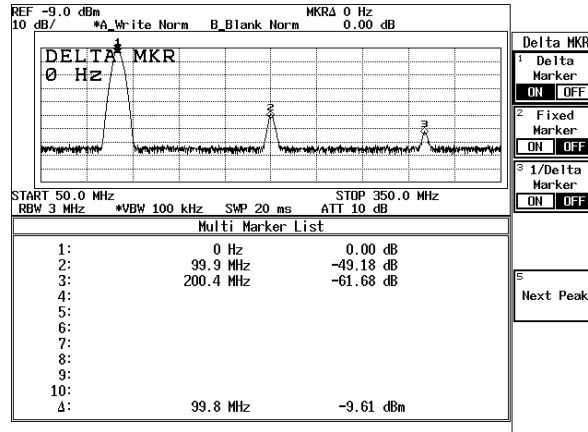

Figure 2-123 Peak List Display

2.3.9.3 Using the Fixed Marker Function

This section describes a method of how to measure harmonic distortion using the fixed marker function which enhances measurement sensitivity and accuracy.

Measurement conditions: The target of the measurement below is a signal that has an output frequency of 100 MHz and a level of -10 dBm.

Use appropriate parameter values when making the measurements in the example shown below.

Setup

1. Connect the unit under test as shown in Figure 2-124.

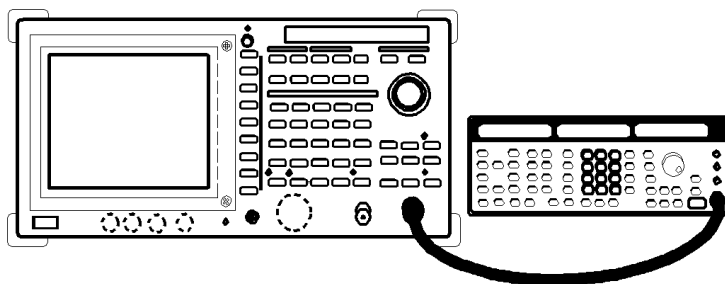

Figure 2-124 Setup for Measuring the Harmonic Distortion

Power on

2. Turn the analyzer and the signal generator power on.

Setting the signal generator

This prepares the signal generator for output.

3. Set the frequency to 100 MHz; the level to -10 dBm; and output to ON.

Initialization

This resets the current settings to the factory defaults or user-defined presets.

4. Press **SHIFT** and **CONFIG(PRESET)**.
This sets the analyzer to its presets values.

Setting the measurement conditions

This changes the analyzer settings so that the input signal is displayed more clearly.

5. Press **FREQ, 1, 0, 0** and **MHz**.
A center frequency of 100 MHz is set.

2.3.9 Harmonic Distortion Measurements

6. Press **SPAN, 1, 0, 0** and **kHz**.
A frequency span of 100 kHz is set.

Specifying the fundamental wave

7. Press **SRCH**.
The normal marker is displayed on the peak of the trace.
8. Press **MKR →** and **Marker → Ref**.
The reference level is set to the peak of the trace.
To improve measurement accuracy, set the level of the fundamental wave to the reference level (See Figure 2-125).

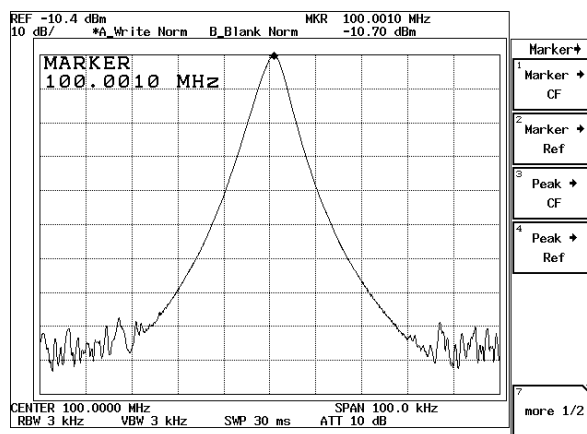

Figure 2-125 Trace of Harmonics

9. Press **more 1/2** and **Marker → CF Step**.
Set the step size of the marker to the center frequency.
10. Press **MKR, Delta Marker** and **Fixed Marker ON/OFF (ON)**.
The Delta marker is displayed and turns on the Delta marker fixed function.

Measuring the secondary harmonics

11. Press **FREQ** and the step key Δ .
The center frequency is moved to the secondary harmonics with the fixed marker still displayed.
12. Press **SRCH**.
The normal marker is displayed on the peak of the trace.
13. Press **MKR →, more 1/2** and **Marker → Ref**.
The reference level is set to the peak level of the secondary harmonics.
To improve measurement accuracy, set the level of the secondary harmonics to the reference level.
The secondary harmonic level relative to the fundamental wave is now displayed in the marker area (See Figure 2-126).

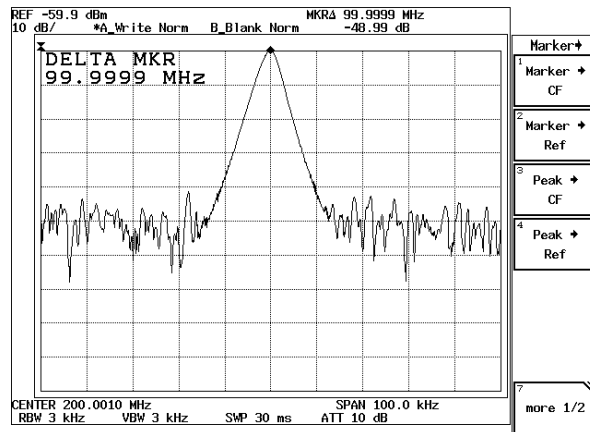

Figure 2-126 Secondary Harmonics

Measuring the tertiary harmonics

14. Press **FREQ** and the step key Δ .
The center frequency moves to the tertiary harmonics.
15. Press **SRCH**.
The normal marker is displayed on the peak of the trace.
16. Press **MKR** \rightarrow and **Marker** \rightarrow **Ref**.
The reference level is set to the peak level of the tertiary harmonics.
To improve measurement accuracy, set the level of the tertiary harmonics to the reference level.
The tertiary harmonic level (this, however, is the difference between the tertiary harmonic level and the fundamental wave level) is displayed in the marker area (See Figure 2-127).

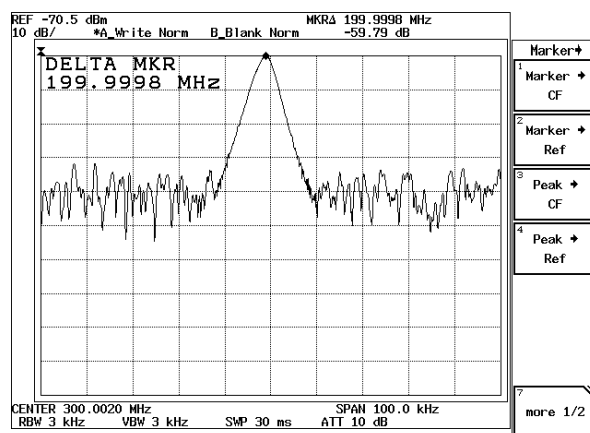

Figure 2-127 Tertiary Harmonics

2.3.10 Third Order Intermodulation Distortion

2.3.10 Third Order Intermodulation Distortion

This section describes a basic technique on how to measure third order intermodulation distortion in two signals used with the narrow-band communication system.

Measurement conditions: The target of the measurement below is third order intermodulation distortion of an RF amplifier (Gain: approx. 8 dB) whose input signal characteristics are as follows:

- Input signal 1: A frequency of 100 MHz and a level of 0 dBm
- Input signal 2: A frequency of 101 MHz and a level of 0 dBm

Use appropriate parameter values when making the measurements shown below.

CAUTION: *The maximum amount of power that can be input to the analyzer is 30 dBm (1 W). When measuring a signal power whose value exceeds this limit, connect an external attenuator so the power cannot exceed 30 dBm.*

Setup

1. Connect the unit under test as shown in Figure 2-128.

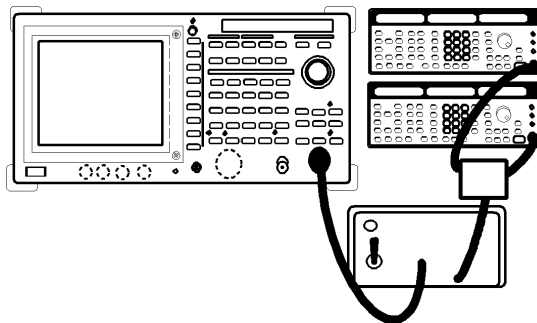

Figure 2-128 Setup for Measuring the Third Order Intermodulation Distortion

Power on

2. Turn the analyzer and the unit under test power on.

Setting the unit under test

3. Activate the signal output for the unit under test.

Initialization

This resets the current settings to the factory defaults or user-defined presets.

4. Press **SHIFT** and **CONFIG(PRESET)**.
This sets the analyzer to its presets values.

Setting the measurement conditions

This changes the analyzer settings so that the input signal is displayed more clearly.

5. Press **FREQ, 1, 0, 0, ., 5** and **MHz**.
A center frequency of 100.5 MHz is set.
6. Press **SPAN, 5** and **MHz**.
A frequency span of 5 MHz is set.
7. Press **LEVEL, 1, 0** and **GHz(+dBm)**.
The reference level is set to +10 dBm.
8. Press **ATT, ATT AUTO/MNL(MNL), 3, 0** and **GHz(dB)**.
The attenuator is set to 30 dB.

NOTE: Set the attenuator to 'input level + 10 dB' or more to avoid the saturation at the input mixer.

9. Press **COUPLE, RBW AUTO/MNL(MNL), 1, 0** and **kHz**.
An RBW of 10 kHz is set.
10. Press **SWP, Sweep time AUTO/MNL(MNL), 1, 0, 0** and **kHz(ms)**.
Sweep time is set to 100 msec (See Figure 2-129).

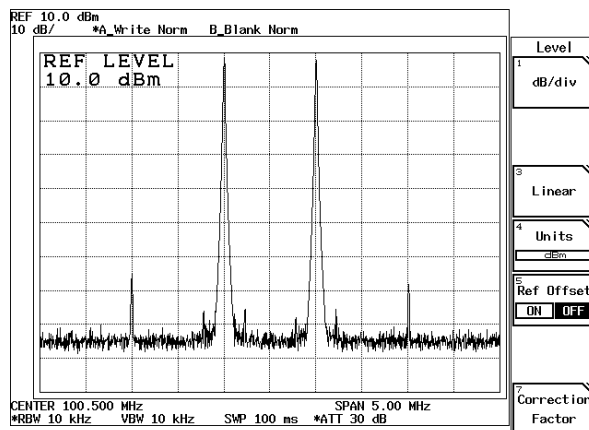

Figure 2-129 Third Order Intermodulation Distortion

Adjusting the reference level

11. Press **SRCH**.
The normal marker is displayed on the trace peak.
12. Press **MKR →** and **Marker → Ref**.
The reference level is set to the peak of the trace (See Figure 2-130).

2.3.10 Third Order Intermodulation Distortion

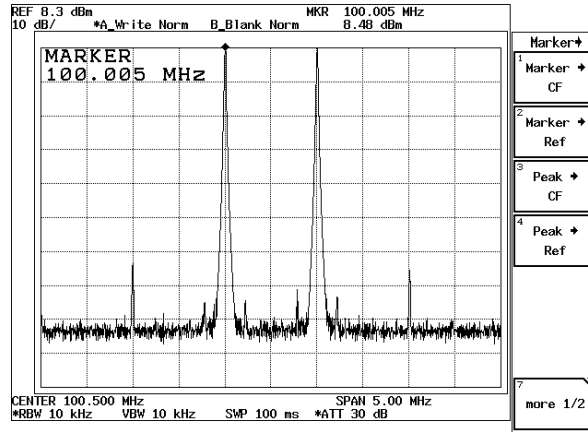

Figure 2-130 Third Order Intermodulation Distortion (Peak → Ref)

Measuring the third order intermodulation distortion

13. Press **MEAS** and *3rd Order Measure*.

Markers are set at the highest and third highest peaks.

The level difference between the markers is displayed in the marker area (See Figure 2-131).

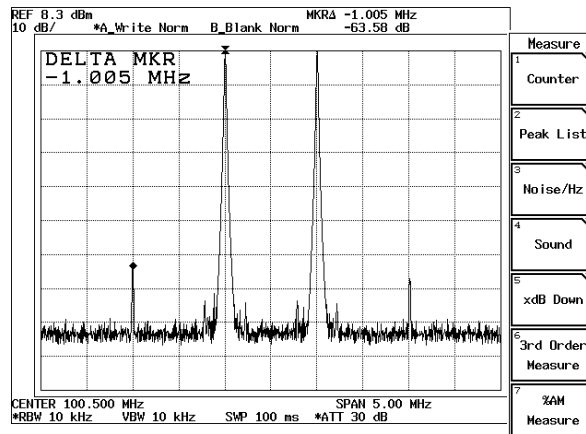

Figure 2-131 Measurement Result of the Third Order Intermodulation Distortion

2.3.11 AM Modulation Frequency and Modulation Factor of AM Signals

This section describes how to measure the residual AM of an AM oscillator (for low amplitude modulation factors).

Measurement conditions: The target of the measurement below is a signal whose input signal characteristics consist of an output frequency of 400 MHz, a level of 0 dBm, a modulation frequency of 1 kHz and a modulation factor of 5%.

Use appropriate parameter values when making the measurements in the example shown below.

Setup

1. Connect the unit under test as shown in Figure 2-132.

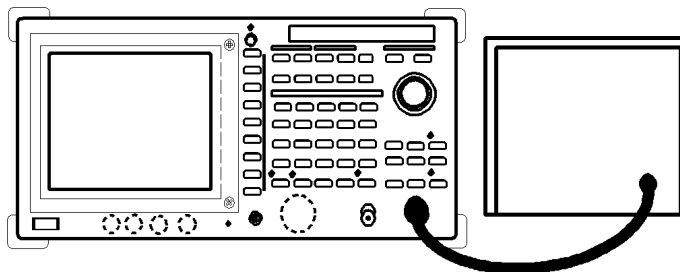

Figure 2-132 Setup for Measuring AM Signal

Power on

2. Turn the analyzer and the unit under test power on.

Setting the unit under test

3. Activate the signal output for the unit under test.

Initialization

This resets the current settings to the factory defaults or user-defined presets.

4. Press **SHIFT** and **CONFIG(PRESET)**.
This sets the analyzer to its presets values.

Setting the measurement conditions

This changes the analyzer settings so that the input signal is displayed more clearly.

5. Press **FREQ, 4, 0, 0** and **MHz**.
A center frequency of 400 MHz is set.
6. Press **SPAN, 5** and **kHz**.
A frequency span of 5 kHz is set.

2.3.11 AM Modulation Frequency and Modulation Factor of AM Signals

7. Press **LEVEL, 5** and **GHz(+dBm)**.
The reference level is set to +5 dBm.
8. Press **SRCH**.
The normal marker is displayed on the trace peak.
9. Press **MKR** and *Delta Marker*.
The delta marker is displayed.
10. Press **SRCH** and *Next Peak*.
The normal marker moves to the next highest peak.

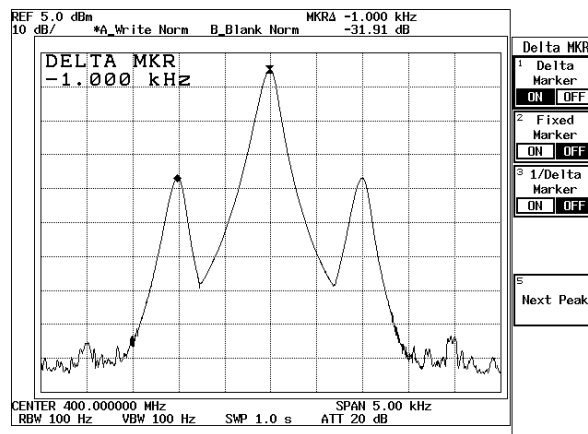

Figure 2-133 AM Signal with Low Modulation Factor

Calculating modulation frequency

11. Read the delta marker's frequency.
This value is the modulation frequency.

Calculating the modulation factor

12. Read the delta marker's level.
Modulation factor m is calculated from the following formula, using ΔLevel as the delta marker's level.

$$m = 10^{\frac{\Delta\text{Level} + 6}{20}}$$

Approximate values are shown in Figure 2-134.

2.3.11 AM Modulation Frequency and Modulation Factor of AM Signals

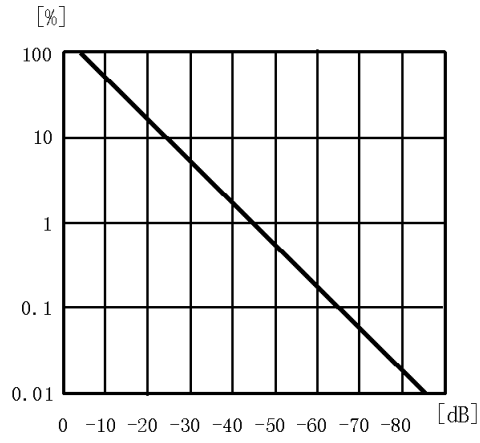

Figure 2-134 Relationship between Δ Level (dB) and Modulation Factor m (%)

2.3.12 Measuring Frequency deviation of FM Signals

2.3.12 Measuring Frequency deviation of FM Signals

This section describes how to measure frequency deviation and modulation index used for FM transmitters and so on.

Measurement conditions: The target of the measurement below is a signal whose input signal characteristics consist of an output frequency of 2000 MHz, a level of -10 dBm, a modulation frequency of 3 kHz and a frequency deviation of 75 kHz.

Use appropriate parameter values when making the measurements in the example shown below.

CAUTION: *The maximum amount of power that can be input to the analyzer is +30 dBm (1 W). When directly measuring an FM transmitter output, connect an external attenuator so the power cannot exceed +30 dBm (1W).*

Setup

1. Connect the unit under test as shown in Figure 2-135.

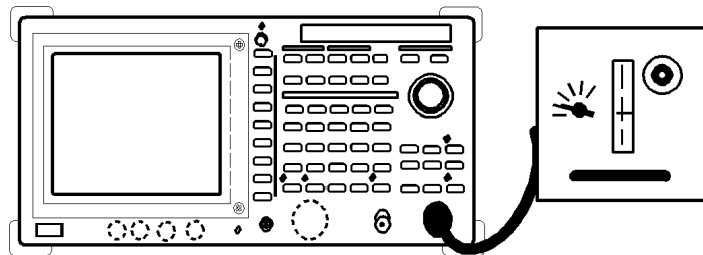

Figure 2-135 Setup for Measuring FM Signal

Power on

2. Turn the analyzer and the unit under test power on.

Setting the unit under test

3. Activate the signal output for the unit under test.

Initialization

This resets the current settings to the factory defaults or user-defined presets.

4. Press **SHIFT** and **CONFIG(PRESET)**.
This sets the analyzer to its presets values.

Setting the measurement conditions

This changes the analyzer settings so that the input signal is displayed more clearly.

5. Press **FREQ, 2** and **GHz**.
A center frequency of 2 GHz is set.

2.3.12 Measuring Frequency deviation of FM Signals

6. Press **SPAN, 4, 0, 0** and **kHz**.
A frequency span of 400 kHz is set.
7. Press **LEVEL, 0** and **MHz(-dBm)**.
The reference level is set to 0 dBm.
8. Press **SWP, Sweep Time AUTO/MNL(MNL), 1, 5** and **MHz(sec)**.
A sweep time of 15 sec is set.
9. Press **A, Trace A Detector** and **Positive**.
The Trace detector is set to positive peak detector mode.

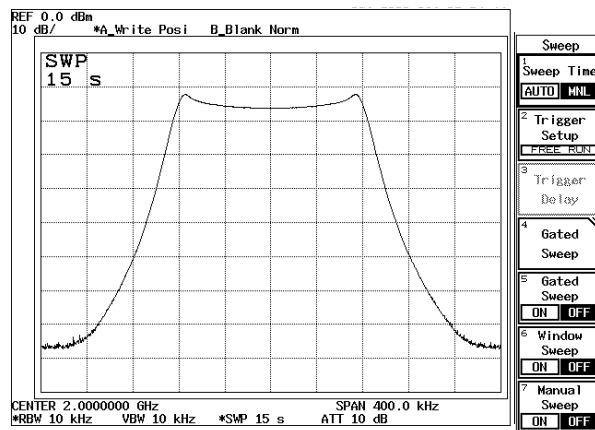

Figure 2-136 Trace of an FM Signal

10. Press **MKR** and move the normal marker to the left-hand peak of the trace.
11. Press **Delta Marker**.
The delta marker is displayed.
12. Move the normal marker to the peak on the right side using the data knob.

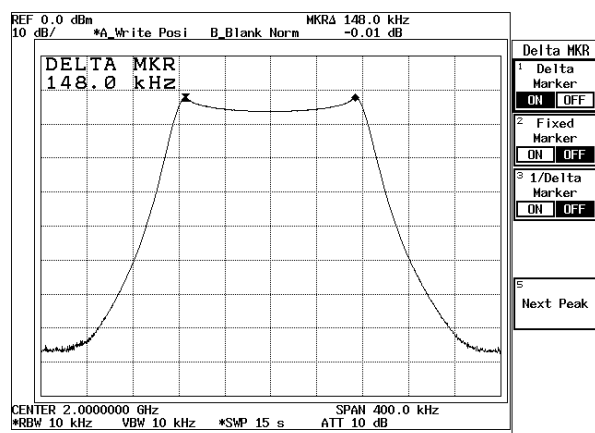

Figure 2-137 Measuring a frequency deviation

2.3.12 Measuring Frequency deviation of FM Signals

Calculating the frequency deviation

13. Read the frequency of the delta marker displayed on the screen.
Calculate the frequency deviation Δf_{peak} from the delta marker frequency Δf_{freq} using the formula shown below.

$$\Delta f_{\text{peak}} = \frac{1}{2} \times \Delta f_{\text{freq}}$$

Calculating modulation index

14. Press **SPAN, 1, 0** and **kHz**.
The frequency span is changed to 10 kHz.
15. Press **SRCH**.
The normal marker is moved to the peak on the trace.
16. Press **Next Peak Right**.
The normal marker moves to the right-hand peak on the trace.

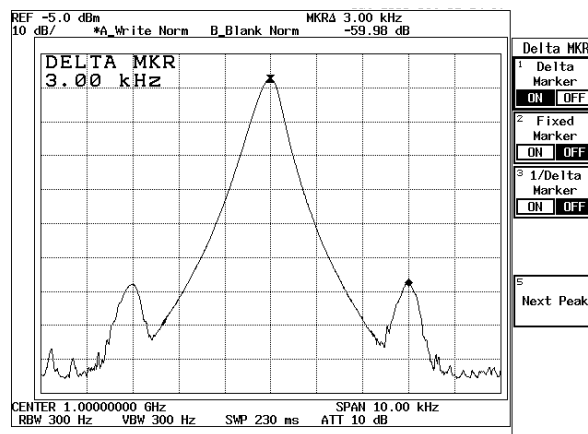

Figure 2-138 Modulation Frequency of the FM Signal

17. Read the frequency of the delta marker.
The modulation index m is calculated from the delta marker frequency f_m and frequency deviation Δf_{peak} , using the following formula.

$$m = \frac{\Delta f_{\text{peak}}}{f_m}$$

2.3.13 Measuring Modulation Index of FM Signals

This section describes the residual FM (FM signals with small modulation index).

The following formula holds if the FM signal modulation index m is less than approximately 0.8.

$$m = \frac{2ESB}{E_c}$$

ESB: Level of the first sideband

E_c : Carrier level

For the logarithmic scale display,

$$m = 10^{\frac{\Delta\text{Level} + 6}{20}}$$

ΔLevel : Difference between the first sideband and the carrier levels [dB]

Measurement conditions: The target of the measurement below is a signal whose input signal characteristics consist of an output frequency of 1 GHz, a level of -10 dBm, a modulation frequency of 3 kHz and a modulation index of 0.2.

Use appropriate parameter values when making the measurements in the example shown below.

Setup

1. Connect the unit under test as shown in Figure 2-139.

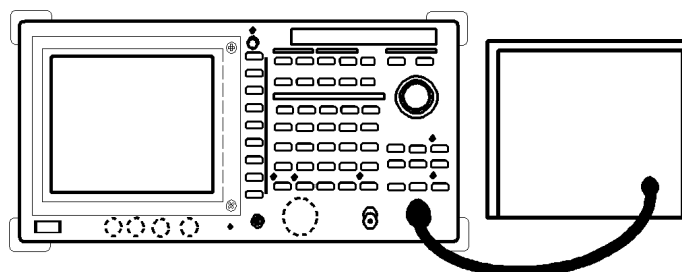

Figure 2-139 Setup for Measuring Modulation Index

Power on

2. Turn the analyzer and the unit under test power on.

Setting the unit under test

3. Activate the signal output for the unit under test.

Initialization

This resets the current settings to the factory defaults or user-defined presets.

4. Press **SHIFT** and **CONFIG(PRESET)**.
This sets the analyzer to its presets values.

2.3.13 Measuring Modulation Index of FM Signals

Setting the measurement conditions

This changes the analyzer settings so that the input signal is displayed more clearly.

5. Press **FREQ, 1** and **GHz**.
A center frequency of 1 GHz is set.
6. Press **SPAN, 1, 0** and **kHz**.
A frequency span of 10 kHz is set.
7. Press **LEVEL, 5** and **MHz(-dBm)**.
The reference level is set to -5 dBm.
8. Press **SRCH**.
The normal marker is displayed on the trace peak.
9. Press **MKR** and *Delta Marker*.
The delta marker is displayed.
10. Press **SRCH** and *Next Peak*.
The normal marker moves to the next highest peak.

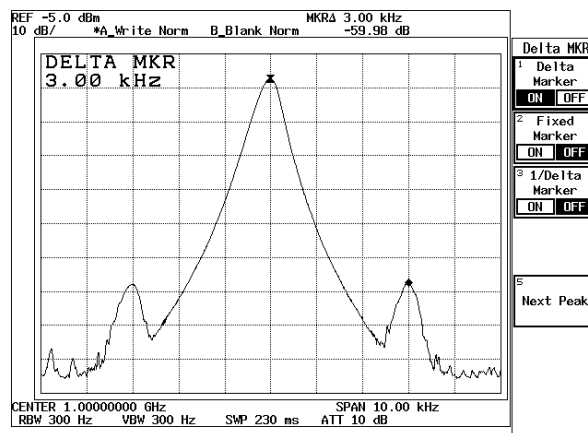

Figure 2-140 FM Signal with Low Modulation Index

Calculating modulation index

11. Read the delta marker level.
Modulation index m is calculated from the following formula, using ΔLevel as delta marker level.

$$m = 10^{\frac{\Delta\text{Level} + 6}{20}}$$

2.3.14 Carrier Frequency and Power Measurements Using Pulsed RF Signals

This section describes how to measure carrier frequency, peak power and average power of pulse modulation signals which are used in the pulse radar and so on.

Measurement conditions: The signal to be measured has a frequency of 1.1 GHz, a pulse repetition rate of 0.333 kHz, a pulse width of 0.8 μ sec and a peak power of 3 kW.

The external attenuator with an attenuation of 50 dB is used on this measurement.

Use appropriate parameter values when taking measurements in the example shown below.

CAUTION: *The maximum amount of power that can be input to the analyzer is +30 dBm (1 W). When measuring a signal power whose value exceeds this limit, connect an external attenuator so the power cannot exceed +30 dBm.*

Setup

1. Connect the unit under test as shown in Figure 2-141.

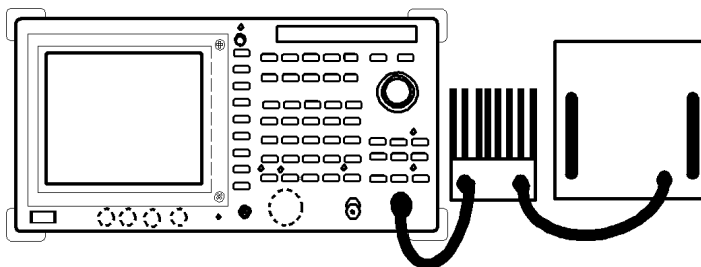

Figure 2-141 Setup for Measuring Pulsed RF Signal

Power on

2. Turn the analyzer and the unit under test power on.

Setting the unit under test

3. Activate the signal output for the unit under test.

Initialization

This resets the current settings to the factory defaults or user-defined presets.

4. Press **SHIFT** and **CONFIG(PRESET)**.
This sets the analyzer to its presets values.

Setting the measurement conditions

This changes the analyzer settings so that the input signal is displayed more clearly.

2.3.14 Carrier Frequency and Power Measurements Using Pulsed RF Signals

5. Press **FREQ, 1, ,, 1** and **GHz**.
A center frequency of 1.1 GHz is set.
6. Press **SPAN, 1, 0** and **MHz**.
A frequency span of 10 MHz is set.
7. Press **LEVEL, 1, 0** and **MHz(-dBm)**.
The reference level is set to -10 dBm.
8. Press **Ref Offset ON/OFF(ON), 5, 0** and **GHz(dB)**.
The level currently being displayed includes the value of the external attenuator.
9. Press **COUPLE, RBW AUTO/MNL(MNL), 1, 0** and **kHz**.
A RBW of 10 kHz is set.

NOTE: Set the RBW to the range shown below so the pulse height becomes large enough to be used.
 $1.7 \times \text{Pulse Repetition Rate} \leq \text{RBW} \leq 0.1 / \text{Pulse width}$

10. Press **VBW AUTO/MNL(MNL), 1, 0, 0** and **kHz**.
A VBW of 100 kHz is set.

NOTE: Set the VBW to 10 times higher than that of the RBW so the RBW is not affected.
 $\text{VBW} \geq 10 \times \text{RBW}$

11. Press **A, Trace A Detector** and **Positive**.
Trace detector mode is set to the positive peak detector mode.
12. Press **ATT, ATT AUTO/MNL(MNL), 3, 0** and **GHz(dB)**.
The attenuator is set to 30 dB.

NOTE: Set the attenuator to 'input level + 10 dB' or more to avoid the saturation at the input mixer.

13. Press **SWP, Sweep Time AUTO/MNL(MNL), 3, ,, 1** and **MHz(sec)**.
A sweep time of 3.1 seconds is set.

Measuring carrier frequency

14. Press **SRCH**.
The normal marker is displayed on the trace peak.
The frequency of the normal marker is the carrier frequency (See Figure 2-142).

2.3.14 Carrier Frequency and Power Measurements Using Pulsed RF Signals

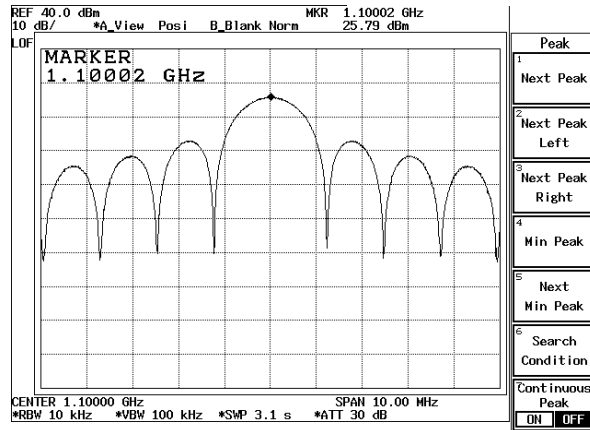

Figure 2-142 Spectrum of a Pulsed Signal

Measuring Peak Power

15. Read the marker level.
Consider this value as apparent peak power P' .
16. Press **MKR** and *Delta Marker*.
The delta marker is displayed.
17. Press *1/Delta Marker ON/OFF*(ON).
The delta marker is displayed in terms of time.
18. Move the delta marker to the minimum position on the main lobe using the data knob.
This value is pulse width τ .

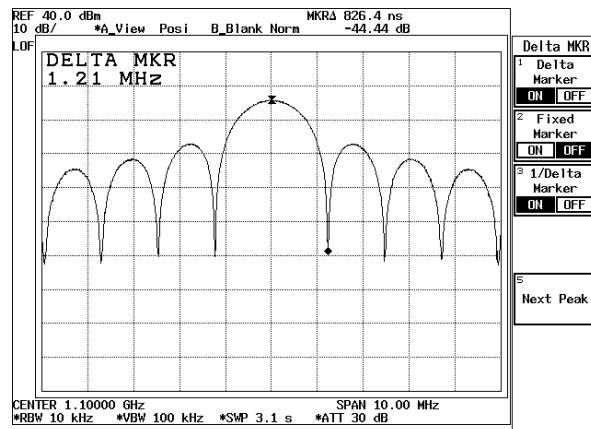

Figure 2-143 Measuring Peak Power

2.3.14 Carrier Frequency and Power Measurements Using Pulsed RF Signals

Calculating the peak power

19. Peak power P is calculated using the formula shown below.

$$P = P' - 20 \log (1.5 \times \tau \times \text{RBW})$$

- P' : Apparent power with RBW set to 10 kHz.
 RBW : Set value of the resolution bandwidth
 τ : Pulse width

Measuring the pulse repetition frequency

20. Press **SPAN** and *Zero Span*.
Zero span is set.
21. Press **SWP, 1, 0** and **kHz(ms)**.
A sweep time of 10 ms is set.
22. Press *Trigger Setup*.
The Trigger Setup dialog box is displayed.
23. Set *Source* to **VIDEO**.
The video trigger starts to sweep.
24. Select *Trigger Level* and adjust the trigger level using the data knob.
Trace is frozen on the screen.
25. Press **RETURN**.
The Trigger Setup dialog box is closed.
26. Press **MKR** and **MKR**.
Move the Normal marker to the peak on the left side turning the data knob.
The normal marker is displayed on the trace peak.
27. Press *Delta Marker*.
Move the Delta marker to the peak on the right side turning the data knob.
The value of the delta marker is the pulse repetition frequency (freq).

2.3.14 Carrier Frequency and Power Measurements Using Pulsed RF Signals

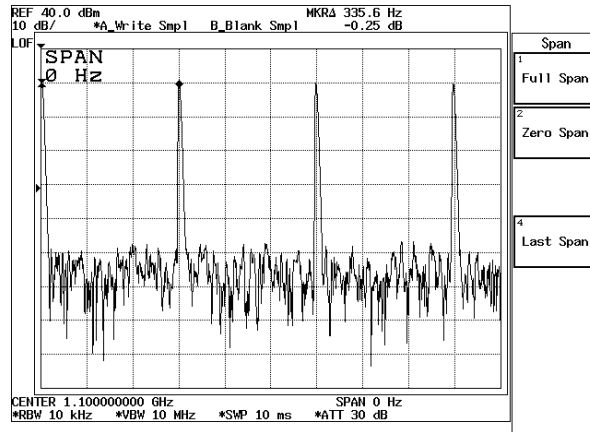

Figure 2-144 Measuring the pulse repetition frequency

Calculating the average power

28. The average power P_{ave} is calculated using the formula shown below.

$$P_{ave} = P_{peak} \times f_{rep} \times \tau$$

P_{peak} : Peak power(W)

f_{rep} : Pulse repetition frequency

τ : Pulse width

2.4 Expanded Functions

2.4.1 Saving/Recalling Measurement Conditions

2.4.1.1 Saving/Recalling Basic Measurement Conditions

(1) Saving data

Data that can be saved to internal memory, floppy disk or the memory card (Option) include the following:

- Basic measurement conditions
- 501/1001-point trace A or B, or trace data for both A and B
Trace data can be saved only when the trace mode is set to either the Write or View mode.
- Level correction data (Correction Factor data)
- Normalize data
Normalized data is saved only when the Normalize mode is turned on.
- User-definable limit line data
- LOSS: Freq data
This is available only for the R3273.
- Spurious measurement table data

Selecting a device to be used for saving data

1. Press **SHIFT** and **RCL(SAVE)**.
The Save menu (used to save data) and a file list are displayed.
Use the step keys to turn pages within the file list.
2. Press *Device RAM/FD(ED)*.
The device is set (See Figure 2-145).

NOTE:

1. *When the analyzer is equipped with a floppy disk drive, Device RAM/FD is displayed; when the analyzer is equipped with a memory card, Device RAM/A/B is displayed.*
 2. *The FD drive cannot be selected when a floppy disk is not set in the Floppy disk drive. The same is true when there is no memory card.*
-

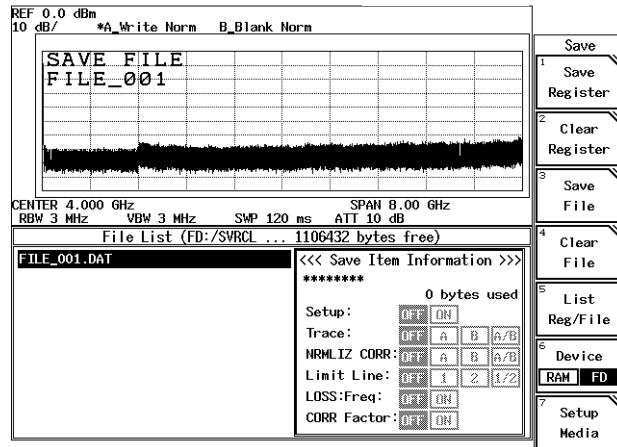

Figure 2-145 Selecting Destination Device

Setting the data to be saved

The data format and data for each item are selected when saving data.

3. Press **Save File** and **Save Item Setup**.
The Save Item Setup dialog box is displayed.

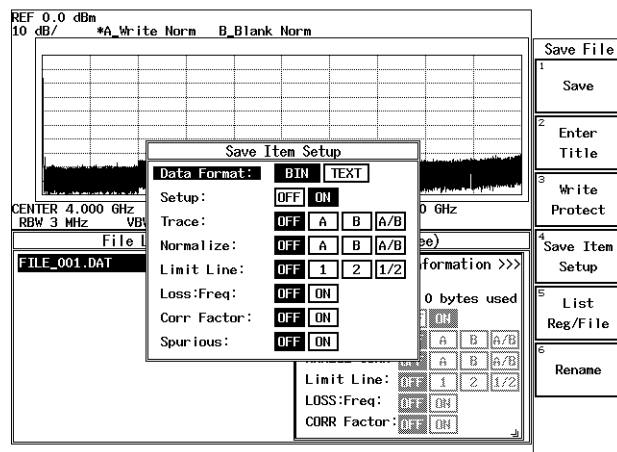

Figure 2-146 Save Item Setup dialog box

4. Select **Data Format** and set this function to **BINARY**.
The format that saves data is set.
5. Select **Setup** and turn this function **ON**.
The function that saves measurement conditions is set.
6. Select **Trace** and set this function to **A/B**.
The function that stores data for both traces A and B is set.

2.4.1 Saving/Recalling Measurement Conditions

7. Select *Normalize* and set this function to *A/B*.
The function that saves data for traces A and B is set.
8. Select *Limit Line* and set this function to *1/2*.
The function that saves data for Limit lines 1 and 2 is set.
9. Select *LOSS:Freq* and turn this function *ON*.
The function that saves data in the LOSS:Freq table is set.
10. Select *Corr Factor* and turn this function *ON*.
The function that saves the level correction value is set.
11. Press **RETURN**.
This closes the Save Item Setup dialog box and returns to the Save menu.

Setting a file to be saved

12. Select the file to be saved from a file list.
Use the data knob to select the file.
The file name is previously assigned. For RAM, the file name starts with REG_01; for floppy disks, it starts with FILE_001.

NOTE: *In the above example a file number is used instead of a file name, but you can use an arbitrary file name if desired. For information on how to set file names, refer to Section 2.4.6.*

Saving data

13. Press *Save File* and *Save*.
The data is saved in the file previously selected (See Figure 2-147).

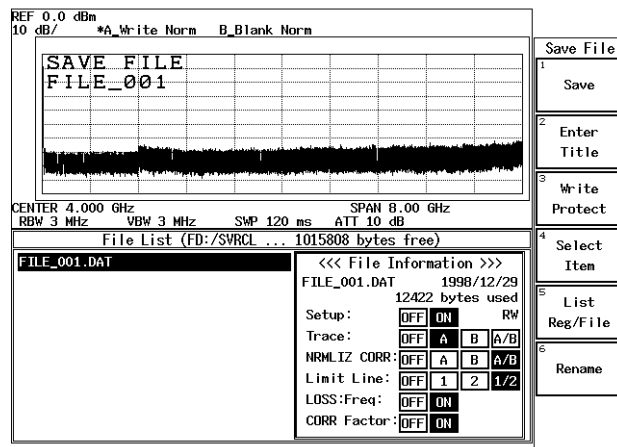

Figure 2-147 File Saved

Deleting the file list

1. Press **SHIFT**, **RCL(SAVE)** and **List Reg/File**.
The file list is deleted.

(2) Protecting Data

To prevent someone from accidentally deleting or overwriting data, you can use the file protection feature.

Selecting the device

1. Press **SHIFT** and **RCL(SAVE)**.
The Save menu and the file list are displayed.
2. Press **Device RAM/FD(FD)**.
The FD is selected.

NOTE: When the analyzer is equipped with a floppy disk drive, **Device RAM/FD** is displayed; when the analyzer is equipped with a memory card, **Device RAM/A/B** is displayed.

Selecting the file

3. Press **Save File**.
The Save File (used to save data to file) is displayed.
4. Select the file from the file list using the data knob.

Protecting the file

5. Press **Write Protect**.
The selected file display changes from RW (read or write) to RO (read only), indicating that data protection has been enabled.

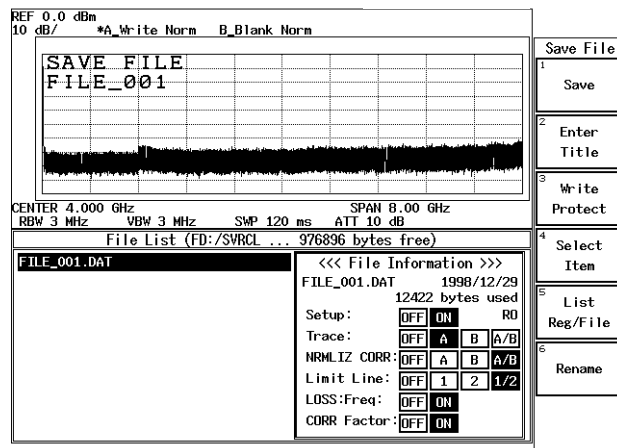

Figure 2-148 File Protection Enabled

2.4.1 Saving/Recalling Measurement Conditions

The write protection can be disabled using the following procedure.

Disabling data protection

1. Press **SHIFT** and **RCL(SAVE)**.
The Save menu and the file list are displayed.
2. Press **Clear File**.
The Clear File menu is displayed.
3. Select the file from the file list.
Use the data knob to select the file.
4. Press **Release Protect**.
The selected file display changes from RO (read only) to RW (read or write), indicating that data protection has been disabled.

(3) Loading Data

Saved conditions and trace data can be used for measurements. Use the following procedure to access this data.

Selecting the device

1. Press **RCL**.
The Recall menu and file list are displayed.
2. Press **Device RAM/FD(FD)**.
The device of FD is set.

NOTE: *When the analyzer is equipped with a floppy disk drive, Device RAM/FD is displayed; when the analyzer is equipped with the memory card, Device RAM/A/B is displayed.*

Selecting the file

3. Press **Recall File**.
The Recall File menu, which is used to read data from a file, is displayed.
4. Select the file from the file list using the data knob (See Figure 2-149).

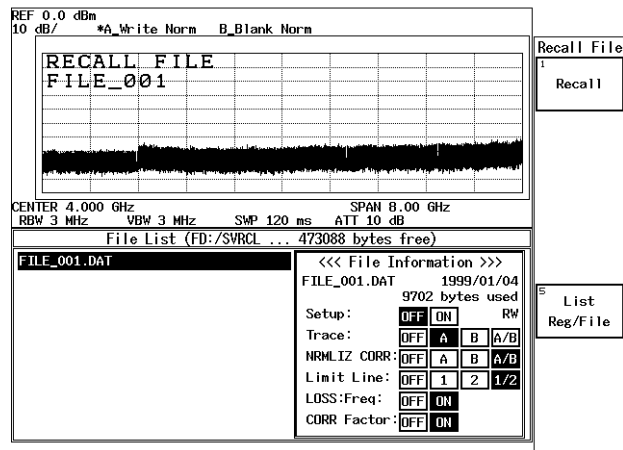

Figure 2-149 Selected File

Reading data

5. Press **Recall**.
The data from the selected file is read (See Figure 2-150).

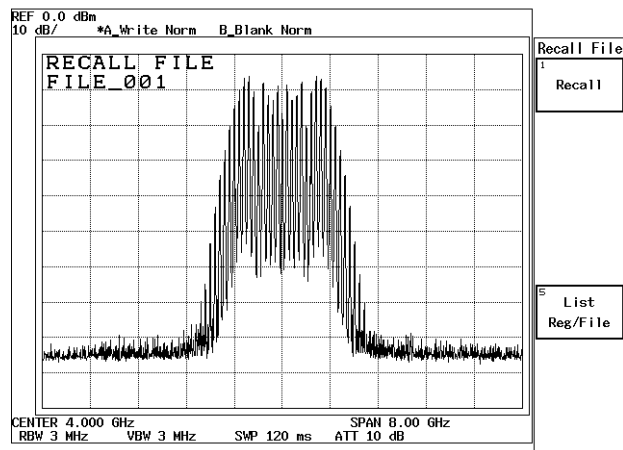

Figure 2-150 Read Data

- (4) Deleting the Data

Data, which has been saved to internal memory or a floppy disk, can be deleted.

Selecting the device

1. Press **SHIFT** and **RECALL(SAVE)**.
The Save menu and file list are displayed.
2. Press **Device RAM/FD(FD)**.
The device of FD is set.

2.4.1 Saving/Recalling Measurement Conditions

NOTE: When the analyzer is equipped with a floppy disk drive, Device RAM/FD is displayed; when the analyzer is equipped with a memory card, Device RAM/A/B is displayed.

Selecting the file

3. Press *Clear File*.
The Clear File menu is displayed.
4. Select a file to be deleted from the file list using the step keys or data knob.

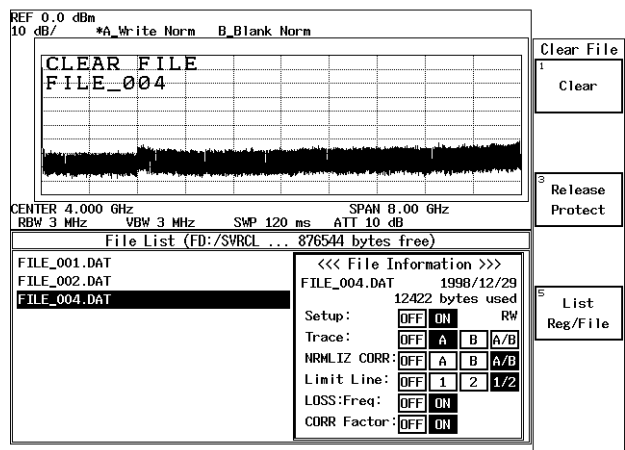

Figure 2-151 File to Be Deleted

Deleting the data

5. Press *Clear*.
The data of the selected file is deleted (See Figure 2-152).

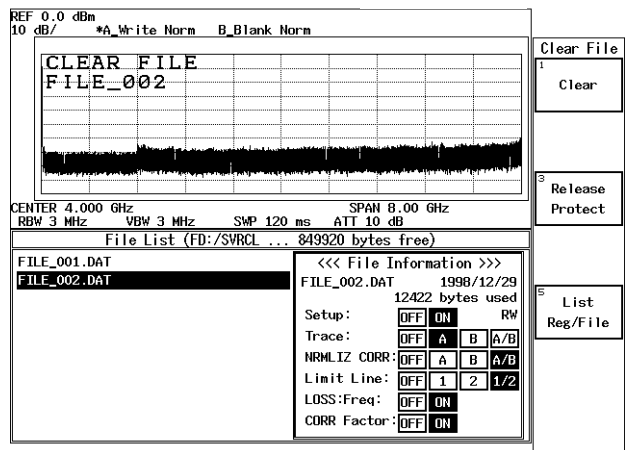

Figure 2-152 File Already Deleted

2.4.1.2 Saving/Recalling OBW Measurement Conditions

OBW measurement conditions, such as the OBW% value, frequency span, resolution bandwidth, video bandwidth, sweep time and trace detector mode, can be saved as user-defined presets.

Saving OBW measurement conditions

1. Press **UTIL** and **OBW**.
The OBW menu is displayed.
2. Press **Parameter Setup** and **Define** → **Default**.
The current measurement condition is saved in the internal memory.

When you wish to change the measurement condition that is already saved, press **UTIL**, **OBW**, **Parameter Setup** and **Default**.

2.4.1.3 Saving/Recalling ACP Measurement Conditions

ACP measurement conditions, such as the channel space, specified bandwidth, frequency span, resolution bandwidth, video bandwidth, sweep time and trace detector mode, can be saved as user-defined presets.

Saving ACP measurement conditions

1. Press **POWER** and **ACP**.
The ACP menu is displayed.
2. Press **Parameter Setup** and **Define** → **Default**.
The current measurement conditions are saved in the internal memory.

When you wish to change the measurement conditions that are already saved, press **POWER**, **ACP**, **Parameter Setup** and **Default**.

2.4.2 Saving Screen Data

2.4.2 Saving Screen Data

Screen data can be saved in either floppy disks or the memory card (option) in BMP (bit map file) the analyzer.

CAUTION: When using the memory card (Option), the word "floppy disk" is referred to as "memory card."

Inserting a floppy disk

1. Insert the floppy disk into the floppy disk drive.

Setting the destination for screen data.

2. Press **CONFIG**, *Copy Config* and *Copy Device*.
The Copy Device dialog box used to set the destination of screen data is displayed.
3. Select **Floppy**.
The floppy disk is set as the Save file destination and the Copy Device dialog box is closed (See Figure 2-153).

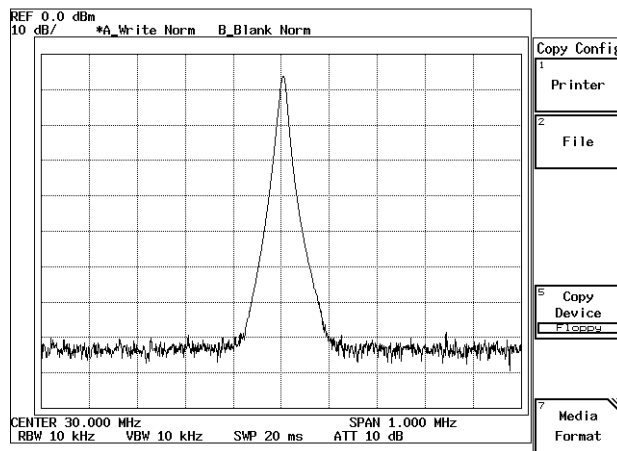

Figure 2-153 Specifying

Setting the type of screen data file

4. Press **File**.
The File dialog box is displayed.

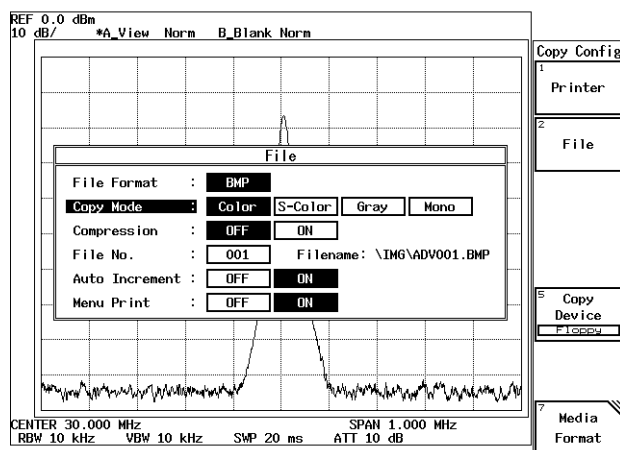

Figure 2-154 File Dialog Box

5. Select **Copy Mode** and set the mode to **Color**.
The output mode is set to color.
6. Select **Compression** and turn this function **OFF**.
The function that disables the image compression function is set.
7. Select **File No.** and set the number to **001**.
The screen file number is set to 001.
8. Select **Auto Increment** and turn this function **ON**.
This function that automatically increments file numbers is set.
9. Press **RETURN**.
The File dialog box is closed.

Saving screen data

10. Display the data you wish to copy on the screen and press **COPY**.
The access lamp is lit and the screen data is saved on the floppy disk.

CAUTION: *Do not remove the floppy disk while the access indicator is lit, or the data on the floppy disk may be damaged.*

2.4.3 Obtaining a Hard Copy of screen data

2.4.3 Obtaining a Hard Copy of screen data

You can make printouts from the screen data using the parallel interface (compliant with Centronix).

The printers compatible with the analyzer use ESC/P, ESC/P Raster or HP PCL as the control codes (some of these printers may present functional restrictions).

ESC/P: Epson Standard Cord for Printer

ESC/P Raster: Epson Standard Cord for Printer Raster mode

HP PCL: Hewlett Packard Printer Command Language

Recommended printers are listed in Table 2-5.

Table 2-5 Recommended Printers

Manufacturer	Model
Epson	PM-900C *1, PM-880C *1, PM-800C *1, PM-770C *1, PM-750C *1, PM-2000C, EM-900C *1, MJ-930C, MJ-830J, MJ-700V2C
Hewlett Packard	DeskJet 880C *2, DeskJet 694C *2, DeskJet 505J, LaserJet 5L
Canon	BJ-M70, BJC-430J, BJC-420J, BJC-410J, BJC-600J, BJC-50V

NOTE: *Only ESC/P Raster and HP PCL are available for color printing.*

**1 indicates that ESC/P Raster is used for color printing.*

**2 indicates that HP PCL is used for color printing.*

Connecting the printer

CAUTION: *Be sure to turn the power off on the analyzer before connecting a printer.*

1. Connect the printer to the **PRINTER** connector on the rear panel using the IBM-PC compatible cable provided.

Setting up output destination

2. Press **CONFIG**, *Copy Config* and *Copy Device*.
The Copy Device dialog box used to select the screen data destination is displayed.
3. Select *Printer*.
The Copy Device dialog box is closed.
The Copy Config menu is displayed.

Setting up control codes and printer mode.

4. Press **Printer**.
The Printer dialog box is displayed (See Figure 2-155).

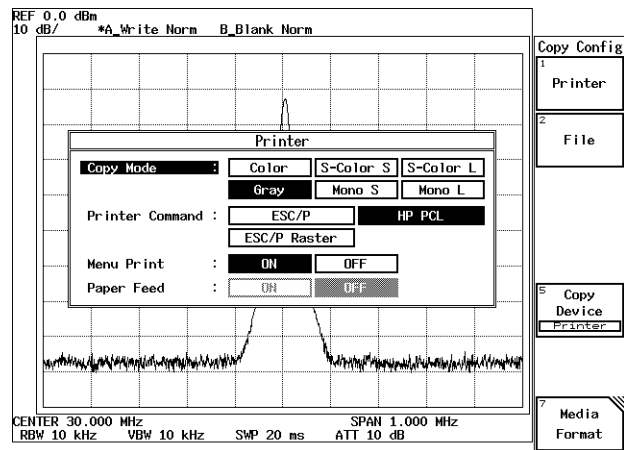

Figure 2-155 Printer dialog box

5. Select **Copy Mode** and set this function to **Gray**.
The output mode is set.
6. Select **Printer Command** and set this function to **HP PCL**.
The type of printer is set.

NOTE: "Printer Command" is set according to the printer used.

7. Select **Menu Print** and turn this function **ON**.
The print menu is displayed.
8. Press **RETURN**.
The Printer dialog box is closed.

Printing

9. Display the screen you wish to print and press **COPY**.
The screen data is sent to the printer. The time required for the data to print depends on the mode and printer used.

NOTE:

1. When you wish to cancel a printout after pressing **COPY**, press **SHIFT** and **COPY** (Cancel).
 2. When Paper Feed is set to **OFF** and you print continuously, some printers may print one screen on two separate sheets of paper. If this happens, remove the papers from the printer using Paper Feed.
-

2.4.4 Formatting Media

The screen data of the analyzer can be saved to either a floppy disk or the memory card (option). This section describes how to format a floppy disk and the memory card.

2.4.4.1 Formatting a Floppy Disk

The analyzer is equipped with a 3.5-inch floppy disk drive. You can save text data (settings, trace data and correction data) and BMP data (display data) to floppy disks using this drive. Data saved on a floppy disk can be processed on a computer.

The following floppy disk formats can be used:

3.5-inch DD 720KB, HD 1.2 MB and 1.44MB (MS-DOS format compatible).

The analyzer can initialize only the HD floppy disks.

Write-protecting the Floppy Disk

This prevents you from accidentally initializing or overwriting a floppy containing previously saved data. The write protect tab is located in the lower right hand corner of the floppy disk.

To write-protect a disk, slide the tab downwards to the other end (a hole appears).

To disable write protection, slide the tab upwards to the original position (until the hole is no longer visible) (See Figure 2-156).

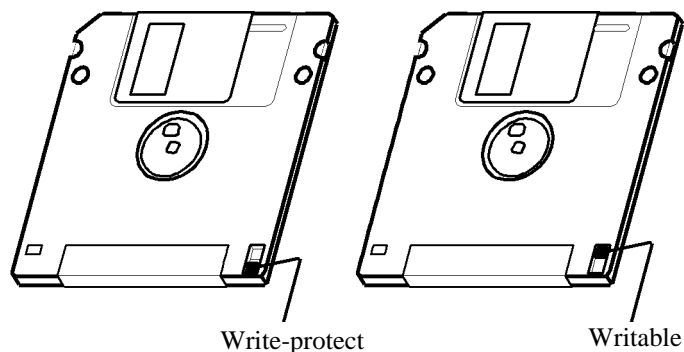

Figure 2-156 Floppy Disk Write Protection

Initializing Floppy Disks

To prepare a floppy disk for use with the analyzer, use the following procedure.

CAUTION: *Formatting a floppy disk causes all data to be erased.*

1. Make sure the floppy disk is not write protected.
2. Insert the floppy disk into the floppy disk drive.
3. Press **CONFIG**, *Copy Config* and *Media Format*.
The Media menu used for initializing floppy disks appears (See Figure 2-157).

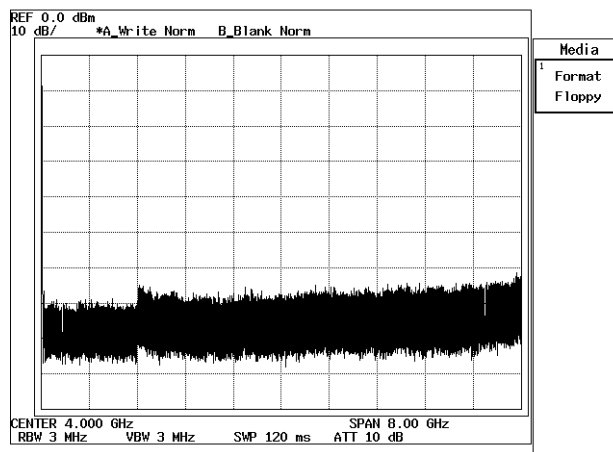

Figure 2-157 Media Menu

4. Press **Format Floppy**.

The dialog box is displayed to prompt you to confirm whether or not to continue formatting. To continue formatting, select **Confirm**.

The floppy disk is formatted with the MS-DOS 1.44MB format. The access lamp is lit while initializing (this takes approx. 1 minute).

CAUTION: Do not remove the floppy disk while the access indicator is lit, or the data on the floppy disk may be damaged.

2.4.4.2 Formatting the Memory Card (Option)

The analyzer can be equipped with the memory card drive as option if desired. You can save data to memory card as well as the floppy disk drive. The memory card drive has two slots, permitting up to two memory cards to be plugged in (The slots in the memory card drive are located at the upper right of the front panel).

Memory cards compatible with the analyzer are as follows.

- Memory cards compliant with the PC card guidelines Ver.4 (of the Japanese Electronic Industry Development Association (JEIDA)), or memory card PCMCIA at Release 2.0 or later under the US standards.
- Types: SRAM, FLASH ATA or PC Card ATA (using Flash ROM)
- Format: MS-DOS format

CAUTION: Flash ROM cards which use the 8- or 16-bit bus system cannot be used in the analyzer. Neither FLASH ATA nor PC Card ATA card can be used in the analyzer. Use a memory card after verifying that it complies with the standards shown above. For more information on the memory card, refer to "Cautions on Using the R3267 Series" in Chapter Caution.

2.4.4 Formatting Media

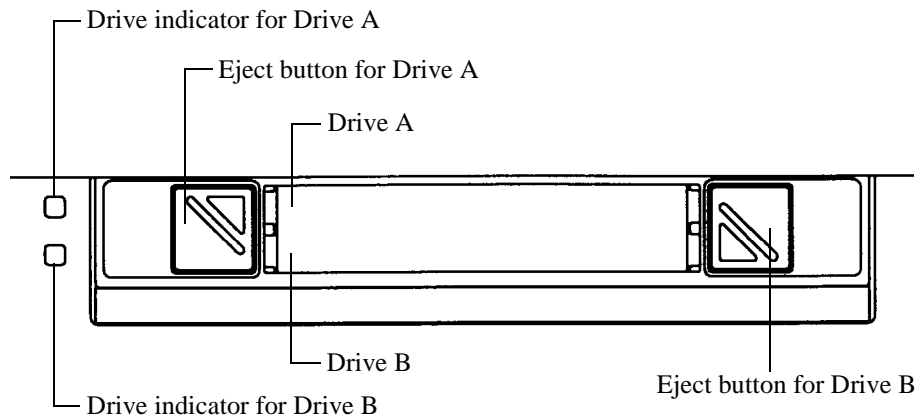

Figure 2-158 Slots in the Memory Card Drive

Plugging in the memory card

1. Plug in the memory card with the label face up.
The drive indicator is dimly lit when the memory card is inserted.

CAUTION: *Never push the Eject button and the memory card simultaneously to prevent damage to the connector.*

Removing the memory card

2. Make sure the drive indicator is dimly lit.

CAUTION: *Do not remove the memory card when the drive indicator is brightly lit, or the data in the card can be corrupt.*

3. Press the corresponding eject button to eject the card.
4. Remove the memory card from the drive.

Initializing the memory card

Be sure to initialize the memory card before saving data in a new SRAM-type memory card.

CAUTION:

1. *FLASH ATA or PC Card ATA memory card cannot be initialized in the analyzer. The memory cards cited above do not require initialization because they are formatted before shipment.*
 2. *When initializing a memory card that has previously been written, all data is deleted. Prior to initializing the memory card that contains data, be sure to save necessary files to other memory cards and so on.*
-

5. Disable write protection prior to using SRAM memory card.
6. Plug the memory card into drive A.
7. Press **CONFIG**, *Copy Config* and *Media Format*.
The Media menu used to initialize the memory card is displayed.
8. Press *Format Card A*.
The dialog box is displayed to prompt you to confirm whether or not to continue formatting. To continue formatting, select **Confirm**.
The drive starts to format the media. Note that the drive indicator will brightly be lit while formatting.

2.4.5 Setting Date and Time

2.4.5 Setting Date and Time

This section describes how to set the date and time. In the following example, a time and date of 1:35 pm Jan.18 1999 is set.

Setting the date and time

1. Press **CONFIG** and **Date/Time**.
The Date/Time dialog box is displayed (See Figure 2-159).

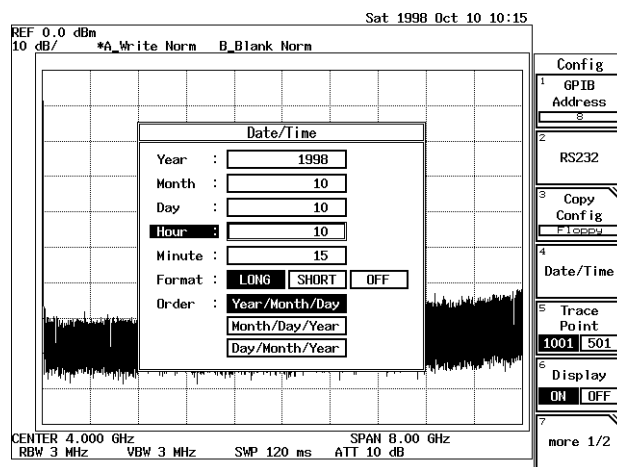

Figure 2-159 Date/Time Dialog Box

2. Select **Year**, and press **1, 9, 9, 9** and **Hz (ENTR)**.
The year is set to 1999.
3. Select **Month**, and press **1** and **Hz (ENTR)**.
The month is set to January.
4. Select **Day**, and press **1, 8** and **Hz (ENTR)**.
The date is set to the 18th.

Setting the time

5. Select **Hour**, and press **1, 3** and **Hz (ENTR)**.
The time is set to 1pm.
6. Select **Minute**, and press **3, 5** and **Hz (ENTR)**.
The minute is set to 35.

Setting the date display format

7. Select **Format**, and set this function to **LONG**.
The format used to set the date is selected.
8. Select **Order** and set this function to **Year/Month/Day**.
A date display mode is set.

9. Press **RETURN**.
The Date/Time dialog box is closed.

2.4.6 Setting the Screen Label

This section describes how to enter your remarks for the screen data. A maximum of 30 characters, which consist of alphanumeric and a few special characters, can be entered.

Setting labels

1. Press **FORMAT**, **Label** and **Label Entry**.

The Label Entry dialog box, which is used to enter alphanumeric characters and special characters, is displayed. This dialog box consists of the two areas: one is the area in which characters entered are displayed, and the other is the area in which the alphanumeric characters to be entered are displayed as buttons. (See Figure 2-160).

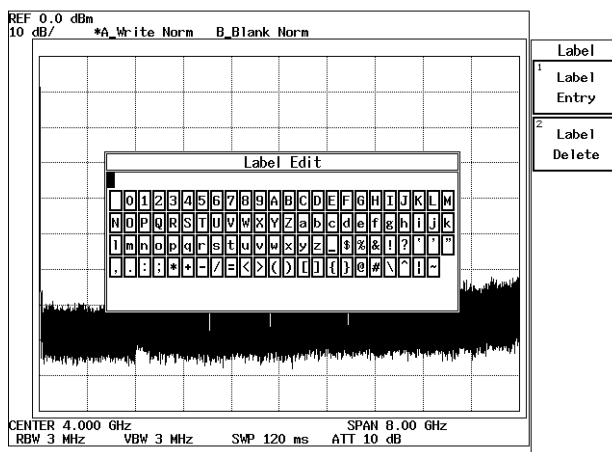

Figure 2-160 Dialog Box Used to Enter Labels

2. Select the characters you wish to enter using the data knob and step keys.
The data knob is used to move the cursor horizontally in the button area; the step keys are used to move the cursor vertically between the rows in the button area. In this example, enter ADVANTEST1 using upper case alphabetic characters.
3. Move the cursor to character A, which is found on the first line, and press the data knob.
Character A will be displayed in the input area within the dialog box. Note that the cursor in this area has been shifted one place to the right.
4. Select character B and press **H_z**. Then press **-(BS)**. Character B appears temporarily in the upper part and disappears when it is corrected by pressing **-(BS)**. Note that the cursor is next to character A on the right hand side.
5. Then enter the rest of the characters: D, V, A, N, T, E, S and T.

2.4.6 Setting the Screen Label

6. Press the numeric key **1**. Check to see if numeric character 1 has been entered after the characters ADVANTEST (the final display is ADVANTEST1). Only numeric characters can be entered directly from the numeric keys.
7. Press **Hz(ENTR)**.
This closes the Label Entry dialog box, and the characters you entered are displayed in the upper left-hand corner of the screen.

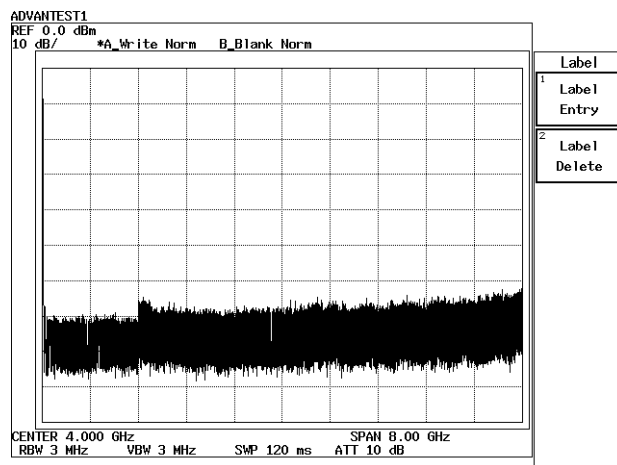

Figure 2-161 Displaying the Screen Label

CAUTION:

1. The dialog box will close, cancelling the data you entered when you press any keys other than numeric keys, the **-(BS)** key and **Hz** key.
2. A new label is always overwrites the old one. As a result, the old alphanumeric character(s) will be left undeleted if the number of characters of the new label is less than that of the old label.
When you wish to delete the entire old label, press the **Label Delete** key first to delete it, press the **Label Edit** key and then enter the new label.

Deleting a label previously set

8. Press **FORMAT**, **Label** and **Label Delete**.
A previously set label is deleted from the screen.

3 REFERENCE

This chapter describes the functions of all panel and soft keys.

- Menu index: Use this index as a key index to Chapter 3.
- Menu map: Shows a list of hierarchical menus on a panel key basis.
- Functional descriptions: Explains the functions of the panel and soft keys.

The panel keys are arranged in alphabetical order.

3.1 Menu Index

This menu index is used to easily find the keys described in Chapter 3.

<u>Operation Key</u>	<u>Pages</u>	<u>Operation Key</u>	<u>Pages</u>
√Nyquist Filter.....	3-15, 3-61	ATT.....	3-7, 3-24
√Nyquist Filter ON/OFF.....	3-15, 3-59	ATT AUTO/MNL.....	3-7, 3-24
√Nyquist Filter Setup.....	3-15, 3-60	ATT switch Count	3-9, 3-35
% AM Measure.....	3-13, 3-52	AUTO	3-10
0.5 dB/div.....	3-12	Auto Adjust.....	3-10, 3-43
1 dB/div.....	3-12	Auto Increment	3-9, 3-33
1/Delta Marker ON/OFF.....	3-14, 3-53	Auto Tune	3-11, 3-45
10 dB/div.....	3-12	Average A.....	3-7, 3-20
10, 5, 2, 1 or 0.5dB/div	3-49	Average B	3-8, 3-25
2 dB/div.....	3-12	Average Loss ON/OFF	3-11, 3-47
3rd Order.....	3-18, 3-82	Average Power.....	3-15, 3-58
3rd Order Measure	3-13, 3-52	Average Times.....	3-15, 3-58
3rd Order Peak	3-19, 3-85	Average Times ON/OFF.....	3-15, 3-18,
5 dB/div.....	3-12		3-61, 3-78,
5th Order.....	3-18, 3-82		3-81, 3-82,
7th Order.....	3-18, 3-82		3-83
9th Order.....	3-18, 3-82	B.....	3-8, 3-9,
A.....	3-7, 3-9,		3-25, 3-33
	3-20, 3-33	Band Lock ON/OFF.....	3-11, 3-47
A←→B	3-7, 3-8,	Band Select	3-11, 3-46
	3-21, 3-26	Baud Rate.....	3-9, 3-30
ABC	3-10	Bias POSI/NEGA	3-11, 3-46
ACP.....	3-15, 3-59	Blank A	3-7, 3-20
ACP OFF	3-15, 3-62	Blank B	3-8, 3-25
Active Marker	3-14, 3-15,	BS Window ON/OFF.....	3-15, 3-60
	3-53, 3-62	C/N Meas	3-18, 3-81
Active Trace A/B	3-15, 3-18,	C/N Meas OFF.....	3-18, 3-81
	3-62, 3-83	CAL	3-8, 3-28
All Auto	3-10, 3-37	Cal 10 MHz Ref.....	3-8, 3-28
Amplitude MAG.....	3-8, 3-28	Cal All.....	3-8, 3-28
Anchor	3-14, 3-54	Cal Corr ON/OFF	3-8, 3-28
Artificial Analog A	3-7, 3-21	Cal Each Item.....	3-8, 3-28
Artificial Analog ON/OFF.....	3-18, 3-21,	Cal Sig Level	3-8, 3-28
	3-80	Center.....	3-11, 3-45

3.1 Menu Index

CF Step Size AUTO/MNL	3-11, 3-45	3-81
Channel Position	3-15, 3-58	Delete Line.....
Channel Power.....	3-15, 3-58	3-10, 3-11,
Channel Width	3-15, 3-58	3-12, 3-15,
Clear.....	3-16, 3-68	3-43, 3-47,
Clear File.....	3-16, 3-68	3-50, 3-59
Clear Register	3-16, 3-66	Delta → CF.....
Coarse	3-8, 3-28	3-14, 3-56
Color	3-10, 3-44	Delta → CF Step.....
Compression	3-9, 3-33	3-14, 3-56
CONFIG.....	3-9, 3-30	Delta → Marker Step.....
Cont Down ON/OFF.....	3-13, 3-52	3-14, 3-56
Cont peak ON/OFF.....	3-17, 3-74	Delta Marker
COPY	3-9, 3-36	3-14, 3-53,
Copy All.....	3-16, 3-69	3-54
Copy Config.....	3-9, 3-30	Delta Marker ON/OFF.....
Copy Device	3-9, 3-33	3-14, 3-53
Copy Mode	3-9, 3-31,	Delta Y Disp Mode Cusr/Data.....
	3-32	3-7, 3-22
Copy Table 1 to 2.....	3-10, 3-43	DET Select AUTO/MNL.....
Copy Table 2 to 1.....	3-10, 3-43	3-7, 3-8,
Corr Factor.....	3-16, 3-68	3-20, 3-23,
Correction Edit.....	3-12, 3-49	3-25, 3-27
Correction Factor	3-12, 3-49	Device RAM/A/B
Correction ON/OFF.....	3-12, 3-49	3-15, 3-16,
Counter.....	3-13, 3-51	3-64, 3-68
Counter ON/OFF	3-13, 3-51	Device RAM/FD.....
COUPLE.....	3-10, 3-37	3-15, 3-16,
Couple to F(T)	3-17, 3-73	3-64, 3-68
CS/BS Setup	3-15, 3-59	Disp Mode REL/ABS.L/ABS.R
Data Format	3-16, 3-67	3-13, 3-52
Data Length.....	3-9, 3-30	Display Control.....
Date/Time	3-9, 3-34	3-10, 3-44
Day.....	3-9, 3-34	Display Line.....
dB μ V/ $\sqrt{\text{Hz}}$	3-13	3-14, 3-17,
dB/div.....	3-12, 3-49	3-54, 3-73
dBc/Hz	3-13, 3-51	Display Line ON/OFF
dBm.....	3-12, 3-49	3-10, 3-40
dBm/Hz.....	3-13, 3-51	Display Line Pos.
dBmV	3-12, 3-49	3-7, 3-8,
dB μ V.....	3-12, 3-49	3-21, 3-26
dB μ V/ $\sqrt{\text{Hz}}$	3-51	Display ON/OFF.....
dB μ Vemf	3-12, 3-49	3-9, 3-35
dBpW	3-12, 3-49	Edit Table.....
Default	3-8, 3-15,	3-18, 3-79,
	3-29, 3-61,	3-81
	3-78	Enter Title
Default IP	3-16, 3-66	3-16, 3-66
Define → Default.....	3-15, 3-18,	Execute Selftest.....
	3-61, 3-78	3-9, 3-35
Delete.....	3-18, 3-79,	Ext Mixer Config
		3-11, 3-46
		Eye Opening
		3-18, 3-79
		Eye Opening OFF.....
		3-18, 3-81
		F/T.....
		3-19, 3-85
		File
		3-9, 3-32
		File Format.....
		3-9, 3-32
		File No.
		3-9, 3-33
		Fine
		3-8, 3-29
		Fixed Marker ON/OFF
		3-14, 3-53
		Fixed MKR Peak
		3-13, 3-51
		Floppy
		3-9, 3-33
		Flow Control.....
		3-9, 3-30
		FORMAT.....
		3-40
		Format.....
		3-9, 3-34
		Format Card A
		3-9, 3-16,
		3-34, 3-69
		Format Card B
		3-9, 3-16,
		3-34, 3-69
		Format Floppy.....
		3-9, 3-16,

FREQ	3-34, 3-69	Limit Width.....	3-17, 3-72
Freq Corr ON/OFF.....	3-11, 3-45	Linear	3-12, 3-49
Freq Offset ON/OFF.....	3-8, 3-29	List OFF.....	3-13, 3-51
Full Span.....	3-11, 3-45	List Reg/File	3-15, 3-16,
FUND Frequency ON/OFF	3-17, 3-71		3-64, 3-68
Gate Position.....	3-18, 3-78	Load Table	3-18, 3-79
Gate Src Ext Gate	3-17, 3-76	Log Linearity	3-8, 3-28
Gate Src IF Trigger.....	3-17	LOSS:Freq.....	3-16, 3-68
Gate Src Trigger.....	3-17	Loss:Freq Edit.....	3-11, 3-47
Gate Width.....	3-76	Loss:Freq ON/OFF	3-11, 3-47
Gated Sweep	3-17, 3-76	Manual	3-15, 3-61,
Gated Sweep ON/OFF.....	3-17, 3-77		3-78
GPIB Address	3-9, 3-30	Manual Tune	3-11, 3-45
Graph	3-15, 3-61	Marker → CF.....	3-14, 3-56
Graph ON/OFF	3-15, 3-61	Marker → CF Step.....	3-14, 3-56
Gray#1	3-10, 3-44	Marker → Marker Step.....	3-14, 3-56
Gray#2	3-10, 3-44	Marker → Ref.....	3-14, 3-56
Harmonics.....	3-18, 3-78	Marker List ON/OFF	3-14, 3-54
Harmonics Number.....	3-18, 3-78	Marker No.....	3-14, 3-15,
Harmonics OFF.....	3-18, 3-78		3-53, 3-62
Hi Sens ON/OFF.....	3-18, 3-83	Marker OFF	3-14, 3-15,
Hour	3-9, 3-34		3-53, 3-54,
IF Step AMP	3-8, 3-28		3-55, 3-62
IM Meas.....	3-18, 3-82	Marker ON.....	3-14, 3-15,
IM Meas OFF.....	3-18, 3-83		3-53, 3-62
Input ATT	3-8, 3-28	Marker Step Size AUTO/MNL.....	3-14, 3-55
Insert	3-18, 3-79,	Max Hold A	3-7, 3-20
	3-81	Max Hold B	3-8, 3-25
Insert Line	3-10, 3-11,	Max Peak	3-19, 3-84,
	3-12, 3-15,		3-85
	3-43, 3-47,	MEAS	3-13, 3-51
	3-50, 3-59	Measuring Window.....	3-19, 3-84
Label	3-10, 3-43	Media Format.....	3-9, 3-33
Label Delete.....	3-10, 3-43	MEDIUM.....	3-10
Label Entry	3-10, 3-43	Menu Print	3-9, 3-32,
Last Span.....	3-17, 3-71		3-33
LCL.....	3-11, 3-48	Min ATT ON/OFF.....	3-7, 3-24
LEVEL.....	3-12, 3-49	Min Hold A.....	3-7, 3-21
Limit Line	3-10, 3-14,	Min Hold B	3-8, 3-26
	3-16, 3-40,	Min Peak	3-17, 3-72
	3-54, 3-67	Minute.....	3-9, 3-34
Limit Line 1	3-10, 3-17,	Mixer INT/EXT	3-11, 3-46
	3-41, 3-73	MKR	3-14, 3-53
Limit Line 1/2	3-10, 3-43	MKR →	3-14, 3-56
Limit Line 2	3-10, 3-17,	Mono#1	3-10, 3-44
	3-41, 3-73	Mono#2.....	3-10, 3-44
Limit Line Edit.....	3-10, 3-43	Month.....	3-9, 3-34
Limit Line Setup.....	3-10, 3-40	Multi Marker.....	3-14, 3-53
Limit Posi.....	3-17, 3-72	Multi MKR OFF	3-14, 3-54
Limit Setup	3-18, 3-82	Multi MKR Setup	3-14, 3-15,
			3-53, 3-62

3.1 Menu Index

NARROW.....	3-10	3-51, 3-54
Negative.....	3-7, 3-8, 3-10, 3-20, 3-22, 3-25, 3-26, 3-40	Peak List Level..... 3-13, 3-14, 3-51, 3-54
Next Min Peak.....	3-17, 3-72	Peak X dB Down..... 3-13, 3-52
Next Peak.....	3-14, 3-17, 3-19, 3-53, 3-72, 3-84, 3-85	Peak Zooming..... 3-19, 3-84, 3-85
Next Peak Left.....	3-17, 3-72	Phase Jitter..... 3-18, 3-81
Next Peak Right.....	3-17, 3-72	Phase Jitter OFF..... 3-18, 3-82
Next Result.....	3-18, 3-79	Phase Noise..... 3-18, 3-81
Noise Corr ON/OFF.....	3-15, 3-59	PLL Band Width..... 3-10, 3-38
Noise/Hz.....	3-13, 3-51	Positive..... 3-7, 3-8, 3-10, 3-20, 3-22, 3-25, 3-26, 3-40
Noise/Hz OFF.....	3-13, 3-51	POWER..... 3-15, 3-58
Normal.....	3-7, 3-8, 3-10, 3-20, 3-22, 3-25, 3-26, 3-40	Power Average A..... 3-7, 3-22
Normal Marker.....	3-14, 3-53	Power Average B..... 3-8, 3-26
Normalize.....	3-16, 3-67	Power Meas OFF..... 3-15, 3-58
Normalize A.....	3-7, 3-21	Power ON Count..... 3-9, 3-35
Normalize A ON/OFF.....	3-7, 3-21	Presel Tune..... 3-11, 3-45
Normalize B.....	3-8, 3-26	Preselector 1.6 GHz/3.6 GHz..... 3-11, 3-46
Normalize B ON/OFF.....	3-8, 3-26	PRESET..... 3-15, 3-63
Normalize with Store Corr.....	3-7, 3-8, 3-21, 3-26	Prev Result..... 3-18, 3-79
OBW.....	3-18, 3-78	Printer..... 3-9, 3-30, 3-33
OBW OFF.....	3-18, 3-78	Printer Command..... 3-9, 3-31
OBW%.....	3-18, 3-78	RBW AUTO/MNL..... 3-10, 3-37
OFF.....	3-14, 3-57	RBW Switching..... 3-8, 3-28
Offset.....	3-10, 3-42, 3-43	RBW:Span ON/OFF..... 3-10, 3-37
Order.....	3-9, 3-18, 3-34, 3-82	RBW≤100Hz ANLG/DGTL..... 3-10, 3-38
Paper Feed.....	3-9, 3-32	RCL..... 3-15, 3-64
Parameter Setup.....	3-15, 3-18, 3-61, 3-78	Recall..... 3-15, 3-64
Parity Bit.....	3-9, 3-30	Recall File..... 3-15, 3-64
Pass Range.....	3-10, 3-41	Recall on POWER..... 3-15, 3-64
Pass/Fail Judgement ON/OFF.....	3-10, 3-18, 3-43, 3-83	Recall Register..... 3-15, 3-64
PBW.....	3-8, 3-28	Ref Offset ON/OFF..... 3-12, 3-49
Peak → CF.....	3-14, 3-56	Reference..... 3-10, 3-42
Peak → Ref.....	3-14, 3-56	Reference Marker ON/OFF..... 3-13, 3-52
Peak Delta Y.....	3-14, 3-17, 3-19, 3-54, 3-73, 3-85	Reference Object..... 3-14, 3-54
Peak List.....	3-13, 3-51	REG #IP..... 3-16
Peak List Freq.....	3-13, 3-14,	REG#1..... 3-15, 3-16
		REG#1, #2, #3, #4, #5..... 3-64, 3-66
		REG#10..... 3-15, 3-16
		REG#2..... 3-15, 3-16
		REG#3..... 3-15, 3-16
		REG#4..... 3-15, 3-16
		REG#5..... 3-15, 3-16
		REG#6..... 3-15, 3-16
		REG#6, #7, #8, #9, #10..... 3-64, 3-66
		REG#7..... 3-15, 3-16
		REG#8..... 3-15, 3-16

REG#9	3-15, 3-16	Source	3-17, 3-75, 3-76
REG#IP	3-66	SPAN	3-17, 3-71
Release Object	3-14, 3-54	Spurious	3-18, 3-68, 3-79
Release Protect.....	3-16, 3-68	Spurious OFF.....	3-18, 3-79
Remove Anchor	3-7, 3-10, 3-22, 3-40	Start Offset.....	3-18
Rename	3-16, 3-68	SRCH.....	3-17, 3-72
REPEAT	3-15, 3-65	Start	3-11, 3-45
Reset Marker.....	3-14, 3-15, 3-53, 3-62	Start Offset.....	3-82
Resolution 1 Hz	3-13	Stop	3-11, 3-45
Resolution 1 kHz	3-13	Stop Bit	3-9, 3-30
Resolution 1 kHz, 100 Hz, 10 Hz or 1 Hz	3-51	Stop Offset	3-18, 3-82
Resolution 10 Hz	3-13	Store	3-8, 3-29
Resolution 100 Hz	3-13	Sweep Time AUTO/MNL	3-10, 3-17, 3-37, 3-75
Result Area Posi UP/LOW	3-10, 3-44	SWP	3-17, 3-75
Revision	3-9, 3-35	Symbol Rate 1/T	3-15, 3-60
Rolloff Factor.....	3-15, 3-60	T/T	3-19, 3-85
RS232.....	3-9, 3-30	Table Init.....	3-10, 3-11, 3-12, 3-15, 3-18, 3-43, 3-47, 3-50, 3-60, 3-79, 3-81
Sample	3-7, 3-8, 3-10, 3-20, 3-22, 3-25, 3-26, 3-40	Table No.1/2/3	3-18, 3-79
Sampling Times	3-7, 3-18, 3-21, 3-80	Test Mode Exit.....	3-9, 3-35
SAVE	3-16, 3-66	Time Ratio Corr ON/OFF.....	3-18, 3-80
Save.....	3-16, 3-66	Total Gain	3-8, 3-28
Save File	3-16, 3-66	Total Power.....	3-15, 3-58
Save Item Setup	3-16, 3-66	Trace	3-16, 3-67
Save Register	3-16, 3-66	Trace A	3-14, 3-54
Save Table.....	3-18, 3-79	Trace A Detector.....	3-7, 3-20, 3-22
Screen FULL/SEPA/CARRIER	3-15, 3-61	Trace B Detector.....	3-8, 3-25, 3-26
Screen Reset.....	3-19, 3-85	Trace Detector.....	3-10, 3-40
Search Condition.....	3-17, 3-72	Trace Marker Move	3-14, 3-54
Selftest	3-9, 3-35	Trace Point 1001/501	3-9, 3-35
Set Anchor	3-7, 3-10, 3-22, 3-40	Trc Disp PAUSE/CONT.....	3-7, 3-21
Setup	3-16, 3-67	Trigger Delay	3-17, 3-75
Setup Media	3-16, 3-69	Trigger Level	3-17, 3-75, 3-76
Show Result	3-18, 3-79	Trigger Setup	3-17, 3-75, 3-76
Signal Ident ON/OFF.....	3-11, 3-47	Units.....	3-12, 3-49
Signal Track ON/OFF.....	3-14, 3-18, 3-54, 3-81, 3-82	User Define.....	3-10, 3-42, 3-43
SINGLE	3-17, 3-70	UTIL	3-18, 3-78
Slope	3-17, 3-75, 3-76	VBW AUTO/MNL.....	3-10, 3-37
Sort.....	3-10, 3-11, 3-12, 3-15, 3-43, 3-47, 3-50, 3-59	VBW:RBW ON/OFF.....	3-10, 3-37

3.1 Menu Index

View A	3-7, 3-20
View B	3-8, 3-25
Volts	3-12, 3-49
Watts	3-12, 3-49
WIDE	3-10
WINDOW	3-19, 3-84
Window ON/OFF	3-19, 3-84
Window Position.....	3-19, 3-84
Window Sweep ON/OFF.....	3-17, 3-19, 3-77, 3-84
Window Width.....	3-19, 3-84
Write A	3-7, 3-20
Write B.....	3-8, 3-25
Write Protect	3-16, 3-66
X Cursor Position.....	3-7, 3-10, 3-18, 3-22, 3-40, 3-80
X Data Mode.....	3-10, 3-42
X dB Down	3-13, 3-51
X dB Left	3-13, 3-52
X dB Right	3-13, 3-52
X Range	3-17, 3-72
x1	3-12
x1, x2, x5 or x10	3-49
x10	3-12
x2	3-12
x5	3-12
XdB Down	3-13, 3-51
XY Cursor	3-7, 3-10, 3-18, 3-21, 3-40, 3-80
XY Cursor ON/OFF.....	3-7, 3-10, 3-18, 3-22, 3-40, 3-80
Y Cursor Auto Set.....	3-18, 3-80
Y Cursor Position.....	3-7, 3-10, 3-18, 3-22, 3-40, 3-80
Y Data Mode.....	3-10, 3-42
Y Range	3-17, 3-73
Year.....	3-9, 3-34
Zero Span	3-17, 3-71
Zoom	3-19, 3-84
Zoom off	3-19, 3-84, 3-85
Zoom on Window	3-19, 3-84, 3-85
Zoom Position.....	3-19, 3-84, 3-85
Zoom Width.....	3-19, 3-84, 3-85

3.2 Menu Map

This section shows the hierarchical menu configuration on a panel key basis.

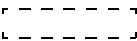
NOTE:  Represents a panel key.
 Represents a dialog box.
 Unless otherwise noted, the soft menus are shown.

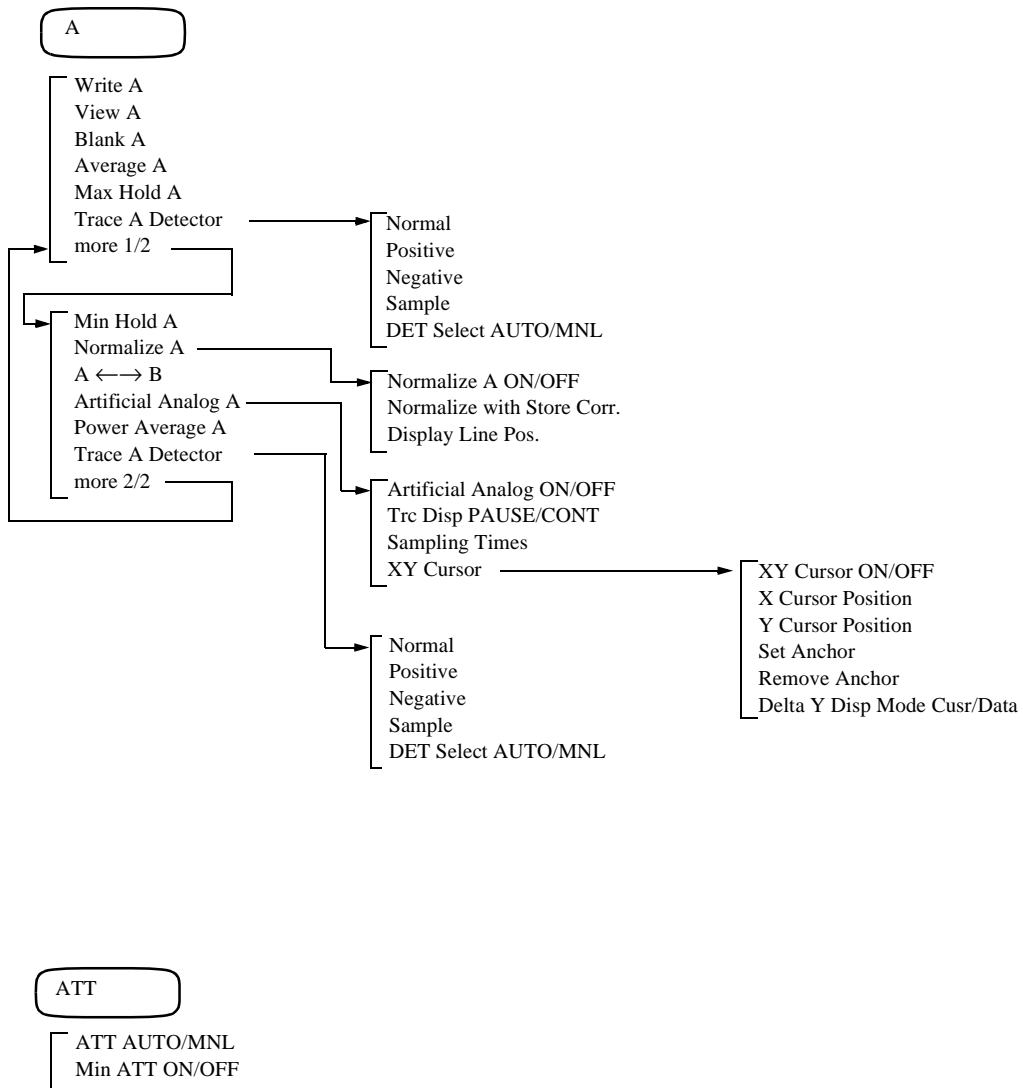

3.2 Menu Map

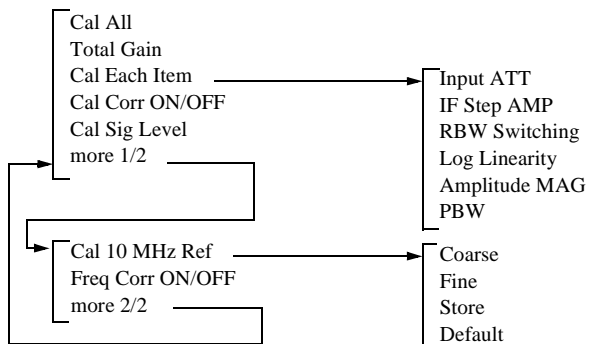
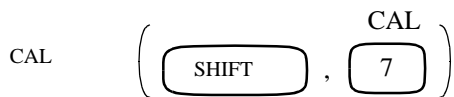
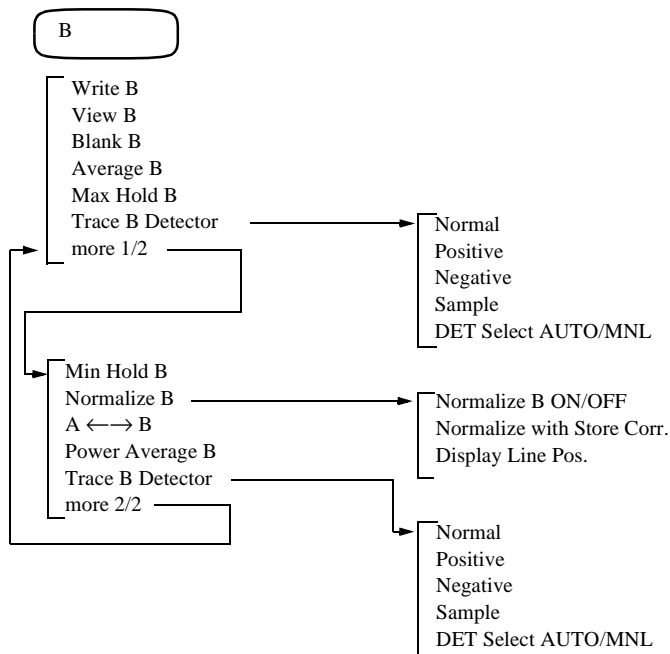

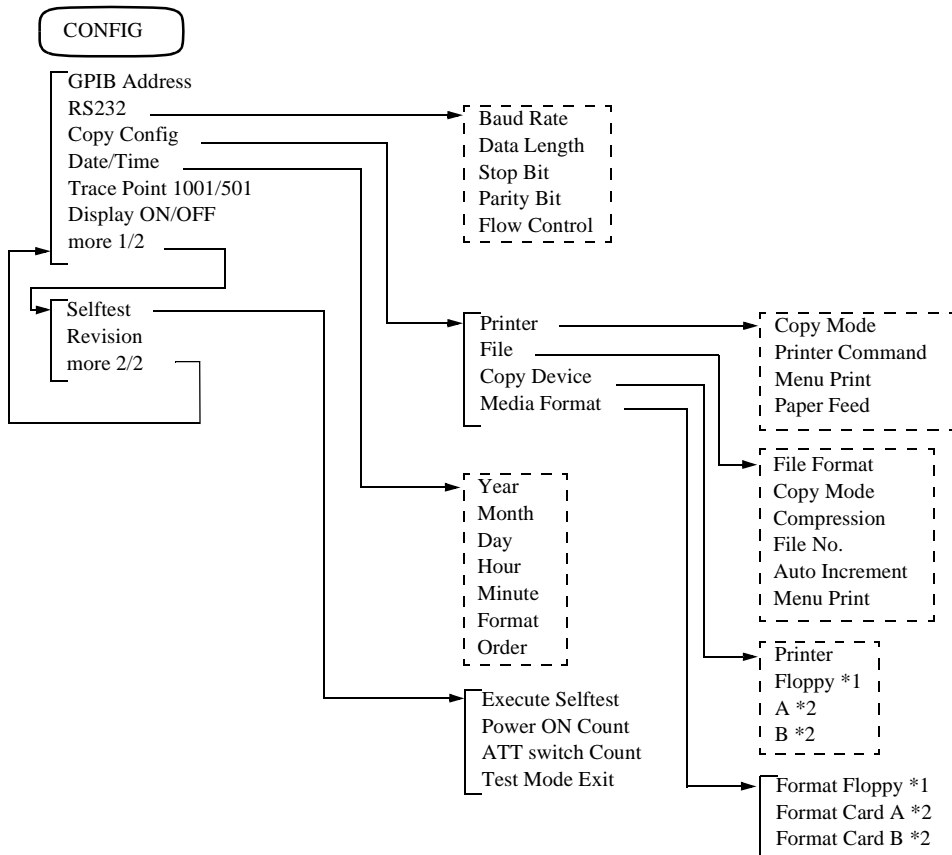

*1: Displayed when equipped with the floppy disk drive.
 *2: Displayed when equipped with the memory card drive (option).

COPY

3.2 Menu Map

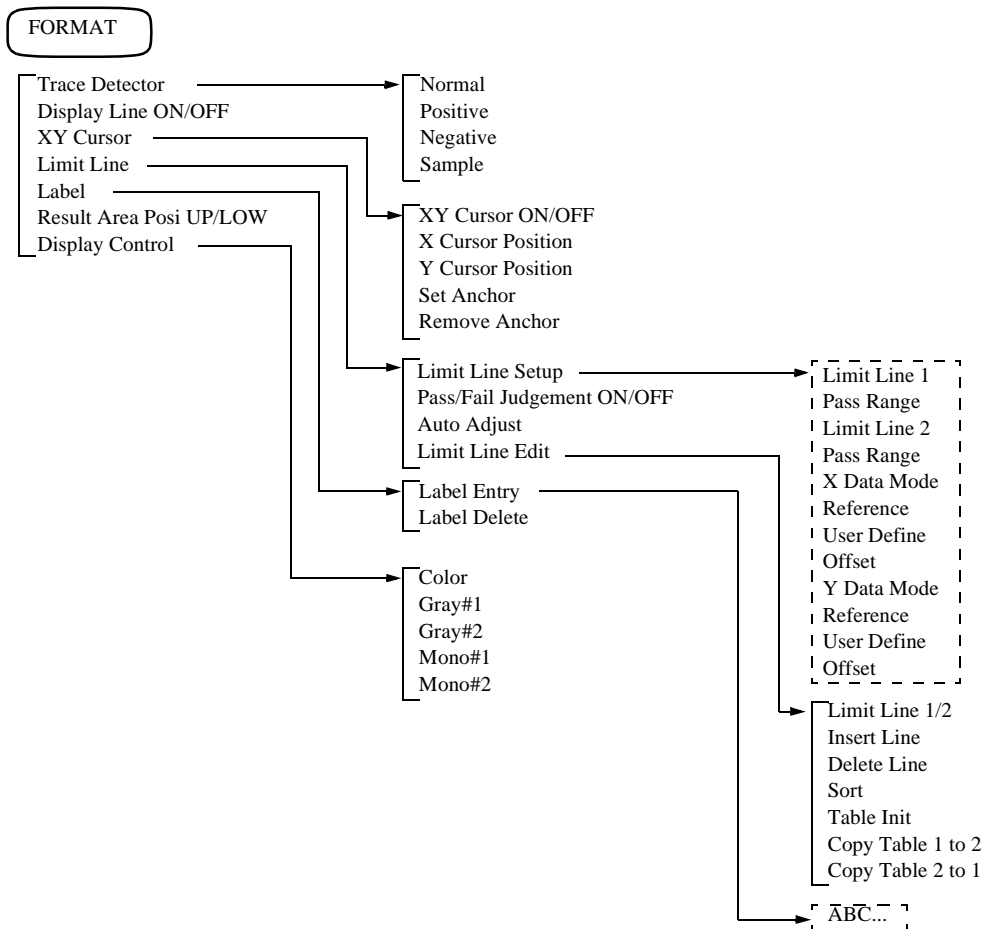
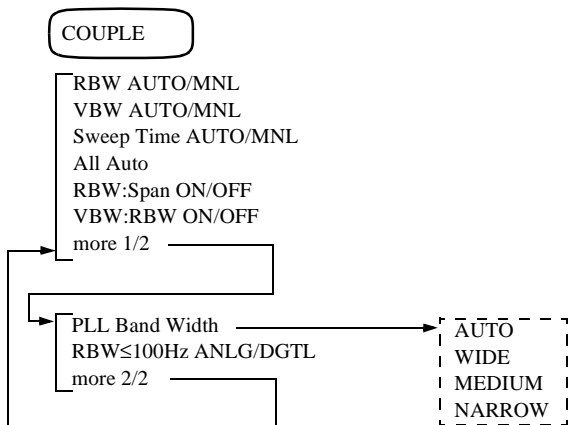

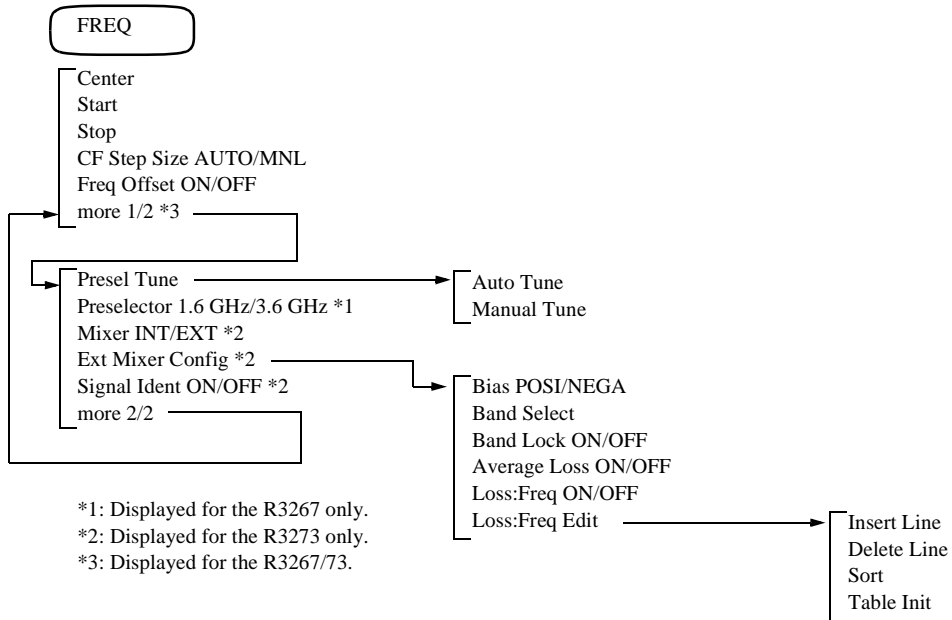

LCL

3.2 Menu Map

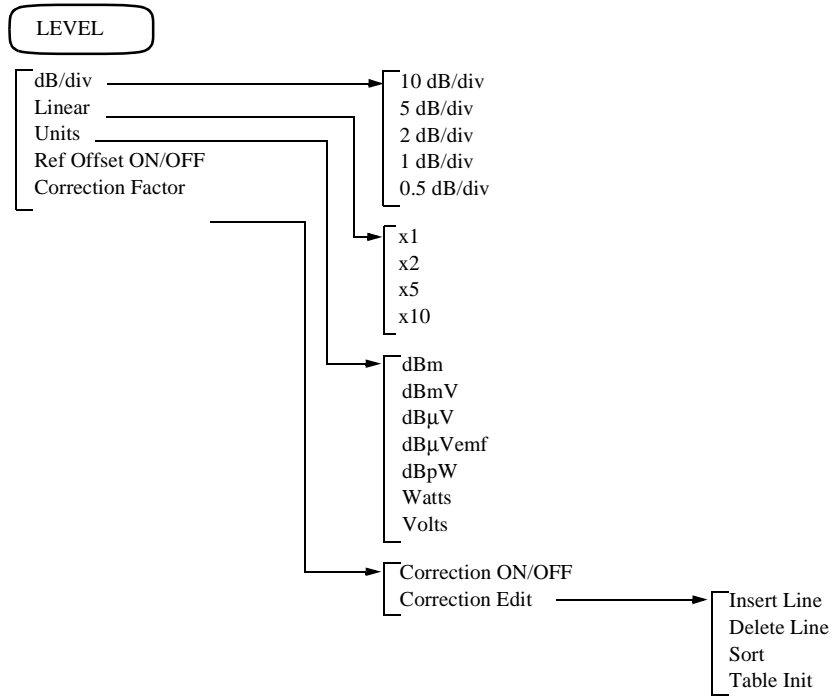

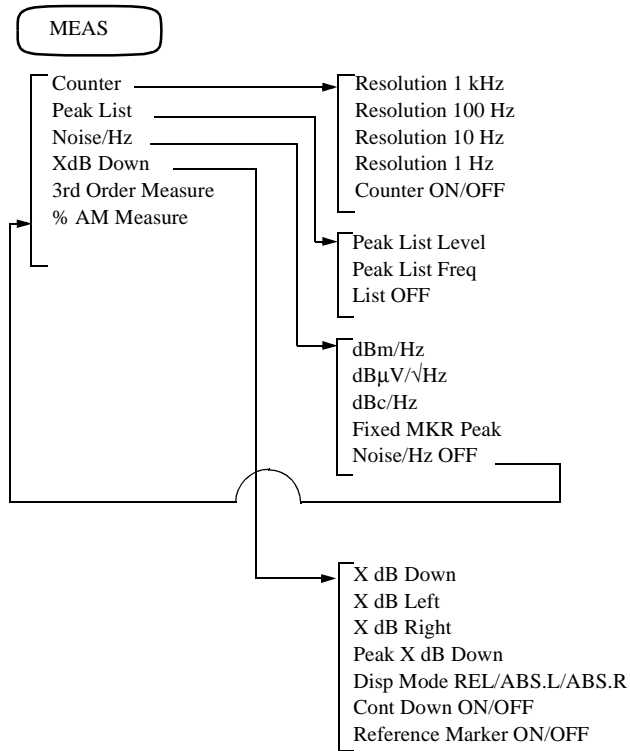

3.2 Menu Map

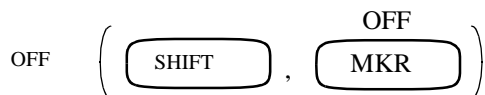
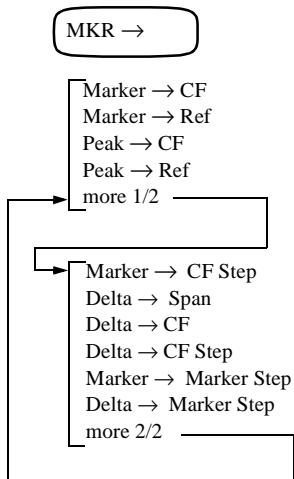
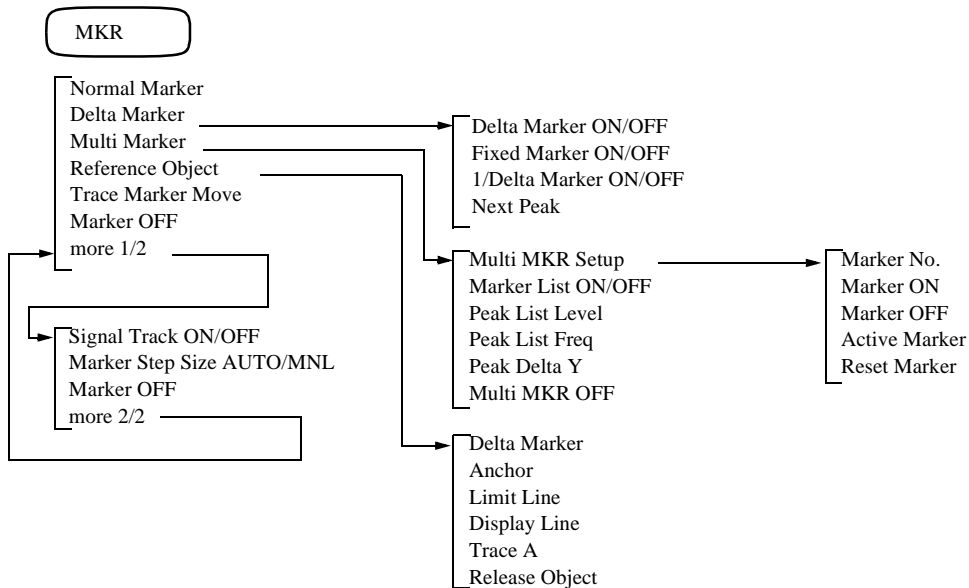

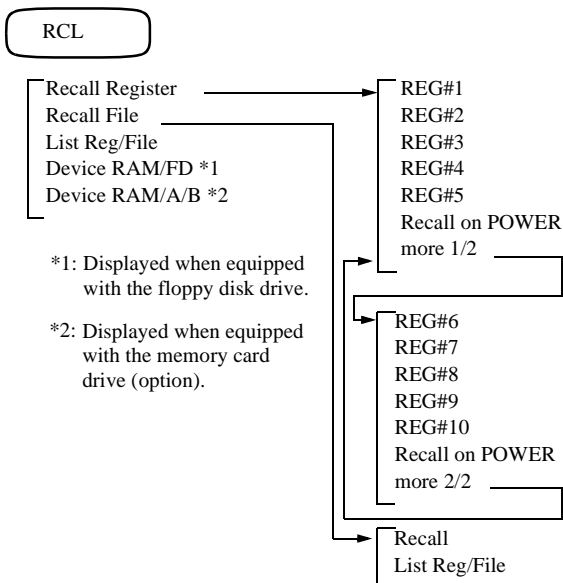
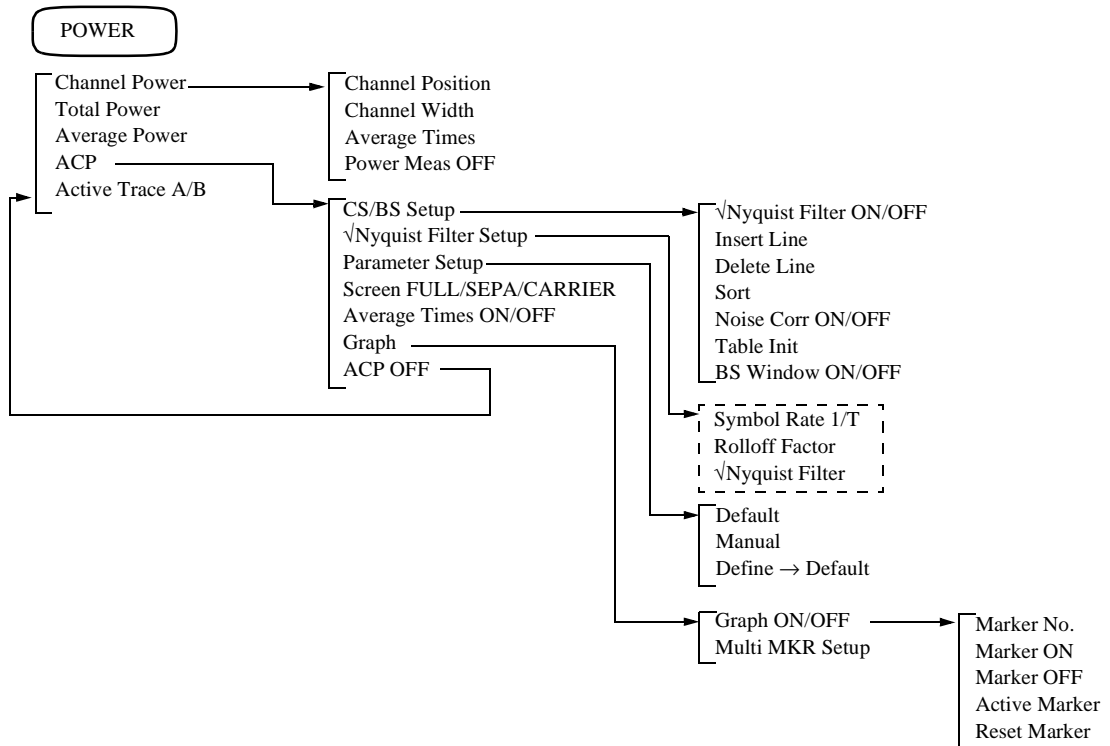

3.2 Menu Map

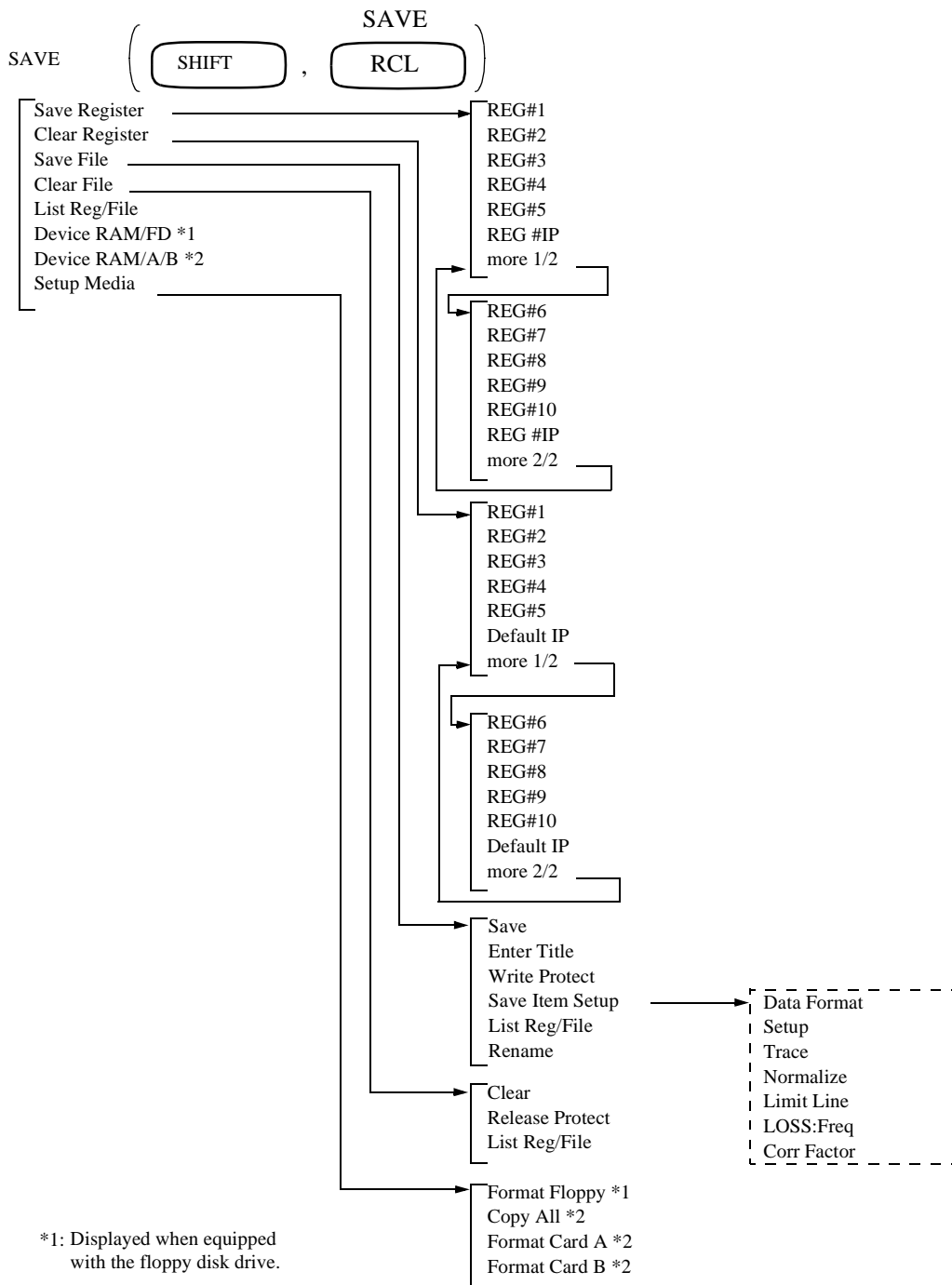

*1: Displayed when equipped with the floppy disk drive.

*2: Displayed when equipped with the memory card drive (option).

SINGLE

SPAN

- Full Span
- Zero Span
- Last Span

SRCH

- Next Peak
- Next Peak Left
- Next Peak Right
- Min Peak
- Next Min Peak
- Search Condition
- Cont peak ON/OFF

- X Range
- Limit Posi
- Limit Width
- Couple to F(T)
- Y Range
- Display Line
- Limit Line 1
- Limit Line 2
- Peak Delta Y

SWP

- Sweep Time AUTO/MNL
- Trigger Setup
- Trigger Delay
- Gated Sweep
- Gated Sweep ON/OFF
- Window Sweep ON/OFF

- Trigger Level
- Source
- Slope

- Trigger Setup
- Gate Src IF Trigger
- Gate Src Ext Gate
- Gate Position
- Gate Width
- Gated Sweep ON/OFF

- Trigger Level
- Source
- Slope

3.2 Menu Map

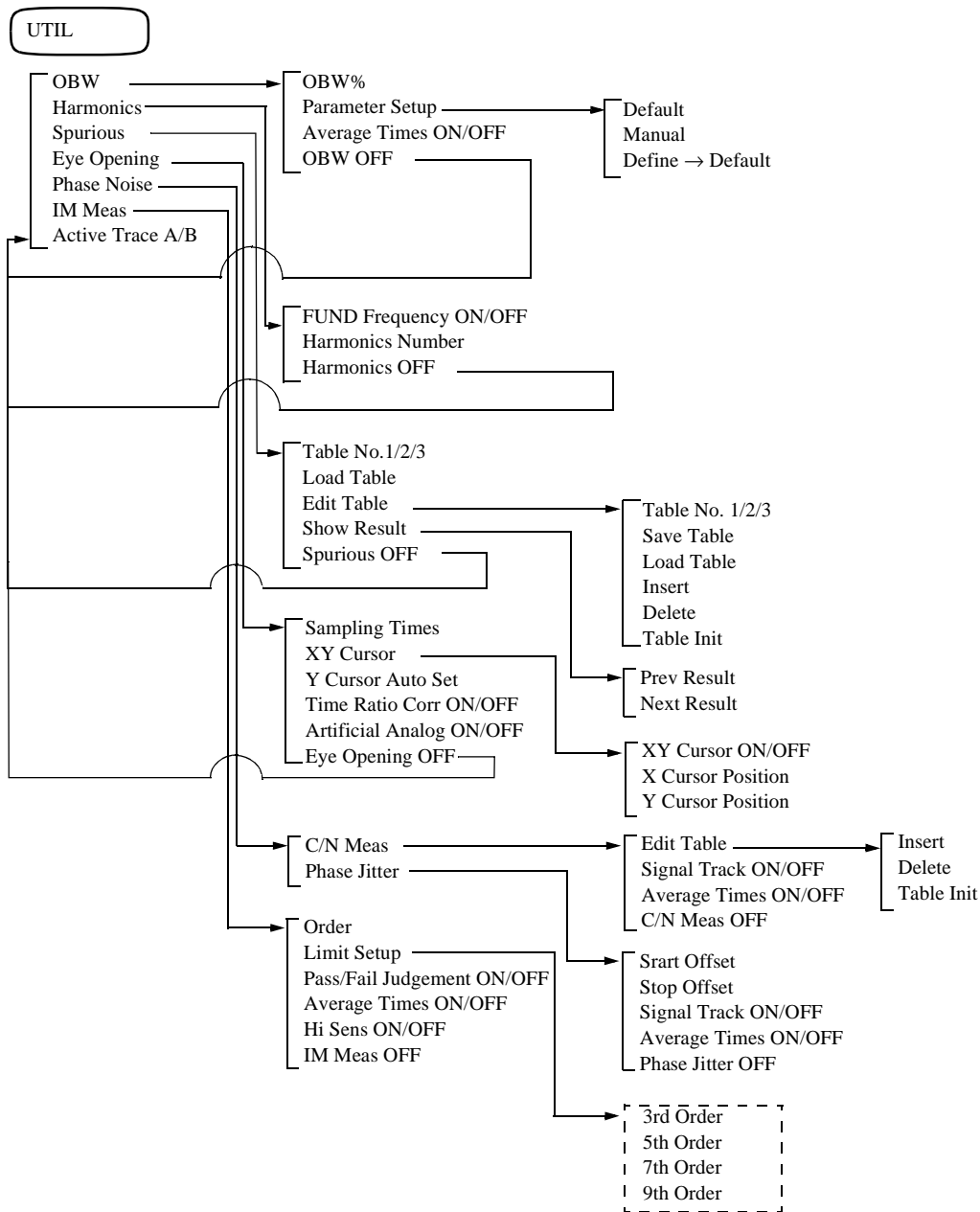

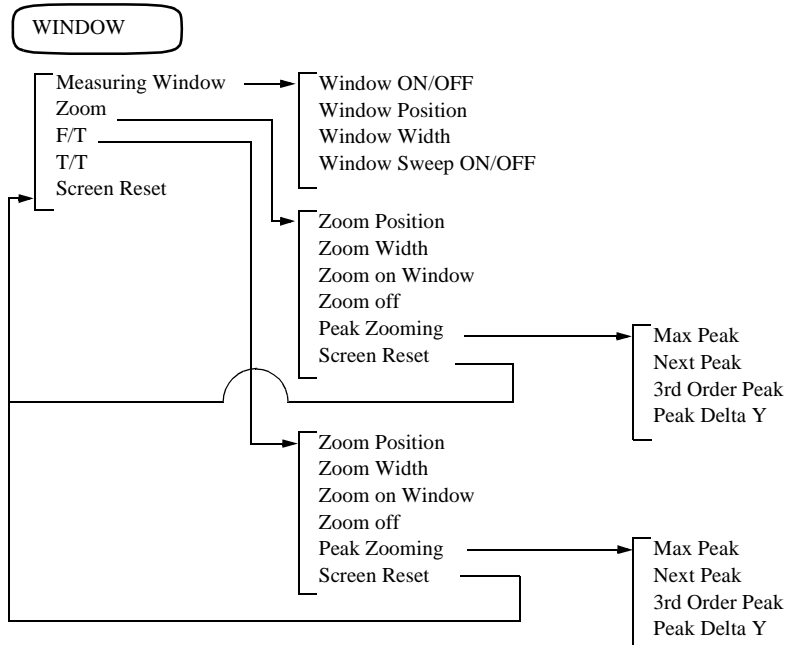

3.3 Functional Description

3.3 Functional Description

This section describes the front panel keys and the soft menus associated with them.

3.3.1 A Key (Trace A)

This section describes the Trace A(1) menu used for the trace function displayed when the A key is pressed.

Write A This mode displays trace data from memory A, which is updated for each sweep.

View A This mode displays trace data previously saved in memory A.

Blank A This mode erases the trace data currently stored in memory A.

Average A Allows you to set the number of times the sweep is performed for averaging. Once sweeping has begun, the result for each sweep (which is averaged with the previous sweeps) is displayed until the set count is reached.

Max Hold A Allows you to set the number of times Max Hold is performed. Once sweeping has begun, the maximum result for each sweep is kept and displayed until the set count is reached.

Trace A Detector Displays the Detector A menu.

Normal Sets the normal detector mode which automatically detects positive or negative peaks for each trace point.

Positive Sets the positive peak detector mode.

Negative Sets the negative peak detector mode.

Sample Sets the sample detector mode.

DET Select AUTO/MNL Toggles the detector mode between AUTO (automatic) or MNL (manual) settings.

AUTO: Automatically sets the most appropriate detector mode from the following modes.

Trace mode	Detector mode
Average A	Sample
Max Hold A	Positive
Min Hold A	Negative
Power Average A	Sample

The detector mode will not change if the Trace is set to Write mode.

	MNL:	Sets the detector mode to manual mode.
<i>more 1/2</i>		Displays the Trace A (2) menu.
<i>Min Hold A</i>		Allows you to set the number of times the sweep Min Hold is performed. Once sweeping has begun, the minimum result for each sweep is kept and displayed until the set count is reached.
<i>Normalize A</i>		Displays the Normalize A menu.
<i>Normalize A ON/OFF</i>		Toggles the Normalize function on or off.
	ON:	Corrects for the level using the normalization data.
	OFF:	Turns off the Normalize function.
<i>Normalize with Store Corr.</i>		This command obtains normalization data and turns the normalization function ON. The waveform data that is displayed on the screen is used for obtaining the normalization data.
<i>Display Line Pos.</i>		Displays the display line and allows you to set the position of the display line.
<i>A ↔ B</i>		Switches the data saved in memory A with the data saved in memory B, and memory B data with memory A.
<i>Artificial Analog A</i>		Displays the Art Analog menu.
<i>Artificial Analog ON/OFF</i>		Toggles the quasi analog trace function on or off.
	ON:	Displays the trace in an intensity proportional to its sweep frequency.
	OFF:	Turns off the quasi analog trace function.
<i>Trc Disp PAUSE/CONT</i>		Toggles the quasi analog trace function between PAUSE and CONT.
	PAUSE:	Halts the quasi analog trace function temporarily.
	CONT:	Continuously updates the quasi analog trace.
<i>Sampling Times</i>		Allows you to set the number of sampling times used when measuring amplitude.
<i>XY Cursor</i>		Displays the XY Cursor menu.

3.3.1 A Key (Trace A)

XY Cursor ON/OFF

Toggles the XY cursor function on or off.

ON: Displays the XY cursor.

OFF: Turns the XY cursor off.

X Cursor Position Allows you to set the X cursor position.

Y Cursor Position Allows you to set the Y cursor position.

Set Anchor Displays the anchor marker at the intersection of X- and Y- cursors.
The X- and Y-values shown for the XY cursor are now relative to the position of the anchor marker.

Remove Anchor Removes the anchor marker from the screen.

Delta Y Disp Mode Cusr/Data

Used to change the displayed contents of ΔY (which is the distance between a point of intersection of Y and the X cursors and the other point of intersection of the other Y cursor and the X cursor).

Cusr: Level difference between two Y cursors

Data: Displays the difference between the maximum and minimum level values (the difference between the green dots) previously obtained.

Power Average A

Displays the trace averaged in units of watt, using data in dBm.

$$PAVG = 10 \log \left[\frac{1}{n} \times \sum_{n=1}^N 10^{\left(\frac{P_{in}}{10}\right)} \right]$$

Where PAVG is the result of averaging the power; Pin is Nth measurement data for i point (1 to 1001); and n is the number of averaging (or number of sweeps)

Trace A Detector

Displays the Detector A menu.

Normal

Sets the normal detector mode which automatically detects positive or negative peaks for each trace point.

Positive

Sets the positive peak detector mode.

Negative

Sets the negative peak detector mode.

Sample

Sets the sample detector mode.

DET Select AUTO/MNL

Toggles the detector mode between AUTO and MNL.

AUTO: Automatically sets the most appropriate detector mode from the following modes.

Trace mode	Detector mode
Average A	Sample
Max Hold A	Positive
Min Hold A	Negative
Power Average A	Sample

The Detector mode will not be changed if the Trace mode is set to Write mode.

MNL: Sets the detector mode to manual mode.

more 2/2

Returns the Trace A (1) menu.

3.3.2 ATT Key (Attenuator)

3.3.2 ATT Key (Attenuator)

This section describes the ATT menu displayed when the **ATT** key is pressed. Pressing this key allows you to set the attenuator.

ATT AUTO/MNL

Toggles the attenuator between AUTO and MNL modes.

AUTO: The attenuator value is automatically based on the reference level.

MNL: Allows you to set the attenuator value manually.

Min ATT ON/OFF

Toggles the Min ATT function on or off.

ON: Sets the attenuator value to the minimum attenuation to limit the attenuation range.

OFF: Turns the Min ATT mode off.

3.3.3 B Key (Trace B)

This section describes the Trace B (1) menu used for the trace function displayed when the **B** key is pressed.

Write B This mode displays trace data from memory B, which is updated for each sweep.

View B This mode displays trace data previously saved in memory B.

Blank B This mode erases the trace data currently stored in memory B.

Average B Allows you to set the number of times the sweep is performed for averaging. Once sweeping has begun, the result for each sweep (which averaged with the previous settings) is displayed until the set count is reached.

Max Hold B Allows you to set the number of times the sweep Max Hold is performed. Once sweeping has begun, the maximum result for each sweep is kept and displayed until the set count is reached.

Trace B Detector Displays the Detector B menu.

Normal Sets the normal detector mode which automatically detects positive or negative peaks for each trace point.

Positive Sets the positive peak detector mode.

Negative Sets the negative peak detector mode.

Sample Sets the sample detector mode.

DET Select AUTO/MNL Toggles the detector mode between AUTO (automatic) or MNL (manual) settings.

AUTO: Automatically sets to one of the following detector modes under which the most appropriate detector is obtained.

Trace mode	Detector mode
Average A	Sample
Max Hold A	Positive
Min Hold A	Negative
Power Average A	Sample

The detector mode will not change if the Trace mode is in Write mode.

MNL: Sets the detector mode to manual mode.

more 1/2

Displays the Trace B (2) menu.

3.3.3 B Key (Trace B)

<i>Min Hold B</i>	Allows you to set the number of times the sweep Min Hold is performed. Once sweeping has begun, the minimum result for each sweep is kept and displayed until the set count is reached.
<i>Normalize B</i>	Displays the Normalize B menu.
<i>Normalize B ON/OFF</i>	<p>Toggles the Normalize function on or off.</p> <p>ON: Corrects for the level using the normalization data.</p> <p>OFF: Turns the Normalize function off.</p>
<i>Normalize with Store Corr.</i>	This command obtains normalization data and turns the normalization function ON. The waveform data that is displayed on the screen is used for obtaining the normalization data.
<i>Display Line Pos.</i>	Displays the display line and allows you to set the position of the display line.
<i>A ↔ B</i>	Switches the data saved in memory A with the data saved in memory B, and memory B data with memory A.
<i>Power Average B</i>	<p>Displays the trace averaged in units of watt, using data in dBm.</p> $P_{AVG} = 10 \log \left[\frac{1}{n} \times \sum_{i=1}^{1001} 10^{\left(\frac{P_{in}}{10}\right)} \right]$ <p>Where Pavg is the result of averaging the power; Pin is Nth measurement data for one point (1 to 1001); and n is the number of averaging (or number of sweeps)</p>
<i>Trace B Detector</i>	Displays the Detector B menu.
<i>Normal</i>	Sets the normal detector mode which automatically detects positive or negative peaks for each trace point.
<i>Positive</i>	Sets the positive peak detector mode.
<i>Negative</i>	Sets the negative peak detector mode.
<i>Sample</i>	Sets the sample detector mode.

DET Select AUTO/MNL

Toggles the detector mode between AUTO and MNL.

AUTO: Automatically sets the most appropriate detector mode from the following modes.

Trace mode	Detector mode
Average B	Sample
Max Hold B	Positive
Min Hold B	Negative
Power Average B	Sample

The detector mode will not be change if the Trace mode is set to Write mode.

MNL: Sets the detector mode to manual mode.

more 2/2

Returns the Trace B (1) menu.

3.3.4 CAL Key (Calibration)

3.3.4 CAL Key (Calibration)

This section describes the menu displayed when the **SHIFT** and **7 (CAL)** keys are pressed.

<i>Cal All</i>	Performs calibrations for all items to see if they meet the specifications. Perform them before taking measurements.
<i>Total Gain</i>	Performs calibrations with more accuracy than Cal All, because user-defined measurement conditions are used. Set the conditions first before the calibrations.
<i>Cal Each Item</i>	Displays the Cal Item menu used for each calibration.
<i>Input ATT</i>	Measures the Input Attenuator switching error and calibrates it.
<i>IF Step AMP</i>	Measures the IF Step AMP switching error and calibrates it.
<i>RBW Switching</i>	Measures the switching error for the IF Filter resolution bandwidth and calibrates it.
<i>Log Linearity</i>	Measures the linearity of the ordinate axis at a range of 10 dB/div to 0.5 dB/div on the LOG scale and calibrates it.
<i>Amplitude MAG</i>	Measures the switching error at a range of 10 dB/div to 0.5 dB/div on the LOG scale and calibrates it.
<i>PBW</i>	Measures PBW (noise power bandwidth) at a resolution bandwidth range of 10 Hz to 10 MHz and calibrates it.
<i>Cal Corr ON/OFF</i>	Toggles the calibration factor function on or off. ON: Calibration is performed using the calibration factor obtained by Cal All or Cal Each Item. OFF: Turns off the calibration factor function.
<i>Cal Sig Level</i>	Sets the calibration signal's output level.
<i>more 1/2</i>	Displays the CAL(2) menu.
<i>Cal 10 MHz Ref</i>	Allows you to enter a correction value in relation to the 10 MHz reference frequency and displays the Cal Ref menu.

NOTE *The above statement does not apply to spectrum analyzers with OPT 23 installed.*

<i>Coarse</i>	Allows you to enter a coarse correction data to the 10 MHz reference frequency.
---------------	---

<i>Fine</i>	Allows you to enter a fine correction data to the 10 MHz reference frequency.
<i>Store</i>	Saves the correction data corresponding to the 10 MHz reference frequency that have previously been modified.
<i>Default</i>	Resets the coarse and fine correction data that are previously entered to the factory defaults.
<i>Freq Corr ON/OFF</i>	Toggles the frequency correction function on or off. ON: Frequencies are corrected based on characteristics set at the factory. OFF: Turns the frequency correction function off.
<i>more 2/2</i>	Displays the CAL(1) menu.

3.3.5 CONFIG Key (Configuration)

3.3.5 CONFIG Key (Configuration)

This section describes the Config(1) menu displayed when the **CONFIG** key is pressed. Pressing this key allows you to set a GPIB interface.

GPIB Address Sets the GPIB address for the analyzer.

RS232 Displays the RS232 dialog box.

RS232						
Baud Rate :	600	1200	2400	4800	9600	19200
Data Length :	7	8				
Stop Bit :	1		2			
Parity Bit :	NONE	ODD	EVEN			
Flow Control :	NONE		XON/XOFF			

Baud Rate Sets the transmission rate to 600, 1200, 2400, 4800, 9600 or 19200 bps.

Data Length Sets the data bit length to 7 or 8 bits.

Stop Bit Sets the stop bit to either 1 or 2.

Parity Bit Sets the parity bit type.

NONE: Does not perform parity checking.

ODD: Sets the parity bit type to odd.

EVEN: Sets the parity bit type to even.

Flow Control Turns the flow control function on.

NONE: No flow control is performed.

XON/XOFF:

Flow control is performed according to the XON or XOFF code sent.

Copy Config Displays the Copy Config menu to select an output device where the screen data is printed.

Printer Displays the Printer dialog box.

Printer			
Copy Mode :	Color	S-Color S	S-Color L
	Gray	Mono S	Mono L
Printer Command :	ESC/P	HP PCL	
	ESC/P Raster		
Menu Print :	ON	OFF	
Paper Feed :	ON	OFF	

Copy Mode Selects an output mode.

Color: Prints the screen data in size L and the actual screen color.

S-Color S:
Changes the screen data into a simple color image and prints it in size S.

S-Color L:
Changes the screen data into a simple color image and prints it in size L.

Gray: Prints the screen data in size L and in a four-level gray scale.

Mono S: Prints the screen data in size S and in monochrome.

Mono L: Prints the screen data in size L and in monochrome.

NOTE *Data printed using the entire size of the paper in portrait orientation is size L.
Data that almost fits the actual screen size and is printed in landscape orientation is size S.
The background of the simple color image is not painted.*

Printer Command Selects a type of printer.

ESC/P: An ESC/P printer can be used.

HP PCL: A HP PCL printer can be used.

ESC/P Raster:
An ESC/P Raster printer can be used.

3.3.5 CONFIG Key (Configuration)

NOTE *Color, S-Color S and S-Color L in the Copy Mode menu are available when HP PCL or ESC/P Raster is selected.*

Menu Print

Toggles the menu print setting on or off.

ON: The menu is printed.

OFF: The menu is not printed.

Paper Feed

Sets whether or not a sheet of paper is fed after a hard copy is output.

This function can be set when Copy Mode is set to S-Color S or Mono S.

ON: Feeds a sheet of paper after the hard copy is output.

OFF: Does not feed a sheet of paper after the hard copy is output.

Multiple screens' data can be printed on an A4-size sheet of paper.

File

Displays the File dialog box.

File	
File Format :	<input checked="" type="radio"/> BMP
Copy Mode :	<input checked="" type="radio"/> Color <input type="radio"/> S-Color <input type="radio"/> Gray <input type="radio"/> Mono
Compression :	<input checked="" type="radio"/> OFF <input type="radio"/> ON
File No. :	<input type="text" value="001"/> Filename: \IMG\ADV001.BMP
Auto Increment :	<input type="text" value="OFF"/> <input checked="" type="radio"/> ON
Menu Print :	<input type="text" value="OFF"/> <input checked="" type="radio"/> ON

File Format

The file has been set to the bitmap format.

Copy Mode

Selects an output mode.

Color: Files are saved in the actual screen color.

S-Color: Files are saved in a simple color image.

Gray: Files are saved in gray scale (4 shades of gray).

Mono: Files are saved in monochrome (black and white).

Compression	<p>Toggles the file compression function on or off. A bitmap file can be compressed in the run-length encoding format.</p> <p>ON: Image compression is turned on.</p> <p>OFF: Image compression is turned off.</p> <hr/> <p>NOTE <i>The compression function is available when Copy Mode is set to Color, S-Color or Gray.</i></p> <hr/>
File No.	Sets the file number.
Auto Increment	<p>Toggles the auto-increment function on or off, which is used to increment the file number automatically.</p> <p>ON: The file number is incremented when the image is filed.</p> <p>OFF: The file number specified in the File NO. field is used.</p>
Menu Print	<p>Toggles the menu print setting on or off.</p> <p>ON: The menu is included when the image is printed.</p> <p>OFF: The menu is not included when the image is printed.</p>
Copy Device	<p>Copy Device dialog box is displayed.</p> <hr/> <p>NOTE <i>*1:When equipped with the floppy disk drive *2:When equipped with the memory card drive (option).</i></p> <hr/>
Printer *1 *2	Sets the destination to printer.
Floppy *1	Selects floppy disk.
A *2	Selects memory card A.
B *2	Selects memory card B.
Media Format	<p>Displays the Format menu.</p> <hr/> <p>NOTE <i>*1:When equipped with the floppy disk drive *2:When equipped with the memory card drive (option).</i></p> <hr/>

3.3.5 CONFIG Key (Configuration)

Format Floppy *1 Format floppy disk.

Format Card A *2 Format memory card A.

Format Card B *2 Format memory card B.

Date/Time

Displays the Date/Time dialog box.

Year

Allows you to set the year.

Month

Allows you to set the month.

Day

Allows you to set the day.

Hour

Allows you to set the hour.

Minute

Allows you to set the minutes.

Format

Selects the date indication mode.

LONG: Displays the date and time.

SHORT: Displays the date only.

OFF: Does not display the date and time.

Order

Selects the format of the date indication.

Year/Month/Day:

Displays in the order of a day of the week, year, month and day.

Month/Day/Year:

Displays in the order of a day of the week, month, day and year.

	Day/Month/Year: Displays in the order of a day of the week, day, month and year.
<i>Trace Point 1001/501</i>	Toggles the trace point on the horizontal axis between 1001 and 501. 1001: Sets the trace points to 1001. 501: Sets the trace points to 501.
<i>Display ON/OFF</i>	Toggles the annotation display function on or off. ON: Displays the annotation. OFF: Removes the annotation.
<i>more 1/2</i>	Displays the Config (2) menu.
<i>Selftest</i>	Displays the Selftest menu.
<i>Execute Selftest</i>	Executes the selftest.
<i>Power ON Count</i>	Displays the number of times the spectrum analyzer is turned on, accumulated total of powerup time.
<i>ATT switch Count</i>	Displays the total switching counts for each internal cells of the attenuator.
<i>Test Mode Exit</i>	Terminates the self-test mode. All settings are reset to their initial values and the spectrum analyzer stops sweeping.
<i>Revision</i>	Displays the software versions and the options implemented in the analyzer.
<i>more 2/2</i>	Returns the Config (1) menu.

3.3.6 COPY Key (Copy)

3.3.6 COPY Key (Copy)

Sends the screen data to the destination selected by *Copy Config*.

(There is no menu associated with this panel key.)

* To cancel the printing, press **SHIFT** and **COPY (Cancel)**.

3.3.7 COUPLE Key (Couple Function)

This section describes the Couple(1) menu displayed when the **COUPLE** key is pressed.

RBW AUTO/MNL

Toggles the resolution bandwidth between AUTO and MNL.

AUTO: Automatically sets an optimum resolution bandwidth based on the current span.

MNL: Allows you to set the resolution bandwidth manually.

VBW AUTO/MNL

Toggles the video bandwidth between AUTO and MNL.

AUTO: Automatically sets an optimum video bandwidth based on the resolution bandwidth.

MNL: Allows you to set the video bandwidth manually.

Sweep Time AUTO/MNL

Toggles the sweep time between AUTO and MNL.

AUTO: Automatically sets an optimum sweep time based on the span.

MNL: Allows you to set the sweep time manually.

All Auto

Automatically sets an optimum resolution bandwidth, video bandwidth and sweep time based on the span.

RBW:Span ON/OFF

Toggles the "span vs. resolution bandwidth" function on or off. This function can be used only when the RBW is set to AUTO.

ON: The ratio of "RBW vs. span" can be changed.

OFF: The value represented by the ratio of "span vs. resolution bandwidth" is 0.01:1.

NOTE *If "Trace Point" is set to a value lower than the value calculated by Span/RBW, the level may not be displayed correctly. If this happens, set "Trace Detector" to "Positive."*

VBW:RBW ON/OFF

Toggles the "resolution bandwidth vs. video bandwidth" function on or off.

This function can be used only when the VBW is set to AUTO.

ON: The ratio of "VBW vs. RBW" can be changed.

OFF: The value represented by the ratio of the resolution bandwidth to the video bandwidth is 1/1.

3.3.7 COUPLE Key (Couple Function)

more 1/2

Displays the Couple(2) menu.

PLL Band Width

Displays the PLL Band Width dialog box.

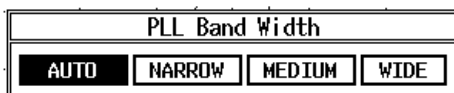

PLL Band Width

Sets the bandwidth of the band-pass filter in the PLL circuit.

AUTO: Automatically sets the filter bandwidth so that optimum phase noise characteristics (corresponding to the frequency span) can be obtained.

NARROW:
Sets a narrow bandwidth.
Phase noise of the carrier frequency is reduced within -100 kHz and +100 kHz.

MEDIUM:
Sets a medium bandwidth.

WIDE: Sets a wide bandwidth.
Phase noise of the carrier frequency is reduced within -10 kHz and +10 kHz.

CAUTION *The phase noise characteristics may be degraded if PLL Bandwidth is set to WIDE, MEDIUM or NARROW. If this happens, set the PLL BandWidth to AUTO.*

RBW≤100Hz ANLG/DGTL

Displays the mode of the filter to be used when an RBW equal to or lower than 100 Hz is selected.

ANLG: An analog filter is used. The highest filter resolution is 10 Hz.

DGTL: A digital filter is used preferentially. The highest filter resolution is 1 Hz.

NOTE:

The tracking generator cannot be used in combination with digital filters.

- *The sweep time is always set to AUTO.*
 - *The VBW cannot be set with an indication of "* * * *". At this time, an output of "-9.9999999000E+08" is obtained in response to the "VB?" GPIB query command.*
 - *The zero span cannot be set if the RBW is 1 Hz or 3Hz. An analog filter is automatically selected if the RBW is 10 Hz, 30 Hz or 100 Hz.*
 - *The maximum span frequency is 1000 times higher than the RBW. However, this value is limited to 700 Hz if an RBW of 1 Hz is used. If the RBW is 10 Hz, 30 Hz or 100 Hz, and if the specified span frequency exceeds the limit shown above, an analog filter is automatically selected.*
 - *The counter, sound, window sweep and gated sweep functions are not available.*
 - *The video trigger in the trigger function cannot be used.*
 - *Sample mode is automatically set for the trace detector. Other modes cannot be used.*
 - *The tracking generator cannot be used with digital filters.*
-

more 2/2

Return the Couple(1) menu.

3.3.8 FORMAT Key (Display format)

3.3.8 FORMAT Key (Display format)

This section describes the Format menu displayed when the **FORMAT** Key is pressed.

Trace Detector	Displays the Trace Detector (Trace Det) menu.
Normal	Sets the normal detector mode which automatically detects positive or negative peaks for each trace point.
Positive	Sets the positive peak detector mode.
Negative	Sets the negative peak detector mode.
Sample	Sets the sample detector mode.

NOTE *If "Trace Point" is set to a value lower than the value calculated by Span/RBW, the level may not be displayed correctly. If this happens, set "Trace Detector" to "Positive."*

Display Line ON/OFF	Toggles the display line indication on or off. This line is used as a base line when comparing trace levels.
ON:	Turns the display line on. The display line position can be changed as necessary.
OFF:	Removes the display line.
XY Cursor	Displays the XY Cursor menu.
XY Cursor ON/OFF	Toggles the XY cursor on or off.
ON:	Displays the XY cursor.
OFF:	Removes the XY cursor.
X Cursor Position	Allows you to set the X cursor position.
Y Cursor Position	Allows you to set the Y cursor position.
Set Anchor	Displays an anchor marker at the intersection of the X- and Y-cursors. The X- and Y-values of the XY cursor are then expressed with values relative to the anchor marker
Remove Anchor	Removes the anchor marker.
Limit Line	Displays Limit Line menu.
Limit Line Setup	Displays Limit Line Setup dialog box.

Limit Line Setup	
Limit Line 1:	<input checked="" type="checkbox"/> ON <input type="checkbox"/> OFF
Pass Range:	<input checked="" type="checkbox"/> ABOVE the Line <input type="checkbox"/> BELOW the Line
Limit Line 2:	<input checked="" type="checkbox"/> ON <input type="checkbox"/> OFF
Pass Range:	<input checked="" type="checkbox"/> ABOVE the Line <input type="checkbox"/> BELOW the Line
X Data Mode:	<input checked="" type="checkbox"/> ABS <input type="checkbox"/> REL
Reference:	<input checked="" type="checkbox"/> LEFT <input type="checkbox"/> CENTER <input type="checkbox"/> User Def
User Define:	<input type="text"/>
Offset:	<input type="text" value="0 Hz"/>
Y Data Mode:	<input checked="" type="checkbox"/> ABS <input type="checkbox"/> REL
Reference:	<input checked="" type="checkbox"/> TOP <input type="checkbox"/> BOTTOM <input type="checkbox"/> User Def
User Define:	<input type="text"/>
Offset:	<input type="text" value="0.00 dB"/>

Limit Line 1

Toggles Limit Line 1 on or off.

ON: Displays the result obtained from Limit Line 1 and Pass Range (PASS or FAIL).

OFF: Removes the result obtained from Limit Line 1 and Pass Range.

Pass Range

Sets the PASS/FAIL criteria based on Limit Line 1.

ABOVE the line:

Values above the limit line are considered PASS.

BELOW the line:

Values below the limit line are considered PASS.

Limit Line 2

Toggles Limit Line 2 on or off.

ON: Displays the result obtained from Limit Line 2 and Pass Range (PASS or FAIL).

OFF: Removes the result obtained from Limit Line 2 and Pass Range.

Pass Range

Sets the PASS/FAIL criteria based on Limit Line 2.

ABOVE the line:

Values above the limit line are considered PASS.

BELOW the line:

Values below the limit line are considered PASS.

3.3.8 FORMAT Key (Display format)

<i>X Data Mode</i>	<p>Sets the data property for the limit line on the X- axis (frequency or time).</p> <p>ABS: Sets Limit Line position (which is set at Limit Line Edit) on the X-axis to absolute mode. The Limit Line position on the X-axis varies depending on the frequency span and center frequency.</p> <p>REL: Sets Limit Line position (which is set at Limit Line Edit) on the X-axis to relative mode. The Limit Line position on the X-axis varies depending on the frequency span and center frequency. The Limit Line position on the X-axis is fixed at a location specified by "Reference" and "Offset" and is not affected by changes to the frequency span or center frequency.</p>
<i>Reference</i>	<p>Sets the reference position.</p> <p>LEFT: Sets a reference position on the furthest point of the X-axis.</p> <p>CENTER: Sets the reference position to the center of the X-axis.</p> <p>User Def: The reference position is set in "User define".</p>
<i>User Define</i>	<p>Sets the reference position on the X-axis.</p>
<i>Offset</i>	<p>Sets the width from the reference position.</p>
<i>Y Data Mode</i>	<p>Sets the data property for Limit Line on the Y- axis (level).</p> <p>ABS: Sets Limit Line position (which is set at Limit Line Edit) on the Y-axis to absolute mode. The Limit Line position on the Y-axis varies depending on the level.</p> <p>REL: Sets Limit Line position (which is set at Limit Line Edit) on the Y-axis to relative mode. The Limit Line position on the Y-axis varies depending on the level. The Limit Line position on the Y-axis is fixed at a location specified by "Reference" and "Offset" and is not affected by changes to the level.</p>
<i>Reference</i>	<p>Sets the reference position.</p> <p>TOP: Sets the reference position to the highest point on the Y-axis.</p>

	BOTTOM:	Sets the reference position to the lowest point on the Y-axis.
	User Def:	The reference position is set in "User Define".
	User Define	Sets the reference position on the X-axis.
	Offset	Sets the offset from the reference position.
	Pass/Fail Judgement ON/OFF	Toggles the Pass/Fail Judgment function, which is based on the Limit lines, on or off.
	ON:	Performs the Pass/Fail judgement based on the specified Limit lines.
	OFF:	Turns the Pass/Fail Judgment function off.
	Auto Adjust	The position of Limit Line is automatically moved so that the distance between the trace and Limit Line stays the same. This function is available only when "Y Data Mode" is set to "REL."
	Limit Line Edit	Displays Edit Menu.
	Limit Line 1/2	Selects the limit line to be edited on the Edit screen.
	Insert Line	A line with the same values is inserted in the line where the cursor is located.
	Delete Line	The line where the cursor is located is deleted.
	Sort	Previously entered data is sorted by frequency.
	Table Init	Deletes all data from the limit line set table.
	Copy Table 1 to 2	The data obtained for Limit line 1 is copied to the Limit line 2 table.
	Copy Table 2 to 1	The data obtained for Limit line 2 is copied to the Limit line 1 table.
	Label	Displays the Label menu.
	Label Entry	Allows you to enter the label name which will appear on the Label Edit screen.
	Label Delete	Removes the currently displayed label.

3.3.8 FORMAT Key (Display format)

<i>Result Area Posi UP/LOW</i>	Toggles the result area function display position between UP and LOW.
	UP: Displays the result on the upper right side in the result area.
	LOW: Displays the result on the lower right side in the result area.
<i>Display Control</i>	Displays the Display Control (Disp Color) menu which is used to set the screen display.
<i>Color</i>	Sets the monitor display to 256 colors.
<i>Gray#1</i>	Sets the monitor display to 16 shades of gray (the background is white).
<i>Gray#2</i>	Sets the monitor display to 16 shades of gray (the background is black).
<i>Mono#1</i>	Sets the monitor display to monochrome (black and white, and the background is white).
<i>Mono#2</i>	Sets the monitor display to monochrome (black and white, and the background is black).

3.3.9 FREQ Key (Frequency)

This section describes the Frequency(1) menu displayed when the **FREQ** key is pressed.

Pressing this key allows you to set a center frequency.

<i>Center</i>	Turns on the center frequency and allows you to set it as desired. The frequency range is specified by the start and stop frequencies.
<i>Start</i>	Turns on the start frequency and allows you to set it as desired.
<i>Stop</i>	Turns on the stop frequency and allows you to set it as desired. The frequency range is specified by the center frequency and frequency span.
<i>CF Step Size AUTO/MNL</i>	Toggles the step size function between AUTO and MNL. This function allows you to change the center frequency using the step keys. AUTO: Automatically sets the step size to 1/10 of the frequency span. MNL: Allows you to set the step size manually.
<i>Freq Offset ON/OFF</i>	Toggles the frequency offset function on or off. ON: Turns on the Frequency Offset and allows you to set it as desired. The frequency can then be changed using the offset value only. Displayed frequency value = Set value + Offset value. OFF: Turns off the offset function.
<i>more 1/2</i>	Displays the Frequency (2) menu.
<hr/> <i>NOTE This function is not displayed on the R3264 screen.</i> <hr/>	
<i>Presel Tune</i>	Displays the Presel menu.
<hr/> <i>NOTE This function is not displayed on the R3264 screen.</i> <hr/>	
<i>Auto Tune</i>	Automatically tunes the Preselector based on the frequency of the peak.
<i>Manual Tune</i>	Manually tunes the Preselector to an arbitrary frequency.

3.3.9 FREQ Key (Frequency)

Preselector 1.6 GHz/3.6 GHz

Toggles the Preselector's frequency band between the 1.6 GHz and 3.6 GHz bands.

1.6 GHz/3.6 GHz:

Sets the frequency band to either 1.6 GHz or 3.6 GHz.

NOTE *Displayed on the R3267 screen only.*

Mixer INT/EXT

Switches between the Internal and External mixers.

INT: Uses the internal mixer.

EXT: Uses the external mixer.

NOTE *Displayed on the R3273 screen only.*

Ext Mixer Config

Displays the Ext Mixer menu.

NOTE *Displayed on the R3273 screen only.*

Bias POSI/NEGA

Toggles the external mixer between positive and negative bias.

Band Select

Selects a frequency band for the external mixer.

The frequency bands are listed in the table shown below.

Frequency Band	Frequency Range[GHz]	Mixing Order [N]
1	12.4 to 18.0	3
2	17.0 to 26.5	4
3	22.0 to 33.0	5
4	26.5 to 40.0	6
5	33.0 to 50.0	8
6	40.0 to 60.0	8
7	50.0 to 75.0	10
8	60.0 to 90.0	12
9	75.0 to 110.0	14
10	90.0 to 140.0	18
11	110.0 to 170.0	22
12	140.0 to 220.0	28
13	170.0 to 260.0	34
14	220.0 to 325.0	42

<i>Band Lock ON/OFF</i>	Toggles the frequency band lock function on or off.
	ON: Locks the frequency band to the one selected for the external mixer.
	OFF: Automatically switches the frequency band according to the start and stop frequencies.
<i>Average Loss ON/OFF</i>	Toggles the correction function (used for the external mixer's intrinsic average conversion loss) on or off.
	ON: Corrects for the conversion loss using an average conversion loss value.
	OFF: Turns the correction function off.
<i>Loss:Freq ON/OFF</i>	Toggles the correction function on or off.
	ON: Corrects for conversion loss using the frequency vs. loss table.
	OFF: Turns the correction function off.
<i>Loss:Freq Edit</i>	Displays the Loss:Freq Edit menu.
<i>Insert Line</i>	A line with the same values is inserted in the line where the cursor is located.
<i>Delete Line</i>	The line where the cursor is located is deleted.
<i>Sort</i>	The data previously entered is sorted by frequency.
<i>Table Init</i>	Deletes all data from the table.
<i>Signal Ident ON/OFF</i>	Toggles the signal identification function on or off.
	ON: More than one spectrum is displayed for one input signal when an external mixer is used. From among these spectrums, the true signal is identified.
	OFF: Turns off the signal identification function.
<i>more 2/2</i>	Returns to the Frequency (1) menu.

3.3.10 LCL Key (GPIB Remote Control)

3.3.10 LCL Key (GPIB Remote Control)

Turns off GPIB remote control.

(There is no menu associated with this panel key.)

3.3.11 LEVEL Key (Level)

This section describes the Level menu displayed when the **LEVEL** key is pressed.

Pressing this key allows you to set a reference level.

<i>dB/div</i>	Displays the dB/div menu and turns the logarithmic-scale display on.
<i>10, 5, 2, 1 or 0.5dB/div</i>	Sets the vertical axis to 10 dB/div, 5 dB/div, 2 dB/div, 1 dB/div or 0.5 dB/div.
<i>Linear</i>	Displays the Linear menu and turns the linear-scale display on.
<i>x1, x2, x5 or x10</i>	Sets the vertical axis scale to x1, x2, x5, or x10.
<i>Units</i>	Displays the Units menu.
<i>dBm</i>	Sets the unit to dBm.
<i>dBmV</i>	Sets the unit to dBm V.
<i>dBμV</i>	Sets the unit to dBμV.
<i>dBμVemf</i>	Sets the unit to dBμVemf
<i>dBpW</i>	Sets the unit to dBpW.
<i>Watts</i>	Sets the unit to Watts.
<i>Volts</i>	Sets the unit to Volts.
<i>Ref Offset ON/OFF</i>	Toggles the reference level offset function on or off. ON: Allows you to set the offset value and displays the reference level increased by the offset value. (Reference level (displayed) = Reference level (set) + Offset value) OFF: Turns off the offset function.
<i>Correction Factor</i>	Displays the Corr. Fact menu.
<i>Correction ON/OFF</i>	Toggles the level correction function on or off. ON: Corrects the level using the correction data. OFF: Turns the level correction function off.
<i>Correction Edit</i>	Displays the Corr. Edit menu.

3.3.11 LEVEL Key (Level)

<i>Insert Line</i>	A line with the same values is inserted in the line where the cursor is located.
<i>Delete Line</i>	The line where the cursor is located is deleted.
<i>Sort</i>	The data previously entered is sorted by frequency.
<i>Table Init</i>	Deletes all data from the table.

3.3.12 MEAS Key (Measurement)

This section describes the Measure menu displayed when the **MEAS** key is pressed.

Counter	Displays the Counter menu.
Resolution 1 kHz, 100 Hz, 10 Hz or 1 Hz	Allows you to set the resolution to 1 kHz, 100 Hz, 10 Hz or 1 Hz.
Counter ON/OFF	Toggles the frequency counter function on or off.
	ON: Measures the active marker frequency using the frequency counter.
	OFF: Turns the frequency counter function off.
Peak List	Displays the Peak list menu.
Peak List Level	Lists the levels and frequencies in descending order of the peak levels.
Peak List Freq	Lists the levels and frequencies in descending order of the peak level frequencies.
List OFF	Turns off the peak list display function.
Noise/Hz	Displays the Noise/Hz menu.
dBm/Hz	Sets the vertical axis unit to dBm, and sets the marker readout signal level unit to dBm/Hz. In addition, the detector is automatically set to Sample mode.
dBμV/\sqrtHz	Sets the vertical axis unit to dB μ V, and sets the marker readout signal level unit to dB μ V/ \sqrt Hz. In addition, the detector is automatically set to Sample mode.
dBc/Hz	Sets the unit of Delta marker signal level to dBc/Hz and turns the marker fixed function ON. In addition, the detector is automatically set to Sample mode.
Fixed MKR Peak	Move the delta marker to the peak currently displayed (on the trace) in order to make it fixed in this position.
Noise/Hz OFF	Turns off the noise measurement mode and returns to the Measure menu.
XdB Down	X dB Down menu is displayed to allow you to set the attenuation.
X dB Down	Moves Normal and Delta markers to an intersection point on the trace X dB down from the present location.

3.3.12 MEAS Key (Measurement)

<i>X dB Left</i>	Moves Normal marker leftwards to an intersection point on the trace X dB down from the present location.
<i>X dB Right</i>	Moves Normal marker rightwards to an intersection point on the trace X dB down from the present location.
<i>Peak X dB Down</i>	Searches for the highest peak within the target range and displays Normal and Delta markers on an intersection point on the trace X dB down from the present location. The reference marker is displayed at the highest peak point.
<i>Disp Mode REL/ABS.L/ABS.R</i>	Selects how the marker data is displayed. REL: The normal marker is displayed on the right; and the delta marker, on the left. ABS.L: The marker on the left is displayed as an absolute value. ABS.R: The marker on the right is displayed as an absolute value.
<i>Cont Down ON/OFF</i>	Toggles the continuous X-dB down function on or off. ON: Repeatedly executes the X-dB down function from the highest peak on the trace for each sweep. OFF: Turns off the continuous X-dB down function.
<i>Reference Marker ON/OFF</i>	Toggles the reference marker function on or off. ON: Displays the reference marker on the X-dB down reference position OFF: Removes the reference marker.
<i>3rd Order Measure</i>	Displays Delta marker on the peak of the fundamental wave and Normal marker on the peak of the third order intermodulation distortion.
<i>% AM Measure</i>	Calculates an AM modulation factor using a peak search, and displays the result in percentage (%).

3.3.13 MKR Key (Marker)

This section describes the MKR(1) menu displayed when the **MKR** key is pressed.

Pressing this key allows you to set the marker.

<i>Normal Marker</i>	Displays Normal marker. The frequency and level of the marker are displayed in the marker area.
<i>Delta Marker</i>	Displays the Delta MKR menu.
<i>Delta Marker ON/OFF</i>	Toggles Delta marker display function on or off. ON: Displays Delta marker at the same position as the Normal marker. The relative values to Normal marker (frequency and level) are displayed in the marker area. OFF: Removes Delta marker.
<i>Fixed Marker ON/OFF</i>	Toggles Fixed Marker function on or off. ON: Holds the frequency and level of Delta marker. OFF: Turns off Fixed Marker function.
<i>1/Delta Marker ON/OFF</i>	Toggles the time display function for Delta marker on or off. ON: Displays a value in frequency on the time axis; and displays a value in time on the frequency axis. OFF: Turns off the inverse number display function.
<i>Next Peak</i>	Moves the marker to the one whose value is next to the current peak within the search range.
<i>Multi Marker</i>	Displays the Multi MKR menu.
<i>Multi MKR Setup</i>	Displays the MKR Setup menu.
<i>Marker No.</i>	Allows you to set the multi-marker number and displays the value you entered.
<i>Marker ON</i>	Displays the multi-marker specified by the number. The frequency and level of the marker are displayed in the marker area.
<i>Marker OFF</i>	Removes the multi-marker specified by the number.
<i>Active Marker</i>	Allows you to set the number of the multi-marker specified.
<i>Reset Marker</i>	Removes all multi-markers except multi-marker No.1.

3.3.13 MKR Key (Marker)

<i>Marker List ON/OFF</i>	Toggles the multi-marker list display function on or off. ON: Displays a list of the current multi-marker numbers, frequencies and levels in ascending order. OFF: Removes the list of multi-markers.
<i>Peak List Level</i>	Lists the levels and frequencies in descending order of the peak levels.
<i>Peak List Freq</i>	Lists the levels and frequencies in descending order of the peak level frequencies.
<i>Peak Delta Y</i>	Allows you to set the level difference used for peak searches.
<i>Multi MKR OFF</i>	Removes all multi-markers from the display.
<i>Reference Object</i>	Displays the Ref Object menu.
<i>Delta Marker</i>	Displays the frequency (or time) and level of Normal marker relative to the delta marker.
<i>Anchor</i>	Displays the frequency (or time) and level of Normal marker relative to the anchor.
<i>Limit Line</i>	Displays the level of Normal marker relative to Limit Line 1 or 2.
<i>Display Line</i>	Displays the level of Normal marker relative to the display line.
<i>Trace A</i>	Displays the level of Normal marker relative to Trace A.
<i>Release Object</i>	Turns off the relative value display mode.
<i>Trace Marker Move</i>	Moves the active marker between Trace A and B every time the Trace Marker Move soft key is pressed (if both traces are displayed).
<i>Marker OFF</i>	All currently displayed markers are removed.
<i>more 1/2</i>	Displays the MKR (2) menu.
<i>Signal Track ON/OFF</i>	Toggles the signal track function on or off. ON: Sets the marker frequency to the center frequency for each sweep, after performing a peak search for the same peak. OFF: Turns off the signal track function.

Marker Step Size AUTO/MNL

Toggles the step size used by the Step keys between Automatic and Manual.

AUTO: Sets the step size to 1/10 of the frequency span.

MNL: Allows you to set the step size manually.
MNL mode is set automatically when the step size is equivalent to the value set by either "Marker → Marker Step" or "Delta → Marker Step."

Marker OFF

All currently displayed markers are removed.

more 2/2

Returns to the MKR (1) menu.

3.3.14 MKR → Key (Marker →)

3.3.14 MKR → Key (Marker →)

This section describes the Marker(1) menu displayed when the **MKR →** key is pressed.

<i>Marker → CF</i>	Makes the currently active marker frequency the center frequency.
<i>Marker → Ref</i>	Makes the currently active marker level the reference level.
<i>Peak → CF</i>	Makes the frequency of the maximum peak level within the search range the center frequency, and moves the marker to the highest peak point.
<i>Peak → Ref</i>	Makes the maximum peak level within the search range the reference level, and moves the marker to the highest peak point.
<i>more 1/2</i>	Displays the MKR → (2) menu.
<i>Marker → CF Step</i>	Sets the marker to the frequency as the step size of the center frequency.
<i>Delta → Span</i>	Sets the difference in frequency between Delta and Normal markers as the span.
<i>Delta → CF</i>	Sets the difference in frequency between Delta and Normal markers as the center frequency.
<i>Delta → CF Step</i>	Sets the difference in frequency between Delta and Normal markers as the step size of the center frequency.
<i>Marker → Marker Step</i>	Sets the marker frequency as the step size of the marker. The Marker Step Size of the MKR key is set to MNL.
<i>Delta → Marker Step</i>	Sets the difference in frequency between Delta and Normal markers as the step size of the marker. The Marker Step Size of the MKR key is set to MNL.
<i>more 2/2</i>	Returns to the MKR → (1) menu.

3.3.15 OFF Key (Marker off)

Pressing **SHIFT** and **MKR (OFF)** removes all the markers currently being displayed.

(There is no menu associated with this panel key.)

3.3.16 POWER Key (Power Measurement)

3.3.16 POWER Key (Power Measurement)

This section describes the Power menu displayed when the **POWER** key is pressed.

Channel Power

Activates the measuring window, and displays the Channel menu. The channel power is calculated using the formula shown below.

$$P_{CH} = 10 \log \left[\sum_{n=X1}^{X2} \left(10^{\frac{P(n)}{10}} \right) \times \frac{1}{PBW} \times \frac{SPAN}{(X2 - X1)} \right]$$

P_{CH}: Channel power

P(n): Data (dBm) for each trace point

SPAN: Current span value

PBW: Noise power bandwidth

X1: Data position of start frequency on the x-axis.

X2: Data position of stop frequency on the x-axis.

Channel Position

Allows you to set the center of the measuring window (channel bandwidth).

Channel Width

Allows you to set the width of the measuring window (channel bandwidth).

Average Times

Allows you to set the number of times the sweep is averaged.

Power Meas OFF

Removes the window and cancels channel power measurements.

Total Power

Measures the total power in the object range (the entire measurement span or window) and displays it.

The total power is calculated using the formula shown below.

The number of trace points on the horizontal axis is set to 1001.

$$P_T = 10 \log \left[\sum_{n=X1}^{X2} \left(10^{\frac{P(n)}{10}} \right) \times \frac{1}{PBW} \times \frac{SPAN}{1001} \right]$$

P_T: Total power to be calculated.

P(n): Data (dBm) for each trace point.

SPAN: Current span value

PBW: Noise power bandwidth

X1: 1

X2: 1001

Average Power

Measures the power averaged over the object range (the entire measurement span or window) and displays it.

Allows you to set the averaging count used to calculate the average power.

With average power measurements, the resolution bandwidth (RBW) is set to a bandwidth wider than the amplitude variation width (the resolution bandwidth must be at least three times wider than the occupied bandwidth). The average power is calculated using the formula shown below.

The number of trace points on the horizontal axis is set to 1001.

$$P_{AVG} = 10 \log \left[\sum_{n=X1}^{X2} \left(10^{\frac{P(n)}{10}} \right) \times \frac{1}{1001} \right]$$

PAVG: Denotes the average power to be calculated.

P (n): Denotes the data (dBm) for each trace point.

X1: 1

X2: 1001

ACP

Displays the ACP menu.

CS/BS Setup

Displays the CS/BS Setup menu, and the editor used to set the channel space and channel bandwidth together.

Nyquist Filter ON/OFF

Toggles the Nyquist filter function on or off.

ON: Turns the Nyquist filter function on.

OFF: Turns the Nyquist filter function off.

Insert Line

A line with the same values is inserted in the line where the cursor is located.

Delete Line

Deletes the currently selected line.

Sort

Sort the CS/BS Setting table by CS.

Noise Corr ON/OFF

Toggles the noise correction function on or off.

ON: Turns the noise correction function on.

The noise correction value measurement can be performed as the ACP measurement whenever the setting values regarding the ACP measurement (such as RBW, VBW, or the measurement offset frequency) are changed.

The noise power measurement frequency and bandwidth, both of which are used to correct noise, vary depending on the Cal Freq Offset settings in the CS/BS Setup dialog box.

Cal Freq Offset AUTO (default):

The offset frequency set in the last line in the CS/BS Setup dialog box and its measurement bandwidth can be used as the noise power measurement frequency and bandwidth.

3.3.16 POWER Key (Power Measurement)

Cal Freq Offset MANUAL:

The noise power measurement frequency and bandwidth can be specified in the Noise field in the CS/BS Setup dialog box. In the same manner as the channel space (CS), the noise power measurement frequency can be specified by using the offset frequency, which deviates from the center frequency. Any noise power measurement bandwidth value can be specified. However, setting the same value as the reference bandwidth (BS) is recommended.

OFF: Turns the noise correction function off.

When the following two conditions are satisfied, the noise correction function can be turned on or off. Otherwise, the function is disabled.

1. The screen display is set to the separate screen mode (SEPA).
2. The trace detector is set to the sample mode.

NOTE *If any signal components other than the spectrum analyzer internal noise exist in the noise power measurement band, noise cannot be corrected successfully. Set the noise power measurement frequency to avoid any non-internal noise signal components in the noise power measurement band.*

Table Init Deletes all data in the table.

BS Window ON/OFF Toggles the ACP bandpass window display on or off.

ON: Displays the window within the bandpass which is targeted for calculating the ACP.

OFF: Removes the window.

√Nyquist Filter Setup Displays the √Nyquist Filter Setup dialog box.

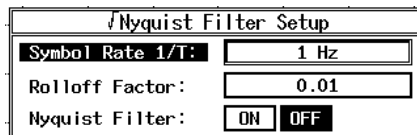

Symbol Rate 1/T Sets the symbol rate.

Rolloff Factor Sets the rolloff factor.

<i>√Nyquist Filter</i>	Toggles the Nyquist filter function on or off. ON: Turns the Nyquist filter function on. OFF: Turns the Nyquist filter function off.
<i>Parameter Setup</i>	Displays the ACP Setup menu.
<i>Default</i>	Reads the frequency span, RBW, VBW, the sweep time and the status of the detector which have previously been saved using "Define → Default."
<i>Manual</i>	Sets the channel space and channel bandwidth.
<i>Define → Default</i>	Registers the frequency span, RBW, VBW, the sweep time and the status of the detector, which have previously been set manually, as the preset values.
<i>Screen FULL/SEPA/CARRIER</i>	Toggles the screen display between the full and separate screen modes. FULL: The entire screen is used. Calculates the power in reference to the band of the entire screen. SEPA: The separate screen is used. CARRIER: The entire screen mode is used. Calculates the power in reference to the power of band specified by the carrier band.
<i>Average Times ON/OFF</i>	Toggles the average function on or off. ON: Sets the number of times averagings are performed, and the measures the average adjacent channel leakage power. OFF: Measures the ACP on a sweep basis.
<i>Graph</i>	Displays the ACP Graph menu.
<i>Graph ON/OFF</i>	Toggles the graph display on or off. ON: Displays the leakage power graph as Trace B and puts Delta marker in the center of the screen. The B memory is used to display the ACP graph. OFF: Turns off the graph display.

3.3.16 POWER Key (Power Measurement)

Multi MKR Setup Displays the Multi MKR Setup menu.

Marker No.

Enter the multi marker number here.

Marker ON

Displays the multi-marker specified at Marker No. in the center of the trace and the frequency and level of the marker in the marker area.

Marker OFF

Removes the multi-marker specified by the number.

Active Marker

Makes the multi-marker specified by the number the active marker.

Reset Marker

Removes all multi-markers except for multi-marker 1.

ACP OFF

Turns off the ACP measurement function, and returns to the power menu.

Active Trace A/B

Toggles the trace data for the power measurement between traces.

A: Trace A is the target for the power measurement.

B: Trace B is the target for the power measurement.

3.3.17 PRESET Key (Initialization)

Pressing **SHIFT** and **CONFIG (PRESET)** allows you to change the current settings of the analyzer to either case:

(There is no softmenu associated with this panel key.)

3.3.18 RCL Key (Data Readout)

3.3.18 RCL Key (Data Readout)

This section describes the Recall menu displayed when the **RCL** key is pressed.

The analyzer changes to the split-screen mode, and a file list will be displayed on the lower screen.

Recall Register	Displays the Recall Reg (1) menu.
REG#1, #2, #3, #4, #5	Reads data from register.1, 2, 3, 4 or 5 and sets it.
Recall on POWER	Reads data immediately after turning the power on, and sets it.
more 1/2	Displays the Recall Reg (2) menu.
REG#6, #7, #8, #9, #10	Reads data from register 6, 7, 8, 9 or 10 and sets it.
Recall on POWER	Reads data immediately after turning the power on, and sets it.
more 2/2	Returns to the Recall Reg (1) menu.
Recall File	Displays the Recall File menu.
Recall	Reads data selected by List Reg/File.
List Reg/File	Displays a list of registers or files.
List Reg/File	Displays a list of registers or files.
Device RAM/FD	Sets the destination for saved files.
	RAM: Sets the destination to internal memory.
	FD: Sets the destination to floppy disk.

NOTE *Displayed when equipped with the floppy disk drive.*

Device RAM/A/B	Sets the destination for saved files.
	RAM: Sets the destination to internal memory.
	A: Sets the destination to memory card A.
	B: Sets the destination to memory card B.

NOTE *Displayed when equipped with the memory card drive (option).*

3.3.19 REPEAT Key (Continuous Sweep)

Pressing this key activates the continuous sweep mode.

If this key is pressed during a sweep, the sweep is paused and the sweep lamp is turned off. Pressing the **REPEAT** key again causes the analyzer to wait for another sweep to start and then the sweep lamp turns back on. The sweep will start after a signal is received (which in turn depends on the current trigger mode setting).

(There is no softmenu associated with this panel key.)

3.3.20 SAVE Key (Saving Data)

3.3.20 SAVE Key (Saving Data)

This section describes the Save menu displayed when the **SHIFT** and **RCL(SAVE)** keys is pressed. The analyzer changes to split-screen mode, and the file list is displayed on the lower screen.

<i>Save Register</i>	Displays the Save Reg (1) menu.
<i>REG#1, #2, #3, #4, #5</i>	Saves the current setting values set to register 1, 2, 3, 4 or 5.
<i>REG#IP</i>	Saves the current set values as the initial values.
<i>more 1/2</i>	Displays the Save Reg (2) menu.
<i>REG#6, #7, #8, #9, #10</i>	Saves the current setting values set to register 6, 7, 8, 9 or 10.
<i>REG#IP</i>	Saves the current set values as the initial values.
<i>more 2/2</i>	Returns to the Save Reg (1) menu.
<i>Clear Register</i>	Displays the Clear Reg (1).
<i>REG#1, #2, #3, #4, #5</i>	Clears the data saved in Register 1, 2, 3, 4 or 5.
<i>Default IP</i>	Sets the initial values to the factory defaults.
<i>more 1/2</i>	Displays the Clear Reg(2) menu.
<i>REG#6, #7, #8, #9, #10</i>	Clears the data saved in Register 6, 7, 8, 9 or 10.
<i>Default IP</i>	Sets the initial values to the factory defaults.
<i>more 2/2</i>	Returns to the Clear Reg (1) menu.
<i>Save File</i>	Displays the Save File menu.
<i>Save</i>	Saves the current data to the register or file currently selected in List Reg/File.
<i>Enter Title</i>	Allows you to enter a name for the file currently saved.
<i>Write Protect</i>	Write-protects the register or file currently selected in List Reg/File.
<i>Save Item Setup</i>	Displays the Setup Save Item Setup dialog box.

Save Item Setup				
Data Format:	<input checked="" type="checkbox"/> BIN	<input type="checkbox"/> TEXT		
Setup:	<input type="checkbox"/> OFF	<input checked="" type="checkbox"/> ON		
Trace:	<input type="checkbox"/> OFF	<input type="checkbox"/> A	<input type="checkbox"/> B	<input type="checkbox"/> A/B
Normalize:	<input type="checkbox"/> OFF	<input type="checkbox"/> A	<input type="checkbox"/> B	<input type="checkbox"/> A/B
Limit Line:	<input type="checkbox"/> OFF	<input type="checkbox"/> 1	<input type="checkbox"/> 2	<input type="checkbox"/> 1/2
Loss:Freq:	<input type="checkbox"/> OFF	<input checked="" type="checkbox"/> ON		
Corr Factor:	<input type="checkbox"/> OFF	<input checked="" type="checkbox"/> ON		
Spurious:	<input type="checkbox"/> OFF	<input checked="" type="checkbox"/> ON		

- Data Format** Sets the data format for saving data.
- Setup** Used to set whether or not the measurement conditions are saved.
- OFF: Used when the measurement conditions are not saved.
- ON: Used when the measurement conditions are saved.
- Trace** Used to control how the trace is saved.
- OFF: Does not save the trace data.
- A: Saves the trace data to memory A.
- B: Saves the trace data to memory B.
- A/B: Saves the trace data to memory A and memory B.
- Normalize** Used to control how normalization data is saved.
- OFF: Does not save the normalization data.
- A: Saves the normalization data for trace A.
- B: Saves the normalization data for trace B.
- A/B: Saves the normalization data for trace A and trace B.
- Limit Line** Used to control how Limit Line conditions are saved.
- OFF: Does not save the current values.
- 1: Saves the current values for Limit Line 1.
- 2: Saves the current values for Limit Line 2.
- 1/2: Saves the current values for both Limit Line 1 and 2.

3.3.20 SAVE Key (Saving Data)

<i>LOSS:Freq</i>	Toggles the saving function of the frequency vs frequency loss table on or off. OFF: Does not save the frequency vs frequency loss table. ON: Saves the frequency vs frequency loss table.
<i>Corr Factor</i>	Sets whether or not the correction data for a level is saved. OFF: Does not save the correction data. ON: Saves the correction data.
<i>Spurious</i>	Toggles the spurious table data saving function on or off. OFF: Does not save the table data. ON: Saves the table data.
<i>List Reg/File</i>	Toggles the display function of the register and file on or off.
<i>Rename</i>	Changes the name of a file selected in List Reg/File.
<i>Clear File</i>	Displays the Clear File menu.
<i>Clear</i>	Deletes the currently selected file in List Reg/File section.
<i>Release Protect</i>	Cancels the write protection for the files selected in List Reg/File.
<i>List Reg/File</i>	Toggles the display function of the register and file on or off.
<i>List Reg/File</i>	Displays a list of registers or files.
<i>Device RAM/FD</i>	Sets the destination for saved files. RAM: Sets the destination to internal memory. FD: Sets the destination to floppy disk.
<hr/> <i>NOTE</i> <i>Displayed when equipped with the floppy disk drive.</i> <hr/>	
<i>Device RAM/A/B</i>	Sets the destination for saved files. RAM: Sets the destination to internal memory. A: Sets the destination to memory card A. B: Sets the destination to memory card B.

	NOTE <i>Displayed when equipped with the memory card drive (option).</i>
Setup Media	Displays the Setup Media menu.
Format Floppy *1	Used to format floppy disks.
	NOTE <i>Displayed when equipped with the floppy disk drive.</i>
Copy All	Saves all the contents of memory card A in memory card B.
	NOTE <i>Displayed when equipped with the memory card drive (option).</i>
Format Card A	Format memory card A.
	NOTE <i>Displayed when equipped with the memory card drive (option).</i>
Format Card B	Format memory card B.
	NOTE <i>Displayed when equipped with the memory card drive (option).</i>

3.3.21 SINGLE Key (Single Sweep)

3.3.21 SINGLE Key (Single Sweep)

Pressing the **SINGLE** key causes the analyzer to sweep once.

If this key is pressed during a sweep, the sweep is paused and the sweep lamp is turned off. Pressing the **SINGLE** key again causes the analyzer to wait until a sweep starts again (which in turn depends on when it receives a signal). This is controlled by the trigger mode setting.

(There is no softmenu associated with this panel key.)

3.3.22 SPAN Key (Frequency Span)

This section describes the Span menu displayed when the **SPAN** key is pressed.

Pressing this key allows you to set a frequency span.

In addition, the center frequency and frequency span are displayed in the annotation area below the bottom scale line.

<i>Full Span</i>	Sets the frequency span to the full span of the analyzer.
<i>Zero Span</i>	Set a zero span at the center frequency.
<i>Last Span</i>	Resets the frequency span to the previous value.

3.3.23 SRCH Key (Peak Search)

3.3.23 SRCH Key (Peak Search)

This section describes the Peak menu displayed when the **SRCH** key is pressed.

- Next Peak** Moves the present marker to the next highest peak within the search range.
- Next Peak Left** Moves the present marker to the next higher frequency peak on the left side of the current marker.
- Next Peak Right** Moves the present marker to the next higher frequency peak on the right side of the current marker.
- Min Peak** Moves the present marker to the minimum peak within the search range.
- Next Min Peak** Moves the present marker to the next highest peak within the search range.
- Search Condition** Displays the Search Condition dialog box.

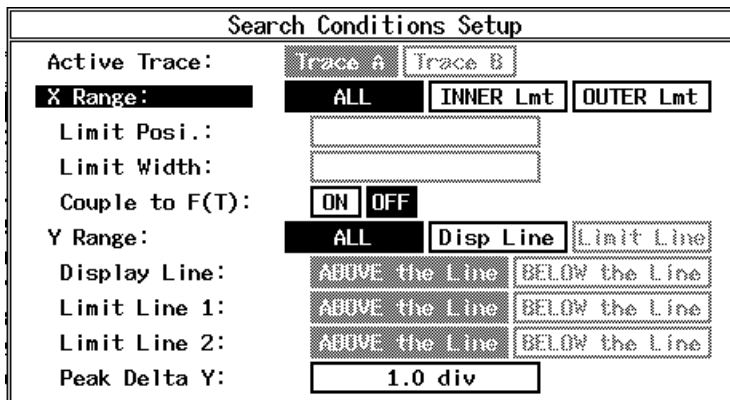

- X Range** Sets the search range for the X-axis
 - ALL: The entire X-axis is used.
 - INNER Lmt: Sets the search range to within the search limits.
 - OUTER Lmt: Sets the search range outside the search limits.
- Limit Posi** Sets the position of the search limits.
- Limit Width** Sets the width of the search limits.

<i>Couple to F(T)</i>	Toggles the fixed search range function on or off. ON: The search range is fixed on the screen. The position of the search range does not change even if the center frequency and the frequency span are changed. OFF: Only search range is fixed on the screen, and the search range is moved when changing the center frequency and the frequency span settings. The position of the search range varies according to changes in the center frequency and frequency span.
<i>Y Range</i>	Sets the search range for the Y-axis. ALL: The entire Y-axis is used. Display Line: Sets the display line to within the search range. Limit Line: Sets Limit Line 1 and 2 to within the search range.
<i>Display Line</i>	Bases the search range on the display line. ABOVE the line: Sets the search range to the area above the display line. BELOW the line: Sets the search range to the area below the display line.
<i>Limit Line 1</i>	Bases the search range on Limit Line 1. ABOVE the line: Sets the search range to the area above Limit Line 1. BELOW the line: Sets the search range to the area below Limit Line 1.
<i>Limit Line 2</i>	Bases the search range on Limit Line 2. ABOVE the line: Sets the search range to the area above Limit Line 2. BELOW the line: Sets the search range to the area below Limit Line 2.
<i>Peak Delta Y</i>	Allows you to set a level difference used for peak searches.

3.3.23 SRCH Key (Peak Search)

Cont peak ON/OFF

Toggles the continuous peak search function on or off.

ON: Peak searches are carried out continuously for a trace.

OFF: Turns off the continuous peak search function.

3.3.24 SWP Key (Sweep Time)

This section describes the menu displayed when the **SWP** key is pressed.

Pressing this key allows you to set sweep conditions.

Sweep Time AUTO/MNL

Toggles the sweep mode between AUTO and MNL.

AUTO: Automatically sets an optimum sweep time according to the span setting.

MNL: Allows you to set the sweep time manually.

Trigger Setup

Displays the Trigger Setup dialog box.

Trigger Level

Sets the trigger threshold level. This applies only to the video and external triggers.

Source

Allows you to enter the trigger condition.

FREE RUN:

Performs sweeps automatically.

LINE: Sweeps are synchronized with the AC power supply.

VIDEO: Sweeps are synchronized with the video signal.

EXT: Sweeps are synchronized with the external triggers signal.

IF: Sweeps are synchronized with the IF signal.

Slope

Switches between positive (+) and negative (-) polarities. This applies to the video trigger, external trigger or IF trigger only.

+: Triggers the sweep circuitry to start sweeping with a leading edge.

-: Triggers the sweep circuitry to start sweeping with a trailing edge.

Trigger Delay

Sets the delay time from the trigger point. This is available only when the zero span is set.

3.3.24 SWP Key (Sweep Time)

<i>Gated Sweep</i>	<p>Displays the Gated Sweep menu and changes to the split-screen mode.</p> <p>On the upper screen, Trace A with a gated sweep is displayed; on the lower screen, Trace B is displayed to show the waveform, position and width of the gate signal.</p>
<i>Trigger Setup</i>	<p>Displays the Trigger Setup menu.</p> <p>Use this menu to set the conditions for the gate signal trigger.</p>
<i>Trigger Level</i>	<p>Sets the trigger threshold level. This applies only to the video and IF triggers.</p>
<i>Source</i>	<p>Sets the sweep mode.</p> <p>FREE RUN: Performs sweeps automatically.</p> <p>LINE: Sweeps are synchronized with the AC power supply.</p> <p>VIDEO: Sweeps are synchronized with the video signal.</p> <p>EXT: Sweeps are synchronized with the external triggers signal.</p> <p>IF: Sweeps are synchronized with the IF signal.</p>
<i>Slope</i>	<p>Switches between positive (+) and negative (-) polarities. This applies to the video trigger, external trigger or IF trigger only.</p> <p>+: Triggers the sweep circuitry to start sweeping with a leading edge.</p> <p>-: Triggers the sweep circuitry to start sweeping with a trailing edge.</p>
<i>Gate Src Trigger</i>	<p>Specifies the gate signal source. The EXT or IF signal is used as the gate signal in Trigger Setup.</p> <p>Allows you to set Gate Src Trigger only when the EXT or IF trigger is selected in Trigger Setup.</p>
<i>Gate Src Ext Gate</i>	<p>Specifies the gate signal source. The signal, which is input to the Gate In connector on the rear panel, is used as the gate signal.</p>
<i>Gate Position</i>	<p>Sets the position of the gate signal.</p>
<i>Gate Width</i>	<p>Sets the width of the gate signal.</p>

Gated Sweep ON/OFF

Toggles the gated sweep mode on or off.

ON: Sweeps according to the gate conditions such as the gate position and gate width.

OFF: Turns the gated sweep mode off.

Gated Sweep ON/OFF

Toggles the gated sweep mode on or off.

ON: Performs sweeps according to the set gate conditions.

OFF: Turns the gated sweep mode off.

Window Sweep ON/OFF

Toggles the window sweep function on or off.

ON: Performs sweeps within the range specified by the measuring window.

OFF: Performs sweeps within the entire span range.

3.3.25 UTIL Key (Utility)

3.3.25 UTIL Key (Utility)

This section describes the Utility menu displayed when the **UTIL** key is pressed.

OBW	Displays the OBW menu. Enters into split-screen mode. A trace is displayed on the upper screen and a list of harmonics measurement data is displayed on the lower screen.
OBW%	Sets the percentage of occupied power compared to the total power when measuring the occupied bandwidth.
Parameter Setup	Displays the OBW Setup menu.
Default	Resets the frequency span, resolution bandwidth, video bandwidth, sweep time, detector and OBW% to the factory defaults.
Manual	Manually sets the frequency span, resolution bandwidth, video bandwidth, sweep time, detector and OBW% to arbitrary values.
Define → Default	Resets the values currently being used to the factory defaults.
Average Times ON/OFF	Toggles the average function on or off. ON: Sets the averaging times and calculates the average of the occupied bandwidth OFF: Turns the average function off.
OBW OFF	Terminates the occupied bandwidth measurement, and returns to the Utility menu.
Harmonics	Displays the Harmonics menu. Enters into split-screen mode. A trace is displayed on the upper screen and a list of harmonics measurement data is displayed on the lower screen.
FUND Frequency ON/OFF	Toggles the fundamental frequency setup function on or off. ON: Allows you to set the fundamental frequency and displays the values as entered. OFF: Sets the center frequency currently being used to the fundamental frequency.
Harmonics Number	Allows you to set the order of the harmonics to be measured.
Harmonics OFF	Turns the harmonics measurement function off. The screen is displayed in the full-screen mode and returns to the Utility menu.

<i>Spurious</i>	Displays the Spurious menu. Enters into the split-screen mode. A trace is displayed on the upper screen and a list of spurious table information is displayed on the lower screen.
<i>Table No.1/2/3</i>	Allows you to select which of the three tables is used.
<i>Load Table</i>	Reads data from the table selected.
<i>Edit Table</i>	Displays the Edit Table menu. A list of data specified by a table number is displayed in full-screen mode.
<i>Table No.1/2/3</i>	Allows you to select which of the three tables is used.
<i>Save Table</i>	Saves data in the table selected.
<i>Load Table</i>	Reads data from the table selected.
<i>Insert</i>	Inserts a row at the cursor.
<i>Delete</i>	Deletes the row where the cursor is currently on.
<i>Table Init</i>	Removes all data from the table.
<i>Show Result</i>	Displays the Show Result menu. The measurement result is displayed in Full screen mode.
<i>Prev Result</i>	Displays the previous result screen (page).
<i>Next Result</i>	Displays the next screen of the current table.
<i>Spurious OFF</i>	Displays Full screen mode and turns the spurious measurement function off.
<i>Eye Opening</i>	Displays the Eye Opening menu. Eye opening (or eye pattern) measurement sweeps the frequencies more than one time, saves them and calculates their eye opening ratios. This measurement can be performed when the vertical and horizontal axes are set to a linear scale and zero span, respectively. When the vertical and horizontal axes are set, the screen is split into two, the upper screen displays the artificial analog waveform and the lower screen displays the opening measurements. The X and Y cursors are also displayed. The opening ratio is calculated from the waveform data located by the X and Y cursors (which are used to retrieve amplitudes and time periods, respectively).

3.3.25 UTIL Key (Utility)

NOTE:

1. *Display the opening ratio on the screen before performing the eye opening measurement.*
 2. *When the measurement window is displayed, the waveform used for the opening ratio measurement is enlarged vertically (in the amplitude direction) in the measurement window.*
-

Sampling Times Specifies the number of times the waveform should be acquired to calculate eye opening ratios.

XY Cursor Display the XY Cursor menu.

XY Cursor ON/OFF

Toggles the X and Y cursor function on or off. While the eye opening measurement is being performed, this cannot be toggled off.

ON: Displays the XY cursor.

OFF: Turns the XY cursor off.

X Cursor Position Moves the X cursor. The opening ratio is calculated from the amplitudes located by the X cursor. If the measurement window is displayed, the selected waveform is zoomed in and displayed in the measurement window.

Y Cursor Position Moves the Y cursor. The opening ratio is calculated from the time periods located by the Y cursor.

Y Cursor Auto Set Calculates the amplitude average from the waveform data acquired according to the Sample Time setting, and positions the Y cursor at the amplitude average point.

Time Ratio Corr ON/OFF Toggles the internal jitter compensation function in this instrument on or off.

ON: Compensates for the internal jitter of this instrument and calculates the opening ratio along the time domain.

OFF: Does not compensate for internal jitter.

Artificial Analog ON/OFF Toggle the artificial analog display function on or off.

ON: Up to 32 waveforms can be displayed in gray scale. This allows you to see all the eye openings at one time.

OFF: The artificial analog display function is turned off.

<i>Eye Opening OFF</i>	Turns off the eye opening measurement function and artificial analog display function simultaneously. The split screens are also turned off and the Utility menu is displayed.
<i>Phase Noise</i>	Displays the Phase Noise menu. A menu used to measure phase noises and phase jitters is displayed.
<i>C/N Meas</i>	Displays the C/N Meas menu. A variety of settings for the phase noise measurement can be performed. For this measurement, a phase noise is calculated using an offset frequency which is deviated from the carrier frequency or the current center frequency. A maximum offset frequency of 10 points can be measured.
<i>Edit Table</i>	Displays the Edit Table menu, allowing you to set the desired offset frequency.
<i>Insert</i>	Enters the same data in the current cursor position.
<i>Delete</i>	Deletes the data at the current cursor position.
<i>Table Init</i>	Deletes all data from the table.
<i>Signal Track ON/OFF</i>	Toggles the signal track mode on or off. ON: The signal track mode is turned on, and measurements are taken by keeping track of the carrier frequency, which results in changes to the center frequency. OFF: Turns the signal track mode off.
<i>Average Times ON/OFF</i>	Toggles the trace averaging function on or off. ON: Sets the number of averaging times and traces and averages the phase noise waveform for each offset frequency. OFF: Turns the trace average function off.
<i>C/N Meas OFF</i>	The phase noise measurement function is turned off, and the screen returns to the Phase Noise menu.
<i>Phase Jitter</i>	Displays the Phase Jitter menu. A variety of parameters used to measure phase jitter can be set. A jitter is calculated by specifying a phase noise integration range based on an offset frequency deviated from the carrier frequency that is the same as the current center frequency.

3.3.25 UTIL Key (Utility)

Start Offset Sets the lower limit of the phase noise integration range.

Stop Offset Sets the upper limit of the phase noise integration range.

Signal Track ON/OFF

Toggles the signal track mode on or off.

ON: The signal track mode is turned on, and measurements are taken by keeping track of the carrier frequency, which results in changes to the center frequency.

OFF: Turns the signal track mode off.

Average Times ON/OFF

Toggles the trace averaging function on or off.

ON: Sets the number of averaging times, traces and then averages the phase noise waveform for each offset frequency.

OFF: Turns the trace average function off.

Phase Jitter OFF The phase noise measurement function is turned off, and the Phase Noise menu is displayed.

IM Meas

Displays the IM Meas menu in two-screen mode. Traces are displayed on the upper screen, and odd-harmonic measurement data is displayed on the lower screen.

Order

Sets the degrees used. The degrees available are 3, 5, 7 and 9.

Limit Setup

Displays the Limit Setup dialog box.

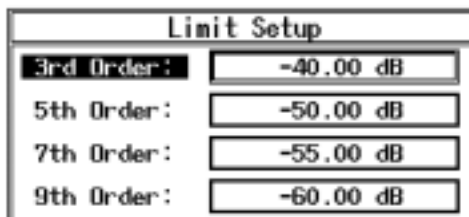

3rd Order Sets the limit value for a third-order harmonic signal.

5th Order Sets the limit value for a fifth-order harmonic signal.

7th Order Sets the limit value for a seventh-order harmonic signal.

9th Order Sets the limit value for a ninth-order harmonic signal.

- Pass/Fail Judgement ON/OFF*** Toggles the Pass/Fail Judgement function on or off. This function compares a measured value with the value set in the Limit Setup dialog box.
- ON: Performs a Pass/Fail judgement. The result is Fail if the measurement value is greater than the limit value.
- OFF: Does not perform a Pass/Fail judgement.
- Average Times ON/OFF*** Toggles the trace averaging function on or off.
- ON: Sets the number of averaging times.
- OFF: Turns the trace average function off.
- Hi Sens ON/OFF*** Toggles the Hi Sense measurement mode on or off. This function is used to increase measurement sensibility.
- ON: Decreases the reference level by 20 dB before a harmonic signal is measured.
- OFF: A harmonic signal is measured within a single screen.
- IM Meas OFF*** Turns off the odd harmonic measurement function, and returns to the Utility menu display.
- Active Trace A/B*** Switches the traces used in the occupied bandwidth power, harmonics or spurious measurements between trace A and trace B.
- A: Uses Trace A.
- B: Uses Trace B.

3.3.26 WINDOW Key

3.3.26 WINDOW Key

This section describes the Window menu displayed when the **WINDOW** key is pressed.

<i>Measuring Window</i>	Displays the Meas Window menu.
<i>Window ON/OFF</i>	Toggles the measuring window display function on or off. ON: Displays the measuring window on the screen. OFF: Removes the measuring window.
<i>Window Position</i>	Allows you to set the position of the measuring window.
<i>Window Width</i>	Allows you to set the width of the measuring window.
<i>Window Sweep ON/OFF</i>	Toggles the window sweep function on or off. ON: Performs sweeps within the range specified by the measuring window. OFF: Performs sweeps over the entire span range.
<i>Zoom</i>	Displays the Zoom menu and enters into split-screen mode. On the upper screen, three cursors are displayed: one vertical line used to indicate the center position of the zoom and two vertical lines used to indicate the frequency span. On the lower screen, the magnified trace is displayed. The unit of the X-axis is either frequency or time for the upper and lower screens.
<i>Zoom Position</i>	Allows you to set the center position of the zoom.
<i>Zoom Width</i>	Allows you to set the zoom width (the span frequency on the lower screen).
<i>Zoom on Window</i>	The magnified screen on the lower screen is displayed in full screen mode.
<i>Zoom off</i>	Returns full-screen mode to split-screen mode.
<i>Peak Zooming</i>	Displays the Peak Zoom menu.
<i>Max Peak</i>	The cursor is displayed at the maximum peak on the trace on the upper screen, and is magnified in the center of the lower screen.
<i>Next Peak</i>	The cursor is displayed at the second highest peak with respect to the present peak on the upper screen, and is magnified in the center of the lower screen.

	3rd Order Peak	The cursor is displayed at the third order intermodulation distortion (from the highest peak), and is magnified in the center of the lower screen.
	Peak Delta Y	Allows you to set the level difference used for a peak search and displays the value you entered.
	Screen Reset	Displays the upper screen in full-screen mode, and turns the Zoom function off.
F/T		Displays the Zoom menu, and switches to split-screen display mode. A zoom center position cursor and a zero span cursor are displayed on the upper screen. The unit of the upper screen X-axis is in frequency; the unit of the lower screen X-axis (which represents the zero span) is in time.
	Zoom Position	Allows you to set the center position of the zoom.
	Zoom Width	(Cannot be used in this mode.)
	Zoom on Window	The magnified screen on the lower screen is displayed in full-screen mode.
	Zoom off	Returns full-screen mode to the split-screen display mode.
	Peak Zooming	Displays the Peak Zoom menu.
	Max Peak	The cursor is displayed at the maximum peak on the trace on the upper screen, and is magnified in the center of the lower screen.
	Next Peak	The cursor is displayed at the second highest peak with respect to the present peak on the upper screen, and is magnified in the center of the lower screen.
	3rd Order Peak	The cursor is displayed at the third order intermodulation distortion (from the highest peak), and is magnified in the center of the lower screen.
	Peak Delta Y	Allows you to set the level difference used for a peak search and displays the value you entered.
	Screen Reset	Displays the upper screen in full-screen mode, and returns to the Window menu.
T/T		Switches to split-screen mode to display the units of the upper and lower X-axes in time (zero span at the center frequency). You can set different frequencies using split-screens.
	Screen Reset	Displays the upper screen in full screen mode.

3.4 List of Settings

3.4 List of Settings

This section shows various settings that are used with the analyzer.

3.4.1 Set Resolution

Table 3-1 Center Frequency Set Resolution vs. Frequency Span

Frequency span	Center frequency set resolution
10 GHz \leq Span	10 MHz
1 GHz \leq Span < 10 GHz	1 MHz
100 MHz \leq Span < 1 GHz	100 kHz
10 MHz \leq Span < 100 MHz	10 kHz
1 MHz \leq Span < 10 MHz	1 kHz
100 kHz \leq Span < 1 MHz	100 Hz
10 kHz \leq Span < 100 kHz	10 Hz
Span \leq 10 kHz	1 Hz

3.4.2 Set Values for RBW, VBW and Sweep-Time

When set to AUTO, the values for RBW, VBW and Sweep-time are displayed in the table below. The settings such as "RBW: Span" and "RBW: VBW" are set to OFF.

Table 3-2 Values for RBW, VBW and Sweep-Time (using AUTO)

Frequency span	RBW	VBW
200 MHz \leq Span	3 MHz	3 MHz
60 MHz \leq Span < 200 MHz	1 MHz	1 MHz
20 MHz \leq Span < 60 MHz	300 kHz	300 kHz
6 MHz \leq Span < 20 MHz	100 kHz	100 kHz
2 MHz \leq Span < 6 MHz	30 kHz	30 kHz
300 kHz \leq Span < 2 MHz	10 kHz	10 kHz
100 kHz \leq Span < 300 kHz	3 kHz	3 kHz
30 kHz \leq Span < 100 kHz	1 kHz	1 kHz
10 kHz \leq Span < 30 kHz	300 Hz	300 Hz
5 kHz \leq Span < 10 kHz	100 Hz	100 Hz
1 kHz \leq Span < 5 kHz	30 Hz	30 Hz
Span < 1 kHz	10 Hz	10 Hz

$$\text{Sweep Time (Sec)} = \text{SPAN} \div (\text{RBW} \times m \times k)$$

Where m is either RBW or VBW, whichever is smaller.

k is determined as follows:

k = 0.2 if RBW = 3 kHz and SPAN \leq 220 kHz

k = 0.39 if RBW = 1 kHz and SPAN \leq 60 kHz

k = 0.5 if none of the above is encountered.

NOTE: The above conditions do not apply to the digital filter mode.

3.4.3 Factory Defaults

The table below lists the factory defaults (for both analyzer parameters and individual settings).

Table 3-3 Factory Defaults

Parameter	R3267	R3273	R3264
Center frequency	4 GHz	13.25 GHz	1.75 GHz
Frequency span	8 GHz	26.5 GHz	3.5 GHz
Reference level	0 dBm	0 dBm	0 dBm
Sweep time	AUTO 120 ms	AUTO 400 ms	AUTO 60 ms
Resolution bandwidth (RBW)	AUTO 3 MHz	AUTO 3 MHz	AUTO 3 MHz
Video bandwidth (VBW)	AUTO 3 MHz	AUTO 3 MHz	AUTO 3 MHz
Input attenuator	AUTO 10 dB	AUTO 10 dB	AUTO 10 dB
Trigger mode	FREE RUN	FREE RUN	FREE RUN
Trace mode	A: WRITE B: BLANK	A: WRITE B: BLANK	A: WRITE B: BLANK
Vertical gradation	10 dB/div	10 dB/div	10 dB/div

3.4.4 Defaults Configuration Values

These are the default settings used when the Defaults Config soft key is pressed.

Table 3-4 Default Settings (1 of 3)

Panel	Menu/Dialog box	Default
A	Trace Detector DET Select	AUTO
	Normalize A	OFF
	Artificial Analog	OFF
	Art Analog Trc Disp	CONT
	XY Cursor	OFF
	Delta Y Disp Mode	CURS
ATT	ATT	AUTO
	Min ATT	ON
B	Trace Detector DET Select	AUTO
	Normalize B	OFF
CONFIG	Trace Point	1001
	Display	ON
COUPLE	RBW	AUTO
	VBW	AUTO
	Sweep Time	AUTO
	RBW:Span	OFF
	VBW:RBW	OFF
	PLL Band Width	AUTO

3.4.4 Defaults Configuration Values

Table 3-4 Default Settings (2 of 3)

Panel	Menu/Dialog box		Default
FORMAT	Display Line		OFF
	XY Cursor		OFF
	Limit Line Setup	Limit Line 1	OFF
		Pass Range	BELOW the line
	Limit Line 2	Pass Range	ABOVE the line
		X data mode	ABS
	Reference	LEFT	
	Y data mode	ABS	
	Reference	TOP	
	Label Entry		Un-title
FREQ	CF Step Size		AUTO
	Freq Offset		OFF
LEVEL	Ref Offset		OFF
	Correction Factor	Corr Factor	OFF
MEAS	Counter		OFF
	Sound	Sound	AM
		Squelch	OFF
	X dB Down	Disp mode	REL
MEAS	X dB Down	Continuos	OFF
	Down	Ref. Marker	OFF
MKR	Delta MKR		OFF
	Fixed MKR		OFF
	1/Delta MKR		OFF
	Marker List		OFF
	Signal Track		OFF
POWER	ACP	$\sqrt{\text{Nyquist Filter}}$	OFF
		Screen	FULL
	Average		OFF
	Graph		OFF
	parameter Setup		Manual
SAVE	Select Item	Data Format	BINARY
		Setup	ON
	Trace		OFF
	Limit Line		OFF
	Normalize Corr		OFF
	Loss:Freq		OFF
	Corr Factor		OFF
Suprious		OFF	

Table 3-4 Default Settings (3 of 3)

Panel	Menu/Dialog box		Default
SRCH	Search Condition	X Range	ALL
		Couple to F(T)	OFF
		Y Range	ALL
		Display Line	ABOVE the line
		Limit Line 1	ABOVE the line
		Limit Line 2	ABOVE the line
		Peak Delta Y	1.0 div
		Continous Peak	OFF
SWEEP	Trigger Setup	Trigger	FREE RUN
		Slope	+
		Trigger Level	50%
		Delay Time	0.00 μ s
		Gated Sweep	OFF
		Window Sweep	OFF
UTIL	OBW	OBW Setup	Manual
	Harmonics	FUND Frequency	OFF
	Spurious	Tabel No	1
WINDOW	Window		OFF
	Window Sweep		OFF

3.4.5 Parameters Range

3.4.5 Parameters Range

Table 3-5 Parameters Range

Panel	Menu/Dialog box		Min	Max
A	Average A		2	999
	Max Hold A		2	999
	Min Hold A		2	999
	Power Average A		2	999
ATT	Min ATT		0dB	R3264/67: 75dB R3273: 70dB
B	Average A		2	999
	Max Hold A		2	999
	Min Hold B		2	999
	Power Average B		2	999
CONFIG	GPIB&Others	GPIB Address	0	30
COUPLE	RBW:Span		0.001:1	0.1:1
	VBW:RBW		0.003:1	3:1
FORMAT	Display Line			
	Limit Line Setup	Limit Line 1, 2 X-axis	-1GHz	400GHz
		Limit Line 1, 2 Y-axis	-100dBm	+100dBm
FREQ	Freq Offset (ON)		-100GHz	+100GHz
LEVEL	Ref Offset (ON)		-100dB	+100dB
MEAS	Sound	Volume	1	8
		Marker Pause Time	100ms	1000s
MKR	Multi Marker	Marker No.	1	10
POWER	Channel Power	Average Times	1	999
	ACP	Average Times	2	999
		Symbol Rate	1Hz	1GHz
		Role Factor	0.01	0.99
SRCH	Search Condition	Peak Delta Y	0.1div	10div
SWEEP	Trigger Setup	Delay Time	0.00 μ s	1s
UTIL	OBW	Average Times	2	999
	Harmonics	Harmonics Number	2	10
WINDOW	Zoom	Peak Delta Y	0.1div	10div
	F/T	Peak Delta Y	0.1div	10div

4 PRINCIPLE OF MEASUREMENT

This chapter describes the input saturation, internal operation and Nyquist filter in ACP measurements, and the gated sweep of the analyzer.

4.1 Input Saturation

Measurement error may increase depending on the setting of the attenuator when a relatively large input signal is input. This problem can be caused by an input saturation. This section describes input saturation.

- Cause of input saturation

A block diagram of the analyzer input section is shown in Figure 4-1. The input signal at the input connector passes through the attenuator and enters the mixer.

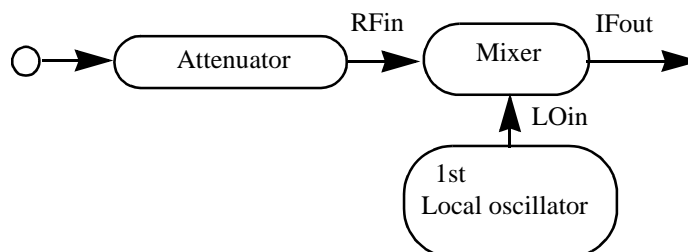

Figure 4-1 Input Section Block Diagram

The output level of the mixer is usually proportional to the input level. The mixer output becomes saturated as the input reaches a certain level, and the error increases (see Figure 4-2).

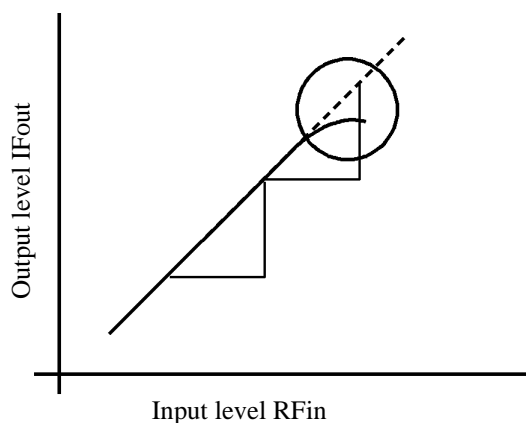

Figure 4-2 Relationship between the Input and Output of the Mixer

- Measures against input saturation
Mixer input level must be lowered by adjusting the attenuator to an optimum level once input saturation appears.

CAUTION *If the output from the attenuator is too low, you cannot analyze the weak signal. However, internal circuitry of the mixer, may be damaged if the output from the attenuator is too large.*

4.1 Input Saturation

To measure a continuous wave (CW), the attenuator is automatically set to an optimum value only when the input peak value is set to a level below the reference level.

When measuring a signal with a wide modulation bandwidth (whose resolution bandwidth (RBW) is narrower than the modulation bandwidth), the displayed input level becomes a value smaller than the minimum level required for the measurement. If this happens, the input level must be set to an optimum value manually.

- How to check an optimum value
 1. To calculate a rough attenuator set value, use the formula shown below.
Input attenuator set value (dB) \geq Input level (dBm) + 10 dB
 2. There is no input saturation if the peak value stays unchanged on the screen if the attenuation value is decreased by 1. You can take measurements under these conditions. Otherwise, increase the attenuation value until no changes in the peak value are observed on the screen.

4.2 Measuring Adjacent Channel Leakage Power (ACP)

This section describes the difference between the operation processes (used for each measurement mode) and correction operation using the Root Nyquist filter.

4.2.1 Differences between Full Screen and Separate Screen Operation Processes

There are two modes of measuring the adjacent channel leakage power for the analyzer: the Full screen and Separate screen modes.

The features and internal processes of both modes are as follows.

- Full screen mode

In this mode, the upper adjacent channel leakage power is calculated as a ratio of the upper adjacent channel power P_U (calculated by integrating the trace data over the specified bandwidth) to the total power P_C (calculated by integrating the trace data over the entire frequency range on the measurement screen). In the same manner, the lower adjacent channel leakage power is calculated using the lower adjacent channel power P_L instead of P_U .

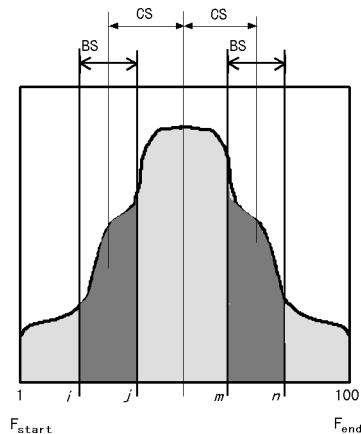

CS: channel space

BS: specified bandwidth

Figure 4-3 Full Screen Mode

The total power P_C is calculated by using the formula shown below by adding up the power level at each point over the entire frequency axis on the screen.

$$P_C = \sum_{n=1}^{1001} 10^{\frac{P(n)}{10}}$$

The lower adjacent channel power (P_L) and the upper adjacent channel power (P_U) are calculated by using the formula shown below.

$$P_L = \sum_{n=f_{Lch}-\frac{BS}{2}}^{f_{Lch}+\frac{BS}{2}} 10^{\frac{P(n)}{10}}$$

$$P_U = \sum_{n=f_{Uch}-\frac{BS}{2}}^{f_{Uch}+\frac{BS}{2}} 10^{\frac{P(n)}{10}}$$

The upper adjacent channel leakage power (Q_U) and the lower adjacent channel leakage power (Q_L)

4.2.1 Differences between Full Screen and Separate Screen Operation Processes

are calculated by using the formula shown below.

$$Q_U = 10 \text{ Log} \left(\frac{P_U}{P_C} \right)$$

$$Q_L = 10 \text{ Log} \left(\frac{P_L}{P_C} \right)$$

- Separate screen mode

In this mode, the upper adjacent channel leakage power is calculated as a ratio of the upper adjacent channel power P_U (calculated by integrating the trace data over the specified bandwidth) to the total power P_C (calculated by integrating the trace data within the specified bandwidth of the reference channel). In the same manner, the lower adjacent channel leakage power is calculated using the lower adjacent channel power P_L instead of P_U .

When measuring each power, the frequency span is set to the specified bandwidth and the center frequency is set to the channel frequency of each channel. In addition, the reference level is decreased by 20 dB to improve the dynamic range when measuring the adjacent channels. (The reference channel is displayed on the upper screen, and each of the adjacent channels is displayed on either side on the lower screen.)

This mode requires more time to take measurements, though measurement accuracy is higher than Full screen mode.

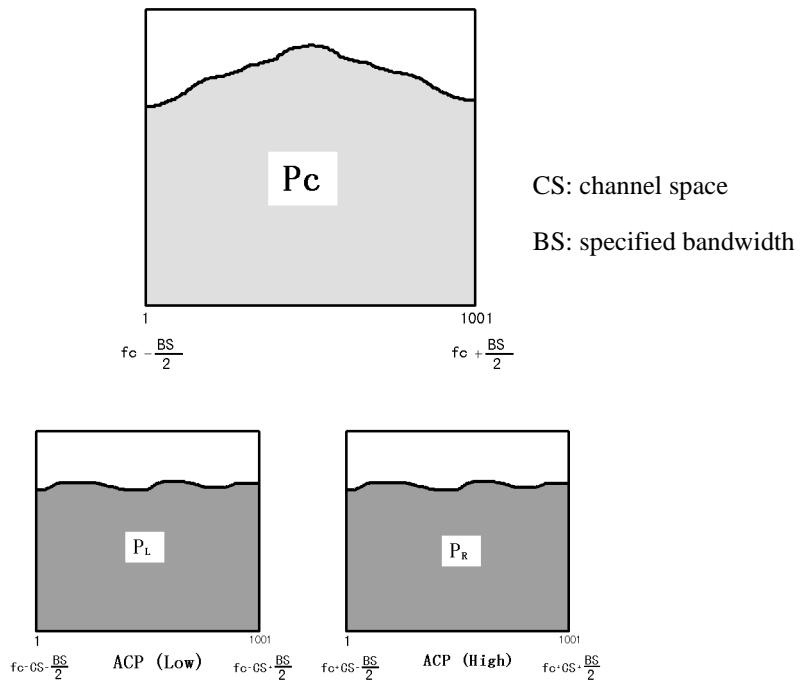

Figure 4-4 Separate Screen Mode

The reference channel power (P_C), the upper and lower adjacent leakage power (P_U and P_L , respectively), the upper and lower adjacent channel leakage power (Q_U and Q_L , respectively) is calculated by using the formula shown below.

4.2.1 Differences between Full Screen and Separate Screen Operation Processes

$$P_C = \sum_{n=1}^{1001} 10^{\frac{P(n)}{10}}$$

$$P_L = \sum_{n=1}^{1001} 10^{\frac{P(n)}{10}}$$

$$P_U = \sum_{n=1}^{1001} 10^{\frac{P(n)}{10}}$$

$$Q_U = 10 \text{ Log} \left(\frac{P_U}{P_C} \right)$$

$$Q_L = 10 \text{ Log} \left(\frac{P_L}{P_C} \right)$$

4.2.2 Root Nyquist Filter

4.2.2 Root Nyquist Filter

The analyzer has the capability of correcting for the Root Nyquist filter when measuring the adjacent channel leakage power.

When calculating the power of each channel by integrating the trace data, the corresponding Root Nyquist filter's coefficient (H(n)) is multiplied.

$$P'_{U} = \sum_{n=a}^b 10^{\left(\frac{P(n)}{10}\right)} \times H(n)$$

$$a = f_{Uch} - \frac{(1+\alpha)}{2T}, \quad b = f_{Uch} + \frac{(1+\alpha)}{2T}$$

$$P'_{L} = \sum_{n=a}^b 10^{\left(\frac{P(n)}{10}\right)} \times H(n)$$

$$a = f_{Lch} - \frac{(1+\alpha)}{2T}, \quad b = f_{Lch} + \frac{(1+\alpha)}{2T}$$

Root Nyquist filter's coefficient (H(n)) is calculated by substituting Symbol rate (T) and Rolloff factor (α) into the formula shown below.

$$|H(n)| = \begin{cases} 1 & 0 \leq |f| \leq (1-\alpha)/2T \\ \cos \left[\frac{T}{4\alpha} (2\pi |f| - \pi (1-\alpha)/T) \right] & (1-\alpha)/2T \leq |f| \leq (1+\alpha)/2T \\ 0 & (1+\alpha)/2T \leq |f| \end{cases}$$

The characteristics of the Root Nyquist filter is shown in Figure 4-5.

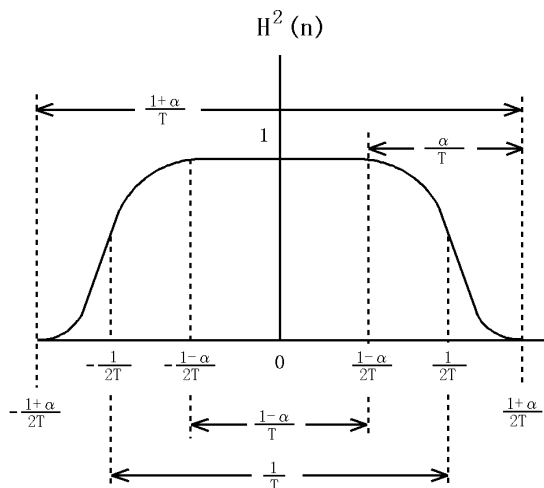

Figure 4-5 Characteristics of the Root Nyquist Filter

4.2.3 Noise Correction Function

The measurement limit value of the adjacent channel leakage power (ACP) is determined based on the spectrum analyzer internal noise level and the third order distortion efficiency.

The power equivalent to the internal noise power of the spectrum analyzer can be corrected by using the noise correction function. Accordingly, the ACP measurement dynamic range is expandable.

The upper and lower adjacent channel leakage power (Q_U and Q_L , respectively) in the separate screen mode can be expressed by the following formulas:

$$Q_U = 10 \text{Log} \frac{P_U}{P_C}$$

$$Q_L = 10 \text{Log} \frac{P_L}{P_C}$$

P_U, P_L : Adjacent channel power

P_C : Reference channel power

If the adjacent channel power is as similar to the spectrum analyzer internal noise power, the adjacent channel power measurement value can be affected by the internal noise power. The adjacent channel leakage power after the noise correction can be obtained by using the noise correction function to subtract noise power from the adjacent channel power measurement value as shown below.

The upper and lower adjacent channel power (P_U' and P_L' , respectively), after the noise correction, can be obtained by using the following formulas:

$$P_U' = P_U - P_{NU} \times \frac{BS}{NBS}$$

$$P_L' = P_L - P_{NL} \times \frac{BS}{NBS}$$

P_U, P_L : The upper and lower adjacent channel power before the noise correction.

P_{NU}, P_{NL} : The noise power in the upper and lower internal noise power measurement band.

NBS : The internal noise power measurement bandwidth

BS : The reference bandwidth

The upper and lower adjacent channel leakage power (Q_U' and Q_L' , respectively) after the noise correction can be obtained by the following formulas:

$$Q_U' = 10 \text{Log} \frac{P_U'}{P_C}$$

$$Q_L' = 10 \text{Log} \frac{P_L'}{P_C}$$

4.3 Operation of the Gated Sweep

4.3 Operation of the Gated Sweep

This section describes the gated sweep operation of the analyzer.

The spectrum of a burst signal comprises RF signal spectrums and spectrums caused by on/off operations. The gated sweep function is especially effective when measuring RF signal spectrum that only depends on applications.

The gated sweep function measures RF signal spectrum using the signals in steady state (either the burst on or off period) excluding the signals in transient state (such as leading and trailing edges of the burst signals to be measured).

In addition, during transient periods, the local oscillator stops sweeping to indicate the spectrum as a continuous spectrum.

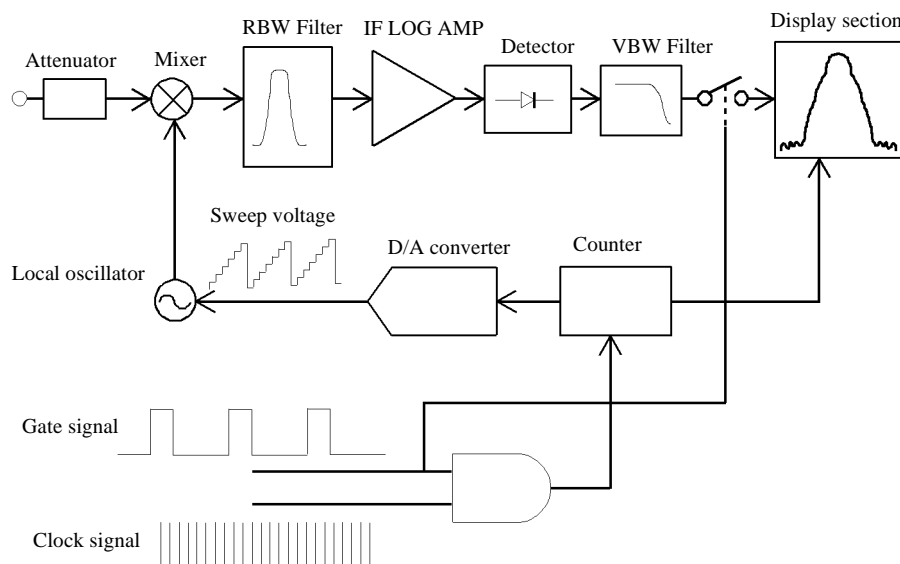

Figure 4-6 Internal Block Diagram

Two types of gate signals are available in the analyzer.

- * External gate signal: Input signal connected to the EXT GATE connector
 - * Internal gate signal: Signal that is generated from the following settings
- | | |
|------------------|---|
| Trigger source | |
| IF trigger | Envelope of the IF signal (Bandwidth: approx. 10 MHz) |
| External trigger | Input signal applied to the EXT TRIG connector |
| Trigger slope | |
| Leading edge | |
| Trailing edge | |
| Gate position | |
| Gate width | |

The gate position and the gate width of the gate signal are generated in reference to the leading and trailing

edges of the trigger signal.

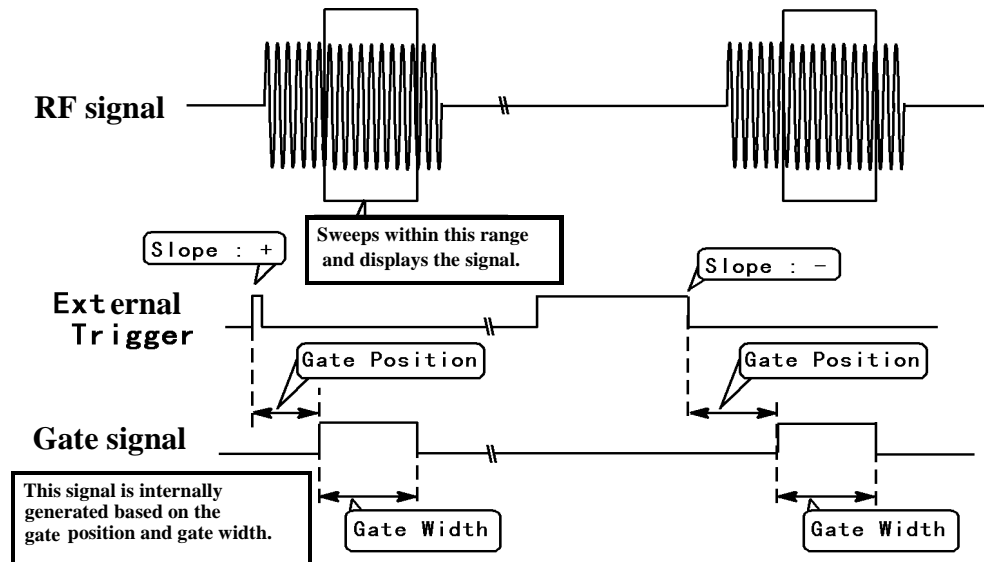

Figure 4-7 Generating the Internal Gate Signal

4.4 Eye Opening Calculation

4.4 Eye Opening Calculation

The instrument calculates eye opening ratios as described below.

When the maximum and minimum amplitudes retrieved by the X cursor in the measurement window are represented as A and B, respectively, the following expression is used:

$$\text{Eye opening ratio (for amplitude)} = 2B / (A + B) \times 100 (\%)$$

When the maximum and minimum time intervals retrieved by the Y cursor are represented as A' and B', respectively, the following expression is used:

$$\text{Eye opening ratio (for time)} = 2B' / (A' + B') \times 100 \%$$

4.4.1 Calculation Using No Measurement Window

When performing the eye opening measurement without displaying the measurement window, the maximum and minimum amplitudes A and B are calculated from the waveform data located by the X cursor as shown in Figure 4-8 and the opening ratio is calculated from A and B.

The maximum and minimum time periods A' and B' are calculated from the waveform data located by the Y cursor on the screen.

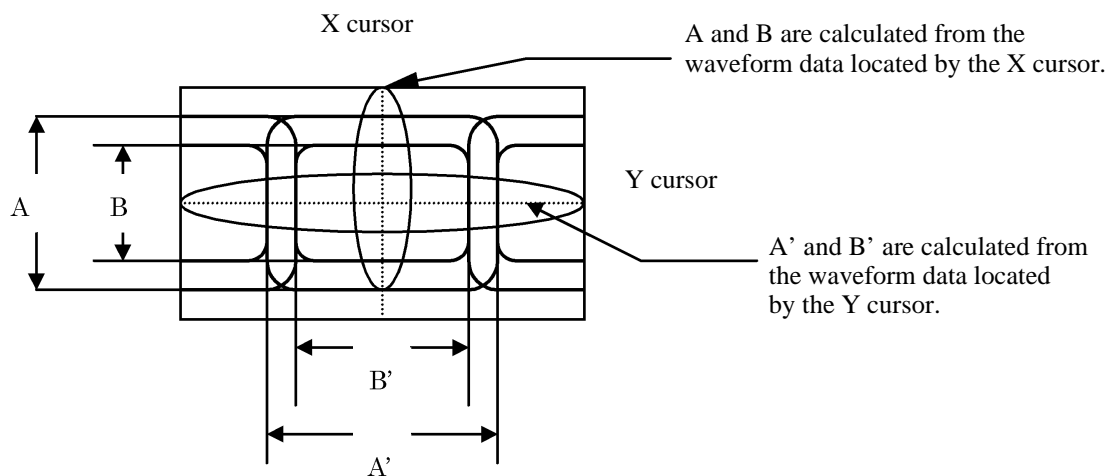

Figure 4-8 Eye Opening Ratio Calculation (Using No Measurement Window)

4.4.2 Calculation using the Measurement Window

When displaying the measurement window and performing the eye opening measurement, the maximum and minimum amplitudes A and B are calculated from the waveform data included in the measurement window shown in Figure 4-9.

The maximum and minimum time periods A' and B' are calculated from the waveform data located by the Y cursor on the screen.

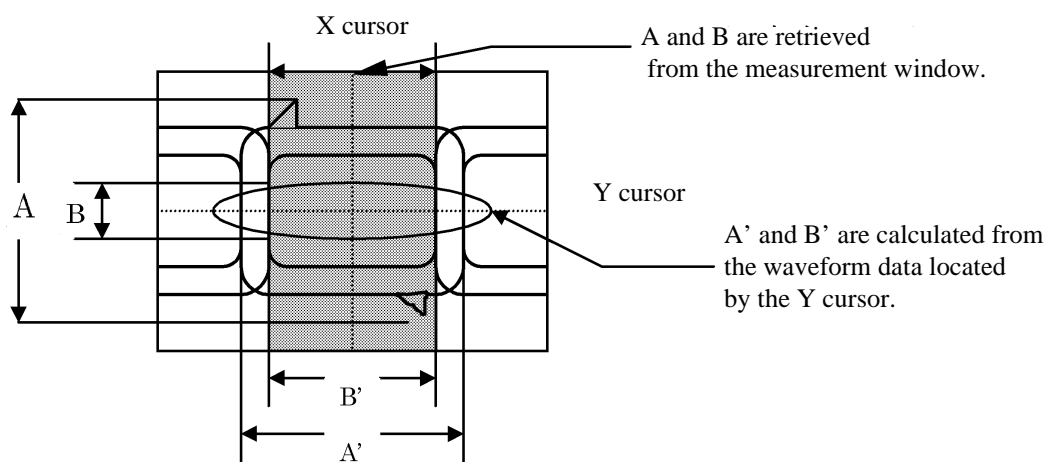

Figure 4-9 Eye Opening Calculation (Using the Measurement Window)

4.5 Phase Jitter Measurement

This section describes the phase jitter measurement function that is built in this instrument.

The phase jitter measurement function used in this instrument measures RMS (root mean squared) phase jitters using the equation shown below. Where RMS phase jitter is $\Delta\theta_{RMS}$ [rad], the carrier power is P_c [W] and the sideband (SSB) power is P_n [W].

$$\Delta\theta_{RMS} = \sqrt{2 \frac{P_n}{P_c}} \quad (1)$$

In this instrument, carrier power P_c is measured first, power spectrum P_n is measured by summation between the start offset and stop offset frequencies and then $\Delta\theta_{RMS}$ is calculated from the expression (1). If the range between the start offset and stop offset frequencies must be divided due to a data acquisition problem, P_n is the sum of the powers within these ranges.

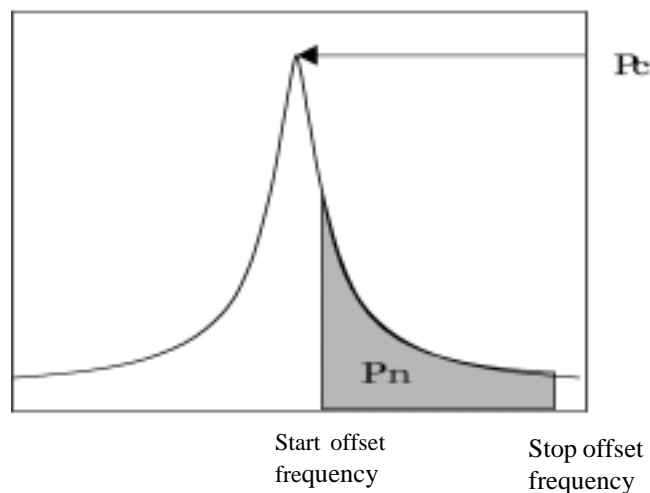

Figure 4-10 RMS Phase Jitter Measurement Method

4.5.1 Additional Functions

The following two functions are available for improving measurement accuracy. If measurements are taken with these functions enabled, however, the amount of time required to perform measurements increases, but the variations between the measurement results are smaller compared to measurements taken when these functions are disabled.

Signal track function: The center frequency can always be tracked and then set when the carrier frequency drifts.

Average function: Performs averaging a specified number of times after dBm data has been converted into watts when sideband power is measured. To obtain stable measurement results, increase the number of times averaging is performed.

5 REMOTE PROGRAMMING

5.1 GPIB Command Index

This GPIB command index can be used as the index for Chapter 5.

<u>GPIB Command</u>	<u>Pages</u>	<u>GPIB Command</u>	<u>Pages</u>
*CLS	5-44	AG.....	5-22
*ESE	5-44	AGL	5-29
*ESR	5-44	AGL OFF.....	5-29
*IDN	5-44	AGL ON	5-29
*RST	5-44	AGR.....	5-21
*SRE	5-44	AGS	5-21
*STB	5-44	AL.....	5-26
*TST	5-44	ALLCOPY A: B:.....	5-36
.	5-43	AM.....	5-21
0 to 9	5-43	AMAX OFF.....	5-21
AA.....	5-23	AMAX ON	5-21
AAVG OFF.....	5-21	AMIN OFF	5-21
AAVG ON.....	5-21	AMIN ON.....	5-21
AB.....	5-21	AMMOD.....	5-31
ACHB	5-22	AMMOD OFF	5-31
ACP.....	5-35	AMMOD ON.....	5-31
ACP OFF	5-35	ANLG OFF.....	5-23
ACP ON.....	5-35	ANLG ON.....	5-23
ACPAVG	5-35	ANLGDLT CUSR	5-23
ACPBSW OFF.....	5-35	ANLGDLT DATA	5-23
ACPBSW ON.....	5-35	ANLGDSP CONT	5-23
ACPNCOF AUTO.....	5-35	ANLGDSP PAUS.....	5-23
ACPNCOF MNL.....	5-35	ANLGTM	5-23
ACPNCOR OFF	5-35	ANNOT OFF	5-25
ACPNCOR ON.....	5-35	ANNOT ON.....	5-25
ACPNC SBS	5-35	ANORM OFF	5-21
ACPREF	5-35	ANORM ON.....	5-21
ACPSCR CARR	5-35	APAVG OFF	5-21
ACPSCR FULL	5-35	APAVG ON.....	5-21
ACPSCR SEPA	5-35	AR.....	5-21
ACPST DEF	5-35	AS	5-26, 5-38
ACPST MNL.....	5-35	AT	5-23
ACPST USR	5-35	ATMIN	5-23
ACTRC TRA	5-21	ATMIN OFF.....	5-23
ACTRC TRB	5-21	ATMIN ON.....	5-23
AD.....	5-44	AUNITS DBEMF.....	5-30
ADG OFF	5-35	AUNITS DBM.....	5-30
ADG ON.....	5-35	AUNITS DBMV.....	5-30

5.1 GPIB Command Index

AUNITS DBPW	5-30	CN2.....	5-31
AUNITS DBUV	5-30	CN3.....	5-31
AUNITS V	5-30	CNAVG	5-40
AUNITS W	5-30	CNIS	5-40
AV.....	5-21	CNIS OFF.....	5-40
AVGOBW	5-39	CNIS ON.....	5-40
AW.....	5-21	CNOFSDEL.....	5-40
BA.....	5-26	CNOFSIN	5-40
BAVG OFF.....	5-22	CNRES.....	5-31
BAVG ON	5-22	CNSIG OFF	5-40
BB	5-22	CNSIG ON.....	5-40
BG.....	5-22	CONTS	5-38
BGR.....	5-22	CORS	5-26
BGS.....	5-22	CORS OFF.....	5-26
BM	5-22	CORS ON	5-26
BMAX OFF.....	5-22	COUNT OFF	5-31
BMAX ON.....	5-22	COUNT ON.....	5-31
BMIN OFF.....	5-22	COVR	5-26
BMIN ON	5-22	COVR OFF.....	5-26
BND.....	5-29	COVR ON.....	5-26
BNDLC OFF.....	5-29	CP OFF	5-37
BNDLC ON.....	5-29	CP ON.....	5-37
BNORM OFF	5-22	CPLMK ANC	5-32
BNORM ON	5-22	CPLMK DLIN.....	5-32
BPAVG OFF.....	5-22	CPLMK DLT.....	5-32
BPAVG ON.....	5-22	CPLMK LLIN.....	5-32
BR	5-22	CPLMK OFF	5-32
BV	5-22	CPLMK TRA.....	5-32
BW	5-22	CR OFF.....	5-30
CA.....	5-29	CR ON	5-30
CARRBS.....	5-35	CRDEL	5-30
CC OFF.....	5-24	CRIN.....	5-30
CC ON	5-24	CS.....	5-29
CDB OFF.....	5-31	CSBSDEL.....	5-35
CDB ON	5-31	CSBSIN	5-35
CF.....	5-29	CSRDX	5-23
CLALL.....	5-24	CSRDY	5-23
CLATT.....	5-24	CSRX.....	5-23
CLCREF	5-24	CSRY	5-23
CLDREF	5-24	CWA	5-21
CLFREF.....	5-24	CWB	5-22
CLLOG	5-24	DB.....	5-43
CLMAG.....	5-24	DC0.....	5-31
CLN	5-24	DC1.....	5-31
CLPBW.....	5-24	DC2.....	5-31
CLRBW	5-24	DD.....	5-30
CLSREF.....	5-24	DEL.....	5-36
CLSTEP	5-24	DEL REG.....	5-36
CLTOTAL	5-24	DET NEG	5-22
CN0.....	5-31	DET NRM.....	5-22
CN1	5-31	DET POS	5-22

DET SMP.....	5-22	GTSRC RF.....	5-38
DETB NEG.....	5-22	GTSWP OFF.....	5-38
DETB NRM.....	5-22	GTSWP ON.....	5-38
DETB POS.....	5-22	GTWID.....	5-38
DETB SMP.....	5-22	GZ.....	5-43
DETSEL AUTO.....	5-22	HARM.....	5-39
DETSEL MNL.....	5-22	HARM OFF.....	5-39
DEV A:.....	5-36	HARM ON.....	5-39
DEV B:.....	5-36	HCCMPRS OFF.....	5-25
DEV ED:.....	5-36	HCCMPRS ON.....	5-25
DEV RAM:.....	5-36	HCDEV FDD.....	5-25
DL.....	5-28	HCDEV MA.....	5-25
DL OFF.....	5-28	HCDEV MB.....	5-25
DL ON.....	5-28	HCDEV PRT.....	5-25
DL0.....	5-44	HCFILE.....	5-25
DL1.....	5-44	HCIMAG COL.....	5-25
DL2.....	5-44	HCIMAG GRY.....	5-25
DL3.....	5-44	HCIMAG MON.....	5-25
DL4.....	5-44	HCIMAG SCOL.....	5-25
DN.....	5-43	HCOPY.....	5-25
DRBW OFF.....	5-26	HRMFND.....	5-39
DRBW ON.....	5-26	HRMFND OFF.....	5-39
DRBWOV.....	5-26	HRMFND ON.....	5-39
DS.....	5-34	HRMNUM.....	5-39
DY.....	5-37	HZ.....	5-43
ENT.....	5-43	IMAVG.....	5-41
ERRNO.....	5-44	IMHS OFF.....	5-41
EYEAMPM.....	5-40	IMHS ON.....	5-41
EYECOR OFF.....	5-40	IMLS3.....	5-41
EYECOR ON.....	5-40	IMLS5.....	5-41
EYEOPN.....	5-40	IMLS7.....	5-41
EYEOPN OFF.....	5-40	IMLS9.....	5-41
EYEOPN ON.....	5-40	IMM OFF.....	5-41
EYESMP.....	5-40	IMM ON.....	5-41
FA.....	5-29	IMMDF.....	5-41
FB.....	5-29	IMMREF.....	5-41
FC OFF.....	5-24	IMMRES.....	5-41
FC ON.....	5-24	IMODR.....	5-41
FO.....	5-29	IMPFC OFF.....	5-41
FO OFF.....	5-29	IMPFC ON.....	5-41
FO ON.....	5-29	IP.....	5-36
FPL.....	5-27	KZ.....	5-43
FPU.....	5-27	LARNG ABOVE.....	5-27
FS.....	5-36	LARNG BELOW.....	5-27
FX OFF.....	5-32	LBRNG ABOVE.....	5-27
FX ON.....	5-32	LBRNG BELOW.....	5-27
FXPK.....	5-31	LC.....	5-44
GTPOS.....	5-38	LIMAPOS ABS.....	5-28
GTSRC EGT.....	5-38	LIMAPOS REL.....	5-28
GTSRC EXT.....	5-38	LIMASFT.....	5-28
GTSRC IF.....	5-38	LIMPOS ABS.....	5-27

5.1 GPIB Command Index

LIMPOS REL	5-27	MKMKS	5-34
LIMSFT	5-28	MKN	5-32, 5-33
LIMTYP FREQ	5-27	MKOFF.....	5-32
LIMTYP TIME.....	5-27	MKRL.....	5-34
LIMXREF.....	5-27	MKSCPL OFF.....	5-37
LIMXREF CENT	5-27	MKSCPL ON.....	5-37
LIMXREF LEFT	5-27	MKSPOS	5-37
LIMXREF UDEF	5-27	MKSWID.....	5-37
LIMYREF.....	5-28	MKSX ALL	5-37
LIMYREF BOTM	5-28	MKSX IN.....	5-37
LIMYREF TOP	5-28	MKSX OUT.....	5-37
LIMYREF UDEF	5-28	MKSY ALL	5-37
LL1.....	5-30	MKSY DLIN	5-37
LL10.....	5-30	MKSY LLIN.....	5-37
LL2.....	5-30	MKSYDL ABOVE.....	5-37
LL5.....	5-30	MKSYDL BELOW	5-37
LMSFAT.....	5-28	MKSYLA ABOVE.....	5-37
LMTA OFF.....	5-27	MKSYLA BELOW	5-37
LMTA ON	5-27	MKSYLB ABOVE.....	5-37
LMTADEL	5-27	MKSYLB BELOW.....	5-37
LMTAIN.....	5-27	MKTRACE TRA	5-32
LMTB OFF.....	5-27	MKTRACE TRB	5-32
LMTB ON.....	5-27	ML	5-32
LMTBDEL.....	5-27	MLF1	5-33
LMTBIN	5-27	MLF10.....	5-33
LOF.....	5-28	MLF2	5-33
LON Label name	5-28	MLF3	5-33
LS.....	5-36	MLF4	5-33
LTSP	5-36	MLF5	5-33
LVF OFF.....	5-29	MLF6	5-33
LVF ON	5-29	MLF7	5-33
LVFDEL	5-29	MLF8	5-33
LVFIN.....	5-29	MLF9	5-33
M0.....	5-34	MLN1.....	5-33
M1	5-34	MLN10.....	5-33
M2	5-34	MLN2.....	5-33
M3	5-34	MLN3.....	5-33
MA	5-43	MLN4.....	5-33
MC	5-34	MLN5.....	5-33
MDF1	5-32	MLN6.....	5-33
MDF2.....	5-32	MLN7.....	5-33
MDL1.....	5-32	MLN8.....	5-33
MDL2.....	5-32	MLN9.....	5-33
MF.....	5-32	MLSF	5-33
MFL	5-32	MLSL.....	5-33
MIS	5-37	MLT OFF.....	5-33
MK	5-32, 5-33	MLT ON	5-33
MKBW.....	5-31	MLTSCR FT.....	5-42
MKCF	5-34	MLTSCR OFF.....	5-42
MKCS	5-34	MLTSCR TT.....	5-42
MKD	5-32	MLTSCR ZM	5-42

MMI A:.....	5-36	PIOOUT.....	5-44
MMI B:.....	5-36	PJAVG.....	5-40
MMI FD:.....	5-36	PJIT.....	5-40
MN.....	5-32, 5-33	PJIT OFF.....	5-40
MNPRT.....	5-25	PJIT ON.....	5-40
MNPRT OFF.....	5-25	PJSIG OFF.....	5-40
MNPRT ON.....	5-25	PJSIG ON.....	5-40
MO.....	5-32	PJSRTO.....	5-40
MPA.....	5-32	PJSTPO.....	5-40
MPM.....	5-32	PKCF.....	5-34
MR.....	5-34	PKLST.....	5-33
MS.....	5-43	PKRL.....	5-34
MTCF.....	5-34	PKTHIRD.....	5-31
MTCS.....	5-34	PKZM3.....	5-42
MTMKS.....	5-34	PKZMN.....	5-42
MTSP.....	5-34	PKZMX.....	5-42
MV.....	5-43	PLLBW.....	5-26
MW.....	5-43	PLLBW AUTO.....	5-26
MXE.....	5-29	PLLBW MID.....	5-26
MXI.....	5-29	PLLBW NARW.....	5-26
MXN.....	5-29	PLLBW WIDE.....	5-26
MXON.....	5-29	PLS FREQ.....	5-33
MXP.....	5-29	PLS LEVEL.....	5-33
MZ.....	5-43	PLS OFF.....	5-33
NI.....	5-31	PPA.....	5-29
NIC.....	5-31	PPM.....	5-29
NIF.....	5-31	PRESL EXTD.....	5-29
NIM.....	5-31	PRESL STD.....	5-29
NIRES.....	5-31	PRT COL.....	5-25
NIU.....	5-31	PRT GRY.....	5-25
NQST OFF.....	5-35	PRT MOL.....	5-25
NQST ON.....	5-35	PRT MOS.....	5-25
NXL.....	5-37	PRT SCOLL.....	5-25
NXM.....	5-37	PRT SCOLS.....	5-25
NXP.....	5-37	PRTCMD ESC.....	5-25
NXR.....	5-37	PRTCMD PCL.....	5-25
OBW.....	5-39	PRTCMDDESCR.....	5-25
OBW OFF.....	5-39	PS.....	5-37
OBW ON.....	5-39	PWAVG.....	5-34
OBWPER.....	5-39	PWCH.....	5-34
OBWST DEF.....	5-39	PWM.....	5-34
OBWST MNL.....	5-39	PWTM.....	5-34
OBWST USR.....	5-39	PWTOTAL.....	5-34
OPF.....	5-27	RB.....	5-26
OPR.....	5-44	RC.....	5-36
OPREVT.....	5-44	RC REG.....	5-36
PFC OFF.....	5-27	REDLT OFF.....	5-32
PFC ON.....	5-27	REDLT ON.....	5-32
PFEED OFF.....	5-25	RESPOS LOW.....	5-28
PFEED ON.....	5-25	RESPOS UP.....	5-28
PFJ.....	5-27	REV.....	5-25

5.1 GPIB Command Index

RFACT.....	5-35	TRGSRC FREE	5-38
RL	5-30	TRGSRC IF	5-38
RLSANC.....	5-23	TRGSRC LINE.....	5-38
RO	5-30	TRGSRC RF	5-38
RO OFF.....	5-30	TRGSRC VIDEO	5-38
RO ON	5-30	TS.....	5-38
RQS.....	5-44	TYP	5-25
S0	5-44	UP	5-43
S1	5-44	US	5-43
S2	5-44	VA.....	5-26
SC.....	5-43	VB.....	5-26
SCRSEL TRA.....	5-42	VER	5-25
SCRSEL TRB	5-42	WDO OFF.....	5-42
SETANC.....	5-23	WDO ON	5-42
SG OFF.....	5-32	WDOSWP OFF	5-38
SG ON.....	5-32	WDOSWP ON.....	5-38
SI.....	5-38	WDX	5-34, 5-42
SIGID OFF	5-29	WLX	5-34, 5-42
SIGID ON	5-29	XDB	5-31
SN	5-38	XDL	5-31
SNGLS.....	5-38	XDR	5-31
SP	5-36	XYCSR OFF.....	5-23
SPRDEL.....	5-39	XYCSR ON	5-23
SPRIN	5-39	ZMOFF	5-42
SPRLD	5-39	ZMON.....	5-42
SPRSV	5-39	ZMPOS	5-42
SPRTBL.....	5-39	ZMWID	5-42
SPURI	5-39	ZS.....	5-36
SPURI OFF.....	5-39		
SPURI ON	5-39		
SR.....	5-38		
ST.....	5-26, 5-38		
SV	5-36		
SV REG	5-36		
SW	5-26, 5-38		
SWM.....	5-38		
SWPCNT	5-22		
SYMRT.....	5-35		
TA	5-21		
TAA	5-23		
TAB	5-23		
TB	5-22		
TBA	5-23		
TBB.....	5-23		
TPL	5-25		
TPS.....	5-25		
TRGDT	5-38		
TRGLVL.....	5-38		
TRGSLP FALL.....	5-38		
TRGSLP RISE.....	5-38		
TRGSRC EXT	5-38		

5.2 GPIB Remote Programming

The analyzer is equipped with a GPIB (General Purpose Interface Bus) that complies with IEEE Standard 488.1-1978. This bus allows you to attach and use an external device to remotely control the analyzer.

5.2.1 GPIB

The GPIB is a high-performance interface bus used to connect measuring instruments to a computer. IEEE Standard 488.1-1978 defines the operations of the GPIB. Since the GPIB has a bus-configured interface, connected devices are designated by assigning them a specific address. You can connect up to 15 devices in parallel using a single bus. GPIB devices perform one or more of the following functions:

- **Talker** Sends data to the bus. Only one active talker can exist on the GPIB bus.
- **Listener** Receives data from the bus. Multiple active listeners can exist on the GPIB bus.
- **Controller** Specifies which devices are designated as “talkers” or “listeners”. Only one active controller can operate on the GPIB bus. Controllers used to control IFC and REN messages are referred to as system controllers.

When there are multiple controllers attached to the bus, the system controller becomes the active controller by default. Other devices that can act as controllers operate as addressable devices when the system is activated.

The TCT (Take Control) interface message is used to set a controller other than the system controller as the active controller. After this setting is made, the system controller becomes inactive.

The controller controls the entire system by sending interface messages or device messages to each measuring instrument. The functions of the messages are:

- **Interface message:** messages used to control the GPIB bus
- **Device message:** messages used to control specific devices

5.2.2 GPIB Setup

5.2.2 GPIB Setup

(1) Connecting the GPIB

The following figure shows the standard GPIB connector and how it can be connected in parallel, or “stacked” with other connectors. Attach the GPIB connectors and secure them by tightening the screws to prevent them from coming apart during use.

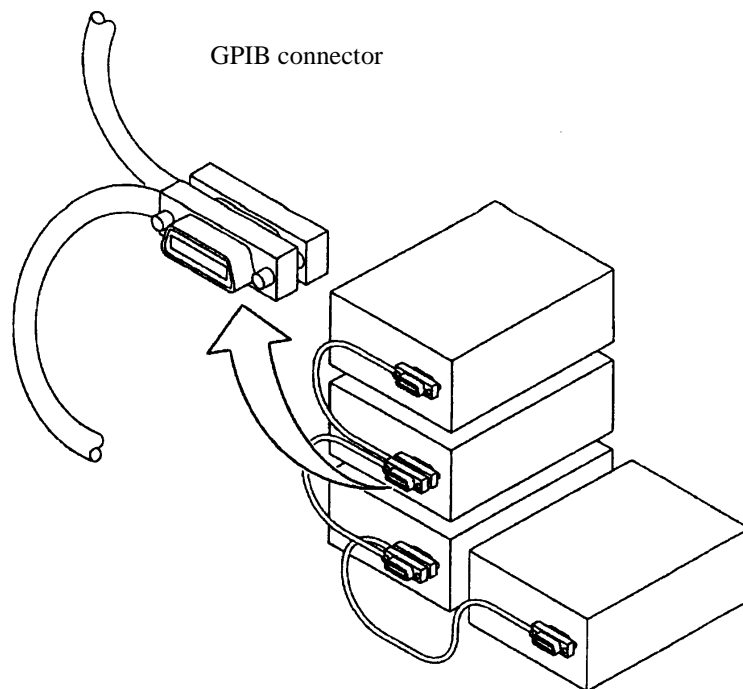

The following conditions should be observed when using a GPIB interface:

- The total GPIB cable length in a single bus system must not be more than 20m (you can calculate the current cable length using the formula $\text{total length} = n \times 2\text{m}$, where, n is the number of devices to be connected, including the GPIB controller).
- No more than 15 devices can be connected to a single bus system.
- There are no restrictions concerning the method of connection between cables. However, no more than three GPIB connectors should be connected to a single device, since more than this may damage the connector mounting due to excessive strain.

(Example) The total cable length in a system with five devices should be 10m or less ($2\text{m} \times 5 \text{ devices} = 10\text{m}$). There is no restriction on the length of the cables between the individual devices as long as the total length does not exceed 10m. However, if you connect 10 devices or more, make sure that at least some of the cables attaching the devices are less than 2m so that the total is less than 20m.

(2) Setting the GPIB Address

Use the following procedure to set the GPIB address for the analyzer:

1. Press **CONFIG** and *GPIB Address*.
The GPIB Address dialog box is displayed.
2. Use the data knob, the step keys, or the numeric keys to set the GPIB address as required.
3. Press **ENTR (Hz)** to set the address.

(3) Measurements without displaying characters

When in the remote control mode, measurement speed becomes higher if you turn OFF "Display ON/OFF."

1. Press **CONFIG** and *Display ON/OFF(OFF)*.
OFF is selected, and all indications except for the trace are removed.

5.2.3 GPIB Interface Functions

Code	Description
SH1	Source handshake
AH1	Acceptor handshake
T6	Basic talker, serial polling, listener-specified talker cancel
TE0	Extended talker (not available)
L4	Basic listener function, talker-specified listener cancel
LE0	Extended listener (not available)
SR1	Service request function
RL1	Remote, local, local lockout
PP0	Parallel polling (not available)
DC1	Device clear
DT0	Device trigger (not available)
C0	System controller (not available) (standard)
C1	System controller (option)
C2	IFC transmission, Controller Charging Functions (option)
C3	REN Transmission Function (option)
C4	SRQ Response Function (option)
C12	Interface Message Transmission Function and Control privilege Exchanging Function (option)
E1	Using open-collector bus driver

5.2.4 Responses to Interface Messages

The IEEE Standard 488.1-1978 defines how the analyzer responds to interface messages. The responses are described in this section.

For information on how to send interface messages to the analyzer, refer to the instruction manual of the controller you are using.

(1) Interface Clear (IFC)

The IFC message is transmitted directly to the analyzer through a signal line. The message allows the analyzer to stop the operation of the GPIB bus. Although all input/output operation is stopped, the input/output buffer is not cleared. Note that the DCL is used to clear the buffer.

(2) Remote Enable (REN)

The REN message is transmitted directly to the analyzer through a signal line. If the analyzer is specified as a listener when the message is true, the analyzer is in remote mode. The analyzer remains in remote mode until the GTL message is received, REN becomes false, or you press the **LOCAL** key.

When the analyzer is in local mode, it ignores all received data, and key inputs (except for **LOCAL** key input) and when the analyzer is in LOCAL LOCKOUT mode, it ignores all key input.

(3) Serial Polling Enable (SPE)

When the analyzer is receiving a message from an external device, it is in serial polling mode. If the analyzer is specified as a talker in this mode, it sends status bytes instead of normal messages. the analyzer remains in the serial polling mode until the SPD (Serial Polling Disable) message or the IFC message is received.

When the analyzer sends an SRQ (Service Request) message to the controller, bit 6 (RQS bit) of the response data is set to 1 (true). When the analyzer has finished sending this message, the RQS bit reverts to 0 (false). The SRQ message is sent directly through a signal line.

(4) Device Clear (DCL)

When the analyzer receives a DCL message, it performs the following actions:

- Clears the input and output buffers.
- Resets syntax analysis, execution control, and response data generation.
- Cancels all commands that prevent the remote command from being executed next.
- Cancels commands that are paused to wait for other parameters.

When the analyzer receives the DCL message, it does not do the following:

- Changes data set or stored in the analyzer.
- Interrupt front panel operation.
- Modifie or interrupt any the analyzer operations being executed.
- Change any status bytes other than MAV (MAV becomes 0 when the output buffer is cleared).

(5) Selected Device Clear (SDC)

The SDC message operates in the same manner as the DCL message. However, it is executed only when the analyzer is a listener. In other cases, the SDC message is ignored.

(6) Go to Local (GTL)

The GTL message puts the analyzer into local mode. In local mode, all the operations normally accessible from the front panel are available.

(7) Local Lockout (LLO)

The LLO message puts the analyzer in the local lockout mode. If the analyzer is set to the remote mode when this is done, all operations normally available from the front panel are disabled (note that in the normal remote mode, you can perform front panel operations using the **LOCAL** key).

You can use one of the following three methods to set the analyzer to local mode from the local lockout mode:

- Send a GTL message to the analyzer
- Set the REN message to false (the local lockout mode will be canceled)
- Turn the analyzer power off and on again

5.2.5 Message Exchange Protocol

The analyzer receives program messages from controllers or other devices through the GPIB bus and generates response data. Program messages include commands, queries (commands used to query response data) and data. The procedure used to exchange these commands, queries and data is explained in this section.

(1) GPIB Buffers

The analyzer is equipped with the following two buffers:

(a) Input Buffer

The input buffer is used to store data temporarily for command analysis (it has a length of 1024 bytes so an input larger than this is ignored.)

Use either of the following two methods to clear this buffer:

- Turn the analyzer power on.
- Execute DCL or SDC.

(b) Output Buffer

The output buffer is used to store data which is going to be read from the controller (1024 bytes).

Use either of the following two methods to clear this buffer:

- Turn the analyzer power on.
- Execute DCL or SDC.

5.2.6 Command Syntax

(2) Message Exchange

GPIB control between a controller and a device consists of two main elements: query and response data generation. These are explained below.

(a) Parser

The parser receives command messages in the order of reception from the input buffer, analyzes the syntax, and determines what the received command is.

(b) Response Data Generation

When the parser determines what the query is, the analyzer generates data in the output buffer in response (that is, to output data a query must be sent immediately before the data).

5.2.6 Command Syntax

Command programs for the analyzer are defined using the following format:

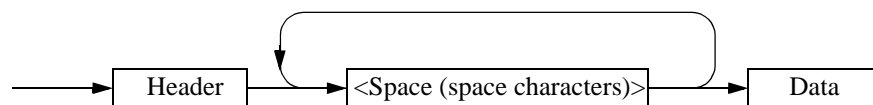

(1) Header

Two types of header are available: the common command header and the simple header. The common command header has an asterisk (*) at the beginning of the mnemonic.

The simple header is a functionally independent command that has no hierarchical structure.

You can form a query command by attaching a “?” in the rear of a header.

(2) Space (Space Character)

You should separate the header from the data by one or more spaces.

(3) Data

When the command requires multiple data, data is separated by commas. A space may be inserted before or after each comma. For more information on data types, see Section 5.2.7 Data Formats.

(4) Writing Multiple Commands

You can write multiple commands by separating them with semicolons in one line.

5.2.7 Data Formats

The analyzer uses the following data formats for the input and output data.

(1) Numeric Data

There are three numeric data formats, any of which can be used for input. Some commands add units to the data when the data is input. The following shows the three numeric data formats.

- Integer type: NR1 format

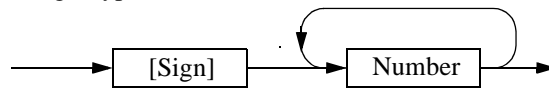

- Fixed-point type: NR2 format

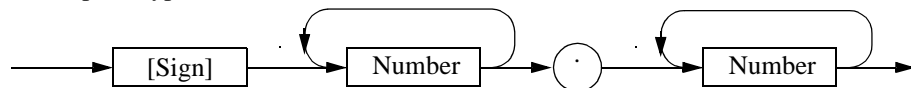

- Floating-point type: NR3 format

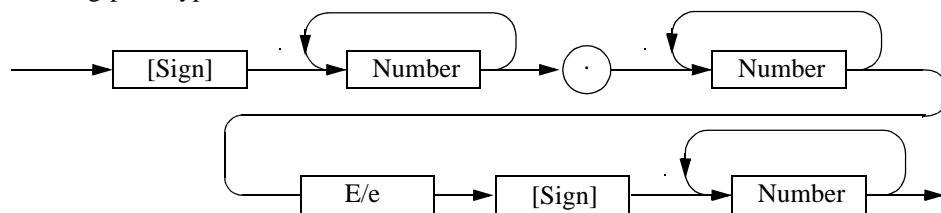

(2) Units

The table below lists the units that you can use.

Unit	Exponential	Description
GZ	10^9	Frequency
MZ	10^6	Frequency
KZ	10^3	Frequency
HZ	10^0	Frequency
VOLT	10^0	Voltage
MV	10^{-3}	Voltage
UV	10^{-6}	Voltage
NV	10^{-9}	Voltage
MW	10^{-3}	Power
DB	10^0	dB correspondence
MA	10^{-3}	Electric Current
SC	10^0	Second
MS	10^{-3}	Second
US	10^{-6}	Second
PER	10^0	Percentage
%	10^0	Percentage

5.2.8 Status Bytes

The analyzer has a hierarchical status register structure which complies with IEEE Standard 488.2-1987. This is used to send information on the status of various aspects of a device to the controller. This section explains the status byte and event assignments operation models.

(1) Status Register

The analyzer uses the status register model defined by IEEE Standard 488.2-1987. This consists of a condition register, an event register and an enable register.

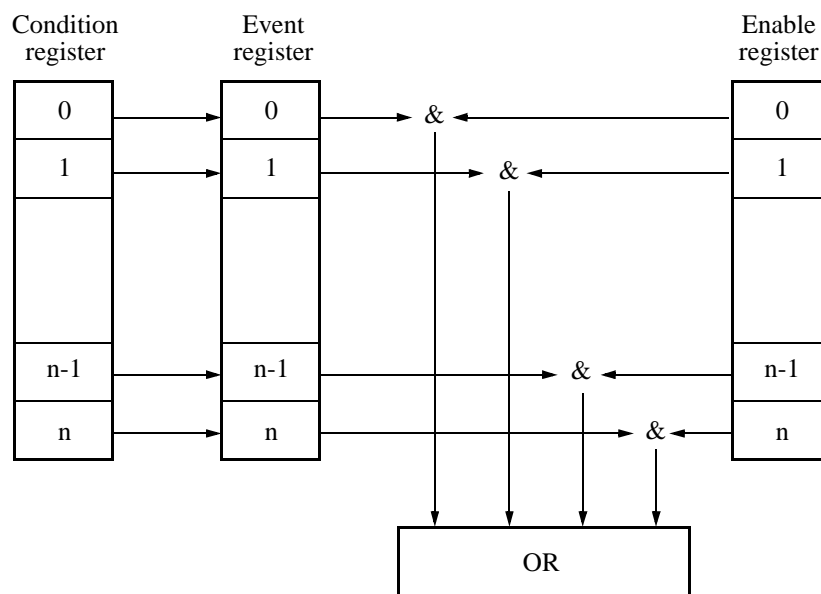

(a) Condition Register

The condition register continuously monitors the status of devices, showing their latest status. However, this register is used internally, so no data can be written into or read out from this register.

(b) Event Register

The event register latches and retains the status information from the condition register (in some cases, it retains status changes).

Once the register is set, the condition is maintained until a query command reads out the information or the register is reset by means of the *CLS command. No data can be written into the event register.

(c) Enable Register

The enable register specifies which bit in the event register is to be used as the valid status to generate a summary. The enable register is ANDed with the event register. The OR of the result of the AND operation is generated as a summary. The summary is written into the following status byte registers.

Any data can be written into the enable register.

The following three types of status registers are used in the analyzer:

- Status byte register
- Standard event register
- Standard operation status register

The arrangement of the status registers of the analyzer are shown in Figure 5-1.

The status registers are shown in detail in Figure 5-2.

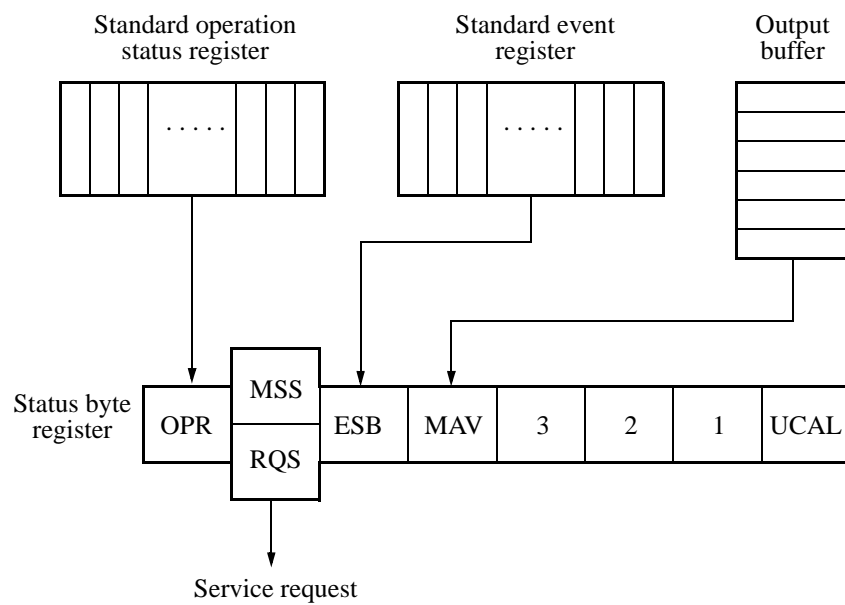

Figure 5-1 Arrangement of the Three Status Registers

5.2.8 Status Bytes

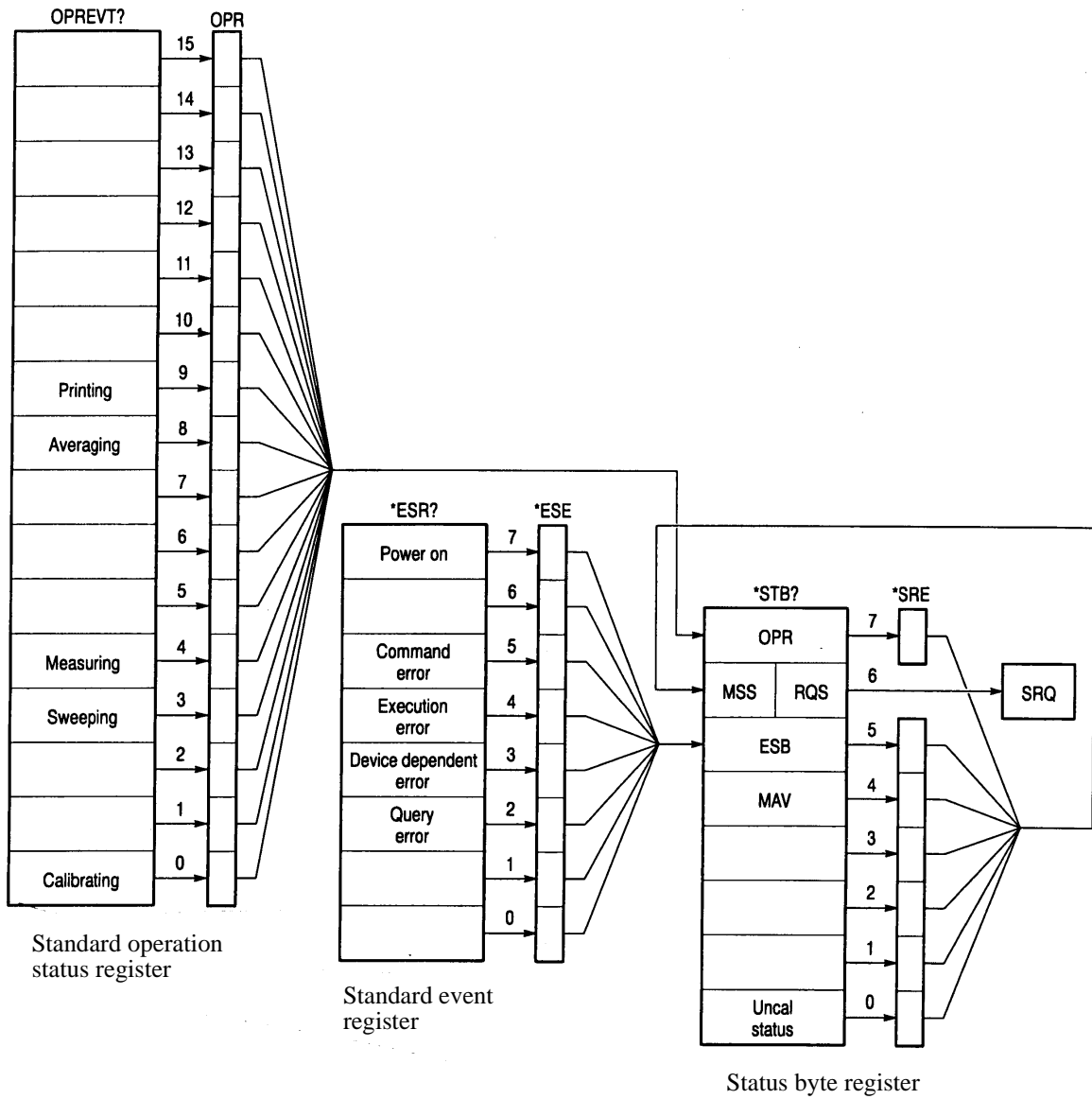

Figure 5-2 Details of the Three Status Registers

(2) Event Enable Register

Each event register has an enable register to determine which bit is available. The enable register sets the corresponding bit in decimal value.

- Set of Service Request Enable Register: *SRE
- Set of Standard Even Status Enable Register: *ESE
- Set of Operation Status Enable Register: OPR

Example: Only the Measuring bit in the operation status register is available.

The OPR bit of the status byte register is set to 1 when the Measuring bit of the operation status register is set to one.

PRINT @8;"OPR16" (An example of the program in N88BASIC)

OUTPUT 708;"*OPR16" (An example of the program for the HP200 and 300 series)

Example: The OPR (the summary of Operation Status Register) bit and ESB (the summary of Event Status Register) bit of the status byte register are available.

The MSS bit of the status byte register is set to 1 when the OPR bit or the ESB bit is set to one.

PRINT @8;"SRE160" (An example of the program in N88BASIC)

OUTPUT 708;"*SRE160" (An example of the program for the HP200 and 300 series)

(3) Standard Operation Status Register

Bit assignments for the event register (which represents the standard operation status) is listed below:

Bit	Functional definition	Description
15 to 10		This is always 0
9	Printing	This is set to 1 at the end of printing
8	Averaging	This is set to 1 when averaging is completed
7 to 5		This is always 0
4	Measuring	This is set to 1 at the end of sequence measurement
3	Sweeping	This is set to 1 when sweeping is completed
2 to 1		This is always 0
0	Calibrating	This is set to 1 when calibration data acquisition finishes

5.2.8 Status Bytes

(4) Status Byte Register

The status byte register summarizes the information from the status register. In addition, a summary of the status byte register is sent to the controller as a service request. As a result, this register operates slightly differently from the status register. This section explains the status byte register.

The structure of the status byte register is shown in Figure 5-3.

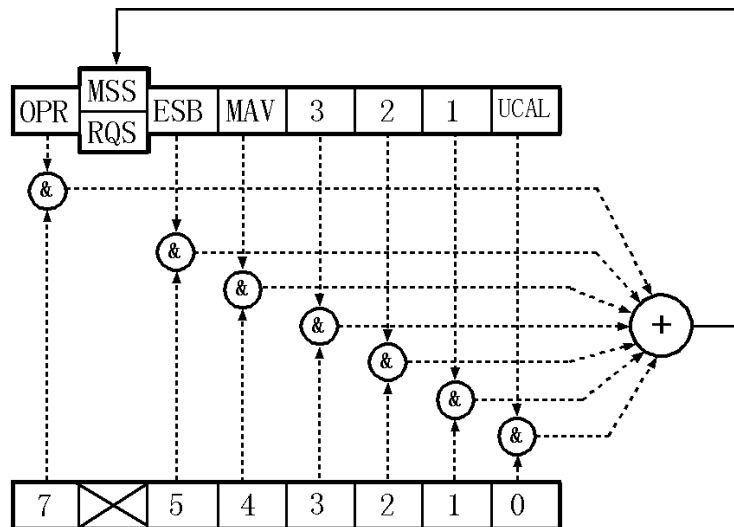

Figure 5-3 Structure of the Status Byte Register

This status byte register has the same functions as the status register, except for the following three points:

- The summary of the status byte register is written in bit 6 of the status byte register.
- Bit 6 of the enable register is always valid and cannot be changed.
- Bit 6 (MSS) of the status byte register writes the RQS of the service request.

The register responds to serial polling from the controller. On doing so, bits 0 to 5 and bit 7 of the status byte register and the RQS are read out, and then the RQS is reset to 0. Other bits are not cleared until each factor has been reset to 0.

When the *CLS and S2 commands are executed, the status byte register, the RQS bit, and the MSS bit can be cleared. Consequently, the SRQ line is now false.

The table below explains the meanings of the bits in the status byte register.

Bit	Function	Description
7	OPR	The OPR bit is a summary of the standard operation status register
6	MSS	The RQS bit is true when the MSS bit of the status byte register is set to 1. The MSS bit is the summary bit for the entire status data structure. The serial poll cannot read out the MSS bit. (However, the MSS bit is understood to be 1 when the RQS bit is 1.) To read the MSS bit, use the common command *STB?. The *STB? command can read out bit 0 to 5 and bit 7 of the status byte register and the MSS bit. In this case, neither the status byte register nor the MSS bit can be cleared. The MSS bit cannot become 0 until all the unmasked factors in the status register structure have been cleared
5	ESB	The ESB bit is a summary of the standard event register
4	MAV	Summary bit for the output buffer. The analyzer does not use this bit.
3 to 1		This is always 0
0	UCAL	This is set to 1 when an signal level error occurs because the sweep is too fast

5.2.8 Status Bytes

(5) Standard event register

The table below explains the meanings of the bits in the standard event register.

Bit	Functional definition	Description
7	Power on	This is set to 1 when the analyzer is switched on
6		This is always 0
5	Command Error	This is set to 1 when the parser finds a syntax error
4	Execution Error	This is set to 1 when the system fails to execute an instruction received as a GPIB command for some reason (such as out-of-range parameter)
3	Device Dependent Error	This is set to 1 when errors other than command errors, execution errors, or query errors occur
2	Query Error	This is set to 1 when no data exists or data has been deleted when the controller attempts to read out data from the analyzer
1	Request Control	Not supported in the analyzer
0	Operation Complete	Not supported in the analyzer

5.2.9 GPIB Command Codes

The following tables list the GPIB commands by function.

Listener Code Column: An asterisk (*) in the Listener Code Column indicates that the function requires numeric data together with the function code.

The sign [*] in the Listener Code Column indicates that the function can be omitted.

String data such as file name, label and so on can receive characters, which are found after the command and prior to the delimiter, as input values. However, when data begins with a “/”, the characters between “/” and “/” are received as input.

Output Format Column: A comma (,) in the Output Format column indicates that multiple items are output.

ON/OFF or AUTO/MANUAL in the Output Format column indicates that the code outputs 1 or 0, respectively.

All frequencies are in hertz (Hz), and all times are in seconds. Levels are output in the currently displayed unit.

Table 5-1 A Key/B Key (Trace A/Trace B) (1 of 3)

Function	Listener Code	Talker Request		Panel Key	Remarks
		Code	Output Format		
Trace	Active Trace A	ACTRC TRA	ACTRC?	0:Activates Trace A	A
	Active Trace B	ACTRC TRB		1:Activates Trace B	B
	Trace A	---	TA?	(Low-order bytes) 0: Write 1: View 2: Blank 3: Normalize (High-order bytes) 0: Nothing 1: +Max Hold 2: +Averaging 3: +Min Hold 4: Power Average	A
	A Write	AW	---	---	A
	A View	AV	---	---	A
	A Blank	AB	---	---	A
	A Max Hold ON	AM	---		A
	OFF	AMAX ON AMAX OFF	AMAX?	0: OFF 1: ON	A A
	A Min Hold ON	AMIN ON	AMIN?	0: OFF	A
	OFF	AMIN OFF		1: ON	A
	A Averaging ON	AAVG ON AGR	AAVG?	0: OFF 1: ON	A A
	OFF	AAVG OFF AGS	AAVG?		A A
	A Normalize ON	ANORM ON	ANORM?	0: OFF	A
	OFF	ANORM OFF		1: ON	A
	Normalize with Store Corr.	AR	---	---	A
	Power Average ON	APAVG ON APAVG OFF	APAVG?	0: OFF 1: ON	 A
	Clearing Trace A	CWA	---	---	A

5.2.9 GPIB Command Codes

Table 5-1 A Key/B Key (Trace A/Trace B) (2 of 3)

Function	Listener Code	Talker Request		Panel Key	Remarks		
		Code	Output Format				
Trace	Trace B	—	TB?	(Low-order bytes) 0: Write 1: View 2: Blank 3: Normalize (High-order bytes) 0: Nothing 1: +Max Hold 2: +Averaging 3: +Min Hold 4: Power Average	B		
B Write	BW	—	—	B			
B View	BV	—	—	B			
B Blank	BB	—	—	B			
B Max Hold ON	BM	—	—	B			
OFF	BMAX ON BMAX OFF	BMAX?	0: OFF 1: ON	B B			
B MIN Hold ON	BMIN ON	BMIN?	0: OFF	B			
OFF	BMIN OFF	—	1: ON	B			
B Averaging ON	BAVG ON	BAVG?	0: OFF	B			
OFF	BGR BAVG OFF BGS	— BAVG? —	1: ON	B B B			
B Normalize ON	BNORM ON	BNORM?	0: OFF	B			
OFF	BNORM OFF	—	1: ON	B			
Normalize with Store Corr.	BR	—	—	B			
Power Average ON	BPAVG ON	BPAVG?	0: OFF				
	BPAVG OFF	—	1: ON				
Clearing Trace B	CWB	—	—	B			
A←→B	ACHB	—	—	A&B			
Number of sweep	SWPCNT * AG * BG *	SWPCNT? AG? BG?	Integer (2 to 999)	A&B A&B A&B	Common for the following functions: A Max Hold, A Min Hold, A Average, B Max Hold, B Min Hold and B Average.		
Trace detector	Trace A	normal Positive Negative Sample	DET NRM DET POS DET NEG DET SMP	DET?	0: normal 1: Positive 2: Negative 3: Sample	A A A A	
	Trace B	normal Positive Negative Sample	DET NRM DET POS DET NEG DET SMP	DET B?	0: normal 1: Positive 2: Negative 3: Sample	B B B B	
	Detector Selection	AUTO MANUAL	DETSSEL AUTO DETSSEL MNL	DETSSEL?	0: MNL 1: AUTO	A&B A&B	Common for the following functions: A Max Hold, A Min Hold, A Average, B Max Hold, B Min Hold and B Average.

Table 5-1 A Key/B Key (Trace A/Trace B) (3 of 3)

Function	Listener Code	Talker Request		Panel Key	Remarks	
		Code	Output Format			
Artificial Analog	Artificial Analog ON OFF	ANLG ON ANLG OFF	ANLG?	0: OFF 1: ON	A A	Available only when the XY cursor is set to on.
	Display Mode PAUSE CONT	ANLGDSP PAUS ANLGDSP CONT	ANLGDSP?	0: PAUSE 1: CONT	A A	
	Sampling Times	ANLGTM *	ANLGTM?	Integer (2 to 32)	A	
	Y display mode Cursor Data	ANLGLT CUSR ANLGLT DATA	ANLGLT?	0: Cursor 1: Data	A	
XY Cursor	XY Cursor ON OFF	XYCSR ON XYCSR OFF	XYCSR?	0: OFF 1: ON	A&B A&B	Available only when the XY cursor is set to on.
	X Cursor Position	CSRX *	CSRX?	Frequency/hour	A&B	
	Y Cursor Position	CSRY *	CSRY?	Level	A&B	
	Reading of ΔX value	—	CSRDX?	Frequency/Time	A	
	Reading of ΔY value	—	CSRDY?	Level	A	
	Set Anchor	SETANC	—	—	A&B	
Remove Anchor	RLSANC	—	—	A&B		
Trace Data	Output from A memory ASCII BINARY	— —	TAA? TBA?	5 bytes + Delimiter 2 bytes × 1001 points (or 501 points)		For 1 point EOI signal
	Output from B memory ASCII BINARY	— —	TAB? TBB?	5 bytes + Delimiter 2 bytes × 1001 points (or 501 points)		For 1 point EOI signal
	Input from A memory ASCII BINARY	TAA TBA	— —	— —		For 1 point EOI signal
	Input from B memory ASCII BINARY	TAB TBB	— —	— —		For 1 point EOI signal

Table 5-2 ATT Key (Attenuator)

Function	Listener Code	Talker Request		Panel Key	Remarks
		Code	Output Format		
Attenuator	ATT	AT *	AT?	Level	ATT
	ATT AUTO	AA	AA?	0: MNL 1: AUTO	ATT
	Min.ATT	ATMIN *	ATMIN?	Level	ATT
	Min.ATT ON OFF	ATMIN ON[*] ATMIN OFF	ATMINON?	0: OFF 1: ON	ATT ATT

5.2.9 GPIB Command Codes

Table 5-3 CAL Key (Calibration)

Function	Listener Code	Talker Request		Panel Key	Remarks	
		Code	Output Format			
Calibration	Cal ALL	CLALL	—	—	CAL	Saves the correction value. Initializes the correction value.
	Total Gain Cal.	CLGAIN	—	—	CAL	
	Input ATT Cal.	CLATT	—	—	CAL	
	IF Step AMP Cal.	CLSTEP	—	—	CAL	
	RBW Switching Cal.	CLRBW	—	—	CAL	
	Log Linearity Cal.	CLLOG	—	—	CAL	
	Amplitude MAG Cal.	CLMAG	—	—	CAL	
	PBW Cal.	CLPBW	—	—	CAL	
	Calibration level	CLN *	CLN?	Level	CAL	
	Cal 10 M Reference Coarse	CLCREF *	CLCREF?	Integer (0 to 255)	CAL	
	Cal 10 M Reference Fine	CLFREF *	CLFREF?	Integer (0 to 255)	CAL	
	Cal 10 M Reference Default	CLDREF	—	—	CAL	
	Cal 10 M Reference Store	CLSREF	—	—	CAL	
	Freq Corr ON	FC ON	FC?	0: OFF	CAL	
	OFF	FC OFF		1: ON	CAL	
	Cal Corr ON	CC ON	CC?	0: OFF	CAL	
OFF	CC OFF		1: ON	CAL		

Table 5-4 CONFIG Key (Configuration)

Function	Listener Code	Talker Request		Panel Key	Remarks
		Code	Output Format		
Trace Point switching	Number of points 501 points	TPS	TP?	0: 501 points	CONFIG
	1001 points	TPL		1: 1001 points	CONFIG
Printer output	Color mode	PRT COL	---	---	CONFIG
	Simple color image Standard Size	PRT SCOLL	---	---	CONFIG
	Reduced Size	PRT SCOLS	---	---	CONFIG
	Gray mode	PRT GRY	---	---	CONFIG
	Monochrome L size	PRT MOL	---	---	CONFIG
	S size	PRT MOS	---	---	CONFIG
	Printer command ESC/P	PRTCMD ESC	---	---	CONFIG
	PCL ESC/P Raster	PRTCMD PCL PRTCMD ESCR	---	---	CONFIG CONFIG
Menu Print ON	MNPRT ON	MNPRT?	0: OFF	CONFIG	
OFF	MNPRT OFF		1: ON		
Paper Feed ON	PFEED ON	PFEED?	0: OFF	CONFIG	
OFF	PFEED OFF		1: ON		
Execution of the command	HCOPY	---	---	COPY	
Bitmap file	Copy image COLOR	HCIMAG COL	---	---	CONFIG
	Simple color image	HCIMAG SCOL	---	---	CONFIG
	GRAY	HCIMAG GRY	---	---	CONFIG
	MONO	HCIMAG MON	---	---	CONFIG
	Compression ON	HCCMPRS ON	---	---	CONFIG
	OFF	HCCMPRS OFF	---	---	CONFIG
	File No.	HCFILE *	---	Integer (000 to 999)	CONFIG
Menu Print ON	MNPRT ON	MNPRT?	0: OFF	CONFIG	
OFF	MNPRT OFF		1: ON		
Execution of the command	HCOPY	---	---	COPY	
Reading image data	---	BMP?	binary data <EOI>		
Copy Config	Copy Device Printer	HCDEV PRT	---	---	CONFIG
	Memory card A	HCDEV MA	---	---	CONFIG
	Memory card B	HCDEV MB	---	---	CONFIG
	Floppy disk	HCDEV FDD	---	---	CONFIG
Execution of the command	HCOPY	---	---	COPY	
Indication	Annotation ON	ANNOT ON	ANNOT?	0: OFF	CONFIG
	OFF	ANNOT OFF		1: ON	
Others	Reading machine version	---	VER?	0: R3267 1: R3273 2: R3264	
	Reading machine type (Character string)	---	TYP?	Character string + Delimiter	
	Reading the revision	---	REV?	Character string + Delimiter	

Area enclosed with thick lines is for optional functions.

5.2.9 GPIB Command Codes

Table 5-5 COUPLE Key (Couple Function)

Function	Listener Code	Talker Request		Panel Key	Remarks
		Code	Output Format		
Couple function	RBW	RB *	RB?	Frequency	COUPLE
	RBW AUTO	BA	BA?	0: MNL 1: AUTO	COUPLE
	VBW	VB *	VB?	Frequency	COUPLE
	VBW AUTO	VA	VA?	0: MNL 1: AUTO	COUPLE
	Sweep Time	SW * ST *	SW? ST?	Time Time	COUPLE COUPLE
	Sweep Time AUTO	AS	AS?	0: MNL 1: AUTO	COUPLE
	Couple All AUTO	AL	AL?	0: MNL 1: ALL AUTO	COUPLE
	RBW: SPAN	CORS *	CORS?	Ratio (0.001 to 0.1)	COUPLE
	RBW: SPAN ON OFF	CORS ON[*] CORS OFF	CORSON?	0: OFF 1: ON	COUPLE COUPLE
	VBW: RBW	COVR *	COVR?	Ratio (0.003 to 3)	COUPLE
	VBW: RBW ON OFF	COVR ON[*] COVR OFF	COVRON?	0: OFF 1: ON	COUPLE COUPLE
	PLL bandwidth AUTO Wide Medium Narrow	PLLBW AUTO PLLBW WIDE PLLBW MID PLLBW NARW	PLLBW?	0: Auto 1: Narrow 2: Medium 3: Wide	COUPLE COUPLE COUPLE COUPLE
	RBW≤100Hz Digital Analog	DRBW ON DRBW OFF	DRBW?	0: Analog 1: Digital	COUPLE COUPLE
	IF/ADC Over range status	—	DRBWV?	0: Normal 1: Over range	COUPLE

Table 5-6 FORMAT Key (Display Format) (1 of 2)

Function	Listener Code	Talker Request		Panel Key	Remarks
		Code	Output Format		
Limit line	Selecting limit line types				
	Frequency domain	LIMTYP FREQ	LIMTYP?	0: Frequency domain	FORMAT
	Time domain	LIMTYP TIME		1: Time domain	FORMAT
	PASS/FAIL judgment ON	PFC ON	PFC?	0: OFF	FORMAT
	OFF	PFC OFF		1: ON	FORMAT
	Reading the judgment result	—	PFJ?	0: PASS 1: FAIL	FORMAT
	Reading the judgment result (in detail)	—	OPF?	0: PASS 1: FAIL (Upper) 2: FAIL (Lower) 3: FAIL (Upper & Lower) 4: Error	FORMAT
	Upper side FAIL points Reading	—	FPU?	Number of points n<DLM> f1, l1<DLM>... fn, ln <DLM>	FORMAT
	Lower side FAIL points Reading	—	FPL?	Number of points n<DLM> f1, l1<DLM>... fn, ln <DLM>	FORMAT
	Limit Line 1				
	ON	LMTA ON	LMTA?	0:OFF	FORMAT
	OFF	LMTA OFF		1: ON	FORMAT
	PASS range ABOVE the Line	LARNG ABOVE	LARNG?	0: Above the Line	FORMAT
	BELOW the Line	LARNG BELOW		1: Below the Line	FORMAT
	Entering data in the table	LMTAIN *	—	Frequency (Time), Level	FORMAT
	Deleting the table	LMTADEL	—	—	FORMAT
	Limit Line 2				
	ON	LMTB ON	LMTB?	0:OFF	FORMAT
	OFF	LMTB OFF		1: ON	FORMAT
PASS range ABOVE the Line	LBRNG ABOVE	LBRNG?	0: Above the Line	FORMAT	
BELOW the Line	LBRNG BELOW		1: Below the Line	FORMAT	
Entering data in the table	LMTBIN *	—	Frequency (Time), Level	FORMAT	
Deleting the table	LMTBDEL	—	—	FORMAT	
X position mode					
Absolute mode	LIMPOS ABS	LIMPOS?	0: Absolute mode	FORMAT	
Relative mode	LIMPOS REL		1: Relative mode	FORMAT	
X reference position					
On the left side	LIMXREF LEFT	LIMXREFSW?	0: On the left side	FORMAT	
In the center of the screen	LIMXREF CENT		1: In the center of the screen	FORMAT	
At the user-defined position	LIMXREF UDEF [*]		2: At the user-defined position	FORMAT	
Reading of X reference position	—	LIMXREF?	Frequency/Time		

5.2.9 GPIB Command Codes

Table 5-6 FORMAT Key (Display Format) (2 of 2)

Function	Listener Code	Talker Request		Panel Key	Remarks	
		Code	Output Format			
Limit line	X-axis display position offset	LIMSFT *	LIMSFT?	Frequency/Time	FORMAT	
	Y position mode					
	Absolute mode	LIMAPOS ABS	LIMAPOS?	0: Absolute mode	FORMAT	
	Relative mode	LIMAPOS REL		1: Relative mode	FORMAT	
	Y-axis reference position TOP	LIMYREF TOP	LIMYREFSW?	0: TOP	FORMAT	
	BOTTOM	LIMYREF BOTM		1: BOTTOM	FORMAT	
	User Def	LIMYREF UDEF[*]		2: User Def	FORMAT	
Reading of Y reference position	---	LIMYREF?	Level	FORMAT		
Y-axis display position offset	LIMASFT *	LIMASFT?	Level	FORMAT		
Limit line automatic adjustment (Auto Adjust)	LMSFAT	---	---	FORMAT		
Display line	Display line	DL *	DL?	Level	FORMAT	
	Display line ON OFF	DL ON[*] DL OFF	DLON?	0: OFF 1: ON	FORMAT FORMAT	
Label	Writing label	LON Label name	LB?	Character string	FORMAT	Label name: Maximum 30 characters.
	Deleting label	LOF	---	---	FORMAT	
Result display	Specification of the result display area position					
	Lower right Upper left	RESPOS LOW RESPOS UP	RESPOS?	0: LOW 1: UP	FORMAT FORMAT	

Table 5-7 FREQ Key (Frequency)

Function	Listener Code	Talker Request		Panel Key	Remarks		
		Code	Output Format				
Frequency	Center frequency	CF *	CF?	Frequency	FREQ	Valid for the R3267 and R3273 only Area enclosed with thick lines is valid only for the R3267 Area enclosed with dashed lines is valid only for the R3273 Deleting all data in the table	
	CF step size	CS *	CS?	Frequency	FREQ		
	CF step size AUTO	CA	CA?	0: MNL 1: AUTO	FREQ		
	Freq Offset size	FO *	FO?	Frequency	FREQ		
	Freq Offset size ON	FO ON[*]	FOON?	0: OFF	FREQ		
	OFF	FO OFF		1: ON	FREQ		
	Start frequency	FA*	FA?	Frequency	FREQ		
	Stop frequency	FB*	FB?	Frequency	FREQ		
	Presel tune						
	Auto Tune	PPA	---	---	FREQ		
	Manual Tune	PPM *	PPM?	Integer (-100 to 100)	FREQ		
	Preselector 1.6 GHz	PRESL STD	PRESL?	0: 1.6 GHz	FREQ		
	Preselector 3.6 GHz	PRESL EXTD		1: 3.6 GHz	FREQ		
	Internal mixer	MXI	MXR?	0: INT (Internal)	FREQ		
	External mixer	MXE		1: EXT (External)	FREQ		
	Signal Ident ON	SIGID ON	SIGID?	0: OFF	FREQ		
	OFF	SIGID OFF		1: ON	FREQ		
	Positive bias	MXP *	MXP?	Level	FREQ		
	Negative bias	MXN *	MXN?	Level	FREQ		
	Reading the bias mode	---	MXON?	0: Positive bias 1: Negative bias	FREQ		
	Band selection	BND *	BND?	Integer	FREQ		
	Band lock ON	BNDLC ON	BNDLC?	0: OFF	FREQ		
	OFF	BNDLC OFF		1: ON	FREQ		
	Average loss	AGL *	AGL?	Level	FREQ		
	Average loss ON	AGL ON[*]	AGLON?	0: OFF	FREQ		
	OFF	AGL OFF		1: ON	FREQ		
	Loss vs Freq ON	LVF ON	LVF?	0: OFF	FREQ		
OFF	LVF OFF		1: ON	FREQ			
Entering Loss vs Freq	LVFIN *	---	Frequency, Level, Bias	FREQ			
Deleting Loss vs Freq	LVFDEL	---	---	FREQ			

5.2.9 GPIB Command Codes

Table 5-8 LEVEL Key

Function	Listener Code	Talker Request		Panel Key	Remarks	
		Code	Output Format			
Reference level	Reference level	RL *	RL?	Level	LEVEL	
	X dB/div	DD *	DD?	0: 10 dB/ 1: 5 dB/ 2: 2 dB/ 3: 1 dB/ 4: 0.5 dB/	LEVEL	
	Linear scaling factor ×1	LL1	LL?	0: ×1	LEVEL	
	×2	LL2		1: ×2	LEVEL	
	×5	LL5		2: ×5	LEVEL	
	×10	LL10		3: ×10	LEVEL	
	Reference level units displayed		AUNITS?			
	dBm	AUNITS DBM		0: dBm	LEVEL	
	dBmV	AUNITS DBMV		1: dBmV	LEVEL	
	dBμV	AUNITS DBUV		2: dBμV	LEVEL	
	dBμVemf	AUNITS DBEMF		3: dBμ Vemf	LEVEL	
dBpW	AUNITS DBPW	4: dBpW		LEVEL		
W	AUNITS W	5: W		LEVEL		
V	AUNITS V	6: V	LEVEL			
Level offset	RO *	RO?	Level	LEVEL		
Level offset ON	RO ON[*]	ROON?	0: OFF	LEVEL		
OFF	RO OFF		1: ON	LEVEL		
Level offset	Level offset ON	CR ON	CR?	0: OFF	LEVEL	
	OFF	CR OFF		1: ON	LEVEL	
	Entering correction factor (in the table)	CRIN *	---	Frequency, Level	LEVEL	
	Deleting correction factor (from the table)	CRDEL	---	---	LEVEL	Deleting all data in the table.

Table 5-9 MEAS Key

Function	Listener Code	Talker Request		Panel Key	Remarks
		Code	Output Format		
X dB Down	Value of X dB down	MKBW *	MKBW?	Level	MEAS
	X dB down	XDB	—	—	MEAS
	X dB down Left	XDL	—	—	MEAS
	X dB down Right	XDR	—	—	MEAS
	Display mode REL.	DC0	DC?	0: Relative mode	MEAS
	ABS. L.	DC1		1: Absolute mode (Left side)	MEAS
ABS. R.	DC2		2: Absolute mode (Right side)	MEAS	
Continuous dB Down ON	CDB ON	CDB?	0: OFF	MEAS	
OFF	CDB OFF		1: ON	MEAS	
Frequency counter	Counter ON	COUNT ON	COUNT?	0: OFF	MEAS
	OFF	COUNT OFF		1: ON	MEAS
	Resolution 1 kHz	CN0	CN?	0: 1 kHz	MEAS
	100 Hz	CN1		1: 100 Hz	MEAS
10 Hz	CN2		2: 10 Hz	MEAS	
1 Hz	CN3		3: 1 Hz	MEAS	
Reading counter value	—	CNRES?	Frequency	MEAS	
Unit	Noise/Hz	NI *	NI?	Frequency	MEAS
	dBm/Hz ON	NIM	NION?	0: OFF	MEAS
	dB μ V/ \sqrt Hz ON	NIU		1: dBm/Hz	MEAS
	dBc/Hz	NIC		2: dB μ V/ \sqrt Hz	MEAS
	Noise/Hz OFF	NIF		3: dBc/Hz	MEAS
	Reading the result	—	NIRES?	Level	MEAS
Fixed Marker Peak	FXPK	—	—	MEAS	
Intermodulation distortion	3rd Order Measure	PKTHIRD	—	—	MEAS
AM measurement	% AM measurement ON	AMMOD ON	AMMODON?	0: OFF	MEAS
	OFF	AMMOD OFF		1: ON	
Reading of the result	—	AMMOD?	Value (%)		

5.2.9 GPIB Command Codes

Table 5-10 MKR key (1 of 2)

Function	Listener Code	Talker Request		Panel Key	Remarks
		Code	Output Format		
Marker Marker ON	MN[*]	MN?	0: Marker OFF 1: Normal marker 2: Delta marker	MKR	
	OFF MKOFF MO	— —		MKR MKR	
Delta marker ON	MKD[*]	—	Frequency (Time)	MKR	
Reading Marker frequency (time)	—	MF?	Frequency (Time)	MKR	When set to Delta mode, frequency (time) is used.
Reading marker level	—	ML?	Level	MKR	When set to Delta mode, level is used.
Reading marker frequency (time) and marker level	—	MFL?	Marker frequency (time) and marker level	MKR	When set to Delta mode, frequency (time) difference and level difference is used.
Normal marker	MK[*] MKN[*]	— —	Frequency (Time)	MKR MKR	
	Reading Delta marker absolute frequency	—	MDF1?	Normal marker frequency (time)	
Reading Normal marker absolute level	—	MDL1?	Normal marker level	MKR	
Reading Delta marker absolute frequency	—	MDF2?	Delta marker frequency (level)	MKR	
Reading Delta marker absolute level	—	MDL2?	Delta marker level	MKR	
Fixed marker ON OFF	FX ON FX OFF	FX?	0: OFF 1: ON	MKR MKR	
	1/Delta marker ON OFF	REDLT ON REDLT OFF	REDLT? 1: ON	MKR MKR	
Signal track ON OFF	SG ON SG OFF	SG?	0: OFF 1: ON	MKR MKR	
	Marker step size	MPM *	MPM?	Frequency (time)	
Marker step size AUTO	MPA	MPA?	0: MNL 1: AUTO	MKR	
Specifying the coupling with the marker				MKR	
Coupling OFF	CPLMK OFF	CPLMK?	0: Without coupling	MKR	
Coupling with Delta marker	CPLMK DLT		1: Coupling with Delta marker	MKR	
Coupling with Anchor	CPLMK ANC		2: Coupling with Anchor	MKR	
Coupling with the limit line	CPLMK LLIN		3: Coupling with the limit line	MKR	
Coupling with the display line	CPLMK DLIN		4: Coupling with the display line	MKR	
Coupling with Trace A	CPLMK TRA		5: Coupling with Trace A	MKR	
Moving the marker between the traces					
Trace A	MKTRACE TRA	MKTRACE?	0: Blank	MKR	
Trace B	MKTRACE TRB		1: Trace A	MKR	
			2: Trace B		

Table 5-10 MKR key (2 of 2)

Function	Listener Code	Talker Request		Panel Key	Remarks
		Code	Output Format		
Marker Multi-marker ON OFF	MLT ON	MLT?	0: OFF	MKR	
	MLT OFF		1: ON	MKR	
Moving the active marker	MK[*]	---	Frequency (time)	MKR	
	MKN[*]	---		MKR	
	MN[*]	---		MKR	
Multi-marker No.1 ON OFF	MLN1[*]	---	Frequency (time)	MKR	
	MLF1	---	---	MKR	
Multi-marker No.2 ON OFF	MLN2[*]	---	Frequency (time)	MKR	
	MLF2	---	---	MKR	
Multi-marker No.3 ON OFF	MLN3[*]	---	Frequency (time)	MKR	
	MLF3	---	---	MKR	
Multi-marker No.4 ON OFF	MLN4[*]	---	Frequency (time)	MKR	
	MLF4	---	---	MKR	
Multi-marker No.5 ON OFF	MLN5[*]	---	Frequency (time)	MKR	
	MLF5	---	---	MKR	
Multi-marker No.6 ON OFF	MLN6[*]	---	Frequency (time)	MKR	
	MLF6	---	---	MKR	
Multi-marker No.7 ON OFF	MLN7[*]	---	Frequency (time)	MKR	
	MLF7	---	---	MKR	
Multi-marker No.8 ON OFF	MLN8[*]	---	Frequency (time)	MKR	
	MLF8	---	---	MKR	
Multi-marker No.9 ON OFF	MLN9[*]	---	Frequency (time)	MKR	
	MLF9	---	---	MKR	
Multi-marker No.10 ON OFF	MLN10[*]	---	Frequency (time)	MKR	
	MLF10	---	---	MKR	
Reading all frequencies of the multi-markers	---	MLSF?	Frequencies (×10) and Delta marker	MKR	A total of 11 outputs.
Reading all levels for the multi-markers	---	MLSL?	Levels (×10) and Delta marker	MKR	
Peak list Frequency Level OFF	PLS FREQ PLS LEVEL PLS OFF	---	---	MKR MKR MKR	
Reading the peak list	---	PKLST?	Number of settings n<DLM> Frequency (time) 1, Level 1<DLM> ... Frequency (time) n, Level n<DLM>	MKR	<DLM>=Delimiter

5.2.9 GPIB Command Codes

Table 5-11 MKR → Key (Maker →)

Function	Listener Code	Talker Request		Panel Key	Remarks
		Code	Output Format		
Marker →	Marker → CF	MKCF	—	—	MKR →
		MC	—	—	MKR →
	Marker → Ref	MKRL	—	—	MKR →
		MR	—	—	MKR →
	Marker → CF Step	MKCS	—	—	MKR →
		M0	—	—	MKR →
	ΔMarker → Span	MTSP	—	—	MKR →
		DS	—	—	MKR →
	ΔMarker → CF	MTCF	—	—	MKR →
	ΔMarker → CF Step	MTCS	—	—	MKR →
		M1	—	—	MKR →
	Marker → Marker Step	MKMKS	—	—	MKR →
M2		—	—	MKR →	
ΔMarker → Marker Step	MTMKS	—	—	MKR →	
	M3	—	—	MKR →	
Peak → CF	PKCF	—	—	MKR →	
Peak → Ref	PKRL	—	—	MKR →	

Table 5-12 POWER Key (Power measurement) (1 of 2)

Function	Listener Code	Talker Request		Panel Key	Remarks
		Code	Output Format		
Power measurement	Number of averaging	PWTM *	PWTM?	Integer (1 to 999)	POWER
	Channel power	PWCH	PWCH?	Level, Level	POWER
	Reading channel power status	—	PWCHON?	0: Power measurement OFF 1: Channel power ON	POWER
	Channel (window) position	WLX *	WLX?	Frequency in the center of the window (Starting from the left edge in time)	POWER
	Channel (window) width	WDX *	WDX?	Frequency (time)	POWER
	Total power	PWTOTAL	PWTOTAL?	Level, Level	POWER
	Reading the status of the total power	—	PWTOTALON?	0: Power measurement OFF 2: Total power ON	POWER
	Average power	PWAVG	PWAVG?	Level, Level	POWER
	Reading the average power status	—	PWAVGON?	0: Power measurement OFF 3: Average power ON	POWER
	Power measurement OFF	PWM	—	—	POWER

Table 5-12 POWER Key (Power measurement) (2 of 2)

Function	Listener Code	Talker Request		Panel Key	Remarks
		Code	Output Format		
ACP measurement mode ON OFF	ACP ON ACP OFF	ACPON?	0: OFF 1: ON	POWER	
Reading the result	—	ACP?	Number of sets n<DLM> Lower1 Frequency, Level <DLM> Lowern Frequency, Level <DLM> Reference power (Level)	POWER	Outputs 5 sets Max. <DLM>=Delimiter
Entering CS/BS table	CSBSIN *	—	Enter CS frequency first and then BS frequency.	POWER	
Carrier bandwidth	CARRBS*	CARRBS?	BS frequency		
Deleting CS/BS table	CSBSDEL	—	—	POWER	Deleting all data in the table.
Number of averaging	ACPAVG *	ACPAVG?	Integer (1 to 999)	POWER	Set this field to OFF when "1" is specified.
Parameter setup Default Manual Define → Default	ACPST USR ACPST MNL ACPST DEF	ACPST?	0: STD (Unused) 1: Default 2: Manual	POWER	
Screen Full Sepa Carrier	ACPSCR FULL ACPSCR SEPA ACPSCR CARR	ACPSCR?	0: Full-screen 1: Separate screen 2: Full-screen(Carrier)	POWER	
ACP Graph ON OFF	ADG ON ADG OFF	ADG?	0: OFF 1: ON	POWER	
Symbol rate 1/T	SYMRT *	SYMRT?	Frequency (1 Hz to 1 GHz)	POWER	
Rolloff factor	RFACT *	RFACT?	Real number (0.01 to 0.99)	POWER	
√Nyquist filter ON OFF	NQST ON NQST OFF	NQST?	0: OFF 1: ON	POWER	
BS Window ON OFF	ACPBSW ON ACPBSW OFF	ACPBSW?	0: OFF 1: ON	POWER	
Noise correction ON OFF	ACPNCOR ON ACPNCOR OFF	ACPNCOR?	0: OFF 1: ON	POWER	
Noise power measurement frequency/bandwidth Specification AUTO MANUAL	ACPNCOF AUTO ACPNCOF MNL	ACPNCOF?	0: Manual 1: Automatic	POWER	
Noise power measurement frequency/bandwidth	ACPNCBSBS*	ACP- NCBSBS?	ncs, nbs	POWER	ncs: Noise power measurement fre- quency nbs: Noise power measurement band- width
The noise correction status of the measurement result	—	ACPNCST?	0:Not applied 1: Applied	POWER	

5.2.9 GPIB Command Codes

Table 5-13 PRESET Key (Initialization)

Function		Listener Code	Talker Request		Panel Key	Remarks
			Code	Output Format		
Preset	Instrument preset	IP	—	—	PRESET	

Table 5-14 RCL Key (Reading Data)

Function		Listener Code	Talker Request		Panel Key	Remarks
			Code	Output Format		
Recall	RC REG_nn	—	—		RCL	nn: 00 to 10
	RC file name	—	—		RCL	File name: Maximum 8 characters.

Table 5-15 SAVE Key (Saving Data)

Function		Listener Code	Talker Request		Panel Key	Remarks
			Code	Output Format		
Save	Save	SV REG_nn	—	—	SAVE	nn: 00 to 10
		SV file name	—	—	SAVE	File name: Maximum 8 characters.
	Deletion	DEL REG_nn	—	—	SAVE	
		DEL file name	—	—	SAVE	
Memory card	Initializing the card	MMI A:	—	—	SAVE	The area within the thick lines is for optional functions. The drive can be specified as MA. The drive can be specified as MB. Either "MA:" or "MB" can be specified.
		MMI B:	—	—	SAVE	
	All copy	ALLCOPY A: B:	—	—	SAVE	
	Drive selection	DEV RAM:	—	—	SAVE	
		DEV A: DEV B:	— —	— —	SAVE SAVE	
Floppy Disk	Initializing the disk	MMI FD:	—	—	SAVE	
	Drive selection	DEV RAM:	—	—	SAVE	
		DEV ED:	—	—	SAVE	

Table 5-16 SPAN Key (Frequency Span)

Function		Listener Code	Talker Request		Panel Key	Remarks	
			Code	Output Format			
Frequency span	Frequency span	SP *	SP?	Frequency	SPAN		
	Full span	FS	—	—	SPAN		
	Zero span	ZS	—	—	SPAN		
	Last span	LS	—	—	—	SPAN	
		LTSP	—	—	—	SPAN	

Table 5-17 SRCH Key (Peak Search)

	Function	Listener Code	Talker Request		Panel Key	Remarks
			Code	Output Format		
Peak search	Peak search	PS	---	---	SRCH	
	Next peak	NXP	---	---	SRCH	
	Next peak LEFT	NXL	---	---	SRCH	
	Next peak RIGHT	NXR	---	---	SRCH	
	Min. peak	MIS	---	---	SRCH	
	Next Min. peak	NXM	---	---	SRCH	
	Continuous peak ON	CP ON	CP?	0: OFF	SRCH	
	Continuous peak OFF	CP OFF		1: ON	SRCH	
	Search condition					
	X-axis range ALL	MKSX ALL	MKSX?	0: ALL	SRCH	
	INNER Limit	MKSX IN		1: INNER Limit	SRCH	
	OUTER Limit	MKSX OUT		2: OUTER Limit	SRCH	
	Limit position	MKSPoS *	MKSPoS?	Frequency in the center of the window (Starting from the left edge in time)	SRCH	
	Limit width	MKSWID *	MKSWID?	Frequency (time)	SRCH	
	Couple to F (T) ON	MKSCPL ON	MKSCPL?	0: OFF	SRCH	
	Couple to F (T) OFF	MKSCPL OFF		1: ON	SRCH	
	Y-axis Range					
	ALL	MKSY ALL	MKSY?	0: ALL	SRCH	
	Display Line	MKSY DLIN		1: Display Line	SRCH	
	Limit Line	MKSY LLIN		2: Limit Line	SRCH	
Display Line ABOVE the line	MKSYDL ABOVE	MKSYDL?	0: ABOVE the Line	SRCH		
Display Line BELOW the line	MKSYDL BELOW		1: BELOW the Line	SRCH		
Limit Line 1 ABOVE the line	MKSYLA ABOVE	MKSYLA?	0: ABOVE the Line	SRCH		
Limit Line 1 BELOW the line	MKSYLA BELOW		1: BELOW the Line	SRCH		
Limit Line 2 ABOVE the line	MKSYLB ABOVE	MKSYLB?	0: ABOVE the Line	SRCH		
Limit Line 2 BELOW the line	MKSYLB BELOW		1: BELOW the Line	SRCH		
Peak ΔY div	DY *	DY?	Real number (0.1 to 10.0)	SRCH		

5.2.9 GPIB Command Codes

Table 5-18 SWP/SINGLE Key (Sweep Time)

Function	Listener Code	Talker Request		Panel Key	Remarks	
		Code	Output Format			
Sweep condition	Sweep mode	—	SWM?	00: Normal & Full 01: Normal & Window 10: Manual & Full 11: Manual & Window 20: Single & Full 21: Single & Window	SWP	
	Normal	CONTS SN	— —	— —	SWP SWP	
	Single	SNGLS SI	— —	— —	SINGLE SINGLE	
	Window Sweep ON OFF	WDOSWP ON WDOSWP OFF	WDOSWP?	0: OFF 1: ON	SWP SWP	
	Sweep Reset & Start	SR	—	—	SWP	
	Take Sweep	TS	—	—	SWP	
	Gated Sweep ON OFF	GTSWP ON GTSWP OFF	GTSWP?	0: OFF 1: ON	SWP SWP	
	Gate Position	GTPOS *	GTPOS?	Time	SWP	
	Gate Width	GTWID *	GTWID?	Time	SWP	
	Gate Source IF Signal Ext Trigger Ext Gate In RF Signal	GTSRC IF GTSRC EXT GTSRC EGT GTSRC RF	GTSRC?	0: Ext Trigger 1: IF Signal 2: RF Signal 3: Ext Gate IN	SWP SWP SWP SWP	RF is option.
	Trigger mode Free Run Line Video Ext IF Signal RF Signal	TRGSRC FREE TRGSRC LINE TRGSRC VIDEO TRGSRC EXT TRGSRC IF TRGSRC RF	TRGSRC?	0: Free Run 1: Line 2: Video 3: Ext 4: IF Signal 5: RF Signal	SWP SWP SWP SWP SWP SWP	
	Trigger Slope - +	TRGSLP FALL TRGSLP RISE	TRGSLP?	0: - 1: +	SWP SWP	
	Trigger Level	TRGLVL *	TRGLVL?	Integer (%)	SWP	
	Delay Time	TRGDT *	TRGDT?	Time (Sweep time to 1 sec)	SWP	
	Sweep Time	SW * ST *	SW? ST?	Time Time	SWP SWP	
	Sweep Time AUTO	AS	AS?	0: AUTO 1: MNL	SWP SWP	

Table 5-19 UTIL Key (Utility) (1 of 3)

Function	Listener Code	Talker Request		Panel Key	Remarks
		Code	Output Format		
OBW Measurement	OBW measurement mode ON OFF	OBW ON OBW OFF	OBWON?	0: OFF 1: ON	A total of 2 outputs (Both for Frequency) Use "OFF" when "1" is set.
	Reading the result	---	OBW?	OBW, Fc	
	OBW%	OBWPER *	OBWPER?	Real number (10.0 to 99.9%)	
	Averaging number	AVGOBW *	AVGOBW?	Integer (1 to 999)	
	Parameter setup Default Manual Define → Default	OBWST USR OBWST MNL OBWST DEF	OBWST?	0: STD (Unused) 1: Default 2: Manual	
Harmonics measurement	Harmonics measurement mode ON OFF	HARM ON HARM OFF	HARMON?	0: OFF 1: ON	n = HRMNUM? <DLM>=Delimiter
	Reading the result values	---	HARM?	Number of sets n<DLM> Frequency1, Level1<DLM> ... Frequency n, Level n<DLM>	
	Harmonics Number	HRMNUM *	HRMNUM?	Integer	
	Fund Frequency	HRMFND *	HRMFND?	Frequency	
	Fund Frequency ON OFF	HRMFND ON HRMFND OFF	HRMFNDON?	0: OFF 1: ON	
Spurious	Spurious measurement ON OFF	SPURI ON SPURI OFF	SPURION?	0: OFF 1: ON	Number of times the measurement table must be repeated (0 to 10) m: Number of times the spurious must be repeated (0 to 10) f: Spurious frequency l: Spurious level j: Test conclusions <DLM>=Delimiter
	Reading the result values	---	SPURI?	Number of times the measurement table n<DLM> m1<DLM> f1, l1, j1 <DLM> ... fm1, lm1, jm1<DLM> m2<DLM> f1, l1, j1<DLM> ... fm2, lm2, jm2<DLM> mn<DLM> f1, l1, j1<DLM> ... fmn, lmn, jmn<DLM>	
	Table selection	SPRTBL *	SPRTBL?	Integer (1 to 3)	
	Saving the table information	SPRSV	---	---	
	Loading the table information	SPRLD	---	---	
	Entering data in the table	SPRIN *	---	* Input number (integer), start frequency, stop frequency, RBW and limit value	
	Deleting the table	SPRDEL	---	---	

5.2.9 GPIB Command Codes

Table 5-19 UTIL Key (Utility) (2 of 3)

Function	Listener Code	Talker Request		Panel Key	Remarks	
		Code	Output Format			
Eye opening measurement	Eye opening ratio ON OFF	EYEOPN ON EYEOPN OFF	EYEOPNON?	0: OFF 1: ON	UTIL	
	Reading the result	---	EYEOPN?	d1, d2	UTIL	d1: Opening ratio (for amplitude) d2: Opening ratio (for time)
	Number of samples	EYESMP *	EYESMP?	Integer (2 to 999)	UTIL	
	Positioning the Y cursor automatically	EYEAMPM	EYEAMPM?	Level	UTIL	
	Internal jitter compensation ON OFF	EYECOR ON EYECOR OFF	EYECOR?	0: OFF 1: ON	UTIL	
Phase noise measurement	C/N measurement mode ON OFF	CNIS ON CNIS OFF	CNISON?	0: OFF 1: ON	UTIL	
	Offset frequency data readout	---	CNIS?	Set number n<DLM> Offset frequency 1 Level 1<DLM>.... Offset frequency n, Level n<DLM>	UTIL	<DLM>=Delimiter
	Table input	CNOFSIN *	---	Offset frequency	UTIL	
	Deleting the table	CNOFSDEL	---		UTIL	Deletes all data from the table.
	Signal track ON OFF	CNSIG ON CNSIG OFF	CNSIG?	0: OFF 1: ON	UTIL	
	Average number	CNAVG *	CNAVG?	Integer (1 to 999)	UTIL	When 1 is specified, the average function is turned off.
Phase jitter measurement	Phase jitter measurement mode ON OFF	PJIT ON PJIT OFF	PJITON?	0: OFF 1: ON	UTIL	
	Result value readout	---	PJIT?	Carrier level, total SSB noise and phase jitter	UTIL	
	Start offset frequency	PJSRTO *	PJSRTO?	Offset frequency	UTIL	
	Stop offset frequency	PJSTPO *	PJSTPO?	Offset frequency	UTIL	
	Signal track ON OFF	PJSIG ON PJSIG OFF	PJSIG?	0: OFF 1: ON	UTIL	
Average number	PJAVG *	PJAVG?	Integer (1 to 999)	UTIL	When 1 is specified, the average function is turned off.	

Table 5-19 UTIL Key (Utility) (3 of 3)

Function	Listener Code	Talker Request		Panel Key	Remarks	
		Code	Output Format			
IM measurement	IM measurement mode ON OFF	IMM ON IMM OFF	IMMON?	0: OFF 1: ON	UTIL	
	Reference wave data readout	---	IMMREF?	Frequency, Level	UTIL	
	Delta frequency readout	---	IMMDF?	Delta frequency		
	Distortion signal data readout	---	IMMRES?	Set number n <DLM> LL1,LJ1,UL1,UJ1<DLM> LL2,LJ2,UL2,UJ2<DLM> LLn,LJn,ULn,UJn<DLM> <DLM>=Delimiter	UTIL	n: Result set number corresponding to the degree LLn: Level difference in the lower frequency signal LJn: Pass/Fail judgment result for the lower frequency signal 0: Pass 1: Fail -1: Judgment off ULn: Level difference for the upper frequency signal UJn: Pass/Fail judgment result for the upper frequency signal
	Degree setting	IMODR *	IMODR?	Degree	UTIL	Only 3, 5, 7 or 9 can be specified.
	Criteria input 3 rd order 5 th order 7 th order 9 th order	IMLS3 * IMLS5 * IMLS7 * IMLS9 *	IMLS3? IMLS5? IMLS7? IMLS9?	Level	UTIL	
	Pass/Fail judgment ON OFF	IMPFC ON IMPFC OFF	IMPFC?	0 : OFF 1 : ON	UTIL	
	Average number	IMAVG *	IMAVG?	Integer (1 to 999)	UTIL	When 1 is specified, the average function is turned off.
	HI sense mode ON OFF	IMHS ON IMHS OFF	IMHS?	0 : OFF 1 : ON	UTIL	

5.2.9 GPIB Command Codes

Table 5-20 WINDOW Key (Window)

Function	Listener Code	Talker Request		Panel Key	Remarks	
		Code	Output Format			
Window	Window ON OFF	WDO ON WDO OFF	WDO?	0: OFF 1: ON	WINDOW WINDOW	
	Window position	WLX *	WLX?	Frequency in the center of the window (Starting from the left edge in time)	WINDOW	
	Window width	WDX *	WDX?	Frequency (time)	WINDOW	
Separate screen	Separate screen					
	Zoom	MLTSCR ZM	MLTSCR?	0: Zoom OFF	WINDOW	
	F/T	MLTSCR FT		1: Zoom	WINDOW	
	T/T	MLTSCR TT		2: F/T	WINDOW	
	OFF (Screen Reset)	MLTSCR OFF		3: T/T	WINDOW	
	Zoom window position	ZMPOS *	ZMPOS?	Frequency in the center of the window (Starting from the left edge in time)	WINDOW	
	Zoom window width	ZMWID *	ZMWID?	Frequency (time)	WINDOW	
	Zoom on Window	ZMON	---	---	WINDOW	
	Zoom off	ZMOFF	---	---	WINDOW	
	Max peak	PKZMX	---	---	WINDOW	
	Next peak	PKZMN	---	---	WINDOW	
	3rd order peak	PKZM3	---	---	WINDOW	
	Upper screen activated	SCRSEL TRA	SCRSEL?	0: Upper screen activated	WINDOW	
Lower screen activated	SCRSEL TRB		1: Lower screen activated	WINDOW		

Table 5-21 Numeric keys/Step keys/Data knob/Unit keys (Entering data)

Function	Listener Code	Talker Request		Panel Key	Remarks
		Code	Output Format		
Entering data	0 to 9	0 to 9	—	—	
	. (Decimal point)	.	—	—	
	↑ (Step-up)	UP	—	—	
	↓ (Step-down)	DN	—	—	
	GHz	GZ	—	—	
	MHz	MZ	—	—	
	kHz	KZ	—	—	
	Hz	HZ	—	—	
	mV	MV	—	—	
	mW	MW	—	—	
	dB	DB	—	—	
	mA	MA	—	—	
	sec	SC	—	—	
	ms	MS	—	—	
	μs	US	—	—	
	ENTER	ENT	—	—	

5.2.9 GPIB Command Codes

Table 5-22 Miscellaneous

Function	Listener Code	Talker Request		Panel Key	Remarks
		Code	Output Format		
Miscellaneous					
Outputting error number	—	ERRNO?	Integer		Refer to the error number found in the Error Message List.
Local	LC	—	—	LCL	
Reading GPIB address	—	AD?	Integer (0 to 30)		
Specification of the delimiter CR LF <EOL> LF <EOL> CR LF LF <EOL>	DL0 DL1 DL2 DL3 DL4	— — — — —	— — — — —		
Service request interruption ON OFF	S0 S1	— —	— —		
Status clear	S2	—	—		
Service request mask	RQS *	RQS?	Decimal number corresponding to the SRQ bit		
Outputting ID of the instrument	—	*IDN?	Manufacturer name (character string), instrument type (character string), Serial number (character string) and revision (character string)		
Initializing the instrument	*RST	—	—		
Clearing the queues related to the status byte	*CLS	—	—		
Accessing the standard event enable register	*ESE	*ESE?	Decimal number corresponding to the register bits		
Reading or clearing the standard event enable register	—	*ESR?	Decimal number corresponding to the register bits		
Accessing the service request enable register	*SRE	*SRE?	Decimal number corresponding to the register bits		
Reading the status byte and MSS bit	—	*STB?	Decimal number corresponding to the status byte		
Accessing the operation status enable register	OPR	OPR?	Decimal number corresponding to the register bits		
Reading or clearing the operation status register	—	OPREVT?	Decimal number corresponding to the register bits		
Reading of the self test result	—	*TST?	0: Pass 1: Power Up & CPU Block 2: Synthe Block 4: RF Block 8: IF Output 16: Log/AD Block 32: IF BLOCK	For the item which resulted in an error, the return value is the value obtained by ORing the related bits.	
PIO data output	PIOOUT *	—	—	Outputs data with respect to 0 to 255 to the PARALLEL port pins 2 thru 9 as a set of eight-bit data.	

5.2.10 Example Programs

This section describes remote control examples used with GPIB port.

5.2.10.1 Sample Programs for Setting or Reading Measurement Conditions

CAUTION *Visual Basic 4.0 (referred to as VB henceforth) is used in the sample programs shown here. Also, National Instruments-made GPIB board (referred to as NI-made for brevity henceforth) is used for the GPIB control board; NI-made driver is used for the control driver.*

- Program examples using VB

Example VB-1: Setting the center frequency after performing an analyzer master reset

```

Call ibclr(spa)                ' Performs a Device Clear.

Call ibwrt(spa, "IP")          ' preset
Call ibwrt(spa, "CF 30MZ")    ' Set the center frequency to 30 MHz.

```

Example VB-2: Setting the start frequency to 300 kHz, setting the stop frequency to 800 kHz and adding 50 kHz to the frequency offset.

```

Call ibclr(spa)                ' Performs a Device Clear.
Call ibwrt(spa, "FA 300KZ")    ' Set the start frequency to 300 kHz.
Call ibwrt(spa, "FB 800KZ")    ' Set the stop frequency to 800 kHz.
Call ibwrt(spa, "FO 50KZ")    ' Add 50 kHz to the frequency offset.

```

Example VB-3: Setting the reference level to 87 dB μ V (in 5 dB/div) and the RBW to 100 kHz

```

Call ibclr(spa)                ' Performs a Device Clear.

Call ibwrt(spa, "AUNITS DBUV") ' Set the level unit to dB $\mu$ V.
Call ibwrt(spa, "RL 87DB")     ' Set the reference level to 87 dB ( $\mu$ V).
Call ibwrt(spa, "DD 5DB")     ' Set the vertical gradation to 5 dB/div.
Call ibwrt(spa, "RB 100KZ")    ' Set the RBW to 100 kHz.

```

Example VB-4: Setting the instrument using variables

```

Dim A As String
Dim B As String
Dim C As String

A = "10"
B = "2"
C = "20"

Call ibclr(spa)                ' Performs a Device Clear.

Call ibwrt(spa, "CF " & A & "MZ") ' Set the start frequency to A MHz.
Call ibwrt(spa, "SP " & B & "MZ") ' Set the span frequency to B MHz.
Call ibwrt(spa, "AT " & C & "DB") ' Set the ATT to C dB.

```

5.2.10 Example Programs

Example VB-5: Saving set values in Register 5 and recalling them from Register 5

```

Dim LabelBuff As String           ' Character string buffer for the label

LabelBuff = "SPECTRUM Analyzer"   ' Set the label.

Call ibclr(spa)                   ' Performs a Device Clear.

Call ibwrt(spa, "CF 30MZ")        ' Set the parameter.
Call ibwrt(spa, "SP 1MZ")
Call ibwrt(spa, "DET POS")
Call ibwrt(spa, "LON " & LabelBuff) ' Set the label.

Call ibwrt(spa, "SV REG_05")      ' Save the data in Register 5.

Call ibwrt(spa, "CF 1GZ")        ' Change the set parameters.
Call ibwrt(spa, "SP 200MZ")

Call ibwrt(spa, "RC REG_05")     ' Recall the data from Register 5.

```

Example VB-6: Enter Limit line1 in the table and turn the LTMA on

```

Call ibclr(spa)                   ' Perform a device clear.

'Call ibwrt(spa, "IP")            ' Reset the spectrum analyzer.
Call ibwrt(spa, "LMTADEL")       ' Clear the table used for Limit Line 1.
Call ibwrt(spa, "AUNITS DBUV")   ' Set the unit of level to dBµV.

Call ibwrt(spa, "LMTAIN 25MZ,-57.5DB") ' Enter data use by Limit Line 1.
Call ibwrt(spa, "LMTAIN 35MZ,-57.5DB")
Call ibwrt(spa, "LMTAIN 35MZ,-55.5DB")
Call ibwrt(spa, "LMTAIN 55MZ,-55.5DB")
Call ibwrt(spa, "LMTAIN 55MZ,-52.5DB")
Call ibwrt(spa, "LMTAIN 65MZ,-52.5DB")
Call ibwrt(spa, "LMTAIN 65MZ,-50.0DB")
Call ibwrt(spa, "LMTAIN 68MZ,-50.0DB")
Call ibwrt(spa, "LMTAIN 68MZ,-46.5DB")
Call ibwrt(spa, "LMTAIN 75MZ,-46.5DB")
Call ibwrt(spa, "LMTAIN 75MZ,-44.5DB")
Call ibwrt(spa, "LMTAIN 82MZ,-44.5DB")
Call ibwrt(spa, "LMTAIN 82MZ,-42.5DB")

Call ibwrt(spa, "FA 0MZ")        ' Start frequency of 0 MHz
Call ibwrt(spa, "FB 100MZ")     ' Stop frequency of 100 MHz
Call ibwrt(spa, "LMTA ON")      ' Turn Limit line 1 on.

```

Example VB-7: Sample Program of the Gated Sweep

```

Call ibclr(spa)                   ' Perform a device clear.

Call ibwrt(spa, "GTSRC EXT")     ' Set the Gate signal source to EXT.
Call ibwrt(spa, "GTSLP RISE")   ' Set the Gate signal slope to plus (+).
Call ibwrt(spa, "GTWID 10MS")   ' Set the window width of the gated sweep to 10 msec.
Call ibwrt(spa, "GTPOS 10US")   ' Set the window position of the gated sweep to 10 µsec.
Call ibwrt(spa, "GTSWP ON")     ' Turn the gated sweep on.

```

5.2.10.2 Sample Programs for Reading Data

In order to output measurement data or settings, use the "xx?" command. This ensures that the data is read when the device is in the talker mode. Available output formats are listed in the table below. The delimiter positioned at the end of data can be specified from 5 types (refer to "Others" in the GPIB code list). Once set, "xx?" command continues to operate until it is changed.

Output Format	
Frequency	$\pm \text{D.DDDDDDDDDDD} \text{ E} \pm \text{DD} \text{ CR LF}$ ↑ ↑ ↑ ↑ 1 2 3 4 • Data size (1 to 3) is a maximum of 19 bytes, and the unit is Hz. Example Specify "CF?" and output as center frequency.
Level	$\pm \text{D.DDDDDDD} \text{ E} \pm \text{DD} \text{ CR LF}$ ↑ ↑ ↑ ↑ 1 2 3 4 • Data size (1 to 3) is a maximum of 19 bytes, and the unit corresponds to each UNIT setting. Example Specify "ML?" and output as marker level.
Time	$\pm \text{D.DDD} \text{ E} \pm \text{DD} \text{ CR LF}$ ↑ ↑ ↑ ↑ 1 2 3 4 • Data size (1 to 3) is a maximum of 19 bytes, and the unit is sec. Example Specify "SW?" and output sweep time.
	$\text{DDDD} \text{ CR LF}$ ↑ ↑ 2 4 • The maximum byte of the data size corresponds to the maximum size of the output data. Example ON/OFF status or Averaging count is output.

- <Supplement>
- 1= Sign (a space for plus sign; "-" for minus sign)
 - 2= Mantissa of data
 - 3= Exponent of data
 - 4= Delimiter (CR/LF in initial setting can be changed with "DLn" code.)

5.2.10 Example Programs

Example VB-8: Output the marker level

```

Dim sep As Integer

Call ibclr(spa) ' Perform a device clear.

Call ibwrt(spa, "CF 30MZ") ' Set the parameter.
Call ibwrt(spa, "SP 1MZ")
Call ibwrt(spa, "MK 30MZ") ' The marker frequency is set to 30 MHz.
Call ibwrt(spa, "TS")

Call ibwrt(spa, "ML?") ' Read the marker level.

Rdbuf = Space(30) ' Allocate a total of 30 bytes to the buffer area.

Call ibrd(spa, Rdbuf) ' Read the data (30 bytes Max.).
sep = InStr(1, Rdbuf, vbCrLf, 0) ' Check the number of character to the delimiter.
RichTextBox1.Text = "MarkerLevel = " & Left(Rdbuf, sep - 1)
' Outputs the data on the screen.

```

An example display:
MarkerLevel = -16.22

Example VB-9: Reading the center frequency and displaying it

```

Dim sep As Integer

Call ibclr(spa) ' Performs a Device Clear.

Call ibwrt(spa, "CF?") ' Query command for the center frequency.

Rdbuf = Space(30) ' Allocate the buffer memory space to 30 bytes.
Call ibrd(spa, Rdbuf) ' Read the data (30 bytes Max.)
sep = InStr(1, Rdbuf, vbCrLf, 0) ' Check the number of characters prior to the delimiter.
RichTextBox1.Text = "CenterFreq = " & Left(Rdbuf, sep - 1)
' Display the data on the screen.

```

An example display:
CenterFreq = 30.000E+6

Example VB-10: Reading the level and display unit and displaying them

```

Dim sep As Integer

Call ibclr(spa) ' Performs a Device Clear.

Call ibwrt(spa, "RL?") ' Query command for the reference level.

Rdbuf = Space(30) ' Allocate the buffer memory space to 30 bytes.
Call ibrd(spa, Rdbuf) ' Read the data (30 bytes Max.) from the spectrum analyzer.
sep = InStr(1, Rdbuf, vbCrLf, 0) ' Check the number of characters prior to the delimiter.
RichTextBox1.Text = "RefLevel = " & Left(Rdbuf, sep - 1) ' Display the data on the screen.

Call ibwrt(spa, "AUNITS?") ' Query command for the level unit

Rdbuf = Space(3)
Call ibrd(spa, Rdbuf)
sep = InStr(1, Rdbuf, vbCrLf, 0) ' Check the number of characters prior to the delimiter.
RichTextBox1.Text = RichTextBox1.Text & vbCrLf & "UNIT = " & Left(Rdbuf, sep - 1) ' Display the previous result, followed by a return mark and the
' most recent result.

An example display:
RefLevel = 0.0E + 0
UNIT = 0

```

Example VB-11: Executing the 6 dB-down operation, reading the frequency and level and displaying them

```

Dim sep As Integer

Call ibclr(spa) ' Performs a Device Clear.

Call ibwrt(spa, "CF 30MZ") ' Set the parameter.
Call ibwrt(spa, "SP 20MZ")

Call ibwrt(spa, "MKBW 6DB") ' Set a 6 dB down measurement.
Call ibwrt(spa, "PS") ' Peak search.
Call ibwrt(spa, "XDB") ' Perform the 6 dB down measurement.
Call ibwrt(spa, "MFL?") ' Query command for the marker level and frequency.

Rdbuf = Space(50) ' Allocate the buffer memory space to 50 bytes.
Call ibrd(spa, Rdbuf) ' Read the data (50 bytes Max.) from the spectrum analyzer.

sep = InStr(1, Rdbuf, vbCrLf, 0) ' Check the number of characters prior to the delimiter.

RichTextBox1.Text = "Marker Freq & Level = " & Left(Rdbuf, sep - 1) ' Display the data on the screen.

An example display:
Marker Freq & Level = 400000, 1.16

```

5.2.10 Example Programs

Example VB-12: Measuring OBW and displaying it

```

Dim LENG1 As Integer, LENG2 As Integer
Dim OBW As String
Dim FC As String
Dim searchchar As String

Call ibclr(spa) ' Perform a device clear.

Call ibwrt(spa, "CF 30MZ") ' Send the command already set.
Call ibwrt(spa, "SP 1MZ")
Call ibwrt(spa, "MK 30MZ")
Call ibwrt(spa, "OBW ON")
Call ibwrt(spa, "TS")

Call ibwrt(spa, "OBW?") ' Send the query command.
Rdbuf = Space(60) ' Allocate the area to the read buffer.
Call ibrd(spa, Rdbuf) ' Read the read buffer (the maximum number of bytes to be output
' is determined by the buffer area size).

' Formatting output character string
LENG1 = InStr(1, Rdbuf, Chr(44), 0) ' Search for the first comma.
OBW = Mid(Rdbuf, 1, LENG1 - 1) ' Read the character prior to the comma.

DoEvents

LENG2 = InStr((LENG1 + 1), Rdbuf, Chr(13), 0) 'Determine the last data by searching for the delimiter.
FC = Mid(Rdbuf, (LENG1 + 1), (LENG2 - 1)) 'Read the data between the second comma and the delimiter.

RichTextBox1.Text = "OBW = " & OBW & vbCrLf & "Fc = " & FC & vbCrLf
' Display the data on the screen.

An example display:
OBW(99%) = 171000
FC = 2.503E+07

```

Example VB-13: Reading and displaying the three largest peak levels

```
Dim pk1 As String, pk2 As String, pk3 As String
```

```
Call ibclr(spa) ' Perform a device clear.
```

```
Call ibwrt(spa, "CF 0MZ") ' Apply the settings.
```

```
Call ibwrt(spa, "SP 100MZ")
```

```
Call ibwrt(spa, "PS") ' Search for the peak.
```

```
Call ibwrt(spa, "ML?") ' Query command to search for the marker level
```

```
Rdbuf = Space(25) ' Reserve buffer memory space.
```

```
Call ibrd(spa, Rdbuf) ' Receives the output.
```

```
pk1 = LeftB(Rdbuf, (InStrB(1, Rdbuf, Chr(13), 1) - 1))
```

```
' Read the data between the starting point and the delimiter.
```

```
Call ibwrt(spa, "NXP") ' Search for the next peak.
```

```
Call ibwrt(spa, "ML?")
```

```
Rdbuf = Space(25)
```

```
Call ibrd(spa, Rdbuf)
```

```
pk2 = LeftB(Rdbuf, (InStrB(1, Rdbuf, Chr(13), 1) - 1))
```

```
' Read the data between the starting point and the delimiter.
```

```
Call ibwrt(spa, "NXP")
```

```
Call ibwrt(spa, "ML?")
```

```
Rdbuf = Space(25)
```

```
Call ibrd(spa, Rdbuf)
```

```
pk3 = LeftB(Rdbuf, (InStrB(1, Rdbuf, Chr(13), 1) - 1))
```

```
' Read the data between the starting point and the delimiter.
```

```
RichTextBox1.Text = "1st PK = " & pk1 & vbCrLf & "2nd PK = " & pk2 & vbCrLf & "3rd PK = " & pk3 & vbCrLf
```

```
' Display the data on the screen.
```

```
An example display:
```

```
1st PK = 9.44
```

```
2nd PK = 10.06
```

```
3rd PK = 11.84
```

5.2.10.3 Sample Programs for Inputting or Outputting Trace Data

Trace data on the screen includes data for 501 or 1001 points on the frequency axis. For inputting and outputting data, it is necessary to transfer data for 501 or 1001 points from the left side (start frequency) in order. Each point level is expressed by an integer from 1792 to 14592 (however, if the trace exceeds the upper limit of the vertical scale, a value greater than 14592 is transferred).

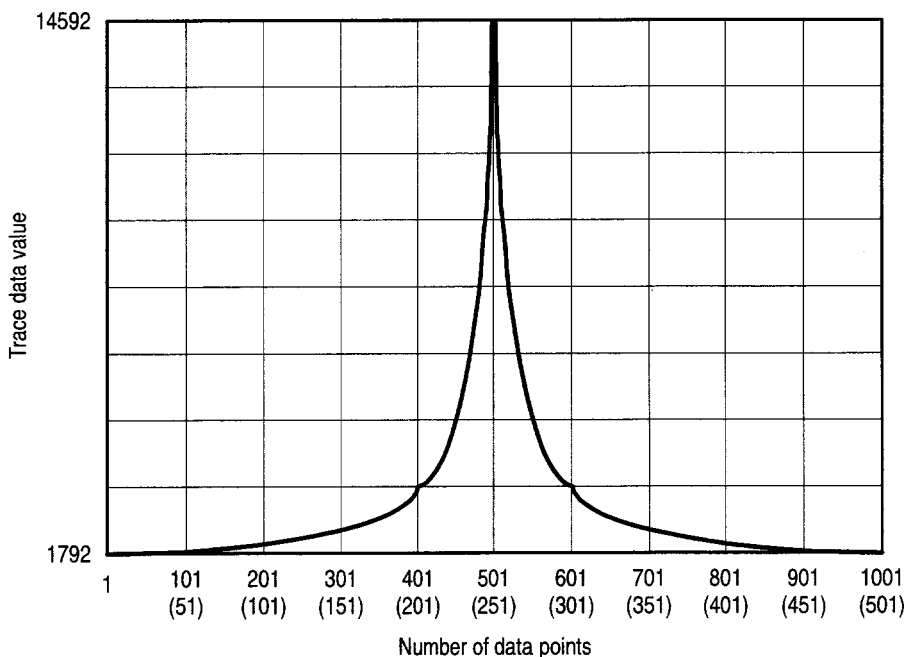

Figure 5-4 Relationship between Screen Graticule and Trace Data

Trace data can be input or output in either ASCII or binary format.

Table 5-23 Trace Accuracy Specification Codes

GPIB Code	Description
TPS	Sets the number of measurement points to 501.
TPL	Sets the number of measurement points to 1001.

Table 5-24 I/O formatI

I/O format	Description		
ASCII format	<p style="text-align: center;"> <u>DDDD</u> CR LF ↑ ↑ Delimiter Data for one point Five-byte data without header </p>		
		Input GPIB code	Output GPIB code
	Memory A Memory B	TAA TAB	TAA? TAB?
Binary format	<p style="text-align: center;"> <u>DD</u> <u>DD</u> <u>DD</u> <u>DD</u> + EOI ↑ ↑ ↑ ↑ ↑ ↑ ↑ ↑ Low-order byte Low-order byte for 1st point for 1001/501st point High-order byte High-order byte for 1st point for 1001/501st point Delimiter </p> <p>Each point data is divided into two parts: high-and low-order bytes. EOI signal is attached at the end of the data for continuous 1001/501 points.</p>		
		Input GPIB code	Output GPIB code
	Memory A Memory B	TBA TBB	TBA? TBB?

5.2.10 Example Programs

Example VB-14: Read the trace data in ASCII format

```

Dim tr(1000) As String          ' Allocate an array in the buffer for 1001 points.
Dim i As Integer

Call ibclr(spa)                 ' Perform a device clear.

Call ibwrt(spa, "DL0")         ' CR LF EOI
Call ibwrt(spa, "DET NEG")     ' Set it to the negative detector.
Call ibwrt(spa, "TAA?")

For i = 0 To 1000 Step 1       ' Repeat the operation for 1001 points.
    tr(i) = Space(7)           ' Allocate a total of 7 bytes (5 bytes for the data, and 2 bytes for
                                ' delimiters).
    Call ibrd(spa, tr(i))      ' Read the data.
    RichTextBox1.Text = RichTextBox1.Text & "tr(" & Str(i) & ") = " & Left(tr(i), 5) & vbCrLf
                                ' Output it to the screen.

    DoEvents
Next i

Call ibwrt(spa, "DL3")         ' Convert the delimiter back into the standard format.

```

Example VB-15: Read the A memory data in binary format

```

Dim tr(1000) As Integer        ' Allocate an array in the buffer for 1001 points
Dim i As Integer
Dim res As String

Call ibclr(spa)                ' Perform a device clear
Call ibconfig(0, IbcEndBitIsNormal, 0) ' Set the GPIB-board software so that the End bit of the Ibst
                                ' variables is set to 1 only when EOI has been received.
Call ibconfig(spa, IbcReadAdjust, 1) ' Set the read operation to have each pair of bytes swapped.

Call ibwrt(spa, "DL2")         ' Set the delimiter to EOI only.
Call ibwrt(spa, "DET NEG")     ' Set it to the negative detector.
Call ibwrt(spa, "TBA?")       ' Query for Trace A in binary data.

Call ibrdi(spa, tr(), 1001 * 2) ' Read whole 1001 points data.

For i = 0 To 1000 Step 1       ' Repeat the operation for 1001 points.
    res = res & Str(tr(i)) & vbCrLf
    DoEvents
Next i
RichTextBox1.Text = res        ' Display the data on the screen.

Call ibwrt(spa, "DL0")         ' Set the delimiter to default pattern (CR LF EOI).

Call ibconfig(0, IbcEndBitIsNormal, 1) ' Reset the GPIB software to the standard settings.
Call ibconfig(spa, IbcReadAdjust, 0)   ' Reset the read operation condition to the normal setting.

```

Example VB-16: Enter data into A memory in ASCII mode

(When the 501 point mode is set, change 1001 and 1000 to 501 and 500, respectively.)

```
Dim trdata(1000) As Integer
Dim i As Integer

trdata(0) = 1792
For i = 1 To 1000 Step 1
    trdata(i) = Str(Val(trdata(i - 1)) + 12)
    DoEvents
Next i

Call ibclr(spa)
Call ibwrt(spa, "AB")
Call ibwrt(spa, "TAA")

For i = 0 To 1000 Step 1
    Call ibwrt(spa, CStr(trdata(i)))
    DoEvents
Next i

Call ibwrt(spa, "AV")
```

' Provide a temporary data used to test the input (*).

' When there is the data, the steps between the place marked with
' (*) and this point are not required.

' Perform a device clear.
' Set Trace A to BLANK.
' Set Trace A in ASCII.

' Send data corresponding to 1001 points.
' Obtain an unused file number.

' Set Trace A to VIEW.

5.2.10 Example Programs

5.2.10.4 Program Examples Using the Status Byte

Example VB-17: Execute single sweeping and wait until its finished (when not using SRQ)

```

Dim state As Integer

Call ibclr(spa) ' Performs a Device Clear.
Call ibwrt(spa, "SI") ' Turn the single sweep mode on.
Call ibwrt(spa, "OPR8") ' Enables Sweep-end bit of operation status register
Call ibwrt(spa, "*CLS") ' Clear the status byte.
Call ibwrt(spa, "SI") ' Begin sweeping.

Do

    Call ibwrt(spa, "*STB?") ' Query command to read the status byte.
    Rdbuf = Space(8) ' Reserve a maximum of 8 bytes including the delimiter.
    Call ibrd(spa, Rdbuf) ' Read the data.
    state = Val(Rdbuf) ' Convert the character string into numeric values.

    DoEvents ' Check the loop for other events currently taking place.
Loop Until (state And 128) ' Exit from the loop if the sweep-end bit is set to 1.

```

Example VB-18: Measure CW-ACP, and read the measurements (When not using SRQ signals)

```

Dim state As Integer
Dim sep1 As Integer, sep2 As Integer
Dim UPF As String, LOF As String, UPL As String, LOL As String
Dim i As Integer
Dim cnt As Integer

Call ibclr(spa) ' Perform a device clear.

Call ibwrt(spa, "ACPST MNL") ' Set ACP measurement conditions manually.
Call ibwrt(spa, "CF 1500MZ") ' Set a center frequency of 1.5 GHz.
Call ibwrt(spa, "SP 250KZ") ' Set a span of 250 kHz.
Call ibwrt(spa, "RB 1KZ") ' Set an RBW of 1 kHz.
Call ibwrt(spa, "VB 3KZ") ' Set a VBW of 3 kHz.
Call ibwrt(spa, "ST 20SC") ' Set a sweep time of 20 sec.
Call ibwrt(spa, "CSBSDEL") ' Clear the channel space and bandwidth previously set.
Call ibwrt(spa, "CSBSIN 50KZ,21KZ") ' Set a channel space of 50 kHz and a bandwidth of 21 kHz.
Call ibwrt(spa, "OPR 16") ' Set Measuring bit of Operation Status Register to Enabled.
Call ibwrt(spa, "*CLS") ' Clear the status byte.
Call ibwrt(spa, "ACP ON") ' Start the ACP measurement.

Do
    Call ibwrt(spa, "*STB?") ' Query for the status byte.
    Rdbuf = Space(8) ' Allocate 8 bytes.
    DoEvents
    Call ibrd(spa, Rdbuf) ' Read the data.
    state = Val(Rdbuf) ' Convert the data in ASCII format into binary format.
    DoEvents ' Execute other events in Windows at this time.
Loop Until (state And 128) ' Return to the Do statement until the Measuring bit is set to 1.

Call ibwrt(spa, "ACP?") ' Query for an ACP measurement result.
Rdbuf = Space(3) ' Allocate a total of 3 bytes: 1 byte for integer and 2 bytes for
' delimiter.
Call ibrd(spa, Rdbuf) ' Read the data.

cnt = CInt(Rdbuf) ' Convert the buffer contents into integer-type data.

```

```

For i = 1 To cnt Step 1

    Rdbuf = Space(81)                ' Allocate a total of 81 bytes: 19 × 4 bytes real number (Max.) + '
                                     ' × 3 + CRLF.
    Call ibrd(spa, Rdbuf)           ' Read the data.

    sep1 = InStr(1, Rdbuf, ",", 0)   ' Search for the item separator (this is a comma) from the head of
                                     ' the buffer.
    LOF = Left(Rdbuf, sep1 - 1)      ' Read the character strings between the head of the buffer and the
                                     ' separator.

    sep2 = InStr(sep1 + 1, Rdbuf, ",", 0) ' Search for the next item separator (this is a comma).
    LOL = Mid(Rdbuf, sep1 + 1, sep2 - sep1 - 1) ' Read the strings between the separators.
    sep1 = InStr(sep2 + 1, Rdbuf, ",", 0) ' Search for the next item separator (this is a comma).
    UPF = Mid(Rdbuf, sep2 + 1, sep1 - sep2 - 1) ' Read the strings between the separators.
    sep2 = InStr(sep1, Rdbuf, Chr(13), 0) ' Search for the next item separator (this is the CR).
    UPL = Mid(Rdbuf, sep1 + 1, sep2 - sep1 - 1) ' Read the strings between the separators.

    RichTextBox1.Text = LOF & " Hz: " & LOL & vbCrLf & UPF & " Hz: " & UPL & vbCrLf
                                     ' Output the screen.

    DoEvents
Next i

```

Example VB-19: Reading the peak frequency and level at the end of a single sweep (when using SRQ)

```

Dim boardID As Integer
Dim I As Integer
Dim res As Integer
Dim CFLEV As String

boardID = 0                ' Set the board ID.

Call ibclr(spa)           ' Performs a Device Clear.

Call ibwrt(spa, "SI")     ' Turn the single sweep mode on.

Call ibwrt(spa, "*CLS")   ' Clear the status byte.
Call ibwrt(spa, "OPR 8") ' Enables the Sweep-end bit of the operation status register
Call ibwrt(spa, "*SRE 128") ' Enables the Operation status bit of the status byte.
Call ibwrt(spa, "S0")    ' Specify Send mode for the SRQ signal.

For I = 1 To 10 Step 1    ' A loop of 10 times
    Call ibwrt(spa, "SI") ' Begin sweeping
    Call WaitSRQ(boardID, res) ' Wait until SRQ interruption occurs.

    Call ibwrt(spa, "PS") ' Execute the peak search.
    Call ibwrt(spa, "MFL?") ' Query for marker frequency and level

    Rdbuf = Space(43)    ' Reserve 43 bytes.
    Call ibrd(spa, Rdbuf) ' Read the data.

    CFLEV = Left(Rdbuf, InStr(1, Rdbuf, Chr(13), 0) - 1)
    RichTextBox1.Text = RichTextBox1.Text & "Freq ,Level = " & CFLEV & vbCrLf
                                     ' Display data on the screen and start a new line.

```

5.2.10 Example Programs

DoEvents ' Execute other events in Windows if any.
Next I

Example VB-20 Outputting the current screen data in bitmap format and saving it into the file (bitmap.bmp)

NOTE: *Depending on the copy image, compression of files and screen status, the amount of bitmap data varies. A data file of up to 300 KB can be output.*

Tmo%=14 ' A timeout of 30 sec.
Call ibtmo(spa,tmo%) ' A timeout of 30 seconds is set.
Call ibwrt(spa,"DL2") ' Selects only EOI as a delimiter.

Call ibwrt(spa,"HCIMAG SCOL") ' Sets a simple color image to make a copy.
Call ibwrt(spa,"HCCMPRS OFF") ' Turns the compression mode off.
Call ibwrt(spa,"BMP?") ' Requests the bitmap data output.
Call ibrdf(spa,"bitmap.bmp") ' Saves the bitmap data into the file.

Call ibwrt(spa,"DL0") ' Changes the delimiter back to CR, LF and EOI.

5.3 RS-232 Remote Control Function

Most controllers (such as personal computers) do not have a GPIB interface, but the R3131 series can still be controlled using the RS-232 interface.

5.3.1 GPIB and RS-232 Compatibility

The control codes and functions are the same as those used for serial control, except for those which especially refer to the GPIB interface.

5.3.2 Features of RS-232 Remote Control

The following functions can be controlled by serial control.

- Measurement conditions setup: Measurement conditions each can be input in much the same as the key operation on the front panel.
- Output of the setup status: Both the setup status and data can be read out.
- Status: Status bytes which show the current status of the analyzer can be read out in the same way GPIB readouts.

5.3.3 Parameter Setup Window

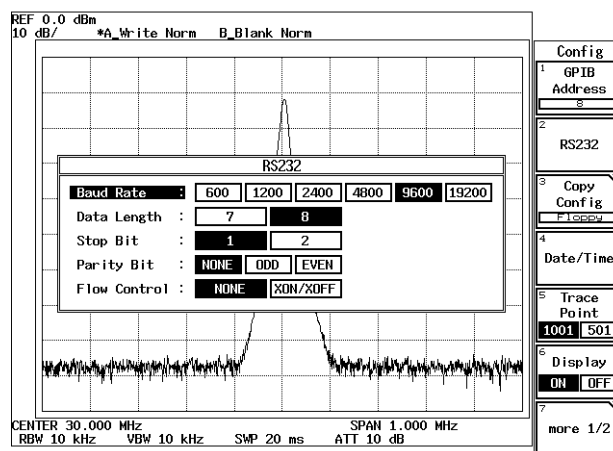

Figure 5-5 Parameter Setup

1. Transmission speed: Select from 600, 1200, 2400, 4800, 9600 or 19200.
2. Data length: Select seven bits or eight bits as the number of data bits.
3. Stop bit: Select one or two bits.
4. Parity check: Select from NONE, ODD or EVEN.
5. Flow control: Select either NONE or XON/XOFF.

5.3.4 Interface connection

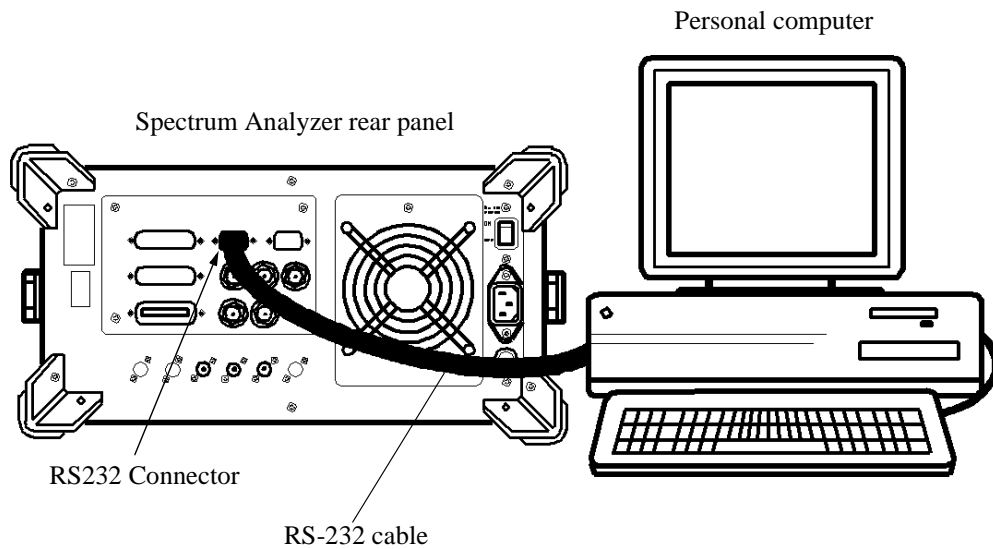
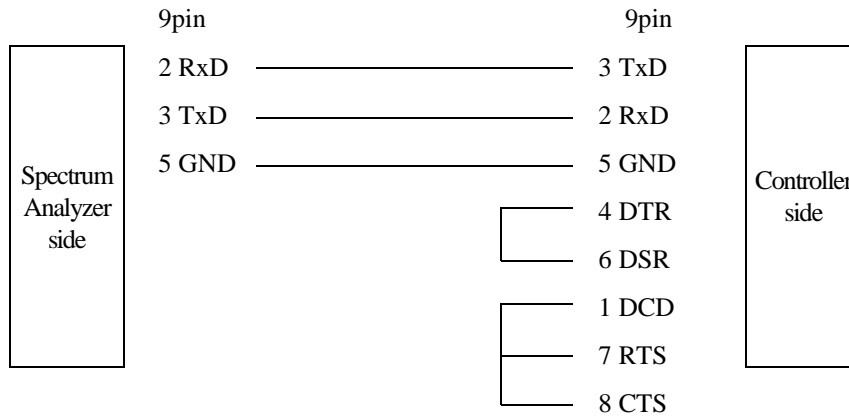

Figure 5-6 Connection Between the Controller and the analyzer

Although the analyzer uses only three pins, the controller side needs more connections for input and output.

NOTE:

1. When you send or receive data using the cable connections shown in Figure 5-7, set *XON/XOFF* to valid (*ON*).
 2. *DCD*, *DTR* and *DSR* are not used in the analyzer. When you use *CTS* and *RTS*, use a cable with cross-connection to connect the controller to the analyzer. Flow control is not performed using *CTS* or *RTS*. Set *XON/XOFF* to valid (*ON*) to perform flow control.
-



Pin No.(9pin)	Signal name	Remarks
1	DCD:Data Carrier Detector	Receive carrier detection
2	RxD: Receive Data	
3	TxD: Transmit Data	
4	DTR: Data Terminal Ready	
5	GND: Ground	Signal ground
6	DSR: Data set Ready	
7	RTS: Request To Send	Request signal for sending
8	CTS: Clear to Send	Clear signal for sending
9	CI: Data signal rate selector	N.C

Figure 5-7 Cable Wiring Diagram

5.3.5 Data Format

Transmission messages between the analyzer and the controller are in ASCII code character strings and followed by carriage returns (CR) and line feeds (LF).

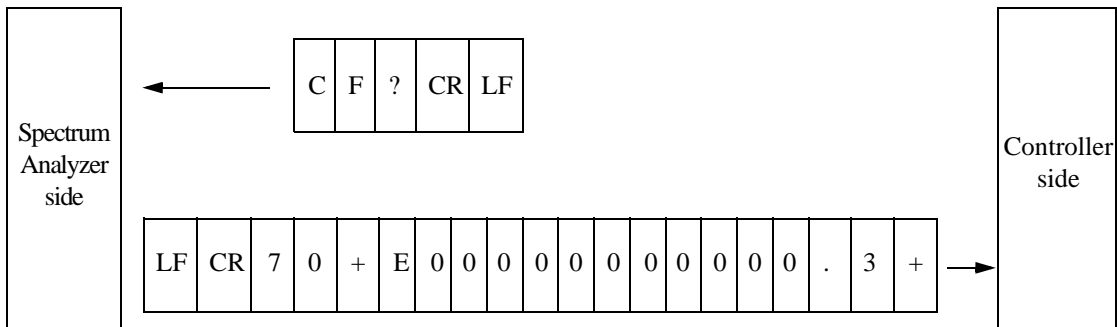

Figure 5-8 Data Format

5.3.6 Differences Between RS-232 and GPIB

NOTE:

1. *Transmission data must be in ASCII code.*
 2. *Delimit the data from the controller with <CR> or <CR + LF>. Query data and the GPIB delimiters are the same. Therefore, send DL0 or DL3 after serial port was opened (refer to the example of RS-232 remote program).*
-

- Data transmission example:
Personal computers can recognize both CF 30.0MZ <CR> and CF 30.0MZ <CR + LF>.

The format for query data is +3.00000000000E+07 <CR + LF> (send DL0 or DL3). The output data of this RS-232 and GPIB are the same number of characters except delimiters (CR and LF).

5.3.6 Differences Between RS-232 and GPIB

- Command code
Trace data input or output can only be formatted in ASCII.
Bitmap data files cannot be transferred.
-

NOTE: *The following commands are unavailable: TBA, TBB and BMP.*

5.3.7 Panel Control

During remote control operation, spectrum analyzer panel control is affected as follows.

- The remote lamp does not light.
 - The key panel is not disabled.
-

NOTE:*If any settings are changed during remote control, the operation of the analyzer may become unstable.*

5.3.8 Remote Control Usage Examples

The following examples show typical remote control commands, and are written in "Microsoft Quick Basic" (licensed by Microsoft Corporation).

The Open command statement OPEN" COM1: 9600, N, 8, 1, ASC" FOR RANDOM AS #1 shown below has the following characteristics: baud rate is 9600 bps, no parity, 8 bit data length, stop bit of 1, ASCII format and random access mode.

Example: This program is used to check the status byte register to see if the sweep has been completed.

```

OPEN "COM1:9600,N,8,1,ASC" FOR RANDOM AS #1
PRINT #1, "DL3"           ' CR and LF are set as the GPIB delimiter.
PRINT #1, "SI"           ' Single sweep is performed.
PRINT #1, "OPR8"        ' Sweep completion bit in the GPIB operation register is set.
PRINT #1, "CLS"         ' Clearing the status bytes.
PRINT #1, "SI"           ' Single sweep is performed.
MEAS.LOOP:               ' Read out the status bytes.
PRINT #1, "*STB?"
INPUT #1, STAT
IF (STAT AND 128) = 0 THEN GOTO MEAS.LOOP
PRINT #1, "PS"           ' Peak search.
PRINT #1, "ML?"         ' Read out the peak level.
INPUT#1,MLEVEL
PRINT MLEVEL
END

```

6 SPECIFICATIONS

6.1 R3264 Specifications

(1) Frequency

Characteristics	Specification
Frequency range:	9 kHz to 3.5 GHz Harmonic order N=1
Frequency reading accuracy:	$\pm (\text{Frequency reading} \times \text{Frequency reference accuracy} + \text{Span} \times \text{Span accuracy} + 0.15 \times \text{Resolution bandwidth} + 10 \text{ Hz})$
Marker frequency counter (SPAN < 1 GHz) Accuracy (S/N > 25 dB): Delta counter: Resolution:	$\pm (\text{Marker frequency} \times \text{Frequency reference accuracy} + 5 \text{ Hz} \times N + 1\text{LSD})$ $\pm (\Delta\text{Frequency} \times \text{Frequency reference accuracy} + 10 \text{ Hz} \times N + 2\text{LSD})$ 1 Hz to 1 kHz
Reference frequency source stability Aging: Temperature stability:	$\pm 3 \times 10^{-8}/\text{day}$ $\pm 1 \times 10^{-7}/\text{year}$ $\pm 1 \times 10^{-7}$ Temperature range: 0 to 40°C in reference to the frequency measured at 25°C $\pm 2^\circ\text{C}$
OPT21 Aging: Temperature stability:	$\pm 5 \times 10^{-9}/\text{day}$ $\pm 8 \times 10^{-8}/\text{year}$ $\pm 5 \times 10^{-8}$ Temperature range: 0 to 40°C in reference to the frequency measured at 25°C $\pm 2^\circ\text{C}$
OPT22 Aging: Temperature stability:	$\pm 3 \times 10^{-10}/\text{day}$ $\pm 2 \times 10^{-8}/\text{year}$ $\pm 5 \times 10^{-9}$ Temperature range: 0 to 50°C in reference to the frequency measured at 25°C
A warm-up (Nominal):	$\pm 1 \times 10^{-8}/30 \text{ min}$ } In reference to the frequency measured 24 hours after $\pm 5 \times 10^{-9}/60 \text{ min}$ } the power-on at an ambient temperature of 25°C
OPT23 Frequency accuracy: Aging: Temperature stability:	$\pm 5 \times 10^{-9}$ $\pm 1 \times 10^{-10}/\text{month}$ $\pm 1 \times 10^{-9}$ Temperature range: 0 to 40°C in reference to the frequency measured at 25°C
Warm-up:	$\pm 1 \times 10^{-9}/15 \text{ min}$

6.1 R3264 Specifications

Characteristics	Specification																									
Frequency stability Residual FM (ZERO span): Drift:	< 3 Hz × Np-p/0.1 sec Same as the reference source (After a warm-up of 60 min.)																									
Signal purity: (dBc/Hz)	<table border="1"> <thead> <tr> <th>Offset</th> <th>1 kHz</th> <th>10 kHz</th> <th>100 kHz</th> <th>1 MHz</th> </tr> </thead> <tbody> <tr> <td>Frequency</td> <td></td> <td></td> <td></td> <td></td> </tr> <tr> <td>9 kHz to 1 GHz</td> <td>-100</td> <td>-113</td> <td>-118</td> <td>-135</td> </tr> <tr> <td>1 GHz to 2.6 GHz</td> <td>-100</td> <td>-110</td> <td>-118</td> <td>-135</td> </tr> <tr> <td>2.6 GHz to 3.5 GHz</td> <td>-98</td> <td>-108</td> <td>-112</td> <td>-135</td> </tr> </tbody> </table>	Offset	1 kHz	10 kHz	100 kHz	1 MHz	Frequency					9 kHz to 1 GHz	-100	-113	-118	-135	1 GHz to 2.6 GHz	-100	-110	-118	-135	2.6 GHz to 3.5 GHz	-98	-108	-112	-135
Offset	1 kHz	10 kHz	100 kHz	1 MHz																						
Frequency																										
9 kHz to 1 GHz	-100	-113	-118	-135																						
1 GHz to 2.6 GHz	-100	-110	-118	-135																						
2.6 GHz to 3.5 GHz	-98	-108	-112	-135																						
Frequency span Range: Accuracy:	20 Hz to 3.5 GHz, ZERO SPAN ± 1%																									
Resolution bandwidth (3dB) Range: Accuracy: Selectivity:	1 Hz to 10 MHz (1, 3, 10 sequences), 5 MHz ±25%: RBW = 3 MHz, 5 MHz ±15%: RBW = 100 Hz to 1 MHz ±25% (25°C ±10°C): RBW = 30 Hz ±10%:RBW=1 Hz to 100 Hz (digital filter) <15:1 (RBW = 100 Hz to 5 MHz) <20:1 (RBW = 30 Hz) <5:1 (RBW = 1 Hz to 100 Hz, digital filter)																									
Video bandwidth Range:	1 Hz to 10 MHz (1, 3, 10 sequences), 5 MHz																									
Frequency sweep Sweep time: Zero span: Span > 0 Hz: Accuracy: Trigger:	1 μsec to 1000 sec 20 msec to 1000 sec ±3% (Excluding digital filters) Free run, line, video, external, IF																									
Gated sweep Gate position: Resolution: Gate width: Resolution: Trigger:	100 nsec to 1 sec 100 nsec 1 μsec to 1 sec 100 nsec IF (mixer input is -40 dBm or more) External trigger or External gate																									
Delayed sweep Delay time: Resolution:	100 nsec to 1 sec 100 nsec																									

(2) Amplitude Range

Characteristics	Specification
Measurement range:	+30 dBm to Average noise level
Maximum safe input Average continuous power (Input ATT \geq 10dB): DC input:	+30 dBm (1W) 50V
Display range Log: Linear:	10×10 div 10, 5, 2, 1, 0.5dB/div 10% of reference level/div
Reference level range Log: Linear:	-140 dBm to +60 dBm (in 0.1 dB steps) 22.4nV to 223V (steps of about 1% of full scale)
Input ATT range:	0 to 75 dB (5 dB steps)

(3) Dynamic Range

Characteristics	Specification																				
Average noise level:	Resolution bandwidth 100 Hz (analog), Input ATT 0 dB, Video bandwidth 1 Hz <table border="1" data-bbox="660 1115 1399 1301"> <thead> <tr> <th>Frequency</th> <th>Average noise level</th> </tr> </thead> <tbody> <tr> <td>10 kHz</td> <td>-100 dBm</td> </tr> <tr> <td>100 kHz</td> <td>-101 dBm</td> </tr> <tr> <td>1 MHz</td> <td>-125 dBm</td> </tr> <tr> <td>10 MHz to 3.5 GHz</td> <td>$-(130 - 2f \text{ (GHz)})$ dBm</td> </tr> </tbody> </table> Resolution bandwidth 1 Hz (digital), Input ATT 0 dB <table border="1" data-bbox="660 1373 1399 1559"> <thead> <tr> <th>Frequency</th> <th>Average noise level</th> </tr> </thead> <tbody> <tr> <td>10 kHz</td> <td>-120 dBm</td> </tr> <tr> <td>100 kHz</td> <td>-121 dBm</td> </tr> <tr> <td>1 MHz</td> <td>-141 dBm</td> </tr> <tr> <td>10 MHz to 3.5 GHz</td> <td>$-(150 - 2f \text{ (GHz)})$ dBm</td> </tr> </tbody> </table>	Frequency	Average noise level	10 kHz	-100 dBm	100 kHz	-101 dBm	1 MHz	-125 dBm	10 MHz to 3.5 GHz	$-(130 - 2f \text{ (GHz)})$ dBm	Frequency	Average noise level	10 kHz	-120 dBm	100 kHz	-121 dBm	1 MHz	-141 dBm	10 MHz to 3.5 GHz	$-(150 - 2f \text{ (GHz)})$ dBm
Frequency	Average noise level																				
10 kHz	-100 dBm																				
100 kHz	-101 dBm																				
1 MHz	-125 dBm																				
10 MHz to 3.5 GHz	$-(130 - 2f \text{ (GHz)})$ dBm																				
Frequency	Average noise level																				
10 kHz	-120 dBm																				
100 kHz	-121 dBm																				
1 MHz	-141 dBm																				
10 MHz to 3.5 GHz	$-(150 - 2f \text{ (GHz)})$ dBm																				
1 dB gain compression:	10 MHz to 100 MHz -3 dBm 100 MHz to 3.5 GHz 0 dBm																				

6.1 R3264 Specifications

(4) Spurious Response

Characteristics	Specification
2nd order harmonic distortion:	< -70 dBc (10 MHz to 3.5 GHz, mixer level -30 dBm)
2 signal 3rd order harmonic distortion:	($\Delta f \geq 5$ kHz when digital filters are used) < -70 dBc (10 MHz to 100 MHz, mixer level -30 dBm) < -80 dBc (100 MHz to 1 GHz, mixer level -30 dBm) < -85 dBc (1 GHz to 3.5 GHz, mixer level -30 dBm)
Residual response (no input, input ATT 0 dB, 50 Ω termination)	< -100 dBm (1 MHz to 3.5 GHz) < -90 dBm (300 kHz to 3.5 GHz)

(5) Amplitude Accuracy

Characteristics	Specification
Frequency response (input ATT 10 dB) Flatness (Relative values): For a 30 MHz calibration single:	± 1.5 dB (9 kHz to 3.5 GHz) ± 3.0 dB (9 kHz to 3.5 GHz)
Calibration signal accuracy (30 MHz):	-10 dBm ± 0.3 dB
IF gain error (After automatic calibration):	0 dBm to -50 dBm ± 0.5 dB 0 dBm to -80 dBm ± 0.7 dB
Scale display accuracy (After automatic calibration) Log: Linear:	0 dB to -90 dB ± 0.85 dB max ± 0.2 dB/1 dB $\pm 5\%$ of reference level
Input ATT switching error (in reference to 10 dB, at 15 dB to 75 dB)	9 kHz to 3.5 GHz ± 1.1 dB/5 dB steps, 2.0 dB max
Resolution bandwidth switching error (Resolution bandwidth in reference to 300 kHz, after automatic calibration):	< ± 0.3 dB (RBW = 100 Hz to 5 MHz) < ± 1.0 dB (RBW = 30 Hz) < ± 0.5 dB (RBW = 1 Hz to 100Hz, digital filter)
Total level accuracy	± 1.0 dB (Typical) Frequency range: 50 MHz to 2.6 GHz RBW: 3 kHz to 1 MHz Frequency span < RBW \times 20 Input ATT: 10 dB Log scale display: 0 dB to -50 dB Reference level: 0 dBm to -50 dBm Detection mode: Sample Ambient Temperature: 20°C to 30°C S/N ratio ≥ 20 dB

(6) Input and Output

Characteristics	Specification
RF input Connector: Impedance: VSWR (Input ATT \geq 10 dB):	N-type female 50 Ω (nominal) < 1.5 : 1 (< 3.5 GHz) (nominal)
Calibration signal output Connector: Frequency: Impedance: Amplitude:	BNC female, front panel 30 MHz \times (1 \pm frequency reference accuracy) 50 Ω (nominal) -10 dBm \pm 0.3 dB
10 MHz frequency reference output Connector: Impedance: Frequency accuracy: Amplitude range:	BNC female, rear panel 50 Ω (nominal) 10 MHz \times frequency reference accuracy 0 dBm \pm 5 dB
10 MHz frequency reference input Connector: Frequency: Frequency (OPT25): Impedance: Amplitude range:	BNC female, rear panel 10 MHz Automatically switched to 10 MHz, 15 MHz or 19.6608 MHz 50 Ω (nominal) -5 dBm to +5 dBm
Probe power supply: *	\pm 12.6V (100mA) (nominal)
21.4 MHz, IF output Connector: Impedance:	BNC female, rear panel 50 Ω (nominal)
421.4 MHz, IF output Connector: Impedance:	BNC female, rear panel 50 Ω (nominal)
Video output Connector:	VGA (15 pins, female), rear panel 640 \times 480 dots (equivalent to VGA)
X axis output Connector: Impedance: Amplitude:	BNC female, rear panel 1 k Ω (nominal), DC coupled About -5V to +5V
Y axis output Connector: Impedance: Amplitude:	BNC female, rear panel 220 Ω (nominal) About 2V for full scale (with 10 dB/div)
External trigger input Connector: Impedance: Trigger level:	BNC female, rear panel 10 k Ω (nominal), DC coupled TTL level

* This probe power supply is not available if OPT22 or OPT23 is installed.

6.1 R3264 Specifications

Characteristics	Specification
External gate input Connector: Impedance: Stops sweeping: Allowed to sweep:	BNC female, rear panel 10 k Ω (nominal), DC coupled While a TTL output is at LOW level. While a TTL output is at HIGH level.
Trigger output Connector: Amplitude:	BNC female, rear panel TTL level
I/O interface GPIB: RS232: Printer: Extended I/O port: FDD:	IEEE-488 bus connector, rear panel D-SUB 9pins, rear panel D-SUB 25pins, rear panel D-SUB 25pins, rear panel 3.5 inch floppy disk drive
Direct print:	Output with ESC/P, PCL, ESC/P raster commands

(7) General Specifications

Characteristics	Specification
Temperature Operating environment range Storage environment range Relative humidity	0°C to +50°C -20°C to +60°C 85% or less (Without condensation)
AC input power source	Automatic switching to 100 VAC or 220 VAC For 100 VAC: 100 to 120 VAC, 50 or 60 Hz For 220 VAC: 220 to 240 VAC, 50 or 60 Hz
Power consumption	300 VA or below
Mass	18 kg or less (not including options, accessories, etc.)
Dimensions	Approximately 178(H) \times 355(W) \times 423.5(D)mm (rear feet and connectors are not included in above dimensions)

6.2 R3267 Specifications

(1) Frequency

Characteristics	Specification																		
Frequency range:	100 Hz to 8 GHz <table border="1" data-bbox="742 593 1332 846"> <thead> <tr> <th>Frequency</th> <th>Frequency band</th> <th>Harmonic order N</th> </tr> </thead> <tbody> <tr> <td>100 Hz to 3.5 GHz</td> <td>0</td> <td>1</td> </tr> <tr> <td>1.6 GHz to 3.5 GHz</td> <td>1</td> <td>1</td> </tr> <tr> <td>3.5 GHz to 7 GHz</td> <td>2</td> <td>1</td> </tr> <tr> <td>6.9 GHz to 8 GHz</td> <td>3</td> <td>1</td> </tr> <tr> <td colspan="3">Built-in YIG tuning pre-selector at 1.6 GHz to 8 GHz</td> </tr> </tbody> </table>	Frequency	Frequency band	Harmonic order N	100 Hz to 3.5 GHz	0	1	1.6 GHz to 3.5 GHz	1	1	3.5 GHz to 7 GHz	2	1	6.9 GHz to 8 GHz	3	1	Built-in YIG tuning pre-selector at 1.6 GHz to 8 GHz		
Frequency	Frequency band	Harmonic order N																	
100 Hz to 3.5 GHz	0	1																	
1.6 GHz to 3.5 GHz	1	1																	
3.5 GHz to 7 GHz	2	1																	
6.9 GHz to 8 GHz	3	1																	
Built-in YIG tuning pre-selector at 1.6 GHz to 8 GHz																			
Frequency reading accuracy:	$\pm (\text{Frequency reading} \times \text{Frequency reference accuracy} + \text{Span} \times \text{Span accuracy} + 0.15 \times \text{Resolution bandwidth} + 10 \text{ Hz})$																		
Marker frequency counter (SPAN < 1 GHz) Accuracy (S/N > 25 dB): Delta counter: Resolution:	$\pm (\text{Marker frequency} \times \text{Frequency reference accuracy} + 5 \text{ Hz} \times N + 1\text{LSD})$ $\pm (\Delta\text{Frequency} \times \text{Frequency reference accuracy} + 10 \text{ Hz} \times N + 2\text{LSD})$ 1 Hz to 1 kHz																		
Reference frequency source stability																			
Aging:	$\pm 3 \times 10^{-8}/\text{day}$ $\pm 1 \times 10^{-7}/\text{year}$																		
Temperature stability:	$\pm 1 \times 10^{-7}$ Temperature range: 0 to 40°C in reference to the frequency measured at 25°C $\pm 2^\circ\text{C}$																		
OPT21																			
Aging:	$\pm 5 \times 10^{-9}/\text{day}$ $\pm 8 \times 10^{-8}/\text{year}$																		
Temperature stability:	$\pm 5 \times 10^{-8}$ Temperature range: 0 to 40°C in reference to the frequency measured at 25°C $\pm 2^\circ\text{C}$																		
OPT22																			
Aging:	$\pm 3 \times 10^{-10}/\text{day}$ $\pm 2 \times 10^{-8}/\text{year}$																		
Temperature stability:	$\pm 5 \times 10^{-9}$ Temperature range: 0 to 50°C in reference to the frequency measured at 25°C																		
A warm-up (Nominal):	$\pm 1 \times 10^{-8}/30 \text{ min}$ } In reference to the frequency measured 24 hours after $\pm 5 \times 10^{-9}/60 \text{ min}$ } the power-on at an ambient temperature of 25°C																		
OPT23																			
Frequency accuracy:	$\pm 5 \times 10^{-9}$																		
Aging:	$\pm 1 \times 10^{-10}/\text{month}$																		
Temperature stability:	$\pm 1 \times 10^{-9}$ Temperature range: 0 to 40°C in reference to the frequency measured at 25°C																		
Warm-up:	$\pm 1 \times 10^{-9}/15 \text{ min}$																		

6.2 R3267 Specifications

Characteristics	Specification																				
Frequency stability Residual FM (ZERO span): Drift:	< 3 Hz × Np-p/0.1 sec Same as the reference source (After a warm-up of 60 min.)																				
Signal purity: (dBc/Hz)	<table border="1"> <thead> <tr> <th>Frequency \ Offset</th> <th>1 kHz</th> <th>10 kHz</th> <th>100 kHz</th> <th>1 MHz</th> </tr> </thead> <tbody> <tr> <td>100 Hz to 1 GHz</td> <td>-100</td> <td>-113</td> <td>-118</td> <td>-135</td> </tr> <tr> <td>1 GHz to 2.6 GHz</td> <td>-100</td> <td>-110</td> <td>-118</td> <td>-135</td> </tr> <tr> <td>2.6 GHz to 8 GHz</td> <td>-98</td> <td>-108</td> <td>-112</td> <td>-135</td> </tr> </tbody> </table>	Frequency \ Offset	1 kHz	10 kHz	100 kHz	1 MHz	100 Hz to 1 GHz	-100	-113	-118	-135	1 GHz to 2.6 GHz	-100	-110	-118	-135	2.6 GHz to 8 GHz	-98	-108	-112	-135
Frequency \ Offset	1 kHz	10 kHz	100 kHz	1 MHz																	
100 Hz to 1 GHz	-100	-113	-118	-135																	
1 GHz to 2.6 GHz	-100	-110	-118	-135																	
2.6 GHz to 8 GHz	-98	-108	-112	-135																	
Frequency span Range: Accuracy:	20 Hz to 8 GHz, ZERO SPAN ± 1%																				
Resolution bandwidth (3dB) Range: Accuracy: Selectivity:	1 Hz to 10 MHz (1, 3, 10 sequences), 5 MHz ±25%: RBW = 3 MHz, 5 MHz ±15%: RBW = 100 Hz to 1 MHz ±25% (25°C ±10°C): RBW = 30 Hz ±10%:RBW=1 Hz to 100 Hz (digital filters) <15:1 (RBW = 100 Hz to 5 MHz) <20:1 (RBW = 30 Hz) <5:1 (RBW = 1 Hz to 100 Hz, digital filters)																				
Video bandwidth Range:	1 Hz, 10 MHz (1, 3, 10 sequences), 5 MHz																				
Frequency sweep Sweep time: Zero span: Span > 0 Hz: Accuracy: Trigger:	1 μsec to 1000 sec 20 msec to 1000 sec ±3% (Excluding digital filters) Free run, line, video, external, IF																				
Gated sweep Gate position: Resolution: Gate width: Resolution: Trigger:	100 nsec to 1 sec 100 nsec 1 μsec to 1 sec 100 nsec IF (Mixer input is -40 dBm or more) External trigger or External gate																				
Delayed sweep Delay time: Resolution:	100 nsec to 1 sec 100 nsec																				

(2) Amplitude Range

Characteristics	Specification
Measurement range:	+30 dBm to Average noise level
Maximum safe input Average continuous power (Input ATT ≥ 10dB): DC input:	+30 dBm (1W) 0V (DC signal must not be applied)
Display range Log: Linear:	10 × 10div 10, 5, 2, 1, 0.5dB/div 10% of reference level/div
Reference level range Log: Linear:	-140 dBm to +60 dBm (in 0.1 dB steps) 22.4nV to 223V (steps of about 1% of full scale)
Input ATT range	0 to 75 dB (5 dB steps)

(3) Dynamic Range

Characteristics	Specification																																																			
Average noise level	<p>Resolution bandwidth 100 Hz (analog), Input ATT 0 dB, Video bandwidth 1 Hz</p> <table border="1"> <thead> <tr> <th>Frequency</th> <th>Frequency band</th> <th>Average noise level</th> </tr> </thead> <tbody> <tr> <td>1 kHz</td> <td>0</td> <td>-90 dBm</td> </tr> <tr> <td>10 kHz</td> <td>0</td> <td>-100 dBm</td> </tr> <tr> <td>100 kHz</td> <td>0</td> <td>-101 dBm</td> </tr> <tr> <td>1 MHz</td> <td>0</td> <td>-125 dBm</td> </tr> <tr> <td>10 MHz to 3.5 GHz</td> <td>0</td> <td>-(130 - f (GHz)) dBm</td> </tr> <tr> <td>1.6 GHz to 3.5 GHz</td> <td>1</td> <td>-125 dBm</td> </tr> <tr> <td>3.5 GHz to 7.0 GHz</td> <td>2</td> <td>-125 dBm</td> </tr> <tr> <td>6.9 GHz to 8.0 GHz</td> <td>3</td> <td>-125 dBm</td> </tr> </tbody> </table> <p>Resolution bandwidth 1 Hz (digital), Input ATT 0 dB</p> <table border="1"> <thead> <tr> <th>Frequency</th> <th>Frequency band</th> <th>Average noise level</th> </tr> </thead> <tbody> <tr> <td>10 kHz</td> <td>0</td> <td>-120 dBm</td> </tr> <tr> <td>100 kHz</td> <td>0</td> <td>-121 dBm</td> </tr> <tr> <td>1 MHz</td> <td>0</td> <td>-141 dBm</td> </tr> <tr> <td>10 MHz to 3.5 GHz</td> <td>0</td> <td>-(150 - f (GHz)) dBm</td> </tr> <tr> <td>1.6 GHz to 3.5 GHz</td> <td>1</td> <td>-145 dBm</td> </tr> <tr> <td>3.5 GHz to 7.0 GHz</td> <td>2</td> <td>-145 dBm</td> </tr> <tr> <td>6.9 GHz to 8.0 GHz</td> <td>3</td> <td>-145 dBm</td> </tr> </tbody> </table>	Frequency	Frequency band	Average noise level	1 kHz	0	-90 dBm	10 kHz	0	-100 dBm	100 kHz	0	-101 dBm	1 MHz	0	-125 dBm	10 MHz to 3.5 GHz	0	-(130 - f (GHz)) dBm	1.6 GHz to 3.5 GHz	1	-125 dBm	3.5 GHz to 7.0 GHz	2	-125 dBm	6.9 GHz to 8.0 GHz	3	-125 dBm	Frequency	Frequency band	Average noise level	10 kHz	0	-120 dBm	100 kHz	0	-121 dBm	1 MHz	0	-141 dBm	10 MHz to 3.5 GHz	0	-(150 - f (GHz)) dBm	1.6 GHz to 3.5 GHz	1	-145 dBm	3.5 GHz to 7.0 GHz	2	-145 dBm	6.9 GHz to 8.0 GHz	3	-145 dBm
Frequency	Frequency band	Average noise level																																																		
1 kHz	0	-90 dBm																																																		
10 kHz	0	-100 dBm																																																		
100 kHz	0	-101 dBm																																																		
1 MHz	0	-125 dBm																																																		
10 MHz to 3.5 GHz	0	-(130 - f (GHz)) dBm																																																		
1.6 GHz to 3.5 GHz	1	-125 dBm																																																		
3.5 GHz to 7.0 GHz	2	-125 dBm																																																		
6.9 GHz to 8.0 GHz	3	-125 dBm																																																		
Frequency	Frequency band	Average noise level																																																		
10 kHz	0	-120 dBm																																																		
100 kHz	0	-121 dBm																																																		
1 MHz	0	-141 dBm																																																		
10 MHz to 3.5 GHz	0	-(150 - f (GHz)) dBm																																																		
1.6 GHz to 3.5 GHz	1	-145 dBm																																																		
3.5 GHz to 7.0 GHz	2	-145 dBm																																																		
6.9 GHz to 8.0 GHz	3	-145 dBm																																																		
1 dB gain compression:	<p>10 MHz to 100 MHz -3 dBm 100 MHz to 8GHz 0 dBm</p>																																																			

6.2 R3267 Specifications

(4) Spurious Response

Characteristics	Specification			
2nd order harmonic distortion		Frequency range	Frequency band	Mixer level
	< -70 dBc	10 MHz to 3.5 GHz	0	-30 dBm
	< -90 dBc	> 1.6 GHz	1, 2, 3	-10 dBm
2 signal 3rd order harmonic distortion	$\Delta f \geq 5\text{kHz}$ (when digital filters are used)			
		Frequency range	Frequency band	Mixer level
	< -70 dBc	10 MHz to 100 MHz	0	-30 dBm
	< -80 dBc	100 MHz to 1 GHz	0	-30 dBm
	< -85 dBc	1 GHz to 3.5 GHz	0	-30 dBm
< -90 dBc	1.6 GHz to 8 GHz	1, 2, 3	-30 dBm	
Image/multiple/out-band response		Frequency range		
	< -70 dBc	10 MHz to 8 GHz		
Residual response (no input, input ATT 0 dB, 50 Ω termination)		Frequency range		
	< -100 dBm	1 MHz to 3.5 GHz		
	< -90 dBm	300 kHz to 8 GHz		

(5) Amplitude Accuracy

Characteristics	Specification												
Frequency response (with an input ATT of 10 dB, band 1, 2 or 3 is automatically tuned on the pre-selector): Flatness within the bands (Relative values)	<table border="1"> <thead> <tr> <th>Frequency band</th> <th>Frequency range</th> </tr> </thead> <tbody> <tr> <td>0</td> <td>100 Hz to 3.5 GHz±1.5 dB</td> </tr> <tr> <td>0</td> <td>50 MHz to 2.6 GHz±1.0 dB</td> </tr> <tr> <td>1</td> <td>1.6 GHz to 3.5 GHz±1.5 dB</td> </tr> <tr> <td>2</td> <td>3.5 GHz to 7.0 GHz±1.5 dB</td> </tr> <tr> <td>3</td> <td>6.9 GHz to 8.0 GHz±1.5 dB</td> </tr> </tbody> </table>	Frequency band	Frequency range	0	100 Hz to 3.5 GHz±1.5 dB	0	50 MHz to 2.6 GHz±1.0 dB	1	1.6 GHz to 3.5 GHz±1.5 dB	2	3.5 GHz to 7.0 GHz±1.5 dB	3	6.9 GHz to 8.0 GHz±1.5 dB
Frequency band	Frequency range												
0	100 Hz to 3.5 GHz±1.5 dB												
0	50 MHz to 2.6 GHz±1.0 dB												
1	1.6 GHz to 3.5 GHz±1.5 dB												
2	3.5 GHz to 7.0 GHz±1.5 dB												
3	6.9 GHz to 8.0 GHz±1.5 dB												
Complementary error due to band switching	±0.5 dB												
For a 30 MHz calibration signal	100 Hz to 8.0 GHz±3.0 dB												
Calibration signal accuracy (30 MHz)	-10 dBm ±0.3 dB												
IF gain error (After automatic calibration)	0 dBm to -50 dBm ±0.5 dB 0 dBm to -80 dBm ±0.7 dB												
Scale display accuracy (After automatic calibration) Log:	0 dB to -90 dB ±0.85 dB max ±0.2 dB/1 dB												
Linear:	± 5% of reference level												
Input ATT switching error (in reference to 10 dB, at 15 dB to 75 dB)	100 Hz to 8 GHz ±1.1 dB/5 dB steps, 2.0 dB max												
Resolution bandwidth switching error (Resolution bandwidth in reference to 300 kHz, after automatic calibration):	<±0.3 dB (RBW = 100 Hz to 5 MHz) <±1.0 dB (RBW = 30 Hz) <±0.5 dB (RBW = 1 Hz to 100Hz, digital filters)												
Total level accuracy	±1.0 dB (Typical) Frequency range: 50 MHz to 2.6 GHz (Frequency band : 0) RBW: 3 kHz to 1 MHz Frequency span < RBW × 20 Input ATT: 10 dB Logarithmic scale display: 0 dB to -50 dB Reference level: 0 dBm to -50 dBm Detection mode: Sample Ambient temperature: 20°C to 30°C S/N ratio ≥ 20 dB												

6.2 R3267 Specifications

(6) Input and Output

Characteristics	Specification
RF input Connector: Impedance: VSWR (Input ATT \geq 10 dB setting frequency):	N-type female 50 Ω (nominal) < 1.5 : 1 (< 3.5 GHz) (nominal) < 2.1 : 1 (> 3.5 GHz) (nominal)
Calibration signal output Connector: Frequency: Impedance: Amplitude:	BNC female, front panel 30 MHz \times (1 \pm frequency reference accuracy) 50 Ω (nominal) -10 dBm \pm 0.3 dB
10 MHz frequency reference output Connector: Impedance: Frequency accuracy: Amplitude range:	BNC female, rear panel 50 Ω (nominal) 10 MHz \times frequency reference accuracy 0 dBm \pm 5 dB
10 MHz frequency reference input Connector: Frequency: Frequency (OPT25): Impedance: Amplitude range:	BNC female, rear panel 10 MHz Automatically switched to 10 MHz, 15 MHz or 19.6608 MHz 50 Ω (nominal) -5 dBm to +5 dBm
Probe power supply: *	\pm 12.6V (100mA) (nominal)
21.4 MHz, IF output Connector: Impedance:	BNC female, rear panel 50 Ω (nominal)
421.4 MHz, IF output Connector: Impedance:	BNC female, rear panel 50 Ω (nominal)
Video output Connector:	VGA (15 pins, female), rear panel 640 \times 480 dots (equivalent to VGA)
X axis output Connector: Impedance: Amplitude:	BNC female, rear panel 1 k Ω (nominal), DC coupled About -5V to +5V
Y axis output Connector: Impedance: Amplitude:	BNC female, rear panel 220 Ω (nominal) About 2V for full scale (with 10 dB/div)
External trigger input Connector: Impedance: Trigger level:	BNC female, rear panel 10 k Ω (nominal), DC coupled TTL level

* This probe power supply is not available if OPT22 or OPT23 is installed.

Characteristics	Specification
External gate input Connector: Impedance: Stops sweeping: Allowed to sweep:	BNC female, rear panel 10 k Ω (nominal), DC coupled While a TTL output is at LOW level. While a TTL output is at HIGH level.
Trigger output Connector: Amplitude:	BNC female, rear panel TTL level
I/O interface GPIB: RS232: Printer: Extended I/O port: FDD:	IEEE-488 bus connector, rear panel D-SUB 9pins, rear panel D-SUB 25pins, rear panel D-SUB 25pins, rear panel 3.5 inch floppy disk drive
Direct print:	Output with ESC/P, PCL, ESC/P raster commands

(7) General Specifications

Characteristics	Specification
Temperature Operating environment range Storage environment range Relative humidity	0°C to +50°C -20°C to +60°C 85% or less (Without condensation)
AC input power source	Automatic switching to 100 VAC or 220 VAC For 100 VAC: 100 to 120 VAC, 50 or 60 Hz For 220 VAC: 220 to 240 VAC, 50 or 60 Hz
Power consumption	300 VA or below
Mass	18 kg or less (not including options, accessories, etc.)
Dimensions	Approximately 178(H) \times 355(W) \times 423.5(D)mm (rear feet and connectors are not included in above dimensions)

6.3 R3273 Specifications

6.3 R3273 Specifications

(1) Frequency

Characteristics	Specification																		
Frequency range:	100 Hz to 26.5 GHz 18 GHz to 60 GHz (external mixer used, synchronizable with up to 325 GHz) <table border="1" style="margin-left: 20px;"> <thead> <tr> <th>Frequency</th> <th>Frequency band</th> <th>Harmonic order N</th> </tr> </thead> <tbody> <tr> <td>100 Hz to 3.5 GHz</td> <td>0</td> <td>1</td> </tr> <tr> <td>3.5 GHz to 7.5 GHz</td> <td>1</td> <td>1</td> </tr> <tr> <td>7.4 GHz to 15.4 GHz</td> <td>2</td> <td>2</td> </tr> <tr> <td>15.2 GHz to 26.5 GHz</td> <td>3</td> <td>4</td> </tr> <tr> <td colspan="3">Built-in YIG tuning pre-selector at 3.5 GHz to 26.5 GHz</td> </tr> </tbody> </table>	Frequency	Frequency band	Harmonic order N	100 Hz to 3.5 GHz	0	1	3.5 GHz to 7.5 GHz	1	1	7.4 GHz to 15.4 GHz	2	2	15.2 GHz to 26.5 GHz	3	4	Built-in YIG tuning pre-selector at 3.5 GHz to 26.5 GHz		
Frequency	Frequency band	Harmonic order N																	
100 Hz to 3.5 GHz	0	1																	
3.5 GHz to 7.5 GHz	1	1																	
7.4 GHz to 15.4 GHz	2	2																	
15.2 GHz to 26.5 GHz	3	4																	
Built-in YIG tuning pre-selector at 3.5 GHz to 26.5 GHz																			
Frequency reading accuracy:	$\pm (\text{Frequency reading} \times \text{Frequency reference accuracy} + \text{Span} \times \text{Span accuracy} + 0.15 \times \text{Resolution bandwidth} + 10 \text{ Hz})$																		
Marker frequency counter (SPAN < 1 GHz) Accuracy (S/N > 25 dB): Delta counter: Resolution:	$\pm (\text{Marker frequency} \times \text{Frequency reference accuracy} + 5 \text{ Hz} \times N + 1\text{LSD})$ $\pm (\Delta\text{Frequency} \times \text{Frequency reference accuracy} + 10 \text{ Hz} \times N + 2\text{LSD})$ 1 Hz to 1 kHz																		
Reference frequency source stability	$\pm 3 \times 10^{-8}/\text{day}$ $\pm 1 \times 10^{-7}/\text{year}$ Aging: Temperature stability: $\pm 1 \times 10^{-7}$ Temperature range: 0 to 40°C in reference to the frequency measured at 25°C ±2°C																		
OPT21 Aging: Temperature stability:	$\pm 5 \times 10^{-9}/\text{day}$ $\pm 8 \times 10^{-8}/\text{year}$ $\pm 5 \times 10^{-8}$ Temperature range: 0 to 40°C in reference to the frequency measured at 25°C ±2°C																		
OPT22 Aging: Temperature stability:	$\pm 3 \times 10^{-10}/\text{day}$ $\pm 2 \times 10^{-8}/\text{year}$ $\pm 5 \times 10^{-9}$ Temperature range: 0 to 50°C in reference to the frequency measured at 25°C																		
A warm-up (Nominal):	$\pm 1 \times 10^{-8}/30 \text{ min}$ $\pm 5 \times 10^{-9}/60 \text{ min}$																		
OPT23 Frequency accuracy: Aging: Temperature stability:	$\pm 5 \times 10^{-9}$ $\pm 1 \times 10^{-10}/\text{month}$ $\pm 1 \times 10^{-9}$ Temperature range: 0 to 40°C in reference to the frequency measured at 25°C																		
Warm-up:	$\pm 1 \times 10^{-9}/15 \text{ min}$																		

Characteristics	Specification																																		
Frequency stability Residual FM: Drift:	< 3 Hz × Np-p/0.1 sec Same as the reference source (After a warm-up of 60 min.)																																		
Signal purity: (dBc/Hz)	<table border="1"> <thead> <tr> <th rowspan="2">Frequency \ Offset</th> <th colspan="4">Offset</th> </tr> <tr> <th>1 kHz</th> <th>10 kHz</th> <th>100 kHz</th> <th>1 MHz</th> </tr> </thead> <tbody> <tr> <td>100 Hz to 1 GHz</td> <td>-100</td> <td>-113</td> <td>-118</td> <td>-135</td> </tr> <tr> <td>1 GHz to 2.6 GHz</td> <td>-100</td> <td>-110</td> <td>-118</td> <td>-135</td> </tr> <tr> <td>2.6 GHz to 7.5 GHz</td> <td>-98</td> <td>-108</td> <td>-112</td> <td>-135</td> </tr> <tr> <td>7.4 GHz to 15.4 GHz</td> <td>-89</td> <td>-102</td> <td>-106</td> <td>-129</td> </tr> <tr> <td>15.2 GHz to 26.5 GHz</td> <td>-83</td> <td>-96</td> <td>-100</td> <td>-123</td> </tr> </tbody> </table>	Frequency \ Offset	Offset				1 kHz	10 kHz	100 kHz	1 MHz	100 Hz to 1 GHz	-100	-113	-118	-135	1 GHz to 2.6 GHz	-100	-110	-118	-135	2.6 GHz to 7.5 GHz	-98	-108	-112	-135	7.4 GHz to 15.4 GHz	-89	-102	-106	-129	15.2 GHz to 26.5 GHz	-83	-96	-100	-123
Frequency \ Offset	Offset																																		
	1 kHz	10 kHz	100 kHz	1 MHz																															
100 Hz to 1 GHz	-100	-113	-118	-135																															
1 GHz to 2.6 GHz	-100	-110	-118	-135																															
2.6 GHz to 7.5 GHz	-98	-108	-112	-135																															
7.4 GHz to 15.4 GHz	-89	-102	-106	-129																															
15.2 GHz to 26.5 GHz	-83	-96	-100	-123																															
Frequency span Range: Accuracy:	20 Hz to 26.5 GHz, ZERO SPAN ±1%																																		
Resolution bandwidth (3dB) Range: Accuracy: Selectivity:	1 Hz to 10 MHz (1, 3, 10 sequences), 5 MHz ±25%: RBW = 3 MHz, 5 MHz ±15%: RBW = 100 Hz to 1 MHz ±25% (25°C ±10°C): RBW = 30 Hz ±10%: RBW = 1 Hz to 100 Hz (digital filters) <15:1 (RBW = 100 Hz to 5 MHz) <20:1 (RBW = 30 Hz) <5:1 (RBW = 1 Hz to 100Hz, digital filters)																																		
Video bandwidth Range:	1 Hz to 10 MHz (1, 3, 10 sequences), 5 MHz																																		
Frequency sweep Sweep time: Zero span: Span > 0 Hz: Accuracy: Trigger:	1 μsec to 1000 sec 20 msec to 1000 sec ±3% (Excluding digital filters) Free-run, line, video, external, IF																																		
Gated sweep Gate position: Resolution: Gate width: Resolution: Trigger:	100 nsec to 1 sec 100 nsec 1 μsec to 1 sec 100 nsec IF (Mixer input is -40 dBm or more) External trigger or External gate																																		
Delayed sweep Delay time: Resolution:	100 ns to 1 s 100 ns																																		

6.3 R3273 Specifications

(2) Amplitude Range

Characteristics	Specification
Measurement range	+30 dBm to Average noise level
Maximum safe input Average continuous power (Input ATT \geq 10dB): DC input:	+30 dBm (1W) 0V (DC signal must not be applied)
Display range Log: Linear:	10 \times 10div 10, 5, 2, 1, 0.5dB/div 10% of reference level/div
Reference level range Log: Linear:	-140 dBm to +60 dBm (in 0.1 dB steps) 22.4nV to 223V (steps of about 1% of full scale)
Input ATT range	0 to 70 dB (10 dB steps)

(3) Dynamic Range

Characteristics	Specification																																																									
Average noise level	<p>Resolution bandwidth 100 Hz (analog), Input ATT 0 dB, Video bandwidth 1 Hz</p> <table border="1"> <thead> <tr> <th>Frequency</th> <th>Frequency band</th> <th>Average noise level</th> </tr> </thead> <tbody> <tr> <td>1 kHz</td> <td>0</td> <td>-90 dBm</td> </tr> <tr> <td>10 kHz</td> <td>0</td> <td>-100 dBm</td> </tr> <tr> <td>100 kHz</td> <td>0</td> <td>-101 dBm</td> </tr> <tr> <td>1 MHz</td> <td>0</td> <td>-125 dBm</td> </tr> <tr> <td>10 MHz to 3.5 GHz</td> <td>0</td> <td>-(130 - f (GHz)) dBm</td> </tr> <tr> <td>3.5 GHz to 7.5 GHz</td> <td>1</td> <td>-125 dBm</td> </tr> <tr> <td>7.4 GHz to 15.4 GHz</td> <td>2</td> <td>-122 dBm</td> </tr> <tr> <td>15.2 GHz to 22.0 GHz</td> <td>3</td> <td>-120 dBm</td> </tr> <tr> <td>22.0 GHz to 26.5 GHz</td> <td>3</td> <td>-117 dBm</td> </tr> </tbody> </table> <p>Resolution bandwidth 1 Hz (digital), Input ATT 0 dB</p> <table border="1"> <thead> <tr> <th>Frequency</th> <th>Frequency band</th> <th>Average noise level</th> </tr> </thead> <tbody> <tr> <td>10 kHz</td> <td>0</td> <td>-120 dBm</td> </tr> <tr> <td>100 kHz</td> <td>0</td> <td>-121 dBm</td> </tr> <tr> <td>1 MHz</td> <td>0</td> <td>-141 dBm</td> </tr> <tr> <td>10 MHz to 3.5 GHz</td> <td>0</td> <td>-(150 - f (GHz)) dBm</td> </tr> <tr> <td>3.5 GHz to 7.5 GHz</td> <td>1</td> <td>-145 dBm</td> </tr> <tr> <td>7.4 GHz to 15.4 GHz</td> <td>2</td> <td>-142 dBm</td> </tr> <tr> <td>15.2 GHz to 22.0 GHz</td> <td>3</td> <td>-140 dBm</td> </tr> <tr> <td>22.0 GHz to 26.5 GHz</td> <td>3</td> <td>-137 dBm</td> </tr> </tbody> </table>	Frequency	Frequency band	Average noise level	1 kHz	0	-90 dBm	10 kHz	0	-100 dBm	100 kHz	0	-101 dBm	1 MHz	0	-125 dBm	10 MHz to 3.5 GHz	0	-(130 - f (GHz)) dBm	3.5 GHz to 7.5 GHz	1	-125 dBm	7.4 GHz to 15.4 GHz	2	-122 dBm	15.2 GHz to 22.0 GHz	3	-120 dBm	22.0 GHz to 26.5 GHz	3	-117 dBm	Frequency	Frequency band	Average noise level	10 kHz	0	-120 dBm	100 kHz	0	-121 dBm	1 MHz	0	-141 dBm	10 MHz to 3.5 GHz	0	-(150 - f (GHz)) dBm	3.5 GHz to 7.5 GHz	1	-145 dBm	7.4 GHz to 15.4 GHz	2	-142 dBm	15.2 GHz to 22.0 GHz	3	-140 dBm	22.0 GHz to 26.5 GHz	3	-137 dBm
Frequency	Frequency band	Average noise level																																																								
1 kHz	0	-90 dBm																																																								
10 kHz	0	-100 dBm																																																								
100 kHz	0	-101 dBm																																																								
1 MHz	0	-125 dBm																																																								
10 MHz to 3.5 GHz	0	-(130 - f (GHz)) dBm																																																								
3.5 GHz to 7.5 GHz	1	-125 dBm																																																								
7.4 GHz to 15.4 GHz	2	-122 dBm																																																								
15.2 GHz to 22.0 GHz	3	-120 dBm																																																								
22.0 GHz to 26.5 GHz	3	-117 dBm																																																								
Frequency	Frequency band	Average noise level																																																								
10 kHz	0	-120 dBm																																																								
100 kHz	0	-121 dBm																																																								
1 MHz	0	-141 dBm																																																								
10 MHz to 3.5 GHz	0	-(150 - f (GHz)) dBm																																																								
3.5 GHz to 7.5 GHz	1	-145 dBm																																																								
7.4 GHz to 15.4 GHz	2	-142 dBm																																																								
15.2 GHz to 22.0 GHz	3	-140 dBm																																																								
22.0 GHz to 26.5 GHz	3	-137 dBm																																																								
1 dB gain compression:	10 MHz to 100 MHz -3 dBm 100 MHz to 3.5 GHz 0 dBm 3.5 GHz to 7.5 GHz -10 dBm 7.5 GHz to 26.5 GHz -3 dBm																																																									

(4) Spurious Response

Characteristics	Specification			
2nd order harmonic distortion		Frequency range	Frequency band	Mixer level
	< -70 dBc	10 MHz to 3.5 GHz	0	-30 dBm
	< -100 dBc	> 3.5 GHz	1, 2, 3	-10 dBm
2 signal 3rd order harmonic distortion	$\Delta f \geq 5\text{kHz}$ (when digital filters are used)			
		Frequency range	Frequency band	Mixer level
	< -70 dBc	10 MHz to 100 MHz	0	-30 dBm
	< -80 dBc	100 MHz to 1 GHz	0	-30 dBm
	< -85 dBc	1 GHz to 3.5 GHz	0	-30 dBm
	< -70 dBc	3.5 GHz to 7.5 GHz	1	-30 dBm
< -75 dBc	7.5 GHz to 26.5 GHz	2, 3	-30 dBm	
Image/multiple/out-band response		Frequency range		
	< -70 dBc	10 MHz to 18 GHz		
	< -60 dBc	10 MHz to 23 GHz		
	< -50 dBc	10 MHz to 26.5 GHz		
Residual response (no input, input ATT 0 dB, 50 Ω termination)		Frequency range		
	< -100 dBm	1 MHz to 3.5 GHz		
	< -90 dBc	300 kHz to 26.5 GHz		

6.3 R3273 Specifications

(5) Amplitude Accuracy

Characteristics	Specification												
Frequency response (with an input ATT of 10 dB, band 1, 2 or 3 is automatically tuned on the pre-selector): Flatness within the bands Relative values Complementary error due to band switching For a 30 MHz calibration signal	<table border="1"> <thead> <tr> <th>Frequency band</th> <th>Frequency range</th> </tr> </thead> <tbody> <tr> <td>0</td> <td>100 Hz to 3.5 GHz\pm1.5 dB</td> </tr> <tr> <td>0</td> <td>50 MHz to 2.6 GHz\pm1.0 dB</td> </tr> <tr> <td>1</td> <td>3.5 GHz to 7.5 GHz\pm1.5 dB</td> </tr> <tr> <td>2</td> <td>7.4 GHz to 15.4 GHz\pm3.5 dB</td> </tr> <tr> <td>3</td> <td>15.4 GHz to 26.5 GHz\pm4.0 dB</td> </tr> </tbody> </table> \pm 0.5 dB 100 Hz to 26.5 GHz \pm 5.0 dB	Frequency band	Frequency range	0	100 Hz to 3.5 GHz \pm 1.5 dB	0	50 MHz to 2.6 GHz \pm 1.0 dB	1	3.5 GHz to 7.5 GHz \pm 1.5 dB	2	7.4 GHz to 15.4 GHz \pm 3.5 dB	3	15.4 GHz to 26.5 GHz \pm 4.0 dB
Frequency band	Frequency range												
0	100 Hz to 3.5 GHz \pm 1.5 dB												
0	50 MHz to 2.6 GHz \pm 1.0 dB												
1	3.5 GHz to 7.5 GHz \pm 1.5 dB												
2	7.4 GHz to 15.4 GHz \pm 3.5 dB												
3	15.4 GHz to 26.5 GHz \pm 4.0 dB												
Calibration signal accuracy (30 MHz)	-10 dBm \pm 0.3 dB												
IF gain error (After automatic calibration)	0 dBm to -50 dBm \pm 0.5 dB 0 dBm to -80 dBm \pm 0.7 dB												
Scale display accuracy (after automatic calibration) Log: Linear:	0 dB to -90 dB \pm 0.85 dB max \pm 0.2 dB/1 dB \pm 5% of reference level												
Input ATT switching error (in reference to 10 dB, at 20 dB to 70 dB)	100 Hz to 12.4 GHz \pm 1.1 dB/10 dB steps, 2.0 dB max 12.4 Hz to 18 GHz \pm 1.3 dB/10 dB steps, 2.5 dB max 18 GHz to 26.5 GHz \pm 1.8 dB/10 dB steps, 3.5 dB max												
Resolution bandwidth switching error (Resolution bandwidth in reference to 300 kHz, after automatic calibration):	< \pm 0.3 dB (RBW = 100 Hz to 5 MHz) < \pm 1.0 dB (RBW = 30 Hz) < \pm 0.5 dB (RBW = 1 Hz to 100 Hz, digital filters)												
Total level accuracy	\pm 1.0 dB (Typical) Frequency range: 50 MHz to 2.6 GHz (Frequency band : 0) RBW: 3 kHz to 1 MHz Frequency span < RBW \times 20 Input ATT: 10 dB Logarithmic scale display: 0 dB to -50 dB Reference level: 0 dBm to -50 dBm Detection mode: Sample Ambient temperature: 20°C to 30°C S/N ratio \geq 20 dB												

(6) Input and Output

Characteristics	Specification
RF input Connector: Impedance: VSWR (Input ATT \geq 10 dB):	N-type female (can be converted to SMA) 50 Ω (nominal) < 1.5 : 1 (< 3.5 GHz) (nominal) < 2.1 : 1 (> 3.5 GHz) (nominal)
Calibration signal output Connector: Frequency: Impedance: Amplitude:	BNC female, front panel 30 MHz \times (1 \pm frequency reference accuracy) 50 Ω (nominal) -10 dBm \pm 0.3 dB
10 MHz frequency reference output Connector: Impedance: Frequency accuracy: Amplitude range:	BNC female, rear panel 50 Ω (nominal) 10 MHz \times frequency reference accuracy 0 dBm \pm 5 dB
10 MHz frequency reference input Connector: Frequency: Frequency (OPT25): Impedance: Amplitude range:	BNC female, rear panel 10 MHz Automatically switched to 10 MHz, 15 MHz or 19.6608 MHz 50 Ω (nominal) 0 dBm \pm 5 dB
Probe power supply: *	\pm 12.6V (100mA) (nominal)
21.4 MHz, IF output Connector: Impedance:	BNC female, rear panel 50 Ω (nominal)
421.4 MHz, IF output Connector: Impedance:	BNC female, rear panel 50 Ω (nominal)
1st LO output Connector: Impedance: Frequency range: Amplitude:	SMA female, front panel 50 Ω (nominal) 3.921 GHz to 7.921 GHz > +10 dBm
Video output Connector:	VGA (15 pins, female), rear panel 640 \times 480 dots (equivalent to VGA)
X axis output Connector: Impedance: Amplitude:	BNC female, rear panel 1 k Ω (nominal), DC coupled About -5V to +5V
Y axis output Connector: Impedance: Amplitude:	BNC female, rear panel 220 Ω (nominal) About 2V for full scale (with 10 dB/div)

* This probe power supply is not available if OPT22 or OPT23 is installed.

6.3 R3273 Specifications

Characteristics	Specification
External trigger input Connector: Impedance: Trigger level:	BNC female, rear panel 10 k Ω (nominal), DC coupled TTL level
External gate input Connector: Impedance: Stops sweeping: Allowed to sweep:	BNC female, rear panel 10 k Ω (nominal), DC coupled While a TTL output is at LOW level. While a TTL output is at HIGH level.
Trigger output Connector: Amplitude:	BNC female, rear panel TTL level
I/O interface GPIB: RS232: Printer: Extended I/O port: FDD:	IEEE-488 bus connector, rear panel D-SUB 9pins, rear panel D-SUB 25pins, rear panel D-SUB 25pins, rear panel 3.5 inch floppy disk drive
Direct print:	Output with ESC/P, PCL, ESC/P raster commands

(7) General Specifications

Characteristics	Specification
Temperature Operating environment range Storage environment range Relative humidity	0°C to +50°C -20°C to +60°C 85% or less (Without condensation)
AC input power source	Automatic switching to 100 VAC or 220 VAC For 100 VAC: 100 to 120 VAC, 50 or 60 Hz For 220 VAC: 220 to 240 VAC, 50 or 60 Hz
Power consumption	300 VA or below
Mass	18 kg or less (not including options, accessories, etc.)
Dimensions	Approximately 178(H) \times 355(W) \times 423.5(D)mm (rear feet and connectors are not included in above dimensions)

6.4 Specifications for the Memory Card (Option)

Specifications	Memory card
Connector	68-pin two piece connector
Interface	Compliant with JEIDA Ver4.0
External dimensions	TYPE-I (86 × 54 × 3.3mm) TYPE-II (86 × 54 × 5mm)
Environmental conditions	Operating temperature: 0°C to 55°C Storage temperature: -20°C to 60°C Relative humidity: 95% or less (Without condensation) Note: The data shown above may vary depending on card manufacturers.

APPENDIX

A.1 Before Contacting with a Problem

When a problem occurs, check the list below. If you cannot fix the problem, contact a sales representative from the address and telephone number located at the end of this manual. The problems shown below are not covered by warranty.

Problem	Probable Cause	Solution
Power indicator does not light.	Two power switches are not turned on.	The MAIN POWER switch (on the rear panel) and the POWER switch (on the front panel) must be turned on.
	The power cable is not connected properly.	Turn off the MAIN POWER and the POWER switches, and then connect the power cable to the AC power connector on the analyzer. Finally, connect the other end of the power cable to the outlet (refer to Section 1.3.4).
	The power fuse is blown.	Check the power fuse (refer to Section 1.3.3). If the fuse is blown, an abnormal condition may have occurred. Contact a sales representative for repair.
Error message is displayed.	An operational error occurred.	Refer to the list of error messages to fix the problem (see Section A.2).
	A malfunction or failure of the analyzer is the cause of this problem.	
No trace is displayed on the screen with the SWEEP indicator lit.	Trace intensity is too low.	Adjust the trace using the INTENSITY button.
	Bad connection with the input cable or connector.	Reconnect the input cable or connector.
Not sweeping	The sweep mode is set to SINGLE.	Set the mode to REPEAT.
Signal level is incorrect.	AMPTD CAL has not been adjusted.	Perform the calibration.
Pressing a key has no effect.	GPIB is set to the remote control.	Cancel the program currently being executed and press the LCL key.
Cannot read from the floppy disk drive (Recall function).	Defective floppy disk	Confirm that the floppy disk is defective by trying it in another drive.
	Defective floppy disk drive	Contact a sales representative for repairs.

A.1 Before Contacting with a Problem

Problem	Probable Cause	Solution
Cannot save to a floppy disk (Save function).	The write protect tab is in the ON position.	Move the write protect tab to the OFF position.
	The floppy disk is not formatted.	Format the floppy disk.
	Insufficient memory	Use another floppy disk.

A.2 Error Message

In this section, the error messages that are displayed while the analyzer is being used are described.

Code	Error message	Remarks
1	Sound demodulation is active. Turn Sound demodulation off.	
2	Vertical scale is set to Linear. Set the scale to dB/div.	
3	Preselector is turned on. Select manual tuning.	
5	Span is set to 0 Hz. Change the span.	
7	Trace mode is set to Blank. Change to Write mode.	
8	Not available for baseband freq. Move marker before executing.	
9	Power measurement is active. Turn power measurement off.	
10	Signal track is active. Turn Signal Track off.	
11	Noise measurement is active. Turn Noise measurement off.	
13	Frequency Counter is active. Turn Frequency Counter off.	
14	Delta marker is not active. Turn the Delta marker on.	
15	External mixer is selected. Set the mixer to Internal.	
17	Not available in Separate-screen mode. Set to Full-screen mode.	
18	View/Blank Trace mode is selected. Set the Trace to Write mode.	
19	Trigger source incorrect. Set the trigger source to Video/IF.	Set the trigger source to Video or IF. Change the trigger source to Video or IF.
20	Marker not on selected trace. Move the marker first.	
22	Scale not set to 10dB/div. Change to 10dB/div first.	
23	Parameter is out of range.	
25	Calculated power is off the scale.	Calculated result is outside the scale. Set the reference level to a higher value.
26	Editor is active. Quit the editor first.	

A.2 Error Message

Code	Error message	Remarks
27	Frequency table contains no data.	There is no data in the frequency table. Enter data into the table.
28	No Cal signal detected. Check the CAL OUT signal.	
30	Not available for OBW measurements. Quit OBW first.	
31	Not available for Harmonics measurements. Quit Harmonics first.	
32	Not available for Spurious measurements. Quit Spurious first.	
33	Not available for ACP measurements. Quit ACP first.	
34	Not available for ACP graph mode. Quit ACP graph mode first.	
35	Eye Opening measurement is active. Turn Eye Opening measurement off.	The eye opening measurement function is being performed. Turn the eye opening measurement func- tion off.
36	Only available in Separate-screen mode using Sample Detector.	
37	Internal mixer is selected. Set the mixer to External.	
39	Trace average is operating. Turn Trace average off.	
41	Trace Point is set to 501. Change to 1001.	
42	Not available. Turn off Zoom mode.	
43	No trace data.	
44	Attenuator is set to manual. Select Auto mode.	
45	The active marker is out of range. Move the marker or check the search conditions.	
46	No peak points found. Check the search conditions.	
47	There are no more peak points.	
48	Trace Max/Min Hold is active. Turn Max/Mix Hold off.	
49	Normal marker is not active. Turn the Normal marker on.	
52	Currently sweeping. Stop the sweep before proceeding.	

Code	Error message	Remarks
60	Vertical scale is set to dB/div. Set the scale to Linear.	The vertical axis is not set to a linear scale. Set the linear scale.
61	Not available for C/N measurements. Quit C/N first.	Disabled during a phase noise measurement. Terminate the phase noise measurement.
62	Not available for Phase Jitter measurements. Quit Phase Jitter first.	Disabled during a phase jitter measurement. Terminate the phase jitter measurement.
63	Not available for IM measurements. Quit IM Meas. first.	Disabled during an odd-harmonic measurement. Terminate the odd-harmonic measurement.
67	Not available in F/T or F/F mode.	Cannot be executed while the F/T, the F/F or the zoom function is being used. Reset the zoom function.
68	Not available in T/T or T/F mode.	Cannot be executed while the T/T, the T/F or the zoom function is being used. Reset the zoom function.
69	Not available in T/T mode.	
70	Display line is not active.	The Display line cannot be selected because it is not active.
71	Limit Line 1 is not active.	Limit line 1 cannot be selected because it is not active.
72	Limit Line 2 is not active.	Limit line 2 cannot be selected because it is not active.
73	No limit lines are active.	Limit line 1 and Limit line 2 cannot be selected because they are not active.
74	Invalid data mode. Set to Relative mode.	The Y data mode is set to the Absolute mode. Change Y data mode to Relative mode.
75	Not available. Set to F/T or F/F mode.	
76	No 3rd order peak found. Check the search conditions.	
77	This function is not available.	The trace is not zoomed in.
78	This function is already active.	The trace is already zoomed in.
79	Trace Normalize is active. Turn Trace Normalize off.	
80	Not available in Gated sweep mode.	
81	Not available in Manual sweep mode.	
82	Not available in Window sweep mode.	
83	Not available in either Manual or Window sweep mode.	

A.2 Error Message

Code	Error message	Remarks
85	Incorrect data. Set span to $(1.0 + \alpha) * T_f$ or more.	The measurement condition is incorrect. Change the measurement condition to meet the following: Frequency span > $(1.0 + \text{Rolloff factor}) \times$ Symbol rate
87	Root Nyquist filter is active. Turn the filter off.	
88	Separate-screen mode is active. Change to Full-screen mode.	
90	Not available. Set XY anchor first.	
95	Not available. Turn off Artificial Analog mode.	
96	Not available. Turn on Artificial Analog mode.	
100	Not available in High speed ADC mode.	
105	Not available in Frequency Domain mode.	
110	Not available in Continuous peak mode.	
111	Not available in Continuous XdB Down mode.	
115	Trigger source is not VIDEO or EXT. Set trigger to VIDEO or EXT.	
120	Not available. Change the sweep time to less than 500sec.	
125	Not available in Digital RBW mode.	Disabled while the digital RBW mode is set.
126	Reached the limit of span in Digital RBW mode.	The value for SPAN is at the maximum and cannot be increased while in the digital RBW mode.
127	Not available. Change span to less than the limit.	The current SPAN value is greater than the limit value. Reduce the value until it is below the limit value which corresponds to the targeted RBW.
300	Printer is not ready. Check printer setup.	
301	Printer cable problem. Check printer cable.	
302	Printer not responding.	
304	SIO port is busy.	Serial I/O port is in operation. Check to see if the item is properly set in the RS232 dialog box under the Config menu.

Code	Error message	Remarks
305	Input buffer overflow.	The input buffer overflowed. Send the data again to the input buffer.
400	Input ATT Cal failed.	The calibration failed. Run the user self test to check the problem again.
401	IF Step AMP Cal failed.	The calibration failed. Run the user self test to check the problem again.
402	Log Linearity Cal failed.	The calibration failed. Run the user self test to check the problem again.
403	Total Gain Cal failed.	The calibration failed. Run the user self test to check the problem again.
404	RBW Switching Cal failed.	The calibration failed. Run the user self test to check the problem again.
405	Amplitude MAG Cal failed.	The calibration failed. Run the user self test to check the problem again.
406	Insufficient Cal data. Execute CAL ALL.	Cannot be corrected because of insufficient correction conditions. Perform CAL ALL.
409	Normal ADC Cal failed.	The calibration failed. Run the user self test to check the problem again.
600	Illegal parameter(s).	
601	Illegal file or device name.	
602	Incompatible firmware version. Data cannot be used with this analyzer.	
603	Cannot be formatted.	The device cannot be formatted. Try to format it using personal computer and so on.
604	Cannot rename this file.	The file name on a RAM disk cannot be changed.
605	Corrupt file data.	The saved data cannot be used since it is corrupt.
607	Specified device does not exist.	The specified device name cannot be found. Use the correct device name.
608	No media present.	The device is not ready for operation. Insert a floppy disk or the memory card.
609	Directory not found.	

A.2 Error Message

Code	Error message	Remarks
610	File already exists.	
611	File not found.	
612	Invalid disk format (Type 1)	The data saved in the floppy or memory card is corrupt. Format the floppy disk or memory card.
613	Write-protected file.	This file cannot be deleted because it is a read-only file.
614	Disk is full.	
615	Write-protected file.	This file is a read-only type.
616	Read-only media.	This media is a read-only type. Slide the write-protect switch to the write position.
618	Invalid boot sector signature.	The boot signature cannot be recognized. The data saved in the floppy or memory card is corrupt. Format the floppy or memory card.
619	CRC error.	CRC error occurred. Try one more time. If the problem continues, format the media.
621	Invalid Frequency-Correction data. Contact a service engineer.	
625	Device name too long.	The device name is too long. Specify it properly.
626	Extension too long.	The file extension is too long. A maximum of 3 characters is allowed.
627	Filename too long.	The file name is too long. A maximum of 8 characters is allowed.
628	Pathname too long.	The pass name is too long. Specify it properly.
631	I/O error.	An access error to the floppy disk or memory card occurred. Try it again. If the problem continues, format the media.
633	Invalid disk format (Type 2)	The disk geometry is invalid. Format the floppy disk or memory card.
634	Selected file or register is empty.	There is no data in the file or register. Specify the saved data.
800	The last process is in progress.	The spectrum analyzer is busy taking measurements repeatedly. This process continues until the measurements are complete the number of times specified.

A.3 Glossary

Average Noise Level

This sensitivity represents spectrum analyzer's capability of detecting the smallest signal and is directly related with noises generated from a spectrum analyzer itself. The sensitivity, however, varies depends on the resolution bandwidth used. In general, the maximum input sensitivity of a spectrum analyzer is expressed as average noise level when the instrument is used with its minimum resolution bandwidth.

Bandwidth Accuracy

The bandwidth accuracy of the resolution bandwidth filter is expressed by the deviation from the nominal value of the 3 dB lowered point. This deficiency has almost no effect when measuring normal signals at a continuous level, but it should be taken into consideration when measuring the level of a noise signal.

Bandwidth Selectivity

The bandpass filter normally attenuates using a Gaussian distribution instead of the so-called rectangular characteristic. Consequently, if two adjacent signals of different sizes are mixed, the smaller signal hides at the tail of the larger signal (Figure A-1).

Therefore, the bandwidth at a certain attenuation range (60 dB) should also be defined. The ratio between the 3 dB width and 60 dB width is expressed as the bandwidth selectivity ($BW_{60\text{ dB}}/BW_{3\text{ dB}}$).

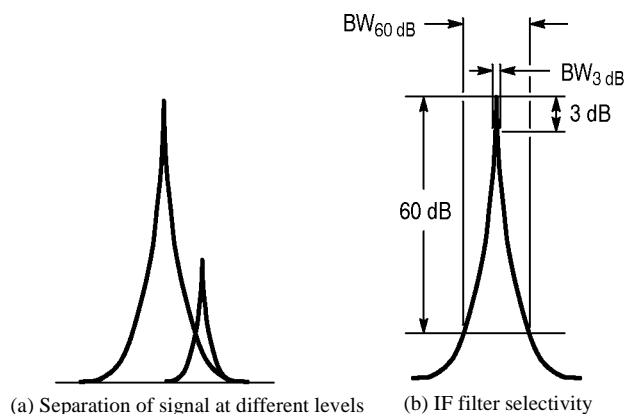

Figure A-1 Bandwidth Selectivity

Bandwidth Switching Uncertainty

Several resolution bandwidth filters are used to obtain an optimal resolution in signal spectrum analysis according to the scan width. When switching from one resolution bandwidth filter to another while measuring one signal, an error is generated for the differences in loss. This error is defined as the bandwidth switching uncertainty.

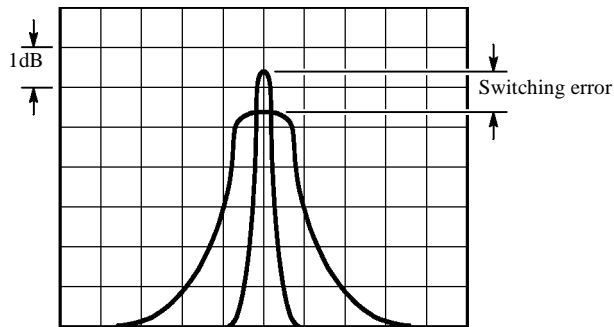

Figure A-2 Bandwidth Switching Uncertainty

Frequency Response

This term represents amplitude characteristics (frequency characteristics) for a given frequency. In the spectrum analyzer, frequency response means the frequency characteristics (flatness) of the input attenuator and mixer for the input frequency, and is given in $\pm \Delta\text{dB}$.

Gain Compression

If the input signal is greater than a certain value, the correct value is not displayed on the screen, and the input signal appears as if it were compressed. This phenomenon is called gain compression, and it reflects an error in the linearity of the input signal range. Normally, the gain compression for a spectrum analyzer is specified as the input signal level that produces a 1 dB error from a perfect linear response.

IF Gain Uncertainty

The uppermost scale on the screen is the reference used to read the absolute level of an input signal on the spectrum analyzer. The level set for this uppermost scale is referred to as the reference level.

The reference level is set using the REF LEVEL key and displayed in dBm or dBμ. The absolute accuracy of this display is determined by the IF gain uncertainty assuming the input attenuator is at a constant level.

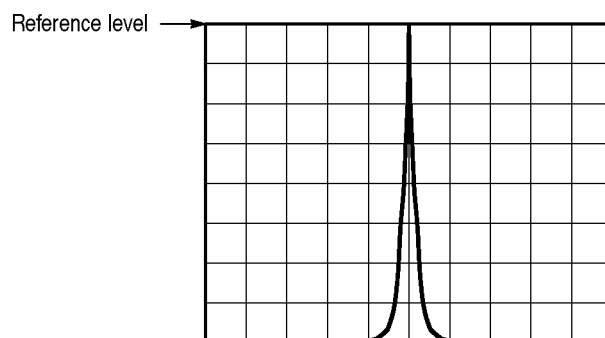

Figure A-3 IF Gain Uncertainty

Maximum Input Level

This is the maximum level allowed for the input circuit of the spectrum analyzer. The level can be modified by the input attenuator.

Maximum Input Sensitivity

This is the maximum sensitivity of the spectrum analyzer for detecting signals. Sensitivity depends on the resolution bandwidth and is affected by the noise generated by the spectrum analyzer itself. The maximum input sensitivity is normally reflected as the average noise level in the minimum resolution bandwidth of the spectrum analyzer.

Noise Sidebands

Spectrum analyzer efficiency is reduced by noise generated in the local oscillator and phase lock loop of the analyzer. This noise will appear in the vicinity of the spectrum on the screen.

To compensate for this, the sideband of the analyzer is defined so that signals out of the sideband can be analyzed in a certain range. This range is called the noise sideband.

The spectrum analyzer's noise sideband characteristics are shown in the following example.

Example: Suppose the noise level measured in the resolution bandwidth of 1 kHz is -70 dB at 20 kHz apart from the carrier. The noise level is normally expressed by the energy contained in the 1 Hz bandwidth (Figure A-4(b)). With a bandwidth of 1 Hz, the following applies: Since the value is -70 dB when the bandwidth is 1 kHz, the signals within the 1 Hz bandwidth will be lower than this by about $10 \log 1 \text{ Hz}/1 \text{ kHz}$ [dB], or about 30 dB; consequently, it is expressed as -100 dB/Hz at 20 kHz apart from the carrier when the resolution bandwidth is 1 kHz.

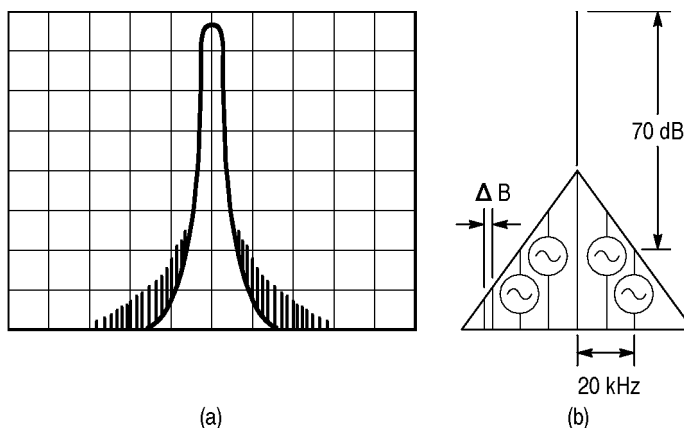
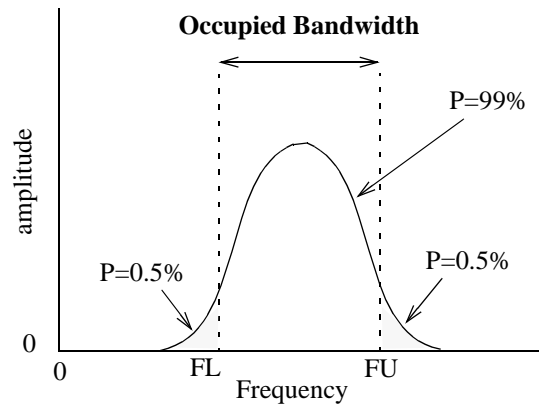

Figure A-4 Noise Sidebands

Occupied Bandwidth

When information is transmitted through radio waves, the extension of the frequency spectrum is caused along with the modulation. The occupied bandwidth is defined as the width of frequency spectrum that occupies 99% of all averaged electric power (see Figure A-5).

**Figure A-5 Occupied Bandwidth****Quasi Peak Value Measurements**

Reception interference for wireless communication generally occurs as impulse noise. Interference due to noise energy is evaluated in proportion to the quasi peak value. The parameters required for this evaluation, such as measurement bandwidth, detection time constant and so on, are defined as the quasi peak value. There are two standards which affect this sort of measurement: JRTC for Japan only, and CISPR (International Special Committee on Radio Interference) which applies internationally.

Residual FM

The short-term frequency stability of the local oscillators built in the spectrum analyzer is expressed as residual FM. The frequency width fluctuating per unit time is expressed as p-p. This also determines the measurement limit value when measuring the residual FM of a signal.

Residual Response

Residual response is a measure of how much (in the input level calculation) the spurious signal generated by the spectrum analyzer is suppressed. Residual response is generated by leaks of signals such as local oscillation output in the spectrum analyzer. This should be taken into consideration when analyzing a low-level input signal.

Resolution Bandwidth

The spectrum analyzer uses the bandpass filter (BPF) to analyze the frequency components contained in the input signal. The 3dB bandwidth of the BPF is called the resolution bandwidth (See Figure A-6(a) below). BPF characteristics should be set according to the sweep width and the sweep speed used for the trace. This spectrum analyzer sets the optimal value for the sweep width. In general, smaller bandwidths improve resolution so the resolution of the spectrum analyzer should be expressed using the narrowest resolution bandwidth (See Figure A-6(b) below).

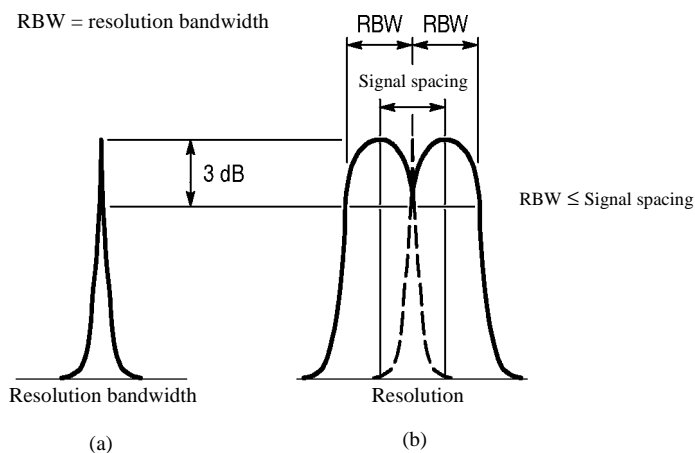

Figure A-6 Resolution Bandwidth

Spurious Response

Spurious signals are signals that cause distortion to an ideal signal, and are classified according to their characteristics.

Second harmonic distortion:

This is the distortion caused by the non-linearity of a spectrum analyzer (especially generated in the mixer) when an ideal, undistorted signal is input to the spectrum analyzer. This performance determines spectrum analyzer's capability of measuring harmonic distortion (see Figure A-7).

Third order distortion:

This is the distortion caused by the non-linearity of a spectrum analyzer when two signals with different frequencies f_1 and f_2 are input, thus outputting two signals: one signal with frequency $2f_1 - f_2$; and another signal with frequency $2f_2 - f_1$. The amplitude of these signals depends on the input levels at the mixer (see Figure A-7). The maximum value is specified.

Image/Multiple/Extra-band responses:

In addition to the two types of spurious signals described above, there is a third type called "non-harmonic spurious" that is generated by the spectrum analyzer with a frequency proper to each spectrum analyzer. There are three types of responses in the non-harmonic spurious: the image, multiple and extra-band responses.

A.3 Glossary

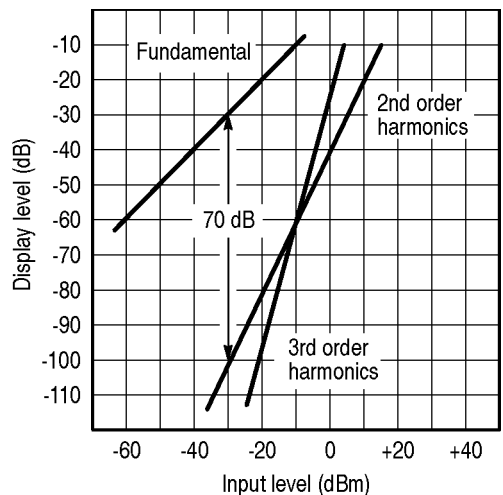

Figure A-7 Spurious Response

VSWR (Voltage Standing Wave Ratio)

This shows the state of impedance matching when a spectrum analyzer is connected to a voltage source whose output impedance is ideal and nominal. The VSWR is expressed as the ratio of the maximum value to minimum value of a standing wave which consists of traveling and reflected waves. The VSWR is another expression of the reflection coefficient or return loss.

Referring to Figure A-8, The signal at the receiving end E_1 is the same as the signal at the transmitting end (E_0 , or the spectrum analyzer input section) if the impedance of the receiving end is matched to that of the transmitting end.

The reflection coefficient is expressed in the formula shown below when the reflected wave E_R exists due to a mismatch between the impedances.

Reflection coefficient $m = \text{Reflected wave } E_R / \text{Traveling wave } E_0$

The Return loss is expressed in the formula shown below.

$$\begin{aligned} \text{Return loss} &= 20 \log E_R / E_0 \text{ [dB]} \text{ VSWR} \\ &= (E_0 + E_R) / (E_0 - E_R) \end{aligned}$$

The relationship of VSWR with the reflection coefficient is as follows.

$$\text{VSWR} = (1 + |m|) / (1 - |m|)$$

The range of VSWR is between 1 and ∞ the nearer to 1 this value is, the better the state of impedance matching is.

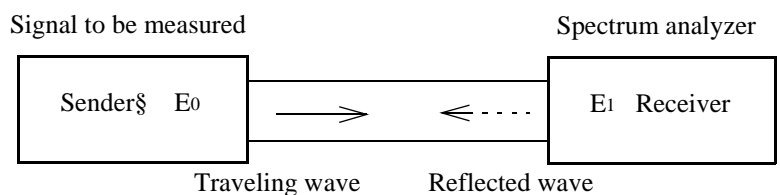

Figure A-8 V.S.W.R

Zero Span

The spectrum analyzer sweeps at any frequency along the horizontal axis as the time axis but will not sweep in zero span mode.

A.4 dB Conversion Formulas

A.4 dB Conversion Formulas

Definitions

$$\begin{array}{ll}
 0\text{dBV} = 1\text{Vrms} & Y\text{dBV} = 20\log \frac{X\text{V}}{1\text{V}} \\
 0\text{dBm} = 1\text{mW} & Y\text{dBm} = 10\log \frac{X\text{mW}}{1\text{mW}} \\
 0\text{dB}\mu\text{V} = 1\mu\text{Vrms} & Y\text{dB}\mu\text{V} = 20\log \frac{X\mu\text{V}}{1\mu\text{V}} \\
 0\text{dBpw} = 1\text{pW} & Y\text{dBpw} = 10\log \frac{X\text{pW}}{1\text{pW}}
 \end{array}$$

Conversion formulas

<p>If R = 50 Ω: dBV ≅ (dBm - 13dB) dBμV ≅ (dBm + 107dB) dBμVemf ≅ (dBm + 113dB) dBpw ≅ (dBm + 90dB)</p>	<p>If R = 75 Ω: dBV ≅ (dBm - 11dB) dBμV ≅ (dBm + 109dB) dBμVemf ≅ (dBm + 115dB) dBpw ≅ (dBm + 90dB)</p>
---	---

Examples

Converting 1mV into dBμV:	$20\log \frac{1\text{mV}}{1\mu\text{V}} = 20\log 10^3 = 60\text{dB}\mu\text{V}$
Converting 0dBm into dBμV:	$ \begin{cases} 0\text{dBm} + 107\text{dB} = 107\text{dB}\mu\text{V} (R = 50\Omega) \\ 0\text{dBm} + 109\text{dB} = 109\text{dB}\mu\text{V} (R = 75\Omega) \end{cases} $
Converting 60dBμV into dBm:	$ \begin{cases} 60\text{dB}\mu\text{V} - 107\text{dB} = -47\text{dBm} (R = 50\Omega) \\ 60\text{dB}\mu\text{V} - 109\text{dB} = -49\text{dBm} (R = 75\Omega) \end{cases} $
Converting 10V/m into dBμV/m:	$20\log \frac{10\text{V/m}}{1\mu\text{V/m}} = 140\text{dB}\mu\text{V/m}$

Relationship between dBm and Watt

+50dBm	+40dBm	+30dBm	+20dBm	+10dBm	+0dBm	-10dBm	-20dBm	-30dBm
100W	10W	1W	100mW	10mW	1mW	0.1mW	0.01mW	0.001mW

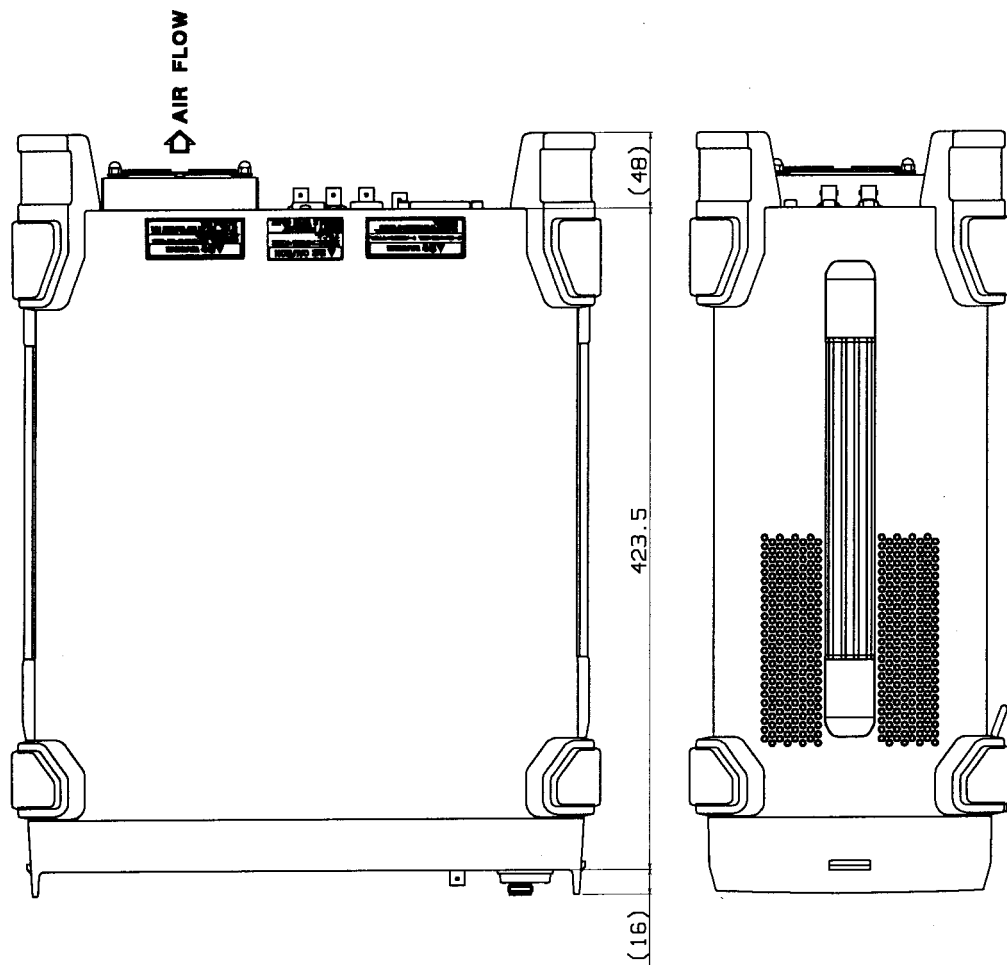
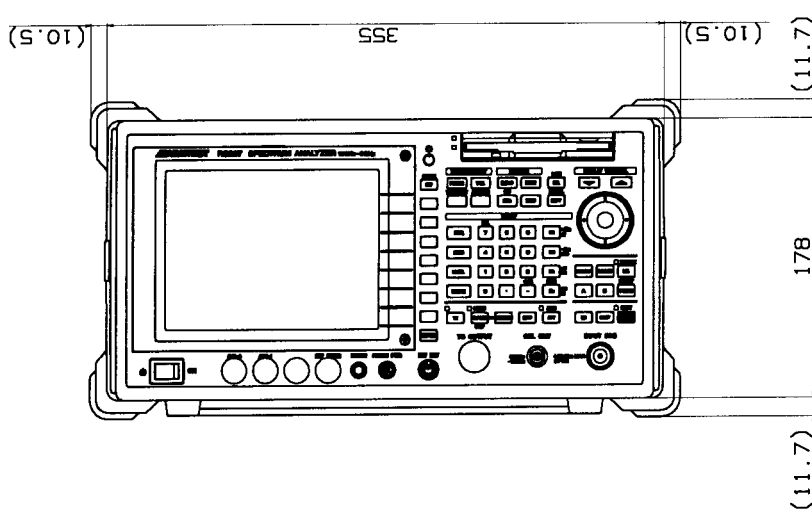

Unit : mm

NOTE

This drawing shows external dimensions of this instrument.

The difference in products and options used can cause a change in the appearance of the instrument.

DIMENSIONAL OUTLINE DRAWING

ALPHABETICAL INDEX

	[Symbol]		
√Nyquist Filter		3-15, 3-61	
√Nyquist Filter ON/OFF		3-15, 3-59	
√Nyquist Filter Setup		3-15, 3-60	
% AM Measure		3-13, 3-52	
	[Numerics]		
0.5 dB/div		3-12	
1 dB/div		3-12	
1/Delta Marker ON/OFF		3-14, 3-53	
10 dB/div		3-12	
10, 5, 2, 1 or 0.5dB/div		3-49	
2 dB/div		3-12	
3rd Order		3-18, 3-82	
3rd Order Measure		3-13, 3-52	
3rd Order Peak		3-19, 3-85	
5 dB/div		3-12	
5th Order		3-18, 3-82	
7th Order		3-18, 3-82	
9th Order		3-18, 3-82	
	[A]		
A		3-7, 3-9, 3-20, 3-33	
A←→B		3-7, 3-8, 3-21, 3-26	
ABC		3-10	
Accessories		1-2	
ACP		2-87, 3-15, 3-59, 4-3	
ACP Measurement Conditions		2-137	
ACP OFF		3-15, 3-62	
Active Marker		3-14, 3-15, 3-53, 3-62	
Active Trace A/B		3-15, 3-18, 3-62, 3-83	
Additional Functions		4-12	
Adjacent Channel Leakage Power		2-87, 4-3	
All Auto		3-10, 3-37	
AM Modulation Frequency		2-117	
AM Signals		2-117	
Amplitude MAG		3-8, 3-28	
Anchor		3-14, 3-54	
Artificial Analog A		3-7, 3-21	
Artificial Analog ON/OFF		3-18, 3-21, 3-80	
ATT		3-7, 3-24	
ATT AUTO/MNL		3-7, 3-24	
ATT switch Count		3-9, 3-35	
Attenuator		3-24	
AUTO		3-10	
Auto Adjust		3-10, 3-43	
Auto Increment		3-9, 3-33	
Auto Tune		3-11, 3-45	
Average A		3-7, 3-20	
Average B		3-8, 3-25	
Average Loss ON/OFF		3-11, 3-47	
Average Power		3-15, 3-58	
Average Times		3-15, 3-58	
Average Times ON/OFF		3-15, 3-18, 3-61, 3-78, 3-81, 3-82, 3-83	
	[B]		
B		3-8, 3-9, 3-25, 3-33	
Band Lock ON/OFF		3-11, 3-47	
Band Select		3-11, 3-46	
Basic Measurement Conditions		2-130	
Baud Rate		3-9, 3-30	
Bias POSI/NEGA		3-11, 3-46	
Blank A		3-7, 3-20	
Blank B		3-8, 3-25	
BS Window ON/OFF		3-15, 3-60	
Burst Signals		2-97	
Burst signals		2-101	
	[C]		
C/N Meas		3-18, 3-81	
C/N Meas OFF		3-18, 3-81	
CAL		3-8, 3-28	
Cal 10 MHz Ref		3-8, 3-28	
Cal All		2-62, 3-8, 3-28	
Cal Corr ON/OFF		3-8, 3-28	
Cal Each Item		2-64, 3-8, 3-28	
Cal Sig Level		3-8, 3-28	
Calculation Using No Measurement Window		4-10	
Calculation using the Measurement Window		4-11	
Calibration		1-15, 2-61, 3-28	
Carrier Frequency and Power Measurements		2-125	
CDMA		2-75	
CDMA Channel Power		2-81	
Center		3-11, 3-45	

Alphabetical Index

CF Step Size AUTO/MNL	3-11, 3-45	dB μ V	3-12, 3-49
Channel Position	3-15, 3-58	dB μ V/ $\sqrt{\text{Hz}}$	3-51
Channel Power	3-15, 3-58	dB μ Vemf	3-12, 3-49
Channel Width	3-15, 3-58	dBpW	3-12, 3-49
Cleaning	1-13	Default	3-8, 3-15, 3-29, 3-61, 3-78
Clear	3-16, 3-68	Default IP	3-16, 3-66
Clear File	3-16, 3-68	Defaults Configuration Values	3-87
Clear Register	3-16, 3-66	Define \rightarrow Default	3-15, 3-18, 3-61, 3-78
Coarse	3-8, 3-28	Delete	3-18, 3-79, 3-81
Color	3-10, 3-44	Delete Line	3-10, 3-11, 3-12, 3-15, 3-43, 3-47, 3-50, 3-59
Command Syntax	5-12	Delta \rightarrow CF	3-14, 3-56
Compression	3-9, 3-33	Delta \rightarrow CF Step	3-14, 3-56
CONFIG	3-9, 3-30	Delta \rightarrow Marker Step	3-14, 3-56
Configuration	3-30	Delta \rightarrow Span	3-14, 3-56
Connector Section	2-3	Delta Marker	3-14, 3-53, 3-54
Cont Down ON/OFF	3-13, 3-52	Delta Marker ON/OFF	3-14, 3-53
Cont peak ON/OFF	3-17, 3-74	Delta Markers	2-105
Continuous Sweep	3-65	Delta Y Disp Mode Cusr/Data	3-7, 3-22
Control Section	2-9	DET Select AUTO/MNL	3-7, 3-8, 3-20, 3-23, 3-25, 3-27
COPY	3-9, 3-36	Device RAM/A/B	3-15, 3-16, 3-64, 3-68
Copy All	3-16, 3-69	Device RAM/FD	3-15, 3-16, 3-64, 3-68
Copy Config	3-9, 3-30	Differences Between RS-232 and GPIB	5-62
Copy Device	3-9, 3-33	Digital Modulation Signal	2-71
Copy Mode	3-9, 3-31, 3-32	Disp Mode REL/ABS.L/ABS.R	3-13, 3-52
Copy Table 1 to 2	3-10, 3-43	Display Control	3-10, 3-44
Copy Table 2 to 1	3-10, 3-43	DISPLAY CONTROL Section	2-6
Corr Factor	3-16, 3-68	Display format	3-40
Correction Edit	3-12, 3-49	Display Line	2-26, 3-14, 3-17, 3-54, 3-73
Correction Factor	3-12, 3-49	Display Line ON/OFF	3-10, 3-40
Correction ON/OFF	3-12, 3-49	Display Line Pos.	3-7, 3-8, 3-21, 3-26
Counter	3-13, 3-51	Display ON/OFF	3-9, 3-35
Counter ON/OFF	3-13, 3-51	Display Section	2-2
COUPLE	3-10, 3-37	Displaying Spectrums	2-18
Couple Function	3-37	Dual Parameters	2-53, 2-57
Couple to F(T)	3-17, 3-73	Dynamic Range	2-36
CS/BS Setup	3-15, 3-59		
[D]			
Data Format	3-16, 3-67, 5-61		
Data Formats	5-13		
Data Length	3-9, 3-30		
Data Readout	3-64		
Date and Time	2-146		
Date/Time	3-9, 3-34		
Day	3-9, 3-34		
dB μ V/ $\sqrt{\text{Hz}}$	3-13		
dB/div	3-12, 3-49		
dBc/Hz	3-13, 3-51		
dBm	3-12, 3-49		
dBm/Hz	3-13, 3-51		
dBmV	3-12, 3-49		

- [E]**
- Edit Table 3-18, 3-79, 3-81
 - Enter Title 3-16, 3-66
 - Entering Data 2-14
 - ENTRY Section 2-7
 - Environmental Conditions 1-4
 - ERROR MESSAGE A-3
 - Example Programs 5-45
 - Execute Selftest 3-9, 3-35
 - Expanded Functions 2-130
 - Ext Mixer Config 3-11, 3-46
 - Eye Opening 3-18, 3-79
 - Eye Opening Calculation 4-10
 - Eye Opening OFF 3-18, 3-81
- [F]**
- F/T 3-19, 3-85
 - F/T Function 2-49
 - Factory Defaults 3-87
 - Features of RS-232 Remote Control 5-59
 - File 3-9, 3-32
 - File Format 3-9, 3-32
 - File No. 3-9, 3-33
 - Fine 3-8, 3-29
 - Fixed Marker Function 2-111
 - Fixed Marker ON/OFF 3-14, 3-53
 - Fixed MKR Peak 3-13, 3-51
 - Floppy 3-9, 3-33
 - Floppy Disk 2-142
 - Floppy Disk Drive Section 2-4
 - Flow Control 3-9, 3-30
 - FM Signals 2-120, 2-123
 - FORMAT 3-40
 - Format 3-9, 3-34
 - Format Card A 3-9, 3-16, 3-34, 3-69
 - Format Card B 3-9, 3-16, 3-34, 3-69
 - Format Floppy 3-9, 3-16, 3-34, 3-69
 - Formatting Media 2-142
 - FREQ 3-11, 3-45
 - Freq Corr ON/OFF 3-8, 3-29
 - Freq Offset ON/OFF 3-11, 3-45
 - Frequency 3-45
 - Frequency deviation 2-120
 - Frequency Domain 2-41, 2-53
 - Front Panel 2-1
 - Full Screen 4-3
 - Full Screen Mode 2-87
 - Full Span 3-17, 3-71
 - Functional Description 3-20
 - FUND Frequency ON/OFF 3-18, 3-78
 - Fuse 1-5
- [G]**
- Gate Position 3-17, 3-76
 - Gate Src Ext Gate 3-17, 3-76
 - Gate Src IF Trigger 3-17
 - Gate Src Trigger 3-76
 - Gate Width 3-17, 3-76
 - Gated Sweep 2-97, 3-76, 4-8
 - Gated Sweep ON/OFF 3-17, 3-77
 - GLOSSARY A-9
 - GPIB 5-7
 - GPIB Address 3-9, 3-30
 - GPIB and RS-232 Compatibility 5-59
 - GPIB Command Codes 5-21
 - GPIB Command Index 5-1
 - GPIB Interface Functions 5-9
 - GPIB Remote Control 3-48
 - GPIB Remote Programming 5-7
 - GPIB Setup 5-8
 - Graph 3-15, 3-61
 - Graph ON/OFF 3-15, 3-61
 - Gray#1 3-10, 3-44
 - Gray#2 3-10, 3-44
- [H]**
- Hard Copy 2-140
 - Harmonic Distortion Measurements 2-105
 - Harmonics 3-18, 3-78
 - Harmonics Number 3-18, 3-78
 - Harmonics OFF 3-18, 3-78
 - Hi Sens ON/OFF 3-18, 3-83
 - Hour 3-9, 3-34
- [I]**
- IF Step AMP 3-8, 3-28
 - IM Meas 3-18, 3-82
 - IM Meas OFF 3-18, 3-83
 - Initialization 3-63
 - Input ATT 3-8, 3-28
 - Input Saturation 4-1
 - Insert 3-18, 3-79, 3-81
 - Insert Line 3-10, 3-11, 3-12, 3-15, 3-43, 3-47, 3-50, 3-59
 - Interface connection 5-60
 - Interface Messages 5-10

Alphabetical Index

INTRODUCTION 1-1

[L]

Label 3-10, 3-43
 Label Delete 3-10, 3-43
 Label Entry 3-10, 3-43
 Last Span 3-17, 3-71
 LCL 3-11, 3-48
 LEVEL 3-12, 3-49
 Level Correction Data 2-29
 Limit Line 3-10, 3-14, 3-16, 3-40, 3-54, 3-67
 Limit Line 1 3-10, 3-17, 3-41, 3-73
 Limit Line 1/2 3-10, 3-43
 Limit Line 2 3-10, 3-17, 3-41, 3-73
 Limit Line Edit 3-10, 3-43
 Limit line Function 2-65
 Limit Line Setup 3-10, 3-40
 Limit Posi 3-17, 3-72
 Limit Setup 3-18, 3-82
 Limit Width 3-17, 3-72
 Limited-life Parts 1-15
 Linear 3-12, 3-49
 List of Settings 3-86
 List OFF 3-13, 3-51
 List Reg/File 3-15, 3-16, 3-64, 3-68
 Load Table 3-18, 3-79
 Log Linearity 3-8, 3-28
 LOSS:Freq 3-16, 3-68
 Loss:Freq Edit 3-11, 3-47
 Loss:Freq ON/OFF 3-11, 3-47

[M]

Manual 3-15, 3-61, 3-78
 Manual Tune 3-11, 3-45
 Marker 3-53
 Marker → 3-56
 Marker → CF 3-14, 3-56
 Marker → CF Step 3-14, 3-56
 Marker → Marker Step 3-14, 3-56
 Marker → Ref 3-14, 3-56
 Marker List ON/OFF 3-14, 3-54
 Marker No. 3-14, 3-15, 3-53, 3-62
 Marker OFF 3-14, 3-15, 3-53, 3-54, 3-55, 3-62

Marker off 3-57
 Marker ON 3-14, 3-15, 3-53, 3-62
 MARKER Section 2-5
 Marker Step Size AUTO/MNL 3-14, 3-55
 Max Hold A 3-7, 3-20
 Max Hold B 3-8, 3-25
 Max Peak 3-19, 3-84, 3-85
 MEAS 3-13, 3-51
 Measurement 3-51, 5-45
 Measurement Conditions 2-130, 5-45
 Measurement Examples 2-71
 MEASUREMENT Section 2-4
 Measuring Frequency Using Counter 2-23
 Measuring Window 2-26, 3-19, 3-84
 Media Format 3-9, 3-33
 MEDIUM 3-10
 Memory Card 2-143
 Memory card 6-21
 Menu Index 3-1
 Menu Map 3-7
 Menu Print 3-9, 3-32, 3-33
 Message Exchange Protocol 5-11
 Min ATT ON/OFF 3-7, 3-24
 Min Hold A 3-7, 3-21
 Min Hold B 3-8, 3-26
 Min Peak 3-17, 3-72
 Minute 3-9, 3-34
 Mixer INT/EXT 3-11, 3-46
 MKR 3-14, 3-53
 MKR → 3-14, 3-56
 MKR → Key 3-56
 Modulation Factor 2-117
 Modulation Index 2-123
 Mono#1 3-10, 3-44
 Mono#2 3-10, 3-44
 Month 3-9, 3-34
 Multi Marker 3-14, 3-53
 Multi MKR OFF 3-14, 3-54
 Multi MKR Setup 3-14, 3-15, 3-53, 3-62

[N]

NARROW 3-10
 Negative 3-7, 3-8, 3-10, 3-20, 3-22, 3-25, 3-26, 3-40
 Next Min Peak 3-17, 3-72
 Next Peak 3-14, 3-17,

- 3-19, 3-53,
3-72, 3-84,
3-85
- Next Peak Left 3-17, 3-72
- Next Peak Right 3-17, 3-72
- Next Result 3-18, 3-79
- Noise Corr ON/OFF 3-15, 3-59
- Noise/Hz 3-13, 3-51
- Noise/Hz OFF 3-13, 3-51
- Normal 2-105, 3-7,
3-8, 3-10,
3-20, 3-22,
3-25, 3-26,
3-40
- Normal Marker 3-14, 3-53
- Normalize 3-16, 3-67
- Normalize A 3-7, 3-21
- Normalize A ON/OFF 3-7, 3-21
- Normalize B 3-8, 3-26
- Normalize B ON/OFF 3-8, 3-26
- Normalize with Store Corr. 3-7, 3-8,
3-21, 3-26
- [O]**
- OBW 2-84, 3-18,
3-78
- OBW Measurement Conditions 2-137
- OBW OFF 3-18, 3-78
- OBW% 3-18, 3-78
- Occupied Bandwidth 2-84
- OFF 3-14, 3-57
- Offset 3-10, 3-42,
3-43
- Operating Environment 1-4
- Operating Menus 2-14
- Operating the Markers 2-18
- OPERATION 2-1
- Option 2-143
- Option Section 2-9
- Order 3-9, 3-18,
3-34, 3-82
- [P]**
- Panel Control 5-62
- Panel Description 2-1
- Paper Feed 3-9, 3-32
- Parameter Setup 3-15, 3-18,
3-61, 3-78
- Parameter Setup Window 5-59
- Parameters Range 3-90
- Parity Bit 3-9, 3-30
- Pass Range 3-10, 3-41
- Pass/Fail Judgement ON/OFF 3-10, 3-18,
3-43, 3-83
- Pass/Fail Judgments 2-65
- PBW 3-8, 3-28
- Peak → CF 3-14, 3-56
- Peak → Ref 3-14, 3-56
- Peak Delta Y 3-14, 3-17,
3-19, 3-54,
3-73, 3-85
- Peak List 2-108, 3-13,
3-51
- Peak List Freq 3-13, 3-14,
3-51, 3-54
- Peak List Level 3-13, 3-14,
3-51, 3-54
- Peak X dB Down 3-13, 3-52
- Peak Zooming 3-19, 3-84,
3-85
- Phase Jitter 3-18, 3-81
- Phase Jitter Measurement 4-12
- Phase Jitter OFF 3-18, 3-82
- Phase Noise 3-18, 3-81
- PLL Band Width 3-10, 3-38
- Positive 3-7, 3-8,
3-10, 3-20,
3-22, 3-25,
3-26, 3-40
- POWER 3-15, 3-58
- Power Average A 3-7, 3-22
- Power Average B 3-8, 3-26
- Power Cable 1-7
- Power Meas OFF 3-15, 3-58
- Power ON Count 3-9, 3-35
- Power Supply Specifications 1-5
- Power Switch 2-3
- Precautions in Use 1-8
- Presel Tune 3-11, 3-45
- Preselector 1.6 GHz/3.6 GHz 3-11, 3-46
- PRESET 3-15, 3-63
- Prev Result 3-18, 3-79
- PRINCIPLE OF MEASUREMENT 4-1
- Printer 3-9, 3-30,
3-33
- Printer Command 3-9, 3-31
- Problem A-1
- Product Description 1-1
- Pulsed RF Signals 2-125
- [R]**
- R3264 SPECIFICATIONS 6-1
- R3267 SPECIFICATIONS 6-7
- R3273 SPECIFICATIONS 6-14
- RBW 3-86

Alphabetical Index

RBW AUTO/MNL	3-10, 3-37		
RBW Switching	3-8, 3-28		
RBW:Span ON/OFF	3-10, 3-37		
RBW≤100Hz ANLG/DGTL	3-10, 3-38		
RCL	3-15, 3-64		
Reading Data	5-47		
Rear Panel	2-12		
Recall	3-15, 3-64		
Recall File	3-15, 3-64		
Recall on POWER	3-15, 3-64		
Recall Register	3-15, 3-64		
Ref Offset ON/OFF	3-12, 3-49		
REFERENCE	3-1		
Reference	3-10, 3-42		
Reference Marker ON/OFF	3-13, 3-52		
Reference Object	3-14, 3-54		
REG #IP	3-16		
REG#1	3-15, 3-16		
REG#1, #2, #3, #4, #5	3-64, 3-66		
REG#10	3-15, 3-16		
REG#2	3-15, 3-16		
REG#3	3-15, 3-16		
REG#4	3-15, 3-16		
REG#5	3-15, 3-16		
REG#6	3-15, 3-16		
REG#6, #7, #8, #9, #10	3-64, 3-66		
REG#7	3-15, 3-16		
REG#8	3-15, 3-16		
REG#9	3-15, 3-16		
REG#IP	3-66		
Release Object	3-14, 3-54		
Release Protect	3-16, 3-68		
Remote Control Usage Examples	5-63		
REMOTE Section	2-8		
Remove Anchor	3-7, 3-10, 3-22, 3-40		
Rename	3-16, 3-68		
REPEAT	3-15, 3-65		
Reset Marker	3-14, 3-15, 3-53, 3-62		
Resolution 1 Hz	3-13		
Resolution 1 kHz	3-13		
Resolution 1 kHz, 100 Hz, 10 Hz or 1 Hz	3-51		
Resolution 10 Hz	3-13		
Resolution 100 Hz	3-13		
Result Area Posi UP/LOW	3-10, 3-44		
Revision	3-9, 3-35		
Rolloff Factor	3-15, 3-60		
Root Nyquist Filter	4-6		
RS232	3-9, 3-30		
RS-232 and GPIB	5-62		
RS-232 Remote Control Function	5-59		
			[S]
Sample	3-7, 3-8, 3-10, 3-20, 3-22, 3-25, 3-26, 3-40		
Sampling Times	3-7, 3-18, 3-21, 3-80		
SAVE	3-16, 3-66		
Save	3-16, 3-66		
Save File	3-16, 3-66		
Save Item Setup	3-16, 3-66		
Save Register	3-16, 3-66		
Save Table	3-18, 3-79		
Save/Recall Section	2-5		
Screen Annotation	2-10		
Screen Data	2-138		
Screen FULL/SEPA/CARRIER	3-15, 3-61		
Screen Label	2-147		
Screen Reset	3-19, 3-85		
Search Condition	3-17, 3-72		
Selftest	3-9, 3-35		
SEPARATE Display	2-93		
Separate Screen	4-3		
Set Anchor	3-7, 3-10, 3-22, 3-40		
Set Resolution	3-86		
Setup	3-16, 3-67		
Setup Media	3-16, 3-69		
Show Result	3-18, 3-79		
Signal Ident ON/OFF	3-11, 3-47		
Signal Track ON/OFF	3-14, 3-18, 3-54, 3-81, 3-82		
SINGLE	3-17, 3-70		
Single Sweep	3-70		
Slope	3-17, 3-75, 3-76		
Sort	3-10, 3-11, 3-12, 3-15, 3-43, 3-47, 3-50, 3-59		
Source	3-17, 3-75, 3-76		
SPAN	3-17, 3-71		
SPECIFICATIONS	6-1		
Spurious	3-18, 3-68, 3-79		
Spurious OFF	3-18, 3-79		
Start Offset	3-18		
SRCH	3-17, 3-72		
Start	3-11, 3-45		
Start Offset	3-82		
Status Byte	5-56		

- Status Bytes 5-14
- Stop 3-11, 3-45
- Stop Bit 3-9, 3-30
- Stop Offset 3-18, 3-82
- Store 3-8, 3-29
- Storing 1-14
- Sweep Time 3-75
- Sweep Time AUTO/MNL 3-10, 3-17, 3-37, 3-75
- Sweep-Time 3-86
- SWP 3-17, 3-75
- Symbol Rate 1/T 3-15, 3-60
- System Checkout 1-10
- [T]**
- T/T 3-19, 3-85
- Table Init 3-10, 3-11, 3-12, 3-15, 3-18, 3-43, 3-47, 3-50, 3-60, 3-79, 3-81
- Table No.1/2/3 3-18, 3-79
- Test Mode Exit 3-9, 3-35
- Third Order Intermodulation Distortion . 2-114
- Time Domain 2-44, 2-57, 2-101
- Time Ratio Corr ON/OFF 3-18, 3-80
- Total Gain 2-63, 3-8, 3-28
- Total Power 3-15, 3-58
- Trace 3-16, 3-67
- Trace A 3-14, 3-20, 3-54
- Trace A Detector 3-7, 3-20, 3-22
- Trace B 3-25
- Trace B Detector 3-8, 3-25, 3-26
- Trace Data 5-52
- Trace Detector 3-10, 3-40
- Trace Marker Move 3-14, 3-54
- Trace Point 1001/501 3-9, 3-35
- Transporting 1-14
- Trc Disp PAUSE/CONT 3-7, 3-21
- Trigger Delay 3-17, 3-75
- Trigger Level 3-17, 3-75, 3-76
- Trigger Setup 3-17, 3-75, 3-76
- Two Signals 2-33
- [U]**
- UNCAL Message 2-39
- Units 3-12, 3-49
- User Define 3-10, 3-42, 3-43
- UTIL 3-18, 3-78
- Utility 3-78
- [V]**
- VBW 3-86
- VBW AUTO/MNL 3-10, 3-37
- VBW:RBW ON/OFF 3-10, 3-37
- View A 3-7, 3-20
- View B 3-8, 3-25
- Volts 3-12, 3-49
- [W]**
- Watts 3-12, 3-49
- WIDE 3-10
- Wide Band Digital Modulation Signal ... 2-78
- WINDOW 3-19, 3-84
- Window ON/OFF 3-19, 3-84
- Window Position 3-19, 3-84
- Window Sweep ON/OFF 3-17, 3-19, 3-77, 3-84
- Window Width 3-19, 3-84
- Write A 3-7, 3-20
- Write B 3-8, 3-25
- Write Protect 3-16, 3-66
- [X]**
- X Cursor Position 3-7, 3-10, 3-18, 3-22, 3-40, 3-80
- X Data Mode 3-10, 3-42
- X dB Down 3-13, 3-51
- X dB Left 3-13, 3-52
- X dB Right 3-13, 3-52
- X Range 3-17, 3-72
- x1 3-12
- x1, x2, x5 or x10 3-49
- x10 3-12
- x2 3-12
- x5 3-12
- XdB Down 3-13, 3-51
- XY Cursor 3-7, 3-10, 3-18, 3-21, 3-40, 3-80
- XY Cursor ON/OFF 3-7, 3-10, 3-18, 3-22, 3-40, 3-80

Alphabetical Index

[Y]

Y Cursor Auto Set	3-18, 3-80
Y Cursor Position	3-7, 3-10, 3-18, 3-22, 3-40, 3-80
Y Data Mode	3-10, 3-42
Y Range	3-17, 3-73
Year	3-9, 3-34

[Z]

Zero Span	3-17, 3-71
Zoom	3-19, 3-84
Zoom off	3-19, 3-84, 3-85
Zoom on Window	3-19, 3-84, 3-85
Zoom Position	3-19, 3-84, 3-85
Zoom Width	3-19, 3-84, 3-85

IMPORTANT INFORMATION FOR ADVANTEST SOFTWARE

PLEASE READ CAREFULLY: This is an important notice for the software defined herein. Computer programs including any additions, modifications and updates thereof, operation manuals, and related materials provided by ADVANTEST (hereafter referred to as "SOFTWARE"), included in or used with hardware produced by ADVANTEST (hereafter referred to as "PRODUCTS").

SOFTWARE License

All rights in and to the SOFTWARE (including, but not limited to, copyright) shall be and remain vested in ADVANTEST. ADVANTEST hereby grants you a license to use the SOFTWARE only on or with ADVANTEST PRODUCTS.

Restrictions

- (1) You may not use the SOFTWARE for any purpose other than for the use of the PRODUCTS.
- (2) You may not copy, modify, or change, all or any part of, the SOFTWARE without permission from ADVANTEST.
- (3) You may not reverse engineer, de-compile, or disassemble, all or any part of, the SOFTWARE.

Liability

ADVANTEST shall have no liability (1) for any PRODUCT failures, which may arise out of any misuse (misuse is deemed to be use of the SOFTWARE for purposes other than it's intended use) of the SOFTWARE. (2) For any dispute between you and any third party for any reason whatsoever including, but not limited to, infringement of intellectual property rights.

LIMITED WARRANTY

1. Unless otherwise specifically agreed by Seller and Purchaser in writing, ADVANTEST will warrant to the Purchaser that during the Warranty Period this Product (other than consumables included in the Product) will be free from defects in material and workmanship and shall conform to the specifications set forth in this Operation Manual.
2. The warranty period for the Product (the "Warranty Period") will be a period of one year commencing on the delivery date of the Product.
3. If the Product is found to be defective during the Warranty Period, ADVANTEST will, at its option and in its sole and absolute discretion, either (a) repair the defective Product or part or component thereof or (b) replace the defective Product or part or component thereof, in either case at ADVANTEST's sole cost and expense.
4. This limited warranty will not apply to defects or damage to the Product or any part or component thereof resulting from any of the following:
 - (a) any modifications, maintenance or repairs other than modifications, maintenance or repairs (i) performed by ADVANTEST or (ii) specifically recommended or authorized by ADVANTEST and performed in accordance with ADVANTEST's instructions;
 - (b) any improper or inadequate handling, carriage or storage of the Product by the Purchaser or any third party (other than ADVANTEST or its agents);
 - (c) use of the Product under operating conditions or environments different than those specified in the Operation Manual or recommended by ADVANTEST, including, without limitation, (i) instances where the Product has been subjected to physical stress or electrical voltage exceeding the permissible range and (ii) instances where the corrosion of electrical circuits or other deterioration was accelerated by exposure to corrosive gases or dusty environments;
 - (d) use of the Product in connection with software, interfaces, products or parts other than software, interfaces, products or parts supplied or recommended by ADVANTEST;
 - (e) the occurrence of an event of force majeure, including, without limitation, fire, explosion, geological change, storm, flood, earthquake, tidal wave, lightning or act of war; or
 - (f) any negligent act or omission of the Purchaser or any third party other than ADVANTEST.
5. **EXCEPT TO THE EXTENT EXPRESSLY PROVIDED HEREIN, ADVANTEST HEREBY EXPRESSLY DISCLAIMS, AND THE PURCHASER HEREBY WAIVES, ALL WARRANTIES, WHETHER EXPRESS OR IMPLIED, STATUTORY OR OTHERWISE, INCLUDING, WITHOUT LIMITATION, (A) ANY WARRANTY OF MERCHANTABILITY OR FITNESS FOR A PARTICULAR PURPOSE AND (B) ANY WARRANTY OR REPRESENTATION AS TO THE VALIDITY, SCOPE, EFFECTIVENESS OR USEFULNESS OF ANY TECHNOLOGY OR ANY INVENTION.**
6. **THE REMEDY SET FORTH HEREIN SHALL BE THE SOLE AND EXCLUSIVE REMEDY OF THE PURCHASER FOR BREACH OF WARRANTY WITH RESPECT TO THE PRODUCT.**
7. **ADVANTEST WILL NOT HAVE ANY LIABILITY TO THE PURCHASER FOR ANY INDIRECT, INCIDENTAL, SPECIAL, CONSEQUENTIAL OR PUNITIVE DAMAGES, INCLUDING, WITHOUT LIMITATION, LOSS OF ANTICIPATED PROFITS OR REVENUES, IN ANY AND ALL CIRCUMSTANCES, EVEN IF ADVANTEST HAS BEEN ADVISED OF THE POSSIBILITY OF SUCH DAMAGES AND WHETHER ARISING OUT OF BREACH OF CONTRACT, WARRANTY, TORT (INCLUDING, WITHOUT LIMITATION, NEGLIGENCE), STRICT LIABILITY, INDEMNITY, CONTRIBUTION OR OTHERWISE.**

CUSTOMER SERVICE DESCRIPTION

In order to maintain safe and trouble-free operation of the Product and to prevent the incurrence of unnecessary costs and expenses, ADVANTEST recommends a regular preventive maintenance program under its maintenance agreement.

ADVANTEST's maintenance agreement provides the Purchaser on-site and off-site maintenance, parts, maintenance machinery, regular inspections, and telephone support and will last a maximum of ten years from the date the delivery of the Product. For specific details of the services provided under the maintenance agreement, please contact the nearest ADVANTEST office listed at the end of this Operation Manual or ADVANTEST's sales representatives.

Some of the components and parts of this Product have a limited operating life (such as, electrical and mechanical parts, fan motors, unit power supply, etc.). Accordingly, these components and parts will have to be replaced on a periodic basis. If the operating life of a component or part has expired and such component or part has not been replaced, there is a possibility that the Product will not perform properly. Additionally, if the operating life of a component or part has expired and continued use of such component or part damages the Product, the Product may not be repairable. Please contact the nearest ADVANTEST office listed at the end of this Operation Manual or ADVANTEST's sales representatives to determine the operating life of a specific component or part, as the operating life may vary depending on various factors such as operating condition and usage environment.

CLAIM FOR DAMAGE IN SHIPMENT TO ORIGINAL BUYER

The product should be thoroughly inspected immediately upon original delivery to buyer. All material in the container should be checked against the enclosed packing list or the instruction manual alternatively. ADVANTEST will not be responsible for shortage unless notified immediately.

If the product is damaged in any way, a claim should be filed by the buyer with carrier immediately. (To obtain a quotation to repair shipment damage, contact ADVANTEST or the local supplier.) Final claim and negotiations with the carrier must be completed by buyer.

SALES & SUPPORT OFFICES

Advantest America Measuring Solutions, Inc. (North America)

New Jersey Office

258 Fernwood Avenue, Edison, NJ 08837

Phone: (1) (732) 346-2600 Facsimile: (1) (732) 346-2610

Santa Clara Office

3201 Scott Blvd., Santa Clara, CA 95054

Phone: (1) (408) 988-7700 Facsimile: (1) (408) 987-0688

ROHDE & SCHWARZ Engineering and Sales GmbH (Europe)

Mühlendorfstraße 15, D-81671 München, Germany

P.O.B. 80 14 29, D-81614 München, Germany

Phone: (49) (89) 4129-13711 Facsimile: (49) (89) 4129-13723

Advantest (Singapore) Pte. Ltd. (Singapore)

438A Alexandra Road, #8-03/06

Alexandra Technopark, Singapore 119967

Phone: (65) (6) 274-3100 Facsimile: (65) (6) 274-4055

Advantest Korea Co., Ltd. (Korea)

16Fl., MIRAEWASARAM Bldg., 942-1

Daechi-Dong, Kangnam-Ku, Seoul, Korea

Phone: (82) (02) 3452-7710 Facsimile: (82) (02) 3452-7970

Advantest (Suzhou) Co., Ltd. (China)

5F, No. 46 Factory Building,

No. 555 Gui Ping Road, Shanghai, China 200233

Phone: (86) (21) 6485-2725 Facsimile: (86) (21) 6485-2726

Technology Support on the Leading Edge

ADVANTEST®

ADVANTEST CORPORATION

Shinjuku-NS Building, 4-1, Nishi-Shinjuku 2-chome, Shinjuku-ku, Tokyo 163-0880, Japan
Phone: +81-3-3342-7500 Facsimile: +81-3-5322-7270 Telex: 232-4914 ADVAN J