

**Agilent
FieldFox
RF Analyzer
N9912A**

User's Guide

Manufacturing Part Number: N9912-90001

Print Date: Nov. 1, 2013

Supersedes: July 2, 2013

©Agilent Technologies, Inc.



Agilent Technologies

Warranty Statement

The material contained in this document is provided "as is," and is subject to being changed, without notice, in future editions. Further, to the maximum extent permitted by applicable law, Agilent disclaims all warranties, either express or implied with regard to this manual and any information contained herein, including but not limited to the implied warranties of merchantability and fitness for a particular purpose. Agilent shall not be liable for errors or for incidental or consequential damages in connection with the furnishing, use, or performance of this document or any information contained herein. Should Agilent and the user have a separate written agreement with warranty terms covering the material in this document that conflict with these terms, the warranty terms in the separate agreement will control.

DFARS/Restricted Rights Notice

If software is for use in the performance of a U.S. Government prime contract or subcontract, Software is delivered and licensed as "Commercial computer software" as defined in DFAR 252.227-7014 (June 1995), or as a "commercial item" as defined in FAR 2.101(a) or as "Restricted computer software" as defined in FAR 52.227-19 (June 1987) or any equivalent agency regulation or contract clause. Use, duplication or disclosure of Software is subject to Agilent Technologies' standard commercial license terms, and non-DOD Departments and Agencies of the U.S. Government will receive no greater than Restricted Rights as defined in FAR 52.227-19(c)(1-2) (June 1987). U.S. Government users will receive no greater than Limited Rights as defined in FAR 52.227-14 (June 1987) or DFAR 252.227-7015 (b) (2) (November 1995), as applicable in any technical data.

Technology Licenses

The hardware and/or software described in this document are furnished under a license and may be used or copied only in accordance with the terms of such license.

Contacting Agilent

Assistance with test and measurements needs and information on finding a local Agilent office are available on the Web at: <http://www.agilent.com/find/assist>

If you do not have access to the Internet, please contact your Agilent field engineer.

In any correspondence or telephone conversation, refer to the Agilent product by its model number and full serial number. With this information, the Agilent representative can determine whether your product is still within its warranty period.

Safety and Regulatory Information

The safety and regulatory information pertaining to this product is located on page 184.

Where to Find the Latest Information

Documentation is updated periodically. For the latest information, please visit:

<http://www.agilent.com/find/fieldfox>

Software Updates

Is your product software up-to-date? Periodically, Agilent releases software updates to fix known defects and incorporate product enhancements. To search for software updates for your product, go to www.agilent.com/find/fieldfoxsupport

Elements of this product's Software use SharpZipLib as an "as provided" stand alone capability.

Copyright 2004 John Reilly

This program is free software; you can redistribute it and/or modify it under the terms of the GNU General Public License as published by the Free Software Foundation; either version 2 of the License, or (at your option) any later version.

This program is distributed in the hope that it will be useful, but WITHOUT ANY WARRANTY; without even the implied warranty of MERCHANTABILITY or FITNESS FOR A PARTICULAR PURPOSE. See the GNU General Public License for more details.

To receive a copy of the GNU General Public License, write to the Free Software Foundation, Inc., 59 Temple Place - Suite 330, Boston, MA 02111-1307, USA.

Linking this library statically or dynamically with other modules is making a combined work based on this library. Thus, the terms and conditions of the GNU General Public License cover the whole combination.

As a special exception, the copyright holders of this library give you permission to link this library with independent modules to produce an executable, regardless of the license terms of these independent modules, and to copy and distribute the resulting executable under terms of your choice, provided that you also meet, for each linked independent module, the terms and conditions of the license of that module. An independent module is a module which is not derived from or based on this library. If you modify this library, you may extend this exception to your version of the library, but you are not obligated to do so. If you do not wish to do so, delete this exception statement from your version.

Elements of this product's software use ANTLR.

Copyright (c) 2005-2008 Terence Parr

All rights reserved.

Conversion to C#: Copyright (c) 2008-2009 Sam Harwell, Pixel Mine, Inc.

All rights reserved.

Redistribution and use in source and binary forms, with or without modification, are permitted provided that the following conditions are met:

1. Redistributions of source code must retain the above copyright notice, this list of conditions and the following disclaimer.
2. Redistributions in binary form must reproduce the above copyright notice, this list of conditions and the following disclaimer in the documentation and/or other materials provided with the distribution.
3. The name of the author may not be used to endorse or promote products derived from this software without specific prior written permission.

THIS SOFTWARE IS PROVIDED BY THE AUTHOR "AS IS" AND ANY EXPRESS OR IMPLIED WARRANTIES, INCLUDING, BUT NOT LIMITED TO, THE IMPLIED WARRANTIES OF MERCHANTABILITY AND FITNESS FOR A PARTICULAR PURPOSE ARE DISCLAIMED.

IN NO EVENT SHALL THE AUTHOR BE LIABLE FOR ANY DIRECT, INDIRECT, INCIDENTAL, SPECIAL, EXEMPLARY, OR CONSEQUENTIAL DAMAGES (INCLUDING, BUT NOT LIMITED TO, PROCUREMENT OF SUBSTITUTE GOODS OR SERVICES; LOSS OF USE, DATA, OR PROFITS; OR BUSINESS INTERRUPTION) HOWEVER CAUSED AND ON ANY THEORY OF LIABILITY, WHETHER IN CONTRACT, STRICT LIABILITY, OR TORT (INCLUDING NEGLIGENCE OR OTHERWISE) ARISING IN ANY WAY OUT OF THE USE OF THIS SOFTWARE, EVEN IF ADVISED OF THE POSSIBILITY OF SUCH DAMAGE.

A.07.25 Firmware Release Updates.....	7
Overview.....	8
Options and Features.....	8
Accessories.....	9
FieldFox Manuals, Software, and Supplemental Help.....	10
Preparing for Initial Use of Your New FieldFox.....	11
Check the Shipment.....	11
Meeting Power Requirements for the AC/DC Adapter.....	11
Install the Lithium-Ion Battery.....	12
FieldFox ON/OFF Settings.....	13
FieldFox High-Temperature Protection.....	14
Avoid Overpowering the FieldFox.....	14
Take the FieldFox Tour.....	16
Front Panel.....	17
Top Panel.....	18
Side Panel.....	18
Screen Tour.....	19
How to Enter Numeric Values.....	20
CAT (Cable and Antenna Test) Mode.....	21
CAT Mode Settings.....	22
Return Loss Measurements.....	28
1-Port Cable Loss Measurements.....	28
2-Port Insertion Loss Measurements.....	30
DTF (Distance to Fault) Measurements.....	31
DTF Measurement Settings.....	32
NA (Network Analyzer) Mode.....	39
NA Mode Settings.....	39
Time Domain - Option 010.....	52
Time Domain (Transform) Settings.....	53
Trace Settings.....	57
Gating.....	58

Calibration for CAT, NA, and VVM Modes	60
Verifying Calibration and Jumper Cable Integrity	66
Calibration Method Summary.....	66
SA (Spectrum Analyzer) Mode.....	68
SA Mode Settings	69
Channel Measurements	94
Interference Analyzer (SA Mode) - Option 236.....	103
Spectrogram and Waterfall Displays.....	103
Record Playback	107
Built-in Power Meter Mode - Option 311.....	116
Power Meter Settings.....	116
Power Meter Mode – Option 302	119
Power Meter Settings.....	120
Pulse Measurements Mode - Option 330.....	126
Pulse Measurement Settings.....	127
VVM (Vector Voltmeter) Mode – Option 308	137
Overview	138
VVM Mode Settings.....	138
1-Port Cable Trimming Measurements.....	142
2-Port Transmission Measurements.....	143
Data Analysis Features.....	144
All about Markers.....	144
All about Limit Lines	154
All about Trace Math.....	157
File Management.....	160
Saving and Recalling Files	160
Printing.....	167
System Settings.....	168
Run/Hold	168

Preset	169
User Preset	169
Volume Control	170
Display Settings	171
Preferences.....	172
System Configuration	175
Service Diagnostics.....	181
Working with the Lithium-Ion Battery	184
Viewing Battery Charge Status	184
Charging the Battery.....	185
Reconditioning the Battery	187
Battery Care.....	188
Maximizing Battery Life.....	188
Lithium Ion Battery Disposal	189
Safety Considerations	190
Certification and Compliance Statements.....	198
Appendix A: Connector Care Review	199
Appendix B: Specifications/Data Sheet	200
Appendix C: Instrument Calibration.....	201
Index.....	202

A.07.25 Firmware Release Updates

For customers upgrading FieldFox firmware, the following is a list of changes from the previous release:

CAT Mode

DTF Frequency annotations33

Power Meter Mode

Source Control (ON/OFF/Power Level).....121

All Modes (System)

Recall *.png and *.jpg files.....162

User Preset.....169

Startup Mode Preference.....174

New Mode

Pulse Measurements (Opt 330)126

NOTE This release automatically adjusts the Time setting for areas that observe Daylight Saving. Therefore, after upgrading to this release, your FieldFox Time may have been adjusted by one hour.

Overview

Options and Features

Options and Features	Learn more
Cable and Antenna Test (CAT) Mode <ul style="list-style-type: none">▪ 2 MHz to 4 GHz (Option 104)▪ 2 MHz to 6 GHz (Option 106) Measurements: <ul style="list-style-type: none">▪ Distance-to-fault (DTF)▪ DTF & Return Loss▪ Return Loss (dB)▪ VSWR▪ DTF (VSWR)▪ Cable Loss (1-Port)▪ Insertion loss (2-Port) (Option 110)	CAT Mode on page 21
Transmission Measurement (Option 110)	CAT Mode on page 21 NA Mode on page 39
QuickCal (Option 111) Built-in cal kit. Industry first!	Cal on page 61
Spectrum Analyzer (SA) Mode General purpose measurements for basic monitoring and troubleshooting. <ul style="list-style-type: none">▪ 100 kHz to 4 GHz (Option 230)▪ 100 kHz to 6 GHz (Option 231)▪ Preamplifier for Spectrum Analyzer (Option 235)▪ Interference Measurements (Option 236)	SA Mode on page 68 On page 75 On page 103
Channel Power Meter Mode (Option 311) No Power Meter required	On page 116
Power Meter Mode (Option 302) Use with Agilent External USB Power Sensors	Power Meter Mode on page 116
Network Analyzer (NA) Mode (Option 303) <ul style="list-style-type: none">▪ 2 MHz to 4 GHz (Option 104)▪ 2 MHz to 6 GHz (Option 106)▪ Vector 1-port (Standard)▪ Scalar 2-port (Option 110) Measurements: <ul style="list-style-type: none">▪ S11 Reflection (several formats)▪ S21 Transmission (several formats) (Option 110)▪ A receiver▪ R receiver	NA Mode on page 39
Vector Voltmeter (VVM) Mode (Option 308) Measure electrical length Measurements:	VVM Mode on page 137

<ul style="list-style-type: none"> ▪ 1-Port Cable Trimming (Mag and Phase) ▪ 2-Port Transmission (Magnitude only) 	
Designed for Field Environment	
<ul style="list-style-type: none"> ▪ Lightweight 6.2 lbs (2.8 kg) including battery ▪ Rugged, weather resistant shell with no fan/vents ▪ Daylight viewable 6.5" (16.5 cm) color LCD ▪ Backlit keys for night use ▪ Integrated kickstand ▪ Configurable hand and shoulder straps ▪ Softcase for carrying all gear ▪ Quick Reference Guide with laminated pages 	
Slots for removable USB Flash Drive and microSD Card	Save / Recall on page 162
<ul style="list-style-type: none"> ▪ Expands internal storage ▪ Useful for file transfer ▪ Flash Drive and microSD Card not included ▪ FieldFox release 4.0 supports microSDHC (high-capacity) Card 	
Battery or AC Power	On page 184.
<ul style="list-style-type: none"> ▪ Rechargeable Li-Ion battery with ~4 hr life ▪ Easily removable battery ▪ AC/DC adapter ▪ External battery charger (N9910X-872) 	
FieldFox Data Link Software	
<ul style="list-style-type: none"> ▪ Easily manage files and compile reports ▪ Reads data from the FieldFox and plots traces ▪ Help file included with the software installation ▪ Download the latest version of the software at http://www.agilent.com/find/fieldfox 	
Additional Features	Languages on page 172
<ul style="list-style-type: none"> ▪ Menus localized to 7 languages 	

Accessories

The following accessories are included with every FieldFox. Spare accessories can be ordered at any time.

Accessory Part Number	Description
N9910X-873	AC/DC Adapter
N9910X-870	Lithium-Ion Battery
N9910X-880	Softcase w/ Backpack & Shoulder Strap
N9910X-890	User's Guide (printed copy)
N9910X-891	Quick Reference Guide (printed copy)

To see a complete list of accessories that are available for the FieldFox, please visit: <http://www.agilent.com/find/fieldfox>.

FieldFox Manuals, Software, and Supplemental Help

The following manuals and software are available for the FieldFox. For the very latest versions, please visit the FieldFox support website at:

www.agilent.com/find/fieldfoxsupport.

Check the manual revision on the first page of each manual.

- **User's Guide** – This manual, included with shipment.
- **Quick Reference Guide** – Printed copy with laminated pages for outdoor use included with shipment.
- **Supplemental Online Help** - Concepts and Reference information.
<http://na.tm.agilent.com/fieldfox/help/FieldFox.htm>
- **FieldFox Data Link Software and Help** – Free download.
- **Service Guide** – Free download.
- **Firmware Updates** – Check to see if you have the latest FieldFox firmware.

Conventions that are used in the Manual

- **Hardkey** indicates a front panel button. The functionality of these buttons does not change.

The six Softkey menus change dynamically and follow these color conventions:

- **Softkey** Blue indicates an available setting.
- **Softkey** Green indicates a change in menu level when selected.
- **Softkey** Black indicates the default or selected setting.
- **Softkey** Yellow indicates an active entry in process.
- **Softkey** Grey indicates a key that is NOT available.

Safety Notes

The following safety notes are used throughout this manual. Familiarize yourself with each of the notes and its meaning before operating this instrument. More pertinent safety notes for using this product are located in “Safety Considerations” on page 190.

CAUTION

Caution denotes a hazard. It calls attention to a procedure that, if not correctly performed or adhered to, could result in **damage to or destruction of the product**. Do not proceed beyond a caution notice until the indicated conditions are fully understood and met.

WARNING

Warning denotes a hazard. It calls attention to a procedure which, if not correctly performed or adhered to, could result in **injury or loss of life**. Do not proceed beyond a warning note until the indicated conditions are fully understood and met.

Preparing for Initial Use of Your New FieldFox

Check the Shipment

When you receive your FieldFox, check the shipment according to the following procedure:

1. Inspect the shipping container for damage. Signs of damage may include a dented or torn shipping container or cushioning material that indicates signs of unusual stress or compacting. If not damaged, **save the packaging material** in case the FieldFox needs to be returned.
2. Carefully remove the contents from the shipping container, and verify that the standard accessories and your ordered options are included in the shipment according to the Box Contents List.
3. For any question or problems, refer to Contacting Agilent on page 2.

Meeting Power Requirements for the AC/DC Adapter

Voltage: 100 VAC to 250 VAC

Frequency: 50 Hz to 60 Hz

Current: 1.25 – 0.56 A

The AC/DC adapter supplied with the analyzer is equipped with a three-wire power cord, in accordance with international safety standards. The power cable appropriate to the original product shipping location is included with the FieldFox.

Various AC power cables are available from Agilent that are unique to specific geographic areas. You can order additional AC power cables that are correct for use in different areas. For the power cord part number information please visit: <http://www.agilent.com/find/fieldfox>

Install the Lithium-Ion Battery



Step	Notes
1. Open the battery door.	Push the button on the battery compartment door while sliding the door outward.
2. Insert the battery.	The terminals end of the battery is inserted into the compartment.
3. Close the battery door.	Slide the battery compartment door upwards until it latches.

Battery Usage

When you receive your FieldFox, the lithium-ion battery is not installed, and it is partially charged to approximately 40% to preserve battery life. A lithium-ion battery has no memory effect, so it can be used partially charged, as shipped.

A fully charged battery will power your FieldFox for about four hours, so if you plan to use it for this long, you should fully charge the battery.

NOTE The FieldFox will shut down to prevent the battery from discharging to a level that is damaging. If this occurs, charge the battery either internally or externally.

Learn more about the lithium-ion battery on page 184.

Battery charge status is viewable:

-  In the upper-right corner of the screen.
- On the Battery screen. To access the screen, select **System**, **Service**, **Diagnostics**, and **Battery**.
- On the battery. Open the FieldFox battery compartment door to view the battery LCD.

To conserve battery power:

- Use **Run/Hold** to single-trigger a measurement when needed. **Hold** is shown on the display.
- Press **System** then **Display** then **Brightness**. Use the **▲▼** arrows, the rotary knob, or numeric keypad to adjust the brightness to dim the FieldFox display as much as possible.
- Briefly press the power button to switch to Stand By mode when the FieldFox is not being used. Press again to restore power. All current settings are preserved.

NOTE

When powered by the battery only, the FieldFox can stay in Stand By mode for a maximum of four hours and then it powers off automatically. When the relative battery charge drops about 20%, the FieldFox will power off to preserve the remaining charge.

To recharge a battery:

Use ONLY a FieldFox charger to recharge a battery.

- The battery can be fully charged while in the FieldFox in about 4 hours with the FieldFox either ON or OFF.
- It can be fully charged externally using the external battery charger (Opt 872) in about 4 hours.

When the battery is removed, the FieldFox can still be powered by the AC/DC adapter.

FieldFox ON/OFF Settings

- To turn power **ON**, briefly press the power button. Boot-up takes about 1 minute.
- To switch to **Stand By** mode (low battery drain), briefly press the power button. To turn power ON, briefly press the power button. Power and settings are restored instantly. See the Note above concerning Stand By mode.
- To turn Power **OFF** (very low battery drain), press and hold the power button until power is OFF - about 4 seconds. Data and instrument state are NOT automatically saved when the FieldFox is powered OFF. Learn how to save data and instrument state on page 160.
- You can make a setting to automatically **Power ON** the FieldFox when a power source is connected. Learn how on page 181.

Power button LED status

- Solid green – Power is ON
- Blinking green – FieldFox in Stand By mode
- Blinking amber – Battery charging.
- Blinking amber and green – Stand By mode and battery charging.
- Not lit – Power is Off and battery is not charging.

FieldFox High-Temperature Protection

The following features prevent degradation or damage in the event of high internal temperatures in the FieldFox.

NOTE Do NOT store the FieldFox in the softcase while powered ON or in Stand By mode.

How to monitor the internal FieldFox temperature:

- Press **System**, then **Service Diagnostics**.
- Then **Internal Temperatures**.

The temperature at which the following events occur is the average of the RF1, RF2, SB1, SB2 temperatures. These temperatures come from internal sensors embedded within FieldFox.

Temperature Control Mode

At approximately 73 °C, the FieldFox enters Temperature Control mode by reducing display intensity and measurement speed. This should decrease the internal temperature which preserves measurement accuracy and maintains the long-term reliability of the FieldFox.

When entering Temperature Control mode, save your instrument state and data that you want to keep.

When the temperature drops to approximately 71°C, normal operating settings are restored.

NOTE Measurement speed specifications do NOT apply in Temperature Control Mode.

High-Temp Shutdown

In extreme situations, Temperature Control mode may not stop an increase in the FieldFox internal temperature. At approximately 75°C, High-Temperature Shutdown will engage and turn OFF the FieldFox.

Just prior to shutdown, the FieldFox will display a warning of imminent shutdown.

Avoid Overpowering the FieldFox

The FieldFox can be damaged with too much power or voltage applied. Exceeding the maximum RF power levels shown below will cause an **ADC Over Range** message to appear on the screen.

WARNING

Maximum Input Voltages and Power:

- **RF OUT Connector: ±50 VDC, +23 dBm RF**
- **RF IN: ±50 VDC, +27 dBm RF**
- **DC Input: 19 VDC, 4 ADC**

Learn more about Maximum power and voltages in the FieldFox Data Sheet on page 200.

NOTE Very often, coaxial cables and antennas build up a static charge, which, if allowed to discharge by connecting to the FieldFox, may damage the instrument input circuitry. To avoid such damage, it is recommended to dissipate any static charges by temporarily attaching a short to the cable or antenna prior to attaching to the FieldFox.

Take the FieldFox Tour

Front Panel

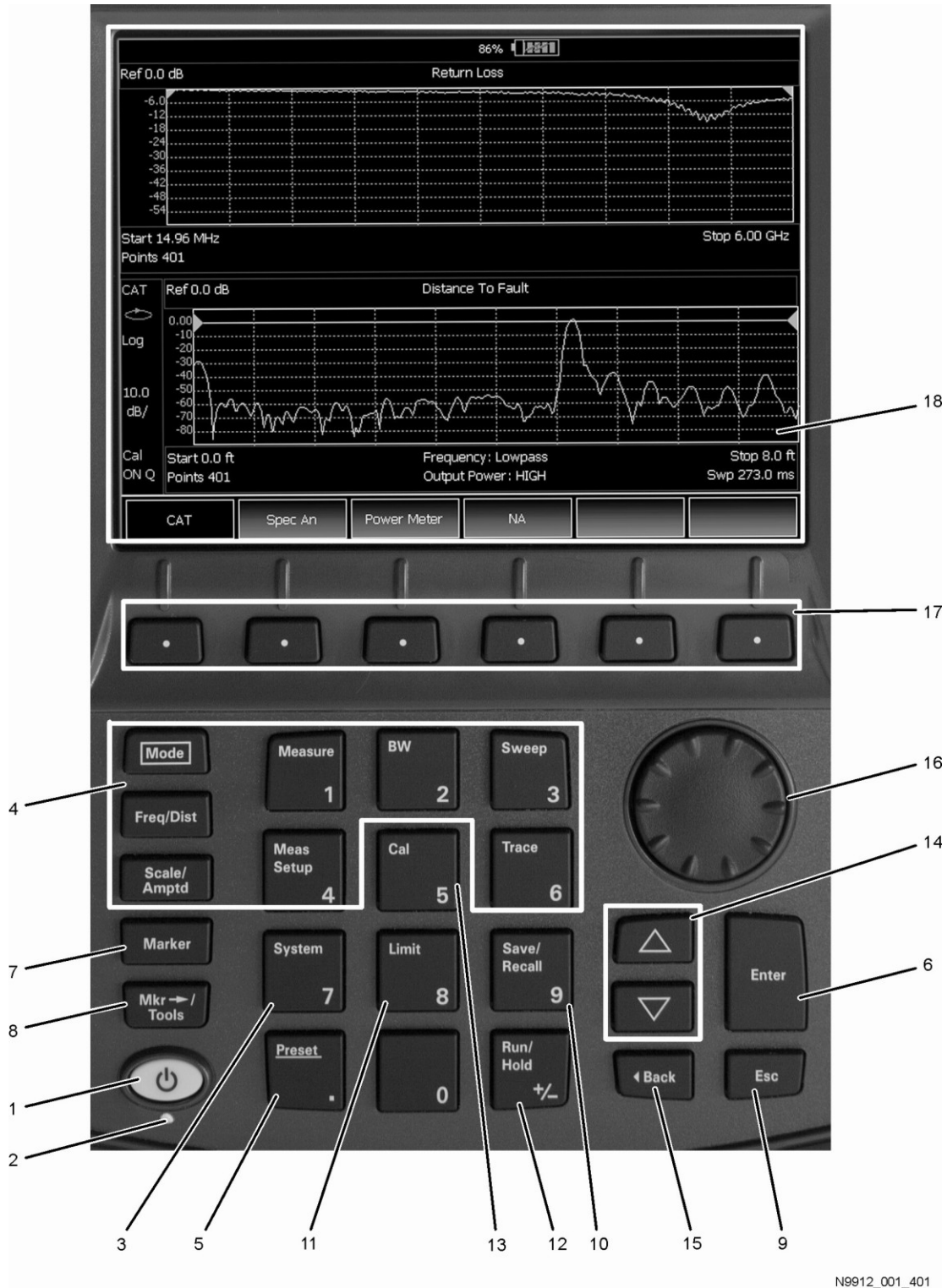

N9912_001_401

Front Panel

No.	Caption	Description	Learn More on Page:
1	Power	ON: press momentarily. STAND BY: with FieldFox power ON, press briefly. OFF: press and hold until the FieldFox shuts off (about 4 seconds).	13
2	LED	Not lit: FieldFox OFF, not charging Green: FieldFox ON. Charging status indicated by battery icon on screen Orange, flashing: FieldFox STAND BY Orange, intensity increasing, flashing slowly: FieldFox OFF, charging	13
3	System	Displays a submenu for system setup	168
4	Function keys	Includes: Freq/Dist , Scale/Amptd , BW , Sweep , Trace , Meas Setup , Measure , and Mode	Refer to specific Mode.
5	Preset	Returns the analyzer to a known state	169
6	Enter	Confirms a parameter selection or configuration	--
7	Marker	Activates marker function	144
8	Mkr→/Tools	Displays a submenu for marker functions	148
9	Esc	Exits and closes the dialog box or clears the character input	--
10	Save/Recall	Saves the current trace or recalls saved data from memory	160
11	Limit	Sets limit lines for quick Pass/Fail judgment	154
12	Run/Hold	Toggles between free Run and Hold/Single operation.	168
13	Cal	Displays a submenu for calibration functions	52
14	Arrow keys	Increases or decreases a value or setting.	--
15	◀Back	Returns to the previous menu selection.	--
16	Rotary knob	Highlights an item for selection, or enables incremental changes to values.	--
17	Softkeys	Allows selection of settings for configuring and performing measurements, and for other FieldFox functions.	--
18	Screen	Transflective screen, viewable under all lighting conditions. If you are using your FieldFox in direct sunlight, you do not need to shield the display from the sunlight. In bright lighting conditions, the display is brighter and easier to read when you allow light to fall directly on the screen. Alternative color modes exist that maximize viewing in direct sunlight conditions, as well as other conditions such as nighttime work. Note: Clean the Transflective screen with gentle and minimal wiping using Isopropyl alcohol applied to a lint-free cloth.	169 - Display settings 19 - Screen Tour







Top Panel



Caption	Description	Learn More
RF OUT	For CAT and NA measurements, use to make reflection measurements. Maximum: ± 50 VDC, +23 dBm RF	CAT Mode on page 21 NA Mode on page 39
Ext Trig/Ext Ref	External Reference connector to connect to an external frequency reference. Maximum: 5.5 VDC.	Ext Ref on page 178. Ext Trig (SA Mode) on page 86
RF IN	For CAT and NA mode, use to make transmission measurements. For SA use to make all measurements. Maximum: ± 50 VDC, +27 dBm RF.	SA Mode on page 68

Side Panel



Caption	Description	Learn More
	Ethernet cable connector to read trace data using the FieldFox Data Link Software. Download the latest version of the software at http://www.agilent.com/find/fieldfox	
	Reserved for future use.	
	DC power connector used to connect to the AC/DC adapter. Maximum: 19 VDC, 4 ADC.	On page 12
	Micro Secure Digital slot. Use to extend the memory of the FieldFox.	File locations on page 160
	Standard USB connector used to connect a power sensor for Power Meter Mode. Also used to save files to a USB flash drive. Use of Keyboard and Mouse is NOT supported.	File locations on page 160
	Audio output jack for use with SA Mode Tune and Listen.	On page 79

Screen Tour

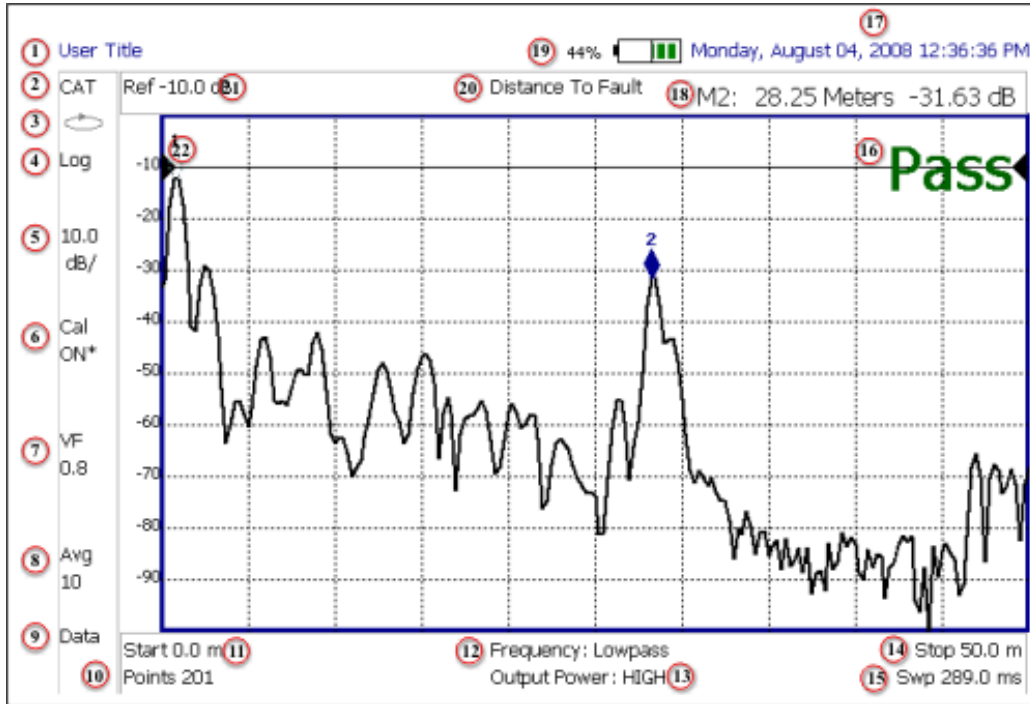

Caption	Description	Learn More on Page:
1	Title – write your own text here	171
2	Current Mode	
3	Run / Hold	168
4	Display Format	Mode dependent
5	Scale/division	Mode dependent
6	Calibration Status (CAT and NA)	60
	Detection Method (SA)	
7	Velocity Factor (Fault Meas)	34
8	Averaging Status and Count	Mode dependent
9	Data / Mem Display (CAT and NA)	157- Trace Math
	Step / FFT (SA)	79 - Res BW
10	Resolution Setting	Mode dependent
11	Measurement Start Freq or Distance	Mode dependent
12	Bandpass / Lowpass setting (Fault Meas)	34
	IF BW in NA Mode	
13	Output Power Level (CAT and NA)	26
14	Measurement Stop Freq or Distance	Mode dependent
15	Actual Sweep Time	Mode dependent
16	Limit Line Status	154
17	Time and Date	176
18	Marker Readout	144
19	Battery Status	184
20	Measurement Type (CAT and NA)	
21	Reference Level	Mode dependent
22	Reference Position	Mode dependent

How to Enter Numeric Values

Many settings on the FieldFox require the entry of numeric values.

How to enter numeric values

Use any combination of the following keys:

- Numeric 0–9 keys, along with the polarity (**+/-**) key.
- Up/Down arrow keys to increment or decrement values.
- Rotary knob to scroll through a set of values.
- **Back** erases previously entered values.
- **Esc** exits data entry without accepting the new value.

To complete the setting:

- Press **Enter** or a different **softkey** or **hardkey**.

Multiplier Abbreviations

Many times after entering numeric values, a set of multiplier or suffix softkeys are presented. The following explains the meaning of these abbreviations.

Select Frequency multipliers as follows:

- **GHz** Gigahertz (1e9 Hertz)
- **MHz** Megahertz (1e6 Hertz)
- **kHz** Kilohertz (1e3 Hertz)
- **Hz** Hertz

Select Time multipliers as follows:

- **s** Seconds
- **ms** milliseconds (1e-3)
- **us** microseconds (1e-6)
- **ns** nanoseconds (1e-9)
- **ps** picoseconds (1e-12)

CAT (Cable and Antenna Test) Mode

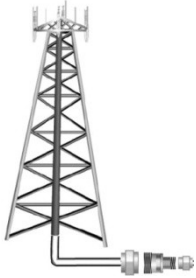

CAT Mode is typically used to test an entire transmission system, from the transmitter to the antenna. This process is sometimes referred to as Line Sweeping.

CAT Mode is similar to NA (Network Analyzer) Mode. Learn more in the **Supplemental Online Help**: <http://na.tm.agilent.com/fieldfox/help/FieldFox.htm>

CAT Mode **Distance to Fault** measurements are discussed on page 31.

In this Chapter

Measurement Selection.....	22
Quick Settings	23
Frequency Range	23
Scale Settings	24
Averaging	24
Single/Continuous	25
Resolution	25
Sweep Time.....	26
Output Power	26
Interference Rejection	26
Coupled Frequency	27

Procedures

Return Loss Measurement	27
1-Port Cable Loss Measurement.....	28
2-Port Insertion Loss Measurement	30
Distance to Fault Measurements.....	31

See Also

All about Calibration.....	52
Set Markers.....	144
Use Limit Lines	154
Use Trace Math	157
Making 75Ω (ohm) Measurements at the FieldFox Supplemental Online Help: http://na.tm.agilent.com/fieldfox/help/FieldFox.htm	

CAT Mode Settings

Select **CAT Mode** before making any setting in this chapter.

How to select CAT Mode

- Press **Mode**.
- Then **CAT**.

Measurement Selection

How to select a CAT Mode Measurement

Learn more about the following measurements in the **Supplemental Online Help**: <http://na.tm.agilent.com/fieldfox/help/FieldFox.htm>

- Press **Measure 1**.
- Then choose one of the following: These softkeys also appear after CAT Mode is selected.
 - **Distance to Fault** 1-port reflection measurement that uses Inverse Fourier Transform (IFT) calculations to determine and display the distance to, and relative size of, a fault or disruption in the transmission line. Units are in return loss format, expressed as a positive number in dB, unless the measurement selected is DTF (VSWR). Learn more about DTF Measurements on page 31.
 - **Return Loss & DTF** Displays both a Return Loss measurement and a DTF measurement. Use this format to display the frequency settings that are used to make the DTF measurement. The frequency range settings for these two measurements can be coupled or uncoupled. Learn more on page 27.
 - Calibrations are applied to both traces.
 - When in Hold mode and Single sweep is performed, only the active trace is triggered. Use the **▲▼** arrows to activate a trace.
 - **Return Loss** 1-port reflection measurement that displays the amount of incident signal energy MINUS the amount of energy that is reflected. The higher the trace is on the screen, the more energy being reflected back to the FieldFox. Learn how to measure Return Loss on page 26.
 - **VSWR** (Voltage Standing Wave Ratio – also known as SWR) 1-port reflection measurement that displays the ratio of the maximum reflected voltage over the minimum reflected voltage. The higher the trace is on the screen, the more energy being reflected back to the FieldFox.
 - **DTF (VSWR)** Distance to Fault in VSWR format.
 - **Cable Loss (1-Port)** 1-port reflection measurement that displays the loss of a transmission line. Learn more on page 26.
 - **Insertion Loss (2-Port)** (Option 110 ONLY) 2-port transmission measurement that accurately displays the loss through a cable or other device in dB. Both ends of the cable must be connected to the FieldFox. NO phase information is included in this measurement. Learn more on page 30.
 - **DTF (Lin)** Distance to Fault in Linear format.

Quick Settings Table

Both CAT and NA Modes allow you to view and change most relevant settings from a single location. All of these settings are discussed in this chapter and, unless otherwise noted, ALL of these settings can also be made using the standard softkey menus.

How to view and change Quick Settings

- Press **Meas Setup** 4.
- Then **Settings**.
- Press **Next Page** and **Previous Page** to view all settings. If these softkeys are NOT available, then all available settings fit on one page.
- To change a setting:
 - Use the **▲|▼** arrows to highlight a setting.
 - Then press **Edit**. The current setting changes to **yellow**.
 - Some settings require you to press a softkey to change the value. Otherwise, use the numeric keypad, **▲|▼** arrows, or rotary knob to change the value.
 - When finished changing a value, press **Done Edit**.
- Press **Dock Window** to relocate the Settings table to a position relative to the trace window. The Dock Window setting persists through a Preset. Choose from the following:
 - **Full (Default setting)** Only the Settings table is shown on the screen. The trace window is temporarily not shown.
 - **Left** The Settings table is shown to the left of the trace window.
 - **Bottom** The Settings table is shown below the trace window.
- When finished changing ALL settings, press **Done** to save your settings.

Frequency Range

Set the range of frequencies over which you would like to make CAT Mode measurements.

When the frequency range is changed after a calibration is performed, the cal becomes interpolated. Learn more on page 64.

How to set Frequency Range

- Press **Freq/Dist**.
- Then choose from the following:
 - **Start** and **Stop** frequencies - beginning and end of the sweep.
 - **Center** and **Span** frequencies – the center frequency and span of frequencies (half on either side of center).
- Follow each setting by entering a value using the numeric keypad, **▲|▼** arrows, or the rotary knob.
 - After using the keypad, select a multiplier key. Learn about multiplier abbreviations on page 20.

- After using the **▲|▼** arrows or the rotary knob, press **Enter**. The amount of frequency increment is based on the current span and can NOT be changed in CAT Mode.

Scale Settings

Adjust the Y-axis scale to see the relevant portions of the data trace. The Y-axis is divided into 10 graticules.

This setting can be changed at any time without affecting calibration accuracy.

How to set Scale

- Press **Scale / Amptd**.
- Then choose from the following:
 1. **Autoscale** Automatically adjusts the Y-axis to comfortably fit the Min and Max amplitude of the trace on the screen.
 2. **Autoscale All** Autoscales all of the traces on the screen, useful only for dual-trace configurations.
 3. Set Scale, Reference Level, and Reference Position:
 - **Scale** Manually enter a **scale per division** to view specific areas of the trace.
 - **Ref Level** Manually set the value of the reference line. Enter a negative value by pressing **Run/Hold (+/-)** either before or after typing a value.
 - **Ref Position** Manually set the position of the reference line. Values must be between **0** (TOP line) and **10** (BOTTOM line)
 4. Set Top and Bottom graticule values. The scale per division is calculated.
 - **Top** to set the value of the Top graticule.
 - **Bottom** to set the value of the Bottom graticule.
 - Enter a negative value by pressing **Run/Hold (+/-)** either before or after typing a value.

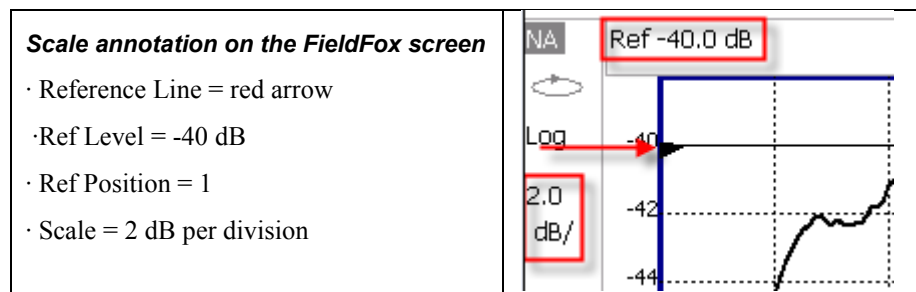

Averaging

Trace Averaging helps to smooth a trace to reduce the effects of random noise on a measurement. The FieldFox computes each data point based on the average of the same data point over several consecutive sweeps.

Average Count determines the number of sweeps to average; the higher the average count, the greater the amount of noise reduction.

An average counter is shown in the left edge of the screen as **Avg N**. This shows the number of previous sweeps that have been averaged together to form the current trace. When the counter reaches the specified count, then a 'running average' of the last **N** sweeps is displayed. Average Count = 1 means there is NO averaging.

This setting can be changed at any time without affecting calibration accuracy.

NOTE Averaging is often used to increase the dynamic range of a measurement. To achieve the highest dynamic range, select NA mode and reduce the IF Bandwidth setting. Learn more about dynamic range on page 51.

How to set Trace Averaging

- Press **BW 2**.
- Then **Average N** where **N** is the current count setting.
- Enter a value using the numeric keypad. Enter 1 for NO averaging.
- Press **Enter**.
- While Trace Averaging is in process, press **Sweep 3** then **Restart** to restart the averaging at 1.

Single or Continuous Measure

This setting determines whether the FieldFox measures continuously or only once each time the **Single** button is pressed. Use **Single** to conserve battery power or to allow you to save or analyze a specific measurement.

This setting can be changed at any time without affecting calibration accuracy.

How to set Single or Continuous

- Press **Sweep 3**.
- Then choose one of the following:
 - **Single** Automatically sets Continuous OFF and causes FieldFox to make ONE measurement, then hold for the next Single key press. When a data trace is displayed, the entire trace is measured, then holds. The **Hold** annotation changes to an arrow --> while the measurement occurs.
 - **Continuous** Makes continuous measurements. This is the typical setting when battery power is not critical.
- You can also use **Run / Hold +/-** to toggle between Single and Continuous.

Resolution (Number of Data Points)

Data points are individual measurements that are made and plotted across the X-axis to form a trace. Select more data points to increase measurement resolution. However, more data points require more time to complete an entire measurement sweep.

When the Resolution is changed after a calibration is performed, the cal becomes interpolated. Learn more on page 64.

How to set Resolution

- Press **Sweep 3**.

- Then **Resolution**.
- Then choose one of the following:
101 | 201 | 401 | 601 | 801 | 1001 | 1601 | 4001 | 10001
- Using SCPI, Resolution can be set to any number of points between 3 and 10001. See the Programming Guide at www.agilent.com/find/fieldsfoxsupport

Sweep Time

The fastest possible sweep time is always used as the default setting. Use the **Min Swp Time** setting to slow the sweep time when measuring long lengths of cable. Learn more in the **Supplemental Online Help**:

<http://na.tm.agilent.com/fieldfox/help/FieldFox.htm>.

The actual sweep time is shown on the FieldFox screen. See the Screen Tour on page 19. To increase the sweep time, enter a value that is higher than the actual sweep time. The increase will not be exactly the amount that you enter, as the actual sweep time is the composite of many factors.

NOTE Measurement speed specifications do NOT apply in Temperature Control Mode. Learn more on page 14.

How to set Sweep Time

- Press **Sweep 3**.
- Then **Min Swp Time**.
- Enter a value using the numeric keypad.
- Press a multiplier key. Learn about multiplier abbreviations on page 20.

Output Power

Set the power level out of the FieldFox to High, Low, or manually set power level to a value between High and Low.

Generally, the high power setting is used when measuring passive, high-loss devices to place the signal farther from the noise floor. However, for devices that are sensitive to high power levels such as amplifiers, use the Low power setting.

For best measurement accuracy, use the **Manual** power setting at -15 dBm. After calibration, the power level can be decreased for amplifiers, or increased for higher dynamic range.

Caution Power Level settings in this mode will NOT change Power Level settings in other modes. To help prevent damage to your DUT, use caution when changing modes with your DUT connected to the FieldFox test ports.

How to set Output Power

Output power is NOT leveled with any of the power settings.

- Press **Meas Setup 4**.
- Then **Power**
- Then **Output Power**
 - **High** (Default setting) Sets output power to the maximum achievable power at all displayed frequencies. Please see the FieldFox Specifications for expected power levels.

- **Low** Sets output power to approximately -27 dBm,
- **Man** Set output power to an arbitrary value,
 - Then press **Nominal Power**
 - Then enter a value using the numeric keypad, the **▲▼** arrows, or the rotary knob.
 - Press **Enter**.

Interference Rejection

Use this setting when you suspect that other signals in the area are interfering with a measurement. Interference may look like a spike or lack of stability in the measurement trace. While monitoring a measurement at a specific frequency, toggle this setting between ON and OFF. If the measurement result decreases while ON, then there is an interfering signal in the area. Continue to make measurements with Interference Rejection ON. However, this will slow the measurement speed.

Once enabled, up to SIX sweeps may be required before the interfering signal is neutralized.

This setting can be changed at any time without affecting calibration accuracy.

How to set Interference Rejection

- Press **Meas Setup 4**.
- Then **Interference Rejection [current setting]**.
- Then choose from the following:
 - **Off** No interference rejection and fastest possible sweep speed.
 - **Minimum** The lowest level of Interference rejection.
 - **Medium** The medium level of Interference rejection.
 - **Maximum** The highest level of Interference rejection.

Coupled Frequency

This setting, especially useful for a Return Loss & DTF measurement, allows both measurements to have different frequency ranges.

How to set Coupled Frequency

With a **Return Loss & DTF** measurement present:

- Press **Meas Setup 4**
- Select the DTF measurement (Tr2) using the **▲▼** arrows.
- Then choose from the following:
 - **Coupled Freq ON** - Both the Return Loss and DTF traces have the same frequency range settings.
 - **Coupled Freq OFF** (default setting) - Both traces are allowed to have individual frequency range settings. When set to OFF:

- The Return Loss measurement frequency settings are made in the usual manner. Learn how on page 23. When a new Start or Stop frequency is selected, Coupled Frequency is automatically set to OFF.
- The DTF measurement is made using the frequencies as determined by the **DTF Frequency Mode** setting. Learn more on page 33.

Return Loss Measurements

Return loss can be thought of as the absolute value of the reflected power as compared to the incident power.

When measuring an OPEN or SHORT, all incident power is reflected and approximately 0 dB return loss is displayed.

When measuring a LOAD, very little power is reflected and values of 40 dB to 60 dB are displayed.

The minus sign is usually ignored when conveying return loss. For example, a component is said to have 18 dB return loss, rather than -18 dB.

How to measure Return Loss

- Connect the cable or any adapter used to connect the device under test (DUT).
- Select **Preset** then **Preset**. Returns the FieldFox to known settings.
- Select **Mode** then **CAT** (Cable and Antenna Test)
- Then **Return Loss** (Default measurement).
- Press **Freq/Dist** and enter **Start** and **Stop** frequency values of the measurement.
- Press **Meas Setup 4** then **Settings** to make appropriate settings before calibrating.
- Disconnect the cable or DUT and press **Cal 5** then follow the calibration prompts.
- Reconnect the cable or DUT.
- The return loss trace is displayed on the FieldFox screen.

1-Port Cable Loss Measurements

While all cables have inherent loss, weather and time will deteriorate cables and cause even more energy to be absorbed by the cable. This makes less power available to be transmitted.

A deteriorated cable is not usually apparent in a Distance to Fault measurement, where more obvious and dramatic problems are identified. A Cable Loss measurement is necessary to measure the accumulated losses throughout the length of the cable.

A 2-port Insertion Loss measurement is usually more accurate than a 1-port Cable Loss measurement. However, to perform a 2-port Insertion Loss measurement, both ends of the cable must be connected to the FieldFox, and the FieldFox must have option 110 installed.

NOTE In high-loss conditions, a Cable Loss measurement becomes ‘noisy’ as the test signal becomes indistinguishable in the FieldFox noise floor. This can occur when measuring a very long cable and using relatively high measurement frequencies. To help with this condition, use High Power (page 26) and Averaging. (page 24).

How to make a 1-port Cable Loss Measurement

1. Press **Preset** then **Preset**.
2. Then **More** then **Cable Loss (1-Port)**.
3. Connect the cable to be tested.
4. Press **Freq/Dist** and enter **Start** and **Stop** frequency values of the measurement.
5. Press **Sweep 3** then **Min Swp Time**. Increase the Sweep Time until a stable trace is visible on the screen. The amount of time that is required increases with longer cable lengths. Learn more in the **Supplemental Online Help**: <http://na.tm.agilent.com/fieldfox/help/FieldFox.htm>
6. Remove the cable to be tested.
7. Press **Cal 5**, then **QuickCal** or **OSL**.
8. Follow the prompts to perform calibration at the end of the jumper cable or adapter. Learn more about Calibration on page 61.
9. Connect the cable to be tested.

NOTE Low-level standing waves (also known as ‘ripple’) which may be visible in reflection measurements, can hide the actual loss of the cable. Steps 10 through 13 can minimize the ripple. Perform the measurement with and without steps 10 through 13 and choose the method with the least amount of ripple.

10. Connect a LOAD at the end of the cable to be tested. This limits the reflections to faults that are located in the cable under test.
11. Press **Trace 6** then **Data->Mem** to store the trace into Memory.
12. Remove the LOAD and leave the end of the cable to be tested open.
13. Press **Data Math** then **Data – Mem**. The ripple in the measurement is removed. These minor imperfections in the cable should not be considered in the Cable Loss measurement.
14. Use Averaging to remove random noise from high-loss measurements. Press **BW 2** then **Average**.

The displayed trace shows the Cable Loss values in one direction through the cable. A Return Loss measurement would show the loss for both down the cable and back. Therefore, a Cable Loss measurement is the same as a Return Loss measurement divided by 2.

The average Cable Loss across the specified frequency range is shown on the screen below the graticules.

2-Port Insertion Loss Measurements

A 2-port Insertion Loss measurement, available with option 110, is used to measure the loss through a DUT (device under test) – or cable – over a specified frequency range. The FieldFox signal source is transmitted out the RF OUT connector, through the DUT, and into the RF IN connector. Both ends of the DUT must be connected to the FieldFox, either directly or indirectly using the cable used in the normalization cal.

‘Insertion’ loss simply means **loss** through a device, usually expressed in dB. It is exactly the same measurement as “S21 Transmission” in NA Mode.

2-port Insertion Loss measurements are generally more accurate than 1-port Cable Loss measurements.

NOTE A Normalization Cal is REQUIRED for making accurate 2-port CAT or NA measurements. Learn how on page 63.

For highest accuracy, when measuring the DUT also attach any cable or adapter that was used in the normalization cal.

How to make a 2-port Insertion Loss Measurement

1. Press **Mode** then **CAT**.
2. Then **More** then **Insertion Loss (2-Port)**.
3. Press **Freq/Dist** and enter **Start** and **Stop** frequency values of the measurement.
4. Press **Sweep 3**, then select a **Resolution** setting.
5. Press **Cal 5**, then press **Normalization**. Perform normalization as explained on page 63.
6. Connect the DUT and view the insertion loss measurement results.

When measuring very long lengths of cable, it may be necessary to increase the sweep time. Learn how on page 26. Learn why in the **Supplemental Online Help**: <http://na.tm.agilent.com/fieldfox/help/FieldFox.htm>

DTF (Distance to Fault) Measurements

CAT Mode **Distance to Fault** (DTF) measurements are generally used to locate problems, or faults, in a length of cable or transmission line. In this chapter, the cable to be tested is referred to as the DUT (Device Under Test).

Settings that are NOT unique to DTF measurements are documented in the CAT Mode chapter on page 21.

In this Chapter

How to make DTF Measurements	31
DTF Settings Table	32
DTF Measurement (Format)	32
DTF Start and Stop Distance	32
Frequency Mode.....	33
Coupled Frequency	34
Cable (Correction) Specifications.....	34
Window Settings	37
DTF Units	37
Calculated DTF Values.....	37
About Alias Faults	38

Optional settings

Markers.....	144
Limit Lines.....	154
Save Measurement Settings and Results	160
Trace Math is NOT available in DTF Measurements.	

How to make DTF Measurements

Before starting, you may need the following:

- Jumper cable or adapter to connect the beginning of the DUT to the FieldFox.
 - LOAD with correct connector type and gender to terminate the end of the DUT (if possible).
 - The known length and cable type of the DUT. If the cable type is not known, then the Cable Loss (dB/Meter) and Velocity Factor of the DUT are required.
1. Connect any necessary jumper cable or adapter to the FieldFox RF OUT port. Do NOT connect the DUT.
 2. Press **Preset** then **Preset** to return the FieldFox to the default settings.
 3. Then **Mode** then **CAT**.
 4. Then **DTF**.
 5. Press **Freq/Dist**, then **Stop Distance** and enter the length of the DUT. You can optionally set the **Start Distance**.
 6. Press **Cal 5** and follow the Cal prompts. Learn all about Calibration on page 52.

7. Disconnect any components or antenna that should NOT be measured and connect a LOAD at the end of the DUT.
8. Press **Meas Setup 4** then **DTF Cable Specifications**.
9. Either press **Recall Coax Cable**, or enter the **Velocity Factor** and **Cable Loss** of the DUT.
10. Connect the start end of the DUT to the FieldFox.
11. Press **Meas Setup 4** then **Settings** then **Next Page**. If the **Alias-free Range** setting is **False**, then you may see Alias faults on the screen. Learn more on page 38.

DTF Measurement Settings

DTF Settings Table

You can set and view all of the DTF settings, including some calculated values, on the DTF Settings table. Learn about the calculated values on page 37.

How to make settings on the DTF settings table

- Press **Meas Setup 4**.
- Then **Settings**.
- Press **Next Page** and **Previous Page** to view all settings.
- To change a setting:
 - Use the **▲▼** arrows or rotary knob to highlight a setting.
 - Numeric settings can be changed by pressing numbers using the numeric keypad. Then press Enter or select a suffix if available.
 - Other settings require you to press **Edit**, then press a softkey to change the value.
 - When finished changing a value, press **Done Edit**.
- Press **Dock Window** to relocate the Settings table to a position relative to the trace window. The Dock Window setting persists through a Preset. Choose from the following:
 - **Full (Default setting)** Only the Settings table is shown on the screen. The trace window is temporarily not shown.
 - **Left** The Settings table is shown to the left of the trace window.
 - **Bottom** The Settings table is shown below the trace window.
- When finished changing ALL settings, press **Done** to save your settings.

DTF Measurement (Format)

You can select from 3 different DTF Formats.

- Press **Measure 1**
- Then choose from:
 - **Distance to Fault (dB)** Faults are displayed on the Y-axis in return loss format, expressed as a positive number in dB.

DTF (VSWR) Faults are displayed on the Y-axis in SWR. Learn more about SWR at the FieldFox Supplemental Online Help:
<http://na.tm.agilent.com/fieldfox/help/FieldFox.htm>

- **More** then **DTF Lin** Faults are displayed on the Y-axis in linear (unitless) format.

DTF Start and Stop Distance

In DTF measurements, you set the physical length of cable or other device to be tested. The FieldFox calculates the frequency range of the measurement from this distance. The longer the cable to be tested, the lower the frequencies that are used. You can also set the frequencies manually using the Frequency Mode [Bandpass] setting.

How to set Start and Stop Distance

- With a DTF measurement present, press **Freq/Dist**.
- Then choose from the following:
 - **Start Distance** Enter a value using the numeric keypad, the **▲▼** arrows, or the rotary knob, then **Enter**. By default, the Start Distance is set to **0** Meters. This means that the measurement will display faults starting at the point at which calibration standards are connected.
 - **Stop Distance** Enter a value between the start distance and **5 km** (or 16,404 ft.) using the numeric keypad, the **▲▼** arrows, or the rotary knob, then **Enter**.

Frequency Mode

All DTF measurements are made with frequency settings and, using Inverse Fourier Transform (IFT), the time and distance to faults are calculated.

NOTE The start and stop frequencies for the measurement are always annotated on the screen below the start and stop distances.

How to set Frequency Mode

With a DTF measurement present,

- Press **Meas Setup 4**
- Then **Freq Mode**
- Choose one of the following:
 - **Lowpass Mode** The frequency range of a DTF measurement is set automatically based on the Start and Stop Distances. Use Lowpass mode when the DUT is a cable ONLY.
 - **Bandpass Mode** (Default setting) The frequency range of a DTF measurement is set manually. Use Bandpass mode when the DUT contains a diplexer or other filtering device which does not pass some frequencies.

Typically, you will set the frequency range of the measurement to the passband of the filter. However, you may also want to test the ability of the filter to **reject** unwanted frequencies. In this case, set the frequency range to include those frequencies which the filter may not be adequately rejecting.

When the DTF frequencies are set manually, they may not be the optimum frequencies for measuring the distance to fault. The distance may no longer be alias-free. Learn more about alias-free range on page 38.

How to manually set Frequencies in Bandpass Mode

- Press **Freq/Dist**
- Then **Min Start Freq** and type the start frequency to use for the DTF measurement.
- Then **Max Stop Freq** and type the stop frequency to use for the DTF measurement.

OR

- Press **More**
- Then **Max Freq Span** and type the frequency range to use for the DTF measurement.
- Then **Center Frequency** and type the center frequency of the range to use for the DTF measurement.

These settings specify the minimum and maximum frequencies to be used for the DTF measurement. These exact frequencies may not be used, but a narrower frequency range may be used that will still pass through the bandpass filter.

To see the frequencies that are used in the DTF measurement, press **Meas Setup** **4** then **Settings** then **Next Page**. The calculated Start and Stop frequencies determine the exact frequency range being used.

Coupled Frequency

When a **Return Loss & DTF** measurement is present, this setting allows you to have different frequency ranges for each measurement. Learn more on page 27.

Cable (Correction) Specifications

By default, the FieldFox does NOT correct DTF measurements to account for the inherent loss of a cable. However, to make more accurate DTF measurements, the Cable Loss and Velocity Factor values should be considered.

About Velocity Factor and Cable Loss

- Velocity Factor is a property of the physical material of a cable. A VF of 1.0 corresponds to the speed of light in a vacuum, or the fastest VF possible. A polyethylene dielectric cable has VF = 0.66 and a cable with PTFE dielectric has VF = 0.7.
- Cable Loss is specified in dB/meter. In addition to the length of the cable, loss is also directly proportional to the frequency of the signal that passes through the cable.

The following is an example showing how DTF cable correction works:

The DUT is a 100 meter transmission cable. The Cable Loss value is .1 dB/meter. This means that a signal traveling ONE WAY through the cable will lose 10 dB of power (100 m * .1dB/m). Because the FieldFox performs this measurement with 1 port, the test signal travels down the cable and then back, for a total loss of 20 dB.

After a calibration has been performed, for the purpose of illustrating this point, connect an OPEN to the end of the cable – a maximum-sized fault - for 100% reflection of the 300 MHz test signal.

Without compensation for the loss of the cable, a -20 dB response would be visible at 100 meters, which is the OPEN at the end of the DUT. This is from 10 dB of loss through the cable in each direction.

With compensation for the loss using the manufacturer’s specification, the FieldFox compensates the trace as though the signal traveling through 100 meters was increased by +20 dB. Therefore the response will show 0 dB for 100% reflection.

How to enter Cable Loss and Velocity Factor

Cable Loss and Velocity factor can be entered using one of the following methods:

- Manually enter cable loss and velocity factor for the measurement.
- Select or create a cable file which contains the cable loss and velocity factor.

With a DTF measurement present:

- Press **Meas Setup 4**.
- Then **DTF Cable Specifications**
- Select **Cable Corr**
 - **Auto** Use Cable Loss and Velocity Factor values from a Cable file. See “How to Edit, Save, and Recall a Cable File” below. This will overwrite a manually-entered value.
 - **Man** (Default setting) Manually enter a value for Cable Loss and Velocity Factor.
- Then:
 - **Velocity Factor** Using the numeric keypad, enter a value between 0.01 and 1. Then press **Enter**.
 - **Cable Loss** Using the numeric keypad, enter a positive Cable Loss value in dB/m, then press **Enter**.

How to Edit a Cable File

The FieldFox includes many predefined cable files with the manufacturer’s specifications. You can edit these files or create new cable files using the following procedure or using the FieldFox Data Link Software. Learn more at: www.agilent.com/find/fieldsfoxsupport

The Cable correction data survives a Mode Preset and Preset.

With a DTF measurement present:

- Press **Meas Setup 4**
- Then **DTF Cable Specifications**
- Then **Edit/Save/Recall Cables**
- Press **New** then **Yes** to clear all data from the existing DTF Cable table and reset header information to default settings.
- Then **Edit Cable** to open the Cable Editor.

- Then use the ▲▼ arrows to select a field,
 - When editing Cable Description information, press **Edit** then modify the selected field using the FieldFox labeler.
 - When editing Frequency/Loss pairs, enter numbers using the numeric keypad, then select a frequency suffix. Then **Enter**. Learn more about “How the Freq/Loss pairs are applied” below.
- Optionally choose from the following:
 - **Previous / Next Page** Quickly scrolls through pages of Freq/Loss data.
 - **Add Data** Add a blank Freq/Loss pair to the table,
 - **Delete/Clear** then:
 - **Delete Line** Remove the selected Freq/Loss pair from the table.
 - **Clear All** then **Yes** Remove all Freq/Loss pairs from the table and resets header information to default settings.
- Press **Done** to close the Cable Editor.

How to Save or Recall a Cable

- Press **Save Cable** to save your changes to the specified Storage Device. Enter a filename using the FieldFox labeler (learn more on page 160). Learn more about Cable files below.
- Press **Recall Cable** to load a Cable file from the specified Storage Device.
- **Storage Device** Changes the device used to save or recall Cable files. This is a different setting from the Save/Recall Storage Device setting. Choose from **Internal** (default setting), **USB** (must be connected) or **SD card**.

About Cable files

- Cable files are saved to, and recalled from, the **Cables** folder. If the folder does not already exist on a USB or SD card, it is created automatically before storing the file.
- Cable files are stored as *.xml files. Existing cable files that are preloaded into the FieldFox firmware can be overwritten. Your edited file will NOT be overwritten when firmware is updated.

How the Freq/Loss pairs are applied

When the cable file contains one Freq/Loss pair, that correction value is applied to the entire displayed frequency span.

When the cable file contains two or more Freq/Loss pairs, the Loss value that is used is interpolated from the Freq/Loss pairs and the DTF center frequency. For example, using a cable file with the following Freq/Loss pairs:

1 GHz: 0.1 dB/m

2 GHz: 0.2 dB/m

The center frequency for the measurement is determined from the calculated (Stop – Start) frequency values (seen on the second page of DTF Settings):

Calculated Start = 2.0 MHz

Calculated Stop = 3.598 GHz

Center Freq = 1.80 GHz

The Loss value for the measurement is interpolated from the Freq/Loss pairs at the Center Freq:

1 GHz = 0.1 dB/m

1.8 GHz = 0.18 dB/m

2 GHz = 0.2 dB/m

The correction for loss at 5 meters in one direction: $0.18 \text{ dB/m} * 5\text{m} = 0.9 \text{ dB}$.

All DTF measurements correct for loss for travel down the DUT and back, so double the correction: $0.9 \text{ dB} * 2 = 1.8 \text{ dB}$.

Window Settings

Window settings provide the ability to choose between optimizing DTF measurements for resolving closely-spaced faults or for the ability to measure low-level faults.

How to select Window settings

- Press **Meas Setup 4**.
- Then **Settings**.
- Then press **▲|▼** arrows to move to the Window row.
- Then press **Edit**.
- Then press **Window** repeatedly and choose from the following:
 - **Maximum – Optimized for dynamic range**, the noise floor is lowered to provide the ability to measure low-level responses. (Default setting)
 - **Medium** – Compromise between Min and Max window settings.
 - **Minimum – Best Response Resolution**, providing the ability to resolve between two closely-spaced responses.
- Then press **Done Edit**.
- Again press **Done**.

DTF Units

The DTF Units setting is available ONLY on the DTF Settings table.

By default, X-axis units for DTF measurement settings are displayed in Meters.

- Select DTF Units.
- Then choose from:
 - M (meters)
 - Feet

Calculated DTF values

Press **Next Page** on the DTF Settings Table to view the following **calculated Values** noted on the FieldFox screen with c - <setting> :

Start Frequency – Start frequency that is used to calculate DTF.

Stop Frequency – Stop frequency that is used to calculate DTF.

Range Resolution. Indicates the accuracy of the distance to fault measurement. For example, with range resolution of 500 mm, if the distance to fault is 10 meters, this value could be inaccurate by +/- 500 mm or between 9.5 to 10.5 meters. This value is calculated from frequency span / resolution (points).

Response Resolution, not displayed, indicates the distance that could be between two faults and still show as separate faults. Learn more in Window Settings on page 37.

Maximum Distance. The distance that could be viewed with the current settings. Defined by: $Vf * c * Points / (2 * Bandwidth)$ where:

- Vf = velocity factor
- c = speed of light
- Points = resolution
- Bandwidth = frequency range

Alias-free Range (On/Off)

- On = No Alias images
- Off = Alias images may appear in the response.

About Alias Faults

An alias fault is not a true device response. An alias fault appears because of the method used to convert frequency to time.

On the DTF Settings page (above) the **c - Alias-free Range = Off** setting indicates alias images MAY appear on the screen.

Shorter stop distances (less than 10 meters) and a higher resolution (1001 points) will be **more** likely to result in **Alias-free Range = Off**.

When the Alias-free Range = Off, the following procedure will help to determine if a response is true or an alias response:

1. Put a marker on the response in question and note the distance to the fault.
2. Change the start or stop distance.

A true fault response will not move in distance. That is, if a true fault is present at 10.3 meters, changing the stop distance from 15 m to 20 m will not move the fault; the fault will remain at 10.3 meters. However, an alias response will appear to move.

An un-terminated cable (with NO perfect load at the end) will show faults that appear to be beyond the end of the cable. These are NOT alias faults. These faults appear as the signal reflects off the open at the end of the cable and travels back down the cable toward the connection at the FieldFox. Re-reflections are measured at the FieldFox as mirror images of the original faults. The largest fault is the open end of the cable. To avoid confusion, set the Stop distance shortly after that fault.

NA (Network Analyzer) Mode

Learn more about NA Mode measurements in the FieldFox Supplemental Online Help: <http://na.tm.agilent.com/fieldfox/help/FieldFox.htm>

In this Chapter

Measurement Selection.....	40
Quick Settings	41
Calibration Settings.....	42
Format	42
Frequency Range	43
Scale Settings	43
Electrical Delay.....	44
Phase Offset.....	45
Averaging	45
IF Bandwidth.....	46
Smoothing	46
Single/Continuous	46
Resolution (number of points)	47
Sweep Time.....	47
Output Power	48
System Impedance.....	48
Port Extensions.....	48
Velocity Factor	49
S21 Transmission Measurement	50
Increase Dynamic Range	51

See Also

All about Calibration.....	60
Set Markers.....	144
Use Limit Lines	154
Use Trace Math	157

Learn how to make **75Ω** (ohm) Measurements in the **Supplemental Online Help:** <http://na.tm.agilent.com/fieldfox/help/FieldFox.htm>

NA Mode Settings

Select NA Mode before making any setting in this section.

How to select NA Mode

- Press **Mode**.
- Then **NA**.

Measurement Selection

How to select a NA Measurement

- Press **Measure 1**.
- Then choose from the following:
 - **S11** 1-port reflection measurement.
 - **S21** 2-port transmission measurement. Requires Opt 110. Learn how to make this measurement on page 48.
 - **More** - These measurements are typically used as diagnostic tools for service personnel.
 - **A** Measurement of the A receiver.
 - **R1** Measurement of the R1 receiver.

NOTE

The A and R1 receiver measurements are NOT corrected for absolute power. They are only useful for making relative measurements. The Y-Axis and markers are labeled in dB - NOT dBm. Specifically, R1 does NOT indicate the actual power levels out of the source port. The actual power level is close to the typical output power of +5 dBm (High power) and -25 dBm (Low power).

Learn more about raw receiver measurements in the FieldFox Supplemental Online Help: <http://na.tm.agilent.com/fieldfox/help/FieldFox.htm>

Multi-Trace Configurations

In NA Mode you can display multiple traces on the FieldFox screen.

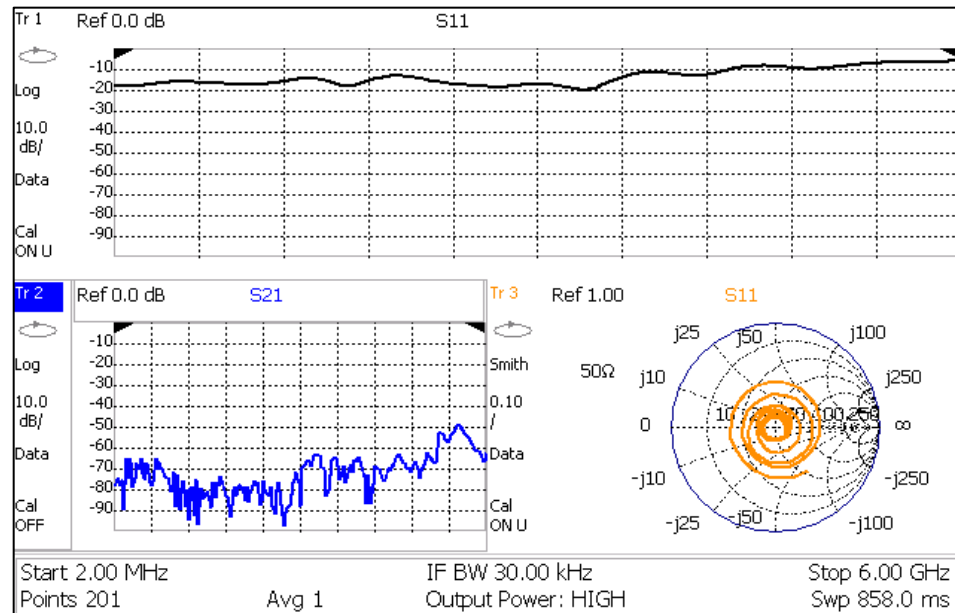

A 3-trace configuration. Tr2 is the ACTIVE trace as indicated by the highlighted Tr 2

Trace Setting Notes

- The Frequency Range, IF BW, Resolution, Average, and Output Power settings are common for all displayed traces.

- All other trace settings, such as measurement, format, and limit lines, are applied individually to the **ACTIVE** trace in the same manner as when a single trace is present.
- When creating markers, by default a marker is created on ALL traces as shown in the above image. However, they can be created individually by disabling Coupled Markers. Learn more on page 147.

How to select a multi-trace configuration

- Press **Trace 6**
- Then **Num Traces**
- Then choose from the following:
The default measurements depend on the options that are installed.

- x1** 1 trace standard configuration
- x2** 2 traces **overlaid** on a single graticule
- x2H** 2 traces on separate **horizontal** graticules
- x3H** 3 traces on separate **horizontal** graticules
- X3** 3 traces **overlaid** on a single graticule
- x4** 4 traces on separate graticules

- How to activate a trace in order to change a setting
- Use the **▲|▼** arrows **OR**
- Press **Trace 6** then select **Trace 1**, **Trace 2**, **Trace 3**, or **Trace 4**. Only traces that are shown can be activated.

How to maximize the viewing of the active trace

- Press **System 7**
- Then **Full Screen**.
- Press any key to return to the standard display.

Quick Settings

Both CAT and NA Modes allow you to view and change most relevant settings from a single location. All of these settings are discussed in this chapter and, unless otherwise noted, ALL of these settings can also be made using the standard softkey menus.

How to view and change Quick Settings

- Press **Meas Setup 4**.
- Then **Settings**.
- Press **Next Page** and **Previous Page** to view all settings. If these softkeys are NOT available, then all available settings fit on one page.
- To change a setting:
 - Use the **▲|▼** arrows to highlight a setting.

- Then press **Edit**. The current setting changes to **yellow**.
- Some settings require you to press a softkey to change the value. Otherwise, use the numeric keypad, **▲▼** arrows, or rotary knob to change the value.
- When finished changing a value, press **Done Edit**.
- Press **Dock Window** to relocate the Settings table to a position relative to the trace window. The Dock Window setting persists through a Preset. Choose from the following:
 - **Full (Default setting)** Only the Settings table is shown on the screen. The trace window is temporarily not shown.
 - **Left** The Settings table is shown to the left of the trace window.
 - **Bottom** The Settings table is shown below the trace window.
- When finished changing ALL settings, press **Done** to save your settings.

Calibration Settings

NA Mode has a page specifically for making settings that pertain to Port Extensions, including Velocity Factor and Media Type.

Learn more about Port Extensions on page 48.

NOTE The N9912A does NOT support Media Type: Waveguide.

How to view and change Calibration Settings

- Press **Meas Setup 4**.
- Then **Calibration Settings**
- Make these settings in the same manner as Quick Settings in the previous section.

Format

Select the display format in which to present measurement results. This setting can be changed at any time without affecting calibration accuracy.

NOTE Learn more about Display Formats in the FieldFox Supplemental Online Help: <http://na.tm.agilent.com/fieldfox/help/FieldFox.htm>

The marker onscreen readout can be changed to formats other than the display format. Learn how to set marker format on page 149.

How to select a NA Format

- Press **Measure 1**.
- Then **Format [current setting]**.
- Then choose from the following:
 - **Log Magnitude** Displays magnitude in dB
 - **Linear** Displays positive values only. Y-axis: Unitless (U) for ratioed measurements; Watts (W) for unratioed measurements.
 - **VSWR** (S11 and Fault Location Only) Displays unitless reflection data.

- **Phase** (S11 Only) Displays phase in degrees. The trace ‘wraps’ every 360 degrees, from +180 to –180, for easy scaling.
- **Smith** (S11 Only) Displays series resistance and reactance.
- **More** then
- **Polar** (S11 Only) Displays magnitude and phase of the reflection coefficient.
- **Group Delay** (S11 Only). Displays propagation time (in seconds) from the RF port to the point where it is reflected, and back to the A receiver. The aperture setting is the frequency range/(number of points – 1). Use Smoothing as the Group Delay aperture. Learn how to set Smoothing on page 46. Learn more about Group Delay in the FieldFox Supplemental Online Help: <http://na.tm.agilent.com/fieldfox/help/FieldFox.htm>
- **Unwrap Phase** Same as Phase, but without 180 degree wrapping.

NOTE Phase is unwrapped by comparing the phase from one data point to the next. If the phase difference between two data points is greater than 180 degrees, or if the phase of the first data point is greater than 180 degrees from DC, than the phase measurement is probably NOT accurate. Increase the resolution setting to ensure that the phase measurement is accurate.

Frequency Range

Set the range of frequencies over which you would like to make measurements. When the frequency range is changed after a calibration is performed, the cal becomes interpolated. Learn more on page 64.

How to set Frequency Range

This can be done in two ways:

- Press **Freq/Dist**
- Then choose from the following:
 1. **Start** and **Stop** frequencies – Specify the beginning and end of the sweep.
 2. **Center** and **Span** frequencies - Specify the center frequency and span of frequencies (half on either side of center).
- Follow each by entering a value using the numeric keypad, the **▲▼** arrows, or the rotary knob.
- After using the **▲▼** arrows or the rotary knob, press **Enter**. The increment setting of the arrows is based on the current span and can NOT be changed in NA Mode.
- After using the keypad, select a multiplier key. Learn about multiplier abbreviations on page 20.

Scale Settings

Adjust the Y-axis scale to see the relevant portions of the data trace. The Y-axis is divided into 10 graticules.

This setting can be changed at any time without affecting calibration accuracy.

How to set Scale

- Press **Scale / Amptd**.
- Then choose from the following methods:
 1. **Autoscale** Automatically adjusts the Y-axis to comfortably fit the Min and Max amplitude of the trace on the screen.
 2. **Autoscale All** Autoscales all of the traces on the screen, useful only for multi-trace configurations.
 3. Set Scale, Reference Level, and Reference Position
 - **Scale** Manually enter a **scale per division** to view specific areas of the trace.
 - **Ref Level** Manually set the value of the reference line. Enter a negative value by pressing **Run/Hold (+/-)** either before or after typing a value.
 - **Ref Position** Manually set the position of the reference line. Values must be between 0 (TOP line) and 10 (BOTTOM line)

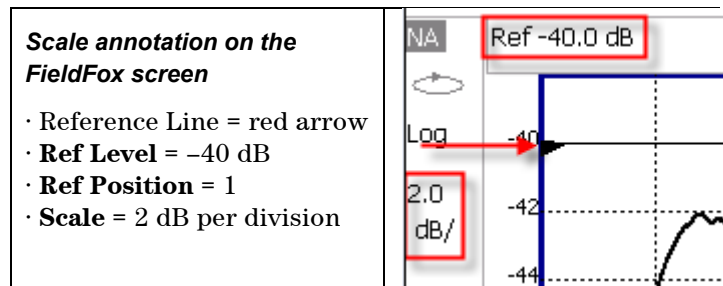

Electrical Delay

Electrical delay is a mathematical function that simulates a variable length of lossless transmission line. Use the electrical delay feature to compensate for the linear phase shift through a device and view only the deviation from linear phase of the device.

You can set the electrical delay independently for each measurement trace. To apply an electrical delay to all measurement traces, use Port Extensions. Learn how on page 48.

Phase is available only with S11 measurements – NOT S21.

Learn how to set Phase formats on page 42.

How to set Electrical Delay

- Press **Scale / Amptd**
- Then **More**
- Then **Electrical Delay**
- Enter a time value using the numeric keypad, the **▲▼** arrows, or the rotary knob.
- Press a multiplier key. Learn about multiplier abbreviations on page 20.

Electrical Delay can also be set using the **Mkr->Delay** feature. Learn how on page 153.

Phase Offset

Phase format is available only with S11 measurements. Learn more on page 42.

Phase offset mathematically adjusts the phase measurement by a specified amount, up to 360°. Use this feature in the following ways:

Improve the display of a phase measurement. This is similar to the way you would change the reference level in an amplitude measurement. Change the phase response to center or align the response on the screen.

Emulate a projected phase shift in your measurement. For example, if you know that you need to add a cable and that the length of that cable will add a certain phase shift to your measurement, you can use phase offset to add that amount and simulate the complete device measurement.

You can set the phase offset independently for each measurement trace.

How to set Phase Offset

- Press **Scale / Amptd**
- Then **More**
- Then **Phase Offset**
- Enter a value in degrees using the numeric keypad, the **▲|▼** arrows, or the rotary knob. Press **Enter**

Averaging

Averaging helps to reduce the effects of random noise on a measurement. You specify the number of measurements to be averaged. The more measurements averaged, the greater the amount of noise reduction. An average counter is shown in the left edge of the screen as **Avg <n>** where <n> is the number of measurements that are averaged.

Averaging can be set before or after calibration. When set before calibration, each calibration standard is measured <n> times and averaged. More time is needed to perform the calibration, but there will be less noise in the resulting error terms which means that subsequent measurements will also have less noise. In addition, noise is further reduced by continuing to average after calibration.

How to set Averaging

- Press **BW 2**.
- Then **Average <n>** where <n> is the number of measurements to average.
- Enter a value using the numeric keypad. Enter **1** for NO averaging.
- Press **Enter**.
- Then **Average Mode** Choose from the following:
 - **Sweep** - Each data point is based on the average of the same data point being measured over <n> consecutive sweeps. The average counter shows the number of previous sweeps that have been averaged together to form the current trace. When the counter reaches the specified count, then a 'running average' of the last <n> sweeps is displayed.

- **Point** - Each data point is measured <n> times and averaged before going to the next data point. On subsequent sweeps, averaging restarts by measuring each data point again <n> times. The average counter is not updated because data is not displayed until all the averages have been applied.
- **Point averaging is usually faster than sweep averaging.** However, you may need to increase the Point Average count to obtain the same level of noise reduction as with sweep averaging.
- While averaging is in process, press **Sweep 3**, then **Restart** to restart the averaging at 1.

IF Bandwidth

The FieldFox converts the received signal from its source to a lower intermediate frequency (IF). The bandwidth of the IF bandpass filter is adjustable. Reducing the IF receiver bandwidth reduces the effect of random noise on a measurement. However, narrower IF bandwidths cause longer sweep times.

How to set IF BW

- Press **BW 2**.
- Then **F BW**
- Then choose from the following: **300 Hz | 1 kHz | 3 kHz | 10 kHz | 30 kHz**

Smoothing

Trace smoothing averages a number of **adjacent** data points to smooth the peak-to-peak noise values on a displayed trace. The number of adjacent data points that are averaged is known as the smoothing aperture. Aperture is set by specifying a percentage of the X-axis span.

Trace smoothing does NOT significantly increase measurement time.

Smoothing is used in Group Delay measurements, although it can be used with any NA format EXCEPT Polar or Smith Chart. Learn more about NA Mode formats, including Group Delay, on page 42.

When enabled, **Smo** appears on the FieldFox screen.

How to set Smoothing

- Press **BW 2**.
- Then **Smoothing ON OFF**
- Then **Sm. Aperture** and enter a value between 0 and 25 (percent) using the numeric keypad.
- Press **Enter**

Single or Continuous Measure

This setting determines whether the FieldFox measures continuously or only once each time the **Single** button is pressed. Use **Single** to conserve battery power or to allow you to save or analyze a specific measurement.

This setting can be changed at any time without affecting calibration accuracy.

How to set Single or Continuous

- Press **Sweep 3**.
- Then choose one of the following:
 - **Single** Automatically sets Continuous OFF and causes FieldFox to make ONE measurement, then hold for the next Single key press. When a data trace is displayed, the entire trace is measured, then holds. The **Hold** annotation changes to an arrow --> while the measurement occurs.
 - **Continuous** Makes continuous measurements. This is the typical setting when battery power is not critical.

You can also use **Run / Hold +/-** to toggle between Single and Continuous.

Resolution (Number of Data Points)

Data points are individual measurements that are made and plotted across the X-axis to form a trace. Select more data points to increase measurement resolution. However, more data points also takes more time to complete an entire measurement sweep.

When the Resolution is changed after a calibration is performed, the cal becomes interpolated. Learn more on page 64.

How to set Resolution

- Press **Sweep 3**.
- Then **Resolution**.
- Then choose from the following:
101 | 201 | 401 | 601 | 801 | 1001 | 1601 | 4001 | 10001.
- Using SCPI, Resolution can be set to ANY number of points between 3 and 10001. See the Programming Guide at www.agilent.com/find/fieldsfoxsupport

Sweep Time

The fastest possible sweep time is always used as the default setting. Use the **Min Swp Time** setting to slow the sweep time when measuring long lengths of cable. Learn more at the FieldFox Supplemental Online Help: <http://na.tm.agilent.com/fieldfox/help/FieldFox.htm>

The actual sweep time is shown on the FieldFox screen. See the Screen Tour on page 19. To increase the sweep time, enter a value that is higher than the actual sweep time. The increase will not be exactly the amount that you enter, as the actual sweep time is the composite of many factors.

NOTE Measurement speed specifications do NOT apply in Temperature Control Mode. Learn more on page 14.

How to set Sweep Time

- Press **Sweep 3**.
- Then **Min Swp Time**.
- Enter a value using the numeric keypad.
- Press a multiplier key. Learn about multiplier abbreviations on page 20.

Output Power

Set the power level out of the FieldFox to High, Low, or manually set power level to a value between High and Low.

Generally, the high power setting is used when measuring passive, high-loss devices to place the signal farther from the noise floor. However, for devices that are sensitive to high power levels such as amplifiers, use the Low power setting.

For best measurement accuracy, use the **Manual** power setting at -15 dBm. After calibration, the power level can be decreased for amplifiers, or increased for higher dynamic range.

Caution Power Level settings in this mode will NOT change Power Level settings in other modes. To help prevent damage to your DUT, use caution when changing modes with your DUT connected to the FieldFox test ports.

How to set Output Power

Output power is NOT leveled with any of the power settings:

- Press **Meas Setup 4**.
- Then **Output Power**
 - **High** (Default setting) Sets output power to the maximum achievable power at all displayed frequencies. Please see the FieldFox Specifications (page 200) for expected power levels.
 - **Low** Sets output power to approximately -27 dBm,
 - **Man** Set output power to an arbitrary value,
 - Then press **Nominal Power**
 - Then enter a value using the numeric keypad, the **▲|▼** arrows, or the rotary knob.
 - Press **Enter**.

System Impedance (Z0)

To accurately view data presented in Smith Chart format, first set the System Impedance.

Learn how to select Smith Chart format on page 42.

Learn how to make 75 Ω measurements at the FieldFox Supplemental Online Help: <http://na.tm.agilent.com/fieldfox/help/FieldFox.htm>

How to set System Impedance

- Press **Meas Setup 4**.
- Then **Settings**.
- Then scroll to **System Z0** and press **Edit**
- Then type either **50** or **75** and press **Enter**

Port Extensions

Port extensions allow you to electrically move the calibration reference plane on port 1 after you have performed a calibration.

Phase measurements, and therefore Port Extensions, are NOT available on port 2.

Why use Port Extensions

Use port extensions if you are unable to perform a calibration directly at your device because the location is not accessible. Perform a calibration at a convenient place, then use port extensions to compensate for the time delay (phase shift) to the desired reference plane. On the FieldFox, port extensions does not compensate for the loss of the additional electrical length, nor any mismatch errors beyond the calibration reference plane.

Also use port extensions if you have already performed a calibration, and then decide that you need to add a length of transmission line in the measurement configuration. Use port extensions to "tell" the FieldFox that you have added the length to a specific port.

With S11, the FieldFox doubles the port extension valued that you enter to account for the additional delay in the forward and reverse directions.

Port extensions and Electrical Delay differ in the following ways:

- Electrical delay is applied to a specific trace.
- Port extensions are applied to specific ports.

Port Extensions and Electrical Delay can be set independently. When both are set, the delay adds together. Learn more about Electrical Delay on page 44.

How to apply Port Extensions

- Press **Meas Setup 4**.
- Then **Port Extensions**
- Then **Port Extensions ON**
- Then **Port1 Extension**
- Then enter time value using the numeric keypad, the **▲▼** arrows, or the rotary knob. Press **Enter** or select a seconds (time) multiplier.

You can also set Port Extensions by pressing **Meas Setup 4** then **Calibration** (settings).

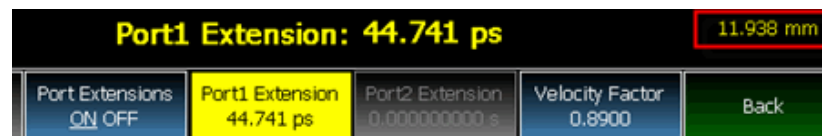

While setting Port Extension, the physical length of the extension, at the current Velocity Factor setting, is visible to the right (red box in above image).

Velocity Factor

The electrical delay or port extension value is entered as delay, or **electrical length**, in units of time.

Entering the velocity factor causes the FieldFox to accurately display the equivalent **physical length** in meters (NOT available in feet) that corresponds to the entered electrical delay.

Velocity factor is the ratio of the velocity of wave propagation in a coaxial cable to the velocity of wave propagation in free space. This velocity depends on the relative permittivity of the cable dielectric (ϵ_r).

$$\text{Velocity factor} = 1/\sqrt{\epsilon_r}$$

VF = 0.66 corresponds to wave propagation through a polyethylene dielectric.

VF = 1.0 (default setting) corresponds to wave propagation through free space (a vacuum).

How to set Velocity Factor

- Press **Meas Setup 4**.
- Then **Port Extensions**
- Then **Velocity Factor**
- Then enter a value between 0.1 and 1 using the numeric keypad, then press **Enter**.

You can also set Velocity Factor by pressing **Meas Setup 4** then **Calibration** (settings).

S21 Transmission Measurements

An S21 Transmission measurement, available with option 110, is used to measure the loss through a DUT – or cable – over a specified frequency range. The FieldFox signal source is transmitted out the RF OUT connector, through the DUT, and into the RF IN connector. Both ends of the DUT must be connected to the FieldFox.

An S21 measurement is exactly the same measurement as “2-Port Insertion Loss” in CAT Mode.

NOTE A Normalization Cal is REQUIRED when making 2-port CAT or NA measurements.

For highest accuracy, when measuring the DUT also attach any cable or adapter that was used in the normalization cal.

How to make an S21 Transmission Measurement

1. Press **Mode** then **NA** then **S21 Transmission**.
2. Press **Freq/Dist** and enter **Start** and **Stop** frequency values of the measurement.
3. Press **Sweep 3** then select a **Resolution** setting.
4. Press **Cal 5** then press **Normalization**. Perform normalization as explained on page 63.
5. Connect the DUT and view the transmission measurement results.

When measuring very long lengths of cable, it may be necessary to increase the sweep time. Learn how on page 26. Learn why at the FieldFox Supplemental Online Help: <http://na.tm.agilent.com/fieldfox/help/FieldFox.htm>

Increase Dynamic Range

Dynamic range is the difference between maximum input power to the FieldFox receiver (without compressing the receiver), and the minimum measurable power (noise floor). Measurement accuracy is increased when the DUT response is at least 10 dB above the noise floor. For a measurement to be valid, input signals must be within these boundaries.

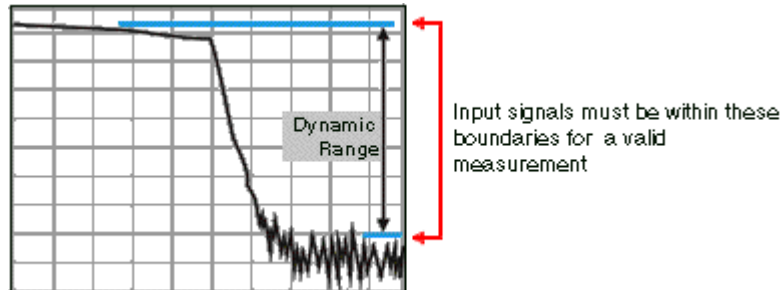

The following settings will increase the dynamic range of your **NA mode** measurement.

- Increase Power Level: Press **Meas 4** then **Output Power High**
- Lower the IFBW: Press **BW 2** then **IF BW**
- Increase Averaging: Press **BW 2** then **Average**

The following procedure **MAY** increase the dynamic range of your NA mode measurement. The results you see will depend on the performance of your DUT.

With an S21 trace active:

1. With RF OUT (port-2) open, press **Trace 6** then **Math and Memory** then **Data->Mem**
2. Re-connect the DUT.
3. Press **Data Math** then **Data-Mem**

Time Domain - Option 010

With NA Mode, Time Domain (Opt 010), frequency information is used to calculate and display measurements with time as the horizontal display axis. The response values appear separated in time allowing a different perspective of the test device's performance and limitations.

NA Mode settings that are NOT unique to Time Domain are documented in the NA Mode chapter on page 39.

In this Chapter

Overview 52

Time Domain (Transform) Settings

Transform Settings Table 53

Frequency Range and Points 54

Stimulus (Mode)..... 54

Set Frequency Lowpass 54

Start/Stop Time..... 54

Distance Units 55

Window Layout 55

Transform Window..... 55

Line Loss and Velocity Factor 56

Data Chain 57

Trace Settings

Transform Enable 57

Gating Enable 57

Gating Settings

Start, Stop, Center, and Span Gate Times 58

Gating Type..... 58

Overview

In normal NA Mode operation, the FieldFox measures the characteristics of a test device as a function of frequency. With Time Domain (opt 010), frequency information is used to calculate the inverse Fourier transform and display measurements with time on the horizontal display axis. The response values appear separated in time, allowing a different perspective of the test device's performance and limitations.

The graphic below compares the same cable reflection measurement data in both the frequency and time domain. The cable has two bends. Each bend creates a mismatch or change in the line impedance.

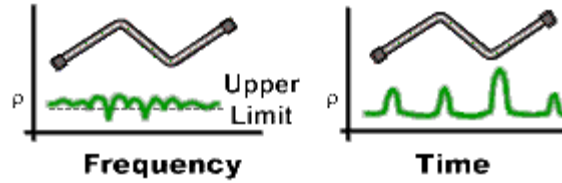

The frequency domain of an S11 measurement shows reflections caused by mismatches in the cable. It is impossible to determine where the mismatches physically occur in the cable.

The Time Domain response shows both the location and the magnitude of each mismatch. The responses indicate that the second cable bend is the location of a significant mismatch. This mismatch can be gated out, allowing you to view the frequency domain response as if the mismatch were not present. Learn more about gating on page 58.

Markers that are created on a Time Domain trace can be used to pinpoint the distance of the mismatch from the reference plane.

For more information on Time Domain theory, see <http://cp.literature.agilent.com/litweb/pdf/5989-5723EN.pdf>

Time Domain (Transform) Settings

You can set and view most of the Time Domain settings on the Transform Settings table.

Transform Settings Table

The following settings are listed in the order they appear on the Transform Settings menu selection.

How to make settings on the Transform settings table

- Press **Meas Setup 4**.
- Then **Transform**.
- Then **Transform Settings**.
- Press **Next Page** and **Previous Page** to view all settings.
- To change a setting:
 - Use the **▲▼** arrows or rotary knob to highlight a setting.
 - Numeric settings can be changed by pressing numbers using the numeric keypad. Then press **Enter** or select a suffix if available.
 - Some settings allow you to press **Edit** to toggle the value. Other settings require that you then press a softkey to change the value.
 - When finished changing a value, press **Done Edit**.
- Press **Dock Window** to relocate the Settings table to a position relative to the trace window. The Dock Window setting persists through a Preset. Choose from the following:
 - **Full (Default setting)** Only the Settings table is shown on the screen. The trace window is temporarily not shown.

- **Left** The Settings table is shown to the left of the trace window.
- **Bottom** The Settings table is shown below the trace window.
- When finished changing ALL settings, press **Done** to save your settings.

Frequency Range and Points

Like CAT mode, all Time Domain measurements are made in the frequency domain and, using Inverse Fourier Transform (IFT), time is calculated. Select the frequency range from which Time Domain measurements are calculated. Increasing the data points will improve measurement resolution. However, more data points will usually result in slower sweep updates.

Set frequency range and points before selecting Stimulus Mode.

Stimulus (Mode)

There are three variations on how the Time Domain transform algorithm is applied to the frequency domain measurement. Each method has a unique application.

- **Lowpass Impulse** - Highest resolution. Most useful for seeing small responses in devices that pass low frequencies, such as cables.
- **Lowpass Step** - Easiest to identify inductive and capacitive discontinuities in devices that pass low frequencies such as cables.

In both Lowpass modes, frequencies down to DC and negative frequencies are extrapolated. Therefore, when either Lowpass mode is selected, **Set Freq.Low Pass** is automatically applied to adjust the start frequency. Learn more about Set Frequency Lowpass below.

When the Start Frequency or resolution is changed AFTER selecting a Lowpass mode, then Stimulus mode is set to **Band Pass** and Transform is disabled.

- **Band pass** - Easiest method - can be used with any frequency sweep. Most useful for measuring band limited devices such as filters and DC blocked cables. This mode does NOT show capacitive and inductive reactance. For the same frequency span and number of points, band pass mode has twice the impulse width, which hides closely spaced responses degrading the response resolution.

Set Frequency Lowpass

NOTE This setting is made automatically when either Lowpass mode is selected.

USE ONLY IN LOW PASS MODES. When this setting is made, the start frequency is adjusted to be harmonics of the start frequency. Start frequency is computed by the following formula:

Low Pass Start Frequency = Stop Frequency / Number of points.

Start/Stop Time

The following settings adjust the **display resolution**, allowing you to zoom IN or OUT on a response. When the start or stop time is updated, they may be automatically adjusted to limit the display to one alias-free response on either side of zero time.

How to set Start and Stop time

- Press **Measure 4**
- Then **Transform**
- Then **Transform Start Stop**
- Then choose from:
 - **Start** Sets the transform start time that is displayed on the FieldFox screen.
 - **Stop** Sets the transform stop time that is displayed on the FieldFox screen.

NOTE Zero (0) seconds is always the **calibration reference plane**. Negative values are useful if moving the reference plane.

Distance Units

When markers are present on a Time Domain trace, marker X-axis values are shown both in units of time (seconds) and distance. Select the units in which the marker distance data is presented.

Distance Units are also used when setting Time Domain Line Loss. Learn more on page 56.

Choose from: m (meters), or Feet.

Window Layout

This setting is used to create additional traces, or select a new layout for traces that are already created,

Choose from: x1, x2, x2H, x3H, x4.

Learn more about multi-trace configurations on page 40.

Transform Window

There are abrupt transitions in a frequency domain measurement at the start and stop frequencies, causing overshoot and ringing in a Time Domain response. The Window setting reduces the abruptness of the frequency domain transitions. This causes you to make a tradeoff in the Time Domain response.

The Window setting applies to ALL traces.

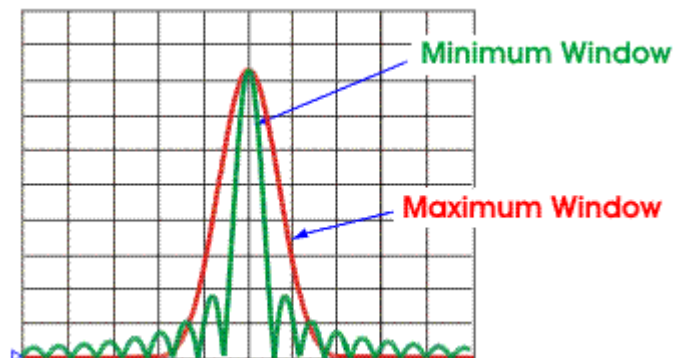

How to make Window setting

- Press **Measure 4**
- Then **Transform**
- Then **More**
- Then **Transform Window**
- A settings table appears that allows you to navigate and select the following settings. These settings are made exactly like those made on the Transform Settings table. Learn how on page 53.

NOTE Any of the following four methods can be used to make this same Window setting. Impulse Width values are calculated from the frequency span and Kaiser Beta value.

1. Window	Min	Medium	Max
2. Percent	0	50	100
3. Kaiser Beta	0	6.50	13.00
4. Impulse Width	100.455 ps	168.501 ps	231.284 ps

Line Loss and Velocity Factor

By default, the FieldFox does NOT correct Time Domain measurements to account for the inherent loss of a cable. However, to make more accurate measurements, Line Loss and Velocity Factor should be considered.

About Velocity Factor and Line Loss

- Velocity Factor is a property of the physical material of a cable. A VF of 1.0 corresponds to the speed of light in a vacuum, or the fastest VF possible. A polyethylene dielectric cable has VF = 0.66 and a cable with PTFE dielectric has VF = 0.7.
- Line Loss is specified in dB/m (or ft). In addition to the length of the cable, loss is also directly proportional to the frequency of the signal that passes through the cable.

The following is an example showing how Line Loss works:

The DUT is a 100 meter transmission cable. The Line Loss value is .1 dB/meter. This means that a signal traveling ONE WAY through the cable will lose 10 dB of power (100 m * .1dB/m). Because the FieldFox performs this measurement with 1 port, the test signal travels down the cable and then back, for a total loss of 20 dB.

For the purpose of illustrating this point, connect an OPEN to the end of the cable – a maximum-sized fault - for 100% reflection of the 300 MHz test signal.

Without compensation for the loss of the cable, a -20 dB response would be visible at 100 meters, which is the OPEN at the end of the DUT. This is from 10 dB of loss through the cable in each direction.

With compensation for the loss using the manufacturer's specification, the FieldFox compensates the trace as though the signal traveling through 100 meters was increased by +20 dB. Therefore the response will show 0 dB for 100% reflection.

Data Chain

This setting, available only on the Table Settings, reverts to the default when the FieldFox is Preset. Choose from the following:

- **Standard** – The normal FieldFox data processing chain. Transform calculations are performed AFTER error correction and trace math.
- **8510** – The data processing chain used by the Agilent 8510 network analyzer. Transform calculations are performed BEFORE error correction and trace math. Learn more at the FieldFox Supplemental Online Help website: <http://na.tm.agilent.com/fieldfox/help/FieldFox.htm>

Trace Settings

The following two settings apply to specific traces.

Transform Enable

Enable Time Domain transform for the specific trace.

- Select the trace.
- Press **Measure 4**
- Then **Transform**
- Then choose from:
 - **On** Trace displays Time Domain data.
 - **Off** Trace displays frequency domain data.

Gate Enable

Enable Gating for the specific trace.

- Select the trace.
- Press **Measure 4**
- Then **Transform**
- Then choose from:
 - **On** Trace displays Time Domain data.
 - **Off** Trace displays frequency domain data.

Gating

Perhaps the most beneficial feature of Time Domain transform is the Gating function. When viewing the Time Domain response of a device, the gating function can be used to "virtually" remove undesired responses. You can then simultaneously view a frequency domain trace as if the undesired response did not exist. This allows you to characterize devices without the effects of external devices such as connectors or adapters.

Gating is best performed while viewing a Time Domain trace. Then, either disable Transform, or separately view a frequency domain trace to see the trace with the gated effects removed.

NOTE When a discontinuity in a test device reflects energy, that energy will not reach subsequent discontinuities. This can "MASK", or hide, the true response which would have occurred if the previous discontinuity were not present. The Gating feature does NOT compensate for this.

How to make Time Domain Gating settings

- Press **Measure 4**
- Then **Transform**
- Then **Gating**
- Then choose from:
 - **On** Gating is being performed.
 - **Off** Gating is NOT being performed.

Start, Stop, Center, and Span Gate Times

These settings specify the time in the trace to be gated (in or out). The gate times can be specified using either Start and Stop or Center and Span.

- Press **Gating Start/Stop**
- A settings table appears that allows you to navigate and select the following settings. These settings are made exactly like those made on the Transform Settings table. Learn how on page 53.

Gating Type

This setting defines the type of filtering that will be performed for the gating function. The gate start and stop flags on the display point toward the part of the trace you want to keep.

- Choose from the following:
 - **Bandpass** - KEEPS the responses within the Gating Start and Stop times.
 - **Notch** - REMOVES the responses within the Gating Start and Stop times.

Gating Shape

This setting defines the filter characteristics of the gate function. Choose from Minimum, Normal, Wide, Maximum.

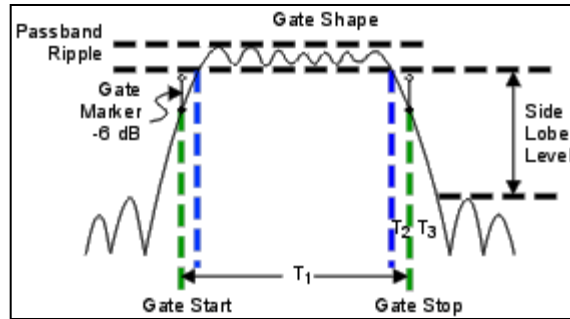

Time domain Gate Shape setting

Gate Shape	Passband Ripple	Sidelobe Levels	Cutoff Time	Minimum Gate Span
Minimum	± 0.1 dB	-48 dB	1.4/Freq Span	2.8/Freq Span
Normal	± 0.1 dB	-68 dB	2.8/Freq Span	5.6/Freq Span
Wide	± 0.1 dB	-57 dB	4.4/Freq Span	8.8/Freq Span
Maximum	± 0.01 dB	-70 dB	12.7/Freq Span	25.4/Freq Span

Cutoff time is the time between the stop time (-6 dB on the filter skirt) and the peak of the first sidelobe.

- T_1 is the gate span, which is equal to the stop time minus the start time.
- T_2 is the time between the edge of the passband and the 6 dB point, representing the cutoff rate of the filter.
- T_3 is the time between the 6 dB point and the edge of the gate stopband.

For all filter shapes T_2 is equal to T_3 , and the filter is the same on both sides of the center time.

Minimum gate span is twice the cutoff time. Each gate shape has a minimum recommended gate span for proper operation. This is a consequence of the finite cutoff rate of the gate. If you specify a gate span that is smaller than the minimum span, the response will show the following effects:

- distorted gate shape that has no passband
- distorted shape
- incorrect indications of start and stop times
- may have increased sidelobe levels.

Calibration for CAT, NA, and VVM Modes

The FieldFox performs a calibration automatically when powered ON and when Preset is performed. In addition, calibration can be performed manually. Key presses are identical in all of these Modes.

In this Chapter

Why and When to Calibrate	60
Definitions	61
Preset Calibration.....	61
QuickCal.....	61
O,S,L Calibration	62
Normalize	63
Compatible Mode Calibrations.....	64
Compatible 1-port and 2-port Calibrations.....	65
Save a Calibration	65
Verify Calibration	66
Calibration Method Summary	66

NOTE ECal and Waveguide Calibrations are NOT supported on the N9912A.

See Also

Making 75 ohm Measurements at the FieldFox Supplemental Online Help:
<http://na.tm.agilent.com/fieldfox/help/FieldFox.htm>

Why and When to Calibrate

There are well-defined and understood systematic errors that are measured and calculated during the calibration process. These errors are caused by leakage signals inside the FieldFox, by the frequency response of the FieldFox receivers, and by reflections inside the FieldFox that interact with the DUT. After calibration, these errors are removed from subsequent measurements.

To maintain highest measurement accuracy, perform a new calibration when any of the following changes occur:

- When any of the following measurement settings change: Frequency Range, Power Level, and Resolution. Therefore, make these measurement settings before calibrating. Increased Averaging and higher Resolution cause slower sweeps and slower calibration times. Learn about Interpolation and Questionable Accuracy on page 64.
- When the FieldFox temperature changes more than about 10°F (5°C). Learn how to monitor the internal temperature on page 14.
- When the connection to the DUT changes, requiring a different jumper cable or adapter.

Definitions

DUT (Device Under Test) is the cable, antenna, transmission line, or anything else that is connected to the FieldFox that is to be measured.

OPEN, SHORT, and LOAD are calibration standards. These are precision components that are used during calibration and to terminate a DUT during some measurements. When an RF signal 'hits' these components, the signals are reflected in a predictable manner.

- A SHORT and OPEN standard both cause 100% of an RF signal to be reflected. The difference between these two standards is what happens to the phase of the reflected signal, which is beyond the scope of this discussion. Although an OPEN standard is a precision component, simply leaving **nothing** connected at the end of a cable can be a reasonable substitute for an OPEN.
- A LOAD standard completely absorbs the incident signal and NO signal is reflected back to the source.

Calibration Reference Plane is the point at which cal standards are connected during a calibration. This can be either the FieldFox RF OUT connector, or at the end of a jumper cable or adapter.

Preset Calibration (also known as CalReady)

Every FieldFox is factory calibrated at the RF Out connector over the entire frequency range of the FieldFox using a number of data points that allows reasonable interpolation over the FieldFox frequency range.

This CalReady condition allows you to start using your FieldFox immediately if you are measuring a device that is directly connected to the RF Out test port. CalReady applies to the entire frequency range of the FieldFox. It can be used to check the integrity of the jumper cable.

Cal ON is shown on the screen when powered ON or Preset.

When measuring a DUT using a jumper cable or adapter - NOT a direct connection to the RF Out connector – then a QuickCal or O,S,L Cal is recommended.

Learn how to see when your factory CalReady calibration was performed on page 181.

QuickCal

QuickCal is ideal for a quick and simple calibration of the measurement when using a jumper cable or adapter to connect the DUT to the FieldFox test ports. QuickCal corrects for phase shift, time delay, and loss of adapters or jumper cables.

QuickCal does not require a specific Cal Kit and is a very simple calibration. If the highest accuracy is required, a mechanical calibration with a high quality calibration kit is recommended.

If the DUT has 3.5 mm-female or SMA-female connectors, QuickCal is NOT recommended.

How to perform a QuickCal

Press **Esc** at any time during the QuickCal to stop the calibration.

- In CAT, NA, or VVM Mode, press **Cal 5**.

- Then (if necessary) press **Cal Type** to see **QuickCal**.
- Then **Start Cal**.

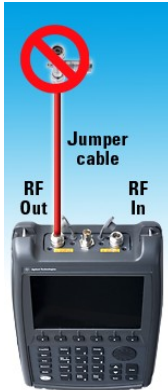

Step 1

1. Disconnect the DUT from the FieldFox.
2. If a jumper cable or adapter is required to connect the DUT to the FieldFox, connect **those** components to the FieldFox RF Out connector NOW. The effects of those components will be measured and removed during the calibration, and only the effects of the DUT will be displayed in the measurement results. **These should be high-quality components!**
3. Do NOT connect anything at the point where the DUT connects.
4. Then press **QuickCal**.

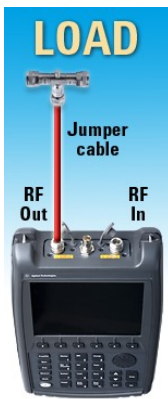

Step 2

Connect a Load standard at the point where the DUT will be connected and press **Measure** under the following conditions:

When a jumper cable has too much loss. If a 'Cal Failed' error appears and you skipped the Load measurement, then perform the Cal again but measuring the Load.

When your DUT has high return loss such as the reject band of a filter. Then measuring the load improves accuracy. Even with the optional Load, phase accuracy begins to degrade when the return loss is greater than about 20dB.

Press **Skip Step** in all other cases and when making DTF measurements. Measuring a load would do little to improve accuracy.

- Press **Finish**.
- **Cal ON Q** is shown on the screen when a QuickCal is correcting the measurement.

Using QuickCal with a Long Jumper Cable

QuickCal requires a sufficient frequency span to adequately characterize the jumper cable (the cable between the instrument port and the DUT). If a 'Cal Failed' error appears and you connected the optional Load standard, then increase the frequency span of the measurement until the error no longer appears. After the calibration, you can then decrease the frequency span as needed and rely on interpolation. Learn more about Interpolation on page 64.

QuickCal is also limited in how much jumper cable loss it can tolerate. If QuickCal without the load is failing, then measure the load during the QuickCal to see if that resolves the issue.

O,S,L Cal

An OPEN, SHORT, LOAD Cal is performed using discrete standards from a Cal Kit. Several Cal Kit definitions are built into the FieldFox firmware.

NOTE Visit www.agilent.com/find/fieldfoxsupport to see a complete list of supported Cal Kits. Also at this website, download DataLink software that allows you to edit Cal Kit definitions or add a new Cal Kit.

O,S,L Cal is extremely accurate when performed using the recommended Cal Kits with standards that are in clean and good repair, and when using correct connection procedures.

CAL ON U is shown on the screen when an O,S,L Cal is correcting the measurement.

How to perform O,S,L Cal

Before performing an O,S,L Cal, set the Measurement type, Frequency Range, Power Level, and Resolution of the measurement. The calibration will remain highly accurate until these settings change, or the physical connection to the FieldFox changes.

- Disconnect the DUT from the FieldFox.
- If a jumper cable or adapter is required to connect the DUT to the FieldFox, then connect **those** components to the FieldFox RF Out connector NOW. The effects of those components will be measured and removed during the calibration, and only the effects of the DUT will be displayed in the measurement results. **These should be high-quality components!**
- In CAT or NA Mode, press **Cal 5**.
- Then (if necessary) press **Cal Type** to choose **O,S,L**.
- Then (if necessary) press **Connector Type**.
- Then using the **▲▼** arrows or the rotary knob, select the connector type and gender of your DUT port to be measured and press **Enter**. This will determine the type and gender of cal kit to use. For example, if a Type-N Male connector is used on the DUT port to be measured, then the Type-N Male standards (OPEN, SHORT, AND LOAD) will ALL be connected in place of the DUT during the calibration.
- If there is more than one Cal Kit for the selected connector type, press **Cal Kit** and select the correct Cal Kit to use.

NOTE Calibration kit definitions are unique to each connector type and connector sex. They must be correctly applied to obtain the most accurate calibration.

- Then press **Start Cal**.
- Press **Open**, **Short**, and **Load** in any order.
- Connect the corresponding standard at the point where the DUT will be connected, then press **Measure**.
- Measure each of the three standards. Standards can be measured again at any time if you feel a standard was not connected securely.
- Press **Finish** to complete the O,S,L calibration.

Normalize

Normalize is used to calibrate a **2-port Insertion Loss** measurement (CAT Mode) and a **S21 Transmission** measurement (NA Mode). One of these measurements must be selected before performing a Normalize Cal.

NOTE A Normalization Cal is REQUIRED to make **accurate** 2-port Transmission or Insertion Loss measurements.

How to perform a Normalization

- Press **Cal 5**.
- **Cal Type [Normalize]** should appear.
- Connect a short, high-quality, phase stable cable between the FieldFox **RF OUT** and **RF IN** connectors.

NOTE All subsequent insertion loss measurements are made relative to the insertion loss of this cable. For example, if you use a Normalization cable with 1 dB of loss, then after pressing **Normalize**, the display will show 0 dB of loss with this cable in place. Therefore, for highest accuracy, when measuring the DUT also attach the cable that was used in the normalization cal.

- Press **Start Cal** then **Thru** then **Measure**
- Press **Finish**.
- Connect the DUT between the **RF OUT** and **RF IN** connectors.

NOTE A Normalization cal will NOT be interpolated if the Resolution or Frequency range changes.

CAL ON U is shown on the screen when a Normalization Cal is correcting the measurement.

Interpolation

Highest measurement accuracy is achieved when the measurement type, frequency range, power level, and resolution settings remain the same during the measurement as when the FieldFox was calibrated. If these settings change after a calibration, the FieldFox will interpolate the calibration so that VERY accurate measurements continue to be made.

Interpolated Calibrations are only **slightly less accurate** than a calibration performed at the measurement settings. For example, if frequency settings change after a Preset Calibration is performed, the Preset Calibration is only slightly less accurate. Learn more about the relative accuracy of FieldFox calibrations on page 66.

When a calibration is being interpolated, an asterisk is added to the screen annotation as follows: **Cal ON***

For highest accuracy: a new cal should be performed when the temperature changes more than about 10°F (5°C), or when the connection to the DUT requires a different jumper cable or adapters.

How to turn Error Correction OFF

“Error Correction” is applying the results of a calibration to a measurement. Error Correction is automatically turned ON after a calibration. You could turn Error Correction OFF in order to see the effects of a calibration on the measurement.

- Press **Cal 5** then **Error Correction ON OFF**.
- Then **Exit** or **Esc**.
- **Cal OFF** is shown on the screen when Correction is OFF.

- **Cal OFF*** is shown on the screen when switching from a 1-port measurement to a 2-port measurement or vice-versa. Calibration for the current measurement has NOT been performed.

Cal ON ? – Questionable Accuracy

If a change made by the user to the output power setting, or a change made automatically by the FieldFox firmware makes accurate calibration interpolation questionable, a question mark is added to the screen annotation for all calibration states (Ex: **Cal ON ?**). The resulting measurement accuracy depends on how much the setting has changed. For optimum accuracy, recalibrate using the new settings.

Compatible Mode Calibrations

Because CAT, NA, and VVM modes are very similar, a 1-port or 2-port calibration that is performed in one mode is automatically applied in the other modes. This occurs **ONLY** when modes have the same frequency data points, have the same Power Level, and have the same IF BW. CAT Mode IF BW is 30 kHz and is **NOT** selectable.

Compatible 1-port and 2-port Calibrations

Typically, a 1-port calibration and a 2-port normalization can **NOT** be maintained at the same time. The most recently performed calibration will usually overwrite the other.

- In CAT mode, the 1-port measurement is Return Loss or DTF, and the 2-port measurement is Insertion Loss.
- In NA mode, the 1-port measurement is S11, and the 2-port measurement is S21.

However, a 1-port calibration **CAN** coexist with a 2-port normalization **ONLY** when **BOTH** of the following conditions occur:

1. A 1-port Cal already exists, then a Normalization Cal is performed. They can **NOT** be performed in the reverse order.
2. The Frequency Range, Resolution, Power (Hi/Low), and IF BW (in NA Mode) settings of the two calibrations are identical.

When **both** conditions occur, you can switch between the 1-port and the 2-port measurements, and both will remain fully calibrated.

In a DTF measurement, the frequency range over which the calibration is made can be viewed using the calculated Start and Stop Frequency on the Settings page. Learn how to see this on page 37.

Save the Calibration

After performing any type of calibration, you can save the FieldFox settings along with the calibration into a STATE (*.sta) file. These settings and calibration can then be recalled as necessary. Learn how on page 160.

Verifying Calibration and Jumper Cable Integrity

After calibrating, it is important to verify that the calibration is good. When using a jumper cable, also verify that the cable is of high quality.

Verify a Calibration

- Connect a LOAD standard at the calibration reference plane (where calibration standards were connected). This may be at the end of the jumper cable or at FieldFox RF OUT connector.
- In CAT Mode, select a Return Loss measurement.
- In NA Mode, select a S11 Reflection with Log Mag format.
- Observe the trace on the FieldFox screen:
 - Lower than 40 dB indicates a GOOD calibration.
 - Higher than 30 dB indicates that you should recalibrate.

Verifying Phase Accuracy

- Connect a LOAD standard at the calibration reference plane (where calibration standards were connected).
- In NA Mode, select a S11 Reflection with Polar or Smith Chart format.
- Because all LOAD standards have delay, you should see a small amount of phase rotation as a function of frequency.
- In general, the measurement result should agree with the characteristics of the calibration standard.

Test the Jumper Cable

With the LOAD standard still connected, move the jumper cable while observing the trace.

- If the measurement trace is relatively stable, the jumper cable is of good quality.
- If you observe significant movement in the peaks of the measurement trace when moving the cable (>5 dB), the jumper cable may need to be replaced.

Calibration Method Summary

- **O,S,L** is ALWAYS the most accurate Cal method. The quality of an O,S,L Cal is completely dependent on the quality of the OPEN, SHORT, LOAD standards. Use high quality standards to ensure the most accurate calibration.
- **QuickCal** is ideal for DTF measurements. QuickCal should be performed when good accuracy is required and when using a jumper cable or adapter.
 - QuickCal is NOT recommended when the DUT has 3.5 mm-female or SMA-female connectors.
 - Even with the optional Load, phase accuracy begins to degrade when the return loss is greater than about 20dB.
- **Preset Cal** is ONLY useful for DUT connections made at the RF Out port and most accurate at room temperature.

- **For highest accuracy**, a new QuickCal or O,S,L Cal should be performed:
 - when the temperature changes more than about 10°F (5°C)
 - when the connection to the DUT requires a different jumper cable or adapters.

SA (Spectrum Analyzer) Mode

SA Mode measures signals at the RF IN port. The RF OUT connector is NOT used.

General purpose Spectrum Analyzer measurements are available with Option 230 or 231. SA measurements require NO calibration.

For a comprehensive SA Mode tutorial, see Spectrum Analysis Basics (App Note 150) at <http://cp.literature.agilent.com/litweb/pdf/5952-0292.pdf>

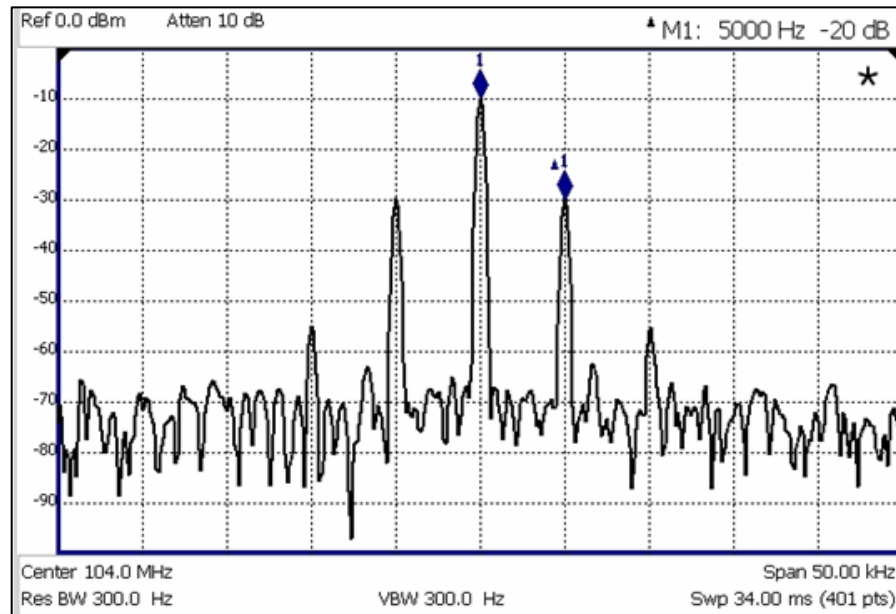

SA display with markers
Carrier with 5 kHz frequency modulation and deviation of 1 kHz

In this Chapter

Frequency Range	69
Radio Standard	71
Channel Selection	72
Scale and Units	73
External Gain	74
Attenuation and Preamp Control	74
Check for Compressed Measurements	76
Field Strength Measurements	76
Tune and Listen	79
Independent Source	79
Resolution Bandwidth	79
Video Bandwidth	83
Sweep Type	83
Sweep Acquisition	83
Zero Span Measurements	85

Triggering.....	86
Single/Continuous/Restart	86
Points.....	88
Trace Display States.....	88
Average Type.....	89
Average Count.....	89
Detection Method.....	90
Display Line.....	91
Noise Marker	91
Band/Interval Power Marker.....	92
Frequency Counter at Marker	93
Audio Beep at Marker Power	94
Channel Measurements	94
o Channel Power	
o Occupied Bandwidth	
o Adjacent Channel Power Ratio	

See Also

Interference Analyzer (Opt 236)

Spectrogram Display	103
Waterfall Display.....	106
Record / Playback.....	107

Optional settings

Markers.....	144
Limit Lines.....	154
Save Measurement Settings and Results	160

SA Mode Settings

Select SA Mode before making any setting in this chapter.
 Because there is no calibration, these settings can be made in any order.

How to select SA Mode

- Press **Mode**.
- Then **SA**.

Frequency Range

The X-axis frequency range determines the frequencies that are measured for each sweep. The default Start frequency is 0 Hz. However, the Start frequency can be set as low as -100 MHz. The internal LO of the FieldFox can be seen at 0 Hz, which will mask signals that may be present.

NOTE Although the start frequency can be set as low as -100 MHz, amplitude accuracy is specified above 2 MHz. Below 2 MHz, frequency accuracy is maintained, but amplitude accuracy is degraded.

The frequency range of the measurement can be changed using the following methods:

- Set Center and Span frequencies
- Set Start and Stop frequencies
- Toggle between Zero and Last selected span
- Set Full Span of the FieldFox
- Using Channel selection. Learn how on page 72.
- Using Marker -> Center (frequency). Learn how on page 148.

How to set Frequency Range

- Press **Freq/Dist**.
- Then choose from the following:
 - **Center** and **Freq Span** frequencies. This is the most common method of entering frequency range. Enter the frequency of interest. The Center frequency is at the exact center of the X-axis. The Frequency Span places half of the frequency range on either side of center. When the Center and Frequency Span values are entered, then the X-axis annotation on the screen shows the Center and Span frequencies.
 - **Start** and **Stop** frequencies. Start is the beginning of the X-axis and Stop is the end of the X-axis. When the Start and Stop frequencies are entered, then the X-axis annotation on the screen shows the Start and Stop frequencies.
- Follow each of these by entering a value using the numeric keypad, the **▲▼** arrows, or the rotary knob.
- When using the **▲▼** arrows, press **Enter**. The increment setting of the arrows is based on the current span. This can be changed in SA Mode. See **How to change frequency step size** below.
- After using the keypad, select a multiplier key. Learn about multiplier abbreviations on page 20.

Two more ways to change the frequency range

- Press **Freq/Dist**.
- Then choose from the following:
 - **Zero/Last Span** Each key press toggles the frequency span between 0 Hz and the last specified frequency span.
 - **More**
 - Then **Full Span** Selects the entire frequency span of the FieldFox. The Center frequency is set automatically.

How to change frequency step size

When using the **▲▼** arrows to change any of the frequency settings, the size of the frequency step can be changed.

- Press **Freq/Dist**
- Then **More**
- Then **CF Step Auto Man**
 - **Auto** Each press of the **▲▼** arrows increments or decrements the value by 1/10th (one division) of the current frequency span. **Note:** To change this setting from **Man** to **Auto**, press **CF Step** twice.
 - **Man** Type a step size value using the numeric keypad, then select a multiplier key. Learn about multiplier abbreviations on page 20.

Radio Standard

A Radio Standard is a collection of settings that are applied to the FieldFox for specific RF protocols. When a Radio Standard is applied, the FieldFox frequency and channel settings change to that of the standard.

By default, the FieldFox locates the center frequency of the standard in the middle of the screen and sets the frequency span to cover all of the Uplink and Downlink frequencies. The selected Radio Standard name appears in the center of the screen below the X-axis.

After a Radio Standard has been selected, the frequency range can be changed by selecting channel numbers rather than frequency. Learn how on page 72.

When a Channel Measurement is selected such as ACPR, other relevant settings will be changed such as Integration BW. Learn more about Radio Standards and Channel Measurements on page 95.

How to select a Radio Standard

- Press **Measure 1** OR **Freq/Dist** then **More**
- Then **Radio Standard**
- Then select a standard using the **▲▼** arrows or rotary knob and press **Enter**.

Custom Radio Standards

Beginning with Rev A.05.50, your own custom Radio Standards can be imported into the FieldFox. Custom standards are created in *.csv (spreadsheet) format.

A template and instructions for creating your custom Radio Standard is at: www.agilent.com/find/fieldsfoxsupportReference/CustomRadioStandard.htm

Once imported, the *.csv file is stored in the FieldFox \User Data\ folder. The custom Radio Standards are read and presented at the top of the list of internal Radio Standards.

How to Import and Delete a Custom Radio Standard

First, press **Save/Recall** and select the **Device** from which the Radio Standard will be read. Most likely this will be **USB** or **SD Card**.

- Press **Measure 1** OR **Freq/Dist** then **More**
- Then **Radio Standard**
- Then **Import Radio Standards**

- Then select the *.csv file using the ▲▼ arrows or rotary knob and press **Enter**.
- Custom Radio Standards can be removed from the FieldFox by selecting **Measure 1** then **Radio Standard** then **Delete Radio Standard**.
- Then select the *.csv file to delete using the ▲▼ arrows or rotary knob and press **Enter**.

Note: To overwrite a custom standard that is already uploaded to the FieldFox, you must first delete the *.csv file from the FieldFox, then re-upload the file that contains the standard. A predefined internal standard (such as GSM 450) can NOT be deleted from the FieldFox.

Channel Selection

After a Radio Standard has been selected, the frequency range can be changed by selecting channel numbers rather than frequency. Once enabled, the channel number is appended to the X-axis frequency range.

How to enable Channel selection

- Press **Freq/Dist**
- Then **More**
- Then **Unit Freq Chan**

How to change the Channel Number of the measurement

With Unit = **Chan** the FieldFox will NOT allow you to specify channels outside of the selected Radio Standard.

- Press **Freq/Dist**
- Then choose from the following:
 - **Center Channel** Places the center frequency of the specified channel in the middle of the X-axis.
 - **Start Channel** Places the lowest frequency of the specified channel at the beginning of the X-axis.
 - **Stop Channel** Places the highest frequency of the specified channel at the end of the X-axis.
 - **Freq Span** Changes the span of frequencies while the center frequency remains unchanged.
 - Follow each of the above settings by entering a value using the numeric keypad or the rotary knob.
 - Use the ▲▼ arrows to increment the channel number by an amount specified by the Channel Step value (see below).
 - Then press **Enter**.

Select either Uplink or Downlink Frequencies

Press **Chan Direction** to toggle between **Uplink** and **Downlink**. If either of these selections is not available, then the selected Radio Standard does not contain those frequencies.

Channel number X-axis annotation

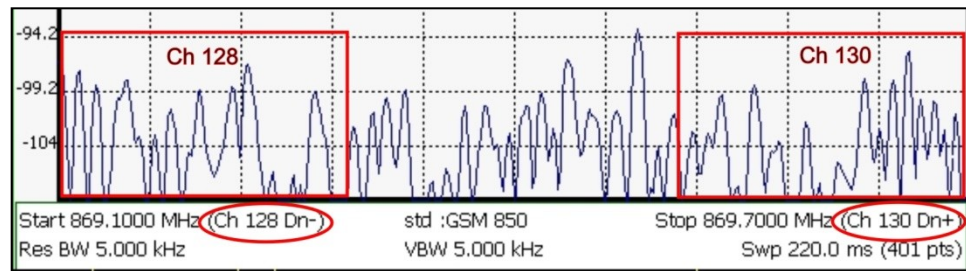

- **Dn** indicates **Downlink** frequencies.
- **Up** (not shown) indicates **Uplink** frequencies
- (-) indicates that the lowest frequency in the channel (128) is at the left edge of the screen.
- (+) indicates that the highest frequency in the channel (130) is at the right edge of the screen.
- When Center Channel or Freq Span is specified, the X-axis shows the Center Freq (Channel) and Frequency Span.
- When Start or Stop Channel is specified, the X-axis shows the Start Freq (Channel) and Stop Freq (Channel).

Change Channel Step Size (Optional)

This setting allows you to use the  arrows to increment the channel number by the specified value.

- Press **Channel Step**
- Enter a step value using the numeric keypad, the  arrows, or the rotary knob. Then press **Enter**.

Scale and Units

Adjust the Y-axis scale to see the relevant portions of the data trace.

The Y-axis is divided into 10 graticules. A Reference Level is shown on the screen as a solid horizontal bar that can be placed at any graticule.

When RF Attenuation set to **Auto**, the RF Attenuation is coupled to Reference Level.

How to set Scale

Press **Scale / Amptd**. Then choose from the following:

- **Scale Type [current setting]**
 - **Log** Logarithmic scale (default setting). The Y-axis reference line represents the specified absolute Reference Level in the current **Unit** selection. Y-axis graticules show dB below or above the reference line.
 - **Lin** Linear scale. The Y-axis reference line represents the specified absolute Reference Level in the current **Unit** selection. Y-axis graticules show percent of Reference Level (%) below or above the reference line.
- Manually set Scale, Reference Level, and Reference Position.

- **Scale** Manually adjust the scale per division to view specific areas of the current trace. Enter a value using the numeric keypad, the **▲▼** arrows, or the rotary knob. Then press **Enter**.
- **Ref Level** Manually set the value of the reference line. Enter a negative value by pressing **Run/Hold (+/-)** either before or after typing a value. This can also change the RF Attenuation setting. See **Attenuation Control – Auto**.
- **Ref Position** Manually set the position of the reference line. Values must be between 0 (TOP line) and 10 (BOTTOM line). Default position is zero (top).
- Press **More**, then **Autoscale** Automatically adjusts the Y-axis to comfortably fit the Min and Max amplitude of the trace on the screen.

How to set Y-axis Units

The Unit setting appears for the reference line, marker readouts, and trigger level. All Unit choices are available in both Log and Linear Scale Types.

The UNIT setting survives Mode Preset, but NOT Preset.

- Press **Scale / Amptd**, then **More**, then **Unit**
- Then choose from the following:
 - **dBm** (default setting), **dBmV** (dB milli Volts), **dBuV** (dB microVolts), **W** (watts), **V** (volts), **A** (amps), **dBmA** (dB milliAmps), **dBuA** (dB microAmps).

Antenna correction units are available ONLY by loading or editing an Antenna file that contains the desired units setting. Learn more on page 77.

External Gain

When using an external amplifier or attenuator, the SA Mode trace amplitude values can be offset to compensate for the effect of the external device. This effectively moves the reference plane of the SA measurement port out to just beyond the external device. For example, when using an external preamp with gain of +10 dB, enter this value for External Gain, and the data trace across the displayed frequency span will be adjusted down by 10 dB.

When RF Atten is set to Auto, you may see a change in the RF Attenuation value. This is an attempt to measure the signal at top of screen (the Reference Level) without overloading the SA first mixer.

How to set External Gain

- Press **Scale/Amptd**.
- Then **More**
- Then **External Gain**
- Enter a value using the numeric keypad, the **▲▼** arrows, or the rotary knob (positive for gain; negative for loss). Values less than 5 dB must be typed using the numeric keypad. Then press **Enter**

ExtGain xx dB is shown at the top of the screen.

Attenuation Control

Both the RF Attenuation and Pre Amp functions control the power level into the SA.

When too much power is present at the RF IN port, **ADC Over Range** appears on the FieldFox screen. This does not necessarily mean that damage has occurred, but that the measurement is probably compressed.

When high power levels are present at the RF IN connector, internal attenuation can be switched in to keep the FieldFox receiver from compressing. At extremely high power levels, use external attenuation to protect the internal circuitry from being damaged.

WARNING

The FieldFox can be damaged with too much power.

RF Damage Level: +27 dBm

DC Damage Level: ±50 VDC

The displayed power level is automatically adjusted for RF Attenuation. As the attenuation value changes, the displayed power level should NOT change.

How to set Attenuation

The default Attenuation setting is 10 dB. This value can be changed from 0 to 31 dB in 1 dB steps.

- Press **Scale/Amptd**.
- Then **RF Atten Auto Man**.
- **Auto** RF Attenuation is set by adjusting the Reference Level. As the Reference Level is lowered, for example from -10 dB to -30 dB, the FieldFox assumes that you are looking at low-level signals. The RF Attenuation value is automatically lowered in 5 dB steps to allow low-level signals to be viewed. The RF Attenuation value is never automatically lowered below 5 dB.
- **Man** RF Attenuation is set manually. Enter a value using the numeric keypad, the **▲▼** arrows, or the rotary knob. Values less than 5 dB must be typed using the numeric keypad. Then press **Enter**

#Atten xx dB is shown at the top of the screen. (#) means manual setting.

Preamplifier Control (Opt 235)

When **very low-level** signals are analyzed, an internal preamplifier can be used to boost the signal level by approximately 22 dB. The gain of the preamp is NOT adjustable. The displayed signal level is automatically adjusted for the increase in system gain.

How to control the Preamp

By default, the preamp is OFF.

- Press **Scale/Amptd**.
- Then **Preamp ON OFF**. The underlined setting is the current setting. When ON, **PA** is shown to the left of the graticules on the display.

Check for Compressed Measurements

Compression occurs when too much power into an amplifier causes it to no longer amplify in a linear manner. When too much power goes into the FieldFox RF IN connector, the amplifiers in the SA receiver compress and signal power will not be displayed accurately. This can occur even if **ADC Over Range** is not displayed. Increase the RF Attenuation value to prevent the SA receiver from being compressed.

How to Check for a Compressed Measurement

- Using a marker at the signal peak, make note of the signal power level.
- Increase the RF Attenuation level by 5 dB.
 - If the signal level does **NOT** change, then NO compression exists. This indicates that the signal is in the linear region of the FieldFox receiver.
 - If the signal level **DOES** increase, then the receiver was compressed. Set the RF Attenuation value at the setting when further increases no longer result in an increase in the displayed power level.

Field Strength Measurements

To measure the strength of any signal transmitted through the air, an antenna must be connected to the FieldFox. The Field Strength feature allows you to enter the frequency response of the receiving antenna (the Antenna Factor) and associated cabling, and then have amplitude corrections automatically compensate the displayed trace for that response.

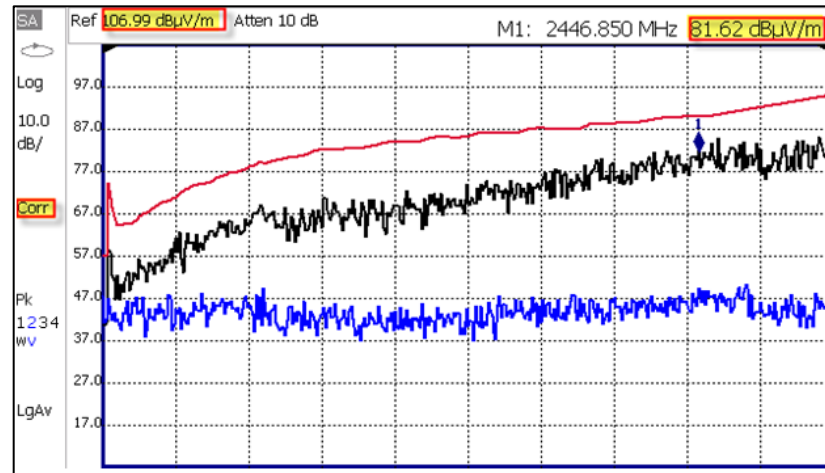

Field Strength Measurements

Trace 1 - Corrected trace with antenna factor. (Antenna = ON, Apply Corr = ON)

Trace 2 - (View) Uncorrected trace (Apply Corr = OFF)

Red Trace - Current correction factor. See below.

- Learn how to set Y-Axis **Units** on page 73.
- Use a Band Power marker to measure total power over a range of frequencies. Learn how on page 154.

How to select correction for Field Strength measurements

The Antenna and Cable correction data survives a Mode Preset and Preset. All Correction ON/OFF states survive a Mode Preset, but NOT a Preset.

- Press **Scale/Amptd**.
- Then **More**
- Then **Corrections**
- Then choose from the following:
 - **Apply Corrections ON OFF** Turn ON and OFF correction for all settings
 - **Antenna ON OFF** Turn ON and OFF Antenna correction.
 - **Edit/Save/Recall Antennas** Recall or edit an Antenna Correction table. See below.
 - **Cable ON OFF** Turn ON and OFF Cable correction.
 - **Edit/Save/Recall Cables** Recall or edit a Cable Correction table. See below.
 - **View Corrections ON OFF** Turn ON and OFF **Red Trace** - Antenna/Cable corrections.

Using the Antenna/Cable Editor

The Antenna Editor and the Cable Editor menus are identical. Both tables include header information, and a Frequency/Value table.

NOTE The FieldFox limits Antenna and Cable correction to a maximum of 90 values.

Setting	Value
Description	Correction Fa
Freq Interpolation	!LIN
Antenna Unit	dB μ V/m
Frequency	Antenna Factor
26.00000000 MHz	20.000 dB
30.00000000 MHz	17.500 dB

FieldFox Antenna Editor

How to use the Antenna/Cable Editor

- Press **New** then **Yes** to clear all data from the existing Antenna or Cable table and reset header information to default settings.
- Then **Edit Antenna** or **Edit Cable** to open the Antenna / Cable Editor.
- Then use the **▲▼** arrows to select a field,
 - When editing Header information, press **Edit** then modify the selected field using the FieldFox labeler.

- When editing Frequency/Value pairs, enter numbers using the numeric keypad, and a frequency suffix when necessary. Then **Enter**. Positive Values are interpreted as LOSS for both Cable Loss and Antenna Gain Factor. Learn more about “How the Freq/Value pairs are applied” below.
- Optionally choose from the following:
 - **Previous / Next Page** Quickly scrolls through pages of Freq/Value data.
 - **Add Data** Add a blank Freq/Value pair to the table,
 - **Delete/Clear** then:
 - **Delete Line** Remove the selected Freq/Value pair from the table.
 - **Clear All** then **Yes** Remove all Freq/Value pairs from the table and resets header information to default settings.

When the table edits are complete

- Press **Done** to closes the Antenna/Cable Editor.
- Press **Save Antenna** or **Save Cable** to saves your changes to the specified Storage Device. Enter a filename using the FieldFox labeler (learn how on page 160). Learn more about Antenna and Cable files below.
- Press **Recall Antenna** or **Recall Cable** to load an Antenna or Cable file from the specified Storage Device.
- **Storage Device** Changes the device used to save or recall files. Choose from Internal (default setting), USB (must be connected) or SD card. This is a different setting from the Save/Recall Storage Device setting.

About the Antenna/Cable header fields

- **Description:** Enter a description for the antenna or cable correction table. This is NOT the filename used to save the file.
- **Antenna Unit:** Units in which the measurement will be displayed. Select **NONE** (default setting) to select from standard SA Units on the Scale menu. Learn how on page 73.
 Choose from: **dB μ V/m** - (dB micro Volts per meter), **dB μ A/m** - (dB micro Amps per meter), **dBG** (gauss), **dBpT** (tesla).
- **Freq Interpolation:** Set to LINear and can NOT be edited.

About the Freq/Value pairs

- Positive Values are interpreted as LOSS for both Cable Loss and Antenna Gain Factor.
- When one Freq/Value pair is entered, that correction value is applied to the entire displayed frequency span.
- When two or more Freq/Value pairs are entered, the data points between the lowest and highest frequencies are corrected. Linear interpolation is applied between frequencies when necessary.

About Antenna and Cable files

- Cable files are saved and recalled from the **Cables** folder.

- Antenna files are saved and recalled from the **Antenna** folder.
- If the folder does not already exist on a USB or SD card, it is created automatically before storing the file.
- All SA Mode Antenna and Cable files are saved and recalled as *.csv files, which allows them to also be read by spreadsheet programs.
- The FieldFox can also read *.ANT (Antenna) files that were created from older Agilent Spectrum Analyzers.
- Data Link does NOT support the SA Mode cable or antenna (*.csv or *.ANT) files. Learn more about Data Link software at: www.agilent.com/find/fieldfoxsupport

How to create a Cable file from an S21 (NA mode) measurement

1. Measure the S21 of a cable. Learn how in NA Mode on page 50.
2. Use Manage Folders to change the active folder to CABLES. Learn how to manage folders on page 165.
3. Save the measurement as a *.csv file. Learn how on page 162.
4. Recall the *.csv file for correction.

Tune & Listen (AM/FM)

The Tune & Listen feature can be used to identify an interfering AM or FM signal. The demodulated AM or FM signal can be heard through the internal speaker or through headphones using the 3.5 mm jack located on the FieldFox side panel. The Tune & Listen tuner is separate from the SA display. This allows you to listen to one frequency while displaying a different range of frequencies. The Tune & Listen measurement alternates between normal SA sweeps for the display and performing audio demodulation at the Tune Frequency. See the Listen Time setting for more information.

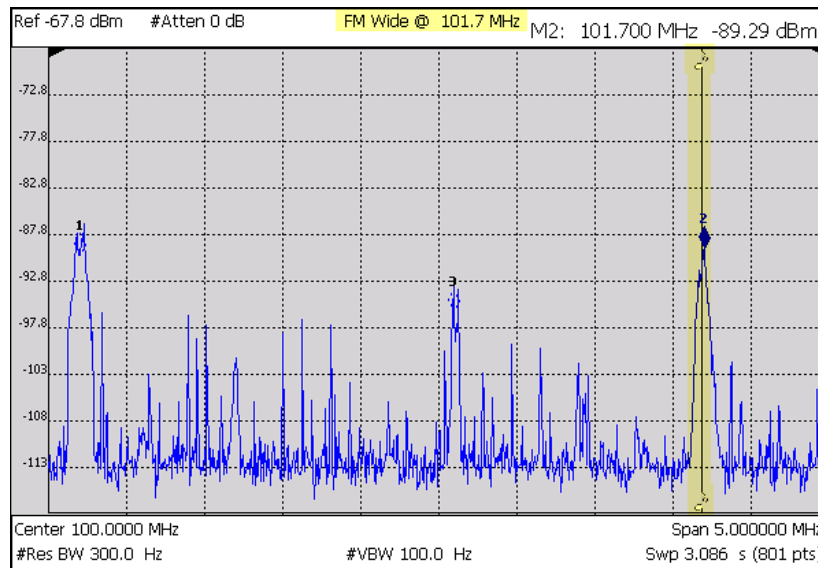

Tune & Listen ON with Tune Frequency indicated by a vertical bar (highlighted).

How to select Tune & Listen

- Press **Measure 1**
- Then **Tune & Listen**
- Then choose a demodulation type. Select a setting based on the type of interfering signal you suspect is being broadcast.
 - **None** Turns Tune & Listen OFF
 - **AM** Amplitude Modulation
 - **FM Narrow** Frequency Modulation; Narrow bandwidth. Choose when interfering transmission consist of voice or data.
 - **FM Wide** Frequency Modulation; Wide bandwidth. Choose for high quality music transmissions of FM broadcast radio.

Tune Frequency

The Tune & Listen tuner is separate from the SA display. This allows you to listen to one frequency while displaying a different range of frequencies.

Set the Tune Frequency using one of three methods:

1. Selecting Preset, Mode Preset, or Meas Preset sets Tune Frequency to 3.0 GHz.
2. Specify Tune Frequency:

- Press **Meas Setup 4**
 - Then **Tune Freq**
 - Enter a value using the numeric keypad, **▲▼** arrows, or the rotary knob. Then select a multiplier key. Learn about multiplier abbreviations on page 20.
3. Using **Mkr->Tune Freq**
 - Create a normal marker at the frequency of interest. Learn how on page 144.
 - Press **Mkr->/Tools**
 - Then **Mkr->Tune Freq** to change the Tune Frequency to that of the marker.

Tip To improve sound quality, try increasing power by reducing the Attenuation setting and, if available, turn ON the Preamplifier. Learn how on page 74.

Listen Time

While Tune & Listen is actively demodulating a signal, the SA does not sweep and update the display. Listen Time sets the amount of time that the FieldFox demodulates, then stops to perform a single sweep and update the display, then again demodulates.

To select Listen Time:

- Press **Meas Setup 4**
- Then **Listen Time**
- Enter a value using the numeric keypad, **▲▼** arrows, or the rotary knob. Then select a multiplier key. Learn about multiplier abbreviations on page 20.

Volume Control

To increase or decrease the Volume of the demodulated signal:

- Press **Meas Setup 4**
- Then **Volume**
- Enter a value in percent between 0 and 100 (loudest) using the numeric keypad, **▲▼** arrows, or the rotary knob.
- Volume can also be changed and easily muted from the **System** menu. Learn more on page 169.

Demod ON and OFF

To quickly stop the audio demodulation and perform only the normal SA sweeps, select the following:

- Press **Meas Setup 4**
- Then **Demod ON OFF**

Independent Source/Tracking Generator

A tracking generator, a popular option with Spectrum Analyzers, is a source which always tracks the SA receiver.

Like a traditional tracking generator, the Independent Source feature can set the internal FieldFox source to track the SA receiver frequency range. It can also set the internal source to a CW frequency that is independent of the SA frequency.

Independent Source can be enabled ONLY when the FieldFox is in SA mode.

To view the internal source, you must connect a cable or device between the RF OUT connector and the RF IN connector.

NOTES The FieldFox output power is approximate and NOT flat across the frequency range.

In SA mode, amplitude accuracy may be compromised when the Independent Source is ON, Battery Saver is ON, and the Preamp is ON. For highest amplitude accuracy under these conditions, turn Battery Saver OFF. Learn how on page 175.

How to make Independent Source Settings

- Press **Measure 1**.
- Then **Source**
- **Source Enable ON OFF**
 - **ON** Turns ON the internal source.
 - **OFF** Turns OFF the internal source.
- **Source Mode** Choose from the following:
 - **Tracking** The internal source sweeps simultaneously (tracks) with the SA receiver over the displayed frequency range, emulating NA mode measurements. **Src** is annotated on the screen.
 - **CW** The source is set to a CW frequency independent from the SA setting. **Srcw** is annotated on the screen.

- **Coupled CW** The source is set to a CW frequency, but that frequency “tracks” the SA receiver Center Frequency setting. Therefore, the signal always appears at center of the display. **Srcp** is annotated on the screen.
- **Normalize ON OFF** With Source Enable ON and Source Mode = **Tracking**, Normalize ON stores the current measurement trace into Trace 4 in View state as a reference trace. All subsequent trace measurements subtract out this Trace 4 reference trace, and therefore become relative to it. This causes measurements to appear near the ZERO absolute level on the y-axis (0 dBm if UNIT is set to dBm). **SrcN** is annotated on the screen. Normalize is automatically turned OFF when the frequency range or Resolution is changed. Learn more about Trace Display States on page 88.
- **Source Atten** Sets the source attenuation from 0 to 31 dB in 1 dB steps. This effectively sets the source output power. While changing the source attenuation, the approximate **Nominal Output** power is annotated to the right of the active entry setting.
- **Source CW Freq** Sets the CW frequency that is used when Source Mode is set to CW.

NOTE By default, the source output will turn off momentarily at the end of each SA sweep. To cause the source to stay ON at the end of each sweep, turn battery saver OFF. (Learn about Battery Saver on page 174.)

- Press **System 7**
- Then **Preferences**
- Then **Battery Saver OFF**

Resolution Bandwidth (Res BW)

In SA Mode, the Res BW provides the ability to resolve, or see closely spaced signals. The narrower (lower) the Res BW, the better the spectrum analyzer can resolve signals. In addition, as the Res BW is narrowed, less noise is measured by the spectrum analyzer ADC and the noise floor on the display lowers as a result. This allows low level signals to be seen and measured. However, as the Res BW is narrowed, the sweep speed becomes slower.

How to set Res BW

- Press **BW 2**.
- Then **Res BW Auto | Man**.
 - **Auto** Res BW is coupled to the frequency span. As the frequency span is narrowed, the Res BW is also narrowed providing increased ability to resolve signals.
To change this setting from **Man** to **Auto**, press **Res BW** twice.
 - **Man** Enter a Res BW value using the numeric keypad, the **▲|▼** arrows, or the rotary knob. Then press a multiplier if necessary or press **Enter**.

The current Res BW setting is shown at the bottom of the screen.

#Res BW x.xx XHz (#) means manual setting.

This setting could impact the accuracy of the measurement. See Specifications on page 200.

NOTE The Res BW setting also affects the Sweep Type setting. Learn how on page 83

Video Bandwidth (Video BW)

Video BW is a smoothing operation that is performed after measurement data is acquired. The trace data is effectively smoothed so that the average power level of the displayed noise is the same, but the peaks and valleys of adjacent data points are smoothed together. More smoothing occurs as the Video BW is set lower. However, as the Video BW is narrowed, the sweep speed becomes slower.

How to set VBW

- Press **BW 2**.
- Then **Video BW Auto Man**.
 - **Auto** Couples Video BW to the ResBW in a 1-to-1 ratio.
 - **Man** Enter a Video BW value using the numeric keypad, the **▲▼** arrows, or the rotary knob. Then press a multiplier if necessary or press **Enter**.

NOTE To change this setting from **Man** to **Auto**, press **Video BW** twice.

The current Video BW setting is shown at the bottom of the screen.

VBW x.xx XHz (#) means manual setting.

When the Res BW/Video BW ratio exceeds 10,000, a **Meas UNCAL** warning may appear to indicate that the Video BW filter has reached the maximum capacity for averaging.

In Zero Span, the maximum Res BW/ Video BW ratio is 100.

Sweep Type

In SA mode, the FieldFox uses two sweep types to process inputs signals. The sweep type that is currently being used (**FFT** or **Step**) is displayed in the lower-left corner of the FieldFox screen.

For a more comprehensive tutorial, see Spectrum Analysis Basics (App Note 150) at <http://cp.literature.agilent.com/litweb/pdf/5952-0292.pdf>

How to set Sweep Type

- Press **BW 2**.
- Then **Advanced**
- Then **Sweep Type Auto FFT Step**
 - **Auto** The FieldFox selects the most efficient sweep type based on the Res BW. When Res BW is set to 200 kHz and below, **FFT** sweep type is selected. Above 200 kHz, and **Step** sweep type is being performed.
 - **FFT** The FieldFox uses FFT sweep type regardless of the Res BW.
 - **Step** The FieldFox uses Step sweep type regardless of the Res BW. This is useful for capturing impulsive noise that may be generated from nearby electrical equipment.

Sweep Acquisition

When set to Auto, Sweep Acquisition is set to the minimum value required with the current settings in order to achieve amplitude accuracy when measuring CW signals yielding the fastest sweep update rate.

However, you can adjust this setting in order to increase the probability of intercepting and viewing pulsed RF signals.

For example, with **SwpAcquisition** set to **Auto** a pulsed GSM signal is NOT visible on the FieldFox screen, as shown in a blue trace in the following image.

However, while watching the trace, increase the SwpAcquisition value until the pulse spectrum rises out of the noise and reaches its maximum level. Increasing the SwpAcquisition value beyond this point only slows the update rate (increases the actual Sweep time readout) but does not improve measurement quality.

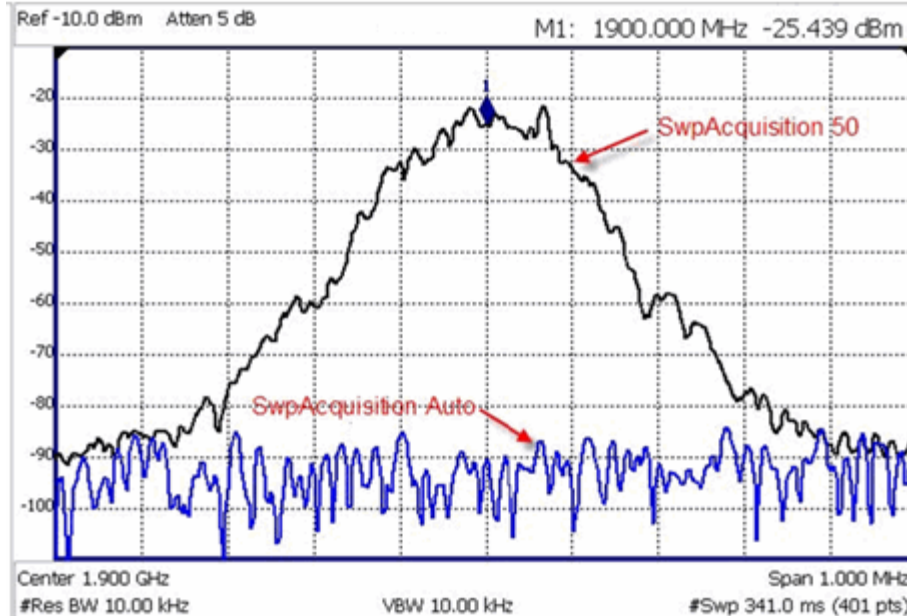

A GSM signal in a framed data format; timeslot zero ON; all others OFF; PRF = 218Hz, Duty Cycle = 12.5%. The pulsed signal becomes visible on every sweep update with SwpAcquisition = 50.

How to set Sweep Acquisition Parameter

- Press **Sweep 3**.
- Then **SwpAcquisition Auto Man**.
- Then choose from the following:
 - **Auto** Sweep is set to the fastest sweep possible with the current settings.
 - **Man** Enter a relative acquisition value between **1** and **5000**, where:
 - 1 = Fastest sweep possible
 - 5,000 = Slowest sweep possible
 - # is shown in front of the actual sweep time to indicate a manual setting.

Some Detector and Video Bandwidth settings will raise the Auto Sweep Acquisition value greater than 1. In these cases, manually setting Sweep Acquisition lower than the Auto value may have NO effect.

NOTE Measurement speed specifications do NOT apply in Temperature Control Mode. Learn more on page 14.

Zero Span Measurements

When setting the frequency span to Zero, there is NO spectrum of frequencies to display, so the X-axis units becomes Time. The SA becomes like a tunable oscilloscope, with the center frequency being the frequency of interest. This capability is useful for analyzing modulation characteristics, such as pulsed measurements.

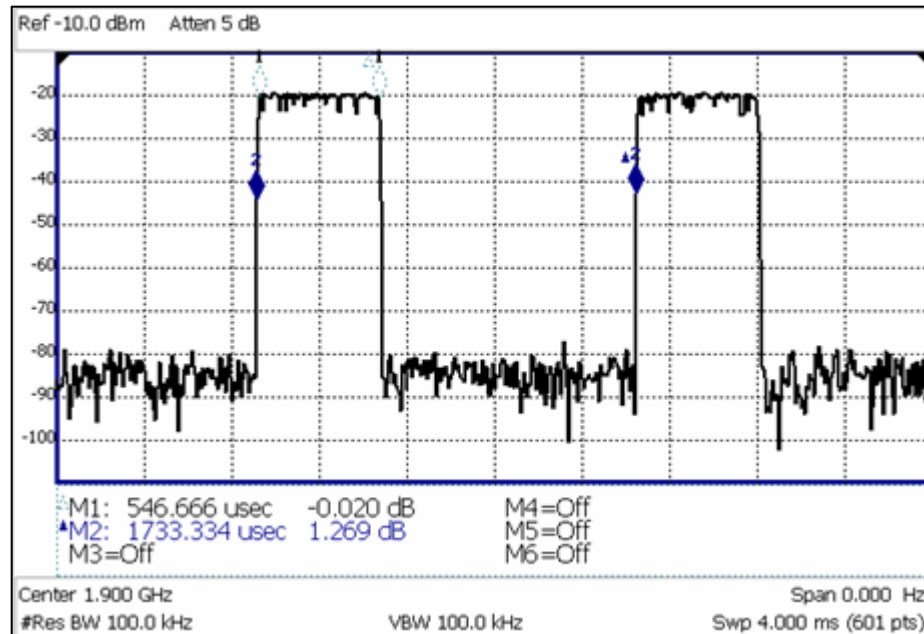

GSM signal, framed data format, timeslot 0 and 3 on. Sweep Time is set to approximately the frame interval. Press Single several times until the waveform section of interest is viewable and stable. Then markers can be used to measure the timeslot width and interval as shown.

How to set Zero Span

- Set **Center** to the frequency of interest
 - then set **Span** to 0 Hz
 - or select **Zero/Last Span**. Each key press toggles the frequency span between 0 Hz and the last specified frequency span.

How to change Sweep Time in Zero Span.

- Press **Sweep 3**
- Then **SweepTime**
- Enter a value using the numeric keypad.
- Then select a multiplier key. Learn about multiplier abbreviations on page 20.

When the sweep time is longer than can be acquired with the current available memory, **Meas UNCAL** is displayed on the screen. Learn more on page 92.

Four times the amount of memory is available with the FieldFox A.04.00 release, allowing longer sweep times in Zero Span.

Triggering

External and Video triggering allows you to start a FieldFox sweep which is initiated by an external event such as a signal burst.

External and Video triggering can be used in either Zero Span (time domain) or frequency span measurements. However, Video triggering in frequency domain sweeps is limited to cases where Res BW is less than or equal to 200 kHz.

FFT Gating is available for non-zero span measurements. Learn more about FFT Gating at: www.agilent.com/find/fieldsfoxsupportFieldFox.htm

NOTE The following Trigger Settings are available ONLY when performing an FFT sweep or when in Zero Span. Learn more about FFT on page 83 . Learn more about Zero Span on page 85.

Trigger Type

- Press **Sweep 3**
- Then **Trigger Settings**
- Then **Trig Type**
- Then choose from the following:
 - **Free Run** Triggering is provided by the FieldFox internal circuitry. A new sweep begins when the previous sweep ends.
 - **External** A sweep is triggered on an external TTL signal at the **EXT TRIG/EXT REF** BNC connector on the FieldFox top panel. Choose to trigger on the rising slope at about 1.7 V or on the falling slope at about 1.0 V using the Trigger Slope setting (below).
 - **Video** A sweep is triggered on a signal at the RF IN connector when the amplitude of the incoming signal exceeds the settable Trigger Level. In frequency domain sweeps, Res BW must be set to 200 kHz or less. This setting is called Video trigger because the signal that initiates the trigger appears on the display.

Trigger Slope

Trigger Slope determines which edge of an External or Video trigger signal initiates a sweep.

- Press **Sweep 3**
- Then **Trigger Settings**
- Then **Trig Slope**
- Then choose from the following:
 - **Pos** Sweep is triggered by the rising (positive) edge of signal.
 - **Neg** Sweep is triggered by the falling (negative) edge of signal.

Trigger Delay

After a valid External or Video trigger signal is received, the sweep begins after the specified Trigger Delay time. Only positive values are allowed.

To see the rising edge of a repetitive signal which is triggered on that edge, use trigger delay to clearly view the **subsequent** signal one period later.

- Press **Sweep 3**
- Then **Trigger Settings**
- Then **Trig Delay**
- Enter a value using the numeric keypad, the **▲▼** arrows, or the rotary knob.
- Then select a multiplier key or press **Enter**. Learn about multiplier abbreviations on page 20.

Trigger Level

Used with Video triggering, an incoming signal with this amplitude or higher (for positive slope) will initiate a sweep. The Units depend on the Scale Type setting: (Log or Linear). Learn more on page 73.

The Video Trigger Level is a time domain (Zero Span) signal level comparison. Therefore, the sweep will trigger close to the displayed level in Zero Span measurements. In frequency span measurements, processing can cause broadband signal energy to display at lower power levels than the originating time domain signal. Therefore, you may need to set the trigger level higher than the displayed level.

- Press **Sweep 3**
- Then **Trigger Settings**
- Then **Trig Level**
- Enter a value using the numeric keypad, the **▲▼** arrows, or the rotary knob.
- Then select a multiplier key or press **Enter**. Learn about multiplier abbreviations on page 20.

Auto Trigger Time

If an External or Video trigger signal is not received before the specified Auto Trig Time, a sweep will occur automatically.

Enter **0** to set Auto Trigger **OFF**. When Auto Trigger is OFF, the FieldFox does NOT sweep unless a valid External or Video trigger signal is received.

- Press **Sweep 3**
- Then **Trigger Settings**
- Then **AutoTrig Time [current setting]**
- Enter a Auto Trig Time using the numeric keypad.
- Then select a multiplier key. Learn about multiplier abbreviations on page 20.

Single / Continuous / Restart

NOTE The following behavior is unique to SA Mode.

This setting determines whether the FieldFox measures continuously or only once each time the **Single** or **Run / Hold +/-** button is pressed. Use **Hold / Single** or to conserve battery power or to allow you to save or analyze a specific trace.

How to set Single, Continuous, or Restart

- Press **Sweep 3**.

- Then choose one of the following:
 - **Continuous**
 - **ON** Causes the SA to make continuous sweeps. This is the typical setting for making measurements. Each **Run / Hold +/-** press causes the SA to toggle between continuous sweep and Hold.
 - **OFF** Causes the SA to Hold. Each **Run / Hold +/-** or **Single** press causes the SA to make ONE sweep, then Hold. The **Hold** annotation changes to an arrow --> while the sweep occurs.
 - **Single** Automatically sets Continuous OFF and causes the SA to make ONE sweep, then Hold.
 - **Restart** Resets the Average counter to 1. When in Hold, causes the SA to make ONE sweep, then Hold. The Average counter has is used with MaxHold and MinHold Trace States. Learn more on page 89.

Points

Points is the number of measured frequencies the X-axis. The higher number of data points, the better the ability to resolve closely spaced signals and the slower the sweep speed.

How to set number of points

- Press **Sweep 3**
- Then **Points [current setting]**
- Then choose from: **101 | 201 | 401 | 601 | 801 | 1001**

Trace Display States

In SA Mode you can display up to four of the following types of trace states. All SA settings are applied to all displayed traces.

A color-coded legend for displayed traces is visible in the left pane of the SA Mode screen:

W = Clear/Write; **M** = MaxHold; **m** = MinHold; **A** = Average; **V** = View

How to display Trace States

- Press **Trace 6**.
- Then **Trace 1,2,3,4** repeatedly to select a trace number to display. Traces are displayed in the following colors:
 - Trace 1 - **Yellow** Trace 2 - **Blue**
 - Trace 3 - **Orange** Trace 4 - **Red**
- Then **State [current setting]**.
- Then choose from the following Trace States:
 - **Clr/Wr** (Clear/Write) Displays the actual measured data for each sweep.
 - **MaxHold** Displays the maximum response of the input signal at each data point over multiple sweeps. See also **Average Count** on page 89.

- **MinHold** Displays the minimum response of the input signal at each data point over multiple sweeps. See also **Average Count** on page 89.
 - **Average** Each data point is averaged over multiple sweeps as set by the Average Count setting. Learn more in following **Average Type** section.
 - **View** Displays and then holds the last complete measurement trace on the screen.
 - **Blank** Displays no trace.
- Press **Default All** to return all traces to their default settings: Trace 1 (Clear/Write); all other traces (Blank).

NOTE **Trace 4** data WILL be overwritten by the FieldFox when using the Independent Source Normalize feature (page 79) or using Field Strength antenna or cable corrections (page 76).

Average Type

In SA Mode, there are four different processes in which Averaging is performed:

- Average Traces – Learn more on page 88.
- Detection Method Averaging – Learn more on page 90.
- Noise Marker Averaging - Learn more on page 92.
- Video BW filtering (for non-Zero Span measurements) - Learn more on page 83.

There are two types of mathematical averaging that can be performed. Select ONE of these types and it is used for all of the above averaging processes.

How to set Average Type

- Press **Meas Setup 4**
- Then choose from the following:
 - **Auto** - The FieldFox chooses the most appropriate type of averaging for the current settings. When Detection Method is set to Average, a Noise Marker is present, or a Channel measurement is active, then **Power Average** is ALWAYS selected. Otherwise, **Log Average** is selected.
 - **Log** Averaging – Best for displaying Trace Averaging. **LgAv** is shown on the left side of the FieldFox screen when selected.
 - **Power** (Linear) Averaging – Best for measuring true power levels. Used in Detection Average and Noise Marker Average. Mathematically, trace noise is 2.5 dB higher than when using Log Average. **PAvg** is shown on the left side of the FieldFox screen when selected.

Average Count

The Average Count setting is used mainly with the Average Trace State described above. In this Trace State, the Average Count setting determines the number of sweeps to average. The higher the average count, the greater the amount of noise reduction.

When Trace (display) State is set to **Average**, **MaxHold**, or **MinHold**, the average counter is shown in the left edge of the screen below the Average Type.

For all three of these Trace States, when **Sweep 3 Continuous** is set to **OFF**, press **Restart** to reset the sweep count to 1, perform <n> sweeps, then return to **Hold**.

How to set Average Count

- Press **Meas Setup 4**
- Then **Average Count**
- Enter a value from 1 to 10,000 using the numeric keypad, the **▲▼** arrows, or the rotary knob.
- Press **Enter**

Detection Method

In SA Mode, the X-axis is comprised of data points, also known as “buckets”. The number of data points is specified using the Resolution setting. Learn how on page 88.

Regardless of how many data points are across the X-axis, each data point must represent what has occurred over some frequency range and time interval.

From the frequency span of the measurement, the span of each data point is calculated as $(\text{frequency span} / (\text{data points} - 1))$. The detection method allows you to choose how the measurements in each bucket are displayed.

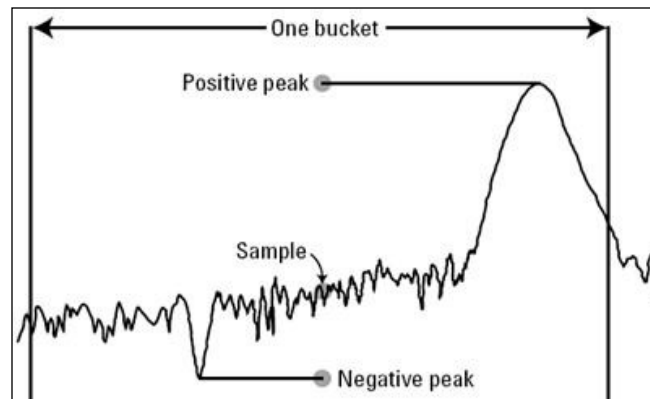

One bucket showing Positive peak, Sample, and Negative peak Detection methods.

How to set Detection Method

The current Detection method is labeled on the left edge of the screen. When a method is selected manually, a # precedes the label. For example: # **Nrm** means that **Normal** was selected from the softkeys.

- Press **Trace_6**
- Then **Detector**
- Then choose from the following:
 - **Auto** Displays the most appropriate Detection method based on other settings. [**# is NOT shown**]

- **Normal [Nrm]** Provides a better visual display of random noise than **Positive peak** and avoids the missed-signal problem of the **Sample Mode**. Should the signal both rise and fall within the bucket interval, then the algorithm classifies the signal as noise. An odd-numbered data point displays the maximum value encountered during its bucket. An even-numbered data point displays the minimum value encountered during its bucket. If the signal is NOT classified as noise (does NOT rise and fall) then Normal is equivalent to Positive Peak.
- **Positive Peak [Pk]** Displays the maximum value of all the measurements in each bucket. This setting ensures that no signal is missed. However, it is not a good representation of the random noise in each bucket.
- **Negative Peak [NPK]** Displays the minimum value of all the measurements in each bucket.
- **Sample [Smp]** Displays the center measurement of all the measurements in each bucket. This setting gives a good representation of the random noise in each bucket. However, it does not ensure that all signals are represented.
- **Average [#RMS]** Displays the Root Mean Squared (RMS) average power of all the measurements in each bucket. This is the preferred method when making power measurements. Learn more on page 153.

Display Line

A display line is a simple, horizontal line that can be placed at any amplitude level on the SA screen. Use a display line as mental guide for visual feedback. A display line is similar to a Limit Line, except that no PASS/FAIL testing occurs. A display line is easier to create than a Limit Line. Learn about Limit lines on page 154.

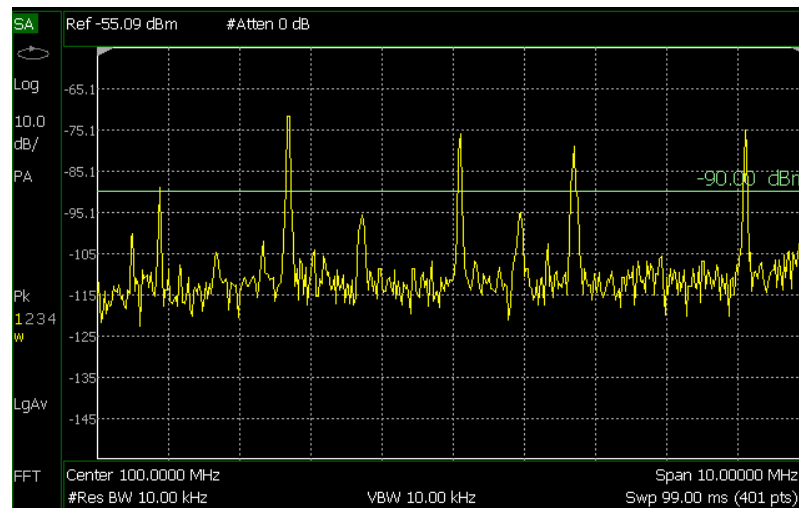

Display line with annotation

How to create and move a Display Line

- Press **Limit 8**
- Then **Display Line OFF ON**

- Then enter a Y-axis value using the  arrows or the rotary knob, then press **Enter**. Or enter a value using the numeric keypad and press a suffix key or press **Enter**.

Noise Marker

For comparison purposes, electronic noise measurements are often displayed as though the measurement was made in a 1 Hz Res BW. However, making an actual measurement at a 1 Hz Res BW is impossible, and at 10 Hz, extremely slow.

A Noise Marker, unique to SA Mode, mathematically calculates the noise measurement as though it were made using a 1 Hz bandwidth.

Several data points (or ‘buckets’) are averaged together to calculate the Noise Marker readout. To accurately measure noise, the Noise Marker should NOT be placed on, or too close to, a signal. The distance from a signal depends on several factors. To know if an accurate reading is being made, move the Noise Marker until consistent measurements are displayed in adjacent data points.

In addition, when a Noise Marker is displayed, the Detection method is automatically switched to Average and **PAvg** is shown on the FieldFox screen. This occurs only when Detection is set to Auto. Learn more on page 90.

With a Noise Marker present, the Res BW can be changed and the displayed noise floor will also change, but the Noise Marker readout will remain about the same.

Noise Markers can be used like regular markers. A Noise Marker is distinguished from a regular marker by **(1Hz)** after the marker readout value. Learn more about regular markers on page 144.

How to measure Noise with a marker

- Press **Marker** to create or select a Normal or Delta marker to use to measure Noise.
- Then **More**.
- Then **Marker Function**.
- Then **Noise ON OFF**.

Band/Interval Power Marker

A Band/Interval Power marker, unique to SA Mode, accumulates the power that is measured over several adjacent data points (or ‘buckets’). The range of buckets being measured is displayed with vertical posts around the marker. This Band Span value is selectable.

This feature is very similar to a channel power measurement (page 96).

When the frequency span is set to Zero span, the marker is referred to as an Interval marker because it averages power over a specific time interval. In this case the range is specified as the Interval Span. Learn more about Zero span measurements on page 85.

If the Detection method and Averaging type are set to Auto when you enable a Band/Interval Power marker, the Detection method will change to Average (RMS) and Averaging type will change to Power average. Other Detection methods or Averaging type settings will usually cause measurement inaccuracy. Learn more about Detection method on page 90, and Averaging Type on page 89.

Summary:

- In Zero span, an Interval Power Marker yields the **average power** over the specified time interval.
- In non-Zero span, a Band Power Marker yields the **total power** over the specified frequency range.

How to measure Band/Interval Power with a marker

- Press **Marker** to create or select a Normal or Delta marker to use to measure Band/Interval Power.
- Then press **More**
- Then **Marker Function**
- Then **Band/Int Power**
- Then **Band (or Interval) Span**
- Then choose from the following:
 - **Auto** Measures power over 5% of the displayed span, or ½ graticules. The Band Span is automatically updated to remain at 5% when you change the frequency span.
 - **Man** Enter a frequency or time value using the **▲▼** arrows or the rotary knob, then press **Enter**. Or enter a value using the numeric keypad and select a frequency or time suffix. The Band Span remains at the frequency or time value that you set as the span changes.

Frequency Counter at Marker

Available in SA Mode ONLY. Use any existing marker to make highly-accurate frequency counter readings. For highest accuracy, lock the FieldFox to a stable external frequency reference. Learn how on page 178.

When Frequency Counter is ON, the FieldFox uses background sweeps to zoom on the signal, measure the signal peak with 1 Hz resolution, and display the frequency of the signal peak in the marker annotation area. The marker does not move to the signal peak.

When Freq Counter is ON, measurement sweeps are considerably slower.

How to use Frequency Counter

- Press **Marker**.
- Press Normal, Delta, or Peak, or select an existing marker to use as a frequency counter.
- Locate the marker somewhere on a CW signal. It does NOT have to be on the peak.
- Then **More**
- Then **Freq Count ON**
- With Freq Count ON, you can scroll through the existing markers that are located on a discrete CW signal, and read the frequency of the signal peak. However, each frequency count update requires another sweep. If the FieldFox is in HOLD, press **Single** to update the frequency count results.

Audio Beep at Marker Power

When enabled, the Audio Beep feature emits a repetitive beep sound which varies in tone pitch and repetition rate to indicate the relative power level of the active marker. The highest tone pitch and fastest beep rate occurs when the marker Y-axis position is at the top of the display. Conversely, the lowest pitch and repetition rate occurs at the bottom of the display. Therefore, it is important to scale the signals that you intend to measure between the top and bottom of the screen. Learn more about Scale on page 73.

Audio Beep can be used with any marker type or function, including Band/Interval Power. Learn more on page 92.

How to use Audio Beep

- Press **Marker**
- Optionally, press **Marker 1 2 3 4 5 6** to select an existing marker to use with Audio Beep. A marker will be created if one does not already exist.
- Then **More**
- Then **Marker Function**
- Then **Audio Beep ON OFF**

Audio Beep does NOT beep when the FieldFox is in Hold mode.

While Audio Beep is ON, press **Marker 1 2 3 4 5 6** to toggle Audio Beep through the existing markers.

To set FieldFox speaker volume control, press **System**, then **Volume**. Learn more on page 169.

Meas UNCAL Error

Meas UNCAL appears in the lower-left corner of the screen when the FieldFox can NOT display accurate measurement results with the current settings. Usually, the part of the trace that is inaccurate is shown at -200 dB.

The following situation can produce **Meas UNCAL**:

- In Zerospan, when Sweep Time is set too high for the current Res BW. Lower the Res BW or the Sweep Time setting.
- When the ResBW/VBW ratio exceeds 10,000, causing the VBW filter to reach the maximum capacity for averaging.

Old Data Indicator (*)

In SA mode, when the current trace does not exactly match the annotation that is on the screen, an asterisk is displayed in the upper-right corner of the screen graticule area. This would occur, for example, when the Res BW setting is changed while in sweep Hold mode. The annotation is changed immediately, but the trace is not updated until the next sweep occurs. Therefore, the current data trace does not match the screen annotation. See the asterisk on page 68.

Channel Measurements

The following Channel Measurements are offered in SA Mode:

Channel Power	96
Occupied Bandwidth.....	97
Adjacent Channel Power Ratio	99

The following four sections (Radio Standards and Channel Measurements, Measurement Preset, Averaging, and Traces) are relevant for ALL Channel Measurements.

Radio Standards and Channel Measurements

To tune the frequency range of any of the Channel Measurements using channels instead of frequency, first select a Radio Standard, then select Units = CHAN. Learn how to select a Radio Standard and channels on page 71.

When you **first select a Radio Standard**, then select a **Channel Measurement**:

- With Units = **FREQ** selected, the center frequency and span will ALWAYS change to the full frequency range of that standard (Uplink and Downlink) to allow for a quick scan of energy. The X-axis annotation indicates the frequency range.
- With Units = **CHAN** selected, the FieldFox chooses either the uplink or downlink band, and displays that range of frequencies. You can then tune within that Standard using Start CHAN, Stop CHAN, or Center CHAN. The X-axis annotation indicates the frequency range.

When you **first select a Channel Measurement**, then select a **Radio Standard**, the BW, Offset, RRC, Integration BW, and Span settings are changed to those of the standard. In addition, Res BW can also change when set to 'Auto(couple)'. However, center frequency is NOT changed unless you first select Units = CHAN.

Measurement Preset

Measurement Preset allows you to easily reset any of the channel measurements to its default settings. The Center Frequency, Preamp ON|OFF, RF Attenuation, Markers, Limits, and Radio Standard settings are NOT reset.

To select Measurement Preset:

- Press **Preset** then **Meas Preset**

Averaging

By default in ALL Channel measurements, averaging is enabled and set to display the average of the last 15 measurements. When enabled, this average setting is automatically making the following 'averaging' settings in order to provide the most accurate power measurements:

- Averaging Type is set to Power.
- Trace State is set to Average.
- Detector is set to Average.
- Count is set to 15.

Any of these settings can be changed manually during a Channel measurement. Learn more about these settings starting at page 89.

To change Averaging:

- Press **Meas Setup 4**.
- Then **Average Enable ON OFF** OFF effectively sets the Average Count to 1.
- Then **Average Count**
- Enter a value between 1 and 10,000 using the numeric keypad, **▲▼** arrows, or the rotary knob.
- Press **Enter**.

Traces

Only one measurement trace can be displayed in Channel Measurements.

Channel Power (CHP)

Channel Power measures total power over the specified Integrated BW. The Integration Bandwidth (IBW) can be adjusted to measure the power over multiple channels.

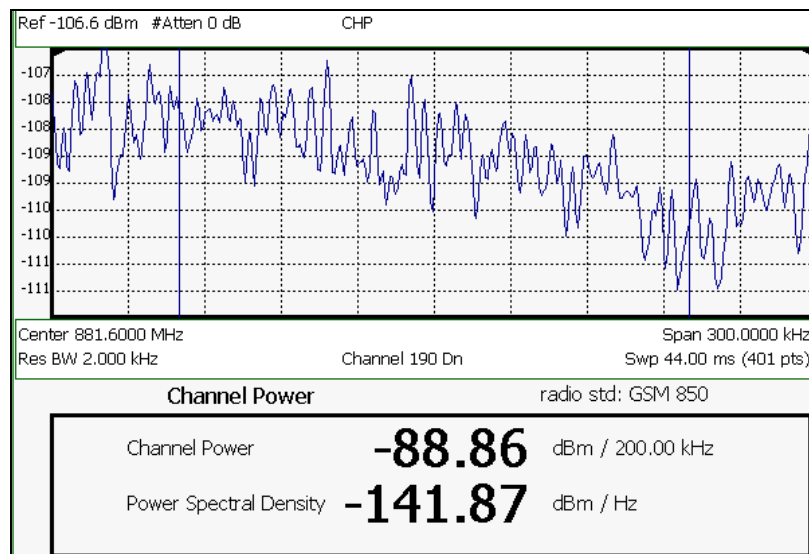

Channel Power measurement; Chan 190 Downlink; GSM850 Radio Standard

The following two Channel Power levels are displayed:

- **Channel Power** - measures total power over the specified Integrated BW.
- **Power Spectral Density** – same measured power, but mathematically normalized to a 1 Hz bandwidth using the same algorithm as Noise Marker. Learn more about the Noise Marker on page 91.

How to select Channel Power

- Press **Measure 1**
- Then **Channel Measurements**
- Then **Channel Power**

When Channel Power is selected, the following settings are maintained from a previous measurement: Center Frequency, Preamp ON|OFF, and RF Attenuation.



Integration Bandwidth

When Channel Power is selected, vertical posts appear on the display to mark the current Integration Bandwidth setting. The displayed Channel Power and Power Spectral Density values are measured and calculated over the specified Integration Bandwidth.

By default, the displayed frequency span is automatically coupled to the Integration Bandwidth. As you change the Integration Bandwidth, the frequency span is adjusted so that the vertical posts appear to NOT move. However, when you manually change the frequency span, the Integration Bandwidth is no longer coupled to the frequency span.

When a Radio Standard is selected, the appropriate Integration Bandwidth is set automatically. Learn more about Radio Standards on page 71.

To change Integration Bandwidth:

- Press **Meas Setup 4**
- Then **Integrating BW**
- Enter a value between 100 Hz and 3 GHz using the numeric keypad,   arrows, or the rotary knob.
- Press **Enter**

Other Channel Power Settings

All relevant FieldFox settings are made automatically to ensure the highest accuracy, such as ResBW, VideoBW, and sweep (SwpAcquisition) speed. These, and all other SA Mode settings, can be changed manually in a Channel Power measurement.

- Learn about Measurement Preset on page 95.
- Learn about Averaging on page 95.
- Learn about RRC Weighting on page 102.

Occupied Bandwidth

Occupied Bandwidth measures the power of the displayed frequency span and displays vertical posts at the frequencies between which the specified percentage of the power is contained. The frequency span between the two vertical posts is the Occupied Bandwidth. The Occupied Power, the power that is contained between the two posts, is also displayed in dBm.

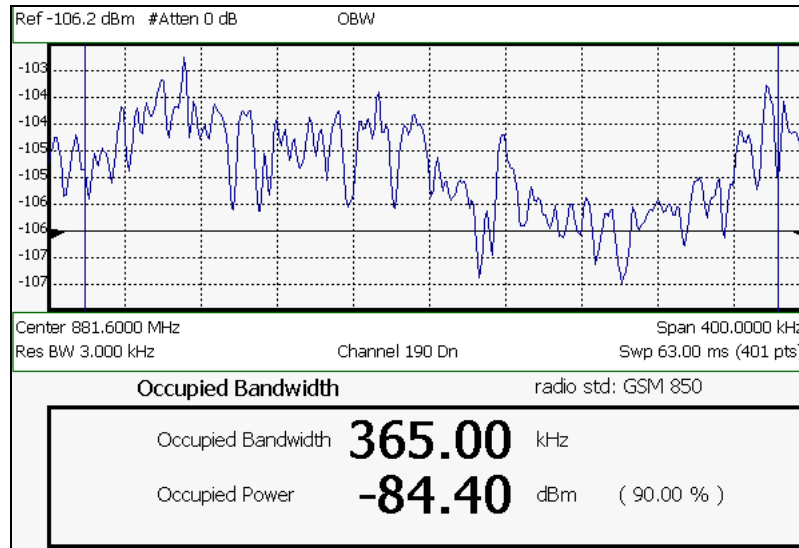

OBW measurement; Chan 190 Downlink; GSM850 Radio Standard

How to select Occupied Bandwidth

- Press **Measure_1**
- Then **Channel Measurements**
- Then **Occupied BW**

When Occupied Bandwidth is selected, the following settings are maintained from a previous measurement: Center Frequency, Preamp ON|OFF, and RF Attenuation.

Frequency Span

Occupied BW is calculated from power that is measured over the entire displayed Frequency Span. The frequency span can be entered using arbitrary frequencies or by using a Radio Standard in conjunction with channel numbers. Learn how to select a Radio Standard and channels on page 71.

To change Frequency Span:



- Press **Freq/Dist**
- Then **Freq Span**
- Enter a value using the numeric keypad, **▲|▼** arrows, or the rotary knob.
- Press **Enter**

Power Percent

This setting specifies the percentage of total measured power to display between the vertical posts. The measurement defaults to 99% of the occupied bandwidth power. The remaining power (1% of default setting) is evenly distributed; .5% of the power on the outside of each side of the vertical posts.

To change Power Percent:

- Press **Meas Setup 4**
- Then **Power Percent**

- Enter a value between 10 and 99.99 using the numeric keypad,   arrows, or the rotary knob.
- Press **Enter**.

Other Occupied Bandwidth Settings

All relevant FieldFox settings are made automatically to ensure the highest accuracy, such as ResBW, VideoBW, and sweep (SwpAcquisition) speed. These, and all other SA Mode settings, can be changed manually in a Occupied Bandwidth measurement.

- Learn about Measurement Preset on page 95.
- Learn about Averaging on page 95.

Adjacent Channel Power Ratio(ACPR)

ACPR measures the power of a carrier channel and the power in its adjacent (offset) channels. The measurement results can help you determine whether the carrier power is set correctly and whether the transmitter filter is working properly.

You can measure the channel power in one, two, or three adjacent (offset) channels on the low frequency and high frequency side of the center channel.

Limits can be used to quickly see if too much power is measured in the adjacent channels.

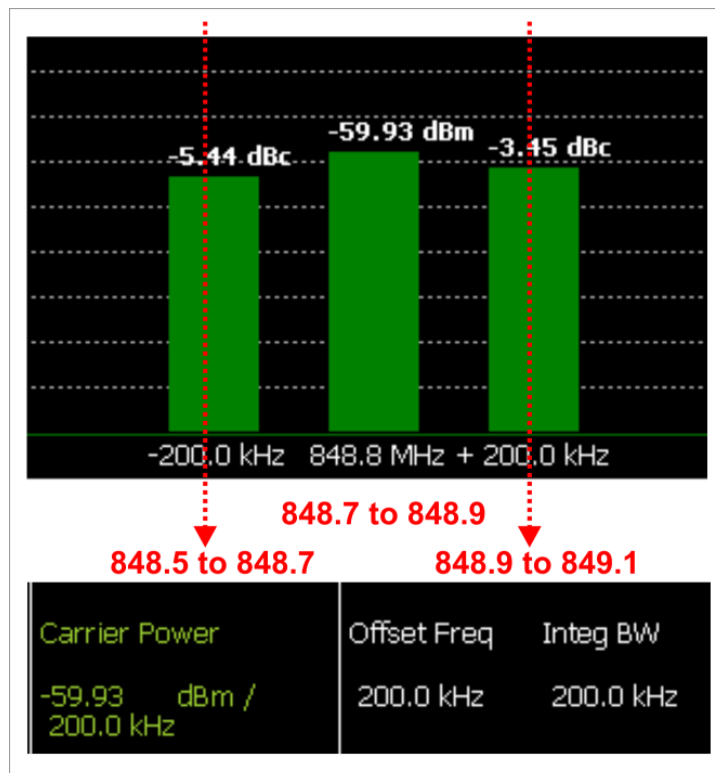

GSM 850-Ch 251-Up with one Offset.
Red Freqs (Mhz) added to illustrate Offset and Integ BW.

Data in the ACPR graphical chart is always presented in dBm for the carrier, and dBc (dB below the carrier) for the offsets. This can NOT be changed. Use the **Meas Type** setting (next page) to change how the data is presented in the table below the graph.

How to select ACPR

- Press **Measure 1**
- Then **Channel Measurements**
- Then **Adjacent Channel Power**

When ACPR is selected, the following settings are maintained from a previous measurement: Center Frequency, Preamp ON|OFF, and RF Attenuation.

Frequency Range/Channel

When a Radio Standard is selected, the appropriate center frequency or channel and span is set automatically. The frequency or channel number can then be changed from the **Freq/Dist** menu. Learn how to select a Radio Standard and channels on page 71.

The frequency range of an ACPR measurement can also be entered using arbitrary frequencies.

When a Radio Std is NOT selected, the center frequency of a previous measurement is maintained when ACPR is selected.

Integration Bandwidth

The Integration Bandwidth of the carrier and offsets is the frequency span over which power is measured.

To change Integration Bandwidth:

- Press **Meas Setup 4**
- Then **Integrating BW**
- Enter a value between 100 Hz and 100 MHz using the numeric keypad, **▲▼** arrows, or the rotary knob.
- Press **Enter**

How to define adjacent (Offset) channels

An offset represents a range of frequencies over which power is measured. You can specify up to three offsets. The frequency range for each offset is specified with an Offset Freq and Integ BW. Each offset that is created has a Lower (carrier MINUS Offset Freq) and Upper (carrier PLUS Offset Freq) set of frequencies.

- Press **Meas Setup 4**
- Then **Offsets**
- Press **Offset 1 2 3** to select an offset.
- Then **Offset State** to set that offset ON or OFF.
- Select **Offset Freq** This is the difference between the **carrier center frequency** and the **center frequency of the offset channel**. Then enter a value using the numeric keypad.

- Select **Offset Integ BW** This is the frequency range over which power is measured in that offset; half of the range below and half above the Offset Freq.

How to set limits for adjacent channels

You can set a unique threshold power for each of the offsets that will cause a FAIL indication (RED bar). This occurs when the calculated **dBc** power (on top of the offset bar) is ABOVE the specified level.

To set limits, with an ACPR measurement on the screen:

- Press **Limit 8**
- Then **Set Limits (1,2, or 3)**
- Then choose from the following:
 - **Lower Offset** Sets a limit for the lower-frequency offset.
 - **Upper Offset** Sets a limit for the higher-frequency offset.
- Then enter a value using the numeric keypad, **▲|▼** arrows, or the rotary knob.
- Then **Limit Test ON OFF**

Measurement Type

This setting determines how the measured carrier and offset power levels in the **table** are presented. (Data in the graphical chart is always presented in dBm for the carrier and dBc for the offsets.)

To select Meas Type:

- Press **Meas Setup 4**.
- Then **More**
- Then **Meas Type**
- Then choose from the following:
 - **Total Pwr Ref** – Integrated carrier power is represented in dBm, and relative powers between offsets and carrier are represented as dBc (dB below the carrier).
 - **PSD Ref (Power Spectral Density)** – Integrated carrier power is normalized to a 1 Hz density as dBm/Hz using a similar algorithm as Noise Marker. Learn more about the Noise Marker on page 91.

For both Meas Types, choose the reference for the offset data.

- **Auto** – dB or dBc value is computed by subtracting the measured carrier power from the measured offset power.
- **Man** – dB or dBc value is computed by subtracting the entered RefValue from the measured offset power.
 - Press **Ref Value**
 - Then enter a value to be used to reference the data using the numeric keypad, **▲|▼** arrows, or the rotary knob.

Other ACPR Settings

All relevant FieldFox settings are made automatically to ensure the highest accuracy, such as ResBW, VideoBW, and sweep (SwpAcquisition) speed. These, and all other SA Mode settings, can be changed manually in a ACPR measurement.

- Learn about Measurement Preset on page 95.
- Learn about Averaging on page 95.

RRC Weighting

RRC, or Root-Raised-Cosign weighting, is offered with Channel Power and ACPR measurements.

When RRC Weighting is applied to transmitted and received power, the edges of the channel are 'smoothed' to help prevent interference. To accurately measure a channel that has RRC weighting, set the same value of RRC weighting as that used in the transmitter and receiver.

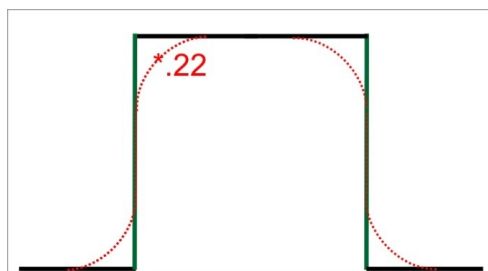

Channel power measurement with .22 RRC applied

RRC Weighting is set and enabled automatically when included in a selected radio standard.

To set and enable RRC Weighting:

- Press **Meas Setup 4**
- Then **RRC Weighting ON OFF**
- Then **More**
- Then **RRC Alpha [current setting]**
- Enter a value between 0 (no smoothing) and 1 (most smoothing) using the numeric keypad, **▲▼** arrows, or the rotary knob. A standard level of filtering is .22.
- Press **Enter**

Interference Analyzer (SA Mode) - Option 236

Option 236 provides Spectrogram display, Waterfall display, and Record/Playback. .

In this Chapter

Spectrogram and Waterfall Displays	103
Spectrogram Display	103
Common Waterfall and Spectrogram Settings	105
Waterfall Display	106
Record Playback	107
About Sessions	107
About State and User Tags	108
How to Record a Session	109
How to Playback a Session	110
Recording Configuration	111
Playback Configuration	113
Manage Sessions	113
Record Playback Example	114

Spectrogram and Waterfall Displays

Spectrogram and Waterfall displays provide a visual history of the measured spectrum. Each display type can be used to locate intermittent signals or to view signal levels over time.

Spectrogram is a single horizontal line of color-coded power while Waterfall uses a 3-D color-coded display. The functional difference between these two displays is that Spectrogram provides less trace detail than Waterfall display. However, it also allows more traces to be viewed.

These two displays can NOT be used with Channel Measurements.

NOTE: Although this document refers to past traces as ‘records’ these traces are not saved in Spectrogram and Waterfall displays. They are only drawn on the FieldFox screen.

Spectrogram Display

Spectrogram draws the most recent trace record at the top of the stack of previously-drawn trace records. Drawing the live trace on the display is optional.

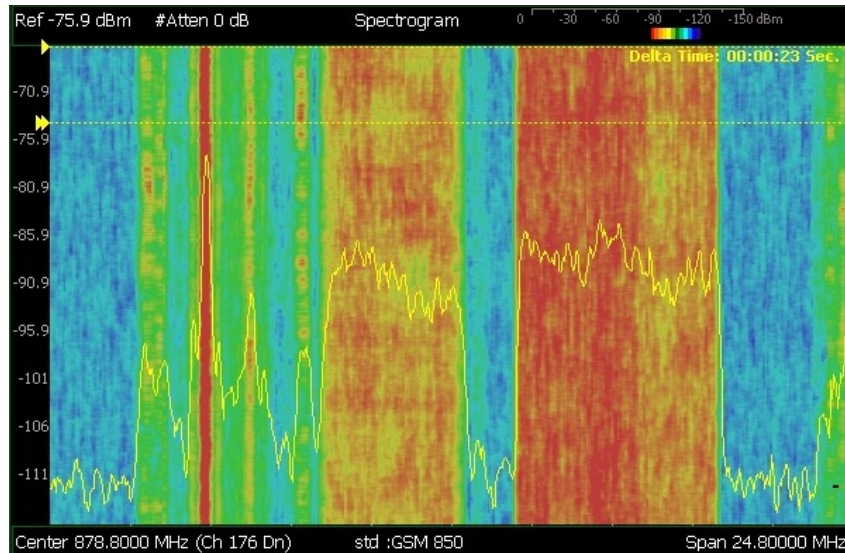

Spectrogram display- Overlay view- with time markers 23 seconds apart.

The following settings all contribute to the sweep time of an individual trace, and therefore, the total elapsed time that can appear on the screen in Spectrogram display:

- Frequency Range. Learn more on page 69.
- Resolution BW and Video BW. Learn more on page 79
- Sweep Time (Acquisition). Learn more on page 83.
- Resolution (Number of Points). Learn more on page 88.

How to select Spectrogram

- Press **Meas 1**
- Then **Interference Analysis**
- Then **Spectrogram**

How to modify the Spectrogram

You can change how the spectrogram is displayed relative to the data trace. This setting affects the total number of trace records that can be displayed.

- Press **Meas Setup 4**.
- Then **Spectrogram Settings**
- Then **Spectrogram View**
- Then choose from the following:
 - **Overlay** Displays the data trace over the spectrogram with NO graticules. Total trace records: 340.
 - **Full Screen** Displays the spectrogram with NO data trace. Total trace records: 340.
 - **Top** Displays the data trace above the spectrogram. Total trace records: 130.
 - **Bottom** Displays the data trace below the spectrogram. Total trace records: 130.

How to Restart the Spectrogram

Press **Sweep 3** then **Restart**

Averaging

Averaging can be enabled on the underlying measurement. Press **Meas 4** then **Average Type**. Learn more on page 88.

Common Settings for Waterfall and Spectrogram

Set Red and Blue Limits

The colors displayed on the Waterfall and Spectrogram represent the various measured power levels:

- Red = Highest power levels
- Blue = Lowest power levels

NOTE: The full Red-to-Blue color spectrum is visible only with Indoor display colors. Learn more on page 171.

Adjust the Red and Blue limits to the power levels that you expect to measure. The Blue limit must always be less than the Red limit.

- Press **Meas Setup 4**.
- Then **Spectrogram / Waterfall Settings**
- Then choose from the following:
 - **Red Limit** Using the **▲▼** arrows , rotary knob, or keypad, select the HIGHEST power level that you expect to measure. This power level, and those measured higher than this level, appear Red.
 - **Blue Limit** Using the **▲▼** arrows , rotary knob, or keypad, select the LOWEST power levels that you expect to measure. This power level, and those measured lower than this level, appear Blue.

Time Markers

Use Time Markers to determine the elapsed time between any two displayed records.

NOTE: Spectrogram displays the most recent record at the top of the screen. Waterfall displays the most recent record at the bottom.

To create Time Markers:

- Press **Meas Setup 4**
- Then **Time Markers**
- Then **Time**
- Then enter a value from 0 (the most recent sweep record) to the maximum value, using the numeric keypad, **▲▼** arrows, or the rotary knob. A **▶** indicates the Time Marker.
- Then **Delta**
- Then enter a value from 0 (the most recent sweep record) to the maximum value, using the numeric keypad, **▲▼** arrows, or the rotary knob. A **▶▶** indicates the Delta Marker.

- At the current sweep speed, the difference in time between these two markers appears at the upper-right corner of the view as **Delta Time: hh:mm:ss Sec.**
- An invalid (very large number) appears when a trace record is not available at one or both of these markers.

How to Restart the Spectrogram

Press **Sweep 3** then **Restart**

Averaging

Averaging can be enabled on the underlying measurement. Press **Trace 6** then **State [Average]**. Learn more on page 88.

Measurement Preset

Measurement Preset resets ONLY the Spectrogram and Waterfall display settings. It does not reset the measurement settings.

- Press **Preset**
- Then **Meas Preset**

Waterfall Display

The live trace is always drawn on a Waterfall display. Older trace records scroll up from the displayed trace and eventually off the screen. Because of this, locate the live trace on the bottom of the screen using the scale and reference settings. Learn more on page 73.

Note: Although this document refers to past traces as ‘records’ these traces are not saved. They are only drawn on the FieldFox screen.

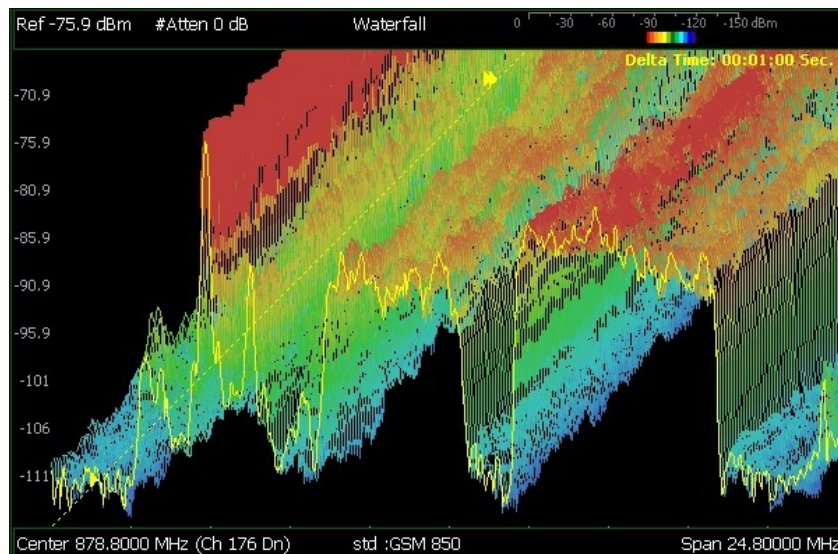

Waterfall display- moderate angle- with time markers 1 minute apart.

The following settings all contribute to the sweep time of an individual trace, and therefore, the total elapsed time that can appear on the screen in Waterfall display:

- Frequency Range. Learn more on page 69.

- Resolution BW and Video BW. Learn more on page 79
- Sweep Time (Acquisition). Learn more on page 83.
- Resolution (Number of Points). Learn more on page 88.

Waterfall Angle

This setting allows you to show more or less detail. More detail provides fewer (time) records.

- Press **Meas Setup 4**
- Then **Spectrogram Settings**
- Then **Waterfall Angle**
- Then choose from the following:
 - **Moderate** Compromise between detail and number of records.
 - **Steep** Least detail with highest number of records.
 - **Gradual** Most detail with lowest number of records.
 - **Wide Angle** Moderate angle with increased space between records.

Learn how to set **Red and Blue Limits** and **Time Markers** on page 105.

Record Playback

Record Playback allows you to record SA trace sweeps and play them back at a later time. Use this feature to monitor spectrum activity over a period of time.

You can record traces continuously, record a specified number of traces (segments), or record when triggered by a specified power level.

Traces can be recorded from, or played back into, any measurement type (such as Channel Power or Occupied BW) or any display type (such as Spectrogram and Waterfall).

When GPS is enabled and displayed, the current location and elevation are saved and played back with traces.

Recordings can be saved to the FieldFox Internal memory, an SD Card, or a USB flash drive.

About Sessions

A Recording Session is a collection of recorded traces and the instrument states that generated them.

Before recording can occur, a new session must be initiated or an existing session must be opened. Sessions can later be opened for playing or continued recording. Only one session can be open at a time.

You close the session when finished recording or playing. A session is also closed when the FieldFox is Preset (or Mode Preset), an Instrument State is recalled, or when Mode is changed from SA.

Each session is saved as a folder containing a set of files on the specified storage device.

How long can a recording session last?

There are many variables that determine the possible length of a recording session. But one key variable is the amount of available memory.

When a session is opened or a new session is initiated, an estimate is made of the maximum number of traces that can be saved, based on the available disk space and the current number of data points (resolution). Recording will stop when that number is reached. This estimate always maintains 4 MB of available disk space on the specified storage device. You can decrease the number of traces to further limit recording. The resolution setting can NOT be changed after a session is opened.

To maximize the amount of space that is available, save recorded traces to a USB Flash drive or SD card. Learn how in Manage Sessions on page 113.

You can determine the length of time over which recording can occur by setting the Record Interval (the time between recorded traces) and other settings. Learn more in Recording Configuration on page 111.

To view and edit the maximum number of records

Just after opening or initiating a session...

- Press **Session Data**
- Then **Trace Record Limit <n>** (n = Max number of traces that can be recorded).
- **Clear All Records** Empties that session of recorded traces. Learn more in Manage Sessions on page 113.

FieldFox Setting Changes during Record and Playback

During Recording

When any of the following State settings are changed during recording, the State counter is incremented (see About State and User Tags on page 109) and the settings are saved to the Session file along with the first trace to be recorded with the new setting. During playback, the trace and display annotation will reflect the change on the screen.

State settings: Frequency Range, Resolution BW, Video BW, Zerospan Sweep Time, Sweep Acquisition, Preamp On/Off, Attenuation, Detector, Average Type, Trigger Settings, Independent Source.

Other display settings, such as Scale and Reference Level, can also be changed during recording but are not saved with the session file. Think of these as settings that help YOU see the recording and playback activity. They do NOT change the data that is recorded.

During Playback

The State setting changes listed above are NOT allowed during playback.

However, all other display settings can be changed during playback to help you analyze the recorded data.

The recordings can be played into different measurements such as Channel Power or Occupied BW. When the recorded data is not compatible with the measurement type, a **MEAS UNCAL** message will appear on the screen.

The data can also be played back in Spectrogram and Waterfall displays.

Record/Playback Exceptions

- Markers can be activated and moved to help analyze recorded data. However, marker position control is only available when playback is Paused.
- Field Strength Corrections is saved with the session file and it is also allowed during playback. Learn about this Field Strength Corrections on page 76.
- Frequency Counter at Marker is NOT allowed during Recording or Playback. Learn about this feature on page 93.

About State and User Tags

When any of the State settings (listed above) are changed during a recording, a 'state tag' is inserted at the first trace number to be recorded with the new setting.

In addition, you can insert a 'User Tag' at any time during a recording session to indicate an external event, such as when an antenna is moved. During playback, you can move quickly to any of these tags, or scroll through these tags.

A symbol is used on the screen annotation to distinguish a User Tag from a State Tag when scrolling through tags during playback.

Screen Annotation

During a record or playback session, the following is displayed in the top-left area of the screen:

AutoSession02: 92/95 (state 4/5) * _
Sep.22.2009 09:15:15 AM

where:

- **AutoSession** is an auto-generated name for sessions. **02** is the auto-generated number, incremented with each new session. The name can be changed using Manage Sessions. Learn more on page 113.
- **92/95** is the current and total trace number: currently trace is 92 of 95 total traces.
- **state 4/5** is the current and total state tag or user tag number: 4 of 5 total tags.
- ***** (Asterisk) indicates that a state has changed. **#** (Pound) indicates that a User Tag has been inserted.
- **Sep.22...** is the date and time of recording.
- When GPS is enabled and displayed, the current location and elevation are annotated at the bottom of the playback display. Learn more about GPS on page 176.

NOTE If Recording or Playback is not occurring when you think it should, check the following:

- Is the sweep in **HOLD**? (upper-left annotation)
- Is Recording or Playback **Paused**? (mid-left annotation)
- Is the Record or Playback **Interval** set to a long delay? (Configuration settings.)

How to Record a Session

- Press **Trace 6**
- Then **Record Playback Setup**
- Optionally set resolution (points). Learn how on page 88. This can NOT be changed after a session is opened.
- Then either:
 - **New Session** OR
 - **Recall Session** then **Open** and select a session.
- Then **Recorder Player**
- Then **Record**

REC is displayed in the left of screen graticules.

During recording, choose from the following:

- **Pause Resume** Temporarily halts recording until pressed again. The incoming trace continues to sweep. Press again to continue recording.
- **Stop** Immediately stops recording. Then choose from the following:
 - Press **Play** to start replaying the recording from the beginning.
 - Press **Record** to continue recording.
- **User Tag** Press to insert a User Tag at the current recorded trace. This allows you to quickly move to this location during playback. Learn more in **About State and User Tags** on page 109.

How to Playback a Session

- Press **Trace 6**
- If the session is already open, skip the following step. Otherwise:
- Then **Record Playback Setup**
 - Press **Recall Session** Then select a session to playback and press **Open**.
- Then **Recorder Player**
- Then **Play**

PLAY is displayed in the left of screen graticules during playback. When the end of the recording is reached, playback begins again at trace 1 and continues to loop indefinitely.

During playback, choose from the following:

- **Pause Resume** Temporarily halts playback. Then choose from the following:
 - **Pause Resume** Press to continue playing.
 - **Playback State/Tag** Allows you to continue playback from a state tag, or scroll through the state tags. Enter a value between 1 and the total number of state tags using the numeric keypad, **▲▼** arrows, or the rotary knob. Learn more in **About State and User Tags** on page 109.

- **Playback Trace** Activated automatically when **Paused**. Allows you to continue playback from a specific trace, or scroll through traces manually. Enter a value between 1 and the total number of traces using the numeric keypad, **▲▼** arrows, or the rotary knob.
- **Stop** Immediately stops playback. Then choose from the following:
 - **Play** Start playback from trace 1.
 - **Record** Resume recording from the last recorded trace.
 - **Record Playback Setup** Return to the setup menu to change Configuration settings or Close the session.

Recording Configuration

To change Recording Configuration settings:

- Press **Trace 6**
- Then **Record Playback Setup**
- Then **New Session** or **Recall** an existing session.
- Then **Recording Configuration**

Then choose from the following:

- **Record Time** Sets the amount of time to record traces. Default is MAX, which is to record indefinitely. Enter a value between 1s and 1 Ms (million) seconds using the numeric keypad, **▲▼** arrows, or the rotary knob. When set, a timer appears during recording in the lower-left corner which counts DOWN from the specified time.
- **Record Source** Sets where, in the FieldFox data flow, data is recorded. **Learn more about Record Source on page 112.**

Choose from the following:

- **RawMeas** Records raw measurement data.
- **Trace 1,2,3,4** Records data from the corresponding trace in its current state.
- **Record Interval** Sets the amount of time to wait between individual trace recordings. Default is MIN, which is to wait 0 seconds (record traces as fast as possible). Enter a value in seconds between 0 (no delay) and 10,000 seconds - about 3 hrs) using the numeric keypad, **▲▼** arrows, or the rotary knob.
- **Segment Count** Sets the number of traces to record, after which the recording will automatically pause. Press **Pause/Resume** or **Record** to capture another N traces, or **Stop** to end recording. Default is OFF, which is NO limit to the number of traces to be recorded. When set, a counter appears in the lower-left corner which counts UP to the specified number of recordings.
- **FreqMaskTrigger** Sets the power level which will trigger a recording. Set these power levels (mask) exactly as you would set Limit Lines. (Learn how on page 154.) With **Record ON**, when any data point measurement is higher than an upper limit, or lower than a lower limit, recording begins. See Frequency Mask Trigger Configuration in the following section to learn how to configure the mask.

Typically you would use FreqMaskTrigger with Segment Count, but it can also be used with Record Time and Record Interval.

When used with **Segment Count**:

- When a mask limit is exceeded, subsequent traces are recorded until the specified segment count is reached. Once segment count is reached, exceeding another mask limit will again cause traces to be recorded until the segment count is reached, and so forth.
- To record only those traces that exceed the limit, set Segment Count to 1
- To record ALL traces after a limit is exceeded, set Segment Count OFF.

When used with **Record Time**, the timer counts down even when traces are not being recorded (limits are not being exceeded). Recording starts when a limit is exceeded and stops when the timer reaches 0.

When used with **Record Interval**, a trace is recorded when a limit is exceeded, then no recordings during the specified 'wait' interval, then the next trace is recorded, followed by another time delay, and so forth. This pattern repeats indefinitely if Segment Count is OFF, or (if ON) until Segment Count is reached.

Frequency Mask Trigger Configuration

Create or recall a Frequency Mask to be used with the FreqMaskTrigger feature.

NOTE The Mask file is saved to, and recalled from, the Save /Recall Storage Device location – NOT from the Record Playback Storage Device location. These are two different settings. Learn how to set the Save /Recall Storage Device on page 162.

A mask that is in use during a recording is NOT saved with the recording and does NOT automatically appear during playback. Like Limits lines, it is saved and recalled with a state file.

Although they are created in the same manner, Limit Line files and FreqMask files can NOT be used interchangeably.

- Press **Trace 6**
- Then **Record Playback Setup**
- Then **New Session** or **Recall** an existing session. The current mask appears as soon as a session is opened.
- Then **FreqMaskTrigger Configuration**
- Then choose from the following
 - **Edit Mask** Create or modify the current mask. Learn how to edit the Mask / Limit Line table on page 154.
 - **Save Mask** Saves the current mask to a file.
 - **Recall Mask** Loads a mask file.

Record Source

The simplest way to use Record Playback is to record **RawMeas** data, which is can then be played back into all of the current Trace States.

However, for more complicated processing, refer to the following diagram. This illustrates where in the FieldFox data flow data is recorded and played back.

NOTE For this discussion, it is important to understand Trace States. Learn more on page 88.

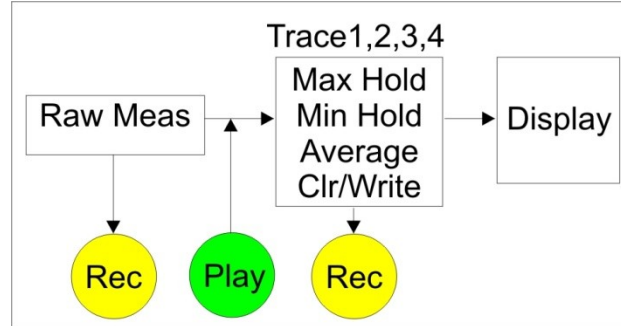

FieldFox Data Flow and Record Playback data points

- Data can be recorded at the **Raw Meas** block where data is acquired after ResBW, VideoBW, and Detector processing, but before any trace state processing.
- Data can be recorded from Traces 1,2,3, or 4 which includes the trace state (Max Hold, Min Hold, and so forth).
- Recording from a Clear/Write trace yields exactly the same data as recording from the Raw Meas block.
- Data is ALWAYS played back at the same location in the data flow: just after the Raw Meas block, through all currently active Traces, and onto the display.
- See an **example** using Record Playback with Max Hold traces on page 114.

Playback Configuration

By default, trace sweeps are played back as fast as the trace can be drawn on the screen. The following setting allows you to slow playback. In addition, you can manually scroll through individual traces using Playback Trace, or scroll through State and User Tags using Playback State/Tag. Learn more in **How to Playback a Session** on page 110.

To slow playback of a session

- Record a new session or Open an existing session.
- Press **Playback Configuration**
- Then **Playback Interval**
- Enter a value in seconds between 0 (no delay) and 100 using the numeric keypad, **▲▼** arrows, or the rotary knob. After using the keypad, select a multiplier key. Learn about multiplier abbreviations on page 20.
- Press **Enter**

Manage Sessions

- Press **Trace 6**
- Then **Record Playback Setup**

The following selections are available ONLY when a session is NOT open.

- Then **Storage Device** to select the media which stores the sessions to be managed. This is a different setting from the Save/Recall Storage Device setting.
- Then choose from the following:
 - **Internal** FieldFox memory (default)
 - **SD Card** An external SD Card (must be inserted)
 - **USB** An external USB flash drive (must be inserted)
- Then **Manage Sessions**
- Then choose from the following:
 - **Name** Using the FieldFox labeler, change the name of the session. AutoSession (n) is the default name where (n) is the next-available number. Learn how to use the labeler on page 160.
 - **Sort** Arrange the listing of sessions **by Name**, **by Date**, or **by (file) Size**.
 - **Delete** After a confirmation prompt, removes the contents of the selected session from the list.
 - **Copy** Copies the selected session to a different storage device, or the same storage device with 'Copy_' appended to the beginning of the name.
 - **Copy All** Copies ALL of the listed sessions to a different storage device, or the same storage device with 'Copy_' appended to the beginning of the names.

Record Playback Example

The following “Interval Recording” example shows how you can record spectral activity over a longer period of time with less trace storage.

- Press **Trace 6** then, with **Trace** = 1, press **State** then **Max Hold**
- Then **Record Playback Setup**
- Then **New Session**
- Then **Recording Configuration**
- Then **Record Source** to **Trace1**
- Then **Record Interval** to **10 s**(seconds).
- Then **Back**
- Then **Recorder Player**
- Then **Record** At the end of each 10 second record interval, the Max Hold trace is recorded and the Max Hold processing is reset for the next 10 second record interval.
- Then **Stop** to end the recording.

This session can be played back into any Trace State. For example:

Play the Max Hold recording into a **Clear/Write trace** to see the data exactly as it was recorded.

- Press **Trace 6** then with **Trace** = 1 and press **State** then **Clr/Wr**

- Then **Record Player**

- Then **Play**

Play the Max Hold recording into a **Max Hold trace** to show the accumulation of “Max Hold” activity over the entire recording.

- Press **Trace 6** then with **Trace** = 1 and press **State** then **Max Hold**

- Then **Record Player**

- Then **Play**

Built-in Power Meter Mode - Option 311

Built-in Power Meter (also known as Channel Power Meter) uses the RF IN connector to make quick and simple power measurements over a selectable frequency span. A power sensor is NOT required.

NOTE There are NO SCPI commands to set or control Built-in Power Meter Mode.

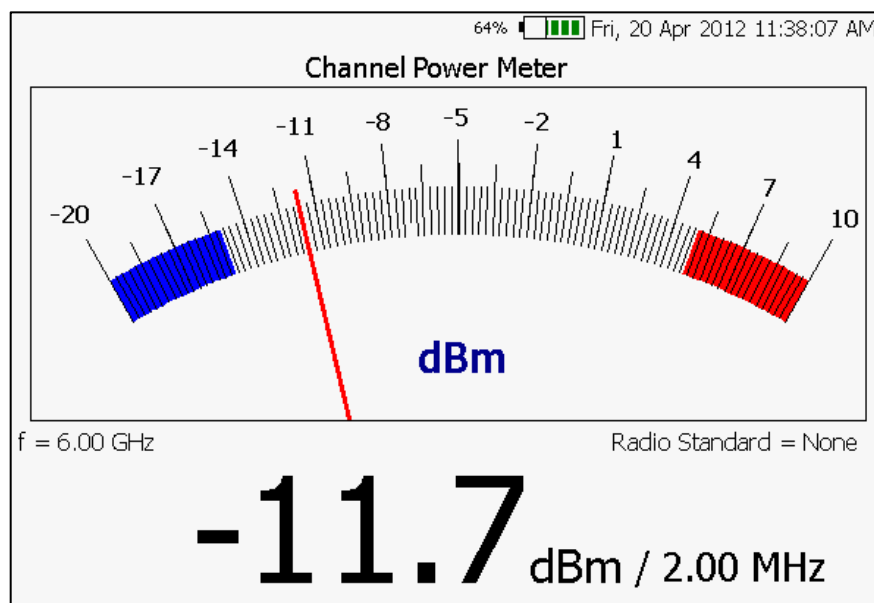

In this Chapter

Set Frequency/Span.....117

The following Built-in Power Meter settings are identical to the standard Power Meter settings.

Learn more about these settings:

Set Scale121

Set Relative and Offset Power123

Set Display Units123

Set Averaging.....124

Single/Continuous124

Set Limits124

Power Meter Settings

Connect the power to be measured to the RF IN port on the FieldFox top panel. Select Built-in Power Meter Mode before making any setting in this section.

How to select Built-in Power Meter Mode

- Press **Mode**.

- Then **Power Meter (Built-in)**.

CAUTION

Please observe the RF IN port damage level.

+27 dBm (320 mW) average

+33 dBm peak (2 W) <10µs

+50 V

Frequency/ Span / Step

Valid Built-in Power Meter measurements can be made over the entire frequency range of the FieldFox. Although it is possible to enter a center frequency below the FieldFox minimum frequency, the LO feed-thru of the internal SA hardware will invalidate these Built-in Power Meter measurements.

The measurement span (also known as Channel Width and Integration BW) is the frequency range, half above and half below the center frequency, over which power is detected and displayed. The maximum measurement span is 100 MHz.

A **Radio Standard** can also be used to set the center frequency and span. Learn more about Radio Standards on page 71.

How to enter center frequency, step size, and span

The default frequency is 50 MHz.

- Press **Freq/Dist** or **Meas Setup 4**.
- Then **Frequency**.
- Then **Center**.
- Then type a value using the numeric keypad. Then press a multiplier key. Learn about multiplier abbreviations on page 20. The current frequency (f) is shown on the FieldFox screen.
- Optionally, use the **▲▼** arrows to quickly change Center frequency. The size of the frequency step can also be changed. Press **CF Step** then type a step size value using the numeric keypad, then select a multiplier key.
- Optionally press **Span (Ch Wid)** Type a value using the numeric keypad. Then press a multiplier key. The default span is 2 MHz. The maximum measurement span is 100 MHz. The current span setting is shown as the dividend in the digital display. For example: **-10 dBm / 1.00 MHz**

Attenuation

The Attenuation setting controls the power level into the FieldFox.

To compare Built-in Power Meter Mode measurements to SA Channel Power measurements, use the same attenuation settings. Built-in Power Meter Mode defaults to 30 dB attenuation, while SA mode defaults to 10 dB attention. In Built-in Power Meter Mode, the attenuation setting is NOT annotated on the screen.

How to set Attenuation

- Press **Scale/Amptd**
- Then **More**

- Then **Internal Atten**
 - **30 dB**
 - **10 dB**

Note: The following Built-in Power Meter settings are identical to the standard Power Meter settings. To learn about these settings, please refer to the following pages:

Set Scale	121
Set Relative and Offset Power	123
Set Display Units	123
Set Averaging.....	124
Single/Continuous	124
Set Limits	124

Power Meter Mode – Option 302

Power Meter measurements are made with Agilent USB power sensors. Power readings are displayed on the FieldFox screen.

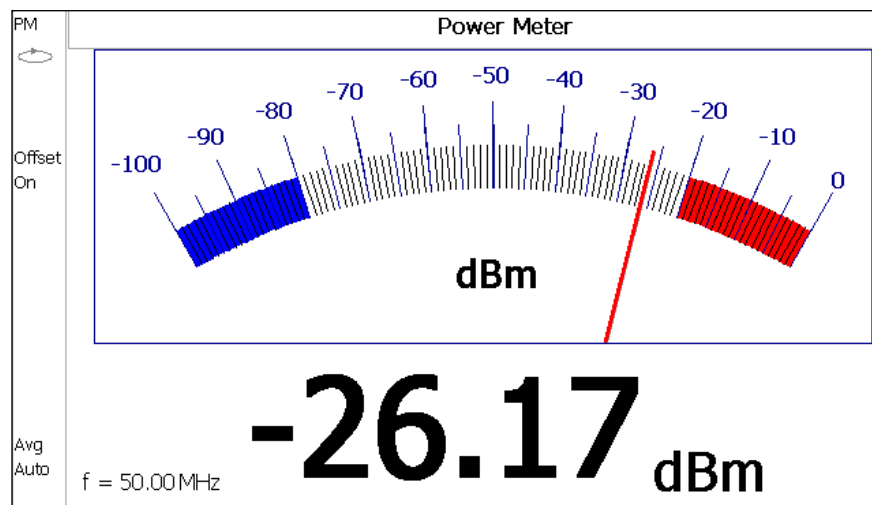

In this Chapter

Supported Power Sensors	119
How to Connect the Power Sensor	119
Average/Peak	120
Zeroing.....	120
Set Frequency.....	121
Set Source Control	121
Set Scale	121
Set Relative and Offset Power	123
Set Display Units	123
Set Averaging.....	124
Single/Continuous	124
Step Detection Mode	124
Set Limits	124

Supported Power Sensors

For a complete list of supported Agilent USB Power Sensors, please visit:
www.agilent.com/find/usbsensorsforfieldfox

NOTE The FieldFox does NOT support the following Agilent USB Power Sensor features: External Triggering (Time Gated Burst Power Measurement), Power Sweep Operation, and Frequency Sweep Operation. External Zeroing is NOT allowed on the U2020 X-series Power Sensors.

CAUTION Please refer to your USB Power Sensor User's Guide and observe the damage levels of your device.

How to Connect the Power Sensor

Connect your Power Sensor to one of the USB ports.

NOTE Use an attenuator between the DUT and the power sensor when measuring power levels that are higher than +20 dBm. The attenuator value can be subtracted from the measurement using the Offset feature, discussed on page 123.

A sequence of status lights are displayed on the base of the power sensor.

- **Green blinking** light indicates the power sensor is communicating or self-tests are being performed. Because the FieldFox is usually communicating with the power sensor when it is connected, this is the normal mode of operation.
- **Amber light** indicates Zeroing is being performed.
- **Red light** indicates an error has occurred with the power sensor. Refer to power sensor documentation.
- **No light** indicates the FieldFox is not communicating with the power sensor. This is the case when in Hold mode or when NOT in Power Meter Mode.

Power Meter Settings

Select Power Meter Mode before making any setting in this section.

How to select Power Meter Mode

- Press **Mode**.
- Then **Power Meter (USB Sensor)**.

Average / Peak

- Press **Measure 1**
- Then choose from the following:
 - **Average** Measures and reports the average of the power measurements.
 - **Peak** Available ONLY on the U202x power sensors. Measures and reports peak power detected at sensor input.

Zeroing

The Agilent USB Power Sensors perform Internal Zeroing automatically. Because Agilent USB Power Sensors have an internal switch, Internal Zeroing does NOT require that the power source be turned OFF.

For highest measurement accuracy, when measuring power levels below -30 dBm, External Zeroing should be performed.

During External Zeroing, the power source MUST be turned OFF or the power sensor disconnected from the power source (device under test). Power is OFF when power sensor measurements are below -60 dBm. When power higher than this is detected at the sensor, a warning message is shown on the FieldFox and External Zeroing will not proceed.

NOTE External Zeroing is NOT allowed on the U2020 X-series Power Sensors.

How to perform External Zeroing

- Press **Cal 5**.
- Then **External Zero**.

While either Internal or External Zeroing is being performed, “**Zeroing...**” is shown on the FieldFox screen. While this message is present, do NOT make any changes to the FieldFox.

In addition, once External Zeroing has started, the power source must be OFF for the entire time that the Zeroing message is present. Otherwise, the calibration will be compromised but NO warning is shown.

Frequency

A table of correction factors versus frequency is stored within the Agilent U2000 Series Power Sensors. The frequency of the power to be measured is entered in the FieldFox so that the appropriate correction factor can be used.

The frequency of the power measurement is NOT limited by the frequency range of the FieldFox, but the frequency range of the power sensor, which can be much wider.

How to enter Frequency of the Power Measurement

- Press **Freq/Dist** or **Meas Setup 4**.
- Then **Frequency**.
- Then type a value using the numeric keypad. The default frequency is 50 MHz.
- Then press a multiplier key. Learn about multiplier abbreviations on page 20.

The current frequency is shown on the FieldFox screen.

Source Control

This feature may require an option on some FieldFox models.

With the FieldFox internal source enabled, these settings allow you to make simple, absolute power measurements. The source and the power sensor can be physically separated by a long distance when using a long USB cable.

Set the internal source frequency by setting the frequency of the power measurement. Learn how in the previous section.

Power Meter measurements are limited by the frequency range of the internal source when enabled. For example, assume the frequency range of your sensor is 9 kHz to 18 GHz and the frequency range of the FieldFox is 2 MHz to 6 GHz.

- With the Source ON, measurements can be made from 2 MHz to 6 GHz.
- With the Source OFF, measurements can be made from 9 kHz to 18 GHz.

How to set Source Control and Power Level

- Press **Freq/Dist**
- Then **Advanced**
- Then **Source Enable**
 - **ON** Turn ON the internal source
 - **OFF** Turn OFF the internal source

Optionally set the power level.

- Press **Src Nom Power** (0.0 dBm default setting) Set output power to an arbitrary value at the displayed CW frequency.
- Then enter a value using the numeric keypad, the **▲▼** arrows, or the rotary knob.
- Press **Enter**

NOTE Amplitude accuracy may be compromised when the Source is ON, Battery Saver is ON, and the Preamp is ON. For highest amplitude accuracy under these conditions, turn Battery Saver OFF. Learn how on page 175.

Scale

The scale of the Power Meter display can be set manually or automatically. The major and minor ticks are set automatically and can NOT be changed. Although the scale settings are limited, you can view measurements beyond these settings by performing Autoscale.

How to Scale the Power Meter display

Manually:

- Press **Scale / Amptd**.
- Then choose from the following:
 - **Scale Min** Sets the low power level of the power meter display. Type a number and select the units or press **Enter**. This value is limited to -100 dBm.
 - **Scale Max** Sets the high power level of the power meter display. Type a number and select the units or press **Enter**. This value is limited to 100 dBm.

Autoscale:

Using Autoscale, the current reading is used for the center of the scale, and Min and Max values are set accordingly.

- Press **Scale / Amptd**.
- Then **More**.
- Then **Autoscale**.

Relative and Offset Power Measurements

Power measurements can be made that are relative to another reading or that are offset by a fixed value.

- Use Relative to measure the difference between power levels.
- Use Offset to account for components or a long length of cable that is used before the power sensor. For example, if using a 10 dB attenuator to protect the FieldFox, enter an Offset Value of 10 to read the power as it would appear without attenuation. If using a 10 dB amplifier, enter an Offset Value of -10 to read the power as it would appear without amplification.

How to set Relative and Offset Power Measurements

- Press **Scale / Amptd**.
- Then choose from the following:
 - **Relative On Off** When switched to ON, the FieldFox measures and stores the current power level. Subsequent power measurements display a power level which is relative to the stored value. When relative is ON, the units change from dBm to dB or from Watts to %.
 - **Offset On Off** Toggles ON and OFF the displayed power level using the Offset value.
 - **Offset Val** Value by which the power meter display is offset. A positive value compensates for a component with loss. A negative value compensates for a component with gain. Offset values are limited to +/- 100 dB.

Display Units

Select whether to display power in dBm or Watts. When making relative power measurements, these change to dB and %.

How to set Power Meter display units

- Press **Meas Setup 4** or **Scale / Amptd**.
- Then **Unit**.
- Then choose from the following:
 - **dBm (dB)** Sets Power Meter display to dBm or dB.
 - **Watt (%)** Sets Power Meter display to Watts or %.

Resolution

Resolution sets the number of digits to display after the decimal point on the digital power meter display.

How to set Resolution

- Press **Scale / Amptd**.
- Then **More**.
- Then choose from **0, 1, 2, or 3**.

Averaging

Averaging is used to improve measurement accuracy in low power or noisy power situations. Increased averaging improves measurement accuracy, but also reduces measurement speed.

How to set Power Meter Averaging

- Press **BW 2** or **Meas Setup 4**.
- Then choose from the following:
 - **Averaging Auto Man Off**
 - **Auto** Allows the USB Power Sensor to use its Auto Averaging settings. See the USB Power Sensor documentation for details.
 - **Man** Manually enter an averaging count by setting **Num Averages**.
 - **OFF** Performs NO averaging.
 - **Num Averages** Sets the number of Power Meter readings to be averaged before a valid reading is displayed. When a number is entered, **Averaging** is automatically set to Man.

Single or Continuous Measure

This setting determines whether the FieldFox measures continuously or only once each time the **Single** button is pressed. Use **Single** to conserve battery power or to allow you to save or analyze a specific measurement.

This setting can be changed at any time without affecting calibration accuracy.

How to set Single or Continuous

- Press **Sweep 3**.
- Then choose from the following:
 - **Single** Automatically sets Continuous OFF and causes FieldFox to make ONE measurement, then hold for the next Single key press. When a data trace is displayed, the entire trace is measured, then holds. The **Hold** annotation changes to an arrow --> while the measurement occurs.
 - **Continuous** Makes continuous measurements. This is the typical setting when battery power is not critical.

You can also use **Run / Hold +/-** to toggle between Single and Continuous.

Step Detection Mode

The FieldFox supports the Step Detection feature that is present in U2000 series power meters. When enabled, this feature reduces settling time after a significant step in the measured power. For more information, please refer to the USB Power Meter documentation.

How to set Step Detection mode

- Press **Meas Setup 4**.
- Then **Step Detection ON Off**

- Then choose from the following:
 - **ON** Enables step detection (default setting)
 - **OFF** Disables step detection

Limits

In Power Meter Mode, Minimum and Maximum limits set a visible range of acceptable readings between these two values. Readings that are below the minimum or above the maximum are clearly visible on the power meter display.

How to set Limits

- Press **Limit 8**.
- Then choose from the following:
 - **Min Limit On Off** Toggles the display of the Minimum limit ON and OFF.
 - **Min Limit Value** Sets the Minimum limit power value. Power reading lower than this will exceed the limit.
 - **Max Limit On Off** Toggles the display of the Maximum limit ON and OFF.
 - **Max Limit Value** Sets the Maximum limit power value. Power reading higher than this will exceed the limit.

Pulse Measurements Mode - Option 330

Pulsed power meter measurements, available with Option 330, are made with Agilent U2020 X-Series USB Peak Power Sensors. These sensors are capable of detecting, measuring, and storing data from a train of pulses at the RF input. This data is queried from the USB Power Sensor and displayed on the FieldFox screen. You can then analyze the data using several selectable settings.

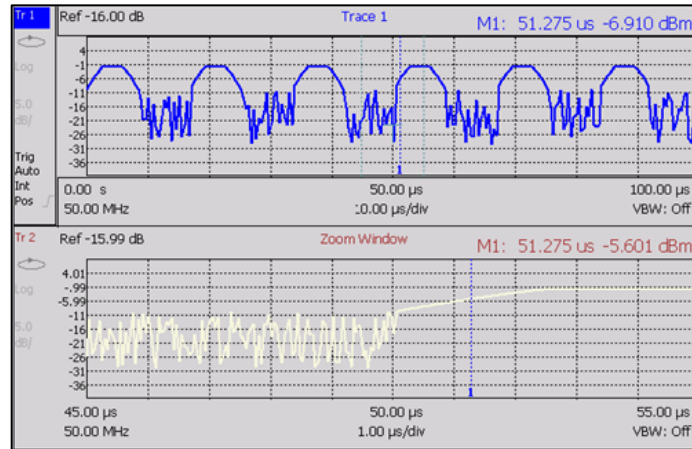

In this Chapter

Supported Power Sensors	127
Measurement Selection.....	127
Frequency / Time.....	128
Zoom Window.....	129
Scale	129
Averaging	130
Video Bandwidth	130
Single or Continuous Measure	131
Resolution	131
Triggering.....	131
Pulse Timing Diagram	133
Marker Settings.....	133
Amplitude Markers.....	134
Marker Search	134
Auto Analysis	135
Pulse Top.....	135
Grid	136

NOTE Many of the features included with the FieldFox Pulse Measurements Mode are discussed in detail in these two documents:

- Agilent U2020 X-Series USB Peak Power Sensors Programmer's Guide.
<http://cp.literature.agilent.com/litweb/pdf/U2021-90003.pdf>
- "Best Practices For Making The Most Accurate Radar Pulse Measurements"
<http://cp.literature.agilent.com/litweb/pdf/5991-0434EN.pdf>

Supported Power Sensors

Pulse measurements are made using any of the Agilent U2020 X-Series USB Peak Power Sensors.

Zeroing of the U2020 X-Series USB Peak Power Sensors is performed automatically at power up, every 5 seconds, and prior to measuring low level signals.

Switching between Pulse Measurement Mode and Power Meter Mode

NOT Supported - Using a single USB Peak Power Sensor and switching between Power Meter Mode and Pulse Measurement Mode. Both modes will attempt to program the sensor, which could cause one or both modes to hang, or at least report inaccurate data.

Supported - Using one U2000A Average Power Sensor connected to the top USB port for Power Meter Mode, and one Peak Power Sensor connected to the bottom USB port for Pulse Measurement Mode.

How to Connect the Power Sensor

Connect your Power Sensor to one of the FieldFox USB ports.

NOTE

Use an attenuator between the DUT and the power sensor when measuring power levels that are higher than +20 dBm. The attenuator value can be subtracted from the measurement using the Offset feature, discussed on page 123.

A sequence of status lights are displayed on the base of the power sensor.

- **Green blinking** light indicates the power sensor is communicating or self-tests are being performed. Because the FieldFox is usually communicating with the power sensor when it is connected, this is the normal mode of operation.
- **Amber light** indicates Zeroing is being performed.
- **Red light** indicates an error has occurred with the power sensor. Refer to power sensor documentation.
- **No light** indicates the FieldFox is not communicating with the power sensor. This is the case when in Hold mode or when NOT in Pulsed Measurement Mode.

Pulse Measurement Settings

Select Pulse Measurement Mode before making any setting in this section.

How to select Pulse Measurement Mode

- Press **Mode**
- Then **More** if your FieldFox contains more than five measurement modes.
- Then **Pulse Measurement**

Measurement Selection

The pulse measurement results are presented as either a traditional power meter display or as a trace graph.

How to select the Measurement

- Press **Measure 1**
- Then choose from the following:
 - **Average** Average power (Meter display)
 - **Peak** Peak power (Meter display)
 - **Pk to Avg** Displays the difference between the above two measurements (Meter display)
 - **Trace Graph** (default) The primary trace (**Tr 1**) plots pulse data in amplitude versus time. Optionally, you can enable a secondary 'zoom' trace. Learn how on page 129.

When a 'Meter display' measurement is selected, the following Pulse Measurement Mode settings are identical to the standard USB Power Meter Mode settings.

- Learn how to set **Scale** on page 121.
- Learn how to set **Relative and Offset Power** on page 123.
- Learn how to set **Display Units** on page 123.
- Learn how to set **Limits** on page 124.

Frequency / Time

How to set Frequency

- Press **Freq/Dist**
- Then choose from the following:
 - **Frequency** Sets the center frequency of the carrier on which pulse modulation resides. This is used to set amplitude correction of the USB Power Sensor.

How to set Time

Specify the time over which data will be acquired by the USB Power Sensor. When Trace Graph is selected, **Tr 1** is annotated with these values. Time can be specified using either of the following pairs of values:

- **Center 1** and **Time/div 1** Specify the center time and time per division.
- **Start Time** and **Time Length** Specify the start time and length of acquisition.
 - A positive start time indicates a delay after the sensor detects a pulse signal.
 - A negative start time displays data that is acquired BEFORE the sensor detects a pulse signal (or T-zero).
- Follow each by entering a value using the numeric keypad, the **▲▼** arrows, or the rotary knob.
- After using the keypad, select a multiplier key. Learn about multiplier abbreviations on page 20.

Zoom Window

When Trace Graph is selected as the measurement, a secondary Zoom Trace can be used to view a zoomed portion of **Tr 1**. When Zoom Window is ON, blue vertical posts appear on **Tr 1** to indicate the current start, center, and stop times of the zoom window. The zoom window can be scaled using the standard Scale settings.

How to make Zoom Window settings

- Press **Trace 6**
- Then **Zoom Window**
- Then choose from the following:
 - **ON** Opens the zoom window on the bottom half of the FieldFox screen. The window includes the zoomed trace.
 - **OFF** Closes the zoom window.
- **Zoom Center** While monitoring the **T** within the blue vertical posts on Tr 1, enter a value for the center time using the numeric keypad, the **▲|▼** arrows, or the rotary knob.
- **Zoom Time/div** While monitoring the blue vertical posts on the primary trace, enter a value for the zoom window span using the numeric keypad, the **▲|▼** arrows, or the rotary knob.
- **Trace 1** Press to select **Tr 1**. This can also be done by using the **▲|▼** arrows. Select a trace before making trace settings, such as Scale.
- **Zoom Trace** Press to select the zoom trace.

Scale

For Meter-style measurements, learn how to set Scale, Relative and Offset Power, display Units, and Resolution beginning on page 121.

How to set Scale for Trace Graph measurements

- Select a trace to scale using the **▲|▼** arrows.
- Press **Scale / Amptd**
- Then choose from the following methods:
 - **Autoscale** Automatically adjusts the Y-axis to comfortably fit the Min and Max amplitude of the trace on the screen.
 - Set Scale, Reference Level, and Reference Position:
 - **Scale** Manually enter a **scale per division** to view specific areas of the trace.
 - **Ref Level** Manually set the value of the reference line. Enter a negative value by pressing **Run/Hold (+/-)** either before or after typing a value.
 - **Ref Position** Manually set the position of the reference line. Values must be between **0** (TOP line) and **10** (BOTTOM line).
 - **Offset ON** Enable Offset. When only trace 1 is visible, **Offset ON** appears to the left of the trace.

- **Offset Val** Enter a value by which all amplitude values will be offset. This can have the effect of virtually removing a component from the measurement path. A positive value compensates for a component with loss. A negative value compensates for a component with gain. Offset values are limited to +/- 100 dB.

Averaging

Averaging helps to reduce the effects of random noise on a measurement. The more measurements that are averaged, the greater the amount of noise reduction. Averaging is allowed for all pulse measurements.

Averaging is performed in the USB Power Sensor before the data is sent to the FieldFox.

Annotation in the left pane shows the state of the Average setting. When Manual is selected, the 'Num of Averages' setting is also shown.

How to set Averaging

- Press **BW 2**.
- Then **Averaging**
- Then choose from the following:
 - **Auto** Averaging is set to a reasonable value by the USB Power Sensor.
 - **Man** Averaging is set to the value specified in the 'Num Averages' setting.
 - **Off** Averaging is OFF
- **Num Averages** Select a value using the numeric keypad, then press **Enter**.

Video Bandwidth

The Video Bandwidth setting enables an FIR (finite impulse response) filter within the USB Power Sensor. The filter setting affects the appearance of the trace results.

Video Bandwidth is allowed for all pulse measurements

How to set Video Bandwidth

- Press **BW 2**.
- Then **Video Bandwidth**
- Then choose from the following:
 - **Off** Video Bandwidth is disabled.
 - **Low** Similar to a low pass filter, ripple in the pass band is minimized but allows higher side-lobes on the filter skirt.
 - **Medium** Smooth pass band with reasonable transition ripple.
 - **High** The pass band ripple is similar to the OFF setting, but the transition skirts are smoother.

Single or Continuous Measure

This setting determines whether the FieldFox continuously queries the USB Power Sensor for data, or only once each time the **Single** button is pressed. Use **Single** to conserve battery power or to allow you to save or analyze specific data.

How to set Single or Continuous

- Press **Sweep 3**
- Then choose one of the following:
 - **Single** Automatically sets Continuous OFF and causes the FieldFox to query the USB Power Sensor ONCE, then hold for the next **Single** key press. **Hold** is annotated in the upper left corner of the display.
 - **Continuous** Queries the USB Power Sensor whenever a valid trigger signal is present. This is the typical setting when battery power is not critical.

You can also use **Run / Hold +/-** to toggle between Single and Continuous.

Resolution

Resolution is the number of individual acquisitions that occur in the USB Power Sensor. This data is read by the FieldFox and plotted across the X-axis to form a trace. More data points increases measurement resolution. However, more data points requires more time to acquire, query, and plot.

How to set Resolution

- Press **Sweep 3**
- Then **Resolution**
- Then choose from the following:
 - **Low** 240 data points.
 - **Medium** 1000 data points.
 - **High** Calculated value - approximately 8000 data points.

Triggering

For pulse measurements, a trigger signal refers to the event that causes the USB Peak Power Sensor to initiate measurement acquisition. It does NOT refer to triggering the FieldFox.

Trigger settings can be used with ALL pulse measurements unless stated otherwise.

A **Waiting for Trigger** message on the FieldFox screen is posted on behalf of the USB Power Sensor when it is waiting for a pulse signal at the RF Input (Internal) or a TTL signal at the USB Sensor External Trigger input.

How to make Trigger settings

- Press **Sweep 3**
- Then **Trigger**
- Then **Trig Type**

- Then choose from the following:
 - **Freerun** The USB Power Sensor acquires data without waiting for a trigger. This mode is NOT supported for Trace Graph measurements.
 - **Internal** The USB Power Sensor acquires data when a valid pulse signal is detected at the RF input. The following Trigger settings determine the validity of the trigger signal.
 - **External** The USB Power Sensor acquires data when a valid TTL signal is detected at the USB Power Sensor external trigger input.

Trigger Edge

This setting determines which edge of a trigger signal initiates data acquisition.

- Press **Sweep 3**
- Then **Trigger**
- Then **Trig Edge**
- Then choose from the following:
 - **Pos** Acquisition is triggered by the rising (positive) edge of a valid signal.
 - **Neg** Acquisition is triggered by the falling (negative) edge of a valid signal.

Trigger Delay

After a valid trigger signal is received at the USB Power Sensor, data acquisition begins after the specified Trigger Delay time **PLUS** the specified Start time. See the Pulse Timing diagram on page 133 for more information.

- Press **Sweep 3**
- Then **Trigger**
- Then **Trig Delay**
- Then enter a value using the numeric keypad, the **▲▼** arrows, or the rotary knob.

Auto Trigger

Used ONLY when Trigger Type = Internal, this setting determines whether the trigger level is set manually or is set to the default level in the USB Power Sensor firmware.

- Press **Sweep 3**
- Then **Trigger**
- Then **AutoTrig**
- Then choose from the following:
 - **ON** Trigger level is determined by the USB Power Sensor firmware.
 - **OFF** The trigger level is set manually using the Trigger Level setting.

Trigger Level

Used when Trigger Type = Internal AND Auto Trigger = OFF (Manual).

- Press **Sweep 3**

- Then **Trigger**
- Then **Trig Level**
- Then set the trigger level using the numeric keypad, the **▲▼** arrows, or the rotary knob. A line appears on **Tr 1** at the current trigger level setting. Data acquisition occurs when the RF input signal crosses the line. This setting can be used with either Positive or Negative edge triggering.

Trigger Settings Annotation

Trigger settings are annotated on the FieldFox screen as highlighted in **red** in the following image:



Trig Level = -10 dBm, Trig Type (**Int**), Pos Slope (/), Delay

Pulse Timing Diagram

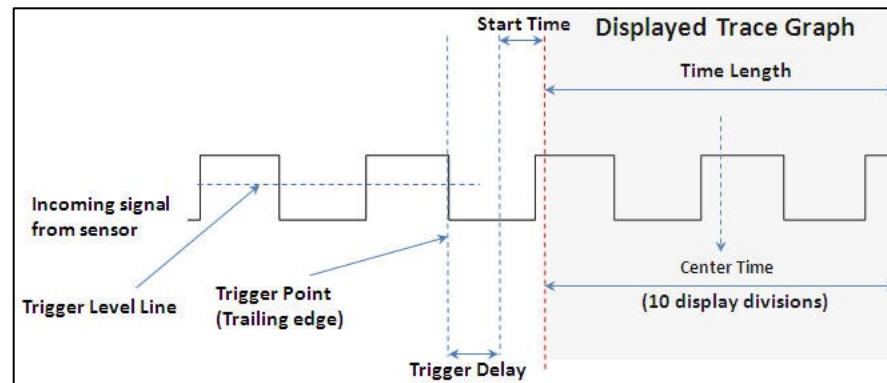

Marker Settings

Markers are not allowed with Meter-style measurements.

Markers are displayed on **Tr 1** and also on the zoom trace if the marker is within the zoom window time span.

Up to six standard markers can be used to provide readouts of the Y-axis amplitude at the current X-axis location.

The six standard markers can also be used as Delta Markers.

Learn more about standard markers on page 144.

Amplitude Markers

Amplitude markers are horizontal dotted lines that you can move to any amplitude level on the screen. The two amplitude markers can be set independently or used as a pair of delta markers.

Amplitude markers can be used as a visually comparison aid with the pulse measurement traces.

How to make Amplitude Marker settings

- Press **Marker**
- Then **More**
- Then **Ampl Markers**
- Then choose from the following:
 - **OFF** Amplitude markers are NOT displayed.
 - **ON** Amplitude markers ARE displayed at their previous positions.
- Then **Ampl Mkr 1 or 2**
- Enter a value in dBm for the marker using the numeric keypad, the **▲▼** arrows, or the rotary knob.
- Press **Delta AmplMkr**
- Then choose from the following:
 - **ON** AmplMkr 2 value is relative to AmplMkr 1. When AmplMkr 1 is moved, AmplMkr 2 also moves to maintain the AmplMkr 2 value between them.
 - **OFF** The two amplitude markers move independent of one another.

Marker Search

Use Marker Search to find and move markers to locations on the **Tr 1** trace.

How to Search with Markers

- Activate the marker to be used for the search
- Then press **Mrk ->/Tools**.
- Then **Marker Search**
- Then **Zone Search**
- Then choose from the following:
 - **ON** Available ONLY when the zoom window is enabled, the search is limited to the zone defined by the zoom window.
 - **OFF** The search is performed over the entire **Tr 1** trace.

Then choose from the following:

- **Target**, **Peak**, and **Minimum**. Learn more about these standard features beginning on page 149.
- **Rise Time** Select, then set a value in dB. Delta markers are created and placed at the Peak and at the specified value BEFORE the Peak.

- **Fall Time** Select, then set a value in dB. Delta markers are created and placed at the Peak and at the specified value AFTER the Peak.

NOTE Rise and Fall time in Marker Search uses different criteria than in Auto Analysis and will therefore result in different reported values.

Auto Analysis

Auto Analysis reports the following TEN pulse measurements:



1 - Average Power	Average power level of all measured data points
2 - Peak Power	Highest reading of all measured data points
3 - Peak minus Average	Difference between the above two results
4 - Pulse Top	Power value based on the specified Pulse Top setting.
5 - Rise Time	The time it takes for a pulse to rise from 10% to 90% of its peak value.
6 - Fall Time	The time it takes for a pulse to fall from 90% to 10% of its peak value.
7 - Pulse Width	The time between the rising edge and falling edge of a pulse.
8 - Pulse Period	The time of one complete pulse cycle
9 - Duty Cycle	The ratio of the pulse duration to the pulse period.
10 - Pulse Rep Freq	The rate, in pulses / sec, at which pulses recur.

How to enable Auto Analysis

- Press **Mrk ->/Tools**.
- Then **Auto Analysis**
- Then choose from the following:
 - **OFF** Analysis OFF
 - **ON** The Analysis values appear below trace 1.

Pulse Top

Pulse Top is NOT the same as the pulse Peak. Pulse Top is used to set and report the reference power level. You enter a value in percent, and the Pulse Top value is reported in the Auto Analysis table in dB down from 100% of the reference power level.

How to set Pulse Top

- Press **Mrk ->/Tools**
- Then **Pulse Top**
- Then enter a percent value between 0 and 100 using the numeric keypad, the **▲/▼** arrows, or the rotary knob.
 - When set to 10%, 10 dB down from the 100% reference level is reported.
 - When set to 50%, 3 dB down from the 100% reference level is reported.

- When set to 90%, 0.5 dB down from the 100% reference level is reported.

Grid

Enables and disables the display of a 10 x 10 grid on the FieldFox screen.

How to enable Grid display

- Press **Mrk ->/Tools**
- Then **Grid**
 - OFF** Grid OFF
 - ON** A grid of X/Y lines appears on the screen.

VVM (Vector Voltmeter) Mode – Option 308

VVM Mode measures the electrical length of cables and other devices. The 1-Port Cable Trimming application displays the electrical length in both Magnitude and Phase. The 2-Port Transmission measurement displays Magnitude ONLY.

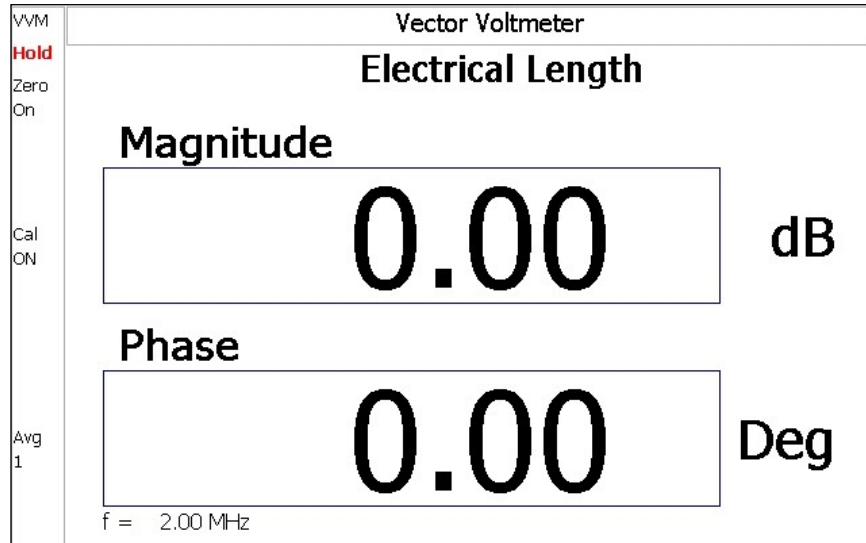

Display for the 1-Port Cable Trimming measurement

In this Chapter

Overview	138
VVM Calibration.....	141
Measurement Selection.....	138
Frequency Selection.....	139
Display Resolution.....	139
IF Bandwidth.....	139
Output Power	139
Averaging	140
Single/Continuous	141
Zeroing.....	141

Procedures

1-Port Cable Trimming Measurement	142
2-Port Transmission Measurement.....	143

Overview

In the FieldFox, both 1-port and 2-port measurement types use a different configuration setup from the HP/Agilent 8508A Vector Voltmeter.

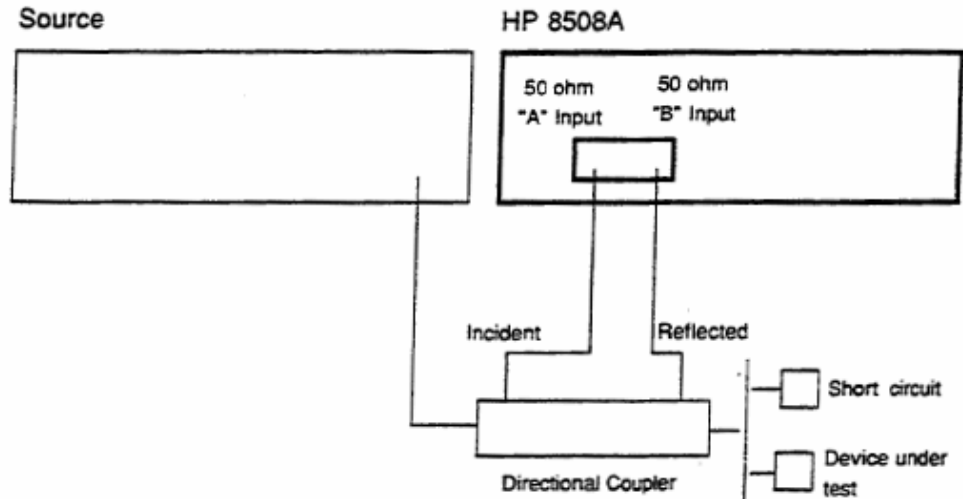

Typical 8508A measurement configuration – taken from the 8508A manual.

The above block diagram requires an external source and directional coupler to measure the electrical length of a DUT or cable to be trimmed. Separate paths are used to measure the Incident signal (A) and Reflected signal (B). To measure the ratio of the Reflected / Incident signals, you were required to select B/A for both the Magnitude and Phase display.

In the FieldFox, the source and directional coupler are inside the instrument. This allows you to connect the DUT to ONLY the FieldFox RF Out port, with NO external instruments, in order to make Cable Trimming measurements.

See the FieldFox block diagram and Cable Trimming procedures beginning on page 142.

VVM Mode Settings

Select VVM Mode before making any setting in this section.

How to select VVM Mode

- Press **Mode**
- Then **VVM**

Measurement Selection

How to select a VVM Measurement

- Press **Measure 1**
- Then choose from the following:
 - **1-Port Cable Trimming** 1-port reflection measurement. Learn how to make this measurement on page 142.

- **2-Port Transmission** 2-port transmission MAGNITUDE ONLY measurement. Learn how to make this measurement on page 143.

Frequency Selection

VVM measurements are made at a single CW frequency.

How to set Frequency

NOTE Frequency can be set to 1 Hz resolution.

- Press **Freq/Dist**
- Then **Frequency**
- Enter a value using the numeric keypad, the **▲▼** arrows, or the rotary knob.
- After using the **▲▼** arrows or the rotary knob, press **Enter**. The increment setting of the arrows is based on the current span and can NOT be changed in VVM Mode.
- After using the keypad, select a multiplier key. Learn about multiplier abbreviations on page 20.

Display Resolution

You can display either one digit or two digits after the decimal point for both magnitude and phase readings.

This setting survives a Preset and Mode Preset.

How to set Resolution

- Press **Scale/Amptd**
- Then **Resolution**
- Then choose from:
 - **1** 0.0 (default)
 - **2** 0.00

IF Bandwidth

Reducing the IF receiver bandwidth reduces the effect of random noise on a measurement. However, narrower IF bandwidths also cause longer measurement times.

For highest accuracy, perform calibration and Zero AFTER changing the IF Bandwidth. Learn about Zeroing on page 141.

How to set IF BW

- Press **BW 2**.
- Then **IF BW**
- Then choose from the following: **300 Hz | 1 kHz | 3 kHz | 10 kHz | 30 kHz**

Output Power

Set the power level out of the FieldFox to High, Low, or manually set power level to a value between High and Low.

Generally, the high power setting is used when measuring passive, high-loss devices to place the signal farther from the noise floor. However, for devices that are sensitive to high power levels such as amplifiers, use the Low power setting.

For best measurement accuracy, use the **Manual** power setting at -15 dBm. After calibration, the power level can be decreased for amplifiers, or increased for higher dynamic range.

Caution Power Level settings in this mode will NOT change Power Level settings in other modes. To help prevent damage to your DUT, use caution when changing modes with your DUT connected to the FieldFox test ports.

How to set Output Power

- Press **Meas Setup 4** then **More**
- Then **Output Power**
 - **High** (Default setting) Sets output power to the maximum achievable power at all displayed frequency.
 - **Low** Sets output power to approximately -27 dBm.
 - **Man** Set output power to an arbitrary value.
 - Then press **Nominal Power**
 - Then enter a value using the numeric keypad, the **▲/▼** arrows, or the rotary knob.
 - Press **Enter**.

Averaging

Averaging helps to reduce the effects of random noise on a measurement. The FieldFox computes the displayed value over several consecutive readings.

Average Count determines the number of readings to average. The higher the average count, the greater the amount of noise reduction.

An average counter is shown in the left edge of the screen as **Avg N**. This shows the number of previous readings that have been averaged together. When the counter reaches the specified count, then a 'running average' of the last **N** readings is displayed.

Average Count = 1 means there is NO averaging.

This setting can be changed at any time without affecting calibration accuracy.

How to set Averaging

- Press **Meas Setup 4**
- Then **More**
- Then **Average N** where **N** is the current count setting.
- Enter a value using the numeric keypad. Enter **1** for NO averaging.
- Press **Enter**.

- While Averaging is in process, press **Meas Setup 4**, then **More**, then **Restart** to restart the averaging.

Single or Continuous Measure

This setting determines whether the FieldFox measures continuously or only once each time the **Single** button is pressed. Use **Single** to conserve battery power or to allow you to save or analyze a specific measurement.

This setting can be changed at any time without affecting calibration accuracy.

How to set Single or Continuous

- Press **Sweep 3**.
- Then choose one of the following:
 - **Single** Automatically sets Continuous OFF and causes FieldFox to make ONE measurement, then hold for the next Single key press. When a data trace is displayed, the entire trace is measured, then holds. The **Hold** annotation changes to an arrow --> while the measurement occurs.
 - **Continuous** Makes continuous measurements. This is the typical setting when battery power is not critical.
- You can also use **Run / Hold +/-** to toggle between Single and Continuous.

VVM Calibration

In VVM Mode, calibration is performed in the same manner as in CAT and NA Modes. In summary, a Preset Cal is sufficient when the DUT is connected directly to the FieldFox RF Out test port. When using an adapter or jumper cable to connect the DUT, first perform a QuickCal + Load or OSL Cal before making measurements. Learn more about these FieldFox calibrations on page 52.

To make an accurate measurement, set **Zero OFF** before calibrating.

Zeroing

When performing a Cable Trimming operation, one cable is compared to another. After measuring the first, shorter cable, pressing Zero performs the same operation as Data->Memory, then Data/Mem, also known as Normalization. All subsequent electrical length measurements are relative to the stored measurement.

To make an accurate measurement, set **Zero OFF** before calibrating. Zero after changing the IF Bandwidth.

How to select Zeroing

- Press **Meas Setup 4**
- Then **Zero**
- Press **Zero Off** to turn zeroing off.

1-Port Cable Trimming Measurements

A 1-Port Cable Trimming measurement is used in a cable fabrication procedure to validate proper electrical length.

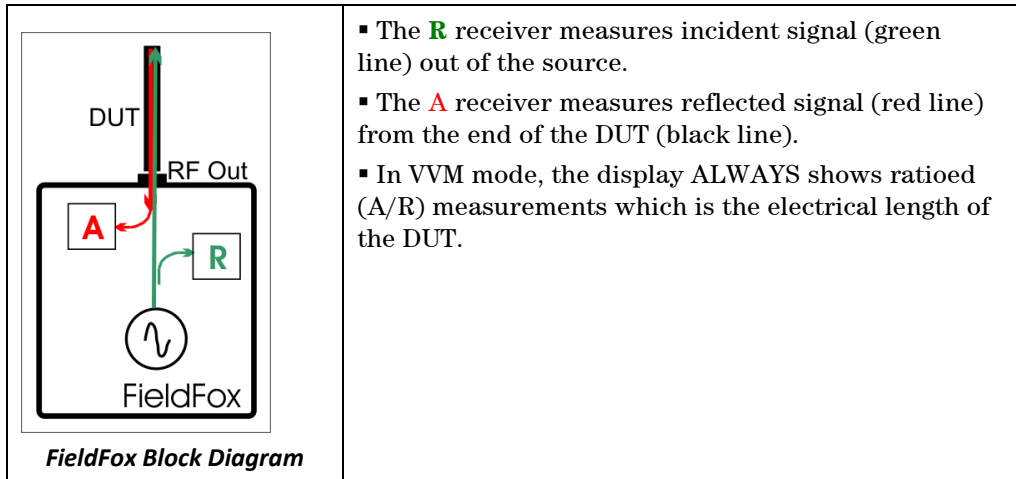

How to make a 1-Port Cable Trimming Measurement

Setup:

1. Press **Mode** then **VVM** then **1-Port Cable Trimming**.
2. Press **Freq/Dist** and enter the frequency needed for the VVM measurement.
3. Press **Meas Setup 4** then **Zero OFF**.
4. If using an adapter or jumper cable to connect the cables to the FieldFox, press **Cal 5** then select **Calibration Type**, then either **QuickCal** (+ Load) or **OSL Cal**. Follow the FieldFox calibration prompts. Learn more about VVM calibration on page 141.

Verification: Perform the following **optional steps** to ensure that the FieldFox is properly calibrated. Steps 1 through 9 need only be done once to determine the difference in phase between the Open and Short standard. Once that value is known, perform steps 10 through 14 to verify a calibration.

1. Press **Mode** then **NA**. Select **S11**.
2. Press **Freq/Dist** and enter start and stop frequencies that span about 40% of the VVM measurement frequency. For example, for a 1 GHz measurement, enter Start .8 GHz and Stop 1.2 GHz
3. Perform a calibration using a cal kit (NOT Quick Cal).
4. Press **Meas 1** then **Format Phase**
5. Connect the Short standard to the RF OUT calibration plane.
6. Press **Trace 6** then **Math and Memory** then **Data -> Mem**
7. Connect the Open standard to the RF OUT calibration plane.
8. Press **Data Math** then **Data/Mem**
9. Press **Marker** then scroll the marker to the VVM frequency. The Y-axis value is the phase difference in degrees between the Open standard and the Short standard at that frequency. **Remember this value!**
10. Press **Mode** then **VVM**.
11. Connect the Short standard to the RF OUT calibration plane.

12. Press **Meas Setup 4** then press **Zero**.
13. Connect the Open standard to the RF OUT calibration plane.
14. Confirm that magnitude measurement is less than -0.1 dB and the phase is within $.1$ degrees of the value from step 9.

Perform Cable Trimming:

1. Attach the shortest cable to the FieldFox RF OUT connector. This cable is the reference cable. Leave the end of the reference cable open (unterminated).
2. Press **Meas Setup 4** then press **Zero**.
3. Remove the reference cable from the FieldFox RF OUT connector.
4. Connect an unterminated, longer cable to the FieldFox RF OUT connector.
5. Observe the displayed phase difference between the reference cable and the attached cable.
6. Carefully trim the cable until the phase shift reads zero. **The attached cable's electrical length is now matched to the reference cable.**
7. Repeat steps 4 through 6 for the remaining cables to be trimmed.

2-Port Transmission Measurements

A 2-Port Transmission measurement is used for measuring electrical length, insertion loss, gain, or isolation of a device. The FieldFox signal source is transmitted out the RF OUT connector, through the DUT, and into the RF IN connector. Both ends of the DUT must be connected to the FieldFox.

NOTE Only Magnitude, NOT Phase, is displayed.

In the following image, the gain of an amplifier is being measured.

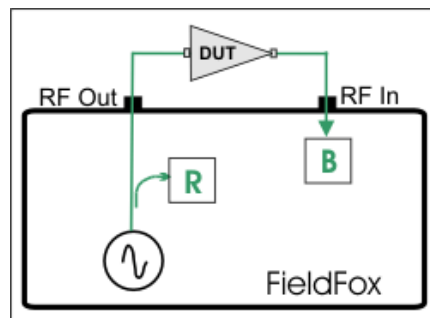

2-Port Transmission measurement of an amplifier

How to make a 2-Port Transmission Measurement

1. Press **Mode** then **VVM** then **2-Port Transmission**.
2. Press **Freq/Dist** and enter the measurement frequency.
3. Connect the RF Out and RF In test port cables to form a Thru connection. If an adapter is needed to make the connection, the measurement results will be in error by the amount of loss in that adapter.
4. Press **Meas Setup 4** then **Zero**.
5. Connect the DUT as in the diagram above.
6. The displayed magnitude value is the gain of the amplifier. To measure isolation of the amplifier, reverse the connection to the amplifier (RF Out to the amplifier output).

Data Analysis Features

The following features can be used after a measurement to analyze the results.

In this Chapter

All about Markers	144
About Delta Markers	145
Marker Table.....	147
Coupled Markers.....	147
Marker Colors.....	148
Marker Trace.....	148
Marker Format	148
Searching with Markers.....	149
What Is a 'Peak'	152
Marker Functions.....	153
SA Noise Marker	153
SA Band Power Marker	154
SA Frequency Counter at Marker	154
All about Limit Lines	154
Relative Limit Lines	155
Build From Trace	156
Limit Options.....	156
How to Save and Recall Limits	157
All about Trace Math.....	157
About Math Operations.....	158

All about Markers

Markers move along the X-axis range of the measurement trace to provide a numerical readout of each measured data point. Markers also allow you to search for specific Y-axis values.

A trace can contain up to six markers.

The marker readout on the FieldFox screen displays X and Y-axis information for the current active marker ONLY.

A Marker Table can be displayed that allows you to simultaneously view X and Y-axis information for all markers.

Markers can be used in **CAT**, **NA**, **SA**, and **Pulse Measurements** Modes.

How to create Markers

- Press **Marker**.
- Then **Markers 1..6** to select a marker to activate.
- Then **Normal** to activate that marker. A marker is created on the trace in the middle of the X-axis. That marker is now **active**.

- Then move the marker using the rotary knob, the ▲▼ arrows, or by entering an X-axis position with the number keys.
- Then press **Enter**.

How to move a Marker after it is created

- Press **Marker**.
- Then **Markers 1..6** repeatedly until the marker of interest is selected. The OFF, Normal, or Delta softkey is black to indicate the current setting of each marker.
- Then move the marker as when it was first created.
- Markers can also be moved using one of the marker search functions. Learn more on page 148.

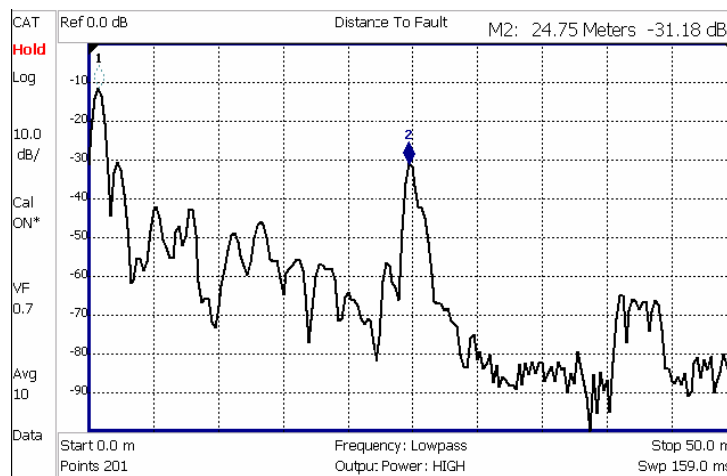

Marker 2 is Active, marker 1 is NOT active.

About Delta Markers

A Delta marker provides X-and Y-axis readout information that is **relative** to a 'reference' marker.

A Delta marker is created with a ▲ (delta symbol) to distinguish it from the reference marker.

All six markers can be a Delta marker pair.

Peak search functions can be performed using delta markers.

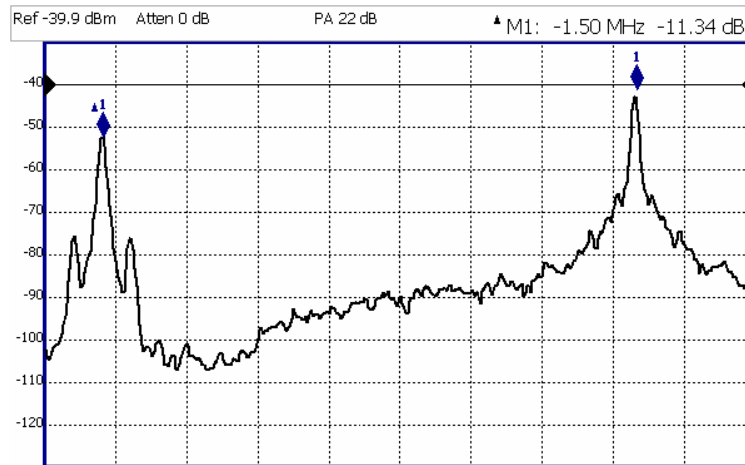

A Delta marker and its associated reference marker. The marker readout shows the difference between the two markers in frequency and amplitude.

How to Create a Delta Marker

- Create a **Normal** marker and move it to the reference position.
- Press **Delta**. The marker becomes the reference marker and fixed in its X-Axis position.
- Move the Delta marker using the numeric keypad, the **▲▼** arrows, or the rotary knob.
- Press **Enter** when finished.

How to move the Reference marker

- Press **Delta** to turn the Delta marker OFF.
- Move the marker to the new position.
- Then press **Delta** again, to turn the Delta marker back ON.

Fix the position of the Reference marker (SA Mode ONLY)

In SA mode, the reference marker can be fixed at the Y-axis position of the data trace when the marker was created, or it can 'float' with each sweep at the Y-axis position of the data trace. In CAT and NA mode, the reference marker always floats with the data trace. This setting applies to all SA markers.

- Create a Delta marker.
- From the **Mrk ->/Tools** menu, press **More**, then **Marker Properties**, then **Delta Ref Fixed**
 - **OFF** – The reference marker floats at the data trace Y-axis position.
 - **ON** – The reference marker is fixed at the Y-axis position of the data trace when the marker was created (default SA mode).

Marker Table

The Marker Table can be displayed at the bottom of the FieldFox screen. It can display information for up to 6 markers in a full-width window, and up to 3 markers for a half-width window (NA mode). The marker table “squeezes” the graticule area when activated.

How to display the Marker table

- Press **Marker**.
- Then **Marker Table On Off**.

Coupled Markers

Coupled Markers, available in NA Mode only, allows you to simultaneously create and move markers that have the same number for all traces. For example, when marker 2 is created on a trace, a marker 2 is created for ALL traces. When any marker 2 is moved, they all move together to the same X-axis position.

- Coupled markers are relevant only in multi-trace configurations.
- All markers are either coupled or uncoupled. There can NOT be one marker coupled and another uncoupled.
- Peak functions move the marker to the peak on the **active trace**, while all other markers move to the same X-axis position.



Coupled Markers ON allows Marker 1 to be moved on ALL traces at the same time.

How to create Uncoupled Markers

NOTE Markers are coupled by default.

To create markers that are NOT coupled (move independently on each trace):

- Press **Marker**
- Then **More**
- Then **Coupled Markers OFF**

Marker Colors

As shown in the above image, in NA and CAT Modes, markers are the same color as the trace to which they are assigned. In SA Mode, the marker color is NOT the same as the trace.

Marker colors can NOT be changed.

Marker Trace (CAT and NA Modes)

The Marker Trace setting is used to move markers between the data trace and memory trace.

When Coupled Markers is ON, this setting applies to the active marker for ALL traces that are coupled. Otherwise, this setting applies to the active marker on only the active trace.

How to move a marker between traces

- With at least one marker present, press **Marker** then **More**.
- Then select the marker to move using **Marker 1,2,3,4,5,6**.
- Then toggle **Marker Trace Auto Data Mem**.
 - **Auto** - Marker resides on data trace when it is visible. Marker resides on memory trace when only IT is visible (Default setting).
 - **Data** - Marker resides on data trace, even when not visible.
 - **Mem** - Marker resides on memory trace, even when not visible.

Marker Trace (SA Mode)

Marker Trace determines the trace number on which a marker resides. A marker is created on, or can later be changed to, the trace number specified by the Marker Trace selection. When changed, a marker moves to the same X-axis location on the specified trace. Learn more about SA Traces on page 88.

How to move a marker between traces

- With two or more traces present, press **Marker** and **Enter** to create a marker. The marker is created on the current Marker Trace selection (default setting is 1).
- Then **More**
- Then select the marker to move using **Marker 1,2,3,4,5,6**.
- Then toggle **Marker Trace 1,2,3,4**
 - The selected marker is moved to the specified trace.

When a marker is moved to a 'blank' trace (not visible) the marker moves to the same X-axis position at either the Y-axis position of the last data, or to the ZERO position.

Marker Format

The Marker Format setting, available ONLY in NA Mode, allows you to choose the format of the marker readout that appears in the upper-right corner of the screen and in the marker table. The marker format can be independent of the trace format, and can be set independently for each trace. All markers on a trace have the same marker format.

How to choose marker format

- Press **Marker**
- Then **More**
- Then **Marker Format**
- Then choose from the following:

Selection	Example Y-axis value
Default Same as displayed format	
R + jX Complex impedance format (3 rd number is distance for Time Domain)	22.8Ω -j61.4Ω 287.9fF
Z Magnitude Impedance Mag.	66.08Ω
Phase	73.8°
Real	0.2003
More	
Imaginary	-0.6727
Mag & Phase	0.705, -73.7°

To view other formats, change the trace format, then select **Default**. Learn how to change format on page 42.

Searching with Markers

Marker Searches are used to move markers to locations on the trace which exhibits the characteristics of the search criteria. Learn ‘What is a Peak’ on page 152.

How to Search with Markers

The following menu structure applies to NA Mode. Keystrokes will be slightly different for CAT, Pulse Measurements, and SA Modes.

- Activate the marker to be used for the search (NOT necessary with Bandwidth search.)
- Then press **Mrk ->/Tools**.
- Then **Marker Search**

- Then choose one of the following:
 - **Tracking ON OFF** (NA Mode ONLY)
 - **ON** causes the active marker to search for the specified criteria with each new sweep. Search criteria can include: Target, Bandwidth, Peak, Min. The searches begin with the first sweep after Tracking is turned ON, based on the current search type. The stimulus setting for a marker can NOT be changed manually. **Trk** appears next to the marker number.
 - **OFF** causes a new marker search only when the search feature is re-executed.
 - **Peak** Moves the active marker to the HIGHEST amplitude data point of the trace. Peak Excursion value is ignored. In SA Mode, the LO feed-through signal (0 Hz) is also ignored.
 - **Min** (Not available in DTF) Moves the active marker to the LOWEST amplitude data point of the trace.
 - **Target** (NA Mode ONLY) Enter the Target value. The marker moves to the first occurrence of the Target value to the right of its current position. The FieldFox interpolates between measured data points to find the exact Target value to two decimal points. The interpolated X-axis value is displayed in the marker readout or marker table. Subsequent presses of the Target softkey cause the marker to move to the right to find the next occurrence of the Target value. When the marker reaches the end of the stimulus range, it "wraps around" and continues the search from the beginning of the stimulus range.
 - **Bandwidth ON OFF** (NA Mode ONLY) Use to quickly toggle BW Markers ON and OFF. When OFF, the marker table appears showing the X and Y-axis positions of all enabled markers.
 - **Bandwidth** (NA Mode ONLY) Specify the level in dB from the peak or valley where bandwidth is measured.
 - **Negative** numbers search for a **Peak** bandpass, such as a filter S21 response.
 - Either of the following TWO methods can be used to search for a **Valley** or Notch filter, such as the S11 response of a bandpass filter.
 - **Negative** values search down from the TOP (MAX) of the response.
 - **Positive** values search up from the BOTTOM (MIN) of the notch.
 - If you first enter Negative, then Positive values, it may be necessary to press **Marker**, then **More**, then **Markers All Off**.

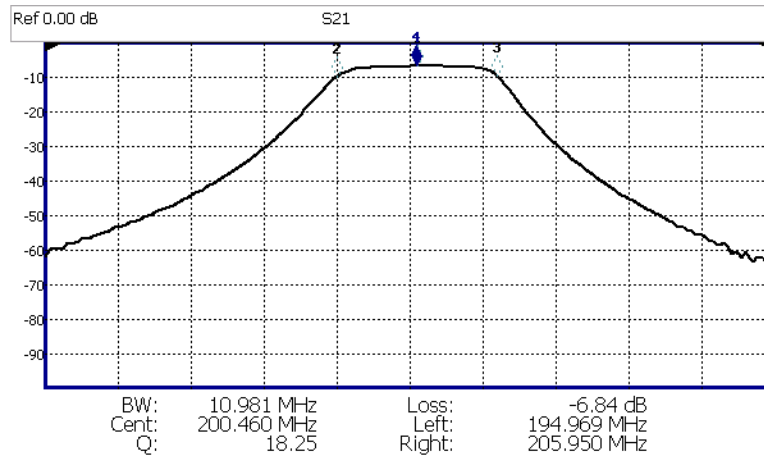

**S21 of a filter with BW Markers and associated readout values.
 The search criteria is -3 dB.**

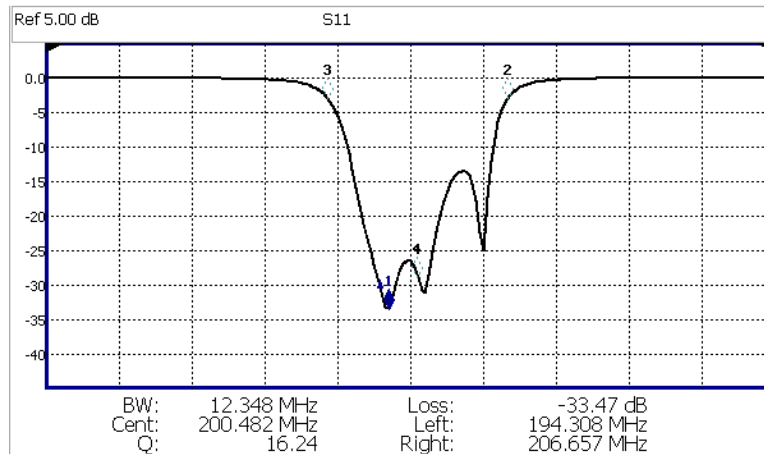

**S11 of the same filter with same search criteria: -3 dB.
 The same values would result from a search criteria of approximately +30.4 dB.**

Press **Enter** and four markers are automatically created to find the first negative or positive bandpass over the displayed frequency range.

Bandwidth Search can be used ONLY with Log Mag display format.

The following six values are displayed for Bandwidth Search:

- **BW:** Width of the filter. (marker 2 freq) **minus** (marker 3 freq).
- **Center:** Marker 4 frequency. Mathematical midpoint between marker 2 and marker 3.
- **Q:** Center Frequency / Bandwidth.
- **Loss:** Marker 1 amplitude.
- **Left:** Frequency of marker 2 or 3 (to left of marker 1).
- **Right:** Frequency of marker 2 or 3 (to right of marker 1).

Press **Back** to return to the previous menu.

Press **Peak Search** then choose from the following:

- **Peak** Moves the active marker to the HIGHEST amplitude data point of the trace. Peak Excursion value is ignored. In SA Mode, the LO feed-through signal (0 Hz) is also ignored.
- **Next Peak** Moves the active marker to the next highest amplitude peak from where it currently resides.
- **Peak Left** Moves the active marker to the next data point to the left that meets the 'Peak' criteria. When no data points to the left meet the 'Peak' criteria, the marker does not move.
- **Peak Right** Moves the active marker to the next data point to the right that meets the 'Peak' criteria. When no data points to the right meet the 'Peak' criteria, the marker does not move.

The following applies to DTF Measurements ONLY:

- **More** then:
- **Track Peaks ON OFF** When Track Peaks is ON, markers will find the new peak with every sweep. While in this Mode, the markers can NOT be turned OFF or moved.
- **Find 3 Peaks** Three markers are created and find the highest peaks (faults) on the trace.

What Is a 'Peak'

You define what the FieldFox considers a "peak" by setting the Peak **Threshold** and Peak **Excursion**.

These two peak criteria settings are set individually for each trace and for each mode (CAT, SA, or NA).

These settings do NOT survive a FieldFox or Mode Preset.

NOTE The Peak Threshold and Excursion settings are NOT available in DTF measurements. To make these settings, create a non-DTF CAT mode measurement, then change the measurement back to DTF.

How to set Peak Criteria

- Press **Mrk ->/Tools**.
- In **CAT and NA** modes:
 - Then **Peak Search**.
- In **SA** mode:
 - Then **More**
 - Then **Mkr Properties**
- Then **Peak Criteria**
- Then select the following:
 - **Peak Threshold** Minimum amplitude (dB). To be considered valid, the peak must be **above** the threshold level. The valley on either side can be below the threshold level. Default = -190 for CAT and NA Modes; -90 for SA Mode.

Note: CAT mode Loss measurements are displayed in positive values. In these cases, the Peak Threshold setting is inverted. For example, Peak Threshold = -20 will consider any peak that has less Loss than 20 dB to be valid.

- **Peak Excursion** The vertical distance (dB) between the peak and the valleys on both sides. To be considered a peak, data values must "fall off" from the peak on both sides by the excursion value. Default = 0.5 dB for CAT and NA Modes; 6 dB for SA Mode.

For example, the settings for the trace in the following image are:

- Threshold: -10 dB
- Excursion: 1 dB
- Scale = 1 dB / Division.

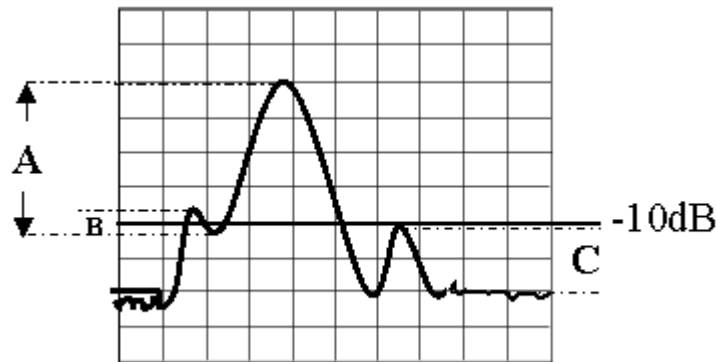

Peak A = **Valid Peak** (Above Threshold and Excursion Settings)

Peak B = **Invalid Peak** (Below 1 dB Excursion Setting)

Peak C = **Invalid Peak** (Below -10 dB Threshold Setting)

Marker Functions

Marker functions are used to change FieldFox frequency or distance settings to those of the active marker.

How to use Marker Functions

- Activate the marker to move.
- Then press **Mrk ->/Tools**
- Then **Mkr ->**
- Then choose one of the following:
 - **Mrk -> Center** (Not available in DTF or SA Mode with zero span) The center frequency of the measurement becomes the value of the active marker. The frequency span is adjusted accordingly.
 - **Mkr -> Delay** (NA Mode ONLY.) The group delay value of the active marker becomes the electrical delay setting of the trace. Learn how to set group delay format on page 42. Learn more about electrical delay on page 44.
 - **Mkr->RefLev** (SA Mode ONLY) The reference level becomes the magnitude of the active marker.

- **Mkr->Tune Freq** (SA Mode with Tune & Listen ONLY) The Tune & Listen Frequency becomes the frequency of the active marker.

The following applies to DTF Measurements ONLY:

- **More** then:
- **Marker=>Start Distance** The Start Distance of the measurement becomes the value of the active marker. Markers that would no longer appear on the screen are moved to the new Start Distance.
- **Marker=>Stop Distance** The Stop Distance of the measurement becomes the value of the active marker. Markers that would no longer appear on the screen are moved to the new Stop Distance.

SA Marker Functions

The following Marker Functions are available in SA Mode ONLY:

- Noise Marker
- Band/Interval Power Marker
- Frequency Counter at Marker
- Audio Beep with Marker

Learn more about these marker functions starting on page 92.

All about Limit Lines

Limit lines are visual representations, drawn on the FieldFox screen, of the specified limits for a measurement. With this capability, you can easily compare measured data versus specifications. Optionally, you can enable an audible beep and display **Pass or Fail** information for each measurement.

- You can have up to as many limit line segments as there are data points for each measurement trace allowing you to test all aspects of your measurements.
- Limit lines are available in CAT Mode, NA Mode, and SA Mode. Power Meter Mode uses different limit settings. Learn more on page 124125.
- Limit lines and limit testing are NOT allowed in NA Mode with **Smith Chart** or **Polar** display formats.
- A simple Display Line is also available in SA Mode ONLY. Learn more on page 91.
- Limit lines can be saved and recalled with an *.sta file. Learn more on page 160. They can also be saved and recalled independently from the Limit softkeys. Learn more on page 157.

How to Create Fixed Limit Lines

There are two ways to build a Fixed limit line:

1. Build (limits) From a Trace. Learn how on page 156
2. Enter X/Y data points into the on-screen editor. The limit line is formed as the FieldFox ‘connects the dots’ on the screen. To create frequency gaps that are NOT tested, use separate limit lines. The X-axis values for two lines can overlap.

- Press **Limit 8**.
- Then **Edit Limits**. A limit line table appears.
- Use the Up / Down arrows and rotary knob to navigate the cursor to the following editable cells.
 - **Description** - Press **Edit**, then enter a description for the limit line using the FieldFox labeler (learn how on page 160).
 - **Fixed/Relative** – Press **Edit** to toggle between the following:
 - **Fixed** - the limit line does not move. The X/Y coordinates are absolute locations on the screen.
 - **Relative** - the limit line moves relative to the center frequency and reference level. **Note:** It is easiest to first create Fixed Limits, then change this setting to Relative. Learn more on page 155.
 - **Upper/Lower** – Press **Edit** to toggle between the following:
 - **Upper** - FAILS any measured data point **ABOVE** the line.
 - **Lower** - FAILS any measured data point **BELOW** the line.
 - **Off/On** – Press **Edit** to toggle between the following:
 - **On** - Limit line is drawn on the screen and PASS/FAIL testing occurs.
 - **Off** - Limit line is NOT drawn on the screen and testing does NOT occur.
 - **Frequency** – Enter a numeric X-axis value of the data point.
 - **Amplitude** – Enter a numeric Y-axis value of the data point.
- Press **Add** then choose from the following:
 - **Add Point** - Adds a blank X/Y data point below the cursor.
 - **Add Limit** - Adds a default limit line below the current limit.
- Press **Clear** then choose from the following:
 - **Clear Point** - Removes the X/Y data point on which the cursor resides.
 - **Clear Limit** - Removes the limit Line on which the cursor resides.
 - **Clear All** - Removes ALL limit lines.
- Press **<Back** to return to the Limit menu.

Relative Limit Lines

Relative limit lines are X/Y coordinates that are referenced to the center frequency (X-axis) and Reference level (Y-axis).

Use relative limits to test devices or signals that are identical except for the center frequency or amplitude. With relative limit lines in place, you change the center frequency of the measurement and the limits look as though they are in the same location.

The same is true for Reference Level. When you expect to measure a different power level, instead of changing the Y-axis value of all of the fixed limits, simply change to relative limits. The limits will then remain a constant Y-axis distance from the Reference Level.

Each limit line can be changed at any time from Fixed to Relative, and Relative to Fixed.

How to Create a Relative Limit Line

The easiest way to create a Relative limit line is to create a Fixed Limit at a specific center frequency and reference level. Learn how on page 154. Then change the limit line to Relative. The X/Y data points will be re-calculated relative to the center frequency and reference level.

Build From Trace

A limit line can be built from an existing trace. One X/Y point is made from each measured data point. Then, using an offset value, you can shift the limit line UP for upper limits or DOWN for lower limits.

Once limit lines have been built from the trace, changes that you make to the trace, such as frequency range, do NOT change the limits. However, the limit line properties can be edited just like standard limit lines.

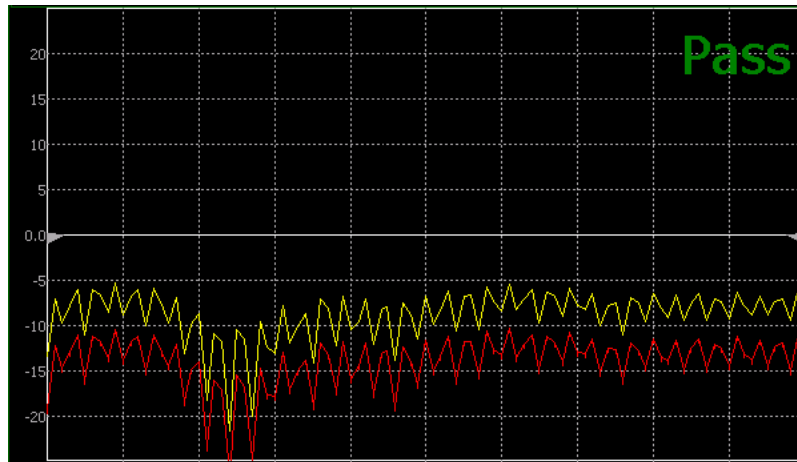

A lower limit line (red) built from the trace (yellow) shifted down 5 dB.

How to Build Limit Lines from a Trace

NOTE Build from Trace is NOT allowed for traces with more than 1001 data points.

- Select the trace from which limits will be built.
- Press **Limit 8**.
- Then **Edit Limits**.
- Then **Build From Trace**. A limit line table appears.
- Use the **▲|▼** arrows to select ON.
- Use **Offset** to shift the limit line UP or DOWN. Learn how below.

Limit Options

How to set Limit Options

- Press **Exit** if the limit table is visible.
- Then **Options**.

- Then choose from the following:
 - **Beep**
 - **On Pass** Audible beep sounds when a sweep passes.
 - **On Fail** Audible beep sounds when a sweep fails.
 - **Off** No audible beep sounds.
 - **Warning On Off** Shows **Pass** or **Fail** indication on the display with each sweep. Data points that fail are highlighted.
 - **Limit Type**
 - **Offset** Shifts the limit line up or down. Enter an offset value using the rotary knob, the **▲|▼** arrows, or by entering a value with the number keys.
 - Enter a **positive** offset to shift the limit line UP, usually used with UPPER limits.
 - Enter a **negative** offset to shift the limit line DOWN, usually used with LOWER limits.
 - **Margin** Shifts the limit line up or down like an offset, but only virtually. The limit line does NOT appear to move. Enter a Margin value using the rotary knob, the **▲|▼** arrows, or by entering a value with the number keys.
 - Enter a **positive** margin to virtually shift the limit line UP.
 - Enter a **negative** margin to virtually shift the limit line DOWN.

How to Save and Recall Limits

In addition to saving and recalling limits with an *.sta file, limit lines can also be saved and then recalled independent of the current mode or measurement. Use this feature to recall and apply existing limit lines to measurements with different settings or even a different frequency range.

Limit line files can be loaded into the FieldFox Data Link Software. Learn how in the help file that is included in the Data Link software.

How to Save and Recall Limits

- Press **Save/Recall** then **Select Device** to set the Device (Internal, SD card, or USB flash drive) to be used for the Save or Recall. Learn more on page 162.
- Then press **Limit**.
- Then choose from the following:
 - **Save Limits** After limit lines have been defined, this saves the line definition to a file on the specified device.
 - **Recall Limits** Recalls a limit Line definition from the specified device.

All about Trace Math

Trace Math is available ONLY in CAT and NA Modes, but not in DTF measurements.

A trace is a series of measurement data points that are connected to form a line. This 'live' data trace is updated as data points are measured.

A memory trace is a live trace that has been stored in the FieldFox volatile memory. It then becomes static, meaning it is not updated with measurements. It can be displayed on the screen by itself, or with a data trace for comparison purposes.

- In NA mode, memory traces are the same color as data traces, but muted (duller).
- In CAT mode, the data trace is displayed in yellow and the memory trace is displayed in blue.

How to display data and memory traces

- Press **Trace 6**.
- Then **Data->Mem** to store the current live trace into memory. A 'beep' sounds to confirm the data trace has been saved to memory. There is no display annotation that indicates that the memory trace has been stored.
 - Press **Data** to view only the data trace.
 - Press **Memory** to view only the memory trace.
 - Press **Data & Memory** to view both the live trace and the stored memory trace.

How to perform Trace Math

Trace math is performed between a live trace and a memory trace. When one of the following math operations are selected, the yellow data trace displays the current measurement with the selected trace math applied. The math operation symbol indicated below in [brackets] is displayed on the lower left corner of the screen.

- Press **Trace 6**.
- If not already stored, press **Data->Mem** to store the current live trace into memory.
- Then **Data Math**.
- Then choose one of the following:
 - **Data + Memory** [D+M] Current measurement data is added to the data in memory.
 - **Data - Memory** [D-M] Current measurement data is subtracted from the data in memory.
 - **Data / Memory** [D/M] Current measurement data is divided by the data in memory.
 - **Math Off** [Data] Displays trace data with NO math applied.

About Math Operations

Data / Memory and **Data - Memory** math operations are performed on complex linear data before it is formatted. Because data is often viewed in log format, it is not always clear which of the two math operations should be used. Remember: dividing linear data is the same as subtracting logarithmic data. The following illustrates, in general, when to use each operation.

Use **Data / Memory** for normalization purposes, such as when comparing traces "before" and "after" a change is made or when measuring trace noise. In the following table, the Data/Mem values intuitively show the differences between traces. It is not obvious what Data-Mem is displaying.

Values to compare	Data/Mem	Data-Mem
0.5 dB and 0.6 dB	0.1 dB	-39 dB
0.5 dB and 0.7 dB	0.2 dB	-33 dB

Use **Data - Memory** to show the relative differences between two signals. Use for comparison of very small signals, such as the S11 match of two connectors.

In the following table, Data/Mem shows both pairs of connectors to have the same 2 dB difference. However, the second pair of connectors have much better S11 performance (-50 and -52) and the relative significance is shown in the Data-Mem values.

Values to compare	Data/Mem	Data-Mem for S-parameters with 20*log relationship	Data-Mem for absolute power levels with 10*log relationship
-10 dB and -12 dB	2 dB	-24 dB	-14 dB
-50 dB and -52 dB	2 dB	-64 dB	-54 dB

File Management

The FieldFox can save any of the following types of files:

- Current settings and calibration
- Trace data (*.csv and *.S1P)
- Picture of the FieldFox screen

In addition, files can be saved to the internal memory, a USB Flash drive, or a microSD card.

In this Chapter

Save Files	160
Recall Files.....	162
Set File Type and Device	162
Manage Files	164
Manage Folders	165
Edit Keywords.....	165
Prefixes for Filenames	166

See Also

Erase User Data	181
-----------------------	-----

Saving and Recalling Files

NOTE FieldFox State files are intended to be recalled on the same instrument model on which they were saved. Sometimes you may be able to recall them within model families. An error will result when trying to recall a state file that was saved on a different model family.

The FieldFox model families are:

- N991x (VNA/SA) model family
- N992x (VNA) model family
- N993x (SA) model family

Save Files

How to Save a File

- Press **Save/Recall 9**.
- Then **Save**.
- At the top of the current 'labeler' screen (see following image) check the **File Type** to save and **Device** (Internal, USB, Storage Card) to which the file is saved. Learn how to change these settings on page 162.
- Then use the labeler to specify a filename.

NOTE Insert only ONE USB Flash Drive in the FieldFox when saving or copying files.

How to use the FieldFox labeler

The FieldFox labeler is used to edit or change the current filename. It is also used for many other labeling functions, such as creating a title, prefix, and keyword to display on the FieldFox screen.

- Press **Select** to add the cursor character to the end of the existing filename.
- Press **Backspace** to erase the last character from the current filename.
- Press **Clear** to erase the current filename.
- The preselected keywords (File, Site, and so forth) can be selected just like a single character. These keywords can also be edited. Learn more on page 165.

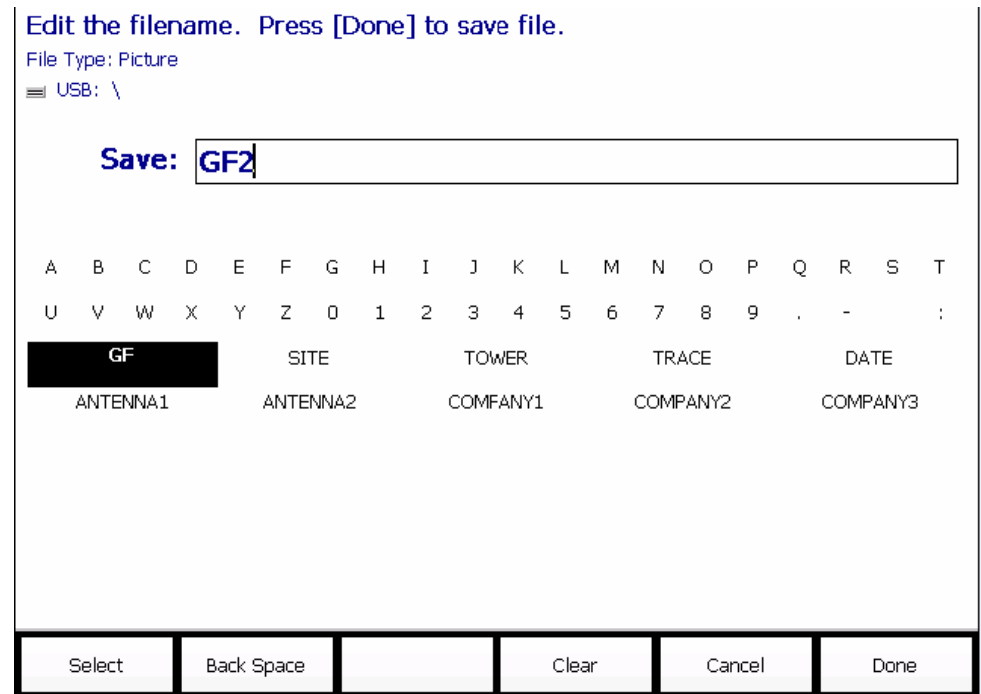

*The FieldFox labeler. The current filename is **GF2**. The cursor is on the custom **GF** keyword. The file will be saved to USB (flash drive). File Type is "Picture".*

How to move the cursor

- Use the rotary knob to move cursor on the same row. The cursor will change rows when it comes to a row end.
- Use the **▲|▼** arrows to move the cursor up and down the rows.

When the current filename is complete

- Press **Done** to save the file to the specified filename. If the filename already exists, a warning is displayed.
- Press **Cancel** to close the labeler without saving a file.
- If the filename already exists, you are prompted to choose from the following:
 - Press **Yes** to overwrite the existing file.
 - Press **Cancel** to edit the filename.

Recall Files

The FieldFox can recall **State** files, **Trace + State** files, and image files.

State Files

ALL FieldFox instrument settings for ALL Modes are saved and recalled in a *.sta file. If error correction is ON in CAT or NA Mode, then calibration data is also saved and recalled.

If error correction is OFF (CalRdy is active), calibration data is NOT saved in the *.sta file. When a Trace + State file is recalled on a FieldFox other than the one it was saved on, differences in the CalRdy calibration data may result in differences between the displayed traces.

Image Files

The FieldFox can open and display *.png, *.jpg, and *.jpeg files.

How to Recall an *.sta File

NOTE Before recalling a file, first set **File Type** to State or Trace + State, and also **Select Device** from which the file will be recalled.

- Press **Save/Recall 9**.
- Then **Recall**.
- Navigate to the file to be recalled using the Up/Down arrow keys.
- Then **Recall File** or **Enter**.

Set File Type and Select Device

The following File TYPE and DEVICE settings are used to determine the type of file to save, and the location to be used for all file operations.

These two settings remain through an instrument preset, but are reset to the default values when the FieldFox power is shutdown.

Select Device (location of File Save/Recall)

- Press **Save/Recall 9**.
- Then **Select Device** to set the **LOCATION** where the file is to be saved. Choose from the following:
 - **Internal** Saves/Recalls files to/from the FieldFox internal memory. To specify a folder, first select Manage Folders (learn how on page 165). The Data Link software will read data ONLY from the \UserData folder.
 - **SD Card** Saves/Recalls files to/from the microSD card (not included), inserted in the card slot. See FieldFox Tour on page 16. Only the root folder is available.
 - **USB** Saves/Recalls files to or from a USB Flash drive (not included) that is inserted in one of the USB connectors. Only the root folder is available.

NOTE Insert only ONE USB Flash Drive in the FieldFox when saving or copying files.

How to set File Type

State files are the only file type that can be recalled by the FieldFox.

- Press **Save/Recall 9**.
- Then **File Type**. Choose one of the following:
 - **State** Saves ALL FieldFox instrument settings for ALL Modes to a *.sta file. If a calibration is ON in CAT or NA Mode, calibration data is also saved. This file can be opened ONLY by a FieldFox.
 - **Trace + State** Saves the current trace and instrument settings to a *.sta file. In SA Mode, all traces are saved. This file can be opened ONLY by a FieldFox. When recalled, the FieldFox sweep is set to Hold.
 - **Picture** Saves a 640 x 453 pixel image of the FieldFox screen to a *.png file. The picture does NOT include the softkeys.
 - **Data (S1P) / (2P)** Saves CAT and NA Mode trace data to an *.S1P or *.S2P file, depending on the active measurement. This file format is used by CAE programs such as Agilent's Microwave Design System (MDS) and Advanced Design System (ADS). It can also be imported into spreadsheet software such as Microsoft Excel.

About SNP Files

- Phase data is NOT available for port 2 (RF IN port).
- The SNP file includes header information and the following data:
 - **S1P** - saves 1-port (receiver) data for the active data trace. *.s1p Files contain 1 stimulus value and 1 S-parameter (total of 3 scalar values)
Stim Real(Sxx) Imag(Sxx)
 - **S2P (NA Mode ONLY)** - saves data for two S-parameters (S11, S21) if they are both displayed. *.s2p Files contain 1 stimulus value and 4 S-parameters (total of 9 scalar values)
Stim Real(S11) Imag(S11) Real(S21) Imag(S21) Real(S12) Imag(S12) Real(S22) Imag(S22)
 - Zeros are returned for S12, and S22 parameters and for S21 phase. When both are corrected, data is returned for both S-parameters, even when not displayed. When the format is Mag/Phase, zero-filled data appears as 0 dB and 0 degrees. When the format is Real/Imaginary, zero-filled data appears as (1,0).
- Data is returned with the correction type that is applied for each S-parameter. The correction type for each S-parameter is annotated in the header.
- Only the data trace is saved – not the memory trace.
- The data for all S-parameters are written to an S2P file according to the format of Trace 1. In Smith Chart or Polar format, files are saved Real/Imaginary format. All other trace formats are saved in Mag/Phase format.
- Trace Math is ignored when saving data to an SNP file.
 - **Data (csv)** Saves trace data from the current Mode to a *.csv file. This format can be imported into spreadsheet software such as Microsoft Excel.
 - In **SA Mode**, all visible data traces are saved. Each trace is saved to a separate column that is labeled with the Trace State.
 - In **CAT and NA Modes**, only the data trace is saved – not the memory trace.
 - In **Power Meter and VVM Mode**, NO data is saved.

	A	B	C	D	E
1	! FILETYPE CSV				
2	! VERSION 1		1		
3	! Timestam		24 June 2008 13:14:56		
4	! NAME Agilent Technologies				
5	! MODEL N9912				
6	! DATA Freq	SA Clear-Write	SA Max Hold	SA Min Hold	SA Average
7	! FREQ UNIT Hz				
8	! DATA UNIT dB				
9	BEGIN				
10	0	-0.119247593	-0.09389364	-0.13572734	-0.1107232
11	15000000	-86.62706485	-75.5567264	-101.81957	-85.785432
12	30000000	-63.17858645	-60.2945464	-66.7374236	-63.460433

*Image of header information and three rows of data from a *.csv file saved in SA Mode with 4 traces visible. Column A is always the frequency at which the data is measured.*

Manage Files

Files that are stored in the FieldFox internal memory, microSD card, and USB Flash drive, can be copied to another device or deleted.

How to Manage files

- Press **Save/Recall 9**.
- Then **Select Device** to select the location (Internal, USB, or microSD Card) of the file to copy or delete.

NOTE When selecting **Internal**, it may also be necessary to first select **Manage Folders** to specify an active folder which contains the files to copy or delete.

- Then **More**.
- Then **Manage Files**.
- Then choose from the following:

NOTE For **Copy File** and **Copy All Files**, files are always copied to a subdirectory titled Copy_<date.time stamp> of when the file was copied. For example, "Copy_June.27.2013-00.40.47". A new subdirectory is created every time a file is copied. Files can NOT be copied to other folders. To get a file to a different folder, it must be saved to the specified folder.

- **Copy File** Select a file to copy. Then select a device to copy the file to. Choose from **Internal**, **USB** (must be inserted), or **SD Card** (must be inserted).
- **Copy All Files** All files that appear will be copied. Then select a device to copy the file to. Choose from **Internal**, **USB** (must be inserted), or **SD Card** (must be inserted).
- **Delete File** The **selected** file is deleted after a warning prompt is displayed.

NOTE Insert only ONE USB Flash Drive in the FieldFox when saving or copying files.

Manage Folders

You can create new folders, delete old folders, and select the active folder to which files can be saved. The Parent folder [...] is listed when not in the root directory.

How to Manage Folders

- Press **Save/Recall 9**.
- Then **More**.
- Then **Manage Folders**.
- Then choose from the following:
 - **Change Folder** Changes the active folder to which files can be saved. The active device and current folder is displayed at the top of the screen. Use the **▲|▼** arrows to highlight a folder within the current folder. Each time the **Change Folder** softkey is pressed, the highlighted folder becomes the active folder.
 - **Create Folder** A new folder is created in the current folder. Select a name for the new folder from one of the displayed keywords: You can change these keywords using the following **Edit Keywords** function.
 - **Delete Folder** The **selected** folder and its contents are deleted after a warning prompt is displayed. A “Parent” folder or system folder can NOT be deleted.
- Press **Exit** when finished.

Edit Keywords

The preselected keywords (FILE, SITE, and so forth) can be edited to meet your specific needs. Your keywords will remain in the FieldFox until you change them. Keywords are limited to 30 characters.

How to edit keywords

- Press **Save/Recall 9**.
- Then **More**.
- Then **Edit Keywords**.
- Then **Next Page** and **Previous Page** to view all keywords.
- Use the **▲|▼** arrows to select a keyword to edit.
- When a keyword is selected, then press **Edit**.
- Then choose from the following:
 - Press **Select** to add the cursor character to the end of the selected keyword.
 - Press **Backspace** to erase the last character from the end of the selected keyword.
 - Press **Clear** to erase the selected keyword.

How to move the cursor:

- Use the rotary knob to move the cursor along the same row. The cursor will change rows when it comes to a row end.
- Use the  arrows to move the cursor up and down between rows.

When the selected keyword is complete:

- Press **Done** to save all keywords and close the Edit Keywords labeler. These keywords will exist on the FieldFox until changed.
- Press **Cancel** to close the labeler without saving changes.

Prefixes for Filenames

A prefix is used as a default filename to which characters can be added. The prefix can be customized, and quickly enabled or disabled. When enabled, the current prefix is automatically entered as the start of a filename when performing a Save operation.

How to enable and disable the current Prefix

- Press **Save/Recall 9**.
- Then **More**.
- Then **Prefix ON OFF**. The current selection is underlined.

How to edit the current Prefix

- Press **Save/Recall 9**.
- Then **More**.
- Then **Prefix**.
- Then choose from the following:
 - Press **Select** to add the cursor character to the end of the Prefix.
 - Press **Backspace** to erase the last character from the end of the Prefix.
 - Press **Clear** to erase the Prefix.
 - The preselected keywords (File, Site, and so forth) can be selected just like a single character. These keywords can also be edited. See **Edit Keywords**.

How to move the cursor

- Use the rotary knob to move cursor on the same row.
- Use the  arrows to move the cursor up and down the rows.

When the Prefix is complete

- Press **Done** to save the Prefix and close the labeler. This Prefix will exist on the FieldFox until it is changed.
- Press **Cancel** to close the labeler without saving changes.

Printing

You can NOT print the measurement display directly from the FieldFox to a printer. You can save a Picture file to a USB Flash Drive or microSD card and then print from any computer. Measurements can also be printed using the FieldFox Data Link software.

System Settings

In this Chapter

Run/Hold.....	168
Preset.....	169
User Preset.....	169
Volume Control.....	169
Display Settings.....	169
Brightness.....	171
Colors.....	171
Trace Width.....	171
Title.....	171
Edit Keywords.....	172
Full Screen Mode.....	172
Preferences	
Quick Settings Table.....	173
Save and Reset Preferences.....	173
Language.....	174
Startup Mode.....	174
Battery Saver.....	174
System Configuration	
Options (Licensing).....	175
GPS.....	176
Frequency Reference Source.....	178
Security Level.....	179
Date and Time Settings.....	179
LAN Settings.....	180
Power ON.....	181
Service Diagnostics	
Erase User Data.....	182

See Also



Battery Usage.....	12
FieldFox Internal Temperatures.....	14

Run/Hold

The **Run/Hold** key determines whether the FieldFox sweeps continuously or does NOT sweep, but holds the display results of the last sweep that was performed.

Use **Hold** to conserve battery power or to allow you to save or analyze the results of a specific measurement sweep.

The current sweep mode is shown on the screen as:

-  Continuous
- **Hold** Hold
-  is displayed while a single sweep occurs.

How to perform a single sweep while in Hold

- Press **Sweep 3**.
- Then choose one of the following:
 - **Single** Automatically sets Continuous OFF (Hold) and causes FieldFox to make ONE measurement sweep, then hold for the next Single key press.
 - **SA Mode ONLY** – With **Continuous OFF** each successive **Run/Hold** press also causes a single sweep.
 - **Continuous ON OFF** Makes continuous sweeps. This is the typical setting when battery power is not critical.

Preset

The Preset key restores the FieldFox measurement settings to a known condition. You can preset the entire instrument, or just the current Mode (CAT, SA, Power Meter, NA.)

When Preset, the FieldFox performs a calibration for use in CAT and NA Modes. Learn more on page 61.

The following settings always survive Preset and Mode Preset:

- External Reference state (page 178)
- SA Units (page 73)
- SA Correction states (page 76)
- VVM Display Resolution (page 139)
- Marker Peak Excursion and Threshold (page 152)
- Volume Control

How to Preset the FieldFox

- Press **Preset**.
- Then choose one of the following:
 - **Preset** Returns ALL Modes to the factory default settings.
 - **Mode Preset** Returns only the current Mode to the factory default settings. The current settings for all other Modes remain.

User Preset

User Preset allows you to store custom settings for each mode, then recall the settings when the Preset key is pressed. Your custom settings are saved to a standard State file (UserPreset.sta). However, unlike State files, calibration data is NOT saved. Learn more about State files on page 162.

How to set User Preset

- Make your custom settings for all modes.
- When finished, press **Preset**.
- Then **Save User Preset**, then select **Yes** to confirm.
- Then **User Preset ON**

How to recall User Preset

- Press **Preset**.
- Then choose from the following:
 - **Preset (User)** The entire UserPreset.sta file is recalled. ALL modes assume the settings that were in place when the User Preset was saved. The active mode is the mode that was visible when the file was saved.
 - **Mode Preset (User)** The settings for only the current mode are recalled from UserPreset.sta.

NOTES

- Only the instrument settings are saved to UserPreset.sta. No trace data or calibration data is saved.
- User Preset ON / OFF is saved as a Preference setting. Like all preferences, this setting survives a FieldFox shutdown and power ON. Therefore, when User Preset is ON during shutdown, the FieldFox will load UserPreset.sta when it is powered ON.
- To return to Factory Preset, select **User Preset OFF**. The contents of UserPreset.sta remain stored on the FieldFox. When User Preset is OFF, you can also set the Startup Mode preference that determines which mode will be visible after powering ON. Learn more on page 162.

Volume Control

System volume control is a FieldFox global setting which sets speaker volume for ALL success beeps, key press clicks, and individual features that use the FieldFox speaker, such as SA Mode Tune and Listen.

The volume control setting remains through a FieldFox Preset. To cause your volume control setting to remain through a FieldFox shutdown, save the setting as a Preference. Learn how on page 172.

How to set FieldFox Volume Control

- Press **System 7**
- Then **Volume**
- Then use the **▲|▼** arrows, the rotary knob, or numeric keypad to enter a value between 0 (lowest volume) and 100 (highest volume).
- Press **Volume** again and select **Mute** to quickly turn OFF the speaker volume. Press **Volume** again to set volume ON to the previous volume control.

Display Settings

You can adjust the FieldFox for optimum viewing in a wide range of lighting conditions.

Display settings remain through a FieldFox Preset. To cause the display brightness, color settings, and trace width to remain through a FieldFox shutdown, save the display settings as Preferences. Learn how on page 172..

NOTE Clean the transfective screen with gentle and minimal wiping using Isopropyl alcohol applied to a lint-free cloth.

Display Brightness

Change the brightness of the background.

How to set Display Colors

- Press **System 7**
- Then **Display**
- Then **Brightness**
- Use the **▲|▼** arrows, the rotary knob, or numeric keypad to enter a value between 0 and 100%.

Display Colors

Change Display Colors to alter the viewing scheme.

How to set Display Colors

- Press **System 7**
- Then **Display**
- Then **Display Colors**
- Then choose one of the following:

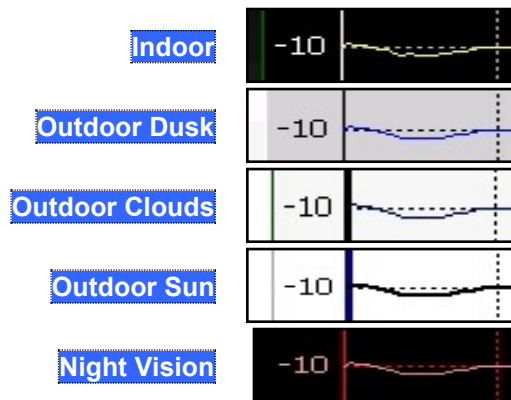

Trace Width

You can set width of all displayed traces on the FieldFox. This may allow better viewing or enhance the look of screen images. This setting can be saved with Preferences.

How to set Trace Width

- Press **System 7**
- Then **Display**
- Then **Display Colors**
- Then **More**
- Then **Trace Width**
- Then choose one of the following:
 - **Normal** - Standard width.
 - **Wide** - Enhanced width.

Title

A custom title can be made to appear in the upper-left corner of the FieldFox screen. The title can contain up to approximately 65 alpha-numeric characters. To view the Title area, see the Screen Tour on page 19.

How to add or edit a Title

- Press **System 7**
- Then **Display**
- Then **Title**
- Then enter or edit a title using the FieldFox labeler. This is the same labeler function that is used to name files. Learn how to use the labeler on page 160.
- Then **Title ON OFF** to make the title appear and disappear from the screen.

Edit Keywords

During a file save operation, keywords can be quickly appended to other text to create unique filenames. The Edit Keywords feature allows you to create custom keywords. Learn all about Edit Keywords on page 165.

Full Screen Mode

Full Screen Mode maximizes the display of trace. The screen annotations and the soft keys are removed.

How to set Full Screen Mode

- Press **System 7**
- Then **Full Screen**

To **Exit** Full Screen Mode, press any key.

Preferences

FieldFox preferences are settings that survive a shutdown. When your FieldFox is turned OFF, then back ON, these settings remain. All preference settings can be restored to their factory defaults. Learn how on page 173

There are two ways to make FieldFox preference settings:

- From softkey selections throughout the FieldFox menu structure. Do this to temporarily try a setting, then press Save Current Settings (as preferences). Learn how in the next section.
- From the Quick Settings table.

Quick Settings Table

All preferences can be set from the Quick Settings table. They are immediately saved as Preferences when **Done** is pressed.

How to view and change Preference Quick Settings

- Press **System 7**
- Then **Preferences**
- Then **Preferences**
- Press **Next Page** and **Previous Page** to view all settings.
- To change a setting:
 - Use the **▲|▼** arrows to highlight a setting.
 - Then press **Edit**. The current setting changes to **yellow**.
 - Some settings require you to press a softkey to change the value. Otherwise, use the numeric keypad, **▲|▼** arrows, or rotary knob to change the value.
 - When finished changing a value, press **Done Edit**
 - When finished changing ALL preferences, press **Done**. All changes are immediately saved as Preferences.
- To exit the editing session without saving changes, press **Esc** at any time.

Learn more about these preference settings:

Setting	Learn more...
Language	on page 174
Display Settings	on page 171
Audio	on page 169
Date and Time	on page 179
GPS	on page 176
CAT Distance Units	on page 37
Battery Saver	on page 174

Save and Reset Preferences

All preference settings can be made at one time from the Quick Settings table.

All settings that can be saved as preferences (except Battery Saver) can also be made from individual softkey selections throughout the FieldFox menu structure. However, they ONLY remain set through a FieldFox shutdown when the current settings are saved as preferences.

The table above shows a list of all of these settings and where they are discussed in this User's Guide.

How to save current settings as Preferences

- Using softkeys, configure the settings as you would like them to remain.
- Press **System 7**
- Then **Preferences**
- Then **Save Current Settings** There is a beep when your settings have been saved.
- Press **Reset Preferences** to restore the factory default settings.

Language

Choose the language in which to display FieldFox softkeys and other messages.

How to select a Language

- Press **System 7**
- Then **Preferences**
- Then **Language**
- Then choose from the following:
 - **English**
 - **Espanol** – Spanish
 - **Deutsch** – German
 - **Italiano** – Italian
 - **Francais** – French
 - **Russian**
 - **Japanese**
 - **Chinese**
 - **Turkish**

Startup Mode

The Startup Mode setting determines the mode that becomes active (visible) when User Preset is set to OFF (Factory Preset) and the FieldFox is powered ON. Learn more about User Preset on page 169.

How to set Startup Mode

- Press **System 7**
- Then **Preferences**

- Then **Preferences**
- Then scroll to **Startup Mode** and press **Edit**.
- Then repeatedly press the **Startup Mode** to scroll through the available choices.
 - **<Default>** is the factory default mode for your FieldFox model.
 - Built-in Power Meter Mode is NOT allowed as a Startup Mode.

Battery Saver

When the battery saver is OFF, the source power is left ON at the end of the sweep which consumes more power. This feature is used in CAT, NA and VVM modes.

NOTE In SA mode, amplitude accuracy may be compromised when the Independent Source is ON, Battery Saver is ON, and the Preamp is ON. For highest amplitude accuracy under these conditions, turn Battery Saver OFF.

How to set Battery Saver

- Press **System 7**
- Then **Preferences**
- Then **Battery Saver**
 - **ON** – Default setting. To conserve battery power, the RF source power is turned OFF at the end of each CAT, NA, and VVM Mode sweep. This behavior does not impact FieldFox measurements.
 - **OFF** – Source power is kept ON at all times, including during trigger Hold mode and between single sweep acquisitions. The RF source stays at the stop frequency until another sweep begins. This provides a constant, uninterrupted RF output from the RF OUT port. This behavior also provides the highest trace stability sweep-to-sweep which may only be evident while using either single sweep or Run/Hold. With Battery Save OFF, the use of a full battery charge is reduced by approximately 45 minutes.

System Configuration

Options (Licensing)

You can view and install options on your FieldFox. See all available options on page 8.

How to view the Installed Options

- Press **System 7**
- Then **System Configuration**
- Then **Options(Licensing)**
- Then **Show Options**

The currently installed options are listed.

How to Install Options

A .lic file must already be on a USB Flash Drive. To learn how to obtain a .lic file, visit: <http://www.agilent.com/find/softwarelicense>

Insert the USB Flash Drive in the FieldFox.

- Press **System 7**
- Then **System Configuration**
- Then **Options**
- Then **Install Options** The FieldFox reads, validates, then installs the options.
- Press and hold the power button to shutdown, then restart the FieldFox.

How to Delete ALL Options

Deleting individual options is NOT supported.

- Press **System 7**
- Then **System Configuration**
- Then **Options**
- Then **Advanced**
- Then **Delete All Options**

After a warning message, all options on the FieldFox are deleted.

NOTE **Delete All CFG Options** is to be used by Service Personnel ONLY.

GPS

GPS (Global Positioning System) allows you to ‘stamp’ each data trace with your physical position in latitude/longitude/elevation format. This can be useful when making measurements on cell towers or other antennas at remote locations.

NOTE This feature is usable ONLY with the GPS receiver that is shipped with Microsoft “Streets and Trips” and “AutoRoute” (versions 2010 and later). The GPS receiver is NOT available from Agilent. Only the GPS USB receiver is used with the FieldFox. Therefore, it is NOT necessary to purchase the very latest version of the map software.

- GPS can be used in all FieldFox modes.
- Your GPS settings can be saved with Preferences. Learn more on page 172.

How to make GPS settings

- Press **System 7**
- Then **System Configuration**
- Then **GPS**
- Then choose from the following:
 - **OFF** - Disable GPS (default setting).

- **External** - Enable GPS using an external, customer-supplied, USB dongle device. When enabled, a check is made to detect a USB GPS device at the USB connectors. When a device is detected, a search is made for satellites overhead. The GPS works best when outdoors and in full view of the open sky. When several satellites are found, the following screen appears and is updated frequently:

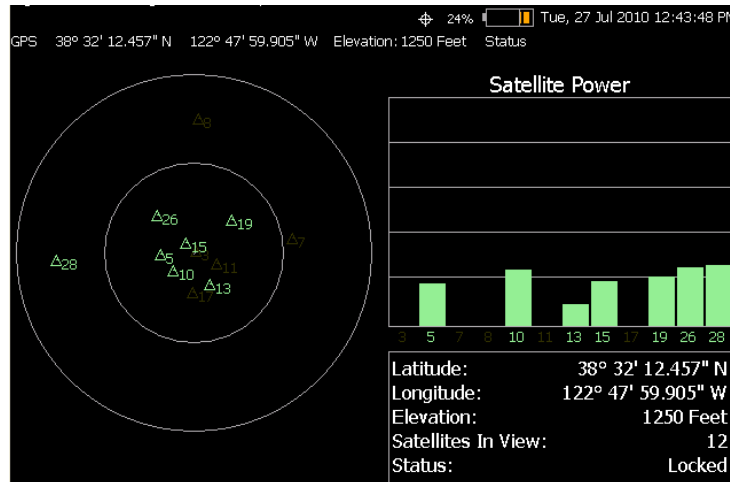

- The left portion of the screen shows satellites and the corresponding number on the adjacent Satellite Power chart.
- **Sync Clock ON OFF** Enable and disable the synchronization of the FieldFox internal clock to the GPS UTC time standard.

NOTE The GPS Sync setting has the same restrictions as the Date and Time setting. Time can be changed BACK no more than once a day and no more than 6 hours at a time. Learn more on page 179.



- **ON** The FieldFox clock is synchronized and updated approximately every second to the time of the GPS clock. Learn how to set the local time zone on page 179.
- **OFF** The FieldFox clock is NOT synched with GPS. When set to OFF after Sync was ON, the date and time does NOT revert back to the settings before the clock was synchronized.
- **Display ON OFF** Enable and disable the GPS display on the FieldFox main window.
- **Lat/Lon Format** Change the format of the GPS display on the FieldFox screen. Choose from:
 - **ddd°mm' ss.sss"** degrees, minutes, seconds (default setting)
 - **ddd°mm.mmmmm'** degrees, minutes, fractional minutes
 - **ddd.dddddd°** decimal degrees
- **Elevation Unit** Choose from:
 - **m** (Meters)
 - **Feet**

GPS Status

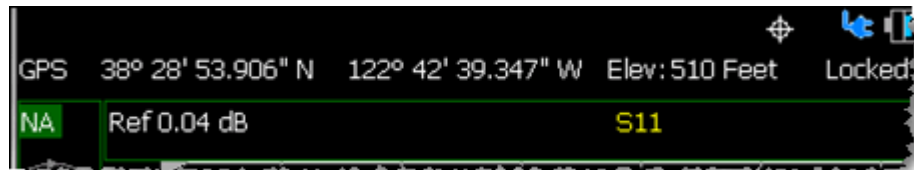
With GPS enabled and a device detected, the following is displayed at the top of the FieldFox screen:



In the above image, the following icons show if the FieldFox is locked on satellites:

-  - GPS ON and locked on satellites
-  - GPS ON, but NOT locked on satellites
-  - GPS ON, but no GPS receiver is present or detected

Saving Data with GPS Enabled

GPS position and clock data are included when data is saved with the following file types: *.csv, *.SnP, State, State+Trace data save.

A warning is shown if the GPS is ON but unlocked at time of save, or if the GPS feature is ON but no GPS is physically present at time of save.

The following is a sample S1P file with GPS information:

```
!GPS Latitude: 38 28.87717 N
!GPS Longitude: 122 42.66625 W
!GPS TimeStamp: 06/25/2010 16:24:48
!GPS Seconds Since Last Read: 2
```

Frequency Reference Source

The FieldFox can phase lock with an external 10 MHz reference signal. When a high-stability 10 MHz reference signal is available, this can improve the accuracy and stability of measurements in CAT, NA, and SA Modes.

The External Reference setting will survive a FieldFox or Mode Preset and is saved as part of the Instrument State.

How to set External Reference

Connect the 10 MHz External Reference to the **EXT TRIG/EXT REF** BNC connector on the FieldFox top panel. Learn about External Trigger Input on page 86.

- Press **System 7**
- Then **System Configuration**
- Then **Frequency Ref**
- Then **Freq Ref Source Int Ext**

NOTE The FieldFox may take up to 10 seconds to lock to a valid External Reference source.

When switched to Ext, if the FieldFox does NOT find an appropriate signal with which it can lock, then **Ext Ref UNLOCKED** is displayed in the lower-left corner of the screen. This can occur when any of the following conditions exist:

- NO external reference signal is present.
- A low-level external reference signal is present.
- A very high-level external reference signal is present.
- The external reference is off-frequency.

For best results, the signal should be between -5 dBm and +5 dBm.

Security Level

For security reasons, you can prevent frequency information from appearing on the FieldFox while in SA, NA, or CAT modes.

How to set Security Level

- Press **System 7**
- Then **System Configuration**
- Then **Security Level**
- Then choose from the following:
 - **None** All frequency settings are visible.
 - **High** Frequency information is blanked from the following:
 - Display annotation
 - Softkeys
 - Marker display and marker table
 - Calibration properties
 - All settings tables
 - Limit line tables
 - All saved .png files
 - Any of the following will re-display frequency information:
 - Set to **None**, Preset, Mode Preset, or FieldFox restart.

Date and Time, Format, and Time Zone Settings

Set the local date and time, Date and Time format, and Time Zone that is shown on the FieldFox screen. The Date and Time is also used to identify files that are saved.

The Date and Time can also be set by synchronizing with GPS satellites. Learn more on page 176.

NOTE

Because of licensing security, the Date and Time setting is restricted as follows:

- Can be set backward no more than 6 hours at a time.
- Can be set forward any amount of time.
- Can be set backward or forward no more than once in a day. A new day begins at midnight.

The GPS Sync setting has the same restrictions.

There is no restriction for setting the Time Zone.

To change the Date and Time backward a significant amount, send an email to ctd-soco_support@agilent.com.

TIP

BEFORE setting the Date and Time, be absolutely certain that the Time Zone setting is correct.

How to set Date and Time, Date and Time Format, and Time Zone

- Press **System 7**.
- Then **System Configuration**.
- Then **Date and Time**.
- Press the **▲|▼** arrows to highlight the row to be edited.
- Then press **Edit**.
- Use the **▲|▼** arrows or rotary knob to select the field to be edited.
- Use the **▲|▼** arrows or numeric keypad to edit that field.
- Press **Cancel** or **Done** when the edits are complete.
- Press **Done** to exit the Date and Time settings. The readout in the upper-right corner of the FieldFox screen will update accordingly.

LAN Settings

Configure the LAN settings to be used to communicate with the Data Link Software. Learn more at: www.agilent.com/find/fieldfoxsupport.

Use knob. Press [Edit] to make changes. Press [Done] to exit.	
Setting	Value
Current IP Address	192.168.1.102
Current Subnet Mask	255.255.255.0
Current Gateway	192.168.1.1
Hostname	A-N9912A-00000
Obtain IP Address using:	DHCP
Static IP Address	123.456.789.123.123
Static Subnet Mask	0.0.0.0
Static Gateway	0.0.0.0
Apply Settings at:	PowerUp

LAN Settings

How to configure the LAN settings

The first three 'Current...' settings can NOT be edited.

- Press **System 7**.
- Then **System Configuration**.
- Then **LAN**.
- Use the **▲|▼** arrows to select one of the following, then press **Edit**.
 - **Hostname** Change the name that can be used to address the FieldFox if your server supports this feature. The default hostname is generated automatically.
 - **Obtain IP** Choose from:

- **DHCP** - IP Address is assigned dynamically. If your server supports this feature, the IP Address for the FieldFox is assigned each time it is started.
- **Static** - Set the IP Address manually. The Address remains until you change it.
- **Static IP Address** - Enter the IP Address – including periods - in the format nnn.nnn.nnn.nnn
- **Static Subnet Mask** - Enter the Subnet Mask – including periods - in the format nnn.nnn.nnn.nnn
- **Static Gateway** - Enter the Static Gateway – including periods - in the format nnn.nnn.nnn.nnn
- **Apply Settings** Choose from:
 - **Power Up** The above settings take effect when the FieldFox is started.
 - **Now** The above settings take effect immediately.

NOTE To make the LAN settings persist after power up, toggle **Apply Settings** to **Now** then back to **Power Up**. You should see a message indicating that the LANconfig file was saved.

- Press **Done Edit** when finished.

Power ON

When the FieldFox is without a power source, this setting allows the FieldFox to power ON as soon as a charged battery or the DC Adapter is inserted without pressing the power button.

How to set Power ON

- Press **System 7**
- Then **System Configuration**
- Then **Power ON**
- Then choose from the following:
 - **Auto** The FieldFox will power ON when a charged battery or the DC Adapter is inserted.
 - **Manual** The FieldFox will power ON only when the power button is pressed.

Service Diagnostics

- The Service diagnostics menu is generally used to display service-related information. To access these menu items, press **System 7** then **Service Diagnostics**.

System Information

The System information table shows important information about your FieldFox. The following is the most useful information:

- **Model Number** – FieldFox model
- **Serial Number** – Identification number of your FieldFox

- **Firmware Release** – The currently installed version of software. Check to see if you have the latest firmware at: www.agilent.com/find/fieldfoxsupport
- **Network Identity** – The network name and current IP address of your FieldFox.
- **Reflectometer Cal** - The Factory (CalReady) Calibration shows the date and time that the factory cal was performed for each test port and the Thru connection. The format is P1 <date time>, P2 <date time>, P1-P2 <date time>. The factory calibration is updated when you send your FieldFox to Agilent for Instrument Calibration. Learn more on page 181.

Error Log

The Error Log shows the information that has appeared on the FieldFox screen. The most recent information is at the top of the table.

Press **Clear Errors** to erase this information.

Battery

Learn about this table on page 184.

Internal Temperatures

Learn all about this table and the importance of the internal FieldFox temperatures on page 14.

Erase User Data

All data that you have written to the FieldFox can be erased with the press of a button. You would do this if your FieldFox is located in a secure environment and must be routinely erased of sensitive data.

All data is deleted from the FieldFox internal “UserData” partition. This includes all State files and Trace + State files (*.sta), all Data files (*.csv, *.snp), all Picture files (*.png), all Cal Kit files, and all Cable files.

External media that is inserted (mini-SD card or USB flash drive) is NOT erased.

The "Lost Clusters" folder and files is NOT erased because it is part of the file system housekeeping.

How to Erase User Data

- Press **System 7**.
- Then **Service Diagnostics**.
- Then **Advanced**.
- Then **Erase User Data**.
- Then **Confirm Erase**.
- Then the following occurs:
 - All data files and folders are deleted from the “UserData” partition.
 - A large file of 0s is written to all of the free blocks on the partition.

- The large file is deleted. All blocks released by deleting this file are now available for use.
- The FieldFox is rebooted, which manages the newly-freed data and re-writes the factory cal kits and cable files.

Working with the Lithium-Ion Battery

In this Chapter

Viewing Battery Charge Status.....	184
Charging the Battery	184
Reconditioning the Battery	187
Battery Care	188
Maximizing Battery Life	188
Battery Disposal.....	189

See Also



Installing the Battery	12
Conserving Battery Power	12
Battery Safety Considerations.....	192

Viewing Battery Charge Status

You can view the battery charge status in the following ways:

- Icons in the upper right of the front panel screen.
- Battery screen - select **System** then **Service Diagnostics** then **Battery**.
- Built-in battery gauge. Learn more in the following section.

Front Panel Icons

Icon	Status
	Connected to external power through the AC/DC adapter. Battery installed and charging. The amount of charge is indicated by the number of bars shown.
	Battery not charging with 84% battery life remaining.
	Battery fully charged. A fully charged battery MAY NOT read 100%. Learn more on page 187, Reconditioning the Battery.

Service Diagnostics – Battery Screen

The Battery screen displays the following information. To access the screen, select **System** then **Service Diagnostics** then **Battery**.

Additional battery information is available using SCPI commands.

1. **Status** – Fully charged, No battery, Charging, Empty, or Discharging.
2. **External DC Supply** – True or False indicates if an external DC supply is connected.
3. **Battery Present** – True or False indicates if a battery is installed.

NOTE Items 4 through 8 are read directly from the battery. The information is based on the battery's internal sensors and memory.

4. **Voltage** – measured by the battery's sensor.

5. **Current** – amount of current being consumed when operating from internal battery. If battery is charging, indicates amount of charging current.
6. **Battery Temperature** – internal temperature of the battery as measured by a sensor embedded in the battery.
7. **Present Run Time to Empty** – minutes of power remaining based on amount of current being used now.
8. **Charge Cycles** – number of charge cycles the battery has experienced. Charge cycle defined as $\geq 80\%$ change in relative state of charge.

Built-In Battery Gauge

Each lithium ion battery has an LED gauge that displays its charge status. The gauge is active unless the battery is in shutdown mode.

To view the LED gauge, open the FieldFox battery compartment door, remove the battery, then press the button on the battery.

The battery in your FieldFox will have either 4 or 5 LED segments.

5-segment Gauge	Charge Remaining	4-segment Gauge	Charge Remaining
5 segments	$\geq 80\%$	4 segments	$\geq 75\%$
4 segments	60% to 79%	3 segments	50%,to 74%
3 segments	40% to 59%	2 segments	25% to 49%
2 segments	20% to 39%	1 segment	< 25%
1 segment	< 20%		

Charging the Battery

When you receive your FieldFox, the lithium-ion battery is partially charged to approximately 30% to 40% to preserve battery life. Allow four hours to fully charge the battery internally, or three hours by using the external battery charger (N9910X-872). A fully charged battery will power your FieldFox for about four hours. It is NOT necessary for you to do any type of battery preconditioning before use.

The FieldFox circuitry ALWAYS prevents the battery from discharging to a level that is damaging. However, if the battery is **completely** discharged, the FieldFox may not turn ON. If this occurs, the battery can still be charged either internally or externally.

Because a lithium-ion battery has no memory effect, you can charge a battery at any time regardless of the current charge status. However, this could impair the accuracy of its internal charge-remaining indicator. When the Max Error is 10% or greater, the battery should be reconditioned. Learn more on page 187.

Internal Charging with the AC/DC Adapter

Important: Read the safety information for the AC/DC adapter on page 191.

Internal charging time for a fully depleted battery is approximately 4 hours with the FieldFox either ON or OFF.



AC/DC adapter

To charge a battery inside the FieldFox, insert the AC/DC adapter plug into the Power connector on the FieldFox side panel (middle hinged door), then plug the adapter into an AC outlet.

- **FieldFox ON:** Charging is indicated by a battery icon in the upper right of the front panel screen.
- **FieldFox OFF:** Charging is indicated by the FieldFox power LED glowing amber, with its intensity increasing from dim to bright every few seconds. This pattern repeats until the LED turns off when charging is done. Learn more on page 17.

Using the External Battery Charger (N9910X-872)

Important: Read the safety information for the External Charger on page 192.



External Battery Charger (N9910X-872)

The external battery charger (N9910X-872), lets you charge a fully depleted battery in approximately three hours. It is a two bay, level-3 stand-alone battery charger that is compliant with the standard Smart Battery System. The two bays are charged sequentially on a first-come, first-served basis, though a discharge can be performed in the left bay while the right bay is charging. It uses an external universal switching power supply

External Battery Charger LED	Charging Status
Green	Fully charged
Green flashing	Fast charging
Yellow flashing	Reconditioning – the accuracy of the battery’s internal LED charge gauge is being renewed. See “Reconditioning Batteries.”
Yellow/green	Battery is reconditioned
Red flashing	Error
Yellow	Standby

For more information, refer to the Instruction Manual included with the external battery charger.

Reconditioning the Battery

The battery contains electronics that monitors battery usage and tracks how much capacity is available. This function can become less accurate because of temperature fluctuations, aging, self-discharge, repeated partial charging, and other factors. Reconditioning - also known as recalibrating - restores the accuracy of the battery capacity tracking system.

Reconditioning does NOT affect actual battery performance. It only recalibrates the charge level indicator.

Reconditioning is done by fully charging the battery, fully discharging it, recharging it again, and then verifying that the error has been corrected.

How to determine if a battery needs reconditioning

1. Press **System** then **Service Diagnostics** then **Battery**.
2. On the Battery screen, if the Max Error is 10% or greater, the battery needs to be reconditioned.

This error will affect many of the displayed battery charge indicators.

After reconditioning, if the battery is not fully charged or continues to show more than a 9% Max Error reading, repeat the reconditioning procedure.

If the third reconditioning does not restore a full charge and give an error reading of 9% or less, the battery may need replacement.

You can recondition a battery internally, or with the External Charger (N9910X-872). The external charger process is faster and simpler.

How to perform Internal Reconditioning

1. Fully charge the battery inside the FieldFox (either ON or OFF) using the AC/DC adapter.
2. Confirm that the battery is fully charged. When fully charged, the following icon appears on the FieldFox: 
3. Fully discharge the battery by disconnecting the AC/DC adapter, then leave the FieldFox ON until it shuts down (about four to five hours).
4. Remove the battery from the FieldFox, wait one minute, then re-install the battery.
5. Reconnect the AC/DC adapter.
6. Charge the battery and verify a full charge.
7. Check the **System** then **Service Diagnostics** then **Battery** screen to verify that the Max Error is less than 10%.

How to Recondition with the External Battery Charger (N9910X-872)

1. Insert a battery into the left bay of the external charger.
2. Press the button labeled Push to Recalibrate Left Battery Bay
3. The charger will charge the battery fully, discharge it completely, then recharge it fully again. The entire process can take up to 12 hours.
4. Install the battery into the FieldFox.
5. On the System, Battery screen, verify that the battery is fully charged and reconditioned.

Battery Care

Visually inspect the battery periodically for signs of degradation, such as swelling, cracking of the battery shell, or leakage of fluid. If degradation occurs, replace the battery and dispose of it properly. Learn how on page 189. Operation with a degraded battery could result in damage to the FieldFox. Learn more on page 192.

Maximizing Battery Life

- If AC power is continuously available (Ex: in a workbench environment), remove the battery and use the AC/DC adapter.

- If AC power is not continuously available (Ex: in a field environment), use the battery and recharge it when it holds a 20% to 50% charge, as shown on the screen's battery charge icon. At this charge level, 2 or 3 segments show on the battery gauge.
- If the FieldFox is not going to be used for more than a week, remove the battery. Best practice is to store the battery with a charge of about 50%. At this charge level, 3 segments show on the battery gauge. Batteries that remain idle eventually lose their ability to hold a charge.
- Allow a battery to warm to room temperature before charging it. Temperature shock can damage the battery chemistry and in some cases cause a short circuit.
- Store batteries in a cool, dry location, away from metal objects and corrosive gases.
Storage temperature limits (20% to 50% relative charge is recommended):

Transportation:	-20°C to 50°C
Within 1 month:	-20°C to 45°C
Within 6 months:	-20°C to 40°C
Within 1 year:	-20°C to 35°C
- Battery charging limits:

Charge temperature:	0°C to 45°C (<10°C slows charge on some batteries)
Discharge temperature:	-10°C to 60°C
- Operate the FieldFox on battery power between the ambient temperatures of -10 and +50°C (-14 to +122°F). Using the battery at lower or higher temperatures can damage it and reduce operating life. Cold temperatures affect battery chemistry, reducing charge capacity, especially below 0°C (32°F).

Lithium Ion Battery Disposal

When you notice a large decrease in charge capacity after proper recharging, it's probably time to replace the battery.

Lithium-Ion batteries need to be disposed of properly. Contact your local waste management facility for information regarding environmentally sound collection, recycling, and disposal of the batteries. Regulations vary for different countries. Dispose of the battery in accordance with local regulations.

Agilent Technologies, through Rechargeable Battery Recycling Corporation (RBRC), offers free and convenient battery recycling options in the U.S. and Canada. Contact RBRC at 877-2-RECYCLE (877.273.2925) or online at: <http://www.call2recycle.org/> for the nearest recycling location

Safety Considerations

Agilent has designed and tested the FieldFox in accordance with IEC Publication 61010-1:2001 Safety Requirements for Electrical Equipment for Measurement, Control and Laboratory Use, and the FieldFox is supplied in a safe condition. The FieldFox is also designed for use in Installation Category II and pollution Degree 2 per IEC 61010 and IEC 60664 respectively. Read the following safety notices carefully before you start to use this FieldFox to ensure safe operation and to maintain the product in a safe condition.

For the FieldFox

WARNING

No operator serviceable parts inside except for the lithium-ion battery. Refer servicing to qualified personnel. To prevent electrical shock do not remove covers.

WARNING

If this product is not used as specified, the protection provided by the equipment could be impaired. This product must be used in a normal condition (in which all means for protection are intact) when attached to the AC-DC adapter.

WARNING

The unit may be used only in the operating conditions and positions specified by the manufacturer. The Agilent N9912 Handheld Cable and Antenna Tester complies with the following standards

IEC 61010 2nd Edition/EN 61010 2nd Edition

Canada: CSA C22.2 No. 61010-1-04

USA: UL 61010-1 2nd Edition

WARNING

Do not install substitute parts or perform any unauthorized modification to the product. Return the product to Agilent Technologies or a designated repair center for service to ensure that safety features are maintained.

WARNING

Applicable local or national safety regulations and rules for the prevention of accidents must be observed in all work performed.

WARNING

Ensure that the connections with information technology equipment comply with IEC950 / EN60950.

WARNING

Observe all ratings and markings of the instrument before connecting the instrument.

Maximum Input Voltages and Power:

RF Output Connector: 50V DC, +23 dBm RF

Ext Trig/Ref Connector: 5.5 V DC

RF Input: ± 50 VDC, +27 dBm RF

DC Input: 19VDC, 4ADC

WARNING

When performing a measurement, ensure that the right safety and performance ratings of the instrument and accessories are used.

Do not expose the circuit or operate the instrument without its cover or while power is being supplied.

Do not operate the instrument in any environment at risk of explosion.

CAUTION

The power cord and connectors shall be compatible with the connector used in the premise electrical system. Failure to ensure adequate earth grounding by not using the correct components may cause product damage and serious injury.

CAUTION

The measuring terminals on this instrument are designed to be used with external signals described in Measurement Category I, but NOT with external signals described in Categories.

For the AC/DC Adapter

WARNING

The AC/DC adapter is a Safety Class 1 Product (provided with a protective earthing ground incorporated in the power cord). The mains plug shall only be inserted in a socket outlet provided with a protective earth contact. Any interruption of the protective conductor inside or outside of the product is likely to make the product dangerous. Intentional interruption is prohibited.

WARNING

Use only the designated AC/DC adapter supplied with the instrument.

WARNING

Use only the designated power cord supplied with the AC/DC adapter.

WARNING

No operator serviceable parts inside this product. Do not perform any unauthorized modification to the product. Return the product to Agilent Technologies or a designated repair center for service to ensure that safety features are maintained.

WARNING

Operated at an ambient temperature: 0 to 40°C; full power rating; derate linearly to 50 W at 50°C.

Maximum output rating: +15V/4.0 A.

Input rating: AC 100–240 V, 50/60Hz

WARNING

Main Plug : Use a 3–pin main plug that complies with IEC 60884–1, Plugs and Socket–Outlets for Household and Similar Purposes – Parts1: General Requirements and country specific safety authority requirements, such as UL, SA, BSI, VDE, CCC, SA, NZ, and PSE.

WARNING

Appliance Connector: Use an appliance connector certified to IEC 60320–1/EN 60320–1 requirements

WARNING

To prevent electrical shock, disconnect the AC to DC adapter from the mains before cleaning. Use a dry cloth or one slightly dampened with water to clean the external case parts. Do not attempt to clean internally.

WARNING

When the FieldFox is connected to the AC/DC adapter, position the adapter so the power cord is readily accessible. The power cord is the disconnecting device. It removes main power to the AC/DC adapter. The FieldFox front panel switch is only for the DC power within the instrument, and not for the AC/DC adapter. Alternately, an AC switch or circuit breaker (which is readily identifiable and is easily reached by the operator) may be installed and used as a disconnecting device to remove mains power from the AC/DC adapter.

WARNING

To avoid overheating, always disconnect the FieldFox from the AC/DC adapter before storing the FieldFox in the backpack.

If you prefer to leave the FieldFox connected to the AC/DC adapter while inside the backpack, you can disconnect the AC/DC adapter from its AC power source to prevent overheating.

CAUTION

The AC/DC adapter has an auto-ranging line voltage input – be sure the supply voltage is within the specified range.

CAUTION

The AC/DC adapter is for indoor use only.

CAUTION

Never use a modified or damaged charger. Use the original AC–DC adapter ONLY.

CAUTION

The AC/DC adapter is designed for use in Installation Category II and Pollution Degree 2 per IEC 61010 Second Edition and 664.

For the External Battery Charger (N9910X–872)

CAUTION

If charging batteries externally, use the optional external charger available from Agilent, or another SMBus charger of level II or higher.

Never use a non–SMBus charger because the battery issues commands over the SMBus to the charger to control the charge rate and voltage.

Never use a modified or damaged charger.

For the Battery

Lithium battery packs may get hot, explode, or ignite and cause serious injury if exposed to abuse conditions. Be sure to follow these safety warnings:

WARNING

Lithium-ion batteries:

Must not be exposed to high temperatures (>70°C) or fire.

Must be kept away from children.

Must not be short circuited.

Must be replaced only with Agilent qualified Li-ion batteries.

If replaced or charged improperly, there is a danger of explosion.

WARNING

Do not connect the positive terminal and negative terminal of the battery to each other with any metal object (such as wire).

WARNING

Do not carry or store the battery with necklaces, hairpins, or other metal objects.

WARNING

Do not pierce the battery with nails, strike the battery with a hammer, step on the battery, or otherwise subject it to strong impacts or shocks.

WARNING

Do not solder directly onto the battery.

WARNING

Do not expose the battery to water or salt water, or allow the battery to get wet.

WARNING

Do not disassemble or modify the battery. The battery contains safety and protection devices, which if damaged, may cause the battery to generate heat, explode, or ignite.

WARNING

Do not place the battery in direct sunlight, or use or store the battery inside cars in hot weather. Doing so may cause the battery to generate heat, explode, or ignite. Using the battery in this manner may also result in a loss of performance and a shortened life expectancy.

WARNING

There is a danger of explosion if the battery is incorrectly replaced. Replace only with the same or equivalent type of battery recommended. Discard used batteries according to manufacturer's instructions.

WARNING

If you are charging the batteries internally, even while the FieldFox is powered off, the FieldFox may become warm. Allow for proper ventilation.

WARNING

Do not discharge the battery using any device except the FieldFox or the external battery charger (N9910X-872). When the battery is used in a device other than those specified, it may damage the battery or reduce its life expectancy. If the device causes an abnormal current to flow, it may cause the battery to become hot, explode, or ignite and cause serious injury

Battery Protective Functions

The following protective functions are designed into the lithium-ion rechargeable battery system used in FieldFox.

The protective functions can be divided between two categories: active and passive. Active protection refers to the type of protection that depends on at least two or more protection devices working together to enable the protection. Passive protection refers to the type of protection that is always enabled independent of any other protection device.

Active Protection

Primary Overcharge Voltage: This prevents the battery from being charged if the voltage across any cell exceeds approximately 4.35 V per cell. Once the overcharge protection is tripped, the voltage across each cell must drop below approximately 4.15 V to reset the protection and permit charging.

Secondary Overcharge Voltage: This is a one-time, permanent protection that is triggered when the voltage across any cell exceeds approximately 4.45 V. Once this protection is tripped, the battery can no longer be used and must be replaced.

Overdischarge Voltage: This prevents the battery from discharging if the voltage across any cell drops below approximately 2.6 V. Once the overdischarge voltage protection is tripped, the voltage across each cell must be charged to approximately 3 V to reset the protection and permit discharging.

Primary Overcharge Current: This prevents the battery from being charged if the average charging current reaches or exceeds 3.5A for a time period of 120 seconds or more.

Secondary Overcharge Current: This prevents the battery from being charged if the charging current reaches or exceeds $4A \pm 20\%$ for a time period of 20 milliseconds or more.

Primary Overdischarge Current: This prevents the battery from being discharged if the average current out of the battery reaches or exceeds 5A for a time period of 120 seconds or more. This protection can be reset by removing the load.

Secondary Overdischarge Current: This prevents the battery from being discharged if the current out of the battery reaches or exceeds 6A for a time period of 20 milliseconds or more. This protection can be reset by removing the load.

Short Circuit Protection: This prevents the battery from being charged or discharged and protects against damage or lost data if the current in or out of the battery reaches or exceeds 12.5A for a time period of 183 microseconds or more. This protection can be reset by removing the load.

Overtemperature Charging: The system microcontroller prevents the battery from being charged if the cell temperature exceeds 46C. Once the overtemperature charging protection is tripped, the cell temperature has to drop to or below 45C to reset the protection and permit charging.

Overtemperature Discharging: The system microcontroller prevents the battery from being discharged if the cell temperature exceeds 65C. Once the overtemperature discharging protection is tripped, the battery is automatically shut off which results in turning off the instrument as well.

Passive Protection

Reverse Charging: A reverse protection diode prevents against damage or lost data due to a reverse charge polarity applied to the battery terminals.

Primary Overtemperature: A PTC(positive temperature coefficient) polyfuse in series between the Li-ion cells and the charging and discharging transistors will open up and limit current flow to the battery terminals as a function of very high temperatures. This protection is resettable once the overstress condition is removed.

The maximum operating temperature of this fuse is 85C.

Secondary Overtemperature: A second PTC polyfuse built into each Li-ion cell will open up and limit current flow as a function of very high temperatures.

Tertiary Overtemperature: A current interrupt device (CID) within each Li-ion cell will permanently open up when the temperature reaches 95C. As each cell fuse is permanently interrupted, overall battery performance will become severely degraded, up to and including disabling the battery.

Overcurrent Fuse: This is a one-time blow fuse with a rated current of 12A.

Batteries: Safe Handling and Disposal

To learn how to safely handle and dispose of the FieldFox battery, refer to the Material Safety Data Sheet for the manufacturer of the battery at:

<http://na.tm.agilent.com/fieldfox/help/Reference/MSDS.htm>

Environmental Requirements

Refer to the Specifications section of this document.

Electrical Requirements

The FieldFox allows you to use either the lithium-ion battery or the AC/DC adapter - both are included.

Electrostatic Discharge (ESD) Precautions

The FieldFox was constructed in an ESD protected environment. This is because most of the semiconductor devices used in this instrument are susceptible to damage by static discharge.

Static charges are generated in numerous ways, such as simple contact, separation of materials, and normal motions of persons working with the FieldFox. To prevent instrument damage, practice industry accepted techniques for handling static sensitive devices when using the FieldFox.

Very often, coaxial cables and antennas also build up a static charge, which, if allowed to discharge by connecting to the FieldFox, may damage the instrument input circuitry. To avoid such damage, it is recommended to dissipate any static charges by temporarily attaching a short to the cable or antenna prior to attaching to the instrument.

FieldFox Markings



The CSA mark is a registered trademark of CSA International.



The C-Tick mark is a registered trademark of the Australian Spectrum Management Agency.

This symbol combines the following three markings:

CE indicates product compliance with all relevant European legal Directives (if accompanied by a year, it signifies when the design was proven).

ICES indicates product compliance with the Canadian Interference-Causing Equipment Standard (ICES-001).

ISM indicates this is an Industrial Scientific and Medical Group 1 Class B product (CISPR 11, Clause 4)

The Korean Certification (KC) mark is required for products that are subject to legally compulsory certification. The KC mark includes the marking's identifier code that has up to 26 digits and follows this format: **KCC-VWX-YYY-ZZZZZZZZZZZZ**

This equipment is Class B suitable for home electromagnetic environment and is suitable for use in all areas.



B급 기기

(가정용 방송통신기자재)

이 기기는 가정용(B급) 전자파적합기기로서 주로 가정에서 사용하는 것을 목적으로 하며, 모든 지역에서 사용할 수 있습니다.



The standby symbol is used to mark a position of the instrument power line switch.



This symbol indicates separate collection for electrical and electronic equipment, mandated under EU law as of August 13, 2005. All electric and electronic equipment are required to be separated from normal waste for disposal (Reference WEEE Directive, 2002/96/EC).



Indicates the time period which no hazardous or toxic substance elements are expected to leak or deteriorate during normal use. Forty years is the expected useful life of the product.



CAUTION, risk of danger, refer to safety information in manual.



Dispose of properly



Hot surface - connectors get hot during extended operation, so care must be taken when making connections and disconnections.

Battery Markings



The CE mark shows that the product complies with all relevant European legal Directives (if accompanied by a year, it signifies when the design was proven).



The battery parts can be recycled. Consult local or country regulations.



Dispose of properly

Do not throw batteries away – collect as small chemical waste.



Recycle the old battery properly. Consult local or country regulations related to disposal.



Keep battery away from excessive heat. Do not dispose of by burning.



UL recognized in Canada and the United States.

Packaging Markings



This symbol on all primary and secondary packaging indicates compliance to China standard GB 18455–2001.

AC/DC Adapter Markings



The UL Marks are registered certification marks of Underwriters Laboratories Inc. (UL). It means that UL has tested and evaluated representative samples of that product and determined that it meets UL's safety requirements. When accompanied by a 'C' and 'US', it indicates compliance to both Canadian and US requirements.



NOM Mark (Normality of Mexico) indicates that the product was tested by an accredited laboratory in Mexico and meets Mexico's safety requirements.



Japan's safety and EMC compliance mark.



China's safety and EMC compliance mark.



Taiwan's safety and EMC compliance mark.



Singapore's safety mark.



Korea's safety and EMC mark.



GOST, Russia's safety and EMC mark.

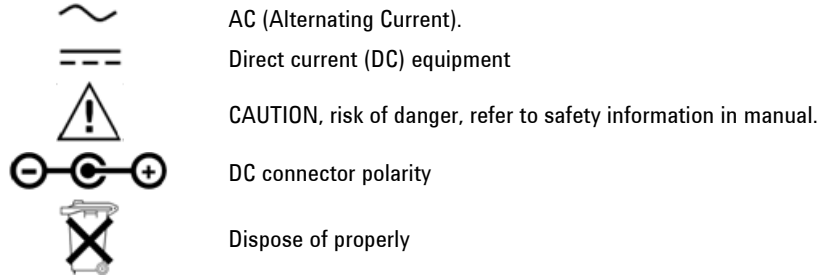

Certification and Compliance Statements

Certification

Agilent Technologies, Inc. certifies that this product met its published specifications at the time of shipment from the factory. Agilent Technologies, Inc. further certifies that its calibration measurements are traceable to the United States National Institute of Standards and Technology, to the extent allowed by the Institute's calibration facility, and to the calibration facilities of other International Standards Organization members.

Manufacturer's Declaration

This product has been designed and tested in accordance with accepted industry standards, and has been supplied in a safe condition. The documentation contains information and warnings that must be followed by the user to ensure safe operation and to maintain the product in a safe condition.

Declaration of Conformity

Should the Declaration of Conformity be required, contact an Agilent Sales Representative, or the closest Agilent Sales Office. See [Contacting Agilent](#).

Compliance with German Noise Requirements

This is to declare that this instrument is in conformance with the German Regulation on Noise Declaration for Machines (Laermangabe nach der Maschinenlaermrrordnung –3. GSGV Deutschland).

Acoustic Noise Emission	Geraeuschemission
LpA <70 dB	LpA <70 dB
Operator position	am Arbeitsplatz
Normal position	normaler Betrieb
per ISO 7779	nach DIN 45635 t.19

Compliance with Canadian EMC Requirements

This ISM device complies with Canadian ICES–001.
Cet appareil ISM est conforme a la norme NMB du Canada.

Appendix A: Connector Care Review

Proper connector care and connection techniques are critical for accurate and repeatable measurements. The following table contains for tips on connector care.

Prior to making connections to your analyzer, carefully review the information about inspecting, cleaning, and gauging connectors. For course numbers about additional connector care instruction, contact Agilent Technologies. Refer to:

Handling and Storage

Do

- Keep connectors clean
- Extend sleeve or connector nut
- Use plastic end-caps during storage

Do Not

- Touch mating-plane surfaces
- Set connectors contact-end down
- Store connectors or adapters loose

Visual Inspection

Do

- Inspect all connectors carefully
- Look for metal particles, scratches, and dents

Do Not

- Use a damaged connector - ever

Connector Cleaning

Do

- Try compressed air first
- Use isopropyl alcohol ^a
- Clean connector threads

Do Not

- Use any abrasives
- Get liquid into plastic support beads

Gaging Connectors

Do

- Clean and zero the gage before use
- Use the correct gage type
- Use correct end of calibration block
- Gage all connectors before first use

Do Not

- Use an out-of-specification connector

Making Connections

Do

- Align connectors carefully
- Make preliminary connection contact lightly
- Turn only the connector nut
- Use a torque wrench for final connection

Do Not

- Apply bending force to connection
- Over tighten preliminary connection
- Twist or screw any connection
- Tighten past torque wrench “break” point

^aCleaning connectors with alcohol shall only be done with the DC power cord removed, in a well-ventilated area, and with the power to the FireFox turned OFF. Allow all residual alcohol moisture to evaporate, and the fumes to dissipate prior to energizing the instrument.

Appendix B: Specifications/Data Sheet

To ensure the highest accuracy and consistency, the N9912A Specifications are now stored ONLY at :

<http://cp.literature.agilent.com/litweb/pdf/N9912-90006.pdf>

Appendix C: Instrument Calibration

Over time, the active components in the FieldFox age and the performance may degrade or drift. To ensure that the FieldFox is performing to the published specifications, you should have an instrument calibration performed periodically.

How Often Should I Get an Instrument Calibrated?

You determine the calibration period which best meets your requirements. However, a 12 month calibration cycle is appropriate for most users.

There are two things to consider: performance drift and connector wear.

The instrument specifications are set to consider the performance drift that may occur over a 12 month period. Therefore, getting the instrument calibrated at 12 month intervals ensures that the analyzer maintains performance within the operating specifications. If you need the analyzer to maintain more consistent operation, you may want to have the instrument calibrated more often.

Connector wear is a bigger factor and depends on the number of connections that are made. The test ports become noticeably worn after 500 to 700 connections. This could represent about 12 months with average use. With more frequent connections, the calibration cycle should be sooner. You can extend the time between calibrations and thereby save money by using connector savers and by performing proper **Connector Care**. Learn more on page 199.

How Do I Get an Instrument Calibrated?

To get your Agilent instrument calibrated, send it to one of the Agilent Technologies service centers. Please visit this website to learn how: www.agilent.com/find/calibration.

What Are My Choices of Instrument Calibration?

The following types of instrument calibration are available from Agilent Technologies service center:

Agilent Calibration	Includes the test data from the calibration and the certificate of calibration, stating the instrument has been calibrated and is operating within the published specifications.
ANSI Z540 Calibration	Includes the test data from the calibration and the certificate of calibration, stating the instrument has been calibrated using a process in compliance with ANSI Z540.1 and is operating within the published specifications.
ISO 17025 Calibration	Includes the test data from the calibration and the certificate of calibration, stating the instrument has been calibrated using a process in compliance with ISO 17025 and is operating within the published specifications.

Index

1

- 1-port cable loss measurements
 - CAT mode, 28
- 1-port cable trimming
 - measurements, VVM mode, 142

2

- 2-port insertion loss measurements
 - CAT mode, 30
- 2-port transmission measurements,
 - VVM mode, 143

A

- AC/DC adapter
 - markings, 197
 - power requirements, 11
 - using, 185
- accessories, 9
- Adjacent Channel Power (ACPR), 99
- Agilent, contacting, 2
- Alias Faults, 38
- all about limit lines, 154
- all about markers, 144
- all about trace math, 157
- AM FM Tune & Listen, 79
- Antenna Corrections, 76
- appendix B, 199
- attenuation, 75
- averaging, 24
- Averaging, 45
 - VVM, 140
- avoid overpowering, 14

B

- Band Power Marker SA mode, 92, 154
- bandpass mode, 33
- battery
 - care, 188
 - charge status, viewing, 184
 - charging, 13
 - external, 187
 - internal, 185
 - disposal, 189
 - gauge**, 185
 - icons, display, 184
 - installing, 12
 - LED, 187
 - markings, 197
 - maximizing life, 13, 189

- protective functions, 194
- reconditioning
 - external, 188
 - internal, 188
- safe handling, 195
- service diagnostics, 184
- viewing charge status, 12
- Battery Saver, 175
- bridge cancellation measurements,
 - VVM mode, 143
- brightness, display, 171
- Built-in Power Meter, 116

C

- Cable (Correction) Specifications
 - DTF, 34
- cable and antenna test. See CAT
- cable loss measurements, 29
- Cal On ?, 65
- Calculated DTF values, 37
- calibration
 - annotation, 65
 - Cal On ?, 65
 - CAT and NA modes, 60
 - verifying integrity, 66
- care of the battery, 188
- CAT mode
 - 1-port cable loss measurements, 28
 - 2-port insertion loss measurements, 30
 - calibration, 60
 - DTF measurements, 31
 - DTF settings, 32
 - return loss measurements, 28
 - settings, 22
- CD, included, 10
- certification statements, 198
- Channel Power (CHP), 96
- Channel Selection, 72
- charge status, viewing, 184
- charging the battery
 - externally, 187
 - internally, 185
- Clean Screen, 17
- colors, display, 171
- compliance statements, 198
- compressed measurement, 76
- Compressed SA Measurements, 76
- connector care review, 199
- considerations, safety, 190
- contacting Agilent, 2
- control, temperature, 14
- Coupled Frequency, 27
- Coupled Markers, 147

- CPM, 116
- cursor, moving, 166

D

- data analysis features, 144
- data indicator (*), old, 94
- date/time setting, 180
- declaration of conformity, 198
- delta marker, 146
- detection method, 90, 91
- display
 - brightness, 171
 - colors, 171
 - front panel, 19
 - settings, 171
- Display Resolution
 - VVM, 139
- disposal of battery, 189
- dissipate static charge, 15
- distance to fault. See DTF
- distance, start and stop, 33
- DTF
 - measurements, 31
 - settings, 32
- DTF Measurement, 32
- DTF Start and Stop Distance, 33
- DTF Units, 37
- Dynamic Range, 51

E

- Edit a Cable File
 - DTF, 35
- Electrical Delay, 44
- Erase User Data, 182
- error
 - correction, 64
 - max, 185, 188
 - meas UNCAL, 94
 - red flashing LED, external
 - battery charger, 187
 - systematic, 60
- ESD, 195
- External Gain, 74
- External triggering, 86
- external zeroing, 121

F

- features
 - overview, 8
- features, data analysis, 144
- Field Strength Measurements, 76
- file management, 160
- files

- managing, 164
- prefixes, 166
- printing, 167
- saving and recalling, 160
- FM Tune & Listen, 79
- folders, 165
- Format
 - NA Mode, 42
- FreqMaskTrigger, 111
- frequency
 - range, setting, 23
 - step size, 70
- Frequency Counter at SA Marker, 93, 154
- Frequency Mode
 - DTF, 33
- Frequency Range
 - NA Mode, 43
- Frequency Reference Source, 178
- front panel, 17

G

- Gating, 58
- gauge, battery**, 185
- getting started information, 11
- GPS, 176
- group delay, 43

H

- high-temperature protection, 14
- hold, 168
- how to
 - add or edit a title, 172
 - change
 - frequency step size, 70
 - check for a compressed measurement, 76
 - control the preamp, 75
 - create
 - delta marker, 146
 - limit lines, 156
 - markers, 144
 - determine if a battery needs reconditioning, 188
 - display "live" and memory traces, 158
 - edit keywords, 165
 - edit, enable and disable the current prefix, 166
 - enter
 - numeric values, 20
 - make
 - 1-port cable loss measurement, 29
 - 2-port insertion loss measurement, 30
 - 2-Port transmission measurement, 143
 - DTF measurements, 31

- S21 transmission
 - measurement, 50
- manage files, 164
- manage folders, 165
- measure return loss, 28
- monitor the internal FieldFox
 - temperature, 14
- move
 - cursor, 161, 166
 - marker, 145
 - reference marker, 146
- name files, 161
- perform
 - external battery reconditioning, 188
 - internal reconditioning, 188
 - normalization, 64
 - QuickCal, 61
 - single sweep while in Hold, 169
 - trace math, 158
- preset, 169
- recall an *.sta file, 162
- recondition battery with external battery charger, 188
- save
 - file, 160
- save and recall limits, 157
- select
 - CAT mode, 22
 - CAT mode measurements, 22
 - NA formats, 42
 - NA measurements, 40
 - NA mode, 39
 - SA mode, 69
 - Windows settings, 37
 - zeroing, 141
- set
 - attenuation, 75
 - date and time, 180
 - detection method, 90, 91, 96, 98
 - display colors, 171
 - frequency range, 23, 70
 - full screen mode, 172
 - interference rejection, 27
 - limit options, 156
 - output power, 48, 140
 - peak criteria, 152
 - res BW, 82
 - resolution, 25, 47
 - scale, 24
 - start and stop distance, 33
 - sweep acquisition parameter, 84
 - sweep time, 26
 - sweep type, 25, 47, 141
 - trace averaging, 25
 - video BW, 83
 - zero span, 85
- turn error correction OFF, 64
- use

- marker search functions, 149
- view and change Quick Settings, 23, 41

I

- icons, battery, 184
- IF Bandwidth
 - NA Mode, 46
 - VVM, 139
- Independent Source, 81
- indicator (*), old data, 94
- initial use, preparing for, 11
- input voltages and power, maximum, 14
- insertion loss measurements, 30
- installing
 - battery, 12
- Interference Analyzer, 103
- interference rejection, 27
- Interval Power Marker, 92

K

- keywords, 165

L

- LAN Settings, 180
- language, settings, 174
- latest information, where to find, 2
- LED
 - battery, 187
 - on/off settings, 13, 17
- Licensing, 175
- limit lines
 - saving and recalling, 157
 - setting, 156
- lithium-ion battery
 - installing, 12

M

- managing
 - files, 164
 - folders, 165
- manuals, 10
- marker
 - table, 147
- markers
 - creating, 144
 - delta, 145
 - moving, 145
 - noise, 153
 - search function, 148
 - trace, 148
- Markers
 - Coupled, 147
- markings
 - AC/DC adapter, 197
 - battery, 197

- FieldFox, 196
- packaging, 197
- math
 - operations, 158
- maximizing battery life, 189
- maximum input voltages and power, 14
- Meas UNCAL error, 94
- Measurement Selection
 - NA Mode, 40
- measurements
 - 1-port cable loss, CAT mode, 28
 - 1-port cable trimming, VVM mode, 142
 - 2-port insertion loss, CAT mode, 30
 - 2-port transmission, VVM mode, 143
 - bridge cancellation, VVM mode, 143
 - compressed, 76
 - distance to fault (DTF)
 - CAT mode, 31
 - S21 transmission, NA mode, 50
 - selection, 22
- mode
 - NA, 39
 - power meter, 119
 - SA, 68
 - temperature control, 14
 - VVM, 137
- moving the cursor, 166
- multipliers, 20
- Multi-Trace Configurations, 40

N

- NA Factory Cal, 182
- NA mode
 - calibration, 60
 - S21 transmission measurements, 50
 - settings, 39
- network analyzer, 39
- normalization, 64
- numeric values, 20

O

- O, S, L cal, 63
- Occupied Bandwidth, 97
- old data indicator (*), 94
- on/off settings, 13
- Opt 010, 52
- options
 - and features, 8
 - installing, 175
- output power, 48, 140
- Output Power
 - NA Mode, 26, 48, 140
- overpowering, avoid, 14
- overview, 8

P

- packaging markings, 197
- panel
 - front, 17
 - top, 18
- peak
 - criteria, 152
 - excursion, 153
 - threshold, 152
- Phase Offset, 45
- Playback Configuration, 113
- Points SA mode, 88
- Port Extensions, 48
- power meter mode, 119
- power requirements for the AC/DC adapter, 11
- power sensor input, 14
- Power Spectral Density, 96
- power, maximum, 14
- prefixes for file names, 166
- preparing for initial use, 11
- preset settings, 169
- printing, 167
- protection, high temperature, 14
- protective functions of the battery, 194
- Pulse Measurements, 126

Q

- Quick Cal, 61
- Quick Settings, 41

R

- Radio Standard, 71
- recalling files, 160, 162
- reconditioning the battery
 - externally, 188
 - internally, 188
- Record Source, 112
- Record/Playback, 107
- Recording Configuration, 111
- reference marker, 146
- resolution, 25
- Resolution
 - NA Mode, 47
- Resolution Bandwidth SA mode, 82
- Restart, 87
- return loss
 - measurements, CAT mode, 28
- reviewconnector care, 199
- RRC Weighting, 102
- run/hold, 168

S

- S11 measurements, NA mode, 39
- S21 measurements, 50
 - NA mode, 50
- SA mode

- settings, 69
- SA Mode Units, 73
- SA Units, 74
- safety considerations, 190
- Save Preferences, 173
- saving files, 160
- Scale Settings
 - NA Mode, 43
- scale, setting, 24
- Screen cleaning, 17
- screen, front panel, 19
- Security Level, 179
- service
 - diagnostics, 184
- Sessions, 107
- settings
 - CAT mode, 22
 - display, 171
 - DTF, 32
 - NA mode, 39
 - preset, 169
 - SA mode, 69
 - windows, 37
- Smoothing, 46
- Source Control with USB Power Meter, 121
- Specifications/Data Sheet, 200
- Spectrogram Display, 103
- spectrum analyzer mode, 68
- stand-by mode, 13
- start and stop distance, 33
- Startup Mode, 174
- static charge, dissipate, 15
- Step Detection Mode, 124
- sweep
 - acquisition parameter, 84
 - time, 26
 - type, 25, 47, 141
- Sweep Time
 - NA Mode, 47
- Sweep Type
 - SA Mode, 83
- system configuration settings, 175
- System Impedance (Z0), 48
- system settings, 168

T

- temperature control mode, 14
- Time Domain, 52
- Time Zone, 179
- time/date setting, 180
- title, editing, 172
- top panel, 18
- trace averaging, setting, 25
- Trace Display States, 88
- trace math, 157
- Trace Width, 171
- Tracking Generator, 81
- Transform, 52
- Transform Window, 55
- Triggering - SA Mode, 86

Tune & Listen (AM/FM), 79

U

User Preset, 169

User Tags, 109

V

values

multipliers, 20

numeric, 20

VBW, 83

vector voltmeter, 137

Velocity Factor, 49

verifying integrity of

calibration, 66

jumper cables, 66

Video Bandwidth SA mode, 83

Video triggering, 86

viewing

charge status, battery, 184

Volume Control, 170

VVM mode

1-port cable trimming

measurements, 142

2-port transmission

measurements, 143

bridge cancellation

measurements, 143

W

Waterfall Display, 106

where to find the latest information,

2

Window Settings

DTE, 37

windows settings, 37

Z

zero span, 85

Zeroing

VVM, 141

Zeroing, power sensor, 120