



**Agilent N9340B  
Handheld  
Spectrum Analyzer**

**User's Guide**



**Agilent Technologies**

# Notices

© Agilent Technologies, Inc. 2008-2009

No part of this manual may be reproduced in any form or by any means (including electronic storage and retrieval or translation into a foreign language) without prior agreement and written consent from Agilent Technologies, Inc. as governed by United States and international copyright laws.

## Manual Part Number

N9340-90008

## Edition

Second edition, July 2009

Printed in China

Agilent Technologies, Inc.  
No. 116 Tuo Xin West 1st Street  
Hi-Tech Industrial Zone (South),  
Chengdu 610041, China

## Software Revision

This guide is valid for A.01.00 revisions of the Agilent N9340B Handheld Spectrum Analyzer firmware.

### CAUTION

A **CAUTION** notice denotes a hazard. It calls attention to an operating procedure, practice, or the like that, if not correctly performed or adhered to, could result in damage to the product or loss of important data. Do not proceed beyond a **CAUTION** notice until the indicated conditions are fully understood and met.

### WARNING

A **WARNING** notice denotes a hazard. It calls attention to an operating procedure, practice, or the like that, if not correctly performed or adhered to, could result in personal injury or death. Do not proceed beyond a **WARNING** notice until the indicated conditions are fully understood and met.

## Warranty

**The material contained in this document is provided "as is," and is subject to being changed, without notice, in future editions. Further, to the maximum extent permitted by applicable law, Agilent disclaims all warranties, either express or implied, with regard to this manual and any information contained herein, including but not limited to the implied warranties of merchantability and fitness for a particular purpose. Agilent shall not be liable for errors or for incidental or consequential damages in connection with the furnishing, use, or performance of this document or of any information contained herein. Should Agilent and the user have a separate written agreement with warranty terms covering the material in this document that conflict with these terms, the warranty terms in the separate agreement shall control.**

## Technology Licenses

The hardware and/or software described in this document are furnished under a license and may be used or copied only in accordance with the terms of such license.

## Restricted Rights Legend

If software is for use in the performance of a U.S. Government prime contract or subcontract, Software is delivered and licensed as "Commercial computer software" as defined in DFAR 252.227-7014 (June 1995), or as a "commercial item" as defined in FAR 2.101(a) or as "Restricted computer software" as defined in FAR 52.227-19 (June 1987) or any equivalent agency regulation or contract clause. Use, duplication or disclosure of Software is subject to Agilent Technologies' standard commercial license terms, and non-DOD Departments and Agencies of the U.S. Government will receive no greater than Restricted Rights as defined in FAR 52.227-19(c)(1-2) (June 1987). U.S. Government users will receive no greater than Limited Rights as defined in FAR 52.227-14 (June 1987) or DFAR 252.227-7015 (b)(2) (November 1995), as applicable in any technical data.

# Contents

## 1 Overview

- Introduction 2
- Front Panel Overview 5
  - Display Annotations 6
- Top Panel Overview 7
- Instrument Markings 8

## 2 Getting Started

- Checking Shipment and Order List 10
- Power Requirements 11
- AC Power Cords 12
- Safety Considerations 13
- Working with Batteries 16
- Powering on the Analyzer for the First Time 18
- Preparation for Use 19
- Making a Basic Measurement 20

## 3 System and File

- System Setting 24
  - Power On and Preset Settings 24
  - Factory Default Settings 25
  - Visual and Audio Adjustment 26
  - General system settings 26
  - Switch Timer 27
  - IP configuration 27
  - Upgrading Firmware 28
  - Ext Input 28
  - Adding an Option 29
  - Show System 30
  - Show Error 30
  - Perform a Time Base Calibration 30

Low Frequency Channel 31

File 32

## 4 Making Measurements

Measuring Multiple Signals 38

Measuring a Low-Level Signal 43

Improving Frequency Resolution and Accuracy 48

Making Distortion Measurements 49

Making a Stimulus Response Transmission Measurement 55

Measuring Stop Band Attenuation of a Low-pass Filter 57

Making a Reflection Calibration Measurement 59

Measuring Return Loss Using the Reflection Calibration Routine 62

Making an Average Power Measurement 63

Spectrogram 68

Demodulating an FM Signal 71

Analysis the Demodulated Signals 73

ASK/FSK Demodulation Analysis 76

Monitoring the ADSL Signal with Option XDM 79

## 5 Key Reference

Amplitude 82

BW/SWP 86

Enter 92

ESC/CLR 92

Frequency 93

Marker 95

MEAS 100

MODE 112

SPAN 128

TRACE 132

LIMIT 137

## **6 Error Messages**

Overview 140

Error Message List 141

## **7 Troubleshooting**

Check the basics 146

Warranty and Service Options 147

Contact Agilent Technologies 148

## **8 Menu Map**

### **Documentation Conventions:**

1. A pair of curly brackets { } indicates a softkey, for example {Start} refers to the Start softkey.
2. A pair of square brackets [ ] indicates a hardkey, for example, [ENTER] refers to the ENTER hardkey.
3. "Analyzer" refers to Agilent N9340B handheld spectrum analyzer in the following chapters.
4. "DUT" refers to a device under test.



# Agilent N9340B Handheld Spectrum Analyzer

## 1 Overview



# Introduction

The Agilent N9340B is a handheld spectrum analyzer with a frequency range of 100 kHz to 3 GHz, tunable to 9 kHz. It has several different measurement modes. Each mode offers a set of automatic measurements that pre-configure the analyzer settings for ease of use. It provides ultimate measurement flexibility in a package that is ruggedized for field environments and convenient for mobile applications.

## Functionality and Feature

The Agilent N9340B provides your with a comprehensive functionality set and measurement convenience, including:

- **Power Measurement**

provides power measurement functionality on OBW (Occupied Bandwidth), channel power, ACPR (Adjacent Channel Power Ratio).

- **Spectrogram**

provides the capability to analyze the stability of a signal over the time. With option INM, the N9340B can unattended monitor the signal capturing performance or intermittent events over extended periods of time.

- **Spectrum Emission Mask**

provides a Pass/Fail testing capability with a mask for out-of-channel emissions measurement.

- **High Accuracy Power Measurement**

The N9340B supports Agilent U2000 series power sensors for high accuracy power measurement as a power meter.



- **IBOC Measurement (Option IBC)**  
Provides the in-band-on-channel measurement capability through a dedicated measurement personality and selected hardware improvement.
- **xDSL Measurement (Option XDM)**  
supports measurements on ADSL, ADSL2+ and VDSL networks.
- **Demodulation analysis function**  
provides AM/FM and ASK/FSK demodulation analysis function. (AM/FM: Option-AMA  
ASK/FSK: Option-DMA)
- **Tracking generator (Option TG3)**  
provides an RF source for scalar network analysis.
- **High-sensitivity measurement (Option PA3)**  
includes a 3 GHz pre-amplifier enabling highly sensitivity measurements, useful in the analysis of low-level signals.

For the latest product technical information, please refer to the link below:

<http://www.agilent.com/find/n9340b>

For the latest option information, please refer to the link below:

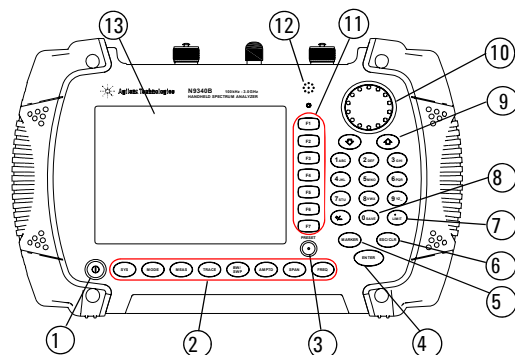
[http://www.agilent.com/find/n9340b\\_upgrades](http://www.agilent.com/find/n9340b_upgrades)

### Optimized Usability

The Agilent N9340B handheld spectrum analyzer provides enhanced usability:

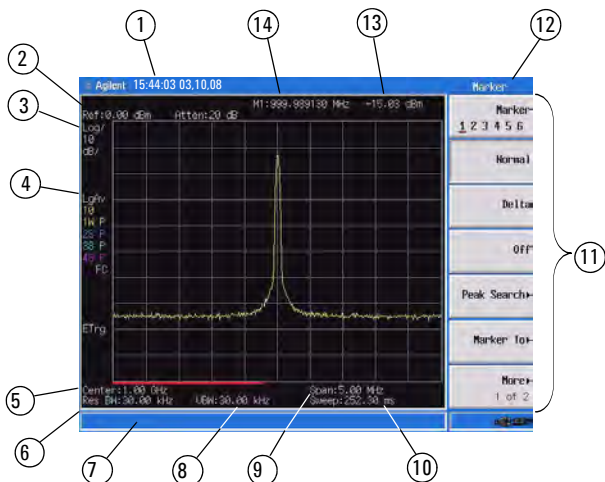
- The **6.5-inch TFT colorful LCD screen** (640 × 480 pixels) enables you to read the scans easily and clearly outdoors.
- **Arc-shaped handle** and **rugged rubber casing** ensure a comfortable and firm hold and ruggedness.
- **SCPI** remote control via **USB** and **LAN** port.
- The **PC software** in the N9340B Helpkit CD is convenient for your further editing and data analysis.
- **4-hour-time battery** provides you a continuous work time in the field test.
- The **light sensor** adjusts the display brightness according to the environment to save power.
- The **headphone jack** on the top panel is for the audio signal analysis and monitor.
- **Back-lit keys** makes you find the right keys in darkness easily.

## Front Panel Overview



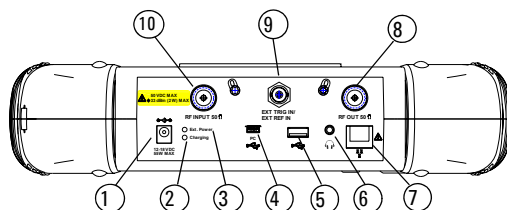
Caption	Function
1 Power Switch	Toggles the analyzer between on and off
2 Function keys	Includes hardkeys: <b>SYS, FREQ, SPAN, AMPTD, BW/SWP, TRACE, MEAS, and MODE</b>
3 Preset	Returns the analyzer to a known state, also turns on/off power save feature (press for 1 sec.)
4 Enter	Confirms a parameter selection or configuration
5 MARKER	Activates the marker function
6 ESC/CLR	Exits and closes the dialog box or clears the character input
7 LIMIT	Sets limit lines for quick Pass/Fail judgement
8 Save	Quick saves the current screen/trace
9 Arrow keys	Increases or decreases a parameter step by step
10 Knob	Selects an mode or edits a numerical parameter
11 Softkeys	Indicates current menu functions on the LCD
12 Speaker	Actives in demodulation mode
13 Screen	Displays measured traces and status

## Display Annotations



	Description	Associated Function Key
1	Time and Date	[SYS] > {Setting} > {General}
2	Reference Level	[AMPTD]
3	Amplitude Scale	[AMPTD]
4	Detector Mode	[TRACE] > {More} > {Detector}
5	Center Frequency	[FREQ] > {Center Freq}
6	Resolution Bandwidth	[BW/SWP] > {RBW}
7	Display Status Line	Displays status and error messages.
8	Video Bandwidth	[BW/SWP] > {VBW}
9	Frequency Span	[SPAN]
10	Sweep Time	[BW/SWP] > {Sweep Time}
11	Key Menu	See key label description in the key reference for more information.
12	Key Menu Title	Refers to the current activated function
13	Marker Amplitude	[Marker]
14	Marker Frequency	[Marker]

## Top Panel Overview



Caption	Function
1 External DC power connector	Provides input for the DC power source via an AC-DC adapter, or Automotive type DC adapter.
2 LED indicator (Charging)	Lights (On) when the battery is charging
3 LED indicator	Lights (On) when external DC power is connected to the tester
4 USB interface (Device)	Connects to a PC
5 USB interface (Host)	Connects to a USB memory stick or disk
6 Headphone	Connects to a headphone
7 LAN Interface	Connects to a PC for SCPI remote control
8 RF OUT Connector	The output for the built-in tracking generator. Enabled with Option TG3.
9 EXT TRIG IN/REF IN (BNC, Female)	Connects to an external TTL signal or a 10 MHz reference signal. The TTL signal is used to trigger the analyzer's internal sweep
10 RF IN Connector (50 Ω)	Accepts an external input with a frequency range from 100 kHz to 3 GHz, tunable to 9 kHz.

## Instrument Markings



The **CE** mark shows that the product complies with all relevant European Legal Directives.



The **CSA** mark is a registered trademark of the Canadian Standards Association.



The **C-Tick** mark is a registered trademark of the Australian Spectrum Management Agency.

**ISM1-A**

This symbol is an Industrial Scientific and Medical Group 1 Class A product (CISPR 11, Clause 4)

**ICES/NMB-001**

The ISM device complies with Canadian Interference-Causing Equipment Standard-001.



indicates that the user must refer to specific instructions in use.



The symbol is used to mark a position of the instrument **power switch**.



indicates this product complies with the **WEEE Directive** (2002/96/EC) marking requirements and you must not discard this equipment in domestic household waste. Do not dispose in domestic household waste. To return unwanted products, contact your local Agilent office, or refer to

<http://www.agilent.com/environment/product/>



Agilent N9340B  
Handheld Spectrum Analyzer

## 2 Getting Started

Information on checking the analyzer when received, preparation for use, basic instrument use, familiarity with controls, defining preset conditions, updating firmware, and contacting Agilent Technologies.



### Checking Shipment and Order List

Check the shipment and order list when you receive the shipment.

- Inspect the shipping container for damages. Signs of damage may include a dented or torn shipping container or cushioning material that indicate signs of unusual stress or compacting.
- Carefully remove the contents from the shipping container, and verify if the standard accessories and your ordered options are included in the shipment.
- For any question or problem, contact Agilent Technologies Customer Contact Center (CCC) for consultant and service. See “[Contact Agilent Technologies](#)” on page 148. For the latest service information please refer to:  
<http://www.agilent.com/find/assist>



## Power Requirements

The AC power supplied must meet the following requirements:

---

<b>Voltage:</b>	100 VAC to 240 VAC
<b>Frequency:</b>	47 to 63 Hz
<b>Power:</b>	Maximum 63 W




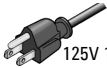


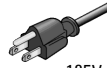


---

The AC/DC power supply charger adapter supplied with the analyzer is equipped with a three-wire power cord, in accordance with international safety standards. This power cord grounds the analyzer cabinet when it is connected to an appropriate power line outlet. The power cord appropriate to the original shipping location is included with the analyzer.

Various AC power cables are available from Agilent that are unique to specific geographic areas. You can order additional AC power cords that are correct for use in different areas. The AC Power Cords table provides a list of the available AC power cords, the plug configurations, and identifies the geographic area in which each cable is typically used.

The detachable power cord is the product disconnecting device. It disconnects the main AC circuits from the DC supply before other parts of the product. The front-panel switch is only a standby switch and does not disconnect instrument from AC LINE power.

## AC Power Cords

Plug Type	Cable Part Number	Plug <sup>a</sup> Description	For use in Country & Region
 250V 10A	8121-1703	BS 1363/A	Option 900 United Kingdom, Hong Kong, Singapore, Malaysia
 250V 10A	8120-0696	AS 3112:2000	Option 901 Australia, New Zealand
 250V 16A	8120-1692	IEC 83 C4	Option 902 Continental Europe, Korea, Indonesia, Italy, Russia
 125V 10A	8120-1521	CNS 10917-2 /NEMA 5-15P	Option 903 United States, Canada, Taiwan, Mexico
 250V 10A	8120-2296	SEV 1011	Option 906 Switzerland
 230V 15A	8120-4600	SABS 164-1	Option 917 South Africa, India
 125V 15A	8120-4754	JIS C8303	Option 918 Japan
 250V 16A	8120-5181	SI 32	Option 919 Israel
 250V 10A	8120-8377	GB 1002	Option 922 China

## Safety Considerations

Agilent has designed and tested the N9340B handheld spectrum analyzer for Measurement, Control and Laboratory Use in accordance with Safety Requirements IEC 61010-1: 2001, UL 61010-1 (2004), and CSA C22.2 No.61010-1-04. The tester is supplied in a safe condition. The N9340B is also designed for use in Installation Category II and Pollution Degree 2 per IEC 61010 and IEC 60664 respectively.

Read the following safety notices carefully before you start to use a N9340B handheld spectrum analyzer to ensure safe operation and to maintain the product in a safe condition.

---

**WARNING** **Personal injury may result if the analyzer's cover is removed. There are no operator-serviceable parts inside. Always contact Agilent qualified personnel for service. Disconnect the product from all voltage sources while it is being opened.**

---

**WARNING** **This product is a Safety Class I analyzer. The main plug should be inserted in a power socket outlet only if provided with a protective earth contact. Any interruption of the protective conductor inside or outside of the product is likely to make the product dangerous. Intentional interruption is prohibited.**

---

**WARNING** **Electrical shock may result when cleaning the analyzer with the power supply connected. Do not attempt to clean internally. Use a dry soft cloth to clean the outside case only.**

---

**WARNING** **Always use the three-pin AC power cord supplied with this product. Failure to ensure adequate earth grounding by not using this cord may cause personal injury and product damage.**

---

## 2 Getting Started

### WARNING

**Danger of explosion if the battery is incorrectly replaced. Replace only with the same type battery recommended. Do NOT dispose of batteries in a fire. Do NOT place batteries in the trash. Batteries must be recycled or disposed of properly.**

---

### CAUTION

Recharge the battery only in the analyzer. If left unused, a fully charged battery will discharge itself over time.

Temperature extremes will affect the ability of the battery to charge. Allow the battery to cool down or warm up as necessary before use or charging.

Storing a battery in extreme hot or cold temperatures will reduce the capacity and lifetime of a battery. Battery storage is recommended at a temperature of less than 25 °C.

Never use a damaged or worn-out adapter or battery. Charging the batteries internally, even while the analyzer is powered off, the analyzer may keep warm. To avoid overheating, always disconnect the analyzer from the AC adapter before storing the analyzer into the soft carrying case.

---

### CAUTION

Connect the automotive adapter to the power output connector for IT equipment, when charging the battery on your automotive.

---

### CAUTION

The VxWorks operating system requires full conformity to USB 1.1 or USB 2.0 standards from a USB disk. Not all the USB disk are built that way. If you have problems connecting a particular USB disk, please reboot the analyzer before inserting the next USB stick.

---

## Environmental Requirements

The N9340B is designed for use under the following conditions:

- Operating temperature:  
0 °C to 40 °C (using AC-DC adapter)  
-10 °C to +50 °C (using battery)
- Storage temperature: -40 °C to +70 °C
- Battery temperature: 0 °C to 45 °C
- Humidity: 85% ± 5%

## Electrical Requirements

The analyzer allows the use of either a lithium battery pack (internal), AC-DC adapter shipped with the analyzer, or optional automotive +12 VDC adapter for its power supply.

## Electrostatic Discharge (ESD) Precautions

This analyzer was constructed in an ESD protected environment. This is because most of the semiconductor devices used in this analyzer are susceptible to damage by static discharge.

Depending on the magnitude of the charge, device substrates can be punctured or destroyed by contact or proximity of a static charge. The result can cause degradation of device performance, early failure, or immediate destruction.

These charges are generated in numerous ways, such as simple contact, separation of materials, and normal motions of persons working with static sensitive devices.

When handling or servicing equipment containing static sensitive devices, adequate precautions must be taken to prevent device damage or destruction. Only those who are thoroughly familiar with industry accepted techniques for handling static sensitive devices should attempt to service circuitry with these devices.

# Working with Batteries

**CAUTION**

Full charge the battery before first using the analyzer.

## Installing a Battery



Step	Notes
1 Open the battery cover	Use a phillips type screwdriver, loosen the retaining screw, then pull the battery cover open.
2 Insert the battery	Observe correct battery polarity orientation when installing.
3 Close the battery cover	Push the cover closed, then re-fasten the cover with the retaining screw.

## Viewing Battery Status

Determine the battery status using either of the following methods:

- Checking the battery icon in the lower-right corner of the front-panel screen: it indicates the approximate level of charge.
- Press the gray button in the upper right corner of the battery, the number of lighted green LED indicates the percentage of the battery power.
- Press **[SYS] > {More} > {Show System} > {Page down}** to check the current battery information.

## Charging a Battery

You may charge the battery both in the tester and in the external battery charger (option BCG).

**CAUTION**

Connect the automotive adapter to the IT power outlet of your automobile (with option 1DC) for battery recharging.

---

- 1 Insert the battery in the analyzer.
- 2 Plug in the AC-DC adapter and switch on the external power.
- 3 The charge indicator lights, indicating that the battery is charging. When the battery is fully charged, the green charging indicator turns off.

During charging and discharging, the battery voltage, current, and temperature are monitored. If any of the monitored conditions exceed their safety limits, the battery will terminate any further charging or discharging until the error condition is corrected.

The charging time for a fully depleted battery, is approximately four hours.

### Powering on the Analyzer for the First Time

Insert the battery into the analyzer or connect the analyzer to an external line power supply via the AC-DC adapter, then press the power switch on the front panel of your N9340B to power on the analyzer.

**CAUTION**

Use only the original AC-DC adapter or originally supplied battery for the power source.

The maximum RF input level of an average continuous power is 33 dBm (or  $\pm 50$  VDC signal input). Avoid connecting a signal into the analyzer that exceeds the maximum level.

---

Allow the analyzer to warm-up for 30 minutes before making a calibrated measurement. To meet its specifications, the analyzer must meet operating temperature conditions.



Install battery



Press Power Switch





## Preparation for Use

Use **[SYS]** hardkey to check or set the system settings of your analyzer.

### Setting up your N9340B

- 1 Press **[SYS] > {Setting} > {General}** to set time and power saving mode:
  - Press **{Time/Date}** to set the time and date.
- 2 Press **[SYS] > {Setting} > {Language}** to select a language displayed on screen. There are 11 languages for your selection.
- 3 Press **[SYS] > {Brightness}** and then rotate the knob to adjust display brightness.
- 4 Press **[SYS] > {Key Beep}** to toggle the buzzer beep function between on and off.

### Checking Instrument Information

- 1 Press **[SYS] > {More} > {Show System}** to display the system information.
- 2 Press **[SYS] > {More} > {Option}** to display the option information.
- 3 Press **[SYS] > {More} > {Show Error}** to display the error information.

**Testing buttons** Press **[SYS] > {More} > {Diagnostics} > {Front Panel}** to test all the front panel keys except **[PRESET]**, **[ESC/CLR]** and power switch.

# Making a Basic Measurement

This section provides information on basic analyzer operations. It assumes that you are familiar with the front and top panel buttons and keys, and display annotations of your analyzer. If you are not, please refer to “[Front Panel Overview](#)” on page 5, and “[Top Panel Overview](#)” on page 7, and “[Instrument Markings](#)” on page 8.

For more details on making measurements, please refer to “[Making Measurements](#)” on page 37”.

## Entering Data

When setting measurement parameters, there are several ways to enter or modify active function values:

### 1 Using the Front Panel Knob

Increases or decreases the current value.

### 2 Using the Arrow Keys

Increases or decreases the current value by the step unit defined.

Press **[FREQ] > {CF Step}** to set the frequency by an auto-coupled step (Step = Span/10, when **{CF Step}** mode is set to **Auto**).

### 3 Using the Numeric Keypad

Enters a specific value. Then press a terminator key (either a specified unit softkey or **[ENTER]**) to confirm input.

### 4 Using the Unit Softkeys

Terminates a parameter value which requires a unit input.

### 5 Using the Enter Key

Terminates an entry or confirms a selection.

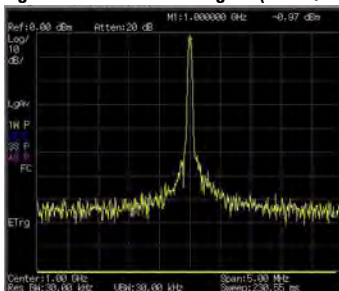
## Viewing a Signal on the Analyzer

- 1 Use a signal generator to generate a CW signal of 1.0 GHz, at a power level of 0.0 dBm.
- 2 Press **[SYS] > {Setting} > {PwrOn/Preset} > {Preset Type}** and select **DFT** to toggle the preset setting to factory-defined status.
- 3 Press the green **[Preset]** key to restore the analyzer to its factory-defined setting.
- 4 Connect the generator's **RF OUT** connector to analyzer's **RF IN** connector.
- 5 Press **[FREQ] > 1 > {GHz}** to set the analyzer center frequency to 1 GHz.
- 6 Press **[SPAN] > 5 > {MHz}** to set the analyzer frequency span to 5 MHz.
- 7 Press **[MARKER] > {Peak Search}** to place a marker (M1) at the highest peak (1 GHz) on the display.

The Marker amplitude and frequency values appear in the function block and in the upper-right corner of the screen.

Use the front-panel knob, arrow keys, or the softkeys in the Peak Search menu to move the marker and read out the value of both frequency and amplitude displayed on the screen.

**Figure 2-1 View a signal (1 GHz, 0 dBm)**



## 2 Getting Started



### 3

## System and File

This chapter provides the information on basic system setting and file operation, Such as, display, option activation, calibration, firmware upgrade and test data saving/loading.



## System Setting

This section provides you the basic system configuration which is frequently used before or after the measurement operation. Please refer to the description below to get a better user experience and ease your test and measurement.

### Power On and Preset Settings

#### Selecting a preset type

Press **[SYS] > {Setting} > {PwrOn/Preset} > {Preset Type}** to choose the preset types. The analyzer has three types of preset setting for you to choose from:

**DFT** Restores the analyzer to its factory-defined setting. The factory default settings can be found, "[Factory Default Settings](#)" on page 25.

**User** Restores the analyzer to a user-defined setting. Refer to the descriptions as below.

**Last** Restores the analyzer to the last time setting.

#### Saving a User-defined Preset

If you frequently use system settings that are not the factory defaults, refer to the following steps to create a user-defined system settings that can be easily recalled at the power up state:

- 1 Set analyzer parameters by the knob, the arrow keys or the numeric keypad.
- 2 Press **[SYS] > {Setting} > {PwrOn/Preset} > {Save User}** to save the current parameters as the user preset setting.
- 3 Press **[SYS] > {Setting} > {PwrOn/Preset} > {Preset Type User}** to set the preset mode to user defined system setting.
- 4 Press **[Preset]**, the instrument will be set to the state you previously saved.

## Factory Default Settings

<b>Parameter</b>	<b>Default Setting</b>
Center Frequency	1.5 GHz
Start Frequency	0.0 Hz
Stop Frequency	3.0 GHz
Span	3.0 GHz
Reference Level	0.0 dBm
Attenuation	Auto (20 dB)
Scale/DIV	10 dB/DIV
Scale Type	Log
RBW	Auto (1 MHz)
VBW	Auto (1 MHz)
Average Type	Log Power
Sweep time	Auto
Sweep Mode	Normal
Trace 1	Clear write
Trace 2	Blank
Trace 3	Blank
Trace 4	Blank
Trace 1 Detection	Pos Peak
Trace 2 Detection	Pos Peak
Trace 3 Detection	Pos Peak
Trace 4 Detection	Pos Peak
Trace Average	All Off
Marker	All Off
File Type	Trace
Save Path	Local
Mode	Spectrum Analyzer
External Input type	Trigger in (TTL signal input)

## Visual and Audio Adjustment

### Display Adjustment

Press **[SYS] > {Brightness}** to toggles the screen brightness between **Auto** and **Man**. When it sets to **Auto**, the brightness will adjust according to the environment automatically with the built-in light sensor. When it sets to **Man**, you can set a fixed brightness value manually.

### Setting Button Backlight

Press **[SYS] > {KeyBackLight} > {BackLight}** to toggles the button backlight Auto and Man. You can select the backlight brightness and the auto-off idle time in manual mode.

### Setting Key Beep

Press **[SYS] > {Key Beep}** to activate the key beep function as an indicator of key operation.

## General system settings

Provides the following system setting options:

### Time/Date

Press **[SYS] > {Setting} > {General} > {Time/Date}** to set the date and time of the analyzer.

You need to input the time in a HHMMSS format, and the date in a YYYYMMDD format.

### Power Manager

Press **[SYS] > {Setting} > {General} > {Power manager}** to select a power saving mode from the followings. You can choose the idle time limit as 5, 15, 30 minutes or 4 hours in all the three mode.

- **Backlight**

The analyzer turns off the backlight of the LCD screen after a user-defined idle time. Press any key to re-activate the backlight after the backlight power-saving mode has been triggered.



- **LCD**

The analyzer turns off the LCD display after a user-defined idle time. Press any key to re-activate the LCD display after the LCD display power-saving mode has been triggered.

- **All - Backlight & LCD**

The analyzer turns off the both the LCD display and the backlight after a user-defined idle time. Press any key to re-activate the backlight and LCD display after the backlight and LCD power-saving mode has been triggered.

**NOTE**

Pressing [**Preset**] for more than 1 second will turn off the LCD display for power saving. Press any key will turn on the display immediately.

---

## Switch Timer

Pressing [**SYS**] > {**Switch Timer**} > {**Timer**} sets the time switch to power on/off the N9340B in a user-defined time and date. This switch timer function requires the power supply connected or charged battery installed.

Press {**Repeat Mode Everyday**} to set the N9340B boot up/off in the pre-saved time everyday. The pre-saved date is invalid in this mode.

## IP configuration

The N9340B supports LAN port connection for data transfer. Press [**SYS**] > {**Setting**} > {**IP Admin**} > {**IP Address Static**} to manually set the IP address, gateway and subnet mask with the proper LAN information, or just press [**SYS**] > {**Setting**} > {**IP Admin**} > {**IP Address DHCP**} to get the IP address in LAN dynamically according DHCP.

Press {**Apply**} to enable all the configurations you set.

## Upgrading Firmware

Follow the steps below to update the N9340B firmware:

- 1 Download the latest N9340B firmware from [http://www.agilent.com/find/n9340b\\_upgrades](http://www.agilent.com/find/n9340b_upgrades)
- 2 Extract files to the root directory of a USB stick. You will see a folder named “N9340DATA” with file *Bappupgrade.hy*.
- 3 Insert the USB stick into the top panel USB connector.
- 4 Press **[SYS] > {More} > {Upgrade} > {Firmware}** to activate the updating procedure. Press Enter to upgrade the firmware. The analyzer will perform the update automatically.
- 5 Unplug the USB stick and restart the N9340B when message “All modules have been upgraded, please restart” is displayed.
- 6 Press **[SYS] > {More} > {Show System}** to find the updated MCU firmware version.

#### NOTE

Please make sure your USB stick is in FAT16 or FAT32 format. USB stick with self-startup partition or multi-partitions is not support by N9340B.

#### CAUTION

**In updating process, there must be a constant power supply to for at least 15 minutes. If power fails during the updating process it can cause damage to the instrument.**

## Ext Input

Toggles the channel for external input between **Ref** and **Trig**. **Ref** refers to a 10 MHz reference signal; **Trig** refers to a TTL signal.

### External Reference (Ref)

Use the external reference function as follows:

- 1 Input a 10 MHz signal to the **EXT TRIG IN/REF IN** connector.
- 2 Press **[SYS] > {Setting} > {Input/Output Ref}** to enable the external reference signal input.

The analyzer then turns off its internal reference.

### External Trigger (Trig)

When an external TTL signal is used for triggering function, the analyzer uses the inner reference as default.

Use the external trigger function as follows:

- 1 Press **[SYS] > {Setting} > {Input/Output Trig}** to enable the external TTL signal input.
- 2 Press **[SPAN] > {Zero Span}** to activate the **Trigger** function.
- 3 Access the associated softkeys to select the rising edge (**Ext Rise**) or the falling edge (**Ext Fall**) as the trigger threshold.

#### NOTE

The trace will halt in external trigger mode till the trigger threshold is met or the free run function is activated.

## Adding an Option

Pressing **[SYS] > {More} > {Option} > {Add Option}** brings up a dialog box for entering the option license code. Use the numeric keypad to input the option license code and then use the **[ENTER]** key as a terminator. If the analyzer recognizes the option license code, a message “*Option activated successfully*” will appear in the status line. Otherwise, a message “*Invalid option licence*” will appear in the status line.

Press **[SYS] > {More} > {Option} > {Show Option}** to view the installed options.

## Show System

Pressing **[SYS] > {More} > {Show system}** displays the following hardware, software and battery information of the analyzer:

Machine Model	Battery Info
MCU Firmware Version	Name
DSP Firmware Version	Serial NO.
FPGA Firmware Version	Capacity
RF Firmware Version	Temperature
RF Module S/N	Charge Cycles
KeyBoard Module S/N	Voltage
This Run Time	Current
Temperature	Charge Status
Source Voltage	Remain Time
Power Source	Host ID

## Show Error

Pressing **[SYS] > {More} > {Show Error}** accesses a list of the 30 most recent error messages. The most recent error will appear at the bottom of the list. If the error list is longer than 30 entries, the analyzer reports an error message [-350, Query overflow]. When in remote control, and the error list is greater than 30 entries, the error display is halted and a message at the bottom of the list informs the user that error exceed 30.

For more information, refer to [“Error Messages”](#) on page 139.

## Perform a Time Base Calibration

The N9340B provides a manual calibration function to calibrate the time base. The analyzer should warm up for approximately 30 minutes before calibration.

When the calibration function is triggered, the current measurement is interrupted and a gauge displays on the LCD. The gauge simply indicates calibration action rather than calibration course, as the calibration time is unpredictable. When the calibration is finished, the LCD displays a calibration, and the interrupted measurement restarts.

**NOTE**

Time base calibration takes during a short time only when the inner temperature is stable. When the inner temperature is increasing, calibration takes a long-time course or will fail. If the input reference signal is abnormal, the calibration cycle will take a long and unpredictable time to exit, and the LCD displays an error message.

Please refer to the operation procedures as below:

- 1 Use a BNC cable to connect a 10 MHz reference signal to the **EXT TRIG IN** connector.
- 2 press **[SYS] > {More} > {Calibration} > {Time Base}** to initiate a calibration.

## Low Frequency Channel

Press **[SYS] > {More} > {More} > {LowFreqChannel}** to enable the low frequency channel function. When this softkey is enabled, the trace in the low frequency range will have a better DANL.

This softkey is only available in spectrum analysis mode with option XDM or option IBC.

## File

Pressing **[SYS] > {File}** accesses to the menu that allows you to manage the file saving and loading.

#### NOTE

A USB memory stick of FAT32 or FAT16 format and with only one memory zone is primarily required when using USB memory stick for file saving and loading.

---

### Viewing file list

Refer to the following two steps to view file list:

- 1 Select the directory to view.  
Press **[SYS] > {File} > {View}** to toggle the displayed file list from **local** memory or an external **USB** memory stick.

Select the file type you wish to view.

Press **[SYS] > {File} > {File setup} > {File type}** to select a file type.

### File Types

Each file type has a specific purpose as defined below. Pressing **[SYS] > {File} > {File Setup} > {File type}** allows the user to select a file type from one of the following:

- Trace (\*.DAT)  
A trace file records trace data and controls.
- Screen (\*.JPG)  
A screen file records graphic information of the current screen.
- State (\*.STA)  
A state file records the current controls and settings of the analyzer. Use this file type for saving test parameters for future recall, such as Frequency, Amplitude and BW settings.
- Limit (\*.LIM)  
A limit file records the limit settings. You can edit the limit file and transfer this file between the N9340B and PC software.

- CSV (\*.CSV)  
A CSV file records the trace data and available for review on PC.
- Setup (\*.SET)  
A setup file records the system setting information, such as language, date/time, and power saving mode. This file type is not used for test parameter setup information.

### Save Path

Press **[SYS] > {File} > {File Setup} > {Save Path}** to select a path from the local memory or external USB memory device.

## Saving a file

#### NOTE

When selecting a file type, you can edit a file name by pressing the numeric and alphabetic hardkeys on the right side of the analyzer's front panel.

Refer to the following three steps to save a file:

- 1 Press **[SYS] > {File} > {File Setup}** to select the save path and file type.
- 2 Edit a file name.  
A file name can consist of letters and digits. A single key stroke on the numerical keypad inputs a digital number; and consecutive key stroke selects and inputs a letter.
- 3 Press **{Save}** to save the file.

When a file saving completes, the message *"File Saved"* displays on the bottom line of the screen.

#### NOTE

When the saving path to USB, files are automatically saved into a folder named as N9340DATA in the root directory of the USB memory stick.  
If the USB memory stick connection can not be updated, remove the USB memory stick, then cycle the power and re-insert the USB memory stick.

#### Saving Multiple Test Setups

Test Setups that are unique and are necessary to recall frequently can be saved as an instrument state file. Other file types are described on “File Types” on page 32.

#### Quick Saving a Trace or a Screen

Press [**0/Save**] to quickly save a trace or a screen to either the local memory or an external USB device, depending upon the setup of the save path.

Refer to the steps for saving a trace/screen:

- 1 Press [**SYS**] > {**File**} > {**File Setup**} > {**Shortcut Type**} to indicate the shortcut type to either a trace or a screen copy.
- 2 Press [**SYS**] > {**File**} > {**File Setup**} > {**Save Path**} to either local memory or an external USB device.
- 3 Press [**Return**], [**Save**] to save a trace or a screen copy to the pre-defined memory. The trace or screen will be automatically assigned with a default file name. A trace will be assigned with a file name, such as *HYTRACE*, *HYTRACE\_1*, and consecutive decimal numbers appended to the alphabetic file name, such as *HYSCREEN*, *HYSCREEN\_1* and consecutive decimal numbers appended to the alphabetic file name.

#### NOTE

[**SYS**] > {Screen Save} is also available for screen save. When this key is pressed, a pop-up window indicates you input a file name for the screen you want to save.

#### Quick saving a setup

Press [**SYS**] > {**More**} > {**More**} > {**SaveSYS Setup**} to quick save the current system settings. This does not include the test parameters, such as, Frequency, BW, and Amplitude settings.



## Quick loading a setup

- **Load default**

Press **[SYS] > {More} > {More} > {LoadSYS Setup} > {Load default}** to recall the factory default setup.

- **User Setup**

Press **[SYS] > {More} > {More} > {LoadSYS Setup} > {User Setup}** to recall a customized setup that has been saved previously.

**NOTE**

All the quick saving utility of system state is equal to the saving utility under the **[SYS] > {File}**.

---

## Deleting a file

- 1 Press **[SYS] > {File} > {View}** to select a directory.
- 2 Press **[SYS] > {File} > {File setup} > {File type}** to select a file type.
- 3 Rotate the knob to highlight a file.
- 4 Press **{Delete}** to delete a selected file. The file will be deleted once user presses **Yes** to confirm deleting.

**CAUTION**

Once a file is deleted, it CANNOT be recovered. Carefully decide whether to delete a file before proceeding.

---

## Loading a file

- 1 Press **[SYS] > {File} > {View}** to select a directory.
- 2 Press **{File Setup} > {File type}** to select a file type.
- 3 Rotate the knob to highlight a file.
- 4 Press **{Load Now}** to recall the saved file.

**NOTE**

The screen file can not be loaded into the analyzer.

---

### **3 System and File**



Agilent N9340B  
Handheld Spectrum Analyzer

## 4 Making Measurements

# Measuring Multiple Signals

This section provides information on measuring multiple signals.

## Comparing Signals on the Same Screen

The N9340B can easily compare frequency and amplitude signal differences. For example, measuring radio or television signal spectra. The Delta Marker function allows two signals to be compared when both appear on the screen at the same time.

In this following example, a 50 MHz input signal is used to measure frequency and amplitude differences between two signals on the same screen. The Delta Marker function is demonstrated in this example.

- 1 Press **[PRESET]** to set the analyzer to a factory default setting.
- 2 Input a signal (0 dB, 50 MHz) to the **RF IN** connector of the analyzer.
- 3 Set the analyzer start frequency, stop frequency and reference level to view the 50 MHz signal and its harmonics up to 100 MHz:
  - Press **[FREQ] > 40 > {MHz}**
  - Press **[FREQ] > 110 > {MHz}**
  - Press **[AMPTD] > 0 > {dBm}**
- 4 Press **[MARKER] > {Peak search}** to place a marker on the highest peak on the display (50 MHz). The **{Next Left PK}** and **{Next Right PK}** softkeys are available to move the marker from peak to peak.
- 5 Press **[MARKER] > {Delta}** to anchor the first marker (labeled as M1) and activate a delta marker.

The label on the first marker now reads 1R, indicating that it is the reference point.
- 6 Move the second marker to another signal peak using the front panel knob or by using the **{Peak**

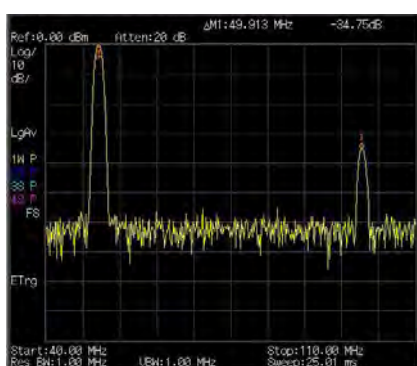
**Search}** softkey. In this example the next peak is 100 MHz, a harmonic of the 50 MHz signal:

- Press **[MARKER]** > **{Peak Search}** > **{Next Right PK}** or **{Next Left PK}**.

**NOTE**

To increase the resolution of the marker readings, turn on the frequency count function. For more information, please refer to “[Improving Frequency Resolution and Accuracy](#)” on page 48.

**Figure 4-2 Delta pair marker with signals (same screen)**



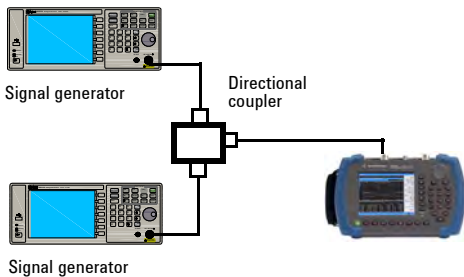
### Resolving Signals of Equal Amplitude

In this example a decrease in resolution bandwidth is used in combination with a decrease in video bandwidth to resolve two signals of equal amplitude with a frequency separation of 100 kHz.

Notice that the final RBW selected is the same width as the signal separation while the VBW is slightly narrower than the RBW.

- 1 Connect two sources to the analyzer input as shown below.

**Figure 4-3 Setup for obtaining two signals**



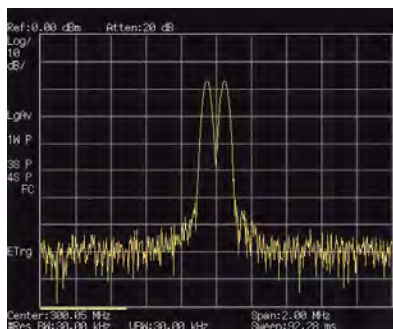
- 2 Set one source to 300 MHz. Set the frequency of the other source to 300.1 MHz. Set both source amplitudes to  $-20$  dBm.
- 3 Setup the analyzer to view the signals:
  - Press **[PRESET]**
  - Press **[FREQ] > 300.05 > {MHz}**
  - Press **[SPAN] > 2 > {MHz}**
  - Press **[BW/SWP] > 30 > {kHz}**

Use the knob or the arrow keys to further reduce the resolution bandwidth and better resolve the signals.

As you decrease the resolution bandwidth, you improve the resolution of the individual signals and it also increases the sweep time. For fastest measurement times, use the widest possible resolution bandwidth.

Under factory preset conditions, the resolution bandwidth is coupled to the span.

**Figure 4-4 Resolving signals of equal amplitude**

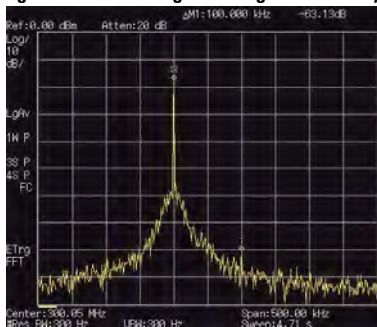


### Resolving Small Signals Hidden by Large Signals

This example uses narrow resolution bandwidths to resolve two input signals with a frequency separation of 50 kHz and an amplitude difference of 60 dB.

- 1 Connect two sources to the analyzer input connector as shown in [Figure 4-3](#) on page 40.
- 2 Set one source to 300 MHz at -10 dBm. Set the other source to 300.05 MHz at -70 dBm.
- 3 Set the analyzer as follows:
  - Press **[PRESET]**
  - Press **[FREQ] > 300.05 > {MHz}**
  - Press **[SPAN] > 500 > {kHz}**
  - Press **[BW/SWP] > 300 > {Hz}**
- 4 Reduce the resolution bandwidth filter to view the smaller hidden signal. Place a delta marker on the smaller signal:
  - Press **[MARKER] > {Peak Search}**
  - Press **[MARKER] > {Delta}**
  - Press **[MARKER] > {Peak Search} > {Next Right PK}** or **{Next Left PK}**

**Figure 4-5** Resolving small signal hidden by a large signal





## Measuring a Low-Level Signal

This section provides information on measuring low-level signals and distinguishing them from spectrum noise. There are four main useful techniques as follows to measure a low-level signal.

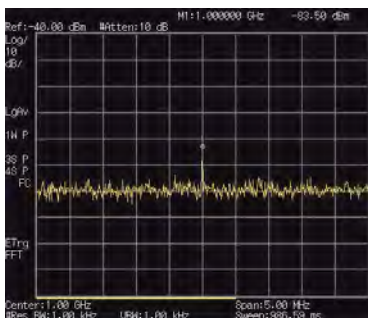
### Reducing Input Attenuation

The ability to measure a low-level signal is limited by internally generated noise in the spectrum analyzer.

The input attenuator affects the level of a signal passing through the analyzer. If a signal is very close to the noise floor, reducing input attenuation will bring the signal out of the noise.

- 1 Preset the analyzer:
- 2 Input a signal (1 GHz, -80 dBm) to **RF IN**.
- 3 Set the CF, span and reference level:
  - Press **[FREQ]** > **1** > **{GHz}**
  - Press **[SPAN]** > **5** > **{MHz}**
  - Press **[AMPTD]** > **-40** > **{dBm}**
- 4 Move the desired peak (in this example, 1 GHz) to the center of the display:
  - Press **[MARKER]** > **{Peak Search}**
  - Press **[MARKER]** > **{Marker To}** > **{To Center}**

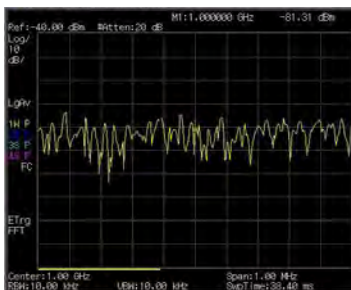
**Figure 4-6** A signal closer to the noise level (Atten: 10 dB)



## 4 Making Measurements

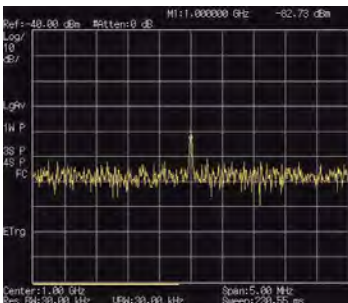
- 5 Reduce the span to 1 MHz and if necessary re-center the peak.
  - Press [**SPAN**] > **1** > {MHz}
- 6 Set the attenuation to 20 dB. Note that increasing the attenuation moves the noise floor closer to the signal level.
  - Press [**AMPTD**] > {Attenuation} > **20** > {dB}

**Figure 4-7 A signal closer to the noise level (Atten: 20 dB)**



- 7 Press [**AMPTD**] > {Attenuation} > **0** > {dB} to set the attenuation to 0 dB.

**Figure 4-8 A signal closer to the noise level (Atten: 0 dB)**



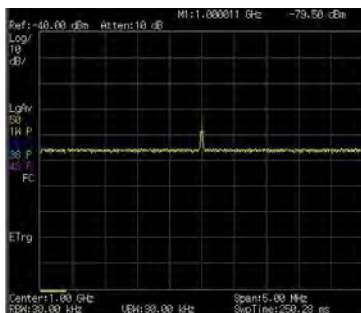
## Decreasing the Resolution Bandwidth

Resolution bandwidth settings affect the level of internal noise without affecting the amplitude level of continuous wave (CW) signals. Decreasing the RBW by a decade reduces the noise floor by 10 dB.

- 1 Refer to “Reducing Input Attenuation” on page 43, and follow steps 1, 2 and 3.
- 2 Decrease the resolution bandwidth:
  - Press **[BW/SWP]**, and toggle RBW setting to **Man (manual)**, then decrease the resolution bandwidth using the knob, the arrow keys or the numeric keypad.

The low level signal appears more clearly because the noise level is reduced.

**Figure 4-9** Decreasing resolution bandwidth

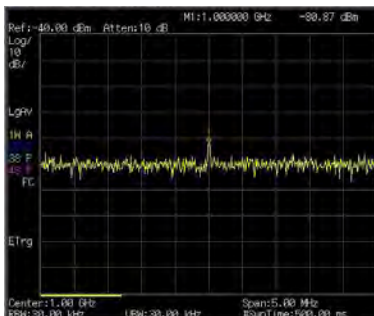


### Using the Average Detector and Increased Sweep Time

The analyzer's noise floor response may mask low-level signals. Selecting the instruments averaging detector and increasing the sweep time will smooth the noise and improve the signal's visibility. Slower sweep times are necessary to average noise variations.

- 1 Refer to "Reducing Input Attenuation" on page 43, and follow steps 1, 2 and 3.
- 2 Press [TRACE] > {More} > {Detector} > {Average} to select the average detector.
- 3 Press [BW/SWP] > {Sweep Time} to set the sweep time to 500 ms.  
Note how the noise appears to smooth out. The analyzer has more time to average the values for each of the displayed data points.
- 4 Press [BW/SWP] > {Avg Type} to change the average type.

Figure 4-10 Using the average detector



## Trace Averaging

Averaging is a digital process in which each trace point is averaged with the previous sweeps data average for the same trace point.

Selecting averaging, when the analyzer is auto coupled, changes the detection mode to sample, smoothing the displayed noise level.

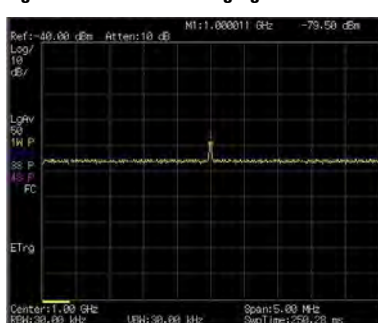
**NOTE**

This is a trace processing function and is not the same as using the average detector (as described on [page 46](#)).

- 1 Refer to the first procedure “[Reducing Input Attenuation](#)” on page 43, and follow steps 1, 2 and 3.
- 2 Press [TRACE] > {Average} (On) to turn average on.
- 3 Press 50 > [ENTER] to set the average number to 50.

As the averaging routine smooths the trace, low level signals become more visible.

**Figure 4-11 Trace averaging**



### Improving Frequency Resolution and Accuracy

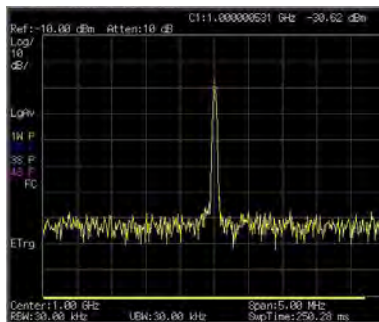
Using the frequency counter to improve frequency resolution and accuracy.

**NOTE**

Marker count properly functions only on CW signals or discrete spectral components. The marker must be > 40 dB above the displayed noise level.

- 1 Press **[PRESET]** (Factory Preset)
- 2 Input a signal (1 GHz, -30 dBm) to the analyzer's **RF IN** connector.
- 3 Set the center frequency to 1 GHz and the span to 5 MHz.
- 4 Press **[MARKER] > {More} > {Mode} > {Freq Count}** to turn the frequency counter on.
- 5 Move the marker by rotating the knob, to a point half-way down the skirt of the signal response.
- 6 Press **[MARKER] > {More} > {Mode} > {Normal}** to turn off the marker counter.

**Figure 4-12 Using the frequency counter**



## Making Distortion Measurements

This section provides information on measuring and identifying signal distortion.

### Identifying Analyzer Generated Distortion

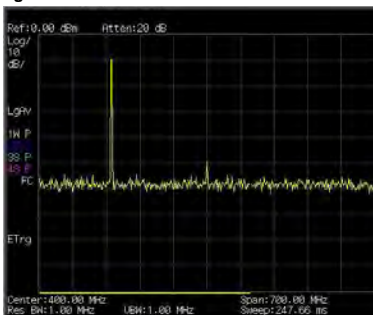
High level input signals may cause analyzer distortion products that could mask the real distortion present on the measured signal. Use trace and the RF attenuator to determine which signals, if any, may be internally generated distortion products.

In this example, a signal from a signal generator is used to determine whether the harmonic distortion products are generated by the analyzer.

- 1 Input a signal (200 MHz, -10 dBm) to the analyzer **RF IN** connector.
- 2 Set the analyzer center frequency and span:
  - Press **[PRESET]** (factory preset)
  - Press **[FREQ] > 400 > {MHz}**
  - Press **[SPAN] > 700 > {MHz}**

The signal produces harmonic distortion products (spaced 200 MHz from the original 200 MHz signal)

**Figure 4-13 Harmonic distortion**



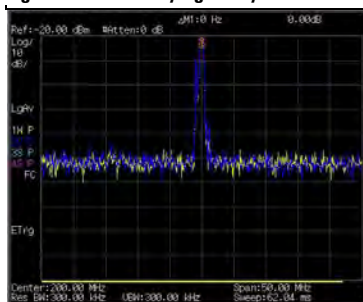
## 4 Making Measurements

- 3 Change the center frequency to the value of the second (400 MHz) harmonic:
  - Press **[MARKER] > {Peak Search}**
  - Press **[MARKER] > {Marker To} > {To Center}**
- 4 Change the span to 50 MHz and re-center the signal:
  - Press **[SPAN] > 50 > {MHz}**
  - Press **[MARKER] > {Peak Search}**
- 5 Set the attenuation to 0 dB:
  - Press **[AMPTD] > {Attenuation} > 0 > {dB}**
  - Press **[MARKER] > {Marker To} > {To Ref}**
- 6 To determine whether the harmonic distortion products are generated by the analyzer, first save the trace data in trace 2 as follows:
  - Press **[TRACE] > {Trace (2)}**
  - Press **[TRACE] > {Clear Write}**
- 7 Allow trace 2 to update (minimum two sweeps), then store the data from trace 2 and place a delta marker on the harmonic of trace 2:
  - Press **[TRACE] > {View}**
  - Press **[MARKER] > {Peak Search}**
  - Press **[MARKER] > {Delta}**

The [Figure 4-14](#) shows the stored data in trace 2 and the measured data in trace 1. The Marker Delta indicator reads the difference in amplitude between the reference and active trace markers.

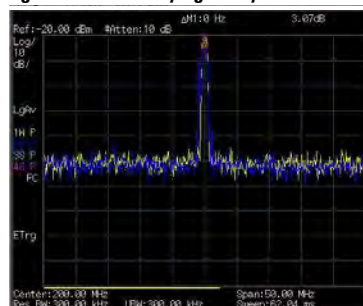


Figure 4-14 Identifying Analyzer Distortion (0 dB atten)



8 Press [AMPTD] > {Attenuation} > 10 > {dB} to increase the RF attenuation to 10 dB.

Figure 4-15 Identifying Analyzer Distortion (10 dB atten)



The marker readout comes from two sources:

- Increased input attenuation causes poorer signal-to-noise ratio. This causes the marker delta value to be positive.
- Reduced contribution of the analyzer circuits to the harmonic measurement causes the marker to be negative.

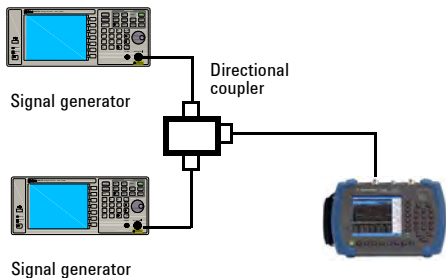
A large marker delta value readout indicates significant measurement errors. Set the input attenuator at a level to minimize the absolute value of marker delta.

### Third-Order Intermodulation Distortion

Two-tone, third-order intermodulation (TOI) distortion is a common test in communication systems. When two signals are present in a non-linear system, they may interact and create third-order intermodulation distortion products that are located close to the original signals. System components such as amplifiers and mixers generate these distortion products.

In this example we test a device for third-order intermodulation using markers. Two sources are used, one set to 300 MHz and the other to 301 MHz.

- 1 Connect the equipment as shown in figure below.



This combination of signal generators and directional coupler (used as a combiner) results in a two-tone source with very low intermodulation distortion.

Although the distortion from this setup may be better than the specified performance of the analyzer, it is useful for determining the TOI performance of the source/analyzer combination.

After the performance of the source/analyzer combination has been verified, the DUT (device under test, for example, an amplifier) would be inserted between the directional coupler output and the analyzer input.

**NOTE**

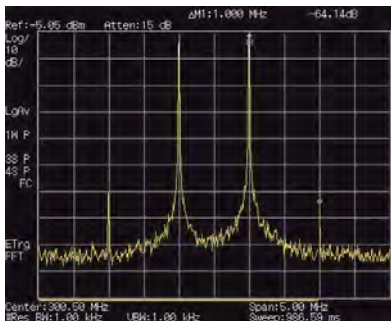
The coupler used should have a high isolation between the two input ports to limit the sources intermodulation.

- 2 Set one source (signal generator) to 300 MHz and the other source to 301 MHz. This will define the frequency separation at 1 MHz. Set both sources equal in amplitude, as measured by the analyzer. In this example, they are both set to -5 dBm.
- 3 Set the analyzer center frequency and span:
  - Press [**PRESET**] (Factory preset)
  - Press [**FREQ**] > **300.5** > {MHz}
  - Press [**SPAN**] > **5** > {MHz}
- 4 Reduce the RBW until the distortion products are visible:
  - Press [**BW/SWP**] > {RBW}, and reduce the RBW using the knob, the arrow keys or the numeric keypad.
- 5 Move the signal to the reference level:
  - Press [**MARKER**] > {Peak Search}
  - Press [**MARKER**] > {Marker To} > {To Ref}
- 6 Reduce the RBW until the distortion products are visible:
  - Press [**BW/SWP**] > {RBW}, and reduce the RBW using the knob, the arrow keys or the numeric keypad.
- 7 Activate the second marker and place it on the peak of the distortion product (beside the test signal) using the **Next Peak**:
  - Press [**MARKER**] > {Delta}

## 4 Making Measurements

- Press [MARKER] > {Peak Search} > {Next Left (Right) PK}
- 8 Measure the other distortion product:
- Press [MARKER] > {Normal}
  - Press [MARKER] > {Peak Search} > {Next Left (Right) Peak}
- 9 Measure the difference between this test signal and the second distortion product.
- Press [MARKER] > {Normal}
  - Press [MARKER] > {Peak Search} > {Next Left/Right Peak}

Figure 4-16 TOI test screen

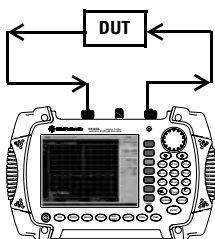


## Making a Stimulus Response Transmission Measurement

The procedure below describes how to use a built-in tracking generator to measure the rejection of a low pass filter, a type of transmission measurement.

- 1 To measure the rejection of a low pass filter, connect the equipment as shown below. A 370 MHz low-pass filter is used as a DUT in this example.

**Figure 4-17 Transmission Measurement Test Setup**



- 2 Press [**Preset**] to perform a factory preset.
- 3 Set the start and stop frequencies and resolution bandwidth:
  - Press [**FREQ**] > {**Start Freq**} > 100 > {**MHz**}
  - Press [**FREQ**] > {**Stop Freq**} > 1 > {**GHz**}
  - Press [**BW/SWP**] > {**RBW**} > 1 > {**MHz**}
- 4 Turn on the tracking generator and if necessary, set the output power to -10 dBm:
 

Press [**MODE**] > {**Track Generator**} > {**Amplitude (On)**} > -10 > {**dBm**}.

**CAUTION**

Excessive signal input may damage the DUT. Do not exceed the maximum power that the device under test can tolerate.

## 4 Making Measurements

- 5 Press **[BW/SWP] > {Sweep Time (Auto)}** to put the sweep time into stimulus response auto coupled mode.

- 6 Increase measurement sensitivity and smooth the noise:

Press **[BW/SWP] > {RBW} > 30 > {kHz}**

Press **[BW/SWP] > {VBW} > 30 > {kHz}**

A decrease in the displayed amplitude is caused by tracking error.

- 7 Connect the cable from the tracking generator output to the analyzer input. Store the frequency response in trace 4 and normalize:

Press **[MEAS] > {Normalize} > {Store Ref} (1 → 4) > {Normalize (On)}**

- 8 Reconnect the DUT to the analyzer and change the normalized reference position:

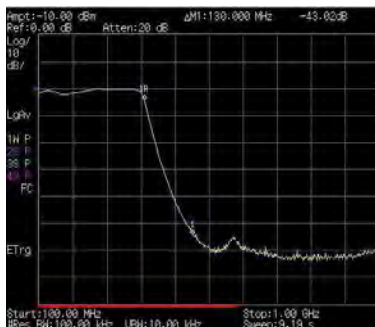
Press **[MEAS] > {Normalize} > {Norm Ref Posn} > 8 > [ENTER]**

- 9 Measure the rejection of the low-pass filter:

Press **[Marker] > {Normal} > 370 > MHz, {Delta} > 130 > {MHz}**

The marker readout displays the rejection of the filter at 130 MHz above the cutoff frequency of the low-pass filter.

**Figure 4-18 Measure the Rejection Range**



## Measuring Stop Band Attenuation of a Low-pass Filter

When measuring filter characteristics, it is useful to look at the stimulus response over a wide frequency range. Setting the analyzer x-axis (frequency) to display logarithmically provides this function. The following example uses the tracking generator to measure the stop band attenuation of a 370 MHz low pass filter.

- 1 Connect the DUT as shown in [Figure 4-17](#) on page 55. This example uses a 370 MHz low pass filter.
- 2 Press [**Preset**] to perform a factory preset.
- 3 Set the start and stop frequencies:
  - Press [**FREQ**] > {**Start Freq**} > **100** > {**MHz**}
  - Press [**FREQ**] > {**Stop Freq**} > **1** > {**GHz**}
  - Press [**AMPTD**] > {**Scale Type**} > {**Log**}
- 4 Press [**BW/SWP**] > **10** > {**kHz**} to set the resolution bandwidth to 10 kHz.

### CAUTION

Excessive signal input may damage the DUT. Do not exceed the maximum power that the device under test can tolerate.

- 5 Turn on the tracking generator and if necessary, set the output power to -10 dBm:
 

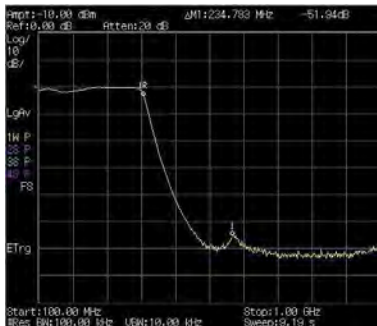
Press [**MODE**] > {**Track Generator**} > {**Amplitude (On)**} > **-10** > {**dBm**}.
- 6 Press [**BW/SWP**] > {**Sweep Time (Auto)**} to put the sweep time into stimulus response auto coupled mode. Adjust the reference level if necessary to place the signal on screen.
- 7 Connect the cable (but not the DUT) from the tracking generator output to the analyzer input. Store the frequency response into trace 4 and normalize:
 

Press [**MEAS**] > {**Normalize**} > {**Store Ref**} (**1** → **4**) > {**Normalize (On)**}

## 4 Making Measurements

- 8 Reconnect the DUT to the analyzer. Note that the units of the reference level have changed to dB, indicating that this is now a relative measurement.
- 9 To change the normalized reference position:  
Press [MEAS] > {Normalize} > {Norm Ref Posn} > 8 > [ENTER]
- 10 Place the reference marker at the specified cut-off frequency:  
Press [MARKER] > {Normal} > 370 > MHz
- 11 Set the 2nd marker as a delta frequency of 37 MHz:  
Press {Delta} > 37 > MHz
- 12 In this example, the attenuation over this frequency range is 19.16 dB/octave (one octave above the cutoff frequency).
- 13 Use the front-panel knob to place the marker at the highest peak in the stop band to determine the minimum stop band attenuation. In this example, the peak occurs at 600 MHz. The attenuation is 51.94 dB.

Figure 4-19 Minimum Stop Band Attenuation



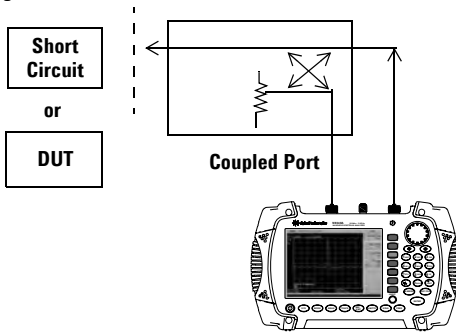


## Making a Reflection Calibration Measurement

The following procedure makes a reflection measurement using a coupler or directional bridge to measure the return loss of a filter. This example uses a 370 MHz low-pass filter as the DUT. The calibration standard for reflection measurements is usually a short circuit connected at the reference plane (the point at which the DUT is connected). A short circuit has a reflection coefficient of 1 (0 dB return loss). It reflects all incident power and provides a convenient 0 dB reference.

- 1 Connect the DUT to the directional bridge or coupler as shown below. Terminate the unconnected port of the DUT.

**Figure 4-20 Reflection Measurement Short Calibration Test Setup**



**NOTE**

If possible, use a coupler or bridge with the correct test port connector types for both calibrating and measuring. Adapters between the test port and DUT degrades coupler/bridge directivity and system source match.

For best response, use the same adapter for the calibration and the measurement. Terminate the second port of a two port device.

## 4 Making Measurements

- 2 Connect the tracking generator output of the analyzer to the directional bridge or coupler.
- 3 Connect the analyzer input to the coupled port of the directional bridge or coupler.
- 4 Press [**Preset**] to perform a factory preset.
- 5 Turn on the tracking generator and if necessary, set the output power to -10 dBm:  
Press [**MODE**] > {**Track Generator**} > {**Amplitude (On)**} > **-10** > {**dBm**}

### CAUTION

Excessive signal input may damage the DUT. Do not exceed the maximum power that the device under test can tolerate.

---

- 6 Set the start and stop frequencies and resolution bandwidth:
  - Press [**FREQ**] > {**Start Freq**} > **100** > {**MHz**}
  - Press [**FREQ**] > {**Stop Freq**} > **1** > {**GHz**}
  - Press [**BW/Avg**] > **1** > {**MHz**}
- 7 Replace the DUT with a short circuit.
- 8 Normalize the trace:  
Press [**MEAS**] > {**Normalize**} > {**Store Ref (1 → 4)**} > {**Normalize (On)**}

This activates the trace 1 minus trace 4 function and displays the results in trace 1.

The normalized trace or flat line represents 0 dB return loss. Normalization occurs with each sweep. Replace the short (cal device) with the DUT.

### NOTE

Since the reference trace is stored in trace 4, changing trace 4 to **Clear Write** invalidates the normalization.

---

Figure 4-21 Short Circuit Normalized



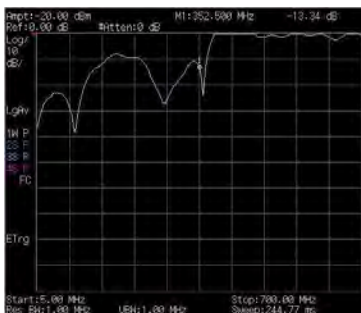
# Measuring Return Loss Using the Reflection Calibration Routine

This procedure uses the reflection calibration routine in the previous procedure “[Making a Reflection Calibration Measurement](#)” on page 59, to calculate the return loss of the 370 MHz low-pass filter.

- 1 After calibrating the system with the above procedure, reconnect the filter in place of the short (cal device) without changing any analyzer settings.
- 2 Use the marker to read return loss. Position the marker with the front-panel knob to read the return loss at that frequency.

Rotate the knob to find the highest peak and the readout is the maximum return loss.

**Figure 4-22 Measuring the Return Loss of the Filter**



## Making an Average Power Measurement

Average power measurements provide a key metric in transmitter performance.

Base station transmit power must be set accurately to achieve optimal coverage in wireless networks. If the transmit power is set too high due to inaccurate power measurements, undesired interference can occur. If the transmit power is set too low, coverage gaps or holes may occur. Either case may affect system capacity and may translate into decreased revenue for service providers.

Average power can be measured for the channel of interest while the base station is active. All other channels should be inactive. Average power is a broadband measurement. If other signals are present the analyzer will also measure their power contributions.

**CAUTION**

The maximum power for the RF IN port and the RF OUT port of the analyzer is +20 dBm. The maximum power for the Power Sensor port is +24 dBm. When directly coupled to a base station, the test set can be damaged by excessive power applied to any of these three ports.

To prevent damage in most situations when directly coupling an analyzer to a base station, use a high power attenuator between the analyzer and the BTS.

---

The analyzer supports the U2000 Series USB power sensors.

The U2000 Series USB power sensors do not need manual calibration and zero routines performed. Calibration and zeroing are performed without removing the power sensor from the source, through internal zeroing. With internal zeroing of U2000 Series USB power sensors, there is no need to disconnect the sensor or power-off the DUT. The U2000 Series do not require 50 MHz reference signal calibration, allowing the factory calibration to ensure measurement accuracy. For best accuracy, users are recommended to perform

## 4 Making Measurements

external zeroing for input signals below  $-30$  dBm for best accuracy.

### NOTE

If you suspect other signals may be present, it is recommended that you turn off all the other channels and measure average power only on the signal of interest.

Another option is to measure channel power (which is less accurate), that filters out all other channels (signals). You can measure channel power for CDMA using the CDMA Analyzer or CDMA Over Air tool. For other modulation formats, use their respective analyzers (that is, GSM, 1xEV-DO, or W-CDMA) or measure channel power using either the spectrum analyzer or the Channel Scanner tool.

---

### NOTE

Connect the power meter as close as possible to the power amplifier/duplexer output. Do not use a coupled port. Sensors may not be as accurate at the power levels provided by coupled ports.

---

## Making a Basic Average Power Measurement

To make an average power measurement, connect the power sensor and cable, zero and calibrate the meter, before making a measurement. Zeroing of the Power Meter will occur automatically:

- Every time the Power Meter function is used.
- When a 5 degree C. change in instrument temperature occurs.
- Whenever the power sensor is changed.
- Every 24 hours (min.).
- Before measuring low level signals –for example, 10 dB above the lowest specified power the power sensor is capable of.

Calibrating the Power Meter every time you cycle the power on and off.

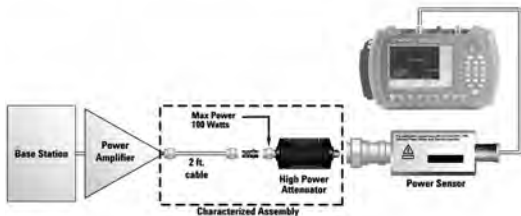
In most situations, you can press **{Zero}** to complete the two steps (zero and cal) together.

### To Make a Basic Average Power Measurement

You can follow the steps below to make a basic average power measurement.

- 1 Press [**Preset**] to perform a factory preset.
- 2 Press [**MODE**] > {**Power Meter**} > [**ENTER**] to turn on the power meter.
- 3 Zero and calibrate the meter. Press {**Zeroing**} to make a Zero operation of the power sensor followed by a calibration operation.
- 4 Connect the power sensor to the power Ref 50 MHz port. The analyzer supports the U2000 Series power sensors.
- 5 Connect the external attenuation, if required, with the power sensor used.
- 6 Connect the analyzer to the base station.  
Connect the power sensor to the signal to be measured. A typical BTS connection is after the output of the power amplifier and duplexer. The connection requires a 2 ft. cable and two Type-N barrel connectors, in addition to the power sensor and external attenuator.

**Figure 4-23 Connection with base station**



### Setting Power Meter Resolution

You can choose from four levels of Power Meter resolution. Higher resolutions provide more accuracy but slow the measurement speed.

- 1 Press [**Preset**] to perform a factory preset.
- 2 Press [**MODE**] > [**Power Meter**] > [**ENTER**] to turn on the power meter.
- 3 Press [**Meas Disp**] > [**Resolution**]. Select 1,2,3 or 4. The four options represent different resolution as follow:
  - [1] = 1
  - [2] = 0.1
  - [3] = 0.01
  - [4] = 0.001

### Setting the Power Meter's Top and Bottom End-Points

Setting the end points (Disk Range) close to expected measurement value changes the sensitivity of the Power Meter scale resolution. This is an advantage in viewing small changes in power. However, this will not affect the overall range of the sensor.

- 1 Press [**Preset**] to perform a factory preset.
- 2 Press [**MODE**] > [**Power Meter**] > [**ENTER**] to turn on the power meter.
- 3 Press [**Meas Disp**] > [**Disp Range**] to access the end-points menu.
- 4 Press [**Top**] and enter the maximum scale value desired using the numeric keypad. Then press [**dBm**] to complete the setup.
- 5 Press [**Bottom**] and enter the minimum scale value desired using the numeric keypad. Then press [**dBm**] to complete the setup.



### Setting the Power Meter's Upper and Lower Limits

The internal Power Meter can be configured to detect when a measurement has failed a user predefined upper and lower limits.

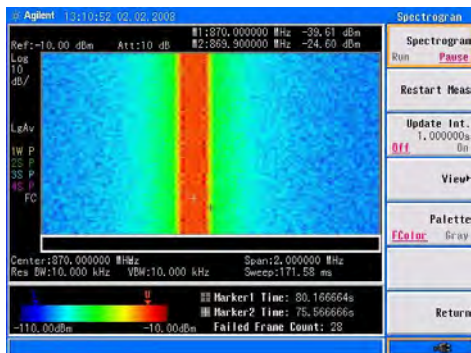
- 1 Press **[Preset]** to perform a factory preset.
- 2 Press **[MODE] > {Power Meter} > [ENTER]** to turn on the power meter.
- 3 Press **{Meas Setup} > {Limits}** to access the limits menu.
- 4 Press **{Limits}** to activate the limits function. Each time the softkey is pressed, the selected option changes.
- 5 Press **{Upper Limits}** and enter the high limit value using the numeric keypad. Then press **{dBm}** to complete the setup.
- 6 Press **{Lower Limits}** and enter the low limit value using the numeric keypad. Then press **{dBm}** to complete the setup.

### Spectrogram

The scrolling three-dimensional display is noted for its ability to track the frequency and power behavior over the time, particularly intermittent signals. The user can use spectrogram to analyze the stability of a signal over the time, or to identify intermittent interference signals in communications systems.

The X-axis represents frequency, and amplitude is represented by color, red for a strong signal and blue for noise floor. The Y-axis represents time, with the trace from the newest sweep displayed at the bottom of the screen. Earlier traces move up toward the top with each new sweep. Two coupled markers allow the user to place a marker on any trace in the spectrogram and view the normal spectrum for the time of that sweep. The time interval between sweeps can be adjusted, and up to 1500 traces can be displayed and saved.

**Figure 4-24 Spectrogram submenu screenshot**



Please refer to the procedures below to perform a Spectrogram measurement.

- 1 Connect the Omni Antenna to RF IN connector.
- 2 Set the center frequency and span.

Press **[FREQ]**, **{Center Freq}**, **[1.8052]**, **{GHz}**, **[SPAN]**, **[5]**, **{MHz}**.

3 Turn on the Spectrogram function.

Press **[MEAS]**, **{More 1 of 2}**, **{Spectrogram}**.

4 Set the update interval time between two frames.

Press **{Update Int. On}**, rotating the knob or pressing numeric keypads to set the update interval time.

5 Turn on Marker 1 and Marker 2.

Press **[MARKER]**, **{State On}**, **{Marker (2)}**, **{State On}**.

6 Press **{Frequency}**, rotate knob to change the frequency of marker as you want.

7 Press **[Meas]**, **{Spectrogram}**, **{Save&Load}**, **{Save RAM}** to save spectrogram data.

The spectrogram has been saved into a spectrogram data file for your further use. It's convenient for you to load the saved file as below: Press **{Save&Load}**, **{Load Spctr}**, Rotating the knob to highlight the file which will be recalled, Press **{Load Now}**, the spectrogram will be loaded.

## Spectrogram Monitoring with Option INM

Option INM extends the N9340B spectrogram capability further with the ability to continuously monitor and save spectrogram data over time not only to the analyzer's internal memory or a USB stick, but also directly to a PC. With option INM users can save more than 1,500 continuous frames of data depending on the size of the USB stick or PC memory.

### NOTE

When in spectrogram auto save process, the measurement will be paused up to more than 10 seconds.

Limit lines with pass/fail functionality is available in this measurement. The N9340B will identify the failed frame of spectrogram data with a red mark.

It allows you to use marker to find the previous/next frame failed data to quickly find the

## 4 Making Measurements

offending event or interference. The spectrogram data may be played back for review on either the analyzer's display or on a PC utilizing N9340B PC Software

### NOTE

For the spectrogram, the marker operation is only within 200 frames displayed on screen. And on PC software, the marker operation is available in whole spectrogram file.

---

### NOTE

The max update rate of spectrogram monitoring function in N9340B PC software is slower than N9340B. If display mode is set to "Spectrg&Trace", the max update rate is 1.5 updates/second. If display mode is set to "trace", the update rate is increased to 2 updates/second.

---

### Spectrogram Audio Alert

The spectrogram provides the sound audio alert with the deferent frequency by the different control parameters. This alert needs two markers to specify the measure channel. The **Band Power** of the channel specified by two markers is measured without the audio alert. The **Alert Limit** is set to specify the lowest band power that makes the buzzer beep.

Please refer to the procedures below to turn on the audio alert.

- 1 Press [**Meas**] > {**Spectrogram**} to access into the spectrogram mode.
- 2 Press [**Marker**] > {**More**} > {**Audio Alert**} to enable the audio alert.

## Demodulating an FM Signal

This section demonstrates how to demodulate and listen to an FM signal using the built-in FM demodulator.

Using the built in FM demodulator you can tune to an FM signal and view the results of the detector output as displayed in the time-domain.

Alternatively, the demodulated signal is also available as an audio output (to the speaker or headphone jack).

- 1 Perform a factory preset:

Press [**Preset**] (Factory Preset, if present).

- 2 Use a signal source or an antenna for an FM signal to analyze. In this example the signal source is used transmitting at 300 MHz with FM deviation of 10 kHz and FM rate of 1 kHz.

### NOTE

If you are using a broadcast FM signal in the United States, for example, the FM channels are broadcasting between 87.7 MHz to 107.7 MHz. The optional preamplifier is essential for the broadcast FM signal demodulation.

- 3 Set the center frequency to the center of the FM signal (in this case 300 MHz):

Press [**FREQ**] > **300** > {MHz}.

- 4 Set the analyzer to zero span for time-domain analysis:

Press [**SPAN**] > {Zero Span}.

Press [**BW/SWP**] > {Sweep Time} > **4** > {ms}.

- 5 Turn off the input attenuation and turn on the optional pre-amplifier:

Press [**AMPTD**] > {Attenuation} > **0** > {dB}.

Press {Preamp On}

## 4 Making Measurements

- 6 Set the resolution bandwidth to capture the full bandwidth of the FM signal. To calculate the required bandwidth use

$$RBW = ((2 \times \text{Frequency Deviation}) + (2 \times \text{Modulation Rate}))$$

In our case the RBW should be:  $(2 \times 10 \text{ kHz}) + (2 \times 1 \text{ kHz}) = 22 \text{ kHz}$  With 1-3-10 sequence RBW selections, choose the next highest RBW of 30 kHz:

Press **[BW/SWP] > 30 > {kHz}**.

- 7 Turn on the FM demodulator:

Press **[SPAN] > {Demod} > {FM ON}**.

Listen to the FM audio signal.

Press **[SPAN] > {Demod} > {Speaker Vol}**, rotate the knob.

Alternatively you can also use the headphone jack.

## Analysis the Demodulated Signals

The N9340B provides the optional AM/FM (Option AMA) and ASK/FSK (Option-DMA) demodulation analysis function for analysis the demodulated signals. These functions can be activated by license key.

### AM/FM Demodulation Analysis

Optional AM/FM demodulation analysis provides modulation metrics, including carrier power, modulation rate, AM depth/FM deviation, SINAD and carrier frequency offset. User definable limits provide Pass/Fail indicators of four types:

Maximum carrier power, Maximum AM modulation index or FM deviation, Minimum AM modulation index or FM deviation, and Minimum carrier frequency offset.

The user can save the waveforms with metrics for reporting as well as the set-up parameters for future measurements or analysis. In the following example, you can use any source available (such as AM/FM radio) as long as it has AM/FM signal generation capability.

#### AM Demodulation Analysis

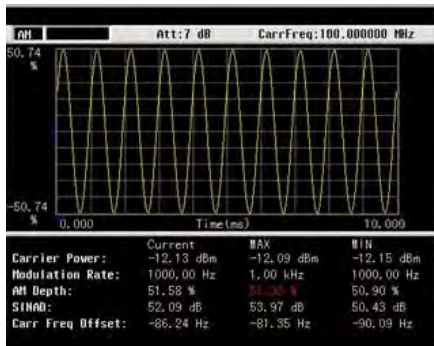
Please refer to the procedures below for the AM demodulation analysis:

- 1 Connect the signal generator to RF IN connector and turn on the signal generator's AM and RF output.
- 2 Turn on the AM demodulation analysis function.  
Press [MODE], Rotating the knob to highlight *Demodulation Analysis*, [ENTER], {AM}.
- 3 Press {Carriers Freq} > [100] > {MHz} to set the carrier frequency.

## 4 Making Measurements

- 4 Set the attenuation state to Auto (default):  
Press **{More 1 of 3}** > **{More 2 of 3}** > **{Attenuation Auto}** > **{More 3 of 3}**
- 5 Press **{Y Scale}** > **{Auto Scale}** > **{Return}** to set the Y scale.
- 6 Set the AM depth limit and turn on the limit function:  
Press **{More 1 of 3}** > **{Limits}** > **{AM Depth UP}** > **[51]** > **{%}** > **{AM Depth Low}** > **[49]** > **{%}** > **{Limits on}**  
The red value in the result indicates the demodulated AM depth exceeds the limits set as above.

Figure 4-25 AM demodulation analysis



## FM Demodulation Analysis

Please refer to the procedures below for the FM demodulation analysis:

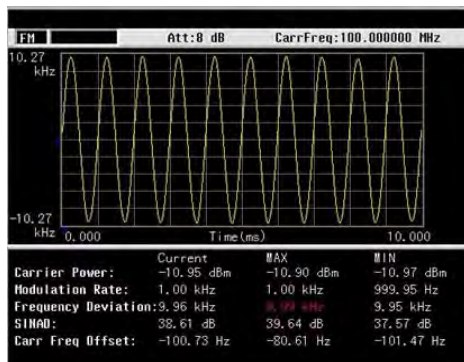
- 1 Connect the signal generator to RF IN connector and turn on the signal generator's FM and RF output.
- 2 Turn on the FM demodulation analysis function.  
Press **[MODE]**, Rotating the knob to highlight **Demodulation Analysis**, **[ENTER]**, **{FM}**.



- 3 Press **{Carries Freq} > [100] > {MHz}** to set the carrier frequency.
- 4 Set the attenuation state to Auto (default):  
Press **{More 1 of 3} > {More 2 of 3} > {Attenuation Auto} > {More 3 of 3}**
- 5 Press **{Y Scale} > {Auto Scale} > {Return}** to set the Y scale.
- 6 Set the FM deviation limit and turn on the limit function:  
Press **{More 1 of 3} > {Limits} > {FreqDev UP} > [11] > {%} > {FreqDev Low} > [9.9] > {%} > {Limits on} > {Return}**

The red value in the result indicates the demodulated FM deviation exceeds the limits set as above.

Figure 4-26 FM demodulation analysis



### ASK/FSK Demodulation Analysis

The ASK/FSK demodulation analysis function supports four display modes:

- Symbol
- Waveform
- ASK/FSK Error
- Eye Diagram.

User definable limits provide Pass/Fail indicators of four types:

- Maximum carrier power
- Maximum ASK modulation depth/FSK frequency deviation
- Minimum ASK modulation depth/FSK frequency deviation
- Maximum carrier frequency offset.

The metrics includes carrier power, ASK/FSK error, ASK depth/FSK frequency deviation, and ASK index etc. The waveform with metrics and setup parameters can be saved for reports and future Measurements.

In the following example, you can use any source available (such as your remote key of the car) as long as it has ASK/FSK generation capability. For ASK/FSK signal, its Filter is Nyquist and Alpha is 0.35.

### ASK Demodulation Analysis

Please refer to the procedures below to analysis the ASK demodulation.

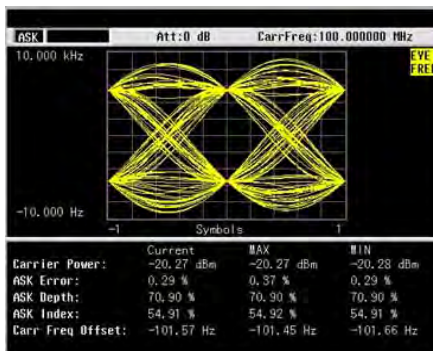
- 1 Connect the signal generator to RF IN connector and turn on the signal generator's ASK and RF output.
- 2 Turn on the ASK demodulation analysis function.

Press **[MODE]**, Rotating the knob to highlight *Demodulation Analysis*, **[ENTER]**, **{ASK}**.

- 3 Press **{Carries Freq}** > **[100]** > **{MHz}** to set the carrier frequency.
- 4 Press **{Symbol Rate}** > **[10]** > **{MHz}** to set the symbol rate.
- 5 Press **{Filter Setup}** > **{Ref Filter}** > **{Nyquist}** > **{Return}** to set the filter type.
- 6 Set the attenuation state to Auto (default):  
Press **{More 1 of 3}** > **{More 2 of 3}** > **{Attenuation Auto}** > **{More 3 of 3}**
- 7 Press **{Y Scale}** > **{Auto Scale}** > **{Return}** to set the Y scale.
- 8 Setting the ASK depth limit and turn on the limit function:  
Press **{More 1 of 3}** > **{Limits}** > **{ASK Depth UP}** > **[71]** > **{%}** > **{ASK Depth Low}** > **[70]** > **{%}** > **{Limits on}** > **{Return}**
- 9 Press **{More}** > **{More}** > **{View}** > **{Eye Diagram}** to view the eye diagram.

The figure below indicates the ASK EYE Diagram as a measurement result.

**Figure 4-27 ASK Eye Diagram**

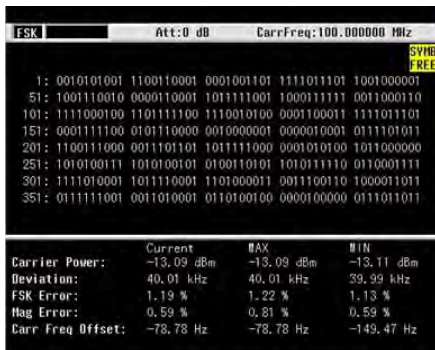


## FSK Demodulation Analysis

Please refer to the procedures below to analysis the ASK demodulation.

- 1 Connect the signal generator to RF IN connector and turn on the signal generator's FSK and RF output.
- 2 Turn on the ASK demodulation analysis function.  
Press **[MODE]**, Rotating the knob to highlight *Demodulation Analysis*, **[ENTER]**, **[FSK]**.
- 3 Press **{Carries Freq} > [100] > {MHz}** to set the carrier frequency.
- 4 Press **{Symbol Rate} > [10] > {ksps}** to set the symbol rate.
- 5 Press **{Filter Setup} > {Ref Filter} > {Nyquist} > {Return}** to set the filter type.
- 6 Set the attenuation state to Auto (default):  
Press **{More} > {More} > {Attenuation Auto} > {More}**
- 7 Press **{Y Scale} > {Auto Scale} > {Return}** to set the Y scale.
- 8 Setting the FSK deviation limit and turn on the limit function:  
Press **{More 1 of 3} > {Limits} > {FreqDev UP} > [41] > {kHz} > {FreqDev Low} > [39] > {kHz} > {Limits on}**

Figure 4-28 FSK Demodulation



## Monitoring the ADSL Signal with Option XDM

xDSL (ADSL and VDSL) is widely used for broadband internet connections at homes and businesses. Service providers occasionally face problems with interference on their xDSL lines. The interference is mainly intermittent intrusion from nearby external sources such as electric motors, elevators, and appliances. In order to monitor, capture and remove intermittent interference, the engineer may need to work in the field for extended periods of time.

The xDSL Measurement mode(Option XDM) provides the capability to measure the ADSL, ADSL2+ and VDSL network with a frequency range of 3 kHz to 40 MHz.

**NOTE**

An xDSL probe from Vierling is required to connect the N9340B analyzer to xDSL networks in the field.

**NOTE**

The option XDM is not available as an upgrade and must be ordered at the time of instrument purchase. The option XDM can be used for other applications which require improved DANL and phase noise at frequencies from 9 kHz to 3 GHz.

**Figure 4-29 xDSL Measurement**



## 4 Making Measurements

Please refer to the procedures below for monitoring the ADSL network.

- 1 Press **[SYS] > {Setting} > {PwrOn/Preset} > {Power On Last}, {Preset Last}**
- 2 Press **[SYS] > {More} > {More} > {LowFreqChannel On}** to enable the low frequency channel.
- 3 Press **[AMPTD] > {More} > {Grid Scale On}**
- 4 Connect the N9340B and ADSL network with a probe.
- 5 Insert a USB stick into N9340B
- 6 Set the start frequency as 3 kHz and stop frequency as 2 MHz.  
Press **[FREQ] > {Start Freq} > [3] > {kHz}**  
Press **{Stop Freq} > [2] > {MHz}**.
- 7 Press **[BW/SWP] > [1] > {kHz}** to set the RBW.
- 8 Press **[MODE]**, Rotating the knob to highlight ***xDSL Measurement***, **[ENTER]**.
- 9 Press **{Disp mode} > {Spctrg&Trace}**
- 10 Press **{Save&Load} > {File Setup} > {File Path USB}**
- 11 Press **{Return} > {Start Save}**

The analyzer begins to automatically save the spectrogram (\*.SPE) or CSV file. when this file size is reach the file size set in the **{File setup}**, the file will be automatically saved, and the spectrogram measurement will restart.



## 5 Key Reference

This Chapter provides descriptions of the Instrument hardkeys and softkey menu functionality, key access to softkey sub-menus, and instrument parameter control options.

Additional reference information is provided in the Menu Maps section.



# Amplitude

Key access: **[AMPTD]**

Activates the reference level function and access the associated softkeys to set functions that affect the way data on the vertical axis is displayed or corrected.

## Ref level

Key access: **[AMPTD] > {Ref level}**

Activates the reference level function.

The reference level is the amplitude power or voltage represented by the top graticule on the display. Changing the value of the reference level changes the absolute amplitude level (in the selected amplitude units) of the top graticule line. To change the reference level, use the arrow keys, the knob, or the numeric keypad. Pressing any digit (0 through 9) on the numeric keypad brings up the terminator menu.

## Attenuation

Key access: **[AMPTD] > {Attenuation}**

Toggles the input attenuation between **Auto** or **Man**.

The input attenuation ranges from 1 dB to 51 dB and allows you to set the attenuation level in 1 dB increments when attenuation is set to **Man**.

The input attenuator, normally coupled to the reference level control, reduces the power level of the analyzer input signal at the input mixer. The attenuator is recoupled when attenuation is set to **Auto**.

### CAUTION

To prevent damage to the input mixer, do not exceed a power level of +33 dBm at the input. A granted power level for stable sensitive measurement is less than 20dBm.



## Preamp

Key access: [AMPTD] > {Preamp}

Toggles the internal preamp between **On** and **Off**.

Preamp results in a correction being applied to compensate for the gain of the preamp at 20 dBm so that amplitude readings show the actual value at the input connector.

### NOTE

When the preamp is on, a PA indication appears on the left side of the display.

---

The preamp is set to on in frequency bands from 1 MHz to 3 GHz, otherwise the correction is not applied even though the **PA** indication still appears.

## Scale/DIV

Key access: [AMPTD]

Sets the logarithmic units per vertical graticule division on the display.

### NOTE

The Scale/Div function is only available when the Scale Type key is set to **Log**.

## Scale Type

Key access: [AMPTD] > {Scale Type}

Toggles the scale type of vertical graticule divisions between logarithmic and linear.

When Scale Type is set to **Log**, a logarithmic units is activated ranging from 1 to 10 dB per division.

When Scale Type is set to **Lin**, the vertical divisions are linearly scaled and the default amplitude units are volts. The top of the display is set to the reference-level value and the bottom graticule becomes zero volts. (Each division of the graticule is one-tenth of the reference level in volts.)

### HiSensitivity

Key access: [AMPTD] > {HiSensitivity}

Press this softkey **On** to set 0 dB attenuation, -50 dBm reference level and turn the pre-amplifier on. It's very helpful to observe the low-level signals with this settings.

### Ref Offset

Key access: [AMPTD] > {Ref Offset}

Adds an offset value which ranges from -327.6 dB to +327.6 dB, to the displayed reference level.

#### NOTE

Reference-level offsets are only entered by using the numeric keypad. Entering an offset does not affect the trace or the attenuation value.

---

Reference-level offsets are used when gain or loss occurs between a device under test and the analyzer input. Thus, the signal level measured by the analyzer may be referred to as the level at the input of an external amplitude conversion device. When an amplitude offset is entered, its value appears in the lower left corner of the display.

### Y Axis Units

Key access: [AMPTD] > {More} > {Y Axis Units}

Sets the amplitude units.

#### NOTE

Amplitude units are maintained for both logarithmic and linear modes depending on the Scale Type setting.

### EMF Mode

Key access: [AMPTD] > {More}

EMF mode is available when the Y Axis Unit is dBmV, dB $\mu$ V or V. This mode is used to measure the port voltage in open circuit.

### Grid Scale

Key access: [AMPTD] > {More}

Press this softkey to turn on the amplitude scale unit display on the left of the graticule. The unit determined by the {Y Axis Unit} softkey.

### BW/SWP

Activates the bandwidth function and accesses the associated softkeys to control resolution bandwidth, video bandwidth and sweep time.

#### RBW

Key access: **[BW/SWP] > {RBW}**

Changes the 3 dB resolution bandwidth on the analyzer from 30 Hz to 1 MHz in a 1, 3, 10 sequence using the knob, step keys or the numeric keypad.

**NOTE**

If an unavailable bandwidth is entered using the numeric keypad, the closest available bandwidth in the 1, 3, 10 sequence is used.

---

As the resolution bandwidth is decreased, the sweep time is modified to maintain amplitude calibration. Resolution bandwidth is also related to span. As span is decreased, resolution bandwidth decreases. As the resolution bandwidth changes, the video bandwidth, if in auto couple mode, changes to maintain the VBW/RBW ratio.

**NOTE**

In non-zero span mode, the value of RBW is determined by whether the setting for RBW is Auto or Man (manual).

---

A “#” mark appears next to RBW on the display when it is not coupled.

#### VBW

Key access: **[BW/SWP] > {VBW}**

Changes the analyzer post-detector filter from 3 Hz to 1 MHz in a 1, 3, 10 sequence using the knob, the step keys, or the numeric keypad.

As the video bandwidth is decreased, the sweep time is increased to maintain amplitude calibration.

**NOTE**

If an unavailable bandwidth entered using the numeric keypad, the closest available bandwidth in the 1, 3, 10 sequence is used.

---

## VBW/RBW

Key access: **[BW/SWP] > {VBW/RBW}**

Selects the ratio between the video and resolution bandwidths.

If signal responses near the noise level are visually masked by the noise, the ratio can be set to less than 1 to lower the noise. The knob and step keys change the ratio in a 1, 3, 10 sequence.

**NOTE**

When preset is set to default, or VBW/RBW is set to Auto, the ratio is set to 1.

---

## Avg Type

Key access: **[BW/SWP] > {Avg Type}**

Accesses the functions to automatically or manually choose from one of the following averaging type:

### Log Pwr

Key access: **[BW/SWP] > {Avg Type} > {Log Pwr}**

Averages the data as appropriate for the logarithmic scaled y-axis.

When average type is set to **Log Pwr**, “LgAv” appears on the left side of the display.

### **Pwr**

Key access: [BW/SWP] > {Avg Type} > {Power}

Converts the scale from logarithmic to linear power units, and then averages the power trace data.

With average type set to **Pwr**, “PAvg” appears on the left side of the display.

### **Voltage**

Key access: [BW/SWP] > {Avg Type} > {Voltage}

Averages the data as appropriate for the linearly scaled y-axis scale.

With average type set to **Voltage**, “VAvg” appears on the left side of the display.

There are actually four types of averaging processes within an N9340B. All, except VBW filtering, are affected by this setting. They are listed as follows:

- **Trace averaging**

Averages signal amplitudes on a trace-to-trace basis. (Press **Log Pwr** or **Pwr**)

- **Average detector**

Averages signal amplitudes during the time or frequency interval and represents the result as a single measurement point.

- **Noise marker**

Averages signal amplitudes across measurement points to reduce variations for noisy signals.

- **VBW filtering**

Performs a form of averaging of video signal.

## Sweep Time

Key access: [BW/SWP] > {Sweep Time}

Selects the sweep time for the analyzer to tune across the displayed frequency span (or, in zero span, the time the analyzer take to sweep the full screen).Inputs may be made using the knob, the arrow keys, or numeric keypad.

**NOTE**

Reducing the sweep time increases the sweep rate.

---

### In non-zero spans

When the sweep time is auto-coupled, the analyzer selects the optimum (shortest) sweep time ranging from 10 ms to 1000 s. The auto selection is determined by three measurement settings:

- Frequency Span
- The selected Resolution Bandwidth
- The selected Video Bandwidth

Note that changing one of the three factors above will change the sweep time. The sweep time is in direct ratio to frequency span and is in reverse ratio to the selected resolution bandwidth and video bandwidth when auto-coupled.

**CAUTION**

With sweep time set to a value less than the minimum auto-coupled value, an annotation "Data out of range" appears in the active function block and the sweep time is automatically converted to the minimum auto-coupled value.

---

### In zero span

Auto-coupled does not function when in a zero span. The sweep time can only be set manually. The sweep time is selectable from 6 s to 200 s in zero span.

### In FFT Mode

In FFT mode, the sweep time default is auto-coupled. The submenu, sweep time is invalid in FFT mode.

## Sweep

Key access: **[BW/SWP] > {Sweep}**

Activates the sweep mode function and accesses associated softkeys to select the trace sweep functions.

### Sweep Type

Key access: **[BW/SWP] > {Sweep}**

Toggles the analyzer between the continuous sweep mode and the single sweep mode.

- **Sweep (Single)**

Puts the analyzer in a single sweep mode. In this mode, pressing **[BW/SWP] > {Single Sweep}** enables a sweep.

- **Sweep (Cont)**

Performs one sweep after another as soon as it is triggered. Pressing **[Preset]** (When Preset Type is set to **Default**) or turning the power on, sets the sweep mode to continuous sweep as default.

### Sweep Mode

Key access: **[BW/SWP] > {Sweep} > {Sweep Mode}**

An N9340B provides two sweep modes to meet different sweep time requirements:

- **Normal**

Activates the default sweep mode.

- **Fast**

Activates the fast sweep mode.



Fast sweep mode provides a fast measurement function that decreases the sweep time. Using Fast Sweep will decrease the measurement accuracy.

## NOTE

Fast sweep is valid only when span is no less than 50 MHz. Measurement data is not guaranteed in fast sweep mode.

## TD Mode

Key access: **[BW/SWP] > {Sweep} > {Sweep Mode}**

The TD mode is used to analyze TDD or TDM signal, for instance the GSM signal frame. When in this mode, the sweep frequency analysis is enabled at RBW of 1 kHz, 3 kHz and 10 kHz. When TD mode is set to Off, the analyzer is sweeping in FFT analysis mode below 30 kHz. In TD mode, you can manually set the sweep time long enough to get a stable measurement result of TDD signal. For example, one time frame for GSM signal is 4.616ms, then the sweep time can be set no less than  $4.616\text{ms} \times 461$  (points of one trace of N9340B) to measure the signal.

## Single Sweep

Key access: **[BW/SWP] > {Sweep} > {Single Sweep}**

When the analyzer is in continuous sweep mode and not in a measurement mode (**[MEAS] > Measure Off**), pressing **[BW/SWP] > {Single Sweep}** will change the sweep setting to single sweep. It will then begin a sweep after the trigger conditions are met. If the analyzer is already in single sweep, pressing **[BW/SWP] > {Single Sweep}** will execute a new sweep as soon as the trigger condition is met.

If average is on (**[TRACE] > {More} > {Average On}**), pressing **[BW/SWP] > {Single Sweep}** will halt averaging of the current value, and then continue averaging from the current count number when a single sweep function triggers.

### Enter

Hardkey function:

- Terminates data entry and enters into the analyzer numerical values keyed from numeric keypad on the front panel.
- Terminate filename entries.

### ESC/CLR

This hardkey provides mainly two types of functions:

#### Clear

- Clears any numeric entry and cancels the active function.
- Clears any title entry and cause the title to revert to the previous name.
- Clears input or output overloads
- Clears error messages from the status line along the bottom of the display.

#### Association with other functions

Provides a permitted setting for triggering other functions such as:

- Activates **LIMIT** function for pass/fail judgements.
- Activates **SAVE** function for current trace saving.

#### CAUTION

When pressing **[ESC/CLR]**, the current parameter annotation in the lower left corner, which is an indicator of available settings of **LIMIT** and **SAVE**, disappears.

---

## Frequency

Activates the center frequency function, and accesses the menu of frequency functions. The center frequency, or start and stop frequency values appear below the graticule on the display.

**NOTE**

When changing both the center frequency and the span, change the frequency first since the span can be limited by the frequency value.

---

### Center Frequency

Key access: [FREQ] > {Center Freq}

Activates the center frequency function, which allows you to set the horizontal center of the display to a specified frequency.

### Start Frequency

Key access: [FREQ] > {Start Freq}

Sets the frequency at the left side of the graticule. The left and right sides of the graticule correspond to the start and stop frequencies. When these frequencies are activated, their values are displayed below the graticule in place of center frequency and span.

### Stop Frequency

Key access: [FREQ] > {Stop Freq}

Sets the frequency at the right side of the graticule. The left and right sides of the graticule correspond to the start and stop frequencies. When these frequencies are activated, their values are displayed below the graticule in place of center frequency and span.

## CF Step

Key access: **[FREQ] > {CF Step}**

Changes the step size for the center frequency function. Once a step size has been selected and the center frequency function is activated, the arrow keys change the center frequency by the step-size value. The step size function is useful for finding harmonics and sidebands beyond the current frequency span of the analyzer. When auto-coupled, the center size is set to one division (10 percent of the span).

## Freq Offset

Key access: **[FREQ] > {Freq Offset}**

Allows you to input a frequency offset value that is added to the frequency readout of the marker, to account for frequency conversions external to the analyzer. Offset entries are added to all frequency readouts including marker, start frequency, and stop frequency. Offsets are not added to the span or frequency count readouts. Entering an offset does not affect the trace display.

## Marker

Accesses the marker control softkeys to select the type and number of markers. Markers are diamond-shaped characters that identify points of traces. Up to six pairs of markers may appear on the display simultaneously; only one pair can be controlled at a time. The marker that is controlled is called the “active” marker. Pressing **[MARKER]** activates the Normal menu key.

## Marker

Key access: **[MARKER]** > **{Marker}**

Selects one of the six possible markers. A marker that has already been selected will become active when it is turned on. If a marker has been turned on and assigned to a specific trace, it will become active on that trace if that marker is selected.

## Normal

Key access: **[MARKER]** > **{Normal}**

Activates a single frequency marker at the center of the active trace if a marker is not already displayed. If a marker is displayed before the **Normal** function is enabled, the marker is enabled at the position of the selected marker. The marker number is indicated above the marker. The knob and/or arrow keys move the marker left or right. If a value is entered from the numeric keypad, the marker is moved to the trace point nearest to that value. Annotation in the active function block and in the upper right corner indicates the frequency and amplitude of the marker (time and amplitude, if in zero span.) Pressing **Normal** turns off the **Delta** function and moves the active marker to the delta marker position.

### Delta

Key access: [MARKER] > {Delta}

Activates a second marker at the position of the first marker. (If no marker is present, two markers appear at the center of the display). The amplitude and frequency (or time) of the first marker is fixed. The marker number is indicated above the delta marker, and the same number is indicated with an R (for example, 1R) above the reference marker. Use the data controls to position the delta marker. Annotation in the active function block and in the upper-right corner of the display indicates the frequency (or time) and amplitude differences between the two markers. The markers will be turned off if the scale type is changed between log and linear.

---

**NOTE**

Pressing **Delta** again moves the reference marker to the active marker position, so you are allowed to make delta measurements from differing reference points without having to turn off the markers and begin again.

---

**NOTE**

The delta marker function permits signal-to-noise measurements provided the signal is a single spectral component (sinusoid). Place a normal marker on the signal, press **Delta**, place the delta marker in the noise, and activate Marker Noise. The indicated amplitude indicates signal-to-noise/Hz.

---

### Off

Key access: [MARKER] > {Off}

Turns off the active function markers.

## Peak Search

Place a marker on the highest peak based on the setting of the Search Criteria as follows:

- **Peak**

Key access: [MARKER] > {Peak Search}

Place a marker on the highest peak.

- **Next Left Peak**

Key access: [MARKER] > {Peak Search} > {Next Left PK}

Moves the marker to the next peak to the left of the current marker. The signal peak must exceed the peak threshold value by the peak excursion value. If there is no peak to the right, the marker will not move and the **No Peak Found** error message will appear on the display.

- **Next Right Peak**

Moves the marker to the next peak to the right of the current marker. The signal peak must exceed the peak threshold value by the peak excursion value. If there is no peak to the right, the marker will not move and the **No Peak Found** error message will appear on the display.

Key access: [MARKER] > {Peak Search} > {Next Right PK}

- **6 Peaks Search**

In non-zero span, pressing **6 Peaks Search** turns all six markers on and puts them on the six highest peak in the current frequency span.

In zero span, the function is not available.

Key access: [MARKER] > {Peak Search} > {Auto Search}

### Marker To

Accesses the following marker function menu keys:

- **To Center**

Key access: [MARKER] > {To Center}

Sets the center frequency of the analyzer to the marker frequency. In Delta mode, pressing [Marker] > {Marker To} > {To Center} sets the center frequency to the marker delta value. The function is not available in zero span.

#### NOTE

When the frequency scale is in log mode, the center frequency is not at the center of the display.

- **To Ref**

Key access: [MARKER] > {Marker To}

Changes the reference level to the active marker value, moving the marked point to the reference level (top line of the graticule). In Delta mode, pressing [Marker] > {Marker To} > {To Ref} sets the reference level to the amplitude difference between the markers.

### Mode

Key access: [MARKER] > {More} > {Mode}

Accesses the following menu keys that allows you to change the active marker readout mode.

- **Normal**

Activates the default readout mode.

- **Freq Count**

Activates a frequency counter mode.

- **Noise**

Activates a noise readout mode for evaluating power density.



## NOTE

Frequency counter is properly effective only on CW signals or discrete peaks. For a valid reading, the marker must be greater than 25 dB above the noise. **Freq Count** function is not supported under **Marker Delta** condition.

## NOTE

**Noise** mode operates only on noise peaks and not supported under **Marker Delta** condition.

## Marker Trace

Key access: [MARKER] > {More} > {Marker Trace}

Activates a marker on the trace if there are no markers turned on. If a marker is currently active, press **Marker Trace** until **1**, **2**, **3**, or **4** is underlined. The active marker will be moved to the selected trace.

Selecting **Auto** will move the marker to the automatically selected trace. The selection order is to look for the lowest numbered trace in the following order of trace modes:

Clear write	Max hold
Min. hold	View

If there is no trace in any of these modes, it selects trace 1 as default.

## All Off

Key access: [MARKER] > {More} > {All Off}

Turns off all of the markers, including markers used for signal track and demodulation. The marker annotation is also removed.

## Marker Table

Key access: [MARKER] > {More} > {Marker Table}

Compresses the graticule and displays the marker number, trace number, marker type, X axis value, and the amplitude in the table.

# MEAS

Hardkey menu access.

In spectrum analysis mode, pressing **[MEAS]** brings up the menu for a suite of power measurements such as adjacent channel power, occupied bandwidth, and channel power.

## OBW

Occupied Bandwidth (OBW) integrates the power of the spectrum in the displayed green frame. The measurement defaults to 99% of the occupied bandwidth power.

Occupied bandwidth measurement are made in either single or continuous sweep mode.

### Selecting a Method

Press **[MEAS] > {OBW} > {Method}** to toggle the occupied bandwidth measurement mode between **percentage (%)** and **dBc**.

- Setting Percentage (%)

Press **{OBW} > {Method} > {Percent}** to edit the percentage of signal power used when determining the occupied bandwidth. Press **{%}** to set the percentage ranging from 10.00% to 99.99%.

- Setting dBc

Press **{OBW} > {Method} > {dBc}** to specify the power level used to determine the emission bandwidth as the number of dB down from the highest signal peak, within the occupied bandwidth span. This function is an independent calculation from the OBW calculation. The x dB bandwidth result is also called the emissions bandwidth (EBW). This sets the green frame (f1 and f2 are the two cross points of the signal and the pair of vertical lines of the displayed green frame) to your specified dB value below the maximum power, and compute the total power in the frame. The emission bandwidth is then calculated ranging from 0.1 dB to 100 dB (the default value is set to 26 dB).

## ACPR

The adjacent channel power ratio (ACPR) measures the power ratio between the main channel power and the adjacent channel power.

ACPR measures the total power (RMS voltage) in the specified channel. The measurement result reports the ratios of the two adjacent channel powers to the main channel power.

### Center Frequency

Key access: [MEAS] > {ACPR} > {Center Freq}

Sets the center frequency of the main channel power.

### Main Channel

Key access: [MEAS] > {ACPR} > {Main Channel}

Specifies the range of integration used in calculating the power in the main channel. Use the knob, the arrow keys, or the numeric keypad to set the bandwidth.

### Adjacent Channel

Key access: [MEAS] > {ACPR} > {Adj Channel}

Specifies the range of integration used in calculating the power in the adjacent channel. Use the knob, the arrow keys, or the numeric keypad to set the bandwidth.

### Channel Space

Key access: [MEAS] > {ACPR} > {Channel Space}

Sets the space value between the center frequency of main channel power and that of the adjacent channel power.

### Channel Power

Channel power function measures the power and power spectral density in the channel bandwidth specified. One pair of vertical lines of the displayed green frame indicates the edges of the channel bandwidth. The center frequency, reference level, and channel bandwidth must be set by the user. The power calculation method used to determine the channel power is a traditional method known as the integration bandwidth (IBW) method. A swept spectrum is used as the basis for this calculation. Therefore, it is important to set the resolution bandwidth correctly before making this measurement using the following formula:

$$RBW = k \times \frac{Span}{n}$$

Where k is a value between 1.2 and 4.0 and n is the number of trace points.

#### Center Frequency

Key access: **[MEAS] > {Channel Power} > {Center Freq}**

Sets the center frequency of the display.

#### Integration Bandwidth

Key access: **[MEAS] > {Channel Power} > {Int BW}**

Specifies the bandwidth of integration bandwidth, which can range from 100 Hz to 3 GHz to calculate the power in a channel. For example, set the main (center) channel bandwidth. The green frame indicates the integration bandwidth.

#### Channel Bandwidth

Key access: **[MEAS] > {Channel Power} > {Channel BW}**

Sets the analyzer span for the channel power measurement using the knob, the arrow keys or the numeric keypad. Be sure the span is set between 1 and 10 times the integration bandwidth.

## Spectrum Emission Mask (SEM)

Spectrum Emission Mask measurement includes the in-band and out-of-band spurious emissions. As it applies to W-CDMA (3GPP), this is the power contained in a specified frequency bandwidth at certain offsets relative to the total carrier power. It may also be expressed as a ratio of power spectral densities between the carrier and the specified offset frequency band. For WLAN, the reference power is taken as the peak PSD in the signal, and all offset results are also the peak PSD in that offset as opposed to the integrated power.

### Avg Number

Key access: [MEAS] > {More} > {SEM} > {Avg Number}

Press **Avg Number (On)** to specify the number of measurement averages used when calculating the measurement result. The average will be displayed at the end of each sweep.

### Meas Type

Key access: [MEAS] > {More} > {SEM} > {Meas Type}

Displays a menu where you can select a measurement reference type, **Total Pwr Ref** or **PSD Ref**. When **Total Pwr Ref** is selected, the power in the carrier is used as the reference in computing the relative power values for the offsets. When **PSD Ref** is selected, the mean power spectral density of the carrier is used in computing the relative power spectral density values for the offsets.

### Ref Channel

accesses the softkeys that enable you to change the reference channel settings:

- **Chan Integ BW**

Key access: [MEAS] > {SEM} > {Ref Channel}

Specifies the integration bandwidth used in calculating the power in the main channel.

## 5 Key Reference

- **Chan Span**

Key access: [MEAS] > {SEM} > {Ref Channel}

Specifies the span used in measuring the power in the main channel.

- **Sweep Time**

Key access: [MEAS] > {SEM} > {Ref Channel}

Specifies the sweep time used in measuring the power in the main channel.

- **Total Pwr Ref**

Key access: [MEAS] > {SEM} > {Ref Channel}

**Total Pwr Ref** is the power in the carrier that is used as the reference in computing the relative power values for the offsets. When **Man** is selected, this can be set by the user. When **Auto** is selected, this is the measured power in the reference carrier.

### Offset/Limits

Key access: [MEAS] > {SEM}

Displays the menus where you can change the following parameters for offset frequency settings and pass/fail tests: **Offset**, **Start Freq**, **Stop Freq**, **Sweep Time**, **Res BW**, and **Limits**. Refer to the tables below for default settings of particular radio standards of interest.

**Table 1 Offsets & Limits Defaulted for W-CDMA (3GPP) Base Station Measurements<sup>a</sup>**

Offset	Start Freq (MHz)	Stop Freq (MHz)	Res BW (kHz)	Abs Start (dBm)	Abs Stop (dBm)	Abs Couple	Rel Start (dBc)	Rel Stop (dBc)	Meas BW
A. On	2.515	2.715	30.00	-14.00	-14.00	Couple	-30.00	-30.00	1
B. On	2.715	3.515	30.00	-14.00	-26.00	Man	-30.00	-30.00	1
C. On	3.515	4.000	30.00	-26.00	-26.00	Couple	-30.00	-30.00	1
D. On	4.000	8.000	1000.00	-13.00	-13.00	Couple	-30.00	-30.00	1
E. On	8.000	12.500	1000.00	-13.00	-13.00	Couple	-30.00	-30.00	1

a. **Fail Mask** is set to **Absolute** and **Rel Stop** is set to **Couple**.

**Table 2 Offsets & Limits Defaulted for W-CDMA (3GPP) Mobile Station Measurements<sup>a</sup>**

Offset	Start Freq (MHz)	Stop Freq (MHz)	Res BW (kHz)	Abs Start (dBm)	Abs Stop (dBm)	Rel Couple	Rel Start (dBc)	Rel Stop (dBc)	Meas BW
A. On	2.515	3.485	30.00	-71.07	-71.07	Man	-35.23	-49.78	1
B. On	4.000	7.500	1000.0	-55.84	-55.84	Man	-35.50	-39.00	1
C. On	7.500	8.500	1000.00	-55.84	-55.84	Man	-39.00	-49.00	1
D. On	8.500	12.000	1000.00	-55.84	-55.84	Couple	-49.00	-49.00	1
E. Off	12.500	15.000	1000.00	-55.84	-55.84	Couple	-49.00	-49.00	1

a. **Abs Stop** is set to **Couple** and **Fail Mask** is set to **Abs AND Rel**.

**Table 3 Offsets & Limits Defaulted for 802.11a and HiperLAN/2 Radio Standards<sup>a</sup>**

Offset	Start Freq (MHz)	Stop Freq (MHz)	Abs Start (dBm)	Abs Stop (dBm)	Abs Couple	Rel Start (dBc)	Rel Stop (dBc)	Rel Couple	Meas BW
A. On	9.00	11.00	16.00	-4.00	Man	0.00	-20.00	Man	1
B. On	11.00	20.00	-4.00	-12.00	Man	-20.00	-28.00	Man	1
C. On	20.00	30.00	-12.00	-24.00	Man	-28.00	-40.00	Man	1
D. On	30.00	50.00	-24.00	-24.00	Couple	-40.00	-40.00	Couple	1
E. Off	50.00	100.00	-24.00	-24.00	Couple	-40.00	-40.00	Couple	1

a. **Fail Res BW** is set to 100 kHz and **Fail Mask** is set to **Rel**.

**Table 4 Offsets & Limits Defaulted for 802.11b Radio Standard<sup>a</sup>**

Offset	Start Freq (MHz)	Stop Freq (MHz)	Abs Start (dBm)	Abs Stop (dBm)	Rel Start (dBc)	Rel Stop (dBc)	Meas BW
A. On	11.00	22.00	-10.00	-10.00	-30.00	-30.00	1
B. On	22.00	50.00	-30.00	-30.00	-50.00	-50.00	1
C. Off	50.00	70.00	-30.00	-30.00	-50.00	-50.00	1
D. Off	70.00	90.00	-30.00	-30.00	-50.00	-50.00	1
E. Off	90.00	100.00	-30.00	-30.00	-50.00	-50.00	1

a. **Res BW** is set to 100 kHz, **Fail Mask** is set to **Rel**, and **Abs Stop** and **Rel Stop** are both set to **Couple**.

### Offset

Key access: [MEAS] > {SEM} > {Offset/Limits}

Selects the offset pairs (upper and lower) that the softkeys affect, and displays the memory selection menu from **A** to **E** (where you can store up to 5 sets of values for **Start Freq**, **Stop Freq**, **Sweep Time**, **Res BW**, **Meas BW**, **Abs Start**, **Abs Stop**, and so forth). Press **Offset** until the letter of the desired offset (A, B, C, D, or E) is underlined. Only one selection at a time is shown on this key label.

### Start Freq

Key access: [MEAS] > {SEM} > {Offset/Limits}

Specifies the inner limit (frequency closest to the carrier) for both segments of the specified offset pair. When **Start Freq (Off)** is selected, the offset pair is not measured.

### Stop Freq

Key access: [MEAS] > {SEM} > {Offset/Limits}

Specifies the outer limit (frequency furthest from the carrier) for both segments of the specified offset pair. The minimum frequency difference between **Start Freq** and **Stop Freq** is limited to 100 Hz.

### Sweep Time

Key access: [MEAS] > {SEM} > {Offset/Limits}

Specifies the sweep time for the currently selected offset, and toggles this function between **Auto** and **Manual** for each offset.

### Res BW

Key access: [MEAS] > {SEM} > {Offset/Limits}



Specifies the resolution bandwidth used in measuring the offset pair. When set to **Auto**, the Res BW from the default tables for “Offset/Limits” on page 104 are used. When set to **Man**, the allowed range is 1 kHz to 1MHz.

### Abs StartAmpt

Key access: [MEAS] > {SEM} > {Offset/Limits} > {More}

Enables you to enter an absolute level limit at **Start Freq** for the currently selected offset ranging from -200.00 to +50.00 dBm with 0.01 dB resolution.

### Abs StopAmpt

Key access: [MEAS] > {SEM} > {Offset/Limits} > {More}

Enters an absolute level limit at **Stop Freq** for the currently selected offset ranging from -200.00 to +50.00 dBm with 0.01 dB resolution, and to toggle this function between **Couple** and **Man**. If set to **Couple**, this is coupled to **Abs Start** to make a flat limit line. If set to **Man**, **Abs Start** and **Abs Stop** you can enter different values to make a sloped limit line.

### Rel StartAmpt

Key access: [MEAS] > {SEM} > {Offset/Limits} > {More}

Enters a relative level limit at **Start Freq** ranging from -150.00 to +50.00 dBc with 0.01 dB resolution.

### Rel StopAmpt

Key access: [MEAS] > {SEM} > {Offset/Limits} > {More}

Enters a relative level limit at **Stop Freq** ranging from -150.00 to +50.00 dBc with 0.01 dB resolution, and to toggle this function between **Couple** and **Man**. If set to **Couple**, this is coupled to **Rel Start** to make a flat limit line. If set to **Man**, **Rel Start** and **Rel Stop** you can enter different values to make a sloped limit line.

### Meas BW

Key access: [MEAS] > {SEM} > {Offset/Limits} > {More} > {More}

Specifies the bandwidth to use when measuring the offset. When using the front panel, only the currently selected offset is affected. All the offsets are affected when remote control. This is the multiplier applied to the resolution bandwidth to determine the bandwidth to integrate when calculating the power. Meas BW is now restricted to be 1 and not changeable.

### Fail Mask

Key access: [MEAS] > {SEM} > {Offset/Limits} > {More} > {More}

Displays the menu to select one of the following logic keys for fail conditions between the measurement results and the test limits:

- **Absolute**

Sets the limit test to show Fail if one offset is larger than the corresponding limit for **Abs Start** and/or **Abs Stop**. This is the default selection for each offset for BTS measurements.

- **Relative**

Sets the limit test to show Fail if one offsets spectrum emission mask measurement results is larger than the corresponding limit for **Rel Start** and/or **Rel Stop**.

- **Abs AND Rel**

Set the limit test to show fail if one offset's emission mask measurement results is larger than both the corresponding limit for **Abs Start** and **Stop** and the limit for **Rel Start** and **Rel Stop**.

- **Abs or Rel**

Set the limit test to show fail if one offset's the absolute emission mask measurement results is larger than the corresponding limit for **Abs Start** and **Stop** or the limit for **Rel Start** and **Rel Stop**.

## Spectrogram

### Spectrogram Run/Pause

Key access: [MEAS] > {Spectrogram} > {Spectrogram}

Toggles the spectrogram monitoring between **Run** and **Pause**.

### Restart Meas

Key access: [MEAS] > {Spectrogram} > {Restart Meas}

Resets the spectrogram display.

### Update Interval

Key access: [MEAS] > {Spectrogram} > {Update Int.}

Enables you to set the interval of time to update data to 1 or more seconds. Or, you may set it to automatically determine the Update Interval that provides the maximum data collection speed.

A data sample is taken every time interval for display on the spectrogram. Increasing the update time allows data capturing over a longer period of time in the spectrogram.

### Spec View

Key access: [MEAS] > {Spectrogram} > {Spec View}

Enables you to view the details in the captured spectrogram. when the Spectrogram is running, Pressing {Spec View} pauses the running spectrogram.

Press {Home}/{End} to view the first /last spectrogram in cache.

Press {Playback} to playback the spectrogram process. The direction and the Update interval is changeable as your need.

### Palette

Key access: [MEAS]> {Spectrogram} > {Palette}

Toggles the spectrogram color mode between full color and gray scale.

### Disp Mode

Key access: [MEAS]> {Spectrogram} > {display}

Allows you to set the spectrogram display mode as trace, spectrogram or both trace and spectrogram.

### Save&Load

Key access: [MEAS]> {Spectrogram} > {Save&Load}

This softkey is only available with option INM activated.

### Start/Stop Save

Key access: [MEAS]> {Spectrogram} > {Save&Load} > {Start/Stop Save}

This softkey allow you to start or stop the automatic save function. Once the spectrogram measurement frames reached the file size set in the {File Setup}, a file (\*.SPE or \*.CSV) will be automatically saved, and the spectrogram measurement will restart.

#### NOTE

The save process takes a few seconds to read from cache. During this period, the measurement is paused.

### Timed Setting

Key access: [MEAS]> {Spectrogram} > {Save&Load} > {Time Setting}

This submenu allows you to configure automatic time save function. You can set start date, time, stop date, time in this menu. Press {Timed Save On}, the N9340B will start the auto-saving function from the **Start Time**.

### File Setup

Key access: [MEAS]> {Spectrogram} > {Save&Load} > {File Setup}

This submenu allows you to set the **File Type**, **File name**, **File Path**, and **File Size** (100-1500 frames).

### Save RAM

Key access: [MEAS]> {Spectrogram} > {Save&Load} > {Save RAM}

Press this key to save the current spectrogram measurement data into a file with default name.

### Save RAM As

Key access: [MEAS]> {Spectrogram} > {Save&Load} > {Save RAM As}

Press this key to save the current spectrogram measurement data into a file with user-defined name.

### Load Spctrg

Key access: [MEAS]> {Spectrogram} > {Save&Load} > {Load Spctrg}

Press this key to load a pre-saved .SPE (Spectrogram) file from local memory or USB stick.

# MODE

Activates the softkey menus to select the measurement mode of your analyzer. The measurement modes are:

- Spectrum Analyzer
- Tracking Generator
- Power Meter
- Demodulation Analysis (Option)
- IBOC (In-Band On-Channel) Measurement (Option)
- xDSL Measurement (Option)

## Spectrum Analyzer

Key access: **[MODE] > {Tracking Generator}**

Select the spectrum analyzer mode, and press **[ENTER]** to make the spectrum analysis and measurement.

## Tracking Generator

Key access: **[MODE] > {Tracking Generator}**

Select this mode, and press **[ENTER]** to make specified measurement with tracking generator. When selected, the Meas softkey menu for the tracking generator mode will appear.

### Amplitude

Key access: **[MODE] > {Tracking Generator } > {Amplitude}**

Activates (**On**) or deactivates (**Off**) the output power of the tracking generator. The power level can then be adjusted using the numeric keypad, arrow keys, or knob. Pressing any digit, 0 through 9, on the numeric keypad brings up the selected terminator menu.

**CAUTION**

Power-level sensitive devices connected to the tracking generator output may be accidentally damaged. This is because the actual source amplitude will be greater than the amplitude indicated on the analyzer, when the power sweep function is being used. The source amplitude value is used as the starting amplitude for a power sweep. The ending amplitude for a power sweep is higher than the source amplitude value and it may actually be set to values beyond specified output levels. Therefore, exercise caution when connecting a power-level sensitive device to the tracking generator output.

**NOTE**

When Amplitude (Off) is selected, the output attenuation on the N9340B is set to the maximum attenuation.

### Amptd Step

Key access: [MODE] > {Tracking Generator} > {Amptd Step}

Allows you to set the step size of the power level range of the tracking generator. The default setting is one vertical scale division when in a logarithmic amplitude scale.

### Amptd Offset

Key access: [MODE]>{Tracking Generator}> {Amptd Offset}

Offsets the displayed power of the tracking generator. Using the amplitude offset capability of the tracking generator allows you to take system losses or gains into account, thereby displaying the actual power delivered to the device under test.

### Normalize

Key access: [MODE]>{Tracking Generator} > {Normalize}

- **Store Ref (1 → 4)**

Copies trace 1 into trace 4. **Store Ref (1 → 4)** must be pressed before pressing **Normalize (On)**. If **Normalize (On)** is pressed before **Store Ref (1 → 4)**,

the error message: *Store reference trace before turning on Normalize (On)* is displayed in the status line, however Normalize has been activate.

- **Normalize**

**Normalize(On)** activates the normalize function. On each sweep, the normalized trace (Trace 4) is subtracted from Trace 1 and the result is added to the normalized reference level. The display shows the result of the following calculation:

Trace 1 - Normalized Trace + Normalized  
Reference Level

The trace data is normalized with respect to the normalized reference level, even if the value of the normalized reference level is changed. This function remains in effect on all subsequent sweeps until it is turned off.

**NOTE**

Segmented sweep is not available when **Normalize (On)** is selected. Trace 1 should be in clear write mode prior to setting normalize to on.

---

The normalize function is useful for applying correction data to a trace while making a stimulus response measurement using a tracking generator. Normalize will compensate for irregularities of the components used in the test setup, isolating the performance of the DUT. For example, connect the cables and use a thru line in place of the device (DUT) to be measured, between the tracking generator and the analyzer input. Notice that the frequency response is not perfectly flat, showing the response of the cables, as well as the flatness of both the tracking generator and the analyzer. Now press **Store Ref (1→ 4)**, **Normalize On**. Notice that the displayed trace is now flat, or normalized. The position of the normalized trace can now be moved to a different position on the display by changing the normalized reference position. This may be useful if the device to be tested has positive gain,



such as an amplifier. Now replace the thru line with the device under test, and an accurate measurement of the gain or loss can be made.

- **Norm Ref Lvl**

Sets the level (in dB) of the normalized reference.

- **Norm Ref Posn**

Offsets the displayed trace without affecting the instrument gain or attenuation settings. This allows the displayed trace to be moved without decreasing measurement accuracy.

- **Ref Trace**

Allows you to view or blank the reference trace on the display.

## Power Meter

Key access: **[MODE] > {Power Meter}**

Use the arrow keys to highlight the mode.

Select this mode, and press **[ENTER]** to make a measurement using the power meter function. When selected, the Power Meter softkey menu will be displayed and many of the instrument hardkeys will be disabled as they are not necessary for this mode.

### Zeroing

Key access: **[MODE] > {Power Meter} > {Zeroing}**

Access the associated Zeroing submenu.

- **Zeroing**

Make a Zero operation of the power sensor.

The U2000 Series USB Power Sensors have their sensor calibration tables stored in non-volatile memory which means that the reference calibration factor is automatically loaded upon power-up.

## 5 Key Reference

- **Zero Type**

Toggles the zeroing type of the Power Sensor between internal and external. When this type is set to **EXT**, pressing **Zeroing** will bring up a message which indicates the external signal need be pulled out. This setting is not affected by the preset in Power Meter menu.

### Meas Disp

Key access: [MODE] > {Power Meter} > {Meas Disp}

Access the Meas Disp submenu for defining the display range and resolution while in Power Meter mode.

- **Disp Range**

Access the associated Disp Range submenu.

- **Auto Range**

Toggles the auto range function between On and Off. When the **Auto Range** is set to On, the Top and Bottom value of the power meter's display range will be set automatically according to the measurement data:

Top = Max. data + 0.5

Bottom = Min. data - 0.5

The default setting is Off.

- **Top**

Set the top value of the power meter' display range.

Range from (Bottom + 0.01) to 200 dBm.

The default value is 20 dBm.

- **Bottom**

Set the bottom value of the power meter' display range.

Range from -200 to (Top - 0.01) dBm.

The default value is -70 dBm.

- **Resolution**

Access the associated Resolution submenu.

When the measurement suffix is W or %, this parameter represents the number of significant digits. When the measurement suffix is dB or dBm, 1 through 4 represents 1, 0.1, 0.01, and 0.001 dB respectively.

The default value is 3.

- **Disp Mode**

Change the display mode between Meter and Chart.

The default mode is Meter.

- **Chart View**

Access the Chart View submenu. This soft key is disabled when the measurement is in process or if the display mode is set to Meter.

This submenu is used to view the measurement chart.

- **Home**

View the first 21 points of current measurement chart.

- **End**

View the latest 21 points of current measurement chart.

- **Prev**

View the previous points of the chart.

- **Next**

View the next points of the chart.

- **Continue/Pause**

Continues or pauses the current measurement. When the measurement is in process, this softkey is displayed as “Pause”; when the measurement is paused, the softkey is displayed as “Continue”.

### Meas Setup

Key access: [MODE] > {Power Meter} > {Meas Setup}

Accesses the Meas Disp submenu which is used to configure the measurement settings.

- **Freq**

Sets a frequency between 1 kHz and 90.0 GHz using the numeric keypad, arrow key or knob. If the frequency does not correspond directly to a frequency in the sensor calibration table, the power sensor calculates the calibration factor using linear interpolation.

- **Power Range**

Accesses the **Power Range** submenu.

- **Auto Range**

Enables and disable auto ranging. When auto ranging is ON, the power sensor selects the best measuring range for the measurement. When auto ranging is OFF, the power sensor remains in the current range and may be manually set by the user.

- **Range**

Selects the Lower or Upper of power ranges when the Auto Range is Off.

- **Limits**

Accesses the **Limits** submenu.

- **Limits**

Enables or disables the limit function.

- **Upper Limit**

Sets a value of the upper test limit for the current measurement. The units used are dependent on the current setting of power unit. When the measured power is greater than the value specified, a failure will be reported.

- **Lower Limit**

Sets the lower test limit value for the current measurement. The units used are dependent on the current setting of power unit. When the measured power is less than the value specified, a failure will be reported.

- **Limit Beep**

Enables or disables the limit beep.

- **Rel/Offset**

Accesses the **Rel/Offset** submenu.

- **Rel**

Enables the comparison of a measurement result to a reference value and sets a reference value on the current measured data.

- **Offset**

Sets a value of the display offset on the current measurement, and enable or disable the display offset. The display offset is applied to the measurement signal after any math calculation.

- **Average**

Accesses the **Average** submenu.

- **Average**

Enables or disables the **Average** function.

- **Avg Count**

Sets a value of the filter length and to set the average count value to be Auto or Manual.

The power sensor automatically sets the number of readings averaged together to satisfy most power measurements averaging requirements. The number of average readings depends on the resolution and the power level settings the power sensor is currently using.

- **Step Detect**

Enables or disables step detection. In AUTO filter mode, the average of the last four values entered into the filter is compared to the entire filter average. If the difference between the two

averages is greater than 12.5%, the digital filter is cleared. The filter will then start storing new measurement data. This feature shortens the filter time required when the input power changes substantially. Note that the result appears to settle faster, although true settling to the final value is unaffected.

- **Meas Interval**

Sets the interval time between two measurements. The default value is 100 ms.

### **Preset**

Key access: **[MODE] > {Power Meter} > {Preset}**

Sets the power meter softkey menu options to the preset conditions. For example, the upper and lower limits are set to their preset limit values.

## **IBOC Measurement**

Key access: **[MODE] > {IBOC Measurement}**

Use the knob or arrow keys to highlight the mode, and press **[ENTER]** to access the AM/FM IBOC (In-Band On-Channel) measurement submenu.

### **AM/FM**

Key access: **[MODE] > {IBOC Measurement} > {AM}/{FM}**

Use this two softkeys to select the AM or FM IBOC measurement submenus.

### **Center Freq**

Key access: **[MODE] > {IBOC Measurement} > {AM}/{FM} > {Center Freq}**

Activates the center frequency function, which allows you to set the horizontal center of the display to a specified frequency.

Range: 530 - 1700 kHz for AM band;  
87.9 - 107.9 MHz for FM band.

## Quick Span

Key access: [MODE] > {IBOC Measurement} > {AM}/{FM}  
> {Quick Span}

Press this softkey to quick set the frequency span with the below configurations:

- **Quick Span** in AM submenu:

**Mask Span** is a shortcut to set center frequency to a standard carrier frequency near current center frequency and set span to 160 kHz.

**AM Band** is a shortcut to set center frequency to 1115 kHz and set span to 1370 kHz.

**AM Channel (Analog)** is a shortcut to set center frequency to a standard carrier frequency near current center frequency and set span to 20 kHz.

**AM Channel (IBOC)** is a shortcut to set center Frequency to a standard carrier frequency near current center frequency and set span to 50 kHz.

- **Quick Span** in FM submenu:

**Mask Span** is a shortcut to set center frequency to a standard carrier frequency near current center frequency and set Span to 1.3 MHz.

**FM Band** is a shortcut to set center frequency to 97.9 MHz and set Span to 21.3 MHz.

**FM Channel Analog** is a shortcut to set center frequency to a standard carrier frequency near current Center Frequency and set Span to 200 kHz.

**FM Channel IBOC** is a shortcut to set center frequency to a standard carrier frequency near current Center Frequency and set Span to 500 kHz.

### NOTE

The **SPAN** hardkey in this mode has the same function in the spectrum analyzer mode. When Mask is turned on, span will be set according to mask standard automatically.

## Mask Function

Key access: [MODE] > {IBOC Measurement} > {AM}/{FM}  
> {Mask Function}

Accesses the submenu to configure the mask related settings.

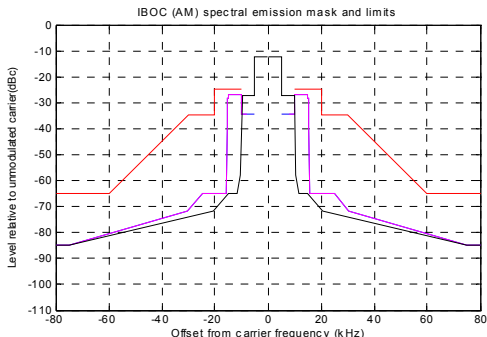
### • Mask Type

There are two types of mask in spectrum mask measurement for IBOC standard: FCC spectral emission mask and NRSC spectral emission limits. NRSC spectral emission is leveraged from the related specifications of iBiquity Digital Corporation.

The mask types for IBOC-AM are listed as below:

- FCC (AM-73.44)
- NRSC-5-B Hybrid 5k
- NRSC-5-B Hybrid 8k
- NRSC-5-B All Digital

**Figure 5-30 IBOC (AM) spectral emission mask and limits**



Trace in red is FCC spectral emission mask.

Trace in blue is NRSC hybrid 5 kHz spectral emissions limits.

Trace in magenta is NRSC hybrid 8 kHz spectral emissions limits.

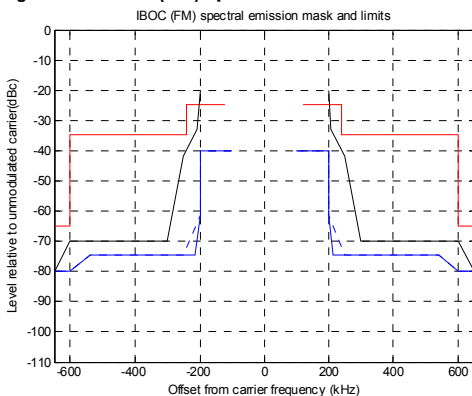
Trace in Black is NRSC all digital spectral emissions limits.



The mask types for IBOC-FM are listed as below:

- FCC (FM-73.317)
- NRSC-5-B Hybrid
- NRSC-5-B Hybrid

**Figure 5-31 IBOC (FM) spectral emission mask and limits**



Trace in red is FCC spectral emissions mask.

Trace in blue is NRSC hybrid spectral emissions limits.

Trace in Black is NRSC all digital spectral emissions limits.

#### • Mask On/Off

Mask On/Off is a switch to enable the mask function.

- Set Span and RBW according to mask standard automatically.
- Set Average Type to Power and Detector to Average (RMS), and also set average on with average times to meet the measurement specification.

#### • Pass/Fail

Pass/Fail On/Off is a switch to enable/disable PASS/FAIL verification.

- **Beep**

Beep On/Off is a switch to enable/disable Pass/Fail beep sound indication.

- **Noise Cancel**

This function is used to reduce the noise level for any possible small signals. It is only available in FM IBOC submenu, when **Mask Type** is set to **NRSC-5-B <Hybird>**.

### Channel

Key access: [MODE] > {IBOC Measurement} > {AM}/{FM} > {Channel}

Press the **Channel** softkey to access a channel list menu with customized channel setting files. The channel file is easy to reload, delete and copy as needed. The channel list function helps you more quickly set up their instruments and complete the measurements.

### Auto Tune

Key access: [MODE] > {IBOC Measurement} > {AM}/{FM} > {Auto Tune}

Press this softkey to automatically find out the largest signal over specific broadcasting frequency band. e measure its carrier frequency more accurate and measure its unmodulated carrier power or nominal power spectral density in a 1 kHz bandwidth of the digital Primary Main sidebands for All Digital IBOC (FM) case. These two parameters will be adopted as 0 Hz offset of mask from carrier frequency and 0 dBc level relative to unmodulated carrier or nominal power spectral density in a 1 kHz bandwidth of the digital Primary Main sidebands for All Digital IBOC (FM) case.

The reference level estimation method is different between IBOC (FM) all digital mode and other modes. This function is correlative to Mask Type selection.

### Tune Range

Key access: [MODE] > {IBOC Measurement} > {AM}/ {FM} > {Tune Range}

Toggles **Tune Range** between **Band** and **Span**. When it is set to **Band**, auto tune is available in whole AM/FM band frequency range. When it is set to **Span**, Auto tune is available in current span frequency range.

## xDSL Measurement

### Spectrogram Run/Pause

Key access: [MODE] > {xDSL Measurement} > {Spectrogram}

Toggles the spectrogram between **Run** and **Pause**.

### Restart Meas

Key access: [MEAS] > {xDSL Measurement} > {Restart Meas}

Resets the spectrogram display.

### Update Interval

Key access: [MEAS] > {xDSL Measurement} > {Update Int.}

Enables you to set the interval of time to update data to 1 or more seconds. Or, you may set it to automatically determine the Update Interval that provides the maximum data collection speed. A data sample is taken every time interval for display on the spectrogram. Increasing the update time allows data capturing over a longer period of time in the spectrogram.

### Spec View

Key access: [MEAS] > {xDSL Measurement} > {Spec View}

Enables you to view the details in the captured

spectrogram. when the Spectrogram is running, Pressing **{Spec View}** will pause the running spectrogram.

Press **{Home}**/**{End}** to view the first /last spectrogram in cache.

Press **{Playback}** to playback the spectrogram process. The direction and the Update interval is changable as your need.

### Palette

Key access: **[MEAS]> {xDSL Measurement} > {Palette}**

Toggles the spectrogram color mode between full color and gray scale.

### Disp Mode

Key access: **[MEAS]> {xDSL Measurement} > {Disp Mode}**

Allows you to set the spectrogram display mode as trace, spectrogram or both trace and spectrogram.

### Save&Load

Key access: **[MEAS]> {xDSL Measurement} > {Save&Load}**

This softkey is only available with option INM activated.

### Start/Stop Save

Key access: **[MEAS]> {Spectrogram} > {Save&Load} > {Start/Stop Save}**

This softkey allow you to start or stop the automatic save function. Once the spectrogram measurement frames reached the file size set in the **{File Setup}**, a file (\*.SPE or \*.CSV) will be automatically saved, and the spectrogram measurement will restart. The save process takes a few seconds to read from cache. During this period, the measurement is paused.

### Timed Setting

Key access: [MEAS]> {Spectrogram} > {Save&Load} > {Time Setting}

This submenu allows you to configure automatic time save function. You can set start date, time, stop date, time in this menu. Press {Timed Save On}, the N9340B will start the auto-saving function from the **Start Time**.

### File Setup

Key access: [MEAS]> {Spectrogram} > {Save&Load} > {File Setup}

This submenu allows you to set the **File Type**, **File name**, **File Path**, and **File Size** (100-1500 frames).

### Save RAM

Key access: [MEAS]> {Spectrogram} > {Save&Load} > {Save RAM}

Press this key to save the current spectrogram measurement data into a file with default name.

### Save RAM As

Key access: [MEAS]> {Spectrogram} > {Save&Load} > {Save RAM As}

Press to save the current spectrogram data into a file with user-defined name.

### Load Spctrg

Key access: [MEAS]> {Spectrogram} > {Save&Load} > {Load Spctrg}

Press this key to load a pre-saved Spectrogram file from local memory or USB stick.

# SPAN

This hardkey accesses the softkey submenu of span functions. Pressing **[SPAN]** allows you to change the frequency range. The frequency-span readout describes the total displayed frequency range. To determine frequency span per horizontal graticule division (when in linear frequency scale type), divide the frequency span by 10.

## Span

Key access: **[SPAN] > {Span}**

Enter a frequency span range value.

## Full

Key access: **[SPAN] > {Full}**

Changes the span to the full frequency range of the analyzer.

## Zero

Key access: **[SPAN] > {Zero}**

Changes the frequency span to zero. In this mode, the current center frequency is displayed in the time domain (the x axis is displayed in units of time), like a conventional oscilloscope.

## Last Span

Key access: **[SPAN] > {Last Span}**

Changes the span to the previous span setting.

## Demod

Key access: **[SPAN] > {Demod}**

Accesses the menu keys to select **AM** demodulation, **FM** demodulation or demodulation **Off**. It also accesses the **Speaker Vol**, and **Delay Time** menu keys described below.

## AM

Key access: [SPAN] > {Demod} > {AM}

Pressing {AM ON} activates the AM demodulation and turns off FM demodulation (if it is on).

## FM

Key access: [SPAN] > {Demod} > {FM}

Pressing {FM ON} activates the FM demodulation and turns off AM demodulation (if it is on). For non-zero spans, a 100 kHz resolution bandwidth is used during the demodulation, regardless of the screen annotation. When the span is set to zero span, the displayed bandwidth is used. For best results, move the signal to be demodulated to within 3 divisions of the top of the display.

## Speaker Vol

Key access: [SPAN] > {Demod} > {Speaker Vol}

Selecting AM or FM turns the speaker on. Press this softkey and rotate the knob to adjust the internal speaker volume.

## Delay Time

Key access: [SPAN] > {Demod} > {Speaker Vol}

Allows you to set the time, in non-zero spans, to pause and demodulate the signal after each sweep. The demodulated signal can be heard during demodulation. In zero span, demodulation is performed (and can be heard) throughout the sweep.

With non-zero spans, in AM the Video BW is set to 3 kHz and the Resolution BW is set to 10 kHz. In FM, the Video BW is set to 30 kHz and the Resolution BW is set to 100 kHz.

When AM or FM demod is enabled, the instrument will tune to the marker frequency and wait for the Demod to take place. **Delay Time** is not available unless AM or FM demod is selected, and span is >0

## 5 Key Reference

Hz. For long demodulation times, pressing **Preset** when **Preset Type** is set to **DFT** will abort the Demod function. The default value is 2 ms.

### NOTE

It is normal to hear clicking sounds when the Auto Alignment function is On. During retrace, a small portion of the analyzer circuitry is realigned. Some of the switching of the analyzer circuitry is done using relays. It is the rapid switching of these relays during retrace that causes the clicking sounds. To eliminate the clicking sounds, turn the auto alignment off by pressing System, Alignments, Auto Align, Off.

When this is done, the Align Now, All function should be performed periodically. Refer to the Specifications Guide for your instrument to learn more information on how often to perform Align Now, All when the auto alignment is off.

---

## Trigger

Key access: **[SPAN] > {Trigger}**

Accesses the menu of keys that allow you to select the trigger mode of the analyzer. This softkey is only available in zero span.

### Free Run

Key access: **[SPAN] > {Trigger} > {Free Run}**

New sweep starts as soon as possible after the current sweep ends. This is the default state of trigger mode.

### Video

Key access: **[SPAN] > {Trigger} > {Video}**

Activates the trigger condition that starts the next sweep if the detected RF envelope voltage rises to a level set by the video trigger level.



### Ext Rise

Key access: **[SPAN] > {Trigger} > {Ext Rise}**

Activates the trigger condition that will start a sweep when the external voltage (connected to **EXT TRG IN** on the rear panel) passes through approximately 2 volts. The external trigger signal must be a 0 V to +5 V TTL signal. Sets the trigger polarity to positive.

### Ext Fall

Key access: **[SPAN] > {Trigger} > {Ext Fall}**

Sets the trigger polarity to negative.

### Trig Delay

Key access: **[SPAN] > {Trigger} > {Trig Delay}**

Allows you to set and turn on or off a delay, during which the analyzer will wait to begin a sweep after receiving an external trigger signal.

## TRACE

Accesses the trace keys to store and manipulate trace information. Each trace comprises a series of data points in which amplitude information is stored. The analyzer updates the data for any active trace with each successive sweep.

### Trace

Key access: [TRACE] > {Trace}

Selects the trace (1-4) for current use.

### Clear Write

Key access: [TRACE] > {Clear Write}

Erases any previously stored trace data and continuously updates the display during following sweeps of the analyzer. This function is activated for trace 1 at power on and factory preset.

### Max Hold

Key access: [TRACE] > {Max Hold}

Maintains the displayed maximum level for each trace point of the selected trace. A trace point is updated if a new maximum level is detected in successive sweeps.

**NOTE**

Changing the vertical scale (**Amplitude, Scale Type, Log or Line**), or pressing **PRESET**, or turning averaging on (**TRACE, Average (On)**) or switching widow in Zone Span restarts the held trace.

---

## Minimum Hold

Key access: [TRACE] > {Min Hold}

Maintains the minimum level for each trace point of the selected trace, and updates each trace point if a new minimum level is detected in successive sweeps.

**NOTE**

Changing the vertical scale (**Amplitude, Scale Type, Log or Line**), or pressing **PRESET**, or turning averaging on (**TRACE, Average (On)**) or switching widow in Zone Span restarts the held trace.

---

## View

Key access: [TRACE] > {View}

Holds and displays the amplitude data of the selected trace. The trace register is not updated as the analyzer sweeps. If a trace is deactivated by pressing **Blank**, the stored trace data can be retrieved by pressing **View**.

## Blank

Key access: [TRACE] > {Blank}

Stores the amplitude data for the selected trace and removes it from the display. The selected trace register will not be updated as the analyzer sweeps. This function is activated for traces 2, 3 and 4 at power-on and **Factory Preset**.

## Detector

Key access: [TRACE] > {More} > {Detector}

Selects a specific detector type, or allows the system to auto select the appropriate detector for a measurement.

For every trace point displayed, there is a finite time during which the data for that point is collected. The analyzer has the ability to look at all

of the data evaluated during that time and present a single point of trace data based on the detector mode. We call the interval during which data for that trace point is being collected, the “bucket”. Thus a trace is more than a series of single points. It is actually a series of trace “buckets”. The data may be sampled many times within each bucket.

- **Normal**

Selects the maximum and minimum video signal values alternately. When selecting the normal detector, “N” appears in the upper-left corner.

- **Average**

Measures the average value of the amplitude across each trace interval (bucket). When **Average** is selected, “A” appears on the upper-left corner.

- **Pos Peak**

Obtains the maximum video signal between the last display point and the present display point and stores this value in memory. It is used primarily when measuring sinusoidal (spectral) components. When **Positive Peak** is selected, “P” appears in the upper-left corner.

- **Sample**

Primarily used to display noise (or noise-like) signals. It should not be used to measure the accurate amplitude of non noise-like signals.

In sample mode, the instantaneous signal value at the present display point is placed in memory. When Sample detector is selected, “S” appears in the upper-left corner of the display.

- **Neg Peak**

Similar to peak detector, but selects the minimum video signal value. Not to be used to measure the most accurate amplitude. When in **Negative Peak** mode, an “N” also appears in the upper-left corner.

## Average

Key access: [TRACE] > {More} > {Average}

Initiates a digital averaging routine that averages the trace points in a number of successive sweeps resulting in trace “smoothing”. Increasing the average number will further smooth the trace. For the information of the type of averaging please refer to “Avg Type” on page 87.

The average is restarted when any of the following occurs:

- A new average number is entered.
- Any related parameter (e.g., center frequency) is changed.

Press **Average (Off)** to turn off averaging.

The number of sweeps can only be set using the numeric keypad, not the knob or arrow keys.

## Save Trace

Key access: [TRACE] > {More} > {Save trace}

Saves a current trace into a file (\*.DAT).

The analyzer uses the filename of the preceding file saved, but adds an integer in 1, 2, 3 sequence to the end of the filename to differentiate it from others.

If there is no record of saved trace in the analyzer, the default file name of the current saved trace will be “HYTRACE.DAT”.

## Save As

Key access: [TRACE] > {More} > {Save as}

Saves a current trace to a file/directory, with a user-defined filename.

The filename is entered using the numeric keypad and terminated by pressing [ENTER].

## 5 Key Reference

Numbers, alpha characters and underline are all valid components of a filename.

### Recall Trace

Key access: **[TRACE]** > **{More}** > **{Recall trace}**

The user may recall a saved trace as the current activated trace.

# LIMIT

## Limit Line

Key access: [**Limit**] > {**Limit Line**}

Activates an adjustable horizontal line that is used as a visual reference line.

The limit line, used for trace arithmetic, has amplitude values that correspond to its vertical position when compared to the reference level. The value of the display line appears in both the active function block and on the left side of the display. The arrow keys, knob, or numeric keypad may be used to adjust the display line. Pressing any digit, 0 through 9, on the numeric keypad brings up the selected terminator menu. To deactivate the display line, press **Display Line (Off)**.

## Limits

Key access: [**Limit**] > {**Limits**}

Turns on the limit pattern function and turns off the limit line function simultaneously.

## Edit Limits

Key access: [**Limit**] > {**Edit Limits**}

Allows you to set a limit pattern for measurements.

You can edit limit points, limit table and limit offset for your limit pattern.

Pressing **X Axis Unit** to toggle the frequency domain or time domain before you set the parameter of limit point.

### Limit Type

Key access: **[Limit] > {Limit Type}**

Defines the limit you are editing as either an upper or lower limit. An upper limit fails if trace 1 exceeds the limit. A lower limit fails if trace 1 falls below the limit.

### Beep

Key access: **[Limit] > {Beep}**

Turns the beep function on or off. When it set to on, it sounds an alarm as an indicator of a measurement limit failure.

### Save Limits

Key access: **[Limit] > {Save Limits}**

Saves the parameters of the current limit pattern in a file (\*.LTM).

Enter the user defined filename using the numeric keypad and press **[ENTER]** as a terminator.

Number, alpha characters and underline are all valid components of a filename.

### Load Limits

Key access: **[Limit] > {Recall Limits}**

Recalls files previously saved containing the limit parameters that may be frequently used for test purposes.





## 6 Error Messages

This chapter contains Error Message information and definitions used by the analyzer.



### Overview

If an improper operation occurs during the instrument configuration, a message will appear on the status line indicating the incident and the how the spectrum analyzer corrected the setting automatically. press **[SYS]** > **{More}** > **{Show errors}** to read the specific descriptions of those messages.

### Example

In this example, a failure explanation is generally included with each error to further define its meaning. The instrument messages in this guide are listed numerically.

<Time>	<Code>	<Message>
07.01 15:48	[F] -330	No matched module
		This message indicates no matched measurement or mode found.
		<Explanation in manual>

**NOTE**

A symbol [F] at the beginning of an error message indicates this is an error caused by manual front panel operation. A symbol [R] at the beginning of an error message indicates this is an error caused by remote control mode.

## Error Message List

Please refer to the error messages list table as below to find the corresponding message description:

Error Code	Error Message	Description
0	No error	
-410	Query INTERRUPTED	Indicates that a condition causing an INTERRUPTED query occurred (see IEEE 488.2, 6.3.2.7)
-350	Query overflow	Indicates the SCPI remote interface error queue overflowed.
-321	Out of memory	Indicates an internal operation needed more memory than that was available.
-224	Illegal parameter value	Indicates you sent a parameter for this command that is NOT allowed.
-223	Too much data	Indicates a legal program data element of block, expression or string type was received that contained more data than the device could handle due to related device-specific requirements or memory.
-222	Data out of range	Indicates a legal data was parsed but could not be executed because of the interpreted value was outside the legal range defined by the analyzer. The displayed results may be clipped.
-220	No matched module	Indicates no matched measurement or mode found.
-200	Execution error	This is a generic execution error for devices that cannot detect more specific errors. The code indicates on those execution errors defined in IEEE 488.2, 11.5.1.1.4 has occurred.
-171	Invalid expression	Indicates the data element was invalid, for example, unmatched parentheses, or an illegal character.

## 6 Error Messages

Error Code	Error Message	Description
-144	Character data too long	Indicates the character data contained more than 12 characters. (see IEEE 488.2, 7.7.1.4)
764	Unable to save file	Indicates a failure occurred while saving a file. The file was not saved.
762	Unable to load file	Indicates a failure occurred while loading a file. The file was not loaded.
612	File NOT found	Indicates the analyzer could not find the specified file.
173	Lame package, please upgrade firmware	Indicates the current firmware is not mostly updated. The firmware needs upgrading.
172	Option install fail, invalid option licence	Indicates the option could not be installed, because of the invalid option licence.
171	File loaded	Indicates the file loading succeeded.
170	The menu is unavailable in this case	Indicates the memo is invalid in this case.
166	Marker counter opened in fast sweep	Indicates the counter's accuracy decreases when in fast sweep mode.
162	Cannot open fast sweep in this case	Indicates current settings do not allow you to open fast sweep. For example, currently in FFT, zero span, or any measurement in power suite does not allow fast sweep.
156	Incorrect alignment file on flash	Indicates an invalid alignment file.
153	RF EEPROM operate fail	Indicates an error when writing alignment file.
152	Alignment file oversize	Indicates the alignment file has error or invalid data.
151	DSP boot fail	Indicates the analyzer cannot process measurement currently, wait the analyzer to reboot. If analyzer froze, try to restart the analyzer.

Error Code	Error Message	Description
150	Mixer overload	Indicates the first mixer in danger. Either increase input attenuation or decrease the input signal level.
149	Mixer saturate	Indicates you need to either increase the input attenuation or decrease the input signal level.
147	Incorrect alignment data in EEPROM	Indicates invalid alignment data occurred.
143	Final IF overload	Indicates you need to either increase the input attenuation or decrease the input signal level.
138	USB device NOT ready	Indicates the USB device is not detected.
136	RBW limit to 30 kHz when in fast sweep	Indicates the analyzer automatically couple the RBW to 30 kHz when in fast sweep mode.
130	Meas uncal	Indicates the measurement is uncalibrated due to fast sweeping through a narrow RBW filter. Check the sweep time, span, and bandwidth settings, or use auto coupling.
119	RF Board Changed	Indicates the RF board was changed, the analyzer needs re-load the alignment data.
116	Cannot communicate with RF	Indicates the MCU cannot find the RF board.

## **6 Error Messages**



## 7 Troubleshooting

This chapter includes information on how to check for a problem with your Agilent Technologies spectrum analyzer, and how to return it for service.

If you experience a problem or would like additional information about your analyzer, Agilent Technologies' worldwide organization is ready to provide the support you need.



### Check the basics

This section includes information on how to check for a problem with your Agilent spectrum analyzer, and how to return it for service.

If you experience a problem or would like additional information about your analyzer, Agilent Technologies' worldwide organization is ready to provide the support you need.

**WARNING** No operator serviceable parts inside. Refer servicing to qualified personnel. To prevent electrical shock, do not remove covers.

---

- Before calling Agilent Technologies, or returning an analyzer for service, perform the quick checks listed below. This check may eliminate the problem.
- Is there power at the receptacle?
- Is the analyzer turned on? Listen for internal fan noise to determine if the analyzer cooling fan is running. Feel the rear side of the analyzer for air flow.
- If other equipment, cables, and connectors are being used with your spectrum analyzer, make sure they are connected properly and operating correctly.
- Review the measurement procedures being performed when the problem first appeared. Make sure all of the settings are correct.
- If the analyzer is not functioning as expected, return the analyzer to a known state by pressing **Preset (Default Preset Type)**.
- Is the measurement being performed, and the results that are expected, within the specifications and capabilities of the analyzer? Refer to the *Technical Overview* for your analyzer.
- Is the analyzer displaying an error message? If so, refer to “[Error Messages](#)” on page 139.



- To meet specifications, the analyzer must be aligned. For more information on how to align the analyzer, refer to “[Running Internal Alignments](#)” on page 23.

**NOTE**

If the analyzer is still under warranty or is covered by a maintenance contract, it will be repaired under the terms of the warranty or plan (the warranty is located at the front of this manual).

If the analyzer is no longer under warranty or is not covered by an Agilent Technologies maintenance plan, Agilent Technologies will notify you of the cost of the repair after examining the analyzer.

---

If a problem persists, please contact the Agilent Technologies office for further information and service.

## Warranty and Service Options

Agilent N9340B handheld spectrum analyzer provides 1-year return-to-Agilent warranty as standard. Besides, we offers several optional maintenance plans to service your analyzer after the warranty has expired:

**R-51B-001-3C** extends this service to 3 years.

**R-50C-011-3** Agilent calibration upfront support plan, 3-year coverage.

The calibration cycle of N9340B Handheld spectrum analyzer is one year.

## Contact Agilent Technologies

Agilent has Sales and Service Offices around the world to provide you with complete support. Go to <http://www.agilent.com/find/assist> for help with:

- product selection, configuration, and purchases.
- technical and application assistance, and consulting.
- rental and leasing options, and refurbished equipment.
- repair, calibration, education and training.

If you do not have access to the internet, call the appropriate number shown below. Or contact your local Agilent Technologies Sales and Service Office.

<b>United States</b>	(tel) 800 829 4444 (fax) 800 829 4433
<b>Canada</b>	(tel) 877 894 4414 (fax) 800 746 4866
<b>Latin America</b>	(tel) +1 (305) 269 7500
<b>China</b>	(tel) 800 810 0189 (fax) 800 820 2816
<b>Korea</b>	(tel) 080 769 0800 (fax) 080 769 0900
<b>Japan</b>	(tel) +81 426 56 7832 (fax) +81 426 56 7840
<b>Taiwan</b>	(tel) 0800 047 866 (fax) 0800 286 331
<b>Europe</b>	(tel) +31 20 547 2111
<b>Australia</b>	(tel) 1 800 629 485 (fax) +61 (3) 9210 5947
<b>Other Asia Pacific Countries</b>	(tel) +65 6375 8100 (fax) +65 6755 0042 Email: <a href="mailto:tm_ap@agilent.com">tm_ap@agilent.com</a>

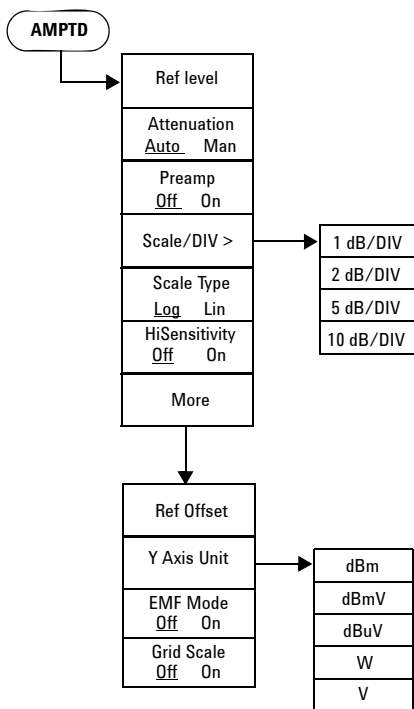


## 8 Menu Map

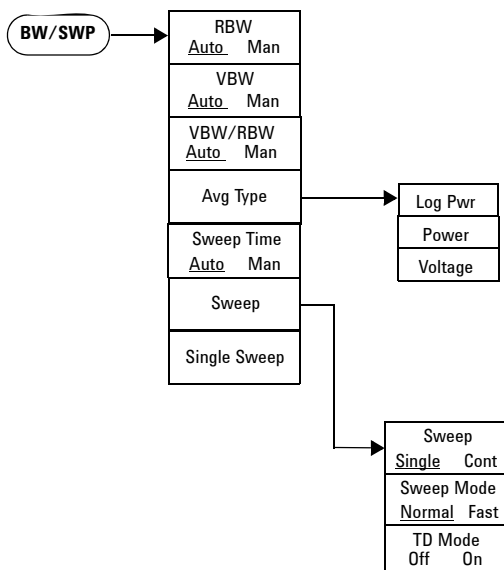
This chapter contains menu maps that visually present the menus and submenus that are accessed by pressing the Hardkeys and Softkey menu selections in the instrument. This is a quick reference guide for the experienced user.



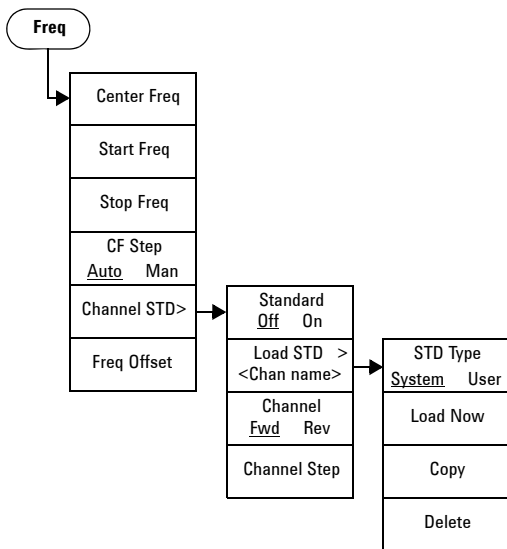
## AMPTD



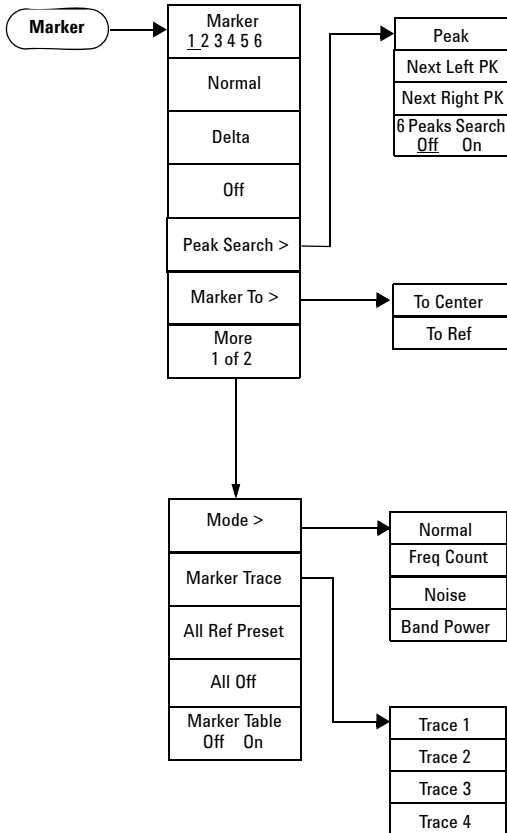
## BW/SWP



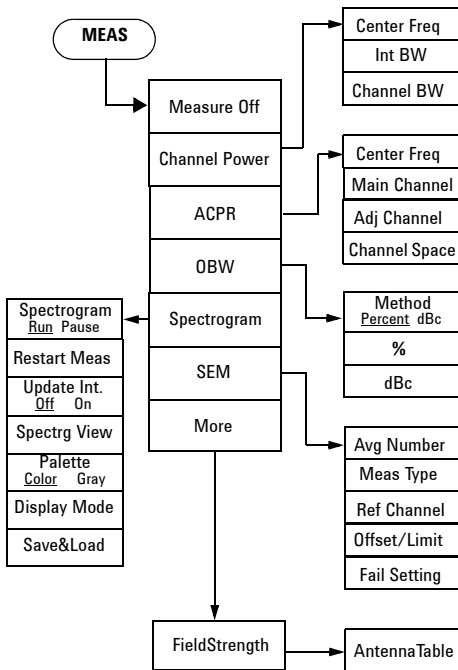
## FREQ



# MARKER

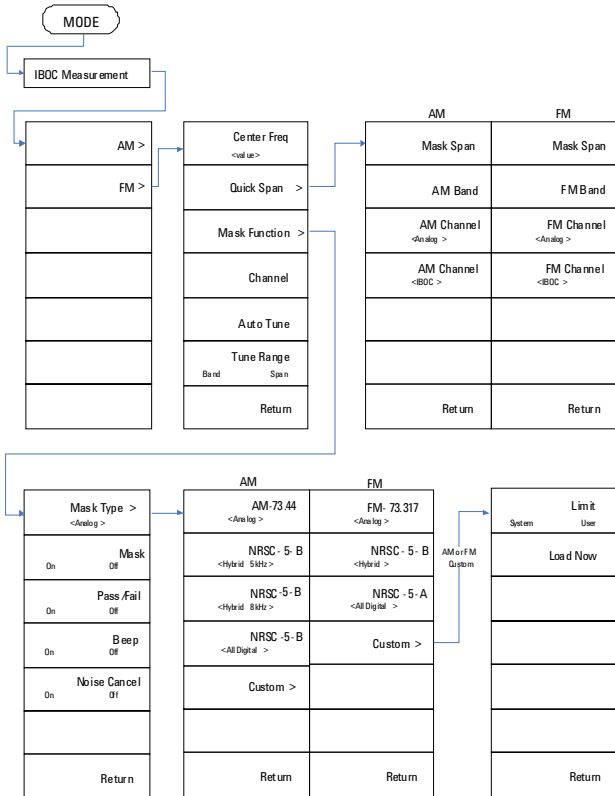


# MEAS

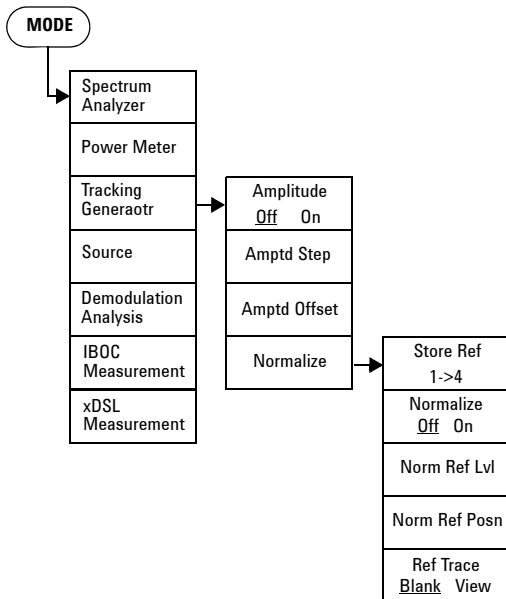




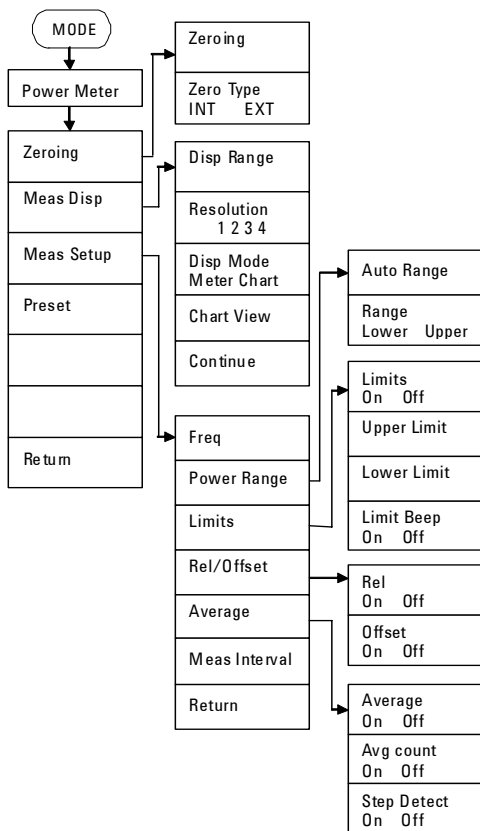
## MODE - IBOC Measurement



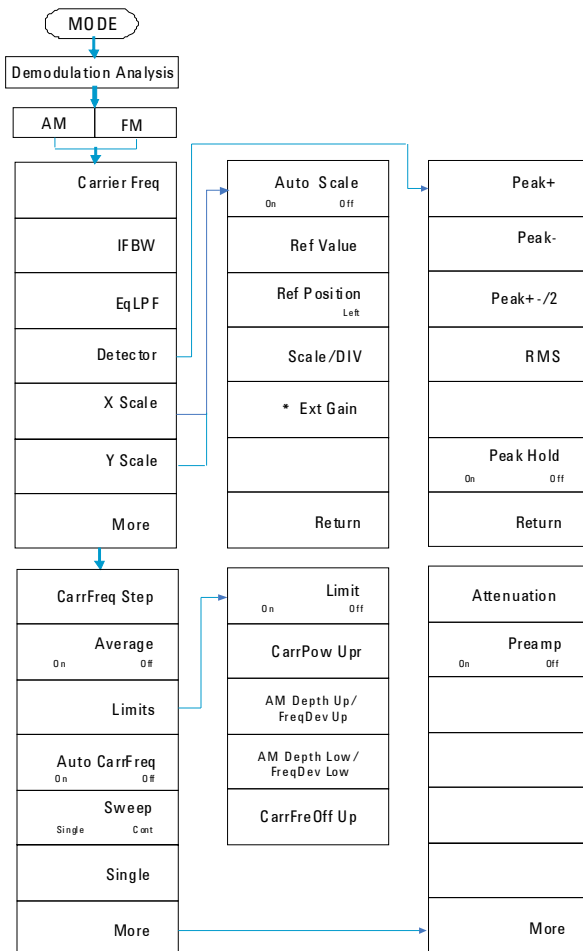
## MODE - Tracking Generator



## MODE - Power Meter

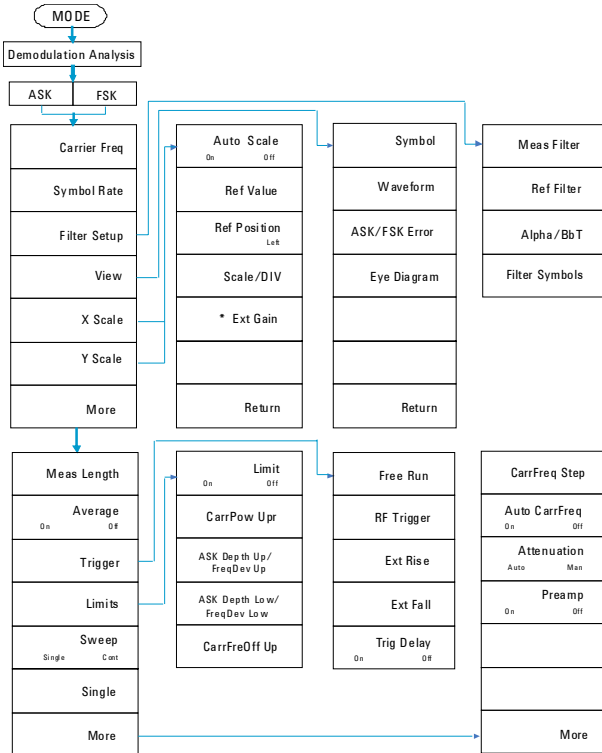


## MODE - Demodulation Analysis (AM/FM)



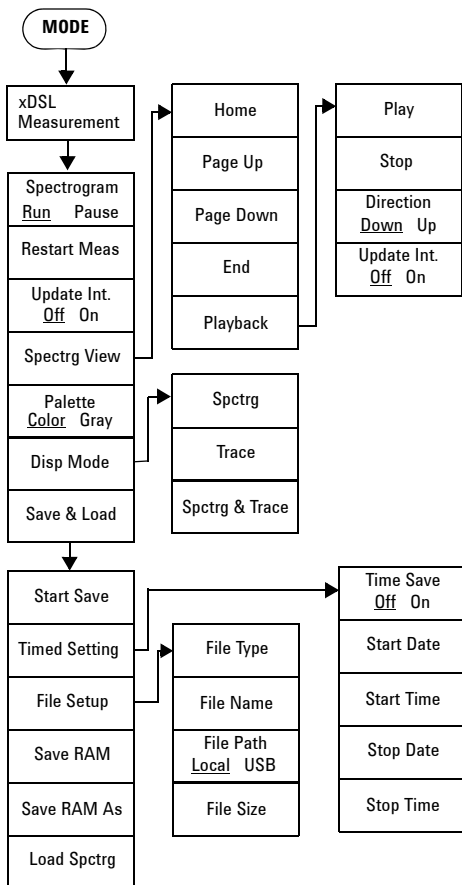
\* **Ext Gain** is only available in **Y Scale** submenu.

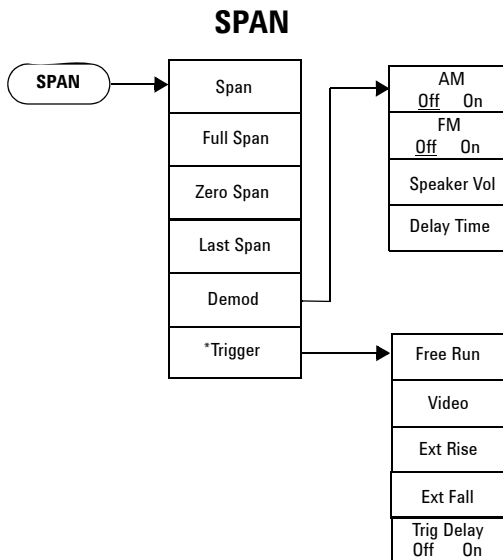
## MODE - Demodulation Analysis (ASK/FSK)



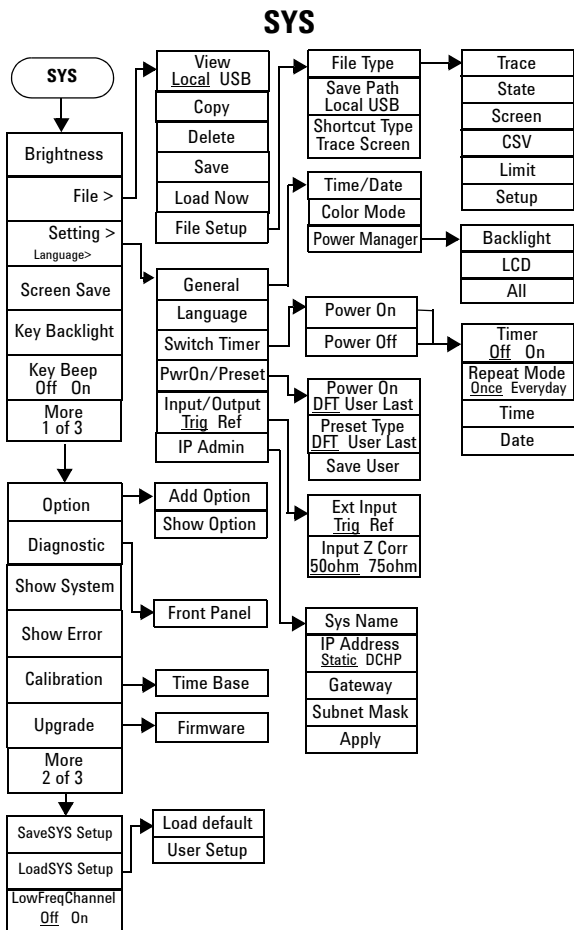
\* **Ext Gain** is only available in **Y Scale** submenu.

## MODE - xDSL



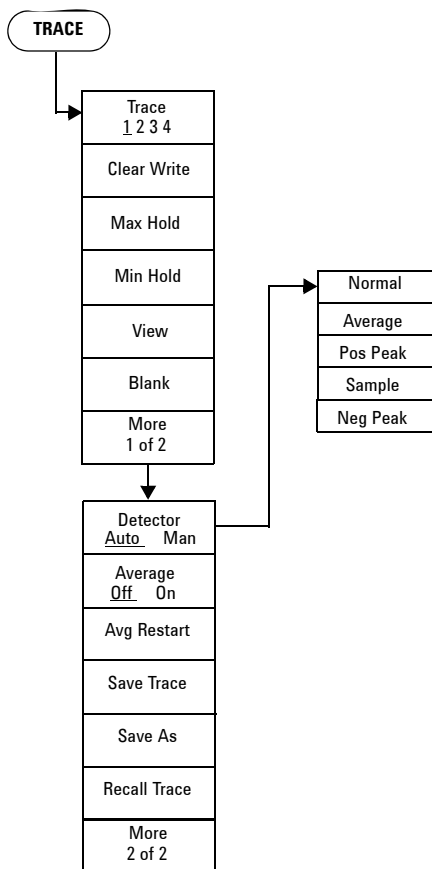


\*The trigger menu is available when span is set to zero span.

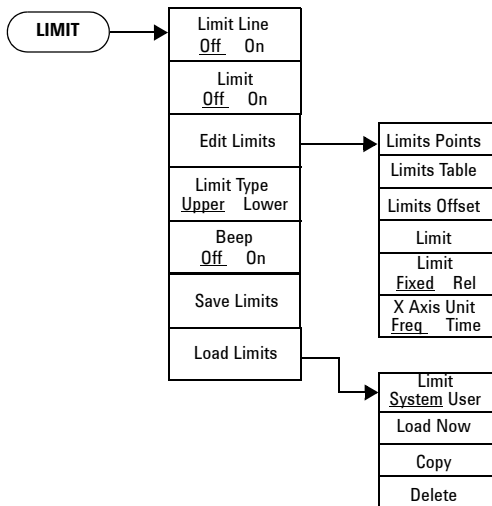




# TRACE



## Limit



# Index

## A

Adding Option, 29  
Amplitude, 82  
Attenuation, 82  
Avg Type, 87

## B

Battery, 16

## C

CF Step, 94  
Checking SYS Info, 19

## D

Display Adjustment, 26

## E

ESC/CLR, 92  
Ext Input, 28

## F

File Type, 32  
Firmware Upgrading, 28  
Frequency, 2, 93  
Front Panel, 5

## I

Instrument Markings, 8  
ISM1-A, 8

## L

Limit Line, 137  
Limit Pattern, 137  
Loading a file, 35

## M

Marker, 95  
Marker Delta, 96  
Marker To, 98  
Measuring ACPR, 101  
Measuring OBW, 100

## P

Peak Search, 97  
Power Manager, 26  
Preamp, 83

## R

Reference Level, 82  
Reference Offset, 84  
Res BW, 86

## S

Saving a file, 33  
Saving a trace, 34  
Scale Type, 83  
Scale/Div, 83  
Setting Key Beep, 26  
Show Error, 30  
Show SYS Info, 30  
Single Sweep, 91  
Span, 128  
Sweep Mode, 90  
Sweep Time, 89

## T

Testing Buttons, 19  
Time Base Calibration, 30  
Top Panel, 7  
Trace, 132  
Tracking Generator, 55

## V

VBW, 86  
View Multi-signals, 38  
Viewing Close Signals, 39  
Viewing Small Signal, 42  
Viewing TOI Distortion, 52

## W

WEEE, 8

## Y

Y Axis Units, 84





**Agilent Technologies**

**DECLARATION OF CONFORMITY**  
According to EN ISO/IEC 17050-1:2004



**Manufacturer's Name:** Agilent Technologies (Chengdu) Co., Ltd.

**Manufacturer's Address:** No. 116, 1st Street Tuo Xin West  
Chengdu Hi-Tech Industrial Development Zone (South),  
Chengdu, 610041, China

**Declares under sole responsibility that the product as originally delivered**

**Product Name:** Handheld Spectrum Analyzer

**Model Number:** N9340B

**Product Options:** This declaration covers all options of the above product(s)

**complies with the essential requirements of the following applicable European Directives, and carries the CE marking accordingly:**

Low Voltage Directive 2006/95/EC  
EMC Directive 2004/108/EC

**and conforms with the following product standards:**

<b>EMC</b>	<b>Standard</b>	<b>Limit</b>
	IEC 61326-2-1:2005 / EN 61326-2-1:2006	
	<i>Reference Standards</i>	
	CISPR 11:2003 / EN 55011:2007	Class A Group 1
	IEC 61000-4-2:2001 / EN 61000-4-2	4 kV/4 kV contact/air
	IEC 61000-4-3:2002 / EN 61000-4-3	3 V/m, 80-2000 MHz, 1 V/m, 2-2.7 GHz
	IEC 61000-4-4:2004 / EN 61000-4-4	0.5 kV signal lines, 1 kV power lines
	IEC 61000-4-5:2001 / EN 61000-4-5	0.5 kV line-line, 1 kV line-ground
	IEC 61000-4-6:2003 / EN 61000-4-6	3 V, 0.15-80 MHz
	IEC 61000-4-11:2004 / EN 61000-4-11	1 cycle, >95%

Canada: ICES/NMB-001:2006  
Australia/New Zealand: AS/NZS CISPR 11:2004

The product was tested in a typical configuration with Agilent Technologies test systems.

**Safety**  
IEC 61010-1:2001 / EN 61010-1:2001  
Canada: CAN/CSA-C22.2 No. 61010-1-04,  
USA: ANSI/UL 61010-1:2004,

**Supplementary Information:**

**This DoC applies to above-listed products placed on the EU market after:**

Sep 28, 2009  
Date

**Shi Wen**  
Quality Manager

For further information, please contact your local Agilent Technologies sales office, agent or distributor,  
or Agilent Technologies Deutschland GmbH, Herrenberger Straße 130, D 71034 Böblingen, Germany.

[www.agilent.com](http://www.agilent.com)

© Agilent Technologies, Inc. 2008-2009

Printed in China

July 2009



N9340-90008



**Agilent Technologies**