

Operating Manual

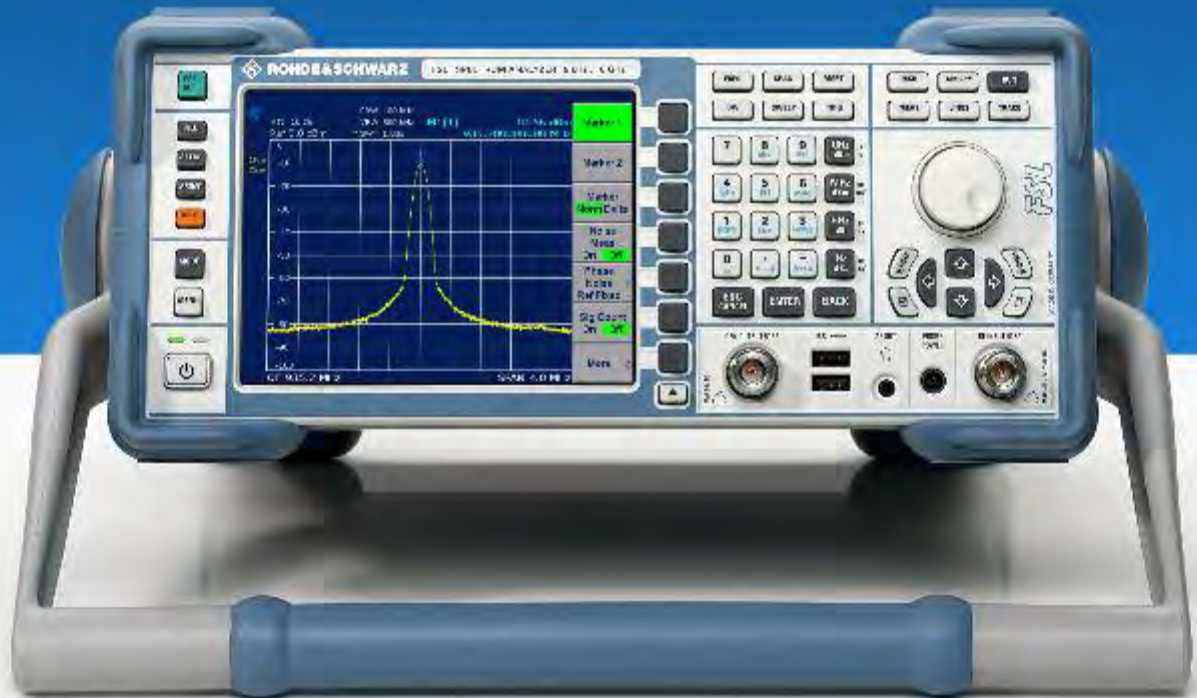

Spectrum Analyzer

R&S® FSL3

1300.2502.03

1300.2502.13

R&S® FSL6

1300.2502.06

1300.2502.16

Printed in Germany

ROHDE & SCHWARZ
Test and Measurement Division

R&S® is a registered trademark of Rohde & Schwarz GmbH & Co. KG
Trade names are trademarks of the owners



Before putting the product into operation for the first time, make sure to read the following



Safety Instructions

Rohde & Schwarz makes every effort to keep the safety standard of its products up to date and to offer its customers the highest possible degree of safety. Our products and the auxiliary equipment required for them are designed and tested in accordance with the relevant safety standards. Compliance with these standards is continuously monitored by our quality assurance system. This product has been designed and tested in accordance with the EC Certificate of Conformity and has left the manufacturer's plant in a condition fully complying with safety standards. To maintain this condition and to ensure safe operation, observe all instructions and warnings provided in this manual. If you have any questions regarding these safety instructions, Rohde & Schwarz will be happy to answer them.

Furthermore, it is your responsibility to use the product in an appropriate manner. This product is designed for use solely in industrial and laboratory environments or in the field and must not be used in any way that may cause personal injury or property damage. You are responsible if the product is used for an intention other than its designated purpose or in disregard of the manufacturer's instructions. The manufacturer shall assume no responsibility for such use of the product.

The product is used for its designated purpose if it is used in accordance with its operating manual and within its performance limits (see data sheet, documentation, the following safety instructions). Using the products requires technical skills and knowledge of English. It is therefore essential that the products be used exclusively by skilled and specialized staff or thoroughly trained personnel with the required skills. If personal safety gear is required for using Rohde & Schwarz products, this will be indicated at the appropriate place in the product documentation.

Symbols and safety labels

Observe operating instructions	Weight indication for units >18 kg	Danger of electric shock	Warning! Hot surface	PE terminal	Ground	Ground terminal	Attention! Electrostatic sensitive devices

Supply voltage ON/OFF	Standby indication	Direct current (DC)	Alternating current (AC)	Direct/alternating current (DC/AC)	Device fully protected by double/reinforced insulation

Safety Instructions

Observing the safety instructions will help prevent personal injury or damage of any kind caused by dangerous situations. Therefore, carefully read through and adhere to the following safety instructions before putting the product into operation. It is also absolutely essential to observe the additional safety instructions on personal safety that appear in other parts of the documentation. In these safety instructions, the word "product" refers to all merchandise sold and distributed by Rohde & Schwarz, including instruments, systems and all accessories.

Tags and their meaning

DANGER	This tag indicates a safety hazard with a high potential of risk for the user that can result in death or serious injuries.
WARNING	This tag indicates a safety hazard with a medium potential of risk for the user that can result in death or serious injuries.
CAUTION	This tag indicates a safety hazard with a low potential of risk for the user that can result in slight or minor injuries.
ATTENTION	This tag indicates the possibility of incorrect use that can cause damage to the product.
NOTE	This tag indicates a situation where the user should pay special attention to operating the product but which does not lead to damage.

These tags are in accordance with the standard definition for civil applications in the European Economic Area. Definitions that deviate from the standard definition may also exist. It is therefore essential to make sure that the tags described here are always used only in connection with the associated documentation and the associated product. The use of tags in connection with unassociated products or unassociated documentation can result in misinterpretations and thus contribute to personal injury or material damage.

Basic safety instructions

1. The product may be operated only under the operating conditions and in the positions specified by the manufacturer. Its ventilation must not be obstructed during operation. Unless otherwise specified, the following requirements apply to Rohde & Schwarz products:
prescribed operating position is always with the housing floor facing down, IP protection 2X, pollution severity 2, overvoltage category 2, use only in enclosed spaces, max. operation altitude max. 2000 m. Unless specified otherwise in the data sheet, a tolerance of $\pm 10\%$ shall apply to the nominal voltage and of $\pm 5\%$ to the nominal frequency.
2. Applicable local or national safety regulations and rules for the prevention of accidents must be observed in all work performed. The product may be opened only by authorized, specially trained personnel. Prior to performing any work on the product or opening the product, the product must be disconnected from the supply network. Any adjustments, replacements of parts, maintenance or repair must be carried out only by technical personnel authorized by Rohde & Schwarz. Only original parts may be used for replacing parts relevant to safety (e.g. power switches, power transformers, fuses). A safety test must always be performed after parts relevant to safety have been replaced (visual inspection, PE conductor test, insulation resistance measurement, leakage current measurement, functional test).
3. As with all industrially manufactured goods, the use of substances that induce an allergic reaction (allergens, e.g. nickel) such as aluminum cannot be generally excluded. If you develop an allergic reaction (such as a skin rash, frequent sneezing, red eyes or respiratory difficulties), consult a physician immediately to determine the cause.

Safety Instructions

4. If products/components are mechanically and/or thermally processed in a manner that goes beyond their intended use, hazardous substances (heavy-metal dust such as lead, beryllium, nickel) may be released. For this reason, the product may only be disassembled, e.g. for disposal purposes, by specially trained personnel. Improper disassembly may be hazardous to your health. National waste disposal regulations must be observed.
5. If handling the product yields hazardous substances or fuels that must be disposed of in a special way, e.g. coolants or engine oils that must be replenished regularly, the safety instructions of the manufacturer of the hazardous substances or fuels and the applicable regional waste disposal regulations must be observed. Also observe the relevant safety instructions in the product documentation.
6. Depending on the function, certain products such as RF radio equipment can produce an elevated level of electromagnetic radiation. Considering that unborn life requires increased protection, pregnant women should be protected by appropriate measures. Persons with pacemakers may also be endangered by electromagnetic radiation. The employer is required to assess workplaces where there is a special risk of exposure to radiation and, if necessary, take measures to avert the danger.
7. Operating the products requires special training and intense concentration. Make certain that persons who use the products are physically, mentally and emotionally fit enough to handle operating the products; otherwise injuries or material damage may occur. It is the responsibility of the employer to select suitable personnel for operating the products.
8. Prior to switching on the product, it must be ensured that the nominal voltage setting on the product matches the nominal voltage of the AC supply network. If a different voltage is to be set, the power fuse of the product may have to be changed accordingly.
9. In the case of products of safety class I with movable power cord and connector, operation is permitted only on sockets with earthing contact and protective earth connection.
10. Intentionally breaking the protective earth connection either in the feed line or in the product itself is not permitted. Doing so can result in the danger of an electric shock from the product. If extension cords or connector strips are implemented, they must be checked on a regular basis to ensure that they are safe to use.
11. If the product has no power switch for disconnection from the AC supply, the plug of the connecting cable is regarded as the disconnecting device. In such cases, it must be ensured that the power plug is easily reachable and accessible at all times (length of connecting cable approx. 2 m). Functional or electronic switches are not suitable for providing disconnection from the AC supply. If products without power switches are integrated in racks or systems, a disconnecting device must be provided at the system level.
12. Never use the product if the power cable is damaged. By taking appropriate safety measures and carefully laying the power cable, ensure that the cable cannot be damaged and that no one can be hurt by e.g. tripping over the cable or suffering an electric shock.
13. The product may be operated only from TN/TT supply networks fused with max. 16 A.
14. Do not insert the plug into sockets that are dusty or dirty. Insert the plug firmly and all the way into the socket. Otherwise this can result in sparks, fire and/or injuries.
15. Do not overload any sockets, extension cords or connector strips; doing so can cause fire or electric shocks.
16. For measurements in circuits with voltages $V_{rms} > 30 V$, suitable measures (e.g. appropriate measuring equipment, fusing, current limiting, electrical separation, insulation) should be taken to avoid any hazards.
17. Ensure that the connections with information technology equipment comply with IEC 950/EN 60950.
18. Never remove the cover or part of the housing while you are operating the product. This will expose circuits and components and can lead to injuries, fire or damage to the product.

Safety Instructions

19. If a product is to be permanently installed, the connection between the PE terminal on site and the product's PE conductor must be made first before any other connection is made. The product may be installed and connected only by a skilled electrician.
20. For permanently installed equipment without built-in fuses, circuit breakers or similar protective devices, the supply circuit must be fused in such a way that suitable protection is provided for users and products.
21. Do not insert any objects into the openings in the housing that are not designed for this purpose. Never pour any liquids onto or into the housing. This can cause short circuits inside the product and/or electric shocks, fire or injuries.
22. Use suitable overvoltage protection to ensure that no overvoltage (such as that caused by a thunderstorm) can reach the product. Otherwise the operating personnel will be endangered by electric shocks.
23. Rohde & Schwarz products are not protected against penetration of water, unless otherwise specified (see also safety instruction 1.). If this is not taken into account, there exists the danger of electric shock or damage to the product, which can also lead to personal injury.
24. Never use the product under conditions in which condensation has formed or can form in or on the product, e.g. if the product was moved from a cold to a warm environment.
25. Do not close any slots or openings on the product, since they are necessary for ventilation and prevent the product from overheating. Do not place the product on soft surfaces such as sofas or rugs or inside a closed housing, unless this is well ventilated.
26. Do not place the product on heat-generating devices such as radiators or fan heaters. The temperature of the environment must not exceed the maximum temperature specified in the data sheet.
27. Batteries and storage batteries must not be exposed to high temperatures or fire. Keep batteries and storage batteries away from children. If batteries or storage batteries are improperly replaced, this can cause an explosion (warning: lithium cells). Replace the battery or storage battery only with the matching Rohde & Schwarz type (see spare parts list). Batteries and storage batteries are hazardous waste. Dispose of them only in specially marked containers. Observe local regulations regarding waste disposal. Do not short-circuit batteries or storage batteries.
28. Please be aware that in the event of a fire, toxic substances (gases, liquids etc.) that may be hazardous to your health may escape from the product.
29. Please be aware of the weight of the product. Be careful when moving it; otherwise you may injure your back or other parts of your body.
30. Do not place the product on surfaces, vehicles, cabinets or tables that for reasons of weight or stability are unsuitable for this purpose. Always follow the manufacturer's installation instructions when installing the product and fastening it to objects or structures (e.g. walls and shelves).
31. Handles on the products are designed exclusively for personnel to hold or carry the product. It is therefore not permissible to use handles for fastening the product to or on means of transport such as cranes, fork lifts, wagons, etc. The user is responsible for securely fastening the products to or on the means of transport and for observing the safety regulations of the manufacturer of the means of transport. Noncompliance can result in personal injury or material damage.
32. If you use the product in a vehicle, it is the sole responsibility of the driver to drive the vehicle safely. Adequately secure the product in the vehicle to prevent injuries or other damage in the event of an accident. Never use the product in a moving vehicle if doing so could distract the driver of the vehicle. The driver is always responsible for the safety of the vehicle; the manufacturer assumes no responsibility for accidents or collisions.
33. If a laser product (e.g. a CD/DVD drive) is integrated in a Rohde & Schwarz product, do not use any other settings or functions than those described in the documentation. Otherwise this may be hazardous to your health, since the laser beam can cause irreversible damage to your eyes. Never try to take such products apart, and never look into the laser beam.



Por favor lea imprescindiblemente antes de la primera puesta en funcionamiento las siguientes informaciones de seguridad



Informaciones de seguridad

Es el principio de Rohde & Schwarz de tener a sus productos siempre al día con los estándares de seguridad y de ofrecer a sus clientes el máximo grado de seguridad. Nuestros productos y todos los equipos adicionales son siempre fabricados y examinados según las normas de seguridad vigentes. Nuestra sección de gestión de la seguridad de calidad controla constantemente que sean cumplidas estas normas. Este producto ha sido fabricado y examinado según el comprobante de conformidad adjunto según las normas de la CE y ha salido de nuestra planta en estado impecable según los estándares técnicos de seguridad. Para poder preservar este estado y garantizar un funcionamiento libre de peligros, deberá el usuario atenerse a todas las informaciones, informaciones de seguridad y notas de alerta. Rohde&Schwarz está siempre a su disposición en caso de que tengan preguntas referentes a estas informaciones de seguridad.

Además queda en la responsabilidad del usuario utilizar el producto en la forma debida. Este producto solamente fue elaborado para ser utilizado en la industria y el laboratorio o para fines de campo y de ninguna manera deberá ser utilizado de modo que alguna persona/cosa pueda ser dañada. El uso del producto fuera de sus fines definidos o despreciando las informaciones de seguridad del fabricante queda en la responsabilidad del usuario. El fabricante no se hace en ninguna forma responsable de consecuencias a causa del maluso del producto.

Se parte del uso correcto del producto para los fines definidos si el producto es utilizado dentro de las instrucciones del correspondiente manual del uso y dentro del margen de rendimiento definido (ver hoja de datos, documentación, informaciones de seguridad que siguen). El uso de los productos hace necesarios conocimientos profundos y el conocimiento del idioma inglés. Por eso se deberá tener en cuenta de exclusivamente autorizar para el uso de los productos a personas peritas o debidamente minuciosamente instruidas con los conocimientos citados. Si fuera necesaria indumentaria de seguridad para el uso de productos de R&S, encontrará la información debida en la documentación del producto en el capítulo correspondiente.

Símbolos y definiciones de seguridad

Ver manual de instrucciones del uso	Informaciones para maquinaria con un peso de > 18kg	Peligro de golpe de corriente	¡Advertencia! Superficie caliente	Conexión a conductor protector	Conexión a tierra	Conexión a masa conductora	¡Cuidado! Elementos de construcción con peligro de carga electrostática

potencia EN MARCHA/PARADA	Indicación Stand-by	Corriente continua DC	Corriente alterna AC	Corriente continua/alterna DC/AC	El aparato está protegido en su totalidad por un aislamiento de doble refuerzo

Informaciones de seguridad

Tener en cuenta las informaciones de seguridad sirve para tratar de evitar daños y peligros de toda clase. Es necesario de que se lean las siguientes informaciones de seguridad concienzudamente y se tengan en cuenta debidamente antes de la puesta en funcionamiento del producto. También deberán ser tenidas en cuenta las informaciones para la protección de personas que encontrarán en otro capítulo de esta documentación y que también son obligatorias de seguir. En las informaciones de seguridad actuales hemos juntado todos los objetos vendidos por Rohde&Schwarz bajo la denominación de „producto“, entre ellos también aparatos, instalaciones así como toda clase de accesorios.

Palabras de señal y su significado

PELIGRO	Indica un punto de peligro con gran potencial de riesgo para el usuario. Punto de peligro que puede llevar hasta la muerte o graves heridas.
ADVERTENCIA	Indica un punto de peligro con un potencial de riesgo mediano para el usuario. Punto de peligro que puede llevar hasta la muerte o graves heridas .
ATENCIÓN	Indica un punto de peligro con un potencial de riesgo pequeño para el usuario. Punto de peligro que puede llevar hasta heridas leves o pequeñas
CUIDADO	Indica la posibilidad de utilizar mal el producto y a consecuencia dañarlo.
INFORMACIÓN	Indica una situación en la que deberían seguirse las instrucciones en el uso del producto, pero que no consecuentemente deben de llevar a un daño del mismo.

Las palabras de señal corresponden a la definición habitual para aplicaciones civiles en el ámbito de la comunidad económica europea. Pueden existir definiciones diferentes a esta definición. Por eso se debiera tener en cuenta que las palabras de señal aquí descritas sean utilizadas siempre solamente en combinación con la correspondiente documentación y solamente en combinación con el producto correspondiente. La utilización de las palabras de señal en combinación con productos o documentaciones que no les correspondan puede llevar a malinterpretaciones y tener por consecuencia daños en personas u objetos.

Informaciones de seguridad elementales

1. El producto solamente debe ser utilizado según lo indicado por el fabricante referente a la situación y posición de funcionamiento sin que se obstruya la ventilación. Si no se convino de otra manera, es para los productos R&S válido lo que sigue: como posición de funcionamiento se define principalmente la posición con el suelo de la caja para abajo , modo de protección IP 2X, grado de suciedad 2, categoría de sobrecarga eléctrica 2, utilizar solamente en estancias interiores, utilización hasta 2000 m sobre el nivel del mar.
A menos que se especifique otra cosa en la hoja de datos, se aplicará una tolerancia de $\pm 10\%$ sobre el voltaje nominal y de $\pm 5\%$ sobre la frecuencia nominal.
2. En todos los trabajos deberán ser tenidas en cuenta las normas locales de seguridad de trabajo y de prevención de accidentes. El producto solamente debe de ser abierto por personal périto autorizado. Antes de efectuar trabajos en el producto o abrirlo deberá este ser desconectado de la corriente. El ajuste, el cambio de partes, la manutención y la reparación deberán ser solamente efectuadas por electricistas autorizados por R&S. Si se reponen partes con importancia para los aspectos de seguridad (por ejemplo el enchufe, los transformadores o los fusibles), solamente podrán ser sustituidos por partes originales. Despues de cada recambio de partes elementales para la seguridad deberá ser efectuado un control de

Informaciones de seguridad

- seguridad (control a primera vista, control de conductor protector, medición de resistencia de aislamiento, medición de medición de la corriente conductora, control de funcionamiento).
3. Como en todo producto de fabricación industrial no puede ser excluido en general de que se produzcan al usarlo elementos que puedan generar alergias, los llamados elementos alergénicos (por ejemplo el níquel). Si se produjeran en el trato con productos R&S reacciones alérgicas, como por ejemplo urticaria, estornudos frecuentes, irritación de la conjuntiva o dificultades al respirar, se deberá consultar inmediatamente a un médico para averiguar los motivos de estas reacciones.
 4. Si productos / elementos de construcción son tratados fuera del funcionamiento definido de forma mecánica o térmica, pueden generarse elementos peligrosos (polvos de sustancia de metales pesados como por ejemplo plomo, berilio, níquel). La partición elemental del producto, como por ejemplo sucede en el tratamiento de materias residuales, debe de ser efectuada solamente por personal especializado para estos tratamientos. La partición elemental efectuada inadecuadamente puede generar daños para la salud. Se deben tener en cuenta las directivas nacionales referentes al tratamiento de materias residuales.
 5. En el caso de que se produjeran agentes de peligro o combustibles en la aplicación del producto que debieran de ser transferidos a un tratamiento de materias residuales, como por ejemplo agentes refrigerantes que deben ser repuestos en periodos definidos, o aceites para motores, deberán ser tenidas en cuenta las prescripciones de seguridad del fabricante de estos agentes de peligro o combustibles y las regulaciones regionales para el tratamiento de materias residuales. Cuiden también de tener en cuenta en caso dado las prescripciones de seguridad especiales en la descripción del producto.
 6. Ciertos productos, como por ejemplo las instalaciones de radiación HF, pueden a causa de su función natural, emitir una radiación electromagnética aumentada. En vista a la protección de la vida en desarrollo deberían ser protegidas personas embarazadas debidamente. También las personas con un bypass pueden correr peligro a causa de la radiación electromagnética. El empresario está comprometido a valorar y señalar áreas de trabajo en las que se corra un riesgo de exposición a radiaciones aumentadas de riesgo aumentado para evitar riesgos.
 7. La utilización de los productos requiere instrucciones especiales y una alta concentración en el manejo. Debe de ponerse por seguro de que las personas que manejen los productos estén a la altura de los requerimientos necesarios referente a sus aptitudes físicas, psíquicas y emocionales, ya que de otra manera no se pueden excluir lesiones o daños de objetos. El empresario lleva la responsabilidad de seleccionar el personal usuario apto para el manejo de los productos.
 8. Antes de la puesta en marcha del producto se deberá tener por seguro de que la tensión preseleccionada en el producto equivalga a la del la red de distribución. Si es necesario cambiar la preselección de la tensión también se deberán en caso dabo cambiar los fusibles correspondientes del producto.
 9. Productos de la clase de seguridad I con alimentación móvil y enchufe individual de producto solamente deberán ser conectados para el funcionamiento a tomas de corriente de contacto de seguridad y con conductor protector conectado.
 10. Queda prohibida toda clase de interrupción intencionada del conductor protector, tanto en la toma de corriente como en el mismo producto ya que puede tener como consecuencia el peligro de golpe de corriente por el producto. Si se utilizaran cables o enchufes de extensión se deberá poner al seguro, que es controlado su estado técnico de seguridad.
 11. Si el producto no está equipado con un interruptor para desconectarlo de la red, se deberá considerar el enchufe del cable de distribución como interruptor. En estos casos deberá asegurar de que el enchufe sea de fácil acceso y nabejo (medida del cable de distribución aproximadamente 2 m). Los interruptores de función o electrónicos no son aptos para el corte de la red eléctrica. Si los productos sin interruptor están integrados en construcciones o instalaciones, se deberá instalar el interruptor al nivel de la instalación.

Informaciones de seguridad

12. No utilice nunca el producto si está dañado el cable eléctrico. Asegure a través de las medidas de protección y de instalación adecuadas de que el cable de eléctrico no pueda ser dañado o de que nadie pueda ser dañado por él, por ejemplo al tropezar o por un golpe de corriente.
13. Solamente está permitido el funcionamiento en redes de distribución TN/TT aseguradas con fusibles de como máximo 16 A.
14. Nunca conecte el enchufe en tomas de corriente sucias o llenas de polvo. Introduzca el enchufe por completo y fuertemente en la toma de corriente. Si no tiene en consideración estas indicaciones se arriesga a que se originen chispas, fuego y/o heridas.
15. No sobrecargue las tomas de corriente, los cables de extensión o los enchufes de extensión ya que esto pudiera causar fuego o golpes de corriente.
16. En las mediciones en circuitos de corriente con una tensión de entrada de $U_{eff} > 30 \text{ V}$ se deberá tomar las precauciones debidas para impedir cualquier peligro (por ejemplo medios de medición adecuados, seguros, limitación de tensión, corte protector, aislamiento etc.).
17. En caso de conexión con aparatos de la técnica informática se deberá tener en cuenta que estos cumplan los requisitos de la EC950/EN60950.
18. Nunca abra la tapa o parte de ella si el producto está en funcionamiento. Esto pone a descubierto los cables y componentes eléctricos y puede causar heridas, fuego o daños en el producto.
19. Si un producto es instalado fijamente en un lugar, se deberá primero conectar el conductor protector fijo con el conductor protector del aparato antes de hacer cualquier otra conexión. La instalación y la conexión deberán ser efecutadas por un electricista especializado.
20. En caso de que los productos que son instalados fijamente en un lugar sean sin protector implementado, autointerruptor o similares objetos de protección, deberá la toma de corriente estar protegida de manera que los productos o los usuarios estén suficientemente protegidos.
21. Por favor, no introduzca ningún objeto que no esté destinado a ello en los orificios de la caja del aparato. No vierta nunca ninguna clase de líquidos sobre o en la caja. Esto puede producir corto circuitos en el producto y/o puede causar golpes de corriente, fuego o heridas.
22. Asegúrese con la protección adecuada de que no pueda originarse en el producto una sobrecarga por ejemplo a causa de una tormenta. Si no se verá el personal que lo utilice expuesto al peligro de un golpe de corriente.
23. Los productos R&S no están protegidos contra el agua si no es que exista otra indicación, ver también punto 1. Si no se tiene en cuenta esto se arriesga el peligro de golpe de corriente o de daños en el producto lo cual también puede llevar al peligro de personas.
24. No utilice el producto bajo condiciones en las que pueda producirse y se hayan producido líquidos de condensación en o dentro del producto como por ejemplo cuando se desplaza el producto de un lugar frío a un lugar caliente.
25. Por favor no cierre ninguna ranura u orificio del producto, ya que estas son necesarias para la ventilación e impiden que el producto se caliente demasiado. No pongan el producto encima de materiales blandos como por ejemplo sofás o alfombras o dentro de una caja cerrada, si esta no está suficientemente ventilada.
26. No ponga el producto sobre aparatos que produzcan calor, como por ejemplo radiadores o calentadores. La temperatura ambiental no debe superar la temperatura máxima especificada en la hoja de datos.

Informaciones de seguridad

27. Baterías y acumuladores no deben de ser expuestos a temperaturas altas o al fuego. Guardar baterías y acumuladores fuera del alcance de los niños. Si las baterías o los acumuladores no son cambiados con la debida atención existirá peligro de explosión (atención celulas de Litio). Cambiar las baterías o los acumuladores solamente por los del tipo R&S correspondiente (ver lista de piezas de recambio). Baterías y acumuladores son deshechos problemáticos. Por favor tirenlos en los recipientes especiales para este fin. Por favor tengan en cuenta las prescripciones nacionales de cada país referente al tratamiento de deshechos. Nunca sometan las baterías o acumuladores a un corto circuito.
28. Tengan en consideración de que en caso de un incendio pueden escaparse gases tóxicos del producto, que pueden causar daños a la salud.
29. Por favor tengan en cuenta que en caso de un incendio pueden desprenderse del producto agentes venenosos (gases, líquidos etc.) que pueden generar daños a la salud.
30. No sitúe el producto encima de superficies, vehículos, estantes o mesas, que por sus características de peso o de estabilidad no sean aptas para él. Siga siempre las instrucciones de instalación del fabricante cuando instale y asegure el producto en objetos o estructuras (por ejemplo paredes y estantes).
31. Las asas instaladas en los productos sirven solamente de ayuda para el manejo que solamente está previsto para personas. Por eso no está permitido utilizar las asas para la sujecion en o sobre medios de transporte como por ejemplo grúas, carretillas elevadoras de horquilla, carros etc. El usuario es responsable de que los productos sean sujetados de forma segura a los medios de transporte y de que las prescripciones de seguridad del fabricante de los medios de transporte sean tenidas en cuenta. En caso de que no se tengan en cuenta pueden causarse daños en personas y objetos.
32. Si llega a utilizar el producto dentro de un vehículo, queda en la responsabilidad absoluta del conductor que conducir el vehículo de manera segura. Asegure el producto dentro del vehículo debidamente para evitar en caso de un accidente las lesiones u otra clase de daños. No utilice nunca el producto dentro de un vehículo en movimiento si esto pudiera distraer al conductor. Siempre queda en la responsabilidad absoluta del conductor la seguridad del vehículo y el fabricante no asumirá ninguna clase de responsabilidad por accidentes o colisiones.
33. Dado el caso de que esté integrado un producto de laser en un producto R&S (por ejemplo CD/DVD-ROM) no utilice otras instalaciones o funciones que las descritas en la documentación. De otra manera pondrá en peligro su salud, ya que el rayo laser puede dañar irreversiblemente sus ojos. Nunca trate de descomponer estos productos. Nunca mire dentro del rayo laser.



ROHDE & SCHWARZ

Kundeninformation zur Batterieverordnung (BattV)

Dieses Gerät enthält eine schadstoffhaltige Batterie. Diese darf nicht mit dem Hausmüll entsorgt werden.

Nach Ende der Lebensdauer darf die Entsorgung nur über eine Rohde&Schwarz-Kundendienststelle oder eine geeignete Sammelstelle erfolgen.

Safety Regulations for Batteries (according to BattV)

This equipment houses a battery containing harmful substances that must not be disposed of as normal household waste.

After its useful life, the battery may only be disposed of at a Rohde & Schwarz service center or at a suitable depot.

Normas de Seguridad para Baterías (Según BattV)

Este equipo lleva una batería que contiene sustancias perjudiciales, que no se debe desechar en los contenedores de basura domésticos.

Después de la vida útil, la batería sólo se podrá eliminar en un centro de servicio de Rohde & Schwarz o en un depósito apropiado.

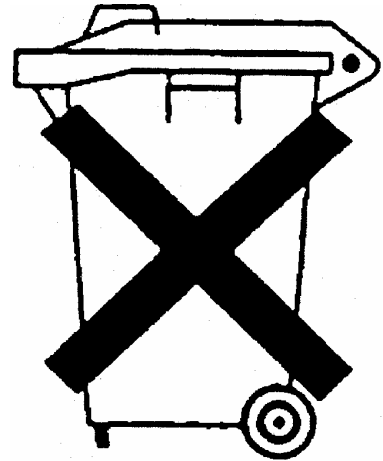

Consignes de sécurité pour batteries (selon BattV)

Cet appareil est équipé d'une pile comprenant des substances nocives. Ne jamais la jeter dans une poubelle pour ordures ménagères.

Une pile usagée doit uniquement être éliminée par un centre de service client de Rohde & Schwarz ou peut être collectée pour être traitée spécialement comme déchets dangereux.

Certified Quality System

DIN EN ISO 9001 : 2000
DIN EN 9100 : 2003
DIN EN ISO 14001 : 1996

DQS REG. NO 001954 QM/ST UM

QUALITÄTSZERTIFIKAT

Sehr geehrter Kunde,
Sie haben sich für den Kauf eines Rohde & Schwarz-Produktes entschieden. Hiermit erhalten Sie ein nach modernsten Fertigungsmethoden hergestelltes Produkt. Es wurde nach den Regeln unseres Managementsystems entwickelt, gefertigt und geprüft.

Das Rohde & Schwarz Managementsystem ist zertifiziert nach:

DIN EN ISO 9001:2000
DIN EN 9100:2003
DIN EN ISO 14001:1996

CERTIFICATE OF QUALITY

Dear Customer,
you have decided to buy a Rohde & Schwarz product. You are thus assured of receiving a product that is manufactured using the most modern methods available. This product was developed, manufactured and tested in compliance with our quality management system standards.

The Rohde & Schwarz quality management system is certified according to:

DIN EN ISO 9001:2000
DIN EN 9100:2003
DIN EN ISO 14001:1996

CERTIFICAT DE QUALITÉ

Cher Client,
vous avez choisi d'acheter un produit Rohde & Schwarz. Vous disposez donc d'un produit fabriqué d'après les méthodes les plus avancées. Le développement, la fabrication et les tests respectent nos normes de gestion qualité.

Le système de gestion qualité de Rohde & Schwarz a été homologué conformément aux normes:

DIN EN ISO 9001:2000
DIN EN 9100:2003
DIN EN ISO 14001:1996



ROHDE & SCHWARZ



Certificate No.: 2005-06

This is to certify that:

Equipment type	Stock No.	Designation
FSL3	1300.2502.03/.13	Spectrum Analyzer
FSL6	1300.2502.06/.16	
FSL-B4	1300.6008.02	OCXO Reference Frequency
FSL-B5	1300.6108.02	Additional Interfaces
FSL-B6	1300.5901.02	TV Trigger
FSL-B7	1300.5601.02	Narrow Resolution Filters
FSL-B8	1300.5701.02	Gated Sweep Function
FSL-B10	1300.6208.02	GPIB Interface
FSL-B22	1300.5953.02	RF Amplifier
FSL-B30	1300.6308.02	DC Power Supply
FSL-B31	1300.6408.02	NIMH Battery Pack
FSL-Z4	1300.5430.02	Additional Charger Unit

complies with the provisions of the Directive of the Council of the European Union on the approximation of the laws of the Member States

- relating to electrical equipment for use within defined voltage limits
(73/23/EEC revised by 93/68/EEC)
- relating to electromagnetic compatibility
(89/336/EEC revised by 91/263/EEC, 92/31/EEC, 93/68/EEC)

Conformity is proven by compliance with the following standards:

EN61010-1 : 2001-12
EN55011 : 1998 + A1 : 1999, Klasse B
EN61326 : 1997 + A1 : 1998 + A2 : 2001

For the assessment of electromagnetic compatibility, the limits of radio interference for Class B equipment as well as the immunity to interference for operation in industry have been used as a basis.

Affixing the EC conformity mark as from 2005

ROHDE & SCHWARZ GmbH & Co. KG
Mühldorfstr. 15, D-81671 München

Munich, 2005-02-11

Central Quality Management MF-QZ / Radde

Documentation Overview

The user documentation for the R&S FSL is divided as follows:

- [Quick Start Guide](#)
- [Operating Manual](#)
- [Service Manual](#)
- [Online Help](#)

The general Safety Instructions are provided in the printed Quick Start Guide and in PDF format on CD-ROM.

Quick Start Guide

This manual is delivered with the instrument in printed form and in PDF format on the CD. It provides the information needed to set up and start working with the instrument. Basic operations and basic measurements are described. Also a brief introduction to remote control is given. More detailed descriptions are provided in the Operating Manual. The Quick Start Guide includes general information (e.g. Safety Instructions) and the following chapters:

Chapter 1	Front and Rear Panel
Chapter 2	Putting into Operation
Chapter 3	Firmware Update and Installation of Firmware Options
Chapter 4	Basic Operations
Chapter 5	Basic Measurement Examples
Chapter 6	Brief Introduction to Remote Control
Appendix A	Printer Interface
Appendix B	LAN Interface

Operating Manual

This manual is a supplement to the Quick Start Guide and is available in PDF format on the CD delivered with the instrument. To retain the familiar structure that applies to all operating manuals of Rohde&Schwarz Test & Measurement instruments, the chapters 1 and 3 exist, but only in form of references to the corresponding Quick Start Guide chapters.

In this manual, all instrument functions are described in detail. For additional information on default settings and parameters, refer to the data sheets. The set of measurement examples in the Quick Start Guide is expanded by more advanced measurement examples. In addition to the brief introduction to remote control in the Quick Start Guide, a description of the commands and programming examples is given. Information on maintenance, instrument interfaces and error messages is also provided. The manual includes the following chapters:

Chapter 1	Putting into Operation, see Quick Start Guide chapters 1 and 2
Chapter 2	Advanced Measurement Examples
Chapter 3	Manual Control, see Quick Start Guide chapter 4
Chapter 4	Instrument Functions
Chapter 5	Remote Control - Basics

Chapter 6	Remote Control - Commands
Chapter 7	Remote Control - Programming Examples
Chapter 8	Maintenance
Chapter 9	Error Messages

This manual is delivered with the instrument on CD only. The printed manual can be ordered from Rohde & Schwarz GmbH & Co. KG.

Service Manual

This manual is available in PDF format on the CD delivered with the instrument. It informs on how to check compliance with rated specifications, on instrument function, repair, troubleshooting and fault elimination. It contains all information required for repairing the R&S FSL by the replacement of modules. The manual includes the following chapters:

Chapter 1	Performance Test
Chapter 2	Adjustment
Chapter 3	Repair
Chapter 4	Software Update / Installing Options
Chapter 5	Documents

Online Help

The Online Help is part of the firmware. It provides a quick access to the description of the instrument functions and the remote control commands. For information on other topics refer to the Quick Start Guide, Operating Manual and Service Manual provided in PDF format on CD or in the Internet. For detailed information on how to use the Online Help, refer to the chapter "Basic Operations" in the Quick Start Guide.

Conventions Used in the Documentation

To visualize important information quickly and to recognize information types faster, a few conventions have been introduced. The following character formats are used to emphasize words:

Bold	All names of graphical user interface elements as dialog boxes, softkeys, lists, options, buttons etc. All names of user interface elements on the front and rear panel as keys, connectors etc.
Courier	All remote commands (apart from headings, see below)
Capital letters	All key names (front panel or keyboard)

The description of a softkey (Operating Manual and Online Help) always starts with the softkey name, and is followed by explaining text and one or more remote control commands framed by two lines. Each remote command is placed in a single line.

The description of remote control commands (Operating Manual and Online Help) always starts with the command itself, and is followed by explaining text including an example, the characteristics and the mode (standard or only with certain options) framed by two grey lines. The remote commands consist of abbreviations to accelerate the procedure. All parts of the command that have to be entered are in capital letters, the rest is added in small letters to complete the words and transport their meaning.

1 Putting into Operation

For details refer to the Quick Start Guide chapters 1, "Front and Rear Panel", and 2, "Preparing for Use".

Contents of Chapter 2

2	Advanced Measurement Examples	2.1
	Test Setup	2.2
	Measurement of Harmonics	2.3
	High-Sensitivity Harmonics Measurements	2.5
	Measuring the Spectra of Complex Signals	2.8
	Separating Signals by Selecting an Appropriate Resolution Bandwidth	2.8
	Intermodulation Measurements	2.9
	Measurement example – Measuring the R&S FSL's intrinsic intermodulation	2.11
	Measuring Signals in the Vicinity of Noise	2.16
	Measurement example – Measuring level at low S/N ratios	2.17
	Noise Measurements	2.20
	Measuring Noise Power Density	2.20
	Measurement example – Measuring the intrinsic noise power density of the R&S FSL at 1 GHz and calculating the R&S FSL's noise figure	2.20
	Measurement of Noise Power within a Transmission Channel	2.23
	Measurement example – Measuring the intrinsic noise of the R&S FSL at 1 GHz in a 1.23 MHz channel bandwidth with the channel power function	2.23
	Measuring Phase Noise	2.27
	Measurement example – Measuring the phase noise of a signal generator at a carrier offset of 10 kHz	2.27
	Measurements on Modulated Signals	2.29
	Measuring Channel Power and Adjacent Channel Power	2.29
	Measurement example 1 – ACPR measurement on an CDMA 2000 signal	2.30
	Measurement example 2 – Measuring adjacent channel power of a W-CDMA uplink signal	2.34
	Amplitude Distribution Measurements	2.38
	Measurement example – Measuring the APD and CCDF of white noise generated by the R&S FSL	2.38
	Measurement Examples of the Bluetooth Measurements Option (K8).....	2.41
	Bluetooth Overview	2.41
	Bluetooth technical parameters	2.41
	Power classes	2.42
	Structure of a Bluetooth data packet	2.42
	Supported Tests	2.43
	Overview of Transmitter Tests	2.44
	Functional Description – Block Diagram	2.46
	Bandwidths	2.47
	Measurement Filter (Meas Filter On)	2.47
	Oversampling	2.48
	Determining Average or Max/Min Values	2.50
	Impact of the sweep count on the measurement results	2.50
	Trigger Concepts	2.51

Measurement Examples of the Cable TV Measurements Option (K20)	2.52
Analog TV Basics	2.53
Analog TV Measurement Examples	2.55
Analog TV settings	2.55
Analog TV test setup.....	2.56
Spectrum measurement.....	2.57
Carriers measurement	2.59
Video scope measurement	2.61
Vision modulation measurement	2.63
Hum measurement	2.65
Digital TV Basics.....	2.67
Digital TV Measurement Examples	2.72
Digital TV settings	2.72
Digital TV test setup.....	2.73
Spectrum measurement.....	2.73
Overview measurement	2.73
Constellation diagram measurement (modulation analysis).....	2.75
Modulation errors measurement (modulation analysis).....	2.76
Echo pattern measurement (channel analysis)	2.77
Channel power measurement.....	2.77
APD measurement.....	2.78
CCDF measurement	2.78
TV Analyzer Measurements	2.79
Tilt measurement	2.79
Channel Tables and Modulation Standards	2.81
Channel tables	2.82
Modulation standards.....	2.84
Example: Creating a channel table.....	2.89
Example: Restoring the default channel tables	2.95
Performing a Measurement without a Channel Table	2.96
Performing a Measurement Using a Channel Table	2.98
Measurement Examples of the WLAN TX Measurements Option (K91)	2.102
Basic Measurement Example	2.102
Setting up the measurement.....	2.102
Performing the level detection	2.103
Performing the main measurement	2.103
Signal Processing of the IEEE 802.11a application	2.104
Abbreviations	2.104
Literature	2.109
Signal Processing of the IEEE 802.11b application	2.109
Abbreviations	2.109
Literature	2.113
802.11b RF carrier suppression	2.113
Definition	2.113
Measurement with R&S spectrum analyzers.....	2.113
Comparison to IQ offset measurement in K91 list mode	2.114

IQ Impairments	2.115
IQ Offset.....	2.115
Gain Imbalance.....	2.115
Quadrature Error.....	2.116
Measurement Examples of the WiMAX Measurements Option (K92).....	2.118
Basic Measurement Example	2.118
Setting up the measurement.....	2.119
Performing the level detection	2.120
Performing the main measurement	2.120
Signal Processing of the IEEE 802.16–2004 OFDM measurement application	2.121
Abbreviations	2.121
Analysis Steps	2.127
Subchannelization	2.127
Synchronization	2.128
Channel Results.....	2.128
Frequency and Clock Offset	2.128
EVM	2.129
IQ Impairments	2.130
RSSI Measurements.....	2.131
CINR Measurements	2.131
Literature.....	2.132

2 Advanced Measurement Examples

This chapter explains how to operate the R&S FSL using typical measurements as examples. Additional background information on the settings is given. Examples of more basic character are provided in the Quick Start Guide, chapter 5, as an introduction. The following topics are included in the Quick Start Guide:

- Measuring a Sinusoidal Signal
 - Measuring the Level and Frequency Using Markers
 - Measuring the Signal Frequency Using the Frequency Counter
- Measuring Harmonics of Sinusoidal Signals
 - Measuring the Suppression of the First and Second Harmonic of an Input Signal
- Measuring Signal Spectra with Multiple Signals
 - Separating Signals by Selecting the Resolution Bandwidth
 - Measuring the Modulation Depth of an AM-Modulated Carrier (Span > 0)
 - Measuring of AM-Modulated Signals
- Measurements with Zero Span
 - Measuring the Power Characteristic of Burst Signals
 - Measuring the Signal-to-Noise Ratio of Burst Signals
 - Measurement of FM-Modulated Signals
- Storing and Loading Instrument Settings
 - Storing an Instrument Configuration (without Traces)
 - Storing Traces
 - Loading an Instrument Configuration (with Traces)
 - Configuring Automatic Loading

Test Setup

All of the following examples are based on the standard settings of the analyzer. These are set with the **PRESET** key. A complete listing of the standard settings can be found in chapter "Instrument Functions", section "Initializing the Configuration – PRESET Key".

In the following examples, a signal generator is used as a signal source. The RF output of the signal generator is connected to the RF input of R&S FSL.

If a 65 MHz signal is required for the test setup, as an alternative to the signal generator, the internal 65 MHz reference generator can be used:

1. Switch on the internal reference generator.
 - Press the **SETUP** key.
 - Press the **Service** softkey.
 - Press the **Input RF/Cal/TG** softkey, until **Cal** is highlighted.
The internal 65 MHz reference generator is now on. The R&S FSL's RF input is switched off.
2. Switch on the RF input again for normal operation of the analyzer. Two ways are possible:
 - Press the **PRESET** key
 - Press the **SETUP** key.
 - Press the **Service** softkey.
 - Press the **Input RF/Cal/TG** softkey, until **RF** is highlighted.
The internal signal path of the R&S FSL is switched back to the RF input in order to resume normal operation.

Measurement of Harmonics

Measuring the harmonics of a signal is a frequent problem which can be solved best by means of a spectrum analyzer. In general, every signal contains harmonics which are larger than others. Harmonics are particularly critical regarding high-power transmitters such as transceivers because large harmonics can interfere with other radio services.

Harmonics are generated by nonlinear characteristics. They can often be reduced by lowpass filters. Since the spectrum analyzer has a nonlinear characteristic, e.g. in its first mixer, measures must be taken to ensure that harmonics produced in the analyzer do not cause spurious results. If necessary, the fundamental wave must be selectively attenuated with respect to the other harmonics with a highpass filter.

When harmonics are being measured, the obtainable dynamic range depends on the second harmonic intercept of the spectrum analyzer. The second harmonic intercept is the virtual input level at the RF input mixer at which the level of the 2nd harmonic becomes equal to the level of the fundamental wave. In practice, however, applying a level of this magnitude would damage the mixer. Nevertheless the available dynamic range for measuring the harmonic distance of a DUT can be calculated relatively easily using the second harmonic intercept.

As shown in Fig. 2-1, the level of the 2nd harmonic drops by 20 dB if the level of the fundamental wave is reduced by 10 dB.

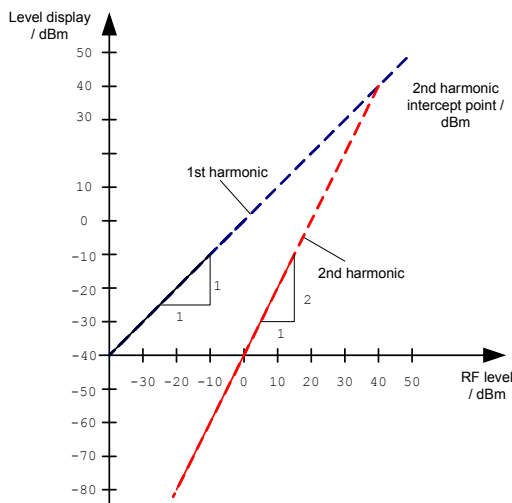

Fig. 2-1 Extrapolation of the 1st and 2nd harmonics to the 2nd harmonic intercept at 40 dBm

The following formula for the obtainable harmonic distortion d_2 in dB is derived from the straight-line equations and the given intercept point:

$$d_2 = S.H.I - P_1 \quad (1)$$

d_2 = harmonic distortion

P_1 = mixer level/dBm

S.H.I. = second harmonic intercept

Note: The mixer level is the RF level applied to the RF input minus the set RF attenuation.

The formula for the internally generated level P_1 at the 2nd harmonic in dBm is:

$$P_1 = 2 \cdot P_I - S.H.I. (2)$$

The lower measurement limit for the harmonic is the noise floor of the spectrum analyzer. The harmonic of the measured DUT should – if sufficiently averaged by means of a video filter – be at least 4 dB above the noise floor so that the measurement error due to the input noise is less than 1 dB.

The following rules for measuring high harmonic ratios can be derived:

- Select the smallest possible IF bandwidth for a minimal noise floor.
- Select an RF attenuation which is high enough to just measure the harmonic ratio.

The maximum harmonic distortion is obtained if the level of the harmonic equals the intrinsic noise level of the receiver. The level applied to the mixer, according to (2), is:

$$P_1 = \frac{P_{noise} \text{ dBm} + IP2}{2} \quad (3)$$

At a resolution bandwidth of 10 Hz (noise level –143 dBm, S.H.I. = 40 dBm), the optimum mixer level is – 51.5 dBm. According to (1) a maximum measurable harmonic distortion of 91.5 dB minus a minimum S/N ratio of 4 dB is obtained.

Note: *If the harmonic emerges from noise sufficiently (approx. >15 dB), it is easy to check (by changing the RF attenuation) whether the harmonics originate from the DUT or are generated internally by the spectrum analyzer. If a harmonic originates from the DUT, its level remains constant if the RF attenuation is increased by 10 dB. Only the displayed noise is increased by 10 dB due to the additional attenuation. If the harmonic is exclusively generated by the spectrum analyzer, the level of the harmonic is reduced by 20 dB or is lost in noise. If both – the DUT and the spectrum analyzer – contribute to the harmonic, the reduction in the harmonic level is correspondingly smaller.*

High–Sensitivity Harmonics Measurements

If harmonics have very small levels, the resolution bandwidth required to measure them must be reduced considerably. The sweep time is, therefore, also increased considerably. In this case, the measurement of individual harmonics is carried out with the spectrum analyzer set to a small span. Only the frequency range around the harmonics will then be measured with a small resolution bandwidth.

Signal generator settings (e.g. R&S SMU):

Frequency: 128 MHz

Level: – 25 dBm

Procedure:

1. Set the spectrum analyzer to its default state.
 - Press the **PRESET** key.
The R&S FSL is set to its default state.
2. Set the center frequency to 128 MHz and the span to 100 kHz.
 - Press the **FREQ** key.
The frequency menu is displayed.
 - In the dialog box, enter *128* using the numeric keypad and confirm with the **MHz** key.
 - Press the **SPAN** key.
 - In the dialog box, enter *100* using the numeric keypad and confirm with the **kHz** key.
The R&S FSL displays the reference signal with a span of 100 kHz and resolution bandwidth of 3 kHz.
3. Switching on the marker.
 - Press the **MKR** key.
The marker is positioned on the trace maximum.
4. Set the measured signal frequency and the measured level as reference values
 - Press the Phase Noise/Ref Fixed softkey.
The position of the marker becomes the reference point. The reference point level is indicated by a horizontal line, the reference point frequency with a vertical line. At the same time, the delta marker 2 is switched on.
 - Press the **Ref Fixed** softkey.
The mode changes from phase noise measurement to reference fixed, the marker readout changes from dB/Hz to dB.

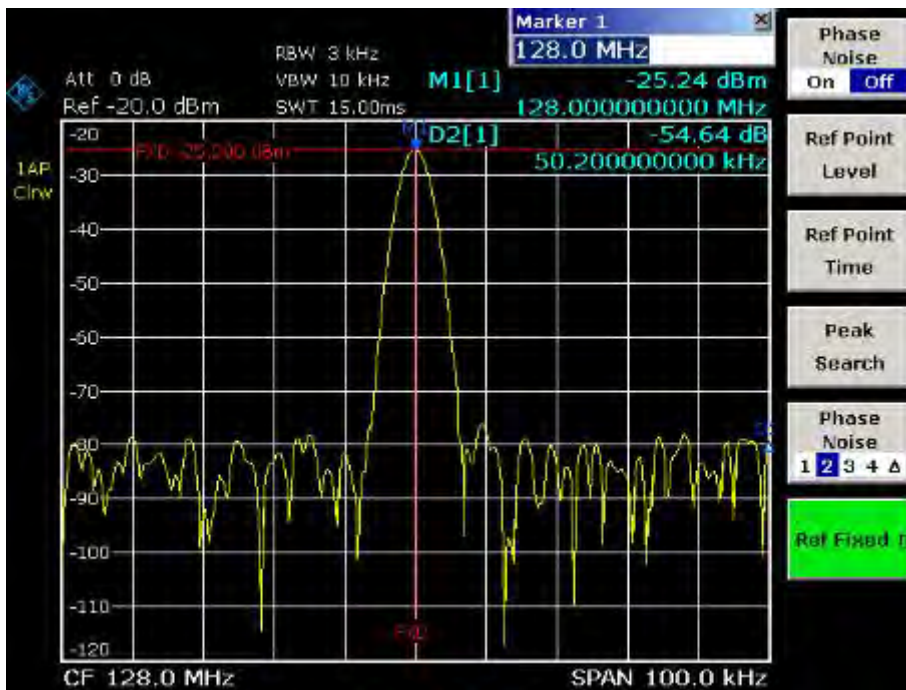

Fig. 2-2 Fundamental wave and the frequency and level reference point

5. Make the step size for the center frequency equal to the signal frequency
 - Press the **FREQ** key.
The frequency menu is displayed.
 - Press the **CF-Stepsize** softkey and press the = **Marker** softkey in the submenu.
The step size for the center frequency is now equal to the marker frequency.
6. Set the center frequency to the 2nd harmonic of the signal
 - Press the **FREQ** key.
The frequency menu is displayed.
 - Press the **UPARROW** key once.
The center frequency is set to the 2nd harmonic.
7. Place the delta marker on the 2nd harmonic.
 - Press the **MKR→** key.
 - Press the **Peak** softkey.
The delta marker moves to the maximum of the 2nd harmonic. The displayed level result is relative to the reference point level (= fundamental wave level).

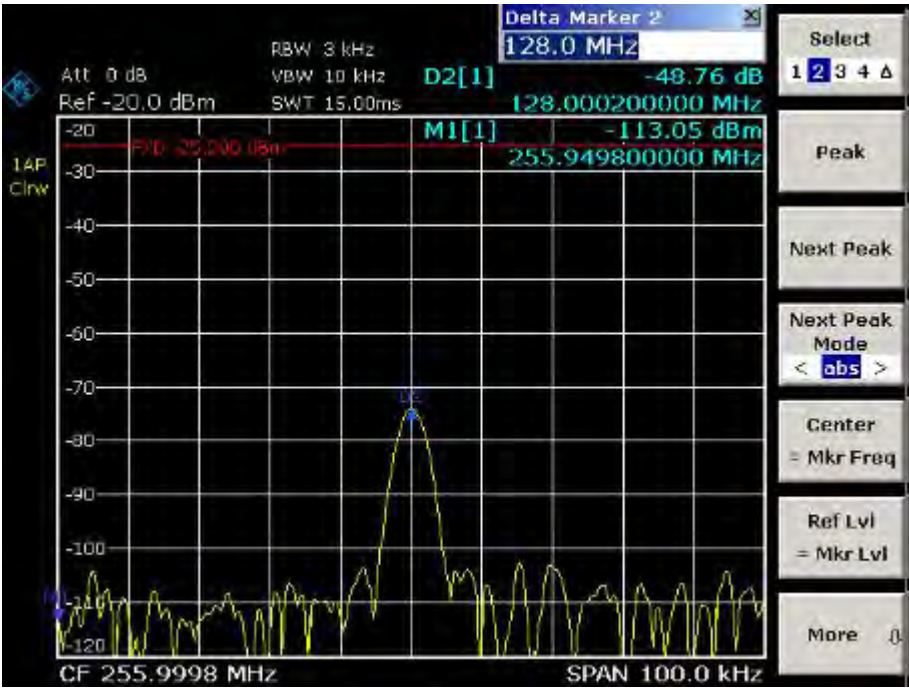

Fig. 2-3 Measuring the level difference between the fundamental wave (= reference point level) and the 2nd harmonic

The other harmonics are measured with steps 5 and 6, the center frequency being incremented or decremented in steps of 128 MHz using the **UPARROW** or **DNARROW** key.

Measuring the Spectra of Complex Signals

Separating Signals by Selecting an Appropriate Resolution Bandwidth

A basic feature of a spectrum analyzer is being able to separate the spectral components of a mixture of signals. The resolution at which the individual components can be separated is determined by the resolution bandwidth. Selecting a resolution bandwidth that is too large may make it impossible to distinguish between spectral components, i.e. they are displayed as a single component.

An RF sinusoidal signal is displayed by means of the passband characteristic of the resolution filter (RBW) that has been set. Its specified bandwidth is the 3 dB bandwidth of the filter.

Two signals with the same amplitude can be resolved if the resolution bandwidth is smaller than or equal to the frequency spacing of the signal. If the resolution bandwidth is equal to the frequency spacing, the spectrum display screen shows a level drop of 3 dB precisely in the center of the two signals. Decreasing the resolution bandwidth makes the level drop larger, which thus makes the individual signals clearer.

If there are large level differences between signals, the resolution is determined by selectivity as well as by the resolution bandwidth that has been selected. The measure of selectivity used for spectrum analyzers is the ratio of the 60 dB bandwidth to the 3 dB bandwidth (= shape factor).

For the R&S FSL, the shape factor for bandwidths is < 5, i.e. the 60 dB bandwidth of the 30 kHz filter is < 150 kHz.

The higher spectral resolution with smaller bandwidths is won by longer sweep times for the same span. The sweep time has to allow the resolution filters to settle during a sweep at all signal levels and frequencies to be displayed. It is given by the following formula.

$$SWT = k \cdot \text{Span}/RBW^2 \quad (1)$$

- SWT = max. sweep time for correct measurement
- k = factor depending on type of resolution filter
= 1 for digital IF filters
- Span = frequency display range
- RBW = resolution bandwidth

If the resolution bandwidth is reduced by a factor of 3, the sweep time is increased by a factor of 9.

Note: *The impact of the video bandwidth on the sweep time is not taken into account in (1). For the formula to be applied, the video bandwidth must be $\geq 3 \times$ the resolution bandwidth.*

FFT filters can be used for resolution bandwidths up to 30 kHz. Like digital filters, they have a shape factor of less than 5 up to 30 kHz. For FFT filters, however, the sweep time is given by the following formula:

$$SWT = k \cdot \text{span}/RBW \quad (2)$$

If the resolution bandwidth is reduced by a factor of 3, the sweep time is increased by a factor of 3 only.

Intermodulation Measurements

If several signals are applied to a transmission two-port device with nonlinear characteristic, intermodulation products appear at its output by the sums and differences of the signals. The nonlinear characteristic produces harmonics of the useful signals which intermodulate at the characteristic. The intermodulation products of lower order have a special effect since their level is largest and they are near the useful signals. The intermodulation product of third order causes the highest interference. It is the intermodulation product generated from one of the useful signals and the 2nd harmonic of the second useful signal in case of two-tone modulation.

The frequencies of the intermodulation products are above and below the useful signals. Fig. 2-4 shows intermodulation products P_{I1} and P_{I2} generated by the two useful signals P_{U1} and P_{U2} .

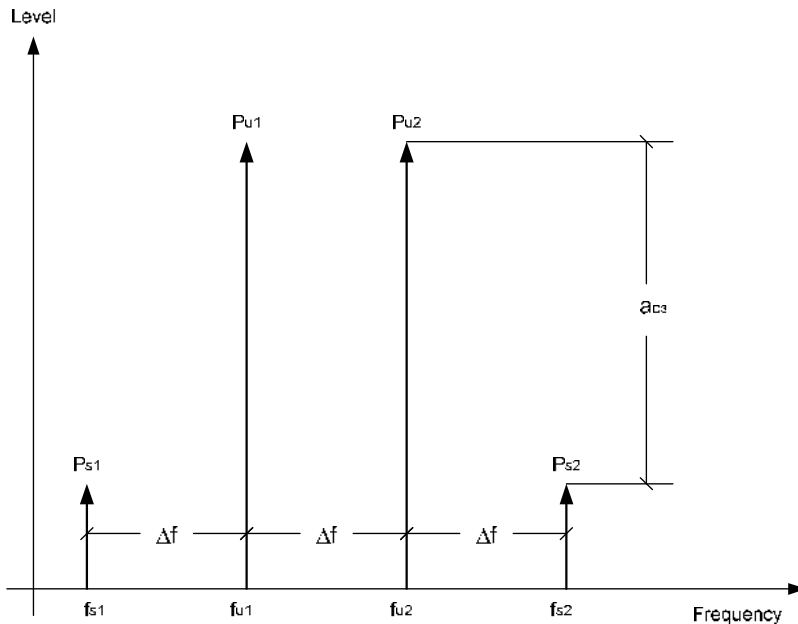

Fig. 2-4 Intermodulation products P_{U1} and P_{U2}

The intermodulation product at f_{i2} is generated by mixing the 2nd harmonic of useful signal P_{U2} and signal P_{U1} , the intermodulation product at f_{i1} by mixing the 2nd harmonic of useful signal P_{U1} and signal P_{U2} .

$$f_{i1} = 2 \times f_{u1} - f_{u2} \quad (1)$$

$$f_{i2} = 2 \times f_{u2} - f_{u1} \quad (2)$$

The level of the intermodulation products depends on the level of the useful signals. If the two useful signals are increased by 1 dB, the level of the intermodulation products increases by 3 dB, which means that spacing a_{D3} between intermodulation signals and useful signals are reduced by 2 dB. This is illustrated in Fig. 2-5.

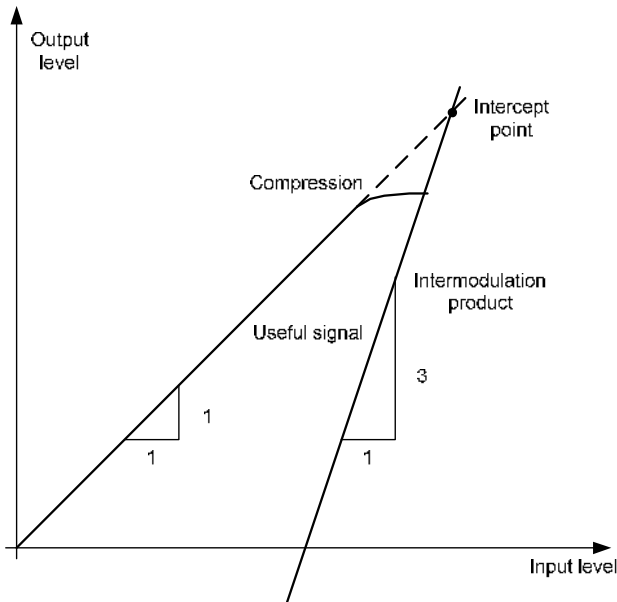

Fig. 2–5 Dependence of intermodulation level on useful signal level

The useful signals at the two–port output increase proportionally with the input level as long as the two–port is in the linear range. A level change of 1 dB at the input causes a level change of 1 dB at the output. Beyond a certain input level, the two–port goes into compression and the output level stops increasing. The intermodulation products of the third order increase three times as much as the useful signals. The intercept point is the fictitious level where the two lines intersect. It cannot be measured directly since the useful level is previously limited by the maximum two–port output power.

It can be calculated from the known line slopes and the measured spacing a_{D3} at a given level according to the following formula.

$$IP3 = \frac{a_{D3}}{2} + P_N \quad (3)$$

The 3rd order intercept point (TOI), for example, is calculated for an intermodulation of 60 dB and an input level P_U of –20 dBm according to the following formula:

$$IP3 = \frac{60}{2} + (-20dBm) = 10dBm \quad (4)$$

Measurement example – Measuring the R&S FSL's intrinsic intermodulation

Test setup:

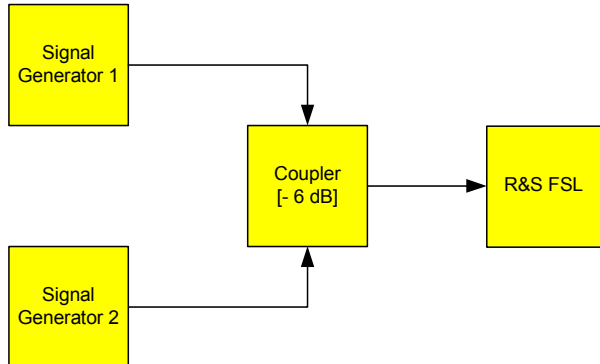

Signal generator settings (e.g. R&S SMU):

	Level	Frequency
Signal generator 1	-4 dBm	999.7 MHz
Signal generator 2	-4 dBm	1000.3 MHz

Procedure:

1. Set the spectrum analyzer to its default settings.
 - Press the **PRESET** key.
 - The R&S FSL is in its default state.
2. Set center frequency to 1 GHz and the frequency span to 3 MHz.
 - Press the **FREQ** key and enter *1 GHz*.
 - Press the **SPAN** key and enter *3 MHz*.
3. Set the reference level to -10 dBm and RF attenuation to 0 dB.
 - Press the **AMPT** key and enter *-10 dBm*.
 - Press the **RF Atten Manual** softkey and enter *0 dB*.
4. Set the resolution bandwidth to 10 kHz.
 - Press the **BW** key.
 - Press the **Res BW Manual** softkey and enter *10 kHz*.
 - The noise is reduced, the trace is smoothed further and the intermodulation products can be clearly seen.
 - Press the **Video BW Manual** softkey and enter *1 kHz*.
5. Measuring intermodulation by means of the 3rd order intercept measurement function
 - Press the **MEAS** key.
 - Press the **TOI** softkey.

The R&S FSL activates four markers for measuring the intermodulation distance. Two markers are positioned on the useful signals and two on the intermodulation products. The 3rd order intercept is calculated from the level difference between the useful signals and the intermodulation products. It is then displayed on the screen:

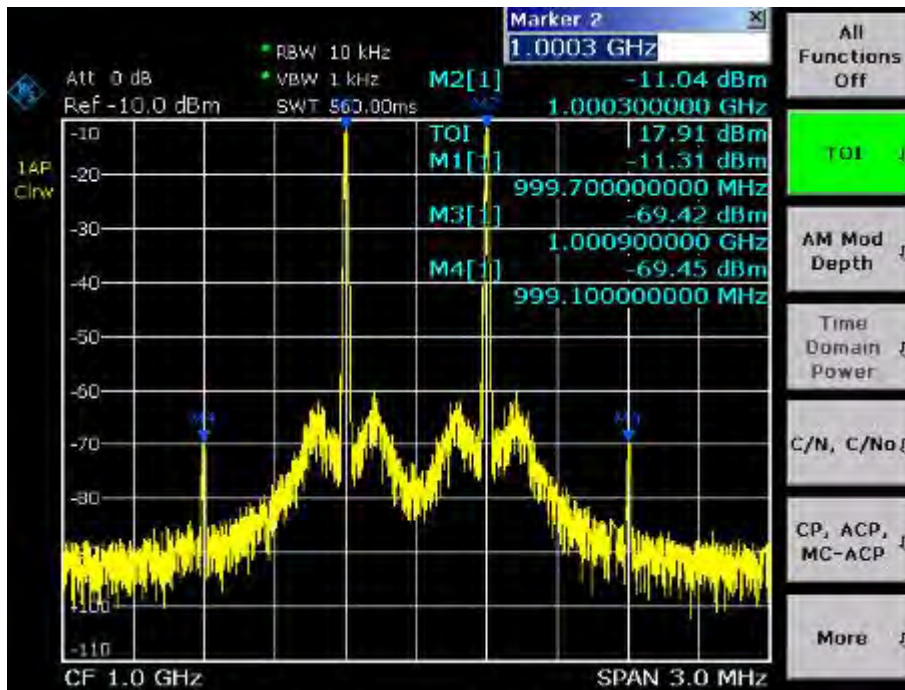

Fig. 2-6 Result of intrinsic intermodulation measurement on the R&S FSL. The 3rd order intercept (TOI) is displayed at the top right corner of the grid.

The level of a spectrum analyzer's intrinsic intermodulation products depends on the RF level of the useful signals at the input mixer. When the RF attenuation is added, the mixer level is reduced and the intermodulation distance is increased. With an additional RF attenuation of 10 dB, the levels of the intermodulation products are reduced by 20 dB. The noise level is, however, increased by 10 dB.

6. Increasing RF attenuation to 10 dB to reduce intermodulation products.
 - Press the **AMPT** key.
 - Press the **RF Atten Manual** softkey and enter *10 dB*.

The R&S FSL's intrinsic intermodulation products disappear below the noise floor.

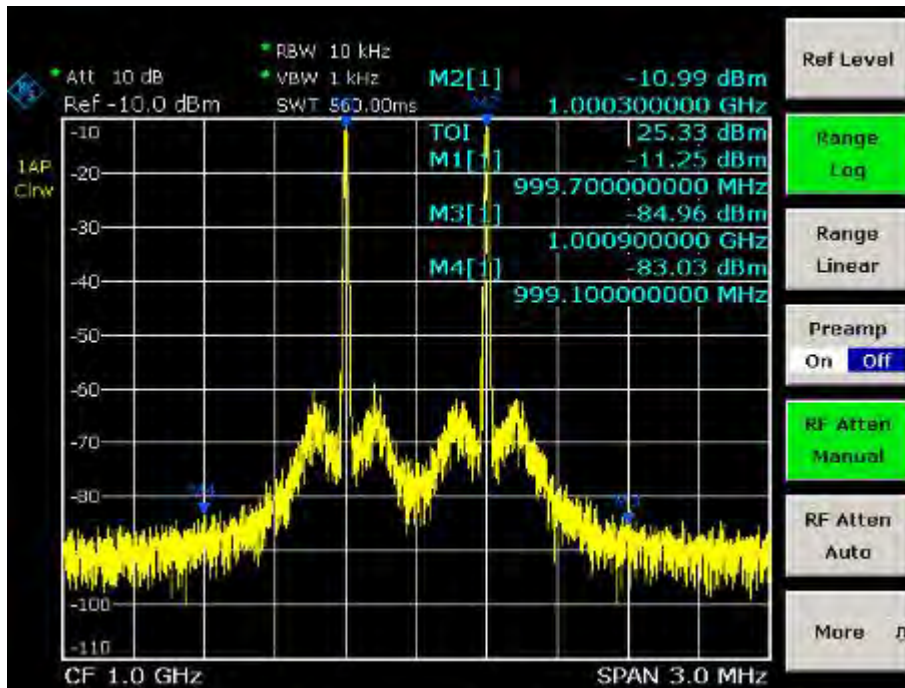

Fig. 2–7 If the RF attenuation is increased, the R&S FSL's intrinsic intermodulation products disappear below the noise floor.

Calculation method:

The method used by the R&S FSL to calculate the intercept point takes the average useful signal level P_u in dBm and calculates the intermodulation d_3 in dB as a function of the average value of the levels of the two intermodulation products. The third order intercept (TOI) is then calculated as follows:

$$TOI/dBm = \frac{1}{2} d_3 + P_u$$

Intermodulation– free dynamic range

The **Intermodulation – free dynamic range**, i.e. the level range in which no internal intermodulation products are generated if two–tone signals are measured, is determined by the 3rd order intercept point, the phase noise and the thermal noise of the spectrum analyzer. At high signal levels, the range is determined by intermodulation products. At low signal levels, intermodulation products disappear below the noise floor, i.e. the noise floor and the phase noise of the spectrum analyzer determine the range. The noise floor and the phase noise depend on the resolution bandwidth that has been selected. At the smallest resolution bandwidth, the noise floor and phase noise are at a minimum and so the maximum range is obtained. However, a large increase in sweep time is required for small resolution bandwidths. It is, therefore, best to select the largest resolution bandwidth possible to obtain the range that is required. Since phase noise decreases as the carrier–offset increases, its influence decreases with increasing frequency offset from the useful signals.

The following diagrams illustrate the intermodulation–free dynamic range as a function of the selected bandwidth and of the level at the input mixer (= signal level – set RF attenuation) at different useful signal offsets.

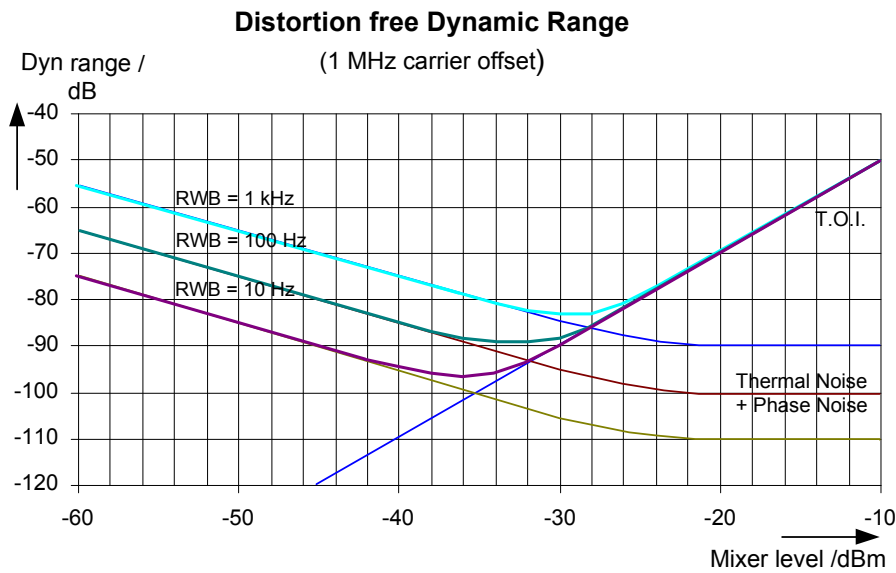

Fig. 2–8 Intermodulation–free range of the R&S FSL as a function of level at the input mixer and the set resolution bandwidth (useful signal offset = 1 MHz, DANL = –145 dBm /Hz, TOI = 15 dBm; typical values at 2 GHz)

The optimum mixer level, i.e. the level at which the intermodulation distance is at its maximum, depends on the bandwidth. At a resolution bandwidth of 10 Hz, it is approx. –35 dBm and at 1 kHz increases to approx. –30 dBm.

Phase noise has a considerable influence on the intermodulation–free range at carrier offsets between 10 and 100 kHz (Fig. 2–9). At greater bandwidths, the influence of the phase noise is greater than it would be with small bandwidths. The optimum mixer level at the bandwidths under consideration becomes almost independent of bandwidth and is approx. –40 dBm.

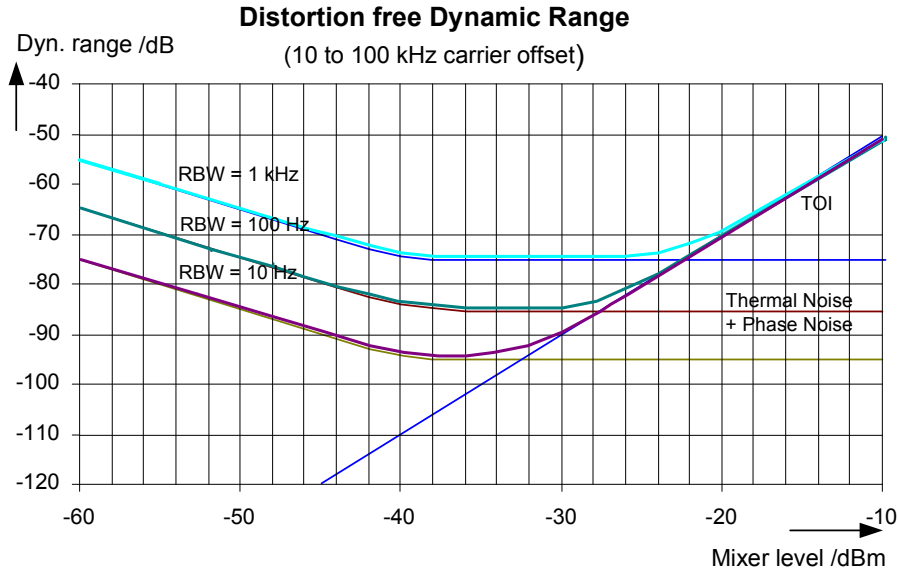

Fig. 2-9 Intermodulation-free dynamic range of the R&S FSL as a function of level at the input mixer and of the selected resolution bandwidth (useful signal offset = 10 to 100 kHz, DANL = -145 dBm /Hz, TOI = 15 dBm; typical values at 2 GHz).

Note: If the intermodulation products of a DUT with a very high dynamic range are to be measured and the resolution bandwidth to be used is therefore very small, it is best to measure the levels of the useful signals and those of the intermodulation products separately using a small span. The measurement time will be reduced— in particular if the offset of the useful signals is large. To find signals reliably when frequency span is small, it is best to synchronize the signal sources and the R&S FSL.

Measuring Signals in the Vicinity of Noise

The minimum signal level a spectrum analyzer can measure is limited by its intrinsic noise. Small signals can be swamped by noise and therefore cannot be measured. For signals that are just above the intrinsic noise, the accuracy of the level measurement is influenced by the intrinsic noise of the spectrum analyzer.

The displayed noise level of a spectrum analyzer depends on its noise figure, the selected RF attenuation, the selected reference level, the selected resolution and video bandwidth and the detector. The effect of the different parameters is explained in the following.

Impact of the RF attenuation setting

The sensitivity of a spectrum analyzer is directly influenced by the selected RF attenuation. The highest sensitivity is obtained at a RF attenuation of 0 dB. The attenuation can be set in 10 dB steps up to 70 dB. Each additional 10 dB step reduces the sensitivity by 10 dB, i.e. the displayed noise is increased by 10 dB.

Impact of the resolution bandwidth

The sensitivity of a spectrum analyzer also directly depends on the selected bandwidth. The highest sensitivity is obtained at the smallest bandwidth (for the R&S FSL: 10 Hz, for FFT filtering: 1 Hz). If the bandwidth is increased, the reduction in sensitivity is proportional to the change in bandwidth. The R&S FSL has bandwidth settings in 1, 3, 10 sequence. Increasing the bandwidth by a factor of 3 increases the displayed noise by approx. 5 dB (4.77 dB precisely). If the bandwidth is increased by a factor of 10, the displayed noise increases by a factor of 10, i.e. 10 dB.

Impact of the video bandwidth

The displayed noise of a spectrum analyzer is also influenced by the selected video bandwidth. If the video bandwidth is considerably smaller than the resolution bandwidth, noise spikes are suppressed, i.e. the trace becomes much smoother. The level of a sinewave signal is not influenced by the video bandwidth. A sinewave signal can therefore be freed from noise by using a video bandwidth that is small compared with the resolution bandwidth, and thus be measured more accurately.

Impact of the detector

Noise is evaluated differently by the different detectors. The noise display is therefore influenced by the choice of detector. Sinewave signals are weighted in the same way by all detectors, i.e. the level display for a sinewave RF signal does not depend on the selected detector, provided that the signal-to-noise ratio is high enough. The measurement accuracy for signals in the vicinity of intrinsic spectrum analyzer noise is also influenced by the detector which has been selected. For details on the detectors of the R&S FSL refer to chapter "Instrument Functions", section "Detector overview" or the Online Help.

Measurement example – Measuring level at low S/N ratios

The example shows the different factors influencing the S/N ratio.

Signal generator settings (e.g. R&S SMU):

Frequency: 128 MHz

Level: – 80 dBm

1. Set the spectrum analyzer to its default state.
 - Press the **PRESET** key.
 - The R&S FSL is in its default state.
2. Set the center frequency to 128 MHz and the frequency span to 100 MHz.
 - Press the **FREQ** key and enter *128 MHz*.
 - Press the **SPAN** key and enter *100 MHz*.
3. Set the RF attenuation to 60 dB to attenuate the input signal or to increase the intrinsic noise.
 - Press the **AMPT** key.
 - Press the **RF Atten Manual** softkey and enter *60 dB*.

The RF attenuation indicator is marked with an asterisk (*Att 60 dB) to show that it is no longer coupled to the reference level. The high input attenuation reduces the reference signal which can no longer be detected in noise.

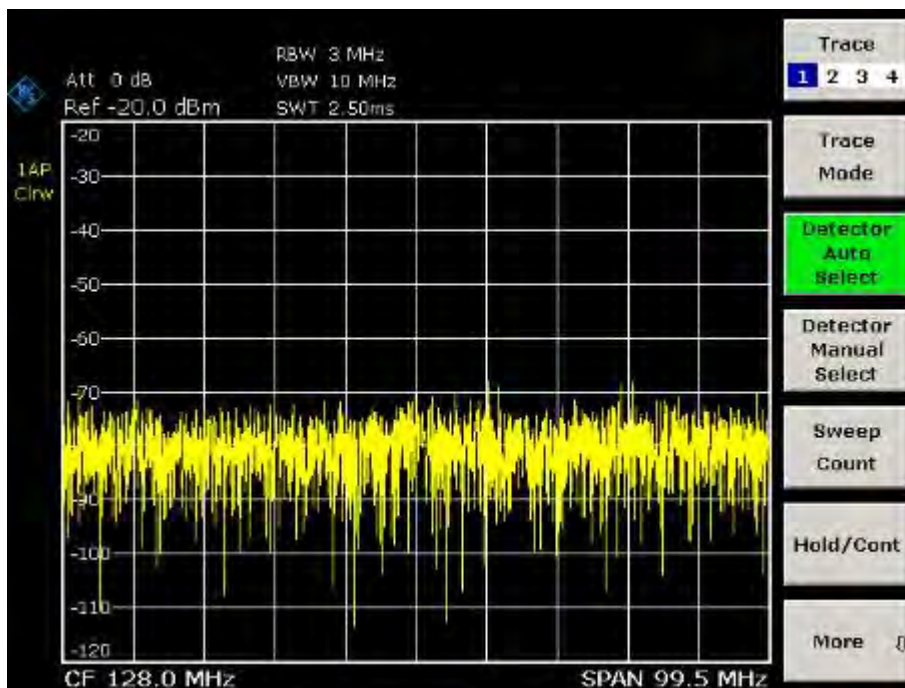

Fig. 2–10 Sinewave signal with low S/N ratio. The signal is measured with the auto peak detector and is completely hidden in the intrinsic noise of the spectrum analyzer.

4. To suppress noise spikes the trace can be averaged.
 - Press the **TRACE** key.
 - Press the **Trace Mode** key.
 - In the **Trace Mode** dialog box, mark **Average** using the rotary knob or the arrow keys and confirm using the rotary knob or the **ENTER** key.

The traces of consecutive sweeps are averaged. To perform averaging, the R&S FSL automatically switches on the sample detector. The RF signal, therefore, can be more clearly distinguished from noise.

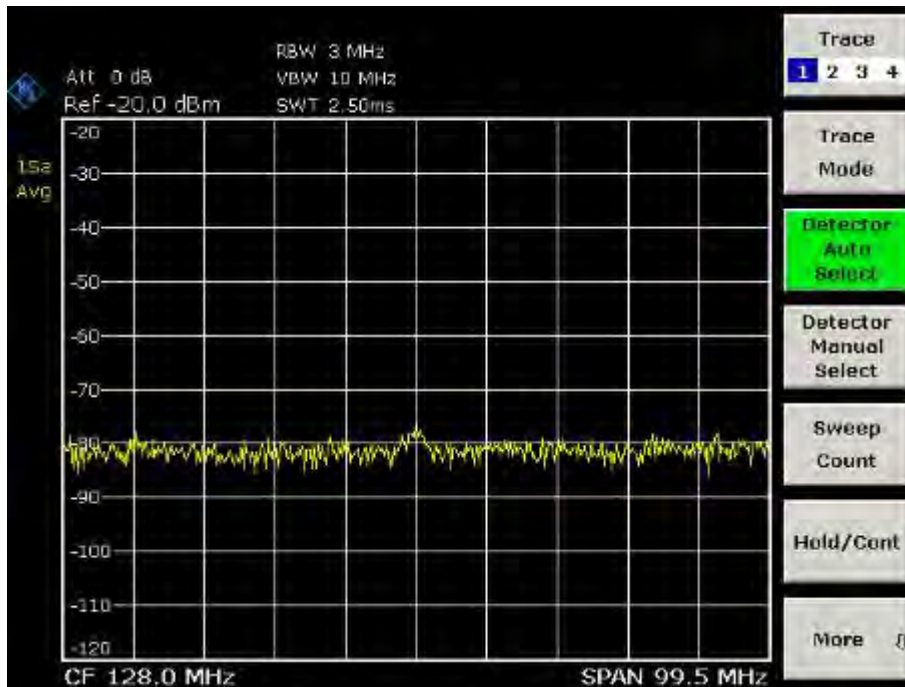

Fig. 2–11 RF sinewave signal with low S/N ratio if the trace is averaged.

5. Instead of trace averaging, a video filter that is narrower than the resolution bandwidth can be selected.
 - Press the **Trace Mode** key.
 - In the **Trace Mode** dialog box, mark **Clear Write** using the rotary knob or the arrow keys and confirm using the rotary knob or the **ENTER** key.
 - Press the **BW** key.
 - Press the **Video BW Manual** softkey and enter *10 kHz*.

The RF signal can be more clearly distinguished from noise.

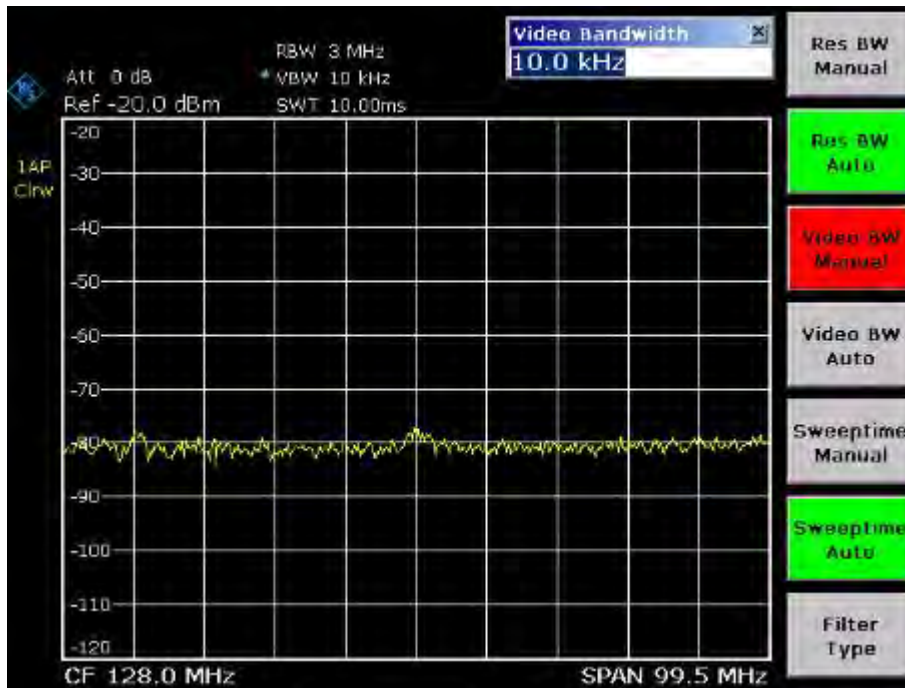

Fig. 2–12 RF sinewave signal with low S/N ratio if a smaller video bandwidth is selected.

6. By reducing the resolution bandwidth by a factor of 10, the noise is reduced by 10 dB.
 - Press the **Res BW Manual** softkey and enter *300 kHz*.

The displayed noise is reduced by approx. 10 dB. The signal, therefore, emerges from noise by about 10 dB. Compared to the previous setting, the video bandwidth has remained the same, i.e. it has increased relative to the smaller resolution bandwidth. The averaging effect of the video bandwidth is therefore reduced. The trace will be noisier.

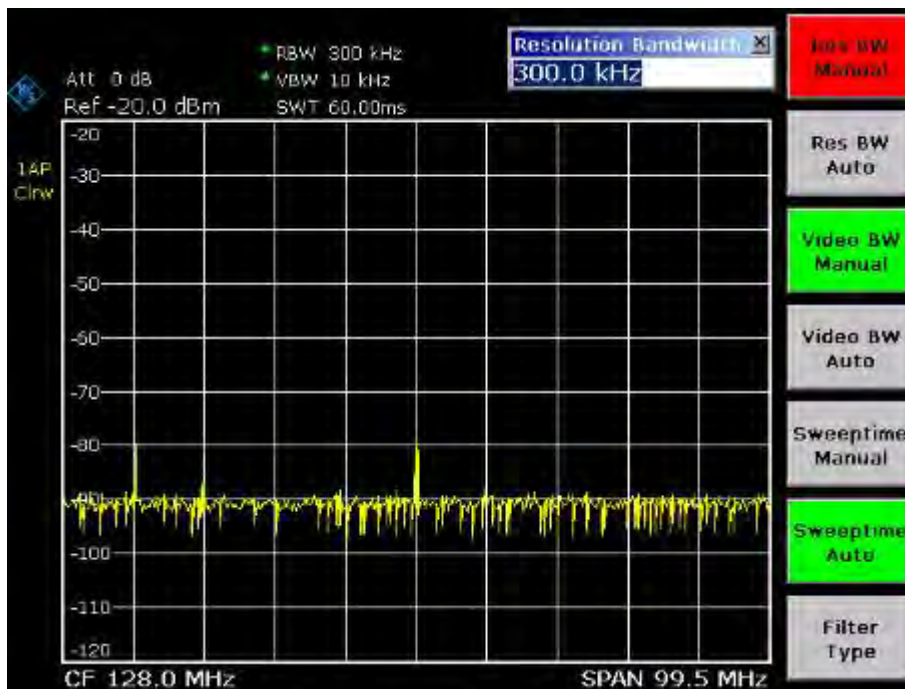

Fig. 2–13 Reference signal at a smaller resolution bandwidth

Noise Measurements

Noise measurements play an important role in spectrum analysis. Noise e.g. affects the sensitivity of radio communication systems and their components.

Noise power is specified either as the total power in the transmission channel or as the power referred to a bandwidth of 1 Hz. The sources of noise are, for example, amplifier noise or noise generated by oscillators used for the frequency conversion of useful signals in receivers or transmitters. The noise at the output of an amplifier is determined by its noise figure and gain.

The noise of an oscillator is determined by phase noise near the oscillator frequency and by thermal noise of the active elements far from the oscillator frequency. Phase noise can mask weak signals near the oscillator frequency and make them impossible to detect.

Measuring Noise Power Density

To measure noise power referred to a bandwidth of 1 Hz at a certain frequency, the R&S FSL provides marker function. This marker function calculates the noise power density from the measured marker level.

Measurement example – Measuring the intrinsic noise power density of the R&S FSL at 1 GHz and calculating the R&S FSL's noise figure

Test setup:

No signal connected to the RF input; RF input terminated with 50 Ω .

1. Set the spectrum analyzer to its default state.
 - Press the **PRESET** key.
The R&S FSL is in its default state.
2. Set the center frequency to 1.234 GHz and the span to 1 MHz.
 - Press the **FREQ** key and enter *1.234 GHz*.
 - Press the **SPAN** key and enter *1 MHz*.
3. Switch on the marker and set the marker frequency to 1.234 GHz.
 - Press the **MKR** key and enter *1.234 GHz*.
4. Switch on the noise marker function.
 - Switch on the **Noise Meas** softkey.
The R&S FSL displays the noise power at 1 GHz in dBm (1Hz).

Note: <i>Since noise is random, a sufficiently long measurement time has to be selected to obtain stable measurement results. This can be achieved by averaging the trace or by selecting a very small video bandwidth relative to the resolution bandwidth.</i>

5. The measurement result is stabilized by averaging the trace.
 - Press the **TRACE** key.
 - Press the **Trace Mode** key.
 - In the **Trace Mode** dialog box, mark **Average** using the rotary knob or the arrow keys and confirm pressing the rotary knob or the **ENTER** key.

The R&S FSL performs sliding averaging over 10 traces from consecutive sweeps. The measurement result becomes more stable.

Conversion to other reference bandwidths

The result of the noise measurement can be referred to other bandwidths by simple conversion. This is done by adding $10 \cdot \log(\text{BW})$ to the measurement result, BW being the new reference bandwidth.

Example

A noise power of -150 dBm (1 Hz) is to be referred to a bandwidth of 1 kHz.

$$P_{[1\text{kHz}]} = -150 + 10 \cdot \log(1000) = -150 + 30 = -120 \text{ dBm (1 kHz)}$$

Calculation method for noise power

If the noise marker is switched on, the R&S FSL automatically activates the sample detector. The video bandwidth is set to 1/10 of the selected resolution bandwidth (RBW).

To calculate the noise, the R&S FSL takes an average over 17 adjacent pixels (the pixel on which the marker is positioned and 8 pixels to the left, 8 pixels to the right of the marker). The measurement result is stabilized by video filtering and averaging over 17 pixels.

Since both video filtering and averaging over 17 trace points is performed in the log display mode, the result would be 2.51 dB too low (difference between logarithmic noise average and noise power). The R&S FSL, therefore, corrects the noise figure by 2.51 dB.

To standardize the measurement result to a bandwidth of 1 Hz, the result is also corrected by $-10 \cdot \log(\text{RBW}_{\text{noise}})$, with $\text{RBW}_{\text{noise}}$ being the power bandwidth of the selected resolution filter (RBW).

Detector selection

The noise power density is measured in the default setting with the sample detector and using averaging. Other detectors that can be used to perform a measurement giving true results are the average detector or the RMS detector. If the average detector is used, the linear video voltage is averaged and displayed as a pixel. If the RMS detector is used, the squared video voltage is averaged and displayed as a pixel. The averaging time depends on the selected sweep time ($=\text{SWT}/501$). An increase in the sweep time gives a longer averaging time per pixel and thus stabilizes the measurement result. The R&S FSL automatically corrects the measurement result of the noise marker display depending on the selected detector (+1.05 dB for the average detector, 0 dB for the RMS detector). It is assumed that the video bandwidth is set to at least three times the resolution bandwidth. While the average or RMS detector is being switched on, the R&S FSL sets the video bandwidth to a suitable value.

The Pos Peak, Neg Peak, Auto Peak and Quasi Peak detectors are not suitable for measuring noise power density.

Determining the noise figure

The noise figure of amplifiers or of the R&S FSL alone can be obtained from the noise power display. Based on the known thermal noise power of a 50 Ω resistor at room temperature (−174 dBm (1Hz)) and the measured noise power P_{noise} the noise figure (NF) is obtained as follows:

$$NF = P_{noise} + 174 - g,$$

where g = gain of DUT in dB

Example

The measured internal noise power of the R&S FSL at an attenuation of 0 dB is found to be −143 dBm/1 Hz. The noise figure of the R&S FSL is obtained as follows

$$NF = -143 + 174 = 31 \text{ dB}$$

Note: If noise power is measured at the output of an amplifier, for example, the sum of the internal noise power and the noise power at the output of the DUT is measured. The noise power of the DUT can be obtained by subtracting the internal noise power from the total power (subtraction of linear noise powers). By means of the following diagram, the noise level of the DUT can be estimated from the level difference between the total and the internal noise level.

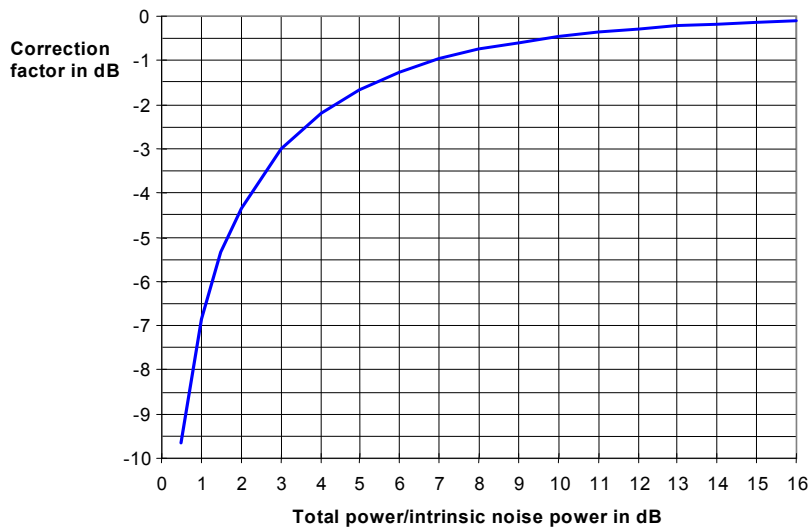

Fig. 2-14 Correction factor for measured noise power as a function of the ratio of total power to the intrinsic noise power of the spectrum analyzer

Measurement of Noise Power within a Transmission Channel

Noise in any bandwidth can be measured with the channel power measurement functions. Thus the noise power in a communication channel can be determined, for example. If the noise spectrum within the channel bandwidth is flat, the noise marker from the previous example can be used to determine the noise power in the channel by considering the channel bandwidth. If, however, phase noise and noise that normally increases towards the carrier is dominant in the channel to be measured, or if there are discrete spurious signals in the channel, the channel power measurement method must be used to obtain correct measurement results.

Measurement example – Measuring the intrinsic noise of the R&S FSL at 1 GHz in a 1.23 MHz channel bandwidth with the channel power function

Test setup:

The RF input of the R&S FSL remains open-circuited or is terminated with 50 Ω .

Procedure:

1. Set the spectrum analyzer to its default state.
 - Press the **PRESET** key.
The R&S FSL is in its default state.
2. Set the center frequency to 1 GHz and the span to 1 MHz.
 - Press the **FREQ** key and enter *1 GHz*.
 - Press the **SPAN** key and enter *2 MHz*.
3. To obtain maximum sensitivity, set RF attenuation on the R&S FSL to 0 dB.
 - Press the **AMPT** key.
 - Press the **RF Atten Manual** softkey and enter *0 dB*.
4. Switch on and configure the channel power measurement.
 - Press the **MEAS** key.
 - Press the **CP, ACP, MC-ACP** softkey.
The R&S FSL activates the channel or adjacent channel power measurement according to the currently set configuration.
 - Press the **CP/ACP Config** softkey.
The submenu for configuring the channel is displayed.
 - Press the **Channel Settings** softkey.
The submenu for channel settings is displayed.

- Press the **Channel Bandwidth** softkey and enter *1.23 MHz*.

The R&S FSL displays the 1.23 MHz channel as two vertical lines which are symmetrical to the center frequency.

- Press the **Adjust Settings** softkey.

The settings for the frequency span, the bandwidth (RBW and VBW) and the detector are automatically set to the optimum values required for the measurement.

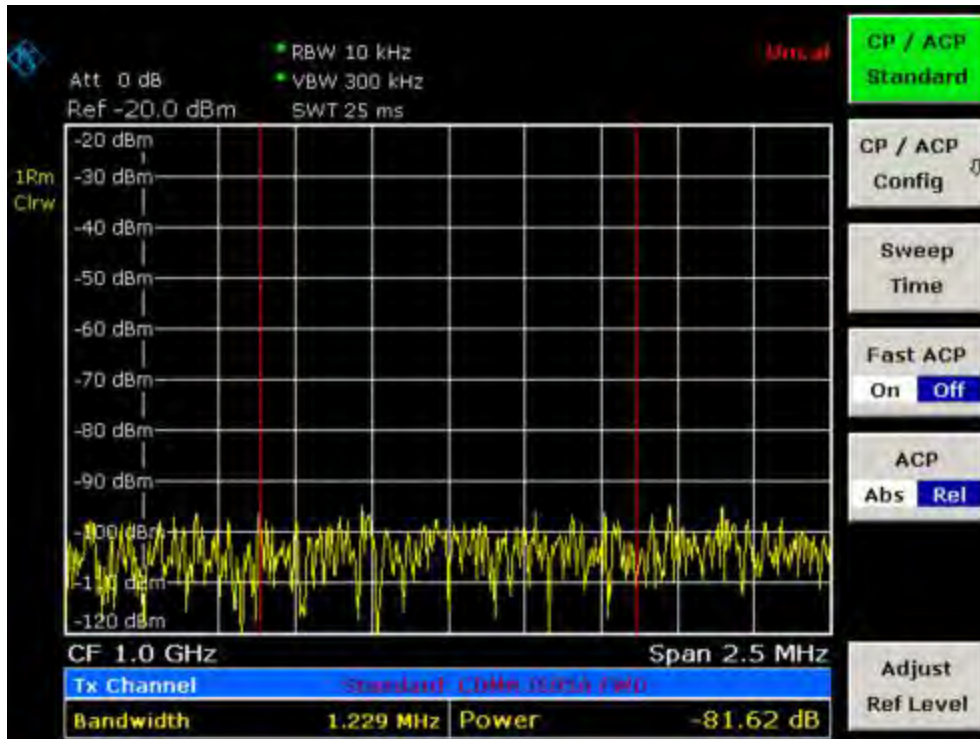

Fig. 2–15 Measurement of the R&S FSL's intrinsic noise power in a 1.23 MHz channel bandwidth.

5. Stabilizing the measurement result by increasing the sweep time

- Press the **▲** key twice.

The main menu for channel and adjacent channel power measurement is displayed.

- Press the **Sweep Time** softkey and enter *1 s*.

The trace becomes much smoother because of the RMS detector and the channel power measurement display is much more stable.

Method of calculating the channel power

When measuring the channel power, the R&S FSL integrates the linear power which corresponds to the levels of the pixels within the selected channel. The analyzer uses a resolution bandwidth which is far smaller than the channel bandwidth. When sweeping over the channel, the channel filter is formed by the passband characteristics of the resolution bandwidth (see Fig. 2-16).

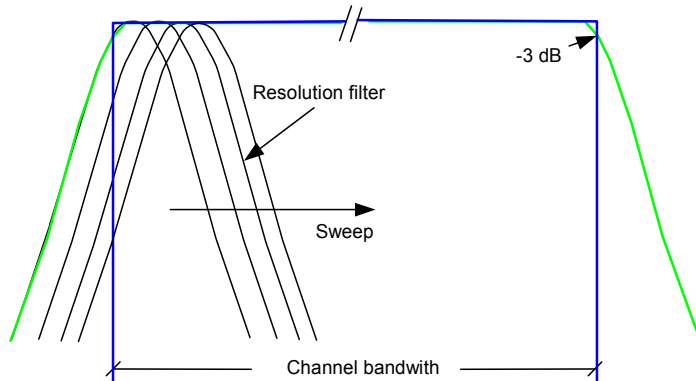

Fig. 2-16 Approximating the channel filter by sweeping with a small resolution bandwidth

The following steps are performed:

- The linear power of all the trace pixels within the channel is calculated.

$$P_i = 10^{(L_i/10)}$$

where P_i = power of the trace pixel i

L_i = displayed level of trace point i

- The powers of all trace pixels within the channel are summed up and the sum is divided by the number of trace pixels in the channel.
- The result is multiplied by the quotient of the selected channel bandwidth and the noise bandwidth of the resolution filter (RBW).

Since the power calculation is performed by integrating the trace within the channel bandwidth, this method is also called the IBW method (Integration Bandwidth method).

Parameter settings

For selection of the sweep time, see next section. For details on the parameter settings refer to chapter "Instrument Functions", section "Settings of the CP / ACP test parameters" or the Online Help.

Sweep time selection

The number of A/D converter values, N , used to calculate the power, is defined by the sweep time. The time per trace pixel for power measurements is directly proportional to the selected sweep time.

If the sample detector is used, it is best to select the smallest sweep time possible for a given span and resolution bandwidth. The minimum time is obtained if the setting is coupled. This means that the time per measurement is minimal. Extending the measurement time does not have any advantages as the number of samples for calculating the power is defined by the number of trace pixels in the channel.

If the RMS detector is used, the repeatability of the measurement results can be influenced by the selection of sweep times. Repeatability is increased at longer sweep times.

Repeatability can be estimated from the following diagram:

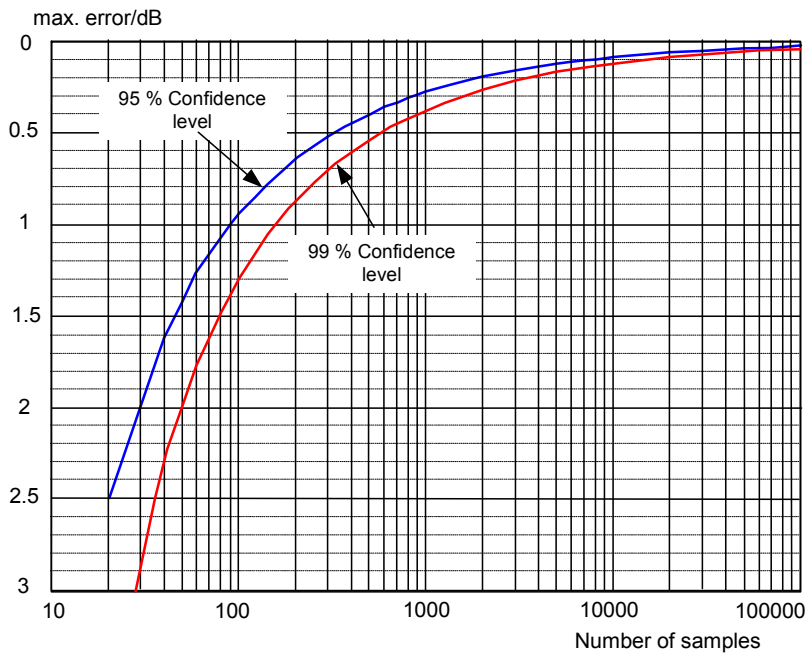

Fig. 2–17 Repeatability of channel power measurements as a function of the number of samples used for power calculation

The curves in Fig. 2–17 indicate the repeatability obtained with a probability of 95% and 99% depending on the number of samples used.

The repeatability with 600 samples is ± 0.5 dB. This means that – if the sample detector and a channel bandwidth over the whole diagram (channel bandwidth = span) is used – the measured value lies within ± 0.5 dB of the true value with a confidence level of 99%.

If the RMS detector is used, the number of samples can be estimated as follows:

Since only uncorrelated samples contribute to the RMS value, the number of samples can be calculated from the sweep time and the resolution bandwidth.

Samples can be assumed to be uncorrelated if sampling is performed at intervals of $1/RBW$. The number of uncorrelated samples is calculated as follows:

$$N_{decorr} = SWT \cdot RBW \text{ (} N_{decorr} \text{ means uncorrelated samples)}$$

The number of uncorrelated samples per trace pixel is obtained by dividing N_{decorr} by 501 (= pixels per trace).

Example

At a resolution bandwidth of 30 kHz and a sweep time of 100 ms, 3000 uncorrelated samples are obtained. If the channel bandwidth is equal to the frequency display range, i.e. all trace pixels are used for the channel power measurement, a repeatability of 0.2 dB with a probability of 99% is the estimate that can be derived from Fig. 2–17.

Measuring Phase Noise

The R&S FSL has an easy-to-use marker function for phase noise measurements. This marker function indicates the phase noise of an RF oscillator at any carrier in dBc in a bandwidth of 1 Hz.

Measurement example – Measuring the phase noise of a signal generator at a carrier offset of 10 kHz

Test setup:

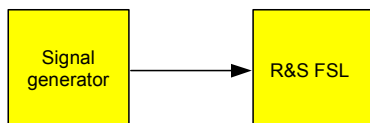

Signal generator settings (e.g. R&S SMU):

Frequency: 100 MHz

Level: 0 dBm

Procedure:

1. Set the spectrum analyzer to its default state.
 - Press the **PRESET** key.
R&S FSL is in its default state.
2. Set the center frequency to 100 MHz and the span to 50 kHz.
 - Press the **FREQ** key and enter *100 MHz*.
 - Press the **SPAN** key and enter *50 kHz*.
3. Set the R&S FSL's reference level to 0 dBm (=signal generator level).
 - Press the **AMPT** key and enter *0 dBm*.
4. Enable phase noise measurement.
 - Press the **MKR** key.
 - Press the Phase Noise/Ref Fixed softkey.

The R&S FSL activates phase noise measurement. Marker 1 (=main marker) and marker 2 (=delta marker) are positioned on the signal maximum. The position of the marker is the reference (level and frequency) for the phase noise measurement. A horizontal line represents the level of the reference point and a vertical line the frequency of the reference point. The dialog box for the delta marker is displayed so that the frequency offset at which the phase noise is to be measured can be entered directly.

5. Set the frequency offset to 10 kHz for determining phase noise.

- Enter *10 kHz*.

The R&S FSL displays the phase noise at a frequency offset of 10 kHz. The magnitude of the phase noise in dBc/Hz is displayed in the delta marker output field at the top right of the screen (Phn2).

6. Stabilize the measurement result by activating trace averaging.

- Press the **TRACE** key.
- Press the **Trace Mode** key.
- In the **Trace Mode** dialog box, mark **Average** using the rotary knob or the arrow keys and confirm using the rotary knob or the **ENTER** key.

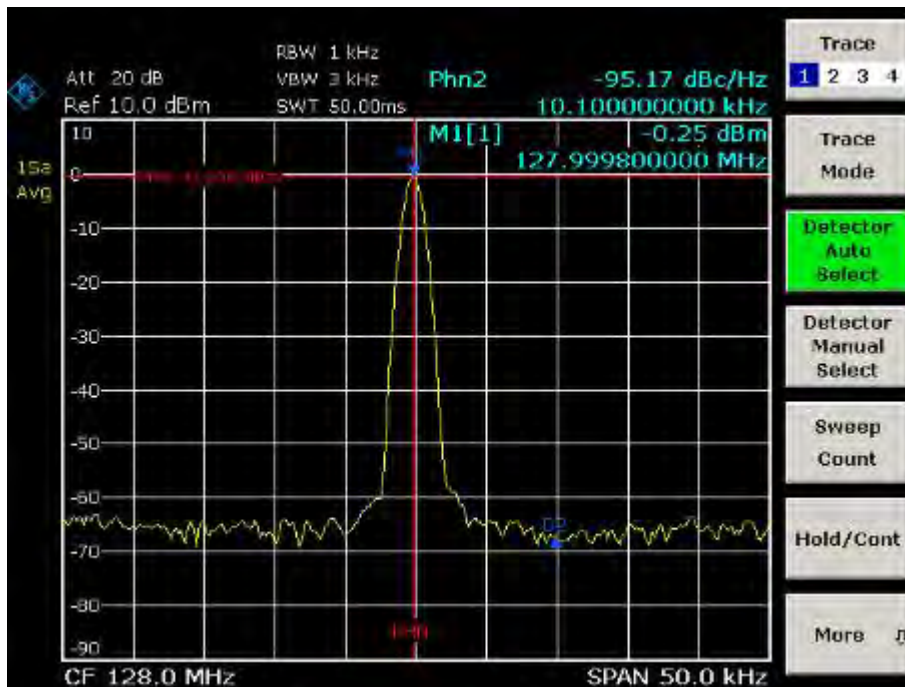

Fig. 2–18 Measuring phase noise with the phase–noise marker function

The frequency offset can be varied by moving the marker with the rotary knob or by entering a new frequency offset as a number.

Measurements on Modulated Signals

For measurements on AM and FM signals refer to the Quick Start Guide, chapter 5, "Basic Measurements Examples".

Measuring Channel Power and Adjacent Channel Power

Measuring channel power and adjacent channel power is one of the most important tasks in the field of digital transmission for a spectrum analyzer with the necessary test routines. While, theoretically, channel power could be measured at highest accuracy with a power meter, its low selectivity means that it is not suitable for measuring adjacent channel power as an absolute value or relative to the transmit channel power. The power in the adjacent channels can only be measured with a selective power meter.

A spectrum analyzer cannot be classified as a true power meter, because it displays the IF envelope voltage. However, it is calibrated such as to correctly display the power of a pure sinewave signal irrespective of the selected detector. This calibration cannot be applied for non-sinusoidal signals. Assuming that the digitally modulated signal has a Gaussian amplitude distribution, the signal power within the selected resolution bandwidth can be obtained using correction factors. These correction factors are normally used by the spectrum analyzer's internal power measurement routines in order to determine the signal power from IF envelope measurements. These factors apply if and only if the assumption of a Gaussian amplitude distribution is correct.

Apart from this common method, the R&S FSL also has a true power detector, i.e. an RMS detector. It correctly displays the power of the test signal within the selected resolution bandwidth irrespective of the amplitude distribution, without additional correction factors being required. The absolute measurement uncertainty of the FSL is < 1.5 dB and a relative measurement uncertainty of < 0.5 dB (each with a confidence level of 95%).

There are two possible methods for measuring channel and adjacent channel power with a spectrum analyzer:

- **IBW method (Integration Bandwidth Method)**
The spectrum analyzer measures with a resolution bandwidth that is less than the channel bandwidth and integrates the level values of the trace versus the channel bandwidth. This method is described in section "[Method of calculating the channel power](#)".
- **Using a channel filter**
For a detailed description, refer to the following section.

Measurement using a channel filter

In this case, the spectrum analyzer makes zero span measurements using an IF filter that corresponds to the channel bandwidth. The power is measured at the output of the IF filter. Until now, this method has not been used for spectrum analyzers, because channel filters were not available and the resolution bandwidths, optimized for the sweep, did not have a sufficient selectivity. The method was reserved for special receivers optimized for a particular transmission method. It is available in R&S FSQ, FSU, FSP and FSL series.

The R&S FSL has test routines for simple channel and adjacent channel power measurements. These routines give quick results without any complex or tedious setting procedures.

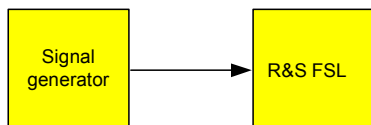
Measurement example 1 – ACPR measurement on an CDMA 2000 signal**Test setup:****Signal generator settings (e.g. R&S SMU):**

Frequency: 850 MHz
Level: 0 dBm
Modulation: CDMA 2000

Procedure:

1. Set the spectrum analyzer to its default state.
 - Press the **PRESET** key.
The R&S FSL is in its default state.
2. Set the center frequency to 850 MHz and span to 4 MHz.
 - Press the **FREQ** key and enter *850 MHz*.
 - Press the **SPAN** key and enter *4 MHz*.
3. Set the reference level to +10 dBm.
 - Press the **AMPT** key and enter *10 dBm*.
4. Configuring the adjacent channel power for the CDMA 2000 MC1.
 - Press the **MEAS** key.
 - Press the **CP, ACP, MC-ACP** softkey.
 - Press the **CP / ACP Standard** softkey.
 - In the standards list, mark **CDMA 2000 MC1** using the rotary knob or the arrow keys and confirm pressing the rotary knob or the **ENTER** key.

The R&S FSL sets the channel configuration according to the 2000 MC1 standard for mobile stations with 2 adjacent channels above and below the transmit channel. The spectrum is displayed in the upper part of the screen, the numeric values of the results and the channel configuration in the lower part of the screen. The various channels are represented by vertical lines on the graph.

The frequency span, resolution bandwidth, video bandwidth and detector are selected automatically to give correct results. To obtain stable results – especially in the adjacent channels (30 kHz bandwidth) which are narrow in comparison with the transmission channel bandwidth (1.23 MHz) – the RMS detector is used.

5. Set the optimal reference level and RF attenuation for the applied signal level.

- Press the **Adjust Ref Level** softkey.

The R&S FSL sets the optimal RF attenuation and the reference level based on the transmission channel power to obtain the maximum dynamic range. Fig. 2–19 shows the result of the measurement.

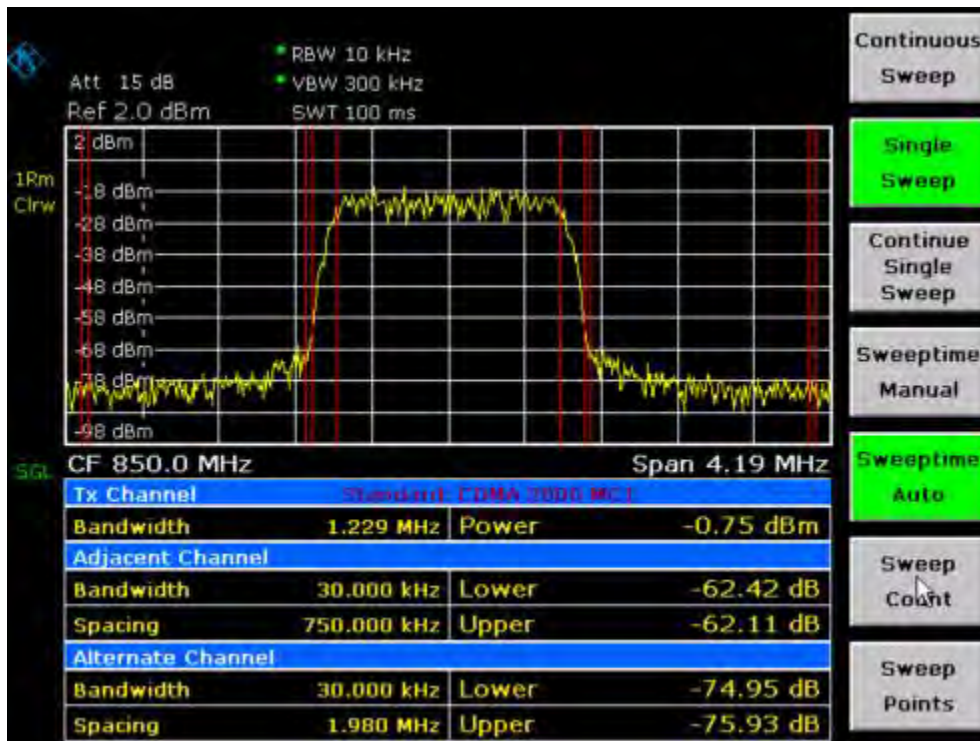

Fig. 2–19 Adjacent channel power measurement on a CDMA 2000 MC1 signal

The repeatability of the results, especially in the narrow adjacent channels, strongly depends on the measurement time since the dwell time within the 30 kHz channels is only a fraction of the complete sweep time. A longer sweep time may increase the probability that the measured value converges to the true value of the adjacent channel power, but this increases measurement time.

To avoid long measurement times, the R&S FSL measures the adjacent channel power with zero span (fast ACP mode). In the fast ACP mode, the R&S FSL measures the power of each channel at the defined channel bandwidth, while being tuned to the center frequency of the channel in question. The digital implementation of the resolution bandwidths makes it possible to select filter characteristics that is precisely tailored to the signal. In case of CDMA 2000 MC1, the power in the useful channel is measured with a bandwidth of 1.23 MHz and that of the adjacent channels with a bandwidth of 30 kHz. Therefore the R&S FSL changes from one channel to the other and measures the power at a bandwidth of 1.23 MHz or 30 kHz using the RMS detector. The measurement time per channel is set with the sweep time. It is equal to the selected measurement time divided by the selected number of channels. The five channels from the above example and the sweep time of 100 ms give a measurement time per channel of 20 ms.

Compared to the measurement time per channel given by the span (= 5 MHz) and sweep time (= 100 ms, equal to 1.66 ms per 30 kHz channel) used in the example, this is a far longer dwell time on the adjacent channels (factor of 12). In terms of the number of uncorrelated samples this means $20000/33 \mu\text{s} = 606$ samples per channel measurement compared to $1667/33 \mu\text{s} = 50.5$ samples per channel measurement.

Repeatability with a confidence level of 95% is increased from ± 1.4 dB to ± 0.38 dB as shown in Fig. 2–17. For the same repeatability, the sweep time would have to be set to 1.2 s with the integration method. Fig. 2–20 shows the standard deviation of the results as a function of the sweep time.

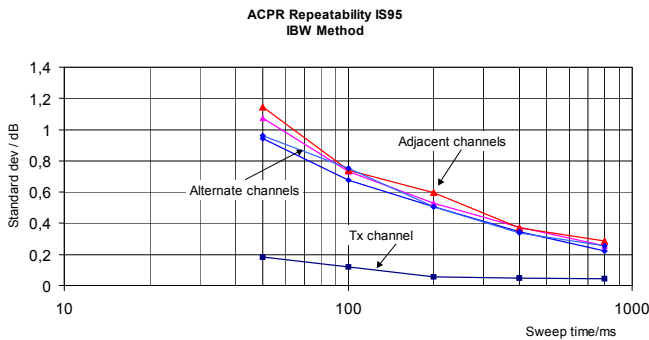

Fig. 2–20 Repeatability of adjacent channel power measurement on CDMA 2000 standard signals if the integration bandwidth method is used

6. Switch to fast ACP mode to increase the repeatability of results.
 - Switch the **Fast ACP** softkey to **On**.

The R&S FSL measures the power of each channel with zero span. The trace represents power as a function of time for each channel (see Fig. 2–23). The numerical results over consecutive measurements become much more stable.

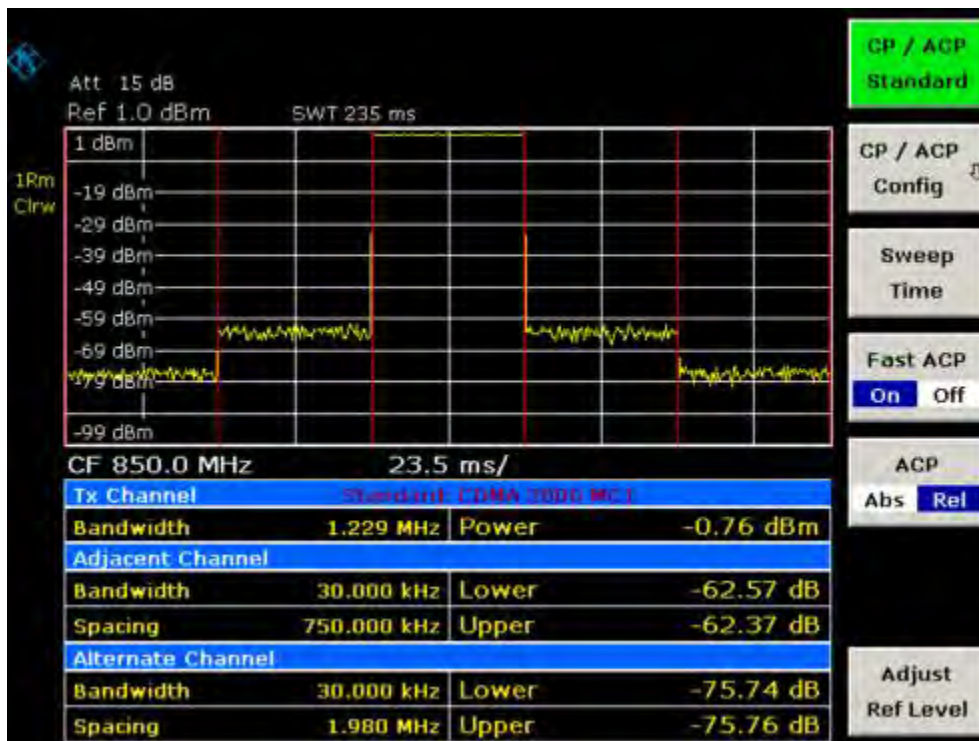

Fig. 2–21 Measuring the channel power and adjacent channel power ratio for 2000 MC1 signals with zero span (Fast ACP)

Fig. 2–22 shows the repeatability of power measurements in the transmit channel and of relative power measurements in the adjacent channels as a function of sweep time. The standard deviation of measurement results is calculated from 100 consecutive measurements as shown in Fig. 2–22. Take scaling into account if comparing power values.

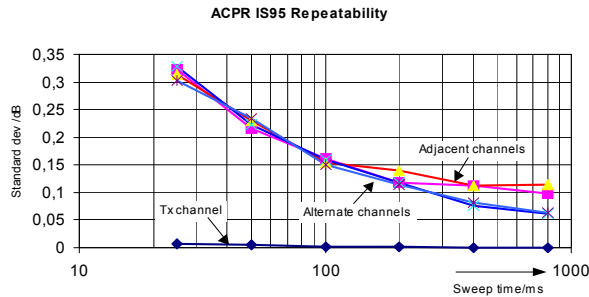

Fig. 2–22 Repeatability of adjacent channel power measurements on CDMA 2000 signals in the fast ACP mode

Note on adjacent channel power measurements on 2000 MC1 base–station signals:

When measuring the adjacent channel power of 2000 MC1 base–station signals, the frequency spacing of the adjacent channel to the nominal transmit channel is specified as ± 750 kHz. The adjacent channels are, therefore, so close to the transmit channel that the power of the transmit signal leaks across and is also measured in the adjacent channel if the usual method using the 30 kHz resolution bandwidth is applied. The reason is the low selectivity of the 30 kHz resolution filter. The resolution bandwidth, therefore, must be reduced considerably, e.g. to 3 kHz to avoid this. This causes very long measurement times (factor of 100 between a 30 kHz and 3 kHz resolution bandwidth).

This effect is avoided with the zero span method which uses steep IF filters. The 30 kHz channel filter implemented in the R&S FSL has a very high selectivity so that even with a ± 750 kHz spacing to the transmit channel the power of the useful modulation spectrum is not measured.

The following figure shows the passband characteristics of the 30 kHz channel filter in the R&S FSL.

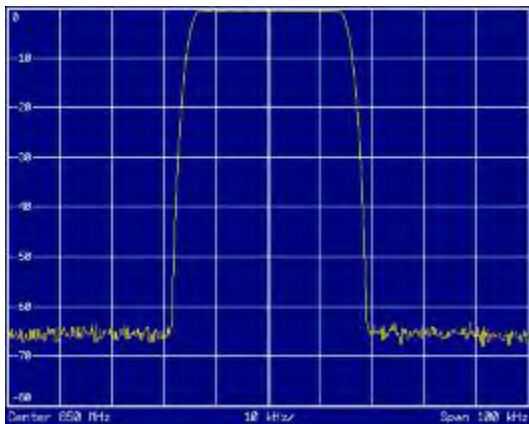
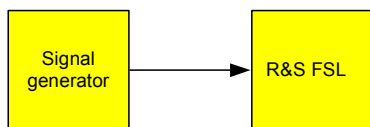

Fig. 2–23 Frequency response of the 30 kHz channel filter for measuring the power in the 2000 MC1 adjacent channel

Measurement example 2 – Measuring adjacent channel power of a W–CDMA uplink signal

Test setup:



Signal generator settings (e.g. R&S SMU):

Frequency: 1950 MHz
Level: 4 dBm
Modulation: 3 GPP W–CDMA Reverse Link

Procedure:

1. Set the spectrum analyzer to its default state.
 - Press the **PRESET** key.
The R&S FSL is in its default state.
2. Set the center frequency to 1950 MHz.
 - Press the **FREQ** key and enter *1950 MHz*.
3. Switch on the ACP measurement for W–CDMA.
 - Press the **MEAS** key.
 - Press the **CP, ACP, MC–ACP** softkey.
 - Press the **CP / ACP Standard** softkey.
 - In the standards list, mark **W–CDMA 3GPP REV** using the rotary knob or the arrow keys and confirm pressing the rotary knob or the **ENTER** key.

The R&S FSL sets the channel configuration to the 3GPP W–CDMA standard for mobiles with two adjacent channels above and below the transmit channel. The frequency span, the resolution and video bandwidth and the detector are automatically set to the correct values. The spectrum is displayed in the upper part of the screen and the channel power, the level ratios of the adjacent channel powers and the channel configuration in the lower part of the screen. The individual channels are displayed as vertical lines on the graph.

4. Set the optimum reference level and the RF attenuation for the applied signal level.
 - Press the **Adjust Ref Level** softkey.

The R&S FSL sets the optimum RF attenuation and the reference level for the power in the transmission channel to obtain the maximum dynamic range. The following figure shows the result of the measurement.

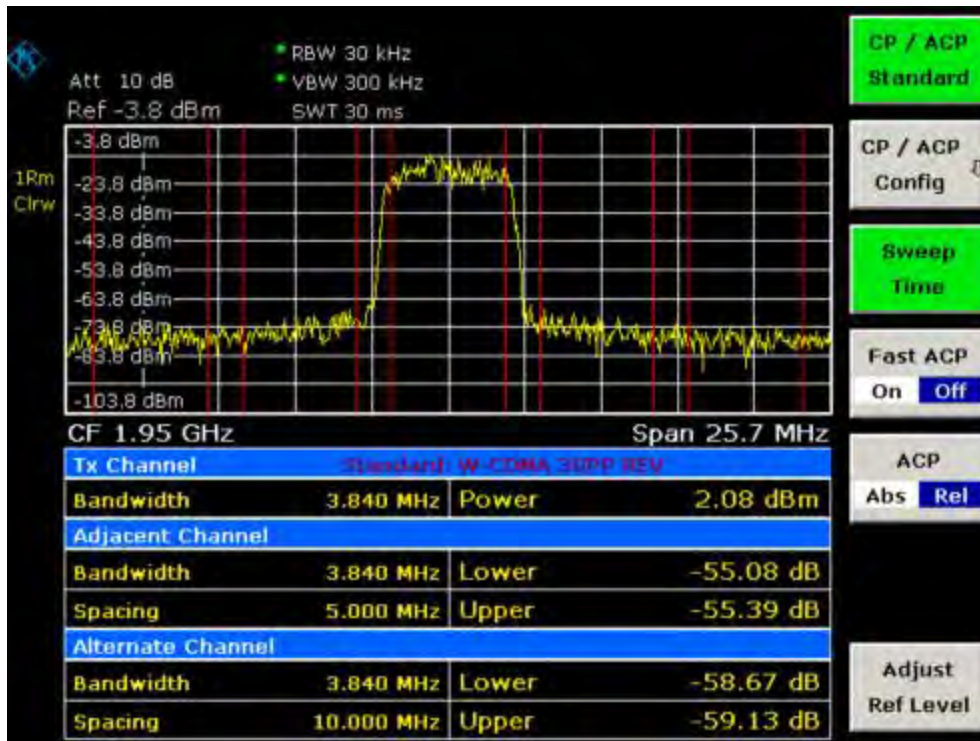

Fig. 2–24 Measuring the relative adjacent channel power on a W–CDMA uplink signal

5. Measuring adjacent channel power with the fast ACP mode.

- Set **Fast ACP** softkey to **On**.
- Press the **Adjust Ref Level** softkey.

The R&S FSL measures the power of the individual channels with zero span. A root raised cosine filter with the parameters $\alpha = 0.22$ and chip rate 3.84 Mcps (= receive filter for 3GPP W–CDMA) is used as channel filter.

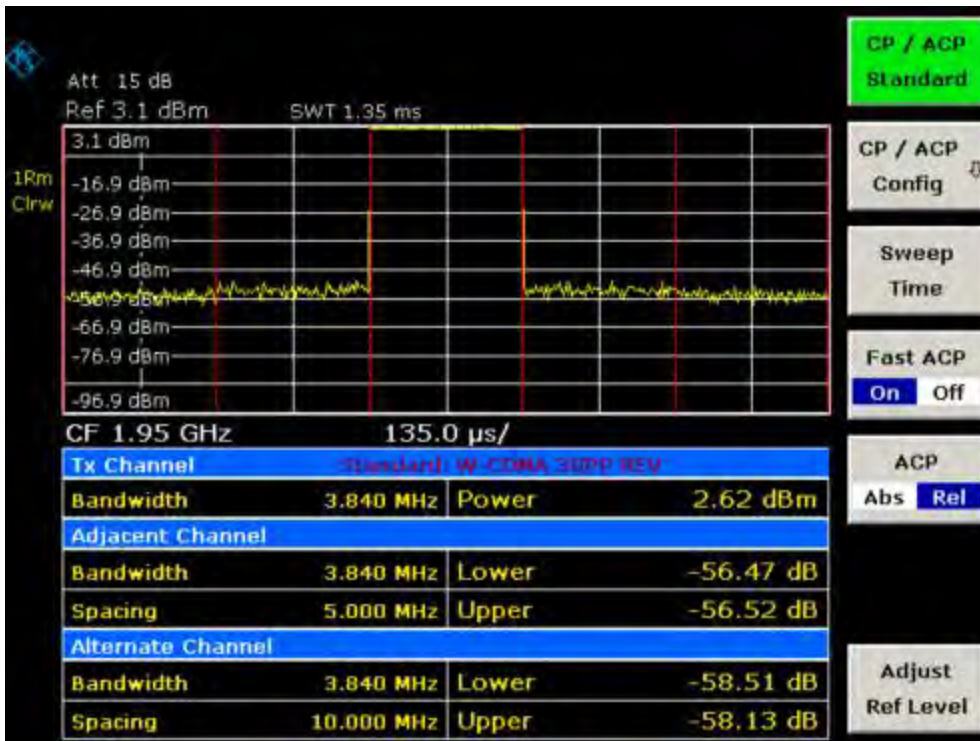

Fig. 2–25 Measuring the adjacent channel power of a W–CDMA signal with the fast ACP mode

Note: With W–CDMA, the R&S FSL's dynamic range for adjacent channel measurements is limited by the 12–bit A/D converter. The greatest dynamic range is, therefore, obtained with the IBW method.

Optimum Level Setting for ACP Measurements on W–CDMA Signals

The dynamic range for ACPR measurements is limited by the thermal noise floor, the phase noise and the intermodulation (spectral regrowth) of the spectrum analyzer. The power values produced by the R&S FSL due to these factors accumulate linearly. They depend on the applied level at the input mixer. The three factors are shown in the figure below for the adjacent channel (5 MHz carrier offset).

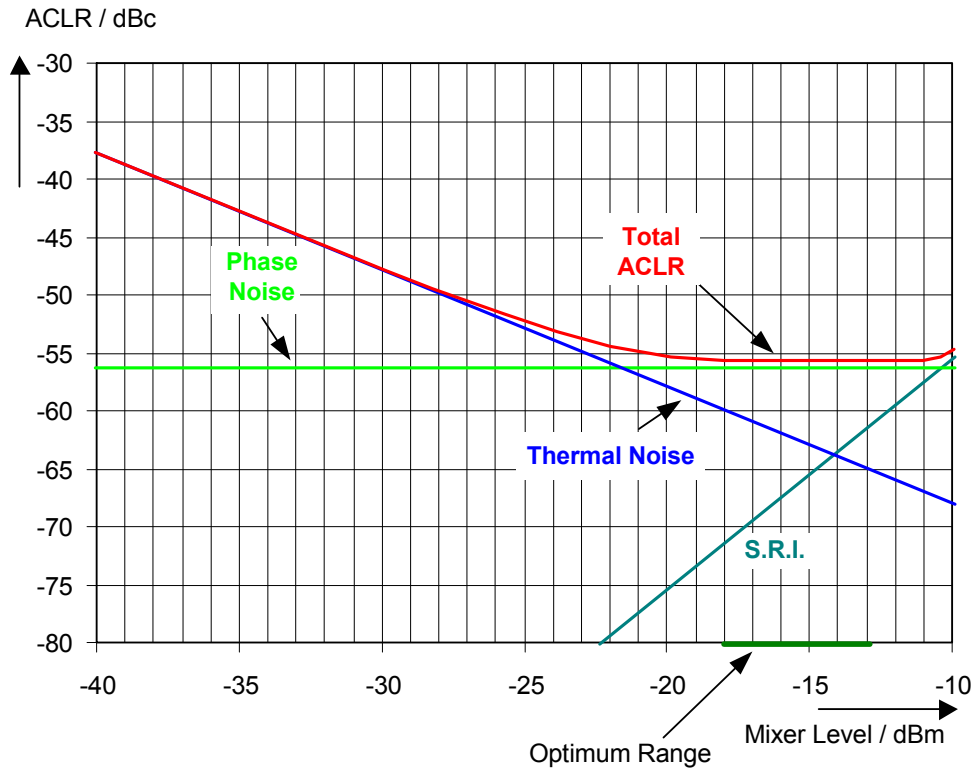

Fig. 2–26 The R&S FSL's dynamic range for adjacent channel power measurements on W–CDMA uplink signals is a function of the mixer level.

The level of the W–CDMA signal at the input mixer is shown on the horizontal axis, i.e. the measured signal level minus the selected RF attenuation. The individual components which contribute to the power in the adjacent channel and the resulting relative level (total ACPR) in the adjacent channel are displayed on the vertical axis. The optimum mixer level is –21 dBm. The relative adjacent channel power (ACPR) at an optimum mixer level is –65 dBc. Since, at a given signal level, the mixer level is set in 10 dB steps with the 10 dB RF attenuator, the optimum 10 dB range is shown in the figure: it spreads from –16 dBm to –26 dBm. In this range, the obtainable dynamic range is 62 dB.

To set the attenuation parameter manually, the following method is recommended:

- Set the RF attenuation so that the mixer level (= measured channel power – RF attenuation) is between –11 dBm and –21 dBm.
- Set the reference level to the largest possible value where no overload (IFOVL) is indicated.

This method is automated with the **Adjust Ref Level** function. Especially in remote control mode, e.g. in production environments, it is best to correctly set the attenuation parameters prior to the measurement, as the time required for automatic setting can be saved.

Note: To measure the R&S FSL's intrinsic dynamic range for W–CDMA adjacent channel power measurements, a filter which suppresses the adjacent channel power is required at the output of the transmitter. A SAW filter with a bandwidth of 4 MHz, for example, can be used.

Amplitude Distribution Measurements

If modulation types are used that do not have a constant zero span envelope, the transmitter has to handle peak amplitudes that are greater than the average power. This includes all modulation types that involve amplitude modulation –QPSK for example. CDMA transmission modes in particular may have power peaks that are large compared to the average power.

For signals of this kind, the transmitter must provide large reserves for the peak power to prevent signal compression and thus an increase of the bit error rate at the receiver.

The peak power or the crest factor of a signal is therefore an important transmitter design criterion. The crest factor is defined as the peak power / mean power ratio or, logarithmically, as the peak level minus the average level of the signal.

To reduce power consumption and cut costs, transmitters are not designed for the largest power that could ever occur, but for a power that has a specified probability of being exceeded (e.g. 0.01%).

To measure the amplitude distribution, the R&S FSL has simple measurement functions to determine both the APD = Amplitude Probability Distribution and CCDF = Complementary Cumulative Distribution Function.

In the APD display mode, the probability of occurrence of a certain level is plotted against the level.

In the CCDF display mode, the probability that the mean signal power will be exceeded is shown in percent.

Measurement example – Measuring the APD and CCDF of white noise generated by the R&S FSL

1. Set the spectrum analyzer to its default state.

- Press the **PRESET** key.

The R&S FSL is in its default state.

2. Configure the R&S FSL for APD measurement

- Press the **AMPT** key and enter *–60 dBm*.

The R&S FSL's intrinsic noise is displayed at the top of the screen.

- Press the **MEAS** key.
- Press the **More** softkey.
- Press the **APD** softkey.

The R&S FSL sets the frequency span to 0 Hz and measures the amplitude probability distribution (APD). The number of uncorrelated level measurements used for the measurement is 100000. The mean power and the peak power are displayed in dBm. The crest factor (peak power – mean power) is output as well.

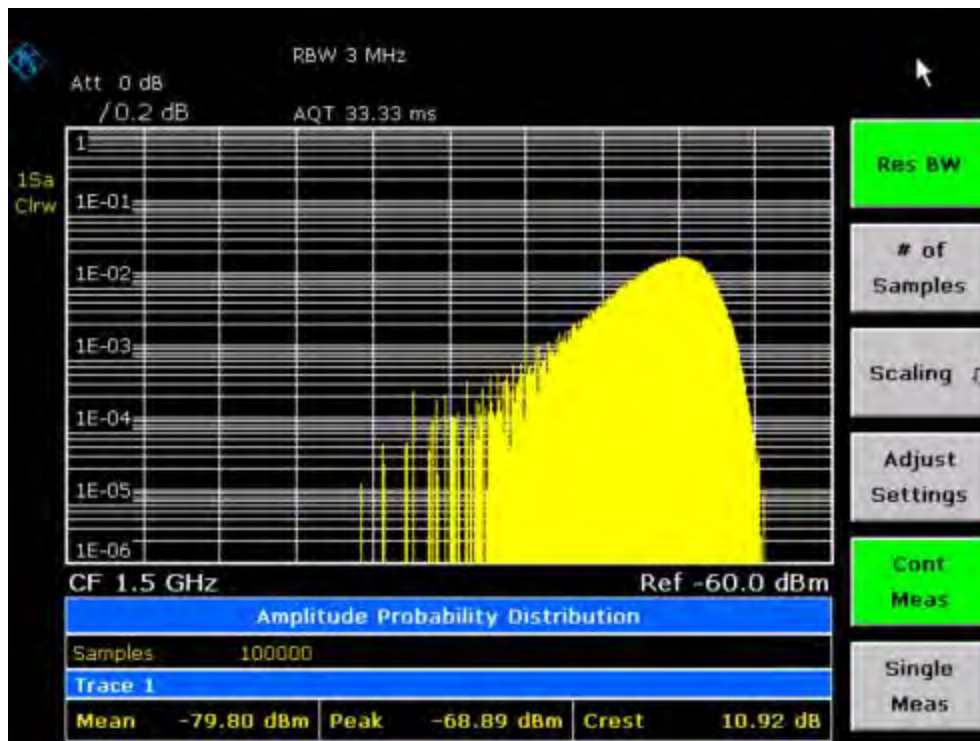

Fig. 2–27 Amplitude probability distribution of white noise

3. Switch to the CCDF display mode.

- Press the ▲ key.
- Press the **CCDF** softkey.

The CCDF display mode is switched on.

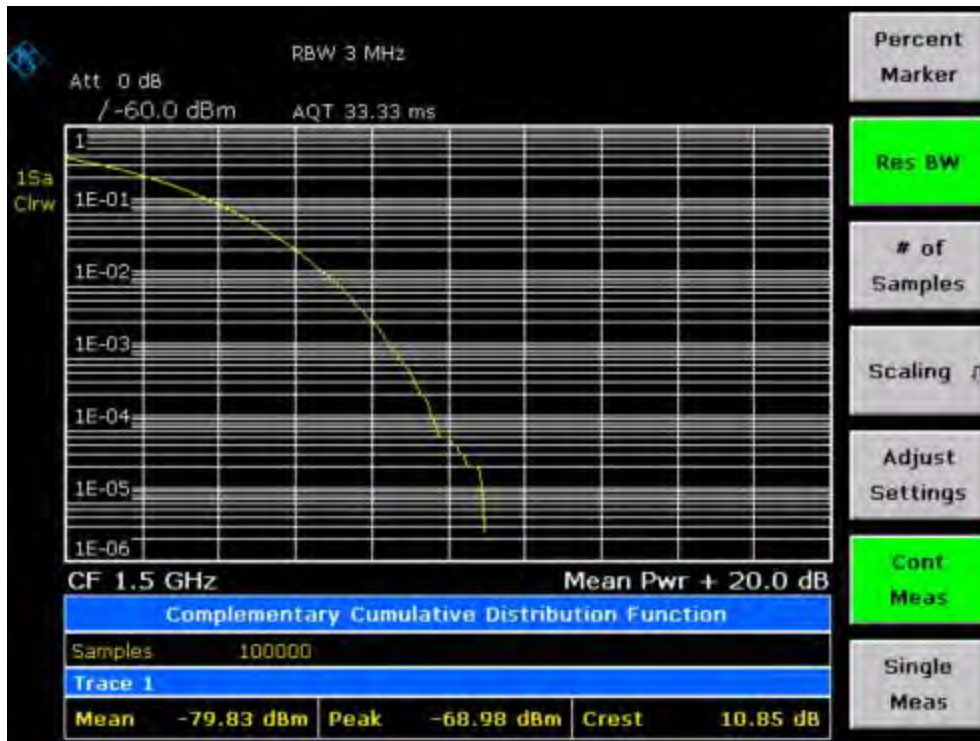

Fig. 2–28 CCDF of white noise

The CCDF trace indicates the probability that a level will exceed the mean power. The level above the mean power is plotted along the X axis of the graph. The origin of the axis corresponds to the mean power level. The probability that a level will be exceeded is plotted along the Y axis.

4. Bandwidth selection

When the amplitude distribution is measured, the resolution bandwidth must be set so that the complete spectrum of the signal to be measured falls within the bandwidth. This is the only way of ensuring that all the amplitudes will pass through the IF filter without being distorted. If the resolution bandwidth which is selected is too small for a digitally modulated signal, the amplitude distribution at the output of the IF filter becomes a Gaussian distribution according to the central limit theorem and so corresponds to a white noise signal. The true amplitude distribution of the signal therefore cannot be determined.

5. Selecting the number of samples

For statistics measurements with the R&S FSL, the number of samples N_{Samples} is entered for statistical evaluation instead of the sweep time. Since only statistically independent samples contribute to statistics, the measurement or sweep time is calculated automatically and displayed. The samples are statistically independent if the time difference is at least $1/\text{RBW}$. The sweep time SWT is, therefore, expressed as follows:

$$\text{SWT} = N_{\text{Samples}} / \text{RBW}$$

Measurement Examples of the Bluetooth Measurements Option (K8)

This section gives background information on Bluetooth Measurements (option K8). It provides information on the following topics:

- [Bluetooth Overview](#)
- [Supported Tests](#)
- [Overview of Transmitter Tests](#)
- [Functional Description – Block Diagram](#)
- [Bandwidths](#)
- [Measurement Filter \(Meas Filter On\)](#)
- [Oversampling](#)
- [Determining Average or Max/Min Values](#)
- [Trigger Concepts](#)

For further information on measurement examples refer also to the Quick Start Guide, chapter 5 "Basic Measurement Examples".

This option is available from firmware version 1.30.

Bluetooth Overview

This section provides the following general information on Bluetooth measurements:

- [Bluetooth technical parameters](#)
- [Power classes](#)
- [Structure of a Bluetooth data packet](#)

Bluetooth technical parameters

Table 2–1 Common Parameters

frequency bands	2402 + (0...78) MHz
channel spacing	1 MHz
symbol rate	1 Msym/s
slot length (frequency hopping)	625 μsec
packet sizes	1, 3, 5 slot packets

Table 2–2 Modulation Parameters Basic Rate

modulation	GFSK
TX filter	Gaussian
BT /	0.5
modulation index	0.28 – 0.35 nominal 0.32
frequency deviation	160 kHz settled 141 kHz 010101 suite

bandwidth -3dB -20dB	220 kHz 1 MHz
bit rate	1 Mbps

Table 2–3 Modulation Parameters Enhanced Data Rate

modulation	$\pi/4$ -DQPSK	8DPSK
TX filter	RRC	RRC
roll-off factor	0.4	0.4
bandwidth -3dB	± 500 kHz	± 500 kHz
bit rate	2 Mbps	3 Mbps

Power classes

Power Class	Maximum (P_{max})	Nominal	Minimum (P_{min})	Power Control
1	100 mW (20 dBm)		1 mW (0 dBm)	from P_{min} (< +4 dBm) to P_{max}
2	2.5 mW (4dBm)	1 mW (0 dBm)	0.25 mW (-6dBm)	optional
3	1 mW (0dBm)			optional

Structure of a Bluetooth data packet

Every Bluetooth data packet is divided into 3 basic section: access code, header and payload. The following figures show the order and bit lengths of the individual sections:

access code 72 bits			54 bits header	240 / 1496 / 2744 bits payload*)
4 bits preamble	64 bits sync word	4 bits trailer		

*) During EUT evaluation the payload contains certain bit sequences: PRBS9 (Pseudo Random Bit Sequence) or 11110000 or 10101010.

The sync word is transmitted as the major part of the access code. For this purpose, the LAP (lower address part) of the BD address is expanded to 64 bit by adding the BCH code and baker.

sync word 64 bits		
BCH code 34 bits	LAP 24 bits	Barker 6 bits

The LAP (lower address part) of the BD address serves as a basis for the sync word.

BD – address 48 bits		
NAP 16 bits	UAP 8 bits	LAP 24 bits

In case of EDR packets the payload is divided into 6 other sections:

DPSK					
guard 5 μ s	SYNC	payload header	user payload 0–2723Symb	CRC code	trailer

Supported Tests

The Bluetooth Measurements Option supports measurements according to the Bluetooth RF Test Specification (Bluetooth SIG) , Revision 2.0.E.3, Mar 2005, on the R&S FSL spectrum analyzer. The following tests are currently implemented according to this specification:

- Output Power
- TX Output Spectrum – Adjacent Channel Power
- Modulation Characteristics
- Initial Carrier Frequency Tolerance (ICFT)
- Carrier Frequency Drift
- EDR Relative Transmit Power
- EDR Carrier Frequency Stability and Modulation Accuracy
- EDR Differential Phase Encoding
- EDR In-band Spurious Emissions

Overview of Transmitter Tests

Table 2–4 Basic Rate Measurements

	Output Power	TX Output Spectrum – Adjacent Channel Power	Modulation Characteristics	Initial Carrier Frequency Tolerance	Carrier Frequency Drift
Hop	on	off	off	on / off	on / off
Trigger	extern	–	–	–	–
Synchronization	Yes (p0), but also possible without	no	yes (p0)	yes (p0)	yes (p0)
Packet Type	longest supported	DH1	longest supported	DH1	all supported packets (DH1/3/5)
Payload	PRBS 9	PRBS 9	11110000 10101010	PRBS 9	10101010
Test Mode	loop back	loop back	loop back	loop back	loop back
Operating Mode	IQ mode	analyzer zero span	IQ mode	IQ mode	IQ mode
RBW	3 MHz	100 kHz	–	–	–
VBW	3 MHz	300 kHz	–	–	–
Power	supported maximum	supported maximum	supported maximum	supported maximum	not specified
Sweep Time	one complete packet	79s per sweep (= 100ms * 10 * 79)	one complete packet	–	one complete packet
Sweep Count	–	10	10 (extern)	10	10
Trace Mode	Maxh	Maxh	–	–	–
Detector	Peak	Aver	–	–	–
Frequency in MHz	low / middle / high	each channel	low / middle / high	low / middle / high	low / middle / high
Span	–	–	–	–	–
Test cond	norm / ext	norm / ext	norm / ext	norm / ext	norm / ext
Results	peak and average power 1) $P_{AV} < 100$ mW (20 dBm) 2) $P_{PK} < 200$ mW (23 dBm) 3) $P_{max} > P_{AV} > P_{min}$ at maximum power step $P_{AV} < 1$ mW (0 dBm)	channel power of all channels 1) $P_{TX}(f) \leq -20$ dBm for $ M-N = 2$ 2) $P_{TX}(f) \leq -40$ dBm for $ M-N \geq 3$	all 8 bit peak deviations and average deviations	carrier offset within the 4 preamble bits	carrier offsets of the 4 bit preamble, of all 10 bit payload sequences; maximum drift rate of all 10 bit payload sequences at 50 μ s offset

Table 2–5 Enhanced Data Rate Measurements

	EDR Relative TX Power	EDR Carrier Frequency Stability and Modulation Accuracy	EDR Differential Phase Encoding	EDR In-band Spurious Emissions
Hop	off	off	off	off
Trigger	–	–	–	extern/ IF power
Synchronization	yes	yes	yes	yes, needed for gate adjustment
Packet Type	longest supported	longest supported	longest supported	longest supported
Payload	PRBS 9	PRBS9	PRBS9	PRBS9
Test Mode	loop back	loop back	TX mode	loop back
Operating Mode	IQ mode	IQ mode	IQ mode	analyzer zero span
RBW	3 MHz	–	–	100 kHz
VBW	3 MHz	–	–	300 kHz
Power	supported minimum/ maximum	supported minimum/ maximum	supported minimum/ maximum	supported minimum/ maximum
Sweep Time	one complete packet	one complete packet	one complete packet	10*79* gate length
Sweep Count	10	200 blocks	100	10
Trace Mode	ClrWr	–	–	Maxh
Detector	Aver	–	–	Aver
Frequency in MHz	low / middle / high	low / middle / high	low / middle / high	each channel
Span	–	–	–	79 MHz
Test cond	norm / ext	norm / ext	norm / ext	norm / ext
Results	ratio of DPSK and GFSK power	carrier frequency stability and error vector magnitude	number of failed packets	channel power of all channels

Functional Description – Block Diagram

The Adjacent Channel Power and EDR In-band Spurious Emissions measurements are performed in the spectrum analyzer operating mode of the analyzer. For this test case the complete frequency band is scanned using a sequence of zero span measurements.

All other test cases are based on a digital I/Q demodulator which determines the temporal characteristics of power and frequency. The output data of the demodulator are the basis for calculation of all relevant measurement results like modulation characteristics or output power. The demodulator reaches a maximum in accuracy and temperature stability by sampling the IF signal and converting it digitally down into the base band (I/Q area).

The measurements are performed by passing the following signal processing steps:

- LAP (Lower Address Part) trigger detection
- Resampling
- Channel filtering
- Automated packet and bit pattern detection
- Limit check
- Parallel display of measurement curves and numeric results on the screen

Fig. 2–1 shows the analyzer hardware from the IF to the processor. The analog IF filter is fixed to 20MHz. The A/D converter samples the 20 MHz IF signal with a sampling frequency of 65.83 MHz.

Low pass filtering is performed after the signal has been down-converted into the complex base band and the data rate is reduced in the sequence. The amount of decimation depends on the selected oversampling factor = points / symbol. The default setting is 4, resulting in a 4 MHz sampling rate. For EDR-measurements, the oversampling factor is always fixed to 4. The resulting I/Q data are stored in a memory of 512 k words for I and Q respectively. The hardware trigger (external or IF power) controls the memory access.

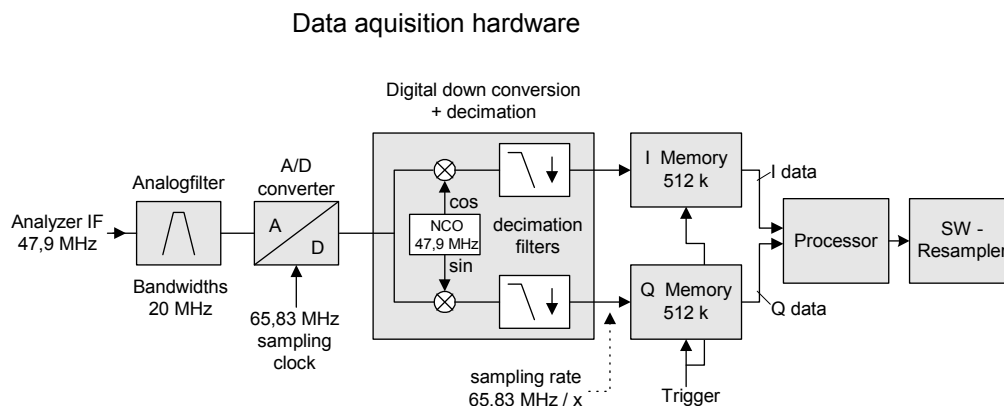

Fig. 2–29 Block diagram of the signal processing architecture of the analyzer

Bandwidths

The Bluetooth RF Specification defines a minimal bandwidth of 3 MHz. The digital bandwidth depends on the selected oversampling factor (= points / symbol). With the default setting of 4, the digital bandwidth is 3 MHz. This digital filter has a flat amplitude characteristics and does not affect the frequency deviation of the signal.

Measurement Filter (Meas Filter On)

The RF Specification allows high distortion power in the first adjacent channels. The 3 MHz filter does not suppress this kind of distortion, which leads to a high interference in modulation. Therefore a precise measurement of the frequency deviation is not possible.

In order to obtain correct deviation results, the analyzer supplies an optional filter with a passband only appropriate for the channel to measure. This filter is used by default. The Bluetooth spectrum has a bandwidth of 1 MHz. The filter is flat within 1.04 MHz (ripple: only 0.02 dB) and has steep edges. This measurement filter is not dependent on the selected oversampling factor. As a result the displayed deviation value is increased by 3.2%, but without the filter the displayed deviation value can increase dramatically due to interference from adjacent channels. Generally the result is more precise, if the displayed deviation is lower with filtering than without filtering. In these cases the inaccuracy caused by the adjacent channel interference is higher than the systematic inaccuracy caused by the filter.

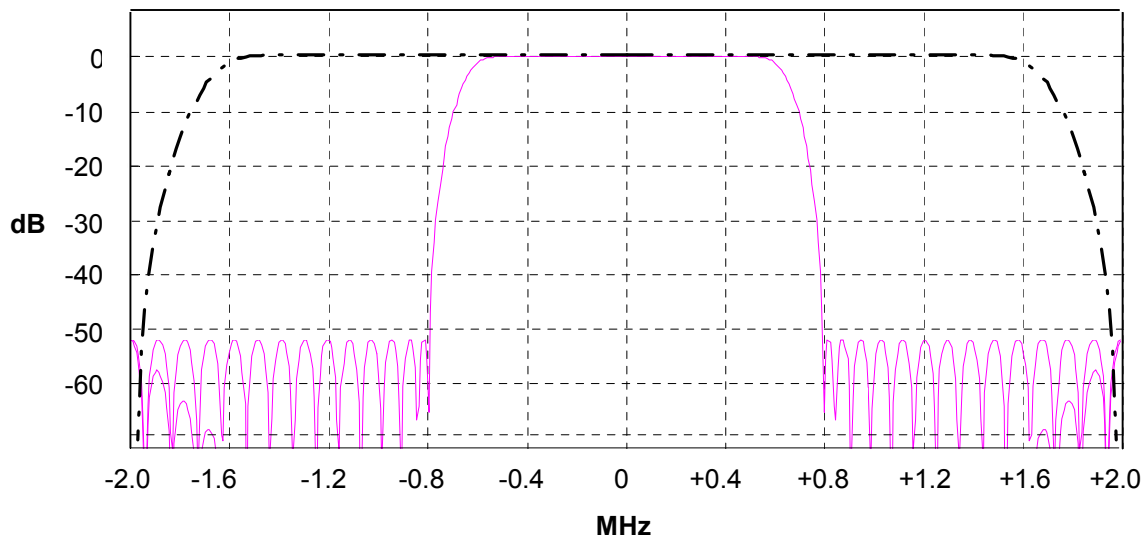

Fig. 2–30 Selection of digital filters

Dashed–dotted curve: Standard filter with 4 points / symbol

Solid curve: Optional measurement filter, independent of the points / symbol setting

Oversampling

The number of samples per symbol is equivalent to the sampling rate in MHz (due to the symbol length of 1 μ s).

Digital bandwidth (flat area)	Points per Symbol	Sampling rate
10 MHz	32	32 MHz
8 MHz	16	16 MHz
5 MHz	8	8 MHz
3.0 MHz	4	4 MHz
1.6 MHz	2	2 MHz

According to the RF Test Specification an oversampling factor of 4 is required at minimum. For Basic Rate measurements, this oversampling factor can be selected as oversampling factor in a range from 2 to 32. For EDR-measurements, the oversampling factor is fixed to 4 which is also the default value.

Although possible but not recommended is a value > 4. It increases the measurement time due to the extended calculation effort. Additionally the resulting bandwidth will be larger than required, which leads to lower measurement accuracy, unless the optional measurement filter (Meas Filter On) is used as described in section [Bandwidths](#).

The analyzer uses a timing offset correction in order to move the samples to the zero crossing points. As a result there is one sample per symbol time, which is especially important for a 0101 symbol sequence in order to obtain the precise value for the peak frequency deviation.

Sampling times before timing offset correction

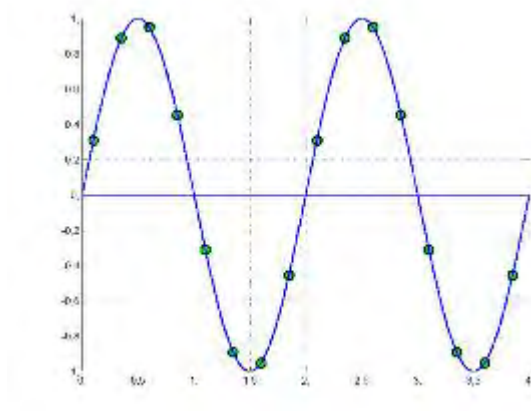

Sampling times after timing offset correction

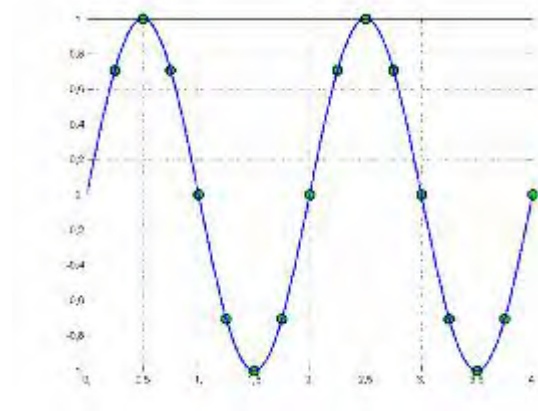

Fig. 2–31 Operation of the timing offset correction

Advantages of the timing offset correction:

- No jitter with low sampling rates
- With one sample per zero, the trespassing point is always a sample in the middle of the bit length. Therefore the maximum values in the frequency deviation of 0101 bit patterns can be detected precisely also with low sampling rates.
- The immunity to interference when determining the data bits is improved.
- Higher suppression of the distortion during peak detection.

Determining Average or Max/Min Values

These functions are very useful in order to obtain more stable results or to find sporadic spurious signals not included in every burst. In many cases the RF Test Specification defines measurements over a 10 burst period.

The number of measurements can be selected using sweep count function, thus adapting the measurement to the individual requirements.

In single sweep mode, the calculation of average or maximum / minimum values is performed over a well-defined number of sweeps (= sweep count).

Continuous sweep mode yields continuous averaging and calculation of maximum / minimum values over the whole measurement time.

Modulation measurements

They are performed in the **Clear Write** trace mode.

In continuous sweep mode, a "live" display is obtained, which allows e.g. an instant view of changes during alignment of a DUT.

In single sweep mode and with the sweep count set to 10, the analyzer will evaluate 10 bursts as required by the RF Test Specification. This means that a result is obtained after exactly 10 bursts.

Power measurements

They are performed in the **Maxhold** trace mode in relation with the defined measurement time. The measurement time is selected in order to make sure that always one complete burst is acquired. In this case, several sweeps are combined to one trace before this result trace is evaluated.

Impact of the sweep count on the measurement results

Trace Mode	Continuous Sweep	Single Sweep & Sweep Count
Clear Write	All measurement results (min., max., average) are updated with every sweep. The corresponding values are calculated based on the current curve.	Starts a measurement with n sweeps (n = sweep count). All measurement results (min., max., average) are calculated based on these n sweeps.
AVG, MaxHold, MinHold	All measurement results (min., max., average) are updated with every sweep. The corresponding values are calculated based on the current curve. The trace is the continuous average value (AVG) or the extreme value (MaxHold, MinHold) since the start of the measurement.	Starts a measurement with n sweeps (n = sweep count). n defines the number of sweeps that are taken into account for the trace math functions (AVG, MaxHold, MinHold). The n sweeps result in one trace and the measurement results (Min, Max, Average) are calculated based on this summarized trace.

The functions described above differ from the detector functions of the instrument:

- Detectors combine the measurement data obtained by oversampling to **one measurement point** on the screen. The kind of combination (Max Peak, Min Peak, Average, RMS) can be selected.
- The trace functions affect complete measurement curves: A resulting curve is calculated from **several subsequent sweeps**. The method of calculation (Average, Maxhold, Minhold) can be selected here as well.

Thus the detector is the arithmetic rule for how sample data collected with a high data rate are combined to a measurement point of one individual measurement curve, whereas the trace mode is the rule of how samples taken from several measurement curves are to be combined to a new resulting curve.

For the ACP measurement, the Average detector is set.

Trigger Concepts

As the DUT (Device Under Test) uses frequency hopping, a trigger method is necessary for two reasons:

- A measurement is only possible during the period of time, when there is a TX signal (burst) at the frequency under request.
- In order to determine the modulation characteristics correctly, a synchronization with the preamble of the signal must be supplied.

If the **Find Sync** softkey is activated, the synchronization is supplied towards the 64 bit sync word. For this purpose, in a first step a burst is searched automatically within the RF signal, or, if selected, the external trigger or the IF power trigger are used to determine the burst position.

In a second step the sync word position is searched by correlation of the signal with the sync word defined in the initialization phase. The correlation is performed directly with the FM signal, not with the data bits, which are only available after the phase shifter has been processed. The find burst process is continued as long as no sync word is found.

After the position of the sync word has been determined, the position of the p0 bit is calculated from the average value of all zero trespassing points, as defined in the RF test specification. Finally the samples are moved in a way that each sample matches one zero trespassing point (phase shifting).

The only measurement possible without synchronization is the Output Power measurement. The specified measurement time is 20% to 80% of the burst length. Without synchronization the burst length is defined via the -3dB points of the power curve. With synchronization the burst starts with the p0 bit. Therefore varying measurement results is possible if the power of the EUT is not constant within the burst.

In order to supply stable synchronization the EUT must be operated in reduced hopping mode. The EUT is only allowed to toggle between two frequencies, because otherwise the repetition time for the same frequency would become higher than the record length.

If the test environment supplies an external trigger that marks the channel to be measured a synchronization is also possible with normal hopping operation.

Measurement Examples of the Cable TV Measurements Option (K20)

This section describes measurement examples for the Cable TV Measurements option (K20). and is divided into the following topics:

- [Analog TV Basics](#)
gives an introduction into the fundamentals of analog modulated TV signals.
- [Analog TV Measurement Examples](#)
describes the test setup, settings for analog TV measurements and gives examples for the different measurement type.
- [Digital TV Basics](#)
gives an introduction into the fundamentals of digital modulated TV signals.
- [Digital TV Measurement Examples](#)
gives an introduction into the fundamentals of digital modulated TV signals.
- [Channel Tables and Modulation Standards](#)
explains the use of channel tables and modulation standards.
- [Performing a Measurement without a Channel Table](#)
shows how to perform a measurement without using a channel table.
- [Performing a Measurement Using a Channel Table](#)
gives an example how to perform a measurement using a channel table.

For further information on measurement examples refer also to the Quick Start Guide, chapter 5 "Basic Measurement Examples".

This option is available from firmware version 1.30.

Analog TV Basics

This section gives an introduction into the fundamentals of analog modulated TV signals. A special focus is laid on the parameters that the Cable TV Measurements option (K20) uses to characterize signals.

For analog modulated TV signals based on PAL, SECAM, and NTSC, Fig. 2–32 shows the situation in principle: the components of the signal, and both frequency and level at the output of a TV transmitter (RF range).

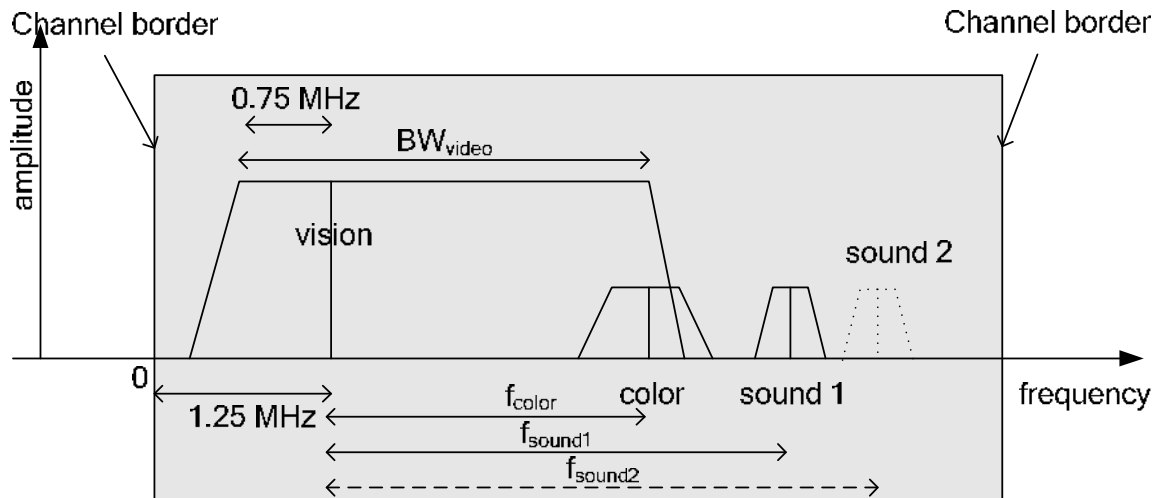

Fig. 2–32 Analog modulated signals in the RF range

The gray area marks the TV channel. Inside this area, all components of a TV signal are located. A TV signal consists of the following:

- The vision carrier, indicated in Fig. 2–32 with "vision", is located 1.25 MHz above the channel start. The vision carrier has the highest level and mainly assesses the total power of the channel. It transmits the luminance information and is amplitude modulated. The amplitude modulation is mostly negative (the smaller the luminance signal the larger the vision carrier level), apart from SECAM/L (large vision carrier level combined with a large luminance signal). Only a part (around 0.75 MHz) of the lower sidebands of the vision carrier is transmitted. Therefore it is called "residual sideband modulation". The video bandwidth BW_{video} amounts to, depending on the standard, approx. 5 MHz (e.g. PAL B/G) or approx. 4 MHz (e.g. M/NTSC).
- The color carrier, indicated in Fig. 2–32 with "color", is shifted by f_{color} to a higher frequency value in respect to the vision carrier. The magnitude of f_{color} depends on the standard. The level of the color carrier is by far smaller than that of the vision carrier. Depending on the standard, the signal is analog quadrature amplitude modulated (e.g. PAL B/G) or frequency modulated (SECAM).
The color carrier is not considered in the measurements of the Cable TV Measurements option.
- One or two sound carriers, indicated in Fig. 2–32 with "sound 1" and "sound 2", are shifted by f_{sound1} or f_{sound2} to a higher frequency value in respect to the vision carrier. The magnitude of f_{sound1} or f_{sound2} depends on the standard. The level of the sound carriers is by far smaller than that of the vision carrier. Depending on the standard, the sound carriers are frequency, amplitude, or NICAM (digitally) modulated. The sound carriers do not need to possess the same modulation. For example, a combination of a frequency modulated carrier with a NICAM modulated carrier is possible.

The large diversity of TV standards based on PAL, SECAM und NTSC differ not only in the parameter described above. Some other parameter are for example:

- number of picture lines and their duration
- form and group delay of the residual sideband filter
- parameters of the used AM / FM / NICAM modulations (e.g. modulation depth, frequency deviation, symbol rate)
- channel width and frequency range of the channels (different from country to country)
- stereo and mono sound signals, stereo transmission type

Analog TV Measurement Examples

These measurements are set up to carry out single channel measurements of analog TV signals. The settings for analog TV measurements are described in section [Analog TV settings](#). The test setup for the following measurement types is provided in section [Analog TV test setup](#).

- [Spectrum measurement](#)
- [Carriers measurement](#)
- [Video scope measurement](#)
- [Vision modulation measurement](#)
- [Hum measurement](#)

Analog TV settings

The Cable TV Measurements option needs to know some of the parameters described in section [Analog TV Basics](#) to perform correct measurements. It therefore stores these parameters in the so-called "modulation standard". Refer to section [Modulation standards](#) for the creation and usage of a modulation standard and a description of the parameters that have to be characterized for an analog TV signal. Section [Analog TV modulation standards](#) contains the description of the parameters that have to be characterized for an analog TV signal. The following list explains the meaning of the parameters:

- **Name:** Choose an arbitrary name for the new modulation standard.
- **Signal Type:** If you want to characterize an analog TV signal, select **Analog TV**.
- **TV Standard:** The standard used to modulate the luminance information. Can be "B/G", "M", "D/K" and so on.
- **Sound System:** Are one or two sound carriers in use? What type of modulation is used for each of them? What are their frequencies, relative to the vision carrier?

The selection "FM 5.5/ FM 5.742" for example specifies, that two frequency modulated sound carriers are used. One is 5.5 MHz and is about 5.472 MHz above the vision carrier.

The values you can choose depend on the selected TV standard. Not all combinations are allowed!

- **Group Delay:** What group delay shall the residual sideband filter have?
- **Color System:** The color information of the video signal is transmitted according to either the PAL or NTSC or SECAM standard. The values you can choose depend on the selected TV standard. Not all combinations are allowed!
- **Bar Line:** The Vision Modulation measurement needs a special test signal, containing a peak white value. You must specify the type and the number of the horizontal line that contains the peak white value.
- **Quiet Line:** Some measurements need a horizontal line with no video information in it. You must specify the number of this horizontal line here. For further information see also [Example: Creating a channel table](#).
- **Sideband Position:** Is the signal in normal position or inverted?

<p>Note: <i>In the dialog boxes, set the parameters always from top to bottom, since all parameters depend on the parameters above them. Otherwise your input might be rejected, e.g. if it specifies an unusual TV standard.</i></p>
--

Analog TV test setup

This section describes the setup used for the analog TV measurement examples. All analog measurement examples are performed in the **Cable TV Analyzer** mode.

6. Press the **MENU** key to display the cable TV measurements main menu.
7. Press the **Channel Setup** softkey.
8. In the **Channel Tables** dialog box, select channel table **<none>**.
9. Press the **Activate** softkey.

The TV standard is automatically set to the default analog TV modulation standard, which has the following parameters (see also [Analog TV settings](#)).

- **Signal Type** = *Analog TV*
- **TV Standard** = *B/G*
- **Sound System** = *FM 5.5 / FM 5.742*
What kind of sound carrier(s) are used.
- **Group Delay** = *General*
This setting has no effect on the measurements in this firmware release.
- **Color System** = *PAL*
- **Bar Line** = *18*
Type = *CCIR 17*
Where is the "white reference" and of what kind is it? The Vision Modulation measurement demands correct settings!
- **Quiet Line** = *22*
Which horizontal line shall be used for "Quiet Line" based CNR / CSO measurement. This line shall have no video information!
- **Sideband Position** = *Normal*
Only change this setting if you have inverted sidebands.

As long as you measure without a channel table, the Cable TV Measurements option expects a signal with these parameters. If your signal does not fit, some measurements may fail.

10. If you use an analog TV test transmitter, configure it to transmit a suitable signal:
 - Choose a reasonable, not too high output level.
 - Set the transmitters's vision carrier frequency to *210.25 MHz*.
11. If your test transmitter is not capable of this or if you want to connect the R&S FSL to your CATV network, which does not contain a suitable signal, change the default analog TV modulation standard:
 - Press the **MEAS** key.
 - Press the **Analog TV** softkey.
 - Press the **Analog TV Settings** softkey.
 - Change the default analog TV modulation standard as described in section [Analog TV modulation standards](#) in order to adapt it to the signal you provide for the R&S FSL.

Spectrum measurement

This measurement gives an overview of the active measurement channel. It is a swept measurement like in the **Spectrum Analyzer** mode. All parameters are set automatically according to the used modulation standard. The spectrum is displayed in a full screen trace.

Test setup:

Refer to the section [Analog TV test setup](#).

Procedure:

1. Press the **MEAS** key.
2. Press the **Analog TV** softkey.
3. Press the **Spectrum** softkey.
4. To adjust the input attenuator, press the **Adjust Attenuation** softkey.
5. Press the **FREQ** key.
6. Enter *210.25 MHz* for the vision carrier frequency of the input signal. Note that this frequency is not the middle of the shown span.
7. Press the **RUN** key.

The spectrum of the input signal is displayed.

The vertical lines mark the vision carrier (VC) and sound carrier (SC1 and SC2) frequencies. They mark the ideal frequencies according to the chosen standard and RF frequency, not the measured ones.

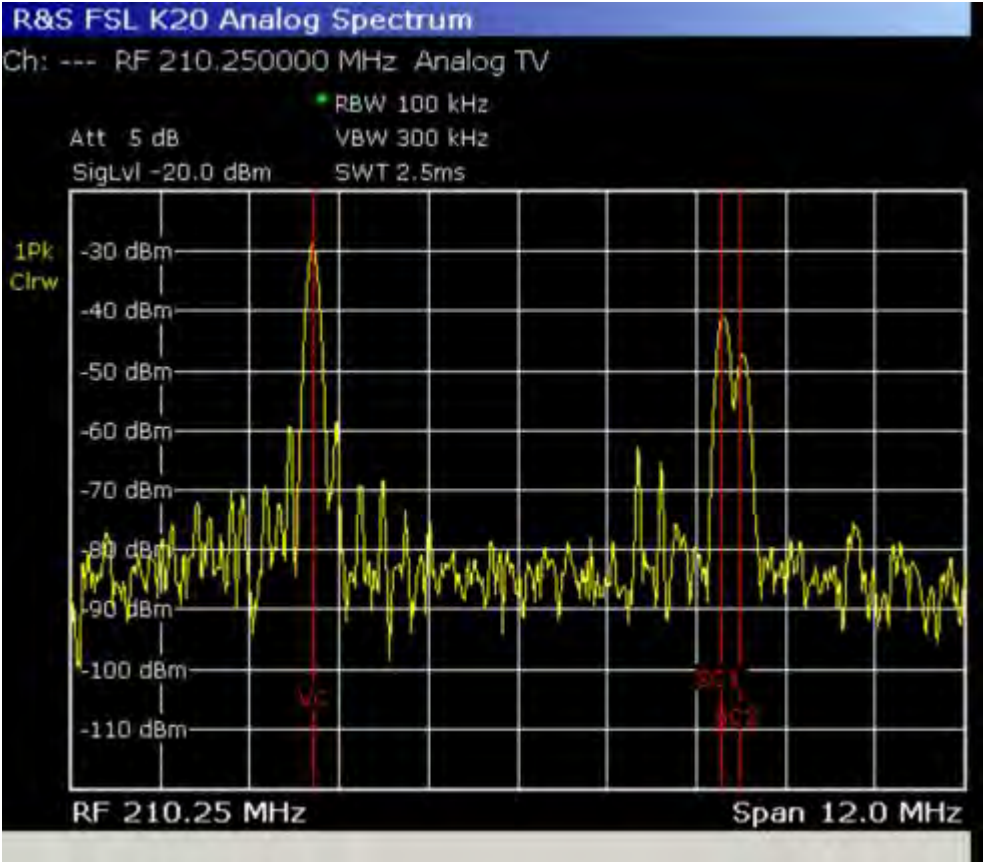

Fig. 2-33 Analog TV Spectrum measurement

Carriers measurement

This measurement determines the carrier power (vision carrier, one or two sound carriers) and the frequency distances. It also compares them against the default values. The sound carrier power is displayed relative to the measured vision carrier power.

The measurement display is split into two panes. In the upper pane, the spectrum as in the corresponding Spectrum measurement is displayed. In the lower pane, the result table for the measurement is displayed.

Test setup:

Refer to the section [Analog TV test setup](#).

Procedure:

1. Press the **MEAS** key.
2. Press the **Analog TV** softkey.
3. Press the **Carriers** softkey.
4. To change the limits, press the **Edit Table** softkey.
5. To adjust the input attenuator, press the **Adjust Attenuation** softkey.
6. Press the **FREQ** key.
7. Enter *210.25 MHz* for the vision carrier frequency of the input signal.
8. Press the **RUN** key.

The upper pane gives a quick overview of the channel, just like in the Spectrum measurement.

In the lower pane, you can check whether the signal meets the requirements. Absolute and relative powers and frequencies are measured and compared against the limits. The result is either **Pass** or **Fail**.

In the measurement example, all results were within the chosen limits, except the absolute power of the vision carrier. This is indicated by red color and a star.

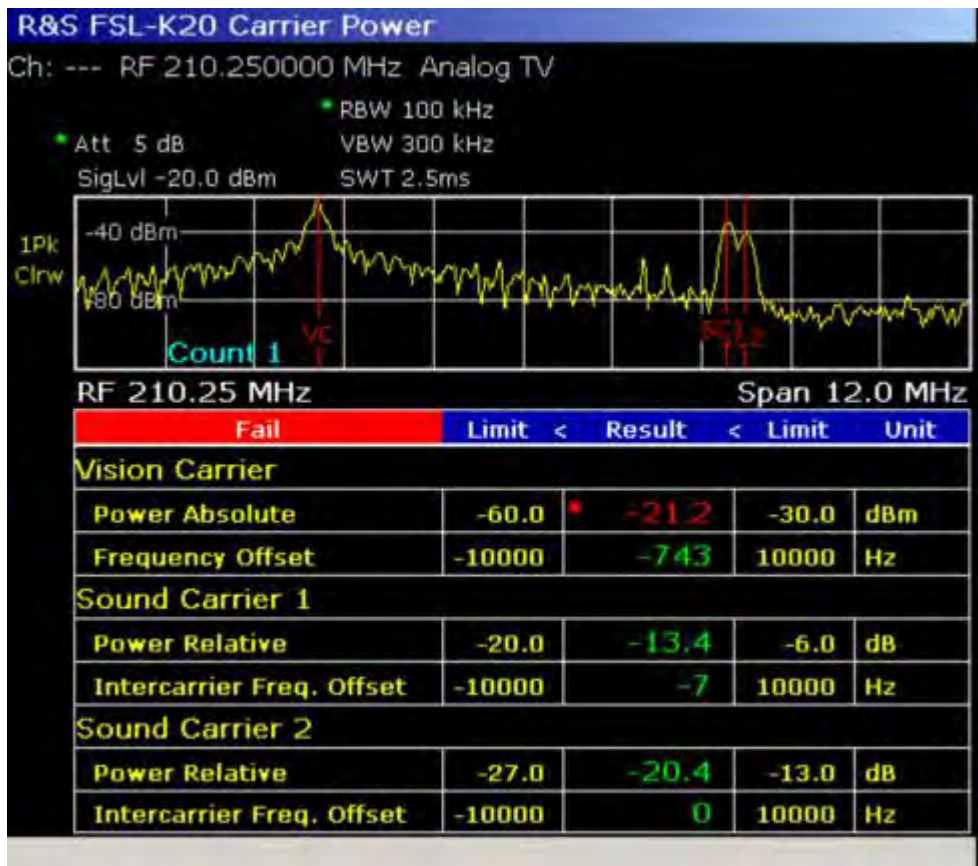

Fig. 2-34 Analog TV Carriers measurement

Note: The "frequency offsets" are measured in this way:
 For sound carriers:
 The TV standard demands that the sound carrier frequency shall be f_1 Hz greater than the vision carrier frequency. The actual frequency distance might be measured to be f_2 .
 The value "Intercarrier frequency offset" is therefore: $f_2 - f_1$.
 For the vision carrier:
 The value "frequency offset" is the measured vision carrier frequency minus the RF frequency.

Video scope measurement

This measurement determines the luminance signal in dependence of the time. The video scope is triggered by the chosen trigger event, i.e. the line to be analyzed. From the result trace, the effects of hum are eliminated ("back porch clamping").

Test setup:

Refer to the section [Analog TV test setup](#).

Procedure:

1. Press the **MEAS** key.
2. Press the **Analog TV** softkey.
3. Press the **More** softkey.
4. Press the **Video Scope** softkey.
5. For the TV standard **M** in combination with another color system than **PAL**, press the **Field 1/2** softkey to select field 1 or 2.
6. Press the **Line** softkey to enter the line number.
7. To change the sweep time, press the **Sweeptime Manual** softkey and enter a value (25 μ s up to 100 μ s).
8. To define a trigger offset, press the **Trigger Offset** softkey and enter a value (-50 μ s up to 50 μ s). Choose 0 μ s to make the display start with the horizontal sync of the specified line. Negative values make the display start earlier.
9. To adjust the input attenuator, press the **Adjust Attenuation** softkey.
10. Press the **FREQ** key.
11. Enter *210.25 MHz* for the vision carrier frequency of the input signal.
12. Press the **RUN** key.

The trace shows the luminance signal during the selected period versus time. The group delay is not compensated internally.

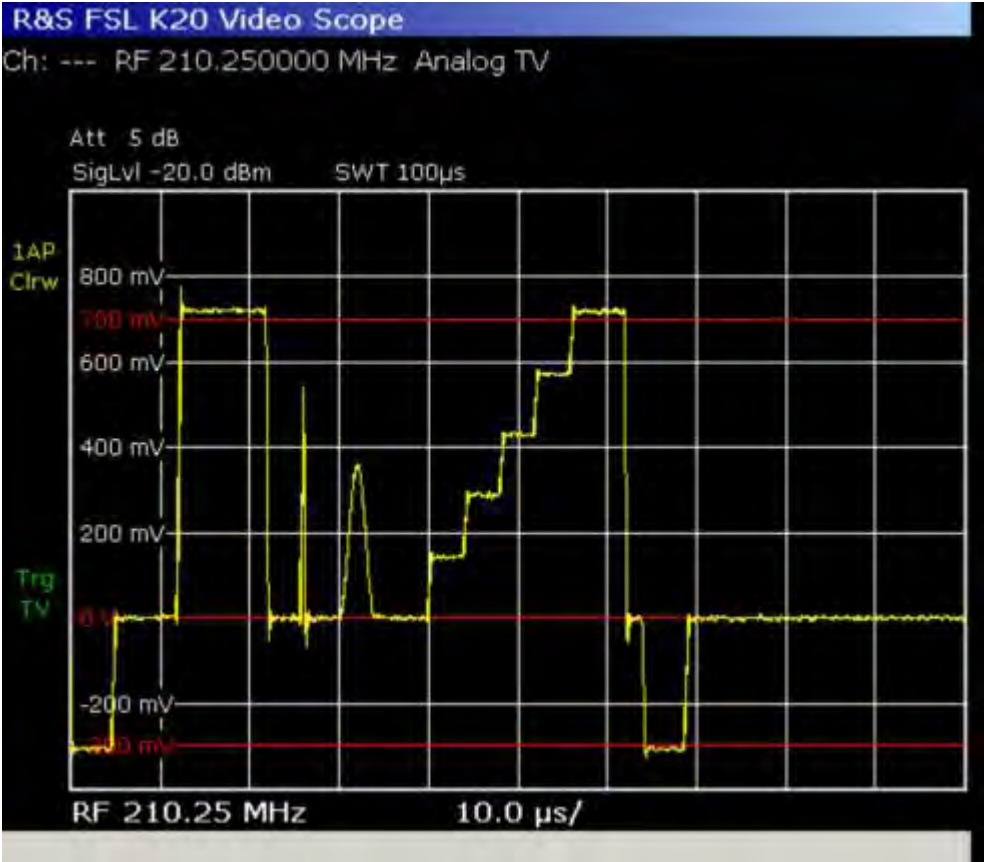

Fig. 2-35 Video Scope measurement

Vision modulation measurement

This measurement determines the "residual picture carrier" and the modulation depth of the vision carrier.

The vision carrier is amplitude modulated (AM). To be more precise, its residual sideband amplitude modulation. Most standards use negative amplitude modulation. Therefore, the vision carrier has its highest level when the luminance signal is equal to the "synchronizing level". And it has its lowest level when the luminance signal is equal to the "peak white level". The "synchronizing level" can be measured in every horizontal synchronizing pulse. The "peak white level" can be measured in special test lines ("bar line"), where a white reference is transmitted.

The residual picture carrier is the ratio of the "peak white level" to the "synchronizing level". The sum of the vision carrier's modulation depth and the residual picture carrier value must equal 1.

The measurement display is split into two panes. In the upper pane, the RF level of the vision carrier during one horizontal line is displayed. In the lower pane, the result table for the measurement is displayed.

Test setup:

Refer to the section [Analog TV test setup](#).

Procedure:

1. Press the **MEAS** key.
2. Press the **Analog TV** softkey.
3. Press the **More** softkey.
4. Press the **Vision Modulation** softkey.
5. To change the limits, press the **Edit Table** softkey. A limit change in the lower two lines leads to a change of the other limits, since the measurement results depend on each other.
6. To adjust input attenuator, press the **Adjust Attenuation** softkey.
7. Press the **FREQ** key.
8. Enter *210.25 MHz* for the vision carrier frequency of the input signal.
9. Press the **RUN** key.

The upper pane shows the RF level of the vision carrier versus time in the "bar line". The "bar line" is specified horizontal line, that holds a white reference. The number of this line is specified in the modulation standard of the measured channel. To be more exactly: It is specified in the analog TV default modulation standard, since no channel table is used right now.

If the input signal does not contain a white reference in the specified line, the results are not correct!

The lower pane shows the numeric results and whether they are within the limits or not.



Fig. 2-36 Vision Modulation measurement

Hum measurement

This measurement determines whether the signal comprises hum, a not-wanted amplitude modulation of the analog TV signal, mostly due to defective amplifiers. For the Hum measurement, the AM modulated frequency must be below 1 KHz and is typically equal to the power line frequency *1 or *2.

Test setup:

Refer to the section [Analog TV test setup](#).

Procedure:

1. Press the **MEAS** key.
2. Press the **Analog TV** softkey.
3. Press the **More** softkey.
4. Press the **Hum** softkey.
5. If you want to adjust the range of the y-axis, press the **Auto Range** softkey.
6. To change the limits, press the **Edit Table** softkey.
7. To adjust the input attenuator, press the **Adjust Attenuation** softkey.
8. Press the **FREQ** key.
9. Enter *210.25 MHz* for the vision carrier frequency of the input signal.
10. Press the **RUN** key.

In case you use a TV test transmitter or your CATV network is in good condition, you will see a rather flat line, since there will be little hum.

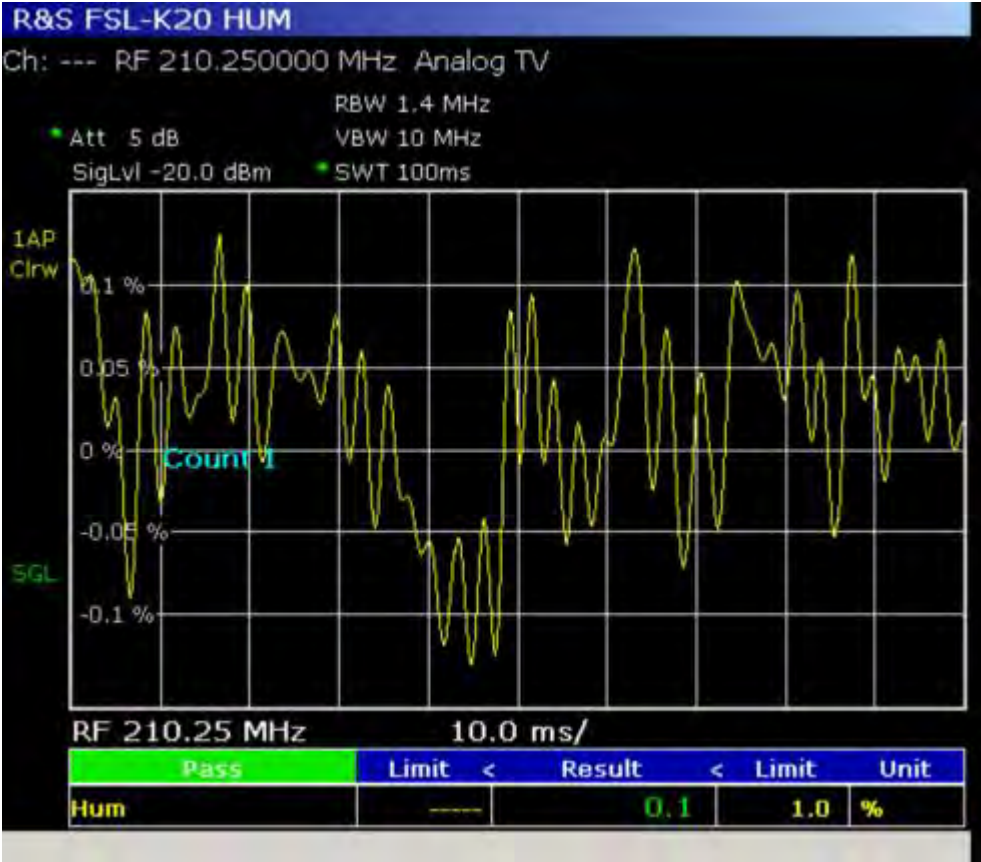

Fig. 2-37 Hum measurement

Digital TV Basics

Cable TV networks use single carrier QAM signals. These signals are continuously modulated. The Cable TV Measurements option does not support burst signals as used in cable modems (e.g. DOCSIS) which rely on TDMA techniques that share the same channel with several subscribers. To get a better understanding, we now want to have a closer look at an ideal QAM transmitter.

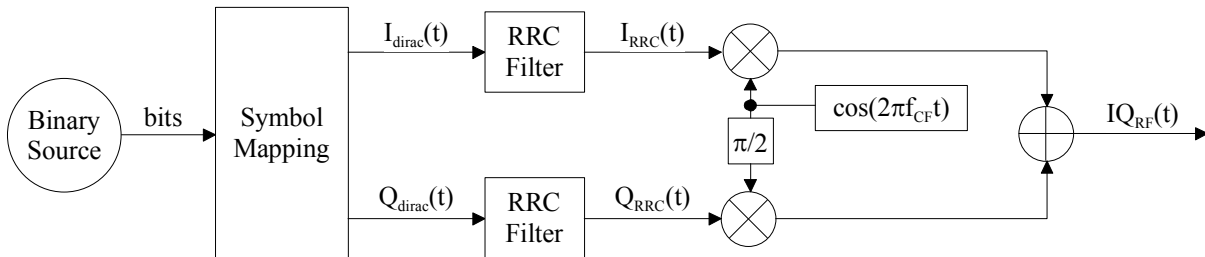

Fig. 2–38 Ideal QAM transmitter

To keep things simple we start with a *binary source* providing a never ending bit stream. Please keep in mind that in reality these bits originate from a video stream which will be source encoded e.g. by a MPEG encoder. To allow errors during the transmission via the cable channel coding (e.g. convolutional coding) will be applied. Finally we get something like "...010010111101010101110110101111010..."

The *symbol mapping* block transforms the digital information (bits) into the continuous signals $I_{dirac}(t)$ and $Q_{dirac}(t)$. $I_{dirac}(t)$ and $Q_{dirac}(t)$ (see Fig. 2–39) consist of dirac pulses that appear at times $t=n \cdot T_{symbol}$ and that can be distinguished by their in-phase "I" and quadrature "Q" levels. For example a 16QAM constellation has 16 different I and Q combinations and 4 different I and Q levels ($4 \cdot 4 = 16$). Typically this is visualized in a constellation diagram (see Fig. 2–40). With $16 = 2^4$ we are able to transmit 4 bits per symbol. Therefore we can calculate:

$$bit_rate = symbol_rate * 4 = 4 / T_{symbol} [bits/second]$$

or more general:

$$bit_rate = symbol_rate * \log_2(M) [bits/second] \text{ for MQAM.}$$

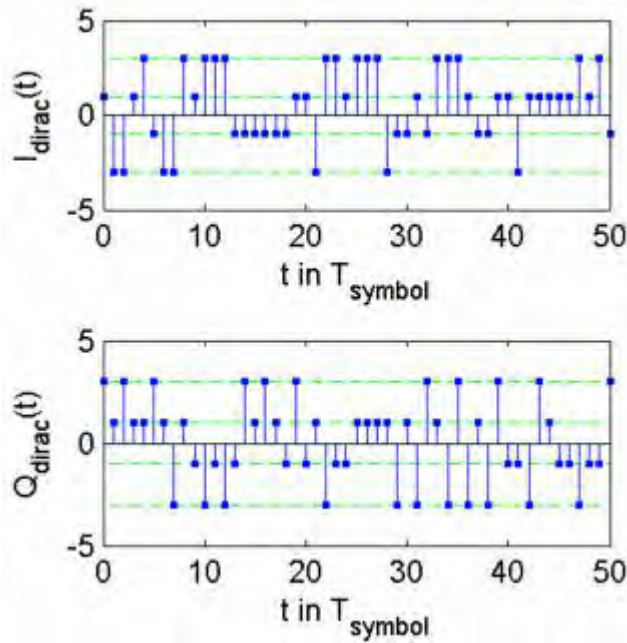

Fig. 2–39 Pulse signals $I_{dirac}(t)$ and $Q_{dirac}(t)$ for 16QAM

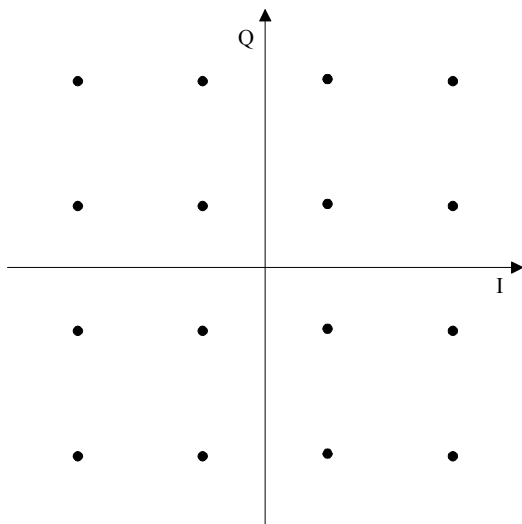

Fig. 2–40 16QAM constellation diagram

Unfortunately the required bandwidth for transmitting dirac pulses is infinite. Let's reduce the bandwidth by applying a so-called pulse shaping filter (as referred to as TX filters). In most QAM systems root raised cosine filters are used. root raised cosine filters are exclusive supported by the Cable TV Measurements option. Via the filter's roll-off factor the occupied bandwidth can be controlled.

$$OccupiedBandwidth = SymbolRate (1 + RollOff)$$

In a cable TV receiver, a filter of the same shape is used as RX filter. The combination of two root raised cosine filters, one in the transmitter (TX) and another one in the receiver (RX), has a very strong property: There will be no inter-symbol interference at the RX filter's output. Due to this property it is very easy for the receiver to retrieve the transmitted symbols. Please note, that in a real-world scenario the channel (causing echoes / multipath propagation) causes inter-symbol interference. In that case the

use of an equalizer is recommendable. Fig. 2-41 shows the signals $I_{RRC}(t)$ and $Q_{RRC}(t)$ that result from filtering $I_{dirac}(t)$ and $Q_{dirac}(t)$ with the root raised cosine filter **RRC**.

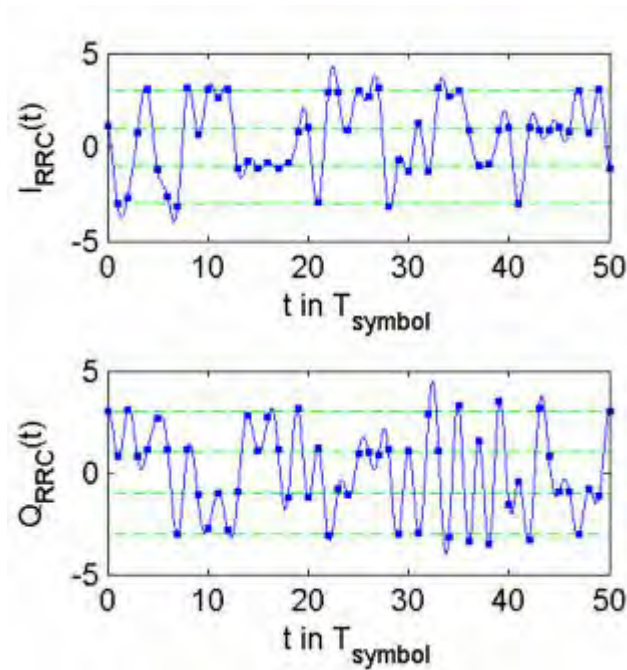

Fig. 2-41 Root raised cosine filtered dirac signals $I_{RRC}(t)$ and $Q_{RRC}(t)$

We notice that the symbol instants (highlighted with squares) are not on the horizontal lines (possible symbols levels) anymore. This is due to the inter-symbol interference introduced by the root raised cosine TX filter. Contrary to the signal filtered with two root raised cosine filters (TX and RX) the one filtered with a single root raised cosine filter (TX) does not satisfy the condition for zero inter-symbol interference. Fig. 2-42 shows the signal obtained by filtering the dirac signals with two root raised cosine filters. The convolution of two root raised cosine filters is also called raised cosine filter. We observe that all symbol instants (highlighted with squares) of $I_{RC}(t)$ and $Q_{RC}(t)$ have exactly the same levels as the signals $I_{dirac}(t)$ and $Q_{dirac}(t)$ in Fig. 2-39. Please note, that the signals $I_{RC}(t)$ and $Q_{RC}(t)$ can only be observed in the receiver and only for a undistorted transmission. They have been mentioned here for explanatory reasons.

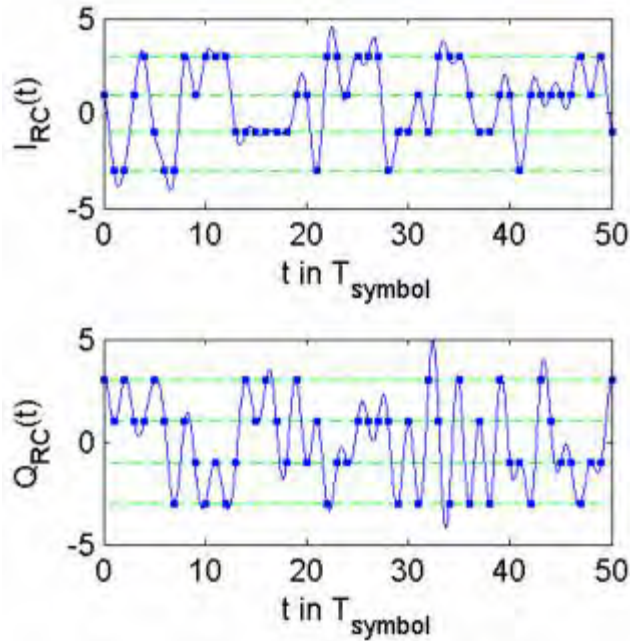

Fig. 2-42 Raised cosine filtered dirac signals $I_{RC}(t)$ and $Q_{RC}(t)$

Let us get back to the ideal transmitter from Fig. 2-38. The next task is to modulate the base band signals $I_{RC}(t)$ and $Q_{RC}(t)$ onto a carrier. The carrier frequency f_{CF} stands for the center of a given TV channel. Fig. 2-43 shows the modulated signal $I_{Q_{RF}}(t)$ with a carrier frequency $f_{CF}=4*\text{symbol_rate}$. In real system the carrier frequency is much higher than here in our example.

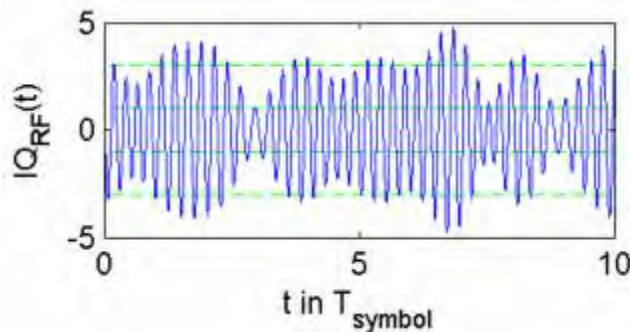

Fig. 2-43 QAM modulated RF signal $I_{Q_{RF}}(t)$

In a real cable TV transmission system however, the receiver would encounter a much worse situation. The measurement signal, i.e. the signal fed into the FSL's RF input, suffers from distortion. Some of it is caused by a non-ideal transmitter, some originates from the TV cable and finally there is thermal noise in every transmission system. Very often it is even not possible to find out from which component the distortion comes from. Luckily this can be found out by driving measurements starting at the transmitters location and continuing at different test points in the cable TV network up to the plug at the subscriber's home.

The objective of the digital TV measurements offered by the Cable TV Measurements option is to analyze and separate different sources of distortion and erroneous parameters.

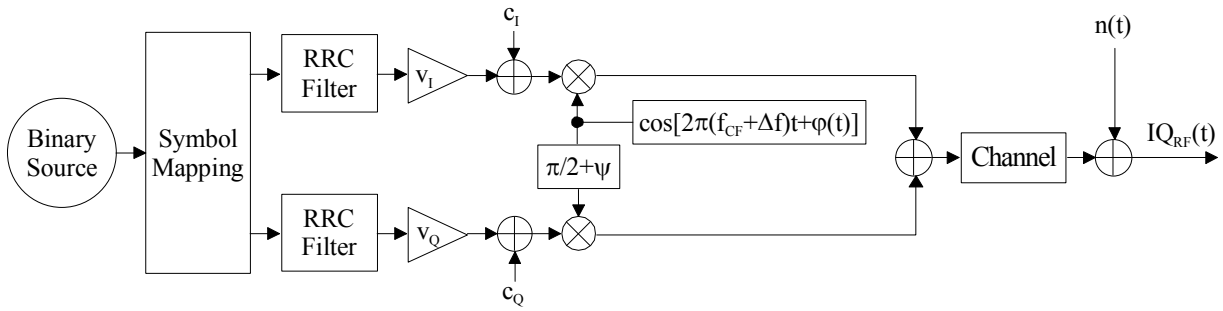

Fig. 2–44 Real–world QAM transmitter and distortion model

Fig. 2–44 shows the transmitter and distortion model assumed by the measurement demodulator of the Cable TV Measurements option. The error parameters and signals are given in the table below.

Table 2–6: Error parameters and signals in a QAM transmission system

Parameter	Ideal Value	Description
v_I, v_Q	$v_I = v_Q$	Gains of I and Q path
c_I, c_Q	$c_I = c_Q = 0$	Carrier leakage in I and Q path
ψ	$\psi = 0$	Quadrature error
Δf	$\Delta f = 0$	Carrier frequency error
$\varphi(t)$	$\varphi(t) = 0$	Phase noise signal
Channel $h(t)$	$h(t) = \delta(t)$	Channel impulse response
$n(t)$	$n(t) = 0$	Thermal noise

Digital TV Measurement Examples

These measurements are set up to carry out single channel measurements of digital TV signals. The settings for digital TV measurements are described in section [Digital TV settings](#). The test setup for the following measurement types is provided in section [Analog TV test setup](#).

- [Spectrum measurement](#)
- [Overview measurement](#)
- [Constellation diagram measurement \(modulation analysis\)](#)
- [Modulation errors measurement \(modulation analysis\)](#)
- [Echo pattern measurement \(channel analysis\)](#)
- [Channel power measurement](#)
- [APD measurement](#)
- [CCDF measurement](#)

Digital TV settings

The Cable TV Measurements option needs to know some of the parameters described in section [Digital TV Basics](#) to perform correct measurements. It therefore stores these parameters in the so-called "modulation standard". Refer to section [Modulation standards](#) for the creation and usage of a modulation standard. Section [Digital TV modulation standards](#) contains the description of the parameters that have to be characterized for a digital TV signal. The following list explains the meaning of the parameters:

- **Name:** Choose an arbitrary name for the new modulation standard.
- **Signal Type:** If you want to characterize an digital TV signal, select **Digital TV**.
- **TV Standard:** Select a TV standard to initialize the following parameters.
- **Constellation** used in the transmitter, e.g. 64QAM.
- **Symbol Rate** of QAM signal.
- **Roll-Off** factor of root raised cosine TX filter.
- **Sideband Position:** Is the signal in normal position or inverted?

Note: *In the dialog boxes, set the parameters always from top to bottom, since all parameters depend on the parameters above them. Otherwise your input might be rejected, e.g. if it specifies an unusual TV standard.*

Digital TV test setup

All measurement examples are performed in the **Cable TV Analyzer** mode. Use a digital TV generator as signal source. Connect the generator directly to the R&S FSL. Set the TV generator to the following parameters:

- center frequency = 100 MHz
- single carrier 64QAM modulation.
- root raised cosine transmit filter with a roll-off factor of 0.15.
- symbol rate = 6.9 MSymbols/s.

This test setup is used throughout all digital TV measurement examples.

Spectrum measurement

This measurement gives an overview of the active measurement channel. All parameters are set according to the modulation standard, referenced in the channel table or by the default digital TV modulation standard. The spectrum is displayed in a full screen trace.

Test setup:

Refer to the section [Digital TV test setup](#).

Procedure:

1. Press the **MEAS** key.
2. Press the **Digital TV** softkey.
3. Press the **Spectrum** softkey.
4. To adjust the input attenuator, press the **Adjust Attenuation** softkey.
5. Press the **RUN** key.

Overview measurement

This measurement determines the modulation accuracy of a digitally modulated single carrier QAM signals. The measurement results are checked against the limits and displayed in a table. In this table, only the important result parameters of digital TV signals are displayed. Less important result parameters are provided by the [Constellation diagram measurement \(modulation analysis\)](#).

Result parameters that failed the check are displayed in red and bold characters, the table cell is marked with a star. Result parameters that passed the checks are displayed in green characters. A global pass or fail comment is displayed in the upper left table corner on a green (for passed) or red (for failed) background.

Table 2–7: Result parameters – Overview

Parameter	Description	Definition
MER (rms)	root mean square of modulation error rate	$\sqrt{\frac{1}{N} \sum_{\nu=0}^{N-1} meas(\nu) - ref(\nu) ^2} \cdot 100 \%$

Parameter	Description	Definition
		$-10 \log_{10} \frac{\frac{1}{N} \sum_{\nu=0}^{N-1} meas(\nu) - ref(\nu) ^2}{E\{ ref(\nu) ^2\}} \quad dB$
MER (peak)	peak of modulation error rate	$\sqrt{\frac{\max_{\nu} meas(\nu) - ref(\nu) ^2}{E\{ ref(\nu) ^2\}}} \cdot 100 \quad \%$
		$-10 \log_{10} \frac{\max_{\nu} meas(\nu) - ref(\nu) ^2}{E\{ ref(\nu) ^2\}} \quad dB$
EVM (rms)	root mean square of error vector magnitude	$\sqrt{\frac{\frac{1}{N} \sum_{\nu=0}^{N-1} meas(\nu) - ref(\nu) ^2}{\max_{\nu} ref(\nu) ^2}} \cdot 100 \quad \%$
		$-10 \log_{10} \frac{\frac{1}{N} \sum_{\nu=0}^{N-1} meas(\nu) - ref(\nu) ^2}{\max_{\nu} ref(\nu) ^2} \quad dB$
EVM (peak)	peak of error vector magnitude	$\sqrt{\frac{\max_{\nu} meas(\nu) - ref(\nu) ^2}{\max_{\nu} ref(\nu) ^2}} \cdot 100 \quad \%$
		$-10 \log_{10} \frac{\max_{\nu} meas(\nu) - ref(\nu) ^2}{\max_{\nu} ref(\nu) ^2} \quad dB$
Carrier Frequency Offset	frequency offset between the received digital TV signal and the frequency setting	
Symbol Rate Offset	frequency offset between the measured symbol rate of the received TV signal and the set symbol rate	

Test setup:

Refer to the section [Digital TV test setup](#).

Procedure:

1. Press the **MEAS** key.
2. Press the **Digital TV** softkey.
3. Press the **Overview** softkey.
4. To magnify one parameter, press the **Zoom** softkey and activate the parameter. To go back to the default setting, activate **None**.
5. To change the limits, press the **Edit Table** softkey.
6. To adjust the input attenuator, press the **Adjust Attenuation** softkey.
7. Press the **RUN** key.

Constellation diagram measurement (modulation analysis)

This measurement displays the constellation diagram of the demodulated signal. Amplitude imbalance, quadrature error and carrier leakage (see. [Modulation errors measurement \(modulation analysis\)](#)) are still present in the used data. The probability of occurrence of points in the complex I/Q plane is represented by different colors. The constellation results are provided only graphically, i.e. reading results via remote control returns only a hardcopy of the display, but not a list of I/Q samples.

Test setup:

Refer to the section [Digital TV test setup](#).

Procedure:

1. Press the **MEAS** key.
2. Press the **Digital TV** softkey.
3. Press the **Modulation Analysis** softkey.
4. Press the **Const Diagram** softkey.
5. To zoom onto one quadrant, press the **Zoom** softkey and choose the desired quadrant. To go back to the complete constellation, select **None**.
6. To display the constellation diagram unchanged, while the I/Q samples are collected in the background, press the **Freeze** softkey. To switch back to the continual update of the display, press the **Freeze** softkey again.
7. To adjust the input attenuator, press the **Adjust Attenuation** softkey.
8. Press the **RUN** key.

Modulation errors measurement (modulation analysis)

This measurement determines the modulation accuracy. The measurement results are checked against the limits and displayed in a table. In this table, only the less important result parameters of digital TV signals are displayed (for details see [Table 2–8](#)). The important result parameters are provided by the [Overview](#) measurement.

Result parameters that failed the check are displayed in red and bold characters, the table cell is marked with a star. Result parameters that passed the checks are displayed in green characters. A global pass or fail comment is displayed in the upper left table corner on a green (for passed) or red (for failed) background.

Table 2–8: Result parameters – Modulation Errors

Parameter	Description	Definition
Amplitude Imbalance	amplification difference of I and Q signal caused by a non-ideal mixer in the transmitter	$AI = \left(\frac{v_2}{v_1} - 1 \right) \cdot 100\%$ $v_1 = \min\{v_I, v_Q\}$ $v_2 = \max\{v_I, v_Q\}$ $v_I : \text{amplification of I component}$ $v_Q : \text{amplification of Q component}$
Quadrature Error	phase offset relative to the ideal phase difference between the I and Q signal	
Carrier Suppression	suppression of carrier, perfect suppression results in $-\infty$ dB	
Phase Jitter (rms)	root mean square of phase jitter	

Test setup:

Refer to the section [Digital TV test setup](#).

Procedure:

1. Press the **MEAS** key.
2. Press the **Digital TV** softkey.
3. Press the **Modulation Analysis** softkey.
4. Press the **Modulation Errors** softkey.
5. To magnify one parameter, press the **Zoom** softkey and activate the parameter. To go back to the default setting, select **None**.
6. To change the limits, press the **Edit Table** softkey.
7. To adjust the input attenuator, press the **Adjust Attenuation** softkey.
8. Press the **RUN** key.

Echo pattern measurement (channel analysis)

This measurement determines the magnitude of the channel impulse response in respect to the corresponding time delay.

Test setup:

Refer to the section [Digital TV test setup](#).

Procedure:

1. Press the **MEAS** key.
2. Press the **Digital TV** softkey.
3. Press the **Channel Analysis** softkey.
4. Press the **Echo Pattern** softkey.
5. To change the unit from μs to km or miles:
 - Press the **Velocity Factor** softkey to define the velocity of propagation for the unit conversion.
 - Press the **Unit** softkey to select the unit.
6. To zoom onto the echo pattern, press the **Zoom** softkey.
7. To adjust the input attenuator, press the **Adjust Attenuation** softkey.
8. Press the **RUN** key.

Channel power measurement

This measurement determines the channel power of a digital TV channel.

For details on the applied measurement modes refer to section [Measuring Channel Power and Adjacent Channel Power](#).

The measurement is setup automatically with data relating to the modulation standard.

The measurement display is split into two panes. In the upper pane, the spectrum trace is displayed. In the lower pane, the result table for the measurement is displayed.

Test setup:

Refer to the section [Digital TV test setup](#).

Procedure:

1. Press the **MEAS** key.
2. Press the **Digital TV** softkey.
3. Press the **Channel Power** softkey.
4. To change the limits, press the **Edit Table** softkey.
5. To adjust the input attenuator, press the **Adjust Attenuation** softkey.
6. Press the **RUN** key.

APD measurement

This measurement determines the amplitude probability density function (APD). The measurement can also be performed in **Spectrum Analyzer** mode, but in the **Cable TV Analyzer** mode most of the parameters are set automatically. For details on the background refer to section [Amplitude Distribution Measurements](#).

Test setup:

Refer to the section [Digital TV test setup](#).

Procedure:

1. Press the **MEAS** key.
2. Press the **Digital TV** softkey.
3. Press the **APD** softkey.
4. To change the scaling parameters of the x– and y–axis:
 - Press the **Scaling** softkey.
 - Press the corresponding softkey to change the parameters: x–Axis Signal Level, x–Axis Range, y–Axis Max. Value, y–Axis Min. Value, Default Settings.
5. To adjust the input attenuator, press the **Adjust Attenuation** softkey.
6. Press the **RUN** key.

CCDF measurement

This measurement determines the complementary cumulative distribution function (CCDF) of the complex base band signal. The measurement can also be performed in **Spectrum Analyzer** mode, but in the **Cable TV Analyzer** mode most of the parameters are set automatically. For details on the measurement background refer to chapter section [Amplitude Distribution Measurements](#).

Test setup:

Refer to the section [Digital TV test setup](#).

Procedure:

1. Press the **MEAS** key.
2. Press the **Digital TV** softkey.
3. Press the **CCDF** softkey.
4. To determine the power exceeded with a given probability, press the **Percent Marker** softkey.
5. To change the scaling parameters of the x– and y–axis:
 - Press the **Scaling** softkey.
 - Press the corresponding softkey to change the parameters: x–Axis Signal Level, x–Axis Range, y–Axis Max. Value, y–Axis Min. Value, Default Settings.
6. To adjust the input attenuator, press the **Adjust Attenuation** softkey.
7. Press the **RUN** key.

TV Analyzer Measurements

The measurement here is set up to carry out multiple channel measurements of TV networks. The measurement provides a fast, automatic change of the measurement channel in order to support a quick succession of measurements.

The following measurement type is provided:

- [Tilt measurement](#)

Tilt measurement

This measurement can determine the amplitude response of the CATV network by measuring the channel power of every channel. Both analog and digital TV channels can be measured. The setup configuration allows to limit the frequency range or to choose particular modulation standards in order to measure only a channel subset of the TV network.

The channel levels are measured in a series of zero–span measurements. Each channel is measured using the information stored in the channel table (modulation standard). Therefore the use of a channel table is mandatory. Channels with the modulation standard **< unused >** are not measured (for details on modulation standards refer to chapter "Instrument Functions", section "Cable TV Measurements Option (K20)". Depending on the set modulation standard one the following measurements is used internally by the firmware:

- analog TV: [Carriers measurement](#)
- digital TV: [Channel power measurement](#)

The measurement result is displayed in form of a bar graph. The colors of the bars indicate the signal type of the modulation standard.

Test setup:

Connect the R&S FSL to your CATV network.

It is not possible to work without a channel table. You cannot even enter the TV Analyzer sub menu, if you have not activated a channel table before. Create a channel table according to you CATV network (or a subset of your network). This task is described in section [Example: Creating a channel table](#). If you do not want to create your own channel table, you can use the example channel table from section [Example: Creating a channel table](#), which is delivered with the Cable TV Measurements option.

Procedure:

1. Press the **MENU** key.
2. Press the **Channel Setup** softkey.
3. Select the appropriate channel table and activate it by pressing the **Activate** softkey.
4. Press the **MEAS** key.
5. Press the **TV Analyzer** softkey.
6. Press the **Tilt** softkey.

7. To restrict the channels to be measured, press the **Tilt Setup** softkey:
The **Tilt Setup** dialog box is displayed.
 - To limit the frequency range, under **Span**, enter a start and stop frequency. Be sure that at least one channel's RF frequency is in this range. Otherwise the measurement display will be empty!
 - To select certain modulation standards for the measurement, under **Modulation Standards**, activate the modulation standards to be included in the measurement.
8. To adjust the range of the y-axis, if logarithmic, press the **Auto Range** softkey.
9. Press the **RUN** key.
10. Observe the exact levels of different channels by turning the rotary knob.
11. Check your network:
 - Do all signals of the same type (e.g. all analog TV signals) have similar levels?
You can do this by selecting the modulation standards to measure before the measurement.
Or you can measure all kinds of signals and distinguish different modulation standards after the measurement by their different colors.
 - You can measure the amplitude response of the network (or of an amplifier) by looking at the levels of signals at different frequencies. Prerequisite is either that you measure before and after the amplifier and compare the results. Or that you know, that the levels are equal at the transmitter.

Channel Tables and Modulation Standards

Measurements with the Cable TV Measurements option can be speeded up significantly if a channel table is used. First of all a channel table, sometimes also referred as channel plan, contains the frequency plan of a cable TV network. Furthermore, for every channel it contains the information about the service broadcast or the information that the channel is **< unused >**.

Typically every country has its own regulations concerning the frequency plan, i.e. the channel locations and the channel widths. Unfortunately the services or programs assigned to this frequency plan differ from one CATV network to another. For example the CATV network of the city of Munich offers different programs than Erding which is only about 40 kilometers away. Therefore the Cable TV Measurements option provides empty channel tables for most countries in the world, where empty means, that all channels are marked as **< unused >**. However, it is not possible to do measurements without any precise information about the services. Therefore the Cable TV Measurements option introduces the concept of the so-called modulation standard.

Modulation standards describe the signal characteristics, or physical layer, transmitted via a channel. The Cable TV Measurements option supports modulation standards that characterize analog TV signals (e.g. NTSC, SECAM, PAL) or digital TV signals (single carrier QAM as for example in DVB-C). Every channel table can comprise several modulation standards. Once defined, every channel can reference one of these modulation standards. Provided that at least one channel references a modulation standard, measurements based on a channel table can easily be done.

You can create numerous channel tables (e.g. for different locations in the network / different measurement tasks) and save them on the R&S FSL. But there can always be only one channel table active at a time. Working without a channel table is realized by activating the special, pseudo channel table called **< none >**.

Normally, the easiest way is not to create a channel table from the scratch, but to load pre-defined channel tables delivered with the Cable TV Measurements option. They already hold the typical frequency plans for many countries. You only have to fill in the modulation standards.

For detailed information on channel tables refer to section [Channel tables](#), for modulation standards refer to section [Modulation standards](#). A detailed example is provided in section [Example: Creating a channel table](#). [Fig. 2-45](#) gives an example of a channel table that references the modulation standard "PAL_BG_STEREO". [Fig. 2-47](#) shows that modulation standard.

Channel tables

This section gives a detailed description of channel tables and their properties.

- Channel tables (see Fig. 2–45) have a **Name**. The name should comprise geographical information, e.g. "SOUTHAMPTON" or "EXAMPLE_WIPFING".
- If desired, a **Description** giving further information on the channel table can be entered.
- Channel tables consist of **Channels**. The Cable TV Measurements option displays one channel per line. A channel table must contain at least one channel.

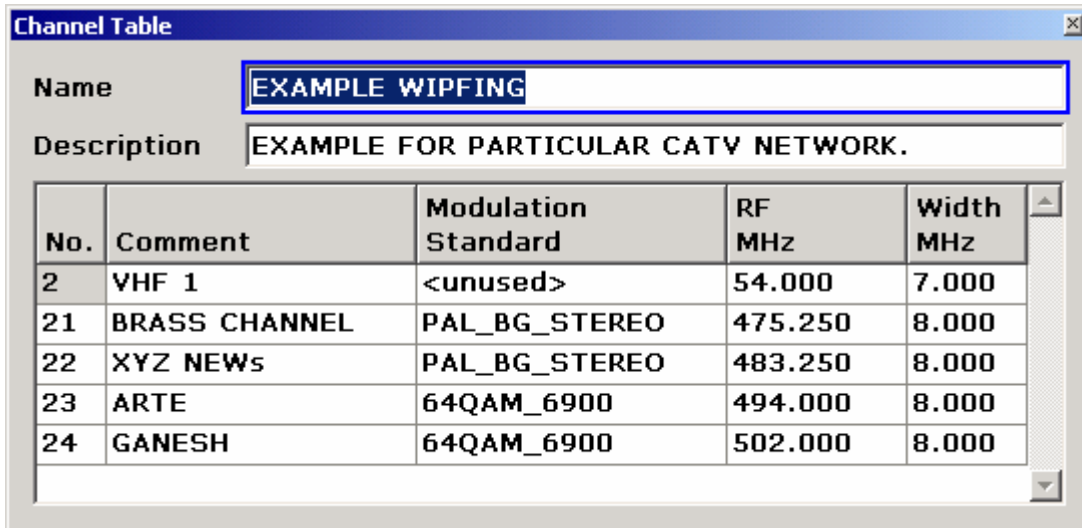

Fig. 2–45 The channel table and its properties

Every channel has the following properties:

- The unique channel number **No.** can be used within measurements to change over from one channel to another quickly.
- A **Comment** can be specified, e.g. the name of the program or the frequency band.
- A **Modulation Standard** is referenced. In case of an empty channel, the modulation standard is set to **< unused >**. Be aware that modulation standards have to be created before making use of them. For details refer to section [Create modulation standards](#) Note, that in order to perform channel table based measurements, there must be at least one channel, that references a modulation standard. It is not possible to do any measurements, if in all channels the modulation standard equals **< unused >**.
- The **RF** frequency represents the characteristic frequency of a channel. For analog TV channels RF is equal to the vision carrier frequency. For digital TV channels and **< unused >** channels it equals the center frequency.
- **Width** stands for the channel's bandwidth.

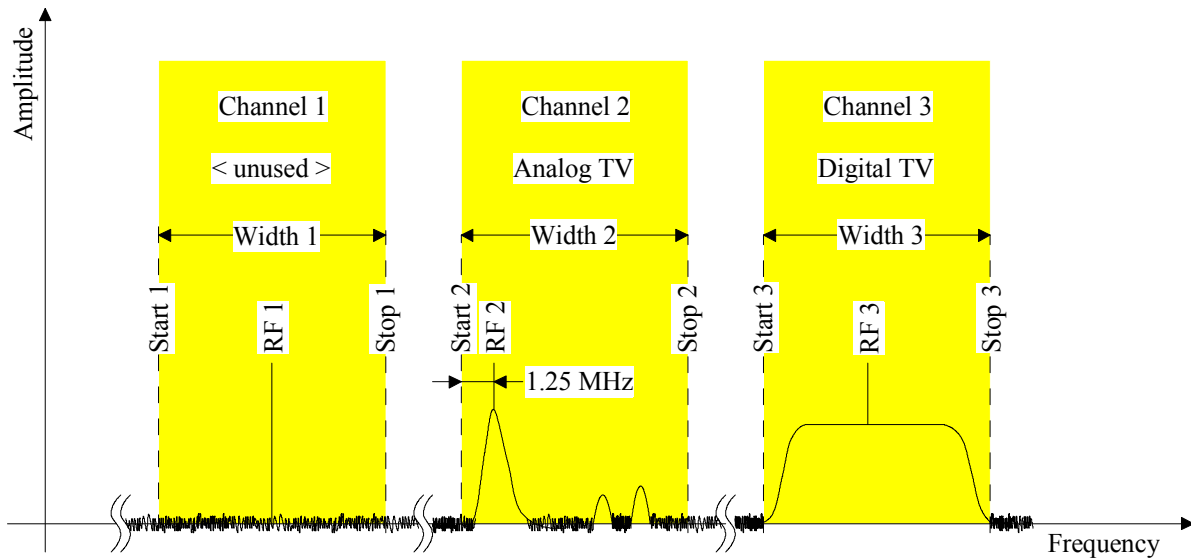

Fig. 2-46 Channel start and stop frequencies versus RF frequency and channel width

Except for **< unused >** channels the calculation of the start and stop frequencies depends on the signal type property (digital or analog TV) of the referenced modulation standard. All corresponding formulae are listed in the table below.

Table 2-9: Channel start and stop frequencies versus RF frequency and channel width

Signal type	Analog TV	Digital TV	< unused >
RF frequency	Start + 1.25 MHz	Start + (Stop - Start) / 2	
Channel Width	Stop - Start		
Start frequency	RF - 1.25 MHz	RF - Width/2	
Stop frequency	Start + Width		

Note: The Cable TV Measurements option automatically adapts the RF frequency if the user changes the modulation standard of a channel (e.g. from an analog to digital modulation standard). This is done in order to keep the channels start and stop frequencies constant.

Modulation standards

All over the world many different transmission standards for TV signals exist. As a guide through the jungle of parameters that describe TV signals (including video and sound sub-signals) the concept of the modulation standard has been introduced.

Most important when dealing with modulation standards is the order of the parameters. Modulation standards (see Fig. 2-47) have always to be created and edited from top to bottom of the **Modulation Standard Options** dialog box. The most important parameters are located at the top of the dialog box. For example, changing the signal type from **Analog TV** to **Digital TV** also alters the complete set of parameters below. Whereas the modulation technique for transmitting the color information is essential in analog TV systems (see **Color System** in Fig. 2-47), it does not exist for digital TV systems. The constellation instead is crucial in digital TV systems (see Fig. 2-48). For that reason the Cable TV Measurements option automatically guides you through the whole process of creating a new modulation standard and only confronts you with mandatory parameters.

A modulation standard is structured as follows:

- The **Name** is arbitrary, but should refer to the main properties of the TV signal, e.g. "PAL_BG_STEREO".
- The **Signal Type** specifies whether the signal is an analog TV or a digital TV signal.

As mentioned above, all described parameters below depend on the chosen signal type. Therefore the remaining parameters will be discussed separately in the sequel.

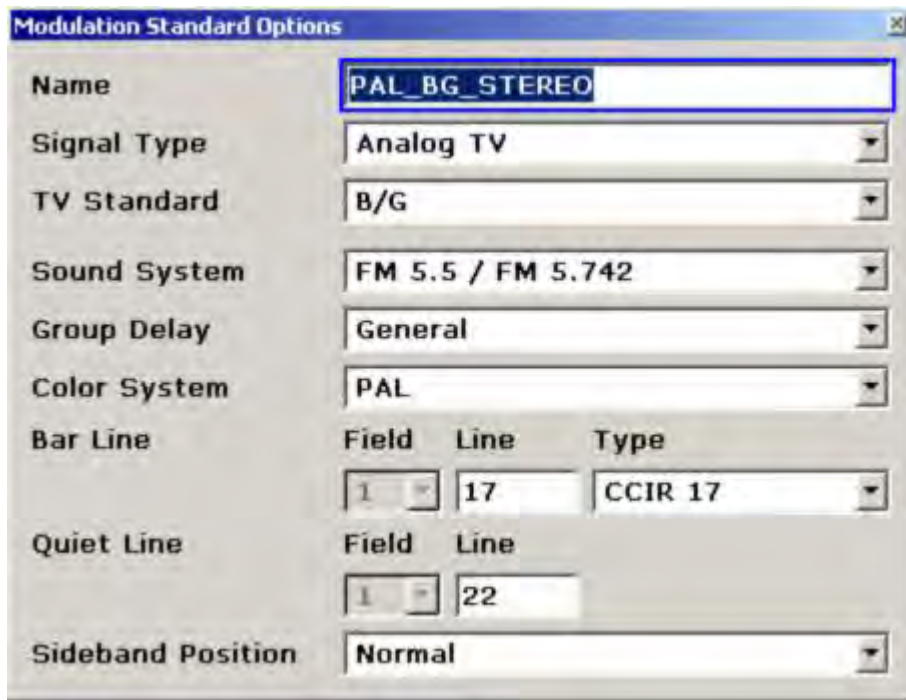

Fig. 2-47 **Modulation Standard Options** dialog box for analog TV

Analog TV modulation standards

This section describes the parameters that characterize analog cable TV signals. Refer to section [Analog TV Basics](#) to learn more about analog cable TV signals. The parameters discussed here can also be modified (temporarily) in the **Analog TV Settings** dialog box.

For analog TV the **Modulations Standard Options** dialog box (see Fig. 2–47) is structured as follows:

- The channel table references modulation standards by their **Name**. Its name (see Fig. 2–48) should comprise information about the used TV standard, the color system and the sound system, e.g. "PAL_BG_STEREO".
- Here the **Signal Type** is always set to **Analog TV**.
- The **TV Standard** characterizes the way the luminance information is modulated. The following analog TV standards exist:
 - B/G
 - D/K
 - I
 - K1
 - L
 - M
 - N
- The **Sound System** parameter specifies how the audio will be transmitted. The possible values depend on the TV Standard selected in the **TV Standard** list. The sound systems are named in the form "sound carrier 1 / sound carrier 2", e.g. "FM 6.5 / FM 6.258". Information about the sound modulation format and the carrier frequency with respect to the vision carrier is included.

Table 2–10: Possible values for the sound systems

TV Standard	Sound System
B/G	FM 5.5 / NICAM 5.85
	FM 5.5 / FM 5.742
	FM 5.5 MONO
D/K K1	FM 6.5 / NICAM 5.85
	FM 6.5 / FM 6.258
	FM 6.5 / FM 6.742
	FM 6.5 MONO
I	FM 6.0 / NICAM 6.552
	FM 6.0 MONO
L	AM 6.5 / NICAM 5.85
	AM 6.5 MONO
M N	FM 4.5 BTSC
	FM 4.5 EIA–J
	FM 4.5 / FM 4.724
	FM 4.5 MONO

- What **Group Delay** shall the residual sideband filter have? The Group Delay setting has no effect on the measurements in this firmware release.
- The **Color System** parameter specifies how color information will be transmitted. The possible values depend on the TV Standard selected in the **TV Standard** list.

Table 2–11: Possible values for the Color Systems

TV Standard	Color System
B/G	PAL
D/K	SECAM
I N	PAL
K1 L	SECAM
M	NTSC
	PAL

- **Bar Line:** The vision modulation measurement needs a special test signal, containing a peak white value. You must specify the type and the number of the horizontal line that contains the peak white value.
- **Quiet Line:** Some measurements need a horizontal line with no video information in it. You must specify the number of this horizontal line here. For further information see also [Example: Creating a channel table](#).
- **Sideband Position:** Is the signal in normal position or inverted?

Sometimes the analog TV signal to be analyzed is only available with an inverted sideband. This can for example happen if the cable operator feeds – for some reason – an inverted signal into the network. It may also happen in R&D labs where measurements on different IF stages of a new TV transmitter or a receiver hardware are to be performed. Please be aware, that these two applications also lead to two different cases when measuring with the Cable TV Measurements option:

- Measurements with channel tables
- Measurements without a channel table, i.e. **< none >**.

The sideband position can either be altered in the modulation standard or in the **Analog TV settings** dialog box. When measuring with a channel table, switching the sideband position (from normal to inverse or vice versa) keeps the channel's start and stop frequencies constant. As a consequence the RF frequency will be modified.

Example:

Channel Information:

RF frequency = 401.25 MHz

Width = 8 MHz

Modulation standard = analog TV with sideband position = normal.

This leads to the following channel borders:

Start frequency = RF – 1.25 MHz = 400 MHz

Stop frequency = Start frequency + Width = 408 MHz.

Next, the sideband position of the referenced modulation standard will be set to inverse. In order to keep the start and stop frequencies constant the RF frequency will be adapted as follows:

RF frequency = Stop frequency – 1.25 MHz = 206.75 MHz.

In case of measurements without a channel table, i.e. **< none >**, we realize that there are no start and stop frequencies existing. Hence, changing the sideband position keeps the RF frequency constant. As a consequence you will analyze different parts of the spectrum depending on the selected sideband position.

Digital TV modulation standards

In the Cable TV Measurements option, digital TV is used as a synonym for quadrature amplitude modulated (QAM) signals. In digital Cable TV networks exclusively single carrier modulated signals are used. The Cable TV Measurements option does not support multicarrier techniques such as OFDM in terrestrial TV networks.

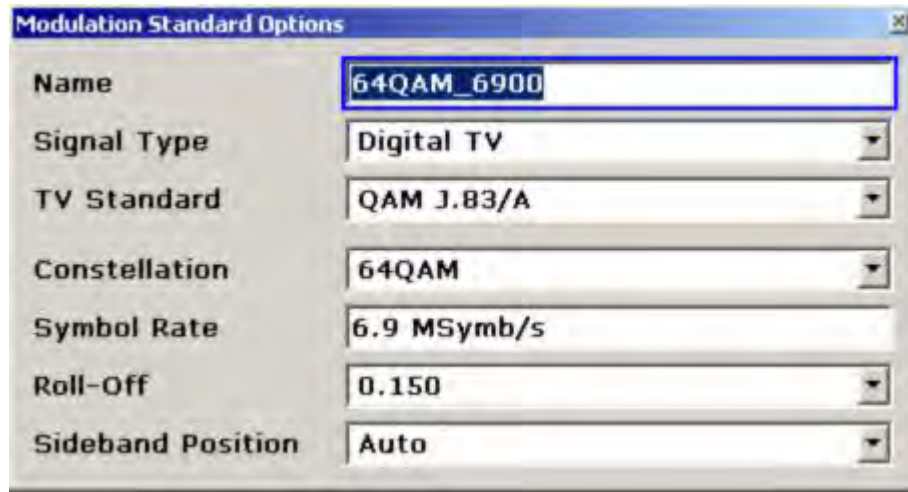

Fig. 2–48 **Modulation Standard Options** dialog box for digital TV

This chapter describes the parameters that characterize digital cable TV signals. Refer to section [Digital TV Basics](#) to learn more about digital TV signals. The parameters discussed here can also be modified (temporarily) in the Digital TV Settings dialog.

For digital TV the **Modulations Standard Options** dialog box is structured as follows:

- The channel table references modulation standards by their **Name**. Its name (see [Fig. 2–48](#)) should comprise information about the used constellation and the symbol rate, e.g. "64QAM_6900".
- Here the **Signal Type** is always set to **Digital TV**.
- Depending on the **TV Standard** the default values of the parameters below are set. The following digital TV standards exist:
 - QAM J.83/A (DVB–C Europe)
 - QAM J.83/B (US Cable)
 - QAM J.83/C (Japanese Cable)
- The **Constellation** parameter supports the values below:
 - 4QAM
 - 16QAM
 - 32QAM
 - 64QAM
 - 128QAM
 - 256QAM
 - 512QAM
 - 1024QAM

Fig. 2–49 shows ideal 16QAM and 32QAM constellation diagrams. 4QAM, 16QAM, 64QAM, 256QAM and 1024QAM have a square structure, whereas 32QAM, 128QAM and 512QAM have a cross structure.

- The **Symbol Rate** and the **Roll-off** factor of the pulse shaping filter determine the occupied bandwidth of the digital TV signal. In the Cable TV Measurements option only root raised cosine filters are supported. The bandwidth can be calculated by the following formula:

$$\text{OccupiedBandwidth} = \text{SymbolRate} (1 + \text{RollOff})$$

The symbol rate can be entered in MHz. For the roll-off factor, the following values are supported:

- 0.120
 - 0.130
 - 0.150
 - 0.180
- The **Sideband Position** parameter can be used to invert the sidebands. The following values are supported:
 - Auto
 - Inverse
 - Normal

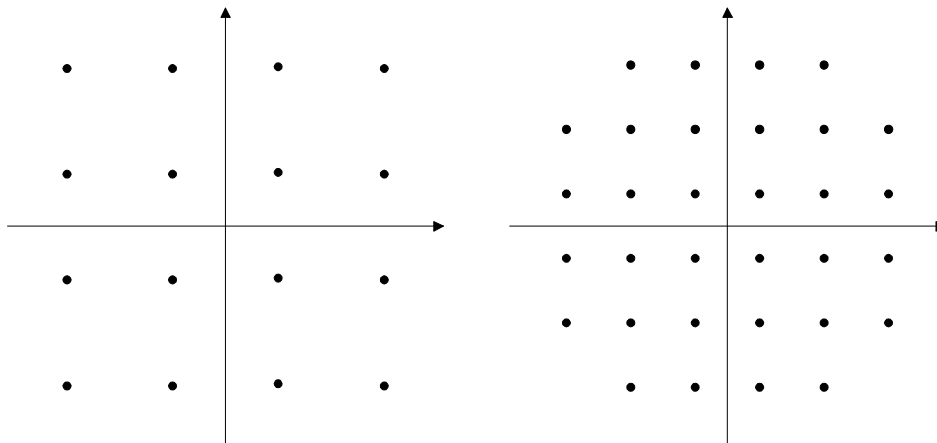

Fig. 2–49 16QAM (square) and 32QAM (cross) constellation diagrams

Example: Creating a channel table

This section gives an exemplary step-by-step instruction for creating a channel table. The basic procedure consists of three steps:

1. Enter frequency plan, i.e. a channel table solely containing < unused > channels.
2. Create modulation standards.
3. Assign modulation standards to channels.

The following sections address these steps.

The channel tables described in this example are delivered with the Cable TV Measurements option. Please note, that contrary to the example here, their names are as follows.

- RS_EXAMPLE_BAVARIA (in example: "EXAMPLE BAVARIA")
- RS_EXAMPLE_WIPFING (in example: "EXAMPLE WIPFING")

Enter frequency plan

Typically every country has its own regulations concerning the frequency plan, i.e. the channel locations and the channel widths. That is what we call a country-specific frequency plan. Table 2-12 shows the frequency plan of "Bavaria". This plan applies to all cable TV networks of Bavaria. Hence, there is no information about the programs included yet, as this information depends on the (local) operator of a particular network. In the first step, we merely want to enter this frequency plan with the Cable TV Measurements option and call this channel table "EXAMPLE BAVARIA".

Table 2-12: Frequency plan example of channel table "EXAMPLE BAVARIA"

Channel No.	Band name	Start frequency in MHz	Width in MHz
2	VHF 1	50.5	7
21	UHF	474	8
22	UHF	482	8
23	UHF	490	8
24	UHF	498	8

1. Press the **MENU** key.
2. Press the **Channel Setup** softkey.
3. Press the **New** softkey to create a new channel table.
4. In the **Name** field, enter *EXAMPLE BAVARIA* as channel table name with the keypad, and press **ESC**.
5. In the **Description** field, enter in the same way *EXAMPLE FOR COUNTRY SPECIFIC FREQUENCY PLAN*.
6. To enter the first channel (line 2 of Table 2-12):
 - Use the knob or the cursor keys to move to the **No.** column of the existing channel.
 - Enter 2 for the channel number.
 - Enter *VHF 1* as **Comment**.
 - Set the **Modulation Standard** to < unused >.

Therefore RF represents the center frequency and can be calculated as
 $RF = Start + Width / 2 = 50.5 \text{ MHz} + 7 \text{ MHz} / 2 = 54 \text{ MHz}$.

- Set the **RF** frequency to *54 MHz*.
 - Set the channel **Width** to *7 MHz*.
7. To enter the second channel (line 3 of [Table 2-12](#)):
- Move down to focus the last channel.
 - Press the **Copy Channel** softkey to copy the last channel.
 - Move down to the copied channel.
 - Set the channel number **No.** to *21*.
 - Enter *UHF* as **Comment**.
 - Set the **Modulation Standard** to **< unused >**,
i.e. $RF = 474\text{ MHz} + 8\text{ MHz} / 2 = 478\text{ MHz}$.
 - Set the **RF** frequency to *478 MHz*.
 - Set the channel **Width** to *8 MHz*.
8. To enter the remaining channels proceed as in step 7
- Channel 22: RF = *486 MHz*
 - Channel 23: RF = *494 MHz*
 - Channel 24: RF = *502 MHz*
9. To save your work, press the **Save Changes** softkey.

Having finished the first step, you have build a channel table as shown in [Fig. 2-50](#). Please note, that it is not possible yet, to do any measurements, as all channels are marked as **< unused >**. Nevertheless, you can use the EXAMPLE BAVARIA channel table as a base model for all channel tables required all over Bavaria.

No.	Comment	Modulation Standard	RF MHz	Width MHz
2	VHF 1	<unused>	54.000	7.000
21	UHF	<unused>	478.000	8.000
22	UHF	<unused>	486.000	8.000
23	UHF	<unused>	494.000	8.000
24	UHF	<unused>	502.000	8.000

Fig. 2-50 Channel table "EXAMPLE BAVARIA" with entered frequency plan

Create modulation standards

For detailed information on channel tables refer to section [Channel tables](#), for modulation standards refer to section [Modulation standards](#). A worked out example can be found in [Example: Creating a channel table](#).

The second and third steps require knowledge about a particular network. Thus, information about the programs (see [Channel tables](#)) and the possible services (see [Modulation standards](#)) has to be collected. For our example, we retrieved this information from the operator of the small cable TV network of Wipfing, a village in Bavaria. We found out, that there is a traditional TV chain, broadcasting their TV program using analog transmission techniques with stereo sound. The technical details are summarized in [Table 2–13](#). Besides, another TV chain, equipped with state-of-the-art Bavarian broadcast technology, feeds two digital DVB–C programs into Wipfing’s cable TV network. The parameters are listed in [Table 2–14](#).

Table 2–13: Analog TV service data for PAL_BG_STEREO modulation standard

Video	PAL B/G
Sound	Stereo: FM 5.5 MHz / FM 5.7421875 MHz
Group delay profile	general
VITS: Bar line	CCIR17, line 17
VITS: Quiet line	line 22
Sideband position	normal

Table 2–14: Digital TV service data for 64QAM_6900 modulation standard

Standard	QAM J.83/A (DVB–C Europe)
Constellation	64QAM
Symbol rate	6.9 MSymbols/s
Roll-off factor of root raised cosine filter	0.15
Sideband position	normal

First of all in the second step, we will copy the EXAMPLE BAVARIA channel table to a new channel table EXAMPLE WIPFING. We do this, because we want to keep the pure frequency plan (as EXAMPLE BAVARIA channel table), and create an additional channel table EXAMPLE WIPFING for our measurements in Wipfing.

1. Press the previous key, to go back to the **Channel Tables** dialog box.
2. Focus the channel table **EXAMPLE BAVARIA** via the knob or cursor keys.
3. Press the **Copy** softkey to copy the **EXAMPLE BAVARIA** channel table.
4. The **Channel Table** dialog box is displayed (see [Fig. 2–50](#)).
5. In the field **Name**, enter *EXAMPLE WIPFING* as channel table name, with the keypad.
6. In the field **Description**, enter in the same way *EXAMPLE FOR PARTICULAR CATV NETWORK*.
7. To save the new channel table, press the **Save Changes** softkey. You will be prompted if any errors are encountered. In that case, please correct all errors. If you followed the steps above everything should be fine.

We will then create the analog modulation standard, which we will call PAL_BG_STEREO and which is based on the information of [Table 2–13](#): We will continue with the channel table EXAMPLE WIPFING from above.

8. Press the **Modulation Options** softkey.

The appearing list of all existing modulation standards is empty right now.

9. In the **Modulation Options** submenu, press the **New** softkey.
 The **Modulation Standard Options** dialog box appears (see for example [Fig. 2-51](#)).
10. Enter the parameters for the modulation standard:
 - In the field **Name**, enter *PAL_BG_STEREO* as modulation standard name with the keypad.
 - Select **Analog TV** as **Signal Type** from the list.
 This is done, because PAL B/G is an analog TV standard.
 - Select **B/G** as **TV Standard**.
 This means that the luminance information of the video signal is transmitted via an AM modulated carrier according to the standard B/G.
 - Select **FM 5.5 / FM 5.742** as **Sound System** from the list.
 That means that there are two sound carriers present, one 5.5 MHz and the other 5.7421875 MHz above (for a normal sideband position) the vision carrier frequency.
 - Select **General** for the **Group Delay** from the list.
 - Select **PAL** for the **Color System** from the list.
 The color information of the video signal is transmitted according to the PAL standard.
 - For the **Bar Line**, set **Line** to *17* and the **Type** to **CCIR17**.
 That means, that a special test signal, the so called bar line, is transmitted in the horizontal line 17 of the TV signal.
 - For the **Quiet Line**, set **Line** to *22*.
 That means, that the horizontal line 22 transmits no luminance information.
 - Select **Normal** as **Sideband Position** from the list.
 - The **Modulation Standard Options** dialog box should now look as in [Fig. 2-51](#).
11. Press the previous key twice to go back to the **Channel Table** dialog box.
12. Press the **Save Changes** softkey to save the channel table and the new modulation standard.

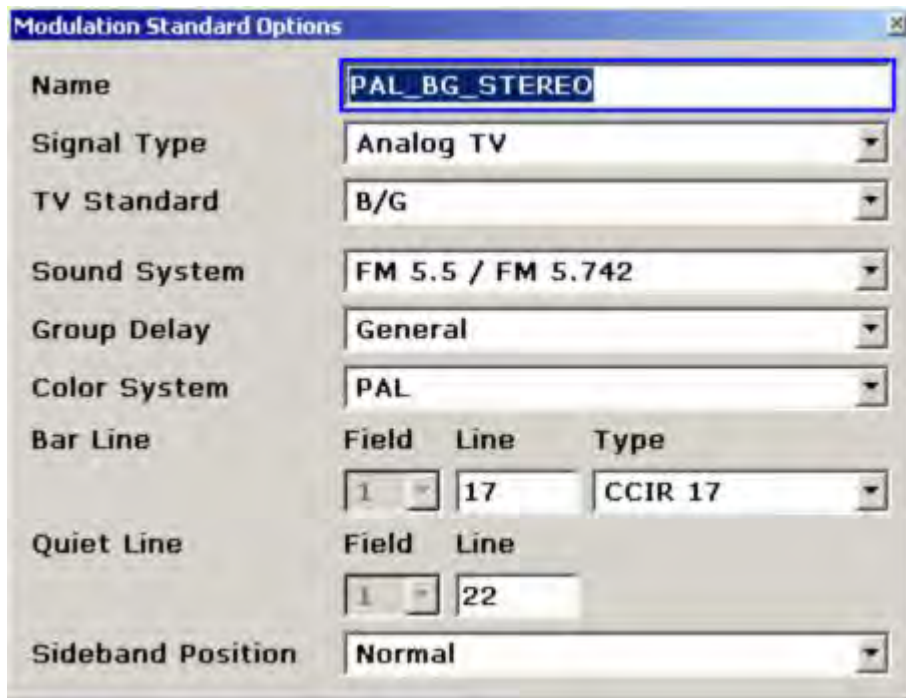

Fig. 2-51 Analog TV modulation standard PAL_BG_STEREO

Up to now, we successfully created the channel table EXAMPLE WIPFING, which contains a frequency plan and the analog TV modulation standard PAL_BG_STEREO. Next, we will create the digital modulation standard 64QAM_6900 based on the information of [Table 2-14](#).

13. Press the **Modulation Options** softkey.

A list with one modulation standard **PAL_BG_STEREO** is displayed.

14. In the **Modulation Options** submenu, press the **New** softkey.

The **Modulation Standard Options** dialog box is displayed (see for example [Fig. 2-51](#)).

15. Enter the parameters for the modulation standard:

- In the field **Name**, enter *64QAM_6900* as modulation standard name with the keypad.
- Select **Digital TV** as **Signal Type** from the list.
This is done, because the desired QAM DVB-C signal is a digital TV signal.
- Select **QAM J.83/A (DVB-C Europe)** as **TV Standard**.
By this means, all parameters below are set to their default values.
- Set **Constellation** to **64QAM**.
- Set the **Symbol Rate** value to *6.9 MSyms/s*.
This can be done by entering 6.9 via the keypad and confirming the input with the MHz key.
- Set the **Roll-off** factor to **0.150**.
- Select **Auto** as **Sideband Position** from the list.
- The **Modulation Standard Options** dialog box should now look as in [Fig. 2-52](#).

16. Press the previous key twice to go back to the **Channel Table** dialog box.

17. Press the **Save Changes** softkey to save the channel table and the new modulation standard.

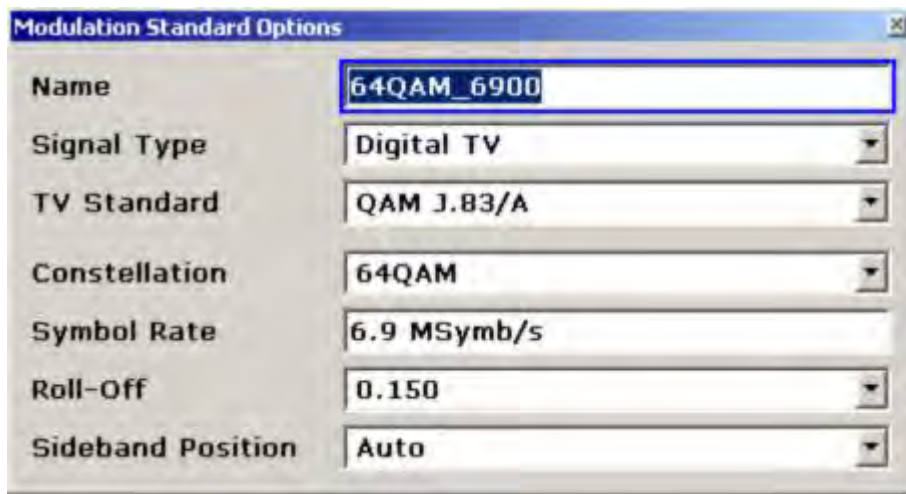

Fig. 2-52 Digital TV modulation standard 64QAM_6900

We have now finished step two, i.e. the channel table EXAMPLE WIPFING contains a frequency plan, the analog modulation standard PAL_BG_STEREO and the digital modulation standard 64QAM_6900.

Assign modulation standards to channels

Finally, in step three, the links between the frequency plan and the modulation standards have to be set. [Table 2–15](#) shows the desired combinations.

Table 2–15: Assignment of programs and services to channels

Channel No.	Program Name	Modulation Standard
2	–	< unused >
21	BRASS CHANNEL	PAL_BG_STEREO
22	XYZ NEWS	PAL_BG_STEREO
23	ARTE	64QAM_6900
24	GANESH	64QAM_6900

1. Do not change channel 2, as no service is available (< unused >).
2. To edit channel 21:
 - Enter *BRASS CHANNEL* into the **Comment** field of channel 21. The band name, entered before, is now replaced by the more meaningful program name.
 - Select **PAL_BG_STEREO** as **Modulation Standard** from the list. The list now offers: < unused >, **64QAM_6900** and **PAL_BG_STEREO**. Furthermore, the RF frequency will be automatically changed from 478 MHz to 475.25 MHz.
3. To edit the channels 22, 23, and 24, proceed to step 2 using the information from [Table 2–15](#).
4. Press the **Save Changes** softkey, to save the channel table.

The complete channel table is shown in [Fig. 2–53](#).

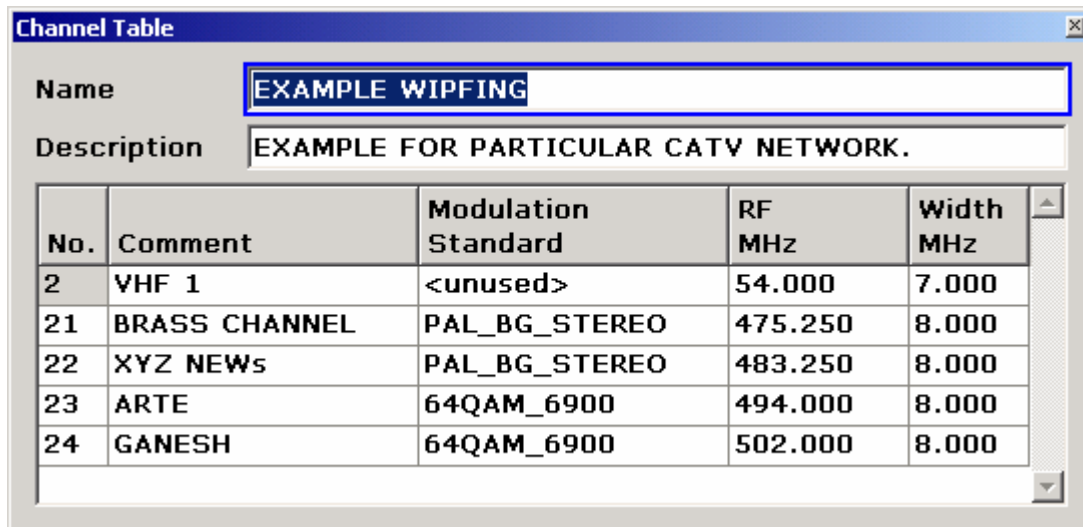

Fig. 2–53 Digital Channel table "EXAMPLE WIPFING"

We now have successfully finished the creation of the channel table "EXAMPLE WIPFING". Please refer to section [Performing a Measurement without a Channel Table](#) to learn more about measurements based on a channel table.

Example: Restoring the default channel tables

The Cable TV Measurements option brings several channel tables with it:

- The typical frequency plans used in different countries, e.g.
 - TV-CHINA
 - TV-EUROPE
 - TV-USA-CATV
 - etc...
- Example channel tables (see [Example: Creating a channel table](#)), e.g.
 - RS_EXAMPLE_BAVARIA
 - RS_EXAMPLE_WIPFING

If you have modified or deleted one of these channel tables, you can restore them in the following way:

1. Press the **MENU** key.
2. Press the **Channel Setup** softkey.
3. Press the **Restore Default Tables** softkey.

Only missing channel tables will be restored. If you want to replace an existing channel table by its default channel table, you have to delete it before.

Performing a Measurement without a Channel Table

The Cable TV Measurements option intends to help network engineers. Network engineers will once create a channel table, and then use it to visit many, many test points, all located in the same cable TV network. If you are a network engineer please see section [Performing a Measurement Using a Channel Table](#). If you work in R&D or you do not have a cable TV network at all (all you have is a single TV transmitter or a frequency where you want to do a measurement ignoring any signals apart), this section describes how to setup an analog TV spectrum measurement without a channel table.

Test setup:

Connect a analog TV generator to your R&S FSL. Set the TV generator to send an analog TV PAL B/G signal with a vision carrier frequency of 210.25 MHz.

Procedure:

1. Press the **MENU** key.
2. Press the **Channel Setup** softkey.
The **Channel Tables** dialog box is displayed. It lists all available channel tables.
3. Select no channel table < **none** > and press the **ENTER** key.
You should always select < **none** > if you do not have a channel table. In this mode you can do all kind of measurements except the [Tilt measurement](#).
4. Press the **MEAS** key.
5. Press the **Analog TV** softkey.
By pressing this softkey you tell the Cable TV Measurements option, that your signal is an analog TV signal and that the **Default Analog Modulation Standard** has to be used. This modulation standard is used for all analog TV measurements knowing the fact that there is no channel table where a modulation standard can be retrieved from.
6. Press the **Spectrum** softkey.
In our example we want to check the spectrum of our analog TV source.
7. Press the **FREQ** key.
8. Press the **RF** softkey.
9. Enter *210.35 MHz* as the **RF** frequency.
10. To adjust the input attenuator, press the **Adjust Attenuation** softkey.
The following figure is displayed:

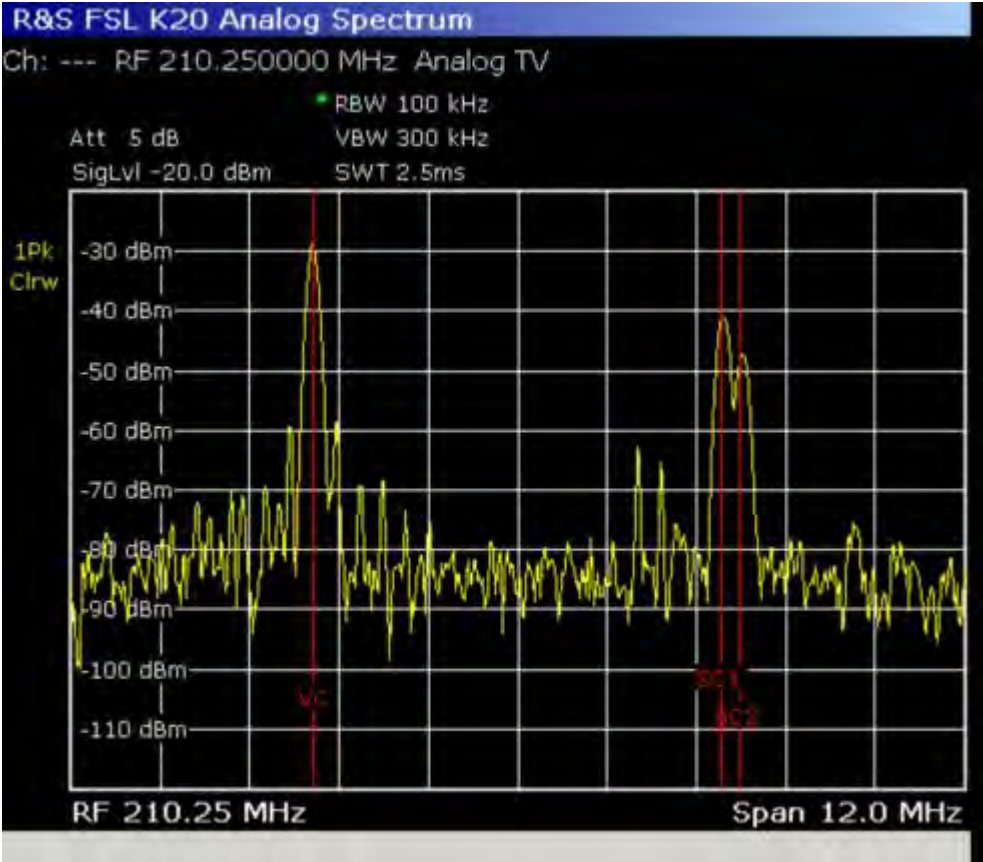

Fig. 2-54 Example for a measurement without a channel table

In practice you would now continue to adapt the modulation settings in depth, i.e. the sound system the test lines and so on. For our example we will stop here.

For further details on analog TV modulation parameters please refer to section [Analog TV settings](#).

Performing a Measurement Using a Channel Table

The use of a channel table can speed up most of the routine measurement tasks. This section will demonstrate how to perform measurements using channel tables.

Test setup:

No special test setup is required. You do not need to supply a signal. We do not need meaningful measurement results here, since the focus is on the operation only.

Procedure:

1. Press the **MENU** key.
2. Press the **Channel Setup** softkey.
3. You should now see a list of Channel Tables, including the example channel table **RS_EXAMPLE_WIPFING**, that was used in section [Example: Creating a channel table](#). If you have deleted it, you must first restore it as shown in section [Example: Restoring the default channel tables](#).
4. Move the cursor to **RS_EXAMPLE_WIPFING** and press the **Activate** softkey.
The Cable TV Measurements option automatically switched to the first channel in the Channel Table.
5. Press the **MEAS** key.
6. Press the **Analog TV** softkey.
7. Press the **Carriers** softkey.

The resulting measurement is displayed (see [Fig. 2-55](#)).

The Cable TV Measurements option configures the measurement according to the information stored in the channel table:

- It automatically sets the span to measure the channel with number 21. The channel borders are marked with red vertical lines.
- It also knows how large the ideal intercarrier frequency offset (vision carrier to audio carriers) should be. This information is needed to calculate the deviation from the ideal value. The ideal sound carrier positions are also marked via red vertical lines.
- The measurement principle is chosen according to the modulation standard given for the current measurement channel. For example: The powers of a NICAM and a FM sound carrier must be measured in different ways.
- The display tells you the actual RF frequency and what modulation standard the channel contains.

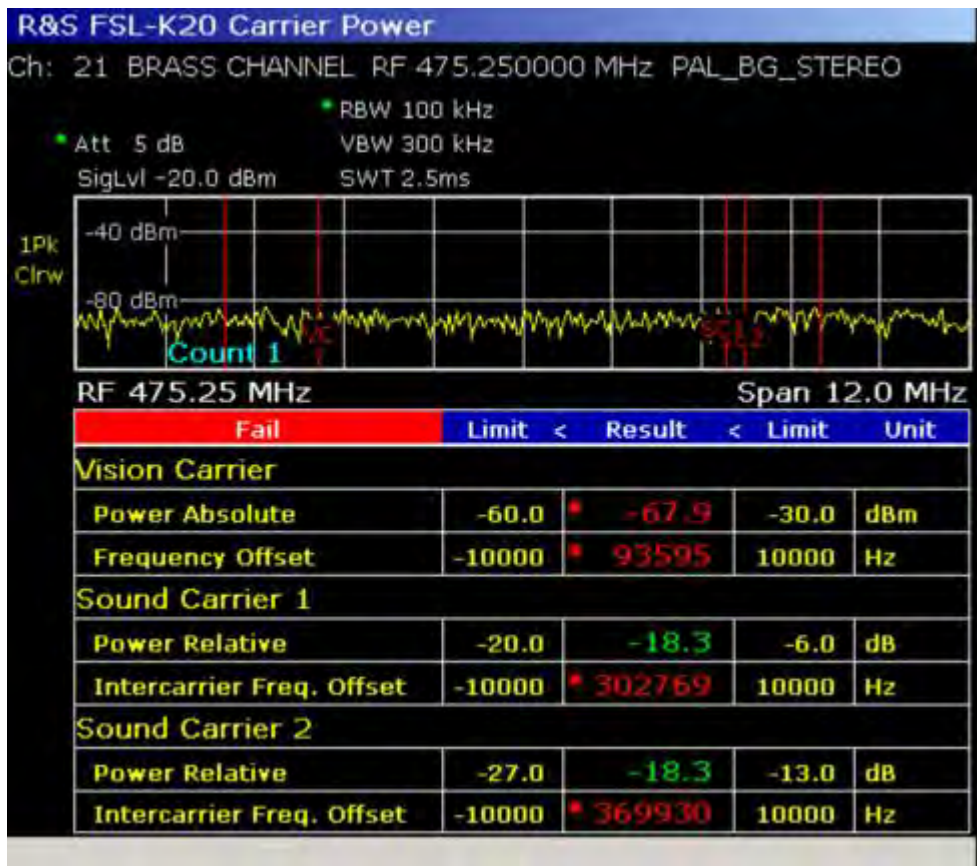

Fig. 2–55 Carriers measurement using a Channel Table. No input signal!

8. Press the **Channel No** softkey.
9. Input a channel number via the numeric keyboard. The Cable TV Measurements option will only allow analog TV channels defined in the active channel table, since we are in a measurement for analog TV channels and digital TV signals would not make sense! The same is true when you use the rotary knob for changing the measurement channel. So, the very small example channel table only allows us to switch to channel 22. Observe how the RF frequency changes.
10. Press the **MEAS** key.
11. Press the **Digital TV** softkey.
This switches to measurements for Digital TV signals.
12. Press the **Spectrum** softkey.
The resulting measurement is displayed (see Fig. 2–56).
The Cable TV Measurements option once again configures the measurement automatically and gives you information about the channel borders and the modulation standard.

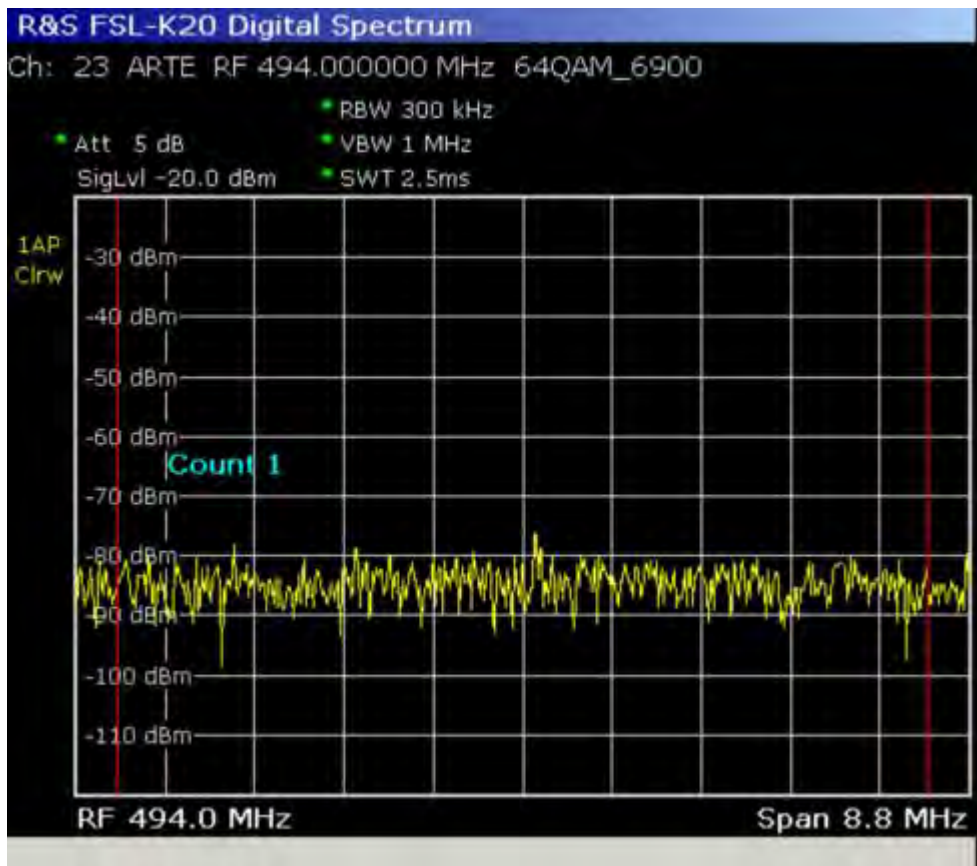

Fig. 2–56 Digital TV spectrum using a Channel Table. No input signal!

13. Press the **Channel No** softkey.
14. Choose one of the digital TV channels that are present in the channel table, because we are in a measurement designed for digital TV signals.
15. Press the **MEAS** key.
16. Press the **TV Analyzer** softkey.
17. Press the **Tilt** softkey.
18. Press the **Auto Range** softkey.

The resulting measurement is displayed (see Fig. 2–57).



Fig. 2-57 Tilt measurement using a Channel Table. No input signal!

The use of a channel table is mandatory for the Tilt measurement. Because the Cable TV Measurements option must know where a channel's power has to be measured and how it has to be done. Each vertical line represents a channel. The blue ones are digital TV channels, the yellow ones are analog TV.

Measurement Examples of the WLAN TX Measurements Option (K91)

This section describes measurement examples for the WLAN TX Measurements option (K91) and gives details to signal processing. For further information on measurement examples refer also to the Quick Start Guide, chapter 5 "Basic Measurement Examples".

This option is available from firmware version 1.20.

Basic Measurement Example

This section helps the user to quickly become familiar with the WLAN TX Measurements option (K91) by working step-by-step through an ordinary measurement. The following steps are described:

1. Setting up the measurement
2. Performing the level detection
3. Performing the main measurement

In this example, a DUT using IEEE 802.11a is be used. The DUT is connected to the analyzer using the RF input of the analyzer. The DUT generates a signal modulated using 16QAM.

Setting up the measurement

1. Activate the **WLAN** mode (for details refer to chapter "Instrument Functions", section "Measurement Mode Selection – MODE Key").
2. Press the **Settings** softkey once to select and open the **General Settings** dialog box.

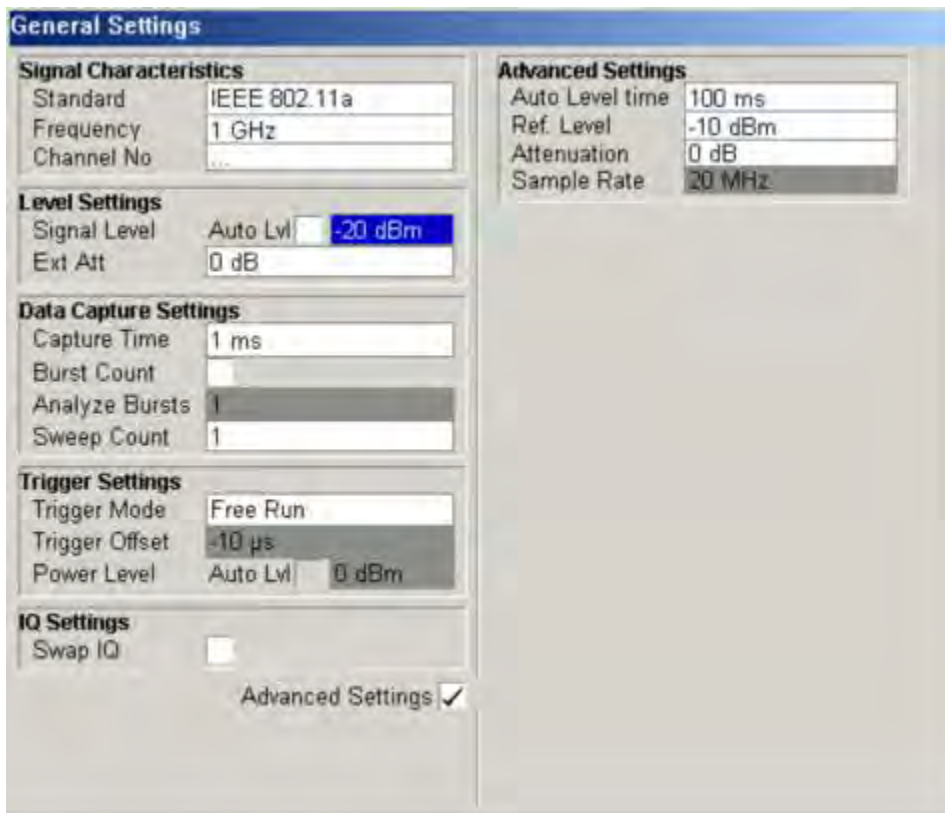

- In the **Frequency** field, enter the desired frequency to measure.
If a frequency is entered, which maps to a specific channel, the **Channel No** field updates.
 - Under **Level Settings**, deactivate the **Auto Lvl** option. In this example the level detection measurement is executed manually (for details see [Performing the level detection](#)).
3. Press the **Settings** softkey once to select and open the **Demod Settings** dialog box.

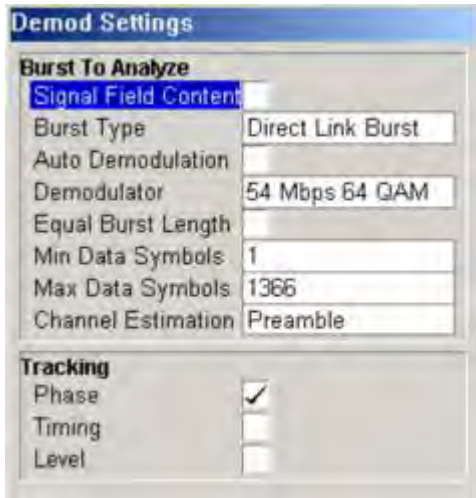

- In the **Demodulator** field, select the used modulation scheme.

Performing the level detection

1. Connect the DUT to the RF input of the spectrum analyzer.

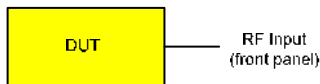

2. Start the level detection measurement by pressing the **SWEEP** hardkey and then the **Auto Level** softkey.

During the level detection measurement the text **Running** is displayed in the status bar at the bottom of the screen.

After successful level detection, the status message **Measurement Complete** is displayed, the signal level field for the selected input displays the detected signal level and the Magnitude Capture Buffer (screen A) displays the zero span trace obtained during the measurement sequence.

Performing the main measurement

1. Select single sweep measurements by pressing the **SWEEP** hardkey and then the **Meas** softkey to select **Single**.
2. Start the measurement by pressing the **RUN** hardkey.

During the measurement, the status message **Running** is displayed.

Measurement results are updated once the measurement has completed. The results are displayed in graphical form. The display can be toggled to a tabular list of measurement points by pressing the **Display** softkey (in the WLAN menu or trace menu).

Signal Processing of the IEEE 802.11a application

Abbreviations

$a_{l,k}$	symbol at symbol l of sub carrier k
EVM_k	error vector magnitude of sub carrier k
EVM	error vector magnitude of current packet
g	signal gain
Δf	frequency deviation between Tx and Rx
l	symbol index $l = [1, \text{nof_Symbols}]$
nof_symbols	number of symbols of payload
H_k	channel transfer function of sub carrier k
k	channel index $k = [-31, 32]$
K_{mod}	modulation dependant normalization factor
ξ	relative clock error of reference oscillator
$r_{l,k}$	sub carrier k of symbol l

This description gives a rough view of the IEEE 802.11a application signal processing. Details are disregarded in order to get a concept overview.

A diagram of the interesting blocks is shown in [Fig. 2–58](#) First the RF signal is down converted to the IF frequency $f_{IF} = 20.4$ MHz. The resulting IF signal $r_{IF}(t)$ is shown on the left-hand side of the figure. After bandpass filtering, the signal is sampled by an Analog to Digital Converter (ADC) at a sampling rate of $f_{s1} = 81.6$ MHz. This digital sequence is resampled to the new sampling frequency of $f_{s2} = 80$ MHz which is a multiple of the Nyquist rate (20 MHz). The subsequent digital down converter shifts the IF signal to the complex base band. In the next step the base band signal is filtered by a FIR filter. To get an idea, the rough transfer function is plotted in the figure. This filter fulfills two tasks: first it suppresses the IF image frequency, secondly it attenuates the aliasing frequency bands caused by the subsequent down sampling. After filtering, the sequence is sampled down by the factor of 4. Thus the sampling rate of the down sampled sequence $r(i)$ is the Nyquist rate of $f_{s3} = 20$ MHz. Up to this point the digital part is implemented in an ASIC.

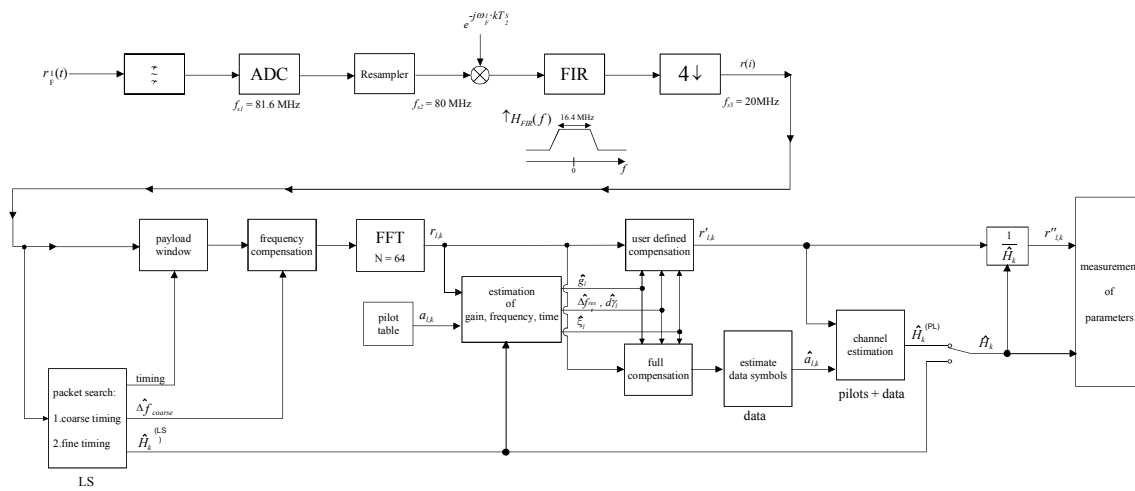

Fig. 2–58 Signal processing of the IEEE 802.11a application

In the lower part of the figure the subsequent digital signal processing is shown. In the first block the packet search is performed. This block detects the Long Symbol (LS) and recovers the timing. The coarse timing is detected first. This search is implemented in the time domain. The algorithm is based on cyclic repetition within the LS after $N = 64$ samples. Numerous treatises exist on this subject, e.g. [1] to [3]. Furthermore a coarse estimate $\hat{\Delta f}_{coarse}^1$ of the Rx–Tx frequency offset Δf is derived from the metric in [6]. This can easily be understood because the phase of $r(i) \cdot r^*(i + N)$ is determined by the frequency offset. As the frequency deviation Δf can exceed half a bin (distance between neighbor sub-carriers) the preceding Short Symbol (SS) is also analyzed in order to detect the ambiguity.

After the coarse timing calculation the time estimate is improved by the fine timing calculation. This is achieved by first estimating the coarse frequency response $\hat{H}_k^{(LS)}$, with $k = [-26, 26]$ denoting the channel index of the occupied sub-carriers. First the FFT of the LS is calculated. After the FFT calculation the known symbol information of the LS sub-carriers is removed by dividing by the symbols. The result is a coarse estimate \hat{H}_k of the channel transfer function. In the next step the complex channel impulse response is computed by an IFFT. Next the energy of the windowed impulse response (the window size is equal to the guard period) is calculated for every trial time. Afterwards the trial time of the maximum energy is detected. This trial time is used to adjust the timing.

Now the position of the LS is known and the starting point of the useful part of the first payload symbol can be derived. In the next block this calculated time instant is used to position the payload window. Only the payload part is windowed. This is sufficient because the payload is the only subject of the subsequent measurements.

In the next block the windowed sequence is compensated by the coarse frequency estimate $\hat{\Delta f}_{coarse}$. This is necessary because otherwise inter channel interference (ICI) would occur in the frequency domain.

The transition to the frequency domain is achieved by an FFT of length 64. The FFT is performed symbol-wise for every of the *nof_symbols* symbols of the payload. The calculated FFTs are described by $r_{l,k}$ with

the symbol index $l = [1, nof_symbols]$ and

the channel index $k = [-31, 32]$.

In case of an additive white Gaussian noise (AWGN) channel the FFT is described by [4], [5]

¹ The hat generally describes an estimate. Example: \hat{x} is the estimate of x .

$$r_{l,k} = K_{\text{mod}} \times a_{l,k} \times g_l \times H_k \times e^{j(\text{phase}_l^{(\text{common})} + \text{phase}_{l,k}^{(\text{timing})})} + n_{l,k} \quad (1)$$

with

- the modulation–dependant normalization factor K_{mod} ,
- the symbol $a_{l,k}$ of sub–carrier k at symbol l ,
- the gain g_l at the symbol l in relation to the reference gain $g = 1$ at the long symbol (LS),
- the channel frequency response H_k at the long symbol (LS),
- the common phase drift $\text{phase}_l^{(\text{common})}$ of all sub–carriers at symbol l (see below),
- the phase $\text{phase}_{l,k}^{(\text{timing})}$ of sub–carrier k at symbol l caused by the timing drift (see below),
- the independent Gaussian distributed noise samples $n_{l,k}$.

The common phase drift in equation (1) is given by

$$\text{phase}_l^{(\text{common})} = 2\pi \times N_s / N \times \Delta f_{\text{rest}} T \times l + d\gamma_l \quad (2)$$

with

- $N_s = 80$ being the number of Nyquist samples of the symbol period,
- $N = 64$ being the number of Nyquist samples $N = 64$ of the useful part of the symbol,
- Δf_{rest} being the (not yet compensated) frequency deviation,
- $d\gamma_l$ being the phase jitter at the symbol l .

In general, the coarse frequency estimate $\hat{\Delta f}_{\text{coarse}}$ (see figure 1) is not error–free. Therefore the remaining frequency error Δf_{rest} represents the not yet compensated frequency deviation in $r_{l,k}$. Consequently the overall frequency deviation of the device under test (DUT) is calculated by $\Delta f = \hat{\Delta f}_{\text{coarse}} + \Delta f_{\text{rest}}$. Remark: The only motivation for dividing the common phase drift in equation (2) into two parts is to be able to calculate the overall frequency deviation of the DUT.

The reason for the phase jitter $d\gamma_l$ in equation (2) may be different. The nonlinear part of the phase jitter may be caused by the phase noise of the DUT oscillator. Another reason for nonlinear phase jitter may be the increase of the DUT amplifier temperature at the beginning of the burst. Please note that besides the nonlinear part the phase jitter $d\gamma_l$ also contains a constant part. This constant part is caused by the not yet compensated frequency deviation Δf_{rest} . To understand this, please keep in mind that the measurement of the phase starts at the first symbol $l = 1$ of the payload. In contrast the channel frequency response H_k in equation (1) represents the channel at the long symbol of the preamble. Consequently the not yet compensated frequency deviation Δf_{rest} produces a phase drift between the long symbol and the first symbol of the payload. Therefore this phase drift appears as a constant value ("DC value") in $d\gamma_l$.

Referring to the IEEE 802.11a measurement standard *Chapter 17.3.9.7 "Transmit modulation accuracy test"* [6], the common phase drift $\text{phase}_l^{(\text{common})}$ must be estimated and compensated from the pilots. Therefore this "symbol wise phase tracking" (Tracking Phase) is activated as the default setting of the R&S FSL–K91.

Furthermore the timing drift in equation (1) is given by

$$\text{phase}_{l,k}^{(\text{timing})} = 2\pi \times N_s / N \times \xi \times k \times l \quad (3)$$

with ξ being the relative clock deviation of the reference oscillator. Normally a symbol-wise timing jitter is negligible and thus not modeled in equation (3). There may be situations where the timing drift has to be taken into account. This is illustrated by an example: In accordance to [6] the allowed clock deviation of the DUT is up to $\xi_{\max} = 20$ ppm. Furthermore a long packet with $nof_symbols = 400$ symbols is assumed. From equations (1) and (3), it results that the phase drift of the highest sub-carrier $k = 26$ in the last symbol $l = nof_symbols$ is 93 degrees. Even in the noise-free case, this would lead to symbol errors. The example shows that it is actually necessary to estimate and compensate the clock deviation, which is accomplished in the next block.

Referring to the IEEE 802.11a measurement standard [6], the timing drift $phase_{l,k}^{(timing)}$ is not part of the requirements. Therefore the "time tracking" (Tracking Time) is not activated as the default setting of the R&S FSL-K91.

The time tracking option should rather be seen as a powerful analyzing option.

In addition the tracking of the gain g_l in equation (1) is supported for each symbol in relation to the reference gain $g = 1$ at the time instant of the long symbol (LS). At this time the coarse channel transfer function $\hat{H}_k^{(LS)}$ is calculated. This makes sense since the sequence $r_{l,k}^1$ is compensated by the coarse channel transfer function $\hat{H}_k^{(LS)}$ before estimating the symbols. Consequently a potential change of the gain at the symbol l (caused, for example, by the increase of the DUT amplifier temperature) may lead to symbol errors especially for a large symbol alphabet M of the MQAM transmission. In this case the estimation and the subsequent compensation of the gain are useful.

Referring to the IEEE 802.11a measurement standard [6], the compensation of the gain g_l is not part of the requirements. Therefore the "gain tracking" (Tracking Gain) is not activated as the default setting of the R&S FSL-K91.

How can the parameters above be calculated? In this application the optimum maximum likelihood algorithm is used. In the first estimation step the symbol-independent parameters Δf_{rest} and ξ are estimated. The symbol dependent parameters can be neglected in this step i.e. the parameters are set to $g_l = 1$ and $d\gamma_l = 0$. Referring to equation (1) the log likelihood function²

$$L_1(\tilde{\Delta f}_{rest}, \tilde{\xi}) = \sum_{l=1}^{nof_symbols} \sum_{k=-21,-7,7,21} \left| r_{l,k} - a_{l,k} \times \hat{H}_k^{(LS)} \times e^{j(\tilde{p}hase_l^{(common)} + \tilde{p}hase_{l,k}^{(timing)})} \right|^2 \quad (4)$$

with

$$\tilde{p}hase_l^{(common)} = 2\pi \times N_s / N \times \tilde{\Delta f}_{rest} T \times l$$

$$\tilde{p}hase_l^{(timing)} = 2\pi \times N_s / N \times \tilde{\xi} \times k \times l$$

must be calculated as a function of the trial parameters $\tilde{\Delta f}_{rest}$ and $\tilde{\xi}$. The trial parameters leading to the minimum of the log likelihood function are used as estimates $\hat{\Delta f}_{rest}$ and $\hat{\xi}$. In equation (4) the known pilot symbols $a_{l,k}$ are read from a table.

In the second step for every symbol l the log likelihood function

$$L_2(\tilde{g}_l, \tilde{d}\gamma_l) = \sum_{k=-21,-7,7,21} \left| r_{l,k} - a_{l,k} \times \tilde{g}_l \times \hat{H}_k^{(LS)} \times e^{j(\tilde{p}hase_l^{(common)} + \tilde{p}hase_{l,k}^{(timing)})} \right|^2$$

with

$$\tilde{p}hase_l^{(common)} = 2\pi \times N_s / N \times \hat{\Delta f}_{rest} T \times l + \tilde{d}\gamma_l$$

$$\tilde{p}hase_l^{(timing)} = 2\pi \times N_s / N \times \hat{\xi} \times k \times l$$

² The tilde generally describes an estimate. Example: \tilde{x} is the trial parameter of x .

is calculated as a function of the trial parameters \tilde{g}_i and $d\tilde{\gamma}_i$. Finally, the trial parameters leading to the minimum of the log likelihood function are used as estimates \hat{g}_i and $d\hat{\gamma}_i$.

This robust algorithm works well even at low signal to noise ratios with the Cramer Rao Bound being reached.

After estimation of the parameters, the sequence $r_{l,k}$ is compensated in the compensation blocks.

In the upper analyzing branch the compensation is user-defined i.e. the user determines which of the parameters are compensated. This is useful in order to extract the influence of these parameters. The resulting output sequence is described by $r'_{l,k}$.

In the lower compensation branch the full compensation is always performed. This separate compensation is necessary in order to avoid symbol errors. After the full compensation the secure estimation of the data symbols $\hat{a}_{l,k}$ is performed. From equation (1) it is clear that first the channel transfer function H_k must be removed. This is achieved by dividing the known coarse channel estimate $\hat{H}_k^{(LS)}$ calculated from the LS. Usually an error free estimation of the data symbols can be assumed.

In the next block a better channel estimate $\hat{H}_k^{(PL)}$ of the data and pilot sub-carriers is calculated by using all *nof_symbols* symbols of the payload (PL). This can be accomplished at this point because the phase is compensated and the data symbols are known. The long observation interval of *nof_symbols* symbols (compared to the short interval of 2 symbols for the estimation of $\hat{H}_k^{(LS)}$) leads to a nearly error-free channel estimate.

In the following equalizer block $r'_{l,k}$ is compensated by the channel estimate. The resulting channel-compensated sequence is described by $r''_{l,k}$. The user may either choose the coarse channel estimate $\hat{H}_k^{(LS)}$ (from the long symbol) or the nearly error-free channel estimate $\hat{H}_k^{(LS)}$ (from the payload) for equalization. In case of using the improved estimate $\hat{H}_k^{(LS)}$ a 2 dB reduction of the subsequent EVM measurement can be expected.

According to the IEEE 802.11a measurement standard [6], the coarse channel estimation $\hat{H}_k^{(LS)}$ (from the long symbol) has to be used for equalization. Therefore the default setting of the R&S FSL-K91 is equalization from the coarse channel estimate derived from the long symbol.

In the last block the measurement variables are calculated. The most important variable is the error vector magnitude

$$EVM_k = \sqrt{\frac{1}{nof_symbols} \sum_{l=1}^{nof_symbols} |r''_{l,k} - K_{mod} \times a_{l,k}|^2} \quad (5)$$

of the sub-carrier k of the current packet. Furthermore the packet error vector magnitude

$$EVM = \sqrt{\frac{1}{52} \sum_{k=-26(k \neq 0)}^{26} EVM_k^2} \quad (6)$$

is derived by averaging the squared EVM_k versus k . Finally the average error vector magnitude

$$\overline{EVM} = \sqrt{\frac{1}{nof_packets} \sum_{counter=1}^{nof_packets} EVM^2(counter)} \quad (7)$$

is calculated by averaging the packet EVM of all *nof_packets* detected packets. This parameter is equivalent to the so-called "RMS average of all errors $Error_{RMS}$ " of the IEEE 802.11a measurement commandment (see [6], *Chapter 17.3.9.7*).

Literature

- [1] Speth, Classen, Meyr: "Frame synchronization of OFDM systems in frequency selective fading channels", VTC '97, pp. 1807–1811
- [2] Schmidl, Cox: "Robust Frequency and Timing Synchronization of OFDM", IEEE Trans. on Comm., Dec. 1997, pp. 1613–621
- [3] Minn, Zeng, Bhargava: "On Timing Offset Estimation for OFDM", IEEE Communication Letters, July 2000, pp. 242–244
- [4] Speth, Fechtel, Fock, Meyr: "Optimum Receiver Design for Wireless Broad-Band Systems Using OFDM – Part I", IEEE Trans. On Comm. VOL. 47, NO 11, Nov. 1999
- [5] Speth, Fechtel, Fock, Meyr: "Optimum Receiver Design for Wireless Broad-Band Systems Using OFDM – Part II", IEEE Trans. On Comm. VOL. 49, NO 4, April. 2001
- [6] IEEE 802.11a, Part 11: Wireless LAN Medium Access Control (MAC) and Physical Layer (PHY) specifications

Signal Processing of the IEEE 802.11b application

Abbreviations

ε	timing offset
Δf	frequency offset
$\Delta \phi$	phase offset
$ARG\{\dots\}$	calculation of the angle of a complex value
EVM	error vector magnitude
\hat{g}_I	estimate of the gain factor in the I-branch
\hat{g}_Q	estimate of the gain factor in the Q-branch
$\Delta \hat{g}_Q$	accurate estimate of the crosstalk factor of the Q-branch in the I-branch
$\hat{h}_s(v)$	estimated baseband filter of the transmitter
$\hat{h}_r(v)$	estimated baseband filter of the receiver
\hat{o}_I	estimate of the IQ-offset in the I-branch
\hat{o}_Q	estimate of the IQ-offset in the I-branch
$r(v)$	measurement signal
$\hat{s}(v)$	estimate of the reference signal
$\hat{s}_n(v)$	estimate of the power normalized and undisturbed reference signal
$REAL\{\dots\}$	calculation of the real part of a complex value
$IMAG\{\dots\}$	calculation of the imaginary part of a complex value

This description gives a rough overview of the signal processing concept of the IEEE 802.11b application.

A block diagram of the measurement application is shown in Fig. 2–59. The baseband signal of an IEEE 802.11b wireless LAN system transmitter is sampled with a sampling rate of 44 MHz.

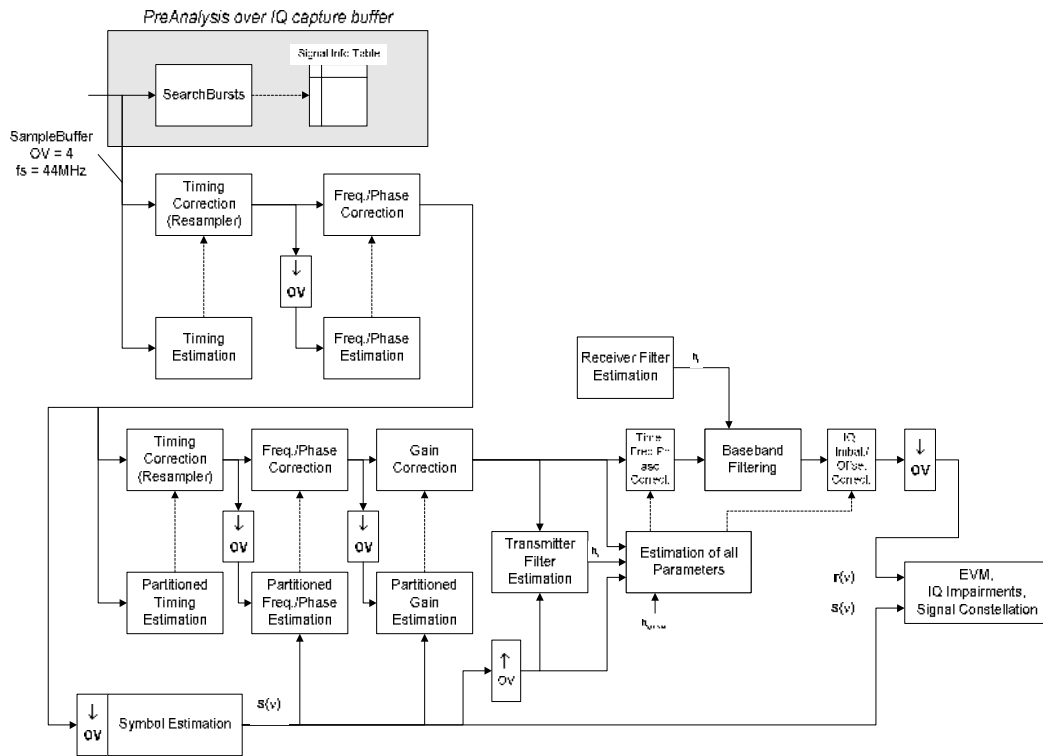

Fig. 2–59 Signal processing of the IEEE 802.11b application

The first task of the measurement application is to detect the position of the bursts within the measurement signal $r_1(v)$. The detection algorithm is able to find the positions of the beginning of short and long bursts and can distinguish between them. The algorithm also detects the initial state of the scrambler. This is required if IEEE 802.11 signals should be analyzed, because this standard does not specify the initial state of the scrambler.

With the knowledge of the start position of the burst, the header of the burst can be demodulated. The bits transmitted in the header provide information about the length of the burst and the modulation type used in the PSDU.

After the start position and the burst length is fully known, better estimates of timing offset, timing drift, frequency offset and phase offset can be calculated using the entire data of the burst.

At this point of the signal processing a demodulation can be performed without decision error. After demodulation the normalized and undisturbed reference signal $s(v)$ is available.

If the frequency offset is not constant and varies with time, the frequency- and phase offset in several partitions of the burst must be estimated and corrected. Additionally, timing offset, timing drift and gain factor can be estimated and corrected in several partitions of the burst. These corrections can be separately switched off in the demodulation settings menu.

Knowing the normalized power and undisturbed reference signal, the transmitter baseband filter is estimated by minimizing the cost function

$$L_1 = \sum_{v=0}^{N-1} \left| r(v) \times e^{-j2\pi\tilde{\Delta}f v} \times e^{-j\Delta\tilde{\phi}} - \sum_{i=-L}^{+L} \tilde{h}_s(i) \times \tilde{s}_n(v-i) - \tilde{o}_I - j\tilde{o}_Q \right|^2 \quad \text{Eq. 2.1}$$

of a maximum-likelihood-based estimator, where $r(v)$ is the over sampled measurement signal, $\hat{s}_n(v)$ the over sampled power normalized and undisturbed reference signal, N the observation length, L the filter length, $\tilde{\Delta}f$, $\Delta\tilde{\phi}$, \tilde{o}_I , \tilde{o}_Q and $\tilde{h}_s(v)$ the variation parameters of the frequency-, the phase, the IQ-offset and the coefficients of the transmitter filter. The frequency-, the phase- and the IQ-offset are estimated jointly with the coefficients of the transmitter filter to increase the estimation quality.

Once the transmitter filter is known, all other unknown signal parameters are estimated with a maximum-likelihood-based estimation, which minimizes the cost function

$$L_2 = \sum_{v=0}^{N-1} \left| r(v - \tilde{\epsilon}) \times e^{-j2\pi\tilde{\Delta}f v} \times e^{-j\Delta\tilde{\phi}} - \tilde{g}_I \times s_I(v) - j\tilde{g}_Q \times s_Q(v) + \Delta\tilde{g}_Q \times s_Q(v) - \tilde{o}_I - j\tilde{o}_Q \right|^2 \quad \text{Eq. 2.2}$$

where \tilde{g}_I resp. \tilde{g}_Q are the variation parameters of the gain used in the I- resp. the Q-branch, $\Delta\tilde{g}_Q$ is the crosstalk factor of the Q-branch into the I-branch and $s_I(v)$ resp. $s_Q(v)$ are the filtered reference signal of the I- resp. the Q-branch. The unknown signal parameters are estimated in a joint estimation process to increase the accuracy of the estimates.

The accurate estimates of the frequency offset, the IQ-imbalance, the quadratur-mismatch and the normalized IQ-offset are displayed by the measurement software. The IQ-imbalance

$$IQ - Imbalance = \left| \frac{\tilde{g}_Q + \Delta\tilde{g}_Q}{\tilde{g}_I} \right| \quad \text{Eq. 2.3}$$

is the quotient of the estimates of the gain factor of the Q-branch, the crosstalk factor and the gain factor of the I-branch, the quadrature-mismatch

$$Quadrature - Mismatch = ARG\{\tilde{g}_Q + j \times \Delta\tilde{g}_Q\} \quad \text{Eq. 2.4}$$

is a measure for the crosstalk of the Q-branch into the I-branch. The normalized IQ-offset

$$IQ - Offset = \frac{\sqrt{\hat{o}_I^2 + \hat{o}_Q^2}}{\sqrt{\frac{1}{2} \cdot [\hat{g}_I^2 + \hat{g}_Q^2]}} \quad \text{Eq. 2.5}$$

is defined as the magnitude of the IQ-offset normalized by the magnitude of the reference signal.

At this point of the signal processing all unknown signal parameters such as timing-, frequency-, phase-, IQ-offset and IQ-imbalance have been evaluated and the measurement signal can be corrected accordingly.

Using the corrected measurement signal $r(v)$ and the estimated reference signal $\hat{s}(v)$ the modulation quality parameters can be calculated. The mean error vector magnitude (EVM)

$$EVM = \frac{\sqrt{\sum_{v=0}^{N-1} |r(v) - \hat{s}(v)|^2}}{\sqrt{\sum_{v=0}^{N-1} |\hat{s}(v)|^2}} \quad \text{Eq. 2.6}$$

is the quotient of the root-mean-square values of the error signal power and the reference signal power, whereas the instant error vector magnitude

$$EVM(v) = \frac{|r(v) - \hat{s}(v)|}{\sqrt{\sum_{v=0}^{N-1} |\hat{s}(v)|^2}} \quad \text{Eq. 2.7}$$

is the momentary error signal magnitude normalized by the root mean square value of the reference signal power.

In [2] a different algorithm is proposed to calculate the error vector magnitude. In a first step the IQ–offset in the I–branch

$$\hat{o}_I = \frac{1}{N} \sum_{v=0}^{N-1} \text{REAL}\{r(v)\} \quad \text{Eq. 2.8}$$

and the IQ–offset of the Q–branch

$$\hat{o}_Q = \frac{1}{N} \sum_{v=0}^{N-1} \text{IMAG}\{r(v)\} \quad \text{Eq. 2.9}$$

are estimated separately, where $r(v)$ is the measurement signal which has been corrected with the estimates of the timing–, frequency– and phase offset, but not with the estimates of the IQ–imbalance and IQ–offset. With these values the IQ–imbalance of the I–branch

$$\hat{g}_I = \frac{1}{N} \sum_{v=0}^{N-1} |\text{REAL}\{r(v) - \hat{o}_I\}| \quad \text{Eq. 2.10}$$

and the IQ–imbalance of the Q–branch

$$\hat{g}_Q = \frac{1}{N} \sum_{v=0}^{N-1} |\text{IMAG}\{r(v) - \hat{o}_Q\}| \quad \text{Eq. 2.11}$$

are estimated in a non–linear estimation in a second step. Finally, the mean error vector magnitude

$$V_{\text{err}}(v) = \frac{\sqrt{\frac{1}{2} \sum_{v=0}^{N-1} [|\text{REAL}\{r(v)\} - \hat{o}_I| - \hat{g}_I]^2 + \frac{1}{2} \sum_{v=0}^{N-1} [|\text{IMAG}\{r(v)\} - \hat{o}_Q| - \hat{g}_Q]^2}}{\sqrt{\frac{1}{2} \cdot [\hat{g}_I^2 + \hat{g}_Q^2]}} \quad \text{Eq. 2.12}$$

can be calculated with a non data aided calculation. The instant error vector magnitude

$$V_{\text{err}}(v) = \frac{\sqrt{\frac{1}{2} [|\text{REAL}\{r(v)\} - \hat{o}_I| - \hat{g}_I]^2 + \frac{1}{2} [|\text{IMAG}\{r(v)\} - \hat{o}_Q| - \hat{g}_Q]^2}}{\sqrt{\frac{1}{2} \cdot [\hat{g}_I^2 + \hat{g}_Q^2]}} \quad \text{Eq. 2.13}$$

is the error signal magnitude normalized by the root mean square value of the estimate of the measurement signal power. The advantage of this method is that no estimate of the reference signal is needed, but the IQ–offset and IQ–imbalance values are not estimated in a joint estimation procedure. Therefore, each estimation parameter is disturbing the estimation of the other parameter and the accuracy of the estimates is lower than the accuracy of the estimations achieved by Eq. 2.14. If the EVM value is dominated by Gaussian noise this method yields similar results as Eq. 2.15.

Literature

- [1] Institute of Electrical and Electronic Engineers, *Part 11: Wireless LAN Medium Access Control (MAC) and Physical Layer (PHY) specifications*, IEEE Std 802.11–1999, Institute of Electrical and Electronic Engineers, Inc., 1999.
- [2] Institute of Electrical and Electronic Engineers, *Part 11: Wireless LAN Medium Access Control (MAC) and Physical Layer (PHY) specifications: Higher-Speed Physical Layer Extensions in the 2.4 GHz Band*, IEEE Std 802.11b–1999, Institute of Electrical and Electronic Engineers, Inc., 1999.

802.11b RF carrier suppression

Definition

The RF carrier suppression, measured at the channel center frequency, shall be at least 15 dB below the peak SIN(x)/x power spectrum. The RF carrier suppression shall be measured while transmitting a repetitive 01 data sequence with the scrambler disabled using DQPSK modulation. A 100 kHz resolution bandwidth shall be used to perform this measurement.

Measurement with R&S spectrum analyzers

The RF carrier suppression as defined in the standard is a determination of peak ratios. The unscrambled 01 data sequence provides a spectrum with distinct peaks enveloped by the transmit filter spectrum. An IQ offset leads to an additional peak at the center frequency.

The following measurement sequence can be used in normal spectrum mode:

1. Use power trigger or external trigger
3. Use gated sweep with gate delay at payload start and gate length = payload length (Delay–Comp ON and RBW = 50 MHz for gate settings)
4. Set RBW = 100 kHz
5. Set Sweep Time = 100 ms
6. Set Span = 20 MHz
7. Set Detector = RMS
8. Set Marker 1 to center frequency
9. Use Marker 2 as Delta Marker and set it to max. peak

Fig. 2–60 is a screenshot of this measurement. The delta marker shows directly the RF carrier suppression in dB (white circled value).

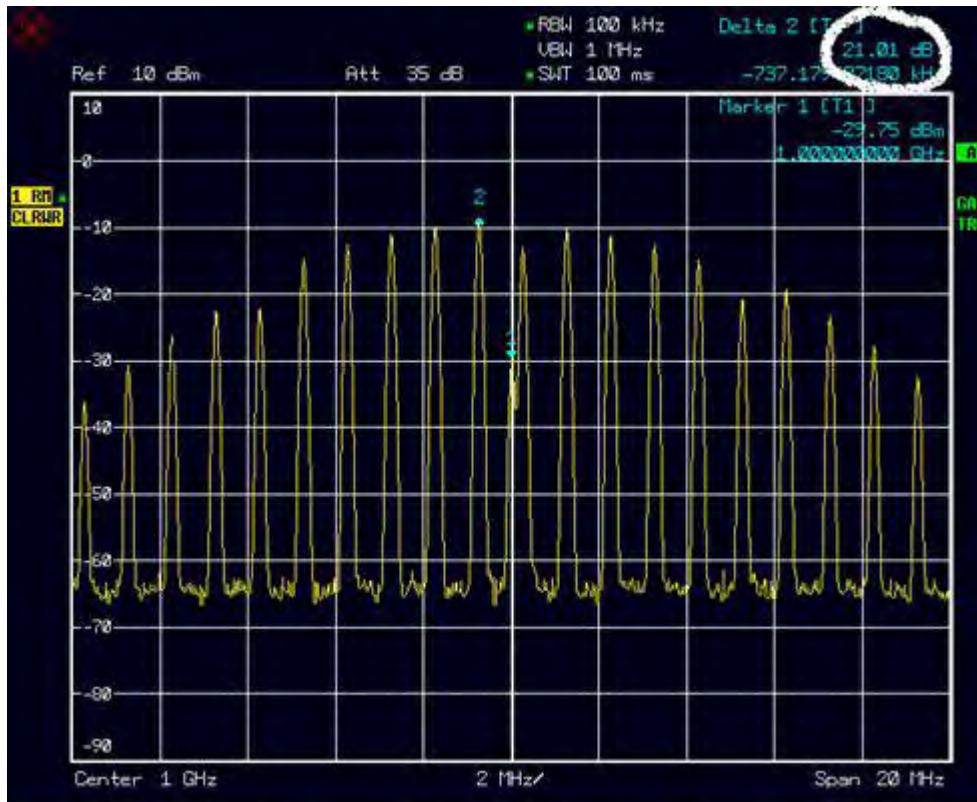

Fig. 2-60 RF carrier suppression measurement

Comparison to IQ offset measurement in K91 list mode

The IQ offset measurement in K91 returns the actual carrier feed through normalized to the mean power at the symbol timings. This measurement doesn't need a special test signal and is independent of the transmit filter shape.

The RF carrier suppression measured according to the standard is inversely proportional to the IQ offset measured in K91 list mode. The difference (in dB) between the two values depends on the transmit filter shape and should be determined with one reference measurement.

The following table lists exemplary the difference for three transmit filter shapes (± 0.5 dB):

Transmit filter	-IQ-Offset [dB] - RF-Carrier-Suppression [dB]
rectangular	11 dB
Root raised cosine, $\alpha = 0.22$	10 dB
Gaussian, $\alpha = 0.3$	9 dB

IQ Impairments

IQ Offset

An IQ-Offset indicates a carrier offset with fixed amplitude. This results in a constant shift of the IQ axes. The offset is normalized by the mean symbol power and displayed in dB.

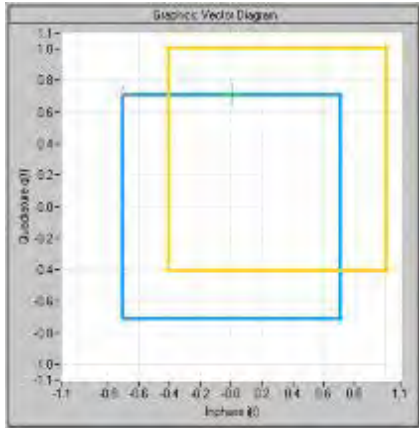

Gain Imbalance

An ideal I/Q modulator amplifies the I and Q signal path by exactly the same degree. The imbalance corresponds to the difference in amplification of the I and Q channel and therefore to the difference in amplitude of the signal components. In the vector diagram, the length of the I vector changes relative to the length of the Q vector.

The entry is displayed in dB and %, where 1 dB offset is roughly 12 % according to the following:
$$\text{Imbalance [dB]} = 20 \log (| \text{Gain}_Q | / | \text{Gain}_I |)$$

Positive values mean that the Q vector is amplified more than the I vector by the corresponding percentage:

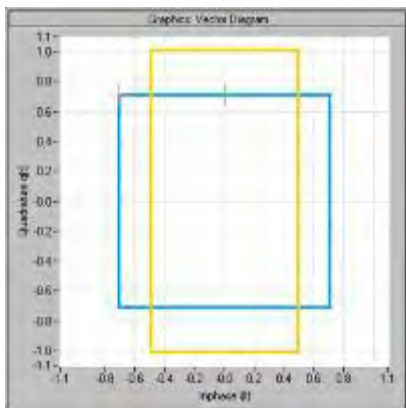

Negative values mean that the I vector is amplified more than the Q vector by the corresponding percentage:

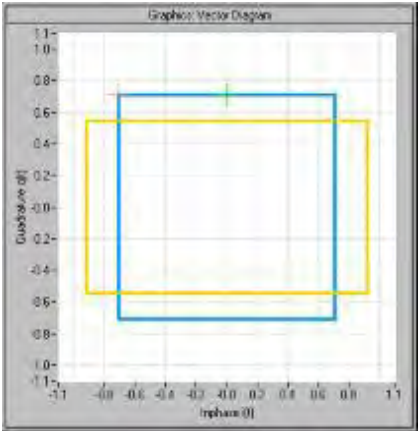

Quadrature Error

An ideal I/Q modulator sets the phase angle to exactly 90 degrees. With a quadrature error, the phase angle between the I and Q vector deviates from the ideal 90 degrees, the amplitudes of both components are of the same size. In the vector diagram, the quadrature error causes the coordinate system to shift.

A positive quadrature error means a phase angle greater than 90 degrees:

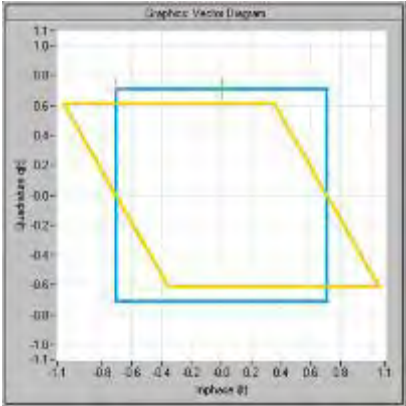

A negative quadrature error means a phase angle less than 90 degrees:

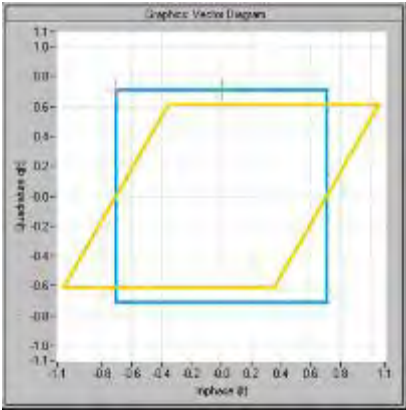

Measurement Examples of the WiMAX Measurements Option (K92)

This section describes measurement examples for the WiMAX 802.16 OFDM Measurements option (K92) and gives details to signal processing. For further information on measurement examples refer also to the Quick Start Guide, chapter 5 "Basic Measurement Examples".

This option is available from firmware version 1.40.

Basic Measurement Example

This section helps the user to quickly become familiar with the WiMAX 802.16 OFDM Measurements option (K92) by working step-by-step through an ordinary measurement. The following steps are described:

1. Setting up the measurement
2. Performing the level detection
3. Performing the main measurement

In this example, a DUT using IEEE 802.16–2004 is be used. The DUT is connected to the analyzer using the RF input of the analyzer. The DUT generates a signal modulated using 16QAM 2/3.

Setting up the measurement

1. Activate the **WiMAX** mode (for details refer to chapter "Instrument Functions", section "Measurement Mode Selection – MODE Key").
2. Press the **Settings** softkey once to select and open the **General Settings** dialog box.

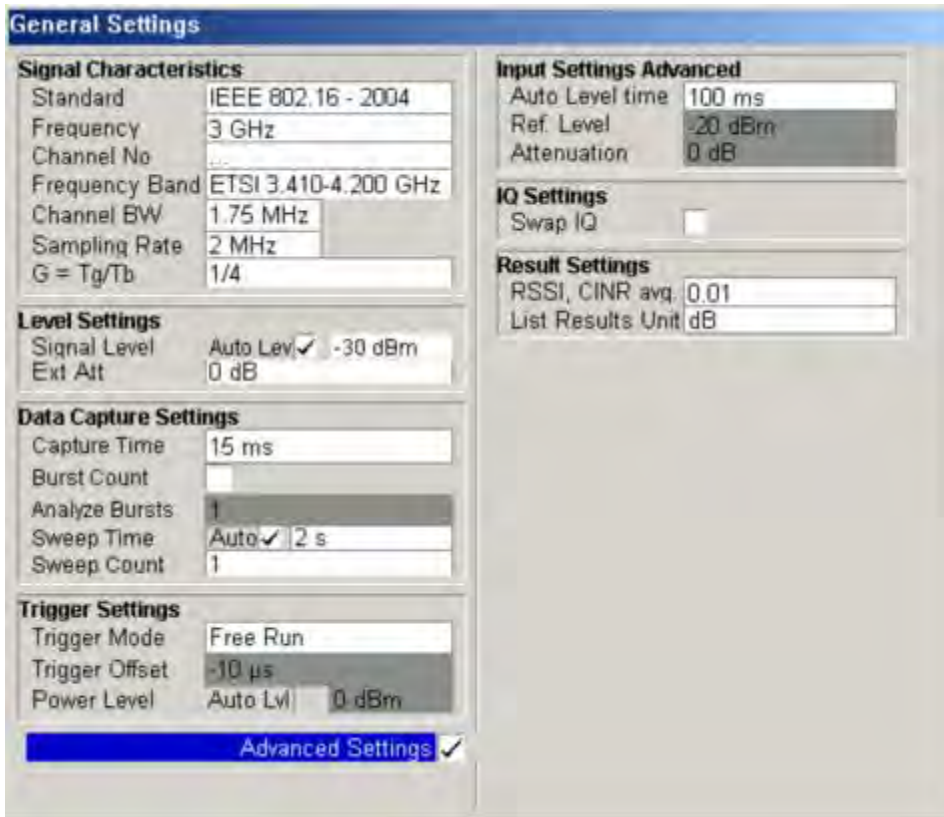

- In the **Frequency** field, enter the desired frequency to measure.
If a frequency is entered, which maps to a specific channel, the **Channel No** field updates.
- In the **Frequency Band** field, select the signal to be analyzed. The target band is either one of the bands given as example in the 802.16–2004 standard³ or an unspecified band.
- In the **Channel BW** or **Sampling Rate** field depending on the characteristics of the signal to be analyzed, select a value. The second parameter is derived from the first according to the standard⁴.
- In the **G = Tg/Tb** field, select a useful time ratio according to the characteristics of the signal to be analyzed.
- Under **Level Settings**, deactivate the **Auto Level** option. In this example the level detection measurement is executed manually (for details see [Performing the level detection](#)).

³ B.3.2 Wireless MAN-OFDM/OFDMA PHY symbol and performance parameters.

⁴ 8.3.2.2 Derived Parameter definitions

- Press the **Settings** softkey once to select and open the **Demod Settings** dialog box.

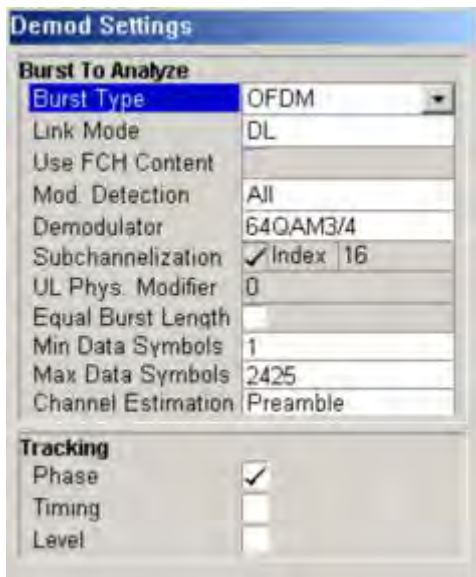

- In the **Link Mode** field, select the link mode of the bursts to be analyzed.
- In the **Demodulator** field, select the used modulation scheme.

Performing the level detection

- Connect the DUT to the RF input of the spectrum analyzer.

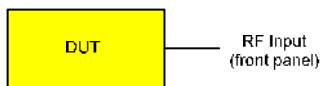

- Start the level detection measurement by pressing the **SWEEP** hardkey and then the **Auto Level** softkey.

During the level detection measurement the text **Running** is displayed in the status bar at the bottom of the screen.

After successful level detection, the status message **Measurement Complete** is displayed, the signal level field for the selected input displays the detected signal level and the Magnitude Capture Buffer (screen A) displays the zero span trace obtained during the measurement sequence.

Performing the main measurement

- Select single sweep measurements by pressing the **SWEEP** hardkey and then the **Run** softkey to select **Single**.
- Start the measurement by pressing the **RUN** hardkey.

During the measurement, the status message **Running** is displayed.

Measurement results are updated once the measurement has completed. The results are displayed in graphical form. The display can be toggled to a tabular list of measurement points by pressing the **Display** softkey (in the WiMAX menu or trace menu).

Signal Processing of the IEEE 802.16–2004 OFDM measurement application

Abbreviations

$N_{FFT} = 256$	FFT length
$a_{l,k}$	symbol from the alphabet at symbol-index l of sub carrier k
EVM_k	error vector magnitude of sub carrier k
EVM	error vector magnitude of current packet
g	signal gain
Δf	frequency deviation between Tx and Rx
l	symbol index $l = [1, nof_Symbols]$
$nof_symbols$	number of symbols of payload
H_k	channel transfer function of sub carrier k
k	channel index $k = [-128, 127]$
K_{mod}	modulation dependent normalization factor
ξ	relative clock error of reference oscillator
$r_{l,k}$	received symbol at symbol-index l of sub carrier k
	$Pilots = \{-88, -63, -38, -13, 13, 38, 63, 88\}$

This description gives a rough view of the IEEE 802.16–2004 OFDM measurement application signal processing. Details are disregarded in order to get a concept overview.

A diagram of the interesting blocks is shown in [Fig. 2–61](#). First the RF signal is down-converted to the IF frequency $f_{IF} = 20.4$ MHz. The resulting IF signal $r_{IF}(t)$ is shown on the left-hand side of the figure. After bandpass filtering, the signal is sampled by an Analog to Digital Converter (ADC) at a sampling rate of $f_{s1} = 81.6$ MHz. This digital sequence is resampled to the new sampling frequency of $f_{s2} = 80$ MHz which is a multiple of the Nyquist rate (20 MHz). The subsequent digital down-converter shifts the IF signal to the complex base band. In the next step the base band signal is filtered by a FIR filter. To get an idea, the rough transfer function is plotted in the figure. This filter fulfils two tasks: first it suppresses the IF image frequency, secondly it attenuates the aliasing frequency bands caused by the subsequent down-sampling. After filtering, the sequence is sampled down by the factor of 4. Thus the sampling rate of the down-sampled sequence $r(i)$ is the Nyquist rate of $f_{s3} = 20$ MHz. Up to this point the digital part is implemented in an ASIC.

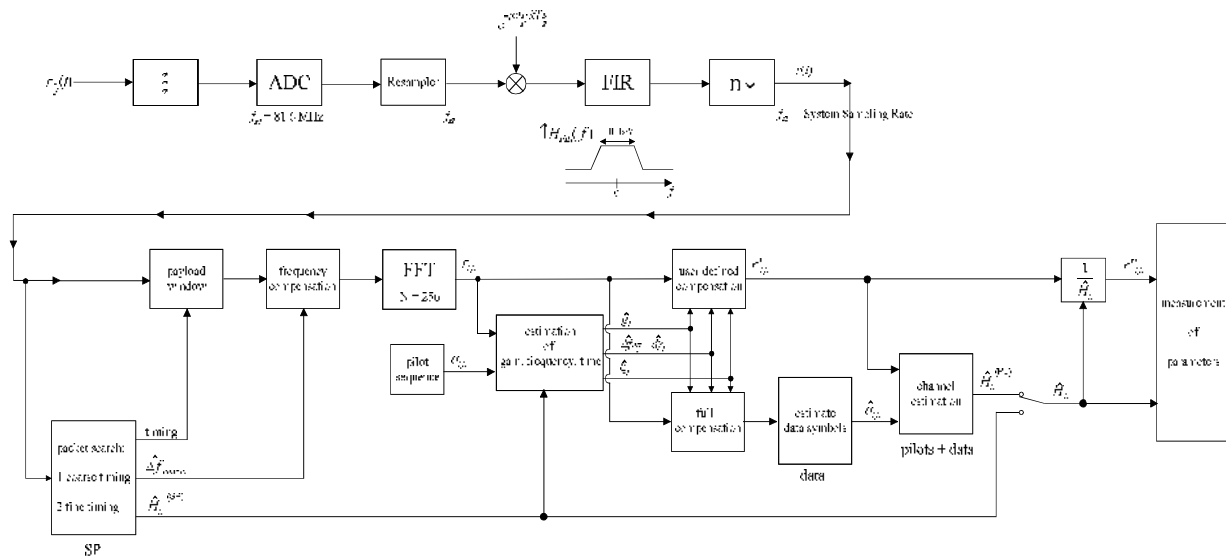

Fig. 2–61 Signal processing of the IEEE 802.16 OFDM measurement application

In the lower part of the figure the subsequent digital signal processing is shown. In the first block the packet search is performed. This block detects the Short Preamble (SP) and recovers the timing. The coarse timing is detected first. This search is implemented in the time domain. The algorithm is based on cyclic repetition within the SP after $N = N_{FFT}/2 = 128$ samples. Note this cyclic repetition occurs also in the Long Preamble (LP). Numerous treatises exist on this subject, e.g. [1]–[3]. Furthermore a coarse estimate $\hat{\Delta f}_{coarse}^5$ of the Rx–Tx frequency offset Δf is derived from the metric in [6]. This can easily be understood because the phase of $r(i) \cdot r^*(i + N)$ is determined by the mod 2π frequency offset. As the frequency deviation Δf can exceed several bins (distance between neighbor sub-carriers) the SP is further used to solve this $n2\pi$ [offset over several bins] ambiguities.

After the coarse timing calculation the time estimate is improved by the fine timing calculation. This is achieved by first estimating the coarse frequency response $\hat{H}_k^{(SP)}$, with $k = [-100, 100]$ denoting the channel index of the occupied sub-carriers. First the FFT of the SP is calculated. After the FFT calculation the known symbol information of the SP sub-carriers is removed by dividing by the symbols. The result is a coarse estimate \hat{H}_k of the channel transfer function. In the next step the complex channel impulse response is computed by an IFFT. Next the energy of the windowed impulse response (the window size is equal to the guard period) is calculated for every trial time. Afterwards the trial time of the maximum energy is detected. This trial time is used to adjust the timing.

Now the position of the SP is known and the starting point of the useful part of the first payload symbol can be derived. In the next block this calculated time instant is used to position the payload window. Only the payload part is windowed. This is sufficient because the payload is the only subject of the subsequent measurements.

In the next block the windowed sequence is compensated by the coarse frequency estimate $\hat{\Delta f}_{coarse}$. This is necessary because otherwise inter channel interference (ICI) would occur in the frequency domain.

⁵ In this paper the hat generally describes an estimate. Example: \hat{x} is the estimate of x .

The transition to the frequency domain is achieved by an FFT of length 256. The FFT is performed symbol-wise for every of the *nof_symbols* symbols of the payload. The calculated FFTs are described by $r_{l,k}$ with

the symbol index $l = [1, \text{nof_symbols}]$ and

the channel index $k = [-128, 127]$.

In case of an additive white Gaussian noise (AWGN) channel the FFT is described by [4], [5]

$$r_{l,k} = K_{\text{mod}} \cdot a_{l,k} \cdot g_l \cdot H_k \cdot e^{j(\text{phase}_l^{(\text{common})} + \text{phase}_{l,k}^{(\text{timing})})} + n_{l,k} \quad (1)$$

with

the modulation-dependent normalization factor K_{mod}

the alphabet symbol $a_{l,k}$ at symbol-index l of sub-carrier k

the gain g_l at the symbol l in relation to the reference gain $g = 1$ at the Short Preamble (SP)

the channel frequency response H_k at the Short Preamble (SP)

the common phase drift $\text{phase}_l^{(\text{common})}$ of all sub-carriers at symbol l (see below)

the phase $\text{phase}_{l,k}^{(\text{timing})}$ of sub-carrier k at symbol l caused by the timing drift (see below)

the independent Gaussian distributed noise samples $n_{l,k}$

The common phase drift in equation (1) is given by

$$\text{phase}_l^{(\text{common})} = 2\pi \cdot N_s / N \cdot \Delta f_{\text{rest}} T \cdot l + d\gamma_l \quad (2)$$

with

$N_s = N_g + N_b$ being the number of Nyquist samples of the symbol period

$N = N_b = 256$ being the number of Nyquist samples of the useful part of the symbol

Δf_{rest} being the (not yet compensated) frequency deviation

$d\gamma_l$ being the phase jitter at the symbol l

In general, the coarse frequency estimate $\hat{\Delta f}_{\text{coarse}}$ (see Fig. 2-61) is not error-free. Therefore the remaining frequency error Δf_{rest} represents the not yet compensated frequency deviation in $r_{l,k}$. Consequently the overall frequency deviation of the device under test (DUT) is calculated by $\Delta f = \hat{\Delta f}_{\text{coarse}} + \Delta f_{\text{rest}}$. Remark: The only motivation for dividing the common phase drift in equation (2) into two parts is to be able to calculate the overall frequency deviation of the DUT.

The reason for the phase jitter $d\gamma_l$ in equation (2) may be different. The nonlinear part of the phase jitter may be caused by the phase noise of the DUT oscillator. Another reason for nonlinear phase jitter may be the increase of the DUT amplifier temperature at the beginning of the burst. Please note that besides the nonlinear part the phase jitter $d\gamma_l$ also contains a constant part. This constant part is caused by the not yet compensated frequency deviation Δf_{rest} . To understand this, please keep in mind that the measurement of the phase starts at the first symbol $l = 1$ of the payload. In contrast the channel frequency response H_k in equation (1) represents the channel at the Short Preamble of the preamble.

Consequently the not yet compensated frequency deviation Δf_{rest} produces a phase drift between the Short Preamble and the first symbol of the payload. Therefore this phase drift appears as a constant value ("DC value") in $d\gamma_l$.

Referring to the IEEE 802.16–2004 measurement standard *Chapter 8.3.10.1.2 "Transmitter constellation error and test method"* [6], the common phase drift $phase_l^{(common)}$ must be estimated and compensated from the pilots. Therefore the "symbol wise phase tracking" (Tracking Phase) is activated as the default setting of the R&S FSL–K92.

Furthermore the timing drift in equation (1) is given by

$$phase_{l,k}^{(timing)} = 2\pi \cdot N_s / N \cdot \xi \cdot k \cdot l \quad (3)$$

with ξ being the relative clock deviation of the reference oscillator. Normally a symbol–wise timing jitter is negligible and thus not modeled in equation (3). There may be situations where the timing drift has to be taken into account. This is illustrated by an example: In accordance to [6] the allowed clock deviation of the DUT is up to $\xi_{max} = \pm 8$ ppm. Furthermore the maximal length of a frame $nof_symbols = 2420$ symbols⁶ is assumed. From equations (1) and (3), it results that the phase drift of the highest sub-carrier $k = 100$ in the last symbol $l = nof_symbols$ is to–do degrees. Even in the noise–free case, this would lead to symbol errors. The example shows that it is actually necessary to estimate and compensate the clock deviation, which is accomplished in the next block.

Referring to the IEEE 802.16–2004 measurement standard [6], the timing drift $phase_{l,k}^{(timing)}$ is not part of the requirements. Therefore the "time tracking" (Tracking Time) is not activated as the default setting of the R&S FSL–K92.

The time tracking option should rather be seen as a powerful analyzing option.

In addition the tracking of the gain g_l in equation (1) is supported for each symbol in relation to the reference gain $g = 1$ at the time instant of the Short Preamble (SP). At this time the coarse channel transfer function $\hat{H}_k^{(SP)}$ is calculated. This makes sense since the sequence $r'_{l,k}$ is compensated by the coarse channel transfer function $\hat{H}_k^{(SP)}$ before estimating the symbols. Consequently a potential change of the gain at the symbol l (caused, for example, by the increase of the DUT amplifier temperature) may lead to symbol errors especially for a large symbol alphabet M of the MQAM transmission. In this case the estimation and the subsequent compensation of the gain are useful.

Referring to the IEEE 802.16–2004 measurement standard [6], the compensation of the gain g_l is not part of the requirements. Therefore the "gain tracking" (Tracking Gain) is not activated as the default setting of the R&S FSL–K92.

How can the parameters above be calculated? In this application the optimum maximum likelihood algorithm is used. In the first estimation step the symbol–independent parameters Δf_{rest} and ξ are estimated. The symbol dependent parameters can be neglected in this step i.e. the parameters are set to $g_l = 1$ and $d\gamma_l = 0$. Referring to equation (1) the log likelihood function⁷

⁶ Assuming the maximal System Sampling Rate $F_s = 32$ MHz.

⁷ In this paper the tilde generally describes the trial parameters. Example: \tilde{x} is the trial parameter of x .

$$L_1(\tilde{\Delta f}_{rest}, \tilde{\xi}) \stackrel{\text{eq.(1)}}{=} \sum_{l=1}^{nof_symbols} \sum_{k \in Pilots} \left| r_{l,k} - a_{l,k} \cdot \hat{H}_k^{(SP)} \cdot e^{j(\tilde{p}hase_l^{(common)} + \tilde{p}hase_{l,k}^{(timing)})} \right|^2$$

with

$$\tilde{p}hase_l^{(common)} \stackrel{\text{eq.(2)}}{=} 2\pi \cdot N_s / N \cdot \tilde{\Delta f}_{rest} T \cdot l$$

$$\tilde{p}hase_l^{(timing)} \stackrel{\text{eq.(3)}}{=} 2\pi \cdot N_s / N \cdot \tilde{\xi} \cdot k \cdot l$$

(4)

must be calculated as a function of the trial parameters $\tilde{\Delta f}_{rest}$ and $\tilde{\xi}$. The trial parameters leading to the minimum of the log likelihood function are used as estimates $\hat{\Delta f}_{rest}$ and $\hat{\xi}$. In equation (4) the known pilot symbols $a_{l,k}$ are read from a table.

In the second step for every symbol l the log likelihood function

$$L_2(\tilde{g}_l, d\tilde{\gamma}_l) \stackrel{\text{eq.(1)}}{=} \sum_{k \in Pilots} \left| r_{l,k} - a_{l,k} \cdot \tilde{g}_l \cdot \hat{H}_k^{(SP)} \cdot e^{j(\tilde{p}hase_l^{(common)} + \hat{p}hase_{l,k}^{(timing)})} \right|^2$$

with

$$\tilde{p}hase_l^{(common)} \stackrel{\text{eq.(2)}}{=} 2\pi \cdot N_s / N \cdot \hat{\Delta f}_{rest} T \cdot l + d\tilde{\gamma}_l$$

$$\hat{p}hase_l^{(timing)} \stackrel{\text{eq.(3)}}{=} 2\pi \cdot N_s / N \cdot \hat{\xi} \cdot k \cdot l$$

is calculated as a function of the trial parameters \tilde{g}_l and $d\tilde{\gamma}_l$. Finally, the trial parameters leading to the minimum of the log likelihood function are used as estimates \hat{g}_l and $d\hat{\gamma}_l$.

This robust algorithm works well even at low signal to noise ratios with the Cramer Rao Bound being reached.

After estimation of the parameters, the sequence $r_{l,k}$ is compensated in the compensation blocks.

In the upper analyzing branch the compensation is user-defined i.e. the user determines which of the parameters are compensated. This is useful in order to extract the influence of these parameters. The resulting output sequence is described by $r'_{l,k}$.

In the lower compensation branch the full compensation is always performed. This separate compensation is necessary in order to avoid symbol errors. After the full compensation the secure estimation of the data symbols $\hat{a}_{l,k}$ is performed.

From equation (1) it is clear that first the channel transfer function H_k must be removed. This is achieved by dividing the known coarse channel estimate $\hat{H}_k^{(SP)}$ calculated from the SP. Usually an error free estimation of the data symbols can be assumed.

In the next block a better channel estimate $\hat{H}_k^{(PL)}$ of the data and pilot sub-carriers is calculated by using all *nof_symbols* symbols of the payload (PL). This can be accomplished at this point because the phase is compensated and the data symbols are known. The long observation interval of *nof_symbols* symbols (compared to the short interval of 1 symbol for the estimation of $\hat{H}_k^{(SP)}$) leads to a nearly error-free channel estimate.

In the following equalizer block $r'_{l,k}$ is compensated by the channel estimate. The resulting channel-compensated sequence is described by $r''_{l,k}$. The user may either choose the coarse channel estimate $\hat{H}_k^{(SP)}$ (from the Short Preamble) or the nearly error-free channel estimate $\hat{H}_k^{(PL)}$ (from the payload) for equalization. In case of using the improved estimate $\hat{H}_k^{(PL)}$ a 2 dB reduction of the subsequent EVM measurement can be expected.

According to the IEEE 802.16-2004 measurement standard [6], the coarse channel estimation (from the Short Preamble) has to be used for equalization. Therefore the default setting of the R&S FSL-K92 is equalization from the coarse channel estimate derived from the Short Preamble.

In the last block the measurement variables are calculated. The most important variable is the error vector magnitude

$$EVM_k = \sqrt{\frac{1}{nof_Symbols} \cdot \sum_{l=1}^{nof_Symbols} |r''_{l,k} - K_{mod} \cdot a_{l,k}|^2} \tag{5}$$

of the sub-carrier k of the current packet. Furthermore the packet error vector magnitude

$$EVM = \sqrt{\frac{1}{200} \cdot \sum_{\substack{k=-100 \\ (k \neq 0)}}^{100} EVM_k^2} \tag{6}$$

is derived by averaging the squared EVM_k versus k . Finally the average error vector magnitude

$$\overline{EVM} = \sqrt{\frac{1}{nof_packets} \sum_{counter=1}^{nof_packets} EVM^2(counter)} \tag{7}$$

is calculated by averaging the packet EVM of all $nof_packets$ detected packets. This parameter is equivalent to the so-called "RMS average of all errors $Error_{RMS}$ " of the IEEE 802.16-2004 measurement commandment (see [6], Chapter 8.3.10.1.2).

Analysis Steps

Preamble related result	Remark
Rough frequency estimation	In case of subchannelization, a rough frequency estimation is obtained by exploiting the cyclic prefix of the OFDM symbols.
Preamble power	
Preamble EVM	Uses payload channel estimation for equalization.
Frequency error vs. preamble	
Phase error vs. preamble	
Channel estimation	Used for equalizing

Payload related result	Remark
Fine frequency estimation	Estimation on pilots used for phase correction if 'Phase Tracking' is selected. Phase tracking needs at least one pilot. In case of subchannelization, the value shown in the result summary table is estimated on pilots and data.
Clock offset estimation	Estimation on pilots used for timing correction if 'Timing Tracking' is selected. Timing tracking needs at least two pilots. In case of subchannelization, the value shown in the result summary table is estimated on pilots and data.
IQ Offset	Power at spectral line 0 normalized to the total transmitted power.
Gain Imbalance	Estimation not available in case of subchannelization.
Quadrature Error	Estimation not available in case of subchannelization.
Payload channel estimation	Combined with the preamble channel estimation.

Burst related result	Remark
EVM All carriers EVM Data carriers EVM Pilot carriers	According to standard normalized to the average power of all 200 used carriers.
Burst Power	
Crest Factor	

Subchannelization

Subchannelization can be used in uplink bursts to allocate only a subset of the available OFDM sub carriers. The measurement software can distinguish between downlink bursts, uplink bursts without subchannelization and uplink bursts with a selectable subchannel index. Thus it is possible to analyze the complete WirelessMAN traffic with one capture buffer shot.

Synchronization

The synchronization of uplink bursts using subchannelization is performed after the synchronization on standard downlink and uplink preambles:

1. Synchronization of downlink and uplink bursts without subchannelization.
2. Pre-analysis of the bursts without subchannelization to determine their length.
3. Extraction of TX power areas without already detected bursts.
4. Synchronization of uplink bursts with the selected subchannel index.

In the following sections, the influence of subchannelization on results is discussed.

Channel Results

The standard requires an interpolation of order 0 for the channel estimation on unallocated sub carriers, i.e. the estimated channel coefficient of the nearest allocated sub carrier shall be used for those sub carriers not part of the allocated subchannels.

For the derived channel results like group delay or flatness difference, the unallocated carriers are not taken into account.



Fig. 2–62 Spectrum Flatness

Frequency and Clock Offset

The measurement software allows selectable compensation of phase, timing and gain errors based on pilot estimations. However, in case of subchannelization the number of pilots is decreased. Bursts with odd subchannel indices do not provide pilots at all. The following table lists the restrictions on the tracking ability for subchannelization:

Tracking	Subchannel Index		
	16 (8 Pilots) 8, 24 (4 Pilots) 4, 12, 20, 28 (2 Pilots)	2, 6, 10, 14, 18, 22, 26, 30 (1 Pilot)	1, 3, 5, 7, 9, 11, 13, 15, 17, 19, 21, 23, 25, 27, 29, 31 (No Pilot)
Phase	Available	Available	Available, but uses rough frequency offset estimation from the synchronization step only
Timing	Available	Not available	Not available
Gain	Available	Available	Not available

While the tracking functionality has to use pilot based estimates, the actual results for frequency and clock offset in the result summary can be data aided. In case of subchannelization the final estimation of frequency and clock offset is done using the already decided data sequence, which gives stable results even without pilots.

EVM

The error vector magnitude of a single constellation point is defined by

$$EVM(l,k) = \sqrt{\frac{|r(l,k) - a(l,k)|^2}{\frac{1}{N_{used}} \sum_{\substack{k=-N_{used}/2 \\ k \neq 0}}^{k=N_{used}/2} |a(l,k)|^2}}$$

where $r(l,k)$ is the received constellation point and $a(l,k)$ is the transmitted constellation point at the l^{th} symbol and carrier number k .

In case of subchannelization, it is required by the standard to include the unallocated carriers $k_{unalloc}$ by assuming $a(l, k_{unalloc}) = 0$ in the denominator of the EVM calculation.

Thus the EVM All Carriers result for one burst in the result summary equals

$$EVM_All_Carr = \sqrt{\frac{\frac{1}{L} \sum_{l=1}^L \frac{1}{N_{used}} \sum_{\substack{k=-N_{used}/2 \\ k \neq 0}}^{k=N_{used}/2} |r(l,k) - a(l,k)|^2}{\frac{1}{L} \sum_{l=1}^L \frac{1}{N_{used}} \sum_{\substack{k=-N_{used}/2 \\ k \neq 0}}^{k=N_{used}/2} |a(l,k)|^2}}$$

where L is the number of symbols in the burst.

This definition is according to the relative constellation error defined in the IEEE 802.16–2004 standard.

Using the equations above, the error power is normalized by the average transmitted power in all 200 carriers. Please notify, that by this definition the same absolute error power leads to different EVM results depending on the number of allocated carriers in case of subchannelization.

IQ Impairments

IQ imbalance in an OFDM transmitter or receiver leads to an interference of the symbols $a_{l,-k}$ with the symbols $a_{l,k}$. In case of subchannelization, the used sub carriers are always situated in such a way, that $a_{l,-k} = 0$, if $a_{l,k} \neq 0$. There is no impact of IQ imbalance on the actually allocated carriers of a subchannelization transmission. The effect can only be seen on the unallocated carriers and yields a pattern around the origin of the constellation diagram.

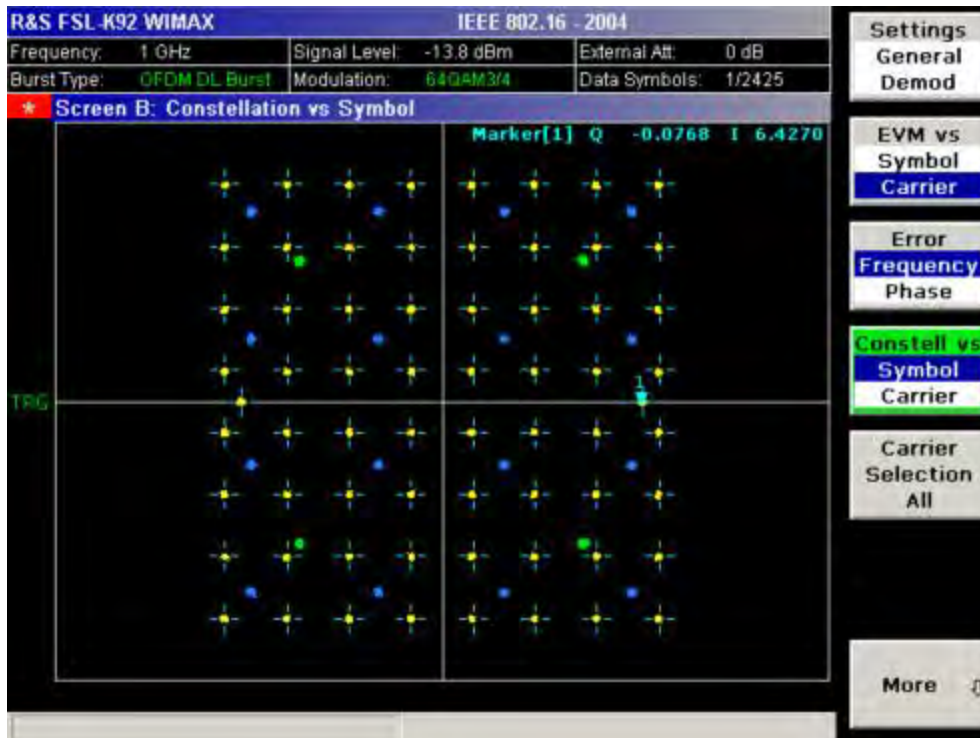

Fig. 2–63 Constellation vs Symbol

The unsymmetrical allocation of the sub carriers prevents a measurement of gain imbalance and quadrature error in case of subchannelization. The influence of the occupied carriers $a_{l,k}$ on the unoccupied carriers $a_{l,-k}$ could be measured, but there is no possibility to distinguish them from an unknown channel coefficient.

RSSI Measurements

See [6] section "8.3.9.2 RSSI mean and standard deviation". The Received Signal Strength Indication [RSSI] is basically the preamble power. The result summary provides the RSSI statistics according to the standard. A possible method to compute RSSI[k] at the antenna connector is given in [6] equation (87). RSSI[k] is the RSSI measurement based on the k–th signal/preamble.

The RSSI statistics of the *result summary* is calculated as follows:

1. RSSI row:
Statistic {min, mean, max} of the R[k]=RSSI[k].
The mean value is $\hat{\mu}_{RSSI\ dBm}[k]$ according to [6] formula (89).
2. RSSI Standard Deviation row:
 $\hat{\sigma}_{RSSI\ dB}$ according to [6] formula (91).

CINR Measurements

See [6] section "8.3.9.3 CINR mean and standard deviation". The result summary provides the Carrier Interference Noise Ratio [CINR] statistics according to the standard. One possible method to estimate the CINR of a single message is to compute the ratio of the sum of signal power and the sum of residual error for each data sample, using equation [6] (92).

$$CINR[k] = \frac{\sum_{n=0}^{N-1} |s[k, n]|^2}{\sum_{n=0}^{N-1} |r[k, n] - s[k, n]|^2}$$

with

- | | |
|--------|---|
| r[k,n] | received/measured sample n within message k |
| s[k,n] | corresponding detected/reference sample (with channel state weighting) corresponding to received symbol n |

The CINR statistics of the *result summary* is calculated as follows:

1. CINR row:
Statistic {min, mean, max} of the CINR[k].
The mean value is $\hat{\mu}_{CINR\ dB}[k]$ according to [6] formula (94).
2. CINR Standard Deviation row
 $\hat{\sigma}_{CINR\ dB}$ according to [6] formula (96).

Literature

- [1] Speth, Classen, Meyr: "Frame synchronisation of OFDM systems in frequency selective fading channels", VTC '97, pp. 1807–1811
- [2] Schmidl, Cox: "Robust Frequency and Timing Synchronization of OFDM", IEEE Trans. on Comm., Dez. 1997, pp. 1613–621
- [3] Minn, Zeng, Bhargava: "On Timing Offset Estimation for OFDM", IEEE Communication Letters, July 2000, pp. 242–244
- [4] Speth, Fechtel, Fock, Meyr: "Optimum Receiver Design for Wireless Broad-Band Systems Using OFDM – Part I", IEEE Trans. On Comm. VOL. 47, NO 11, Nov. 1999
- [5] Speth, Fechtel, Fock, Meyr: "Optimum Receiver Design for Wireless Broad-Band Systems Using OFDM – Part II", IEEE Trans. On Comm. VOL. 49, NO 4, April. 2001
- [6] IEEE 802.16–2004, Part 16: Air Interface for Fixed Broadband Wireless Access Systems; 1 October 2004; Medium Access Control (MAC) and Physical Layer (PHY) specifications

3 Manual Control

For details refer to the Quick Start Guide chapters 4, "Basic Operations".

Contents of Chapter 4

4	Instrument Functions	4.1
	Instrument Functions – Analyzer	4.1
	Measurement Parameters.....	4.2
	Initializing the Configuration – PRESET Key.....	4.3
	Selecting the Frequency and Span – FREQ Key	4.5
	Setting the Frequency Span – SPAN Key	4.10
	Setting the Level Display and Configuring the RF Input – AMPT Key	4.12
	Setting the Bandwidths and Sweep Time – BW Key.....	4.15
	Configuring the Sweep Mode – SWEEP Key	4.20
	Triggering the Sweep – TRIG Key.....	4.23
	Setting Traces – TRACE Key	4.33
	Measurement Functions	4.42
	Using Markers and Delta Markers – MKR Key.....	4.43
	Changing Settings via Markers – MKR-> Key	4.53
	Power Measurements – MEAS Key	4.60
	Using Limit Lines and Display Lines – LINES Key	4.81
	Measurement Modes	4.90
	Measurement Mode Selection – MODE Key.....	4.91
	Measurement Mode Menus – MENU Key	4.93
	Models and Options	4.94
	Tracking Generator (Models 13 and 16).....	4.95
	Analog Demodulation (Option K7).....	4.100
	Bluetooth Measurements (Option K8)	4.118
	Power Meter (Option K9).....	4.141
	Cable TV Measurements (Option K20)	4.145
	WLAN TX Measurements (Option K91)	4.189
	WiMAX 802.16 OFDM Measurements (Option K92).....	4.225
	Instrument Functions – Basic Settings.....	4.260
	General Settings, Printout and Instrument Settings.....	4.261
	Instrument Setup and Interface Configuration – SETUP Key	4.262
	Saving and Recalling Data Sets – FILE Key	4.277
	Manual Control – Local Menu.....	4.283
	Measurement Documentation – PRINT Key	4.284

4 Instrument Functions

This chapter describes the analyzer functions and all basic settings functions of the R&S FSL in detail.

Instrument Functions – Analyzer

In this section, all analyzer functions of the R&S FSL and their application are explained in detail. The basic settings functions are described in section "Instrument Functions – Basic Settings".

For every key a table is provided in which all submenus and corresponding commands are listed. The description of the submenus and commands follows the order of the table. The commands for the optional remote control (if any) are indicated for each softkey. The description is divided into the following topics:

- **"Measurement Parameters"** on page 4.2
This section describes how to reset the instrument, to set up specific measurements and to set the measurement parameters. Examples of basic operations are provided in the Quick Start Guide, chapter 5 "Basic Measurement Examples". Advanced examples are described in chapter "Advanced Measurement Examples".
- **"Measurement Functions"** on page 4.42
This section informs about how to select and configure the measurement functions. Examples of basic operations are provided in the Quick Start Guide, chapter 5 "Basic Measurement Examples". Advanced examples are described in chapter "Advanced Measurement Examples".
- **"Measurement Modes"** on page 4.90
This section describes the provided measurement modes, the change of measurement modes and the access to the menus of all active measurement modes.
- **"Models and Options"** on page 4.90
This section informs about optional functions and their application that are included in the basic unit configuration.

More basic information on operation is given in the Quick Start Guide. The front and the rear view of the instrument together with a table of all available keys and a short description are provided in chapter "Front and Rear Panel". Chapter "Preparing for Use" informs how to start working with the instrument for the first time. A brief introduction on handling the instrument is given in chapter "Basic Operations". This includes also the description of the keys for basic operations like switching the instrument on and off or starting a measurement.

Measurement Parameters

In this section all menus necessary for setting measurement parameters are described. This includes the following topics and keys. For details on changing the mode refer to "[Measurement Mode Selection – MODE Key](#)" on page 4.91.

- "[Initializing the Configuration – PRESET Key](#)" on page 4.3
- "[Selecting the Frequency and Span – FREQ Key](#)" on page 4.5
- "[Setting the Frequency Span – SPAN Key](#)" on page 4.10
- "[Setting the Level Display and Configuring the RF Input – AMPT Key](#)" on page 4.12
- "[Setting the Bandwidths and Sweep Time – BW Key](#)" on page 4.15
- "[Configuring the Sweep Mode – SWEEP Key](#)" on page 4.20
- "[Triggering the Sweep – TRIG Key](#)" on page 4.23
- "[Setting Traces – TRACE Key](#)" on page 4.31

Table 4–1: Sweep Range Variables

Abbreviation	Definition	Value R&S FSL3	Value R&S FSL6
f_{\max}	max. frequency	3 GHz	6 GHz
f_{\min}	min. frequency available	0 Hz	0 Hz
span_{\min}	smallest selectable span > 0 Hz	10 Hz	10 Hz

Initializing the Configuration – PRESET Key

The **PRESET** key resets the instrument to the default setting and therefore provides a defined initial state as a known starting point for measurements.

*Note: If the **LOCAL LOCKOUT** function is active in the remote control mode, the **PRESET** key is disabled.*

Further information

- ["Initial configuration"](#) on page 4.3

Task

- [To preset the instrument](#)

To preset the instrument

1. Define the data set for the preset:
 - To retrieve the originally provided data sets (see [Initial configuration](#)), in the file menu, deactivate the **Startup Recall** softkey.
 - To retrieve customized data sets, in the file menu, activate the **Startup Recall** softkey, press the **Startup Recall Setup** softkey, and select the corresponding file.
For details refer to section "Saving and Recalling Data Sets – FILE Key".
2. Press the **PRESET** key to trigger a preset.
 - Remote: *RST or SYSTem:PRESet (for details refer to chapter "Remote Control – Commands", section "Common Commands" or section "SYSTem Subsystem").

Note: In order to save the current settings after reboot of the instrument, create a shutdown file by switching the analyzer in the standby mode (press the On/Off key on the FRONT panel and wait until the yellow LED is ON). With the battery pack option, use a USB keyboard and terminate the analyzer firmware with ALT+F4 to create the shutdown file.

Initial configuration

The initial configuration is selected in a way that the RF input is always protected against overload, provided that the applied signal levels are in the allowed range for the instrument.

The parameter set of the initial configuration can be customized by using the **Startup Recall** softkey in the file menu. For further information refer to section "Instrument Functions – Basic Settings", "Saving and Recalling Data Sets – FILE Key".

Table 4–2: Initial Configuration

Parameter	Settings
Mode	Spectrum Analysis
Center frequency	$f_{\max} / 2$
Center frequency step size	0.1 * center frequency
Span	3 GHz / 6 GHz (R&S FSL–3/–6)
RF attenuation	auto (0 dB)
Reference level	–20 dBm
Level range	100 dB log
Level unit	dBm
Sweep time	auto
Resolution bandwidth	auto (3 MHz)
Video bandwidth	auto (10 MHz)
FFT filters	off
Span / RBW	50
RBW / VBW	0.33
Sweep	cont
Trigger	free run
Trace 1	clr write
Trace 2/3/4	blank
Detector	auto peak
Frequency offset	0 Hz
Reference level offset	0 dB
Reference level position	100 %
Grid	abs
Cal correction	on
Noise source	off
Input	RF
Tracking generator (models 13, 16)	off

Selecting the Frequency and Span – *FREQ* Key

The **FREQ** key is used to specify the frequency axis, and to set the frequency offset and the signal track function. The frequency axis can be specified either by the start and stop frequency or by the center frequency and the span.

To open the frequency menu

- Press the **FREQ** key.

The frequency menu is displayed. The **Frequency Center** edit dialog box is displayed.

Menu and softkey description

- ["Softkeys of the frequency menu"](#) on page 4.6

To display help to a softkey, press the **HELP** key and then softkey for which you want to display help. To close the help window, press the **ESC** key. For further information refer to section "How to use the Help System".

Tasks

- [To specify the frequency axis by the start and stop frequency](#)
- [To specify the frequency axis by the center frequency and the span](#)
- [To specify the step size for the arrow keys and the rotary knob](#)
- [To modify the frequency axis by an offset](#)
- [To track signals \(only possible when span >0\)](#)

To specify the frequency axis by the start and stop frequency

1. Press the **Start** softkey and enter a start frequency.
2. Press the **Stop** softkey and enter a stop frequency.

To specify the frequency axis by the center frequency and the span

1. Press the **FREQ** key and enter a center frequency in the **Frequency Center** edit dialog box.
2. Press the **SPAN** key and enter the bandwidth you want to analyze.

Note: Entering a value of 0 Hz will cause a change to the zero span analysis mode.

To specify the step size for the arrow keys and the rotary knob

1. Press the **CF Stepsize** softkey.

The softkeys are displayed according to the selected frequency span (zero span or span > 0).

2. To define the step size of the center frequency:
 - Only when span > 0: Press **0.1*Span**, **0.5*Span** or **x*Span** to define the step size for the center frequency as percentage of the span.
 - Only when span = 0: Press **0.1*RBW**, **0.5*RBW** or **x*RBW** to define the step size for the center frequency as percentage of the resolution bandwidth.

- Press the **Center** softkey to set the step size to the value of the center frequency and to remove the dependency of the step size to span or resolution bandwidth.
- Press the **=Marker** softkey to set the step size to the value of the marker and to remove the dependency of the step size to span or resolution bandwidth.
- Press the **Manual** softkey and enter a fixed step size for the center frequency.

Note: The step size assigned to arrow keys corresponds to the selected value; the step size of the rotary knob is $1/10$ of it.

To modify the frequency axis by an offset

- Press the **Frequency Offset** softkey and enter the offset to shift the displayed frequency span.

To track signals (only possible when span >0)

1. Press the **Signal Track** softkey.
The softkeys of this submenu are displayed to start and stop signal tracking with specified parameters.
2. Press the **Track On/Off** softkey to switch signal tracking on or off.
3. Press the **Track BW** softkey and enter a bandwidth for signal tracking.
4. Press the **Track Threshold** softkey and enter the threshold for signal tracking.
5. Press the **Select Trace** softkey and select the trace for signal tracking.

Softkeys of the frequency menu

The following table shows all softkeys available in the frequency menu. It is possible that your instrument configuration does not provide all softkeys. If a softkey is only available with a special option, model or (measurement) mode, this information is delivered in the corresponding softkey description.

Menu / Command	Command
Center	
Start	
Stop	
CF Stepsize ↓	0.1*Span/0.1*RBW
	0.5*Span/0.5*RBW
	x*Span/x*RBW
	Center
	=Marker
	Manual
Frequency Offset	
Signal Track ↓	Track On/Off
	Track BW
	Track Threshold
	Select Trace

Center

Opens an edit dialog box to enter the center frequency. The allowed range of values for the center frequency depends on the frequency span.

$$\text{span} > 0: \text{span}_{min} / 2 \leq f_{center} \leq f_{max} - \text{span}_{min} / 2$$

$$\text{span} = 0: 0 \text{ Hz} \leq f_{center} \leq f_{max}$$

→ Remote: `FREQ:CENT 100MHz`

Start

Opens an edit dialog box to define the start frequency. The following range of values is allowed:

$$f_{min} \leq f_{start} \leq f_{max} - \text{span}_{min}$$

→ Remote: `FREQ:STAR 20MHz`

Stop

Opens an edit dialog box to define the stop frequency. The following range of values for the stop frequency is allowed:

$$f_{min} + \text{span}_{min} \leq f_{stop} \leq f_{max}$$

→ Remote: `FREQ:STOP 2000MHz`

CF Stepsize

Opens a submenu to set the step size of the center frequency. In addition to the **Center**, **=Marker** and **Manual** softkeys, the other softkeys are displayed depending on the selected frequency span.

The step size can be coupled to the span (span > 0) or the resolution bandwidth (span = 0) or it can be manually set to a fixed value.

0.1*Span (span > 0)

Sets the step size for the center frequency to 10% of the span.

→ Remote: `FREQ:CENT:STEP:LINK SPAN`

→ Remote: `FREQ:CENT:STEP:LINK:FACT 10PCT`

0.1*RBW (zero span)

Sets the step size for the center frequency to 10% of the resolution bandwidth. This is the default setting.

→ Remote: `FREQ:CENT:STEP:LINK RBW`

→ Remote: `FREQ:CENT:STEP:LINK:FACT 10PCT`

0.5*Span (span > 0)

Sets the step size for the center frequency to 50% of the span.

- Remote: `FREQ:CENT:STEP:LINK SPAN`
- Remote: `FREQ:CENT:STEP:LINK:FACT 50PCT`

0.5*RBW (zero span)

Sets the step size for the center frequency to 50% of the resolution bandwidth.

- Remote: `FREQ:CENT:STEP:LINK RBW`
- Remote: `FREQ:CENT:STEP:LINK:FACT 50PCT`

x*Span (span > 0)

Opens an edit dialog box to set the step size for the center frequency as % of the span.

- Remote: `FREQ:CENT:STEP:LINK SPAN`
- Remote: `FREQ:CENT:STEP:LINK:FACT 20PCT`

x*RBW (zero span)

Opens an edit dialog box to set the step size for the center frequency as % of the resolution bandwidth. Values between 1 and 100% in steps of 1% are allowed. The default setting is 10%.

- Remote: `FREQ:CENT:STEP:LINK RBW`
- Remote: `FREQ:CENT:STEP:LINK:FACT 20PCT`

Center

Sets the step size to the value of the center frequency and removes the coupling of the step size to span or resolution bandwidth. This function is especially useful during measurements of the signal harmonic content because by entering the center frequency each stroke of the arrow key selects the center frequency of another harmonic.

=Marker

Sets the step size to the value of the current marker and removes the coupling of the step size to span or resolution bandwidth. This function is especially useful during measurements of the signal harmonic content at the marker position because by entering the center frequency each stroke of the arrow key selects the center frequency of another harmonic.

Manual

Opens an edit dialog box to enter a fixed step size for the center frequency.

- Remote: `FREQ:CENT:STEP 120MHz`

Frequency Offset

Opens an edit dialog box to enter a frequency offset that shifts the displayed frequency range by the specified offset. The allowed values range from –100 GHz to 100 GHz. The default setting is 0 Hz.

→ Remote: `FREQ:OFFS 10 MHz`

Signal Track (span > 0)

Opens a submenu to modify the parameters for signal tracking: search bandwidth, threshold value and trace.

The search bandwidth and the threshold value are shown in the diagram by two vertical lines and one horizontal line, which are labeled as **TRK**. After each sweep the center frequency is set to the maximum signal found within the searched bandwidth. If no maximum signal above the set threshold value is found in the searched bandwidth, the track mechanism stops.

→ Remote: `CALC:MARK:FUNC:STR OFF`

Track On/Off (span > 0)

Switches the signal tracking on or off.

→ Remote: `CALC:MARK:FUNC:STR OFF`

Track BW (span > 0)

Opens an edit dialog box to set the search bandwidth for signal tracking. The frequency range is calculated as a function of the center frequency.

→ Remote: `CALC:MARK:FUNC:STR:BAND 1MHZ`

Track Threshold (span > 0)

Opens an edit dialog box to set the threshold value for signal tracking.

→ Remote: `CALC:MARK:FUNC:STR:THR -70DBM`

Select Trace (span > 0)

Opens an edit dialog box to select the trace on which the signal is tracked.

→ Remote: `CALC:MARK:FUNC:STR:TRAC 1`

Setting the Frequency Span – SPAN Key

The **SPAN** key is used to set the frequency span to be analyzed.

To open the span menu

- Press the **SPAN** key.

The span menu is displayed. For span > 0 an edit dialog box to enter the frequency is displayed. For zero span, an edit dialog box to enter the sweep time is displayed.

Menu and softkey description

- ["Softkeys of the span menu"](#) on page 4.10

To display help to a softkey, press the **HELP** key and then softkey for which you want to display help. To close the help window, press the **ESC** key. For further information refer to section "How to use the Help System".

Task

- [To specify the span \(alternatives\)](#)

To specify the span (alternatives)

1. To set the span, use the **Span Manual**, **Full Span**, **Zero Span** and **Last Span** softkeys.
2. To define a frequency range, use the **Start** and **Stop** softkeys.
3. For zero span, press the **Sweeptime Manual** softkey and enter a sweep time.

Softkeys of the span menu

The following table shows all softkeys available in the span menu. It is possible that your instrument configuration does not provide all softkeys. If a softkey is only available with a special option, model or (measurement) mode, this information is delivered in the corresponding softkey description.

Command
Span Manual
Sweeptime Manual
Start
Stop
Full Span
Zero Span
Last Span

Span Manual

Opens an edit dialog box to enter the frequency span. The center frequency is kept constant. The following range is allowed:

$$\text{span} = 0: 0 \text{ Hz}$$

$$\text{span} > 0: \text{span}_{\min} \leq f_{\text{span}} \leq f_{\max}$$

➔ Remote: `FREQ:SPAN 2GHz`

Start

Opens an edit dialog box to enter the start frequency. For details see **Start** softkey in the frequency menu.

→ Remote: `FREQ:STAR 20MHz`

Stop

Opens an edit dialog box to enter the stop frequency. For details see **Stop** softkey in the frequency menu.

→ Remote: `FREQ:STOP 2000MHz`

Full Span

Sets the span to the full frequency range of the R&S FSL, useful for overview measurements.

→ Remote: `FREQ:SPAN:FULL`

Zero Span

Sets the span to 0 Hz (zero span). The x axis becomes the time axis with the grid lines corresponding to 1/10 of the current sweep time (**SWT**).

→ Remote: `FREQ:SPAN 0Hz`

Last Span

Sets the span to the previous value. With this function e.g. a fast change between overview measurement and detailed measurement is possible.

Setting the Level Display and Configuring the RF Input – AMPT Key

The **AMPT** key is used to set the reference level, the level range and unit, the scaling and the RF attenuation.

To open the amplitude menu

- Press the **AMPT** key.

The amplitude menu is displayed. The **Reference Level** dialog box is displayed.

Menu and softkey description

- ["Softkeys of the amplitude menu"](#) on page 4.12

To display help to a softkey, press the **HELP** key and then softkey for which you want to display help. To close the help window, press the **ESC** key. For further information refer to section "How to use the Help System".

Task

- [To specify the amplitude](#)

To specify the amplitude

1. Set the reference level, offset and position, using the **Ref Level**, **Ref Level Offset** and **Ref Level Position** softkeys.
2. Select the level range and the unit for the level axis, using the **Range Log** and **Unit** softkeys.
3. Set the scaling, using the **Range Linear** and/or **Grid Abs / Rel** softkeys.
4. Set the attenuation, using the **RF Atten Manual** or **RF Atten Auto** softkeys.

Softkeys of the amplitude menu

The following table shows all softkeys available in the amplitude menu. It is possible that your instrument configuration does not provide all softkeys. If a softkey is only available with a special option, model or (measurement) mode, this information is delivered in the corresponding softkey description.

Command
Ref Level
Range Log
Range Linear
Preamp On/Off
RF Atten Manual
RF Atten Auto
More ↓
Ref Level Offset
Ref Level Position
Grid Abs / Rel
Unit
Input 50 Ω / 75 Ω

Ref Level

Opens an edit dialog box to enter the reference level in the currently active unit (dBm, dB μ V, etc).

The reference level value is the maximum value the AD converter can handle without distortion of the measured value. Signal levels above this value will not be measured correctly, which is indicated by the status display **IFOVL**.

→ Remote: `DISP:TRAC:Y:RLEV -60dBm`

Range Log

Opens the **Range Log** dialog box to select a value for the level range.

→ Remote: `DISP:TRAC:Y:SPAC LOG`

→ Remote: `DISP:TRAC:Y 120DB`

Range Linear

Opens the **Range Linear** dialog box to select a value for the level range.

→ Remote: `DISP:TRAC:Y:SPAC LIN | LDB`

Preamp On/Off (option RF Preamplifier, B22)

Switches the preamplifier on or off.

→ Remote: `INP:GAIN:STAT ON`

RF Atten Manual

Opens an edit dialog box to enter the attenuation, irrespective of the reference level.

The attenuation can be set in 5 dB steps. The range is specified in the data sheet. If the defined reference level cannot be set for the set RF attenuation, the reference level will be adjusted accordingly.

The RF attenuation defines the level at the input mixer according to the formula:

$$level_{mixer} = level_{input} - RF\ attenuation$$

The maximum mixer level allowed is -10 dBm. Mixer levels above this value may lead to incorrect measurement results, which are indicated by the **OVLD** status display.

→ Remote: `INP:ATT 30 DB`

RF Atten Auto

Sets the RF attenuation automatically as a function of the selected reference level. This ensures that the optimum RF attenuation is always used. It is the default setting.

→ Remote: `INP:ATT:AUTO ON`

Ref Level Offset

Opens an edit dialog box to enter the arithmetic level offset. This offset is added to the measured level irrespective of the selected unit. The scaling of the y axis is changed accordingly. The setting range is ± 200 dB in 0.1 dB steps.

→ Remote: `DISP:WIND:TRAC:Y:RLEV:OFFS -10dB`

Ref Level Position

Opens an edit dialog box to enter the reference level position, i.e. the position of the maximum AD converter value on the level axis. The setting range is from -200 to $+200\%$, 0% corresponding to the lower and 100% to the upper limit of the diagram.

→ Remote: `DISP:WIND:TRAC:Y:RPOS 100PCT`

Grid Abs / Rel (not available with Range Linear)

Switches between absolute and relative scaling of the level axis.

Absolute scaling	The labeling of the level lines refers to the absolute value of the reference level. Absolute scaling is the default setting.
Relative scaling	The upper line of the grid is always at 0 dB. The scaling is in dB whereas the reference level is always in the set unit (for details on unit settings see Unit softkey).

→ Remote: `DISP:WIND:TRAC:Y:MODE ABS`

Unit

Opens the **Unit** dialog box to select the unit for the level axis. The default setting is dBm. If a transducer is switched on, the softkey is not available.

In general, the spectrum analyzer measures the signal voltage at the RF input. The level display is calibrated in RMS values of an unmodulated sinewave signal. In the default state, the level is displayed at a power of 1 mW (= dBm). Via the known input impedance (50 Ω or 75 Ω), conversion to other units is possible. The units dBm, dBmV, dB μ V, V and W are directly convertible.

→ Remote: `CALC:UNIT:POW DBM`

Input 50 Ω / 75 Ω

Changes the input impedance from 50 Ω to 75 Ω and vice versa. Default setting is 50 Ω .

The setting 75 Ω should be selected, if the 50 Ω input impedance is transformed to a higher impedance using a 75 Ω adapter of the RAZ type (= 25 Ω in series to the input impedance of the instrument). The correction value in this case is 1.76 dB = $10 \log (75 \Omega / 50 \Omega)$.

All levels specified in this Operating Manual refer to the default setting of the instrument (50 Ω).

→ Remote: `INP:IMP 50OHM`

Setting the Bandwidths and Sweep Time – BW Key

The **BW** key is used to set the resolution bandwidth, video bandwidth (VBW) and sweep time (SWT). The values available for resolution bandwidth and video bandwidth depend on the selected filter type. For details on channel filters see also "[List of available RRC and channel filters](#)" on page 4.16.

To open the bandwidth menu

- Press the **BW** key.

The bandwidth menu is displayed.

Menu and softkey description

- "[Softkeys of the bandwidth menu](#)" on page 4.18

To display help to a softkey, press the **HELP** key and then softkey for which you want to display help. To close the help window, press the **ESC** key. For further information refer to section "How to use the Help System".

Further information

- "[List of available RRC and channel filters](#)" on page 4.16

Tasks

- [To specify the bandwidth](#)
- [To choose the appropriate filter type](#)

To specify the bandwidth

1. Set the resolution bandwidth using the **Res BW Manual** or **Res BW Auto** softkey.
2. Set the video bandwidth using the **Video BW Manual** or **Video BW Auto** softkey.
3. Set the sweep time using the **SweepTime Manual** or **SweepTime Auto** softkey.
4. Press the **Filter Type** softkey and select the appropriate filters.

To choose the appropriate filter type

Analog and digital filters are used. All resolution bandwidths up to 3 MHz are realized using digital band-passes. As far as the attenuation characteristic is concerned they behave like analog filters but have a much higher measurement speed than comparable analog filters. This is due to the fact that the transient response can be compensated as a result of an accurately defined filter behavior.

Note: Due to the LO feedthrough the overload display **OVL** responds for digital filters if the following combinations are set:
 $RBW < 100 \text{ kHz}$ and start frequency $< 6 * \text{resolution bandwidth}$, or
 $RBW = 100 \text{ kHz}$ and start frequency $< 3 \text{ MHz}$.

The video filters serve for smoothing the displayed trace. Using video bandwidths that are small compared to the resolution bandwidth, only the signal average is displayed and noise peaks and pulsed signals are repressed. If pulsed signals are to be measured, it is recommended to use a video bandwidth that is large compared to the resolution bandwidth ($VBW * 10 \times RBW$) for the amplitudes of pulses to be measured correctly.

The following filter types are available:

- Gaussian filters
available bandwidths: 10 Hz to 3 MHz. This is the default setting.
- EMI (6dB) filters
available bandwidths: 200 Hz, 9kHz, 120 kHz, 1 MHz (available from firmware version 1.30)
- FFT filters
available bandwidths: 1 Hz to 30 kHz (alternative to analog filters)

The FFT algorithm offers considerably higher measurement speeds with all the other settings remaining the same. The reason is that for analog filters the sweep time required for a particular span is proportional to $(\text{Span}/\text{RBW}^2)$. When using the FFT algorithm, however, the sweep time is proportional to (Span/RBW) .

FFT filters are particularly suitable for stationary signals (sinusoidal signals or signals that are continuously modulated in time). For burst signals (TDMA) or pulsed signals, normal filters are preferable. When the tracking generator is used as signal source for the DUT, filtering with the FFT algorithm is not useful. The **FFT** option is thus not available if the tracking generator is switched on.

If the FFT filters are activated, the sweep time display field (SWT) is replaced by the acquisition time (AQT) display field. The sweep time is defined by the selected bandwidth and span, and cannot be changed. The video bandwidth is not defined and therefore cannot be set.

The sample detector and the peak detector are available. If the **Detector Auto Select** softkey in the trace menu is activated, the peak detector is selected.

- channel filters
details see "[List of available RRC and channel filters](#)"
- RRC filters
details see "[List of available RRC and channel filters](#)"

List of available RRC and channel filters

For power measurement a number of especially steep-edged channel filters are available (see the following table).

For filters of type RRC (Root Raised Cosine), the filter bandwidth indicated describes the sampling rate of the filter. For all other filters (CFILter) the filter bandwidth is the 3 dB bandwidth.

Table 4–3: Filter Types

Filter Bandwidth	Filter Type	Application
100 Hz	CFILter	A0
200 Hz	CFILter	
300 Hz	CFILter	
500 Hz	CFILter	
1 kHz	CFILter	SSB
1.5 kHz	CFILter	
2 kHz	CFILter	
2.4 kHz	CFILter	
2.7 kHz	CFILter	

Filter Bandwidth	Filter Type	Application	
3 kHz	CFILter	DAB, Satelite	
3.4 kHz	CFILter		
4 kHz	CFILter		
4.5 kHz	CFILter		
5 kHz	CFILter		
6 kHz	CFILter		
8.5 kHz	CFILter		ETS300 113 (12.5 kHz channels)
9 kHz	CFILter		AM Radio
10 kHz	CFILter	CDMAone	
12.5 kHz	CFILter		
14 kHz	CFILter	ETS300 113 (20 kHz channels)	
15 kHz	CFILter	ETS300 113 (25 kHz channels)	
16 kHz	CFILter		
18 kHz, $\alpha=0.35$	RRC	TETRA	
20 kHz	CFILter	PDC	
21 kHz	CFILter		
24.3 kHz, $\alpha=0.35$	RRC	IS 136	
25 kHz	CFILter	CDPD, CDMAone	
30 kHz	CFILter		
50 kHz	CFILter		
100 kHz	CFILter	FM Radio	
150 kHz	CFILter		
192 kHz	CFILter	PHS	
200 kHz	CFILter	J.83 (8-VSB DVB, USA)	
300 kHz	CFILter		
500 kHz	CFILter		
1.0 MHz	CFILter	CDMAone	
1,28 MHz	RRC	CDMAone	
1.2288 MHz	CFILter		
1.5 MHz	CFILter	DAB	
3.0 MHz	CFILter	W-CDMA 3GPP	
3.75 MHz	CFILter		
3.84 MHz, $\alpha=0.22$	RRC		
4.096 MHz, $\alpha=0.22$	RRC	W-CDMA NTT DOCoMo	
20 MHz	CFILter		

Softkeys of the bandwidth menu

The following table shows all softkeys available in the bandwidth menu. It is possible that your instrument configuration does not provide all softkeys. If a softkey is only available with a special option, model or (measurement) mode, this information is delivered in the corresponding softkey description.

Command
Res BW Manual
Res BW Auto
Video BW Manual
Video BW Auto
Sweeptime Manual
Sweeptime Auto
Filter Type

Res BW Manual

Opens an edit dialog box to enter a value for the resolution bandwidth. The resolution bandwidth can be set in 1, 3, 10 steps in the range between 300 Hz and 3 MHz (10 Hz to 3 MHz with option Narrow IF Filters, R&S FSL–B7). For details on the correlation between resolution bandwidth and filter type refer to "[To choose the appropriate filter type](#)" on page 4.15.

Numeric input is always rounded to the nearest possible bandwidth. For rotary knob or **UP/DNARROW** key inputs, the bandwidth is adjusted in steps either upwards or downwards.

The manual input mode of the resolution bandwidth is indicated by a green asterisk (*) at the **RBW** display.

- Remote: BAND:AUTO OFF
 - Remote: BAND 1MHz
-

Res BW Auto (span > 0)

Couples the resolution bandwidth to the selected span. If the span is changed, the resolution bandwidth is automatically adjusted.

This setting is recommended, when a favorable setting of the resolution bandwidth in relation to the selected span is desired.

- Remote: BAND:AUTO ON
-

Video BW Manual (not available for FFT filter)

Opens an edit dialog box to enter the video bandwidth. The video bandwidth can be selected in 1, 3, 10 steps in the range between 1 Hz and 10 MHz.

Numeric input is always rounded to the nearest possible bandwidth. For rotary knob or UP/DOWN key inputs, the bandwidth is adjusted in steps either upwards or downwards.

The manual input mode of the video bandwidth is indicated by a green asterisk (*) at the **VBW** display.

- Remote: BAND:VID:AUTO OFF
 - Remote: BAND:VID 10 kHz
-

Video BW Auto (not available for FFT filter)

Couples the video bandwidth to the resolution bandwidth. If the resolution bandwidth is changed, the video bandwidth is automatically adjusted.

This setting is recommended, when a minimum sweep time is required for a selected resolution bandwidth. Narrow video bandwidths require longer sweep times due to the longer settling time. Wide bandwidths reduce the signal/noise ratio.

→ Remote: BAND:VID:AUTO ON

Sweeptime Manual (not available for FFT filter)

Opens an edit dialog box to enter the sweep time.

Sweep time	Option TV Trigger, B6 (available from version 1.10)
absolute max. sweep time value: 16000 s	100 µs (zero span)
absolute min. sweep time value: 1 µs (zero span)	25 µs (zero span)
2.5 ms (span > 0)	–

Allowed values depend on the ratio of span to RBW and RBW to VBW.

Numeric input is always rounded to the nearest possible sweep time. For rotary knob or UP/DOWN key inputs, the sweep time is adjusted in steps either downwards or upwards.

The manual input mode of the sweep time is indicated by a green asterisk (*) at the **SWT** display. If the selected sweep time is too short for the selected bandwidth and span, level measurement errors will occur due to a too short settling time for the resolution or video filters. In this case, the R&S FSL displays the error message **UNCAL** and marks the indicated sweep time with a red asterisk (*).

→ Remote: SWE:TIME:AUTO OFF

→ Remote: SWE:TIME 10s

Sweeptime Auto (not available for FFT filter and zero span)

Couples the sweep time to the span, video bandwidth (VBW) and resolution bandwidth (RBW). If the span, resolution bandwidth or video bandwidth are changed, the sweep time is automatically adjusted.

The R&S FSL always selects the shortest sweep time that is possible without falsifying the signal. The maximum level error is < 0.1 dB, compared to using a longer sweep time.

→ Remote: SWE:TIME:AUTO ON

Filter Type

Opens the **Filter Type** dialog box to select the filter type.

For detailed information on filters see "[To choose the appropriate filter](#)" on page 4.15 and "[List of available RRC and channel filters](#)" on page 4.16.

→ Remote: BAND:TYPE NORM

Configuring the Sweep Mode – SWEEP Key

The **SWEEP** key is used to configure the sweep mode. Continuous sweep or single sweep are possible. The sweep time and the number of measurement points are set.

To open the sweep menu

- Press the **SWEEP** key.
The sweep menu is displayed.

Menu and softkey description

- ["Softkeys of the sweep menu"](#) on page 4.20

To display help to a softkey, press the **HELP** key and then softkey for which you want to display help. To close the help window, press the **ESC** key. For further information refer to section "How to use the Help System".

Task

- [To specify the sweep settings](#)

To specify the sweep settings

1. Press the **Sweep Count** softkey and enter the sweep count.
2. Set the sweep time by using the **Sweeptime Manual** or **Sweeptime Auto** softkey.
3. Press the **Sweep Points** softkey and enter the number of sweep points.
4. Select the sweep mode using the **Continuous Sweep** or **Single Sweep** softkey.
5. To repeat the single sweep, press the **Continue Single Sweep** softkey.

Softkeys of the sweep menu

The following table shows all softkeys available in the sweep menu. It is possible that your instrument configuration does not provide all softkeys. If a softkey is only available with a special option, model or (measurement) mode, this information is delivered in the corresponding softkey description.

Command
Continuous Sweep
Single Sweep
Continue Single Sweep
Sweeptime Manual
Sweeptime Auto
Sweep Count
Sweep Points

Continuous Sweep

Sets the continuous sweep mode: the sweep takes place continuously according to the trigger settings. This is the default setting. The trace averaging is determined by the sweep count value (see **Sweep Count** softkey).

→ Remote: INIT:CONT ON

Single Sweep

Sets the single sweep mode: after triggering, starts the number of sweeps that are defined by using the **Sweep Count** softkey. The measurement stops after the defined number of sweeps has been performed.

→ Remote: INIT:CONT OFF

Continue Single Sweep

Repeats the number of sweeps set by using the **Sweep Count** softkey, without deleting the trace of the last measurement.

This is particularly of interest when using the trace configurations **Average** or **Max Hold** to take previously recorded measurements into account for averaging / maximum search. For details on trace configuration refer to "[Setting Traces – TRACE Key](#)" on page 4.31.

→ Remote: INIT:CONM

Sweeptime Manual

Opens an edit dialog box to enter the sweep time. For details see **Sweeptime Manual** softkey in the bandwidth menu.

→ Remote: SWE:TIME 10s

Sweeptime Auto

Sets the automatic sweep time mode. For details see **Sweeptime Auto** softkey in the bandwidth menu.

→ Remote: SWE:TIME:AUTO ON

Sweep Count

Opens an edit dialog box to enter the number of sweeps to be performed in the single sweep mode. Values from 0 to 32767 are allowed. If the values 0 or 1 are set, one sweep is performed. The sweep count is applied to all the traces in a diagram.

The sweep count set in the sweep menu is the same as that in the trace menu (see **Sweep Count** softkey). If the trace configurations **Average**, **Max Hold** or **Min Hold** are set, the sweep count value also determines the number of averaging or maximum search procedures (for details on trace configuration see "[Setting Traces – TRACE Key](#)" on page 4.31).

Example:

TRACE key – **Trace Mode** softkey – **Trace Mode** dialog box: select **Max Hold**

SWEEP key – **Sweep Count** softkey – **Average Sweep Count** dialog box: enter 10

Single Sweep softkey: R&S FSL performs the **Max Hold** function over 10 sweeps.

→ Remote: SWE:COUN 64

Sweep Points

Opens an edit dialog box to enter the number of measurement points to be collected during one sweep.

The following values are possible: 125, 251, 501 (default), 1001, 2001, 4001, 8001, 16001, 32001. If a value \neq 501 is set, the auto peak detector will be turned off automatically.

→ Remote: SWE:POIN 501

Triggering the Sweep – TRIG Key

The **TRIG** key is used to set trigger mode, trigger threshold, trigger delay, trigger polarity and for gated sweep the gate configuration.

To open the trigger menu

- Press the **TRIG** key.
The trigger menu is displayed.

Menu and softkey description

- ["Softkeys of the trigger menu"](#) on page 4.26

To display help to a softkey, press the **HELP** key and then softkey for which you want to display help. To close the help window, press the **ESC** key. For further information refer to section "How to use the Help System".

Further information

- ["Trigger mode overview"](#) on page 4.26

Tasks

- [To specify the trigger settings](#)
- [To use gated sweep operation \(option Gated Sweep, B8\)](#)
- [To trigger on TV signals \(zero span and option TV Trigger, B6\)](#)

To specify the trigger settings

1. Press the **Trg / Gate Source** softkey to select the trigger mode (for details see ["Trigger mode overview"](#) on page 4.26).
2. Press the **Trg / Gate Level** softkey to set the trigger level.
3. Press the **Trigger Offset** softkey to set the trigger offset.
4. For details on gated sweep operation, see ["To use gated sweep operation \(option Gated Sweep, B8\)"](#) on page 4.23.
5. For details on TV signal triggering, see ["To trigger on TV signals \(zero span and option TV Trigger, B6\)"](#).

To use gated sweep operation (option Gated Sweep, B8)

By using a gate in sweep mode and stopping the measurement while the gate signal is inactive, the spectrum for pulsed RF carriers can be displayed without the superposition of frequency components generated during switching. Similarly, the spectrum can also be examined for an inactive carrier. The sweep can be controlled by an external gate or by the internal power trigger.

Gated sweep operation is also possible for span = 0. This enables – e.g. in burst signals – level variations of individual slots to be displayed versus time.

1. Press the **Gate Settings** submenu softkey to define the settings of the gate mode.
 At the center frequency a transition to zero span is made and the time parameters gate delay and gate length are displayed as vertical lines to adjust them easily.
 When quitting the **Gate Settings** submenu, the original span is retrieved so the desired measurement can be performed with the accurately set gate.
2. To set the parameters gate delay and gate length highly accurate, press the **Sweep Time** softkey to alter the x axis in a way that the signal range concerned (e.g. one full burst) is displayed.
3. Press the **Gate Delay** softkey to set the sampling time in a way that the desired portion of the signal is shown.
4. Press the **Gate Mode Lvl/Edge** softkey to set the gate mode.
5. If the **Edge** gate mode has been selected, press the **Gate Length** softkey to set the sampling duration in a way that the desired portion of the signal is shown.
6. Press the **Trg / Gate Polarity Pos/Neg** softkey to set the polarity of the trigger source.
7. Press the **Gated Trigger** softkey to activate the gated sweep mode.

To indicate that a gate is used for the sweep, the enhancement label **GAT** is displayed on the screen. This label appears to the right of the window for which the gate is configured.

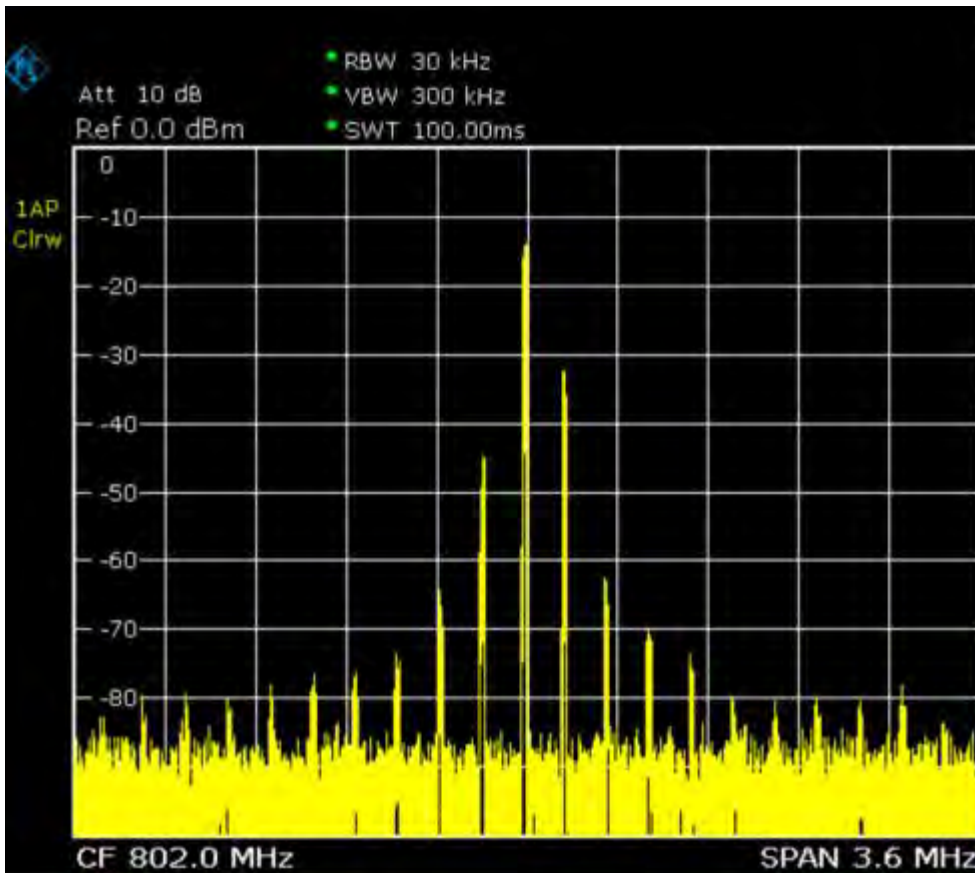

Fig. 4–1: TDMA signal with GATE OFF

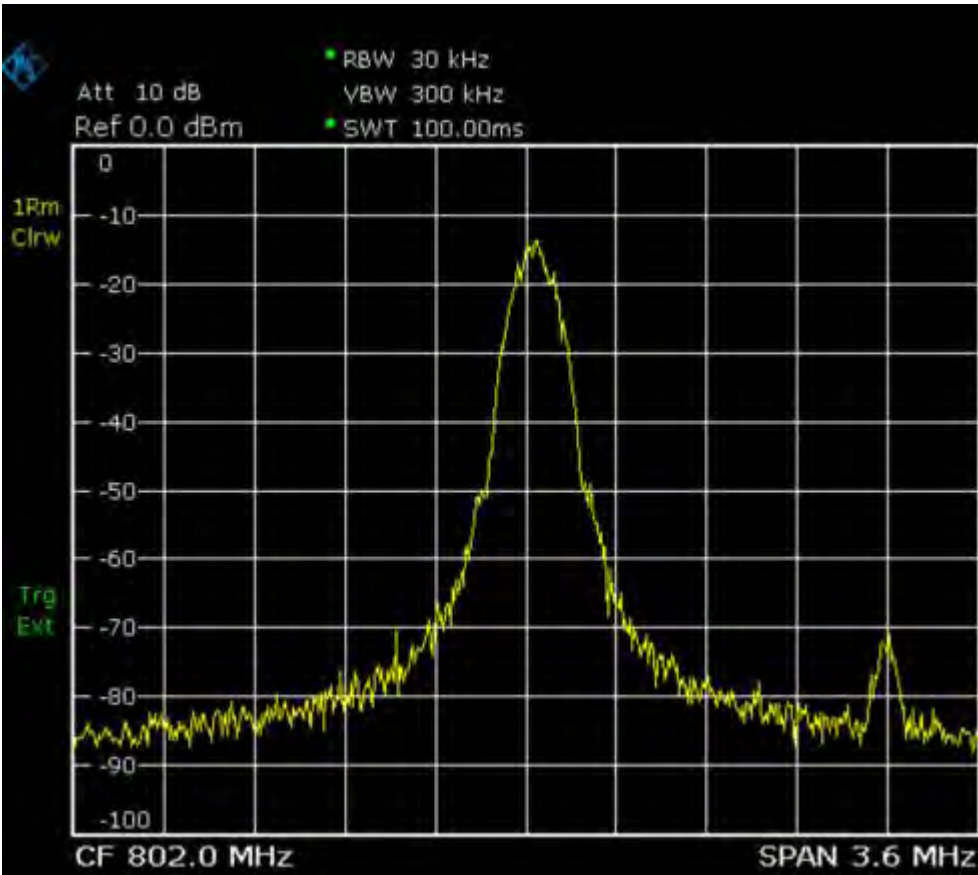

Fig. 4-2: Pulsed signal with GATE ON

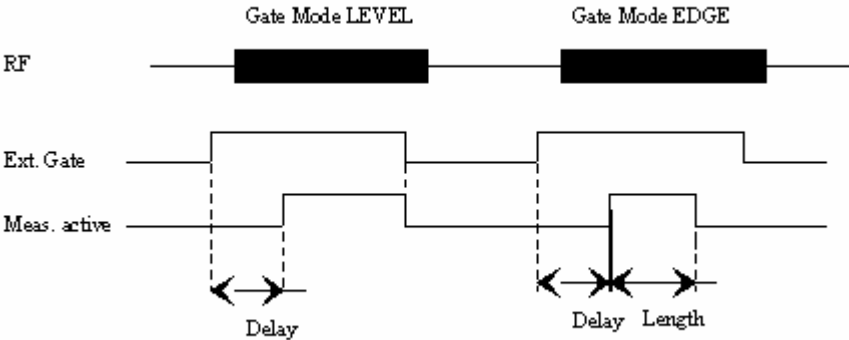

Fig. 4-3: Timing diagram for GATE, GATE DELAY and GATE LENGTH

To trigger on TV signals (zero span and option TV Trigger, B6)

1. Press the **TV Trig Settings** submenu softkey to switch the TV trigger on and define the settings for triggering on TV signal.
2. To configure the TV trigger, press the **Vert Sync**, **Vert Sync Odd Field**, **Vert Sync Even Field** or **Hor Sync** softkey.
3. Press the **Video Pol Pos/Neg** softkey to set the polarity of the video signal.
4. Press the **Lines 625/525** softkey to set the line system to be used.

Option TV Trigger, B6, is available from firmware version 1.10.

Trigger mode overview

The R&S FSL offers the following trigger modes:

- **Free Run**

The start of a sweep is not triggered. Once a measurement is completed, another is started immediately.

- **External**

Triggering via a TTL signal at the input connector **EXT TRIG / GATE IN** on the rear panel.

- **Video**

Triggering by the displayed voltage.

A horizontal trigger line is shown in the diagram. It is used to set the trigger threshold from 0% to 100% of the diagram height.

- **IF Power**

Triggering of the measurement via signals which are outside the measurement channel.

For this purpose, the R&S FSL uses a level detector at the second intermediate frequency. Its threshold can be set in a range between –50 dBm and –10 dBm at the input mixer. The resulting trigger level at the RF input is calculated via the following formula:

$$\text{Mixerlevel}_{min} + \text{RFAtt} - \text{PreampGain} \leq \text{Input Signal} \leq \text{Mixerlevel}_{max} + \text{RFAtt} - \text{PreampGain}$$

The bandwidth at the intermediate frequency is 20 MHz. The R&S FSL is triggered as soon as the trigger threshold is exceeded within a 10 MHz range around the selected frequency (= start frequency in the frequency sweep).

Thus, the measurement of spurious emissions, e.g. for pulsed carriers, is possible even when the carrier lies outside the selected frequency span.

- **TV (option TV Trigger, B6)**

Option TV Trigger, B6, is available from firmware version 1.10 for triggering on TV signals. In this trigger mode, only the **Auto Peak** and the **Sample** detectors are available (for details refer to "[Detector overview](#)" on page 4.36).

In order to display different sections of a TV video signal, the R&S FSL derives several trigger signals from the video signals. This allows triggering as well on the frame repetition as on each line of the TV video signal.

The filter bandwidth is constant: 4.0 MHz for standards with 525 lines or 5.0 MHz for standards with 625 lines. The position of the filter is determined by the firmware in order to place the 3 dB filter bandwidth on the center frequency, as shown in the diagram below. For the center frequency, the value of the vision carrier frequency should be set.

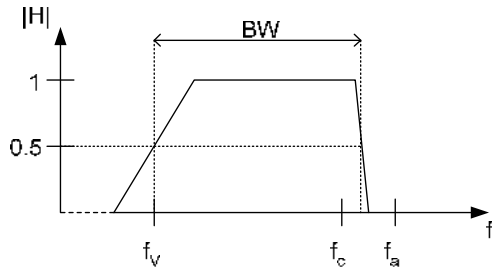

f_v = vision carrier frequency

f_a = aural carrier frequency

f_c = chrominance sub-carrier frequency

BW = -3dB filter bandwidth

Fig. 4-4: 3 dB Filter bandwidth (option TV Trigger, B6, available from firmware version 1.10)

Softkeys of the trigger menu

The following table shows all softkeys available in the trigger menu. It is possible that your instrument configuration does not provide all softkeys. If a softkey is only available with a special option, model or (measurement) mode, this information is delivered in the corresponding softkey description.

Menu / Command	Command
Trg / Gate Source	
Trg / Gate Level	
Trg / Gate Polarity Pos/Neg	
Trigger Offset	
Gated Trigger	
Gate Settings ↓	Gate Mode Lvl/Edge
	Gate Delay
	Gate Length
	Trg / Gate Source
	Trg / Gate Level
	Trg / Gate Polarity Pos/Neg
	Sweep Time
More ↓	
IF Power Retrigger Holdoff	
IF Power Retrigger Hysteresis	
TV Trig Settings	Vert Sync
	Vert Sync Odd Field
	Vert Sync Even Field
	Hor Sync
	Video Pol Pos/Neg
	Lines 625/525
	TV Free Run On/Off

Trg / Gate Source

Opens the **Trigger / Gate Source** dialog box to select the trigger / gate mode. For detailed information on trigger modes see "[Trigger mode overview](#)" on page 4.26.

The gate-related settings are only available with option Gated Sweep, R&S FSL-B8. As gate modes, all modes apart from the TV Trigger mode (option TV Trigger, B6, available from firmware version 1.10) are available. For details see also "[To use gated sweep operation \(option Gated Sweep, B8\)](#)" on page 4.23.

The default setting is **Free Run**. If a trigger mode other than **Free Run** has been set, the enhancement label **TRG** is displayed.

- Remote: TRIG:SOUR IMM | VID | IFP | EXT | TV (Free Run, Video, IF Power, Extern, TV Trigger)
- Remote: SWE:EGAT:SOUR EXT (Extern)

Trg / Gate Level

Opens an edit dialog box to enter the trigger / gate level. The gate-related settings are only available with option Gated Sweep, R&S FSL-B8. For details see also "[Trigger mode overview](#)" on page 4.26 and "[To use gated sweep operation \(option Gated Sweep, B8\)](#)" on page 4.23.

- Remote: TRIG:LEV:VID 50PCT
- Remote: TRIG:LEV:IFP -30DBM

Trg / Gate Polarity Pos/Neg

Sets the polarity of the trigger / gate source. The gate-related settings are only available with option Gated Sweep, R&S FSL-B8.

The sweep starts after a positive or negative edge of the trigger signal. The default setting is **Pos**. The setting applies to all modes with the exception of the **Free Run** mode.

level triggering	In the setting Pos the sweep is stopped by the logic '0' signal and restarted by the logical '1' signal after the gate delay time has elapsed.
edge triggering	The sweep is continued on a '0' to '1' transition for the gate length duration after the gate delay time has elapsed.

For details also see "[To use gated sweep operation \(option Gated Sweep, B8\)](#)" on page 4.23.

- Remote: TRIG:SLOP POS
- Remote: SWE:EGAT:POL POS

Trigger Offset

Opens an edit dialog box to enter the time offset between the trigger signal and the start of the sweep. The time may be entered in multiples of 125 ns in the range -100 s to 100 s (default 0 s).

- offset > 0: start of the sweep is delayed
- offset < 0: sweep starts earlier (pre-trigger)
- only possible for span = 0 and gated trigger switched off
not possible when RMS or average detector activated
- maximum allowed range and the maximum resolution limited by the sweep time:
- $$range_{max} = -499/500 \times sweep\ time$$
- $$resolution_{max} = sweep\ time/500$$

Note: For the option TV Trigger, B6 (available from firmware version 1.10), the allowed offset ranges from $-50\ \mu s$ to $+50\ \mu s$. If the trigger source is changed to TV trigger and the set trigger offset is out of range, the trigger offset is adopted to the closest value allowed.

In the **External** or **IF Power** trigger mode, a common input signal is used for both trigger and gate. Therefore changes to the gate delay will affect the trigger delay (trigger offset) as well.

→ Remote: TRIG:HOLD 10US

Gated Trigger (option Gated Sweep, B8)

Switches the sweep mode with gate on or off .

This softkey requires the **External** or **IF Power** trigger mode. If a different mode is active, the **IF Power** trigger mode is automatically selected.

When the gate is switched on, a gate signal applied to the rear panel connector EXT TRIGGER/GATE or the internal IF power detector controls the sweep of the analyzer.

For details also see "[To use gated sweep operation \(option Gated Sweep, B8\)](#)" on page 4.23.

→ Remote: SWE:EGAT ON

→ Remote: SWE:EGAT:SOUR IFP | EXT

Gate Settings (option Gated Sweep, B8)

Opens a submenu to make all the settings required for gated sweep operation.

For details also see "[To use gated sweep operation \(option Gated Sweep, B8\)](#)" on page 4.23.

Gate Mode Lvl/Edge (option Gated Sweep, B8)

Sets the gate mode. As settings level-triggered or edge-triggered gate mode can be selected.

For details also see "[To use gated sweep operation \(option Gated Sweep, B8\)](#)" on page 4.23.

→ Remote: SWE:EGAT:TYPE EDGE

Gate Delay (option Gated Sweep, B8)

Opens an edit dialog box to enter the gate delay time between the gate signal and the continuation of the sweep. Values between 125 ns and 100 s are allowed. The delay position on the time axis in relation to the sweep is indicated by a line labeled **GD**.

This is useful for e.g. taking into account a delay between the gate signal and the stabilization of an RF carrier.

As a common input signal is used for both trigger and gate when selecting the **External** or **IF Power** trigger mode, changes to the gate delay will affect the trigger delay (trigger offset) as well.

For details also see "[To use gated sweep operation \(option Gated Sweep, B8\)](#)" on page 4.23.

→ Remote: `SWE:EGAT:HOLD 1US`

Gate Length (Gate Mode Edge)

Opens an edit dialog box to enter the gate length. Values between 125 ns and 100 s are allowed. The gate length in relation to the sweep is indicated by a line labeled **GL**.

The length of the gate signal defines when the sweep is to be interrupted. Only in the edge-triggered mode the gate length can be set, while in the level-triggered the gate length depends on the length of the gate signal.

For details also see "[To use gated sweep operation \(option Gated Sweep, B8\)](#)" on page 4.23.

→ Remote: `SWE:EGAT:LENG 100US`

Sweep Time (option Gated Sweep, B8)

Opens an edit dialog box to change the sweep time in order to obtain a higher resolution for positioning gate delay and gate length. When quitting the **Gate Settings** submenu, the original sweep time is retrieved.

For details also see "[To use gated sweep operation \(option Gated Sweep, B8\)](#)" on page 4.23.

IF Power Retrigger Holdoff (

Opens an edit dialog box to define the value for the IF power trigger holdoff. This softkey is only available if the IF power trigger is selected as the trigger source. The holdoff value in s is the time which must pass since another IF power trigger event may happen. The range of the value is between 150 ns and 10 s in the step width of 10 ns.

This softkey is available from firmware version 1.30.

→ Remote: `TRIG:IFP:HOLD 200 ns`

IF Power Retrigger Hysteresis

Opens an edit dialog box to define the value for the IF power trigger hysteresis. This softkey is only available if the IF power trigger is selected as the trigger source. The hysteresis in dB is the value the input signal must decay below the IF power trigger level in order to allow an IF power trigger starting the measurement. The range of the value is between 3 dB and 50 dB in the step width of 1 dB.

This softkey is available from firmware version 1.30.

→ Remote: `TRIG:IFP:HYST 10DB`

TV Trig Settings (zero span and option TV Trigger, B6)

Switches the TV trigger on and opens a submenu to configure the TV signal parameters.

Option TV Trigger, B6, is available from firmware version 1.10.

→ Remote: TRIG:SOUR TV

Vert Sync (zero span and option TV Trigger, B6)

Sets the trigger on the vertical sync signal. The R&S FSL triggers on the frame repetition signal without distinction between the two fields.

Option TV Trigger, B6, is available from firmware version 1.10.

→ Remote: TRIG:VID:FIEL:SEL ALL

Vert Sync Odd Field (zero span and option TV Trigger, B6)

Sets the trigger on the vertical sync signal of the first field.

Option TV Trigger, B6, is available from firmware version 1.10.

→ Remote: TRIG:VID:FIEL:SEL ODD

Vert Sync Even Field (zero span and option TV Trigger, B6)

Sets the trigger on the vertical sync signal of the second field.

Option TV Trigger, B6, is available from firmware version 1.10.

→ Remote: TRIG:VID:FIEL:SEL EVEN

Hor Sync (zero span and option TV Trigger, B6)

Sets the trigger on the horizontal sync signal and opens an edit dialog box to enter the corresponding line. Depending on the selected line system (for details see **Lines 625/525** softkey), values from 1 to 525 or 1 to 625 are allowed. If the range is exceeded, the maximum possible line number will be set.

The default setting is 17, which is used to trigger according to CCIR 473–4 on test line 17.

Option TV Trigger, B6, is available from firmware version 1.10.

→ Remote: TRIG:VID:LINE:NUM 17

Video Pol Pos/Neg (zero span and option TV Trigger, B6)

Sets the polarity of the video signal. Default setting is **Neg**.

Positive video polarity is to be selected e.g. for standard L signals, negative video polarity for signals according to the standards B/G/I/M (color standard PAL or NTSC).

Option TV Trigger, B6, is available from firmware version 1.10.

→ Remote: TRIG:VID:SSIG:POL NEG

Lines 625/525 (zero span and option TV Trigger, B6)

Sets the line system to be used. Default setting is 625 lines.

Option TV Trigger, B6, is available from firmware version 1.10.

→ Remote: TRIG:VID:FORM:LPFR 625

TV Free Run On/Off (zero span and option TV Trigger, B6)

Activates or deactivates the free run trigger mode for option TV Trigger, B6. For details on trigger modes refer to "[Trigger mode overview](#)" on page 4.26. In this mode, only the trace modes **Clear Write** and **View** are available (see also "[Trace mode overview](#)" on page 4.34).

This softkey is available from firmware version 1.30.

→ Remote: TRIG:VID:CONT ON

Setting Traces – TRACE Key

The **TRACE** key is used to configure the data acquisition for measurement and the analysis of the measurement data.

The R&S FSL is capable of displaying up to four different traces at a time in a diagram. A trace consists of a maximum of 501 measurement points on the horizontal axis (frequency or time). If more measured values than measurement points are available, several measured values are combined in one measurement point.

The trace functions are subdivided as follows:

- Display mode of trace (**Clear Write**, **View** and **Blank**). For details on trace modes see "[Trace mode overview](#)" on page 4.34.
- Evaluation of the trace as a whole (**Average**, **Max Hold** and **Min Hold**). For details on trace modes see "[Trace mode overview](#)" on page 4.34. For details on averaging see "[Description of the averaging method](#)" on page 4.35.
- Evaluation of individual measurement points of a trace. For details on detectors see "[Detector overview](#)" on page 4.36.

To open the trace menu

- Press the **TRACE** key.

The trace menu is displayed. The **Trace Configuration** dialog box is displayed.

Menu and softkey description

- "[Softkeys of the trace menu](#)" on page 4.37

To display help to a softkey, press the **HELP** key and then softkey for which you want to display help. To close the help window, press the **ESC** key. For further information refer to section "How to use the Help System".

Further information

- "[Trace mode overview](#)" on page 4.34
- "[Detector overview](#)" on page 4.36
- "[Description of the averaging method](#)" on page 4.35
- "[ASCII file export file format](#)" on page 4.40

Task

- [To specify the trace settings](#)

To specify the trace settings

1. Press the **Trace 1 2 3 4** softkey to select the trace.
2. Press the **Trace Mode** softkey to select the trace mode for the selected trace (for details see "[Trace mode overview](#)" on page 4.34).
3. Press the **Detector Auto Select** softkey for automatic detector selection or press the **Detector Manual Select** softkey to select a detector (for details see "[Detector overview](#)" on page 4.36).
4. To change the sweep count setting, which also determines trace averaging, press the **Sweep Count** softkey.

5. To deactivate the reset of the traces in Min Hold and Max Hold mode after some specific parameter changes, press the **Hold/Cont** softkey.
6. To copy a trace into another trace memory, press the **Copy Trace** softkey.
Upon copying, the contents of the selected memory are overwritten and the new contents are displayed in the **View** mode.
7. To export the active trace in ASCII format:
 - Press the **More** softkey.
 - If necessary, press the **Decim Sep** softkey to change the decimal separator with floating–point numerals.
 - Press the **ASCII File Export** softkey to enter the ASCII file export name.The active trace is saved in ASCII format on a floppy disk.

Trace mode overview

The traces can individually be activated for a measurement or frozen after completion of a measurement. Traces that are not activated are hidden. Each time the trace mode is changed, the selected trace memory is cleared.

The R&S FSL offers 6 different trace modes:

- **Clear Write**

Overwrite mode: the trace is overwritten by each sweep. All available detectors can be selected. This is the default setting.

- **Max Hold**

The maximum value is determined over several sweeps and displayed. The R&S FSL saves the sweep result in the trace memory only if the new value is greater than the previous one. The detector is automatically set to **Positive Peak**.

This mode is especially useful with modulated or pulsed signals. The signal spectrum is filled up upon each sweep until all signal components are detected in a kind of envelope.

This mode is not available for statistics measurements or if the TV trigger is active and the **TV Free Run On/Off** softkey is set to **ON** (option TV Trigger, B6).

- **Min Hold**

The minimum value is determined from several measurements and displayed. The R&S FSL saves for each sweep the smallest of the previously stored/currently measured values in the trace memory. The detector is automatically set to **Negative Peak**.

This mode is useful e.g. for making an unmodulated carrier in a composite signal visible. Noise, interference signals or modulated signals are suppressed whereas a CW signal is recognized by its constant level.

This mode is not available for statistics measurements or if the TV trigger is active and the **TV Free Run On/Off** softkey is set to **ON** (option TV Trigger, B6).

- **Average**

The average is formed over several sweeps. All available detectors can be selected. If the detector is automatically selected, the sample detector is used. For details see also "[Description of the averaging method](#)" on page 4.35.

This mode is not available for statistics measurements or if the TV trigger is active and the **TV Free Run On/Off** softkey is set to **ON** (option TV Trigger, B6).

- **View**

The current contents of the trace memory is frozen and displayed.

If a trace is frozen, the instrument settings, apart from level range and reference level (see below), can be changed without impact on the displayed trace. The fact that the trace and the current instrument setting do not correspond any more is indicated by the enhancement label "*" at the left edge of the grid.

If level range or reference level are changed, the R&S FSL automatically adapts the measured data to the changed display range. This allows an amplitude zoom to be made after the measurement in order to show details of the trace.

- **Blank**

Hides the selected trace.

Description of the averaging method

Averaging is carried out over the measurement points derived from the measurement samples. Several measured values may be combined in a measurement point. This means that with linear level display the average is formed over linear amplitude values. The settings continuous or single sweep (for details see "[Configuring the Sweep Mode – SWEEP Key](#)" on page 4.20) and running averaging apply to the average display analogously.

There are two methods for calculating the average. For a sweep count = 0 , a continuous average is calculated according to the following formula:

$$TRACE = \frac{9 * TRACE + meas. value}{10}$$

Due to the weighting between the new measured value and the trace average, past values have practically no influence on the displayed trace after about ten sweeps. With this setting, signal noise is effectively reduced without need for restarting the averaging process after a change of the signal.

If the sweep count is >1, averaging takes place over the selected number of sweeps. In this case the displayed trace is calculated during averaging according to the following formula:

$$Trace_n = \frac{1}{n} \left[\sum_{i=1}^{n-1} (T_i) + meas. value_n \right]$$

where n is the number of the current sweep. No averaging is carried out for the first sweep but the measured value is stored in the trace memory. With increasing n, the displayed trace is increasingly smoothed since there are more single sweeps for averaging.

After the selected number of sweeps the average trace is saved in the trace memory. Until this number of sweeps is reached, a preliminary average is displayed.

After completion of averaging, i.e. when the averaging length defined by sweep count is attained, continuous averaging is resumed with continuous sweep . The display "Sweep N of N" does not change any more until a new start is triggered. The displayed trace is calculated according to the following formula:

$$Trace = \frac{(N - 1) \cdot Trace_{old} + meas. value}{N}$$

with *Trace*: new; *Trace_{old}*: old trace; *N*: sweep count

The same holds true for single sweep operation if the **Continue Single Sweep** softkey is pressed.

In the single sweep mode, a specific number of sweeps is set. The sweeps are stopped when the selected number of sweeps is attained. The number of the current sweep and the total number of sweeps are shown on the display: "Sweep 3 of 200".

Detector overview

The measurement detector for the individual display modes can be selected directly by the user or set automatically by R&S FSL. The detector activated for the specific trace is identified in the respective trace display field in form of an abbreviation (for details see detector list).

The detectors of the R&S FSL are implemented as pure digital devices. They collect signal power data within each measured point during a sweep. The default number of sweep points is 501. The following detectors are available:

Detector	Indicator	Function
auto peak detector (Auto Peak)	Ap	determines the maximum and the minimum value within a measurement point
peak detector (Positive Peak)	Pk	determines the maximum value within a measurement point
min peak detector (Negative Peak)	Mi	determines the minimum value within a measurement point
RMS detector (RMS)	Rm	determines the root mean square power within a measurement point
average detector (Average)	Av	determines the linear average power within a measurement point
sample detector (Sample)	Sa	selects a random value within a measurement point
quasi peak detector (Quasi Peak)	QP	determines the quasipeak power within a measurement point for EMI measurements (available from firmware version 1.10)

If the TV trigger is active, only the auto peak and the sample detector are available.

The result obtained from the selected detector within a measurement point is displayed as the power value at this measurement point.

All detectors work in parallel in the background, which means that the measurement speed is independent of the detector combination used for different traces.

Note: During a frequency sweep, R&S FSL increments the 1st local oscillator in steps that are smaller than approximately 1/10 of the bandwidth. This makes sure that the oscillator step speed is conforming to the hardware settling times and does not affect the precision of the measured power.

The number of measurement points taken during a sweep is independent of the number of oscillator steps. It is always selected as a multiple or a fraction of 501 (= default number of trace points displayed on the screen). Choosing less than 501 measurement points (e.g. 125 or 251) will lead to an interpolated measurement curve, choosing more than 501 points (e.g. 1001, 2001 ...) will result in several measurement points being overlaid at the same frequency position.

Softkeys of the trace menu

The following table shows all softkeys available in the trace menu. It is possible that your instrument configuration does not provide all softkeys. If a softkey is only available with a special option, model or (measurement) mode, this information is delivered in the corresponding softkey description.

Command
Trace 1 2 3 4
Trace Mode
Detector Auto Select
Detector Manual Select
Sweep Count
Hold/Cont
More ↓
Trace 1 2 3 4
Copy Trace
ASCII File Export
Decim Sep
Trace Math
Trace Math Position

Trace 1 2 3 4

Selects the active trace (1, 2, 3, 4). The default setting is trace 1 in the overwrite mode (see **Clear Write** mode), the other traces are switched off (see **Blank** mode).

→ Remote: (selected via numeric suffix of :TRACe<1 . . . 4>)

Trace Mode

Opens the dialog box **Trace Mode** to select the trace mode. For details see "[Trace mode overview](#)" on page 4.34.

→ Remote: DISP:WIND:TRAC:MODE WRIT | MAXH | MINH | AVER | VIEW (Clear Write, Max Hold, Min Hold, Average, View)

→ Remote: DISP:WIND:TRAC OFF (Blank)

Detector Auto Select

Selects the optimum detector for the selected trace and filter mode. This is the default setting. For details see also "[Detector overview](#)" on page 4.36.

Trace mode	Detector (band-pass filter)	Detector (FFT filter)
Clear/Write	Auto Peak	Max Peak
Average	Sample	Sample
Max Hold	Max Peak	Max Peak
Min Hold	Min Peak	Max Peak

→ Remote: DET:AUTO ON

Detector Manual Select

Opens the dialog box **Detector** to select the detector. For details see "[Detector overview](#)" on page 4.36.

→ Remote: DET APE | POS | NEG | RMS | AVER | SAMP | QPE (Auto Peak, Max Peak, Min Peak, RMS, AVG, Sample, Quasi Peak)

Sweep Count

Opens an edit dialog box to enter the number of sweeps used for averaging. Values from 0 to 32767 are allowed. The default setting is 0. The sweep count is applied to all the traces in a diagram. The sweep count set in the trace menu is the same as that in the sweep menu (see **Sweep Count** softkey).

In the continuous sweep mode, the sweep count value determines the trace averaging:

- sweep count = 0: continuous averaging
- sweep count = 1: no averaging
- sweep count > 1: averaging over the selected number of sweeps; in the continuous sweep mode averaging is performed until the set number of sweeps is attained and is then continued as continuous averaging (see also "[Description of the averaging method](#)" on page 4.35).

→ Remote: SWE:COUN 64

Hold/Cont

Switches on or off the reset of the traces in Min Hold, Max Hold and Average mode after some specific parameter changes have been made. The default setting is off.

Normally, the measurement is started anew after parameter changes, before the measurement results are evaluated (e.g. using a marker). In all cases that require a new measurement after parameter changes, the trace is reset automatically to avoid false results (e.g. with span changes). For applications that require no reset after parameter changes, the automatic reset can be switched off.

→ Remote: DISP:WIND:TRAC:MODE:HCON ON

Copy Trace

Opens an edit dialog box to enter the number of the trace memory, in which the currently selected trace shall be copied.

→ Remote: TRAC:COPY TRACE1,TRACE2

ASCII File Export

Opens an edit dialog box to enter the ASCII File Export Name and saves the active trace in ASCII format on a floppy disk.

The file consists of the header containing important scaling parameters and a data section containing the trace data. For details on an ASCII file see "[ASCII file export file format](#)" on page 4.40.

This format can be processed by spreadsheet calculation programs, e.g. MS–Excel. It is necessary to define ';' as a separator for the data import. Different language versions of evaluation programs may require a different handling of the decimal point. It is therefore possible to select between separators '.' (decimal point) and ',' (comma) using the **Decim Sep** softkey.

- Remote: FORM ASC
- Remote: MMEM:STOR:TRAC 1, 'TRACE.DAT'

Decim Sep

Selects the decimal separator with floating–point numerals for the ASCII file export to support evaluation programs (e.g. MS–Excel) in different languages. The values '.' (decimal point) and ',' (comma) can be set. For details see also **ASCII File Export** softkey.

- Remote: FORM:DEXP:DSEP POIN

Trace Math

Opens the **Trace Mathematics** dialog box to define which trace is subtracted from trace 1. The result is displayed in trace 1 and refers to the zero point defined with the **Trace Math Position** softkey. The following subtractions can be performed:

- T1→T1–T2** Subtracts trace 2 from trace 1.
- T1→T1–T3** Subtracts trace 3 from trace 1
- T1→T1–T4** Subtracts trace 4 from trace 1

If the **Trace Math Off** option is activated, the function is switch off (default setting).

This softkey is available from firmware version 1.30.

- Remote: CALC1:MATH (TRACE1 - TRACE2)
- Remote: CALC:MATH:STAT ON

Trace Math Position

Opens an edit dialog box to define the zero point in % of the diagram height. The range of values extends from –100% to +200%.

This softkey is available from firmware version 1.30.

- Remote: CALC:MATH:POS 50PCT

ASCII file export file format

The data of the file header consist of three columns, each separated by a semicolon: parameter name; numeric value; basic unit. The data section starts with the keyword "Trace <n>" (<n> = number of stored trace), followed by the measured data in one or several columns (depending on measurement) which are also separated by a semicolon.

File contents: header	Description
Type;FSL; Version;1.00; Date;01.Jul 2004; Mode;Spectrum; Center Freq;55000;Hz Freq Offset;0;Hz Span;90000;Hz x–Axis;LIN; Start;10000;Hz Stop;100000;Hz Ref.Level;–30;dBm Level Offset;0;dB Ref Position;75;% y–Axis;LOG; Level Range;100;dB RF Att;20;dB RBW;100000;Hz VBW;30000;Hz SWT;0.005;s Trace Mode;AVERAGE; Detector;SAMPLE; Sweep Count;20;	Instrument model Firmware version Date of data set storage Instrument mode Center frequency Frequency offset Frequency range (0 Hz in zero span and statistics measurements) Scaling of x axis linear (LIN) or logarithmic (LOG) Start/stop of the display range. Unit: Hz for span > 0, s for span = 0, dBm/dB for statistics measurements Reference level Level offset Position of reference level referred to diagram limits (0% = lower edge) Scaling of y axis linear (LIN) or logarithmic (LOG) Display range in y direction. Unit: dB with x axis LOG, % with x axis LIN Input attenuation Resolution bandwidth Video bandwidth Sweep time Display mode of trace: CLR/WRITE,AVERAGE,MAXHOLD,MINHOLD Detector set: AUTOPEAK,MAXPEAK,MINPEAK,AVERAGE, RMS,SAMPLE,QUASPEAK Number of sweeps set
File contents: data section of the file	Description
Trace 1;;; x–Unit;Hz;	Selected trace Unit of x values: Hz with span > 0; s with span = 0; dBm/dB with statistics measurements

File contents: header	Description
y-Unit;dBm; Values; 501; 10000;-10.3;-15.7 10180;-11.5;-16.9 10360;-12.0;-17.4 ...;...;	Unit of y values: dB*/V/A/W depending on the selected unit with y axis LOG or % with y axis LIN Number of measurement points Measured values: <x value>, <y1>, <y2> <y2> being available only with detector AUTOPEAK and containing in this case the smallest of the two measured values for a measurement point.

Measurement Functions

In this section all menus necessary for setting measurement functions are described. This includes the following topics and keys:

- ["Using Markers and Delta Markers – MKR Key"](#) on page 4.43
- ["Changing Settings via Markers – MKR-> Key"](#) on page 4.53
- ["Power Measurements – MEAS Key"](#) on page 4.60
- ["Using Limit Lines and Display Lines – LINES Key"](#) on page 4.81

Using Markers and Delta Markers – MKR Key

The markers are used for marking points on traces, reading out measurement results and for quickly selecting a display section. The R&S FSL provides four markers per trace.

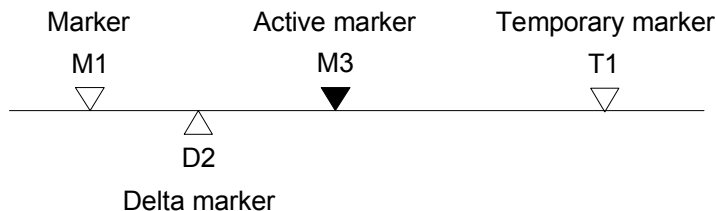

Fig. 4–5: Marker types

All markers can be used either as markers or delta markers. The marker that can be moved by the user is defined in the following as the active marker. Temporary markers are used in addition to the markers and delta markers to evaluate the measurement results. They disappear when the associated function is deactivated.

The measurement results of the active marker (also called marker values) are displayed in the marker field. The marker field is located at the upper right corner of the display and shows the following:

- marker type (M1 in the example)
- trace in square brackets ([1] in the example)
- level (–33.09 dBm in the example)
- marker location (3 GHz in the example)

```
M1[1]          -33.09 dBm
              3.000000000 GHz
```

Fig. 4–6: Marker values

The **MKR** key is used to select and position the absolute and relative measurement markers (markers and delta markers). In addition, the functions for frequency counter, fixed reference point for relative measurement markers and enlargement of the measurement area are assigned to this key.

Also the following measurements can be carried out:

- Noise density (**Noise Meas On/Off** softkey; see also "[Measurement of noise density](#)" on page 4.46)
- Frequency measurement (**Sig Count On/Off** softkey; see also "[Frequency measurement with the frequency counter](#)" on page 4.45)
- Filter or signal bandwidth (**n dB down** softkey)
- AF demodulation (**Marker Demod** softkey; see also "[AF demodulation](#)" on page 4.45)

For further information on markers see also "[Changing Settings via Markers – MKR→ Key](#)" on page 4.53.

To open the marker menu

- Press the **MKR** key.

The marker menu is displayed. If no marker is active, marker 1 will be activated and a peak search on the trace carried out. Otherwise, the edit dialog box for the last activated marker is opened and the current frequency / time value is displayed.

Menu and softkey description

- ["Softkeys of the marker menu"](#) on page 4.47

To display help to a softkey, press the **HELP** key and then softkey for which you want to display help. To close the help window, press the **ESC** key. For further information refer to section "How to use the Help System".

Further information

- ["AF demodulation"](#) on page 4.45
- ["Frequency measurement with the frequency counter"](#) on page 4.45
- ["Measurement of noise density"](#) on page 4.46

Tasks

- [To define the basic marker settings](#)
- [To set a fixed reference point \(phase noise measurement\)](#)
- [To set the demodulation mode and duration](#)

To define the basic marker settings

1. Press the **MKR** key to open the marker menu.

Marker 1 is activated and positioned on the maximum value of the trace as normal marker. When several traces are being displayed, the marker is set to the maximum value (peak) of the trace which has the lowest number (1 to 3) and is not frozen (View mode). In case a marker is already located there, it will be set to the frequency of the next lowest level (next peak).

2. To change to another trace, press the **Marker to Trace** softkey and enter the number of the trace on which the marker is to be placed.

The marker changes to selected trace, but remains on the previous frequency or time. If a trace is turned off, the corresponding markers and marker functions are also deactivated.

3. To switch on a delta marker, press the **Marker 2** softkey.

Marker 2 is switched on as a delta marker. The frequency and level of marker 2 are displayed in relation to marker 1 in the marker field.

4. To change the marker type of marker 2, press the **Marker Norm/Delta** softkey.

Marker 2 becomes a normal marker. The frequency and level of marker 2 are displayed as absolute values in the marker field.

5. To switch off marker 2, press the **Marker 2** softkey again.

Marker 2 is deactivated. Marker 1 becomes the active marker for entry. The frequency and level of marker 1 are displayed in the marker field.

To set a fixed reference point (phase noise measurement)

1. Press the **Phase Noise/Ref Fixed** softkey.

The submenu with the **Phase Noise On/Off** softkey switched on is displayed. The level and frequency or time values of marker 1 immediately become the reference point.

2. To set the maximum of the selected trace as reference point, press the **Peak Search** softkey.

3. To define the values for the reference point, proceed as follows:

- Press the **Ref Point Level** softkey and enter a reference level value.

- If span > 0, press the **Ref Point Frequency** softkey and enter a frequency reference value.
- If span = 0, press the **Ref Point Time** softkey and enter a reference time value.

To set the demodulation mode and duration

1. Press the **Marker Demod** softkey.
The submenu with the **Mkr Demod On/Off** softkey switched on is displayed.
2. To change the demodulation mode, press the **AM** or **FM** softkey.
For details see "[AF demodulation](#)" on page 4.45.
3. To modify the demodulation time for span > 0, press the **Mkr Stop Time** softkey.
4. To change to continuous demodulation for span > 0, press the **Cont Demod** softkey.
5. To tune the volume for acoustic monitoring, press the **Volume** softkey.

AF demodulation

The R&S FSL provides demodulators for AM and FM signals. With these demodulators, a displayed signal can be identified acoustically by using headphones.



CAUTION

Check the volume setting carefully before putting on the headphones in order to protect your hearing.

When span > 0, the demodulation is not continuous. The frequency at which the demodulation takes place is set by the active marker. If the level of the selected frequency is above the threshold line, the sweep stops for the selected time (stop time) and the RF signal is demodulated. When span = 0, the demodulation is continuously active irrespective of the stop time set.

Frequency measurement with the frequency counter

In order to accurately determine the frequency of a signal, the R&S FSL is equipped with a frequency counter which measures the frequency of the RF signal at the intermediate frequency. Using the measured IF, the R&S FSL calculates the frequency of the RF input signal by applying the known frequency conversion factors.

The frequency measurement uncertainty depends only upon the accuracy of the frequency reference used (external or internal reference). Although the R&S FSL always operates synchronously irrespective of the set span, the frequency counter delivers a more exact result than a measurement performed with a marker. This is due to the following:

- The marker measures only the position of the point on the trace and infers from this value the signal frequency. The trace, however, contains only a limited number of points. Depending upon the selected span, each point may contain many measurement values, which therefore limits the frequency resolution.
- The resolution, with which the frequency can be measured with a marker, is dependant on the selected resolution bandwidth which in return affects the necessary measurement time. For this reason, the bandwidth is normally made as wide as possible and the sweep time as short as possible. This results in a loss of frequency resolution. For the measurement with the frequency counter, the sweep is stopped at the reference marker, the frequency is counted with the desired resolution and then the sweep is allowed to continue.

Measurement of noise density

During noise measurement, the noise power density is measured at the position of the marker. When span = 0, all points of the trace are used to determine the noise power density. When span > 0, two points to the right and left of the marker are used for the measurement to obtain a stable result.

The noise power density is indicated in the marker field. With logarithmic amplitude units (dBm, dBmV, dBm μ V, dB μ A), the noise power density is output in dBm/Hz, i.e. as level in 1 Hz bandwidth with reference to 1 mW. With linear amplitude units (V, A, W), the noise voltage density is evaluated in μ V/Hz, the noise current density in μ A/Hz or the noise power density in μ W/Hz.

In the default setting, the R&S FSL uses the sample detector for the noise function.

With the sample detector, the trace can additionally be set to AVERAGE to stabilize the measured values. With RMS detector used, trace averaging must not be used since in this case it produces too low noise levels which cannot be corrected. Instead, the sweep time can be increased to obtain stable measurement results.

The following settings have to be made to ensure that the power density measurement yields correct values:

- Detector: Sample or RMS
- Video bandwidth:
 - ≤ 0.1 resolution bandwidth with sample detector
 - ≥ 3 x resolution bandwidth with RMS detector

- Trace averaging:

With the sample detector, the trace can additionally be set to average to stabilize the measured values. With RMS detector used, trace averaging must not be used since in this case it produces too low noise levels which cannot be corrected. Instead, the sweep time can be increased to obtain stable measurement results.

The R&S FSL uses the following correction factors to evaluate the noise density from the marker level:

- Since the noise power is indicated with reference to 1 Hz bandwidth, the bandwidth correction value is deducted from the marker level. It is $10 \times \lg(1 \text{ Hz}/\text{BW}_{\text{Noise}})$, where BW_{Noise} is the noise or power bandwidth of the set resolution filter (RBW).
- RMS detector: With the exception of bandwidth correction, no further corrections are required since this detector already indicates the power with every point of the trace.
- Sample detector: As a result of video filter averaging and trace averaging, 1.05 dB is added to the marker level. This is the difference between the average value and the RMS value of white noise. With a logarithmic level axis, 1.45 dB is added additionally. Logarithmic averaging is thus fully taken into account which yields a value that is 1.45 dB lower than that of linear averaging.
- To allow a more stable noise display the adjacent (symmetric to the measurement frequency) points of the trace are averaged.
- When span > 0, the measured values are averaged versus time (after a sweep).

Note: The R&S FSL noise figure can be calculated from the measured power density level. It is calculated by deducting the set RF attenuation (RF Att) from the displayed noise level and adding 174 to the result.

Softkeys of the marker menu

The following table shows all softkeys available in the marker menu. It is possible that your instrument configuration does not provide all softkeys. If a softkey is only available with a special option, model or (measurement) mode, this information is delivered in the corresponding softkey description.

Menu / Command	Submenu / Command	Command
Marker 1		
Marker 2		
Marker Norm/Delta		
Noise Meas On/Off		
Phase Noise/Ref Fixed ↓	Phase Noise On/Off	
	Ref Point Level	
	Ref Point Frequency/ Ref Point Time	
	Peak Search	
	Phase Noise 1 2 3 4 ▲	
	Reference Fixed	Reference Fixed On/Off
		Ref Point Level
		Ref Point Frequency/ Ref Point Time
		Peak Search
Sig Count On/Off		
More ↓		
Marker 3		
Marker 4		
Marker to Trace		
Marker Demod ↓	Mkr Demod On/Off	
	AM	
	FM	
	Mkr Stop Time	
	Cont Demod	
	Volume	
n dB down		
All Marker Off		
More ↓		
Marker Zoom		
Marker Peak List ↓	New Search	
	Sort Mode Freq/Lvl	
	Peak Excursion	
	Left Limit	
	Right Limit	
	Threshold	
	Peak List Off	

Marker 1/Marker 2/Marker 3/Marker 4/Marker Norm/Delta

The **Marker <no>** softkey activates the corresponding marker and opens an edit dialog box to enter a value for the marker to be set to. Pressing the softkey again deactivates the selected marker.

Marker 1 is always the reference marker for relative measurements. If activated, markers 2 to 4 are delta markers that refer to marker 1. These markers can be converted into markers with absolute value display by means of the **Marker Norm/Delta** softkey. When marker 1 is the active marker, pressing the **Marker Norm/Delta** softkey switches on an additional delta marker.

- Remote: CALC:MARK ON
 - Remote: CALC:MARK:X <value>
 - Remote: CALC:MARK:Y?
 - Remote: CALC:DELT ON
 - Remote: CALC:DELT:X <value>
 - Remote: CALC:DELT:X:REL?
 - Remote: CALC:DELT:Y?
-

Noise Meas On/Off

Switches the noise measurement for the active marker on or off. The corresponding marker becomes the normal marker. For more details on noise measurement see "[Measurement of noise density](#)" on page 4.46.

- Remote: CALC:MARK:FUNC:NOIS ON
 - Remote: CALC:MARK:FUNC:NOIS:RES?
-

Phase Noise/Ref Fixed

The function of this softkey depends on the setting of the **Noise Meas** softkey:

- **Noise Meas On:** activates phase noise measurements.
 - **Noise Meas Off:** freezes the current position of marker 1 as a reference for relative measurements. Additionally it opens a submenu to set all values of a reference point. Instead of using the current values of the reference marker (marker 1) as reference point for the delta markers, level and frequency or time are set to fixed values and used as reference point.
-

Phase Noise On/Off

Switches the relative measurement to a fixed reference value on or off. The level and frequency or time values of marker 1 immediately become the reference point, but can be altered using the corresponding softkeys (**Ref Point Level**, **Ref Point Frequency**, **Ref Point Time** and **Peak Search**).

- Remote: CALC:DELT2:FUNC:FIX ON
-

Ref Point Level

Opens an edit dialog box to enter a reference level value. All relative level values of the delta markers refer to this reference level.

- Remote: CALC:DELT2:FUNC:FIX:RPO:Y -10dBm
-

Ref Point Frequency (span > 0) / Ref Point Time (zero span)

Opens an edit dialog box to enter a frequency reference or time value. All relative frequency or time values of the delta markers refer to this frequency reference. For phase noise measurement, input of reference time is not possible..

- Remote: CALC:DELT2:FUNC:FIX:RPO:X 10.7MHz
- Remote: CALC:DELT2:FUNC:FIX:RPO:X 5MS

Peak Search

Sets the maximum value of the selected trace as the reference point.

- Remote: CALC:DELT:FUNC:FIX:RPO:MAX

Phase Noise 1 2 3 4 Δ

Selects the normal marker or the delta markers, activates the marker and opens an edit dialog box to enter a value for the marker to be set to. Δ stands for delta marker 1.

Reference Fixed

Opens a submenu for relative measurement to a fixed reference value.

Reference Fixed On/Off

Switches the relative measurement to a fixed reference value on or off. The level and frequency or time values of marker 1 immediately become the reference point, but can be altered using the corresponding softkeys (**Ref Point Level**, **Ref Point Frequency**, **Ref Point Time** and **Peak Search**).

- Remote: CALC:DELT2:FUNC:FIX ON

Sig Count On/Off

Switches the frequency counter on/off. The frequency is counted at the position of the reference marker (marker 1). If no marker is activated, marker 1 is switched on and set at the largest signal.

The sweep stops at the reference marker until the frequency counter has delivered a result. The result is displayed in the marker field (see "[Fig. 4–6: Marker values](#)" on page 4.43), labeled with [Tx CNT]. For more details see "[Frequency measurement with the frequency counter](#)" on page 4.45.

- Remote: CALC:MARK1:COUN ON
- Remote: CALC:MARK:COUN:FREQ?

Marker to Trace

Opens an edit dialog box to enter the number of the trace, on which the marker is to be placed.

- Remote: CALC:MARK1:TRAC 1
- Remote: CALC:DELT:TRAC 1

Marker Demod

Opens a submenu to set the demodulation mode and duration. For more details see also "[AF demodulation](#)" on page 4.45.

Mkr Demod On/Off

Switches the demodulation on/off. For more details see also "[AF demodulation](#)" on page 4.45.

→ Remote: CALC:MARK1:FUNC:DEM ON

AM

Sets AM as demodulation mode. This is the default setting. For more details see also "[AF demodulation](#)" on page 4.45.

→ Remote: CALC:MARK1:FUNC:DEM:SEL AM

FM

Sets FM as demodulation mode. Default setting is AM. For more details see also "[AF demodulation](#)" on page 4.45.

→ Remote: CALC:MARK1:FUNC:DEM:SEL FM

Mkr Stop Time

Opens an edit dialog box to enter the demodulation stop time for span > 0. For more details see also "[AF demodulation](#)" on page 4.45.

→ Remote: CALC:MARK1:FUNC:DEM:HOLD 3s

Cont Demod (span > 0)

Switches the continuous demodulation on or off. If the sweep time is long enough, the set frequency range can be monitored acoustically. For more details see also "[AF demodulation](#)" on page 4.45.

→ Remote: CALC:MARK1:FUNC:DEM:CONT ON

Volume

Opens an edit dialog box to regulate the volume for acoustic monitoring. For more details see also "[AF demodulation](#)" on page 4.45.

→ Remote: SYST:SPE:VOL 0.5

n dB down

Activates the temporary markers T1 and T2, and opens an edit dialog box to enter the value n. If a positive value is entered, the markers T1 and T2 are placed below the active reference marker. If a negative value (e.g. for notch filter measurements) is entered, the markers T1 and T2 are placed above the active reference marker. Marker T1 is placed to the left and marker T2 to the right of the reference marker. The default setting is 3 dB.

Settings	Result displayed in marker field
span > 0	frequency spacing of the two temporary markers
span = 0	pulse width between the two temporary markers
not possible to form the frequency spacing for the n dB value (e.g. because of noise display)	dashes instead of a measured value

- Remote: CALC:MARK1:FUNC:NDBD:STAT ON
- Remote: CALC:MARK1:FUNC:NDBD 3dB
- Remote: CALC:MARK1:FUNC:NDBD:RES?
- Remote: CALC:MARK1:FUNC:NDBD:FREQ? (span > 0)
- Remote: CALC:MARK1:FUNC:NDBD:TIME? (span = 0)

All Marker Off

Switches all markers off.

- Remote: CALC:MARK:AOFF

Marker Zoom (span > 0)

Opens an edit dialog box to enter a display range for the zoom. The area around marker 1 is expanded accordingly and more details of the spectrum can be seen. If no marker is activated, marker 1 is switched on and set at the largest signal..

The following sweep is stopped at the position of the reference marker. The frequency of the signal is counted and the measured frequency becomes the new center frequency. The zoomed display range is then configured and the new settings are used by the R&S FSL for further measurements.

As long as switching to the new frequency display range has not yet taken place, pressing the softkey will abort the procedure. If an instrument setting is changed while using this function, the procedure is aborted.

- Remote: CALC:MARK1:FUNC:ZOOM 1kHz

Marker Peak List

Opens the **Peak List** dialog box and a submenu to define criterias for the sort order and the contents of the peak list. The number of listed peaks is indicated in the title bar. For all listed peaks the frequency and level values are given. A maximum of 50 entries is listed.

This softkey is available from firmware version 1.30.

- Remote: CALC:MARK:FUNC:FPE:COUN?
 - Remote: CALC:MARK:FUNC:FPE:X?
 - Remote: CALC:MARK:FUNC:FPE:Y?
-

New Search

Starts a new peak search and enters the results in the peak list.

This softkey is available from firmware version 1.30.

- Remote: CALC:MARK:FUNC:FPE 3
-

Sort Mode Freq/Lvl

Defines the criteria for sorting:

Freq sorting in ascending order of frequency values (span > 0) or
 time values (span = 0)

Lvl sorting in ascending order of the level

This softkey is available from firmware version 1.30.

- Remote: CALC:MARK:FUNC:FPE:SORT Y
-

Peak List Off

Switches the peak list function off.

This softkey is available from firmware version 1.30.

Changing Settings via Markers – MKR→ Key

The **MKR→** key is used for search functions of measurement markers, assignment of the marker frequency as center frequency, restriction of the search area and characterization of maxima and minima. For details on markers in general, see ["Using Markers and Delta Markers – MKR Key"](#) on page 4.43.

To open the marker→ menu

- Press the **MKR→** key.

The marker→ menu is displayed. If no marker is active, marker 1 will be activated and a peak search on the trace carried out. Otherwise, the edit dialog box for the last activated marker is opened and the current frequency / time value is displayed.

Menu and softkey description

- ["Softkeys of the marker→ menu"](#) on page 4.56

To display help to a softkey, press the **HELP** key and then softkey for which you want to display help. To close the help window, press the **ESC** key. For further information refer to section "How to use the Help System".

Further information

- ["Effect of different peak excursion settings \(example\)"](#) on page 4.55

Tasks

- [To search for a maximum](#)
- [To search for a minimum](#)
- [To specify the search limits](#)
- [To specify the search range](#)
- [To examine a signal at the center in detail](#)
- [To specify the suitable peak excursion](#)

To search for a maximum

1. To search the highest maximum, press the **Peak** softkey.
2. To define the search mode for the next maximum, use the **Next Peak Mode < abs >** softkey.
3. To start the search, press **Next Peak** the softkey.

To search for a minimum

1. To search the minimum, press the **Min** softkey.
2. To define the search mode for the next maximum, use the **Next Min Mode < abs >** softkey.
3. To start the search, press the **Next Min** softkey.

To specify the search limits

1. To define the lower limit, press the **Left Limit** softkey.
2. To define the upper limit, press the **Right Limit** softkey.
3. To define the threshold, press the **Threshold** softkey.
4. To switch the search limits off, press the **Search Lim Off** softkey.

To specify the search range

- Press the **Exclude LO** softkey to include the frequency 0 Hz in the marker search functions.

To examine a signal at the center in detail

1. Press the **PRESET** key to set the R&S FSL to the default setting.
2. Press the **MKR→** key to open the marker→ menu.
3. Marker 1 is activated and set to the largest signal of the trace.
4. Press the **Center =Mkr Freq** softkey to set to the marker frequency.
5. The span is adapted in such a way that the minimum frequency (= 0 Hz) or the maximum frequency is not exceeded.
6. Press the **Ref Lvl =Mkr Lvl** softkey to set the reference level to the measured marker level.
7. Press the **SPAN** key.
8. The edit dialog box to enter a frequency span is displayed.
9. Reduce the span, e.g. using the rotary knob.

To specify the suitable peak excursion

1. If the next peak mode **abs** of softkey **Next Peak Mode < abs > / Next Min Mode < abs >** is used, the default value is sufficient, since, in this mode, the next lower maximum or next higher minimum will always be detected.
2. If the next peak mode **< or >** of softkey **Next Peak Mode < abs > / Next Min Mode < abs >** is used, the 6 dB level change set as a default value may be attained already by the inherent noise of the instrument. To avoid identifying noise peaks as maxima or minima, enter a peak excursion value that is higher than the difference between the highest and the lowest value measured for the displayed inherent noise.

Effect of different peak excursion settings (example)

The following figure shows a trace to be examined.

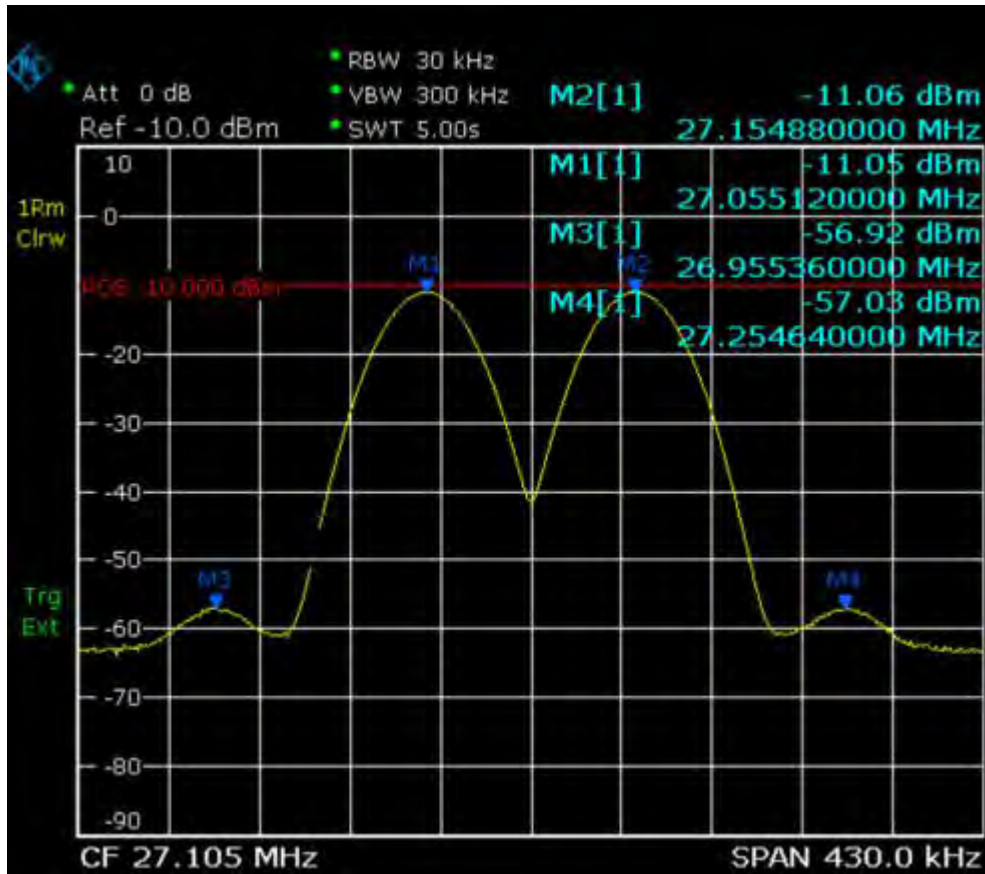

Fig. 4-7: Trace example

The following table lists the signals as indicated by the marker numbers in the diagram above, as well as the minimum of the amplitude decrease to both sides of the signal:

signal #	min. amplitude decrease to both sides of the signal
1	30 dB
2	29.85 dB
3	7 dB
4	7 dB

The detected signals and their order are different depending on the peak excursion setting and the peak search method (whether the next lower maximum or the next relative maximum are searched). The following results are obtained. All tests start with the marker set to signal 1 by pressing the softkey **Peak**.

- 40 dB peak excursion
Result: With both methods apart from signal 1 no signal is detected, as the signal level does not decrease by more than 30 dB to either side of any signal.

next lower maximum	next relative maximum
next peak mode abs : signal 1 (no further signal detected)	next peak mode <: signal 1 (no further signal detected)
	next peak mode >: signal 1 (no further signal detected)

- 20 dB peak excursion

Result: With both methods apart from signal 1 signal 2 is detected, as the signal level decreases at least by 29.85 dB to either side of this signal, which is now greater than the peak excursion.

next lower maximum	next relative maximum
next peak mode abs : signal 2	next peak mode <: signal 1 (no further signal detected)
next peak mode abs : signal 2 (no further signal detected)	next peak mode >: signal 2
	next peak mode >: signal 2 (no further signal detected)

- 6 dB peak excursion

Result: With both methods all signals are detected.

next lower maximum	next relative maximum
next peak mode abs : signal 2	next peak mode <: signal 3
next peak mode abs : signal 3	next peak mode >: signal 1
next peak mode abs : signal 4	next peak mode >: signal 2
	next peak mode >: signal 4

Softkeys of the marker→ menu

The following table shows all softkeys available in the marker→ menu. It is possible that your instrument configuration does not provide all softkeys. If a softkey is only available with a special option, model or (measurement) mode, this information is delivered in the corresponding softkey description.

Menu / Command	Command
Select 1 2 3 4 Δ	
Peak	
Next Peak	
Next Peak Mode < abs >	
Center =Mkr Freq	
Ref Lvl =Mkr Lvl	
More ↓	
Select 1 2 3 4 Δ	
Min	
Next Min	
Next Min Mode < abs >	
Search Limits ↓	Left Limit

Menu / Command	Command
	Right Limit
	Threshold
	Search Lim Off
Peak Excursion	
Exclude LO	

Select 1 2 3 4 Δ

Selects the normal marker or the delta markers, activates the marker and opens an edit dialog box to enter a value for the marker to be set to. Δ stands for delta marker 1.

- Remote: CALC:MARK1 ON
 - Remote: CALC:MARK1:X <value>
 - Remote: CALC:MARK1:Y?
-

Peak

Sets the active marker/delta marker to the highest maximum of the trace.

- Remote: CALC:MARK:MAX
 - Remote: CALC:DELT:MAX
-

Next Peak

Sets the active marker/delta marker to the next maximum of the selected trace according to the mode selected using the **Next Peak Mode < abs >** softkey.

- Remote: CALC:MARK:MAX:NEXT
 - Remote: CALC:DELT:MAX:NEXT
-

Next Peak Mode < abs >

Selects the mode of the **Next Peak** softkey. Three settings are available:

- < Sets the active marker/delta marker to the next maximum left to the marker of the selected trace.
- abs Sets the active marker/delta marker to the next lower maximum of the selected trace.
- > Sets the active marker/delta marker to the next maximum right to the marker of the selected trace.

- Remote: CALC:MARK:MAX:RIGH
 - Remote: CALC:DELT:MAX:RIGH
-

Center =Mkr Freq (span > 0)

Sets the center frequency to the current marker or delta marker frequency. A signal can thus be set to as center frequency, for example to examine it in detail with a smaller span.

Remote: CALC:MARK:FUNC:CENT

Ref Lvl =Mkr Lvl

Sets the reference level to the current marker level.

→ Remote: CALC:MARK:FUNC:REF

Min

Sets the active marker/delta marker to the minimum of the selected trace.

→ Remote: CALC:MARK:MIN

→ Remote: CALC:DELT:MIN

Next Min

Sets the active marker/delta marker to the next minimum of the selected trace according to the mode selected using the **Next Min Mode < abs >** softkey.

→ Remote: CALC:MARK:MIN:NEXT

→ Remote: CALC:DELT:MIN:NEXT

Next Min Mode < abs >

Selects the mode of the **Next Min** softkey. Three settings are available:

< Sets the active marker/delta marker to the next minimum left to the marker of the selected trace.

abs Sets the active marker/delta marker to the next higher minimum of the selected trace.

> Sets the active marker/delta marker to the next minimum right to the marker of the selected trace.

→ Remote: CALC:MARK:MAX:LEFT

→ Remote: CALC:DELT:MAX:LEFT

Search Limits

Opens a submenu to set the limits for maximum or minimum search in the x and y direction.

→ Remote: CALC:MARK:X:SLIM ON

Left Limit

Opens an edit dialog box to enter a value for the lower limit (left vertical line: S1 for span > 0; T1 for zero span). The search is performed between the lines of the left and right limit (see also **Right Limit** softkey).

→ Remote: CALC:MARK:X:SLIM:LEFT 1MHZ

Right Limit

Opens an edit dialog box to enter a value for the upper limit (left vertical line: S2 for span > 0; T2 for zero span). The search is performed between the lines of the left and right limit (see also **Left Limit** softkey). If no value is set, the upper limit corresponds to the stop frequency.

→ Remote: CALC:MARK:X:SLIM:RIGH 10MHZ

Threshold

Opens an edit dialog box to define the threshold line. The threshold line represents the lower level limit for a **Peak** search and the upper level limit for a **Min** search.

Opens an edit dialog box to define the threshold line. The threshold line represents the lower limit of the peak search level range.

→ Remote: CALC:THR -20dBm

→ Remote: CALC:THR ON

Search Lim Off

Deactivates all limits of the search range.

→ Remote: CALC:MARK:X:SLIM OFF

→ Remote: CALC:THR:STAT OFF

Peak Excursion

Opens – for level measurements – an edit dialog box to enter the minimum level value by which a signal must rise or fall so that it will be identified as a maximum or a minimum by the search functions. Entries from 0 dB to 80 dB are allowed; the resolution is 0.1 dB. The default setting for the peak excursion is 6 dB.

For details see also "[To specify the suitable peak excursion](#)" on page 4.54 and "[Effect of different peak excursion settings \(example\)](#)" on page 4.55.

→ Remote: CALC:MARK:PEXC 10dB

Exclude LO

Switches the frequency range limit for the marker search functions on or off.

activated

minimum frequency $\geq 6 \times$ resolution bandwidth (RBW)

Because of the interference by the first local oscillator to the first intermediate frequency at the input mixer, the LO is represented as a signal at 0 Hz. To avoid the marker jumping to the LO at 0 Hz with the peak function when setting the display range, this frequency is excluded.

deactivated

no restriction to the search range. The frequency 0 Hz is included in the marker search functions.

→ Remote: CALC:MARK:LOEX ON

Power Measurements – MEAS Key

With its power measurement functions the R&S FSL is able to measure all the necessary parameters with high accuracy in a wide dynamic range.

A modulated carrier is almost always used (except e.g. SSB–AM) for high–frequency transmission of information. Due to the information modulated upon the carrier, the latter covers a spectrum which is defined by the modulation, the transmission data rate and the signal filtering. Within a transmission band each carrier is assigned a channel taking into account these parameters. In order to ensure error–free transmission, each transmitter must be conforming to the specified parameters. These include among others:

- the output power
- the occupied bandwidth, i.e. the bandwidth which must contain a defined percentage of the power
- the power dissipation allowed in the adjacent channels

The **MEAS** key is used for complex measurement functions as power measurements, occupied bandwidth, signal statistic, carrier to noise spacing, AM modulation depth, third–order intercept point, harmonics and spurious emissions. For measurement examples refer to chapter "Advanced Measurement Examples" and to the Quick Start Guide, chapter 5, "Basic Measurement Examples".

The following measurements can be performed:

- Power in zero span (**Time Domain Power** softkey; for details see "[Power measurement](#)" on page 4.62)
- Channel power and adjacent–channel power with span > 0 and with a single or several carriers (**CP, ACP, MC–ACP** softkey)
- Occupied bandwidth (**OBW** softkey, for details see "[Measurement of occupied bandwidth](#)" on page 4.63)
- Carrier–to–noise ratio (**C/N, C/No** softkey)
- Amplitude probability distribution (**APD** and **CCDF** softkeys, for details refer to chapter "Advanced Measurement Examples", "Amplitude Distribution Measurement")
- Modulation depth (**AM Mod Depth** softkey)
- 3rd order intercept (**TOI** softkey, for details refer to chapter "Advanced Measurement Examples", "Intermodulation Measurements")

To open the power measurement menu

- Press the **MEAS** key.

The power measurement menu is displayed.

Menu and softkey description

- "[Softkeys of the power measurement menu](#)" on page 4.66

To display help to a softkey, press the **HELP** key and then softkey for which you want to display help. To close the help window, press the **ESC** key. For further information refer to section "How to use the Help System".

Further information

- ["Power measurement in zero span"](#) on page 4.62
- ["Measurement of occupied bandwidth"](#) on page 4.63
- ["Predefined CP / ACP standards"](#) on page 4.63
- ["Settings of CP / ACP test parameters"](#) on page 4.64

Tasks

- To measure the power in zero span
- To set the channel configuration
- To measure the occupied bandwidth
- To measure signal statistics
- To measure the carrier-to-noise ratio

To measure the power in zero span

1. Press the **Time Domain Power** softkey to activate the power measurement.
The corresponding submenu is displayed.
2. To limit the power evaluation range, switch on the limits (**Limits On/Off** softkey) and enter the limits by using the **Left Limit** and **Right Limit** softkeys.
3. Select the type of power measurement by using the **Mean** or **RMS** softkey. (RMS or mean power), the settings for max hold and averaging as well as the definition of limits.
4. To calculate and display the peak value, press the **Peak** softkey.
5. To calculate and display the standard deviation from the mean value, press the **Std Dev** softkey.

To set the channel configuration

1. Press the **CP, ACP, MC-ACP** softkey to active channel or adjacent-channel power measurement.
The corresponding submenu is displayed.
2. To use a predefined standard for measurement, press the **CP / ACP Standard** softkey (for details on available standards see ["Predefined CP / ACP standards"](#) on page 4.63).
3. To configure the parameters independently of the predefined standards, press the **CP / ACP Config** softkey (for details see ["Settings of CP / ACP test parameters"](#) on page 4.64).
4. To enter the sweep time, press the **Sweep Time** softkey.
5. To display the whole diagram, press the **Full Size Diagram** softkey.
6. To adjust the reference level to the measured channel power, press the **Adjust Ref Level** softkey.

To measure the occupied bandwidth

1. Press the **OBW** softkey to activate the measurement of the occupied bandwidth (for details see also ["Measurement of occupied bandwidth"](#) on page 4.63).
The corresponding submenu is displayed.
2. Press the **% Power Bandwidth** softkey to enter the percentage of power.

3. To change the channel bandwidth for the transmission channel, press the **Channel Bandwidth** softkey.
4. To optimize the settings for the selected channel configuration, press the **Adjust Settings** softkey (for details see also "[Settings of CP / ACP test parameters](#)" on page 4.64).
5. To adjust the reference level to the measured total power after the first sweep, press the **Adjust Ref Lvl** softkey.

To measure signal statistics

- To activate and configure the measurement of the amplitude probability distribution (APD), press the **APD** softkey (for details refer to chapter "Advanced Measurement Examples", "Amplitude Distribution Measurement").
The corresponding submenu is displayed.
- To activate and configure the measurement of the complementary cumulative distribution (CCDF), press the **CCDF** softkey (for details refer to chapter "Advanced Measurement Examples", "Amplitude Distribution Measurement").
The corresponding submenu is displayed.

To measure the carrier-to-noise ratio

1. Press the **C/N, C/No** softkey to configure the carrier-to-noise ratio measurement.
The corresponding submenu is displayed.
2. To activate the measurements without reference to the bandwidth, press the **C/N** softkey.
3. To activate the measurements with reference to the bandwidth, press the **C/No** softkey.
4. To change the channel bandwidth for the transmission channel, press the **Channel Bandwidth** softkey.
5. To optimize the settings for the selected channel configuration, press the **Adjust Settings** softkey (for details see also "[Settings of CP / ACP test parameters](#)" on page 4.64).

Power measurement in zero span

With the aid of the power measurement function, the R&S FSL determines the power of the signal in zero span by summing up the power at the individual measurement points and dividing the result by the number of measurement points. In this way it is possible to measure for example the power of TDMA signals during transmission or during the muting phase. Both the mean power and the RMS power can be measured by means of the individual power values.

The result is displayed in the marker field. The measured values are updated after each sweep or averaged over a user-defined number of sweeps in order to determine e.g. the mean power over several bursts. For determination of the peak value the maximum value from several sweeps is displayed.

If both the on and off phase of a burst signal are displayed, the measurement range can be limited to the transmission or to the muting phase with the aid of vertical lines. The ratio between signal and noise power of a TDMA signal for instance can be measured by using a measurement as a reference value and after that varying the measurement range.

Upon switching on power measurement the sample detector is activated.

Measurement of occupied bandwidth

An important characteristic of a modulated signal is its occupied bandwidth. In a radio communications system for instance the occupied bandwidth must be limited to enable distortion-free transmission in adjacent channels. The occupied bandwidth is defined as the bandwidth containing a defined percentage of the total transmitted power. A percentage between 10% and 99.9% can be set.

The measurement principle is the following: The bandwidth containing 99% of the signal power is to be determined, for example. The routine first calculates the total power of all displayed points of the trace. In the next step, the points from the right edge of the trace are summed up until 0.5% of the total power is reached. Auxiliary marker 1 is positioned at the corresponding frequency. Then the points from the left edge of the trace are summed up until 0.5% of the power is reached. Auxiliary marker 2 is positioned at this point. 99% of the power is now between the two markers. The distance between the two frequency markers is the occupied bandwidth which is displayed in the marker field.

To ensure correct power measurement, especially for noise signals, and to obtain the correct occupied bandwidth, the following prerequisites and settings are necessary:

- Only the signal to be measured is displayed on the screen. An additional signal would falsify the measurement.
- $RBW \ll$ occupied bandwidth
(approx. 1/20 of occupied bandwidth, for voice communication type 300 Hz or 1 kHz)
- $VBW \geq 3 \times RBW$
- RMS-Detector
- $Span \geq 2$ to 3 x occupied bandwidth

Some of the measurement specifications (e.g. PDC, RCR STD-27B) require measurement of the occupied bandwidth using a peak detector. The detector setting of the R&S FSL has to be changed accordingly then.

Predefined CP / ACP standards

The test parameters for the channel and adjacent-channel measurements are set according to the mobile radio standard. The available standards are listed below.

- NADC IS136
- TETRA
- PDC
- PHS
- CDPD
- CDMA IS95A FWD
- CDMA IS95A REV
- CDMA IS95C Class 0 FWD
- CDMA IS95C Class 0 REV
- CDMA J-STD008 FWD
- CDMA J-STD008 REV
- CDMA IS95C Class 1 FWD
- CDMA IS95C Class 1 REV
- W-CDMA 4.096 FWD

- W-CDMA 4.096 REV
- W-CDMA 3GPP FWD
- W-CDMA 3GPP REV
- CDMA 2000 DS
- CDMA 2000 MC1
- CDMA 2000 MC3
- TD-SCDMA FWD
- TD-SCDMA REV
- WLAN 802.11A
- WLAN 802.11B
- WiMAX
- WIBRO

Note: For the R&S FSL, the channel spacing is defined as the distance between the center frequency of the adjacent channel and the center frequency of the transmission channel. The definition of the adjacent-channel spacing in standards IS95 B / C, IS97 B / C, IS98 B / C and CDMA 2000 DS / MC1 / MC3 is different. These standards define the adjacent-channel spacing from the center of the transmission channel to the closest border of the adjacent channel. This definition is also used for the R&S FSL when the standard settings marked with a dagger are selected.

Settings of CP / ACP test parameters

- **Frequency span**

The frequency span must at least cover the channels to be measured plus a measurement margin of approx. 10%.

Note: If the frequency span is large in comparison to the channel bandwidth (or the adjacent-channel bandwidths) being examined, only a few points on the trace are available per channel. This reduces the accuracy of the waveform calculation for the channel filter used, which has a negative effect on the measurement accuracy. It is therefore strongly recommended that the formulas mentioned be taken into consideration when selecting the frequency span.

For channel power measurements the **Adjust Settings** softkey sets the frequency span as follows:

(No. of transmission channels – 1) x transmission channel spacing + 2 x transmission channel bandwidth + measurement margin

For adjacent-channel power measurements, the **Adjust Settings** softkey sets the frequency span as a function of the number of transmission channels, the transmission channel spacing, the adjacent-channel spacing, and the bandwidth of one of adjacent-channels ADJ, ALT1 or ALT2, whichever is furthest away from the transmission channels:

(No. of transmission channels – 1) x transmission channel spacing + 2 x (adjacent-channel spacing + adjacent-channel bandwidth) + measurement margin

The measurement margin is approx. 10% of the value obtained by adding the channel spacing and the channel bandwidth.

- **Resolution bandwidth (RBW)**

To ensure both, acceptable measurement speed and required selection (to suppress spectral components outside the channel to be measured, especially of the adjacent channels), the resolution bandwidth must not be selected too small or too large. As a general approach, the resolution bandwidth is to be set to values between 1% and 4% of the channel bandwidth.

A larger resolution bandwidth can be selected if the spectrum within the channel to be measured and around it has a flat characteristic. In the standard setting, e.g. for standard IS95A REV at an adjacent channel bandwidth of 30 kHz, a resolution bandwidth of 30 kHz is used. This yields correct results since the spectrum in the neighborhood of the adjacent channels normally has a constant level. For standard NADC/IS136 this is not possible for example, since the spectrum of the transmit signal penetrates into the adjacent channels and a too large resolution bandwidth causes a too low selection of the channel filter. The adjacent-channel power would thus be measured too high.

With the exception of the IS95 CDMA standards, the **Adjust Settings** softkey sets the resolution bandwidth (RBW) as a function of the channel bandwidth:

$$RBW \leq 1/40 \text{ of channel bandwidth}$$

The maximum possible resolution bandwidth (with respect to the requirement $RBW \leq 1/40$) resulting from the available RBW steps (1, 3) is selected.

- **Video bandwidth (VBW)**

For a correct power measurement, the video signal must not be limited in bandwidth. A restricted bandwidth of the logarithmic video signal would cause signal averaging and thus result in a too low indication of the power (–2.51 dB at very low video bandwidths). The video bandwidth should therefore be selected at least three times the resolution bandwidth:

$$VBW \geq 3 \times RBW$$

The **Adjust Settings** softkey sets the video bandwidth (VBW) as a function of the channel bandwidth (see formula above) and the smallest possible VBW with regard to the available step size will be selected.

- **Detector**

The **Adjust Settings** softkey selects the RMS detector. This detector is selected since it correctly indicates the power irrespective of the characteristics of the signal to be measured. The whole IF envelope is used to calculate the power for each measurement point. The IF envelope is digitized using a sampling frequency which is at least five times the resolution bandwidth which has been selected. Based on the sample values, the power is calculated for each measurement point using the following formula:

$$P_{RMS} = \sqrt{\frac{1}{N} \cdot \sum_{i=1}^N s_i^2}$$

s_i = linear digitized video voltage at the output of the A/D converter

N = number of A/D converter values per measurement point

P_{RMS} = power represented by a measurement point

When the power has been calculated, the power units are converted into decibels and the value is displayed as a measurement point.

In principle, the sample detector would be possible as well. Due to the limited number of measurement points used to calculate the power in the channel, the sample detector would yield less stable results.

- **Trace averaging**

The **Adjust Settings** softkey switches off this function. Averaging, which is often performed to stabilize the measurement results, leads to a too low level indication and should therefore be avoided. The reduction in the displayed power depends on the number of averages and the signal characteristics in the channel to be measured.

- **Reference level**

The **Adjust Settings** softkey does not influence the reference level. It can be separately adjusted using the **Adjust Settings** softkey.

Softkeys of the power measurement menu

The following table shows all softkeys available in the power measurement menu. It is possible that your instrument configuration does not provide all softkeys. If a softkey is only available with a special option, model or (measurement) mode, this information is delivered in the corresponding softkey description.

Menu / Command	Submenu / Command	Submenu / Command	Command
All Functions Off			
TOI ↓	Marker 1		
	Marker 2		
	Marker 3		
	Marker 4		
	Search Signals		
AM Mod Depth ↓	same contents as TOI menu		
Time Domain Power ↓	Peak		
	RMS		
	Mean		
	Std Dev		
	Limits On/Off		
	Left Limit		
	Right Limit		
C/N, C/No ↓	C/N		
	C/No		
	Channel Bandwidth		
	Adjust Settings		
CP, ACP, MC-ACP ↓	CP / ACP Standard		
	CP / ACP Config ↓	# of TX Chan	
		# of Adj Chan	
		Channel Settings ↓	Channel Bandwidth
			Channel Spacing
			ACP Ref Settings
			Adjust Ref Level
			Adjust Settings
		Limit Checking ↓	Limit Chk On/Off
			Edit ACP Limit

Menu / Command	Submenu / Command	Submenu / Command	Command
		Power Mode ↓	Clear/Write
			Max Hold
		Select Trace	
		Adjust Settings	
	Sweep Time		
	Fast ACP On/Off		
	ACP Abs/Rel		
	Adjust Ref Level		
More ↓			
All Functions Off			
OBW ↓	% Power Bandwidth		
	Channel Bandwidth		
	Adjust Ref Lvl		
	Adjust Settings		
APD ↓	Percent Marker		
	Res BW		
	# of Samples		
	Scaling ↓	x-Axis Ref Level	
		x-Axis Range	
		y-Axis Max Value	
		y-Axis Min Value	
		Adjust Settings	
		Default Settings	
	Adjust Settings		
	Cont Meas		
	Single Meas		
CCDF ↓	same contents as APD menu		
Harmonic Distortion ↓	Harmonic On/Off		
	No. of Harmonics		
	Harmonic Sweep Time		
	Harmonic RBW Auto		
	Adjust Settings		
Full Size Diagram			

All Functions Off

Switches off all power measurement functions.

→ Remote: CALC:MARK:FUNC:<function> OFF

TOI

Opens a submenu and activates the measurement of the 3rd order intercept point.

A two-tone signal with equal carrier levels is expected at the R&S FSL input. Marker 1 and marker 2 (both normal markers) are set to the maximum of the two signals. Marker 3 and marker 4 (both delta markers) are placed on the intermodulation products. When the function is enabled, the frequency entry is activated for the delta markers. They can be set manually.

The R&S FSL calculates the third order intercept point from the level spacing between normal markers and delta markers and displays it in the marker field.

- Remote: CALC:MARK:FUNC:TOI ON
 - Remote: CALC:MARK:FUNC:TOI:RES?
-

Search Signals

Activates all markers.

- Remote: CALC:MARK:FUNC:TOI:RES?
-

AM Mod Depth

Opens a submenu and activates the measurement of the AM modulation depth. An AM-modulated carrier is required on the screen for ensuring correct operation.

The level value of marker 1 is taken as the carrier level. When this function is activated, marker 2 and marker 3 are automatically set symmetrically to the carrier on the adjacent peak values of the trace as delta markers and marker 2 is activated for the entry.

When the position of marker 2 (delta) is changed, marker 3 (delta) is moved symmetrically with respect to the reference marker (marker 1).

If the edit dialog box is opened for marker 3, the latter can be moved for fine adjustment irrespective of marker 2.

The R&S FSL calculates the power at the marker positions from the measured levels. The AM modulation depth is calculated from the ratio between the power values at the reference marker and at the delta markers. When the powers of the two AM side bands are unequal, the mean value of the two power values is used for AM modulation depth calculation.

- Remote: CALC:MARK:FUNC:MDEP ON
 - Remote: CALC:MARK:FUNC:MDEP:RES?
-

Time Domain Power (zero span)

Activates the power measurement in zero span and opens a submenu to configure the power measurement. For more details see also "[Power measurement in zero span](#)" on page 4.62.

- Remote: CALC:MARK:FUNC:SUMM:STAT ON
-

Peak (zero span)

Activates the calculation of the peak value from the points of the displayed trace or a segment thereof. For more details see also "[Power measurement in zero span](#)" on page 4.62.

- Remote: CALC:MARK:FUNC:SUMM:PPE ON
 - Remote: CALC:MARK:FUNC:SUMM:PPE:RES?
-

RMS (zero span)

Activates the calculation of the RMS value from the points of the displayed trace or a segment thereof. For more details see also "[Power measurement in zero span](#)" on page 4.62.

- Remote: CALC:MARK:FUNC:SUMM:RMS ON
 - Remote: CALC:MARK:FUNC:SUMM:RMS:RES?
-

Mean (zero span)

Activates the calculation of the mean value from the points of the displayed trace or a segment thereof. The linear mean value of the equivalent voltages is calculated.

This can be used for instance to measure the mean power during a GSM burst.

For more details see also "[Power measurement in zero span](#)" on page 4.62.

- Remote: CALC:MARK:FUNC:SUMM:MEAN ON
 - Remote: CALC:MARK:FUNC:SUMM:MEAN:RES?
-

Std Dev (zero span)

Activates the calculation of the standard deviation of measurement points from the mean value and displays them as measured value. The measurement of the mean power is automatically switched on at the same time. For more details see also "[Power measurement in zero span](#)" on page 4.62.

- Remote: CALC:MARK:FUNC:SUMM:SDEV ON
 - Remote: CALC:MARK:FUNC:SUMM:SDEV:RES?
-

Limits On/Off (zero span)

Switches the limitation of the evaluation range on or off. Default setting is off.

When switched off, the evaluation range is not limited. When switched on, the evaluation range is defined by the left and right limit. If only one limit is set, it corresponds to the left limit and the right limit is defined by the stop frequency. If the second limit is also set, it defines the right limit.

For more details see also "[Power measurement in zero span](#)" on page 4.62.

- Remote: CALC:MARK:X:SLIM OFF
-

Left Limit (zero span)

Opens an edit dialog box to enter a value for line 1. For more details see also "[Power measurement in zero span](#)" on page 4.62.

- Remote: CALC:MARK:X:SLIM:LEFT <value>
-

Right Limit (zero span)

Opens an edit dialog box to enter a value for line 2. For more details see also "[Power measurement in zero span](#)" on page 4.62.

- Remote: CALC:MARK:X:SLIM:RIGH <value>
-

C/N, C/No (span > 0)

Opens a submenu to configure the carrier/noise ratio measurement. Measurements without (C/N) and measurements with reference to the bandwidth (C/No) are possible.

C/N (span > 0)

Switches the measurement of the carrier/noise ratio on or off. If no marker is active, marker 1 is activated.

The measurement is performed on the trace where marker 1 is located. To shift marker 1 and measure another trace, use the **Marker to Trace** softkey in the marker menu. To determine the maximum value of the current trace, use the **Phase Noise/Ref Fixed** softkey in the marker menu.

- Remote: CALC:MARK:FUNC:POW:SEL CN
- Remote: CALC:MARK:FUNC:POW:RES? CN
- Remote: CALC:MARK:FUNC:POW OFF

C/No (span > 0)

Switches the measurement of the carrier/noise ratio with reference to a 1 Hz bandwidth on or off. If no marker is active, marker 1 is activated.

The measurement is performed on the trace where marker 1 is located. To shift marker 1 and measure another trace, use the **Marker to Trace** softkey in the marker menu. To determine the maximum value of the current trace, use the **Phase Noise/Ref Fixed** softkey in the marker menu.

- Remote: CALC:MARK:FUNC:POW:SEL CN0
- Remote: CALC:MARK:FUNC:POW:RES? CN0
- Remote: CALC:MARK:FUNC:POW OFF

Channel Bandwidth (span > 0)

Opens an edit dialog box to enter the measurement channel bandwidth. The default setting is 14 kHz.

- Remote: SENS:POW:ACH:BWID 14kHz

Adjust Settings (span > 0)

Enables the RMS detector (see also "[Detector overview](#)" on page 4.36) and adjusts the span to the selected channel bandwidth according to:

$$4 \times \text{channel bandwidth} + \text{measurement margin}$$

The adjustment is performed once; if necessary, the setting can be changed later on.

- Remote: SENS:POW:ACH:PRES CN | CN0

CP, ACP, MC-ACP

Activates the active channel or adjacent-channel power measurement either for a single carrier signal or for several carrier signals, depending on the current measurement configuration, and opens a submenu to configure the channel power measurement. With default settings the measurement is performed by integrating the powers at the display points within the specified channels (IBW method).

When multi-carrier ACP measurement is activated, the number of measurement points is increased to ensure that adjacent-channel powers are measured with adequate accuracy.

- Remote: CALC:MARK:FUNC:POW:SEL CPOW|ACP|MCAC
 - Remote: CALC:MARK:FUNC:POW:RES? CPOW|ACP|MCAC
 - Remote: CALC:MARK:FUNC:POW OFF
-

CP / ACP Standard

Opens an edit dialog box to select the settings according to predefined standards. For details on the available standards see "[Predefined CP / ACP standards](#)" on page 4.63. By default no standard is set.

The selection of the standard influences the following parameters:

- channel spacing and adjacent-channel spacing
- channel bandwidth, adjacent-channel bandwidth, and type of filtering
- resolution bandwidth
- video bandwidth
- detector
- # of adjacent channels
- trace averaging (switched off)

- Remote: CALC:MARK:FUNC:POW:PRES <standard>
-

CP / ACP Config

Opens a submenu to configure the channel power and adjacent channel power measurement independently of the predefined standards (for details see also "[To set the channel configuration](#)" on page 4.61 and "[Settings of CP / ACP test parameters](#)" on page 4.64).

of TX Chan (MC-ACP)

Opens an edit dialog box to enter the number of carrier signals to be taken into account in channel and adjacent-channel power measurements. Values from 1 to 12 are allowed.

- Remote: POW:ACH:TXCH:COUN 4
-

of Adj Chan

Opens an edit dialog box to enter the number of adjacent channels to be considered in the adjacent-channel power measurement. Values from 0 to 3 are allowed.

The following measurements are performed depending on the number of the channels:

- 0 Only the channel powers are measured.
- 1 The channel powers and the power of the upper and lower adjacent channel are measured.
- 2 The channel powers, the power of the upper and lower adjacent channel and of the next higher and lower channel (alternate channel 1) are measured.
- 3 The channel power, the power of the upper and lower adjacent channel, the power of the next higher and lower channel (alternate channel 1) and of the next but one higher and lower adjacent channel (alternate channel 2) are measured.

→ Remote: POW:ACH:ACP 1

Channel Settings

Opens a submenu to define the channel settings.

Channel Bandwidth

Opens the **TX/ACP Channel Bandwidth** dialog box to enter the channel bandwidths for the transmission channels and the adjacent channels. The entry **TX** is only available for the multi-carrier ACP measurement.

The transmission-channel bandwidth is normally defined by the transmission standard. The correct bandwidth is set automatically for the selected standard (see **CP / ACP Standard** softkey).

Measurements in zero span (see **Fast ACP On/Off** softkey) are performed in the zero span mode. The channel limits are indicated by vertical lines. For measurements requiring channel bandwidths deviating from those defined in the selected standard the IBW method is to be used.

With the IBW method (see **Fast ACP On/Off** softkey), the channel bandwidth limits are marked by two vertical lines right and left of the channel center frequency. It can in this way be visually checked whether the entire power of the signal under test is within the selected channel bandwidth.

When measuring according to the IBW method (FAST ACP OFF) the bandwidths of the different adjacent channels are to be entered numerically. Since all adjacent channels often have the same bandwidth, the other channels Alt1 and Alt2 are set to the bandwidth of the adjacent channel on entering the adjacent-channel bandwidth (ADJ). Thus only one value needs to be entered in case of equal adjacent channel bandwidths. The same holds true for the ALT2 channels (alternate channels 2) when the bandwidth of the ALT1 channel (alternate channel 1) is entered.

For details on available channel filters see "[To choose the appropriate filter](#)" on page 4.15.

→ Remote: SENS:POW:ACH:BWID 14kHz

→ Remote: SENS:POW:ACH:BWID:ACH 1kHz

→ Remote: SENS:POW:ACH:BWID:ALT1 14kHz

→ Remote: SENS:POW:ACH:BWID:ALT2 14kHz

Channel Spacing

Opens the **TX/ACP Channel Spacing** dialog box to enter the channel spacings.

The entry **TX** is only available for the multi-carrier ACP measurement.

Since all the adjacent channels often have the same distance to each other, the entry of the adjacent-channel spacing (ADJ) causes channel spacing ALT1 to be set to twice and channel spacing ALT2 to three times the adjacent-channel spacing. Thus only one value needs to be entered in case of equal channel spacing. The same holds true for the ALT2 channels when the bandwidth of the ALT1 channel is entered.

- Remote: SENS:POW:ACH:SPAC:CHAN 20kHz
 - Remote: SENS:POW:ACH:SPAC:ACH 20kHz
 - Remote: SENS:POW:ACH:SPAC:ALT1 40kHz
-

ACP Ref Settings (MC-ACP)

Opens an edit dialog box to select the transmission channel to which the adjacent-channel relative power values should be referenced.

TX Channel 1 – 12	Selection of one of channels 1 to 12.
Min Power TX Channel	The transmission channel with the lowest power is used as a reference channel.
Max Power TX Channel	The transmission channel with the highest power is used as a reference channel.
Lowest & Highest Channel	The outer left-hand transmission channel is the reference channel for the lower adjacent channels, the outer right-hand transmission channel that for the upper adjacent channels.

- Remote: SENS:POW:ACH:REF:TXCH:MAN 1
 - Remote: SENS:POW:ACH:REF:TXCH:AUTO MIN
-

Limit Checking

Opens a submenu to activate and define the limits for the ACP measurement.

This softkey is available from firmware version 1.30.

Limit Chk On/Off

Activates or deactivates the limit check for the ACP measurement.

- Remote: CALC:LIM:ACP ON
 - Remote: CALC:LIM:ACP:ACH:RES?
 - Remote: CALC:LIM:ACP:ALT:RES?
-

Edit ACP Limit

Opens the **ACP Limits** dialog box to define the limits for the ACP measurement.

The following rules apply for the limits:

- A separate limit can be defined for each adjacent channel. The limit applies to both the upper and the lower adjacent channel.
- A relative and/or absolute limit can be defined. The check of both limit values can be activated independently.
- The R&S FSL checks adherence to the limits irrespective of whether the limits are absolute or relative or whether the measurement is carried out with absolute or relative levels. If both limits are active and if the higher of both limit values is exceeded, the measured value is marked by a preceding asterisk.

→ Remote: `CALC:LIM:ACP ON`

→ Remote: `CALC:LIM:ACP:<adjacent-channel> 0dB,0dB`

→ Remote: `CALC:LIM:ACP:<adjacent-channel>:STAT ON`

→ Remote: `CALC:LIM:ACP:<adjacent-channel>:ABS -10dBm,-10dBm`

→ Remote: `CALC:LIM:ACP:<adjacent-channel>:ABS:STAT ON`

For details refer to chapter "Remote Control – Commands", section "CALCulate:LIMit:ACPower Subsystem".

Power Mode

Opens a submenu to select the power mode.

This softkey is available from firmware version 1.30.

Clear/Write

If this mode is activated, the channel power and the adjacent channel powers are calculated directly from the current trace (default mode).

This softkey is available from firmware version 1.30.

→ Remote: `CALC:MARK:FUNC:POW:MODE WRIT`

Max Hold

If this mode is activated, the power values are calculated from the current trace and compared with the previous power value using a maximum algorithm. The higher value is retained. If activated, the enhancement label **Pwr Max** is displayed.

This softkey is available from firmware version 1.30.

→ Remote: `CALC:MARK:FUNC:POW:MODE MAXH`

Select Trace

Opens an edit dialog box to enter the trace number on which the CP/ACP measurement is to be performed. Only activated traces can be selected (for details on trace modes see "[Trace mode overview](#)" on page 4.34).

→ Remote: SENS:POW:TRAC 1

Adjust Settings

Optimizes automatically all instrument settings for the selected channel configuration (channel bandwidth, channel spacing) within a specific frequency range (channel bandwidth). The adjustment is carried out only once. If necessary, the instrument settings can be changed later.

For details on the settings of span, resolution bandwidth, video bandwidth, detector and trace averaging see "[Settings of CP / ACP test parameters](#)" on page 4.64.

→ Remote: SENS:POW:ACH:PRES ACP|CPOW|MCAC|OBAN|OBW|CN|CNO

Sweep Time

Opens an edit dialog box to enter the sweep time. With the RMS detector, a longer sweep time increases the stability of the measurement results.

The function of this softkey is identical to the **SweepTime Manual** softkey in the bandwidth menu.

→ Remote: SWE:TIM <value>

Fast ACP On/Off

Switches between the IBW method (**Fast ACP Off**) and the zero span method (**Fast ACP On**).

When switched on, the R&S FSL sets the center frequency consecutively to the different channel center frequencies and measures the power with the selected measurement time (= sweep time/number of channels). The RBW filters suitable for the selected standard and frequency offset are automatically used (e.g. root raised cos with IS 136). For details on available channel filters see "[To choose the appropriate filter](#)" on page 4.15.

The RMS detector is used for obtaining correct power measurement results. Therefore this requires no software correction factors.

Measured values are output as a list. The powers of the transmission channels are output in dBm, the powers of the adjacent channels in dBm.

The sweep time is selected depending on the desired reproducibility of results. Reproducibility increases with sweep time since power measurement is then performed over a longer time period. As a general approach, it can be assumed that approx. 500 non-correlated measured values are required for a reproducibility of 0.5 dB (99% of the measurements are within 0.5 dB of the true measured value). This holds true for white noise. The measured values are considered as non-correlated when their time interval corresponds to the reciprocal of the measured bandwidth.

With IS 136 the measurement bandwidth is approx. 25 kHz, i.e. measured values at an interval of 40 μ s are considered as non-correlated. A measurement time of 40 ms is thus required per channel for 1000 measured values. This is the default sweep time which the R&S FSL sets in coupled mode. Approx. 5000 measured values are required for a reproducibility of 0.1 dB (99%), i.e. the measurement time is to be increased to 200 ms.

→ Remote: SENS:POW:HSP ON

ACP Abs/Rel

Switches between absolute and relative power measurement in the adjacent channels.

- Abs The absolute power in the adjacent channels is displayed in the unit of the Y axis, e.g. in dBm, dB μ V.
- Rel The level of the adjacent channels is displayed relative to the level of the transmission channel in dBc.

→ Remote: SENS:POW:ACH:MODE ABS

Adjust Ref Level

Adjusts the reference level to the measured channel power. This ensures that the settings of the RF attenuation and the reference level are optimally adjusted to the signal level without overloading the R&S FSL or limiting the dynamic range by a too small S/N ratio. For details on manual settings see "[Settings of CP / ACP test parameters](#)" on page 4.64.

The reference level is not influenced by the selection of a standard. To achieve an optimum dynamic range, the reference level has to be set in a way that places the signal maximum close to the reference level without forcing an overload message. Since the measurement bandwidth for channel power measurements is significantly lower than the signal bandwidth, the signal path may be overloaded although the trace is still significantly below the reference level.

→ Remote: SENS:POW:ACH:PRES:RLEV

OBW (span > 0)

Activates measurement of the occupied bandwidth according to the current configuration and opens a submenu to configure the measurement. The occupied bandwidth is displayed in the marker display field and marked on the trace by temporary markers. For details see also "[Measurement of occupied bandwidth](#)" on page 4.63.

The measurement is performed on the trace with marker 1. In order to evaluate another trace, marker 1 must be placed on another trace (see **Marker to Trace** softkey in the marker menu).

- Remote: CALC:MARK:FUNC:POW:SEL OBW
- Remote: CALC:MARK:FUNC:POW:RES? OBW
- Remote: CALC:MARK:FUNC:POW OFF
-

% Power Bandwidth (span > 0)

Opens an edit dialog box to enter the percentage of total power in the displayed frequency range which defines the occupied bandwidth. Values from 10% to 99.9% are allowed.

→ Remote: SENS:POW:BWID 99PCT

Channel Bandwidth (span > 0)

Opens an edit dialog box to enter the channel bandwidth for the transmission channel. The specified channel bandwidth is used for optimization of the test parameters (for details see "[Settings of CP / ACP test parameters](#)" on page 4.64). The default setting is 14 kHz.

For measurements in line with a specific transmission standard, the bandwidth specified by the standard for the transmission channel must be entered.

→ Remote: SENS:POW:ACH:BWID 14kHz

Adjust Ref Lvl (span > 0)

Adjusts the reference level to the measured total power of the signal. The softkey is activated after the first sweep with active measurement of the occupied bandwidth has been completed and the total power of the signal is thus known.

Adjusting the reference level ensures that the signal path will not be overloaded and the dynamic range not limited by too low a reference level. Since the measurement bandwidth for channel power measurements is significantly lower than the signal bandwidth, the signal path may be overloaded although the trace is distinctly below the reference level. If the measured channel power is equal to the reference level, the signal path cannot be overloaded.

→ Remote: SENS:POW:ACH:PRES:RLEV

APD

Activates the function to measure the amplitude probability density (APD) and opens a submenu.

→ Remote: CALC:STAT:APD ON

Percent Marker

Opens an edit dialog box to enter a probability value and to position marker 1. Thus, the power which is exceeded with a given probability can be determined very easily. If marker 1 is deactivated, it will be switched on automatically.

→ Remote: CALC:MARK:Y:PERC 0...100%

Res BW

Opens an edit dialog box to set the resolution bandwidth directly. The function of this softkey is identical to the **Res BW Manual** softkey in the bandwidth menu.

For correct measurement of the signal statistics the resolution bandwidth has to be wider than the signal bandwidth in order to measure the actual peaks of the signal amplitude correctly. In order not to influence the peak amplitudes the video bandwidth is automatically set to 10 MHz. The sample detector is used for detecting the video voltage.

→ Remote: BAND 3 MHz

of Samples

Opens an edit dialog box to set the number of power measurements that are taken into account for the statistics.

Apart from the number of measurements the overall measurement time depends also on the set resolution bandwidth as the resolution bandwidth directly influences the sampling rate.

→ Remote: CALC:STAT:NSAM <value>

Scaling

Opens a submenu to change the scaling parameters of x- and y-axis.

x–Axis Ref Level

Opens an edit dialog box to enter the reference level in the currently active unit (dBm, dB μ V, etc). The function of this softkey is identical to the **Ref Level** softkey in the amplitude menu.

For the APD function this value is mapped to the right diagram border. For the CCDF function there is no direct representation of this value on the diagram as the x–axis is scaled relatively to the measured mean power.

→ Remote: CALC:STAT:SCAL:X:RLEV <value>

x–Axis Range

Opens the **Range Log** dialog box to select a value for the level range to be covered by the statistics measurement selected. The function is identical to the **Range Log** softkey in amplitude menu.

→ Remote: CALC:STAT:SCAL:X:RANG <value>

y–Axis Max Value

Opens an edit dialog box to define the upper limit of the displayed probability range. Values on the y–axis are normalized which means that the maximum value is 1.0. As the y–axis scaling has a logarithmic axis the distance between max and min value must be at least one decade.

→ Remote: CALC:STAT:SCAL:Y:UPP <value>

y–Axis Min Value

Opens an edit dialog box to define the lower limit of the displayed probability range. As the y–axis scaling has a logarithmic axis the distance between max and min value must be at least one decade. Values in the range $0 < \text{value} < 1$ are allowed.

→ Remote: CALC:STAT:SCAL:Y:LOW <value>

Default Settings

Resets the x– and y–axis scalings to their preset values.

x–axis ref level:	–20 dBm
x–axis range APD:	100 dB
x–axis range CCDF:	20 dB
y–axis upper limit:	1.0
y–axis lower limit:	1E–6

→ Remote: CALC:STAT:PRES

Adjust Settings

Adjusts the level settings according to the measured difference between peak and minimum power for APD measurement or peak and mean power for CCDF measurement in order to obtain maximum power resolution. Adapts the probability scale to the selected number of samples. Adjusts the reference level to the current input signal. For details see also **Adjust Ref Level** softkey.

→ Remote: CALC:STAT:SCAL:AUTO ONCE

Cont Meas

Starts to collect a new sequence of sample data and to calculate the APD or CCDF curve depending on the selected measurement. The next measurement is started automatically as soon as the indicated number of samples has been reached ("CONTinuous MEASurement").

→ Remote: INIT:CONT ON

→ Remote: INIT:IMM

Single Meas

Starts to collect a new sequence of sample data and to calculate the APD or CCDF curve depending on the selected measurement. At the beginning of the measurement previously obtained measurement results are discarded.

→ Remote: INIT:CONT OFF

→ Remote: INIT:IMM

CCDF

Activates the function to measure the complementary cumulative distribution function (CCDF) and opens a submenu.

→ Remote: CALC:STAT:CCDF ON

Harmonic Distortion

Opens a submenu to determine the settings for harmonics measurement and activates the harmonic distortion measurement. With this measurement it is possible to measure easily the harmonics e.g. from a VCO. In addition the THD (total harmonic distortion) is calculated in % and dB.

With span > 0 Hz, an automatic search for the first harmonic is carried out within the set frequency range. Also the level is adjusted. In zero span, the center frequency is unchanged.

In the upper pane, the zero span sweeps on all harmonics are shown, separated by display lines. This provides a very good overview about the measurement. In the lower pane, the mean RMS results are displayed in numerical values. The THD values are displayed in the marker information area.

This softkey is available from firmware version 1.10.

→ Remote: CALC:MARK:FUNC:HARM:STAT ON

→ Remote: CALC:MARK:FUNC:HARM:DIST? TOT

→ Remote: CALC:MARK:FUNC:HARM:LIST?

Harmonic On/Off

Activates/deactivates the harmonic distortion measurement.

This softkey is available from firmware version 1.10.

→ Remote: CALC:MARK:FUNC:HARM:STAT ON

No. of Harmonics

Sets the number of harmonics that shall be measured. The range is from 1 to 26.

This softkey is available from firmware version 1.10.

→ Remote: CALC:MARK:FUNC:HARM:NHAR 2

Harmonic Sweep Time

For details refer to the **Sweeptime Manual** softkey in the bandwidth menu.

This softkey is available from firmware version 1.10.

Harmonic RBW Auto

Enables/disables the automatic adjustment of the resolution bandwidth. The automatic adjustment is carried out according to:

$$RBW_n = RBW_1 * n$$

If RBW_n is not available, the next higher value is used.

This softkey is available from firmware version 1.10.

→ Remote: CALC:MARK:FUNC:HARM:BAND:AUTO OFF

Adjust Settings

Activates the frequency search in the frequency range that was set before starting the harmonic measurement (if harmonic measurement was with span > 0) and adjusts the level.

This softkey is available from firmware version 1.10.

→ Remote: CALC:MARK:FUNC:HARM:PRES

Full Size Diagram (span > 0)

Displays the diagram in full screen size.

→ Remote: DISP:SIZE LARG|SMAL

Using Limit Lines and Display Lines – LINES Key

The **LINES** key is used to configure limit and display lines.

To open the lines menu

- Press the **LINES** key.

The lines menu and the **Select Limit Line** dialog box are displayed. For details on the **Select Limit Line** dialog box refer to "[To select a limit line](#)" on page 4.82.

Menu and softkey description

- "[Softkeys of the lines menu](#)" on page 4.86

To display help to a softkey, press the **HELP** key and then softkey for which you want to display help. To close the help window, press the **ESC** key. For further information refer to section "How to use the Help System".

Further information

- "[Display Lines](#)" on page 4.85
- "[Limit Lines](#)" on page 4.85

Task

- [To work with display lines](#)
- [To select a limit line](#)
- [To create a new limit line](#)
- [To edit an existing limit line](#)
- [To create a new limit line based upon an existing limit line](#)
- [To activate/deactivate a limit line](#)

To work with display lines

Initial situation: The line is switched on (softkey with highlighted background) or off (softkey without highlighted background), for example the Display Line 1.

1. Press the **Display Lines** softkey.
2. Press the **Display Line 1** softkey for the first time.

An edit dialog box is opened to enter the position of the display line (by rotary knob, step keys or numerical entry). If the line was switched off, it is switched on. If it was switched on, it remains switched on.

3. If another softkey is pressed, the edit dialog box for the **Display Line 1** softkey is closed, but the line remains switched on (softkey with highlighted background).
4. Press the **Display Line 1** softkey for the second time.
The edit dialog box for the display line will be opened again.
5. Press the **Display Line 1** softkey again.

The line is switched off (softkey without highlighted background).

To select a limit line

1. To display the **Select Limit Line** dialog box, press the **LINES** key or go to the main limit line menu.

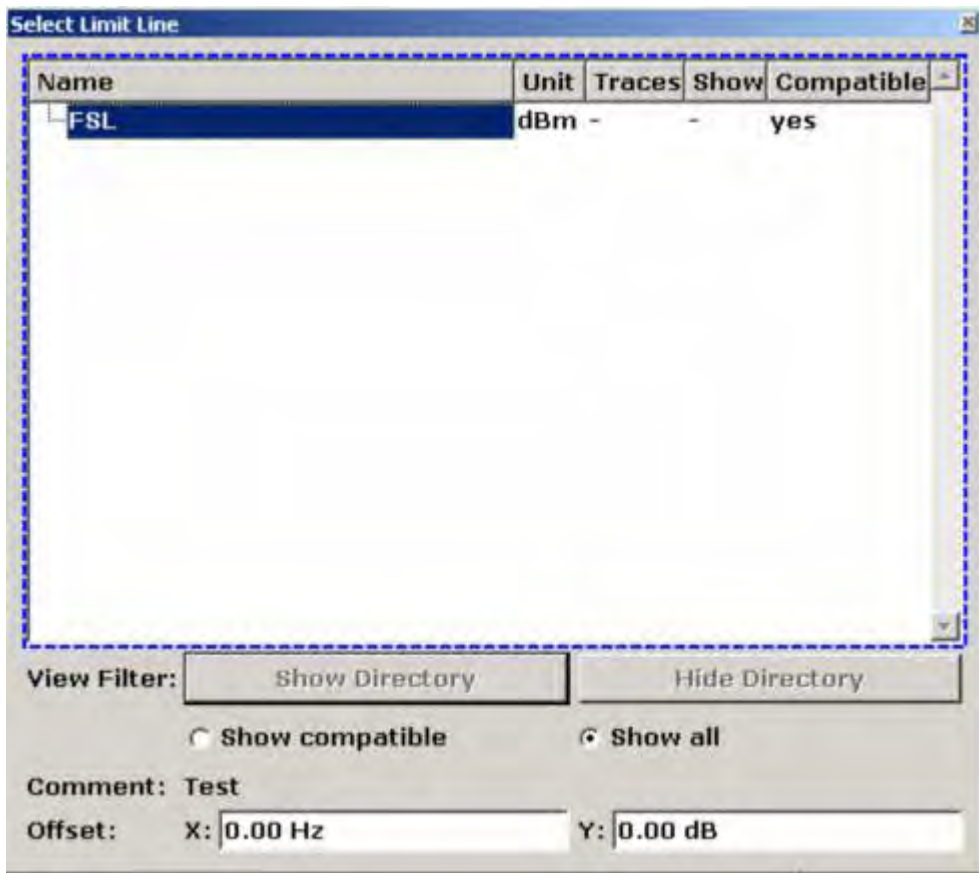

All limit lines, saved in the default directory, and all subdirectories are displayed. For each limit line, the following information is given:

Unit	unit of the y-axis
Traces	selected traces to check
Show	limit line displayed in the measurement diagram or hidden
Compatible	compatibility of the limit line to the current measurement settings

2. To display only the limit lines that are compatible, activate the **Show compatible** option. For details on compatibility refer to "[Limit Lines](#)" on page 4.85.
3. To navigate into a subdirectory, use the **Show Directory** and **Hide Directory** buttons.

To create a new limit line

1. Press the **New** softkey to define a new limit line.

The **Edit Limit Line** dialog box is displayed. For more details on limit lines refer also to "[Limit Lines](#)" on page 4.85.

2. Press the **Edit Name** softkey and enter a name, if you want to save the limit line in the main directory. To save the limit line in an existing subdirectory, enter the relative path. A new subdirectory can only be created using the **FILE** key (for details refer to section "Instrument Functions – Basic Settings", "Saving and Recalling Data Sets – FILE Key").

3. To change the span setting, set the focus in the **X–Axis** field and change the unit via the rotary knob: **Hz** for span > 0 Hz or **s** for zero span.
4. To change between absolute and relative scale mode for the x–axis, set the focus on the **abs** or **rel** option next to the **X–Axis** field and press the **CHECKMARK** key. Relative scaling is always suitable, if masks for bursts are to be defined in zero span, or if masks for modulated signals are required for span > 0 Hz.

absolute: The frequencies or times are interpreted as absolute physical units.

relative: In the data point table, the frequencies are referred to the currently set center frequency. In the zero span mode, the left boundary of the diagram constitutes the reference.

5. To change the scaling of the y–axis, set the focus in the **Y–Axis** field and change the unit using the rotary knob.
6. To change between absolute and relative units for the y–axis, set the focus on the **abs** or **rel** option next to the **Y–Axis** field and press the **CHECKMARK** key.

absolute: The limit values refer to absolute levels or voltages.

relative: The limit values refer to the reference level (Ref Level). Limit values with the unit dB are always relative values.

7. To define the limit line as upper or lower limit line, set the focus on the **Upper** or **Lower** option and press the **CHECKMARK** key.
8. To change between linear or logarithmic scale of the x–axis, set the focus on the **lin** or **log** option and press the **CHECKMARK** key.
9. If the scaling of the y–axis is relative, you can define an absolute threshold value that works as a lower limit for the relative limit values (see figure below). Set the focus in the **Threshold** field and enter a value.

The function is especially useful for mobile radio applications provided the limit values are defined in relation to the carrier power as long as they are above an absolute limit value.

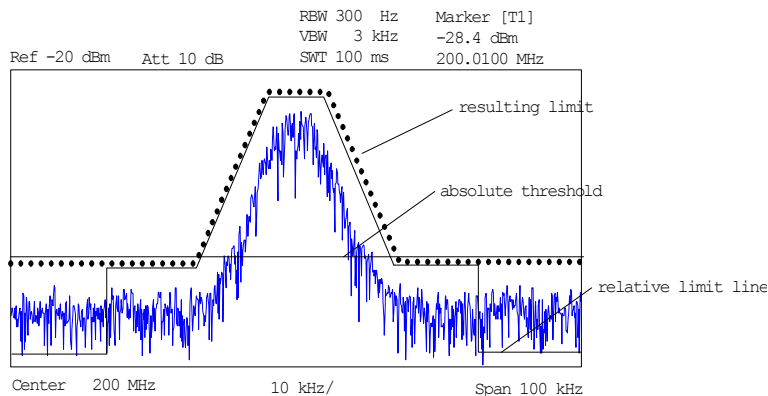

10. To define a signal–level distance to the limit line, press the **Edit Margin** softkey and enter a value.
 If the limit line is defined as an upper limit, the margin means that the level is below the limit line. If the limit line is defined as a lower limit, the margin means that the level is above the limit line.
11. To enter a comment, press the **Edit Comment** and enter a comment, e.g. a description of the application.
12. To enter a new data point:
 - Press the **Insert Value Above** softkey.
 - Enter the new x and y value in the successive displayed edit dialog boxes.

13. To change a data point:
 - Set the focus on the x and y value to be changed and press the **Value** softkey.
 - Enter the new x or y value in the displayed edit dialog box.
14. To delete a data point, select the corresponding entry and press the **Delete Value** softkey.
15. To shift the complete limit line parallel in the horizontal direction, select the **Shift x** button and enter a x shift value.
16. To shift the complete limit line parallel in the vertical direction, select the **Shift y** button and enter an y shift value.
17. Press the **Save Limit Line** softkey.

If an existing name is used, a message box is displayed. You have to confirm before the limit line is overwritten.

To edit an existing limit line

1. In the **Select Limit Line** dialog box, select the limit line you want to alter. For details see also "[To select a limit line](#)" on page 4.82.
2. Press the **Edit** softkey.
3. Edit the data as described in "[To select a limit line](#)" on page 4.82.
4. Save the limit line (**Save Limit Line** softkey).

To create a new limit line based upon an existing limit line

1. In the **Select Limit Line** dialog box, select the limit line you want to use as a basis for a new limit line. For details see also "[To select a limit line](#)" on page 4.82.
2. Press the **Copy to** softkey to transfer the data of the limit line into the **Edit Limit Line** dialog box.
3. Press the **Edit Name** softkey and enter a new name.
4. To shift the complete limit line parallel in the horizontal direction, select the **Shift x** button and enter an x shift value. In this manner, a new limit line can be easily generated based upon an existing limit line which has been shifted horizontally.
5. To shift the complete limit line parallel in the vertical direction, select the **Shift y** button and enter a y shift value. In this manner, a new limit line can be easily generated based upon an existing limit line which has been shifted in Y direction
6. If required, edit the data as described in "[To select a limit line](#)" on page 4.82.
7. Save the limit line (**Save Limit Line** softkey).

To activate/deactivate a limit line

Prerequisites:

- The x– and y–units of limit line and current measurement setting have to be compatible. For details refer to "[Limit Lines](#)" on page 4.85.
 - The limit line has to consist of 2 or more data points.
1. In the **Select Limit Line** dialog box, select the limit line you want to activate/deactivate. For details see also "[To select a limit line](#)" on page 4.82.
 2. To activate or deactivate a limit line for a trace, press the **Select Traces to check** softkey and select or deselect the trace(s) to which this limit line applies.
 3. To deactivate the limit line for all traces, press the **Deselect All** softkey.

Display Lines

Display lines help to evaluate a trace – as do markers. The function of a display line is comparable to that of a ruler that can be shifted on the trace in order to mark absolute values. They are exclusively used to optically mark relevant frequencies or points in time (span = 0) as well as constant level values. It is not possible to check automatically whether the points are below or above the marked level values.

The softkeys for setting and switching the display lines on/off work like triple switches. For details see "[To work with display lines](#)" on page 4.81.

Two different types of display lines are provided:

- Two horizontal level lines for marking levels – Display Line 1 and 2
The level lines are continuous horizontal lines across the entire width of a diagram and can be shifted in y direction.
- Two vertical frequency or time lines for marking frequencies or points in time – Frequency/Time Line 1 and 2
The frequency or time lines are continuous vertical lines across the entire height of the diagram and can be shifted in x direction.

Each line is identified by one of the following abbreviations:

- D1: Display Line 1
- D2: Display Line 2
- F1: Frequency Line 1
- F2: Frequency Line 2
- T1: Time Line 1
- T2: Time Line 2

Limit Lines

Limit lines are used to define amplitude curves or spectral distribution boundaries on the display screen which are not to be exceeded. They indicate, for example, the upper limits for interference radiation or spurious waves which are allowed from a device under test (DUT). For transmission of information in TDMA systems (e.g. GSM), the amplitude of the bursts in a timeslot must adhere to a curve that falls within a specified tolerance band. The lower and upper limits may each be specified by a limit line. Then, the amplitude curve can be controlled either visually or automatically for any violations of the upper or lower limits (GO/NOGO test).

The instrument supports limit lines with a maximum of 50 data points. 8 of the limit lines stored in the instrument can be activated simultaneously. The number of limit lines stored in the instrument is only limited by the capacity of the flash disk used. For details see also "[To select a limit line](#)" on page 4.82.

Limit lines are compatible with the current measurement settings, if the following applies:

- The x unit of the limit line has to be identical to the current setting.
- The y unit of the limit line has to be identical to the current setting with the exception of dB based units; all dB based units are compatible with each other.

At the time of entry, the R&S FSL immediately checks that all limit lines are in accordance with the following guidelines:

- The frequencies/times for each data point must be entered in ascending order, however, for any single frequency/time, two data points may be entered (vertical segment of a limit line).
- The data points are allocated in order of ascending frequency/time. Gaps are not allowed. If gaps are desired, two separate limit lines must be defined and then both enabled.

- The entered frequencies/times need not necessarily be selectable in R&S FSL. A limit line may also exceed the specified frequency or time range. The minimum frequency for a data point is –200 GHz, the maximum frequency is 200 GHz. For the time range representation, negative times may also be entered. The allowed range is –1000 s to +1000 s.

Softkeys of the lines menu

The following table shows all softkeys available in the lines menu. It is possible that your instrument configuration does not provide all softkeys. If a softkey is only available with a special option, model or (measurement) mode, this information is delivered in the corresponding softkey description.

Menu / Command	Command
Select Traces to check	
Deselect All	
New ↓	Edit Name
	Edit Comment
	Edit Margin
	Value
	Insert Value Above
	Delete Value
	Save Limit Line
Edit ↓	same contents as New Limit Line menu
Copy to ↓	same contents as New Limit Line menu
Delete	
Display Lines ↓	Display Line 1
	Display Line 2
	Frequency Line 1
	Frequency Line 2
	Time Line 1
	Time Line 2

Select Traces to check

Opens the **Select Traces to Check** dialog box to activate the selected limit line for a trace. One limit line can be activated for several traces simultaneously. For details see also "[To activate/deactivate a limit line](#)" on page 4.84 .

This softkey is available from firmware version 1.10.

- Remote: CALC:LIM2:TRAC 3
- Remote: CALC:LIM:STAT ON

Deselect All

Deactivates the selected limit line for all assigned traces. For details see also "[To activate/deactivate a limit line](#)" on page 4.84 .

This softkey is available from firmware version 1.10.

- Remote: CALC:LIM:STAT OFF

New

Opens the **Edit Limit Line** dialog box and a submenu to define a new limit line. For details see also "[Limit Lines](#)" on page 4.85 and "[To select a limit line](#)" on page 4.82.

This softkey is available from firmware version 1.10.

Edit Name

Sets the focus on the **Name** field to enter or change the limit line name. A maximum of 8 characters is permitted for each name. All names must be compatible with the Windows XP conventions for file names. The limit line data are stored under this name. The instrument stores all limit lines with LIM as extension.

This softkey is available from firmware version 1.10.

→ Remote: CALC:LIM3:NAME "GSM1"

Edit Comment

Sets the focus on the **Comment** field to enter or change a comment for the limit line. The text must not exceed 40 characters.

This softkey is available from firmware version 1.10.

→ Remote: CALC:LIM5:COMM 'Upper limit for spectrum'

Edit Margin

Sets the focus on the **Margin** field to enter or change a margin for the limit line. The default setting is 0 dB (i.e. no margin).

This softkey is available from firmware version 1.10.

Value

Opens an edit dialog box to change an existing x or y value, depending on the selected column. The softkey is only available if an existing value is selected.

The desired data points are entered in ascending order (two repeated frequencies/time values are permitted).

This softkey is available from firmware version 1.10.

→ Remote: CALC:LIM3:CONT:DATA 1MHz, 3MHz, 30MHz

→ Remote: CALC:LIM3:UPP:DATA -10, 0, 0

→ Remote: CALC:LIM3:LOW:DATA -30, -40, -40

Insert Value Above

Creates an empty line above the selected data point to enter a new data point. This softkey corresponds to the **Insert** button in the dialog box.

It is also possible to add a data point at the end of the list, if the focus is set below the last entry line of the list.

The data points are entered in ascending order (two repeated frequencies/time values are permitted). If the entered values are not in accordance with the ascending order rule, an error message is displayed and the values are discarded.

This softkey is available from firmware version 1.10.

Delete Value

Deletes the selected data point (x and y value). All succeeding data points are shifted up accordingly. This softkey corresponds to the **Delete** button in the dialog box.

The softkey is only available if an existing value is selected.

This softkey is available from firmware version 1.10.

Save Limit Line

Saves the currently edited limit line under the name defined in the **Name** field.

This softkey is available from firmware version 1.10.

Edit

Opens a submenu to edit limit lines. For details see also "[Limit Lines](#)" on page 4.85 and "[To edit an existing limit line](#)" on page 4.84.

This softkey is available from firmware version 1.10.

- Remote: For details refer to chapter "Remote Control – Commands", section "Definition of the limit line".
-

Copy to

Copies the data of the selected limit line and displays it in the **Edit Limit Line** dialog box. If the limit line is edited and saved under a new name, a new limit line can be easily generated by parallel translation or editing of an existing limit line.

For details see also "[Limit Lines](#)" on page 4.85 and "[To create a new limit line based upon an existing limit line](#)" on page 4.84.

This softkey is available from firmware version 1.10.

- Remote: CALC:LIM3:COPY 2
-

Delete

Deletes the selected limit line.

This softkey is available from firmware version 1.10.

- Remote: CALC:LIM3:DEL
-

Display Lines

Opens a submenu to enable, disable and set display lines. Which softkeys are available depends on the display mode (frequency or time range). For details see also "[Display Lines](#)" on page 4.85 and "[To work with display lines](#)" on page 4.81.

Display Line 1 and Display Line 2

Enable or disable the level lines 1/2 and open an edit dialog box to enter the position of the lines. For details see also "[Display Lines](#)" on page 4.85 and "[To work with display lines](#)" on page 4.81.

- Remote: CALC:DLIN:STAT ON
 - Remote: CALC:DLIN -20dBm
-

Frequency Line 1 and Frequency Line 2 (span > 0)

Enable or disable the frequency lines 1/2 and open an edit dialog box to enter the position of the lines. For details see also "[Display Lines](#)" on page 4.85 and "[To work with display lines](#)" on page 4.81.

- Remote: CALC:FLIN:STAT ON
 - Remote: CALC:FLIN 120MHz
-

Time Line 1 and Time Line 2 (zero span)

Enable or disable the time lines 1/2 and open an edit dialog box to enter the position of the lines. For details see also "[Display Lines](#)" on page 4.85 and "[To work with display lines](#)" on page 4.81.

- Remote: CALC:TLIN:STAT ON
 - Remote: CALC:TLIN 10ms
-

Measurement Modes

This section describes the provided measurement modes, the change of measurement modes and the access to the menus of all active measurement modes. For details refer to the following sections:

- ["Measurement Mode Selection – MODE Key"](#) on page 4.91
- ["Measurement Mode Menus – MENU Key"](#) on page 4.93

Measurement Mode Selection – MODE Key

The **MODE** key provides a quick access to the menu of the current measurement mode and a fast change of the measurement mode. You can choose from the following measurement modes:

- [Spectrum Analyzer mode](#)
- [Analog Demodulation mode \(Analog Demodulation option, K7\)](#)
- [Bluetooth mode \(Bluetooth Measurements option, K8\)](#)
- [Cable TV Analyzer mode \(Cable TV Measurements option, K20\)](#)
- [WLAN mode \(WLAN TX Measurements option, K91\)](#)
- [WiMAX mode \(WiMAX 802.16 OFDM Measurements option, K92\)](#)

To change the measurement mode

1. Press the **MODE** key.
The menu of the current measurement mode is displayed and the **Measurement Modes** dialog box is opened.
2. To activate another mode, select the corresponding option and press the **CHECKMARK** key. More than one measurement mode can be activated simultaneously.
3. To deactivate an activated mode, select the corresponding option and press the **CHECKMARK** key.

Spectrum Analyzer mode

In the **Spectrum Analyzer** mode the functions provided correspond to those of a conventional spectrum analyzer. The analyzer measures the frequency spectrum of the test signal over the selected frequency range with the selected resolution and sweep time, or, for a fixed frequency, displays the waveform of the video signal. This mode is set in the initial configuration.

Analog Demodulation mode (Analog Demodulation option, K7)

The **Analog Demodulation** mode requires an instrument equipped with the corresponding optional software. This mode provides measurement functions for demodulating AM, FM, or PM signals. For details refer to "[Analog Demodulation \(Option K7\)](#)" on page 4.100.

Bluetooth mode (Bluetooth Measurements option, K8)

The **Bluetooth** mode requires an instrument equipped with the corresponding optional software. This mode provides measurements to test the conformity of signal sources to the Bluetooth RF Test Specifications. For details refer to "[Bluetooth Measurements \(Option K8\)](#)" on page 4.118.

Cable TV Analyzer mode (Cable TV Measurements option, K20)

The **Cable TV Analyzer** mode requires an instrument equipped with the corresponding optional software. This mode provides ready-made measurements for analog and digital TV signals where most of the parameters are set automatically. For details refer to "[Cable TV Measurements \(Option K20\)](#)" on page 4.145.

WLAN mode (WLAN TX Measurements option, K91)

The **WLAN** mode requires an instrument equipped with the corresponding optional software. This mode provides Wireless LAN TX measurement functions according to IEEE 802.11 a, b, g and j standards. For details refer to "[WLAN TX Measurements \(Option K91\)](#)" on page 4.189

WiMAX mode (WiMAX 802.16 OFDM Measurements option, K92)

The **WiMAX** mode requires an instrument equipped with the corresponding optional software. This mode provides WiMAX 802.16 OFDM measurement functions according to IEEE standards 802.16. For details refer to "[WiMAX 802.16 OFDM Measurements \(Option K92\)](#)" on page 4.225.

Measurement Mode Menus – MENU Key

The **MENU** key provides a quick access to the menu of the current measurement mode. For details on measurement modes refer to "[Measurement Mode Selection – MODE Key](#)" on page 4.91.

To access the main menu of an active measurement mode

- Press the **MENU** key.

The menu of the current measurement mode is displayed.

If the tracking generator and the power meter are available in the current measurement mode, softkeys for these functions are also provided. In the **Spectrum Analyzer** mode with active acoustic monitoring, the softkey **Marker Demod Volume** to control the volume control for acoustic monitoring is displayed.

Menu and softkey description

- "[Optional softkeys of the menu menu](#)" on page 4.93

To display help to a softkey, press the **HELP** key and then softkey for which you want to display help. To close the help window, press the **ESC** key. For further information refer to section "How to use the Help System".

Optional softkeys of the menu menu

Apart from the softkeys of the current measurement mode, the following optional softkeys are available in the menu menu. It is possible that the basic unit does not provide all these softkeys. If a softkey is only available with a special option, model or (measurement) mode, this information is delivered in the corresponding softkey description.

Menu / Command
Tracking Generator
Power Meter
Marker Demod Volume

Tracking Generator (models 13 and 16)

Displays the menu of the **Tracking Generator** measurement mode. For details refer to "[Tracking Generator \(Models 13 and 16\)](#)" on page 4.95.

Power Meter (option Power Sensor Support, K9)

Displays the menu of the **Power Meter** measurement mode. For details refer to "[Power Meter \(Option K9\)](#)" on page 4.141.

Marker Demod Volume (Spectrum Analyzer mode)

Opens a dialog box to regulate the volume for acoustic monitoring.

Models and Options

This section describes models and firmware options that are not included in the basic unit configuration. If hardware options are controlled via the firmware, the provided softkeys are described in the corresponding menu section. The information, with which special option or model these softkeys are supplied, is delivered in the corresponding softkey description.

A list of all available hardware and firmware options is provided on CD. To check the options your instrument provides, refer to the Quick Start Guide, chapter 2 "Preparing for Use", section "Checking the Furnished Items". For details on models and firmware options refer to the following sections:

- ["Tracking Generator \(Models 13 and 16\)"](#) on page 4.95
- ["Analog Demodulation \(Option K7\)"](#) on page 4.100
- ["Bluetooth Measurements \(Option K8\)"](#) on page 4.118
- ["Power Meter \(Option K9\)"](#) on page 4.141
- ["Cable TV Measurements \(Option K20\)"](#) on page 4.145
- ["WLAN TX Measurements \(Option K91\)"](#) on page 4.189
- ["WiMAX 802.16 OFDM Measurements \(Option K92\)"](#) on page 4.225

Tracking Generator (Models 13 and 16)

During operation the tracking generator emits a signal exactly at the input frequency of the R&S FSL.

The tracking generator can be used in all measurement modes. Acquisition of test setup calibration values (see **Source Cal** softkey) and normalization using these correction values (see **Normalize** softkey) is only possible in the tracking generator measurement mode. For details on measurement modes refer to "[Measurement Mode Selection – MODE Key](#)" on page 4.91.

FFT filters (for details see "[To choose the appropriate filter](#)" on page 4.15) are not available when the tracking generator is active.

For measurements with running tracking generator it is recommended to set the start frequency to 3 x resolution bandwidth in order to meet the data sheet accuracy.

Note: The RF characteristics of some DUTs are especially sensitive concerning the input VSWR. In such cases insertion of 10–20 dB attenuation between the DUT and the tracking generator output is recommended.

To open the tracking generator menu

1. Press the **MENU** key.
2. Press the **Tracking Generator** softkey.
The tracking generator menu is displayed.

Menu and softkey description

- "[Softkeys of the tracking generator menu](#)" on page 4.97

Further information

- "[Transmission measurement](#)" on page 4.96
- "[Reflection measurement](#)" on page 4.96
- "[Calibration mechanism](#)" on page 4.96

Tasks

- [To calibrate for transmission and reflection measurement](#)

To calibrate for transmission and reflection measurement

Prerequisite: The instrument is in tracking generator measurement mode (for details refer to "[Measurement Mode Selection – MODE Key](#)" on page 4.91).

1. Press the **Source Power** softkey to enter the generator output level.
If the tracking generator is off, it is switched on.
2. To enter a constant level offset for the tracking generator, press the **Power Offset** softkey.
3. Press the **Source Cal** softkey to open the submenu for calibration.
4. To record a reference trace for transmission measurement, press the **Cal Trans** softkey.

The recording of the reference trace and the completion of the calibration sweep are indicated by message boxes.

- To record a reference trace for reflection measurement, press the **Cal Refl Short** or **Cal Refl Open** softkey.

The recording of the reference trace and the completion of the calibration sweep are indicated by message boxes.

- Press the **Normalize** softkey to switch on the normalization.
- Press the **Ref Value Position** softkey to display the reference line.
- Press the **Ref Value** softkey to enter a value to shift the reference line.
- Press the **Recall** softkey to restore the settings used for source calibration.

Transmission measurement

This measurement will yield the transmission characteristics of a two-port network. The built-in tracking generator serves as a signal source. It is connected to the input connector of the DUT. The input of the R&S FSL is fed from the output of the DUT. A calibration can be carried out to compensate for the effects of the test setup (e.g. frequency response of connecting cables).



Fig. 4–8: Test setup for transmission measurement

Reflection measurement

Scalar reflection measurements can be carried out by means of a reflection-coefficient measurement bridge.

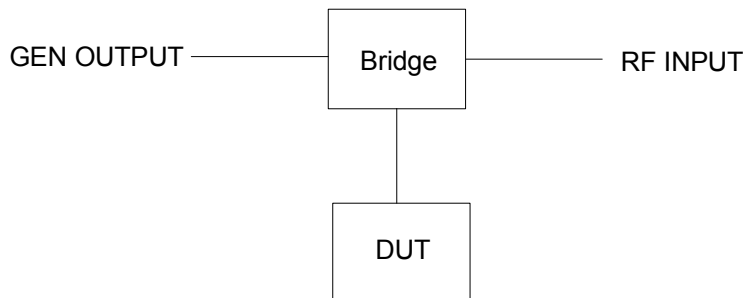

Fig. 4–9: Test setup for reflection measurement

Calibration mechanism

Calibration means a calculation of the difference between the currently measured power and a reference curve, independent of the selected type of measurement (transmission/reflection). The hardware settings used for measuring the reference curve are included in the reference dataset.

Even with normalization switched on, the device settings can be changed in a wide area without stopping the normalization. This reduces the necessity to carry out a new normalization to a minimum.

For this purpose the reference dataset (trace with 501 measured values) is stored internally as a table of 501 points (frequency/level).

Differences in level settings between the reference curve and the current device settings are taken into account automatically. If the span is reduced, a linear interpolation of the intermediate values is applied. If the span increases, the values at the left or right border of the reference dataset are extrapolated to the current start or stop frequency, i.e. the reference dataset is extended by constant values.

An enhancement label is used to mark the different levels of measurement accuracy. This enhancement label is displayed at the right diagram border when normalization is switched on and a deviation from the reference setting occurs. Three accuracy levels are defined:

Table 4–4: Measurement accuracy levels

Accuracy	Enhancement label	Reason/Limitation
high	NOR	no difference between reference setting and measurement
medium	APX (approximation)	change of the following settings: <ul style="list-style-type: none"> • coupling (RBW, VBW, SWT) • reference level, RF attenuation • start or stop frequency • output level of tracking generator • detector (max. peak, min. peak, sample, etc.) change of frequency: <ul style="list-style-type: none"> • max. 501 points within the set sweep limits (corresponds to a doubling of the span)
–	Aborted normalization	more than 500 extrapolated points within the current sweep limits (in case of span doubling)

*Note: At a reference level of –10 dBm and at a tracking generator output level of the same value the R&S FSL operates without overrange reserve, i.e. the R&S FSL is in danger of being overloaded if a signal is applied whose amplitude is higher than the reference line. In this case, either the message **OVL** for overload or **IFOVL** for exceeded display range (clipping of the trace at the upper diagram border = overrange) is displayed in the status line.*

Overloading can be avoided as follows:

- Reducing the output level of the tracking generator (**Source Power** softkey in the tracking generator menu)
- Increasing the reference level (**Ref Level** softkey in the amplitude menu)

Softkeys of the tracking generator menu

The following table shows all softkeys available in the tracking generator menu. It is possible that your instrument configuration does not provide all softkeys. If a softkey is only available with a special option, model or (measurement) mode, this information is delivered in the corresponding softkey description.

Menu / Command	Command
Source On/Off	
Source Power	

Menu / Command	Command
Power Offset	
Source Cal ↓	Cal Trans
	Cal Refl Short
	Cal Refl Open
	Normalize
	Ref Value Position
	Ref Value
	Recall

Source On/Off

Switches the tracking generator on or off. Default setting is off.

→ Remote: `OUTP:STAT ON`

Source Power

Opens an edit dialog box to enter a tracking generator output power. The default output power is -20 dBm. The range is specified in the data sheet.

If the tracking generator is off, it is automatically switched on when an output power value is entered.

→ Remote: `SOUR:POW -20dBm`

Power Offset

Opens an edit dialog box to enter a constant level offset for the tracking generator. Values from -200 dB to +200 dB in 1 dB steps are allowed. The default setting is 0 dB. Offsets are indicated by the enhancement label **LVL**.

With this offset for example attenuators or amplifiers at the output connector of the tracking generator can be taken into account for the displayed output power values on screen or during data entry. Positive offsets apply to an amplifier and negative offsets to an attenuator subsequent to the tracking generator.

→ Remote: `SOUR:POW:OFFS -10dB`

Source Cal

Opens a submenu to configure calibration for transmission and reflection measurement. For details on the test setups see "[Transmission measurement](#)" on page 4.96 and "[Reflection measurement](#)" on page 4.96.

Cal Trans

Starts a sweep that records a reference trace. This trace is used to calculate the difference for the normalized values.

→ Remote: `CORR:METH TRAN`

Cal Refl Short

Starts a sweep as reference trace for short-circuit calibration.

If both calibrations (open circuit, short circuit) are carried out, the calibration curve is calculated by averaging the two measurements and stored in the memory. The order of the two calibration measurements is free.

→ Remote: `CORR:METH REFL`

Cal Refl Open

Starts a sweep as reference trace the open-circuit calibration.

If both calibrations (open circuit, short circuit) are carried out, the calibration curve is calculated by averaging the two measurements and stored in the memory. The order of the two calibration measurements is free.

→ Remote: `CORR:COLL OPEN`

Normalize

Switches the normalization on or off. The softkey is only available if the memory contains a reference trace. For details on normalization see "[Calibration mechanism](#)" on page 4.96.

→ Remote: `CORR ON`

Ref Value Position

Switches the reference line on or off. The reference line marks the reference position at which the normalization result (calculated difference with a reference trace) is displayed. For details on the reference line see "[Calibration mechanism](#)" on page 4.96.

→ Remote: `DISP:WIND:TRAC:Y:RPOS 10PCT`

Ref Value

Opens an edit dialog box to enter a position value that shifts the reference line vertically. By default the reference line corresponds to a difference of 0 dB between the currently measured trace and the reference trace.

If, e.g. after a source calibration, a 10 dB attenuation is inserted into the signal path between DUT and R&S FSL input, the measurement trace will be moved by 10 dB down. Entering a reference value of -10 dB will shift the reference line also by 10 dB down and place the measurement trace on the reference line. The deviation from the nominal power level can be displayed with higher resolution (e.g. 1 dB/div). The power is still displayed in absolute values.

→ Remote: `DISP:WIND:TRAC:Y:RVAL -10dB`

Recall

Restores the settings that were used during source calibration. This can be useful if device settings were changed after calibration (e.g. center frequency, frequency deviation, reference level, etc).

→ Remote: `CORR:REC`

Analog Demodulation (Option K7)

The digital signal processing in the R&S FSL, used in the analyzer mode for digital IF filters, is also ideally suited for demodulating AM, FM, or PM signals. The firmware option FSL–K7 provides the necessary measurement functions.

The R&S FSL is equipped with a demodulator that is capable of performing AM, FM, and PM demodulation at a time. Additionally maximum, minimum and average or current values can be obtained parallelly over a selected number of measurements. In order to make it suitable for bursted signals, the demodulator can be configured in terms of pretrigger time, sample rate and record length.

By sampling (digitization) already at the IF and digital down–conversion to the baseband (I/Q), the demodulator achieves maximum accuracy and temperature stability. There is no evidence of typical errors of an analog down–conversion and demodulation like AM to FM conversion and vice versa, deviation error, frequency response or frequency drift at DC coupling.

This option is available from firmware version 1.10.

To open the analog demodulation menu

- If the **Analog Demodulation** mode is not the active measurement mode, press the **MODE** key and activate the **Analog Demodulation** option.
- If the **Analog Demodulation** mode is already active, press the **MENU** key.

The analog demodulation menu is displayed. If the tracking generator (models 13 and 16) or the power meter (option Power Sensor Support, K9) is available, softkeys for these functions are also provided.

Menu and softkey description

- ["Softkeys of the analog demodulation menu"](#) on page 4.103
- ["Softkeys of the frequency menu \(Analog Demodulation mode\)"](#) on page 4.110
- ["Softkeys of the span menu \(Analog Demodulation mode\)"](#) on page 4.112
- ["Softkeys of the amplitude menu \(Analog Demodulation mode\)"](#) on page 4.113
- ["Softkeys of the bandwidth menu \(Analog Demodulation mode\)"](#) on page 4.115
- ["Softkeys of the sweep menu \(Analog Demodulation mode\)"](#) on page 4.115
- ["Softkeys of the trigger menu \(Analog Demodulation mode\)"](#) on page 4.116

Apart from the power measurement menu that is not available in the **Analog Demodulation** mode, all other menus are provided as described for the base unit. For details refer to the corresponding menu descriptions.

Further information

- ["Circuit description – block diagrams"](#) on page 4.101
- ["Demodulation bandwidth"](#) on page 4.102
- ["AF trigger"](#) on page 4.102
- ["Stability of measurement results"](#) on page 4.102
- ["Sample rate, measurement time and trigger offset"](#) on page 4.103

Circuit description – block diagrams

The software demodulator runs on the main processor of the analyzer. The demodulation process is shown in Fig. 4–10: Block diagram of software demodulator. All calculations are performed simultaneously with the same I/Q data set. Magnitude (= amplitude) and phase of the complex I/Q pairs are determined. The frequency result is obtained from the differential phase.

For details on the analyzer signal processing refer to chapter "Remote Control – Commands", section "TRACe:IQ Subsystem".

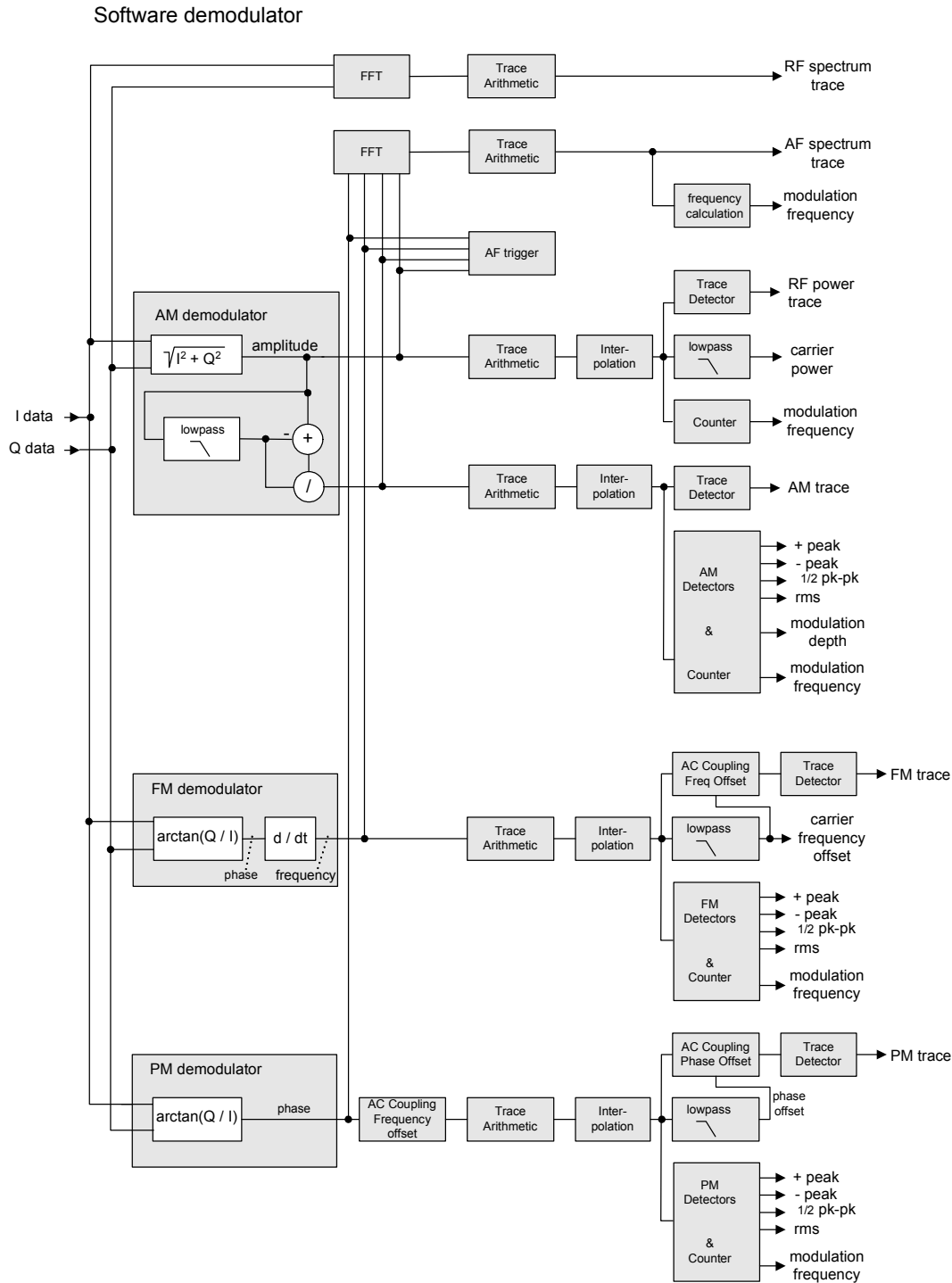

Fig. 4–10: Block diagram of software demodulator

The AM DC, FM DC and PM DC raw data of the demodulators is fed into the *Trace Arithmetic* block that combines consecutive data sets. Possible trace modes are: Clear Write, Max Hold, Min Hold and Average (for details refer to chapter "Instrument Functions", section "Trace mode overview"). The output data of the *Trace Arithmetic* block can be read via remote control.

The collected measurement points are evaluated by the selected detector (for details refer to chapter "Instrument Functions", section "Detector overview"). The result is displayed on the screen and can be read out via remote control.

In addition, important parameters are calculated:

- A counter determines the modulation frequency for AM, FM, and PM.
- A low pass filter suppresses the modulation frequency; the result is:
average power = carrier power (RF power)
average frequency = carrier frequency offset (FM)
The deviation from the selected center frequency is displayed.
- AC coupling is possible with FM and PM display. The carrier frequency offset is subtracted from the FM DC data, and the frequency deviation is determined from the trace data. +Peak, –Peak, $\frac{1}{2}$ Peak–Peak and RMS are displayed.

Demodulation bandwidth

The demodulation bandwidth is not the 3 dB bandwidth but the useful bandwidth which is distortion–free with regard to phase and amplitude.

Therefore the following formulas apply:

- AM: demodulation bandwidth $\geq 2 \times$ modulation frequency
- FM: demodulation bandwidth $\geq 2 \times$ (frequency deviation + modulation frequency)
- PM: demodulation bandwidth $\geq 2 \times$ modulation frequency $\times (1 + \text{phase deviation})$

Note: If the center frequency of the analyzer is not set exactly to the signal frequency, the demodulation bandwidth must be selected larger by the carrier offset, in addition to the requirement described above. This also applies if FM or PM AC coupling has been selected.

In general, the demodulation bandwidth should be as narrow as possible to improve the S/N ratio. The residual FM caused by noise floor and phase noise increases dramatically with the bandwidth, especially with FM.

AF trigger

The analog demodulation option allows triggering to the demodulated signal. The display is stable if a minimum of five modulation periods are within the recording time.

Triggering is always DC–coupled. Therefore triggering is possible directly to the point where a specific carrier level, phase or frequency is exceeded or not attained.

Stability of measurement results

Despite amplitude and frequency modulation, the display of carrier power and carrier frequency offset is stable.

This is achieved by a digital filter which sufficiently suppresses the modulation, provided, however, that the measurement time is $\geq 3 \times 1 / \text{modulation frequency}$, i.e. that at least three periods of the AF signal are recorded.

The mean carrier power for calculating the AM is also calculated with a digital filter that returns stable results after a measurement time of $\geq 3 \times 1 / \text{modulation frequency}$, i.e. at least three cycles of the AF signal must be recorded before a stable AM can be shown.

Sample rate, measurement time and trigger offset

Depending on the sample rate, the maximum demodulation bandwidths listed in the table can be obtained during the measurement. The permissible value range of the measurement time and trigger offset depends on the selected demodulation bandwidth. If the AF filter or the AF trigger are not active, the measurement time enlarges by 20%.

Demod. bandwidth	Sample rate	Measurement time			Trigger offset	
		Min.	Max. with AF filter or AF trigger active	Max. with AF filter and AF trigger deactive	Min.	Max.
18 MHz	32 MHz	31.25 ns	12.5 ms	15 ms	-12.5 ms	507.9 ms
10 MHz	32 MHz	31.25 ns	12.5 ms	15 ms	-12.5 ms	507.9 ms
8 MHz	16 MHz	62.5 ns	25 ms	30 ms	-25 ms	1.015 s
5 MHz	8 MHz	125 ns	50 ms	60 ms	-50 ms	2.031 s
3 MHz	4 MHz	250 ns	100 ms	120 ms	-100 ms	4.063 s
1.6 MHz	2 MHz	500 ns	200 ms	240 ms	-200 ms	8.126 s
800 kHz	1 MHz	1 μ s	400 ms	480 ms	-400 ms	16.25 s
400 kHz	500 kHz	2 μ s	800 ms	960 ms	-800 ms	32.50 s
200 kHz	250 kHz	4 μ s	1.6 s	1.92 s	-1.6 s	65.00 s
100 kHz	125 kHz	8 μ s	3.2 s	3.84 s	-3.2 s	130.0 s
50 kHz	62.5 kHz	16 μ s	6.4 s	7.68 s	-6.4 s	260.0 s
25 kHz	31.25 kHz	32 μ s	12.8 s	15.36 s	-12.8 s	520.0 s
12.5 kHz	15.625 kHz	64 μ s	25.6 s	30.72 s	-25.6 s	1040 s
6.4 kHz	7,8125 kHz	128 μ s	51.2 s	61.44 s	-51.2 s	2080 s
3.2 kHz	3,90625 kHz	256 μ s	102.4 s	122.88 s	-102.4 s	4160 s
1.6 kHz	1,953125 kHz	512 μ s	204.8 s	245.76 s	-204.8 s	8321 s
800 Hz	976,5625 Hz	1.024 ms	409.6 s	491.52 s	-409.6 s	16643 s
400 Hz	488,28125 Hz	2.048 ms	819.2 s	983.04 s	-819.2 s	33287 s
200 Hz	244,140625 Hz	4.096 ms	1638.4 s	1966.08 s	-1638.4 s	66574 s
100 Hz	122,0703125 Hz	8.192 ms	3276.8 s	3932.16 s	-3276.8 s	133148 s

Softkeys of the analog demodulation menu

The following table shows all softkeys available in the analog demodulation menu. It is possible that your instrument configuration does not provide all softkeys. If a softkey is only available with a special option, model or (measurement) mode, this information is delivered in the corresponding softkey description.

For the description of the tracking generator and power meter menus refer to "[Optional softkeys of the menu menu](#)" on page 4.93.

Menu / Command	Submenu / Command	Command
Modulation AM/FM/PM		
Result Display	AF Time Domain	
	AF Spectrum	
	RF Time Domain	
	RF Spectrum	
	Select Trace	
	Diagram Full Size	
Demod BW		
Meas Time		
AF Range ↓	Dev per Division/dB per Division	
	Reference Position	
	Reference Value	
	Deviation Lin/Log	
Demod Settings ↓	AF Coupling AC/DC	
	AF Filter ↓	Low Pass AF Filter
		High Pass AF Filter
		Deemphasis
	Zero Phase Reference Point	
	Phase Wrap On/Off	
	Phase Unit Rad/Deg	
More ↓		
Zoom		

Modulation AM/FM/PM

Selects the display of demodulated AM, FM, or PM signal. In single sweep mode, the data is determined from the current I/Q data set, i.e. a change to AM/FM/PM does not trigger a new measurement.

If FM is selected, the average value of the demodulated signal is mapped depending on the **AF Coupling AC/DC** softkey setting.

→ Remote: CALC:FEED 'XTIM:FM'

Result Display

Opens a submenu to select the measurement result to be displayed. The RF or AF signal in the zero span or the RF or AF frequency spectrum determined via FFT can be selected for display.

In order to display the measurement results, the screen is divided in two halves. In the upper half, the measurement results are displayed as a trace. In the lower half the results of additional evaluation functions are shown.

All displays are determined from the I/Q data set recorded for the measurement. In single sweep mode, the single data set recorded can be evaluated in all displays simply by switching the result display.

AF Time Domain

Selects the AF display in zero span, calculated from the AM, FM, or PM signal.

→ Remote: `CALC:FEED 'XTIM:FM'`

AF Spectrum

Selects the display of the AF spectrum. The AF spectrum can be calculated from the AM, FM, or PM signal in zero span.

→ Remote: `CALC:FEED 'XTIM:FM:AFSP'`

RF Time Domain

Selects the display of the RF signal in zero span. In contrast to normal analyzer operation, the level values are determined from the recorded I/Q data set as root-mean-square values.

The softkey is not available if the RF spectrum display is selected.

→ Remote: `CALC:FEED 'XTIM:RFP'`

RF Spectrum

Selects the display of the RF signal in span > 0. In contrast to normal spectrum analyzer operation, the measured values are determined using FFT from the recorded I/Q data set.

→ Remote: `CALC:FEED 'XTIM:SPECTRUM'`

Select Trace

Opens an edit dialog box to enter the number of the trace for which the data is to be displayed in the lower half of the screen. Only activated traces can be selected.

Diagram Full Size

Switches the diagram to full screen size.

→ Remote: `DISP:SIZE LARG`

Demod BW

Opens an edit dialog box to enter the demodulation bandwidth of the analog demodulation. The demodulation bandwidth determines the sampling rate for recording the signal to be analyzed. For details on the relation between demodulation bandwidth and sampling rate refer to "[Sample rate, measurement time and trigger offset](#)" on page 4.103.

→ Remote: `SENS:BAND:DEM 10MHZ`

Meas Time

Opens an editor for entering the measurement time of the analog demodulation. For details on the measurement time values refer to "[Sample rate, measurement time and trigger offset](#)" on page 4.103.

- Remote: SENS:ADEM:MTIM 62.5US
 - Remote: SENS:SWE:TIME 62.5US
-

AF Range

Opens a submenu for determining the diagram scaling for AF displays.

The range for RF displays is set via the amplitude menu. For details refer to "[Setting the Level Display and Configuring the RF Input – AMPT Key](#)" on page 4.12.

Dev per Division

Opens an edit dialog box to set the modulation depth or the phase or frequency deviation per division:

- AM display: 0.0001% to 1000%
- FM display: 1 Hz/div to 1 MHz/div
- PM display: 0.0001 rad/div to 1000 rad/div

The softkey is not available if logarithmic display is set (**Deviation Lin/Log** softkey).

- Remote: DISP:WIND:TRAC:Y:PDIV 50kHz
-

dB per Division

Opens an edit dialog box to set the modulation depth or the FM or PM deviation to be displayed in the range 0.1 dB/div to 20 dB/div.

The softkey is not available if linear display is set (**Deviation Lin/Log** softkey).

- Remote: DISP:TRAC:Y:PDIV 5DB
-

Reference Position

Determines the position of the reference line for the modulation depth or the phase or frequency deviation on the y axis of the diagram. By default, this line is set to 0.

The position is entered as a percentage of the diagram height with 100 % corresponding to the upper diagram border. The default setting is 50 % (diagram center) for the display of the AM, FM, or PM signal, and 100% (upper diagram border) for the AF spectrum display of the AM, FM, or PM signal.

- Remote: DISP:TRAC:Y:RPOS 50PCT
-

Reference Value

Determines the modulation depth or the frequency or phase deviation at the reference line of the y axis. The reference value is set separately for each display of the AM, FM, and PM signal and the AF spectrum of the AM, FM, and PM signal.

- AM/FM/PM signal display

The trace display takes individual frequency/phase offsets into account (in contrast, the **AF Coupling AC/DC** softkey permits automatic correction by the average frequency/phase offset of the signal, and can therefore not be activated simultaneously).

Possible values: 0 and $\pm 10000\%$ (AM), 0 and ± 10 MHz (FM), 0 and ± 10000 rad (PM).

- AF spectrum display of the AM/FM/PM signal

In the default setting, the reference value defines the modulation depth or the FM/PM deviation at the upper diagram border.

Possible values: 0 and 10000% (AM), 0 and 10 MHz (FM), 0 and 10000 rad (PM).

→ Remote: `DISP:TRAC:Y:RVAL 0HZ`

Deviation Lin/Log

Switches between logarithmic and linear display of the modulation depth or the frequency or phase deviation.

→ Remote: `DISP:TRAC:Y:SPAC LOG`

Demod Settings

Opens a submenu for the demodulation settings.

AF Coupling AC/DC

Controls the automatic correction of the frequency offset and phase offset of the input signal:

- FM signal display

If DC is selected, the absolute frequency is displayed, i.e. an input signal with an offset relative to the center frequency is not displayed symmetrically with respect to the zero line.

If AC is selected, the frequency offset is automatically corrected, i.e. the trace is always symmetric with respect to the zero line.

- PM signal display

If DC is selected, the phase runs according to the existing frequency offset. In addition, the DC signal contains a phase offset of $\pm\pi$.

If AC is selected, the frequency offset and phase offset are automatically corrected, i.e. the trace is always symmetric with respect to the zero line.

The softkey is not available with the AF spectrum display of the FM or PM signal.

→ Remote: `SENS:ADEM:AF:COUP DC`

AF Filter

Opens a submenu to select the appropriate filters. The bandwidth of the demodulated signal can be reduced by high pass or low pass filters and also a de-emphasis can be switched on. The selected filters are used for AM, FM and PM demodulation in common. Individual settings are not possible.

Low Pass AF Filter

Opens the **Low Pass AF Filter** dialog box to select the filter type. Relative and absolute low pass filter are available.

- Relative low pass filters:

The filters (3 dB) can be selected in % of the demodulation bandwidth. The filters are designed as 5th-order Butterworth filter (30 dB/octave) and active for all demodulation bandwidths.

- Absolute low pass filters:

The filter are indicated by the 3 dB cutoff frequency. The 3 kHz and 15 kHz filters are designed as 5th-order Butterworth filter (30 dB/octave). The 150 kHz filter is designed as 8th-order Butterworth filter (48 dB/octave).

The absolute low pass filters are active in the following demodulation bandwidth range:

3 kHz:	$6.4 \text{ kHz} \leq \text{demodulation bandwidth} \leq 4 \text{ MHz}$
15 kHz:	$50 \text{ kHz} \leq \text{demodulation bandwidth} \leq 16 \text{ MHz}$
150 kHz:	$400 \text{ kHz} \leq \text{demodulation bandwidth} \leq 16 \text{ MHz}$

- Remote: SENS:FILT:LPAS
 - Remote: SENS:FILT:LPAS:FREQ
 - Remote: SENS:FILT:LPAS:FREQ:REL
-

High Pass AF Filter

Opens the **High Pass AF Filter** dialog box to switch on a high pass filter with the given limit to separate the DC component. The filters are indicated by the 3 dB cutoff frequency. The filters are designed as 2nd-order Butterworth filter (12 dB/octave).

The high pass filters are active in the following demodulation bandwidth range:

50 Hz:	$200 \text{ Hz} \leq \text{demodulation bandwidth} \leq 4 \text{ MHz}$
300 Hz:	$800 \text{ Hz} \leq \text{demodulation bandwidth} \leq 16 \text{ MHz}$

- Remote: SENS:FILT:HPAS
 - Remote: SENS:FILT:HPAS:FREQ
-

Deemphasis

Opens the **Deemphasis** dialog box to switch on a deemphasis with the given time constant.

The deemphasis is active in the following demodulation bandwidth range:

25 μ s: 25 kHz \leq demodulation bandwidth \leq 18 MHz

50 μ s: 6.4 kHz \leq demodulation bandwidth \leq 18 MHz

75 μ s: 6.4 kHz \leq demodulation bandwidth \leq 18 MHz

750 μ s: 800 Hz \leq demodulation bandwidth \leq 4 MHz

The following table shows the required demodulation bandwidth for an error less than 0.5 dB up to a maximum AF frequency.

deemphasis	25 μ s	50 μ s	75 μ s	750 μ s
max. AF frequency	25 kHz	12 kHz	8 kHz	800 Hz
required demodulation bandwidth	\geq 200 kHz	\geq 100 kHz	\geq 50 kHz	\geq 6.4 kHz

For higher AF frequencies the demodulation bandwidth must be increased.

- Remote: SENS:FILT:DEMP
 - Remote: SENS:FILT:DEMP:TCON
-

Zero Phase Reference Point

Defines the position at which the phase of the PM–demodulated signal is set to 0 rad. The entry is made with respect to time. In the default setting, the first measured value is set to 0 rad.

This softkey is only available in the PM display with DC coupling.

- Remote: SENS:ADEM:PM:RPO:X 10us
-

Phase Wrap On/Off

Activates/deactivates the phase wrap.

On The phase will be displayed in the range $\pm 180^\circ$ ($\pm \Pi$). For example, if the phase exceeds $+180^\circ$, 360° is subtracted from the phase value, with the display thus showing $>-180^\circ$.

Off The phase will not be wrapped.

This softkey is available in the PM signal displays.

- Remote: CALC:FORM PHAS
-

Phase Unit Rad/Deg

Sets the phase unit to rad or deg for displaying PM signals.

- Remote: UNIT:ANGL RAD
-

Zoom

Activates or deactivates the zoom function. The zoom function is not available if the number of measurement points falls below 501.

activated: A 1-to-1 allocation is selected, i.e. each measurement point corresponds to a measured value. The start of the zoom window can be determined in the associated field by entering the time.

deactivated: If more measured values than measurement points are available, several measured values are combined in one measurement point according to the method of the selected trace detector. For details on detectors refer to "[Detector overview](#)" on page 4.36.

→ Remote: ADEM:ZOOM ON

→ Remote: ADEM:ZOOM:START 30US

Softkeys of the frequency menu (Analog Demodulation mode)

The following table shows all softkeys available in the frequency menu in **Analog Demodulation** mode (**FREQ** key). It is possible that your instrument configuration does not provide all softkeys. If a softkey is only available with a special option, model or (measurement) mode, this information is delivered in the corresponding softkey description.

Menu / Command	Command
Center	
CF Stepsize↓	0.1*Span/0.1*Demod BW
	0.5*Span/0.5*Demod BW
	x*Span/x*Demod BW
	=Center
	Manual
AF Center	
AF Start	
AF Stop	

Center

For details refer to the **Center** softkey in the frequency menu of the base unit.

CF Stepsize

For details refer to the **CF Stepsize** softkey in the frequency menu of the base unit.

0.1*Span (RF Spectrum)

For details refer to the **0.1*Span** softkey in the frequency menu of the base unit.

0.1*Demod BW (AF/RF Time Domain, AF Spectrum)

For details see **0.1*RBW** softkey in the frequency menu of the base unit.

0.5*Span (RF Spectrum)

For details refer to the **0.5*Span** softkey in the frequency menu of the base unit.

0.5*Demod BW (AF/RF Time Domain, AF Spectrum)

For details see **0.5*RBW** softkey in the frequency menu of the base unit.

x*Span (RF Spectrum)

For details refer to the **x*Span** softkey in the frequency menu of the base unit.

x*Demod BW (AF/RF Time Domain, AF Spectrum)

For details see **x*RBW** softkey in the frequency menu of the base unit.

=Center

For details refer to the **Center** softkey in the frequency menu of the base unit.

Manual

For details refer to the **Manual** softkey in the frequency menu of the base unit.

AF Center (AF Spectrum)

Opens an edit box to enter the center frequency within the AF spectrum.

→ Remote: ADEM:AF:CENT 1MHZ

AF Start

Opens an edit box to define the start frequency within the AF spectrum.

→ Remote: ADEM:AF:STAR 0HZ

AF Stop

Opens an edit box to define the stop frequency within the AF spectrum.

The maximum AF stop frequency corresponds to half the demodulation bandwidth.

→ Remote: ADEM:AF:STOP 2MHZ

Softkeys of the span menu (Analog Demodulation mode)

The following table shows all softkeys available in the span menu in **Analog Demodulation** mode (**SPAN** key). It is possible that your instrument configuration does not provide all softkeys. If a softkey is only available with a special option, model or (measurement) mode, this information is delivered in the corresponding softkey description.

Command
Span Manual/AF Span Manual
Demod Bandwidth
Full Span/AF Full Span

Span Manual (RF Spectrum)

If the RF spectrum display is active, values between the sampling rate/200 and the demodulation bandwidth/2 are allowed.

For further details refer to the **Span Manual** softkey in the span menu of the base unit.

→ Remote: ADEM:SPEC:SPAN:ZOOM 5 MHz

AF Span Manual (AF Spectrum)

Opens an edit dialog box to enter the frequency range for the AF spectrum display. Values between the sampling rate/1000 and the demodulation bandwidth/2 are allowed.

→ Remote: ADEM:AF:SPAN 2.5 MHz

Demod Bandwidth

For details see **Demod BW** softkey in the analog demodulation menu.

Full Span (RF Spectrum)

If the RF spectrum display is active, the full frequency range corresponds to the demodulation bandwidth.

For further details refer to the **Full Span** softkey in the span menu of the base unit.

→ Remote: ADEM:SPEC:SPAN:ZOOM MAX

AF Full Span (AF Spectrum)

Sets the span to the maximum frequency range for the AF spectrum display. The maximum frequency range corresponds to the demodulation bandwidth.

→ Remote: ADEM:AF:SPAN:FULL

Softkeys of the amplitude menu (Analog Demodulation mode)

The following table shows all softkeys available in the amplitude menu in **Analog Demodulation** mode (**AMPT** key). It is possible that your instrument configuration does not provide all softkeys. If a softkey is only available with a special option, model or (measurement) mode, this information is delivered in the corresponding softkey description.

Menu / Command	Command
Ref Level	
Range Log/Range Linear	
AF Range ↓	Dev per Division/dB per Division
	Reference Position
	Reference Value
	Deviation Lin/Log
Preamp On/Off	
RF Atten Manual	
RF Atten Auto	
More ↓	
Ref Level Offset	
Ref Level Position	
Grid Abs / Rel	
Unit	
Input 50 Ω / 75 Ω	

Ref Level

For details refer to the **Ref Level** softkey in the amplitude menu of the base unit.

Range Log (RF result display)

This softkey is only available for the RF result display. For the RF result display, the **AF Range** softkey is used.

For details refer to the **Range Log** softkey in the amplitude menu of the base unit.

Range Linear (RF result display)

This softkey is only available for the RF result display. For the RF result display, the **AF Range** softkey is used.

For details refer to the **Range Linear** softkey in the amplitude menu of the base unit.

AF Range (AF result display)

For details refer to the **AF Range** softkey in the analog demodulation menu.

Dev per Division

For details refer to the **Dev per Division** softkey in the analog demodulation menu.

dB per Division

For details refer to the **dB per Division** softkey in the analog demodulation menu.

Reference Position

For details refer to the **Reference Position** softkey in the analog demodulation menu.

Reference Value

For details refer to the **Reference Value** softkey in the analog demodulation menu.

Deviation Lin/Log

For details refer to the **Deviation Lin/Log** softkey in the analog demodulation menu.

Preamp On/Off (option RF Preamplifier, B22)

For details refer to the **Preamp On/Off** softkey in the amplitude menu of the base unit.

RF Atten Manual

For details refer to the **RF Atten Manual** softkey in the amplitude menu of the base unit.

RF Atten Auto

For details refer to the **RF Atten Auto** softkey in the amplitude menu of the base unit.

Ref Level Offset

For details refer to the **Ref Level Offset** softkey in the amplitude menu of the base unit.

Ref Level Position

For details refer to the **Ref Level Position** softkey in the amplitude menu of the base unit.

Grid Abs / Rel (not available with Range Linear)

For details refer to the **Grid Abs / Rel** softkey in the amplitude menu of the base unit.

Unit (PM AF result display)

For details refer to the **Unit** softkey in the amplitude menu of the base unit.

Input 50 Ω / 75 Ω

For details refer to the **Input 50 Ω / 75 Ω** softkey in the amplitude menu of the base unit.

Softkeys of the bandwidth menu (Analog Demodulation mode)

The following table shows all softkeys available in the bandwidth menu in **Analog Demodulation** mode (**BW** key). It is possible that your instrument configuration does not provide all softkeys. If a softkey is only available with a special option, model or (measurement) mode, this information is delivered in the corresponding softkey description.

Command
Res BW
Demod BW
Meas Time

Res BW (span > 0)

Opens an edit dialog box to enter a value for the resolution bandwidth.

→ Remote: ADEM:SPEC:BAND:RES 10 kHz

Demod BW

For details refer to the **Demod BW** softkey in the in the analog demodulation menu.

Meas Time

For details refer to the **Meas Time** softkey in the in the analog demodulation menu.

Softkeys of the sweep menu (Analog Demodulation mode)

The following table shows all softkeys available in the sweep menu in **Analog Demodulation** mode (**SWEEP** key). It is possible that your instrument configuration does not provide all softkeys. If a softkey is only available with a special option, model or (measurement) mode, this information is delivered in the corresponding softkey description.

Command
Continuous Sweep
Single Sweep
Continue Sgl Sweep
Meas Time
Sweep Count

Continuous Sweep

For details refer to the **Continuous Sweep** softkey in the in the sweep menu of the base unit.

Single Sweep

For details refer to the **Single Sweep** softkey in the in the sweep menu of the base unit.

Continue Sgl Sweep

For details refer to the **Continue Single Sweep** softkey in the in the sweep menu of the base unit.

Meas Time

For details refer to the **Meas Time** softkey in the in the analog demodulation menu.

Sweep Count

For details refer to the **Sweep Count** softkey in the in the sweep menu of the base unit.

Softkeys of the trigger menu (Analog Demodulation mode)

The following table shows all softkeys available in the trigger menu in **Analog Demodulation** mode (**TRIG** key). It is possible that your instrument configuration does not provide all softkeys. If a softkey is only available with a special option, model or (measurement) mode, this information is delivered in the corresponding softkey description.

Command
Trigger Source
Trigger Level
Trigger Polarity Pos/Neg
Trigger Offset

Trigger Source

Opens the **Trigger** dialog box to select the trigger mode. Additional to the trigger modes described in section "[Trigger mode overview](#)" on page 4.26, the following trigger modes are available:

Selected option	Specified threshold
AM (Offline)	modulation depth of the AM signal
FM (Offline)	frequency of the FM signal
PM (Offline)	phase of the PM signal
RF (Offline)	level of the RF signal

In **Analog Demodulation** mode, the next measurement is triggered if the selected input signal exceeds the threshold specified using the **Trg / Gate Level** softkey. A periodic signal modulated onto the carrier frequency can be displayed in this way. It is recommended that the measurement time covers at least five periods of the audio signal.

For further details refer to the **Trg / Gate Source** softkey in the trigger menu.

- Remote: TRIG:SOUR IMM | IFP | EXT | FM | PM | AM | RF (Free Run, IF Power, Extern, FM (Offline), PM (Offline), AM (Offline), RF (Offline))
-

Trigger Level

For details refer to the **Trg / Gate Level** softkey in the in the trigger menu of the base unit.

Trigger Polarity Pos/Neg

For details refer to the **Trg / Gate Polarity Pos/Neg** softkey in the in the trigger menu of the base unit.

Trigger Offset

For details on the relation between demodulation bandwidth (option Analog Demodulation, R&S FSL–K7) and trigger offset refer to "[Sample rate, measurement time and trigger offset](#)" on page 4.103.

For details refer to the **Trigger Offset** softkey in the in the trigger menu of the base unit.

Bluetooth Measurements (Option K8)

This option provides measurements to test the conformity of signal sources to the Bluetooth RF Test Specification (Bluetooth SIG). For background information on Bluetooth measurements refer to chapter 2, "Advanced Measurement Examples".

This option is available from firmware version 1.30.

To open the Bluetooth menu

- If the **Bluetooth** mode is not the active measurement mode, press the **MODE** key and activate the **Bluetooth** option.
- If the **Bluetooth** mode is already active, press the **MENU** key.
The Bluetooth menu is displayed. .

Menu and softkey description

- ["Softkeys of the Bluetooth menu"](#) on page 4.122
- ["Softkeys of the frequency menu \(Bluetooth mode\)"](#) on page 4.127
- ["Softkeys of the amplitude menu \(Bluetooth mode\)"](#) on page 4.128
- ["Softkeys of the bandwidth menu \(Bluetooth mode\)"](#) on page 4.130
- ["Softkeys of the sweep menu \(Bluetooth mode\)"](#) on page 4.132
- ["Softkeys of the trigger menu \(Bluetooth mode\)"](#) on page 4.136
- ["Softkeys of the measurement menu \(Bluetooth mode\)"](#) on page 4.136

The span menu is not available in the **Bluetooth** mode. All other menus are provided as described for the base unit. For details refer to the corresponding menu descriptions.

Further information

- ["Position of a Bluetooth burst"](#) on page 4.120
- ["Labels used in the measurement displays"](#) on page 4.120

Tasks

- [To adapt the settings to the characteristics of the DUT](#)

Measurements overview

The Bluetooth Measurements option provides the following measurement types:

- ["Output Power"](#) on page 4.120
- ["Adjacent Channel Power"](#) on page 4.121
- ["Modulation Characteristics"](#) on page 4.121
- ["Initial Carrier Frequency Tolerance"](#) on page 4.121
- ["Carrier Frequency Drift"](#) on page 4.121
- ["Relative Transmit Power \(EDR\)"](#) on page 4.122
- ["In-band Spurious Emissions \(EDR\)"](#) on page 4.122

- "Carrier Frequency Stability and Modulation Accuracy (EDR)" on page 4.122
- "Differential Phase Encoding (EDR)" on page 4.122

The basic parameter settings are described in section "To adapt the settings to the characteristics of the DUT" on page 4.119. The settings that can be configured individually for each measurement are the following:

- RBW (the IF bandwidth set up for modulation measurements is valid for all measurements)
- VBW
- RBW auto mode
- VBW auto mode
- trace mode
- detector
- sweep count
- sweep time auto mode
- sweep time

They are available in the corresponding menus as soon as the corresponding measurement is selected. Changes to these settings are always related to the selected measurement. The settings defined in the RF Test Specification can thus be modified individually for development or production. By using the start recall function, the individual configuration of the various tests can be preserved over a preset.

To adapt the settings to the characteristics of the DUT

1. Set the spectrum analyzer to its default state.
 - Press **PRESET**.
 - The R&S FSL is set to its default state.
2. Select the Bluetooth operating mode.
 - Press **MODE** key.
 - In the **Measurement Modes** dialog box, select **Bluetooth**.
 - The **Bluetooth** mode is activated and the main menu of the option is displayed.
3. Select the transmit channel.
 - Press **Channel** softkey and enter the desired channel number.
4. Select the packet length.
 - Press **Packet Type** softkey.
 - The list of available packet type is displayed.
 - Select the desired packet length and confirm the selection with **ENTER**.
5. Select the power class of the DUT.
 - Press **Power Class** softkey and enter the power class.
6. Configure the sync settings (LAP).
 - Press **Find Sync** softkey.
 - The submenu menu for configuration of the sync information is displayed.
 - Press **LAP** softkey and enter the lower address part of the Bluetooth device address of the DUT. The sync word used for the sync search will be calculated.

7. Select a measurement.

- Press the **MEAS** key and select the desired measurement in the softkey menu.
- Configure measurement time, measurement control and the number of measurement cycles by pressing the corresponding softkeys. For further information refer to section "[Softkeys of the measurement menu \(Bluetooth mode\)](#)" on page 4.136.

Further information

This section provides background information on measurements and displayed information.

Position of a Bluetooth burst

The RF Test Specification allows different methods to determine the position of a Bluetooth burst:

- The burst is defined by the p0 bit and the automatically determined packet length (**Find Sync On**).
- The burst is defined by the two 3dB points (**Find Sync Off** and **Find Burst On**). The search of the 3dB points is defined in the RF Test Specification as the alternative method compared with the p0 bit method.

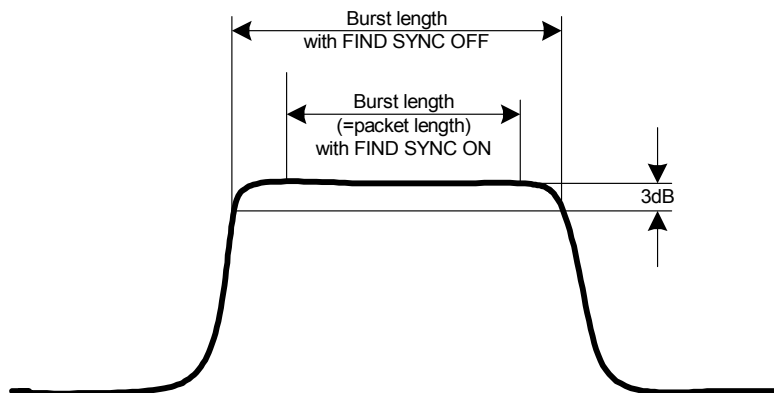

Fig. 4–12 Definition of a Bluetooth burst

Labels used in the measurement displays

- Enhancement label **TDF**

Offset values, set with the **Antenna Gain** softkey that are larger or smaller than 0 dB will activate the enhancement label **TDF** at the right diagram border.

Measurements

In this section, every measurement type is introduced by a short description.

Output Power measurement

The Output Power measurement (**Output Power** softkey) determines the maximum and average output power during a burst of the equipment under test (EUT). For this purpose a complete packet is recorded in the zero span.

The peak value is determined from the complete contents of the measurement curve, whereas the average power is calculated from an area of at least 20% to 80% of the burst.

During the Output Power measurement the Bluetooth demodulator is active in order to determine the sync word within the signal, which is later-on used as the trigger basis. The Bluetooth demodulator is placed in a signal path without video filter. This is why the video filter cannot be activated with the Output Power measurement.

The EUT (equipment under test) must keep the following limits according to the RF Test Specification:

- $P_{AV} < 100 \text{ mW}$ (20 dBm) EIRP
- $P_{PK} < 200 \text{ mW}$ (23 dBm) EIRP
- If the EUT is conforming to power class 1: $P_{AV} > 1 \text{ mW}$ (0 dBm)
- If the EUT is conforming to power class 2: 0.25 mW (–6 dBm) $< P_{AV} < 2.5 \text{ mW}$ (4 dBm)
- If the EUT is conforming to power class 3: $P_{AV} < 1 \text{ mW}$ (0 dBm)

A violation of these limits is marked on the screen in red color.

Adjacent Channel Power measurement

The measurement of the TX Output Spectrum – Adjacent Channel Power measurement (**TX Spec ACP** softkey) measures the power of all adjacent channels.

The following limits are given by the RF Test Specification:

- $P_{TX}(f) \leq -20 \text{ dBm}$ for $|M-N| = 2$
- $P_{TX}(f) \leq -40 \text{ dBm}$ for $|M-N| \geq 3$

with M = Transmit channel of the equipment under test, N = adjacent channel to be measured

A violation of these limits will be marked by red color and an asterisk (*).

Modulation Characteristics measurement

The measurement of the modulation characteristics (**Modulation Char** softkey) determines the maximum frequency deviation of all 8 bit sequences of the payload.

Additionally the average value of the maximum frequency deviation of a packet will be calculated. For this purpose the equipment under test is configured in a way that packets with bit pattern "11110000" and "10101010" are transmitted alternately. According to the RF Test Specification this sequence has to be repeated 10 times.

Initial Carrier Frequency Tolerance measurement

The measurement of the Initial Carrier Frequency Tolerance (**Init Carr Freq Tol** softkey) determines the carrier offset of the four preamble bits. According to the RF Test Specification the calculation of the carrier offset is performed from the middle of the first preamble bit to the middle of the bit following the preamble.

With **Clear/Write** trace mode and single sweep operation the selected number of sweeps will be processed and according to the RF Test Specification the results of all sweeps will be compared with the defined tolerance. If a different trace mode is selected, the analyzer can alternatively combine several traces and determine the measurement results from the resulting trace.

Carrier Frequency Drift measurement

The measurement of the Carrier Frequency Drift (**Carr Freq Drift** softkey) determines the maximum frequency drift between the average value of the preamble bits and any 10 bit group of the payload. Additionally the maximum drift rate between all 10 bit groups in the payload is determined every 50 μ s.

With **Clear/Write** trace mode and single sweep operation the selected number of sweeps will be processed and according to the RF Test Specification the results of all sweeps will be compared with the defined tolerance. If a different trace mode is selected, the analyzer can alternatively combine several traces and determine the measurement results from the resulting trace.

Relative Transmit Power (EDR) measurement

The measurement of the Relative Transmit Power (**Rel TX Power** softkey) is an enhanced data rate measurement (EDR). It determines the average transmission power of the GFSK and DPSK modulated parts of the signal and calculates the ratio of those values.

The measurement results must conform to the requirement:

- $(P_{\text{GFSK}} - 4\text{dB}) < P_{\text{DPSK}} < (P_{\text{GFSK}} + 1\text{dB})$

In-band Spurious Emissions (EDR) measurement

The measurement of the In-band Spurious Emissions (**Spurious Emissions** softkey) is an enhanced data rate measurement (EDR). It verifies whether the level of unwanted signals within the used frequency band lies below the required level. The analyzer records the signal only in those parts of the signal in which the device transmits DPSK-modulated data.

The signal must meet the following conditions:

- $P_{\text{TX}}(f) \leq -20 \text{ dBm}$ for $|M-N| = 2$
- $P_{\text{TX}}(f) \leq -40 \text{ dBm}$ for $|M-N| \geq 3$
with M = transmit channel of the equipment under test, N = adjacent channel to be measured
- $P_{\text{TX}}(f) \leq -26 \text{ dBm}$ in the frequency bands
 $f_{\text{TX}} - 1 \text{ MHz} < f < f_{\text{TX}} - 500 \text{ kHz}$ (Adj500kHz Low)
 $f_{\text{TX}} + 500 \text{ kHz} > f > f_{\text{TX}} + 1 \text{ MHz}$ (Adj500kHz High)

Carrier Frequency Stability and Modulation Accuracy (EDR) measurement

The measurement of the Carrier Frequency Stability and Modulation Accuracy (**Carr Freq Stability** softkey) is an enhanced data rate measurement (EDR). It verifies that the modulation accuracy and the frequency stability are working within the required limits. According to the RF Test Specification, the software records 200 blocks, each with a length of 50 μs for the evaluation. The number of blocks to be recorded can be changed by the softkey **Block Count**.

Differential Phase Encoding (EDR) measurement

The measurement of the Differential Phase Encoding (**Diff Phase** softkey) is an enhanced data rate measurement (EDR). It checks in the time range of the DPSK modulation whether the device modulates the data correctly.

Softkeys of the Bluetooth menu

This menu provides the softkeys for the basic settings, which are common to all tests. The following table shows all softkeys available in the Bluetooth menu. It is possible that your instrument configuration does not provide all softkeys. If a softkey is only available with a special option, model or (measurement) mode, this information is delivered in the corresponding softkey description.

For the description of the tracking generator and power meter menus refer to "[Optional softkeys of the menu menu](#)" on page 4.93.

Menu / Command	Command
Channel	
Packet Type	
Packet Bytes SCO	
Power Class	
Antenna Gain	
Find Sync ↓	Find Sync On/Off
	LAP
	Sync Offset
	Find Burst On/Off
	Burst Offset
	Search Len Auto
	Search Len Manual
More ↓	
Select Trace	
Points / Symbol	

Channel

Opens an edit dialog box to enter the transmission channel number. From the number of the channel the center frequency is calculated in accordance to the RF Test Specification. The default setting is channel number 0.

Setting the channel number is in principle equal to changing the center frequency. The major difference is that the center frequency is not limited to available frequency band values, i.e. values outside the frequency band and between the discrete channels can be selected (see also **Center** softkey in the frequency menu).

→ Remote: CONF:BTO:CHAN 20

Packet Type

Opens a dialog box to select the number of occupied slots in the sent packet. The **AUTO** value is identical to **5 Slot Packet**. The default value is packet type **1 Slot Packet**.

The number of occupied slots is used for the automatic calculation of the sweep time (**SweepTime Auto** softkey) and the search length of the sync word (**Search Len Auto** softkey).

The actually transmitted packet type is determined automatically by the Bluetooth demodulator (which means that the selected packet type need not necessarily correspond to the really transmitted packet type; it will only affect the settings for sweep time and search length as described above).

→ Remote: CONF:BTO:PTYP DH5

Packet Bytes SCO

Opens an edit dialog box to set the number of payload bytes that are transmitted in a packet. For SCO packets, the payload length must be adjusted because those packets have no payload header.

→ Remote: CONF:BTO:PBSC 50

Power Class (Output Power)

Opens an edit dialog box to set one of the Bluetooth power classes (1 to 3). The selection of the power class determines the limits. The default setting is power class 1 (100 mW).

→ Remote: CONF:BTO:PCL 3

Antenna Gain

Opens an edit dialog box to enter a level offset in order to take the gain of an antenna into account for displaying power values. The default setting is 0 dB (see also [Labels used in the measurement displays](#)).

→ Remote: CORR:EGA:INP 10DB

Find Sync

Opens a submenu to set the signal processing functions of the analyzer in order to determine the position of the first preamble bit p0 by correlation with the sync word. For this purpose a sufficient record length of the FM demodulated signal is necessary.

For further information refer to "[Position of a Bluetooth burst](#)" on page 4.120.

Find Sync On/Off

Activates or deactivates the search of the sync word. The default setting is activated.

The results of the modulation measurements [Modulation Characteristics](#), [Initial Carrier Frequency Tolerance](#), [Carrier Frequency Drift](#) can only be calculated when the softkey is activated. The measurement of the [Output Power](#) can be performed with either this softkey or the **Find Burst On/Off** softkey activated. If both softkeys are activated, the search area for the sync word will be limited to the area of the detected burst. If the **Find Burst On/Off** softkey is not activated or no burst is identified, the total record length (search length) is investigated.

For further information refer to "[Position of a Bluetooth burst](#)" on page 4.120.

→ Remote: DDEM:SEAR:SYNC ON

LAP

Opens an edit dialog box to enter the lower 24 bit (Lower Address Part, LAP) of the Bluetooth Device Address (BD_ADDR) of the equipment under test (EUT).

The LAP is used to calculate the 64-bit sync word. The sync word in return is used to determine the start of a packet by correlation and to determine the position of the first preamble bit p0 using the method described in the RF Test Specification.

The values for the lower address part range from 000000h to FFFFFFFh. The default setting is 000000h.

→ Remote: DDEM:SEAR:SYNC:LAP #HA3F45B

Sync Offset

Opens an edit dialog box to define the number of bits to be displayed in front of the of the first preamble bit p0. If the sync word is identified, but the selected measurement time cannot be displayed due to the selected sync offset, the message **SYNC OFFSET INVALID** is displayed.

The value range depends on the search length and the upper limit of symbols (400001 points / symbol). The default setting for the sync offset is 0.

This softkey is only available if the **Find Sync On/Off** softkey is activated.

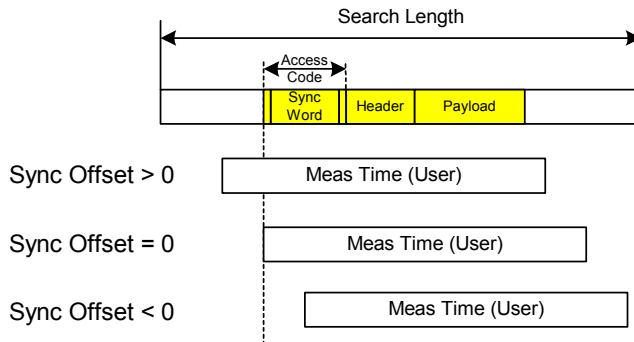

→ Remote: DDEM:SEAR:SYNC:OFFS 10

Find Burst On/Off (Output Power)

Activates the burst search if the **Find Sync On/Off** softkey is deactivated. Beside the synchronization on the sync word, the Output Power measurement can perform a burst search to evaluate the signal according to the standard.

If the **Find Sync On/Off** softkey is not activated and no burst is identified, the message **BURST NOT FOUND** is displayed, and the corresponding bit in the STATus:QUESTionable:SYNC register is set during remote operation.

For further information refer to "[Position of a Bluetooth burst](#)" on page 4.120.

→ Remote: DDEM:SEAR:PULS OFF

Burst Offset

Opens an edit dialog box to define the time to be displayed before the identified burst. The values range from -10 ms to + 10 ms, with negative values moving the burst to the left, positive values to the right. The default setting for the burst offset is 0.

If the burst is identified, but the selected measurement time cannot be displayed due to the selected burst offset, the message **BURST OFFSET INVALID** is displayed.

This softkey is only available if the **Find Sync On/Off** softkey is deactivated and the **Find Burst On/Off** softkey is activated.

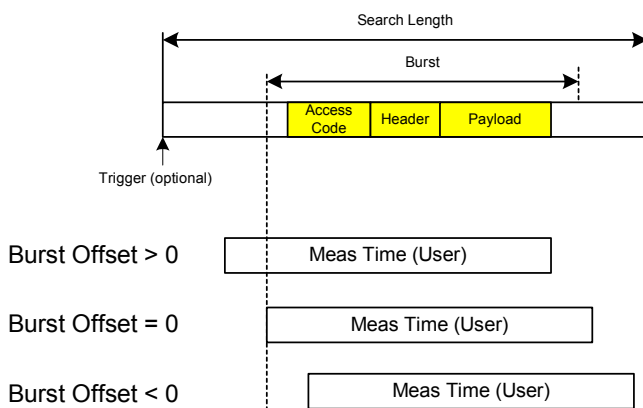

→ Remote: DDEM:SEAR:PULS:OFFS 1MS

Search Len Auto

Activates or deactivates the automatic selection of the search length for the search of the sync word or the burst, depending on the selected packet type. The automatic search length is determined as follows:

Trigger free run:

$$search\ length = 3 * packet\ length + | sync\ offset\ or\ burst\ offset |$$

All other trigger modes:

$$search\ length = 1 * packet\ length + 1\ Slot + | sync\ offset\ or\ burst\ offset |$$

If the selected measurement time is higher than the packet length, the following difference is added to the search length:

$$measurement\ time - packet\ length$$

In the default setting, the automatic calculation of the search length is activated.

→ Remote: DDEM:SEAR:TIME:AUTO OFF

Search Len Manual

Opens an edit dialog box to enter the search length used for determining the sync word or the burst. The unit of the search length is seconds; the values range from 100 μ s to (400001 / points per symbol) μ s. The default setting is 1825 μ s.

The selected number of points / symbol and the maximum search length is listed in the table below.

Points per symbol	Max. search length (number of slots)
2	104.4
4	52.2
8	26.1
16	13.1
32	6.5

For information on the correlation of trigger and record length refer to the **Search Len Auto** softkey.

→ Remote: DDEM:SEAR:TIME 100US

Select Trace

Opens an edit dialog box to select the measurement curve whose numeric results will be displayed in the lower half of the screen. The default curve selected is trace 1.

→ Remote: CONF:BTO:TRAC2:SEL

Points / Symbol
(Output Power, TX Spec ACP, Modulation Char, Init Carr Freq Tol, Carr Freq Drift)

Opens an edit dialog box to change the number of measurement samples per symbol. For Basic Rate measurements, the possible values are 2, 4, 8, 16, 32. The default value is 4. For EDR measurements, the default value is set and cannot be changed.

The RF Test Specification requests an over sampling factor of at least 4. With this over sampling factor a **5 Slot Packet** corresponds to 12500 measurement samples (= 2500 samples / slot).

→ Remote: CONF:BTO:PRAT 16

Softkeys of the frequency menu (Bluetooth mode)

The following table shows all softkeys available in the frequency menu in **Bluetooth** mode (**FREQ** key). It is possible that your instrument configuration does not provide all softkeys. If a softkey is only available with a special option, model or (measurement) mode, this information is delivered in the corresponding softkey description.

Menu / Command	Command
Center	
CF-Stepsize ↓	0.1*Chan Spacing
	= Chan Spacing

Center

Opens an edit dialog box to change the center frequency.

If the frequency channel has been set via the **Channel** softkey, a change of the center frequency is possible, but the relation to the frequency channel will be lost, which means that the value range for the center frequency is not limited to frequencies within valid frequency channels.

The return to the fixed relation between center frequency and Bluetooth frequency channels is performed when **Channel** softkey is pressed or when another measurement is selected. The center frequency will be rounded to the nearest frequency channel.

→ Remote: `FREQ:CENT 100MHz`

CF-Stepsize

Opens a submenu to set the step size of the center frequency.

0.1*Chan Spacing

Sets the step size of the center frequency to 1/10 of the channel spacing.

= Chan Spacing

Sets the step size of the center frequency to the size of the channel spacing.

Softkeys of the amplitude menu (Bluetooth mode)

The following table shows all softkeys available in the amplitude menu in **Bluetooth** mode (**AMPT** key). It is possible that your instrument configuration does not provide all softkeys. If a softkey is only available with a special option, model or (measurement) mode, this information is delivered in the corresponding softkey description.

Menu / Command	Command
Ref Level	
Range ↓	Range
	Reference Position
	Reference Value
	Zoom
Range Log	
Range Linear	
RF Atten Manual	
RF Atten Auto	
More ↓	
Ref Level Offset	
Ref Level Position	
Input 50 Ω / 75 Ω	

Ref Level

The maximum input power of the A/D converter (defined by this value) must be equal or higher than the maximum power of the signal under test.

For details refer to the **Ref Level** softkey in the amplitude menu of the base unit.

Range (Modulation Char, Init Carr Freq Tol, Carr Freq Drift)

Opens a submenu for scaling the x- and y-axis.

Range (Modulation Char, Init Carr Freq Tol, Carr Freq Drift)

Opens an edit dialog box to enter the range for the frequency deviation.

→ Remote: `DISP:TRAC:Y 110dB`

Reference Position (Modulation Char, Init Carr Freq Tol, Carr Freq Drift)

Opens an edit dialog box to enter the position of the reference line for the frequency deviation on the y-axis of the diagram. The unit is % of the diagram height, with 100% corresponding to the upper diagram border.

→ Remote: `DISP:WIND:TRAC:Y:RPOS 50PCT`

Reference Value (Modulation Char, Init Carr Freq Tol, Carr Freq Drift)

Opens an edit dialog box to enter the FM deviation at the reference line on the y-axis. This allows individual frequency offsets to be taken into account for the display of the measurement curves. The valid value range is 0 to ± 1 MHz; the default setting is 0 Hz.

→ Remote: `DISP:TRAC:Y:RVAL 0`

Range Log**(Output Power, TX Spec ACP, Rel TX Power, Spurious Emissions, Carr Freq Stability, Diff Phase)**

For details refer to the **Range Log** softkey in the amplitude menu of the base unit.

Range Linear**(Output Power, TX Spec ACP, Rel TX Power, Spurious Emissions, Carr Freq Stability, Diff Phase)**

For details refer to the **Range Linear** softkey in the amplitude menu of the base unit.

RF Atten Manual

For details refer to the **RF Atten Manual** softkey in the amplitude menu of the base unit.

RF Atten Auto

For details refer to the **RF Atten Auto** softkey in the amplitude menu of the base unit.

Ref Level Offset

For details refer to the **Ref Level Offset** softkey in the amplitude menu of the base unit.

Ref Level Position

For details refer to the **Ref Level Position** softkey in the amplitude menu of the base unit.

Input 50 Ω / 75 Ω

For details refer to the **Input 50 Ω / 75 Ω** softkey in the amplitude menu of the base unit.

Softkeys of the bandwidth menu (Bluetooth mode)

The following table shows all softkeys available in the bandwidth menu in **Bluetooth** mode (**BW** key). It is possible that your instrument configuration does not provide all softkeys. If a softkey is only available with a special option, model or (measurement) mode, this information is delivered in the corresponding softkey description.

Command
Meas Time Manual
Meas Time Auto
Sweeptime Manual
Sweeptime Auto
Res BW Manual
Res BW Auto
Video BW Manual
Video BW Auto
Filter Type
Meas Filter

Meas Time Manual

(Output Power, Modulation Char, Init Carr Freq Tol, Carr Freq Drift, Rel TX Power, Carr Freq Stability, Diff Phase)

Opens an edit dialog box to enter the measurement time. The valid value range is 1 μs to (400001 / points per symbol) μs.

→ Remote: `CONF:BTO:SWE:TIME 10MS`

Meas Time Auto

(Output Power, Modulation Char, Init Carr Freq Tol, Carr Freq Drift, Rel TX Power, Carr Freq Stability, Diff Phase)

Activates the automatic calculation of the measurement time. The automatic sweep time corresponds to the settings defined in the RF Test Specification. By default, the automatic sweep time calculation is activated.

→ Remote: `CONF:BTO:SWE:TIME:AUTO ON`

Sweeptime Manual (TX Spec ACP)

Opens an edit dialog box to enter the sweep time. The valid value range is 10 μ s (minimum measurement time for one channel) to 16000 s. The default setting is 79 s.

→ Remote: `CONF:BTO:SWE:TIME 10MS`

Sweeptime Auto (TX Spec ACP)

Activates the automatic calculation of the sweep time. The automatic sweep time corresponds to the settings defined in the RF Test Specification. By default, it is activated.

→ Remote: `CONF:BTO:SWE:TIME:AUTO ON`

Res BW Manual (Output Power, Rel TX Power)

Opens an edit dialog box to enter the resolution bandwidth. The values range from 1 MHz to 3 MHz. The default value is 3 MHz.

→ Remote: `CONF:BTO:BAND 1KHZ`

Res BW Auto (Output Power, TX Spec ACP, Rel TX Power, Spurious Emissions)

Sets the bandwidth according to the values defined in the RF Test Specification.

→ Remote: `CONF:BTO:BAND:AUTO ON`

Video BW Manual (TX Spec ACP)

The default value is 300 kHz, according to the values defined in the RF Test Specification.

For further details refer to the **Video BW Manual** softkey in the bandwidth menu of the base unit.

→ Remote: `CONF:BTO:BAND:VID 100HZ`

Video BW Auto (TX Spec ACP, Spurious Emissions)

Sets the video bandwidth according to the values defined in the RF Test Specification. In the In-band Spurious Emissions measurement, the video bandwidth is always adjusted automatically. Therefore the softkey is activated by default and its state cannot be changed.

→ Remote: `CONF:BTO:BAND:VID:AUTO ON`

Filter Type (Output Power, TX Spec ACP, Spurious Emissions, Rel TX Power)

Opens the **Filter Type** dialog box to select the filter type. For the measurements Output Power and Rel TX Power, a Gaussian or a channel filter can be selected. For the measurements TX Spec ACP and Spurious Emissions, the filter type is a Gaussian filter.

→ Remote: `BAND:TYPE NORM`

Meas Filter (Modulation Char, Init Carr Freq Tol, Carr Freq Drift)

Activates or deactivates a filter that limits the bandwidth for the modulation measurements. Since the RF Test Specification Rev 2.0.E.3 it is required to use this filter and therefore it is activated by default.

The filter is flat within 1.04 MHz (ripple: only 0.02 dB) and has steep slopes outside this area. The filter has the following characteristics:

- passband ripple up to ± 550 kHz < 0.5 dB (peak to peak)
- minimum attenuation in the transition band
 - ± 650 kHz: ≥ 3 dB
 - ± 1 MHz: ≥ 14 dB
 - ± 2 MHz: ≥ 44 dB

→ Remote: DDEM:FILT:MEAS BTO

Softkeys of the sweep menu (Bluetooth mode)

The following table shows all softkeys available in the sweep menu in **Bluetooth** mode (**SWEEP** key). In the **Bluetooth** mode, the sweep menu is used for direct entry into the measurement menu of the currently selected measurement. It is possible that your instrument configuration does not provide all softkeys. If a softkey is only available with a special option, model or (measurement) mode, this information is delivered in the corresponding softkey description.

Command
Start Test
Continue Test
Continuous Sweep
Single Sweep
Meas Time Manual
Meas Time Auto
Sweeptime Manual
Sweeptime Auto
Block Count
Adjust Gate
Sweep Count
Power Avg Start
Power Avg Stop
Zoom
No. of ACP Chan
Channel List Start
More ↓
Gate Delay
Gate Length
GFSK Start
GFSK Stop
DPSK Start
DPSK Stop

Start Test (Modulation Char)

Initiates a new measurement. All frequency deviation values obtained earlier are discarded.

The bit pattern in the payload is detected automatically. The frequency deviation of a packet is determined according to the procedure defined in the RF Test Specification.

→ Remote: `INIT;*WAI`

Continue Test (Modulation Char)

Measures the frequency deviation of further packets after the bit pattern has been changed at the EUT, just like the **Start Test** softkey did for the first bit pattern type. The results of the preceding measurement are preserved and are taken into account for the new measurements.

→ Remote: `INIT:CONM;*WAI`

Continuous Sweep

Selects the continuous measurement operation. This is the default setting of the instrument.

→ Remote: `INIT:CONT ON;*WAI`

Single Sweep

(Output Power, TX Spec ACP, Init Carr Freq Tol, Carr Freq Drift, Rel TX Power, Spurious Emissions, Carr Freq Stability, Diff Phase)

Selects the single measurement operation and starts a measurement cycle.

→ Remote: `INIT:CONT OFF;*WAI`

Block Count (Carr Freq Stability)

Opens an edit dialog box to enter the number of blocks to be measured. Every block has the length of 50 μ s. The default value is 200 blocks.

This softkey is only available in single sweep operation.

→ Remote: `CONF:BTO:CFST:BCO 1000`

Adjust Gate (Spurious Emissions)

Adjusts the gate settings according to the pre-measurement results.

→ Remote: `CONF:BTO:IBS:GATE:AUTO ONCE`

Sweep Count

(Output Power, TX Spec ACP, Modulation Char, Init Carr Freq Tol, Carr Freq Drift, Rel TX Power, Spurious Emissions, Diff Phase)

Opens an edit dialog box to enter the number of sweeps to be initiated by **Single Sweep** softkey. The valid value range is 0 to 32767.

→ Remote: `CONF:BTO:SWE:COUN 20`

Power Avg Start (Output Power)

Opens an edit dialog box to enter the start position of the evaluation area for the average burst power. The values range from 0 to 100%, the default setting is 20%.

For further information refer to "[Position of a Bluetooth burst](#)" on page 4.120.

→ Remote: CONF:BTO:POW:AVER:STAR 10PCT

Power Avg Stop (Output Power)

Opens an edit dialog box to enter the stop position of the evaluation area for the average burst power. The values range from 0 to 100%, the default setting is 80%.

For further information refer to "[Position of a Bluetooth burst](#)" on page 4.120.

→ Remote: CONF:BTO:POW:AVER:STAR 90PCT

Zoom (Modulation Char, Init Carr Freq Tol, Carr Freq Drift)

Activates or deactivates the zoom function. Opens an edit dialog box to enter the zoom start position. The valid value range for the zoom start position is 0 to (measurement time – 500 / sampling rate). The default setting for the zoom function is 0s (off).

With active zoom function, an area of only 501 samples is displayed.

→ Remote: ADEM:ZOOM ON

→ Remote: ADEM:ZOOM:STAR 500us

No. of ACP Chan (TX Spec ACP, Spurious Emissions)

Opens an edit dialog box to enter the number of adjacent channels, for which the power is to be measured. The values range from 0 to 78. A minimum value of 3 is recommended. The default setting is 78 (all channels).

As with the ACP measurement of the basic instrument firmware this value refers to the number of adjacent channels on one side of the TX channel. This means that with a selected value of 10 the analyzer will measure in total 21 channels (10 lower channels + TX channel + 10 upper channels).

The frequency range required for the measurement is set up automatically. The center frequency will also be adapted automatically dependent on the selected TX channel.

The measurement of the adjacent channels is limited to the available Bluetooth frequency band, which means that at maximum 79 channels (23 channels in France) will be measured.

→ Remote: CONF:BTO:ACLR:ACP 10 (TX Spec ACP)

→ Remote: CONF:BTO:IBS:ACP 20 (Spurious Emissions)

Channel List Start (TX Spec ACP, Spurious Emissions)

Opens an edit dialog box to enter the channel with which the result display table starts. Because of the multiplicity of the measurements results not all channels can be displayed simultaneously.

Gate Delay (Spurious Emissions)

Opens an edit dialog box to enter the time between trigger event and start of the DPSK packet. That is the measurement start time.

→ Remote: SWE:EGAT:HOLD 100us

Gate Length (Spurious Emissions)

Opens an edit dialog box to enter the sweep time in seconds. Usually, this is the length of the DPSK section.

→ Remote: SWE:EGAT:LENG 10ms

GFSK Start (Rel TX Power)

Opens an edit dialog box to enter the start time for the power measurement of the GFSK sections of the packet. The default value is 10%.

The abbreviation GFSK stands for Gaussian Frequency Shift Keying.

→ Remote: CONF:BTO:RTP:GAV:STAR 20

GFSK Stop (Rel TX Power)

Opens an edit dialog box to enter the stop time for the power measurement of the GFSK sections of the packet. The default value is 90%.

The abbreviation GFSK stands for Gaussian Frequency Shift Keying.

→ Remote: CONF:BTO:RTP:GAV:STOP 80

DPSK Start (Rel TX Power)

Opens an edit dialog box to enter the start time for the power measurement of the DPSK sections of the packet. The default value is 10%.

The abbreviation DPSK stands for Differential Phase Shift Keying.

→ Remote: CONF:BTO:RTP:DAV:STAR 20

DPSK Stop (Rel TX Power)

Opens an edit dialog box to enter the stop time for the power measurement of the DPSK sections of the packet. The default value is 90%.

The abbreviation DPSK stands for Differential Phase Shift Keying.

→ Remote: CONF:BTO:RTP:DAV:STOP 80

Softkeys of the trigger menu (Bluetooth mode)

The following table shows all softkeys available in the trigger menu in **Bluetooth** mode (**FREQ** key). It is possible that your instrument configuration does not provide all softkeys. If a softkey is only available with a special option, model or (measurement) mode, this information is delivered in the corresponding softkey description.

Command
Trigger Source
Trg/Gate Level
Trigger Polarity
Trigger Offset

Trigger Source

Opens the **Trigger** dialog box to select one of the following trigger sources: **Free Run**, **External**, **IF Power**.

For further details refer to the **Trg / Gate Source** softkey in the trigger menu of the base unit.

Trg/Gate Level

Opens an edit dialog box to enter the trigger / gate level. This softkey is not available, if the trigger source **Free Run** is selected.

For further details refer to the **Trg / Gate Level** softkey in the trigger menu of the base unit.

Trigger Polarity

For details refer to the **Trg / Gate Polarity Pos/Neg** softkey in the trigger menu of the base unit.

Trigger Offset

For details refer to the **Trigger Offset** softkey in the trigger menu of the base unit.

Softkeys of the measurement menu (Bluetooth mode)

The following table shows all softkeys available in the measurement menu in **Bluetooth** mode (**MEAS** key). It is possible that your instrument configuration does not provide all softkeys. If a softkey is only available with a special option, model or (measurement) mode, this information is delivered in the corresponding softkey description.

In the **Bluetooth** mode, the sweep menu is used for direct entry into the measurement menu of the currently selected measurement. Therefore only the softkeys to select a measurement are described in this section. All other softkeys are linked to the description in section [Softkeys of the sweep menu \(Bluetooth mode\)](#) or [Softkeys of the bandwidth menu \(Bluetooth mode\)](#).

Menu / Command	Submenu / Command	Command	
Output Power	Continuous Sweep		
	Single Sweep		
	Meas Time Manual		
	Meas Time Auto		
	Sweep Count		
	Power Avg Start		
	Power Avg Stop		
TX Spec ACP ↓	Continuous Sweep		
	Single Sweep		
	Sweeptime Manual		
	Sweeptime Auto		
	Sweep Count		
	No. of ACP Chan		
	Channel List Start		
Modulation Char ↓	Start Test		
	Continue Test		
	Continuous Sweep		
	Meas Time Manual		
	Meas Time Auto		
	Sweep Count		
	Zoom		
Init Carr Freq Tol ↓	Continuous Sweep		
	Single Sweep		
	Meas Time Manual		
	Meas Time Auto		
	Sweep Count		
	Zoom		
Carr Freq Drift ↓	see contents of the Init Carr Freq Tol submenu		
EDR ↓	Rel TX Power ↓	Continuous Sweep	
		Single Sweep	
		Meas Time Manual	
		Meas Time Auto	
		Sweep Count	
		More ↓	
		GFSK Start	
		GFSK Stop	
		DPSK Start	
		DPSK Stop	
		Spurious Emissions ↓	Continuous Sweep
			Single Sweep
			Adjust Gate
			Sweep Count

Menu / Command	Submenu / Command	Command
		No. of ACP Chan
		Channel List Start
		More ↓
		Gate Delay
		Gate Length
	Carr Freq Stability ↓	Continuous Sweep
		Single Sweep
		Meas Time Manual
		Meas Time Auto
		Block Count
	Diff Phase ↓	Continuous Sweep
		Single Sweep
		Meas Time Manual
		Meas Time Auto
		Sweep Count

Output Power

Opens a submenu to configure the Output Power measurement. For further details refer to "Output Power measurement" on page 4.120.

- Remote: CONF:BTO:MEAS OPOW
- Remote: CALC:BTO:OPOW?
- Remote: CALC:BTO:OPOW:AVER? MAX

TX Spec ACP

Opens a submenu to configure the TX Spec ACP measurement. For further details refer to "Adjacent Channel Power measurement" on page 4.121.

- Remote: CONF:BTO:MEAS ACLR
- Remote: CALC:BTO:ACLR?
- Remote: CALC:BTO:ACLR:EXC?

Modulation Char

Opens a submenu to configure the Modulation Char measurement. For further details refer to "Modulation Characteristics measurement" on page 4.121.

- Remote: CONF:BTO:MEAS MCH
- Remote: CALC:BTO:MCH:DF1:AVER? MIN
- Remote: CALC:BTO:MCH:DF1:MAX? MIN
- Remote: CALC:BTO:MCH:DF2:PERC?
- Remote: CALC:BTO:MCH:RAT? MIN

Init Carr Freq Tol

Opens a submenu to configure the Init Carr Freq Tol measurement. For further details refer to "[Initial Carrier Frequency Tolerance measurement](#)" on page 4.121.

- Remote: CONF:BTO:MEAS IFCT
 - Remote: CALC:BTO:ICFT? AVER
-

Carr Freq Drift

Opens a submenu to configure the Carr Freq Drift measurement. For further details refer to "[Carrier Frequency Drift measurement](#)" on page 4.121.

- Remote: CONF:BTO:MEAS CFDR
 - Remote: CALC:BTO:CFDR?
 - Remote: CALC:BTO:CFDR:RATE?
-

EDR

Opens a submenu with all available enhanced data rate measurements.

Rel TX Power

Opens a submenu to configure the Rel TX Power measurement. For further details refer to "[Relative Transmit Power \(EDR\) measurement](#)" on page 4.122.

- Remote: CONF:BTO:MEAS RTP
 - Remote: CALC:BTO:RTP? MIN
 - Remote: CALC:BTO:RTP:GFSK? MIN
 - Remote: CALC:BTO:RTP:RAT? MIN
-

Spurious Emissions

Opens a submenu to configure the Spurious Emissions measurement. For further details refer to "[In-band Spurious Emissions \(EDR\) measurement](#)" on page 4.122.

- Remote: CONF:BTO:MEAS IBS
 - Remote: CALC:BTO:IBS?
 - Remote: CALC:BTO:IBS:EXC?
 - Remote: CALC:BTO:IBS:HADJ? LOW
-

Carr Freq Stability

Opens a submenu to configure the Carr Freq Stability measurement. For further details refer to "[Carrier Frequency Stability and Modulation Accuracy \(EDR\) measurement](#)" on page 4.122.

- Remote: CONF:BTO:MEAS CFST
 - Remote: CALC:BTO:CFST:FERR? MIN
 - Remote: CALC:BTO:CFST:FERR:BLOC? AVER
 - Remote: CALC:BTO:CFST:FERR:INIT? MAX
 - Remote: CALC:BTO:CFST:DEVM? AVER
 - Remote: CALC:BTO:CFST:DEVM:PEAK?
 - Remote: CALC:BTO:CFST:DEVM:D99Pct?
 - Remote: CALC:BTO:CFST:COUNt?
-

Diff Phase

Opens a submenu to configure the Diff Phase measurement. For further details refer to "[Differential Phase Encoding \(EDR\) measurement](#)" on page 4.122.

- Remote: CONF:BTO:MEAS DPEN
 - Remote: CALC:BTO:DPEN:NERR?
 - Remote: CALC:BTO:DPEN?
 - Remote: CALC:BTO:DPEN:BER?
-

Power Meter (Option K9)

For precise power measurement a power sensor is connected to the instrument via the front panel (USB connector) or the rear panel (power sensor, option R&S FSL–B5). The Power Sensor Support firmware option provides the power measurement functions for this test setup (see Fig. 4–18: Power sensor support – standard test setup). Both manual control and remote control are supported. The functions of this firmware option are described in this section. For details on the connectors and compatible power sensors refer to the Quick Start Guide, chapter 1, "Front and Rear Panel".

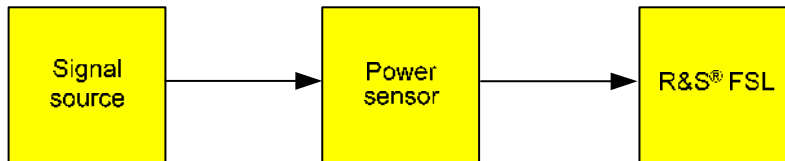

Fig. 4–18: Power sensor support – standard test setup

To open the power meter menu

1. Press the **MENU** key.
2. Press the **Power Meter** softkey.
The power meter menu is displayed.

Menu and softkey description

- ["Softkeys of the power meter menu"](#) on page 4.142

Further information

- ["Power result display"](#) on page 4.142

Tasks

- [To zero the power meter](#)
- [To use the power meter](#)

To zero the power meter

1. Press the **Zero** softkey.
A dialog box is displayed that prompts you to disconnect all signals from the input of the power sensor.
2. Disconnect all signals from the input of the power sensor and press **ENTER** to continue.
3. Wait until zeroing is complete.
A corresponding message is displayed.

To use the power meter

1. Press the **Frequency Coupling** softkey to select the coupling option.
2. If you have selected the **Manual** coupling option, press the **Frequency Manual** softkey to enter the frequency of the signal which power you want to measure.
3. Press the **Unit/Scale** softkey to set the unit for the power result display.

4. If you have selected dB or % as units (relative display), define a reference value:
 - To set the currently measured power as a reference value, press the **Meas→Ref** softkey.
 - To enter a reference value, press the **Reference Value** softkey.
5. Press the **Meas Time** softkey to select the measurement time. For recommendations refer to the **Meas Time** softkey description.
6. Press the **Result Display** softkey to switch between two views of the power measurement display. For more details see also "[Power result display](#)" on page 4.142

Power result display

The result of the power measurement can be displayed in two views. You can switch between these views using the **Result Display** softkey.

- **PWR M** labeled value in the marker field
- split screen mode with the power measurement result displayed in the lower pane in form of a bar graph

Softkeys of the power meter menu

The following table shows all softkeys available in the power meter menu. It is possible that your instrument configuration does not provide all softkeys. If a softkey is only available with a special option, model or (measurement) mode, this information is delivered in the corresponding softkey description.

Command
Power Meter On/Off
Frequency Manual
Frequency Coupling
Unit/Scale
Zero
Meas Time
More ↓
Meas→Ref
Reference Value
Result Display

Power Meter On/Off

Switches the power measurement on or off.

→ Remote: [SENS:] PMET[:STAT] ON

Frequency Manual

Opens an edit dialog box to enter the frequency of the signal to be measured. The power sensor has a memory with frequency-dependent correction factors. This allows extreme accuracy for signals of a known frequency.

→ Remote: [SENSe:] PMET:FREQ 1GHZ

Frequency Coupling

Opens the **Frequency Coupling** dialog box to select the coupling option. The frequency can be coupled automatically to the center frequency of the instrument or to the frequency of marker 1, or manually to a set frequency (see **Frequency Manual** softkey).

→ Remote: [SENS:] PMET:FREQ:LINK CENT

Unit/Scale

Opens the **Unit/Scale** dialog box to select the unit with which the measured power is to be displayed.

If dB or % is selected, the display is relative to a reference value that is defined with either the Meas→Ref softkey or the **Reference Value** softkey.

→ Remote: UNIT:PMET:POW DBM

→ Remote: UNIT:PMET:POW:RAT DB

Zero

Starts zeroing of the power sensor. For details on the zeroing process refer to "[To zero the power meter](#)" on page 4.141.

→ Remote: CAL:PMET:ZERO:AUTO ONCE;*WAI

Meas Time

Opens the **Meas Time** dialog box to select the measurement time. In general, results are more precise with longer measurement times. The following settings are recommended for different signal types to obtain stable and precise results:

Short	Stationary signals with high power (> -40dBm), because they require only a short measurement time and short measurement time provides the highest repetition rates.
Normal	Signals with lower power or of modulated signals
Long	Signals at the lower end of the measurement range (<-50 dBm) or signals with lower power to minimize the influence of noise.

→ Remote: [SENS:] PMET:MTIM LONG

Meas→Ref

Sets the currently measured power as a reference value for the relative display. The reference value can also be set manually via the **Reference Value** softkey.

→ Remote: CALC:PMET:REL[:MAGN]:AUTO ONCE

Reference Value

Opens an edit dialog box to enter a reference value for relative measurements in the unit dBm.

→ Remote: CALC:PMET:REL[:MAGN] -30DBM

Result Display

Switches between two views of the power measurement. For further details refer to "[Power result display](#)" on page 4.142.

→ Remote: DISP[:WIND]:PMET:STAT OFF

Cable TV Measurements (Option K20)

The Cable TV Measurements option provides ready-made measurements for analog and digital TV signals where most of the parameters are set automatically. Thus the measurements can be carried out fast and with a minimum of effort.

Averaging can be applied to the measurement results. If the results are presented in a table, only the values in the table are averaged, not the trace itself. For details refer to "[Setting Traces – TRACE Key](#)" on page 4.33. Measurement specific settings as signal levels, limits etc. are saved using the save / recall function described in section "Instrument Functions – Basic Settings", "Instrument Setup and Interface Configuration – SETUP Key".

This option is available from firmware version 1.30.

To open the Cable TV Analyzer menu

- If the **Cable TV Analyzer** mode is not the active measurement mode, press the **MODE** key and activate the **Cable TV Analyzer** option.
- If the **Cable TV Analyzer** mode is already active, press the **MENU** key.
The Cable TV Analyzer menu is displayed. .

Menu and softkey description

- "[Softkeys of the Cable TV Measurements menu](#)" on page 4.165
- "[Softkeys of the frequency menu \(Cable TV Analyzer mode\)](#)" on page 4.168
- "[Softkeys of the amplitude menu \(Cable TV Analyzer mode\)](#)" on page 4.169
- "[Softkeys of the measurement menu \(Cable TV Analyzer mode\)](#)" on page 4.171

The bandwidth, span, trigger and lines menus are not available in the **Cable TV Analyzer** mode. All other menus are provided as described for the base unit. For details refer to the corresponding menu descriptions.

Further information

- "[Information in the status bar](#)" on page 4.151
- "[Channel tables](#)" on page 4.151
- "[Modulation standards](#)" on page 4.152
- "[Signal level](#)" on page 4.153
- "[Attenuation adjustment](#)" on page 4.153
- "[Labels used in the measurement displays](#)" on page 4.154
- "[Short list of cable TV terms and abbreviations](#)" on page 4.154

Tasks

- "[To edit a channel table](#)" on page 4.147
- "[To create a channel table](#)" on page 4.148
- "[To copy a channel table](#)" on page 4.148
- "[To create a new modulation standard](#)" on page 4.148
- "[To edit a modulation standard](#)" on page 4.149

- ["To copy a modulation standard"](#) on page 4.150
- ["To perform a measurement using a channel table"](#) on page 4.150
- ["To perform a measurement without a channel table"](#) on page 4.150

Measurements overview

All measurements can be performed with or without using a channel table (see also ["To perform a measurement using a channel table"](#) on page 4.150 and ["To perform a measurement without a channel table"](#) on page 4.150). In this section, the measurements are performed using a channel table. For every measurement type, a short introduction is given. For a more detailed description on every measurement type refer to chapter "Advanced Measurement Examples".

The measurements are divided into three groups:

analog TV	Using an analog modulation standard, the measurement of one single channel is performed.
digital TV	Using a digital modulation standard, the measurement of one single channel is performed.
TV analyzer	Measurements on the entire TV network, i.e. several or all channels, are performed.

For detailed information on the softkeys provided for each measurement type, refer to ["Softkeys of the measurement menu \(Cable TV Analyzer mode\)"](#) on page 4.171.

The following measurement types are provided:

- analog TV measurements:
 - ["Spectrum"](#) on page 4.155
 - ["Carriers"](#) on page 4.155
 - ["C/N"](#) on page 4.156
 - ["CSO"](#) on page 4.157
 - ["CTB"](#) on page 4.158
 - ["Video Scope"](#) on page 4.159
 - ["Vision Modulation"](#) on page 4.159
 - ["Hum"](#) on page 4.160
- digital TV measurements:
 - ["Spectrum"](#) on page 4.160
 - ["Overview"](#) on page 4.161
 - ["Constellation Diagram \(Modulation Analysis\)"](#) on page 4.161
 - ["Modulation Errors \(Modulation Analysis\)"](#) on page 4.162
 - ["Echo Pattern \(Channel Analysis\)"](#) on page 4.162
 - ["Channel Power"](#) on page 4.163
 - ["APD"](#) on page 4.163
 - ["CCDF"](#) on page 4.164
- TV analyzer measurement:
 - ["Tilt"](#) on page 4.164

To edit a channel table

1. Press the **Channel Setup** softkey.

The **Channel Tables** dialog box is displayed.

If a measurement is running, the channel table used in the measurement (so-called active channel table) is the channel table in focus. For further details refer also to "[Channel tables](#)" on page 4.151.

2. In the **Channel Tables** dialog box, focus the channel table you want to edit.
3. Press the **Edit** softkey.

The **Channel Table** dialog box and the edit submenu is displayed. Each line in the channel table represents one channel.



The screenshot shows a dialog box titled "Channel Table" with a close button in the top right corner. Below the title bar, there are two text input fields: "Name" containing "TV-AUSTRALIA" and "Description" containing "TV Bands". Below these fields is a table with the following columns: "No.", "Comment", "Modulation Standard", "RF MHz", and "Width MHz". The table contains 14 rows of data, with channel numbers 0 through 107. The "Modulation Standard" for all channels is "<unused>". The "RF MHz" and "Width MHz" values are consistent for each group of channels.

No.	Comment	Modulation Standard	RF MHz	Width MHz
0	VHF 1	<unused>	48.500	7.000
1	VHF 1	<unused>	59.500	7.000
2	VHF 1	<unused>	66.500	7.000
3	VHF 2	<unused>	88.500	7.000
4	VHF 2	<unused>	97.500	7.000
5	VHF 2	<unused>	104.500	7.000
6	VHF 3	<unused>	177.500	7.000
7	VHF 3	<unused>	184.500	7.000
8	VHF 3	<unused>	191.500	7.000
9	VHF 3	<unused>	198.500	7.000
10	VHF 3	<unused>	211.500	7.000
11	VHF 3	<unused>	218.500	7.000
104	Sp Ch lower	<unused>	128.500	7.000
105	Sp Ch lower	<unused>	135.500	7.000
106	Sp Ch lower	<unused>	142.500	7.000
107	Sp Ch lower	<unused>	149.500	7.000

The channels are displayed as they are entered and are not sorted automatically. If you prefer the entries ordered with respect to their channel number, enter the channels accordingly.

4. In the **Name** and **Description** field, edit the name and the description for the channel table via the keypad.

If the name of a channel table is changed, the channel table with the old name is not overwritten but retained, and a new channel table is created additionally.

In the title bar, ***(unsaved changes)** is displayed.

5. To edit an existing channel:
 - In the **No.** and **Comment** column, edit the channel number and a comment for the channel via the keypad.
 - In the **Modulation Standard** column, open the list of all available modulation standards via the **ENTER** key and select a modulation standard from the list. If you want to create, edit or view a

modulation standard, press the **Modulation Options** softkey. For further information refer to "[To create a new modulation standard](#)" on page 4.148.

- In the **RF MHz** column, set an RF value. The RF represents the characteristic frequency of a channel. Its interpretation depends on the modulation standard, e.g. for analog TV. For detailed information refer to the **RF** softkey on page 4.168.

If the modulation standard is changed from an analog to a digital one, the RF frequency is changed automatically. Therefore it is recommended to proceed in the described order, i.e. to set the modulation standard first.

- In the **Width MHz** column, set a width value.

6. To create a new channel:

- Set the focus on a channel and press the **Copy Channel** softkey.
- Change the entries of the channel as desired.

7. To delete a channel, press the **Delete Channel** softkey.

8. To leave the whole channel table without saving the changes, press the **Discard Changes** softkey.

9. To save your changes, press the **Save Changes** softkey.

If the channel table contains invalid entries, an error message is displayed and saving is denied.

To create a channel table

1. In the **Channel Setup** submenu, press the **New** softkey to create a new channel table. For further details refer also to "[Channel tables](#)" on page 4.151.
2. Continue as described in "[To edit a channel table](#)" on page 4.147, step 4.

To copy a channel table

1. Press the **Channel Setup** softkey. For further details refer also to "[Channel tables](#)" on page 4.151.
2. In the **Channel Tables** dialog box, focus the channel table you want to copy.
3. Press the **Copy** softkey.
4. Continue as described in "[To edit a channel table](#)" on page 4.147, step 4.

To create a new modulation standard

1. In the **Channel Setup** submenu, press the **Edit**, **New**, or **Copy** softkey.
2. In the **Modulation Options** submenu, press the **New** softkey.

The **Modulation Standard Options** dialog box is displayed. As soon as you change entries, in the title bar, ***(unsaved changes)** is displayed.

3. Enter a name for the modulation standard. It is recommended to include the TV standard in the name, e.g. XY_DVB-C 16QAM.

If a modulation standard with the entered name already exists, the name is not accepted and a message box is displayed. The input field remains editable.

4. Select the **Signal Type**. Depending on this setting, the fields and entries of the **New Modulation Standard** dialog box are configured. Therefore it is recommended to proceed in the described order.

5. For the **Analog TV** signal type, define the following parameters:

TV standard, sound system, group delay, color system, bar line, quiet line, sideband position. The entries that can be selected may depend on the setting of the previous parameter.

For every parameter a default value is set. Change this setting if necessary.

The screenshot shows the 'Modulation Standard Options' dialog box. The 'Name' field is 'Analog Test'. The 'Signal Type' is 'Analog TV'. The 'TV Standard' is 'B/G'. The 'Sound System' is 'FM 5.5 / FM 5.742'. The 'Group Delay' is 'General'. The 'Color System' is 'PAL'. The 'Bar Line' section has 'Field' set to '1', 'Line' set to '18', and 'Type' set to 'CCIR17'. The 'Quiet Line' section has 'Field' set to '1' and 'Line' set to '22'. The 'Sideband Position' is 'Normal'.

6. For the **Digital TV** signal type, define the following parameters:

TV standard, constellation, symbol rate, roll-off, sideband position. The entries that can be selected may depend on the setting of the previous parameter.

The screenshot shows the 'Modulation Standard Options' dialog box. The 'Name' field is 'Digital Test'. The 'Signal Type' is 'Digital TV'. The 'TV Standard' is 'QAM J83/A (DVB-C Europe)'. The 'Constellation' is '64QAM'. The 'Symbol Rate' is '6.9 MSymb/s'. The 'Roll-Off' is '0.150'. The 'Sideband Position' is 'Auto'.

7. Press the previous key twice to go back to the **Channel Table** dialog box.
 8. Press the **Save Changes** softkey to save the changes.
 The new modulation standard can be used for any channel.
 9. To discard the changes, press the **Discard Changes** softkey.

To edit a modulation standard

1. In the **Channel Setup – Edit / New / Copy** submenu, press the **Modulation Options** softkey.
 In the **Modulation Standards** dialog box, all modulation standards defined for this channel table are displayed.

2. In the **Modulation Standards** dialog box, set the focus on the modulation standard you want to edit.
3. Press the **Edit** softkey.
The **Modulation Standard Options** dialog box is displayed.
4. For further instructions see "[To create a new modulation standard](#)" on page 4.148.

To copy a modulation standard

1. Press the **Channel Setup** softkey.
2. In the **Channel Tables** dialog box, focus the channel table that contains the modulation standard you want to copy.
3. Press the **Copy** softkey (for further details see "[To create a channel table](#)" on page 4.148).
4. Enter a name for the copied channel table.
5. If you want to alter the channel table, continue as described in "[To edit a channel table](#)" on page 4.147, step 4.
6. If you want to alter the modulation standard, press the **Modulation Options** softkey and then the **Edit** softkey (for further details see "[To create a new modulation standard](#)" on page 4.148).

To perform a measurement using a channel table

1. Press the **Channel Setup** softkey.
The **Channel Tables** dialog box is displayed.
2. Select the channel table you want to use for the measurement and press the **ENTER** key or the **Activate** softkey.
If no adequate channel table is available, you can edit or create a channel table, or perform the measurement without a channel table (For details refer to "[To edit a channel table](#)" on page 4.147, "[To create a channel table](#)" on page 4.148 or "[To perform a measurement without a channel table](#)" on page 4.150).
3. Press the **MEAS** key.
4. In the measurement menu, press the softkey for the measurement you want to perform.
5. Set up the measurement as described for every measurement type in section "[Measurements](#)" on page 4.146.
6. Press the **RUN** key to start the measurement.

To perform a measurement without a channel table

1. Press the **Channel Setup** softkey.
The **Channel Tables** dialog box is displayed.
2. Select no channel table < none > and press the **ENTER** key or the **Activate** softkey.
3. Press the **MEAS** key.
4. In the measurement menu, press the **Analog TV** or **Digital TV** softkey.
5. Press the softkey for the measurement you want to perform.
6. Press the **Analog TV Settings** or **Digital TV Settings** softkey to setup the modulation parameters.
The **Analog TV Settings** or **Digital TV Settings** dialog box is displayed.

7. Enter the parameters for the measurement.
 - analog TV: for details refer to the **Analog TV Settings** softkey in the analog TV measurement menu.
 - digital TV: for details refer to the **Digital TV Settings** softkey in the digital TV measurement menu.
8. Press the **Adjust Attenuation** softkey to set the signal level appropriately.
9. Press the **RUN** key to start the measurement.

Information in the status bar

The status bar provides valuable information for working with the application. The information is supplied context-sensitively and always refers to the graphical user interface element in focus. The following types of information are displayed:

- possible range for a parameter
- description what to do
- hints
- warnings

Channel tables

Channel tables are lists of channels, as they occur in a cable TV network. They provide a quick access to the channels to be analyzed. Depending on its designation, a channel table can contain all channels of a cable TV network or it can be restricted to a subset of all available channels, e.g. to all digital DVB-C channels of the cable TV network.



In the **List of Channel Tables**, all available channel tables are sorted in alphabetic order. The name of a channel table displayed in the list corresponds to the file name of the channel table, excluding the file extension (*.cht).

The first list entry is **< none >**. If this entry is selected, no channel table is used. This can be useful for measurements where no appropriate channel table is available, or if the Cable TV Measurements option (K20) is used in a R&D laboratory. The Tilt measurement is not possible if no channel table is used. For a step-by-step instruction refer to "[To perform a measurement without a channel table](#)" on page 4.150.

Some channel tables are provided with the option. In these channel tables, all modulation standards are set to **< unused >** (for further details refer to "[Modulation standards](#)" on page 4.152). Based on this set, you can customize your own channel tables. Use the **Restore Default Tables** softkey to restore the provided channel tables.

Modulation standards

A modulation standard is a set of parameters defining the modulation properties of a TV signal (as used in a TV channel). The signal type is the characteristic parameter of this set. Modulation standards are defined for every channel table individually. As a maximum, 40 modulation standards can be created per channel table. If, in a channel table, the modulation standard of a channel is set to **< unused >**, no modulation standard is defined for this channel and therefore no measurements can be performed for this channel.

If no channel table **< none >** is activated, a default modulation standard can be edited and changed via the **Analog TV Settings** or **Digital TV Settings** softkey, but these changes are not saved permanently. Pressing the **PRESET** key restores the default settings.

Signal level

The signal level represents the expected RMS (digital TV) or peak (analog TV) channel power. This power is only valid for one single channel, which is the current measurement channel. The signal level is not identical to the level of the signal fed into the FSL's RF input. This signal may consist of many TV channels and hence have a much higher total power than the current channel to be investigated.

In most measurements the signal level determines the upper horizontal display line. The signal level value is related to the reference level by a constant offset. The reference level value is the maximum value the AD converter can handle without distortion of the measured value. The signal level can either be entered via the **Signal Lvl** key or by using the auto scale function (e.g. **Auto Range** softkey in the Tilt measurement).

Attenuation adjustment

To get valid measurement results it is very important to set the FSL's hardware, i.e. the attenuator and the preamplifier, in a reasonable way. This can either be done manually or by relying on the **Adjust Attenuation** softkey. Apart from the hardware setting, the displayed grid depends on the signal level of the signal present in the current measurement channel.

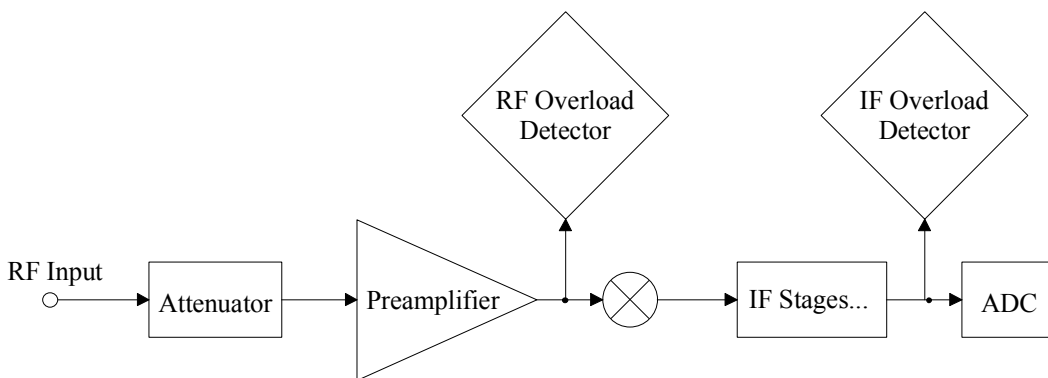

Fig. 4–19 FSL hardware overview (only relevant parts for attenuation adjustment)

Fig. 4–19 shows the FSL's hardware. It only comprises blocks that effect the level settings described in this section. The signal from the device under test, e.g. a single cable TV transmitter or a test point of a cable TV network with many channels, is plugged into the FSL's RF input. The level of the signal is reduced by the electronic attenuator or increased by the preamplifier (option B22 required). Then the signal is fed into the first mixer.

The level of this signal is typically referred to as mixer level. The mixer level is a very crucial parameter. If the mixer level is too high the mixer will be overloaded. As a result, non-linear effects are produced, e.g. intermodulation products, and the intermodulation products (e.g. CTB or CSO) of the device under test can not be distinguished from those of the FSL's mixer. To reveal this, the FSL's hardware has two overload detectors. The RF overload detector reports a mixer overload and the IF overload detector indicates an overload of the analog to digital converter (ADC). The combination of the results of both detectors control the overload message **OVL** displayed on the FSL's screen. Increasing the attenuation reduces the signal to noise ratio but also reduces the mixer's non-linear effects. For cable TV measurements such as **CTB**, **CSO**, **CCDF**, and **APD** that measure non-linearities, it is recommended to chose a higher attenuation than for other measurements.

Attenuator setting	Preamplifier setting
30 dB	off
25 dB	off
20 dB	off
15 dB	off
10 dB	off

Attenuator setting	Preamplifier setting
5 dB	off
0 dB	off
15 dB	on
10 dB	on
5 dB	on
0 dB	on

To adjust the attenuation manually, refer to the table above that lists reasonable combinations of attenuator and preamplifier settings. The maximum total attenuation is achieved with the setting of the first line. If you want to set the FSL hardware manually you should start with the maximum attenuation and then reduce the total attenuation until an overload will be reported (**OVL** displayed on the screen). Depending on the intended measurement, you should then choose an attenuation of about one or two steps higher than the setting that caused an overload. Be aware, that the manual attenuator and the preamplifier setting is kept for all measurements. For further details refer to the **RF Atten Manual** and **Preamp On/Off** softkeys.

Alternatively, you can **automatically** adjust the attenuator and the preamplifier using the **Adjust Attenuation** softkey. The Cable TV Measurements option sets the optimum values for the measurement. If you change to another measurement, these values may be altered automatically in order to find the optimum setting (e.g. low noise or low distortion) for the chosen measurement.

Labels used in the measurement displays

Positions of special values are marked as vertical lines in the measurement display.

Label	Description
VC	Vision Carrier
SC1	Sound Carrier 1
SC2	Sound Carrier 2

Short list of cable TV terms and abbreviations

Term or abbreviation	Description
AM Amplitude Modulation	Analog modulation technique where the carrier amplitude contains the information.
bar line	see VITS
DVB-C Digital Video Broadcasting for Cable Systems	DVB-C uses single carrier QAM as modulation technique.
DVB-T Digital Video Broadcasting Terrestrial	DVB-T uses OFDM as modulation technique.
NTSC National Television System Committee	Technique for transmitting color information in analog TV systems. NTSC is for example adopted by the USA, Canada and Japan.
OFDM Orthogonal Frequency Division Multiplexing	Digital multicarrier modulation technique. OFDM is used in terrestrial TV networks, e.g. DVB-T systems.
PAL Phase Alternation Line	Technique for transmitting color information in analog TV systems used in many European countries.
QAM Quadrature Amplitude Modulation	Digital modulation technique, where both phase and amplitude carry information.
SECAM Système en Couleur avec Mémoire	Technique for transmitting color information in analog TV systems. SECAM is adopted by France, countries of the Eastern block and most Arabic countries.
VITS	Line of a TV picture where a special test signal is transmitted. VITS lines

Term or abbreviation	Description
Vertical Interval Test Signal	are used for in-service measurements (cf. Quiet Line, Bar Line). These lines are invisible, i.e. they are located before the first or after the last visible line of the TV picture.

Measurements

In this section, every measurement type is introduced by a short description and by a basic step-by-step instruction. Also a list with all parameters that can be altered is presented.

Spectrum – analog TV

This measurement gives an overview of the active measurement channel. The spectrum is displayed as a full screen trace. The following parameters can be set:

Parameter
channel number

The basic procedure is the following:

1. Press the **MEAS** key.
2. Press the **Analog TV** softkey.
3. Press the **Spectrum** softkey.
4. To adjust the input attenuator, press the **Adjust Attenuation** softkey.
5. Press the **RUN** key.

For a more detailed description of this measurement type refer to chapter "Advanced Measurement Examples".

Carriers – analog TV

This measurement determines the carrier powers (vision carrier, one or two sound carriers) and their frequencies in analog TV channels and compares them against limits. The sound carrier power frequencies are displayed relative to the measured vision carrier power frequency. The following parameters can be set:

Parameter
channel number
limits

The basic procedure is the following:

1. Press the **MEAS** key.
2. Press the **Analog TV** softkey.
3. Press the **Carriers** softkey.
4. To change the limits, press the **Edit Table** softkey.
5. To adjust the input attenuator, press the **Adjust Attenuation** softkey.
6. Press the **RUN** key.

For a more detailed description of this measurement type refer chapter "Advanced Measurement Examples".

C/N – analog TV

This measurement determines the carrier-to-noise ratio. The measurement consists of two sub-measurements: reference power measurement and noise measurement. The following parameters can be set:

Parameter
reference power
measurement method (In-Service, Off-Service, Quiet Line)
measurement frequencies (CF, Span)
noise reference bandwidth
noise floor correction
limits

The basic procedure is the following:

1. Press the **MEAS** key.
2. Press the **Analog TV** softkey.
3. Press the **C/N** softkey.
4. To change the setting of the reference power:
 - Press the **Reference Power** softkey.
 - Press the **Reference Channel, Same as Meas Channel, or Manual Reference Power** softkey and, if necessary, enter a value.
5. To configure the measurement, press the **C/N Setup** softkey.
The **C/N Setup** dialog box is displayed.
 - Under **Measurement Method**, activate one of the options. For details refer to the **C/N Setup** softkey in the measurement menu.
 - Only for **In-Service** and **Off-Service** measurement method: Under **Measurement Frequencies**, enter the center frequencies and span values. Set the span values relative to the vision carrier of the current measurement.
 - In the **Noise Reference Bandwidth** field, enter a number in order to change the default value.
 - If the DUT's noise is close to the noise of the spectrum analyzer, activate the **Noise Floor Correction** option.
6. To change the limits, press the **Edit Table** softkey.
7. To activate the carrier measurement with the next sweep, press the **Meas Carrier** softkey.
Prerequisite is, that in the **C/N Setup** dialog box under **Measurement Methods** the **Off-Service** option is selected.
8. To adjust the input attenuator, press the **Adjust Attenuation** softkey.
9. Press the **RUN** key.
10. Only for **In-Service** and **Off-Service** measurement method: To measure in the next frequency span defined via the C/N setup, press the **Next Meas Frequency** softkey.

For a more detailed description of this measurement type refer to chapter "Advanced Measurement Examples".

CSO – analog TV

This measurement determines the carrier-to-second order beat ratio (CSO). The measurement consists of two sub-measurements: reference power measurement and beat measurement of second order intermodulation products. The following parameters can be set:

Parameter
reference power
measurement method (Off-Service, Quiet Line)
measurement frequencies (CF, Span)
noise floor correction
limits

The basic procedure is the following:

1. Press the **MEAS** key.
2. Press the **Analog TV** softkey.
3. Press the **CSO** softkey.
4. To change the setting of the reference power:
 - Press the **Reference Power** softkey.
 - Press the **Reference Channel, Same as Meas Channel**, or **Manual Reference Power** softkey and, if necessary, enter a value.
5. To configure the measurement, press the **CSO Setup** softkey.

The **CSO Setup** dialog box is displayed.

 - Under **Measurement Method**, activate one of the options. For details refer to the **CSO Setup** softkey in the measurement menu.
 - Only for **Off-Service** measurement method: Under **Measurement Frequencies**, enter the center frequencies and span values.
 - If the DUT's noise is close to the noise of the spectrum analyzer, activate the **Noise Floor Correction** option.
6. To change the limits, press the **Edit Table** softkey.
7. To activate the carrier measurement with the next sweep, press the **Meas Carrier** softkey. Prerequisite is, that in the **CSO Setup** dialog box under **Measurement Methods** the **Off-Service** option is selected.
8. To adjust the input attenuator, press the **Adjust Attenuation** softkey.
9. Press the **RUN** key.
10. Only for **Off-Service** measurement method: To measure in the next frequency span defined via the C/N setup, press the **Next Meas Frequency** softkey.

For a more detailed description of this measurement type refer chapter "Advanced Measurement Examples".

CTB – analog TV

This measurement determines the carrier-to-composite triple beat ratio (CTB). The measurement consists of two sub-measurements: reference power measurement and beat measurement of third order intermodulation products. The following parameters can be set:

Parameter
reference power
measurement frequencies (CF, Span)
noise floor correction
limits

The basic procedure is the following:

1. Press the **MEAS** key.
2. Press the **Analog TV** softkey.
3. Press the **CTB** softkey.
4. To change the setting of the reference power:
 - Press the **Reference Power** softkey.
 - Press the **Reference Channel, Same as Meas Channel, or Manual Reference Power** softkey and, if necessary, enter a value.
5. To configure the measurement, press the **CTB Setup** softkey.

The **CTB Setup** dialog box is displayed.

 - Under **Measurement Frequencies**, enter the center frequencies and span values.
 - If the DUT's noise is close to the noise of the spectrum analyzer, activate the **Noise Floor Correction** option.
6. To change the limits, press the **Edit Table** softkey.
7. To adjust the input attenuator, press the **Adjust Attenuation** softkey.
8. Press the **RUN** key.
9. To measure in the next frequency span defined via the C/N setup, press the **Next Meas Frequency** softkey.

For a more detailed description of this measurement type refer to chapter "Advanced Measurement Examples".

Video Scope – analog TV

This measurement determines the luminance signal as a function of the time. The following parameters can be set:

Parameter
channel number
field
line

The basic procedure is the following:

1. Press the **MEAS** key.
2. Press the **Analog TV** softkey.
3. Press the **Video Scope** softkey.
4. For the TV standard **M** in combination with another color system than **PAL**, press the **Field 1/2** softkey to select field 1 or 2.
5. Press the **Line** softkey to enter the line number.
6. To change the sweep time, press the **SweepTime Manual** softkey and enter a value.
7. To define a trigger offset, press the **Trigger Offset** softkey and enter a value.
8. To adjust the input attenuator, press the **Adjust Attenuation** softkey.
9. Press the **RUN** key.

For a more detailed description of this measurement type refer to chapter "Advanced Measurement Examples".

Vision Modulation – analog TV

This measurement determines the residual picture carrier and the modulation depth. The following parameters can be set:

Parameter
channel number
limits

The basic procedure is the following:

1. Press the **MEAS** key.
2. Press the **Analog TV** softkey.
3. Press the **Vision Modulation** softkey.
4. To change the limits, press the **Edit Table** softkey.
5. To adjust the input attenuator, press the **Adjust Attenuation** softkey.
6. Press the **RUN** key.

For a more detailed description of this measurement type refer to chapter "Advanced Measurement Examples".

Hum – analog TV

This measurement determines the hum values. The hum is a not-wanted amplitude modulation with a modulating frequency below 1 KHz and typically equal to the power line frequency or its harmonics. The following parameters can be set:

Parameter
channel number
limits

The basic procedure is the following:

1. Press the **MEAS** key.
2. Press the **Analog TV** softkey.
3. Press the **Hum** softkey.
4. To adjust the range of the y-axis, press the **Auto Range** softkey.
5. To change the limits, press the **Edit Table** softkey.
6. To adjust the input attenuator, press the **Adjust Attenuation** softkey.
7. Press the **RUN** key.

For a more detailed description of this measurement type refer to chapter "Advanced Measurement Examples".

Spectrum – digital TV

This measurement gives an overview of the active measurement channel. The spectrum is displayed as a full screen trace. The following parameters can be set:

Parameter
channel number

The basic procedure is the following:

1. Press the **MEAS** key.
2. Press the **Digital TV** softkey.
3. Press the **Spectrum** softkey.
4. To adjust the input attenuator, press the **Adjust Attenuation** softkey.
5. Press the **RUN** key.

For a more detailed description of this measurement type refer to chapter "Advanced Measurement Examples".

Overview – digital TV

This measurement determines the modulation accuracy of digitally modulated single carrier cable TV signals. The measurement results are displayed in a table: **MER (rms)** for the root mean square of the modulation error rate, **MER (peak)** for the peak of the modulation error rate, **EVM (rms)** for the root mean square of the error vector magnitude, **EVM (peak)** for the peak of the error vector magnitude, **Carrier Frequency Offset**, and **Symbol Rate Offset**. Less important result parameters are displayed in the result table of the [Modulation Errors \(Modulation Analysis\) – digital TV](#) measurement. The following parameters can be set:

Parameter
channel number
limits

The basic procedure is the following:

1. Press the **MEAS** key.
2. Press the **Digital TV** softkey.
3. Press the **Overview** softkey.
4. To magnify one parameter, press the **Zoom** softkey and activate the parameter. To go back to the default setting, activate **None**.
5. To change the limits, press the **Edit Table** softkey.
6. To adjust the input attenuator, press the **Adjust Attenuation** softkey.
7. Press the **RUN** key.

For a more detailed description of this measurement type refer to chapter "Advanced Measurement Examples".

Constellation Diagram (Modulation Analysis) – digital TV

This measurement displays the constellation diagram. The following parameters can be set:

Parameter
channel number

The basic procedure is the following:

1. Press the **MEAS** key.
2. Press the **Digital TV** softkey.
3. Press the **Modulation Analysis** softkey.
4. Press the **Const Diagram** softkey.
5. To zoom into one quadrant, press the **Zoom** softkey and activate the parameter. To go back to the general view, activate **None**.
6. To display the constellation diagram unchanged, while the I/Q samples are collected in the background, press the **Freeze** softkey. To switch back to the continual update the display, press the **Freeze** softkey again.
7. To adjust the input attenuator, press the **Adjust Attenuation** softkey.
8. Press the **RUN** key.

For a more detailed description of this measurement type refer to chapter "Advanced Measurement Examples".

Modulation Errors (Modulation Analysis) – digital TV

This measurement determines the modulation accuracy. The measurement results are displayed in a table: **Amplitude Imbalance** (amplification difference of I and Q signal caused by a non-ideal IQ modulator in the transmitter), **Quadrature Error** (phase offset relative to the ideal phase difference between the I and Q signal), **Carrier Suppression**, and **Phase Jitter** (root mean square of phase error). The more important result parameters are displayed in the result table of the [Overview – digital TV](#) measurement. The following parameters can be set:

Parameter
channel number
limits

The basic procedure is the following:

1. Press the **MEAS** key.
2. Press the **Digital TV** softkey.
3. Press the **Modulation Analysis** softkey.
4. Press the **Modulation Errors** softkey.
5. To magnify one parameter, press the **Zoom** softkey and activate the parameter. To go back to the default setting, activate **None**.
6. To change the limits, press the **Edit Table** softkey.
7. To adjust the input attenuator, press the **Adjust Attenuation** softkey.
8. Press the **RUN** key.

For a more detailed description of this measurement type refer to chapter "Advanced Measurement Examples".

Echo Pattern (Channel Analysis) – digital TV

This measurement determines the magnitude of the channel impulse response with respect to the corresponding time delay. The following parameters can be set:

Parameter
channel number
unit
velocity factor

The basic procedure is the following:

1. Press the **MEAS** key.
2. Press the **Digital TV** softkey.
3. Press the **Channel Analysis** softkey.
4. Press the **Echo Pattern** softkey.
5. To change the unit from μ s to km or miles:
 - Press the **Velocity Factor** softkey to define the velocity of propagation for the unit conversion.
 - Press the **Unit** softkey to select the unit.
6. To zoom onto the echo pattern, press the **Zoom** softkey.
7. To adjust the input attenuator, press the **Adjust Attenuation** softkey.
8. Press the **RUN** key.

For a more detailed description of this measurement type refer to chapter "Advanced Measurement Examples".

Channel Power – digital TV

This measurement determines the channel power of a digital TV channel. The following parameters can be set:

Parameter
channel number
limits

The basic procedure is the following:

1. Press the **MEAS** key.
2. Press the **Digital TV** softkey.
3. Press the **Channel Power** softkey.
4. To change the limits, press the **Edit Table** softkey.
5. To adjust the input attenuator, press the **Adjust Attenuation** softkey.
6. Press the **RUN** key.

For a more detailed description of this measurement type refer to chapter "Advanced Measurement Examples".

APD – digital TV

This measurement determines the amplitude probability density function (APD). The following parameters can be set:

Parameter
channel number
x- and y-axis scaling

The basic procedure is the following:

1. Press the **MEAS** key.
2. Press the **Digital TV** softkey.
3. Press the **APD** softkey.
4. To change the scaling parameters of the x- and y-axis:
 - Press the **Scaling** softkey.
 - Press the corresponding softkey to change the parameters: **x-Axis Signal Lvl**, **x-Axis Range**, **y-Axis Max Value**, **y-Axis Min Value**, **Default Settings**.
5. To adjust the input attenuator, press the **Adjust Attenuation** softkey.
6. Press the **RUN** key.

For a more detailed description of this measurement type refer to chapter "Advanced Measurement Examples".

CCDF – digital TV

This measurement determines the complementary cumulative distribution function (CCDF) of the complex base band signal. The following parameters can be set:

Parameter
channel number
power exceeding probability
x- and y-axis scaling

The basic procedure is the following:

1. Press the **MEAS** key.
2. Press the **Digital TV** softkey.
3. Press the **CCDF** softkey.
4. To determine the power exceeded with a given probability, press the **Percent Marker** softkey.
5. To change the scaling parameters of the x- and y-axis:
 - Press the **Scaling** softkey.
 - Press the corresponding softkey to change the parameters: **x-Axis Signal L**, **x-Axis Range**, **y-Axis Max Value**, **y-Axis Min Value**, **Default Settings**.
6. To adjust the input attenuator, press the **Adjust Attenuation** softkey.
7. Press the **RUN** key.

For a more detailed description of this measurement type refer to chapter "Advanced Measurement Examples".

Tilt – TV analyzer

This measurement determines the frequency response of the cable TV network by measuring the channel power of every channel. The whole measurement sequence can take some time, depending on the number of channels. The following parameters can be set:

Parameter
span
modulation standard

The basic procedure is the following:

1. Select the appropriate channel table and activate it (for details refer to ["To perform a measurement using a channel table"](#) on page 4.150).
2. Press the **MEAS** key.
3. Press the **TV Analyzer** softkey.
4. Press the **Tilt** softkey.
5. To restrict the channels to be measured, press the **Tilt Setup** softkey:

The **Tilt Setup** dialog box is displayed.

 - To limit the frequency range, under **Span**, enter a start and stop frequency.
 - To select only channels of certain modulation standards for the measurement, under **Modulation Standards**, activate the modulation standards to be included in the measurement.

6. To adjust the range of the y-axis, press the **Auto Range** softkey.
7. Press the **RUN** key.

For a more detailed description of this measurement type refer to chapter "Advanced Measurement Examples".

Softkeys of the Cable TV Measurements menu

The following table shows all softkeys available in the Cable TV Measurements menu. It is possible that your instrument configuration does not provide all softkeys. If a softkey is only available with a special option, model or (measurement) mode, this information is delivered in the corresponding softkey description.

Menu / Command	Submenu / Command	Submenu / Command	Command
Channel Setup ↓	Activate		
	New ↓	Copy Channel	
		Delete Channel	
		Modulation Options ↓	New
			Delete
			Edit
		Save Changes	
		Discard Changes	
	Copy ↓	same contents as New menu	
	Delete		
	Edit ↓	same contents as New menu	
	Restore Default Tables		
Adjust Attenuation			

Channel Setup

Opens the **Channel Tables** dialog box with all available channel tables listed, and displays a submenu to activate, create, edit, copy, and delete channel tables and modulation standards.

For further information on channel tables refer to "[Channel tables](#)" on page 4.151 and "[Modulation standards](#)" on page 4.152.

Activate

Activates the channel table in focus. Alternatively to this softkey, the rotary knob or the **ENTER** key can be pressed.

Activating a channel table is synonymous to loading the selected channel table and discarding the previously active channel table. As a prerequisite, the channel table must have at least one channel with a digital or analog modulation standard. Otherwise the channel table cannot be loaded and an error message is displayed. If no appropriate channel table exists, select **< none >** for no channel table.

→ Remote: CONF:TV:CTAB:SEL 'TV-ITALY'

New

Creates a new channel table and opens the **Channel Table** dialog box with the according submenu to edit the channel table.

It is recommended to use long names in order to distinguish the channel tables from each other easily.

For further details refer to "[To create a channel table](#)" on page 4.148.

Copy Channel

Copies the channel in focus.

Delete Channel

Deletes the channel in focus. If the channel table consists only of one channel, this channel can not be deleted.

Modulation Options

Opens the **Modulation Standards** dialog box with all available modulation standards of the channel table listed, and displays a submenu to create, edit, and delete a modulation standard.

For further information on modulation standards refer to "[Modulation standards](#)" on page 4.152, "[To create a new modulation standard](#)" on page 4.148, and "[To copy a modulation standard](#)" on page 4.150.

New

Opens the **Modulation Standard Options** dialog box to define a new modulation standard for the channel table.

For further information on modulation standards refer to "[Modulation standards](#)" on page 4.152 and "[To create a new modulation standard](#)" on page 4.148.

- Remote: DDEM:SBAN NORM
 - Remote: DDEM:SRAT 1000000
 - Remote: DDEM:FILT:ALPH R018
 - Remote: TV:MST:NAME 'TEST'
 - Remote: TV:MST:STYP DTV
 - Remote: TV:MST:FILT:GDEL FLAT
 - Remote: SET:TV:STAN DK
 - Remote: SET:TV:STAN:AUD FM65MONO
 - Remote: SET:TV:STAN:COL SEC
-

Delete

Deletes the modulation standard focused in the **Modulation Standards** dialog box.

Edit

Opens the **Modulation Standard Options** dialog box for the modulation standard in focus. Alternatively to this softkey, the rotary knob or the **ENTER** key can be pressed.

For details refer to "[Modulation standards](#)" on page 4.152 and "[To create a new modulation standard](#)" on page 4.148.

- Remote: DDEM:SBAN NORM
 - Remote: DDEM:SRAT 1000000
 - Remote: DDEM:FILT:ALPH R018
 - Remote: TV:MST:NAME 'TEST'
 - Remote: TV:MST:STYP DTV
 - Remote: TV:MST:FILT:GDEL FLAT
 - Remote: SET:TV:STAN DK
 - Remote: SET:TV:STAN:AUD FM65MONO
 - Remote: SET:TV:STAN:COL SEC
-

Save Changes

Saves all changes in channels and modulation standards, if the channel table passes the compliance check. For further details refer to "[To edit a channel table](#)" on page 4.147.

Discard Changes

After confirmation, discards all changes in channels and modulation standards made for the current channel table. Reloads and displays the original channel table.

Copy

Copies the channel table in focus and opens the **Channel Table** dialog box with the according submenu to edit the channel table. If you enter a name that is already in use you are prompted to enter another one.

For further details refer to "[To create a channel table](#)" on page 4.148.

Delete

Deletes the channel table in focus. If the channel table in focus is also the active channel table, no channel table < **none** > will be activated.

Edit

Opens the **Channel Table** dialog box for the channel table in focus and displays a submenu for editing this channel table. For details refer to "[To edit a channel table](#)" on page 4.147.

Restore Default Tables

Restores the default set of channel tables and the channel table examples.

Adjust Attenuation

Adjusts the input attenuator. For details on the adjustment procedure refer to "[Attenuation adjustment](#)" on page 4.153.

→ Remote: POW:ACH:PRES:RLEV

Softkeys of the frequency menu (Cable TV Analyzer mode)

The following table shows all softkeys available in the frequency menu in **Cable TV Analyzer** mode (**FREQ** key). It is possible that your instrument configuration does not provide all softkeys. If a softkey is only available with a special option, model or (measurement) mode, this information is delivered in the corresponding softkey description.

Menu / Command	Command
RF	
Channel	
RF Stepsize ↓	Manual
	Channel Width
Frequency Abs/Rel	

RF

Opens an edit dialog box to enter the RF frequency. The interpretation of the RF frequency depends on the signal type (analog TV or digital TV) to measure:

Signal type	RF
< unused >	center frequency
analog TV	vision carrier frequency
digital TV	center frequency

If the modulation standard or the active measurement channel is changed, the RF is automatically adapted.

If no channel table < none > is activated, the interpretation of the RF frequency depends on the active measurement.

→ Remote: FREQ:RF 10MHZ

Channel

Displays the active channel table to select a particular measurement channel. The active channel is highlighted.

All channels can be selected, except those with modulation standard < unused >. Incompatible channels are marked accordingly; for example an analog TV channel inside a digital TV measurement. If an incompatible channel is selected, the current measurement is aborted, and the spectrum measurement will become the active measurement. If no channel table < none > is activated, this softkey is not available.

If you perform a measurement over all possible channels, use the **Channel No** softkey of the measurement menu to change from one channel to the next channel of the channel table quickly.

→ Remote: FREQ:CHAN 3

RF Stepsize

Opens a submenu to set the RF step size. If no channel table < none > is activated, this softkey is not available.

→ Remote: `FREQ:CENT:STEP 120MHz`

Manual

For details refer to the **Manual** softkey in the frequency menu of the base unit.

Channel Width

Takes the channel width of the current measurement channel as RF step size once.
 If no channel table < none > is activated, this softkey is not available.

Frequency Abs/Rel

Sets the labeling of the frequency axis.
 If absolute labeling is selected, the absolute frequencies are displayed, and all markers are absolute.
 If relative labeling is selected, the reference is set to 0 Hz. The reference depends on the signal type:

Signal type	Reference
< unused >	center frequency
analog TV	vision carrier frequency
digital TV	center frequency

This softkey is not available in the Tilt measurement.

→ Remote: `SWE:SPAC ABS`

Softkeys of the amplitude menu (Cable TV Analyzer mode)

The following table shows all softkeys available in the amplitude menu in **Cable TV Analyzer** mode (**AMPT** key). It is possible that your instrument configuration does not provide all softkeys. If a softkey is only available with a special option, model or (measurement) mode, this information is delivered in the corresponding softkey description.

Command
Signal Lvl
Range Log
Range Linear
Preamp On/Off
Signal Lvl Position
RF Atten Manual
More ↓
Signal Lvl Offset

Command
Signal Lvl Position
Grid Abs/Rel
Unit
Input 50 Ω / 75 Ω

Signal Lvl

Opens an edit dialog box to enter the expected RMS (digital TV) or peak (analog TV) input power of the signal. This parameter is channel-specific and is set, in a cable network with multiple channels, only for the signal of interest. However, mostly channels with the same signal type have the same signal level.

→ Remote: `DISP:TRAC:Y:RLEV -60dBm`

Range Log

For details refer to the **Range Log** softkey in the amplitude menu of the base unit.

Range Linear

For details refer to the **Range Linear** softkey in the amplitude menu of the base unit.

Preamp On/Off

For details refer to the **Preamp On/Off** softkey in the amplitude menu of the base unit.

Signal Lvl Position

For details refer to the **Ref Level Position** softkey in the amplitude menu of the base unit.

RF Atten Manual

Opens an edit dialog box to enter the attenuation. For details see also "[Attenuation adjustment](#)" on page 4.153.

Signal Lvl Offset

For details refer to the **Ref Level Offset** softkey in the amplitude menu of the base unit.

Grid Abs/Rel

For details refer to the **Grid Abs / Rel** softkey in the amplitude menu of the base unit.

Unit

Opens a list containing all allowed units to select the appropriate unit. These units are used for scaling diagrams or input/output of parameters and limits.

The variety of the absolute units depends on the selected measurement, as relative unit dB is used.

The units are selected according to the state of the **Range Log** and **Range Linear** softkeys. For voltage units, the input impedance (**Input 50 Ω / 75 Ω** softkey) is used for the conversion.

→ Remote: CALC:UNIT:POW DBM

Input 50 Ω / 75 Ω

For details refer to the **Input 50 Ω / 75 Ω** softkey in the amplitude menu of the base unit.

Typically, cable TV networks have an impedance of 75 Ω (set the softkey to 75 Ω). For precise (level) measurements an adapter of the RAZ type (= 25 Ω in series to the input impedance of the instrument) should always be used.

Softkeys of the measurement menu (Cable TV Analyzer mode)

The following table shows all softkeys available in the measurement menu in **Cable TV Analyzer** mode (**MEAS** key). It is possible that your instrument configuration does not provide all softkeys. If a softkey is only available with a special option, model or (measurement) mode, this information is delivered in the corresponding softkey description.

Menu / Command	Submenu / Command	Submenu / Command	Command
Analog TV ↓	Spectrum ↓	Channel No	
		Adjust Attenuation	
	Carriers ↓	Channel No	
		Edit Table	
		Adjust Attenuation	
	C/N ↓	Channel No	
		Reference Power ↓	Reference Channel
			Same as Meas Channel
			Manual Reference Power
		C/N Setup ↓	Insert Line
			Delete Line
		Next Meas Frequency	
		Edit Table	
		Meas Carrier	
		Adjust Attenuation	
	CSO ↓	Channel No	
		Reference Power ↓	same contents as in C/N submenu
		CSO Setup ↓	same contents as in C/N Setup submenu
		Next Meas Frequency	

Menu / Command	Submenu / Command	Submenu / Command	Command
		Edit Table	
		Meas Carrier	
		Adjust Attenuation	
	CTB ↓	Channel No	
		Reference Power ↓	same contents as in C/N submenu
		CTB Setup ↓	same contents as in C/N Setup submenu
		Next Meas Frequency	
		Edit Table	
		Meas Carrier	
		Adjust Attenuation	
	Analog TV Settings		
	More ↓		
	Video Scope ↓	Channel No	
		Line	
		Field 1/2	
		Sweeptime Manual	
		Trigger Offset	
		Adjust Attenuation	
	Vision Modulation ↓	Channel No	
		Edit Table	
		Adjust Attenuation	
	Hum ↓	Channel No	
		Auto Range	
		Edit Table	
		Adjust Attenuation	
	Analog TV Settings		
Digital TV ↓	Spectrum ↓	Channel No	
		Adjust Attenuation	
	Overview ↓	Channel No	
		Zoom	
		Edit Table	
		Adjust Attenuation	
	Modulation Analysis ↓	Const Diagram ↓	Channel No
			Zoom
			Freeze
			Adjust Attenuation
		Modulation Errors ↓	Channel No
			Zoom
			Edit Table
			Adjust Attenuation
	Channel Analysis ↓	Echo Pattern ↓	Channel No

Menu / Command	Submenu / Command	Submenu / Command	Command
			Unit
			Zoom
			Velocity Factor
			Adjust Attenuation
		Adjust Attenuation	
	Digital TV Settings		
	More ↓		
	Channel Power ↓	Channel No	
		Edit Table	
		Adjust Attenuation	
	APD ↓	Channel No	
		Scaling ↓	x–Axis Signal Lvl
			x–Axis Range
			y–Axis Max Value
			y–Axis Min Value
			Default Settings
		Adjust Attenuation	
	CCDF ↓	Channel No	
		Percent Marker	
		Scaling ↓	same contents as in APD submenu
		Adjust Attenuation	
	Digital TV Settings		
TV Analyzer ↓	Tilt ↓	Tilt Setup	
		Auto Range	
		Adjust Attenuation	

Analog TV

Opens a submenu with all available analog TV measurements. Every measurement type provides its own submenu to set the parameters. Additionally the **Analog TV Settings** softkey gives access to the modulation standard information.

This softkey is only available if the active channel table has at least one channel with an analog TV modulation standard, or if no channel table < none > is activated.

If a digital TV channel is in use when pressing this softkey, automatically the first analog channel of the active channel table is selected.

For further details refer also to section "Measurements" on page 4.146.

Spectrum

Opens a submenu to measure an analog TV spectrum.

For further information refer to "[Spectrum – analog TV](#)" on page 4.155.

- Remote: CONF:ATV:MEAS ASP
 - Remote: TRAC? TRACE1
-

Channel No

Opens an edit dialog box to select the measurement channel. Select the previous or next channel via the rotary knob or the arrow keys, or enter the channel number.

Only compatible channels can be selected, entries of incompatible channel are skipped. Incompatible channels are channels of a different signal type or channels with the modulation standard **< unused >**.

If you want to select a particular channel, use the **Channel** softkey in the frequency menu. If channel table **< none >** is selected, use the **RF** softkey in the frequency menu for frequency input.

- Remote: FREQ:CHAN 3
-

Carriers

Opens a submenu to measure the carriers powers.

For further information refer to "[Carriers – analog TV](#)" on page 4.155.

- Remote: CONF:ATV:MEAS CARR
 - Remote: CONF:ATV:RES:CARR? ALL
-

Edit Table

Activates the edit mode to change the limits within the result table. To edit a field, press the **ENTER** key. For all available parameters, the limit fields contain default values. If a field is empty, the corresponding limit can not be set for the measurement.

- Remote: CALCulate:ATV:LIMit Subsystem, CALCulate:ATV:LIMit:RESult Subsystem, CALCulate:ATV:RESult Subsystem for analog TV
 - Remote: CALCulate:DTV:LIMit Subsystem, CALCulate:DTV:LIMit:RESult Subsystem, CALCulate:DTV:RESult Subsystem for digital TV
-

Meas Carrier

Switches the carrier or noise measurement on or off.

activated Starts a new carrier measurement with the next sweep.

deactivated Starts a new noise measurement with the next sweep.

This softkey is only available in the **Off-Service** measurement method (setup dialog box).

- Remote: CONF:ATV:CN:MEAS NOIS
 - Remote: CONF:ATV:CSO:MEAS NOIS
 - Remote: CONF:ATV:CTB:MEAS NOIS
-

C/N

Opens a submenu to measure the carrier-to-noise ratio.

For further information refer to "[C/N – analog TV](#)" on page 4.156.

- Remote: CONF:ATV:MEAS CN
 - Remote: CALC:ATV:RES:CN? ALL
-

Reference Power

Opens a submenu to select the reference power method. The state of this submenu is not part of the measurement parameter set. If you switch from one measurement to another, the settings of this submenu are unchanged.

The set reference power method is indicated on the softkey:

- (Meas Ch)** **Reference Channel** softkey
- (same)** **Same as Meas Channel** softkey
- <value>** **Manual Reference Power** softkey

- Remote: ATV:CN:POW:REF:MODE RCH
 - Remote: ATV:CSO:POW:REF:MODE RCH
 - Remote: ATV:CTB:POW:REF:MODE RCH
-

Reference Channel

Displays the active channel table to select a particular measurement channel. For further details refer to the **Channel** softkey in the frequency menu.

- Remote: ATV:CN:POW:REF:CHAN:MAN 5
 - Remote: ATV:CSO:POW:REF:CHAN:MAN 6
 - Remote: ATV:CTB:POW:REF:CHAN:MAN 5
-

Same as Meas Channel

Sets the active measurement channel as reference channel. If the active measurement channel is changed, e.g. via the **Channel No** softkey, the reference channel is also changed automatically. This is the default setting.

- Remote: ATV:CN:POW:REF:MODE MCH
 - Remote: ATV:CSO:POW:REF:MODE MCH
 - Remote: ATV:CTB:POW:REF:MODE MCH
-

Manual Reference Power

Opens an edit dialog box to enter the reference power. The unit is set via the **Unit** softkey in the amplitude menu.

- Remote: ATV:CN:POW:REF:MAN 10
 - Remote: ATV:CSO:POW:REF:MAN 20
 - Remote: ATV:CTB:POW:REF:MAN 10
-

C/N Setup

Opens the **C/N Setup** dialog box to configure the following:

– **Measurement Method**

In-Service: While an analog TV signal is present, a gap between two consecutive channels, where only noise exists, is used to determine the noise power. A noise marker is placed there, and the noise power is determined.

Off-Service: The current measurement channel has to be switched off. An according message prompts you to do so. In this channel, a noise marker is placed, and the noise power is determined.

Quiet Line: While an analog TV signal is present, the carrier-to-noise ratio is measured using the so-called "Quiet Line". The measurement is fully automated.

– **Measurement Frequencies**

The table contains center frequencies (CF) and span values. The center frequency values are relative to the vision carrier frequency. One parameter set defines a frequency span and is used in one measurement. Only selected parameter sets are used in the measurements. If no parameter set is selected at all, the measurement is performed over all listed parameter sets.

For the **Quiet Line** measurement method, the table remains empty. For the other measurement methods, the table must contain at least one parameter set.

– **Noise Reference Bandwidth**

The entered value is multiplied with the measured noise power density to determine the noise power value.

– **Noise Floor Correction**

This option activates or deactivates the noise correction factor measurement. By default, the option is deactivated. In the noise correction factor measurement, the noise of the R&S FSL is determined. Therefore you are prompted to remove the cable from the R&S FSL's RF input when activating the option.

C/N Setup (Off-Service)

Measurement Method

In-Service

Off-Service

Quiet Line

Measurement Frequencies

CF (relative)	Span
<input checked="" type="checkbox"/> 2.75 MHz	10.0 MHz
<input type="checkbox"/>	
<input type="checkbox"/>	
<input type="checkbox"/>	
<input type="checkbox"/>	
<input type="checkbox"/>	
<input type="checkbox"/>	
<input type="checkbox"/>	
<input type="checkbox"/>	
<input type="checkbox"/>	

Noise Reference Bandwidth 5.0 MHz

Noise Floor Correction

- Remote: ATV:CN:MEAS:MODE OSER (Measurement Method)
- Remote: ATV:CN:TABL1:MFR 1,1000,1000 (Measurement Frequencies)
- Remote: ATV:CN:BWID 7MHZ (Noise Reference Bandwidth)
- Remote: ATV:CN:POW:NCOR ON (Noise Floor Correction)

Insert Line

Inserts a line in the **Measurement Frequencies** table to add a parameter set. This softkey is only active, if the focus is on the **Measurement Frequencies** table.

Delete Line

Deletes the focused line in the **Measurement Frequencies** table. This softkey is only active, if the focus is on the **Measurement Frequencies** table.

Next Meas Frequency

Switches from one frequency span to the next according to the parameter sets (center frequency, span) defined under **Measurement Frequencies** in the setup dialog box. Only activated entries are considered.

- Remote: ATV:CN:CFR:NEXT
 - Remote: ATV:CSO:CFR:NEXT
 - Remote: ATV:CTB:CFR:NEXT
-

CSO

Opens a submenu to measure the carrier-to-second order beat ratio (CSO).

For further information refer to "[CSO – analog TV](#)" on page 4.157.

- Remote: CONF:ATV:MEAS CSO
 - Remote: CALC:ATV:RES:CSO? ALL
-

CSO Setup

Opens the **CSO Setup** dialog box to configure the following:

– **Measurement Method**

Off-Service: The current measurement channel has to be switched off. An according message prompts you to do so. In this channel, a noise marker is placed, and the noise power is determined.

Quiet Line: While an analog TV signal is present, the carrier-to-second order beat ratio is measured using the so-called "Quiet Line". The measurement is fully automated.

– **Measurement Frequencies**

The table contains center frequencies (CF) and span values. The center frequency values are relative to the vision carrier frequency. One parameter set defines a frequency span and is used in one measurement. Only selected parameter sets are used in the measurements. If no parameter set is selected at all, the measurement is performed over all listed parameter sets. For the **Quiet Line** measurement method, the table remains empty.

– **Noise Floor Correction**

This option activates or deactivates the noise correction factor measurement. By default, the option is deactivated. In the noise correction factor measurement, the noise of the R&S FSL is determined. Therefore you are prompted to remove the cable from the R&S FSL's RF input when activating the option.

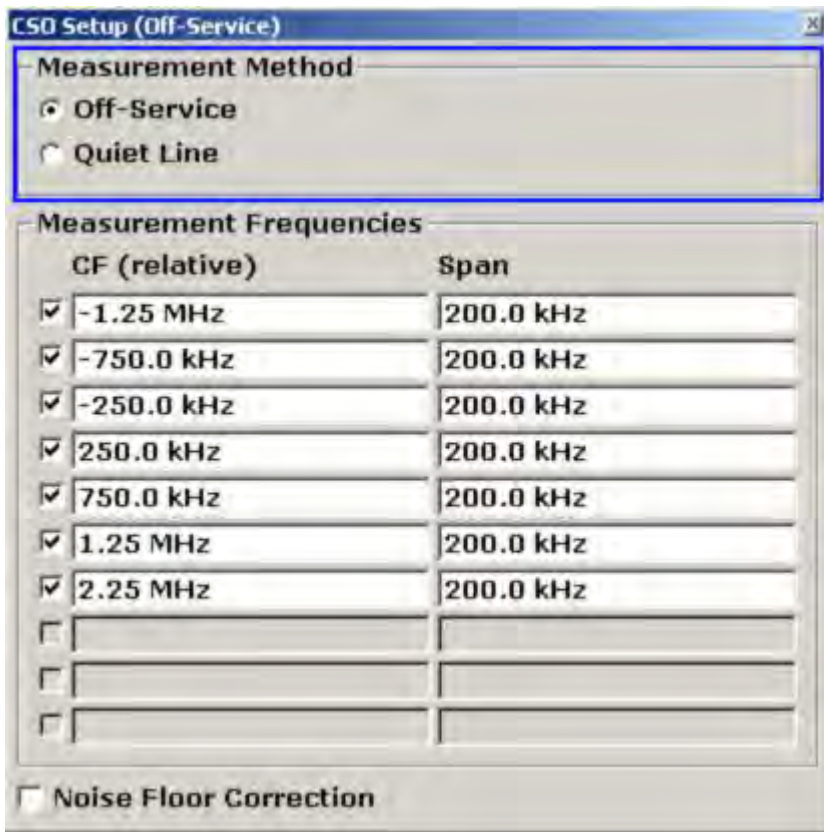

- Remote: ATV:CSO:MEAS:MODE QLIN (Measurement Method)
- Remote: ATV:CSO:TABL2:MFR 1, -2000, 2000 (Measurement Frequencies)
- Remote: ATV:CSO:POW:NCOR ON (Noise Floor Correction)

CTB

Opens a submenu to measure the carrier-to-composite triple beat ratio (CTB). The measurement always takes place off-service with current measurement channel has to be switched off. An according message prompts you to do so. In this channel, a noise marker is placed, and the noise power is determined.

For further information refer to "[CTB – analog TV](#)" on page 4.158.

- Remote: CONF:ATV:MEAS CTB
- Remote: CALC:ATV:RES:CTB? ALL

CTB Setup

Opens the **CTB Setup** dialog box to configure the following:

- **Measurement Frequencies**

The table contains center frequencies (CF) and span values. The center frequency values are relative to the vision carrier frequency. One parameter set defines a frequency span and is used in one measurement. Only selected parameter sets are used in the measurements. If no parameter set is selected at all, the measurement is performed over all listed parameter sets.

– **Noise Floor Correction**

This option activates or deactivates the noise correction factor measurement. By default, the option is deactivated. In the noise correction factor measurement, the noise of the R&S FSL is determined. Therefore you are prompted to remove the cable from the R&S FSL's RF input when activating the option.

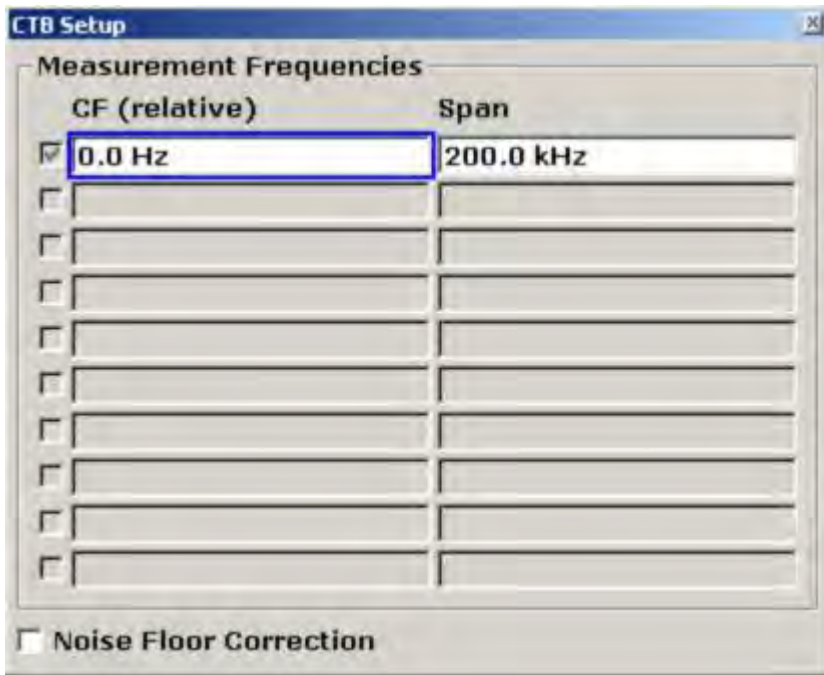

- Remote: ATV:CTB:TABL1:MFR 1,100,10000 (Measurement Frequencies)
- Remote: ATV:CTB:POW:NCOR ON (Noise Floor Correction)

Analog TV Settings

Opens the **Analog TV Settings** dialog box to modify the modulation standard parameters. The displayed parameters are derived from the modulation standard referenced in the active channel table. If no channel table < none > is activated, the default modulation standard is used (for details see also "[Modulation standards](#)" on page 4.152).

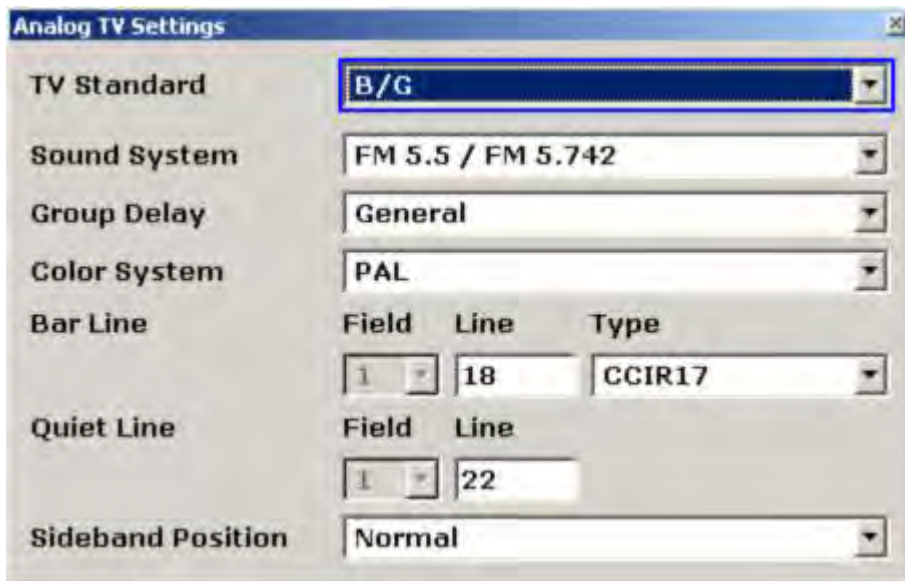

For the modulation standard, the changes made via this softkey are only kept as long as a measurement channel with the same modulation standard is selected. If a measurement channel with a different modulation standard is selected, or the **PRESET** key is pressed, the changes are lost.

If no channel table < none > is activated, the changes of the default modulation standard are kept as long as the **PRESET** key is not pressed.

- Remote: SET:TV:STAN DK (TV Standard)
- Remote: SET:TV:STAN:AUD FM65MONO (Sound System)
- Remote: TV:MST:FILT:GDEL FLAT (Group Delay)
- Remote: SET:TV:STAN:COL SEC (Color System)
- Remote: TRIG:VID:BLIN 16, TRIG:VID:BFI 2, TRIG:VID:BLIN:TYPE CCIR17 (Bar Line)
- Remote: TRIG:VID:QLIN 20, TRIG:VID:QFI 2 (Quiet Line)
- Remote: DDEM:SBAN NORM (Sideband Position)

Video Scope

Opens a submenu to measure the luminance signal. For this measurement, the **TRACE** key is not available.

For further information refer to "[Video Scope – analog TV](#)" on page 4.159.

- Remote: CONF:ATV:MEAS VSC
- Remote: TRAC? TRACE1

Line

Opens an edit dialog box to set the line number of the TV picture. The numbering conventions depend on the following conditions:

TV standard	Color system	Field number	Line numbering
≠ M	–	–	1, 2, ..., 625
≡ M	PAL	–	1, 2, ..., 525
≡ M	NTSC	1	1, 2, ..., 263
≡ M	NTSC	2	1,2, ..., 262

→ Remote: TRIG:VID:LINE 17

Field 1/2

Selects the active field. Field 1 is the default state. This softkey is only available for the TV standard **M** in combination with another color system than **PAL**.

For details on numbering conventions of TV picture lines refer to the **Line** softkey.

→ Remote: TRIG:VID:FIEL 2

Sweeptime Manual

Opens an edit dialog box to enter the total sweep time. Possible values are 25, 50 and 100 μ s. The set value is indicated on the softkey.

→ Remote: SWE:TIME 10s

Trigger Offset

Opens an edit dialog box to enter a value for the trigger offset. The set value is indicated on the softkey.

→ Remote: TRIG:HOLD 500us

Vision Modulation

Opens a submenu to measure the residual picture carrier and the modulation depth.

For further information refer to "[Vision Modulation – analog TV](#)" on page 4.159.

→ Remote: CONF:ATV:MEAS VMOD

→ Remote: CALC:ATV:RES:VMOD? ALL

Hum

Opens a submenu to measure the hum.

For further information refer to "[Hum – analog TV](#)" on page 4.160.

→ Remote: CONF:ATV:MEAS HUM

→ Remote: CALC:ATV:RES:HUM?

Auto Range

Automatically adjusts the x- and y-axis once. Alternatively the range of the y-axis can be changed via the **Range Log** softkey or the **Range Linear** softkey in the amplitude menu.

→ Remote: DISP:TRAC:Y:AUTO ON

Digital TV

Opens a submenu with all available digital TV measurements. Every measurement type provides its own submenu to set the parameters. Additionally the **Digital TV Settings** softkey gives access to the modulation standard information.

This softkey is only available if the active channel table has at least one channel with a digital TV modulation standard, or if no channel table **< none >** is activated.

If an analog TV channel is in use when pressing this softkey, automatically the first digital channel of the active channel table is selected.

For further details refer also to section "[Measurements](#)" on page 4.146.

Spectrum

Opens a submenu to measure a digital TV spectrum.

For further information refer to "[Spectrum – digital TV](#)" on page 4.160.

→ Remote: CONF:DTV:MEAS DSPEC

→ Remote: TRAC? TRACE1

Overview

Opens a submenu to measure the modulation accuracy.

For further information refer to "[Overview – digital TV](#)" on page 4.161.

→ Remote: CONF:DTV:MEAS OVER

→ Remote: CALC:DTV:RES? ALL

Zoom

Opens the **Select Result Parameter** dialog box to set the zoom:

None	The whole result table is displayed (default setting).
[parameter]	The selected parameter is displayed separately in the upper pane.

→ Remote: DISP:ZOOM:OVER MERP

→ Remote: DISP:ZOOM:MERR MERP

Modulation Analysis

Opens a submenu to select one of the following modulation measurements:

- [Const Diagram](#)
 - [Modulation Errors](#)
-

Const Diagram

Opens a submenu to display the constellation diagram. For further information refer to "[Constellation Diagram \(Modulation Analysis\) – digital TV](#)" on page 4.161.

- Remote: CONF:DTV:MEAS CONS
 - Remote: TRAC? TRACE1
-

Zoom

Opens the **Select Constellation Zoom Mode** dialog box to set the zoom:

- < none >** The whole constellation diagram is displayed (default setting).
- Quadrant 1/2/3/4** The selected quadrant is displayed. A pictogram shows the quadrant position.

- Remote: DISP:ZOOM:QUAD 1
-

Freeze

Sets the display mode. If activated, the constellation diagram is displayed unchanged, while the I/Q samples are collected in the background. If deactivated, the constellation diagram is displayed on basis of the current I/Q samples and, in continuous sweep mode, is updated with every measurement.

If a new zoom mode (see **Zoom** softkey) is selected, this softkey is automatically set to off.

- Remote: DISP:TRAC1:MODE:FRE ON
-

Modulation Errors

Opens a submenu to measure the modulation accuracy.

For further information refer to "[Modulation Errors \(Modulation Analysis\) – digital TV](#)" on page 4.162.

- Remote: CONF:DTV:MEAS MERR
 - Remote: CALC:DTV:RES? ALL
-

Channel Analysis

Opens a submenu to select a measurement for checking the transmission performance of a channel:

- [Echo Pattern](#)
-

Echo Pattern

Opens a submenu to measure the magnitude of channel impulse response with respect to the corresponding time delay.

For further information refer to "[Echo Pattern \(Channel Analysis\) – digital TV](#)" on page 4.162.

- Remote: CONF:DTV:MEAS EPAT
 - Remote: TRAC? TRACE1
-

Unit

Opens the **Unit** dialog box to select the unit: s, m.

→ Remote: CALC:DTV:UNIT:POW:EPAT M

Zoom

Opens an edit dialog box to zoom onto the echo pattern measurement, around 0 μ s. The zoom factor can vary from 1 to 20.

→ Remote: DISP:ZOOM:EPAT 2

→ Remote: DISP:ZOOM:EPAT:STAT ON

Velocity Factor

Opens an edit dialog box to enter the velocity of propagation of the signal in the transmission channel (e.g. cable), relative to speed of light.

The velocity factor is used to convert the impulse response results from seconds into meter, when changing the unit via the **Unit** softkey.

→ Remote: CORR:RVEL 2

Digital TV Settings

Opens the **Digital TV Settings** dialog box to modify the modulation standard and equalizer parameters. For details on the modulation standard parameters, refer also to "[Modulation standards](#)" on page 4.152 and "[To create a new modulation standard](#)" on page 4.148.



Under **Equalizer**, the following equalizer parameters can be modified:

- Activating or deactivating the equalizer: If the **Activate** option is activated, the equalizer is switched on and filters the signal.

- Activating or deactivating the **Freeze Equalizer** option: If activated the equalizer coefficients remain unchanged. If deactivated the equalizer taps are changed with every measurement.
 - Pressing the **Reset** button sets all equalizer parameters to their default values.
- Remote: SET:TV:STAN DK (TV Standard)
 - Remote: SOURce:DM:FORM QAM128 (Constellation)
 - Remote: DDEM:SRAT 1000000 (Symbol Rate)
 - Remote: DDEM:FILT:ALPH R018 (Roll-Off)
 - Remote: DDEM:SBAN NORM (Sideband Position)
 - Remote: DDEM:EQU OFF (Activate Equalizer)
 - Remote: DDEM:EQU:FRE ON (Freeze Equalizer)
 - Remote: DDEM:EQU:RES (Reset Equalizer)

Channel Power

Opens a submenu to measure the channel power of a digital TV signal.

For further information refer to "[Channel Power – digital TV](#)" on page 4.163.

APD

Opens a submenu to measure the amplitude probability density function (APD) of a digital TV signal sampled in the complex base band.

For further information refer to "[APD – digital TV](#)" on page 4.163.

- Remote: CONF:DTV:MEAS APD
- Remote: TRAC? TRACE1

Scaling

For details refer to the **Scaling** softkey in the power measurement menu of the base unit.

x–Axis Signal Lvl

For details refer to the **x–Axis Ref Level** softkey in the power measurement menu of the base unit.

x–Axis Range

For details refer to the **x–Axis Range** softkey in the power measurement menu of the base unit.

y–Axis Max Value

For details refer to the **y–Axis Max Value** softkey in the power measurement menu of the base unit.

y–Axis Min Value

For details refer to the **y–Axis Min Value** softkey in the power measurement menu of the base unit.

Default Settings

For details refer to the **Default Settings** softkey in the power measurement menu of the base unit.

CCDF

Opens a submenu to measure the complementary cumulative distribution function (CCDF) of the amplitude of a digital TV signal sampled in the complex base band.

For further information refer to "[CCDF – digital TV](#)" on page 4.164.

- Remote: CONF:DTV:MEAS CCDF
 - Remote: TRAC? TRACE1
-

Percent Marker

For details refer to the **Percent Marker** softkey in the power measurement menu of the base unit.

TV Analyzer

Opens a submenu with all available measurements that can be applied to a set of channels or all channels of the entire TV network (channel table). In these measurements, both analog and digital TV channels can be measured together. This softkey is only available if a channel table is selected.

Every measurement type provides its own submenu to set the parameters. For each measurement, a channel table must be selected. The choice of no channel table **< none >** is not permitted.

For further details refer also to section "[Measurements](#)" on page 4.146.

Tilt

Opens a submenu to measure the frequency response of the cable TV system. Each channel is measured using the information stored in the modulation standard. Channels with the modulation standard **< unused >** are not measured.

For further information refer to "[Tilt – TV analyzer](#)" on page 4.164.

- Remote: CONF:TV:MEAS TILT
 - Remote: TRAC? TRACE1
-

Tilt Setup

Opens the **Tilt Setup** dialog box to define a filter for the Tilt measurement. The following parameters can be defined for the measurement:

- Span** full span or a limited frequency range
- Modulation Standards** channels with certain modulation standards (select one or several) or no restriction (select all)

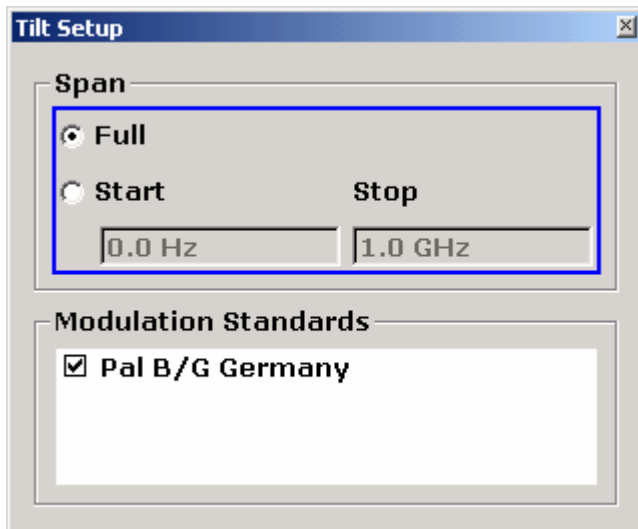

- Remote: `FREQ:SPAN:FULL, FREQ:STAR 20MHz, FREQ:STOP 2000MHz` (Span)
 - Remote: `TV:TILT:MST:CDIS 'Analog TV', TV:TILT:MST:CEN 'Analog TV'` (Modulation Standards)
-

Auto Range

Automatically adjusts the x- and y-axis once. Alternatively the range of the y-axis can be changed via the **Range Log** softkey or the **Range Linear** softkey in the amplitude menu of the base unit.

- Remote: `DISP:TRAC:Y:AUTO ON`
-

WLAN TX Measurements (Option K91)

The WLAN TX Measurements option extends the functionality of the R&S FSL spectrum analyzer to enable Wireless LAN TX measurements according to IEEE standards 802.11 a, b, g and j.

TX measurement of wireless LAN Device Under Test (DUT) according to the standards specified for the device can be performed:

- Modulation formats:
 - IEEE 802.11a, j, g (OFDM): BPSK, QPSK, 16 QAM, 64 QAM
 - IEEE 802.11b, g (single carrier): DBPSK, DQPSK, CCK (5.5 & 11 Mbps), PBCC (5.5, 11 & 22 Mbps)
- Modulation measurements:
 - Constellation diagram
 - Constellation diagram per OFDM carrier
 - I/Q offset and I/Q imbalance
 - Carrier and symbol frequency errors
 - Modulation error (EVM) per OFDM carrier or symbol
 - Amplitude response and group-delay distortion (spectral flatness)
- Amplitude statistics (CCDF) and crest factor
- Transmit spectrum mask
- FFT, also over a selected part of the signal, e.g. preamble
- Payload bit information
- Capture time selectable up to 15 ms (dependent on selected standard), multiple sweeps possible for large number of bursts (10922).

This option is available from firmware version 1.20.

To open the WLAN menu

- If the **WLAN** mode is not the active measurement mode, press the **MODE** key and activate the **WLAN** option.
- If the **WLAN** mode is already active, press the **MENU** or **MEAS** key.
The WLAN menu is displayed. .
- To exit the WLAN measurement mode, select another option. For details refer also to section "[Measurement Mode Selection – MODE Key](#)" on page 4.91.

Menu and softkey description

- "[Softkeys of the WLAN menu](#)" on page 4.195
- "[Softkeys of the sweep menu \(WLAN mode\)](#)" on page 4.221
- "[Softkeys of the marker menu \(WLAN mode\)](#)" on page 4.222
- "[Softkeys of the marker-> menu \(WLAN mode\)](#)" on page 4.223
- "[Softkeys of the lines menu \(WLAN mode\)](#)" on page 4.224
- "[Softkeys of the trace menu \(WLAN mode\)](#)" on page 4.224

The file, setup, and print menus are provided as described for the base unit. For details refer to the corresponding menu descriptions. The span and bandwidth menus are not available in the **WLAN** mode.

The **FREQ**, **AMPT**, and **TRIG** keys open the **General Settings** or the **Demod Settings** dialog box. For details refer to the **Settings General/Demod** softkey description (WLAN menu).

Further information topics

- ["Measurements and result displays"](#) on page 4.190
- ["Rise / fall time measurement"](#) on page 4.193
- ["Title bar information"](#) on page 4.194
- ["Status bar information"](#) on page 4.194

Measurements and result displays

The WLAN option provides two main measurement types:

- IQ measurements (based on captured IQ data)
 - Power vs Time (see **PVT** softkey)
 - EVM vs Symbol, EVM vs Carrier (see **EVM vs Symbol/Carrier** softkey)
 - Phase vs Preamble, Frequency vs Preamble (see **Error Frequency/Phase** softkey)
 - Spectrum Flatness (see **Spectrum Flatness** softkey)
 - Spectrum FFT (see **Spectrum FFT** softkey)
 - Constellation vs Symbol, Constellation vs Carrier (see **Constell vs Symbol/Carrier** softkey)
 - Conditional Cumulative Distribution Function (see **CCDF** softkey)
 - Bit Stream (see **Bitstream** softkey)
 - Signal Field (see **Signal Field** softkey)
- frequency sweep measurements
 - Spectrum mask (see **Spectrum Mask** or **Spectrum IEEE/ETSI** softkeys)
 - Spectrum ACP/ACPR (see **Spectrum ACPR** or **ACP Rel/Abs** softkey)

The measurement result display is divided into two panes:

- [Measurement settings](#)
- Result displays

The results can be displayed in form of a list or a graph (see also **Display List/Graph** softkey).

- ["Result summary list"](#) on page 4.191
- ["Result display graph"](#) on page 4.192

Measurement settings

The overall measurement settings used to obtain the current measurement results are displayed below the title bar (see Fig. 4–20). The following settings are listed:

Setting	Description	Restrictions
Frequency	The frequency of the measured input signal.	
Preamble Type	The type of preamble of analyzed bursts.	
Ref Level	The reference level used for the input signal.	IEEE 802.11b, g (Single Carrier) only
Modulation	Shows the active setting selected in the Demod Settings dialog box: Demodulator or PSDU Modulation to Analyze .	
External Att	The attenuation (positive values) or gain (negative values) applied to the signal externally (i.e. before the RF or IQ connector of the spectrum analyzer), e.g.: External Att = 10 dB means that before the RF connector of the R&S FSL a 10 dB attenuator is used External Att = -20 dB means that before the RF connector of the R&S FSL a amplifier with 20 dB gain is used	
PSDU Data Length	Shows the minimum and maximum number of data bytes that a burst may have if it is to be considered in results analysis.	IEEE 802.11b, g (Single Carrier) only

IEEE 802.11g		
Frequency:	6 GHz	Ref Level: 7.4 dBm
Preamble Type:	OFDM	External Att: 0 dB
Modulation:	11 Mbps 54 QAM	PSDU Len: 1/1366

Fig. 4–20 Measurement settings (example)

Result summary list

The result summary list shows the overall measurement results and provides limit checking for result values in accordance with the selected standard. Result values which are within the limit as specified by the standard are displayed in green. Result values which are outside of the limits specified by the standard are displayed in red with a "*" to the left. Results which have no limits specified by the standard are displayed in white. Limit values are displayed in white (not bold) and can be modified, when focused, via the keypad. To reset the limit values to the values specified in the standard, use the lines menu (**LINES** key).

The results displayed in this list are for the entire measurement. If a specific number of bursts have been requested which requires more than one sweep, the result summary list is updated at the end of each sweep. The number of bursts measured and the number of bursts requested are displayed to show the progress through the measurement. The Min / Mean / Max columns show the minimum, mean or maximum values of the burst results.



Fig. 4–21 Result summary list (example)

Result display graph

Additionally to the selected graphical result display, the Magnitude Capture Buffer display is provided for all IQ measurements. The different result displays are described with the corresponding softkey.

The Magnitude Capture Buffer display shows the complete range of captured data for the last sweep. All analyzed bursts are identified with a green bar at the bottom of the Magnitude Capture Buffer display. If, in the **Demod Settings** dialog box, the **Signal Field Content** option is activated only bursts that match the required criteria are marked with a green bar.

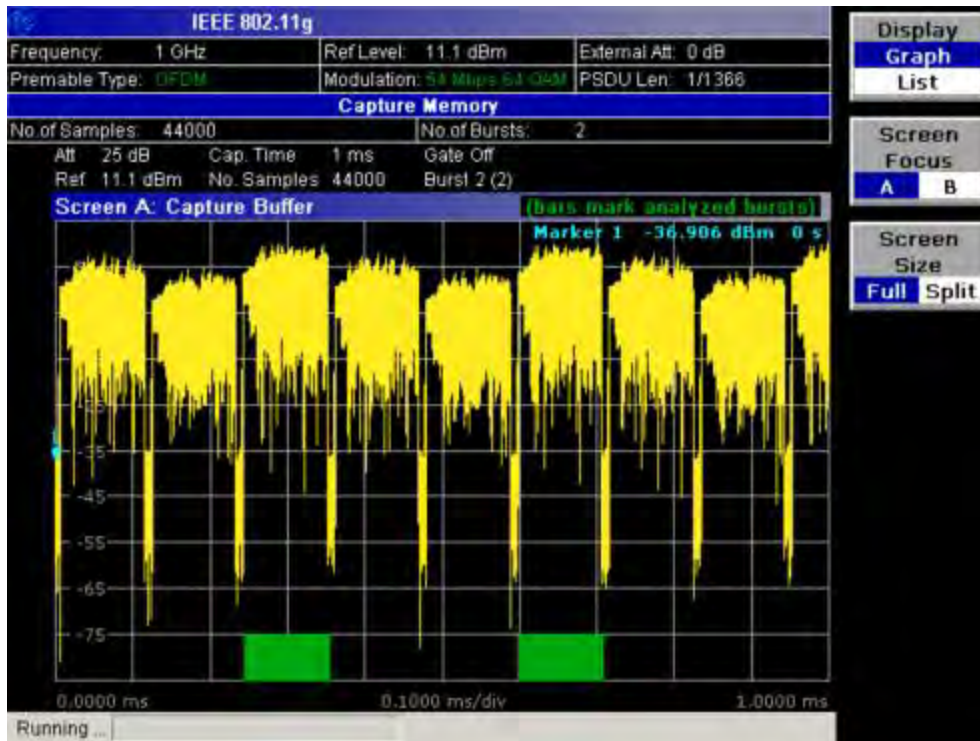

Fig. 4–22 Magnitude capture buffer results (example)

- IQ measurements

All IQ measurements process the same signal data and as such all IQ measurement results are available after a single IQ measurement execution.

IQ measurements can be run in split screen mode (allowing both the Magnitude Capture Buffer display and the selected IQ measurement results to be displayed simultaneously) or in full screen mode (with either the Magnitude Capture Buffer display or the selected IQ measurement results displayed).

- frequency sweep measurements

The frequency sweep measurements use different signal data to IQ measurements and as such it is not possible to run an IQ measurement and then view the results in the frequency sweep measurements and vice-versa. Also because each of the frequency sweep measurements uses different settings to obtain signal data it is not possible to run a frequency sweep measurement and view the results of another frequency sweep measurement.

All frequency sweep measurements are run in full screen mode.

Further information

This section provides background information on measurements and displayed information. For details on signal processing refer to chapter "Advanced Measurement Examples", section "Measurement Examples of the WLAN TX Measurements Option (K91)".

Rise / fall time measurement

The rise/fall time is calculated according to the following algorithm:

- Apply a moving average filter over the burst power (adjustable average length)
- If **Ref Pow Max** is set: Search maximum power P_{\max} over the whole burst. Set $P_{\text{ref}}=P_{\max}$

- If **Ref Pow Mean** is set: Calculate mean power P_{mean} of the whole burst. Set $P_{\text{ref}}=P_{\text{mean}}$
- Rise time
 - Search the first crossing of $0.5xP_{\text{ref}}$ from the left.
 - Search backwards for the 10% crossing $0.1xP_{\text{ref}}$ and note t_{10} .
 - Search forward for the 90% crossing $0.9xP_{\text{ref}}$ and note t_{90} .
 - Return $T_{\text{rise}}=t_{90}-t_{10}$.
- Fall time
 - Search the first crossing of $0.5xP_{\text{ref}}$ from the right.
 - search forwards for the 10% crossing $0.1xP_{\text{ref}}$ and note t_{10} .
 - search backwards for the 90% crossing $0.9xP_{\text{ref}}$ and note t_{90} .
 - Return $T_{\text{fall}}=t_{10}-t_{90}$.

Since the single carrier modes of 802.11b, g use linear modulation formats like BPSK or QPSK, the transmit signal power varies between symbol sampling times. These power variations are determined by the transmit filter, which is not defined in the standard. The R&S FSL-K91 allows fine tuning of the PVT measurements on signals with high crest factors by an adjustable moving average filter and two different reference power settings.

The reference power equals the 100% setting for the rise / fall time calculation. Either the maximum burst power or the mean burst power can be chosen as reference power. Using the mean burst power, rarely power peaks within the burst does not influence the rise / fall time measurement.

The moving average filter smoothes the power trace and thus eliminates the modulation. While a long average length leads to more stable measurement results, it naturally increases the rise / fall times compared to no averaging.

Title bar information

The title bar displays the following information:

- wireless LAN standard applicable to the current measurement (in the middle)

Status bar information

The status bar displays the following information:

- parameter values

When a parameter in a settings dialog box is selected, the minimum and maximum values for the selected parameter are displayed.

When a Boolean parameter in a dialog box is selected, the minimum and maximum values are displayed as N/A for not applicable.

- measurement status

When a measurement is performed, the current measurement status along with detailed information about the progress is displayed.

- error messages (with red background)
- warning messages (with yellow background)

Softkeys of the WLAN menu

The following table shows all softkeys available in the WLAN menu. It is possible that your instrument configuration does not provide all softkeys. If a softkey is only available with a special option, model or (measurement) mode, this information is delivered in the corresponding softkey description.

Menu / Command	Command
Settings General/Demod	
Display List/Graph	
PVT ↓	Settings General/Demod
	Display List/Graph
	Full Burst
	Rising & Falling
	Ramp Up/Down/Up & Down
	Ref Pow Max/Mean
	Average Length
	More ↓
	Gating Settings On/Off
	Import
	Export
	R&S Support
EVM Constell ↓	Settings General/Demod
	Display List/Graph
	EVM vs Symbol/Carrier
	Error Frequency/Phase
	Constell vs Symbol/Carrier
	Carrier Selection
	More ↓
	Gating Settings On/Off
	Import
	Export
	Y-Axis/Div
	R&S Support
Spectrum ↓	Settings General/Demod
	Display List/Graph
	Spectrum Flatness
	Spectrum Mask / Spectrum IEEE/ETSI
	Spectrum FFT
	Spectrum ACPR / Spectrum ACP / ACP Rel/Abs
	More ↓
	same contents as PVT side menu
Statistics ↓	Settings General/Demod
	Display List/Graph
	CCDF
	Bitstream
	Signal Field / PLCP Header

Menu / Command	Command
	More ↓
	same contents as PVT side menu

Settings General/Demod

Opens the **General Settings** or the **Demod Settings** dialog box. Screenshots of the dialog boxes are provided in chapter "Advanced Measurement Examples", section "Measurement Examples of the WLAN TX Measurements Option (K91)".

Alternatively, the **General Settings** dialog box is opened as follows:

- **FREQ** key, with focus on the **Frequency** field
- **AMPT** key, with focus on the **Signal Level (RF)** field
- **TRIG** key, with focus on the **Trigger Mode** field

In the **General Settings** dialog box, all settings related to the overall measurement can be modified. The right pane with the advanced settings is only displayed if the **Advanced Settings** option is activated. The **General Settings** dialog box contains the following elements:

Signal Characteristics	Standard
	Frequency
	Channel No
Level Settings	Signal Level
	Auto Lvl
	Ext Att
Data Capture Settings	Capture Time
	Burst Count
	Analyze Bursts
	Sweep Count
Trigger Settings	Trigger Mode
	Trigger Offset
	Power Level
	Auto Lvl
IQ Settings	Swap IQ
Advanced Settings	Auto Level Time
	Ref Level
	Attenuation
	Sample Rate

In the **Demod Settings** dialog box, the settings associated with the signal modulation can be modified. The settings under **Burst to Analyze** specify the characteristics of the bursts to be considered in the measurement results. Only the bursts which meet the criteria specified in this group will be included in measurement analysis if the **Use Header Content** option is activated. The tracking settings allow various errors in measurement results to be compensated for.

The **Demod Settings** dialog box contains the following elements. If an element is only available for certain standards, the corresponding standards are listed.

Burst to Analyze	Signal Field Content
	Use Header Content
	Burst Type
	Preamble Type
	Auto Demodulation
	Analyze PSDU Mod
	Demodulator
	Equal Burst Length
	Data Symbols
	Min Data Symbols
	Max Data Symbols
	Channel Estimation
	Payload Length
	Min Payload Length
	Max Payload Length
Tracking	Phase
	Timing
	Level

Standard (General Settings dialog box)

Displays a list of all installed standards to select the wireless LAN standard. This is necessary to ensure that the measurements are performed according to the specified standard with the correct limit values and limit lines.

→ Remote: CONF:STAN 0

Frequency (General Settings dialog box)

Specifies the center frequency of the signal to be measured. When the frequency is modified, the **Channel No** field is updated accordingly.

→ Remote: FREQ:CENT 100MHz

Channel No (General Settings dialog box)

Specifies the channel to be measured. When the **Channel No** field is modified, the frequency is updated accordingly.

→ Remote: CONF:CHAN 9

Signal Level (General Settings dialog box)

Specifies the expected mean level of the RF input signal. If an automatic level detection measurement has been executed the signal level (RF) is updated.

For all standards other than IEEE 802.11b & g (Single Carrier), the reference level is set 10 dB higher than the signal level (RF) because of the expected crest factor of the signal. For standards IEEE 802.11b & g (Single Carrier), the reference level is set to the signal level (RF).

→ Remote: CONF:POW:EXP:RF 9

Auto Lvl (General Settings dialog box)

Activates or deactivates the automatic setting of the reference level for measurements.

On The reference level is measured automatically at the start of each measurement sweep. This ensures that the reference level is always set at the optimal level for obtaining accurate results but will result in slightly increased measurement times. For details about automatic level detection refer to chapter "Advanced Measurement Examples".

Off The reference level is defined manually in the **Signal Level** field.

→ Remote: CONF:POW:AUTO 1

→ Remote: CONF:POW:AUTO:SWE:TIME 200MS

Ext Att (General Settings dialog box)

Specifies the external attenuation or gain applied to the RF signal. A positive value indicates attenuation, a negative value indicates gain. All displayed power level values are shifted by this value.

→ Remote: INP:ATT 30dB

Capture Time (General Settings dialog box)

Specifies the time (and therefore the amount of data) to be captured in a single measurement sweep.

→ Remote: SWE:TIME 10ms

Burst Count (General Settings dialog box)

Activates or deactivates a specified number of bursts for capture and analysis.

On The data analysis is performed over a number of consecutive sweeps until the required number of bursts has been captured and analyzed.

Off The data analysis is performed on a single measurement sweep.

→ Remote: BURS:COUN:STAT ON

Analyze Bursts (General Settings dialog box)

Specifies the number of bursts to be measured, if the **Burst Count** option is activated.

→ Remote: BURS:COUN 16

Sweep Count (General Settings dialog box)

Specifies the number of sweeps to be performed for Spectrum ACP/ACPR and Spectrum Mask measurements.

→ Remote: `SWEep:COUNT 64`

Trigger Mode (General Settings dialog box)

Sets the source of the trigger for the measurement sweep.

- Free Run** The measurement sweep starts immediately.
- External** Triggering via a TTL signal at the input connector EXT TRIGGER/GATE IN on the rear panel.
- Power** The measurement sweep starts when the signal power meets or exceeds the specified power trigger level. This trigger mode is not available for Spectrum Mask measurements in ETSI standard. If it is set and then the Spectrum Mask measurement in ETSI standard is selected, it automatically changes to **Free Run**.

→ Remote: `TRIG:MODE IMM`

Trigger Offset (General Settings dialog box)

Specifies the time offset between the trigger signal and the start of the sweep. A negative value indicates a pre-trigger. This field is not available in the **Free Run** trigger mode.

→ Remote: `TRIG:HOLD 500us`

Power Level (General Settings dialog box)

Specifies the trigger level if the **Power** trigger mode is set.

→ Remote: `TRIG:LEV:POW 10 DBM`

Auto Lvl (General Settings dialog box)

Activates or deactivates the automatic measurement of the power trigger level.

- On** The power trigger level is measured automatically at the start of each measurement sweep. This ensures that the power trigger level is always set at the optimal level for obtaining accurate results but will result in a slightly increased measurement times.
- Off** The power trigger level is defined manually in the **Power Level** field.

→ Remote: `TRIG:LEV:POW:AUTO ON`

Swap IQ (General Settings dialog box)

Activates or deactivates the inverted I/Q modulation.

- On** I and Q signals are interchanged.
- Off** Normal I/Q modulation.

→ Remote: `SWAP ON`

Auto Level Time (General Settings dialog box)

Specifies the sweep time used for the automatic level measurements.

→ Remote: CONF:POW:AUTO:SWE:TIME 200MS

Ref Level (General Settings dialog box)

Specifies the reference level to use for measurements. When the reference level is modified the signal level is updated accordingly (depending on the currently selected standard and measurement type). This field is only editable if the **Auto Lvl** is deactivated.

→ Remote: DISP:TRAC:Y:RLEV?

Attenuation (General Settings dialog box)

Specifies the settings for the attenuator. This field is only editable if the **Auto Lvl** option is deactivated. If the **Auto Lvl** option is activated, the RF attenuator setting is coupled to the reference level setting.

→ Remote: INP:ATT 30dB

Sample Rate (General Settings dialog box)

Specifies the sample rate used for IQ measurements.

→ Remote: TRACE:IQ:SRAT 20000

Signal Field Content (Demod Settings dialog box, IEEE 802.11a, g (OFDM), j)

Activates or deactivates the decoding of the captured burst data.

- On Only the bursts are included in the results analysis whose modulation format specified in the signal symbol field matches the modulation format specified in the **Analyze PSDU Mod** field.
- Off The data is demodulated according to the modulation scheme specified in the **Demodulator** field. If any of the analyzed data has a modulation different to that specified the results will be of limited use.

→ Remote: DEM:FORM:SIGS ON

Use Header Content (Demod Settings dialog box, IEEE 802.11b, g – Single Carrier)

Activates or deactivates the PLCP header field decoding of the captured burst data.

- On Only the bursts are included in the results analysis whose modulation format specified in the signal symbol field matches the modulation format specified in the **Analyze PSDU Mod** field.
- Off The data is demodulated according to the modulation scheme specified in the **Demodulator** field. If any of the analyzed data has a modulation different to that specified the results will be of limited use.

→ Remote: DEM:FORM:AUT ON

Burst Type (Demod Settings dialog box, IEEE 802.11a, g (OFDM, Single Carrier), j)

Specifies the type of burst to be included in measurement analysis. Only one burst type can be selected for the measurement results. The following burst types are supported:

Direct Link Burst	IEEE 802.11a, j
OFDM	IEEE 802.11g
Long DSSS-OFDM	IEEE 802.11g
Short DSSS-OFDM	IEEE 802.11g
Long PLCP	IEEE 802.11g
Short PLCP	IEEE 802.11g

→ Remote: DEM:FORM:BAN:BTYPe 'DIRECT'

Preamble Type (Demod Settings dialog box, IEEE 802.11b)

Specifies the type of burst which should be included in measurement analysis. The following burst types are supported: Short PLCP, Long PLCP.

→ Remote: DEM:FORM:BAN:BTYPe 'SHORT'

Auto Demodulation (Demod Settings dialog box, IEEE 802.11a, g (OFDM), j)

Activates or deactivates the automatic detection of the modulation. If activated, the modulation applied to the input data is determined from the modulation type of the first complete burst within the captured data. This option automatically activates the **Signal Field Content** option.

→ Remote: DEM:FORM:AUT ON

Analyze PSDU Mod (Demod Settings dialog box, IEEE 802.11a, g (OFDM), j)

Specifies the modulation of the bursts to be analyzed. Only bursts using the selected modulation are considered in measurement analysis. This option is only available if the **Signal Field Content** or the **Use Header Content** option is activated.

→ Remote: DEM:FORM:AUT ON

Demodulator (Demod Settings dialog box, IEEE 802.11a, g (OFDM), j)

Specifies the modulation to be applied to the measured data. If the captured data uses a different modulation scheme than specified by this field the results will be of limited use. This field is only available if the **Signal Field Content** or the **Use Header Content** option is deactivated.

→ Remote: DEM:FORM:BAN 'QAM16'

Equal Burst Length (Demod Settings dialog box)

Activates or deactivates the burst selection for measurement analysis according to the range or specific number of data symbols/bytes.

Standard	State	Description
IEEE 802.11a, j	On	Only bursts with exactly the number of symbols specified in the Data Symbols field are considered for measurement analysis.
	Off	Only bursts within the range of data symbols specified by the Min Data Symbols and Max Data Symbols fields are considered for measurement analysis.
IEEE 802.11b, g (Single Carrier)	On	Only bursts with exactly the number of data bytes or duration specified in the Payload Length field are considered for measurement analysis.
	Off	Only bursts within the range of data bytes or duration specified by the Min Payload Length and Max Payload Length fields are considered for measurement analysis.
IEEE 802.11g (OFDM)	On	Only bursts with exactly the number of data symbols or duration specified in the Payload Length field are considered for measurement analysis.
	Off	Only bursts within the range of data symbols or duration specified by the Min Payload Length and Max Payload Length fields are considered for measurement analysis.

→ Remote: DEM:FORM:BAN:SYM:EQU ON

→ Remote: DEM:FORM:BAN:DBYTES:EQU ON

→ Remote: DEM:BAN:DUR:EQU ON (PVT)

Data Symbols (Demod Settings dialog box, IEEE 802.11a, j)

Specifies the number of data symbols of a burst to be considered in measurement analysis. This field is only available if the **Equal Burst Length** option is activated.

→ Remote: DEM:FORM:BAN:SYM:MIN 16

Min Data Symbols (Demod Settings dialog box, IEEE 802.11a, j)

Specifies the minimum number of data symbols of a burst to be considered in measurement analysis. This field is only available if the **Equal Burst Length** option is deactivated.

→ Remote: DEM:FORM:BAN:SYM:MIN 16

Max Data Symbols (Demod Settings dialog box, IEEE 802.11a, j)

Specifies the maximum number of data symbols of a burst to be considered in measurement analysis. This field is only available if the **Equal Burst Length** option is deactivated.

→ Remote: DEM:FORM:BAN:SYM:MAX 1300

Channel Estimation (Demod Settings dialog box, IEEE 802.11a, g (OFDM), j)

Specifies how accurately the EVM results are calculated.

Preamble The channel estimation is performed in the preamble as required in the standard.

Payload The channel estimation is performed in the payload.

→ Remote: DEM:CEST ON

Payload Length (Demod Settings dialog box, IEEE 802.11b, g)

Specifies the number of symbols, bytes or duration of a burst to be considered in measurement analysis. This field is only available if the **Equal Burst Length** option is activated.

→ Remote: DEM:FORM:BAN:DBYTeS:MIN 16

→ Remote: DEM:BAN:DUR:MIN 45

Min Payload Length (Demod Settings dialog box, IEEE 802.11b, g)

Specifies the minimum number of symbols, bytes or duration of a burst to be considered in measurement analysis. This field is only available if the **Equal Burst Length** option is deactivated.

→ Remote: DEM:FORM:BAN:DBYTeS:MIN 16

→ Remote: DEM:BAN:DUR:MIN 45

Max Payload Length (Demod Settings dialog box, IEEE 802.11b, g)

Specifies the maximum number of symbols, bytes or duration of a burst to be considered in measurement analysis. This field is only available if the **Equal Burst Length** option is deactivated.

→ Remote: DEM:FORM:BAN:DBYTeS:MAX 1300

→ Remote: DEM:BAN:DUR:MAX 1300

Phase (Demod Settings dialog box)

Activates or deactivates the compensation for phase error. If activated, the measurement results are compensated for phase error on a per-symbol basis.

→ Remote: TRAC:PHAS 1

Timing (Demod Settings dialog box)

Activates or deactivates the compensation for timing error. If activated, the measurement results are compensated for timing error on a per-symbol basis.

→ Remote: TRAC:TIME ON

Level (Demod Settings dialog box)

Activates or deactivates the compensation for level error. If activated, the measurement results are compensated for level error on a per-symbol basis.

→ Remote: TRAC:LEV ON

Display List/Graph

Configures the result display. The measurement results are displayed either in form of a list of measurement points or as a graphical trace.

→ Remote: DISP:WIND1:TABL ON

→ Remote: for result queries see chapter "Remote Control – Commands", section FETCh Subsystem

PVT

Opens the PVT submenu to select the Power vs Time measurement results.

The PVT result displays show the minimum, average and maximum levels measured over the full range of the measured input data, or over complete bursts displayed within the gating lines if gating is switched on. The results are displayed as a single burst. Using screen B in full screen provides additional power information during this measurement.

For IEEE 802.11b and g (single carrier), the PVT results are displayed as percentage values of the reference power. The reference can be set to either the max or mean power of the burst. For both rising and falling edges two time lines are displayed, which mark the points 10% and 90% of the reference power. The time between these two points is compared against the limits specified for the rising and falling edges.

For further details see also "[Rise / fall time measurement](#)" on page 4.193.

→ Remote: CONF:BURS:PVT

Full Burst (IEEE 802.11a, g, j – OFDM)

Displays the PVT results in a single graph with all burst data being displayed.

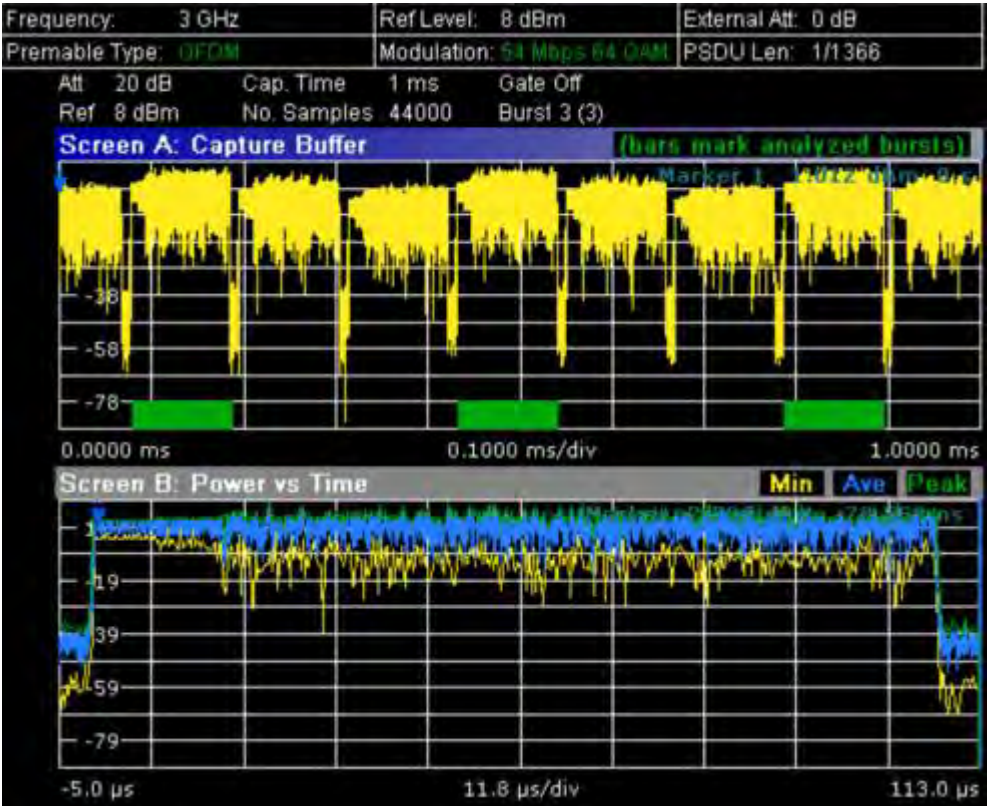

For further details refer to the PVT softkey.

→ Remote: CONF:BURS:PVT:SEL FULL

Rising & Falling (IEEE 802.11a, g, j – OFDM)

Displays the PVT results in two separate graphs, the left hand side showing the rising edge and the right hand side showing the falling edge.



→ Remote: CONF: BURS: PVT: SEL EDGE

Ramp Up/Down/Up & Down (IEEE 802.11b, g – Single Carrier)

Sets the display of the rising/falling edge graph:

- Up** Displays the rising edge graph.
- Down** Displays the falling edge graph.
- Up & Down** Displays the rising and falling edge graph.

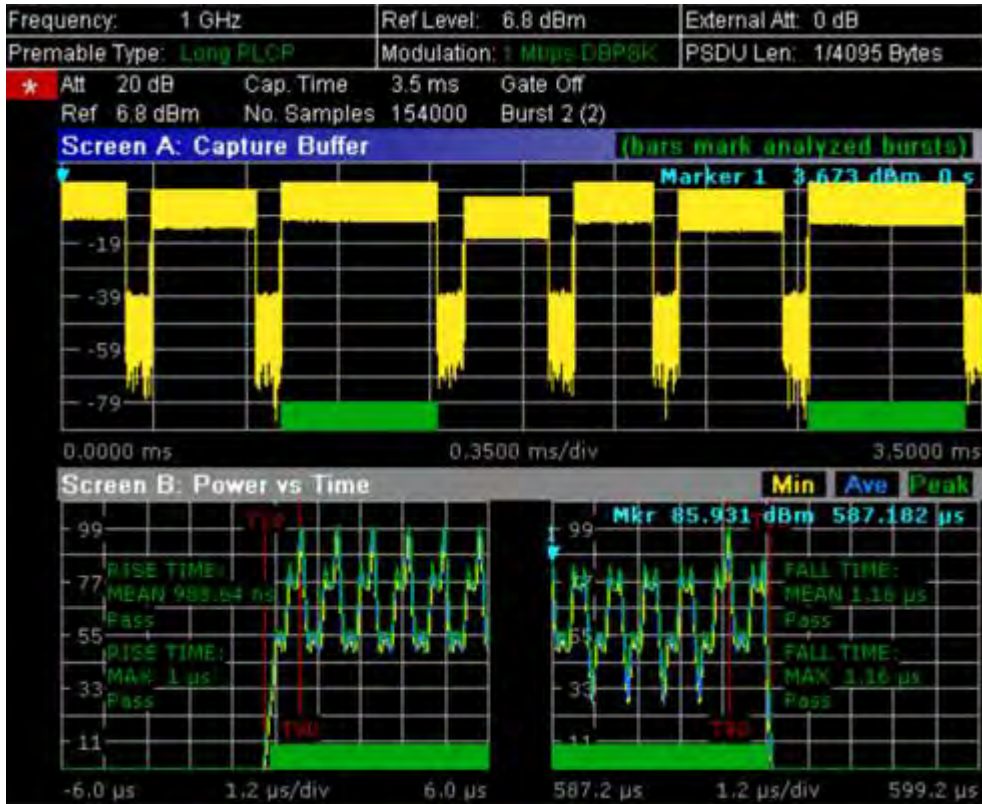

For further details refer to the **PVT** softkey.

→ Remote: CONF:BURS:PVT:SEL RISE

Ref Pow Max/Mean (IEEE 802.11b, g – Single Carrier)

Sets the reference for the rise and fall time calculation to the maximum or mean burst power.

For further details refer to the **PVT** softkey.

→ Remote: CONF:BURS:PVT:RPOW MEAN

Average Length (IEEE 802.11b, g – Single Carrier)

Opens an edit dialog box to enter the number of samples in order to adjust the length of the smoothing filter.

For further details refer to the **PVT** softkey.

→ Remote: CONF:BURS:PVT:AVER 31

Gating Settings On/Off

Activates or deactivates gating, or opens the **Gate Settings** dialog box to specify range of captured data used in results calculation.

- On Uses only the specified range of captured data in results calculation. In the Magnitude Capture Buffer trace, two vertical lines mark the specified range.
- Off Uses all the captured data in results calculation.

In the **Gate Settings** dialog box, the following parameters are set:

- Delay** Start point of captured data to be used in results calculation, i.e. the delay from the start of the captured data in time or samples. If the delay is specified in time, the number of samples is updated accordingly, and vice versa.
- Length** Amount of captured data to be used in results calculation. If the length is specified in time, the number of samples is updated accordingly, and vice versa.
- Link Gate and Mark** If activated, the position of the marker and the gate lines are linked. The marker is positioned half way between gate start and end. The marker position alters when the gate is modified, and the gate lines move with the marker when the marker position is altered.

The gate settings are defined for following measurements: PVT, Spectrum FFT, CCDF, Spectrum Mask, Spectrum ACPR.

If a frequency sweep measurement is active (Spectrum Mask and Spectrum ACP) the result display is switched to the Magnitude Capture Buffer display in order to allow the gate to be set the correct part of the sweep.

- Remote: SWE:EGAT ON
 - Remote: SWE:EGAT:HOLD 125us, SWE:EGAT:HOLD:SAMP 2500 (Delay)
 - Remote: SWE:EGAT:LENG 20ms, SWE:EGAT:LENG:SAMP 200000 (Length)
 - Remote: SWE:EGAT:LINK ON (Link Gate and Mark)
-

Import

Opens the **Choose the file to import** dialog box.

Select the file you want to import and press **ENTER**. The extension of data files is *.iqw.

- Remote: MMEM:LOAD:IQ:STAT
-

Export

Opens the **Choose the file to export** dialog box.

Enter the path and the name of the IQ data file you want to export and press **ENTER**. The extension of data files is *.iqw. If the file cannot be created or there is no valid IQ data to export an error message is displayed.

- Remote: MMEM:STOR:IQ:STAT
-

R&S Support

Creates files that help identifying the current problem. They are stored under C:\R_S\Instr\user\Support. If you contact the Rohde&Schwarz support to get help for a certain problem, send these files to the support in order to identify and solve the problem faster.

Y–Axis/Div

Opens a dialog box to modify the y–axis settings:

Auto Scaling	If activated, the scaling of the y–axis is calculated automatically.
Per Division	Specifies the scaling to be used if Auto Scaling is deactivated.
Unit	Specifies the y–axis unit. With the unit is dB, Auto Scaling is always activated.

→ Remote: DISP:WIND2:TRAC:Y:SCAL:AUTO ON

→ Remote: DISP:WIND2:TRAC:Y:SCAL:DPIV 2

EVM Constell

Opens a submenu to select the error vector magnitude (EVM) or the constellation result displays.

EVM vs Symbol/Carrier

Selects the EVM vs Symbol or EVM vs Carrier result displays.

– EVM vs Symbol

This result display shows the EVM measured over the full range of the measured input data. The results are displayed on a per–symbol basis, with blue vertical lines marking the boundaries of each burst. Note that burst boundary lines are only displayed if the number of analyzed bursts is less than 250.

For IEEE 802.11a, j, g (OFDM) the minimum, average, and maximum traces are displayed.

For IEEE 802.11b, g (Single Carrier) two EVM traces are displayed. The trace labeled with VEC ERR IEEE shows the error vector magnitude as defined in the IEEE 802.11b, g standards. For the trace labeled with EVM a commonly used EVM definition is applied, which is the square root of the momentary error power normalized by the averaged reference power.

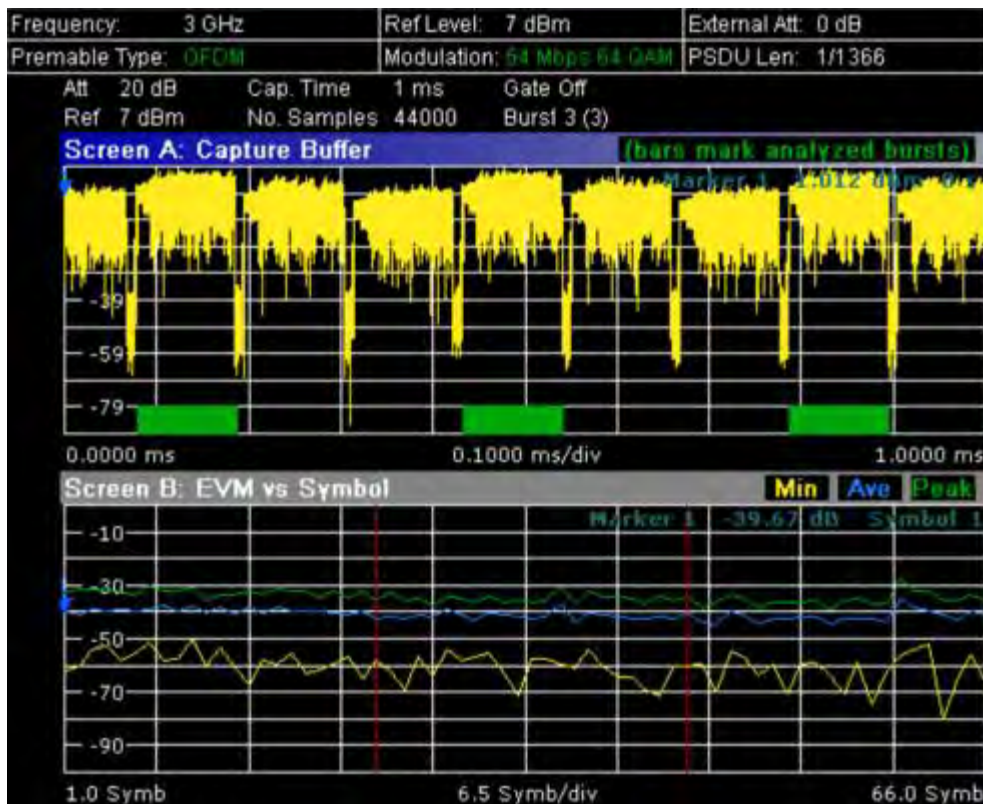

- EVM vs Carrier (IEEE 802.11a, g, j – OFDM)

This result display shows all EVM values recorded on a per-carrier basis over the full set of measured data. An average trace is also displayed.

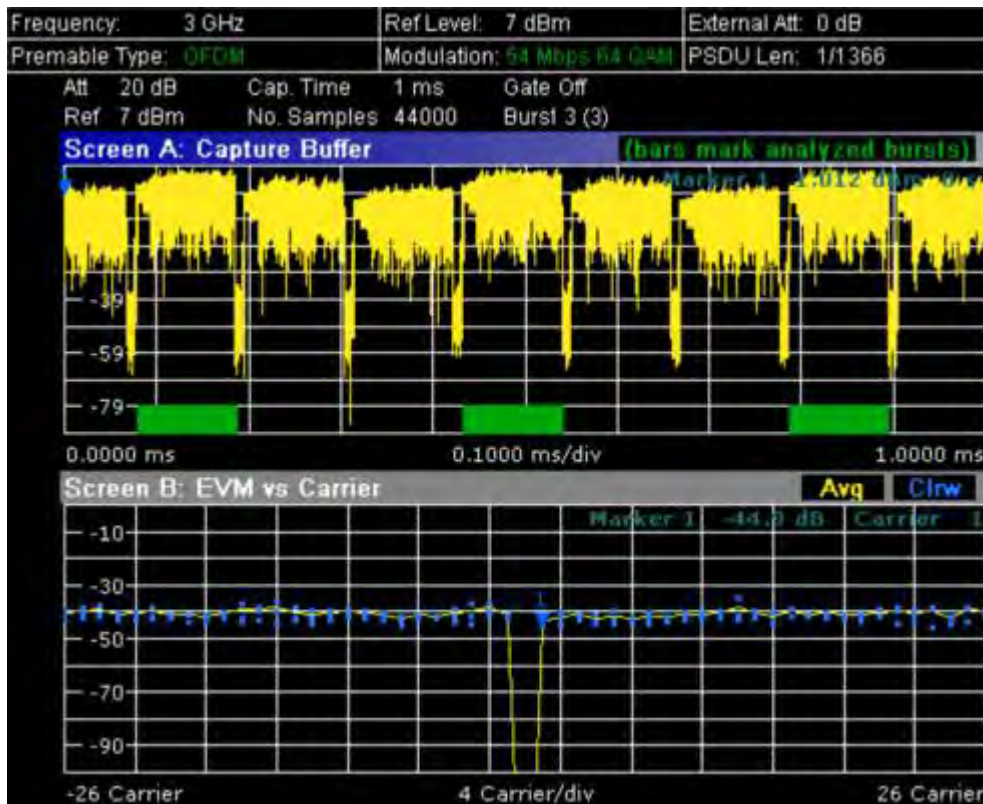

- Remote: CONF:BURS:EVM:ESYM (EVM vs Symbol)
- Remote: CONF:BURS:EVM:ECAR (EVM vs Carrier)

Error Frequency/Phase

Selects the Rel. Frequency Error vs Preamble or the Phase Error vs Preamble result displays.

These result displays show the error values recorded over the preamble part of the burst. A minimum, average and maximum trace are displayed. The results display either relative frequency error or phase error.

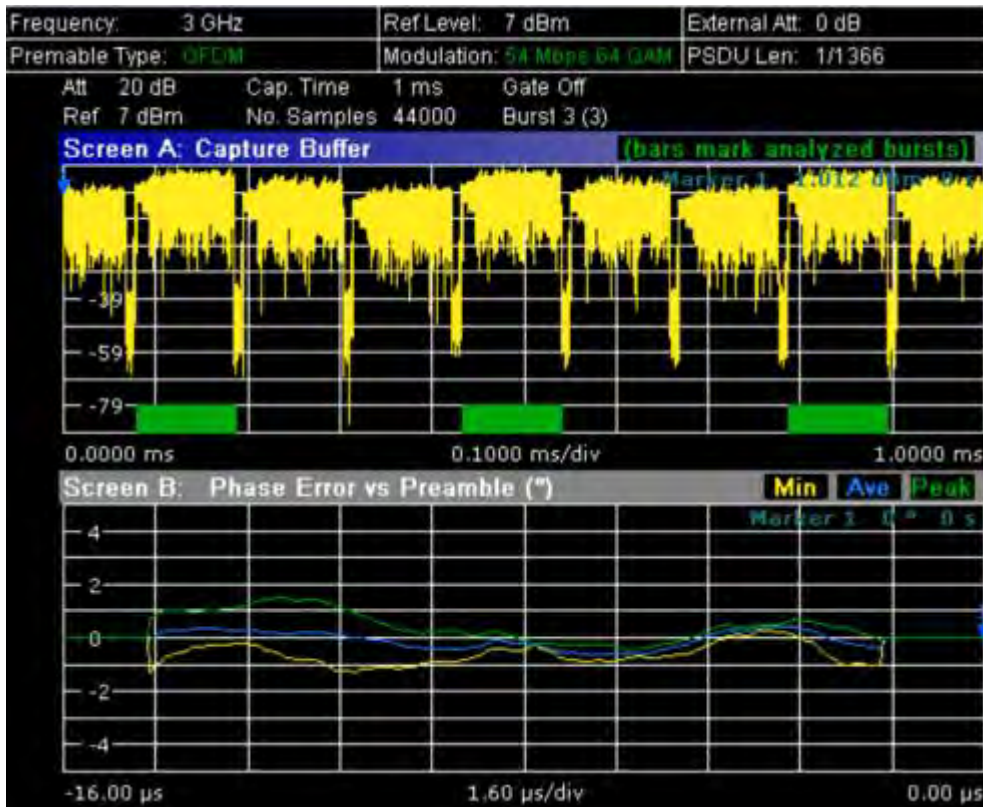

- Remote: CONF:BURS:PRE
- Remote: CONF:BURS:PRE:SEL_FREQ (Frequency Error vs Preamble)
- Remote: CONF:BURS:PRE:SEL_PHAS (Phase Error vs Preamble)

Constellation vs Symbol/Carrier

Selects the Constellation vs Symbol or the Constellation vs Carrier result displays.

- Constellation vs Symbol (all standards)

This result display shows the in-phase and quadrature phase results over the full range of the measured input data. The ideal points for the selected modulations scheme are displayed for reference purposes.

The amount of data displayed in the Constellation results display can be reduced by selecting the carrier or carriers for which data is to be displayed (**Carrier Selection** softkey).



- Constellation vs Carrier (IEEE 802.11a, g, j – OFDM)

This result display shows the in-phase and quadrature phase results over the full range of the measured input data plotted on a per-carrier basis. The magnitude of the in-phase and quadrature part is shown on the y-axis, both are displayed as separate traces (I→ trace 1, Q→ trace 2).

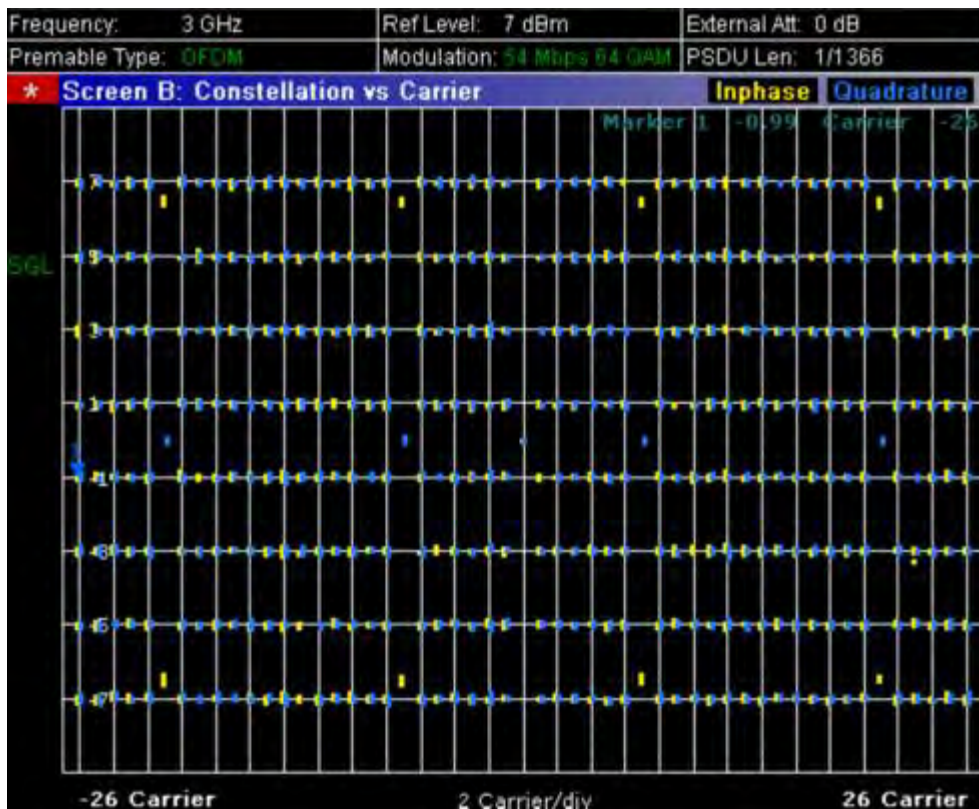

- Remote: CONF: BURS: CONS: CSYM (Constellation vs Symbol)
- Remote: CONF: BURS: CONS: CCAR (Constellation vs Carrier)

Carrier Selection (IEEE 802.11a, g, j – OFDM)

Opens a dialog box to select the carrier for data display. Either a specific carrier number, pilots only or all carriers can be selected.

- Remote: CONF: BURS: CONS: CARR: SEL -26

Spectrum

Opens a submenu for frequency measurements.

Spectrum Flatness (IEEE 802.11a, g, j – OFDM)

Sets the Spectrum Flatness result display.

This result display shows the spectrum flatness and group delay values recorded on a per-carrier basis over the full set of measured data. An average trace is also displayed for each of the result types. An upper and lower limit line representing the limits specified for the selected standard are displayed and an overall pass/fail status is displayed for the obtained (average) results against these limit lines.



→ Remote: CONF:BURS:SPEC:FLAT

**Spectrum Mask (IEEE 802.11b, g – Single Carrier),
Spectrum IEEE/ETSI (IEEE 802.11a, g, j – OFDM)**

Sets the Spectrum Mask result display.

This result display shows power against frequency. The span of the results is 100 MHz for IEEE and 500 MHz for ETSI around the specified measurement frequency. A limit line representing the spectrum mask specified for the selected standard is displayed and an overall pass/fail status is displayed for the obtained results against this limit line.

The number of sweeps is set in the **General Settings** dialog box, **Sweep Count** field. If the measurement is performed over multiple sweeps both a max hold trace and an average trace are displayed.

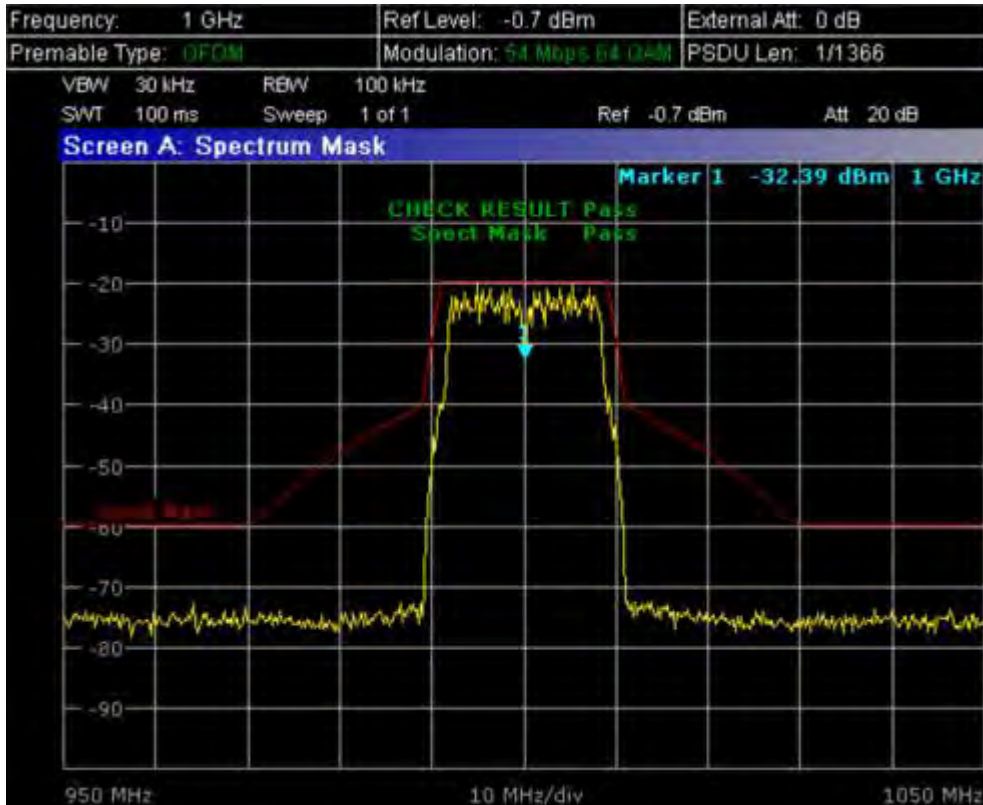

→ Remote: CONF:BURS:SPEC:MASK

→ Remote: CONF:BURS:SPEC:MASK:SEL ETSI

Spectrum FFT

Sets the Spectrum FFT result display.

This result display shows the Power vs Frequency results obtained from a FFT performed over the range of data in the Magnitude Capture Buffer which lies within the gate lines.

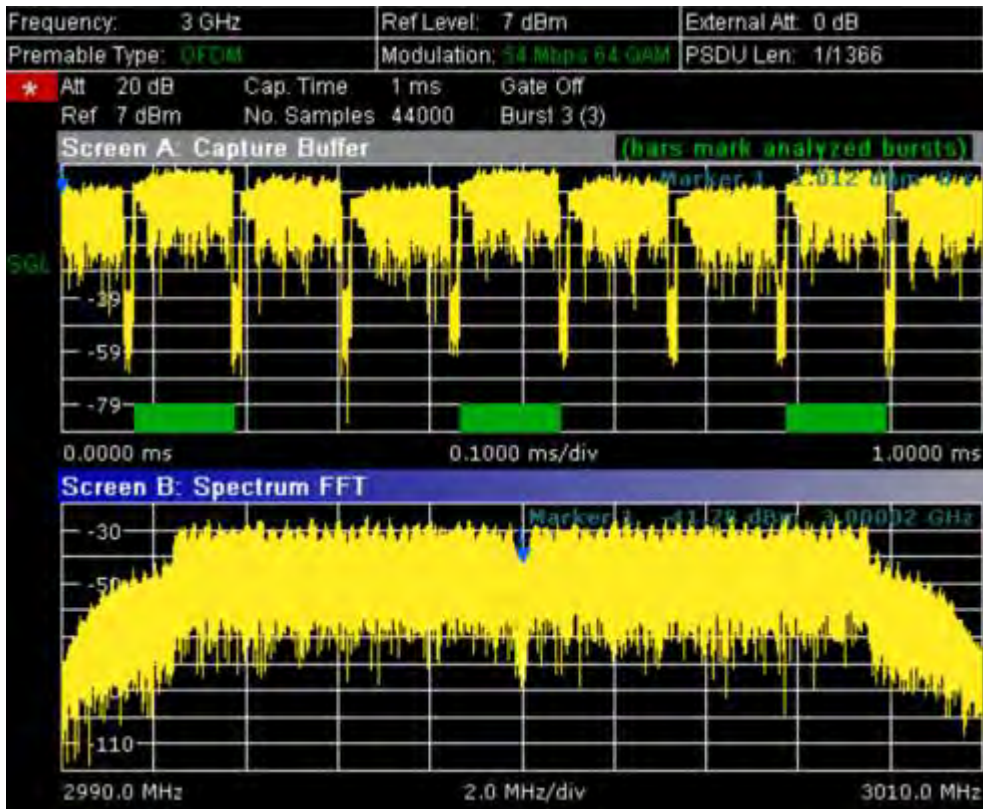

→ Remote: CONF:BURS:SPEC:FFT

Spectrum ACPR (IEEE 802.11a, b)
Spectrum ACP (IEEE 802.11b)
ACP Rel/Abs (IEEE 802.11j)

Sets the ACP (Adjacent Channel Power) result display.

This result display is similar to the Spectrum Mask measurement, and provides information about leakage into adjacent channels. The results show the absolute or relative power measured in the three nearest channels either side of the measured channel. This measurement is the same as the adjacent channel power measurement provided by the spectrum analyzer.

The number of sweeps is set in the **General Settings** dialog box, **Sweep Count** field. If the measurement is performed over multiple sweeps both a max hold trace and an average trace are displayed.

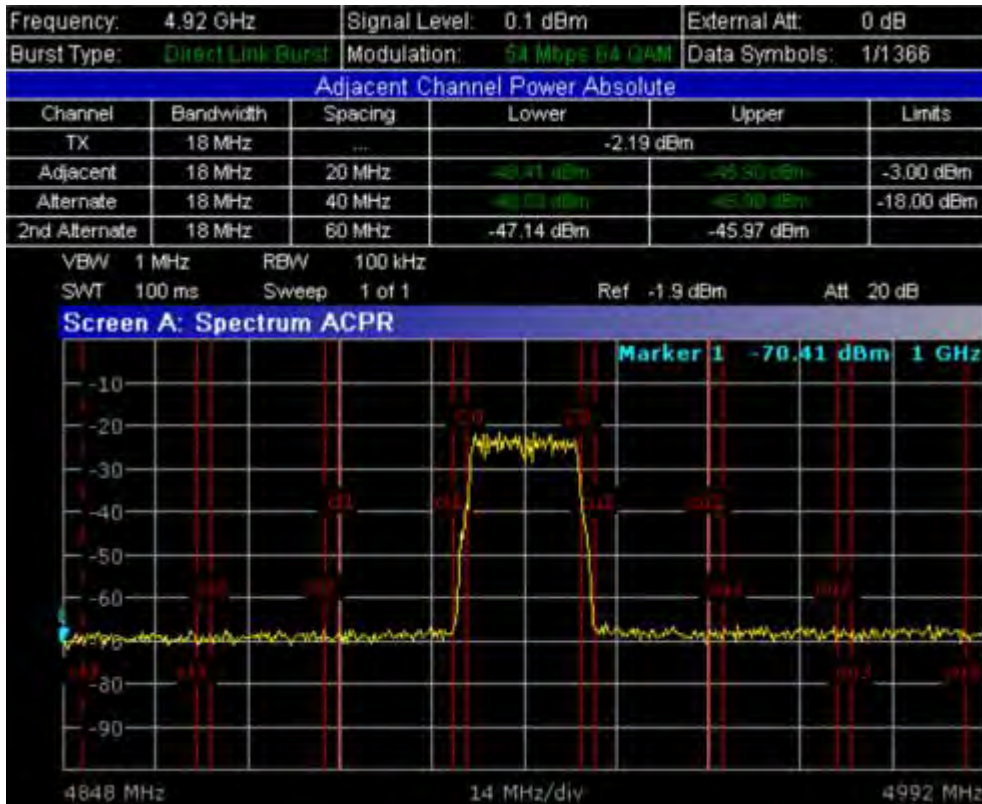

- Remote: CONF: BURS: SPEC: ACPR
- Remote: CALC: MARK: FUNC: POW: RES? (result query)
- Remote: CALC: MARK: FUNC: POW: RES: MAXH? (result query)

Statistics

Opens a submenu to display statistics measurement results.

CCDF

Sets the CCDF result display.

This result display shows the probability of an amplitude within the gating lines exceeding the mean power measured between the gating lines. The x-axis displays power relative to the measured mean power.

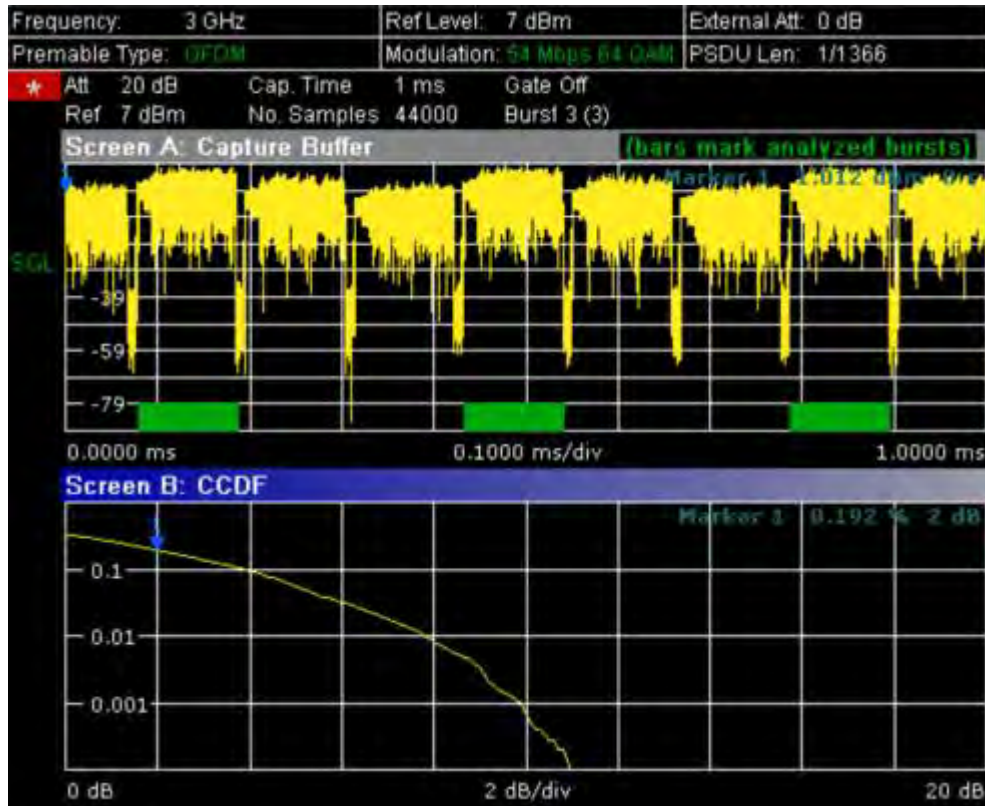

→ Remote: CONF:BURS:STAT:CCDF

Bitstream

Sets the Bitstream result display. This result display shows the demodulated data stream.

- IEEE 802.11a, j, g (OFDM):

The results are grouped by symbol and carrier.

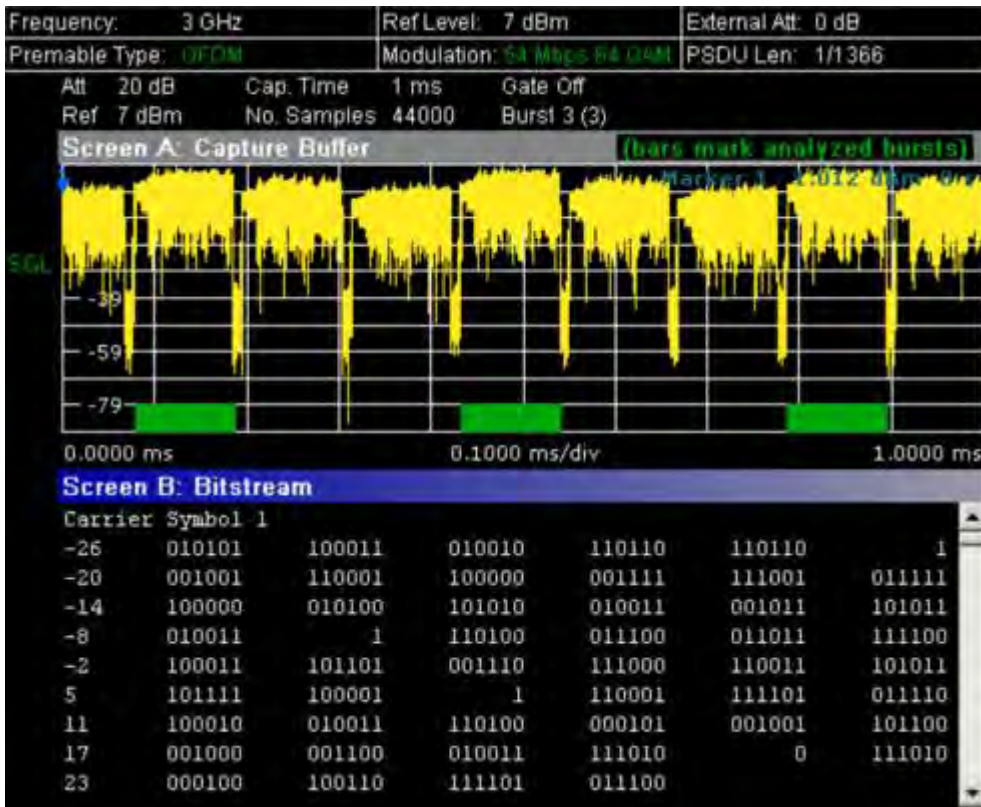

- IEEE 802.11b or g (Single Carrier)

The results are grouped by burst.

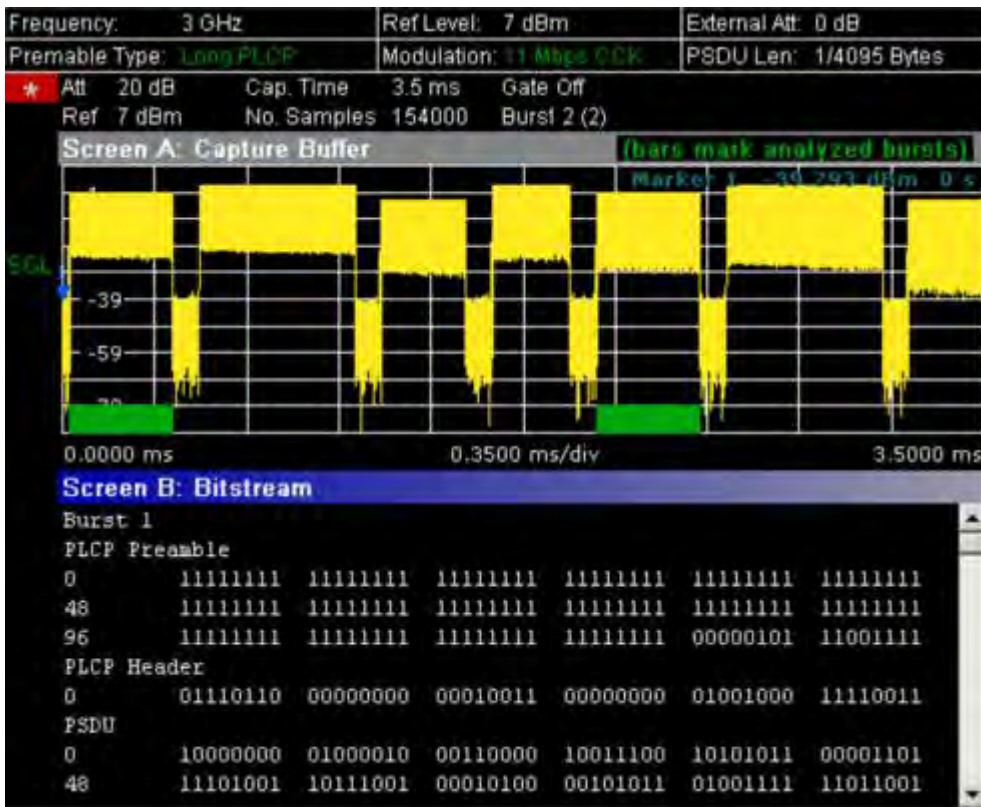

→ Remote: CONF:BURS:STAT:BSTR

**Signal Field (IEEE 802.11a, g, j – OFDM),
PLCP Header (IEEE 802.11b, g – Single Carrier)**

Sets the Signal Field result display or the PLCP Header result display, depending on the selected standard.

Signal Field

This result display shows the decoded data from the signal field of the burst. Therefore it is only available, if, in the **Demod Settings** dialog box, the **Signal Field Content** option is activated.

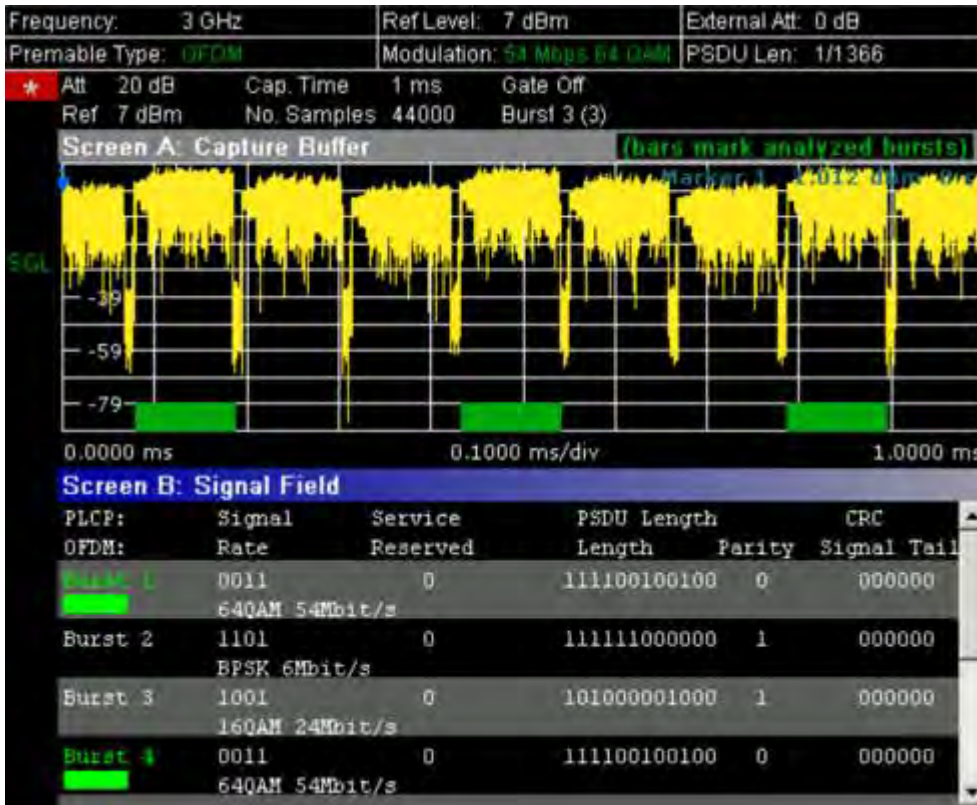

→ Remote: CONF:BURS:STAT:SField

PLCP Header

This result display shows the decoded data from the PLCP header of the burst. The following details are listed:

Column header	Description	Example
Burst	number of the decoded burst A colored block indicates that the burst was successfully decoded.	Burst 1
Signal	signal field The decoded data rate is shown below.	00010100 2 Mbits/s
Service	service field The currently used bits are highlighted. The text below explains the decoded meaning of these bits.	00000000 —/—/—
PSDU Length	length field The decoded time to transmit the PSDU is shown below.	0000000001111000 120 µs
CRC	CRC field The result is displayed below (OK for passed or Failed).	1110100111001110 OK

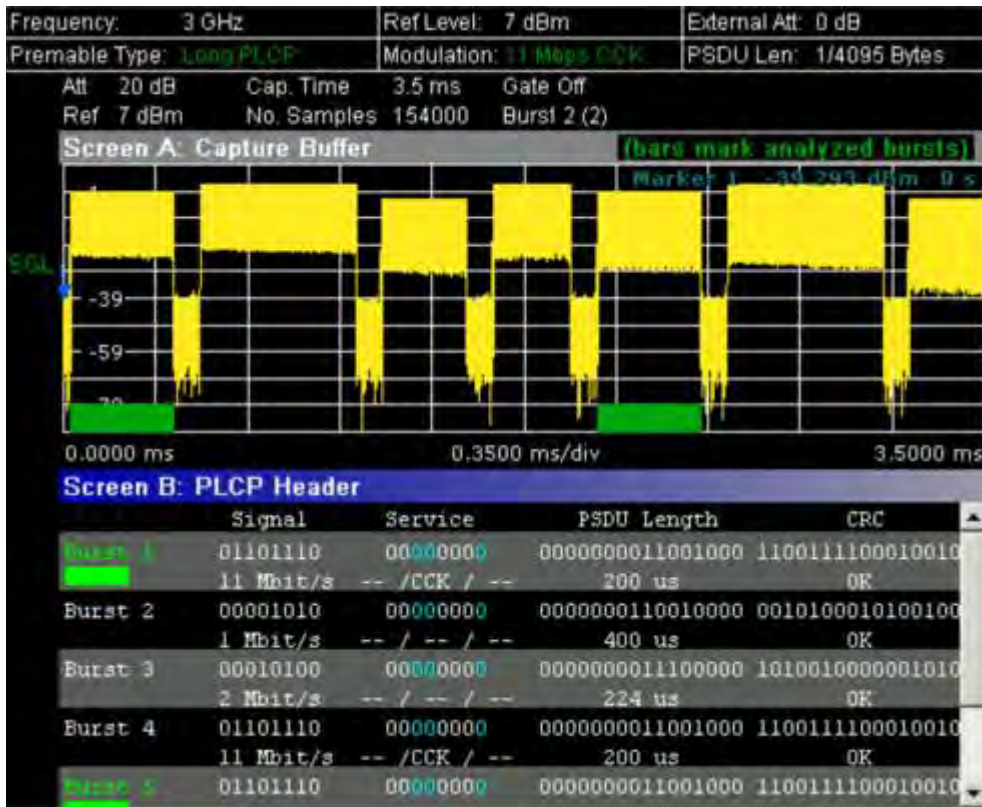

→ Remote: CONF:BURS:STAT:SField

Softkeys of the sweep menu (WLAN mode)

The following table shows all softkeys available in the sweep menu (**SWEEP** key). It is possible that your instrument configuration does not provide all softkeys. If a softkey is only available with a special option, model or (measurement) mode, this information is delivered in the corresponding softkey description.

Command
Meas Single/Cont
Auto Level
Refresh

Meas Single/Cont

Selects the sweep mode.

Single single sweep mode

Cont continuous sweep mode

→ Remote: INIT:CONT OFF (single sweep mode)

→ Remote: INIT:CONT ON (continuous sweep mode)

Auto Level

Starts an automatic level detection measurement. If this softkey is pressed while a measurement is running, the current measurement is aborted and the automatic level detection measurement is started. If the aborted measurement was a continuous measurement it is resumed after the automatic level detection is completed.

→ Remote: CONF:POW:AUTO ON

Refresh

Updates the current measurement results with respect to the current gate settings. This softkey is only available if the measurement results are effected by the gate settings (Spectrum FFT, PVT and CCDF) and if the gate settings are modified after a measurement result has been obtained.

Softkeys of the marker menu (WLAN mode)

The following table shows all softkeys available in the marker menu (**MKR** key). It is possible that your instrument configuration does not provide all softkeys. If a softkey is only available with a special option, model or (measurement) mode, this information is delivered in the corresponding softkey description. Close all settings dialog boxes before opening the marker menu.

Command
Marker 1
Unzoom
Marker Zoom
Marker Off

Marker 1

Opens a dialog box to adjust the marker. The contents of the dialog box depends on the type of graph the marker is adjusted to. After every change, the marker position in the trace and the marker information are updated.

- Remote: CALC:MARK ON
 - Remote: CALC:MARK:X 2ms
 - Remote: CALC2:MARK:Y -2
 - Remote: CALC:MARK:SYMB 2
 - Remote: CALC:MARK:CARR -7
-

Unzoom

Cancels the marker zoom.

- Remote: CALC:MARK:FUNC:ZOOM 1
-

Marker Zoom

Opens an edit dialog box to select the magnification factor for the zoom. The zoom facility is provided for the following result displays: Magnitude Capture Buffer, PVT, Constellation vs Symbol, Constellation vs Carrier. The maximum magnification depends on the type of result display.

→ Remote: CALC:MARK:FUNC:ZOOM 3

Marker Off

Switches off all markers in the active result display.

→ Remote: CALC:MARK:AOFF

Softkeys of the marker→ menu (WLAN mode)

The following table shows all softkeys available in the marker→ menu (**MKR→** key). It is possible that your instrument configuration does not provide all softkeys. If a softkey is only available with a special option, model or (measurement) mode, this information is delivered in the corresponding softkey description.

Command
Peak
Min
MKR → Trace

Peak (Spectrum Flatness result display)

Sets the marker to the peak value of the assigned trace.

→ Remote: CALC:MARK:MAX

Min (Spectrum Flatness result display)

Sets the marker to the minimum value of the assigned trace.

→ Remote: CALC:MARK:MIN

MKR → Trace

Opens an edit dialog box to enter the number of the trace, on which the marker is to be placed. This softkey is available for all result displays with more than one trace.

→ Remote: CALC:MARK:TRAC 2

Softkeys of the lines menu (WLAN mode)

The following table shows all softkeys available in the lines menu (**LINES** key). It is possible that your instrument configuration does not provide all softkeys. If a softkey is only available with a special option, model or (measurement) mode, this information is delivered in the corresponding softkey description.

This menu is only available if the results are displayed in form of a list (for details see [Result summary list](#) and **Display List/Graph** softkey).

Command
Default Current
Default All

Default Current

Resets all limits for the current modulation scheme to the values specified in the selected standard.

→ Remote: see CALCulate:LIMit Subsystem

Default All

Resets all limits for all modulation schemes to the values specified in the selected standard.

→ Remote: see CALCulate:LIMit Subsystem

Softkeys of the trace menu (WLAN mode)

The following table shows all softkeys available in the trace menu (**TRACE** key). It is possible that your instrument configuration does not provide all softkeys. If a softkey is only available with a special option, model or (measurement) mode, this information is delivered in the corresponding softkey description.

Command
Display List/Graph
Screen A/B
Screen Full/Split

Screen A/B

Selects the active screen for IQ measurement results in split and full screen mode. Only the markers of an active screen can be controlled.

→ Remote: DISP:WIND1:SSEL

Screen Full/Split

Changes the display between split and full screen for IQ measurement results. Frequency sweep measurement results are always displayed in full screen.

→ Remote: DISP:FORM SING

WiMAX 802.16 OFDM Measurements (Option K92)

The WiMAX 802.16 OFDM Measurements option extends the functionality of the R&S FSL spectrum analyzer to enable WiMAX 802.16 OFDM measurements according to IEEE standards 802.16.

TX measurements of a WiMAX Device Under Test (DUT) according to the standards specified for the device can be performed:

- Modulation formats:
 - IEEE 802.16–2004: BPSK (IEEE 802.16–2004 only), QPSK, 16QAM, 64QAM
- Modulation measurements:
 - Constellation diagram
 - Constellation diagram per OFDM carrier
 - I/Q offset and I/Q imbalance
 - Carrier and symbol frequency errors
 - Modulation error (EVM) per OFDM carrier or symbol
 - Amplitude response and group–delay distortion (spectral flatness)
- Amplitude statistics (CCDF) and crest factor
- Transmit spectrum mask
- Adjacent Channel Power (absolute and relative)
- FFT, also over a selected part of the signal, e.g. preamble
- Payload bit information
- Capture time selectable up to 15.6 ms, multiple sweeps possible for large number of bursts

This option is available from firmware version 1.40.

To open the WiMAX menu

- If the **WiMAX** mode is not the active measurement mode, press the **MODE** key and activate the **WiMAX** option.
- If the **WiMAX** mode is already active, press the **MENU** or **MEAS** key.
The WiMAX menu is displayed. .
- To exit the WiMAX measurement mode, select another option. For details refer also to section "[Measurement Mode Selection – MODE Key](#)" on page 4.91.

Menu and softkey description

- "[Softkeys of the WiMAX menu](#)" on page 4.230
- "[Softkeys of the sweep menu \(WiMAX mode\)](#)" on page 4.256
- "[Softkeys of the marker menu \(WiMAX mode\)](#)" on page 4.257
- "[Softkeys of the marker→ menu \(WiMAX mode\)](#)" on page 4.258
- "[Softkeys of the lines menu \(WiMAX mode\)](#)" on page 4.258
- "[Softkeys of the trace menu \(WiMAX mode\)](#)" on page 4.259

The file, setup, and print menus are provided as described for the base unit. For details refer to the corresponding menu descriptions. The span and bandwidth menus are not available in the **WiMAX** mode.

The **FREQ**, **AMPT**, and **TRIG** keys open the **General Settings** or the **Demod Settings** dialog box. For details refer to the **Settings General/Demod** softkey description (WiMAX menu).

Further information topics

- ["Measurements and result displays"](#) on page 4.226
- ["Title bar information"](#) on page 4.229
- ["Status bar information"](#) on page 4.230

Measurements and result displays

The WiMAX option provides two main measurement types:

- IQ measurements (based on captured IQ data)
 - Power vs Time (see **PVT** softkey)
 - EVM vs Symbol, EVM vs Carrier (see **EVM vs Symbol/Carrier** softkey)
 - Phase vs Preamble, Frequency vs Preamble (see **Error Frequency/Phase** softkey)
 - Spectrum Flatness (see **Spectrum Flat./Diff./Group Delay** softkey)
 - Spectrum Group Delay (see **Spectrum Flat./Diff./Group Delay** softkey)
 - Spectrum Flatness Adjacent Carrier Power Difference (see **Spectrum Flat./Diff./Group Delay** softkey)
 - Spectrum FFT (see **Spectrum FFT** softkey)
 - Constellation vs Symbol, Constellation vs Carrier (see **Constell vs Symbol/Carrier** softkey)
 - Conditional Cumulative Distribution Function (see **CCDF** softkey)
 - Bit Stream (see **Bitstream** softkey)
- frequency sweep measurements
 - Spectrum Mask (see **Spectrum IEEE/ETSI** softkey)
 - Spectrum ACP/ACPR (see **ACPR Abs/Rel** softkey)

The measurement result display is divided into two panes:

- [Measurement settings](#)
- Result displays

The results can be displayed in form of a list or a graph (see also **Display List/Graph** softkey).

- [Result summary list](#)
- [Result display graph](#)

Measurement settings

The overall measurement settings used to obtain the current measurement results are displayed below the title bar (see Fig. 4–23). The following settings are listed:

Setting	Description
Frequency	The frequency of the measured input signal.
Burst Type	The type of burst being analyzed.
Signal Level	The expected mean signal level for the input signal.
Modulation	Shows the active setting selected in the Demod Settings dialog box, Demodulator list.
External Att	The attenuation (positive values) or gain (negative values) applied to the signal externally (i.e. before the RF or IQ connector of the spectrum analyzer), e.g.: External Att = 10 dB means that before the RF connector of the R&S FSL a 10 dB attenuator is used External Att = –20 dB means that before the RF connector of the R&S FSL a amplifier with 20 dB gain is used.
Data Symbols	Shows the minimum and maximum number of data symbols that a burst may have to be considered in results analysis.

R&S FSL K92 WIMAX		IEEE 802.16 - 2004	
Frequency:	1 GHz	Signal Level:	-13.8 dBm
Burst Type:	OFDM-TD_Burst	External Att:	0 dB
		Modulation:	64QAM3/4
		Data Symbols:	1/2425

Fig. 4–23 Measurement settings (example)

Result summary list

The result summary list shows the overall measurement results and provides limit checking for result values in accordance with the selected standard. Result values which are within the limit as specified by the standard are displayed in green. Result values which are outside of the limits specified by the standard are displayed in red with a "*" to the left. Results which have no limits specified by the standard are displayed in white. Limit values are displayed in white (not bold) and can be modified, when focused, via the keypad. To reset the limit values to the values specified in the standard, use the lines menu (**LINES** key).

The results displayed in this list are for the entire measurement. If a specific number of bursts have been requested which requires more than one sweep, the result summary list is updated at the end of each sweep. The number of bursts measured and the number of bursts requested are displayed to show the progress through the measurement. The Min / Mean / Max columns show the minimum, mean or maximum values of the burst results.

R&S FSL K92 WIMAX		IEEE 802.16 - 2004					
Frequency:	1 GHz	Signal Level:	-13.8 dBm	External Att:	0 dB		
Burst Type:	OFDM DL Burst	Modulation:	64QAM3/4	Data Symbols:	1/2425		
Result Summary							
Bursts:	19	Min	Mean	Limit	Max	Limit	Unit
EVM All Carr.		-42.77	-41.80	-31.00	-40.06	-31.00	dB
EVM Data Carr.		-42.82	-41.78		-39.99		dB
EVM Pilot Carr.		-43.60	-42.29		-41.22		dB
IQ Offset		-61.94	-59.58	-15.00	-57.53	-15.00	dB
Gain Imbalance		-0.01	-0.01		-0.01		dB
Quadrature Err		-0.017	-0.009		-0.004		°
Freq. Err		99.20	100.12	± 8000	100.85	± 8000	Hz
Clock Err		0.09	0.10	± 8	0.11	± 8	ppm
Burst Power		-11.08	-11.06		-11.04		dBm
Crest Factor		6.92	9.75		10.67		dB
RSSI		-8.10	-8.10		-8.10		dBm
RSSI Stnd. Dev			-26.20				dB
CINR		39.50	42.52		43.69		dB
CINR Stnd. Dev.			31.23				dB

Fig. 4–24 Result summary list (example)

Result display graph

Additionally to the selected graphical result display, the Magnitude Capture Buffer display is provided for all IQ measurements. The different result displays are described with the corresponding softkey.

The Magnitude Capture Buffer display shows the complete range of captured data for the last sweep. All analyzed bursts are identified with a green bar at the bottom of the Magnitude Capture Buffer display. Only those bursts match the required criteria. The gate delay line (GD) and gate length line (GL) are displayed in red color.

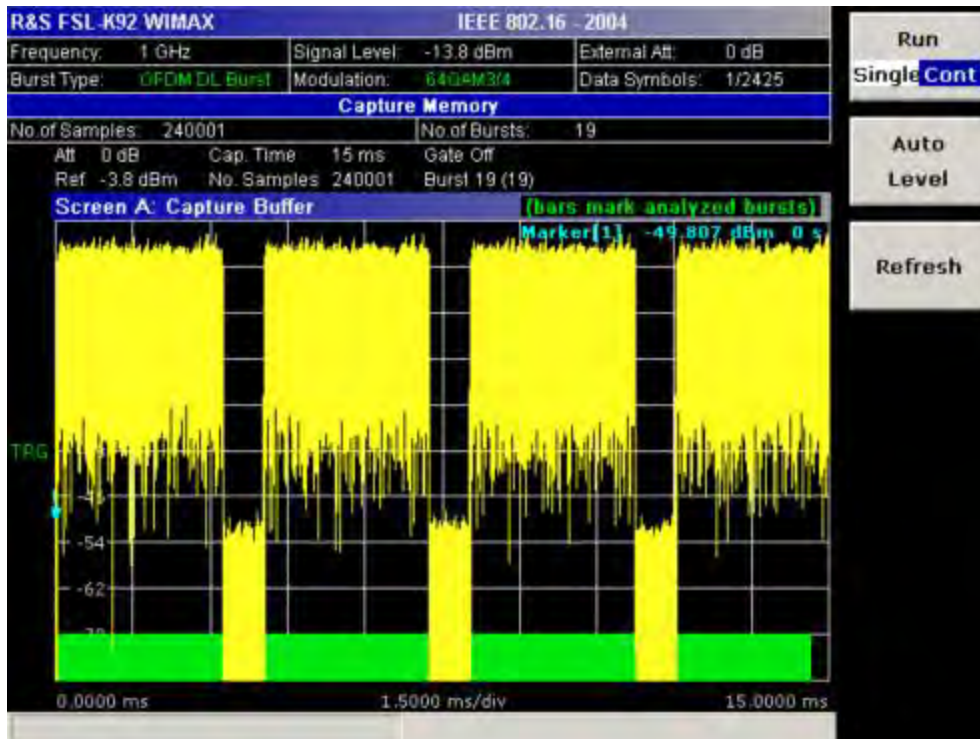

Fig. 4–25 Magnitude capture buffer results (example)

- IQ measurements

All IQ measurements process the same signal data and as such all IQ measurement results are available after a single IQ measurement execution.

IQ measurements can be run in split screen mode (allowing both the Magnitude Capture Buffer display and the selected IQ measurement results to be displayed simultaneously) or in full screen mode (with either the Magnitude Capture Buffer display or the selected IQ measurement results displayed).

- frequency sweep measurements

The frequency sweep measurements use different signal data to IQ measurements and as such it is not possible to run an IQ measurement and then view the results in the frequency sweep measurements and vice-versa. Also because each of the frequency sweep measurements uses different settings to obtain signal data it is not possible to run a frequency sweep measurement and view the results of another frequency sweep measurement.

All frequency sweep measurements are run in full screen mode.

Further information

This section provides background information on measurements and displayed information. For details on signal processing refer to chapter "Advanced Measurement Examples", section "Measurement Examples of the WiMAX 802.16 OFDM Measurements Option (K92)".

Title bar information

The title bar displays the following information:

- wireless LAN standard applicable to the current measurement (in the middle)

Status bar information

The status bar displays the following information:

- parameter values
 When a parameter in a settings dialog box is selected, the minimum and maximum values for the selected parameter are displayed.
 When a Boolean parameter in a dialog box is selected, the minimum and maximum values are displayed as N/A for not applicable.
- measurement status
 When a measurement is performed, the current measurement status along with detailed information about the progress is displayed.
- error messages (with red background)
- warning messages (with blue background)

Softkeys of the WiMAX menu

The following table shows all softkeys available in the WiMAX menu. It is possible that your instrument configuration does not provide all softkeys. If a softkey is only available with a special option, model or (measurement) mode, this information is delivered in the corresponding softkey description.

Menu / Command	Command
Settings General/Demod	
Display List/Graph	
PVT ↓	Settings General/Demod
	Display List/Graph
	Full Burst
	Start End
	Burst Selection
	More ↓
	Gating Settings On/Off
	Import
	Export
	R&S Support
EVM Constell ↓	Settings General/Demod
	EVM vs Symbol/Carrier
	Error Frequency/Phase
	Constell vs Symbol/Carrier
	Carrier Selection
	More ↓
	Gating Settings On/Off
	Import
	Export
	Y-Axis/Div
	R&S Support
Spectrum ↓	Settings General/Demod
	Display List/Graph

Menu / Command	Command
	Spectrum Flat./Diff./Group Delay
	Spectrum IEEE/ETSI
	Spectrum FFT
	ACPR Abs/Rel
	More ↓
	Gating Settings On/Off
	ACP Settings
	Import
	Export
	R&S Support
Statistics ↓	Settings General/Demod
	Display List/Graph
	CCDF
	Bitstream
	Burst Summary
	More ↓
	Gating Settings On/Off
	Import
	Export
	R&S Support

Settings General/Demod

Opens the **General Settings** or the **Demod Settings** dialog box. Screenshots of the dialog boxes are provided in chapter "Advanced Measurement Examples", section "Measurement Examples of the WiMAX 802.16 OFDM Measurements Option (K92)".

Alternatively, the **General Settings** dialog box is opened as follows:

- **FREQ** key, with focus on the **Frequency** field
- **AMPT** key, with focus on the **Signal Level (RF)** field
- **TRIG** key, with focus on the **Trigger Mode** field

In the **General Settings** dialog box, all settings related to the overall measurement can be modified. The right pane with the advanced settings is only displayed if the **Advanced Settings** option is activated. The **General Settings** dialog box contains the following elements:

Signal Characteristics	Standard
	Frequency
	Channel No
	Frequency Band
	Channel BW
	Sampling Rate
	G = Tg/Tb
Level Settings	Signal Level
	Auto Lev
	Ext Att
Data Capture Settings	Capture Time
	Burst Count

	Analyze Bursts
	Sweep Time
	Sweep Count
Trigger Settings	Trigger Mode
	Trigger Offset
	Power Level
	Auto Lvl
Input Settings Advanced	Auto Level Time
	Ref Level
	Attenuation
IQ Settings	Swap IQ
Result Settings	RSSI, CINR avg.
	List Results Unit

In the **Demod Settings** dialog box, the settings associated with the signal modulation can be modified. The settings under **Burst to Analyze** specify the characteristics of the bursts to be considered in the measurement results. Only the bursts which meet the criteria specified in this group will be included in measurement analysis. The tracking settings allow various errors in measurement results to be compensated for.

The **Demod Settings** dialog box contains the following elements. If an element is only available for certain standards, the corresponding standards are listed.

Burst to Analyze	Burst Type
	Link Mode
	Use FCH Content
	Mod. Detection
	Demodulator
	Subchannelization
	Index
	UL Phys. Modifier
	Equal Burst Length
	Data Symbols
	Min Data Symbols
	Max Data Symbols
	Channel Estimation
Tracking	Phase
	Timing
	Level

Standard (General Settings dialog box)

Displays a list of all installed standards to select the WiMAX standard. This is necessary to ensure that the measurements are performed according to the specified standard with the correct limit values and limit lines.

→ Remote: CONF:STAN 0

Frequency (General Settings dialog box)

Specifies the center frequency of the signal to be measured. When the frequency is modified, the **Channel No** field is updated accordingly.

→ Remote: `FREQ:CENT 100MHz`

Channel No (General Settings dialog box)

Specifies the channel to be measured. When the field entry is modified, the center frequency is derived according to the section in the standard mentioned below and updated.

- For the Licensed Bands {ETSI, MMDS, WCS}:

Channel numbers are supported according to [IEEE Std 802.16–2004] "8.3.10.2 Transmitter channel bandwidth and RF carrier frequencies". For the target frequency bands see [IEEE Std 802.16–2004] "B.1 Targeted frequency bands".

- For the License Exempt Bands {U–NII, CEPT}:

Channel numbers are supported according to [IEEE Std 802.16–2004] "8.5.1 Channelization".

→ Remote: `CONF:CHAN 9`

Frequency Band (General Settings dialog box)

Specifies the relationship between the **Channel BW** and the **Sampling Rate** parameters.

→ Remote: `CONF:WIM:FBAN ETSI`

Channel BW (General Settings dialog box)

Specifies the bandwidth of the channel to be measured.

→ Remote: `BAND:CHAN 7MHZ`

Sampling Rate (General Settings dialog box)

Specifies the sample rate used for IQ measurements.

→ Remote: `TRACE:IQ:SRAT 2000000`

G = Tg/Tb (General Settings dialog box)

Specifies the guard time ratio.

→ Remote: `CONF:WIM:IGR 16`

Signal Level (General Settings dialog box)

Specifies the expected level of the RF input signal. If an automatic level detection measurement has been executed, the signal level (RF) is updated.

→ Remote: `CONF:POW:EXP:RF -20`

Auto Lev (General Settings dialog box)

Activates or deactivates the automatic setting of the reference level for measurements.

On The reference level is measured automatically at the start of each measurement sweep. This ensures that the reference level is always set at the optimal level for obtaining accurate results but will result in slightly increased measurement times. For details about automatic level detection refer to chapter "Advanced Measurement Examples".

Off The reference level is defined manually in the **Signal Level** field.

→ Remote: CONF:POW:AUTO ON

→ Remote: CONF:POW:AUTO:SWE:TIME 200MS

Ext Att (General Settings dialog box)

Specifies the external attenuation or gain applied to the RF signal. A positive value indicates attenuation, a negative value indicates gain. All displayed power level values are shifted by this value.

→ Remote: INP:ATT 30dB

Capture Time (General Settings dialog box)

Specifies the time (and therefore the amount of data) to be captured in a single measurement sweep.

→ Remote: SWE:TIME 10ms

Burst Count (General Settings dialog box)

Activates or deactivates a specified number of bursts for capture and analysis.

On The data analysis is performed over a number of consecutive sweeps until the required number of bursts has been captured and analyzed.

Off The data analysis is performed on a single measurement sweep.

→ Remote: BURS:COUN:STAT ON

Analyze Bursts (General Settings dialog box)

Specifies the number of bursts to be measured, if the **Burst Count** option is activated.

→ Remote: BURS:COUN 16

Sweep Time (General Settings dialog box)

Specifies the sweep time for the Spectrum Mask and Spectrum ACP/ACPR measurements:

– If the **Auto** option is activated, the sweep time is calculated automatically.

– If the **Auto** option is deactivated, specify the sweep time.

→ Remote: SWE:ACPR:TIME 1S

→ Remote: SWE:ACPR:TIME:AUTO OFF

Sweep Count (General Settings dialog box)

Specifies the number of sweeps to be performed for Spectrum ACP/ACPR and Spectrum Mask measurements.

→ Remote: SWEep:COUNT 64

Trigger Mode (General Settings dialog box)

Sets the source of the trigger for the measurement sweep.

- Free Run** The measurement sweep starts immediately.
- External** The measurement sweep starts when the external trigger signal meets or exceeds the external trigger level (a fixed value that cannot be altered) at the input connector EXT TRIGGER/GATE IN on the rear panel.
- Power** The measurement sweep starts when the signal power meets or exceeds the specified power trigger level.

→ Remote: TRIG:MODE IMM

Trigger Offset (General Settings dialog box)

Specifies the time offset between the trigger signal and the start of the sweep. A negative value indicates a pre-trigger. This field is not available in the **Free Run** trigger mode.

→ Remote: TRIG:HOLD 5ms

Power Level (General Settings dialog box)

Specifies the trigger level if the **Power** trigger mode is set (see **Trigger Mode** field).

→ Remote: TRIG:LEV:POW 10 DBM

Auto Lvl (General Settings dialog box)

Activates or deactivates the automatic measurement of the power trigger level if the **Power** trigger mode is set (see **Trigger Mode** field).

- On** The power trigger level is measured automatically at the start of each measurement sweep. This ensures that the power trigger level is always set at the optimal level for obtaining accurate results but will result in a slightly increased measurement times.
- Off** The power trigger level is defined manually in the **Power Level** field.

→ Remote: TRIG:LEV:POW:AUTO ON

Auto Level Time (General Settings dialog box)

Specifies the sweep time used for the automatic level measurements.

→ Remote: CONF:POW:AUTO:SWE:TIME 200MS

Ref Level (General Settings dialog box)

Specifies the reference level to use for measurements. When the reference level is modified the signal level is updated accordingly (depending on the currently selected standard and measurement type). This field is only editable if the **Auto Lev** option is deactivated.

→ Remote: DISP:TRAC:Y:RLEV?

Attenuation (General Settings dialog box)

Specifies the settings for the attenuator. This field is only editable if the **Auto Lev** option is deactivated. If the **Auto Lev** option is activated, the RF attenuator setting is coupled to the reference level setting.

→ Remote: INP:ATT 30dB

Swap IQ (General Settings dialog box)

Activates or deactivates the inverted I/Q modulation.

On I and Q signals are interchanged.

Off Normal I/Q modulation.

→ Remote: SWAP ON

RSSI, CINR avg. (General Settings dialog box)

Specifies the mean and standard deviation for the RSSI and CINR results (see [IEEE Std 802.16–2004] "8.3.9.2 RSSI mean and standard deviation", "8.3.9.3 CINR mean and standard deviation").

List Results Unit (General Settings dialog box)

Specifies the units for the results in the results summary table.

→ Remote: UNIT:TABL DB

Burst Type (Demod Settings dialog box)

Specifies the type of burst to be included in measurement analysis. Only one burst type can be selected for the measurement results. The **OFDM** burst type is supported.

→ Remote: DEM:FORM:BAN:BTYPe OFDM

Link Mode (Demod Settings dialog box)

Specifies the link mode of bursts that are to be included in measurement analysis. The following link mode types are supported:

UL Up Link

DL Down Link

→ Remote: CONF:WIM:LMOD UL

Use FCH Content (Demod Settings dialog box)

Activates or deactivates the decoding of the captured burst data FCH field.

OFF This is the default setting and cannot be altered currently.

ON Only the bursts with a modulation format matching the format specified in the **Demodulator** list are included in the results analysis.

Mod. Detection (Demod Settings dialog box)

Specifies the demodulation of the signal. The following values are supported:

None No modulation detection is performed. The signal will be analyzed according to the **Demodulator** setting. Therefore the **Demodulator** setting must match with the modulation format of the sub frame. This setting excludes the analyze of multiple modulation formats in a sub frame.

First Symbol The first data symbol specifies the modulation format, i.e. the signal will be analyzed according to the modulation format of the first data symbol. This setting supports multiple modulation formats in a sub frame.

If **First Symbol** is selected, the **Demodulator** setting is disabled and is automatically updated with the modulation scheme detected in the first symbol.

User Only bursts matching the setting in the **Demodulator** list are analyzed. This setting supports multiple modulation formats in a sub frame.

All All bursts individual payload modulations are analyzed accordingly.

→ Remote: DEM:FORM:AUTO FIRS

Demodulator (Demod Settings dialog box)

Defines the modulation format for signal analysis if the **Mod. Detection** is set to **None** or **User** (see **Mod. Detection** field).

The R&S FSL–K92 measurement application does not distinguish between different coding rates for the same modulation format. If the signal to be analyzed contains the profiles (modulation format A, coding rate B) and (modulation format C, coding rate D), the signal to be analyzed must hold the following condition in order to produce correct measurement results:

$$[A == C \Rightarrow B == D]$$

→ Remote: DEM:FORM:BAN '16QAM1/2'

Subchannelization (Demod Settings dialog box)

Activates or deactivates the subchannelization, if the **Up Link** link mode is set (see **Link Mode** field). If activated, the subchannel index of uplink bursts is analyzed, defined by the **Index** field.

→ Remote: SUBC:STAT ON

Index (Demod Settings dialog box)

Defines the subchannelization index of uplink bursts to be analyzed. Subchannel index 16 is the default subchannel with full occupation.

→ Remote: SUBC 12

UL Phys. Modifier (Demod Settings dialog box)

Specifies a common UL physical modifier for all uplink bursts.

→ Remote: SUBC:ULPH 1

Equal Burst Length (Demod Settings dialog box)

Activates or deactivates the burst selection for measurement analysis according to the range or specific number of data symbols/bytes.

- On Only bursts with exactly the number of symbols specified in the **Data Symbols** field are considered for measurement analysis.
- Off Only bursts within the range of data symbols specified by the **Min Data Symbols** and **Max Data Symbols** fields are considered for measurement analysis.

→ Remote: DEM:FORM:BAN:SYM:EQU ON

Data Symbols (Demod Settings dialog box)

Specifies the number of symbols that a burst must have to be considered for measurement analysis. This field is only available if the **Equal Burst Length** option is activated.

→ Remote: DEM:FORM:BAN:SYMB:MIN 16

Min Data Symbols (Demod Settings dialog box)

Specifies the minimum number of data symbols that a burst must have to be considered in measurement analysis. This field is only available if the **Equal Burst Length** option is deactivated.

→ Remote: DEM:FORM:BAN:SYM:MIN 16

Max Data Symbols (Demod Settings dialog box)

Specifies the maximum number of data symbols that a burst must have to be considered in measurement analysis. This field is only available if the **Equal Burst Length** option is deactivated.

→ Remote: DEM:FORM:BAN:SYM:MAX 1300

Channel Estimation (Demod Settings dialog box)

Specifies how accurately the EVM results are calculated.

- Preamble** The channel estimation is performed in the preamble as required in the standard.
- Payload** The channel estimation is performed in the payload.

→ Remote: DEM:CEST ON

Phase (Demod Settings dialog box)

Activates or deactivates the compensation for phase error. If activated, the measurement results are compensated for phase error on a per-symbol basis.

→ Remote: TRAC:PHAS ON

Timing (Demod Settings dialog box)

Activates or deactivates the compensation for timing error. If activated, the measurement results are compensated for timing error on a per-symbol basis.

→ Remote: TRAC:TIME ON

Level (Demod Settings dialog box)

Activates or deactivates the compensation for level error. If activated, the measurement results are compensated for level error on a per-symbol basis.

→ Remote: TRAC:LEV ON

Display List/Graph

Configures the result display. The measurement results are displayed either in form of a list of measurement points or as a graphical trace.

→ Remote: DISP:TABL OFF

→ Remote: for result queries see chapter "Remote Control – Commands", section FETCH Subsystem

PVT

Opens the PVT submenu to select the Power vs Time measurement results.

The PVT result displays show the measured input data over the full range or over complete bursts, displayed within the gating lines if gating is switched on. The results are displayed as a single burst. If the gate start or gate length are altered then the results can be updated to reflect these changes by pressing the **Refresh** softkey in the sweep menu.

→ Remote: CONF:BURS:PVT

Full Burst

Displays the PVT results in a single graph with all burst data being displayed.

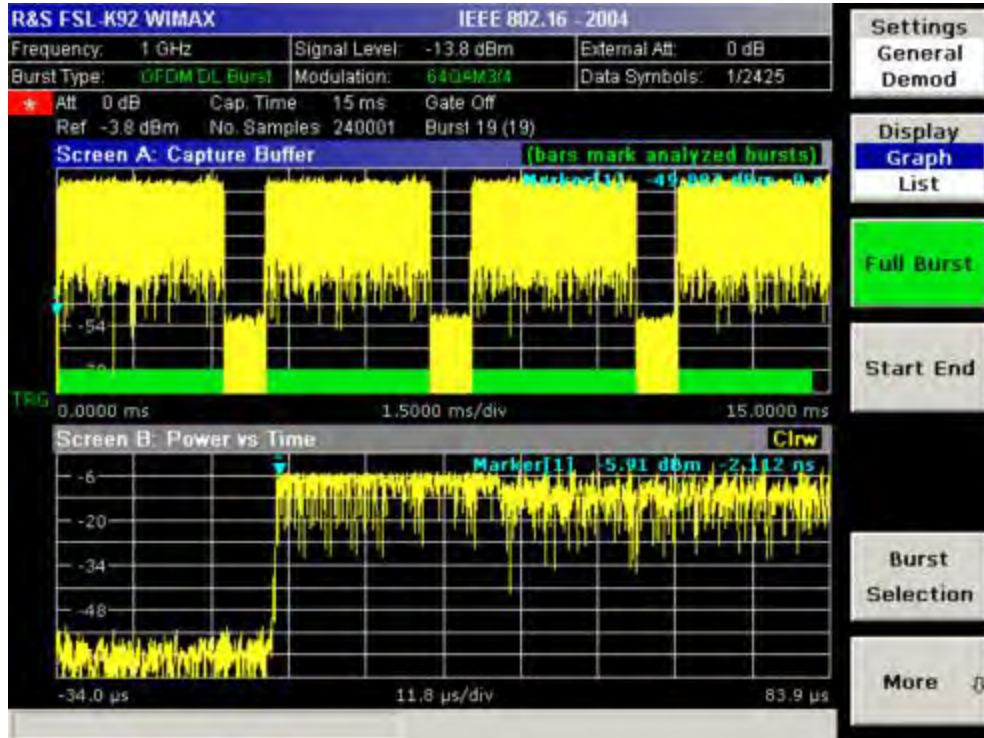

For further details refer to the PVT softkey.

→ Remote: CONF:BURS:PVT:SEL FULL

Start End

Displays the results in two separate graphs, the left hand side showing the start and the right hand side showing the end of a burst.

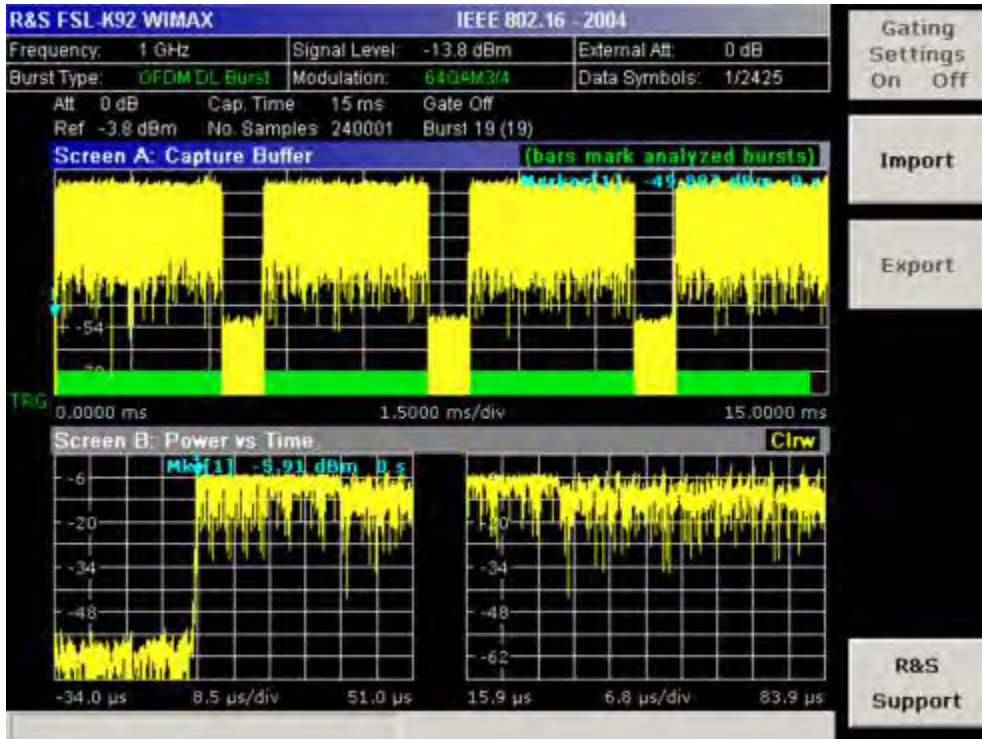

→ Remote: CONF: BURS: PVT: SEL EDGE

Burst Selection

Opens an edit dialog box to select a burst by entering its number.

→ Remote: CONF: BURS: PVT: BURS 1

Gating Settings On/Off (PVT, Spectrum FFT, CCDF, Spectrum Mask, Spectrum ACPR)

Activates or deactivates gating, or opens the **Gate Settings** dialog box to specify range of captured data used in results calculation.

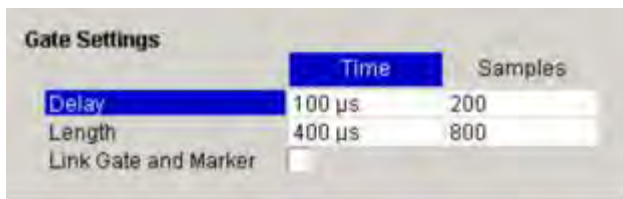

On Uses only the specified range of captured data in results calculation. In the Magnitude Capture Buffer trace, two vertical lines mark the specified range.

Off Uses all the captured data in results calculation.

In the **Gate Settings** dialog box, the following parameters are set:

Delay	Start point of captured data to be used in results calculation, i.e. the delay from the start of the captured data in time or samples. If the delay is specified in time, the number of samples is updated accordingly, and vice versa.
Length	Amount of captured data to be used in results calculation. If the length is specified in time, the number of samples is updated accordingly, and vice versa.
Link Gate and Marker	If activated, the position of the marker and the gate lines are linked. The marker is positioned half way between gate start and end. The marker position alters when the gate is modified, and the gate lines move with the marker when the marker position is altered.

The gate settings are defined for following measurements: PVT, Spectrum FFT, CCDF, Spectrum Mask, Spectrum ACPR.

If a frequency sweep measurement is active (Spectrum Mask and Spectrum ACP) the result display is switched to the Magnitude Capture Buffer display in order to allow the gate to be set the correct part of the sweep.

- Remote: SWE:EGAT ON
- Remote: SWE:EGAT:HOLD 125us, SWE:EGAT:HOLD:SAMP 2500 (Delay)
- Remote: SWE:EGAT:LENG 1 MS, SWE:EGAT:LENG:SAMP 100000 (Length)
- Remote: SWE:EGAT:LINK ON (Link Gate and Mark)

Import

Opens the **Enter Filename for Import** dialog box.

Enter the path and the name of the IQ data file you want to import and press **ENTER** to load the specified IQ data file. The extension of data files is *.iqw. If the file cannot be found or there is no valid IQ data to import an error message is displayed.

- Remote: MMEM:LOAD:IQ:STAT 1, 'C:\R_S\Instr\user\data.iqw'

Export

Opens the **Enter Filename for Export** dialog box.

Enter the path and the name of the IQ data file you want to export and press **ENTER** to write the IQ data into the specified file. The extension of data files is *.iqw. If the file cannot be created or there is no valid IQ data to export an error message is displayed.

- Remote: MMEM:STOR:IQ:STAT 1, 'C:\R_S\Instr\user\data.iqw'

R&S Support

Creates files that help identifying the current problem. The files are stored under C:\R_S\Instr\user\Support. If you contact the Rohde&Schwarz support to get help for a certain problem, send these files to the support in order to identify and solve the problem faster.

EVM Constell

Opens a submenu to select the error vector magnitude (EVM) or the constellation result displays.

EVM vs Symbol/Carrier

Selects the EVM vs Symbol or EVM vs Carrier result displays.

– EVM vs Symbol

This result display shows the EVM measured over the full range of the measured input data. The results are displayed on a per-symbol basis, with blue vertical lines marking the boundaries of each burst. Note that burst boundary lines are only displayed if the number of analyzed bursts is less than 250. The minimum, average, and maximum traces are displayed.

For the trace labeled with EVM a commonly used EVM definition is applied, which is the square root of the momentary error power normalized by the averaged reference power. For details of this measurements please refer to chapter 2.

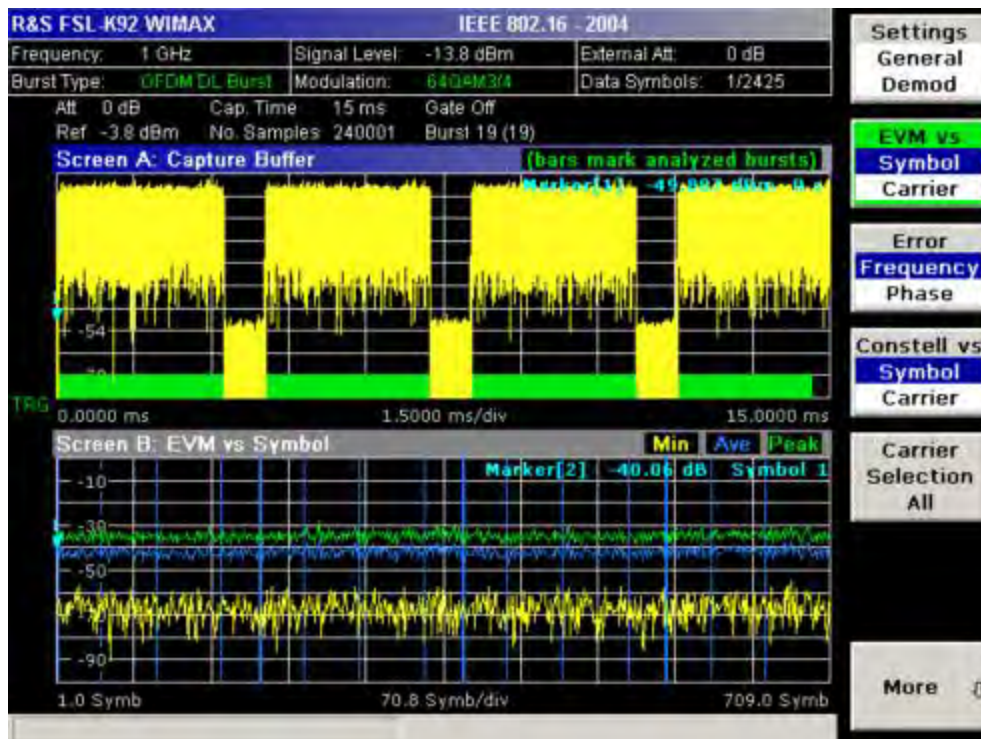

– EVM vs Carrier

This result display shows all EVM values recorded on a per-carrier basis over the full set of measured data. The minimum, average and maximum traces are displayed.

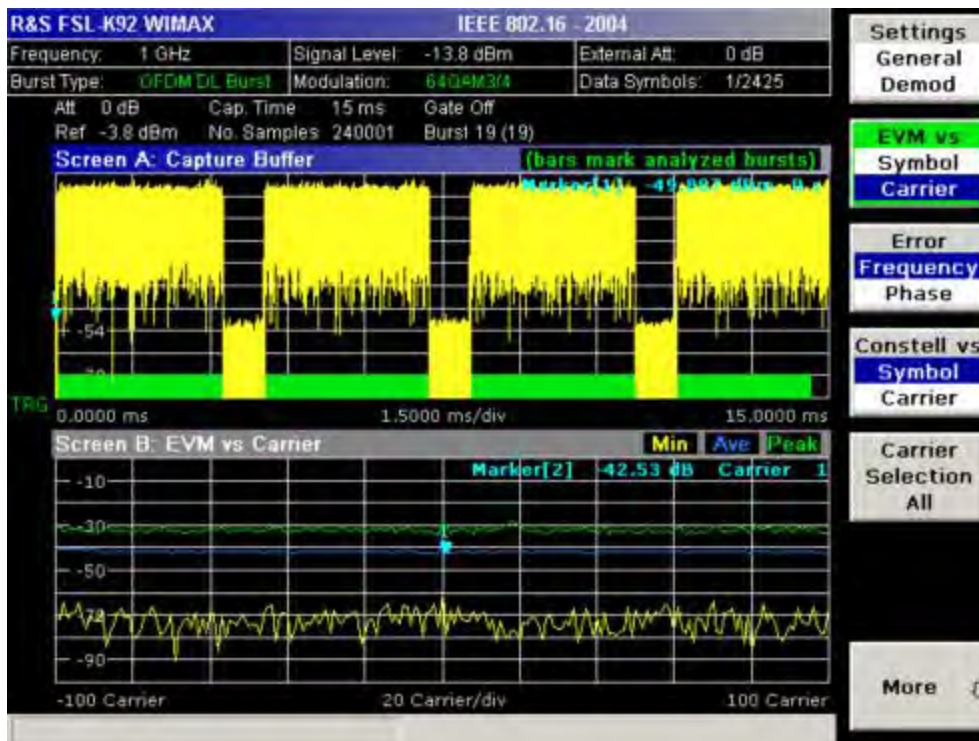

- Remote: CONF: BURS: EVM: ESYM (EVM vs Symbol)
- Remote: CONF: BURS: EVM: ECAR (EVM vs Carrier)

Error Frequency/Phase

Selects the Frequency Error vs Preamble or the Phase Error vs Preamble result displays.

These result displays show the error values recorded over the preamble part of the burst. A minimum, average and maximum trace are displayed. The results display either relative frequency error or phase error.

Using the **Y-Axis/Div** softkey, the scaling of the y-axis can be modified to allow the results to be scaled to an optimum level.

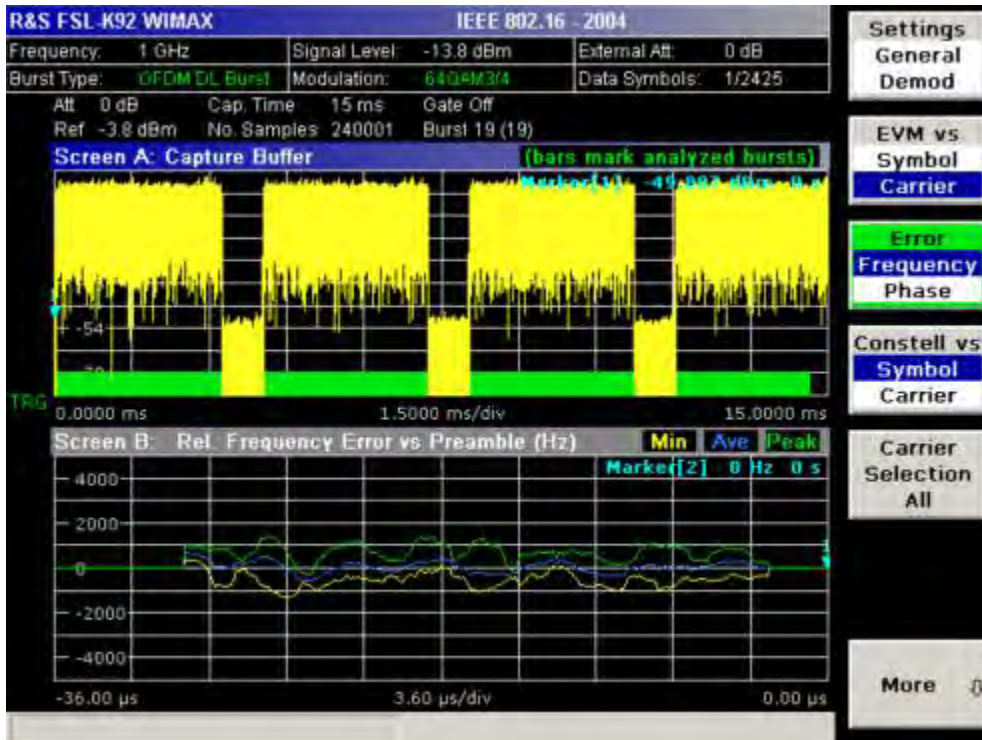

- Remote: CONF : BURS : PRE
- Remote: CONF : BURS : PRE : SEL FREQ (Frequency Error vs Preamble)
- Remote: CONF : BURS : PRE : SEL PHAS (Phase Error vs Preamble)

Constell vs Symbol/Carrier

Selects the Constellation vs Symbol or the Constellation vs Carrier result displays.

- Constellation vs Symbol

This result display shows the in-phase and quadrature phase results over the full range of the measured input data. The ideal points for the selected modulations scheme are displayed for reference purposes.

The amount of data displayed in the Constellation results display can be reduced by selecting the carrier or carriers for which data is to be displayed (**Carrier Selection** softkey).

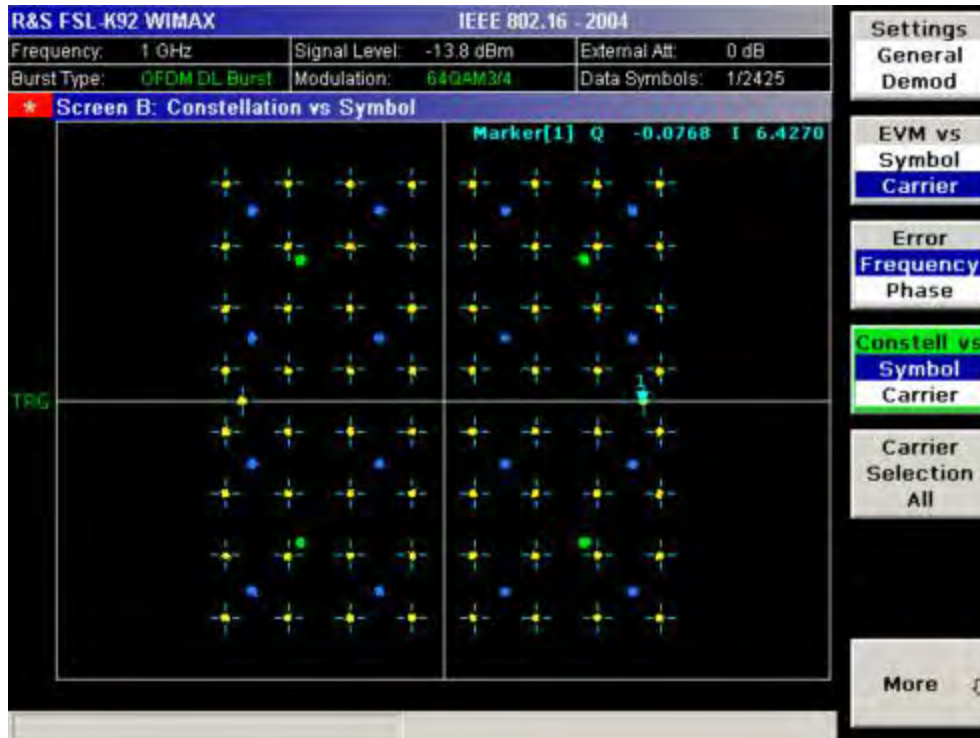

- Constellation vs Carrier

This result display shows the in-phase and quadrature phase results over the full range of the measured input data plotted on a per-carrier basis. The magnitude of the in-phase and quadrature part is shown on the y-axis, both are displayed as separate traces (I-> trace 1, Q-> trace 2).



- Remote: CONF:BURS:CONS:CSYM (Constellation vs Symbol)
- Remote: CONF:BURS:CONS:CCAR (Constellation vs Carrier)

Carrier Selection

Opens a dialog box to select the carrier for data display. Either a specific carrier number, pilots only or all carriers can be selected.

- Remote: CONF:BURS:CONS:CARR:SEL -26

Y-Axis/Div

Opens a dialog box to modify the y-axis settings:

- Auto Scaling** If activated, the scaling of the y-axis is calculated automatically.
- Per Division** Specifies the scaling to be used if **Auto Scaling** is deactivated.
- Unit** Specifies the y-axis unit.

This softkey is only available in the EVM vs Symbol/Carrier and Error Frequency/Phase measurements if trace data are displayed.

- Remote: DISP:WIND2:TRAC1:Y:AUTO ON
- Remote: DISP:WIND2:TRAC1:Y:PDIV 2

Spectrum

Opens a submenu for frequency measurements.

Spectrum Flat./Diff./Group Delay

Sets the Spectrum Flatness result displays.

- Spectrum Flatness and Spectrum Flatness Group Delay

These result displays show either the Spectrum Flatness or the Group Delay values recorded on a per-carrier basis over the full set of measured data. A minimum, average and maximum trace are displayed for each of the result types. If the Spectrum Flatness result display is selected an upper and lower limit line representing the limits specified for the selected standard are displayed. An overall pass/fail status is displayed for the obtained (average) results against these limit lines.



- Spectrum Flatness Difference

This result display shows the adjacent carrier power difference of the preamble part of the burst. A minimum, average and maximum trace are displayed.

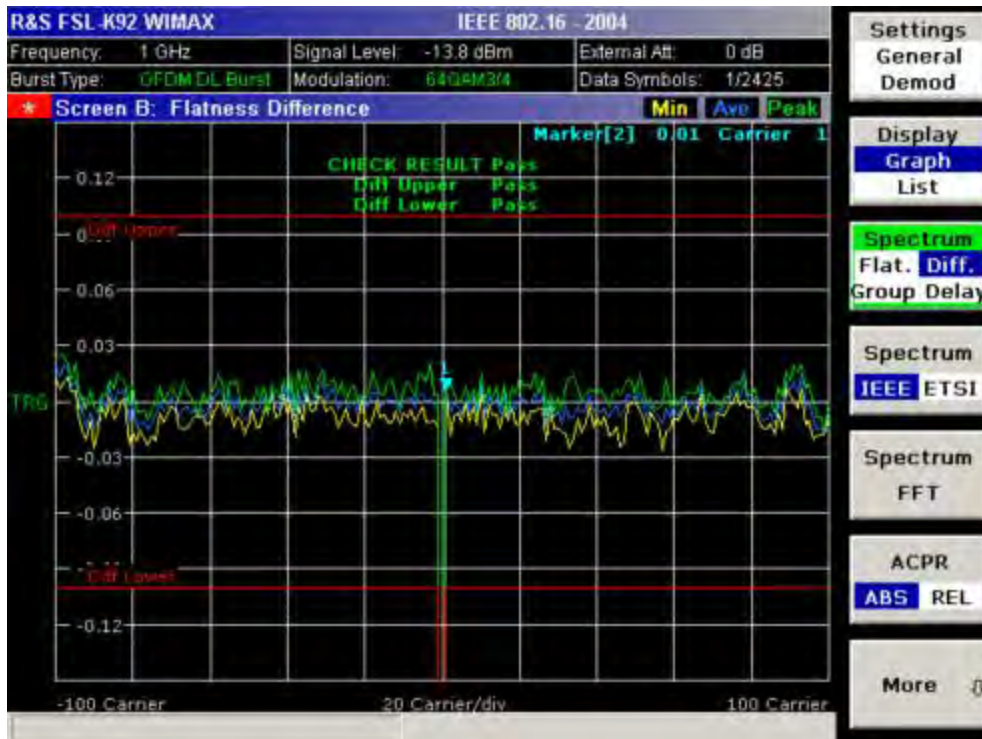

- Remote: CONF:BURS:SPEC:FLAT
- Remote: CONF:BURS:SPEC:FLAT:SEL FLAT (Spectrum Flatness)
- Remote: CONF:BURS:SPEC:FLAT:SEL GRD (Spectrum Flatness Group Delay)
- Remote: CONF:BURS:SPEC:FLAT:SEL DIFF (Spectrum Flatness Difference)

Spectrum IEEE/ETSI

Sets the Spectrum Mask result display.

This result display shows power against frequency. The span of the results is related to the specified sample rate. A limit line representing the spectrum mask specified for the selected standard is displayed and an overall pass/fail status is displayed for the obtained results against this limit line.

The number of sweeps is set in the **General Settings** dialog box, **Sweep Count** field. If the measurement is performed over multiple sweeps both a max hold trace and an average trace are displayed.

- Spectrum IEEE

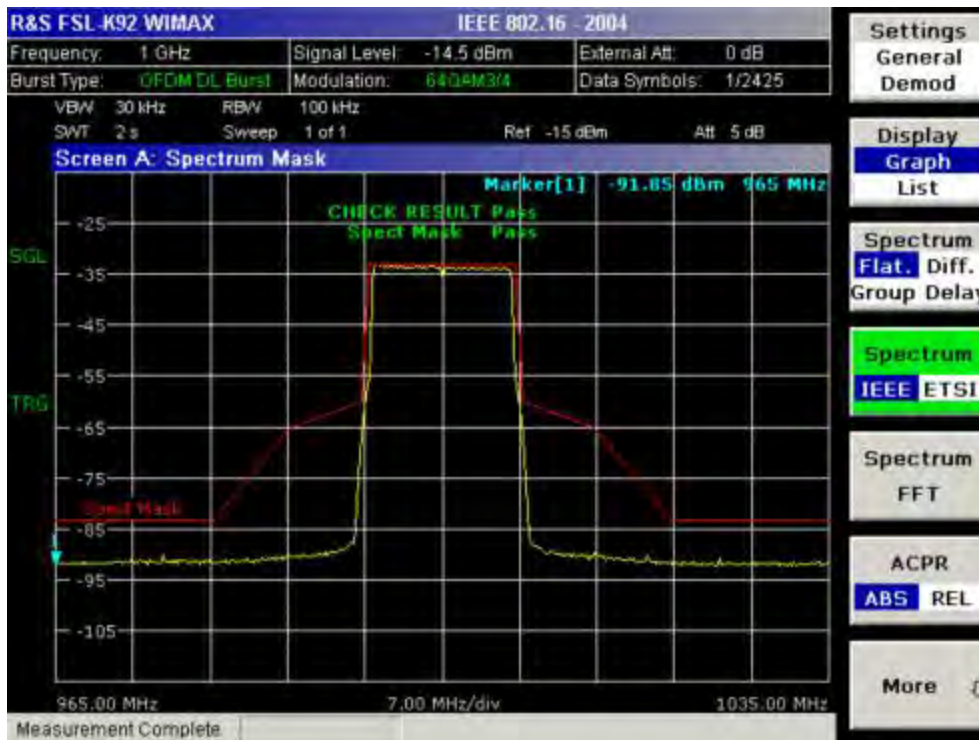

- Spectrum ETSI

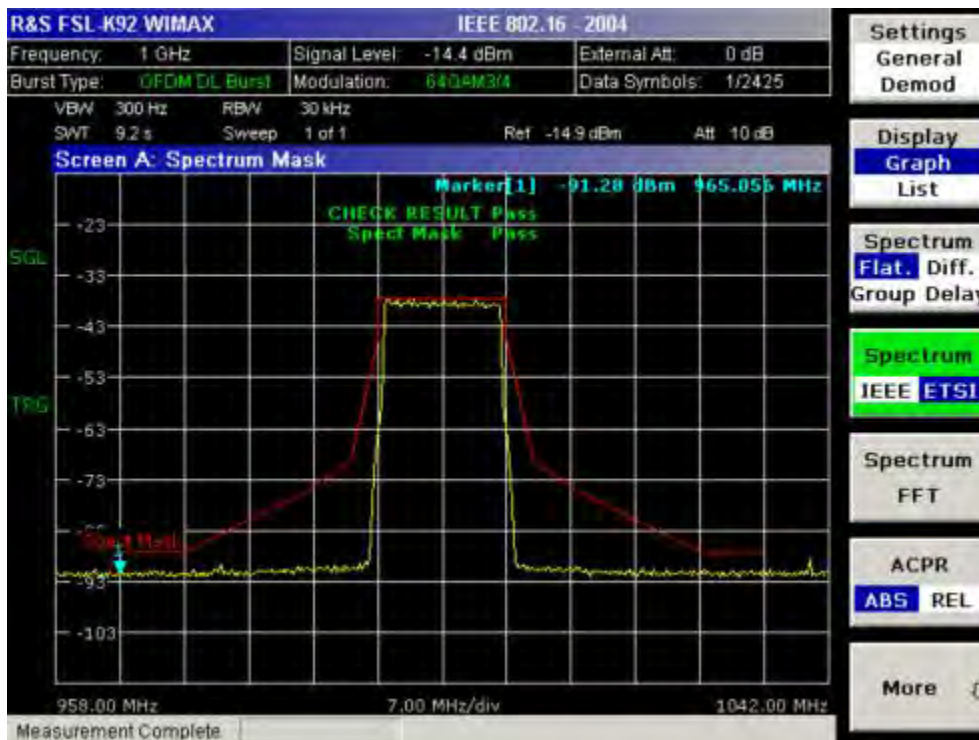

- Remote: CONF:BURS:SPEC:MASK
- Remote: CONF:BURS:SPEC:MASK:SEL IEEE
- Remote: CONF:BURS:SPEC:MASK:SEL ETSI

Spectrum FFT

Sets the Spectrum FFT result display.

This result display shows the Power vs Frequency results obtained from a FFT performed over the range of data in the Magnitude Capture Buffer which lies within the gate lines. If the gate start or gate length are altered then the results can be updated to reflect these changes by pressing the **Refresh** softkey in the sweep menu.

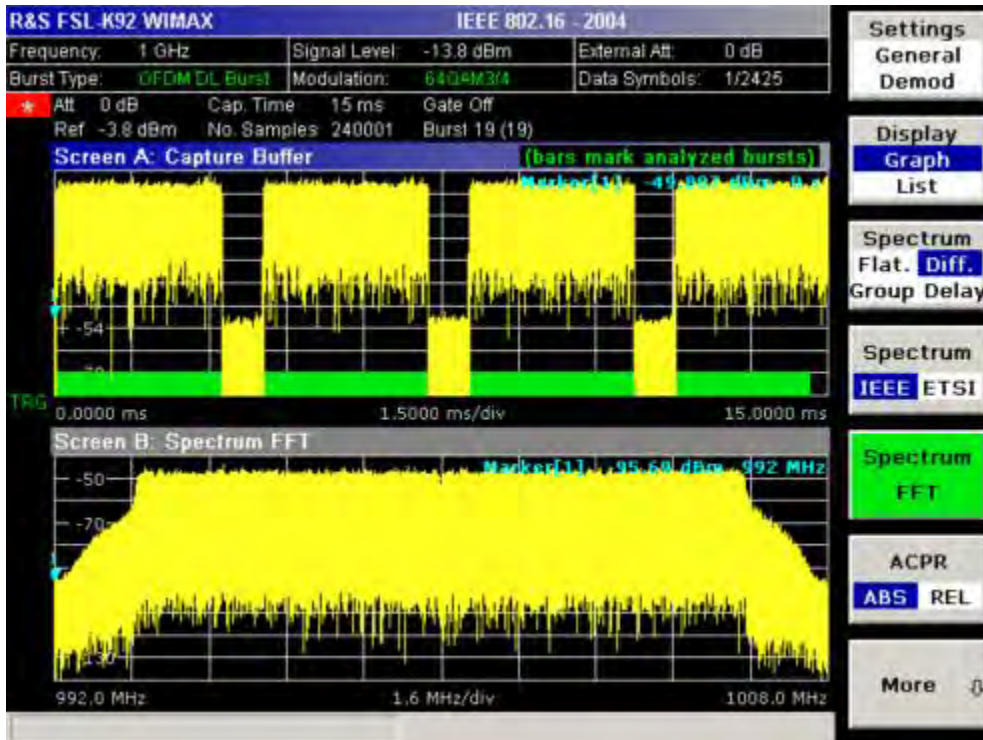

→ Remote: CONF: BURS: SPEC: FFT

ACPR Abs/Rel

Sets the ACPR (Adjacent Channel Power Relative) result display.

This result display is similar to the Spectrum Mask measurement, and provides information about leakage into adjacent channels. The results show the relative power measured in the three nearest channels either side of the measured channel. This measurement is the same as the adjacent channel power measurement provided by the spectrum analyzer.

The number of sweeps is set in the **General Settings** dialog box, **Sweep Count** field. If the measurement is performed over multiple sweeps both a max hold trace and an average trace are displayed.

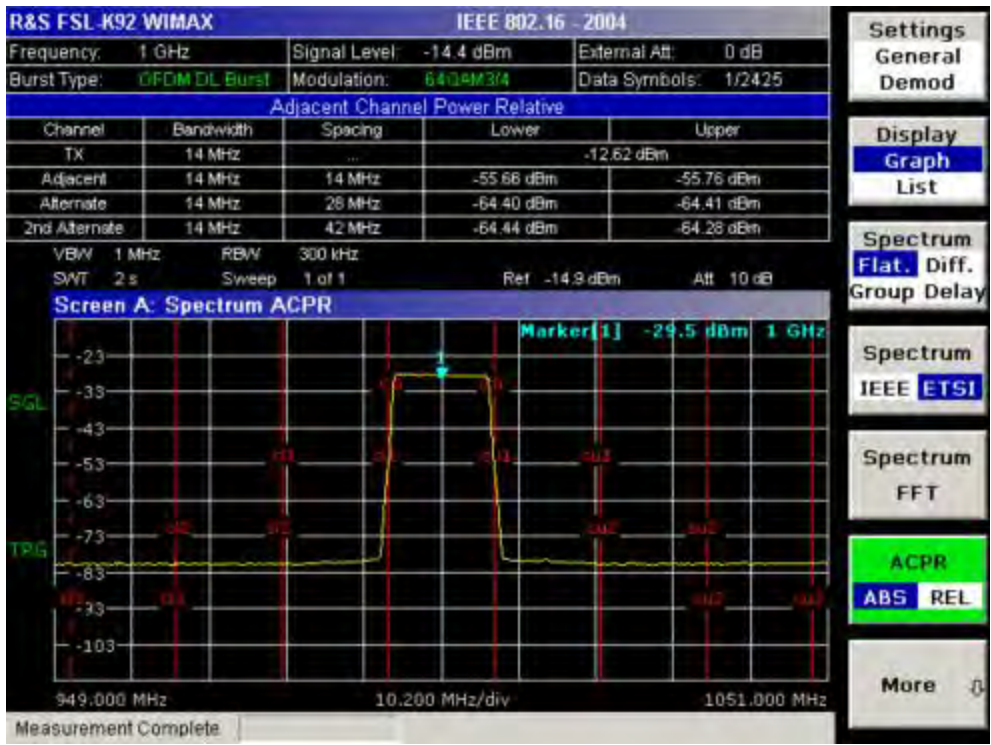

- Remote: CONF : BURS : SPEC : ACPR
- Remote: CONF : BURS : SPEC : ACPR : SEL ABS
- Remote: CALC2 : MARK : FUNC : POW : RES? (result query)
- Remote: CALC2 : MARK : FUNC : POW : RES : MAXH? (result query)

ACP Settings

Opens the **ACP Settings** dialog box to configure the ACPR result display. By default the ACP settings are derived from the **General Settings** dialog box, **Channel BW** field.

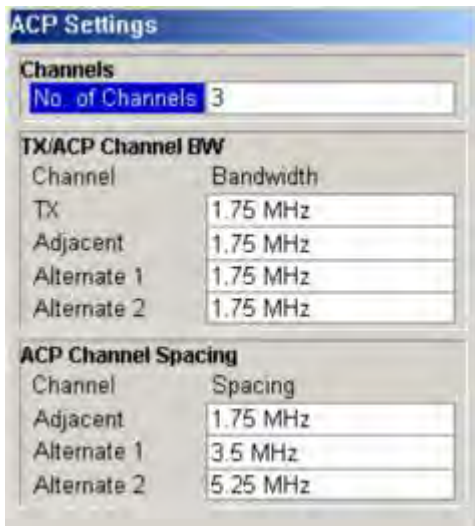

Pane	Field	Description
Channels	Noise Correction	Activates or deactivates the noise correction.
	No. of Channels	Specifies the number of channels adjacent to the transmit channel to be measured. If set to 0 only the transmit channel is measured.
TX/ACP Channel BW	TX	Specifies the bandwidth of the transmit channel to be measured by the ACP measurement.
	Adjacent, Alternate 1, Alternate 2	Specifies the bandwidth of the first to third channel before and after the transmit channel to be measured.
	ACP Channel Spacing	Specifies the spacing of the first to third channel before and after the transmit channel to be measured.

- Remote: POW:NCOR ON (Noise Correction)
- Remote: POW:ACH:ACP 3 (No. of Channels)
- Remote: POW:ACH:BAND 30kHz (TX)
- Remote: POW:ACH:SPAC:ALT1 100kHz (Alternate 1 to 2)
- Remote: POW:ACH:BAND:ALT2 30kHz (Alternate 1 to 2)

Statistics

Opens a submenu to display statistics measurement results.

CCDF

Sets the CCDF result display.

This result display shows the probability of an amplitude within the gating lines exceeding the mean power measured between the gating lines. The x-axis displays power relative to the measured mean power. If the gate start or gate length are altered then the results can be updated to reflect these changes by pressing the **Refresh** softkey in the sweep menu.

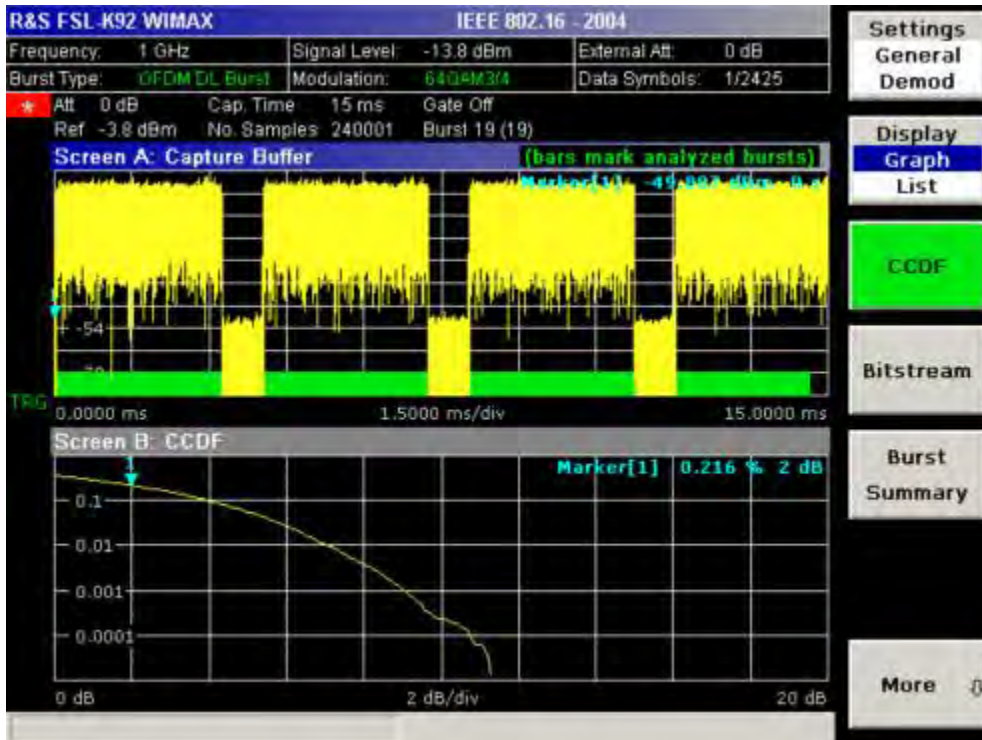

→ Remote: CONF: BURS: STAT: CCDF

Bitstream

Sets the Bitstream result display. This result display shows the demodulated data stream. These results are grouped by burst and symbol. When no dialog boxes are displayed the results can be scrolled through using the cursor keys or rotary knob.

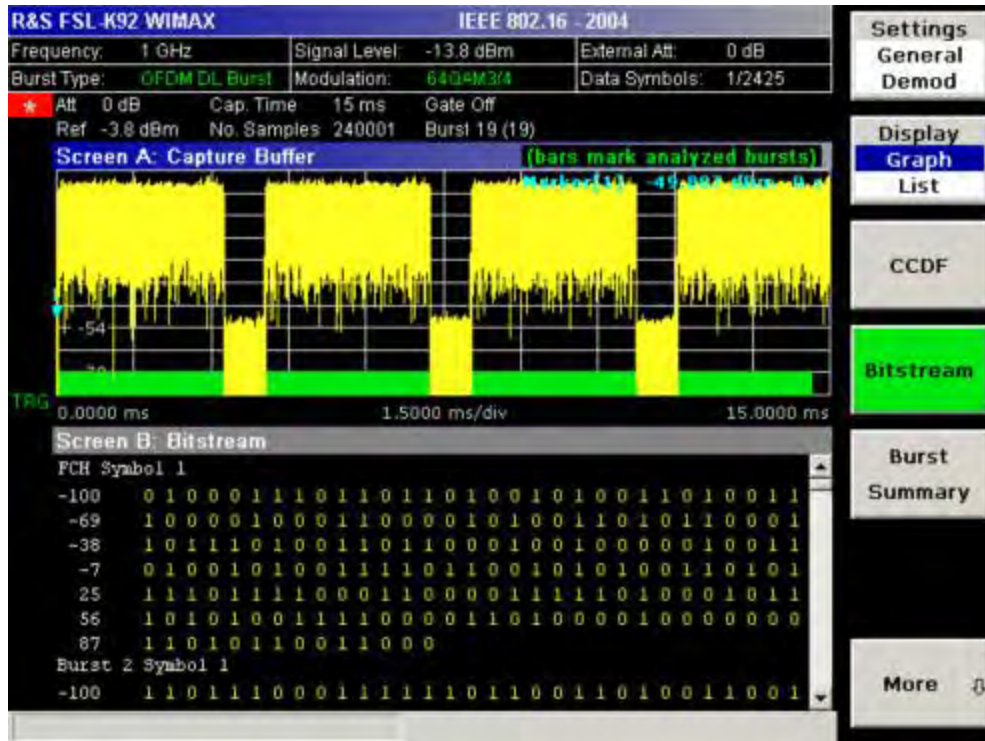

→ Remote: CONF: BURS: STAT: BSTR

Burst Summary

This result display shows the summary data for the analyzed bursts. When no dialog boxes are displayed the results can be scrolled through using the cursor keys or rotary knob.

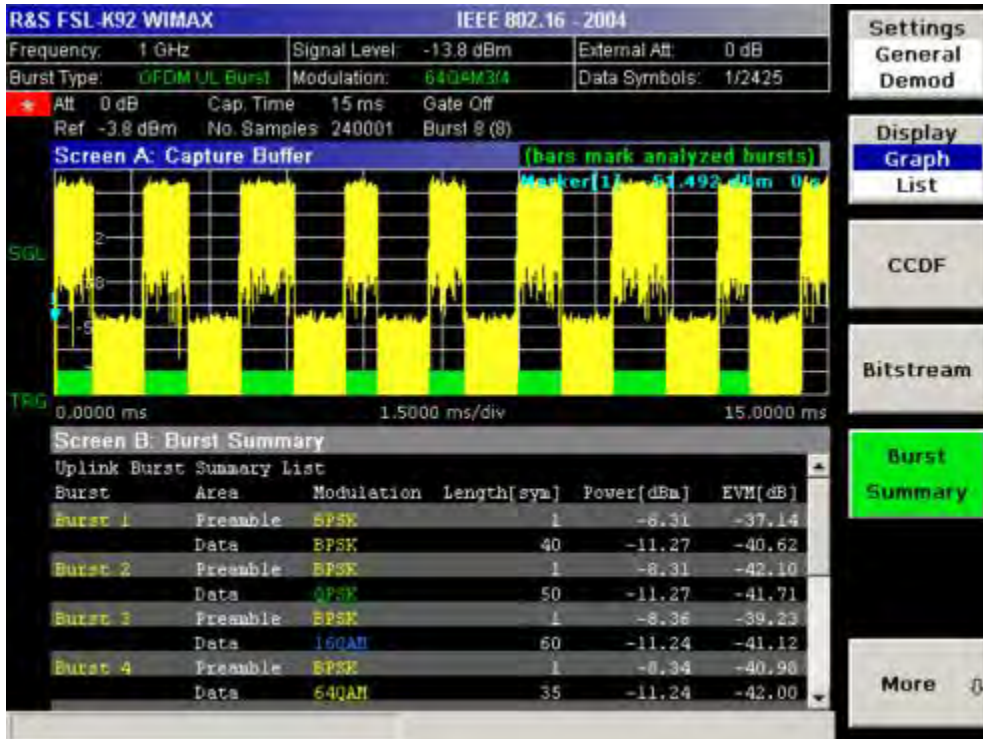

→ Remote: CONF: BURS: STAT: BSUM

Softkeys of the sweep menu (WiMAX mode)

The following table shows all softkeys available in the sweep menu (**SWEEP** key). It is possible that your instrument configuration does not provide all softkeys. If a softkey is only available with a special option, model or (measurement) mode, this information is delivered in the corresponding softkey description.

Command
Run Single/Cont
Auto Level
Refresh

Run Single/Cont

Selects the sweep mode.

- Single** single sweep mode
- Cont** continuous sweep mode

- Remote: INIT:CONT OFF (single sweep mode)
- Remote: INIT:CONT ON (continuous sweep mode)

Auto Level

Starts an automatic level detection measurement. If this softkey is pressed while a measurement is running, the current measurement is aborted and the automatic level detection measurement is started. If the aborted measurement was a continuous measurement it is resumed after the automatic level detection is completed.

→ Remote: CONF:POW:AUTO ON

Refresh

Updates the current measurement results with respect to the current gate settings. This softkey is only available if the measurement results are effected by the gate settings (Spectrum FFT, PVT and CCDF) and if the gate settings are modified after a measurement result has been obtained.

Softkeys of the marker menu (WiMAX mode)

The following table shows all softkeys available in the marker menu (**MKR** key). It is possible that your instrument configuration does not provide all softkeys. If a softkey is only available with a special option, model or (measurement) mode, this information is delivered in the corresponding softkey description. Close all settings dialog boxes before opening the marker menu.

Command
Marker 1
Unzoom
Marker Zoom
Marker Off

Marker 1

Opens a dialog box to adjust the marker. The contents of the dialog box depends on the type of graph the marker is adjusted to. After every change, the marker position in the trace and the marker information are updated.

- Remote: CALC1:MARK1 ON
 - Remote: CALC:MARK:X 2ms
 - Remote: CALC:MARK:Y?
 - Remote: CALC2:MARK:SYMB 2
 - Remote: CALC2:MARK:CARR -7
-

Unzoom

Cancels the marker zoom.

- Remote: CALC:MARK:FUNC:ZOOM 1
-

Marker Zoom

(Magnitude Capture Buffer, PVT, Constellation vs Symbol, Constellation vs Carrier)

Opens an edit dialog box to select the magnification factor for the zoom. The maximum magnification depends on the type of result display.

→ Remote: CALC:MARK:FUNC:ZOOM 4

Marker Off

Switches off all makers in the active result display.

→ Remote: CALC2:MARK:AOFF

Softkeys of the marker→ menu (WiMAX mode)

The following table shows all softkeys available in the marker→ menu (**MKR→** key). It is possible that your instrument configuration does not provide all softkeys. If a softkey is only available with a special option, model or (measurement) mode, this information is delivered in the corresponding softkey description.

Command
MKR → Trace

MKR → Trace

Opens an edit dialog box to enter the number of the trace, on which the marker is to be placed. This softkey is available for all result displays with more than one trace.

→ Remote: CALC2:MARK:TRAC 2

Softkeys of the lines menu (WiMAX mode)

The following table shows all softkeys available in the lines menu (**LINES** key). It is possible that your instrument configuration does not provide all softkeys. If a softkey is only available with a special option, model or (measurement) mode, this information is delivered in the corresponding softkey description.

This menu is only available if the results are displayed in form of a list (for details see [Result summary list](#) and **Display List/Graph** softkey).

Command
Default Current
Default All

Default Current

Resets all limits for the current modulation scheme to the values specified in the selected standard.

→ Remote: see CALCulate:LIMit Subsystem

Default All

Resets all limits for all modulation schemes to the values specified in the selected standard.

→ Remote: see CALCulate:LIMit Subsystem

Softkeys of the trace menu (WiMAX mode)

The following table shows all softkeys available in the trace menu (**TRACE** key). It is possible that your instrument configuration does not provide all softkeys. If a softkey is only available with a special option, model or (measurement) mode, this information is delivered in the corresponding softkey description.

Command
Display List/Graph
Screen Focus A/B
Screen Size Full/Split

Screen Focus A/B

Selects the active screen for IQ measurement results in split and full screen mode. Only the markers of an active screen can be controlled.

→ Remote: DISP:WIND1:SSEL

Screen Size Full/Split

Changes the display between split and full screen for IQ measurement results. Frequency sweep measurement results are always displayed in full screen.

→ Remote: DISP:FORM SING

Instrument Functions – Basic Settings

In this section, all basic settings functions of the R&S FSL and their application are explained in detail. The analyzer functions are described in section "Instrument Functions – Analyzer".

For every key a table is provided in which all submenus and corresponding commands are listed. The description of the submenus and commands follows the order of the table. The commands for the optional remote control (if any) are indicated for each softkey. The description includes the following:

- ["General Settings, Printout and Instrument Settings"](#) on page 4.261

This section provides information on how to prepare measurements and process their results: setting the instrument, managing and retrieving data, returning to manual control, and printout.

More basic information on operation is given in the Quick Start Guide. The front and the rear view of the instrument together with a table of all available keys and a short description are provided in chapter "Front and Rear Panel". Chapter "Preparing for Use" informs how to start working with the instrument for the first time. A brief introduction on handling the instrument is given in chapter "Basic Operations". This includes also the description of the keys for basic operations like switching the instrument on and off or starting a measurement.

General Settings, Printout and Instrument Settings

After putting the instrument into operation and becoming familiar with the handling of the instrument (for details see Quick Start Guide), the preparations for measurements can start. In this section the general settings of the instrument, the data management and the processing of measurement results are described. This includes the following topics and keys:

- ["Instrument Setup and Interface Configuration – SETUP Key"](#) on page 4.262
- ["Saving and Recalling Data Sets – FILE Key"](#) on page 4.277
- ["Manual Control – Local Menu"](#) on page 4.283
- ["Measurement Documentation – PRINT Key"](#) on page 4.284

Instrument Setup and Interface Configuration – SETUP Key

The **SETUP** key is used to set or display the default settings of the instrument: reference frequency, noise source, level correction values, date, time, LAN interface, firmware update and enabling of options, information about instrument configuration and service support functions. For further details refer also to the Quick Start Guide, chapter 2 "Preparing for Use", section "R&S FSL Setup".

To open the setup menu

- Press the **SETUP** key.
The setup menu is displayed.

Menu and softkey description

- "Softkeys of the setup menu" on page 4.262

To display help to a softkey, press the **HELP** key and then softkey for which you want to display help. To close the help window, press the **ESC** key. For further information refer to section "How to use the Help System".

Softkeys of the setup menu

The following table shows all softkeys available in the setup menu. It is possible that your instrument configuration does not provide all softkeys. If a softkey is only available with a special option, model or (measurement) mode, this information is delivered in the corresponding softkey description.

Menu / Command	Submenu / Command	Submenu / Command	Command
Reference Int/Ext			
Transducer ↓	Active On/Off		
	Edit ↓	Insert Line	
		Delete Line	
		Edit Name	
		Edit Unit	
		Edit Value	
		Interpolation Lin/Log	
		Save Factor	
	New ↓	same contents as Edit menu	
	Copy to ↓	same contents as Edit menu	
	Delete		
	Ref Level Adjust Man/Auto		
	Show Directory		
IF Output/IF Video			
Noise Src On/Off			
Alignment ↓	Self Align		
	Show Align Results		
	Corr Data On/Off		
General Setup ↓	Configure Network		
	Network Address ↓	Computer Name	
		IP Address	

Menu / Command	Submenu / Command	Submenu / Command	Command
		Subnet Mask	
		DHCP On/Off	
	GPIB ↓	GPIB Address	
		ID String Factory	
		ID String User	
		GPIB Language	
		Display Update On/Off	
		More ↓	
		GPIB Terminator LFE0I/EOI	
		*IDN/*OPT Format On/Off	
		I/O Logging On/Off	
	Time+Date		
	Meas Display ↓	Screen Title	
		Time+Date On/Off	
		Logo On/Off	
		Annotation On/Off	
		Screen Colors ↓	Select Screen Color Set
			Color On/Off
			Select Object
			Predefined Colors
			User Defined Colors
			Set to Default
		Print Colors ↓	Select Print Color Set
			Color On/Off
			Select Object
			Predefined Colors
			User Defined Colors
			Set to Default
		Display Pwr Save On/Off	
	Soft Frontpanel		
More ↓			
Firmware Update ↓	Firmware Update		
Option Licenses ↓	Install Option		
System Info ↓	Hardware Info		
	Versions+Options		
	System Messages		
	Clear All Messages		

Menu / Command	Submenu / Command	Submenu / Command	Command
Service ↓	Input RF/Cal/TG		
	Comb Frequency		
	Reset Password		
	Selftest		
	Selftest Results		
	Password		
	Service Function		

Reference Int/Ext

Switches between the internal and external reference signal source. The default setting is internal reference. It is important, that the external reference signal is deactivated when switching from external to internal reference to avoid interactions.

If the reference signal is missing when switching to external reference, the message **EXREF** is displayed to indicate that no synchronization is performed.

The R&S FSL can use the internal reference source or an external reference source as frequency standard from which all internal oscillators are derived. A 10 MHz crystal oscillator is used as internal reference source. In the external reference setting, all internal oscillators of the R&S FSL are synchronized to the external reference frequency (also 10 MHz). For details on connectors refer to the Quick Start Guide, chapter 1 "Front and Rear Panel".

→ Remote: ROSC:SOUR INT

Transducer

Opens the **Select Transducer** dialog box and a submenu to activate or deactivate defined transducer factors, to generate new transducer factors or to edit existing ones.

In the **Select Transducer** dialog box, a transducer factor can be edited, deleted or copied, if selected, using the corresponding softkeys. The default directory, in which the transducer factors are saved, is displayed (C:\R_S\INSTR\TRD; the extension of transducer factor files is *.TDF). Subdirectories can be added or deleted via the file manager. They are displayed or hidden using the arrow keys or the **Show Directory** softkey / **Hide Directory** button.

Two different directory views are possible: If the **Show all** option is activated, all transducer factors in the directory are displayed. If the **Show compatible** option is activated, only the compatible transducer factors in the directory are displayed.

For details on transducer factors refer to chapter "Advanced Measurement Examples".

This softkey is available from firmware version 1.10.

→ Remote: CORR:TRAN:SEL FACTOR1

Active On/Off

Activates or deactivates the selected transducer factor. A maximum of 10 transducer factors can be activated at the same time. If an additional transducer factor is activated, its unit compatibility is checked. If one factor has a different unit than dB, all the other activated factors must have the unit dB.

This softkey is available from firmware version 1.10.

- Remote: CORR:TRAN:SEL <name>
 - Remote: CORR:TRAN ON
-

Edit

Opens the **Edit Transducer** dialog box with the data of the selected factor. During editing, a transducer factor remains stored in the background until the factor is saved using the **Save Factor** softkey.

This softkey is available from firmware version 1.10.

- Remote: Comment: CORR:TRAN:COMM <string>
-

Insert Line

Inserts an empty line above the selected reference value to enter a new reference value. When entering a new reference value in the line, the ascending order of frequencies must be taken into consideration, however.

This softkey is available from firmware version 1.10.

Delete Line

Deletes the selected reference value (complete line). The reference values that follow move one line up.

This softkey is available from firmware version 1.10.

Edit Name

Sets the focus on the **Name** field to enter a file name. The extension is added automatically.

This softkey is available from firmware version 1.10.

- Remote: CORR:TRAN:SEL <name>
-

Edit Unit

Sets the focus on the **Unit** field to select the unit.

This softkey is available from firmware version 1.10.

- Remote: CORR:TRAN:UNIT <string>
-

Edit Value

Sets the focus to enter positions and values as frequency/level pairs. The entered data are also displayed graphically. Using the **Shift x** or **Shift y** button, all entered values can be shifted in x or y direction.

This softkey is available from firmware version 1.10.

→ Remote: CORR:TRAN:DATA <freq>,<level>

Interpolation Lin/Log

Sets the scaling of the x axis to linear or logarithmic.

This softkey is available from firmware version 1.10.

→ Remote: CORR:TRAN:SCAL LIN|LOG

Save Factor

Saves the changed factor to a file on the internal flash disk. If a transducer factor with the same name already exists, a confirmation query is displayed. If the new factor is active, the new values are immediately applied.

This softkey is available from firmware version 1.10.

→ Remote: In remote control, the save operation is performed automatically after the definition of the reference values.

New

Opens the **Edit Transducer** dialog box to enter data for a new factor.

This softkey is available from firmware version 1.10.

Copy to

Opens the **Edit Transducer** dialog box to copy the selected factor.

This softkey is available from firmware version 1.10.

Delete

Deletes the selected factor after confirmation.

This softkey is available from firmware version 1.10.

→ Remote: CORR:TRAN DEL

Ref Level Adjust Man/Auto

Adjusts the reference frequency to the selected transducer factor. Manual or automatic adjustment can be selected.

This softkey is available from firmware version 1.10.

→ Remote: CORR:TRAN:ADJ:RLEV ON

Show Directory

Displays the subdirectory of the selected directory.

This softkey is available from firmware version 1.10.

IF Output/IF Video (option Additional Interfaces, B5 only)

Changes the measurement mode of the IF connector.

→ Remote: `OUTP IF VID`

Noise Src On/Off (option Additional Interfaces, B5 only)

Switches the supply voltage for an external noise source on or off. For details on connectors refer to the Quick Start Guide, chapter 1 "Front and Rear Panel" .

→ Remote: `DIAG:SERV:NSO ON`

Alignment

Opens a submenu with the available functions for recording, displaying and activating the data for self alignment.

The correction data and characteristics required for the alignment are determined by comparison of the results at different settings with the known characteristics of the high-precision calibration signal source at 65.83 MHz. The correction data are stored as a file on flash disk and can be displayed using the **Show Align Results** softkey.

Self Align

Starts the recording of correction data of the instrument. If the correction data acquisition has failed or if the correction values are deactivated, a corresponding message is displayed in the status field.

As long as the self alignment data is collected the procedure can be cancelled using the **Abort** button.

→ Remote: `*CAL?`

Show Align Results

Opens a dialog box that displays the correction data of the alignment:

- date and time of last correction data record
- overall results of correction data record
- list of found correction values according to function/module

The results are classified as follows:

PASSED	calibration successful without any restrictions
CHECK	deviation of correction value larger than expected, correction could however be performed
FAILED	deviations of correction value too large, no correction was possible. The found correction data are not applicable.

As long as the self alignment data is collected the procedure can be cancelled using the **Abort** button.

→ Remote: CAL:RES?

→ Remote: CAL:ABOR

Corr Data On/Off

Activates and deactivates the alignment data, e.g. for service purposes the correction data can be deactivated.

→ Remote: CAL:STAT ON

General Setup

Opens a submenu for all general settings such as IP address and LAN settings, date and time, remote control (optional) and MEAS display.

Configure Network

Opens the **Network Connections** dialog box to change the LAN settings. For details refer to the Quick Start Guide, chapter 2 "Preparing for Use", section "Configuring the LAN Interface" and appendix B, "LAN Interface".

Network Address

Opens a submenu to configure the internet protocol properties and the computer name.

Computer Name

Opens an edit dialog box to enter the computer name via the keypad. The naming conventions of Windows apply. If too many characters and/or numbers are entered, in the status line, an according message is displayed. For step-by-step instructions refer to the Quick Start Guide, appendix B "LAN Interface".

IP Address

Opens an edit dialog box to enter the IP address via the keypad. The TCP/IP protocol is preinstalled with the IP address 10.0.0.10. If the DHCP server is available (**DHCP On**), the dialog box entry is read-only.

The IP address consists of four number blocks separated by dots. Each block contains 3 numbers in maximum (e.g. 100.100.100.100), but also one or two numbers are allowed in a block (as an example see the preinstalled address). For step-by-step instructions refer to the Quick Start Guide, chapter 2 "Preparing for Operation".

Subnet Mask

Opens an edit dialog box to enter the subnet mask via the keypad. The TCP/IP protocol is preinstalled with the subnet mask 255.255.255.0. If the DHCP server is available (**DHCP On**), the dialog box entry is read-only.

The subnet mask consists of four number blocks separated by dots. Each block contains 3 numbers in maximum (e.g. 100.100.100.100), but also one or two numbers are allowed in a block (as an example see the preinstalled address). For step-by-step instructions refer to the Quick Start Guide, chapter 2 "Preparing for Operation".

DHCP On/Off

Switches between DHCP server available (On) or not available (Off). If a DHCP server is available in the network, the IP address and subnet mask of the instrument are obtained automatically from the DHCP server. For further details refer to the Quick Start Guide, chapter 2 "Preparing for Operation".

GPIB (option GPIB Interface, B10 only)

Opens a submenu to set the parameters of the remote control interface.

GPIB Address (option GPIB Interface, B10 only)

Opens an edit dialog box to enter the GPIB address. Values from 0 to 30 are allowed. The default address is 20.

→ Remote: SYST:COMM:GPIB:ADDR 20

ID String Factory (option GPIB Interface, B10 only)

Selects the default response to the *IDN? query.

ID String User (option GPIB Interface, B10 only)

Opens an edit dialog box to enter a user-defined response to the *IDN? query. Max. 36 characters are allowed.

GPIB Language (option GPIB Interface, B10 only)

Only the remote control language SCPI is available for the R&S FSL and is set by default.

Display Update On/Off

Defines whether the instrument display is switched off when changing from manual control to remote control. In remote control mode, this softkey is displayed in the local menu (for details refer to section "[Manual Control – Local Menu](#)" on page 4.283).

→ Remote: SYST:DISP:UPD ON

GPIO Terminator LFEOL/EOI (option GPIO Interface, B10 only)

Changes the GPIO receive terminator.

According to the standard the terminator in ASCII is <LF> and/or <EOI>. For binary data transfers (e.g. trace data) from the control computer to the instrument, the binary code used for <LF> might be included in the binary data block, and therefore should not be interpreted as a terminator in this particular case. This can be avoided by changing the receive terminator to EOI.

→ Remote: SYST:COMM:GPIO:RTER EOI

***IDN/*OPT Format On/Off (option GPIO Interface, B10 only)**

Provides the response to the *IDN? and *OPT? remote command in a format that is compatible to the R&S FSP/FSU/FSQ family. This function is intended for re-use of existing control programs together with the R&S FSL. For details on the FSL specific response formats refer to chapter "Remote Control – Commands", section "Common commands" or the Online Help.

I/O Logging On/Off (option GPIO Interface, B10 only)

Activates logging all remote control commands received by the FSL in the log file ScpiLog.txt for debug purposes. Logging the commands may be extremely useful in order to find misspelled keywords in control programs. The corresponding log file will be stored in folder C:\R_S\instr\ScpiLogging.

Time+Date

Opens an edit dialog box to enter time and date for the internal real time clock. For details refer to the Quick Start Guide, chapter 2 "Preparing for Use", section "Setting the Date and Time".

→ Remote: SYST:TIME 12,30

→ Remote: SYST:DATE 2004,10,01

Meas Display

Opens a submenu to configure the display and the print colors.

This softkey is available from firmware version 1.10.

Screen Title

Activates/deactivates the display of a diagram title (if available) and opens an edit dialog box to enter a new title for the active diagram. Max. 20 characters are allowed.

This softkey is available from firmware version 1.10.

→ Remote: DISP:TEXT 'Noise Meas'

→ Remote: DISP:TEXT:STATE ON

Time+Date On/Off

Activates/deactivates the display of date and time above the diagram.

This softkey is available from firmware version 1.10.

→ Remote: `DISP:TIME OFF`

Logo On/Off

Activates/deactivates the display of the Rohde & Schwarz company logo in the upper left corner.

This softkey is available from firmware version 1.10.

→ Remote: `DISP:LOGO ON`

Annotation On/Off

Activates/deactivates the display of the frequency information. For example to protect confidential data it can be useful to hide the frequency information.

This softkey is available from firmware version 1.10.

→ Remote: `DISP:ANN:FREQ ON`

Screen Colors

Opens a submenu to configure the screen colors. For details on screen colors refer to the Quick Start Guide, chapter 2 "Preparing for Use", section "Setting the Screen Colors".

This softkey is available from firmware version 1.10.

→ Remote: `DISP:CMAP2:HSL 0.3,0.8,1.0`

Select Screen Color Set

Opens the **Select Screen Color Set** dialog box to select default or user defined color settings.

If one of the default settings is selected (**Default Colors 1/2**), the default settings for brightness, color tint and color saturation for all display screen elements are restored. The default color schemes provide optimum visibility of all picture elements at an angle of vision from above or below. Default setting is **Default Colors 1**.

If **User Defined Colors** is selected, a user-defined color set can be defined. For step-by-step instruction refer to the Quick Start Guide, chapter 2 "Preparing for Use".

This softkey is available from firmware version 1.10.

→ Remote: `DISP:CMAP:DEF2`

Color On/Off

Switches from color display to black-and-white display and back. The default setting is color display.

This softkey is available from firmware version 1.10.

Select Object

Opens the **Color Setup** dialog box to select the color settings for a selected object.

The **Selected Object** list is displayed to select the object. For setting the color the predefined colors are displayed.

This softkey is available from firmware version 1.10.

- Remote: DISP:CMAP2:HSL 0.3,0.8,1.0 (screen colors)
 - Remote: HCOP:CMAP2:HSL 0.3,0.8,1.0 (print colors)
-

Predefined Colors

In the **Color Setup** dialog box, displays the **Predefined Colors** (alternative to the **Predefined Colors** button). This softkey is only available if, in the **Select Color Set** dialog box, the **User Defined Colors** option is selected or the **Color Setup** dialog box is displayed. For further details refer to the Quick Start Guide, chapter 2 "Preparing for Use".

This softkey is available from firmware version 1.10.

- Remote: DISP:CMAP2:PDEF GRE (screen colors)
 - Remote: HCOP:CMAP2:PDEF GRE (print colors)
-

User Defined Colors

In the **Color Setup** dialog box, displays the **User Defined Colors** (alternative to the **User Defined Colors** button). This softkey is only available if, in the **Select Color Set** dialog box, the **User Defined Colors** option is selected or the **Color Setup** dialog box is displayed. For further details refer to the Quick Start Guide, chapter 2 "Preparing for Use".

This softkey is available from firmware version 1.10.

- Remote: DISP:CMAP2:HSL 0.3,0.8,1.0 (screen colors)
 - Remote: HCOP:CMAP2:HSL 0.3,0.8,1.0 (print colors)
-

Set to Default

Opens the **Set to Default** dialog box to select one of the factory default color settings.

This softkey is available from firmware version 1.10.

- Remote: DISP:CMAP:DEF2 (screen colors)
 - Remote: HCOP:CMAP:DEF2 (print colors)
-

Print Colors

Opens a submenu to select the colors for the printout. To facilitate color selection, the selected color combination is displayed when the menu is entered. The previous colors are restored when the menu is exited.

This softkey is available from firmware version 1.10.

Select Print Color Set

Opens the **Select Print Color Set** dialog box to select the color settings for printout.

Screen Colors	Selects the current screen colors for the printout. The background is always printed in white and the grid in black.
Optimized Colors	Selects an optimized color setting for the printout to improve the visibility of the colors (default setting). Trace 1 is blue, trace 2 black, trace 3 green, and the markers are turquoise. The background is always printed in white and the grid in black.
User Defined Colors	Enables the softkeys to define colors for the printout.

This softkey is available from firmware version 1.10.

→ Remote: HCOP:CMAP:DEF1|DEF2|DEF3

Color On/Off

Switches from color printout to black-and-white printout and back. All colored areas are printed in white and all colored lines in black. This improves the contrast. The default setting is color printout, provided that the selected printer can produce color printouts.

This softkey is available from firmware version 1.10.

→ Remote: HCOP:DEV:COL ON

Display Pwr Save On/Off

Switches the power-save mode for the display on/off and opens an edit dialog box to enter the time for the power-save function to respond. After the elapse of this time the display is completely switched off, i.e. including backlighting. This mode is recommended when the instrument is exclusively operated in remote control.

For details on the power-save mode for the display refer to the Quick Start Guide, chapter 2 "Preparing for Use", section "Automatically Switching Off the Internal Screen".

This softkey is available from firmware version 1.10.

→ Remote: DISP:PSAV ON

→ Remote: DISP:PSAV:HOLD 15

Soft Frontpanel

Activates or deactivates the display of the front panel keys on the screen. Alternatively, the F6 key can be used.

→ Remote: SYST:DISP:FPAN ON

Firmware Update

Opens a submenu to install firmware versions. The installation of a new firmware version can be performed via USB or LAN interface. For details on installation refer to the Quick Start Guide, chapter 3 "Firmware Update and Installation of Firmware Options", section "Firmware Update".

Firmware Update

Opens the **Firmware Update** dialog box. The update path is changed by entering the new path or via the **Browse** button. The installation is started via the **Execute** button. For details on installation refer to the Quick Start Guide, chapter 3 "Firmware Update and Installation of Firmware Options", section "Firmware Update".

→ Remote: SYST:FIRM:UPD 'D:\FW_UPDATE'

Option Licenses

Opens a submenu to install options. For details on options refer to the Quick Start Guide, chapter 3 "Firmware Update and Installation of Firmware Options", section "To activate firmware options".

Install Option

Opens an edit dialog box to enter the license key for the option that you want to install.

System Info

Opens a submenu to display detailed information on module data, device statistics and system messages.

Hardware Info

Opens a dialog box in which all modules (installed hardware components) are listed together with the corresponding hardware revisions.

→ Remote: DIAG:SERV:HWIN?

Versions+Options

Opens a dialog box that displays the model information, serial number, firmware version, and specifications version of the basic device. Additionally the operating time of the instrument, the power on cycles and the attenuator switching cycles are displayed.

For details on options refer to the Quick Start Guide, chapter 3 "Firmware Update and Installation of Firmware Options", section "To activate firmware options".

→ Remote: SYST:VERS?

System Messages

Opens the **System Messages** dialog box that displays the generated system messages in the order of their occurrence. The most recent messages are placed at the top of the list. Messages that have occurred since the last display of system messages menu are marked with an asterisk '*'. The following information is available:

No	device-specific error code
Message	brief description of the message
Component	hardware messages: name of the affected module software messages: name of the affected software
Date/Time	date and time of the occurrence of the message

If the number of error messages exceeds the capacity of the error buffer, **Message buffer overflow** is displayed. To delete messages see **Clear All Messages** softkey.

→ Remote: SYST:ERR:LIST?

Clear All Messages

Deletes all system messages. The softkey is only available if the **System Messages** dialog box is displayed.

→ Remote: SYST:ERR:CLE:ALL?

Service

Opens a submenu that contains additional functions for maintenance and/or trouble shooting.



ATTENTION

The service functions are not necessary for normal measurement operation. However, incorrect use can affect correct operation and/or data integrity of the R&S FSL. Therefore, many of the functions can only be used after entering a password. They are described in the instrument service manual.

Input RF/Cal/TG

Selects the input for measurement.

RF	Switches the input of the R&S FSL to the input connector (normal position). This is the default setting.
Cal	Switches the RF input of the R&S FSL to the internal calibration source (65.83 MHz) and activates the data entry of the output level of the calibration source. Possible values are 0 dB and –30 dB.
TG	Switches the RF input of the R&S FSL to the tracking generator output. Only the models 13 and 16 offer this setting.

→ Remote: DIAG:SERV:INP RF|CAL|TG

Comb Frequency

Opens a dialog box to set the comb generator frequency for the internal calibration:

Comb/1 65.8333 MHz / 1

Comb/64 65.8333 MHz / 64

Comb/65 65.8333 MHz / 65

- Remote: Sine: DIAG:SERV:INP:PULS OFF
 - Remote: Comb: DIAG:SERV:INP:PULS ON
 - Remote: Comb: DIAG:SERV:INP:PRAT COMB64
-

Reset Password

Deactivates all set passwords.

- Remote: SYST:PASS:RES
-

Selftest

Initiates the self test of the instrument modules to identify a defective module in case of failure . All modules are checked consecutively and the test result is displayed.

- Remote: *TST?
-

Selftest Results

Opens the **Selftest Result** dialog box that contains the test results. In case of failure a short description of the failed test, the defective module, the associated value range and the corresponding test results are indicated.

- Remote: DIAG:SERV:STE:RES?
-

Password

Opens an edit dialog box to enter the password. This ensures that the service functions are only used by authorized personnel.

- Remote: SYST:PASS "Password"
-

Service Function

Opens the **Service Function** dialog box to start special service functions. For further information refer to the service manual.

- Remote: DIAG:SERV:SFUNC <value>,<value>...
-

Saving and Recalling Data Sets – FILE Key

The **FILE** key is used to store and load instrument settings and to manage stored files.

The file menu includes functions for storing (**Save** softkey) instrument settings such as instrument configurations (measurement/display settings, etc) and measurement results on permanent storage media, or to load (**Recall** softkey) stored data back onto the instrument.

Functions for management of storage media (**File Manager** softkey) include among others functions for listing, copying, and deleting/rename files.

The R&S FSL is capable of internally storing complete instrument settings with instrument configurations and measurement data in the form of data sets. The respective data are stored on the internal flash disk or, if selected, on a memory stick or network drive. The mass media are assigned to the volume names as follows:

Drive	Designation	Comment
C	operating system, firmware and stored instrument settings	for customer data
A	USB floppy drive	if connected
D	USB memory stick or USB CD-ROM	if connected
E ...Z	additional USB mass storage devices or mounted LAN volumes	if connected

To open the file menu

- Press the **FILE** key.

The file menu is displayed.

Menu and softkey description

- ["Softkeys of the file menu"](#) on page 4.278

To display help to a softkey, press the **HELP** key and then softkey for which you want to display help. To close the help window, press the **ESC** key. For further information refer to section "How to use the Help System".

Further information

- ["Navigation in the dialog boxes for saving and loading data sets"](#) on page 4.277
- ["Navigation in the file manager"](#) on page 4.278

Navigation in the dialog boxes for saving and loading data sets

The **Save**, **Recall** and **Startup Recall** dialog boxes are used to save and recall data sets and use the same navigation principle. Press the **Save** or **Recall** softkey to open the corresponding dialog box.

- **Path** field

To change the directory, press the **Edit Path** softkey.

To select a folder, use the rotary knob or the **UPARROW** and **DNARROW** keys. To open a subfolder, press the **RIGHTARROW** key. To close subfolders, press the **LEFTARROW** key. To confirm the selection, press the rotary knob or the **ENTER** key.

- **Files list**

If the **Startup Recall** dialog box is opened, the focus is on the **Files** list. To set the focus on the **Files** list, press the **Data Set List** softkey.

To select a folder, use the rotary knob or the **UPARROW** and **DNARROW** keys. To open a subfolder, press the **ENTER** key. To select a file, use the rotary knob or the **UPARROW** and **DNARROW** keys. To load the selected file, press the rotary knob or the **ENTER** key. To delete the selected file, press the softkey.

- **File Name field**

If the **Save** or **Recall** dialog box is opened, the focus is on the **File Name** field. Enter the name in the **File Name** field. The extension of the data name is ignored (for details on entering the name, see Quick Start Guide, chapter 4 "Basic Operations").

- **Comment field**

To enter a comment, press the **Edit Comment** softkey (for details on entering the name, see Quick Start Guide, chapter 4 "Basic Operations").

- **Data subsets**

- To select a special item, set the focus on the entry using the arrow keys or the rotary knob. To confirm the selection, press the **CHECKMARK** key. To deselect the item, press the **CHECKMARK** key again.

Navigation in the file manager

- To change from one subfolder to another, use the **ENTER** key.
- To change to the next higher directory, select the dots "..".
- To change into a subfolder, use the **RIGHTARROW** and **LEFTARROW** keys.
- To select a file or a folder, use the **UPARROW** and **DNARROW** keys.
- To confirm the selection of a file or folder, press the **ENTER** key.

Softkeys of the file menu

The following table shows all softkeys available in the file menu. It is possible that your instrument configuration does not provide all softkeys. If a softkey is only available with a special option, model or (measurement) mode, this information is delivered in the corresponding softkey description.

Menu / Command	Submenu / Command	Command
Save		
Recall		
Edit Path		
Edit Comment		
Data Set List		
Items to Save/Rcl		
More ↓		
Data Set Clear		
Startup Recall		
Startup Recall Setup		
File Manager ↓	Edit Path	
	New Folder	
	Copy	

Menu / Command	Submenu / Command	Command
	Rename	
	Cut	
	Paste	
	More ↓	
	Delete	
	Sort Mode ↓	Name
		Date
		Extension
		Size
	File Lists 1/2	
	Current File List 1/2	

Save

Opens the **Save** dialog box to define and store the data set. To navigate in the dialog box and define/enter settings use the corresponding softkeys. For details see also "[Navigation in the dialog boxes for saving and loading data sets](#)" on page 4.277.

Path	Directory in which the data set is stored. The default path for user data sets is C:\R_S\Instr\user
Files	List of data sets already stored.
File Name	Alphanumeric name of data set.
Comment	Comment regarding the data set.
Data subsets	Selection of data subsets to be saved.

→ Remote: MMEM:STOR:STAT 1, 'TEST'

Recall

Opens the **Recall** dialog box to load a data set. For details on the dialog box see **Save** softkey. To navigate in the dialog box and define/enter settings use the corresponding softkeys. For details see also "[Navigation in the dialog boxes for saving and loading data sets](#)" on page 4.277.

→ Remote: MMEM:LOAD:STAT 1, 'C:\R_S\Instr\user\TEST01'

Edit Path

Opens the directory list to select the folder in which the device configuration is to be stored or loaded. The default path is C:\R_S\Instr\user. For details see also "[Navigation in the dialog boxes for saving and loading data sets](#)" on page 4.277.

Edit Comment

Sets the focus on the **Comment** field to enter a comment concerning the current data set. Max. 60 characters are allowed. For details see also "[Navigation in the dialog boxes for saving and loading data sets](#)" on page 4.277.

Data Set List

Sets the focus on the **Files** list. If a file is selected, the corresponding data are displayed. For details on the dialog box see also **Save** softkey and "[Navigation in the dialog boxes for saving and loading data sets](#)" on page 4.277.

Items to Save/Rcl

Sets the focus on the items list. For details on the dialog box see also **Save** softkey and "[Navigation in the dialog boxes for saving and loading data sets](#)" on page 4.277.

Data Set Clear

Deletes the selected data set file.

Startup Recall

Activates or deactivates the startup recall function. If activated, the settings stored in the data set selected via the **Startup Recall Setup** softkey are loaded when booting or for preset. If deactivated, the default settings are loaded.

This softkey is available from firmware version 1.10.

→ Remote: MMEM:LOAD:AUTO 1, 'C:\R_S\Instr\user\TEST'

Startup Recall Setup

Opens the **Startup Recall** dialog box to select the data set for the startup recall function (see also **Startup Recall** softkey).

This softkey is available from firmware version 1.10.

→ Remote: MMEM:LOAD:AUTO 1, 'C:\R_S\Instr\user\TEST'

File Manager

Opens the **File Manager** dialog box and a submenu to manage mass storage media and files. In the upper left corner, the current drive is displayed. Below the folders and subfolders of the current directory are displayed. For details on navigation see also "[Navigation in the file manager](#)" on page 4.278.

The following tasks can be performed:

- to copy files from flash disk to other media
 - to copy files into another directory
 - to rename and delete files
-

Edit Path

For details see **Edit Path** softkey.

→ Remote: MMEM:MSIS "D:"

→ Remote: MMEM:CDIR "C:\R_S\Instr\user"

New Folder

Creates a new folder and opens an edit dialog box to enter name and path (absolute or relative to the current directory) of the new folder.

→ Remote: MMEM:MDIR "C:\R_S\Instr\user\TEST"

Copy

Copies the selected item to the clipboard. The item can be copied later using the **Paste** softkey. For details on navigation see also "[Navigation in the file manager](#)" on page 4.278.

→ Remote: MMEM:COPY "C:\R_S\Instr\user\set.cfg", "E:"

Rename

Opens an edit dialog box to enter a new file or folder name. For details on navigation see also "[Navigation in the file manager](#)" on page 4.278.

→ Remote: MMEM:MOVE "test02.cfg", "set2.cfg"

Cut

Copies the selected file to the clipboard. If the file is later copied to a different directory using the **Paste** softkey, it is deleted in the current directory. For details on navigation see also "[Navigation in the file manager](#)" on page 4.278.

Paste

Copies a file from the clipboard to the currently selected directory. For details on navigation see also "[Navigation in the file manager](#)" on page 4.278.

Delete

Deletes the selected item after confirmation. For details on navigation see also "[Navigation in the file manager](#)" on page 4.278.

→ Remote: MMEM:DEL "test01.hcp"

→ Remote: MMEM:RDIR "C:\R_S\Instr\user\TEST"

Sort Mode

Opens a submenu to select the sorting mode for the displayed files. The entry for the next higher directory level ("..") and the folders are always located at the top of the list.

Name

Sorts the displayed files in alphabetical order of the file names.

Date

Sorts the displayed files in respect to the date.

Extension

Sorts the displayed files in respect to the extension.

Size

Sorts the displayed files in respect to the size.

File Lists 1/2

Splits the screen to copy files from one directory to the other. The focus between the two panes is switched using the **FIELD RIGHT** and **FIELD LEFT** keys.

Current File List 1/2

Changes the focus to the selected file list.

Manual Control – Local Menu

When switched on, the instrument is always in the manual measurement mode and can be operated via the front panel. As soon as the instrument receives a remote command, it is switched to the remote control mode.

In remote control mode, all keys of the instrument except the **PRESET** key are disabled. The **LOCAL** softkey and the **Display Update On/Off** softkey are displayed. Depending on the setting of the **Display Update On/Off** softkey, the diagrams, traces and display fields are displayed or hidden. For further details on the **Display Update On/Off** softkey refer to section "Instrument Setup and Interface Configuration – SETUP Key".

For details on remote control refer to section "Remote Control – Basics".

The change to manual control consists of:

- Enabling the Front Panel Keys
Returning to manual mode enables all inactive keys. The main softkey menu of the current mode is displayed.
- Displaying the measurement diagrams again.
The diagrams, traces and display fields are displayed again.
- Generating the **OPERATION COMPLETE** message
If, at the time of pressing the **LOCAL** softkey, the synchronization mechanism via *OPC, *OPC? or *WAI is active, the currently running measurement procedure is aborted and synchronization is achieved by setting the corresponding bits in the registers of the status reporting system.
- Setting Bit 6 (User Request) of the Event Status Register
With a corresponding configuration of the status reporting system, this bit immediately causes the generation of a service request (SRQ) to inform the control software that the user wishes to return to front panel control. For example this can be used to interrupt the control program and to correct instrument settings manually. This bit is set each time the **LOCAL** softkey is pressed.

To return to manual control

- Press the **LOCAL** softkey.
The instrument switches from remote to manual control, but only if the local lockout function has not been activated in the remote control mode.

Measurement Documentation – PRINT Key

The **PRINT** key is used to select and configure the printer and to customize the screen printout. For detailed information on printer selection and installation refer to the Quick Start Guide.

To open the print menu

- Press the **PRINT** key.
The print menu is displayed.

Menu and softkey description

- "Softkeys of the print menu" on page 4.284

To display help to a softkey, press the **HELP** key and then softkey for which you want to display help. To close the help window, press the **ESC** key. For further information refer to section "How to use the Help System".

Softkeys of the print menu

The following table shows all softkeys available in the trigger menu. It is possible that your instrument configuration does not provide all softkeys. If a softkey is only available with a special option, model or (measurement) mode, this information is delivered in the corresponding softkey description.

Menu / Command	Submenu / Command
Print Screen	
Device Setup	
Device 1/2	
Colors ↓	Select Color Set
	Color On/Off
	Select Object
	Predefined Colors
	User Defined Colors
	Set to Default
Comment	
Install Printer	

Print Screen

Starts to printout all test results displayed on the screen: diagrams, traces, markers, marker lists, limit lines etc. Comments, title, date, and time are included at the bottom margin of the printout. All displayed items belonging to the instrument software (softkeys, tables, dialog boxes) are not printed out.

- ➔ Remote: HCOP : ITEM : ALL
- ➔ Remote: HCOP : IMM

Device Setup

Opens the **Device Setup** dialog box to select file format and the printer. The dialog box consists of two tabs which are selected via the **Device 1/2** softkey. For further information refer to the Quick Start Guide.

- Remote: HCOP:DEV:LANG GDI
 - Remote: SYST:COMM:PRIN:ENUM:FIRS?
 - Remote: SYST:COMM:PRIN:ENUM:NEXT?
 - Remote: SYST:COMM:PRIN:SEL <Printer>
 - Remote: HCOP:PAGE:ORI PORT
 - Remote: HCOP:DEST "SYST:COMM:PRIN"
-

Device 1/2

Selects the tab of the device in the **Device Setup** dialog box. The analyzer is able to manage two print settings independently of each other. For each device the print setting is displayed on the corresponding tab of the **Device Setup** dialog box (**Device Setup** softkey). For further information refer to the Quick Start Guide.

Colors

For details see **Print Colors** softkey of the setup menu.

This softkey is available from firmware version 1.10.

Select Color Set

For details see **Select Print Color Set** softkey of the setup menu.

This softkey is available from firmware version 1.10.

Color On/Off

For details see **Color On/Off** softkey of the setup menu.

This softkey is available from firmware version 1.10.

Select Object

For details see **Select Object** softkey of the setup menu.

This softkey is available from firmware version 1.10.

Predefined Colors

For details see **Predefined Colors** softkey of the setup menu.

This softkey is available from firmware version 1.10.

User Defined Colors

For details see **User Defined Colors** softkey of the setup menu.
This softkey is available from firmware version 1.10.

Set to Default

For details see **Set to Default** softkey of the setup menu.
This softkey is available from firmware version 1.10.

Comment

Opens dialog box to enter a comment. Max. 120 characters are allowed. 60 characters fit in one line. In the first line, at any point a manual line-feed can be forced by entering "@".
Date and time are inserted automatically. The comment is printed below the diagram area, but not displayed on the screen. If a comment should not be printed, it must be deleted.
For details on the alphanumeric entries refer to the Quick Start Guide, chapter 4 "Basic Operations".
This softkey is available from firmware version 1.10.

Install Printer

Opens the **Printers and Faxes** window to install a new printer. All printers that are already installed are displayed. For details refer to the Quick Start Guide, appendix, "Printer Interface".

Contents of Chapter 5

5 Remote Control – Basics	5.1
Introduction	5.1
Getting Started	5.3
Setting the Remote Control (IP/GPIB) Address	5.3
Starting Remote Control Operation	5.4
Returning to Manual Control	5.4
SCPI Command Structure and Syntax	5.5
Structure of a Command.....	5.5
Structure of a Command Line.....	5.7
Responses to Queries.....	5.8
Parameters.....	5.8
Overview of Syntax Elements.....	5.10
Instrument Model and Command Processing	5.11
Command Sequence and Command Synchronization.....	5.13
Status Reporting System	5.14
Structure of an SCPI Status Register.....	5.14
Overview of the Status Registers.....	5.16
Status Byte (STB) and Service Request Enable Register (SRE).....	5.17
IST Flag and Parallel Poll Enable Register (PPE).....	5.18
Event Status Register (ESR) and Event Status Enable Register (ESE).....	5.18
STATUS:OPERation Register.....	5.19
STATUS:QUEStionable Register.....	5.20
STATUS:QUEStionable:ACPLimit Register.....	5.21
STATUS:QUEStionable:FREQuency Register.....	5.21
STATUS:QUEStionable:LIMit Register.....	5.22
STATUS:QUEStionable:LMARgin Register.....	5.23
STATUS:QUEStionable:POWEr Register.....	5.23
STATUS:QUEStionable:SYNC Register.....	5.24
Application of the Status Reporting Systems.....	5.25
Service Request.....	5.25
Serial Poll.....	5.25
Parallel Poll.....	5.25
Query by Means of Commands.....	5.26
Error Queue Query.....	5.26
Reset Values of the Status Reporting System.....	5.26
Interfaces and Protocols	5.28
LAN Interface.....	5.28
VXI Basics.....	5.28
VXI-11 Interface Messages.....	5.30
RSIB Protocol Basics.....	5.30
RSIB Interface Functions.....	5.31
GPIB Interface (Option R&S FSL-B10).....	5.32
GPIB Basics.....	5.32
GPIB Interface Functions.....	5.33
GPIB Interface Messages.....	5.34

Instrument Messages.....	5.35
WLAN TX Measurements Option (K91) – Status Reporting System	5.37
STATus:OPERation Register	5.37
STATus:QUESTionable:LIMit Register	5.37
STATus:QUESTionable:SYNC Register	5.38
Error Reporting.....	5.39
WiMAX 802.16 Measurements Option (K92) – Status Reporting System	5.40
STATus:OPERation Register	5.40
STATus:QUESTionable:LIMit Register	5.40
STATus:QUESTionable:SYNC Register	5.40
Error Reporting.....	5.40

5 Remote Control – Basics

This chapter assumes basic knowledge of programming and operation of the controller. It provides the following:

- Instructions on how to put the R&S FSL into operation via remote control.
- A general introduction to remote control of programmable instruments. This includes the description of the command structure and syntax according to the SCPI standard, the description of command execution and of the status registers.
- Diagrams and tables describing the status registers used in the R&S FSL.
- A description of the interfaces and protocols used for remote control.

In chapter "Instrument Functions" of this manual and in the Online Help, the remote control commands available for an instrument function are listed after each function description. In the Online Help, these remote control commands are linked to their description, provided in the manual in chapter "Remote Control – Commands". Program examples for the R&S FSL can be found in chapter "Remote Control – Programming Examples".

Introduction

The instrument is equipped with the following interfaces for remote control:

- LAN interface: the network allows for a 10 MHz Ethernet IEEE 802.3 and a 100 MHz Ethernet IEEE 802.3u. The protocol is based on TCP/IP and supports the VXI-11 standard.
- Option GPIB Interface, R&S FSL-B10: IEC/IEEE bus interface according to standard IEC 625/IEEE 488

The connectors are located at the rear of the instrument and permit a connection to a controller for remote control via a local area network (LAN) or directly (option GPIB Interface, R&S FSL-B10).

SCPI (**S**tandard **C**ommands for **P**rogrammable **I**nstruments) commands – messages – are used for remote control. Commands that are not taken from the SCPI standard follow the SCPI syntax rules. The instrument supports the SCPI version 1999. The SCPI standard is based on standard IEEE 488.2 and aims at the standardization of device-specific commands, error handling and the status registers. The tutorial "Automatic Measurement Control – A tutorial on SCPI and IEEE 488.2" from John M. Pieper (R&S order number 0002.3536.00) offers detailed information on concepts and definitions of SCPI.

The requirements that the SCPI standard places on command syntax, error handling and configuration of the status registers are explained in detail in the following sections. Tables provide a fast overview of the bit assignment in the status registers. The tables are supplemented by a comprehensive description of the status registers.

VISA is a standardized software interface library providing input and output functions to communicate with instruments. The I/O channel (LAN, GPIB...) is selected at initialization time by means of a channel-specific resource string. For more information about VISA refer to that user documentation.

The programming examples for remote control are all written in Microsoft[®] VISUAL BASIC[®]. Access to the VISA functions require the declaration of the functions and constants prior to their use in the project. This can be accomplished either by adding the modules VISA32.BAS and VPPTYPE.BAS or a reference to the VISA32.DLL to the project.

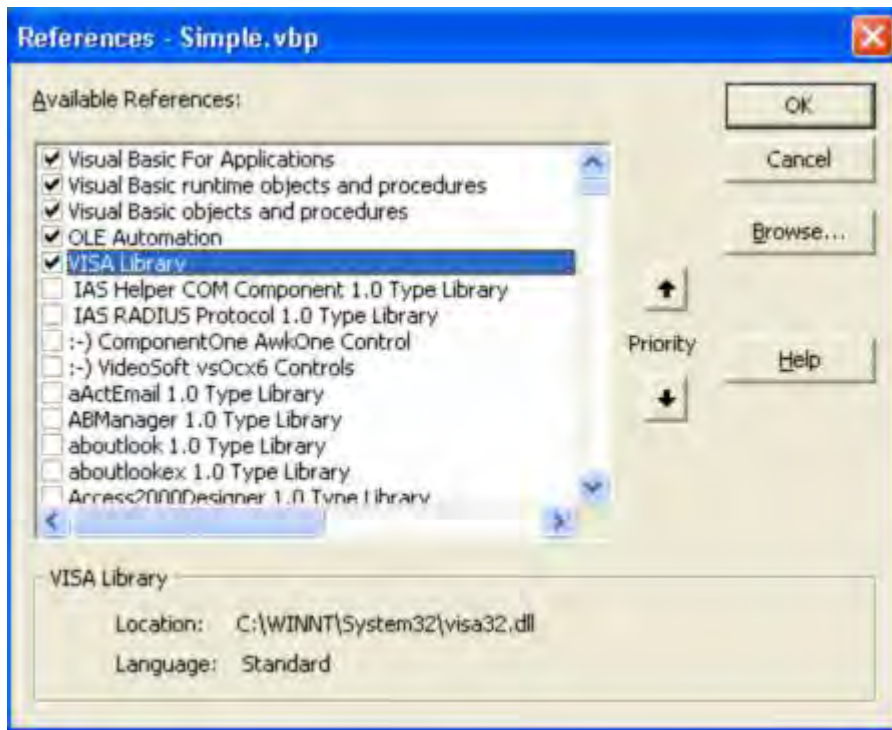

The modules visa32.bas and vpptype.bas can be found in the <VXI\pnpPath>\WinNT\include (typically C:\VXI\pnp\WinNT\include).

Note: Manual control is designed for maximum possible operating convenience. In contrast, the priority of remote control is the "predictability" of the device status. Therefore, control programs should always define an initial device status (e.g. with the command *RST) and then implement the required settings.

To make remote control operation more comfortable and faster, you can use IVI drivers. They bundle remote control commands, reduce the I/O to the instrument by status caching, check status and parameters and offer simulation modes.

Getting Started

The short and simple operating sequence below shows how to put the instrument into operation and quickly set its basic functions. The remote control address, which is factory-set to 10.0.0.10, subnet mask 255.255.255.0 for LAN operation and 20 for operation via GPIB, is used. If you want to change the IP address, see "[Setting the Remote Control \(IP/GPIB\) Address](#)".

To prepare for remote control

1. Connect the instrument to the LAN or directly to the GPIB controller (option GPIB Interface, R&S FSL-B10).

For details refer to the Quick Start Guide, appendix, section "Remote Control with XP Remote Desktop".

2. Switch on the instruments.
3. Write and start the following program on the controller:

```

status = viOpenDefaultRM(defaultRM)           ' Open default resource manager
Cmd = "*RST;*CLS"                             ' Reset instrument and clear status
status = viWrite(vi, Cmd, Len(Cmd),          registers
retCount)

Cmd = "FREQ:CENT 100MHz"                      ' Set center frequency to 100 MHz
status = viWrite(vi, Cmd, Len(Cmd),
retCount)
Cmd = "FREQ:SPAN 10MHz"                      ' Set span to 10 MHz
status = viWrite(vi, Cmd, Len(Cmd),
retCount)
Cmd = "DISP:TRAC:Y:RLEV -10dBm"             ' Set reference level to -10 dBm
status = viWrite(vi, Cmd, Len(Cmd),
retCount)

```

The instrument now performs a sweep in the frequency range of 95 MHz to 105 MHz.

Setting the Remote Control (IP/GPIB) Address

In order to operate the instrument via remote control, it must be addressed using the set IP or GPIB address. The remote control address is factory-set (for details refer to "[Getting Started](#)"), but it can be changed, if it does not fit in the network environment.

To change the GPIB address via R&S FSL

For details see Quick Start Guide, chapter 2, section "Setting the IEC/IEEE Bus Interface".

To change the GPIB address via IEC/IEEE bus

```

status = viOpenDefaultRM(defaultRM)           ' Open default resource manager
status = viOpen(defaultRM, "GPIB:20::INSTR", 0, ' Open connection to instrument
5000, vi)                                     with old address
Cmd = "SYST:COMM:GPIB:ADDR 18"               ' Set instrument to new address
status = viWrite(vi, Cmd, Len(Cmd), retCount)
status = viClose(vi)                         ' Close old connection and reopen
status = viOpen(defaultRM, "GPIB:18::INSTR", 0, with new address
5000, vi)

```

To change the IP address via R&S FSL

For details see Quick Start Guide, chapter 2, section "Configuring the LAN Interface".

Starting Remote Control Operation

On power-on, the instrument is always in the manual operating state ("local" state) and can be operated via the front panel.

To start remote control

- Send an addressed command from a controller to the instrument.

The instrument is switched to remote control ("remote" state). Operation via the front panel is disabled. Only the **Local** softkey is displayed to return to manual operation. The instrument remains in the remote state until it is reset to the manual state via the instrument or via remote control interfaces. Switching from manual operation to remote control and vice versa does not affect the other instrument settings.

- During program execution, send the `SYSTem:DISPlay:UPDate ON` command to activate the display of results.

The changes in the device settings and the recorded measurement curves are displayed on the instrument screen.

- To obtain optimum performance during remote control operation, send the `SYSTem:DISPlay:UPDate OFF` command to hide the display of results and diagrams again (default setting in remote control).

- To prevent unintentional return to manual control, disable the keys of the R&S FSL by the universal command LLO.

Then the transition to manual mode is only possible via remote control.

This function is only available for the GPIB interface.

- To enable the keys of the R&S FSL again, switch the instrument to local mode, i.e. deactivate the REN line of the remote control interface.

Note: *If the instrument is exclusively operated in remote control, it is recommended to switch on the power-save mode for the display. For more details on this mode refer to the Quick Start Guide.*

Returning to Manual Control

Before the transition, command processing must be completed. If command processing is not completed, it is not possible to return to manual operation and the instrument will switch back to remote control immediately.

To return to manual operation via R&S FSL

- Press the **Local** softkey or the **Preset** key.

To return to manual operation via IEC/IEEE bus

```

...
status = viGpibControlREN(vi,          ' Set instrument to manual
VI_GPIB_REN_ADDRESS_GTL)             operation
...

```

SCPI Command Structure and Syntax

SCPI (Standard Commands for Programmable Instruments) describes a standard command set for programming instruments, irrespective of the type of instrument or manufacturer. The goal of the SCPI consortium is to standardize the device-specific commands to a large extent. For this purpose, a model was developed which defines the same functions inside a device or for different devices. Command systems were generated which are assigned to these functions. Thus it is possible to address the same functions with identical commands. The command systems are of a hierarchical structure.

SCPI is based on standard IEEE 488.2, i.e. it uses the same syntactic basic elements as well as the common commands defined in this standard. Part of the syntax of the device responses is defined with greater restrictions than in standard IEEE 488.2 (see section "Responses to Queries").

Structure of a Command

The commands consist of a so-called header and, in most cases, one or more parameters. Header and parameter are separated by a "white space" (ASCII code 0 to 9, 11 to 32 decimal, e.g. blank). The headers may consist of several key words. Queries are formed by directly appending a question mark to the header.

Note: *Not all commands used in the following examples are implemented in the instrument.*

Common commands

Common commands consist of a header preceded by an asterisk "*" and one or several parameters, if any.

Examples:	*RST	RESET, resets the device
	*ESE 253	EVENT STATUS ENABLE, sets the bits of the event status enable register
	*ESR?	EVENT STATUS QUERY, queries the contents of the event status register.

Device-specific commands

- Hierarchy

Device-specific commands are of hierarchical structure (see Fig. 5–1). The different levels are represented by combined headers. Headers of the highest level (root level) have only one key word. This key word denotes a complete command system.

Example: SENSE

This key word denotes the SENSE command system.

For commands of lower levels, the complete path has to be specified, starting on the left with the highest level, the individual key words being separated by a colon ":".

Example: SENSE:FREQUENCY:SPAN 10MHZ

This command lies in the third level of the SENSE system. It sets the frequency span.

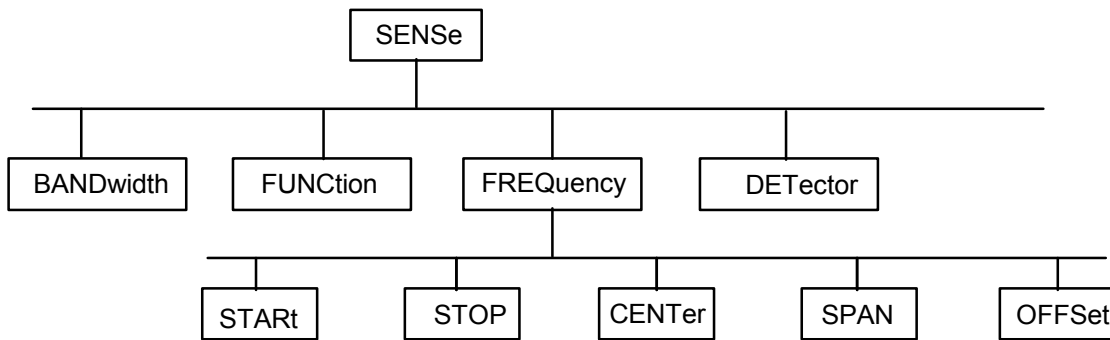

Fig. 5–1 Tree structure the SCPI command systems using the SENSE system as example

- Multiple key words

Some key words occur in several levels within one command system. Their effect depends on the structure of the command, i.e. at which position in the header of a command they are inserted.

Example: `SOURce:FM:POLarity NORMal`

This command contains key word POLarity in the third command level. It defines the polarity between modulator and modulation signal.

Example: `SOURce:FM:EXTernal:POLarity NORMal`

This command contains key word POLarity in the fourth command level. It defines the polarity between modulation voltage and the resulting direction of the modulation only for the external signal source indicated.

- Optional key words

Some command systems permit certain key words to be inserted into the header or omitted. These key words are marked by square brackets in the description. The full command length must be recognized by the instrument for reasons of compatibility with the SCPI standard. Some commands are considerably shortened by these optional key words.

Example: `[SENSe]:BANDwidth[:RESolution]:AUTO`

This command couples the resolution bandwidth of the instrument to other parameters. The following command has the same effect: `BANDwidth:AUTO`

Note: An optional key word must not be omitted if its effect is specified in detail by a numeric suffix.

- Long and short form

The key words feature a long form and a short form. Either the short form or the long form can be entered, other abbreviations are not permitted.

Example: `STATus:QUESTionable:ENABLE 1= STAT:QUES:ENAB 1`

Note: Upper–case and lower–case notation only serves to distinguish the two forms in the manual, the instrument itself does not distinguish upper–case and lower–case letters.

- Parameter

The parameter must be separated from the header by a "white space". If several parameters are specified in a command, they are separated by a comma ",". A few queries permit the parameters MINimum, MAXimum and DEFault to be entered. For a description of the types of parameter, refer to section "Parameters".

Example: SENSE:FREQUENCY:STOP? MAXimum, Response: 3.5E9
This query requests the maximal value for the stop frequency.

- Numeric suffix

If a device features several functions or features of the same kind, e.g. inputs, the desired function can be selected by a suffix added to the command. Entries without suffix are interpreted like entries with the suffix 1. Optional keywords must be specified if they select a function with the suffix.

Example: SYSTEM:COMMUNICATE:SERIAL2:BAUD 9600
This command sets the baud rate of a second serial interface.

Note: In case of remote control, suffix counting may differ from the numbers of the corresponding selection used in manual operation. SCPI prescribes that suffix counting starts with 1. Suffix 1 is the default state and used when no specific suffix is specified. Some standards define a fixed numbering, starting with 0. With GSM, for instance, slots are counted from 0 to 7. In the case of remote control, the slots are selected with the suffixes 1 to 8. If the numbering differs in manual operation and remote control, it is indicated with the respective command.

Structure of a Command Line

A command line may consist of one or several commands. It is terminated by an EOI signal together with the last data byte.

Several commands in a command line must be separated by a semicolon ";". If the next command belongs to a different command system, the semicolon is followed by a colon. A colon ":" at the beginning of a command marks the root node of the command tree.

Example:

```
CALL InstrWrite(analyzer, "SENSE:FREQUENCY:CENTer 100MHz;:INPut:ATTenuation 10")
```

This command line contains two commands. The first one is part of the SENSE command system and is used to determine the center frequency of the instrument. The second one is part of the INPut command system and sets the input signal attenuation.

If the successive commands belong to the same system, having one or several levels in common, the command line can be abbreviated. For that purpose, the second command after the semicolon starts with the level that lies below the common levels (see also Fig. 5–1). The colon following the semicolon must be omitted in this case.

Example:

```
CALL InstrWrite(analyzer, "SENSe:FREQuency:STARt 1E6; SENSe:FREQuency:STOP 1E9")
```

This command line is represented in its full length and contains two commands separated from each other by the semicolon. Both commands are part of the SENSE command system, subsystem FREQUENCY, i.e. they have two common levels.

When abbreviating the command line, the second command begins with the level below SENSE:FREQUENCY. The colon after the semicolon is omitted. The abbreviated form of the command line reads as follows:

```
CALL InstrWrite(analyzer, "SENSe:FREQuency:STARt 1E6;STOP 1E9")
```

However, a new command line always begins with the complete path.

Example:

```
CALL InstrWrite(analyzer, "SENSe:FREQuency:STARt 1E6")
```

```
CALL InstrWrite(analyzer, "SENSe:FREQuency:STOP 1E9")
```

Responses to Queries

A query is defined for each setting command unless explicitly specified otherwise. It is formed by adding a question mark to the associated setting command. According to SCPI, the responses to queries are partly subject to stricter rules than in standard IEEE 488.2.

- The requested parameter is transmitted without header.
Example: INPut:COUPling?, Response: DC
- Maximum values, minimum values and all further quantities, which are requested via a special text parameter are returned as numerical values.
Example: SENSe:FREQuency:STOP? MAX, Response: 3.5E9
- Numerical values are output without a unit. Physical quantities are referred to the basic units or to the units set using the Unit command.
Example: SENSe:FREQuency:CENTer?, Response: 1E6 (for 1 MHz)
- Truth values <Boolean values> are returned as 0 (for OFF) and 1 (for ON).
Example: SENSe:BANDwidth:AUTO?, Response: 1 (for ON)
- Text (character data) is returned in a short form.
Example: SYSTem:COMMunicate:SERial:CONTRol:RTS?, Response STAN (for standard)

Parameters

Most commands require a parameter to be specified. The parameters must be separated from the header by a "white space". Permissible parameters are numerical values, Boolean parameters, text, character strings and block data. The type of parameter required for the respective command and the permissible range of values are specified in the command description.

Numerical values

Numerical values can be entered in any form, i.e. with sign, decimal point and exponent. Values exceeding the resolution of the instrument are rounded up or down. The mantissa may comprise up to 255 characters, the exponent must lie inside the value range -32000 to 32000. The exponent is introduced by an "E" or "e". Entry of the exponent alone is not permissible. In the case of physical quantities, the unit can be entered. Permissible unit prefixes are G (giga), MA (mega), MOHM and MHZ

are also permissible), K (kilo), M (milli), U (micro) and N (nano). If the unit is missing, the basic unit is used.

Example: `SENSe:FREQuency:STOP 1.5GHz = SENSe:FREQuency:STOP 1.5E9`

Special numerical

The texts MINimum, MAXimum, DEFault, UP and DOWN are interpreted as values special numerical values. In the case of a query, the numerical value is provided.

Example:

Setting command: `SENSe:FREQuency:STOP MAXimum`

Query: `SENSe:FREQuency:STOP?`, Response: `3.5E9`

- MIN/MAX
MINimum and MAXimum denote the minimum and maximum value.
- DEF
DEFault denotes a preset value which has been stored in the EPROM. This value conforms to the default setting, as it is called by the *RST command
- UP/DOWN
UP, DOWN increases or reduces the numerical value by one step. The step width can be specified via an allocated step command (see annex C, List of Commands) for each parameter which can be set via UP, DOWN.
- INF/NINF
INFinity, Negative INFinity (NINF) Negative INFinity (NINF) represent the numerical values $-9.9E37$ or $9.9E37$, respectively. INF and NINF are only sent as device responses.
- NAN
Not A Number (NAN) represents the value $9.91E37$. NAN is only sent as device response. This value is not defined. Possible causes are the division of zero by zero, the subtraction of infinite from infinite and the representation of missing values.

Boolean parameters

Boolean parameters represent two states. The ON state (logically true) is represented by ON or a numerical value unequal to 0. The OFF state (logically untrue) is represented by OFF or the numerical value 0. The numerical values are provided as response for query.

Example:

Setting command: `DISPlay:WINDow:STATe ON`

Query: `DISPlay:WINDow:STATe?`, Response: `1`

Text

Text parameters observe the syntactic rules for key words, i.e. they can be entered using a short or long form. Like any parameter, they have to be separated from the header by a white space. In the case of a query, the short form of the text is provided.

Example:

Setting command: `INPut:COUPling GROund`

Query: `INPut:COUPling?`, Response: `GRO`

Strings

Strings must always be entered in quotation marks (' or ").

Example:

`SYSTem:LANGUage "SCPI" or SYSTem:LANGUage 'SCPI'`

Block data

Block data are a transmission format which is suitable for the transmission of large amounts of data. A command using a block data parameter has the following structure:

Example:

```
HEADer:HEADer #45168xxxxxxxx
```

ASCII character # introduces the data block. The next number indicates how many of the following digits describe the length of the data block. In the example the 4 following digits indicate the length to be 5168 bytes. The data bytes follow. During the transmission of these data bytes all end or other control signs are ignored until all bytes are transmitted.

Overview of Syntax Elements

The following survey offers an overview of the syntax elements.

- : The colon separates the key words of a command. In a command line the separating semicolon marks the uppermost command level.
- ; The semicolon separates two commands of a command line. It does not alter the path.
- , The comma separates several parameters of a command.
- ? The question mark forms a query.
- * The asterisk marks a common command.
- " Quotation marks introduce a string and terminate it.
- # The hash symbol # introduces binary, octal, hexadecimal and block data.

Binary: #B10110

Octal: #O7612

Hexa: #HF3A7

Block: #21312

A "white space" (ASCII-Code 0 to 9, 11 to 32 decimal, e.g. blank) separates header and parameter.

Instrument Model and Command Processing

The block diagram in Fig. 5–2 shows how SCPI commands are serviced in the instrument. The individual components work independently and simultaneously. They communicate with each other by means of so-called "messages".

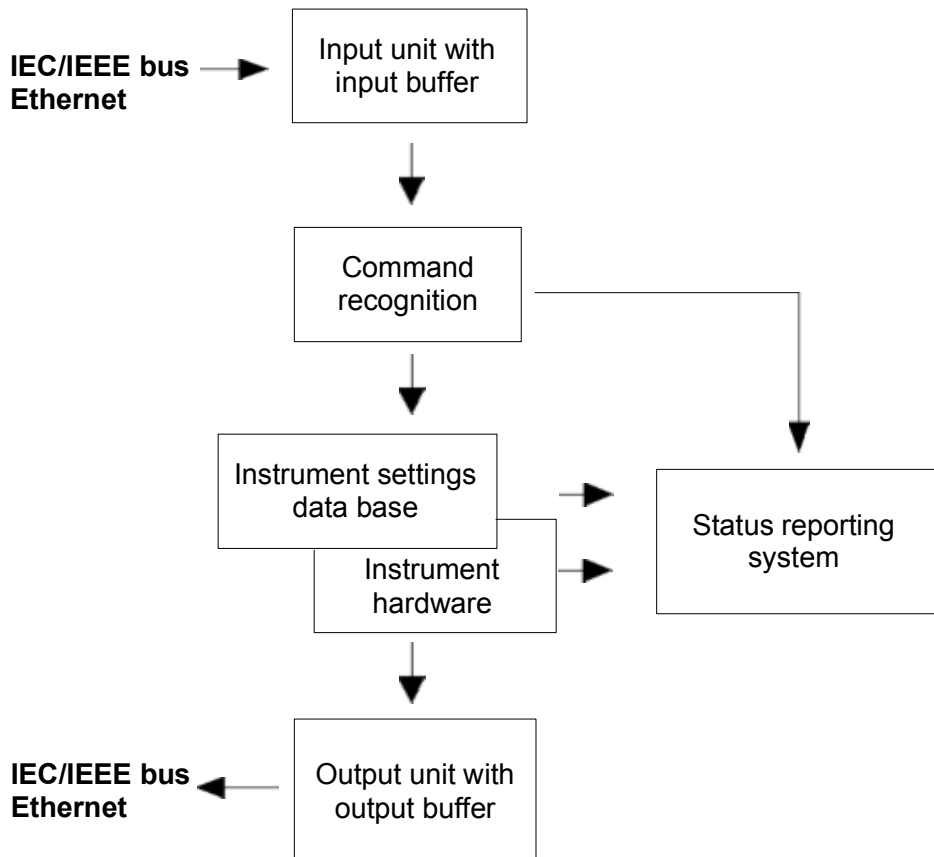

Fig. 5–2 Instrument model in the case of remote control

Input unit

The input unit receives commands character by character from the controller and collects them in the input buffer. The input unit sends a message to the command recognition as soon as the input buffer is full or as soon as it receives a delimiter, <PROGRAM MESSAGE TERMINATOR>, as defined in IEEE 488.2, or the interface message **DCL**.

If the input buffer is full, the traffic is stopped and the data received up to then are processed. Subsequently the traffic is continued. If, however, the buffer is not yet full when receiving the delimiter, the input unit can already receive the next command during command recognition and execution. The receipt of **DCL** clears the input buffer and immediately resets the command recognition.

Command recognition

The command recognition analyses the data received from the input unit. It proceeds in the order in which it receives the data. Only **DCL** is serviced with priority, for example **GET** (Group Execute Trigger) is only executed after the commands received before. Each recognized command is immediately transferred to the internal instrument settings data base but not executed immediately.

The command recognition detects syntax errors in the commands and transfers them to the status reporting system. The rest of a command line after a syntax error is analyzed further if possible and serviced. After the syntax test, the value range of the parameter is checked, if required.

If the command recognition detects a delimiter, it passes the command to an execution unit that performs the instrument settings. In the meantime, the command recognition is ready to process new commands (overlapping execution). A `DCL` command is processed in the same way.

Data base and instrument hardware

Here the expression "instrument hardware" denotes the part of the instrument fulfilling the actual instrument function – signal generation, measurement etc. The controller is not included. The term "database" denotes a database that manages all the parameters and associated settings required for setting the instrument hardware.

Setting commands leads to an alteration in the data set. The data set management enters the new values (e.g. frequency) into the data set, however, only passes them on to the hardware when requested by the command recognition. This only takes place at the end of a command line.

The data are checked for compatibility with the current instrument settings before they are transmitted to the instrument hardware. If the execution is not possible, an "execution error" is signaled to the status reporting system. The corresponding settings are discarded.

Before passing on the data to the hardware, the settling bit in the `STATUS:OPERation` register is set (refer to section "[STATUS:OPERation Register](#)"). The hardware executes the settings and resets the bit again as soon as the new state has settled. This fact can be used to synchronize command servicing.

Queries induce the data set management to send the desired data to the output unit.

Status reporting system

For detailed information refer to section "[Status Reporting System](#)".

Output unit

The output unit collects the information requested by the controller, which it receives from the data base management. It processes it according to the SCPI rules and makes it available in the output buffer.

If the instrument is addressed as a talker without the output buffer containing data or awaiting data from the data base management, the output unit sends error message "Query UNTERMINATED" to the status reporting system. No data are sent on the IEC/IEEE bus or via the Ethernet, the controller waits until it has reached its time limit. This behavior is specified by SCPI.

Command Sequence and Command Synchronization

What has been said above makes clear that all commands can potentially be carried out overlapping. In order to prevent an overlapping execution of commands, one of the commands *OPC, *OPC? or *WAI must be used. All three commands cause a certain action only to be carried out after the hardware has been set. By suitable programming, the controller can be forced to wait for the respective action to occur (refer to [Table 5–1](#)).

Table 5–1 Synchronization using *OPC, *OPC? and *WAI

Command	Action	Programming the controller
*OPC	Sets the Operation Complete bit in the ESR after all previous commands have been executed.	<ul style="list-style-type: none"> – Setting bit 0 in the ESE – Setting bit 5 in the SRE – Waiting for service request (SRQ)
*OPC?	Stops command processing until 1 is returned. This is only the case after the Operation Complete bit has been set in the ESR. This bit indicates that the previous setting has been completed.	Sending *OPC? directly after the command whose processing should be terminated before other commands can be executed.
*WAI	Stops further command processing until all commands sent before *WAI have been executed.	Sending *WAI directly after the command whose processing should be terminated before other commands are executed.

An example for command synchronization can be found in chapter "Remote Control – Programming Examples".

For a couple of commands the synchronization to the end of command execution is mandatory in order to obtain the desired result. The affected commands require either more than one measurement in order to accomplish the desired instrument setting (e.g. auto range functions), or they require a longer period of time for execution. If a new command is received during execution of the corresponding function this may either lead to either to an aborted measurement or to incorrect measurement data.

The following list includes the commands, for which a synchronization via *OPC, *OPC? or *WAI is mandatory:

Table 5–2 Commands with mandatory synchronization (overlapping commands)

Command	Purpose
INIT	start measurement
INIT:CONM	continue measurement
CALC:MARK:FUNC:ZOOM	zoom frequency range around marker 1
CALC:STAT:SCAL:AUTO ONCE	optimize level settings for signal statistic measurement functions
[SENS:]POW:ACH:PRES:RLEV	optimize level settings for adjacent channel power measurements

Status Reporting System

The status reporting system (refer to Fig. 5–4) stores all information on the present operating state of the instrument, and on errors which have occurred. This information is stored in the status registers and in the error queue. The status registers and the error queue can be queried via IEC/IEEE bus or via the Ethernet.

The information is of a hierarchical structure. The register status byte (STB) defined in IEEE 488.2 and its associated mask register service request enable (SRE) form the uppermost level. The STB receives its information from the standard event status register (ESR) which is also defined in IEEE 488.2 with the associated mask register standard event status enable (ESE) and registers STATUS:OPERation and STATUS:QUESTionable which are defined by SCPI and contain detailed information on the instrument.

The IST flag ("Individual STATUS") and the parallel poll enable register (PPE) allocated to it are also part of the status reporting system. The IST flag, like the SRQ, combines the entire instrument status in a single bit. The PPE fulfills the same function for the IST flag as the SRE for the service request.

The output buffer contains the messages the instrument returns to the controller. It is not part of the status reporting system but determines the value of the MAV bit in the STB.

Structure of an SCPI Status Register

Each standard SCPI register consists of 5 parts which each have a width of 16 bits and have different functions (refer to Fig. 5–3). The individual bits are independent of each other, i.e. each hardware status is assigned a bit number that applies to all five parts. For example, bit 3 of the STATUS:OPERation register is assigned to the hardware status "wait for trigger" in all five parts. Bit 15 (the most significant bit) is set to zero for all parts. Thus the contents of the register parts can be processed by the controller as positive integer.

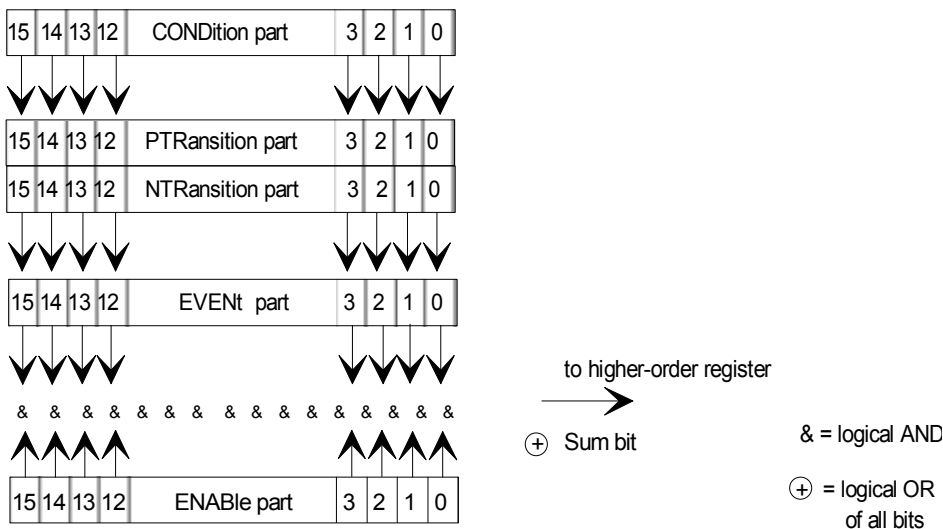

Fig. 5–3 The status–register model

CONDition part

The CONDition part is directly written into by the hardware or the sum bit of the next lower register. Its contents reflects the current instrument status. This register part can only be read, but not written into or cleared. Its contents is not affected by reading.

PTRansition part

The Positive-TRansition part acts as an edge detector. When a bit of the CONDition part is changed from 0 to 1, the associated PTR bit decides whether the EVENT bit is set to 1.

PTR bit =1: the EVENT bit is set.

PTR bit =0: the EVENT bit is not set.

This part can be written into and read at will. Its contents is not affected by reading.

NTRansition part

The Negative-TRansition part also acts as an edge detector. When a bit of the CONDition part is changed from 1 to 0, the associated NTR bit decides whether the EVENT bit is set to 1.

NTR-Bit = 1: the EVENT bit is set.

NTR-Bit = 0: the EVENT bit is not set.

This part can be written into and read at will. Its contents is not affected by reading.

With these two edge register parts the user can define which state transition of the condition part (none, 0 to 1, 1 to 0 or both) is stored in the EVENT part.

EVENT part

The EVENT part indicates whether an event has occurred since the last reading, it is the "memory" of the condition part. It only indicates events passed on by the edge filters. It is permanently updated by the instrument. This part can only be read by the user. Reading the register clears it. This part is often equated with the entire register.

ENABLE part

The ENABLE part determines whether the associated EVENT bit contributes to the sum bit (see below). Each bit of the EVENT part is ANDed with the associated ENABLE bit (symbol '&'). The results of all logical operations of this part are passed on to the sum bit via an OR function (symbol '+').

ENABLE-Bit = 0: the associated EVENT bit does not contribute to the sum bit

ENABLE-Bit = 1: if the associated EVENT bit is "1", the sum bit is set to "1" as well.

This part can be written into and read by the user at will. Its contents is not affected by reading.

Sum bit

As indicated above, the sum bit is obtained from the EVENT and ENABLE part for each register. The result is then entered into a bit of the CONDition part of the higher-order register.

The instrument automatically generates the sum bit for each register. Thus an event, e.g. a PLL that has not locked, can lead to a service request throughout all levels of the hierarchy.

Note: *The service request enable register SRE defined in IEEE 488.2 can be taken as ENABLE part of the STB if the STB is structured according to SCPI. By analogy, the ESE can be taken as the ENABLE part of the ESR.*

Overview of the Status Registers

The following figure shows the status registers used in the R&S FSL.

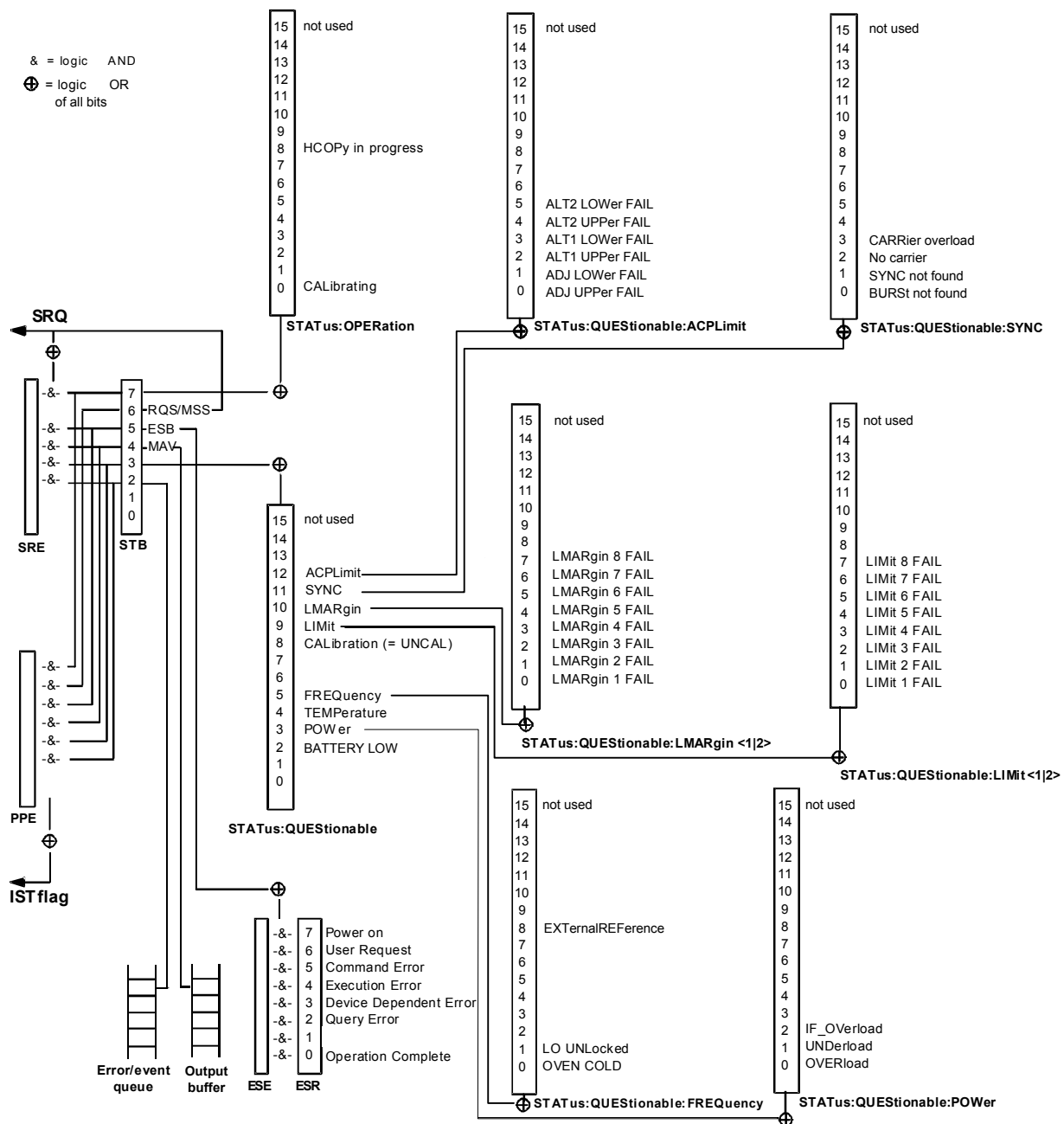

Fig. 5-4 Overview of the status registers

Status Byte (STB) and Service Request Enable Register (SRE)

The STB is already defined in IEEE 488.2. It provides a rough overview of the instrument status by collecting the pieces of information of the lower registers. It can thus be compared with the CONDition part of an SCPI register and assumes the highest level within the SCPI hierarchy. A special feature is that bit 6 acts as the sum bit of the remaining bits of the status byte.

The STATUS BYTE is read using the command "***STB?**" or a serial poll.

The STB is linked to the SRE. The latter corresponds to the ENABLE part of the SCPI registers in its function. Each bit of the STB is assigned a bit in the SRE. Bit 6 of the SRE is ignored. If a bit is set in the SRE and the associated bit in the STB changes from 0 to 1, a service request (SRQ) is generated on the IEC/IEEE bus or via the Ethernet, which triggers an interrupt in the controller if this is appropriately configured and can be further processed there.

The SRE can be set using the command "***SRE**" and read using the command "***SRE?**"

Table 5–3 Meaning of the bits used in the status byte

Bit No.	Meaning
0...1	Not used
2	<p>Error Queue not empty</p> <p>The bit is set when an entry is made in the error queue. If this bit is enabled by the SRE, each entry of the error queue generates a service request. Thus an error can be recognized and specified in greater detail by polling the error queue. The poll provides an informative error message. This procedure is to be recommended since it considerably reduces the problems involved with remote control.</p>
3	<p>QUESTIONable status sum bit</p> <p>The bit is set if an EVENT bit is set in the QUESTIONable: status register and the associated ENABLE bit is set to 1. A set bit indicates a questionable instrument status, which can be specified in greater detail by polling the QUESTIONable status register.</p>
4	<p>MAV bit (message available)</p> <p>The bit is set if a message is available in the output buffer which can be read. This bit can be used to enable data to be automatically read from the instrument to the controller.</p>
5	<p>ESB bit</p> <p>Sum bit of the event status register. It is set if one of the bits in the event status register is set and enabled in the event status enable register. Setting of this bit indicates a serious error which can be specified in greater detail by polling the event status register.</p>
6	<p>MSS bit (master status summary bit)</p> <p>The bit is set if the instrument triggers a service request. This is the case if one of the other bits of this registers is set together with its mask bit in the service request enable register SRE.</p>

Bit No.	Meaning
7	<p>OPERation status register sum bit</p> <p>The bit is set if an EVENT bit is set in the OPERation status register and the associated ENABLE bit is set to 1.</p> <p>A set bit indicates that the instrument is just performing an action. The type of action can be determined by polling the OPERation status register.</p>

IST Flag and Parallel Poll Enable Register (PPE)

By analogy with the SRQ, the IST flag combines the entire status information in a single bit. It can be read by means of a parallel poll (refer to section "Parallel Poll") or using the command *IST?.

The parallel poll enable register (PPE) determines which bits of the STB contribute to the IST flag. The bits of the STB are ANDed with the corresponding bits of the PPE, with bit 6 being used as well in contrast to the SRE. The IST flag results from the ORing of all results. The PPE can be set using commands *PRE and read using command *PRE?.

Event Status Register (ESR) and Event Status Enable Register (ESE)

The ESR is defined in IEEE 488.2. It can be compared with the EVENT part of a SCPI register. The event status register can be read out using command *ESR?.

The ESE is the associated ENABLE part. It can be set using the command *ESE and read using the command *ESE?.

Table 5–4 Meaning of the bits in the event status register

Bit No.	Meaning
0	<p>Operation Complete</p> <p>This bit is set on receipt of the command *OPC exactly when all previous commands have been executed.</p>
1	Not used
2	<p>Query Error</p> <p>This bit is set if either the controller wants to read data from the instrument without having sent a query, or if it does not fetch requested data and sends new instructions to the instrument instead. The cause is often a query which is faulty and hence cannot be executed.</p>
3	<p>Device–dependent Error</p> <p>This bit is set if a device–dependent error occurs. An error message with a number between –300 and –399 or a positive error number, which denotes the error in greater detail, is entered into the error queue.</p>

Bit No.	Meaning
4	Execution Error This bit is set if a received command is syntactically correct but cannot be performed for other reasons. An error message with a number between –200 and –300, which denotes the error in greater detail, is entered into the error queue.
5	Command Error This bit is set if a command is received, which is undefined or syntactically incorrect. An error message with a number between –100 and –200, which denotes the error in greater detail, is entered into the error queue.
6	User Request This bit is set on pressing the Local softkey.
7	Power On (supply voltage on) This bit is set on switching on the instrument.

STATus:OPERation Register

In the CONDition part, this register contains information on which actions the instrument is being executing or, in the EVENT part, information on which actions the instrument has executed since the last reading. It can be read using the commands `STATus:OPERation:CONDition?` or `STATus:OPERation[:EVENT]?`.

Table 5–5 Meaning of the bits in the STATus:OPERation register

Bit No.	Meaning
0	CALibrating This bit is set as long as the instrument is performing a calibration.
1 to 7	Not used
8	HardCOPy in progress This bit is set while the instrument is printing a hardcopy.
9 to 14	Not used
15	This bit is always 0

STATus:QUEStionable Register

This register contains information about indefinite states which may occur if the unit is operated without meeting the specifications. It can be read using the commands `STATus:QUEStionable:CONDition?` and `STATus:QUEStionable[:EVENT]?`.

Table 5–6 Meaning of bits in STATus:QUEStionable register

Bit No.	Meaning
0 to 1	These bits are not used
2	BATTERY LOW If the instrument is running without any external power supply and the charging level of the internal battery is approximately lower than 5% this bit is set to indicate that the system will be shut down automatically in approx. 5 minutes.
3	POWER This bit is set if a questionable power occurs (refer also to section " STATus:QUEStionable:POWER Register ")
4	TEMPERature This bit is set if a questionable temperature occurs.
5	FREQUency The bit is set if a frequency is questionable (refer to section " STATus:QUEStionable:FREQUency Register ")
6 to 7	Not used
8	CALibration The bit is set if a measurement is performed unaligned (label UNCAL)
9	LIMit (device-specific) This bit is set if a limit value is violated (see also section " STATus:QUEStionable:LIMit Register ")
10	LMARgin (device-specific) This bit is set if a margin is violated (see also section " STATus:QUEStionable:LMARgin Register ")
11	SYNC (device-dependent) This bit is set if, in measurements or pre-measurements in GSM MS mode, synchronization to midamble fails or no burst is found. This bit is also set if, in pre-measurements in GSM MS mode, the result differs too strongly from the expected value (see also " STATus:QUEStionable:SYNC Register ").
12	ACPLimit (device-specific) This bit is set if a limit for the adjacent channel power measurement is violated (see also section " STATus:QUEStionable:ACPLimit Register ")
13 to 14	Not used
15	This bit is always 0.

STATus:QUEStionable:ACPLimit Register

This register contains information about the observance of limits during adjacent power measurements. It can be read using the commands 'STATus:QUEStionable:ACPLimit :CONDition?' and 'STATus:QUEStionable:ACPLimit[:EVENT]?'

Table 5–7 Meaning of bits in STATus:QUEStionable:ACPLimit register

Bit No.	Meaning
0	ADJ UPPer FAIL This bit is set if the limit is exceeded in the upper adjacent channel
1	ADJ LOWEr FAIL This bit is set if the limit is exceeded in the lower adjacent channel.
2	ALT1 UPPer FAIL This bit is set if the limit is exceeded in the upper 1st alternate channel.
3	ALT1 LOWEr FAIL This bit is set if the limit is exceeded in the lower 1st alternate channel.
4	ALT2 UPPer FAIL This bit is set if the limit is exceeded in the upper 2nd alternate channel.
5	ALT2 LOWEr FAIL This bit is set if the limit is exceeded in the lower 2nd alternate channel.
6 to 14	Not used
15	This bit is always set to 0.

STATus:QUEStionable:FREQuency Register

This register contains information about the reference and local oscillator. It can be read using the commands STATus:QUEStionable:FREQuency:CONDition? and STATus :QUEStionable:FREQuency[:EVENT]?

Table 5–8 Meaning of bits in STATus:QUEStionable:FREQuency register

Bit No.	Meaning
0	OVEN COLD This bit is set if the reference oscillator has not yet attained its operating temperature. OCXO is displayed.
1	LO UNLoked This bit is set if the local oscillator no longer locks. LOUNL is displayed.
2 to 7	Not used

Bit No.	Meaning
8	EXternalREference Bit 8 indicates that the external reference oscillator is selected and no useable external reference source is connected to the instrument. Therefore the synthesizer can not lock and the frequency accuracy is not guaranteed.
9 to 14	Not used
15	This bit is always 0.

STATus:QUESTionable:LIMit Register

This register contains information about the observance of limit lines. It can be read using the commands `STATus:QUESTionable:LIMit:CONDition?` and `STATus:QUESTionable:LIMit[:EVENT]?`.

Table 5–9 Meaning of bits in STATus:QUESTionable:LIMit register

Bit No.	Meaning
0	LIMit 1 FAIL This bit is set if limit line 1 is violated.
1	LIMit 2 FAIL This bit is set if limit line 2 is violated.
2	LIMit 3 FAIL This bit is set if limit line 3 is violated.
3	LIMit 4 FAIL This bit is set if limit line 4 is violated.
4	LIMit 5 FAIL This bit is set if limit line 5 is violated.
5	LIMit 6 FAIL This bit is set if limit line 6 is violated.
6	LIMit 7 FAIL This bit is set if limit line 7 is violated.
7	LIMit 8 FAIL This bit is set if limit line 8 is violated.
8 to 14	Not used
15	This bit is always 0.

STATUS:QUESTIONABLE:LMARGIN Register

This register contains information about the observance of limit margins. It can be read using the commands `STATUS:QUESTIONABLE:LMARGIN:CONDITION?` and `STATUS:QUESTIONABLE:LMARGIN[:EVENT]?`.

Table 5–10 Meaning of bits in STATUS:QUESTIONABLE:LMARGIN register

Bit No.	Meaning
0	LMARGIN 1 FAIL This bit is set if limit margin 1 is violated.
1	LMARGIN 2 FAIL This bit is set if limit margin 2 is violated.
2	LMARGIN 3 FAIL This bit is set if limit margin 3 is violated.
3	LMARGIN 4 FAIL This bit is set if limit margin 4 is violated.
4	LMARGIN 5 FAIL This bit is set if limit margin 5 is violated.
5	LMARGIN 6 FAIL This bit is set if limit margin 1 is violated.
6	LMARGIN 7 FAIL This bit is set if limit margin 7 is violated.
7	LMARGIN 8 FAIL This bit is set if limit margin 8 is violated.
8 to 14	Not used
15	This bit is always 0.

STATUS:QUESTIONABLE:POWER Register

This register contains all information about possible overloads of the unit. It can be read using the commands `STATUS:QUESTIONABLE:POWER:CONDITION?` and `STATUS:QUESTIONABLE:POWER[:EVENT]?`.

Table 5–11 Meaning of bits in STATus:QUEStionable:POWer register

Bit No.	Meaning
0	OVERload This bit is set if the RF input is overloaded. OVLD is displayed.
1	UNDerload This bit is set if the RF input is underloaded. UNLD is displayed.
2	IF_OVerload This bit is set if the IF path is overloaded. IFOVL is displayed.
3 to 14	Not used
15	This bit is always 0.

STATus:QUEStionable:SYNC Register

This register contains information about sync and bursts not found, and about pre-measurement results exceeding or falling short of expected values (for details on GSM power measurements refer to chapter "Advanced Measurement Examples", and the Quick Start Guide, chapter 5, "Basic Measurement Examples").

It can be read using the commands `STATus:QUEStionable:SYNC:CONDition?` and `STATus:QUEStionable:SYNC[:EVENT]?`.

Table 5–12 Meaning of bits in STATus:QUEStionable:SYNC register

Bit No.	Meaning
0	BURSt not found This bit is set if no burst is found in the measurements/pre-measurements for phase/frequency error (PFE) or carrier power versus time (PVT). If a burst is found in these measurements/pre-measurements, the bit is reset.
1	SYNC not found This bit is set if the synchronization sequence (training sequence) of the midamble is not found in the measurements/pre-measurements for phase/frequency error (PFE) or carrier power versus time (PVT). If the synchronization sequence (training sequence) of the midamble is found in these measurements/pre-measurements, the bit is reset. With option TV Trigger (B6), this bis is set in the free run trigger mode if the trigger does not return data.
2	No carrier This bit is set if the level value determined in the pre-measurements for carrier power versus time (PVT) and spectrum due to modulation is too low. The bit is reset at the beginning of the pre-measurement.
3	Carrier overload This bit is set if the level value determined in the pre-measurements for carrier versus time (PVT) and spectrum due to modulation is too high. The bit is reset at the beginning of the pre-measurement.
4–14	Not used.

Bit No.	Meaning
15	This bit is always 0.

Application of the Status Reporting Systems

In order to be able to effectively use the status reporting system, the information contained there must be transmitted to the controller and further processed there. There are several methods which are represented in the following. For detailed program examples refer to chapter "Remote Control – Programming Examples".

Service Request

Under certain circumstances, the instrument can send a service request (SRQ) to the controller. Usually this service request initiates an interrupt at the controller, to which the control program can react appropriately. As evident from Fig. 5–4, an SRQ is always initiated if one or several of bits 2, 3, 4, 5 or 7 of the status byte are set and enabled in the SRE. Each of these bits combines the information of a further register, the error queue or the output buffer. The ENABLE parts of the status registers can be set so that arbitrary bits in an arbitrary status register initiate an SRQ. In order to make use of the possibilities of the service request effectively, all bits should be set to "1" in enable registers SRE and ESE.

Example: Use of the command *OPC to generate an SRQ at the end of a sweep

1. `CALL InstrWrite(analyzer, "*ESE 1")` 'Set bit 0 in the ESE (Operation Complete)
2. `CALL InstrWrite(analyzer, "*SRE 32")` 'Set bit 5 in the SRE (ESB)?

After its settings have been completed, the instrument generates an SRQ.

The SRQ is the only possibility for the instrument to become active on its own. Each controller program should set the instrument in a way that a service request is initiated in the case of malfunction. The program should react appropriately to the service request. A detailed example for a service request routine is to be found in chapter "Remote Control – Programming Examples".

Serial Poll

In a serial poll, just as with command *STB, the status byte of an instrument is queried. However, the query is realized via interface messages and is thus clearly faster. The serial-poll method has already been defined in IEEE 488.1 and used to be the only standard possibility for different instruments to poll the status byte. The method also works with instruments which do not adhere to SCPI or IEEE 488.2.

The VISUAL BASIC command for executing a serial poll is `IBRSP()`. Serial poll is mainly used to obtain a fast overview of the state of several instruments connected to the controller.

Parallel Poll

In a parallel poll, the controller uses a single command to request up to eight instruments to transmit one bit of information each on the data lines, i.e., to set the data line allocated to each instrument to a logical "0" or "1". In addition to the SRE register, which determines the conditions under which an SRQ is generated, there is a parallel poll enable register (PPE). This register is ANDed with the STB bit by bit,

considering bit 6 as well. The results are ORed, the result is possibly inverted and then sent as a response to the parallel poll of the controller. The result can also be queried without parallel poll by means of the command `*IST?`.

The instrument first has to be set for the parallel poll using the VISUAL BASIC command `IBPPC()`. This command allocates a data line to the instrument and determines whether the response is to be inverted. The parallel poll itself is executed using `IBRPP()`.

The parallel poll method is mainly used to find out quickly which one of the instruments connected to the controller has sent a service request. To this effect, SRE and PPE must be set to the same value.

Query by Means of Commands

Each part of any status register can be read by means of queries. The individual commands are listed in the description of the STATus Subsystem. The returned value is always a number that represents the bit pattern of the queried register. This number is evaluated by the controller program.

Queries are usually used after an SRQ in order to obtain more detailed information on the cause of the SRQ.

Error Queue Query

Each error state in the instrument leads to an entry in the error queue. The entries of the error queue are detailed plain-text error messages that can be displayed via manual control using the setup menu or queried via remote control using the command `SYSTEM:ERROR?`. Each call of `SYSTEM:ERROR?` provides one entry from the error queue. If no error messages are stored there any more, the instrument responds with 0, "No error".

The error queue should be queried after every SRQ in the controller program as the entries describe the cause of an error more precisely than the status registers. Especially in the test phase of a controller program the error queue should be queried regularly since faulty commands from the controller to the instrument are recorded there as well.

Reset Values of the Status Reporting System

Table 5–13 contains the different commands and events causing the status reporting system to be reset. None of the commands, except `*RST` and `SYSTEM:PRESet`, influences the functional instrument settings. In particular, `DCL` does not change the instrument settings.

Table 5–13 Resetting the status reporting system

Event	Switching on supply voltage		DCL,SDC (Device Clear, Selected Device Clear)	*RST or SYSTem:PRE Set	STATus:PRE Set	*CLS
	Power-On-Status-Clear					
	0	1				
Clear STB,ESR	—	yes	—	—	—	yes
Clear SRE,ESE	—	yes	—	—	—	—
Clear PPE	—	yes	—	—	—	—
Clear EVENT parts of the registers	—	yes	—	—	—	yes
Clear ENABLE parts of all OPERATION and QUESTIONable registers; Fill ENABLE parts of all other registers with "1".	—	yes	—	—	yes	—
Fill PTRansition parts with "1"; Clear NTRansition parts	—	yes	—	—	yes	—
Clear error queue	yes	yes	—	—	—	yes
Clear output buffer	yes	yes	yes	1)	1)	1)
Clear command processing and input buffer	yes	yes	yes	—	—	—

1)Every command being the first in a command line, i.e., immediately following a <PROGRAM MESSAGE TERMINATOR> clears the output buffer.

Interfaces and Protocols

The standard instrument is accessed via LAN in order to perform for remote control. Optional a GPIB interface can be used for remote control, provided by option GPIB Interface, R&S FSL–B10.

LAN Interface

To be intergrated in a LAN, the instrument is equipped with a LAN interface, consisting of a connector, a network interface card and protocols (VXI–11 and RSIB). For details on the connector and its use refer to the Quick Start Guide, chapter "Front and Rear Panel". The network interface card supports IEEE 802.3 for a 10 MHz Ethernet and IEEE 802.3u for a 100 MHz Ethernet.

Instrument access via VXI11 or RSIB is usually achieved from high level programming platforms by using VISA as an intermediate abstraction layer. VISA encapsulates the low level VXI, RSIB or even GPIB function calls and thus makes the transport interface transparent for the user. The necessary VISA library is available as a seperate product. For details contact your local R&S sales representative.

VXI Basics

The VXI–11 standard is based on the RPC protocol which in turn relies on TCP/IP as the network/transport layer. The TCP/IP network protocol and the associated network services are preconfigured. TCP/IP ensures connection–oriented communication, where the order of the exchanged messages is adhered to and interrupted links are identified. With this protocol, messages cannot be lost.

Remote control of an instrument via a network is based on standardized protocols which follow the OSI reference model (see Fig. below).

Application	SCPI
Presentation	XDR (VXI-11)
Session	ONC-RPC
Transport	TCP / UDP
Network	IP
Data Link	Ethernet/802.3
Physical	802.3/10BASE-T

Fig. 5–5 Example for LAN remote control based on the OSI reference model

Based on TCP/UDP, messages between the controller and the instrument are exchanged via open network computing (ONC) – remote procedure calls (RPC). With XDR (VXI–11), legal RPC messages are known as VXI–11 standard. Based on this standard, messages are exchanged between the controller and the instrument. The messages are identical with SCPI commands. They can be organized in four groups:

- program messages (control command to the instrument)
- response messages (values returned by the instrument)
- service request (spontaneous queries of the instrument)
- low–level control messages (interface messages).

A VXI–11 link between a controller and an instrument uses three channels: core, abort and interrupt channel. Instrument control is mainly performed on the core channel (program, response and low–level control messages). The abort channel is used for immediate abort of the core channel; the interrupt channel transmits spontaneous service requests of the instrument. Link setup itself is very complex. For more details refer to the VXI–11 specification.

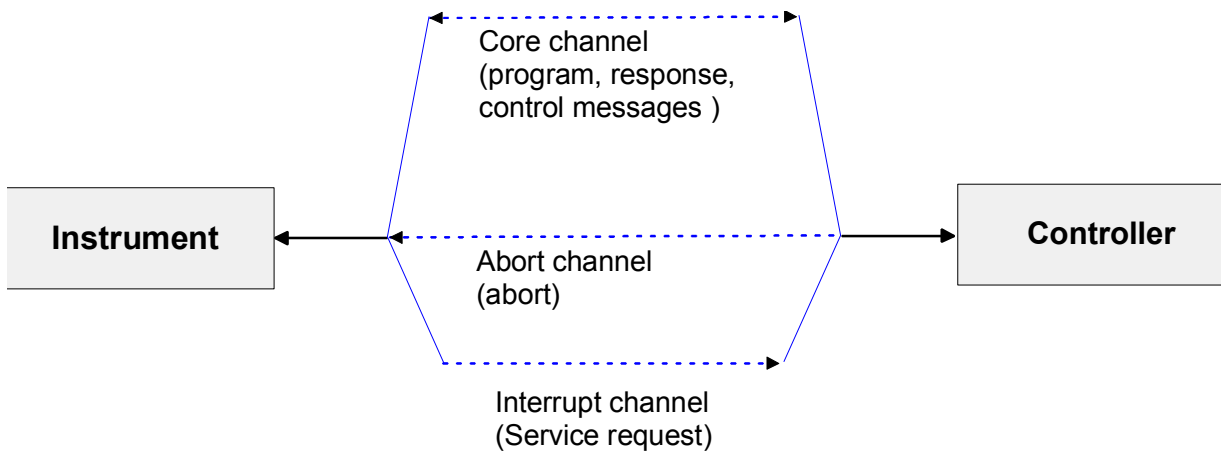

Fig. 5–6 VXI–11 channels between instrument and controller

The number of controllers that can address an instrument is practically unlimited in the network. In the instrument, the individual controllers are clearly distinguished. This distinction continues up to the application level in the controller, i.e. two applications on a computer are identified by the instrument as two different controllers.

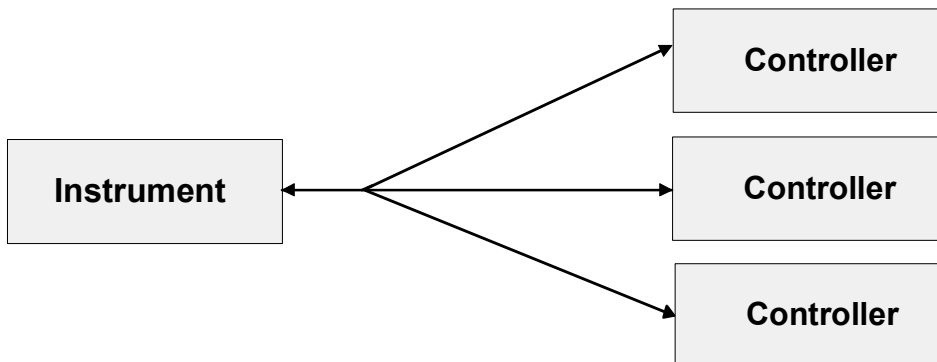

Fig. 5–7 Remote control via LAN from several controllers

The controllers can lock and unlock the instrument for exclusive access. This regulates access to the instrument of several controllers.

VXI-11 Interface Messages

On the Ethernet link, the interface messages are called low-level control messages. These messages can be used to emulate interface messages of the IEC/IEEE bus.

Table 5-14 VXI-11 Interface Messages

Command	Effect on the instrument
&ABO (Abort)	Aborts the processing of the commands just received.
&DCL (Device Clear)	Aborts the processing of the commands just received and sets the command processing software to a defined initial state. Does not change the instrument setting.
>L (Go to Local)	Transition to the "Local" state (manual control)
>R (Go to Remote)	Transition to the "Remote" state (remote control)
&GET (Group Execute Trigger)	Triggers a previously active device function (e.g. a sweep). The effect of the command is the same as with that of a pulse at the external trigger signal input.
&LLO (Local Lockout)	Disables switchover from remote control to manual control by means of the front panel keys
&POL (Serial Poll)	Starts a serial poll
&NREN (Not Remote Enable)	Enables switchover from remote control to manual control by means of the front panel keys

RSIB Protocol Basics

The R&S defined RSIB protocol uses the TCP/IP protocol for communication with the instrument. Remote control over RSIB is done on a message level basis using the SCPI command set of the instrument. The RSIB protocol allows you to control the instrument not only via Visual C++- and Visual Basic programs but also via the two Windows applications WinWord and Excel as well as via National Instruments LabView, LabWindows/CVI and Agilent VEE. The control applications run on an external computer in the network.

A UNIX operating system can be installed on an external computer in addition to a Windows operating system. In this case, the control applications are created either in C or C++. The supported UNIX operating systems include:

- Sun Solaris 2.6 Sparc Station
- Sun Solaris 2.6 Intel Platform
- Red Hat Linux 6.2 x86 Processors

RSIB Interface Functions

The library functions are adapted to the interface functions of National Instruments for GPIB programming. The functions supported by the libraries are listed in the following table.

Function	Description
RSDLLibfind()	Provides a handle for access to a device.
RSDLLibwrt()	Sends a zero-terminated string to a device.
RSDLLilwrt()	Sends a certain number of bytes to a device.
RSDLLibwrtf()	Sends the contents of a file to a device.
RSDLLibrd()	Reads data from a device into a string.
RSDLLilrd()	Reads a certain number of bytes from a device.
RSDLLibrdf()	Reads data from a device into a file.
RSDLLibtmo()	Sets timeout for RSIB functions.
RSDLLibsre()	Switches a device to the local or remote state.
RSDLLibloc()	Temporarily switches a device to the local state.
RSDLLibeot()	Enables/disables the END message for write operations.
RSDLLibrsp()	Performs a serial poll and provides the status byte.
RSDLLibonl()	Sets the device online/offline.
RSDLLTestSrQ()	Checks whether a device has generated an SRQ.
RSDLLWaitSrQ()	Waits until a device generates an SRQ.
RSDLLSwapBytes	Swaps the byte sequence for binary numeric display (only required for non-Intel platforms).

As with the National Instrument interface, the successful execution of a command can be checked by means of the variables *ibsta*, *iberr* and *ibcntl*. For this purpose, all RSIB functions are assigned references to these three variables.

Status word – *ibsta*

The status word *ibsta* provides information on the status of the RSIB interface. The following bits are defined:

Bit designation	Bit	Hex code	Description
ERR	15	8000	Is set when an error has occurred on calling a function. If this bit is set, <i>iberr</i> contains an error code that specifies the error in greater detail.
TIMO	14	4000	Is set when a timeout has occurred on calling a function.
CMPL	8	0100	Is set if the response of the GPIB parser has been read out completely. If a parser response is read out with the function <i>RSDLLilrd()</i> and the length of the buffer is insufficient for the answer, the bit will be cleared.

Error variable – `iberr`

If the ERR bit (8000h) is set in the status word, `iberr` contains an error code which allows the error to be specified in greater detail. Extra error codes are defined for the RSIB protocol, independent of the National Instruments interface.

Error	Error code	Description
IBERR_CONNECT	2	Setup of the connection to the measuring instrument has failed.
IBERR_NO_DEVICE	3	A function of the interface has been called with an illegal device handle.
IBERR_MEM	4	No empty memory available.
IBERR_TIMEOUT	5	Timeout has occurred.
IBERR_BUSY	6	The RSIB protocol is blocked by a function that is still running.
IBERR_FILE	7	Error when reading or writing to a file.
IBERR_SEMA	8	Error upon creating or assigning a semaphore (only under UNIX).

Count variable – `ibcntl`

The variable `ibcntl` is updated with the number of transferred bytes each time a read or write function is called.

GPIB Interface (Option R&S FSL–B10)

The standard instrument is not equipped with an IEC/IEEE bus connector, but can be accessed via the LAN interface for remote control. The option R&S FSL–B10 provides a GPIB interface. For details on the connector and its use refer to the Quick Start Guide, chapter "Front and Rear Panel".

GPIB Basics

The GPIB interface is described by the following characteristics:

- 8-bit parallel data transfer
- bi-directional data transfer
- three-line handshake
- high data transfer rate of max. 700 kbyte/s
- up to 15 instruments can be connected
- maximal length of the interconnecting cables 15 m (single connection, 2m)
- wired-OR connection if several instruments are connected in parallel.

Depending on the bus type the following bus lines are used:

- Data bus with 8 lines D0 to D7.

The transmission is bit–parallel and byte–serial in the ASCII/ISO code. D0 is the least significant bit, D7 the most significant bit.

- Control bus with 5 lines

IFC (Interface Clear) active LOW resets the interfaces of the instruments connected to the default setting.

ATN (Attention) active LOW signals the transmission of interface messages.
inactive HIGH signals the transmission of device messages.

SRQ (Service Request) active LOW enables the connected device to send a service request to the controller.

REN (Remote Enable) active LOW permits switchover to remote control.

EOI (End or Identify) has two functions in connection with ATN:
ATN = HIGH
active LOW marks the end of data transmission.
ATN = LOW
active LOW triggers a parallel poll.

- Handshake bus with three lines

DAV (Data Valid) active LOW signals a valid data byte on the data bus.

NRFD (Not Ready For Data) active LOW signals that one of the connected devices is not ready for data transfer.

NDAC (Not Data Accepted) active LOW signals that the instrument connected is accepting the data on the data bus.

GPIB Interface Functions

Instruments which can be remote controlled via the IEC/IEEE bus can be equipped with different interface functions. Table 5–1 lists the interface functions appropriate for the instrument.

Table 5–1 Interface functions

Control character	Interface function
SH1	Handshake source function (source handshake), full capability
AH1	Handshake sink function (acceptor handshake), full capability
L4	Listener function, full capability, unaddress if MTA.
T6	Talker function, full capability, ability to respond to serial poll, unaddress if MLA
SR1	Service request function (Service Request), full capability
PP1	Parallel poll function, full capability
RL1	Remote/Local switch over function, full capability
DC1	Reset function (Device Clear), full capability
DT1	Trigger function (Device Trigger), full capability
C0	No controller function

GPIB Interface Messages

The messages transferred via the data lines of the IEC/IEEE bus can be divided into two groups: interface messages and device messages

Interface messages are transferred on the data lines of the IEC/IEEE bus when the "ATN" control line is active (LOW). They are used for communication between controller and instruments and can only be sent by the controller which currently has control of the IEC/IEEE bus.

Universal Commands

The universal commands are encoded 10 – 1F hex. They affect all instruments connected to the bus without addressing.

Table 5–2 Universal Commands

Command	QuickBASIC command	Effect on the instrument
DCL (Device Clear)	IBCMD (controller%, CHR\$(20))	Aborts the processing of the commands just received and sets the command processing software to a defined initial state. Does not change the instrument settings.
IFC (Interface Clear)	IBSIC (controller%)	Resets the interfaces to the default setting.
LLO (Local Lockout)	IBCMD (controller%, CHR\$(17))	The LOC/IEC ADDR key is disabled.
SPE (Serial Poll Enable)	IBCMD (controller%, CHR\$(24))	Ready for serial poll.

Command	QuickBASIC command	Effect on the instrument
SPD (Serial Poll Disable)	IBCMD (controller%, CHR\$(25))	End of serial poll.
PPU (Parallel Poll Unconfigure)	IBCMD (controller%, CHR\$(21))	End of the parallel-poll state.

Addressed Commands

The addressed commands are encoded 00 – 0F hex. They are only effective for instruments addressed as listeners.

Table 5–3Addressed Commands

Command	QuickBASIC command	Effect on the instrument
SDC (Selected Device Clear)	IBCLR (device%)	Aborts the processing of the commands just received and sets the command processing software to a defined initial state. Does not change the instrument setting.
GET (Group Execute Trigger)	IBTRG (device%)	Triggers a previously active device function (e.g. a sweep). The effect of the command is the same as with that of a pulse at the external trigger signal input.
GTL (Go to Local)	IBLOC (device%)	Transition to the "Local" state (manual control).
PPC (Parallel Poll Configure)	IBPPC (device%, data%)	Configure instrument for parallel poll. Additionally, the QuickBASIC command executes PPE/PPD.

Instrument Messages

For different interfaces, device messages are more or less alike. They are divided into two groups, depending on the direction they are sent: commands and device responses.

Commands

Commands (program messages) are messages the controller sends to the instrument. They operate the device functions and request information. The commands are subdivided according to two criteria:

- According to the effect they have on the instrument:
 - *Setting commands* cause instrument settings such as a reset of the instrument or setting the frequency.
 - *Queries* cause data to be provided for remote control, e.g. for identification of the device or polling a parameter value. Queries are formed by directly appending a question mark to the header.

- According to their definition in standard:
 - *Common commands* are exactly defined as to their function and notation in standard IEEE 488.2. They refer to functions such as management of the standardized status registers, reset and self test.
 - *Device-specific commands* refer to functions depending on the features of the instrument such as frequency setting. A majority of these commands has also been standardized by the SCPI committee. Device-specific extensions following the SCPI rules are permitted by the standard.

Device responses

Device responses (response messages and service request) are messages the instrument sends to the controller after a query. They can contain measurement results, instrument settings and information on the instrument status (refer to section "Responses to Queries").

WLAN TX Measurements Option (K91) – Status Reporting System

Additionally to the registers provided by the base system, the following registers are used or modified in the WLAN TX Measurements option (K91):

- **STATus:OPERation Register**
Although this register is provided by the base system, the WLAN TX Measurements option (K91) makes use of bits not used within the base system.
- **STATus:QUEStionable:LIMit Register, STATus:QUEStionable:SYNC Register**
Although this register is provided by the base system, the WLAN TX Measurements option (K91) uses different bits and definitions.

The following registers are provided by the base system and are not available from the WLAN TX Measurements option (K91) command tree:

- [STATus:QUEStionable:ACPLimit Register](#)
- [STATus:QUEStionable:LMARgin Register](#)

Detailed information on the status registers of the base system is given in section [Status Reporting System](#). In this section, only the new and altered status registers / bits for the WLAN TX Measurements option (K91) are described.

This option is available from firmware version 1.20.

STATus:OPERation Register

Additionally to the bits assigned by the base system (for details refer to [STATus:OPERation Register](#)), bit no. 4 is defined:

Bit No	Meaning
4	MEASuring This bit is set while a measurement is in progress.

STATus:QUEStionable:LIMit Register

This register comprises information about the observance of limit lines in the corresponding measurement window (LIMit 1 corresponds to screen A, LIMit 2 to screen B). It can be queried with the `STATus:QUEStionable:LIMit<1|2>:CONDition?` and `STATus:QUEStionable:LIMit<1|2>[:EVENT]? commands.`

Note: No limit lines are displayed in screen A and therefore all bits in the LIMit1 register will always be set to 0.

Bit No	Meaning
0 to 1	These bits are not used.
2	LIMit FAIL

Bit No	Meaning
	This bit is set if the ETSI Spectrum Mask limit line is violated.
3	LIMit FAIL This bit is set if the Spectrum Flatness (Upper) limit line is violated.
4	LIMit FAIL This bit is set if the Spectrum Flatness (Lower) limit line is violated.
5	LIMit FAIL This bit is set if the IEEE Spectrum Mask limit line is violated.
6	LIMit FAIL This bit is set if the PVT Rising Edge max limit is violated.
7	LIMit FAIL This bit is set if the PVT Rising Edge mean limit is violated.
8	LIMit FAIL This bit is set if the PVT Falling Edge max limit is violated.
9	LIMit FAIL This bit is set if the PVT Falling Edge mean limit is violated.
10 to 14	These bits are not used.
15	This bit is always 0.

STATus:QUEStionable:SYNC Register

This register contains information about sync and bursts not found, and about pre-measurement results exceeding or falling short of expected values.

The bits can be queried with commands "STATus:QUEStionable:SYNC:CONDition?" and "STATus:QUEStionable:SYNC[:EVENT]?".

Bit No	Meaning
0	BURSt not found This bit is set if an IQ measurement is performed and no bursts are detected.
1	This bit is not used
2	no bursts of REQuired type This bit is set if an IQ measurement is performed and no bursts of the specified type are detected.
3	GATE length too small This bit is set if gating is used in a measurement and the gate length is not set sufficiently large enough.
4	BURSt count too small This bit is set if a PVT measurement is performed with gating active and there is not at least 1 burst within the gate lines.
5	auto level OVERload This bit is set if a signal overload is detected when an auto-level measurement is performed.
6	auto level NoSIGnal This bit is set if no signal is detected by the auto-level measurement.
7 to 14	These bits are not used.
15	This bit is always 0.

Error Reporting

Error reporting for the WLAN TX Measurements option (K91) is carried out using the Service Request (SRQ) interrupt in the GPIB interface. When an error occurs a Service Request interrupt will be generated. The master can then query the slave instrument for the error that triggered the interrupt errors are queried through the "SYSTem:ERRor" command.

WiMAX 802.16 Measurements Option (K92) – Status Reporting System

Additionally to the registers provided by the base system, the following registers are used or modified in the WiMAX 802.16 OFDM Measurements option (K92):

- **STATus:OPERation Register**
Although this register is provided by the base system, the WiMAX 802.16 OFDM Measurements option (K92) makes use of bits not used within the base system.
- **STATus:QUEStionable:LIMit Register, STATus:QUEStionable:SYNC Register**
Although these registers are provided by the base system, the WiMAX 802.16 OFDM Measurements option (K92) uses different bits and definitions.

The following registers are provided by the base system and are not available from the WiMAX 802.16 OFDM Measurements option (K92) command tree:

- [STATus:QUEStionable:ACPLimit Register](#)
- [STATus:QUEStionable:LMARgin Register](#)

Detailed information on the status registers of the base system is given in section [Status Reporting System](#). In this section, only the new and altered status registers / bits for the WiMAX 802.16 OFDM Measurements option (K92) are described.

This option is available from firmware version 1.40.

STATus:OPERation Register

Additionally to the bits assigned by the base system (for details refer to [STATus:OPERation Register](#)), bit no. 4 is defined:

Bit No	Meaning
4	MEASuring This bit is set while a measurement is in progress.

STATus:QUEStionable:LIMit Register

This register comprises information about the observance of limit lines in the corresponding measurement window (LIMit 1 corresponds to screen A, LIMit 2 to screen B). It can be queried with the `STATus:QUEStionable:LIMit<1|2>:CONDition?` and `STATus:QUEStionable:LIMit<1|2>[:EVENT]? commands.`

Note: *No limit lines are displayed in screen A and therefore all bits in the LIMit1 register will always be set to 0.*

Bit No	Meaning
0 to 1	These bits are not used.
2	LIMit FAIL

Bit No	Meaning
	This bit is set if the ETSI Spectrum Mask limit line is violated.
3	LIMit FAIL This bit is set if the IEEE Spectrum Mask limit line is violated.
4	LIMit FAIL This bit is set if the Spectrum Flatness (Upper) limit line is violated.
5	LIMit FAIL This bit is set if the Spectrum Flatness (Lower) limit line is violated.
6	LIMit FAIL This bit is set if the Spectrum Flatness Difference (Upper) limit line is violated.
7	LIMit FAIL This bit is set if the Spectrum Flatness Difference (Lower) limit line is violated.
8 to 14	These bits are not used.
15	This bit is always 0.

STATus:QUEStionable:SYNC Register

This register contains information about sync and bursts not found, and about pre-measurement results exceeding or falling short of expected values.

The bits can be queried with commands "STATus:QUEStionable:SYNC:CONDition?" and "STATus:QUEStionable:SYNC[:EVENT]?".

Bit No	Meaning
0	BURSt not found This bit is set if an IQ measurement is performed and no bursts are detected.
1	This bit is not used.
2	no bursts of REQuired type This bit is set if an IQ measurement is performed and no bursts of the specified type are detected.
3	GATE length too small This bit is set if gating is used in a measurement and the gate length is not set sufficiently large enough.
4	BURSt count too small This bit is set if a PVT measurement is performed with gating active and there is not at least 1 burst within the gate lines.
5	auto level OVERload This bit is set if a signal overload is detected when an auto-level measurement is performed.
6	auto level NoSIGnal This bit is set if no signal is detected by the auto-level measurement.
7 to 14	These bits are not used.
15	This bit is always 0.

Error Reporting

Error reporting for the WiMAX 802.16 OFDM Measurements option (K92) is carried out using the Service Request (SRQ) interrupt in the GPIB interface. When an error occurs a Service Request interrupt will be generated. The master can then query the slave instrument for the error that triggered the interrupt errors are queried through the "SYSTem:ERRor" command.

Contents of Chapter 6

6	Remote Control – Commands	6.1
	Notation	6.2
	Remote Control – Description of Analyzer Commands	6.5
	ABORt Subsystem	6.5
	CALCulate Subsystem.....	6.6
	DISPlay Subsystem	6.98
	FORMat Subsystem	6.104
	INITiate Subsystem	6.105
	INPUt Subsystem	6.108
	OUTPUt Subsystem	6.111
	SENSe Subsystem	6.113
	SOURce Subsystem (Models 13 and 16).....	6.151
	STATus Subsystem	6.152
	SYSTem Subsystem.....	6.163
	TRACe Subsystem	6.164
	TRIGger Subsystem	6.175
	UNIT Subsystem.....	6.180
	Remote Commands of the Analog Demodulation Option (K7)	6.181
	CALCulate Subsystem (Analog Demodulation, K7)	6.182
	DISPlay Subsystem (Analog Demodulation, K7).....	6.192
	INSTrument Subsystem (Analog Demodulation, K7)	6.194
	SENSe Subsystem (Analog Demodulation, K7).....	6.195
	TRACe Subsystem (Analog Demodulation, K7).....	6.222
	TRIGger Subsystem (Analog Demodulation, K7).....	6.223
	UNIT Subsystem (Analog Demodulation, K7)	6.225
	Remote Commands of the Bluetooth Measurements Option (K8)	6.226
	CALCulate:BT0oth Subsystem (BLUETOOTH, K8)	6.226
	CALCulate:DELTamarker Subsystem (BLUETOOTH, K8)	6.245
	CALCulate:MARKer Subsystem (BLUETOOTH, K8).....	6.246
	CONFigure:BT0oth Subsystem (BLUETOOTH, K8)	6.247
	DISPlay Subsystem (BLUETOOTH, K8)	6.261
	INSTrument Subsystem (BLUETOOTH, K8).....	6.262
	SENSe Subsystem (BLUETOOTH, K8)	6.263
	Remote Commands of the Power Meter Option (K9)	6.269
	CALCulate Subsystem (Power Meter, K9)	6.270
	CALibration Subsystem (Power Meter, K9).....	6.272
	DISPlay Subsystem (Power Meter, K9).....	6.273
	FETCh Subsystem (Power Meter, K9)	6.274
	READ Subsystem (Power Meter, K9).....	6.275
	SENSe Subsystem (Power Meter, K9).....	6.276

UNIT Subsystem (Power Meter, K9)	6.278
Remote Commands of the Cable TV Measurements Option (K20)	6.279
ABORt Subsystem (CATV, K20)	6.280
CALCulate Subsystem (CATV, K20)	6.281
CONFigure Subsystem (CATV, K20)	6.331
DISPlay Subsystem (CATV, K20)	6.335
FORMat Subsystem (CATV, K20)	6.340
INITiate Subsystem (CATV, K20)	6.341
INPUt Subsystem (CATV, K20)	6.342
INSTrument Subsystem (CATV, K20)	6.343
MMEMory Subsystem (CATV, K20)	6.344
SENSe Subsystem (CATV, K20)	6.345
SETup:TV Subsystem (CATV, K20)	6.365
SOURce Subsystem (CATV, K20)	6.367
STATus Subsystem (CATV, K20)	6.368
TRACe Subsystem (CATV, K20)	6.373
TRIGger Subsystem (CATV, K20)	6.374
UNIT Subsystem (CATV, K20)	6.377
Remote Commands of the WLAN TX Measurements Option (K91)	6.378
ABORt Subsystem (WLAN, K91)	6.379
CALCulate:BURSt Subsystem (WLAN, K91)	6.380
CALCulate:LIMit Subsystem (WLAN, K91)	6.381
CALCulate:MARKer Subsystem (WLAN, K91)	6.397
CONFigure Subsystem (WLAN, K91)	6.404
DISPlay Subsystem (WLAN, K91)	6.413
FETCh Subsystem (WLAN, K91)	6.416
FORMat Subsystem (WLAN, K91)	6.425
INITiate Subsystem (WLAN, K91)	6.426
INPUt Subsystem (WLAN, K91)	6.427
INSTrument Subsystem (WLAN, K91)	6.428
MMEMory Subsystem (WLAN, K91)	6.429
SENSe Subsystem (WLAN, K91)	6.430
STATus Subsystem (WLAN, K91)	6.444
TRACe Subsystem (WLAN, K91)	6.448
TRIGger Subsystem (WLAN, K91)	6.454
UNIT Subsystem (WLAN, K91)	6.456
Remote Commands of the WiMAX 802.16 OFDM Measurements Option (K92)	6.458
ABORt Subsystem (WiMAX, K92)	6.459
CALCulate:BURSt Subsystem (WiMAX, K92)	6.460
CALCulate:LIMit Subsystem (WiMAX, K92)	6.461
CALCulate:MARKer Subsystem (WiMAX, K92)	6.473
CONFigure Subsystem (WiMAX, K92)	6.480
DISPlay Subsystem (WiMAX, K92)	6.492
FETCh Subsystem (WiMAX, K92)	6.496
FORMat Subsystem (WiMAX, K92)	6.503
INITiate Subsystem (WiMAX, K92)	6.504

INPut Subsystem (WiMAX, K92)	6.505
INSTrument Subsystem (WiMAX, K92).....	6.506
MMEMory Subsystem (WiMAX, K92).....	6.507
SENSe Subsystem (WiMAX, K92)	6.508
STATus Subsystem (WiMAX, K92)	6.522
TRACe Subsystem (WiMAX, K92)	6.526
TRIGger Subsystem (WiMAX, K92)	6.532
UNIT Subsystem (WiMAX, K92).....	6.535
Remote Control – Description of Basic Settings Commands	6.537
Common Commands.....	6.537
CALibration Subsystem	6.542
DIAGnostic Subsystem.....	6.544
DISPlay Subsystem	6.548
FORMat Subsystem	6.554
HCOPY Subsystem.....	6.555
INSTrument Subsystem.....	6.561
MMEMory Subsystem.....	6.562
OUTPut Subsystem (Option Additional Interfaces, B5).....	6.573
SENSe Subsystem	6.574
SOURce Subsystem.....	6.579
STATus Subsystem	6.580
SYSTem Subsystem.....	6.585

6 Remote Control – Commands

This chapter describes all remote control commands for the analyzer functions, firmware options (see list below) and the basic settings functions of the R&S FSL in detail. Commands that are used both for analyzer functions and firmware options are described in the analyzer commands section. The mode information is provided for each command.

A few commands are implemented for reasons of compatibility with the FSP family only. These commands are not described in the R&S FSL documentation, because they have no effect.

Each subsystem starts with a list of commands, which provides quick access to all commands of the subsystem. Be aware, that for one subsystem more than one SCPI command lists can exist, depending on the functionality (analyzer and basic settings, options). For details on the notation refer to "[Notation](#)".

Remote commands of firmware and firmware options

- ["Remote Control – Description of Analyzer Commands"](#) on page 6.5
- ["Remote Commands of the Analog Demodulation Option \(K7\)"](#) on page 6.181
- ["Remote Commands of the Bluetooth Measurements Option \(K8\)"](#) on page 6.226
- ["Remote Commands of the Power Meter Option \(K9\)"](#) on page 6.269
- ["Remote Commands of the Cable TV Measurements Option \(K20\)"](#) on page 6.279
- ["Remote Commands of the WLAN TX Measurements Option \(K91\)"](#) on page 6.378
- ["Remote Commands of the WiMAX 802.16 OFDM Measurements Option \(K92\)"](#) on page 6.458
- Remote Control – Description of Basic Settings Commands

Notation

In the following sections, all commands implemented in the instrument are first listed and then described in detail, arranged according to the command subsystems. The notation is adapted to the SCPI standard. The SCPI conformity information is included in the individual description of the commands.

- [Individual Description](#)
- [Upper/Lower Case Notation](#)
- [Special Characters](#)
- [Description of Parameters](#)

Individual Description

The individual description contains the complete notation of the command. An example for each command, the *RST value and the SCPI information are included as well.

The options and operating modes for which a command can be used are indicated by the following abbreviations:

Abbreviation	Description
A	spectrum analysis
A-F	spectrum analysis – span > 0 only (frequency mode)
A-T	spectrum analysis – zero span only (time mode)
ADEMOD	analog demodulation (option R&S FSL-K7)
BT	BLUETOOTH analyzer (option R&S FSL-K8)
CATV	cable TV analyzer (option R&S FSL-K20)
PSM	power sensor measurements (option R&S FSL-K9)
WiMAX	WiMAX 802.16 OFDM Measurements (option R&S FSL-K92)
WLAN	WLAN TX Measurements (option R&S FSL-K91)

Note: The spectrum analysis (analyzer) mode is implemented in the basic unit. For the other modes, the corresponding options are required.

Upper/Lower Case Notation

Upper/lower case letters are used to mark the long or short form of the key words of a command in the description (see chapter "Remote Control – Basics"). The instrument itself does not distinguish between upper and lower case letters.

Special Characters

- | A selection of key words with an identical effect exists for several commands. These keywords are indicated in the same line; they are separated by a vertical stroke. Only one of these keywords needs to be included in the header of the command. The effect of the command is independent of which of the keywords is used.

Example:

```
SENSe:FREQuency:CW|:FIXed
```

The two following commands with identical meaning can be created. They set the frequency of the fixed frequency signal to 1 kHz:

```
SENSe:FREQuency:CW 1E3
```

```
SENSe:FREQuency:FIXed 1E3
```

A vertical stroke in parameter indications marks alternative possibilities in the sense of "or". The effect of the command is different, depending on which parameter is used.

Example: Selection of the parameters for the command

```
[SENSe<1|2>:]AVERAge:TYPE VIDEo | LINear
```

If parameter `SINGLE` is selected, full screen is displayed, in the case of `SPLIT`, split screen is displayed.

- Key words in square brackets can be omitted when composing the header. The full command length must be accepted by the instrument for reasons of compatibility with the SCPI standards.

Parameters in square brackets can be incorporated optionally in the command or omitted as well.

- { Parameters in braces can be incorporated optionally in the command, either not at all, once or several times.

Description of Parameters

Due to the standardization, the parameter section of SCPI commands consists always of the same syntactical elements. SCPI has therefore specified a series of definitions, which are used in the tables of commands. In the tables, these established definitions are indicated in angled brackets (<...>) and will be briefly explained in the following (see also chapter "Remote Control – Basics", section "Parameters").

<Boolean>

This keyword refers to parameters which can adopt two states, "on" and "off". The "off" state may either be indicated by the keyword `OFF` or by the numeric value 0, the "on" state is indicated by `ON` or any numeric value other than zero. Parameter queries are always returned the numeric value 0 or 1.

<numeric_value> <num>

These keywords mark parameters which may be entered as numeric values or be set using specific keywords (character data). The following keywords given below are permitted:

`MAXimum`: This keyword sets the parameter to the largest possible value.

`MINimum`: This keyword sets the parameter to the smallest possible value.

`DEFault`: This keyword is used to reset the parameter to its default value.

`UP`: This keyword increments the parameter value.

`DOWN`: This keyword decrements the parameter value.

The numeric values associated to `MAXimum`/`MINimum`/`DEFault` can be queried by adding the corresponding keywords to the command. They must be entered following the quotation mark.

Example:

```
SENSe:FREQuency:CENTer? MAXimum
```

Returns the maximum possible numeric value of the center frequency as result.

<arbitrary block program data>

This keyword is provided for commands the parameters of which consist of a binary data block.

Remote Control – Description of Analyzer Commands

In this section all remote control commands for analyzer functions are described in detail. For details on basic settings commands refer to section "Remote Control – Description of Basic Settings Commands".

Subsystems of the analyzer

- "ABORt Subsystem" on page 6.5
- "CALCulate Subsystem" on page 6.6
- "DISPlay Subsystem" on page 6.98
- "FORMat Subsystem" on page 6.104
- "INITiate Subsystem" on page 6.105
- "INPut Subsystem" on page 6.108
- "OUTPut Subsystem" on page 6.111
- "SENSe Subsystem" on page 6.113
- "SOURce Subsystem (Models 13 and 16)" on page 6.151
- "STATus Subsystem" on page 6.152
- "SYSTem Subsystem" on page 6.163
- "TRACe Subsystem" on page 6.164
- "TRIGger Subsystem" on page 6.175
- "UNIT Subsystem" on page 6.180

ABORt Subsystem

The ABORt subsystem contains the commands for aborting triggered actions. An action can be triggered again immediately after being aborted. All commands trigger events, and therefore they have no *RST value.

Commands of the ABORt Subsystem

- [ABORt](#)

ABORt

This command aborts a current measurement and resets the trigger system.

Example

```
ABOR; INIT: IMM
```

Characteristics

RST value: –

SCPI: conform

Mode

all

CALCulate Subsystem

The CALCulate subsystem contains commands for converting instrument data, transforming and carrying out corrections. These functions are carried out subsequent to data acquisition, i.e. following the SENSE subsystem.

The following subsystems are included:

- "CALCulate:DELTamarker Subsystem" on page 6.6
- "CALCulate:DLINe Subsystem" on page 6.16
- "CALCulate:FLINe Subsystem" on page 6.17
- "CALCulate:LIMit Subsystem" on page 6.184
- "CALCulate:MARKer Subsystem" on page 6.18
- "CALCulate:MATH Subsystem" on page 6.88
- "CALCulate:STATistics Subsystem" on page 6.90
- "CALCulate:THReshold Subsystem" on page 6.95
- "CALCulate:TLINE Subsystem" on page 6.96
- "CALCulate:UNIT Subsystem" on page 6.97

CALCulate:DELTamarker Subsystem

The CALCulate:DELTamarker subsystem controls the delta marker functions in the instrument.

Commands of the CALCulate:DELTamarker Subsystem

- CALCulate<1|2>:DELTamarker<1...4>[:STATe]
- CALCulate<1|2>:DELTamarker<1...4>:AOFF
- CALCulate<1|2>:DELTamarker<1...4>:FUNctIon:FIXed[:STATe]
- CALCulate<1|2>:DELTamarker<1...4>:FUNctIon:FIXed:RPOint:MAXimum[:PEAK]
- CALCulate<1|2>:DELTamarker<1...4>:FUNctIon:FIXed:RPOint:X
- CALCulate<1|2>:DELTamarker<1...4>:FUNctIon:FIXed:RPOint:Y
- CALCulate<1|2>:DELTamarker<1...4>:FUNctIon:FIXed:RPOint:Y:OFFSet
- CALCulate<1|2>:DELTamarker<1...4>:FUNctIon:PNOise[:STATe]
- CALCulate<1|2>:DELTamarker<1...4>:FUNctIon:PNOise:RESult?
- CALCulate<1|2>:DELTamarker<1...4>:MAXimum[:PEAK]
- CALCulate<1|2>:DELTamarker<1...4>:MAXimum:LEFT
- CALCulate<1|2>:DELTamarker<1...4>:MAXimum:NEXT
- CALCulate<1|2>:DELTamarker<1...4>:MAXimum:RIGHT
- CALCulate<1|2>:DELTamarker<1...4>:MINimum[:PEAK]
- CALCulate<1|2>:DELTamarker<1...4>:MINimum:LEFT
- CALCulate<1|2>:DELTamarker<1...4>:MINimum:NEXT
- CALCulate<1|2>:DELTamarker<1...4>:MINimum:RIGHT
- CALCulate<1|2>:DELTamarker<1...4>:MODE

- CALCulate<1|2>:DELTamarker<1...4>:TRACe
- CALCulate<1|2>:DELTamarker<1...4>:X
- CALCulate<1|2>:DELTamarker<1...4>:X:RELative?
- CALCulate<1|2>:DELTamarker<1...4>:Y?

CALCulate<1|2>:DELTamarker<1...4>[:STATe]

This command switches on and off the delta marker when delta marker 1 is selected. The corresponding marker becomes the delta marker when delta marker 2 to 4 is selected. If the corresponding marker is not activated, it will be activated and positioned on the maximum of the measurement curve.

If no numeric suffix with DELTmarker is indicated, delta marker 1 is selected automatically.

The numeric suffixes <1|2> are irrelevant for this command.

Parameter

ON | OFF

Example

```
CALC:DELT3 ON
```

Switches marker 3 to delta marker mode.

Characteristics

RST value: OFF

SCPI: device-specific

Mode

all

CALCulate<1|2>:DELTamarker<1...4>:AOFF

This command switches off all active delta markers.

The numeric suffixes <1|2> are irrelevant for this command.

Example

```
CALC:DELT:AOFF
```

Switches off all delta markers.

Characteristics

RST value: –

SCPI: device-specific

Mode

A, ADEMOD, CATV

CALCulate<1|2>:DELTamarker<1...4>:FUNction:FIXed[:STATe]

This command switches the relative measurement to a fixed reference value on or off. Marker 1 will be activated previously and a peak search will be performed, if necessary. If marker 1 is activated, its position becomes the reference point for the measurement. The reference point can then be modified with the

`CALCulate<1|2>:DELTamarker<1...4>:FUNction:FIXed:RPOint:X` commands and `CALCulate<1|2>:DELTamarker<1...4>:FUNction:FIXed:RPOint:Y` independently of the position of marker 1 and of a trace. It applies to all delta markers as long as the function is active.

The numeric suffixes <1|2> are irrelevant for this command.

Parameter

ON | OFF

Example

```
CALC:DELT:FUNC:FIX ON
```

Switches on the measurement with fixed reference value for all delta markers.

```
CALC:DELT:FUNC:FIX:RPO:X 128 MHZ
```

Sets the frequency reference to 128 MHz.

```
CALC:DELT:FUNC:FIX:RPO:Y 30 DBM
```

Sets the reference level to +30 dBm.

Characteristics

RST value: OFF

SCPI: device-specific

Mode

A

CALCulate<1|2>:DELTamarker<1...4>:FUNction:FIXed:RPOint:MAXimum[:PEAK]

This command sets the reference point level for all delta markers for a measurement with fixed reference point (`CALCulate<1|2>:DELTamarker<1...4>:FUNction:FIXed[:STATe]`) to the peak of the selected trace.

For phase-noise measurements

(`CALCulate<1|2>:DELTamarker<1...4>:FUNction:PNOise[:STATe]`), the command defines a new reference point level for delta marker 2.

The numeric suffixes <1|2> are irrelevant for this command.

This command is an event and therefore has no *RST value and no query.

Parameter

<numeric_value>

Example

```
CALC:DELT:FUNC:FIX:RPO:MAX
```

Sets the reference point level for delta markers to the peak of the selected trace.

Characteristics

RST value: –

SCPI: device-specific

Mode

A

CALCulate<1|2>:DELTamarker<1...4>:FUNCTION:FIXed:RPOint:X

This command defines a new frequency reference (span > 0) or time (span = 0) for all delta markers for a measurement with fixed reference value

(CALCulate<1|2>:DELTamarker<1...4>:FUNCTION:FIXed[:STATe]).

For phase-noise measurements

(CALCulate<1|2>:DELTamarker<1...4>:FUNCTION:PNOise[:STATe]), the command defines a new frequency reference or time for delta marker 2.

The numeric suffixes <1|2> are irrelevant for this command.

Parameter

<numeric_value>

Example

```
CALC:DELT:FUNC:FIX:RPO:X 128MHz
```

Sets the frequency reference to 128 MHz.

Characteristics

RST value: – (CALCulate<1|2>:DELTamarker<1...4>:FUNCTION:FIXed[:STATe] is set to OFF)

SCPI: device-specific

Mode

A

CALCulate<1|2>:DELTamarker<1...4>:FUNCTION:FIXed:RPOint:Y

This command defines a new reference point level for all delta markers for a measurement with fixed reference point

(CALCulate<1|2>:DELTamarker<1...4>:FUNCTION:FIXed[:STATe]).

For phase-noise measurements

(CALCulate<1|2>:DELTamarker<1...4>:FUNCTION:PNOise[:STATe]), the command defines a new reference point level for delta marker 2.

The numeric suffixes <1|2> are irrelevant for this command.

Parameter

<numeric_value>

Example

```
CALC:DELT:FUNC:FIX:RPO:Y -10dBm
```

Sets the reference point level for delta markers to –10 dBm.

Characteristics

RST value: – (CALCulate<1|2>:DELTamarker<1...4>:FUNCTION:FIXed[:STATe] is set to OFF)

SCPI: device-specific

Mode

A

CALCulate<1|2>:DELTamarker<1...4>:FUNCTION:FIXed:RPOint:Y:OFFSet

This command defines an additional level offset for the measurement with fixed reference value (CALCulate:DELTamarker:FUNCTION:FIXed:STATe ON). For this measurement, the offset is included in the display of all delta markers.

For phase-noise measurements

(`CALCulate<1|2>:DELTamarker<1...4>:FUNCTION:PNOise[:STATe]`), the command defines an additional level offset which is included in the display of delta marker 2.

The numeric suffixes <1|2> are irrelevant for this command.

Parameter

<numeric_value>

Example

```
CALC:DELT:FUNC:FIX:RPO:Y:OFFS 10dB
```

Sets the level offset for the measurement with fixed reference value or the phase-noise measurement to 10 dB.

Characteristics

RST value: 0 dB

SCPI: device-specific

Mode

A

CALCulate<1|2>:DELTamarker<1...4>:FUNCTION:PNOise[:STATe]

This command switches on or off the phase-noise measurement with all active delta markers. The correction values for the bandwidth and the log amplifier are taken into account in the measurement.

Marker 1 will be activated, if necessary, and a peak search will be performed. If marker 1 is activated, its position becomes the reference point for the measurement.

The reference point can then be modified with the

`CALCulate<1|2>:DELTamarker<1...4>:FUNCTION:FIXed:RPOint:X` and `CALCulate<1|2>:DELTamarker<1...4>:FUNCTION:FIXed:RPOint:Y` commands independently of the position of marker 1 and of a trace (the same commands used for the measurement with fixed reference point).

The numeric suffixes <1|2> and <1...4> are irrelevant for this command.

Parameter

ON | OFF

Example

```
CALC:DELT:FUNC:PNO ON
```

Switches on the phase-noise measurement with all delta markers.

```
CALC:DELT:FUNC:FIX:RPO:X 128 MHZ
```

Sets the frequency reference to 128 MHz.

```
CALC:DELT:FUNC:FIX:RPO:Y 30 DBM
```

Sets the reference level to +30 dBm

Characteristics

RST value: OFF

SCPI: device-specific

Mode

A

CALCulate<1|2>:DELTamarker<1...4>:FUNCtion:PNOise:RESult?

This command queries the result of the phase-noise measurement. The measurement will be switched on, if necessary.

The numeric suffixes <1|2> are irrelevant for this command.

This command is only a query and therefore has no *RST value.

Example

```
CALC:DELT:FUNC:PNO:RES?
```

Outputs the result of phase-noise measurement of the selected delta marker.

Characteristics

RST value: –

SCPI: device-specific

Mode

A

CALCulate<1|2>:DELTamarker<1...4>:MAXimum[:PEAK]

This command positions the delta marker to the current maximum value on the measured curve. If necessary, the corresponding delta marker will be activated first.

The numeric suffixes <1|2> are irrelevant for this command.

This command is an event and therefore has no *RST value and no query.

Example

```
CALC:DELT3:MAX
```

Sets delta marker 3 to the maximum value of the associated trace.

Characteristics

RST value: –

SCPI: device-specific

Mode

A, ADEMOD, CATV

CALCulate<1|2>:DELTamarker<1...4>:MAXimum:LEFT

This command positions the delta marker to the next smaller maximum value to the left of the current value (i.e. descending X values). The corresponding delta marker will be activated first, if necessary.

The numeric suffixes <1|2> are irrelevant for this command.

This command is an event and therefore has no *RST value and no query.

Example

```
CALC:DELT:MAX:LEFT
```

Sets delta marker 1 to the next smaller maximum value to the left of the current value.

Characteristics

RST value: –

SCPI: device-specific

Mode

A, ADEMOD, CATV

CALCulate<1|2>:DELTamarker<1...4>:MAXimum:NEXT

This command positions the delta marker to the next smaller maximum value on the measured curve. The corresponding delta marker will be activated first, if necessary.

The numeric suffixes <1|2> are irrelevant for this command.

This command is an event and therefore has no *RST value and no query.

Example

```
CALC:DELT2:MAX:NEXT
```

Sets delta marker 2 to the next smaller maximum value.

Characteristics

RST value: –

SCPI: device-specific

Mode

A, ADEMOD, CATV

CALCulate<1|2>:DELTamarker<1...4>:MAXimum:RIGHT

This command positions the delta marker to the next smaller maximum value to the right of the current value (i.e. ascending X values). The corresponding delta marker is activated first, if necessary.

The numeric suffixes <1|2> are irrelevant for this command.

This command is an event and therefore has no *RST value and no query.

Example

```
CALC:DELT:MAX:RIGH
```

Sets delta marker 1 to the next smaller maximum value to the right of the current value.

Characteristics

RST value: –

SCPI: device-specific

Mode

A, ADEMOD, CATV

CALCulate<1|2>:DELTamarker<1...4>:MINimum[:PEAK]

This command positions the delta marker to the current minimum value on the measured curve. The corresponding delta marker will be activated first, if necessary.

The numeric suffixes <1|2> are irrelevant for this command.

This command is an event and therefore has no *RST value and no query.

Example

```
CALC:DELT3:MIN
```

Sets delta marker 3 to the minimum value of the associated trace.

Characteristics

RST value: –

SCPI: device-specific

Mode

A, ADEMOD, CATV

CALCulate<1|2>:DELTamarker<1...4>:MINimum:LEFT

This command positions the delta marker to the next higher minimum value to the left of the current value (i.e. descending X values). The corresponding delta marker will be activated first, if necessary.

The numeric suffixes <1|2> are irrelevant for this command.

This command is an event and therefore has no *RST value and no query.

Example

```
CALC:DELT:MIN:LEFT
```

Sets delta marker 1 to the next higher minimum to the left of the current value.

Characteristics

RST value: –

SCPI: device-specific

Mode

A, ADEMOD, CATV

CALCulate<1|2>:DELTamarker<1...4>:MINimum:NEXT

This command positions the delta marker to the next higher minimum value of the measured curve. The corresponding delta marker will be activated first, if necessary.

The numeric suffixes <1|2> are irrelevant for this command.

This command is an event and therefore has no *RST value and no query.

Example

```
CALC:DELT2:MIN:NEXT
```

Sets delta marker 2 to the next higher minimum value.

Characteristics

RST value: –

SCPI: device-specific

Mode

A, ADEMOD, CATV

CALCulate<1|2>:DELTamarker<1...4>:MINimum:RIGHT

This command positions the delta marker to the next higher minimum value to the right of the current value (i.e. ascending X values). The corresponding delta marker will be activated first, if necessary.

The numeric suffixes <1|2> are irrelevant for this command.

This command is an event and therefore has no *RST value and no query.

Example

```
CALC:DELT:MIN:RIGH
```

Sets delta marker 1 to the next higher minimum value to the right of the current value.

Characteristics

RST value: –

SCPI: device-specific

Mode

A, ADEMOD, CATV

CALCulate<1|2>:DELTamarker<1...4>:MODE

This command switches between relative and absolute frequency input of the delta marker (or time with span = 0).

The numeric suffixes <1|2> are irrelevant for this command.

Parameter

ABSolute | RELative

Example

```
CALC:DELT:MODE ABS
```

Switches the frequency/time indication for all delta markers to absolute values.

```
CALC:DELT:MODE REL
```

Switches the frequency/time indication for all delta markers to relative to marker 1.

Characteristics

RST value: REL

SCPI: device-specific

Mode

all

CALCulate<1|2>:DELTamarker<1...4>:TRACe

This command assigns the selected delta marker to the indicated trace. The selected trace must be active, i.e. its state must be different from "BLANK".

The numeric suffixes <1|2> are irrelevant for this command.

Parameter

1 to 4

Example

```
CALC:DELT3:TRAC 2
```

Assigns delta marker 3 to trace 2.

Characteristics

RST value: –

SCPI: device-specific

Mode

A, ADEMOD, CATV

CALCulate<1|2>:DELTamarker<1...4>:X

This command positions the selected delta marker to the indicated frequency (span > 0), time (span = 0) or level (APD measurement = ON or CCDF measurement = ON). The input is in absolute values or relative to marker 1 depending on the command

[CALCulate<1|2>:DELTamarker<1...4>:MODE](#). If reference fixed measurement ([CALCulate<1|2>:DELTamarker<1...4>:FUNCTION:FIXed\[:STATe\]](#) is ON) is active, relative values refer to the reference position are entered. The query always returns absolute values.

The numeric suffixes <1|2> are irrelevant for this command.

Parameter

0 to MAX (frequency | sweep time)

Example

```
CALC:DELT:MOD REL
```

Switches the input for all delta markers to relative to marker 1.

```
CALC:DELT2:X 10.7MHz
```

Positions delta marker 2 10.7 MHz to the right of marker 1.

```
CALC:DELT:X?
```

Outputs the absolute frequency/time of delta marker 1.

```
CALC:DELT:X:REL?
```

Outputs the relative frequency/time/level of delta marker 1.

Characteristics

RST value: –

SCPI: device-specific

Mode

A, ADEMOD, CATV

CALCulate<1|2>:DELTamarker<1...4>:X:RELative?

This command queries the frequency (span > 0) or time (span = 0) of the selected delta marker relative to marker 1 or to the reference position (for [CALCulate<1|2>:DELTamarker<1...4>:FUNCTion:FIXed\[:STATe\]](#) is ON). The command activates the corresponding delta marker, if necessary.

The numeric suffixes <1|2> are irrelevant for this command.

Example

```
CALC:DELT3:X:REL?
```

Outputs the frequency of delta marker 3 relative to marker 1 or relative to the reference position.

Characteristics

RST value: –

SCPI: device-specific

Mode

A, ADEMOD, CATV

CALCulate<1|2>:DELTamarker<1...4>:Y?

This command queries the measured value of the selected delta marker. The corresponding delta marker will be activated, if necessary. The output is always a relative value referred to marker 1 or to the reference position (reference fixed active).

To obtain a correct query result, a complete sweep with synchronization to the sweep end must be performed between the activation of the delta marker and the query of the y value. This is only possible in single sweep mode.

Depending on the unit defined with [CALCulate<1|2>:UNIT:POWer](#) or on the activated measuring functions, the query result is output in the units below:

Parameter or measuring functions	Output unit
DBM DBPW DBUV DBMV DBUA	dB (lin/log)
WATT VOLT AMPere	dB (lin), % (log)
statistics function (APD or CCDF) on	dimensionless output

The numeric suffixes <1|2> are irrelevant for this command.

Example

```
INIT:CONT OFF
```

Switches to single sweep mode.

```
CALC:DELT2 ON
```

Switches on delta marker 2.

```
INIT;*WAI
```

Starts a sweep and waits for its end.

```
CALC:DELT2:Y?
```

Outputs measurement value of delta marker 2.

Characteristics

RST value: –

SCPI: device-specific

Mode

A, ADEMOD, BT, CATV

CALCulate:DLINe Subsystem

The CALCulate:DLINe subsystem defines the position of the display lines.

Commands of the CALCulate:DLINe Subsystem

- [CALCulate<1|2>:DLINe<1|2>](#)
- [CALCulate<1|2>:DLINe<1|2>:STATe](#)

CALCulate<1|2>:DLINe<1|2>

This command defines the position of display line 1 or 2. These lines enable the user to mark any levels in the diagram. The unit depends on the setting made with [CALCulate<1|2>:UNIT:POWer](#).

The numeric suffixes <1|2> are irrelevant for this command.

Parameter

MINimum to MAXimum (depending on current unit)

Example

```
CALC:DLIN -20dBm
```

Characteristics

*RST value: – (STATe to OFF)

SCPI: device-specific

Mode

A

CALCulate<1|2>:DLINe<1|2>:STATe

This command switches display line 1 or 2 (level lines) on or off.
The numeric suffixes <1|2> are irrelevant for this command.

Parameter

ON | OFF

Example

```
CALC:DLIN2:STAT OFF
```

Characteristics

*RST value: OFF

SCPI: device-specific

Mode

A

CALCulate:FLINe Subsystem

The CALCulate:FLINe subsystem defines the position of the frequency lines.

Commands of the CALCulate:FLINe Subsystem

- [CALCulate<1|2>:FLINe<1|2>](#)
- [CALCulate<1|2>:FLINe<1|2>:STATe](#)

CALCulate<1|2>:FLINe<1|2>

This command defines the position of the frequency lines that mark the frequencies.
The numeric suffixes <1|2> are irrelevant for this command.

Parameter

0 to f_{\max}

Example

```
CALC:FLIN2 120MHz
```

Characteristics

*RST value: – (STATe to OFF)

SCPI: device-specific

Mode

A–F

CALCulate<1|2>:FLINe<1|2>:STATe

This command switches the frequency line on or off.
The numeric suffixes <1|2> are irrelevant for this command.

Parameter

ON | OFF

Example

```
CALC:FLIN2:STAT ON
```

Characteristics

*RST value: OFF

SCPI: device-specific

Mode

A-F

CALCulate:LIMit Subsystem

The CALCulate:LIMit subsystem consists of the limit lines and the corresponding limit checks. Limit lines can be defined as upper or lower limit lines. The individual Y values of the limit lines correspond to the values of the X axis (CONTRol). The number of X and Y values must be identical. For details on limit lines refer to chapter "Instrument Functions", section "Using Limit Lines and Display Lines – LINES Key", or the Online Help.

The following subsystems are included:

- ["CALCulate:LIMit:ACPower Subsystem"](#) on page 6.24
- ["CALCulate:LIMit:CONTRol Subsystem"](#) on page 6.24
- ["CALCulate:LIMit:LOWer Subsystem"](#) on page 6.34
- ["CALCulate:LIMit:UPPer Subsystem"](#) on page 6.38

Commands of the CALCulate:LIMit Subsystem

- [CALCulate<1|2>:LIMit<1...8>:CLEAr\[:IMMediate\]](#)
- [CALCulate<1|2>:LIMit<1...8>:COMMeNt](#)
- [CALCulate<1|2>:LIMit<1...8>:COPIY](#)
- [CALCulate<1|2>:LIMit<1...8>:DELeTe](#)
- [CALCulate<1|2>:LIMit<1...8>:FAIL?](#)
- [CALCulate<1|2>:LIMit<1...8>:NAME](#)
- [CALCulate<1|2>:LIMit<1...8>:STATe](#)
- [CALCulate<1|2>:LIMit<1...8>:TRACe](#)
- [CALCulate<1|2>:LIMit<1...8>:UNIT](#)

Further information

- [Example \(analyzer mode\)](#)
- [Definition of the limit line](#)
- [Switching on and evaluating the line](#)

Example (analyzer mode)

Definition and use of a new limit line 5 for trace 2 with the following features:

- upper limit line
- absolute X axis with span > 0.
- 5 ref. values: 126 MHz/–40 dB, 127 MHz/–40 dB, 128 MHz/–20 dB, 129 MHz/–40 dB, 130 MHz/–40 dB
- relative Y axis with unit dB
- absolute threshold value at –35 dBm
- no safety margin

Definition of the limit line

1. Defining the name:

```
CALC:LIM5:NAME 'TEST1'
```

2. Entering the comment:

```
CALC:LIM5:COMM 'Upper limit line'
```

3. Associated trace:

```
CALC:LIM5:TRAC 2
```

4. Defining the X axis range:

```
CALC:LIM5:CONT:DOM FREQ
```

5. Defining the X axis scaling:

```
CALC:LIM5:CONT:MODE ABS
```

6. Defining the Y axis unit:

```
CALC:LIM5:UNIT DB
```

7. Defining the Y axis scaling:

```
CALC:LIM5:UPP:MODE REL
```

8. Defining the X axis values:

```
CALC:LIM5:CONT 126MHZ, 127MHZ, 128MHZ, 129 MHZ, 130MHZ
```

9. Defining the y values:

```
CALC:LIM5:UPP -40, -40, -30, -40, -40
```

10. Defining the y threshold value:

```
CALC:LIM5:UPP:THR -35DBM
```

The definition of the safety margin and shifting in X and/or Y direction can take place as from here (see commands below).

Switching on and evaluating the line

1. Switching on the line:

```
CALC:LIM5:UPP:STAT ON
```

2. Switching on the limit check:

```
CALC:LIM5:STAT ON
```

3. Starting a new measurement with synchronization:

```
INIT;*WAI
```

4. Querying the limit check result:

```
CALC:LIM5:FAIL?
```

CALCulate<1|2>:LIMit<1...8>:CLEar[:IMMediate]

This command deletes the result of the current limit check for all limit lines.

The numeric suffixes <1|2> are irrelevant for this command.

This command is an event and therefore has no *RST value.

This command is available from firmware version 1.10.

Example

```
CALC:LIM:CLE
```

Deletes the result of the limit check.

Characteristics

*RST value: –

SCPI: conform

Mode

A, FM

CALCulate<1|2>:LIMit<1...8>:COMMent

This command defines a comment for the limit line selected (max. 40 characters).

The numeric suffixes <1|2> are irrelevant for this command.

This command is available from firmware version 1.10.

Parameter

<string>

Example

```
CALC:LIM5:COMM Upper limit for spectrum
```

Defines the comment for limit line 5.

Characteristics

*RST value: blank comment

SCPI: device-specific

Mode

A, FM

CALCulate<1|2>:LIMit<1...8>:COPY

This command copies one limit line onto another one

The numeric suffixes <1|2> are irrelevant for this command.

This command is an event and therefore has no *RST value and no query.

This command is available from firmware version 1.10.

Parameter

1 to 8 number of the new limit line

<name> name of the new limit line given as a string

Example

```
CALC:LIM1:COPY 2
```

Copies limit line 1 to line 2.

```
CALC:LIM1:COPY FM2
```

Copies limit line 1 to a new line named FM2.

Characteristics

*RST value: –

SCPI: device-specific

Mode

A, FM

CALCulate<1|2>:LIMit<1...8>:DELeTe

This command deletes the selected limit line.

The numeric suffixes <1|2> are irrelevant for this command.

This command is an event and therefore has no *RST value and no query.

This command is available from firmware version 1.10.

Example

```
CALC:LIM1:DEL
```

Deletes limit line 1.

Characteristics

*RST value: –

SCPI: device-specific

Mode

A, FM

CALCulate<1|2>:LIMit<1...8>:FAIL?

This command queries the result of the limit check of the indicated limit line. It should be noted that a complete sweep must have been performed for obtaining a correct result. A synchronization with *OPC, *OPC? or *WAI should therefore be provided. The result of the limit check is given with 0 for PASS, 1 for FAIL, and 2 for MARGIN.

The numeric suffixes <1|2> are irrelevant for this command.

This command is available from firmware version 1.10.

Example

```
INIT; *WAI
```

Starts a new sweep and waits for its end.

```
CALC:LIM3:FAIL?
```

Queries the result of the check for limit line 3.

Characteristics

*RST value: –

SCPI: conform

Mode

A, FM, WLAN

CALCulate<1|2>:LIMit<1...8>:NAME

This command assigns a name to a limit line numbered 1 to 8. If it does not exist already, a limit line with this name is created.

The numeric suffixes <1|2> are irrelevant for this command.

This command is available from firmware version 1.10.

Parameter

<name of limit line>

Example

```
CALC:LIM1:NAME 'FM1'
```

Assigns the name FM1 to limit line 1.

Characteristics

*RST value: REM1 to REM8 for lines 1 to 8

SCPI: device-specific

Mode

A, FM

CALCulate<1|2>:LIMit<1...8>:STATe

This command switches on or off the limit check for the selected limit line.

The result of the limit check can be queried with [CALCulate<1|2>:LIMit<1...8>:FAIL?](#).

The numeric suffixes <1|2> are irrelevant for this command.

This command is available from firmware version 1.10.

Parameter

ON | OFF

Example

```
CALC:LIM:STAT ON
```

Switches on the limit check for limit line 1.

Characteristics

*RST value: OFF

SCPI: conform

Mode

A, BT; FM

CALCulate<1|2>:LIMit<1...8>:TRACe

This command assigns a limit line to a trace.

The numeric suffixes <1|2> are irrelevant for this command.

This command is available from firmware version 1.10.

Parameter

1 to 4

Example

```
CALC:LIM2:TRAC 3
```

Assigns limit line 2 to trace 3.

Characteristics

*RST value: 1

SCPI: device-specific

Mode

A, FM

CALCulate<1|2>:LIMit<1...8>:UNIT

This command defines the unit of the selected limit line.

Upon selection of the unit DB the limit line is automatically switched to the relative mode. For units different from DB the limit line is automatically switched to absolute mode.

The units DEG, RAD, S, HZ, PCT are not available in spectrum analyzer mode.

The numeric suffixes <1|2> are irrelevant for this command.

This command is available from firmware version 1.10.

Parameter

DBM | DBPW | WATT | DBUV | DBMV | VOLT | DBUA | AMPere | DBPT | DB | DEG | RAD | S | HZ | PCT | UNITLESS

Example

```
CALC:LIM4:UNIT DBUV
```

Sets the unit of limit line 4 to dB μ V.

Characteristics

*RST value: DBM

SCPI: device-specific

Mode

A, FM

CALCulate:LIMit:ACPower Subsystem

The CALCulate:LIMit:ACPower subsystem defines the limit check for adjacent channel power measurement.

Commands of the CALCulate:LIMit:ACPower Subsystem

- CALCulate<1|2>:LIMit<1...8>:ACPower[:STATe]
- CALCulate<1|2>:LIMit<1...8>:ACPower:ACHannel[:RELative]
- CALCulate<1|2>:LIMit<1...8>:ACPower:ACHannel[:RELative]:STATe
- CALCulate<1|2>:LIMit<1...8>:ACPower:ACHannel:ABSolute
- CALCulate<1|2>:LIMit<1...8>:ACPower:ACHannel:ABSolute:STATe
- CALCulate<1|2>:LIMit<1...8>:ACPower:ACHannel:RESult?
- CALCulate<1|2>:LIMit<1...8>:ACPower:ALternate<1|2>[:RELative]
- CALCulate<1|2>:LIMit<1...8>:ACPower:ALternate<1|2>[:RELative]:STATe
- CALCulate<1|2>:LIMit<1...8>:ACPower:ALternate<1|2>:ABSolute
- CALCulate<1|2>:LIMit<1...8>:ACPower:ALternate<1|2>:ABSolute:STATe
- CALCulate<1|2>:LIMit<1...8>:ACPower:ALternate<1|2>:RESult?

CALCulate<1|2>:LIMit<1...8>:ACPower[:STATe]

This command switches on and off the limit check for adjacent–channel power measurements. The `CALCulate<1|2>:LIMit<1...8>:ACPower:ACHannel[:RELative]:STATe` or `CALCulate<1|2>:LIMit<1...8>:ACPower:ALternate<1|2>[:RELative]:STATe` commands must be used in addition to specify whether the limit check is to be performed for the upper/lower adjacent channel or for the alternate adjacent channels. The numeric suffixes <1|2> and <1...8> are irrelevant for this command.

Parameter

ON | OFF

Example

```
CALC:LIM:ACP ON
Switches on the ACP limit check.
```

Characteristics

*RST value: OFF
SCPI: device–specific

Mode

A

CALCulate<1|2>:LIMit<1...8>:ACPower:ACHannel[:RELative]

This command defines the relative limit of the upper/lower adjacent channel for adjacent–channel power measurements. The reference value for the relative limit value is the measured channel power.

It should be noted that the relative limit value has no effect on the limit check as soon as it is below the absolute limit value defined with the `CALCulate<1|2>:LIMit<1...8>:ACPower:ACHannel:ABSolute` command. This

mechanism allows automatic checking of the absolute basic values of adjacent-channel power as defined in mobile radio standards.

The numeric suffixes <1|2> and <1...8> are irrelevant for this command.

Parameter

first value: 0 to 100dB; limit for the upper (lower) adjacent channel

second value: 0 to 100dB; is ignored but must be indicated for reasons of compatibility with the FSP family

Example

```
CALC:LIM:ACP:ACH 30DB, 30DB
```

Sets the relative limit value for the power in the lower and upper adjacent channel to 30 dB below the channel power.

Characteristics

*RST value: 0 dB

SCPI: device-specific

Mode

A

CALCulate<1|2>:LIMit<1...8>:ACPpower:ACHannel[:RELative]:STATe

This command activates the limit check for the relative limit value of the adjacent channel when adjacent-channel power measurement is performed. Before the command, the limit check must be activated using `CALCulate<1|2>:LIMit<1...8>:ACPpower[:STATe]`.

The result can be queried with

`CALCulate<1|2>:LIMit<1...8>:ACPpower:ACHannel:RESult?`. It should be noted that a complete measurement must be performed between switching on the limit check and the result query, since otherwise no correct results are available.

The numeric suffixes <1|2> and <1...8> are irrelevant for this command.

Parameter

ON | OFF

Example

```
CALC:LIM:ACP:ACH 30DB, 30DB
```

Sets the relative limit value for the power in the lower and upper adjacent channel to 30 dB below the channel power.

```
CALC:LIM:ACP:ACH:ABS -35DBM, -35DBM
```

Sets the absolute limit value for the power in the lower and upper adjacent channel to -35 dBm.

```
CALC:LIM:ACP ON
```

Switches on globally the limit check for the channel/adjacent channel measurement.

```
CALC:LIM:ACP:ACH:REL:STAT ON
```

Switches on the check of the relative limit values for adjacent channels.

```
CALC:LIM:ACP:ACH:ABS:STAT ON
```

Switches on the check of absolute limit values for the adjacent channels.

```
INIT;*WAI
```

Starts a new measurement and waits for the sweep end.

```
CALC:LIM:ACP:ACH:RES?
```

Queries the limit check result in the adjacent channels.

Characteristics

*RST value: OFF

SCPI: device-specific

Mode

A

CALCulate<1|2>:LIMit<1...8>:ACPpower:ACHannel:ABSolute

This command defines the absolute limit value for the lower/upper adjacent channel during adjacent-channel power measurement (Adjacent Channel Power).

It should be noted that the absolute limit value has no effect on the limit check as soon as it is below the relative limit value defined with

`CALCulate<1|2>:LIMit<1...8>:ACPpower:ACHannel[:RELative]`. This mechanism allows automatic checking of the absolute basic values of adjacent-channel power as defined in mobile radio standards.

The numeric suffixes <1|2> and <1...8> are irrelevant for this command.

Parameter

first value: –200DBM to 200DBM; limit for the lower and the upper adjacent channel

second value: –200 to 200DBM; is ignored but must be indicated for reasons of compatibility with the FSP family

Example

```
CALC:LIM:ACP:ACH:ABS -35DBM, -35DBM
```

Sets the absolute limit value for the power in the lower and upper adjacent channel to –35 dBm.

Characteristics

*RST value: –200DBM

SCPI: device-specific

Mode

A

CALCulate<1|2>:LIMit<1...8>:ACPpower:ACHannel:ABSolute:STATe

This command activates the limit check for the adjacent channel when adjacent-channel power measurement (Adjacent Channel Power) is performed. Before the command, the limit check for the channel/adjacent-channel measurement must be globally switched on using `CALCulate<1|2>:LIMit<1...8>:ACPpower[:STATe]`.

The result can be queried with

`CALCulate<1|2>:LIMit<1...8>:ACPpower:ACHannel:RESult?`. It should be noted that a complete measurement must be performed between switching on the limit check and the result query, since otherwise no correct results are available.

The numeric suffixes <1|2> and <1...8> are irrelevant for this command.

Parameter

ON | OFF

Example

```
CALC:LIM:ACP:ACH 30DB, 30DB
```

Sets the relative limit value for the power in the lower and upper adjacent channel to 30 dB below the channel power.

```
CALC:LIM:ACP:ACH:ABS -35DBM, -35DBM
```

Sets the absolute limit value for the power in the lower and upper adjacent channel to –35 dBm.

```
CALC:LIM:ACP ON
```

Switches on globally the limit check for the channel/adjacent-channel measurement.

```
CALC:LIM:ACP:ACH:REL:STAT ON
```

Switches on the check of the relative limit values for adjacent channels.

```
CALC:LIM:ACP:ACH:ABS:STAT ON
```

Switches on the check of absolute limit values for the adjacent channels.

```
INIT;*WAI
```

Starts a new measurement and waits for the sweep end.

```
CALC:LIM:ACP:ACH:RES?
```

Queries the limit check result in the adjacent channels.

Characteristics

*RST value: OFF

SCPI: device-specific

Mode

A

CALCulate<1|2>:LIMit<1...8>:ACPpower:ACHannel:RESult?

This command queries the result of the limit check for the upper/lower adjacent channel when adjacent channel power measurement is performed.

If the power measurement of the adjacent channel is switched off, the command produces a query error.

The numeric suffixes <1|2> and <1...8> are irrelevant for this command.

This command is a query and therefore has no *RST value.

Parameter

The result is returned in the form <result>, <result> where <result> = PASSED | FAILED, and where the first returned value denotes the lower, the second denotes the upper adjacent channel.

Example

```
CALC:LIM:ACP:ACH 30DB, 30DB
```

Sets the relative limit value for the power in the lower and upper adjacent channel to 30 dB below the channel power.

```
CALC:LIM:ACP:ACH:ABS -35DBM, -35DBM
```

Sets the absolute limit value for the power in the lower and upper adjacent channel to -35 dB.

```
CALC:LIM:ACP ON
```

Switches on globally the limit check for the channel/adjacent channel measurement.

```
CALC:LIM:ACP:ACH:STAT ON
```

Switches on the limit check for the adjacent channels.

```
INIT;*WAI
```

Starts a new measurement and waits for the sweep end.

```
CALC:LIM:ACP:ACH:RES?
```

Queries the limit check result in the adjacent channels.

Characteristics

*RST value: –

SCPI: device-specific

Mode

A, WLAN

CALCulate<1|2>:LIMit<1...8>:ACPpower:ALTernate<1|2>[:RELative]

This command defines the limit for the first/second alternate adjacent channel for adjacent channel power measurements. The reference value for the relative limit value is the measured channel power.

The numeric suffix after `ALTernate<1|2>` denotes the first or the second alternate channel. The numeric suffixes `<1|2>` with `CALCulate` and `<1...8>` with `LIMit` are irrelevant for this command.

It should be noted that the relative limit value has no effect on the limit check as soon as it is below the absolute limit defined with `CALCulate<1|2>:LIMit<1...8>:ACPpower:ALTernate<1|2>:ABSolute`. This mechanism allows automatic checking of the absolute basic values of adjacent-channel power as defined in mobile radio standards.

Parameter

first value: 0 to 100dB; limit for the lower and the upper alternate adjacent channel

second value: 0 to 100dB; is ignored but must be indicated for reasons of compatibility with the FSP family

Example

```
CALC:LIM:ACP:ALT2 30DB, 30DB
```

Sets the relative limit value for the power in the lower and upper alternate adjacent channel to 30 dB below the channel power.

Characteristics

*RST value: 0 DB

SCPI: device-specific

Mode

A

CALCulate<1|2>:LIMit<1...8>:ACPpower:ALTernate<1|2>[:RELative]:STATe

This command activates the limit check for the first/second alternate adjacent channel for adjacent channel power measurements. Before the command, the limit check must be activated using `CALCulate<1|2>:LIMit<1...8>:ACPpower[:STATe]`.

The numeric suffix after `ALTernate<1|2>` denotes the first or the second alternate channel. The numeric suffixes `<1|2>` with `CALCulate` and `<1...8>` with `LIMit` are irrelevant for this command.

The result can be queried with

`CALCulate<1|2>:LIMit<1...8>:ACPpower:ALTernate<1|2>:RESult?`. It should be noted that a complete measurement must be performed between switching on the limit check and the result query, since otherwise no correct results are obtained.

Parameter

ON | OFF

Example

```
CALC:LIM:ACP:ALT2 30DB, 30DB
```

Sets the relative limit value for the power in the lower and upper second alternate adjacent channel to 30 dB below the channel power.

```
CALC:LIM:ACP:ALT2:ABS -35DBM, -35DBM
```

Sets the absolute limit value for the power in the lower and upper second alternate adjacent channel to -35 dBm.

```
CALC:LIM:ACP ON
```

Switches on globally the limit check for the channel/adjacent channel measurement.

CALC:LIM:ACP:ACH:REL:STAT ON

Switches on the check of the relative limit values for the alternate adjacent channels.

CALC:LIM:ACP:ACH:ABS:STAT ON

Switches on the check of absolute limit values for the alternate adjacent channels.

INIT;*WAI

Starts a new measurement and waits for the sweep end.

CALC:LIM:ACP:ACH:RES?

Queries the limit check result in the second alternate adjacent channels.

Characteristics

*RST value: OFF

SCPI: device-specific

Mode

A

CALCulate<1|2>:LIMit<1...8>:ACPpower:ALTernate<1|2>:ABSolute

This command defines the absolute limit value for the lower/upper alternate adjacent-channel power measurement (Adjacent Channel Power).

The numeric suffix after `ALTernate<1|2>` denotes the first or the second alternate channel. The numeric suffixes `<1|2>` with `CALCulate` and `<1...8>` with `LIMit` are irrelevant for this command.

It should be noted that the absolute limit value for the limit check has no effect as soon as it is below the relative limit value defined with

`CALCulate<1|2>:LIMit<1...8>:ACPpower:ALTernate<1|2>[:RELative]`. This mechanism allows automatic checking of the absolute basic values defined in mobile radio standards for the power in adjacent channels.

Parameter

first value: -200DBM to 200DBM; limit for the lower and the upper alternate adjacent channel

second value: -200 to 200DBM; is ignored but must be indicated for reasons of compatibility with the FSP family

Example

CALC:LIM:ACP:ALT2:ABS -35DBM, -35DBM

Sets the absolute limit value for the power in the lower and upper second alternate adjacent channel to -35 dBm.

Characteristics

*RST value: -200DBM

SCPI: device-specific

Mode

A

CALCulate<1|2>:LIMit<1...8>:ACPpower:ALTernate<1|2>:ABSolute:STATe

This command activates the limit check for the first/second alternate adjacent channel for adjacent-channel power measurement (Adjacent Channel Power).

Before the command, the limit check must be globally switched on for the channel/adjacent-channel power with the `CALCulate<1|2>:LIMit<1...8>:ACPpower[:STATe]` command.

The numeric suffix after `ALternate<1|2>` denotes the first or the second alternate channel. The numeric suffixes `<1|2>` with `CALCulate` and `<1...8>` with `LIMit` are irrelevant for this command.

The result can be queried with

`CALCulate<1|2>:LIMit<1...8>:ACPpower:ALternate<1|2>:RESult?`. It should be noted that a complete measurement must be performed between switching on the limit check and the result query, since otherwise no correct results are available.

Parameter

ON | OFF

Example

```
CALC:LIM:ACP:ALT2 30DB, 30DB
```

Sets the relative limit value for the power in the lower and upper second alternate adjacent channel to 30 dB below the channel power.

```
CALC:LIM:ACP:ALT2:ABS -35DBM, -35DBM
```

Sets the absolute limit value for the power in the lower and upper second alternate adjacent channel to -35 dBm.

```
CALC:LIM:ACP ON
```

Switches on globally the limit check for the channel/adjacent channel measurement.

```
CALC:LIM:ACP:ACH:REL:STAT ON
```

Switches on the check of the relative limit values for the alternative adjacent channels.

```
CALC:LIM:ACP:ACH:ABS:STAT ON
```

Switches on the check of absolute limit values for the alternative adjacent channels.

```
INIT;*WAI
```

Starts a new measurement and waits for the sweep end.

```
CALC:LIM:ACP:ACH:RES?
```

Queries the limit check result in the second alternate adjacent channels.

Characteristics

*RST value: OFF

SCPI: device-specific

Mode

A

CALCulate<1|2>:LIMit<1...8>:ACPpower:ALternate<1|2>:RESult?

This command queries the result of the limit check for the first/second alternate adjacent channel for adjacent channel power measurements.

The numeric suffix after `ALternate<1|2>` denotes the first or the second alternate channel. The numeric suffixes `<1|2>` with `CALCulate` and `<1...8>` with `LIMit` are irrelevant for this command.

If the power measurement of the adjacent channel is switched off, the command produces a query error.

This command is a query and therefore has no *RST value.

Parameter

The result is returned in the form `<result>`, `<result>` where `<result>` = PASSED | FAILED and where the first (second) returned value denotes the lower (upper) alternate adjacent channel.

Example

```
CALC:LIM:ACP:ALT2 30DB, 30DB
```

Sets the relative limit value for the power in the lower and upper second alternate adjacent channel to 30 dB below the channel power.

CALC:LIM:ACP:ALT2:ABS -35DBM, -35DBM

Sets the absolute limit value for the power in the lower and upper second alternate adjacent channel to -35 dBm.

CALC:LIM:ACP ON

Switches on globally the limit check for the channel/adjacent channel measurement.

CALC:LIM:ACP:ALT:STAT ON

Switches on the limit check for the adjacent channels.

INIT;*WAI

Starts a new measurement and waits for the sweep end.

CALC:LIM:ACP:ALT:RES?

Queries the limit check result in the second alternate adjacent channels.

Characteristics

*RST value: –

SCPI: device-specific

Mode

A, WLAN

CALCulate:LIMit:CONTRol Subsystem

The CALCulate:LIMit:CONTRol subsystem defines the X axis (CONTRol axis). This subsystem is available from firmware version 1.10.

Commands of the CALCulate:LIMit:CONTRol Subsystem

- [CALCulate<1|2>:LIMit<1...8>:CONTRol\[:DATA\]](#)
- [CALCulate<1|2>:LIMit<1...8>:CONTRol:SPACing](#)
- [CALCulate<1|2>:LIMit<1...8>:CONTRol:DOMain](#)
- [CALCulate<1|2>:LIMit<1...8>:CONTRol:MODE](#)
- [CALCulate<1|2>:LIMit<1...8>:CONTRol:OFFSet](#)
- [CALCulate<1|2>:LIMit<1...8>:CONTRol:SHIFt](#)

CALCulate<1|2>:LIMit<1...8>:CONTRol[:DATA]

This command defines the X axis values (frequencies or times) of the upper or lower limit lines. The number of values for the CONTRol axis and for the corresponding UPPER and/or LOWER limit lines has to be identical. Otherwise default values are entered for missing values or not required values are deleted.

In analyzer mode, the unit of values depends on the span setting of the X axis. For details refer to [CALCulate<1|2>:LIMit<1...8>:CONTRol:DOMain](#).

The numeric suffixes <1|2> are irrelevant for this command.

This command is available from firmware version 1.10.

Parameter

<numeric_value>,<numeric_value>

Example

CALC:LIM2:CONT 1MHz,30MHz,100MHz, 300MHz,1GHz

Defines 5 reference values for the X axis of limit line 2.

CALC:LIM2:CONT?

Outputs the reference values for the X axis of limit line 2 separated by a comma.

Characteristics

*RST value: – (CALCulate<1|2>:LIMit<1...8>:STATe is set to OFF)

SCPI: conform

Mode

A, FM

CALCulate<1|2>:LIMit<1...8>:CONTrol:SPACing

This command selects linear or logarithmic interpolation for the calculation of limit lines from frequency points.

The numeric suffixes <1|2> are irrelevant for this command.

This command is available from firmware version 1.10.

Parameter

LINear | LOGarithmic

Example

```
CALC:LIM:CONT:SPAC LIN
```

Characteristics

*RST value: LIN

SCPI: device-specific

Mode

A

CALCulate<1|2>:LIMit<1...8>:CONTrol:DOMain

This command defines the span setting for the X axis values.

The numeric suffixes <1|2> are irrelevant for this command.

This command is available from firmware version 1.10.

Parameter

FREQuency | TIME

Example

```
CALC:LIM2:CONT:DOM TIME
```

Defines zero span for the X axis of limit line 2.

Characteristics

*RST value: FREQuency

SCPI: device-specific

Mode

A, FM

CALCulate<1|2>:LIMit<1...8>:CONTrol:MODE

This command selects the relative or absolute scaling for the X axis of the selected limit line.

The numeric suffixes <1|2> are irrelevant for this command.

This command is available from firmware version 1.10.

Parameter

RELative | ABSolute

Example

```
CALC:LIM2:CONT:MODE REL
```

Defines the X axis of limit line 2 as relatively scaled.

Characteristics

*RST value: ABSolute

SCPI: device-specific

Mode

A, FM

CALCulate<1|2>:LIMit<1...8>:CONTrol:OFFSet

This command defines an offset for the X axis value of the selected relative limit line for span > 0 or zero span.

In analyzer mode, the unit of values depends on the span setting of the X axis. For details refer to [CALCulate<1|2>:LIMit<1...8>:CONTrol:DOMain](#).

The numeric suffixes <1|2> are irrelevant for this command.

This command is available from firmware version 1.10.

Parameter

<numeric_value>

Example

```
CALC:LIM2:CONT:OFFS 100us
```

Sets the X offset for limit line 2 (defined in zero span) to 100µs.

Characteristics

*RST value: 0

SCPI: device-specific

Mode

A, FM

CALCulate<1|2>:LIMit<1...8>:CONTrol:SHIFt

This command moves a limit line by the indicated value in x direction. In contrast to [CALCulate<1|2>:LIMit<1...8>:CONTrol:OFFSet](#), the line is shifted by modifying the individual x values and not by means of an additive offset.

In analyzer mode, the unit of values depends on the span setting of the X axis. For details refer to [CALCulate<1|2>:LIMit<1...8>:CONTrol:DOMain](#).

The numeric suffixes <1|2> are irrelevant for this command.

This command is an event and therefore has no *RST value and no query.

This command is available from firmware version 1.10.

Parameter

<numeric_value>

Example

```
CALC:LIM2:CONT:SHIF 50KHZ
```

Shifts all reference values of limit line 2 by 50 kHz.

Characteristics

*RST value: –

SCPI: device-specific

Mode

A, FM

CALCulate:LIMit:LOWer Subsystem

The CALCulate:LIMit:LOWer subsystem defines the lower limit line. This subsystem is available from firmware version 1.10.

Commands of the CALCulate:LIMit:LOWer Subsystem

- CALCulate<1|2>:LIMit<1...8>:LOWer[:DATA]
- CALCulate<1|2>:LIMit<1...8>:LOWer:STATe
- CALCulate<1|2>:LIMit<1...8>:LOWer:OFFSet
- CALCulate<1|2>:LIMit<1...8>:LOWer:MARGin
- CALCulate<1|2>:LIMit<1...8>:LOWer:MODE
- CALCulate<1|2>:LIMit<1...8>:LOWer:SHIFt
- CALCulate<1|2>:LIMit<1...8>:LOWer:SPACing
- CALCulate<1|2>:LIMit<1...8>:LOWer:THReshold

CALCulate<1|2>:LIMit<1...8>:LOWer[:DATA]

This command defines the values for the selected lower limit line.

The number of values for the CONTROl axis and for the corresponding LOWer limit line has to be identical. Otherwise default values are entered for missing values or not necessary values are deleted.

The unit must be identical with the unit selected by CALCulate<1|2>:LIMit<1...8>:UNIT. If no unit is indicated, the unit defined with CALCulate<1|2>:LIMit<1...8>:UNIT is automatically used.

If the measured values are smaller than the LOWer limit line, the limit check signals errors.

The units DEG, RAD, S, HZ, PCT are not available in the spectrum analyzer mode.

The numeric suffixes <1|2> are irrelevant for this command.

This command is available from firmware version 1.10.

Parameter

<numeric_value>,<numeric_value>

Example

```
CALC:LIM2:LOW -30,-40,-10,-40,-30
```

Defines 5 lower limit values for limit line 2 in the preset unit.

```
CALC:LIM2:LOW?
```

Outputs the lower limit values of limit line 2 separated by a comma.

Characteristics

*RST value: – (LIMit:STATe is set to OFF)

SCPI: conform

Mode

A, FM

CALCulate<1|2>:LIMit<1...8>:LOWer:STATe

This command switches on or off the indicated limit line. The limit check is activated separately with `CALCulate<1|2>:LIMit<1...8>:STATe`.

In spectrum analyzer mode, the result of the limit check can be queried with `CALCulate<1|2>:LIMit<1...8>:FAIL?`.

The numeric suffixes <1|2> are irrelevant for this command.

This command is available from firmware version 1.10.

Parameter

ON | OFF

Example

```
CALC:LIM4:LOW:STAT ON
Switches on limit line 4 (lower limit).
```

Characteristics

*RST value: OFF

SCPI: conform

Mode

A, FM

CALCulate<1|2>:LIMit<1...8>:LOWer:OFFSet

This command defines an offset for the Y axis of the selected relative lower limit line. In contrast to `CALCulate<1|2>:LIMit<1...8>:LOWer:SHIFt`, the line is not shifted by modifying the individual Y values but by means of an additive offset.

The numeric suffixes <1|2> are irrelevant for this command.

This command is available from firmware version 1.10.

Parameter

<numeric_value>

Example

```
CALC:LIM2:LOW:OFFS 3dB
Shifts limit line 2 by 3 dB upwards.
```

Characteristics

*RST value: 0

SCPI: device-specific

Mode

A, FM

CALCulate<1|2>:LIMit<1...8>:LOWer:MARGin

This command defines a margin to a lower limit line, at which out-of-limit values are signaled (if the limit check is active), but not handled as a violation of the limit value.

Only the unit dB is available in spectrum analyzer mode.

The numeric suffixes <1|2> are irrelevant for this command.

This command is available from firmware version 1.10.

Parameter

<numeric_value>

Example

```
CALC:LIM:LOW:MARG 10dB
```

Characteristics

*RST value: 0

SCPI: device-specific

Mode

A, FM

CALCulate<1|2>:LIMit<1...8>:LOWer:MODE

This command selects the relative or absolute scaling for the Y axis of the selected lower limit line.

Selecting RELative causes the unit to be switched to DB.

The numeric suffixes <1|2> are irrelevant for this command.

This command is available from firmware version 1.10.

Parameter

RELative | ABSolute

Example

```
CALC:LIM:LOW:MODE REL
```

Defines the Y axis of limit line 2 as relative scaled.

Characteristics

*RST value: ABSolute

SCPI: device-specific

Mode

A, FM

CALCulate<1|2>:LIMit<1...8>:LOWer:SHIFt

This command shifts a limit line by the indicated value in Y direction. In contrast to [CALCulate<1|2>:LIMit<1...8>:LOWer:OFFSet](#), the line is shifted by modifying the individual Y values but not by means of an additive offset.

The numeric suffixes <1|2> are irrelevant for this command.

This command is an event and therefore has no *RST value and no query.

This command is available from firmware version 1.10.

Parameter

<numeric_value>

Example

```
CALC:LIM3:LOW:SHIF 20DB
```

Shifts all Y values of limit line 3 by 20 dB.

Characteristics

*RST value: –

SCPI: device-specific

Mode

A, FM

CALCulate<1|2>:LIMit<1...8>:LOWer:SPACing

This command selects linear or logarithmic interpolation for the lower limit line.

The numeric suffixes <1|2> are irrelevant for this command.

This command is available from firmware version 1.10.

Parameter

LINear | LOGarithmic

Example

```
CALC:LIM:LOW:SPAC LIN
```

Characteristics

*RST value: LIN

SCPI: device-specific

Mode

A

CALCulate<1|2>:LIMit<1...8>:LOWer:THReshold

This command defines an absolute threshold value for limit lines with relative Y axis scaling. The absolute threshold value is used in the limit check as soon as it exceeds the relative limit value.

The unit must correspond to the unit selected with `CALCulate<1|2>:LIMit<1...8>:UNIT` (except dB which is not allowed). If no unit is indicated, the unit defined with `CALCulate<1|2>:LIMit<1...8>:UNIT` is automatically used (exception: dBm instead of dB).

The units DEG, RAD, S, HZ, PCT are not available in the spectrum analyzer mode.

The numeric suffixes <1|2> are irrelevant for this command.

This command is available from firmware version 1.10.

Parameter

<numeric_value>

Example

```
CALC:LIM2:LOW:THR -35DBM
```

Defines an absolute threshold value for limit line 2.

Characteristics

*RST value: -200 dBm

SCPI: device-specific

Mode

A, FM

CALCulate:LIMit:UPPer Subsystem

The CALCulate:LIMit:UPPer subsystem defines the upper limit line. This subsystem is available from firmware version 1.10.

Commands of the CALCulate:LIMit:UPPer Subsystem

- CALCulate<1|2>:LIMit<1...8>:UPPer[:DATA]
- CALCulate<1|2>:LIMit<1...8>:UPPer:MARGIn
- CALCulate<1|2>:LIMit<1...8>:UPPer:MODE
- CALCulate<1|2>:LIMit<1...8>:UPPer:OFFSet
- CALCulate<1|2>:LIMit<1...8>:UPPer:SHIFt
- CALCulate<1|2>:LIMit<1...8>:UPPer:SPACing
- CALCulate<1|2>:LIMit<1...8>:UPPer:STATe
- CALCulate<1|2>:LIMit<1...8>:UPPer:THReshold

CALCulate<1|2>:LIMit<1...8>:UPPer[:DATA]

This command defines the values for the upper limit lines

The number of values for the CONTrol axis and for the corresponding UPPer and/or LOWer limit line has to be identical. Otherwise default values are entered for missing values or not necessary values are deleted.

The unit must be identical with the unit selected by CALCulate<1|2>:LIMit<1...8>:UNIT. If no unit is indicated, the unit defined with CALCulate<1|2>:LIMit<1...8>:UNIT is automatically used.

In spectrum analyzer mode, the limit check indicates errors if the measured values exceed the UPPer limit line. The units DEG, RAD, S, HZ, PCT are not available in spectrum analyzer mode.

The numeric suffixes <1|2> are irrelevant for this command.

This command is available from firmware version 1.10.

Parameter

<numeric_value>,<numeric_value>

Example

```
CALC:LIM2:UPP -10,0,0,-10,-5
```

Defines 5 upper limit values for limit line 2 in the preset unit.

```
CALC:LIM2:UPP?
```

Outputs the upper limit values for limit line 2 separated by a comma.

Characteristics

*RST value: – (CALCulate<1|2>:LIMit<1...8>:STATe is set to OFF)

SCPI: conform

Mode

A, FM

CALCulate<1|2>:LIMit<1...8>:UPPer:MARGin

This command defines a margin to an upper limit line, at which out-of-limit values are signaled (if the limit check is active), but not handled as a violation of the limit value.

Only the unit dB is available in spectrum analyzer mode.

The numeric suffixes <1|2> are irrelevant for this command.

This command is available from firmware version 1.10.

Parameter

<numeric_value>

Example

```
CALC:LIM2:UPP:MARG 10dB
```

Defines the margin of limit line 2 to 10 dB below the limit value.

Characteristics

*RST value: 0

SCPI: device-specific

Mode

A, FM

CALCulate<1|2>:LIMit<1...8>:UPPer:MODE

This command selects the relative or absolute scaling for the Y axis of the selected upper limit line.

Selecting RELative causes the unit to be switched to DB.

The numeric suffixes <1|2> are irrelevant for this command.

This command is available from firmware version 1.10.

Parameter

RELative | ABSolute

Example

```
CALC:LIM2:UPP:MODE REL
```

Defines the Y axis of limit line 2 as relative scaled.

Characteristics

*RST value: ABSolute

SCPI: device-specific

Mode

A, FM

CALCulate<1|2>:LIMit<1...8>:UPPer:OFFSet

This command defines an offset for the Y axis of the selected relative upper limit line. In contrast to [CALCulate<1|2>:LIMit<1...8>:UPPer:SHIFt](#), the line is not shifted by modifying the individual Y values but by means of an additive offset.

Only the unit dB is available in the spectrum analyzer mode.

The numeric suffixes <1|2> are irrelevant for this command.

This command is available from firmware version 1.10.

Parameter

<numeric_value>

Example

CALC:LIM2:UPP:OFFS 3dB

Shifts limit line 2 by 3 dB upwards.

Characteristics

*RST value: 0

SCPI: device-specific

Mode

A, FM

CALCulate<1|2>:LIMit<1...8>:UPPer:SHIFt

This command moves a limit line by the indicated value in Y direction. In contrast to [CALCulate<1|2>:LIMit<1...8>:UPPer:OFFSet](#), the line is shifted by modifying the individual Y values and not by means of an additive offset.

The numeric suffixes <1|2> are irrelevant for this command.

This command is an event and therefore has no *RST value and no query.

This command is available from firmware version 1.10.

Parameter

<numeric_value>

Example

CALC:LIM3:UPP:SHIF 20

Shifts all Y values of limit line 3 by 20 limit line units, e.g. dB.

Characteristics

*RST value: –

SCPI: device-specific

Mode

A, FM

CALCulate<1|2>:LIMit<1...8>:UPPer:SPACing

This command selects linear or logarithmic interpolation for the upper limit line.

The numeric suffixes <1|2> are irrelevant for this command.

This command is available from firmware version 1.10.

Parameter

LINear | LOGarithmic

Example

CALC:LIM:UPP:SPAC LIN

Characteristics

*RST value: LIN

SCPI: device-specific

Mode

A

CALCulate<1|2>:LIMit<1...8>:UPPer:STATe

This command switches on or off the indicated limit line. The limit check is activated separately with `CALCulate<1|2>:LIMit<1...8>:STATe`.

In spectrum analyzer mode, the result of the limit check can be queried with `CALCulate<1|2>:LIMit<1...8>:FAIL?`.

The numeric suffixes <1|2> are irrelevant for this command.

This command is available from firmware version 1.10.

Parameter

ON | OFF

Example

```
CALC:LIM4:UPP:STAT ON
```

Switches on limit line 4 (upper limit).

Characteristics

*RST value: OFF

SCPI: conform

Mode

A, FM

CALCulate<1|2>:LIMit<1...8>:UPPer:THReshold

This command defines an absolute threshold value for limit lines with relative Y axis scaling. The absolute threshold value is used in the limit check as soon as it exceeds the relative limit value.

The unit must correspond to the unit selected with `CALCulate<1|2>:LIMit<1...8>:UNIT` (except dB which is not possible). If no unit is indicated, the unit defined with `CALCulate<1|2>:LIMit<1...8>:UNIT` is automatically used (exception: dBm instead of dB).

The units DEG, RAD, S, HZ, PCT are not available in the spectrum analyzer mode.

The numeric suffixes <1|2> are irrelevant for this command.

This command is available from firmware version 1.10.

Parameter

<numeric_value>

Example

```
CALC:LIM2:UPP:THR -35DBM
```

Defines an absolute threshold value for limit line 2.

Characteristics

*RST value: -200 dBm

SCPI: device-specific

Mode

A, FM

CALCulate:MARKer Subsystem

The CALCulate:MARKer subsystem checks the marker functions in the instrument.

The following subsystem is included:

- "CALCulate:MARKer:FUNCTION Subsystem" on page 6.52

Commands of the CALCulate:MARKer Subsystem

- CALCulate<1|2>:MARKer<1...4>[:STATe]
- CALCulate<1|2>:MARKer<1...4>:AOFF
- CALCulate<1|2>:MARKer<1...4>:COUNT
- CALCulate<1|2>:MARKer<1...4>:COUNT:FREQuency?
- CALCulate<1|2>:MARKer<1...4>:COUNT:RESolution
- CALCulate<1|2>:MARKer<1...4>:LOEXclude
- CALCulate<1|2>:MARKer<1...4>:MAXimum[:PEAK]
- CALCulate<1|2>:MARKer<1...4>:MAXimum:LEFT
- CALCulate<1|2>:MARKer<1...4>:MAXimum:NEXT
- CALCulate<1|2>:MARKer<1...4>:MAXimum:RIGHT
- CALCulate<1|2>:MARKer<1...4>:MINimum[:PEAK]
- CALCulate<1|2>:MARKer<1...4>:MINimum:LEFT
- CALCulate<1|2>:MARKer<1...4>:MINimum:NEXT
- CALCulate<1|2>:MARKer<1...4>:MINimum:RIGHT
- CALCulate<1|2>:MARKer<1...4>:PEXCursion
- CALCulate<1|2>:MARKer<1...4>:TRACe
- CALCulate<1|2>:MARKer<1...4>:X
- CALCulate<1|2>:MARKer<1...4>:X:SLIMits[:STATe]
- CALCulate<1|2>:MARKer<1...4>:X:SLIMits:LEFT
- CALCulate<1|2>:MARKer<1...4>:X:SLIMits:RIGHT
- CALCulate<1|2>:MARKer<1...4>:Y?
- CALCulate<1|2>:MARKer<1...4>:Y:PERCent

CALCulate<1|2>:MARKer<1...4>[:STATe]

This command switches on or off the currently selected marker. If no indication is made, marker 1 is selected automatically. If marker 2, 3 or 4 is selected and used as a delta marker, it is switched to marker mode.

The numeric suffixes <1|2> are irrelevant for this command.

Parameter

ON | OFF

Example

```
CALC:MARK3 ON
```

Switches on marker 3 or switches to marker mode.

Characteristics

*RST value: OFF

SCPI: device-specific

Mode

A, ADEMOD, CATV

CALCulate<1|2>:MARKer<1...4>:AOFF

This command switches off all active markers and all delta markers and active marker/delta marker measurement functions.

The numeric suffixes <1|2> are irrelevant for this command.

This command is an event and therefore has no *RST value and no query.

Example

```
CALC:MARK:AOff
```

Switches off all markers.

Characteristics

*RST value: –

SCPI: device-specific

Mode

A, ADEMOD, CATV

CALCulate<1|2>:MARKer<1...4>:COUNT

This command switches on or off the frequency counter at the marker position.

The count result is queried with `CALCulate<1|2>:MARKer<1...4>:COUNT:FREQuency?`.

Frequency counting is possible only for one marker at a time. If it is activated for another marker, it is automatically deactivated for the previous marker.

It should be noted that a complete sweep must be performed after switching on the frequency counter to ensure that the frequency to be measured is actually reached. The synchronization to the sweep end required for this is only possible in single sweep mode.

The numeric suffixes <1|2> are irrelevant for this command.

Parameter

ON | OFF

Example

```
INIT:CONT OFF
```

Switches to single sweep mode.

```
CALC:MARK ON
```

Switches on marker 1.

```
CALC:MARK:COUN ON
```

Switches on the frequency counter for marker 1.

```
INIT;*WAI
```

Starts a sweep and waits for the end.

```
CALC:MARK:COUN:FREQ?
```

Outputs the measured value.

Characteristics

*RST value: OFF

SCPI: device-specific

Mode

A

CALCulate<1|2>:MARKer<1...4>:COUNT:FREQUENCY?

This command queries the result of the frequency counter for the indicated marker. Before the command, the frequency counter should be switched on and a complete measurement performed to obtain a correct count result. Therefore, a single sweep with synchronization must be performed between switching on the frequency counter and querying the count result.

The numeric suffixes <1|2> are irrelevant for this command.

This command is only a query and therefore has no *RST value.

Example

```
INIT:CONT OFF
```

Switches to single sweep mode.

```
CALC:MARK2 ON
```

Switches marker 2.

```
CALC:MARK2:COUN ON
```

Switches the frequency counter for marker 2.

```
INIT;*WAI
```

Starts a sweep and waits for the end.

```
CALC:MARK2:COUN:FREQ?
```

Outputs the measured value of marker 2.

Characteristics

*RST value: –

SCPI: device-specific

Mode

A

CALCulate<1|2>:MARKer<1...4>:COUNT:RESolution

This command specifies the resolution of the frequency counter.

The numeric suffixes <1|2> and <1...4> are irrelevant for this command.

Parameter

0.1 | 1 | 10 | 100 | 1000 | 10000 Hz

Example

```
CALC:MARK:COUN:RES 1kHz
```

Sets the resolution of the frequency counter to 1 kHz.

Characteristics

*RST value: 1kHz

SCPI: device-specific

Mode

A

CALCulate<1|2>:MARKer<1...4>:LOEXclude

This command switches the local oscillator suppression for peak search on or off. This setting applies to all markers and delta markers.

The numeric suffixes 1|2 and 1 to 4 are irrelevant.

Parameter

ON | OFF

Example

CALC:MARK:LOEX ON

Characteristics

*RST value: ON

SCPI: device-specific

Mode

A-F, ADEMOD, CATV

CALCulate<1|2>:MARKer<1...4>:MAXimum[:PEAK]

This command positions the marker to the current maximum value of the corresponding trace. The corresponding marker is activated first or switched to the marker mode.

The numeric suffixes <1|2> are irrelevant for this command.

This command is an event and therefore has no *RST value and no query.

Note: If no maximum value is found on the trace (level spacing to adjacent values < peak excursion), an execution error (error code: -200) is produced.

Example

CALC:MARK2:MAX

Positions marker 2 to the maximum value of the trace.

Characteristics

*RST value: -

SCPI: device-specific

Mode

A, ADEMOD, CATV

CALCulate<1|2>:MARKer<1...4>:MAXimum:LEFT

This command positions the marker to the next smaller maximum value to the left of the current value (i.e. in descending X values) on the trace.

The numeric suffixes <1|2> are irrelevant for this command.

This command is an event and therefore has no *RST value and no query.

Note: If no next smaller maximum value is found on the trace (level spacing to adjacent values < peak excursion), an execution error (error code: -200) is produced.

Example

CALC:MARK2:MAX:LEFT

Positions marker 2 to the next lower maximum value to the left of the current value.

Characteristics

*RST value: -

SCPI: device-specific

Mode

A, ADEMOD, BT, CATV

CALCulate<1|2>:MARKer<1...4>:MAXimum:NEXT

This command positions the marker to the next smaller maximum value of the corresponding trace.

The numeric suffixes <1|2> are irrelevant for this command.

This command is an event and therefore has no *RST value and no query.

Note: If no next smaller maximum value is found on the trace (level spacing to adjacent values < peak excursion), an execution error (error code: -200) is produced.

Example

```
CALC : MARK2 : MAX : NEXT
```

Positions marker 2 to the next lower maximum value.

Characteristics

*RST value: –

SCPI: device-specific

Mode

A, ADEMOD, CATV

CALCulate<1|2>:MARKer<1...4>:MAXimum:RIGHT

This command positions the marker to the next smaller maximum value to the right of the current value (i.e. in ascending X values) on the corresponding trace.

The numeric suffixes <1|2> are irrelevant for this command.

This command is an event and therefore has no *RST value and no query.

Note: If no next smaller maximum value is found on the trace (level spacing to adjacent values < peak excursion), an execution error (error code: -200) is produced.

Example

```
CALC : MARK2 : MAX : RIGH
```

Positions marker 2 to the next lower maximum value to the right of the current value.

Characteristics

*RST value: –

SCPI: device-specific

Mode

A, ADEMOD, CATV

CALCulate<1|2>:MARKer<1...4>:MINimum[:PEAK]

This command positions the marker to the current minimum value of the corresponding trace.

The corresponding marker is activated first or switched to marker mode, if necessary.

The numeric suffixes <1|2> are irrelevant for this command.

This command is an event and therefore has no *RST value and no query.

Note: If no minimum value is found on the trace (level spacing to adjacent values < peak excursion), an execution error (error code: -200) is produced.

Example

```
CALC : MARK2 : MIN
```

Positions marker 2 to the minimum value of the trace.

Characteristics

*RST value: –

SCPI: device-specific

Mode

A, ADEMOD, CATV

CALCulate<1|2>:MARKer<1...4>:MINimum:LEFT

This command positions the marker to the next higher minimum value to the left of the current value (i.e. in descending X direction) on the corresponding trace.

The numeric suffixes <1|2> are irrelevant for this command.

This command is an event and therefore has no *RST value and no query.

Note: If no next higher minimum value is found on the trace (level spacing to adjacent values < peak excursion), an execution error (error code: –200) is produced.

Example

```
CALC:MARK2:MIN:LEFT
```

Positions marker 2 to the next higher minimum value to the left of the current value.

Characteristics

*RST value: –

SCPI: device-specific

Mode

A, ADEMOD, CATV

CALCulate<1|2>:MARKer<1...4>:MINimum:NEXT

This command positions the marker to the next higher minimum value of the corresponding trace.

The numeric suffixes <1|2> are irrelevant for this command.

This command is an event and therefore has no *RST value and no query.

Note: If no next higher minimum value is found on the trace (level spacing to adjacent values < peak excursion), an execution error (error code: –200) is produced.

Example

```
CALC:MARK2:MIN:NEXT
```

Positions marker 2 to the next higher maximum value.

Characteristics

*RST value: –

SCPI: device-specific

Mode

A, ADEMOD, CATV

CALCulate<1|2>:MARKer<1...4>:MINimum:RIGHT

This command positions the marker to the next higher minimum value to the right of the current value (i.e. in ascending X direction) on the corresponding trace.

The numeric suffixes <1|2> are irrelevant for this command.

This command is an event and therefore has no *RST value and no query.

Note: If no next higher minimum value is found on the trace (level spacing to adjacent values < peak excursion), an execution error (error code: -200) is produced.

Example

```
CALC:MARK2:MIN:RIGH
```

Positions marker 2 to the next higher minimum value to the right of the current value.

Characteristics

*RST value: –

SCPI: device-specific

Mode

A, ADEMOD, CATV

CALCulate<1|2>:MARKer<1...4>:PEXCursion

This command defines the peak excursion, i.e. the spacing below a trace maximum which must be attained before a new maximum is recognized, or the spacing above a trace minimum which must be attained before a new minimum is recognized. The set value applies to all markers and delta markers. The unit depends on the selected operating mode.

The numeric suffixes >1<2> and <1...4> are irrelevant.

Parameter

<numeric_value>

Example

```
CALC:MARK:PEXC 10dB
```

Defines peak excursion 10 dB in spectrum **Spectrum Analyzer** mode.

Characteristics

*RST value: 6dB in **Spectrum Analyzer** mode

SCPI: device-specific

Mode

A, ADEMOD, BT, CATV

CALCulate<1|2>:MARKer<1...4>:TRACe

This command assigns the selected marker (1 to 4) to the indicated measurement curve. The corresponding trace must be active, i.e. its status must be different from "BLANK".

If necessary the corresponding marker is switched on prior to the assignment.

The numeric suffixes <1|2> are irrelevant for this command.

Parameter

1 to 4

Example

```
CALC:MARK3:TRAC 2
```

Assigns marker 3 to trace 2.

Characteristics

*RST value: –

SCPI: device-specific

Mode

A, ADEMOD

CALCulate<1|2>:MARKer<1...4>:X

This command positions the selected marker to the indicated frequency (span > 0), time (span = 0) or level (APD measurement or CCDF measurement ON).

If marker 2, 3 or 4 is selected and used as delta marker, it is switched to marker mode.

The numeric suffixes <1|2> are irrelevant for this command.

Parameter

0 to MAX (frequency | sweep time)

Example

```
CALC:MARK2:X 10.7MHz
```

Positions marker 2 to frequency 10.7 MHz.

Characteristics

*RST value: –

SCPI: device-specific

Mode

A, ADEMOD, CATV

CALCulate<1|2>:MARKer<1...4>:X:SLIMits[:STATe]

This command switches between a limited (ON) and unlimited (OFF) search range.

If the power measurement in zero span is active, this command limits the evaluation range on the trace.

The numeric suffixes <1|2> and <1...4> are irrelevant for this command.

Parameter

ON | OFF

Example

```
CALC:MARK:X:SLIM ON
```

Switches on search limitation.

Characteristics

*RST value: OFF

SCPI: device-specific

Mode

A, ADEMOD, CATV

CALCulate<1|2>:MARKer<1...4>:X:SLIMits:LEFT

This command sets the left limit of the search range for markers and delta markers. Depending on the span setting of the X axis the indicated value defines a frequency (span > 0) or time (span = 0).

The numeric suffixes <1|2> and <1...4> are irrelevant for this command.

If the power measurement in zero span is active, this command limits the evaluation range to the trace.

Note: The function is only available if the search limit for marker and delta marker is switched on (CALCulate<1|2>:MARKer<1...4>:X:SLIMits[:STATe]).

Parameter

0 to MAX (frequency | sweep time)

Example

```
CALC:MARK:X:SLIM ON
```

Switches the search limit function on.

```
CALC:MARK:X:SLIM:LEFT 10MHz
```

Sets the left limit of the search range to 10 MHz.

Characteristics

*RST value: – (is set to the left diagram border on switching on search limits)

SCPI: device-specific

Mode

A, ADEMOD, CATV

CALCulate<1|2>:MARKer<1...4>:X:SLIMits:RIGHT

This command sets the right limit of the search range for markers and delta markers. Depending on the span setting of the X axis the indicated value defines a frequency (span > 0) or time (span = 0).

The numeric suffixes <1|2> and <1...4> are irrelevant for this command.

If the power measurement in zero span is active, this command limits the evaluation range to the trace.

Note: The function is only available if the search limit for marker and delta marker is switched on (`CALCulate<1|2>:MARKer<1...4>:X:SLIMits[:STATe]`).

Parameter

0 to MAX (frequency | sweep time)

Example

```
CALC:MARK:X:SLIM ON
```

Switches the search limit function on.

```
CALC:MARK:X:SLIM:RIGH 20MHz
```

Sets the right limit of the search range to 20 MHz.

Characteristics

*RST value: – (is set to the right diagram border on switching on search limits)

SCPI: device-specific

Mode

A, ADEMOD, CATV

CALCulate<1|2>:MARKer<1...4>:Y?

This command queries the measured value of the selected marker. The corresponding marker is activated before or switched to marker mode, if necessary.

To obtain a correct query result, a complete sweep with synchronization to the sweep end must be performed between the activation of the marker and the query of the Y value. This is only possible in single sweep mode.

The query result is output in the unit determined with `CALCulate<1|2>:UNIT:POWer`.

In the default setting, the output is made depending on the unit determined with `CALCulate<1|2>:UNIT:POWer`; only with linear level scaling is the output in %.

The numeric suffixes <1|2> are irrelevant for this command.

Example

```
INIT:CONT OFF
```

Switches to single sweep mode.

```
CALC:MARK2 ON
```

Switches marker 2.

```
INIT;*WAI
```

Starts a sweep and waits for the end.

```
CALC:MARK2:Y?
```

Outputs the measured value of marker 2.

Characteristics

*RST value: –

SCPI: device-specific

Mode

A, ADEMOD, BT, CATV

CALCulate<1|2>:MARKer<1...4>:Y:PERCent

This command positions the selected marker to the given probability. If marker 2, 3 or 4 is selected and used as a delta marker, it is switched to marker mode.

The numeric suffixes <1|2> are irrelevant for this command.

Note: The command is only available with the CCDF measurement switched on. The associated level value can be determined with the [CALCulate<1|2>:MARKer<1...4>:X](#) command.

Parameter

0 to 100%

Example

```
CALC1:MARK:Y:PERC 95PCT
```

Positions marker 1 to a probability of 95%.

Characteristics

*RST value: –

SCPI: device-specific

Mode

A, CATV

CALCulate:MARKer:FUNCTion Subsystem

The CALCulate:MARKer:FUNCTion subsystem checks the marker functions in the instrument.

The following subsystems are included:

- "CALCulate:MARKer:FUNCTion:HARMonics Subsystem" on page 6.65
- "CALCulate:MARKer:FUNCTion:POWer Subsystem" on page 6.65
- "CALCulate:MARKer:FUNCTion:STRack Subsystem" on page 6.74
- "CALCulate:MARKer:FUNCTion:SUMMary Subsystem" on page 6.76

Commands of the CALCulate:MARKer:FUNCTion Subsystem

- CALCulate<1|2>:MARKer<1...4>:FUNCTion:DEModulation[:STATe]
- CALCulate<1|2>:MARKer<1...4>:FUNCTion:DEModulation:CONTInuous
- CALCulate<1|2>:MARKer<1...4>:FUNCTion:DEModulation:HOLDoff
- CALCulate<1|2>:MARKer<1...4>:FUNCTion:DEModulation:SElect
- CALCulate<1|2>:MARKer<1...4>:FUNCTion:CENTer
- CALCulate<1|2>:MARKer<1...4>:FUNCTion:CSTep
- CALCulate<1|2>:MARKer<1...4>:FUNCTion:FPEaks[:IMMEDIATE]
- CALCulate<1|2>:MARKer<1...4>:FUNCTion:FPEaks:COUNt?
- CALCulate<1|2>:MARKer<1...4>:FUNCTion:FPEaks:SORT
- CALCulate<1|2>:MARKer<1...4>:FUNCTion:FPEaks:X?
- CALCulate<1|2>:MARKer<1...4>:FUNCTion:FPEaks:Y?
- CALCulate<1|2>:MARKer<1...4>:FUNCTion:MDEPTH[:STATe]
- CALCulate<1|2>:MARKer<1...4>:FUNCTion:MDEPTH:RESult?
- CALCulate<1|2>:MARKer<1...4>:FUNCTion:MDEPTH:SEARChsignal
- CALCulate<1|2>:MARKer<1...4>:FUNCTion:NDBDown
- CALCulate<1|2>:MARKer<1...4>:FUNCTion:NDBDown:FREQUency?
- CALCulate<1|2>:MARKer<1...4>:FUNCTion:NDBDown:RESult?
- CALCulate<1|2>:MARKer<1...4>:FUNCTion:NDBDown:STATe
- CALCulate<1|2>:MARKer<1...4>:FUNCTion:NDBDown:TIME?
- CALCulate<1|2>:MARKer<1...4>:FUNCTion:NOISE[:STATe]
- CALCulate<1|2>:MARKer<1...4>:FUNCTion:NOISE:RESult?
- CALCulate<1|2>:MARKer<1...4>:FUNCTion:REFerence
- CALCulate<1|2>:MARKer<1...4>:FUNCTion:TOI[:STATe]
- CALCulate<1|2>:MARKer<1...4>:FUNCTion:TOI:RESult?
- CALCulate<1|2>:MARKer<1...4>:FUNCTion:TOI:SEARChsignal
- CALCulate<1|2>:MARKer<1...4>:FUNCTion:ZOOM

CALCulate<1|2>:MARKer<1...4>:FUNCTion:DEModulation[:STATe]

This command switches on or off the audio demodulator when the indicated marker is reached. With span > 0 the hold time can be defined at the corresponding marker position with `CALCulate<1|2>:MARKer<1...4>:FUNCTion:DEModulation:HOLDoff`. In zero span the demodulation is permanently active.

The numeric suffixes <1|2> are irrelevant for this command.

Parameter

ON | OFF

Example

```
CALC:MARK3:FUNC:DEM ON
```

Switches on the demodulation for marker 3.

Characteristics

*RST value: OFF

SCPI: device-specific

Mode

A

CALCulate<1|2>:MARKer<1...4>:FUNCTion:DEModulation:CONTinuous

This command switches on or off the continuous demodulation for span >0. Thus acoustic monitoring of the signals can be performed.

The numeric suffixes <1|2> and <1...4> are irrelevant for this command.

This command is available from firmware version 1.10.

Parameter

ON | OFF

Example

```
CALC2:MARK3:FUNC:DEM:CONT ON
```

Switches on the continuous ' demodulation.

Characteristics

RST value: OFF

SCPI: device-specific

Mode

A

CALCulate<1|2>:MARKer<1...4>:FUNCTion:DEModulation:HOLDoff

This command defines the hold time at the marker position for the demodulation with span > 0. The setting is independent of the selected marker, the suffixes <1|2> and <1...4> are irrelevant.

The numeric suffixes <1|2> are irrelevant for this command.

Parameter

10ms to 1000s

Example:

```
CALC:MARK:FUNC:DEM:HOLD 3s
```

Characteristics:

*RST value: – (DEModulation is set to OFF)

SCPI: device-specific

Mode:

A

CALCulate<1|2>:MARKer<1...4>:FUNCtion:DEModulation:SElect

This command selects the demodulation type for the audio demodulator. The command is independent of the selected marker, the suffixes 1|2 and 1 to 4 are irrelevant.

The numeric suffixes <1|2> are irrelevant for this command.

Parameter

AM | FM

Example

```
CALC:MARK:FUNC:DEM:SEL FM
```

Characteristics

*RST value: AM

SCPI: device-specific

Mode

A

CALCulate<1|2>:MARKer<1...4>:FUNCtion:CENTer

This command sets the center frequency equal to the frequency of the indicated marker.

If marker 2, 3 or 4 is selected and used as delta marker, the marker is switched to the marker mode.

The numeric suffix <1|2> are irrelevant for this command.

This command is an "event" and therefore has no *RST value and no query.

Example

```
CALC:MARK2:FUNC:CENT
```

Sets the center frequency to the frequency of marker 2.

Characteristics

*RST value: –

SCPI: device-specific

Mode

A–F, CATV

CALCulate<1|2>:MARKer<1...4>:FUNCtion:CSTep

This command sets the step size of the center frequency to the X value of the current marker. If marker 2, 3 or 4 is selected and used as delta marker, it is switched to the marker mode.

The numeric suffix <1|2> are irrelevant for this command.

This command is an event and therefore has no *RST value and no query.

Example

```
CALC:MARK3:FUNC:CST
```

Sets the center frequency to the same value as the frequency of marker 3.

Characteristics

*RST value: –

SCPI: device-specific

Mode

A–F

CALCulate<1|2>:MARKer<1...4>:FUNCTION:FPEaks[:IMMEDIATE]

This command searches the selected trace for the indicated number of maxima. The results are entered in a list and can be queried with the

`CALCulate<1|2>:MARKer<1...4>:FUNCTION:FPEaks:X?` and

`CALCulate<1|2>:MARKer<1...4>:FUNCTION:FPEaks:Y?` commands. The number of maxima found can be queried with

`CALCulate<1|2>:MARKer<1...4>:FUNCTION:FPEaks:COUNT?`. The trace to be examined is selected with `CALCulate<1|2>:MARKer<1...4>:TRACE`. The order of the results in the list can be defined with `CALCulate<1|2>:MARKer<1...4>:FUNCTION:FPEaks:SORT`.

The numeric suffixes <1|2> are irrelevant for this command.

This command is available from firmware version 1.30.

Note: The number of maxima found depends on the waveform and value set for the Peak Excursion parameter (`CALCulate<1|2>:MARKer<1...4>:PEXCursion`), however, a maximum number of 50 maxima are determined. Only the signals which exceed their surrounding values at least by the value indicated by the peak excursion parameter will be recognized as maxima. Therefore, the number of maxima found is not automatically the same as the number of maxima desired.

Parameter

<numeric_value>

Example

```
INIT:CONT OFF
```

Switches to single sweep mode

```
INIT;*WAI
```

Starts measurement and synchronizes to end

```
CALC:MARK:TRAC 1
```

Sets marker 1 to trace 1

```
CALC:MARK:FUNC:FPE:SORT X
```

Sets the sort mode to increasing X values

```
CALC:MARK:FUNC:FPE 3
```

Searches the 3 highest maxima for trace 1

```
CALC:MARK:FUNC:COUN?
```

Queries the number of maxima found

```
CALC:MARK:FUNC:Y?
```

Queries the level of maxima found

```
CALC:MARK:FUNC:X?
```

Queries the frequencies (span <> 0) or time (span = 0) of maxima found.

Characteristics

*RST value: –

SCPI: device-specific

Mode

A

CALCulate<1|2>:MARKer<1...4>:FUNCTION:FPEaks:COUNT?

This query reads out the number of maxima found during the search. If no search for maxima has been performed, 0 is returned.

The numeric suffixes <1|2> are irrelevant for this command.

This command is available from firmware version 1.30.

Example

```
CALC:MARK:FUNC:FPE 3
```

Searches the 3 highest maxima for trace 1

```
CALC:MARK:FUNC:FPE:COUN?
```

Queries the number of maxima found

Characteristics

*RST value: –

SCPI: device-specific

Mode

A

CALCulate<1|2>:MARKer<1...4>:FUNCTION:FPEaks:SORT

This command sets the sort mode for the search for maxima:

X: the maxima are sorted in the list of responses according to increasing X values

Y: the maxima are sorted in the list of responses according to decreasing Y values

The numeric suffixes <1|2> are irrelevant for this command.

This command is available from firmware version 1.30.

Parameter

X | Y

Example

```
CALC:MARK:FUNC:FPE:SORT Y
```

Sets the sort mode to decreasing y values

Characteristics

*RST value: –

SCPI: device-specific

Mode

A

CALCulate<1|2>:MARKer<1...4>:FUNCTION:FPEaks:X?

This query reads out the list of X values of the maxima found. The number of available values can be queried with [CALCulate<1|2>:MARKer<1...4>:FUNCTION:FPEaks:COUNT?](#).

With sort mode X, the X values are in increasing order; with sort mode Y the order corresponds to the decreasing order of the Y values.

The numeric suffixes <1|2> are irrelevant for this command.

This command is available from firmware version 1.30.

Example

```
CALC:MARK:FUNC:FPE:SORT Y
```

Sets the sort mode to decreasing y values

CALC:MARK:FUNC:FPE 3

Searches the 3 highest maxima for trace 1

CALC:MARK:FUNC:FPE:COUN?

Queries the number of maxima found

CALC:MARK:FPE:FUNC:X?

Queries the frequencies (span <> 0) or. time (span = 0) of the maxima found

Return values

107.5E6, 153.8E6, 187.9E6

frequencies in increasing order

2.05E-3, 2.37E-3, 3.71e-3

times in increasing order

Characteristics

*RST value: –

SCPI: device-specific

Mode

A

CALCulate<1|2>:MARKer<1...4>:FUNCTION:FPEaks:Y?

This query reads out the list of X values of the maxima found. The number of available values can be queried with `CALCulate<1|2>:MARKer<1...4>:FUNCTION:FPEaks:COUNT?`.

With sort mode X, the X values are in increasing order; with sort mode Y the order corresponds to the decreasing order of the Y values.

The numeric suffixes <1|2> are irrelevant for this command.

This command is available from firmware version 1.30.

Example

CALC:MARK:FUNC:FPE:SORT Y

Sets the sort mode to decreasing y values

CALC:MARK:FUNC:FPE 3

Searches the 3 highest maxima for trace 1

CALC:MARK:FUNC:FPE:COUN?

Queries the number of maxima found

CALC:MARK:FUNC:FPE:Y?

Queries the levels of the maxima found

Return value

-37.5, -58.3, -59.6

level in decreasing order

Characteristics

*RST value: –

SCPI: device-specific

Mode

A

CALCulate<1|2>:MARKer<1...4>:FUNCTION:MDEPth[:STATe]

This command switches on the measurement of the AM modulation depth. An AM-modulated carrier is required on the screen for correct operation. If necessary, marker 1 is previously activated and set to the largest signal available.

The level value of marker 1 is regarded as the carrier level. On activating the function, marker 2 and marker 3 are automatically set as delta markers symmetrically to the carrier to the adjacent maxima of the trace.

If the position of delta marker 2 is changed, delta marker 3 is moved symmetrically with respect to the reference marker (marker 1). If the position of delta marker 3 is changed, fine adjustment can be performed independently of delta marker 2.

The power at the marker positions is calculated from the measured levels.

The AM modulation depth is calculated from the ratio of power values at the reference marker and the delta markers. If the two AM sidebands differ in power, the average value of the two power values is used for calculating the AM modulation depth.

The numeric suffix <1|2> and <1...4> are irrelevant for this command.

Example

```
CALC:MARK:X 10MHZ
```

Sets the reference marker (marker 1) to the carrier signal at 10 MHz.

```
CALC:MARK:FUNC:MDEP ON
```

Switches on the modulation depth measurement.

```
CALC:DELT2:X 10KHZ
```

Sets delta markers 2 and 3 to the signals at 10 kHz from the carrier signal.

```
CALC:DELT3:X 9.999KHZ
```

Corrects the position of delta marker 3 relative to delta marker 2.

Characteristics

*RST value: OFF

SCPI: device-specific

Mode

A

CALCulate<1|2>:MARKer<1...4>:FUNCTION:MDEPth:RESult?

This command queries the AM modulation depth.

A complete sweep with synchronization to sweep end must be performed between switching on the function and querying the measured value to obtain a correct query result. This is only possible in single sweep mode.

The numeric suffix <1|2> and <1...4> are irrelevant for this command.

This command is only a query and therefore has no *RST value.

Example

```
INIT:CONT OFF
```

Switches to single sweep mode.

```
CALC:MARK:X 10MHZ
```

Sets the reference marker (marker 1) to the carrier signal at 10 MHz.

```
CALC:MARK:FUNC:MDEP ON
```

Switches on the modulation depth measurement.

```
INIT;*WAI
```

Starts a sweep and waits for the end.

```
CALC:MARK:FUNC:MDEP:RES?
```

Outputs the measured value.

Characteristics

*RST value: –

SCPI: device-specific

Mode

A

CALCulate<1|2>:MARKer<1...4>:FUNction:MDEPth:SEARChsignal

This command starts the search of the signals required for the modulation depth measurement. The numeric suffix <1|2> are irrelevant for this command.

Note: No new measurement is done. Only the currently available trace selected for the modulation depth measurement is used

Parameter

ONCE

Example

```
CALC:MARK:FUNC:MDEP:SEAR ONCE
```

Executes the search of an AM modulated signal at the currently available trace.

Characteristics

*RST value: –

SCPI: conform

Mode

A

CALCulate<1|2>:MARKer<1...4>:FUNction:NDBDown

This command defines the level spacing of the two delta markers to the right and left of marker 1. Marker 1 is always used as the reference marker.

The temporary markers T1 and T2 are positioned by n dB below the active reference marker.

The frequency spacing of these markers can be queried with

[CALCulate<1|2>:MARKer<1...4>:FUNction:NDBDown:RESult??](#).

The numeric suffixes <1|2> and <1...4> are irrelevant for this command.

Parameter

<numeric_value>

Example

```
CALC:MARK:FUNC:NDBD 3dB
```

Sets the level spacing to 3 dB.

Characteristics

*RST value: 6dB

SCPI: device-specific

Mode

A

CALCulate<1|2>:MARKer<1...4>:FUNction:NDBDown:FREQuency?

This command queries the two frequencies of the n dB down marker. The two frequency values are separated by comma and output in ascending order.

A complete sweep with synchronization to sweep end must be performed between switching on the function and querying the measured value to obtain a correct query result. This is only possible in single sweep mode.

The numeric suffixes <1|2> and <1...4> are irrelevant for this command.
This command is only a query and therefore has no *RST value.

Example

```
INIT:CONT OFF
```

Switches to single sweep mode.

```
CALC:MARK:FUNC:NDBD ON
```

Switches on the n dB down function.

```
INIT;*WAI
```

Starts a sweep and waits for the end.

```
CALC:MARK:FUNC:NDBD:FREQ?
```

Outputs the frequencies of the temporary markers.

Characteristics

*RST value: –

SCPI: device-specific

Mode

A

CALCulate<1|2>:MARKer<1...4>:FUNction:NDBDown:RESult?

This command queries the frequency spacing (bandwidth) of the n dB down markers.

A complete sweep with synchronization to sweep end must be performed between switching on the function and querying the measured value in order to obtain a correct query result. This is only possible in single sweep mode.

The numeric suffixes <1|2> and <1...4> are irrelevant for this command.

This command is only a query and therefore has no *RST value.

Example

```
INIT:CONT OFF
```

Switches to single sweep mode.

```
CALC:MARK:FUNC:NDBD ON
```

Switches on the n dB down function.

```
INIT;*WAI
```

Starts a sweep and waits for the end.

```
CALC:MARK:FUNC:NDBD:RES?
```

Outputs the measured value.

Characteristics

*RST value: –

SCPI: device-specific

Mode

A

CALCulate<1|2>:MARKer<1...4>:FUNction:NDBDown:STATe

This command switches the "N dB Down" function on or off. Marker 1 is activated first, if necessary.

The numeric suffixes <1|2> and <1...4> are irrelevant for this command.

Parameter

ON | OFF

Example

CALC:MARK:FUNC:NDBD:STAT ON
Switches on the "N dB Down" function.

Characteristics

*RST value: OFF
SCPI: device-specific

Mode

A

CALCulate<1|2>:MARKer<1...4>:FUNCtion:NDBDown:TIME?

This command queries the two frequencies of the n dB down marker. The two frequency values are separated by comma and output in ascending order.

A complete sweep with synchronization to sweep end must be performed between switching on the function and querying the measured value to obtain a correct query result. This is only possible in single sweep mode.

The numeric suffixes <1|2> and <1...4> are irrelevant for this command.

This command is only a query and therefore has no *RST value.

Example

INIT:CONT OFF
Switches to single sweep mode
CALC:MARK:FUNC:NDBD ON
Switches on the n dB down function.
INIT;*WAI
Starts a sweep and waits for the end.
CALC:MARK:FUNC:NDBD:TIME?
Outputs the time values of the temporary markers.

Characteristics

*RST value: –
SCPI: device-specific

Mode

A–T

CALCulate<1|2>:MARKer<1...4>:FUNCtion:NOISe[:STATe]

This command switches the noise measurement on or off for all markers. The noise power density is measured at the position of the markers. The result can be queried with `CALCulate<1|2>:MARKer<1...4>:FUNCtion:NOISe:RESult?`.

The numeric suffixes <1|2> are irrelevant for this command.

Parameter

ON | OFF

Example

```
CALC:MARK:FUNC:NOIS ON
```

Switches on the noise measurement.

Characteristics

*RST value: OFF

SCPI: device-specific

Mode

A

CALCulate<1|2>:MARKer<1...4>:FUNCtion:NOISe:RESult?

This command queries the result of the noise measurement.

A complete sweep with synchronization to the sweep end must be performed between switching on the function and querying the measured value in order to obtain a correct query result. This is only possible in single sweep mode.

The numeric suffixes <1|2> are irrelevant for this command.

This command is an event and therefore has no *RST value and no query.

Example

```
INIT:CONT OFF
```

Switches to single sweep mode.

```
CALC:MARK2 ON
```

Switches on marker 2.

```
CALC:MARK:FUNC:NOIS ON
```

Switches on noise measurement.

```
INIT;*WAI
```

Starts a sweep and waits for the end.

```
CALC:MARK2:NOIS:RES?
```

Outputs the noise result of marker 2.

Characteristics

*RST value: –

SCPI: device-specific

Mode

A

CALCulate<1|2>:MARKer<1...4>:FUNction:REFerence

This command sets the reference level to the power measured by the indicated marker. If marker 2, 3 or 4 is selected and used as delta marker, it is switched to marker mode.

The numeric suffix <1|2> are irrelevant for this command.

This command is an event and therefore has no *RST value and no query.

Example

```
CALC:MARK2:FUNC:REF
```

Sets the reference level to the level of marker 2.

Characteristics

*RST value: –

SCPI: device-specific

Mode

A, CATV

CALCulate<1|2>:MARKer<1...4>:FUNction:TOI[:STATe]

This command initiates the measurement of the third-order intercept point.

A two-tone signal with equal carrier levels is expected at the RF input of the instrument. Marker 1 and marker 2 (both normal markers) are set to the maximum of the two signals. Delta marker 3 and delta marker 4 are positioned to the intermodulation products. The delta markers can be modified separately afterwards with the `CALCulate<1|2>:DELTamarker<1...4>:X` command.

The third-order intercept is calculated from the level spacing between the normal markers and the delta markers.

The numeric suffix <1|2> and <1...4> are irrelevant for this command.

Parameter

ON | OFF

Example

```
CALC:MARK:FUNC:TOI ON
```

Switches on the measurement of the third-order intercept.

Characteristics

*RST value: OFF

SCPI: device-specific

Mode

A

CALCulate<1|2>:MARKer<1...4>:FUNction:TOI:RESult?

This command queries the third-order intercept point measurement.

A complete sweep with synchronization to sweep end must be performed between switching on the function and querying the measured value to obtain a correct query result. This is only possible in single sweep mode.

The numeric suffix <1|2> and <1...4> are irrelevant for this command.

This command is only a query and therefore has no *RST value.

Example

```
INIT:CONT OFF
```

Switches to single sweep mode.

```
CALC:MARK:FUNC:TOI ON
```

Switches the intercept measurement.

```
INIT;*WAI
```

Starts a sweep and waits for the end.

```
CALC:MARK:FUNC:TOI:RES?
```

Outputs the measured value.

Characteristics

*RST value: –

SCPI: device-specific

Mode

A

CALCulate<1|2>:MARKer<1...4>:FUNCTION:TOI:SEARChsignal

This command starts the search of the signals required for the third order intercept measurement.

The numeric suffix <1|2> are irrelevant for this command.

Note: No new measurement is done. Only the currently available trace selected for the TOI measurement is used

Parameter

ONCE

Example

```
CALC:MARK:FUNC:TOI:SEAR ONCE
```

Executes the search for 2 signals and their intermodulation product at the currently available trace.

Characteristics

*RST value: –

SCPI: conform

Mode

A

CALCulate<1|2>:MARKer<1...4>:FUNCTION:ZOOM

This command defines the range to be zoomed around marker 1. Marker 1 is activated first, if necessary.

The subsequent frequency sweep is stopped at the marker position and the frequency of the signal is counted. This frequency becomes the new center frequency, and the zoomed span is set. In order to recognize the end of the operation the synchronization to the sweep end should be activated. This is only possible in single sweep mode.

The numeric suffixes <1|2> are irrelevant for this command.

This command is an event and therefore has no *RST value and no query.

Parameter

<numeric_value>

Example

```
INIT:CONT OFF
Switches to single sweep mode
CALC:MARK:FUNC:ZOOM 1kHz;*WAI
Activates zooming and waits for its end.
```

Characteristics

*RST value: –
 SCPI: device-specific

Mode

A–F

CALCulate:MARKer:FUNCtion:HARMonics Subsystem

The CALCulate:MARKer:FUNCtion:POWER subsystem contains the commands to define the settings for harmonics measurement. This subsystem is available from firmware version 1.10.

Commands of the CALCulate:MARKer:FUNCtion:HARMonics Subsystem

- CALCulate<1|2>:MARKer<1...4>:FUNCtion:HARMonics[:STATe]
- CALCulate<1|2>:MARKer<1...4>:FUNCtion:HARMonics:BANDwidth:AUTO
- CALCulate<1|2>:MARKer<1...4>:FUNCtion:HARMonics:DISToRTion?
- CALCulate<1|2>:MARKer<1...4>:FUNCtion:HARMonics:LIST?
- CALCulate<1|2>:MARKer<1...4>:FUNCtion:HARMonics:NHARMonics
- CALCulate<1|2>:MARKer<1...4>:FUNCtion:HARMonics:PRESet

CALCulate<1|2>:MARKer<1...4>:FUNCtion:HARMonics[:STATe]

This command activates/deactivates the harmonic distortion measurement.

If the measurement is started in span > 0, the last span defines the search range for the first harmonic. The level is determined for the first harmonic.

If the measurement is started in zero span, center frequency and level are used unchanged.

The numeric suffix <1|2> and <1...4> are irrelevant for this command.

This command is available from firmware version 1.10.

Parameter

ON | OFF

Example

```
CALC:MARK:FUNC:HARM ON
Activates the harmonic distortion measurement.
```

Characteristics

RST value: OFF
 SCPI: device-specific

Mode

A–F, A–T

CALCulate<1|2>:MARKer<1...4>:FUNCTION:HARMonics:BANDwidth:AUTO

This command defines the resolution bandwidth of the harmonic in respect to the bandwidth of the first harmonic. For details refer to chapter "Instrument Functions", section "Harmonic RBW Auto".

The numeric suffix <1|2> are irrelevant for this command.

This command is available from firmware version 1.10.

Parameter

OFF identical
ON a multiple

Example

```
CALC:MARK:FUNC:HARM:BAND:AUTO OFF
```

Deactivates the automatic bandwidth enlargement.

Characteristics

RST value: ON
SCPI: device-specific

Mode

A-F, A-T

CALCulate<1|2>:MARKer<1...4>:FUNCTION:HARMonics:DISToRTion?

This command queries the distortion results (THD: total harmonic distortion). Two values separated by a comma are returned: <THD in %>, <THD in dB>.

To obtain a correct result, a complete sweep with synchronization to the end of the sweep must be performed before a query is output. Synchronization is possible only in the single sweep mode.

The numeric suffix <1|2> and <1...4> are irrelevant for this command.

This command is available from firmware version 1.10.

Parameter

TOTAL

Example

```
INIT:CONT OFF
```

Switches to single sweep mode.

```
CALC:MARK:FUNC:HARM:NHARM 3
```

Sets the number of harmonics to be measured to 3.

```
CALC:MARK:FUNC:HARM ON
```

Activates the harmonic distortion measurement.

```
INIT;*WAI
```

Starts a sweep and waits for the end of the sweep.

```
CALC:MARK:FUNC:HARM:DIS? TOT
```

Returns the total distortion in % and dB.

Characteristics

RST value: –
SCPI: device-specific

Mode

A-F, A-T

CALCulate<1|2>:MARKer<1...4>:FUNCTION:HARMonics:LIST?

This command reads out the list of the harmonics. The first value is the absolute power of the first harmonic (the unit is set via the CALCulate<1|2>:UNIT:POWER command). The following values are relative to the carrier signal and have the unit dB. They are separated by commas and correspond to the harmonics to be measured (set via the CALCulate<1|2>:MARKer<1...4>:FUNCTION:HARMonics:NHARmonics command).

To obtain a correct result, a complete sweep with synchronization to the end of the sweep must be performed before a query is output. Synchronization is possible only in the single sweep mode.

The numeric suffixes <1/2> are not relevant.

This command is available from firmware version 1.10.

Example

```
INIT:CONT OFF
```

Switches to single sweep mode.

```
CALC:MARK:FUNC:HARM:NHARM 3
```

Sets the number of harmonics to be measured to 3.

```
CALC:MARK:FUNC:HARM ON
```

Activates the harmonic distortion measurement.

```
INIT;*WAI
```

Starts a sweep and waits for the end of the sweep.

```
CALC:MARK:FUNC:HARM:LIST?
```

Returns the values for the 3 measured harmonics.

Characteristics

RST value: –

SCPI: device-specific

Mode

A-F, A-T

CALCulate<1|2>:MARKer<1...4>:FUNCTION:HARMonics:NHARmonics

This command sets the number of harmonics to be measured.

The numeric suffix <1|2> and <1...4> are irrelevant for this command.

This command is available from firmware version 1.10.

Parameter

1...26

Example

```
CALC:MARK:FUNC:HARM:NHARM 3
```

Sets the number of harmonics to be measured to 3.

Characteristics

RST value: 10

SCPI: device-specific

Mode

A-F, A-T

CALCulate<1|2>:MARKer<1...4>:FUNCTION:HARMonics:PRESet

This command optimizes the device settings depending on the span setting:

- | | |
|-----------|---|
| span > 0 | Frequency and level of the first harmonic are determined and used for the measurement list. |
| zero span | The level of the first harmonic is determined. The frequency remains unchanged. |

The numeric suffixes <1/2> and <1...4> are irrelevant.

This command is an event and therefore has no *RST value.

This command is available from firmware version 1.10.

Example

```
CALC:MARK:FUNC:HARM:PRES
```

Optimizes the device settings for the harmonic measurement.

Characteristics

RST value: –

SCPI: device-specific

Mode

A–F, A–T

CALCulate:MARKer:FUNCTION:POWER Subsystem

The CALCulate:MARKer:FUNCTION:POWER subsystem contains the commands for control of power measurement.

Commands of the CALCulate:MARKer:FUNCTION:POWER Subsystem

- [CALCulate<1|2>:MARKer:FUNCTION:POWer\[:STATe\]](#)
- [CALCulate<1|2>:MARKer:FUNCTION:POWer:MODE](#)
- [CALCulate<1|2>:MARKer:FUNCTION:POWer:PRESet](#)
- [CALCulate<1|2>:MARKer:FUNCTION:POWer:RESult?](#)
- [CALCulate<1|2>:MARKer:FUNCTION:POWer:SElect](#)

Further information

- [CDMA standard abbreviations](#)

CDMA standard abbreviations

Parameter	Standard
NADC	NADC IS136
TETRA	TETRA
PDC	PDC
PHS	PHS
CDPD	CDPD
FIS95A, F8CDma	CDMA IS95A forward
RIS95A, R8CDma	CDMA IS95A reverse

Parameter	Standard
FJ008, F19CDma	CDMA J–STD008 forward
RJ008, R19CDma	CDMA J–STD008 reverse
FIS95C0	CDMA IS95C Class 0 forward
RIS95C0	CDMA IS95C Class 0 reverse
FIS95C1	CDMA IS95C Class 1 forward
RIS95C1	CDMA IS95C Class 1 reverse
FWCDma	W–CDMA 4.096 MHz forward
RWCDma	W–CDMA 4.096 MHz reverse
FW3Gppcdma	W–CDMA 3.84 MHz forward
RW3Gppcdma	W–CDMA 3.84 MHz reverse
D2CDma	CDMA 2000 direct sequence
S2CDma	CDMA 2000 MC1 multi carrier with 1 carrier
M2CDma	CDMA 2000 MC3 multi carrier with 3 carriers
FTCDMa / TCDMa	TD–SCDMA forward
RTCDMA	TD–SCDMA reverse
AWLan	WLAN 802.11A
BWLan	WLAN 802.11B
WIMax	WiMAX
WIBRo	WiBRO

CALCulate<1|2>:MARKer:FUNCtion:POWER[:STATe]

This command switches off the power measurement.

The numeric suffixes <1/2> are not relevant.

This command is an event and therefore has no *RST value.

Parameter

OFF

Example

```
CALC:MARK:FUNC:POW OFF
```

Switches off the power measurement.

Characteristics

*RST value: –

SCPI: device–specific

Mode

A–F

CALCulate<1|2>:MARKer:FUNCtion:POWER:MODE

This commands defines the method by which the channel power values are calculated from the current trace.

The numeric suffixes <1/2> are not relevant.

This command is available from firmware version 1.30.

Parameter

WRITE	The channel power and the adjacent channel powers are calculated directly from the current trace
MAXHold	The power values are calculated from the current trace and compared with the previous power value using a maximum algorithm.

Example

```
CALC:MARK:FUNC:POW:MODE MAXH
Sets the Maxhold channel power mode.
```

Characteristics

*RST value: –
 SCPI: device-specific

Mode

A–F

CALCulate<1/2>:MARKer:FUNCtion:POWER:PRESet

This command selects the power measurement setting for a standard and previously switches on the corresponding measurement, if required.

The configuration for a standard comprises of the parameters weighting filter, channel bandwidth and spacing, resolution and video bandwidth, as well as detector and sweep time. The numeric suffixes <1/2> are not relevant.

Note: The settings for standards IS95A and C differ as far as the calculation method of channel spacings is concerned. For IS95A and J–STD008 the spacing is calculated from the center of the main channel to the center of the corresponding adjacent channel, for IS95C from the center of the main channel to the nearest border of the adjacent channel.

Parameter

NADC | TETRA | PDC | PHS | CDPD | FWCDma | RWCDma | F8CDma | R8CDma | F19Cdma | R19Cdma | FW3Gppcdma | RW3Gppcdma | D2CDma | S2CDma | M2CDma | FIS95A | RIS95A | FIS95C0 | RIS95C0 | FIS95C1 | FIS95C1 | FJ008 | RJ008 | TCDMa | FTCDMa | RTCDMa | AWLan | BWLan | WIMax | WIBRo | NONE

For further details refer to "[CDMA standard abbreviations](#)" on page 6.68.

The parameters WIMax and WIBRo are available from firmware version 1.30.

Example

```
CALC:MARK:FUNC:POW:PRES NADC
Selects the standard setting for NADC
```

Characteristics

*RST value: –
 SCPI: device-specific

Mode

A–F

CALCulate<1|2>:MARKer:FUNCTION:POWER:RESult?

This command queries the result of the performed power measurement. If necessary, the measurement is switched on prior to the query.

The channel spacings and channel bandwidths are configured in the "[SENSe:POWER Subsystem](#)" on page 6.137.

To obtain a correct result, a complete sweep with synchronization to the end of the sweep must be performed before a query is output. Synchronization is possible only in the single sweep mode.

The numeric suffixes <1/2> are not relevant.

This command is a query and therefore has no *RST value.

Parameter

ACPower Adjacent-channel power measurement

Results are output in the following sequence, separated by commas:

Power of transmission channel
 Power of lower adjacent channel
 Power of upper adjacent channel
 Power of lower alternate channel 1
 Power of upper alternate channel 1
 Power of lower alternate channel 2
 Power of upper alternate channel 2

The number of measured values returned depends on the number of adjacent/alternate channels selected with

[\[SENSe<1|2>:\]POWER:ACHannel:ACPairs](#).

With logarithmic scaling (RANGE LOG), the power is output in the currently selected level unit; with linear scaling (RANGE LIN dB or LIN %), the power is output in W. If [\[SENSe<1|2>:\]POWER:ACHannel:MODE](#) is set to REL, the adjacent/alternate-channel power is output in dB.

CPOWER Channel power measurement

With logarithmic scaling (RANGE LOG), the channel power is output in the currently selected level unit; with linear scaling (RANGE LIN dB or LIN %), the channel power is output in W.

MCACpower Channel/adjacent-channel power measurement with several carrier signals

Results are output in the following sequence, separated by commas:

Power of carrier signal 1 to 12 in ascending order
 Total power of all carrier signals
 Power of lower adjacent channel
 Power of upper adjacent channel
 Power of lower alternate channel 1
 Power of upper alternate channel 1
 Power of lower alternate channel 2
 Power of upper alternate channel 2

The number of measured values returned depends on the number of carrier signals and adjacent/alternate channels selected with

[\[SENSe<1|2>:\]POWER:ACHannel:TXChannel:COUNT](#) and
[\[SENSe<1|2>:\]POWER:ACHannel:ACPairs](#).

If only one carrier signal is measured, the total value of all carrier signals will not be output.

With logarithmic scaling (RANGE LOG), the power is output in dBm; with

	linear scaling (RANGE LIN dB or LIN %), the power is output in W. If [SENSe<1 2>:]POWer:ACHannel:MODE is set to REL, the adjacent/alternate-channel power is output in dB.
OBANdwidth OBWidth	Measurement of occupied bandwidth The occupied bandwidth in Hz is returned.
CN	Measurement of carrier-to-noise ratio The carrier-to-noise ratio in dB is returned.
CN0	Measurement of carrier-to-noise ratio referenced to 1 Hz bandwidth. The carrier-to-noise ratio in dB/Hz is returned.

Example of channel/adjacent-channel power measurement

SENS:POW:ACH:ACP 3

Sets the number of adjacent/alternate channels to 3.

SENS:POW:ACH:BAND 30KHZ

Sets the bandwidth of the transmission channel to 30 kHz.

SENS:POW:ACH:BAND:ACH 40KHZ

Sets the bandwidth of each adjacent channel to 40 kHz.

SENS:POW:ACH:BAND:ALT1 50KHZ

Sets the bandwidth of each alternate channel to 50 kHz.

SENS:POW:ACH:BAND:ALT2 60KHZ

Sets the bandwidth of alternate channel 2 to 60 kHz.

SENS:POW:ACH:SPAC 30KHZ

Sets the spacing between the transmission channel and the adjacent channel to 30 kHz, the spacing between the transmission channel and alternate channel 1 to 60 kHz, and the spacing between the transmission channel and alternate channel 2 to 90 kHz.

SENS:POW:ACH:SPAC:ALT1 100KHZ

Sets the spacing between the transmission channel and alternate channel 1 to 100 kHz, and the spacing between the transmission channel and alternate channel 2 to 150 kHz.

SENS:POW:ACH:SPAC:ALT2 140KHZ

Sets the spacing between the transmission channel and alternate channel 2 to 140 kHz.

SENS:POW:ACH:MODE ABS

Switches on absolute power measurement.

CALC:MARK:FUNC:POW:SEL ACP

Switches on the adjacent-channel power measurement.

INIT:CONT OFF

Switches over to single sweep mode.

INIT;*WAI

Starts a sweep and waits for the end of the sweep.

CALC:MARK:FUNC:POW:RES? ACP

Queries the result of adjacent-channel power measurement.

SENS:POW:ACH:REF:AUTO ONCE

Defines the measured channel power as the reference value for relative power measurements.

Note: If the channel power only is to be measured, all commands relating to adjacent/alternate channel bandwidth and channel spacings are omitted. The number of adjacent/alternate channels is set to 0 with

[SENSe<1|2>:]POWer:ACHannel:ACPairs.

Example of occupied bandwidth measurement

SENS:POW:BAND 90PCT

Defines 90% as the percentage of the power to be contained in the bandwidth range to be measured.

```
INIT:CONT OFF
```

Switches over to single sweep mode.

```
INIT;*WAI
```

Starts a sweep and waits for the end of the sweep.

```
CALC:MARK:FUNC:POW:RES? OBW
```

Queries the occupied bandwidth measured.

Characteristics

*RST value: –

SCPI: device-specific

Mode

A–F

CALCulate<1|2>:MARKer:FUNCtion:POWER:SElect

This command selects – and switches on – specified power measurement type.

The channel spacings and channel bandwidths are configured in the "[SENSE:POWER Subsystem](#)" on page 6.137.

The numeric suffixes <1/2> are not relevant.

Note: If CPOWER is selected, the number of adjacent channels ([SENSE<1|2>:]POWER:ACHannel:ACPairs) is set to 0. If ACPower is selected, the number of adjacent channels is set to 1, unless adjacent-channel power measurement is switched on already.
The channel/adjacent-channel power measurement is performed for the trace selected with [SENSE<1|2>:]POWER:TRACe.

The occupied bandwidth measurement is performed for the trace on which marker 1 is positioned. To select another trace for the measurement, marker 1 is to be positioned on the desired trace by means of CALCulate<1|2>:MARKer<1..4>:TRACe.

Parameter

ACPower	Adjacent-channel power measurement with a single carrier signal
CPOWER	Channel power measurement with a single carrier signal (equivalent to adjacent-channel power measurement with <i>NO. OF ADJ CHAN = 0</i>)
MCACpower	Channel/adjacent-channel power measurement with several carrier signals
OBANdwidth OBWidth	Measurement of occupied bandwidth
CN	Measurement of carrier-to-noise ratio
CN0	Measurement of carrier-to-noise ratio referenced to 1 Hz bandwidth

Example

```
CALC:MARK:FUNC:POW:SEL ACP
```

Switches on adjacent-channel power measurement.

Characteristics

*RST value: –

SCPI: device-specific

Mode

A–F

CALCulate:MARKer:FUNCtion:STRack Subsystem

The CALCulate:MARKer:FUNCtion:STRack subsystem defines the settings of the signal track.

Commands of the CALCulate:MARKer:FUNCtion:STRack Subsystem

- CALCulate<1|2>:MARKer:FUNCtion:STRack[:STATe]
- CALCulate<1|2>:MARKer:FUNCtion:STRack:BANDwidth|BWIDth
- CALCulate<1|2>:MARKer:FUNCtion:STRack:THReshold
- CALCulate<1|2>:MARKer:FUNCtion:STRack:TRACe

CALCulate<1|2>:MARKer:FUNCtion:STRack[:STATe]

This command switches the signal-track function on or off.

With signal track activated, the maximum signal is determined after each frequency sweep and the center frequency is set to the frequency of this signal. Thus with drifting signals the center frequency follows the signal.

The numeric suffixes <1/2> are not relevant.

Parameter

ON | OFF

Example

```
CALC:MARK:FUNC:STR ON
Switches on the signal track function.
```

Characteristics

*RST value: OFF

SCPI: device-specific

Mode

A-F

CALCulate<1|2>:MARKer:FUNCtion:STRack:BANDwidth|BWIDth

These commands have the same function. They define the bandwidth around the center frequency within which the largest signal is searched.

The numeric suffixes <1/2> are not relevant.

Note: The entry of the search bandwidth is only possible if the Signal Track function is switched on (CALCulate<1|2>:MARKer:FUNCtion:STRack[:STATe]).

Parameter

10Hz to MAX (span)

Example

```
CALC:MARK:FUNC:STR:BAND 1MHZ
Sets the search bandwidth to 1 MHz.
CALC:MARK:FUNC:STR:BWID 1MHZ
Alternative command for the same function.
```

Characteristics

*RST value: – (= span/10 on activating the function)

SCPI: device-specific

Mode

A–F

CALCulate<1|2>:MARKer:FUNCtion:STRack:THReshold

This command defines the threshold above which the largest signal is searched for.

The response unit depends on the settings defined with `CALCulate<1|2>:UNIT:POWER`.

The numeric suffixes <1/2> are not relevant.

Note: The entry of the search bandwidth is only possible if the Signal Track function is switched on (`CALCulate<1|2>:MARKer:FUNCtion:STRack[:STATE]`).

Parameter

–330dBm to +30dBm

Example

```
CALC:MARK:FUNC:STR:THR -50DBM
```

Sets the threshold for signal tracking to –50 dBm.

Characteristics

*RST value: –120 dBm

SCPI: device-specific

Mode

A–F

CALCulate<1|2>:MARKer:FUNCtion:STRack:TRACe

This command defines the trace on which the largest signal is searched for.

The numeric suffixes <1/2> are not relevant.

Parameter

1 to 4

Example

```
CALC:MARK:FUNC:STR:TRAC 3
```

Defines trace 3 as the trace for signal tracking.

Characteristics

*RST value: 1

SCPI: device-specific

Mode

A–F

CALCulate:MARKer:FUNCTION:SUMMARY Subsystem

This subsystem contains the commands for controlling the power functions in zero span.

Commands of the CALCulate:MARKer:FUNCTION:SUMMARY Subsystem

- CALCulate<1|2>:MARKer:FUNCTION:MSUMmary?
- CALCulate<1|2>:MARKer:FUNCTION:SUMMARY[:STATe]
- CALCulate<1|2>:MARKer:FUNCTION:SUMMARY:AOFF
- CALCulate<1|2>:MARKer:FUNCTION:SUMMARY:AVERage
- CALCulate<1|2>:MARKer:FUNCTION:SUMMARY:MEAN[:STATe]
- CALCulate<1|2>:MARKer:FUNCTION:SUMMARY:MEAN:AVERage:RESult?
- CALCulate<1|2>:MARKer:FUNCTION:SUMMARY:MEAN:PHOLd:RESult?
- CALCulate<1|2>:MARKer:FUNCTION:SUMMARY:MEAN:RESult?
- CALCulate<1|2>:MARKer:FUNCTION:SUMMARY:MODE
- CALCulate<1|2>:MARKer:FUNCTION:SUMMARY:PHOLd
- CALCulate<1|2>:MARKer:FUNCTION:SUMMARY:PPEak[:STATe]
- CALCulate<1|2>:MARKer:FUNCTION:SUMMARY:PPEak:AVERage:RESult?
- CALCulate<1|2>:MARKer:FUNCTION:SUMMARY:PPEak:PHOLd:RESult?
- CALCulate<1|2>:MARKer:FUNCTION:SUMMARY:PPEak:RESult?
- CALCulate<1|2>:MARKer:FUNCTION:SUMMARY:REFerence:AUTO
- CALCulate<1|2>:MARKer:FUNCTION:SUMMARY:RMS[:STATe]
- CALCulate<1|2>:MARKer:FUNCTION:SUMMARY:RMS:AVERage:RESult?
- CALCulate<1|2>:MARKer:FUNCTION:SUMMARY:RMS:PHOLd:RESult?
- CALCulate<1|2>:MARKer:FUNCTION:SUMMARY:RMS:RESult?
- CALCulate<1|2>:MARKer:FUNCTION:SUMMARY:SDEViation[:STATe]
- CALCulate<1|2>:MARKer:FUNCTION:SUMMARY:SDEViation:AVERage:RESult?
- CALCulate<1|2>:MARKer:FUNCTION:SUMMARY:SDEViation:PHOLd:RESult?
- CALCulate<1|2>:MARKer:FUNCTION:SUMMARY:SDEViation:RESult?

CALCulate<1|2>:MARKer:FUNCTION:MSUMmary?

The commands of this subsystem are used to determine the power of a sequence of signal pulses having the same interval, as are typical for the slots of a GSM signal, for example. The number of pulses to be measured as well as the measurement time and the period can be set. To define the position of the first pulse in the trace, a suitable offset can be entered.

The evaluation is performed on the measurement data of a previously recorded trace. The data recorded during the set measurement time is combined to a measured value for each pulse according to the detector specified and the indicated number of results is output as a list.

Trace 1 is always used by the function.

The numeric suffixes <1/2> are not relevant.

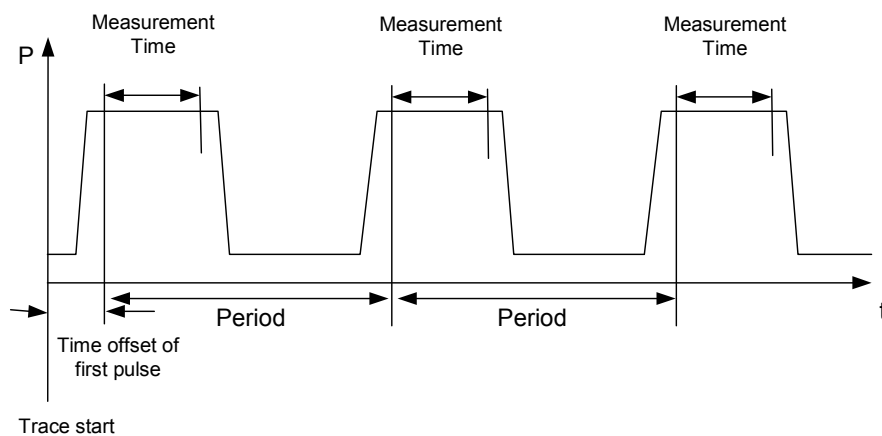
**Parameter**

<time offset of first pulse>, <measurement time>, <period>, < # of pulses to measure>

Example

```
DISP:WIND:TRAC:Y:RLEV -10dBm
```

Sets the reference level to 10 dB

```
INP:ATT 30 dB
```

Sets the input attenuation to 30 dB

```
FREQ:CENT 935.2MHz;SPAN 0Hz
```

Sets the receive frequency to 935.2 MHz and the span to 0 Hz

```
BAND:RES 1MHz;VID 3MHz
```

Sets the resolution bandwidth to 1 MHz and the video bandwidth to 3 MHz

```
DET RMS
```

Sets the RMS detector

```
TRIG:SOUR VID;LEV:VID 50 PCT
```

Selects the trigger source VIDEo and sets the level of the video trigger source to 50 PCT

```
SWE:TIME 50ms
```

Sets the sweep time to 50 ms

```
INIT;*WAI
```

Starts the measurement with synchronization

```
CALC:MARK:FUNC:MSUM? 50US,450US,576.9US,8
```

Queries 8 bursts with an offset of 50 μ s, a test time of 450 μ s and a period of 576.9 μ s

Characteristics

*RST value: –

SCPI: device-specific

Mode

A-T

CALCulate<1|2>:MARKer:FUNCTION:SUMMary[:STATe]

This command switches on or off the previously selected power measurements in zero span. Thus one or several measurements can be first selected and then switched on and off together with `CALCulate<1|2>:MARKer:FUNCTION:SUMMary[:STATe]`.

The numeric suffixes <1/2> are not relevant.

Parameter

ON | OFF

Example

```
CALC:MARK:FUNC:SUMM:STAT ON
```

Characteristics

*RST value: OFF

SCPI: device-specific

Mode

A-T

CALCulate<1|2>:MARKer:FUNCTION:SUMMary:AOFF

This command switches off all measurements in zero span.

The numeric suffixes <1/2> are not relevant.

This command is an event and therefore has no *RST value and no query.

Example

```
CALC:MARK:FUNC:SUMM:AOFF
```

Switches off the functions for power measurement in zero span.

Characteristics

*RST value: –

SCPI: device-specific

Mode

A-T

CALCulate<1|2>:MARKer:FUNCTION:SUMMary:AVERage

This command switches on or off averaging for the active power measurement in zero span.

Averaging is reset by switching it off and on again.

The number of results required for the calculation of average is defined with `[SENSe<1|2>:]AVERage:COUNT`.

Synchronization to the end of averaging is only possible in single sweep mode.

The numeric suffixes <1/2> are not relevant.

Parameter

ON | OFF

Example

```
INIT:CONT OFF
```

Switches to single sweep mode.

```
CALC:MARK:FUNC:SUMM:AVER ON
```

Switches on the calculation of average.

AVER:COUN 200
 Sets the measurement counter to 200.
 INIT;*WAI
 Starts a sweep and waits for the end.

Characteristics

*RST value: OFF
 SCPI: device-specific

Mode

A-T

CALCulate<1|2>:MARKer:FUNCtion:SUMMary:MEAN[:STATe]

This command switches on or off the measurement of the mean value.

The numeric suffixes <1/2> are not relevant.

Note: The measurement is performed on the trace on which marker 1 is positioned. In order to evaluate another trace, marker 1 must be positioned on another trace with
[CALCulate<1|2>:MARKer<1...4>:TRACe](#).

Parameter

ON | OFF

Example

CALC:MARK:FUNC:SUMM:MEAN ON
 Switches on the function.

Characteristics

*RST value: OFF
 SCPI: device-specific

Mode

A-T

CALCulate<1|2>:MARKer:FUNCtion:SUMMary:MEAN:AVERage:RESult?

This command queries the result of the measurement of the averaged mean value. The query is only possible if averaging has been activated previously using
[CALCulate<1|2>:MARKer:FUNCtion:SUMMary:AVERage](#).

A complete sweep with synchronization to sweep end must be performed between switching on the function and querying the measured value to obtain a correct query result. This is only possible in single sweep mode.

The numeric suffixes <1/2> are not relevant.

This command is only a query and therefore has no *RST value.

Example

INIT:CONT OFF
 Switches to single sweep mode.
 CALC:MARK:FUNC:SUMM:MEAN ON
 Switches on the function.
 CALC:MARK:FUNC:SUMM:AVER ON
 Switches on the average value calculation.
 INIT;*WAI
 Starts a sweep and waits for the end.

CALC:MARK:FUNC:SUMM:MEAN:AVER:RES?

Outputs the result.

Characteristics

*RST value: –

SCPI: device-specific

Mode

A–T

CALCulate<1|2>:MARKer:FUNCTION:SUMMARY:MEAN:PHOLD:RESult?

This command queries the result of the measurement of the mean value with active peak hold.

The query is only possible if the peak hold function has been switched on previously using

[CALCulate<1|2>:MARKer:FUNCTION:SUMMARY:PHOLD](#).

The query is possible only if the peak hold function is active.

A complete sweep with synchronization to sweep end must be performed between switching on the function and querying the measured value to obtain a correct query result. This is only possible in single sweep mode.

The numeric suffixes <1/2> are not relevant.

This command is only a query and therefore has no *RST value.

Example

INIT:CONT OFF

Switches to single sweep mode.

CALC:MARK:FUNC:SUMM:MEAN ON

Switches on the function.

CALC:MARK:FUNC:SUMM:PHOL ON

Switches on the peak value measurement.

INIT;*WAI

Starts a sweep and waits for the end.

CALC:MARK:FUNC:SUMM:MEAN:PHOL:RES?

Outputs the result.

Characteristics

*RST value: –

SCPI: device-specific

Mode

A–T

CALCulate<1|2>:MARKer:FUNCTION:SUMMARY:MEAN:RESult?

This command queries the result of the measurement of the mean value.

A complete sweep with synchronization to sweep end must be performed between switching on the function and querying the measured value to obtain a correct query result. This is only possible in single sweep mode.

The numeric suffixes <1/2> are not relevant.

This command is only a query and therefore has no *RST value.

Example

INIT:CONT OFF

Switches to single sweep mode.

CALC:MARK:FUNC:SUMM:MEAN ON

Switches on the function.

INIT;*WAI

Starts a sweep and waits for the end.

CALC:MARK:FUNC:SUMM:MEAN:RES?

Outputs the result.

Characteristics

*RST value: –

SCPI: device-specific

Mode

A–T

CALCulate<1|2>:MARKer:FUNCtion:SUMMery:MODE

This command selects absolute or relative power measurement in zero span.

The reference power for relative measurement is defined with

[CALCulate<1|2>:MARKer:FUNCtion:SUMMery:REFeRence:AUTO](#). If the reference power is not defined, the value 0 dBm is used.

The numeric suffixes <1|2> and <1...4> are irrelevant for this command.

Parameter

ABSolute | RELative

Example

CALC:MARK:FUNC:SUMM:MODE REL

Switches the power measurement in zero span to relative.

Characteristics

RST value: ABSolute

SCPI: device-specific

Mode

A–T

CALCulate<1|2>:MARKer:FUNCtion:SUMMery:PHOLd

This command switches on or off the peak–hold function for the active power measurement in zero span.

The peak–hold function is reset by switching it off and on again.

The numeric suffixes <1/2> are not relevant.

Parameter

ON | OFF

Example

CALC:MARK:FUNC:SUMM:PHOL ON

Switches on the function.

Characteristics

*RST value: OFF

SCPI: device-specific

Mode

A–T

CALCulate<1|2>:MARKer:FUNCtion:SUMMary:PPEak[:STATe]

This command switches on or off the measurement of the positive peak value.
The numeric suffixes <1/2> are not relevant.

Parameter

ON | OFF

Example

```
CALC:MARK:FUNC:SUMM:PPE ON
```

Switches on the function.

Characteristics

*RST value: OFF

SCPI: device-specific

Mode

A–T

CALCulate<1|2>:MARKer:FUNCtion:SUMMary:PPEak:AVERage:RESult?

This command is used to query the result of the measurement of the averaged positive peak value. The query is only possible if averaging has been activated previously using [CALCulate<1|2>:MARKer:FUNCtion:SUMMary:AVERage](#).

A complete sweep with synchronization to sweep end must be performed between switching on the function and querying the measured value to obtain a correct query result. This is only possible in single sweep mode.

The numeric suffixes <1/2> are not relevant.

This command is only a query and therefore has no *RST value.

Example

```
INIT:CONT OFF
```

Switches to single sweep mode.

```
CALC:MARK:FUNC:SUMM:PPE ON
```

Switches on the function.

```
CALC:MARK:FUNC:SUMM:AVER ON
```

Switches on the calculation of average.

```
INIT;*WAI
```

Starts a sweep and waits for the end.

```
CALC:MARK:FUNC:SUMM:PPE:AVER:RES?
```

Outputs the result.

Characteristics

*RST value: –

SCPI: device-specific

Mode

A–T

CALCulate<1|2>:MARKer:FUNCTION:SUMMary:PPEak:PHOLd:RESult?

This command is used to query the result of the measurement of the positive peak value with active peak hold function. The query is only possible if the peak hold function has been activated previously using `CALCulate<1|2>:MARKer:FUNCTION:SUMMary:PHOLd`.

A complete sweep with synchronization to sweep end must be performed between switching on the function and querying the measured value to obtain a correct query result. This is only possible in single sweep mode.

The numeric suffixes <1/2> are not relevant.

This command is only a query and therefore has no *RST value.

Example

```
INIT:CONT OFF
```

Switches to single sweep mode.

```
CALC:MARK:FUNC:SUMM:PPE ON
```

Switches on the function.

```
CALC:MARK:FUNC:SUMM:PHOL ON
```

Switches on the measurement of the peak value.

```
INIT;*WAI
```

Starts a sweep and waits for the end.

```
CALC:MARK:FUNC:SUMM:PPE:PHOL:RES?
```

Outputs the result.

Characteristics

*RST value: –

SCPI: device-specific

Mode

A–T

CALCulate<1|2>:MARKer:FUNCTION:SUMMary:PPEak:RESult?

This command is used to query the result of the measurement of the positive peak value. The measurement may have to be switched on previously.

A complete sweep with synchronization to sweep end must be performed between switching on the function and querying the measured value to obtain a correct query result. This is only possible in single sweep mode.

The numeric suffixes <1/2> are not relevant.

This command is only a query and therefore has no *RST value.

Example

```
INIT:CONT OFF
```

Switches to single sweep mode.

```
CALC:MARK:FUNC:SUMM:PPE ON
```

Switches on the function.

```
INIT;*WAI
```

Starts a sweep and waits for the end.

```
CALC:MARK:FUNC:SUMM:PPE:RES?
```

Outputs the result.

Characteristics

*RST value: –

SCPI: device-specific

ModeA-T

CALCulate<1|2>:MARKer:FUNCtion:SUMMary:REFerence:AUTO

This command sets the currently measured average value (`CALCulate<1|2>:MARKer:FUNCtion:SUMMary:MEAN[:STATe]`) and RMS value (`CALCulate<1|2>:MARKer:FUNCtion:SUMMary:RMS[:STATe]`) as reference values for relative measurements in zero span.

If the measurement of RMS value and average is not activated, the reference value 0 dBm is used.

If the function `CALCulate<1|2>:MARKer:FUNCtion:SUMMary:AVERage` or `CALCulate<1|2>:MARKer:FUNCtion:SUMMary:PHOLd` is switched on, the current value is the accumulated measurement value at the time considered.

The numeric suffixes <1|2> and <1...4> are irrelevant for this command.

This command is an event and therefore has no *RST value and no query.

Parameter

ONCE

Example

```
CALC:MARK:FUNC:SUMM:REF:AUTO ONCE
```

Takes the currently measured power as reference value for the relative power measurement in zero span.

Characteristics

RST value: –

SCPI: device-specific

ModeA-T

CALCulate<1|2>:MARKer:FUNCtion:SUMMary:RMS[:STATe]

This command switches on or off the measurement of the effective (RMS) power. If necessary the function is switched on previously.

The numeric suffixes <1/2> are not relevant.

Parameter

ON | OFF

Example

```
CALC:MARK:FUNC:SUM:RMS ON
```

Switches on the function.

Characteristics

*RST value: OFF

SCPI: device-specific

ModeA-T

CALCulate<1|2>:MARKer:FUNCTION:SUMMary:RMS:AVERAge:RESult?

This command queries the result of the measurement of the averaged RMS value. The query is only possible if averaging has been activated previously using [CALCulate<1|2>:MARKer:FUNCTION:SUMMary:AVERAge](#).

A complete sweep with synchronization to sweep end must be performed between switching on the function and querying the measured value to obtain a correct query result. This is only possible in single sweep mode.

The numeric suffixes <1/2> are not relevant.

This command is only a query and therefore has no *RST value.

Example

```
INIT:CONT OFF
```

Switches to single sweep mode.

```
CALC:MARK:FUNC:SUMM:RMS ON
```

Switches on the function.

```
CALC:MARK:FUNC:SUMM:AVER ON
```

Switches on the average value calculation.

```
INIT;*WAI
```

Starts a sweep and waits for the end.

```
CALC:MARK:FUNC:SUMM:RMS:AVER:RES?
```

Outputs the result.

Characteristics

*RST– value: –

SCPI: device–specific

Mode

A–T

CALCulate<1|2>:MARKer:FUNCTION:SUMMary:RMS:PHOLd:RESult?

This command queries the result of the measurement of the RMS value with active peak hold. The query is only possible only if the peak hold function has been activated previously using [CALCulate<1|2>:MARKer:FUNCTION:SUMMary:PHOLd](#).

A complete sweep with synchronization to sweep end must be performed between switching on the function and querying the measured value to obtain a correct query result. This is only possible in single sweep mode.

The numeric suffixes <1/2> are not relevant.

This command is only a query and therefore has no *RST value.

Example

```
INIT:CONT OFF
```

Switches to single sweep mode.

```
CALC:MARK:FUNC:SUMM:RMS ON
```

Switches on the function.

```
CALC:MARK:FUNC:SUMM:PHOL ON
```

Switches on the peak value measurement.

```
INIT;*WAI
```

Starts a sweep and waits for the end.

```
CALC:MARK:FUNC:SUMM:RMS:PHOL:RES?
```

Outputs the result.

Characteristics

*RST value: –

SCPI: device-specific

Mode

A–T

CALCulate<1|2>:MARKer:FUNCtion:SUMMary:RMS:RESult?

This command queries the result of the measurement of the RMS power value.

A complete sweep with synchronization to sweep end must be performed between switching on the function and querying the measured value to obtain a correct query result. This is only possible in single sweep mode.

The numeric suffixes <1/2> are not relevant.

This command is only a query and therefore has no *RST value.

Example

```
INIT:CONT OFF
```

Switches to single sweep mode.

```
CALC:MARK:FUNC:SUMM:RMS ON
```

Switches on the function.

```
INIT;*WAI
```

Starts a sweep and waits for the end.

```
CALC:MARK:FUNC:SUMM:RMS:RES?
```

Outputs the result.

Characteristics

*RST value: –

SCPI: device-specific

Mode

A–T

CALCulate<1|2>:MARKer:FUNCtion:SUMMary:SDEViation[:STATe]

This command switches on or off the measurement of the standard deviation.

On switching on the measurement, the mean power measurement is switched on as well.

The numeric suffixes <1/2> are not relevant.

Parameter

ON | OFF

Example

```
CALC:MARK:FUNC:SUMM:SDEV ON
```

Switches on the measurement of the standard deviation.

Characteristics

*RST value: OFF

SCPI: device-specific

Mode

A

CALCulate<1/2>:MARKer:FUNCtion:SUMMary:SDEVIation:AVERage:RESult?

This command queries the result of the averaged standard deviation determined in several sweeps. The query is possible only if averaging is active.

A complete sweep with synchronization to sweep end must be performed between switching on the function and querying the measured value to obtain a correct query result. This is only possible in single sweep mode.

The numeric suffixes <1/2> are not relevant.

This command is only a query and therefore has no *RST value.

Example

```
INIT:CONT OFF
```

Switches to single sweep mode.

```
CALC:MARK:FUNC:SUMM:SDEV ON
```

Switches on the function.

```
CALC:MARK:FUNC:SUMM:AVER ON
```

Switches on the calculation of average.

```
INIT;*WAI
```

Starts a sweep and waits for the end.

```
CALC:MARK:FUNC:SUMM:MEAN:SDEV:RES?
```

Outputs the result.

Characteristics

*RST value: –

SCPI: device-specific

Mode

A–T

CALCulate<1/2>:MARKer:FUNCtion:SUMMary:SDEVIation:PHOLd:RESult?

This command queries the maximum standard deviation value determined in several sweeps. The query is possible only if the peak hold function is active.

A complete sweep with synchronization to sweep end must be performed between switching on the function and querying the measured value to obtain a correct query result. This is only possible in single sweep mode.

The numeric suffixes <1/2> are not relevant.

This command is only a query and therefore has no *RST value.

Example

```
INIT:CONT OFF
```

Switches to single sweep mode.

```
CALC:MARK:FUNC:SUMM:SDEV ON
```

Switches on the function.

```
CALC:MARK:FUNC:SUMM:PHOL ON
```

Switches on the peak value measurement.

```
INIT;*WAI
```

Starts a sweep and waits for the end.

```
CALC:MARK:FUNC:SUMM:SDEV:PHOL:RES?
```

Outputs the result.

Characteristics

*RST value: –

SCPI: device-specific

Mode

A–T

CALCulate<1|2>:MARKer:FUNCtion:SUMMery:SDEViation:RESult?

This command queries the results of the standard deviation measurement.

A complete sweep with synchronization to sweep end must be performed between switching on the function and querying the measured value to obtain a correct query result. This is only possible in single sweep mode.

The numeric suffixes <1/2> are not relevant.

This command is only a query and therefore has no *RST value.

Example

```
INIT:CONT OFF
```

Switches to single sweep mode.

```
CALC:MARK:FUNC:SUMM:SDEV ON
```

Switches on the function.

```
INIT;*WAI
```

Starts a sweep and waits for the end.

```
CALC:MARK:FUNC:SUMM:SDEV:RES?
```

Outputs the result.

Characteristics

*RST value: –

SCPI: device-specific

Mode

A–T

CALCulate:MATH Subsystem

The CALCulate:MATH subsystem allows to process data from the SENSE-subsystem in numeric expressions.

Commands of the CALCulate:MATH Subsystem

- [CALCulate<1|2>:MATH\[:EXPreSSion\]\[:DEFine\]](#)
- [CALCulate<1|2>:MATH:POSition](#)
- [CALCulate<1|2>:MATH:STATe](#)

CALCulate<1|2>:MATH[:EXPreSSion][:DEFine]

This command defines the mathematical expression for relating traces to trace1.

This command is available from firmware version 1.30.

Parameter

(TRACE1–TRACE2) Subtracts trace 2 from trace 1.

(TRACE1–TRACE3) Subtracts trace 3 from trace 1.

(TRACE1–TRACE4) Subtracts trace 4 from trace 1.

Example

```
CALC1:MATH (TRACE1 - TRACE2)
```

Selects the subtraction of trace 2 from trace 1.

Characteristics

*RST value: –

SCPI: conform

Mode

A

CALCulate<1|2>:MATH:POSition

This command defines the position of the result of the trace mathematics. The indication is in % of the screen height, with 100% corresponding to the upper diagram border.

This command is available from firmware version 1.30.

Parameter

–100PCT to 200PCT

Example

```
CALC:MATH:POS 50PCT
```

Sets the position to the horizontal diagram center.

Characteristics

*RST value: 50PCT

SCPI: device-specific

Mode

A

CALCulate<1|2>:MATH:STATe

This command switches the mathematical relation of traces on or off.

This command is available from firmware version 1.30.

Parameter

ON | OFF

Example

```
CALC:MATH:STAT ON
```

Switches on the trace mathematics.

Characteristics

*RST value: OFF

SCPI: conform

Mode

A

CALCulate:STATistics Subsystem

The CALCulate:STATistics subsystem controls the statistical measurement functions in the instrument.

Commands of the CALCulate:STATistics Subsystem

- CALCulate:STATistics:APD[:STATe]
- CALCulate:STATistics:CCDF[:STATe]
- CALCulate:STATistics:NSAMples
- CALCulate:STATistics:PRESet
- CALCulate:STATistics:RESult<1...4>?
- CALCulate:STATistics:SCALE:AUTO
- CALCulate:STATistics:SCALE:X:RANGE
- CALCulate:STATistics:SCALE:X:RLEVEL
- CALCulate:STATistics:SCALE:Y:LOWer
- CALCulate:STATistics:SCALE:Y:UPPer

CALCulate:STATistics:APD[:STATe]

This command switches on or off the measurement of amplitude distribution (APD). On activating this function, the CCDF measurement is switched off.

Parameter

ON | OFF

Example

```
CALC:STAT:APD ON  
Switches on the APD measurement.
```

Characteristics

*RST value: OFF
SCPI: device-specific

Mode

A

CALCulate:STATistics:CCDF[:STATe]

This command switches on or off the measurement of the complementary cumulative distribution function (CCDF). On activating this function, the APD measurement is switched off.

Parameter

ON | OFF

Example

```
CALC:STAT:CCDF ON  
Switches on the CCDF measurement.
```

Characteristics

*RST value: OFF

SCPI: device-specific

Mode

A

CALCulate:STATistics:NSAMples

This command sets the number of measurement points to be acquired for the statistical measurement functions.

Parameter

100 to 1E9

Example

CALC:STAT:NSAM 500

Sets the number of measurement points to be acquired to 500.

Characteristics

*RST value: 100000

SCPI: device-specific

Mode

A, CATV

CALCulate:STATistics:PRESet

This command resets the scaling of the X and Y axes in a statistical measurement. The following values are set:

x-axis ref level: -20 dBm

x-axis range APD: 100 dB

x-axis range CCDF: 20 dB

y-axis upper limit: 1.0

y-axis lower limit: 1E-6

This command is an event and therefore has no *RST value and no query.

Example

CALC:STAT:PRES

Resets the scaling for statistical functions

Characteristics

*RST value: -

SCPI: device-specific

Mode

A, CATV

CALCulate:STATistics:RESult<1...4>?

This command reads out the results of statistical measurements of a recorded trace. The trace is selected with the numeric suffix <1...4> attached to RESult.

Parameter

The required result is selected via the following parameters:

MEAN	Average (=RMS) power in dBm measured during the measurement time.
PEAK	Peak power in dBm measured during the measurement time.
CFACtor	Determined CREST factor (= ratio of peak power to average power) in dB.
ALL	Results of all three measurements mentioned before, separated by commas: <mean power>,<peak power>,<crest factor>

Example

```
CALC:STAT:RES2? ALL
```

Reads out the three measurement results of trace 2. Example of answer string:
5.56,19.25,13.69 i.e. mean power: 5.56 dBm, peak power 19.25 dBm, CREST factor 13.69 dB

Characteristics

*RST value: –

SCPI: device-specific

Mode

A, CATV

CALCulate:STATistics:SCALe:AUTO

This command optimizes the level setting of the instrument depending on the measured peak power, in order to obtain maximum instrument sensitivity.

To obtain maximum resolution, the level range is set as a function of the measured spacing between peak power and the minimum power for the APD measurement and of the spacing between peak power and mean power for the CCDF measurement. In addition, the probability scale for the number of test points is adapted.

This command is an event and therefore has no *RST value and no query.

*Note: Subsequent commands have to be synchronized with *WAI, *OPC or *OPC? to the end of the auto range process which would otherwise be aborted.*

Parameter

ONCE

Example

```
CALC:STAT:SCAL:AUTO ONCE;*WAI
```

Adapts the level setting for statistical measurements.

Characteristics

*RST value: –

SCPI: device-specific

Mode

A, CATV

CALCulate:STATistics:SCALe:X:RANGe

This command defines the level range for the X axis of the measurement diagram. The setting is identical to the level range setting defined with the `DISPlay[:WINDow<1|2>]:TRACe<1...4>:Y[:SCALe]` command.

Parameter

10dB to 200dB

Example

```
CALC:STAT:SCAL:X:RANG 20dB
```

Characteristics

*RST value: 100dB

SCPI: device-specific

Mode

A, CATV

CALCulate:STATistics:SCALe:X:RLEVel

This command defines the reference level for the X axis of the measurement diagram. The setting is identical to the reference level setting using the `DISPlay[:WINDow<1|2>]:TRACe<1...4>:Y[:SCALe]:RLEVel` command.

With the reference level offset $\neq 0$ the indicated value range of the reference level is modified by the offset.

The unit depends on the setting performed with `CALCulate<1|2>:UNIT:POWer`.

Parameter

-120dBm to 20dBm

Example

```
CALC:STAT:SCAL:X:RLEV -60dBm
```

Characteristics

*RST value: -20dBm

SCPI: device-specific

Mode

A, CATV

CALCulate:STATistics:SCALe:Y:LOWer

This command defines the lower limit for the Y axis of the diagram in statistical measurements. Since probabilities are specified on the Y axis, the entered numerical values are dimensionless.

Parameter

1E-9 to 0.1

Example

```
CALC:STAT:SCAL:Y:LOW 0.001
```

Characteristics

*RST value: 1E-6

SCPI: device-specific

Mode

A, CATV

CALCulate:STATistics:SCALe:Y:UPPer

This command defines the upper limit for the Y axis of the diagram in statistical measurements. Since probabilities are specified on the Y axis, the entered numerical values are dimensionless.

Parameter

1E-8 to 1.0

Example

```
CALC:STAT:Y:UPP 0.01
```

Characteristics

*RST value: 1.0

SCPI: device-specific

Mode

A, CATV

CALCulate:THReshold Subsystem

The CALCulate:THReshold subsystem controls the threshold value for the maximum/minimum search of markers.

Commands of the CALCulate:THReshold Subsystem

- CALCulate<1|2>:THReshold
- CALCulate<1|2>:THReshold:STATe

CALCulate<1|2>:THReshold

This command defines the threshold value for the maximum/minimum search of markers with marker search functions. The associated display line is automatically switched on. The numeric suffixes <1/2> are not relevant.

Parameter

MINimum to MAXimum (depending on current unit)

Example

```
CALC:THR -82DBM
```

Sets the threshold value to –82 dBm.

Characteristics

*RST value: – (STATe to OFF)

SCPI: device-specific

Mode

A, ADEMOD

CALCulate<1|2>:THReshold:STATe

This command switches on or off the threshold line. The unit depends on the setting performed with CALCulate<1|2>:UNIT:POWer.

The numeric suffixes <1/2> are not relevant.

Parameter

ON | OFF

Example

```
CALC:THR:STAT ON
```

Switches on the threshold line.

Characteristics

*RST value: OFF

SCPI: device-specific

Mode

A, ADEMOD

CALCulate:TLINe Subsystem

The CALCulate:TLINe subsystem defines the position of the time lines.

Commands of the CALCulate:TLINe Subsystem

- CALCulate<1|2>:TLINe<1|2>
- CALCulate<1|2>:TLINe<1|2>:STATe

CALCulate<1|2>:TLINe<1|2>

This command defines the position of the time lines that mark the times.
The numeric suffixes <1/2> are not relevant.

Parameter

0 to 1000s

Example

```
CALC:TLIN 10ms
```

Characteristics

*RST value: – (STATe to OFF)

SCPI: device-specific

Mode

A–T

CALCulate<1|2>:TLINe<1|2>:STATe

This command switches the time line on or off.
The numeric suffixes <1/2> are not relevant.

Parameter

ON | OFF

Example

```
CALC:TLIN2:STAT ON
```

Characteristics

*RST value: OFF

SCPI: device-specific

Mode

A–T

CALCulate:UNIT Subsystem

The CALCulate:UNIT subsystem defines the units for the parameters that can be set and the measurement results.

Commands of the CALCulate:UNIT Subsystem

- [CALCulate<1|2>:UNIT:POWer](#)

CALCulate<1|2>:UNIT:POWer

This command selects the unit for power.
The numeric suffixes <1/2> are not relevant.

Parameter

DBM | V | A | W | DBPW | WATT | DBPT | DBUV | DBMV | VOLT | DBUA | AMPere

Example

```
CALC:UNIT:POW DBM
```

Sets the power unit to dBm.

Characteristics

*RST value: dBm
SCPI: device-specific

Mode

A

DISPlay Subsystem

The DISPlay subsystem controls the selection and presentation of textual and graphic information as well as of measurement data on the display.

Commands of the DISPlay Subsystem

- DISPlay[:WINDow<1|2>]:SIZE
- DISPlay[:WINDow<1|2>]:TRACE<1...4>[:STATe]
- DISPlay[:WINDow<1|2>]:TRACe<1...4>:MODE
- DISPlay[:WINDow<1|2>]:TRACe<1...4>:MODE:HCONTinuous
- DISPlay[:WINDow<1|2>]:TRACe<1...4>:Y:SPACing
- DISPlay[:WINDow<1|2>]:TRACe<1...4>:Y[:SCALe]
- DISPlay[:WINDow<1|2>]:TRACe<1...4>:Y[:SCALe]:MODE
- DISPlay[:WINDow<1|2>]:TRACe<1...4>:Y[:SCALe]:RLEVel
- DISPlay[:WINDow<1|2>]:TRACe<1...4>:Y[:SCALe]:RLEVel:OFFSet
- DISPlay[:WINDow<1|2>]:TRACe<1...4>:Y[:SCALe]:RPOSition (models 13, 16)
- DISPlay[:WINDow<1|2>]:TRACE<1...4>:Y[:SCALe]:RVALue (models 13, 16)
- DISPlay[:WINDow<1|2>]:TRACe<1...4>:Y[:SCALe]:RVALue:AUTO

DISPlay[:WINDow<1|2>]:SIZE

This command switches the measurement window for channel and adjacent–channel power measurements to full screen or half screen. Only "1" is allowed as a numerical suffix.

Parameter

LARGE | SMALL

Example

```
DISP:SIZE LARG
```

Displays the measurement diagram in full screen size.

Characteristics

*RST value: SMALL

SCPI: device–specific

Mode

A, ADEMOD

DISPlay[:WINDow<1|2>]:TRACE<1...4>[:STATe]

This command switches on or off the display of the corresponding trace. The numeric suffixes <1|2> are irrelevant.

Parameter

ON | OFF

Example

```
DISP:TRAC3 ON
```

Characteristics

*RST value: ON for TRACe1, OFF for TRACe2 to 4

SCPI: conform

Mode

all

DISPlay[:WINDow<1|2>]:TRACe<1...4>:MODE

This command defines the type of display and the evaluation of the traces. WRITE corresponds to the Clr/Write mode of manual operation. The trace is switched off (= BLANK in manual operation) with `DISPlay[:WINDow<1|2>]:TRACe<1...4>[:STATe]`.

The number of measurements for AVERage, MAXHold and MINHold is defined with the `[SENSe<1|2>:]AVERage:COUNT` or `[SENSe<1|2>:]SWEep:COUNT` commands. It should be noted that synchronization to the end of the indicated number of measurements is only possible in single sweep mode.

If calculation of average values is active, selection between logarithmic and linear averaging is possible. For more detail see command `SENSe:AVERage:TYPE`.

The numeric suffixes <1|2> are irrelevant.

Parameter

WRITE | VIEW | AVERage | MAXHold | MINHold |RMS

For details on trace modes refer to chapter "Instrument Functions", section "Trace mode overview" or the online help.

Example

```
SWE:CONT OFF
```

Switching to single sweep mode.

```
SWE:COUN 16
```

Sets the number of measurements to 16.

```
DISP:TRAC3:MODE MAXH
```

Switches on the calculation of the for trace 3.

```
INIT;*WAI
```

Starts the measurement and waits for the end of the 16 sweeps.

Characteristics

*RST value: WRITE for TRACe1, STATe OFF for TRACe2/3/4

SCPI: device-specific

Mode

all

DISPlay[:WINDow<1|2>]:TRACe<1...4>:MODE:HCONtinuous

This command defines, whether traces in Min Hold, Max Hold and Average mode are reset after parameter change or not.

Normally, the measurement is started anew after parameter changes, before the measurement results are evaluated (e.g. using a marker). In all cases that require a new measurement after parameter changes, the trace is reset automatically to avoid false results (e.g. with span changes). For applications that require no reset after parameter changes, the automatic reset can be switched off.

The numeric suffixes <1|2> are irrelevant.

Parameter

OFF After certain parameter changes the traces are reset.
 ON The automatic reset is switched off.

Example

DISP:WIND:TRAC3:MODE:HCON ON
 Switches off the reset function.

Characteristics

*RST value: OFF
 SCPI: device-specific

Mode

A, CATV

DISPlay[:WINDow<1|2>]:TRACe<1...4>:Y:SPACing

This command toggles between linear and logarithmic display. On a linear scale, switchover between the units % and dB is also possible (DISPlay[:WINDow<1|2>]:TRACe<1...4>:Y:SPACing command).
 The numeric suffixes <1|2> and <1...4> are irrelevant.

Parameter

LINear | LOGarithmic | PERCent | LDB

Example

DISP:TRAC:Y:SPAC LIN

Characteristics

*RST value: LOGarithmic
 SCPI: conform

Mode

A, ADEMOD, CATV

DISPlay[:WINDow<1|2>]:TRACe<1...4>:Y[:SCALE]

This command defines the display range of the Y axis (level axis) with logarithmic scaling (DISPlay[:WINDow<1|2>]:TRACe<1...4>:Y:SPACing).
 For linear scaling, the display range is fixed and cannot be modified.
 The numeric suffixes <1|2> and <1...4> are irrelevant.

Parameter

10 dB to 200 dB or value in Hz

Example

DISP:TRAC:Y 110dB

Characteristics

*RST value: 100dB
 SCPI: device-specific

Mode

all

DISPlay[:WINDow<1|2>]:TRACe<1...4>:Y[:SCALe]:MODE

This command defines the scale type of the Y axis (absolute or relative).

When `SYSTEM:DISPlay:UPDate` is set to OFF, this command has no immediate effect on the screen. The numeric suffixes <1|2> and <1...4> are irrelevant.

Parameter

ABSolute | RELative

Example

```
DISP:TRAC:Y:MODE REL
```

Characteristics

*RST value: ABS

SCPI: device-specific

Mode

all

DISPlay[:WINDow<1|2>]:TRACe<1...4>:Y[:SCALe]:RLEVel

This command defines the reference level.

With the reference level offset <> 0, the indicated value range of the reference level is modified by the offset.

The unit depends on the setting defined with `CALCulate<1|2>:UNIT:POWer`.

The numeric suffixes <1|2> and <1...4> are irrelevant.

Parameter

<numeric_value> in dBm, range specified in data sheet

Example

```
DISP:TRAC:Y:RLEV -60dBm
```

Characteristics

*RST value: -20dBm

SCPI: conform

Mode

A, CATV

DISPlay[:WINDow<1|2>]:TRACe<1...4>:Y[:SCALe]:RLEVel:OFFSet

This command defines the offset of the reference level.

The numeric suffixes <1|2> and <1...4> are irrelevant.

Parameter

-200dB to 200dB

Example

```
DISP:TRAC:Y:RLEV:OFFS -10dB
```

Characteristics

*RST value: 0dB

SCPI: conform

Mode

A, CATV, WLAN

DISPlay[:WINDow<1|2>]:TRACe<1...4>:Y[:SCALe]:RPOSition (models 13, 16)

This command requires a tracking generator and active normalization in the **Tracking Generator** mode. It defines the position of the reference value.

The numeric suffixes <1|2> and <1...4> are irrelevant.

Parameter

0 to 100PCT

Example

```
DISP:TRAC:Y:RPOS 50PCT
```

Characteristics

*RST value:

100 PCT Spectrum Analyzer mode

50 PCT Tracking Generator mode

SCPI: conform

Mode

A, ADEMOD, BT, CATV

DISPlay[:WINDow<1|2>]:TRACE<1...4>:Y[:SCALe]:RVALue (models 13, 16)

This command requires a tracking generator and active normalization in the **Tracking Generator** mode. The command defines the power value assigned to the reference position.

The numeric suffixes <1|2> and <1...4> are irrelevant.

Parameter

<numeric_value>

Example

```
DISP:TRAC:Y:RVAL -20dBm
```

(Analyzer)

```
DISP:TRAC:Y:RVAL 0
```

Sets the power value assigned to the reference position to 0 dB (tracking generator)

Characteristics

*RST value: 0 dB, coupled to reference level

SCPI: device-specific

Mode

A, ADEMOD, BT

DISPlay[:WINDow<1|2>]:TRACe<1...4>:Y[:SCALe]:RVALue:AUTO

This command defines whether the reference value for the Y axis is coupled to the reference level (default) or not.

The numeric suffixes <1|2> and <1...4> are irrelevant.

Parameter

ON | OFF

Example

DISP:TRAC:Y:RVAL:AUTO ON

Characteristics

*RST value: ON

SCPI: device-specific

Mode

A

FORMat Subsystem

The FORMat subsystem specifies the data format of the data transmitted from and to the instrument.

Commands of the FORMat Subsystem

- [FORMat:DEXPort:DSEPARATOR](#)

FORMat:DEXPort:DSEPARATOR

This command defines which decimal separator (decimal point or comma) is to be used for outputting measurement data to the file in ASCII format. Different languages of evaluation programs (e.g. MS–Excel) can thus be supported.

Parameter

POINT | COMMA

Example

```
FORM:DEXP:DSEP POIN
```

Sets the decimal point as separator.

Characteristics

*RST value: – (factory setting is POINT; *RST does not affect setting)

SCPI: device–specific

Mode

all

INITiate Subsystem

The INITiate subsystem is used to control the init–measurement function.

Commands of the INITiate Subsystem

- INITiate<1|2>[:IMMediate]
- INITiate<1|2>:CONMeas
- INITiate<1|2>:CONTInuous
- INITiate<1|2>:DISPlay

INITiate<1|2>[:IMMediate]

The command initiates a new measurement sequence.

With sweep count > 0 or average count > 0, this means a restart of the indicated number of measurements. With trace functions MAXHold, MINHold and AVERage, the previous results are reset on restarting the measurement.

In single sweep mode, synchronization to the end of the indicated number of measurements can be achieved with the command *OPC, *OPC? or *WAI. In continuous–sweep mode, synchronization to the sweep end is not possible since the overall measurement never ends.

This command is an event and therefore has no *RST value and no query.

Example

```
INIT:CONT OFF
```

Switches to single sweep mode.

```
DISP:WIND:TRAC:MODE AVER Switches on trace averaging.
```

```
SWE:COUN 20
```

Setting the sweep counter to 20 sweeps.

```
INIT;*WAI
```

Starts the measurement and waits for the end of the 20 sweeps.

Characteristics

*RST value: –

SCPI: conform

Mode

all

INITiate<1|2>:CONMeas

This command continues a stopped measurement at the current position in single sweep mode. The function is useful especially for trace functions MAXHold, MINHold and AVERage, if the previous results are not to be cleared with sweep count > 0 or average count > 0 on restarting the measurement (INIT:IMMediate resets the previous results on restarting the measurement).

The single sweep mode is automatically switched on. Synchronization to the end of the indicated number of measurements can then be performed with the commands *OPC, *OPC? or *WAI. In the continuous sweep mode, synchronization to the sweep end is not possible since the overall measurement "never" ends.

This command is an event and therefore has no *RST value and no query.

Example

```
INIT:CONT OFF
```

Switches to single sweep mode.

```
DISP:WIND:TRAC:MODE AVER
```

Switches on trace averaging.

```
SWE:COUN 20
```

Setting the sweep counter to 20 sweeps.

```
INIT;*WAI
```

Starts the measurement and waits for the end of the 20 sweeps.

```
INIT:CONM;*WAI
```

Continues the measurement (next 20 sequences) and waits for the end.

Characteristics

*RST value: –

SCPI: device-specific

Mode

A, CATV

INITiate<1|2>:CONTinuous

This command determines whether the trigger system is continuously initiated (continuous) or performs single measurements (single).

In the **Spectrum Analyzer** mode, this setting refers to the sweep sequence (switching between continuous/single sweep).

Parameter

ON | OFF

Example

```
INIT:CONT OFF
```

Switches the sequence single sweep.

```
INIT:CONT ON
```

Switches the sequence to continuous sweep.

Characteristics

*RST value: ON

SCPI: conform

Mode

all

INITiate<1|2>:DISPlay

This command switches the display during a single sweep measurement on (ON) or off (OFF). The numeric suffixes <1|2> are irrelevant for this command.

Parameter

ON | OFF

Example

```
INIT:CONT OFF
```

Switches to single sweep mode

```
INIT:DISP OFF
```

Sets the display behavior to OFF

INIT; *WAI

Starts the measurement with display switched off.

Characteristics

*RST value: ON

SCPI: device-specific

Mode

A

INPut Subsystem

The INPut subsystem controls the input characteristics of the RF inputs of the instrument.

Commands of the INPut Subsystem

- INPut<1|2>:ATTenuation
- INPut<1|2>:ATTenuation:AUTO
- INPut<1|2>:GAIN:STATe
- INPut<1|2>:IMPedance
- INPut<1|2>:UPORt[:VALue]?
- INPut<1|2>:UPORt:STATe

INPut<1|2>:ATTenuation

This command programs the input attenuator. To protect the input mixer against damage from overloads, the setting 0 dB can be obtained by entering numerals, not by using the `DEC` command.

The attenuation can be set in 5 dB steps. If the defined reference level cannot be set for the set RF attenuation, the reference level will be adjusted accordingly.

In the default state with **Spectrum Analyzer** mode, the attenuation set on the step attenuator is coupled to the reference level of the instrument. If the attenuation is programmed directly, the coupling to the reference level is switched off.

Parameter

<numeric_value> in dB; range specified in data sheet

Example

```
INP:ATT 30dB
```

Sets the attenuation on the attenuator to 30 dB and switches off the coupling to the reference level.

Characteristics

*RST value: 0 dB (AUTO is set to ON)

SCPI: conform

Mode

all

INPut<1|2>:ATTenuation:AUTO

This command automatically couples the input attenuation to the reference level (state ON) or switches the input attenuation to manual entry (state OFF). The minimum input attenuation set with the coupling switched on is 5 dB.

Parameter

ON | OFF

Example

```
INP:ATT:AUTO ON
```

Couples the attenuation set on the attenuator to the reference level.

Characteristics

*RST value: ON

SCPI: conform

Mode

all

INPut<1|2>:GAIN:STATe

This command switches on the preamplifier for the instrument.

Parameter

ON | OFF

Example

```
INP:GAIN:STAT ON
```

Switches on 20 dB preamplification.

Characteristics

*RST value: OFF

SCPI: conform

Mode

A, CATV

INPut<1|2>:IMPedance

This command sets the nominal input impedance of the instrument. The set impedance is taken into account in all level indications of results.

The setting 75 Ω should be selected, if the 50 Ω input impedance is transformed to a higher impedance using a 75 Ω adapter of the RAZ type (= 25 Ω in series to the input impedance of the instrument). The correction value in this case is 1.76 dB = 10 log (75 Ω / 50 Ω).

Parameter

50 | 75

Example

```
INP:IMP 75
```

Characteristics

*RST value: 50 Ω

SCPI: conform

Mode

all

INPut<1|2>:UPORt[:VALue]?

This command queries the control lines of the user ports.

This command is a query and therefore has no *RST value.

Example

```
INP:UPOR?
```

Characteristics

RST value: –

SCPI: device-specific

Modeall

INPut<1|2>:UPORt:STATe

This command toggles the control lines of the user ports between INPut and OUTPut. With ON, the user port is switched to INPut, with OFF to OUTPut.

Parameter

ON | OFF

Example

INP:UPOR:STAT ON

Characteristics

RST value: ON

SCPI: device-specific

Modeall

OUTPut Subsystem

The OUTPut subsystem controls the output features of the instrument.

Commands of the OUTPut Subsystem

- `OUTPut<1|2>[:STATe]` (models 13 and 16)
- `OUTPut:UPORt[:VALue]`
- `OUTPut:UPORt:STATe`

OUTPut<1|2>[:STATe] (models 13 and 16)

This command switches the tracking generator on or off.

Note: With the tracking generator switched on, the maximum stop frequency is limited to 3 GHz. This upper limit is automatically modified by the set frequency offset of the generator.

If measurements in compliance with specs are to be performed with the tracking generator, the start frequency has to be ≥ 3 x resolution bandwidth.

If a sweep time shorter than recommended in the data sheet is selected, the sweep time indicator SWT on the screen is marked with a red asterisk and the message UNCAL is also displayed.

With the tracking generator switched on, the FFT filters (BAND:MODE:FFT) are not available.

Parameter

ON | OFF

Example

```
OUTP ON
```

Switches on the tracking generator.

Characteristics

*RST value: –

SCPI: conform

Mode

A

OUTPut:UPORt[:VALue]

This command sets the control lines of the user ports.

The user port is written to with the given binary pattern. If the user port is programmed to INPut instead of OUTPut, the output value is temporarily stored.

Parameter

#B00000000 to #B11111111

Example

```
OUTP:UPOR #B10100101
```

Characteristics

*RST value: –

SCPI: device-specific

Modeall

OUTPut:UPORt:STATe

This command switches the control line of the user ports between INPut and OUTPut. The user port is switched to OUTPut with parameter ON, to INPut with OFF.

Parameter

ON | OFF

Example

```
OUTP:UPOR:STAT ON
```

Characteristics

*RST value: OFF

SCPI: device-specific

Modeall

SENSe Subsystem

The SENSe subsystem is organized in several subsystems. The commands of these subsystems directly control device-specific settings, they do not refer to the signal characteristics of the measurement signal.

The SENSe subsystem controls the essential parameters of the analyzer. In accordance with the SCPI standard, the keyword "SENSe" is optional for this reason, which means that it is not necessary to include the SENSe node in command sequences.

The following subsystems are included:

- "SENSe:AVERAge Subsystem" on page 6.113
- "SENSe:BANDwidth Subsystem" on page 6.115
- "SENSe:CORRection Subsystem (Models 13 and 16)" on page 6.119
- "SENSe:DETEctor Subsystem" on page 6.122
- "SENSe:FREQuency Subsystem" on page 6.123
- "SENSe:LIST Subsystem" on page 6.127
- "SENSe:MPOWer Subsystem" on page 6.132
- "SENSe:POWer Subsystem" on page 6.137
- "SENSe:SWEep Subsystem" on page 6.145

SENSe:AVERAge Subsystem

The SENSe:AVERAge subsystem calculates the average of the acquired data. A new test result is obtained from several successive measurements.

There are two types of average calculation: logarithmic and linear. In case of logarithmic average calculation (denoted with VIDEO), the average value of the measured logarithmic power is calculated and in case of linear average calculation, the linear power is averaged before the logarithm is applied.

Commands of the SENSe:AVERAge Subsystem

- [SENSe<1|2>:]AVERAge[:STATe<1...4>]
- [SENSe<1|2>:]AVERAge:COUNt
- [SENSe<1|2>:]AVERAge:COUNt:AUTO
- [SENSe<1|2>:]AVERAge:TYPE

[SENSe<1|2>:]AVERAge[:STATe<1...4>]

This command switches on or off the average calculation for the selected trace (STATe<1...4>). The numeric suffixes <1/2> are not relevant.

Parameter

ON | OFF

Example

```
AVER OFF
```

Switches off the average calculation for trace 1.

```
SENS:AVER:STAT3 ON
```

Switches on the average calculation for trace 3.

Characteristics

*RST value: OFF

SCPI: conform

Mode

all

[SENSe<1|2>:]AVERAge:COUNT

This command defines the number of measurements which contribute to the average value.

It should be noted that continuous averaging will be performed after the indicated number has been reached in continuous sweep mode.

In single sweep mode, the sweep is stopped as soon as the indicated number of measurements (sweeps) is reached. Synchronization to the end of the indicated number of measurements is only possible in single sweep mode.

The [SENSe<1|2>:]AVERAge:COUNT command effects the same as the [SENSe<1|2>:]SWEep:COUNT command. In both cases, the number of measurements is defined whether the average calculation is active or not.

The number of measurements applies to all traces.

The numeric suffixes <1/2> are not relevant.

Parameter

0 to 32767

Example

```
SWE:CONT OFF
```

Switching to single sweep mode.

```
AVER:COUN 16
```

Sets the number of measurements to 16.

```
AVER:STAT ON
```

Switches on the calculation of average.

```
INIT;*WAI
```

Starts the measurement and waits for the end of the 16 sweeps.

Characteristics

*RST value: 0

SCPI: conform

Mode

all

[SENSe<1|2>:]AVERAge:COUNT:AUTO

This command is implemented only for reasons of compatibility with the FSP family. It selects a suitable number of counts for the selected measurement type.

The numeric suffixes <1/2> are not relevant.

Parameter

ON | OFF

Example

```
AVER:COUN:AUTO ON
```

Characteristics

RST value: OFF

SCPI: conform

Mode

all

[SENSe<1|2>:]AVERAge:TYPE

This command selects the type of average function.

Parameter

VIDeo The logarithmic power values are averaged.

LINear The power values are averaged before they are converted to logarithmic values.

Example

```
AVER:TYPE LIN
```

Switches to linear average calculation.

Characteristics

RST value: VIDeo

SCPI: device-specific

Mode

A

SENSe:BANDwidth Subsystem

This subsystem controls the setting of the instruments filter bandwidths. Both groups of commands (BANDwidth and BWIDth) perform the same functions.

Commands of the SENSe:BANDwidth Subsystem

- [SENSe<1|2>:]BANDwidth|BWIDth[:RESolution]
- [SENSe<1|2>:]BANDwidth|BWIDth[:RESolution]:AUTO
- [SENSe<1|2>:]BANDwidth|BWIDth[:RESolution]:RATio
- [SENSe<1|2>:]BANDwidth|BWIDth[:RESolution]:TYPE
- [SENSe<1|2>:]BANDwidth|BWIDth:VIDeo
- [SENSe<1|2>:]BANDwidth|BWIDth:VIDeo:AUTO
- [SENSe<1|2>:]BANDwidth|BWIDth:VIDeo:RATio
- [SENSe<1|2>:]BANDwidth|BWIDth:VIDeo:TYPE

[SENSe<1|2>:]BANDwidth|BWIDth[:RESolution]

This command defines the analyzers resolution bandwidth.

The resolution bandwidth can be set in 1, 3, 10 steps in the range between 1 kHz and 3 MHz (10 Hz to 3 MHz with option Narrow IF Filters, R&S FSL-B7). For details on the correlation between resolution bandwidth and filter type refer to chapter "Instrument Functions", section "To choose the appropriate filter type".

If the resolution bandwidth is modified, the coupling to the span is automatically switched off.

The numeric suffixes <1/2> are not relevant.

Parameter

<numeric_value>

Example

BAND 1MHz

Sets the resolution bandwidth to 1 MHz

Characteristics

*RST value: – (AUTO is set to ON)

SCPI: conform

Mode

all, except ADEMOD

[SENSe<1|2>:]BANDwidth|BWIDth[:RESolution]:AUTO

This command either automatically couples the resolution bandwidth of the instrument to the span or cancels the coupling.

The automatic coupling adapts the resolution bandwidth to the currently set frequency span according to the relationship between frequency span and resolution bandwidth. The 6 dB bandwidths 200 Hz, 9 kHz and 120 kHz and the channel filters available are not set by the automatic coupling.

The ratio resolution bandwidth/span can be modified with the [\[SENSe<1|2>:\]BANDwidth|BWIDth\[:RESolution\]:RATio](#) command.

The numeric suffixes <1/2> are not relevant.

Parameter

ON | OFF

Example

BAND:AUTO OFF

Switches off the coupling of the resolution bandwidth to the span.

Characteristics

*RST value: ON

SCPI: conform

Mode

A–F, CATV

[SENSe<1|2>:]BANDwidth|BWIDth[:RESolution]:RATio

This command defines the ratio resolution bandwidth (Hz) / span (Hz). The ratio to be entered is reciprocal to the ratio span/RBW used in manual control.

The numeric suffixes <1/2> are not relevant.

Parameter

0.0001 to 1

Example

BAND:RAT 0.1

Characteristics

*RST value: 0.02 with BAND:TYPE NORMal or RBW > 30 kHz; 0.01 with BAND:TYPE FFT for RBW ≤ 30 kHz

SCPI: conform

Mode

A

[SENSe<1|2>:]BANDwidth|BWIDth[:RESolution]:TYPE

This command switches the filter type for the resolution bandwidth between "normal" analog or FIR filters in 1, 3, 10 steps and the FFT filtering for bandwidths <100 kHz.

For detailed information on filters see chapter "Instrument Functions", section "To choose the appropriate filter" and "List of available RRC and channel filters".

The numeric suffixes <1/2> are not relevant.

Note: When changing the filter type, the next larger filter bandwidth is selected if the same filter bandwidth is not available for the new filter type.

Parameter

NORMal	Gaussian filters
FFT	FFT filters
CFILter	channel filters
RRC	RRC filters
PULSe	EMI (6dB) filters (available from firmware version 1.30)

Example

BAND:TYPE NORM

Characteristics

*RST value: NORMal

SCPI: device-specific

Mode

all, except ADEMOD

[SENSe<1|2>:]BANDwidth|BWIDth:VIDeo

This command defines the instruments video bandwidth. Bandwidths from 1 Hz to 10 MHz in 1, 3, 10 steps are available. The command is not available if FFT filtering is switched on and the set bandwidth is ≤ 30 kHz or if the quasi-peak detector is switched on.

The numeric suffixes <1/2> are not relevant.

Parameter

1Hz to 10MHz

Example

BAND:VID 10kHz

Characteristics

*RST value: – (AUTO is set to ON)

SCPI: conform

Mode

A, CATV

[SENSe<1|2>:]BANDwidth|BWIDth:VIDeo:AUTO

This command either automatically couples the instruments video bandwidth to the resolution bandwidth or cancels the coupling.

The ratio video bandwidth/resolution bandwidth can be modified with the `[SENSe<1|2>:]BANDwidth|BWIDth[:RESolution]:RATio` command.

The numeric suffixes <1/2> are not relevant.

Parameter

ON | OFF

Example

BAND:VID:AUTO OFF

Characteristics

*RST value: ON

SCPI: conform

Mode

A, CATV

[SENSe<1|2>:]BANDwidth|BWIDth:VIDeo:RATio

This command defines the ratio video bandwidth (Hz) / resolution bandwidth (Hz). The ratio to be entered is reciprocal to the ratio RBW/VBW used in manual control.

The numeric suffixes <1/2> are not relevant.

Parameter

0.01 to 1000

Example

BAND:VID:RAT 3

Sets the coupling of video bandwidth to video bandwidth = 3*resolution bandwidth

Characteristics

*RST value: 3

SCPI: conform

Mode

A

[SENSe<1|2>:]BANDwidth|BWIDth:VIDeo:TYPE

This command selects the position of the video filter in the signal path, provided that the resolution bandwidth is ≤ 100 kHz.

The essential difference between the two modes is the transient response at falling signal edges: If LINear is selected, the measurement with logarithmic level scaling yields a much "flatter" falling edge than LOGarithmic. This behavior is due to the conversion of linear power into logarithmic level. If the linear power is halved, the level decreases by only 3 dB.

The numeric suffixes <1/2> are not relevant.

Parameter

LINear	The video filter is connected ahead of the logarithmic amplifier (default).
LOGarithmic	The video filter follows the logarithmic amplifier

Example

```
BAND:VID:TYPE LIN
```

Video filter ahead of the logarithmic amplifier

Characteristics

RST value: LIN

SCPI: device-specific

Mode

A

SENSe:CORRection Subsystem (Models 13 and 16)

This subsystem controls calibration and normalization during operation with the tracking generator.

Commands of the SENSe:CORRection Subsystem

- [SENSe<1|2>:]CORRection[:STATe]
- [SENSe<1|2>:]CORRection:COLLect[:ACQuire]
- [SENSe<1|2>:]CORRection:EGAIN:INPut[:MAGNitude]
- [SENSe<1|2>:]CORRection:METhod
- [SENSe<1|2>:]CORRection:RECall

[SENSe<1|2>:]CORRection[:STATe]

This command activates/deactivates the normalization of the measurement results provided that the tracking generator is active. The command is available only after acquisition of a reference trace for the selected type of measurement (transmission/reflection, see [SENSe<1|2>:]CORRection:COLLect[:ACQuire] command).

The numeric suffixes <1/2> are not relevant.

Parameter

ON | OFF

Example

```
CORR ON
```

Activates normalization.

Characteristics

*RST value: OFF

SCPI: conform

Mode

A

[SENSe<1|2>:]CORRection:COLLect[:ACQuire]

When the tracking generator is active, this command determines the type of result acquisition for the normalization reference measurement and starts the measurement selected:

To obtain a correct reference measurement, a complete sweep with synchronization to the end of the sweep must have been carried out. This is only possible in the single sweep mode.

The numeric suffixes <1/2> are not relevant.

This command is an "event" and therefore has no *RST value and no query.

Parameter

THRough	"TRANsmission" mode	calibration with direct connection between tracking generator and device input
	"REFLection" mode	calibration with short circuit at the input
OPEN	only allowed in "REFLection" mode	calibration with open input

Example

```
INIT:CONT OFF
```

Selects single sweep operation

```
CORR:COLL THR;*WAI
```

Starts the measurement of reference data using direct connection between generator and device input and waits for the sweep end.

Characteristics

*RST value: –

SCPI: conform

Mode

A

[SENSe<1|2>:]CORRection:EGAIN:INPut[:MAGNitude]

This command makes an external gain known to the analyzer, which will take it into account during the display of measurement results. With this function the gain of an antenna or of an external preamplifier can be taken into account for the measurement values.

The numeric suffixes <1/2> are not relevant.

Parameter

–200...200dB

Example

```
CORR:EGA:INP 10DB
```

Takes 10 dB external gain into account.

Characteristics

*RST value: 0 dB

SCPI: device-specific

Mode

A

[SENSe<1|2>:]CORRection:MEtHod

This command selects the type of measurement with active tracking generator (transmission/reflection).

The numeric suffixes <1/2> are not relevant.

Parameter

TRANsmission | REFLection

Example

```
CORR: METH TRAN
```

Sets the type of measurement to "transmission".

Characteristics

*RST value: TRANsmission

SCPI: device-specific

Mode

A

[SENSe<1|2>:]CORRection:RECall

This command restores the instrument setting that was applied to the measurement of the reference data, provided that the tracking generator is active.

The numeric suffixes <1/2> are not relevant.

This command is an event and therefore has no *RST value and no query.

Example

```
CORR: REC
```

Characteristics

*RST value: –

SCPI: conform

Mode

A

SENSe:DETECTOR Subsystem

The SENSe:DETECTOR subsystem controls the acquisition of measurement data via the selection of the detector for the corresponding trace.

Commands of the SENSe:DETECTOR Subsystem

- [SENSe<1|2>:]DETECTOR<1...4>[:FUNCTION]
- [SENSe<1|2>:]DETECTOR<1...4>[:FUNCTION]:AUTO

[SENSe<1|2>:]DETECTOR<1...4>[:FUNCTION]

This command switches on the detector for the data acquisition in the selected trace.

The trace is indicated as numeric suffix in DETECTOR.

The numeric suffixes <1/2> are not relevant.

Parameter

APEak | NEGative | POSitive | SAMPlE | RMS | AVERAge | QPEak

For details on detectors refer to chapter "Instrument Functions", section "Detector overview".

Example

```
DET POS
```

Sets the detector to "positive peak".

Characteristics

*RST value: APEak

SCPI: conform

Mode

A, CATV

[SENSe<1|2>:]DETECTOR<1...4>[:FUNCTION]:AUTO

This command either couples the detector to the current trace setting or turns coupling off. The trace is selected by the numeric suffix at DETECTOR.

The numeric suffixes <1/2> are not relevant.

Parameter

ON | OFF

Example

```
DET:AUTO OFF
```

Characteristics

*RST value: ON

SCPI: conform

Mode

A, CATV

SENSe:FREQUENCY Subsystem

The SENSe:FREQUENCY subsystem defines the frequency axis of the active display. The frequency axis can either be defined via the start/stop frequency or via the center frequency and span.

Commands of the SENSe:FREQUENCY Subsystem

- [SENSe<1|2>:]FREQUENCY:CENTer
- [SENSe<1|2>:]FREQUENCY:CENTer:STEP
- [SENSe<1|2>:]FREQUENCY:CENTer:STEP:AUTO
- [SENSe<1|2>:]FREQUENCY:CENTer:STEP:LINK
- [SENSe<1|2>:]FREQUENCY:CENTer:STEP:LINK:FACTor
- [SENSe<1|2>:]FREQUENCY:MODE
- [SENSe<1|2>:]FREQUENCY:OFFSet
- [SENSe<1|2>:]FREQUENCY:SPAN
- [SENSe<1|2>:]FREQUENCY:SPAN:FULL
- [SENSe<1|2>:]FREQUENCY:START
- [SENSe<1|2>:]FREQUENCY:STOP

[SENSe<1|2>:]FREQUENCY:CENTer

This command defines the center frequency of the analyzer or the measuring frequency for span = 0.

The numeric suffixes <1/2> are not relevant.

Parameter

0 to f_{\max}

Example

```
FREQ:CENT 100MHz
```

Characteristics

*RST value: $f_{\max}/2$ with f_{\max} = maximum frequency

SCPI: conform

Mode

all

[SENSe<1|2>:]FREQUENCY:CENTer:STEP

This command defines the step size of the center frequency.

The numeric suffixes <1/2> are not relevant.

Parameter

0 to f_{\max}

Example

```
FREQ:CENT:STEP 120MHz
```

Characteristics

*RST value: – (AUTO 0.1 × SPAN is switched on)

SCPI: conform

Mode

all

[SENSe<1|2>:]FREQUency:CENTer:STEP:AUTO

This command couples the step size of the center frequency to the span (ON) or sets the value of the center frequency entered via [SENSe<1|2>:]FREQUency:CENTer:STEP (OFF).

The numeric suffixes <1/2> are not relevant.

Parameter

ON | OFF

Example

```
FREQ:CENT:STEP:AUTO ON
```

Activates the coupling of the step size to the span.

Characteristics

*RST value: ON

SCPI: device-specific

Mode

all

[SENSe<1|2>:]FREQUency:CENTer:STEP:LINK

This command couples the step size of the center frequency to span (span >0) or to the resolution bandwidth (span = 0) or cancels the couplings.

The numeric suffixes <1/2> are not relevant.

Parameter

SPAN coupling to frequency display range (for span > 0)

RBW coupling to resolution bandwidth (for span = 0)

OFF manual input, no coupling

Example

```
FREQ:CENT:STEP:LINK SPAN
```

Characteristics

*RST value: SPAN

SCPI: device-specific

Mode

A, ADEMODO

[SENSe<1|2>:]FREQuency:CENTer:STEP:LINK:FACTor

This command couples the step size of the center frequency with a factor to the span (span >0) or to the resolution bandwidth (span = 0).

The numeric suffixes <1/2> are not relevant.

Parameter

1 to 100 PCT

Example

```
FREQ:CENT:STEP:LINK:FACT 20PCT
```

Characteristics

*RST value: – (AUTO 0.1 × SPAN is switched on)

SCPI: device-specific

Mode

A

[SENSe<1|2>:]FREQuency:MODE

This command switches between span > 0 (SWEep) and zero span (CW | FIXed) in the **Spectrum Analyzer** mode.

For CW and FIXed, the frequency setting is via the `[SENSe<1|2>:]FREQuency:CENTer` command. In the sweep mode, the setting is via the `[SENSe<1|2>:]FREQuency:START`, `[SENSe<1|2>:]FREQuency:STOP`, `[SENSe<1|2>:]FREQuency:CENTer`, and `[SENSe<1|2>:]FREQuency:SPAN` commands.

The numeric suffixes <1/2> are not relevant.

Parameter

CW | FIXed | SWEep

Example

```
FREQ:MODE SWE
```

Characteristics

*RST value: SWEep

SCPI: conform

Mode

A

[SENSe<1|2>:]FREQuency:OFFSet

This command defines the frequency offset of the instrument.

The numeric suffixes <1/2> are not relevant.

Parameter

<numeric_value>

Example

```
FREQ:OFFS 1GHZ
```

Characteristics

*RST value: 0 Hz

SCPI: conform

Mode

A, ADEM0D

[SENSe<1|2>:]FREQUENCY:SPAN

This command defines the frequency span in the **Spectrum Analyzer** mode.

The numeric suffixes <1/2> are not relevant.

Parameter

0 to f_{\max}

Example

```
FREQ:SPAN 10MHz
```

Characteristics

*RST value: f_{\max} with f_{\max} = maximum frequency

SCPI: conform

Mode

A, CATV

[SENSe<1|2>:]FREQUENCY:SPAN:FULL

This command sets the frequency span to its maximum.

The numeric suffixes <1/2> are not relevant.

Example

```
FREQ:SPAN:FULL
```

Characteristics

*RST value: –

SCPI: conform

Mode

A, CATV

[SENSe<1|2>:]FREQUENCY:START

This command defines the start frequency of the analyzer. This command is only available with span > 0.

The numeric suffixes <1/2> are not relevant.

Parameter

0 to f_{\max}

Example

```
FREQ:STAR 20MHz
```

Characteristics

*RST value: 0

SCPI: conform

Mode

A–F, CATV

[SENSe<1|2>:]FREQuency:STOP

This command defines the stop frequency of the analyzer. This command is only available with span > 0.

The numeric suffixes <1/2> are not relevant.

Parameter0 to f_{\max} **Example**

FREQ:STOP 2000MHz

Characteristics*RST value: f_{\max}

SCPI: conform

Mode

A–F, CATV

SENSe:LIST Subsystem

The commands of this subsystem are used for measuring the power at a list of frequency points with different device settings. The measurement is always performed in zero span. A new trigger event is required for each test point (exception: trigger FREE RUN).

The results are output as a list in the order of the entered frequency points. The number of results per test point depends on the number of concurrently active measurements (peak/RMS/average). The number of frequencies is limited to 100 entries.

Selection of concurrently active measurements and setting of parameters that are constant for the whole measurement is performed via a configuration command (`[SENSe<1|2>:]LIST:POWer:SET`). This also includes the setting for trigger and gate parameters.

Note: Settings that are not directly included in commands of this subsystem can be configured by sending the corresponding commands prior to the [SENSe:LIST Subsystem](#) commands. Please note that changes to the trigger level have to be executed in zero span in order to take effect for the [SENSe:LIST Subsystem](#) commands.

Commands of the SENSe:LIST Subsystem

- `[SENSe<1|2>:]LIST:POWer[:SEQuence]`
- `[SENSe<1|2>:]LIST:POWer:RESult?`
- `[SENSe<1|2>:]LIST:POWer:SET`
- `[SENSe<1|2>:]LIST:POWer:STATe`

Further information

- [More details on the SENSe:LIST Subsystem](#)

More details on the SENSe:LIST Subsystem

The following setting parameters can be selected independently for each frequency point:

- analyzer frequency
- reference level
- resolution filter
- resolution bandwidth
- video bandwidth
- measurement time
- detector

The commands of this subsystem can be used in two different ways:

- Instrument setup, measurement and querying of the results in a single command line. With this method, there is the least delay between the measurement and the result output. However, it requires the control computer to wait for the response from the instrument.
- Instrument setup and querying of the result list at the end of the measurement: With this method, the control computer may be used for other activities while the measurement is being performed. However, more time is needed for synchronization via service request.

[SENSe<1|2>:]LIST:POWer[:SEQuence]

This command configures the list of settings (max. 200 entries) for the multiple power measurement and starts a measurement sequence. When synchronizing the command with *OPC, a service request is generated as soon as all frequency points are processed and the defined number of individual measurements is reached.

To reduce the setting time, all indicated parameters are set up simultaneously at each test point.

The query form of the command processes the list and immediately returns the list of results.

The number of results per test point depends on the setting of the

[\[SENSe<1|2>:\]LIST:POWer:SET](#) command.

The numeric suffixes <1/2> are not relevant.

Parameter

The following parameters are the settings for an individual frequency point. They are repeated for every other frequency point.

<code><analyzer freq></code>	Receive frequency for the signal to be measured (= center frequency in manual operation) Range of values: 0 Hz to max. frequency, depending on the instrument model.
<code><ref level></code>	Reference level Range of values: +20 dBm to –130 dBm in 0.1 dB steps
<code><rf att></code>	RF input attenuation Range of values: 0 dB to 30 dB in 5 dB steps
<code><filter type></code>	for details refer to "[SENSe<1 2>:]BANDwidth BWIDth[:RESolution]:TYPE" on page 6.117
<code><rbw></code>	Resolution bandwidth

For the range of values refer to chapter "Instrument Functions", section "Res BW Manual".

Refer to chapter "Instrument Functions", section "To choose the appropriate filter type", for possible combinations of filter type and filter bandwidth for the <filter type> = CFILter and <filter type> = RRC.

- <vbw> Video bandwidth
Range of values: 1 Hz to 10 MHz in 1, 3, 10 steps. The value is ignored for <filter type> = CFILter or RRC
- <meas time> Measurement time
Range of values: 1us to 16000s
For details refer to chapter "Instrument Functions", section "Sweeptime Manual"
- <trigger level> Reserved. Must be set to 0.

Return values

The query command returns a list of comma-separated values (CSV) which contains the power measurement results in floating-point format. The unit depends on the setting with [CALCulate<1|2>:UNIT:POWer](#)

The command

```
SENSe:LIST:POWer?
935.2MHz,0dBm,10dB,OFF,NORM,1MHz,3MHz,440us,0,
935.4MHz,0dBm,10dB,10dB,NORM,30kHz,100kHz,440us,0,
935.6MHz,0dBm,10dB,20dB,NORM,30kHz,100kHz,440us,0
```

thus returns the following list, for example:

-28.3,-30.6,-38.1

If the command sequence is extended to

```
SENSe:LIST:POWer:SET ON,ON,ON,IMM,POS,0,0
SENSe:LIST:POWer?
935.2MHz,0dBm,10dB,OFF,NORM,1MHz,3MHz,440us,0,
935.4MHz,0dBm,10dB,10dB,NORM,30kHz,100kHz,440us,0,
935.6MHz,0dBm,10dB,20dB,NORM,30kHz,100kHz,440us,0
```

the result list is extended to 3 results per frequency point (peak, RMS and average):

-28.3, -29.6, 1.5, -30.6, -31.9, 0.9, -38.1, -40.0, 2.3

Example

```
SENSe:LIST:POWer
935.2MHz,0dBm,10dB,OFF,NORM,1MHz,3MHz,440us,0,
935.4MHz,0dBm,10dB,10dB,CFIL,30kHz,100kHz,440us,0,
935.6MHz,0dBm,10dB,20dB,CFIL,30kHz,100kHz,440us,0
```

Performs a measurement sequence with the following settings:

Step	Freq. [MHz]	Ref Level [dBm]	RF Att [dB]	el Att [dB]	Filter type	RBW	VBW	Meas Time [us]	TRG Level (reserved)
1	935.2	0	10	OFF	Normal	1 MHz	3 MHz	440	0
2	935.4	0	10	10	Channel	30 kHz	100 kHz	440	0
3	935.6	0	10	20	Channel	30 kHz	100 kHz	440	0

```
SENSe:LIST:POWer?
935.2MHz,0dBm,10dB,OFF,NORM,1MHz,3MHz,440us,0,
935.4MHz,0dBm,10dB,10dB,CFIL,30kHz,100kHz,440us,0,
935.6MHz,0dBm,10dB,20dB,CFIL,30kHz,100kHz,440us,0
```

Performs the same measurement and returns the result list immediately after the last frequency point.

Note: The measurement is performed in zero span and therefore the span is set to 0 Hz. If the span > 0 is set, the function is automatically switched off.

The measurement is not compatible with other measurements, especially as far as marker, adjacent channel power measurement or statistics are concerned. The corresponding commands thus automatically deactivate the function.

The function is only available in REMOTE operation. It is deactivated when switching the instrument back to LOCAL.

Characteristics

*RST value: –

SCPI: device-specific

Mode

A-F, A-T

[SENSe<1|2>:]LIST:POWer:RESult?

This command queries the result of a previous list measurement as configured and initiated with [SENSe<1|2>:]LIST:POWer[:SEQuence]. The measured results are output in a list of floating point values separated by commas. The unit of the results depends on the setting made with the CALCulate<1|2>:UNIT:POWer command.

This command may be used to obtain measurement results in an asynchronous way, using the service request mechanism for synchronization with the end of the measurement.

If no measurement results are available, the command will return a query error.

The numeric suffixes <1/2> are not relevant.

Example

```
*ESE 1
```

```
*SRE 32
```

Configuration of the status reporting system for the generation of an SRQ on operation complete

```
SENSe:LIST:POWer
935.2MHz,-20dBm,10dB,OFF,NORM,1MHz,3MHz,434us,0,
935.4MHz,-20dBm,10dB,10dB,NORM,30kHz,100kHz,434us,0,
935.6MHz,-20dBm,10dB,20dB,NORM,30kHz,100kHz,434us,0;
*OPC
```

Configuring and starting the measurement

...

Further actions of the control computer during measurement

```
On SRQ:
```

```
SENSe:LIST:POWer:RESult?
```

Response to service request

Characteristics

*RST value: –

SCPI: device-specific

Mode

A-F, A-T

[SENSe<1|2>:]LIST:POWer:SET

This command defines the constant settings for the list during multiple power measurement. Parameters <PEAK meas>, <RMS meas> and <AVG meas> define, which measurements are to be performed at the same time at the frequency point. Correspondingly, one, two or three results per frequency point are returned for the [SENSe<1|2>:]LIST:POWer[:SEQuence] command. If all three parameters are set to OFF, the command generates an execution error. The numeric suffixes <1/2> are not relevant.

Parameter

<PEAK meas>	ON: activates the measurement of the peak power (peak detector) OFF: deactivates the measurement of the peak power
<RMS meas>	ON: activates the measurement of the RMS power (RMS detector) OFF: deactivates the measurement of the RMS power
<AVG meas>	ON: activates the measurement of the average power (average detector) OFF: deactivates the measurement of the average power
<trigger mode>	Selection of the trigger source used for the list measurement Possible values: IMMEDIATE EXTERNAL IFPOWER
<trigger slope>	Used trigger slope Possible values: POSITIVE NEGATIVE
<trigger offset>	Offset between the detection of the trigger signal and the start of the measurement at the next frequency point. Range of values: 0 s, 125 ns to 100s
<gate length>	Gate length with gated sweep Range of values: 0 s, 125 ns to 100s The value 0 s deactivates the use of gated trigger; other values activate the gated trigger function. Values <> 0 s are only possible if <trigger mode> is different from IMMEDIATE. Otherwise, an execution error is triggered.

Return values

The query command returns a list of comma-separated values (CSV) of the settings, i.e.

```
ON,ON,ON,IMM,POS,0,0
```

if the configuration has been set with the command

```
SENSe:LIST:POWer:SET ON,ON,ON,IMM,POS,0,0
```

Example

```
SENSe:LIST:POWer:SET ON,OFF,OFF,EXT,POS,10US,434US
```

Characteristics

*RST value: ON,OFF,OFF,IMM,POS,0S,0S

SCPI: device-specific

Mode

A-F, A-T

[SENSe<1|2>:]LIST:POWer:STATe

This command deactivates the list measurement.

The numeric suffixes <1/2> are not relevant.

Parameter

OFF

Example

```
SENSe:LIST:POWer:STATe OFF
```

Characteristics

*RST value: –

SCPI: device-specific

Mode

A–F, A–T

SENSe:MPOWER Subsystem

The commands of this subsystem are used to determine the mean burst power or peak burst power for a given number of signal bursts, and for outputting the results in a list. Since all the settings required for a measurement are combined in a single command, the measurement speed is considerably higher than when using individual commands.

For measuring the signal bursts, the gated sweep function is used in zero span. The gate is controlled either by an external trigger signal or by the video signal. An individual trigger event is required for each burst to be measured. If an external trigger signal is used, the threshold is fixed to TTL level, while with a video signal the threshold can be set as desired.

Commands of the SENSe:MPOWER Subsystem

- [\[SENSe<1|2>:\]MPOWER\[:SEQuence\]](#)
- [\[SENSe<1|2>:\]MPOWER:FTYPE](#)
- [\[SENSe<1|2>:\]MPOWER:RESult\[:LIST\]?](#)
- [\[SENSe<1|2>:\]MPOWER:RESult:MIN?](#)

Further information

- [More details on the SENSe:MPOWER Subsystem](#)

More details on the SENSe:MPOWER Subsystem

The following graphics shows the relation between trigger time, trigger offset (for delayed gate opening) and measurement time.

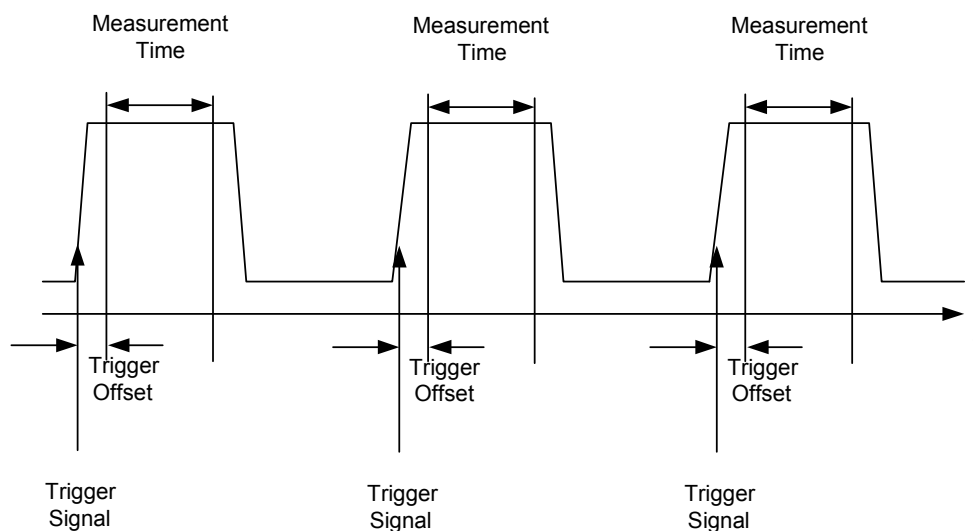

Depending on the settings made, the measurements are performed with the RMS detector for RMS power or the PEAK detector for peak power. For all these measurements, trace 1 of the selected system is used.

The setting parameters for this measurement are:

- analyzer frequency
- resolution bandwidth
- measurement time used for a single burst
- trigger source
- trigger level
- trigger offset
- type of power measurement (PEAK, MEAN)
- number of bursts to be measured

The commands of this subsystem can be used in two different ways:

- Setting up the instrument and at the same time querying the result list: This method ensures the smallest delay between measurement and the output of the measured values, but requires the control computer to wait actively for the response of the instrument.
- Setting up the instrument and querying the result list after synchronization to the end of measurement: With this method the control computer can be used for other activities while the instrument is performing the measurement at the cost of additional time needed for synchronization via service request.

[SENSe<1|2>:]MPOWER[:SEquence]

This command configures the instrument setup for multiple burst power measurement and starts a measurement sequence. When synchronizing the command with *OPC, a service request is generated as soon as the defined number of individual measurements (# of meas) is reached.

To reduce the setting time, the setup is performed simultaneously for all selected parameters.

The command in the form of a query makes the instrument settings, performs the defined number of measurements and outputs the measurement results list.

The numeric suffixes <1/2> are not relevant.

Parameter

<analyzer freq>	Receive frequency for the burst signals to be measured (= center frequency in manual operation) Range: 0 Hz to max. frequency, depending on instrument model
<rbw>	resolution bandwidth for the measurement Range: 10 Hz to 10 MHz in steps of 1, 3, 10
<meas time>	Time span during which measurement samples are sampled for RMS / peak measurement. The type of measurement is selected by <type of meas>. Range: 1us to 30s
<trigger source>	trigger signal source. Possible settings: EXTernal: The trigger signal is fed from the "Ext. Trigger/Gate" input on the rear of the unit. VIDeo: The internal video signal is used as trigger signal.
<trigger level>	Signal level at which the trigger becomes active. For <trigger source> = VIDeo this is the level of the video signal as a percentage of the diagram height. If <trigger source> = EXTernal is selected, the value entered here is ignored, as in this case the trigger input uses TTL levels. Range: 0 – 100PCT(<trigger source> = VIDeo)
<trigger offset>	Offset between the detection of the trigger signal and the start of the measurement. Range: 125 ns to 100s
<type of meas>	Determines whether mean power (RMS) or peak power (PEAK) is to be measured. The detector is selected accordingly. Possible values: MEAN, PEAK
<# of meas>	Number of individual bursts to be measured. Range: 1 to 32001

Return values

The query command returns a list separated by commas (comma separated values = CSV), which contains the power measurement results in floating–point format. The unit used for the return values is always dBm.

The command `SENSe:MPOWer? 935.2MHz,1MHz,434us,VIDEO,50PCT,5us,MEAN,20`

may, for instance, cause the following list to be returned:

18.3,18.6,18.1,18.0,17.9,18.3,18.6,18.1,18.0,17.9,18.3,18.6,18.1,18.0,17.9,18.3,18.6,18.1,18.0,17.9

Example

`SENSe:MPOWer 935.2MHz,1MHz,434us,VIDEO,50PCT,5us,MEAN,20`

Performs a measurement sequence with the following settings:

Frequency = 935.2 MHz,

Resolution bandwidth = 1 MHz

Measurement time = 434 μ s

Trigger source = VIDEO

Trigger threshold = 50%

Trigger offset = 5 μ s

Type of measurement = MEAN power

No. of measurements = 20

SENSe:MPOWer? 935.2MHz,1MHz,434us,VIDEO,50PCT,5us,MEAN,20

Performs the same measurement and in addition returns the results list immediately after completion of the last measurement.

Note: *The measurement function always uses trace 1.*

Repeated use of the command without changes to its parameters (i.e. using the same settings again) will speed up the measurement since the previous hardware settings will be cached and therefore additional hardware settling times will be avoided. This also holds true if only part of the parameters (e.g. only the trigger delay) are changed, as in this case the rest of the parameters will be cached.

This measurement is not compatible with other measurements, especially as far as marker functions, adjacent-channel measurement or statistics are concerned. The corresponding functions are therefore automatically switched off. In return incompatible commands will automatically deactivate the multi burst power function.

The function is only available in the REMOTE operation. It is deactivated on switching back to LOCAL.

Characteristics

*RST value: –

SCPI: device-specific

Mode

A

[SENSe<1|2>:]MPOWer:FTYPE

This command defines the filter type for the measurement.

The numeric suffixes <1/2> are not relevant.

Parameter

NORMal | CFILter | RRC

Example

SENSe:MPOWer:FTYPE CFILter

Characteristics

*RST value: –

SCPI: device-specific

Mode

A

[SENSe<1|2>:]MPOWer:RESult[:LIST]?

This command queries the results of a multiple burst power measurement as configured and initiated with [SENSe<1|2>:]MPOWer[:SEquence]. The results are output in a comma-separated list of floating point values. The unit used for the return values is always dBm.

This command may be used to obtain measurement results in an asynchronous way using the service request mechanism for synchronization with the end of the measurement.

The numeric suffixes <1/2> are not relevant.

If no measurement results are available, the command will return a query error.

Example

```
*ESE 1
*SRE 32
```

Configuration of status reporting systems for the generation of an SRQ on operation complete

```
SENSe:MPOWer 935.2MHz,1MHz,434us,VIDEO,50PCT,5us,MEAN,20;*OPC
```

Configuring and starting the measurement

...

Further actions of the control computer during measurement

On SRQ:

Response to service request

```
SENSe:MPOWer:RESult?
```

Characteristics

*RST value: –

SCPI: device-specific

Mode

A

[SENSe<1|2>:]MPOWer:RESult:MIN?

This command queries the minimum power value in a multiple burst power measurement as configured and initiated with `[SENSe<1|2>:]MPOWer[:SEquence]`. The unit used for the return values is always dBm.

The numeric suffixes <1/2> are not relevant.

If no measurement result is available, the command will return a query error.

Example

```
*ESE 1
*SRE 32
```

Configuration of status reporting systems for the generation of an SRQ on operation complete

```
SENSe:MPOWer 935.2MHz,1MHz,434us,VIDEO,50PCT,5us,MEAN,20;*OPC
```

Configuring and starting the measurement

...

Further actions of the control computer during measurement

On SRQ:

Response to service request

```
SENSe:MPOWer:RESult:MIN?
```

Characteristics

*RST value: –

SCPI: device-specific

Mode

A

SENSe:POWer Subsystem

This subsystem controls the setting of the instruments channel and adjacent channel power measurements.

Commands of the SENSe:POWer Subsystem

- [SENSe<1|2>:]POWer:ACHannel:ACPairs
- [SENSe<1|2>:]POWer:ACHannel:BANDwidth|BWIDth[:CHANnel]
- [SENSe<1|2>:]POWer:ACHannel:BANDwidth|BWIDth:ACHannel
- [SENSe<1|2>:]POWer:ACHannel:BANDwidth|BWIDth:ALTErnate<1|2>
- [SENSe<1|2>:]POWer:ACHannel:MODE
- [SENSe<1|2>:]POWer:ACHannel:PRESet
- [SENSe<1|2>:]POWer:ACHannel:PRESet:RLEVel
- [SENSe<1|2>:]POWer:ACHannel:REFerence:AUTO
- [SENSe<1|2>:]POWer:ACHannel:REFerence:TXCHannel:AUTO
- [SENSe<1|2>:]POWer:ACHannel:REFerence:TXCHannel:MANual
- [SENSe<1|2>:]POWer:ACHannel:SPACing[:ACHannel]
- [SENSe<1|2>:]POWer:ACHannel:SPACing:ALTErnate<1|2>
- [SENSe<1|2>:]POWer:ACHannel:SPACing:CHANnel
- [SENSe<1|2>:]POWer:ACHannel:TXCHannel:COUNT
- [SENSe<1|2>:]POWer:BANDwidth|BWIDth
- [SENSe<1|2>:]POWer:HSPeed
- [SENSe<1|2>:]POWer:TRACe

[SENSe<1|2>:]POWer:ACHannel:ACPairs

This command sets the number of adjacent channels (upper and lower channel in pairs). The figure 0 stands for pure channel power measurement.

The numeric suffixes <1/2> are not relevant.

Parameter

0 | 1 | 2 | 3

Example

```
POW:ACH:ACP 3
```

Sets the number of adjacent channels to 3, i.e. the adjacent channel and alternate adjacent channels 1 and 2 are switched on.

Characteristics

*RST value: 1

SCPI: device-specific

Mode

A–F

[SENSe<1|2>:]POWer:ACHannel:BANDwidth|BWIDth[:CHANnel]

This command sets the channel bandwidth of the radio communication system. The bandwidths of adjacent channels are not influenced by this modification.

With [SENSe<1|2>:]POWer:HSPeed set to ON, steep-edged channel filters are available. For further information on filters refer to chapter "Instrument Functions", section "List of available RRC and channel filters".

The numeric suffixes <1/2> are not relevant.

Parameter

100 Hz to 1000 MHz

Example

```
POW:ACH:BWID 30kHz
```

Sets the bandwidth of the TX channel to 30 kHz.

Characteristics

*RST value: 14 kHz

SCPI: device-specific

Mode

A-F

[SENSe<1|2>:]POWer:ACHannel:BANDwidth|BWIDth:ACHannel

This command defines the channel bandwidth of the adjacent channel of the radio transmission system. If the bandwidth of the adjacent channel is changed, the bandwidths of all alternate adjacent channels are automatically set to the same value.

With [SENSe<1|2>:]POWer:HSPeed set to ON, steep-edged channel filters are available. For further information on filters refer to chapter "Instrument Functions", section "List of available RRC and channel filters".

The numeric suffixes <1/2> are not relevant.

Parameter

100 Hz to 1000 MHz

Example

```
POW:ACH:BWID:ACH 30kHz
```

Sets the bandwidth of all adjacent channels to 30 kHz.

Characteristics

*RST value: 14 kHz

SCPI: device-specific

Mode

A-F

[SENSe<1|2>:]POWer:ACHannel:BANDwidth|BWIDth:ALternate<1|2>

This command defines the channel bandwidth of the first/second alternate adjacent channel of the radio transmission system. If the channel bandwidth of alternate adjacent channel 1 is changed, the bandwidth of alternate adjacent channel 2 is automatically set to the same value.

With [SENSe<1|2>:]POWer:HSPeed set to ON, steep-edged channel filters are available. For further information on filters refer to chapter "Instrument Functions", section "List of available RRC and channel filters".

The numeric suffixes <1/2> are not relevant.

Parameter

100 Hz to 1000 MHz

Example

POW:ACH:BWID:ALT2 30kHz

Characteristics

*RST value: 14 kHz

SCPI: device-specific

Mode

A-F

[SENSe<1|2>:]POWer:ACHannel:MODE

This command switches between absolute and relative adjacent channel measurement. The command is only available with span > 0 and if the number of adjacent channel is greater than 0.

The numeric suffixes <1/2> are not relevant.

This command is available from firmware version 1.10.

Parameter

ABSolute | RELative

Example

POW:ACH:MODE REL

Sets the adjacent channel measurement mode to relative.

Characteristics

RST value: RELative

SCPI: device-specific

Mode

A-F

[SENSe<1|2>:]POWer:ACHannel:PRESet

This command adjusts the frequency span, the measurement bandwidths and the detector as required for the number of channels, the channel bandwidths and the channel spacings selected in the active power measurement. If necessary, adjacent-channel power measurement is switched on prior to the adjustment.

To obtain correct results, a complete sweep with synchronization to the end of the sweep must be performed after the adjustment. Synchronization is possible only in the single sweep mode.

The result is queried with the `CALCulate<1|2>:MARKer:FUNction:POWer:RESult?` command.

The numeric suffixes <1/2> are not relevant.

Parameter

ACPpower | CPOWer | MCACpower | OBANdwidth | OBWidth | CN | CNO

Example

POW:ACH:PRES ACP

Sets the frequency span, the measurement bandwidths and the detector as required for the ACP measurement.

```
INIT:CONT OFF
```

Switches over to single sweep mode.

```
INIT; *WAI
```

Starts a sweep and waits for the end of the sweep.

```
CALC:MARK:FUNC:POW:RES? ACP
```

Queries the result of the adjacent-channel power measurement.

Characteristics

*RST value: –

SCPI: device-specific

Mode

A–F

[SENSe<1|2>:]POWer:ACHannel:PRESet:RLEVEL

This command adapts the reference level to the measured channel power and – if required – switches on previously the adjacent channel power measurement. This ensures that the signal path of the instrument is not overloaded. Since the measurement bandwidth is significantly smaller than the signal bandwidth in channel power measurements, the signal path can be overloaded although the trace is still significantly below the reference level. If the measured channel power equals the reference level, the signal path is not overloaded.

The numeric suffixes <1/2> are not relevant.

Note: Subsequent commands have to be synchronized with *WAI, *OPC or *OPC? to the end of the auto range process which would otherwise be aborted.

Example

```
POW:ACH:PRESet:RLEV; *WAI
```

Adapts the reference level to the measured channel power.

Characteristics

*RST value: –

SCPI: device-specific

Mode

A–F, CATV

[SENSe<1|2>:]POWer:ACHannel:REFERENCE:AUTO

This command sets the reference value to the currently measured channel power for the relative measurement.

The numeric suffixes <1/2> are not relevant.

This command is an event and therefore has no *RST value and no query.

Parameter

ONCE

Example

```
POW:ACH:REF:AUTO ONCE
```

Characteristics

RST value: –

SCPI: device-specific

Mode

A–F

[SENSe<1|2>:]POWer:ACHannel:REference:TXCHannel:AUTO

This command activates the automatic selection of a transmission channel to be used as a reference channel in relative adjacent–channel power measurements.

The transmission channel with the highest power, the transmission channel with the lowest power, or the transmission channel nearest to the adjacent channels can be defined as a reference channel.

The command is available only for multicarrier channel and adjacent–channel power measurements with span > 0 (`CALCulate<1|2>:MARKer:FUNction:POWer:SElect`).

The numeric suffixes <1/2> are not relevant.

Parameter

MINimum	Transmission channel with the lowest power
MAXimum	Transmission channel with the highest power
LHIGhest	Lowermost transmission channel for the lower adjacent channels, uppermost transmission channel for the upper adjacent channels

Example

```
POW:ACH:REF:TXCH:AUTO MAX
```

The transmission channel with the highest power is used as a reference channel.

Characteristics

*RST value: –

SCPI: device–specific

Mode

A–F

[SENSe<1|2>:]POWer:ACHannel:REference:TXCHannel:MANual

This command selects a transmission channel to be used as a reference channel in relative adjacent–channel power measurements.

The command is available only for multicarrier channel and adjacent–channel power measurements with span > 0 (`CALCulate<1|2>:MARKer:FUNction:POWer:SElect`).

The numeric suffixes <1/2> are not relevant.

Parameter

1 to 12

Example

```
POW:ACH:REF:TXCH:MAN 3
```

Transmission channel 3 is used as a reference channel.

Characteristics

*RST value: 1

SCPI: device–specific

Mode

A–F

[SENSe<1|2>:]POWer:ACHannel:SPACing[:ACHannel]

This command defines the channel spacing of the adjacent channel to the TX channel. At the same time, the spacing of alternate adjacent channels 1 and 2 is set to the double or triple of the entered value.

The numeric suffixes <1/2> are not relevant.

Parameter

100 Hz to 2000 MHz

Example

```
POW:ACH:SPAC:ACH 33kHz
```

Sets the spacing between the carrier signal and the adjacent channel to 33 kHz or the alternate adjacent channel 1 to 66 kHz or the alternate adjacent channel 2 to 99 kHz

Characteristics

*RST value: 14 kHz

SCPI: device-specific

Mode

A-F

[SENSe<1|2>:]POWer:ACHannel:SPACing:ALTErnate<1|2>

This command defines the spacing between the first (ALTErnate1) or the second alternate adjacent channel (ALTErnate2) and the TX channel. If the spacing to the alternate adjacent channel ALTErnate1 is modified, the spacing to alternate adjacent channel 2 is set to 1.5 times the entered value.

The numeric suffixes <1/2> are not relevant.

Parameter

100 Hz to 2000 MHz

Example

```
POW:ACH:SPAC:ALT1 100kHz
```

Sets the spacing between TX channel and alternate adjacent channel 1 to 100 kHz and between TX channel and alternate adjacent channel 2 to 150 kHz.

Characteristics

*RST value: 40 kHz (ALT1), 60 kHz (ALT2)

SCPI: device-specific

Mode

A-F

[SENSe<1|2>:]POWer:ACHannel:SPACing:CHANnel

This command defines the channel spacing for the carrier signals.

The numeric suffixes <1/2> are not relevant.

Parameter

100 Hz to 2000 MHz

Example

```
POW:ACH:SPAC:CHAN 25kHz
```

Characteristics

*RST value: 20 kHz

SCPI: device-specific

Mode

A-F

[SENSe<1|2>:]POWer:ACHannel:TXChannel:COUNT

This command selects the number of carrier signals.

The command is available only for multicarrier channel and adjacent-channel power measurements with span > 0 ([CALCulate<1|2>:MARKer:FUNCTION:POWer:SElect](#)).

The numeric suffixes <1/2> are not relevant.

Parameter

1 to 12

Example

```
POW:ACH:TXCH:COUN 3
```

Characteristics

*RST value: 4

SCPI: device-specific

Mode

A-F

[SENSe<1|2>:]POWer:BANDwidth|BWIDth

This command defines the percentage of the power with respect to the total power. This value is the basis for the occupied bandwidth measurement

([\[SENSe<1|2>:\]POWer:ACHannel:PRESet](#)).

The numeric suffixes <1/2> are not relevant.

Parameter

10 to 99.9PCT

Example

```
POW:BWID 95PCT
```

Characteristics

*RST value: 99PCT

SCPI: device-specific

Mode

A-F

[SENSe<1|2>:]POWer:HSPeed

This command switches on or off the high-speed channel/adjacent channel power measurement. The measurement itself is performed in zero span on the center frequencies of the individual channels. The command automatically switches to zero span and back.

Depending on the selected mobile radio standard, weighting filters with $\sqrt{\cos}$ characteristic or very steep-sided channel filters are used for band limitation.

The numeric suffixes <1/2> are not relevant.

Parameter

ON | OFF

Example

POW:HSP ON

Characteristics

*RST value: OFF

SCPI: device-specific

Mode

A–F

[SENSe<1|2>:]POWer:TRACe

This command assigns the channel/adjacent channel power measurement to the indicated trace. The corresponding trace must be active, i.e. its state must be different from blank.

The numeric suffixes <1/2> are not relevant.

Note: The measurement of the occupied bandwidth (OBW) is performed on the trace on which marker 1 is positioned. To evaluate another trace, marker 1 must be positioned to another trace with `CALCulate<1|2>:MARKer<1...4>:TRACe`.

Parameter

1 to 4

Example

POW:TRAC 2

Assigns the measurement to trace 2.

Characteristics

*RST value: –

SCPI: device-specific

Mode

A

SENSe:SWEEp Subsystem

This subsystem controls the sweep parameters.

Commands of the SENSe:SWEEp Subsystem

- [SENSe<1|2>:]SWEEp:COUNT
- [SENSe<1|2>:]SWEEp:COUNT:CURRENT?
- [SENSe<1|2>:]SWEEp:EGATE
- [SENSe<1|2>:]SWEEp:EGATE:HOLDoff
- [SENSe<1|2>:]SWEEp:EGATE:LENGTH
- [SENSe<1|2>:]SWEEp:EGATE:POLarity
- [SENSe<1|2>:]SWEEp:EGATE:SOURce
- [SENSe<1|2>:]SWEEp:EGATE:TYPE
- [SENSe<1|2>:]SWEEp:POINTS
- [SENSe<1|2>:]SWEEp:TIME
- [SENSe<1|2>:]SWEEp:TIME:AUTO

[SENSe<1|2>:]SWEEp:COUNT

This command defines the number of sweeps started with single sweep, which are used for calculating the average or maximum value. If the values 0 or 1 are set, one sweep is performed. The numeric suffixes <1/2> are not relevant.

Parameter

0 to 32767

Example

```
SWE:COUNT 64
```

Sets the number of sweeps to 64.

```
INIT:CONT OFF
```

Switches to single sweep mode.

```
INIT;*WAI
```

Starts a sweep and waits for its end.

Characteristics

*RST value: 0

SCPI: conform

Mode

A, ADEMOD, CATV

[SENSe<1|2>:]SWEep:COUNT:CURRENT?

This query command returns the current number of started sweeps. A sweep count value should be set and the device should be in single sweep mode.

The numeric suffixes <1/2> are not relevant.

Example

```
SWE:COUNT 64
```

Sets sweep count to 64

```
INIT:CONT OFF
```

Switches to single sweep mode

```
INIT
```

Starts a sweep (without waiting for the sweep end!)

```
SWE:COUN:CURR?
```

Queries the number of started sweeps

Characteristics

*RST value: 0

SCPI: conform

Mode

A, ADEMOD

[SENSe<1|2>:]SWEep:EGATe

This command switches on/off the sweep control by an external gate signal. If the external gate is selected the trigger source is automatically switched to EXTERNAL as well.

In case of measurement with external gate, the measured values are recorded as long as the gate is opened. During a sweep the gate can be opened and closed several times. The synchronization mechanisms with *OPC, *OPC? and *WAI remain completely unaffected.

The sweep end is detected when the required number of measurement points (501 in **Spectrum Analyzer** mode) has been recorded.

The numeric suffixes <1/2> are not relevant.

Parameter

ON | OFF

Example

```
SWE:EGAT ON
```

Switches on the external gate mode.

```
SWE:EGAT:TYPE EDGE
```

Switches on the edge-triggered mode.

```
SWE:EGAT:HOLD 100US
```

Sets the gate delay to 100 μ s.

```
SWE:EGAT:LEN 500US
```

Sets the gate opening time to 500 μ s.

```
INIT; *WAI
```

Starts a sweep and waits for its end.

Characteristics

*RST value: OFF

SCPI: device-specific

ModeA, WLAN, WiMAX

[SENSe<1|2>:]SWEep:EGATe:HOLDoff

This command defines the delay time between the external gate signal and the continuation of the sweep.

The numeric suffixes <1/2> are not relevant.

Parameter

125 µs to 100 s

Example

SWE:EGAT:HOLD 100us

Characteristics

*RST value: 0s

SCPI: device-specific

ModeA, BT

[SENSe<1|2>:]SWEep:EGATe:LENGth

In case of edge triggering, this command determines the time interval during which the instrument sweeps.

The numeric suffixes <1/2> are not relevant.

Parameter

0 to 100 s

Example

SWE:EGAT:LENG 10ms

Characteristics

*RST value: 0s

SCPI: device-specific

ModeA, BT

[SENSe<1|2>:]SWEep:EGATe:POLarity

This command determines the polarity of the external gate signal. The setting applies both to the edge of an edge-triggered signal and the level of a level-triggered signal.

The numeric suffixes <1/2> are not relevant.

Parameter

POSitive | NEGative

Example

SWE:EGAT:POL POS

Characteristics

*RST value: POSitive

SCPI: device-specific

Mode

A

[SENSe<1|2>:]SWEep:EGATe:SOURce

This command toggles between external gate signal and IF power signal as a signal source for the gate mode. If an IF power signal is used, the gate is opened as soon as a signal at > -20 dBm is detected within the IF path bandwidth (10 MHz).

The numeric suffixes <1/2> are not relevant.

Parameter

EXTernal | IFPower

Example

```
SWE:EGAT:SOUR IFP
```

Switches the gate source to IF power.

Characteristics

*RST value: IFPower

SCPI: device-specific

Mode

A, CATV

[SENSe<1|2>:]SWEep:EGATe:TYPE

This command sets the type of triggering (level or edge) by the external gate signal.

The gate is edge-triggered (`[SENSe<1|2>:]SWEep:EGATe:TYPE`):

After detection of the set gate signal edge, the gate remains open until the gate delay (`[SENSe<1|2>:]SWEep:EGATe:HOLDoff`) has expired.

The gate is level-triggered (`[SENSe<1|2>:]SWEep:EGATe:TYPE`):

After detection of the gate signal, the gate remains open until the gate signal disappears. The gate opening time cannot be defined with the parameter

`[SENSe<1|2>:]SWEep:EGATe:LENGth`.

A delay between applying the gate signal and the start of recording measured values can be defined with `[SENSe<1|2>:]SWEep:EGATe:HOLDoff`.

The numeric suffixes <1/2> are not relevant.

Parameter

LEVel | EDGE

Example

```
SWE:EGAT:TYPE EDGE
```

Characteristics

*RST value: EDGE

SCPI: device-specific

Mode

A

[SENSe<1|2>:]SWEep:POINTs

This command defines the number of measurement points to be collected during one sweep. The numeric suffixes <1/2> are not relevant.

Parameter

125 | 251 | 501 | 1001 | 2001 | 4001 | 8001 | 16001 | 32001

Example

SWE:POIN 251

Characteristics

*RST value: 501

SCPI: conform

Mode

A, CATV

[SENSe<1|2>:]SWEep:TIME

This command defines the sweep time. The available time values vary depending on the span setting.

If [SENSe<1|2>:]SWEep:TIME is directly programmed, automatic coupling to resolution bandwidth and video bandwidth is switched off.

The numeric suffixes <1/2> are not relevant.

Parameter

span > 0 2,5 ms to 16000 s

zero span 1 ms to 16000 s

Example

SWE:TIME 10s

Characteristics

*RST value: – (AUTO is set to ON)

SCPI: conform

Mode

A, ADEMOD, CATV, WLAN, WiMAX

[SENSe<1|2>:]SWEep:TIME:AUTO

This command controls the automatic coupling of the sweep time to the frequency span and bandwidth settings.

If [SENSe<1|2>:]SWEep:TIME is directly programmed, automatic coupling is switched off.

The numeric suffixes <1/2> are not relevant.

Parameter

ON | OFF

Example

SWE:TIME:AUTO ON

Switches on the coupling to frequency span and bandwidths.

Characteristics

*RST value: ON

SCPI: conform

Mode

A, CATV

SOURce Subsystem (Models 13 and 16)

The SOURce subsystem controls the output signals of the instrument for the models with tracking generator, 13 and 16.

The following subsystem is included:

- "SOURce:POWer Subsystem" on page 6.151

SOURce:POWer Subsystem

The SOURce:POWer subsystem controls the power of the tracking generator signal.

Commands of the SOURce:POWer Subsystem

- SOURce<1|2>:POWer[:LEVel][:IMMediate][:AMPLitude]
- SOURce<1|2>:POWer[:LEVel][:IMMediate]:OFFSet

SOURce<1|2>:POWer[:LEVel][:IMMediate][:AMPLitude]

This command defines the output level of the tracking generator.

Parameter

<numeric_value> in dBm, range specified in data sheet

Example

```
SOUR:POW -20dBm
```

Sets the tracking generator level to –20 dBm.

Characteristics

*RST value: –20 dBm

SCPI: conform

Mode

all

SOURce<1|2>:POWer[:LEVel][:IMMediate]:OFFSet

This command defines a level offset for the tracking generator level. Thus, for example, attenuators or amplifiers at the output of the tracking generator can be taken into account for the setting.

Parameter

–200 dB to +200 dB

Example

```
SOUR:POW:OFFS -10dB
```

Sets the level offset of the tracking generator to – 20 dBm.

Characteristics

*RST value: 0dB

SCPI: conform

Mode

all

STATus Subsystem

The STATus subsystem contains the commands for the status reporting system (see chapter "Remote Control – Basics", section "Status Reporting System"). *RST does not influence the status registers.

The following subsystem is included:

- "STATus:QUESTIONable Subsystem" on page 6.152

STATus:QUESTIONable Subsystem

The STATus:QUESTIONable subsystem contains information about the observance of limits during adjacent power measurements, the reference and local oscillator, the observance of limit lines and limit margins and possible overloads of the unit.

Commands of the STATus:QUESTIONable Subsystem

- STATus:QUESTIONable:ACPLimit[:EVENT]?
- STATus:QUESTIONable:ACPLimit:CONDition?
- STATus:QUESTIONable:ACPLimit:ENABLE
- STATus:QUESTIONable:ACPLimit:PTRansition
- STATus:QUESTIONable:ACPLimit:NTRansition
- STATus:QUESTIONable:FREQuency[:EVENT]?
- STATus:QUESTIONable:FREQuency:CONDition?
- STATus:QUESTIONable:FREQuency:ENABLE
- STATus:QUESTIONable:FREQuency:PTRansition
- STATus:QUESTIONable:FREQuency:NTRansition
- STATus:QUESTIONable:LIMit<1|2> [:EVENT]?
- STATus:QUESTIONable:LIMit<1|2>:CONDition?
- STATus:QUESTIONable:LIMit<1|2>:ENABLE
- STATus:QUESTIONable:LIMit<1|2>:PTRansition
- STATus:QUESTIONable:LIMit<1|2>:NTRansition
- STATus:QUESTIONable:LMARgin<1|2>[:EVENT]?
- STATus:QUESTIONable:LMARgin<1|2>:CONDition?
- STATus:QUESTIONable:LMARgin<1|2>:ENABLE
- STATus:QUESTIONable:LMARgin<1|2>:PTRansition
- STATus:QUESTIONable:LMARgin<1|2>:NTRansition
- STATus:QUESTIONable:POWer[:EVENT]?
- STATus:QUESTIONable:POWer:CONDition?
- STATus:QUESTIONable:POWer:ENABLE
- STATus:QUESTIONable:POWer:PTRansition
- STATus:QUESTIONable:POWer:NTRansition
- STATus:QUESTIONable:SYNC[:EVENT]?

- STATus:QUEStionable:SYNC:CONDition?
- STATus:QUEStionable:SYNC:ENABle
- STATus:QUEStionable:SYNC:PTRansition
- STATus:QUEStionable:SYNC:NTRansition

STATus:QUEStionable:ACPLimit[:EVENT]?

This command queries the contents of the EVENT section of the STATus:QUEStionable:ACPLimit register. Readout deletes the contents of the EVENT section.

Example

```
STAT:QUES:ACPL?
```

Characteristics

*RST value: –

SCPI: device-specific

Mode

all

STATus:QUEStionable:ACPLimit:CONDition?

This command queries the contents of the CONDition section of the STATus:QUEStionable:ACPLimit register. Readout does not delete the contents of the CONDition section.

Example

```
STAT:QUES:ACPL:COND?
```

Characteristics

*RST value: –

SCPI: device-specific

Mode

all

STATus:QUEStionable:ACPLimit:ENABle

This command sets the bits of the ENABle section of the STATus:QUEStionable:ACPLimit register. The ENABle register selectively enables the individual events of the associated EVENT section for the summary bit.

Parameter

0 to 65535

Example

```
STAT:QUES:ACPL:ENAB 65535
```

Characteristics

*RST value: –

SCPI: device-specific

Mode

all

STATus:QUEStionable:ACPLimit:PTRansition

This command sets the edge detectors of all bits of the STATus:QUEStionable: ACPLimit register from 0 to 1 for the transitions of the CONDition bit.

Parameter

0 to 65535

Example

STAT:QUES:ACPL:PTR 65535

Characteristics

*RST value: –

SCPI: device-specific

Mode

all

STATus:QUEStionable:ACPLimit:NTRansition

This command sets the edge detectors of all bits of the STATus:QUEStionable: ACPLimit register from 1 to 0 for the transitions of the CONDition bit.

Parameter

0 to 65535

Example

STAT:QUES:ACPL:NTR 65535

Characteristics

*RST value: –

SCPI: device-specific

Mode

all

STATus:QUEStionable:FREQuency[:EVENT]?

This command queries the contents of the EVENT section of the STATus:QUEStionable: FREQuency register.

Readout deletes the contents of the EVENT section.

Example

STAT:QUES:FREQ?

Characteristics

*RST value: –

SCPI: device-specific

Mode

all

STATus:QUEStionable:FREQuency:CONDition?

This command queries the contents of the CONDition section of the STATus:QUEStionable:FREQuency register. Readout does not delete the contents of the CONDition section.

Example

```
STAT:QUES:FREQ:COND?
```

Characteristics

*RST value: –

SCPI: device-specific

Mode

all

STATus:QUEStionable:FREQuency:ENABle

This command sets the bits of the ENABle section of the STATus:QUEStionable:FREQuency register. The ENABle register selectively enables the individual events of the associated EVENT section for the summary bit.

Parameter

0 to 65535

Example

```
STAT:QUES:FREQ:ENAB 65535
```

Characteristics

*RST value: –

SCPI: device-specific

Mode

all

STATus:QUEStionable:FREQuency:PTRansition

This command sets the edge detectors of all bits of the STATus:QUEStionable:FREQuency register from 0 to 1 for the transitions of the CONDition bit.

Parameter

0 to 65535

Example

```
STAT:QUES:FREQ:PTR 65535
```

Characteristics

*RST value: –

SCPI: device-specific

Mode

all

STATus:QUEStionable:FREQuency:NTRansition

This command sets the edge detectors of all bits of the STATus:QUEStionable:FREQuency register from 1 to 0 for the transitions of the CONDition bit.

Parameter

0 to 65535

Example

STAT:QUES:FREQ:NTR 65535

Characteristics

*RST value: –

SCPI: device-specific

Mode

all

STATus:QUEStionable:LIMit<1|2> [:EVENT]?

This command queries the contents of the EVENT section of the STATus:QUEStionable:LIMit register. Readout deletes the contents of the EVENT section.

This command is available from firmware version 1.10.

Example

STAT:QUES:LIM?

Characteristics

*RST value: –

SCPI: device-specific

Mode

all

STATus:QUEStionable:LIMit<1|2>:CONDition?

This command queries the contents of the CONDition section of the STATus:QUEStionable:LIMit register.

Readout does not delete the contents of the CONDition section.

This command is available from firmware version 1.10.

Example

STAT:QUES:LIM:COND?

Characteristics

*RST value: –

SCPI: device-specific

Mode

all

STATus:QUEStionable:LIMit<1|2>:ENABle

This command sets the bits of the ENABle section of the STATus:QUEStionable register. The ENABle register selectively enables the individual events of the associated EVEnt section for the summary bit.

This command is available from firmware version 1.10.

Parameter

0 to 65535

Example

```
STAT:QUES:ENAB 65535
```

Characteristics

*RST value: –

SCPI: device-specific

Mode

all

STATus:QUEStionable:LIMit<1|2>:PTRansition

This command sets the edge detectors of all bits of the STATus:QUEStionable:LIMit register from 0 to 1 for the transitions of the CONDition bit.

This command is available from firmware version 1.10.

Parameter

0 to 65535

Example

```
STAT:QUES:PTR 65535
```

Characteristics

*RST value: –

SCPI: device-specific

Mode

all

STATus:QUEStionable:LIMit<1|2>:NTRansition

This command sets the edge detectors of all bits of the STATus:QUEStionable:LIMit register from 1 to 0 for the transitions of the CONDition bit.

This command is available from firmware version 1.10.

Parameter

0 to 65535

Example

```
STAT:QUES:NTR 65535
```

Characteristics

*RST value: –

SCPI: device-specific

Mode

all

STATus:QUESTionable:LMARgin<1|2>[:EVENT]?

This command queries the contents of the EVENT section of the STATus:QUESTionable:LMARgin register. Readout deletes the contents of the EVENT section.

Example

STAT:QUES:LMAR?

Characteristics

*RST value: –

SCPI: device-specific

Mode

all

STATus:QUESTionable:LMARgin<1|2>:CONDition?

This command queries the contents of the CONDition section of the STATus:QUESTionable:LMARgin register. Readout does not delete the contents of the CONDition section.

Example

STAT:QUES:LMAR:COND?

Characteristics

*RST value: –

SCPI: device-specific

Mode

all

STATus:QUESTionable:LMARgin<1|2>:ENABLE

This command sets the bits of the ENABLE section of the STATus:QUESTionable:LMARgin register. The ENABLE register selectively enables the individual events of the associated EVENT section for the summary bit.

Parameter

0 to 65535

Example

STAT:QUES:LMAR:ENAB 65535

Characteristics

*RST value: –

SCPI: device-specific

Mode

all

STATus:QUESTionable:LMARgin<1|2>:PTRansition

This command sets the edge detectors of all bits of the STATus:QUESTionable:LMARgin register from 0 to 1 for the transitions of the CONDition bit.

Parameter

0 to 65535

Example

```
STAT:QUES:LMAR:PTR 65535
```

Characteristics

*RST value: –

SCPI: device-specific

Mode

all

STATus:QUESTionable:LMARgin<1|2>:NTRansition

This command sets the edge detectors of all bits of the STATus:QUESTionable:LMARgin register from 1 to 0 for the transitions of the CONDition bit.

Parameter

0 to 65535

Example

```
STAT:QUES:LMAR:NTR 65535
```

Characteristics

*RST value: –

SCPI: device-specific

Mode

all

STATus:QUESTionable:POWer[:EVENT]?

This command queries the contents of the EVENT section of the STATus:QUESTionable:POWer register. Readout deletes the contents of the EVENT section.

Example

```
STAT:QUES?
```

Characteristics

*RST value: –

SCPI: conform

Mode

all

STATus:QUESTionable:POWer:CONDition?

This command queries the contents of the CONDition section of the STATus:QUESTionable:POWer register. Readout does not delete the contents of the CONDition section.

Example

```
STAT:QUES:COND?
```

Characteristics

*RST value: –

SCPI: conform

Mode

all

STATus:QUEStionable:POWer:ENABle

This command sets the bits of the ENABle section of the STATus:QUEStionable:POWer register. The ENABle register selectively enables the individual events of the associated EVENT section for the summary bit.

Parameter

0 to 65535

Example

```
STAT:QUES:ENAB 65535
```

Characteristics

*RST value: –

SCPI: conform

Mode

all

STATus:QUEStionable:POWer:PTRansition

This command sets the edge detectors of all bits of the STATus:QUEStionable:POWer register from 0 to 1 for the transitions of the CONDition bit.

Parameter

0 to 65535

Example

```
STAT:QUES:PTR 65535
```

Characteristics

*RST value: –

SCPI: conform

Mode

all

STATus:QUEStionable:POWer:NTRansition

This command sets the edge detectors of all bits of the STATus:QUEStionable:POWer register from 1 to 0 for the transitions of the CONDition bit.

Parameter

0 to 65535

Example

```
STAT:QUES:NTR 65535
```

Characteristics

*RST value: –

SCPI: conform

Mode

all

STATus:QUESTIONable:SYNC[:EVENT]?

This command queries the contents of the EVENT section of the STATus:QUESTIONable:SYNC register.

Readout deletes the contents of the EVENT section.

This command is available from firmware version 1.30.

Example

```
STAT:QUES:SYNC?
```

Characteristics

*RST value: –

SCPI: device-specific

Mode

all

STATus:QUESTIONable:SYNC:CONDition?

This command queries the contents of the CONDition section of the STATus:QUESTIONable:SYNC register. Readout does not delete the contents of the CONDition section.

This command is available from firmware version 1.30.

Example

```
STAT:QUES:SYNC:COND?
```

Characteristics

*RST value: –

SCPI: device-specific

Mode

all

STATus:QUESTIONable:SYNC:ENABLE

This command sets the bits of the ENABLE section of the STATus:QUESTIONable:SYNC register. The ENABLE register selectively enables the individual events of the associated EVENT section for the summary bit.

This command is available from firmware version 1.30.

Parameter

0 to 65535

Example

```
STAT:QUES:SYNC:ENAB 65535
```

Characteristics

*RST value: –

SCPI: device-specific

Mode

all

STATus:QUESTionable:SYNC:PTRansition

This command sets the edge detectors of all bits of the STATus:QUESTionable:SYNC register from 0 to 1 for the transitions of the CONDition bit.

This command is available from firmware version 1.30.

Parameter

0 to 65535

Example

```
STAT:QUES:SYNC:PTR 65535
```

Characteristics

*RST value: –

SCPI: device-specific

Mode

all

STATus:QUESTionable:SYNC:NTRansition

This command sets the edge detectors of all bits of the STATus:QUESTionable:SYNC register from 1 to 0 for the transitions of the CONDition bit.

This command is available from firmware version 1.30.

Parameter

0 to 65535

Example

```
STAT:QUES:SYNC:NTR 65535
```

Characteristics

*RST value: –

SCPI: device-specific

Mode

all

SYSTem Subsystem

This subsystem contains a series of commands for general functions.

The following subsystem is included:

- ["SYSTem:SPEaker Subsystem"](#) on page 6.163

SYSTem:SPEaker Subsystem

This subsystem controls the headset functions.

Commands of the SYSTem:SPEaker Subsystem

- [SYSTem:SPEaker:VOLume](#)

SYSTem:SPEaker:VOLume

This command sets the volume of the headset for demodulated signals.

Parameter

0 to 1; value 0 is the lowest volume, value 1 the highest volume.

Example

```
SYST:SPE:VOL 0.5
```

Characteristics

*RST value: 0

SCPI: device-specific

Mode

all

TRACe Subsystem

The TRACe subsystem controls access to the instruments internal trace memory.

The following subsystem is included:

- ["TRACe:IQ Subsystem"](#) on page 6.165

Commands of the TRACe Subsystem

- [TRACe<1|2>\[:DATA\]](#)
- [TRACe:COPY](#)

TRACe<1|2>[:DATA]

This command transfers trace data from the control computer to the instrument, the query reads trace data out of the instrument. The transfer of trace data from the control computer to the instrument takes place by indicating the trace name and then the data to be transferred.

For details on saving and recalling data refer to chapter "Remote Control – Basics", section "MMEMory Subsystem".

Return values

501 results are returned. The returned values are scaled in the current level unit.

FORMat REAL, 32 is used as format for binary transmission, and FORMat ASCii for ASCII transmission. For details on formats refer to "[Formats for returned values: ASCII format and binary format](#)" on page 6.196.

Note: With the AUTO PEAK detector, only positive peak values can be read out.

Parameter

TRACE1 | TRACE2 | TRACE3 | TRACE4 , <block> | <numeric_value>

TRACE1 to TRACE4 = trace memory to be read out.

<block> or <numeric_value> = data to be transferred.

Example

```
TRAC TRACE1
TRAC? TRACE1
```

Characteristics

*RST value: –

SCPI: conform

Mode

all

TRACe:COPY

This command copies data from one trace to another.

This command is an event and therefore has no query and no *RST value.

Parameter

TRACE1 | TRACE2 | TRACE3 | TRACE4 , TRACE1 | TRACE2 | TRACE3 | TRACE4

The first operand the destination of the data to be copied, the second operand describes the source.

Example

```
TRAC:COPY TRACE1,TRACE2
```

Characteristics

*RST value: –

SCPI: conform

Mode

A, CATV

TRACe:IQ Subsystem

The commands of this subsystem are used for collection and output of measured IQ data. A special memory is therefore available in the instrument with 512k words for the I and Q data. The measurement is always performed in zero span at the selected center frequency. The number of samples to be collected and the sample rate can be set (for details refer to "Sample rate" on page 6.166). Prior to being stored in memory or output via GPIB, the measurement data are corrected in terms of frequency response.

The block diagram below shows the analyzer hardware from the IF section to the processor. The A/D converter samples the IF signal (47.9 MHz) at a rate of 65.83 MHz.

The digital signal is down-converted to the complex baseband, lowpass-filtered, and the sampling rate is reduced. The output sampling rate is set between 10 kHz and 65.83 MHz. The continuously adjustable sampling rates are realized using an optimal decimation filter and subsequent resampling on the set sampling rate.

The I/Q data are written to separate memories of 512 k words each. The memories are hardware-triggered. 512 samples are designated as buffer for triggering, which leads to a max. recording length of (512k – 512) samples.

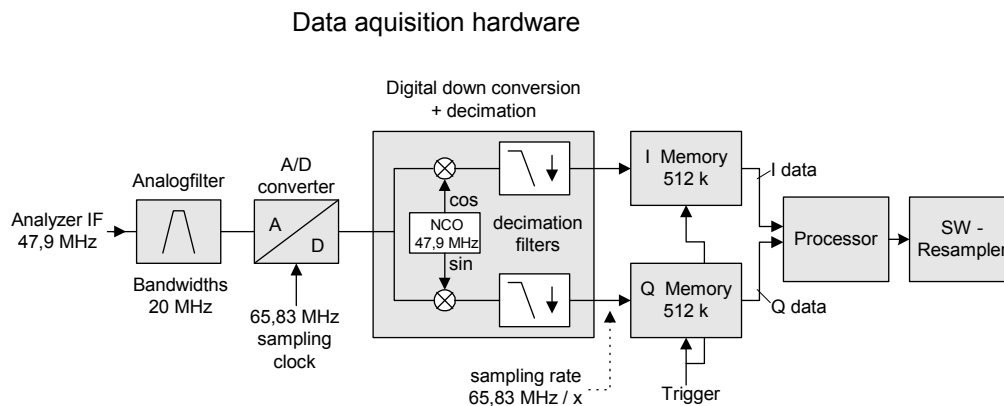

Fig. 6–1 Block diagram illustrating signal processing in analyzer

The trigger sources EXT (external trigger) and IFP (IF Power Trigger) can be used for triggering, additionally IMM (Free Run). The number of test points to be recorded prior to the trigger point can be selected for all available trigger sources, except for FREE RUN.

The measurement results are output in the form of a list, with the Q values following immediately after the list of I values in the output buffer. The `FORMAT` command can be used to select between binary output (32 bit IEEE 754 floating-point values) and output in ASCII format.

For details on formats refer to "Formats for returned values: ASCII format and binary format" on page 6.196.

The commands of this subsystem can be used in two ways:

- Measurement and result query with one

This method causes the least delay between measurement and output of the result data, but it requires the control computer to wait actively for the response data.

- Setting up the instrument, start of the measurement via `INIT` and query of the result list at the end of the measurement:

With this method the control computer can be used for other activities during the measurement. In this case the additional time needed for synchronization via service request must be taken into account.

Commands of the TRACe:IQ Subsystem

- `TRACe<1|2>:IQ[:STATe]`
- `TRACe<1|2>:IQ:AVERAge[:STATe]`
- `TRACe<1|2>:IQ:AVERAge:COUNT`
- `TRACe<1|2>:IQ:DATA?`
- `TRACe<1|2>:IQ:DATA:MEMory?`
- `TRACe<1|2>:IQ:SET`
- `TRACe<1|2>:IQ:SRATe`
- `TRACe<1|2>:IQ:SYNChronize[:STATe]`

Further information

- [Sample rate](#)

Sample rate

Depending on the sample rate, the maximum bandwidths listed in the table can be obtained during the measurement. The sample rate can be set in the range from 10 kHz to 65.83 MHz.

- [65.8 MHz to 10.7 MHz](#)
- [10.7 MHz to 3.2 MHz](#)
- [3.2 MHz to 1 MHz](#)
- [1 MHz to 105 kHz](#)
- [105 kHz to 10 kHz](#)

65.8 MHz to 10.7 MHz

Sample rate from [Hz]	Sample rate to [Hz]	Max bandwidth [Hz]
65 800 000.000	32 916 666.670	20 000 000.000
22 500 000.000	20 248 687.500	17 998 833.330
20 248 687.500	16 401 436.880	14 579 055.000
16 401 436.880	14 812 500.000	13 166 666.670
14 812 500.000	13 331 250.000	11 850 000.000
13 331 250.000	11 998 125.000	10 665 000.000
11 998 125.000	10 798 312.500	9 598 500.000

10.7 MHz to 3.2 MHz

Sample rate from [Hz]	Sample rate to [Hz]	Max bandwidth [Hz]
10 798 312.500	9 875 000.000	8 777 777.778
9 875 000.000	8 887 500.000	7 900 000.000
8 887 500.000	7 998 750.000	7 110 000.000
7 998 750.000	7 406 250.000	6 583 333.333
7 406 250.000	6 665 625.000	5 925 000.000
6 665 625.000	6 583 333.333	5 851 851.852
6 583 333.333	5 925 000.000	5 266 666.667
5 925 000.000	5 332 500.000	4 740 000.000
5 332 500.000	4 937 500.000	4 388 888.889
4 937 500.000	4 443 750.000	3 950 000.000
4 443 750.000	4 232 142.857	3 761 904.762
4 232 142.857	3 950 000.000	3 511 111.111
3 950 000.000	3 703 125.000	3 291 666.667
3 703 125.000	3 332 812.500	2 962 500.000
3 332 812.500	3 291 666.667	2 925 925.926

3.2 MHz to 1 MHz

Sample rate from [Hz]	Sample rate to [Hz]	Max bandwidth [Hz]
3 291 666.667	2 962 500.000	2 633 333.333
2 962 500.000	2 821 428.571	2 507 936.508
2 821 428.571	2 539 285.714	2 257 142.857
2 539 285.714	2 468 750.000	2 194 444.444
2 468 750.000	2 370 000.000	2 106 666.667
2 370 000.000	2 194 444.444	1 950 617.284
2 194 444.444	2 116 071.429	1 880 952.381
2 116 071.429	1 975 000.000	1 755 555.556
1 975 000.000	1 851 562.500	1 645 833.333
1 851 562.500	1 795 454.545	1 595 959.596
1 795 454.545	1 645 833.333	1 462 962.963
1 645 833.333	1 481 250.000	1 316 666.667
1 481 250.000	1 346 590.909	1 196 969.697
1 346 590.909	1 234 375.000	1 097 222.222
1 234 375.000	1 139 423.077	1 012 820.513
1 139 423.077	1 039 473.684	923 976.608

1 MHz to 105 kHz

Sample rate from [Hz]	Sample rate to [Hz]	Max bandwidth [Hz]
1 039 473.684	940 476.191	835 978.836
940 476.191	846 428.571	752 380.952
846 428.571	779 605.263	692 982.456
779 605.263	705 357.143	626 984.127
705 357.143	637 096.774	566 308.244
637 096.774	580 882.353	516 339.869
580 882.353	529 017.857	470 238.095
529 017.857	477 822.581	424 731.183
477 822.581	435 661.765	387 254.902
435 661.765	395 000.000	351 111.111
395 000.000	359 090.909	319 191.919
359 090.909	323 770.492	287 795.993
323 770.492	294 776.119	262 023.217
294 776.119	266 891.892	237 237.237
266 891.892	240 853.659	214 092.141
240 853.659	217 032.967	192 918.193
217 032.967	195 544.555	173 817.382
195 544.555	176 339.286	156 746.032
176 339.286	159 274.194	141 577.061
159 274.194	143 810.680	127 831.715
143 810.680	129 934.211	115 497.076
129 934.211	117 559.524	104 497.355
117 559.524	105 803.571	94 047.619

105 kHz to 10 kHz

Sample rate from [Hz]	Sample rate to [Hz]	Max bandwidth [Hz]
105 803.571	95 410.628	84 809.447
95 410.628	85 869.565	76 328.502
85 869.565	77 450.980	68 845.316
77 450.980	69 787.986	62 033.765
69 787.986	62 898.089	55 909.413
62 898.089	56 752.874	50 446.999
56 752.874	51 077.586	45 402.299
51 077.586	46 001.553	40 890.269
46 001.553	41 404.612	36 804.100
41 404.612	37 264.151	33 123.690
37 264.151	33 588.435	29 856.387
33 588.435	30 229.592	26 870.748
30 229.592	27 228.860	24 203.431

Sample rate from [Hz]	Sample rate to [Hz]	Max bandwidth [Hz]
27 228.860	24 524.007	21 799.117
24 524.007	22 075.261	19 622.454
22 075.261	19 869.215	17 661.525
19 869.215	17 889.493	15 901.771
17 889.493	16 100.543	14 311.594
16 100.543	14 493.640	12 883.235
14 493.640	13 044.914	11 595.479
13 044.914	11 741.974	10 437.310
11 741.974	10 572.805	9 398.049
10 572.805	10 000.000	8 460.509

TRACe<1|2>:IQ[:STATe]

This command switches the I/Q data acquisition on or off.

Note: The I/Q data acquisition is not compatible with other measurement functions. Therefore all other measurement functions will be switched off as soon as the I/Q measurement function is switched on. Additionally a trace display is not possible in this operating mode. Therefore all traces are set to "BLANK".

Parameter

ON | OFF

Example

TRAC: IQ ON

Switches on I/Q data acquisition

Characteristics

*RST value: OFF

SCPI: device-specific

Mode

A-T

TRACe<1|2>:IQ:AVERAge[:STATe]

The command enables averaging of the recorded I/Q data provided that I/Q data acquisition was previously enabled with `TRACe<1|2>:IQ[:STATe]`.

Parameter

ON | OFF

Example

TRAC: IQ ON

Switches on acquisition of I/Q data.

TRAC: IQ: AVER ON

Enables averaging of the I/Q measurement data.

TRAC: IQ: AVER: COUN 10

Selects averaging over 10 data sets.

TRAC: IQ: DATA?

Starts the measurement and reads out the averaged data.

Characteristics

*RST value: OFF

SCPI: device-specific

Mode

A-T

TRACe<1|2>:IQ:AVERage:COUNT

This command defines the number of I/Q data sets that are to serve as a basis for averaging.

Parameter

0 to 32767

Example

TRAC:IQ ON

Switches on acquisition of I/Q data.

TRAC:IQ:AVER ON

Enables averaging of the I/Q measurement data

TRAC:IQ:AVER:COUN 10

Selects averaging over 10 data sets

TRAC:IQ:DATA?

Starts the measurement and reads out the averaged data.

Characteristics

*RST value: 0

SCPI: conform

Mode

all

TRACe<1|2>:IQ:DATA?

This command starts a measurement with the settings defined via [TRACe<1|2>:IQ:SET](#) and returns the list of measurement results immediately after they are corrected in terms of frequency response. The number of measurement results depends on the settings defined with [TRACe<1|2>:IQ:SET](#), the output format depends on the settings of the FORMat subsystem.

Note: The command requires that all response data are read out completely before the instrument accepts further commands.

Return values

The result values are scaled linear in unit *Volt* and correspond to the voltage at the RF input of the instrument. In ASCII format, the number of the returned values is 2 * the number of samples. The first set contains the I-data, the second the Q-data.

Note: If the sampling rate exceeds 512k (≡ 524288), the data are output in 512k blocks.

In binary format, the number of I- and Q-data can be calculated as follows:

$$\# \text{ of I-Data} = \# \text{ of Q-Data} = \frac{\# \text{ of DataBytes}}{8}$$

The offset of Q-data in the output buffer can be calculated as follows:

$$Q\text{-Data-Offset} = \frac{(\# \text{ of DataBytes})}{2} + \text{LengthIndicatorDigits}$$

with LengthIndicatorDigits being the number of digits of the length indicator including the #. In the example above (#41024...) this results in a value of 6 for LengthIndicatorDigits and the offset for the Q-data will result in $512 + 6 = 518$.

For further details on formats refer to "[Formats for returned values: ASCII format and binary format](#)" on page 6.196.

Example

TRAC:IQ:STAT ON

Enables acquisition of I/Q data

TRAC:IQ:SET NORM,10MHz,32MHz,EXT,POS,0,4096

Measurement configuration:

Sample Rate: 32 MHz

Trigger Source: External

Trigger Slope: Positive

Pretrigger Samples: 0

of Samples: 4096

FORMat REAL,32

Selects format of response data

TRAC:IQ:DATA?

Starts measurement and reads results

Characteristics

*RST value: –

Note: Using the command with the *RST values for the TRACe<1|2>:IQ:SET command, the following minimum buffer sizes for the response data are recommended: ASCII format 10 kBytes, binary format: 2 kBytes

SCPI: device-specific

Mode

A–T

TRACe<1|2>:IQ:DATA:MEMory?

This command permits the readout of previously acquired (and frequency response corrected) I/Q data from the memory, with indication of the offset related to the start of measurement and with indication of the number of measurement values. Therefore a previously acquired data set can be read out in smaller portions. The maximum amount of available data depends on the settings of the TRACe<1|2>:IQ:SET command, the output format on the settings in the FORMat subsystem.

Note: The command requires that all response data are read out completely before the instrument accepts further commands.
If there are not I/Q data available in memory because the corresponding measurement had not been started, the command will cause a query error.

Parameter

- <offset samples> Offset of the values to be read related to the start of the acquired data.
Value range: 0 to <# of samples> – 1, with <# of samples> being the value indicated with the TRACe<1|2>:IQ:SET command.
- <# of samples> Number of measurement values to be read.
Value range: 1 to <# of samples> – <offset samples> with <# of samples> being the value indicated with the TRACe<1|2>:IQ:SET command.

Return values

The returned values are scaled linear in unit Volt and correspond to the voltage at the RF input of the instrument.

The format of the output buffer corresponds to the `TRACe<1|2>:IQ:DATA?` command.

Example

```
TRAC:IQ:STAT ON
```

Enables acquisition of I/Q data

```
TRAC:IQ:SET NORM,10MHz,32MHz,EXT,POS,100,4096
```

To configure the measurement:

Sample Rate: 32 MHz

Trigger Source: External

Slope: Positive

Pretrigger Samples: 100

of Samples: 4096

```
INIT;*WAI
```

Starts measurement and wait for sync

```
FORMat REAL,32
```

Determines output format

To read the results:

```
TRAC:IQ:DATA:MEM? 0,2048
```

Reads 2048 I/Q data starting at the beginning of data acquisition

```
TRAC:IQ:DATA:MEM? 2048,1024
```

Reads 1024 I/Q data from half of the recorded data

```
TRAC:IQ:DATA:MEM? 100,512
```

Reads 512 I/Q data starting at the trigger point (<Pretrigger Samples> was 100)

Characteristics

*RST value: –

SCPI: device-specific

Mode

A–T, WLAN, WiMAX

TRACe<1|2>:IQ:SET

This command defines the settings of the analyzer hardware for the measurement of I/Q data. This allows setting the bandwidth of the analog filters in front of the A/D converter as well as setting the sample rate, trigger conditions and the record length.

Note: If this command is omitted, the current analyzer settings will be used for the corresponding parameters.

This command switches to IQ mode automatically (see also

`TRACe<1|2>:IQ[:STATe]`*).*

The parameter <filter_type> and <sample_rate> have no effect but are indicated for reasons of compatibility with the FSP family.

The trigger level can be set using the `TRIGger<1|2>[:SEquence]:LEVel:IFPower` command.

Parameter

<filter type>	can be omitted
<rbw>	can be omitted
<sample rate>	Sampling rate for the data acquisition.

<trigger mode>	Value range: 10 kHz to 65.83 MHz, continuously adjustable Selection of the trigger source used for the measurement. Values: IMMEDIATE EXTERNAL IFCPower
<trigger slope>	Used trigger slope. Values: POSITIVE
<pretrigger samples>	Number of measurement values to be recorded before the trigger point. Range: -16253439 (= $-(2^{24}-1-512k-512)$) ... 523775 (= $512*1024 - 512 - 1$). Negative values correspond to a trigger delay.
<# of samples>	Number of measurement values to record. Value range: 1 ... 523776 (= $512*1024 - 512$)

Example

TRAC:IQ:SET NORM,10MHz,32MHz,EXT,POS,0,2048

Reads 2048 I/Q-values starting at the trigger point.

sample rate: 32 MHz

trigger: External

slope: Positive

TRAC:IQ:SET NORM,10MHz,4MHz,EXT,POS,1024,512

Reads 512 I/Q-values from 1024 measurement points before the trigger point.

filter type: NORMAL

RBW: 10 MHz

sample rate: 4 MHz

trigger: External

slope: Positive

Characteristics

*RST values: -, -, 32MHz, IMM, POS, 0, 128

Note: For using these default settings with the TRACe<1|2>:IQ:DATA? command the following minimum buffer sizes for the response data are recommended: ASCII format 10 kBytes, Binary format 2 kBytes.

SCPI: device-specific

Mode

A-T

TRACe<1|2>:IQ:SRATE

This command sets the sampling rate for the I/Q data acquisition. Thus the sample rate can be modified without affecting the other settings.

Parameter

10 kHz to 65.83 MHz, continuously adjustable

Example

TRAC:IQ:SRATE 4MHZ

Characteristics

*RST value: 32 MHz

SCPI: device-specific

Mode

A–T

TRACe<1|2>:IQ:SYNChronize[:STATe]

This command activates the synchronization of I/Q data acquisition and trigger point.

Prerequisites are that the I/Q data acquisition is activated using the `TRACe<1|2>:IQ[:STATe]` command and the sampling rate is set to 32 MHz.

The synchronization ensures that the data acquisition starts always with the same phase shift to the trigger point. The constant phase shift is necessary for correct I/Q data averaging.

Parameter

ON|OFF

Example

```
TRAC:IQ ON
```

Activates the I/Q data acquisition.

```
TRAC:IQ:SYNC ON
```

Activates the synchronization of I/Q data acquisition and trigger point.

```
TRAC:IQ:SET NORM,10MHz,32MHz,EXT,POS,0,2048
```

Reads 2048 I/Q values from the trigger point.

filter type: NORMAL

RBW: 10 MHz

sample rate: 32 MHz

trigger: External

slope: Positive

```
TRAC:IQ:AVER ON
```

Activates the I/Q data averaging.

```
TRAC:IQ:AVER:COUN 10
```

Selects averaging over 10 data sets.

```
TRAC:IQ:DATA?
```

Starts the measurement and reads the averaged data.

Characteristics

RST value: ON

SCPI: device-specific

Mode

A–T

TRIGger Subsystem

The TRIGger subsystem is used to synchronize instrument actions with events. It is thus possible to control and synchronize the start of a sweep.

Commands of the TRIGger Subsystem

- TRIGger<1|2>[:SEQuence]:HOLDoff[:TIME]
- TRIGger<1|2>[:SEQuence]:IFPower:HOLDoff
- TRIGger<1|2>[:SEQuence]:IFPower:HYSteresis
- TRIGger<1|2>[:SEQuence]:LEVel:IFPower
- TRIGger<1|2>[:SEQuence]:LEVel:VIDeo
- TRIGger<1|2>[:SEQuence]:SLOPe
- TRIGger<1|2>[:SEQuence]:SOURce
- TRIGger<1|2>[:SEQuence]:VIDeo:CONTinuous (option TV Trigger, B6)
- TRIGger<1|2>[:SEQuence]:VIDeo:FIELD:SElect (option TV Trigger, B6)
- TRIGger<1|2>[:SEQuence]:VIDeo:FORMat:LPFRame (option TV Trigger, B6)
- TRIGger<1|2>[:SEQuence]:VIDeo:LINE:NUMBer (option TV Trigger, B6)
- TRIGger<1|2>[:SEQuence]:VIDeo:SSIGnal:POLarity (option TV Trigger, B6)

TRIGger<1|2>[:SEQuence]:HOLDoff[:TIME]

This command defines the length of the trigger delay.

A negative delay time (pretrigger) can be set in zero span only.

Parameter

–100 s to +100 s

for TV trigger (option B6, available from firmware version 1.10): –50 μ s to +50 μ s

Example

```
TRIG:HOLD 500us
```

Characteristics

*RST value: 0 s

SCPI: conform

Mode

all

TRIGger<1|2>[:SEQuence]:IFPower:HOLDoff

ffThis command sets the holding time before the next IF power trigger event.

This command is available from firmware version 1.30.

Parameter

<numeric_value> in s: 150 ns to 1000 s

Example

```
TRIG:SOUR IFP
```

Sets the IF power trigger source.

```
TRIG:IFP:HOLD 200 ns
```

Sets the holding time to 200 ns.

Characteristics

*RST value: 150 ns

SCPI: device-specific

Mode

A-F

TRIGger<1|2>[:SEQuence]:IFPower:HYSTerisis

sThis command sets the limit that the hysteresis value has to fall below in order to trigger the next measurement.

This command is available from firmware version 1.30.

Parameter

<numeric_value> in dB: 3 dB to 50 dB

Example

```
TRIG:SOUR IFP
```

Sets the IF power trigger source.

```
TRIG:IFP:HYST 10DB
```

Sets the hysteresis limit value.

Characteristics

*RST value: 3 dB

SCPI: device-specific

Mode

A-F

TRIGger<1|2>[:SEQuence]:LEVel:IFPower

This command sets the level of the IF power trigger source.

Parameter

-50 to -10 DBM

Example

```
TRIG:LEV:IFP -30DBM
```

Characteristics

*RST value: -20 DBM

SCPI: device-specific

Mode

all

TRIGger<1|2>[:SEQuence]:LEVel:VIDeo

This command sets the level of the video trigger source.

Parameter

0 to 100 PCT

Example

```
TRIG:LEV:VID 50PCT
```

Characteristics

*RST value: 50 PCT

SCPI: device-specific

Mode

all, except ADEMOD

TRIGger<1|2>[:SEQuence]:SLOPe

This command selects the slope of the trigger signal. The selected trigger slope applies to all trigger signal sources except the TV trigger (option B6, available from firmware version 1.10).

Parameter

POSitive | NEGative

Example

```
TRIG:SLOP NEG
```

Characteristics

*RST value: POSitive

SCPI: conform

Mode

all

TRIGger<1|2>[:SEQuence]:SOURce

This command selects the trigger source for the start of a sweep.

Parameter

IMMEDIATE (Free Run) | EXTern | IFPower | VIDeo

TV (option TV Trigger, B6, available from firmware version 1.10)

For details on trigger modes refer to chapter "Instrument Functions", section "Trigger mode overview".

Example

```
TRIG:SOUR EXT
```

Selects the external trigger input as source of the trigger signal

Characteristics

*RST value: IMMEDIATE

SCPI: conform

Mode

A, ADEMOD, CATV

TRIGger<1|2>[:SEQuence]:VIDeo:CONTInuous (option TV Trigger, B6)

Activates or deactivates the free run trigger mode.
This command is available from firmware version 1.30.

Parameter

ON | OFF

Example

```
TRIG:VID:CONT ON
```

Characteristics

*RST value: OFF

SCPI: device-specific

Mode

A-T

TRIGger<1|2>[:SEQuence]:VIDeo:FIELd:SELEct (option TV Trigger, B6)

With active TV trigger this command activates triggering at the vertical sync signal.
Option TV Trigger, B6, is available from firmware version 1.10.

Parameter

ALL (both fields) | ODD (odd fields) | EVEN (even fields)

Example

```
TRIG:VID:FIEL:SEL ALL
```

Characteristics

*RST value: –

SCPI: conform

Mode

A-T

TRIGger<1|2>[:SEQuence]:VIDeo:FORMat:LPFRame (option TV Trigger, B6)

This command defines the line system in use (525 or 625 lines) with active TV trigger.
Option TV Trigger, B6, is available from firmware version 1.10.

Parameter

525 | 625

Example

```
TRIG:VID:FORM:LPFR 525
```

Characteristics

*RST value: 625

SCPI: conform

Mode

A-T

TRIGger<1|2>[:SEQuence]:VIDeo:LINE:NUMBer (option TV Trigger, B6)

With active TV trigger this command activates triggering at the horizontal sync signal of the indicated line number.

Option TV Trigger, B6, is available from firmware version 1.10.

Parameter

<numeric_value>

Example

```
TRIG:VID:LINE:NUMB 17
```

Characteristics

*RST value: –

SCPI: conform

Mode

A–T

TRIGger<1|2>[:SEQuence]:VIDeo:SSIGnal:POLarity (option TV Trigger, B6)

With active TV trigger this command selects the polarity of the video sync signal.

Option TV Trigger, B6, is available from firmware version 1.10.

Parameter

NEGative | POSitive

Example

```
TRIG:VID:SSIG:POL NEG
```

Characteristics

*RST value: NEGative

SCPI: conform

Mode

A–T

UNIT Subsystem

The UNIT subsystem sets the basic unit of the setting parameters.

Commands of the UNIT Subsystem

- [UNIT<1|2>:POWER](#)

UNIT<1|2>:POWER

This command selects the default unit.

Parameter

DBM | V | A | W | DBPW | WATT | DBPT | DBUV | DBMV | VOLT | DBUA | AMPere

Example

```
UNIT:POW DBUV
```

Sets the power unit to dBm.

Characteristics

*RST value: DBM

SCPI: conform

Mode

A

Remote Commands of the Analog Demodulation Option (K7)

In this section all remote control commands for Analog Demodulation option are described in detail. The abbreviation ADEMODO stands for the Analog Demodulation operating mode. For details on conventions used in this chapter refer to section "Notation" on page 6.2 at the beginning of this chapter.

For further information on analyzer or basic settings commands, refer to the corresponding subsystem in "Remote Control – Description of Analyzer Commands" on page 6.5 or section "Remote Control – Description of Basic Settings Commands".

This option is available from firmware version 1.10.

Subsystems of the Analog Demodulation option (K7)

- "CALCulate Subsystem (Analog Demodulation, K7)" on page 6.182
- "DISPlay Subsystem (Analog Demodulation, K7)" on page 6.192
- "INSTrument Subsystem (Analog Demodulation, K7)" on page 6.194
- "SENSe Subsystem (Analog Demodulation, K7)" on page 6.195
- "TRACe Subsystem (Analog Demodulation, K7)" on page 6.222
- "TRIGger Subsystem (Analog Demodulation, K7)" on page 6.223
- "UNIT Subsystem (Analog Demodulation, K7)" on page 6.225

CALCulate Subsystem (Analog Demodulation, K7)

The CALCulate subsystem contains commands for converting instrument data, transforming and carrying out corrections. These functions are carried out subsequent to data acquisition, i.e. following the SENSE subsystem.

The following subsystems are included:

- "CALCulate:DELTamarker Subsystem" on page 6.182
- "CALCulate:FEED Subsystem" on page 6.183
- "CALCulate:FORMat Subsystem" on page 6.184
- "CALCulate:MARKer Subsystem" on page 6.185
- "CALCulate:UNIT Subsystem" on page 6.191

CALCulate:DELTamarker Subsystem (Analog Demodulation, K7)

The CALCulate:DELTamarker subsystem controls the delta marker functions in the instrument.

Commands of the CALCulate:DELTamarker Subsystem

– [CALCulate<1|2>:DELTamarker<1...4>:Y?](#)

CALCulate<1|2>:DELTamarker<1...4>:Y?

Depending on the unit defined with [CALCulate<1|2>:UNIT:POWer](#) or on the activated measuring functions, the query result is output in the units below:

Result display	Output unit
AM result display (R&S FSL-K7)	% (lin) dB (log)
FM result display (R&S FSL-K7)	Hz (lin) dB (log)
PM result display (R&S FSL-K7)	rad deg (lin) dB (log)
RF result display (R&S FSL-K7)	output unit defined with CALCulate<1 2>:UNIT:POWer

For further details refer to "[CALCulate<1|2>:DELTamarker<1...4>:Y?](#)" on page 6.15.

CALCulate:FEED Subsystem (Analog Demodulation, K7)

The CALCulate:FEED subsystem selects the type of evaluation of the measured data. This corresponds to the selection of the result display in manual mode.

Commands of the CALCulate:FEED Subsystem

– [CALCulate<1|2>:FEED](#)

CALCulate<1|2>:FEED

This command selects the measured data that are to be displayed.

The numeric suffixes <1|2> are irrelevant.

Parameter

XTIM:AM:RELative[:TDOMain]	Demodulated AM signal in standardized display
XTIM:AM:RELative:AFSPectrum<1...4>	AF spectrum of the demodulated AM signal in standardized display, results referenced to traces 1 to 4
XTIM:AM[:ABSolute][:TDOMain]	Demodulated AM signal in level display Same as 'XTIM:RFPower'
XTIM:RFPower[:TDOMain]	RF power of the signal
XTIM:FM[:TDOMain]	Demodulated FM signal
XTIM:FM:AFSPectrum<1...4>	AF spectrum of the demodulated FM signal, results referenced to traces 1 to 4
XTIM:PM[:TDOMain]	Demodulated PM signal
XTIM:PM:AFSPectrum<1...4>	AF spectrum of the demodulated PM signal, results referenced to traces 1 to 4
XTIM:AMSummary<1...4>[:ABSolute]	AM results in level display, referenced to traces 1 to 4
XTIM:AMSummary<1...4>:RELative	AM results in standardized display, referenced to traces 1 to 4
XTIM:FMSummary<1...4>	FM results, referenced to traces 1 to 4
XTIM:PMSummary<1...4>	PM results, referenced to traces 1 to 4
XTIM:SPECTrum	RF spectrum of the signal determined from the measured data via FFT

Example

```
INST:SEL ADEM
```

Activates analog demodulator.

```
CALC:FEED 'XTIM:FM'
```

Selects the display of the FM signal.

Characteristics

RST value: –

SCPI: conform

Mode

ADEM0D

CALCulate:FORMat Subsystem (Analog Demodulation, K7)

The CALCulate:FORMat subsystem defines the conversion of measured data.

Commands of the CALCulate:FORMat Subsystem

- [CALCulate<1|2>:FORMat](#)

CALCulate<1|2>:FORMat

This command activates the limitation to $\pm 180^\circ$.

The numeric suffixes <1|2> are irrelevant.

Parameter

PHASe Limitation to $\pm 180^\circ$

UPHase Unwrapped

Example

```
CALC:FORM PHAS
```

Activates the limitation to $\pm 180^\circ$.

Characteristics

RST value: UPHase

SCPI: conform

Mode

ADEM0D

CALCulate:MARKer Subsystem (Analog Demodulation, K7)

The CALCulate:MARKer subsystem checks the marker functions in the instrument.

The following subsystem is included:

- ["CALCulate:MARKer:FUNCTION:ADEMod Subsystem \(Analog Demodulation, K7\)"](#) on page 6.186

Commands of the CALCulate:MARKer Subsystem

- [CALCulate<1|2>:MARKer<1...4>:PEXCursion](#)
- [CALCulate<1|2>:MARKer<1...4>:Y?](#)

CALCulate<1|2>:MARKer<1...4>:PEXCursion

The unit depends on the active display.

Example

```
CALC:MARK:PEXC 100 HZ
Defines peak excursion 100 Hz
```

Characteristics

*RST value:

6dB	RF displays
5 PCT	AM displays
50 kHz	FM displays
0.5 RAD	PM displays

For further details refer to ["CALCulate<1|2>:MARKer<1...4>:PEXCursion"](#) on page 6.48.

CALCulate<1|2>:MARKer<1...4>:Y?

If the analog demodulator (option Analog Demodulation, R&S FSL–K7) is activated, the query result is output in the following units:

Result display	Output unit
AM	%
FM	Hz
PM	rad/deg (defined with CALCulate<1 2>:UNIT:ANGLE)
RF	output unit defined with CALCulate<1 2>:UNIT:POWER

For further details refer to ["CALCulate<1|2>:MARKer<1...4>:Y?"](#) on page 6.50.

CALCulate:MARKer:FUNCTION:ADEMod Subsystem (Analog Demodulation, K7)

The CALCulate:MARKer:FUNCTION:ADEMod subsystem contains the marker functions for the option Analog Demodulation, R&S FSL–K7.

Commands of the CALCulate:MARKer:FUNCTION:ADEMod Subsystem

- CALCulate<1|2>:MARKer:FUNCTION:ADEMod:AFRequency[:RESult<1...4>?]
- CALCulate<1|2>:MARKer:FUNCTION:ADEMod:AM[:RESult<1...4>?]
- CALCulate<1|2>:MARKer:FUNCTION:ADEMod:CARRier[:RESult<1...4>?]
- CALCulate<1|2>:MARKer:FUNCTION:ADEMod:FERRor[:RESult<1...4>?]
- CALCulate<1|2>:MARKer:FUNCTION:ADEMod:FM[:RESult<1...4>?]
- CALCulate<1|2>:MARKer:FUNCTION:ADEMod:PM[:RESult<1...4>?]
- CALCulate<1|2>:MARKer:FUNCTION:ADEMod:SINad:RESult<1...4>?
- CALCulate<1|2>:MARKer:FUNCTION:ADEMod:THD:RESult<1...4>?

CALCulate<1|2>:MARKer:FUNCTION:ADEMod:AFRequency[:RESult<1...4>?]

This command queries the audio frequency with analog demodulation. The numeric suffix (:RESult<1...4>) indicates whether trace 1, 2, 3 or 4 is selected. The numeric suffixes <1|2> are irrelevant.

Note: If several demodulation modes are activated simultaneously (e.g. with the [SENSe:]ADEMod:FM[:TDOMain] [:TYPE] command, the audio frequency of the display mode selected with CALCulate<1|2>:FEED is returned.

Example

```
ADEM ON
Switches on analog demodulator
CALC:FEED 'XTIM:AM:TDOM'
Switches on AM result display.
or
CALC:FEED 'XTIM:FM:TDOM'
Switches on FM result display.
or
CALC:FEED 'XTIM:FM:AFSP'
DISP:TRAC ON
Switches on AF spectrum result display of FM and trace.
CALC:MARK:FUNC:ADEM:AFR?
Queries the audio frequency.
```

Characteristics

*RST value: –
SCPI: device-specific

Mode

ADEMOD

CALCulate<1|2>:MARKer:FUNCtion:ADEMod:AM[:RESult<1...4>?]

This command queries the results of the AM modulation measurement. The numeric suffix (:RESult<1...4>) indicates whether trace 1, 2, 3 or 4 is selected. The numeric suffixes <1|2> are irrelevant.

Parameter

PPEak	Result of measurement with detector +PK
MPEak	Result of measurement with detector –PK
MIDDLE	Result of averaging \pm PK/2
RMS	Result of rms measurement

Example

```
ADEM ON
Switches on the analog demodulator.
CALC:FEED 'XTIM:AM:REL:TDOM'
Switches on the AM result display.
DISP:TRAC ON
Switches on the trace.
CALC:MARK:FUNC:ADEM:AM? PPE
Queries the peak value.
```

Characteristics

RST value: –
 SCPI: device-specific

Mode

ADEMOD

CALCulate<1|2>:MARKer:FUNCtion:ADEMod:CARRier[:RESult<1...4>?]

This command queries the carrier power. The numeric suffix (:RESult<1...4>) indicates whether trace 1, 2, 3 or 4 is selected. The numeric suffixes <1|2> are irrelevant.

With RF Power result display, the carrier power is determined from trace 1 to 4 indicated in the numeric suffix. With all other result displays, the carrier power is determined from the current trace data (CLR/WRITE trace).

This command is only a query and therefore has no *RST value.

Example

```
ADEM ON
Switches on analog demodulator
CALC:FEED 'XTIM:RFP'
Switches on RF power result display
CALC:MARK:FUNC:ADEM:CARR?
Queries the carrier power
```

Characteristics

*RST value: –
 SCPI: device-specific

Mode

ADEMOD

CALCulate<1|2>:MARKer:FUNCtion:ADEMod:FERRor[:RESult<1...4>?]

This command queries the frequency error with FM and PM demodulation. With FM demodulation, trace 1 to 4 is selected with the numeric suffix (:RESult<1...4>). With PM demodulation, the frequency error is determined from the current measurement data (CLR/WRITE trace). The numeric suffixes <1|2> are irrelevant.

The offset thus determined differs from that calculated in the `[SENSe:]ADEMod:FM:OFFSet?` command since, for determination of the frequency deviation, the modulation is removed by means of lowpass filtering, producing results that are different from those obtained by averaging with the `SENSe` command.

This command is only available for traces in the FM and PM result display. If another result display is selected, the command is disabled.

Example

```
ADEM ON
Switches on analog demodulator
CALC:FEED 'XTIM:FM:TDOM'
Switches on FM result display
CALC:MARK:FUNC:ADEM:FERR?
Queries the frequency error of trace 1
```

Characteristics

*RST value: –
SCPI: device-specific

Mode

ADEMOD

CALCulate<1|2>:MARKer:FUNCtion:ADEMod:FM[:RESult<1...4>?]

This command queries the results of FM modulation measurement. The numeric suffix (:RESult<1...4>) indicates whether trace 1, 2, 3 or 4 is selected. The numeric suffixes <1|2> are irrelevant.

Parameter

PPEak	Result of measurement with detector +PK
MPEak	Result of measurement with detector –PK
MIDDLE	Result of averaging \pm PK/2
RMS	Result of rms measurement

Example

```
ADEM ON
Switches on the analog demodulator.
CALC:FEED 'XTIM:FM:TDOM'
Switches on the FM result display.
```

CALC:MARK:FUNC:ADEM:FM? PPE

Queries the peak value.

Characteristics

*RST value: –

SCPI: device-specific

Mode

ADEMOD

CALCulate<1|2>:MARKer:FUNCtion:ADEMod:PM[:RESult<1..4>?]

This command queries the results of PM modulation measurement of analog demodulation. The numeric suffix (:RESult<1..4>) indicates whether trace 1, 2, 3 or 4 is selected. The numeric suffixes <1|2> are irrelevant.

Parameter

PPEak	Result of measurement with detector +PK
MPEak	Result of measurement with detector –PK
MIDDLE	Result of averaging \pm PK/2
RMS	Result of rms measurement

Example

ADEM ON

Switches on the analog demodulator.

CALC:FEED 'XTIM:PM:TDOM'

Switches on the FM result display.

CALC:MARK:FUNC:ADEM:PM? PPE

Queries the peak value.

Characteristics

*RST value: –

SCPI: device-specific

Mode

ADEMOD

CALCulate<1|2>:MARKer:FUNCtion:ADEMod:SINad:RESult<1..4>?

This command queries the result of the SINAD measurement. The numeric suffix (:RESult<1..4>) indicates whether trace 1, 2, 3 or 4 is selected. The numeric suffixes <1|2> are irrelevant.

This command is a query only and thus has no *RST value.

Example

ADEM ON

Switches on analog demodulator

CALC:FEED 'XTIM:FM:AFSP'

DISP:TRAC ON

Switches on AF spectrum of FM and trace

CALC:MARK:FUNC:ADEM:SIN:RES?

Queries SINAD value

Characteristics

*RST value: –

SCPI: device-specific

Mode

ADEMOD

CALCulate<1|2>:MARKer:FUNCtion:ADEMod:THD:RESult<1...4>?

This command queries the result of the THD measurement. The numeric suffix (:RESult<1...4>) indicates whether trace 1, 2, 3 or 4 is selected. The numeric suffixes <1|2> are irrelevant.

This command is a query only and thus has no *RST value.

Example

ADEM ON

Switches on analog demodulator

CALC:FEED 'XTIM:FM:AFSP'

Switches on AF spectrum of FM and trace

DISP:TRAC ON

Switches on the trace

CALC:MARK:FUNC:ADEM:THD:RES?

Queries THD result

Characteristics

*RST value: –

SCPI: device-specific

Mode

ADEMOD

CALCulate:UNIT Subsystem (Analog Demodulation, K7)

The CALCulate:Unit subsystem defines the units for the parameters that can be set and the measurement results.

Commands of the CALCulate:UNIT Subsystem

- [CALCulate<1|2>: UNIT:ANGLE](#)

CALCulate<1|2>: UNIT:ANGLE

This command selects the unit for angles.

Parameter

DEG | RAD

Example:

```
CALC:UNIT:ANGL DEG
```

Characteristics:

*RST value: RAD

SCPI: device-specific

Mode

ADEMOD

DISPlay Subsystem (Analog Demodulation, K7)

The DISPlay subsystem controls the selection and presentation of textual and graphic information as well as of measurement data on the display.

Commands of the DISPlay Subsystem

- [DISPlay\[:WINDow<1|2>\]:SIZE](#)
- [DISPlay\[:WINDow<1|2>\]:TRACE<1...4>:Y\[:SCALe\]:PDIVision](#)
- [DISPlay\[:WINDow<1|2>\]:TRACe<1...4>:Y\[:SCALe\]:RPOSition](#)
- [DISPlay\[:WINDow<1|2>\]:TRACE<1...4>:Y\[:SCALe\]:RVALue](#)
- [DISPlay\[:WINDow<1|2>\]:TRACe<1...4>:Y:SPACing](#)

[DISPlay\[:WINDow<1|2>\]:SIZE](#)

This command switches the measurement window for active analog demodulation to full screen or half screen.

For further details refer to "[DISPlay\[:WINDow<1|2>\]:SIZE](#)" on page 6.98.

[DISPlay\[:WINDow<1|2>\]:TRACE<1...4>:Y\[:SCALe\]:PDIVision](#)

This command defines the scaling of the Y axis in the current unit. The numeric suffix in TRACE<1...4> is irrelevant. The numeric suffixes <1|2> are irrelevant.

Parameter

<numeric_value>

Example

```
DISP:TRAC:Y:PDIV +10kHz
Sets the Y scale to 10 kHz/div.
```

Characteristics

*RST value:

20 PCT	linear AM display
50 kHz	linear FM display
2 rad	linear PM display
10 dB	logarithmic AF spectrum display

SCPI: conform

Mode

ADEMODO

DISPlay[:WINDow<1|2>]:TRACe<1...4>:Y[:SCALe]:RPOSition

Characteristics

*RST value:

100 PCT AF spectrum display of AM, FM, or PM

50 PCT AM, FM, or PM display

For further details refer to "[DISPlay\[:WINDow<1|2>\]:TRACe<1...4>:Y\[:SCALe\]:RPOSition \(models 13, 16\)](#)" on page 6.102.

DISPlay[:WINDow<1|2>]:TRACe<1...4>:Y[:SCALe]:RVALue

This command defines the reference value assigned to the reference position. Separate reference values are maintained for the various displays.

Example

DISP:TRAC:Y:RVAL 0

Sets the value assigned to the reference position to 0 Hz (analog demodulation)

Characteristics

*RST value:

0 PCT AM display

0 Hz FM display

0 rad PM display

100 PCT AF spectrum display of AM signal

250 kHz AF spectrum display of FM signal

10 rad AF spectrum display of PM signal

For further details refer to "[DISPlay\[:WINDow<1|2>\]:TRACe<1...4>:Y\[:SCALe\]:RPOSition \(models 13, 16\)](#)" on page 6.102.

DISPlay[:WINDow<1|2>]:TRACe<1...4>:Y:SPACing

When the AF spectrum result display is selected, only the parameters LINear and LOGarithmic are allowed.

For further details refer to "[DISPlay\[:WINDow<1|2>\]:TRACe<1...4>:Y:SPACing](#)" on page 6.100.

INSTRument Subsystem (Analog Demodulation, K7)

The INSTRument subsystem selects the operating mode of the unit either via text parameters or fixed numbers.

Commands of the INSTRument Subsystem

- [INSTRument\[:SElect\]](#)
- [INSTRument:NSElect](#)

INSTRument[:SElect]

Parameter

ADEMod (Analog Demodulation option, R&S FSL–K7)

For further details refer to section "Remote Control – Description of Basic Settings Commands", INSTRument subsystem.

INSTRument:NSElect

Parameter

3 (Analog Demodulation option, R&S FSL–K7)

For further details refer to section "Remote Control – Description of Basic Settings Commands", INSTRument subsystem.

SENSe Subsystem (Analog Demodulation, K7)

The SENSe subsystem is organized in several subsystems. The commands of these subsystems directly control device-specific settings, they do not refer to the signal characteristics of the measurement signal.

The SENSe subsystem controls the essential parameters of the analyzer. In accordance with the SCPI standard, the keyword "SENSe" is optional for this reason, which means that it is not necessary to include the SENSe node in command sequences.

The following subsystems are included:

- "SENSe:ADEMod Subsystem" on page 6.195
- "SENSe:BANDwidth Subsystem" on page 6.217
- "SENSe:FILTer Subsystem" on page 6.218
- "SENSe:FREQuency Subsystem" on page 6.221
- "SENSe:SWEEp Subsystem" on page 6.221

SENSe:ADEMod Subsystem (Analog Demodulation, K7)

The SENSe:ADEMod Subsystem contains commands to set up the instrument for the measurement of analog demodulated signals and query the result at the end of the measurement.

Commands of the SENSe:ADEMod Subsystem

- [SENSe:]ADEMod[:STATe]
- [SENSe:]ADEMod:AF:CENTer
- [SENSe:]ADEMod:AF:COUPling
- [SENSe:]ADEMod:AF:SPAN
- [SENSe:]ADEMod:AF:SPAN:FULL
- [SENSe:]ADEMod:AF:STARt
- [SENSe:]ADEMod:AF:STOP
- [SENSe:]ADEMod:AM[:ABSolute][:TDOMain][:TYPE]
- [SENSe:]ADEMod:AM[:ABSolute][:TDOMain]:RESult?
- [SENSe:]ADEMod:AM:RELative[:TDOMain][:TYPE]
- [SENSe:]ADEMod:AM:RELative[:TDOMain]:RESult?
- [SENSe:]ADEMod:AM:RELative:AFSPectrum[:TYPE]
- [SENSe:]ADEMod:AM:RELative:AFSPectrum:RESult?
- [SENSe:]ADEMod:BANDwidth|BWIDth:DEModulation
- [SENSe:]ADEMod:FM[:TDOMain][:TYPE]
- [SENSe:]ADEMod:FM[:TDOMain]:RESult?
- [SENSe:]ADEMod:FM:AFSPectrum[:TYPE]
- [SENSe:]ADEMod:FM:AFSPectrum:RESult?
- [SENSe:]ADEMod:FM:OFFSet?
- [SENSe:]ADEMod:MTIME

- [SENSe:]ADEMod:PM[:TDOMain][:TYPE]
- [SENSe:]ADEMod:PM[:TDOMain]:RESult?
- [SENSe:]ADEMod:PM:AFSPectrum[:TYPE]
- [SENSe:]ADEMod:PM:AFSPectrum:RESult?
- [SENSe:]ADEMod:PM:RPOint[:X]
- [SENSe:]ADEMod:RLENgth?
- [SENSe:]ADEMod:SET
- [SENSe:]ADEMod:SPECtrum[:TYPE]
- [SENSe:]ADEMod:SPECtrum:BANdwidth|BWIDth[:RESolution]
- [SENSe:]ADEMod:SPECtrum:RESult?
- [SENSe:]ADEMod:SPECtrum:SPAN[:MAXimum]
- [SENSe:]ADEMod:SPECtrum:SPAN:ZOOM
- [SENSe:]ADEMod:SRATe?
- [SENSe:]ADEMod:ZOOM[:STATe]
- [SENSe:]ADEMod:ZOOM:STARt

Further information

- Trace mode result types
- Formats for returned values: ASCII format and binary format

Trace mode result types

The following result types can be set:

WRITE	The current trace results will be obtained
AVERage	The trace results will be averaged over the given # of measurements
MAXHold	The maximum trace result values will be obtained over the given # of measurements
MINHold	The minimum trace result values will be obtained over the given # of measurements
VIEW	The trace results are frozen and displayed, i.e. they are not calculated for subsequent measurements. Traces in this mode cannot be queried.
OFF	The result type will not be used.

*Note: It is not possible to query trace data when result type VIEW is selected.
Each value besides OFF can only be assigned to one result type at a time.
If all result types are set to OFF, the AM, FM, or PM demodulator will be deactivated.*

Formats for returned values: ASCII format and binary format

- ASCII Format (FORMat ASCII):
The command reads out a list of comma separated values (CSV) of the measured values in floating point format.
- Binary Format (FORMat REAL,32):
The command reads out binary data (Definite Length Block Data according to IEEE 488.2), each measurement value being formatted in 32 Bit IEEE 754 Floating–Point–Format. The schematics of the result string will be as follows:

#41024<value1><value2>...<value n> with

#4 number of digits (= 4 in the example) of the following number of data bytes

1024 number of following data bytes (= 1024 in the example)

<value> 4-byte floating point value

[SENSe:]ADEMod[:STATe]

This command activates the analog demodulator of the instrument. The instrument will be set to zero span at the current center frequency. The sample detector will be set, the demodulator itself will be set up according to the parameters of command [SENSe:]ADEMod:SET.

Parameter

ON | OFF

Example

ADEM ON

Switches the analog demodulator on.

Characteristics

*RST value: OFF

SCPI: device-specific

Mode

ADEMOD

[SENSe:]ADEMod:AF:CENTer

This command sets the center frequency for AF spectrum result display.

Parameter

<numeric_value>

Example

ADEM ON

Switches on the analog demodulator

CALC:FEED 'XTIM:FM:AFSP'

Switches on AF spectrum result display of FM

ADEM:BAND 5 MHz

Sets the measurement bandwidth to 5 MHz

ADEM:AF:CENT 500kHz

Sets the AF center frequency to 500 kHz

ADEM:AF:SPAN 200kHz

Sets the AF span to 200 kHz

Characteristics

*RST value: 1.25 MHz

SCPI: device-specific

Mode

ADEMOD

[SENSe:]ADEMod:AF:COUPling

This command selects the coupling of the AF path of the analyzer.

Parameter

AC | DC

Example

```
ADEM:AF:COUP DC
Switches on DC coupling.
```

Characteristics

*RST value: AC (PM); DC (FM)

SCPI: device-specific

Mode

ADEMOD

[SENSe:]ADEMod:AF:SPAN

This command sets the span for AF spectrum result display.
The span is limited to half the measurement bandwidth of analog demodulation
([\[SENSe:\]ADEMod:BANDwidth|BWIDth:DEModulation](#)).

Parameter

<numeric_value>

Example

```
ADEM ON
Switches on the analog demodulator
CALC:FEED 'XTIM:FM:AFSP'
Switches on AF spectrum result display of FM
ADEM:BAND 5 MHz
Sets the measurement bandwidth to 5 MHz
ADEM:AF:CENT 500kHz
Sets the AF center frequency to 500 kHz
ADEM:AF:SPAN 200kHz
Sets the AF span to 200 kHz
```

Characteristics

*RST value: 2.5 MHz

SCPI: device-specific

Mode

ADEMOD

[SENSe:]ADEMod:AF:SPAN:FULL

This command sets the maximum span for AF spectrum result display.
The maximum span corresponds to half the measurement bandwidth of analog demodulation
([\[SENSe:\]ADEMod:BANDwidth|BWIDth:DEModulation](#)).

Example

```
ADEM ON
Switches on the analog demodulator
CALC:FEED 'XTIM:FM:AFSP'
Switches on AF spectrum result display of FM
ADEM:BAND 5 MHz
Sets the measurement bandwidth to 5 MHz
ADEM:AF:SPAN:FULL
Sets the AF span to 2.5 MHz
```

Characteristics

*RST value: –
 SCPI: device-specific

Mode

ADEMOD

[SENSe:]ADEMod:AF:STARt

This command sets the start frequency for AF spectrum result display.

Parameter

<numeric_value>

Example

```
ADEM ON
Switches on analog demodulator
CALC:FEED 'XTIM:FM:AFSP'
Switches on AF spectrum result display of FM
ADEM:BAND 5 MHz
Sets the measurement bandwidth to 5 MHz
ADEM:AF:STAR 0kHz
Sets the AF start frequency to 0 kHz
ADEM:AF:STOP 500kHz
Sets the AF stop frequency to 500 kHz
```

Characteristics

*RST value: 0 MHz
 SCPI: device-specific

Mode

ADEMOD

[SENSe:]ADEMod:AF:STOP

This command sets the stop frequency for AF spectrum result display.

The stop frequency is limited to half the measurement bandwidth of analog demodulation ([\[SENSe:\]ADEMod:BANDwidth|BWIDth:DEModulation](#)).

Parameter

<numeric_value>

Example

```
ADEM ON
Switches on the analog demodulator
```

CALC:FEED 'XTIM:FM:AFSP'
 Switches on AF spectrum result display of FM
 ADEM:BAND 5 MHz
 Sets the measurement bandwidth to 5 MHz
 ADEM:AF:STAR 0kHz
 Sets the AF start frequency to 0 kHz
 ADEM:AF:STOP 500kHz
 Sets the AF stop frequency to 500 kHz

Characteristics

*RST value: 2.5 MHz
 SCPI: device-specific

Mode

ADEMODO

[SENSe:]ADEMod:AM[:ABSolute][:TDOMain][:TYPE]

This command selects the result types of the RF signal to be measured simultaneously in zero span.

Parameter

<result type 1|2|3|4>: WRITe, AVERAge, MAXHold, MINHold, VIEW, OFF; for details see "[Trace mode result types](#)" on page 6.196.

Example

ADEM:AM AVER,MAXH,MINH
 Determines average, max hold and min hold values at a time.
 ADEM:AM WRIT,OFF,OFF
 Determines only the current measurement values.
 ADEM:AM OFF,OFF,OFF
 Switches AM demodulation off.

Characteristics

*RST value: WRITe,OFF,OFF
 SCPI: device-specific

Mode

ADEMODO

[SENSe:]ADEMod:AM[:ABSolute][:TDOMain]:RESult?

This command reads the result data of the RF signal in zero span for the specified result type. The data format of the output data block is defined by the FORMat command.

Parameter

<result type>: WRITe, AVERAge, MAXHold, MINHold; for details see "[Trace mode result types](#)" on page 6.196.

Note: The result type indicated must be one of those configured by [SENSe:]ADEMod:AM[:ABSolute][:TDOMain][:TYPE]. Otherwise a query error will be generated.

Return Values

ASCII Format (FORMat ASCII) or Binary Format (FORMat REAL,32); for details see "[Formats for returned values: ASCII format and binary format](#)" on page 6.196. The output units are described in "[CALCulate<1|2>:MARKer<1...4>:PEXCursion](#)" on page 6.48.

Example

```
ADEM:SET 8MHz,32000,EXT,POS,-500,30
```

Sets up demodulator parameters

```
ADEM:AM AVER,MAXH,MINH
```

Sets up AM results to be measured

```
ADEM ON
```

Switches on demodulator

```
INIT;*WAI
```

Starts measurement and waits for sync

```
FORM ASC
```

Selects output format

```
ADEM:AM:RES? AVER
```

Reads AM average results

```
ADEM:AM:RES? MAXH
```

Reads AM max hold results

```
ADEM:AM:RES? MINH
```

Reads AM min hold results

Characteristics

*RST value: –

SCPI: device-specific

Mode

ADEMOD

[SENSe:]ADEMod:AM:RELative[:TDOMain][:TYPE]

This command selects the result types to be measured simultaneously by AM demodulation.

Parameter

<result type 1|2|3|4>: WRITe, AVERAge, MAXHold, MINHold, VIEW, OFF; for details see "[Trace mode result types](#)" on page 6.196.

Example

```
ADEM:AM:REL AVER,MAXH,MINH
```

Determines average, max hold and min hold values simultaneously.

```
ADEM:AM:REL WRIT,OFF,OFF
```

Determines only the current measurement values.

```
ADEM:AM:REL OFF,OFF,OFF
```

Switches AM demodulation off.

Characteristics

*RST value: OFF,OFF,OFF

SCPI: device-specific

Mode

ADEMOD

[SENSe:]ADEMod:AM:RELative[:TDOMain]:RESult?

This command reads the result data obtained by AM demodulation for the specified result type. The data format of the output data block is defined by the `FORMat` command.

Parameter

<result type>: WRITe, AVERage, MAXHold, MINHold; for details see "[Trace mode result types](#)" on page 6.196.

Note: The result type indicated must be one of those configured by `[SENSe:]ADEMod:AM:RELative[:TDOMain][:TYPE]`. Otherwise a query error will be generated.

Return Values

ASCII Format (`FORMat ASCII`) or Binary Format (`FORMat REAL,32`); for details see "[Formats for returned values: ASCII format and binary format](#)" on page 6.196. The output units are described in "[CALCulate<1|2>:MARKer<1...4>:PEXCursion](#)" on page 6.48.

Example

```
ADEM:SET 8MHz,32000,EXT,POS,-500,30
```

Sets up demodulator parameters

```
ADEM:FM AVER,MAXH,MINH
```

Selects FM results to be measured

```
ADEM:AM:REL WRIT,OFF,OFF
```

Selects AM results to be measured

```
ADEM ON
```

Switches on demodulator

```
INIT;*WAI
```

Starts measurement and waits for sync

```
FORM ASC
```

Selects output format

```
ADEM:FM:RES? AVER
```

Reads FM average results

```
ADEM:FM:RES? MAXH
```

Reads FM max hold results

```
ADEM:FM:RES? MINH
```

Reads FM min hold results

```
ADEM:AM:REL:RES? WRIT
```

Reads current AM result data

Characteristics

*RST value: –

SCPI: device-specific

Mode

ADEMOD

[SENSe:]ADEMod:AM:RELative:AFSPectrum[:TYPE]

This command selects the AF spectrum result types of the AM-demodulated signal to be measured simultaneously.

Parameter

<result type 1|2|3|4>: WRITe, AVERage, MAXHold, MINHold, VIEW, OFF; for details see "[Trace mode result types](#)" on page 6.196.

Note: The result type "AF spectrum of AM–demodulated signal" cannot be activated at the same time as "AF spectrum of FM or PM demodulated signal".

Example

ADEM:AM:REL:AFSP AVER,MAXH,MINH

Determines average, maximum and minimum value simultaneously

ADEM:AM:REL:AFSP WRIT,OFF,OFF

Determines only current measurement results

ADEM:AM:REL:AFSP OFF,OFF,OFF

Switches off calculation of the AF spectrum

Characteristics

*RST value: OFF,OFF,OFF

SCPI: device–specific

Mode

ADEMOD

[SENSe:]ADEMod:AM:RELative:AFSPectrum:RESult?

This command reads out the AF spectrum result data of the AM–demodulated signal for the specified result type. The data format of the output data is determined with the `FORMat` command.

Parameter

<result type>: WRITe, AVERage, MAXHold, MINHold; for details see "[Trace mode result types](#)" on page 6.196.

Note: The specified result type must be one of those configured with the `[SENSe:]ADEMod:AM:RELative:AFSPectrum[:TYPE]` command. Otherwise a query error will be generated.

Return Values

ASCII Format (FORMat ASCII) or Binary Format (FORMat REAL,32); for details see "[Formats for returned values: ASCII format and binary format](#)" on page 6.196. The output units are described in section "[CALCulate<1|2>:MARKer<1...4>:PEXCursion](#)" on page 6.48.

Example

ADEM:SET 8MHz,32000,EXT,POS,-500,30

Sets the demodulator

ADEM:FM AVER,MAXH,MINH

Selects the FM results to be measured

ADEM:AM:REL WRIT,OFF,OFF

Selects the AM results to be measured

ADEM:AM:REL:AFSP WRIT,OFF,OFF

Selects the AF spectrum results of the demodulated AM signal to be measured

ADEM ON

Switches on the demodulator

INIT;*WAI

Starts the measurement and waits for the termination

FORM ASC

Selects the output format

ADEM:FM:RES? AVER

Reads the FM average result data

ADEM:FM:RES? MAXH

Reads the FM Maxhold result data

ADEM:FM:RES? MINH

Reads the FM Minhold result data

ADEM:AM:REL:RES? WRIT

Reads the current AM result data

ADEM:AM:REL:AFSP:RES? WRIT

Reads the current AF spectrum result data of the demodulated AM signal

Characteristics

*RST value: –

SCPI: device-specific

Mode

ADEMOD

[SENSe:]ADEMod:BANDwidth|BWIDth:DEModulation

This command defines the demodulation bandwidth used for analog demodulation. The required sampling rate is automatically set depending on the selected demodulation bandwidth. The available demodulation bandwidths are determined by the existing sampling rates (see table below).

Parameter

<numeric_value>

For details refer on the correlation of bandwidth and sample rate refer to chapter "Instrument Functions", section "Analog Demodulation (Option K7)" – "Sample rate, measurement time and trigger offset".

Example

ADEM:BAND:DEM 1MHz

Sets the demodulation bandwidth to 1 MHz.

Characteristics

*RST value: 5 MHz

SCPI: device-specific

Mode

ADEMOD

[SENSe:]ADEMod:FM[:TDOMain][:TYPE]

This command selects the result types to be created in parallel by analog demodulation.

Parameter

<result type 1|2|3|4>: WRITe, AVERage, MAXHold, MINHold, VIEW, OFF; for details see "[Trace mode result types](#)" on page 6.196.

Example

ADEM:FM AVER,MAXH,MINH

"Creates average, max hold and min hold values simultaneously

DEM:FM WRIT,OFF,OFF

Only creates the current measurement values

ADEM:FM OFF,OFF,OFF

Switches analog demodulator off

Characteristics

*RST value: WRITe,OFF,OFF

SCPI: device-specific

Mode

ADEM0D

[SENSe:]ADEMod:FM[:TDOMain]:RESult?

This command reads the result data obtained by analog demodulation for the specified result type. The data format of the output data block is defined by the FORMat command.

Parameter

<result type>: WRITe, AVERage, MAXHold, MINHold; for details see "[Trace mode result types](#)" on page 6.196.

Note: The result type indicated must be one of those configured by [SENSe:]ADEMod:FM[:TDOMain][:TYPE]. Otherwise a query error will be generated.

Return Values

ASCII Format (FORMat ASCII) or Binary Format (FORMat REAL,32); for details see "[Formats for returned values: ASCII format and binary format](#)" on page 6.196. The output units are described in "[CALCulate<1|2>:MARKer<1...4>:PEXCursion](#)" on page 6.48.

Example

```
ADEM:SET 8MHz,32000,EXT,POS,-500,30
```

Sets up demodulator parameters

```
ADEM:FM AVER,MAXH,MINH
```

Selects FM results to be measured

```
ADEM:AM WRIT,OFF,OFF
```

Selects AM results to be measured

```
ADEM ON
```

Switches on demodulator

```
INIT;*WAI
```

Starts measurement and waits for sync

```
FORM ASC
```

Selects output format

```
ADEM:FM:RES? AVER
```

Reads FM average results

```
ADEM:FM:RES? MAXH
```

Reads FM max hold results

```
ADEM:FM:RES? MINH
```

Reads FM min hold results

```
ADEM:AM:RES? WRIT
```

Reads current AM results

Characteristics

*RST value: –

SCPI: device-specific

Mode

ADEM0D

[SENSe:]ADEMod:FM:AFSPectrum[:TYPE]

This command selects the AF spectrum result types of the FM–demodulated signal to be measured simultaneously.

Parameter

<result type 1|2|3|4>: WRITe, AVERage, MAXHold, MINHold, VIEW, OFF; for details see "[Trace mode result types](#)" on page 6.196.

Note: The result type "AF spectrum of the FM demodulated signal" cannot be activated at the same time as "AF spectrum of AM or PM demodulated signal".

Example

```
ADEM:FM:AFSP AVER,MAXH,MINH
```

Determines average, maximum and minimum value simultaneously

```
ADEM:FM:AFSP WRIT,OFF,OFF
```

Determines only current measurement results

```
ADEM:FM:AFSP OFF,OFF,OFF
```

Switches calculation of AF spectrum off

Characteristics

*RST value: OFF,OFF,OFF

SCPI: device–specific

Mode

A

[SENSe:]ADEMod:FM:AFSPectrum:RESult?

This command reads out the AF spectrum result data of the FM demodulated signal for the specified result type. The data format of the output data is determined with the FORMat command.

Parameter

<result type>: WRITe, AVERage, MAXHold, MINHold; for details see "[Trace mode result types](#)" on page 6.196.

Note: The specified result type must be one of those configured with the `[SENSe:]ADEMod:FM:AFSPectrum[:TYPE]` command. Otherwise a query error will be generated.

Return Values

ASCII Format (FORMat ASCII) or Binary Format (FORMat REAL,32); for details see "[Formats for returned values: ASCII format and binary format](#)" on page 6.196. The output units are described in "[CALCulate<1|2>:MARKer<1...4>:PEXCursion](#)" on page 6.48.

Example

```
ADEM:SET 8MHz,32000,EXT,POS,-500,30
```

Sets demodulator

```
ADEM:FM AVER,MAXH,MINH
```

Selects the FM results to be measured

```
ADEM:AM:REL WRIT,OFF,OFF
```

Selects the AM results to be measured

```
ADEM:FM:AFSP WRIT,OFF,OFF
```

Selects the AF spectrum results of the demodulated FM signal to be measured

```
ADEM ON
```

Switches the demodulator on

```

INIT; *WAI
Starts the measurement and waits for termination
FORM ASC
Selects output format
ADEM:FM:RES? AVER
Reads FM average result data
ADEM:FM:RES? MAXH
Reads FM maxhold result data
ADEM:FM:RES? MINH
Reads FM minhold result data
ADEM:AM:RES? WRIT
Reads current AM result data
ADEM:FM:AFSP:RES? WRIT
Reads current AF spectrum result data of demodulated FM signal

```

Characteristics

*RST value: –
 SCPI: device-specific

Mode

ADEMOD

[SENSe:]ADEMod:FM:OFFSet?

This command calculates the FM offset of the currently available measurement data set.

If averaging has been activated before acquiring the data set (using `[SENSe:]ADEMod:FM[:TDOMain] [:TYPE]`), the averaged FM offset over several measurements can also be obtained by setting `<result type> = AVERage`.

The offset thus determined differs from the one calculated by the `CALCulate<1|2>:MARKer:FUNction:ADEMod:FERRor[:RESult<1...4>?]` command since, for determination of the frequency deviation, the modulation is removed by means of lowpass filtering, producing results that are different from those obtained by averaging.

Parameter

`<result type>`

IMMediate The current measurement results will be used for calculating the FM offset

AVERage The measurement results that were averaged over the given # of measurements will be used for calculating the FM offset

Note: If no average measurement was active during the last measurement sequence only the `[SENSe:]ADEMod:FM:OFFSet? IMMediate` command will return a correct result (data to calculate the offset are taken from the last measured data set).
`[SENSe:]ADEMod:FM:OFFSet? AVERage` will cause a query error in this case.

Example

```

ADEM:SET 8MHz,32000,EXT,POS,-500,30
Sets up demodulator parameters to execute 30 measurements
ADEM:FM AVER,OFF,OFF
Selects FM results to perform averaging
ADEM:AM OFF,OFF,OFF
Switches off AM demodulation
ADEM ON
Switches on analog demodulator

```

```
INIT; *WAI
```

Starts measurement and waits for sync

```
ADEM:FM:OFFS? IMM
```

Reads FM offset of last measurement of the sequence of 30

```
ADEM:FM:OFFS? AVER
```

Reads FM offset averaged over 30 measurements

Characteristics

*RST values: –

SCPI: device-specific

Mode

ADEMOD

[SENSe:]ADEMod:MTIME

This command defines the measurement time for analog demodulation.

Parameter

<numeric_value>

Example

```
ADEM:BAND:MTIM 62.5us
```

Sets the measurement time to 62.5 μ s.

Characteristics

*RST value: 62.5us

SCPI: device-specific

Mode

ADEMOD

[SENSe:]ADEMod:PM[:TDOMain][:TYPE]

This command selects the result types of the PM-demodulated signal to be created simultaneously.

Note: Only one result type can be assigned at a time. If all result types are set to OFF, the PM demodulator is switched off.

Parameter

<result type 1|2|3|4>: WRITe, AVERage, MAXHold, MINHold, VIEW; for details see "[Trace mode result types](#)" on page 6.196.

Example

```
ADEM:PM AVER,MAXH,MINH
```

Determines average, maximum and minimum value simultaneously

```
ADEM:PM WRIT,OFF,OFF
```

Determines only current measurement results

```
ADEM:PM OFF,OFF,OFF
```

Switches the PM demodulator off.

Characteristics

RST value: OFF,OFF,OFF

SCPI: device-specific

Mode

ADEMOD

[SENSe:]ADEMod:PM[:TDOMain]:RESult?

This command reads the result data of the PM demodulation for the specified result type. The data format of the output data is determined with the `FORMat` command.

Parameter

<result type>: WRITe, AVERage, MAXHold, MINHold; for details see "[Trace mode result types](#)" on page 6.196.

Note: The specified result type must be one of those configured with the `[SENSe:]ADEMod:PM[:TDOMain] [:TYPE]` command. Otherwise a query error will be generated.

Return Values

ASCII Format (FORMat ASCII) or Binary Format (FORMat REAL,32); for details see "[Formats for returned values: ASCII format and binary format](#)" on page 6.196. The output units are described in "[CALCulate<1|2>:MARKer<1...4>:PEXCursion](#)" on page 6.48.

Example

```
ADEM:SET 8MHz,32000,EXT,POS,-500,30
```

Sets the demodulator parameters.

```
ADEM:PM AVER,MAXH,MINH
```

Selects the PM results to be measured.

```
ADEM:AM WRIT,OFF,OFF
```

Selects the AM results to be measured.

```
ADEM ON
```

Switches on the demodulator.

```
INIT;*WAI
```

Starts the measurement and waits for termination.

```
FORM ASC
```

Selects the output format.

```
ADEM:PM:RES? AVER
```

Reads the PM average result data.

```
ADEM:PM:RES? MAXH
```

Reads the PM maxhold result data.

```
ADEM:PM:RES? MINH
```

Reads the PM minhold result data.

```
ADEM:AM:RES? WRIT
```

Reads the current AM result data.

Characteristics

RST value: –

SCPI: device-specific

Mode

ADEMOD

[SENSe:]ADEMod:PM:AFSPectrum[:TYPE]

This command selects the AF spectrum result types of the PM-demodulated signal to be measured simultaneously.

Parameter

<result type 1|2|3|4>: WRITe, AVERAge, MAXHold, MINHold, VIEW; for details see "[Trace mode result types](#)" on page 6.196.

Note: The result type "AF spectrum of the PM demodulated signal" cannot be activated at the same time as "AF spectrum of AM or FM demodulated signal".

Example

```
ADEM:PM:AFSP AVER,MAXH,MINH
```

Determines average, maximum and minimum value simultaneously

```
ADEM:PM:AFSP WRIT,OFF,OFF
```

Determines only current measurement results

```
ADEM:PM:AFSP OFF,OFF,OFF
```

Switches calculation of AF spectrum off

Characteristics

RST value: OFF,OFF,OFF

SCPI: device-specific

Mode

ADEMOD

[SENSe:]ADEMod:PM:AFSPectrum:RESult?

This command reads out the AF spectrum result data of the PM-demodulated signal for the specified result type. The data format of the output data is determined with the `FORMat` command.

Parameter

<result type>: WRITe, AVERAge, MAXHold, MINHold; for details see "[Trace mode result types](#)" on page 6.196.

Note: The specified result type must be one of those configured with the `[SENSe:]ADEMod:PM:AFSPectrum[:TYPE]` command. Otherwise a query error will be generated.

Return Values

ASCII Format (`FORMat ASCII`) or Binary Format (`FORMat REAL,32`); for details see "[Formats for returned values: ASCII format and binary format](#)" on page 6.196. The output units are described in section "[CALCulate<1|2>:MARKer<1...4>:PEXCursion](#)" on page 6.48.

Example

```
ADEM:SET 8MHz,32000,EXT,POS,-500,30
```

Sets demodulator

```
ADEM:PM AVER,MAXH,MINH
```

Selects the PM results to be measured

```
ADEM:AM:REL WRIT,OFF,OFF
```

Selects the AM results to be measured

```
ADEM:PM:AFSP WRIT,OFF,OFF
```

Selects the AF spectrum results of the demodulated PM signal to be measured

```
ADEM ON
```

Switches the demodulator on

```
INIT;*WAI
```

Starts the measurement and waits for termination

```
FORM ASC
```

Selects output format

ADEM:PM:RES? AVER

Reads PM average result data

ADEM:PM:RES? MAXH

Reads PM maxhold result data

ADEM:PM:RES? MINH

Reads PM minhold result data

ADEM:AM:RES? WRIT

Reads current AM result data

ADEM:PM:AFSP:RES? WRIT

Reads current AF spectrum result data of demodulated PM signal

Characteristics

RST value: –

SCPI: device-specific

Mode

ADEMOD

[SENSe:]ADEMod:PM:RPOint[:X]

This command determines the position where the phase of the PM–demodulated signal is set to 0 rad. The maximum possible value depends on the measurement time selected in the instrument; this value is output in response to the query ADEM:PM:RPO:X? MAX.

Parameter

0 s to measurement time

Example

ADEM:PM:RPO:X 500us

Sets the position where the phase to 0 rad setting to 500 μ s.

Characteristics

RST value: 0 s

SCPI: conform

Mode

ADEMOD

[SENSe:]ADEMod:RLEnGth?

This command returns the record length set up for the current analog demodulation measurement.

Example

ADEM:RLEN?

Returns the current record length.

Characteristics

*RST value: –

SCPI: device-specific

Mode

ADEMOD

[SENSe:]ADEMod:SET

This command configures the analog demodulator of the instrument.

Parameter

<sample rate>	The frequency at which measurement values are taken from the A/D-converter and stored in I/Q memory. Allowed range: refer to chapter "Instrument Functions", section "Analog Demodulation (Option K7)" – "Sample rate, measurement time and trigger offset".
<record length>	Number of samples to be stored in I/Q memory. Allowed range: 1 to 400001 with AF filter or AF trigger active 1 to 480001 with both AF filter and AF trigger deactive
<trigger source>	Selection of the trigger source to use for the demodulator. Allowed values: IMMEDIATE EXTERNAL IFPOWER RFPower AF AM AMRelative FM PM (see note below)
<trigger slope>	Used slope of the trigger signal. Allowed values: POSITIVE NEGATIVE The value indicated here will be ignored for <trigger source> = IMMEDIATE.
<offset samples>	Number of samples to be used as an offset to the trigger signal. Allowed range: –65024 to 130559 (= –64 * 1024 + 512 to 128 * 1024 – 513) The value indicated here will be ignored for <trigger source> = IMMEDIATE.
<# of meas>	Number of repetitions of the measurement to be executed. The value indicated here is especially necessary for the average/maxhold/minhold function. Allowed range: 0 to 32767

Note: After selecting IFPOWER, the trigger threshold can be set with the `TRIGGER<1|2>[:SEQUENCE]:LEVEL:IFPOWER` command.

Example

```
ADEM:SET 8MHz, 32000, EXT, POS, -500, 30
```

Performs a measurement at:

sample rate	8 MHz
record length	32000
trigger source	EXTERNAL
trigger slope	POSITIVE
offset samples	–500 (500 samples before trigger occurred)
# of meas	30

Characteristics

*RST value:

sample rate	8 MHz
record length	501

trigger source IMMEDIATE
 trigger slope POSITIVE
 offset samples 0
 # of meas 0

SCPI: device-specific

Mode

ADEMOD

[SENSe:]ADEMod:SPECTrum[:TYPE]

This command selects the result types to be created in parallel by the RF spectrum measurement with active analog demodulation.

Parameter

<result type 1|2|3|4>: WRITe, AVERAge, MAXHold, MINHOLD, VIEW, OFF; for details see "[Trace mode result types](#)" on page 6.196.

Example

ADEM:SPEC AVER,MAXH,MINH

Creates average, max hold and min hold values at a time

ADEM:SPEC WRIT,OFF,OFF

Only creates the current measurement values

ADEM:SPEC OFF,OFF,OFF

Switches analog demodulator off

Characteristics

*RST value: OFF,OFF,OFF

SCPI: device-specific

Mode

ADEMOD

[SENSe:]ADEMod:SPECTrum:BANDwidth|BWIDth[:RESolution]

This command sets the resolution bandwidth for spectrum representation that was determined from the analog demodulation data.

The recording time required is calculated from the sampling rate indirectly set via

[\[SENSe:\]ADEMod:SPECTrum:SPAN\[:MAXimum\]](#) or

[\[SENSe:\]ADEMod:BANDwidth|BWIDth:DEModulation](#). If the available recording time is not sufficient for the given bandwidth, the recording time is set to its maximum and the resolution bandwidth is enlarged to the resulting bandwidth.

Parameter

1 Hz to 10 MHz

Example

ADEM ON

Switches on the analog demodulator

```
CALC:FEED 'XTIM:SPEC'
```

Switches on the RF spectrum result display

or

```
CALC:FEED 'XTIM:FM:AFSP'
```

Switches on the AF spectrum result display of FM signal

```
ADEM:SPEC:BAND:RES 61.2kHz
```

Sets the resolution bandwidth to 61.2 kHz.

Characteristics

*RST value: 61.2 kHz

SCPI: device-specific

Mode

ADEMOD

[SENSe:]ADEMod:SPECTrum:RESult?

This command reads out the RF spectrum result data for the specified result type. The data format of the output data block is defined by the FORMat command.

Parameter

<result type>: WRITe, AVERage, MAXHold, MINHold; for details see "[Trace mode result types](#)" on page 6.196.

Note: The result type indicated must be one of those configured by [SENSe:]ADEMod:SPECTrum[:TYPE]. Otherwise a query error will be generated.

Return Values

ASCII Format (FORMat ASCII) or Binary Format (FORMat REAL,32); for details see "[Formats for returned values: ASCII format and binary format](#)" on page 6.196. The output units are described in "[CALCulate<1|2>:MARKer<1...4>:PEXCursion](#)" on page 6.48.

Example

```
ADEM:SET 8MHz,32000,EXT,POS,-500,30
```

Sets up demodulator parameters

```
ADEM:SPEC AVER,MAXH,MINH
```

Selects RF spectrum results to be measured

```
ADEM:SPEC WRIT,OFF,OFF
```

Selects AM results to be measured

```
ADEM ON
```

Switches on demodulator

```
INIT;*WAI
```

Starts measurement and waits for sync

```
FORM ASC
```

Selects output format

```
ADEM:SPEC:RES? AVER
```

Reads RF spectrum average results

```
ADEM:SPEC:RES? MAXH
```

Reads RF spectrum max hold results

```
ADEM:SPEC:RES? MINH
```

Reads RF spectrum min hold results

```
ADEM:SPEC:RES? WRIT
```

Reads spectrum current results

Characteristics

*RST value: –

SCPI: device-specific

Mode

ADEMOD

[SENSe:]ADEMod:SPECTrum:SPAN[:MAXimum]

This command sets the maximum frequency range for displaying the RF spectrum that was determined from the FM demodulation data. The maximum span corresponds to the measurement bandwidth of analog demodulation (for details refer to [\[SENSe:\]ADEMod:BANDwidth|BWIDth:DEModulation](#)). For details refer on the relation of bandwidth and sample rate refer to chapter "Instrument Functions", section "Analog Demodulation (Option K7)" – "Sample rate, measurement time and trigger offset".

Parameter

<numeric_value>

Example

ADEM ON

Switches on the analog demodulator

CALC:FEED 'XTIM:SPEC'

Switches on RF spectrum result display.

ADEM:SPEC:SPAN:MAX 5 MHz

Sets the max. span to 5 MHz

ADEM:SPEC:SPAN:ZOOM 1 MHz

Sets the displayed span to 1 MHz

Characteristics

*RST value: 5 MHz

SCPI: device-specific

Mode

ADEMOD

[SENSe:]ADEMod:SPECTrum:SPAN:ZOOM

This command sets the frequency range for the RF spectrum result display determined from analog demodulation data. The frequency range for result display is limited to the maximum span ([\[SENSe:\]ADEMod:SPECTrum:SPAN\[:MAXimum\]](#)) or to the measurement bandwidth of analog demodulation ([\[SENSe:\]ADEMod:BANDwidth|BWIDth:DEModulation](#)).

Parameter

<numeric_value>

Example

ADEM ON

Switches on the analog demodulator

CALC:FEED 'XTIM:SPEC'

Switches on RF spectrum result display"

ADEM:SPEC:SPAN:MAX 5 MHz

Sets the maximum span to 5 MHz

ADEM:SPEC:SPAN:ZOOM 1 MHz

Sets displayed span to 1 MHz

Characteristics

*RST value: 5 MHz

SCPI: device-specific

Mode

ADEM0D

[SENSe:]ADEMod:SRATe?

This command returns the sample rate set up for the current analog demodulation measurement.

Example

```
ADEM:SRAT?
```

Returns the current sample rate.

Characteristics

*RST value: –

SCPI: device-specific

Mode

ADEM0D

[SENSe:]ADEMod:ZOOM[:STATe]

The command enables or disables the zoom function for the analog-demodulated measurement data. Depending on the selected measurement time and the demodulation bandwidth, the number of recorded test points may be greater than that shown on the display.

If the zoom function is enabled, 501 test points of the result memory are displayed from the specified start time with `[SENSe:]ADEMod:ZOOM:START`.

If the zoom function is disabled, data reduction is used to adapt the test points to the number of points available on the display.

Parameter

ON | OFF

Example

```
ADEM:ZOOM ON
```

Switches on the zoom function

Characteristics

*RST value: OFF

SCPI: device-specific

Mode

ADEM0D

[SENSe:]ADEMod:ZOOM:START

The command selects the start time for the display of individual measured values of the analog demodulation. The maximum possible value depends on the measurement time, which is set in the instrument and can be queried with the `[SENSe:]ADEMod:MTIME` command.

If the zoom function is enabled, 501 test points of the result memory are displayed from the specified start time with `[SENSe:]ADEMod:ZOOM:START`.

Parameter

0 s to measurement time – (500 * 1/sample rate)

Example

ADEM:ZOOM ON

Switches on the zoom function

ADEM:ZOOM:STAR 500us

Sets the starting point of the display to 500 μs.

Characteristics

*RST value: 0 s

SCPI: device-specific

Mode

ADEM0D

SENSe:BANDwidth Subsystem (Analog Demodulation, K7)

This subsystem controls the setting of the instruments filter bandwidths. Both groups of commands (BANDwidth and BWIDth) perform the same functions.

Commands of the SENSe:BANDwidth Subsystem

– [SENSe<1|2>:]BANDwidth|BWIDth:DEMod

[SENSe<1|2>:]BANDwidth|BWIDth:DEMod

This command sets the bandwidth for analog demodulation. Depending on the selected demodulation bandwidth, the instrument selects the required sampling rate.

The available values of the demodulation bandwidths are determined by the sampling rates. For details on the correlation between demodulation bandwidth and sampling rate refer to chapter "Instrument Functions", sections "Analog Demodulation (Option K7)" – "Sample rate, measurement time and trigger offset".

Parameter

<numeric_value>

Example:

BAND:DEM 1MHz

Sets test bandwidth to 1 MHz

Characteristics:

*RST value: 5 MHz

SCPI: device-specific

Mode

A–F, ADEM0D

SENSe:FILTer Subsystem (Analog Demodulation, K7)

The SENSe:FILTer subsystem selects the filters to reduce the bandwidth of the demodulated signal. The selected filters are used for AM, FM and PM demodulation in common.

Commands of the SENSe:FILTer subsystem

- [SENSe<1|2>:]FILTer:DEMPHasis[:STATe]
- [SENSe<1|2>:]FILTer:DEMPHasis:TCONstant
- [SENSe<1|2>:]FILTer:HPASs[:STATe]
- [SENSe<1|2>:]FILTer:HPASs:FREQuency
- [SENSe<1|2>:]FILTer:LPASs[:STATe]
- [SENSe<1|2>:]FILTer:LPASs:FREQuency[:ABSolute]
- [SENSe<1|2>:]FILTer:LPASs:FREQuency:RELative

[SENSe<1|2>:]FILTer:DEMPHasis[:STATe]

This command activates/deactivates the selected deemphasis. The numeric suffixes <1|2> are irrelevant.

Parameter

ON | OFF

Example

```
SENS:FILT:DEMP ON
```

Activates the selected deemphasis.

Characteristics

RST value: OFF

SCPI: device-specific

Mode

ADEMODO

[SENSe<1|2>:]FILTer:DEMPHasis:TCONstant

This command selects the deemphasis. For details on deemphasis refer to chapter "Instrument Functions", section "Analog Demodulation (Option K7)", **Deemphasis** softkey.

The numeric suffixes <1|2> are irrelevant.

Parameter

25 us | 50 us | 75 us | 750 us

Example

```
SENS:FILT:DEMP:TCON 750 us
```

Selects the deemphasis for the demodulation bandwidth range from 800 Hz to 4 MHz with a time constant of 750 μ s.

Characteristics

RST value: 50 us

SCPI: device-specific

ModeADEMOD

[SENSe<1|2>:]FILTer:HPASs[:STATE]

This command activates/deactivates the selected high pass filter.

The numeric suffixes <1|2> are irrelevant.

Parameter

ON | OFF

Example

```
SENS:FILT:HPAS ON
```

Activates the selected high pass filter.

Characteristics

RST value: OFF

SCPI: device-specific

ModeADEMOD

[SENSe<1|2>:]FILTer:HPASs:FREQuency

This command selects the high pass filter type. For details on filters refer to chapter "Instrument Functions", section "Analog Demodulation (Option K7)", **High Pass AF Filter** softkey.

The numeric suffixes <1|2> are irrelevant.

Parameter

50 Hz | 300 Hz

Example

```
SENS:FILT:HPAS:FREQ 300 Hz
```

Selects the high pass filter for the demodulation bandwidth range from 800 Hz to 16 MHz.

Characteristics

RST value: 300 Hz

SCPI: device-specific

ModeADEMOD

[SENSe<1|2>:]FILTer:LPASs[:STATE]

This command activates/deactivates the selected low pass filter.

The numeric suffixes <1|2> are irrelevant.

Parameter

ON | OFF

Example

```
SENS:FILT:LPAS ON
```

Activates the selected low pass filter.

Characteristics

RST value: OFF

SCPI: device-specific

Mode

ADEMOD

[SENSe<1|2>:]FILTer:LPASs:FREQuency[:ABSolute]

This command selects the absolute low pass filter type. For details on filters refer to chapter "Instrument Functions", section "Analog Demodulation (Option K7)", **Low Pass AF Filter** softkey.

The numeric suffixes <1|2> are irrelevant.

Parameter

3 kHz | 15 kHz | 150 kHz

Example

```
SENS:FILT:LPAS:FREQ 150 kHz
```

Selects the low pass filter for the demodulation bandwidth range from 400 kHz to 16 MHz.

Characteristics

RST value: 15 kHz

SCPI: device-specific

Mode

ADEMOD

[SENSe<1|2>:]FILTer:LPASs:FREQuency:RELAtive

This command selects the relative low pass filter type. For details on filters refer to chapter "Instrument Functions", section "Analog Demodulation (Option K7)", **Low Pass AF Filter** softkey.

The numeric suffixes <1|2> are irrelevant.

Parameter

5 PCT | 10 PCT | 25 PCT

Example

```
SENS:FILT:LPAS:FREQ 25 PCT
```

Selects the low pass filter as 25% of the demodulation bandwidth.

Characteristics

RST value: 25 PCT

SCPI: device-specific

Mode

ADEMOD

SENSe:FREQUENCY Subsystem (Analog Demodulation, K7)

The SENSe:FREQUENCY subsystem defines the frequency axis of the active display. The frequency axis can either be defined via the start/stop frequency or via the center frequency and span.

Commands of the SENSe:FREQUENCY Subsystem

- [\[SENSe<1|2>:\]FREQUENCY:CENTer:STEP:LINK](#)

[SENSe<1|2>:]FREQUENCY:CENTer:STEP:LINK

Parameter

SPAN	coupling to frequency display range (for RF spectrum result display)
RBW	coupling to resolution bandwidth (for all result displays except RF spectrum)
OFF	manual input, no coupling

For further details refer to "[\[SENSe<1|2>:\]FREQUENCY:CENTer:STEP:LINK](#)" on page 6.124.

SENSe:SWEep Subsystem (Analog Demodulation, K7)

This subsystem controls the sweep parameters.

Commands of the SENSe:SWEep Subsystem

- [\[SENSe<1|2>:\]SWEep:TIME](#)

[SENSe<1|2>:]SWEep:TIME

Parameter

Refer to chapter "Instrument Functions", section "Analog Demodulation (Option K7)" – "Sample rate, measurement time and trigger offset".

For further details refer to "[\[SENSe<1|2>:\]SWEep:TIME](#)" on page 6.149.

TRACe Subsystem (Analog Demodulation, K7)

The TRACe subsystem controls access to the instruments internal trace memory.

Commands of the TRACe Subsystem

– [TRACe<1|2>\[:DATA\]](#)

TRACe<1|2>[:DATA]

If the analog demodulator (option Analog Demodulation, R&S FSL–K7) is active, only the displayed trace data is read out and recalled. A portion of the measurement data that can be called by means of a marker, however, is calculated from the raw measurement data. These results are no longer available after recalling a trace; the associated queries generate a query error.

For further information refer to "[TRACe<1|2>\[:DATA\]](#)" on page 6.164.

TRIGger Subsystem (Analog Demodulation, K7)

The TRIGger subsystem is used to synchronize instrument actions with events. It is thus possible to control and synchronize the start of a sweep.

Commands of the TRIGger Subsystem

- TRIGger<1|2>[:SEQuence]:LEVel:AM[:ABSolute]
- TRIGger<1|2>[:SEQuence]:LEVel:AM:RELative
- TRIGger<1|2>[:SEQuence]:LEVel:FM
- TRIGger<1|2>[:SEQuence]:LEVel:PM
- TRIGger<1|2>[:SEQuence]:SOURce

TRIGger<1|2>[:SEQuence]:LEVel:AM[:ABSolute]

The command sets the level when RF power signals are used as trigger source.

Note: For triggering with AF, AM, AMRelative, FM, and PM trigger sources to be successful, the measurement time must cover at least 5 periods of the audio signal.

Parameter

–100 to +30 dBm

Example

```
TRIG:LEV:AM -30 dBm
```

Sets the RF power signal trigger threshold to –30 dBm

Characteristics

*RST value: –20 dBm

SCPI: device-specific

Mode

ADEMODO

TRIGger<1|2>[:SEQuence]:LEVel:AM:RELative

The command sets the level when AM–modulated signals are used as trigger source.

Note: For triggering with AF, AM, AMRelative, FM, and PM trigger sources to be successful, the measurement time must cover at least 5 periods of the audio signal.

Parameter

–100 to +100 %

Example

```
TRIG:LEV:AM:REL -20 %
```

Sets the AM trigger threshold to –20 %

Characteristics

*RST value: 0 %

SCPI: device-specific

Mode

ADEMODO

TRIGger<1|2>[:SEQuence]:LEVel:FM

The command sets the level when FM–modulated signals are used as trigger source.

Note: For triggering with AF, AM, AMRelative, FM, and PM trigger sources to be successful, the measurement time must cover at least 5 periods of the audio signal.

Parameter

–10 to +10 MHz

Example

```
TRIG:LEV:FM 10 kHz
```

Sets the FM trigger threshold to 10 kHz

Characteristics

*RST value: 0 Hz

SCPI: device–specific

Mode

ADEMOD

TRIGger<1|2>[:SEQuence]:LEVel:PM

The command sets the level when PM–modulated signals are used as trigger source.

Note: For triggering with AF, AM, AMRelative, FM, and PM trigger sources to be successful, the measurement time must cover at least 5 periods of the audio signal.

Parameter

–1000 to +1000 RAD | DEG

Example

```
TRIG:LEV:PM 1.2 RAD
```

Sets the PM trigger threshold to 1.2 rad

Characteristics

*RST value: 0 RAD

SCPI: device–specific

Mode

ADEMOD

TRIGger<1|2>[:SEQuence]:SOURce

Parameter

IMMediate (Free Run) | EXTern | IFPower | AF | FM | AM | AMRelative | PM

The parameter AM corresponds to the RF power signal, the parameter AMRelative corresponds to the AM signal.

For details on trigger modes refer to chapter "Instrument Functions", section "Analog Demodulation (Option K7)".

Note: For triggering with AF, AM, AMRelative, FM, and PM trigger sources to be successful, the measurement time must cover at least 5 periods of the audio signal.

For further details refer to "[TRIGger<1|2>\[:SEQuence\]:SOURce](#)" on page 6.177.

UNIT Subsystem (Analog Demodulation, K7)

The UNIT subsystem sets the basic unit of the setting parameters.

Commands of the UNIT Subsystem

- [UNIT:ANGLE](#)

UNIT:ANGLE

This command selects the unit for angles.

Parameter

DEG | RAD

Example

```
UNIT:ANGL DEG
```

Characteristics

RST value: RAD

SCPI: conform

Mode

ADEMODO

Remote Commands of the Bluetooth Measurements Option (K8)

In this section all remote control commands for the Bluetooth Measurements option are described in detail. The abbreviation BT stands for the Bluetooth operating mode. For details on conventions used in this chapter refer to section "Notation" on page 6.2 at the beginning of this chapter.

For further information on analyzer or basic settings commands, refer to the corresponding subsystem in "Remote Control – Description of Analyzer Commands" on page 6.5 or section "Remote Control – Description of Basic Settings Commands".

This option is available from firmware version 1.30.

Subsystems of the Bluetooth Measurements option (K9)

- "CALCulate:BT0oth Subsystem (BLUETOOTH, K8)" on page 6.226
- "CALCulate:DELTamarker Subsystem (BLUETOOTH, K8)" on page 6.245
- "CALCulate:MARKer Subsystem (BLUETOOTH, K8)" on page 6.246
- "CONFIgure:BT0oth Subsystem (BLUETOOTH, K8)" on page 6.247
- "DISPlay Subsystem (BLUETOOTH, K8)" on page 6.261
- "INSTrument Subsystem (BLUETOOTH, K8)" on page 6.262
- "SENSe Subsystem (BLUETOOTH, K8)" on page 6.263

CALCulate:BT0oth Subsystem (BLUETOOTH, K8)

The following commands are used to configure the BLUETOOTH analyzer operating mode. This operating mode requires option R&S FSL–K8.

Commands of the CALCulate:BT0oth Subsystem

- CALCulate<1|2>:BT0oth:ACLR[:LIST]?
- CALCulate<1|2>:BT0oth:ACLR:EXCEPTIONS?
- CALCulate<1|2>:BT0oth:CFDRift[:MAXimum]?
- CALCulate<1|2>:BT0oth:CFDRift:RATE?
- CALCulate<1|2>:BT0oth:CFSTability:COUNT?
- CALCulate<1|2>:BT0oth:CFSTability:DEVM:[RMS]?
- CALCulate<1|2>:BT0oth:CFSTability:DEVM:D99Pct?
- CALCulate<1|2>:BT0oth:CFSTability:DEVM:PEAK?
- CALCulate<1|2>:BT0oth:CFSTability:FERRor:[TOTal]?
- CALCulate<1|2>:BT0oth:CFSTability:FERRor:BLOCK?
- CALCulate<1|2>:BT0oth:CFSTability:FERRor:INITial?
- CALCulate<1|2>:BT0oth:DPENcoding:[TOTal]?
- CALCulate<1|2>:BT0oth:DPENcoding:BER?
- CALCulate<1|2>:BT0oth:DPENcoding:NERRor?
- CALCulate<1|2>:BT0oth:IBSemissions:[List]?

- CALCulate<1|2>:BT0oth:IBSemissions:EXCeptions?
- CALCulate<1|2>:BT0oth:IBSemissions:HADJacent?
- CALCulate<1|2>:BT0oth:ICFTolerance?
- CALCulate<1|2>:BT0oth:MCHar:DF<1|2>:AVERAge?
- CALCulate<1|2>:BT0oth:MCHar:DF<1|2>:MAXimum?
- CALCulate<1|2>:BT0oth:MCHar:DF2:PERCent?
- CALCulate<1|2>:BT0oth:MCHar:RATio?
- CALCulate<1|2>:BT0oth:OPOWER[:PEAK]?
- CALCulate<1|2>:BT0oth:OPOWER:AVERAge?
- CALCulate<1|2>:BT0oth:PLENght?
- CALCulate<1|2>:BT0oth:PTYPE?
- CALCulate<1|2>:BT0oth:RTPower:[DPSK]?
- CALCulate<1|2>:BT0oth:RTPower:GFSK?
- CALCulate<1|2>:BT0oth:RTPower:RATio?
- CALCulate<1|2>:BT0oth:STATus?

Further information

- Example: Adapting the settings to the characteristics of the DUT

Example: Adapting the settings to the characteristics of the DUT

```

INST:SEL BTO
Activates the Bluetooth Measurements option
INIT:CONT OFF
Selects single sweep operation
CONF:BTO:CHAN 10
Selects channel 10
CONF:BTO:PCL 1
Selects power class 1
CONF:BTO:PRAT 4
Selects 4 points per symbol
CONF:BTO:PTYP DH1
Selects 1 slot packet
DDEM:SEAR:SYNC ON
Activates the FIND SYNC function
DDEM:SEAR:SYNC:OFFS 0
Sets the sync offset = 0
DDEM:SEAR:SYNC:LAP #H0
Sets the lower address part = 0
DDEM:SEAR:TIME:AUTO ON
Selects automatic search length

```

CALCulate<1|2>:BT0oth:ACLR[:LIST]?

This command determines the power of the selected adjacent channels. The number of adjacent channel pairs is defined with the [CONFigure:BT0oth:ACLR:ACPairs](#) command.

The results are returned as a list of power values. The structure of the list is as follows:

<TX channel – n>...<TX channel – 1> <TX channel> <TX channel + 1>...<TX channel + n>

The number of adjacent channels is limited at the Bluetooth band limits.

The numeric suffixes <1|2> are irrelevant for this command.

Note: This command is only available with active Adjacent Channel Power measurement (see [CONFigure:BT0oth:MEASurement](#) command). With all other measurements this command will lead to a query error.

Example

```
INST:SEL BTO
```

Activates the Bluetooth Measurements option.

```
INIT:CONT OFF
```

Selects single sweep operation.

```
CONF:BTO:MEAS ACLR
```

Activates the Adjacent Channel Power measurement.

```
INIT;*WAI
```

Starts the measurement with synchronization.

```
CALC:BTO:ACLR?
```

Queries the power list.

Characteristics

RST value: –

SCPI: device-specific

Mode

BT

CALCulate<1|2>:BT0oth:ACLR:EXceptions?

This command determines the number of exceptions which occurred during the adjacent channel power measurement according to the Bluetooth specification.

The numeric suffixes <1|2> are irrelevant for this command.

Note: This command is only available with active Adjacent Channel Power measurement (see [CONFigure:BT0oth:MEASurement](#) command). With all other measurements this command will lead to a query error.

Example

```
INST:SEL BTO
```

Activates the Bluetooth Measurements option.

```
INIT:CONT OFF
```

Selects single sweep operation.

```
CONF:BTO:MEAS ACLR
```

Activates the Adjacent Channel Power measurement.

```
INIT;*WAI
```

Starts the measurement with synchronization.

```
CALC:BTO:ACLR?
```

Queries the power list.

CALC: BTO: ACLR: EXC?

Queries the number of exceptions.

Characteristics

RST value: –

SCPI: device-specific

Mode

BT

CALCulate<1|2>:BT0oth:CFDRift[:MAXimum]?

This command determines the maximum Carrier Frequency Drift.

The numeric suffixes <1|2> are irrelevant for this command.

Note: This command is only available with active Carrier Frequency Drift measurement (see [CONFigure:BT0oth:MEASurement](#) command). With all other measurements this command will lead to a query error.

Example

For the first steps refer to "[Example: Adapting the settings to the characteristics of the DUT](#)" on page 6.227.

```
CONF: BTO: MEAS CFDR
```

Activates the Carrier Frequency Drift measurement.

```
INIT; *WAI
```

Starts the measurement with synchronization.

```
CALC: BTO: CFDR?
```

Queries the result.

Characteristics

RST value: –

SCPI: device-specific

Mode

BT

CALCulate<1|2>:BT0oth:CFDRift:RATE?

This command determines the maximum Carrier Frequency Drift per 50 μ s.

The numeric suffixes <1|2> are irrelevant for this command.

Note: This command is only available with active Carrier Frequency Drift measurement (see [CONFigure:BT0oth:MEASurement](#) command). With all other measurements this command will lead to a query error.

Example

For the first steps refer to "[Example: Adapting the settings to the characteristics of the DUT](#)" on page 6.227.

```
CONF: BTO: MEAS CFDR
```

Activates the Carrier Frequency Drift measurement.

```
INIT; *WAI
```

Starts the measurement with synchronization.

```
CALC: BTO: CFDR: RATE?
```

Queries the result.

Characteristics

RST value: –

SCPI: device-specific

Mode

BT

CALCulate<1|2>:BT0oth:CFSTability:COUNT?

This command reads the number of measured blocks during or after a measurement.

The numeric suffixes <1|2> are irrelevant for this command.

Note: This command is only available with active Carrier Frequency Stability and Modulation Accuracy measurement (see [CONFigure:BT0oth:MEASurement](#) command). With all other measurements this command will lead to a query error.

Example

For the first steps refer to "[Example: Adapting the settings to the characteristics of the DUT](#)" on page 6.227.

```
CONF:BT0:MEAS CFST
```

Activates the Carrier Frequency Stability and Modulation Accuracy measurement.

```
INIT;*WAI
```

Starts the measurement with synchronization.

```
CALC:BT0:CFST:COUNT?
```

Reads the number of measured blocks.

Characteristics

RST value: –

SCPI: device-specific

Mode

BT

CALCulate<1|2>:BT0oth:CFSTability:DEVM:[RMS]?

This command reads the root mean square (RMS) of the differential error vector magnitude (DEVM) in the Carrier Frequency Stability and Modulation Accuracy measurement.

The numeric suffixes <1|2> are irrelevant for this command.

Note: This command is only available with active Carrier Frequency Stability and Modulation Accuracy measurement (see [CONFigure:BT0oth:MEASurement](#) command). With all other measurements this command will lead to a query error.

Parameter

MINimum | MAXimum | AVERage

Example

For the first steps refer to "[Example: Adapting the settings to the characteristics of the DUT](#)" on page 6.227.

```
CONF:BT0:MEAS CFST
```

Activates the Carrier Frequency Stability and Modulation Accuracy measurement.

```
INIT;*WAI
```

Starts the measurement with synchronization.

```
CALC:BT0:CFST:DEVM? AVER
```

Reads the root mean square of the average differential error vector magnitude.

Characteristics

RST value: –

SCPI: device-specific

Mode

BT

CALCulate<1|2>:BT0oth:CFSTability:DEVM:D99Pct?

This command reads 99% of the differential error vector magnitude (DEVM) in the Carrier Frequency Stability and Modulation Accuracy measurement.

The numeric suffixes <1|2> are irrelevant for this command.

Note: This command is only available with active Carrier Frequency Stability and Modulation Accuracy measurement (see [CONFigure:BT0oth:MEASurement](#) command). With all other measurements this command will lead to a query error.

Example

For the first steps refer to "[Example: Adapting the settings to the characteristics of the DUT](#)" on page 6.227.

```
CONF:BT0:MEAS CFST
```

Activates the Carrier Frequency Stability and Modulation Accuracy measurement.

```
INIT;*WAI
```

Starts the measurement with synchronization.

```
CALC:BT0:CFST:DEVM:D99Pct?
```

Reads 99% of the differential error vector magnitude.

Characteristics

RST value: –

SCPI: device-specific

Mode

BT

CALCulate<1|2>:BT0oth:CFSTability:DEVM:PEAK?

This command reads the peak of the differential error vector magnitude (DEVM) in the Carrier Frequency Stability and Modulation Accuracy measurement.

The numeric suffixes <1|2> are irrelevant for this command.

Note: This command is only available with active Carrier Frequency Stability and Modulation Accuracy measurement (see [CONFigure:BT0oth:MEASurement](#) command). With all other measurements this command will lead to a query error.

Example

For the first steps refer to "[Example: Adapting the settings to the characteristics of the DUT](#)" on page 6.227.

```
CONF:BT0:MEAS CFST
```

Activates the Carrier Frequency Stability and Modulation Accuracy measurement.

```
INIT;*WAI
```

Starts the measurement with synchronization.

```
CALC:BT0:CFST:DEVM:PEAK?
```

Reads the peak of the differential error vector magnitude.

Characteristics

RST value: –

SCPI: device-specific

Mode

BT

CALCulate<1|2>:BT0oth:CFSTability:FERRor:[TOTa]?

This command reads the carrier frequency deviation of all packets in the Carrier Frequency Stability and Modulation Accuracy measurement.

The numeric suffixes <1|2> are irrelevant for this command.

Note: This command is only available with active Carrier Frequency Stability and Modulation Accuracy measurement (see [CONFigure:BT0oth:MEASurement](#) command). With all other measurements this command will lead to a query error.

Parameter

MINimum | MAXimum | AVERage

Example

For the first steps refer to "[Example: Adapting the settings to the characteristics of the DUT](#)" on page 6.227.

```
CONF:BT0:MEAS CFST
```

Activates the Carrier Frequency Stability and Modulation Accuracy measurement.

```
INIT;*WAI
```

Starts the measurement with synchronization.

```
CALC:BT0:CFST:FERR? MIN
```

Reads the minimum carrier frequency deviation of all packets.

Characteristics

RST value: –

SCPI: device-specific

Mode

BT

CALCulate<1|2>:BT0oth:CFSTability:FERRor:BLOCK?

This command reads the maximum frequency deviation of all blocks in the Carrier Frequency Stability and Modulation Accuracy measurement.

The numeric suffixes <1|2> are irrelevant for this command.

Note: This command is only available with active Carrier Frequency Stability and Modulation Accuracy measurement (see [CONFigure:BT0oth:MEASurement](#) command). With all other measurements this command will lead to a query error.

Parameter

MINimum | MAXimum | AVERage

Example

For the first steps refer to "[Example: Adapting the settings to the characteristics of the DUT](#)" on page 6.227.

```
CONF:BT0:MEAS CFST
```

Activates the Carrier Frequency Stability and Modulation Accuracy measurement.

```
INIT; *WAI
```

Starts the measurement with synchronization.

```
CALC: BTO: CFST: FERR: BLOC? AVER
```

Reads the maximum average frequency deviation of all blocks.

Characteristics

RST value: –

SCPI: device-specific

Mode

BT

CALCulate<1|2>:BT0oth:CFSTability:FERRor:INITial?

This command reads the combined frequency deviation of all packets and all blocks in the Carrier Frequency Stability and Modulation Accuracy measurement.

The numeric suffixes <1|2> are irrelevant for this command.

Note: This command is only available with active Carrier Frequency Stability and Modulation Accuracy measurement (see [CONFigure:BT0oth:MEASurement](#) command). With all other measurements this command will lead to a query error.

Parameter

MINimum | MAXimum | AVERage

Example

For the first steps refer to "[Example: Adapting the settings to the characteristics of the DUT](#)" on page 6.227.

```
CONF: BTO: MEAS CFST
```

Activates the Carrier Frequency Stability and Modulation Accuracy measurement.

```
INIT; *WAI
```

Starts the measurement with synchronization.

```
CALC: BTO: CFST: FERR: INIT? MAX
```

Reads the combined maximum frequency deviation of all packets and all blocks.

Characteristics

RST value: –

SCPI: device-specific

Mode

BT

CALCulate<1|2>:BT0oth:DPENcoding:[TOTA]?

This command reads the number of tested packets in the Differential Phase Encoding measurement.

The numeric suffixes <1|2> are irrelevant for this command.

Note: This command is only available with active Differential Phase Encoding measurement (see [CONFigure:BT0oth:MEASurement](#) command). With all other measurements this command will lead to a query error.

Example

For the first steps refer to "[Example: Adapting the settings to the characteristics of the DUT](#)" on page 6.227.

```
CONF: BTO: MEAS DPEN
```

Activates the Differential Phase Encoding measurement.

```
INIT; *WAI
```

Starts the measurement with synchronization.

```
CALC: BTO: DPEN?
```

Reads the number of tested packets.

Characteristics

RST value: –

SCPI: device-specific

Mode

BT

CALCulate<1|2>:BT0oth:DPENcoding:BER?

This command reads the bit error rate (BER) in the Differential Phase Encoding measurement.

The numeric suffixes <1|2> are irrelevant for this command.

Note: This command is only available with active Differential Phase Encoding measurement (see [CONFigure:BT0oth:MEASurement](#) command). With all other measurements this command will lead to a query error.

Example

For the first steps refer to "[Example: Adapting the settings to the characteristics of the DUT](#)" on page 6.227.

```
CONF: BTO: MEAS DPEN
```

Activates the Differential Phase Encoding measurement.

```
INIT; *WAI
```

Starts the measurement with synchronization.

```
CALC: BTO: DPEN: BER?
```

Reads the bit error rate.

Characteristics

RST value: –

SCPI: device-specific

Mode

BT

CALCulate<1|2>:BT0oth:DPENcoding:NERRor?

This command reads the number of passed packets in the Differential Phase Encoding measurement.

The numeric suffixes <1|2> are irrelevant for this command.

Note: This command is only available with active Differential Phase Encoding measurement (see [CONFigure:BT0oth:MEASurement](#) command). With all other measurements this command will lead to a query error.

Example

For the first steps refer to "[Example: Adapting the settings to the characteristics of the DUT](#)" on page 6.227.

```
CONF: BTO: MEAS DPEN
```

Activates the Differential Phase Encoding measurement.

```
INIT;*WAI
```

Starts the measurement with synchronization.

```
CALC: BTO: DPEN: NERR?
```

Reads the number of passed packets.

Characteristics

RST value: –

SCPI: device-specific

Mode

BT

CALCulate<1|2>:BT0oth:IBSemiissions:[List]?

This command reads the power of all adjacent channels in the In-band Spurious Emissions measurement.

The numeric suffixes <1|2> are irrelevant for this command.

Note: This command is only available with active In-band Spurious Emissions measurement (see [CONFigure:BT0oth:MEASurement](#) command). With all other measurements this command will lead to a query error.

Example

For the first steps refer to "[Example: Adapting the settings to the characteristics of the DUT](#)" on page 6.227.

```
CONF: BTO: MEAS IBS
```

Activates the In-band Spurious Emissions measurement.

```
CONF: BTO: CHAN 7
```

Adjust the TX channel number.

```
INIT;*WAI
```

Starts the measurement with synchronization.

```
CALC: BTO: IBS?
```

Reads the results of the In-band Spurious Emissions measurement.

Characteristics

RST value: –

SCPI: device-specific

Mode

BT

CALCulate<1|2>:BT0oth:IBSemiissions:EXCeptions?

This command reads the number of results that exceeded the specified limits in the In-band Spurious Emissions measurement.

The numeric suffixes <1|2> are irrelevant for this command.

Note: This command is only available with active In-band Spurious Emissions measurement (see [CONFigure:BT0oth:MEASurement](#) command). With all other measurements this command will lead to a query error.

Example

For the first steps refer to "[Example: Adapting the settings to the characteristics of the DUT](#)" on page 6.227.

```
CONF: BTO: MEAS IBS
```

Activates the In-band Spurious Emissions measurement.

```
CONF: BTO: CHAN 7
```

Adjust the TX channel number.

```
INIT; *WAI
```

Starts the measurement with synchronization.

```
CALC: BTO: IBS: EXC?
```

Reads the number of results that exceeded the specified limits.

Characteristics

RST value: –

SCPI: device-specific

Mode

BT

CALCulate<1|2>:BT0oth:IBSemiissions:HADJacent?

This command reads the power of the upper or lower frequency band (500 kHz) of the TX channel in the In-band Spurious Emissions measurement.

The numeric suffixes <1|2> are irrelevant for this command.

Note: This command is only available with active In-band Spurious Emissions measurement (see [CONFigure:BT0oth:MEASurement](#) command). With all other measurements this command will lead to a query error.

Parameter

UPPer | LOWer

Example

For the first steps refer to "[Example: Adapting the settings to the characteristics of the DUT](#)" on page 6.227.

```
CONF: BTO: MEAS IBS
```

Activates the In-band Spurious Emissions measurement.

```
CONF: BTO: CHAN 7
```

Adjust the TX channel number.

```
INIT; *WAI
```

Starts the measurement with synchronization.

```
CALC: BTO: IBS: HADJ? LOW
```

Reads the power of the lower frequency band.

Characteristics

RST value: –

SCPI: device-specific

Mode

BT

CALCulate<1|2>:BT0oth:ICFTolerance?

This command determines the Initial Carrier Frequency Tolerance.

The numeric suffixes <1|2> are irrelevant for this command.

Note: This command is only available with active Modulation Characteristics measurement (see [CONFigure:BT0oth:MEASurement](#) command). With all other measurements this command will lead to a query error.

Parameter

MINimum | MAXimum | AVERage

Example

For the first steps refer to ["Example: Adapting the settings to the characteristics of the DUT"](#) on page 6.227.

```
CONF:BTO:MEAS ICFT
```

Activates the Initial Carrier Frequency Tolerance measurement.

```
CONF:BTO:SWE:COUN 20
```

Initiates the sweep counter with 20.

```
INIT;*WAI
```

Starts the measurement with synchronization.

```
CALC:BTO:ICFT? AVER
```

Queries the average value.

Characteristics

RST value: –

SCPI: device-specific

Mode

BT

CALCulate<1|2>:BT0oth:MCHar:DF<1|2>:AVERage?

This command determines the average frequency deviation for varying bit patterns of the payload. The suffixes of DF<1|2> assign the frequency deviation and the bit pattern as follows:

Frequency deviation	$\Delta f_{1\text{avg}}$	$\Delta f_{2\text{avg}}$
Bit pattern	"11110000"	"10101010"

The numeric suffixes <1|2> of CALCulate are irrelevant for this command.

Note: This command is only available with active Modulation Characteristics measurement (see [CONFigure:BT0oth:MEASurement](#) command). With all other measurements this command will lead to a query error.

Parameter

MINimum | MAXimum

Example

For the first steps refer to ["Example: Adapting the settings to the characteristics of the DUT"](#) on page 6.227.

```
CONF:BTO:MEAS MCH
```

Activates the Modulation Characteristics measurement.

```
CONF:BTO:SWE:COUN 20
```

Initiates the sweep counter with 20.

... EUT emits bit pattern 1111000

```
INIT:IMM;*WAI
```

Starts the measurement with synchronization and erase previous measurement results.

```
CALC:BTO:MCH:DF1:AVER? MIN
```

Queries minimum value "11110000".

Characteristics

RST value: –

SCPI: device-specific

Mode

BT

CALCulate<1|2>:BT Ooth:MCHar:DF<1|2>:MAXimum?

This command determines the maximum frequency deviation for different bit patterns of the payload. The suffixes of DF<1|2> assign the frequency deviation and the bit pattern as follows:

Frequency deviation	$\Delta f_{1\max}$	$\Delta f_{2\max}$
Bit pattern	"11110000"	"10101010"

The numeric suffixes <1|2> of CALCulate are irrelevant for this command.

Note: This command is only available with active Modulation Characteristics measurement (see [CONFigure:BT Ooth:MEASurement](#) command). With all other measurements this command will lead to a query error.

Parameter

MINimum | MAXimum | AVERage

Example

For the first steps refer to "[Example: Adapting the settings to the characteristics of the DUT](#)" on page 6.227.

```
CONF: BTO: MEAS MCH
```

Activates the Modulation Characteristics measurement.

```
CONF: BTO: SWE: COUN 20
```

Initiates the sweep counter with 20.

... EUT emits bit pattern 1111000

```
INIT: IMM; *WAI
```

Starts the measurement with synchronization and erase previous measurement results.

```
CALC: BTO: MCH: DF1: MAX? MIN
```

Queries minimum value "11110000".

Characteristics

RST value: –

SCPI: device-specific

Mode

BT

CALCulate<1|2>:BT Ooth:MCHar:DF2:PERCent?

This command determines the percentage of measurements of the frequency deviation, for which the value of $\Delta f_{2\max}$ is within the allowed range. Therefore only the numeric suffix 2 is allowed for DF.

The numeric suffixes <1|2> of CALCulate are irrelevant for this command.

Note: This command is only available with active Modulation Characteristics measurement (see [CONFigure:BT Ooth:MEASurement](#) command). With all other measurements this command will lead to a query error.

Example

For the first steps refer to "[Example: Adapting the settings to the characteristics of the DUT](#)" on page 6.227.

```
CONF: BTO: MEAS MCH
Activates the Modulation Characteristics measurement.
CONF: BTO: SWE: COUN 20
Initiates the sweep counter with 20.
... EUT emits bit pattern 10101010
INIT; *WAI
Starts the measurement with synchronization.
CALC: BTO: MCH: DF2: PERC?
Queries the percentage of "in range" measurements.
```

Characteristics

RST value: –
 SCPI: device-specific

Mode

BT

CALCulate<1|2>:BT0oth:MCHar:RATio?

This command determines the ratio of the average frequency deviations for varying bit patterns of the payload.

The numeric suffixes <1|2> are irrelevant for this command.

Note: This command is only available with active Modulation Characteristics measurement (see [CONFigure:BT0oth:MEASurement](#) command). With all other measurements this command will lead to a query error.

Parameter

MINimum | MAXimum | AVERage

Example

For the first steps refer to "[Example: Adapting the settings to the characteristics of the DUT](#)" on page 6.227.

```
CONF: BTO: MEAS MCH
Activates the Modulation Characteristics measurement.
CONF: BTO: SWE: COUN 20
Initiates the sweep counter with 20.
... EUT emits bit pattern 1111000
INIT: IMM; *WAI
Starts the measurement with synchronization and erase previous measurement results.
... EUT emits bit pattern 10101010
INIT: CONM; *WAI
Starts additional measurement with synchronization.
CALC: BTO: MCH: RAT? MIN
Queries the minimum value.
```

Characteristics

RST value: –
 SCPI: device-specific

Mode

BT

CALCulate<1|2>:BT0oth:OPOWER[:PEAK]?

This command reads the peak value of the Output Power measurement according to the BLUETOOTH standard.

The numeric suffixes <1|2> are irrelevant for this command.

Note: This command is only available with active Output Power measurement (see [CONFigure:BT0oth:MEASurement](#) command). With all other measurements it will lead to a query error.

Example

For the first steps refer to "[Example: Adapting the settings to the characteristics of the DUT](#)" on page 6.227.

```
CONF: BTO: MEAS OPOW
```

Activates the Output Power measurement.

```
INIT; *WAI
```

Starts the measurement with synchronization.

```
CALC: BTO: OPOW?
```

Queries the output power result.

Characteristics

RST value: –

SCPI: device-specific

Mode

BT

CALCulate<1|2>:BT0oth:OPOWER:AVERAge?

This command reads the average value of the Output Power measurement according to the Bluetooth standard.

With a sweep count value of ≥ 1 ([CONFigure:BT0oth:SWEep:COUNT](#)) and trace mode clear/write ([DISPlay\[:WINDow<1|2>\]:TRACe<1..4>:MODE](#)) the selected number of measurements is performed when a single sweep is started ([INITiate<1|2>\[:IMMediate\]](#)). During these measurements the minimum and maximum values are determined. If only a single measurement is performed, the minimum and maximum value will be identical.

The numeric suffixes <1|2> are irrelevant for this command.

Note: This command is only available with active Output Power measurement (see [CONFigure:BT0oth:MEASurement](#) command). With all other measurements it will lead to a query error.

Parameter

MINimum | MAXimum | AVERAge

Example

For the first steps refer to "[Example: Adapting the settings to the characteristics of the DUT](#)" on page 6.227.

```
CONF: BTO: MEAS OPOW
```

Activates the Output Power measurement.

```
CONF: BTO: SWE: COUN 20
```

Activates measurement over 20 sweeps.

```
INIT; *WAI
```

Activates measurement over 20 sweeps.

CALC: BTO: OPOW: AVER? MAX

Queries the maximum average value of the Output Power measurement.

Characteristics

RST value: –

SCPI: device-specific

Mode

BT

CALCulate<1|2>:BT0oth:PLENght?

This command reads the length of the packet analyzed by the preceding measurement.

The numeric suffixes <1|2> are irrelevant for this command.

Note: This command is only available, if a measurement was started via [INITiate<1|2>\[:IMMEDIATE\]](#) before and if this measurement is completed. With a missing or incomplete measurement the command will cause a query error.

This command is only available with the measurements Output Power, Modulation Characteristics, Initial Carrier Frequency Tolerance, and Carrier Frequency Drift (see [CONFigure:BT0oth:MEASurement](#) command).

Example

INST:SEL BTO

Activates the Bluetooth Measurements option

INIT:CONT OFF

Selects single sweep operation

CONF:BTO:MEAS OPOW

Activates the Output Power measurement

INIT;*WAI

Starts the measurement with synchronization

CALC: BTO: PLEN?

Queries the packet length

Characteristics

RST value: –

SCPI: device-specific

Mode

BT

CALCulate<1|2>:BT0oth:PTYPe?

This command determines the type of the packet analyzed by a preceding measurement.

The numeric suffixes <1|2> are irrelevant for this command.

Note: This command is only available, if a measurement was started via [INITiate<1|2>\[:IMMEDIATE\]](#) before and if this measurement is completed. With a missing or incomplete measurement the command will cause a query error.

This command is only available with the measurements Output Power, Modulation Characteristics, Initial Carrier Frequency Tolerance, and Carrier Frequency Drift (see [CONFigure:BT0oth:MEASurement](#) command).

Response

The following packet types are recognized and returns as character data: AUX1, DH1, DH3, DH5, DM1, DM3, DM5, FHS, HV1, HV2, HV3, DV, NULL, POLL, UNDEF

Example

```

INST:SEL BTO
Activates the Bluetooth Measurements option
INIT:CONT OFF
Selects single sweep operation
CONF:BTO:MEAS OPOW
Activates the Output Power measurement
INIT;*WAI
Starts the measurement with synchronization
CALC:BTO:PTYP?
Queries the packet type

```

Characteristics

RST value: –
 SCPI: device-specific

Mode

BT

CALCulate<1|2>:BT Ooth:RTPower:[DPSK]?

This command reads the average transmission power for the DPSK sections of the packet in the Relative Transmission Power measurement. With a sweep count ≤ 1 , the command returns the current value, irrespective of the parameter.

The numeric suffixes <1|2> are irrelevant for this command.

Note: This command is only available with active Relative Transmit Power measurement (see [CONFigure:BT Ooth:MEASurement](#) command). With all other measurements this command will lead to a query error.

Parameter

MINimum | MAXimum | AVERage

Example

For the first steps refer to "[Example: Adapting the settings to the characteristics of the DUT](#)" on page 6.227.

```

CONF:BTO:MEAS RTP
Activates the Relative Transmit Power measurement.
CONF:BTO:SWE:COUN 10
Initiates the sweep counter with 10.
INIT;*WAI
Starts the measurement with synchronization.
CALC:BTO:RTP? MIN
Reads the lowest recorded average power of the DPSK section of all packets.

```

Characteristics

RST value: –
 SCPI: device-specific

Mode

BT

CALCulate<1|2>:BT0oth:RTPower:GFSK?

This command reads the transmission power for the GFSK sections of the packet in the Relative Transmission Power measurement. With a sweep count ≤ 1 , the command returns the current value, irrespective of the parameter.

The numeric suffixes <1|2> are irrelevant for this command.

Note: This command is only available with active Relative Transmit Power measurement (see [CONFigure:BT0oth:MEASurement](#) command). With all other measurements this command will lead to a query error.

Parameter

MINimum | MAXimum | AVERage

Example

For the first steps refer to "[Example: Adapting the settings to the characteristics of the DUT](#)" on page 6.227.

```
CONF: BTO: MEAS RTP
```

Activates the Relative Transmit Power measurement.

```
CONF: BTO: SWE: COUN 10
```

Initiates the sweep counter with 10.

```
INIT; *WAI
```

Starts the measurement with synchronization.

```
CALC: BTO: RTP: GFSK? MIN
```

Reads the highest recorded average power of the GFSK section of all packets.

Characteristics

RST value: –

SCPI: device-specific

Mode

BT

CALCulate<1|2>:BT0oth:RTPower:RATio?

This command reads the ratio of the transmission power for the GFSK and DPSK modulation in the Relative Transmission Power measurement ($P_{\text{DPSK}}/P_{\text{GFSK}}$). With a sweep count ≤ 1 , the command returns the current value, irrespective of the parameter.

The numeric suffixes <1|2> are irrelevant for this command.

Note: This command is only available with active Relative Transmit Power measurement (see [CONFigure:BT0oth:MEASurement](#) command). With all other measurements this command will lead to a query error.

Parameter

MINimum | MAXimum | AVERage

Example

For the first steps refer to "[Example: Adapting the settings to the characteristics of the DUT](#)" on page 6.227.

```
CONF: BTO: MEAS RTP
```

Activates the Relative Transmit Power measurement.

```
CONF: BTO: SWE: COUN 10
```

Initiates the sweep counter with 10.

```
INIT; *WAI
```

Starts the measurement with synchronization.

CALC: BTO: RTP: RAT? MIN
Queries the minimum value.

Characteristics

RST value: –
SCPI: device-specific

Mode

BT

CALCulate<1|2>:BT0oth:STATus?

This command queries the status of a preceding measurement.

Results: 0: PASS, 1: FAIL

The numeric suffixes <1|2> are irrelevant for this command.

Note: This command is only available, if a measurement was started via `INITiate<1|2>[:IMMEDIATE]` before and if this measurement is completed. With a missing or incomplete measurement the command will cause a query error.

Example

INST: SEL BTO

Activates the Bluetooth Measurements option

INIT: CONT OFF

Selects single sweep operation

CONF: BTO: MEAS OPOW

Activates Output Power measurement

INIT; *WAI

Starts the measurement with synchronization

CALC: BTO: STAT?

Queries the status

Characteristics

RST value: –
SCPI: device-specific

Mode

BT

CALCulate:DELTamarker Subsystem (BLUETOOTH, K8)

The CALCulate:DELTamarker subsystem controls the delta marker functions in the instrument.

Commands of the CALCulate:DELTamarker Subsystem

– [CALCulate<1|2>:DELTamarker<1...4>:Y?](#)

CALCulate<1|2>:DELTamarker<1...4>:Y?

Depending on the unit defined with [CALCulate<1|2>:UNIT:POWer](#) or on the activated measuring functions, the query result is output in the units below:

Result display	Output unit
OUTPUT POWER result display	dB
TX SPECTRUM ACP result display	dB
MODULATION CHARACTERISTICS result display	Hz
INITIAL CARR FREQ TOL result display	Hz
CARRIER FREQ DRIFT result display	Hz
RELATIVE TX POWER	dB
IN-BAND SPURIOUS EMISSIONS	dB
CARRIER FREQUENCY STABILITY	–
DIFF PHASE ENCODING	–

For further details refer to "[CALCulate<1|2>:DELTamarker<1...4>:Y?](#)" on page 6.15.

CALCulate:MARKer Subsystem (BLUETOOTH, K8)

The CALCulate:MARKer subsystem checks the marker functions in the instrument.

Commands of the CALCulate:MARKer Subsystem

- [CALCulate<1|2>:MARKer<1...4>:PEXCursion](#)
- [CALCulate<1|2>:MARKer<1...4>:Y?](#)

CALCulate<1|2>:MARKer<1...4>:PEXCursion

The unit depends on the selected operating mode.

Example

```
CALC:MARK:PEXC 100 HZ
Defines peak excursion 100 Hz
```

Characteristics

RST value: 6dB

For further details refer to "[CALCulate<1|2>:MARKer<1...4>:PEXCursion](#)" on page 6.48.

CALCulate<1|2>:MARKer<1...4>:Y?

If the analog demodulator (option Analog Demodulation, R&S FSL–K7) is activated, the query result is output in the following units:

Result display	Output unit
AM	%
FM	Hz
PM	rad/deg (defined with UNIT:ANGLE)
RF	output unit defined with CALCulate<1 2>:UNIT:POWer

For further details refer to "[CALCulate<1|2>:MARKer<1...4>:Y?](#)" on page 6.50.

CONFigure:BT0oth Subsystem (BLUETOOTH, K8)

The following commands are used for configuration of the BLUETOOTH analyzer operating mode.

Commands of the CONFigure:BT0oth Subsystem

- CONFigure:BT0oth:ACLR:ACPairs
- CONFigure:BT0oth:BANDwidth|BWIDth[:RESolution]
- CONFigure:BT0oth:BANDwidth|BWIDth[:RESolution]:AUTO
- CONFigure:BT0oth:BANDwidth|BWIDth:VIDeo
- CONFigure:BT0oth:BANDwidth|BWIDth:VIDeo:AUTO
- CONFigure:BT0oth:CFSTability:BCOunt
- CONFigure:BT0oth:CHANnel
- CONFigure:BT0oth:DETector<1...4>[:FUNction]
- CONFigure:BT0oth:IBSemiissions:ACPairs
- CONFigure:BT0oth:IBSemiissions:GATE:AUTO
- CONFigure:BT0oth:MEASurement
- CONFigure:BT0oth:PBSCo
- CONFigure:BT0oth:PCLass
- CONFigure:BT0oth:POWer:AVERage:STARt
- CONFigure:BT0oth:POWer:AVERage:STOP
- CONFigure:BT0oth:PRATe
- CONFigure:BT0oth:PTYPe
- CONFigure:BT0oth:RTPower:DAVerage:STARt
- CONFigure:BT0oth:RTPower:DAVerage:STOP
- CONFigure:BT0oth:RTPower:GAVerage:STARt
- CONFigure:BT0oth:RTPower:GAVerage:STOP
- CONFigure:BT0oth:SWEEp:COUNT
- CONFigure:BT0oth:SWEEp:TIME
- CONFigure:BT0oth:SWEEp:TIME:AUTO
- CONFigure:BT0oth:TRACe<1...4>:MODE
- CONFigure:BT0oth:TRACe<1...4>:SElect

CONFigure:BT0oth:ACLR:ACPairs

This command selects the number of adjacent channel pairs during the Adjacent Channel Power measurement. The number of adjacent channels will be limited as soon as the border of the Bluetooth frequency band is reached.

Note: This command is only available with active Adjacent Channel Power measurement (see `CONFigure:BT0oth:MEASurement` command).

Parameter

1 to 78

Example

```
CONF: BTO: ACLR: ACP 10
```

Selects 10 adjacent channel pairs.

Characteristics

*RST value: 78

SCPI: device-specific

Mode

BT

CONFigure:BT0oth: BANDwidth| BWIDth[: RESolution]

This command sets the resolution bandwidth of the analyzer for the currently selected Bluetooth measurement (see [SENSe<1|2>:]BANDwidth|BWIDth[:RESolution] command).

For the measurements of modulation characteristics, initial carrier frequency tolerance, and carrier frequency drift (CONFigure:BT0oth:MEASurement), the resolution bandwidth corresponds to the IF bandwidth of the signal. If the resolution bandwidth is changed, its coupling to the settings according to the RF Test Specification is cancelled.

Note: The settings for the measurements are valid for all three measurements.
For all other Bluetooth measurements the setting is only valid for the currently active measurement (see CONFigure:BT0oth:MEASurement command).
This command is not available with active Adjacent Channel Power measurement.

Parameter

300kHz to 10MHz

Example

```
INST: SEL BTO
```

Activates the Bluetooth Measurements option.

```
CONF: BTO: MEAS OPOW
```

Activates the Output Power measurement.

```
CONF: BTO: BAND 1KHZ
```

Sets the resolution bandwidth to 1kHz.

Characteristics

*RST value: – (AUTO is set to ON)

SCPI: device-specific

Mode

BT

CONFigure:BT0oth: BANDwidth| BWIDth[: RESolution]: AUTO

This command couples the resolution bandwidth to the settings according to the RF Test Specification.

Note: The settings for the measurements of Modulation Characteristics, Initial Carrier Frequency Tolerance, and Carrier Frequency Drift are common to all three measurements.
For all other Bluetooth measurements the setting is only valid for the currently active measurement (see CONFigure:BT0oth:MEASurement command).

Parameter

ON | OFF

Example

```
INST:SEL BTO
```

Activates the Bluetooth Measurements option.

```
CONF:BTO:MEAS MCH
```

Activates the Modulation Characteristics measurement.

```
CONF:BTO:BAND:AUTO ON
```

Activates the RBW coupling.

Characteristics

*RST value: ON

SCPI: device-specific

Mode

BT

CONFigure:BT0oth:BANDwidth|BWIDth:VIDeo

This command sets the video bandwidth for the Adjacent Channel Power measurement (see [CONFigure:BT0oth:MEASurement](#) command).

The available filters have a bandwidth range of 1 Hz to 10 MHz. On a change in video bandwidth its link according to the RF Test Specification is switched off.

Note: This setting is only available for Output Power measurements.

Parameter

1 Hz to 10 MHz

Example

```
INST:SEL BTO
```

Activates the Bluetooth Measurements option.

```
CONF:BTO:MEAS ACLR
```

Activates the Adjacent Channel Power measurement.

```
CONF:BTO:BAND:VID 100HZ
```

Sets the video bandwidth to 100 Hz.

Characteristics

*RST value: – (AUTO is set to ON)

SCPI: device-specific

Mode

BT

CONFigure:BT0oth:BANDwidth|BWIDth:VIDeo:AUTO

This command links the video bandwidth to the settings according to the RF Test Specification. It is only available for the Adjacent Channel Power measurement (see [CONFigure:BT0oth:MEASurement](#) command).

Note: This setting is only valid for the currently active measurement (see [CONFigure:BT0oth:MEASurement](#) command) and it is independent of the other Bluetooth measurements.

Parameter

ON | OFF

Example

INST:SEL BTO

Activates the Bluetooth Measurements option.

CONF:BTO:MEAS ACLR

Activates the Adjacent Channel Power measurement.

CONF:BTO:BAND:VID:AUTO ON

Switches the VBW coupling on.

Characteristics

*RST value: ON

SCPI: device-specific

Mode

BT

CONFigure:BT0oth:CFSTability:BCOunt

This command sets the number of blocks to be measured.

Note: This command is only available with active Carrier Frequency Stability and Modulation Accuracy measurement (see [CONFigure:BT0oth:MEASurement](#) command).

Parameter

0 to 1,000,000

Example

CONF:BTO:CFST:BCO 1000

Selects 1000 blocks to be measured.

Characteristics

RST value: 200

SCPI: device-specific

Mode

BT

CONFigure:BT0oth:CHANnel

This command selects the frequency channel for the measurements according to the Bluetooth standard.

Parameter

0 to 78

Example

CONF:BTO:CHAN 20

Selects channel 20

Characteristics

*RST value: 0

SCPI: device-specific

Mode

BT

CONFigure:BT0oth:DETector<1...4>[:FUNCTION]

This command selects the detector for the currently selected Bluetooth measurement. The numeric suffix assigns the detector to a trace (1 to 4).

Note: The RMS detector is not available for the measurements Modulation Characteristics, Initial Carrier Frequency Tolerance, and Carrier Frequency Drift (see [CONFigure:BT0oth:MEASurement](#) command).
The setting is valid for the currently selected measurement (see [CONFigure:BT0oth:MEASurement](#) command) and independent of other Bluetooth measurements.

Parameter

APEak | NEGative | POSitive | SAMPlE | RMS | AVERAge

Example

```
INST:SEL BTO
```

Activates the Bluetooth Measurements option.

```
CONF:BT0:MEAS OPOW
```

Activates the Output Power measurement.

```
CONF:BT0:DET2 RMS
```

Sets the detector for trace 2 to RMS.

Characteristics

*RST value:

PEAK	Output Power
AVER	Adjacent Channel Power EDR Rel TX Power EDR In-band Spurious Emissions
APEAK	Modulation Characteristics Initial Carrier Frequency Tolerance Carrier Frequency Drift EDR Differential Phase Encoding EDR Carrier Frequency Stability and Modulation Accuracy

SCPI: device-specific

Mode

BT

CONFigure:BT0oth:IBSemiissions:ACPairs

This command selects the number of adjacent channel pairs during the In-band Spurious Emissions measurement. The number of adjacent channels will be limited as soon as the border of the Bluetooth frequency band is reached.

Note: This command is only available with active In-band Spurious Emissions measurement (see [CONFigure:BT0oth:MEASurement](#) command).

Parameter

1 to 78

Example

```
CONF:BT0:IBS:ACP 20
```

Selects 20 adjacent channel pairs.

Characteristics

*RST value: 78

SCPI: device-specific

Mode

BT

CONFigure:BT0oth:IBSemiissions:GATE:AUTO

This command adjusts the gate settings for the In-band Spurious Emissions automatically.

Note: This command is only available with active In-band Spurious Emissions measurement (see [CONFigure:BT0oth:MEASurement](#) command).

Parameter

ONCE

Example

CONF:BT0:IBS:GATE:AUTO ONCE

Adjusts the gate automatically once.

Characteristics

RST value: ONCE

SCPI: device-specific

Mode

BT

CONFigure:BT0oth:MEASurement

This command selects the current measurement according to the Bluetooth standard.

Parameter

OPOWer	Output Power measurement
ACLR	Adjacent Channel Power measurement
MCHar	Modulation Characteristics measurement
ICFTolerance	Initial Carrier Frequency Tolerance measurement
CFDRift	Carrier Frequency Drift measurement
RTPower	Relative Transmit Power (EDR) measurement
IBSemiissions	Spurious Emissions (EDR) measurement
DPENcoding	Differential Phase Encoding (EDR) measurement
CFSTability	Carrier Frequency Stability and Modulation Accuracy (EDR) measurement

Example

CONF:BT0:MEAS ACLR

Selects the measurement of the adjacent channel power.

Characteristics

*RST value: OPOWer

SCPI: device-specific

ModeBT

CONFigure:BT0oth:PBSCo

This command selects the number of payload bytes that are transmitted in a packet.

Parameter

1 – 1000

Example

```
CONF:BT0:PBSC 50
```

Selects the number of payload bytes.

Characteristics

RST value: 1

SCPI: device-specific

ModeBT

CONFigure:BT0oth:PCLass

This command selects the power class for the Output Power measurement. The power class defines the limits for the output power measurement.

Parameter

1 to 3

Example

```
CONF:BT0:PCL 3
```

Selects power class 3

Characteristics

*RST value: 1

SCPI: device-specific

ModeBT

CONFigure:BT0oth:POWer:AVERage:STARt

This command defines the start position for the calculation of the average power of a burst.

Note: Depending on the setting FIND SYNC ON or OFF ([SENSe<1 | 2>:]DDEMod:SEARCH:SYNC[:STATe] command) the burst is either defined by the p0 bit and the packet length or the 3 dB points according to the RF Test Specification. As a result there are different areas within the burst for calculating the average power:

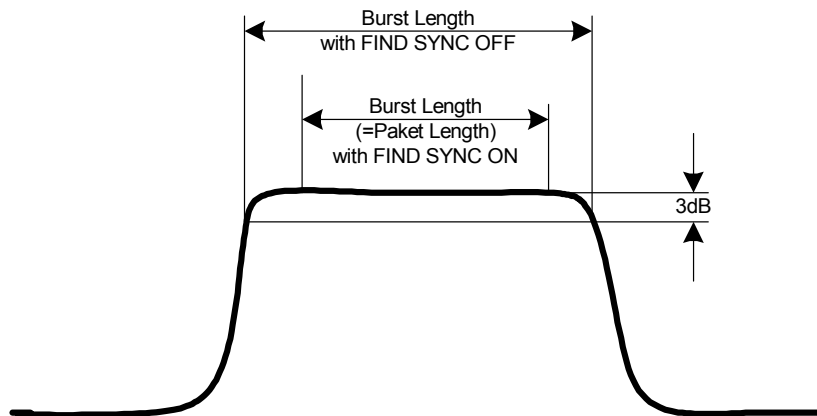

Parameter

0 to 100PCT

Example

CONF:BT0:POW:AVER:STAR 10PCT

Sets the starting point for the calculation to 10% of the burst length.

Characteristics

*RST value: 20%

SCPI: device-specific

Mode

BT

CONFigure:BT0oth:POWer:AVERage:STOP

This command defines the end position for the calculation of the average power of a burst.

Note: Depending on the setting FIND SYNC ON or OFF

([SENSe<1 | 2>:]DDEMod:SEARch:SYNC[:STATe] command) the burst is either defined by the p0 bit and the packet length or the 3 dB points according to the RF Test Specification. As a result there are different areas within the burst for calculating the average power (see CONFigure:BT0oth:POWer:AVERage:STARt command).

Parameter

0 to 100PCT

Example

CONF:BT0:POW:AVER:STAR 90PCT

Sets the end point for the calculation to 90% of the burst length.

Characteristics

*RST value: 80%

SCPI: device-specific

Mode

BT

CONFigure:BT0oth:PRATe

This command selects the number of measurement samples (points) per symbol for the measurement. This command is not available for EDR measurements. For EDR measurements, this parameter is set to 4 points/symbol and cannot be changed.

Note: The RF Test Specification specifies an oversampling factor of at least 4.

Parameter

2 | 4 | 8 | 16 | 32

Example

CONF: BTO: PRAT 16
Selects 16 points/symbol.

Characteristics

*RST value: 4
SCPI: device-specific

Mode

BT

CONFigure:BT0oth:PTYPe

This command selects the packet type to be measured.

Parameter

DH1	1 slot packet
DH3	3 slot packet
DH5	5 slot packet
AUTO	automatic selection of the packet type

Example

CONF: BTO: PTYP DH5
Selects type "5 slot packet".

Characteristics

*RST value: DH1
SCPI: device-specific

Mode

BT

CONFigure:BT0oth:RTPower:DAverage:STARt

This command sets the start time for the power measurement of the DPSK sections of the packet.

Note: This command is only available with active Relative Transmit Power measurement (see [CONFigure:BT0oth:MEASurement](#) command).

Parameter

0 to 100%

Example

CONF: BTO: RTP: DAV: STAR 20
Sets the start time for the power measurement of the DPSK sections of the packet.

Characteristics

RST value: 10%
SCPI: device-specific

ModeBT

CONFigure:BT0oth:RTPower:DAverage:STOP

This command sets the stop time for the power measurement of the DPSK sections of the packet.

Note: This command is only available with active Relative Transmit Power measurement (see [CONFigure:BT0oth:MEASurement](#) command).

Parameter

0 to 100%

Example

```
CONF:BT0:RTP:DAV:STOP 80
```

Sets the stop time for the power measurement of the DPSK sections of the packet.

Characteristics

RST value: 90%

SCPI: device-specific

ModeBT

CONFigure:BT0oth:RTPower:GAverage:START

This command sets the start time for the power measurement of the GFSK sections of the packet.

Note: This command is only available with active Relative Transmit Power measurement (see [CONFigure:BT0oth:MEASurement](#) command).

Parameter

0 to 100%

Example

```
CONF:BT0:RTP:GAV:STAR 20
```

Sets the start time for the power measurement of the GFSK sections of the packet.

Characteristics

RST value: 10%

SCPI: device-specific

ModeBT

CONFigure:BT0oth:RTPower:GAverage:STOP

This command sets the stop time for the power measurement of the GFSK sections of the packet.

Note: This command is only available with active Relative Transmit Power measurement (see [CONFigure:BT0oth:MEASurement](#) command).

Parameter

0 to 100%

Example

```
CONF:BTO:RTP:GAV:STOP 80
```

Sets the stop time for the power measurement of the GFSK sections of the packet.

Characteristics

RST value: 90%

SCPI: device-specific

Mode

BT

CONFigure:BT0oth:SWEp:COUNT

This command defines the number of sweeps for the currently selected Bluetooth measurement. This number will be started as a "single sweep". With trace mode setting clear/write ([CONFigure:BT0oth:TRACe<1..4>:MODE](#)) the measurement results will be calculated for each sweep and taken into account for the calculation of minimum, maximum and average values. For the remaining trace settings (AVER, MAXH, MINH) the measurement results will be calculated from the resulting trace. In average mode the value 0 defines the sliding average of the measurement data over 10 sweeps.

Note: The setting is valid only for the currently active measurement (see [CONFigure:BT0oth:MEASurement](#) command) and independent of the other Bluetooth measurements.

Parameter

0 to 32767

Example

```
INST:SEL BTO
```

Activates the Bluetooth Measurements option.

```
CONF:BTO:MEAS OPOW
```

Activates the Output Power measurement.

```
INIT:CONT OFF
```

Selects single sweep operation.

```
CONF:BTO:SWE:COUN 20
```

Sets the number of sweeps to 20.

```
INIT;*OPC
```

Starts a sweep with synchronization.

Characteristics

*RST value:

- | | |
|-----|---|
| 0 | Output Power |
| 10 | Adjacent Channel Power
Modulation Characteristics
Initial Carrier Frequency Tolerance
Carrier Frequency Drift
EDR Relative TX Power
EDR In-band Spurious Emissions |
| 100 | Differential Phase Encoding |

Mode

BT

CONFigure:BT0oth:SWEp:TIME

This command defines the duration of a sweep sequence for the active Bluetooth measurement.

Parameter

<numeric_value>

(1us to 130560us) / (points per symbol)	Output Power Modulation Characteristics Initial Carrier Frequency Tolerance Carrier Frequency Drift EDR Relative TX Power EDR Differential Phase Encoding EDR Carrier Frequency Stability and Modulation Accuracy
10µs ... 16000s	Adjacent Channel Power

Direct programming using the [[SENSE<1|2>](#):] [SWEp:TIME](#) command will cancel the coupling to the settings according to the RF Test Specification.

Note: The setting is valid only for the currently active measurement (see [CONFigure:BT0oth:MEASurement](#) command) and independent of the other Bluetooth measurements.

Example

```
INST:SEL BTO
```

Activates the Bluetooth Measurements option.

```
CONF:BT0:MEAS OPOW
```

Activates the Output Power measurement.

```
CONF:BT0:SWE:TIME 10MS
```

Sets a sweep time of 10 ms.

Characteristics

*RST value: – (AUTO is set to ON)

SCPI: device-specific

Mode

BT

CONFigure:BT0oth:SWEp:TIME:AUTO

This command couples the sweep time to the settings according to the RF Test Specification.

Note: The setting is valid only for the currently active measurement (see [CONFigure:BT0oth:MEASurement](#) command) and independent of the other Bluetooth measurements.

Parameter

ON | OFF

Example

```
INST:SEL BTO
```

Activates the Bluetooth Measurements option.

```
CONF:BT0:MEAS OPOW
```

Activates the Output Power measurement.

```
CONF:BT0:SWE:TIME:AUTO ON
```

Switches the sweep time coupling on.

Characteristics

*RST value: ON

SCPI: device-specific

Mode

BT

CONFigure:BT0oth:TRACe<1...4>:MODE

This command defines the way of displaying and evaluating the measurement curves for the selected Bluetooth measurement. WRITe corresponds to manual operating mode Clr/Write.

The numeric suffix selects the trace related to this setting.

The number of measurement to be executed for AVERage, MAXHold and MINHold is defined with the `CONFigure:BT0oth:SWEep:COUNT` command. Please note that a synchronization to the end of the indicated number of measurements is only possible during single sweep operation.

Note: The setting is valid only for the currently active measurement (see `CONFigure:BT0oth:MEASurement` command) and independent of the other Bluetooth measurements.

Parameter

WRITe | VIEW | AVERage | MAXHold | MINHold | BLANK

Example

```
INST:SEL BTO
```

Activates the Bluetooth Measurements option.

```
CONF:BTO:MEAS OPOW
```

Activates the Output Power measurement.

```
INIT:CONT OFF
```

Selects single sweep operation.

```
CONF:BTO:SWE:COUN 10
```

Sets the sweep count to 10.

```
CONF:BTO:TRAC2:MODE AVER
```

Switches averaging for trace 2 on.

```
INIT;*OPC
```

Starts a measurement with synchronization.

Characteristics

*RST value: WRITe

SCPI: device-specific

Mode

BT

CONFigure:BT0oth:TRACe<1...4>:SELEct

This command selects the measurement curve for evaluation of the modulation characteristics.

Example

```
INST:SEL BTO
```

Activates the Bluetooth Measurements option.

```
CONF:BTO:MEAS ACLR
```

Activates the Adjacent Channel Power measurement.

INIT:CONT OFF

Selects single sweep operation.

CONF: BTO: TRAC2: SEL

Selects trace 2 for measurement result queries.

Characteristics

*RST value: –

SCPI: device-specific

Mode

BT

DISPlay Subsystem (BLUETOOTH, K8)

The DISPlay subsystem controls the selection and presentation of textual and graphic information as well as of measurement data on the display.

Commands of the DISPlay Subsystem

- [DISPlay\[:WINDow<1|2>\]:TRACe<1...4>:Y\[:SCALe\]:PDIVision](#)
- [DISPlay\[:WINDow<1|2>\]:TRACe<1...4>:Y\[:SCALe\]:RPOSition](#)
- [DISPlay\[:WINDow<1|2>\]:TRACe<1...4>:Y\[:SCALe\]:RVALue](#)

[DISPlay\[:WINDow<1|2>\]:TRACe<1...4>:Y\[:SCALe\]:PDIVision](#)

This command defines the scaling of the y-axis in the currently selected unit. The numeric suffix in TRACE<1...4> is irrelevant.

Parameter

<numeric_value>

Example

```
DISP:TRAC:Y:PDIV 10kHz
Sets the Y scale to 10 kHz/div.
```

Characteristics

*RST value: –
SCPI: conforming

Mode

BT

[DISPlay\[:WINDow<1|2>\]:TRACe<1...4>:Y\[:SCALe\]:RPOSition](#)

This command defines the position of the reference value. In **Bluetooth** mode, the selected reference position is valid for all measurements.

Characteristics

*RST value: 50 PCT

For further details refer to "[DISPlay\[:WINDow<1|2>\]:TRACe<1...4>:Y\[:SCALe\]:RPOSition \(models 13, 16\)](#)" on page 6.102.

[DISPlay\[:WINDow<1|2>\]:TRACe<1...4>:Y\[:SCALe\]:RVALue](#)

This command defines the result value assigned to the reference position on the graticule.

Example

```
DISP:TRAC:Y:RVAL 0
Sets the value assigned to the reference position to 0 Hz
```

Characteristics

*RST value: 0 Hz

For further details refer to "[DISPlay\[:WINDow<1|2>\]:TRACe<1...4>:Y\[:SCALe\]:RPOSition \(models 13, 16\)](#)" on page 6.102.

INSTRument Subsystem (BLUETOOTH, K8)

The INSTRument subsystem selects the operating mode of the unit either via text parameters or fixed numbers.

Commands of the INSTRument Subsystem

- INSTRument[:SElect]
- INSTRument:NSElect

INSTRument[:SElect]

Parameter

BTOoth Bluetooth mode (option Bluetooth Measurements, R&S FSL–K8)

For details refer to section "Remote Control – Description of Basic Settings Commands", INSTRument subsystem.

INSTRument:NSElect

Parameter

<numeric value>

12 Bluetooth mode (option Bluetooth Measurements, R&S FSL–K8)

For details refer to section "Remote Control – Description of Basic Settings Commands", INSTRument subsystem.

SENSe Subsystem (BLUETOOTH, K8)

The SENSe subsystem controls the essential parameters of the Bluetooth Measurements option. In accordance with the SCPI standard, the keyword "SENSe" is optional for this reason, which means that it is not necessary to include the SENSe node in command sequences.

The following subsystem is included:

- "SENSe:ADEMod Subsystem (BLUETOOTH, K8)" on page 6.263
- "SENSe:DDEMod Subsystem (BLUETOOTH, K8)" on page 6.265

[SENSe<1|2>:]CORRection:EGAI:n:INPut[:MAGNItude]

This command makes an external gain known to the analyzer, which will take it into account during the display of measurement results. With this function the gain of an antenna or of an external preamplifier can be taken into account for the measurement values.

The numeric suffixes <1|2> are irrelevant for this command.

Parameter

–200 to +200 dB

Example

```
CORR:EGA:INP 10DB
```

Takes 10 dB external gain into account

Characteristics

*RST value: 0 dB

SCPI: device-specific

Mode

BT

SENSe:ADEMod Subsystem (BLUETOOTH, K8)

The SENSe:ADEMod Subsystem contains commands to set up the instrument for the measurement of analog demodulated signals.

Commands of the SENSe:ADEMod Subsystem

- [SENSe:]ADEMod:ZOOM[:STATe]
- [SENSe:]ADEMod:ZOOM:START

[SENSe:]ADEMod:ZOOM[:STATe]

The command enables or disables the zoom function. Depending on the selected measurement time and the demodulation bandwidth, the number of recorded measurement points may be greater than that shown on the display.

If the zoom function is enabled, 501 test points of the result memory are displayed from the start time specified by the [SENSe:]ADEMod:ZOOM:START command.

If the zoom function is disabled, data reduction is used to adapt the measurement points to the number of points available on the display.

Note: The zoom function is only available for the Output Power, Modulation Characteristics, Initial Carrier Frequency Tolerance, and Carrier Frequency Drift measurements.

Parameter

ON | OFF

Example

ADEM:ZOOM ON

Switches on the zoom function

Characteristics

*RST value: OFF

SCPI: device-specific

Mode

BT

[SENSe:]ADEMod:ZOOM:STARt

The command sets the start time for the display of individual measured values.

The zoom function is enabled or disabled by the [SENSe:]ADEMod:ZOOM[:STATe] command.

Note: The zoom function is only available for the Output Power, Modulation Characteristics, Initial Carrier Frequency Tolerance, and Carrier Frequency Drift measurements.

Parameter

0 s to (meas time – 500 / sampling rate)

Example

ADEM:ZOOM ON

Switches on the zoom function

ADEM:ZOOM:STAR 500us

Sets the starting point of the display to 500 µs.

Characteristics

*RST value: 0 s

SCPI: device-specific

ModeBT

SENSe:DDEMod Subsystem (BLUETOOTH, K8)

This subsystem controls the parameters for digital demodulators.

Commands of the SENSe:DDEMod Subsystem

- [SENSe<1|2>:]DDEMod:FILTer:MEASurement
- [SENSe<1|2>:]DDEMod:SEARch:PULSe[:STATe]
- [SENSe<1|2>:]DDEMod:SEARch:PULSe:OFFSet
- [SENSe<1|2>:]DDEMod:SEARch:SYNC[:STATe]
- [SENSe<1|2>:]DDEMod:SEARch:SYNC:LAP
- [SENSe<1|2>:]DDEMod:SEARch:SYNC:OFFSet
- [SENSe<1|2>:]DDEMod:SEARch:TIME
- [SENSe<1|2>:]DDEMod:SEARch:TIME:AUTO

[SENSe<1|2>:]DDEMod:FILTer:MEASurement

This command selects the receive filter for the signal to measure.

The numeric suffixes <1|2> are irrelevant for this command.

Note: This command is only available with active Modulation Characteristics, Initial Carrier Frequency Tolerance, and Carrier Frequency Drift measurement (see [CONFigure:BT0oth:MEASurement](#) command). With all other measurements it will lead to a query error.

Parameter

OFF | BT0oth

Example

```
DDEM:FILT:MEAS BTO
```

Activates the Bluetooth measurement filter.

Characteristics

*RST value: ON

SCPI: device-specific

Mode

BT

[SENSe<1|2>:]DDEMod:SEARch:PULSe[:STATe]

This command switches the search for a signal burst on or off.

The numeric suffixes <1|2> are irrelevant for this command.

Parameter

ON | OFF

Example

```
DDEM:SEAR:PULS OFF
```

Characteristics

*RST value: ON

SCPI: device-specific

ModeBT

[SENSe<1|2>:]DDEMod:SEARch:PULSe:OFFSet

This command defines the time to be recorded before a signal burst is recognized. The valid value range is 0 to ± 10 ms.

The numeric suffixes <1|2> are irrelevant for this command.

Parameter

0 to 10 ms

Example

```
DDEM:SEAR:PULS:OFFS 1MS
```

Sets the burst offset to 1ms before the start of the burst.

Characteristics

*RST value: 0

SCPI: device-specific

ModeBT

[SENSe<1|2>:]DDEMod:SEARch:SYNC[:STATe]

This command switches the search for a sync pattern on or off.

The numeric suffixes <1|2> are irrelevant for this command.

Parameter

ON | OFF

Example

```
DDEM:SEAR:SYNC ON
```

Switches the sync pattern search on.

Characteristics

*RST value: OFF

SCPI: device-specific

ModeBT

[SENSe<1|2>:]DDEMod:SEARch:SYNC:LAP

This command determines the 24 least significant bits (LAP) of the DUT 'Bluetooth device address'. They are used to define the synchronization pattern to determine the start of a packet. The value range is 0 to FFFFFFF hex.

The numeric suffixes <1|2> are irrelevant for this command.

Parameter

<hex>

Example

```
DDEM:SEAR:SYNC:LAP #HA3F45B
```

Sets on LAP A3F45B Hex

Characteristics

*RST value: #H0

SCPI: device-specific

Mode

BT

[SENSe<1|2>:]DDEMod:SEARch:SYNC:OFFSet

This command defines the number of bits to be recorded before the first preamble bit is detected. The valid value range is 0 to ± 10000 .

The numeric suffixes <1|2> are irrelevant for this command.

Parameter

0 to 10,000

Example

DDEM:SEAR:SYNC:OFFS 10

Sets the sync offset to 10 bits before the preamble bits.

Characteristics

*RST value: 0

SCPI: device-specific

Mode

BT

[SENSe<1|2>:]DDEMod:SEARch:TIME

This command selects manual setting of the record length and defines the record length to be used for the search of sync word and burst. The input of the record length is expected in seconds.

The numeric suffixes <1|2> are irrelevant for this command.

Note: For information on the correlation of trigger and record length refer to the [\[SENSe<1|2>:\]DDEMod:SEARch:TIME:AUTO](#) command.

Parameter100 μ s to 130560 μ s / (points per symbol)

Points per Symbol	Maximum record length
2	104.4 slots
4	52.2 slots
8	26.1 slots
16	13.1 slots
32	6.5 slots

Example

DDEM:SEAR:TIME 100US

Sets the record length for sync word and burst search to 100 μ s.

Characteristics*RST value: 1875 μ s

SCPI: device-specific

Mode

BT

[SENSe<1|2>:]DDEMod:SEARch:TIME:AUTO

This command activates the automatic setting of the record length for the sync word and burst search, depending on the selected packet type.

The automatic record length is determined as follows:

Trigger free run:

$$\text{search length} = 3 * \text{packet length} + | \text{sync offset or burst offset} |$$

All other trigger modes:

$$\text{search length} = 1 * \text{packet length} + 1 \text{ Slot} + | \text{sync offset or burst offset} |$$

If the selected measurement time is higher than the packet length, the following difference is added to the search length:

$$\text{measurement time} - \text{packet length}$$

The numeric suffixes <1|2> are irrelevant for this command.

Parameter

ON | OFF

Example

```
DDEMod:SEAR:TIME:AUTO OFF
```

Selects manual input for the record length

Characteristics

*RST value: ON

SCPI: device-specific

Mode

BT

Remote Commands of the Power Meter Option (K9)

In this section all remote control commands for Power Meter option are described in detail. The abbreviation For details on conventions used in this chapter refer to section "[Notation](#)" on page 6.2 at the beginning of this chapter.

For further information on analyzer or basic settings commands, refer to the corresponding subsystem in "[Remote Control – Description of Analyzer Commands](#)" on page 6.5 or section "Remote Control – Description of Basic Settings Commands".

Subsystems of the Power Meter option (K9)

- "[CALCulate Subsystem \(Power Meter, K9\)](#)" on page 6.270
- "[CALibration Subsystem \(Power Meter, K9\)](#)" on page 6.272
- "[DISPlay Subsystem \(Power Meter, K9\)](#)" on page 6.273
- "[FETCh Subsystem \(Power Meter, K9\)](#)" on page 6.274
- "[READ Subsystem \(Power Meter, K9\)](#)" on page 6.275
- "[SENSe Subsystem \(Power Meter, K9\)](#)" on page 6.276
- "[UNIT Subsystem \(Power Meter, K9\)](#)" on page 6.278

CALCulate Subsystem (Power Meter, K9)

The CALCulate subsystem contains commands for converting instrument data, transforming and carrying out corrections. These functions are carried out subsequent to data acquisition, i.e. following the SENSE subsystem.

The following subsystems are included:

- "CALCulate:PMETer Subsystem" on page 6.270

CALCulate:PMETer Subsystem (Power Meter, K9)

This subsystem controls the instrument settings for power sensor measurements.

Commands of the CALCulate:PMETer Subsystem

- CALCulate<1|2>:PMETer:RELative[:MAGNitude]
- CALCulate<1|2>:PMETer:RELative[:MAGNitude]:AUTO
- CALCulate<1|2>:PMETer:RELative:STATe

CALCulate<1|2>:PMETer:RELative[:MAGNitude]

This command sets the reference value for relative measurements.
The numeric suffixes <1|2> are irrelevant.

Parameter

–200 to 200

Example

```
:CALC:PMET:REL -30
```

Sets the reference value for relative measurements to –30 dBm.

Characteristics

*RST value: 0

SCPI: device-specific

Mode

PSM

CALCulate<1|2>:PMETer:RELative[:MAGNitude]:AUTO

This command takes the current measurement value as reference value for relative measurements.

The numeric suffixes <1|2> are irrelevant.

Parameter

ONCE

Example

```
:CALC:PMET:REL:AUTO ONCE
```

Takes the current measurement value as reference value for relative measurements.

Characteristics

*RST value: –

SCPI: device-specific

Mode

PSM

CALCulate<1|2>:PMETer:RELative:STATe

This command switches between relative and absolute display of the measured power.

The numeric suffixes <1|2> are irrelevant.

Parameter

ON | OFF

Example

```
:CALC:PMET:REL:STAT ON
```

Activates the relative display of the measured value.

Characteristics

*RST value: OFF

SCPI: device-specific

Mode

PSM

CALibration Subsystem (Power Meter, K9)

The CALibration subsystem determines the data for system error correction in the instrument.

The following subsystem is included:

- ["CALibration:PMETer Subsystem"](#) on page 6.272

CALibration:PMETer Subsystem (Power Meter, K9)

The CALibration:PMETer Subsystem determines the error correction data for measurements in the power meter mode.

Commands of the CALibration:PMETer Subsystem

- [CALibration:PMETer:ZERO:AUTO](#)

CALibration:PMETer:ZERO:AUTO

This command starts zeroing of the power sensor.

Parameter

ONCE

Example

```
:CAL:PMET:ZERO:AUTO ONCE;*WAI
```

Starts zeroing and delays the execution of further commands until zeroing is concluded.

Characteristics

*RST value: –

SCPI: device-specific

Mode

PSM

DISPlay Subsystem (Power Meter, K9)

The DISPlay subsystem controls the selection and presentation of textual and graphic information as well as of measurement data on the display.

Commands of the DISPlay Subsystem

- [DISPlay\[:WINDow<1|2>\]:PMETer:STATe](#)

DISPlay[:WINDow<1|2>]:PMETer:STATe

This command switches the bar graph view for power sensor measurement on and off. If the view is switched off, the value for power sensor measurement is displayed in the marker field. The numeric suffixes <1|2> are irrelevant.

Parameter

ON | OFF

Example

```
DISP:PMET:STAT OFF
```

Switches the bar graph view off.

Characteristics

*RST value: ON

SCPI: device-specific

Mode

PSM

FETCh Subsystem (Power Meter, K9)

The FETCh subsystem contains commands for reading out results of complex measurement tasks.

The following subsystem is included:

- ["FETCh:PMETer Subsystem"](#) on page 6.274

FETCh:PMETer Subsystem (Power Meter, K9)

The FETCh:PMETer subsystem contains commands to read measurement results of power sensor measurements without starting the measurement itself.

Commands of the FETCh:PMETer Subsystem

- [FETCh<1|2>:PMETer?](#)

FETCh<1|2>:PMETer?

This command reads the result of the power sensor measurement.

If no measurement has been performed, this command will lead to a query error. This command is a query and therefore has no *RST value.

Example

```
FETC : PMET ?
```

Reads the result of the power sensor measurement.

Characteristics

*RST value: –

SCPI: device-specific

Mode

PSM

READ Subsystem (Power Meter, K9)

The READ subsystem contains commands for starting complex measurement tasks, and for querying the results subsequently.

The following subsystem is included:

- ["READ:PMETer Subsystem"](#) on page 6.275

READ:PMETer Subsystem

This subsystem contains commands to start power sensor measurements and to read the results after the measurement is concluded.

Commands of the READ:PMETer Subsystem

- [READ<1|2>:PMETer?](#)

READ<1|2>:PMETer?

This command starts a power sensor measurement and reads the result after the measurement is concluded.

This command is a query and therefore has no *RST value.

Example

```
READ:PMET?
```

Starts a measurement and read the result.

Characteristics

*RST value: –

SCPI: device-specific

Mode

PSM

SENSe Subsystem (Power Meter, K9)

The SENSe subsystem is organized in several subsystems. The commands of these subsystems directly control device-specific settings, they do not refer to the signal characteristics of the measurement signal.

The SENSe subsystem controls the essential parameters of the analyzer. In accordance with the SCPI standard, the keyword "SENSe" is optional for this reason, which means that it is not necessary to include the SENSe node in command sequences.

The following subsystems are included:

- ["SENSe:PMETer Subsystem"](#) on page 6.276

SENSe:PMETer Subsystem (Power Meter, K9)

This subsystem controls the device settings for power sensor measurements.

Commands of the SENSe:PMETer Subsystem

- [\[SENSe<1|2>:\]PMETer\[:STATe\]](#)
- [\[SENSe<1|2>:\]PMETer:FREQuency](#)
- [\[SENSe<1|2>:\]PMETer:FREQuency:LINK](#)
- [\[SENSe<1|2>:\]PMETer:MTIME](#)

[\[SENSe<1|2>:\]PMETer\[:STATe\]](#)

This command switches the power sensor measurements on or off.
The numeric suffixes <1|2> are irrelevant.

Parameter

ON | OFF

Example

```
PMET ON
```

Switches the power sensor measurements on.

Characteristics

*RST value: OFF

SCPI: device-specific

Mode

PSM

[\[SENSe<1|2>:\]PMETer:FREQuency](#)

This command sets the frequency of the power sensor. The limits f_{\min} and f_{\max} are defined by the power sensor.

The numeric suffixes <1|2> are irrelevant.

Parameter

f_{\min} ... f_{\max}

Example

```
PMET:FREQ 1GHZ
```

Sets the frequency of the power sensor to 1 GHz.

Characteristics

*RST value: 50 MHz

SCPI: device-specific

Mode

PSM

[SENSe<1|2>:]PMETer:FREQuency:LINK

This command sets the frequency coupling of the power sensor.

The numeric suffixes <1|2> are irrelevant.

Parameter

CENTER couples the frequency to the center frequency of the analyzer

MARKer1 couples the frequency to the position of marker 1

OFF switches the frequency coupling off

Example

```
PMET:FREQ:LINK CENT
```

Couples the frequency to the center frequency of the analyzer

Characteristics

*RST value: CENT

SCPI: device-specific

Mode

PSM

[SENSe<1|2>:]PMETer:MTIME

This command sets the measurement duration of the power sensor.

The numeric suffixes <1|2> are irrelevant.

Parameter

SHORT | NORMAl | LONG

Example

```
PMET:MTIM SHOR
```

Sets a short measurement duration for measurements of stationary high power signals.

Characteristics

*RST value: NORM

SCPI: device-specific

Mode

PSM

UNIT Subsystem (Power Meter, K9)

The UNIT subsystem sets the basic unit of the setting parameters.

The following subsystems are included:

- ["UNIT:PMETer Subsystem"](#) on page 6.278

UNIT:PMETer Subsystem (Power Meter, K9)

The UNIT:PMETer subsystem sets the basic unit for power sensor measurement.

Commands of the UNIT:PMETer Subsystem

- [UNIT<1|2>:PMETer:POWer](#)
- [UNIT<1|2>:PMETer:POWer:RATio](#)

UNIT<1|2>:PMETer:POWer

This command selects the unit for absolute power sensor measurement.

Parameter

DBM | WATT | W

Example

```
UNIT:PMET:POW DBM
```

Characteristics

*RST value: DBM

SCPI: conform

Mode

PSM

UNIT<1|2>:PMETer:POWer:RATio

This command selects the unit for relative power sensor measurement.

Parameter

DB | PCT

Example

```
UNIT:PMET:POW DB
```

Characteristics

*RST value: DB

SCPI: conform

Mode

PSM

Remote Commands of the Cable TV Measurements Option (K20)

This chapter describes the remote commands for the Cable TV Measurement option (K20). The abbreviation CATV stands for the Cable TV operating mode. For details on conventions used in this chapter refer to section "Notation" on page 6.2 at the beginning of this chapter.

For further information on analyzer or basic settings commands, refer to the corresponding subsystem in "Remote Control – Description of Analyzer Commands" on page 6.5 or section "Remote Control – Description of Basic Settings Commands".

This option is available from firmware version 1.30.

Subsystems of the cable TV analyzer option (K20)

- "ABORt Subsystem (CATV, K20)" on page 6.280
- "CALCulate Subsystem (CATV, K20)" on page 6.281
- "CONFigure Subsystem (CATV, K20)" on page 6.331
- "DISPlay Subsystem (CATV, K20)" on page 6.335
- "FORMat Subsystem (CATV, K20)" on page 6.340
- "INITiate Subsystem (CATV, K20)" on page 6.341
- "INPut Subsystem (CATV, K20)" on page 6.342
- "INSTrument Subsystem (CATV, K20)" on page 6.343
- "MMEMory Subsystem (CATV, K20)" on page 6.344
- "SENSe Subsystem (CATV, K20)" on page 6.345
- "SETup:TV Subsystem (CATV, K20)" on page 6.365
- "SOURce Subsystem (CATV, K20)" on page 6.367
- "STATus Subsystem (CATV, K20)" on page 6.368
- "TRACe Subsystem (CATV, K20)" on page 6.373
- "TRIGger Subsystem (CATV, K20)" on page 6.374
- "UNIT Subsystem (CATV, K20)" on page 6.377

ABORt Subsystem (CATV, K20)

The ABORt subsystem contains the commands for aborting triggered actions.

Commands of the ABORt Subsystem

- [ABORt](#)

ABORt

For details refer to "[ABORt](#)" on page 6.5.

CALCulate Subsystem (CATV, K20)

The CALCulate subsystem contains commands for converting instrument data, transforming and carrying out corrections. These functions are carried out subsequent to data acquisition, i.e. following the SENSE subsystem.

The following subsystems are included:

- ["CALCulate:ATV Subsystem \(CATV, K20\)"](#) on page 6.281
- ["CALCulate:DELTamarker Subsystem \(CATV, K20\)"](#) on page 6.305
- ["CALCulate:DTV Subsystem \(CATV, K20\)"](#) on page 6.307
- ["CALCulate:MARKer Subsystem \(CATV, K20\)"](#) on page 6.323
- ["CALCulate: STATistics Subsystem \(CATV, K20\)"](#) on page 6.328
- ["CALCulate:UNIT Subsystem \(CATV, K20\)"](#) on page 6.328

CALCulate:ATV Subsystem (CATV, K20)

The CALCulate:ATV subsystem contains commands to analyze the analog TV measurement data.

The following subsystems are included:

- ["CALCulate:ATV:LIMit Subsystem \(CATV, K20\)"](#) on page 6.281
- ["CALCulate:ATV:RESult Subsystem \(CATV, K20\)"](#) on page 6.300
- ["CALCulate:ATV:UNIT:POWer Subsystem \(CATV, K20\)"](#) on page 6.304

CALCulate:ATV:LIMit Subsystem (CATV, K20)

The CALCulate:ATV:LIMit subsystem sets and checks the measurement limits for analog TV measurements.

The following subsystem is included:

- ["CALCulate:ATV:LIMit:RESult Subsystem \(CATV, K20\)"](#) on page 6.290

Commands of the CALCulate:ATV:LIMit Subsystem

- [CALCulate<1|2>:ATV:LIMit:CARRiers:S1IFoffset:LOWer](#)
- [CALCulate<1|2>:ATV:LIMit:CARRiers:S1IFoffset:UPPer](#)
- [CALCulate<1|2>:ATV:LIMit:CARRiers:S1PRelative:LOWer](#)
- [CALCulate<1|2>:ATV:LIMit:CARRiers:S1PRelative:UPPer](#)
- [CALCulate<1|2>:ATV:LIMit:CARRiers:S2IFoffset:LOWer](#)
- [CALCulate<1|2>:ATV:LIMit:CARRiers:S2IFoffset:UPPer](#)
- [CALCulate<1|2>:ATV:LIMit:CARRiers:S2PRelative:LOWer](#)
- [CALCulate<1|2>:ATV:LIMit:CARRiers:S2PRelative:UPPer](#)
- [CALCulate<1|2>:ATV:LIMit:CARRiers:VCFoffset:LOWer](#)
- [CALCulate<1|2>:ATV:LIMit:CARRiers:VCFoffset:UPPer](#)
- [CALCulate<1|2>:ATV:LIMit:CARRiers:VCPabsolute:LOWer](#)
- [CALCulate<1|2>:ATV:LIMit:CARRiers:VCPabsolute:UPPer](#)

- CALCulate<1|2>:ATV:LIMit:CN:CN[:LOWer]
- CALCulate<1|2>:ATV:LIMit:CSO:CSO[:LOWer]
- CALCulate<1|2>:ATV:LIMit:CTB:CTB[:LOWer]
- CALCulate<1|2>:ATV:LIMit:HUM:HUM:LOWer
- CALCulate<1|2>:ATV:LIMit:HUM:HUM:UPPer
- CALCulate<1|2>:ATV:LIMit:VMODulation:MDEPth:LOWer
- CALCulate<1|2>:ATV:LIMit:VMODulation:MDEPth:UPPer
- CALCulate<1|2>:ATV:LIMit:VMODulation:RPC:LOWer
- CALCulate<1|2>:ATV:LIMit:VMODulation:RPC:UPPer
- CALCulate<1|2>:ATV:LIMit:VMODulation:VCPower:LOWer
- CALCulate<1|2>:ATV:LIMit:VMODulation:VCPower:UPPer

CALCulate<1|2>:ATV:LIMit:CARRiers:S1IFoffset:LOWer

This command defines the lower frequency offset limit of the sound carrier 1.
The numeric suffixes <1|2> are irrelevant.

Parameter

<numeric_value> in Hz: $\pm 999,999$ Hz

Example

```
CALC:ATV:LIM:CARR:S1IF:LOW 1KHZ
```

Sets the lower frequency offset limit for sound carrier 1 to 1 kHz.

Characteristics

RST value: -10 kHz

SCPI: device-specific

Mode

CATV

CALCulate<1|2>:ATV:LIMit:CARRiers:S1IFoffset:UPPer

This command defines the upper frequency offset limit of the sound carrier 1.
The numeric suffixes <1|2> are irrelevant.

Parameter

<numeric_value> in Hz: $\pm 999,999$ Hz

Example

```
CALC:ATV:LIM:CARR:S1IF:UPP 10KHZ
```

Sets the upper frequency offset limit for sound carrier 1 to 10 kHz.

Characteristics

RST value: 10 kHz

SCPI: device-specific

Mode

CATV

CALCulate<1|2>:ATV:LIMit:CARRiers:S1PRelative:LOWer

This command defines the relative lower power limit of the sound carrier 1.
The numeric suffixes <1|2> are irrelevant.

Parameter

<numeric_value> in dB: ± 200 dB

Example

```
CALC:ATV:LIM:CARR:S1PR:LOW -10
```

Sets the relative lower power limit for sound carrier 1 to -10 dB.

Characteristics

RST value: -20 dB

SCPI: device-specific

Mode

CATV

CALCulate<1|2>:ATV:LIMit:CARRiers:S1PRelative:UPPer

This command defines the relative upper power limit of the sound carrier 1.
The numeric suffixes <1|2> are irrelevant.

Parameter

<numeric_value> in dB: ± 200 dB

Example

```
CALC:ATV:LIM:CARR:S1PR:UPP 20
```

Sets the relative lower power limit for sound carrier 1 to 20 dB.

Characteristics

RST value: -6 dB

SCPI: device-specific

Mode

CATV

CALCulate<1|2>:ATV:LIMit:CARRiers:S2IFoffset:LOWer

This command defines the lower frequency offset limit of the sound carrier 2.
The numeric suffixes <1|2> are irrelevant.

Parameter

<numeric_value> in Hz: $\pm 999,999$ Hz

Example

```
CALC:ATV:LIM:CARR:S2IF:LOW 1KHZ
```

Sets the lower frequency offset limit for sound carrier 2 to 1 kHz.

Characteristics

RST value: -10 kHz

SCPI: device-specific

Mode

CATV

CALCulate<1|2>:ATV:LIMit:CARRiers:S2IFoffset:UPPer

This command defines the upper frequency offset limit of the sound carrier 2.
The numeric suffixes <1|2> are irrelevant.

Parameter

<numeric_value> in Hz: $\pm 999,999$ Hz

Example

```
CALC:ATV:LIM:CARR:S2IF:UPP 500000HZ
```

Sets the upper frequency offset limit for sound carrier 2 to 500 kHz.

Characteristics

RST value: 10 kHz

SCPI: device-specific

Mode

CATV

CALCulate<1|2>:ATV:LIMit:CARRiers:S2PRelative:LOWer

This command defines the relative lower power limit of the sound carrier 2.
The numeric suffixes <1|2> are irrelevant.

Parameter

<numeric_value> in dB: ± 200 dB

Example

```
CALC:ATV:LIM:CARR:S2PR:LOW -20
```

Sets the relative lower power limit for sound carrier 2 to -20 dB.

Characteristics

RST value: -27 dB

SCPI: device-specific

Mode

CATV

CALCulate<1|2>:ATV:LIMit:CARRiers:S2PRelative:UPPer

This command defines the relative upper power limit of the sound carrier 2.
The numeric suffixes <1|2> are irrelevant.

Parameter

<numeric_value> in dB: ± 200 dB

Example

```
CALC:ATV:LIM:CARR:S2PR:UPP -14
```

Sets the relative lower power limit for sound carrier 2 to -14 dB.

Characteristics

RST value: -13 dB

SCPI: device-specific

Mode

CATV

CALCulate<1|2>:ATV:LIMit:CARRiers:VCFoffset:LOWer

This command defines the lower frequency offset limit of the vision carrier.
The numeric suffixes <1|2> are irrelevant.

Parameter

<numeric_value> in Hz: $\pm 999,999$ Hz

Example

```
CALC:ATV:LIM:CARR:VCF:LOW -1KHZ
```

Sets the lower frequency offset limit of the vision carrier to -1 kHz.

Characteristics

RST value: -10 kHz

SCPI: device-specific

Mode

CATV

CALCulate<1|2>:ATV:LIMit:CARRiers:VCFoffset:UPPer

This command defines the upper frequency offset limit of the vision carrier.
The numeric suffixes <1|2> are irrelevant.

Parameter

<numeric_value> in Hz: $\pm 999,999$ Hz

Example

```
CALC:ATV:LIM:CARR:VCF:UPP 1KHZ
```

Sets the upper frequency offset limit of the vision carrier to 1 kHz.

Characteristics

RST value: 10 kHz

SCPI: device-specific

Mode

CATV

CALCulate<1|2>:ATV:LIMit:CARRiers:VCPabsolute:LOWer

This command defines the absolute lower limit for the vision carrier.
The numeric suffixes <1|2> are irrelevant.

Parameter

<numeric_value> in dBm: ± 200 dB

Example

```
CALC:ATV:LIM:CARR:VCP:LOW -40
```

Sets the absolute lower limit of the vision carrier to -40 dBm.

Characteristics

RST value: -60 dBm

SCPI: device-specific

Mode

CATV

CALCulate<1|2>:ATV:LIMit:CARRiers:VCPabsolute:UPPer

This command defines the absolute upper limit for the vision carrier.
The numeric suffixes <1|2> are irrelevant.

Parameter

<numeric_value> in dBm: ± 200 dB

Example

```
CALC:ATV:LIM:CARR:VCP:UPP -20
```

Sets the absolute lower limit of the vision carrier to -20 dBm.

Characteristics

RST value: -30 dBm

SCPI: device-specific

Mode

CATV

CALCulate<1|2>:ATV:LIMit:CN:CN[:LOWer]

This command defines the lower limit for the carrier-to-noise ratio.
The numeric suffixes <1|2> are irrelevant.

Parameter

<numeric_value> in dB: ± 200 dB

Example

```
CALC:ATV:LIM:CN:CN 10
```

Sets the lower limit of the carrier-to-noise ratio to 10 dB.

Characteristics

RST value: 40 dB

SCPI: device-specific

Mode

CATV

CALCulate<1|2>:ATV:LIMit:CSO:CSO[:LOWer]

This command defines the lower limit for the carrier-to-second order beat ratio.
The numeric suffixes <1|2> are irrelevant.

Parameter

<numeric_value> in dB: ± 200 dB

Example

```
CALC:ATV:LIM:CSO:CSO 10
```

Sets the lower limit of the carrier-to-second order beat ratio to 10 dB.

Characteristics

RST value: 0 dB

SCPI: device-specific

Mode

CATV

CALCulate<1|2>:ATV:LIMit:CTB:CTB[:LOWer]

This command defines the lower limit for the carrier-to-composite triple beat ratio. The numeric suffixes <1|2> are irrelevant.

Parameter

<numeric_value> in dB: ± 200 dB

Example

```
CALC:ATV:LIM:CTB:CTB 10
```

Sets the lower limit of the carrier-to-second order beat ratio to 10 dB.

Characteristics

RST value: 0 dB

SCPI: device-specific

Mode

CATV

CALCulate<1|2>:ATV:LIMit:HUM:HUM:LOWer

This command defines the lower limit for the hum values. The numeric suffixes <1|2> are irrelevant.

Parameter

<numeric_value> in dB: ± 60 dB

Example

```
CALC:ATV:LIM:HUM:HUM:LOW 10
```

Sets the lower limit for the hum values to 10 dB.

Characteristics

RST value: 40 dB

SCPI: device-specific

Mode

CATV

CALCulate<1|2>:ATV:LIMit:HUM:HUM:UPPer

This command defines the upper limit for the hum values. The numeric suffixes <1|2> are irrelevant.

Parameter

<numeric_value> in PCT: 0.1% to 100.000%

Example

```
CALC:ATV:LIM:HUM:HUM:UPP 6
```

Sets the upper limit of the hum values to 6%.

Characteristics

RST value: 1%

SCPI: device-specific

Mode

CATV

CALCulate<1|2>:ATV:LIMit:VMODulation:MDEPth:LOWer

This command defines the lower modulation depth limit for the vision modulation.
The numeric suffixes <1|2> are irrelevant.

Parameter

<numeric_value> in %: 0% to 100%

Example

```
CALC:ATV:LIM:VMOD:MDEP:LOW 0.5
```

Sets the lower modulation depth limit of the vision modulation to 0.5%.

Characteristics

RST value: 0%

SCPI: device-specific

Mode

CATV

CALCulate<1|2>:ATV:LIMit:VMODulation:MDEPth:UPPer

This command defines the upper modulation depth limit for the vision modulation.
The numeric suffixes <1|2> are irrelevant.

Parameter

<numeric_value> in %: 0% to 100%

Example

```
CALC:ATV:LIM:VMOD:MDEP:UPP 30
```

Sets the upper modulation depth limit of the vision modulation to 30%.

Characteristics

RST value: 100%

SCPI: device-specific

Mode

CATV

CALCulate<1|2>:ATV:LIMit:VMODulation:RPC:LOWer

This command defines the lower limit for the residual picture in the Vision Modulation measurement.

The numeric suffixes <1|2> are irrelevant.

Parameter

<numeric_value> in %: 0% to 100%

Example

```
CALC:ATV:LIM:VMOD:RPC:LOW 0.5
```

Sets the lower limit for the residual picture to 0.5%.

Characteristics

RST value: 0%

SCPI: device-specific

Mode

CATV

CALCulate<1|2>:ATV:LIMit:VMODulation:RPC:UPPer

This command defines the upper limit for the residual picture in the Vision Modulation measurement.

The numeric suffixes <1|2> are irrelevant.

Parameter

<numeric_value> in %: 0% to 100%

Example

```
CALC:ATV:LIM:VMOD:RPC:UPP 80
```

Sets the upper limit for the residual picture to 80%.

Characteristics

RST value: 100%

SCPI: device-specific

Mode

CATV

CALCulate<1|2>:ATV:LIMit:VMODulation:VCPower:LOWer

This command defines the lower vision carrier power limit in the Vision Modulation measurement.

The numeric suffixes <1|2> are irrelevant.

Parameter

<numeric_value> in dBm: ± 200 dBm

Example

```
CALC:ATV:LIM:VMOD:VCP:LOW -50
```

Sets the lower vision carrier power limit to -50 dBm.

Characteristics

RST value: -60 dBm

SCPI: device-specific

Mode

CATV

CALCulate<1|2>:ATV:LIMit:VMODulation:VCPower:UPPer

This command defines the upper vision carrier power limit in the Vision Modulation measurement.

The numeric suffixes <1|2> are irrelevant.

Parameter

<numeric_value> in dBm: ± 200 dBm

Example

```
CALC:ATV:LIM:VMOD:VCP:UPP 20
```

Sets the upper vision carrier power limit to 20 dBm.

Characteristics

RST value: 30 dBm

SCPI: device-specific

Mode

CATV

CALCulate:ATV:LIMit:RESult Subsystem (CATV, K20)

The CALCulate:ATV:LIMit:RESult subsystem checks the measurement limits for analog TV measurements.

Commands of the CALCulate:ATV:LIMit:RESult Subsystem

- CALCulate<1|2>:ATV:LIMit:RESult:CARRiers:S1IFoffset:LOWer?
- CALCulate<1|2>:ATV:LIMit:RESult:CARRiers:S1IFoffset:UPPer?
- CALCulate<1|2>:ATV:LIMit:RESult:CARRiers:S1PRelative:LOWer?
- CALCulate<1|2>:ATV:LIMit:RESult:CARRiers:S1PRelative:UPPer?
- CALCulate<1|2>:ATV:LIMit:RESult:CARRiers:S2IFoffset:LOWer?
- CALCulate<1|2>:ATV:LIMit:RESult:CARRiers:S2IFoffset:UPPer?
- CALCulate<1|2>:ATV:LIMit:RESult:CARRiers:S2PRelative:LOWer?
- CALCulate<1|2>:ATV:LIMit:RESult:CARRiers:S2PRelative:UPPer?
- CALCulate<1|2>:ATV:LIMit:RESult:CARRiers:VCFoffset:LOWer?
- CALCulate<1|2>:ATV:LIMit:RESult:CARRiers:VCFoffset:UPPer?
- CALCulate<1|2>:ATV:LIMit:RESult:CARRiers:VCPabsolute:LOWer?
- CALCulate<1|2>:ATV:LIMit:RESult:CARRiers:VCPabsolute:UPPer?
- CALCulate<1|2>:ATV:LIMit:RESult:CN:CN[:LOWer]?
- CALCulate<1|2>:ATV:LIMit:RESult:CSO:CSO[:LOWer]?
- CALCulate<1|2>:ATV:LIMit:RESult:CTB:CTB[:LOWer]?
- CALCulate<1|2>:ATV:LIMit:RESult:HUM:HUM:LOWer?
- CALCulate<1|2>:ATV:LIMit:RESult:HUM:HUM:UPPer?
- CALCulate<1|2>:ATV:LIMit:RESult:VMODulation:MDEPth:LOWer?
- CALCulate<1|2>:ATV:LIMit:RESult:VMODulation:MDEPth:UPPer?
- CALCulate<1|2>:ATV:LIMit:RESult:VMODulation:RPC:LOWer?
- CALCulate<1|2>:ATV:LIMit:RESult:VMODulation:RPC:UPPer?
- CALCulate<1|2>:ATV:LIMit:RESult:VMODulation:VCPower:LOWer?
- CALCulate<1|2>:ATV:LIMit:RESult:VMODulation:VCPower:UPPer?

CALCulate<1|2>:ATV:LIMit:RESult:CARRiers:S1IFoffset:LOWer?

This command performs a lower limit check for the frequency offset of the sound carrier 1.

The numeric suffixes <1|2> are irrelevant.

This command is a query and therefore has no *RST value.

Example

```
CALC:ATV:LIM:CARR:S1IF:LOW 1KHZ
```

Sets the lower frequency offset limit for sound carrier 1 to 1 kHz.

```
INIT;*WAI
```

Starts a new measurement and waits for the sweep end.

```
CALC:ATV:LIM:RES:CARR:S1IF:LOW?
```

Performs a lower limit check for the frequency offset of the sound carrier 1.

Characteristics

RST value: –

SCPI: device-specific

Mode

CATV

CALCulate<1|2>:ATV:LIMit:RESult:CARRiers:S1IFoffset:UPPer?

This command performs an upper limit check for the frequency offset of the sound carrier 1.

The numeric suffixes <1|2> are irrelevant.

This command is a query and therefore has no *RST value.

Example

```
CALC:ATV:LIM:CARR:S1IF:UPP 10KHZ
```

Sets the upper frequency offset limit for sound carrier 1 to 10 kHz.

```
INIT;*WAI
```

Starts a new measurement and waits for the sweep end.

```
CALC:ATV:LIM:RES:CARR:S1IF:UPP?
```

Performs an upper limit check for the frequency offset of the sound carrier 1.

Characteristics

RST value: –

SCPI: device-specific

Mode

CATV

CALCulate<1|2>:ATV:LIMit:RESult:CARRiers:S1PRelative:LOWer?

This command performs a lower limit check for the relative power of the sound carrier 1.

The numeric suffixes <1|2> are irrelevant.

This command is a query and therefore has no *RST value.

Example

```
CALC:ATV:LIM:CARR:S1PR:LOW -10
```

Sets the relative lower power limit for sound carrier 1 to –10 dB.

```
INIT;*WAI
```

Starts a new measurement and waits for the sweep end.

```
CALC:ATV:LIM:RES:CARR:S1PR:LOW?
```

Performs a lower limit check for the relative power of the sound carrier 1.

Characteristics

RST value: –

SCPI: device-specific

Mode

CATV

CALCulate<1|2>:ATV:LIMit:RESult:CARRiers:S1PRelative:UPPer?

This command performs an upper limit check for the relative power of the sound carrier 1.

The numeric suffixes <1|2> are irrelevant.

This command is a query and therefore has no *RST value.

Example

```
CALC:ATV:LIM:CARR:S1PR:UPP 20
```

Sets the relative lower power limit for sound carrier 1 to 20 dB.

```
INIT;*WAI
```

Starts a new measurement and waits for the sweep end.

```
CALC:ATV:LIM:RES:CARR:S1PR:UPP?
```

Performs an upper limit check for the relative power of the sound carrier 1.

Characteristics

RST value: –

SCPI: device-specific

Mode

CATV

CALCulate<1|2>:ATV:LIMit:RESult:CARRiers:S2IFoffset:LOWer?

This command performs a lower limit check for the frequency offset of the sound carrier 2.

The numeric suffixes <1|2> are irrelevant.

This command is a query and therefore has no *RST value.

Example

```
CALC:ATV:LIM:CARR:S2IF:LOW 1KHZ
```

Sets the lower frequency offset limit for sound carrier 2 to 1 kHz.

```
INIT;*WAI
```

Starts a new measurement and waits for the sweep end.

```
CALC:ATV:LIM:RES:CARR:S2IF:LOW?
```

Performs a lower limit check for the frequency offset of the sound carrier 2.

Characteristics

RST value: –

SCPI: device-specific

Mode

CATV

CALCulate<1|2>:ATV:LIMit:RESult:CARRiers:S2IFoffset:UPPer?

This command performs an upper limit check for the frequency offset limit of the sound carrier 2. The numeric suffixes <1|2> are irrelevant. This command is a query and therefore has no *RST value.

Example

```
CALC:ATV:LIM:CARR:S2IF:UPP 500000HZ
```

Sets the upper frequency offset limit for sound carrier 2 to 500 kHz.

```
INIT;*WAI
```

Starts a new measurement and waits for the sweep end.

```
CALC:ATV:LIM:RES:CARR:S2IF:UPP?
```

Performs an upper limit check for the frequency offset limit of the sound carrier 2.

Characteristics

RST value: –

SCPI: device-specific

Mode

CATV

CALCulate<1|2>:ATV:LIMit:RESult:CARRiers:S2PRelative:LOWer?

This command performs a lower limit check for the relative power of the sound carrier 2. The numeric suffixes <1|2> are irrelevant. This command is a query and therefore has no *RST value.

Example

```
CALC:ATV:LIM:CARR:S2PR:LOW -20
```

Sets the relative lower power limit for sound carrier 2 to –20 dB.

```
INIT;*WAI
```

Starts a new measurement and waits for the sweep end.

```
CALC:ATV:LIM:RES:CARR:S2PR:LOW?
```

Performs a lower limit check for the relative power of the sound carrier 2.

Characteristics

RST value: –

SCPI: device-specific

Mode

CATV

CALCulate<1|2>:ATV:LIMit:RESult:CARRiers:S2PRelative:UPPer?

This command performs an upper limit check for the relative power of the sound carrier 2. The numeric suffixes <1|2> are irrelevant. This command is a query and therefore has no *RST value.

Example

```
CALC:ATV:LIM:CARR:S2PR:UPP -14
```

Sets the relative lower power limit for sound carrier 2 to –14 dB.

```
INIT;*WAI
```

Starts a new measurement and waits for the sweep end.

```
CALC:ATV:LIM:RES:CARR:S2PR:UPP?
```

Performs an upper limit check for the relative power of the sound carrier 2.

Characteristics

RST value: –

SCPI: device-specific

Mode

CATV

CALCulate<1|2>:ATV:LIMit:RESult:CARRiers:VCFoffset:LOWer?

This command performs a lower limit check for the frequency offset of the vision carrier.

The numeric suffixes <1|2> are irrelevant.

This command is a query and therefore has no *RST value.

Example

```
CALC:ATV:LIM:CARR:VCF:LOW -1KHZ
```

Sets the lower frequency offset limit of the vision carrier to –1 kHz.

```
INIT;*WAI
```

Starts a new measurement and waits for the sweep end.

```
CALC:ATV:LIM:RES:CARR:VCF:LOW?
```

Performs a lower limit check for the frequency offset of the vision carrier.

Characteristics

RST value: –

SCPI: device-specific

Mode

CATV

CALCulate<1|2>:ATV:LIMit:RESult:CARRiers:VCFoffset:UPPer?

This command performs an upper limit check for the frequency offset of the vision carrier.

The numeric suffixes <1|2> are irrelevant.

This command is a query and therefore has no *RST value.

Example

```
CALC:ATV:LIM:CARR:VCF:UPP 1KHZ
```

Sets the upper frequency offset limit of the vision carrier to 1 kHz.

```
INIT;*WAI
```

Starts a new measurement and waits for the sweep end.

```
CALC:ATV:LIM:RES:CARR:VCF:UPP?
```

Performs an upper limit check for the frequency offset of the vision carrier.

Characteristics

RST value: –

SCPI: device-specific

Mode

CATV

CALCulate<1|2>:ATV:LIMit:RESult:CARRiers:VCPabsolute:LOWer?

This command performs a lower limit check for the absolute vision carrier power.
The numeric suffixes <1|2> are irrelevant.
This command is a query and therefore has no *RST value.

Example

```
CALC:ATV:LIM:CARR:VCP:LOW -40
```

Sets the absolute lower limit of the vision carrier to –40 dBm.

```
INIT;*WAI
```

Starts a new measurement and waits for the sweep end.

```
CALC:ATV:LIM:RES:CARR:VCP:LOW?
```

Performs a lower limit check for the absolute vision carrier power.

Characteristics

RST value: –

SCPI: device-specific

Mode

CATV

CALCulate<1|2>:ATV:LIMit:RESult:CARRiers:VCPabsolute:UPPer?

This command performs an upper limit check for the absolute vision carrier power.
The numeric suffixes <1|2> are irrelevant.
This command is a query and therefore has no *RST value.

Example

```
CALC:ATV:LIM:CARR:VCP:UPP -20
```

Sets the absolute lower limit of the vision carrier to –20 dBm.

```
INIT;*WAI
```

Starts a new measurement and waits for the sweep end.

```
CALC:ATV:LIM:RES:CARR:VCP:UPP?
```

Performs an upper limit check for the absolute vision carrier power.

Characteristics

RST value: –

SCPI: device-specific

Mode

CATV

CALCulate<1|2>:ATV:LIMit:RESult:CN:CN[:LOWer]?

This command performs a lower limit check for the carrier-to-noise ratio.
The numeric suffixes <1|2> are irrelevant.
This command is a query and therefore has no *RST value.

Example

```
CALC:ATV:LIM:CN:CN 10
```

Sets the lower limit of the carrier-to-noise ratio to 10 dB.

```
INIT;*WAI
```

Starts a new measurement and waits for the sweep end.

```
CALC:ATV:LIM:RES:CN:CN?
```

Performs a lower limit check for the carrier-to-noise ratio.

Characteristics

RST value: –

SCPI: device-specific

Mode

CATV

CALCulate<1|2>:ATV:LIMit:RESult:CSO:CSO[:LOWer]?

This command performs a lower limit check for the carrier-to-second order beat ratio.

The numeric suffixes <1|2> are irrelevant.

This command is a query and therefore has no *RST value.

Example

```
CALC:ATV:LIM:CSO:CSO 10
```

Sets the lower limit of the carrier-to-second order beat ratio to 10 dB.

```
INIT;*WAI
```

Starts a new measurement and waits for the sweep end.

```
CALC:ATV:LIM:RES:CSO:CSO?
```

Performs a lower limit check for the carrier-to-second order beat ratio.

Characteristics

RST value: –

SCPI: device-specific

Mode

CATV

CALCulate<1|2>:ATV:LIMit:RESult:CTB:CTB[:LOWer]?

This command performs a lower limit check for the carrier-to-composite triple beat ratio.

The numeric suffixes <1|2> are irrelevant.

This command is a query and therefore has no *RST value.

Example

```
CALC:ATV:LIM:CTB:CTB 10
```

Sets the lower limit of the carrier-to-second order beat ratio to 10 dB.

```
INIT;*WAI
```

Starts a new measurement and waits for the sweep end.

```
CALC:ATV:LIM:RES:CTB:CTB?
```

Performs a lower limit check for the carrier-to-composite triple beat ratio.

Characteristics

RST value: –

SCPI: device-specific

Mode

CATV

CALCulate<1|2>:ATV:LIMit:RESult:HUM:HUM:LOWer?

This command performs a lower limit check for the hum values.
 The numeric suffixes <1|2> are irrelevant.
 This command is a query and therefore has no *RST value.

Example

```
CALC:ATV:LIM:HUM:HUM:LOW 10
```

Sets the lower limit for the hum values to 10 dB.

```
INIT;*WAI
```

Starts a new measurement and waits for the sweep end.

```
CALC:ATV:LIM:RES:HUM:HUM:LOW?
```

Performs a lower limit check for the hum values.

Characteristics

RST value: –

SCPI: device-specific

Mode

CATV

CALCulate<1|2>:ATV:LIMit:RESult:HUM:HUM:UPPer?

This command performs an upper limit check for the hum values.
 The numeric suffixes <1|2> are irrelevant.
 This command is a query and therefore has no *RST value.

Example

```
CALC:ATV:LIM:HUM:HUM:UPP 6
```

Sets the upper limit of the hum values to 6%.

```
INIT;*WAI
```

Starts a new measurement and waits for the sweep end.

```
CALC:ATV:LIM:RES:HUM:HUM:UPP?
```

Performs an upper limit check for the hum values.

Characteristics

RST value: –

SCPI: device-specific

Mode

CATV

CALCulate<1|2>:ATV:LIMit:RESult:VMODulation:MDEPth:LOWer?

This command performs a lower limit check for the modulation depth of the Vision Modulation measurement.

The numeric suffixes <1|2> are irrelevant.

This command is a query and therefore has no *RST value.

Example

```
CALC:ATV:LIM:VMOD:MDEP:LOW 0.5
```

Sets the lower modulation depth limit of the vision modulation to 0.5%.

```
INIT;*WAI
```

Starts a new measurement and waits for the sweep end.

CALC:ATV:LIM:RES:VMOD:MDEP:LOW?

Performs a lower limit check for the modulation depth of the Vision Modulation measurement.

Characteristics

RST value: –

SCPI: device-specific

Mode

CATV

CALCulate<1|2>:ATV:LIMit:RESult:VMODulation:MDEPth:UPPer?

This command performs an upper limit check for the modulation depth of the Vision Modulation measurement.

The numeric suffixes <1|2> are irrelevant.

This command is a query and therefore has no *RST value.

Example

CALC:ATV:LIM:VMOD:MDEP:UPP 30

Sets the upper modulation depth limit of the vision modulation to 30%.

INIT;*WAI

Starts a new measurement and waits for the sweep end.

CALC:ATV:LIM:RES:VMOD:MDEP:UPP?

Performs an upper limit check for the modulation depth of the Vision Modulation measurement.

Characteristics

RST value: –

SCPI: device-specific

Mode

CATV

CALCulate<1|2>:ATV:LIMit:RESult:VMODulation:RPC:LOWer?

This command performs a lower limit check for the residual picture in the Vision Modulation measurement.

The numeric suffixes <1|2> are irrelevant.

This command is a query and therefore has no *RST value.

Example

CALC:ATV:LIM:VMOD:RPC:LOW 0.5

Sets the lower limit for the residual picture to 75%.

INIT;*WAI

Starts a new measurement and waits for the sweep end.

CALC:ATV:LIM:RES:VMOD:RPC:LOW?

Performs a lower limit check for the residual picture in the Vision Modulation measurement.

Characteristics

RST value: –

SCPI: device-specific

Mode

CATV

CALCulate<1|2>:ATV:LIMit:RESult:VMODulation:RPC:UPPer?

This command performs an upper limit check for the residual picture in the Vision Modulation measurement.

The numeric suffixes <1|2> are irrelevant.

This command is a query and therefore has no *RST value.

Example

```
CALC:ATV:LIM:VMOD:RPC:UPP 80
```

Sets the upper limit for the residual picture to 80%.

```
INIT;*WAI
```

Starts a new measurement and waits for the sweep end.

```
CALC:ATV:LIM:RES:VMOD:RPC:UPP?
```

Performs an upper limit check for the residual picture in the Vision Modulation measurement.

Characteristics

RST value: –

SCPI: device-specific

Mode

CATV

CALCulate<1|2>:ATV:LIMit:RESult:VMODulation:VCPower:LOWer?

This command performs a lower limit check for the vision carrier power in the Vision Modulation measurement.

The numeric suffixes <1|2> are irrelevant.

This command is a query and therefore has no *RST value.

Example

```
CALC:ATV:LIM:VMOD:VCP:LOW -50
```

Sets the lower vision carrier power limit to 10 dBm.

```
INIT;*WAI
```

Starts a new measurement and waits for the sweep end.

```
CALC:ATV:LIM:RES:VMOD:VCP:LOW?
```

Performs a lower limit check for the vision carrier power in the Vision Modulation measurement.

Characteristics

RST value: –

SCPI: device-specific

Mode

CATV

CALCulate<1|2>:ATV:LIMit:RESult:VMODulation:VCPower:UPPer?

This command performs an upper limit check for the vision carrier power in the Vision Modulation measurement.

The numeric suffixes <1|2> are irrelevant.

This command is a query and therefore has no *RST value.

Example

```
CALC:ATV:LIM:VMOD:VCP:UPP 20
```

Sets the upper vision carrier power limit to 20 dBm.

INIT; *WAI

Starts a new measurement and waits for the sweep end.

CALC:ATV:LIM:RES:VMOD:VCP:UPP?

Performs an upper limit check for the vision carrier power in the Vision Modulation measurement.

Characteristics

RST value: –

SCPI: device-specific

Mode

CATV

CALCulate:ATV:RESult Subsystem (CATV, K20)

The CALCulate:ATV:RESult subsystem displays the measurement results for analog TV measurements.

Commands of the CALCulate:ATV:RESult Subsystem

- CALCulate<1|2>:ATV:RESult:CARRiers?
- CALCulate<1|2>:ATV:RESult:CN?
- CALCulate<1|2>:ATV:RESult:CSO?
- CALCulate<1|2>:ATV:RESult:CTB?
- CALCulate<1|2>:ATV:RESult:HUM?
- CALCulate<1|2>:ATV:RESult:VMODulation?

CALCulate<1|2>:ATV:RESult:CARRiers?

This command reads the measurement values (power, frequency) of the Carrier Power measurements.

The numeric suffixes <1|2> are irrelevant.

This command is a query only and thus has no *RST value.

Parameter

VCPabsolute	vision carrier power absolute
VCOffset	vision carrier frequency offset
S1PRelative	sound carrier 1 power relative
S1FOffset	sound carrier 1 intercarrier frequency offset
S2PRelative	sound carrier 2 power relative
S2FOffset	sound carrier 2 intercarrier frequency offset
ALL	Results of all measurements above, separated by commas. If a measurement result is not valid, a comma will be output only.

Example

CONF:ATV:MEAS CARR

Configures the analog TV Carrier Power measurement.

INIT; *WAI

Starts a new measurement and waits for the sweep end.

CALC:ATV:RES:CARR? VCF

Reads the result of the vision carrier frequency offset measurement.

or

CALC:ATV:RES:CARR? ALL

Reads all measured values.

Characteristics

RST value: –

SCPI: device-specific

Mode

CATV

CALCulate<1|2>:ATV:RESult:CN?

This command reads the measurement values of the carrier-to-noise ratio measurements.

The numeric suffixes <1|2> are irrelevant.

This command is a query only and thus has no *RST value.

Parameter

RPOWer reference power

NRBW noise reference bandwidth

NFCorrection noise floor correction

MFRelative measurement frequency (relative)

CN carrier-to-noise ratio

ALL Results of all measurements above, separated by commas.
If a measurement result is not valid, a comma will be output only.

Example

CONF:ATV:MEAS CN

Configures the analog TV carrier-to-noise ratio measurement.

INIT;*WAI

Starts a new measurement and waits for the sweep end.

CALC:ATV:RES:CN? NFC

Reads the result of the noise floor correction measurement.

or

CALC:ATV:RES:CN? ALL

Reads all measured values.

Characteristics

RST value: –

SCPI: device-specific

Mode

CATV

CALCulate<1|2>:ATV:RESult:CSO?

This command reads the measurement values of the carrier-to-second order beat ratio measurements.

The numeric suffixes <1|2> are irrelevant.

This command is a query only and thus has no *RST value.

Parameter

RPOWer	reference power
NFCorrection	noise reference bandwidth
MFRelative	measurement frequency relative
CSO	carrier-to-second order beat ratio
ALL	Results of all measurements above, separated by commas. If a measurement result is not valid, a comma will be output only.

Example

```
CONF:ATV:MEAS CSO
```

Configures the analog TV carrier-to-second order beat ratio measurement.

```
INIT;*WAI
```

Starts a new measurement and waits for the sweep end.

```
CALC:ATV:RES:CSO? RPOW
```

Reads the result of the reference power measurement.

or

```
CALC:ATV:RES:CSO? ALL
```

Reads all measured values.

Characteristics

RST value: –

SCPI: device-specific

Mode

CATV

CALCulate<1|2>:ATV:RESult:CTB?

This command reads the measurement values of the carrier-to-composite triple beat ratio measurements.

The numeric suffixes <1|2> are irrelevant.

This command is a query only and thus has no *RST value.

Parameter

RPOWer	reference power
NFCorrection	noise reference bandwidth
MFRelative	measurement frequency relative
CTB	carrier-to-composite triple beat ratio
ALL	Results of all measurements above, separated by commas. If a measurement result is not valid, a comma will be output only.

Example

```
CONF:ATV:MEAS CTB
```

Configures the analog TV carrier-to-composite triple beat ratio measurement.

```
INIT;*WAI
```

Starts a new measurement and waits for the sweep end.

CALC:ATV:RES:CTB? MFR

Reads the result of the relative measurement frequency measurement.

or

CALC:ATV:RES:CTB? ALL

Reads all measured values.

Characteristics

RST value: –

SCPI: device-specific

Mode

CATV

CALCulate<1|2>:ATV:RESult:HUM?

This command reads the measurement values of the hum measurement.

The numeric suffixes <1|2> are irrelevant.

This command is a query only and thus has no *RST value.

Example

CONF:ATV:MEAS HUM

Configures the analog TV hum measurement.

INIT;*WAI

Starts a new measurement and waits for the sweep end.

CALC:ATV:RES:HUM?

Reads the measured value.

Characteristics

RST value: –

SCPI: device-specific

Mode

CATV

CALCulate<1|2>:ATV:RESult:VMODulation?

This command reads the measurement values of the Vision Modulation measurements.

The numeric suffixes <1|2> are irrelevant.

This command is a query only and thus has no *RST value.

Parameter

VCPower vision carrier power

RPC residual picture carrier

MDEPTH modulation depth

ALL Results of all measurements above, separated by commas.
If a measurement result is not valid, a comma will be output only.

Example

CONF:ATV:MEAS VMOD

Configures the analog TV Vision Modulation measurement.

INIT;*WAI

Starts a new measurement and waits for the sweep end.

```
CALC:ATV:RES:VMOD? MDEP
```

Reads the result of the modulation depth measurement.

or

```
CALC:ATV:RES:VMOD? ALL
```

Reads all measured values.

Characteristics

RST value: –

SCPI: device-specific

Mode

CATV

CALCulate:ATV:UNIT:POWer Subsystem (CATV, K20)

The CALCulate:ATV:UNIT:POWer subsystem sets the unit for the measurements for analog TV measurements.

Commands of the CALCulate:ATV:UNIT:POWer Subsystem

- [CALCulate<1|2>:ATV:UNIT:POWer:HUM](#)
- [CALCulate<1|2>:ATV:UNIT:POWer:VCPabsolute](#)

CALCulate<1|2>:ATV:UNIT:POWer:HUM

This command defines the unit of the hum measurement values.

The numeric suffixes <1|2> are irrelevant.

Parameter

DB | PCT

Example

```
CALC:ATV:UNIT:POW:HUM PCT
```

Sets the unit for the hum measurement values to percent.

Characteristics

RST value: dB

SCPI: device-specific

Mode

CATV

CALCulate<1|2>:ATV:UNIT:POWer:VCPabsolute

This command defines the unit of the absolute vision carrier power.

The numeric suffixes <1|2> are irrelevant.

Parameter

DB | PCT

Example

```
CALC:ATV:UNIT:POW:VCP DB
```

Sets the unit for the absolute vision carrier power to dB.

Characteristics

RST value: dBm

SCPI: device-specific

Mode

CATV

CALCulate:DELTamarker Subsystem (CATV, K20)

The CALCulate:DELTamarker subsystem controls the delta marker functions in the instrument.

Commands of the CALCulate:DELTamarker Subsystem

- [CALCulate<1|2>:DELTamarker<1...4>\[:STATe\]](#)
- [CALCulate<1|2>:DELTamarker<1...4>:AOFF](#)
- [CALCulate<1|2>:DELTamarker<1...4>:MAXimum\[:PEAK\]](#)
- [CALCulate<1|2>:DELTamarker<1...4>:MAXimum:LEFT](#)
- [CALCulate<1|2>:DELTamarker<1...4>:MAXimum:NEXT](#)
- [CALCulate<1|2>:DELTamarker<1...4>:MAXimum:RIGHT](#)
- [CALCulate<1|2>:DELTamarker<1...4>:MINimum\[:PEAK\]](#)
- [CALCulate<1|2>:DELTamarker<1...4>:MINimum:LEFT](#)
- [CALCulate<1|2>:DELTamarker<1...4>:MINimum:NEXT](#)
- [CALCulate<1|2>:DELTamarker<1...4>:MINimum:RIGHT](#)
- [CALCulate<1|2>:DELTamarker<1...4>:MODE](#)
- [CALCulate<1|2>:DELTamarker<1...4>:X](#)
- [CALCulate<1|2>:DELTamarker<1...4>:X:RELative?](#)
- [CALCulate<1|2>:DELTamarker<1...4>:Y?](#)

CALCulate<1|2>:DELTamarker<1...4>[:STATe]

For details refer to "[CALCulate<1|2>:DELTamarker<1...4>:AOFF](#)" on page 6.7.

CALCulate<1|2>:DELTamarker<1...4>:AOFF

For details refer to "[CALCulate<1|2>:DELTamarker<1...4>:AOFF](#)" on page 6.7.

CALCulate<1|2>:DELTamarker<1...4>:MAXimum[:PEAK]

For details refer to "[CALCulate<1|2>:DELTamarker<1...4>:MAXimum\[:PEAK\]](#)" on page 6.11.

CALCulate<1|2>:DELTamarker<1...4>:MAXimum:LEFT

For details refer to "[CALCulate<1|2>:DELTamarker<1...4>:FUNCTION:PNOise:RESult?](#)" on page 6.11.

CALCulate<1|2>:DELTamarker<1...4>:MAXimum:NEXT

For details refer to "[CALCulate<1|2>:DELTamarker<1...4>:MAXimum:NEXT](#)" on page 6.12.

CALCulate<1|2>:DELTamarker<1...4>:MAXimum:RIGHT

For details refer to "[CALCulate<1|2>:DELTamarker<1...4>:MAXimum:RIGHT](#)" on page 6.12.

CALCulate<1|2>:DELTamarker<1...4>:MINimum[:PEAK]

For details refer to "[CALCulate<1|2>:DELTamarker<1...4>:MINimum\[:PEAK\]](#)" on page 6.12.

CALCulate<1|2>:DELTamarker<1...4>:MINimum:LEFT

For details refer to "[CALCulate<1|2>:DELTamarker<1...4>:MINimum:LEFT](#)" on page 6.13.

CALCulate<1|2>:DELTamarker<1...4>:MINimum:NEXT

For details refer to "[CALCulate<1|2>:DELTamarker<1...4>:MINimum:NEXT](#)" on page 6.13.

CALCulate<1|2>:DELTamarker<1...4>:MINimum:RIGHT

For details refer to "[CALCulate<1|2>:DELTamarker<1...4>:MINimum:RIGHT](#)" on page 6.13.

CALCulate<1|2>:DELTamarker<1...4>:MODE

For details refer to "[CALCulate<1|2>:DELTamarker<1...4>:MODE](#)" on page 6.14.

CALCulate<1|2>:DELTamarker<1...4>:X

For details refer to "[CALCulate<1|2>:DELTamarker<1...4>:X](#)" on page 6.14.

CALCulate<1|2>:DELTamarker<1...4>:X:RELative?

For details refer to "[CALCulate<1|2>:DELTamarker<1...4>:X:RELative?](#)" on page 6.15.

CALCulate<1|2>:DELTamarker<1...4>:Y?

Parameter

<numeric_value> in DBM

For further details refer to "[CALCulate<1|2>:DELTamarker<1...4>:Y?](#)" on page 6.15.

CALCulate:DTV Subsystem (CATV, K20)

The CALCulate:DTV subsystem contains commands to analyze the digital TV measurement data.

The following subsystems are included:

- ["CALCulate:DTV:LIMit Subsystem \(CATV, K20\)"](#) on page 6.307
- ["CALCulate:DTV:RESult Subsystem \(CATV, K20\)"](#) on page 6.314
- ["CALCulate:DTV:UNIT:POWer Subsystem \(CATV, K20\)"](#) on page 6.323

CALCulate:DTV:LIMit Subsystem (CATV, K20)

The CALCulate:DTV:LIMit subsystem sets and checks the measurement limits for digital TV measurements.

The following subsystem is included:

- ["CALCulate:DTV:LIMit:RESult Subsystem \(CATV, K20\)"](#) on page 6.307

Commands of the CALCulate:DTV:LIMit Subsystem

- [CALCulate:DTV:LIMit:CFOffset:LOWer](#)
- [CALCulate:DTV:LIMit:CFOffset:UPPer](#)
- [CALCulate:DTV:LIMit:CHPower:UPPer](#)
- [CALCulate:DTV:LIMit:CHPower:LOWer](#)
- [CALCulate:DTV:LIMit:CSUPpression\[:LOWer\]](#)
- [CALCulate:DTV:LIMit:EVMPeak:LOWer](#)
- [CALCulate:DTV:LIMit:EVMPeak:UPPer](#)
- [CALCulate:DTV:LIMit:EVMRms:LOWer](#)
- [CALCulate:DTV:LIMit:EVMRms:UPPer](#)
- [CALCulate:DTV:LIMit:IMBalance:LOWer](#)
- [CALCulate:DTV:LIMit:IMBalance:UPPer](#)
- [CALCulate:DTV:LIMit:MERPeak:LOWer](#)
- [CALCulate:DTV:LIMit:MERPeak:UPPer](#)
- [CALCulate:DTV:LIMit:MERRms:LOWer](#)
- [CALCulate:DTV:LIMit:MERRms:UPPer](#)
- [CALCulate:DTV:LIMit:PJITter\[:UPPer\]](#)
- [CALCulate:DTV:LIMit:QERRor:LOWer](#)
- [CALCulate:DTV:LIMit:QERRor:UPPer](#)
- [CALCulate:DTV:LIMit:SROffset:LOWer](#)
- [CALCulate:DTV:LIMit:SROffset:UPPer](#)

CALCulate:DTV:LIMit:CFOffset:LOWer

This command defines the lower limit of the carrier frequency offset in the overview measurement.

Parameter

<numeric_value> in Hz: $\pm 99,999$ Hz

Example

```
CALC:DTV:LIM:CFOF:LOW -10KHZ
```

Sets the lower limit for the carrier frequency offset to -10 kHz.

Characteristics

RST value: -30 kHz

SCPI: device-specific

Mode

CATV

CALCulate:DTV:LIMit:CFOffset:UPPer

This command defines the upper limit of the carrier frequency offset in the overview measurement.

Parameter

<numeric_value> in Hz: $\pm 99,999$ Hz

Example

```
CALC:DTV:LIM:CFOF:UPP 20KHZ
```

Sets the upper limit for the carrier frequency offset to 20 kHz.

Characteristics

RST value: 30 kHz

SCPI: device-specific

Mode

CATV

CALCulate:DTV:LIMit:CHPower:UPPer

This command defines the upper limit for the channel power measurement.

Parameter

<numeric_value> in dB: ± 200 dBm

Example

```
CALC:DTV:LIM:CHP:UPP -18
```

Sets the upper limit for the channel power measurement to -18 dBm.

Characteristics

RST value: 30 dBm

SCPI: device-specific

Mode

CATV

CALCulate:DTV:LIMit:CHPower:LOWer

This command defines the lower limit for the channel power measurement.

Parameter

<numeric_value> in dB: ± 200 dB

Example

```
CALC:DTV:LIM:CHP:LOW -22
```

Sets the lower limit for the channel power measurement to -22 dBm.

Characteristics

RST value: -60 dBm

SCPI: device-specific

Mode

CATV

CALCulate:DTV:LIMit:CSUPpression[:LOWer]

This command defines the lower limit of the carrier suppression in the modulation errors measurement.

Parameter

<numeric_value> in dB: 0 to 200 dB

Example

```
CALC:DTV:LIM:CSUP 30
```

Sets the lower limit for the carrier suppression to 30 dB.

Characteristics

RST value: 35 dB

SCPI: device-specific

Mode

CATV

CALCulate:DTV:LIMit:EVMPeak:LOWer

This command defines the lower limit of the error vector magnitude peak in the overview measurement.

Parameter

<numeric_value> in dB: 0 to 80 dB

Example

```
CALC:DTV:LIM:EVMP:LOW 5DB
```

Sets the lower limit for the error vector magnitude peak to 5 dB.

Characteristics

RST value: 20.7 dB

SCPI: device-specific

Mode

CATV

CALCulate:DTV:LIMit:EVMPeak:UPPer

This command defines the upper limit of the error vector magnitude peak in the overview measurement.

Parameter

<numeric_value> in percent (PCT): 0.01 to 100%

Example

```
CALC:DTV:LIM:EVMP:UPP 1PCT
```

Sets the upper limit for the error vector magnitude peak to 1%.

Characteristics

RST value: 22%

SCPI: device-specific

Mode

CATV

CALCulate:DTV:LIMit:EVMRms:LOWer

This command defines the lower limit of the root mean square value of the error vector magnitude in the overview measurement.

Parameter

<numeric_value> in dB: 0 to 80 dB

Example

```
CALC:DTV:LIM:EVMR:LOW 5DB
```

Sets the lower limit for the root mean square value of the error vector magnitude to 5 dB.

Characteristics

RST value: 27.1 dB

SCPI: device-specific

Mode

CATV

CALCulate:DTV:LIMit:EVMRms:UPPer

This command defines the upper limit of the root mean square value of the error vector magnitude in the overview measurement.

Parameter

<numeric_value> in percent (PCT): 0.01 to 100%

Example

```
CALC:DTV:LIM:EVMR:UPP 2PCT
```

Sets the upper limit for the root mean square value of the error vector magnitude to 2%.

Characteristics

RST value: 4.4%

SCPI: device-specific

Mode

CATV

CALCulate:DTV:LIMit:IMBalance:LOWer

This command defines the lower limit of the I/Q amplitude imbalance value in the modulation errors measurement.

Parameter

<numeric_value> in percent (PCT): $\pm 100\%$

Example

```
CALC:DTV:LIM:IMB:LOW 7
```

Sets the lower limit for the I/Q amplitude imbalance value to 7%.

Characteristics

RST value: -2%

SCPI: device-specific

Mode

CATV

CALCulate:DTV:LIMit:IMBalance:UPPer

This command defines the upper limit of the I/Q amplitude imbalance value in the modulation errors measurement.

Parameter

<numeric_value> in percent (PCT): $\pm 100\%$

Example

```
CALC:DTV:LIM:IMB:UPP 10
```

Sets the upper limit for the I/Q amplitude imbalance value to 10%.

Characteristics

RST value: 2%

SCPI: device-specific

Mode

CATV

CALCulate:DTV:LIMit:MERPeak:LOWer

This command defines the lower limit of the modulation error rate peak in the overview measurement.

Parameter

<numeric_value> in dB: 0 to 80 dB

Example

```
CALC:DTV:LIM:MERP:LOW 15
```

Sets the lower limit for the modulation error rate peak to 15 dB.

Characteristics

RST value: 10 dB

SCPI: device-specific

Mode

CATV

CALCulate:DTV:LIMit:MERPeak:UPPer

This command defines the upper limit of the modulation error rate peak in the overview measurement.

Parameter

<numeric_value> in percent (PCT): 0.01 to 100%

Example

```
CALC:DTV:LIM:MERP:UPP 20
```

Sets the upper limit for the modulation error rate peak to 20%.

Characteristics

RST value: 3.2%

SCPI: device-specific

Mode

CATV

CALCulate:DTV:LIMit:MERRms:LOWer

This command defines the lower limit of the root mean square value of the modulation error rate in the overview measurement.

Parameter

<numeric_value> in dB: 0 to 80 dB

Example

```
CALC:DTV:LIM:MERR:LOW 20
```

Sets the lower limit for the root mean square value of the modulation error rate to 20 dB.

Characteristics

RST value: 24 dB

SCPI: device-specific

Mode

CATV

CALCulate:DTV:LIMit:MERRms:UPPer

This command defines the upper limit of the root mean square value of the modulation error rate in the overview measurement.

Parameter

<numeric_value> in percent (PCT): 0.01 to 100%

Example

```
CALC:DTV:LIM:MERR:UPP 30
```

Sets the upper limit for the root mean square value of the modulation error rate to 30%.

Characteristics

RST value: 6.3%

SCPI: device-specific

Mode

CATV

CALCulate:DTV:LIMit:PJITter[:UPPer]

This command defines the upper limit of the phase jitter (root mean square value of the phase error) in the modulation errors measurement.

Parameter

<numeric_value> in deg: 0 to 180°

Example

```
CALC:DTV:LIM:PJIT 1
```

Sets the upper limit for the phase jitter to 1 deg.

Characteristics

RST value: 2 deg

SCPI: device-specific

Mode

CATV

CALCulate:DTV:LIMit:QERRor:LOWer

This command defines the lower limit of the quadrature error in the modulation errors measurement.

Parameter

<numeric_value> in deg: ± 180°

Example

```
CALC:DTV:LIM:QERR:LOW 10
```

Sets the lower limit for the quadrature error to 10 deg.

Characteristics

RST value: -2 deg

SCPI: device-specific

Mode

CATV

CALCulate:DTV:LIMit:QERRor:UPPer

This command defines the upper limit of the quadrature error in the modulation errors measurement.

Parameter

<numeric_value> in deg: ± 180°

Example

```
CALC:DTV:LIM:QERR:UPP 20
```

Sets the upper limit for the quadrature error to 20 deg.

Characteristics

RST value: +2 deg

SCPI: device-specific

Mode

CATV

CALCulate:DTV:LIMit:SROffset:LOWer

This command defines the lower limit of the symbol rate offset in the overview measurement.

Parameter

<numeric_value> in symb/s: $\pm 99,999$ symb/s

Example

```
CALC:DTV:LIM:SROF:LOW -5000
```

Sets the lower limit for the symbol rate offset to -5000 symb/s.

Characteristics

RST value: -10000 symb/s

SCPI: device-specific

Mode

CATV

CALCulate:DTV:LIMit:SROffset:UPPer

This command defines the upper limit of the symbol rate offset in the overview measurement.

Parameter

<numeric_value> in symb/s: $\pm 99,999$ symb/s

Example

```
CALC:DTV:LIM:SROF:UPP 1000
```

Sets the upper limit for the symbol rate offset to 1000 symb/s.

Characteristics

RST value: 10000 symb/s

SCPI: device-specific

Mode

CATV

CALCulate:DTV:LIMit:RESult Subsystem (CATV, K20)

The CALCulate:DTV:LIMit:RESult subsystem checks the measurement limits for digital TV measurements.

Commands of the CALCulate:DTV:LIMit:RESult Subsystem

- [CALCulate:DTV:LIMit:RESult:CFOffset:LOWer?](#)
- [CALCulate:DTV:LIMit:RESult:CFOffset:UPPer?](#)
- [CALCulate:DTV:LIMit:RESult:CHPower?](#)
- [CALCulate:DTV:LIMit:RESult:CSUPpression\[:LOWer\]?](#)
- [CALCulate:DTV:LIMit:RESult:EVMPeak:LOWer?](#)
- [CALCulate:DTV:LIMit:RESult:EVMPeak:UPPer?](#)
- [CALCulate:DTV:LIMit:RESult:EVMRms:LOWer?](#)
- [CALCulate:DTV:LIMit:RESult:EVMRms:UPPer?](#)
- [CALCulate:DTV:LIMit:RESult:IMBalance:LOWer?](#)
- [CALCulate:DTV:LIMit:RESult:IMBalance:UPPer?](#)

- CALCulate:DTV:LIMit:RESult:MERPeak:LOWer?
- CALCulate:DTV:LIMit:RESult:MERPeak:UPPer?
- CALCulate:DTV:LIMit:RESult:MERRms:LOWer?
- CALCulate:DTV:LIMit:RESult:MERRms:UPPer?
- CALCulate:DTV:LIMit:RESult:PJITter[:UPPer]?
- CALCulate:DTV:LIMit:RESult:QERRor:LOWer?
- CALCulate:DTV:LIMit:RESult:QERRor:UPPer?
- CALCulate:DTV:LIMit:RESult:SROFfset:LOWer?
- CALCulate:DTV:LIMit:RESult:SROFfset:UPPer?

CALCulate:DTV:LIMit:RESult:CFOFfset:LOWer?

This command performs a lower limit check for the carrier frequency offset in the overview measurement.

This command is a query and therefore has no *RST value.

Example

```
CALC:DTV:LIM:CFOF:LOW -10KHZ
```

Sets the lower limit for the carrier frequency offset to –10 kHz.

```
INIT;*WAI
```

Starts a new measurement and waits for the sweep end.

```
CALC:DTV:LIM:RES:CFOF:LOW?
```

Performs a lower limit check for the carrier frequency offset.

Characteristics

RST value: –

SCPI: device-specific

Mode

CATV

CALCulate:DTV:LIMit:RESult:CFOFfset:UPPer?

This command performs an upper limit check for the carrier frequency offset in the overview measurement.

This command is a query and therefore has no *RST value.

Example

```
CALC:DTV:LIM:CFOF:UPP 20KHZ
```

Sets the upper limit for the carrier frequency offset to 20 kHz.

```
INIT;*WAI
```

Starts a new measurement and waits for the sweep end.

```
CALC:DTV:LIM:RES:CFOF:UPP?
```

Performs an upper limit check for the carrier frequency offset.

Characteristics

RST value: –

SCPI: device-specific

Mode

CATV

CALCulate:DTV:LIMit:RESult:CHPower?

This command queries the result of the channel power measurement. Upper and lower limit check can not be handled separately.

Parameter

PASS | FAIL

Example

```
CALC:DTV:LIM:CHP:UPP -18
```

Sets the upper limit for the channel power measurement to –18 dBm.

```
CALC:DTV:LIM:CHP:LOW -22
```

Sets the lower limit for the channel power measurement to –22 dBm.

```
INIT;*WAI
```

Starts a new measurement and waits for the sweep end.

```
CALC:DTV:LIM:RES:CHP?
```

Performs a limit check for the channel power measurement.

Characteristics

RST value: –

SCPI: device-specific

Mode

CATV

CALCulate:DTV:LIMit:RESult:CSUPpression[:LOWer]?

This command performs a lower limit check for the lower limit of the carrier suppression in the modulation errors measurement.

This command is a query and therefore has no *RST value.

Example

```
CALC:DTV:LIM:CSUP 30
```

Sets the lower limit for the carrier suppression to 30 dB.

```
INIT;*WAI
```

Starts a new measurement and waits for the sweep end.

```
CALC:DTV:LIM:RES:CSUP?
```

Performs a lower limit check for the lower limit of the carrier suppression.

Characteristics

RST value: –

SCPI: device-specific

Mode

CATV

CALCulate:DTV:LIMit:RESult:EVMPeak:LOWer?

This command performs an lower limit check for the error vector magnitude peak in the overview measurement.

This command is a query and therefore has no *RST value.

Example

```
CALC:DTV:LIM:EVMP:LOW 5DB
```

Sets the lower limit for the error vector magnitude peak to 5 dB.

```
INIT; *WAI
```

Starts a new measurement and waits for the sweep end.

```
CALC:DTV:LIM:RES:EVMP:LOW?
```

Performs an lower limit check for the error vector magnitude peak.

Characteristics

RST value: –

SCPI: device-specific

Mode

CATV

CALCulate:DTV:LIMit:RESult:EVMPeak:UPPer?

This command performs an upper limit check for the error vector magnitude peak in the overview measurement.

This command is a query and therefore has no *RST value.

Example

```
CALC:DTV:LIM:EVMP:UPP 1PCT
```

Sets the upper limit for the error vector magnitude peak to 1%.

```
INIT; *WAI
```

Starts a new measurement and waits for the sweep end.

```
CALC:DTV:LIM:RES:EVMP:UPP?
```

Performs an upper limit check for the error vector magnitude peak.

Characteristics

RST value: –

SCPI: device-specific

Mode

CATV

CALCulate:DTV:LIMit:RESult:EVMRms:LOWer?

This command performs an lower limit check for the root mean square value of the error vector magnitude in the overview measurement.

This command is a query and therefore has no *RST value.

Example

```
CALC:DTV:LIM:EVMR:LOW 5DB
```

Sets the lower limit for the root mean square value of the error vector magnitude to 5 dB.

```
INIT; *WAI
```

Starts a new measurement and waits for the sweep end.

```
CALC:DTV:LIM:RES:EVMR:LOW?
```

Performs an lower limit check for the root mean square value of the error vector magnitude.

Characteristics

RST value: –

SCPI: device-specific

Mode

CATV

CALCulate:DTV:LIMit:RESult:EVMRms:UPPer?

This command performs an upper limit check for the root mean square value of the error vector magnitude in the overview measurement.

This command is a query and therefore has no *RST value.

Example

```
CALC:DTV:LIM:EVMR:UPP 2PCT
```

Sets the upper limit for the root mean square value of the error vector magnitude to 2%.

```
INIT;*WAI
```

Starts a new measurement and waits for the sweep end.

```
CALC:DTV:LIM:RES:EVMR:UPP?
```

Performs an upper limit check for the root mean square value of the error vector magnitude.

Characteristics

RST value: –

SCPI: device-specific

Mode

CATV

CALCulate:DTV:LIMit:RESult:IMBalance:LOWer?

This command performs a lower limit check for the I/Q amplitude imbalance value in the modulation errors measurement.

This command is a query and therefore has no *RST value.

Example

```
CALC:DTV:LIM:IMB:LOW 7
```

Sets the lower limit for the I/Q amplitude imbalance value to 7%.

```
INIT;*WAI
```

Starts a new measurement and waits for the sweep end.

```
CALC:DTV:LIM:RES:IMB:LOW?
```

Performs a lower limit check for the I/Q amplitude imbalance value.

Characteristics

RST value: –

SCPI: device-specific

Mode

CATV

CALCulate:DTV:LIMit:RESult:IMBalance:UPPer?

This command performs an upper limit check for the I/Q amplitude imbalance value in the modulation errors measurement.

This command is a query and therefore has no *RST value.

Example

```
CALC:DTV:LIM:IMB:UPP 10
```

Sets the upper limit for the I/Q amplitude imbalance value to 10%.

```
INIT;*WAI
```

Starts a new measurement and waits for the sweep end.

```
CALC:DTV:LIM:RES:IMB:UPP?
```

Performs an upper limit check for the I/Q amplitude imbalance value.

Characteristics

RST value: –

SCPI: device-specific

Mode

CATV

CALCulate:DTV:LIMit:RESult:MERPeak:LOWer?

This command performs a lower limit check for the modulation error rate peak in the overview measurement.

This command is a query and therefore has no *RST value.

Example

```
CALC:DTV:LIM:MERP:LOW 20
```

Sets the lower limit for the modulation error rate peak to 20 dB.

```
INIT;*WAI
```

Starts a new measurement and waits for the sweep end.

```
CALC:DTV:LIM:RES:MERP:LOW?
```

Performs a lower limit check for the modulation error rate peak.

Characteristics

RST value: –

SCPI: device-specific

Mode

CATV

CALCulate:DTV:LIMit:RESult:MERPeak:UPPer?

This command performs an upper limit check for the modulation error rate peak in the overview measurement.

This command is a query and therefore has no *RST value.

Example

```
CALC:DTV:LIM:MERP:UPP 20
```

Sets the upper limit for the modulation error rate peak to 20%.

```
INIT;*WAI
```

Starts a new measurement and waits for the sweep end.

```
CALC:DTV:LIM:RES:MERP:UPP?
```

Performs an upper limit check for the modulation error rate peak.

Characteristics

RST value: –

SCPI: device-specific

Mode

CATV

CALCulate:DTV:LIMit:RESult:MERRms:LOWer?

This command performs a lower limit check for the root mean square value of the modulation error rate in the overview measurement.

This command is a query and therefore has no *RST value.

Example

```
CALC:DTV:LIM:MERR:LOW 30
```

Sets the lower limit for the root mean square value of the modulation error rate to 30 dB.

```
INIT;*WAI
```

Starts a new measurement and waits for the sweep end.

```
CALC:DTV:LIM:RES:MERR:LOW?
```

Performs a lower limit check for the root mean square value of the modulation error rate.

Characteristics

RST value: –

SCPI: device-specific

Mode

CATV

CALCulate:DTV:LIMit:RESult:MERRms:UPPer?

This command performs an upper limit check for the root mean square value of the modulation error rate in the overview measurement.

This command is a query and therefore has no *RST value.

Example

```
CALC:DTV:LIM:MERR:UPP 30
```

Sets the upper limit for the root mean square value of the modulation error rate to 30%.

```
INIT;*WAI
```

Starts a new measurement and waits for the sweep end.

```
CALC:DTV:LIM:RES:MERR:UPP?
```

Performs an upper limit check for the root mean square value of the modulation error rate.

Characteristics

RST value: –

SCPI: device-specific

Mode

CATV

CALCulate:DTV:LIMit:RESult:PJITter[:UPPer]?

This command performs an upper limit check for the phase jitter in the modulation errors measurement.

This command is a query and therefore has no *RST value.

Example

```
CALC:DTV:LIM:PJIT 1
```

Sets the upper limit for the phase jitter to 1 deg.

```
INIT;*WAI
```

Starts a new measurement and waits for the sweep end.

```
CALC:DTV:LIM:RES:PJIT?
```

Performs an upper limit check for the phase jitter.

Characteristics

RST value: –

SCPI: device-specific

Mode

CATV

CALCulate:DTV:LIMit:RESult:QERRor:LOWer?

This command performs a lower limit check for the quadrature error in the modulation errors measurement.

This command is a query and therefore has no *RST value.

Example

```
CALC:DTV:LIM:QERR:LOW 10
```

Sets the lower limit for the quadrature error to 10 deg.

```
INIT;*WAI
```

Starts a new measurement and waits for the sweep end.

```
CALC:DTV:LIM:RES:QERR:LOW?
```

Performs a lower limit check for the quadrature error.

Characteristics

RST value: –

SCPI: device-specific

Mode

CATV

CALCulate:DTV:LIMit:RESult:QERRor:UPPer?

This command performs an upper limit check for the quadrature error in the modulation errors measurement.

This command is a query and therefore has no *RST value.

Example

```
CALC:DTV:LIM:QERR:UPP 20
```

Sets the upper limit for the quadrature error to 20 deg.

```
INIT;*WAI
```

Starts a new measurement and waits for the sweep end.

```
CALC:DTV:LIM:RES:QERR:UPP?
```

Performs an upper limit check for the quadrature error.

Characteristics

RST value: –

SCPI: device-specific

Mode

CATV

CALCulate:DTV:LIMit:RESult:SROffset:LOWer?

This command performs a lower limit check for the symbol rate offset in the overview measurement.

This command is a query and therefore has no *RST value.

Example

```
CALC:DTV:LIM:SROF:LOW -5000
```

Sets the lower limit for the symbol rate offset to –5000 symb/s.

```
INIT; *WAI
```

Starts a new measurement and waits for the sweep end.

```
CALC:DTV:LIM:RES:SROF:LOW?
```

Performs a lower limit check for the symbol rate offset.

Characteristics

RST value: –10000

SCPI: device-specific

Mode

CATV

CALCulate:DTV:LIMit:RESult:SROffset:UPPer?

This command performs an upper limit check for the symbol rate offset in the overview measurement.

This command is a query and therefore has no *RST value.

Example

```
CALC:DTV:LIM:SROF:UPP 1000
```

Sets the upper limit for the symbol rate offset to 1000 symb/s.

```
INIT; *WAI
```

Starts a new measurement and waits for the sweep end.

```
CALC:DTV:LIM:RES:SROF:UPP?
```

Performs an upper limit check for the symbol rate offset.

Characteristics

RST value: 10000

SCPI: device-specific

Mode

CATV

CALCulate:DTV:RESult Subsystem (CATV, K20)

The CALCulate:DTV:RESult subsystem displays the measurement results for digital TV measurements.

Commands of the CALCulate:DTV:RESult Subsystem

– [CALCulate<1|2>:DTV:RESult?](#)

CALCulate<1|2>:DTV:RESult?

This command reads the measurement values for the digital TV measurements.

The numeric suffixes <1|2> are irrelevant.

This command is a query only and thus has no *RST value.

Parameter

Overview	MERRms	root mean square of the modulation error rate
	MERPeak	peak of the modulation error rate
	EVMRms	root mean square of the error vector magnitude
	EVMPeak	peak of the error vector magnitude
	CFOffset	carrier frequency offset

	SROffset	symbol rate offset
	ALL	Results of all measurements above, separated by commas. If a measurement result is not valid, a comma will be output only.
Modulation Errors	IMBalance	amplitude imbalance
	QERRor	quadrature error
	CSUPpression	carrier suppression
	PJITter	phase jitter
	ALL	Results of all measurements above, separated by commas. If a measurement result is not valid, a comma will be output only.

Example

```
CONF:DTV:MEAS MERR
```

Configures the digital TV modulation errors measurement.

```
INIT;*WAI
```

Starts a new measurement and waits for the sweep end.

```
CALC:DTV:RES? QERR
```

Reads the result (quadrature error) of the modulation errors measurement.

or

```
CALC:DTV:RES? ALL
```

Reads all measured values.

Characteristics

RST value: –

SCPI: device-specific

Mode

CATV

CALCulate:DTV:UNIT:POWer Subsystem (CATV, K20)

The CALCulate:DTV:UNIT:POWer subsystem sets the unit for the measurements for digital TV measurements.

Commands of the CALCulate:DTV:UNIT:POWer Subsystem

- CALCulate<1|2>:DTV:UNIT:POWer:EPATtern
- CALCulate<1|2>:DTV:UNIT:POWer:EVMPeak
- CALCulate<1|2>:DTV:UNIT:POWer:EVMRms
- CALCulate<1|2>:DTV:UNIT:POWer:MERPeak
- CALCulate<1|2>:DTV:UNIT:POWer:MERRms

CALCulate<1|2>:DTV:UNIT:POWer:EPATtern

This command defines the unit of the echo pattern measurement.
The numeric suffixes <1|2> are irrelevant.

Parameter

s | m

Example

```
CALC:DTV:UNIT:POW:EPAT M
```

Sets the unit for the echo pattern measurement to meters.

Characteristics

RST value: s (seconds)

SCPI: device-specific

Mode

CATV

CALCulate<1|2>:DTV:UNIT:POWer:EVMPeak

This command defines the unit of the error vector magnitude peak in the overview measurement.

The numeric suffixes <1|2> are irrelevant.

Parameter

DB | PCT

Example

```
CALC:DTV:UNIT:POW:EVMP DB
```

Sets the unit for the error vector magnitude peak to dB.

Characteristics

RST value: % (PCT)

SCPI: device-specific

Mode

CATV

CALCulate<1|2>:DTV:UNIT:POWer:EVMRms

This command defines the unit of the root mean square value of the error vector magnitude in the overview measurement.

The numeric suffixes <1|2> are irrelevant.

Parameter

DB | PCT

Example

```
CALC:DTV:UNIT:POW:EVMR PCT
```

Sets the unit for the root mean square value of the error vector magnitude to percent.

Characteristics

RST value: dB

SCPI: device-specific

ModeCATV

CALCulate<1|2>:DTV:UNIT:POWer:MERPeak

This command defines the unit of the modulation error rate peak in the overview measurement. The numeric suffixes <1|2> are irrelevant.

Parameter

DB | PCT

Example

```
CALC:DTV:UNIT:POW:MERP PCT
```

Sets the unit for the unit of the modulation error rate peak to percent.

Characteristics

RST value: dB

SCPI: device-specific

ModeCATV

CALCulate<1|2>:DTV:UNIT:POWer:MERRms

This command defines the unit of the root mean square value of the modulation error rate in the overview measurement.

The numeric suffixes <1|2> are irrelevant.

Parameter

DB | PCT

Example

```
CALC:DTV:UNIT:POW:MERR DB
```

Sets the unit for the root mean square value of the modulation error rate to dB.

Characteristics

RST value: % (PCT)

SCPI: device-specific

ModeCATV

CALCulate:MARKer Subsystem (CATV, K20)

The CALCulate:MARKer subsystem checks the marker functions in the instrument.

The following subsystem is included:

- "CALCulate:MARKer:FUNCTION Subsystem (CATV, K20)" on page 6.328

Commands of the CALCulate:MARKer Subsystem

- CALCulate<1|2>:MARKer<1...4>[:STATe]
- CALCulate<1|2>:MARKer<1...4>:AOFF
- CALCulate<1|2>:MARKer<1...4>:LOEXclude
- CALCulate<1|2>:MARKer<1...4>:MAXimum[:PEAK]
- CALCulate<1|2>:MARKer<1...4>:MAXimum:LEFT
- CALCulate<1|2>:MARKer<1...4>:MAXimum:NEXT
- CALCulate<1|2>:MARKer<1...4>:MAXimum:RIGHT
- CALCulate<1|2>:MARKer<1...4>:MINimum[:PEAK]
- CALCulate<1|2>:MARKer<1...4>:MINimum:LEFT
- CALCulate<1|2>:MARKer<1...4>:MINimum:NEXT
- CALCulate<1|2>:MARKer<1...4>:MINimum:RIGHT
- CALCulate<1|2>:MARKer<1...4>:PEXCursion
- CALCulate<1|2>:MARKer<1...4>:X
- CALCulate<1|2>:MARKer<1...4>:X:SLIMits:LEFT
- CALCulate<1|2>:MARKer<1...4>:X:SLIMits:RIGHT
- CALCulate<1|2>:MARKer<1...4>:X:SLIMits[:STATe]
- CALCulate<1|2>:MARKer<1...4>:Y?
- CALCulate<1|2>:MARKer<1...4>:Y:PERCent

CALCulate<1|2>:MARKer<1...4>[:STATe]

For details refer to "CALCulate<1|2>:MARKer<1...4>[:STATe]" on page 6.42.

CALCulate<1|2>:MARKer<1...4>:AOFF

For details refer to "CALCulate<1|2>:MARKer<1...4>:AOFF" on page 6.43.

CALCulate<1|2>:MARKer<1...4>:LOEXclude

For details refer to "CALCulate<1|2>:MARKer<1...4>:LOEXclude" on page 6.44.

CALCulate<1|2>:MARKer<1...4>:MAXimum[:PEAK]

For details refer to "CALCulate<1|2>:MARKer<1...4>:MAXimum[:PEAK]" on page 6.45.

CALCulate<1|2>:MARKer<1...4>:MAXimum:LEFT

For details refer to "[CALCulate<1|2>:MARKer<1...4>:MAXimum:LEFT](#)" on page 6.45.

CALCulate<1|2>:MARKer<1...4>:MAXimum:NEXT

For details refer to "[CALCulate<1|2>:MARKer<1...4>:MAXimum:NEXT](#)" on page 6.46.

CALCulate<1|2>:MARKer<1...4>:MAXimum:RIGHT

For details refer to "[CALCulate<1|2>:MARKer<1...4>:MAXimum:RIGHT](#)" on page 6.46.

CALCulate<1|2>:MARKer<1...4>:MINimum[:PEAK]

For details refer to "[CALCulate<1|2>:MARKer<1...4>:MINimum\[:PEAK\]](#)" on page 6.46.

CALCulate<1|2>:MARKer<1...4>:MINimum:LEFT

For details refer to "[CALCulate<1|2>:MARKer<1...4>:MINimum:LEFT](#)" on page 6.47.

CALCulate<1|2>:MARKer<1...4>:MINimum:NEXT

For details refer to "[CALCulate<1|2>:MARKer<1...4>:MINimum:NEXT](#)" on page 6.47.

CALCulate<1|2>:MARKer<1...4>:MINimum:RIGHT

For details refer to "[CALCulate<1|2>:MARKer<1...4>:MINimum:RIGHT](#)" on page 6.47.

CALCulate<1|2>:MARKer<1...4>:PEXCursion

For details refer to "[CALCulate<1|2>:MARKer<1...4>:PEXCursion](#)" on page 6.48.

CALCulate<1|2>:MARKer<1...4>:X

For details refer to "[CALCulate<1|2>:MARKer<1...4>:X](#)" on page 6.49.

CALCulate<1|2>:MARKer<1...4>:X:SLIMits:LEFT

For details refer to "[CALCulate<1|2>:MARKer<1...4>:X:SLIMits:LEFT](#)" on page 6.49.

CALCulate<1|2>:MARKer<1...4>:X:SLIMits:RIGHT

For details refer to "[CALCulate<1|2>:MARKer<1...4>:X:SLIMits:RIGHT](#)" on page 6.50.

CALCulate<1|2>:MARKer<1...4>:X:SLIMits[:STATe]

For details refer to "[CALCulate<1|2>:MARKer<1...4>:X:SLIMits\[:STATe\]](#)" on page 6.49.

CALCulate<1|2>:MARKer<1...4>:Y?

For details refer to "[CALCulate<1|2>:MARKer<1...4>:Y?](#)" on page 6.50.

CALCulate<1|2>:MARKer<1...4>:Y:PERCent

For details refer to "[CALCulate<1|2>:MARKer<1...4>:Y:PERCent](#)" on page 6.51.

CALCulate:MARKer:FUNCTion Subsystem (CATV, K20)

The CALCulate:MARKer:FUNCTion subsystem checks the marker functions in the instrument.

Commands of the CALCulate:MARKer:FUNCTion Subsystem

- [CALCulate<1|2>:MARKer<1...4>:FUNCTion:CENTer](#)
- [CALCulate<1|2>:MARKer<1...4>:FUNCTion:REFerence](#)

CALCulate<1|2>:MARKer<1...4>:FUNCTion:CENTer

For details refer to "[CALCulate<1|2>:MARKer<1...4>:FUNCTion:CENTer](#)" on page 6.54.

CALCulate<1|2>:MARKer<1...4>:FUNCTion:REFerence

For details refer to "[CALCulate<1|2>:MARKer<1...4>:FUNCTion:REFerence](#)" on page 6.63.

CALCulate: STATistics Subsystem (CATV, K20)

The CALCulate: STATistics subsystem defines the scaling for the APD and CCDF measurements.

Commands of the CALCulate: STATistics Subsystem

- [CALCulate: STATistics:NSAMples](#)
- [CALCulate:STATistics:PRESet](#)
- [CALCulate:STATistics:RESult<1...4>?](#)
- [CALCulate:STATistics:SCALE:AUTO](#)
- [CALCulate:STATistics:SCALE:X:RANGE](#)
- [CALCulate:STATistics:SCALE:X:RLEVEL](#)
- [CALCulate:STATistics:SCALE:Y:LOWer](#)
- [CALCulate:STATistics:SCALE:Y:UPPer](#)

CALCulate: STATistics:NSAMples

For details refer to "[CALCulate:STATistics:NSAMples](#)" on page 6.91.

CALCulate:STATistics:PRESet

For details refer to "[CALCulate:STATistics:PRESet](#)" on page 6.91.

CALCulate:STATistics:RESult<1...4>?

For details refer to "[CALCulate:STATistics:RESult<1...4>?](#)" on page 6.92.

CALCulate:STATistics:SCALE:AUTO

For details refer to "[CALCulate:STATistics:SCALE:AUTO](#)" on page 6.92.

CALCulate:STATistics:SCALE:X:RANGE

For details refer to "[CALCulate:STATistics:SCALE:X:RANGE](#)" on page 6.93.

CALCulate:STATistics:SCALE:X:RLEVel

For details refer to "[CALCulate:STATistics:SCALE:X:RLEVel](#)" on page 6.93.

CALCulate:STATistics:SCALE:Y:LOWer

For details refer to "[CALCulate:STATistics:SCALE:Y:LOWer](#)" on page 6.94.

CALCulate:STATistics:SCALE:Y:UPPer

For details refer to "[CALCulate:STATistics:SCALE:Y:UPPer](#)" on page 6.94.

CALCulate:UNIT Subsystem (CATV, K20)

The CALCulate:UNIT subsystem defines the units for the parameters that can be set and the measurement results.

Commands of the CALCulate:UNIT Subsystem

- [CALCulate<1|2>:UNIT:POWer](#)

CALCulate<1|2>:UNIT:POWer

This command selects the unit for power.

The numeric suffixes <1|2> are irrelevant.

Parameter

DBM | DBUV | DBMV | DBPW | VOLT | V | W | WATT | A | AMPere

Example

```
CALC:UNIT:POW V
```

Sets the unit to Volt.

Characteristics

RST value: dBm

SCPI: device-specific

Mode

CATV

CONFigure Subsystem (CATV, K20)

The CONFigure subsystem contains commands for configuring complex measurement tasks.

The following subsystems are included:

- "CONFigure:ATV Subsystem (CATV, K20)" on page 6.331
- "CONFigure:DTV Subsystem (CATV, K20)" on page 6.333
- "CONFigure:TV Subsystem (CATV, K20)" on page 6.334

CONFigure:ATV Subsystem (CATV, K20)

The CONFigure:ATV subsystem contains commands to configure analog TV measurements.

Commands of the CONFigure:ATV Subsystem

- [CONFigure:ATV:CN:MEASurement](#)
- [CONFigure:ATV:CSO:MEASurement](#)
- [CONFigure:ATV:CTB:MEASurement](#)
- [CONFigure:ATV:MEASurement](#)

CONFigure:ATV:CN:MEASurement

This command configures a new carrier or noise measurement with the next sweep for the Carrier-to-Noise Ratio measurement.

Parameter

CARRier | NOISe

Example

```
CONF:ATV:MEAS CN
```

Configures the analog TV carrier-to-noise ratio measurement.

```
ATV:CN:MEAS:MODE OSER
```

Sets the Off-Service measurement method.

```
CONF:ATV:CN:MEAS CARR
```

Configures a new carrier measurement with the next sweep.

```
INIT;*OPC
```

Starts the new noise measurement.

Characteristics

RST value: CARRier

SCPI: device-specific

Mode

CATV

CONFigure:ATV:CSO:MEASurement

This command configures a new carrier or noise measurement with the next sweep for the Carrier-to-Second Order Beat Ratio measurement.

Parameter

CARRier | NOISe

Example

CONF:ATV:MEAS CSO

Configures the analog TV carrier-to-second order beat ratio measurement.

ATV:CSO:MEAS:MODE OSER

Sets the Off-Service measurement method.

CONF:ATV:CSO:MEAS CARR

Configures a new carrier measurement with the next sweep.

INIT;*OPC

Starts the new noise measurement.

Characteristics

RST value: CARRier

SCPI: device-specific

Mode

CATV

CONFigure:ATV:CTB:MEASurement

This command configures a new carrier or noise measurement with the next sweep for the Carrier-to-Composite Triple Beat Ratio measurement.

Parameter

CARRier | NOISe

Example

CONF:ATV:MEAS CTB

Configures the analog TV carrier-to-composite triple beat ratio measurement.

ATV:CTB:MEAS:MODE OSER

Sets the Off-Service measurement method.

CONF:ATV:CTB:MEAS CARR

Configures a new carrier measurement with the next sweep.

INIT;*OPC

Starts the new noise measurement.

Characteristics

RST value: CARRier

SCPI: device-specific

Mode

CATV

CONFigure:ATV:MEASurement

This command defines the analog measurement type.

Parameter

ASPectrum	Spectrum measurement
CARRiers	Carrier Power measurement
CN	Carrier-to-Noise Ratio measurement
HUM	Hum measurement
VMODulation	Vision Modulation measurement
CTB	Carrier-to-Composite Triple Beat Ratio measurement

CSO	Carrier-to-Second Order Beat Ratio measurement
VSCOpe	Video Scope measurement

Example

```
CONF:ATV:MEAS CARR
```

Configures the R&S FSL to measure the carrier power.

Characteristics

RST value: SPECTrum

SCPI: device-specific

Mode

CATV

CONFigure:DTV Subsystem (CATV, K20)

The CONFigure:DTV subsystem contains commands to configure digital TV measurements.

Commands of the CONFigure:DTV:MEASurement Subsystem– [CONFigure:DTV:MEASurement](#)**CONFigure:DTV:MEASurement**

This command defines the digital measurement type.

Parameter

DSPECTrum	Spectrum measurement
CHPower	Channel Power measurement
CONS	Constellation Diagram measurement
MERRors	Modulation Errors measurement
EPATtern	Echo Pattern measurement
APD	Amplitude Probability Density Function measurement
CCDF	Complementary Cumulative Distribution Function measurement
OVERview	Overview measurement

Example

```
CONF:DTV:MEAS APD
```

Configures the R&S FSL to measure the amplitude probability density function.

Characteristics

RST value: SPECTrum

SCPI: device-specific

Mode

CATV

CONFigure:TV Subsystem (CATV, K20)

The CONFigure:TV subsystem contains commands to configure TV Analyzer measurements.

Commands of the CONFigure:TV Subsystem

- [CONFigure:TV:CTABLE:SElect](#)
- [CONFigure:TV:MEASurement](#)

CONFigure:TV:CTABLE:SElect

This command activates the selected channel table.

Parameter

<file_name>, max. 45 characters

Example

```
CONF:TV:CTAB:SEL 'TV-ITALY'
```

Activates the channel table TV-ITALY.

Characteristics

RST value: <none>

SCPI: device-specific

Mode

CATV

CONFigure:TV:MEASurement

This command defines the TV Analyzer measurement type.

Parameter

TILT (Tilt measurement)

Example

```
CONF:TV:MEAS TILT
```

Configures the R&S FSL to measure the channel power of every channel.

Characteristics

RST value: –

SCPI: device-specific

Mode

CATV

DISPlay Subsystem (CATV, K20)

The DISPlay subsystem controls the selection and presentation of textual and graphic information as well as of measurement data on the display.

Commands of the DISPlay Subsystem

- DISPlay[:WINDow<1|2>]:TRACe<1...4>[:STATe]
- DISPlay[:WINDow<1|2>]:TRACe<1...4>:MODE
- DISPlay[:WINDow<1|2>]:TRACe<1...4>:MODE:FREeze[:STATe]
- DISPlay[:WINDow<1|2>]:TRACe<1...4>:MODE:HCONTinuous
- DISPlay[:WINDow<1|2>]:TRACe<1...4>:Y[:SCALe]
- DISPlay[:WINDow<1|2>]:TRACe<1...4>:Y[:SCALe]:AUTO
- DISPlay[:WINDow<1|2>]:TRACe<1...4>:Y[:SCALe]:MODE
- DISPlay[:WINDow<1|2>]:TRACe<1...4>:Y[:SCALe]:RLEVel
- DISPlay[:WINDow<1|2>]:TRACe<1...4>:Y[:SCALe]:RLEVel:OFFSet
- DISPlay[:WINDow<1|2>]:TRACe<1...4>:Y[:SCALe]:RPOSition
- DISPlay[:WINDow<1|2>]:TRACe<1...4>:Y:SPACing
- DISPlay[:WINDow<1|2>]:ZOOM:EPATtern
- DISPlay[:WINDow<1|2>]:ZOOM:EPATtern:STATe
- DISPlay[:WINDow<1|2>]:ZOOM:MERRors
- DISPlay[:WINDow<1|2>]:ZOOM:OVERview
- DISPlay[:WINDow<1|2>]:ZOOM:QUADrant

DISPlay[:WINDow<1|2>]:TRACe<1...4>[:STATe]

For details refer to "DISPlay[:WINDow<1|2>]:TRACe<1...4>[:STATe]" on page 6.98.

DISPlay[:WINDow<1|2>]:TRACe<1...4>:MODE

For details refer to "DISPlay[:WINDow<1|2>]:TRACe<1...4>:MODE" on page 6.99.

DISPlay[:WINDow<1|2>]:TRACe<1...4>:MODE:FREeze[:STATe]

This command sets the display mode of the constellation diagram.

The numeric suffixes <1|2> are irrelevant.

Parameter

- ON The constellation diagram is displayed unchanged, while the I/Q samples are collected in the background.
- OFF The constellation diagram is displayed on basis of the current I/Q samples and, in continuous sweep mode, is updated with every measurement.

Example

```
DISP:TRAC1:MODE:FRE ON
```

Sets the display mode of the constellation diagram to on.

Characteristics

RST value: OFF

SCPI: device-specific

Mode

CATV

DISPlay[:WINDow<1|2>]:TRACe<1...4>:MODE:HCONTinuous

For details refer to "[DISPlay\[:WINDow<1|2>\]:TRACe<1...4>:MODE:HCONTinuous](#)" on page 6.99.

DISPlay[:WINDow<1|2>]:TRACe<1...4>:Y[:SCALE]

For details refer to "[DISPlay\[:WINDow<1|2>\]:TRACe<1...4>:Y\[:SCALE\]](#)" on page 6.100.

DISPlay[:WINDow<1|2>]:TRACe<1...4>:Y[:SCALE]:AUTO

This command activates or deactivates the automatic scaling for the Hum and Tilt measurement. If activated, the scaling is automatically optimized to the best display of data. This rescaling may affect the values of any of the parameters under the SCALE node.

The numeric suffixes <1|2> and <1...4> are irrelevant.

Parameter

ON | OFF | ONCE

Example

```
DISP:TRAC:Y:AUTO ON
```

Activates the automatic scaling for the Hum measurement

Characteristics

RST value: OFF

SCPI: conform

Mode

CATV

DISPlay[:WINDow<1|2>]:TRACe<1...4>:Y[:SCALE]:MODE

For details refer to "[DISPlay\[:WINDow<1|2>\]:TRACe<1...4>:Y\[:SCALE\]:MODE](#)" on page 6.101.

DISPlay[:WINDow<1|2>]:TRACe<1...4>:Y[:SCALE]:RLEVel

For details refer to "[DISPlay\[:WINDow<1|2>\]:TRACe<1...4>:Y\[:SCALE\]:RLEVel](#)" on page 6.101.

DISPlay[:WINDow<1|2>]:TRACe<1...4>:Y[:SCALe]:RLEVel:OFFSet

For details refer to "[DISPlay\[:WINDow<1|2>\]:TRACe<1...4>:Y\[:SCALe\]:RLEVel:OFFSet](#)" on page 6.101.

DISPlay[:WINDow<1|2>]:TRACe<1...4>:Y[:SCALe]:RPOSition

For details refer to "[DISPlay\[:WINDow<1|2>\]:TRACe<1...4>:Y\[:SCALe\]:RPOSition \(models 13, 16\)](#)" on page 6.102.

DISPlay[:WINDow<1|2>]:TRACe<1...4>:Y:SPACing

Parameter

LINear | LOGarithmic

For further details refer to "[DISPlay\[:WINDow<1|2>\]:TRACe<1...4>:Y:SPACing](#)" on page 6.100.

DISPlay[:WINDow<1|2>]:ZOOM:EPATtern

This command sets the zoom factor for the Echo Pattern measurement.
The numeric suffixes <1|2> are irrelevant.

Parameter

1 ... 20

Example

```
DISP:ZOOM:EPAT 2
```

Sets the zoom factor for the Echo Pattern measurement.

Characteristics

RST value: 1

SCPI: device-specific

Mode

CATV

DISPlay[:WINDow<1|2>]:ZOOM:EPATtern:STATe

This command activates or deactivates the zoom on around 0 μ s for the Echo Pattern measurement.

The numeric suffixes <1|2> are irrelevant.

Parameter

ON | OFF

Example

```
DISP:ZOOM:EPAT:STAT ON
```

Switches on the zoom for the Echo Pattern measurement.

Characteristics

RST value: OFF

SCPI: device-specific

Mode

CATV

DISPlay[:WINDow<1|2>]:ZOOM:MERRors

This command sets the zoom for the Modulation Errors measurement.

The numeric suffixes <1|2> are irrelevant.

Parameter

NONE The whole result table is displayed.

<parameter> The result table of the selected parameter is displayed.
with parameter = IMBalance | QERRor | SUPpression | PJITter | MERRms
| MERPeak | EVMRms | EVMPeak

Example

```
DISP:ZOOM:MERR MERP
```

Displays the measurement results of the peak of the modulation error rate.

Characteristics

RST value: NONE

SCPI: device-specific

Mode

CATV

DISPlay[:WINDow<1|2>]:ZOOM:OVERview

This command sets the zoom for the Overview measurement.

The numeric suffixes <1|2> are irrelevant.

Parameter

NONE The whole result table is displayed.

<parameter> The result table of the selected parameter is displayed.
with parameter = MERRms | MERPeak | EVMRms | EVMPeak | CFOffset
| SROffset

Example

```
DISP:ZOOM:OVER MERP
```

Displays the measurement results of the peak of the modulation error rate.

Characteristics

RST value: NONE

SCPI: device-specific

Mode

CATV

DISPlay[:WINDow<1|2>]:ZOOM:QUADrant

This command sets the zoom for the constellation diagram.
The numeric suffixes <1|2> are irrelevant.

Parameter

NONE The whole constellation diagram is displayed.
1 | 2 | 3 | 4 The selected quadrant is displayed.

Example

```
DISP:ZOOM:QUAD 1
```

Display the first quadrant of the constellation diagram.

Characteristics

RST value: NONE

SCPI: device-specific

Mode

CATV

FORMat Subsystem (CATV, K20)

The FORMat subsystem specifies the data format of the data transmitted from and to the instrument.

Commands of the FORMat Subsystem

- [FORMat\[:DATA\]](#)
- [FORMat:DEXPort:DSEPARATOR](#)

FORMat[:DATA]

For details refer to the command description of the basic unit, section "Remote Control – Description of Basic Settings Commands", FORMat subsystem.

FORMat:DEXPort:DSEPARATOR

For details refer to "[FORMat:DEXPort:DSEPARATOR](#)" on page 6.104.

INITiate Subsystem (CATV, K20)

The INITiate subsystem is used to control the init-measurement function.

Commands of the INITiate Subsystem

- [INITiate<1|2>\[:IMMediate\]](#)
- [INITiate<1|2>:CONMeas](#)
- [INITiate<1|2>:CONTInuous](#)

INITiate<1|2>[:IMMediate]

For details refer to "[INITiate<1|2>\[:IMMediate\]](#)" on page 6.105.

INITiate<1|2>:CONMeas

For details refer to "[INITiate<1|2>:CONMeas](#)" on page 6.105.

INITiate<1|2>:CONTInuous

For details refer to "[INITiate<1|2>:CONTInuous](#)" on page 6.106.

INPut Subsystem (CATV, K20)

The INPut subsystem controls the input characteristics of the RF inputs of the instrument.

Commands of the INPut Subsystem

- [INPut:ATTenuation](#)
- [INPut:ATTenuation:AUTO](#)
- [INPut:GAIN:STATe](#)
- [INPut:IMPedance](#)

INPut:ATTenuation

For details refer to "[INPut<1|2>:ATTenuation](#)" on page 6.108.

INPut:ATTenuation:AUTO

For details refer to "[INPut<1|2>:ATTenuation:AUTO](#)" on page 6.108.

INPut:GAIN:STATe

For details refer to "[INPut<1|2>:GAIN:STATe](#)" on page 6.109.

INPut:IMPedance

For details refer to "[INPut<1|2>:IMPedance](#)" on page 6.109.

INSTRUMENT Subsystem (CATV, K20)

The INSTRUMENT subsystem selects the operating mode of the unit either via text parameters or fixed numbers.

Commands of the INSTRUMENT Subsystem

- INSTRUMENT[:SElect]
- INSTRUMENT:NSElect

INSTRUMENT[:SElect]

Parameter

CATV (Cable TV Measurements option, R&S FSL–K20)

For further details refer to section "Remote Control – Description of Basic Settings Commands", INSTRUMENT subsystem.

INSTRUMENT:NSElect

Parameter

30 (Cable TV Measurements option, R&S FSL–K20)

For further details refer to section "Remote Control – Description of Basic Settings Commands", INSTRUMENT subsystem.

MMEMemory Subsystem (CATV, K20)

The MMEMemory (mass memory) subsystem provides commands which allow for access to the storage media of the instrument and for storing and loading various instrument settings.

Commands of the MMEMemory Subsystem

- [MMEMemory:STORe<1|2>:TRACe](#)

MMEMemory:STORe<1|2>:TRACe

For details refer to the command description of the basic unit, section "Remote Control – Description of Basic Settings Commands", MMEMemory subsystem.

SENSe Subsystem (CATV, K20)

The SENSe subsystem is organized in several subsystems. The commands of these subsystems directly control device-specific settings, they do not refer to the signal characteristics of the measurement signal.

The SENSe subsystem controls the essential parameters of the analyzer. In accordance with the SCPI standard, the keyword "SENSe" is optional for this reason, which means that it is not necessary to include the SENSe node in command sequences.

The following subsystems are included:

- "SENSe:ATV Subsystem (CATV, K20)" on page 6.345
- "SENSe:BANDwidth Subsystem (CATV, K20)" on page 6.355
- "SENSe:CORRection Subsystem (CATV, K20)" on page 6.356
- "SENSe:DETEctor Subsystem (CATV, K20)" on page 6.356
- "SENSe:DDEMod Subsystem (CATV, K20)" on page 6.357
- "SENSe:FREQuency Subsystem (CATV, K20)" on page 6.359
- "SENSe:POWEr Subsystem (CATV, K20)" on page 6.361
- "SENSe:SWEep Subsystem (CATV, K20)" on page 6.361
- "SENSe:TV Subsystem (CATV, K20)" on page 6.362

SENSe:ATV Subsystem (CATV, K20)

The SENSe:ATV subsystem contains commands to control the analog TV measurement settings.

The following subsystems are included:

- "SENSe:ATV:CN Subsystem (CATV, K20)" on page 6.345
- "SENSe:ATV:CSO Subsystem (CATV, K20)" on page 6.349
- "SENSe:ATV:CTB Subsystem (CATV, K20)" on page 6.353

SENSe:ATV:CN Subsystem (CATV, K20)

The SENSe:ATV:CN subsystem contains commands for the Carrier-to-Noise Ratio (C/N) measurement setup.

Commands of the SENSe:ATV:CN Subsystem

- [SENSe<1|2>:]ATV:CN:BWIDth
- [SENSe<1|2>:]ATV:CN:CFRelative:NEXT
- [SENSe<1|2>:]ATV:CN:MEASurement:MODE
- [SENSe<1|2>:]ATV:CN:POWEr:NCORrection
- [SENSe<1|2>:]ATV:CN:POWEr:REFerence:CHANnel:MANual
- [SENSe<1|2>:]ATV:CN:POWEr:REFerence:MANual
- [SENSe<1|2>:]ATV:CN:POWEr:REFerence:MODE
- [SENSe<1|2>:]ATV:CN:TABLE<1...10>:MFRequencies

[SENSe<1|2>:]ATV:CN:BWIDth

This command defines the noise reference bandwidth in the C/N measurement.
The numeric suffixes <1|2> are irrelevant.

Parameter

<numeric_value> in Hz: 100 Hz to 20 MHz

Example

```
ATV:CN:BWID 7MHZ
```

Sets the noise reference bandwidth to 7 MHz.

Characteristics

RST value: 5 MHz

SCPI: device-specific

Mode

CATV

[SENSe<1|2>:]ATV:CN:CFRelative:NEXT

This command switches from one frequency range to the next according to the measurement frequencies defined by the [\[SENSe<1|2>:\]ATV:CN:TABLE<1...10>:MFRrequencies](#) command.

The numeric suffixes <1|2> are irrelevant.

This command is an event and therefore has no *RST value and no query.

Parameter

<numeric_value> in Hz: (RF-10 MHz) to (RF+10 MHz)

Example

```
ATV:CN:TABLE1:MFR 1,1000,1000
```

Activates the first row entries for the measurement and sets the center frequency to 1 kHz and the span to 1 kHz.

```
ATV:CN:TABLE2:MFR 1,2000,2000
```

Activates the second row entries for the measurement and sets the center frequency to 2 kHz and the span to 2 kHz.

```
ATV:CN:CFR:NEXT
```

Switches from the frequency range defined in table row 1 to 2.

Characteristics

RST value: –

SCPI: device-specific

Mode

CATV

[SENSe<1|2>:]ATV:CN:MEASurement:MODE

This command defines the measurement method for the Carrier-to-Noise Ratio measurement.
The numeric suffixes <1|2> are irrelevant.

Parameter

ISERvice (In-Service)	While an analog TV signal is present, a gap between two consecutive channels, where only noise exists, is used to determine the noise power. A
--------------------------	--

noise marker is placed there, and the noise power is determined.

OSERvice
(Off–Service) The current measurement channel is switched off by the provider. In this channel, a noise marker is placed, and the noise power is determined.

QLINE
(Quiet Line) While an analog TV signal is present, the carrier–to–noise ratio is measured using the so–called "Quiet Line". The measurement is fully automated.

Example

```
ATV:CN:MEAS:MODE OSER
```

Sets the Off–Service measurement method.

Characteristics

RST value: ISER

SCPI: device–specific

Mode

CATV

[SENSe<1|2>:]ATV:CN:POWer:NCORrection

This command activates or deactivates the noise floor correction.

The numeric suffixes <1|2> are irrelevant.

Parameter

ON | OFF

Example

```
ATV:CN:POW:NCOR ON
```

Activates the noise floor correction.

Characteristics

RST value: OFF

SCPI: device–specific

Mode

CATV

[SENSe<1|2>:]ATV:CN:POWer:REFerence:CHANnel:MANual

This command defines the reference channel.

The numeric suffixes <1|2> are irrelevant.

Parameter

<numeric_value>, corresponding to active channel

Example

```
ATV:CN:POW:REF:CHAN:MAN 5
```

Sets channel 5 in the active channel table as reference channel.

Characteristics

RST value: active measurement channel

SCPI: device–specific

Mode

CATV

[SENSe<1|2>:]ATV:CN:POWer:REFerence:MANual

This command defines the manual reference power. The unit is set via the `CALCulate<1|2>:UNIT:POWer` command.

The numeric suffixes <1|2> are irrelevant.

Parameter

<numeric_value> in dB: ± 200 dB

Example

```
ATV:CN:POW:REF:MAN 10
```

Sets the reference power to 10.

Characteristics

RST value: 0

SCPI: device-specific

Mode

CATV

[SENSe<1|2>:]ATV:CN:POWer:REFerence:MODE

This command defines the reference power method.

The numeric suffixes <1|2> are irrelevant.

Parameter

RCHannel	reference channel (<code>[SENSe<1 2>:]ATV:CN:POWer:REFerence:CHANnel:MANual</code> command)
MCHannel	same as measurement channel
MANual	manual reference power (<code>[SENSe<1 2>:]ATV:CN:POWer:REFerence:MANual</code> command)

Example

```
ATV:CN:POW:REF:MODE RCH
```

Sets the reference channel method.

Characteristics

RST value: MCH

SCPI: device-specific

Mode

CATV

[SENSe<1|2>:]ATV:CN:TABLE<1...10>:MFRrequencies

This command defines the measurement frequencies (center frequencies and span values), and activates or deactivates them for the C/N measurement.

The numeric suffix <1...10> defines the table row. The numeric suffixes <1|2> are irrelevant.

Parameter

0 | 1, <numeric_value>, <numeric_value>

0	deactivated
1	activated

first numeric value center frequency in Hz
 second numeric value span in Hz

Example

ATV:CN:TABLE1:MFR 1,1000,1000

Activates the entries of the first table row for the measurement and sets the center frequency to 1 kHz and the span to 1 kHz.

ATV:CN:TABLE2:MFR 1,2000,2000

Activates the second row entries for the measurement and sets the center frequency to 2 kHz and the span to 2 kHz.

Characteristics

RST value: 1,1.25 KHz,1 MHz (row 1); 0,1.25 kHz,1 MHz (row 2–10)

SCPI: device-specific

Mode

CATV

SENSe:ATV:CSO Subsystem (CATV, K20)

The SENSe:ATV:CSO subsystem contains commands for the Carrier-to-Second Order Beat Ratio (CSO) measurement setup.

Commands of the SENSe:ATV:CSO Subsystem

- [SENSe<1|2>:]ATV:CSO:CFRelative:NEXT
- [SENSe<1|2>:]ATV:CSO:MEASurement:MODE
- [SENSe<1|2>:]ATV:CSO:POWer:NCORrection
- [SENSe<1|2>:]ATV:CSO:POWer:REFerence:CHANnel:MANual
- [SENSe<1|2>:]ATV:CSO:POWer:REFerence:MANual
- [SENSe<1|2>:]ATV:CSO:POWer:REFerence:MODE
- [SENSe<1|2>:]ATV:CSO:TABLE<1...10>:MFRequencies

[SENSe<1|2>:]ATV:CSO:CFRelative:NEXT

This command switches from one frequency range to the next according to the measurement frequencies defined by the [SENSe<1|2>:]ATV:CSO:TABLE<1...10>:MFRequencies command.

The numeric suffixes <1|2> are irrelevant.

This command is an event and therefore has no *RST value and no query.

Example

ATV:CSO:TABLE1:MFR 1,-1000,1000

Activates the entries of the first table row for the measurement and sets the center frequency to –1 kHz and the span to 1 kHz.

ATV:CSO:TABLE2:MFR 1,-2000,2000

Activates the second row entries for the measurement and sets the center frequency to –2 kHz and the span to 2 kHz.

ATV:CSO:CFR:NEXT

Switches from the frequency range defined in table row 1 to 2.

Characteristics

RST value: –

SCPI: device-specific

Mode

CATV

[SENSe<1|2>:]ATV:CSO:MEASurement:MODE

This command defines the measurement method for the Carrier-to-Second Order Beat Ratio measurement.

The numeric suffixes <1|2> are irrelevant.

Parameter

OSERvice (Off-Service) The current measurement channel is switched off by the provider. In this channel, a noise marker is placed, and the noise power is determined.

QLINe (Quiet Line) While an analog TV signal is present, the carrier-to-noise ratio is measured using the so-called "Quiet Line". The measurement is fully automated.

Example

```
ATV:CSO:MEAS:MODE QLIN
```

Sets the Quiet Line measurement method.

Characteristics

RST value: OSER

SCPI: device-specific

Mode

CATV

[SENSe<1|2>:]ATV:CSO:POWer:NCORrection

This command activates or deactivates the noise floor correction.

The numeric suffixes <1|2> are irrelevant.

Parameter

ON | OFF

Example

```
ATV:CSO:POW:NCOR ON
```

Activates the noise floor correction.

Characteristics

RST value: OFF

SCPI: device-specific

Mode

CATV

[SENSe<1|2>:]ATV:CSO:POWer:REFerence:CHANnel:MANual

This command defines the reference channel.

The numeric suffixes <1|2> are irrelevant.

Parameter

<numeric_value>, corresponding to active channel

Example

```
ATV:CSO:POW:REF:CHAN:MAN 6
```

Sets channel 6 in the active channel table as reference channel.

Characteristics

RST value: active measurement channel

SCPI: device-specific

Mode

CATV

[SENSe<1|2>:]ATV:CSO:POWer:REFerence:MANual

This command defines the manual reference power. The unit is set via the [CALCulate<1|2>:UNIT:POWer](#) command.

The numeric suffixes <1|2> are irrelevant.

Parameter

<numeric_value>: ± 200 dB

Example

```
ATV:CSO:POW:REF:MAN 20
```

Sets the reference power to 20.

Characteristics

RST value: 10

SCPI: device-specific

Mode

CATV

[SENSe<1|2>:]ATV:CSO:POWer:REFerence:MODE

This command defines the reference power method.

The numeric suffixes <1|2> are irrelevant.

Parameter

RCHannel	reference channel ([SENSe<1 2>:]ATV:CSO:POWer:REFerence:CHANnel:MANual command)
MCHannel	same as measurement channel
MANual	manual reference power ([SENSe<1 2>:]ATV:CSO:POWer:REFerence:MANual command)

Example

```
ATV:CSO:POW:REF:MODE RCH
```

Sets the reference channel method.

Characteristics

RST value: MCH

SCPI: device-specific

Mode

CATV

[SENSe<1|2>]:ATV:CSO:TABLE<1...10>:MFrequencies

This command defines the measurement frequencies (center frequencies and span values), and activates or deactivates them for the CSO measurement.

The numeric suffixes <1|2> are irrelevant.

The numeric suffix <1...10> defines the table row.

Parameter

```
0 | 1,<numeric_value>,<numeric_value>
```

0 deactivated

1 activated

first numeric value center frequency in Hz

second numeric value span in Hz

Example

```
ATV:CSO:TABLE1:MFR 1,-1000,1000
```

Activates the entries of the first table row for the measurement and sets the center frequency to -1 kHz and the span to 1 kHz.

```
ATV:CSO:TABLE2:MFR 1,-2000,2000
```

Activates the second row entries for the measurement and sets the center frequency to -2 kHz and the span to 2 kHz.

Characteristics

RST value:

Row	State	Center frequency	Span
1	ON	-1.25 MHz	200 kHz
2	ON	-750 kHz	200 kHz
3	ON	-250 kHz	200 kHz
4	ON	250 kHz	200 kHz
5	ON	750 kHz	200 kHz
6	ON	1.25 MHz	200 kHz
7	ON	2.25 MHz	200 kHz
8	OFF	3.25 MHz	200 kHz
9	OFF	4.25 MHz	200 kHz
10	OFF	5.25 MHz	200 kHz

SCPI: device-specific

Mode

CATV

SENSe:ATV:CTB Subsystem (CATV, K20)

The SENSe:ATV:CTB subsystem contains commands for the Carrier-to-Composite Triple Beat Ratio (CTB) measurement setup.

Commands of the SENSe:ATV:CTB Subsystem

- [SENSe<1|2>:]ATV:CTB:CFRelative:NEXT
- [SENSe<1|2>:]ATV:CTB:POWer:NCORrection
- [SENSe<1|2>:]ATV:CTB:POWer:REFerence:CHANnel:MANual
- [SENSe<1|2>:]ATV:CTB:POWer:REFerence:MANual
- [SENSe<1|2>:]ATV:CTB:POWer:REFerence:MODE
- [SENSe<1|2>:]ATV:CTB:TABLE<1...10>:MFRequencies

[SENSe<1|2>:]ATV:CTB:CFRelative:NEXT

This command switches from one frequency range to the next according to the measurement frequencies defined by the [SENSe<1|2>:]ATV:CTB:TABLE<1...10>:MFRequencies command.

The numeric suffixes <1|2> are irrelevant.

This command is an event and therefore has no *RST value and no query.

Example

```
ATV:CTB:TABLE1:MFR 1,100,10000
```

Activates the entries of the first table row for the measurement and sets the center frequency to 100 Hz and the span to 10 kHz.

```
ATV:CTB:TABLE2:MFR 1,200,20000
```

Activates the second row entries for the measurement and sets the center frequency to 200 Hz and the span to 20 kHz.

```
ATV:CTB:CFR:NEXT
```

Switches from the frequency range defined in table row 1 to 2.

Characteristics

RST value: –

SCPI: device-specific

Mode

CATV

[SENSe<1|2>:]ATV:CTB:POWer:NCORrection

This command activates or deactivates the noise floor correction.

The numeric suffixes <1|2> are irrelevant.

Parameter

ON | OFF

Example

```
ATV:CTB:POW:NCOR ON
```

Activates the noise floor correction.

Characteristics

RST value: OFF

SCPI: device-specific

Mode

CATV

[SENSe<1|2>:]ATV:CTB:POWer:REFerence:CHANnel:MANual

This command defines the reference channel.

The numeric suffixes <1|2> are irrelevant.

Parameter

<numeric_value>, corresponding to active channel

Example

```
ATV:CTB:POW:REF:CHAN:MAN 5
```

Sets channel 5 in the active channel table as reference channel.

Characteristics

RST value: active measurement channel

SCPI: device-specific

Mode

CATV

[SENSe<1|2>:]ATV:CTB:POWer:REFerence:MANual

This command defines the manual reference power. The unit is set via the [CALCulate<1|2>:UNIT:POWer](#) command.

The numeric suffixes <1|2> are irrelevant.

Parameter

<numeric_value>: ± 200 dB

Example

```
ATV:CTB:POW:REF:MAN 10
```

Sets the reference power to 10.

Characteristics

RST value: 0

SCPI: device-specific

Mode

CATV

[SENSe<1|2>:]ATV:CTB:POWer:REFerence:MODE

This command defines the reference power method.

The numeric suffixes <1|2> are irrelevant.

Parameter

RCHannel	reference channel ([SENSe<1 2>:]ATV:CTB:POWer:REFerence:CHANnel:MANual command)
MCHannel	same as measurement channel
MANual	manual reference power ([SENSe<1 2>:]ATV:CTB:POWer:REFerence:MANual command)

Example

```
ATV:CTB:POW:REF:MODE MAN
```

Sets the reference channel method.

Characteristics

RST value: RCH

SCPI: device-specific

Mode

CATV

[SENSe<1|2>:]ATV:CTB:TABLE<1...10>:MFRrequencies

This command defines the measurement frequencies (center frequencies and span values), and activates or deactivates them for the CTB measurement.

The numeric suffix <1...10> defines the table row. The numeric suffixes <1|2> are irrelevant.

Parameter

0 | 1, <numeric_value>, <numeric_value>

0 deactivated

1 activated

first numeric value center frequency in Hz

second numeric value span in Hz

Example

```
ATV:CTB:TABLE1:MFR 1,100,10000
```

Activates the entries of the first table row for the measurement and sets the center frequency to 100 Hz and the span to 10 kHz.

```
ATV:CTB:TABLE2:MFR 1,200,20000
```

Activates the second row entries for the measurement and sets the center frequency to 200 Hz and the span to 20 kHz.

Characteristics

RST value: 1,0 Hz, 200 kHz (row 1); 0,0,200 kHz (row 2–10)

SCPI: device-specific

Mode

CATV

SENSe:BANDwidth Subsystem (CATV, K20)

This subsystem controls the setting of the instruments filter bandwidths. Both groups of commands (BANDwidth and BWIDth) perform the same functions.

Commands of the SENSe:BANDwidth Subsystem

- [SENSe<1|2>:]BANDwidth|BWIDth[:RESolution]
- [SENSe<1|2>:]BANDwidth|BWIDth[:RESolution]:AUTO
- [SENSe<1|2>:]BANDwidth|BWIDth:VIDeo
- [SENSe<1|2>:]BANDwidth|BWIDth:VIDeo:AUTO

[SENSe<1|2>:]BANDwidth|BWIDth[:RESolution]

For details refer to "[SENSe<1|2>:]BANDwidth|BWIDth[:RESolution]" on page 6.115.

[SENSe<1|2>:]BANDwidth|BWIDth[:RESolution]:AUTO

For details refer to "[SENSe<1|2>:]BANDwidth|BWIDth[:RESolution]:AUTO" on page 6.116.

[SENSe<1|2>:]BANDwidth|BWIDth:VIDeo

For details refer to "[SENSe<1|2>:]BANDwidth|BWIDth:VIDeo" on page 6.117.

[SENSe<1|2>:]BANDwidth|BWIDth:VIDeo:AUTO

For details refer to "[SENSe<1|2>:]BANDwidth|BWIDth:VIDeo:AUTO" on page 6.118.

SENSe:CORRection Subsystem (CATV, K20)

The SENSe:CORRection subsystem controls correction factors.

Commands of the SENSe:CORRection Subsystem

- [SENSe<1|2>:]CORRection:RVELocity

[SENSe<1|2>:]CORRection:RVELocity

This command defines the velocity of propagation of the signal in the transmission channel (e.g. cable), relative to speed of light.

The numeric suffixes <1|2> are irrelevant.

Parameter

<numeric_value>

Example

```
CORR:RVEL 2
```

Sets the velocity of propagation to 2.

Characteristics

RST value: 1

SCPI: device-specific

Mode

CATV

SENSe:DETEctor Subsystem (CATV, K20)

The SENSe:DETEctor subsystem controls the acquisition of measurement data via the selection of the detector for the corresponding trace.

Commands of the SENSe:DETEctor Subsystem

- [SENSe<1|2>:]DETEctor<1...4>[:FUNction]
- [SENSe<1|2>:]DETEctor<1...4>[:FUNction]:AUTO

[SENSe<1|2>:]DETEctor<1...4>[:FUNction]

For details refer to "[SENSe<1|2>:]DETEctor<1...4>[:FUNction]" on page 6.122.

[SENSe<1|2>:]DETEctor<1...4>[:FUNction]:AUTO

For details refer to "[SENSe<1|2>:]DETEctor<1...4>[:FUNction]:AUTO" on page 6.122.

SENSe:DDEMod Subsystem (CATV, K20)

The SENSe:DDEMod subsystem controls the digital TV settings.

Commands of the SENSe:DDEMod Subsystem

- [SENSe<1|2>:]DDEMod:EQUalizer[:STATe]
- [SENSe<1|2>:]DDEMod:EQUalizer:FREeze[:STATe]
- [SENSe<1|2>:]DDEMod:EQUalizer:RESet
- [SENSe<1|2>:]DDEMod:FILTer:ALPHa
- [SENSe<1|2>:]DDEMod:SBANd
- [SENSe<1|2>:]DDEMod:SRATe

[SENSe<1|2>:]DDEMod:EQUalizer[:STATe]

This command activates or deactivates the equalizer.

The numeric suffixes <1|2> are irrelevant.

Parameter

ON | OFF

Example

```
DDEM: EQU OFF
```

Switches the equalizer off.

Characteristics

RST value: ON

SCPI: device-specific

Mode

CATV

[SENSe<1|2>:]DDEMod:EQUalizer:FREeze[:STATe]

This command defines the change of the equalizer coefficients.

The numeric suffixes <1|2> are irrelevant.

Parameter

ON The equalizer coefficients remain unchanged.

OFF The equalizer taps are changed with every measurement.

Example

```
DDEM: EQU: FRE ON
```

Activates the change of the equalizer coefficients.

Characteristics

RST value: OFF

SCPI: device-specific

Mode

CATV

[SENSe<1|2>:]DDEMod:EQUalizer:RESet

This command resets the equalizer and all equalizer parameters are set to their default values. The numeric suffixes <1|2> are irrelevant.

Example

DDEM: EQU: RES

Resets the equalizer.

Characteristics

RST value: –

SCPI: device-specific

Mode

CATV

[SENSe<1|2>:]DDEMod:FILTer:ALPHA

This command defines the roll-off. The numeric suffixes <1|2> are irrelevant.

Parameter

R012 | R013 | R015 | R018

Example

DDEM: FILT: ALPH R018

Sets the roll-off to 0.180.

Characteristics

RST value: R015

SCPI: device-specific

Mode

CATV

[SENSe<1|2>:]DDEMod:SBANd

This command defines the sideband position. The numeric suffixes <1|2> are irrelevant.

Parameter

AUTO | NORMal | INVerse

Example

DDEM: SBAN NORM

Sets the sideband position to normal.

Characteristics

RST value: AUTO

SCPI: device-specific

Mode

CATV

[SENSe<1|2>:]DDEMod:SRATe

This command defines the symbol rate.

The numeric suffixes <1|2> are irrelevant.

Parameter

<numeric_value>

Example

DDEM:SRAT 1000000

Sets the symbol rate to 1.0 MSymb/s

Characteristics

RST value: 6.9 MSYMB/S

SCPI: device-specific

Mode

CATV

SENSe:FREQUENCY Subsystem (CATV, K20)

The SENSe:FREQUENCY subsystem defines the frequency axis of the active display. The frequency axis can either be defined via the start/stop frequency or via the center frequency and span.

Commands of the SENSe:FREQUENCY Subsystem

- [SENSe<1|2>:]FREQUENCY:CHANnel
- [SENSe<1|2>:]FREQUENCY:RF
- [SENSe<1|2>:]FREQUENCY:SPAN:FULL
- [SENSe<1|2>:]FREQUENCY:START
- [SENSe<1|2>:]FREQUENCY:STEP
- [SENSe<1|2>:]FREQUENCY:STOP

[SENSe<1|2>:]FREQUENCY:CHANnel

This command defines the active measurement channel. To display the available channel tables and channels refer to the "[CONFigure:TV Subsystem \(CATV, K20\)](#)" on page 6.334.

The numeric suffixes <1|2> are irrelevant.

Parameter

<numeric_value>

Example

CONF:TV:CTAB:SEL 'TV-EUROPE'

Selects and activates the channel table TV-EUROPE.

```
FREQ:CHAN 3
```

Sets channel 3 as active measurement channel.

Characteristics

RST value: active measurement channel

SCPI: device-specific

Mode

CATV

[SENSe<1|2>:]FREQUENCY:RF

This command defines the RF frequency. The interpretation of the RF frequency depends on the signal type. For details refer to chapter "Instrument Functions", section "Cable TV Measurement Option (K20)", **RF** softkey.

The numeric suffixes <1|2> are irrelevant.

Parameter

<numeric_value> in Hz: 5 MHz to 1.5 GHz

Example

```
FREQ:RF 10MHZ
```

Sets the RF frequency to 10 MHz.

Characteristics

RST value: 1.5 GHz for R&S FSL3, 48.25 MHz for R&S FSL6 (the `FREQ:RF DEF` command sets 48.25 MHz for all models)

SCPI: device-specific

Mode

CATV

[SENSe<1|2>:]FREQUENCY:SPAN:FULL

For details refer to "[SENSe<1|2>:]FREQUENCY:SPAN:FULL" on page 6.126.

[SENSe<1|2>:]FREQUENCY:START

For details refer to "[SENSe<1|2>:]FREQUENCY:START" on page 6.126.

[SENSe<1|2>:]FREQUENCY:STEP

For details refer to "[SENSe<1|2>:]FREQUENCY:CENTER:STEP" on page 6.123.

[SENSe<1|2>:]FREQUENCY:STOP

For details refer to "[SENSe<1|2>:]FREQUENCY:STOP" on page 6.127.

SENSe:POWer Subsystem (CATV, K20)

The SENSe:POWer subsystem adjusts the input attenuator.

Commands of the SENSe:POWer Subsystem

- [\[SENSe<1|2>:\]POWer:ACHannel:PRESet:RLEVel](#)

[SENSe<1|2>:]POWer:ACHannel:PRESet:RLEVel

For details refer to "[\[SENSe<1|2>:\]POWer:ACHannel:PRESet:RLEVel](#)" on page 6.140.

SENSe:SWEep Subsystem (CATV, K20)

This subsystem controls the sweep parameters.

Commands of the SENSe:SWEep Subsystem

- [\[SENSe<1|2>:\]SWEep:COUNT](#)
- [\[SENSe<1|2>:\]SWEep:POINts](#)
- [\[SENSe<1|2>:\]SWEep:SPACing](#)
- [\[SENSe<1|2>:\]SWEep:TIME](#)
- [\[SENSe<1|2>:\]SWEep:TIME:AUTO](#)

[SENSe<1|2>:]SWEep:COUNT

For details refer to "[\[SENSe<1|2>:\]SWEep:COUNT](#)" on page 6.145.

[SENSe<1|2>:]SWEep:POINts

For details refer to "[\[SENSe<1|2>:\]SWEep:POINts](#)" on page 6.149.

[SENSe<1|2>:]SWEep:SPACing

This command defines the labeling of the frequency axis. For details refer to chapter "Instrument Functions", section "Cable TV Measurement Option (K20)", **Frequency Abs/Rel** softkey.

The numeric suffixes <1|2> are irrelevant.

Parameter

ABSolute | RELative

Example

SWE:SPAC ABS

Sets absolute labeling of the frequency axis.

Characteristics

RST value: REL

SCPI: device-specific

Mode

CATV

[SENSe<1|2>:]SWEep:TIME

For details refer to "[SENSe<1|2>:]SWEep:TIME" on page 6.149.

[SENSe<1|2>:]SWEep:TIME:AUTO

For details refer to "[SENSe<1|2>:]SWEep:TIME:AUTO" on page 6.149.

SENSe:TV Subsystem (CATV, K20)

The SENSe:DDEMod subsystem controls the TV settings.

Commands of the SENSe:TV Subsystem

- [SENSe<1|2>:]TV:MSTandard:FILTer:GDELay
- [SENSe<1|2>:]TV:MSTandard:NAME
- [SENSe<1|2>:]TV:MSTandard:STYPe
- [SENSe<1|2>:]TV:TILT:MSTandard:CDISable
- [SENSe<1|2>:]TV:TILT:MSTandard:CENable

[SENSe<1|2>:]TV:MSTandard:FILTer:GDELay

This command defines the group delay for a modulation standard.

The numeric suffixes <1|2> are irrelevant.

Parameter

GENERAL | GHAlf | AUSTRalia | DANMark | NEWZealand | NORWay | SWEDenfull | FLAT | OIRT | CHINA | CCIR | TDF | FFC

Example

```
TV:MST:FILT:GDEL FLAT
Sets the group delay FLAT.
```

Characteristics

RST value: GENERAL

SCPI: device-specific

Mode

CATV

[SENSe<1|2>:]TV:MSTandard:NAME

This command defines the name for a modulation standard.

The numeric suffixes <1|2> are irrelevant.

Parameter

<string>: 1 to 15 characters

Example

```
TV:MST:NAME 'TEST'
```

Gives the modulation standard the name 'TEST'.

Characteristics

RST value: Analog TV

SCPI: device-specific

Mode

CATV

[SENSe<1|2>:]TV:MSTandard:STYPe

This command defines the signal type of a modulation standard.

The numeric suffixes <1|2> are irrelevant.

Parameter

ATV | DTV

Example

```
TV:MST:STYP DTV
```

Sets the signal type DTV.

Characteristics

RST value: ATV

SCPI: device-specific

Mode

CATV

[SENSe<1|2>:]TV:TILT:MSTandard:CDISable

This command deactivates a modulation standard for the Tilt measurement.

The numeric suffixes <1|2> are irrelevant.

Parameter

<string>: modulation standard name

Example

```
TV:TILT:MST:CDIS 'Analog TV'
```

Deactivates the modulation standard Analog TV.

Characteristics

RST value: –

SCPI: device-specific

Mode

CATV

[SENSe<1|2>:]TV:TILT:MSTandard:CENable

This command activates a modulation standard for the Tilt measurement.

The numeric suffixes <1|2> are irrelevant.

Parameter

<string>: modulation standard name

Example

TV:TILT:MST:CEN 'Analog TV'

Activates the modulation standard Analog TV.

Characteristics

RST value: –

SCPI: device-specific

Mode

CATV

SETup:TV Subsystem (CATV, K20)

The SETup:TV subsystem controls the modulation standard settings.

Commands of the SETup:TV Subsystem

- [SETup:TV:STANdard](#)
- [SETup:TV:STANdard:AUDio](#)
- [SETup:TV:STANdard:COLor](#)

SETup:TV:STANdard

This command sets the TV standard.

Parameter

BG | DK | I | K1 | L | M | N (analog TV)

J83A | J83B | J83C (digital TV)

Example

```
SET:TV:STAN DK
```

Sets the TV standard DK.

Characteristics

RST value: BG

SCPI: device-specific

Mode

CATV

SETup:TV:STANdard:AUDio

This command sets the sound system for analog TV measurements.

Parameter

FM55NICAM585 | FM55FM5742 | FM55MONO | FM65NICAM585 | FM65FM6258 |
 FM65FM6742 | FM65MONO | FM60NICAM6552 | FM60MONO | AM65NICAM585 |
 AM60MONO | FM45BTSC | FM45EIA_J | FM45FM4742 | FM45MONO

Example

```
SET:TV:STAN:AUD FM65MONO
```

Sets the sound system FM65MONO.

Characteristics

RST value: FM65FM6742

SCPI: device-specific

Mode

CATV

SETup:TV:STANdard:COLor

This command sets the color system for analog TV measurements.

Parameter

PAL | NTSC | SECam

Example

SET:TV:STAN:COL SEC
Sets the color system SECam.

Characteristics

RST value: PAL
SCPI: device-specific

Mode

CATV

SOURce Subsystem (CATV, K20)

The SOURce subsystem controls the digital TV settings.

Commands of the SOURce Subsystem

- [SOURce:DM:FORMat](#)

SOURce:DM:FORMat

This command sets the constellation parameter for digital TV measurements.

Parameter

QAM4 | QAM16 | QAM32 | QAM64 | QAM128 | QAM256 | QAM512 | QAM1024

Example

```
SOURce:DM:FORM QAM128
```

Sets the constellation parameter

Characteristics

RST value: QAM64

SCPI: device-specific

Mode

CATV

STATus Subsystem (CATV, K20)

The STATus subsystem contains the commands for the status reporting system (see chapter "Remote Control – Basics", section "Status Reporting System"). *RST does not influence the status registers.

Commands of the STATus Subsystem

- STATus:QUEStionable:ACPLimit:CONDition?
- STATus:QUEStionable:ACPLimit:ENABLE
- STATus:QUEStionable:ACPLimit:NTRansition
- STATus:QUEStionable:ACPLimit:PTRansition
- STATus:QUEStionable:ACPLimit[:EVENT?]
- STATus:QUEStionable:FREQuency:CONDition?
- STATus:QUEStionable:FREQuency:ENABLE
- STATus:QUEStionable:FREQuency:NTRansition
- STATus:QUEStionable:FREQuency:PTRansition
- STATus:QUEStionable:FREQuency[:EVENT?]
- STATus:QUEStionable:LIMit<1|2>:CONDition?
- STATus:QUEStionable:LIMit<1|2>:ENABLE
- STATus:QUEStionable:LIMit<1|2>:NTRansition
- STATus:QUEStionable:LIMit<1|2>:PTRansition
- STATus:QUEStionable:LIMit<1|2>[:EVENT?]
- STATus:QUEStionable:LMARgin<1|2>:CONDition?
- STATus:QUEStionable:LMARgin<1|2>:ENABLE
- STATus:QUEStionable:LMARgin<1|2>:NTRansition
- STATus:QUEStionable:LMARgin<1|2>:PTRansition
- STATus:QUEStionable:LMARgin<1|2>[:EVENT?]
- STATus:QUEStionable:POWer:CONDition?
- STATus:QUEStionable:POWer:ENABLE
- STATus:QUEStionable:POWer:NTRansition
- STATus:QUEStionable:POWer:PTRansition
- STATus:QUEStionable:POWer[:EVENT?]
- STATus:QUEStionable:SYNC:CONDition?
- STATus:QUEStionable:SYNC:ENABLE
- STATus:QUEStionable:SYNC:NTRansition
- STATus:QUEStionable:SYNC:PTRansition
- STATus:QUEStionable:SYNC[:EVENT?]

STATus:QUEStionable:ACPLimit:CONDition?

For details refer to "STATus:QUEStionable:ACPLimit:CONDition?" on page 6.153.

STATus:QUESTIONable:ACPLimit:ENABLE

For details refer to "[STATus:QUESTIONable:ACPLimit:ENABLE](#)" on page 6.153.

STATus:QUESTIONable:ACPLimit:NTRansition

For details refer to "[STATus:QUESTIONable:ACPLimit:NTRansition](#)" on page 6.154.

STATus:QUESTIONable:ACPLimit:PTRansition

For details refer to "[STATus:QUESTIONable:ACPLimit:PTRansition](#)" on page 6.154.

STATus:QUESTIONable:ACPLimit[:EVENT?]

For details refer to "[STATus:QUESTIONable:ACPLimit\[:EVENT?\]](#)" on page 6.153.

STATus:QUESTIONable:FREQUENCY:CONDition?

For details refer to "[STATus:QUESTIONable:FREQUENCY:CONDition?](#)" on page 6.155.

STATus:QUESTIONable:FREQUENCY:ENABLE

For details refer to "[STATus:QUESTIONable:FREQUENCY:ENABLE](#)" on page 6.155.

STATus:QUESTIONable:FREQUENCY:NTRansition

For details refer to "[STATus:QUESTIONable:FREQUENCY:NTRansition](#)" on page 6.156.

STATus:QUESTIONable:FREQUENCY:PTRansition

For details refer to "[STATus:QUESTIONable:FREQUENCY:PTRansition](#)" on page 6.155.

STATus:QUESTIONable:FREQUENCY[:EVENT?]

For details refer to "[STATus:QUESTIONable:FREQUENCY\[:EVENT?\]](#)" on page 6.154.

STATus:QUESTIONable:LIMit<1|2>:CONDition?

For details refer to "[STATus:QUESTIONable:LIMit<1|2>:CONDition?](#)" on page 6.156.

STATus:QUESTIONable:LIMit<1|2>:ENABLE

For details refer to "[STATus:QUESTIONable:LIMit<1|2>:ENABLE](#)" on page 6.157.

STATus:QUESTionable:LIMit<1|2>:NTRansition

For details refer to "[STATus:QUESTionable:LIMit<1|2>:NTRansition](#)" on page 6.157.

STATus:QUESTionable:LIMit<1|2>:PTRansition

For details refer to "[STATus:QUESTionable:LIMit<1|2>:PTRansition](#)" on page 6.157.

STATus:QUESTionable:LIMit<1|2>[:EVENT?]

For details refer to "[STATus:QUESTionable:LIMit<1|2> \[:EVENT?\]](#)" on page 6.156.

STATus:QUESTionable:LMARgin<1|2>:CONDition?

For details refer to "[STATus:QUESTionable:LMARgin<1|2>:CONDition?](#)" on page 6.158.

STATus:QUESTionable:LMARgin<1|2>:ENABLE

For details refer to "[STATus:QUESTionable:LMARgin<1|2>:ENABLE](#)" on page 6.158.

STATus:QUESTionable:LMARgin<1|2>:NTRansition

For details refer to "[STATus:QUESTionable:LMARgin<1|2>:NTRansition](#)" on page 6.159.

STATus:QUESTionable:LMARgin<1|2>:PTRansition

For details refer to "[STATus:QUESTionable:LMARgin<1|2>:PTRansition](#)" on page 6.159.

STATus:QUESTionable:LMARgin<1|2>[:EVENT?]

For details refer to "[STATus:QUESTionable:LMARgin<1|2>\[:EVENT?\]](#)" on page 6.158.

STATus:QUESTionable:POWER:CONDition?

For details refer to "[STATus:QUESTionable:POWER:CONDition?](#)" on page 6.159.

STATus:QUESTionable:POWER:ENABLE

For details refer to "[STATus:QUESTionable:POWER:ENABLE](#)" on page 6.160.

STATus:QUESTionable:POWER:NTRansition

For details refer to "[STATus:QUESTionable:POWER:NTRansition](#)" on page 6.160.

STATus:QUEStionable:POWEr:PTRansition

For details refer to "[STATus:QUEStionable:POWEr:PTRansition](#)" on page 6.160.

STATus:QUEStionable:POWEr[:EVENT?]

For details refer to "[STATus:QUEStionable:POWEr\[:EVENT?\]](#)" on page 6.159.

STATus:QUEStionable:SYNC:CONDition?

This command queries the contents of the CONDition section of the STATus:QUEStionable:SYNC register.

Example

```
STAT:QUES:SYNC:COND?
```

Characteristics

RST value: –

SCPI: conform

Mode

CATV

STATus:QUEStionable:SYNC:ENABLE

This command sets the bits of the ENABLE section of the STATus:QUEStionable:SYNC register. The ENABLE register selectively enables the individual events of the associated EVENT section for the summary bit.

Parameter

0 to 65535

Example

```
STAT:QUES:SYNC:ENAB 1
```

Characteristics

RST value: –

SCPI: conform

Mode

CATV

STATus:QUEStionable:SYNC:NTRansition

This command sets the edge detectors of all bits of the STATus:QUEStionable:SYNC register from 1 to 0 for the transitions of the CONDition bit.

Parameter

0 to 65535

Example

```
STAT:QUES:SYNC:NTR 1
```

Characteristics

RST value: –

SCPI: conform

Mode

CATV

STATus:QUEStionable:SYNC:PTRansition

This command sets the edge detectors of all bits of the STATus:QUEStionable:SYNC register from 0 to 1 for the transitions of the CONDition bit.

Parameter

0 to 65535

Example

STAT:QUES:SYNC:PTR 65535

Characteristics

RST value: –

SCPI: conform

Mode

CATV

STATus:QUEStionable:SYNC[:EVENT?]

This command queries the contents of the EVENT section of the STATus:QUEStionable:SYNC register. Readout deletes the contents of the EVENT section.

Example

STAT:QUES:SYNC?

Characteristics

RST value: –

SCPI: conform

Mode

CATV

TRACe Subsystem (CATV, K20)

The TRACe subsystem controls access to the instruments internal trace memory.

Commands of the TRACe Subsystem

– [TRACe<1|2>\[:DATA\]](#)

TRACe<1|2>[:DATA]

For details refer to "[TRACe<1|2>\[:DATA\]](#)" on page 6.164.

TRIGger Subsystem (CATV, K20)

The TRIGger subsystem is used to synchronize instrument actions with events. It is thus possible to control and synchronize the start of a sweep.

Commands of the TRIGger Subsystem

- TRIGger<1|2>[:SEQuence]:HOLDoff[:TIME]
- TRIGger<1|2>[:SEQuence]:VIDeo:BFieLd[:NUMBer]
- TRIGger<1|2>[:SEQuence]:VIDeo:BLINe[:NUMBer]
- TRIGger<1|2>[:SEQuence]:VIDeo:BLINe:TYPE
- TRIGger<1|2>[:SEQuence]:VIDeo:FIELD[:NUMBer]
- TRIGger<1|2>[:SEQuence]:VIDeo:LINE[:NUMBer]
- TRIGger<1|2>[:SEQuence]:VIDeo:QFieLd[:NUMBer]
- TRIGger<1|2>[:SEQuence]:VIDeo:QLINe[:NUMBer]

TRIGger<1|2>[:SEQuence]:HOLDoff[:TIME]

For details refer to "TRIGger<1|2>[:SEQuence]:HOLDoff[:TIME]" on page 6.175.

TRIGger<1|2>[:SEQuence]:VIDeo:BFieLd[:NUMBer]

This command sets the bar field parameter for analog TV measurements.

Parameter

1 | 2

Example

```
TRIG:VID:BFI 2
```

Sets the bar field parameter to 2.

Characteristics

RST value: 1

SCPI: device-specific

Mode

CATV

TRIGger<1|2>[:SEQuence]:VIDeo:BLINe[:NUMBer]

This command sets the bar line parameter for analog TV measurements.

Parameter

<numeric_value>

Example

```
TRIG:VID:BLIN 16
```

Sets the bar line parameter to 16.

Characteristics

RST value: 18

SCPI: device-specific

Mode

CATV

TRIGger<1|2>[:SEQUence]:VIDeo:BLINe:TYPE

This command sets the bar line type for analog TV measurements.

Parameter

CCIR17 | FCC | NTC7

Example

```
TRIG:VID:BLIN:TYPE CCIR17
```

Sets the bar line type to CCIR17.

Characteristics

RST value: CCIR17

SCPI: device-specific

Mode

CATV

TRIGger<1|2>[:SEQUence]:VIDeo:FIELd:[NUMBer]

This command defines the active field in the Video Scope measurement.

Parameter

1 | 2

Example

```
TRIG:VID:FIEL 2
```

Sets the active field 2.

Characteristics

RST value: 1

SCPI: conform

Mode

CATV

TRIGger<1|2>[:SEQUence]:VIDeo:LINE:[NUMBer]

This command activates triggering at the horizontal sync signal of the indicated line number in the Video Scope measurement..

Parameter

<numeric_value>, depending on the numbering conventions of the TV standard and the color system

Example

```
TRIG:VID:LINE 17
```

Characteristics

*RST value: 1

SCPI: conform

ModeCATV

TRIGger<1|2>[:SEQuence]:VIDeo:QFIeld[:NUMBer]

This command sets the quiet line field for analog TV measurements.

Parameter

1 | 2

Example

```
TRIG:VID:QFI 2
```

Sets the quiet line field to 2.

Characteristics

RST value: 1

SCPI: device-specific

ModeCATV

TRIGger<1|2>[:SEQuence]:VIDeo:QLINe[:NUMBer]

This command sets the quiet line parameter for analog TV measurements.

Parameter

<numeric_value>

Example

```
TRIG:VID:QLIN 20
```

Sets the quiet line parameter to 20.

Characteristics

RST value: 22

SCPI: device-specific

ModeCATV

UNIT Subsystem (CATV, K20)

The UNIT subsystem sets the basic unit of the setting parameters.

Commands of the UNIT Subsystem

- [UNIT<1|2>:POWer](#)

UNIT<1|2>:POWer

This command selects the default unit.

Parameter

DBM | DBUV | DBMV | DBPW | VOLT | V | W | WATT | A | AMPere

Example

```
UNIT:POW DBUV
```

Sets the power unit to dBm.

Characteristics

*RST value: DBM

SCPI: conform

Mode

CATV

Remote Commands of the WLAN TX Measurements Option (K91)

This chapter describes the remote commands for the WLAN TX Measurements option (K91). The abbreviation WLAN stands for the operating mode Wireless LAN. For details on conventions used in this chapter refer to section "Notation" on page 6.2 at the beginning of this chapter.

For further information on analyzer or basic settings commands, refer to the corresponding subsystem in section "Remote Control – Description of Analyzer Commands" on page 6.5 or section "Remote Control – Description of Basic Settings Commands".

This option is available from firmware version 1.20.

Subsystems of the WLAN TX Measurements option (K91)

- "ABORt Subsystem (WLAN, K91)" on page 6.379
- "CALCulate:BURSt Subsystem (WLAN, K91)" on page 6.380
- "CALCulate:LIMit Subsystem (WLAN, K91)" on page 6.381
- "CALCulate:MARKer Subsystem (WLAN, K91)" on page 6.397
- "CONFigure Subsystem (WLAN, K91)" on page 6.404
- "DISPlay Subsystem (WLAN, K91)" on page 6.413
- "FETCh Subsystem (WLAN, K91)" on page 6.416
- "FORMat Subsystem (WLAN, K91)" on page 6.425
- "INITiate Subsystem (WLAN, K91)" on page 6.426
- "INPut Subsystem (WLAN, K91)" on page 6.427
- "INSTrument Subsystem (WLAN, K91)" on page 6.428
- "MMEMory Subsystem (WLAN, K91)" on page 6.429
- "SENSE Subsystem (WLAN, K91)" on page 6.430
- "STATus Subsystem (WLAN, K91)" on page 6.444
- "TRACe Subsystem (WLAN, K91)" on page 6.448
- "TRIGger Subsystem (WLAN, K91)" on page 6.454
- "UNIT Subsystem (WLAN, K91)" on page 6.456

ABORt Subsystem (WLAN, K91)

The ABORt subsystem contains the commands for aborting triggered actions.

Commands of the ABORt Subsystem

- [ABORt](#)

ABORt

For details refer to "[ABORt](#)" on page 6.5.

CALCulate:BURSt Subsystem (WLAN, K91)

The CALCulate:BURSt subsystem checks the IQ measurement results.

Commands of the CALCulate:BURSt Subsystem

- [CALCulate<1|2>:BURSt\[:IMMediate\]](#)

CALCulate<1|2>:BURSt[:IMMediate]

This command forces the IQ measurement results to be recalculated according to the current settings.

This command is an event and therefore has no *RST value and no query.

Example

```
CALC1: BURS
```

Starts the recalculation of the IQ measurement results.

Characteristics

RST value: –

SCPI: device-specific

Mode

WLAN

CALCulate:LIMit Subsystem (WLAN, K91)

The CALCulate:LIMit subsystem consists of the limit lines and the corresponding limit checks.

Commands of the CALCulate:LIMit Subsystem

- CALCulate<1|2>:LIMit<1..8>:FAIL?
- CALCulate<1|2>:LIMit<1>:ACPower:ACHannel?
- CALCulate<1|2>:LIMit<1>:ACPower:ACHannel:RESult?
- CALCulate<1|2>:LIMit<1>:ACPower:ALTernate?
- CALCulate<1|2>:LIMit<1>:ACPower:ALTernate:RESult?
- CALCulate<1|2>:LIMit<1>:BURSt:ALL
- CALCulate<1|2>:LIMit<1>:BURSt:ALL:RESult?
- CALCulate<1|2>:LIMit<1>:BURSt:EVM[:AVERage]
- CALCulate<1|2>:LIMit<1>:BURSt:EVM[:AVERage]:RESult?
- CALCulate<1|2>:LIMit<1>:BURSt:EVM:ALL[:AVERage]
- CALCulate<1|2>:LIMit<1>:BURSt:EVM:ALL[:AVERage]:RESult?
- CALCulate<1|2>:LIMit<1>:BURSt:EVM:ALL:MAXimum
- CALCulate<1|2>:LIMit<1>:BURSt:EVM:ALL:MAXimum:RESult?
- CALCulate<1|2>:LIMit<1>:BURSt:EVM:DATA[:AVERage]
- CALCulate<1|2>:LIMit<1>:BURSt:EVM:DATA[:AVERage]:RESult?
- CALCulate<1|2>:LIMit<1>:BURSt:EVM:DATA:MAXimum
- CALCulate<1|2>:LIMit<1>:BURSt:EVM:DATA:MAXimum:RESult?
- CALCulate<1|2>:LIMit<1>:BURSt:EVM:MAXimum
- CALCulate<1|2>:LIMit<1>:BURSt:EVM:MAXimum:RESult?
- CALCulate<1|2>:LIMit<1>:BURSt:EVM:PILot[:AVERage]
- CALCulate<1|2>:LIMit<1>:BURSt:EVM:PILot[:AVERage]:RESult?
- CALCulate<1|2>:LIMit<1>:BURSt:EVM:PILot:MAXimum
- CALCulate<1|2>:LIMit<1>:BURSt:EVM:PILot:MAXimum:RESult?
- CALCulate<1|2>:LIMit<1>:BURSt:FERRor[:AVERage]
- CALCulate<1|2>:LIMit<1>:BURSt:FERRor[:AVERage]:RESult?
- CALCulate<1|2>:LIMit<1>:BURSt:FERRor:MAXimum
- CALCulate<1|2>:LIMit<1>:BURSt:FERRor:MAXimum:RESult?
- CALCulate<1|2>:LIMit<1>:BURSt:IQOFFset[:AVERage]
- CALCulate<1|2>:LIMit<1>:BURSt:IQOFFset[:AVERage]:RESult?
- CALCulate<1|2>:LIMit<1>:BURSt:IQOFFset:MAXimum
- CALCulate<1|2>:LIMit<1>:BURSt:IQOFFset:MAXimum:RESult?
- CALCulate<1|2>:LIMit<1>:BURSt:SYMBOLerror[:AVERage]
- CALCulate<1|2>:LIMit<1>:BURSt:SYMBOLerror[:AVERage]:RESult?

- CALCulate<1|2>:LIMit<1>:BURSt:SYMBolerror:MAXimum
- CALCulate<1|2>:LIMit<1>:BURSt:SYMBolerror:MAXimum:RESult?
- CALCulate<1|2>:LIMit<1>:BURSt:TFALI[:AVERAge]
- CALCulate<1|2>:LIMit<1>:BURSt:TFALI[:AVERAge]:RESult?
- CALCulate<1|2>:LIMit<1>:BURSt:TFALI:MAXimum
- CALCulate<1|2>:LIMit<1>:BURSt:TFALI:MAXimum:RESult?
- CALCulate<1|2>:LIMit<1>:BURSt:TRISe[:AVERAge]
- CALCulate<1|2>:LIMit<1>:BURSt:TRISe[:AVERAge]:RESult?
- CALCulate<1|2>:LIMit<1>:BURSt:TRISe:MAXimum
- CALCulate<1|2>:LIMit<1>:BURSt:TRISe:MAXimum:RESult?
- CALCulate<1|2>:LIMit<1>:SPECTrum:MASK:CHECK:X?
- CALCulate<1|2>:LIMit<1>:SPECTrum:MASK:CHECK:Y?

CALCulate<1|2>:LIMit<1...8>:FAIL?

For option WLAN TX Measurements, K91, the numeric suffixes <1...8> specify the limit lines as follows:

Suffix	Limit
1 to 2	These indexes are not used
3	ETSI Spectrum Mask limit line
4	Spectrum Flatness (Upper) limit line
5	Spectrum Flatness (Lower) limit line
6	IEEE Spectrum Mask limit line
7	PVT Rising Edge max limit
8	PVT Rising Edge mean limit
9	PVT Falling Edge max limit
10	PVT Falling Edge mean limit

For further details refer to "CALCulate<1|2>:LIMit<1...8>:FAIL?" on page 6.21.

CALCulate<1|2>:LIMit<1>:ACPpower:ACHannel?

This command returns the ACP adjacent channel limit for IEEE 802.11j if defined. This command is a query only and thus has no *RST value.

Parameter

numeric value in dB

Example

```
CALC:LIM:ACP:ACH?
```

Returns the IEEE 802.11j ACP adjacent channel limit.

Characteristics

*RST value: –

SCPI: device-specific

Mode

WLAN

CALCulate<1|2>:LIMit<1>:ACPoweR:ACHannel:RESult?

For details refer to "[CALCulate<1|2>:LIMit<1...8>:ACPoweR:ACHannel:RESult?](#)" on page 6.27.

CALCulate<1|2>:LIMit<1>:ACPoweR:ALTErnate?

This command returns the ACP alternate channel limit for IEEE 802.11j if defined.

Parameter

numeric value in dB

Example

```
CALC:LIM:ACP:ALT?
```

Returns the IEEE 802.11j ACP alternate channel limit.

Characteristics

*RST value: –

SCPI: device-specific

Mode

WLAN

CALCulate<1|2>:LIMit<1>:ACPoweR:ALTErnate:RESult?

For details refer to "[CALCulate<1|2>:LIMit<1...8>:ACPoweR:ALTErnate<1|2>:RESult?](#)" on page 6.30.

CALCulate<1|2>:LIMit<1>:BURSt:ALL

This command sets or returns all the limit values.

Parameter

The results are input or output as a list of values separated by ',' in the following (ASCII) format:

```
<average frequency error>, <max frequency error>,
<average symbol error>, <max symbol error>,
<average IQ offset>, <maximum IQ offset>,
<average EVM all bursts>, <max EVM all bursts>,
<average EVM data carriers >, <max EVM data carriers >
<average EVM pilots >, <max EVM pilots >
```

Note: The units for the EVM results are specified with the [UNIT:EVM](#) command.

Example

```
CALC:LIM:BURS:ALL?
```

All limit values are returned

Characteristics

*RST value: –

SCPI: device-specific

Mode

WLAN

CALCulate<1|2>:LIMit<1>:BURSt:ALL:RESUlt?

This command returns all the limit results.

This command is a query only and thus has no *RST value.

Parameter

For details on formats refer to "CALCulate<1|2>:LIMit<1>:BURSt:ALL" on page 6.383.

Example

```
CALC:LIM:BURS:ALL:RES?
```

All limit values are returned

Characteristics

*RST value: –

SCPI: device-specific

Mode

WLAN

CALCulate<1|2>:LIMit<1>:BURSt:EVM[:AVERAge]

This command sets the average Error Vector Magnitude Limit for the IEEE 802.11b standard.

Parameter

numeric value in dB

Example

```
CALC:LIM:BURS:EVM -25.0
```

Average EVM limit is set to –25 dB

Characteristics

*RST value: –

SCPI: device-specific

Mode

WLAN

CALCulate<1|2>:LIMit<1>:BURSt:EVM[:AVERAge]:RESUlt?

This command returns the average Error Vector Magnitude Limit result (PASSED | FAILED) for the IEEE 802.11b standard.

This command is a query only and thus has no *RST value.

Example

```
CALC:LIM:BURS:EVM:RES?
```

Average EVM limit result is returned

Characteristics

*RST value: –

SCPI: device-specific

ModeWLAN

CALCulate<1|2>:LIMit<1>:BURSt:EVM:ALL[:AVERAge]

This command sets the average Error Vector Magnitude Limit. This is a combined figure that represents the pilot, data and the free carrier.

Parameter

numeric value in dB

Example

```
CALC:LIM:BURS:EVM:ALL -25.0
```

Average EVM for all carrier limit is set to -25.0 dB

Characteristics

*RST value: –

SCPI: device-specific

ModeWLAN

CALCulate<1|2>:LIMit<1>:BURSt:EVM:ALL[:AVERAge]:RESult?

This command returns the average Error Vector Magnitude Limit result (PASSED | FAILED). This is a combined figure that represents the pilot, data and the free carrier.

This command is a query only and thus has no *RST value.

Example

```
CALC:LIM:BURS:EVM:ALL:RES?
```

Average EVM for all carrier limit result is returned

Characteristics

*RST value: –

SCPI: device-specific

ModeWLAN

CALCulate<1|2>:LIMit<1>:BURSt:EVM:ALL:MAXimum

This command sets the maximum Error Vector Magnitude Limit. This is a combined figure that represents the pilot, data and the free carrier.

Parameter

numeric value in dB

Example

```
CALC:LIM:BURS:EVM:ALL:MAX?
```

Maximum EVM for all carrier limit is returned

Characteristics

*RST value: –

SCPI: device-specific

Mode

WLAN

CALCulate<1|2>:LIMit<1>:BURSt:EVM:ALL:MAXimum:RESult?

This command returns the maximum Error Vector Magnitude Limit result (PASSED | FAILED).

This is a combined figure that represents the pilot, data and the free carrier.? (K91)"

This command is a query only and thus has no *RST value.

Example

```
CALC:LIM:BURS:EVM:ALL:MAX:RES?
```

Maximum EVM for all carrier limit result is returned

Characteristics

*RST value: –

SCPI: device-specific

Mode

WLAN

CALCulate<1|2>:LIMit<1>:BURSt:EVM:DATA[:AVERAge]

This command sets the average Error Vector Magnitude limit summary for the data carrier.

Parameter

numeric value in dB

Example

```
CALC:LIM:BURS:EVM:DATA -30.0
```

Average EVM for data carrier limit is set to –30.0 dB

Characteristics

*RST value: –

SCPI: device-specific

Mode

WLAN

CALCulate<1|2>:LIMit<1>:BURSt:EVM:DATA[:AVERAge]:RESult?

This command returns the average Error Vector Magnitude limit result summary (PASSED | FAILED) for the data carrier.? (K91)"

This command is a query only and thus has no *RST value.

Example

```
CALC:LIM:BURS:EVM:DATA:RES?
```

Average EVM for data carrier limit result is returned

Characteristics

*RST value: –

SCPI: device-specific

Mode

WLAN

CALCulate<1|2>:LIMit<1>:BURSt:EVM:DATA:MAXimum

This command sets the maximum Error Vector Magnitude limit summary for the data carrier.

Parameter

numeric value in dB

Example

```
CALC:LIM:BURS:EVM:DATA:MAX?
Maximum EVM for data burst limit is returned
```

Characteristics

*RST value: –
SCPI: device-specific

Mode

WLAN

CALCulate<1|2>:LIMit<1>:BURSt:EVM:DATA:MAXimum:RESult?

This command returns the maximum Error Vector Magnitude limit result summary (PASSED | FAILED) for the data carrier.? (K91)"

This command is a query only and thus has no *RST value.

Example

```
CALC:LIM:BURS:EVM:DATA:MAX:RES?
Maximum EVM for data carrier limit result is returned Characteristics.
```

*RST value: –
SCPI: device-specific

Mode

WLAN

CALCulate<1|2>:LIMit<1>:BURSt:EVM:MAXimum

This command sets the maximum Error Vector Magnitude Limit for the IEEE 802.11b standard.

Parameter

numeric value in dB

Example

```
CALC:LIM:BURS:EVM:MAX?
Maximum EVM limit is returned
```

Characteristics

*RST value: –
SCPI: device-specific

Mode

WLAN

CALCulate<1|2>:LIMit<1>:BURSt:EVM:MAXimum:RESult?

This command returns the maximum Error Vector Magnitude Limit result (PASSED | FAILED) for the IEEE 802.11b standard.

This command is a query only and thus has no *RST value.

Example

CALC:LIM:BURS:EVM:MAX:RES?
Maximum EVM limit result is returned

Characteristics

*RST value: –
SCPI: device-specific

Mode

WLAN

CALCulate<1|2>:LIMit<1>:BURSt:EVM:PILot[:AVERAge]

This command sets the average Error Vector Magnitude limit summary for the pilot carriers.

Parameter

numeric value in dB

Example

CALC:LIM:BURS:EVM:PIL -8.0
Average EVM for pilot carrier limit is set to –8.0 dB

Characteristics

*RST value: –
SCPI: device-specific

Mode

WLAN

CALCulate<1|2>:LIMit<1>:BURSt:EVM:PILot[:AVERAge]:RESult?

This command returns the average Error Vector Magnitude limit result summary (PASSED | FAILED) for the pilot carriers.? (K91)"

This command is a query only and thus has no *RST value.

Example

CALC:LIM:BURS:EVM:PIL:RES?
Average EVM for pilot carrier limit result is returned

Characteristics

*RST value: –
SCPI: device-specific

Mode

WLAN

CALCulate<1|2>:LIMit<1>:BURSt:EVM:PILot:MAXimum

This command sets the maximum Error Vector Magnitude limit summary for the pilot carriers.

Parameter

numeric value in dB

Example

CALC:LIM:BURS:EVM:PIL:MAX?
Maximum EVM for pilot carrier limit is returned

Characteristics

*RST value: –

SCPI: device-specific

Mode

WLAN

CALCulate<1|2>:LIMit<1>:BURSt:EVM:PILot:MAXimum:RESult?

This command returns the maximum Error Vector Magnitude limit result summary (PASSED | FAILED) for the pilot carriers.? (K91)"

This command is a query only and thus has no *RST value.

Example

```
CALC:LIM:BURS:EVM:PIL:MAX:RES?
```

Maximum EVM for pilot carrier limit result is returned

Characteristics

*RST value: –

SCPI: device-specific

Mode

WLAN

CALCulate<1|2>:LIMit<1>:BURSt:FERRor[:AVERage]

This command sets the average frequency error limit.

Parameter

numeric value in Hertz

Example

```
CALC:LIM:BURS:FERR 10000
```

The average frequency error limit is set to 10 kHz

Characteristics

*RST value: –

SCPI: device-specific

Mode

WLAN

CALCulate<1|2>:LIMit<1>:BURSt:FERRor[:AVERage]:RESult?

This command returns the average frequency error limit result.

This command is a query only and thus has no *RST value.

Example

```
CALC:LIM:BURS:FERR:RES?
```

Average frequency error limit result is returned

Characteristics

*RST value: –

SCPI: device-specific

ModeWLAN

CALCulate<1|2>:LIMit<1>:BURSt:FERRor:MAXimum

This command sets the maximum frequency error limit.

Parameter

numeric value in Hertz

Example

```
CALC:LIM:BURS:FERR:MAX?
```

Maximum frequency error limit is returned

Characteristics

*RST value: –

SCPI: device-specific

ModeWLAN

CALCulate<1|2>:LIMit<1>:BURSt:FERRor:MAXimum:RESult?

This command returns the maximum frequency error limit result.

This command is a query only and thus has no *RST value.

Example

```
CALC:LIM:BURS:FERR:MAX:RES?
```

Maximum frequency error limit result is returned

Characteristics

*RST value: –

SCPI: device-specific

ModeWLAN

CALCulate<1|2>:LIMit<1>:BURSt:IQOFFset[:AVERage]

This command sets the average IQ Offset error limit.

Parameter

numeric value in dB: –1000000 to 1000000

Example

```
CALC:LIM:BURS:IQOF -10.0
```

Average IQ Offset error limit is set to –10.0 dB

Characteristics

*RST value: –

SCPI: device-specific

ModeWLAN

CALCulate<1|2>:LIMit<1>:BURSt:IQOFset[:AVERAge]:RESult?

This command returns the average IQ Offset error limit result.

Example

```
CALC:LIM:BURS:IQOF:RES?
```

Average IQ Offset error limit result is returned

Characteristics

*RST value: –

SCPI: device-specific

Mode

WLAN

CALCulate<1|2>:LIMit<1>:BURSt:IQOFset:MAXimum

This command sets the maximum IQ Offset error limit.

Parameter

numeric value in dB: –1000000 to 1000000

Example

```
CALC:LIM:BURS:IQOF:MAX 15.0
```

Maximum IQ Offset error limit is set to –15.0 dB

Characteristics

*RST value: –

SCPI: device-specific

Mode

WLAN

CALCulate<1|2>:LIMit<1>:BURSt:IQOFset:MAXimum:RESult?

This command returns the maximum IQ Offset error limit result.

Example

```
CALC:LIM:BURS:IQOF:MAX:RES?
```

Maximum IQ Offset error limit result is returned

Characteristics

*RST value: –

SCPI: device-specific

Mode

WLAN

CALCulate<1|2>:LIMit<1>:BURSt:SYMBOLerror[:AVERAge]

This command sets the average symbol error limit.

Parameter

numeric value in Hertz

Example

```
CALC:LIM:BURS:SYMB 10000
```

The average symbol error limit is set to 10kHz

Characteristics

*RST value: –

SCPI: device-specific

Mode

WLAN

CALCulate<1|2>:LIMit<1>:BURSt:SYMBolerror[:AVERage]:RESult?

This command returns the average symbol error limit result.

This command is a query only and thus has no *RST value.

Example

```
CALC:LIM:BURS:SYMB:RES?
```

Average symbol error limit result is returned

Characteristics

*RST value: –

SCPI: device-specific

Mode

WLAN

CALCulate<1|2>:LIMit<1>:BURSt:SYMBolerror:MAXimum

This command sets the maximum symbol error limit.

Parameter

numeric value in Hertz

Example

```
CALC:LIM:BURS:SYMB:MAX?
```

Maximum symbol error limit is returned

Characteristics

*RST value: –

SCPI: device-specific

Mode

WLAN

CALCulate<1|2>:LIMit<1>:BURSt:SYMBolerror:MAXimum:RESult?

This command returns the maximum symbol error limit result.

This command is a query only and thus has no *RST value.

Example

```
CALC:LIM:BURS:SYMB:MAX:RES?
```

Maximum symbol error limit result is returned.

Characteristics

*RST value: –

SCPI: device-specific

Mode

WLAN

CALCulate<1|2>:LIMit<1>:BURSt:TFALI[:AVERAge]

This command sets the average fall time limit.

Parameter

numeric value in seconds

Example

```
CALC:LIM:BURS:TFAL 0.000001
```

The average fall time limit is set to 1 μ s

Characteristics

*RST value: –

SCPI: device-specific

Mode

WLAN

CALCulate<1|2>:LIMit<1>:BURSt:TFALI[:AVERAge]:RESult?

This command returns the average fall time limit result.

This command is a query only and thus has no *RST value.

Example

```
CALC:LIM:BURS:TFAL1:RES?
```

Average fall time limit result is returned

Characteristics

*RST value: –

SCPI: device-specific

Mode

WLAN

CALCulate<1|2>:LIMit<1>:BURSt:TFALI:MAXimum

This command sets the maximum fall time limit.

Parameter

numeric value in seconds

Example

```
CALC:LIM:BURS:TFAL1:MAX 0.000001
```

The maximum fall time limit set to 1 μ s.

Characteristics

*RST value: –

SCPI: device-specific

Mode

WLAN

CALCulate<1|2>:LIMit<1>:BURSt:TFALl:MAXimum:RESult?

This command returns the maximum fall time limit result.

This command is a query only and thus has no *RST value.

Example

```
CALC:LIM:BURS:TRIS:MAX:RES?
```

Maximum fall time limit result is returned

Characteristics

*RST value: –

SCPI: device-specific

Mode

WLAN

CALCulate<1|2>:LIMit<1>:BURSt:TRISe[:AVERAge]

This command sets the average rise time limit.

Parameter

numeric value in seconds

Example

```
CALC:LIM:BURS:TRIS 0.000001
```

The average rise time limit is set to 1 μ s

Characteristics

*RST value: –

SCPI: device-specific

Mode

WLAN

CALCulate<1|2>:LIMit<1>:BURSt:TRISe[:AVERAge]:RESult?

This command returns the average rise time limit result.

This command is a query only and thus has no *RST value.

Example

```
CALC:LIM:BURS:TRIS:RES?
```

The average rise time limit result is returned

Characteristics

*RST value: –

SCPI: device-specific

ModeWLAN

CALCulate<1|2>:LIMit<1>:BURSt:TRISe:MAXimum

This command sets the maximum rise time limit.

Parameter

numeric value in seconds

Example

```
CALC:LIM:BURS:TRIS:MAX 0.000001
```

Maximum rise time limit is set to 1 μ s

Characteristics

*RST value: –

SCPI: device-specific

ModeWLAN

CALCulate<1|2>:LIMit<1>:BURSt:TRISe:MAXimum:RESult?

This command returns the maximum rise time limit result.

This command is a query only and thus has no *RST value.

Example

```
CALC:LIM:BURS:TRIS:MAX:RES?
```

Maximum rise time limit result is returned

Characteristics

*RST value: –

SCPI: device-specific

ModeWLAN

CALCulate<1|2>:LIMit<1>:SPECtrum:MASK:CHECK:X?

This command returns the X-value at the maximum overstepping of the spectrum mask limits.

This command is a query only and thus has no *RST value.

Example

```
CALC:LIM:SPEC:MASK:CHEC:X?
```

Returns the frequency at the maximum overstepping.

Characteristics

*RST value: –

SCPI: device-specific

ModeWLAN

CALCulate<1|2>:LIMit<1>:SPECtrum:MASK:CHECK:Y?

This command returns the Y-value at the maximum overstepping of the spectrum mask limits.
This command is a query only and thus has no *RST value.

Example

```
CALC:LIM:SPEC:MASK:CHECK:Y?
```

Returns the power at the maximum overstepping.

Characteristics

*RST value: –

SCPI: device-specific

Mode

WLAN

CALCulate:MARKer Subsystem (WLAN, K91)

The CALCulate:MARKer subsystem checks the marker functions in the instrument.

The following subsystem is included:

- "CALCulate:MARKer:FUNCTION Subsystem (WLAN, K91)" on page 6.402

Commands of the CALCulate:MARKer Subsystem

- CALCulate<1|2>:MARKer<1>[:STATe]
- CALCulate<1|2>:MARKer<1>:AOFF
- CALCulate<1|2>:MARKer<1>:BSYMBOL
- CALCulate<1|2>:MARKer<1>:CARRIER
- CALCulate<1|2>:MARKer<1>:MAXimum
- CALCulate<1|2>:MARKer<1>:MINimum
- CALCulate<1|2>:MARKer<1>:SYMBOL
- CALCulate<1|2>:MARKer<1>:TRACE
- CALCulate<1|2>:MARKer<1>:X
- CALCulate<1|2>:MARKer<1>:Y

CALCulate<1|2>:MARKer<1>[:STATe]

This command switches the markers on or off.

Parameter

ON | OFF

Example

```
CALC1:MARK1:STATE ON
```

Switches the screen A marker ON.

```
CALC2:MARK1:STATE OFF
```

Switches the screen B marker OFF.

Characteristics

RST value: ON

SCPI: device-specific

Mode

WLAN

CALCulate<1|2>:MARKer<1>:AOFF

This command switches off all active markers in the specified measurement window. The window is set by the numeric suffix of CALCulate<1|2>.

Example

```
CALC1:MARK:AOFF
```

Switches off all markers in the screen A window.

```
CALC2:MARK:AOFF
```

Switches off all markers in the screen B window.

Characteristics

RST value: –

SCPI: device-specific

Mode

WLAN

CALCulate<1|2>:MARKer<1>:BSYMBOL

This command positions the selected marker to the indicated symbol in the indicated burst. The first numeric value is the burst number and the second numeric value is the symbol number.

This command only applies to 802.11b standard for the following result displays:

- Constellation vs Symbol
- EVM vs Symbol

This command is a query only and thus has no *RST value.

Parameter

<numeric_value>,<numeric_value>

Example

```
CALC:MARK1:BSYM 2,10
```

Positions marker 1 to symbol 10 of burst 2.

```
CALC:MARK1:BSYM?
```

Outputs the burst and symbol values of marker 1.

Characteristics

*RST value: –

SCPI: device-specific

Mode

WLAN

CALCulate<1|2>:MARKer<1>:CARRIER

This command positions the selected marker to the indicated carrier.

This command is query only for the following result displays:

- Constellation vs Symbol
- Constellation vs Carrier

Parameter

<numeric_value>

Example

```
CALC:MARK:CARR -7
```

Positions marker 1 to carrier –7.

```
CALC:MARK:CARR?
```

Outputs the carrier value of marker 1.

Characteristics

*RST value: –

SCPI: device-specific

ModeWLAN

CALCulate<1|2>:MARKer<1>:MAXimum

This command sets the selected marker to the maximum peak value in the current trace. This command is only available for the Spectrum Flatness result display.

This command is an event and therefore has no *RST value and no query.

Example

```
CALC2:MARK:MAX
```

Set marker 1 in screen B to maximum value in trace.

Characteristics

RST value: –

SCPI: device-specific

ModeWLAN

CALCulate<1|2>:MARKer<1>:MINimum

This command sets the selected marker to the minimum peak value in the current trace. This command is only available for the Spectrum Flatness result display.

This command is an event and therefore has no *RST value and no query.

Example

```
CALC2:MARK:MIN
```

Set marker 1 in screen B to minimum value in trace.

Characteristics

RST value: –

SCPI: device-specific

ModeWLAN

CALCulate<1|2>:MARKer<1>:SYMBOL

This command positions the selected marker to the indicated symbol.

This command is query only for the following result displays:

- Constellation vs Symbol
- Constellation vs Carrier

Parameter

<numeric_value>

Example

```
CALC:MARK:SYMB 2
```

Positions marker 1 to symbol 2.

```
CALC:MARK:SYMB?
```

Outputs the symbol value of marker 1.

Characteristics

*RST value: –

SCPI: device-specific

Mode

WLAN

CALCulate<1|2>:MARKer<1>:TRACe

This command assigns the selected marker to the indicated measurement curve in the selected measurement window.

This command is only available for the following result displays:

- Constellation versus Carrier
- EVM vs Symbol
- Frequency Error vs Preamble
- Phase Error vs Preamble
- PVT Full Burst
- PVT Rising / Falling
- Spectrum Flatness
- Spectrum Mask, if Max Hold trace is displayed
- Spectrum ACP/ACPR, if Max Hold trace is displayed

Example

```
"CALC2:MARK:TRAC 2
```

Assigns marker 1 in screen B to trace 2.

Characteristics

*RST value: 1

SCPI: device-specific

Mode

WLAN

CALCulate<1|2>:MARKer<1>:X

This command positions the selected marker to the indicated inphase (Constellation vs Symbol), frequency (Spectrum FFT, Spectrum Mask, Spectrum APCR), time (Magnitude Capture Buffer, Auto level, PVT Full Burst, PVT Rising / Falling), power (CCDF), sub-carrier (Constellation vs Carrier, EVM vs Carrier, Spectrum Flatness) or symbol (EVM vs Symbol) in the selected measurement window.

This command is query only for the following result displays:

- Constellation vs Symbol
- Constellation vs Carrier

Parameter

<numeric_value> in Hz, s, dB

Example

```
CALC:MARK:X 2ms
```

Positions marker 1 to time 2ms.

Characteristics

*RST value: –

SCPI: device-specific

Mode

WLAN

CALCulate<1|2>:MARKer<1>:Y

This command positions the selected marker to the indicated quadrature (Constellation vs Symbol), magnitude of I or Q (Constellation vs Carrier), EVM (EVM vs Carrier) or abs (Spectrum Flatness) in the selected measurement window.

This command is query only for the following result displays:

- Auto Level
- Constellation vs Symbol
- Constellation vs Carrier
- EVM vs Symbol
- PVT Full
- PVT Rising / Falling
- Magnitude Capture Buffer
- Spectrum Mask
- Spectrum ACP/ACPR
- Spectrum FFT
- CCDF

Parameter

<numeric_value> in percent or dB

Example

```
CALC2:MARK:Y -2
```

Positions marker 1 in screen B to –2.

```
CALC:MARK:Y?
```

Outputs the measured value of marker 1.

Characteristics

*RST value: –

SCPI: device-specific

Mode

WLAN

CALCulate:MARKer:FUNCTION Subsystem (WLAN, K91)

The measurement window is selected by CALCulate 1 (screen A) or 2 (screen B).

Commands of the CALCulate:MARKer:FUNCTION Subsystem

- [CALCulate<1|2>:MARKer<1>:FUNCTION:POWER:RESult\[:CURRent\]?](#)
- [CALCulate<1|2>:MARKer<1>:FUNCTION:POWER:RESult:MAXHold?](#)
- [CALCulate<1|2>:MARKer<1>:FUNCTION:ZOOM](#)

CALCulate<1|2>:MARKer<1>:FUNCTION:POWER:RESult[:CURRent]?

This command queries the current result values of the adjacent channel power measurement. An ACPR (Adjacent channel power relative) measurement must have previously been run, for there to be summary data available.

Results are output separated by commas in the following order:

- Power of main channel
- Power of lower adjacent channel
- Power of upper adjacent channel
- Power of lower alternate adjacent channel 1
- Power of upper alternate adjacent channel 1
- Power of lower alternate adjacent channel 2
- Power of upper alternate adjacent channel 2

Adjacent channel power values are output in dB.

This command is a query only and thus has no *RST value.

Example

```
CALC:MARK:FUNC:POW:RES?
```

Characteristics

*RST value: –

SCPI: device-specific

Mode

WLAN

CALCulate<1|2>:MARKer<1>:FUNCTION:POWER:RESult:MAXHold?

This command queries the maximum result values of the adjacent channel power measurement. An ACPR (Adjacent channel power relative) measurement must have previously been run with more than one sweep, for there to be maximum summary data available.

For details on the output refer to

["CALCulate<1|2>:MARKer<1>:FUNCTION:POWER:RESult\[:CURRent\]?"](#) on page 6.402.

This command is a query only and thus has no *RST value.

Example

```
CALC:MARK:FUNC:POW:RES:MAXH?
```

Characteristics

*RST value: –

SCPI: device-specific

Mode

WLAN

CALCulate<1|2>:MARKer<1>:FUNCtion:ZOOM

This command sets the magnification factor for the zoom. It is only available for the following result displays:

- Constellation vs Carrier
- Constellation vs Symbol
- PVT
- Magnitude Capture Buffer

Parameter

<numeric_value>

Example

```
INIT:CONT OFF
```

Switches to single sweep mode

```
CALC:MARK:FUNC:ZOOM 3;*WAI
```

Activates zooming and waits for its end.

Characteristics

*RST value: –

SCPI: device-specific

Mode

WLAN

CONFigure Subsystem (WLAN, K91)

The CONFigure subsystem contains commands for configuring complex measurement tasks. The CONFigure subsystem is closely linked to the functions of the FETCH subsystem, where the measurement results are queried.

Commands of the CONFigure Subsystem

- CONFigure:BURSt:CONSt:CARRier:SElect
- CONFigure:BURSt:CONSt:CCARrier[:IMMediate]
- CONFigure:BURSt:CONSt:CSYMBOL[:IMMediate]
- CONFigure:BURSt:EVM:ECARrier[:IMMediate]
- CONFigure:BURSt:EVM:ESYMBOL[:IMMediate]
- CONFigure:BURSt:PREamble[:IMMediate]
- CONFigure:BURSt:PREamble:SElect
- CONFigure:BURSt:PVT[:IMMediate]
- CONFigure:BURSt:PVT:AVERage
- CONFigure:BURSt:PVT:RPOWer
- CONFigure:BURSt:PVT:SElect
- CONFigure:BURSt:SPECtrum:ACPR[:IMMediate]
- CONFigure:BURSt:SPECtrum:FFT[:IMMediate]
- CONFigure:BURSt:SPECtrum:FLATness[:IMMediate]
- CONFigure:BURSt:SPECtrum:MASK[:IMMediate]
- CONFigure:BURSt:SPECtrum:MASK:SElect
- CONFigure:BURSt:STATistics:BSTReam[:IMMediate]
- CONFigure:BURSt:STATistics:CCDF[:IMMediate]
- CONFigure:BURSt:STATistics:SFIeld [:IMMediate]
- CONFigure:CHANnel
- CONFigure:POWer:AUTO
- CONFigure:POWer:AUTO:SWEp:TIME
- CONFigure:POWer:EXPEcted:RF
- CONFigure:STANdard

CONFigure:BURSt:CONSt:CARRier:SElect

This remote control command is only available when Constellation vs Symbol measurement is selected. When the Constellation versus Symbol measurement is initiated, it will calculate the results of the selected carrier.

Parameter

–26 to 26 | ALL | PILOTS

Example

```
CONF: BURS: CONS: CARR: SEL -26
Carrier -26 is selected.
```

```
CONF: BURS: CONS: CARR: SEL 10
```

Carrier 10 is selected.

```
CONF: BURS: CONS: CARR: SEL ALL
```

All carriers are selected.

```
CONF: BURS: CONS: CARR: SEL PIL
```

Pilots only.

Characteristics

*RST value: ALL

SCPI: device-specific

Mode

WLAN

CONFigure: BURSt: CONST: CCARrier[:IMMediate]

This remote control command configures the measurement type to be Constellation vs Carrier. After this command has been executed, the specified measurement will only be started when the user issues the `INITiate[:IMMediate]` command.

Example

```
CONF: BURS: CONS: CCAR
```

Configures the Constellation versus Carrier measurement type.

Characteristics

*RST value: –

SCPI: device-specific

Mode

WLAN

CONFigure: BURSt: CONST: CSYMBOL[:IMMediate]

This remote control command configures the measurement type to be Constellation vs Symbol. After this command has been executed, the specified measurement will only be started when the user issues the `INITiate[:IMMediate]` command.

Example

```
CONF: BURS: CONS: CSYM
```

Configures the Constellation versus Symbol measurement type.

Characteristics

*RST value: –

SCPI: device-specific

Mode

WLAN

CONFigure: BURSt: EVM: ECARrier[:IMMediate]

This remote control command configures the measurement type to be EVM vs Carrier. After this command has been executed, the specified measurement will only be started when the user issues the `INITiate[:IMMediate]` command.

Example

```
CONF: BURS: EVM: ECAR
```

Configures the EVM vs Carrier measurement type.

Characteristics

*RST value: –

SCPI: device-specific

Mode

WLAN

CONFigure: BURSt: EVM: ESyMbol[: IMMEDIATE]

This remote control command configures the measurement type to be EVM vs Symbol. After this command has been executed, the specified measurement will only be started when the user issues the `INITiate[: IMMEDIATE]` command.

Example

```
CONF: BURS: EVM: ESYM
```

Configures the EVM vs Symbol measurement type.

Characteristics

*RST value: –

SCPI: device-specific

Mode

WLAN

CONFigure: BURSt: PREamble[: IMMEDIATE]

This remote control command configures the measurement type to be Phase or Frequency vs Preamble. After this command has been executed, the specified measurement will only be started when the user issues the `INITiate[: IMMEDIATE]` command.

Example

```
CONF: BURS: PRE
```

Configures the preamble measurement type.

Characteristics

*RST value: –

SCPI: device-specific

Mode

WLAN

CONFigure: BURSt: PREamble: SElect

This remote control command configures the interpretation of the preamble measurement results.

Parameter

PHASe | FREQuency

Example

```
CONF: BURS: PRE: SEL PHAS
```

Configures the Phase vs Preamble measurement type.

Characteristics

*RST value: –

SCPI: device-specific

Mode

WLAN

CONFigure:BURSt:PVT[:IMMEDIATE]

This remote control command configures the measurement type to be Power vs Time. After this command has been executed, the specified measurement will only be started when the user issues the `INITiate[:IMMEDIATE]` command.

Example

```
CONF: BURS: PVT
```

Configures the Power vs Time measurement type.

Characteristics

*RST value: –

SCPI: device-specific

Mode

WLAN

CONFigure:BURSt:PVT:AVERAge

This remote control command configures the measurement type to set the burst power averaging length to the desired value. This command is only valid when the selected standard is IEEE 802.11b.

Parameter

<numeric_value>

Example

```
CONF: BURS: PVT: AVER 31
```

Configures the burst power average length of 31.

Characteristics

*RST value: –

SCPI: device-specific

Mode

WLAN

CONFigure:BURSt:PVT:RPOWer

This remote control command configures the use of either mean or maximum burst power as a reference power for the 802.11b PVT measurement.

Parameter

MEAN | MAXimum

Example

```
CONF: BURS: PVT: RPOW MEAN
```

Configures to use mean burst power as a reference power.

Characteristics

*RST value: –
 SCPI: device-specific

Mode

WLAN

CONFigure:BURSt:PVT:SElect

This remote control configures how to interpret the Power vs Time measurement results.

Parameter	Description	Wireless LAN standard
EDGE	configures the measurement to be rising and falling edge	all
FALL	configures the measurement to be falling edge only	IEEE 802.11b & g (CCK)
FULL	configures the measurement to be full burst	IEEE 802.11a, j & g (OFDM), IEEE 802.11 Turbo Mode
RISE	configures the measurement to be rising edge only	IEEE 802.11b & g (CCK)

Example

CONF: BURS: PVT: SEL FULL
 Interprets the measurement results as full burst

Characteristics

*RST value: –
 SCPI: device-specific

Mode

WLAN

CONFigure:BURSt:SPECTrum:ACPR[:IMMediate]

This remote control command configures the measurement type to be ACPR (adjacent channel power relative) After this command has been executed, the specified measurement will only be started when the user issues the `INITiate[:IMMediate]` command.

Example

CONF: BURS: SPEC: ACPR
 Configures the ACPR measurement type.

Characteristics

*RST value: –
 SCPI: device-specific

Mode

WLAN

CONFigure:BURSt:SPECTrum:FFT[:IMMediate]

This remote control command configures the measurement type to be FFT (Fast Fourier Transform). After this command has been executed, the specified measurement will only be started when the user issues the `INITiate[:IMMediate]` command.

Example

```
CONF: BURS: SPEC: FFT
```

Configures the FFT measurement type.

Characteristics

*RST value: –

SCPI: device-specific

Mode

WLAN

CONFigure: BURSt: SPECtrum: FLATness[: IMMEDIATE]

This remote control command configures the measurement type to be Spectrum Flatness. After this command has been executed, the specified measurement will only be started when the user issues the `INITiate[: IMMEDIATE]` command.

Example

```
CONF: BURS: SPEC: FLAT
```

Configures the Spectrum Flatness measurement type.

Characteristics

*RST value: –

SCPI: device-specific

Mode

WLAN

CONFigure: BURSt: SPECtrum: MASK[: IMMEDIATE]

This remote control command configures the measurement type to be Spectrum Mask. After this command has been executed, the specified measurement will only be started when the user issues the `INITiate[: IMMEDIATE]` command.

Example

```
CONF: BURS: SPEC: MASK
```

Configures the Spectrum Mask measurement type.

Characteristics

*RST value: –

SCPI: device-specific

Mode

WLAN

CONFigure: BURSt: SPECtrum: MASK: SELect

This remote control configures the interpretation of the Spectrum Mask measurement results. This command is only available for IEEE 802.11a.

Parameter

IEEE | ETSI

Example

```
CONF: BURS: SPEC: MASK: SEL ETSI
```

Interprets the measurement results using the ETSI standard.

Characteristics

*RST value: –

SCPI: device-specific

Mode

WLAN

CONFigure:BURSt:STATistics:BSTream[:IMMediate]

This remote control command configures the measurement type to be Bit Stream. After this command has been executed, the specified measurement will only be started when the user issues the `INITiate[:IMMediate]` command.

Example

```
CONF: BURS: STAT: BSTR
```

Configures the Bit Stream measurement type.

Characteristics

*RST value: –

SCPI: device-specific

Mode

WLAN

CONFigure:BURSt:STATistics:CCDF[:IMMediate]

This remote control command configures the measurement type to be CCDF (conditional cumulative distribution functions.). After this command has been executed, the specified measurement will only be started when the user issues the `INITiate[:IMMediate]` command.

Example

```
CONF: BURS: STAT: CCDF
```

Configures the CCDF measurement type.

Characteristics

*RST value: –

SCPI: device-specific

Mode

WLAN

CONFigure:BURSt:STATistics:SField [:IMMediate]

This remote control command configures the measurement type to be Signal Field. After this command has been executed, the specified measurement will only be started when the user issues the `INITiate[:IMMediate]` command.

Example

```
CONF: BURS: STAT: SField
```

Configures the Signal Field measurement type.

Characteristics

*RST value: –

SCPI: device-specific

ModeWLAN

CONFigure:CHANnel

This remote control command is used to specify the input channel for which measurements are to be performed. This command will automatically cause the internal measurement frequency to be re-calculated.

Parameter

<numeric_value>

Example

CONF:CHAN 9

Specifies channel 9 as frequency measurement.

Characteristics

*RST value: 0

SCPI: device-specific

ModeWLAN

CONFigure:POWer:AUTO

This remote control command is used to switch on or off automatic power level detection. When switched on, power level detection is performed at the start of each measurement sweep.

Parameter

ONCE | ON | OFF

If this command is issued with the ONCE parameter then the auto level routine is performed immediately one time.

Example

CONF:POW:AUTO ON

Configures the automatic detection of the input power level.

Characteristics

*RST value: –

SCPI: device-specific

ModeWLAN

CONFigure:POWer:AUTO:SWEep:TIME

This remote control command is used to specify the sweep time for the automatic power level detection.

Parameter

numeric value in seconds

Example

CONF:POW:AUTO:SWE:TIME 200MS

Configures a 200 ms sweep time for the auto-level detection.

Characteristics

*RST value: 100ms

SCPI: device-specific

Mode

WLAN

CONFigure:POWer:EXPEcted:RF

This remote control command is used to specify the mean power level of the source signal as supplied to the Analyzer RF input. This value will be overwritten if Auto Level is turned on.

Parameter

<numeric_value> in dBm

Example

```
CONF:POW:EXP:RF 9
```

Assumes an input signal strength of 9 dBm.

Characteristics

*RST value: –

SCPI: device-specific

Mode

WLAN

CONFigure:STANdard

This remote control command specifies which Wireless LAN standard the option is configured to measure.

Parameter

- 0 IEEE 802.11a
- 1 IEEE 802.11b
- 2 IEEE 802.11j (10 MHz)
- 3 IEEE 802.11j (20 MHz)
- 4 IEEE 802.11g

Example

```
CONF:STAN 0
```

Selects the IEEE 802.11a standard for the measurement.

Characteristics

*RST value: 0

SCPI: device-specific

Mode

WLAN

DISPlay Subsystem (WLAN, K91)

The DISPlay subsystem controls the selection and presentation of textual and graphic information as well as of measurement data on the display. In contrast to the basic device, the WLAN TX Measurements option supports the split screen modus.

Commands of the DISPlay Subsystem

- DISPlay:FORMat
- DISPlay[:WINDow<1|2>]:SSElect
- DISPlay[:WINDow<1|2>]:TABLe
- DISPlay[:WINDow<1|2>]:TRACe<1...3>:Y[:SCALe]:AUTO
- DISPlay[:WINDow<1|2>]:TRACe<1...3>:Y[:SCALe]:PDIVision
- DISPlay[:WINDow<1|2>]:TRACe<1...3>:Y[:SCALe]:RLEVel
- DISPlay[:WINDow<1|2>]:TRACe<1...3>:Y[:SCALe]:RLEVel:OFFSet

DISPlay:FORMat

This command sets the visible screen display type to full or split screen.

Parameter

SPLit | SINGle

Example

```
DISP:FORM SINGLE
Sets the display to full screen.
```

Characteristics

*RST value: SPL
SCPI: device-specific

Mode

WLAN

DISPlay[:WINDow<1|2>]:SSElect

This command selects whether screen A or screen B is active. SSElect means Screen SElect.

Example

```
DISP:WIND1:SSEL
Sets the screen A active.
```

Characteristics

*RST value: 1
SCPI: device-specific

Mode

WLAN

DISPlay[:WINDow<1|2>]:TABLe

This command selects whether the results table is displayed.

Parameter

ON | OFF

Example

DISP:WIND1:TABL ON
Hides the results table

Characteristics

*RST value: ON
SCPI: device-specific

Mode

WLAN

DISPlay[:WINDow<1|2>]:TRACe<1...3>:Y[:SCALe]:AUTO

This command switches on or off automatic scaling of the Y-axis for the specified trace display. Automatic scaling sets the Y-axis to automatically scale to best fit the measurement results. This command is only available for the following result displays:

- EVM vs Carrier
- EVM vs Symbol.
- Frequency error vs Preamble
- Phase error vs Preamble

The numeric suffix at WINDow<1|2> must be 2 as the relevant results are always displayed in screen B. The numeric suffix at TRACe<1...3> must be 1.

Parameter

ON | OFF

Example

DISP:WIND2:TRAC:Y:SCAL:AUTO ON
switches on automatic scaling of the Y-axis for the active trace

Characteristics

*RST value: ON

Mode

WLAN

DISPlay[:WINDow<1|2>]:TRACe<1...3>:Y[:SCALe]:PDIVision

This command sets the size of each Y scale division for the specified trace display. Note that this command has no affect if automatic scaling of the Y-axis is enabled. This command is only available for the following result displays:

- EVM vs Carrier
- EVM vs Symbol.
- Frequency error vs Preamble
- Phase error vs Preamble

The numeric suffix at WINDow<1|2> must be 2 as the relevant results are always displayed in screen B. The numeric suffix at TRACe<1...3> must be 1.

Parameter

<numeric_value>

Example

```
DISP:WIND2:TRAC:Y:SCAL:DPIV 2
```

Sets the Y scale division to size to 2.

Characteristics

*RST value: 3

Mode

WLAN

DISPlay[:WINDow<1|2>]:TRACe<1...3>:Y[:SCALe]:RLEVel

This remote control command can be used to set the current internal instrument reference level used when performing measurements. The numeric suffix at WINDow<1|2> and TRACe<1...3> are irrelevant.

Parameter

numeric value in dB

Example

```
DISP:TRAC:Y:RLEV?
```

returns the current reference level in use

Characteristics

*RST value: –

Mode

WLAN

DISPlay[:WINDow<1|2>]:TRACe<1...3>:Y[:SCALe]:RLEVel:OFFSet

For details refer to "[DISPlay\[:WINDow<1|2>\]:TRACe<1...4>:Y\[:SCALe\]:RLEVel:OFFSet](#)" on page 6.101.

FETCh Subsystem (WLAN, K91)

The FETCh subsystem contains commands for reading out results of complex measurement tasks. This subsystem is closely linked to the CONFigure and SENSE subsystems.

Commands of the DISPlay Subsystem

- FETCh:BURSt:ALL?
- FETCh:BURSt:COUnT?
- FETCh:BURSt:CRESt[:AVERAge?]
- FETCh:BURSt:CRESt:MAXimum?
- FETCh:BURSt:CRESt:MINimum?
- FETCh:BURSt:EVM:[IEEE]:AVERAge?
- FETCh:BURSt:EVM:[IEEE]:MAXimum?
- FETCh:BURSt:EVM:[IEEE]:MINimum?
- FETCh:BURSt:EVM:ALL:AVERAge?
- FETCh:BURSt:EVM:ALL:MAXimum?
- FETCh:BURSt:EVM:ALL:MINimum?
- FETCh:BURSt:EVM:DATA:AVERAge?
- FETCh:BURSt:EVM:DATA:MAXimum?
- FETCh:BURSt:EVM:DATA:MINimum?
- FETCh:BURSt:EVM:DIRect:AVERAge?
- FETCh:BURSt:EVM:DIRect:MAXimum?
- FETCh:BURSt:EVM:DIRect:MINimum?
- FETCh:BURSt:EVM:PILOt:AVERAge?
- FETCh:BURSt:EVM:PILOt:MAXimum?
- FETCh:BURSt:EVM:PILOt:MINimum?
- FETCh:BURSt:FERRor:AVERAge?
- FETCh:BURSt:FERRor:MAXimum?
- FETCh:BURSt:FERRor:MINimum?
- FETCh:BURSt:GIMBalance:AVERAge?
- FETCh:BURSt:GIMBalance:MAXimum?
- FETCh:BURSt:GIMBalance:MINimum?
- FETCh:BURSt:IQOFfset:AVERAge?
- FETCh:BURSt:IQOFfset:MAXimum?
- FETCh:BURSt:IQOFfset:MINimum?
- FETCh:BURSt:PAYLoad?
- FETCh:BURSt:PEAK?
- FETCh:BURSt:PREamble?
- FETCh:BURSt:QUADOffset:AVERAge?

- FETCh:BURSt:QUADOffset:MAXimum?
- FETCh:BURSt:QUADOffset:MINimum?
- FETCh:BURSt:RMS[:AVERAge?]
- FETCh:BURSt:RMS:MAXimum?
- FETCh:BURSt:RMS:MINimum?
- FETCh:BURSt:SYMBolerror:AVERAge?
- FETCh:BURSt:SYMBolerror:MAXimum?
- FETCh:BURSt:SYMBolerror:MINimum?
- FETCh:BURSt:TFALI:AVERAge?
- FETCh:BURSt:TFALI:MAXimum?
- FETCh:BURSt:TFALI:MINimum?
- FETCh:BURSt:TRISe:AVERAge?
- FETCh:BURSt:TRISe:MAXimum?
- FETCh:BURSt:TRISe:MINimum?
- FETCh:SYMBol:COUNT?

Further information

- ASCII formats for returned values

ASCII formats for returned values

The results are output as a list of result strings separated by commas.

Returned values for IEEE 802.11a, j, g(OFDM) & Turbo Mode

<preamble power>,
 <payload power>,
 <min rms power>,<average rms power>,<max rms power>,<>,
 <peak power>,
 <min crest factor>,<average crest factor>,<max crest factor>,
 <min frequency error>,<average frequency error> , <max frequency error>,
 <min symbol error> , <average symbol error> , <max symbol error>,
 <min IQ offset> , <average IQ offset> , <maximum IQ offset>,
 <min gain imbalance> , <average gain imbalance> , <max gain imbalance>,
 <min quadrature offset> , <average quadrature offset> , <max quadrature offset>,
 <min EVM all bursts> , <average EVM all bursts> , <max EVM all bursts>,
 <min EVM data carriers> , <average EVM data carriers > , <max EVM data carriers >
 <min EVM pilots> , <average EVM pilots > , <max EVM pilots >

Returned values for IEEE 802.11b & g (CCK)

<min rise time>, <average rise time>, <max rise time>,
 <min fall time>, <average fall time>, <max fall time>,
 <min rms power>, <average rms power>, <max rms power>,
 <min peak power>, <average peak power>, <max peak power>,
 <min crest factor>, <average crest factor>, <max crest factor>,
 <min frequency error>, <average frequency error>, <max frequency error>,
 <min chip clock error>, <average chip clock error>, <max chip clock error>,
 <min phase error>, <average phase error>, <max phase error>,
 <min IQ offset>, <average IQ offset>, <maximum IQ offset>,
 <min gain imbalance>, <average gain imbalance>, <max gain imbalance>,
 <min quadrature offset>, <average quadrature offset>, <max quadrature offset>,
 <min EVM IEEE>, <average EVM IEEE>, <max EVM IEEE>,
 <min EVM Direct>, <average EVM Direct >, <max EVM Direct >

FETCh:BURSt:ALL?

This command returns all the results. The results are output as a list of result strings separated by commas in ASCII format. For details on the format refer to "[ASCII formats for returned values](#)" on page 6.417. The units for the EVM results are specified with the `UNIT:EVM` command.

Example

```
FETCh:BURSt:ALL?
```

All calculated results are returned

Characteristics

*RST value: –

SCPI: device-specific

Mode

WLAN

FETCh:BURSt:COUNT?

This command returns the number of analyzed bursts.

This command is a query only and thus has no *RST value.

Example

```
FETCh:BURSt:COUN?
```

The analyzed number of bursts are returned

Characteristics

*RST value: –

SCPI: device-specific

Mode

WLAN

FETCh:BURSt:CRESt[:AVERAge?] / FETCh:BURSt:CRESt:MAXimum? / FETCh:BURSt:CRESt:MINimum?

This command returns the average, minimum or maximum determined CREST factor (= ratio of peak power to average power) in dB.]

This command is a query only and thus has no *RST value.

Example

```
FETC: BURS: CRES: MAX?
```

The maximum calculated crest factor from the most recent measurement is returned.

Characteristics

*RST value: –

SCPI: device-specific

Mode

WLAN

FETCh:BURSt:EVM:[IEEE]:AVERAge? / FETCh:BURSt:EVM:[IEEE]:MAXimum? / FETCh:BURSt:EVM:[IEEE]:MINimum?

This command returns the Error Vector Magnitude measurement results summary (average, minimum or maximum value) in dB for the IEEE 802.11b standard. This result is the value before filtering.???

This command is a query only and thus has no *RST value.

Example

```
FETC: BURS: EVM: MAX?
```

The maximum EVM recorded before filtering.

Characteristics

*RST value: –

SCPI: device-specific

Mode

WLAN

FETCh:BURSt:EVM:ALL:AVERAge? / FETCh:BURSt:EVM:ALL:MAXimum? / FETCh:BURSt:EVM:ALL:MINimum?

This command returns the Error Vector Magnitude measurement results summary (average, minimum or maximum value) in dB. This is a combined figure that represents the pilot, data and the free carrier.

This command is a query only and thus has no *RST value.

Example

```
FETC: BURS: EVM: ALL: MAX?
```

The maximum EVM recorded for all measurement carrier is returned.

Characteristics

*RST value: –

SCPI: device-specific

Mode

WLAN

FETCh:BURSt:EVM:DATA:AVERAge? / FETCh:BURSt:EVM:DATA:MAXimum? / FETCh:BURSt:EVM:DATA:MINimum?

This command returns the Error Vector Magnitude measurement results summary for the data carrier (average, minimum or maximum value) in dB.

This command is a query only and thus has no *RST value.

Example

```
FETC: BURS: EVM: DATA: MAX?
```

The maximum EVM recorded for the data carrier is returned.

Characteristics

*RST value: –

SCPI: device-specific

Mode

WLAN

FETCh:BURSt:EVM:DIRect:AVERAge? / FETCh:BURSt:EVM:DIRect:MAXimum? / FETCh:BURSt:EVM:DIRect:MINimum?

This command returns the Error Vector Magnitude measurement results summary (average, minimum or maximum value) in dB for the IEEE 802.11b standard. This result is the value after filtering.???

This command is a query only and thus has no *RST value.

Example

```
FETC: BURS: EVM: DIR: MAX?
```

The maximum EVM recorded after filtering.

Characteristics

*RST value: –

SCPI: device-specific

Mode

WLAN

FETCh:BURSt:EVM:PILot:AVERAge? / FETCh:BURSt:EVM:PILot:MAXimum? / FETCh:BURSt:EVM:PILot:MINimum?

This command returns the Error Vector Magnitude measurement results summary for the EVM pilot carrier (average, minimum or maximum value) in dB.???

This command is a query only and thus has no *RST value.

Example

```
FETC: BURS: EVM: PIL: MAX?
```

The maximum EVM recorded for the EVM pilot carrier is returned.

Characteristics

*RST value: –

SCPI: device-specific

Mode

WLAN

FETCh:BURSt:FERRor:AVERage? / FETCh:BURSt:FERRor:MAXimum? / FETCh:BURSt:FERRor:MINimum?

This command returns the measured average, minimum or maximum frequency errors in Hertz.???

This command is a query only and thus has no *RST value.

Example

```
FETC: BURS: FERR: MAX?
```

The maximum frequency error from the most recent measurement is returned.

Characteristics

*RST value: –

SCPI: device-specific

Mode

WLAN

FETCh:BURSt:GIMBalance:AVERage? / FETCh:BURSt:GIMBalance:MAXimum? / FETCh:BURSt:GIMBalance:MINimum?

This command returns the measured average, minimum or maximum IQ Imbalance errors in dB.???

This command is a query only and thus has no *RST value.

Example

```
FETC: BURS: GIMB: MAX?
```

The maximum IQ Imbalance error from the most recent measurement is returned.

Characteristics

*RST value: –

SCPI: device-specific

Mode

WLAN

FETCh:BURSt:IQOffset:AVERage? / FETCh:BURSt:IQOffset:MAXimum? / FETCh:BURSt:IQOffset:MINimum?

This command returns the measured average, minimum or maximum IQ Offset errors in dB.???

This command is a query only and thus has no *RST value.

Example

```
FETC: BURS: IQOF: MAX?
```

The maximum IQ Offset error from the most recent measurement is returned.

Characteristics

*RST value: –

SCPI: device-specific

Mode

WLAN

FETCh:BURSt:PAYLoad?

This command returns the measured power in the payload of the burst.
This command is a query only and thus has no *RST value.

Example

```
FETC: BURS: PAYL?
```

The burst payload power is returned

Characteristics

*RST value: –

SCPI: device-specific

Mode

WLAN

FETCh:BURSt:PEAK?

This command returns the Peak power in dBm measured during the measurement time.

Example

```
FETC: BURS: PEAK?
```

The calculated peak power from the most recent measurement is returned.

Characteristics

*RST value: –

SCPI: device-specific

Mode

WLAN

FETCh:BURSt:PREAmble?

This command returns the measured power in the burst preamble.
This command is a query only and thus has no *RST value.

Example

```
FETC: BURS: PRE?
```

The burst preamble power is returned

Characteristics

*RST value: –

SCPI: device-specific

Mode

WLAN

FETCh:BURSt:QUADOffset:AVERAge? / FETCh:BURSt:QUADOffset:MAXimum? / FETCh:BURSt:QUADOffset:MINimum?

This command returns the accuracy in terms of the phase error of symbols within a burst.???

This command is a query only and thus has no *RST value.

Example

```
FETC: BURS: QUAD: MAX?
```

The maximum angle error recorded for a symbol during the measurement.

Characteristics

*RST value: –

SCPI: device-specific

Mode

WLAN

FETCh:BURSt:RMS[:AVERAge?] / FETCh:BURSt:RMS:MAXimum? / FETCh:BURSt:RMS:MINimum?

This command returns the average, minimum or maximum RMS burst power in dBm measured during the measurement.]

This command is a query only and thus has no *RST value.

Example

```
FETC : BURSt : RMS : MAX?
```

The maximum calculated RSM burst power from the most recent measurement is returned.

Characteristics

*RST value: –

SCPI: device-specific

Mode

WLAN

FETCh:BURSt:SYMBolerror:AVERAge? / FETCh:BURSt:SYMBolerror:MAXimum? / FETCh:BURSt:SYMBolerror:MINimum?

This command returns the percentage of symbols that were outside permissible de-modulation range within a burst.???

Example

```
FETC : BURSt : SYMB : MAX?
```

The maximum number of symbols that were out of range per burst.

Characteristics

*RST value: –

SCPI: device-specific

Mode

WLAN

FETCh:BURSt:TFALI:AVERAge? / FETCh:BURSt:TFALI:MAXimum? / FETCh:BURSt:TFALI:MINimum?

This command returns the average, minimum or maximum burst fall time in seconds.

This command is a query only and thus has no *RST value.

Example

```
FETC : BURSt : TFAL : MAX?
```

The maximum calculated fall time from the most recent measurement is returned.

Characteristics

*RST value: –

SCPI: device-specific

Mode

WLAN

FETCh:BURSt:TRISe:AVERAge? / FETCh:BURSt:TRISe:MAXimum? / FETCh:BURSt:TRISe:MINimum?

This command returns the average, minimum or maximum burst rise time in seconds.

This command is a query only and thus has no *RST value.

Example

```
FETC:BURS:TRIS:MAX?
```

The maximum calculated rise time from the most recent measurement is returned.

Characteristics

*RST value: –

SCPI: device-specific

Mode

WLAN

FETCh:SYMBol:COUNt?

This command returns the number of symbols for each analyzed burst as a comma separated list.

This command is a query only and thus has no *RST value.

Example

```
FETC:SYMB:COUN?
```

The analyzed number of symbols for each burst are returned

Characteristics

*RST value: –

SCPI: device-specific

Mode

WLAN

FORMat Subsystem (WLAN, K91)

The FORMat subsystem specifies the data format of the data transmitted from and to the instrument.

Commands of the FORMat Subsystem

- [FORMat\[:DATA\]](#)

FORMat[:DATA]

For details refer to section "Remote Control – Description of Basic Settings Commands", FORMat Subsystem.

INITiate Subsystem (WLAN, K91)

The INITiate subsystem configures the instrument prior to a measurement being carried out. It is basically used to tell the instrument which measurement is to be performed and takes any necessary step to set up the instrument for the measurement.

Commands of the INITiate Subsystem

- [INITiate\[:IMMediate\]](#)
- [INITiate:CONTInuous](#)

INITiate[:IMMediate]

For details refer to "[INITiate<1|2>\[:IMMediate\]](#)" on page 6.105.

INITiate:CONTInuous

For details refer to "[INITiate<1|2>:CONTInuous](#)" on page 6.106.

INPut Subsystem (WLAN, K91)

The INPut subsystem controls the input characteristics of the RF inputs of the instrument.

Commands of the INPut Subsystem

- [INPut<1|2>:ATTenuation](#)

INPut:ATTenuation

For details refer to "[INPut<1|2>:ATTenuation](#)" on page 6.108.

INSTRument Subsystem (WLAN, K91)

The INSTRument subsystem selects the operating mode of the unit either via text parameters or fixed numbers.

Commands of the INSTRument Subsystem

- [INSTRument\[:SElect\]](#)
- [INSTRument:NSElect](#)

INSTRument[:SElect]

Parameter

WLAN (WLAN TX Measurements option, R&S FSL–K91)

For further details refer to section "Remote Control – Description of Basic Settings Commands", INSTRument subsystem.

INSTRument:NSElect

Parameter

16 (WLAN TX Measurements option, R&S FSL–K91)

For further details refer to section "Remote Control – Description of Basic Settings Commands", INSTRument subsystem.

MMEMory Subsystem (WLAN, K91)

The MMEMory (mass memory) subsystem provides commands to store and load IQ data.

Commands of the MMEMory Subsystem

- [MMEMory:LOAD:IQ:STATe](#)
- [MMEMory:STORe:IQ:STATe](#)

MMEMory:LOAD:IQ:STATe

This command loads the IQ data from the specified .iqw file.

Parameter

1,<file_name>

Example

MMEM:LOAD:IQ:STAT 1,'C:\R_S\Instr\user\data.iqw'

Loads IQ data from the specified file.

Characteristics

*RST value: –

SCPI: device-specific

Mode

WLAN

MMEMory:STORe:IQ:STATe

This command stores the IQ data to the specified .iqw file.

Parameter

1,<file_name>

Example

MMEM:STOR:IQ:STAT 1,'C:\R_S\Instr\user\data.iqw'

Stores IQ data to the specified file.

Characteristics

*RST value: –

SCPI: device-specific

Mode

WLAN

SENSe Subsystem (WLAN, K91)

The SENSe command is used to set and get the values of parameters in the remote instrument. The get variant of the SENSe command differs from set in that it takes no parameter values (unless otherwise stated) but is followed by the character '?' and will return the parameter's value in the same format as it is set.

Commands of the SENSe Subsystem

- [SENSe:]BURSt:COUNT
- [SENSe:]BURSt:COUNT:STATe
- [SENSe:]DEMod:BANalyze:DURation:EQUal
- [SENSe:]DEMod:BANalyze:DURation:MAX
- [SENSe:]DEMod:BANalyze:DURation:MIN
- [SENSe:]DEMod:CESTimation
- [SENSe:]DEMod:FILTer:CATalog?
- [SENSe:]DEMod:FILTer:MODulation
- [SENSe:]DEMod:FORMat[:BCONtent]:AUTo
- [SENSe:]DEMod:FORMat:BANalyze
- [SENSe:]DEMod:FORMat:BANalyze:BTYPe
- [SENSe:]DEMod:FORMat:BANalyze:DBYTes:EQUal
- [SENSe:]DEMod:FORMat:BANalyze:DBYTes:MAX
- [SENSe:]DEMod:FORMat:BANalyze:DBYTes:MIN
- [SENSe:]DEMod:FORMat:BANalyze:SYMbols:EQUal
- [SENSe:]DEMod:FORMat:BANalyze:SYMbols:MAX
- [SENSe:]DEMod:FORMat:BANalyze:SYMbols:MIN
- [SENSe:]DEMod:FORMat:BTRate
- [SENSe:]DEMod:FORMat:SIGSymbol
- [SENSe:]FREQuency:CENTer
- [SENSe:]POWer:ACHannel:MODE
- [SENSe:]SWAPiq
- [SENSe:]SWEep:COUNT
- [SENSe:]SWEep:EGATe
- [SENSe:]SWEep:EGATe:HOLDoff[:TIMe]
- [SENSe:]SWEep:EGATe:HOLDoff:SAMPle
- [SENSe:]SWEep:EGATe:LENGth[:TIMe]
- [SENSe:]SWEep:EGATe:LENGth:SAMPle
- [SENSe:]SWEep:EGATe:LINK
- [SENSe:]SWEep:TIME

- [SENSe:]TRACking:LEVel
- [SENSe:]TRACking:PHASe
- [SENSe:]TRACking:TIME

Further information

- Analysis modulation format

Analysis modulation format

Parameter	Standard	Description
BPSK3	IEEE 802.11j (10 MHz)	BI Phase shift keying at 3 Mbps
BPSK45	IEEE 802.11j (10 MHz)	BI Phase shift keying at 6 Mbps
BPSK6	IEEE 802.11a, g (OFDM), j (20 MHz) & Turbo	BI Phase shift keying at 6 Mbps
BPSK9	IEEE 802.11a, g (OFDM), j (20 MHz) & Turbo	BI Phase shift keying at 9 Mbps
BPSK	Alias for BI	Phase shift keying at higher data rate for selected standard
QPSK6	IEEE 802.11j (10 MHz)	Quadrature phase shift keying at 6 Mbps
QPSK9	IEEE 802.11j (10 MHz)	Quadrature phase shift keying at 9 Mbps
QPSK12	IEEE 802.11a, g (OFDM), j (20 MHz) & Turbo	Quadrature phase shift keying at 12 Mbps
QPSK18	IEEE 802.11a, g (OFDM), j (20 MHz) & Turbo	Quadrature phase shift keying at 18 Mbps
QPSK	Alias for Quadrature phase shift keying at higher data rate for selected standard	
QAM1612	IEEE 802.11j (10 MHz)	Quadrature Amplitude Modulation at 12 Mbps
QAM1618	IEEE 802.11j (10 MHz)	Quadrature Amplitude Modulation at 18 Mbps
QAM1624	IEEE 802.11a, g (OFDM), j (20 MHz) & Turbo	Quadrature Amplitude Modulation at 24 Mbps
QAM1636	IEEE 802.11a, g (OFDM), j (20 MHz) & Turbo	Quadrature Amplitude Modulation at 36 Mbps
QAM16	Alias for Quadrature Amplitude Modulation at higher data rate for selected standard	
QAM6424	IEEE 802.11j (10 MHz)	Quadrature Amplitude Modulation at 24 Mbps
QAM6427	IEEE 802.11j (10 MHz)	Quadrature Amplitude Modulation at 27 Mbps
QAM6448	IEEE 802.11a, g (OFDM), j (20 MHz) & Turbo	Quadrature Amplitude Modulation at 48 Mbps
QAM6454	IEEE 802.11a, g (OFDM), j (20 MHz) & Turbo	Quadrature Amplitude Modulation at 54 Mbps
QAM64	Alias for Quadrature Amplitude Modulation at higher data rate for selected standard	
DBPSK	IEEE 802.11b & g (Single Carrier)	Differential BI Phase shift keying
DQPSK	IEEE 802.11b & g (Single Carrier)	Differential Quadrature phase shift keying
CCK55	IEEE 802.11b & g (Single Carrier)	Complimentary Code Keying at 5.5 Mbps

Parameter	Standard	Description
CCK11	IEEE 802.11b & g (Single Carrier)	Complimentary Code Keying at 11 Mbps
PBCC55	IEEE 802.11b & g (Single Carrier)	PBCC at 5.5 Mbps
PBCC11	IEEE 802.11b & g (Single Carrier)	PBCC at 11 Mbps
PBCC22	IEEE 802.11g (Single Carrier)	PBCC at 11 Mbps

[SENSe:]BURSt:COUNT

This command defines the number of bursts that will be analyzed by the measurement. This parameter is ignored if the setting for the [SENSe:]BURSt:COUNT:STATe parameter is off.

Parameter

<numeric_value>

Example

```
BURS:COUN 16
```

Sets the number of bursts to 16.

Characteristics

*RST value: 1

SCPI: device-specific

Mode

WLAN

[SENSe:]BURSt:COUNT:STATe

When this command is set to on, the burst count parameter will be used by the measurement, otherwise the burst count parameter will be ignored.

Parameter

ON | OFF

Example

```
BURS:COUN:STAT ON
```

Sets the burst count state to ON

Characteristics

*RST value: OFF

SCPI: device-specific

Mode

WLAN

[SENSe:]DEMod:BANalyze:DURation:EQUal

When this command is set to ON then only bursts of equal length will take part in the PVT analysis. When this command is set to true the value specified by the [SENSe:]DEMod:BANalyze:DURation:MIN command specifies the duration that a burst must last in order to take part in measurement analysis.

Parameter

ON | OFF

Example

```
DEM: BAN: DUR: EQU ON
```

Only bursts of equal length will take part in the measurement analysis.

Characteristics

*RST value: OFF

SCPI: device-specific

Mode

WLAN

[SENSe:]DEMod:BANalyze:DURation:MAX

This command specifies the maximum duration in microseconds required for bursts to qualify for measurement analysis. Only bursts with the specified duration will be used in the measurement analysis.

This value will not have any immediate effect if the

[SENSe:]DEMod:BANalyze:DURation:EQUal command has been set to true as in this case no range of durations is allowed and only bursts with exactly the duration specified by the [SENSe:]DEMod:BANalyze:DURation:MIN command shall take part in measurement analysis

Parameter

<numeric_value>

Example

```
DEM: BAN: DUR: MAX 1300
```

Only bursts which have a maximum duration of 1300 microseconds are analyzed.

Characteristics

*RST value: 5464

SCPI: device-specific

Mode

WLAN

[SENSe:]DEMod:BANalyze:DURation:MIN

This command specifies the duration in microseconds required for bursts to qualify for measurement analysis. Only bursts with the specified duration will be used in the measurement analysis. When the [SENSe:]DEMod:BANalyze:DURation:EQUal command has been set to true then this command specifies the exact duration required for a burst to take part in measurement analysis. When the [SENSe:]DEMod:FORMat:BANalyze:DBYTes:EQUal command is set to false this command specifies the minimum duration required for a burst to take part in measurement analysis.

Parameter

<numeric_value>

Example

```
DEM: BAN: DUR: MIN 45
```

Only bursts which last 48 microseconds are analyzed.

Characteristics

*RST value: 1

SCPI: device-specific

Mode

WLAN

[SENSe:]DEMod:CESTimation

This command defines whether channel estimation will be done in preamble and payload (if set to 1) or only in preamble (if set to 0). The effect of this is most noticeable for the EVM measurement results, where the results will be improved when this feature is enabled.

However, this functionality is not supported by the IEEE 802.11 standard and must be disabled if the results are to be strictly measured against the standard.

Parameter

ON | OFF

Example

```
DEMod:CEST ON
```

Specifies that the IQ measurement results will use channel estimation in preamble & payload.

Characteristics

*RST value: OFF

SCPI: device-specific

Mode

WLAN

[SENSe:]DEMod:FILTer:CATalog?

This command reads the names of all available filters. The file names are output without file extension. Syntax of output format: filter_1,filter_2, ... ,filter_n.

This command is a query only and thus has no *RST value.

Example

```
DEMod:FILT:CAT?
```

Reads all filter names

Characteristics

*RST value: 0

SCPI: device-specific

Mode

WLAN

[SENSe:]DEMod:FILTer:MODulation

This command selects the TX and RX filters. The names of the filters correspond to the file names; a query of all available filters is possible by means of the

[\[SENSe:\]DEMod:FILTer:CATalog?](#) command.

Parameter

<string>,<string>

DEF_TX: default transmit filter, DEF_RX: default receive filter

Example

```
DEMod:FILT:MOD 'DEF_TX','DEF_RX'
```

DEF_TX is selected for the TX filter and DEF_RX for the RX filter

Characteristics

*RST value: AUTO,AUTO

SCPI: device-specific

Mode

WLAN

[SENSe:]DEMod:FORMat[:BCONtent]:AUTO

When this command is set to ON then the signal symbol field of the burst is analyzed to determine the modulation scheme of the first burst. When this field is set to ON only bursts which match the modulation scheme are considered in results analysis.

Parameter

ON | OFF

Example

```
DEM:FORM:AUT ON
```

Specifies that the signal symbol field should be decoded.

Characteristics

*RST value: –

SCPI: device-specific

Mode

WLAN

[SENSe:]DEMod:FORMat:BANalyze

The remote control command sets the analysis modulation format that will be assumed when the measurement is performed. If the `[SENSe:]DEMod:FORMat:SIGSymbol` parameter has been set to ON, this command can be used to measure only certain burst types within a measurement sequence.

Parameter

For details refer to "[Analysis modulation format](#)" on page 6.431.

Example

```
DEM:FORM:BAN 'QAM16'
```

Only bursts that are of the QAM16 modulation format are analyzed.

Characteristics

*RST value: QAM64

SCPI: device-specific

Mode

WLAN

[SENSe:]DEMod:FORMat:BANalyze:BTYPe

This remote control command specifies the type of burst to be analyzed. Only bursts of the specified type take part in measurement analysis.

Parameter

DIRECT	IEEE 802.11a, IEEE 802.11j (10MHz), IEEE 802.11j (20MHz), IEEE 802.11g, 802.11 OFDM Turbo – Direct Link Burst
LONG-OFDM	IEEE 802.11g – Long DSSS OFDM
SHORT-OFDM	IEEE 802.11g – Short DSSS OFDM
LONG	IEEE 802.11b, IEEE 802.11g – Long PLCP Burst
SHORT	IEEE 802.11b, IEEE 802.11g – Short PLCP Burst

Example

DEM:FORM:BA:N:BTYPe 'DIRECT'
Only DIRECT bursts are analyzed.

Characteristics

*RST value: DIRECT
SCPI: device-specific

Mode

WLAN

[SENSe:]DEMod:FORMat:BANalyze:DBYTes:EQUal

When this command is set to ON then only bursts of equal length will take part in the measurement analysis. The number of data bytes that a burst must have in order to take part in measurement analysis is specified by the [\[SENSe:\]DEMod:FORMat:BANalyze:DBYTes:MIN](#) command.

Parameter

ON | OFF

Example

DEM:FORM:BA:N:DBYTes:EQU ON
Only bursts of equal length will take part in the measurement analysis.

Characteristics

*RST value: OFF
SCPI: device-specific

Mode

WLAN

[SENSe:]DEMod:FORMat:BANalyze:DBYTes:MAX

This command specifies the maximum number of data bytes required for bursts to qualify for measurement analysis. Only bursts with the specified number of data bytes will be used in the measurement analysis.

This value will not have any immediate effect if the [\[SENSe:\]DEMod:FORMat:BANalyze:DBYTes:EQUal](#) command has been set to ON. In this case, no range of symbols is allowed and only bursts with exactly the number of data bytes specified by the [\[SENSe:\]DEMod:FORMat:BANalyze:DBYTes:MIN](#) command shall take part in measurement analysis.

Parameter

<numeric_value>

Example

```
DEM:FORM:BAN:DBYTeS:MAX 1300
```

Only bursts which contain a maximum of 1300 data bytes are analyzed.

Characteristics

*RST value: 64

SCPI: device-specific

Mode

WLAN

[SENSe:]DEMod:FORMat:BANalyze:DBYTeS:MIN

This command specifies the number of data bytes required for bursts to qualify for measurement analysis. Only bursts with the specified number of data bytes will be used in the measurement analysis.

If the `[SENSe:]DEMod:FORMat:BANalyze:DBYTeS:EQUal` command has been set to ON, this command specifies the exact number of data bytes required for a burst to take part in measurement analysis. If the `[SENSe:]DEMod:FORMat:BANalyze:DBYTeS:EQUal` command is set to OFF, this command specifies the minimum number of data bytes required for a burst to take part in measurement analysis.

Parameter

<numeric_value>

Example

```
DEM:FORM:BAN:DBYTeS:MIN 16
```

Only bursts which contain 16 data bytes are analyzed.

Characteristics

*RST value: 1

SCPI: device-specific

Mode

WLAN

[SENSe:]DEMod:FORMat:BANalyze:SYMBols:EQUal

When this command is activated then only bursts of equal length will take part in the measurement analysis. When this command is set to true the value specified by the `[SENSe:]DEMod:FORMat:BANalyze:SYMBols:MIN` command specifies the number of symbols that a burst must have in order to take part in analysis.

Parameter

ON | OFF

Example

```
DEM:FORM:BAN:SYM:EQU ON
```

Only bursts of equal length will take part in analysis.

Characteristics

*RST value: OFF

SCPI: device-specific

Mode

WLAN

[SENSe:]DEMod:FORMat:BANalyze:SYMBOLs:MAX

This command specifies the maximum number of data symbols required for bursts to qualify for measurement analysis. Only bursts with the specified number of symbols will be used in the measurement analysis. The number of data symbols is defined as the uncoded bits including service and tail bits.

This value will not have any immediate effect if the

[SENSe:]DEMod:FORMat:BANalyze:SYMBOLs:EQUal command has been set to true as in this case no range of symbols is allowed and only bursts with exactly the number of symbols specified by the [SENSe:]DEMod:FORMat:BANalyze:SYMBOLs:MIN command shall take place in measurement analysis.

Parameter

<numeric_value>

Example

```
DEM:FORM:BAN:SYM:MAX 1300
```

Only bursts which contain a maximum symbol count of 1300 are analyzed.

Characteristics

*RST value: 64

SCPI: device-specific

Mode

WLAN

[SENSe:]DEMod:FORMat:BANalyze:SYMBOLs:MIN

This command specifies the number of data symbols required for bursts to qualify for measurement analysis. Only bursts with the specified number of symbols will be used in the measurement analysis. The number of data symbols is defined as the uncoded bits including service and tail bits.

When the [SENSe:]DEMod:FORMat:BANalyze:SYMBOLs:EQUal command has been set to true then this command specifies the exact number of symbols required for a burst to take part in measurement analysis. When the [SENSe:]DEMod:FORMat:BANalyze:SYMBOLs:EQUal command is set to false this command specifies the minimum number of symbols required for a burst to take part in measurement analysis.

Parameter

<numeric_value>

Example

```
DEM:FORM:BAN:SYM:MIN 16
```

Only bursts which contain a symbol count of 16 are analyzed.

Characteristics

*RST value: 1

SCPI: device-specific

Mode

WLAN

[SENSe:]DEMod:FORMat:BTRate

The remote control command is used to specify the bit rate for IEEE 802.11b signals. This command can be used as an alternative to [\[SENSe:\]DEMod:FORMat:BANalyze](#). The bit rate can be set as follows:

Parameter

10	1 Mbit/s
20	2 Mbit/s
55	5.5 Mbit/s
110	11 Mbit/s

Example

```
DEM:FORM:BTR 20
```

Configures to demodulate 2 Mbit/s signals

Characteristics

*RST value: 10 (= 1mbit)

SCPI: device-specific

Mode

WLAN

[SENSe:]DEMod:FORMat:SIGSymbol

If this command is set to ON, the signal symbol field of the burst is analyzed to determine the details of the burst. Only burst which match the supplied burst type and modulation are considered in results analysis. For IEEE 802.11b this command can only be queried as the decoding of the signal field is always performed for the IEEE 802.11b standard.

Parameter

ON | OFF

Example

```
DEM:FORM:SIGS ON
```

Specifies that the signal symbol field should be decoded.

Characteristics

*RST value: –

SCPI: device-specific

Mode

WLAN

[SENSe:]FREQuency:CENTer

For details refer to "[\[SENSe<1|2>:\]FREQuency:CENTer](#)" on page 6.123.

[SENSe:]POWER:ACHannel:MODE

This command sets the ACP measurement mode for the IEEE 802.11j standard to either absolute or relative.

Parameter

ABS Absolute measurement
REL Relative measurement

Example

```
POW:ACH:MODE ABS  
Sets the ACP measurement to absolute mode
```

Characteristics

*RST value: REL
SCPI: device-specific

Mode

WLAN

[SENSe:]SWAPiq

This command defines whether or not the recorded IQ pairs should be swapped (I \leftrightarrow Q) before being processed.

Parameter

ON | OFF

Example

```
SWAP ON  
Specifies that IQ values should be swapped.
```

Characteristics

*RST value: OFF
SCPI: device-specific

Mode

WLAN

[SENSe:]SWEep:COUNT

This command specifies the number of sweeps for Spectrum Mask and Spectrum ACPR measurements.

Parameter

<numeric_value>

Example

```
SWEep:COUNT 64  
Sets the number of sweeps to 64.
```

Characteristics

*RST value: 1
SCPI: conform

Mode

WLAN

[SENSe:]SWEep:EGATe

For details refer to "[SENSe<1|2>:]SWEep:EGATe" on page 6.146.

[SENSe:]SWEep:EGATe:HOLDoff[:TIME]

This command defines the gate delay in the capture buffer in time units. The range of this value is dependent on the last run measurement.

Parameter

<numeric_value>

Example

```
SWE:EGAT:HOLD 125us
```

Sets a delay of 125 μ s in the capture buffer.

Characteristics

*RST value: 100 μ s

SCPI: device-specific

Mode

WLAN

[SENSe:]SWEep:EGATe:HOLDoff:SAMPle

This command defines the gate delay in the capture buffer as a number of samples. The range of this value is dependent on the last run measurement.

Parameter

<numeric_value>

Example

```
SWE:EGAT:HOLD:SAMP 2500
```

Sets a delay of 2500 samples in the capture buffer.

Characteristics

*RST value: 2000

SCPI: device-specific

Mode

WLAN

[SENSe:]SWEep:EGATe:LENGth[:TIME]

This command defines the gate time in the capture buffer in time units. The range of this value is dependent on the last run measurement.

Parameter

<numeric_value>

Example

```
SWE:EGAT:LENG 20ms
```

Sets a gate length of 20 milliseconds between sweeps.

Characteristics

*RST value: 400µs

SCPI: device-specific

Mode

WLAN

[SENSe:]SWEep:EGATe:LENGth:SAMPle

This command defines the gate time in the capture buffer as a number of samples. The range of this value is dependent on the last run measurement.

Parameter

<numeric_value>

Example

```
SWE:EGAT:LENG:SAMP 200000
```

Sets a gate length of 200000 samples in the capture buffer.

Characteristics

*RST value: 8000

SCPI: device-specific

Mode

WLAN

[SENSe:]SWEep:EGATe:LINK

This command links together the movement of the gating lines and the capture buffer marker.

Parameter

ON | OFF

Example

```
SWE:EGAT:LINK ON
```

Links the gating lines as marker with the gating line delay and length are changed gate position.

Characteristics

*RST value: 0

SCPI: device-specific

Mode

WLAN

[SENSe:]SWEep:TIME

The RST value for the WLAN TX Measurements option (K91) is 1 ms.

For further details refer to "[SENSe<1|2>:]SWEep:TIME" on page 6.149.

[SENSe:]TRACking:LEVel

This command defines whether or not the measurement results should be compensated for level.

Parameter

ON | OFF

Example

TRAC:LEV ON

Specifies that the measurement results should be compensated for level.

Characteristics

*RST value: OFF

SCPI: device-specific

Mode

WLAN

[SENSe:]TRACking:PHASe

This command defines whether or not the measurement results should be compensated for phase.

Parameter

ON | OFF

Example

TRAC:PHAS ON

Specifies that the measurement results should be compensated for phase.

Characteristics

*RST value: ON

SCPI: device-specific

Mode

WLAN

[SENSe:]TRACking:TIME

This command defines whether or not the measurement results should be compensated for time.

Parameter

ON | OFF

Example

TRAC:TIME ON

Specifies that the measurement results should be compensated for time.

Characteristics

*RST value: OFF

SCPI: device-specific

Mode

WLAN

STATus Subsystem (WLAN, K91)

The STATus subsystem contains the commands for the status reporting system (see chapter "Remote Control – Basics", section "Status Reporting System"). For the STATus:QUESTionable:LIMit register, the measurement window is selected by LIMit 1 (screen A) or 2 (screen B). *RST does not influence the status registers.

Commands of the STATus Subsystem

- STATus:QUESTionable:ACPLimit[:EVENT]?
- STATus:QUESTionable:ACPLimit:CONDition?
- STATus:QUESTionable:ACPLimit:ENABLE
- STATus:QUESTionable:ACPLimit:PTRansition
- STATus:QUESTionable:ACPLimit:NTRansition
- STATus:QUESTionable:LIMit<1|2> [:EVENT]?
- STATus:QUESTionable:LIMit<1|2>:CONDition?
- STATus:QUESTionable:LIMit<1|2>:ENABLE
- STATus:QUESTionable:LIMit<1|2>:PTRansition
- STATus:QUESTionable:LIMit<1|2>:NTRansition
- STATus:QUESTionable:POWer[:EVENT]?
- STATus:QUESTionable:POWer:CONDition?
- STATus:QUESTionable:POWer:ENABLE
- STATus:QUESTionable:POWer:PTRansition
- STATus:QUESTionable:POWer:NTRansition
- STATus:QUESTionable:SYNC[:EVENT]?
- STATus:QUESTionable:SYNC:CONDition?
- STATus:QUESTionable:SYNC:ENABLE
- STATus:QUESTionable:SYNC:PTRansition
- STATus:QUESTionable:SYNC:NTRansition

STATus:QUESTionable:ACPLimit[:EVENT]?

For details refer to "[STATus:QUESTionable:ACPLimit\[:EVENT\]?](#)" on page 6.153.

STATus:QUESTionable:ACPLimit:CONDition?

For details refer to "[STATus:QUESTionable:ACPLimit:CONDition?](#)" on page 6.153.

STATus:QUESTionable:ACPLimit:ENABLE

For details refer to "[STATus:QUESTionable:ACPLimit:ENABLE](#)" on page 6.153.

STATus:QUESTionable:ACPLimit:PTRansition

For details refer to "[STATus:QUESTionable:LIMit<1|2>:PTRansition](#)" on page 6.157.

STATus:QUESTionable:ACPLimit:NTRansition

For details refer to "[STATus:QUESTionable:ACPLimit:NTRansition](#)" on page 6.154.

STATus:QUESTionable:LIMit<1|2> [:EVENT]?

For details refer to "[STATus:QUESTionable:LIMit<1|2> \[:EVENT\]?](#)" on page 6.156.

STATus:QUESTionable:LIMit<1|2>:CONDition?

For details refer to "[STATus:QUESTionable:LIMit<1|2>:CONDition?](#)" on page 6.156.

STATus:QUESTionable:LIMit<1|2>:ENABLE

For details refer to "[STATus:QUESTionable:LIMit<1|2>:ENABLE](#)" on page 6.157.

STATus:QUESTionable:LIMit<1|2>:PTRansition

For details refer to "[STATus:QUESTionable:LIMit<1|2>:PTRansition](#)" on page 6.157.

STATus:QUESTionable:LIMit<1|2>:NTRansition

For details refer to "[STATus:QUESTionable:LIMit<1|2>:NTRansition](#)" on page 6.157.

STATus:QUESTionable:POWER[:EVENT]?

For details refer to "[STATus:QUESTionable:POWER\[:EVENT\]?](#)" on page 6.159.

STATus:QUESTionable:POWER:CONDition?

For details refer to "[STATus:QUESTionable:POWER:CONDition?](#)" on page 6.159.

STATus:QUESTionable:POWER:ENABLE

For details refer to "[STATus:QUESTionable:POWER:ENABLE](#)" on page 6.160.

STATus:QUESTionable:POWER:PTRansition

For details refer to "[STATus:QUESTionable:POWER:PTRansition](#)" on page 6.160.

STATus:QUESTIONable:POWER:NTRansition

For details refer to "[STATus:QUESTIONable:POWER:NTRansition](#)" on page 6.160.

STATus:QUESTIONable:SYNC[:EVENT]?

This command queries the contents of the EVENT section of the STATus:QUESTIONable:SYNC register. Readout does not delete the contents of the EVENT section.

Example

```
STAT:QUES:SYNC?
```

Characteristics

*RST value: –

SCPI: device-specific

Mode

WLAN

STATus:QUESTIONable:SYNC:CONDition?

This command queries the contents of the CONDition section of the STATus:QUESTIONable:SYNC register. Readout does not delete the contents of the CONDition section.

Example

```
STAT:QUES:SYNC:COND?
```

Characteristics

*RST value: –

SCPI: conform

Mode

WLAN

STATus:QUESTIONable:SYNC:ENABLE

This command sets the bits of the ENABLE section of the STATus:QUESTIONable:SYNC register. The ENABLE register selectively enables the individual events of the associated EVENT section for the summary bit.

Parameter

0 to 65535

Example

```
STAT:QUES:SYNC:ENAB 65535
```

All events bits will be represented in the SYNC summary bit.

Characteristics

*RST value: –

SCPI: device-specific

Mode

WLAN

STATus:QUEStionable:SYNC:PTRansition

This command determines what bits in the STATus:QUEStionable:SYNC Condition register will set the corresponding bit in the STATus:QUEStionable:SYNC Event register when that bit has a positive transition (0 to 1). The variable <number> is the sum of the decimal values of the bits that are to be enabled.

Parameter

0 to 65535

Example

```
STAT:QUES:SYNC:PTR 65535
```

All condition bits will be summarized in the Event register when a positive transition occurs.

Characteristics

*RST value: –

SCPI: device-specific

Mode

WLAN

STATus:QUEStionable:SYNC:NTRansition

This command determines what bits in the STATus:QUEStionable:SYNC Condition will set the corresponding bit in the STATus:QUEStionable:SYNC Event register when that bit has a negative transition (1 to 0). The variable <number> is the sum of the decimal values of the bits that are to be enabled.

Parameter

0 to 65535

Example

```
STAT:QUES:SYNC:NTR 65535 -
```

All condition bits will be summarized in the Event register when a positive transition occurs.

Characteristics

*RST value: –

SCPI: device-specific

Mode

WLAN

TRACe Subsystem (WLAN, K91)

The TRACe subsystem controls access to the instrument's internal trace memory.

Commands of the TRACe Subsystem

- [TRACE\[:DATA\]](#)
- [TRACE:IQ:DATA:MEMory?](#)
- [TRACE:IQ:SRATe](#)

Further information

- [IQ Measurements](#)
- [Constellation vs Symbol](#)
- [Constellation vs Carrier](#)
- [Power vs Time – Full Burst and Rising /Falling Data](#)
- [Spectrum Flatness](#)
- [Spectrum FFT](#)
- [Statistics Bitstream data](#)
- [Statistics CCDF – Complementary cumulative distribution function](#)
- [Statistics Signal Field data](#)
- [EVM vs Carrier](#)
- [EVM vs Symbol](#)
- [Error vs Preamble](#)
- [Frequency Sweep Measurements](#)
- [Spectrum Mask](#)
- [Spectrum ACPR](#)

IQ Measurements

There are a number of measurements that can be performed in IQ mode. No data will be returned for any of the following measurements, should it be requested, until such time as a measurement belonging to the IQ group has been previously run.

Running a frequency sweep measurement for example, Spectrum Mask, will not generate results for this measurement group.

Constellation vs Symbol

This measurement represents I and Q data. For IEEE 802.11a and j the data will be returned as a repeating array of interleaved I and Q data in groups of selected carriers, until all the data is exhausted. For IEEE 802.11b the data will be returned as a repeating array of interleaved I and Q data in symbol order until all the data is exhausted.

Each I and Q point will be returned in floating point format. TRACE1 is used for this measurement results.

IEEE 802.11a & j only

- If "All Carriers" is selected, it will return 52 per of I and Q data per symbol.
- If "Pilots Only" is selected, it will return 4 per of I and Q per symbol in the following order: Carrier – 21, Carrier –7, Carrier 7, Carrier 21.
- If a single carrier is selected, it will return 1 per of I and Q data per symbol.

Constellation vs Carrier

This measurement represents I and Q data. Data will be returned as a repeating array of interleaved I and Q data in groups of 53 channels including the channel 0, until all the data is exhausted.

Each I and Q point will be returned in floating point format. TRACE1 is used for this measurement results.

Power vs Time – Full Burst and Rising /Falling Data

Both measurement results are once again simply slightly different views of the same results data.

All fully complete bursts within the capture time are analyzed into three master bursts. The three master bursts relate to the minimum, maximum and average values across all complete bursts. This data is returned in dBm values to the user on a per sample basis. Each sample will in some way relate to an analysis of each corresponding sample within each processed burst.

The type of PVT data returned will be determined by the TRACE number passed as an argument to the SCPI command, in addition to the graphic type that is selected.

If the graphic type selected is full burst, then the return data is as follows.

TRACE1	full burst, minimum burst data values
TRACE2	full burst, mean burst data values
TRACE3	full burst, maximum burst data values

If the graphic type selected is EDGe, then the return data is as follows.

TRACE1	rising edge, minimum burst data values
TRACE2	rising edge, mean burst data values
TRACE3	rising edge, maximum burst data values
TRACE4	falling edge, minimum burst data values
TRACE5	falling edge, mean burst data values
TRACE6	falling edge, maximum burst data values

For IEEE 802.11b only

- If the graphic type selected is RISing or FALLing then only 3 traces are available (1 to 3) and represent the minimum, mean and maximum bursts data for the respective graph selection.
- The number of samples returned during full burst analysis will depend on the modulation type and will typically be 5000.
- The number of samples returned when the rising and falling graphic type is selected will be less than what is returned for full burst and will be approximately 400 samples.
- The samples will be returned in floating point format as a single sequence of comma delimited values.

Spectrum Flatness

There are four separate traces that are available with this measurement. Trace data for a particular trace will only be returnable by querying the appropriate trace

Spectrum flatness provides two basic graph types. These are an absolute power value graph (ABS) and a relative group delay graph, which are both plotted on a per carrier basis. All 52 carriers are drawn, in addition to the unused 0 carrier. Both the absolute power and group delay graph groups will allow all the data points to be returned as one trace and an average of all the channels as the other trace.

E.g. the return data will either be one single group of 53 carriers if the average trace is selected or a repeating group of 53 carriers if all the data is requested.

TRACE1	ABS	(all analyzed trains)
TRACE2	Group Delay	(all analyzed trains)
TRACE3	ABS	(average trace)
TRACE4	Group Delay	(average trace)

Absolute power results are returned in dB and group delay results are returned in ns.

Spectrum FFT

All FFT points will be returned if the data for this measurement is requested. This will be an exhaustive call, due to the fact that there are nearly always more FFT points than IQ samples. The number of FFT points is the number presented by a power of 2 that is higher than the total number of samples.

E.g. if there were 20000 samples, then 32768 FFT points would be returned.

Data will be returned in floating point format in dBm. TRACE1 is used for this measurement results.

Statistics Bitstream data

IEEE 802.11a & j only

Data will be returned in repeating groups of 52 data channels where each symbol value will be represented by an integer value within one byte. Channel 0 is unused and will therefore not have any data associated with it, with no return data being provided.

The number of repeating groups that are returned will be equal to the number of measured symbols.

Currently, 64QAM has the highest data rate and it contains symbol values up to 63, making the proposal of one byte sufficient in size to represent all symbol data values, regardless of the modulation type in use.

Data will be returned in ASCII printable hexadecimal character format. TRACE1 is used for this measurement results.

IEEE 802.11b only

Data will be returned in burst order. Each burst will be represented as a series of bytes. For each burst the first 9 or 18 bytes represents the PLCP Preamble for Short and Long burst types respectively. The next 6 bytes represents the PLCP Header. The remaining bytes represent the PSDU.

Data will be returned in ASCII printable hexadecimal character format. TRACE1 is used for this measurement results.

Statistics CCDF – Complementary cumulative distribution function

Up to a maximum of 201 data points will be returned in addition to a data count value. The first value in the return data will represent the quantity of probability values that follow. Each of the potential 201 data points will be returned as probability value and will represent the total number of samples that are equal to or exceed the corresponding power level. Probability data will be returned up to the power level that contains at least one sample. It is highly unlikely that the full 201 data values will ever be returned.

Each probability value will be returned as a floating point number, with a value less than 1.

Statistics Signal Field data

IEEE 802.11a & j only

Data will be returned as an array of hexadecimal values, with each hexadecimal value representing the 24 bit long signal field for a single burst.

IEEE 802.11b only

Data will be returned as an array of hexadecimal values, with each hexadecimal value representing the 48 bit long signal field for a single burst

EVM vs Carrier

Two trace types are provided with this measurement. There is an average EVM value for each of the 53 channels or a repeating group of EVM values for each channel. The number of repeating groups will correspond to the number of fully analyzed trains.

Each EVM value will be returned as a floating point number, expressed in units of dBm.

TRACE1 Average EVM values per channel

TRACE2 All EVM values per channel for each full train of the capture period

EVM vs Symbol

Three traces types are available with this measurement. The basic trace types show either the minimum, mean or maximum EVM value, as measured over the complete capture period.

The number of repeating groups that are returned will be equal to the number of measured symbols.

Each EVM value will be returned as a floating point number, expressed in units of dBm.

IEEE 802.11a & j only

TRACE1 Minimum EVM values

TRACE2 Mean EVM values

TRACE3 Maximum EVM values

IEEE 802.11b only

TRACE1 EVM IEEE values

TRACE2 EVM Direct values

Error vs Preamble

Three traces types are available with this measurement. The basic trace types show either the minimum, mean or maximum frequency or phase value as measured over the preamble part of the burst.

Frequency Sweep Measurements

No data will be returned for this type of measurement, should it be requested, until such time as a measurement has been previously run.

Running an IQ measurement will not generate results for this type of measurement.

Spectrum Mask

Result data will be returned as 501 measurement points in floating point format. These trace points are obtained directly from the base system via the measurement API and the quantity is therefore a fixed value. Only an array of Y data will be returned. TRACE1 is used for this measurement results.

Spectrum ACPR

Result data will be returned as 501 measurement points in floating point format. These trace points are obtained directly from the base system via the measurement API and the quantity is therefore a fixed value. Only an array of Y data will be returned. TRACE1 is used for this measurement results.

TRACE[:DATA]

This command returns all the measured data that relates to the currently selected measurement type. All results are returned in ASCII format. The returned data depends on the currently selected measurement type. `DISPlay:FORMat` is not supported with this command.

The following measurement types are available:

- "IQ Measurements" on page 6.448
- "Constellation vs Symbol" on page 6.448
- "Constellation vs Carrier" on page 6.449
- "Power vs Time – Full Burst and Rising /Falling Data" on page 6.449
- "Spectrum Flatness" on page 6.450
- "Spectrum FFT" on page 6.450
- "Statistics Bitstream data" on page 6.450
- "Statistics CCDF – Complementary cumulative distribution function" on page 6.451
- "Statistics Signal Field data" on page 6.451
- "EVM vs Carrier" on page 6.451
- "EVM vs Symbol" on page 6.451
- "Error vs Preamble" on page 6.451
- "Frequency Sweep Measurements" on page 6.452
- "Spectrum Mask" on page 6.452
- "Spectrum ACPR" on page 6.452

This command is a query only and thus has no *RST value.

Parameter

TRACE1 | TRACE2 | TRACE3 | TRACE4 | TRACE5 | TRACE6

Example

```
TRAC? TRACE2
```

The measurement data for the selected graph is returned.

Characteristics

*RST value: –

SCPI: conform

Mode

WLAN

TRACE:IQ:DATA:MEMory?

For details refer to "[TRACe<1|2>:IQ:DATA:MEMory?](#)" on page 6.171.

TRACE:IQ:SRATe

This command allows the sample rate for IQ measurements to be specified.

Example

```
TRACE:IQ:SRAT 20000
```

Specifies a sample rate of 20 MHz.

Characteristics

*RST value: –

SCPI: device-specific

Mode

WLAN

TRIGger Subsystem (WLAN, K91)

The trigger subsystem is used to synchronize device action(s) with events.

Commands of the TRIGger Subsystem

- TRIGger[:SEquence]:HOLDoff
- TRIGger[:SEquence]:MODE
- TRIGger[:SEquence]:LEVel:POWer
- TRIGger[:SEquence]:LEVel:POWer:AUTO

TRIGger[:SEquence]:HOLDoff

This command defines the length of the trigger delay. A negative delay time (pretrigger) can be set.

Parameter

<numeric_value>

Example

```
TRIG:HOLD 500us
```

Configures to use a holdoff period of 500 μ s after the trigger condition has been met.

Characteristics

*RST value: -10μ s

SCPI: Conform

Mode

WLAN

TRIGger[:SEquence]:MODE

This command configures how triggering is to be performed.

Parameter

IMMediate	automatically triggers the next measurement at the end of the previous measurement. This corresponds to the FREE RUN setting.
EXTernal	the next measurement is triggered by the signal at the external trigger input e.g. a gated trigger
POWer	triggering of the measurement via signals which are the measurement channel.

Example

```
TRIG:MODE IMM
```

AUTO triggering will occur for the next measurement at the specified video percentage value.

Characteristics

*RST value: IMMediate

SCPI: device-specific

Mode

WLAN

TRIGger[:SEQuence]:LEVel:POWer

This command accepts the level of the input signal for which triggering will occur.

Parameter

<numeric_value>

Example

```
TRIG:LEV:POW 10 DBM
```

Set to 10 dBm for RF measurement.

Characteristics

*RST value: 0 DBM

SCPI: device-specific

Mode

WLAN

TRIGger[:SEQuence]:LEVel:POWer:AUTO

This command specifies whether or not an automatic power trigger level calculation is performed before each main measurement. The setting of this command is ignored if the setting for the [TRIGger\[:SEQuence\]:MODE](#) command is not POWER.

Parameter

ON | OFF

Example

```
TRIG:LEV:POW:AUTO ON
```

Specifies that an automatic power trigger level calculation should be performed before the start of each main measurement.

Characteristics

*RST value: OFF

SCPI: device-specific

Mode

WLAN

UNIT Subsystem (WLAN, K91)

The unit subsystem specifies the units for specific result types.

Commands of the UNIT Subsystem

- UNIT:EVM
- UNIT:GIMBalance
- UNIT:PREamble

UNIT:EVM

This command specifies the units for EVM results.

Parameter

DB EVM results returned in dB
PCT EVM results returned in %

Example

```
UNIT:EVM PCT  
EVM results to be returned in %.
```

Characteristics

*RST value: DB
SCPI: device-specific

Mode

WLAN

UNIT:GIMBalance

This command specifies the units for Gain Imbalance results.

Parameter

DB Gain Imbalance results returned in dB
PCT Gain Imbalance results returned in %

Example

```
UNIT:GIMB PCT  
Gain Imbalance results to be returned in %.
```

Characteristics

*RST value: DB
SCPI: device-specific

Mode

WLAN

UNIT:PREamble

This command specifies the units for Preamble error results.

Parameter

HZ Preamble error results returned in Hz

PCT Preamble error results returned in %

Example

```
UNIT:PRE PCT
```

Preamble error results to be returned in %.

Characteristics

*RST value: DB

SCPI: device-specific

Mode

WLAN

Remote Commands of the WiMAX 802.16 OFDM Measurements Option (K92)

This chapter describes the remote commands for the WiMAX 802.16 OFDM Measurements option (K92). The abbreviation WiMAX stands for the operating mode of this option. For details on conventions used in this chapter refer to section "Notation" on page 6.2 at the beginning of this chapter.

For further information on analyzer or basic settings commands, refer to the corresponding subsystem in section "Remote Control – Description of Analyzer Commands" on page 6.5 or section "Remote Control – Description of Basic Settings Commands".

This option is available from firmware version 1.40.

Subsystems of the WiMAX 802.16 OFDM Measurements option (K92)

- "ABORt Subsystem (WiMAX, K92)" on page 6.459
- "CALCulate:BURSt Subsystem (WiMAX, K92)" on page 6.460
- "CALCulate:LIMit Subsystem (WiMAX, K92)" on page 6.461
- "CALCulate:MARKer Subsystem (WiMAX, K92)" on page 6.473
- "CONFigure Subsystem (WiMAX, K92)" on page 6.480
- "DISPlay Subsystem (WiMAX, K92)" on page 6.492
- "FETCh Subsystem (WiMAX, K92)" on page 6.496
- "FORMat Subsystem (WiMAX, K92)" on page 6.503
- "INITiate Subsystem (WiMAX, K92)" on page 6.504
- "INPut Subsystem (WiMAX, K92)" on page 6.505
- "INSTrument Subsystem (WiMAX, K92)" on page 6.506
- "MMEMory Subsystem (WiMAX, K92)" on page 6.507
- "SENSE Subsystem (WiMAX, K92)" on page 6.508
- "STATus Subsystem (WiMAX, K92)" on page 6.522
- "TRACe Subsystem (WiMAX, K92)" on page 6.526
- "TRIGger Subsystem (WiMAX, K92)" on page 6.532
- "UNIT Subsystem (WiMAX, K92)" on page 6.535

ABORt Subsystem (WiMAX, K92)

Commands of the ABORt Subsystem

- [ABORt](#)

ABORt

For details refer to "[ABORt](#)" on page 6.5.

CALCulate:BURSt Subsystem (WiMAX, K92)

The CALCulate:BURSt subsystem checks the IQ measurement results.

Commands of the CALCulate:BURSt Subsystem

- [CALCulate<1|2>:BURSt\[:IMMediate\]](#)

CALCulate<1|2>:BURSt[:IMMediate]

This command forces the IQ measurement results to be recalculated according to the current settings.

This command is an event and therefore has no *RST value and no query.

Example

```
CALC1: BURS
```

Starts the recalculation of the IQ measurement results.

Characteristics

RST value: –

SCPI: device-specific

Mode

WiMAX

CALCulate:LIMit Subsystem (WiMAX, K92)

The CALCulate:LIMit subsystem consists of the limit lines and the corresponding limit checks.

Commands of the CALCulate:LIMit Subsystem

- CALCulate<1|2>:LIMit<1...8>:FAIL?
- CALCulate<1|2>:LIMit<1>:BURSt:ALL
- CALCulate<1|2>:LIMit<1>:BURSt:ALL:RESult?
- CALCulate<1|2>:LIMit<1>:BURSt:EVM:ALL[:AVERage]
- CALCulate<1|2>:LIMit<1>:BURSt:EVM:ALL[:AVERage]:RESult?
- CALCulate<1|2>:LIMit<1>:BURSt:EVM:ALL:MAXimum
- CALCulate<1|2>:LIMit<1>:BURSt:EVM:ALL:MAXimum:RESult?
- CALCulate<1|2>:LIMit<1>:BURSt:EVM:DATA[:AVERage]
- CALCulate<1|2>:LIMit<1>:BURSt:EVM:DATA[:AVERage]:RESult?
- CALCulate<1|2>:LIMit<1>:BURSt:EVM:DATA:MAXimum
- CALCulate<1|2>:LIMit<1>:BURSt:EVM:DATA:MAXimum:RESult?
- CALCulate<1|2>:LIMit<1>:BURSt:FERRor[:AVERage]
- CALCulate<1|2>:LIMit<1>:BURSt:FERRor[:AVERage]:RESult?
- CALCulate<1|2>:LIMit<1>:BURSt:FERRor:MAXimum
- CALCulate<1|2>:LIMit<1>:BURSt:FERRor:MAXimum:RESult?
- CALCulate<1|2>:LIMit<1>:BURSt:IQOFFset[:AVERage]
- CALCulate<1|2>:LIMit<1>:BURSt:IQOFFset[:AVERage]:RESult?
- CALCulate<1|2>:LIMit<1>:BURSt:IQOFFset:MAXimum
- CALCulate<1|2>:LIMit<1>:BURSt:IQOFFset:MAXimum:RESult?
- CALCulate<1|2>:LIMit<1>:BURSt:SSTiming[:AVERage]
- CALCulate<1|2>:LIMit<1>:BURSt:SSTiming[:AVERage]:RESult?
- CALCulate<1|2>:LIMit<1>:BURSt:SSTiming:MAXimum
- CALCulate<1|2>:LIMit<1>:BURSt:SSTiming:MAXimum:RESult?
- CALCulate<1|2>:LIMit<1>:BURSt:SYMBOLerror[:AVERage]
- CALCulate<1|2>:LIMit<1>:BURSt:SYMBOLerror[:AVERage]:RESult?
- CALCulate<1|2>:LIMit<1>:BURSt:SYMBOLerror:MAXimum
- CALCulate<1|2>:LIMit<1>:BURSt:SYMBOLerror:MAXimum:RESult?
- CALCulate<1|2>:LIMit<1>:SPECTrum:MASK:CHECK:X?
- CALCulate<1|2>:LIMit<1>:SPECTrum:MASK:CHECK:Y?

CALCulate<1|2>:LIMit<1...8>:FAIL?

This command queries the limit check result of the limit line indicated in the selected measurement window. To obtain a valid result, a complete sweep must be performed. A synchronization with *OPC, *OPC? or *WAI is therefore recommended.

The numeric suffixes <1...8> specify the limit lines as follows:

- 1 to 2 not used
- 3 ETSI Spectrum Mask limit line
- 4 IEEE Spectrum Mask limit line
- 5 Spectrum Flatness (Upper) limit line
- 6 Spectrum Flatness (Lower) limit line
- 7 Spectrum Flatness Difference (Upper) limit line
- 8 Spectrum Flatness Difference (Lower) limit line

Note: No limit lines are displayed in screen A. Therefore all commands with the suffix 1 for CALCulate will return 0.

This command is only a query and therefore has no *RST value.

Parameter

- 0 PASSED
- 1 FAILED

Example

```
INIT; *WAI
```

Starts a new sweep and waits for its end.

```
CALC2:LIM1:FAIL?
```

Queries the result of the check for limit line 1 in screen B.

Characteristics

RST value: –

SCPI: device-specific

Mode

WiMAX

CALCulate<1|2>:LIMit<1>:BURSt:ALL

This command sets or returns all the limit values.

Parameter

The results are input or output as a list of values separated by commas in the following (ASCII) format:

Result input/output in ASCII format	Description
<average EVM all bursts>, <max EVM all bursts>	dB or % depending on selected units (UNIT:EVM)
<average EVM data carriers >, <max EVM data carriers >	dB or % depending on selected units (UNIT:EVM)
<average Frequency Error>, <max Frequency Error>	Down Link Mode: Hz; .Up Link Mode: %
<average Symbol Error>, <max Symbol Error>	Down Link Mode: ppm; Up Link Mode: %
<average SS Timing>, <maximum SS Timing >	Only returned in Up Link mode and maintained for backward compatibility. When setting, use a value of 0, and ignore when querying.

Example

```
CALC:LIM:BURS:ALL?
```

All limit values are returned.

Characteristics

RST value: –

SCPI: device-specific

Mode

WiMAX

CALCulate<1|2>:LIMit<1>:BURSt:ALL:RESult?

This command returns all the limit results.

This command is only a query and therefore has no *RST value.

Parameter

0 PASSED

1 FAILED

The results are output as a list of result strings separated by commas. For the output order see [CALCulate<1|2>:LIMit<1>:BURSt:ALL](#) command.

Example

```
CALC:LIM:BURS:ALL:RES?
```

All limit values are returned.

Characteristics

RST value: –

SCPI: device-specific

Mode

WiMAX

CALCulate<1|2>:LIMit<1>:BURSt:EVM:ALL[:AVERAge]

This command sets the average Error Vector Magnitude Limit. This is a combined figure that represents the pilot, data and the free carrier.

Parameter

–1000000 to 1000000 dB or %

If no unit is specified the unit specified by the [UNIT:EVM](#) command is used.

Example

```
CALC:LIM:BURS:EVM:ALL -25.0
```

Average EVM for all carrier limit is set to –25.0 dB.

Characteristics

RST value: –

SCPI: device-specific

Mode

WiMAX

CALCulate<1|2>:LIMit<1>:BURSt:EVM:ALL[:AVERAge]:RESult?

This command returns the average Error Vector Magnitude Limit result (PASSED | FAILED).

This is a combined figure that represents the pilot, data and the free carrier.

This command is only a query and therefore has no *RST value.

Example

```
CALC:LIM:BURS:EVM:ALL:RES?
```

Average EVM for all carrier limit result is returned.

Characteristics

RST value: –

SCPI: device-specific

Mode

WiMAX

CALCulate<1|2>:LIMit<1>:BURSt:EVM:ALL:MAXimum

This command sets the maximum Error Vector Magnitude Limit. This is a combined figure that represents the pilot, data and the free carrier.

Parameter

–1000000 to 1000000 dB or %

If no unit is specified the unit specified by the [UNIT:EVM](#) command is used.

Example

```
CALC:LIM:BURS:EVM:ALL:MAX?
```

Maximum EVM for all carrier limit is returned.

Characteristics

RST value: –

SCPI: device-specific

Mode

WiMAX

CALCulate<1|2>:LIMit<1>:BURSt:EVM:ALL:MAXimum:RESult?

This command returns the maximum Error Vector Magnitude Limit result (PASSED | FAILED). This is a combined figure that represents the pilot, data and the free carrier.

This command is only a query and therefore has no *RST value.

Example

```
CALC:LIM:BURS:EVM:ALL:MAX:RES?
```

Maximum EVM for all carrier limit result is returned.

Characteristics

RST value: –

SCPI: device-specific

Mode

WiMAX

CALCulate<1|2>:LIMit<1>:BURSt:EVM:DATA[:AVERage]

This command sets the average Error Vector Magnitude Limit for the data carrier.

Parameter

–1000000 to 1000000 dB or %

If no unit is specified the unit specified by the [UNIT:EVM](#) command is used.

Example

```
CALC:LIM:BURS:EVM:DATA -30.0
```

Average EVM for data carrier limit is set to -30.0 dB.

Characteristics

RST value: –

SCPI: device-specific

Mode

WiMAX

CALCulate<1|2>:LIMit<1>:BURSt:EVM:DATA[:AVERAge]:RESult?

This command returns the average Error Vector Magnitude limit result summary for the data carrier in dB.

This command is only a query and therefore has no *RST value.

Parameter

0 PASSED

1 FAILED

Example

```
CALC:LIM:BURS:EVM:DATA:RES?
```

Average EVM for data carrier limit result is returned.

Characteristics

RST value: –

SCPI: device-specific

Mode

WiMAX

CALCulate<1|2>:LIMit<1>:BURSt:EVM:DATA:MAXimum

This command sets the maximum Error Vector Magnitude Limit for the data carrier.

Parameter

-1000000 to 1000000 dB or %

If no unit is specified the unit specified by the [UNIT:EVM](#) command is used.

Example

```
CALC:LIM:BURS:EVM:DATA:MAX?
```

Maximum EVM for data burst limit is returned.

Characteristics

RST value: –

SCPI: device-specific

Mode

WiMAX

CALCulate<1|2>:LIMit<1>:BURSt:EVM:DATA:MAXimum:RESult?

This command returns the maximum Error Vector Magnitude limit result summary for the data carrier in dB.

This command is only a query and therefore has no *RST value.

Parameter

0 PASSED
1 FAILED

Example

```
CALC:LIM:BURS:EVM:DATA:MAX:RES?
```

Maximum EVM for data carrier limit result is returned.

Characteristics

RST value: –

SCPI: device-specific

Mode

WiMAX

CALCulate<1|2>:LIMit<1>:BURSt:FERRor[:AVERage]

This command sets the average frequency error limit.

Parameter

–1000000 to 1000000 Hz or %

If no unit is specified the unit depends on the current Up/Down Link Mode: Hz in Down Link mode, % in Up Link mode.

Note: There is no relationship between the Down Link and Up Link values. Setting a Down Link value in Up Link mode does not change the displayed limit value.

Example

```
CALC:LIM:BURS:FERR 10000
```

The average frequency error limit is set to 10000 Hz.

Characteristics

RST value: –

SCPI: device-specific

Mode

WiMAX

CALCulate<1|2>:LIMit<1>:BURSt:FERRor[:AVERage]:RESult?

This command returns the average frequency error limit result.

This command is only a query and therefore has no *RST value.

Parameter

0 PASSED
1 FAILED

Example

```
CALC:LIM:BURS:FERR:RES?
```

Average frequency error limit result is returned.

Characteristics

RST value: –

SCPI: device-specific

Mode

WiMAX

CALCulate<1|2>:LIMit<1>:BURSt:FERRor:MAXimum

This command sets the maximum frequency error limit.

Parameter

–1000000 to 1000000 Hz or %

If no unit is specified the unit depends on the current Up/Down Link Mode: Hz in Down Link mode, % in Up Link mode.

Note: There is no relationship between the Down Link and Up Link values. Setting a Down Link value in Up Link mode does not change the displayed limit value.

Example

```
CALC:LIM:BURS:FERR:MAX?
```

Maximum frequency error limit is returned.

Characteristics

RST value: –

SCPI: device-specific

Mode

WiMAX

CALCulate<1|2>:LIMit<1>:BURSt:FERRor:MAXimum:RESult?

This command returns the maximum frequency error limit result.

This command is only a query and therefore has no *RST value.

Parameter

0 PASSED

1 FAILED

Example

```
CALC:LIM:BURS:FERR:MAX:RES?
```

Maximum SS Timing limit result is returned.

Characteristics

RST value: –

SCPI: device-specific

Mode

WiMAX

CALCulate<1|2>:LIMit<1>:BURSt:IQOFfset[:AVERAge]

This command sets the average IQ offset error limit.

Parameter

–1000000 to 1000000 dB

Example

```
CALC:LIM:BURS:IQOF -10.0
```

Average IQ offset error limit is set to –10.0 dB.

Characteristics

*RST value: –

SCPI: device-specific

Mode

WiMAX

CALCulate<1|2>:LIMit<1>:BURSt:IQOFfset[:AVERAge]:RESult?

This command returns the average IQ offset error limit result.

Example

```
CALC:LIM:BURS:IQOF:RES?
```

Average IQ offset error limit result is returned.

Characteristics

*RST value: –

SCPI: device-specific

Mode

WiMAX

CALCulate<1|2>:LIMit<1>:BURSt:IQOFfset:MAXimum

This command sets the maximum IQ offset error limit.

Parameter

–1000000 to 1000000 dB

Example

```
CALC:LIM:BURS:IQOF:MAX 15.0
```

Maximum IQ offset error limit is set to –15.0 dB.

Characteristics

*RST value: –

SCPI: device-specific

Mode

WiMAX

CALCulate<1|2>:LIMit<1>:BURSt:IQOFset:MAXimum:RESult?

This command returns the maximum IQ offset error limit result.

Example

```
CALC:LIM:BURS:IQOF:MAX:RES?
```

Maximum IQ offset error limit result is returned.

Characteristics

*RST value: –

SCPI: device-specific

Mode

WiMAX

CALCulate<1|2>:LIMit<1>:BURSt:SSTiming[:AVERAge]

This command is only supported for reasons of compatibility with the FSP family. It sets the average Subscriber Station Timing limit. This value is only returned in Up Link mode.

Parameter

0PCT

Example

```
CALC:LIM:BURS:SST 0
```

The average SS Timing limit is set to 0%.

Characteristics

RST value: –

SCPI: device-specific

Mode

WiMAX

CALCulate<1|2>:LIMit<1>:BURSt:SSTiming[:AVERAge]:RESult?

This command returns the average Subscriber Station Timing limit result.

This command is only a query and therefore has no *RST value.

Parameter

0 PASSED

1 FAILED

Example

```
CALC:LIM:BURS:SST:RES?
```

Average SS Timing limit result is returned.

Characteristics

RST value: –

SCPI: device-specific

Mode

WiMAX

CALCulate<1|2>:LIMit<1>:BURSt:SSTiming:MAXimum

This command is only supported for reasons of compatibility with the FSP family. It sets the maximum Subscriber Station Timing limit. This value is only returned in Up Link mode.

Parameter

0PCT

Example

```
CALC:LIM:BURS:SST:MAX?
```

Maximum SS Timing limit is returned.

Characteristics

RST value: –

SCPI: device-specific

Mode

WiMAX

CALCulate<1|2>:LIMit<1>:BURSt:SSTiming:MAXimum:RESult?

This command returns the maximum Subscriber Station Timing limit.

This command is only a query and therefore has no *RST value.

Parameter

0 PASSED

1 FAILED

Example

```
CALC:LIM:BURS:SST:MAX:RES?
```

Maximum SS Timing limit result is returned.

Characteristics

RST value: –

SCPI: device-specific

Mode

WiMAX

CALCulate<1|2>:LIMit<1>:BURSt:SYMBOLerror[:AVERage]

This command sets the average symbol error limit.

Parameter

<numeric_value> in ppm or %: –1000000 to 1000000

If no unit is specified the unit depends on the current Up/Down Link Mode: ppm in Down Link mode, % in Up Link mode.

Note: There is no relationship between the Down Link and Up Link values. Setting a Down Link value in Up Link mode does not change the displayed limit value.

Example

```
CALC:LIM:BURS:SYMB 10000
```

The average symbol error limit is set to 10000 Hz.

Characteristics

RST value: –

SCPI: device-specific

ModeWiMAX

CALCulate<1|2>:LIMit<1>:BURSt:SYMBolerror[:AVERage]:RESult?

This command returns the average symbol error limit result.

This command is only a query and therefore has no *RST value.

Parameter

0 PASSED

1 FAILED

Example

CALC:LIM:BURS:SYMB:RES?

Average symbol error limit result is returned.

Characteristics

RST value: –

SCPI: device-specific

ModeWiMAX

CALCulate<1|2>:LIMit<1>:BURSt:SYMBolerror:MAXimum

This command sets the maximum symbol error limit.

Parameter

<numeric_value> in ppm or %: –1000000 to 1000000

If no unit is specified the unit depends on the current Up/Down Link Mode: ppm in Down Link mode, % in Up Link mode.

Note: There is no relationship between the Down Link and Up Link values. Setting a Down Link value in Up Link mode does not change the displayed limit value.

Example

CALC:LIM:BURS:SYMB:MAX?

Maximum symbol error limit is returned.

Characteristics

RST value: –

SCPI: device-specific

ModeWiMAX

CALCulate<1|2>:LIMit<1>:BURSt:SYMBolerror:MAXimum:RESult?

This command returns the maximum symbol error limit result.
This command is only a query and therefore has no *RST value.

Parameter

0 PASSED
1 FAILED

Example

CALC:LIM:BURS:SYMB:MAX:RES?
Maximum symbol error limit result is returned.

Characteristics

RST value: –
SCPI: device-specific

Mode

WiMAX

CALCulate<1|2>:LIMit<1>:SPECtrum:MASK:CHECK:X?

This command returns the x-value at the maximum overstepping of the spectrum mask limits.
This command is only a query and therefore has no *RST value.

Example

CALC:LIM:SPEC:MASK:CHEC:X?
Returns the frequency at the maximum overstepping.

Characteristics

RST value: –
SCPI: device-specific

Mode

WiMAX

CALCulate<1|2>:LIMit<1>:SPECtrum:MASK:CHECK:Y?

This command returns the y-value at the maximum overstepping of the spectrum mask limits.
This command is only a query and therefore has no *RST value.

Example

CALC:LIM:SPEC:MASK:CHEC:Y?
Returns the power at the maximum overstepping.

Characteristics

RST value: –
SCPI: device-specific

Mode

WiMAX

CALCulate:MARKer Subsystem (WiMAX, K92)

The CALCulate:MARKer subsystem checks the marker functions in the instrument.

The following subsystem is included:

- "CALCulate:MARKer:FUNCTion Subsystem (WiMAX, K92)" on page 6.477

Commands of the CALCulate:MARKer Subsystem

- CALCulate<1|2>:MARKer<1>[:STATe]
- CALCulate<1|2>:MARKer<1>:AOFF
- CALCulate<1|2>:MARKer<1>:BURSt
- CALCulate<1|2>:MARKer<1>:CARRier
- CALCulate<1|2>:MARKer<1>:MAXimum[:PEAK]
- CALCulate<1|2>:MARKer<1>:MINimum[:PEAK]
- CALCulate<1|2>:MARKer<1>:SYMBol
- CALCulate<1|2>:MARKer<1>:TRACe
- CALCulate<1|2>:MARKer<1>:X
- CALCulate<1|2>:MARKer<1>:Y?

CALCulate<1|2>:MARKer<1>[:STATe]

This command switches the markers on or off.

Parameter

ON | OFF

Example

```
CALC1:MARK1 ON
Switches the screen A marker ON.
```

Characteristics

RST value: ON
SCPI: device-specific

Mode

WiMAX

CALCulate<1|2>:MARKer<1>:AOFF

This command switches off all active markers in the specified measurement window. The window is set by the numeric suffix of CALCulate<1|2>.

Example

```
CALC1:MARK:AOFF
Switches off all markers in the screen A window.
CALC2:MARK:AOFF
Switches off all markers in the screen B window.
```

Characteristics

RST value: –

SCPI: device-specific

Mode

WiMAX

CALCulate<1|2>:MARKer<1>:BURSt

This command positions the selected marker to the indicated burst. This command is only available for the Constellation vs Symbol result display.

Parameter

1 to <number of captured bursts in capture buffer>

Example

```
CALC2:MARK:BURS 2
```

Positions marker 1 in screen B to burst 2.

```
CALC2:MARK:BURS?
```

Outputs the symbol value of marker 1 in screen B.

Characteristics

RST value: –

SCPI: device-specific

Mode

WiMAX

CALCulate<1|2>:MARKer<1>:CARRier

This command positions the selected marker to the indicated carrier.

This command is only available for the following result displays:

- Constellation vs Symbol
- Constellation vs Carrier

Parameter

–100 to 100

Example

```
CALC2:MARK:CARR -7
```

Positions marker 1 in screen B to carrier –7.

```
CALC2:MARK:CARR?
```

Outputs the carrier value of marker 1 in screen B.

Characteristics

RST value: –

SCPI: device-specific

Mode

WiMAX

CALCulate<1|2>:MARKer<1>:MAXimum[:PEAK]

This command sets the selected marker to the maximum peak value in the current trace.

This command is only available for the following result display:

- Spectrum Flatness

This command is an event and therefore has no *RST value and no query.

Example

```
CALC2:MARK:MAX
```

Set marker 1 in screen B to maximum value in trace.

Characteristics

RST value: –

SCPI: device-specific

Mode

WiMAX

CALCulate<1|2>:MARKer<1>:MINimum[:PEAK]

This command sets the selected marker to the minimum peak value in the current trace.

This command is only available for the following result display:

- Spectrum Flatness

This command is an event and therefore has no *RST value and no query.

Example

```
CALC2:MARK:MIN
```

Set marker 1 in screen B to minimum value in trace.

Characteristics

RST value: –

SCPI: device-specific

Mode

WiMAX

CALCulate<1|2>:MARKer<1>:SYMBOL

This command positions the selected marker to the indicated symbol.

This command is only available for the following result displays:

- Constellation vs Symbol
- Constellation vs Carrier

Parameter

1 to <number of symbols in selected burst>

Example

```
CALC2:MARK:SYMB 2
```

Positions marker 1 in screen B to symbol 2.

```
CALC2:MARK:SYMB?
```

Outputs the symbol value of marker 1 in screen B.

Characteristics

RST value: –

SCPI: device-specific

Mode

WiMAX

CALCulate<1|2>:MARKer<1>:TRACe

This command assigns the selected marker to the indicated measurement curve in the selected measurement window.

This command is only available for the following result displays:

- Constellation vs Carrier
- EVM vs Symbol
- PVT Full Burst
- PVT Rising / Falling

Parameter

1 to 3

Example

```
CALC2:MARK:TRAC 2
```

Assigns marker 1 in screen B to trace 2.

Characteristics

RST value: 1

SCPI: device-specific

Mode

WiMAX

CALCulate<1|2>:MARKer<1>:X

This command positions the selected marker to the indicated inphase (Constellation vs Symbol), frequency (Spectrum FFT, Spectrum Mask), time (Magnitude Capture Buffer, Auto Level, PVT Full Burst, PVT Rising / Falling), power (CCDF), sub-carrier (Constellation vs Carrier, EVM vs Carrier, Spectrum Flatness) or symbol (EVM vs Symbol) in the selected measurement window.

For the following result displays, this command is a query only:

- Constellation vs Symbol
- Constellation vs Carrier

Parameter

1 to <maximum range for selected measurement>

Example

```
CALC:MARK:X 2ms
```

Positions marker 1 in screen A to time 2 ms.

Characteristics

RST value: –

SCPI: device-specific

ModeWiMAX

CALCulate<1|2>:MARKer<1>:Y?

This command queries the marker value of the indicated quadrature (Constellation vs Symbol), magnitude of I or Q (Constellation vs Carrier), EVM (EVM vs Carrier) or abs (Spectrum Flatness) in the selected measurement window.

This command is only a query and therefore has no *RST value.

This command is only available for the following result displays:

- Auto Level
- Constellation vs Symbol
- Constellation vs Carrier
- EVM vs Symbol
- PVT Full
- PVT Rising / Falling
- Magnitude Capture Buffer
- Spectrum Mask
- Spectrum FFT
- CCDF

Example

CALC:MARK:Y?

Outputs the measured value of marker 1 in screen A.

Characteristics

RST value: –

SCPI: device-specific

ModeWiMAX

CALCulate:MARKer:FUNCTION Subsystem (WiMAX, K92)

The measurement window is selected by CALCulate 1 (screen A) or 2 (screen B).

Commands of the CALCulate:MARKer:FUNCTION Subsystem

- CALCulate<1|2>:MARKer<1>:FUNCTION:POWER:RESUlt[:CURRENT]?
- CALCulate<1|2>:MARKer<1>:FUNCTION:POWER:RESUlt:MAXHold?
- CALCulate<1|2>:MARKer<1>:FUNCTION:ZOOM

CALCulate<1|2>:MARKer<1>:FUNCTION:POWER:RESult[:CURRENT]?

This command queries the current result values of the adjacent channel power measurement. An ACPR (Adjacent channel power relative) measurement must have previously been run to provide the summary data.

This command is only a query and therefore has no *RST value.

Results are output separated by commas. Adjacent channel power values are output in dB. The order is as follows:

- Power of main channel
- Power of lower adjacent channel
- Power of upper adjacent channel
- Power of lower alternate adjacent channel 1
- Power of upper alternate adjacent channel 1
- Power of lower alternate adjacent channel 2
- Power of upper alternate adjacent channel 2
- Power of lower alternate adjacent channel 3
- Power of upper alternate adjacent channel 3
- Power of lower alternate adjacent channel 4
- Power of upper alternate adjacent channel 4

Example

```
CALC2:MARK:FUNC:POW:RES?
```

Characteristics

RST value: –

SCPI: device-specific

Mode

WiMAX

CALCulate<1|2>:MARKer<1>:FUNCTION:POWER:RESult:MAXHold?

This command queries the maximum result values of the adjacent channel power measurement. An ACPR (Adjacent channel power relative) measurement must have previously been run to provide the summary data.

For details on the result output refer to

[CALCulate<1|2>:MARKer<1>:FUNCTION:POWER:RESult\[:CURRENT\]?](#)

Example

```
CALC2:MARK:FUNC:POW:RES:MAXH?
```

Characteristics

RST value: –

SCPI: device-specific

Mode

WiMAX

CALCulate<1|2>:MARKer<1>:FUNCtion:ZOOM

This command defines the ratio to be zoomed around the marker 1 in the selected measurement window. The default value is 1, where the full trace is shown.

This command is only available for the following result displays:

- Constellation vs Carrier
- Constellation vs Symbol
- PVT Full Burst
- PVT Rising / Falling
- Magnitude Capture Buffer

This command is only a query and therefore has no *RST value.

Parameter

1 to 1000000

Example

CALC:MARK:FUNC:ZOOM 2

Zooms 50% in screen A.

CALC:MARK:FUNC:ZOOM 4

Zooms 25% in screen A.

CALC:MARK:FUNC:ZOOM 1

Deactivates zooming in screen A.

Characteristics

RST value: 1

SCPI: device-specific

Mode

WiMAX

CONFigure Subsystem (WiMAX, K92)

The CONFigure subsystem contains commands for configuring complex measurement tasks. The CONFigure subsystem is closely linked to the functions of the FETCH subsystem, where the measurement results are queried.

Commands of the CONFigure Subsystem

- `CONFigure:BURSt:CONSt:CARRier:SElect`
- `CONFigure:BURSt:CONSt:CCARRier[:IMMediate]`
- `CONFigure:BURSt:CONSt:CSYMBOL[:IMMediate]`
- `CONFigure:BURSt:EVM:ECARRier[:IMMediate]`
- `CONFigure:BURSt:EVM:ESYMBOL[:IMMediate]`
- `CONFigure:BURSt:PREamble[:IMMediate]`
- `CONFigure:BURSt:PREamble:SElect`
- `CONFigure:BURSt:PVT[:IMMediate]`
- `CONFigure:BURSt:PVT:BURSt`
- `CONFigure:BURSt:PVT:SElect`
- `CONFigure:BURSt:SPECtrum:ACPR[:IMMediate]`
- `CONFigure:BURSt:SPECtrum:ACPR:SElect`
- `CONFigure:BURSt:SPECtrum:FFT[:IMMediate]`
- `CONFigure:BURSt:SPECtrum:FLATness[:IMMediate]`
- `CONFigure:BURSt:SPECtrum:FLATness:SElect`
- `CONFigure:BURSt:SPECtrum:MASK[:IMMediate]`
- `CONFigure:BURSt:SPECtrum:MASK:SElect`
- `CONFigure:BURSt:STATistics:BSTReam[:IMMediate]`
- `CONFigure:BURSt:STATistics:BSUMmary[:IMMediate]`
- `CONFigure:BURSt:STATistics:CCDF[:IMMediate]`
- `CONFigure:CHANnel`
- `CONFigure:POWER:AUtO`
- `CONFigure:POWER:AUtO:SWEEp:TIME`
- `CONFigure:POWER:EXPEcted:RF`
- `CONFigure:STANdard`
- `CONFigure:WIMax:FBANd`
- `CONFigure:WIMax:IGRatio`
- `CONFigure:WIMax:LMODe`

CONFigure:BURSt:CONSt:CARRier:SElect

This command selects carriers and pilots. It is only available if the Constellation vs Symbol measurement is selected (see `CONFigure:BURSt:CONSt:CSYMBOL[:IMMediate]` command).

Parameter

–100 to 100 carrier number
 ALL all carriers
 PILOTS only pilots

Example

```
CONF: BURS: CONS: CSYM
```

Configures the Constellation vs Symbol measurement type.

```
CONF: BURS: CONS: CARR: SEL -26
```

Carrier –26 is selected.

```
INIT
```

Starts a Constellation vs Symbol measurement. The results of the selected carrier (–26) is calculated.

Characteristics

RST value: ALL

SCPI: device-specific

Mode

WiMAX

CONFigure: BURSt: CONSt: CCARrier[:IMMediate]

This command configures the Constellation vs Carrier measurement type.

This command is an event and therefore has no *RST value and no query.

Example

```
CONF: BURS: CONS: CCAR
```

Configures the Constellation vs Carrier measurement type.

```
INIT
```

Starts a Constellation vs Carrier measurement.

Characteristics

RST value: –

SCPI: device-specific

Mode

WiMAX

CONFigure: BURSt: CONSt: CSYMBOL[:IMMediate]

This command configures the Constellation vs Symbol measurement type.

This command is an event and therefore has no *RST value and no query.

Example

```
CONF: BURS: CONS: CSYM
```

Configures the Constellation vs Symbol measurement type.

```
INIT
```

Starts a Constellation vs Symbol measurement.

Characteristics

RST value: –

SCPI: device-specific

ModeWiMAX

CONFigure:BURSt:EVM:ECARrier[:IMMediate]

This command configures the EVM vs Carrier measurement type.

This command is an event and therefore has no *RST value and no query.

Example

```
CONF: BURS: EVM: ECAR
```

Configures the EVM vs Carrier measurement type.

```
INIT
```

Starts a EVM vs Carrier measurement.

Characteristics

RST value: –

SCPI: device-specific

ModeWiMAX

CONFigure:BURSt:EVM:ESYMBOL[:IMMediate]

This command configures the EVM vs Symbol measurement type.

This command is an event and therefore has no *RST value and no query.

Example

```
CONF: BURS: EVM: ESYM
```

Configures the EVM vs Symbol measurement type.

```
INIT
```

Starts a EVM vs Symbol measurement.

Characteristics

RST value: –

SCPI: device-specific

ModeWiMAX

CONFigure:BURSt:PREAmble[:IMMediate]

This command configures the Phase or Frequency vs Preamble measurement type. The selection between the both measurements is made via the [CONFigure:BURSt:PREAmble:SElect](#) command.

This command is an event and therefore has no *RST value and no query.

Example

```
CONF: BURS: PRE
```

Configures the Phase or Frequency vs Preamble measurement type.

```
CONF: BURS: PRE: SEL  FREQ
```

The measurement results are interpreted as Frequency Error vs Preamble.

```
INIT
```

Starts a Frequency Error vs Preamble measurement.

Characteristics

RST value: –

SCPI: device-specific

ModeWiMAX

CONFigure:BURSt:PREamble:SElect

This command configures the interpretation of the preamble measurement results.

Parameter

PHASe | FREQuency

Example

```
CONF: BURS: PRE
```

Configures the Phase or Frequency vs Preamble measurement type.

```
CONF: BURS: PRE: SEL  FREQ
```

The measurement results are interpreted as Frequency Error vs Preamble.

Characteristics

RST value: –

SCPI: device-specific

ModeWiMAX

CONFigure:BURSt:PVT[:IMMediate]

This command configures the Power vs Time (PVT) measurement type. For further settings of the Power vs Time measurement see the [CONFigure:BURSt:PVT:BURSt](#) and [CONFigure:BURSt:PVT:SElect](#) commands.

This command is an event and therefore has no *RST value and no query.

Example

```
CONF: BURS: PVT
```

Configures the Power vs Time measurement type.

```
INIT
```

Starts a Power vs Time measurement.

Characteristics

RST value: –

SCPI: device-specific

ModeWiMAX

CONFigure:BURSt:PVT:BURSt

This command specifies the burst that is used for the Power vs Time measurement results.n

Parameter

1 to 10922

Example

```
CONF: BURS: PVT
```

Configures the Power vs Time measurement type.

```
CONF: BURS: PVT: BURS 1
```

Uses burst 1 for the Power vs Time measurement results.

Characteristics

RST value: –

SCPI: device-specific

Mode

WiMAX

CONFigure: BURSt: PVT: SElect

This command configures the interpretation of the Power vs Time (PVT) measurement results.

Parameter

FULL | EDGE

Example

```
CONF: BURS: PVT
```

Configures the Power vs Time measurement type.

```
CONF: BURS: PVT: SEL FULL
```

The measurement results are interpreted as full burst.

Characteristics

RST value: FULL

SCPI: device-specific

Mode

WiMAX

CONFigure: BURSt: SPECtrum: ACPR[: IMMEDIATE]

This command configures the ACPR (adjacent channel power relative) measurement type.

This command is an event and therefore has no *RST value and no query.

Example

```
CONF: BURS: SPEC: ACPR
```

Configures the ACPR measurement type.

```
INIT
```

Starts an ACPR measurement.

Characteristics

RST value: –

SCPI: device-specific

Mode

WiMAX

CONFigure:BURSt:SPECtrum:ACPR:SELect

This command specifies the type of ACP measurement to be performed.

Parameter

ABSolute | RELative

Example

```
CONF: BURS: SPEC: ACPR: SEL ABS
```

Specifies the ACP measurement type absolute.

Characteristics

RST value: REL

SCPI: device-specific

Mode

WiMAX

CONFigure:BURSt:SPECtrum:FFT[:IMMediate]

This command configures the FFT (Fast Fourier Transform) measurement type.

This command is an event and therefore has no *RST value and no query.

Example

```
CONF: BURS: SPEC: FFT
```

Configures the FFT measurement type.

```
INIT
```

Starts an FFT measurement.

Characteristics

RST value: –

SCPI: device-specific

Mode

WiMAX

CONFigure:BURSt:SPECtrum:FLATness[:IMMediate]

This command configures the Spectrum Flatness measurement type. For settings for the Spectrum Flatness measurement see [CONFigure:BURSt:SPECtrum:FLATness:SELect](#) command.

This command is an event and therefore has no *RST value and no query.

Example

```
CONF: BURS: SPEC: FLAT
```

Configures the Spectrum Flatness measurement type.

```
INIT
```

Starts a Spectrum Flatness measurement.

Characteristics

RST value:

SCPI: device-specific

Mode

WiMAX

CONFigure:BURSt:SPECtrum:FLATness:SElect

This command configures the interpretation of the Spectrum Flatness measurement results.

Parameter

FLATness	spectrum flatness
GRDelay	group delay
DIFFerence	flatness difference

Example

```
CONF: BURS: SPEC: FLAT
```

Configures the Spectrum Flatness measurement type.

```
CONF: BURS: SPEC: FLAT: SEL GRD
```

Configures the group delay for the Spectrum Flatness measurement.

Characteristics

RST value: –

SCPI: device-specific

Mode

WiMAX

CONFigure:BURSt:SPECtrum:MASK[:IMMediate]

This command configures the Spectrum Mask measurement type. For settings for the Spectrum Mask measurement see [CONFigure:BURSt:SPECtrum:MASK:SElect](#) command.

This command is an event and therefore has no *RST value and no query.

Example

```
CONF: BURS: SPEC: MASK
```

Configures the Spectrum Mask measurement type.

```
INIT
```

Starts a Spectrum Mask measurement.

Characteristics

RST value: –

SCPI: device-specific

Mode

WiMAX

CONFigure:BURSt:SPECtrum:MASK:SElect

This command configures the interpretation of the Spectrum Mask measurement results..

Parameter

IEEE	interpretation according to IEEE standard
ETSI	interpretation according to ETSI standard

Example

```
CONF: BURS: SPEC: MASK
```

Configures the Spectrum Mask measurement type.

```
CONF: BURS: SPEC: MASK: SEL ETSI
```

The measurement results are interpreted using the ETSI standard.

Characteristics

RST value: –

SCPI: device-specific

Mode

WiMAX

CONFigure: BURSt: STATistics: BStReam[:IMMEDIATE]

This command configures the Bit Stream measurement type.

This command is an event and therefore has no *RST value and no query.

Example

```
CONF: BURS: STAT: BSTR
```

Configures the Bit Stream measurement type.

```
INIT
```

Starts a Bit Stream measurement.

Characteristics

RST value: –

SCPI: device-specific

Mode

WiMAX

CONFigure: BURSt: STATistics: BSUMmary[:IMMEDIATE]

This command configures the Burst Summary measurement type.

This command is an event and therefore has no *RST value and no query.

Example

```
CONF: BURS: STAT: BSUM
```

Configures the Burst Summary measurement type.

Characteristics

RST value: –

SCPI: device-specific

Mode

WiMAX

CONFigure: BURSt: STATistics: CCDF[:IMMEDIATE]

This command configures the CCDF (conditional cumulative distribution functions) measurement type.

This command is an event and therefore has no *RST value and no query.

Example

```
CONF: BURS: STAT: CCDF
```

Configures the CCDF measurement type.

```
INIT
```

Starts a Bit Stream measurement.

Characteristics

RST value: –

SCPI: device-specific

Mode

WiMAX

CONFigure:CHANnel

This command specifies the measurement input channel. This command will automatically cause the internal measurement frequency to be recalculated.

Parameter

0 to 3153

Example

```
CONF: CHAN 9
```

Defines the frequency of channel 9 as measurement range.

Characteristics

RST value: 0

SCPI: device-specific

Mode

WiMAX

CONFigure:POWer:AUTO

This command switches on or off the automatic power level detection.

Parameter

ON | OFF | ONCE

Example

```
CONF: POW: AUTO ON
```

At the start of every measurement sweep the input power level is detected automatically.

Characteristics

RST value: –

SCPI: device-specific

Mode

WiMAX

CONFigure:POWer:AUTO:SWEep:TIME

This command specify the sweep time for the automatic power level detection.

Parameter

1ms to 1s

Example

```
CONF:POW:AUTO ON
```

At the start of every measurement sweep the input power level is detected automatically.

```
CONF:POW:AUTO:SWE:TIME 200MS
```

The sweep time is set to 200 ms power level.

Characteristics

RST value: 100 ms

SCPI: device-specific

Mode

WiMAX

CONFigure:POWER:EXpected:RF

This command specifies the input power level of the source signal that will be supplied at the analyzer RF input.

Parameter

<numeric_value> in dBm

Example

```
CONF:POW:EXP:RF -20
```

Assumes an input signal strength of -20 dBm.

Characteristics

RST value: -

SCPI: device-specific

Mode

WiMAX

CONFigure:STANdard

This command specifies the Wireless LAN standard to be measured.

Parameter

0 IEEE 802.16 – 2004

Example

```
CONF:STAN 0
```

The measurements will be performed according to IEEE 802.16 – 2004.

Characteristics

RST value: 1

SCPI: device-specific

Mode

WiMAX

CONFigure:WIMax:FBANd

This command configures the Phase or Frequency Vs Preamble measurement type.

Parameter

The suffix 1 can be omitted in the input (see list below) and is omitted in the output (see example).

Selection	Value	Range in GHz	Description
UNSPECIFIED	Unspecified		
ETSI or ETSI1	ETSI	3.410–4.200	Licensed Band
ETSI2	ETSI	10.000–10.680	Licensed Band
MMDS or MMDS1	MMDS	2.150–2.162	Licensed Band
MMDS2	MMDS	2.500–2.690	Licensed Band
WCS or WCS1	WCS	2.305–2.320	Licensed Band
WCS2	WCS	2.345–2.360	Licensed Band
CEPT or CEPT1	CEPT	5.470–5.725	License Exempt Band
CEPT2	CEPT	5.725–5.875	License Exempt Band
UNII or UNII1	U–NII	5.250–5.350	License Exempt Band
UNII2	U–NII	5.725–5.825	License Exempt Band

Example

CONF:WIM:FBAN ETSI

Configures the frequency band to be ETSI 3.41GHz – 4.2GHz.

CONF:WIM:FBAN?

After frequency band is set to ETSI this will return "ETSI" as the current frequency band.

CONF:WIM:FBAN ETSI1

Configures the frequency band to be ETSI 3.41GHz – 4.2GHz.

CONF:WIM:FBAN?

After frequency band is set to ETSI1 this will return "ETSI" as the current frequency band.

CONF:WIM:FBAN ETSI2

Configures the frequency band to be ETSI 10.0GHz – 10.68GHz.

CONF:WIM:FBAN?

After frequency band is set to ETSI2 this will return "ETSI2" as the current frequency band.

Characteristics

RST value: –

SCPI: device-specific

Mode

WiMAX

CONFigure:WIMax:IGRatio

This command specifies the number of guard samples.

Parameter

valid range: $\frac{T_g}{T_b} \in \{1/32, 1/16, 1/8, 1/4\}$

The ratio can be set to one of four values – 4, 8, 16 or 32. The table below shows the relationship between these values and the number of guard samples.

Value	Guard samples (T_g/T_b)
4	1/4
8	1/8
16	1/16
32	1/32

Example

```
CONF:WIM:IGR 16
```

Sets the number of guard samples to 1/16.

Characteristics

RST value: –

SCPI: device-specific

Mode

WiMAX

CONFigure:WIMax:LMODe

This command specifies only to analyze the Down Link or Up Link bursts during a measurement.

Parameter

UL | DL

Example

```
CONF:WIM:LMODe UL
```

Only the Up Link bursts are analyzed.

Characteristics

RST value: –

SCPI: device-specific

Mode

WiMAX

DISPlay Subsystem (WiMAX, K92)

The DISPlay subsystem controls the selection and presentation of textual and graphic information as well as of measurement data on the display. In contrast to the basic device, the WiMAX 802.16 OFDM Measurements option supports the split screen modus.

Commands of the DISPlay Subsystem

- DISPlay:FORMat
- DISPlay[:WINDow<1|2>]:SSElect
- DISPlay[:WINDow<1|2>]:TABLe
- DISPlay[:WINDow<1|2>]:TABLe:UNIT
- DISPlay[:WINDow<1|2>]:TRACe1:Y[:SCALe]:AUTO
- DISPlay[:WINDow<1|2>]:TRACe1:Y[:SCALe]:PDIVision
- DISPlay[:WINDow<1|2>]:TRACe<1...3>:Y[:SCALe]:RLEVel[:RF]
- DISPlay[:WINDow<1|2>]:TRACe<1...3>:Y[:SCALe]:RLEVel?
- DISPlay[:WINDow<1|2>]:TRACe<1...3>:Y[:SCALe]:RLEVel:OFFSet

DISPlay:FORMat

This command sets the screen display type to full or split screen.

Parameter

SPLit | SINGle

Example

```
DISP:FORM SING
```

Sets the display to full screen.

Characteristics

RST value: SPLit

SCPI: device-specific

Mode

WiMAX

DISPlay[:WINDow<1|2>]:SSElect

This command selects whether screen A or screen B is active. The numeric suffix <1|2> defines the active window.

Example

```
DISP:WIND1:SSEL
```

Sets screen A active.

Characteristics

RST value: 1

SCPI: device-specific

Mode

WiMAX

DISPlay[:WINDow<1|2>]:TABLe

This command shows or hides the results table.

Parameter

ON | OFF

Example

```
DISP:TABL OFF
```

Hides the results table.

Characteristics

RST value: OFF

SCPI: device-specific

Mode

WiMAX

DISPlay[:WINDow<1|2>]:TABLe:UNIT

This command specifies the unit for the parameters listed in the results table.

Parameter

DB results returned in dB

PCT results returned in percent

Example

```
DISP:TABL:UNIT DB
```

Results are returned in dB.

Characteristics

RST value: DB

SCPI: device-specific

Mode

WiMAX

DISPlay[:WINDow<1|2>]:TRACe1:Y[:SCALE]:AUTO

This command switches on or off automatic scaling of the y-axis for trace 1. If switched on, the y-axis is scaled to best fit the measurement results automatically.

This command is only available for the following result displays:

- EVM vs Carrier
- EVM vs Symbol
- Frequency Error vs Preamble
- Phase Error vs Preamble

Parameter

ON | OFF

Example

```
DISP:WIND2:TRAC1:Y:AUTO ON
```

Switches on automatic scaling of the y-axis for the active trace.

Characteristics

RST value: ON
 SCPI: conform

Mode

WiMAX

DISPlay[:WINDow<1|2>]:TRACe1:Y[:SCALE]:PDIVision

This command sets the size of each y scale division for trace 1. It has no affect if automatic scaling of the y-axis is enabled.

This command is only available for the following result displays:

- EVM vs Carrier
- EVM vs Symbol
- Frequency Error vs Preamble
- Phase Error vs Preamble

Parameter

1E-6 to 10E12

Example

```
DISP:WIND2:TRAC1:Y:AUTO OFF
```

Switches off automatic scaling of the y-axis for the active trace.

```
DISP:WIND2:TRAC1:Y:PDIV 2
```

Sets the y scale division to size to 2.

Characteristics

RST value: 3
 SCPI: conform

Mode

WiMAX

DISPlay[:WINDow<1|2>]:TRACe<1...3>:Y[:SCALE]:RLEVel[:RF]

This command specifies the reference level applied to an RF measurements.
 The numeric suffixes of WINDow<1|2> and TRACe<1 to 3> are irrelevant.

Parameter

<numeric_value> in dBm, range specified in data sheet

Example

```
DISP:TRAC:Y:RLEV 10
```

Reference level of the analyzer is 10 dB

```
DISP:TRAC:Y:RLEV:RF -10
```

Reference level of the analyzer is -10 dB

Characteristics

RST value: 0 dB
 SCPI: conform

ModeWiMAX

DISPlay[:WINDow<1|2>]:TRACe<1...3>:Y[:SCALe]:RLEVel?

This command queries the current internal instrument reference level used when performing measurements.

The numeric suffixes of WINDow<1|2> and TRACe<1 to 3> are irrelevant.

This command is only a query and therefore has no *RST value.

Example

```
DISP:TRAC:Y:RLEV?
```

Returns the current reference level in use.

Characteristics

RST value: –

SCPI: conform

ModeWiMAX

DISPlay[:WINDow<1|2>]:TRACe<1...3>:Y[:SCALe]:RLEVel:OFFSet

This command specifies the external attenuation/gain applied to measurements. The value corresponds to the reference level offset in spectrum analyzer mode (see

[DISPlay\[:WINDow<1|2>\]:TRACe<1...4>:Y\[:SCALe\]:RLEVel:OFFSet](#) command).

The numeric suffixes of WINDow<1|2> and TRACe<1 to 3> are irrelevant.

Parameter

–200 to 200 dB

Example

```
DISP:TRAC:Y:RLEV:OFFS 10
```

External attenuation (level offset) of the analyzer is 10 dB

```
DISP:TRAC:Y:RLEV:OFFS -10
```

External attenuation of the analyzer is –10 dB. i.e. a gain of 10 dB

Characteristics

RST value: 0 dB

SCPI: conform

ModeWiMAX

FETCh Subsystem (WiMAX, K92)

The FETCh subsystem contains commands for reading out results of complex measurement tasks. This subsystem is closely linked to the CONFigure and SENSE subsystems.

Commands of the DISPlay Subsystem

- FETCh:BURSt:ALL?
- FETCh:BURSt:CINR?
- FETCh:BURSt:COUNT?
- FETCh:BURSt:CRESt:AVERAge?
- FETCh:BURSt:CRESt:MAXimum?
- FETCh:BURSt:CRESt:MINimum?
- FETCh:BURSt:EVM:ALL:AVERAge?
- FETCh:BURSt:EVM:ALL:MAXimum?
- FETCh:BURSt:EVM:ALL:MINimum?
- FETCh:BURSt:EVM:DATA:AVERAge?
- FETCh:BURSt:EVM:DATA:MAXimum?
- FETCh:BURSt:EVM:DATA:MINimum?
- FETCh:BURSt:EVM:PILot:AVERAge?
- FETCh:BURSt:EVM:PILot:MAXimum?
- FETCh:BURSt:EVM:PILot:MINimum?
- FETCh:BURSt:FERRor:AVERAge?
- FETCh:BURSt:FERRor:MAXimum?
- FETCh:BURSt:FERRor:MINimum?
- FETCh:BURSt:GIMBalance:AVERAge?
- FETCh:BURSt:GIMBalance:MAXimum?
- FETCh:BURSt:GIMBalance:MINimum?
- FETCh:BURSt:IQOFset:AVERAge?
- FETCh:BURSt:IQOFset:MAXimum?
- FETCh:BURSt:IQOFset:MINimum?
- FETCh:BURSt:QUADoffset:AVERAge?
- FETCh:BURSt:QUADoffset:MAXimum?
- FETCh:BURSt:QUADoffset:MINimum?
- FETCh:BURSt:RMS:AVERAge?
- FETCh:BURSt:RMS:MAXimum?
- FETCh:BURSt:RMS:MINimum?
- FETCh:BURSt:RSSI?
- FETCh:BURSt:SSTiming:AVERAge?
- FETCh:BURSt:SSTiming:MAXimum?

- FETCh:BURSt:SSTiming:MINimum?
- FETCh:BURSt:SYMBOLerror:AVERage?
- FETCh:BURSt:SYMBOLerror:MAXimum?
- FETCh:BURSt:SYMBOLerror:MINimum?
- FETCh:SYMBOL:COUNT?

Further information

- [ASCII formats for returned values](#)

ASCII formats for returned values

The results are output as a list of result strings separated by commas.

<min EVM all bursts>, <average EVM all bursts>, <max EVM all bursts>,
 <min EVM data carriers>, <average EVM data carriers >, <max EVM data carriers >
 <min EVM pilots>, <average EVM pilots >, <max EVM pilots >
 <min IQ offset>, <average IQ offset>, <maximum IQ offset>,
 <min gain imbalance>, <average gain imbalance>, <max gain imbalance>,
 <min quadrature offset>, <average quadrature offset>, <max quadrature offset>,
 <min frequency error>,<average frequency error>, <max frequency error>,
 <min symbol error>, <average symbol error>, <max symbol error>,
 <min burst power>,<average burst power>,<max burst power>,
 <min crest factor>,<average crest factor>,<max crest factor>,
 <min SS timing>,<average SS timing>,<max SS timing>,
 <min RSSI>,<average RSSI>,<max RSSI>,
 <min RSSI Standard Deviation>,<average RSSI Standard Deviation>,<max RSSI Standard Deviation>,
 <min CINR>,<average CINR>,<max CINR>,
 <min CINR Standard Deviation>,<average CINR Standard Deviation>,<max CINR Standard Deviation>,

FETCh:BURSt:ALL?

This command returns all the results. The results are output as a list of result strings separated by commas in ASCII format. For details on the format refer to "[ASCII formats for returned values](#)" on page 6.497. The units for the EVM results are specified with the `UNIT: EVM` command.

This command is only a query and therefore has no *RST value.

Example

```
FETCh:BURSt:ALL?
```

All calculated results are returned.

Characteristics

RST value: –

SCPI: device-specific

Mode

WiMAX

FETCh:BURSt:CINR?

This command returns all the CINR results separated by commas. For details on the format refer to "[ASCII formats for returned values](#)" on page 6.497.

This command is only a query and therefore has no *RST value.

Example

```
FETC: BURS: CINR?
```

The calculated CINR results from the most recent measurement.

Characteristics

RST value: –

SCPI: device-specific

Mode

WiMAX

FETCh:BURSt:COUNT?

This command returns the number of bursts analyzed in the last sweep.

This command is only a query and therefore has no *RST value.

Example

```
FETC: BURS: COUN?
```

The number of analyzed bursts in the most recent measurement is returned.

Characteristics

RST value: –

SCPI: device-specific

Mode

WiMAX

**FETCh:BURSt:CRESt:AVERAge? / FETCh:BURSt:CRESt:MAXimum? /
FETCh:BURSt:CRESt:MINimum? /**

This command returns the determined crest factor (average, minimum or maximum value) in dBm. The crest factor is the ratio of peak power to average power.

This command is only a query and therefore has no *RST value.

Example

```
FETC: BURS: CRES: MAX?
```

The calculated maximum crest factor from the most recent measurement is returned.

Characteristics

RST value: –

SCPI: device-specific

Mode

WiMAX

**FETCh:BURSt:EVM:ALL:AVERAge? / FETCh:BURSt:EVM:ALL:MAXimum? /
FETCh:BURSt:EVM:ALL:MINimum?**

This command returns the Error Vector Magnitude (EVM) measurement results summary (average, minimum or maximum value) in percent or dB. The results summary is a combined figure that represents the pilot, data and the free carrier. The unit is specified with the [UNIT:TABLE](#) command.

This command is only a query and therefore has no *RST value.

Example

```
FETC: BURS: EVM: ALL: MIN?
```

The minimum Error Vector Magnitude value is returned.

Characteristics

RST value: –

SCPI: device-specific

Mode

WiMAX

**FETCh:BURSt:EVM:DATA:AVERAge? / FETCh:BURSt:EVM:DATA:MAXimum? /
FETCh:BURSt:EVM:DATA:MINimum?**

This command returns the Error Vector Management measurement results summary (average, minimum or maximum value) for the data carrier in dB or percent. The unit is specified with the [UNIT:TABLE](#) command.

This command is only a query and therefore has no *RST value.

Example

```
FETC: BURS: EVM: DATA: MAX?
```

The maximum EVM recorded for the data carrier is returned.

Characteristics

RST value: –

SCPI: device-specific

Mode

WiMAX

**FETCh:BURSt:EVM:PILot:AVERAge? / FETCh:BURSt:EVM:PILot:MAXimum? /
FETCh:BURSt:EVM:PILot:MINimum?**

This command returns the Error Vector Management measurement results summary for the EVM pilot carrier in dB or percent. The unit is specified with the [UNIT:TABLE](#) command.

This command is only a query and therefore has no *RST value.

Example

```
FETC: BURS: EVM: PIL: MAX?
```

The maximum EVM recorded for the EVM pilot carrier is returned.

Characteristics

RST value: –

SCPI: device-specific

Mode

WiMAX

FETCh:BURSt:FERRor:AVERage? / FETCh:BURSt:FERRor:MAXimum? / FETCh:BURSt:FERRor:MINimum?

This command returns the measured average, minimum or maximum frequency errors in Hz.???

This command is only a query and therefore has no *RST value.

Example

```
FETC: BURS: FERR: MAX?
```

The maximum frequency error from the most recent measurement is returned.

Characteristics

RST value: –

SCPI: device-specific

Mode

WiMAX

FETCh:BURSt:GIMBalance:AVERage? / FETCh:BURSt:GIMBalance:MAXimum? / FETCh:BURSt:GIMBalance:MINimum?

This command returns the measured average, minimum or maximum IQ imbalance errors in percent or dB. The unit is specified with the [UNIT:TABLE](#) command.

This command is only a query and therefore has no *RST value.

Example

```
FETC: BURS: GIMB: MAX?
```

The maximum IQ Imbalance error from the most recent measurement is returned.

Characteristics

RST value: –

SCPI: device-specific

Mode

WiMAX

FETCh:BURSt:IQOffset:AVERage? / FETCh:BURSt:IQOffset:MAXimum? / FETCh:BURSt:IQOffset:MINimum?

This command returns the measured average, minimum or maximum IQ offset errors in percent or dB. The unit is specified with the [UNIT:TABLE](#) command.

This command is only a query and therefore has no *RST value.

Example

```
FETC: BURS: IQOF: MAX?
```

The maximum IQ Offset error from the most recent measurement is returned.

Characteristics

RST value: –

SCPI: device-specific

Mode

WiMAX

FETCh:BURSt:QUADoffset:AVERAge? / FETCh:BURSt:QUADoffset:MAXimum? / FETCh:BURSt:QUADoffset:MINimum?

This command returns the accuracy in terms of the phase error of symbols within a burst in degrees.

This command is only a query and therefore has no *RST value.

Example

```
FETC:BURS:QUAD:MAX?
```

The maximum angle error recorded for a symbol during the measurement.

Characteristics

RST value: –

SCPI: device-specific

Mode

WiMAX

FETCh:BURSt:RMS:AVERAge? / FETCh:BURSt:RMS:MAXimum? / FETCh:BURSt:RMS:MINimum?

This command returns the average, minimum or maximum RMS burst power in dBm measured during the measurement.

This command is only a query and therefore has no *RST value.

Example

```
FETC:BURS:RMS:MAX?
```

The maximum burst power recorded for the most recent measurement is returned.

Characteristics

RST value: –

SCPI: device-specific

Mode

WiMAX

FETCh:BURSt:RSSI?

This command returns all the received signal strength indicator (RSSI) results separated by commas. For details on the format refer to "[ASCII formats for returned values](#)" on page 6.497.

This command is only a query and therefore has no *RST value.

Example

```
FETC:BURS:RSSI?
```

The calculated RSSI results from the most recent measurement is returned.

Characteristics

RST value: –

SCPI: device-specific

Mode

WiMAX

FETCh:BURSt:SSTiming:AVERage? / FETCh:BURSt:SSTiming:MAXimum? / FETCh:BURSt:SSTiming:MINimum?

This command returns the measured average, minimum or maximum Subscriber Station Timing in percent.

This command is only a query and therefore has no *RST value.

Example

```
FETC:BURS:SST:MAX?
```

The maximum SS Timing from the most recent measurement is returned.

Characteristics

RST value: –

SCPI: device-specific

Mode

WiMAX

FETCh:BURSt:SYMBOLerror:AVERage? / FETCh:BURSt:SYMBOLerror:MAXimum? / FETCh:BURSt:SYMBOLerror:MINimum?

This command returns the ppm of symbols that were outside permissible demodulation range within a burst..

This command is only a query and therefore has no *RST value.

Example

```
FETC:BURS:SYMB:MAX?
```

The maximum number of symbols that were out of range per burst is returned.

Characteristics

RST value: –

SCPI: device-specific

Mode

WiMAX

FETCh:SYMBOL:COUNT?

This command returns the number of symbol in each analyzed burst found in the last measurement sweep. The results are output as a list of result strings separated by ',' in the following (ASCII) format:

<Symbols in 1st burst>, < Symbols in 2nd burst >, ..., < Symbols in last burst >

This command is only a query and therefore has no *RST value.

Example

```
FETC:SYMB:COUN?
```

The calculated symbols in the analyzed bursts for the most recent measurement are returned.

Characteristics

RST value: –

SCPI: device-specific

Mode

WiMAX

FORMat Subsystem (WiMAX, K92)

The FORMat subsystem specifies the data format of the data transmitted from and to the instrument.

Commands of the FORMat Subsystem

- [FORMat\[:DATA\]](#)

FORMat[:DATA]

For details refer to section "Remote Control – Description of Basic Settings Commands", FORMat Subsystem.

INITiate Subsystem (WiMAX, K92)

The INITiate subsystem configures the instrument prior to a measurement being carried out. It is basically used to tell the instrument which measurement is to be performed and takes any necessary step to set up the instrument for the measurement.

Commands of the INITiate Subsystem

- [INITiate\[:IMMediate\]](#)
- [INITiate:CONTinuous](#)

INITiate[:IMMediate]

For details refer to "[INITiate<1|2>\[:IMMediate\]](#)" on page 6.105.

INITiate:CONTinuous

For details refer to "[INITiate<1|2>:CONTinuous](#)" on page 6.106.

INPut Subsystem (WiMAX, K92)

The INPut subsystem controls the input characteristics of the RF inputs of the instrument.

Commands of the INPut Subsystem

- [INPut:ATTenuation](#)
- [INPut:SElect](#)

INPut:ATTenuation

For details refer to "[INPut<1|2>:ATTenuation](#)" on page 6.108.

INPut:SElect

This command specifies the RF input as currently selected signal input.

Parameter

RF

Example

```
INPut:SEL RF  
Selects RF input.
```

Characteristics

RST value: RF

SCPI: conform

Mode

WiMAX

INSTRument Subsystem (WiMAX, K92)

The INSTRument subsystem selects the operating mode of the unit either via text parameters or fixed numbers.

Commands of the INSTRument Subsystem

- [INSTRument\[:SElect\]](#)
- [INSTRument:NSElect](#)

INSTRument[:SElect]

Parameter

WiMAX (WiMAX 802.16 OFDM Measurements option, R&S FSL–K92)

For further details refer to section "Remote Control – Description of Basic Settings Commands", INSTRument subsystem.

INSTRument:NSElect

Parameter

23 (WiMAX 802.16 OFDM Measurements option, R&S FSL–K92)

For further details refer to section "Remote Control – Description of Basic Settings Commands", INSTRument subsystem.

MMEMory Subsystem (WiMAX, K92)

The MMEMory (mass memory) subsystem provides commands to store and load IQ data.

Commands of the MMEMory Subsystem

- [MMEMory:LOAD:IQ:STATe](#)
- [MMEMory:STORE:IQ:STATe](#)

MMEMory:LOAD:IQ:STATe

This command loads the IQ data from the specified *.iqw file.

Parameter

1,<file_name>

Example

```
MMEM:LOAD:IQ:STAT 1, 'C:\R_S\Instr\user\data.iqw'
```

Loads IQ data from the specified file.

Characteristics

*RST value: –

SCPI: device-specific

Mode

WiMAX

MMEMory:STORE:IQ:STATe

This command stores the IQ data to the specified *.iqw file.

Parameter

1,<file_name>

Example

```
MMEM:STOR:IQ:STAT 1, 'C:\R_S\Instr\user\data.iqw'
```

Stores IQ data to the specified file.

Characteristics

*RST value: –

SCPI: device-specific

Mode

WiMAX

SENSe Subsystem (WiMAX, K92)

The SENSe command is used to set and get the values of parameters in the remote instrument. The get variant of the SENSe command differs from set in that it takes no parameter values (unless otherwise stated) but is followed by the character '?' and will return the parameter's value in the same format as it is set.

Commands of the SENSe Subsystem

- [SENSe:]BANDwidth:CHANnel
- [SENSe:]BURSt:COUNT
- [SENSe:]BURSt:COUNT:STATe
- [SENSe:]DEMod:CESTimation
- [SENSe:]DEMod:FILTer:CATalog?
- [SENSe:]DEMod:FILTer:MODulation
- [SENSe:]DEMod:FORMat[:BCONtent]:AUTo
- [SENSe:]DEMod:FORMat:BANalyze
- [SENSe:]DEMod:FORMat:BANalyze:BTYPe
- [SENSe:]DEMod:FORMat:BANalyze:SYMBOLs:EQUal
- [SENSe:]DEMod:FORMat:BANalyze:SYMBOLs:MAX
- [SENSe:]DEMod:FORMat:BANalyze:SYMBOLs:MIN
- [SENSe:]FREQuency:CENTer
- [SENSe:]POWer:ACHannel:ACPairs
- [SENSe:]POWer:ACHannel:BANDwidth|BWIDth[:CHANnel]
- [SENSe:]POWer:ACHannel:BANDwidth|BWIDth:ACHannel
- [SENSe:]POWer:ACHannel:BANDwidth|BWIDth:ALTErnate<1|2>
- [SENSe:]POWer:ACHannel:MODE
- [SENSe:]POWer:ACHannel:SPACing[:ACHannel]
- [SENSe:]POWer:ACHannel:SPACing:ALTErnate<1|2>
- [SENSe:]POWer:NCORrection
- [SENSe:]SUBChannel
- [SENSe:]SUBChannel:STATe
- [SENSe:]SUBChannel:ULPHysmod
- [SENSe:]SWAPiq
- [SENSe:]SWEep:ACPR:TIME
- [SENSe:]SWEep:ACPR:TIME:AUTO
- [SENSe:]SWEep:COUNT
- [SENSe:]SWEep:EGATe
- [SENSe:]SWEep:EGATe:HOLDoff[:TIME]
- [SENSe:]SWEep:EGATe:HOLDoff:SAMPLE
- [SENSe:]SWEep:EGATe:LENGth[:TIME]

- [SENSe:]SWEep:EGATe:LENGth:SAMPle
- [SENSe:]SWEep:EGATe:LINK
- [SENSe:]SWEep:TIME
- [SENSe:]TRACking:LEVel
- [SENSe:]TRACking:PHASe
- [SENSe:]TRACking:TIME

[SENSe:]BANDwidth:CHANnel

This command specifies the channel bandwidth for the signal to be measured. The channel is selected via the `CONFigure:CHANnel` command.

Parameter

1.25 MHz to 28 MHz

Example

```
CONF:CHAN 9
```

Defines the frequency of channel 9 as measurement range.

```
BAND:CHAN 7MHZ
```

Sets a channel bandwidth value of 7 MHz.

Characteristics

RST value: 1.75 MHz

SCPI: conform

Mode

WiMAX

[SENSe:]BURSt:COUNT

This command defines the number of bursts that will be analyzed by the measurement.

Parameter

1 to 10922

Example

```
BURSt:COUNT 16
```

Sets the number of bursts to 16.

Characteristics

*RST value: 1

SCPI: device-specific

Mode

WiMAX

[SENSe:]BURSt:COUNT:STATe

When this command is set to on, the burst count parameter will be used by the measurement, otherwise the burst count parameter will be ignored.

Parameter

ON | OFF

Example

```
BURS:COUN:STAT ON
```

Sets the burst count state to ON

Characteristics

*RST value: OFF
SCPI: device-specific

Mode

WiMAX

[SENSe:]DEMod:CESTimation

This command defines whether improved channel estimation will be used for IQ measurements. The effect of this is most noticeable for the EVM measurement results, where the results will be improved when this feature is enabled.

However, this functionality is not supported by the IEEE 802.16 standard and must be disabled if the results are to be strictly measured against the standard.

Parameter

ON | OFF

Example

```
DEM:CEST ON
```

Specifies that the IQ measurement results will use improved channel estimation.

Characteristics

*RST value: OFF
SCPI: device-specific

Mode

WiMAX

[SENSe:]DEMod:FILTer:CATalog?

This command reads the names of all available filters. The file names are output without file extension. Syntax of output format: filter_1,filter_2, ... ,filter_n.

This command is a query only and thus has no *RST value.

Example

```
DEM:FILT:CAT?
```

Reads all filter names

Characteristics

*RST value: 0
SCPI: device-specific

Mode

WiMAX

[SENSe:]DEMod:FILTer:MODulation

This command selects the TX and RX filters. The names of the filters correspond to the file names; a query of all available filters is possible by means of the [\[SENSe:\]DEMod:FILTer:CATalog?](#) command.

Parameter

<string>, <string>

DEF_TX: default transmit filter, DEF_RX: default receive filter

Example

DEM:FILT:MOD 'DEF_TX', 'DEF_RX'

DEF_TX is selected for the TX filter and DEF_RX for the RX filter

Characteristics

*RST value: AUTO,AUTO

SCPI: device-specific

Mode

WiMAX

[SENSe:]DEMod:FORMat[:BCONtent]:AUTO

This command is used to specify how the signal should be demodulated.

Parameter

NONE Demodulation off (Brute force mode), the specified modulation is used for all bursts.

FIRSt Retrieves the first valid payload modulation and analyzes all bursts with same modulation.

USER Analyzes all bursts carrying the modulation specified.

ALL Retrieves all bursts individual payload modulation and analyzes accordingly.

Example

DEM:FORM:AUTO FIRS

Specifies that the first symbol field should be decoded.

Characteristics

*RST value: –

SCPI: device-specific

Mode

WiMAX

[SENSe:]DEMod:FORMat:BANalyze

The remote control command sets the analysis modulation format that will be assumed when the measurement is performed. If the `[SENSe:]DEMod:FORMat:BANalyze` parameter has been set to ON, this command can be used to measure only certain burst types within a measurement sequence.

Parameter

BPSK1/2 BI-Phase shift keying

QPSK1/2 Quadrature phase shift keying

QPSK3/4 Quadrature phase shift keying

16QAM1/2 Quadrature Amplitude Modulation

16QAM3/4 Quadrature Amplitude Modulation

64QAM2/3 Quadrature Amplitude Modulation

64QAM3/4 Quadrature Amplitude Modulation

Example

```
DEM:FORM:BAN '16QAM1/2'
```

Only bursts that are of the QAM16 modulation format are analyzed.

Characteristics

*RST value: 16QAM1/2

SCPI: device-specific

Mode

WiMAX

[SENSe:]DEMod:FORMat:BANalyze:BTYPe

This remote control command specifies the type of burst to be analyzed. Only bursts of the specified type take part in measurement analysis.

Parameter

OFDM | OFDMA

Example

```
DEM:FORM:BAN:BTYPe OFDM
```

Only OFDM bursts are analyzed.

Characteristics

*RST value: DIRECT

SCPI: device-specific

Mode

WiMAX

[SENSe:]DEMod:FORMat:BANalyze:SYMBOLs:EQUal

If this command is activated only bursts of equal length will take part in the PVT analysis. The number of symbols that a burst must have in order to take part in the PVT analysis are specified by the [\[SENSe:\]DEMod:FORMat:BANalyze:SYMBOLs:MIN](#) command.

Parameter

ON | OFF

Example

```
DEM:FORM:BAN:SYMB:EQU ON
```

Only bursts of equal length will take part in the PVT analysis.

Characteristics

*RST value: OFF

SCPI: device-specific

Mode

WiMAX

[SENSe:]DEMod:FORMat:BANalyze:SYMBols:MAX

This command specifies the maximum number of data symbols required for bursts to qualify for measurement analysis. Only bursts with the specified number of symbols will be used in the measurement analysis. The number of data symbols is defined as the uncoded bits including service and tail bits.

This value will not have any immediate effect if the

[\[SENSe:\]DEMod:FORMat:BANalyze:SYMBols:EQUal](#) command has been set to ON. In this case, no range of symbols is allowed and only bursts with exactly the number of symbols specified by the [\[SENSe:\]DEMod:FORMat:BANalyze:SYMBols:MIN](#) command shall take place in measurement analysis.

Parameter

1 to 2425

Example

```
DEM:FORM:BAN:SYMB:MAX 1300
```

Only bursts which contain a maximum symbol count of 1300 are analyzed.

Characteristics

*RST value: 64

SCPI: device-specific

Mode

WiMAX

[SENSe:]DEMod:FORMat:BANalyze:SYMBols:MIN

This command specifies the number of data symbols required for bursts to qualify for measurement analysis. Only bursts with the specified number of symbols will be used in the measurement analysis. The number of data symbols is defined as the uncoded bits including service and tail bits.

If the [\[SENSe:\]DEMod:FORMat:BANalyze:SYMBols:EQUal](#) command has been set to ON, this command specifies the exact number of symbols required for a burst to take part in measurement analysis. If the [\[SENSe:\]DEMod:FORMat:BANalyze:SYMBols:EQUal](#) command is set to OFF, this command specifies the minimum number of symbols required for a burst to take part in measurement analysis.

Parameter

1 to 2425

Example

```
DEM:FORM:BAN:SYMB:MIN 16
```

Only bursts which contain a symbol count of 16 are analyzed.

Characteristics

*RST value: 1

SCPI: device-specific

Mode

WiMAX

[SENSe:]FREQuency:CENTer

For details refer to "[\[SENSe<1|2>:\]FREQuency:CENTer](#)" on page 6.123.

[SENSe:]POWER:ACHannel:ACPairs

This command sets the number of adjacent channels pairs (upper and lower channel pairs).

Parameter

0 to 3

0 stands for pure channel power measurement

Example

```
POW:ACH:ACP 3
```

Sets the number of adjacent channels to 3, i.e. the adjacent channel and alternate adjacent channels 1 and 2 are switched on.

Characteristics

RST value: –

SCPI: device-specific

Mode

WiMAX

[SENSe:]POWER:ACHannel:BANDwidth|BWIDth[:CHANnel]

This command sets the channel bandwidth of the system. The bandwidths of adjacent channels are not influenced by this modification.

Parameter

0 Hz to 100 GHz

Example

```
POW:ACH:BAND 30kHz
```

Sets the bandwidth of the TX channel to 30 kHz.

Characteristics

RST value: –

SCPI: device-specific

Mode

WiMAX

[SENSe:]POWER:ACHannel:BANDwidth|BWIDth:ACHannel

This command defines the channel bandwidth of the adjacent channel of the system.

Parameter

0 Hz to 100 GHz

Example

```
POW:ACH:BAND:ACH 30kHz
```

Sets the bandwidth of the adjacent channel to 30 kHz.

Characteristics

RST value: –

SCPI: device-specific

Mode

WiMAX

[SENSe:]POWer:ACHannel:BANDwidth|BWIDth:ALTernate<1|2>

This command defines the channel bandwidth of the first/second alternate adjacent channel of the system.

Parameter

0 Hz to 100 GHz

Example

```
POW:ACH:BAND:ALT2 30kHz
```

Sets the bandwidth of the second alternate channel to 30 kHz.

Characteristics

RST value: –

SCPI: device-specific

Mode

WiMAX

[SENSe:]POWer:ACHannel:MODE

This command sets the ACP measurement mode to either absolute or relative.

Parameter

ABS Absolute measurement

REL Relative measurement

Example

```
POW:ACH:MODE ABS
```

Sets the ACP measurement to absolute mode.

Characteristics

*RST value: REL

SCPI: device-specific

Mode

WiMAX

[SENSe:]POWer:ACHannel:SPACing[:ACHannel]

This command defines the channel spacing of the adjacent channel to the TX channel.

Parameter

0 Hz to 100 GHz

Example

```
POW:ACH:SPAC 33kHz
```

Sets the spacing between the carrier signal and the adjacent channel to 33 kHz

Characteristics

RST value: –

SCPI: device-specific

Mode

WiMAX

[SENSe:]POWer:ACHannel:SPACing:ALTErnate<1|2>

This command defines the channel spacing of the alternate adjacent channel to the TX channel..

Parameter

0 Hz to 100 GHz

Example

```
POW:ACH:SPAC:ALT1 100kHz
```

Sets the spacing between TX channel and alternate adjacent channel 1 to 100 kHz.

Characteristics

RST value: –

SCPI: device-specific

Mode

WiMAX

[SENSe:]POWer:NCORrection

This command activates or deactivates the noise correction.

Parameter

ON | OFF

Example

```
POW:NCOR ON
```

Activates the noise correction.

Characteristics

RST value: OFF

SCPI: device-specific

Mode

WiMAX

[SENSe:]SUBChannel

This command sets the sub-channel to be used in the measurement. It is only available in Up Link mode.

Parameter

1 to 31

Example

```
SUBC 12
```

Sets the sub-channel to 12.

Characteristics

RST value: –

SCPI: device-specific

Mode

WiMAX

[SENSe:]SUBChannel:STATe

This command enables or disables the use of sub channels in the measurement analysis. It is only available in Up Link mode.

Parameter

ON | OFF

Example

```
SUBC:STAT ON
```

Specifies that the measurement will be analyzed using the specified SUBChannel.

Characteristics

RST value: OFF

SCPI: device-specific

Mode

WiMAX

[SENSe:]SUBChannel:ULPHysmod

This command sets the Up Link Physical Modifier to be used in the measurement. It is only available in Up Link mode.

Parameter

0 to 255

Example

```
SUBC:ULPH 1
```

Sets the UL Physical Modifier to 1.

Characteristics

RST value: –

SCPI: device-specific

Mode

WiMAX

[SENSe:]SWAPiq

This command defines whether or not the recorded IQ pairs should be swapped (I<-->Q) before being processed.

Parameter

ON | OFF

Example

```
SWAP ON
```

Specifies that IQ values should be swapped.

Characteristics

*RST value: OFF

SCPI: device-specific

Mode

WiMAX

[SENSe:]SWEep:ACPR:TIME

This command specifies the sweep time for the Spectrum Mask and Spectrum ACP/ACPR measurements. (K92)

Parameter

10 ms to 16000 s

Example

```
SWE:ACPR:TIME:AUTO OFF
```

Deactivates the automatic calculation of the sweep time.

```
SWE:ACPR:TIME 1S
```

Sets the sweep time to 1 s.

Characteristics

RST value: 2s

SCPI: device-specific

Mode

WiMAX

[SENSe:]SWEep:ACPR:TIME:AUTO

This command activates or deactivates the automatic calculation of the sweep time for the Spectrum Mask and Spectrum ACP/ACPR measurements.

Parameter

ON | OFF

Example

```
SWE:ACPR:TIME:AUTO OFF
```

Deactivates the automatic calculation of the sweep time.

Characteristics

RST value: ON

SCPI: device-specific

Mode

WiMAX

[SENSe:]SWEep:COUNT

This command specifies the number of sweeps for Spectrum Mask and Spectrum ACP/ACPR measurements.

Parameter

1 to 32767

Example

```
SWEep:COUNT 64
```

Sets the number of sweeps to 64.

Characteristics

*RST value: 1

SCPI: conform

Mode

WiMAX

[SENSe:]SWEep:EGATe

For details refer to "[SENSe<1|2>:]SWEep:EGATe" on page 6.146.

[SENSe:]SWEep:EGATe:HOLDoff[:TIME]

This command defines the gate delay in the capture buffer in time units.

Parameter

0 to 262.14 ms

Example

```
SWE:EGAT:HOLD 125us
```

Sets a delay of 125 μ s in the capture buffer.

Characteristics

*RST value: 0 s

SCPI: device-specific

Mode

WiMAX

[SENSe:]SWEep:EGATe:HOLDoff:SAMPle

This command defines the gate delay in the capture buffer as a number of samples.

Parameter

0 to 50E6

Example

```
SWE:EGAT:HOLD:SAMP 2500
```

Sets a delay of 2500 samples in the capture buffer.

Characteristics

*RST value: 0

SCPI: device-specific

Mode

WiMAX

[SENSe:]SWEep:EGATe:LENGth[:TIME]

This command defines the gate time in the capture buffer in time units.

Parameter

0 to 262.14 ms

Example

```
SWE:EGAT:LENG 1 MS
```

Sets a gate length of 1 milliseconds between sweeps.

Characteristics

*RST value: 0 s

SCPI: device-specific

ModeWiMAX

[SENSe:]SWEep:EGATe:LENGth:SAMPle

This command defines the gate time in the capture buffer as a number of samples.

Parameter

0 to 50E6

Example

```
SWE:EGAT:LENG:SAMP 100000
```

The WLAN 802.11 option will enforce a gate length of 100000 samples in the capture buffer.

Characteristics

*RST value: 0

SCPI: device-specific

ModeWiMAX

[SENSe:]SWEep:EGATe:LINK

This command links together the movement of the gating lines and the capture buffer marker.

Parameter

ON | OFF

Example

```
SWE:EGAT:LINK ON
```

Keeps the capture buffer marker on the centre of the gating lines if the gating line delay and length are changed.

Characteristics

*RST value: 0

SCPI: device-specific

ModeWiMAX

[SENSe:]SWEep:TIME

The RST value for the WiMAX 802.16 OFDM Measurements option (K92) is 24 μ s.

For further details refer to "[SENSe<1|2>:]SWEep:TIME" on page 6.149.

[SENSe:]TRACking:LEVel

This command defines whether or not the measurement results should be compensated for level.

Parameter

ON | OFF

Example

```
TRAC:LEV ON
```

Specifies that the measurement results should be compensated for level.

Characteristics

*RST value: OFF

SCPI: device-specific

Mode

WiMAX

[SENSe:]TRACking:PHASe

This command defines whether or not the measurement results should be compensated for phase.

Parameter

ON | OFF

Example

```
TRAC:PHAS ON
```

Specifies that the measurement results should be compensated for phase.

Characteristics

*RST value: ON

SCPI: device-specific

Mode

WiMAX

[SENSe:]TRACking:TIME

This command defines whether or not the measurement results should be compensated for time.

Parameter

ON | OFF

Example

```
TRAC:TIME ON
```

Specifies that the measurement results should be compensated for time.

Characteristics

*RST value: OFF

SCPI: device-specific

Mode

WiMAX

STATus Subsystem (WiMAX, K92)

The STATus subsystem contains the commands for the status reporting system (see chapter "Remote Control – Basics", section "Status Reporting System"). For the STATus:QUESTionable:LIMit register, the measurement window is selected by LIMit 1 (screen A) or 2 (screen B). *RST does not influence the status registers.

Commands of the STATus Subsystem

- STATus:QUESTionable:LIMit<1|2> [:EVENT]?
- STATus:QUESTionable:LIMit<1|2>:CONDition?
- STATus:QUESTionable:LIMit<1|2>:ENABLE
- STATus:QUESTionable:LIMit<1|2>:PTRansition
- STATus:QUESTionable:LIMit<1|2>:NTRansition
- STATus:QUESTionable:POWer[:EVENT]?
- STATus:QUESTionable:POWer:CONDition?
- STATus:QUESTionable:POWer:ENABLE
- STATus:QUESTionable:POWer:PTRansition
- STATus:QUESTionable:POWer:NTRansition
- STATus:QUESTionable:SYNC[:EVENT]?
- STATus:QUESTionable:SYNC:CONDition?
- STATus:QUESTionable:SYNC:ENABLE
- STATus:QUESTionable:SYNC:PTRansition
- STATus:QUESTionable:SYNC:NTRansition

STATus:QUESTionable:LIMit<1|2> [:EVENT]?

For details refer to "[STATus:QUESTionable:LIMit<1|2> \[:EVENT\]?](#)" on page 6.156.

STATus:QUESTionable:LIMit<1|2>:CONDition?

For details refer to "[STATus:QUESTionable:LIMit<1|2>:CONDition?](#)" on page 6.156.

STATus:QUESTionable:LIMit<1|2>:ENABLE

For details refer to "[STATus:QUESTionable:LIMit<1|2>:ENABLE](#)" on page 6.157.

STATus:QUESTionable:LIMit<1|2>:PTRansition

For details refer to "[STATus:QUESTionable:LIMit<1|2>:PTRansition](#)" on page 6.157.

STATus:QUESTionable:LIMit<1|2>:NTRansition

For details refer to "[STATus:QUESTionable:LIMit<1|2>:NTRansition](#)" on page 6.157.

STATus:QUESTIONable:POWer[:EVENT]?

For details refer to "[STATus:QUESTIONable:POWer\[:EVENT\]?](#)" on page 6.159.

STATus:QUESTIONable:POWer:CONDition?

For details refer to "[STATus:QUESTIONable:POWer:CONDition?](#)" on page 6.159.

STATus:QUESTIONable:POWer:ENABle

For details refer to "[STATus:QUESTIONable:POWer:ENABle](#)" on page 6.160.

STATus:QUESTIONable:POWer:PTRansition

For details refer to "[STATus:QUESTIONable:POWer:PTRansition](#)" on page 6.160.

STATus:QUESTIONable:POWer:NTRansition

For details refer to "[STATus:QUESTIONable:POWer:NTRansition](#)" on page 6.160.

STATus:QUESTIONable:SYNC[:EVENT]?

This command queries the contents of the EVENT section of the STATus:QUESTIONable:SYNC register. Readout does not delete the contents of the EVENT section.

Example

```
STAT:QUES:SYNC?
```

Characteristics

*RST value: –

SCPI: device-specific

Mode

WiMAX

STATus:QUESTIONable:SYNC:CONDition?

This command queries the contents of the CONDition section of the STATus:QUESTIONable:SYNC register. Readout does not delete the contents of the CONDition section.

Example

```
STAT:QUES:SYNC:COND?
```

Characteristics

*RST value: –

SCPI: conform

Mode

WiMAX

STATus:QUESTIONable:SYNC:ENABLE

This command sets the bits of the ENABLE section of the STATus:QUESTIONable:SYNC register. The ENABLE register selectively enables the individual events of the associated EVENT section for the summary bit.

Parameter

0 to 65535

Example

```
STAT:QUES:SYNC:ENAB 65535
```

All events bits will be represented in the SYNC summary bit.

Characteristics

*RST value: –

SCPI: device-specific

Mode

WiMAX

STATus:QUESTIONable:SYNC:PTRansition

This command determines what bits in the STATus:QUESTIONable:SYNC Condition register will set the corresponding bit in the STATus:QUESTIONable:SYNC Event register when that bit has a positive transition (0 to 1). The variable <number> is the sum of the decimal values of the bits that are to be enabled.

Parameter

0 to 65535

Example

```
STAT:QUES:SYNC:PTR 65535
```

All condition bits will be summarized in the Event register when a positive transition occurs.

Characteristics

*RST value: –

SCPI: device-specific

Mode

WiMAX

STATus:QUESTIONable:SYNC:NTRansition

This command determines what bits in the STATus:QUESTIONable:SYNC Condition will set the corresponding bit in the STATus:QUESTIONable:SYNC Event register when that bit has a negative transition (1 to 0). The variable <number> is the sum of the decimal values of the bits that are to be enabled.

Parameter

0 to 65535

Example

```
STAT:QUES:SYNC:NTR 65535
```

All condition bits will be summarized in the Event register when a positive transition occurs.

Characteristics

*RST value: –

SCPI: device-specific

Mode

WiMAX

TRACe Subsystem (WiMAX, K92)

The TRACe subsystem controls access to the instrument's internal trace memory.

Commands of the TRACe Subsystem

- [TRACE\[:DATA\]](#)
- [TRACE:IQ:DATA:MEMory?](#)
- [TRACE:IQ:SRATe](#)

Further information

- [Constellation vs Symbol](#)
- [Constellation vs Carrier](#)
- [Power vs Time – Full Burst and Start / End Data](#)
- [Spectrum Flatness/Group Delay/Flatness Difference](#)
- [Spectrum FFT](#)
- [Statistics Bit Stream data](#)
- [Statistics Burst Summary data](#)
- [Statistics CCDF – Complementary cumulative distribution function](#)
- [EVM vs Carrier](#)
- [EVM vs Symbol](#)
- [Frequency Sweep Measurements](#)
- [Spectrum Mask](#)
- [Spectrum ACPR](#)

Constellation vs Symbol

This measurement represents I and Q data. Data will be returned as a repeating array of interleaved I and Q data in groups of selected carriers, until all the data is exhausted.

Each I and Q point will be returned in floating point format. TRACE1 is used for this measurement results.

- If "All Carriers" is selected, it will return 52 per of I and Q data per symbol.
- If "Pilots Only" is selected, it will return 4 per of I and Q per symbol in the following order: Carrier –21, Carrier –7, Carrier 7, Carrier 21.
- If a single carrier is selected, it will return 1 per of I and Q data per symbol.

Constellation vs Carrier

This measurement represents I and Q data. Data will be returned as a repeating array of interleaved I and Q data in groups of 53 channels including the channel 0, until all the data is exhausted.

Each I and Q point will be returned in floating point format. TRACE1 is used for this measurement results.

Power vs Time – Full Burst and Start / End Data

Both measurement results are once again simply slightly different views of the same results data.

All fully complete bursts within the capture time are analyzed. This data is returned in dBm values on a per sample basis. Each sample will in some way relate to an analysis of each corresponding sample within each processed burst.

The type of PVT data returned will be determined by the TRACE number passed as an argument to the SCPI command, in addition to the graphic type that is selected.

If the graphic type selected is full burst, then the return data is as follows.

TRACE1 full burst, burst data values

If the graphic type selected is rising/falling, then the return data is as follows.

TRACE1 start, burst data values

TRACE2 end, burst data values

The number of samples returned during full burst analysis will depend on the modulation type and will typically be 5000.

The number of samples returned when the rising and falling graphic type is selected will be less than what is returned for full burst and will be approximately 400 samples. The samples will be returned in floating point format as a single sequence of comma delimited values.

Spectrum Flatness/Group Delay/Flatness Difference

There are three separate traces that are available with these measurements. Trace data for a particular trace will only be returnable by querying the appropriate trace.

The graph data returned is as follows:

- Spectrum Flatness
absolute power value (ABS)
- Group Delay
relative group delay
- Spectrum Difference
adjacent carrier power difference in the preamble part of the burst

All traces are plotted on a per carrier basis. All 200 carriers are drawn, in addition to the unused 0 carrier.

TRACE1 Minimum absolute power value (ABS) or
Minimum group delay values or
Minimum adjacent carrier power difference

TRACE2 Mean absolute power value (ABS) or
Mean group delay values or
Mean adjacent carrier power difference

TRACE3 Maximum absolute power value (ABS) or
Maximum group delay values or
Maximum adjacent carrier power difference

Absolute power and adjacent carrier power results are returned in dB, group delay results are returned in ns.

Spectrum FFT

All FFT points will be returned if the data for this measurement is requested. This will be an exhaustive call, due to the fact that there are nearly always more FFT points than IQ samples. The number of FFT points is the number presented by a power of 2 that is higher than the total number of samples.

E.g. if there were 20000 samples, then 32768 FFT points would be returned.

Data will be returned in floating point format in dBm. TRACE1 is used for this measurement results.

Statistics Bit Stream data

Data will be returned in repeating groups of 52 data channels where each symbol value will be represented by an integer value within one byte. Channel 0 is unused and will therefore not have any data associated with it, with no return data being provided.

The number of repeating groups that are returned will be equal to the number of measured symbols.

Currently, 64QAM has the highest data rate and it contains symbol values up to 63, making the proposal of one byte sufficient in size to represent all symbol data values, regardless of the modulation type in use.

Data will be returned in ASCII printable hexadecimal character format. TRACE1 is used for this measurement results.

Statistics Burst Summary data

Data will be returned in repeating groups of 6 comma separated values as follows:

- 1st value – burst number
If this value is 0 then it is an FCH burst.
- 2nd value – area with:
 - 0 = preamble
 - 1 = data
- 3rd value – modulation with:
 - 0 = BPSK
 - 1 = QPSK
 - 2 = 16QAM
 - 3 = 64QAM
- 4th value – symbol length
This is an integer value giving the number of symbols in the current area.
- 5th value – power in dBm for the current area
This is returned as a float
- 6th value – EVM in dB for the current area
This is returned as a float.

Example:

Burst	Area	Modulation	Length	Power	EVM
FCH	Preamble	QPSK	1	-1.96	-43.75
	Data	BPSK	1	-2.96	-33.75
Burst 2	Preamble	QPSK	1	-3.96	-23.75
	Data	64QAM	26	-4.96	-13.75

SCPI would return the following:

```
B|A|M|L |P |E
u|r|o|e |o |V
r|e|d|n |w |M
s|a| | |e |
t| | | |r |
```

```
0,0,1, 1,-1.96,-43.75,
0,1,0, 1,-2.96,-33.75,
2,0,1, 1,-3.96,-23.75,
2,1,3,26,-4.96,-13.75
```

The number of repeating groups that are returned will be equal to the number of rows in the Burst Summary results.

Data will be returned in ASCII printable hexadecimal character format. TRACE1 is used for this measurement results.

Statistics CCDF – Complementary cumulative distribution function

Up to a maximum of 201 data points will be returned in addition to a data count value. The first value in the return data will represent the quantity of probability values that follow. Each of the potential 201 data points will be returned as probability value and will represent the total number of samples that are equal to or exceed the corresponding power level. Probability data will be returned up to the power level that contains at least one sample. It is highly unlikely that the full 201 data values will ever be returned.

Each probability value will be returned as a floating point number, with a value less than 1.

EVM vs Carrier

Two trace types are provided with this measurement. There is an average EVM value for each of the 53 channels or a repeating group of EVM values for each channel. The number of repeating groups will correspond to the number of fully analyzed trains.

Each EVM value will be returned as a floating point number, expressed in units of dBm.

TRACE1 Average EVM values per channel

TRACE2 All EVM values per channel for each full train of the capture period

EVM vs Symbol

Three traces types are available with this measurement. The basic trace types show either the minimum, mean or maximum EVM value, as measured over the complete capture period.

The number of repeating groups that are returned will be equal to the number of measured symbols.

Each EVM value will be returned as a floating point number, expressed in units of dBm.

IEEE 802.11a & j only

TRACE1 Minimum EVM values
 TRACE2 Mean EVM values
 TRACE3 Maximum EVM values

IEEE 802.11b only

TRACE1 EVM IEEE values
 TRACE2 EVM Direct values

Frequency Sweep Measurements

Only the Spectrum Mask measurement is performed in frequency sweep mode. No data will be returned for this measurement, should it be requested, until such time as a measurement has been previously run.

Running an IQ measurement will not generate results for this type of measurement.

Spectrum Mask

Result data will be returned as 501 measurement points in floating point format. These trace points are obtained directly from the base system via the measurement API and the quantity is therefore a fixed value. Only an array of Y data will be returned.

TRACE1 Clear write values
 TRACE2 Max hold values

Spectrum ACPR

Result data will be returned as 501 measurement points in floating point format. These trace points are obtained directly from the base system via the measurement API and the quantity is therefore a fixed value. Only an array of Y data will be returned.

TRACE1 Clear write values
 TRACE2 Max hold values

TRACE[:DATA]

This command returns all the measured data that relates to the currently selected measurement type. All results are returned in ASCII format. The returned data depends on the currently selected measurement type. [DISPlay:FORMat](#) is not supported with this command.

The following measurement types are available:

- ["Constellation vs Symbol"](#) on page 6.526
- ["Constellation vs Carrier"](#) on page 6.526
- ["Power vs Time – Full Burst and Start / End Data"](#) on page 6.527
- ["Spectrum Flatness/Group Delay/Flatness Difference"](#) on page 6.527
- ["Spectrum FFT"](#) on page 6.528
- ["Statistics Bit Stream data"](#) on page 6.528
- ["Statistics Burst Summary data"](#) on page 6.528
- ["Statistics CCDF – Complementary cumulative distribution function"](#) on page 6.529
- ["EVM vs Carrier"](#) on page 6.529

- "EVM vs Symbol" on page 6.529
- "Frequency Sweep Measurements" on page 6.530
- "Spectrum Mask" on page 6.530
- "Spectrum ACPR" on page 6.530

This command is a query only and thus has no *RST value.

Parameter

TRACE1 | TRACE2 | TRACE3

Example

```
TRACE TRACE1
```

The measurement data for the selected graph is returned.

Characteristics

*RST value: –

SCPI: conform

Mode

WiMAX

TRACE:IQ:DATA:MEMory?

For details refer to "TRACe<1|2>:IQ:DATA:MEMory?" on page 6.171.

TRACE:IQ:SRATe

This command allows the sample rate for IQ measurements to be specified.

Example

```
TRACE:IQ:SRAT 2000000
```

Specifies a sample rate of 20 MHz.

Characteristics

*RST value: –

SCPI: device-specific

Mode

WiMAX

TRIGger Subsystem (WiMAX, K92)

The trigger subsystem is used to synchronize device action(s) with events.

Commands of the TRIGger Subsystem

- TRIGger[:SEquence]:HOLDoff
- TRIGger[:SEquence]:MODE
- TRIGger[:SEquence]:LEVel[:EXTernal]?
- TRIGger[:SEquence]:LEVel:POWer
- TRIGger[:SEquence]:LEVel:POWer:AUTO

TRIGger[:SEquence]:HOLDoff

This command defines the length of the trigger delay. A negative delay time (pretrigger) can be set in zero span only.

Parameter

–3.25ms to 837.33ms

Example

TRIG:HOLD 5ms

A holdoff period of 5 ms is used after the trigger condition has been met.

Characteristics

*RST value: 0 s

SCPI: conform

Mode

WiMAX

TRIGger[:SEquence]:MODE

This command configures how triggering is to be performed.

Parameter

IMMediate automatically triggers the next measurement at the end of the previous measurement. This corresponds to the FREE RUN setting.

EXTernal the next measurement is triggered by the signal at the external trigger input e.g. a gated trigger

POWer triggering of the measurement via signals which are the measurement channel

Example

TRIG:MODE IMM

AUTO triggering will occur for the next measurement at the specified video percentage value.

Characteristics

*RST value: IMMediate

SCPI: device-specific

ModeWiMAX

TRIGger[:SEquence]:LEVel[:EXTernal]?

This command queries the level of the external trigger input for which triggering will occur. This command is only a query and therefore has no *RST value.

Example

```
TRIG:MODE EXT
```

Sets the power trigger mode.

```
TRIG:LEV?
```

Queries the level for the external trigger input.

Characteristics

RST value: –

SCPI: device-specific

ModeWiMAX

TRIGger[:SEquence]:LEVel:POWer

This command sets the level of the input signal for which triggering will occur.

Parameter

–50 to 20 dBm

Example

```
TRIG:MODE POW
```

Sets the external trigger mode.

```
TRIG:LEV:POW 10 DBM
```

Sets the level to 10 dBm for RF measurement.

Characteristics

*RST value: –20 DBM

SCPI: device-specific

ModeWiMAX

TRIGger[:SEquence]:LEVel:POWer:AUTO

This command specifies whether or not an automatic power trigger level calculation is performed before each main measurement. The setting of this command is ignored if the setting for the `TRIGger[:SEquence]:MODE` command is not POWER.

Parameter

ON | OFF

Example

```
TRIG:LEV:POW:AUTO ON
```

Specifies that an automatic power trigger level calculation should be performed before the start of each main measurement.

Characteristics

*RST value: OFF

SCPI: device-specific

Mode

WiMAX

UNIT Subsystem (WiMAX, K92)

The unit subsystem specifies the units for specific result types.

Commands of the UNIT Subsystem

- [UNIT:EVM](#)
- [UNIT:PREamble](#)
- [UNIT:TABLE](#)

UNIT:EVM

This command specifies the units for EVM results.

Parameter

DB EVM results returned in dB
PCT EVM results returned in %

Example

```
UNIT:EVM PCT  
EVM results to be returned in %.
```

Characteristics

RST value: DB
SCPI: device-specific

Mode

WiMAX

UNIT:PREamble

This command specifies the units for Preamble error results.

Parameter

HZ Preamble error results returned in Hz
DEG Preamble error results returned in degrees

Example

```
UNIT:PRE Hz  
Preamble error results to be returned in Hz.
```

Characteristics

RST value: Hz
SCPI: device-specific

Mode

WiMAX

UNIT:TABLE

This command specifies the Table of Results parameters that can be displayed as dB or degrees.

Parameter

DB results returned in dB

PCT results returned in %

Example

UNIT:TABLE DB

Results to be returned in dB.

Characteristics

RST value: DB

SCPI: device-specific

Mode

WiMAX

Remote Control – Description of Basic Settings Commands

In this section all remote control commands for basic settings are described in detail. For details on analyzer commands refer to section "Remote Control – Description of Analyzer Commands".

Subsystems for basic settings

- "Common Commands" on page 6.537
- "CALibration Subsystem" on page 6.542
- "DIAGnostic Subsystem" on page 6.544
- "DISPlay Subsystem" on page 6.548
- "FORMat Subsystem" on page 6.554
- "HCOPY Subsystem" on page 6.555
- "INSTrument Subsystem" on page 6.561
- "MMEMory Subsystem" on page 6.562
- "OUTPut Subsystem (Option Additional Interfaces, B5)" on page 6.573
- "SENSe Subsystem" on page 6.574
- "SOURce Subsystem" on page 6.579
- "STATus Subsystem" on page 6.580
- "SYSTem Subsystem" on page 6.585

Common Commands

The common commands are taken from the IEEE 488.2 (IEC 625–2) standard. A particular command has the same effect on different devices. The headers of these commands consist of an asterisk "*" followed by three letters. Many common commands refer to the status reporting system which is described in detail in chapter 4 "Remote Control – Basics".

Available Common Commands

- *CAL?
- *CLS
- *ESE
- *ESR?
- *IDN?
- *IST?
- *OPC
- *OPT?
- *PCB
- *PRE

- *PSC
- *RST
- *SRE
- *STB?
- *TRG
- *TST?
- *WAI

***CAL?**

CALIBRATION QUERY initiates a calibration of the instrument and subsequently queries the calibration status. Responses > 0 indicate errors.

***CLS**

CLEAR STATUS sets the status byte (STB), the standard event register (ESR) and the EVENT part of the QUEStionable and the OPERation register to zero. The command does not alter the mask and transition parts of the registers. It clears the output buffer.

***ESE**

EVENT STATUS ENABLE sets the event status enable register to the value indicated. The query form *ESE? returns the contents of the event status enable register in decimal form.

Parameter

0 to 255

***ESR?**

STANDARD EVENT STATUS QUERY returns the contents of the event status register in decimal form (0 to 255) and subsequently sets the register to zero.

Parameter

0 to 255

***IDN?**

IDENTIFICATION QUERY queries the instrument identification.

Example: " Rohde&Schwarz, FSL3, 123456/789, 1.03"

FSL3	Device name
123456/789	Serial number of the instrument
1.03	Firmware version number

***IST?**

INDIVIDUAL STATUS QUERY returns the contents of the IST flag in decimal form. The IST flag is the status bit which is sent during a parallel poll (see chapter 4, "Remote Control – Basics").

Parameter

0 | 1

***OPC**

OPERATION COMPLETE sets bit 0 in the event status register after all preceding commands have been executed. This bit can be used to initiate a service request (see chapter 4, "Remote Control – Basics").

***OPT?**

OPTION IDENTIFICATION QUERY queries the options included in the instrument and returns a list of the options installed. The options are separated from each other by means of commas.

Parameter

Option string	Description
B4	OCXO Reference Frequency
B5	Additional Interfaces
B6	TV Trigger
B7	Narrow IF Filters
B8	Gated Sweep
B10	GPIB Interface
B22	RF Preamplifier
B30	DC Power Supply
B31	NIMH Battery Pack
K7	Analog Demodulation
K8	Bluetooth Measurements
K9	Power Sensor Support
K20	Cable TV Measurements
K91	WLAN TX Measurements
K92	WiMAX TX Tests

Example

B4, B5, B6, B7, B8, B10, B22, B30, B31, K7, K9

***PCB**

PASS CONTROL BACK indicates the controller address which the remote control is to be returned to after termination of the triggered action.

Parameter

0 to 30

***PRE**

PARALLEL POLL REGISTER ENABLE sets the parallel poll enable register to the indicated value. The query form `*PRE?` returns the contents of the parallel poll enable register in decimal form.

Parameter

0 to 255

***PSC**

POWER ON STATUS CLEAR determines whether the contents of the ENABLE registers are preserved or reset during power-up.

The query form `*PSC?` reads out the contents of the power-on-status-clear flag. The response can be 0 or 1.

Parameter

- 0 Causes the contents of the status registers to be preserved. Thus a service request can be generated when switching on the instrument, if the status registers ESE and SRE are suitably configured.
 - 1 Resets the registers.
-

***RST**

RESET sets the instrument to a defined default status. The command essentially corresponds to pressing the **PRESET** key. The default settings are described in chapter 2, section "Initializing the Configuration – PRESET Key".

***SRE**

SERVICE REQUEST ENABLE sets the service request enable register to the indicated value. Bit 6 (MSS mask bit) remains 0. This command determines under which conditions a service request is generated. The query form `*SRE?` reads the contents of the service request enable register in decimal form. Bit 6 is always 0.

Parameter

0 to 255

***STB?**

READ STATUS BYTE QUERY reads out the contents of the status byte in decimal form.

***TRG**

TRIGGER initiates all actions in the currently active test screen expecting a trigger event. This command corresponds to the `INITiate:IMMEDIATE` command. For details refer to chapter 5, "Remote Control – Description of Analyzer Commands", section "TRIGger Subsystem".

***TST?**

SELF TEST QUERY initiates the self test of the instrument and outputs an error code in decimal form.

Parameter

0 = no error

***WAI**

WAIT-to-CONTINUE permits servicing of subsequent commands only after all preceding commands have been executed and all signals have settled (see chapter 4, "Remote Control – Basics", and command `*OFC`).

CALibration Subsystem

The commands of the CALibration subsystem determine the data for system error correction in the instrument.

Commands of the CALibration Subsystem

- CALibration[:ALL]?
- CALibration:ABORt
- CALibration:RESult?
- CALibration:STATe

CALibration[:ALL]?

This command initiates the acquisition of system error correction data. A "0" is returned if the acquisition was successful.

Note: During the acquisition of correction data the instrument does not accept any remote control commands.

In order to recognize when the acquisition of correction data is completed, the MAV bit in the status byte can be used. If the associated bit is set in the Service Request Enable Register, the instrument generates a service request after the acquisition of correction data has been completed.

Example

*CLS

Resets the status management.

*SRE 16

Enables MAV bit in the Service Request Enable Register.

*CAL?

Starts the correction data recording, and then a service request is generated.

Characteristics

*RST value: –

SCPI: conform

Mode

all

CALibration:ABORt

This command has no effect, but is implemented to provide compatibility with the FSP family. The collection of self alignment data can only be aborted via manual control. For details refer to chapter 3, "Instrument Functions – Basic Settings", section "Instrument Setup and Interface Configuration – SETUP Key" – "Alignment".

This command is an event and therefore has no *RST value and no query.

Example

CAL:ABOR

Characteristics

*RST value: –

SCPI: device-specific

Mode

all

CALibration:RESult?

This command outputs the results of the correction data acquisition. The lines of the result table are output as string data separated by commas:

```
Total Calibration Status: PASSED, Date (dd/mm/yyyy): 12/07/2004,  
Time: 16:24:54, Runtime: 00.06
```

Example

```
CAL:RES?
```

Characteristics

*RST value: –

SCPI: device-specific

Mode

all

CALibration:STATe

This command determines whether the current calibration data are taken into account by the instrument (ON) or not (OFF).

Parameter

ON | OFF

Example

```
CAL:STAT OFF
```

Sets up the instrument to ignore the calibration data.

Characteristics

*RST value: –

SCPI: conform

Mode

all

DIAGnostic Subsystem

The DIAGnostic subsystem contains the commands which support instrument diagnostics for maintenance, service and repair. In accordance with the SCPI standard, all of these commands are device-specific.

Commands of the DIAGnostic Subsystem

- DIAGnostic<1|2>:SERVice:BIOSinfo?
- DIAGnostic<1|2>:SERVice:HWInfo?
- DIAGnostic<1|2>:SERVice:INPut[:SElect]
- DIAGnostic<1|2>:SERVice:INPut:PULSed[:STATe]
- DIAGnostic<1|2>:SERVice:INPut:PULSed:PRATe
- DIAGnostic<1|2>:SERVice:NSource (option Additional Interfaces, B5)
- DIAGnostic<1|2>:SERVice:SFUNction
- DIAGnostic<1|2>:SERVice:STESt:RESult?

DIAGnostic<1|2>:SERVice:BIOSinfo?

This command reads the CPU board BIOS version and returns it as ASCII string.
The numeric suffix <1|2> is ignored with this command.

Example

```
DIAG:SERV:BIOS?
Returns the following strings:
V1.5: V1.5-26-3
V2.0: V2.0-17-2
```

Characteristics

*RST value: –
SCPI: device-specific

Mode

all

DIAGnostic<1|2>:SERVice:HWInfo?

This command queries the contents of the module info table. Table lines are output as string data and are separated by commas.

```
"<component 1>|<serial #>|<order #>|<model>|<HWC>|<rev>|<sub rev>",
"<component 2>|<serial #>|<order #>|<model>|<HWC>|<rev>|<sub rev>",...
```

The individual columns of the table are separated from each other by |.

The numeric suffix <1|2> is ignored with this command.

Example

```
DIAG:SERV:HWIN?
```

Result (shortened)

```
RF_ATTEN_7|650551/007|1067.7684|02|00|20|04,  
IF-FILTER|648158/037|1093.5540|03|01|07|05,  
...
```

Characteristics

*RST value: –

SCPI: device-specific

Mode

all

DIAGnostic<1|2>:SERVice:INPut[:SElect]

This command toggles between the RF input on the front panel and the internal 65.83 MHz reference signal.

Parameter

CALibration | RF | TG

Example

```
DIAG:SERV:INP CAL
```

Characteristics

*RST value: RF

SCPI: device-specific

Mode

all

DIAGnostic<1|2>:SERVice:INPut:PULSed[:STATe]

This command has no effect (only the comb generator is available), but is implemented to provide compatibility with the FSP family.

Parameter

ON | OFF

Example

```
DIAG:SERV:INP:PULS ON
```

Characteristics

*RST value: ON

SCPI: conform

Mode

all

DIAGnostic<1|2>:SERVice:INPut:PULSed:PRATe

This command sets the comb generator frequency. This command only takes effect, if the internal reference signal is selected for calibration (`DIAGnostic<1|2>:SERVice:INPut[:SElect]`).

Parameter

COMB1 65.8333 MHz / 1
 COMB64 65.8333 MHz / 64
 COMB65 65.8333 MHz / 65

Example

```
DIAG:SERV:INP:PULS:PRAT COMB64
```

Sets the comb generator frequency to $\frac{1}{64}$ of 65.8333 MHz.

Characteristics

*RST value: COMB1
 SCPI: conform

Mode

all

DIAGnostic<1|2>:SERVice:NSOource (option Additional Interfaces, B5)

This command switches the 28 V supply of the noise source at the rear panel on or off. The numeric suffix <1|2> is ignored with this command.

Parameter

ON | OFF

Example

```
DIAG:SERV:NSO ON
```

Characteristics

*RST value: OFF
 SCPI: device-specific

Mode

all

DIAGnostic<1|2>:SERVice:SFUNction

This command activates a service function which can be selected by indicating the five parameters: function group number, board number, function number, parameter 1 and parameter 2 (see service manual). The contents of the parameter string are identical to the code to be entered in the edit dialog box of manual operation.

The entry of a service function is accepted only if the system password level 1 or level 2 has been entered previously (`SYSTem:PASSword[:CENable]`).

The numeric suffix <1|2> is ignored with this command.

Parameter

<string>

Example

```
DIAG:SERV:SFUN 2.0.2.12.1
```

Characteristics

*RST value: –

SCPI: device-specific

Mode

all

DIAGnostic<1|2>:SERVice:STES:RESult?

This command reads the results of the self test out of the instrument. The lines of the result table are output as string data separated by commas:

```
"Total Selftest Status: PASSED", "Date (dd/mm/yyyy): 09/07/2004  
TIME: 16:24:54", "Runtime: 00:06", ...
```

The numeric suffix <1|2> is ignored with this command.

Example

```
DIAG:SERV:STES:RES?
```

Characteristics

*RST value: –

SCPI: device-specific

Mode

all

DISPlay Subsystem

The DISPlay subsystem controls the selection and presentation of textual and graphic information as well as of measurement data on the display.

Commands of the DISPlay Subsystem

- [DISPlay:ANNotation:FREQuency](#)
- [DISPlay:CMAP<1...27>:DEFault<1|2>](#)
- [DISPlay:CMAP<1...27>:HSL](#)
- [DISPlay:CMAP<1...27>:PDEFined](#)
- [DISPlay:FORMat](#)
- [DISPlay:LOGO](#)
- [DISPlay:PSAVe\[:STATe\]](#)
- [DISPlay:PSAVe:HOLDoff](#)
- [DISPlay\[:WINDow<1|2>\]:TEXT\[:DATA\]](#)
- [DISPlay\[:WINDow<1|2>\]:TEXT:STATe](#)
- [DISPlay\[:WINDow<1|2>\]:TIME](#)

Further Information

- [CMAP suffix assignment](#)

CMAP suffix assignment

Each numeric suffix of CMAP is assigned one or several graphical elements which can be modified by varying the corresponding color setting. The following assignment applies:

CMAP1	Background
CMAP2	Grid
CMAP3	Function field + status field + data entry text
CMAP4	Function field LED on
CMAP5	Function field LED warn
CMAP6	Enhancement label text
CMAP7	Status field background
CMAP8	Trace 1
CMAP9	Trace 2
CMAP10	Trace 3
CMAP11	Marker
CMAP12	Lines
CMAP13	Measurement status + limit check pass
CMAP14	Limit check fail
CMAP15	Reserved
CMAP16	Reserved

CMAP17	Table selected field text
CMAP18	Table selected field background
CMAP19	Reserved
CMAP20	Reserved
CMAP21	Reserved
CMAP22	Reserved
CMAP23	Reserved
CMAP24	Reserved
CMAP25	Reserved
CMAP26	Logo
CMAP27	Trace 4

DISPlay:ANNotation:FREQuency

This command switches the X axis annotation on or off.
 This command is available from firmware version 1.10.

Parameter

ON | OFF

Example

```
DISP:ANN:FREQ OFF
```

Characteristics

*RST value: ON

SCPI: conform

Mode

all

DISPlay:CMAP<1...27>:DEFault<1|2>

This command resets the screen colors of all display items to their default settings. Two default settings DEFault1 and DEFault2 are available. The numeric suffix of CMAP is irrelevant.

This command is an event and therefore has no query and no *RST value.

This command is available from firmware version 1.10.

Example

```
DISP:CMAP:DEF2
```

Selects default setting 2 for setting the colors.

Characteristics

*RST value: –

SCPI: conform

Mode

all

DISPlay:CMAP<1...27>:HSL

This command defines the color table of the instrument.

For the numeric suffix assignment of CMAP refer to "[CMAP suffix assignment](#)" on page 6.548.

The set values are not changed by *RST.

This command is available from firmware version 1.10.

Parameter

hue = TINT

sat = SATURATION

lum = BRIGHTNESS

The value range is 0 to 1 for all parameters.

Example

```
DISP:CMAP2:HSL 0.3,0.8,1.0
```

Changes the grid color.

Characteristics

*RST value: –

SCPI: conform

Mode

all

DISPlay:CMAP<1...27>:PDEFined

This command defines the color table of the instrument using predefined color values. Each numeric suffix of CMAP is assigned to one or several graphical elements which can be modified by varying the corresponding color setting.

For the numeric suffix assignment of CMAP refer to "[CMAP suffix assignment](#)" on page 6.548.

The values set are not changed by *RST.

This command is available from firmware version 1.10.

Parameter

BLACK | BLUE | BROWN | GREEN | CYAN | RED | MAGenta | YELLOW | WHITE | DGRAY |
LGRAY | LBLUE | LGREEN | LCYan | LRED | LMAGenta

Example

```
DISP:CMAP2:PDEF GRE
```

Characteristics

*RST value: –

SCPI: conform

Mode

all

DISPlay:FORMat

This command has no effect but is implemented for reasons of compatibility with the FSP family. It switches the measurement result display between FULL SCREEN and SPLIT SCREEN.

This command is available from firmware version 1.10.

Parameter

SINGle | SPLit

Example

DISP:FORM SPL

Switches the display to 2 measurement windows.

Characteristics

*RST value: SINGle

SCPI: device-specific

ModeA

DISPlay:LOGO

This command switches the company logo on the screen on or off.

This command is available from firmware version 1.10.

Parameter

ON | OFF

Example

DISP:LOGO OFF

Characteristics

*RST value: ON

SCPI: device-specific

Modeall

DISPlay:PSAVe[:STATe]

This command switches on or off the power-save mode of the display. With the power-save mode activated the display including backlight is completely switched off after the elapse of the response time (see [DISPlay:PSAVe:HOLDoff](#) command).

Note: This mode is recommended for preserving the display especially if the instrument is exclusively operated via remote control.

This command is available from firmware version 1.20.

Parameter

ON | OFF

Example

DISP:PSAVe ON

Switches on the power-save mode.

Characteristics

*RST value: OFF

SCPI: device-specific

Modeall

DISPlay:PSAVe:HOLDoff

This command sets the holdoff time for the power–save mode of the display. The available value range is 1 to 60 minutes, the resolution 1 minute. The entry is dimensionless.

This command is available from firmware version 1.20.

Parameter

1 to 60

Example

```
DISP:PSAV:HOLD 30
```

Characteristics

*RST value: 15

SCPI: device–specific

Mode

all

DISPlay[:WINDow<1|2>]:TEXT[:DATA]

This command defines a comment (max. 20 characters) which can be displayed on the screen.

This command is available from firmware version 1.10.

Parameter

<string>

Example

```
DISP:WIND:TEXT Noise Measurement  
Defines the screen title.
```

Characteristics

*RST value: "" (empty)

SCPI: conform

Mode

all

DISPlay[:WINDow<1|2>]:TEXT:STATe

This command switches on or off the display of the comment (screen title).

This command is available from firmware version 1.10.

Parameter

ON | OFF

Example

```
DISP:TEXT:STAT ON  
Switches on the title.
```

Characteristics

*RST value: OFF

SCPI: conform

Mode

all

DISPlay[:WINDow<1|2>]:TIME

This command switches on or off the screen display of date and time. The numeric suffix in WINDow<1| 2> is irrelevant.

This command is available from firmware version 1.10.

Parameter

ON | OFF

Example

```
DISP:TIME ON
```

Characteristics

*RST value: OFF

SCPI: device-specific

Mode

all

FORMat Subsystem

The FORMat subsystem specifies the data format of the data transmitted from and to the instrument.

Commands of the FORMat Subsystem

– FORMat[:DATA]

FORMat[:DATA]

This command specifies the data format for the data transmitted from the instrument to the control PC. It is used for the transmission of trace data. The data format of trace data received by the instrument is automatically recognized, regardless of the format which is programmed. In the spectrum mode, the format setting REAL, 32 is used for the binary transmission of trace data (see also TRACe<1 | 2>[:DATA] command).

Parameter

ASCIi | REAL | UINt | MATLAB [,8 | 32]

ASCII data are transmitted in plain text, separated by commas. REAL data are transmitted as 32-bit IEEE 754 floating-point numbers in the "definite length block format". The format UINt is only used in operating mode vector signal analysis, for the symbol table.

Example

```
FORM REAL, 32
FORM ASC
FORM UINt, 8
```

Characteristics

*RST value: ASCII

SCPI: conform

Mode

all

HCOPy Subsystem

The HCOPy subsystem controls the output of display information for documentation purposes on output devices or files. The instrument allows two independent printer configurations which can be set separately with the numeric suffix <1|2>.

Commands of the HCOPy Subsystem

- HCOPy[:IMMEDIATE<1|2>]
- HCOPy:ABORT
- HCOPy:CMAP<1...27>:DEFAULT
- HCOPy:CMAP<1...27>:HSL
- HCOPy:CMAP<1...27>:PDFINED
- HCOPy:DESTINATION<1|2>
- HCOPy:DEVICE:COLOR
- HCOPy:DEVICE:LANGUAGE<1|2>
- HCOPy:ITEM:ALL
- HCOPy:ITEM:WINDOW<1|2>:TEXT
- HCOPy:ITEM:WINDOW<1|2>:TRACE:STATE
- HCOPy:PAGE:ORIENTATION<1|2>

HCOPy[:IMMEDIATE<1|2>]

This command starts a hardcopy output. The numeric suffix selects which printer configuration (1 or 2) is to be used for the hardcopy output. If there is no suffix, configuration 1 is automatically selected.

Parameter

- 1 Starts the hardcopy output to device 1 (default).
- 2 Starts the output to device 2.

This command is an event and therefore has no *RST value and no query.

Example

HCOP

Characteristics

*RST value: –
SCPI: conform

Mode

all

HCOPy:ABORT

This command aborts a running hardcopy output.

This command is an event and therefore has no *RST value and no query.

Example

```
HCOP:ABOR
```

Characteristics

*RST value: –

SCPI: conform

Mode

all

HCOPY:CMAP<1...27>:DEFault

This command resets the colors for a hardcopy to the selected default settings. DEFault1 (SCREEN COLORS, but background white), DEFault2 (OPTIMIZED COLOR SET) and DEFault3 (USER DEFINED). The numeric suffix in CMAP is not significant.

This command is an event and therefore has no query and no *RST value.

This command is available from firmware version 1.10.

Parameter

- 1 screen colors
- 2 optimized color set
- 3 user defined color set

Example

```
HCOP:CMAP:DEF2
```

Selects the optimized color set for the color settings of a hardcopy.

Characteristics

*RST value: –

SCPI: conform

Mode

all

HCOPY:CMAP<1...27>:HSL

This command defines the color table in user defined colors.

To each numeric suffix of CMAP is assigned one or several picture elements which can be modified by varying the corresponding color setting. For details on the CMAP assignment refer to "[CMAP suffix assignment](#)" on page 6.548.

The values set are not changed by *RST.

This command is available from firmware version 1.10.

Parameter

hue = tint

sat = saturation

lum = brightness

The value range is 0 to 1 for all parameters.

Example

```
HCOP:CMAP2:HSL 0.3,0.8,1.0
```

Changes the grid color

Characteristics

*RST value: –

SCPI: conform

Mode

all

HCOPY:CMAP<1...27>:PDEFined

This command defines the color table in user defined colors using predefined color values. To each numeric suffix of CMAP is assigned one or several picture elements which can be modified by varying the corresponding color setting. For details on the CMAP assignment refer to "[CMAP suffix assignment](#)" on page 6.548.

The values set are not changed by *RST.

This command is available from firmware version 1.10.

Parameter

BLACK | BLUE | BROWN | GREEN | CYAN | RED | MAGENTA | YELLOW | WHITE | DGRAY | LGRAY | LBLUE | LGREEN | LCYAN | LRED | LMAGENTA

Example

```
HCOPY:CMAP2:PDEF GRE
```

Characteristics

*RST value: –

SCPI: conform

Mode

all

HCOPY:DESTination<1|2>

This command selects the printer output medium (Disk, Printer or Clipboard) associated with configuration 1 or 2.

This command is an event and therefore has no *RST value and no query.

Note: The type of instrument is selected with [SYSTEM:COMMunicate:PRINter:SElect <1|2>](#), which will automatically select a default output medium. Therefore the [HCOPY:DESTination<1|2>](#) command should always be sent after setting the device type.

Parameter

MMEM	Directs the hardcopy to a file. The MMEMory:NAME command defines the file name. All formats can be selected for HCOPY:DEvice:LANGuage<1 2> .
SYST:COMM:PRIN	Directs the hardcopy to the printer. The printer is selected with the SYSTEM:COMMunicate:PRINter:SElect <1 2> command. GDI should be selected for HCOPY:DEvice:LANGuage<1 2> .
SYST:COMM:CLIP	Directs the hardcopy to the clipboard. EWMF should be selected for HCOPY:DEvice:LANGuage<1 2> .

Example

```
SYST:COMM:PRIN:SEL2 'LASER on LPT1'
```

Selects the printer and output medium for device 2.

```
HCOP:DEST2 'SYST:COMM:PRIN'
```

Selects the printer interface as device 2.

Characteristics

*RST value: –
 SCPI: conform

Mode

all

HCOPY:DEvIce:COLor

This command selects between color and monochrome hardcopy of the screen.
 This command is available from firmware version 1.10.

Parameter

ON | OFF

Example

```
HCOP:DEV:COL ON
```

Characteristics

*RST value: OFF
 SCPI: conform

Mode

all

HCOPY:DEvIce:LANGUage<1|2>

This command determines the data format of the printout.

Parameter

- | | |
|-----------|--|
| GDI | Graphics Device Interface:
Default format for the output to a printer configured under Windows.
Must be selected for the output to the printer interface.
Can be used for the output to a file. The printer driver configured
under Windows is used in this case and a printer-specific file format is
thus generated.
(see also HCOPY:DESTination<1 2> command) |
| WMF, EWMF | WINDOWS Metafile and Enhanced Metafile Format:
Data formats for output files which can be integrated in corresponding
programs for documentation purposes at a later time. WMF can only
be used for output to a file and EWMF also for the output to the
clipboard.
(see also HCOPY:DESTination<1 2> command) |
| BMP | Bitmap:
Data format for output to files only.
(see also HCOPY:DESTination<1 2> command) |

Example

```
HCOP:DEV:LANG WMF
```

Characteristics

*RST value: –

SCPI: conform

Mode

all

HCOPY:ITEM:ALL

This command selects the complete screen to be output.

The hardcopy output is always provided with comments, title, time and date. As an alternative to the whole screen, e.g. only traces ([HCOPY:ITEM:WINDow<1|2>:TRACe:STATe](#) command) can be output.

Example

```
HCOP:ITEM:ALL
```

Characteristics

*RST value: OFF

SCPI: conform

Mode

all

HCOPY:ITEM:WINDow<1|2>:TEXT

This command defines the comment text for the printout.

The numeric suffixes <1|2> are irrelevant for this command.

Parameter

<string> with a maximum of 100 characters; line feed by means of character @

Example

```
HCOP:ITEM:WIND:TEXT 'comment'
```

Characteristics

RST value: –

SCPI: device-specific

Mode

all

HCOPY:ITEM:WINDow<1|2>:TRACe:STATe

This command selects the output of the currently displayed trace.

The numeric suffixes <1|2> are irrelevant for this command.

Both the [HCOPY:ITEM:WINDow<1|2>:TRACe:STATe](#) command and the [HCOPY:ITEM:ALL](#) command enable the output of the whole screen.

Parameter

ON | OFF

Example

HCOP:ITEM:WIND:TRACe:STAT ON

Characteristics

*RST value: OFF

SCPI: device-specific

Mode

all

HCOPY:PAGE:ORIENTATION<1|2>

The command selects the format of the output (portrait and landscape) (hardcopy unit 1 or 2).

Note: The command is only available provided that the output device "printer" (HCOPY:DESTINATION<1|2>) has been selected.

Parameter

LANDscape | PORTrait

Example

HCOP:PAGE:ORI LAND

Characteristics

*RST value: –

SCPI: conform

Mode

all

INSTRUMENT Subsystem

The INSTRUMENT subsystem selects the operating mode of the unit either via text parameters or fixed numbers.

Commands of the INSTRUMENT Subsystem

- [INSTRUMENT\[:SElect\]](#)
- [INSTRUMENT:NSElect](#)

INSTRUMENT[:SElect]

This command switches between the measurement modes by means of text parameters.

Parameter

SANalyzer spectrum analyzer

The parameters of the other measurement modes are included in the option descriptions.

Example

```
INST SAN
```

Switches the instrument to spectrum analyzer mode.

Characteristics

*RST value: SANalyzer

SCPI: conform

Mode

all

INSTRUMENT:NSElect

This command switches between the measurement modes by means of numbers.

Parameter

1 spectrum analyzer

The parameters of the other measurement modes are included in the option descriptions.

Example

```
INST:NSEL 1
```

Switches the instrument to spectrum analyzer mode.

Characteristics

*RST value: 1

SCPI: conform

Mode

all

MMEMory Subsystem

The MMEMory (mass memory) subsystem provides commands which allow for access to the storage media of the instrument and for storing and loading various instrument settings.

The various drives can be addressed via the "mass storage unit specifier" <msus> using the conventional DOS syntax. The internal hard disk is addressed by "C:". For details on drives refer to chapter 3, "Instrument Functions – Basic Settings", section "Saving and Recalling Data Sets – FILE Key".

The file names <file_name> are indicated as string parameters with the commands being enclosed in quotation marks. They also comply with DOS conventions.

DOS file names consist of max. 8 ASCII characters and an extension of up to three characters separated from the file name by a dot "." Both, the dot and the extension are optional. The dot is not part of the file name. DOS file names do not distinguish between uppercase and lowercase notation. All letters and digits are permitted as well as the special characters "_", "^", "\$", "~", "!", "#", "%", "&", "-", "{", "}", "(", ")", "@", and "'". Reserved file names are CLOCK\$, CON, AUX, COM1 to COM4, LPT1 to LPT3, NUL and PRN.

The two characters "*" and "?" have the function of so-called "wildcards", i.e., they are variables for selection of several files. The question mark "?" replaces exactly one character, the asterisk means any of the remaining characters in the file name. "*. *" thus means all files in a directory.

Commands of the MMEMory Subsystem

- MMEMory:CATalog?
- MMEMory:CDIRectory
- MMEMory:CLEar:ALL
- MMEMory:CLEar:STATe
- MMEMory:COpy
- MMEMory:DATA
- MMEMory:DELeTe
- MMEMory:LOAD:AUTO
- MMEMory:LOAD:STATe
- MMEMory:MDIRectory
- MMEMory:MOVE
- MMEMory:MSIS
- MMEMory:NAME
- MMEMory:RDIRectory
- MMEMory:SELEct[:ITEM]:ALL
- MMEMory:SELEct[:ITEM]:DEFault
- MMEMory:SELEct[:ITEM]:HWSettings
- MMEMory:SELEct[:ITEM]:LINes:ALL
- MMEMory:SELEct[:ITEM]:NONE
- MMEMory:SELEct[:ITEM]:SCData (models 13 and 16)
- MMEMory:SELEct[:ITEM]:TRACe[:ACTive]
- MMEMory:SELEct[:ITEM]:TRANSDucer:ALL

- MMEMory:STORe<1|2>:STATe
- MMEMory:STORe<1|2>:TRACe

MMEMory:CATalog?

This command reads the indicated directory. According to DOS convention, wild card characters can be entered in order to query e.g. a list of all files of a certain type.

Parameter

<path> = DOS Path name

The path name should be in conformance with DOS conventions and may also include the drive name.

Example

```
MMEM:CAT:LONG? 'C:\R_S\Instr\user\DATA'
```

Queries the contents of directory C:\R_S\Instr\user directory

```
MMEM:CAT? 'C:\R_S\Instr\user\DATA\*.LOG'
```

Returns all files in C:\R_S\Instr\user with extension ".LOG"

```
MMEM:CAT? 'C:\R_S\Instr\user\SPOOL?.WMF'
```

Returns all files in C:\R_S\Instr\user whose names start with SPOOL, have 6 letters and the extension ".WMF".

Response value

List of file names in the form of strings separated by commas, i.e.

SPOOL1.WMF,SPOOL2.WMF,SPOOL3.WMF

Characteristics

*RST value: -

SCPI: conform

Mode

all

MMEMory:CDIRectory

This command changes the current directory.

Parameter

<directory_name> = DOS path name

In addition to the path name, the indication of the directory may contain the drive name. The path name complies with the DOS conventions.

Example

```
MMEM:CDIR 'C:\R_S\Instr\user'
```

Returns the list of files in directory C:\R_S\Instr\user.

Characteristics

*RST value: -

SCPI: conform

Mode

all

MMEMory:CLEar:ALL

This command deletes all device settings in the current directory. The current directory can be selected with the **MMEMory:CDIRectory** command. The default directory is C:\R_S\Instr\user. This command is an event and therefore has no *RST value and no query.

Example

```
MMEM:CLE:ALL
```

Characteristics

*RST value: –

SCPI: device-specific

Mode

all

MMEMory:CLEar:STATe

This command deletes the instrument setting selected by <file_name>. All associated files on the mass memory storage are cleared.

This command is an event and therefore has no *RST value and no query.

Parameter

1,<file_name>

with <file_name> = DOS file name without extension

The file name includes indication of the path and may also include the drive. The path name complies with DOS conventions.

Example

```
MMEM:CLE:STAT 1, 'TEST'
```

Characteristics

*RST value: –

SCPI: device-specific

Mode

all

MMEMory:COPI

This command copies the files indicated in <file_source> to the destination directory indicated with <file_destination> or to the destination file indicated by <file_destination> when <file_source> is just a file.

This command is an event and therefore has no *RST value and no query.

Parameter

<file_source>,<file_destination> = <file_name> = DOS file name

The indication of the file name may include the path and the drive name. The file names and path information must be in accordance with the DOS conventions.

Example

```
MMEM:COPI 'C:\R_S\Instr\user\SETUP.CFG,E:'
```

Characteristics

*RST value: –

SCPI: conform

Mode

all

MMEMory:DATA

This command writes the block data contained in <block> into the file characterized by <file_name>. The delimiter must be set to EOI to obtain error-free data transfer.

The associated query command reads the indicated file from the mass memory and transfers it to the remote control computer. It should be noted that the buffer memory of the control computer should be large enough to store the file. The setting of the delimiter is irrelevant in this case.

The command is useful for reading stored device settings or trace data from the instrument or for transferring them to the instrument.

Parameter

<file_name>[,<block>]

<file_name> selects the file to be transferred

<block> binary data block with the following structure:

- character '#'
- digit for the length of the length information
- indicated number of digits as length information (number of bytes) for the binary data themselves
- binary data with the indicated number of bytes

Example

```
MMEM:DATA 'TEST01.HCP,#217This is the file'
```

means: #2: the next 2 characters are the length indication; 17: number of subsequent binary data bytes; This is the file: 17 bytes stored as binary data in the file TEST01.HCP.

```
MMEM:DATA? 'TEST01.HCP'
```

Transfers the file TEST01.HCP from the instrument to the control computer.

Characteristics

*RST value: –

SCPI: conform

Mode

all

MMEMory:DELeTe

This command deletes the indicated files.

Parameter

<file_name> = DOS file name

The indication of the file name contains the path and, optionally, the drive name. Indication of the path complies with DOS conventions.

Example

```
MMEM:DEL 'TEST01.HCP'
```

The file TEST01.HCP is deleted.

Characteristics

*RST value: –

SCPI: conform

Mode

all

MMEMory:LOAD:AUTO

This command defines which device setting is automatically loaded after the device is switched on. The contents of the file are read after switching on the device and used to define the new device state.

The data set defined as auto recall set can also be restored by the *RST command.

This command is an event and therefore has no *RST value and no query.

Parameter

1,<file_name>

with <file_name> = DOS file name without extension

The file name includes indication of the path and may also include the drive name. The path name complies with DOS conventions.

Example

```
MMEM:LOAD:AUTO 1, 'C:\R_S\Instr\user\TEST'
```

Characteristics

*RST value: –

SCPI: device-specific

Mode

all

MMEMory:LOAD:STATe

This command loads device settings from *.FSL.dfl files. The contents of the file are loaded and set as the new device state.

Parameter

1,<file_name>

with <file_name> = DOS file name without extension

The file name includes indication of the path and may also include the drive name. The path name complies with DOS conventions.

Example

```
MMEM:LOAD:STAT 1, 'C:\R_S\Instr\user\TEST01'
```

Characteristics

*RST value: –

SCPI: conform

Mode

all

MMEMory:MDIRectory

This command creates a new directory. The file name includes indication of the path and may also include the drive name. The path name complies with DOS conventions.

This command is an event and therefore has no *RST value and no query.

Parameter

<directory_name> = DOS path name

Example

```
MMEM:MDIR 'C:\R_S\Instr\user'
```

Characteristics

*RST value: –

SCPI: device-specific

Mode

all

MMEMory:MOVE

This command renames existing files, if <file_destination> contains no path indication. Otherwise the file is moved to the indicated path and stored under the file name specified there, if any.

This command is an event and therefore has no *RST value and no query.

Parameter

<file_source>, <file_destination> = <file_name> = DOS file name

The file name includes indication of the path and may also include the drive. The path name complies with DOS conventions.

Example

```
MMEM:MOVE 'C:\TEST01.CFG', 'SETUP.CFG'
```

Renames TEST01.CFG in SETUP.CFG in directory C:\.

```
MMEM:MOVE 'C:\TEST01.CFG', 'C:\R_S\Instr\user'
```

Moves TEST01.CFG from C:\ to C:\R_S\Instr\user.

```
MMEM:MOVE 'C:\TEST01.CFG', 'C:\R_S\Instr\user\SETUP.CFG'
```

Moves TEST01.CFG from C:\ to C:\R_S\Instr\user and renames the file in SETUP.CFG.

Characteristics

*RST value: –

SCPI: conform

Mode

all

MMEMory:MSIS

This command changes to the drive indicated. The drive may be the internal hard disk C:.

Parameter

<device> = A: | C: ... Z:

The path name complies with DOS conventions.

Example

```
MMEM:MSIS 'C:'
```

Characteristics

*RST value: "C:

SCPI: conform

Mode

all

MMEMory:NAME

This command defines a destination file for the printout started with the `HCOPY[:IMMEDIATE<1|2>]` command. In this case the printer output must be routed to file as destination.

This command is an event and therefore has no *RST value and no query.

Parameter

<file_name> = DOS file name

The file name includes indication of the path and may also include the drive name. The file name and path information comply with DOS conventions.

Example

```
HCOP:DEV:LANG BMP
```

Selection of data format.

```
HCOP:DEST MMEM
```

Selection of the output device.

```
MMEM:NAME 'PRINT1.BMP'
```

Selection of file name.

```
HCOP:IMM
```

Start of the printout.

Characteristics

*RST value: –

SCPI: conform

Mode

all

MMEMory:RDIRectory

This command deletes the indicated directory. The directory name includes indication of the path and may also include the drive name. The path name complies with DOS conventions.

This command is an event and therefore has no *RST value and no query.

Parameter

<directory_name> = DOS path name

Example

```
MMEM:RDIR 'C:\TEST'
```

Characteristics

*RST value: –

SCPI: device-specific

Mode

all

MMEMory:SElect[:ITEM]:ALL

This command includes all data subsets in the list device settings to be stored/loaded.

This command is an event and therefore has no *RST value.

Example

```
MMEM:SEL:ALL
```

Characteristics

*RST value: –

SCPI: device-specific

Mode

all

MMEMory:SElect[:ITEM]:DEfault

This command sets the default list of device settings to be stored/loaded. For details on hardware settings refer to the [MMEMory:SElect\[:ITEM\]:HWSettings](#) command.

Example

```
MMEM:SEL:DEfault
```

Characteristics

*RST value: –

SCPI: device-specific

Mode

all

MMEMory:SElect[:ITEM]:HWSettings

This command includes the hardware settings in the list of data subsets of a device setting to be stored/loaded. The hardware settings include:

- current configuration of general device parameters (general setup)
- current setting of the measurement hardware including markers
- activated limit lines:

A data set may include 8 limit lines at maximum. This number includes the activated limit lines and, if available, the de-activated limit lines last used.

Therefore the combination of the non-activated restored limit lines depends on the sequence of use with the [MMEMory:LOAD:STATe](#) command.

- user-defined color setting
- configuration for the hardcopy output
- tracking generator settings (models 13 and 16)
- correction data for source calibration (models 13 and 16)

Parameter

ON | OFF

Example

```
MMEM:SEL:HWS ON
```

Characteristics

*RST value: ON

SCPI: device-specific

Mode

all

MMEMory:SElect[:ITEM]:LINes:ALL

This command adds all limit lines (activated and de-activated) to the list of device settings to be stored/loaded.

This command is available from firmware version 1.10.

Parameter

ON | OFF

Example

```
MMEM:SEL:LIN:ALL ON
```

Characteristics

*RST value: ON

SCPI: device-specific

Mode

all

MMEMory:SElect[:ITEM]:NONE

This command deletes all data subsets from the list of device settings to be stored/loaded.

This command is an event and therefore has no *RST value.

Example

```
MMEM:SEL:NONE
```

Characteristics

*RST value: –

SCPI: device-specific

Mode

all

MMEMory:SElect[:ITEM]:SCData (models 13 and 16)

This command adds the tracking generator calibration data to the list of device settings to be stored/loaded.

This command is only available in conjunction with the tracking generator.**Parameter**

ON | OFF

Example

```
MMEM:SEL:SCD ON
```

Inserts the tracking generator correction data in the list of data subsets.

Characteristics

*RST value: OFF

SCPI: device-specific

Mode

all

MMEMory:SElect[:ITEM]:TRACe[:ACTive]

This command adds the active traces to the list of data subsets of a save/recall device setting. Active traces are all traces whose state is not blank.

Parameter

ON | OFF

Example

MMEM:SEL:TRAC ON

Characteristics

*RST value: OFF, i.e. no traces will be stored

SCPI: device-specific

Mode

all

MMEMory:SElect[:ITEM]:TRANsducer:ALL

This command includes all transducer factors and sets in the list of data subsets of a device setting to be stored/loaded.

This command is available from firmware version 1.10.

Parameter

ON | OFF

Example

MMEM:SEL:TRAN:ALL ON

Characteristics

*RST value: ON

SCPI: device-specific

Mode

all

MMEMory:STORe<1|2>:STATe

This command stores the current device settings in a *.FSL.dfl file. The numeric suffix in STORe<1|2> is irrelevant with this command.

A list of the extensions used is contained under [MMEMory:LOAD:STATe](#).

This command is an event and therefore has no *RST value and no query.

Parameter

1,<file_name>

with <file_name> = DOS file name without extension

The file name includes indication of the path and may also include the drive name. The path name complies with DOS conventions.

Example

```
MMEM:STOR:STAT 1, 'TEST'
```

Characteristics

*RST value: –

SCPI: conform

Mode

all

MMEMory:STORe<1|2>:TRACe

This command stores the selected trace (1 to 4) in a file with ASCII format. The file format is described in chapter 2, "Instrument Functions – Analyzer", section "Setting Traces – TRACE Key", **ASCII File Export** softkey.

The decimal separator (decimal point or comma) for floating–point numerals contained in the file is defined with the `FORMat:DEXPort:DSEPARATOR` command.

This command is an event and therefore has no *RST value and no query.

Parameter

1 to 4,<file_name>

with 1 to 4 = selected measurement curve trace 1 to 4 and <file_name> = DOS file name

The file name includes indication of the path and the drive name. Indication of the path complies with DOS conventions.

Example

```
MMEM:STOR:TRAC 3, 'TEST.ASC'
```

Stores trace 3 in the file TEST.ASC.

Characteristics

*RST value: –

SCPI: device–specific

Mode

all

OUTPut Subsystem (Option Additional Interfaces, B5)

The OUTPut subsystem controls the output features of the instrument.

Commands of the OUTPut Subsystem

– [OUTPut<1|2>:IF\[:SOURce\]](#)

OUTPut<1|2>:IF[:SOURce]

This command switches the source of the IF output between the demodulated signal and the IF signal.

Note: The AF output available at the frontpanel can only be used when the IF output source is set to video.

Parameter

IF | VIDeo

Example

```
OUTP IF VID
```

Selects the video signal for the IF output connector.

Characteristics

*RST value: IF

SCPI: conform

Mode

A

SENSe Subsystem

The SENSe subsystem is organized in several subsystems. The commands of these subsystems directly control device-specific settings; they do not refer to the signal characteristics of the measurement signal.

The SENSe subsystem controls the essential parameters of the analyzer. In accordance with the SCPI standard, the keyword "SENSe" is optional for this reason, which means that it is not necessary to include the SENSe node in command sequences.

The following subsystems are included:

- "SENSe:CORRection Subsystem (Models 13 and 16)" on page 6.574
- "SENSe:ROSCillator Subsystem" on page 6.574

SENSe:CORRection Subsystem (Models 13 and 16)

This subsystem controls calibration and normalization during operation with the tracking generator.

Commands of the SENSe:CORRection Subsystem

- [SENSe<1|2>:]CORRection:TRANsducer[:STATe]
- [SENSe<1|2>:]CORRection:TRANsducer:ADJust:RLEVel[:STATe]
- [SENSe<1|2>:]CORRection:TRANsducer:COMMeNt
- [SENSe<1|2>:]CORRection:TRANsducer:DATA
- [SENSe<1|2>:]CORRection:TRANsducer:DELeTe
- [SENSe<1|2>:]CORRection:TRANsducer:SCALing
- [SENSe<1|2>:]CORRection:TRANsducer:SELeCt
- [SENSe<1|2>:]CORRection:TRANsducer:UNIT
- [SENSe<1|2>:]CORRection:TRANsducer:VIEW

[SENSe<1|2>:]CORRection:TRANsducer[:STATe]

This command switches the selected transducer factor on or off.

Note: Prior to this command, the [SENSe<1|2>:]CORRection:TRANsducer:SELeCt command must be sent.

This command is available from firmware version 1.10.

Parameter

ON | OFF

Example

```
CORR:TRAN ON
```

Characteristics

*RST value: OFF

SCPI: device-specific

Mode A

[SENSe<1|2>:]CORRection:TRANsducer:ADJust:RLEVel[:STATe]

This command switches the automatic adjustment of the reference level to the selected transducer factor on or off.

Note: Prior to this command, the [SENSe<1|2>:]CORRection:TRANsducer:SElect command must be sent.

This command is available from firmware version 1.10.

Parameter

ON | OFF

Example

CORR:TRAN:ADJ:RLEV ON

Characteristics

*RST value: OFF

SCPI: device-specific

Mode

A

[SENSe<1|2>:]CORRection:TRANsducer:COMMeNT

This command defines the comment for the selected transducer factor.

Note: Prior to this command, the [SENSe<1|2>:]CORRection:TRANsducer:SElect command must be sent.

This command is available from firmware version 1.10.

Parameter

<string>

Example

CORR:TRAN:COMM 'FACTOR FOR ANTENNA'

Characteristics

*RST value: (empty comment)

SCPI: device-specific

Mode A**[SENSe<1|2>:]CORRection:TRANsducer:DATA**

This command defines the reference values of the transducer factor selected. These values are entered as a sequence of frequency/level pairs. The frequencies must be sent in ascending order.

Note: Prior to this command, the [SENSe<1|2>:]CORRection:TRANsducer:SElect command must be sent. The level values are sent as dimensionless numbers; the unit is specified by means of the [SENSe<1|2>:]CORRection:TRANsducer:UNIT command.

This command is available from firmware version 1.10.

Parameter

<freq>, <level>

Example

```
SENS:CORR:TRAN:SEL 'TRAN_1'
```

Selects the transducer factor

```
CORR:TRAN:UNIT 'DB'
```

Selects the unit for the transducer.

```
CORR:TRAN:DATA 1MHZ,-30,2MHZ,-40
```

Defines the frequency/level pairs 1 MHz, -30 dB and 2 MHz, -40 dB.

Characteristics

*RST value: –

SCPI: device-specific

Mode

A

[SENSe<1|2>:]CORRection:TRANsdruce:DELeTe

This command deletes the selected transducer factor.

This command is an event and therefore has no *RST value.

Note: Prior to this command, the [\[SENSe<1|2>:\]CORRection:TRANsdruce:SELeT](#) command must be sent.

This command is available from firmware version 1.10.

Example

```
CORR:TRAN:DEL
```

Characteristics

*RST value: –

SCPI: device-specific

Mode

A

[SENSe<1|2>:]CORRection:TRANsdruce:SCALIng

This command defines whether the frequency scaling of the transducer factor is linear or logarithmic.

Note: Prior to this command, the [\[SENSe<1|2>:\]CORRection:TRANsdruce:SELeT](#) command must be sent.

This command is available from firmware version 1.10.

Parameter

LINear | LOGarithmic

Example

```
CORR:TRAN:SCAL LOG
```

Characteristics

*RST value: LINear

SCPI: device-specific

Mode

A

[SENSe<1|2>:]CORRection:TRANsducer:SElect

This command selects the transducer factor designated by <name>. If <name> does not exist yet, a new transducer factor is created.

Note: This command must be sent prior to the subsequent commands for modifying/activating transducer factors.

This command is available from firmware version 1.10.

Parameter

<name> = Name of the transducer factor in string data form with a maximum of 8 characters.

Example

```
CORR:TRAN:SEL 'FACTOR1'
```

Characteristics

*RST value: –

SCPI: device-specific

Mode

A

[SENSe<1|2>:]CORRection:TRANsducer:UNIT

This command defines the unit of the transducer factor selected.

Note: Prior to this command, the `[SENSe<1|2>:]CORRection:TRANsducer:SElect` command must be sent.

This command is available from firmware version 1.10.

Parameter

<string> = DB | DBM | DBMV | DBUV | DBUV/M | DBUA DBUA/M | DBPW | DBPT

Example

```
CORR:TRAN:UNIT 'DBUV'
```

Characteristics

*RST value: DB

SCPI: device-specific

Mode

A

[SENSe<1|2>:]CORRection:TRANsducer:VIEW

This command switches on the display of the active transducer factor or set.

Note: Prior to this command, the `[SENSe<1|2>:]CORRection:TRANsducer:SElect` command must be sent.

This command is available from firmware version 1.10.

Parameter

ON | OFF

Example

```
CORR:TRAN:VIEW ON
```

Characteristics

*RST value: OFF

SCPI: device-specific

Mode

A

SENSe:ROSCillator Subsystem

This subsystem controls the reference oscillator. The numeric suffix in SENSe is irrelevant for the commands of this subsystem.

Commands of the SENSe:ROSCillator Subsystem

– [\[SENSe<1|2>:\]ROSCillator:SOURce](#)

[SENSe<1|2>:]ROSCillator:SOURce

This command controls selection of the reference oscillator.

If the external reference oscillator is selected, the reference signal must be connected to the rear panel of the instrument.

Parameter

INTernal | EXTernal

Example

```
ROSC:SOUR EXT
```

Characteristics

*RST value: –

SCPI: conform

Mode

all

SOURce Subsystem

The SOURce subsystem controls the output signals of the instrument.

Commands of the SOURce Subsystem

- SOURce<1|2>:EXTernal<1|2>:ROSCillator[:SOURce]
- SOURce:TEMPerature:APRobe?

SOURce<1|2>:EXTernal<1|2>:ROSCillator[:SOURce]

This command switches between external and internal reference oscillator.

Parameter

INTernal | EXTernal

Example

```
SOUR:EXT:ROSC EXT
```

Switches to external reference oscillator

Characteristics

*RST value: INT

SCPI: device-specific

Mode

all

SOURce:TEMPerature:APRobe?

This command queries the sensor temperature.

Parameter

1 (CPU)

Example

```
SOUR:TEMP:APR? 1
```

Queries the temperature of the CPU sensor.

Characteristics

RST value: –

SCPI: device-specific

Mode

all

STATus Subsystem

The STATus subsystem contains the commands for the status reporting system (see chapter 4 "Remote Control – Basics", section "Status Reporting System"). *RST does not influence the status registers.

Commands of the STATus Subsystem

- STATus:OPERation[:EVENT]?
- STATus:OPERation:CONDition?
- STATus:OPERation:ENABLE
- STATus:OPERation:PTRansition
- STATus:OPERation:NTRansition
- STATus:PRESet
- STATus:QUEStionable[:EVENT]?
- STATus:QUEStionable:CONDition?
- STATus:QUEStionable:ENABLE
- STATus:OPERation:PTRansition
- STATus:QUEStionable:NTRansition
- STATus:QUEue[:NEXT?]

STATus:OPERation[:EVENT]?

This command queries the contents of the EVENT section of the STATus:OPERation register. The contents of the EVENT section are deleted after readout.

Example

```
STAT:OPER?
```

Characteristics

*RST value: –

SCPI: conform

Mode

all

STATus:OPERation:CONDition?

This command queries the CONDition section of the STATus:OPERation register. Readout does not delete the contents of the CONDition section. The value returned reflects the current hardware status.

Example

```
STAT:OPER:COND?
```

Characteristics

*RST value: –

SCPI: conform

Modeall

STATus:OPERation:ENABle

This command sets the bits of the ENABle section of the STATus:OPERation register. The ENABle register selectively enables the individual events of the associated EVENT section for the summary bit in the status byte.

Parameter

0 to 65535

Example

```
STAT:OPER:ENAB 65535
```

Characteristics

*RST value: –

SCPI: conform

Modeall

STATus:OPERation:PTRansition

This command sets the edge detectors of all bits of the STATus:OPERation register from 0 to 1 for the transitions of the CONDition bit.

Parameter

0 to 65535

Example

```
STAT:OPER:PTR 65535
```

Characteristics

*RST value: –

SCPI: conform

Modeall

STATus:OPERation:NTRansition

This command sets the edge detectors of all bits of the STATus:OPERation register from 1 to 0 for the transitions of the CONDition bit.

Parameter

0 to 65535

Example

```
STAT:OPER:NTR 65535
```

Characteristics

*RST value: –

SCPI: conform

Modeall

STATus:PRESet

This command resets the edge detectors and ENABLE parts of all registers to a defined value. All PTRansition parts are set to FFFFh, i.e. all transitions from 0 to 1 are detected. All NTRansition parts are set to 0, i.e. a transition from 1 to 0 in a CONDition bit is not detected. The ENABLE part of the STATus:OPERation and STATus:QUEStionable registers are set to 0, i.e. all events in these registers are not passed on.

Example

STAT:PRESet

Characteristics

*RST value: –

SCPI: conform

Modeall

STATus:QUEStionable[:EVENT]?

This command queries the contents of the EVENT section of the STATus:QUEStionable register. The contents of the EVENT section are deleted after the readout.

Example

STAT:QUES?

Characteristics

*RST value: –

SCPI: conform

Modeall

STATus:QUEStionable:CONDition?

This command queries the CONDition section of the STATus:QUEStionable register. Readout does not delete the contents of the CONDition section.

Example

STAT:QUES:COND?

Characteristics

*RST value: –

SCPI: conform

Modeall

STATus:QUEStionable:ENABle

This command sets the bits of the ENABle section of the STATus:QUEStionable register. The ENABle register selectively enables the individual events of the associated EVENt section for the summary bit in the status byte.

Parameter

0 to 65535

Example

```
STAT:QUES:ENAB 65535
```

Characteristics

*RST value: –

SCPI: conform

Mode

all

STATus:QUEStionable:PTRansition

This command sets the edge detectors of all bits of the STATus:QUEStionable register from 0 to 1 for the transitions of the CONDition bit.

Parameter

0 to 65535

Example

```
STAT:QUES:PTR 65535
```

Characteristics

*RST value: –

SCPI: conform

Mode

all

STATus:QUEStionable:NTRansition

This command sets the edge detectors of all bits of the STATus:OPERation register from 1 to 0 for the transitions of the CONDition bit.

Parameter

0 to 65535

Example

```
STAT:QUES:NTR 65535
```

Characteristics

*RST value: –

SCPI: conform

Mode

all

STATus:QUEue[:NEXT?]

This command queries the earliest error queue entry and deletes it.

Positive error numbers indicate device-specific errors, negative error numbers are error messages defined by SCPI. If the error queue is empty, the error number 0, "No error", is returned. This command is identical to the [SYSTem:ERRor\[:NEXT\]?](#) command.

Example

```
STAT:QUES?
```

Characteristics

*RST value: –

SCPI: conform

Mode

all

SYSTEM Subsystem

This subsystem contains a series of commands for general functions.

Commands of the SYSTEM Subsystem

- SYSTEM:COMMunicate:GPIB[:SELF]:ADDRess
- SYSTEM:COMMunicate:GPIB[:SELF]:RTERminator
- SYSTEM:COMMunicate:PRINter:ENUMerate[:NEXT?]
- SYSTEM:COMMunicate:PRINter:ENUMerate:FIRSt?
- SYSTEM:COMMunicate:PRINter:SELEct <1|2>
- SYSTEM:DATE
- SYSTEM:DISPlay:FPANel
- SYSTEM:DISPlay:UPDate
- SYSTEM:ERRor[:NEXT]?
- SYSTEM:ERRor:CLEar:ALL
- SYSTEM:ERRor:LIST?
- SYSTEM:FIRMware:UPDate
- SYSTEM:FORMat:IDENt
- SYSTEM:LANGuage
- SYSTEM:PASSword[:CENable]
- SYSTEM:PASSword:RESet
- SYSTEM:PRESet
- SYSTEM:TIME
- SYSTEM:VERSion?

SYSTEM:COMMunicate:GPIB[:SELF]:ADDRess

This command changes the GPIB address of the unit.

Parameter

0 to 30

Example

```
SYST:COMM:GPIB:ADDR 18
```

Characteristics

*RST value: – (no influence on this parameter, factory default 20)

SCPI: conform

Mode

all

SYSTEM:COMMunicate:GPIB[:SELF]:RTERminator

This command changes the GPIB receive terminator.

According to the standard the terminator in ASCII is <LF> and/or <EOI>. For binary data transfers (e.g. trace data) from the control computer to the instrument, the binary code (0AH) used for <LF> might be included in the binary data block, and therefore should not be interpreted as a terminator in this particular case. This can be avoided by changing the receive terminator to EOI.

Output of binary data from the instrument to the control computer does not require such a terminator change.

Parameter

LFEOI | EOI

Example

SYST:COMM:GPIB:RTER EOI

Characteristics

*RST value: – (no influence on this parameter, factory default LFEOI)

SCPI: device-specific

Mode

all

SYSTEM:COMMunicate:PRINter:ENUMerate[:NEXT?]

This command queries the name of the next printer installed under Windows XP.

The `SYSTEM:COMMunicate:PRINter:ENUMerate:FIRSt?` command should be sent previously to return to the beginning of the printer list and query the name of the first printer.

The names of other printers can then be queried with the `SYSTEM:COMMunicate:PRINter:ENUMerate[:NEXT?]` command. After all available printer names have been output, an empty string enclosed by quotation marks ("") is output for the next query. Further queries are answered by a query error.

Example

SYST:COMM:PRIN:ENUM:NEXT?

Characteristics

*RST value: NONE

SCPI: device-specific

Mode

all

SYSTEM:COMMunicate:PRINter:ENUMerate:FIRSt?

This command queries the name of the first printer (in the list of printers) available under Windows XP.

The names of other installed printers can be queried with the `SYSTEM:COMMunicate:PRINter:ENUMerate[:NEXT?]` command.

If no printer is configured an empty string is output.

Example

```
SYST:COMM:PRIN:ENUM:FIRS?
```

Characteristics

*RST value: NONE

SCPI: device-specific

Mode

all

SYSTEM:COMMunicate:PRINter:SElect <1|2>

This command selects one of the printers configured under Windows XP including the associated output destination.

The specified printer name must be a string as returned by the commands

`SYSTEM:COMMunicate:PRINter:ENUMerate:FIRSt?` or

`SYSTEM:COMMunicate:PRINter:ENUMerate[:NEXT?]`

Note: The `HCOPY:DESTination<1|2>` command is used to select an output medium other than the default one.

Parameter

<printer_name>

Example

```
SYST:COMM:PRIN:SEL LASER on LPT1
```

Characteristics

*RST value: NONE

SCPI: device-specific

Mode

all

SYSTEM:DATE

This command is used to enter the date for the internal calendar.

The sequence of entry is year, month, day.

Parameter

1980 to 2099, 1 to 12, 1 to 31

Example

```
SYST:DATE 2000,6,1
```

Characteristics

*RST value: –

SCPI: conform

Mode

all

SYSTEM:DISPlay:FPANel

This command activates or deactivates the display of the front panel keys on the screen. With the display activated, the instrument can be operated on the screen using the mouse by pressing the corresponding buttons.

Parameter

ON | OFF

Example

SYST:DISP:FPAN ON

Characteristics

*RST value: OFF

SCPI: device-specific

Mode

all

SYSTEM:DISPlay:UPDate

In remote control mode, this command switches on or off the instrument display. When switched on, only the diagrams, traces and display fields are displayed and updated.

Note: The best performance is obtained if the display output is switched off during remote control.

Parameter

ON | OFF

Example

SYST:DISP:UPD ON

Characteristics

*RST value: OFF

SCPI: device-specific

Mode

all

SYSTEM:ERRor[:NEXT]?

This command queries the earliest error queue entry and deletes it.

Positive error numbers indicate device-specific errors, negative error numbers are error messages defined by SCPI. If the error queue is empty, the error number 0, "No error", is returned.

This command is a query and therefore has no *RST value.

Example

STAT:ERR?

Characteristics

*RST value: –

SCPI: conform

Modeall

SYSTEM:ERRor:CLEar:ALL

This command deletes all entries in the table SYSTEM MESSAGES.

This command is an event and therefore has no query and no *RST value.

Example

```
SYST:ERR:CLE:ALL?
```

Characteristics

*RST value: –

SCPI: device-specific

Modeall

SYSTEM:ERRor:LIST?

This command reads all system messages and returns a list of comma separated strings. Each string corresponds to an entry in the table SYSTEM MESSAGES.

If the error list is empty, an empty string "" will be returned.

This command is a query and therefore has no *RST value.

Example

```
SYST:ERR:LIST?
```

Characteristics

*RST value: –

SCPI: device-specific

Modeall

SYSTEM:FIRMware:UPDate

This command starts a firmware update using the *.msi files in the selected directory. The default path is D:\FW_UPDATE. The path is changed via the [MMEemory:CDIRectory](#) command. To store the update files the [MMEemory:DATA](#) command is used.

This command is an event and therefore has no query and no *RST value.

Example

```
SYST:FIRM:UPD 'D:\FW_UPDATE'
```

Starts the firmware update from directory D:\FW_UPDATE.

Characteristics

*RST value: –

SCPI: device-specific

Modeall

SYSTEM:FORMat:IDENt

This command adapts the return value of *IDN? to the FSP.

Parameter

LEGacy (FSP) | FSL

Example

SYST:FORM:IDEN FSP

Adapts the return value of *IDN? to the FSP.

Characteristics

RST value: FSL

SCPI: device-specific

Mode

all

SYSTEM:LANGUage

This command defines the system language.

Parameter

SCPI

Example

SYST:LANG 'SCPI'

Sets the system language to SCPI.

Characteristics

RST value: SCPI

SCPI: device-specific

Mode

all

SYSTEM:PASSword[:CENable]

This command enables access to the service functions by means of the password.

This command is an event and therefore has no *RST value and no query.

Parameter

<password>

Example

SYST:PASS XXXX

Characteristics

*RST value: –

SCPI: conform

Mode

all

SYSTem:PASSword:RESet

This command resets the service password.

This command is an event and therefore has no *RST value and no query.

Example

```
SYST:PASS:RES
```

Characteristics

*RST value: –

SCPI: conform

Mode

all

SYSTem:PRESet

This command initiates an instrument reset.

The effect of this command corresponds to that of the **PRESET** key with manual control or to the *RST command. For details on preset settings refer to chapter 2 "Instrument Functions – Analyzer", section "Initializing the Configuration – PRESET Key".

Example

```
SYST:PRES
```

Characteristics

*RST value: –

SCPI: conform

Mode

all

SYSTem:TIME

This command sets the internal clock. The sequence of entry is hour, minute, second.

Parameter

0 to 23, 0 to 59, 0 to 59

Example

```
SYST:TIME 12,30,30
```

Characteristics

*RST value: –

SCPI: conform

Mode

all

SYSTEM:VERSion?

This command queries the number of the SCPI version, which is relevant for the instrument.
This command is a query and therefore has no *RST value.

Example

```
SYST:VERS?
```

Characteristics

*RST value: –

SCPI: conform

Mode

all

Contents of Chapter 7

7 Remote Control – Programming Examples	7.1
Service Request.....	7.1
Initiate Service Request	7.1
Waiting for the Arrival of a Service Request	7.2
Waiting Without Blocking the Keyboard and Mouse	7.3
Service Request Routine	7.4
Reading Out the Output Buffer	7.5
Reading Error Messages	7.5
Evaluation of SCPI Status Registers.....	7.5
Evaluation of Event Status Register.....	7.6
Default Setting of the R&S FSL	7.7
Setting the Status Register	7.7
Default Setting for Measurements	7.7
Using Marker and Delta Marker	7.9
Marker Search Functions, Limitation of Search Range	7.9
Frequency Counting.....	7.11
Operation with Fixed Reference Point (Reference Fixed)	7.11
Phase and Phase Noise Measurement	7.12
Shape Factor Measurement (using n dB down)	7.14
Measuring the Third Order Intercept Point.....	7.15
Measuring the AM Modulation Depth.....	7.16
Limit Lines and Limit Test	7.17
Measuring the Channel and Adjacent Channel Power.....	7.19
Occupied Bandwidth Measurement	7.21
Time Domain Power Measurement.....	7.22
Fast Power Measurement on Power Ramps	7.23
Power Measurement with Multi-Summary Marker	7.23
Multi-Burst Power Measurement.....	7.25
Fast Level Measurement Using Frequency Lists	7.27
Level Correction of Transducers (Definition of Transducer Factors)	7.28
Reading Trace Data	7.29
Measuring the Magnitude and Phase of a Signal (I/Q Data Acquisition)	7.31
Averaging I/Q Data	7.33
Storing and Loading Device Settings	7.34
Storing Instrument Settings.....	7.34
Loading Device Settings	7.35
Reading and Writing Files	7.36
Reading a File from the Instrument.....	7.36
Creating a File on the Instrument.....	7.37
Configuring and Starting a Printout	7.38
Programming Examples of the WLAN TX Measurements Option (K91)	7.41
Synchronization Entry of Option	7.41
Selecting Measurements.....	7.41
Running Synchronized Measurements	7.42

Programming Examples of the WiMAX 802.16 OFDM Measurements Option (K92)7.44
 Synchronization Entry of Option7.44
 Selecting Measurements.....7.44
 Running Synchronized Measurements7.45

7 Remote Control – Programming Examples

The following programming examples have a hierarchical structure, i.e. subsequent examples are based on previous ones. It is thus possible to compile very easily an operational program from the modules of the given examples. In this chapter, more complex programming examples are given. In the Quick Start Guide, chapter 6, basic steps in remote control programming are provided.

Service Request

The service request routine requires an extended initialization of the instrument in which the relevant bits of the transition and enable registers are set. In addition the service request event must be enabled in the VISA session.

Initiate Service Request

```

REM ---- Example of initialization of the SRQ in the case of errors -----
PUBLIC SUB SetupSRQ()
CALL InstrWrite(analyzer, "*CLS")           'Reset status reporting system
CALL InstrWrite(analyzer,"*SRE 168")       'Enable service request for
                                           'STAT:OPER,STAT:QUES and ESR
                                           'register
CALL InstrWrite(analyzer,"*ESE 60")        'Set event enable bit for
                                           'command, execution, device-
                                           'dependent and query error
CALL InstrWrite(analyzer,"STAT:OPER:ENAB 32767")
                                           'Set OPERation enable bit for
                                           'all events
CALL InstrWrite(analyzer,"STAT:OPER:PTR 32767")
                                           'Set appropriate OPERation
                                           'Ptransition bits
CALL InstrWrite(analyzer,"STAT:QUES:ENAB 32767")
                                           'Set questionable enable bits
                                           'for all events
CALL InstrWrite(analyzer,"STAT:QUES:PTR 32767")
                                           'Set appropriate questionable
                                           'Ptransition bits
CALL viEnableEvent(analyzer, VI_EVENT_SERVICE_REQ, VI_QUEUE, 0)
                                           'Enable the event for service
                                           'request
Status = viWaitOnEvent(analyzer, VI_EVENT_SERVICE_REQ, SRQWaitTimeout,
VI_NULL, VI_NULL)
IF (status = VI_SUCCESS) THEN CALL Srq      'If SRQ is recognized =>
                                           'subroutine for evaluation
END SUB
REM *****

```

Waiting for the Arrival of a Service Request

There are basically two methods of waiting for the arrival of a service request:

1. Blocking (user inputs not possible):

This method is appropriate if the waiting time until the event to be signalled by an SRQ is short (shorter than the selected timeout), if no response to user inputs is required during the waiting time, and if – as the main criterion – the event is absolutely certain to occur.

Reason:

From the time the `viWaitOnEvent()` function is called until the occurrence of the expected event, it does not allow the program to respond to mouse clicks or key entries during the waiting time.

Moreover, it returns an error if the SRQ event does not occur within the predefined timeout period. The method is, therefore, in many cases not suitable for waiting for measurement results, especially when using triggered measurements.

The following function calls are required:

```
Status = viWaitOnEvent(analyzer, VI_EVENT_SERVICE_REQ, SRQWaitTimeout,
                        VI_NULL, VI_NULL)
                        'Wait for service request user
                        'inputs are not possible during
                        'the waiting time!

IF (status = VI_SUCCESS) THEN CALL Srq
                        'If SRQ is recognized =>
                        'subroutine for evaluation
```

2. Non-blocking (user inputs possible):

This method is recommended if the waiting time until the event to be signalled by an SRQ is long (longer than the selected timeout), and user inputs should be possible during the waiting time, or if the event is not certain to occur. This method is, therefore, the preferable choice for waiting for the end of measurements, i.e. the output of results, especially in the case of triggered measurements.

The method necessitates a waiting loop that checks the status of the SRQ line at regular intervals and returns control to the operating system during the time the expected event has not yet occurred. In this way, the system can respond to user inputs (mouse clicks, key entries) during the waiting time.

It is advisable to employ the `Hold()` auxiliary function, which returns control to the operating system for a selectable waiting time (see section "Waiting Without Blocking the Keyboard and Mouse"), so enabling user inputs during the waiting time.

```

result% = 0
For i = 1 To 10           'Abort after max. 10 loop
                        'iterations
Status = viWaitOnEvent(analyzer, VI_EVENT_SERVICE_REQ,
                        VI_TMO_IMMEDIATE, VI_NULL,
                        VI_NULL)
                        'Check event queue

If (status = VI_SUCCESS) Then
    result% = 1
    CALL Srq           'If SRQ is recognized =>
                    'subroutine for evaluation

Else
    CALL Hold(20)     'Call hold function with
                    '20 ms 'waiting time. User inputs
                    'are possible.

Endif
Next i
If result% = 0 Then
    Debug.Print "Timeout Error; Program aborted"
                    'Output error message

    STOP             'Stop software
Endif

```

Waiting Without Blocking the Keyboard and Mouse

A frequent problem with remote control programs using Visual Basic is to insert waiting times without blocking the keyboard and the mouse.

If the program is to respond to user inputs also during a waiting time, control over the program events during this time must be returned to the operating system. In Visual Basic, this is done by calling the *DoEvents* function. This function causes keyboard- or mouse-triggered events to be executed by the associated elements. For example, it allows the operation of buttons and input fields while the user waits for an instrument setting to be completed.

The following programming example describes the *Hold()* function, which returns control to the operating system for the period of the waiting time selectable in milliseconds.

```

Rem *****
Rem The waiting function below expects the transfer of the desired
Rem waiting time in milliseconds. The keyboard and the mouse remain
Rem operative during the waiting period, thus allowing desired elements
Rem to be controlled
Rem *****

```

```

Public Sub Hold(delayTime As Single)
    Start = Timer                                'Save timer count on calling the
                                                'function
    Do While Timer < Start + delayTime / 1000 'Check timer count
        DoEvents                                'Return control to operating
                                                'system to enable control of
                                                'desired elements as long as
                                                'timer has not elapsed
    Loop
End Sub
Rem *****

```

The waiting procedure is activated simply by calling *Hold(<Waiting time in milliseconds>)*.

Service Request Routine

A service request is processed in the service request routine.

Note: the variables userN% and userM% must be pre-assigned usefully!

```

REM ----- Service request routine -----
Public SUB Srq()
ON ERROR GOTO noDevice                'No user existing
CALL viReadSTB(analyzer, STB%)       'Serial poll, read status byte
IF STB% > 0 THEN                       'This instrument has bits set in
                                        'the STB
    SRQFOUND% = 1
    IF (STB% AND 16) > 0 THEN CALL Outputqueue
    IF (STB% AND 4) > 0 THEN CALL ErrorQueueHandler
    IF (STB% AND 8) > 0 THEN CALL Questionablestatus
    IF (STB% AND 128) > 0 THEN CALL Operationstatus
    IF (STB% AND 32) > 0 THEN CALL Esrread
END IF
noDevice:
END SUB                                'End of SRQ routine
Rem *****

```

Reading out the status event registers, the output buffer and the error/event queue is effected in subroutines.

Reading Out the Output Buffer

```

REM ----- Subroutine for the individual STB bits -----
Public SUB Outputqueue()
                                'Reading the output buffer
result$ = SPACE$(100)           'Make space for response
CALL InstrRead(analyzer, result$)
Debug.Print "Contents of Output Queue : "; result$
END SUB
REM *****

```

Reading Error Messages

```

REM ----- Subroutine for reading the error queue -----
Public SUB ErrorQueueHandler()
ERROR$ = SPACE$(100)           'Make space for error variable
CALL InstrWrite(analyzer, "SYSTEM:ERROR?")
CALL InstrRead(analyzer, ERROR$)
Debug.Print "Error Description : "; ERROR$
END SUB
REM *****

```

Evaluation of SCPI Status Registers

```

REM ----- Subroutine for evaluating Questionable Status Register -----
Public SUB Questionablestatus()
Ques$ = SPACE$(20)             'Preallocate blanks to text
                                'variable
CALL InstrWrite(analyzer, "STATus:QUEStionable:EVENT?")
CALL InstrRead(analyzer, Ques$)
Debug.Print "Questionable Status: "; Ques$
END SUB
REM *****

```

```

REM ----- Subroutine for evaluating Operation Status Register -----
Public SUB Operationstatus()
Oper$ = SPACE$(20)                                'Preallocate blanks to text
                                                'variable

CALL InstrWrite(analyzer, "STATUS:OPERation:EVENT?")
CALL InstrRead(analyzer, Oper$)
Debug.Print "Operation Status: "; Oper$
END SUB
REM *****

```

Evaluation of Event Status Register

```

REM ----- Subroutine for evaluating the Event Status Register -----
Public SUB Esrread()
Esr$ = SPACE$(20)                                'Preallocate blanks to text
                                                'variable

CALL InstrWrite(analyzer, "*ESR?")                'Read ESR
CALL InstrRead(analyzer, Esr$)

IF (VAL(Esr$) AND 1) > 0 THEN Debug.Print "Operation complete"
IF (VAL(Esr$) AND 2) > 0 THEN Debug.Print "Request Control"
IF (VAL(Esr$) AND 4) > 0 THEN Debug.Print "Query Error"
IF (VAL(Esr$) AND 8) > 0 THEN Debug.Print "Device dependent error"
IF (VAL(Esr$) AND 16) > 0 THEN
    Debug.Print "Execution Error; Program aborted"
                                                'Output error message
    STOP                                        'Stop software
    END IF
IF (VAL(Esr$) AND 32) > 0 THEN
    Debug.Print "Command Error; Program aborted"
                                                'Output error message
    STOP                                        'Stop software
    END IF
IF (VAL(Esr$) AND 64) > 0 THEN Debug.Print "User request"
IF (VAL(Esr$) AND 128) > 0 THEN Debug.Print "Power on"
END SUB
REM *****

```

Default Setting of the R&S FSL

The following settings are an example of how to modify the default setting of the R&S FSL.

It should be noted that only some settings are necessary depending on the example of application. In particular, the settings for resolution bandwidth, video bandwidth and sweep time are often not needed since these parameters are automatically calculated in the default setting on modifying the frequency range (span). The insertion loss is also automatically calculated depending on the reference level. The level detectors are coupled to the selected trace mode in the default setting.

The settings which are automatically calculated in the default setting are marked by (*) in the following programming example.

Setting the Status Register

```

REM *****
Public Sub SetupStatusReg()
'----- IEEE 488.2 status register -----
CALL InstrWrite(analyzer,"*CLS")           'Reset Status Registers
CALL InstrWrite(analyzer,"*SRE 168")       'Enable service request for
                                           'STAT:OPER-,STAT:QUES- and ESR
                                           'registers
CALL InstrWrite(analyzer,"*ESE 61")        'Set Event Enable bit for:
                                           'Operation Complete
                                           'Command-, Execution-, Device-
                                           'dependent and Query Error

'----- SCPI status register -----
CALL InstrWrite(analyzer,"STAT:OPER:ENAB 0")
                                           'Disable OPERation Status Reg
CALL InstrWrite(analyzer,"STAT:QUES:ENAB 0")
                                           'Disable Questionable Status
                                           'Register

End Sub
REM *****

```

Default Setting for Measurements

```

REM *****
Public Sub SetupInstrument()
'----- R&S FSL default setting -----
CALL SetupStatusReg                       'Set status registers
CALL InstrWrite(analyzer,"*RST")           'Reset instrument
CALL InstrWrite(analyzer,"SYST:DISP:UPD ON")
                                           'ON: display on
                                           'OFF: off(improved performance)
CALL InstrWrite(analyzer,"INIT:CONT OFF")
                                           'Single sweep

```

```

'----- Set frequency -----
CALL InstrWrite(analyzer,"FREQUENCY:CENTER 100MHz")
                                'Center frequency
CALL InstrWrite(analyzer,"FREQ:SPAN 1 MHz")
                                'Span
'----- Set level -----
CALL InstrWrite(analyzer,"DISP:WIND:TRAC:Y:RLEV -20dBm")
                                'Reference level
CALL InstrWrite(analyzer,"INP:ATT 10dB") 'Input attenuation (*)
'----- Scale y axis -----
CALL InstrWrite(analyzer,"DISP:WIND:TRAC:Y:SPAC LOG")
                                'Log level axis
CALL InstrWrite(analyzer,"DISP:WIND:TRAC:Y:SCAL 100dB")
                                'Level range
CALL InstrWrite(analyzer,"DISP:WIND:TRAC:Y:SCAL:MODE ABS")
                                'Absolute scaling
CALL InstrWrite(analyzer,"CALC:UNIT:POW DBM")
                                'Unit of y axis
'----- Trace and detector settings -----
CALL InstrWrite(analyzer,"DISP:WIND:TRAC1:MODE AVER")
                                'Trace1 average
CALL InstrWrite(analyzer,"AVER:TYPE VID") 'Average mode video;
                                '"LIN" for linear
CALL InstrWrite(analyzer,"SWE:COUN 10") 'Sweep count
CALL InstrWrite(analyzer,"DISP:WIND:TRAC2:STAT OFF")
                                'Trace2 blank
CALL InstrWrite(analyzer,"DISP:WIND:TRAC3:STAT OFF")
                                'Trace3 blank
CALL InstrWrite(analyzer,"CALC:MATH:STAT OFF")
                                'Trace mathematics off
CALL InstrWrite(analyzer,"DETECTOR1 RMS" 'Detector Trace1 (*)
CALL InstrWrite(analyzer,"DET2:AUTO ON") 'Detector Trace2 (*)
CALL InstrWrite(analyzer,"DET3:AUTO ON") 'Detector Trace3 (*)
'----- Bandwidth and sweep time -----
CALL InstrWrite(analyzer,"BAND:RES 100KHz")
                                'Resolution BW (*)
CALL InstrWrite(analyzer,"BAND:VID 1MHz") 'Video bandwidth (*)
CALL InstrWrite(analyzer,"SWE:TIM 100ms") 'Sweep time (*)
END SUB
REM *****

```

Using Marker and Delta Marker

Marker Search Functions, Limitation of Search Range

The example below is based on an AM-modulated signal at 100 MHz with the following characteristics:

- Carrier signal level: -30 dBm
- AF frequency: 100 kHz
- Modulation depth: 50 %

Marker 1 and delta marker 2 are set one after the other to the highest maxima of the measurement curve and then the frequency and level are read out. The default setting of the R&S FSL can be used for the following measurements (SetupInstrument).

```

REM *****
Public Sub MarkerSearch()
result$ = Space$(100)
CALL SetupInstrument           'Default setting
'----- Peak search without search limit -----
CALL InstrWrite(analyzer,"INIT:CONT OFF")
                                'Switch to single sweep
CALL InstrWrite(analyzer,"CALC:MARK:PEXC 6DB")
                                'Define peak excursion
CALL InstrWrite(analyzer,"CALC:MARK:STAT ON")
                                'Switch on Marker 1
CALL InstrWrite(analyzer,"CALC:MARK:TRAC 1")
                                'Assign Marker 1 to Trace 1
CALL InstrWrite(analyzer,"INIT;*WAI")
                                'Perform sweep with sync
CALL InstrWrite(analyzer,"CALC:MARK:MAX;X?;Y?")
                                'Marker to peak - read out
                                'frequency and level

CALL InstrRead(analyzer, result$)
Print "Marker 1: ";result$
CALL InstrWrite(analyzer,"CALC:DELT2:STAT ON;MAX;MAX:LEFT")
                                'Switch on delta marker 2
                                'Peak and then Next Peak Left
CALL InstrWrite(analyzer,"CALC:DELT:MODE ABS")
                                'Delta marker2 frequency output
                                'absolute
CALL InstrWrite(analyzer,"CALC:DELT2:X?;Y?")
                                'Delta marker 2 - read out
                                'frequency and level

CALL InstrRead(analyzer, result$)
Print "Delta 2: ";result$

```

```

'----- Peak search with search limit in x direction -----
CALL InstrWrite(analyzer,"CALC:MARK:X:SLIM:STAT ON;LEFT 0Hz;RIGHT
                    100.05MHz")
                    'Search limit on and set below
                    'LF on the right side

CALL InstrWrite(analyzer,"CALC:DELT3:STAT ON;MAX;MAX:RIGHT")
                    'Delta marker 3 on peak and then
                    'Next Peak Right

CALL InstrWrite(analyzer,"CALC:DELT3:X?;Y?")
                    'Delta marker 3; Read out
                    'frequency and level, both must
                    'have the value 0

CALL InstrRead(analyzer, result$)
Print "Delta 3: ";result$

'----- Peak search with search limit in y direction -----
CALL InstrWrite(analyzer,"CALC:THR:STAT ON")
CALL InstrWrite(analyzer,"CALC:THR -35DBM")
                    'Threshold on and set above LF

CALL InstrWrite(analyzer,"CALC:DELT3:STAT ON;MAX;MAX:NEXT")
                    'Delta marker 3 on
                    'Peak and then Next Peak
                    ' => is not found

CALL InstrWrite(analyzer,"CALC:DELT3:X:REL?;:CALC:DELT3:Y?")
CALL InstrRead(analyzer, result$)
                    'Delta marker 3; read out
                    'frequency and level, both must
                    'have the value 0

Print "Delta 3: ";result$

'---- Set center frequency and reference level by means of markers -----
CALL InstrWrite(analyzer,"CALC:MARK2:FUNC:CENT")
                    'Delta marker 2 -> Marker and
                    'center frequency = Marker 2

CALL InstrWrite(analyzer,"CALC:MARK2:FUNC:REF")
                    'Ref level = Marker 2

CALL InstrWrite(analyzer,"INIT;*WAI")
                    'Perform sweep with sync

END SUB

REM *****

```

Frequency Counting

The following example is based on a signal with a level of -30 dBm at 100 MHz. The default setting of the R&S FSL can also be used for this measurement (SetupInstrument). The objective of frequency counting is to determine the exact frequency of the signal at 100 MHz.

```

REM *****
Public Sub MarkerCount()
result$ = Space$(100)
CALL SetupInstrument           'Default setting
'----- Measure signal frequency with frequency counter -----
CALL InstrWrite(analyzer,"INIT:CONT OFF") 'Single sweep on
CALL InstrWrite(analyzer,"CALC:MARK:PEXC 6DB")
                                     'Peak excursion
CALL InstrWrite(analyzer,"CALC:MARK:STAT ON")
                                     'Marker 1 on
CALL InstrWrite(analyzer,"CALC:MARK:TRAC 1")
                                     'Assign marker 1 to trace 1
CALL InstrWrite(analyzer,"CALC:MARK:X 100MHz")
                                     'Set marker 1 to 100 MHz
CALL InstrWrite(analyzer,"CALC:MARK:COUNT:RES 1HZ")
                                     'Frequency counter 1 Hz
CALL InstrWrite(analyzer,"CALC:MARK:COUNT ON")
                                     'Frequency counter on
CALL InstrWrite(analyzer,"INIT;*WAI")   'Perform sweep with sync
CALL InstrWrite(analyzer,"CALC:MARK:COUNT:FREQ?")
                                     'Query measured frequency
CALL InstrRead(analyzer, result$)      'and read it out
Print "Marker Count Freq: ";result$
END SUB
REM *****

```

Operation with Fixed Reference Point (Reference Fixed)

The following example is based on a signal with a level of -20 dBm at 100 MHz. The harmonics of the signal lie at 200 MHz, 300 MHz, etc. In the presence of high-quality signal sources these harmonics may be outside the dynamic range of the R&S FSL. In order to measure harmonic suppression, however, the level must be set to higher sensitivity for measuring the harmonics; the carrier has to be suppressed by a notch filter to avoid overloading the R&S FSL RF input.

In the following example, two measurements are therefore performed with different level settings, first with a high reference level at the carrier frequency and then with a low reference level at the frequency of the 3rd harmonic.

The default setting of the R&S FSL for measurements (SetupInstrument) is used as starting point and adaptations are then made for the measurement.

```

REM *****
Public Sub RefFixed()
result$ = Space$(100)
CALL SetupInstrument           'Default setting
'----- Measure the reference point -----
CALL InstrWrite(analyzer,"INIT:CONT OFF") 'Single sweep
CALL InstrWrite(analyzer,"CALC:MARK:PEXC 6DB")
                                     'Peak Excursion
CALL InstrWrite(analyzer,"CALC:MARK:STAT ON")
                                     'Marker1 on
CALL InstrWrite(analyzer,"CALC:MARK:TRAC 1")
                                     'Assign Marker 1 to Trace 1
CALL InstrWrite(analyzer,"INIT;*WAI")   'Perform sweep with sync
CALL InstrWrite(analyzer,"CALC:MARK:MAX") 'Set Marker1 to 100 MHz
CALL InstrWrite(analyzer,"CALC:DELT:FUNC:FIX ON")
                                     'Reference fixed
'-----Setting frequency, level and bandwidth for harmonic measurement -----
CALL InstrWrite(analyzer,"FREQ:CENT 400MHz;Span 1MHz")
                                     'Set freq. of 3rd harmonic
CALL InstrWrite(analyzer,"BAND:RES 1kHz") 'and appropriate RBW
CALL InstrWrite(analyzer,"SWEEP:TIME:AUTO ON")
                                     'Couple sweep time
CALL InstrWrite(analyzer,"INP:ATT:AUTO ON")
                                     'Optimize level
CALL InstrWrite(analyzer,"DISP:WIND:TRAC:Y:RLEV -50dBm")
CALL InstrWrite(analyzer,"INIT;*WAI")   'Perform sweep with sync
CALL InstrWrite(analyzer,"CALC:DELT:MODE REL")
                                     'Delta marker frequency relative
CALL InstrWrite(analyzer,"CALC:DELT:MAX;X?;Y?")
                                     'Read out delta marker
CALL InstrRead(analyzer, result$)      'Read out frequency and level
Print "Deltamarker 1: "; result$
END SUB
REM *****

```

Phase and Phase Noise Measurement

During phase noise measurement the noise power referred to 1 Hz is brought into proportion to the power of an adjacent carrier signal. The spacing often used between the measured frequency and the carrier frequency is 10 kHz.

For the noise measurement the measured absolute level is referred to a bandwidth of 1 Hz.

The following example is again based on a signal with a level of -30 dBm at 100 MHz. Two markers are used to determine the noise and the phase noise at an offset of 10 kHz from the carrier signal.

```

REM *****
Public Sub Noise()
result$ = Space$(100)
'----- R&S FSL default setting -----
CALL SetupStatusReg           'Configure status register
CALL InstrWrite(analyzer,"*RST") 'Reset instrument
CALL InstrWrite(analyzer,"INIT:CONT OFF") 'Single sweep
'----- Set frequency -----
CALL InstrWrite(analyzer,"FREQUENCY:CENTER 100MHz")
                                'Center frequency
CALL InstrWrite(analyzer,"FREQ:SPAN 100 kHz")
                                'Span
'----- Set level -----
CALL InstrWrite(analyzer,"DISP:WIND:TRAC:Y:RLEV -20dBm")
                                'Reference level
CALL InstrWrite(analyzer,"INIT;*WAI") 'Perform sweep with sync
'----- Set reference point -----
CALL InstrWrite(analyzer,"CALC:MARK:PEXC 6DB")
                                'Peak excursion
CALL InstrWrite(analyzer,"CALC:MARK:STAT ON")
                                'Marker 1 on
CALL InstrWrite(analyzer,"CALC:MARK:TRAC 1")
                                'Assign marker1 to tracel
CALL InstrWrite(analyzer,"CALC:MARK:MAX") 'Set marker1 to 100 MHz
CALL InstrWrite(analyzer,"CALC:DELT:FUNC:PNO ON")
                                'Define phase noise reference
                                'point
'----- Measure phase noise -----
CALL InstrWrite(analyzer,"CALC:DELT:X 10kHz")
                                'Set delta marker
CALL InstrWrite(analyzer,"CALC:DELT:FUNC:PNO:RES?")
                                'Read out result of phase noise
                                'meas
CALL InstrRead(analyzer, result$)
Print "Phase Noise [dBc/Hz]: "; result$
'----- Measure noise -----
CALL InstrWrite(analyzer,"CALC:MARK:X 99.96MHz")
                                'Set Marker 1
CALL InstrWrite(analyzer,"CALC:MARK:FUNC:NOIS:RES?")
                                'Read out result
CALL InstrRead(analyzer, result$)
Print "Noise [dBm/Hz]: "; result$
END SUB
REM *****

```

Shape Factor Measurement (using n dB down)

The n-dB-down function of the R&S FSL is used twice to determine the shape factor of a filter (ratio of bandwidths at 60 dB and 3 dB below the filter maximum).

The following example is again based on a signal with a level of -30 dBm at 100 MHz. The shape factor is determined for the 30 kHz resolution bandwidth. The default setting of the R&S FSL is used for measurements (SetupInstrument).

```

REM *****
Public Sub ShapeFactor()
result$ = Space$(100)
'----- R&S FSL default setting -----
CALL SetupInstrument           'Default setting
CALL InstrWrite(analyzer,"INIT:CONT OFF") 'Single sweep
'----- Set frequency -----
CALL InstrWrite(analyzer,"FREQ:SPAN 1MHz")
                                'Span
CALL InstrWrite(analyzer,"BAND:RES 30kHz")
                                'Resolution bandwidth
CALL InstrWrite(analyzer,"INIT;*WAI")
                                'Perform sweep with sync
'----- Measure 60 dB value -----
CALL InstrWrite(analyzer,"CALC:MARK:PEXC 6DB")
                                'Peak excursion
CALL InstrWrite(analyzer,"CALC:MARK:STAT ON")
                                'Marker1 on
CALL InstrWrite(analyzer,"CALC:MARK:TRAC 1")
                                'Assign marker1 to trace1
CALL InstrWrite(analyzer,"CALC:MARK:MAX")
                                'Set marker1 to 100 MHz
CALL InstrWrite(analyzer,"CALC:MARK:FUNC:NDBD 45dB")
                                'Read out bandwidth measured at
                                '45 dB
CALL InstrWrite(analyzer,"CALC:MARK:FUNC:NDBD:RES?")
CALL InstrRead(analyzer,result$)
result60 = Val(result$)
'----- Measure 3 dB down value -----
CALL InstrWrite(analyzer,"CALC:MARK:FUNC:NDBD 3dB")
                                'Read out bandwidth measured at
                                '3 dB
CALL InstrWrite(analyzer,"CALC:MARK:FUNC:NDBD:RES?")
CALL InstrRead(analyzer,result$)
result3 = Val(result$)
'----- Read out shape factor-----
Print "Shapfaktor 60dB/3dB: ";result60/result3
END SUB
REM *****

```

Measuring the Third Order Intercept Point

The third order intercept point (TOI) is the (virtual) level of two adjacent useful signals at which the intermodulation products of third order have the same level as the useful signals.

The intermodulation product at f_{S2} is obtained by mixing the first harmonic of the useful signal P_{N2} with signal P_{N1} , the intermodulation product at f_{S1} by mixing the first harmonic of the useful signal P_{N1} with signal P_{N2} .

$$f_{S1} = 2 \times f_{n1} - f_{n2} \quad (1)$$

$$f_{S2} = 2 \times f_{n2} - f_{n1} \quad (2)$$

The following example is based on two adjacent signals with a level of -30 dBm at 100 MHz and 110 MHz. The intermodulation products lie at 90 MHz and 120 MHz according to the above formula. The frequency is set so that the examined mixture products are displayed in the diagram. Otherwise, the default setting of the R&S FSL is used for measurements (SetupInstrument).

```

REM *****
Public Sub TOI()
result$ = Space$(100)

'----- R&S FSL default setting -----
CALL SetupStatusReg           'Set status registers
CALL InstrWrite(analyzer,"*RST") 'Reset instrument
CALL InstrWrite(analyzer,"INIT:CONT OFF") 'Single sweep
CALL InstrWrite(analyzer,"SYST:DISP:UPD ON")
                                'ON: display on
                                'OFF: off

'----- Set frequency -----
CALL InstrWrite(analyzer,"FREQ:START 85MHz;STOP 125 MHz")
                                'Span

'----- Set level -----
CALL InstrWrite(analyzer,"DISP:WIND:TRAC:Y:RLEV -20dBm")
                                'Reference level
CALL InstrWrite(analyzer,"INIT;*WAI") 'Perform sweep with sync

'----- TOI measurement -----
CALL InstrWrite(analyzer,"CALC:MARK:PEXC 6DB")
                                'Peak excursion
CALL InstrWrite(analyzer,"CALC:MARK:FUNC:TOI ON")
                                'Switch on TOI measurement
CALL InstrWrite(analyzer,"CALC:MARK:FUNC:TOI:RES?")
                                'and read out results

CALL InstrRead(analyzer,result$)

'----- Read out result -----
Print "TOI [dBm]: ";result$

END SUB

REM *****

```

Measuring the AM Modulation Depth

The example below is based on an AM-modulated signal at 100 MHz with the following characteristics:

- Carrier signal level: -30 dBm
- AF frequency: 100 kHz
- Modulation depth: 50 %

The default setting of the analyzer for measurements can be used for the measurements described below (SetupInstrument).

```

REM *****
Public Sub AMMod()
result$ = Space$(100)
CALL SetupInstrument           'Default setting
CALL InstrWrite(analyzer,"BAND:RES 30kHz") 'Set appropriate RBW
'----- Peak search -----
CALL InstrWrite(analyzer,"INIT:CONT OFF") 'Single sweep
CALL InstrWrite(analyzer,"INIT;*WAI")     'Perform sweep with sync
CALL InstrWrite(analyzer,"CALC:MARK:PEXC 6DB")
                                           'Peak excursion
CALL InstrWrite(analyzer,"CALC:MARK:STAT ON")
                                           'Marker 1 on
CALL InstrWrite(analyzer,"CALC:MARK:TRAC 1")
                                           'Assign marker1 to trace1
'----- Measure modulation depth-----
CALL InstrWrite(analyzer,"CALC:MARK:MAX;FUNC:MDEP ON")
                                           'Marker to Peak;
CALL InstrWrite(analyzer,"CALC:MARK:FUNC:MDEP:RES?")
                                           'Measure mod. depth
CALL InstrRead(analyzer, result$)         'Read out result
'----- Read out result -----
Print "AM Mod Depth [%]: ";result$
END SUB
REM *****

```

Limit Lines and Limit Test

The example below shows the definition and use of a new limit line 5 for trace 1 with the following characteristics:

- Upper limit line
- Absolute x axis in the frequency range
- 5 reference values:
 - 120 MHz / -70 dB, 126 MHz/-40 dB, 127 MHz/-40 dB, 128 MHz/-10 dB,
 - 129 MHz/-40 dB, 130 MHz/-40 dB, 136 MHz / -70 dB
- Relative y axis with unit dB
- Absolute threshold at -75 dBm
- No margin

The signal of the integrated calibration source (128 MHz, -30 dBm) is used to check the limit test.

REM *****

Public Sub LimitLine()

result\$ = Space\$(100)

'----- **R&S FSL default setting** -----

CALL SetupInstrument 'Default setting

CALL InstrWrite(analyzer, "FREQUENCY:CENTER 128MHz;Span 10MHz")
'Span

CALL InstrWrite(analyzer, "Diag:Serv:Inp Cal;CSO -30dBm")
'Cal signal on

'----- **Definition of limit lines** -----

CALL InstrWrite(analyzer, "CALC:LIM5:NAME 'TEST1'")
'Define name

CALL InstrWrite(analyzer, "CALC:LIM5:COMM 'Upper limit'")
'Define comment

CALL InstrWrite(analyzer, "CALC:LIM5:TRAC 1")
'Assign trace

CALL InstrWrite(analyzer, "CALC:LIM5:CONT:DOM FREQ")
'Define x axis range

CALL InstrWrite(analyzer, "CALC:LIM5:CONT:MODE ABS")
'Define x axis scaling

CALL InstrWrite(analyzer, "CALC:LIM5:UNIT DB")
'Define y axis unit

CALL InstrWrite(analyzer, "CALC:LIM5:UPP:MODE REL")
'Define y axis scaling

'----- **Definition of data points and threshold** -----

xlimit\$ = "CALC:LIM5:CONT 120MHZ,126MHZ,127MHZ,128MHZ,129MHZ,130MHZ,136MHZ"

CALL InstrWrite(analyzer, xlimit\$) 'Set values for x axis

CALL InstrWrite(analyzer, "CALC:LIM5:UPP -70,-40,-40,-20,-40,-40,-70")
'Set values for y axis

CALL InstrWrite(analyzer, "CALC:LIM5:UPP:THR -75DBM")
'Set y threshold (only
'possible for relative
'y axis)

```

'----- Definition of margin or x /y offset-----
'A margin or an x /y offset can be defined here.

'----- Activate and evaluate the limit line -----
CALL InstrWrite(analyzer,"CALC:LIM5:UPP:STAT ON")
                                'Activate line 5
CALL InstrWrite(analyzer,"CALC:LIM5:STAT ON")
                                'Activate limit check
CALL InstrWrite(analyzer,"INIT;*WAI")      'Perform sweep with sync
CALL InstrWrite(analyzer,"CALC:LIM5:FAIL?")
                                'Query result of limit check
CALL InstrRead(analyzer, result$)         'Result: 1 (= FAIL)

'----- Read out result -----
Print "Limit Result Line 5: ";result$

'----- Evaluate limit line by means of status register -----
CALL InstrWrite(analyzer,"*CLS")          'Reset status register

'----- Measure -----
CALL InstrWrite(analyzer,"INIT;*OPC")     'Perform sweep with sync
CALL viEnableEvent(analyzer, VI_EVENT_SERVICE_REQ, VI_QUEUE, 0)
Status = viWaitOnEvent(analyzer, VI_EVENT_SERVICE_REQ, SRQWaitTimeout,
VI_NULL, VI_NULL)
IF (status = VI_SUCCESS) THEN CALL Srq     'If SRQ is recognized =>
                                          'subroutine for evaluation

'----- Read out result -----
IF (status% = 1) THEN
    CALL InstrWrite(analyzer,"STAT:QUES:LIM1:COND?")
                                'Read out STAT:QUES:LIMit
                                'register

    CALL InstrRead(analyzer, result$)

    IF ((Val(result$) And 16) <> 0) THEN
        Print "Limit5 failed"
    ELSE
        Print "Limit5 passed"
    END IF
END IF
END SUB
REM *****

```

Measuring the Channel and Adjacent Channel Power

In the following example, the channel and adjacent channel power is first measured on a signal with a level of 0 dBm at 800 MHz to IS95. Then the channel and adjacent channel power is measured on a GSM signal at 935.2 MHz with fast ACP measurement (FAST ACP).

In addition, the limit test is activated.

```

REM *****
Public Sub ACP()
result$ = Space$(100)
'----- R&S FSL default setting -----
CALL SetupStatusReg           'Set status register
CALL InstrWrite(analyzer,"*RST")      'Reset instrument
CALL InstrWrite(analyzer,"INIT:CONT OFF") 'Single sweep
CALL InstrWrite(analyzer,"SYST:DISP:UPD ON")
                                     'ON: display on
                                     'OFF: off
'----- Set frequency -----
CALL InstrWrite(analyzer,"FREQ:CENT 800MHz")
                                     'Set frequency
'----- Set level -----
CALL InstrWrite(analyzer,"DISP:WIND:TRAC:Y:RLEV 10dBm")
                                     'Reference level
'----- Example 1: Configure CP/ACP for CDMA -----
CALL InstrWrite(analyzer,"CALC:MARK:FUNC:POW:SEL ACP")
                                     'ACP measurement on
CALL InstrWrite(analyzer,"CALC:MARK:FUNC:POW:PRES F8CDMA")
                                     'Select CDMA800 FWD
CALL InstrWrite(analyzer,"SENS:POW:ACH:ACP 2")
                                     'Select 2 adjacent channels
CALL InstrWrite(analyzer,"SENS:POW:ACH:PRES ACP")
                                     'Optimize settings
CALL InstrWrite(analyzer,"SENS:POW:ACH:PRES:RLEV")
                                     'Optimize reference level
CALL InstrWrite(analyzer,"SENS:POW:ACH:MODE ABS")
                                     'Absolute measurement
CALL InstrWrite(analyzer,"SENS:POW:HSP ON")
                                     'Fast ACP measurement
'----- Perform measurement and query results -----
CALL InstrWrite(analyzer,"INIT;*WAI")      'Perform sweep with sync
CALL InstrWrite(analyzer,"CALC:MARK:FUNC:POW:RES? ACP")      'Query result
                                     CALL InstrRead(analyzer, result$)

```

```

'----- Read out result -----
Print "Result (CP, ACP low, ACP up, Alt low, Alt up): "
Print result$

'----- Example 2: Configure CP/ACP manually for GSM -----
result$ = Space$(100)
CALL InstrWrite(analyzer, "FREQ:CENT 935.2MHz")
                                'Set frequency
CALL InstrWrite(analyzer, "CALC:MARK:FUNC:POW:SEL ACP")
                                'ACP measurement on
CALL InstrWrite(analyzer, "SENS:POW:ACH:ACP 1")
'1 adjacent channel
CALL InstrWrite(analyzer, "SENS:POW:ACH:BAND 200KHZ")
'Channel bandw. 200 kHz
CALL InstrWrite(analyzer, "SENS:POW:ACH:BAND:ACH 200KHZ")
                                'Adjacent channel band-
                                'width 200 kHz
CALL InstrWrite(analyzer, "SENS:POW:ACH:SPAC 200KHZ")
                                'Channel spacing 200 kHz
CALL InstrWrite(analyzer, "SENS:POW:ACH:PRES ACP")
                                'Optimize settings
CALL InstrWrite(analyzer, "SENS:POW:ACH:PRES:RLEV")
                                'Optimize reference level
CALL InstrWrite(analyzer, "SENS:POW:ACH:MODE ABS")
                                'Absolute measurement

'----- Start measurement and query result -----
CALL InstrWrite(analyzer, "INIT;*WAI")      'Perform sweep with sync
CALL InstrWrite(analyzer, "CALC:MARK:FUNC:POW:RES? ACP")
                                'Query result

CALL InstrRead(analyzer, result$)

'----- Read out result -----
Print "Result (CP, ACP low, ACP up): "
Print result$

'----- Active limit check -----
result$ = Space$(100)
CALL InstrWrite(analyzer, "CALC:LIM:ACP:ACH 30DB, 30DB")
                                'Set relative limit
CALL InstrWrite(analyzer, "CALC:LIM:ACP:ACH:ABS -35DBM, -35DBM")
                                'Set absolute limit
CALL InstrWrite(analyzer, "CALC:LIM:ACP:ACH:STAT ON")
                                'Rel. limit check on
CALL InstrWrite(analyzer, "CALC:LIM:ACP:ACH:ABS:STAT ON")
                                'Abs. limit check on
CALL InstrWrite(analyzer, "CALC:LIM:ACP ON")
                                'Limit check on

```

```

'----- Start measurement and query result -----
CALL InstrWrite(analyzer,"INIT;*WAI")      'Perform sweep with sync
CALL InstrWrite(analyzer,"CALC:LIM:ACP:ACH:RES?")
                                           'Query result of limit check

CALL InstrRead(analyzer, result$)

'----- Read out result -----
Print "Result Limit Check: ";result$

END SUB
REM *****

```

Occupied Bandwidth Measurement

In the following example, the bandwidth is to be found in which 95% of the power of a GSM signal is contained. Signal frequency is 935.2 MHz; channel bandwidth is 200 kHz.

```

REM *****
Public Sub OBW()
result$ = Space$(100)

'----- R&S FSL default setting -----
CALL SetupStatusReg                      'Set status register
CALL InstrWrite(analyzer,"*RST")          'Reset instrument
CALL InstrWrite(analyzer,"INIT:CONT OFF") 'Single sweep
CALL InstrWrite(analyzer,"SYST:DISP:UPD ON")
                                           'ON: display on
                                           'OFF: off

'----- Configure R&S FSL for OBW for GSM -----
CALL InstrWrite(analyzer,"FREQ:CENT 935.2MHz")
                                           'Set frequency
CALL InstrWrite(analyzer,"CALC:MARK:FUNC:POW:SEL OBW")
                                           'OBW measurement on
CALL InstrWrite(analyzer,"SENS:POW:ACH:BAND 200KHZ")
                                           'Channel bandw. 200 kHz
CALL InstrWrite(analyzer,"SENS:POW:BWID 95PCT")
                                           'Percentage of power
CALL InstrWrite(analyzer,"SENS:POW:ACH:PRES OBW")
                                           'Set frequency and optimize
                                           reference level
CALL InstrWrite(analyzer,"SENS:POW:ACH:PRES:RLEV")
CALL InstrWrite(analyzer,"SENS:POW:NCOR OFF")
                                           'Noise correction
                                           'OFF: switch off
                                           'ON: switch on

```

```

'----- Perform measurement and query results -----
CALL InstrWrite(analyzer,"INIT;*WAI")      'Perform sweep with sync
CALL InstrWrite(analyzer,"CALC:MARK:FUNC:POW:RES? OBW")
                                           'Query result

CALL InstrRead(analyzer, result$)
Print result$
END SUB
REM *****

```

Time Domain Power Measurement

In the following example, the mean carrier power of a signal with 300 kHz bandwidth at 100 MHz is to be determined. In addition, the peak power, the rms value and the standard deviation are measured. To do this, the time-domain-power measurement functions are used.

```

REM *****
Public Sub TimeDomainPower()
result$ = Space$(100)
'----- R&S FSL default setting -----
CALL SetupStatusReg      'Set status register
CALL InstrWrite(analyzer,"*RST")      'Reset instrument
CALL InstrWrite(analyzer,"INIT:CONT OFF") 'Single sweep
CALL InstrWrite(analyzer,"SYST:DISP:UPD ON")
                                           'ON: display on
                                           'OFF: off

'----- Configure R&S FSL for time domain power measurement -----
CALL InstrWrite(analyzer,"FREQ:CENT 100MHz;SPAN 0Hz")
                                           'Set frequency

CALL InstrWrite(analyzer,"BAND:RES 300kHz")
                                           'Resolution bandwidth

CALL InstrWrite(analyzer,"SWE:TIME 200US") 'Sweep time
CALL InstrWrite(analyzer,"CALC:MARK:FUNC:SUMM:PPE ON")
                                           'Peak measurement on
CALL InstrWrite(analyzer,"CALC:MARK:FUNC:SUMM:MEAN ON")
                                           'Mean measurement on
CALL InstrWrite(analyzer,"CALC:MARK:FUNC:SUMM:RMS ON")
                                           'RMS measurement on
CALL InstrWrite(analyzer,"CALC:MARK:FUNC:SUMM:SDEV ON")
                                           'Standard deviation on

```

```

'----- Perform measurement and query results -----
CALL InstrWrite(analyzer,"INIT;*WAI")      'Perform sweep with sync
                                           'Query results:
query$ = " CALC:MARK:FUNC:SUMM:PPE:RES?;"  'Peak measurement
query$ = query$ + ":CALC:MARK:FUNC:SUMM:MEAN:RES?;"
                                           'Mean measurement
query$ = query$ + ":CALC:MARK:FUNC:SUMM:RMS:RES?;"
                                           'RMS measurement
query$ = query$ + ":CALC:MARK:FUNC:SUMM:SDEV:RES?"
                                           'Standard deviation

CALL InstrWrite(analyzer, query$)
CALL InstrRead(analyzer, result$)
Print result$
END SUB
REM *****

```

Fast Power Measurement on Power Ramps

A frequent task in mobile radio tests is measurement of a DUT at various power control levels at the highest possible speed. The R&S FSL offers two test functions for this task, which can be used depending on the signal characteristics.

In the following, the two methods are presented by means of two examples.

Power Measurement with Multi-Summary Marker

The multi-summary marker function is suitable for measuring the power of a sequence of pulses with the following characteristics:

- The pulses occur at identical time intervals, which is typical of GSM transmission in slots, for example.
- The level of the first signal is reliably above threshold.
- The subsequent pulses may have any levels.

The function uses the first pulse as a trigger signal. The power of the subsequent pulses is determined exclusively via the timing pattern selected for the pulse sequence. The function is, therefore, suitable for adjustments where the DUT output power varies considerably and is not reliably above the trigger threshold.

The measurement accuracy is determined by the ratio of pulse duration to total measurement time; this should not be below 1:50.

The function always uses TRACE 1.

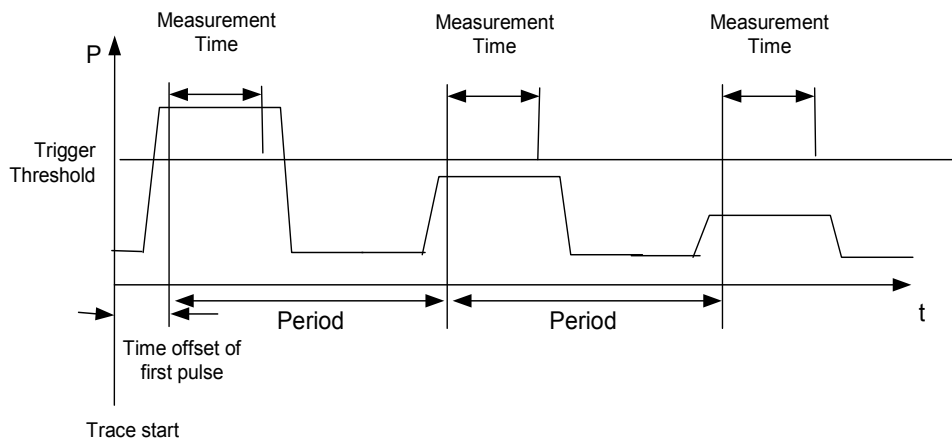

Fig. 7-1 Block diagram illustrating signal processing in analyzer

In the example below, a GSM puls sequence of 8 pulses is measured with an offset of 50 μ s of the first pulse, 450 μ s measurement time/pulse and 576.9 μ s pulse period.

```

REM *****
Public Sub MultiSumMarker()
result$ = Space$(200)
'----- R&S FSL default setting-----
CALL SetupStatusReg           'Configure status register
CALL InstrWrite(analyzer,"*RST") 'Reset instrument
CALL InstrWrite(analyzer,"INIT:CONT OFF") 'Single sweep mode
CALL InstrWrite(analyzer,"SYST:DISP:UPD ON")
                                'ON: switch display on
                                'OFF: switch display off
'----- Configure R&S FSL for power measurement in time domain -----
CALL InstrWrite(analyzer,"FREQ:CENT 935.2MHz;SPAN 0Hz")
                                'Frequency setting
CALL InstrWrite(analyzer,"DISP:WIND:TRAC:Y:RLEV 10dBm")
                                'Set reference level to 10 dB
CALL InstrWrite(analyzer,"INP:ATT 30 dB") 'Set input attenuation to 30 dB
CALL InstrWrite(analyzer,"BAND:RES 1MHz;VID 3MHz")
                                'Bandwidth setting
CALL InstrWrite(analyzer,"DET RMS") 'Select RMS detector
CALL InstrWrite(analyzer,"TRIG:SOUR VID") 'Trigger source: video
CALL InstrWrite(analyzer,"TRIG:LEV:VID 50 PCT")
                                'Trigger threshold: 50%
CALL InstrWrite(analyzer,"SWE:TIME 50ms") 'Sweep time  $\geq$  1 frame
    
```



```

'----- Perform measurement and query results -----
CALL InstrWrite(analyzer,"INIT;*WAI")      'Perform sweep with sync
                                           'Query results:

cmd$ = "CALC:MARK:FUNC:MSUM? "
cmd$ = cmd$ + "50US,"                      'Offset of first pulse
cmd$ = cmd$ + "450US,"                    'Measurement time
cmd$ = cmd$ + "576.9US,"                  'Pulse period
cmd$ = cmd$ + "8"                          'Number of bursts
CALL InstrWrite(analyzer,cmd$)
CALL InstrRead(analyzer, result$)         'Read results
Print result$

END SUB

REM *****

```

Multi-Burst Power Measurement

The multi-burst power measurement function is suitable for measuring the power of a sequence of pulses with the following characteristics:

- The pulses occur at variable time intervals.
- The levels of all pulses of the sequence are reliably above the trigger threshold, or an external trigger signal is used.

The function requires one trigger event per pulse. This means that if the video trigger or the IF power trigger is used, the levels of all pulses must be above the trigger threshold.

The function is, therefore, particularly suitable for re-measuring DUTs already adjusted and whose output power is within the specified range. The measurement is optimized for minimum overhead relative to the actual measurement time.

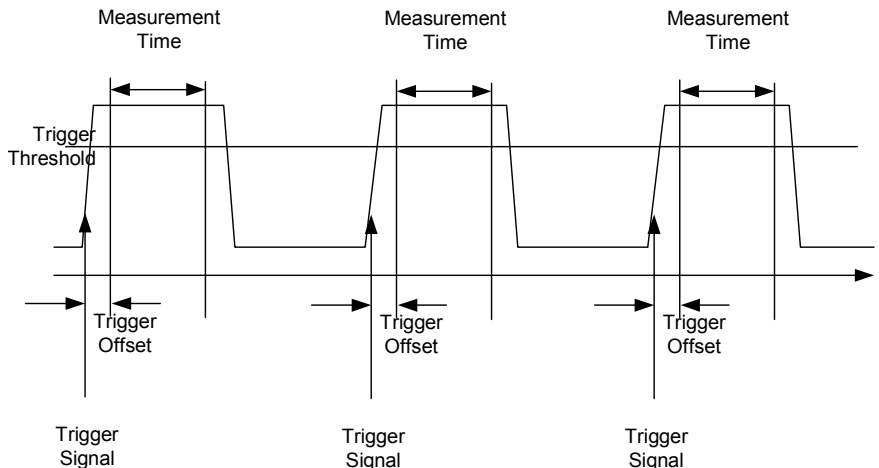

Fig. 7-2 Block diagram illustrating signal processing in analyzer

Either the root-mean-square power or the peak power is measured, depending on whether the RMS detector or the PEAK detector is selected. The function always uses TRACE 1.

The following parameters are to be set for this measurement:

- Analyzer frequency
- Resolution bandwidth
- Measurement time per single pulse
- Trigger source
- Trigger threshold
- Trigger offset
- Type of power measurement (PEAK, MEAN)
- Number of pulses to be measured

During the measurement, each pulse is mapped into a pixel of the screen, i.e. any change of the trace can be detected only at the left-hand edge of the screen. Maximum measurement speed is as usual achieved with the display switched off.

In the example below, a GSM pulse sequence of 8 pulses is measured with 5 μ s trigger offset, 434 μ s measurement time/pulse, video trigger with 50% trigger threshold, and peak detection:

```

REM *****
Public Sub MultiBurstPower()
result$ = Space$(200)
'----- R&S FSL default setting -----
CALL SetupStatusReg           'Configure status register
CALL InstrWrite(analyzer,"*RST") 'Reset instrument
CALL InstrWrite(analyzer,"INIT:CONT OFF") 'Single sweep mode
CALL InstrWrite(analyzer,"SYST:DISP:UPD OFF")
                                'OFF: display off
'----- Perform measurement and query results -----
cmd$ = "MPOW? "
cmd$ = cmd$ + "935.2 MHZ,"      'Center frequency
cmd$ = cmd$ + "1MHZ,"          'Resolution bandwidth
cmd$ = cmd$ + "434US,"         'Measurement time
cmd$ = cmd$ + "VID,"           'Trigger source
cmd$ = cmd$ + "50PCT,"         'Trigger threshold
cmd$ = cmd$ + "1US,"           'Trigger offset, must be > 125 ns
cmd$ = cmd$ + "PEAK,"          'Peak detector
cmd$ = cmd$ + "8"              'Number of bursts
CALL InstrWrite(analyzer, cmd$)
CALL InstrRead(analyzer, result$) 'Read results
Print result$
END SUB
REM *****

```

Fast Level Measurement Using Frequency Lists

A typical task for the R&S FSL is power measurement at a number of frequency points, e.g. at multiples of the fundamental (harmonics measurement), or at frequencies defined by a mobile radio standard (e.g. spectrum due to transients at ± 200 kHz, ± 400 kHz, etc about the carrier frequency of a GSM signal). In many cases, different level and/or bandwidth settings are required for the different frequency points to match the channel spacing and meet the requirements of dynamic range.

Especially for this application, the R&S FSL offers a number of remote-control functions (commands available in SENSE:LIST subsystem) that allow level measurement based on a frequency list with different instrument settings assigned to different frequencies. Not only the frequency list can be programmed, but also the measurement types (PEAK, RMS, AVG) to be performed simultaneously can be selected.

The example below describes a harmonics measurement on a dual-band amplifier. The harmonics level in general decreases as the frequency increases. To boost measurement sensitivity, therefore, the reference level is lowered by 10 dB from the third harmonic.

The following settings are used:

Reference level: 10.00 dBm up to first harmonic, 0 dBm from 2nd harmonic
 RF attenuation: 20 dB
 Electronic attenuation: 0 dB (OFF)
 Filter type: NORMal
 RBW: 1 MHz
 VBW: 3 MHz
 Measurement time: 300 μ s
 Trigger delay: 100 μ s
 Trigger: video, 45 %

Frequency	Type
935.2 MHz	GSM 900 fundamental
1805.2 MHz	GSM 1800 fundamental
1870.4 MHz	GSM 900 2nd harmonic
2805.6 MHz	GSM 900 3rd harmonic
3610.4 MHz	GSM 1800 2nd harmonic
3740.8 MHz	GSM 900 4th harmonic
5815.6 MHz	GSM 1800 3rd Harmonic

The frequencies are selected in ascending order to minimize system-inherent waiting times resulting from frequency changes.

At each frequency point the peak power and the rms power are measured. The peak power and the rms power values are stored alternately in the results memory.

REM *****

Public Sub FrequencyList()

result\$ = Space\$(500)

'----- R&S FSL default setting -----

CALL SetupStatusReg 'Configure status register

CALL InstrWrite(analyzer,"*RST") 'Reset instrument

CALL InstrWrite(analyzer,"INIT:CONT OFF") 'Single sweep mode

CALL InstrWrite(analyzer,"SYST:DISP:UPD OFF")
'Display off

```
'-----Configure R&S FSL for power measurement based on frequency list -
CALL InstrWrite(analyzer, "TRIG:LEV:IFP -20dBm")
                                     'Set IF power trigger level
CALL InstrWrite(analyzer, "LIST:POWer:SET ON,ON,OFF,IFP,POS,100us,0")
'----- Perform measurement and query results -----
cmd$ = "LIST:POWer?"
cmd$ = cmd$ + "935.2MHZ,10dBm,20dB,OFF,NORM,1MHz,3MHz,300us,0,"
cmd$ = cmd$ + "1805.2MHZ,10dBm,20dB,OFF,NORM,1MHz,3MHz,300us,0,"
cmd$ = cmd$ + "1870.4MHZ,10dBm,20dB,OFF,NORM,1MHz,3MHz,300us,0,"
cmd$ = cmd$ + "2805.6MHZ,0dBm,20dB,OFF,NORM,1MHz,3MHz,300us,0,"
cmd$ = cmd$ + "3610.4MHZ,10dBm,20dB,OFF,NORM,1MHz,3MHz,300us,0,"
cmd$ = cmd$ + "3740.8MHZ,0dBm,20dB,OFF,NORM,1MHz,3MHz,300us,0,"
cmd$ = cmd$ + "5815.6MHZ,0dBm,20dB,OFF,NORM,1MHz,3MHz,300us,0"
CALL InstrWrite(analyzer, cmd$)
CALL InstrRead(analyzer, result$)
Print result$
END SUB
REM *****
```

Level Correction of Transducers (Definition of Transducer Factors)

In more complex test systems, the frequency response of the test setup must be taken into account in all power measurements to avoid any measurement errors being introduced from sources other than the DUT.

The R&S FSL offers the possibility of defining a frequency-dependent attenuation correction factor (transducer factor).

In the example below, a factor with the following characteristics is defined:

Name:	Transtest
Unit:	dB
Scaling:	lin
Comment:	simulated cable correction
Frequency	Level
10 MHz	0 dB
100 MHz	3 dB
1 GHz	7 dB
3 GHz	10 dB

The factor is defined and can be activated as required.

```

REM *****
Public Sub TransducerFactor()
'----- Define transducer factor -----
CALL InstrWrite(analyzer,"CORR:TRAN:SEL 'TRANSTEST'")
                                'Define "Transtest"
                                'transducer factor
CALL InstrWrite(analyzer,"CORR:TRAN:UNIT 'DB'")
                                'Unit 'dB'
CALL InstrWrite(analyzer,"CORR:TRAN:SCAL LIN")
                                'Linear frequency axis
CALL InstrWrite(analyzer,"CORR:TRAN:COMM 'Simulated cable correction'")
cmd$ = "CORR:TRAN:DATA "
                                'Enter frequency and level
cmd$ = cmd$ + "10MHz, 0,"
                                'values. Level values without
cmd$ = cmd$ + "100MHz, 3,"
                                'unit!
cmd$ = cmd$ + "1GHz, 7,"
cmd$ = cmd$ + "3GHz, 10"
CALL InstrWrite(analyzer,cmd$)
                                'Enter frequency and level values
'----- Activate transducer -----
CALL InstrWrite(analyzer,"CORR:TRAN:STAT ON")
                                'Activate transducer factor
END SUB
REM *****

```

Reading Trace Data

In the following example, the trace data recorded together at the default setting is read out and displayed on the screen in the form of a list. Reading is performed consecutively in the binary format and in the ASCII format, at span > 0 and also at span = 0.

In the binary format the message header is evaluated with the length information and used to calculate the x axis values.

In the ASCII format only the list of level values is output.

The binary data is read out in 3 steps:

1. Reading the number of digits of the length information
2. Reading the length information
3. Reading trace data

This procedure is necessary with programming languages that support only structures with similar data types (arrays) (such as Visual Basic) since the data types of header and data differ in binary data.

REM *****

Public Sub ReadTrace()

```
'----- Define variables -----
Dim traceData(1250) As Single      'Buffer for floating point
                                   'binary data
Dim digits As Byte                'Number of digits of
                                   'length information
Dim traceBytes As Integer         'Length of trace data in bytes
Dim traceValues As Integer       'Number of values in buffer
Dim retCount As Integer          'Return count from read
asciiResult$ = Space$(25000)     'Buffer for ASCII trace data
result$ = Space$(100)            'Buffer for simple results
startFreq$ = Space$(100)        'Buffer for start frequency
span$ = Space$(100)              'Buffer for span

'----- R&S FSL default setting -----
CALL SetupInstrument              'Default setting
CALL InstrWrite(analyzer,"INIT:CONT OFF") 'Single sweep
CALL InstrWrite(analyzer,"INIT;*WAI")  'Perform sweep with sync

'----- Define span for read out -----
CALL InstrWrite(analyzer,"FREQ:START?") 'Read out start frequency
CALL InstrRead(analyzer,startFreq$)
startFreq = Val(startFreq$)
CALL InstrWrite(analyzer,"FREQ:SPAN?")  'Read out span
CALL InstrRead(analyzer,span$)
span = Val(span$)

'----- Read out in binary format -----
CALL InstrWrite(analyzer, "FORMAT REAL,32")
                                   'Select binary format
CALL InstrWrite(analyzer, "TRAC1? TRACE1")
                                   'Read out trace 1
CALL viRead(analyzer, result$, 2, retCount)
                                   'Read out and store
digits = Val(Mid$(result$, 2, 1))    'number of digits of
                                   'length information
result$ = Space$(100)                'Initialize buffer again
CALL viRead(analyzer, result$, digits, retCount)
                                   'Read out
traceBytes = Val(Left$(result$, digits)) 'and store length information
CALL viRead(analyzer, traceData(0), traceBytes, retCount)
                                   'Read trace data into buffer
CALL viRead(analyzer, result$, 1, retCount)
                                   'Read the terminator <NL>
```

R&S FSL Measuring the Magnitude and Phase of a Signal (I/Q Data Acquisition)

```
'----- Read out binary data as pairs of frequency/level values -----
traceValues = traceBytes/4           'Single precision = 4 bytes
stepsize = span/traceValues         'Calculate frequency step width
For i = 0 To traceValues - 1
  Print "Value["; i; "] = "; startFreq+stepsize*i; ", "; traceData(i)
Next i

'----- Time domain default setting -----
CALL InstrWrite(analyzer,"FREQ:SPAN 0Hz") Switchover to time domain
CALL InstrWrite(analyzer,"INIT;*WAI")     'Perform sweep with sync

'----- Read out in ASCII format -----
CALL InstrWrite(analyzer,"FORMAT ASCII")  'Select ASCII format
CALL InstrWrite(analyzer,"TRAC1? TRACE1") 'Read out Trace 1
CALL InstrRead(analyzer, asciiResult$)
Print "Contents of Tracel: ",asciiResult$ 'Output
END SUB
REM *****
```

Measuring the Magnitude and Phase of a Signal (I/Q Data Acquisition)

Due to the R&S FSL's internal architecture, it is capable of measuring and outputting the magnitude and phase of a signal in addition to its power values. This opens up a variety of possibilities for more in-depth analysis (FFT, demodulation, etc).

I/Q data is stored in memory areas each containing 512 k words. Hardware triggering controls the memory.

The following example shows the steps necessary to collect data at a predefined sampling rate and read it from the I/Q memory.

Data is output in the form of voltage values referred to the analyzer input. Data can be read in binary or ASCII format.

In binary format, the length information carried in the message header is evaluated and used for calculating the x axis values.

In ASCII format, only a list of voltage values is output.

Binary data is read in three steps:

1. The number of digits carrying the length information is read.
2. The length information itself is read.
3. The trace data is read.

This procedure is necessary with programming languages like Visual Basic which support only structures of identical data types (arrays), whereas the binary data format uses different data types in the header and the data section.

Note: *The arrays for measured data are dimensioned in such a way that they can accommodate the I/Q data of the R&S FSL (2 x 512 k).*

Measuring the Magnitude and Phase of a Signal (I/Q Data Acquisition) R&S FSL

REM *****

Public Sub ReadIQData()

```
'----- Create variables -----
Dim IData(131072) As Single          'Buffer for floating-point
                                     'I data (= 512*1024 bytes)
Dim QData(131072) As Single          'Buffer for floating-point
                                     'Q data (= 512*1024 bytes)
                                     'Note:
                                     'Visual Basic cannot read in
                                     'data volumes larger than
                                     '512 k words!
Dim digits As Byte                   'No. of digits as length
Dim IQBytes As Long                  'Length of trace data in bytes
Dim IQValues As Long                 'No. of meas. values in buffer
Dim retCount As Integer              'Return count from read
asciiResult$ = Space$(6553600)       'Buffer for ASCII I/Q data
                                     '(= 25*2*1024 bytes)
result$ = Space$(100)                'Buffer for simple results
'----- Default setting -----
CALL SetupInstrument                 'Default setting
CALL InstrWrite(analyzer,"TRAC:IQ:STAT ON")
                                     'Activate I/Q data
                                     'acquisition mode; must be
                                     'done before TRAC:IQ:SET !
                                     'Select number of test points
                                     '(= 512 * 1024 - 512) at
                                     'RBW 10 MHz, 'sample rate 32 MHz,
                                     'trigger free run, pos. trigger
                                     'edge and 0 s trigger delay.
CALL InstrWrite(analyzer,"TRAC:IQ:SET NORM,10MHz,32MHz,IMM,POS,0,130560")
'----- Read-out in binary format-----
CALL InstrWrite(analyzer, "FORMAT REAL,32")
                                     'Set binary format
CALL InstrWrite(analyzer, "TRAC:IQ:DATA?")
                                     'Measure + read out I/Q data
CALL viRead(analyzer, result$, 2, retCount)
                                     'Read and store length for
digits = Val(Mid$(result$, 2, 1))    'number of digits
result$ = Space$(100)                'Re-initialize buffer
CALL viRead(analyzer, result$, digits, retCount)
                                     'Read and store length
IQBytes = Val(Left$(result$, digits))
IQBytes = IQBytes / 2                 'Divide no. per buffer in half
CALL viRead(analyzer, IData(0), IQBytes, retCount)
                                     'Read I data in buffer
CALL viRead(analyzer, QData(0), IQBytes, retCount)
                                     'Read Q data in buffer
```



```

CALL viRead(analyzer, result$, 1, retCount)
                                     'Read in end character <NL>
'----- Output of binary data as frequency/level pair -----
IQValues = IQBytes/4                 'Single Precision = 4 Bytes
For i = 0 To IQValues - 1
  Print "I-Value["; i; "] = "; IData(i)
  Print "Q-Value["; i; "] = "; QData(i)
Next i
'----- Read-out in ASCII format -----
CALL InstrWrite(analyzer, "FORMAT ASCII") 'Set ASCII format
CALL InstrWrite(analyzer, "TRAC:IQ:DATA?")
                                     'Re-measure and read out
                                     'I/Q data

CALL InstrRead(analyzer, asciiResult$)
CALL InstrWrite(analyzer, "TRAC:IQ:STAT OFF")
                                     'Stop I/Q data aquisition
                                     'mode if no further
                                     'measurements are to be
                                     'done

END SUB
REM *****

```

Averaging I/Q Data

The R&S FSL has averaging capability also for I/Q measurements, i.e. I/Q data can be averaged over several test runs. This is subject to the following conditions:

1. An external trigger signal must be available for data measurement, and the trigger signal must be phase-locked to the signal measured.
2. The same reference-frequency signal must be used for the DUT and the R&S FSL.
3. The sampling rate must be 32 MHz, since only with this sampling frequency will the measurement be performed phase-synchronous with the trigger signal.

If all of the above conditions are fulfilled, no phase shift will occur between consecutive test runs. Phase shift may falsify the measured average so that in extreme cases a value of 0 is obtained.

The default setting of the instrument for data measurement without averaging has to be changed as follows:

```

REM *****
'----- R&S FSL default setting -----
CALL SetupInstrument           'Default setting
CALL InstrWrite(analyzer,"TRAC:IQ:STAT ON")
                                'Activate I/Q data acquisition
                                'mode; this must be
                                'done before TRAC:IQ:SET!
'Select max. number of test points (= 512 * 1024 - 512) at 10 MHz RBW,
                                '32 MHz sampling rate, external
                                'trigger, pos. trigger edge and
                                '0 s trigger delay.
CALL InstrWrite(analyzer,"TRAC:IQ:SET NORM,10MHz,32MHz,EXT,POS,0,130560")
CALL InstrWrite(analyzer,"TRAC:IQ:AVER ON")  'Switch on I/Q averaging
CALL InstrWrite(analyzer,"TRAC:IQ:AVER:COUN 10")      'Set 10 test runs
'----- Read data in binary format -----
...
REM *****

```

Storing and Loading Device Settings

Storing Instrument Settings

In the following example, the settings/measurement data to be stored are determined; only the hardware settings are stored. The selection commands for the other settings are indicated with the status OFF for the sake of completeness.

```

REM *****
Public Sub StoreSettings()
'This subroutine selects the settings to be stored and creates
'the data set "TEST1" in directory C:\R_S\Instr\user. It uses
'the default setting and resets the instrument after storage
'of the setting.
'----- R&S FSL default setting -----
CALL SetupInstrument
CALL InstrWrite(analyzer,"INIT:CONT OFF")  'Single sweep
CALL InstrWrite(analyzer,"INIT;*WAI")      'Perform sweep with sync
'----- Select items to be stored -----
CALL InstrWrite(analyzer,"MMEM:SEL:HWS ON")
                                'Save hardware settings
CALL InstrWrite(analyzer,"MMEM:SEL:TRAC OFF")
                                'No storing of traces
CALL InstrWrite(analyzer,"MMEM:SEL:LIN:ALL OFF")
                                'Save only active limit lines

```

```

'----- Define comment -----
CALL InstrWrite(analyzer,"MMEM:COMM 'Test Setup'")
'----- Store selected items -----
CALL InstrWrite(analyzer,"MMEM:STOR:STAT 1,'C:\R_S\Instr\user\TEST1'")
'----- Reset instrument -----
CALL InstrWrite(analyzer,"*RST")
END SUB
REM *****

```

Loading Device Settings

In the following example, data set TEST1 stored under C:\R_S\Instr\user is reloaded into the instrument:

```

REM *****
Public Sub LoadSettings()
'This subroutine loads data set "TEST1" in directory C:\R_S\Instr\user.
'----- Default setting of status register -----
CALL SetupStatusReg           'Configure status register
'----- Load data set -----
CALL InstrWrite(analyzer,"MMEM:LOAD:STAT 1,'C:\R_S\Instr\user\TEST1'")
'----Start measurement using the data set loaded -----
CALL InstrWrite(analyzer,"DISP:TRAC1:MODE WRITE")
                                'Set trace to Clr/Write
CALL InstrWrite(analyzer,"INIT;*WAI")    'Start the sweep
END SUB
REM *****

```

Reading and Writing Files

Reading a File from the Instrument

In the following example, the TEST1.FSL.DFL file stored under C:\R_S\Instr\user is read from the instrument and stored in the controller.

```

REM *****
Public Sub ReadFile()
'----- Generate variables -----
Dim digits As Byte           'Number of digits of
                             'length information
Dim fileBytes As Long       'Length of file with trace data
                             'in bytes
result$ = Space$(100)       'Buffer for simple results
'----- Default setting of status register -----
CALL SetupStatusReg         'Configure status register
'----- Read out file -----
CALL InstrWrite(analyzer, "MMEM:DATA? 'C:\R_S\Instr\user\TEST1.FSL.DFL'")
                             'Select file
CALL ilrd(analyzer, result$, 2) 'Read and store number of
digits = Val(Mid$(result$, 2, 1)) 'digits of length information
CALL ilrd(analyzer, result$, digits) 'Read and store length
fileBytes = Val(Left$(result$, digits)) 'information
FileBuffer$ = Space$(fileBytes) 'Buffer for file
CALL ilrd(analyzer, FileBuffer, fileBytes) 'Read file into buffer
CALL ilrd(analyzer, result$, 1) 'Read terminator <NL>
'----- Store file to controller -----
Open "TEST1.FSL.DFL" For Output As #1
Print #1, FileBuffer;       ' ; to avoid linefeed at
                             ' end of file

Close #1
END SUB
REM *****

```

Creating a File on the Instrument

In the following example, the TEST1.FSL.DFL file available on the controller is stored in the instrument under C:\R_S\Instr\user\DUPLICAT.FSL.DFL.

```

REM *****
Public Sub WriteFile()
'----- Generate variables -----
FileBuffer$ = Space$(100000)           'Buffer for file
Dim digits As Long                     'Number of digits of
                                        'length information
Dim fileBytes As Long                   'Length of file in bytes
fileSize$ = Space$(100)                 'Length of file as a string
result$ = Space$(100)                  'Buffer for simple results
'----- Default setting of status register -----
CALL SetupStatusReg                    'Configure status register
'----- Prepare the definite length block data -----
fileBytes = FileLen("H:\work\vb\test1.set")
                                        'Determine length of file
fileSize$ = Str$(fileBytes)
digits = Len(fileSize$) - 1             'Determine number of digits of
fileSize$ = Right$(fileSize$, digits)  'length information
FileBuffer$ = "#" + Right$(Str$(digits), 1) + fileSize$
                                        'Store length information in
                                        'file buffer
'----- Read file from controller -----
Open "H:\work\vb\TEST1.FSL.DFL" For Binary As #1
FileBuffer$ = FileBuffer$ + Left$(Input(fileBytes, #1), fileBytes)
Close #1
'----- Write file -----
CALL InstrWrite(analyzer, "SYST:COMM:GPIB:RTER EOI") 'Set receive
                                                    'terminator on the
                                                    'instrument
CALL InstrWrite(analyzer, "MMEM:DATA 'file \DUPLICAT.FSL.DFL'," +
  FileBuffer$) 'Select file
END SUB
REM *****

```

Configuring and Starting a Printout

The following example shows the configuration of the output format and output device for printing out the measurement screen.

Proceed in the following order:

1. Set the measurement required for the printout
2. Query available output devices
3. Select an output device
4. Select the output interface
5. Configure the output format
6. Start printout with synchronization to the end

It is assumed that the setting required is a signal with a power of -20 dBm at 100 MHz and that the printer required is the No. 6 of the printers available. The data is first output on the selected printer, then to a file.

REM *****

Public Sub HCopy()

DIM Devices(100) as string 'Buffer for printer name

FOR i = 0 TO 49

 Devices\$(i) = Space\$(50) 'Preallocate buffer for
 'printer name

NEXT i

'----- **R&S FSL default setting** -----

CALL SetupStatusReg 'Configure status register

CALL InstrWrite(analyzer,"*RST") 'Reset instrument

CALL InstrWrite(analyzer,"INIT:CONT OFF") 'Single sweep

CALL InstrWrite(analyzer,"SYST:DISP:UPD ON")
'Display on

'----- **Configure measurement** -----

CALL InstrWrite(analyzer,"FREQ:CENT 100MHz;SPAN 10MHz")
'Set frequency

CALL InstrWrite(analyzer,"DISP:WIND:TRAC:Y:RLEV -10dBm")
'Reference level

CALL InstrWrite(analyzer,"INIT;*WAI") 'Perform measurement

```

'----- Query regarding available output devices -----
CALL InstrWrite(analyzer,"SYST:COMM:PRIN:ENUM:FIRST?")
                                     'Read out first output
CALL InstrRead(analyzer,Devices$(0))   'device and indicate
Debug.Print "Printer 0: "+Devices$(0)  'name
For i = 1 to 99
    CALL InstrWrite(analyzer,"SYST:COMM:PRIN:ENUM:NEXT?")
                                     'Read out the next
    CALL InstrRead(analyzer,Devices$(i)) 'printer name
    IF Left$(Devices$(i),2) = "" THEN GOTO SelectDevice
                                     'Abort at end of list
    Debug.Print "Printer"+Str$(i)+": " Devices$(i)
                                     'Indicate printer name
NEXT i
SelectDevice:
'----- Select device, printer language and output interface -----
CALL InstrWrite(analyzer,"SYST:COMM:PRIN:SEL "+ Devices(6))
                                     'Select printer #6
CALL InstrWrite(analyzer,"HCOP:DEST 'SYST:COMM:PRIN'")
                                     'Configuration:
                                     '"Output to printer interface"
CALL InstrWrite(analyzer,"HCOP:DEV:LANG GDI")
                                     'Output language 'GDI'
'----- Select orientation (portrait/landscape) and color/BW -----
CALL InstrWrite(analyzer,"HCOP:PAGE:ORI PORTRait")
                                     'Portrait
CALL InstrWrite(analyzer,"HCOP:DEV:COL OFF")
                                     'Black and white
'----- Configure and start print out -----
CALL InstrWrite(analyzer,"HCOP:ITEM:ALL")
                                     'Select complete screen
'CALL InstrWrite(analyzer,"HCOP:ITEM:WIND:TRAC:STAT ON")
                                     'alternative: only traces
CALL InstrWrite(analyzer,"*CLS")      'Reset status registers
CALL InstrWrite(analyzer,"HCOP:IMMediate;*OPC")
                                     'Start print out
CALL viEnableEvent(vi, VI_EVENT_SERVICE_REQ, VI_QUEUE, 0)
status = viWaitOnEvent(vi, VI_EVENT_SERVICE_REQ, SRQWaitTimeout, VI_NULL,
VI_NULL)                               'Wait for service request
IF (status = VI_SUCCESS) THEN CALL Srq  'If SRQ is recognized =>
                                     'Subroutine for evaluation

```

```
'---- Print out into file in WMF format (BMP format) -----
CALL InstrWrite(analyzer,"HCOP:DEST 'MMEM'")
                                'Configuration: "Print to file"
CALL InstrWrite(analyzer,"HCOP:DEV:LANG WMF")
                                'File format WMF
'CALL InstrWrite(analyzer,"HCOP:DEV:LANG BMP")
                                'File format BMP
CALL InstrWrite(analyzer,"MMEM:NAME 'C:\R_S\Instr\user\PRINT1.WMF'")
                                'Determine file name
CALL InstrWrite(analyzer,"*CLS")
                                'Reset status registers
CALL InstrWrite(analyzer,"HCOP:IMMEDIATE;*OPC")
                                'Start print out
status = viWaitOnEvent(vi, VI_EVENT_SERVICE_REQ, SRQWaitTimeout, VI_NULL,
VI_NULL)
                                'Wait for service request
IF (status = VI_SUCCESS) THEN CALL Srq
                                'If SRQ is recognized =>
                                'Subroutine for evaluation

END SUB
REM *****
```

Programming Examples of the WLAN TX Measurements Option (K91)

The following section provides some examples of commonly performed operations when using the WLAN TX Measurements option (K91). For more general remote control examples refer to the programming examples chapter in the instrument user manual.

This option is available from firmware version 1.20.

Synchronization Entry of Option

The following example shows how to synchronize entering the WLAN TX Measurements option.

```
analyzer = 20                                'Instrument address
CALL InstrWrite(analyzer, "INST:SEL WLAN;*OPC?")
                                           'waits for 1 from *OPC?
```

Selecting Measurements

Measurements are selected using the command `CONFigure:BURSt:<Meas Type>` where `<Meas Type>` is as follows:

<code><Meas Type></code>	Measurement Type
PVT	Power vs Time (PVT)
PVT:SElect:EDGE	PVT rising and falling edge
PVT:SElect:FULL	PVT full burst (802.11a only)
PVT:SElect:RISE	PVT rising burst (802.11b only)
PVT:SElect:FALL	PVT falling burst (802.11b only)
EVM:ECARrier	EVM vs Carrier
EVM:ESYMBOL	EVM vs Symbol
SPECTrum:MASK	Spectrum Mask
SPECTrum:MASK:SElect:IEEE	Spectrum Mask IEEE
SPECTrum:MASK:SElect:ETSI	Spectrum Mask ETSI
SPECTrum:FLATness	Spectrum Flatness
SPECTrum:FFT	Spectrum FFT
SPECTrum:ACPR	Spectrum ACPR
CONstellation:CCARrier	Constellation vs Carrier
CONstellation:CSYMBOL	Constellation vs Symbol

<Meas Type>	Measurement Type
STATistics:CCDF	CCDF
STATistics:BSTReam	Bit Steam
STATistics:SField	Signal Field

The following example shows how to select a Spectrum Mask ETSI measurement:

```
REM select Spectrum Mask Select ETSI
CALL InstrWrite(analyzer, "SPECTrum:MASK:SElect:ETSI")
```

Running Synchronized Measurements

The following examples show how measurements can be synchronized. Synchronization is necessary to ensure that the measurement has completed before the measurement results and markers are requested.

PUBLIC SUB SweepSync ()

```
REM The command INITiate[:IMMEDIATE] starts a single sweep if the
REM command INIT:CONT OFF was previously sent. It should be ensured that
REM the next command is only then executed when the entire sweep is
REM complete.
CALL InstrWrite(analyzer, "INIT:CONT OFF")
REM ----- First possibility: Use of *WAI -----
CALL InstrWrite(analyzer, "INIT:IMM;*WAI")
REM ----- Second possibility: Use of *OPC? -----
OpcOk$ = SPACE$(2) 'Space for *OPC?           'Provide response
CALL InstrWrite(analyzer, "INIT:IMM;*OPC?")
REM ----- Here the controller can service other instrument-----
CALL InstrRead(analyzer, OpcOk$)           'Wait for "1" from *OPC?
REM ----- Third possibility: Use of *OPC -----
REM In order to be able to use the service request function in
REM conjugation with a National Instruments GPIB driver, the setting
REM "Disable Auto Serial Poll" must be changed to "yes" by means of
REM the GPIB configuration
REM (e.g. Windows Start menu: Settings -> Control Panel -> GPIB)!
CALL InstrWrite(analyzer, "*SRE 32")       'Permit service request for ESR
CALL InstrWrite(analyzer, "*ESE 1")       'Set event-enable bit for
                                           'operation-complete bit
CALL InstrWrite(analyzer, "INIT:IMM;*OPC") 'Start sweep and
                                           'synchronize with OPC
status = viWaitOnEvent(vi, VI_EVENT_SERVICE_REQ, SRQWaitTimeout, VI_NULL,
VI_NULL)                                  'Wait for service request
```

```

REM ----- Fourth possibility: Use of INIT:IMM -----
REM In order to be able to use the service request function in
REM conjugation with a National Instruments GPIB driver, the setting
REM "Disable Auto Serial Poll" must be changed to "yes" by means of
REM the GPIB configuration
REM (e.g. Windows Start menu: Settings -> Control Panel -> GPIB)!
CALL InstrWrite(analyzer, "*SRE 128")      'Permit service request for ESR
CALL InstrWrite(analyzer, "*ESE 0")        'Set event-enable bit for
                                           'operation-complete bit
CALL InstrWrite(analyzer, "STATus:OPERation:ENABLE 16")
                                           'Enable bit 4 of status operation
                                           'register'
CALL InstrWrite(analyzer, "STAT:OPERation:NTRansition 16")
                                           'Set Negative transition to 1
CALL InstrWrite(analyzer, "STATus:OPERation:PTRansition 0")
                                           'Set Positive transition to 0
CALL InstrWrite(analyzer, "INIT:IMM")      'Start sweep and synchronize with
                                           'OPC

status = viWaitOnEvent(vi, VI_EVENT_SERVICE_REQ, SRQWaitTimeout, VI_NULL,
VI_NULL)                                'Wait for service request

REM Continue main program here.

END SUB

REM *****

```

Programming Examples of the WiMAX 802.16 OFDM Measurements Option (K92)

The following section provides some examples of commonly performed operations when using the WiMAX 802.16 OFDM Measurements option (K92). For more general remote control examples refer to the programming examples chapter in the instrument user manual.

This option is available from firmware version 1.40.

Synchronization Entry of Option

The following example shows how to synchronize entering the WLAN TX Measurements option.

```
analyzer = 20                                'Instrument address
CALL InstrWrite(analyzer, "INST:SEL WLAN;*OPC?")
                                                'waits for 1 from *OPC?
```

Selecting Measurements

Measurements are selected using the command `CONFigure:BURSt:<Meas Type>` where `<Meas Type>` is as follows:

<code><Meas Type></code>	Measurement Type
PVT	Power Vs Time (PVT)
PVT:SElect:EDGE	PVT Start and End
PVT:SElect:FULL	PVT full burst
EVM:ECARrier	EVM Vs Carrier
EVM:ESYMBOL	EVM Vs Symbol
SPECTrum:MASK	Spectrum Mask
SPECTrum:MASK:SElect:IEEE	Spectrum Mask IEEE
SPECTrum:MASK:SElect:ETSI	Spectrum Mask ETSI
SPECTrum:FLATness	Spectrum Flatness
SPECTrum:FLATness:SElect FLATNESS	Spectrum Flatness
SPECTrum:FLATness:SElect GRDELAY	Spectrum Flatness – Group Delay
SPECTrum:FLATness:SElect DIFFERENCE	Spectrum Flatness – Difference
SPECTrum:FFT	Spectrum FFT
SPECTrum:ACPR	Spectrum ACPR
SPECTrum:ACPR:SElect ABS	Spectrum ACPR (Absolute)

<Meas Type>	Measurement Type
SPECTrum:ACPR:SElect REL	Spectrum ACPR (Relative)
CONSt:CCARrier	Constellation Vs Carrier
CONSt:CSYMBOL	Constellation Vs Symbol
STATistics:CCDF	CCDF
STATistics:BSTReam	Bit Steam
STATistics:BSUMmary	Burst Summary
PREamble	Preamble Error
PREamble:SElect FREQ	Frequency Error Vs Preamble
PREamble:SElect PHASE	Phase Error Vs Preamble

The following example shows how to select a Spectrum Mask ETSI measurement:

```
REM select Spectrum Mask Select ETSI
CALL InstrWrite(analyzer, "SPECTrum:MASK:SElect:ETSI")
```

Running Synchronized Measurements

The following examples show how measurements can be synchronized. Synchronization is necessary to ensure that the measurement has completed before the measurement results and markers are requested.

PUBLIC SUB SweepSync ()

```
REM The command INITiate[:IMMediate] starts a single sweep if the
REM command INIT:CONT OFF was previously sent. It should be ensured that
REM the next command is only then executed when the entire sweep is
REM complete.
CALL InstrWrite(analyzer, "INIT:CONT OFF")
REM ----- First possibility: Use of *WAI -----
CALL InstrWrite(analyzer, "INIT:IMM;*WAI")
REM ----- Second possibility: Use of *OPC? -----
OpcOk$ = SPACE$(2) 'Space for *OPC?           'Provide response
CALL InstrWrite(analyzer, "INIT:IMM;*OPC?")
REM ----- Here the controller can service other instrument-----
CALL InstrRead(analyzer, OpcOk$)           'Wait for "1" from *OPC?
```

```

REM ----- Third possibility: Use of *OPC -----
REM In order to be able to use the service request function in
REM conjugation with a National Instruments GPIB driver, the setting
REM "Disable Auto Serial Poll" must be changed to "yes" by means of
REM the GPIB configuration
REM (e.g. Windows Start menu: Settings -> Control Panel -> GPIB)!
CALL InstrWrite(analyzer, "*SRE 32")      'Permit service request for ESR
CALL InstrWrite(analyzer, "*ESE 1")      'Set event-enable bit for
                                         'operation-complete bit
CALL InstrWrite(analyzer, "INIT:IMM;*OPC") 'Start sweep and
                                         'synchronize with OPC

status = viWaitOnEvent(vi, VI_EVENT_SERVICE_REQ, SRQWaitTimeout, VI_NULL,
VI_NULL)                                'Wait for service request

REM ----- Fourth possibility: Use of INIT:IMM -----
REM In order to be able to use the service request function in
REM conjugation with a National Instruments GPIB driver, the setting
REM "Disable Auto Serial Poll" must be changed to "yes" by means of
REM the GPIB configuration
REM (e.g. Windows Start menu: Settings -> Control Panel -> GPIB)!
CALL InstrWrite(analyzer, "*SRE 128")    'Permit service request for ESR
CALL InstrWrite(analyzer, "*ESE 0")      'Set event-enable bit for
                                         'operation-complete bit

CALL InstrWrite(analyzer, "STATus:OPERation:ENABle 16")
                                         'Enable bit 4 of status operation
                                         'register'

CALL InstrWrite(analyzer, "STAT:OPERation:NTRansition 16")
                                         'Set Negative transition to 1

CALL InstrWrite(analyzer, "STATus:OPERation:PTRansition 0")
                                         'Set Positive transition to 0

CALL InstrWrite(analyzer, "INIT:IMM")    'Start sweep and synchronize with
                                         'OPC

status = viWaitOnEvent(vi, VI_EVENT_SERVICE_REQ, SRQWaitTimeout, VI_NULL,
VI_NULL)                                'Wait for service request

REM Continue main program here.

END SUB

REM *****

```

Contents of Chapter 8

- 8 Maintenance 8.1**
- Cleaning the Outside.....8.1
- Storing and Packing.....8.1
- List of Power Cables Available8.1

8 Maintenance

The following chapter contains information on the maintenance of the R&S FSL. The instrument does not need a periodic maintenance. What is necessary is essentially the cleaning of the instrument. However, it is recommended to check the rated data from time to time.

Follow the instructions in the service manual and the safety instructions when exchanging modules or ordering spares. The order no. for spare parts is included in the service manual. The service manual includes further information particularly on troubleshooting, repair, exchange of modules (including battery exchange, adjustment of the OCXO oscillator) and alignment.

The address of our support center and a list of all Rohde & Schwarz service centers can be found at the beginning of this manual.

Cleaning the Outside

The outside of the instrument is suitably cleaned using a soft, line-free dust cloth. Make sure that vents are not obstructed.



ATTENTION

Never use solvents such as thinners, acetone and similar things, as they may damage the front panel labeling or plastic parts.

Storing and Packing

The storage temperature range of the instrument is given in the data sheet. If the instrument is to be stored for a longer period of time, it must be protected against dust.

Repack the instrument as it was originally packed when transporting or shipping. The two protective foam plastic parts prevent the control elements and connectors from being damaged. The antistatic packing foil avoids any undesired electrostatic charging to occur.

If you do not use the original packaging, provide for sufficient padding to prevent the instrument from slipping inside the package. Wrap antistatic packing foil around the instrument to protect it from electrostatic charging.

List of Power Cables Available

Table 8–1 List of power cables available

Stock No.	Earthed-contact connector	Preferably used in
DS 006.7013.00	BS1363: 1967' complying with IEC 83: 1975 standard B2	Great Britain
DS 006.7020.00	Type 12 complying with SEV-regulation 1011.1059, standard sheet S 24 507	Switzerland

Stock No.	Earthed-contact connector	Preferably used in
DS 006.7036.00	Type 498/13 complying with US-regulation UL 498, or with IEC 83	USA/Canada
DS 006.7107.00	Type SAA3 10 A, 250 V, complying with AS C112-1964 Ap.	Australia
DS 0025.2365.00 DS 0099.1456.00	DIN 49 441, 10 A, 250 V, angular DIN 49 441, 10 A, 250 V, straight	Europe (except Switzerland)

Contents of Chapter 9

9 Error Messages	9.1
SCPI-Specific Error Messages	9.1
Device-Specific Messages	9.7
WLAN TX Measurements Option Messages (K91)	9.8
WiMAX 802.16 OFDM Measurements Option Messages (K92)	9.9

9 Error Messages

Error messages are entered in the error/event queue of the status reporting system in the remote control mode and can be queried with the command `SYSTem:ERRor?`. The answer format of R&S FSL to the command is as follows:

```
<error code>, "<error text with queue query>;
<remote control command concerned>"
```

The indication of the remote control command with prefixed semicolon is optional.

Example:

The command `"TEST:COMMAND"` generates the following answer to the query `SYSTem:ERRor?` :

```
-113,"Undefined header;TEST:COMMAND"
```

The subsequent list contains the description of error texts displayed on the instrument.

Distinction is made between error messages defined by SCPI, which are marked by negative error codes, and the device-specific error messages for which positive error codes are used.

The right-hand column in the following tables contains the error text in bold which is entered in the error/event queue and can be read out by means of query `SYSTem:ERRor?`. A short explanation of the error cause is given below. The left-hand column contains the associated error code.

SCPI-Specific Error Messages

No Error

Error code	Error text in the case of queue poll Error explanation
0	No error This message is displayed if the error queue does not contain any entries.

Command Error – Faulty command; sets bit 5 in the ESR register.

Error code	Error text in the case of queue poll Error explanation
-100	Command Error The command is faulty or invalid.
-101	Invalid Character The command contains an invalid sign. Example: A header contains an ampersand, " SENSe& ".

Error code	Error text in the case of queue poll Error explanation
-102	Syntax error The command is invalid. Example: The command contains block data the instrument does not accept.
-103	Invalid separator The command contains an invalid sign instead of a separator. Example: A semicolon is missing after the command.
-104	Data type error The command contains an invalid value indication. Example: ON is indicated instead of a numeric value for frequency setting.
-105	GET not allowed A Group Execute Trigger (GET) is within a command line.
-108	Parameter not allowed The command contains too many parameters. Example: Command SENSe:FREQuency:CENTer permits only one frequency indication.
-109	Missing parameter The command contains too few parameters. Example: The command SENSe:FREQuency:CENTer requires a frequency indication.
-110	Command header error The header of the command is faulty.
-111	Header separator error The header contains an invalid separator. Example: the header is not followed by a "White Space", " *ESE255 "
-112	Program mnemonic too long The header contains more than 12 characters.
-113	Undefined header The header is not defined for the instrument. Example: *XYZ is undefined for every instrument.
-114	Header suffix out of range The header contains an invalid numeric suffix. Example: SENSe3 does not exist in the instrument.
-120	Numeric data error The command contains a faulty numeric parameter.
-121	Invalid character in number A number contains an invalid character. Example: An "A" in a decimal number or a "9" in an octal number.
-123	Exponent too large The absolute value of the exponent is greater than 32000.
-124	Too many digits The number includes too many digits.
-128	Numeric data not allowed The command includes a number which is not allowed at this position. Example: The command INPut:COUPLing requires indication of a text parameter.
-130	Suffix error The command contains a faulty suffix.

Error code	Error text in the case of queue poll Error explanation
-131	Invalid suffix The suffix is invalid for this instrument. Example: nHz is not defined.
-134	Suffix too long The suffix contains more than 12 characters.
-138	Suffix not allowed A suffix is not allowed for this command or at this position of the command. Example: The command *RCL does not permit a suffix to be indicated.
-140	Character data error The command contains a faulty text parameter
-141	Invalid character data The text parameter either contains an invalid character or it is invalid for this command. Example: Write error with parameter indication;INPut:COUPLing XC.
-144	Character data too long The text parameter contains more than 12 characters.
-148	Character data not allowed The text parameter is not allowed for this command or at this position of the command. Example: The command *RCL requires a number to be indicated.
-150	String data error The command contains a faulty string.
-151	Invalid string data The command contains a faulty string. Example: An END message has been received prior to the terminating apostrophe.
-158	String data not allowed The command contains an allowed string at an invalid position. Example: A text parameter is set in quotation marks, INPut:COUPLing "DC"
-160	Block data error The command contains faulty block data.
-161	Invalid block data The command contains faulty block data. Example: An END message was received prior to reception of the expected number of data.
-168	Block data not allowed The command contains allowed block data at an invalid position. Example: The command *RCL requires a number to be indicated.
-170	Expression error The command contains an invalid mathematical expression.
-171	Invalid expression The command contains an invalid mathematical expression. Example: The expression contains mismatching parentheses.
-178	Expression data not allowed The command contains a mathematical expression at an invalid position.

Execution Error – Error on execution of a command; sets bit 4 in the ESR register

Error code	Error text in the case of queue poll Error explanation
-200	Execution error Error on execution of the command.
-201	Invalid while in local The command is not executable while the device is in local due to a hard local control. Example: The device receives a command which would change the rotary knob state, but the device is in local so the command can not be executed.
-202	Settings lost due to rtl A setting associated with hard local control was lost when the device changed to LOCS from REMS or to LWLS from RWLS.
-210	Trigger error Error on triggering the device.
-211	Trigger ignored The trigger (GET, *TRG or trigger signal) was ignored because of device timing considerations. Example: The device was not ready to respond.
-212	Arm ignored An arming signal was ignored by the device.
-213	Init ignored Measurement initialization was ignored as another measurement was already in progress.
-214	Trigger deadlock The trigger source for the initiation of measurement is set to GET and subsequent measurement is received. The measurement cannot be started until a GET is received, but the GET would cause an interrupted-error)
-215	Arm deadlock The trigger source for the initiation of measurement is set to GET and subsequent measurement is received. The measurement cannot be started until a GET is received, but the GET would cause an interrupted-error.
-220	Parameter error The command contains a faulty or invalid parameter.
-221	Settings conflict There is a conflict between setting of parameter value and instrument state.
-222	Data out of range The parameter value lies out of the allowed range of the instrument.
-223	Too much data The command contains too many data. Example: The instrument does not have sufficient storage space.
-224	Illegal parameter value The parameter value is invalid. Example: The text parameter is invalid , <code>TRIGger : SWEEp : SOURce TASTE</code>
-230	Data corrupt or stale The data are incomplete or invalid. Example: The instrument has aborted a measurement.
-231	Data questionable The measurement accuracy is suspect.

Error code	Error text in the case of queue poll Error explanation
-240	Hardware error The command cannot be executed due to problems with the instrument hardware.
-241	Hardware missing Hardware is missing. Example: An option is not fitted.
-250	Mass storage error A mass storage error occurred.
-251	Missing mass storage The mass storage is missing. Example: An option is not installed.
-252	Missing media The media is missing. Example: There is no floppy in the floppy disk drive.
-253	Corrupt media The media is corrupt. Example: The floppy is bad or has the wrong format.
-254	Media full The media is full. Example: There is no room on the floppy.
-255	Directory full The media directory is full.
-256	File name not found The file name cannot be found on the media.
-257	File name error The file name is wrong. Example: An attempt is made to copy to a duplicate file name.
-258	Media protected The media is protected. Example: The write-protect tab on the floppy is present.
-260	Expression error The expression contains an error.

Device Specific Error; sets bit 3 in the ESR register

Error code	Error text in the case of queue poll Error explanation
-300	Device-specific error R&S FSL-specific error not defined in greater detail.
-310	System error This error message suggests an error within the instrument. Please inform the R&S Service.
-313	Calibration memory lost Loss of the non-volatile data stored using the *CAL? command. This error occurs when the correction data recording has failed.

Error code	Error test in the case of queue poll Error explanation
-330	Self-test failed The self test could not be executed.
-350	Queue overflow This error code is entered in the queue instead of the actual error code if the queue is full. It indicates that an error has occurred but not been accepted. The queue can accept 5 entries.

Query Error – Error in data request; sets bit 2 in the ESR register

Error code	Error text in the case of queue poll Error explanation
-400	Query error General error occurring when data are requested by a query.
-410	Query INTERRUPTED The query has been interrupted. Example: After a query, the instrument receives new data before the response has been sent completely.
-420	Query UNTERMINATED The query is incomplete. Example: The instrument is addressed as a talker and receives incomplete data.
-430	Query DEADLOCKED The query cannot be processed. Example: The input and output buffers are full, the instrument cannot continue operation.
-440	Query UNTERMINATED after indefinite response A query is in the same command line after a query which requests an indefinite response.

Device-Specific Messages

Error code	Error text in the case of queue poll Error explanation
1052	Frontend LO is Unlocked This message is displayed when the phase regulation of the local oscillator fails in the RF front-end.
1060	Trigger-Block Gate Delay Error- gate length < Gate Delay This message is displayed when the gate signal length is not sufficient for the pull-in delay with a predefined gate delay.
1064	Tracking LO is Unlocked This message is displayed when the phase regulation of the local oscillator fails on the tracking generator module.

Error code	Error text in the case of queue poll Error explanation
2028	Hardcopy not possible during measurement sequence This message is displayed when a printout is started during scan sequences that cannot be interrupted. Such sequences are for example: <ul style="list-style-type: none"> • Recording the system error correction data (alignment) • Instrument self test In such cases synchronization to the end of the scan sequence should be performed prior to starting the printout.
2033	Printer Not Available This message is displayed when the selected printer is not included in the list of available output devices. A possible cause is that the required printer driver is missing or incorrectly installed.
2034	CPU Temperature is too high This message is displayed when the temperature of the processor exceeds 70 °C.

WLAN TX Measurements Option Messages (K91)

The list of possible warning & error messages are shown below.

This option is available from firmware version 1.20.

Status Bar Message	Description
Gate length too small – must be greater than 1	This message is only displayed for the FFT measurement. This message indicates that there are no samples contained within the gating lines. Increase the Gate length and then, in the sweep menu, press the Refresh softkey to remove this error.
No valid analyzed bursts within gating lines	This message is only displayed for the PVT measurement. This message indicates that there are no complete & valid bursts contained within the gating lines. Increase the Gate length and then, in the sweep menu, press the Refresh softkey to remove this error.
No bursts found	<p>This message is displayed if no valid burst was detected in the input data. To correct this problem check the following:</p> <p>The connections between the DUT and analyzer are correct.</p> <p>The input signal is of a sufficient level.</p> <p>The capture time is long enough to capture at least one complete burst. If running with a Free Run trigger then the capture time must be greater than the burst length (ideally at least twice the burst length) to ensure that a complete burst is recorded.</p> <p>Check that the demod settings are correct.</p>
No bursts of desired type to analyze	This message is displayed if bursts are found, but none of desired type to analyse. Check that the setting for Burst Type is correct.
No signal found	This message is displayed when an automatic level detection measurement is executed and the measured signal level is lower the permitted minimum value.
No power trigger for Spectrum Mask ETSI	This message is displayed when the Spectrum Mask ETSI measurement is selected whilst the trigger is set to power. No action is required as the trigger is automatically set to Free Run in this case.
Signal overload detected	This message is displayed when the OVLD enhancement label is displayed and indicates that the input mixer is overloaded. If this message is displayed then try increasing the setting for the Signal Level parameter (or settings Auto Level). If this does not clear the problem then an external attenuation may need to be applied.

WiMAX 802.16 OFDM Measurements Option Messages (K92)

The list of possible warning & error messages are shown below.

This option is available from firmware version 1.40.

Status Bar Message	Description
Gate length too small – must be greater than 1	This message is only displayed for the FFT measurement. This message indicates that there are no samples contained within the gating lines. Increase the Gate length and then, in the sweep menu, press the Refresh softkey to remove this error.
No valid analyzed bursts within gating lines	This message is only displayed for the PVT measurement. This message indicates that there are no complete & valid bursts contained within the gating lines. Increase the Gate length and then, in the sweep menu, press the Refresh softkey to remove this error.
No bursts found	<p>This message is displayed if no valid burst was detected in the input data. To correct this problem check the following:</p> <p>The connections between the DUT and analyzer are correct.</p> <p>The input signal is of a sufficient level.</p> <p>The capture time is long enough to capture at least one complete burst. If running with a Free Run trigger then the capture time must be greater than the burst length (ideally at least twice the burst length) to ensure that a complete burst is recorded.</p> <p>Check that the demodulation settings are correct.</p>
No bursts of desired type to analyze	This message is displayed if bursts are found, but none of desired type to analyze. Check that the setting for Burst Type is correct.
No signal found	This message is displayed when an automatic level detection measurement is executed and the measured signal level is lower the permitted minimum value.
Signal overload detected	This message is displayed when the OVLD enhancement label is displayed and indicates that the input mixer is overloaded. If this message is displayed then try increasing the setting for the Signal Level parameter (or settings Auto Level). If this does not clear the problem then an external attenuation may need to be applied.

Index

*

* (enhancement label) 4.35
 *CAL? 6.538
 *CLS 6.538
 *ESE 6.538
 *ESR? 6.538
 *IDN? 6.538
 *IST? 6.539
 *OPC 6.539
 *OPT? 6.539
 *PCB 6.540
 *PRE 6.540
 *PSC 6.540
 *RST 6.540
 *SRE 6.540
 *STB? 6.540
 *TRG 6.541
 *TST? 6.541
 *WAI 6.541

A

abbreviations (K92) 2.121
 ABORt 6.5
 addressed command 5.35
 adjacent-channel power
 number of channels 4.71
 Adjacent-Channel Power measurement (K8) 4.121
 adjustment
 attenuation (K20) 4.153
 AF trigger (K7) 4.102
 alignment results 4.267
 AM demodulation 4.50
 AM modulation depth 4.68
 amplitude menu 4.12
 amplitude menu (K20) 4.169
 amplitude menu (K7) 4.113
 amplitude menu (K8) 4.128
 amplitude menu (K91) 4.196
 amplitude menu (K92) 4.231
 AMPT key 4.12
 analog demodulation
 AF trigger (K7) 4.102
 bandwidth (K7) 4.102
 circuit description (K7) 4.101
 measurement results (K7) 4.102
 measurement time (K7) 4.103
 sample rate (K7) 4.103
 trigger offset (K7) 4.103
 analog demodulation (K7) 4.100
 analog demodulation menu (K7) 4.100, 4.103
 Analog Demodulation mode (K7) 4.91
 analysis steps (K92) 2.127
 annotation 4.271
 antenna gain (K8) 4.124
 ASCII # 5.10
 attenuation
 adjustment (K20) 4.153
 automatic 4.13
 manual 4.13, 6.108
 auto level (K91) 2.103
 auto level (K92) 2.120
 Auto Peak detector 4.36

Average detector 4.36
 Average mode 4.34
 averaging
 continuous sweep 4.35
 single sweep 4.35
 sweep count 4.35

B

bandwidth
 occupied 4.63
 occupied (K20) 2.88
 resolution 4.18
 resolution (K7) 4.115
 video 4.18
 bandwidth menu 4.18
 bandwidth menu (K7) 4.115
 bandwidth menu (K8) 4.130
 bar graph (K9) 4.142
 BD_ADDR (K8) 4.124
 Blank mode 4.35
 block data 5.10
 Bluetooth device address (K8) 4.124
 Bluetooth menu (K8) 4.118, 4.122
 Bluetooth mode (K8) 4.91
 menus 4.118
 Boolean parameter 5.9
 BW key 4.15

C

Cable TV Analyzer menu (K20) 4.145
 Cable TV Analyzer mode (K20) 4.91
 menus 4.145
 cable TV measurement
 APD – digital TV (K20) 4.163
 C/N – analog TV (K20) 4.156
 Carriers – analog TV (K20) 4.155
 CCDF – digital TV (K20) 4.164
 Channel Power – digital TV (K20) 4.163
 Constellation Diagram – digital TV (K20) 4.161
 CSO – analog TV (K20) 4.157
 CTB – analog TV (K20) 4.158
 display labels (K20) 4.154
 Echo Pattern – digital TV (K20) 4.162
 Hum – analog TV (K20) 4.160
 Modulation Errors – digital TV (K20) 4.162
 Overview – digital TV (K20) 4.161
 Spectrum – analog TV (K20) 4.155
 Spectrum – digital TV (K20) 4.160
 status bar information (K20) 4.151
 Tilt – TV analyzer (K20) 4.164
 Video Scope – analog TV (K20) 4.159
 Vision Modulation – analog TV (K20) 4.159
 with channel table (K20) 4.150
 without channel table (K20) 4.150
 Cable TV Measurements menu (K20) 4.165
 CALCulate<1|2>: UNIT:ANGLE (K7) 6.191
 CALCulate<1|2>:ATV:LIMit:CARRiers:S1IOffset:LOWer (K20) 6.282
 CALCulate<1|2>:ATV:LIMit:CARRiers:S1IOffset:UPPer (K20) 6.282
 CALCulate<1|2>:ATV:LIMit:CARRiers:S1PRelative:LOWer (K20) 6.283

CALCulate<1|2>:ATV:LIMit:CARRiers:S1PRelative:UPPer (K20) 6.283
 CALCulate<1|2>:ATV:LIMit:CARRiers:S2IFffset:LOWer (K20) 6.283
 CALCulate<1|2>:ATV:LIMit:CARRiers:S2IFffset:UPPer (K20) 6.284
 CALCulate<1|2>:ATV:LIMit:CARRiers:S2PRelative:LOWer (K20) 6.284
 CALCulate<1|2>:ATV:LIMit:CARRiers:S2PRelative:UPPer (K20) 6.284
 CALCulate<1|2>:ATV:LIMit:CARRiers:VCFoffse:LOWer (K20) 6.285
 CALCulate<1|2>:ATV:LIMit:CARRiers:VCFoffse:UPPer (K20) 6.285
 CALCulate<1|2>:ATV:LIMit:CARRiers:VCPabsolute:LOWer (K20) 6.285
 CALCulate<1|2>:ATV:LIMit:CARRiers:VCPabsolute:UPPer (K20) 6.286
 CALCulate<1|2>:ATV:LIMit:CN:CN[:LOWer] (K20) 6.286
 CALCulate<1|2>:ATV:LIMit:CSO:CSO[:LOWer] (K20) 6.286
 CALCulate<1|2>:ATV:LIMit:CTB:CTB[:LOWer] (K20) 6.287
 CALCulate<1|2>:ATV:LIMit:HUM:HUM:LOWer (K20) 6.287
 CALCulate<1|2>:ATV:LIMit:HUM:HUM:UPPer (K20) 6.287
 CALCulate<1|2>:ATV:LIMit:RESult:CARRiers:S1IFffset:LOWer? (K20) 6.291
 CALCulate<1|2>:ATV:LIMit:RESult:CARRiers:S1IFffset:UPPer? (K20) 6.291
 CALCulate<1|2>:ATV:LIMit:RESult:CARRiers:S1PRelative:LOWer? (K20) 6.291
 CALCulate<1|2>:ATV:LIMit:RESult:CARRiers:S1PRelative:UPPer? (K20) 6.292
 CALCulate<1|2>:ATV:LIMit:RESult:CARRiers:S2IFffset:LOWer? (K20) 6.292
 CALCulate<1|2>:ATV:LIMit:RESult:CARRiers:S2IFffset:UPPer? (K20) 6.293
 CALCulate<1|2>:ATV:LIMit:RESult:CARRiers:S2PRelative:LOWer? (K20) 6.293
 CALCulate<1|2>:ATV:LIMit:RESult:CARRiers:S2PRelative:UPPer? (K20) 6.293
 CALCulate<1|2>:ATV:LIMit:RESult:CARRiers:VCFoffse:LOWer? (K20) 6.294
 CALCulate<1|2>:ATV:LIMit:RESult:CARRiers:VCFoffse:UPPer? (K20) 6.294
 CALCulate<1|2>:ATV:LIMit:RESult:CARRiers:VCPabsolute:LOWer? (K20) 6.295
 CALCulate<1|2>:ATV:LIMit:RESult:CARRiers:VCPabsolute:UPPer? (K20) 6.295
 CALCulate<1|2>:ATV:LIMit:RESult:CN:CN[:LOWer]? (K20) 6.295
 CALCulate<1|2>:ATV:LIMit:RESult:CSO:CSO[:LOWer]? (K20) 6.296
 CALCulate<1|2>:ATV:LIMit:RESult:CTB:CTB[:LOWer]? (K20) 6.296
 CALCulate<1|2>:ATV:LIMit:RESult:HUM:HUM:LOWer? (K20) 6.297
 CALCulate<1|2>:ATV:LIMit:RESult:HUM:HUM:UPPer? (K20) 6.297
 CALCulate<1|2>:ATV:LIMit:RESult:VMODulation:MDEPth:LOWer? (K20) 6.297
 CALCulate<1|2>:ATV:LIMit:RESult:VMODulation:MDEPth:UPPer? (K20) 6.298
 CALCulate<1|2>:ATV:LIMit:RESult:VMODulation:RPC:LOWer? (K20) 6.298
 CALCulate<1|2>:ATV:LIMit:RESult:VMODulation:RPC:UPPer? (K20) 6.299
 CALCulate<1|2>:ATV:LIMit:RESult:VMODulation:VCPower:LOWer? (K20) 6.299
 CALCulate<1|2>:ATV:LIMit:RESult:VMODulation:VCPower:UPPer? (K20) 6.299
 CALCulate<1|2>:ATV:LIMit:VMODulation:MDEPth:LOWer (K20) 6.288
 CALCulate<1|2>:ATV:LIMit:VMODulation:MDEPth:UPPer (K20) 6.288
 CALCulate<1|2>:ATV:LIMit:VMODulation:RPC:LOWer (K20) 6.288
 CALCulate<1|2>:ATV:LIMit:VMODulation:RPC:UPPer (K20) 6.289
 CALCulate<1|2>:ATV:LIMit:VMODulation:VCPower:LOWer (K20) 6.289
 CALCulate<1|2>:ATV:LIMit:VMODulation:VCPower:UPPer (K20) 6.289
 CALCulate<1|2>:ATV:RESult:CARRiers (K20) 6.300
 CALCulate<1|2>:ATV:RESult:CN (K20) 6.301
 CALCulate<1|2>:ATV:RESult:CSO (K20) 6.301
 CALCulate<1|2>:ATV:RESult:CTB (K20) 6.302
 CALCulate<1|2>:ATV:RESult:HUM (K20) 6.303
 CALCulate<1|2>:ATV:RESult:VMODulation (K20) 6.303
 CALCulate<1|2>:ATV:UNIT:POWer:HUM (K20) 6.304
 CALCulate<1|2>:ATV:UNIT:POWer:VCPabsolute (K20) 6.304
 CALCulate<1|2>:BTOoth:ACLR[:LIST]? (K8) 6.228
 CALCulate<1|2>:BTOoth:ACLR:EXceptions? (K8) 6.228
 CALCulate<1|2>:BTOoth:CFDRift[:MAXimum]? (K8) 6.229
 CALCulate<1|2>:BTOoth:CFDRift:RATE? (K8) 6.229
 CALCulate<1|2>:BTOoth:CFStability:COUNt? 6.230
 CALCulate<1|2>:BTOoth:CFStability:DEVM[:RMS]? 6.230
 CALCulate<1|2>:BTOoth:CFStability:DEVM:D99Pct? 6.231
 CALCulate<1|2>:BTOoth:CFStability:DEVM:PEAK? 6.231
 CALCulate<1|2>:BTOoth:CFStability:FERRor:[TOTAl]? 6.232
 CALCulate<1|2>:BTOoth:CFStability:FERRor:BLOCK? 6.232
 CALCulate<1|2>:BTOoth:CFStability:FERRor:INITial? 6.233
 CALCulate<1|2>:BTOoth:DPENcoding:[TOTAl]? 6.233
 CALCulate<1|2>:BTOoth:DPENcoding:BER? 6.234
 CALCulate<1|2>:BTOoth:DPENcoding:NERror? 6.234
 CALCulate<1|2>:BTOoth:IBSemiissions:[List]? 6.235
 CALCulate<1|2>:BTOoth:IBSemiissions:EXceptions? 6.235
 CALCulate<1|2>:BTOoth:IBSemiissions:HADJacent? 6.236
 CALCulate<1|2>:BTOoth:ICFTolerance? (K8) 6.236
 CALCulate<1|2>:BTOoth:MCHar:DF<1|2>:AVERAge? (K8) 6.237
 CALCulate<1|2>:BTOoth:MCHar:DF<1|2>:MAXimum? (K8) 6.238
 CALCulate<1|2>:BTOoth:MCHar:DF2:PERCent? (K8) 6.238
 CALCulate<1|2>:BTOoth:MCHar:RATio? (K8) 6.239
 CALCulate<1|2>:BTOoth:OPOWer[:PEAK]? (K8) 6.240
 CALCulate<1|2>:BTOoth:OPOWer:AVERAge? (K8) 6.240
 CALCulate<1|2>:BTOoth:PLENgtH? (K8) 6.241
 CALCulate<1|2>:BTOoth:PTYPE? (K8) 6.241
 CALCulate<1|2>:BTOoth:RTPower[:DPSK]? 6.242
 CALCulate<1|2>:BTOoth:RTPower:GFSK? 6.243
 CALCulate<1|2>:BTOoth:RTPower:RATio? 6.243
 CALCulate<1|2>:BTOoth:STATus? (K8) 6.244
 CALCulate<1|2>:BURSt[:IMMediate] (K91) 6.380
 CALCulate<1|2>:BURSt[:IMMediate] (K92) 6.460
 CALCulate<1|2>:DELtAmarker<1...4>[:STATe] 6.7
 CALCulate<1|2>:DELtAmarker<1...4>:AOFF 6.7
 CALCulate<1|2>:DELtAmarker<1...4>:FUNCTION:FIXed[:S TATE] 6.8
 CALCulate<1|2>:DELtAmarker<1...4>:FUNCTION:FIXed:RP Oint:MAXimum[:PEAK] 6.8
 CALCulate<1|2>:DELtAmarker<1...4>:FUNCTION:FIXed:RP Oint:X 6.9
 CALCulate<1|2>:DELtAmarker<1...4>:FUNCTION:FIXed:RP Oint:Y 6.9
 CALCulate<1|2>:DELtAmarker<1...4>:FUNCTION:FIXed:RP Oint:Y:OFFSet 6.9
 CALCulate<1|2>:DELtAmarker<1...4>:FUNCTION:PNOise[: STATe] 6.10

CALCulate<1|2>:DELTAmarker<1...4>:FUNCTION:PNOise:RESult? 6.11
 CALCulate<1|2>:DELTAmarker<1...4>:MAXimum[:PEAK] 6.11
 CALCulate<1|2>:DELTAmarker<1...4>:MAXimum:LEFT 6.11
 CALCulate<1|2>:DELTAmarker<1...4>:MAXimum:NEXT 6.12
 CALCulate<1|2>:DELTAmarker<1...4>:MAXimum:RIGHT 6.12
 CALCulate<1|2>:DELTAmarker<1...4>:MINimum[:PEAK] 6.12
 CALCulate<1|2>:DELTAmarker<1...4>:MINimum:LEFT 6.13
 CALCulate<1|2>:DELTAmarker<1...4>:MINimum:NEXT 6.13
 CALCulate<1|2>:DELTAmarker<1...4>:MINimum:RIGHT 6.13
 CALCulate<1|2>:DELTAmarker<1...4>:MODE 6.14
 CALCulate<1|2>:DELTAmarker<1...4>:TRACe 6.14
 CALCulate<1|2>:DELTAmarker<1...4>:X 6.14
 CALCulate<1|2>:DELTAmarker<1...4>:X:RELative? 6.15
 CALCulate<1|2>:DELTAmarker<1...4>:Y? 6.15
 CALCulate<1|2>:DELTAmarker<1...4>:Y? (K20) 6.306
 CALCulate<1|2>:DELTAmarker<1...4>:Y? (K8) 6.245
 CALCulate<1|2>:DLINe<1|2> 6.16
 CALCulate<1|2>:DLINe<1|2>:STATe 6.17
 CALCulate<1|2>:DTV:RESult (K20) 6.322
 CALCulate<1|2>:DTV:UNIT:POWer:EPATtern (K20) 6.324
 CALCulate<1|2>:DTV:UNIT:POWer:EVMPeak (K20) 6.324
 CALCulate<1|2>:DTV:UNIT:POWer:EVMRms (K20) 6.324
 CALCulate<1|2>:DTV:UNIT:POWer:MERRPeak (K20) 6.325
 CALCulate<1|2>:DTV:UNIT:POWer:MERRms (K20) 6.325
 CALCulate<1|2>:FLINe<1|2> 6.17
 CALCulate<1|2>:FLINe<1|2>:STATe 6.18
 CALCulate<1|2>:FORMat (K7) 6.184
 CALCulate<1|2>:LIMit<1...8>:CONTRol:SPACing 6.32
 CALCulate<1|2>:LIMit<1...8>:ACPower[:STATe] 6.24
 CALCulate<1|2>:LIMit<1...8>:ACPower:ACHannel[:RELati ve] 6.24
 CALCulate<1|2>:LIMit<1...8>:ACPower:ACHannel[:RELati ve]:STATe 6.25
 CALCulate<1|2>:LIMit<1...8>:ACPower:ACHannel:ABSolut e 6.26
 CALCulate<1|2>:LIMit<1...8>:ACPower:ACHannel:ABSolut e:STATe 6.26
 CALCulate<1|2>:LIMit<1...8>:ACPower:ACHannel:RESult? 6.27
 CALCulate<1|2>:LIMit<1...8>:ACPower:ALTErnate<1|2>[:R ELative] 6.28
 CALCulate<1|2>:LIMit<1...8>:ACPower:ALTErnate<1|2>[:R ELative]:STATe 6.28
 CALCulate<1|2>:LIMit<1...8>:ACPower:ALTErnate<1|2>:A BSolute 6.29
 CALCulate<1|2>:LIMit<1...8>:ACPower:ALTErnate<1|2>:A BSolute:STATe 6.29
 CALCulate<1|2>:LIMit<1...8>:ACPower:ALTErnate<1|2>:R ESult? 6.30
 CALCulate<1|2>:LIMit<1...8>:CLEar[:IMMediate] 6.20
 CALCulate<1|2>:LIMit<1...8>:COMMeNt 6.20
 CALCulate<1|2>:LIMit<1...8>:CONTRol[:DATA] 6.31
 CALCulate<1|2>:LIMit<1...8>:CONTRol:DOMain 6.32
 CALCulate<1|2>:LIMit<1...8>:CONTRol:MODE 6.32
 CALCulate<1|2>:LIMit<1...8>:CONTRol:OFFSet 6.33
 CALCulate<1|2>:LIMit<1...8>:CONTRol:SHIFt 6.33
 CALCulate<1|2>:LIMit<1...8>:COPY 6.21
 CALCulate<1|2>:LIMit<1...8>:DELeTe 6.21
 CALCulate<1|2>:LIMit<1...8>:FAIL? 6.21
 CALCulate<1|2>:LIMit<1...8>:FAIL? (K91) 6.382
 CALCulate<1|2>:LIMit<1...8>:FAIL? (K92) 6.461
 CALCulate<1|2>:LIMit<1...8>:LOWer[:DATA] 6.34
 CALCulate<1|2>:LIMit<1...8>:LOWer:MARGin 6.35
 CALCulate<1|2>:LIMit<1...8>:LOWer:MODE 6.36
 CALCulate<1|2>:LIMit<1...8>:LOWer:OFFSet 6.35
 CALCulate<1|2>:LIMit<1...8>:LOWer:SHIFt 6.36
 CALCulate<1|2>:LIMit<1...8>:LOWer:SPACing 6.37
 CALCulate<1|2>:LIMit<1...8>:LOWer:STATe 6.35
 CALCulate<1|2>:LIMit<1...8>:LOWer:THReshold 6.37
 CALCulate<1|2>:LIMit<1...8>:NAME 6.22
 CALCulate<1|2>:LIMit<1...8>:STATe 6.22
 CALCulate<1|2>:LIMit<1...8>:TRACe 6.23
 CALCulate<1|2>:LIMit<1...8>:UNIT 6.23
 CALCulate<1|2>:LIMit<1...8>:UPPer[:DATA] 6.38
 CALCulate<1|2>:LIMit<1...8>:UPPer:MARGin 6.39
 CALCulate<1|2>:LIMit<1...8>:UPPer:MODE 6.39
 CALCulate<1|2>:LIMit<1...8>:UPPer:OFFSet 6.39
 CALCulate<1|2>:LIMit<1...8>:UPPer:SHIFt 6.40
 CALCulate<1|2>:LIMit<1...8>:UPPer:SPACing 6.40
 CALCulate<1|2>:LIMit<1...8>:UPPer:STATe 6.41
 CALCulate<1|2>:LIMit<1...8>:UPPer:THReshold 6.41
 CALCulate<1|2>:LIMit<1>:ACPower:ACHannel (K91) 6.382
 CALCulate<1|2>:LIMit<1>:ACPower:ALTErnate? (K91) 6.383
 CALCulate<1|2>:LIMit<1>:BURSt:ALL (K91) 6.383
 CALCulate<1|2>:LIMit<1>:BURSt:ALL (K92) 6.462
 CALCulate<1|2>:LIMit<1>:BURSt:ALL:RESult (K91) 6.384
 CALCulate<1|2>:LIMit<1>:BURSt:ALL:RESult? (K92) 6.463
 CALCulate<1|2>:LIMit<1>:BURSt:EVM[:AVERAge] (K91) 6.384
 CALCulate<1|2>:LIMit<1>:BURSt:EVM[:AVERAge]:RESult ? (K91) 6.384
 CALCulate<1|2>:LIMit<1>:BURSt:EVM:ALL[:AVERAge] (K91) 6.385
 CALCulate<1|2>:LIMit<1>:BURSt:EVM:ALL[:AVERAge] (K92) 6.463
 CALCulate<1|2>:LIMit<1>:BURSt:EVM:ALL[:AVERAge]:RE Sult? (K91) 6.385
 CALCulate<1|2>:LIMit<1>:BURSt:EVM:ALL[:AVERAge]:RE Sult? (K92) 6.463
 CALCulate<1|2>:LIMit<1>:BURSt:EVM:ALL:MAXimum (K91) 6.385
 CALCulate<1|2>:LIMit<1>:BURSt:EVM:ALL:MAXimum (K92) 6.464
 CALCulate<1|2>:LIMit<1>:BURSt:EVM:ALL:MAXimum:RE Sult? (K91) 6.386
 CALCulate<1|2>:LIMit<1>:BURSt:EVM:ALL:MAXimum:RE Sult? (K92) 6.464
 CALCulate<1|2>:LIMit<1>:BURSt:EVM:DATA[:AVERAge] (K91) 6.386
 CALCulate<1|2>:LIMit<1>:BURSt:EVM:DATA[:AVERAge] (K92) 6.464
 CALCulate<1|2>:LIMit<1>:BURSt:EVM:DATA[:AVERAge]: RESult? (K91) 6.386
 CALCulate<1|2>:LIMit<1>:BURSt:EVM:DATA[:AVERAge]: RESult? (K92) 6.465
 CALCulate<1|2>:LIMit<1>:BURSt:EVM:DATA:MAXimum (K91) 6.387
 CALCulate<1|2>:LIMit<1>:BURSt:EVM:DATA:MAXimum (K92) 6.465
 CALCulate<1|2>:LIMit<1>:BURSt:EVM:DATA:MAXimum:R ESult? (K91) 6.387
 CALCulate<1|2>:LIMit<1>:BURSt:EVM:DATA:MAXimum:R ESult? (K92) 6.466
 CALCulate<1|2>:LIMit<1>:BURSt:EVM:MAXimum (K91) 6.387
 CALCulate<1|2>:LIMit<1>:BURSt:EVM:MAXimum:RESult? (K91) 6.387
 CALCulate<1|2>:LIMit<1>:BURSt:EVM:PILOt[:AVERAge] (K91) 6.388
 CALCulate<1|2>:LIMit<1>:BURSt:EVM:PILOt[:AVERAge]:R ESult? (K91) 6.388

CALCulate<1|2>:LIMit<1>:BURSt:EVM:PILot:MAXimum (K91) 6.388
 CALCulate<1|2>:LIMit<1>:BURSt:EVM:PILot:MAXimum:RESult? (K91) 6.389
 CALCulate<1|2>:LIMit<1>:BURSt:FERRor[:AVERAge] (K91) 6.389
 CALCulate<1|2>:LIMit<1>:BURSt:FERRor[:AVERAge] (K92) 6.466
 CALCulate<1|2>:LIMit<1>:BURSt:FERRor[:AVERAge]:RESult? (K91) 6.389
 CALCulate<1|2>:LIMit<1>:BURSt:FERRor[:AVERAge]:RESult? (K92) 6.466
 CALCulate<1|2>:LIMit<1>:BURSt:FERRor:MAXimum (K91) 6.390
 CALCulate<1|2>:LIMit<1>:BURSt:FERRor:MAXimum (K92) 6.467
 CALCulate<1|2>:LIMit<1>:BURSt:FERRor:MAXimum:RESult? (K91) 6.390
 CALCulate<1|2>:LIMit<1>:BURSt:FERRor:MAXimum:RESult? (K92) 6.467
 CALCulate<1|2>:LIMit<1>:BURSt:IQOffset[:AVERAge] (K91) 6.390
 CALCulate<1|2>:LIMit<1>:BURSt:IQOffset[:AVERAge] (K92) 6.468
 CALCulate<1|2>:LIMit<1>:BURSt:IQOffset[:AVERAge]:RESult? (K91) 6.391
 CALCulate<1|2>:LIMit<1>:BURSt:IQOffset[:AVERAge]:RESult? (K92) 6.468
 CALCulate<1|2>:LIMit<1>:BURSt:IQOffset:MAXimum (K91) 6.391
 CALCulate<1|2>:LIMit<1>:BURSt:IQOffset:MAXimum (K92) 6.468
 CALCulate<1|2>:LIMit<1>:BURSt:IQOffset:MAXimum:RESult? (K91) 6.391
 CALCulate<1|2>:LIMit<1>:BURSt:IQOffset:MAXimum:RESult? (K92) 6.469
 CALCulate<1|2>:LIMit<1>:BURSt:SSTiming[:AVERAge] (K92) 6.469
 CALCulate<1|2>:LIMit<1>:BURSt:SSTiming[:AVERAge]:RESult? (K92) 6.469
 CALCulate<1|2>:LIMit<1>:BURSt:SSTiming:MAXimum (K92) 6.470
 CALCulate<1|2>:LIMit<1>:BURSt:SSTiming:MAXimum:RESult? (K92) 6.470
 CALCulate<1|2>:LIMit<1>:BURSt:SYMBOLerror[:AVERAge] (K91) 6.391
 CALCulate<1|2>:LIMit<1>:BURSt:SYMBOLerror[:AVERAge] (K92) 6.470
 CALCulate<1|2>:LIMit<1>:BURSt:SYMBOLerror[:AVERAge]:RESult? (K91) 6.392
 CALCulate<1|2>:LIMit<1>:BURSt:SYMBOLerror[:AVERAge]:RESult? (K92) 6.471
 CALCulate<1|2>:LIMit<1>:BURSt:SYMBOLerror:MAXimum (K91) 6.392
 CALCulate<1|2>:LIMit<1>:BURSt:SYMBOLerror:MAXimum (K92) 6.471
 CALCulate<1|2>:LIMit<1>:BURSt:SYMBOLerror:MAXimum:RESult? (K91) 6.392
 CALCulate<1|2>:LIMit<1>:BURSt:SYMBOLerror:MAXimum:RESult? (K92) 6.472
 CALCulate<1|2>:LIMit<1>:BURSt:TFALI[:AVERAge] (K91) 6.393
 CALCulate<1|2>:LIMit<1>:BURSt:TFALI[:AVERAge]:RESult? (K91) 6.393
 CALCulate<1|2>:LIMit<1>:BURSt:TFALI:MAXimum (K91) 6.393
 CALCulate<1|2>:LIMit<1>:BURSt:TFALI:MAXimum:RESult? (K91) 6.394
 CALCulate<1|2>:LIMit<1>:BURSt:TRISef[:AVERAge] (K91) 6.394
 CALCulate<1|2>:LIMit<1>:BURSt:TRISef[:AVERAge]:RESult (K91) 6.394
 CALCulate<1|2>:LIMit<1>:BURSt:TRISef:MAXimum (K91) 6.395
 CALCulate<1|2>:LIMit<1>:BURSt:TRISef:MAXimum:RESult? (K91) 6.395
 CALCulate<1|2>:LIMit<1>:SPECTrum:MASK:CHECK:X (K91) 6.395
 CALCulate<1|2>:LIMit<1>:SPECTrum:MASK:CHECK:X? (K92) 6.472
 CALCulate<1|2>:LIMit<1>:SPECTrum:MASK:CHECK:Y (K91) 6.396
 CALCulate<1|2>:LIMit<1>:SPECTrum:MASK:CHECK:Y? (K92) 6.472
 CALCulate<1|2>:MARKer<1...4>[:STATe] 6.42
 CALCulate<1|2>:MARKer<1...4>:AOFF 6.43
 CALCulate<1|2>:MARKer<1...4>:COUNT 6.43
 CALCulate<1|2>:MARKer<1...4>:COUNT:FREQUency? 6.44
 CALCulate<1|2>:MARKer<1...4>:COUNT:RESolution 6.44
 CALCulate<1|2>:MARKer<1...4>:FUNCTION:CENTer 6.54
 CALCulate<1|2>:MARKer<1...4>:FUNCTION:CSTep 6.54
 CALCulate<1|2>:MARKer<1...4>:FUNCTION:DEModulation[:STATe] 6.53
 CALCulate<1|2>:MARKer<1...4>:FUNCTION:DEModulation:CONTinuous 6.53
 CALCulate<1|2>:MARKer<1...4>:FUNCTION:DEModulation:HOLDoff 6.53
 CALCulate<1|2>:MARKer<1...4>:FUNCTION:DEModulation:SELEct 6.54
 CALCulate<1|2>:MARKer<1...4>:FUNCTION:FPEaks[:IMMeDiate] 6.55
 CALCulate<1|2>:MARKer<1...4>:FUNCTION:FPEaks:COUNt? 6.56
 CALCulate<1|2>:MARKer<1...4>:FUNCTION:FPEaks:SORT 6.56
 CALCulate<1|2>:MARKer<1...4>:FUNCTION:FPEaks:X? 6.56
 CALCulate<1|2>:MARKer<1...4>:FUNCTION:FPEaks:Y? 6.57
 CALCulate<1|2>:MARKer<1...4>:FUNCTION:HARMonics[:STATe] 6.65
 CALCulate<1|2>:MARKer<1...4>:FUNCTION:HARMonics:Bandwidth:AUTO 6.66
 CALCulate<1|2>:MARKer<1...4>:FUNCTION:HARMonics:Distortion? 6.66
 CALCulate<1|2>:MARKer<1...4>:FUNCTION:HARMonics:LIST? 6.67
 CALCulate<1|2>:MARKer<1...4>:FUNCTION:HARMonics:NHARMonics 6.67
 CALCulate<1|2>:MARKer<1...4>:FUNCTION:HARMonics:PRESEt 6.68
 CALCulate<1|2>:MARKer<1...4>:FUNCTION:MDEPth[:STATe] 6.57
 CALCulate<1|2>:MARKer<1...4>:FUNCTION:MDEPth:RESult? 6.58
 CALCulate<1|2>:MARKer<1...4>:FUNCTION:MDEPth:SEARCHsignal ONCE 6.59
 CALCulate<1|2>:MARKer<1...4>:FUNCTION:NDBDown 6.59
 CALCulate<1|2>:MARKer<1...4>:FUNCTION:NDBDown:FREQUency? 6.59
 CALCulate<1|2>:MARKer<1...4>:FUNCTION:NDBDown:RESult? 6.60
 CALCulate<1|2>:MARKer<1...4>:FUNCTION:NDBDown:STATe 6.60
 CALCulate<1|2>:MARKer<1...4>:FUNCTION:NDBDown:TIME? 6.61
 CALCulate<1|2>:MARKer<1...4>:FUNCTION:NOISef[:STATe] 6.62
 CALCulate<1|2>:MARKer<1...4>:FUNCTION:NOISef:RESult? 6.62
 CALCulate<1|2>:MARKer<1...4>:FUNCTION:REFERENCE 6.63

CALCulate<1|2>:MARKer<1...4>:FUNction:SUMMary:MO
 DE 6.81
 CALCulate<1|2>:MARKer<1...4>:FUNction:SUMMary:REF
 erence:AUTO 6.84
 CALCulate<1|2>:MARKer<1...4>:FUNction:TOI[:STATe]
 6.63
 CALCulate<1|2>:MARKer<1...4>:FUNction:TOI:RESuIt?
 6.63
 CALCulate<1|2>:MARKer<1...4>:FUNction:TOI:SEARChsi
 gnal ONCE 6.64
 CALCulate<1|2>:MARKer<1...4>:FUNction:ZOOM 6.64
 CALCulate<1|2>:MARKer<1...4>:LOEXclude 6.44
 CALCulate<1|2>:MARKer<1...4>:MAXimum[:PEAK] 6.45
 CALCulate<1|2>:MARKer<1...4>:MAXimum:LEFT 6.45
 CALCulate<1|2>:MARKer<1...4>:MAXimum:NEXT 6.46
 CALCulate<1|2>:MARKer<1...4>:MAXimum:RIGHT 6.46
 CALCulate<1|2>:MARKer<1...4>:MINimum[:PEAK] 6.46
 CALCulate<1|2>:MARKer<1...4>:MINimum:LEFT 6.47
 CALCulate<1|2>:MARKer<1...4>:MINimum:NEXT 6.47
 CALCulate<1|2>:MARKer<1...4>:MINimum:RIGHT 6.47
 CALCulate<1|2>:MARKer<1...4>:PEXCursion 6.48
 CALCulate<1|2>:MARKer<1...4>:PEXCursion (K7) 6.185
 CALCulate<1|2>:MARKer<1...4>:PEXCursion (K8) 6.246
 CALCulate<1|2>:MARKer<1...4>:TRACe 6.48
 CALCulate<1|2>:MARKer<1...4>:X 6.49
 CALCulate<1|2>:MARKer<1...4>:X (K91) 6.400
 CALCulate<1|2>:MARKer<1...4>:X:SLIMits[:STATe] 6.49
 CALCulate<1|2>:MARKer<1...4>:X:SLIMits:LEFT 6.49
 CALCulate<1|2>:MARKer<1...4>:X:SLIMits:RIGHT 6.50
 CALCulate<1|2>:MARKer<1...4>:Y? 6.50
 CALCulate<1|2>:MARKer<1...4>:Y? (K7) 6.185
 CALCulate<1|2>:MARKer<1...4>:Y? (K8) 6.246
 CALCulate<1|2>:MARKer<1...4>:Y:PERCent 6.51
 CALCulate<1|2>:MARKer<1>[:STATe] (K91) 6.397
 CALCulate<1|2>:MARKer<1>[:STATe] (K92) 6.473
 CALCulate<1|2>:MARKer<1>:AOFF (K91) 6.397
 CALCulate<1|2>:MARKer<1>:AOFF (K92) 6.473
 CALCulate<1|2>:MARKer<1>:BSYMBOL (K91) 6.398
 CALCulate<1|2>:MARKer<1>:BURSt (K92) 6.474
 CALCulate<1|2>:MARKer<1>:CARRier (K91) 6.398
 CALCulate<1|2>:MARKer<1>:CARRier (K92) 6.474
 CALCulate<1|2>:MARKer<1>:FUNction:POWer:RESuIt[:C
 URRent]? (K91) 6.402
 CALCulate<1|2>:MARKer<1>:FUNction:POWer:RESuIt[:C
 URRent]? (K92) 6.478
 CALCulate<1|2>:MARKer<1>:FUNction:POWer:RESuIt:M
 AXHold? (K91) 6.402
 CALCulate<1|2>:MARKer<1>:FUNction:POWer:RESuIt:M
 AXHold? (K92) 6.478
 CALCulate<1|2>:MARKer<1>:FUNction:ZOOM (K91)
 6.403
 CALCulate<1|2>:MARKer<1>:FUNction:ZOOM (K92)
 6.479
 CALCulate<1|2>:MARKer<1>:MAXimum (K91) 6.399
 CALCulate<1|2>:MARKer<1>:MAXimum[:PEAK] (K92)
 6.475
 CALCulate<1|2>:MARKer<1>:MINimum (K91) 6.399
 CALCulate<1|2>:MARKer<1>:MINimum[:PEAK] (K92)
 6.475
 CALCulate<1|2>:MARKer<1>:SYMBOL (K91) 6.399
 CALCulate<1|2>:MARKer<1>:SYMBOL (K92) 6.475
 CALCulate<1|2>:MARKer<1>:TRACe (K91) 6.400
 CALCulate<1|2>:MARKer<1>:TRACe (K92) 6.476
 CALCulate<1|2>:MARKer<1>:X (K92) 6.476
 CALCulate<1|2>:MARKer<1>:Y (K91) 6.401
 CALCulate<1|2>:MARKer<1>:Y? (K92) 6.477
 CALCulate<1|2>:MARKer:FUNction:ADEMod:AFRequenc
 y[:RESuIt<1...4>]? (K7) 6.186
 CALCulate<1|2>:MARKer:FUNction:ADEMod:AM[:RESuIt
 <1...4>]? (K7) 6.187
 CALCulate<1|2>:MARKer:FUNction:ADEMod:CARRier[:R
 ESuIt<1...4>]? (K7) 6.187
 CALCulate<1|2>:MARKer:FUNction:ADEMod:FERRor[:RE
 Sult<1...4>]? (K7) 6.188
 CALCulate<1|2>:MARKer:FUNction:ADEMod:FM[:RESuIt
 <1...4>]? (K7) 6.188
 CALCulate<1|2>:MARKer:FUNction:ADEMod:PM[:RESuIt]
 ? (K7) 6.189
 CALCulate<1|2>:MARKer:FUNction:ADEMod:SiNad:RESu
 It<1...4>? (K7) 6.189
 CALCulate<1|2>:MARKer:FUNction:ADEMod:THD:RESuIt
 <1...4>? (K7) 6.190
 CALCulate<1|2>:MARKer:FUNction:MSUMmary? 6.76
 CALCulate<1|2>:MARKer:FUNction:POWer[:STATe] 6.69
 CALCulate<1|2>:MARKer:FUNction:POWer:MODE] 6.69
 CALCulate<1|2>:MARKer:FUNction:POWer:PRESet 6.70
 CALCulate<1|2>:MARKer:FUNction:POWer:RESuIt? 6.71
 CALCulate<1|2>:MARKer:FUNction:POWer:SElect 6.73
 CALCulate<1|2>:MARKer:FUNction:STRack[:STATe] 6.74
 CALCulate<1|2>:MARKer:FUNction:STRack:BANDwidth
 6.74
 CALCulate<1|2>:MARKer:FUNction:STRack:BWIDth 6.74
 CALCulate<1|2>:MARKer:FUNction:STRack:THReshold
 6.75
 CALCulate<1|2>:MARKer:FUNction:STRack:TRACe 6.75
 CALCulate<1|2>:MARKer:FUNction:SUMMary[:STATe]
 6.78
 CALCulate<1|2>:MARKer:FUNction:SUMMary:AOff 6.78
 CALCulate<1|2>:MARKer:FUNction:SUMMary:AVERAge
 6.78
 CALCulate<1|2>:MARKer:FUNction:SUMMary:MEAN[:ST
 ATe] 6.79
 CALCulate<1|2>:MARKer:FUNction:SUMMary:MEAN:AVE
 Rage:RESuIt? 6.79
 CALCulate<1|2>:MARKer:FUNction:SUMMary:MEAN:PH
 OLd:RESuIt? 6.80
 CALCulate<1|2>:MARKer:FUNction:SUMMary:MEAN:RE
 Sult? 6.80
 CALCulate<1|2>:MARKer:FUNction:SUMMary:PHOLd
 6.81
 CALCulate<1|2>:MARKer:FUNction:SUMMary:PPEak[:ST
 ATe] 6.82
 CALCulate<1|2>:MARKer:FUNction:SUMMary:PPEak:AV
 ERage:RESuIt? 6.82
 CALCulate<1|2>:MARKer:FUNction:SUMMary:PPEak:PH
 OLd:RESuIt? 6.83
 CALCulate<1|2>:MARKer:FUNction:SUMMary:PPEak:RE
 Sult? 6.83
 CALCulate<1|2>:MARKer:FUNction:SUMMary:RMS[:STA
 Te] 6.84
 CALCulate<1|2>:MARKer:FUNction:SUMMary:RMS:AVE
 Rage:RESuIt? 6.85
 CALCulate<1|2>:MARKer:FUNction:SUMMary:RMS:PHOL
 d:RESuIt? 6.85
 CALCulate<1|2>:MARKer:FUNction:SUMMary:RMS:RESu
 It? 6.86
 CALCulate<1|2>:MARKer:FUNction:SUMMary:SDEviation
 [:STATe] 6.86
 CALCulate<1|2>:MARKer:FUNction:SUMMary:SDEviation
 :AVERAge:RESuIt? 6.87
 CALCulate<1|2>:MARKer:FUNction:SUMMary:SDEviation
 :PHOLd:RESuIt? 6.87
 CALCulate<1|2>:MARKer:FUNction:SUMMary:SDEviation
 :RESuIt? 6.88
 CALCulate<1|2>:MATH[:EXPRession][:DEFine] 6.88
 CALCulate<1|2>:MATH:POSition 6.89
 CALCulate<1|2>:MATH:STATe 6.89
 CALCulate<1|2>:PMETer:RELative[:MAGNitude] (K9)
 6.270
 CALCulate<1|2>:PMETer:RELative[:MAGNitude]:AUTO
 (K9) 6.270
 CALCulate<1|2>:PMETer:RELative:STATe (K9) 6.271
 CALCulate<1|2>:THReshold 6.95
 CALCulate<1|2>:THReshold:STATe 6.95

- CALCulate<1|2>:TLINe<1|2> 6.96
- CALCulate<1|2>:TLINe<1|2>:STATe 6.96
- CALCulate<1|2>:UNIT:POWer 6.97
- CALCulate<1|2>:UNIT:POWer (K20) 6.330
- CALCulate:DTV:LIMit:CFOffset:LOWer (K20) 6.308
- CALCulate:DTV:LIMit:CFOffset:UPPer (K20) 6.308
- CALCulate:DTV:LIMit:CHPower:LOWer (K20) 6.309
- CALCulate:DTV:LIMit:CHPower:UPPer (K20) 6.308
- CALCulate:DTV:LIMit:CSUPpression[:LOWer] (K20) 6.309
- CALCulate:DTV:LIMit:EVMPeak:LOWer] (K20) 6.309
- CALCulate:DTV:LIMit:EVMPeak:UPPer (K20) 6.310
- CALCulate:DTV:LIMit:EVMRms:LOWer (K20) 6.310
- CALCulate:DTV:LIMit:EVMRms:UPPer (K20) 6.310
- CALCulate:DTV:LIMit:IMBalance:LOWer (K20) 6.311
- CALCulate:DTV:LIMit:IMBalance:UPPer (K20) 6.311
- CALCulate:DTV:LIMit:MERPeak:LOWer (K20) 6.311
- CALCulate:DTV:LIMit:MERPeak:UPPer (K20) 6.312
- CALCulate:DTV:LIMit:MERRms:LOWer (K20) 6.312
- CALCulate:DTV:LIMit:MERRms:UPPer (K20) 6.312
- CALCulate:DTV:LIMit:PJTter[:UPPer] (K20) 6.313
- CALCulate:DTV:LIMit:QERRor:LOWer (K20) 6.313
- CALCulate:DTV:LIMit:QERRor:UPPer (K20) 6.313
- CALCulate:DTV:LIMit:RESult:CFOffset:LOWer? (K20) 6.315
- CALCulate:DTV:LIMit:RESult:CFOffset:UPPer? (K20) 6.315
- CALCulate:DTV:LIMit:RESult:CHPower? (K20) 6.316
- CALCulate:DTV:LIMit:RESult:CSUPpression[:LOWer]? (K20) 6.316
- CALCulate:DTV:LIMit:RESult:EVMPeak:LOWer? (K20) 6.316
- CALCulate:DTV:LIMit:RESult:EVMPeak:UPPer? (K20) 6.317
- CALCulate:DTV:LIMit:RESult:EVMRms:LOWer? (K20) 6.317
- CALCulate:DTV:LIMit:RESult:EVMRms:UPPer? (K20) 6.318
- CALCulate:DTV:LIMit:RESult:IMBalance:LOWer? (K20) 6.318
- CALCulate:DTV:LIMit:RESult:IMBalance:UPPer? (K20) 6.318
- CALCulate:DTV:LIMit:RESult:MERPeak:LOWer? (K20) 6.319
- CALCulate:DTV:LIMit:RESult:MERPeak:UPPer? (K20) 6.319
- CALCulate:DTV:LIMit:RESult:MERRms:LOWer? (K20) 6.319
- CALCulate:DTV:LIMit:RESult:MERRms:UPPer? (K20) 6.320
- CALCulate:DTV:LIMit:RESult:PJTter[:UPPer]? (K20) 6.320
- CALCulate:DTV:LIMit:RESult:QERRor:LOWer? (K20) 6.321
- CALCulate:DTV:LIMit:RESult:QERRor:UPPer? (K20) 6.321
- CALCulate:DTV:LIMit:RESult:SROffset:LOWer? (K20) 6.321
- CALCulate:DTV:LIMit:RESult:SROffset:UPPer? (K20) 6.322
- CALCulate:DTV:LIMit:SROffset:LOWer (K20) 6.314
- CALCulate:DTV:LIMit:SROffset:UPPer (K20) 6.314
- CALCulate:STATistics:APD[:STATe] 6.90
- CALCulate:STATistics:CCDF[:STATe] 6.90
- CALCulate:STATistics:NSAMples 6.91
- CALCulate:STATistics:PRESet 6.91
- CALCulate:STATistics:RESult<1...4>? 6.92
- CALCulate:STATistics:SCALE:AUTO 6.92
- CALCulate:STATistics:SCALE:X:RANGe 6.93
- CALCulate:STATistics:SCALE:X:RLeVel 6.93
- CALCulate:STATistics:SCALE:Y:LOWer 6.94
- CALCulate:STATistics:SCALE:Y:UPPer 6.94
- calibration
 - transmission measurement 4.98
- CALibration[:ALL]? 6.542
- CALibration:ABORT 6.542
- CALibration:PMETer:ZERO:AUTO (K9) 6.272
- CALibration:RESult? 6.543
- CALibration:STATe 6.543
- Carrier Frequency Drift measurement (K8) 4.122
- Carrier Frequency Stability and Modulation Accuracy measurement (K8) 4.122
- CATV network (K20) 2.81
- CCIR 473–4 4.31
- center frequency 4.7
 - step size 4.7
- center frequency (K8) 4.123
- channel
 - bandwidth 4.70, 4.72, 4.76
 - number 4.71, 4.72
 - spacing 4.73
- channel (K20) 2.82
- channel number (K8) 4.123
- channel table (K20) 2.81, 4.151
- channel width (K20) 2.81
- characters
 - special 6.2
- CINR measurements (K92) 2.131
- Clear Write mode 4.34
- colon 5.10
- color printout 4.272
- color settings
 - default 4.271
- comma 5.10
- command
 - # 5.10
 - addressed 5.35
 - colon 5.10
 - comma 5.10
 - description 6.2
 - header 5.5
 - line 5.7
 - long form 5.6
 - overlapping execution 5.13
 - programming examples 7.1
 - query 5.8
 - question mark 5.8, 5.10
 - quotation mark 5.10
 - recognition 5.11
 - sequence 5.13
 - short form 5.6
 - structure 5.5
 - suffix 5.7
 - syntax elements 5.10
 - universal 5.34
 - white space 5.10
- common commands 6.537
- CONDition register part 5.14
- CONFigure:ATV:CN:MEASurement (K20) 6.331
- CONFigure:ATV:CSO:MEASurement (K20) 6.331
- CONFigure:ATV:CTB:MEASurement (K20) 6.332
- CONFigure:ATV:MEASurement (K20) 6.332
- CONFigure:BT0oth:ACLR:ACPairs (K8) 6.247
- CONFigure:BT0oth:BANDwidth|BWIDth[:RESolution] (K8) 6.248
- CONFigure:BT0oth:BANDwidth|BWIDth[:RESolution]:AUT O (K8) 6.248
- CONFigure:BT0oth:BANDwidth|BWIDth:VIDeo (K8) 6.249
- CONFigure:BT0oth:BANDwidth|BWIDth:VIDeo:AUTO (K8) 6.249
- CONFigure:BT0oth:CFSTability:BCOunt (K8) 6.250
- CONFigure:BT0oth:CHANnel (K8) 6.250
- CONFigure:BT0oth:DETEctor<1...4> (K8) 6.251
- CONFigure:BT0oth:IBSemiissions:ACPairs (K8) 6.251
- CONFigure:BT0oth:IBSemiissions:GATE:AUTO (K8) 6.252
- CONFigure:BT0oth:MEASurement (K8) 6.252

CONFigure:BT0oth:PBSCo (K8) 6.253
 CONFigure:BT0oth:PCLass (K8) 6.253
 CONFigure:BT0oth:POWer:AVERAge:STARt (K8) 6.253
 CONFigure:BT0oth:POWer:AVERAge:STOP (K8) 6.254
 CONFigure:BT0oth:PRAte (K8) 6.254
 CONFigure:BT0oth:PTYPe (K8) 6.255
 CONFigure:BT0oth:RTPower:DAVerage:STARt (K8) 6.255
 CONFigure:BT0oth:RTPower:DAVerage:STOP (K8) 6.256
 CONFigure:BT0oth:RTPower:GAVerage:STARt (K8) 6.256
 CONFigure:BT0oth:RTPower:GAVerage:STOP (K8) 6.256
 CONFigure:BT0oth:SWEep:COUNT (K8) 6.257
 CONFigure:BT0oth:SWEep:TIME (K8) 6.258
 CONFigure:BT0oth:SWEep:TIME:AUTO (K8) 6.258
 CONFigure:BT0oth:TRACe<1...4>:MODE (K8) 6.259
 CONFigure:BT0oth:TRACe<1...4>:SElect (K8) 6.259
 CONFigure:BURSt:CONSt:CARRier:SElect (K91) 6.404
 CONFigure:BURSt:CONSt:CCARrier[:IMMEDIATE] (K91) 6.405
 CONFigure:BURSt:CONSt:CCARrier[:IMMEDIATE] (K92) 6.481
 CONFigure:BURSt:CONSt:CSYMBOL[:IMMEDIATE] (K91) 6.405
 CONFigure:BURSt:CONSt:CSYMBOL[:IMMEDIATE] (K92) 6.481
 CONFigure:BURSt:EVM:ECARrier[:IMMEDIATE] (K91) 6.405
 CONFigure:BURSt:EVM:ECARrier[:IMMEDIATE] (K92) 6.482
 CONFigure:BURSt:EVM:ESYMBOL[:IMMEDIATE] (K91) 6.406
 CONFigure:BURSt:EVM:ESYMBOL[:IMMEDIATE] (K92) 6.482
 CONFigure:BURSt:PREAmble[:IMMEDIATE] (K91) 6.406
 CONFigure:BURSt:PREAmble[:IMMEDIATE] (K92) 6.482
 CONFigure:BURSt:PREAmble:SElect (K91) 6.406
 CONFigure:BURSt:PREAmble:SElect (K92) 6.483
 CONFigure:BURSt:PVT[:IMMEDIATE] (K91) 6.407
 CONFigure:BURSt:PVT[:IMMEDIATE] (K92) 6.483
 CONFigure:BURSt:PVT:AVERAge (K91) 6.407
 CONFigure:BURSt:PVT:BURSt (K92) 6.483
 CONFigure:BURSt:PVT:RPOWer (K91) 6.407
 CONFigure:BURSt:PVT:SElect (K91) 6.408
 CONFigure:BURSt:PVT:SElect (K92) 6.484
 CONFigure:BURSt:SPECTrum:ACPR[:IMMEDIATE] (K91) 6.408
 CONFigure:BURSt:SPECTrum:ACPR[:IMMEDIATE] (K92) 6.484
 CONFigure:BURSt:SPECTrum:ACPR:SElect (K92) 6.485
 CONFigure:BURSt:SPECTrum:FFT[:IMMEDIATE] (K91) 6.408
 CONFigure:BURSt:SPECTrum:FFT[:IMMEDIATE] (K92) 6.485
 CONFigure:BURSt:SPECTrum:FLATness[:IMMEDIATE] (K91) 6.409
 CONFigure:BURSt:SPECTrum:FLATness[:IMMEDIATE] (K92) 6.485
 CONFigure:BURSt:SPECTrum:FLATness:SElect (K92) 6.486
 CONFigure:BURSt:SPECTrum:MASK[:IMMEDIATE] (K91) 6.409
 CONFigure:BURSt:SPECTrum:MASK[:IMMEDIATE] (K92) 6.486
 CONFigure:BURSt:SPECTrum:MASK:SElect (K91) 6.409
 CONFigure:BURSt:SPECTrum:MASK:SElect (K92) 6.486
 CONFigure:BURSt:STATistics:BSTReam[:IMMEDIATE] (K91) 6.410
 CONFigure:BURSt:STATistics:BSTReam[:IMMEDIATE] (K92) 6.487
 CONFigure:BURSt:STATistics:BSUMmary[:IMMEDIATE] (K92) 6.487

CONFigure:BURSt:STATistics:CCDF[:IMMEDIATE] (K91) 6.410
 CONFigure:BURSt:STATistics:CCDF[:IMMEDIATE] (K92) 6.487
 CONFigure:BURSt:STATistics:SFleld [:IMMEDIATE] (K91) 6.410
 CONFigure:CHANnel (K91) 6.411
 CONFigure:CHANnel (K92) 6.488
 CONFigure:DTV:MEASurement (K20) 6.333
 CONFigure:POWer:AUTO (K91) 6.411
 CONFigure:POWer:AUTO (K92) 6.488
 CONFigure:POWer:AUTO:SWEep:TIME (K91) 6.411
 CONFigure:POWer:AUTO:SWEep:TIME (K92) 6.488
 CONFigure:POWer:EXPEcted:RF (K91) 6.412
 CONFigure:POWer:EXPEcted:RF (K92) 6.489
 CONFigure:STANdard (K91) 6.412
 CONFigure:STANdard (K92) 6.489
 CONFigure:TV:CTABle:SElect (K20) 6.334
 CONFigure:TV:MEASurement (K20) 6.334
 CONFigure:WIMax:FBANd (K92) 6.490
 CONFigure:WIMax:IGRatio (K92) 6.490
 CONFigure:WIMax:LMODe (K92) 6.491
 continuous sweep 4.21
 control
 output level 4.98
 copy
 file 4.281
 limit line 4.88
 coupling
 resolution bandwidth 4.18
 sweep time 4.19
 video bandwidth 4.19
 create folder 4.281

D

date 4.271
 DCL 5.11
 default color settings 4.271
 default scalings of x- and y-axis 4.78
 delay
 gate signal 4.30
 delete
 file 4.281
 limit line 4.88
 delimiter 5.11
 delta marker 4.43
 demodulation bandwidth (K7) 4.102
 detector
 auto select 4.37
 IF overload (K20) 4.153
 RF overload (K20) 4.153
 detector overview 4.36
 DIAGnostic<1|2>:SERvice:BIOSinfo? 6.544
 DIAGnostic<1|2>:SERvice:HWINfo? 6.544
 DIAGnostic<1|2>:SERvice:INPut[:SElect] 6.545
 DIAGnostic<1|2>:SERvice:INPut:PULSed[:STATe] 6.545
 DIAGnostic<1|2>:SERvice:INPut:PULSed:PRAte 6.546
 DIAGnostic<1|2>:SERvice:NSORce 6.546
 DIAGnostic<1|2>:SERvice:SFUNction 6.546
 DIAGnostic<1|2>:SERvice:STESt:RESult? 6.547
 diagram title 4.270
 Differential Phase Encoding measurement (K8) 4.122
 display
 date 4.271
 power-save mode 4.273
 time 4.271
 display lines 4.85, 4.89
 display range
 frequency 4.7
 level 4.13
 DISPlay[:WINDow<1|2>]:PMETer:STATe (K9) 6.273

DISPlay:WINDow<1|2>:SIZE 6.98
 DISPlay:WINDow<1|2>:SIZE (K7) 6.192
 DISPlay:WINDow<1|2>:SSElect (K91) 6.413
 DISPlay:WINDow<1|2>:SSElect (K92) 6.492
 DISPlay:WINDow<1|2>:TABLE (K91) 6.414
 DISPlay:WINDow<1|2>:TABLE (K92) 6.493
 DISPlay:WINDow<1|2>:TABLE:UNIT (K92) 6.493
 DISPlay:WINDow<1|2>:TEXT:DATA] 6.552
 DISPlay:WINDow<1|2>:TEXT:STATe 6.552
 DISPlay:WINDow<1|2>:TIME 6.553
 DISPlay:WINDow<1|2>:TRACe<1...4>
 Y[:SCALe]:RPOSition (K7) 6.193
 Y[:SCALe]:RPOSition (K8) 6.261
 DISPlay:WINDow<1|2>:TRACe<1...4>[:STATe] 6.98
 DISPlay:WINDow<1|2>:TRACe<1...4>:MODE 6.99
 DISPlay:WINDow<1|2>:TRACe<1...4>:MODE:FREeze[:S
 TATE] 6.335
 DISPlay:WINDow<1|2>:TRACe<1...4>:MODE:HCONtinuo
 us 6.99
 DISPlay:WINDow<1|2>:TRACe<1...4>:Y[:SCALe] 6.100
 DISPlay:WINDow<1|2>:TRACe<1...4>:Y[:SCALe]:AUTO
 (K20) 6.336
 DISPlay:WINDow<1|2>:TRACe<1...4>:Y[:SCALe]:MODE
 6.101
 DISPlay:WINDow<1|2>:TRACe<1...4>:Y[:SCALe]:PDIVisi
 on (K7) 6.192
 DISPlay:WINDow<1|2>:TRACe<1...4>:Y[:SCALe]:PDIVisi
 on (K8) 6.261
 DISPlay:WINDow<1|2>:TRACe<1...4>:Y[:SCALe]:RLEVel
 6.101
 DISPlay:WINDow<1|2>:TRACe<1...4>:Y[:SCALe]:RLEVel
 :OFFSet 6.101
 DISPlay:WINDow<1|2>:TRACe<1...4>:Y[:SCALe]:RPOSit
 ion 6.102
 DISPlay:WINDow<1|2>:TRACe<1...4>:Y[:SCALe]:RVALu
 e 6.102
 DISPlay:WINDow<1|2>:TRACe<1...4>:Y[:SCALe]:RVALu
 e (K7) 6.193
 DISPlay:WINDow<1|2>:TRACe<1...4>:Y[:SCALe]:RVALu
 e (K8) 6.261
 DISPlay:WINDow<1|2>:TRACe<1...4>:Y[:SCALe]:RVALu
 e:AUTO 6.102
 DISPlay:WINDow<1|2>:TRACe<1...4>:Y:SPACing 6.100
 DISPlay:WINDow<1|2>:TRACe<1...4>:Y:SPACing (K20)
 6.337
 DISPlay:WINDow<1|2>:TRACe<1...4>:Y:SPACing (K7)
 6.193
 DISPlay:WINDow<1|2>:TRACe<1...3>:Y[:SCALe]:RLEVe
 l? (K92) 6.495
 DISPlay:WINDow<1|2>:TRACe<1...3>:Y[:SCALe]:RLEVe
 l[:RF] (K92) 6.494
 DISPlay:WINDow<1|2>:TRACe<1...3>:Y[:SCALe]:RLEVe
 l:OFFSet (K92) 6.495
 DISPlay:WINDow<1|2>:TRACe<1...4>:Y[:SCALe]:AUTO
 (K91) 6.414
 DISPlay:WINDow<1|2>:TRACe<1...4>:Y[:SCALe]:PDIVisi
 on (K91) 6.414
 DISPlay:WINDow<1|2>:TRACe<1...4>:Y[:SCALe]:RLEVe
 l (K91) 6.415
 DISPlay:WINDow<1|2>:TRACe1:Y[:SCALe]:AUTO (K92)
 6.493
 DISPlay:WINDow<1|2>:TRACe1:Y[:SCALe]:PDIVision
 (K92) 6.494
 DISPlay:WINDow<1|2>:ZOOM:EPATtern 6.337
 DISPlay:WINDow<1|2>:ZOOM:EPATtern:STATe 6.337
 DISPlay:WINDow<1|2>:ZOOM:MERRors 6.338
 DISPlay:WINDow<1|2>:ZOOM:QUADrant 6.339
 DISPlay:ANNotation:FREQUency 6.549
 DISPlay:CMAP<1...27>:DEFault<1|2> 6.549
 DISPlay:CMAP<1...27>:HSL 6.550
 DISPlay:CMAP<1...27>:PDEFined 6.550
 DISPlay:FORMat 6.550

DISPlay:FORMat (K91) 6.413
 DISPlay:FORMat (K92) 6.492
 DISPlay:LOGO 6.551
 DISPlay:PSAVe[:STATe] 6.551
 DISPlay:PSAVe:HOLDoff 6.552
 double dagger 5.10

E

Edit Limit Line dialog box 4.82, 4.84
 ENABle register part 5.15
 EOI (command line) 5.7
 equalizer (K20) 2.69
 equipment under test (K8) 4.124
 error messages 9.1
 error queue query 5.26
 error reporting (K91) 5.39
 error reporting (K92) 5.41
 error variable – iberr 5.32
 ESE (event status enable register) 5.18
 ESR (event status register) 5.18
 EUT (K8) 4.124
 EVENT register part 5.15
 event status enable register (ESE) 5.18
 event status register (ESR) 5.18
 external noise source 4.267
 external trigger 4.26

F

FETCh<1|2>:PMETer? (K9) 6.274
 FETCh:BURSt:ALL? (K91) 6.418
 FETCh:BURSt:ALL? (K92) 6.497
 FETCh:BURSt:CINR? (K92) 6.498
 FETCh:BURSt:COUNt? (K91) 6.418
 FETCh:BURSt:COUNt? (K92) 6.498
 FETCh:BURSt:CRESt[:AVERAge?] (K91) 6.419
 FETCh:BURSt:CRESt:AVERAge? (K92) 6.498
 FETCh:BURSt:CRESt:MAXimum (K91) 6.419
 FETCh:BURSt:CRESt:MAXimum? (K92) 6.498
 FETCh:BURSt:CRESt:MINimum (K91) 6.419
 FETCh:BURSt:CRESt:MINimum? (K92) 6.498
 FETCh:BURSt:EVM:[IEEE]:AVERAge? (K91) 6.419
 FETCh:BURSt:EVM:[IEEE]:MAXimum? (K91) 6.419
 FETCh:BURSt:EVM:[IEEE]:MINimum? (K91) 6.419
 FETCh:BURSt:EVM:ALL:AVERAge (K91) 6.419
 FETCh:BURSt:EVM:ALL:AVERAge? (K92) 6.499
 FETCh:BURSt:EVM:ALL:MAXimum? (K92) 6.499
 FETCh:BURSt:EVM:ALL:MINimum (K91) 6.419
 FETCh:BURSt:EVM:ALL:MINimum? (K92) 6.499
 FETCh:BURSt:EVM:DATA:AVERAge (K91) 6.420
 FETCh:BURSt:EVM:DATA:AVERAge? (K92) 6.499
 FETCh:BURSt:EVM:DATA:MAXimum (K91) 6.420
 FETCh:BURSt:EVM:DATA:MAXimum? (K92) 6.499
 FETCh:BURSt:EVM:DATA:MINimum (K91) 6.420
 FETCh:BURSt:EVM:DATA:MINimum? (K92) 6.499
 FETCh:BURSt:EVM:DIRect:AVERAge? (K91) 6.420
 FETCh:BURSt:EVM:DIRect:MAXimum? (K91) 6.420
 FETCh:BURSt:EVM:DIRect:MINimum? (K91) 6.420
 FETCh:BURSt:EVM:PILot:AVERAge? (K91) 6.420
 FETCh:BURSt:EVM:PILot:AVERAge? (K92) 6.499
 FETCh:BURSt:EVM:PILot:MAXimum? (K91) 6.420
 FETCh:BURSt:EVM:PILot:MAXimum? (K92) 6.499
 FETCh:BURSt:EVM:PILot:MINimum? (K91) 6.420
 FETCh:BURSt:EVM:PILot:MINimum? (K92) 6.499
 FETCh:BURSt:FERRor:AVERAge? (K91) 6.421
 FETCh:BURSt:FERRor:AVERAge? (K92) 6.500
 FETCh:BURSt:FERRor:MAXimum? (K91) 6.421
 FETCh:BURSt:FERRor:MAXimum? (K92) 6.500
 FETCh:BURSt:FERRor:MINimum? (K91) 6.421
 FETCh:BURSt:FERRor:MINimum? (K92) 6.500
 FETCh:BURSt:GIMBalance:AVERAge? (K91) 6.421

FETCh:BURSt:GIMBalance:AVERage? (K92) 6.500
 FETCh:BURSt:GIMBalance:MAXimum? (K91) 6.421
 FETCh:BURSt:GIMBalance:MAXimum? (K92) 6.500
 FETCh:BURSt:GIMBalance:MINimum? (K91) 6.421
 FETCh:BURSt:GIMBalance:MINimum? (K92) 6.500
 FETCh:BURSt:IQOffset:AVERage? (K91) 6.421
 FETCh:BURSt:IQOffset:AVERage? (K92) 6.500
 FETCh:BURSt:IQOffset:MAXimum? (K91) 6.421
 FETCh:BURSt:IQOffset:MAXimum? (K92) 6.500
 FETCh:BURSt:IQOffset:MINimum? (K91) 6.421
 FETCh:BURSt:IQOffset:MINimum? (K92) 6.500
 FETCh:BURSt:PAYLoad? (K91) 6.422
 FETCh:BURSt:PEAK? (K91) 6.422
 FETCh:BURSt:PREamble? (K91) 6.422
 FETCh:BURSt:QUADOffset:AVERage? (K91) 6.422
 FETCh:BURSt:QUADOffset:AVERage? (K92) 6.501
 FETCh:BURSt:QUADOffset:MAXimum? (K91) 6.422
 FETCh:BURSt:QUADOffset:MAXimum? (K92) 6.501
 FETCh:BURSt:QUADOffset:MINimum? (K91) 6.422
 FETCh:BURSt:QUADOffset:MINimum? (K92) 6.501
 FETCh:BURSt:RMS[:AVERage?] (K91) 6.423
 FETCh:BURSt:RMS:MAXimum (K91) 6.423
 FETCh:BURSt:RMS:MINimum? (K91) 6.423
 FETCh:BURSt:RSSI (K92) 6.501
 FETCh:BURSt:SSTiming:AVERage? (K92) 6.502
 FETCh:BURSt:SSTiming:MAXimum? (K92) 6.502
 FETCh:BURSt:SSTiming:MINimum? (K92) 6.502
 FETCh:BURSt:SYMBOLerror:AVERage? (K91) 6.423
 FETCh:BURSt:SYMBOLerror:AVERage? (K92) 6.502
 FETCh:BURSt:SYMBOLerror:MAXimum? (K91) 6.423
 FETCh:BURSt:SYMBOLerror:MAXimum? (K92) 6.502
 FETCh:BURSt:SYMBOLerror:MINimum? (K91) 6.423
 FETCh:BURSt:SYMBOLerror:MINimum? (K92) 6.502
 FETCh:BURSt:TFALI:AVERage? (K91) 6.423
 FETCh:BURSt:TFALI:MAXimum? (K91) 6.423
 FETCh:BURSt:TFALI:MINimum? (K91) 6.423
 FETCh:BURSt:TRISe:AVERage? (K91) 6.424
 FETCh:BURSt:TRISe:MAXimum? (K91) 6.424
 FETCh:BURSt:TRISe:MINimum? (K91) 6.424
 FETCh:SYMBOL:COUNT? (K91) 6.424
 FETCh:SYMBOL:COUNT? (K92) 6.502
 field, first 4.31
 field, second 4.31
 file
 copy 4.281
 delete 4.281
 FILE key 4.277
 file menu 4.278
 filter
 root raised cosine (K20) 2.68
 RX (K20) 2.69
 TX (K20) 2.68
 firmware
 update 4.273
 version 4.274
 fixed reference 4.48
 FM demodulation 4.50
 FORMat[:DATA] 6.554
 FORMat[:DATA] (K91) 6.425
 FORMat[:DATA] (K92) 6.503
 FORMat:DEXPort:DSEParator 6.104
 FREQ key 4.5
 frequency
 axis 4.5
 band (K8) 4.123
 center 4.7
 display 4.271
 line 4.89
 offset 4.9
 power meter 4.142
 specify frequency axis 4.5
 start 4.7

 stop 4.7
 frequency menu 4.6
 frequency menu (K20) 4.168
 frequency menu (K7) 4.110
 frequency menu (K8) 4.127, 4.136
 frequency menu (K91) 4.196
 frequency menu (K92) 4.231
 frequency plan (K20) 2.81

G

gate
 delay 4.30
 external/internal 4.29
 length 4.30
 mode 4.29
 GET (Group Execute Trigger) 5.11

H

harmonics measurement 4.79
 HCOPy[:IMMEDIATE<1|2>] 6.555
 HCOPy:ABORt 6.555
 HCOPy:CMAP<1...27>:DEFault1|2|3 6.556
 HCOPy:CMAP<1...27>:HSL 6.556
 HCOPy:CMAP<1...27>:PDEFined 6.557
 HCOPy:DESTination<1|2> 6.557
 HCOPy:DEvIce:COLor 6.558
 HCOPy:DEvIce:LANGUage<1|2> 6.558
 HCOPy:ITEM:ALL 6.559
 HCOPy:ITEM:WINDow<1|2>:TEXT 6.559
 HCOPy:ITEM:WINDow<1|2>:TRACe:STATe 6.559
 HCOPy:PAGE:ORlentation<1|2> 6.560
 header 5.5
 horizontal sync signal 4.31

I

IEC/IEEE bus
 command description 6.2
 interface 5.32
 interface functions 5.33
 impedance
 cable TV networks (K20) 4.171
 input 4.14
 Initial Carrier Frequency Tolerance measurement (K8)
 4.121
 initial configuration 4.3
 INITiate<1|2>[:IMMEDIATE] 6.105
 INITiate<1|2>:CONMeas 6.105
 INITiate<1|2>:CONTinuous 6.106
 INITiate<1|2>:DISPlay 6.106
 INPut<1|2>:ATTenuation 6.108
 INPut<1|2>:ATTenuation:AUTO 6.108
 INPut<1|2>:GAIN:STATe 6.109
 INPut<1|2>:IMPedance 6.109
 INPut<1|2>:UPORt[:VALue]? 6.109
 INPut<1|2>:UPORt:STATe 6.110
 INPut:SELEct (K92) 6.505
 instrument functions 4.1, 4.260
 INSTRument[:NSElect] (K20) 6.343
 INSTRument[:NSElect] (K7) 6.194
 INSTRument[:NSElect] (K8) 6.262
 INSTRument[:NSElect] (K91) 6.428
 INSTRument[:NSElect] (K92) 6.506
 INSTRument[:SELEct] 6.561
 INSTRument[:SELEct] (K20) 6.343
 INSTRument[:SELEct] (K7) 6.194
 INSTRument[:SELEct] (K8) 6.262
 INSTRument[:SELEct] (K91) 6.428
 INSTRument[:SELEct] (K92) 6.506
 INSTRument:NSElect 6.561
 interface functions
 IEC/IEEE bus 5.33

interference
 inter-symbol K20 2.69
 intermodulation product 2.9
 interrupt 5.25
 inter-symbol interference K20 2.69
 IST flag 5.18
 IVI driver 5.2

K

key

AMPT 4.12
 BW 4.15
 ESC 6.20
 FILE 4.277
 FREQ 4.5
 LINES 4.81
 MEAS 4.60
 MENU 4.93
 MKR 4.43
 MKR→ 4.53
 MODE 4.91
 MODE (remote control) 6.561
 PRESET 4.3, 6.540, 6.591
 PRINT 4.284
 SETUP 4.262
 SPAN 4.10
 SWEEP 4.20
 TRACE 4.33
 TRIG 4.23

L

LAN 5.28

interface 5.28
 RSIB protocol 5.30
 VXI protocol 5.28

LAP (K8) 4.124

level

axis 4.14
 display range 4.13
 range 4.13
 reference 4.13
 trigger 4.28

level detection (K91) 2.103

level detection (K92) 2.120

limit

ACP measurement 4.74
 evaluation range 4.69

limit check

ACP measurement 4.73

limit line 4.85

copy 4.88
 delete 4.88
 edit 4.88
 new 4.87
 scaling 4.83
 shift 4.84
 span setting 4.83
 unit 4.83

line

display 4.85
 frequency (Frequency Line 1, 2) 4.89
 limit 4.85
 threshold 4.59
 time (Time Line 1, 2) 4.89

line system 4.32

LINES key 4.81

lines menu 4.86

lines menu (K91) 4.224

lines menu (K92) 4.258

LO exclude 4.59

local menu 4.283

logo 4.271

lower-case (commands) 5.6, 6.2

M

maintenance 8.1

manual control 4.283

changing to 4.283

manual operation

return to 5.4

marker 4.43

center frequency to 4.57

peak 4.57

reference level to 4.58

search limit 4.58

signal track 4.9

to trace 4.49

zoom 4.51

marker menu (K91) 4.222

marker menu (K92) 4.257

marker→ menu 4.56

marker→ menu (K91) 4.223

marker→ menu (K92) 4.258

Max Hold mode 4.34

maximum search 4.57

maximum value 4.68

mean power (GSM burst) 4.69

mean value 4.69

MEAS key 4.60

measurement

Adjacent Channel Power (K8) 4.121

Carrier Frequency Drift (K8) 4.122

Carrier Frequency Stability and Modulation Accuracy (K8) 4.122

Differential Phase Encoding (K8) 4.122

functions 4.42

Initial Carrier Frequency Tolerance (K8) 4.121

Modulation Characteristics (K8) 4.121

Output Power (K8) 4.120

parameters 4.2

reflection 4.96

Relative Transmit Power (K8) 4.122

Spurious Emissions (K8) 4.122

starting (K91) 2.103

starting (K92) 2.120

time 4.143

transmission 4.96

measurement example (K91)

basic 2.102

measurement example (K92)

basic 2.118

measurement menu (K20) 4.171

measurement menu (K8) 4.136

measurement mode

Analog Demodulation (K7) 4.91

available modes 4.91

Bluetooth (K8) 4.91

Cable TV Analyzer (K20) 4.91

changing 4.91

displaying main menus 4.93

Spectrum Analyzer 4.91

WiMAX (K92) 4.92

WLAN (K91) 4.92

measurements

Bluetooth (K8) 4.118

cable TV (K20) 4.146

CINR (K92) 2.131

RSSI (K92) 2.131

WiMAX 802.16 OFDM (K92) 4.226

WLAN TX (K91) 4.190

menu

amplitude 4.12

- amplitude (K20) 4.169
 - amplitude (K7) 4.113
 - amplitude (K8) 4.128
 - amplitude (K91) 4.196
 - amplitude (K92) 4.231
 - analog demodulation (K7) 4.100, 4.103
 - bandwidth 4.18
 - bandwidth (K7) 4.115
 - bandwidth (K8) 4.130
 - Bluetooth (K8) 4.118, 4.122
 - Cable TV Analyzer (K20) 4.145
 - Cable TV Measurements (K20) 4.165
 - file 4.278
 - frequency 4.6
 - frequency (K20) 4.168
 - frequency (K7) 4.110
 - frequency (K8) 4.127, 4.136
 - frequency (K91) 4.196
 - frequency (K92) 4.231
 - lines 4.86
 - lines (K91) 4.224
 - lines (K92) 4.258
 - marker (K91) 4.222
 - marker (K92) 4.257
 - marker-> 4.56
 - marker-> (K91) 4.223
 - marker-> (K92) 4.258
 - measurement (K20) 4.171
 - measurement (K8) 4.136
 - menu 4.93
 - power measurement 4.66
 - power meter (K9) 4.141, 4.142
 - print 4.284
 - setup 4.262
 - span 4.10
 - span (K7) 4.112
 - sweep 4.20
 - sweep (K7) 4.115
 - sweep (K8) 4.132
 - sweep (K91) 4.221
 - sweep (K92) 4.256
 - trace 4.37
 - trace (K91) 4.224
 - trace (K92) 4.259
 - tracking generator 4.97
 - trigger 4.27
 - trigger (K7) 4.116
 - trigger (K91) 4.196
 - trigger (K92) 4.231
 - WiMAX (K92) 4.225, 4.230
 - WLAN (K91) 4.189, 4.195
 - MENU key 4.93
 - menu menu 4.93
 - Min Hold mode 4.34
 - minimum search 4.58
 - MKR key 4.43
 - MKR-> key 4.53
 - MMEemory:CATalog? 6.563
 - MMEemory:CDIRectory 6.563
 - MMEemory:CLEar:ALL 6.564
 - MMEemory:CLEar:STATe 6.564
 - MMEemory:COpy 6.564
 - MMEemory:DATA 6.565
 - MMEemory:DELeTe 6.565
 - MMEemory:LOAD:AUTO 6.566
 - MMEemory:LOAD:IQ:STATe (K91) 6.429
 - MMEemory:LOAD:IQ:STATe (K92) 6.507
 - MMEemory:LOAD:STATe 6.566
 - MMEemory:MDIRectory 6.567
 - MMEemory:MOVE 6.567
 - MMEemory:MSIS 6.567
 - MMEemory:NAME 6.568
 - MMEemory:RDIRectory 6.568
 - MMEemory:SELEct[:ITEM]:ALL 6.569
 - MMEemory:SELEct[:ITEM]:DEFAult 6.569
 - MMEemory:SELEct[:ITEM]:HWSettings 6.569
 - MMEemory:SELEct[:ITEM]:LINES:ALL 6.570
 - MMEemory:SELEct[:ITEM]:NONE 6.570
 - MMEemory:SELEct[:ITEM]:SCData 6.570
 - MMEemory:SELEct[:ITEM]:TRACe[:ACTIve] 6.571
 - MMEemory:SELEct[:ITEM]:TRANsdUcer:ALL 6.571
 - MMEemory:STORe<1|2>:STATe 6.571
 - MMEemory:STORe<1|2>:TRACe 6.572
 - MMEemory:STORe:IQ:STATe (K91) 6.429
 - MMEemory:STORe:IQ:STATe (K92) 6.507
 - mode
 - see also measurement mode 4.91
 - trigger 4.28
 - MODE key 4.91
 - model 4.94
 - model 13 and 16 – tracking generator 4.95
 - Modulation Characteristics measurement (K8) 4.121
 - modulation depth 4.68
 - modulation standard (K20) 2.81, 4.152
 - < unused > 2.82
- ## N
- Negative Peak detector 4.36
 - noise
 - source, external 4.267
 - normalization 4.99
 - NTRansition register part 5.15
 - numerical values (command) 5.8
- ## O
- occupied bandwidth 4.63
 - occupied bandwidth (K20) 2.88
 - offset
 - frequency 4.9
 - gate signal 4.30
 - reference level 4.14
 - trigger 4.28
 - operating time 4.274
 - option 4.94
 - Additional Interfaces (B5) 4.141
 - Analog Demodulation mode (K7) 4.100
 - Bluetooth Measurements (K8) 4.118
 - Gated Sweep (B8) 4.23
 - Power Meter (K9) 4.141
 - RF Preamplifier (B22) 4.13
 - TV Trigger (B6) 4.26
 - WiMAX 802.16 OFDM Measurements (K92) 4.225
 - WLAN TX Measurements (K91) 4.189
 - output level
 - control 4.98
 - Output Power measurement (K8) 4.120
 - OUTPut<1|2>[:STATe] 6.111
 - OUTPut<1|2>:IF[:SOURce] 6.573
 - OUTPut:UPOrt[:VALue] 6.111
 - OUTPut:UPOrt:STATe 6.112
 - over sampling factor (K8) 4.127
 - overlapping execution 5.12
 - overview
 - Bluetooth measurements (K8) 2.41
 - overwrite mode 4.34
- ## P
- p0 bit (K8) 2.51, 4.120
 - packing 8.1
 - parallel poll 5.26
 - enable register (PPE) 5.18
 - parameter
 - block data 5.10

- boolean 5.9
 - numerical values 5.8
 - string 5.9
 - text 5.9
- path 4.279
- peak search 4.57
- physical layer (K20) 2.81
- polarity
 - external trigger/gate 4.28
 - trigger edge 4.28
 - video 4.31
- Positive Peak detector 4.36
- power bandwidth percentage 4.76
- power cables 8.1
- power measurement 4.60
 - occupied bandwidth 4.63
 - trace 4.75
 - zero span 4.62
- power measurement menu 4.66
- power meter (K9) 4.141
 - frequency 4.142
 - menu 4.141, 4.142
- power sensor support (K9) 4.141
- power, mean 4.69
- PPE (parallel poll enable register) 5.18
- preset instrument 4.3
- PRESET key 4.3
- pre-trigger 4.29
- print
 - screen 4.284
- PRINT key 4.284
- print menu 4.284
- protocol
 - RSIB 5.30
 - VXI 5.28
- PTRansition register part 5.15

Q

- QAM (K20) 2.87
- query 5.8, 5.26, 5.35
- question mark 5.8, 5.10
- quotation mark 5.10

R

- READ<1|2>:PMETer? (K9) 6.275
- reference
 - external 4.264
 - fixed 4.48
 - internal 4.264
 - level to marker level 4.58
 - value 4.143
- reference level 4.13
 - channel power 4.76
 - offset 4.14
 - to marker level 4.58
- reference point
 - frequency 4.49
 - level 4.48
 - peak search 4.49
 - time 4.49
- reflection measurement 4.96
- Relative Transmit Power measurement (K8) 4.122
- remote control
 - basics 5.1
 - changing to 4.283
 - IP address 5.3
 - programming examples 7.1
 - starting 5.4
- rename
 - file 4.281
 - folder 4.281

- reset
 - status reporting system 5.26
 - switch on or off 4.38
- resolution bandwidth 4.18
- resolution bandwidth (K7) 4.115
- RMS detector 4.36
- RMS value 4.69
- roll-off factor (K20) 2.68
- root raised cosine 2.88
 - filter (K20) 2.68
- RSIB protocol 5.30
- RSSI measurements (K92) 2.131
- RX filter (K20) 2.69

S

- Sample detector 4.36
- sample number 4.77
- save
 - limit line 4.88
- scalar reflection measurement 4.96
- scaling 4.13
 - level axis 4.14
 - limit line 4.83
 - x- and y-axis (signal statistic) 4.77
- SCPI
 - conformity information 6.2
 - introduction 5.5
 - version 5.1
- search
 - bandwidth 4.9
 - minimum 4.58
 - peak 4.57
 - range 4.58
- Select Limit Line dialog box 4.84
- self test 4.276
- [SENSe<1|2>]:ATV:CN:BWIDth (K20) 6.346
- [SENSe<1|2>]:ATV:CN:CFRelative:NEXt (K20) 6.346
- [SENSe<1|2>]:ATV:CN:MEASurement:MODE (K20) 6.346
- [SENSe<1|2>]:ATV:CN:POWer:NCORrection (K20) 6.347
- [SENSe<1|2>]:ATV:CN:POWer:REFerence:CHANnel:MANual (K20) 6.347
- [SENSe<1|2>]:ATV:CN:POWer:REFerence:MANual (K20) 6.348
- [SENSe<1|2>]:ATV:CN:POWer:REFerence:MODE (K20) 6.348
- [SENSe<1|2>]:ATV:CN:TABLE<1...10>:MFRequencies (K20) 6.348
- [SENSe<1|2>]:ATV:CSO:CFRelative:NEXt (K20) 6.349
- [SENSe<1|2>]:ATV:CSO:MEASurement:MODE (K20) 6.350
- [SENSe<1|2>]:ATV:CSO:POWer:NCORrection (K20) 6.350
- [SENSe<1|2>]:ATV:CSO:POWer:REFerence:CHANnel:MANual (K20) 6.351
- [SENSe<1|2>]:ATV:CSO:POWer:REFerence:MANual (K20) 6.351
- [SENSe<1|2>]:ATV:CSO:POWer:REFerence:MODE (K20) 6.351
- [SENSe<1|2>]:ATV:CSO:TABLE<1...10>:MFRequencies (K20) 6.352
- [SENSe<1|2>]:ATV:CTB:CFRelative:NEXt (K20) 6.353
- [SENSe<1|2>]:ATV:CTB:POWer:NCORrection (K20) 6.353
- [SENSe<1|2>]:ATV:CTB:POWer:REFerence:CHANnel:MANual (K20) 6.354
- [SENSe<1|2>]:ATV:CTB:POWer:REFerence:MANual (K20) 6.354
- [SENSe<1|2>]:ATV:CTB:POWer:REFerence:MODE (K20) 6.354
- [SENSe<1|2>]:ATV:CTB:TABLE<1...10>:MFRequencies (K20) 6.355
- [SENSe<1|2>]:CORrection:RVELocity 6.356

[SENSe<1|2>]:DDEMod:EQualizer[:STATe] 6.357
 [SENSe<1|2>]:DDEMod:EQualizer:FREeze[:STATe] 6.357
 [SENSe<1|2>]:DDEMod:EQualizer:RESet 6.358
 [SENSe<1|2>]:DDEMod:FiLTer:ALPHa 6.358
 [SENSe<1|2>]:DDEMod:SBANd 6.358
 [SENSe<1|2>]:DDEMod:SRATe 6.359
 [SENSe<1|2>]:FREQuency:CHANnel (K20) 6.359
 [SENSe<1|2>]:FREQuency:RF (K20) 6.360
 [SENSe<1|2>]:SWEep:SPACing (K20) 6.361
 [SENSe<1|2>]:TV:MSTandard:FiLTer:GDElAy 6.362
 [SENSe<1|2>]:TV:MSTandard:NAME 6.362
 [SENSe<1|2>]:TV:MSTandard:STYPe 6.363
 [SENSe<1|2>]:JADEMod:ZOOM[:STATe>] (K7) 6.216
 [SENSe<1|2>]:JADEMod:ZOOM[:STATe>] (K8) 6.263
 [SENSe<1|2>]:JADEMod:ZOOM:STARt (K7) 6.216
 [SENSe<1|2>]:JADEMod:ZOOM:STARt (K8) 6.264
 [SENSe<1|2>]:JAVERage[:STATe<1...4>] 6.113
 [SENSe<1|2>]:JAVERage:COUNT 6.114
 [SENSe<1|2>]:JAVERage:COUNT:AUTo 6.114
 [SENSe<1|2>]:JAVERage:TYPE 6.115
 [SENSe<1|2>]:BANDwidth|BWiDth[:RESolution] 6.115
 [SENSe<1|2>]:BANDwidth|BWiDth[:RESolution]:AUTo 6.116
 [SENSe<1|2>]:BANDwidth|BWiDth[:RESolution]:RATio 6.116
 [SENSe<1|2>]:BANDwidth|BWiDth[:RESolution]:TYPE 6.117
 [SENSe<1|2>]:BANDwidth|BWiDth:DEMod (K7) 6.217
 [SENSe<1|2>]:BANDwidth|BWiDth:ViDeo 6.117
 [SENSe<1|2>]:BANDwidth|BWiDth:ViDeo:AUTo 6.118
 [SENSe<1|2>]:BANDwidth|BWiDth:ViDeo:RATio 6.118
 [SENSe<1|2>]:BANDwidth:ViDeo:TYPE 6.118
 [SENSe<1|2>]:CORRection[:STATe] 6.119
 [SENSe<1|2>]:CORRection:COLlect[:ACQuire] 6.120
 [SENSe<1|2>]:CORRection:EGain:INPut[:MAGNitude] 6.120
 [SENSe<1|2>]:CORRection:EGain:INPut[:MAGNitude] (K8) 6.263
 [SENSe<1|2>]:CORRection:METhod 6.121
 [SENSe<1|2>]:CORRection:RECall 6.121
 [SENSe<1|2>]:CORRection:TRANSDucer[:STATe] 6.574
 [SENSe<1|2>]:CORRection:TRANSDucer:ADJust:RLEVel[:STATe] 6.575
 [SENSe<1|2>]:CORRection:TRANSDucer:COMMeNt 6.575
 [SENSe<1|2>]:CORRection:TRANSDucer:DATA 6.575
 [SENSe<1|2>]:CORRection:TRANSDucer:DELeTe 6.576
 [SENSe<1|2>]:CORRection:TRANSDucer:SCALing 6.576
 [SENSe<1|2>]:CORRection:TRANSDucer:SElect 6.577
 [SENSe<1|2>]:CORRection:TRANSDucer:UNIT 6.577
 [SENSe<1|2>]:CORRection:TRANSDucer:VIEW 6.577
 [SENSe<1|2>]:JDEMod:FiLTer:MEASurement (K8) 6.265
 [SENSe<1|2>]:JDEMod:SEARch:PULSe[:STATe] (K8) 6.265
 [SENSe<1|2>]:JDEMod:SEARch:PULSe:OFFSet (K8) 6.266
 [SENSe<1|2>]:JDEMod:SEARch:SYNC[:STATe] (K8) 6.266
 [SENSe<1|2>]:JDEMod:SEARch:SYNC:LAP (K8) 6.266
 [SENSe<1|2>]:JDEMod:SEARch:SYNC:OFFSet (K8) 6.267
 [SENSe<1|2>]:JDEMod:SEARch:TIME (K8) 6.267
 [SENSe<1|2>]:JDEMod:SEARch:TIME:AUTo (K8) 6.268
 [SENSe<1|2>]:JDETEctor<1...4>[:FUNction] 6.122
 [SENSe<1|2>]:JDETEctor<1...4>[:FUNction]:AUTo 6.122
 [SENSe<1|2>]:FiLTer:DEMPHasis (K7) 6.218
 [SENSe<1|2>]:FiLTer:DEMPHasis:TCONstant (K7) 6.218
 [SENSe<1|2>]:FiLTer:HPASs[:STATe] (K7) 6.219
 [SENSe<1|2>]:FiLTer:HPASs:FREQuency (K7) 6.219
 [SENSe<1|2>]:FiLTer:LPASs[:STATe] (K7) 6.219
 [SENSe<1|2>]:FiLTer:LPASs:FREQuency[:ABSolute] (K7) 6.220
 [SENSe<1|2>]:FiLTer:LPASs:FREQuency:RElative (K7) 6.220
 [SENSe<1|2>]:FREQuency:CENTer 6.123
 [SENSe<1|2>]:FREQuency:CENTer:STEP 6.123
 [SENSe<1|2>]:FREQuency:CENTer:STEP:AUTo 6.124
 [SENSe<1|2>]:FREQuency:CENTer:STEP:LiNK 6.124
 [SENSe<1|2>]:FREQuency:CENTer:STEP:LiNK (K7) 6.221
 [SENSe<1|2>]:FREQuency:CENTer:STEP:LiNK:FACTOR 6.125
 [SENSe<1|2>]:FREQuency:MODE 6.125
 [SENSe<1|2>]:FREQuency:OFFSet 6.125
 [SENSe<1|2>]:FREQuency:SPAN 6.126
 [SENSe<1|2>]:FREQuency:SPAN:FULL 6.126
 [SENSe<1|2>]:FREQuency:STARt 6.126
 [SENSe<1|2>]:FREQuency:STOP 6.127
 [SENSe<1|2>]:LiST:POWer[:SEQuence] 6.128
 [SENSe<1|2>]:LiST:POWer:RESult? 6.130
 [SENSe<1|2>]:LiST:POWer:SET 6.131
 [SENSe<1|2>]:LiST:POWer:STATe 6.132
 [SENSe<1|2>]:JMPOWer[:SEQuence] 6.133
 [SENSe<1|2>]:JMPOWer:FTYPe 6.135
 [SENSe<1|2>]:JMPOWer:RESult[:LiST]? 6.135
 [SENSe<1|2>]:JMPOWer:RESult:MIN? 6.136
 [SENSe<1|2>]:JPMETer[:STATe] (K9) 6.276
 [SENSe<1|2>]:JPMETer:FREQuency (K9) 6.276
 [SENSe<1|2>]:JPMETer:FREQuency:LiNK (K9) 6.277
 [SENSe<1|2>]:JPMETer:MTIME (K9) 6.277
 [SENSe<1|2>]:JPOWer:ACHannel:ACPairs 6.137
 [SENSe<1|2>]:JPOWer:ACHannel:BANDwidth|BWiDth[:CHANnel] 6.138
 [SENSe<1|2>]:JPOWer:ACHannel:BANDwidth|BWiDth:ACHannel 6.138
 [SENSe<1|2>]:JPOWer:ACHannel:BANDwidth|BWiDth:ALTErnate<1|2> 6.138
 [SENSe<1|2>]:JPOWer:ACHannel:MODE 6.139
 [SENSe<1|2>]:JPOWer:ACHannel:PRESet 6.139
 [SENSe<1|2>]:JPOWer:ACHannel:PRESet:RLEVel 6.140
 [SENSe<1|2>]:JPOWer:ACHannel:REFEreNce:AUTo 6.140
 [SENSe<1|2>]:JPOWer:ACHannel:REFEreNce:TXCHannel:AUTo 6.141
 [SENSe<1|2>]:JPOWer:ACHannel:REFEreNce:TXCHannel:MANual 6.141
 [SENSe<1|2>]:JPOWer:ACHannel:SPACing:ACHannel 6.142
 [SENSe<1|2>]:JPOWer:ACHannel:SPACing:ALTErnate<1|2> > 6.142
 [SENSe<1|2>]:JPOWer:ACHannel:SPACing:CHANnel 6.142
 [SENSe<1|2>]:JPOWer:ACHannel:TXCHannel:COUNT 6.143
 [SENSe<1|2>]:JPOWer:BANDwidth|BWiDth 6.143
 [SENSe<1|2>]:JPOWer:HSPeEd 6.143
 [SENSe<1|2>]:JPOWer:TRACe 6.144
 [SENSe<1|2>]:JROSCillator:SOURce 6.578
 [SENSe<1|2>]:JSWEep:COUNT 6.145
 [SENSe<1|2>]:JSWEep:COUNT:CURRent? 6.146
 [SENSe<1|2>]:JSWEep:EGATe 6.146
 [SENSe<1|2>]:JSWEep:EGATe:HOLDoff 6.147
 [SENSe<1|2>]:JSWEep:EGATe:LENGth 6.147
 [SENSe<1|2>]:JSWEep:EGATe:POLarity 6.147
 [SENSe<1|2>]:JSWEep:EGATe:SOURce 6.148
 [SENSe<1|2>]:JSWEep:EGATe:TYPE 6.148
 [SENSe<1|2>]:JSWEep:POINts 6.149
 [SENSe<1|2>]:JSWEep:TIME 6.149
 [SENSe<1|2>]:JSWEep:TIME (K7) 6.221
 [SENSe<1|2>]:JSWEep:TIME:AUTo 6.149
 [SENSe<1|2>]:JTV:TILT:MSTandard:CDISable (K20) 6.363
 [SENSe<1|2>]:JTV:TILT:MSTandard:CENable (K20) 6.363
 [SENSe]:JADEMod[:STATe] (K7) 6.197
 [SENSe]:JADEMod:AF:CENTer (K7) 6.197
 [SENSe]:JADEMod:AF:COUPLing (K7) 6.198

- [SENSe:]ADEMod:AF:SPAN (K7) 6.198
- [SENSe:]ADEMod:AF:SPAN:FULL (K7) 6.198
- [SENSe:]ADEMod:AF:START (K7) 6.199
- [SENSe:]ADEMod:AF:STOP (K7) 6.199
- [SENSe:]ADEMod:AM[:TDOMain][:TYPE] (K7) 6.200
- [SENSe:]ADEMod:AM[:TDOMain]:RESult? (K7) 6.200
- [SENSe:]ADEMod:AM:RELative[:TDOMain][:TYPE] (K7) 6.201
- [SENSe:]ADEMod:AM:RELative[:TDOMain]:RESult? (K7) 6.202
- [SENSe:]ADEMod:AM:RELative:AFSPectrum[:TYPE] (K7) 6.202
- [SENSe:]ADEMod:AM:RELative:AFSPectrum:RESult? (K7) 6.203
- [SENSe:]ADEMod:BANDwidth | BWIDth:DEModulation (K7) 6.204
- [SENSe:]ADEMod:FM[:TDOMain][:TYPE] (K7) 6.204
- [SENSe:]ADEMod:FM[:TDOMain]:RESult? (K7) 6.205
- [SENSe:]ADEMod:FM:AFSPectrum[:TYPE] (K7) 6.206
- [SENSe:]ADEMod:FM:AFSPectrum:RESult? (K7) 6.206
- [SENSe:]ADEMod:FM:OFFSet? (K7) 6.207
- [SENSe:]ADEMod:MTIME (K7) 6.208
- [SENSe:]ADEMod:PM[:TDOMain][:TYPE] (K7) 6.208
- [SENSe:]ADEMod:PM[:TDOMain]:RESult? (K7) 6.209
- [SENSe:]ADEMod:PM:AFSPectrum[:TYPE] (K7) 6.209
- [SENSe:]ADEMod:PM:AFSPectrum:RESult? (K7) 6.210
- [SENSe:]ADEMod:PM:RPOINT[:X] (K7) 6.211
- [SENSe:]ADEMod:RENGth? (K7) 6.211
- [SENSe:]ADEMod:SET (K7) 6.212
- [SENSe:]ADEMod:SPECTrum[:TYPE] (K7) 6.213
- [SENSe:]ADEMod:SPECTrum:BANDwidth|BWIDth[:RESolution] (K7) 6.213
- [SENSe:]ADEMod:SPECTrum:RESult? (K7) 6.214
- [SENSe:]ADEMod:SPECTrum:SPAN:ZOOM (K7) 6.215
- [SENSe:]ADEMod:SRATe? (K7) 6.216
- [SENSe:]BANDwidth:CHANnel (K92) 6.509
- [SENSe:]BURSt:COUnT (K91) 6.432
- [SENSe:]BURSt:COUnT (K92) 6.509
- [SENSe:]BURSt:COUnT:STATe (K91) 6.432
- [SENSe:]BURSt:COUnT:STATe (K92) 6.509
- [SENSe:]DEMod:BANalyze:DURation:EQUal (K91) 6.432
- [SENSe:]DEMod:BANalyze:DURation:MAX (K91) 6.433
- [SENSe:]DEMod:BANalyze:DURation:MIN (K91) 6.433
- [SENSe:]DEMod:CESTimation (K91) 6.434
- [SENSe:]DEMod:CESTimation (K92) 6.510
- [SENSe:]DEMod:FILTer:CATalog? (K91) 6.434
- [SENSe:]DEMod:FILTer:CATalog? (K92) 6.510
- [SENSe:]DEMod:FILTer:MODulation (K91) 6.434
- [SENSe:]DEMod:FILTer:MODulation (K92) 6.510
- [SENSe:]DEMod:FORMat[:BContent]:AUTo (K91) 6.435
- [SENSe:]DEMod:FORMat[:BContent]:AUTo (K92) 6.511
- [SENSe:]DEMod:FORMat:BANalyze (K91) 6.435
- [SENSe:]DEMod:FORMat:BANalyze (K92) 6.511
- [SENSe:]DEMod:FORMat:BANalyze:BTYPe (K91) 6.436
- [SENSe:]DEMod:FORMat:BANalyze:BTYPe (K92) 6.512
- [SENSe:]DEMod:FORMat:BANalyze:DBYTes:EQUal (K91) 6.436
- [SENSe:]DEMod:FORMat:BANalyze:DBYTes:MAX (K91) 6.436
- [SENSe:]DEMod:FORMat:BANalyze:DBYTes:MIN (K91) 6.437
- [SENSe:]DEMod:FORMat:BANalyze:SYMBOLs:EQUal (K91) 6.437
- [SENSe:]DEMod:FORMat:BANalyze:SYMBOLs:EQUal (K92) 6.512
- [SENSe:]DEMod:FORMat:BANalyze:SYMBOLs:MAX (K91) 6.438
- [SENSe:]DEMod:FORMat:BANalyze:SYMBOLs:MAX (K92) 6.513
- [SENSe:]DEMod:FORMat:BANalyze:SYMBOLs:MIN (K91) 6.438
- [SENSe:]DEMod:FORMat:BANalyze:SYMBOLs:MIN (K92) 6.513
- [SENSe:]DEMod:FORMat:BANalyze:SYMBOLs:MIN (K91) 6.438
- [SENSe:]DEMod:FORMat:BANalyze:SYMBOLs:MIN (K92) 6.513
- [SENSe:]DEMod:FORMat:SIGSymbol (K91) 6.439
- [SENSe:]DEMod:FORMat:SIGSymbol (K92) 6.514
- [SENSe:]POWer:ACHannel:ACPairs (K92) 6.514
- [SENSe:]POWer:ACHannel:MODE (K91) 6.439
- [SENSe:]POWer:ACHannel:MODE (K92) 6.515
- [SENSe:]POWer:NCORrection (K92) 6.516
- [SENSe:]SWAPiq (K91) 6.440
- [SENSe:]SWAPiq (K92) 6.517
- [SENSe:]SWEep:ACPR:TIME (K92) 6.518
- [SENSe:]SWEep:ACPR:TIME:AUTO (K91) 6.518
- [SENSe:]SWEep:COUnT (K91) 6.440
- [SENSe:]SWEep:COUnT (K92) 6.518
- [SENSe:]SWEep:EGATe:HOLDoff[:TIME] (K91) 6.441
- [SENSe:]SWEep:EGATe:HOLDoff[:TIME] (K92) 6.519
- [SENSe:]SWEep:EGATe:HOLDoff:SAMPle (K91) 6.441
- [SENSe:]SWEep:EGATe:HOLDoff:SAMPle (K92) 6.519
- [SENSe:]SWEep:EGATe:LENGth[:TIME] (K91) 6.441
- [SENSe:]SWEep:EGATe:LENGth[:TIME] (K92) 6.519
- [SENSe:]SWEep:EGATe:LENGth:SAMPle (K91) 6.442
- [SENSe:]SWEep:EGATe:LENGth:SAMPle (K92) 6.520
- [SENSe:]SWEep:EGATe:LINK (K91) 6.442
- [SENSe:]SWEep:EGATe:LINK (K92) 6.520
- [SENSe:]SWEep:TIME (K91) 6.442
- [SENSe:]SWEep:TIME (K92) 6.520
- [SENSe:]TRACking:LEVel (K91) 6.443
- [SENSe:]TRACking:LEVel (K92) 6.520
- [SENSe:]TRACking:PHASe (K91) 6.443
- [SENSe:]TRACking:PHASe (K92) 6.521
- [SENSe:]TRACking:TIME (K91) 6.443
- [SENSe:]TRACking:TIME (K92) 6.521
- sensitivity
 - APD measurement 4.79
 - CCDF measurement 4.79
- serial poll 5.25
- service request (SRQ) 5.17, 5.25
- service request enable register (SRE) 5.17
- setting command 5.35
- setup
 - general 4.268
- SETUP key 4.262
- setup menu 4.262
- SETup:TV:STANdard 6.365
- SETup:TV:STANdard:AUDio 6.365
- SETup:TV:STANdard:COLor 6.366
- signal count 4.49
- signal level (K20) 4.153
- signal processing (K91)
 - IEEE 802.11a 2.104
 - IEEE 802.11b 2.110
- signal processing (K92) 2.121
- signal tracking 4.9
 - search bandwidth 4.9
- softkey
 - # of Adj Chan 4.72
 - # of Adj Chan (remote control) 6.137
 - # of Samples 4.77
 - # of Samples (remote control) 6.91
 - # of TX Chan 4.71
 - # of TX Chan (remote control) 6.143
 - % Power Bandwidth 4.76
 - % Power Bandwidth (remote control) 6.143
 - *IDN*OPT Format FSL Legacy 4.270
 - = Center 4.8
 - = Chan Spacing (K8) 4.128
 - = Marker 4.8
 - = Marker (remote control) 6.54
 - 0.1 * RBW 4.7
 - 0.1 * RBW (remote control) 6.124, 6.125
 - 0.1 * Span 4.7
 - 0.1 * Span (remote control) 6.124, 6.125

- 0.1*Chan Spacing (K8) 4.128
- 0.1*Demod BW (K7) 4.110
- 0.5 * RBW 4.8
- 0.5 * RBW (remote control) 6.124, 6.125
- 0.5 * Span 4.8
- 0.5 * Span (remote control) 6.124, 6.125
- 0.5*Demod BW (K7) 4.111
- ACP Abs/Rel 4.76
- ACP Abs/Rel (remote control) 6.139
- ACP Ref Settings 4.73
- ACP Ref Spacing (remote control) 6.141
- ACP Rel/Abs (K91) 4.217
- ACP Rel/Abs (remote control, K91) 6.402, 6.408
- ACP Settings (K92) 4.253
- ACP Settings (remote control, K92) 6.514, 6.515, 6.516
- ACPR Abs/Rel (K92) 4.252
- ACPR Abs/Rel (remote control, K92) 6.478, 6.484, 6.485
- Activate (K20) 4.165
- Activate (remote control, K20) 6.334
- Active On/Off 4.265
- Active On/Off (remote control) 6.574, 6.577
- Adjust Attenuation (K20) 4.168
- Adjust Gate (K8) 4.133
- Adjust Gate (remote control, K8) 6.252
- Adjust Ref Level 4.76
- Adjust Ref Level (remote control) 6.140
- Adjust Ref Lvl 4.77
- Adjust Settings 4.70, 4.75, 4.79, 4.80
- Adjust Settings (remote control) 6.92, 6.139
- AF Center (K7) 4.111
- AF Center (remote control, K7) 6.197
- AF Coupling AC/DC (K7) 4.107
- AF Coupling AC/DC (remote control, K7) 6.198
- AF Filter (K7) 4.108
- AF Full Span (K7) 4.112
- AF Full Span (remote control, K7) 6.198
- AF Range (K7) 4.106
- AF Span Manual (K7) 4.112
- AF Span Manual (remote control, K7) 6.198
- AF Spectrum (K7) 4.105
- AF Start (K7) 4.111
- AF Start (remote control, K7) 6.199
- AF Stop (K7) 4.111
- AF Stop (remote control, K7) 6.199
- AF Time Domain (K7) 4.105
- Alignment 4.267
- All Functions off 4.67
- All Functions off (remote control) 6.78
- All Marker Off 4.51
- AM 4.50
- AM (remote control) 6.54
- AM Mod Depth 4.68
- AM Mod Depth (remote control) 6.57, 6.58
- Analog TV (K20) 4.173
- Analog TV (remote control, K20) 6.332
- Analog TV Settings (K20) 4.181
- Analog TV Settings (remote control, K20) 6.362, 6.374, 6.375, 6.376
- Annotation On/Off 4.271
- Annotation On/Off (remote control) 6.549
- Antenna Gain (K8) 4.124
- Antenna Gain (remote control, K8) 6.263
- APD 4.77
- APD (K20) 4.186
- APD (remote control) 6.90, 6.92
- ASCII File Export 4.38
- Auto Level (K91) 4.222
- Auto Level (K92) 4.257
- Auto Level (remote control, K92) 6.488
- Auto Lvl (remote control, K91) 6.411
- Auto Range (K20) 4.183, 4.188
- Auto Range (remote control, K20) 6.336
- Average Length (K91) 4.207
- Average Length (remote control, K91) 6.407
- Bitstream (K91) 4.218
- Bitstream (K92) 4.255
- Bitstream (remote control, K91) 6.410
- Bitstream (remote control, K92) 6.487
- Block Count (K8) 4.133
- Block Count (remote control, K8) 6.250
- Burst Offset (K8) 4.126
- Burst Offset (remote control, K8) 6.266
- Burst Selection (K92) 4.241
- Burst Selection (remote control, K92) 6.483
- Burst Summary (K92) 4.256
- Burst Summary (remote control, K92) 6.487
- C/N 4.70
- C/N (K20) 4.175
- C/N (remote control) 6.69, 6.71, 6.73
- C/N (remote control, K20) 6.301
- C/N Setup (K20) 4.176
- C/N Setup (remote control, K20) 6.346, 6.347, 6.348
- C/N, C/No 4.70
- C/No 4.70
- C/No (remote control) 6.69, 6.71, 6.73
- Cal Refl Open 4.99
- Cal Refl Open (remote control) 6.120, 6.121
- Cal Refl Short 4.99
- Cal Refl Short (remote control) 6.121
- Cal Trans 4.98
- Cal Trans (remote control) 6.121
- Cal Type Sine/Comb 4.276
- Cal Type Sine/Comb (remote control) 6.545
- Carr Freq Drift (K8) 4.139
- Carr Freq Drift (remote control, K8) 6.229
- Carr Freq Stability (K8) 4.140
- Carr Freq Stability (remote control, K8) 6.230, 6.231, 6.232, 6.233
- Carrier Selection (K91) 4.213
- Carrier Selection (K92) 4.247
- Carrier Selection (remote control, K91) 6.404
- Carrier Selection (remote control, K92) 6.480
- Carriers (K20) 4.174
- Carriers (remote control, K20) 6.300
- CCDF 4.79
- CCDF (K20) 4.187
- CCDF (K91) 4.218
- CCDF (K92) 4.254
- CCDF (remote control) 6.90, 6.92
- CCDF (remote control, K91) 6.410
- CCDF (remote control, K92) 6.487
- Center 4.7
- Center (K8) 4.128
- Center (remote control) 6.123
- Center =Mkr Freq 4.57
- Center =Mkr Freq (remote control) 6.54
- CF Stepsize 4.7
- CF Stepsize (remote control) 6.123
- CF-Stepsize (K8) 4.128
- Channel (K20) 4.168
- Channel (K8) 4.123
- Channel (remote control, K20) 6.359
- Channel (remote control, K8) 6.250
- Channel Analysis (K20) 4.184
- Channel Bandwidth 4.70, 4.72, 4.76
- Channel Bandwidth (remote control) 6.138
- Channel List Start (K8) 4.134
- Channel No (K20) 4.174
- Channel Power (K20) 4.186
- Channel Settings 4.72
- Channel Setup (K20) 4.165
- Channel Spacing 4.73
- Channel Spacing (remote control) 6.142

- Channel Width (K20) 4.169
- Clear All Messages 4.275
- Clear All Messages (remote control) 6.588, 6.589
- Clear/Write 4.74
- Color On/Off 4.271, 4.273, 4.285
- Color On/Off (remote control) 6.558
- Colors 4.271, 4.285
- Comment 4.286
- Computer Name 4.268
- Const Diagram (K20) 4.184
- Constell vs Symbol/Carrier (K91) 4.212
- Constell vs Symbol/Carrier (K92) 4.246
- Constell vs Symbol/Carrier (remote control, K91) 6.405
- Constell vs Symbol/Carrier (remote control, K92) 6.481
- Cont Demod 4.50
- Cont Demod (remote control) 6.53
- Cont Meas 4.79
- Cont Meas (remote control) 6.105, 6.106
- Continue Single Sweep 4.21
- Continue Single Sweep (remote control) 6.105
- Continue Test (K8) 4.133
- Continuous Sweep 4.21
- Continuous Sweep (K8) 4.133
- Continuous Sweep (remote control) 6.105, 6.106
- Copy 4.281
- Copy (K20) 4.167
- Copy (remote control) 6.564
- Copy Channel (K20) 4.166
- Copy to 4.88, 4.266
- Copy to (remote control) 6.21
- Copy Trace 4.38
- Copy Trace (remote control) 6.164
- Corr Data On/Off 4.268
- Corr Data On/Off (remote control) 6.543
- CP / ACP Config 4.71
- CP / ACP Standard 4.71
- CP / ACP Standard (remote control) 6.70
- CP, ACP, MC-ACP 4.71
- CP, ACP, MC-ACP (remote control) 6.69, 6.71, 6.73
- CSO (K20) 4.178
- CSO (remote control, K20) 6.301
- CSO Setup (K20) 4.178
- CSO Setup (remote control, K20) 6.350, 6.352
- CTB (K20) 4.179
- CTB (remote control, K20) 6.302
- CTB Setup (K20) 4.179
- CTB Setup (remote control, K20) 6.353, 6.355
- Current File List 1/2 4.282
- Cut 4.281
- Data Set Clear 4.280
- Data Set Clear (remote control) 6.564
- Data Set List 4.280
- Date 4.282
- dB per Division (K7) 4.106
- dB per Division (remote control, K7) 6.192
- Decim Sep 4.39
- Decim Sep (remote control) 6.104
- Deemphasis (K7) 4.109
- Deemphasis (remote control, K7) 6.218
- Default All (K91) 4.224
- Default All (K92) 4.259
- Default Colors 1 (remote control) 6.549
- Default Colors 2 (remote control) 6.549
- Default Current (K91) 4.224
- Default Current (K92) 4.258
- Default Settings 4.78
- Default Settings (remote control) 6.91, 6.94
- Delete 4.88, 4.266, 4.281
- Delete (K20) 4.166, 4.167
- Delete (remote control) 6.21, 6.565, 6.568, 6.576
- Delete Channel (K20) 4.166
- Delete Line 4.265
- Delete Line (K20) 4.177
- Delete Value 4.88
- Demod Bandwidth (K7) 4.112
- Demod BW (K7) 4.105
- Demod BW (remote control, K7) 6.217
- Demod Settings (K7) 4.107
- Demod Settings (remote control, K91) 6.432, 6.433, 6.434, 6.435, 6.436, 6.437, 6.438, 6.439, 6.443
- Deselect All 4.86
- Detector Auto Select 4.37
- Detector Auto Select (remote control) 6.122
- Detector Manual Select 4.38
- Detector Manual Select (remote control) 6.122
- Detector Manual Select (remote control, K8) 6.251
- Dev per Division (K7) 4.106
- Deviation Lin/Log (K7) 4.107
- Deviation Lin/Log (remote control, K7) 6.193
- Device 1/2 4.285
- Device 1/2 (remote control) 6.568
- Device Setup 4.285
- Device Setup (remote control) 6.557, 6.558, 6.560, 6.586, 6.587
- DHCP On/Off 4.269
- Diagram Full Size (K7) 4.105
- Diagram Full Size (remote control, K7) 6.192
- Diff Phase (K8) 4.140
- Diff Phase (remote control, K8) 6.233, 6.234
- Digital TV (K20) 4.183
- Digital TV (remote control, K20) 6.333, 6.334
- Digital TV Settings (K20) 4.185
- Digital TV Settings (remote control, K20) 6.357, 6.358, 6.359
- Discard Changes (K20) 4.167
- Display Line 1 4.89
- Display Line 1 (remote control) 6.16, 6.17
- Display Line 2 4.89
- Display Line 2 (remote control) 6.16, 6.17
- Display Lines 4.89
- Display List/Graph (K91) 4.204
- Display List/Graph (K92) 4.239
- Display List/Graph (remote control, K91) 6.414
- Display Pwr Save 4.273
- Display Pwr Save (remote control) 6.551, 6.552
- Display Update On/Off 4.269
- DPSK Start (K8) 4.135
- DPSK Start (remote control, K8) 6.255
- DPSK Stop (K8) 4.135
- DPSK Stop (remote control, K8) 6.256
- Echo Pattern (K20) 4.184
- Edit 4.88, 4.265
- Edit (K20) 4.167
- Edit (remote control) 6.20, 6.23, 6.32, 6.36, 6.37, 6.38, 6.39, 6.40, 6.575
- Edit ACP Limit 4.74
- Edit ACP Limit (remote control) 6.24, 6.25, 6.26, 6.28, 6.29
- Edit Comment 4.87, 4.279
- Edit Margin 4.87
- Edit Name 4.87, 4.265
- Edit Name (remote control) 6.577
- Edit Path 4.279, 4.280
- Edit Path (remote control) 6.563, 6.567
- Edit Table (K20) 4.174
- Edit Table (remote control, K20) 6.282, 6.283, 6.284, 6.285, 6.286, 6.287, 6.288, 6.289, 6.308, 6.309, 6.310, 6.311, 6.312, 6.313, 6.314
- Edit Unit 4.265
- Edit Unit (remote control) 6.577
- Edit Values 4.266
- Edit Values (remote control) 6.575
- EDR (K8) 4.139
- Error Frequency/Phase (K91) 4.211

- Error Frequency/Phase (K92) 4.245
- Error Frequency/Phase (remote control, K91) 6.406
- Error Frequency/Phase (remote control, K92) 6.482, 6.483
- EVM Constell (K91) 4.209
- EVM Constell (K92) 4.243
- EVM vs Symbol/Carrier (K91) 4.209
- EVM vs Symbol/Carrier (K92) 4.243
- EVM vs Symbol/Carrier (remote control, K91) 6.405, 6.406
- EVM vs Symbol/Carrier (remote control, K92) 6.482
- Exclude LO 4.59
- Exclude LO (remote control) 6.44
- Export (K91) 4.208
- Export (K92) 4.242
- Export (remote control, K91) 6.429
- Export (remote control, K92) 6.507
- Ext Att (remote control, K91) 6.427
- Extension 4.282
- Fast ACP On/Off 4.75
- Fast ACP On/Off (remote control) 6.143
- Field 1/2 (K20) 4.182
- Field 1/2 (remote control, K20) 6.375
- File Lists 1/2 4.282
- File Manager 4.280
- Filter Type 4.19
- Filter Type (K8) 4.131
- Filter Type (remote control) 6.117
- Find Burst On/Off (K8) 4.125
- Find Burst On/Off (remote control, K8) 6.265
- Find Sync (K8) 4.124
- Find Sync On/Off (K8) 4.124
- Find Sync On/Off (remote control, K8) 6.266
- Firmware Update 4.273, 4.274
- Firmware Update (remote control) 6.589
- FM 4.50
- FM (remote control) 6.54
- Freeze (K20) 4.184
- Freeze (remote control, K20) 6.335
- Frequency Abs/Rel (K20) 4.169
- Frequency Abs/Rel (remote control, K20) 6.361
- Frequency Coupling (K9) 4.143
- Frequency Coupling (remote control, K9) 6.277
- Frequency Line 1 4.89
- Frequency Line 1 (remote control) 6.17, 6.18
- Frequency Line 2 4.89
- Frequency Line 2 (remote control) 6.17, 6.18
- Frequency Manual (K9) 4.142
- Frequency Manual (remote control, K9) 6.276
- Frequency Offset 4.9
- Frequency Offset (remote control) 6.125
- Full Burst (K91) 4.205
- Full Burst (K92) 4.240
- Full Burst (remote control, K91) 6.408
- Full Burst (remote control, K92) 6.484
- Full Size Diagram 4.80
- Full Size Diagram (remote control) 6.98
- Full Span 4.11
- Full Span (K7) 4.112
- Full Span (remote control) 6.126
- Full Span (remote control, K7) 6.215
- Gate Delay 4.30
- Gate Delay (K8) 4.135
- Gate Delay (remote control) 6.147
- Gate Length 4.30
- Gate Length (K8) 4.135
- Gate Length (remote control) 6.147
- Gate Mode Lvl/Edge 4.29
- Gate Mode Lvl/Edge (remote control) 6.148
- Gate Settings 4.29
- Gated Trigger 4.29
- Gated Trigger (remote control) 6.146, 6.148
- Gating Settings On/Off (K91) 4.208
- Gating Settings On/Off (K92) 4.241
- Gating Settings On/Off (remote control, K91) 6.441, 6.442
- Gating Settings On/Off (remote control, K92) 6.519, 6.520
- General Settings (remote control, K91) 6.411, 6.412, 6.415, 6.427, 6.432, 6.439, 6.440, 6.442, 6.453, 6.454, 6.455
- General Setup 4.268
- GFSK Start (K8) 4.135
- GFSK Start (remote control, K8) 6.256
- GFSK Stop (K8) 4.135
- GFSK Stop (remote control, K8) 6.256
- GPIB 4.269
- GPIB Address 4.269
- GPIB Address (remote control) 6.585
- GPIB Language 4.269
- GPIB Terminator LFEOI/EOI 4.270
- GPIB Terminator LFEOI/EOI (remote control) 6.586
- Grid Abs / Rel 4.14
- Grid Abs/Rel (remote control) 6.101
- Hardware Info 4.274
- Hardware Info (remote control) 6.539, 6.544
- Harmonic Distort 4.79
- Harmonic On/Off 4.80
- Harmonic RBW Auto 4.80
- Harmonic Sweep Time 4.80
- High Pass AF Filter (K7) 4.108
- High Pass AF Filter (remote control, K7) 6.219
- Hold/Cont 4.38
- Hor Sync 4.31
- Hor Sync (remote control) 6.179
- Hum (K20) 4.182
- Hum (remote control, K20) 6.303
- I/O Logging On/Off 4.270
- ID String Factory 4.269
- ID String User 4.269
- IF Output IF/Video 4.267
- IF Output IF/Video (remote control) 6.573
- IF Power Retrigger Holdoff 4.30
- IF Power Retrigger Holdoff (remote control) 6.175
- IF Power Retrigger Hysteresis 4.30
- IF Power Retrigger Hysteresis (remote control) 6.176
- Import (K91) 4.208
- Import (K92) 4.242
- Import (remote control, K91) 6.429
- Import (remote control, K92) 6.507
- Init Carr Freq Tol (K8) 4.139
- Input 50 Ω / 75 Ω 4.14
- Input 50 Ω / 75 Ω (remote control) 6.109
- Input RF/Cal/TG 4.275
- Input RF/Cal/TG (remote control) 6.545
- Insert Line 4.265
- Insert Line (K20) 4.177
- Insert Value 4.88
- Install Option 4.274
- Install Printer 4.286
- Installed Options (remote control) 6.539, 6.544
- Interpolation Lin/Log 4.266
- Interpolation Lin/Log (remote control) 6.576
- IP Address 4.268
- Items to Save/Rcl 4.280
- Items to Save/Rcl (remote control) 6.571
- LAP (K8) 4.124
- LAP (remote control, K8) 6.266
- Last Span 4.11
- Left Limit 4.58, 4.69
- Left Limit (remote control) 6.49
- Limit Checking 4.73
- Limit Chk On/Off 4.73
- Limit Chk On/Off (remote control) 6.24, 6.27, 6.30

- Limit Line Select dialog box (remote control) 6.35, 6.41
- Limits On/Off 4.69
- Limits On/Off (remote control) 6.49
- Line (K20) 4.182
- Line (remote control) 6.375
- Lines 625/525 4.32
- Lines 625/525 (remote control) 6.178
- Local 4.283
- Logo On/Off 4.271
- Logo On/Off (remote control) 6.551
- Low Pass AF Filter (K7) 4.108
- Low Pass AF Filter (remote control, K7) 6.219, 6.220
- Manual 4.8
- Manual (remote control) 6.123
- Manual Reference Power (K20) 4.175
- Manual Reference Power (remote control, K20) 6.348, 6.351, 6.354
- Marker 1 4.48
- Marker 1 (K91) 4.222
- Marker 1 (K92) 4.257
- Marker 1 (remote control, K91) 6.397, 6.398, 6.399, 6.400, 6.401
- Marker 1 (remote control, K92) 6.473, 6.474, 6.475, 6.476, 6.477
- Marker 1 to 4 (remote control) 6.7, 6.14, 6.15, 6.42, 6.49, 6.50
- Marker 2 4.48
- Marker 3 4.48
- Marker 4 4.48
- Marker Demod 4.50
- Marker Demod Volume 4.93
- Marker List (remote control) 6.55
- Marker Norm/Delta 4.48
- Marker Norm/Delta (remote control) 6.7
- Marker Off (K91) 4.223
- Marker Off (K92) 4.258
- Marker Off (remote control, K91) 6.397
- Marker Off (remote control, K92) 6.473
- Marker Peak List 4.52
- Marker to Trace 4.49
- Marker to Trace (remote control) 6.14
- Marker Trace (remote control) 6.48
- Marker Zoom 4.51
- Marker Zoom (K91) 4.223
- Marker Zoom (K92) 4.258
- Marker Zoom (remote control) 6.64
- Marker Zoom (remote control, K91) 6.403
- Marker Zoom (remote control, K92) 6.479
- Max Hold 4.74
- Mean 4.69
- Mean (remote control) 6.79, 6.80
- Meas Carrier (K20) 4.174
- Meas Carrier (remote control, K20) 6.331, 6.332
- Meas Display 4.270
- Meas Filter (K8) 4.132
- Meas Filter (remote control, K8) 6.265
- Meas Single/Cont (K91) 4.221
- Meas Single/Cont (remote control, K91) 6.426
- Meas Time (K7) 4.106
- Meas Time (K9) 4.143
- Meas Time (remote control, K7) 6.208, 6.221
- Meas Time (remote control, K9) 6.277
- Meas Time Auto (K8) 4.130
- Meas Time Manual (K8) 4.130
- Meas to Ref (K9) 4.143
- Meas to Ref (remote control, K9) 6.270
- Min 4.58
- Min (K91) 4.223
- Min (remote control) 6.12, 6.46
- Min (remote control, K91) 6.399
- MKR → Trace (K91) 4.223
- MKR → Trace (K92) 4.258
- MKR → Trace (remote control, K91) 6.400
- MKR → Trace (remote control, K92) 6.476
- Mkr Demod On/Off 4.50
- Mkr Demod On/Off (remote control) 6.53
- Mkr List On/Off (remote control) 6.55
- Mkr Stop Time 4.50
- Mkr Stop Time (remote control) 6.53
- Modulation AM/FM/PM (remote control, K7) 6.183
- Modulation Analysis (K20) 4.183
- Modulation Char (K8) 4.138
- Modulation Char (remote control, K8) 6.236, 6.237, 6.238, 6.239
- Modulation Errors (K20) 4.184
- Modulation FM/PM/AM (K7) 4.104
- Modulation Options (K20) 4.166
- Modulation Options (remote control, K20) 6.358, 6.359, 6.362, 6.363, 6.365, 6.366
- n dB down 4.51
- n dB down (remote control) 6.59, 6.60, 6.61
- Name 4.281
- Name (remote control) 6.22
- Network Address 4.268
- New 4.87, 4.266
- New (K20) 4.166
- New (remote control) 6.20, 6.23, 6.32, 6.36, 6.37, 6.38, 6.39, 6.40
- New Folder 4.281
- New Folder (remote control) 6.567
- New Search 4.52
- Next Meas Frequency (K20) 4.178
- Next Meas Frequency (remote control, K20) 6.346, 6.349, 6.353
- Next Min 4.58
- Next Min (remote control) 6.13, 6.47
- Next Min Mode < abs > 4.58
- Next Peak 4.57
- Next Peak (remote control) 6.11, 6.12, 6.13, 6.45, 6.46, 6.47
- Next Peak Mode < abs > 4.57
- No. of ACP Chan (K8) 4.134
- No. of ACP Chan (remote control, K8) 6.247, 6.251
- No. of Harmonics 4.80
- Noise Meas On/Off 4.48
- Noise Meas On/Off (remote control) 6.62
- Noise Src On/Off 4.267
- Noise Src On/Off (remote control) 6.546
- Normalize 4.99
- Normalize (remote control) 6.119
- OBW 4.76
- OBW (remote control) 6.69, 6.73
- Option Licenses 4.274
- Other LAN Settings 4.268
- Output Power (K8) 4.138
- Output Power (remote control, K8) 6.240
- Overview (K20) 4.183
- Packet Bytes SCO (K8) 4.123
- Packet Bytes SCO (remote control, K8) 6.253
- Packet Type (K8) 4.123
- Packet Type (remote control, K8) 6.255
- Password 4.276
- Password (remote control) 6.590
- Paste 4.281
- Peak 4.57, 4.68
- Peak (K91) 4.223
- Peak (remote control) 6.11, 6.45, 6.82, 6.83
- Peak (remote control, K91) 6.399
- Peak Excursion 4.59
- Peak Excursion (remote control) 6.48
- Peak List Off 4.52
- Peak Search 4.49
- Peak Search (remote control) 6.8, 6.55, 6.56, 6.57
- Percent Marker 4.77

- Percent Marker (remote control) 6.51
- Ph Noise On/Off (remote control) 6.8, 6.10, 6.11
- Ph Noise/Ref Fixed (remote control) 6.8, 6.10
- Phase Noise 1 2 3 4 4.49
- Phase Noise On/Off 4.48
- Phase Noise/Ref Fixed 4.48
- Phase Unit Rad/Deg (K7) 4.109
- Phase Unit Rad/Deg (remote control, K7) 6.225
- Phase Wrap On/Off (K7) 4.109
- Phase Wrap On/Off (remote control, K7) 6.184
- PLCP Header (remote control, K91) 6.410
- Points / Symbol (K8) 4.127
- Points / Symbol (remote control, K8) 6.254
- Power Avg Start (K8) 4.134
- Power Avg Stop (K8) 4.134
- Power Class (K8) 4.124
- Power Level (remote control, K91) 6.455
- Power Meter 4.93
- Power Mode 4.74
- Power Mode (remote control) 6.69
- Power Offset 4.98, 6.151
- Powermeter On/Off (K9) 4.142
- Powermeter On/Off (remote control, K9) 6.276
- Preamp On/Off 4.13
- Preamp On/Off (remote control) 6.109
- Predefined Colors 4.272, 4.285
- Predefined Colors (remote control) 6.550, 6.557
- Print Colors 4.272
- Print Screen 4.284
- Print Screen (remote control) 6.555, 6.559, 6.568
- PVT (K91) 4.204
- PVT (K92) 4.239
- PVT (remote control, K91) 6.407
- PVT (remote control, K92) 6.483
- R&S Support (K91) 4.209
- R&S Support (K92) 4.242
- Ramp Up/Down/Up & Down (K91) 4.207
- Ramp Up/Down/Up & Down (remote control, K91) 6.408
- Range (K8) 4.129
- Range (remote control, K8) 6.261
- Range Linear 4.13
- Range Linear (K7) 4.113
- Range Linear (remote control) 6.100
- Range Log 4.13
- Range Log (K7) 4.113
- Range Log (remote control) 6.100
- Recall 4.99, 4.279
- Recall (remote control) 6.121, 6.566
- Ref Level 4.13
- Ref Level (K8) 4.129
- Ref Level (remote control) 6.93, 6.101
- Ref Level Adjust Man/Auto 4.266
- Ref Level Adjust Man/Auto (remote control) 6.575
- Ref Level Offset 4.14
- Ref Level Offset (remote control) 6.101
- Ref Level Position 4.14
- Ref Level Position (remote control) 6.102
- Ref Lvl =Mkr Lvl 4.58
- Ref Lvl =Mkr Lvl (remote control) 6.63
- Ref Point Frequency 4.49
- Ref Point Frequency (remote control) 6.9
- Ref Point Level 4.48
- Ref Point Level (remote control) 6.9
- Ref Point Time (remote control) 6.9
- Ref Pow Max/Mean (K91) 4.207
- Ref Pow Max/Mean (remote control, K91) 6.407
- Ref Value 4.99
- Ref Value (remote control) 6.102
- Ref Value Position 4.99
- Ref Value Position (remote control) 6.102
- Reference Channel (K20) 4.175
- Reference Channel (remote control, K20) 6.347, 6.351, 6.354
- Reference Fixed 4.49
- Reference Fixed On/Off 4.49
- Reference Int/Ext 4.264
- Reference Int/Ext (remote control) 6.578, 6.579
- Reference Position (K7) 4.106
- Reference Position (K8) 4.129
- Reference Position (remote control, K7) 6.193
- Reference Position (remote control, K8) 6.261
- Reference Power (K20) 4.175
- Reference Power (remote control, K20) 6.348, 6.351, 6.354
- Reference Value (K7) 4.107
- Reference Value (K8) 4.129
- Reference Value (K9) 4.143
- Reference Value (remote control, K7) 6.193
- Reference Value (remote control, K8) 6.261
- Reference Value (remote control, K9) 6.270
- Refresh (K91) 4.222
- Refresh (K92) 4.257
- Rel TX Power (K8) 4.139
- Rel TX Power (remote control, K8) 6.242, 6.243
- Rename 4.281
- Rename (remote control) 6.567
- Res BW 4.77
- Res BW (K7) 4.115
- Res BW (remote control) 6.115
- Res BW (remote control, K7) 6.213
- Res BW Auto 4.18
- Res BW Auto (K8) 4.131
- Res BW Auto (remote control) 6.116
- Res BW Auto (remote control, K8) 6.248
- Res BW Manual 4.18
- Res BW Manual (K8) 4.131
- Res BW Manual (remote control) 6.115, 6.116
- Res BW Manual (remote control, K8) 6.248
- Reset Password 4.276
- Restore Default Tables (K20) 4.167
- Result Display (K7) 4.104
- Result Display (K9) 4.144
- Result Display (remote control, K9) 6.273
- RF (K20) 4.168
- RF (remote control, K20) 6.360
- RF Atten Auto 4.13
- RF Atten Auto (remote control) 6.108
- RF Atten Manual 4.13
- RF Atten Manual (K20) 4.170
- RF Atten Manual (remote control) 6.108
- RF Spectrum (K7) 4.105
- RF Stepsize (K20) 4.169
- RF Time Domain (K7) 4.105
- Right Limit 4.59, 4.69
- Right Limit (remote control) 6.50
- Rising & Falling (K91) 4.206
- Rising & Falling (remote control, K91) 6.408
- RMS 4.69
- RMS (remote control) 6.84, 6.86
- Run Single/Cont (K92) 4.256
- Run Single/Cont (remote control, K92) 6.504
- Same as Meas Channel (K20) 4.175
- Save 4.279
- Save (remote control) 6.571, 6.572
- Save Changes (K20) 4.167
- Save Factor 4.266
- Save Limit Line 4.88
- Scaling 4.77
- Screen A/B (K91) 4.224
- Screen A/B (remote control, K91) 6.413
- Screen Colors (remote control) 6.550, 6.556
- Screen Focus A/B (K92) 4.259
- Screen Focus A/B (remote control, K92) 6.492

- Screen Full/Split (K91) 4.224
- Screen Full/Split (remote control, K91) 6.413
- Screen Size Full/Split (K92) 4.259
- Screen Size Full/Split (remote control, K92) 6.492
- Screen Title 4.270
- Screen Title (remote control) 6.552
- Search Len Auto (K8) 4.126
- Search Len Manual (K8) 4.127
- Search Len Manual (remote control, K8) 6.267, 6.268
- Search Lim Off 4.59
- Search Lim Off (remote control) 6.49, 6.95
- Search Limits 4.58
- Search Limits (remote control) 6.49
- Search Signals 4.68
- Select 1 2 3 4 4.57
- Select 1 2 3 4 (remote control) 6.42, 6.50
- Select Color set 4.271
- Select Color Set 4.273, 4.285
- Select Color Set (remote control) 6.556
- Select Directory 4.267
- Select Directory (remote control) 6.577
- Select Items (remote control) 6.570
- Select Object 4.272, 4.285
- Select Trace 4.9, 4.75
- Select Trace (K7) 4.105
- Select Trace (K8) 4.127
- Select Trace (remote control) 6.75, 6.144
- Select Traces to check 4.86
- Select Traces to check (remote control) 6.22, 6.23
- Self Align 4.267
- Self Align (remote control) 6.542
- Selftest 4.276
- Selftest (remote control) 6.541
- Selftest Results 4.276
- Selftest Results (remote control) 6.547
- Service 4.275
- Service Function 4.276
- Service Function (remote control) 6.546
- Set to Default 4.272, 4.286
- Set to Default (remote control) 6.549, 6.556
- Settings General/Demod (K91) 4.196
- Settings General/Demod (K92) 4.231
- Settings General/Demod (remote control, K92) 6.483, 6.488, 6.489, 6.490, 6.491, 6.493, 6.495, 6.505, 6.509, 6.510, 6.511, 6.512, 6.513, 6.516, 6.517, 6.518, 6.520, 6.521, 6.531, 6.532, 6.533
- Shift X Limit Line (remote control) 6.33
- Shift Y Limit Line (remote control) 6.36, 6.40
- Show Align Results 4.267
- Show Align Results (remote control) 6.542, 6.543
- Sig Count On/Off 4.49
- Sig Count On/Off (remote control) 6.43, 6.44
- Signal Field (K91) 4.220
- Signal Field (remote control, K91) 6.410
- Signal Level (K20) 4.170
- Signal Track 4.9
- Signal Track (remote control) 6.74
- Single Meas 4.79
- Single Meas (remote control) 6.105, 6.106
- Single Sweep 4.21
- Single Sweep (K8) 4.133
- Single Sweep (remote control) 6.105, 6.106
- Size 4.282
- Soft Frontpanel 4.273
- Soft Frontpanel (remote control) 6.588
- Sort Mode 4.281
- Sort Mode Freq/Lvl 4.52
- Sort Mode Freq/Lvl (remote control) 6.56
- Source Cal 4.98
- Source On/Off 4.98
- Source On/Off (remote control) 6.111
- Source Power 4.98, 6.151
- Span Manual 4.10
- Span Manual (K7) 4.112
- Span Manual (remote control) 6.126
- Span Manual (remote control, K7) 6.215
- Spectrum (K20) 4.174, 4.183
- Spectrum (K91) 4.213
- Spectrum (K92) 4.247
- Spectrum ACPR (K91) 4.217
- Spectrum ACPR (remote control, K91) 6.402, 6.408
- Spectrum ETSI/IEEE (K91) 4.215
- Spectrum ETSI/IEEE (K92) 4.249
- Spectrum FFT (K91) 4.216
- Spectrum FFT (K92) 4.251
- Spectrum FFT (remote control, K91) 6.408
- Spectrum FFT (remote control, K92) 6.485
- Spectrum Flat./Diff./Group Delay (K92) 4.248
- Spectrum Flat./Diff./Group Delay (remote control, K92) 6.485, 6.486
- Spectrum Flatness (K91) 4.214
- Spectrum Flatness (remote control, K91) 6.409
- Spectrum IEEE/ETSI (remote control, K91) 6.409
- Spectrum IEEE/ETSI (remote control, K92) 6.486
- Spectrum Mask (K91) 4.215
- Spectrum Mask (remote control, K91) 6.409
- Spurious Emissions (K8) 4.139
- Spurious Emissions (remote control, K8) 6.235, 6.236
- Start 4.7, 4.11
- Start (remote control) 6.126
- Start End (K92) 4.241
- Start Frequency (remote control) 6.126
- Start Test (K8) 4.133
- Startup Recall 4.280
- Startup Recall (remote control) 6.566
- Startup Recall Setup 4.280
- Statistics (K91) 4.217
- Statistics (K92) 4.253
- Std Dev 4.69
- Std Dev (remote control) 6.86, 6.88
- Stop 4.7, 4.11
- Stop (remote control) 6.127
- Stop Frequency (remote control) 6.127
- Subnet Mask 4.269
- Sweep Count 4.21, 4.38
- Sweep Count (K8) 4.133
- Sweep Count (remote control) 6.145
- Sweep Count (remote control, K8) 6.257
- Sweep Points 4.22
- Sweep Points (remote control) 6.149
- Sweep Time 4.30, 4.75
- Sweep Time (remote control) 6.149
- Sweeptime Auto 4.19, 4.21
- Sweeptime Auto (K8) 4.131
- Sweeptime Auto (remote control) 6.149
- Sweeptime Auto (remote control, K8) 6.258
- Sweeptime Manual 4.19, 4.21
- Sweeptime Manual (K20) 4.182
- Sweeptime Manual (K8) 4.131
- Sweeptime Manual (remote control) 6.149
- Sweeptime Manual (remote control, K8) 6.258
- Sync Offset (K8) 4.125
- Sync Offset (remote control, K8) 6.267
- System Info 4.274
- System Messages 4.274
- System Messages (remote control) 6.588, 6.589
- Threshold 4.59
- Threshold (remote control) 6.95
- Tilt (K20) 4.187
- Tilt Setup (K20) 4.188
- Tilt Setup (remote control, K20) 6.363
- Time Domain Power 4.68
- Time Domain Power (remote control) 6.78
- Time Line 1 4.89

- Time Line 1 (remote control) 6.96
- Time Line 2 4.89
- Time Line 2 (remote control) 6.96
- Time+Date 4.270
- Time+Date (remote control) 6.587, 6.591
- Time+Date On/Off 4.271
- Time+Date On/Off (remote control) 6.553
- TOI 4.68
- TOI (remote control) 6.63
- Trace 1 2 3 4 4.37
- Trace 1 2 3 4 (remote control, K8) 6.259
- Trace Math 4.39
- Trace Math (remote control) 6.88, 6.89
- Trace Math Position 4.39
- Trace Mode 4.37
- Trace Mode (remote control) 6.78, 6.79, 6.80, 6.81, 6.82, 6.83, 6.85, 6.87, 6.101
- Trace Mode (remote control, K8) 6.259
- Track BW 4.9
- Track BW (remote control) 6.74
- Track On/Off 4.9
- Track On/Off (remote control) 6.74
- Track Threshold 4.9
- Track Threshold (remote control) 6.75
- Tracking Generator 4.93
- Transducer 4.264
- Trg / Gate Level 4.28
- Trg / Gate Level (remote control) 6.177
- Trg / Gate Polarity Pos/Neg 4.28
- Trg / Gate Polarity Pos/Neg (remote control) 6.147, 6.177
- Trg / Gate Source 4.28
- Trg / Gate Source (remote control) 6.148, 6.176, 6.177
- Trg/Gate Level (K8) 4.136
- Trigger Offset 4.28
- Trigger Offset (K20) 4.182
- Trigger Offset (K7) 4.117
- Trigger Offset (remote control) 6.175
- Trigger Source (K7) 4.116
- Trigger Source (K8) 4.136
- Trigger Source (remote control, K7) 6.224
- TV Analyzer (K20) 4.187
- TV Free Run On/Off 4.32
- TV Free Run On/Off (remote control) 6.178
- TV Trig Settings 4.31
- TX Spec ACP (K8) 4.138
- TX Spec ACP (remote control, K8) 6.228
- Unit 4.14
- Unit (K20) 4.171, 4.185
- Unit (remote control) 6.97, 6.180
- Unit (remote control, K20) 6.304, 6.324, 6.325, 6.330, 6.377
- Unit/Scale (K9) 4.143
- Unit/Scale (remote control, K9) 6.271, 6.278
- Unzoom (K91) 4.222
- Unzoom (K92) 4.257
- Unzoom (remote control, K91) 6.403
- Unzoom (remote control, K92) 6.479
- Update Path (remote control) 6.589
- User Def'd Colors 4.272, 4.286
- User Def'd Colors (remote control) 6.556
- User Defined (remote control) 6.556
- Value 4.87
- Values (remote control) 6.31, 6.34, 6.38
- Velocity Factor (K20) 4.185
- Velocity Factor (remote control, K20) 6.356
- Versions+Options 4.274
- Versions+Options (remote control) 6.538, 6.592
- Vert Sync 4.31
- Vert Sync (remote control) 6.178
- Vert Sync Even Field 4.31
- Vert Sync Even Field (remote control) 6.178
- Vert Sync Odd Field 4.31
- Vert Sync Odd Field (remote control) 6.178
- Video BW Auto 4.19
- Video BW Auto (K8) 4.131
- Video BW Auto (remote control) 6.118
- Video BW Auto (remote control, K8) 6.249
- Video BW Manual 4.18
- Video BW Manual (K8) 4.131
- Video BW Manual (remote control) 6.117
- Video BW Manual (remote control, K8) 6.249
- Video Pol Pos/Neg 4.31
- Video Pol Pos/Neg (remote control) 6.179
- Video Scope (K20) 4.181
- Vision Modulation (K20) 4.182
- Vision Modulation (remote control, K20) 6.303
- Volume 4.50
- Volume (remote control) 6.163
- X * RBW 4.8
- X * RBW (remote control) 6.124, 6.125
- X * Span 4.8
- X * Span (remote control) 6.124, 6.125
- x Offset (remote control) 6.33
- x*Demod BW (K7) 4.111
- x-Axis Range 4.78
- x-Axis Range (remote control) 6.93
- x-Axis Ref Level 4.78
- x-Axis Ref Level (remote control) 6.93
- y Offset (remote control) 6.35, 6.39
- y-Axis Max Value 4.78
- y-Axis Max Value (remote control) 6.94
- y-Axis Min Value 4.78
- Y-Axis/Div (K91) 4.209
- Y-Axis/Div (K92) 4.247
- Y-Axis/Div (remote control, K91) 6.414
- Y-Axis/Div (remote control, K92) 6.493, 6.494
- Zero (K9) 4.143
- Zero (remote control, K9) 6.272
- Zero Phase Reference Point (K7) 4.109
- Zero Phase Reference Point (remote control, K7) 6.211
- Zero Span 4.11
- Zero Span (remote control) 6.126
- Zoom (K20) 4.183, 4.184, 4.185
- Zoom (K7) 4.110
- Zoom (K8) 4.134
- Zoom (remote control, K20) 6.337, 6.338, 6.339
- Zoom (remote control, K7) 6.216
- SOURce<1|2>:EXTernal<1|2>:ROSCillator[:SOURce] 6.579
- SOURce<1|2>:POWer[:LEVel][:IMMEDIATE][:AMPLitude] 6.151
- SOURce<1|2>:POWer[:LEVel][:IMMEDIATE]:OFFSet 6.151
- SOURce:TEMPerature:APRobe? 6.579
- SPAN key 4.10
- span menu 4.10
- span menu (K7) 4.112
- special characters 6.2
- Spectrum Analyzer mode 4.91
- Spurious Emissions measurement (K8) 4.122
- SRE (service request enable register) 5.17
- SRQ (service request) 5.17, 5.25
- start frequency 4.7
- status bar (K91) 4.194
- status bar (K92) 4.230
- status byte (STB) 5.17
- STATus OPERation register 5.19
- STATus QUEStionable register 5.20
 - ACPLimit register 5.21
 - FREQuency register 5.21
 - LIMit register 5.22
 - LMARgin register 5.23
 - POWer register 5.23
 - SYNC 5.24

- status register
 - CONDition part 5.14
 - ENABle part 5.15
 - ESE 5.18
 - ESR 5.18
 - EVENT part 5.15
 - NTRansition part 5.15
 - overview 5.16
 - PPE 5.18
 - PTRansition part 5.15
 - SRE 5.17
 - STATus OPERation 5.19
 - STATus QUEStionable 5.20
 - STATus QUEStionable ACPLimit 5.21
 - STATus QUEStionable FREQuency 5.21
 - STATus QUEStionable LIMit 5.22
 - STATus QUEStionable LMARgin 5.23
 - STATus QUEStionable POWer 5.23
 - STATus QUEStionable SYNC 5.24
 - STB 5.17
 - structure 5.14
 - sum bit 5.15
 - status reporting system 5.14
 - resetting values 5.26
 - STATus:ERRor 6.588
 - STATus:OPERation[:EVENT]? 6.580
 - STATus:OPERation:CONDition? 6.580
 - STATus:OPERation:ENABle 6.581
 - STATus:OPERation:NTRansition 6.581
 - STATus:OPERation:PTRansition 6.581
 - STATus:PRESet 6.582
 - STATus:QUEStionable[:EVENT]? 6.582
 - STATus:QUEStionable:ACPLimit[:EVENT]? 6.153
 - STATus:QUEStionable:ACPLimit:CONDition? 6.153
 - STATus:QUEStionable:ACPLimit:ENABle 6.153
 - STATus:QUEStionable:ACPLimit:NTRansition 6.154
 - STATus:QUEStionable:ACPLimit:PTRansition 6.154
 - STATus:QUEStionable:CONDition? 6.582
 - STATus:QUEStionable:ENABle 6.583
 - STATus:QUEStionable:FREQuency[:EVENT]? 6.154
 - STATus:QUEStionable:FREQuency:CONDition? 6.155
 - STATus:QUEStionable:FREQuency:ENABle 6.155
 - STATus:QUEStionable:FREQuency:NTRansition 6.156
 - STATus:QUEStionable:FREQuency:PTRansition 6.155
 - STATus:QUEStionable:LIMit<1|2>[:EVENT]? 6.156
 - STATus:QUEStionable:LIMit<1|2>:CONDition? 6.156
 - STATus:QUEStionable:LIMit<1|2>:ENABle 6.157
 - STATus:QUEStionable:LIMit<1|2>:NTRansition 6.157
 - STATus:QUEStionable:LIMit<1|2>:PTRansition 6.157
 - STATus:QUEStionable:LMARgin<1|2>[:EVENT]? 6.158
 - STATus:QUEStionable:LMARgin<1|2>:CONDition? 6.158
 - STATus:QUEStionable:LMARgin<1|2>:ENABle 6.158
 - STATus:QUEStionable:LMARgin<1|2>:NTRansition 6.159
 - STATus:QUEStionable:LMARgin<1|2>:PTRansition 6.159
 - STATus:QUEStionable:NTRansition 6.583
 - STATus:QUEStionable:POWer[:EVENT]? 6.159
 - STATus:QUEStionable:POWer:CONDition? 6.159
 - STATus:QUEStionable:POWer:ENABle 6.160
 - STATus:QUEStionable:POWer:NTRansition 6.160
 - STATus:QUEStionable:POWer:PTRansition 6.160
 - STATus:QUEStionable:PTRansition 6.583
 - STATus:QUEStionable:SYNC[:EVENT]? (K20) 6.372
 - STATus:QUEStionable:SYNC[:EVENT]? 6.161
 - STATus:QUEStionable:SYNC[:EVENT]? (K91) 6.446
 - STATus:QUEStionable:SYNC[:EVENT]? (K92) 6.523
 - STATus:QUEStionable:SYNC:CONDition? 6.161
 - STATus:QUEStionable:SYNC:CONDition? (K20) 6.371
 - STATus:QUEStionable:SYNC:CONDition? (K91) 6.446
 - STATus:QUEStionable:SYNC:CONDition? (K92) 6.523
 - STATus:QUEStionable:SYNC:ENABle 6.161
 - STATus:QUEStionable:SYNC:ENABle (K20) 6.371
 - STATus:QUEStionable:SYNC:ENABle (K91) 6.446
 - STATus:QUEStionable:SYNC:ENABle (K92) 6.524
 - STATus:QUEStionable:SYNC:NTRansition 6.162
 - STATus:QUEStionable:SYNC:NTRansition (K20) 6.371
 - STATus:QUEStionable:SYNC:NTRansition (K91) 6.447
 - STATus:QUEStionable:SYNC:NTRansition (K92) 6.524
 - STATus:QUEStionable:SYNC:PTRansition 6.162
 - STATus:QUEStionable:SYNC:PTRansition (K20) 6.372
 - STATus:QUEStionable:SYNC:PTRansition (K91) 6.447
 - STATus:QUEStionable:SYNC:PTRansition (K92) 6.524
 - STATus:QUEue 6.584
 - STB (status byte) 5.17
 - step size
 - center frequency 4.7
 - stop frequency 4.7
 - storing 8.1
 - string 5.9
 - subchannelization
 - channel results (K92) 2.128
 - clock offset (K92) 2.128
 - EVM (K92) 2.129
 - frequency (K92) 2.128
 - IQ impairments (K92) 2.130
 - subchannelization (K92) 2.127
 - suffix 5.7
 - sum bit 5.15
 - supply voltage, external noise source 4.267
 - sweep
 - continue single sweep 4.21
 - continuous 4.21
 - count 4.21, 4.38
 - Free Run 4.26
 - gated 4.23, 4.29
 - single 4.21
 - time 4.21
 - SWEEP key 4.20
 - sweep menu 4.20
 - sweep menu (K7) 4.115
 - sweep menu (K8) 4.132
 - sweep menu (K91) 4.221
 - sweep menu (K92) 4.256
 - sweep time
 - coupling 4.19
 - switching cycles 4.274
 - sync signal 4.31
 - sync word (K8) 2.51, 4.124
 - synchronization (K92) 2.128
 - syntax elements of commands 5.10
 - SYSTEM:COMMunicate:GPiB[:SELf]:ADDRes 6.585
 - SYSTEM:COMMunicate:GPiB[:SELf]:RTERminator 6.586
 - SYSTEM:COMMunicate:PRINter:ENUMerate:FIRSt? 6.586
 - SYSTEM:COMMunicate:PRINter:ENUMerate:NEXt? 6.586
 - SYSTEM:COMMunicate:PRINter:SELEct <1|2> 6.587
 - SYSTEM:DATE 6.587
 - SYSTEM:DISPlay:FPANel 6.588
 - SYSTEM:DISPlay:UPDate 6.588
 - SYSTEM:ERRor:CLEar:ALL 6.589
 - SYSTEM:ERRor:LIST? 6.589
 - SYSTEM:FIRMware:UPDate 6.589
 - SYSTEM:FORMat:IDENt 6.590
 - SYSTEM:LANGuage 6.590
 - SYSTEM:PASSword[:CENable] 6.590
 - SYSTEM:PASSword:RESEt 6.591
 - SYSTEM:PRESet 6.591
 - SYSTEM:SPEaker:VOLume 6.163
 - SYSTEM:TIME 6.591
 - SYSTEM:VERSion? 6.592
- ## T
- test
 - self test 4.276
 - text parameter 5.9

threshold
 line 4.59
 signal tracking 4.9
 time 4.271
 line 4.89
 title
 diagram 4.270
 title bar (K91) 4.194
 title bar (K92) 4.229
 trace 4.37
 Clear Write 4.34
 power measurement 4.75
 signal tracking 4.9
 TRACE key 4.33
 trace menu 4.37
 trace menu (K91) 4.224
 trace menu (K92) 4.259
 trace mode 4.37
 Average 4.34
 Blank 4.35
 Clear Write 4.34
 Max Hold 4.34
 Min Hold 4.34
 remote control 6.98, 6.99
 View 4.35
 TRACE[:DATA] (K91) 6.452
 TRACE[:DATA] (K92) 6.530
 TRACe<1|2>[:DATA] 6.164
 TRACe<1|2>[:DATA] (K7) 6.222
 TRACe<1|2>:IQ[:STATE] 6.169
 TRACe<1|2>:IQ:AVERAge[:STATE] 6.169
 TRACe<1|2>:IQ:AVERAge:COUNT 6.170
 TRACe<1|2>:IQ:DATA? 6.170
 TRACe<1|2>:IQ:DATA:MEMory? 6.171
 TRACe<1|2>:IQ:SET 6.172
 TRACe<1|2>:IQ:SRATe 15.625kHz to 32MHz 6.173
 TRACe<1|2>:IQ:SYNChronize[:STATE] 6.174
 TRACe:COpy 6.164
 TRACE:IQ:SRATe (K91) 6.453
 TRACE:IQ:SRATe (K92) 6.531
 tracking generator 4.95
 menu 4.95, 4.97
 transducer 4.264
 activating 4.265
 transmission measurement 4.96
 TRIG key 4.23
 trigger
 concepts (K8) 2.51
 extern (K8) 2.51
 external 4.26
 external gate 4.29
 gated sweep 4.29
 level 4.28
 offset 4.28
 slope 4.28
 trigger menu 4.27
 trigger menu (K7) 4.116
 trigger menu (K91) 4.196
 trigger menu (K92) 4.231
 trigger mode 4.28
 External 4.26
 Free Run 4.26
 IF power 4.26
 TV 4.26
 Video 4.26
 TRIGger[:SEquence]:HOLDoff (K91) 6.454
 TRIGger[:SEquence]:HOLDoff (K92) 6.532
 TRIGger[:SEquence]:LEVel:POWer (K91) 6.455
 TRIGger[:SEquence]:LEVel:POWer (K92) 6.533
 TRIGger[:SEquence]:LEVel:POWer:AUTO (K91) 6.455
 TRIGger[:SEquence]:LEVel:POWer:AUTO (K92) 6.533
 TRIGger[:SEquence]:MODE (K91) 6.454

TRIGger[:SEquence]:MODE (K92) 6.532
 TRIGger<1|2>[:SEquence]:HOLDoff 6.175
 TRIGger<1|2>[:SEquence]:IFPower:HOLDoff 6.175
 TRIGger<1|2>[:SEquence]:IFPower:HYSteresis 6.176
 TRIGger<1|2>[:SEquence]:LEVel:AM[:ABSolute] (K7) 6.223
 TRIGger<1|2>[:SEquence]:LEVel:AM:RELative (K7) 6.223
 TRIGger<1|2>[:SEquence]:LEVel:FM (K7) 6.224
 TRIGger<1|2>[:SEquence]:LEVel:IFPower 6.176
 TRIGger<1|2>[:SEquence]:LEVel:PM (K7) 6.224
 TRIGger<1|2>[:SEquence]:LEVel:VIDeo 6.177
 TRIGger<1|2>[:SEquence]:SLOPe 6.177
 TRIGger<1|2>[:SEquence]:SOURce 6.177
 TRIGger<1|2>[:SEquence]:SOURce (K7) 6.224
 TRIGger<1|2>[:SEquence]:VIDeo:BFieLd[:NUMBer] 6.374
 TRIGger<1|2>[:SEquence]:VIDeo:BLINe[:NUMBer] 6.374
 TRIGger<1|2>[:SEquence]:VIDeo:BLINe:TYPE 6.375
 TRIGger<1|2>[:SEquence]:VIDeo:CONTinuous 6.178
 TRIGger<1|2>[:SEquence]:VIDeo:FIeLd:NUMBer (K20) 6.375
 TRIGger<1|2>[:SEquence]:VIDeo:FIeLd:SElect 6.178
 TRIGger<1|2>[:SEquence]:VIDeo:FORMat:LPPFRame 6.178
 TRIGger<1|2>[:SEquence]:VIDeo:LINE:NUMBer 6.179, 6.375
 TRIGger<1|2>[:SEquence]:VIDeo:QFieLd[:NUMBer] 6.376
 TRIGger<1|2>[:SEquence]:VIDeo:QLINe[:NUMBer] 6.376
 TRIGger<1|2>[:SEquence]:VIDeo:SSIGnal:POLarity 6.179
 TV trigger 4.31
 TX filter (K20) 2.68

U

unit 4.143
 limit line 4.83
 UNIT<1|2>:PMETer:POWer (K9) 6.278
 UNIT<1|2>:PMETer:POWer:RATio (K9) 6.278
 UNIT<1|2>:POWer 6.180
 UNIT<1|2>:POWer (K20) 6.377
 UNIT:ANGLe (K7) 6.225
 UNIT:EVM 6.535
 UNIT:EVM (K91) 6.456
 UNIT:GIMBalance (K91) 6.456
 UNIT:PREamble 6.535
 UNIT:PREamble (K91) 6.457
 UNIT:TABLE 6.536
 universal command 5.34
 upper-case (commands) 5.6, 6.2

V

vertical sync signal 4.31
 video bandwidth 4.18
 video polarity 4.31
 video triggering 4.26
 View mode 4.35
 VXI interface messages 5.30
 VXI protocol 5.28

W

white space 5.10
 WiMAX menu (K92) 4.225, 4.230
 WiMAX mode (K92) 4.92
 WLAN menu (K91) 4.189, 4.195
 WLAN mode (K91) 4.92

Z

zero span 4.11
 zeroing (K9) 4.141
 zoom 4.51
 amplitude 4.35