



ROHDE & SCHWARZ

Test and Measurement
Division

Operating Manual

cdmaOne Base Station Tests

Application Firmware Module FSIQK71

1126.4498.02

Printed in the Federal
Republic of Germany

Contents

Data Sheet

Safety Instructions

Contents of Application Firmware FSIQK71 Manual

cdmaOne Base Station Tests - Application Firmware Module FSIQK71

1	Enabling the Firmware Option	1
2	Getting Started.....	2
	Basic Settings in the Code Domain Measurement Mode.....	3
	Measurement 1: Measuring the Spectrum	4
	Measurement 2: Measuring modulation quality.....	5
	Setting: Synchronizing the reference frequencies.....	5
	Measurement 3: Code domain power measurement with an active channel	6
	Setting: Behavior with a deviating center frequency setting.....	6
	Measurement 4: Code domain power measurement with nine active channels.....	7
	Setting: Behavior in case of overdrive.....	7
	Setting: Threshold values for demodulation	8
	Summary	9
3	Setup for Base Station Tests	10
	Standard test setup	10
	Presetting.....	11
4	cdmaOne Test Model	12
	Calculation of the nominal code power distribution.....	12
5	Menu Overview	13
6	Configuration of cdmaOne Measurements.....	14
	Measurement of Channel Power	15
	Measurement of Adjacent-Channel Power - ACPR	16
	Measurement of the RHO Factor - MODULATION QUALITY	18
	Spectrum Measurement - SPECTRUM.....	19
	Time Domain Measurement - TIME DOMAIN.....	20
	Selecting the Input Channel - INPUT CHAN CDMA	21
	Automatic Adaptation to the Input Level - LEVEL AUTO ADJUST.....	21
	Code Domain Measurements on cdmaOne Signals.....	22
	Continuous Measurement - Continuous Sweep	22
	Single Measurement - Single Sweep.....	22
	MARKER Functions	23
	CDP Display Mode.....	25
	Configuration of Limit Checking – Limit Settings	36
	Configuration of cdmaOne Demodulation - MEAS SETTINGS	39
	Level Settings - REF LEVEL	43
	Automatic Adaptation to the Input Level - LEVEL AUTO ADJUST.....	43
	Setting the Trigger - TRIGGER Key.....	44
	Setting the Trace - TRACE 1 Key.....	45

Overview of the Other Menus.....	46
SYSTEM Key Group	46
CONFIGURATION Key Group.....	46
FREQUENCY Key Group	46
LEVEL Key Group, INPUT Key.....	46
MARKER Key Group.....	46
LINES Key Group.....	46
SWEEP Key Group	47
HCOPY and MEMORY Key Group	47
7 Remote-Control Commands for the CDP Measurement	48
CALCulate -Subsystem	48
CONFigure:CDPower Subsystem	50
INSTrument Subsystem	53
SENSE:CDPower Subsystem	53
SENSE:DETECTOR Subsystem.....	54
TRACe Subsystem	55
Alphabetical List of Commands.....	56
Table of Softkeys with Assignment of IEC/IEEE Commands.....	57
CONFIGURATION Key Group.....	57
8 Checking Rated Specifications	61
Required Measuring Equipment and Accessories	61
Test Procedure	62
Code-Domain Power	63
Modulation Quality.....	64
Performance Test Report	65
9 Glossary	66
10 Index	67

Contents of Application Firmware FSIQK71 Manual

This manual contains all information on the operation of FSIQ equipped with Application Firmware FSIQK71. It includes operation via menus and the remote-control commands for the code domain measurement mode.

The manual comprises the data sheet and 9 chapters:

- The data sheet** informs on the guaranteed technical data and the firmware characteristics.
- Chapter 1** describes how to enable the application firmware module.
- Chapter 2** describes typical examples of measurements by means of tests.
- Chapter 3** describes the measurement setup for base station tests.
- Chapter 4** describes the cdmaOne test model as stipulated in standard TIA/EIA-97-C.
- Chapter 5** gives a schematic overview on the cdmaOne BTS control menus.
- Chapter 6** contains a detailed description of the possible base station test measurements as a reference section for manual operation. The chapter also presents a list of remote-control commands associated with each function.
- Chapter 7** describes all remote-control commands defined for the code domain measurement. An alphabetic list of all remote-control commands and a table of softkeys with the assignment of commands are given at the end of this chapter.
- Chapter 8** describes the checking of rated specifications of code domain power and modulation quality measurements.
- Chapter 9** contains an explanation of terms related to measured quantities of the code domain measurement.
- Chapter 10** contains the index of the present operating manual.

This manual is a supplement to the FSIQ operating manual. It includes exclusively functions of Application Firmware FSIQK71. For all other descriptions, please refer to the FSIQ operating manual.



Before putting the product into operation for the first time, make sure to read the following



Safety Instructions

Rohde & Schwarz makes every effort to keep the safety standard of its products up to date and to offer its customers the highest possible degree of safety. Our products and the auxiliary equipment required for them are designed and tested in accordance with the relevant safety standards. Compliance with these standards is continuously monitored by our quality assurance system. This product has been designed and tested in accordance with the EC Certificate of Conformity and has left the manufacturer's plant in a condition fully complying with safety standards. To maintain this condition and to ensure safe operation, observe all instructions and warnings provided in this manual. If you have any questions regarding these safety instructions, Rohde & Schwarz will be happy to answer them.

Furthermore, it is your responsibility to use the product in an appropriate manner. This product is designed for use solely in industrial and laboratory environments or in the field and must not be used in any way that may cause personal injury or property damage. You are responsible if the product is used for an intention other than its designated purpose or in disregard of the manufacturer's instructions. The manufacturer shall assume no responsibility for such use of the product.

The product is used for its designated purpose if it is used in accordance with its operating manual and within its performance limits (see data sheet, documentation, the following safety instructions). Using the products requires technical skills and knowledge of English. It is therefore essential that the products be used exclusively by skilled and specialized staff or thoroughly trained personnel with the required skills. If personal safety gear is required for using Rohde & Schwarz products, this will be indicated at the appropriate place in the product documentation.

Symbols and safety labels

Observe operating instructions	Weight indication for units >18 kg	Danger of electric shock	Warning! Hot surface	PE terminal	Ground	Ground terminal	Attention! Electrostatic sensitive devices

Supply voltage ON/OFF	Standby indication	Direct current (DC)	Alternating current (AC)	Direct/alternating current (DC/AC)	Device fully protected by double/reinforced insulation

Safety Instructions

Observing the safety instructions will help prevent personal injury or damage of any kind caused by dangerous situations. Therefore, carefully read through and adhere to the following safety instructions before putting the product into operation. It is also absolutely essential to observe the additional safety instructions on personal safety that appear in other parts of the documentation. In these safety instructions, the word "product" refers to all merchandise sold and distributed by Rohde & Schwarz, including instruments, systems and all accessories.

Tags and their meaning

DANGER	This tag indicates a safety hazard with a high potential of risk for the user that can result in death or serious injuries.
WARNING	This tag indicates a safety hazard with a medium potential of risk for the user that can result in death or serious injuries.
CAUTION	This tag indicates a safety hazard with a low potential of risk for the user that can result in slight or minor injuries.
ATTENTION	This tag indicates the possibility of incorrect use that can cause damage to the product.
NOTE	This tag indicates a situation where the user should pay special attention to operating the product but which does not lead to damage.

These tags are in accordance with the standard definition for civil applications in the European Economic Area. Definitions that deviate from the standard definition may also exist. It is therefore essential to make sure that the tags described here are always used only in connection with the associated documentation and the associated product. The use of tags in connection with unassociated products or unassociated documentation can result in misinterpretations and thus contribute to personal injury or material damage.

Basic safety instructions

1. The product may be operated only under the operating conditions and in the positions specified by the manufacturer. Its ventilation must not be obstructed during operation. Unless otherwise specified, the following requirements apply to Rohde & Schwarz products:
prescribed operating position is always with the housing floor facing down, IP protection 2X, pollution severity 2, overvoltage category 2, use only in enclosed spaces, max. operation altitude max. 2000 m. Unless specified otherwise in the data sheet, a tolerance of $\pm 10\%$ shall apply to the nominal voltage and of $\pm 5\%$ to the nominal frequency.
2. Applicable local or national safety regulations and rules for the prevention of accidents must be observed in all work performed. The product may be opened only by authorized, specially trained personnel. Prior to performing any work on the product or opening the product, the product must be disconnected from the supply network. Any adjustments, replacements of parts, maintenance or repair must be carried out only by technical personnel authorized by Rohde & Schwarz. Only original parts may be used for replacing parts relevant to safety (e.g. power switches, power transformers, fuses). A safety test must always be performed after parts relevant to safety have been replaced (visual inspection, PE conductor test, insulation resistance measurement, leakage current measurement, functional test).
3. As with all industrially manufactured goods, the use of substances that induce an allergic reaction (allergens, e.g. nickel) such as aluminum cannot be generally excluded. If you develop an allergic reaction (such as a skin rash, frequent sneezing, red eyes or respiratory difficulties), consult a physician immediately to determine the cause.

Safety Instructions

4. If products/components are mechanically and/or thermally processed in a manner that goes beyond their intended use, hazardous substances (heavy-metal dust such as lead, beryllium, nickel) may be released. For this reason, the product may only be disassembled, e.g. for disposal purposes, by specially trained personnel. Improper disassembly may be hazardous to your health. National waste disposal regulations must be observed.
5. If handling the product yields hazardous substances or fuels that must be disposed of in a special way, e.g. coolants or engine oils that must be replenished regularly, the safety instructions of the manufacturer of the hazardous substances or fuels and the applicable regional waste disposal regulations must be observed. Also observe the relevant safety instructions in the product documentation.
6. Depending on the function, certain products such as RF radio equipment can produce an elevated level of electromagnetic radiation. Considering that unborn life requires increased protection, pregnant women should be protected by appropriate measures. Persons with pacemakers may also be endangered by electromagnetic radiation. The employer is required to assess workplaces where there is a special risk of exposure to radiation and, if necessary, take measures to avert the danger.
7. Operating the products requires special training and intense concentration. Make certain that persons who use the products are physically, mentally and emotionally fit enough to handle operating the products; otherwise injuries or material damage may occur. It is the responsibility of the employer to select suitable personnel for operating the products.
8. Prior to switching on the product, it must be ensured that the nominal voltage setting on the product matches the nominal voltage of the AC supply network. If a different voltage is to be set, the power fuse of the product may have to be changed accordingly.
9. In the case of products of safety class I with movable power cord and connector, operation is permitted only on sockets with earthing contact and protective earth connection.
10. Intentionally breaking the protective earth connection either in the feed line or in the product itself is not permitted. Doing so can result in the danger of an electric shock from the product. If extension cords or connector strips are implemented, they must be checked on a regular basis to ensure that they are safe to use.
11. If the product has no power switch for disconnection from the AC supply, the plug of the connecting cable is regarded as the disconnecting device. In such cases, it must be ensured that the power plug is easily reachable and accessible at all times (length of connecting cable approx. 2 m). Functional or electronic switches are not suitable for providing disconnection from the AC supply. If products without power switches are integrated in racks or systems, a disconnecting device must be provided at the system level.
12. Never use the product if the power cable is damaged. By taking appropriate safety measures and carefully laying the power cable, ensure that the cable cannot be damaged and that no one can be hurt by e.g. tripping over the cable or suffering an electric shock.
13. The product may be operated only from TN/TT supply networks fused with max. 16 A.
14. Do not insert the plug into sockets that are dusty or dirty. Insert the plug firmly and all the way into the socket. Otherwise this can result in sparks, fire and/or injuries.
15. Do not overload any sockets, extension cords or connector strips; doing so can cause fire or electric shocks.
16. For measurements in circuits with voltages $V_{rms} > 30 V$, suitable measures (e.g. appropriate measuring equipment, fusing, current limiting, electrical separation, insulation) should be taken to avoid any hazards.
17. Ensure that the connections with information technology equipment comply with IEC 950/EN 60950.
18. Never remove the cover or part of the housing while you are operating the product. This will expose circuits and components and can lead to injuries, fire or damage to the product.

Safety Instructions

19. If a product is to be permanently installed, the connection between the PE terminal on site and the product's PE conductor must be made first before any other connection is made. The product may be installed and connected only by a skilled electrician.
20. For permanently installed equipment without built-in fuses, circuit breakers or similar protective devices, the supply circuit must be fused in such a way that suitable protection is provided for users and products.
21. Do not insert any objects into the openings in the housing that are not designed for this purpose. Never pour any liquids onto or into the housing. This can cause short circuits inside the product and/or electric shocks, fire or injuries.
22. Use suitable overvoltage protection to ensure that no overvoltage (such as that caused by a thunderstorm) can reach the product. Otherwise the operating personnel will be endangered by electric shocks.
23. Rohde & Schwarz products are not protected against penetration of water, unless otherwise specified (see also safety instruction 1.). If this is not taken into account, there exists the danger of electric shock or damage to the product, which can also lead to personal injury.
24. Never use the product under conditions in which condensation has formed or can form in or on the product, e.g. if the product was moved from a cold to a warm environment.
25. Do not close any slots or openings on the product, since they are necessary for ventilation and prevent the product from overheating. Do not place the product on soft surfaces such as sofas or rugs or inside a closed housing, unless this is well ventilated.
26. Do not place the product on heat-generating devices such as radiators or fan heaters. The temperature of the environment must not exceed the maximum temperature specified in the data sheet.
27. Batteries and storage batteries must not be exposed to high temperatures or fire. Keep batteries and storage batteries away from children. If batteries or storage batteries are improperly replaced, this can cause an explosion (warning: lithium cells). Replace the battery or storage battery only with the matching Rohde & Schwarz type (see spare parts list). Batteries and storage batteries are hazardous waste. Dispose of them only in specially marked containers. Observe local regulations regarding waste disposal. Do not short-circuit batteries or storage batteries.
28. Please be aware that in the event of a fire, toxic substances (gases, liquids etc.) that may be hazardous to your health may escape from the product.
29. Please be aware of the weight of the product. Be careful when moving it; otherwise you may injure your back or other parts of your body.
30. Do not place the product on surfaces, vehicles, cabinets or tables that for reasons of weight or stability are unsuitable for this purpose. Always follow the manufacturer's installation instructions when installing the product and fastening it to objects or structures (e.g. walls and shelves).
31. Handles on the products are designed exclusively for personnel to hold or carry the product. It is therefore not permissible to use handles for fastening the product to or on means of transport such as cranes, fork lifts, wagons, etc. The user is responsible for securely fastening the products to or on the means of transport and for observing the safety regulations of the manufacturer of the means of transport. Noncompliance can result in personal injury or material damage.
32. If you use the product in a vehicle, it is the sole responsibility of the driver to drive the vehicle safely. Adequately secure the product in the vehicle to prevent injuries or other damage in the event of an accident. Never use the product in a moving vehicle if doing so could distract the driver of the vehicle. The driver is always responsible for the safety of the vehicle; the manufacturer assumes no responsibility for accidents or collisions.
33. If a laser product (e.g. a CD/DVD drive) is integrated in a Rohde & Schwarz product, do not use any other settings or functions than those described in the documentation. Otherwise this may be hazardous to your health, since the laser beam can cause irreversible damage to your eyes. Never try to take such products apart, and never look into the laser beam.



Por favor lea imprescindiblemente antes de la primera puesta en funcionamiento las siguientes informaciones de seguridad



Informaciones de seguridad

Es el principio de Rohde & Schwarz de tener a sus productos siempre al día con los standards de seguridad y de ofrecer a sus clientes el máximo grado de seguridad. Nuestros productos y todos los equipos adicionales son siempre fabricados y examinados según las normas de seguridad vigentes. Nuestra sección de gestión de la seguridad de calidad controla constantemente que sean cumplidas estas normas. Este producto ha sido fabricado y examinado según el comprobante de conformidad adjunto según las normas de la CE y ha salido de nuestra planta en estado impecable según los standards técnicos de seguridad. Para poder preservar este estado y garantizar un funcionamiento libre de peligros, deberá el usuario atenerse a todas las informaciones, informaciones de seguridad y notas de alerta. Rohde&Schwarz está siempre a su disposición en caso de que tengan preguntas referentes a estas informaciones de seguridad.

Además queda en la responsabilidad del usuario utilizar el producto en la forma debida. Este producto solamente fue elaborado para ser utilizado en la industria y el laboratorio o para fines de campo y de ninguna manera deberá ser utilizado de modo que alguna persona/cosa pueda ser dañada. El uso del producto fuera de sus fines definidos o despreciando las informaciones de seguridad del fabricante queda en la responsabilidad del usuario. El fabricante no se hace en ninguna forma responsable de consecuencias a causa del maluso del producto.

Se parte del uso correcto del producto para los fines definidos si el producto es utilizado dentro de las instrucciones del correspondiente manual del uso y dentro del margen de rendimiento definido (ver hoja de datos, documentación, informaciones de seguridad que siguen). El uso de los productos hace necesarios conocimientos profundos y el conocimiento del idioma inglés. Por eso se deberá tener en cuenta de exclusivamente autorizar para el uso de los productos a personas peritas o debidamente minuciosamente instruidas con los conocimientos citados. Si fuera necesaria indumentaria de seguridad para el uso de productos de R&S, encontrará la información debida en la documentación del producto en el capítulo correspondiente.

Símbolos y definiciones de seguridad

Ver manual de instrucciones del uso	Informaciones para maquinaria con un peso de > 18kg	Peligro de golpe de corriente	¡Advertencia! Superficie caliente	Conexión a conductor protector	Conexión a tierra	Conexión a masa conductora	¡Cuidado! Elementos de construcción con peligro de carga electrostática

potencia EN MARCHA/PARADA	Indicación Stand-by	Corriente continua DC	Corriente alterna AC	Corriente continua/alterna DC/AC	El aparato está protegido en su totalidad por un aislamiento de doble refuerzo

Informaciones de seguridad

Tener en cuenta las informaciones de seguridad sirve para tratar de evitar daños y peligros de toda clase. Es necesario de que se lean las siguientes informaciones de seguridad concienzudamente y se tengan en cuenta debidamente antes de la puesta en funcionamiento del producto. También deberán ser tenidas en cuenta las informaciones para la protección de personas que encontrarán en otro capítulo de esta documentación y que también son obligatorias de seguir. En las informaciones de seguridad actuales hemos juntado todos los objetos vendidos por Rohde&Schwarz bajo la denominación de „producto“, entre ellos también aparatos, instalaciones así como toda clase de accesorios.

Palabras de señal y su significado

PELIGRO	Indica un punto de peligro con gran potencial de riesgo para el usuario. Punto de peligro que puede llevar hasta la muerte o graves heridas.
ADVERTENCIA	Indica un punto de peligro con un potencial de riesgo mediano para el usuario. Punto de peligro que puede llevar hasta la muerte o graves heridas .
ATENCIÓN	Indica un punto de peligro con un potencial de riesgo pequeño para el usuario. Punto de peligro que puede llevar hasta heridas leves o pequeñas
CUIDADO	Indica la posibilidad de utilizar mal el producto y a consecuencia dañarlo.
INFORMACIÓN	Indica una situación en la que deberían seguirse las instrucciones en el uso del producto, pero que no consecuentemente deben de llevar a un daño del mismo.

Las palabras de señal corresponden a la definición habitual para aplicaciones civiles en el ámbito de la comunidad económica europea. Pueden existir definiciones diferentes a esta definición. Por eso se debiera tener en cuenta que las palabras de señal aquí descritas sean utilizadas siempre solamente en combinación con la correspondiente documentación y solamente en combinación con el producto correspondiente. La utilización de las palabras de señal en combinación con productos o documentaciones que no les correspondan puede llevar a malinterpretaciones y tener por consecuencia daños en personas u objetos.

Informaciones de seguridad elementales

1. El producto solamente debe ser utilizado según lo indicado por el fabricante referente a la situación y posición de funcionamiento sin que se obstruya la ventilación. Si no se convino de otra manera, es para los productos R&S válido lo que sigue: como posición de funcionamiento se define principalmente la posición con el suelo de la caja para abajo , modo de protección IP 2X, grado de suciedad 2, categoría de sobrecarga eléctrica 2, utilizar solamente en estancias interiores, utilización hasta 2000 m sobre el nivel del mar.
A menos que se especifique otra cosa en la hoja de datos, se aplicará una tolerancia de $\pm 10\%$ sobre el voltaje nominal y de $\pm 5\%$ sobre la frecuencia nominal.
2. En todos los trabajos deberán ser tenidas en cuenta las normas locales de seguridad de trabajo y de prevención de accidentes. El producto solamente debe de ser abierto por personal périto autorizado. Antes de efectuar trabajos en el producto o abrirlo deberá este ser desconectado de la corriente. El ajuste, el cambio de partes, la manutención y la reparación deberán ser solamente efectuadas por electricistas autorizados por R&S. Si se reponen partes con importancia para los aspectos de seguridad (por ejemplo el enchufe, los transformadores o los fusibles), solamente podrán ser sustituidos por partes originales. Despues de cada recambio de partes elementales para la seguridad deberá ser efectuado un control de

Informaciones de seguridad

- seguridad (control a primera vista, control de conductor protector, medición de resistencia de aislamiento, medición de medición de la corriente conductora, control de funcionamiento).
3. Como en todo producto de fabricación industrial no puede ser excluido en general de que se produzcan al usarlo elementos que puedan generar alergias, los llamados elementos alergénicos (por ejemplo el níquel). Si se produjeran en el trato con productos R&S reacciones alérgicas, como por ejemplo urticaria, estornudos frecuentes, irritación de la conjuntiva o dificultades al respirar, se deberá consultar inmediatamente a un médico para averiguar los motivos de estas reacciones.
 4. Si productos / elementos de construcción son tratados fuera del funcionamiento definido de forma mecánica o térmica, pueden generarse elementos peligrosos (polvos de sustancia de metales pesados como por ejemplo plomo, berilio, níquel). La partición elemental del producto, como por ejemplo sucede en el tratamiento de materias residuales, debe de ser efectuada solamente por personal especializado para estos tratamientos. La partición elemental efectuada inadecuadamente puede generar daños para la salud. Se deben tener en cuenta las directivas nacionales referentes al tratamiento de materias residuales.
 5. En el caso de que se produjeran agentes de peligro o combustibles en la aplicación del producto que debieran de ser transferidos a un tratamiento de materias residuales, como por ejemplo agentes refrigerantes que deben ser repuestos en periodos definidos, o aceites para motores, deberán ser tenidas en cuenta las prescripciones de seguridad del fabricante de estos agentes de peligro o combustibles y las regulaciones regionales para el tratamiento de materias residuales. Cuiden también de tener en cuenta en caso dado las prescripciones de seguridad especiales en la descripción del producto.
 6. Ciertos productos, como por ejemplo las instalaciones de radiación HF, pueden a causa de su función natural, emitir una radiación electromagnética aumentada. En vista a la protección de la vida en desarrollo deberían ser protegidas personas embarazadas debidamente. También las personas con un bypass pueden correr peligro a causa de la radiación electromagnética. El empresario está comprometido a valorar y señalar áreas de trabajo en las que se corra un riesgo de exposición a radiaciones aumentadas de riesgo aumentado para evitar riesgos.
 7. La utilización de los productos requiere instrucciones especiales y una alta concentración en el manejo. Debe de ponerse por seguro de que las personas que manejen los productos estén a la altura de los requerimientos necesarios referente a sus aptitudes físicas, psíquicas y emocionales, ya que de otra manera no se pueden excluir lesiones o daños de objetos. El empresario lleva la responsabilidad de seleccionar el personal usuario apto para el manejo de los productos.
 8. Antes de la puesta en marcha del producto se deberá tener por seguro de que la tensión preseleccionada en el producto equivalga a la del la red de distribución. Si es necesario cambiar la preselección de la tensión también se deberán en caso dabo cambiar los fusibles correspondientes del producto.
 9. Productos de la clase de seguridad I con alimentación móvil y enchufe individual de producto solamente deberán ser conectados para el funcionamiento a tomas de corriente de contacto de seguridad y con conductor protector conectado.
 10. Queda prohibida toda clase de interrupción intencionada del conductor protector, tanto en la toma de corriente como en el mismo producto ya que puede tener como consecuencia el peligro de golpe de corriente por el producto. Si se utilizaran cables o enchufes de extensión se deberá poner al seguro, que es controlado su estado técnico de seguridad.
 11. Si el producto no está equipado con un interruptor para desconectarlo de la red, se deberá considerar el enchufe del cable de distribución como interruptor. En estos casos deberá asegurar de que el enchufe sea de fácil acceso y nabejo (medida del cable de distribución aproximadamente 2 m). Los interruptores de función o electrónicos no son aptos para el corte de la red eléctrica. Si los productos sin interruptor están integrados en construcciones o instalaciones, se deberá instalar el interruptor al nivel de la instalación.

Informaciones de seguridad

12. No utilice nunca el producto si está dañado el cable eléctrico. Asegure a través de las medidas de protección y de instalación adecuadas de que el cable de eléctrico no pueda ser dañado o de que nadie pueda ser dañado por él, por ejemplo al tropezar o por un golpe de corriente.
13. Solamente está permitido el funcionamiento en redes de distribución TN/TT aseguradas con fusibles de como máximo 16 A.
14. Nunca conecte el enchufe en tomas de corriente sucias o llenas de polvo. Introduzca el enchufe por completo y fuertemente en la toma de corriente. Si no tiene en consideración estas indicaciones se arriesga a que se originen chispas, fuego y/o heridas.
15. No sobrecargue las tomas de corriente, los cables de extensión o los enchufes de extensión ya que esto pudiera causar fuego o golpes de corriente.
16. En las mediciones en circuitos de corriente con una tensión de entrada de $U_{eff} > 30 \text{ V}$ se deberá tomar las precauciones debidas para impedir cualquier peligro (por ejemplo medios de medición adecuados, seguros, limitación de tensión, corte protector, aislamiento etc.).
17. En caso de conexión con aparatos de la técnica informática se deberá tener en cuenta que estos cumplan los requisitos de la EC950/EN60950.
18. Nunca abra la tapa o parte de ella si el producto está en funcionamiento. Esto pone a descubierto los cables y componentes eléctricos y puede causar heridas, fuego o daños en el producto.
19. Si un producto es instalado fijamente en un lugar, se deberá primero conectar el conductor protector fijo con el conductor protector del aparato antes de hacer cualquier otra conexión. La instalación y la conexión deberán ser efecutadas por un electricista especializado.
20. En caso de que los productos que son instalados fijamente en un lugar sean sin protector implementado, autointerruptor o similares objetos de protección, deberá la toma de corriente estar protegida de manera que los productos o los usuarios estén suficientemente protegidos.
21. Por favor, no introduzca ningún objeto que no esté destinado a ello en los orificios de la caja del aparato. No vierta nunca ninguna clase de líquidos sobre o en la caja. Esto puede producir corto circuitos en el producto y/o puede causar golpes de corriente, fuego o heridas.
22. Asegúrese con la protección adecuada de que no pueda originarse en el producto una sobrecarga por ejemplo a causa de una tormenta. Si no se verá el personal que lo utilice expuesto al peligro de un golpe de corriente.
23. Los productos R&S no están protegidos contra el agua si no es que exista otra indicación, ver también punto 1. Si no se tiene en cuenta esto se arriesga el peligro de golpe de corriente o de daños en el producto lo cual también puede llevar al peligro de personas.
24. No utilice el producto bajo condiciones en las que pueda producirse y se hayan producido líquidos de condensación en o dentro del producto como por ejemplo cuando se desplaza el producto de un lugar frío a un lugar caliente.
25. Por favor no cierre ninguna ranura u orificio del producto, ya que estas son necesarias para la ventilación e impiden que el producto se caliente demasiado. No pongan el producto encima de materiales blandos como por ejemplo sofás o alfombras o dentro de una caja cerrada, si esta no está suficientemente ventilada.
26. No ponga el producto sobre aparatos que produzcan calor, como por ejemplo radiadores o calentadores. La temperatura ambiental no debe superar la temperatura máxima especificada en la hoja de datos.

Informaciones de seguridad

27. Baterías y acumuladores no deben de ser expuestos a temperaturas altas o al fuego. Guardar baterías y acumuladores fuera del alcance de los niños. Si las baterías o los acumuladores no son cambiados con la debida atención existirá peligro de explosión (atención celulas de Litio). Cambiar las baterías o los acumuladores solamente por los del tipo R&S correspondiente (ver lista de piezas de recambio). Baterías y acumuladores son deshechos problemáticos. Por favor tirenlos en los recipientes especiales para este fin. Por favor tengan en cuenta las prescripciones nacionales de cada país referente al tratamiento de deshechos. Nunca sometan las baterías o acumuladores a un corto circuito.
28. Tengan en consideración de que en caso de un incendio pueden escaparse gases tóxicos del producto, que pueden causar daños a la salud.
29. Por favor tengan en cuenta que en caso de un incendio pueden desprenderse del producto agentes venenosos (gases, líquidos etc.) que pueden generar daños a la salud.
30. No sitúe el producto encima de superficies, vehículos, estantes o mesas, que por sus características de peso o de estabilidad no sean aptas para él. Siga siempre las instrucciones de instalación del fabricante cuando instale y asegure el producto en objetos o estructuras (por ejemplo paredes y estantes).
31. Las asas instaladas en los productos sirven solamente de ayuda para el manejo que solamente está previsto para personas. Por eso no está permitido utilizar las asas para la sujecion en o sobre medios de transporte como por ejemplo grúas, carretillas elevadoras de horquilla, carros etc. El usuario es responsable de que los productos sean sujetados de forma segura a los medios de transporte y de que las prescripciones de seguridad del fabricante de los medios de transporte sean tenidas en cuenta. En caso de que no se tengan en cuenta pueden causarse daños en personas y objetos.
32. Si llega a utilizar el producto dentro de un vehículo, queda en la responsabilidad absoluta del conductor que conducir el vehículo de manera segura. Asegure el producto dentro del vehículo debidamente para evitar en caso de un accidente las lesiones u otra clase de daños. No utilice nunca el producto dentro de un vehículo en movimiento si esto pudiera distraer al conductor. Siempre queda en la responsabilidad absoluta del conductor la seguridad del vehículo y el fabricante no asumirá ninguna clase de responsabilidad por accidentes o colisiones.
33. Dado el caso de que esté integrado un producto de laser en un producto R&S (por ejemplo CD/DVD-ROM) no utilice otras instalaciones o funciones que las descritas en la documentación. De otra manera pondrá en peligro su salud, ya que el rayo laser puede dañar irreversiblemente sus ojos. Nunca trate de descomponer estos productos. Nunca mire dentro del rayo laser.

cdmaOne Base Station Tests - Application Firmware Module FSIQK71

Signal Generator FSIQ used with Application Firmware FSIQK71 becomes a cdmaOne base station tester. The basic unit is extended by the code domain measurement mode. In addition, some base station tests which are performed in the analyzer and vector analyzer modes and require several settings can be called via a separate softkey.

A prerequisite for operating FSIQ with option FSIQK71 is configuration with option FSIQB70, DSP and IQ memory extension.

1 Enabling the Firmware Option

Firmware Option FSIQK71 is enabled in the *CONFIGURATION SETUP* menu by entering a keyword. The keyword is delivered with the option. If the option is factory-installed, it is already enabled.

CONFIGURATION SETUP menu:

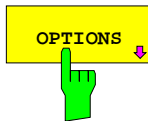

The *OPTIONS* softkey opens a submenu where keywords for new firmware options (application firmware modules) can be entered. Available options are displayed in a table which is opened when entering the submenu.

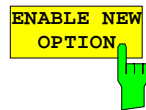

The *ENABLE NEW OPTION* softkey activates the entry of the keyword for a firmware option.

One or several keywords can be entered in the entry field. On entering a valid keyword, *OPTION KEY OK* is displayed on the message line and the option is entered in the *FIRMWARE OPTIONS* table.

The *FIRMWARE OPTIONS* table can be displayed in the *FIRMWARE OPTIONS* softkey in the *INFO* menu.

In case of invalid keywords, *OPTION KEY INVALID* is displayed on the message line.

2 Getting Started

The following chapter explains basic cdmaOne measurements by means of a setup with Signal Generator SMIQ. It describes how operating and measurement errors can be avoided using correct presetting.

The measurement screen is presented in chapter 6 for each measurement.

Key settings are shown as examples to avoid measurement errors. Following the correct setting, the effect of an incorrect setting is shown. The following measurements are performed:

- Measurement 1: Measuring the spectrum
- Measurement 2: Measuring the modulation quality
 - Setting: Synchronization of reference frequencies
- Measurement 3: Measuring relative code domain power
 - Setting: Setting the analyzer center frequency to the DUT frequency
- Measurement 4: Measuring relative code domain power with 9 active code channels
 - Setting: Analyzer at full amplitude (setting of reference level)
 - Setting: Setting of threshold for inactive channels

The measurements are performed using the following units and accessories:

- Signal Analyzer FSIQ with Application Firmware FSIQK71: cdmaOne base station tests (option FSIQB70 required)
- Vector Signal Generator SMIQ with option SMIQB42: digital standard IS- 95 CDMA (options SMIQB20 and SMIQB11 required)
- 1 coaxial cable, 50 Ω , approx. 1 m, N connector
- 1 coaxial cable, 50 Ω , approx. 1 m, BNC connector

Conventions for displaying settings on FSIQ:

- [<KEY>] Press a key on the front panel, eg [**SPAN**]
- [<SOFTKEY>] Press a softkey, eg [*MARKER -> PEAK*]
- [<nn unit>] Enter a value and terminate by entering the unit, eg [*12 kHz*]

Conventions for displaying settings on SMIQ:

- [<KEY>] Press a key on the front panel, eg [**FREQ**]
- <MENU> Select a menu, parameter or a setting, eg *DIGITAL STD*.
The menu level is marked by an indentation.
- <nn unit> Enter a value and terminate by entering the unit, eg *12 kHz*

Basic Settings in the Code Domain Measurement Mode

In the default setting after PRESET, FSIQ is in the analyzer mode. The following default settings of the code domain measurement are activated provided the code domain measurement mode is selected.

Parameter	Setting
CDMA standard	CDMA forward 800
Transmitter nominal power	0 dB
Upper/lower limit value of power tolerance	2 dB / -4 dB
Upper/lower limit value of pilot power ratio	0,5 dB / - 0.5 dB
Upper/lower limit value of inactive channel power ratio	-27 dB
Upper/lower limit value of pilot time alignment	3 μ s / - 3 μ s
Upper/lower limit value of channel time error	50 ns / - 50 ns
Upper/lower limit value of channel phase error	50 mrad / - 50 mrad
Upper/lower limit value of frequency error	200 Hz / -200 Hz
Demodulation time	AUTO ON
PN offset	0
Threshold value	-23 dB

IEC/IEEE-bus command:

```
:INSTRument[:SElect] CDPower
```

Measurement 1: Measuring the Spectrum

The measurement of the spectrum gives an overview of the cdmaOne signal and the spurious emissions close to the carrier.

Test setup On power up of the two units, the RF output of SMIQ is connected to the input of FSIQ (coaxial cable with N connectors).

Settings on SMIQ: .
[PRESET]
[LEVEL: 0 dBm]
[FREQ: 870.03 MHz]
DIGITAL STD
IS95
STATE: ON
SAVE / RCL MAPPING
MODE: FWD_LINK_18
GET PREDEFINED MAPPING...: PILOT
MODULATION
FWD LINK FILTER: IS-95 + EQUALIZER
FILTER MODE: LOW EVM
LOW DISTORTION MODE: OFF

Settings on FSIQ: .
[PRESET]
[CENTER: 870.03 MHz]
[MODE: CDMA ONE BTS: POWER
[REF: 0 dBm]

Measurement on FSIQ: The following is displayed:

- The spectrum of the cdmaOne signal (pilot only) on the trace
- The signal channel power within the 1.23 MHz channel bandwidth (in the marker info field)

Measurement 2: Measuring modulation quality

The measurement of the modulation quality allows the determination of the RHO factor to TIA/EIA-97-C. In the following example, the display of the error vector diagram is selected.

The synchronization of the reference oscillator is performed during the next step (setting 1) to show the behavior of the unit in the absence of synchronization.

Settings on SMIQ: *As for measurement 1*

Settings on FSIQ: *As for measurement 1, plus*

```

[REF:                ATTEN AUTO NORMAL]
[REF:                +10 dBm]
[MODE:              CDMA ONE BTS: MODULATION QUALITY
MEAS RESULT:          MEAS SIGNAL: POLAR [IQ] VECTOR
[menu change key UP]
RESULT LENGTH         100

```

Measurement on FSIQ: The following is displayed:

- Screen A: IQ trace of a cdmaOne signal (pilot only) after the prescribed receive filtering
- Screen B: signal error (numerical results)

RHO The cdmaOne-relevant test parameter rho represents a quality factor for the compliance of the test signal with an ideal receive signal and should be > 0.9995.

Frequency error The frequency error may be several 100 Hz in this setting since the reference oscillators are synchronized and the center frequencies of the two units slightly differ.

Setting: Synchronizing the reference frequencies

The synchronization of the reference oscillators both of the DUT and analyzer strongly reduces the measured frequency error.

Test setup Connect the reference input (EXT REF IN/OUT) on the rear panel of FSIQ to the reference input (REF) on the rear panel of SMIQ (coaxial cable with BNC connectors).

Settings on SMIQ: *As for measurement 1, plus:*

```

UTILITIES:
REF OSC
SOURCE: EXT
EXT FREQUENCY: 10 MHz

```

Settings on FSIQ: *As for step1, plus*

```

SETUP:                REFERENCE INT

```

Measurement on FSIQ: Frequency error The displayed frequency error should be < 10 Hz.

The reference frequencies of the analyzer and of the DUT should be synchronized

Measurement 3: Code domain power measurement with an active channel

The following sequence shows a relative code domain power measurement with an active channel. With this measurement, the individual power values of the code channels are normalized to the sum of all code power values (= 0 dB) and displayed as relative values. A horizontal line indicates the threshold below which all channels are considered as inactive.

Settings on SMIQ: *As under Synchronizing the reference frequencies*

Settings on FSIQ: *As under Synchronizing the reference frequencies, plus*
[MODE: *CDMA ONE BTS: CDP MEAS]*
DISPLAY MODE CDP *CDP RELATIVE*

Measurement on FSIQ: *A CODE DOMAIN POWER RELATIVE diagram with an active code channel (channel 0) is presented.*
The level of this channel is 0 dB (referred to the total power of the cdmaOne signal), ie the total transmit power is concentrated in this code channel.

Setting: Behavior with a deviating center frequency setting

In the following setting, the behavior of the DUT and the analyzer with deviating center frequency setting is shown.

Settings on SMIQ: *Tune the center frequency of the signal generator in 10 kHz steps up to 869.830 MHz and observe the analyzer screen:*

Measurement on FSIQ:

- *At about 869.930 MHz, the level of inactive channels has strongly increased, the measurement time is considerably extended.*
- *At about 869.830 MHz, no measurement is possible, the analyzer displays all channels with the same level.*

Settings on SMIQ: *Set again the signal generator center frequency to 870.03 MHz:*
[FREQ: *870.03 MHz]*

The analyzer center frequency should be accurately set to the DUT frequency

Measurement 4: Code domain power measurement with nine active channels

The following sequence shows a relative code domain power measurement with 9 active code channels.

Settings on SMIQ: *As for measurement 3, plus*
 DIGITAL STD
 IS-95
 SAVE / RCL MAPPING:
 GET PREDEFINED MAPPING: 09CHAN

Settings on FSIQ: *As for measurement 3, plus*
 [REF: REF LEVEL 10dBm]

Measurement on FSIQ: A CODE DOMAIN POWER RELATIVE diagram with 9 active code channels is displayed.
 The channels bearing the numbers 0, 1 and 32 are management channels and highlighted in blue. The other channels are traffic channels and are represented in yellow. The power values of the different channels are normalized to the total power of all channels (TOTAL POWER).
 At this point, the total power of the cdmaOne signal is distributed over the 9 code channels in line with the TIA/EIA-97-C test model (see following section cdmaOne test model).

Setting: Behavior in case of overdrive

The effect of insufficient analyzer level is shown below. The CODE DOMAIN measurement mode offers the *LEVEL AUTO ADJUST* softkey which activates the automatic adaptation of the analyzer level to the input signal, thus preventing overdrive.

Settings on SMIQ: *Change level from 0 dBm to +10 dBm*
 [LEVEL: +10dBm]

Measurement on FSIQ: The analyzer indicates overdrive by a red OVL symbol at the left-hand top of the screen. The overdrive causes a strong increase of the CODE POWER inactive channels.

Settings on FSIQ: *As above, plus*
 [MODE cdmaOne BTS
 CDP MEAS: LEVEL AUTO ADJUST]

Measurement on FSIQ: The *LEVEL AUTO ADJUST* softkey is used for the automatic level adjustment of the analyzer to the input signal. Overdrive of the analyzer does not occur again.

The analyzer should not be overdriven

Summary

The most important settings for the correct demodulation of a cdmaOne BTS signal are summarized in the menus *MEAS SETTINGS*, *LIMIT SETTINGS* and *REF LEVEL (CONFIGURATION MODE - cdmaOne BTS - CDP MEAS)*.

It is indispensable to set the analyzer center frequency accurately to the DUT frequency and to set correctly the analyzer level using the *REF LEVEL* or *LEVEL AUTO ADJUST* softkeys. Overdrive of the measuring instrument causes larger errors (can be noticed by adjacent channel crosstalk in the CDPR diagram) and an underdrive increased noise power in the non-occupied code channels.

The analyzer assumes a channel configuration in line with the test model to TIA/EIA-97-C (section Test Setups), table Base Station Test Model, Nominal). In case of incorrect synchronization (for example, if no signal is applied to the analyzer input connector), all 64 code channels are displayed in the CDPR diagram with the same power.

3 Setup for Base Station Tests



Caution:

Before turning the instrument on, the following conditions must be fulfilled:

- instrument covers are in place and all fasteners are tightened,
- fan openings are free from obstructions,
- signal levels at the input connectors are all below specified maximum values. The level at the FSIQ RF input of +20 dBm with a 0 dB input attenuator must under no circumstances be exceeded. ,
- signal outputs are correctly connected and not overloaded.

Non-observance may cause damage to the instrument .

This section describes how to set up the FSIQ for cdmaOne base station tests. As a prerequisite for starting the test, the instrument must be correctly set up and connected to the AC power supply as described in chapter 1 of the operating manual for the FSIQ basic unit. Furthermore, the application firmware module must be properly installed following the instructions given in chapter 1 of the present manual.

Standard test setup

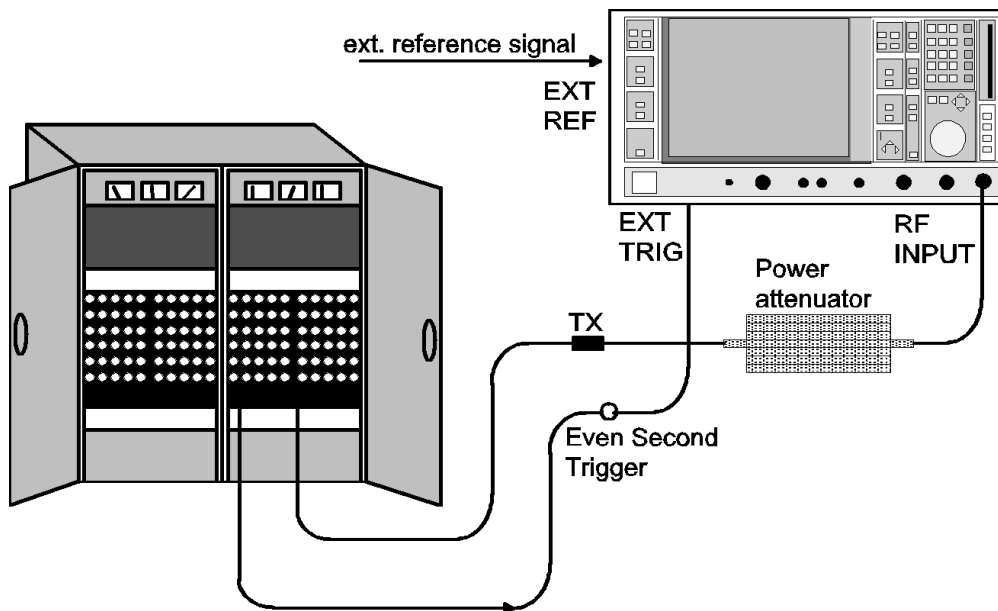

Fig. 3-1 BTS test setup

- Connect trigger output of BTS to the rear BNC connector *EXT TRIG GATE* (external trigger or gate input) of FSIQ. With this trigger signal, FSIQ can measure the pilot time alignment error.
- Connect antenna output (or TX output) of BTS to FSIQ RF input via a power attenuator of suitable attenuation.

Note: The following values are recommended for the external attenuator to ensure that the FSIQ RF input is protected and the sensitivity of the FSIQ is not reduced too much. The FSIQ level display is automatically corrected by the entered value.

Max. power	Recommended ext. attenuation
≥ 55 to 60 dBm	35 to 40 dB
≥ 50 to 55 dBm	30 to 35 dB
≥ 45 to 50 dBm	25 to 30 dB
≥ 40 to 45 dBm	20 to 25 dB
≥ 35 to 40 dBm	15 to 20 dB
≥ 30 to 35 dBm	10 to 15 dB
≥ 25 to 30 dBm	5 to 10 dB
≥ 20 to 25 dBm	0 to 5 dB
< 20 dBm	0 dB

- Connect the external reference frequency to the rear BNC connector *EXT REF IN/OUT* of FSIQ.

Presetting

- Enter external attenuation (reference level offset)
- Enter reference level
- Enter center frequency
- Set the trigger
- Select standard and measurement

4 cdmaOne Test Model

Calculation of the nominal code power distribution

The nominal power distribution of the code channels is described in standard TIA/EIA-97-C (section Test Setups, table Base Station Test Model, Nominal) as test model:

	No. of Channels	Channel No.	Rel. Power
Pilot Channel	1	0	-7 dB
Paging Channel	1	1	-7.3 dB
Sync Channel	1	32	-13.3 dB
Traffic Channels	6		-10.3 dB

For the general case (with a deviating number of traffic channels), the power values are obtained from the table Base Station Test Model, General:

	Rel. Power
Pilot Channel	$P_{\text{Pilot}} = 10 \cdot \log_{10}(0.2) = -7\text{dB}$
Paging Channel	$P_{\text{Paging}} = P_{\text{Traffic}} + 3\text{dB}$
Sync Channel	$P_{\text{Sync}} = P_{\text{Traffic}} - 3\text{dB}$
Traffic Channel	<p>Same power in each traffic channel:</p> $P_{\text{Traffic}} = 10 \cdot \log_{10} \left \frac{0.8}{(N_{\text{Traffic}} + 0.5 + 2)} \right =$ $= 10 \cdot \log_{10}(0.8) - 10 \cdot \log_{10}(N_{\text{Traffic}} + 2.5) =$ $= -1\text{dB} - 10 \cdot \log_{10}(N_{\text{Traffic}} + 2.5);$

5 Menu Overview

Application Firmware Module FSIQK71 (cdmaOne base station tests) extends FSIQ by the code domain measurement mode. Additional softkeys are available which allow overview measurements in the analyzer and vector analyzer modes.

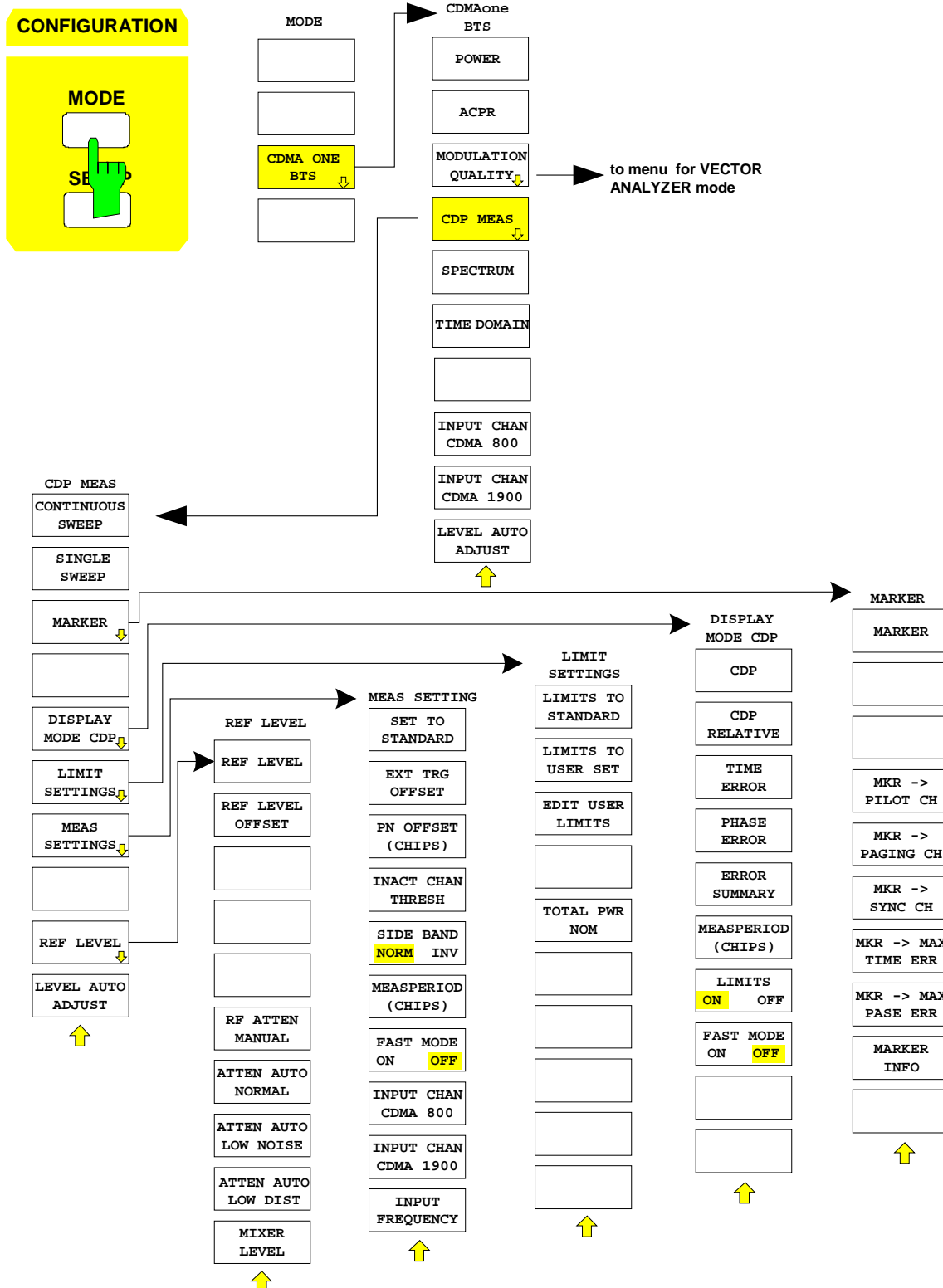

Fig. 5-1 Overview of menus

6 Configuration of cdmaOne Measurements

The most important parameters for the correct demodulation of a cdmaOne BTS signal are summarized in the menu *cdmaOne BTS* (*CONFIGURATION* key group, *Mode* key) and are explained below using the softkey functions.

The *CDP MEAS* softkey activates the code domain measurement mode and opens the submenu for setting the measurement. The other menus of FSIQ either have the same function as in the basic unit or in main menu *CDP MEAS*, or they are not available for the code domain measurement mode (the softkeys are shown in grey).

The trigger setting for measurement is performed in the menu *TRIGGER*. The settings for display mode and evaluation of the trace are performed in the menu *TRACE1*. These menus are described after the *CDP MEAS* menu.

The display is set to *FULL SCREEN* in code domain measurements. Examples for the different measurement masks in the various result display modes are shown in the description for the relevant softkey.

The *POWER*, *ACPR*, *MODULATION QUALITY* and *SPECTRUM* softkeys activate base station tests in the analyzer or vector analyzer mode. The required settings are performed by pressing the corresponding softkey, a subsequent modification of settings is possible. The other menus of FSIQ correspond to the menus of these modes and are described in the operating manual of FSIQ.

CONFIGURATION MODE menu

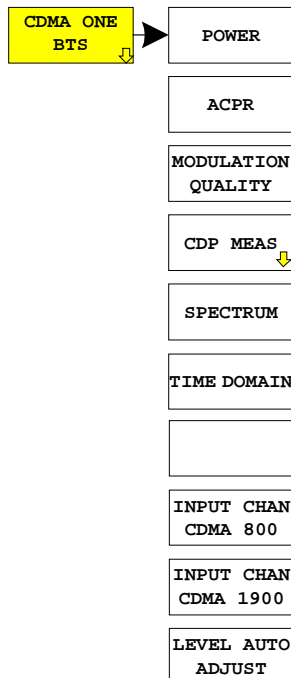

The *CDMA ONE BTS* softkey opens a submenu for setting the various measurement modes of option FSIQK71:

- *POWER* activates the channel power measurement with defined settings in the analyzer mode.
- *ACPR* activates the adjacent channel power measurement with defined settings in the analyzer mode.
- *MODULATION QUALITY* activates the RHO factor measurement in the vector analyzer mode.
- *CDP MEAS* activates the code domain measurement mode and opens another submenu for selecting and configuring the different CODE DOMAIN measurements. All other menus of FSIQ are adapted to the functions of the code domain measurement mode.
- *SPECTRUM* activates an overview measurement with defined settings in the analyzer mode.
- *TIME DOMAIN* activates the measurement of the cdmaOne signal CREST factor in the time domain display mode (analyzer mode).

Measurement of Channel Power

Submenu: CONFIGURATION- MODE – cdmaOne BTS – POWER

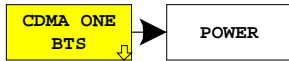

The *POWER* softkey activates the measurement of the cdmaOne signal channel power .

FSIQ measures the RF signal power in the 1.23 MHz bandwidth. The bandwidth is displayed numerically in the marker info field at the top right edge of the screen.

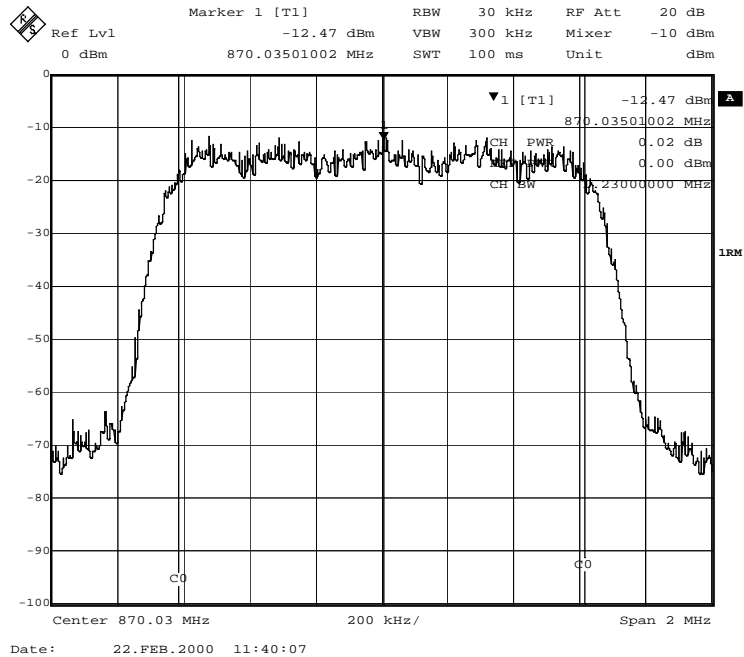

Fig. 6-1 Power measurement in the 1.23 MHz transmission channel

Pressing the softkey activates the analyzer mode with defined settings:

SYSTEM PRESET		
After Preset the following user-specific settings are restored and so the adaptation to the DUT is maintained:		Reference Level Center Frequency Input Attenuation Mixer Level
MARKER NORMAL	CHANNEL POWER	
MARKER NORMAL	POWER MEAS SETTINGS - ACP STANDARD	CDMA_ONE 1900 FWD
FREQUENCY SPAN		2 MHz
SWEEP SWEEP	SWEEP TIME	MANUAL 0.1 sec

Starting from these settings, FSIQ can be operated in all functions available in the ANALYZER mode, ie all test parameters can be adapted to the requirements of the specific measurement.

IEC/IEEE-bus command: :CONFigure:IS95:MEASurement POWER

Query of results: :CALCulate:MARKer:FUNCTion:POWER:RESult? CPOWER

Measurement of Adjacent-Channel Power - ACPR

Submenu: CONFIGURATION MODE – cdmaOne BTS – ACPR

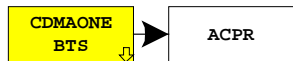

The ACPR softkey activates the adjacent-channel power measurement in the default setting according to TIA/EIA-97-C, Class1 (cdmaOne 1900 FWD).

FSIQ measures the channel power and the relative power of adjacent channels and of the next channels but one.

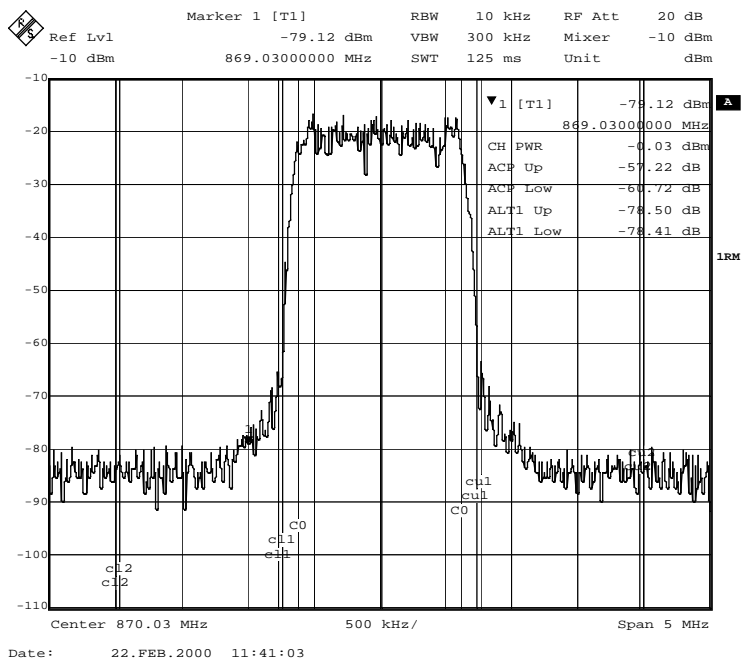



Fig. 6-2 Adjacent-channel power measurement of a cdmaOne base station.

Pressing the softkey activates the analyzer mode with defined settings:

SYSTEM PRESET		
After Preset the following user-specific settings are restored and so the adaptation to the DUT is maintained:		Reference Level Center Frequency Input Attenuation Mixer Level
MARKER NORMAL	ADJACENT CHAN POWER	
MARKER NORMAL	POWER MEAS SETTINGS - ACP STANDARD	CDMA_ONE 1900 FWD
SWEEP SWEEP	SWEEP TIME	MANUAL 0.125 sec
SWEEP COUPLING	RES BW	MANUAL 10 kHz

Starting from these settings, FSIQ can be operated in all functions available in the ANALYZER mode, ie all test parameters can be adapted to the requirements of the specific measurement. In particular, the setting of the ACP standard can be modified as follows:

- Press **MARKER NORMAL** key.
- Change to the left-hand menu using menu key 
- Press the **POWER MEAS SETTINGS** softkey
- Press **ACP STANDARD** softkey, a table is displayed for selecting the ACP standard

After selection, the following operations can be performed:

- ACP limit values can be adapted using the **EDIT ACP LIMITS** softkey
- Bandwidth can be modified using the **CHANNEL BANDWIDTH** softkey and
- Limit checking of measured values can be switched on or off using the **LIMIT CHECK** softkey

IEC/IEEE-bus command: :CONFigure:IS95:MEASurement ACPR

Query of results: :CALCulate:MARKer:FUNCTion:POWer:RESult? ACPower

Measurement of the RHO Factor - MODULATION QUALITY

Submenu: CONFIGURATION- MODE – cdmaOne BTS – MODULATION QUALITY

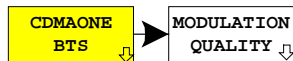

The MODULATION QUALITY softkey leads to the vector analyzer mode and the constellation diagram is shown in the upper half of the screen, in the lower one the ERROR SUMMARY with the modulation errors of the cdmaOne signal.

The setting allows the measurement of the RHO factor in line with TIA/EIA-97-C Chapter "Waveform Quality Measurement Equipment", Table "Accuracy of Waveform Quality Measurement Equipment". On measuring the RHO factor, the base station is to be configured such that only the pilot channel is transmitted (see also chapter Performance Test).

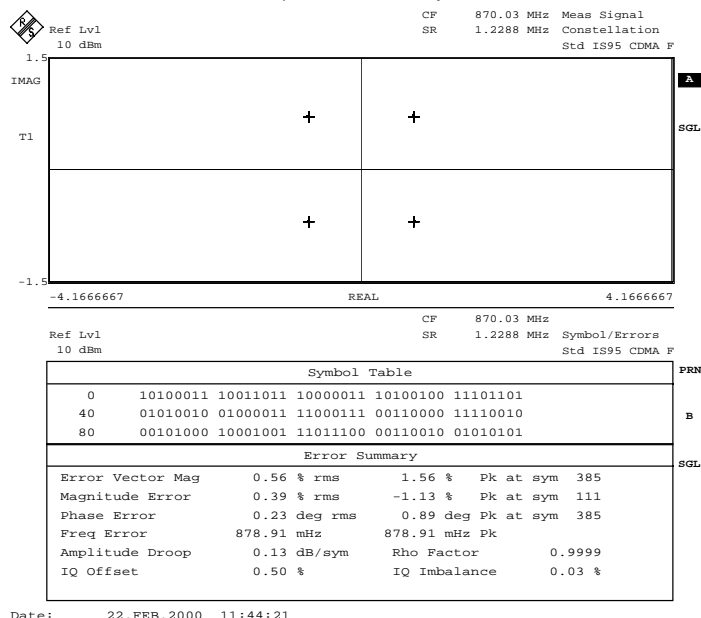

Fig. 6-3 Vector analysis of cdmaOne signal (pilot only)

Pressing the softkey activates the vector analyzer mode with defined settings:

SYSTEM PRESET		
After Preset the following user-specific settings are restored and so the adaptation to the DUT is maintained: Reference Level; Center Frequency; Input Attenuation; Mixer Level		
CONFIGURATION MODE	VECTOR ANALYZER	
	DIGITAL STANDARDS	IS95-CDMA FWD CH
SYSTEM DISPLAY	SPLIT SCREEN	
	ACTIVE SCREEN B	
CONFIGURATION MODE	VECTOR ANALYZER	
	MEAS RESULT	SYMB TABLE /ERROR
SYSTEM DISPLAY	ACTIVE SCREEN A	

Starting from these settings, FSIQ can be operated in all functions available in the vector analyzer mode, ie all test parameters can be adapted to the requirements of the specific measurement. This can be done in the MODULATION QUALITY submenu which is identical to the VECTOR ANALYZER menu.

IEC/IEEE-bus command: :CONFIGure:IS95:MEASurement MODulation

Query of results: :CALCulate<1|2>:MARKer<1|2>:FUNction:DDEMod:RESult? RHO

Spectrum Measurement - SPECTRUM

Submenu: CONFIGURATION- MODE – cdmaOne BTS – SPECTRUM

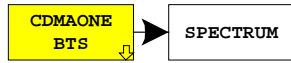

The *SPECTRUM* softkey displays the spectrum of the cdmaOne BTS signal with a span of 5 MHz in the ANALYZER mode. This submenu allows the overview display of the cdmaOne transmit signal and the checking of the harmonics close to the carrier.

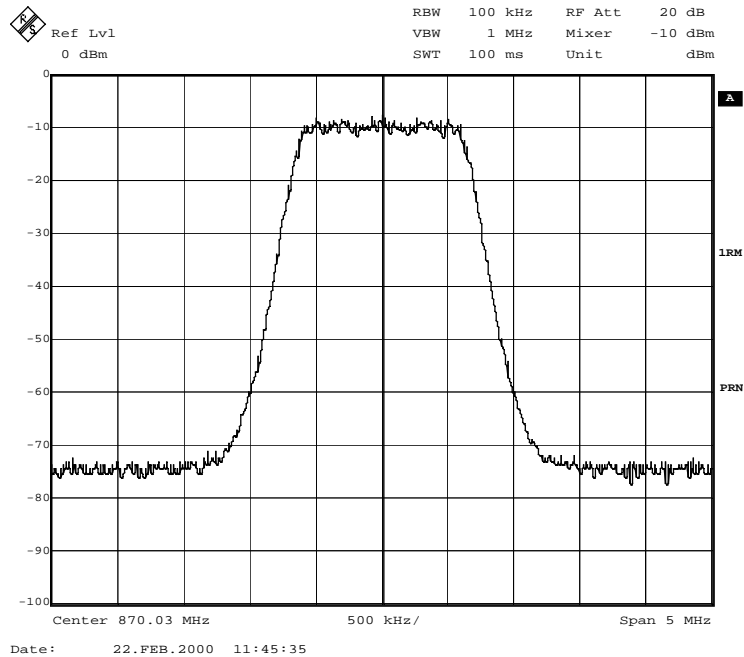

Fig. 6-4 Spectrum display of cdmaOne signal at a 5 MHz span.

Pressing the softkey activates the analyzer mode with defined settings:

SYSTEM PRESET		
After Preset the following user-specific settings are restored and so the adaptation to the DUT is maintained:		Reference Level Center Frequency Input Attenuation Mixer Level
FREQUENCY SPAN		5 MHz
SWEEP SWEEP	SWEEP TIME	MANUAL 0.1 sec
SWEEP COUPLING	RES BW	MANUAL 100 kHz
TRACE 1	DETECTOR	RMS

Starting from these settings, FSIQ can be operated in all functions available in the ANALYZER mode, ie all test parameters can be adapted to the requirements of the specific measurement.

IEC/IEEE-bus command: :CONFigure:IS95:MEASurement FDOMain

Query of results: -- (visual evaluation)

Time Domain Measurement - TIME DOMAIN

Submenu: CONFIGURATION- MODE – cdmaOne BTS – TIME DOMAIN

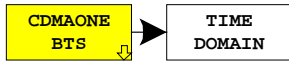

The *TIME DOMAIN* softkey displays the CREST factor of the cdmaOne BTS signal in the ANALYZER mode. The CREST factor designates the level difference between the peak power and rms power of the signal in dB.

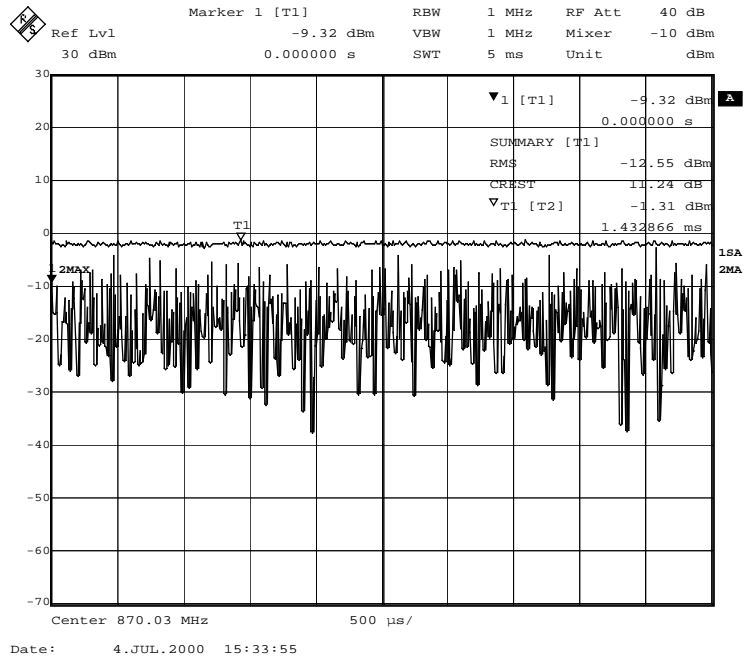

Fig. 6-5 Time domain display of cdmaOne signal.

Pressing the softkey activates the analyzer mode with defined settings:

SYSTEM PRESET		
After Preset the following user-specific settings are restored and so the adaptation to the DUT is maintained:		
		Reference Level
		Center Frequency
		Input Attenuation
		Mixer Level
FREQUENCY SPAN		ZERO SPAN
TRACE 1	DETECTOR	SAMPLE
MARKER NORMAL		MARKER 1
TRACE 2		MAX HOLD
TRACE 2	DETECTOR	MAX PEAK
MARKER SEARCH	SUMMARY MARKER	ON
MARKER SEARCH	SUMMARY MARKER	RMS
MARKER NORMAL	MARKER INFO	ON

Starting from these settings, FSIQ can be operated in all functions available in the ANALYZER mode, ie all test parameters can be adapted to the requirements of the specific measurement.

IEC/IEEE-bus command: :CONFigure:IS95:MEASurement TDOMain

Query of results: :CALCulate<1|2>:MARKer<1...4>:FUNctioN:CRESt?
 :CALCulate:MARKer:FUNctioN:SUMMARY:RMS:RESult?
 :CALCulate:MARKer:FUNctioN:SUMMARY:STATE ON

Selecting the Input Channel - INPUT CHAN CDMA

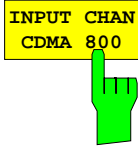

The *INPUT CHAN CDMA 800* softkey opens a window for entering a channel number in the CDMA 800 MHz frequency band. The corresponding center frequency of the analyzer is calculated from it and indicated in the display:

Base station (869 to 894 MHz)

$$F_{TX} = 870 \text{ MHz} + N \times 0.03; N = 1 \text{ to } 799$$

or

$$F_{TX} = 870 \text{ MHz} + (N - 1023) \times 0.03; N = 991 \text{ to } 1023$$

The channel assignment is obtained from TIA/EIA-97-C (chapter CDMA Receiver Minimum Standards, table CDMA Channel Number to CDMA Frequency Assignment Correspondence for Band Class 0).

IEC/IEEE bus commands:

```
:CONFigure:CDPower:PRESet FWCDMA8 | NONE
:CONFigure:CDPower:CHANnel 1
```

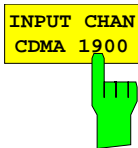

The *INPUT CHAN CDMA 1900* softkey opens a window for entering a channel number in the CDMA 1900 MHz frequency band. The corresponding center frequency of the analyzer is calculated from it and indicated in the display:

Base station (1930 to 1990 MHz)

$$F_{TX} = 1930.000 \text{ MHz} + N \times 0.05; N = 1 \text{ to } 1199$$

The channel assignment is obtained from TIA/EIA-97-C (chapter CDMA Receiver Minimum Standards, table CDMA Channel Number to CDMA Frequency Assignment Correspondence for Band Class 1).

IEC/IEEE bus commands:

```
:CONFigure:CDPower:PRESet FWCDMA19 | NONE
:CONFigure:CDPower:CHANnel 1
```

Automatic Adaptation to the Input Level - LEVEL AUTO ADJUST

Submenu: *CONFIGURATION- MODE – LEVEL AUTO ADJUST*

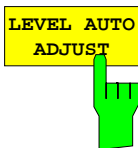

The *LEVEL AUTO ADJUST* softkey is used for setting automatically the RF attenuation and IF gain to the level of the applied signal. Manual re-adjustment is permissible with the *REF LEVEL* softkey.

The instrument is to be switched to the *ATTEN MANUAL* mode so as to set the RF attenuation and IF gain to optimum values independently of each other. This mode is maintained after changing from code-domain power measurements to the analyzer or vector analyzer mode.

IEC/IEEE-bus command: :SENSe:CDPower:LEVel:ADJust

The softkey is only available for *TIME DOMAIN* and *CDP* measurement.

Code Domain Measurements on cdmaOne Signals

Submenu: CONFIGURATION- MODE – cdmaOne BTS – CDP MEAS

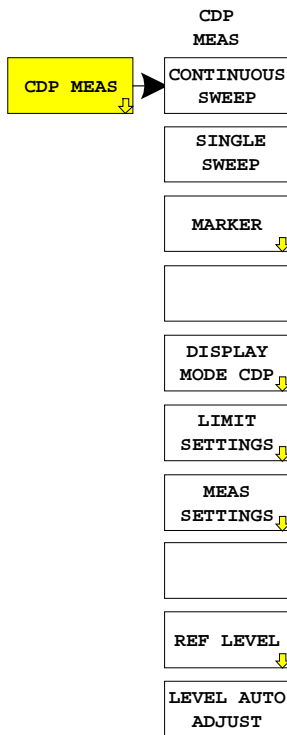

The *CDP MEAS* softkey activates the code domain measurement mode and opens a submenu for configuring the measurements. All settings can be performed in these submenus. An exception is the trigger setting which is done in the *SWEEP TRIGGER* menu.

IEC/IEEE-bus command:

```
:INSTRument[:SElect] CDPower
```

or

```
:CONFigure:IS95:MEASurement CDPower
```

Query of results

- ```
:CALCulate:FEED `XTIM:CDP:ERR:SUMM` ;
:CALCulate:MARKer:FUNCTion:CDPower:RESult?
PTOTal | CPOWER | PERRor | FERRor |
ERRor | ACHannels | PTAlIgnment | ACOunt
```
- ```
:TRACe:DATA? TRACE1
```
- Marker functions (see *MARKER* submenu)

Continuous Measurement - Continuous Sweep

Submenu: CONFIGURATION- MODE – cdmaOne BTS – CDP MEAS – CONTINUOUS SWEEP

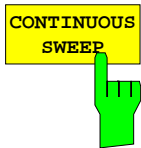

The *CONTINUOUS SWEEP* softkey sets a continuous measurement mode. The start of the actual measurement, however, may depend on an external trigger. (see section Trigger Settings - *TRIGGER* Menu)

IEC/IEEE-bus command: `:INITiate:CONTInuous ON;`
`:INITiate:IMMediate`

Single Measurement - Single Sweep

Submenu: CONFIGURATION- MODE – cdmaOne BTS – CDP MEAS – SINGLE SWEEP

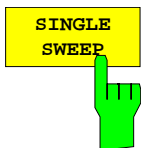

The *SINGLE SWEEP* softkey sets the single measurement mode. A single sweep is performed upon pressing the softkey. The start of the actual measurement, however, may depend on an external trigger (see section Key group *SWEEP*).

IEC/IEEE-bus command: `:INITiate:CONTInuous OFF;`
`:INITiate:IMMediate`

MARKER Functions

Submenu: *CONFIGURATION- MODE – cdmaOne BTS – CDP MEAS – MARKER*

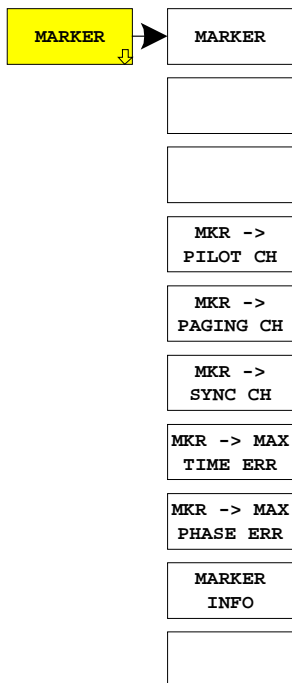

The *MARKER* softkey opens a submenu with the marker settings.

These settings can only be selected in the graphical display modes

- CDP
- CDP RELATIVE
- TIME ERROR
- PHASE ERROR

Markers are not available in the tabulated display mode *ERROR SUMMARY*.



The *MARKER* softkey switches the marker on or off.

IEC/IEEE-bus command: :CALCulate:MARKer:STATe ON
:CALCulate:MARKer:X <channel_number>
:CALCulate:MARKer:Y?

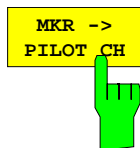

The *MKR -> PILOT CH* softkey sets the marker to the pilot channel (WALSH channel #0)

IEC/IEEE-bus command: :CALCulate:MARKer:FUNction:PILot
:CALCulate:MARKer:Y?

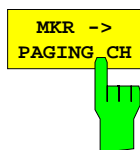

The *MKR -> PAGING CH* softkey sets the marker to the paging channel (WALSH channel #1)

IEC/IEEE-bus command: :CALCulate:MARKer:FUNction:PAGing
:CALCulate:MARKer:Y?

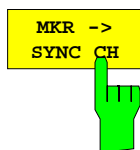

The *MKR -> SYNC CH* softkey sets the marker to the sync channel (WALSH channel #32)

IEC/IEEE-bus command: :CALCulate:MARKer:FUNction:SYNC
:CALCulate:MARKer:Y?

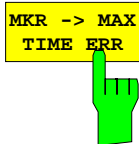

MKR -> MAX
TIME ERR

The *MKR -> MAX TIME ERR* softkey sets the marker to the code channel with the maximum measured value for timing error.

IEC/IEEE-bus command: :CALCulate:MARKer:FUNCTion:TERRor
:CALCulate:MARKer:X?
(queries the channel)
:CALCulate:MARKer:Y?
(queries the value)

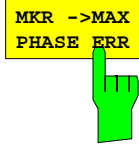

MKR -> MAX
PHASE ERR

The *MKR -> MAX PHASE ERR* softkey sets the marker to the code channel with the maximum measured value for phase error.

IEC/IEEE-bus command: :CALCulate:MARKer:FUNCTion:PERRor
:CALCulate:MARKer:X?
(queries the channel)
:CALCulate:MARKer:Y?
(queries the value)



MARKER
INFO

The *MARKER INFO* softkey switches the *MARKER INFO* field on and off.

This field shows additional information and measured values which are not shown in the selected display mode:

The CDP display mode indicates for example the absolute power of the different code channels. Additional information is given in the marker info field for the currently selected channel:

- Total Power
- CDP
- CDP RATIO
- Phase Error
- Time Error

IEC/IEEE-bus command: :DISPlay:WINDow:MINFo ON | OFF

CDP Display Mode

Submenu: *CONFIGURATION- MODE – cdmaOne BTS – CDP MEAS – DISPLAY MODE CDP*

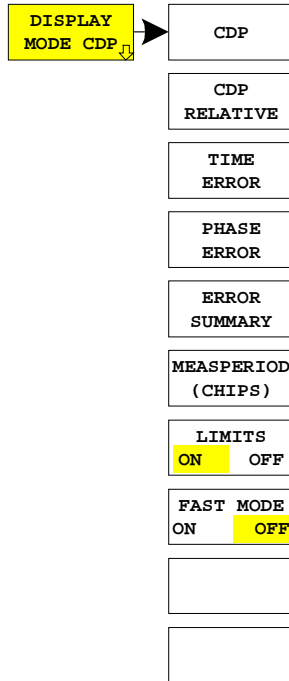

The *DISPLAY MODE CDP* softkey opens a submenu for setting the display mode, the limit checking and some other test parameters.

The following display modes are available:

CDP	Code Domain Power
CDP RELATIVE	Relative Code Domain Power
TIME ERROR	Pilot Channel to Code Channel Time Tolerance according to TIA/EIA-97-C (Section "Pilot Channel to Code Channel Time Tolerance" and Section "Code Domain Measurement Equipment", Table "Accuracy of Code Domain Measurement Equipment")
PHASE ERROR	Pilot Channel to Code Channel Phase Tolerance according to TIA/EIA-97-C (Section "Pilot Channel to Code Channel Phase Tolerance" and Section "Code Domain Measurement Equipment", Table "Accuracy of Code Domain Measurement Equipment")
ERROR SUMMARY	Display of the most important measured values, limit values and set test parameters

The demodulation period is set in number of chips using the *MEAS PERIOD (CHIPS)* softkey.

The limit check is switched on with *LIMITS ON/OFF*. The limit check settings are performed in the *LIMIT SETTINGS* menu.

The measurement speed can be increased by switching off the calculation of timing and phase errors with *FAST MODE ON*.

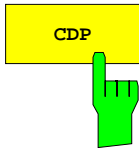

The *CDP* softkey sets the display mode Code Domain Power. This diagram displays the power of code channels in absolute scaling.

An info field with further measured values that cannot be seen in the *CDP* display can be inserted using the *MARKER INFO* softkey in the *MARKER NORMAL* menu.

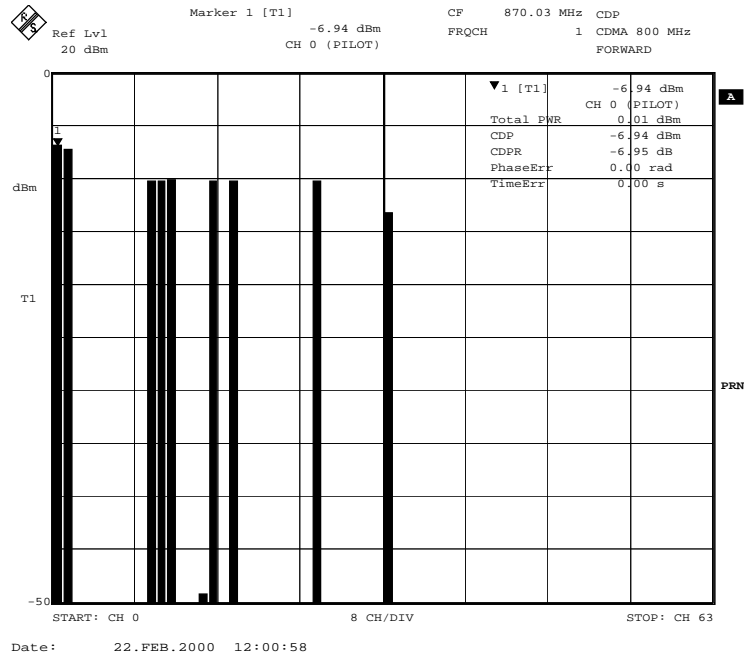

Fig. 6-6 Display of the Code Domain Power with marker info. All measured values for the code selected with the marker are displayed in the marker info field.

IEC/IEEE bus commands:

```
:CALCulate:FEED "XPOW:CDP"
:CALCulate:MARKer:FUNction:CDPower:RESult? CPower
```



The *CDP RELATIVE* softkey sets the display mode to relative code domain power measurement .
 With this measurement, the individual power values of all code channels are normalized to the sum of all code power values (= 0 dB) and displayed as relative values.
 A horizontal line indicates the set threshold value (INA = Inactive Channel Threshold) below which all channels are considered as inactive.
 Code channels with a level below this threshold are assumed to be inactive for further evaluation; for such channels, further error evaluation is not carried out.

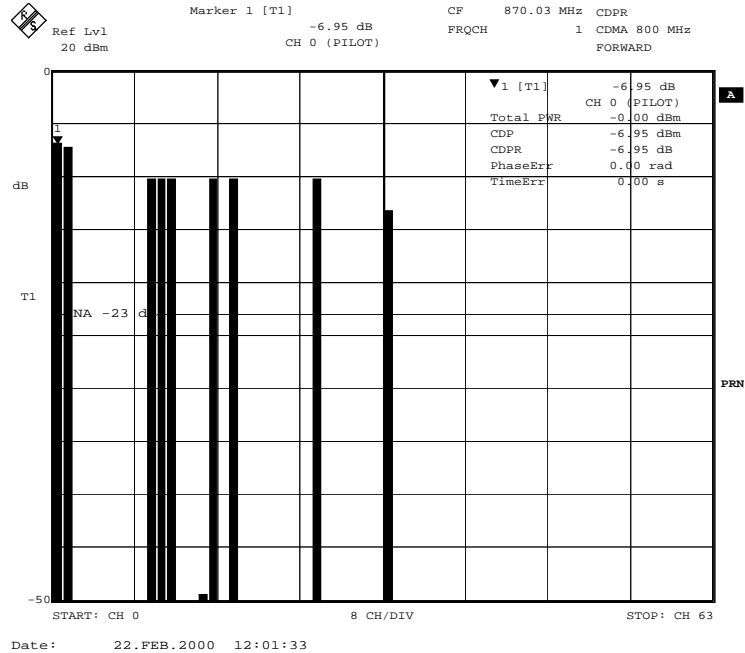
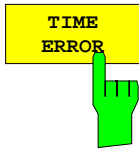

Fig. 6-7 Display of the relative code domain power measurement with threshold for inactive channels

IEC/IEEE-bus command: :CALCulate:FEED "XPOW:CDP:RAT"



The *TIME ERROR* softkey sets the display mode **Pilot Channel to Code Channel Time Tolerance**.

Time shifts of code channels referred to the pilot channel are displayed here. The scaling of the y-axis is adapted to the limit values.

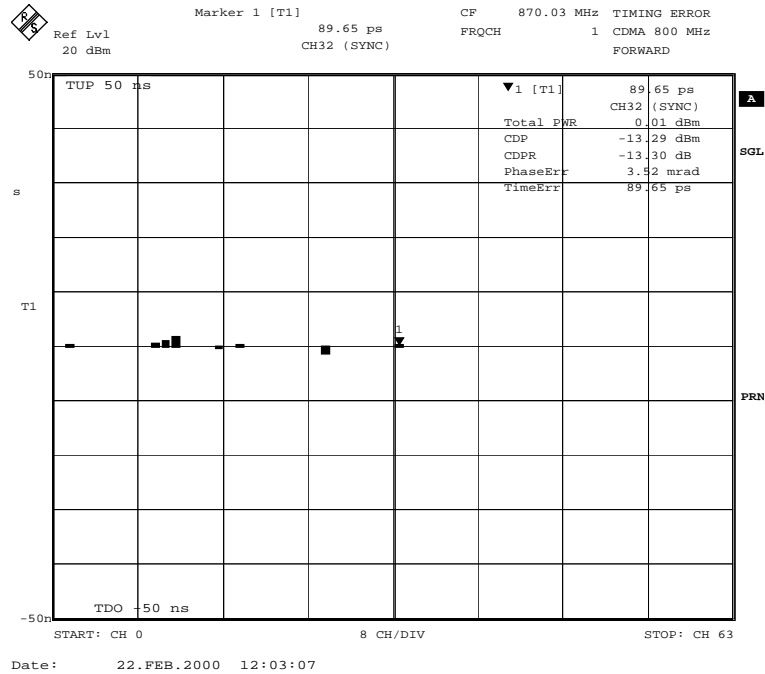
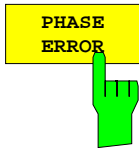

Fig. 6-8 Display of timing error (referred to the pilot channel) for assigned code channels

IEC/IEEE bus commands:

```
:CALCulate:FEED "XTIM:CDP:ERR"
```

```
:CALCulate:MARKer:FUNCTion:CDPower:RESult? TERROR
```



The *PHASE ERROR* softkey sets the display mode **Pilot Channel to Code Channel Phase Tolerance**.
 Time shifts of code channels referred to the pilot channel are displayed here. The scaling of the y-axis is adapted to the nominal value.

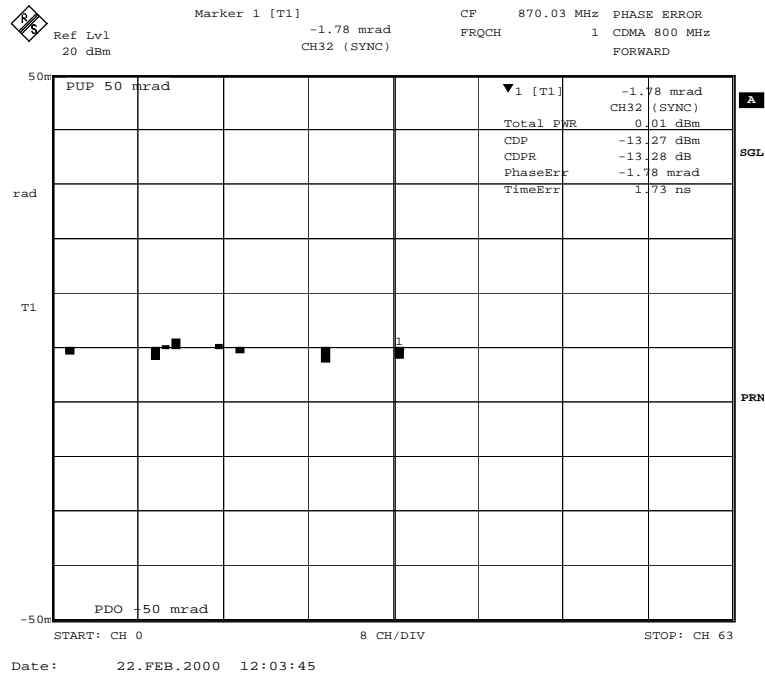

Fig. 6-9 Display of phase error (referred to the pilot channel) for assigned code channels

IEC/IEEE bus commands:

```
:CALCulate:FEED "XTIM:CDP:ERR:PHAS"
:CALCulate:MARKer:FUNCTION:CDPower:RESult? PERRor
```



The *ERROR SUMMARY* softkey opens a tabulated display of the most important measured values, limit values and set test parameters:

Measured values of the different code channels are indicated in the upper half **(A)** of the diagram, eg:

- CODE PWR
- CODE PWR RATIO (Code PWR referred to Total PWR)
- TIMING ERROR
- PHASE ERROR.

The center section **(B)** contains numerical values for the total cdmaOne signal, eg:

- TOTAL PWR (sum of the power values of all code channels)
- PILOT to TOTAL PWR (pilot channel power referred to the sum power)
- PILOT TIME ALIGNMENT
- FREQUENCY ERROR

The display of PILOT TIME ALIGNMENT is suppressed if no external trigger is on since the measurement is referred to the trigger point (EVEN SECOND TRIGGER).

The lower half **(C)** contains setting parameters which will be considered in the measurement or the results, eg:

- INACTIVE CHANNEL THRESHOLD
- TRIGGER OFFSET
- PN OFFSET

Additional general information are available such as

- Number of active code channels
- MEASPERIOD (set value or current value if AUTO is selected)
- AVERAGE ON /OFF

Ref Lvl 20 dBm

CF 870.03 MHz ERROR SUMMARY
FRQCH 1 CDMA 800 MHz
FORWARD

CDP Error Summary							A	
WALSH CHAN	CODE PWR	CODE P/ TOTAL P	IS97 nom-PWR	TIMING ERROR	PHASE ERROR	STATUS		
No Type	[dBm]	[dB]	[dB]	[ns]	[mrad]			
0 Pilot	-7.0	-7.0	-7.0	0.0	0.0	pass	A	
1 Paging	-7.3	-7.3	-7.3	0.1	0.4	pass		
32 Sync	-13.4	-13.4	-13.3	0.0	-0.3	pass		
9 Traffic	-10.3	-10.3	-10.3	-0.0	0.2	pass		
10 Traffic	-10.3	-10.3	-10.3	0.2	-0.5	pass		
11 Traffic	-10.3	-10.3	-10.3	-0.1	-0.3	pass		
15 Traffic	-10.3	-10.3	-10.3	0.1	-0.1	pass		
17 Traffic	-10.3	-10.3	-10.3	0.2	-0.4	pass		
25 Traffic	-10.3	-10.3	-10.3	-0.3	0.5	pass		
max inact	-49.3	-49.3	<-27.0			pass		
Limits / lower				-50.0	-50.0			B
upper				50.0	50.0			
Total Pwr	-0.1 dBm	0.0	-4.0 ...	2.0	pass	C		
Pilot/Total Pwr	-7.0 dB	-7.0	-0.5 ...	0.5	pass			
Pilot Time Align	-40.770 ns	-3.0 ...	3.0	pass				
Frequency Err	5.482 MHz	-200.0 ...	200.0	pass				
inact CHAN thresh	-23.0 dB	ext Trigger Offs	2.355 μs					
No of active CHAN	9	Meas Period	4096					
pn Offset	0 CHIPS	Average	OFF					

Date: 22.FEB.2000 12:10:32

Fig. 6-10 Structure of ERROR SUMMARY

The numbers of code channels, their designation as well as the measured values are highlighted in grey in the table below:

Ref Lvl 20 dBm CF 870.03 MHz ERROR SUMMARY FRQCH 1 CDMA 800 MHz FORWARD

CDP Error Summary						
WALSH CHAN	CODE	CODE P/	IS97	TIMING	PHASE	STATUS
No Type	FWR [dBm]	TOTAL P [dB]	nom-FWR [dB]	ERROR [ns]	ERROR [mrad]	
0 Pilot	-7.0	-7.0	-7.0	0.0	0.0	pass
1 Paging	-7.3	-7.3	-7.3	0.1	0.4	pass
32 Sync	-13.4	-13.4	-13.3	0.0	-0.3	pass
9 Traffic	-10.3	-10.3	-10.3	-0.0	0.2	pass
10 Traffic	-10.3	-10.3	-10.3	0.2	-0.5	pass
11 Traffic	-10.3	-10.3	-10.3	-0.1	-0.3	pass
15 Traffic	-10.3	-10.3	-10.3	0.1	-0.1	pass
17 Traffic	-10.3	-10.3	-10.3	0.2	-0.4	pass
25 Traffic	-10.3	-10.3	-10.3	-0.3	0.5	pass
max inact	-49.3	-49.3	<-27.0			pass
Limits / lower				-50.0	-50.0	
upper				50.0	50.0	
Total Pwr	-0.1 dBm		0.0	-4.0 ...	2.0	pass
Pilot/Total Pwr	-7.0 dB		-7.0	-0.5 ...	0.5	pass
Pilot Time Align	-40.770 ns			-3.0 ...	3.0	pass
Frequency Err	5.482 mHz			-200.0 ...	200.0	pass
inact CHAN thresh	-23.0 dB		ext Trigger Offs		2.355 μ s	
No of active CHAN	9		Meas Period		4096	
pn Offset	0 CHIPS		Average		OFF	

Date: 22.FEB.2000 12:10:32

Fig. 6-11 ERROR SUMMARY: Measured values

The limit values used to perform limit checking are marked with grey. The limit values are obtained from the predefined standard limits or the user limits.

Modifications of these limits by pressing the *LIMIT TO STANDARD* or *LIMIT TO USER SET* softkey affect directly the displayed limit values and will be considered in limit checking.

Checking can be switched on or off using the *LIMITS ON/OFF* softkey.

Ref Lvl 20 dBm CF 870.03 MHz ERROR SUMMARY FRQCH 1 CDMA 800 MHz FORWARD

CDP Error Summary						
WALSH CHAN	CODE	CODE P/	IS97	TIMING	PHASE	STATUS
No Type	FWR [dBm]	TOTAL P [dB]	nom-FWR [dB]	ERROR [ns]	ERROR [mrad]	
0 Pilot	-7.0	-7.0	-7.0	0.0	0.0	pass
1 Paging	-7.3	-7.3	-7.3	0.1	0.4	pass
32 Sync	-13.4	-13.4	-13.3	0.0	-0.3	pass
9 Traffic	-10.3	-10.3	-10.3	-0.0	0.2	pass
10 Traffic	-10.3	-10.3	-10.3	0.2	-0.5	pass
11 Traffic	-10.3	-10.3	-10.3	-0.1	-0.3	pass
15 Traffic	-10.3	-10.3	-10.3	0.1	-0.1	pass
17 Traffic	-10.3	-10.3	-10.3	0.2	-0.4	pass
25 Traffic	-10.3	-10.3	-10.3	-0.3	0.5	pass
max inact	-49.3	-49.3	<-27.0			pass
Limits / lower				-50.0	-50.0	
upper				50.0	50.0	
Total Pwr	-0.1 dBm		0.0	-4.0 ...	2.0	pass
Pilot/Total Pwr	-7.0 dB		-7.0	-0.5 ...	0.5	pass
Pilot Time Align	-40.770 ns			-3.0 ...	3.0	pass
Frequency Err	5.482 mHz			-200.0 ...	200.0	pass
inact CHAN thresh	-23.0 dB		ext Trigger Offs		2.355 μ s	
No of active CHAN	9		Meas Period		4096	
pn Offset	0 CHIPS		Average		OFF	

Date: 22.FEB.2000 12:10:32

Fig. 6-12 ERROR SUMMARY: Limit values

In the following table, the columns Code P / Total P and their nominal distribution are in grey.

Except PILOT / TOTAL PWR and the limit value for INACT CHAN POWER RATIO, the **nominal distribution is used only as information** and will not be considered in limit checking.

The nominal distribution of code power values is obtained from the test model in standard TIA/EIA-97-C (section Test Setups, table Base Station Test Model, Nominal).

WALSH CHAN		CODE PWR	CODE P / TOTAL P	IS97 nom-PWR	TIMING ERROR	PHASE ERROR	STATUS
No	Type	[dBm]	[dB]	[dB]	[ns]	[mrad]	
0	Pilot	-7.0	-7.0	-7.0	0.0	0.0	pass
1	Paging	-7.3	-7.3	-7.3	0.1	0.4	pass
32	Sync	-13.4	-13.4	-13.3	0.0	-0.3	pass
9	Traffic	-10.3	-10.3	-10.3	-0.0	0.2	pass
10	Traffic	-10.3	-10.3	-10.3	0.2	-0.5	pass
11	Traffic	-10.3	-10.3	-10.3	-0.1	-0.3	pass
15	Traffic	-10.3	-10.3	-10.3	0.1	-0.1	pass
17	Traffic	-10.3	-10.3	-10.3	0.2	-0.4	pass
25	Traffic	-10.3	-10.3	-10.3	-0.3	0.5	pass
	max inact	-49.3	-49.3	<-27.0			pass
Limits / lower					-50.0	-50.0	
upper					50.0	50.0	
Total Pwr		-0.1 dBm	0.0	-4.0 ...	2.0	pass	
Pilot/Total Pwr		-7.0 dB	-7.0	-0.5 ...	0.5	pass	
Pilot Time Align		-40.770 ns		-3.0 ...	3.0	pass	
Frequency Err		5.482 MHz		-200.0 ...	200.0	pass	
inact CHAN thresh		-23.0 dB		ext Trigger Offs	2.355 μs		
No of active CHAN		9		Meas Period	4096		
pn Offset		0 CHIPS		Average	OFF		

Date: 22.FEB.2000 12:10:32

Fig. 6-13 ERROR SUMMARY: Nominal power distribution

The display of the nominal power distribution is suppressed in the following cases:

- There is no traffic channel
- One of the management channels (pilot, paging or sync) is missing

The suppression is effective, for example when *INACT CHAN THRESH* is set such that only the pilot channel meets the trigger condition.

The right-hand column marked in grey on the display shows the status of limit checking (pass / fail). Checking can be switched off using the *LIMITS OFF* softkey.

Ref Lvl 20 dBm		CF 870.03 MHz		ERROR SUMMARY			
		FRQCH		1 CDMA 800 MHz			
				FORWARD			
CDP Error Summary							
WALSH CHAN	CODE	CODE P/	IS97	TIMING	PHASE	STATUS	
No	Type	[dBm]	[dB]	[ns]	[mrad]		
0	Pilot	-7.0	-7.0	-7.0	0.0	0.0	pass
1	Paging	-7.3	-7.3	-7.3	0.1	0.4	pass
32	Sync	-13.4	-13.4	-13.3	0.0	-0.3	pass
9	Traffic	-10.3	-10.3	-10.3	-0.0	0.2	pass
10	Traffic	-10.3	-10.3	-10.3	0.2	-0.5	pass
11	Traffic	-10.3	-10.3	-10.3	-0.1	-0.3	pass
15	Traffic	-10.3	-10.3	-10.3	0.1	-0.1	pass
17	Traffic	-10.3	-10.3	-10.3	0.2	-0.4	pass
25	Traffic	-10.3	-10.3	-10.3	-0.3	0.5	pass
max	inact	-49.3	-49.3	<-27.0			pass
Limits / lower				-50.0	-50.0		
upper				50.0	50.0		
Total Pwr		-0.1 dBm	0.0	-4.0 ...	2.0		pass
Pilot/Total Pwr		-7.0 dB	-7.0	-0.5 ...	0.5		pass
Pilot Time Align		-40.770 ns		-3.0 ...	3.0		pass
Frequency Err		5.482 MHz		-200.0 ...	200.0		pass
inact CHAN thresh		-23.0 dB	ext Trigger Offs		2.355 µs		
No of active CHAN		9	Meas Period		4096		
pn Offset		0 CHIPS	Average		OFF		

Date: 22.FEB.2000 12:10:32

Fig. 6-14 ERROR SUMMARY: Limit checking

IEC/IEEE bus commands:

```
:CALCulate:FEED "XTIM:CDP:ERR:SUMM"
:CALCulate:MARKer:FUNCTion:CDPower:RESult? PTOTAL |
CPOWER | PERRror | FERRor |
TERRor | ACHannels |
PTALignment | ACOunt
```

or

```
:TRACe:DATA? TRACE1
```

MEASPERIOD
(CHIPS)



The *MEASPERIOD* softkey sets the demodulation period in number of chips. The function of this softkey is identical to that of the softkey with the same name in the *MEAS SETTINGS* menu.

The permissible setting values are: Auto, 1k, 2k, 4k, 8k, 12k, 16k, 20k, 24k

In the Auto mode, the demodulator calculates the signal/noise ratio of the cdmaOne signal and automatically selects a suitable setting for *MEASPERIOD*. The period currently selected is indicated in the display mode *ERROR SUMMARY*. Default setting is *AUTO*.

MEAS PERIOD
<input checked="" type="checkbox"/> Auto
1k
2k
4k
8k
12k
16k
20k
24k

IEC/IEEE bus commands:

```
:SENSe:CDPower:MPERiod:AUTO ON | OFF
```

```
:SENSe:CDPower:MPERiod 1|2|4|8|12|16|20|24
```

LIMITS
ON OFF



The *LIMITS ON / OFF* softkey switches the limit checking on and off in the display mode *ERROR SUMMARY*.

The *ERROR SUMMARY* with limit checking switched off (*LIMITS OFF*) is presented below.

CDP Error Summary							
WALSH CHAN	CODE	CODE P/	IS97	TIMING	PHASE		
No	Type	[dBm]	TOTAL P	nom-PWR	ERROR	ERROR	STATUS
			[dB]	[dB]	[ns]	[mrad]	
0	Pilot	-6.9	-7.0	-7.0	0.0	0.0	
1	Paging	-7.3	-7.3	-7.3	0.1	0.5	
32	Sync	-13.3	-13.4	-13.3	-0.1	-0.3	
9	Traffic	-10.3	-10.3	-10.3	0.1	0.2	
10	Traffic	-10.3	-10.3	-10.3	0.0	-0.5	
11	Traffic	-10.3	-10.3	-10.3	-0.1	0.1	
15	Traffic	-10.3	-10.3	-10.3	0.0	0.2	
17	Traffic	-10.3	-10.3	-10.3	0.2	0.2	
25	Traffic	-10.3	-10.3	-10.3	-0.2	0.4	
max inact		-49.2	-49.2	<-27.0			
Limits / lower					-50.0	-50.0	
upper					50.0	50.0	
Total Pwr		0.0 dBm		0.0	-4.0 ...	2.0	
Pilot/Total Pwr		-7.0 dB		-7.0	-0.5 ...	0.5	
Pilot Time Align		15.658 ns			-3.0 ...	3.0	
Frequency Err		-13.994 MHz			-200.0 ...	200.0	
inact CHAN thresh		-23.0 dB		ext Trigger Offs		2.355 µs	
No of active CHAN		9		Meas Period		4096	
pn Offset		0 CHIPS		Average		OFF	

Date: 22.FEB.2000 14:54:59

Fig. 6-15 *ERROR SUMMARY* with *LIMIT CHECK* off

IEC/IEEE-bus command: :CALCulate:LIMit:STATE ON | OFF

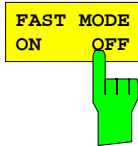

The FAST MODE ON / OFF softkey switches the calculation of timing and phase errors on and off.

The display mode ERROR SUMMARY is shown below without calculation of timing and phase errors (FAST MODE ON).

CF 870.03 MHz ERROR SUMMARY
FRQCH 1 CDMA 800 MHz
FORWARD

Ref Lvl 20 dBm

CDP Error Summary						
WALSH CHAN	CODE PWR	CODE P/TOTAL P	IS97 nom-PWR	TIMING ERROR	PHASE ERROR	STATUS
No Type	[dBm]	[dB]	[dB]	[ns]	[mrad]	
0 Pilot	-6.9	-7.0	-7.0			
1 Paging	-7.2	-7.3	-7.3			
32 Sync	-13.3	-13.4	-13.3			
9 Traffic	-10.2	-10.3	-10.3			
10 Traffic	-10.2	-10.3	-10.3			
11 Traffic	-10.2	-10.3	-10.3			
15 Traffic	-10.2	-10.3	-10.3			
17 Traffic	-10.2	-10.3	-10.3			
25 Traffic	-10.2	-10.3	-10.3			
max inactive	-49.1	-49.2	<-27.0			pass
Limits / lower				-50.0	-50.0	
upper				50.0	50.0	
Total Pwr	0.0 dBm		0.0	-4.0 ...	2.0	pass
Pilot/Total Pwr	-7.0 dB		-7.0	-0.5 ...	0.5	pass
Pilot Time Align	-49.860 ns			-3.0 ...	3.0	pass
Frequency Err	4.569 MHz			-200.0 ...	200.0	pass
inactive CHAN thresh	-23.0 dB		ext Trigger Offs		2.355 μs	
No of active CHAN	9		Meas Period		4096	
pn Offset	0 CHIPS		Average		OFF	

Date: 22.FEB.2000 14:48:13

Fig. 6-16 ERROR SUMMARY: in FAST MODE

IEC/IEEE-bus command:

:SENSe:DETEctor:CDPower:FUNCTION:MODE FAST | NORMAl

Configuration of Limit Checking – Limit Settings

Submenu: *CONFIGURATION MODE – cdmaOne BTS – LIMIT SETTINGS*

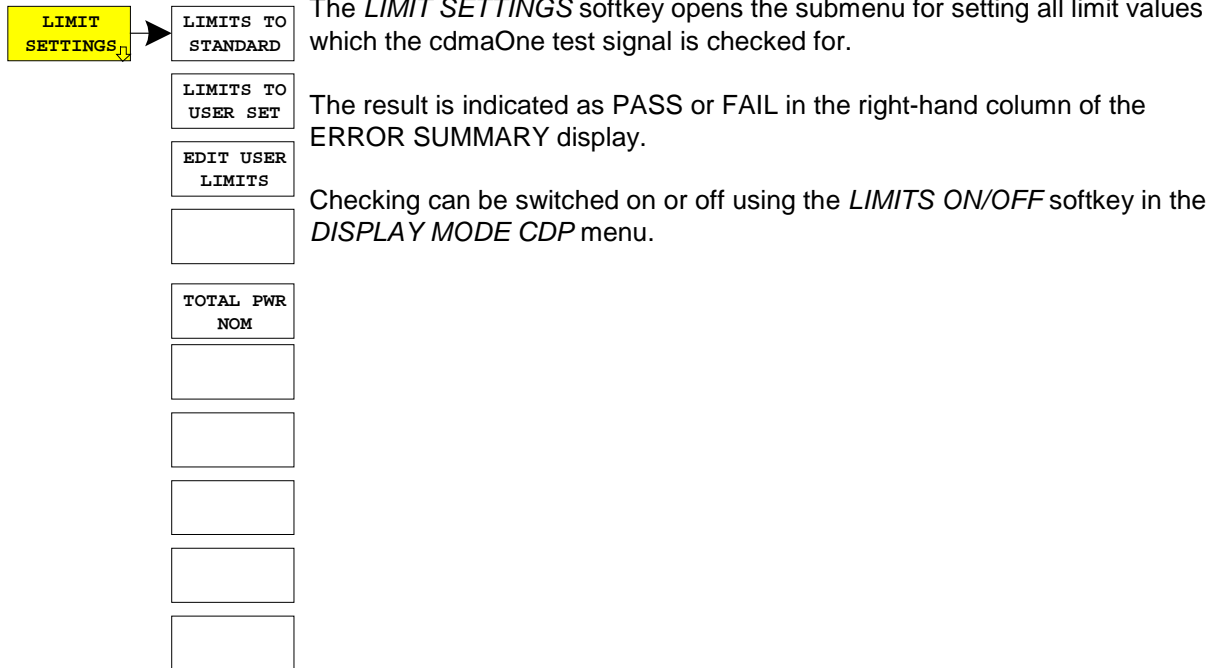

Limit checking is performed using the following measured values or CDMA channels:

Channels	Designation	Test standard
Sync, Paging, Traffic channels	TIMING ERROR	TIA/EIA-97- C, Chapter "CDMA Transmitter Minimum Standards", Section "Pilot Channel to Code Channel Time Tolerance"
Sync, Paging, Traffic channels	PHASE ERROR	TIA/EIA-97- C, Chapter "CDMA Transmitter Minimum Standards", Section "Pilot Channel to Code Channel Phase Tolerance"
Pilot channel	Pilot PWR to Total PWR Ratio	TIA/EIA-97-C, Chapter "CDMA Transmitter Minimum Standards", Section "Pilot Power"
	Pilot Time Alignment	Pilot Time Alignment Error TIA/EIA-97-C Chapter "CDMA Transmitter Minimum Standards", Section "Pilot Time Tolerance"
Inactive channels	Inact Channels PWR Ratio	TIA/EIA-97-B Chapter "CDMA Transmitter Minimum Standards", Section "Code Domain Power"
Received signal	Total Power	TIA/EIA-97-B Chapter "CDMA Transmitter Minimum Standards", Section "Total Power"
Received signal	Frequency error	TIA/EIA-97-C, Chapter "CDMA Transmitter Minimum Standards", Section "Frequency Tolerance"

LIMITS TO
STANDARD

The *LIMITS TO STANDARD* softkey sets the current limit values to the limit values required by standards IS95 and TIA/EIA-97-C.

The following default settings are used:

	Lower Limit	Upper Limit
Total PWR Tolerance	- 4 dB	+ 2dB
Pilot PWR Ratio	- 0.5 dB	+ 0.5 dB
Pilot Time Alignment	- 3 μ s	+ 3 μ s
Inact. Chan PWR Ratio		- 27 dB
Chan Time Error	- 50 ns	+ 50 ns
Chan Phase Error	- 50 mrad	+ 50 mrad
Frequency Error	- 200 Hz	+ 200 Hz

The limit value settings are adopted at a keystroke and appear on the ERROR SUMMARY display.

IEC/IEEE-bus command: :CONFigure:CDPower:LIMit:STANdard ON

LIMITS TO
USER SET

The *LIMITS TO USER SET* softkey sets the limit values set by the user, they appear on the ERROR SUMMARY display.

The user-specific limit values can be set and modified in a list with the softkeys *EDIT USER LIMITS*.

IEC/IEEE-bus command: :CONFigure:CDPower:LIMit:STANdard OFF

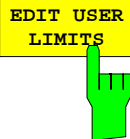

The *EDIT USER LIMITS* softkey serves for setting user-specific limits of code-domain measurement.

The softkey opens an editable list with the following entries:

CDP USER LIMITS		
	Lower Limit	Upper Limit
Total PWR Tolerance	-4 dB	+2 dB
Pilot PWR Ratio	-0.5 dB	+0.5 dB
Pilot Time Alignment	-3 us	+3 us
Inact. Chan PWR Ratio		-27 dB
Chan Time Error	-50 ns	+50 ns
Chan Phase Error	-50 mrad	+50 mrad
Frequency Error	-200 Hz	+200 Hz

The numeric values indicated in the columns Lower Limit and Upper Limit can be modified and are used for limit checking with the *LIMIT TO USER SET* softkey.

IEC/IEEE bus commands:

```
:CONFigure:CDPower:LIMit:UPPer:POWer:TOLerance 2 dB
:CONFigure:CDPower:LIMit:LOWer:POWer:TOLerance -4 dB

:CONFigure:CDPower:LIMit:UPPer:POWer:PRATio +0.5dB
:CONFigure:CDPower:LIMit:LOWer:POWer:PRATio -0.5dB

:CONFigure:CDPower:LIMit:UPPer:TIME:PALignment 4 us
:CONFigure:CDPower:LIMit:LOWer:TIME:PALignment -3 us

:CONFigure:CDPower:LIMit:UPPer:POWer:ICRatio -27 dB

:CONFigure:CDPower:LIMit:UPPer:ERRor:CTIME 50ns
:CONFigure:CDPower:LIMit:LOWer:ERRor:CTIME -50ns

:CONFigure:CDPower:LIMit:UPPer:ERRor:CPHase 50e-3
:CONFigure:CDPower:LIMit:LOWer:ERRor:CPHase -50e-3

:CONFigure:CDPower:LIMit:UPPer:ERRor:FREQuency 200 Hz
:CONFigure:CDPower:LIMit:LOWer:ERRor:FREQuency -200 Hz
```

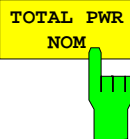

The *TOTAL PWR NOM* softkey opens a field for entering the nominal power of the cdmaOne base station. The nominal power and measured power of the base station are compared with each other on checking the limit values for TOTAL PWR TOLERANCE.

IEC/IEEE-bus command:

```
:CONFigure:CDPower:LIMit:POWer:NOMinal 3
```

Configuration of cdmaOne Demodulation - MEAS SETTINGS

Submenu: CONFIGURATION MODE – cdmaOne BTS – MEAS SETTINGS

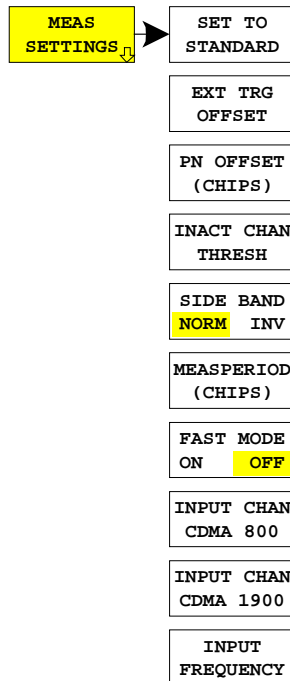

The *MEAS SETTINGS* softkey opens a submenu with setting parameters for the cdmaOne demodulation.

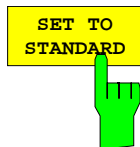

The *SET TO STANDARD* softkey is used to perform the default settings for the cdmaOne demodulation.

The following operating parameters are modified:

- INACT CHAN THRESH: -23 dB
- LIMITS TO STANDARD
- LIMITS ON
- DISPLAY MODE CDP RATIO

IEC/IEEE-bus command: :SENSe:CDPower:PRESet

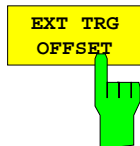

The *EXT TRG OFFSET* softkey is identical to the softkey of the same name in the vector analyzer mode.

It is available in the submenu:

SWEEP – TRIGGER – TRIGGER OFFSET.

This function can be used to compensate for the analog trigger delay in the measurement of the *PILOT TIME ALIGNMENT* with the aid of a trigger signal from the base station (*EVEN SECON TRIGGER*).

IEC/IEEE-bus command: :TRIGger:SEQuence:HOLDoff <num_value>

PN OFFSET
(CHIPS)



The *PN OFFSET [CHIPS]* softkey opens a window for entering a correction value (CHIPS) for the calculation of the *PILOT TIME ALIGNMENT*. Each base station in the cdmaOne DMA network can be operated with a different PN offset referred to the *EVEN SECOND TRIGGER*.

During demodulation, the nominal zero crossing of the PN sequence (*PN ROLL OVER*) is determined and referred to the trigger input. The BTS-specific PN offset can be entered here and is automatically considered by the software in the calculation of *PILOT TIME ALIGNMENT*.

IEC/IEEE-bus command: :SENSe:CDPower:PNOffset 5

INACT CHAN
THRESH



The *INACT CHAN THRESH* softkey sets a threshold value in the cdmaOne demodulator above which a code channel is assumed to be active. The set value is referenced to the total power (*TOTAL POWER*). While further modulation errors such as *PHASE ERROR* and *TIMING ERROR* are calculated for the first 9 active channels, they are not calculated as channels that are recognized as inactive.

A nominal power distribution in line with the test model of TIA/EIA-97-B is calculated and displayed in the *ERROR SUMMARY* under *NOM PWR*.

IEC/IEEE-bus command: :SENSe:CDPower:ICTReshold -23 dB

SIDE BAND
NORM INV



The *SIDE BAND NORM / INV* softkey is used to perform the cdmaOne demodulation both in the normal (NORM) and inverted position (INV).

NORM The normal position allows the measurement of RF signals from the base station.

INV The inverted position is useful for measurements on IF modules or components in case of spectral inversion.

The default setting is NORM, ie the spectral normal position.

IEC/IEEE-bus command: :SENSe:CDPower:SBAND NORMal | INVers

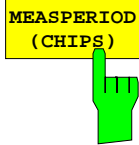

The *MEASPERIOD* softkey sets the demodulation period of the cdmaOne demodulator. The function of this softkey is identical to the function with the same name in the DISPLAY MODE CDP menu.

The settable values are: AUTO, 1k, 2k, 4k, 8k, 12k, 16k, 20k, 24k
The default setting of the instrument is 4k, ie the demodulator uses a data set length of 4k CHIPS for the demodulation and error calculation.

In the AUTO mode, the demodulator automatically calculates the required MEASPERIOD using the signal/noise ratio of the applied signal and indicates the selected setting in DISPLAY ERROR SUMMARY under MEASPERIOD.

For measurements conforming to IS95 and TIA/EIA-97-C, a MEASPERIOD of at least 2K should be set (64CHIPS * 20 = 1280 CHIPS, TIA/EIA-97-C chapter CDMA Standard Test Conditions, section Code-Domain Measurement Equipment).

<input type="checkbox"/> MEAS PERIOD
<input checked="" type="checkbox"/> Auto
1k
2k
4k
8k
12k
16k
20k
24k

IEC/IEEE bus commands:

```
:SENSe:CDPower:MPERiod:AUTO ON | OFF
:SENSe:CDPower:MPERiod 1|2|4|8|12|16|20|24
```

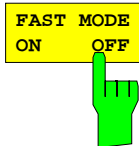

The *FAST MODE* softkey switches the calculation of timing and phase errors on and off for the channels recognized as being active.

Since the calculation of such errors involves high computation for long measurement periods, activating this function can increase the measurement speed.

With *FAST MODE ON*, the corresponding measured values are not displayed in the *ERROR SUMMARY*, the *TIME ERROR* and *PHASE ERROR* softkeys in the *DISPLAY MODE* can no longer be selected.

IEC/IEEE-bus command:

```
:SENSe:DETECTOR:CDPower:FUNCTion:MODE FAST | NORMAl
```

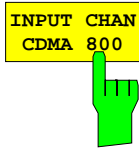

The *INPUT CHAN CDMA 800* softkey opens a window for entering a channel number in the CDMA 800 MHz frequency band. The corresponding center frequency of the analyzer is calculated from it and indicated in the display:

Base station (869 to 894 MHz)

$$F_{TX} = 870 \text{ MHz} + N \times 0.03; N = 1 \text{ to } 799$$

or

$$F_{TX} = 870 \text{ MHz} + (N - 1023) \times 0.03; N = 991 \text{ to } 1023$$

The channel assignment is obtained from TIA/EIA-97-C (chapter CDMA Receiver Minimum Standards, table CDMA Channel Number to CDMA Frequency Assignment Correspondence for Band Class 0).

IEC/IEEE bus commands:

```
:CONFigure:CDPower:PRESet FWCDMA8 | NONE
:CONFigure:CDPower:CHANnel 1
```

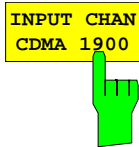

The *INPUT CHAN CDMA 1900* softkey opens a window for entering a channel number in the CDMA 1900 MHz frequency band. The corresponding center frequency of the analyzer is calculated from it and indicated in the display:

Base station (1930 to 1990 MHz)

$$F_{TX} = 1930.000 \text{ MHz} + N \times 0.05; N = 1 \text{ to } 1199$$

The channel assignment is obtained from TIA/EIA-97-C (chapter CDMA Receiver Minimum Standards, table CDMA Channel Number to CDMA Frequency Assignment Correspondence for Band Class 1).

IEC/IEEE bus commands:

```
:CONFigure:CDPower:PRESet FWCDMA19 | NONE
:CONFigure:CDPower:CHANnel 1
```

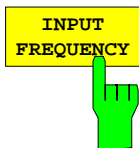

The *INPUT FREQUENCY* softkey activates the direct entry of the center frequency.

The entered center frequency is checked whether it is within the channel spacing of the CDMA 800 or CDMA 1900 band. In case of compliance, the associated band (CDMA 800 or CDMA 1900) and the corresponding channel number are also indicated in the display.

IEC/IEEE-bus command: :SENSe:FREQuency:CENTer 870.03 MHz

Level Settings - REF LEVEL

Submenu: CONFIGURATION- MODE – cdmaOne BTS – REF LEVEL

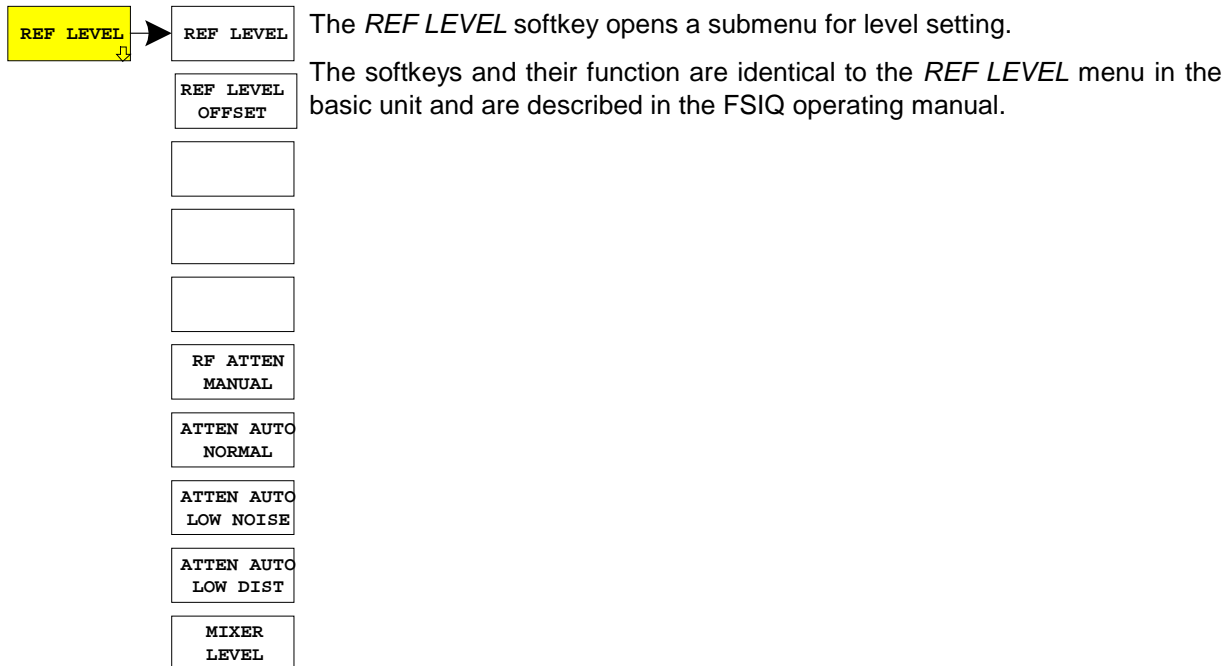

Automatic Adaptation to the Input Level - LEVEL AUTO ADJUST

Submenu: CONFIGURATION- MODE – cdmaOne BTS – LEVEL AUTO ADJUST



The *LEVEL AUTO ADJUST* softkey is used for setting automatically the RF attenuation and IF gain to the level of the applied signal. Manual re-adjustment is permissible with the *REF LEVEL* softkey.

The instrument is to be switched to the *ATTEN MANUAL* mode so as to set the RF attenuation and IF gain to optimum values independently of each other. This mode is maintained after changing from code-domain power measurements to the analyzer or vector analyzer mode.

IEC/IEEE-bus command: :SENSe:CDPower:LEVel:ADJust

Setting the Trigger - TRIGGER Key

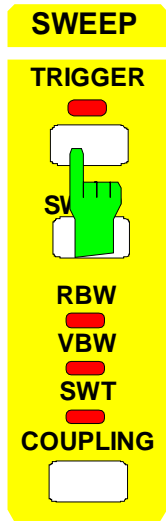

- TRIGGER
- FREE RUN
- VIDEO
- EXTERN
- TRIGGER OFFSET
- SLOPE POS NEG
- MEAS ONLY IF SYNC'D
- FIND BURST ON OFF
- FIND SYNC ON OFF
- SYNC OFFSET
- SYNC PATTERN

The softkeys *FREE RUN*, *EXTERN*, *TRIGGER OFFSET* and *SLOPE POS/NEG* are available in the *TRIGGER* menu.

For measurements with exact time reference, such as *PILOT TIME ALIGNMENT*, the trigger output of the base station (*EVEN SECOND TRIGGER*) is to be connected to the rear panel trigger input and activated with *SWEEP-TRIGGER-EXTERN*. Any delays of the signal source can be compensated with the *TRIGGER OFFSET* softkey (step width of 40 ns).

IEC/IEEE bus commands:

```
:TRIGger:SOURce IMMEDIATE|EXTernal
:TRIGger:HOLDoff <num_value>
:TRIGger:SLOPe POSitive | NEGative
```

Setting the Trace - TRACE 1 Key

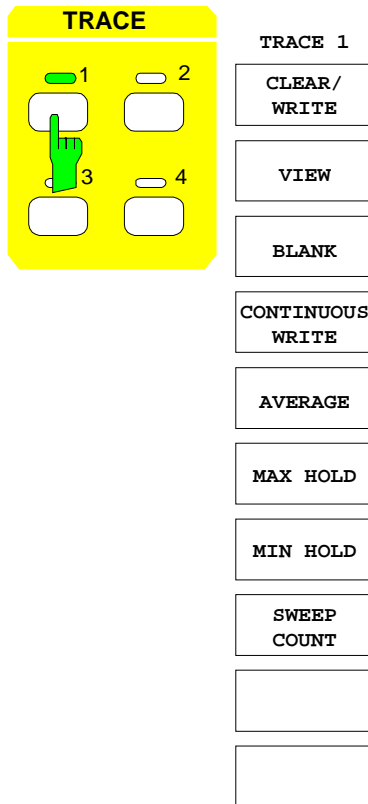

The *TRACE1* menu provides the softkeys for selecting the display mode (*CLEAR/WRITE*, *VIEW*, *BLANK*, *CONTINUOUS WRITE*) and for selecting the evaluation of the trace (*AVERAGE*, *MAX HOLD*, *MIN HOLD*).

In case of averaging, the maximum values are indicated on displaying the error table for measured peak values, for RMS values quadratic averaging is performed, and linear averaging for other displays.

In the *ERROR SUMMARY* table, it is indicated whether averaging is activated or not.

The *SWEEP COUNT* softkey activates the entry of the number of sweeps over which averaging is to be performed.

In contrast to the analyzer mode, **No** averaging is performed in the setting *SWEEP COUNT* = 0; the setting acts like *SWEEP COUNT* = 1.

IEC/IEEE bus commands:

```
:DISPlay:WINDow:TRACe:MODE WRITE | VIEW |
                                AVERAge | MAXHold | MINHold
:DISPlay:WINDow:TRACe:MODE:CWrite ON | OFF
:DISPlay:WINDow:TRACe:STATe ON | OFF
:SENSe:SWEep:COUNT 1
```

Overview of the Other Menus

SYSTEM Key Group

The *PRESET*, *CAL* and *INFO* menus in the code-domain measurement mode are identical to the corresponding menus in the basic unit and are described in the FSIQ operating manual.

The parameters marked with grey are not available in the *DISPLAY* menu. The screen display is set to *FULL SCREEN* in the code-domain measurement mode. The remaining softkeys are identical to those of the basic unit and are described in the FSIQ operating manual.

CONFIGURATION Key Group

The *MODE* menu enables selection of the mode. The Analyzer, Vector Analyzer and Tracking Generator modes are described in the operating manual for the FSIQ basic unit. The code-domain measurement mode is described in the present manual.

The *SETUP* menu in the code-domain measurement mode is identical to the corresponding menu in the basic unit and is described in the FSIQ operating manual.

FREQUENCY Key Group

In the *CENTER* menu, the center frequency can be set for synchronization with the DUT and a frequency offset entered.

The *SPAN*, *START* and *STOP* keys have no function in the code-domain measurement mode.

LEVEL Key Group, INPUT Key

The *REF*, *RANGE* and *INPUT* menus in the code-domain measurement mode are identical to the corresponding menus in the basic unit and are described in the FSIQ operating manual.

MARKER Key Group

The *NORMAL* menu in the code-domain measurement mode is identical to the *CONFIGURATION MODE - cdmaOne BTS - CDP MEAS – MARKER* submenu.

The *SEARCH*, *DELTA*, *MKR* → keys have no function in the code-domain measurement mode.

LINES Key Group

The *LIMITS* menu in the code-domain measurement mode is identical to the *CONFIGURATION MODE - cdmaOne BTS - CDP MEAS – LIMIT SETTINGS* submenu.

The *DLINES* key has no function in the code-domain measurement mode.

SWEEP Key Group

The softkeys *FREE RUN*, *EXTERN*, *TRIGGER OFFSET* and *SLOPE POS/NEG* are available in the *TRIGGER* menu (see above).

In the *SWEEP* menu, the parameter *RESULT LENGTH* marked in grey is not available, it is replaced by the parameter *MEASPERIOD (CHIPS)* in the *CONFIGURATION MODE - cdmaOne BTS - CDP MEAS - MEAS SETTINGS* menu.

The remaining softkeys of the *SWEEP* menu in the code-domain measurement mode are identical to the softkeys of the *CONFIGURATION MODE - cdmaOne BTS - CDP MEAS* submenu.

The *COUPLING* menu in the code-domain measurement mode is identical to the *COUPLING* menu in the *VECTOR ANALYZER* mode and is described in the FSIQ operating manual.

HCOPY and MEMORY Key Group

The *SETTINGS*, *SAVE*, *RECALL* and *CONFIG* menus in the code-domain measurement mode are identical to the corresponding menus in the basic unit and are described in the FSIQ operating manual.

7 Remote-Control Commands for the CDP Measurement

The following chapter describes the remote-control commands for the code-domain measurements. An alphabetical list at the end of this chapter provides an overview of the commands.

The commands, which are also valid for the basic unit in the signal analysis and vector signal analysis modes as well as the system settings, are described in the FSIQ operating manual.

CALCulate -Subsystem

The display is always set to full screen in code domain measurements. Therefore, only numeric suffix 1 is valid for CALCulate.

:CALCulate<1>:FEED <string>

This command selects the measured data that are to be displayed.

Parameter: <string>::= 'XPOW:CDP'
'XPOW:CDP:RAT'
'XTIM:CDP:ERR'
'XTIM:CDP:ERR:PHAS'
'XTIM:CDP:ERR:SUMM'

Example: " :CALC:FEED `XTIM:CDP:ERR` "

Features: *RST value: `XTIM:DDEM:MEAS` (vector signal analysis)
SCPI: conforming

The string parameters have the following meaning:

'XPOW:CDP'	Result display of code domain power as bargraph
'XPOW:CDP:RAT'	Result display of code domain power ratio as bargraph
'XTIM:CDP:ERR'	Result display of timing error as bargraph
'XTIM:CDP:ERR:PHAS'	Result display of phase error as bargraph
'XTIM:CDP:ERR:SUMM'	Result display in tabular form

CALCulate<1>:MARKer<1>:FUNCTION:CRESt?

This command queries the Crest factor in the time domain measurement.

Example: "CALC:MARK:FUNC:CRESt?"

Features: *RST value: --
SCPI: conforming

:CALCulate<1>:MARKer<1>:FUNCTION:PILot

This command sets the marker1 to Walsh channel 0.

Example: " :CALC:MARK:FUNC:PIL "

Features: *RST value: _
SCPI: device-specific

This command is an <Event> and has therefore neither *RST value nor query.

:CALCulate<1>:MARKer<1>:FUNCTION:PAGing

This command sets the marker1 to Walsh channel 1.

Example: " :CALC:MARK:FUNC:PAG "

Features: *RST value: _
SCPI: device-specific

This command is an <Event> and has therefore neither *RST value nor query.

:CALCulate<1>:MARKer<1>:FUNCTION:SYNC

This command sets the marker1 to Walsh channel 32.

Example: " : CALC : MARK : FUNC : SYNC "

Features: *RST value: _
SCPI: device-specific

This command is an <Event> and has therefore neither *RST value nor query.

:CALCulate<1>:MARKer<1>:FUNCTION:TERRor

This command sets the marker to the Walsh channel with the largest timing error.

Example: " : CALC : MARK : FUNC : TERR "

Features: *RST value: _
SCPI: device-specific

This command is an <Event> and has therefore neither *RST value nor query.

CACulate<1>:MARKer<1>:FUNCTION:PERRor

This command sets the marker to the Walsh channel with the largest phase error.

Example: " : CALC : MARK : FUNC : PERR "

Features: *RST value: _
SCPI: device-specific

This command is an <Event> and has therefore neither *RST value nor query.

:CALCulate<1>:MARKer<1>:FUNCTION:CDPower:RESult? PTOTal | FERRor | ACHannels | PTALignment | ACOunt | TERRor | PERRor | CPOWer

This command queries the measured and calculated code domain power values.

Example: " : CALC : MARK : FUNC : CDP : RES ? PTOT "

Features: *RST value: -
SCPI: device-specific

PTOTal	Total power
FERRor	Frequency error in Hz
ACHannels	Number of active channels
PTALignment	Pilot time alignment, trigger offset relative to PN zero crossing in chips
ACOunt	Averaging count
TERRor	Timing error, up to 18 values in the following format: <channel 1> , <time error 2> , <channel 2> , <time error 2> , ... <channel N> , <time error N>
PERRor	Phase error, up to 18 values in the following format: <channel 1> , <phase error 2> , <channel 2> , < phase error 2> , ... <channel N> , < phase error N>
CPOWer	Channel power, up to 64 values separated by commas

The result of the CDP RATIO measurement can be calculated as follows:

CHANNEL POWER (in dB) - TOTAL POWER (in dB) = CDP RATIO

CONFigure:CDPower Subsystem

This subsystem comprises the commands for configuring the code domain power measurements. The display is set to full screen in the code domain measurements. Therefore, only numeric suffix 1 is valid for CONFigure.

CONFigure<1>:IS95:MEASurement POWer | ACPR | MODulation | CDPower | FDOMain | TDOMain

This command selects the cdmaOne measurement. The settings of the predefined measurements are described for the associated softkey in chapter 6 .

Parameter:	POWer	Chanel Power Measurement with predefined settings
	ACPR	Adjacent Chanel Power Measurement with predefined settings
	MODulation	Measurement of RHO factor with predefined settings
	CDPower	Code Domain Power measurement. This selection has the same effect as command INSTRument:SElect CDPower.
	FDOMain	Overview measurement in the frequency domain with predefined settings
	TDOMain	Measurement of Crest factor in the time domain with predefined settings

Example: "CONF:IS95:MEAS MOD"

Features: *RST value: POWer
SCPI: device-specific

:CONFigure<1>:CDPower:PREset FWCDMA8 | FWCDMA19 | NONE

This command selects the CDMA standard.

FWCDMA8	CDMA forward 800
FWCDMA19	CDMA forward 1900
NONE	No standard selected

Example: ":CONF:CDP:PRE RWCDMA19"

Features: *RST value: FWCDMA8
SCPI: device-specific

:CONFigure<1>:CDPower:CHANnel 1...1199

This command determines the channel frequency.

Example: ":CONF:CDP:CHAN 799"

Features: *RST value: 1
SCPI: device-specific

:CONFigure<1>:CDPower:LIMit:POWER:NOMinal <numeric_value>

This command selects the nominal power of the transmitter.

Example: ":CONF:CDP:LIM:POW:NOM 3"

Features: *RST value: 0dB
SCPI: device-specific

:CONFigure<1>:CDPower:LIMit:STANdard ON | OFF

This command switches the limit values to default values (ON) or to user-defined values (OFF).

Example: ":CONF:CDP:LIM:STAN OFF"

Features: *RST value: ON
SCPI: device-specific

:CONFigure<1>:CDPower:LIMit:UPPer:POWer:TOLerance <numeric_value>

This command sets the upper limit value for the power tolerance.

Example: " :CONF:CDP:LIM:UPP:POW:TOL 10 "

Features: *RST value: 2 dB
SCPI: device-specific

:CONFigure<1>:CDPower:LIMit:UPPer:POWer:PRATio <numeric_value>

This command sets the upper limit value for the pilot power ratio.

Example: " :CONF:CDP:LIM:UPP:POW:PRAT -1 "

Features: *RST value: 0.5 dB
SCPI: device-specific

:CONFigure<1>:CDPower:LIMit:UPPer:POWer:ICRatio <numeric_value>

This command sets the upper limit value for the inactive channel power ratio.

Example: " :CONF:CDP:LIM:UPP:POW:ICR 4 "

Features: *RST value: -27 dB
SCPI: device-specific

:CONFigure<1>:CDPower:LIMit:UPPer:TIME:PALignment <numeric_value>

This command sets the upper limit value for the pilot time alignment.

Example: " :CONF:CDP:LIM:UPP:TIME:PAL 4us "

Features: *RST value: 3 μ s
SCPI: device-specific

:CONFigure<1>:CDPower:LIMit:UPPer:ERRor:CTIME <numeric_value>

This command sets the upper limit value for the channel timing error.

Example: " :CONF:CDP:LIM:UPP:ERR:CTIM 4ns "

Features: *RST value: 50 ns
SCPI: device-specific

:CONFigure<1>:CDPower:LIMit:UPPer:ERRor:CPHase <numeric_value>

This command sets the upper limit value for the channel phase error.

Example: " :CONF:CDP:LIM:UPP:ERR:CPH 52e-3 "

Features: *RST value: 50 mRad
SCPI: device-specific

:CONFigure<1>:CDPower:LIMit:UPPer:ERRor:FREQuency <numeric_value>

This command sets the upper limit value for the frequency error.

Example: " :CONF:CDP:LIM:UPP:ERR:FREQ 220 "

Features: *RST value: 200 Hz
SCPI: device-specific

:CONFigure<1>:CDPower:LIMit:LOWer:POWER:TOLerance <numeric_value>

This command sets the lower limit value for the power tolerance.

Example: " :CONF:CDP:LIM:LOW:POW:TOL -10 "

Features: *RST value: -4 dB
SCPI: device-specific

:CONFigure<1>:CDPower:LIMit:LOWer:POWER:PRATio <numeric_value>

This command sets the lower limit value for the pilot power ratio.

Example: " :CONF:CDP:LIM:LOW:POW:PRAT -1 "

Features: *RST value: -0.5 dB
SCPI: device-specific

:CONFigure<1>:CDPower:LIMit:LOWer:TIME:PALignment <numeric_value>

This command sets the lower limit value for the pilot time alignment.

Example: " :CONF:CDP:LIM:LOW:TIME:PAL -4us "

Features: *RST value: -3 μ s
SCPI: device-specific

:CONFigure<1>:CDPower:LIMit:LOWer:ERRor:CTIME <numeric_value>

This command sets the lower limit value for the channel timing error.

Example: " :CONF:CDP:LIM:LOW:ERR:CTIM -500ns "

Features: *RST value: -50 ns
SCPI: device-specific

:CONFigure<1>:CDPower:LIMit:LOWer:ERRor:CPHase <numeric_value>

This command sets the lower limit value for the channel phase error.

Example: " :CONF:CDP:LIM:LOW:ERR:CPH -52e-3 "

Features: *RST value: -50 mrad
SCPI: device-specific

:CONFigure<1>:CDPower:LIMit:LOWer:ERRor:FREQuency <numeric_value>

This command sets the lower limit value for the frequency error.

Example: " :CONF:CDP:LIM:LOW:ERR:FREQ -220 "

Features: *RST value: -200 Hz
SCPI: device-specific

INSTrument Subsystem

The display is set to full screen in the predefined time domain measurement. Therefore, only numeric suffix 1 is valid for `INSTrument`.

:INSTrument<1>[:SElect] SANalyzer | DDEMod | ADEMod | BGSM | MSGM | **CDPower**

This command switches between the operating modes by means of text parameters.

Selection `CDPower` presets the instrument as described in Chapter 2, Section "Basic settings in the Code Domain Measurement Mode".

Example: `" :INST CDP "`

Features: *RST value: SANalyzer
SCPI: conforming

SENSe:CDPower Subsystem

This subsystem controls the parameters for the code domain power (option FSIQK71). The suffix in `SENSe<1|2>` is not significant in this subsystem.

:[SENSe<1|2>:]CDPower:PRESet

This command is for CDP presetting.

Inactive Channel Threshold	-23 dB
Limits	set to standard
Result display	CDPR

Example: `" :CDP :PRES "`

Features: *RST value: -
SCPI: device-specific

This command is an <Event> and has therefore neither *RST value nor query.

:[SENSe<1|2>:]CDPower:LEVel:ADJust

This command is used for setting automatically the RF attenuation and IF gain to the level of the applied signal. The instrument is to be switched to the *ATTEN MANUAL* mode so as to set the RF attenuation and IF gain separately to optimum values. This mode is maintained after changing from code-domain power measurements to the analyzer or vector analyzer modes.

Example: `" :CDP :LEV :ADJ "`

Features: *RST value: -
SCPI: device-specific

This command is an <Event> and has therefore neither *RST value nor query.

:[SENSe<1|2>:]CDPower:MPERiod 1 | 2 | 4 | 8 | 12 | 16 | 20 | 24

This command sets the processing width of the DSP.

Example: `" :CDP :MPER 16 "`

Features: *RST value: 8
SCPI: device-specific

:[SENSe<1|2>:]CDPower:MPERiod:AUTO ON | OFF

This command activates (ON) the automatic determination of the optimum demodulation period. The demodulator calculates the signal/noise ratio of the cdmaOne signal and automatically selects a suitable setting.

Example: " :CDP:MPER:AUTO ON "

Features: *RST value: ON
SCPI: device-specific

:[SENSe<1|2>:]CDPower:PNOFset <numeric_value>

This command sets the nominal offset value of the base station (in chips).

Example: " :CDP:PNOF 5 "

Features: *RST value: 0
SCPI: device-specific

:[SENSe<1|2>:]CDPower:ICTReshold -27 dB ...+ 6 dB

This command sets the threshold value in the CDPR diagram from which a channel is treated as active. The level entered refers to the total signal power.

Example: " :CDP:ICTR -10DB "

Features: *RST value: -23dB
SCPI: device-specific

:[SENS<1|2>:]CDPower:SBANd NORMal | INVers

This command is for interchanging the left and the right sideband.

Example: " :CDP:CDP:SBAN INV "

Features: *RST value: NORM
SCPI: device-specific

SENSe:DETEctor Subsystem

:[SENS<1|2>:]DETEctor:CDPower[:FUNCTion]:MODE FAST | NORMal

This command enables faster calculation. The timing error and phase error are not calculated in the fast mode.

Example: " :DET:CDP:MODE FAST "

Features: *RST value: NORMAL
SCPI: device-specific

TRACe Subsystem

TRACe[:DATA] TRACE1

This command transfers trace data from the controller to the instrument, the query reads trace data out of the instrument.

Example: "TRAC TRACE1,"+A\$ (A\$: data list in the current format)
 "TRAC? TRACE1"

Features: *RST value: -
 SCPI: conforming

CDP Measurement

Only TRACE1 can be read out. Independently of the display mode (CDP, CDP Ratio, Error Summary, etc.), the following measured values are always transferred:

power	1 value, total power
no of active channels	1 value
frequency error	1 value, frequency error in Hz
pilot time alignment	1 value, trigger offset relative to PN zero crossing in chips
sub estimate	1 value, estimated length of sub-interval
mean count estimate	1 value
average count	1 value
active channels	9 values, non-active channels are marked with -1
time error	9 values
phase error	9 values
channel power	64 values

Alphabetical List of Commands

Command	Parameter	Page
:CALCulate:FEED	'XPOW:CDP' 'XPOW:CDP:RAT' 'XTIM:CDP:ERR' 'XTIM:CDP:ERR:PHAS' 'XTIM:CDP:ERR:SUMM'	48
:CALCulate:MARKer:FUNCTion:CDPower:RESult?	PTOTAL FERRor ACHannels PTALignment ACOunt TERRor PERRor CPOWer	49
:CALCulate:MARKer:FUNCTion:CRESt?		48
:CALCulate:MARKer:FUNCTion:PAGing		48
:CALCulate:MARKer:FUNCTion:PERRor		49
:CALCulate:MARKer:FUNCTion:PILOt		48
:CALCulate:MARKer:FUNCTion:SYNC		49
:CALCulate:MARKer:FUNCTion:TERRor		49
:CONFigure:CDPower:CHANnel	1 to 1199	50
:CONFigure:CDPower:LIMit:LOWer:ERRor:CPHase	<numeric_value>	52
:CONFigure:CDPower:LIMit:LOWer:ERRor:CTIME	<numeric_value>	52
:CONFigure:CDPower:LIMit:LOWer:ERRor:FREQuency	<numeric_value>	52
:CONFigure:CDPower:LIMit:LOWer:POWer:PRATio	<numeric_value>	52
:CONFigure:CDPower:LIMit:LOWer:POWer:TOLerance	<numeric_value>	52
:CONFigure:CDPower:LIMit:LOWer:TIME:PALignment	<numeric_value>	52
:CONFigure:CDPower:LIMit:POWer:NOMinal	<numeric_value>	50
:CONFigure:CDPower:LIMit:STANdard	ON OFF	50
:CONFigure:CDPower:LIMit:UPPer:ERRor:CPHase	<numeric_value>	51
:CONFigure:CDPower:LIMit:UPPer:ERRor:CTIME	<numeric_value>	51
:CONFigure:CDPower:LIMit:UPPer:ERRor:FREQuency	<numeric_value>	52
:CONFigure:CDPower:LIMit:UPPer:POWer:ICRatio	<numeric_value>	51
:CONFigure:CDPower:LIMit:UPPer:POWer:PRATio	<numeric_value>	51
:CONFigure:CDPower:LIMit:UPPer:POWer:TOLerance	<numeric_value>	51
:CONFigure:CDPower:LIMit:UPPer:TIME:PALignment	<numeric_value>	51
:CONFigure:CDPower:PRESet	FWCDMA8 FWCDMA19 NONE	50
:CONFigure:IS95:MEASurement	POWer ACPR MODulation CDPower FDOMain TDOMain	50
:INSTrument[:SElect]	SANalyzer DDEMod ADEMod BGSM MSGM CDPower	53
:[SENSe:]CDPower:ICTReshold	-27dB to 6 dB	54
:[SENSe:]CDPower:LEVel:ADJust		53
:[SENSe:]CDPower:MPERiod	1 2 4 8 12 16 20 24	53
:[SENSe:]CDPower:MPERiod:AUTO	ON OFF	54
:[SENSe:]CDPower:PNOFset	<num_value>	54
:[SENSe:]CDPower:PRESet		53
:[SENSe:]CDPower:SBANd	NORMal INVers	54
:[SENSe:]DETEctor:CDPower[:FUNCTion]:MODE	FAST NORMal	54
TRACe[:DATA]	TRACE1	55

Table of Softkeys with Assignment of IEC/IEEE Commands

CONFIGURATION Key Group

MODE	
CDMA ONE BTS	
POWER	:CONFigure:IS95:MEASurement POWER Query of results :CALCulate:MARKer:FUNCTion:POWER:RESult? CPOWER
ACPR	:CONFigure:IS95:MEASurement ACPR Query of results: :CALCulate:MARKer:FUNCTion:POWER:RESult? ACPower
MODULATION QUALITY	Leads to the menu for vector analyzer mode :CONFigure:IS95:MEASurement MODulation Query of results: :CALCulate<1 2>:MARKer<1 2>:FUNCTion:DDEMod:RESult? RHO
SPECTRUM	:CONFigure:IS95:MEASurement FDOMain Query of results: -- (visual evaluation)
TIME DOMAIN	:CONFigure:IS95:MEASurement TDOMain Query of results: :CALCulate<1 2>:MARKer<1..4>:FUNCTion:CRESt? :CALCulate<1 2>:MARKer<1..4>:FUNCTion:SUMMery:RMS:RESult? :CALCulate<1 2>:MARKer<1..4>:FUNCTion:SUMMery[:STATE] ON
INPUT CHAN CDMA 800	:CONFigure:CDPower:PRESet FWCDMA8 NONE :CONFigure:CDPower:CHANnel <numeric value>
INPUT CHAN CDMA 1900	:CONFigure:CDPower:PRESet FWCDMA19 NONE :CONFigure:CDPower:CHANnel <numeric value>
LEVEL AUTO ADJUST	:SENSe:CDPower:LEVel:ADJust
CDP MEAS	:INSTrument[:SElect] CDPower Query of results: :CALCulate:MARKer:FUNCTion:CDPower:RESult? PTOTal CPOWER PERRor FERRor TERRor ACHannels PTAligment ACount or :TRACe:DATA? TRACE1 or marker functions (see marker submenu)
CONTINUOUS SWEEP	:INITiate:CONTinuous ON; INITiate[:IMMediate]
SINGLE SWEEP	:INITiate:CONTinuous OFF; INITiate[:IMMediate]
MARKER	--
MARKER	:CALCulate:MARKer<1>[:STATE] ON OFF; :CALCulate:MARKer<1>:X <channel_number>; :CALCulate:MARKer<1>:Y?

MKR-> PILOT CH	:CALCulate:MARKer<1>:FUNction:PIlot; :CALCulate:MARKer<1>:Y?
MKR-> PAGING CH	:CALCulate:MARKer<1>:FUNction:PAGing; :CALCulate:MARKer<1>:Y?
MKR-> SYNC CH	:CALCulate:MARKer<1>:FUNction:SYNC; :CALCulate:MARKer<1>:Y?
MKR->MAX TIME ERR	:CALCulate:MARKer<1>:FUNction:TERRor; :CALCulate:MARKer<1>:X? ; :CALCulate:MARKer<1>:Y?
MKR->MAX PHASE ERR	:CALCulate:MARKer<1>:FUNction:PERRor; :CALCulate:MARKer<1>:X? ; :CALCulate:MARKer<1>:Y?
MARKER INFO	DISPlay:WINDow:MINfo ON OFF (screen display)
DISPLAY MODE CDP	--
CDP	:CALCulate:FEED `XPOW:CDP`; :CALCulate:MARKer:FUNction:CDPower:RESult? CPower
CDP RELATIVE	:CALCulate:FEED `XPOW:CDP:RAT`
TIME ERROR	:CALCulate:FEED `XTIM:CDP:ERR`; :CALCulate:MARKer:FUNction:CDPower:RESult? TERRor
PHASE ERROR	:CALCulate:FEED `XTIM:CDP:ERR:PHAS`; :CALCulate:MARKer:FUNction:CDPower:RESult? PERRor
ERROR SUMMARY	:CALCulate:FEED `XTIM:CDP:ERR:SUMM`; :CALCulate:MARKer:FUNction:CDPower:RESult? PTOTal CPower PERRor FERRor TERRor ACHannels PTAlignment ACOunt or :TRACe:DATA? TRACE1
MEASPERIOD [CHIPS]	:[SENSe:]CDPower:MPERiod 1 2 4 8 12 16 20 24 :[SENSe:]CDPower:MPERiod:AUTO ON OFF
LIMITS ON OFF	:CALCulate:LIMit:STATe ON OFF
FAST MODE ON OFF	:[SENSe:]DETEctor:CDPower[:FUNction]:MODE FAST NORMal
LIMIT SETTINGS	--
LIMITS TO STANDARD	:CONFIgure:CDPower:LIMit:STANdard ON
LIMITS TO USER SET	:CONFIgure:CDPower:LIMit:STANdard OFF

EDIT USER LIMITS	<pre> :CONFigure:CDPower:LIMit:UPPer:POWer:TOLerance <numeric_value> :CONFigure:CDPower:LIMit:UPPer:POWer:PRATio <numeric_value> :CONFigure:CDPower:LIMit:UPPer:POWer:ICRatio <numeric_value> :CONFigure:CDPower:LIMit:UPPer:TIME:PALignment <numeric_value> :CONFigure:CDPower:LIMit:UPPer:ERRor:CTIME <numeric_value> :CONFigure:CDPower:LIMit:UPPer:ERRor:CPHase <numeric_value> :CONFigure:CDPower:LIMit:UPPer:ERRor:FREQuency <numeric_value> :CONFigure:CDPower:LIMit:LOWer:POWer:TOLerance <numeric_value> :CONFigure:CDPower:LIMit:LOWer:POWer:PRATio <numeric_value> :CONFigure:CDPower:LIMit:LOWer:TIME:PALignment <numeric_value> :CONFigure:CDPower:LIMit:LOWer:ERRor:CTIME <numeric_value> :CONFigure:CDPower:LIMit:LOWer:ERRor:CPHase <numeric_value> :CONFigure:CDPower:LIMit:LOWer:ERRor:FREQuency <numeric_value> </pre>
TOTAL PWR NOM	<pre> :CONFigure:CDPower:LIMit:POWer:NOMinal <numeric value> </pre>
MEAS SETTINGS	--
SET TO STANDARD	<pre> :[SENSe:]CDPower:PRESet </pre>
EXT TRG OFFSET	<pre> :TRIGger[:SEQuence]:HOLDoff <numeric value> </pre>
PN-OFFSET (CHIPS)	<pre> :[SENSe:]CDPower:PNOffset <numeric_value> </pre>
INACT CHAN TRESH	<pre> :[SENSe:]CDPower:ICTReshold <numeric_value> </pre>
SIDE BAND NORM INV	<pre> :[SENSe:]CDPower:SBAND NORMAl INVerse </pre>
MEASPERIOD [CHIPS]	<pre> :[SENSe:]CDPower:MPERiod 1 2 4 8 12 16 20 24 :[SENSe:]CDPower:MPERiod:AUTO ON OFF </pre>
FAST MODE ON OFF	<pre> :[SENSe:]DETEctor:CDPower[:FUNCTion]:MODE FAST NORMAl </pre>
INPUT CHAN CDMA 800	<pre> :CONFigure:CDPower:PRESet FWCDMA8 NONE :CONFigure:CDPower:CHANnel <numeric value> </pre>
INPUT CHAN CDMA 1900	<pre> :CONFigure:CDPower:PRESet FWCDMA19 NONE :CONFigure:CDPower:CHANnel <numeric value> </pre>
INPUT FREQUENCY	<pre> :[SENSe:]FREQuency:CENTer <numeric_value> </pre>
REF LEVEL	--
REF LEVEL	<pre> :DISPlay[:WINDow]:TRACe:Y[:SCALe]:RLEVel <numeric_value> </pre>
REF LEVEL OFFSET	<pre> :DISPlay[:WINDow<]:TRACe:Y[:SCALe]:RLEVel:OFFSet <num_value> </pre>
RF ATTEN MANUAL	<pre> :INPut:ATTenuation <numeric_value> </pre>
ATTEN AUTO NORMAL	<pre> :INPut:ATTenuation:AUTO:MODE NORMAl; :INPut:ATTenuation:AUTO ON </pre>

ATTEN AUTO LOW NOISE	:INPut:ATTenuation:AUTO:MODE LNOise; :INPut:ATTenuation:AUTO ON
ATTEN AUTO LOW DIST	:INPut:ATTenuation:AUTO:MODE LDIStortion; :INPut:ATTenuation:AUTO ON
MIXER LEVEL	:INPut:MIXer <numeric value>
LEVEL AUTO ADJUST	:SENSe:CDPower:LEVel:ADJust

8 Checking Rated Specifications

- Switch off FSIQ before removing or inserting modules.
- Check the setting of the AC supply voltage selector (230 V) prior to switching on the unit.
- Measure the parameters after a warm-up time of at least 30 min. and the completion of system error correction of FSIQ and SMIQ. Only then is it ensured that the specifications are complied with.
- Unless specified otherwise all settings are made after a PRESET.
- Conventions for settings on FSIQ during the measurement:

[<KEY>] Press a key on the front panel, eg [SPAN]

[<SOFTKEY>] Press a softkey, eg [MARKER -> PEAK]

[<nn unit>] Enter a value and terminate by entering the unit, eg [12 kHz]

{<nn>} Enter values indicated in one of the following tables.

Successive entries are separated by [:], eg [**SPAN**: 15 kHz].

- The values stated hereinafter are not guaranteed values. Only the data sheet specifications are binding.

Required Measuring Equipment and Accessories

Table 8-1 Required Measuring Equipment and Accessories

Item	Instrument type	Recommended characteristics	Recommended equipment	R&S Order No.	Use
1	Signal generator	Vector signal generator for generating cdmaOne signals	SMIQ with options: SMIQB42 SMIQB20 SMIQB11	1125.5555.xx 1104.7936.02 1125.5190.02 1085.4502.04	

Test Procedure

The performance test refers exclusively to results of the code-domain power and modulation quality. It is not required to check the POWER, ACPR and SPECTRUM results since they are covered by the performance test of the basic unit.

Default settings on SMIQ: **[PRESET]**
[LEVEL : 0 dBm]
[FREQ: 870.03 MHz]
 DIGITAL STD
 IS95
 STATE: ON
 SAVE / RCL MAPPING:
 MODE: FWD_LINK_18
 GET PREDEFINED MAPPING: PILOT
 MODULATION
 FWD LINK FILTER: IS-95 + EQUALIZER
 FILTER MODE: LOW EVM
 LOW DISTORTION MODE: OFF

Set trigger output to *EVEN SECOND TRIGGER*.

Check set channels against the following table:

CHAN	WALSH Code	PWR	Data	State
0	0	-7	0000	ON
1	32	-13.3	PRBS	ON
2	1	-7.3	PRBS	ON
3	9	-10.3	PRBS	ON
4	10	-10.3	PRBS	ON
5	11	-10.3	PRBS	ON
6	15	-10.3	PRBS	ON
7	17	-10.3	PRBS	ON
8	25	-10.3	PRBS	ON
all other channels:				OFF

Perform a system error correction of SMIQ (menu *UTILITIES CALIB*).

Default settings on FSIQ: **[REF:** +15 dBm]
[MODE: cdmaOne BTS: Spectrum
[CENTER: 870.3. MHz]
[TRIGGER: TRIGGER OFFSET: 0µs]

Test setup and other settings

- Connect external trigger input of FSIQ to SMIQ
- [TRIGGER:** TRIGGER OFFSET: 0µs]
- Connect external reference output of FSIQ to SMIQ

SMIQ UTILITIES
 SOURCE: EXT

FSIQ **[SETUP:** REFERENCE INT]

Code-Domain Power

Setting on SMIQ: *Default setting*

Settings on FSIQ: **Default setting and**
[MODE: cdmaOne BTS
CDP MEAS DISPLAY MODE CDP: CDP]
[menu change key UP]
[LIMIT SETTINGS EDIT USER LIMITS]
CDP USER LIMITS to be set according to following table:

CDP USER LIMITS		
	Lower Limit	Upper Limit
Total PWR Tolerance	-0.5 dB	+0.5 dB
Pilot PWR Ratio	-0.5 dB	+0.5 dB
Pilot Time Alignment	-0.13 us	+0.13 us
Inact. Chan PWR Ratio		-27 dB
Chan Time Error	-10 ns	+10 ns
Chan Phase Error	-10 mrad	+10 mrad
Frequency Error	-10 Hz	+10 Hz

[menu change key UP]
[menu change key UP]
[MEAS SETTINGS INACT CHAN TRESHOLD: -23 dBm
EXT TRIGGER OFFSET:
SMIQ firmware version < 5 1.35 μs]
SMIQ firmware version ≥ 5.00 (HX)
SMIQB10 1.35 μs]
SMIQB20 3.90 μs]

[menu change key UP]
[LIMIT SETTINGS TOTAL PWR NOM : 0 dBm

Measurement on FSIQ: **[MODE: cdmaOne BTS**
CDP MEAS DISPLAY MODE CDP: ERROR SUMMARY



Ref Lvl
20 dBm

CF 870.03 MHz ERROR SUMMARY
FRQCH 1 CDMA 800 MHz
FORWARD

CDP Error Summary						
WALSH CHAN	CODE	CODE P/	ISS7	TIMING	PHASE	STATUS
No Type	PWR [dBm]	TOTAL P [dB]	nom-PWR [dB]	ERROR [ns]	ERROR [mrad]	
0 Pilot	-7.0	-7.0	-7.0	0.0	0.0	pass
1 Paging	-7.3	-7.3	-7.3	0.1	0.4	pass
32 Sync	-13.4	-13.4	-13.3	0.0	-0.3	pass
9 Traffic	-10.3	-10.3	-10.3	-0.0	0.2	pass
10 Traffic	-10.3	-10.3	-10.3	0.2	-0.5	pass
11 Traffic	-10.3	-10.3	-10.3	-0.1	-0.3	pass
15 Traffic	-10.3	-10.3	-10.3	0.1	-0.1	pass
17 Traffic	-10.3	-10.3	-10.3	0.2	-0.4	pass
25 Traffic	-10.3	-10.3	-10.3	-0.3	0.5	pass
max inactive	-49.3	-49.3	<-27.0			pass
Limits / lower				-50.0	-50.0	PRM
upper				50.0	50.0	
Total Pwr	-0.1 dBm		0.0	-4.0 ...	2.0	pass
Pilot/Total Pwr	-7.0 dB		-7.0	-0.5 ...	0.5	pass
Pilot Time Align	-40.770 ns			-3.0 ...	3.0	pass
Frequency Err	5.482 MHz			-200.0 ...	200.0	pass
inactive CHAN thresh	-23.0 dB		ext Trigger Offs		2.355 µs	
No of active CHAN	9		Meas Period		4096	
pn Offset	0 CHIPS		Average		OFF	

Date: 22.FEB.2000 12:10:32

Nominal value: The measurement should give the STATUS PASS for all measured parameters.

- Enter the displayed measured values in the test report.

Modulation Quality

Settings on SMIQ:

Default setting and:

DIGITAL STD

IS-95

SAVE / RCL MAPPING:

GET PREDEFINED MAPPING: PILOT

- Check set channels against the following table:

CHAN	WALSH Code	PWR	Data	State
0	0	-7	0000	ON
all other channels:				OFF

Settings on FSIQ:

Default setting and:

[MODE: cdmaOne BTS: MODULATION QUALITY

[menu change key UP]

CDP MEAS REF LEVEL: -3 dBm

- Measurement on FSIQ: ➤ Read the measured value for RHO and enter it in the test report.

Performance Test Report

Note: The values specified in the data sheet are guaranteed limits. To these limits, the tolerances of the instruments used in the performance test must be added because of their measurement uncertainty. The attenuation of the connecting cables is to be taken into account as well.

Table 8-2 Performance Test Report

Item	Parameter tested	Measure acc. to page	Min. value	Actual value	Max. value	Unit
1	Total PWR	63	-0,5	————	+0,5	dBm
2	Pilot PWR to Total PWR Ratio	63	-7,5	————	-6.5	dB
3	Pilot Time Alignment	63	-135	————	+135	ns
4	Frequency Error	63	-10	————	+10	Hz
5	Max Timing Error	63	-10	————	+10	ns
6	Max Phase Error	63	-10	————	+10	mrad
7	RHO	64	0.9995	————		

9 Glossary

EVEN SECOND TRIGGER	Trigger signal of base station generated every other second (even number). The BTS timebase is synchronized with the universal time (UTC).
PN-OFFSET	PILOT PN Sequence Offset: This index value indicates the number of CHIPS by which the 0 state of the PN generator is shifted with respect to the EVEN SECOND TRIGGER. The entered PN offset value is automatically taken into account for the calculation of the PILOT TIME ALIGNMENT.
PILOT CHANNEL	Unmodulated signal which is spread with Walsh code 0 and continuously sent by the base station. It is used for timing and phase synchronization of the receiver.
SYNC CHANNEL, PAGING CHANNEL	Code channel 32 is the synchronization channel (SYNC) and code channel 1 is the paging channel of the base station. They are used for synchronization and call setup.
TRAFFIC CHANNEL	Any code channel 2 to 63 without 32 (32 = SYNC channel). It contains the user data of the base station to the mobile station.
WALSH CODE	Spreading code of a channel in the cdmaOne system. The code has a length of 64, ie a symbol of the input data sequence is spread to a length of 64 output symbols. The 1/64 of the period of a Walsh code is known as a chip.
INA = Inactive Channel Threshold	Threshold below which all channels are considered as inactive.

10 Index

A

ACP measurement	16
Adjacent-channel power	16
Auto mode	34
Averaging	45

C

CDMA 800/1900 MHz frequency band	42
CDP	26
Center frequency	42, 46
Channel	
number	21, 42
paging	23, 66
pilot	23
sync	23, 66
Chips	34
Code domain measurements	22
Code domain power	26
Code domain power ratio	27
Code P / Total P	32
Commands	
alphabetical list	56
assignment to softkey	57
description	48

D

Default setting	
cdmaOne demodulation	39
limit values	37
preset	3
Delay	44
Demodulation period	34
Display mode	25

E

Error	
frequency	30
phase	24, 29, 35
summary	30
timing	24, 28, 35
Even second trigger	30, 40, 44, 66
External trigger	22, 30, 44

F

FAIL	36
Fast mode	41
Free run	44
Frequency	42
error	30
offset	46

H

Harmonics	19
-----------------	----

I

INA = Inactive Channel Threshold	27, 30, 66
----------------------------------------	------------

K

Key	
CAL	46
CENTER	46
CONFIG	47
COUPLING	47
DELTA	46
DISPLAY	46
DLINES	46
INFO	46
INPUT	46
LIMITS	46
MKR TO	46
MODE	14
NORMAL	46
PRESET	46
RANGE	46
RECALL	47
REF	46
SAVE	47
SEARCH	46
SETTINGS	47
SETUP	46
SPAN	46
START	46
STOP	46
SWEEP	47
TRACE 1	45
TRIGGER	44, 47

L

Limit check	31, 34
configuration	36

M

Marker	23
Measurement period	34
Measurement speed	25
Menu overview	13
Mode	
code domain measurements	22
fast mode	41
Modulation Quality	18

N

Nominal power	38
Nominal power distribution	32
suppression	32
nom-PWR	32
Number of chips	34

O

Offset	
frequency	46
PN	30, 40, 66
trigger	30

P

Paging channel	23, 66
PASS	36
Phase error	24, 29, 35

Phase tolerance.....	29	LEVEL AUTO ADJUST.....	21, 43, 53
Pilot channel.....	23, 66	LIMIT SETTINGS.....	36
phase error.....	24, 29	LIMITS ON / OFF.....	34
timing error.....	24, 28	LIMITS TO STANDARD.....	37, 50
Pilot channel to code channel phase tolerance.....	29	LIMITS TO USER SET.....	37, 50
Pilot channel to code channel time tolerance.....	28	MARKER.....	23
Pilot time alignment.....	30, 39, 44	MARKER INFO.....	24
PN offset.....	40, 66	MAX HOLD.....	45
Pilot to total power.....	30	MEAS SETTINGS.....	39
PN offset.....	30, 40	MEASPERIOD [CHIPS].....	34, 41, 53, 54
Power		MIN HOLD.....	45
adjacent-channel power.....	16	MKR -> MAX PHASE ERR.....	24, 49
channel power.....	15	MKR -> MAX TIME ERR.....	24, 49
code domain.....	25, 26	MKR -> PAGING CH.....	23, 48
code domain power ratio.....	27	MKR -> PILOT CH.....	23, 48
nominal.....	38	MKR -> SYNC CH.....	23, 49
Power measurement.....	15	MODULATION QUALITY.....	18, 50
Preset.....	3	OPTIONS.....	1
Q		PHASE ERROR.....	29, 48, 49
Quality of waveform.....	18	PN OFFSET [CHIPS].....	40, 54
R		POWER.....	15, 50
RHO factor.....	18	REF LEVEL.....	43
S		RESULT LENGTH.....	47
Second trigger.....	30, 40, 44, 66	SET TO STANDARD.....	39, 53
Signal/noise ratio.....	34, 54	SIDE BAND NORM / INV.....	40, 54
Softkey		SINGLE SWEEP.....	22
ACPR.....	16, 50	SLOPE POS/NEG.....	44
ANALOG BW AUTO.....	47	SPECTRUM.....	19, 50
ANALOG BW MANUAL.....	47	SWEEP COUNT.....	45
AVERAGE.....	45	TIME DOMAIN.....	20, 48, 50
BLANK.....	45	TIME ERROR.....	28, 48, 49
CDMA ONE BTS.....	14	TOTAL PWR NOM.....	38, 50
CDP.....	26, 48, 49	TRIGGER OFFSET.....	44
CDP MEAS.....	22, 53	VIEW.....	45
CDP RELATIVE.....	27, 48, 49	Spectrum.....	19
CLEAR/WRITE.....	45	Sync channel.....	23, 66
CONTINUOUS SWEEP.....	22	Synchronization with the DUT.....	46
CONTINUOUS WRITE.....	45		
DISPLAY MODE CDP.....	25, 48, 49	T	
EDIT USER LIMITS.....	38, 51, 52	Test setup.....	10
ENABLE OPTION.....	1	Threshold.....	30, 66
ERROR SUMMARY.....	30, 48, 49, 55	Time reference.....	44
EXT TRG OFFSET.....	39	Time tolerance.....	28
EXTERN.....	44	Timing error.....	24, 28, 35
FAST MODE.....	35, 41, 54	Total power.....	30
FREE RUN.....	44	Total power tolerance.....	38
FREQUENCY.....	46	Traffic channel.....	66
FREQUENCY OFFSET.....	46	Trigger	
INACT CHAN THRESH.....	40, 54	even second.....	30, 40, 44, 66
INPUT CHAN CDMA 1900.....	21, 42, 50	external.....	30, 44, 66
INPUT CHAN CDMA 800.....	21, 42, 50	offset.....	30, 44
INPUT FREQUENCY.....	42	slope.....	44
		W	
		Waveform quality.....	18