

Noise Figure Analyzers NFA Series

User's Guide



Manufacturing Part Number: N8972-90115

**February 2013
Supersedes January 2011**

© Copyright 2001-2013 Agilent Technologies

Safety Notices

This product and related documentation must be reviewed for familiarization with safety markings and instructions before use.

This instrument has been designed and tested in accordance with IEC Publication 61010-1+A1+A2:1991 Safety Requirements for Electrical Equipment for Measurement, Control and Laboratory Use and has been supplied in a safe condition. The instruction documentation contains information and warnings which must be followed by the user to ensure safe operation and to maintain the instrument in a safe condition.

The information contained in this document is subject to change without notice.

Agilent Technologies makes no warranty of any kind with regard to this material, including but not limited to, the implied warranties of merchantability and fitness for a particular purpose. Agilent Technologies shall not be liable for errors contained herein or for incidental or consequential damages in connection with the furnishing, performance, or use of this material.

The following safety symbols are used throughout this manual. Familiarize yourself with the symbols and their meaning before operating this instrument.

WARNING

***Warning* denotes a hazard. It calls attention to a procedure which, if not correctly performed or adhered to, could result in injury or loss of life. Do not proceed beyond a warning note until the indicated conditions are fully understood and met.**

CAUTION

***Caution* denotes a hazard. It calls attention to a procedure that, if not correctly performed or adhered to, could result in damage to or destruction of the instrument. Do not proceed beyond a caution sign until the indicated conditions are fully understood and met.**

NOTE

***Note* calls out special information for the user's attention. It provides operational information or additional instructions of which the user should be aware.**

WARNING

This is a Safety Class 1 Product (provided with a protective earthing ground incorporated in the power cord). The mains plug shall only be inserted in a socket outlet provided with a protected earth contact. Any interruption of the protective conductor inside or outside of the product is likely to make the product dangerous. Intentional interruption is prohibited.

WARNING

If this product is not used as specified, the protection provided by the equipment could be impaired. This product must be used in a normal condition (in which all means for protection are intact) only.

WARNING

No operator serviceable parts inside. Refer servicing to qualified personnel. To prevent electrical shock do not remove covers.

WARNING

For continued protection against fire hazard, replace line fuses only with the same type and ratings (115V range; type F 5A 125V; 239V range F 5A 250V). The use of other fuses or materials is prohibited.

CAUTION

To prevent electrical shock, disconnect the instrument from the mains (line) before cleaning. Use a dry cloth or one slightly dampened with water to clean the external case parts. Do not attempt to clean internally.

Environmental requirements: This product is designed for indoor use only and to meet the following environmental conditions:

- Operating temperature: 0° C to +55° C

- Operating humidity: <95% relative
- Altitude: up to 4500 m

Warranty

This Agilent Technologies instrument product is warranted against defects in material and workmanship for a period of three years from date of shipment. During the warranty period, Agilent Technologies Company will, at its option, either repair or replace products which prove to be defective.

For warranty service or repair, this product must be returned to a service facility designated by Agilent Technologies. Buyer shall prepay shipping charges to Agilent Technologies and Agilent Technologies shall pay shipping charges to return the product to Buyer. However, Buyer shall pay all shipping charges, duties, and taxes for products returned to Agilent Technologies from another country.

Agilent Technologies warrants that its software and firmware designated by Agilent Technologies for use with an instrument will execute its programming instructions when properly installed on that instrument. Agilent Technologies does not warrant that the operation of the instrument, or software, or firmware will be uninterrupted or error-free.

LIMITATION OF WARRANTY

The foregoing warranty shall not apply to defects resulting from improper or inadequate maintenance by Buyer, Buyer-supplied software or interfacing, unauthorized modification or misuse, operation outside of the environmental specifications for the product, or improper site preparation or maintenance.

NO OTHER WARRANTY IS EXPRESSED OR IMPLIED. AGILENT TECHNOLOGIES SPECIFICALLY DISCLAIMS THE IMPLIED WARRANTIES OF MERCHANTABILITY AND FITNESS FOR A PARTICULAR PURPOSE.

EXCLUSIVE REMEDIES

THE REMEDIES PROVIDED HEREIN ARE BUYER'S SOLE AND EXCLUSIVE REMEDIES. AGILENT TECHNOLOGIES SHALL NOT BE LIABLE FOR ANY DIRECT, INDIRECT, SPECIAL, INCIDENTAL, OR CONSEQUENTIAL DAMAGES, WHETHER BASED ON CONTRACT, TORT, OR ANY OTHER LEGAL THEORY.

Where to Find the Latest Information

Documentation is updated periodically. For the latest information about Agilent NFA Noise Figure Analyzers, including firmware upgrades and application information, please visit the following Internet URL:

<http://www.agilent.com/find/nf/>

Contents

1. Getting Started

What You will Find in this Chapter	16
The Noise Figure Analyzer Features	18
Product Family	18
3.0 GHz Mechanical Switch.	18
Microwave Front Panel Connector.	18
Product Options	19
Main Features	19
Overview of the Front Panel	21
Overview of the Rear Panel	25
Overview of the Front Panel Keys.	27
How the Front Panel Keys are Organized	27
Navigating Through the Menu System.	27
Display Annotation	30
Making a Fixed Frequency Measurement	34
Performing Common File Operations	39
Formatting a Diskette	39
Saving a File	41
Loading a File	42
Renaming a File	42
Copying a File	43
Deleting a File	44
Working with Tables	45
Using the Alpha Editor	46

2. Making Basic Measurements

What You will Find in this Chapter	50
--	----

Contents

Entering Excess Noise Ratio (ENR) Data	51
Selecting a Common ENR Table	51
Entering ENR Table Data for Normal Noise Sources	52
Saving an ENR Table	58
Entering a Spot ENR Value	58
Entering a Spot Thot Value	59
Using a Smart Noise Source	60
Setting the Tcold value	62
Setting the Measurement Frequencies	65
Selecting Sweep Frequency Mode	65
Selecting List Frequency Mode	67
Selecting Fixed Frequency Mode	70
Setting the Bandwidth and Averaging	71
Effect of Bandwidth and Averaging on Speed, Jitter, and Measurement Accuracy 71	
Selecting a Bandwidth Value	71
Setting Averaging	72
Calibrating the Analyzer	74
To perform a calibration	76
Selecting the Input Attenuation Range	78
Displaying the Measurement Results	81
Selecting the Display Format	81
Selecting Result Types to Display	84
Graphical Features	85
Setting the Scaling	90
Working with Markers	93
Indicating an Invalid Result	102
RF Input Over and Under Range Conditions	103
IF Input Over and Under Range Conditions	103
Example of a Basic Amplifier Measurement	104

Contents

Calibrating the Noise Figure Analyzer	105
Making Measurements	108
3. Advanced Features	
What You will Find in this Chapter	112
Setting up Limit Lines	113
Creating a Limit Line	115
Using Loss Compensation	119
Examples where Loss Compensation is applied	119
Configuring Fixed Loss Compensation	119
Configuring Table Loss Compensation	122
Working with S2P, S1, and S2 File Formats	127
Setting Temperature of Loss.	129
Making Manual Measurements	131
Manual Measurements Procedure	133
4. Making Extended Frequency Measurements	
What You will Find in this Chapter	136
Overview of Configuring Extended Frequency Measurements.	137
Measurement Modes	139
Basic Measurement — No Frequency Conversion	140
Frequency Down-converting DUT.	142
Frequency Up-converting DUT	145
System Downconverter	148
Comparison of the 8970B and the NFA Series Measurement Modes	151
Choosing and Setting Up the Local Oscillator.	152
Selecting a Local Oscillator for Extended Frequency measurements with the NFA 152	
Selecting a Local Oscillator for the NFA	153

Contents

Setting up the NFA to drive the Local Oscillator.	154
Connecting the System	157
Setting Up the Noise Figure Analyzer	157
Measuring a Frequency-Converting DUT	159
Sidebands and Images	161
Signal Leakage	162
LO Leakage	162
LO Harmonics	163
Other signals from the DUT.	163
Single Sideband Measurements	164
Double Sideband Measurements	166
Fixed IF	170
Fixed LO	171
Making Frequency-Converting DUT Measurements	172
Making Down-Converting DUT Measurements using a Fixed IF and Variable LO (8970B Mode 1.3)172	
Making Down-converting DUT Measurements using a Variable IF and Fixed LO (8970B Mode 1.4)181	
Making Up-converting DUT Measurements using a Fixed IF and Variable LO (8970B Mode1.3 with SUM)182	
Making Up-converting DUT Measurements using a Variable IF and Fixed LO (8970B Mode1.4 with SUM)183	
Measurements with a System Downconverter	184
USB, LSB or DSB?	185
Measurement Modes with a DSB System Downconverter	186
Measurement Modes with an SSB System Downconverter	187
FIXED IF, LSB:	190
FIXED IF, USB:.	191
FIXED LO, LSB	192
FIXED LO, USB	193

Contents

Making System Downconverter Measurements	194
Using a Fixed IF and Variable LO (8970B Mode1.1)	195
Using a Variable IF and Fixed LO (8970B Mode1.2)	204
Frequency Restrictions	207
Glossary of Restricted Terms	207
General Restrictions	208
Frequency-Downconverting DUT	209
Frequency Up-converting DUT	211
System Downconverter	213
5. Performing System Operations	
What You will Find in this Chapter	218
Setting the GPIB Addresses	219
To Set the GPIB Addresses	219
Configuring the Serial Port	221
Configuring the Characteristics of an External LO	223
Custom Command Set	223
Settling Time	226
Minimum and Maximum Frequencies	226
Multiplier	227
Configuring the Internal Alignment	228
Turning Alignment Off and On	228
Changing Alignment Mode	228
Alignment of the YIG Tuned Filter (YTF)	229
Displaying Error, System and Hardware Information	230
Displaying the Error History	230
Displaying System Information	230
Displaying Hardware Information	230
Presetting the Noise Figure Analyzer	231

Contents

Defining the Power-On/Preset Conditions	232
Setting the Power On Conditions	232
Setting the Preset Conditions	232
Restoring System Defaults	233
Setting the Time and Date	234
To turn the time and date on and off	234
To set the time and date	234
Configuring a Printer with the NFA	235
To Configure a Printer with the NFA	235
Testing Correct Printer Operation	238
6. Front Panel Key Reference	
MEASURE Keys	240
Frequency/Points	240
Averaging/Bandwidth	245
Calibrate	247
Meas Mode	248
Mode Setup	250
ENR	252
DISPLAY Keys	258
Scale	258
Format	262
Result	264
Marker	266
CONTROL Keys	271
Loss Comp	271
Limit Lines	277
Full Screen	280
Corr	281

Contents

Sweep	284
Restart	288
SYSTEM Keys	289
System (Local)	289
File	302
Save Trace	309
Preset	309
Print Setup	310
Print	312
Data Entry Keys	313
Numeric Keys	313
Back Space	313
Enter	313
Up/Down Arrow Keys	313
Display and Menu Control Keys	314
Viewing Angle	314
On	314
Standby	314
Next Window	315
Zoom	315
Help	315
Tab Keys	316
ÚPrev	316
Esc	316
Preset/Power Up Groups	317
Preset/Power Up — “Persistent” Group Items	317
Preset/Power Up - “Survive Preset” Group Items	319
Unsaved Items	320
State Items	320
Default States	321

Contents

7. Troubleshooting

What You'll Find in This Chapter	328
Before You Call Agilent Technologies	329
Check the Basics	329
Read the Warranty	330
Service Options	330
Connector Care	331
Contacting Agilent Technologies	331
How to Return Your Analyzer for Service	332
Detailing the Problem	332
Original Packaging	332
Other Packaging	334
NFA Battery Information	335
Error Messages	336
Informational Messages	337
Error Queues	340
Error Message Format	341
Error Message Types	342
0: No Error	343
-499 to -400: Query Errors	344
-199 to -100: Command Errors	346
-399 to -300 and 201 to 799: Device-Specific Errors	352
-299 to -200: Execution Errors	371

1 **Getting Started**

This chapter introduces you to basic features of the Noise Figure Analyzer, including front panel and rear panel descriptions, and an overview of the display annotation. You also learn how to make a basic fixed frequency measurement.

What You will Find in this Chapter

This chapter introduces the basic functions of the Noise Figure Analyzer (NFA). This chapter covers the following:

- The Noise Figure Analyzer Features
- Overview of the Front Panel
- Overview of the Rear Panel
- Display Annotation
- Overview of the Front Panel Keys
- Making a Fixed Frequency Measurement
- Performing Common File Operations
- Working with Tables
- Using the Alpha Editor

Figure 1-1 NFA with a Normal Noise Source connected



The Noise Figure Analyzer Features

Product Family

The Agilent Series Noise Figure Analyzer (NFA) family comprises the following models:

- The N8972A (NFA); frequency range 10 MHz to 1.5 GHz.
- The N8973A (NFA); frequency range 10 MHz to 3.0 GHz.
- The N8974A (NFA); frequency range 10 MHz to 6.7 GHz.
- The N8975A (NFA); frequency range 10 MHz to 26.5 GHz.

3.0 GHz Mechanical Switch

The N8974A and N8975A NFA models have a mechanical switch fitted to allow them to switch between the 10 MHz to 3.0 GHz frequency range and the 3.0 GHz to 6.7 GHz and the 3.0 GHz to 26.5 GHz frequency ranges respectively. If the frequency range you are working in crosses the 3.0 GHz point, the mechanical switch operates. The mechanical switch has a limited number of cycles over which it is reliable.

To maximize the switches reliable life, switching over the 3.0 GHz switch should be limited where possible.

Microwave Front Panel Connector

The N8974A and N8975A NFA models are fitted with a precision 3.5mm male input connector. The models are supplied with a Precision 3.5mm Coaxial Adaptor (83059B). When making connection you need to ensure you apply the correct torque and you use the adaptor where needed. Correct torque value guidance is in the *Agilent NFA Series Performance Verification and Calibration Guide*.

Product Options

The NFA family offers the following product options:

- 1D5 The Hi-Stability 10 MHz option.

Main Features

The NFA includes the following main features:

- A dedicated user interface to allow easy measurement set up and interpretation of results
- A GPIB port to allow remote operation
- Built-in 17cm color LCD display
- Measurement results can be displayed in graphical, table or meter mode
- Dual-trace display allows simultaneous display of any two of the following noise parameters: Noise Figure, Gain, Y-Factor, P_{hot} , P_{cold} , $T_{effective}$
- Measurement modes equivalent to the Agilent 8970B Noise Figure Meter
- Single-sideband and double-sideband measurements
- Fully compatible with Agilent's existing range of Noise Sources, for example the 346 and 347 series
- A dedicated 2nd GPIB allows control of a local oscillator
- An internal disk drive and a 3.5" floppy disk drive for storing ENR tables, instrument states, limits, frequency lists, loss compensation tables, and screen captures
- A Centronics printer port
- An RS232 serial port for serial communication
- Normal noise source ENR table entry from front panel, floppy disk, or over the GPIB
- Limit lines with pass/fail notification

The Noise Figure Analyzer Features

- Marker functions to display measurement data on a trace or a recalled trace
- Manual measurements which can be made on a single frequency point or over a number of points over a frequency range
- A Smart Noise Source (SNS) port, when connected to an SNS allows the facility to automatically upload it's ENR values and monitor the ambient temperature of the SNS

Overview of the Front Panel

Figure 1-2 Front Panel Overview

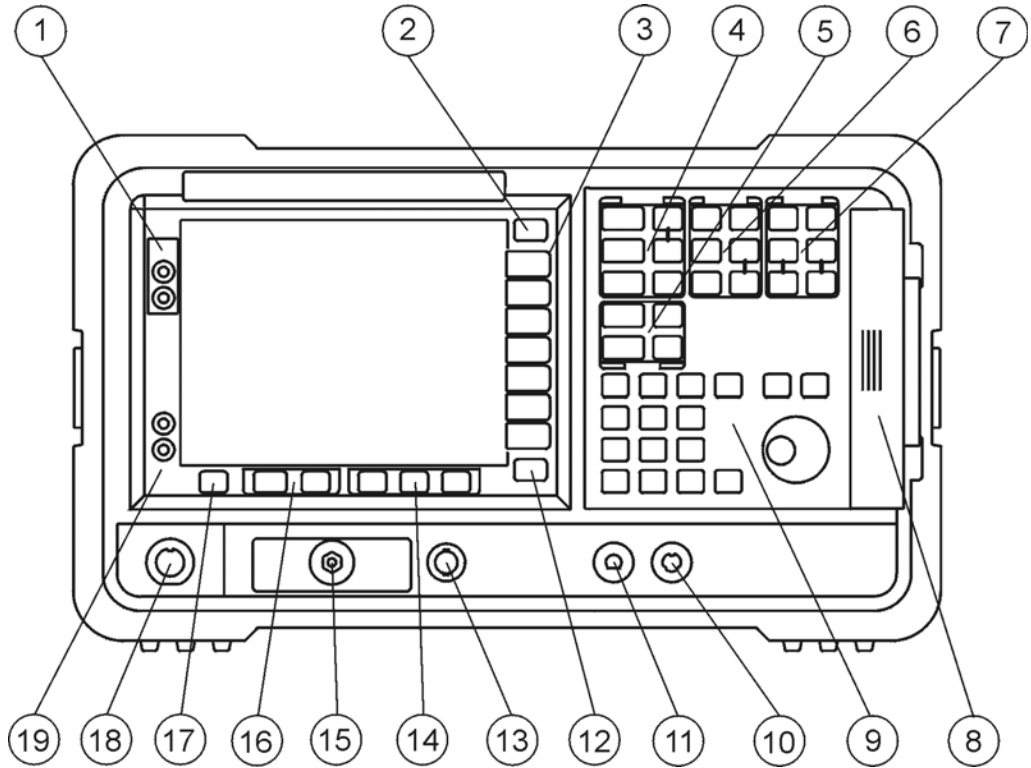

Table 1-1 Front Panel Item Descriptions

Item	Description
1	Viewing Angle keys allow you to adjust the display so that it can be optimally viewed from different angles.
2	The Esc (escape) key cancels any entry in progress. Esc clears error messages from the display status line, clears data input entries, and aborts a print (if one is in progress).



Table 1-1 Front Panel Item Descriptions

Item	Description
3	<p>Menu keys are the unlabeled keys next to the screen. The menu key labels are shown on the display next to these unlabeled keys.</p> <p>See Chapter 6 , “Front Panel Key Reference” for a more extensive description of all the keys.</p>
4	<p>The MEASURE functions allow you to configure the NFA parameters needed for making measurements.</p> <p>The Frequency/Points and Averaging/Bandwidth keys activate the primary set up function menu keys.</p> <p>The Calibrate key removes any second stage noise contribution from the measurement. The ENR key accesses the ENR menu.</p> <p>The Meas Mode and Mode Setup keys are used to configure the NFA to measure mixers and devices at frequencies greater than the basic frequency of the NFA using a Local Oscillator.</p>
5	<p>The DISPLAY functions allow you to configure the display results.</p> <p>The Scale key allows you to set the scale of the graph results. The Format key allows you to set the format of the result. The Marker key allows you to control the markers and search the trace. The Result key allows you set which measurements you want to display.</p>
6	<p>The CONTROL functions allow you to setup the NFA’s advanced features. These are Loss Comp, Limit Lines, correction (Corr key) setting including input calibration ranges, Sweep mode including Manual Meas. Also, measurement Restart and a Full Screen display. The Full Screen functions in all display formats.</p>
7	<p>SYSTEM functions affect the state of the NFA. Various setup and alignment routines are accessed with the System key.</p> <p>The green Preset key resets the NFA to a known state.</p> <p>The File key menu allows you to save and load the various NFA file types and access the File Manager. The Save Trace key executes the Save function defined under File.</p> <p>The Print Setup menu keys allow you to configure hardcopy output. The Print key sends hardcopy data to the printer.</p>

Table 1-1 Front Panel Item Descriptions

Item	Description
8	The Media Door on the right side of the front panel accesses the 3.5 inch disk drive.
9	<p>The Data Entry Keys, which include the Up/Down arrow keys, RPG (rotatable knob), and numeric keys, allow you to enter or change the numeric value of an active function.</p> <p>The Numeric Keys allows entry of exact values for many of the NFA functions. To terminate a numeric, where no unit labels have been presented, press the Enter key.</p> <p>The RPG allows continuous change of functions such as marker position.</p> <p>The Up/Down arrow keys allow discrete increases or decreases of the active function value.</p>
10	EXT KEYBOARD. The EXT KEYBOARD connector is a 6-pin mini-DIN connector for future use with PC keyboards. Not currently supported.
11	PROBE POWER provides power for other accessories.
12	The ← Prev key accesses the previously selected menu. Continuing to press ← Prev key takes you to earlier menus in the present menu system.
13	NOISE SOURCE DRIVE OUTPUT +28V PULSED this connector provides a 28 Vdc level to switch the noise source on. The noise source is off when no voltage is applied.
14	Tab Keys are used to move between, table input fields, fields on forms, and to move within the fields of the dialog box accessed by the File menu keys.
15	INPUT 50Ω This is the input connector for the NFA. N8972/3A models have a Type-N connector. N8974/5A models have a precision 3.5 mm connector.

Table 1-1 Front Panel Item Descriptions

Item	Description
16	<p>The  <i>Next Window</i> key selects which graph or result parameter is active.</p> <p>Pressing  <i>Zoom</i> key while in graph mode allows you to switch between the dual-graph and single-graph display.</p>
17	<p>Press the Help key and then any front panel or menu key to get a short description of the key function and the associated remote command. The next key you press removes the help window from the display.</p>
18	<p>The Smart Noise Source (SNS) connector provides the interface to upload the ENR data, monitor the ambient temperature, and switch the SNS off and on.</p>
19	<p>The ?(On) key turns the NFA on, while the O (Standby) key switches the NFA to standby.</p> <p>After turning on the NFA, with the factory default Alignment running, allow 60 minutes of warm-up time to ensure the NFA meets its specifications.</p>

Overview of the Rear Panel

Figure 1-3 Rear Panel Overview

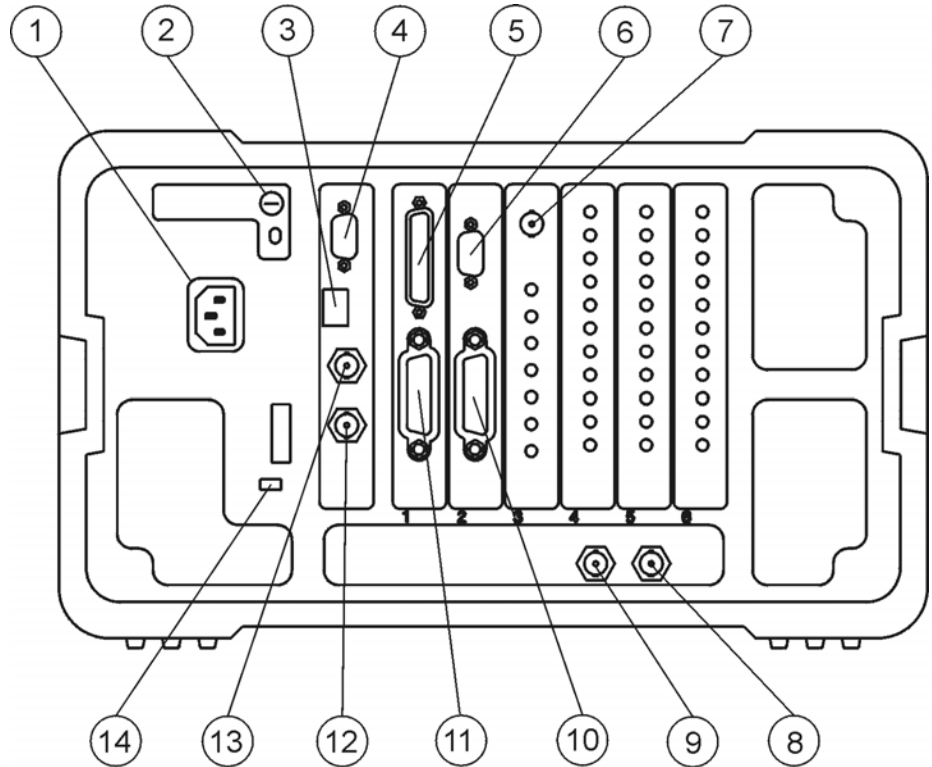

Table 1-2 Rear Panel Item Descriptions

Item	Description
1	Power input is the input for the AC line-power source. Make sure that the line-power source outlet has a protective ground contact.

Table 1-2 Rear Panel Item Descriptions

Item	Description
2	Line Fuse. The fuse is removed by twisting counterclockwise 1/4 turn. Replace only with a fuse of the same rating. See the label on the rear panel and information in the <i>Setup Guide</i> .
3	Service Connector. The service connector is for service use only.
4	VGA OUTPUT drives an external VGA compatible monitor with a signal that has 31.5 kHz horizontal, 60 Hz vertical synchronizing rate, non-interlaced.
5	PARALLEL interface port is for printing only.
6	RS-232 interface supports remote instrument operation.
7	Presel Tune Connector it is not currently supported.
8	10 MHz REF IN accepts an external frequency source to provide the 10 MHz, -15 to +10 dBm frequency reference used by the NFA.
9	10 MHz REF OUT provides a 10 MHz, 0 dBm minimum, timebase reference signal.
10	LO GPIB port is for the control of an external LO by the NFA.
11	MAIN GPIB interface port supports remote instrument operation.
12	AUX OUT (TTL) it is not currently supported.
13	AUX IN (TTL) it is not currently supported.
14	Power On Selection selects an instrument power preference. This preference applies after power has been absent for > 20 seconds. The PWR NORM position causes the instrument to remain off when power is applied. The PWR ALWAYS ON position causes it to turn on. The PWR ALWAYS ON mode is useful if an external power switch is used to control a rack of several instruments.

Overview of the Front Panel Keys

How the Front Panel Keys are Organized

The front panel keys are divided into four main groups:

- **MEASURE** keys, which are used to configure the measurement parameters, such as frequency range, bandwidth, number of measurement points and so forth.
- **CONTROL** keys, which are used to configure advanced measurement parameters, such as Loss Compensation and Limit Lines
- **SYSTEM** keys, which perform system-level operations such as configuring the NFA's GPIB address, displaying status information and configuring an external LO.
- **DISPLAY** keys, which adjust the display characteristics of the measurement, for example setting which parameters are displayed, whether the display format is graph, table or meter, adjusting the scaling etc.

In addition to the four main groupings, the keys are also further grouped according to key size and closeness to the display. The large keys placed in column nearest the display (**Frequency/Points**, **Averaging/Bandwidth**, **Calibrate**, **Scale** and **Format**) are typically the keys which you use most frequently when performing a measurement.

Navigating Through the Menu System

Menu keys

Pressing any of the grey front panel keys in the **MEASURE**, **DISPLAY**, **RESULT** or **SYSTEM** key groupings accesses menus of functions that are displayed along the right-hand side of the display. These keys are called **menu keys**. See Figure 1-4.

Figure 1-4

Menu Keys

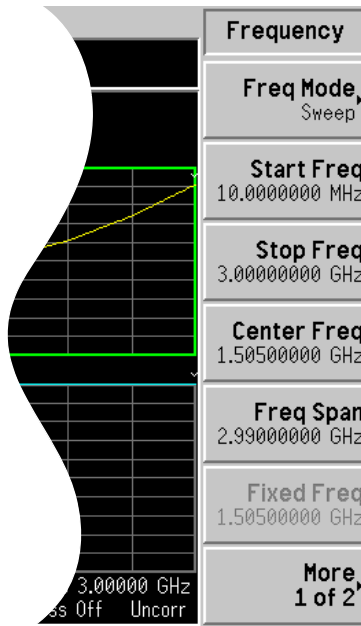

Action keys

Pressing any of the white keys (**Calibrate**, **Full Screen**, **Restart**, **Save Trace** and **Print**) invokes an action and these keys are called **action keys**.

To activate a menu key function

To activate a menu key function, press the key immediately to the right of the screen menu key. The menu keys that are displayed depend on which front panel key is pressed and which menu level or page is selected.

When a menu key value is selected, it is called an **active function**. The function label of the active function is highlighted after that key is selected. For example, if you press the **Frequency/Points** key the menu of related configuration parameters appears. If you now press the menu key labeled **Start Freq** key, the **Start Freq** appears in the active function area. The Start Frequency can be changed using any of the data entry controls.

Selecting a function within a menu key

Some menu keys have functions contained within them, for example, **On** and **Off**. To turn the function on, press the menu key so that **On** is underlined. To turn the function off, press the menu key so that **Off** is underlined.

In some menus, one key label is always highlighted to show which key is selected but the menu is immediately exited when a selection is made. For example, when you press the **Orientation** key (a **Print Setup** menu key) its own menu of keys appears. The **Portrait** key, which is the Orientation menu default key, is highlighted. When you press another Orientation menu key, the highlight moves to that key to show it is selected.

For a summary of all front panel keys and their related menu keys, see [Chapter 6 , “Front Panel Key Reference.”](#)

Display Annotation

The display annotation, shown in Figure 1-5, is referenced by numbers. Table 1-3 has a description and, where appropriate, a function key indicating which key activates the function related to the annotation. Refer to [Chapter 6, “Front Panel Key Reference”](#) for more information on a specific key.

Figure 1-5 Display Annotation

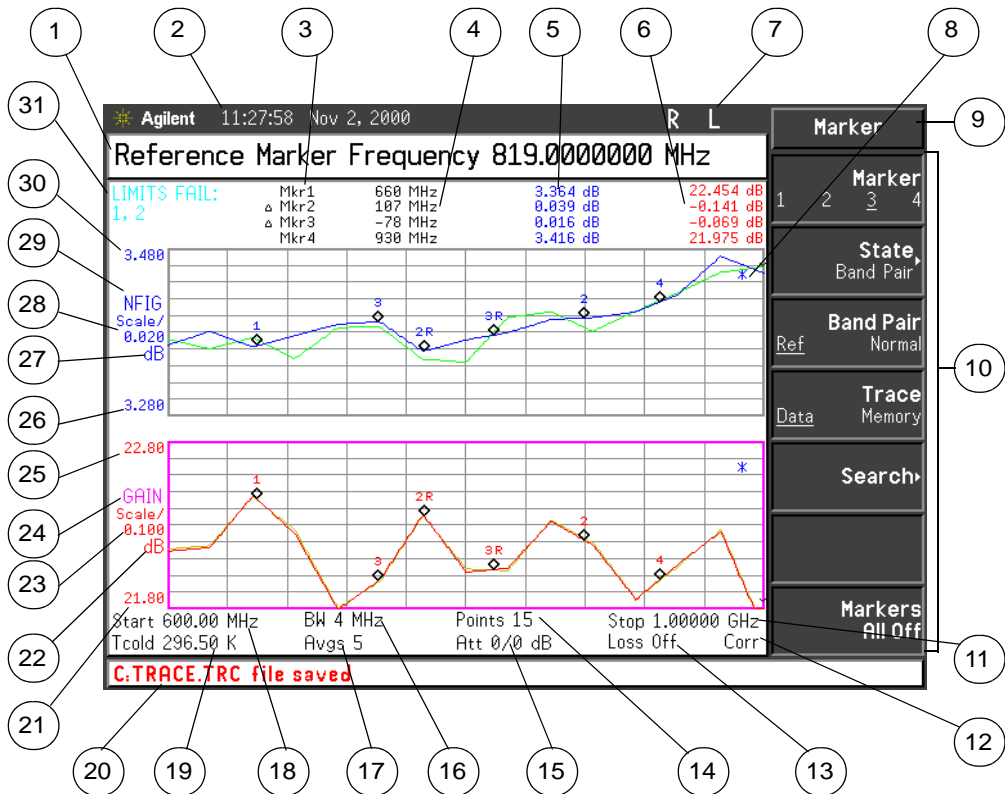

Each item is given a description and where applicable a function key associated with it.

Table 1-3 Display annotation item descriptions

Item	Description
1	The active function area displays the label and value of the currently active key.
2	The time and date display, controlled by the Time/Date menu key, under the System key menus.
3	The marker numbers are displayed in this column, each row displays the markers results. It is controlled by the Marker and the State menu keys.
4	The markers frequency is displayed in this column. It is controlled by the Marker and the State menu keys.
5	The upper trace measurement result is displayed in this column. It is controlled by either the Result, Marker, State menu keys.
6	The lower trace measurement result is displayed in this column. It is controlled by either the Result, Marker, State menu keys.
7	The GPIB annunciators RLTS. The following GPIB modes are possible: <ul style="list-style-type: none"> • R — Remote operation • L — GPIB Listen • T — GPIB Talk • S — GPIB SRQ (Service Request)
8	The data invalid indicator appears when a measurement starts. It disappears after a complete sweep.
9	The key menu title, this is dependent on which key is selected.
10	The key menu, see key label descriptions in Chapter 6, “Front Panel Key Reference” .

Table 1-3 Display annotation item descriptions

Item	Description
11	The frequency span or stop frequency, controlled by the Freq Span or Stop Freq key.
12	Displays the measurement correction state, uncorrected or corrected. Controlled by the calibration state and the Corr key.
13	Displays the Loss Compensation status, On or Off. Controlled by the Loss Comp key.
14	The number of points, controlled by the Points menu key.
15	Displays the value of attenuation being applied. The left item is the RF attenuator and the right item is the microwave attenuator. On the N8972/3A only the RF attenuator status is displayed.
16	The bandwidth, controlled by the Bandwidth menu key. This is fixed at 4 MHz on the N8972A model.
17	The number of averages, controlled by the Averages menu key.
18	The center frequency or start frequency, controlled by the Center Freq or Start Freq menu keys.
19	The T_{cold} temperature value, controlled by the Tcold menu key.
20	The display status line, displays instrument status and error messages.
21	The lower trace lower limit, controlled by the Lower Limit menu key.
22	The lower trace unit of measurement on the Y-axis, controlled by the Result key or Scale menu key.
23	The lower trace scale, controlled by the Scale/Div menu key.
24	The lower trace result type, controlled by the Result key.
25	The lower trace upper limit, controlled by the Upper Limit menu key.
26	The upper trace lower limit, controlled by the Lower Limit menu key.

Table 1-3 Display annotation item descriptions

Item	Description
27	The upper trace unit of measurement on the Y-axis, controlled by the Result key or Scale menu key.
28	The upper trace scale, controlled by the Scale/Div menu key.
29	The upper trace result type, controlled by the Result key.
30	The upper trace upper limit, controlled by the Upper Limit menu key.
31	The limit line failure indicator.
Shown in Figure 1-6	The measurement mode status, controlled by the Meas Mode key. This information is displayed by default. The status disappears when the marker results are switched on.

Figure 1-6 Measurement Mode Status



Basic Setup Measurement Mode

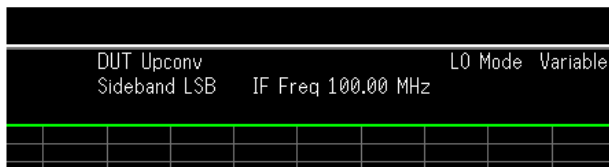

Using a Converter Measurement Mode

Making a Fixed Frequency Measurement

The Fixed Frequency Measurement is the simplest type of measurement to explain, in terms of getting you started making measurements.

NOTE

You can experiment with the keys without damaging the NFA. To return to a known state at anytime, press the green **Preset** key.

Noise figure measurements are made by measuring the output power of the DUT for two different input noise power levels. Typically, the high power input comes from a calibrated noise source, and the low power input uses the noise power generated at ambient temperature.

A fixed frequency measurement is made by measuring a device at a specific frequency. To display the result on the NFA use the meter display format, as this is ideal for displaying fixed results. To make a fixed frequency measurement on a device using the method described, its operating frequency range must be within the frequency range of the NFA and requires no frequency conversion.

The techniques used in the procedure are explained in greater detail in [Chapter 2 , “Making Basic Measurements”](#).

You need an appropriate noise source, either an SNS or a normal noise source. The normal noise source input is connected to the **28V OUTPUT** using a BNC cable and its output is connected to the **INPUT 50 W**. The SNS input is connected to the SNS port using the 11730A cable and its output is connected to the **INPUT 50 W**.

The following example measures the corrected noise figure and gain of a device at a frequency of 900 MHz and verifies it meets the manufacture's specification listed in Table 1-4. The averaging is On and set to 10. The bandwidth is set to the default 4 MHz.

Table 1-4 The Example DUT Specifications

Frequency Range	Typical Gain	Minimum Gain	Typical Noise Figure
900 MHz	23 dB	17 dB	3.5 dB

When you are making measurements, follow the procedure and change the values to meet your needs.

- Step 1.** Turn the instrument on by pressing **On** and wait for the power-up process to complete.

NOTE

To obtain greater accuracy, it is recommended the NFA warm up for at least one hour with **Alignment(On)**. The default setting is **Alignment(On)**

- Step 2.** Press **System, More 1 of 3, Power On/Preset, Preset (Factory)**.

Press the green **Preset** key.

NOTE

If the noise source ENR measurement table has been entered previously, you can use this data to calibrate the NFA. The NFA interpolates points automatically. Hence, you ignore Steps 3 and 4. See [“Entering Excess Noise Ratio \(ENR\) Data” on page 51](#).

The normal noise source ENR values are typically found on the body of the noise source, the certificate of calibration, or on the diskette supplied with the noise source. The SNS ENR values are uploaded to the NFA.

- Step 3.** Press the **ENR** key, and set the **ENR Mode** menu key to **ENR Mode(Spot)**.

Getting Started

Making a Fixed Frequency Measurement

- Step 4.** Press the **Spot ENR** menu key and enter an ENR value if different from the default value.

If the frequency you want to measure is not a listed ENR value, then you need to interpolate to an appropriate value. The default value is 15.200 dB.

- Step 5.** Select the frequency you want to measure using the **Frequency/Points** key.

Press the **Frequency/Points** key. Press the **Freq Mode** menu key and select the **Fixed** menu key. The **Freq Mode** menu key has Fixed mode displayed.

Press the **Fixed Freq** menu key and enter the numeric frequency value you want to measure using the numeric key pad. On this occasion enter **900**. Terminate the value using the unit label keys. On this occasion **MHz**.

- Step 6.** Select the averaging and bandwidth you want using the **Averaging/Bandwidth** key.

Press the **Averaging/Bandwidth** key and set the averaging to On, by selecting the **Averaging(On)** menu key.

Press the **Averages** menu key and enter the value you want, on this occasion enter **10**. Terminate it with the **Enter** key. The default value is 1.

NOTE

On the N8972A model, the average mode menu key is unavailable. The average mode is performed at the default **Average Mode(Point)**. On other models set the averaging mode to **Average Mode(Point)**. See “Selecting the Averaging Mode” on page 72 for an explanation of these averaging modes. Essentially in Fixed Frequency mode either averaging mode gives an identical result.

Press the **Bandwidth** menu key and select the bandwidth value you want from the list presented to you. On this occasion, the default 4 MHz value is used. The N8972A only offers a 4 MHz bandwidth.

- Step 7.** Connect the normal noise source input to the NFA's **28V OUTPUT** with a BNC cable or if using an SNS connect it to the SNS port. Connect the preferred noise source's output to the **INPUT 50 W**.

NOTE

When using the N8974A and N8975A care must be taken to torque the precision 3.5mm connector to the correct value. To find the correct value of torque to apply, see the *Performance Verification and Calibration Guide*.

- Step 8.** Set the display mode to meter mode.

Press the **Format** key, the **Format** menu key and select the **Meter** menu key.

- Step 9.** Press the **Calibrate** key twice.

The first time you press the key you will be prompted to press it again. This two-stroke calibration is a safety feature, it keeps you from accidentally pressing the **Calibrate** key and erasing any previous calibration data.

The calibration corrects for any second stage noise contribution caused by the NFA. When the calibration is complete the **Uncorr** text in the bottom right hand corner changes to **Corr** text.

The calibration is performed at the default input attenuator settings. If you need to change these settings, see [“Selecting the RF Input Attenuation Range” on page 78](#).

- Step 10.** Connect the device under test between the noise source output and the NFA's input.

The measurement result is displayed in meter format, similar to Figure 1-7.

Getting Started
Making a Fixed Frequency Measurement

Figure 1-7 Typical Fixed Frequency Measurement Result in Meter Format.



The result displayed in Figure 1-7 shows the DUT noise figure and gain at 900 MHz.

Thus the DUT meets the manufacturer’s specification as listed in Table 1-4.

Performing Common File Operations

This section describes how to use the functions located under the front-panel **File** key. This section covers:

- Formatting a diskette
- Saving a file
- Loading a file
- Renaming a file
- Copying a file
- Deleting a file

Formatting a Diskette

You can format a diskette in the NFA. The format is MS-DOS. It is not necessary to format your diskette with the NFA; pre-formatted disks can be used with the NFA.

- Step 1.** Place the diskette you wish to format into the diskette drive (A:) of the NFA.
- Step 2.** Access the file manager menu by pressing **File** key, **File Manager**. See Figure 1-8.

Figure 1-8 File Manager Menu

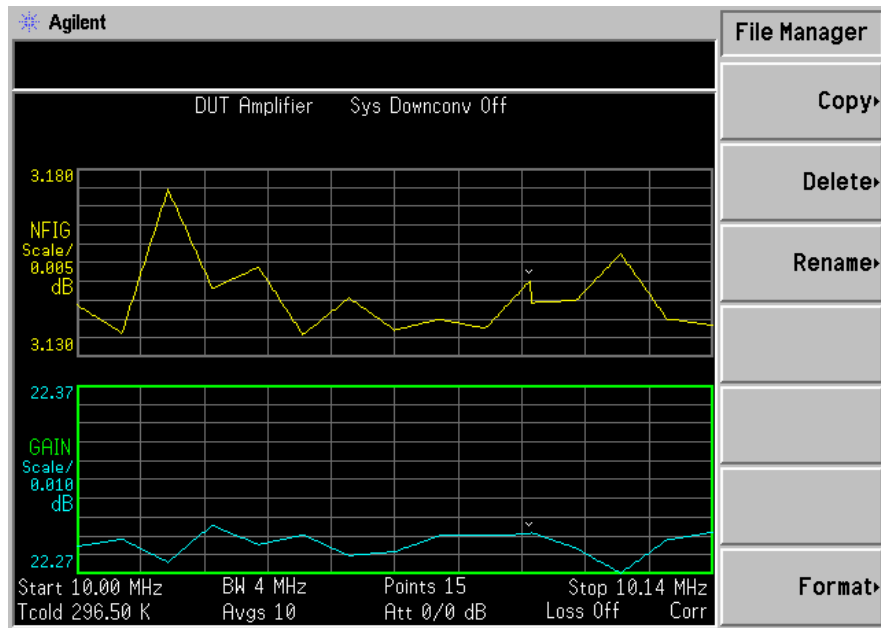

Step 3. Start the format process by pressing **Format**, then **Enter**.

CAUTION

To abort disk format press any key, except **Enter**.

When a disk is formatted all data on the disk is destroyed. A dialog box appears on the NFA display to warn you, allowing you the opportunity to abort formatting.

Step 4. Press **Enter**, a second time to format the disk.

The format process takes approximately three minutes.

You are now ready to save files to the disk.

Saving a File

You can save files (ENR tables, states, traces, limits, frequency lists, loss tables, or screens) to a floppy disk (A:), or the internal drive (C:) of the NFA.

Step 1. To access the Save menu press **File, Save**.

Step 2. Select the type of file you want to save.

For example, if you have limit line table data present and want to save it, press **Limits**.

Step 3. Select the limit line table file you wish to save (**1, 2, 3** or **4**).

For example, to save file 2, press **2**.

Step 4. Enter a filename using the Alpha Editor menu keys. See [“Using the Alpha Editor” on page 46](#).

NOTE

You must select a unique filename and no greater than eight characters. The NFA does not allow you to overwrite an existing file. If you select a file name that already exists, the NFA displays the error message: File already exists.

Step 5. Select the drive you wish to save to by pressing **Tab** →, to move to directory and file list, press **Select**.

NOTE

If the correct drive is not listed in the Path: field, highlight “. . .” at the top of the directory list. This enables you to move up a directory. Press **Select**. To highlight the desired drive, [-A-] or [-C-]) use the arrow keys or the RPG, press **Select** when highlighted.

Step 6. Press **Enter**, to save the file to the drive.

Loading a File

You can load files (ENR tables, states, limits, frequency lists, or loss tables) from a floppy disk (A:\), or the internal drive (C:\).

NOTE Files saved in previous versions of firmware can not be loaded into a NFA with newer firmware.

NOTE Not all the file types you save can be loaded back into the NFA. For example, screen files and trace files. The trace file is in a CSV (comma separated value) format, designed for use with a PC.

- Step 1.** To access the Load menu press **File, Load**.
- Step 2.** Select the type of file you want to load (ENR tables, states, limits, frequency lists, or loss tables).
- Step 3.** Select the drive where your file is located by pressing **Tab** →. Use the RPG to highlight [-C-] or [-A-], then press **Select**.
- Step 4.** Select the file you want to load into the NFA by changing the highlighted file with the up or down arrow keys to highlight the file name.
- Step 5.** Press **Enter** to load the specified file.

Renaming a File

You can rename a file in the [-C-] or [-A-] drive as follows:

- Step 1.** Press **File, File Manager, Rename** to access the Rename menu items.
- Step 2.** Select the type of file you want to rename (ENR tables, states, traces, limits, frequency lists, loss tables, or screens).

For example, if you are renaming an ENR table file, press **ENR**.
- Step 3.** Select the drive where your file is located, by pressing the **Tab** → key, press **Select**. To change drive, use the arrow keys to highlight [-C-] or [-A-], then press **Select**.

- Step 4.** Select the file you want to rename by moving the cursor with the RPG or arrow keys to highlight the file name.
- Step 5.** Press **Tab** → to enter the Alpha Editor menu. File names are limited to eight (8) characters.
- Step 6.** Press **Enter** and your file is now renamed and visible within the directory displayed on your NFA.

Copying a File

This allows you to copy a file to a different location on both the [-C-] and [-A-] drive.

- Step 1.** To access the Copy menu press **File, File Manager, Copy**.
- Step 2.** Put a formatted floppy in the A: drive.
- Step 3.** Select the type of file you want to copy (ENR tables, states, traces, limits, frequency lists, loss tables or screens).

For example, if you are copying a State file, press **State**.
- Step 4.** Select the drive where your file is located, by pressing **Tab** → to highlight the `From:Path:` field. Select the drive, using the RPG or arrow keys to highlight [-C-] or [-A-], then press **Select**.
- Step 5.** Select the file you wish to copy by highlighting the filename using the front-panel knob or arrow keys.
- Step 6.** Press **Tab** → to move to the `To:Path:` field and select the drive where you want to copy the file using the RPG or arrow keys then press **Select**.

NOTE

If the correct drive is not listed in the `Path:` field, highlight `..` at the top of the directory list. This enables you to move up a directory. Press **Select**, to highlight the desired drive, ([-A-] or [-C-]) then press **Select** again.

- Step 7.** Copy the file by pressing **Enter**.

Deleting a File

This allows you to delete a file from the [-C-] or [-A-] drive.

- Step 1.** To access the Delete menu press **File, File Manager, Delete**.
- Step 2.** Select the type of file you want to delete (ENR tables, states, traces, limits, frequency lists, loss tables, or screens).
- Step 3.** Select the drive where the file you wish to delete is located, by pressing **Tab** → then using the RPG or arrow keys to highlight [-C-] or [-A-], then press **Select**.

NOTE

If the correct drive is not listed in the Path: field, highlight ". ." at the top of the directory list. This enables you to move up a directory. Press **Select**, to highlight the desired drive, ([-A-] or [-C-]) then press **Select** again.

- Step 4.** Select the file you want to delete by moving the cursor with the RPG or arrow keys to highlight the file name.
- Step 5.** Press **Enter** and your file is now deleted and is no longer visible in the directory displayed on your NFA.

Working with Tables

The Frequency List, ENR Table, Limit Line Editor, and Loss Compensation Tables use table forms. The following is an overview of how to use the features in these tables.

Table 1-5 Using Tables

To...	Use the...
Move the highlight bar within the table	Tab keys
Bring the highlight bar to the top of the table	Home key
Clear the table of all entries	Clear Table menu key
Delete a single row entry	Delete Row menu key
Add a new entry	Add menu key
Move the highlight bar up one row	Row Up menu key
Move the highlight bar down one row	Row Down menu key
Move the table up a page block	Page Up menu key
Move the table down a page block	Page Down menu key
Enter a value	Numerical key pad
Terminate a value	The unit values presented by the menu keys ^a
Connect Limit Line points	The arrow keys or the RPG

- a. A limit line value is a unitless value and it depends on the result's scale unit used.

Using the Alpha Editor

The Alpha Editor is a menu driven text entry system. You enter the character data with the menu keys. If numeric data is needed also use the numeric keypad. To edit the data use the **Back Space** key. After completing the entry terminate it by pressing the **Enter** key.

The Alpha Editor allows you to:

- name files when saving.
- enter the alphabetical portion of the model ID and the serial number of the noise source in an ENR table.
- create suffix and prefix commands used to set the External LO frequency and power levels.

The LO Commands Alpha Editor have more character options available, see Figure 1-9.

Figure 1-9 Alpha Editor Character Set

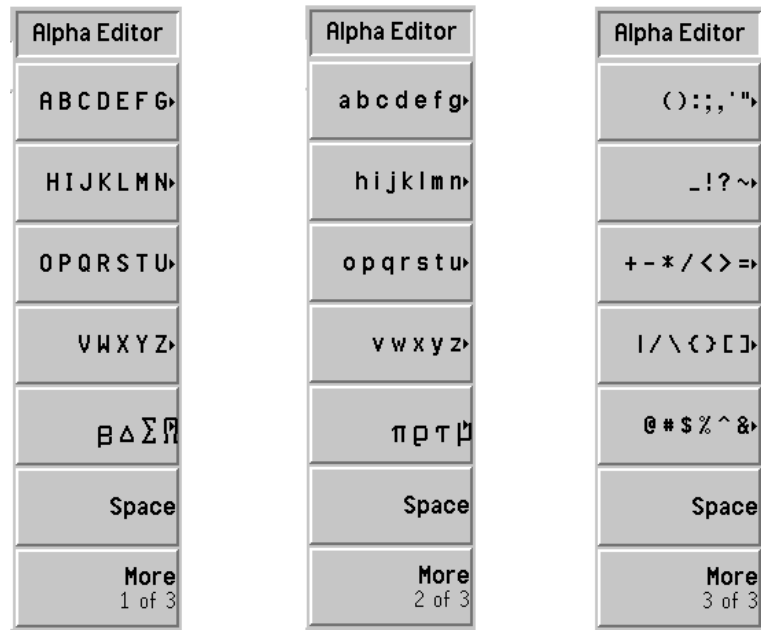

The Alpha Editor is used as follows. In the example, a three character file name, NEW, is created.

- Step 1.** Press the **HIJKLMN** key.
- Step 2.** Press the **N** key.
- Step 3.** Press the **ABCDEFGG** key.
- Step 4.** Press the **E** key.
- Step 5.** Press the **VWXYZ** key.
- Step 6.** Press the **W** key.

Getting Started
Using the Alpha Editor

2 **Making Basic Measurements**

This chapter describes how to make basic noise figure measurements using your NFA and also covers the most common measurement related tasks.

What You will Find in this Chapter

This chapter describes the procedures to set up the NFA and uses a basic example to demonstrate the NFA measuring noise figure and gain of a device which has no frequency conversion.

- Entering Excess Noise Ratio (ENR) Data
- Setting the Measurement Frequencies
- Setting the Bandwidth and Averaging
- Calibrating the Analyzer
- Displaying the Measurement Results
- Example of a Basic Amplifier Measurement

Entering Excess Noise Ratio (ENR) Data

You can enter ENR data for the noise source you are using as a table of values or as a single spot value. The table of values are used for measurements at several frequencies. The single spot value is used for single frequency measurements or it is applied across the whole frequency measurement range.

There are two types of noise source. The first type, for example, Agilent 346B, a normal noise source. These need their ENR data to be entered manually either using the ENR data stored previously on a diskette or by using the keypad. The other type, for example, Agilent N4000A, a Smart Noise Source (SNS), can upload the data automatically or when requested.

Selecting a Common ENR Table

You can use the same, Common, ENR table for calibration and making measurements, or you can use separate, Meas and Cal, ENR tables when a different noise source is used during DUT measurements from that used for calibration.

NOTE

ENR tables can contain up to 81 frequency points.

To use the same ENR table for calibration and measurement, press the **Common Table** menu key to select **Common Table(On)**; see Figure 2-1.

This is the default setting. In this mode the **Cal Table** is not accessible.

Making Basic Measurements
Entering Excess Noise Ratio (ENR) Data

Figure 2-1 Menu Keys showing Common ENR Table On

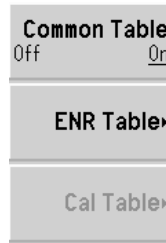

To use different ENR tables for calibration and measurement, press the **Common Table** menu key to select **Common Table(Off)**; see Figure 2-2.

In this mode, the **Cal Table** menu key is accessible. This is the ENR table of the noise source used to calibrate the NFA. The **Meas Table** is used to make measurements. In **Common Table(Off)** mode the **ENR Table** is the **Meas Table** in the **Common Table(On)** mode.

Figure 2-2 Menu Keys showing Common ENR Table Off



NOTE

If you are using an SNS when **Common Table(Off)** is set, you need to set **Auto Load ENR(Off)** and use the **Fill Table From SNS** menu key. See “Loading the SNS ENR data to the Measurement or Calibration Table.” on page 61.

Entering ENR Table Data for Normal Noise Sources

You can enter ENR data in the form of an ENR table in four ways:

- manually by inputting the required frequencies and corresponding ENR values

- loading the ENR data from a diskette, on which the data has been previously stored
- loading the ENR data from the internal memory, where the data has been previously stored
- loading the ENR data over GPIB, see the *Programmer's Reference* for more details

NOTE

Agilent normal noise sources have the ENR values printed on the body of the device. These ENR values are also provided within separate text in the form of a calibration report, and on a diskette which is supplied with every Agilent noise source.

To enter ENR table data manually

NOTE

If the NFA has arrived from the factory, and you are entering ENR data for the first time, the ENR table is empty. You can create this condition with an NFA which has been used previously by pressing **Clear Table**. The typical display is shown in Figure 2-3.

Enter the ENR data manually as follows:

Step 1. Press the **ENR** key, and the **ENR Table** menu key.

An ENR Table appears on the display with the first frequency point in the table highlighted, see Figure 2-3. For details on working with tables, see [“Working with Tables” on page 45](#).

Figure 2-3

An Empty ENR Table

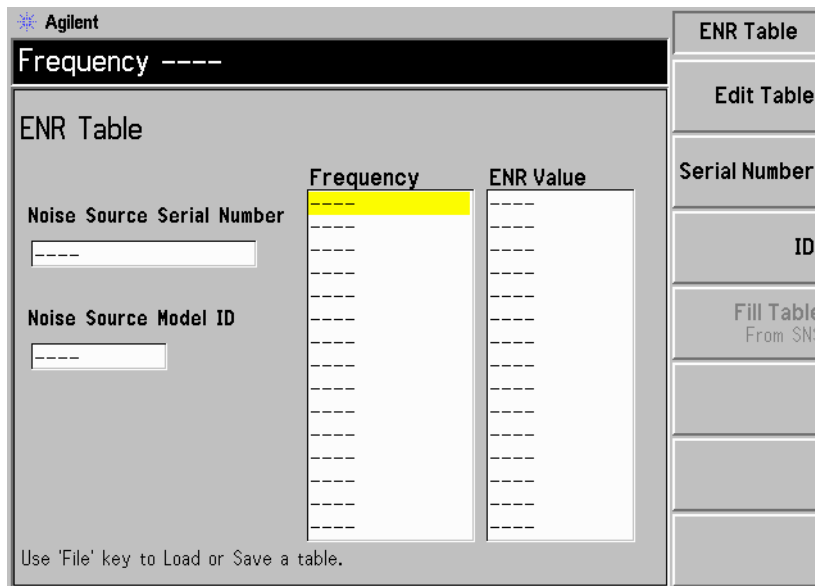

Step 2. Optional Step

Press the **Serial Number** menu key and enter the noise source serial number using the numeric keys and the Alpha Editor.

For details on using the Alpha Editor, see [“Using the Alpha Editor” on page 46.](#)

Step 3. Optional Step

Press the **ID** menu key and enter the noise source model number using the numeric keys and the Alpha Editor.

Step 4. Press the **Edit Table** menu key to enter the noise source ENR values.

The table editing and navigation menu items now appear.

Step 5. Enter the frequency value in the table using the numeric keys. Terminate it using the unit menu keys.

Step 6. Press the **Tab** → key to move the highlight to the ENR Value column and enter the corresponding ENR value of the ENR list.

When terminating the ENR value you can use either **dB**, **K**, **C**, or **F** menu keys. The **K**, **C**, or **F** entry is converted to appear in the table as dB.

Step 7. Press the **Tab** → key to move the highlight to the Frequency column and enter the next frequency value on the ENR list.

Step 8. Repeat steps 5 to 7 until all the frequency and ENR values you need are entered.

Step 9. After completing the ENR table entries, press the **Prev** key or **ENR** key to return to the ENR menu.

Step 10. Optional Step

Once you have completed entering the ENR data, save the ENR table using the **File** key.

For details on saving files, see [“Saving an ENR Table” on page 58](#).

NOTE

ENR table data survives a power cycle and preset (except **Restore Sys Defaults**). You only need to save the ENR data to save you from entering the data again.

Making Basic Measurements
Entering Excess Noise Ratio (ENR) Data

Figure 2-4 A Typical ENR Table after data entry

The screenshot shows the Agilent ENR Table interface. At the top, it displays "ENR Value 15.400 dB". Below this is the "ENR Table" section, which includes a table with two columns: "Frequency" and "ENR Value". The table contains 13 rows of data. The 12th row, corresponding to 12.0000000 GHz, is highlighted in yellow. To the left of the table are input fields for "Noise Source Serial Number" (3318A14197) and "Noise Source Model ID" (346B). To the right of the table is a vertical toolbar with buttons: "Edit Table", "Row Up", "Row Down", "Page Up", "Page Down", "Add", "Delete Row", and "Clear Table". At the bottom of the table area, there is a note: "Use 'File' key to Load or Save a table."

Frequency	ENR Value
10.0000000 MHz	15.330 dB
100.0000000 MHz	15.560 dB
1.000000000 GHz	15.360 dB
2.000000000 GHz	15.120 dB
3.000000000 GHz	14.970 dB
4.000000000 GHz	14.910 dB
5.000000000 GHz	14.850 dB
6.000000000 GHz	14.900 dB
7.000000000 GHz	14.860 dB
8.000000000 GHz	14.890 dB
9.000000000 GHz	15.010 dB
10.00000000 GHz	15.110 dB
11.00000000 GHz	15.260 dB
12.00000000 GHz	15.400 dB
13.00000000 GHz	15.440 dB

NOTE You can insert the frequencies into the ENR Table entry in any order, as the NFA automatically sorts the frequency list into ascending order.

NOTE When results are needed at non-cardinal ENR data points, a linearly interpolated value is automatically used at these points.

To load ENR data from memory

If the noise source you are using has its ENR data supplied or previously stored on a diskette or internal memory, you can load this ENR data into the NFA as follows.

Step 1. If the ENR file is on diskette, insert the diskette into the floppy drive of the NFA.

For more details on loading files, see [“Loading a File” on page 42](#).

Step 2. Press the **File** key.

Step 3. Press the **Load** menu key to access the file system.

Step 4. Press the **ENR** menu key.

Step 5. Press either the **Meas Table** or **Cal Table** menu key.

A list of available files on the [-A-] or [-C-] drive is displayed. Use the arrow keys to access the appropriate file.

Step 6. Press the **Enter** key.

A Loading File Warning: this may take some time prompt appears on the display and disappears when complete. On completion a message, for example, C: xxx.ENR file loaded appears in display status line.

Saving an ENR Table

You can save an ENR table to the NFA's internal memory or to floppy disk as follows:

- Step 1.** Press the **File** key.
- Step 2.** Press the **Save** menu key.
- Step 3.** Press the **ENR** menu key.
- Step 4.** Press either the **Meas Table** or **Cal Table** menu key. Also, if you are using an SNS, an **SNS** menu key is available to select.

The **Alpha Editor** now appears, allowing you to create a name for the file.

- Step 5.** Input the name of the ENR table.

[See "Using the Alpha Editor" on page 46](#) for details on using editor.

- Step 6.** Select using the arrow keys whether you want to save the files to the [-A-] or [-C-] drive.
- Step 7.** Press **Enter** to save the file.

Entering a Spot ENR Value

When making a measurement in fixed frequency mode you can enter a specific spot ENR value corresponding to the fixed frequency. The spot ENR value can also be applied across the whole measurement frequency range.

To enter a Spot ENR value:

- Step 1.** Press the **ENR** key, then the **Spot** menu key.
- Step 2.** Press the **Spot ENR** menu key.
- Step 3.** Enter an ENR value using the numeric keys and terminate it using the unit termination menu keys. The default value is 15.20 dB.

NOTE

If you are using a noise source with a calibrated ENR list and the frequency you want to measure is not a listed ENR value, then you need to interpolate the ENR list to an appropriate value.

To Enable Spot ENR Mode

- Step 1.** Press the **ENR** key, and select the **ENR Mode(Spot)** menu key.
- Step 2.** Press the **Spot** menu key, and select the **Spot Mode(ENR)** menu key.

Entering a Spot T_{hot} Value

When making a manual measurement you can enter a specific spot T_{hot} value. The spot T_{hot} value is applied across the whole measurement frequency range

To enter a Spot T_{hot} value:

- Step 1.** Press the **ENR** key, then the **Spot** menu key.
- Step 2.** Press the **Spot That** menu key.
- Step 3.** Enter a T_{hot} value using the numeric keys and terminate it using the unit termination menu keys. The default value is 9892.80 K.

To Enable Spot That Mode

- Step 1.** Press the **ENR** key, and select the **ENR Mode(Spot)** menu key.
- Step 2.** Press the **Spot** menu key, and select the **Spot Mode(That)** menu key.

Using a Smart Noise Source

NOTE

If there is an SNS connected to the NFA's Smart Noise Source port, the NFA, by default, selects the SNS as its noise source. If an SNS is not connected the NFA uses the normal noise source.

Selecting the Source Preference

If noise sources are connected to both ports you need to select a preference either **Preference(Normal)** or **Preference(SNS)**. The default setting is **Preference(SNS)**.

To select a noise source preference:

- Step 1.** Press the **ENR** key.
- Step 2.** Press the **SNS Setup** menu key.
- Step 3.** Press the **Preference** menu key changing it from the default **Preference(SNS)** to **Preference(Normal)**.

Loading the SNS ENR data to the Common Table.

You can enable the NFA to automatically upload the ENR data to the Common Table. To enable automatic loading on power up or the connection of the SNS to the NFA's Smart Noise Source port, set **Auto Load ENR(On)**. This enables the ENR data to load into the Common Table automatically. If you do not want to automatically upload the ENR data into the Common Table, press **Auto Load ENR(Off)**.

If you have selected **Auto Load ENR(Off)**, you can use the **Fill Table From SNS** menu key to upload the ENR data from the SNS. The **Fill Table From SNS** menu key is found under the **ENR Table** menu key. It is only active when an SNS is connected. This allows you to choose when to upload the ENR data to the ENR Table.

CAUTION

Do not disconnect the noise source from the NFA port while the data is being transferred.

Loading the SNS ENR data to the Measurement or Calibration Table.

NOTE

When an SNS is connected and **Auto Load ENR(On)** enabled, the **Common Table(On)** is set automatically. Hence, the SNS ENR data is loaded into the common ENR table.

You can use the **Fill Table From SNS** menu key to upload the ENR data from the SNS. This allows you to choose between **Meas Table** or **Cal Table**, as the destination for the ENR data.

- Step 1.** Press the **ENR** key.
- Step 2.** Press the **SNS Setup** menu key.
- Step 3.** Press the **Auto Load ENR** menu key setting it to **Auto Load ENR(Off)**.
- Step 4.** Press the **Common Table** menu key setting it to **Common Table(Off)**.
- Step 5.** Press the **Meas Table** or **Cal Table** menu key.
- Step 6.** Press the **Fill Table From SNS** menu key and wait until all the data is uploaded.

CAUTION

Do not disconnect the noise source from the NFA port while the data is being transferred.

Setting the T_{cold} value

When making measurements in different ambient temperature conditions you can change the T_{cold} value.

The default temperature value is set at 296.50K. The T_{cold} menu key is set to **Tcold(Default)** to confirm this default temperature.

There are three methods of changing the T_{cold} value. These are dependant on the type of noise source you are using.

- The first method is applicable when using either type of noise source and allows you to enter a T_{cold} value manually. This method is explained in “Changing the User Tcold value manually” on page 62.
- The second method is applicable when using the SNS noise source and it uploads the value automatically and updates the value after every sweep. This method is explained in “Setting the SNS Tcold value to Update Automatically” on page 63.
- The third method is applicable when using the SNS where you can set the value to be updated as you need. This method is explained in “Setting the SNS User Tcold value” on page 64.

Changing the User T_{cold} value manually

To change the User T_{cold} value:

- Step 1.** Press the **ENR** key.
- Step 2.** Press the **Tcold** menu key.

NOTE

When using an SNS, the **SNS Tcold** menu key must set to **SNS Tcold(Off)** for this feature to work.

- Step 3.** Press the **User Tcold** menu key setting it from the default **User Tcold(Off)** to **User Tcold(On)**.

The **Tcold** menu key, under the ENR menu keys, is now set to **Tcold(User)** to confirm you are using this temperature mode.

Step 4. Press the **User Value** menu key.

Enter a T_{cold} value using the numeric keys and terminate it using the unit termination menu keys.

The unit termination menu keys are in **K** (Kelvin), **C** (Celsius) or **F** (Fahrenheit).

NOTE

The lower limit is 0K and upper limit is 29,650,000K. The default value is 296.5K. The **K** value is always displayed. The **K** values are converted from the entered °C and °F.

Setting the SNS T_{cold} value to Update Automatically

This feature is only available when an SNS is connected to the NFA.

To set the SNS T_{cold} value:

Step 1. Press the **ENR** key.

Step 2. Press the **Tcold** menu key.

Step 3. Press the **SNS Tcold** menu key, if required, setting it to **SNS Tcold(On)**.

The **Tcold** menu key, under the ENR menu keys, is now set to **Tcold(Auto)** to confirm you are using this temperature mode.

Making Basic Measurements
Entering Excess Noise Ratio (ENR) Data

Setting the SNS User T_{cold} value

This feature only works when an SNS is connected to the NFA.

To change the User T_{cold} value:

Step 1. Press the **ENR** key.

Step 2. Press the **Tcold** menu key.

NOTE

When using an SNS, **SNS Tcold** must set to **SNS Tcold(Off)** for this feature to work.

Step 3. Press the **User Tcold** menu key changing it from the default **User Tcold(Off)** to **User Tcold(On)**.

Step 4. Press the **User Tcold From SNS** menu key.

The NFA uploads the Tcold value from the SNS and displays the value in the **User Value** menu key.

The **Tcold** menu key, under the ENR menu keys, is now set to **Tcold(User)** to confirm you are using this temperature mode.

Setting the Measurement Frequencies

Before you set the frequencies you want to measure, you need to select a frequency mode. Three frequency modes are available:

- **Sweep** — the measurement frequencies are obtained from the start and stop (or equivalent center and span) frequencies and the number of measurement points.
- **List** — the measurement frequencies are obtained from the frequency list entries.
- **Fixed** — where the measurement frequency is taken at a single fixed frequency. An example of using this mode is explained in [“Making a Fixed Frequency Measurement” on page 34](#).

Selecting Sweep Frequency Mode

In sweep frequency mode you set the start and stop frequencies (or equivalent center and span frequencies) over which the sweep is made. You also need to set the number of measurement points. These measurement points are equally spaced over the frequency span. The maximum number of points is 401 and the default number of points is 11.

CAUTION

The N8974A and N8975A NFA models have a mechanical switch fitted to allow them to switch between the RF frequency range and the microwave frequency range. If the frequency range you are working in crosses the 3.0 GHz point, the mechanical switch operates. The mechanical switch has a limited number of cycles over which it is reliable.

Switching over the 3.0 GHz switch should be limited where possible.

NOTE

You can press **Full Span** at anytime to return the frequency range to the specific NFA model's full range setting. If you do this after a calibration and the calibration has been made over a narrower frequency range, the calibration is invalid.

Making Basic Measurements

Setting the Measurement Frequencies

To make a measurement over a specific frequency range:

- Step 1.** Press the **Frequency/Points** key.
- Step 2.** Press the **Freq Mode** menu key to select frequency mode to **Freq Mode(Sweep)**.
- Step 3.** Set the frequency range by either entering the **Start Freq** and **Stop Freq** frequencies, or the **Center Freq** and the **Freq Span**.

Use the numeric key pad to enter the value you want. Use the unit menu keys to terminate the number.

- Step 4.** Press the **More 1 of 2, Points** menu keys.
- Step 5.** Enter the number of measurement points using the numeric keys. Press the **Enter** key to terminate.

NOTE

The greater number of frequency points selected, the greater the time required by the measurement.

Selecting List Frequency Mode

List frequency mode allows you to enter the frequency points where measurements are made. This allows you to specify measurement points, for example, in areas of interest that would have less coverage than in the sweep mode to allow unevenly spaced measurement points.

Frequency lists are limited to 401 entries.

To set the NFA to use the data in the frequency list table:

Step 1. Press the **Frequency/Points, Freq Mode** menu keys.

Step 2. Press the **Fixed** menu key to set the frequency mode to **Freq Mode(List)**.

You can create a frequency list in the following ways:

- Manually, by specifying each individual point.
- From the swept points, by specifying the measurement frequency range and setting the NFA to generate equally spaced points within that range, using the **Fill** menu key.
- Loading a list from the internal memory or diskette, where the data has been previously stored.
- Loading a list over GPIB; see the *Programmer's Reference* if you want to use this method.

To Create a Frequency List Manually

Step 1. Press the **Frequency/Points** key and press the **More 1 of 2** menu key.

Step 2. Press the **Freq List** menu key.

A Frequency List table appears on the display.

Figure 2-5 An Empty Frequency List

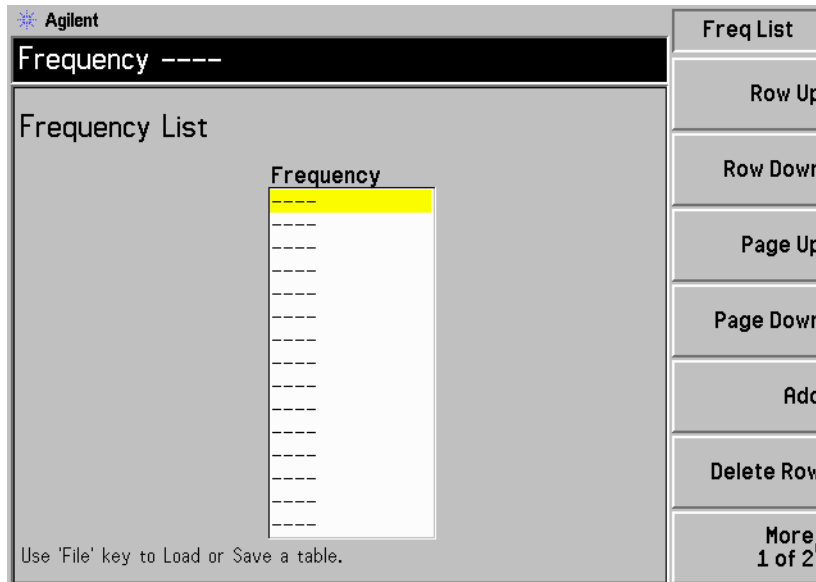

NOTE You do not need to enter the frequency values in ascending order, as the NFA continually sorts the values into ascending order.

Step 3. Press the **More 1 of 2**, **Clear Table** menu keys.

You are prompted to press this key again, this feature ensures you do not accidentally clear a valid Frequency list table. Press the **Clear Table** menu key again. Clearing the table allows you to start entering points knowing there are no previous entries remaining.

The first frequency point in the table is highlighted.

Step 4. Enter the frequency value you want using the numeric keys. Terminate it using the unit menu keys which are presented to you.

Step 5. Press the **Tab** → key or **Row Down** menu key.

The next frequency point on the table is highlighted.

Enter the next frequency value by using the numeric key pad and the unit termination keys.

Step 6. Repeat step 5 until your list is complete.

Step 7. Save the Frequency List to the NFA internal memory or to a diskette if required using the **File** key. See “Saving a File” on page 41 for an explanation of this.

NOTE

If you do not save the frequency list, you may lose the data. This depends on your Power On/Preset condition. See “Defining the Power-On/Preset Conditions” on page 232 for an explanation of these.

Creating a Frequency List from Swept Points

You can create a frequency list from the swept mode frequency and points data.

To set the NFA to use the swept mode data:

Step 1. Press the **Frequency/Points, More 1 of 2** menu keys.

Step 2. Press the **Freq List, More 1 of 2** menu keys.

Step 3. Pressing the **Fill** menu key.

This clears the current frequency list and fills the list with the frequencies generated by the sweep frequency mode.

Selecting Fixed Frequency Mode

The fixed frequency mode is used when you want to make a measurement at a single frequency. [See “Making a Fixed Frequency Measurement” on page 34](#) for more details of this mode.

NOTE

If you have not entered the noise source ENR data which you intend using for the fixed frequency mode measurement, you need to specify a spot ENR value and set the ENR mode to spot.

To set a fixed frequency:

- Step 1.** Press the **Frequency/Points, Freq Mode** menu keys.
- Step 2.** Press the **Fixed** menu key to set the frequency mode to **Freq Mode(Fixed)**.

The Fixed Freq menu key is now available.

- Step 3.** Press the Fixed Freq menu key and enter the frequency value using the numeric keys and the unit termination menu keys.

Setting the Bandwidth and Averaging

Effect of Bandwidth and Averaging on Speed, Jitter, and Measurement Accuracy

Jitter is a natural occurrence when measuring noise. To reduce jitter you must increase the number of averages or increase the measurement bandwidth.

If the bandwidth is reduced, you need to increase the number of averages to maintain the same uncertainty.

The greater the number of averages chosen, the more accurate the measurement, as this reduces jitter on the measurement. However, this has to be considered against how long it takes to complete the measurement.

Therefore, there is a trade off between speed and the accuracy/uncertainty of a measurement.

NOTE

On the N8972A model, the average mode menu key is unavailable. Point mode averaging is used on this model.

Selecting a Bandwidth Value

The default bandwidth is 4MHz. To change the bandwidth value:

Step 1. Press the **Averaging/Bandwidth** key.

The current bandwidth is shown on the **Bandwidth** menu key.

Step 2. Press the **Bandwidth** menu key and select the bandwidth you want from the list of available options.

NOTE

On the N8972A model, the bandwidth menu key is unavailable. The bandwidth is fixed at 4MHz.

Setting Averaging

Increased averaging reduces jitter and provides more accurate measurement results. However, the measurement speed is sacrificed. The maximum number of averages allowed is 999. The default value is 1 and this equivalent to setting averaging to off.

Enabling averaging

Averaging can be enabled by setting the **Averaging(On)**. To disable averaging set **Averaging(Off)**

Setting the Number of Averages

To set the number of averages you want:

- Step 1.** Press the **Averaging/Bandwidth** key, and then the **Averages** menu key.
- Step 2.** Enter the numeric value you want using the numeric key pad. Terminate it with the **Enter** key.

Selecting the Averaging Mode

Averaging Mode can be set to **Average Mode(Point)** or **Average Mode(Sweep)**.

The difference between the averaging modes is:

- In Point mode, the selected number of averages are measured at each point before moving to the next measurement point in the sweep. The measurement is complete after one sweep. The measurement restarts if **Sweep(Cont)** mode is selected.
- In Sweep mode, a single value is measured at each point in the sweep. The result at each point is built up by averaging the results from multiple sweeps until the selected number of averages have been measured at each point. The average counter is incremented at the end of each sweep. If **Sweep(Sing)** mode is selected the measurement is complete. If **Sweep(Cont)** mode is selected the measurement continues, using exponential averaging at each point.

Point averaging provides the fastest overall measurement time, as only one sweep is required to obtain the averages at each measurement point.

Sweep averaging takes longer overall, as multiple sweeps are required to obtain the averages at all frequencies. However, initial results are obtained quickly at all frequencies.

Calibrating the Analyzer

To compensate for the noise contribution of the NFA, the associated cabling, and so forth in the measurement path, a calibration is necessary. The calibration measures the NFA's noise contribution with no DUT (device under test) in place. This correction is often referred to as the second stage calibration. The correction is then applied to the measurement with the DUT in place.

To perform calibration you need to enter the ENR values and set up the frequency range, number of measurement points, the bandwidth, the averaging, and measurement mode to be used during the measurement.

If you alter the frequency range after you have calibrated the NFA, it changes NFA's status to uncorrected or interpolated corrected states. You need to recalibrate before you make another measurement to obtain as accurate a measurement result as possible.

Corrected measurements

You can make corrected measurements only at frequencies which are covered by the current calibration. Attempting to make corrected measurements at frequencies less than the lowest calibration frequency or greater than the highest calibration frequency generates an error and invalidates the calibration.

To proceed you must either:

- perform a calibration over the desired measurement frequency range,
- perform uncorrected measurements,
- change the measurement frequency to that covered by the existing calibration.

When to perform calibration

You must calibrate the NFA whenever:

- you power cycle the NFA
- you Preset the NFA
- you select a measurement frequency or frequency range outside the currently calibrated range

- you change the fixed IF frequency in certain modes
- you change frequency mode
- you change measurement mode
- there is a large temperature variation since the last calibration
- the input signal level can no longer be measured using one of the calibrated input attenuator ranges
- when an invalid result is detected and the condition is indicated by a “xx”. See [“Indicating an Invalid Result” on page 102](#) for an explanation of these condition.

Interpolated results

You obtain interpolated results from the NFA whenever you change certain measurement parameters, for example, the number of points.

Calibration indicator

Whenever anything within the NFA changes to invalidate the current calibration, the Corr field at the bottom right-hand corner of the display switches to Uncorr. Figure 2-6 shows this indicator.

Figure 2-6

Corrected/Uncorrected indicator

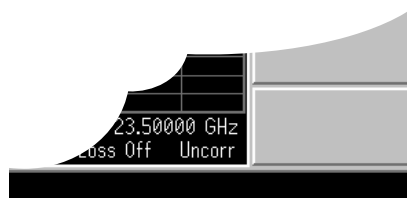

Corrected/Uncorrected indicator

Interpolated calibration

Whenever anything within the NFA changes to force the current calibration to interpolate the measurement results, the white Corr field at the bottom right-hand corner of the display switches to a yellow Corr.

For Agilent 8970B users

All the NFA models have more RF ranges than the Agilent 8970B and unlike the Agilent 8970B, all of these ranges can be calibrated using a 15dB ENR noise source without the need for external amplification.

To perform a calibration

- Step 1.** Verify that the correct ENR table is loaded in the NFA, or input the ENR values of the noise source into the NFA.

[See “Entering Excess Noise Ratio \(ENR\) Data” on page 51](#) for more details.

- Step 2.** Configure the measurement parameters (frequency range, number of points, bandwidth, averages, and measurement mode) you want to use for the measurement.
- Step 3.** Connect the noise source output directly to the NFA input.

NOTE

If you are following this procedure using an N8974A or an N8975A models care needs to be taken when connecting the precision 3.5 mm connector by applying the correct torque. For an explanation of the connectors and guidance on the correct torque values, see the *Performance Verification and Calibration Guide*.

Figure 2-7

NFA Calibration with Normal Noise Source

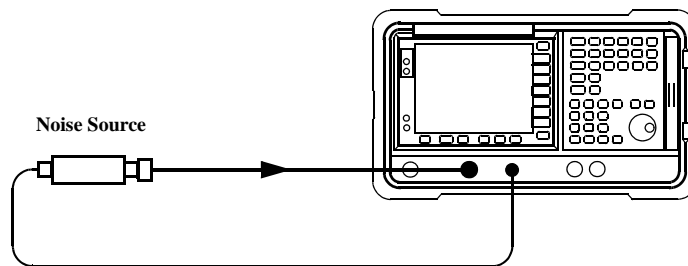

NOTE

You may need to use connector adaptors to connect the noise source output to the NFA input during calibration. The connectors you use need to be included in the measurement. If you remove the connectors from the measurement you need to apply Loss Compensation to compensate for any loss caused by the connectors removal. See “Using Loss Compensation” on page 119 for an explanation of this.

Step 4. If required select an input attenuator range by pressing the **Corr** key and the **Input Cal** menu key to set the minimum and maximum input attenuation.

[See “Selecting the RF Input Attenuation Range” on page 78](#) for more details on input attenuation.

Step 5. Press the **Calibrate** key twice to initiate the calibration.

The first time you press the key you are prompted to press it again. This two-stroke key press feature prevents you from accidentally pressing **Calibrate** and erasing the calibration data.

The NFA performs the calibration, displaying a percentage counter while this is happening.

When the calibration is finished the calibration indicator changes from a white **Uncorr** display to a white **Corr** display. Also the **Corrected** menu key is now available to you. This allows you to make corrected or uncorrected measurements by switch between **Corrected(On)** and **Corrected(Off)** respectively.

NOTE

When performing a calibration only noise figure and effective temperature result types are calculated by the NFA. If you wish to see the results during a calibration you need to select either of these two result types to display them.

Selecting the Input Attenuation Range

Selecting the RF Input Attenuation Range

When working in the RF frequency range of 10 MHz to 3.0 GHz, the NFA has a default input attenuation range for calibration of 0dB to 20dB. In the default mode the calibration takes 5 sweeps as 5 attenuator ranges need to be calibrated. The greater the attenuator range selected, the greater the number of calibration sweeps there are, hence, the longer the calibration routine.

When measuring a high-gain device you may need to increase the input attenuation. If you do not know the gain of the DUT, you can perform calibration using the default range, note what error codes are presented and then calibrate again using increased attenuation value. The attenuation value is indicated on the display as shown in Figure 2-8 and Figure 2-9. If the NFA continues to display error codes, there is a need to add external attenuator pads and correct for this attenuation using the Loss Compensation feature. For an explanation of how to use the feature, see [“Using Loss Compensation” on page 119](#).

If an error message occurs while calibrating, you need to recalibrate. For a complete list of error codes see [Chapter 7 “Troubleshooting”](#).

To select the RF input attenuation:

- Step 1.** Press the **Corr** (Corrected) key.
- Step 2.** Press the **Input Cal** menu key and select the attenuation range you want
- Step 3.** Set the attenuator range using the **Min RF Atten** and **Max RF Atten** menu keys, and select the attenuation values you want from the list.

Figure 2-8 N8972A and N8973A Attenuator Indicators

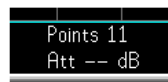

Invalid Indicator

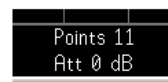

Valid Indicator

Figure 2-9 N8974A and N8975A Attenuator Indicators

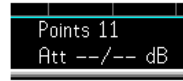

Invalid Indicators

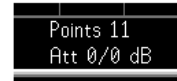

Valid Indicators

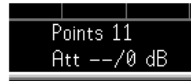

Invalid RF Indicator and Valid Microwave Indicator

Selecting Microwave Input Attenuation Range

The N8974A and N8975A models have a microwave frequency range. When working in the microwave frequency range of 3.0 GHz to 26.5 GHz, the NFA has a default input attenuation for calibration of 0 dB. Unlike the RF attenuators, the microwave attenuators cannot autorange. Therefore there is a risk of overdriving the instrument. In most cases 0 dB attenuation is adequate. A guide to the input powers that each range can handle can be seen in Table 2-1.

Table 2-1 Power Detection and Ranging

Attenuation	Maximum Input Power	DUT Parameters
0 dB	-30 dBm	Combined NF and Gain of DUT ≤ 25 dB over full bandwidth
15 dB	-20 dBm	Combined NF and Gain of DUT > 25 dB and ≤ 35 dB over full bandwidth
30 dB	-10 dBm	Combined NF and Gain of DUT > 35 dB and < 45 dB over full bandwidth

Making Basic Measurements

Calibrating the Analyzer

To select the microwave input attenuation:

- Step 1.** Press the **Corr** (Corrected) key.
- Step 2.** Press the **Input Cal** menu key and select the attenuation range you want
- Step 3.** Set the attenuator range using the **Min mW Atten** and **Max mW Atten** menu keys, and select the attenuation values you want from the list.

Setting the Microwave Input Attenuation after a Calibration

The microwave attenuators cannot autorange. Hence, when making a microwave measurement you must manually set the microwave input attenuation to avoid overdriving the NFA. To set the microwave input attenuation:

- Step 1.** Press the **Sweep** key.
- Step 2.** Press the **Manual Meas, More 1 of 2** menu key.
- Step 3.** Press the **Fixed mW Att** menu key and select the attenuation range you want.
- Step 4.** Press the **More 2 of 2** menu key.
- Step 5.** Press the **RF/mW Atten** menu key to enable **RF/mW Atten(Fixed)**.

NOTE

If you want to set the RF input attenuation, “Setting the Microwave Input Attenuation after a Calibration” procedure can be applied to RF input attenuation. The procedure is similar except you need to substitute **Fixed RF Att** in **Step 3**.

Displaying the Measurement Results

The NFA features a 17 cm color display and a comprehensive set of display features to allow you to analyze the measurement results in detail, or quickly obtain pass/fail indication.

The following display format features are available:

- Graph, Table or Meter mode display
- Single or dual-graph display allowing any two available result types to be displayed simultaneously
- Zoom to display only one result graph on the display
- Combine option to display two result types on the same graph
- Markers for searching the trace
- Display an active trace, a memory trace, or both
- Save the current active trace data to memory
- Switch the graticule on or off
- Switch display annotation on or off

NOTE

If the NFA's display has been previously disabled in Remote mode, you need to press the **System (LOCAL)** key to activate the display.

Selecting the Display Format

You can display the measurement results in either:

- Graph format
- Table format
- Meter format

The default display provides a display of noise figure and gain on the dual-graph display. The upper graph is noise figure and the lower graph is gain.

Making Basic Measurements

Displaying the Measurement Results

In all formats you can choose two result parameters you want to display.

To set the display format:

- Step 1.** Press the **Format** key.
- Step 2.** Press the **Format** menu key and select the **Graph**, **Table** or **Meter** menu key to select the display mode you want. See Figure 2-10.

Figure 2-10 **Format modes**

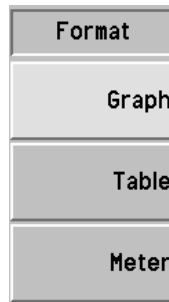

Navigating Around the Display

Active Graph

The active graph is highlighted by a green border. Noise Figure is the active graph by default.

NOTE

When in table or meter format the active measurement parameter title has a green border around it.

Figure 2-11

Dual-graph display

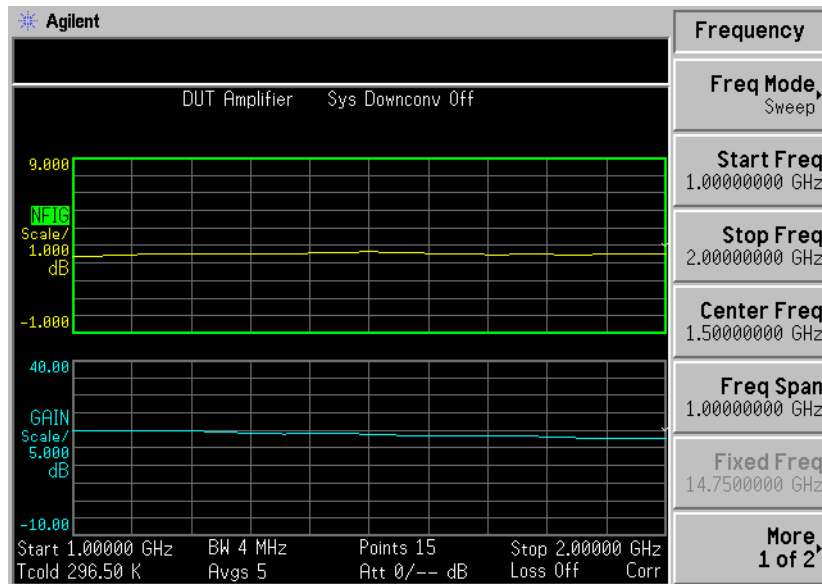

Changing the Active Graph

To change the active graph, press the  key below the display. This key allows you to set the upper or lower graph as the active graph.

NOTE

When in table or meter format the  key changes the active parameter.

Viewing the Full Screen

You can fill the entire display and remove the menu keys, the active function area annotation, and the display status line annotation from the display. Press the **Full Screen** key to view the full screen. Pressing the **Full Screen** key again returns it to the previous display. All other key presses are ignored except: **Zoom**, **Next Window**, **Save Trace**, **Help**, **Preset**, **Print**, **Power Standby**, and the Viewing Angle keys.

NOTE

The **Full Screen** key also functions in table or meter format.

Selecting Result Types to Display

You can choose to display any pair of measurement results in all of the display format modes.

NOTE You cannot display the same result type in both graphs. If you attempt this, an error message Each result type selected must differ from all others is displayed in the status line.

The measurement result types are as follows, with their units in parenthesis:

- Noise Figure (dB or linear)
- Gain (dB or linear)
- Y Factor (dB or linear)
- Teffective (Kelvin, K; Celsius, C; Fahrenheit, F)
- Phot (dB or linear)
- Pcold (dB or linear)

To specify which measurement results are displayed

Step 1. Select which measurement result is active using the  key.

The active measurement is highlighted by a green border.

Step 2. Press the **Result** key and select the result type that you want to display.

Step 3. Press the  key to make the other measurement result active.

Step 4. Press the **Result** key and select the result type you want to display.

NOTE When you press the **Scale** key, the active measurement result's scale menu keys are shown.

Graphical Features

Viewing a single graph



While in graph format mode, you can press the  key located below the display and the active graph fills the display as a single graph, as shown in Figure 2-12. Pressing the key again returns the display to dual-graph.

Figure 2-12 **Displaying a single graph**

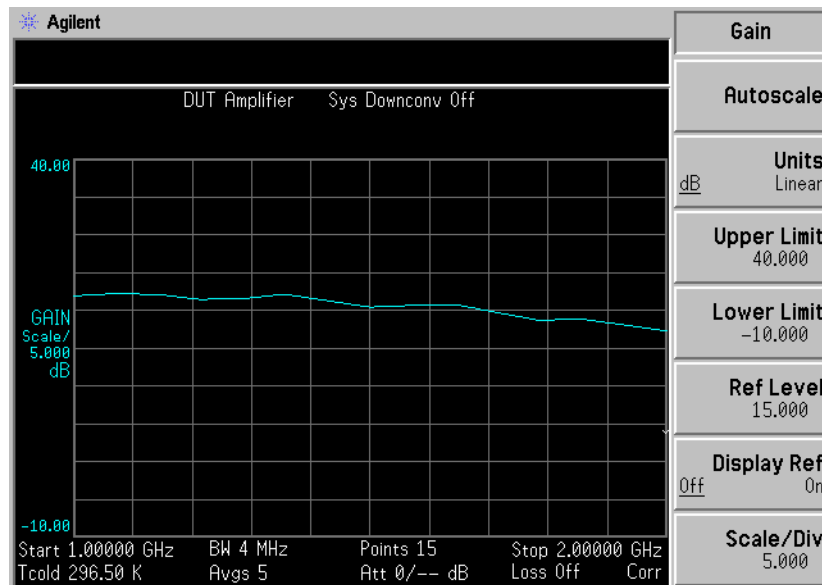

NOTE

When in single graph mode, pressing the  key displays the other single graph.

Making Basic Measurements

Displaying the Measurement Results

Combining two graphs on the same graph

You can combine the upper and lower graphs from a dual-graph display into a single combined display. The default setting is **Combined(Off)** and the graphs are not combined.

NOTE When combining two graphs the Y-scale result limits are not re-scaled and both graphs have their own Y-scale result limits.

To combine the two graphs:

- Step 1.** Press the **Format** key and ensure **Format(Graph)** is selected.
- Step 2.** Press the **Combined(On)** menu key to combine the two currently displayed graphs on the same graph.

Figure 2-13 Typical display with two traces combined on the same graph

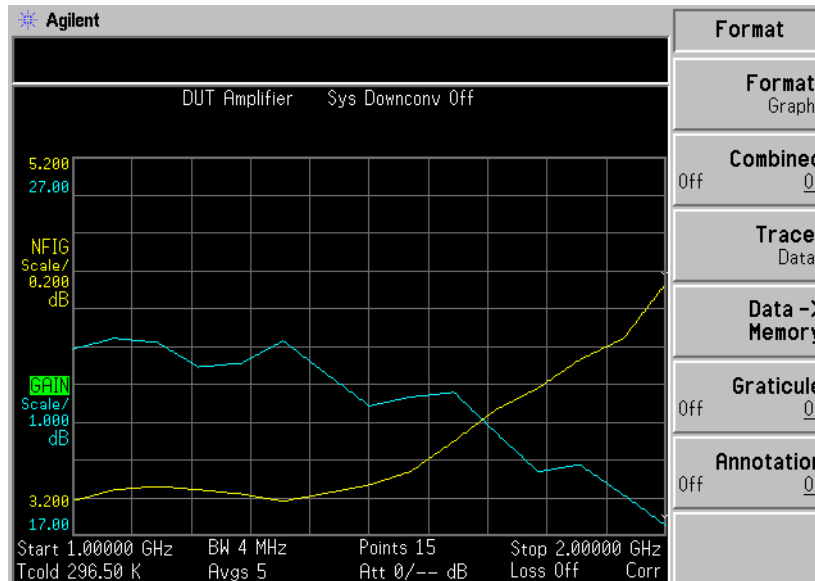

Displaying the Current Data Trace and the Recalled Memory Trace

When a trace finishes its first complete sweep, the **Data -> Memory** menu key becomes active.

To save a trace to memory, press the **Data -> Memory** menu key. After pressing the **Data -> Memory** menu key, the **Trace** menu key becomes active.

To view the saved trace, press the **Trace** menu key, followed by the **Memory** menu key. The memory trace is presented in the display.

To view both the saved trace and the current active trace, press the **Trace** menu key, followed by the **Data & Memory** menu key.

To view the current data trace only, press the **Trace** menu key, followed by the **Data** menu key. This is the default setting.

NOTE

Pressing **Autoscale** does not re-scale a memory trace.

Making Basic Measurements

Displaying the Measurement Results

Turning the Graticule On and Off

When **Graticule(On)** is set, the graticules are displayed on the screen. This is the default setting. When **Graticule(Off)** is set the graticules are not displayed on the screen.

To turn the graticule on or off:

- Step 1.** Press the **Format** key.
- Step 2.** Press the Graticule menu key to select the Graticule(Off) or Graticule(On) as required.

Figure 2-14 Typical Graph with Graticule Switched Off

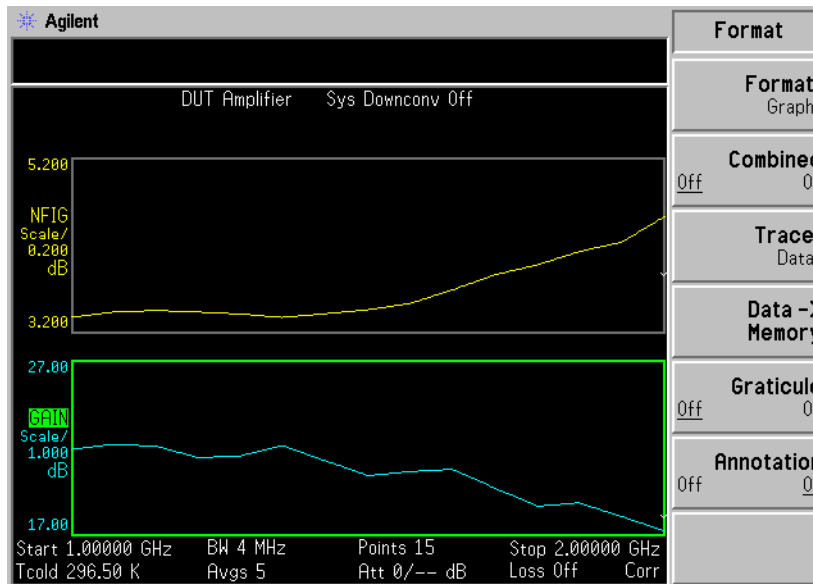

Turning the Display Annotation On or Off

When **Annotation(On)** is set, the annotation is displayed on the screen. This is the default setting. When **Annotation(Off)** is set the annotation is not displayed on the screen.

To turn the annotation on or off:

- Step 1.** Press the **Format** key.
- Step 2.** Press the **Annotation** menu key to select **Annotation(Off)** or **Annotation(On)** as required.

Figure 2-15 Typical Graph with Annotation Switched Off

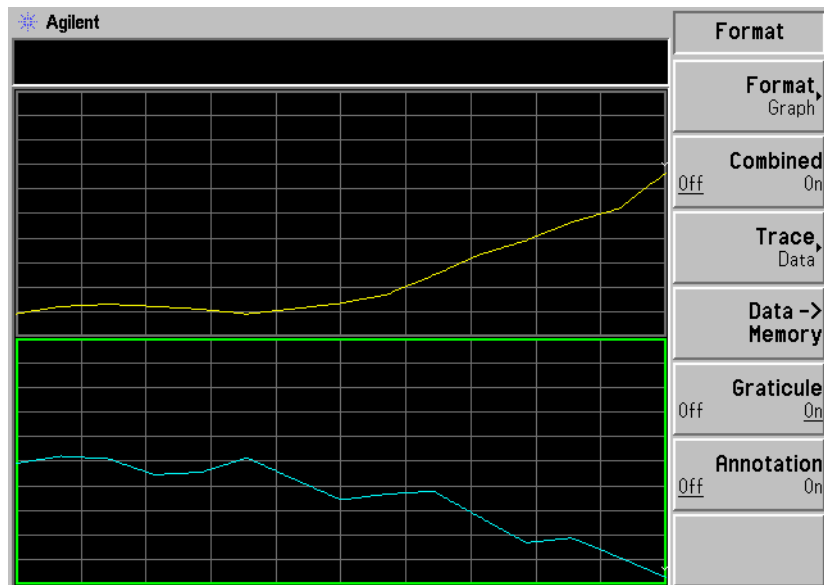

NOTE When **Annotation(Off)** is selected and limit lines are set to **Test(On)** the limit line failure indicator is disabled.

Setting the Scaling

You can set the result's scale parameters in the active graph. To set the scale, press the **Scale** key.

NOTE To change the active graph, press the **Result** key and select another measurement parameter's menu key. Press the **Scale** key to set the scale of the measurement parameter.

Figure 2-16 Typical Noise Figure Displayed on a Graph

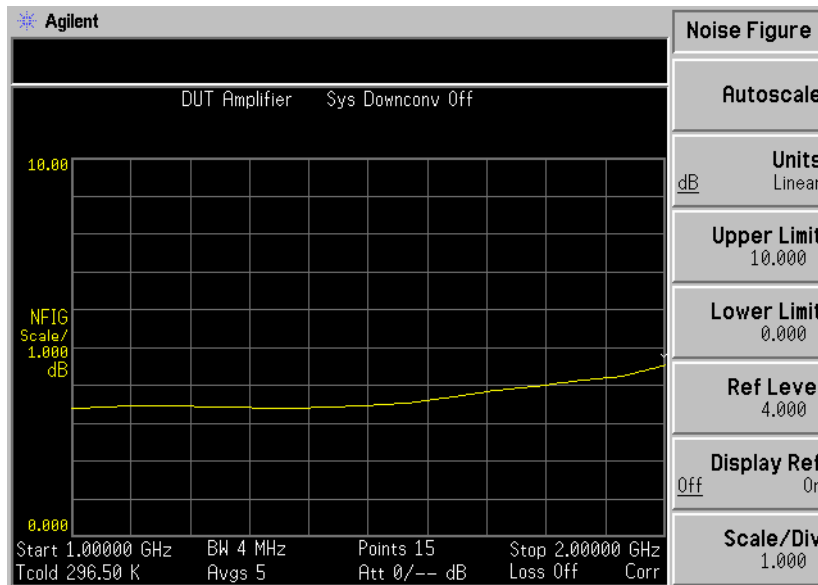

You can set the scale for the measurement parameter or press the **Autoscale** menu key. Pressing **Autoscale** selects the optimum values for **Upper Limit**, **Lower Limit**, and **Scale/Div**.

NOTE If limit lines are set to **Display(On)**, and **Autoscale** is pressed or the scale is changed, the limit lines may no longer appear in the display.

NOTE If a memory trace is set to display, and **Autoscale** is pressed or the scale is changed, the memory trace may no longer appear in the display.

Setting Noise Figure Scale

NOTE The following procedure can also be applied to other result types

To make Noise Figure the active screen and set up the noise figure parameters use the following procedure.

- Step 1.** Press the **Result** key.
- Step 2.** Press the **Noise Figure** menu key.
- Step 3.** Press the **Scale** key.
- Step 4.** Press the **Units** menu key and select, either logarithmic ratio **Units(dB)** or linear ratio **Units(Linear)**.
- Step 5.** Press the **Upper Limit** menu key. Change the upper limit value using the RPG or the numeric keys. Values are entered using the numeric keys, and terminated using the **Enter** key if the units are dB. If your units are linear, terminate them using the engineering multiplier menu keys presented.
- Step 6.** Press the **Lower Limit** menu key. Change the lower limit value using the RPG or the numeric keys. Values are entered using the numeric keys, and terminated using the **Enter** key if the units are dB. If your units are linear terminate them using the engineering multiplier menu keys presented.

NOTE The upper limit, lower limit, and scale per division values are coupled, therefore changing one of these may affect the others.

Making Basic Measurements
Displaying the Measurement Results

- Step 7.** Press the **Scale/Div** menu key. Change the scale per division value using the RPG or the numeric keys. Values are entered using the numeric keys, and terminated using the **Enter** key if the units are dB. If your units are linear terminate them using the engineering multiplier menu keys presented.

Setting the Reference Level

NOTE The reference level minimum and maximum limits are restricted to the values of the upper and lower scale settings.

NOTE The reference level is only visible when the **Display Ref(On)** is enabled.

- Step 1.** Press the **Display Ref** menu key if you want the reference level displayed in the active graph. The default setting is **Display Ref(Off)**. Set the **Display Ref(On)** to switch the reference level on.
- Step 2.** Press the **Ref Level** menu key. Change the reference level value using the RPG or the numeric keys. Values that are entered using the numeric keys are terminated using the **Enter** key.

Working with Markers

NOTE

The marker functions only apply when you are working in graph format.

Marker functions measure the frequency and measurement result by placing a diamond-shaped marker at a point on the trace. The measurement result displayed depends on the result type selected.

You can compare results by placing markers on a previously saved (memory) trace and the current (data) trace and measuring the difference.

The NFA has four markers, **Marker(1)**, **Marker(2)**, **Marker(3)**, and **Marker(4)**. The markers are coupled to both the lower graph trace and upper graph trace.

Each marker can be enabled as a normal, delta, or band pair marker. The active marker's frequency is displayed in the active function area. The enabled marker's results are displayed in the annotation above the upper graph where the measurement mode status is displayed when all the markers are off.

Selecting Markers

To select a marker:

- Step 1.** Press the **Marker** key.
- Step 2.** Press the Marker menu key to select the marker of interest.

The active marker is identified by being underlined in the **Marker** menu key label. See Figure 2-17.

Figure 2-17

The Active Marker is Underlined



- Step 3.** Press the **State** menu key and press the **Normal** menu key to highlight it.

Figure 2-18

A Normal State Marker

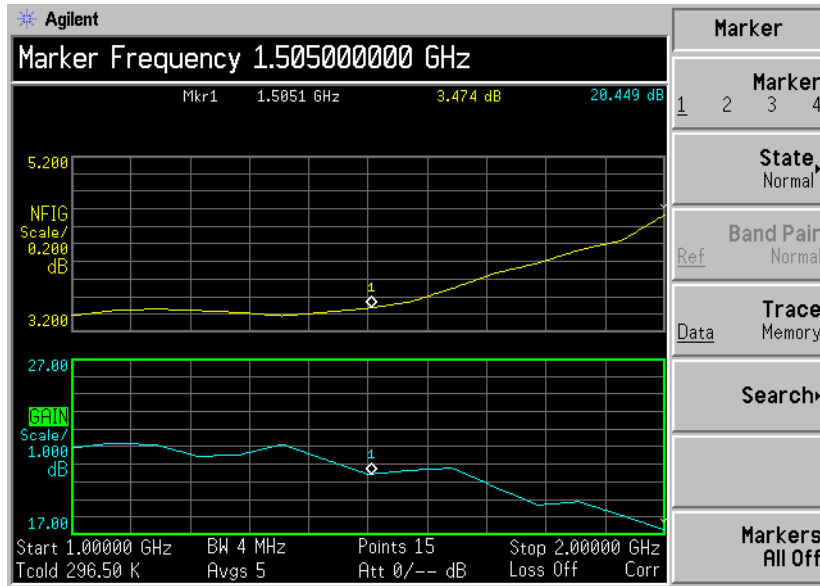

A single coupled pair of markers are now placed on both traces. Turn the RPG to place the markers at the point on the trace you want to measure or use the numeric keys to enter the frequency of interest. The marker frequency and measurement parameter are annotated above the graph. Its frequency value is displayed in the active function area.

To turn an active marker off

To turn an active marker off, press the **State** menu key and press the **Off** menu key. This also removes the marker annotation above the graph and the marker frequency from active function area.

To change the active marker

The default active marker setting is **Marker(1)**. To change the active marker, press the **Marker** menu key. This moves the active marker from **Marker(1)** to **Marker(2)**. Press it again and it moves the active marker from **Marker(2)** to **Marker(3)**. This process is repeated until it returns to the **Marker(1)**.

Figure 2-19 Four Normal State Markers

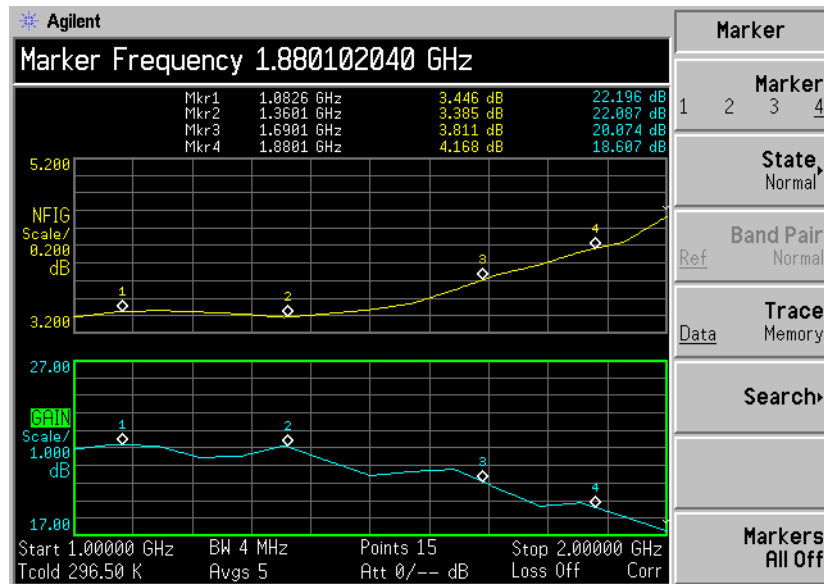

To Switch all the Markers Off

To switch all the markers off press **Markers All Off**. This turns off all the markers and associated annotation.

Changing the Marker States

To use Delta Markers

The **State(Delta)** menu key places a reference marker at the current position of the active marker. The delta markers enable you to measure the difference between the reference marker and the delta marker position on the trace. Turn the RPG to place the delta marker to the point on the trace you want to measure. The position of the reference marker remains fixed. The delta marker has its frequency and measurement result value differences annotated relative to the reference marker above the upper graph. Its actual frequency value is displayed in the active function area. See Figure 2-20.

Figure 2-20 The Delta Marker State enabled

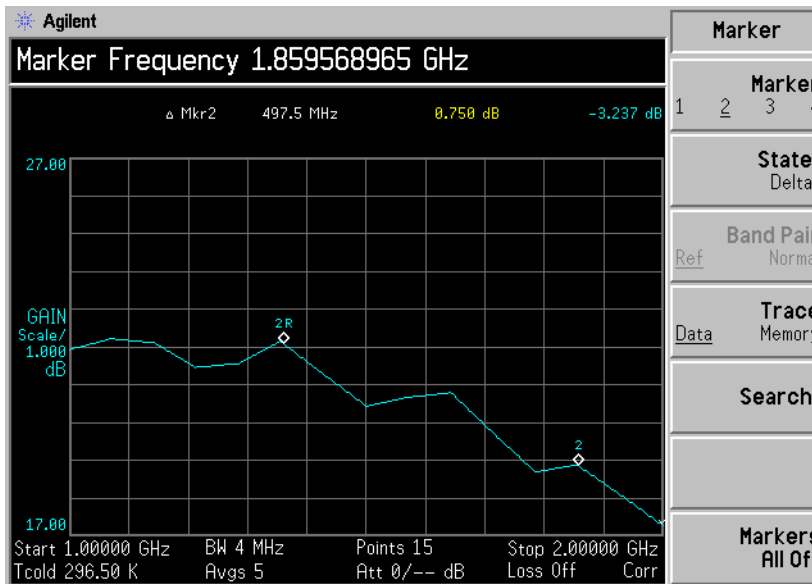

To activate a Delta marker:

- Step 1.** Press the **Marker** key.
- Step 2.** Press the **Marker** menu key to select the marker of interest.
- Step 3.** Press the **State** menu key and press the **Delta** menu key to highlight it. Use the RPG to move the Delta marker from the reference. The annotation displays the difference.

To use Band Pair Markers

The **State(Band Pair)** menu key places two markers allowing you to choose to move either the normal marker or the reference marker. This feature is similar to the **State(Delta)** except you can choose to move either marker. The position of the reference marker remains fixed until **Band Pair(Normal)** menu key is pressed and the active marker becomes the fixed marker. This can be altered by pressing the **Band Pair(Ref)** menu key to enable the reference marker as the active marker. The active marker has its frequency and measurement result value differences annotated above the graph. Its actual frequency value is displayed in the active function area. See Figure 2-21.

Figure 2-21 Band Pair with Reference Marker Enabled

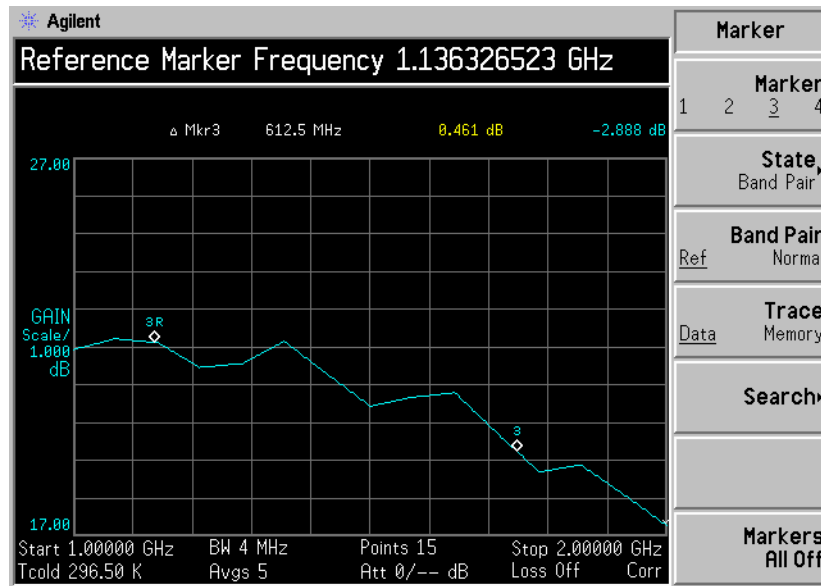

To activate the Band Pair markers:

- Step 1.** Press the **Marker** key.
- Step 2.** Press the **Marker** menu key to select the marker of interest.
- Step 3.** Press the **State** menu key and press the **State(Band Pair)** menu key to highlight it.

The **Band Pair(Ref)** and **Band Pair(Normal)** menu keys in the Band Pair menu key is no longer disabled.

- Step 4.** Use the RPG to move the active marker from the reference. The annotation displays the difference between the reference and the normal markers position.
- Step 5.** Pressing the **Band Pair** menu key sets the **Band Pair(Normal)** as the fixed marker allowing you to move the reference marker. Pressing the **Band Pair** menu key again sets the **Band Pair(Ref)** as the fixed marker allowing you to move the normal marker.

Making Basic Measurements
Displaying the Measurement Results

Figure 2-22 Band Pair with Normal Marker Enabled

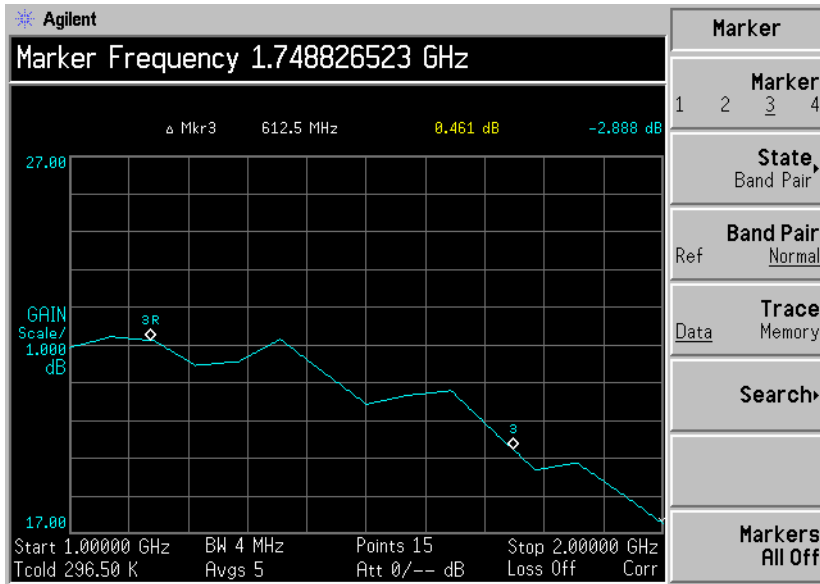

Marking Memory Traces

Markers can be placed on a memory trace. See “Displaying the Current Data Trace and the Recalled Memory Trace” on page 87 to obtain an explanation on memory traces. The default setting is **Trace(Data)** where the marker is placed on the active trace.

To place a marker on the recalled memory trace:

- Step 1.** Enable the **Trace(Memory)** menu key.
- Step 2.** Set the marker you want to use to **Normal**, **Delta**, or **Band Pair**.

The marker is placed on the memory trace. If **Trace(Data&Memory)** on the format menu is enabled, switching between **Trace(Data)** and **Trace(Memory)** switches the marker between the traces.

NOTE

If a marker is set to **Trace(Memory)** and the Memory trace is not displayed, the marker and its annotation are not displayed.

Searching with Markers

The **Search** menu key accesses a further menu which allows you to place an active marker on the minimum and maximum points of a trace, while in Normal or Delta state. When in Band Pair state you can search for the Minimum Peak to Maximum Peak on the trace. You can set these to repeat continuously, or by manually pressing the **Find** menu key as required.

NOTE If you are searching continuously the markers have additional annotation which identifies which marker is the minimum and the maximum. The annotation is “∨” a minimum, “∧” a maximum. If you change the active graph the annotation remains on the original graph.

Searching for Min or Max point You need to have activated a Normal or Delta marker state to perform a minimum or maximum search.

Figure 2-23 Typical Trace showing Maximum Point Found

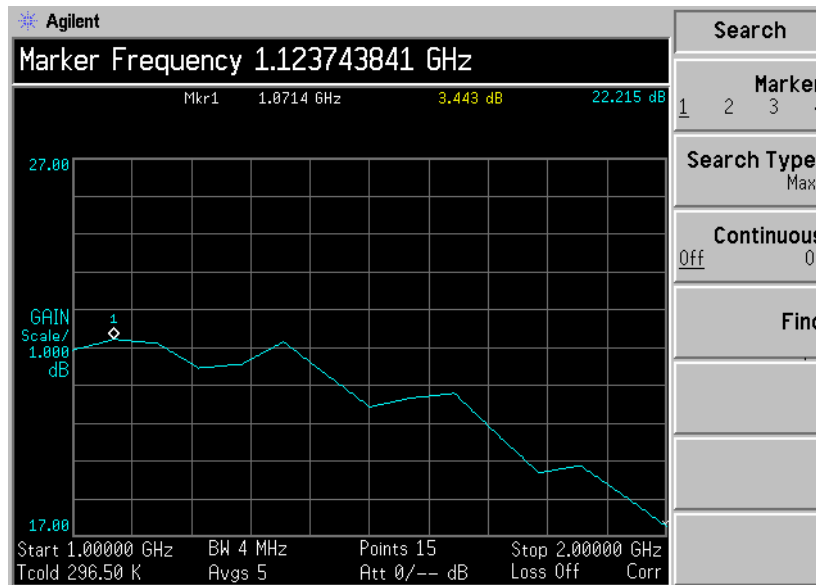

To search for the maximum point:

Step 1. Press the **Search** menu key.

Step 2. Press the **Search Type** menu key to select the **Search Type(Max)**.

Step 3. Press the **Find** menu key.

The marker is now placed at the maximum point of the trace.

If you want to continuously find the maximum point on the trace, select **Continuous(On)**.

Searching for Peak to Peak points

You need to have activated a marker state to Band Pair to perform a Peak to Peak search.

Figure 2-24

Peak to Peak Found

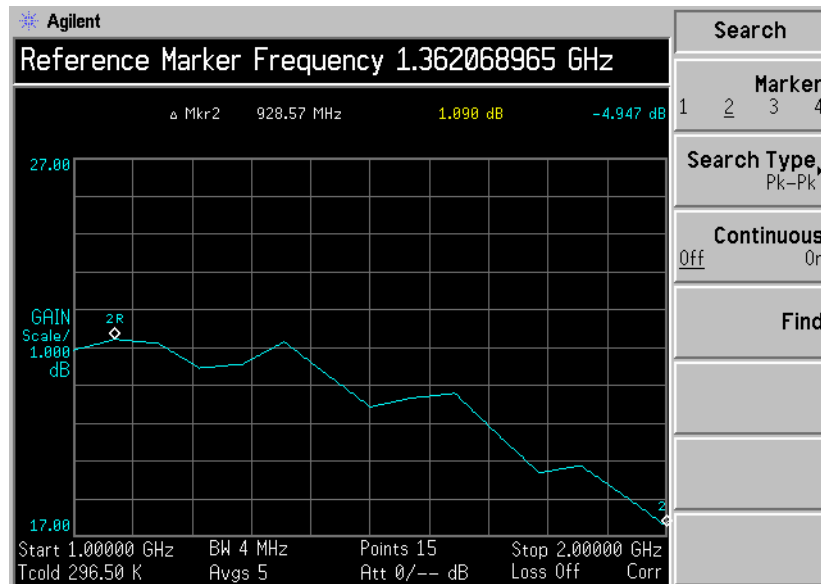

Step 1. Press the **Search** menu key.

Step 2. Press the **Search Type** menu key to select **Pk-Pk**.

Step 3. Press the **Find** menu key.

The markers are now on the maximum and minimum points of the trace.

If you want to continuously find the maximum and minimum points on the trace, select **Continuous(On)**.

The annotation displays the difference between the two points.

Indicating an Invalid Result

When an invalid result is detected while in graph display format, the graph is drawn at the top of the screen for the current measurement point and a special marker indicator is displayed. Also in table and meter formats the same special indicators are used to display an invalid result.

Several invalid result conditions may exist simultaneously. These conditions are ranked in order of severity and only the most severe condition present is displayed.

The ranking order is:

Table 2-2 **Ranking Order of Invalid Result Conditions**

Ranking Order	Invalid Result Condition	Marker Indicator
1	Hot power \leq cold power	“==”
2	Corrected calculation not possible	“XX”
3	Measurement result calculation invalid	“_”

The ranked order 2 only occurs if a corrected measurement is requested and either:

- The input range used at this measurement point is not calibrated.
- The input range is calibrated, but the calibration data is invalid at this point.

RF Input Over and Under Range Conditions

The NFA can detect when the RF input power is either too large for the current input attenuation or too small for the current input attenuation. This causes the RF input to over range or under range respectively.

These conditions are indicated beside a marker readout or table/meter entry as RFO or RFU, for RF input over or under range respectively.

The over range condition could occur when the RF input power is so large that even with the maximum input attenuation, the output power from the input stage is still sufficiently large to create a non-linear response at subsequent stages. This problem could be solved by using external attenuation.

The under range condition could occur when, for example, the RF input attenuation has been fixed at such a value that the level of input power, less attenuation would not lead to compression of the subsequent stages. This problem could be solved by either allowing the RF input attenuators to autorange or choosing a lower value of fixed attenuation.

IF Input Over and Under Range Conditions

The NFA can detect when the power presented to the IF input section detector is either too large for the current IF input attenuation or too small for the current IF input attenuation. This causes the IF input section to over range or IF input section to under range respectively.

These conditions are indicated beside a marker readout or table/meter entry as IFO or IFU, for IF input section over or under range respectively.

The over range condition could occur when the RF attenuation is fixed at a too small a value for the level of input power and subsequently the IF section's input power is so large that even with the maximum IF attenuation, the power level at the IF detector is too large to obtain linear measurements. This problem could be solved by using more RF input attenuation or allowing the RF input attenuators to autorange.

Example of a Basic Amplifier Measurement

Noise figure measurements are made by measuring the output power of the DUT for two different input noise power levels. Typically, the high power input comes from a calibrated noise source, and the low power input uses the noise power generated at ambient temperature.

This section uses a DUT to show how a basic noise figure measurement and various basic operations are performed. The DUT used is a low noise amplifier with a usable frequency range of 20 MHz to 3.0 GHz. The specifications of interest to the example are listed in Table 2-3.

Table 2-3 **The Example DUT Specifications**

Frequency Range	Typical Gain	Minimum Gain	Typical Noise Figure
20 MHz to 3 GHz.	19 dB	14 dB	3.8 dB

The example sets a frequency range of interest of 1.0 GHz to 2.0 GHz. The purpose of the measurement is to verify the specified table results are as stated over the frequency range of interest.

When you are making measurements, follow the procedure and change the values to meet your needs.

NOTE

For these basic measurements confirm the NFA **Meas Mode** is in the default setting. This status is displayed above the graphs as follows:.

- **DUT: Amplifier**
 - **System Downconverter: Off**
-

Calibrating the Noise Figure Analyzer

The first step is to calibrate the NFA to obtain the corrected measurement you wish to make.

- Step 1.** Turn the instrument on by pressing **On** and wait for the power-up process to complete.

NOTE

To obtain greater accuracy, it is recommended the NFA warm up for at least one hour with **Alignment(On)**. The default setting is **Alignment(On)**

- Step 2.** Press **System, Power On/Preset, Preset (Factory)** and press the green **Preset** key to return the NFA to its factory-default state.
- Step 3.** Press **ENR, ENR Mode(Table), Common Table(On), ENR Table** to enter the ENR values of the noise source.

In this example, a 346B noise source is used which has the following Frequency/ENR pairs up to 2 GHz (covering the required frequency range of 1.0 GHz to 2.0 GHz):

Table 2-4 Example Noise Source ENR/Frequency values

Frequency GHz	ENR dB
.01	15.29
.10	15.39
1.0	15.17
2.0	15.10

- Step 4.** Press the **Frequency/Points** key to set the frequency parameters of the measurement:
- **Freq Mode** — Sweep
 - **Start Freq** — 1.0 GHz
 - **Stop Freq** — 2.0 GHz
 - **Points** — 15

Making Basic Measurements

Example of a Basic Amplifier Measurement

Step 5. Press the **Averaging/Bandwidth** key to set the bandwidth and averaging you want.

This example uses the following settings:

- **Averaging** — On
- **Averages** — 5
- **Average Mode** — Point
- **Bandwidth** — 4 MHz

Step 6. Press **Corr, Input Cal** to set the minimum and maximum input attenuation, if required.

This example uses the default minimum and maximum input attenuation of **Min RF Atten(0 dB)** and **Max RF Atten(20 dB)**, respectively.

Step 7. Connect the noise source input to the **28V OUTPUT** port using a BNC cable, and connect the output to the **INPUT 50 W** port as shown in Figure 2-25.

NOTE

When using the N8974A and N8975A models care must be taken to torque the precision 3.5mm connector to the correct value. To find the correct value of torque to apply, see the *Performance Verification and Calibration Guide*.

Figure 2-25 Calibration Setup with Normal Noise Source

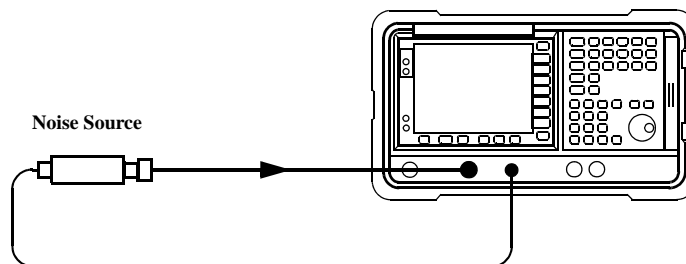

Step 8. Press the **Calibrate** key twice to calibrate the NFA.

Once you have set the frequency span, averaging, bandwidth, and calibrated; a graph similar to Figure 2-26 is now displayed.

With calibration completed and no device under test inserted, both gain and noise figure with **Corrected(On)** are near zero dB. This shows that the NFA has removed the noise contribution from the measurement system. Since the input is noise, there is some variation above and below zero.

Figure 2-26 Typical Graph after calibration is complete

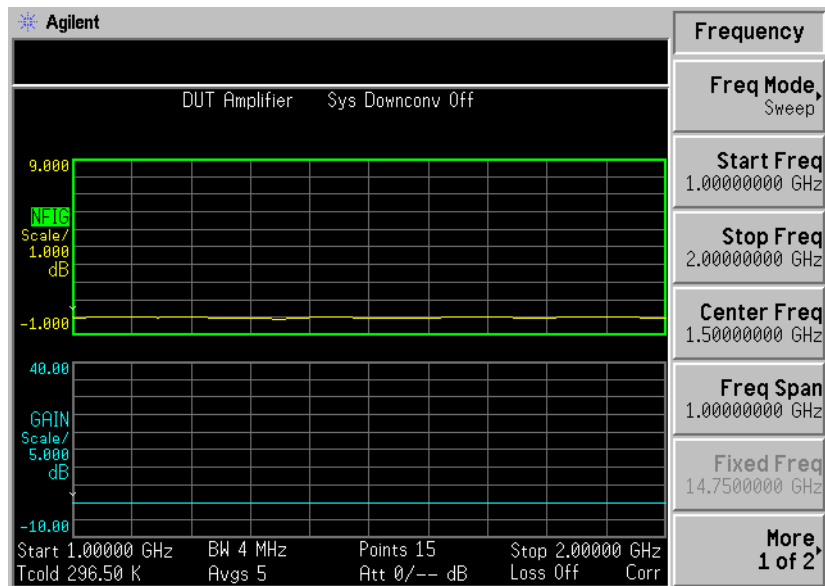

Press the **Format** key to select **Format** menu key to **Table**. A result similar to Figure 2-27 is now displayed. The expectation is 0 dB of noise figure and gain. It may be better to view these results using table format mode.

Making Basic Measurements
Example of a Basic Amplifier Measurement

Figure 2-27 Typical Tabulated Results after Calibration

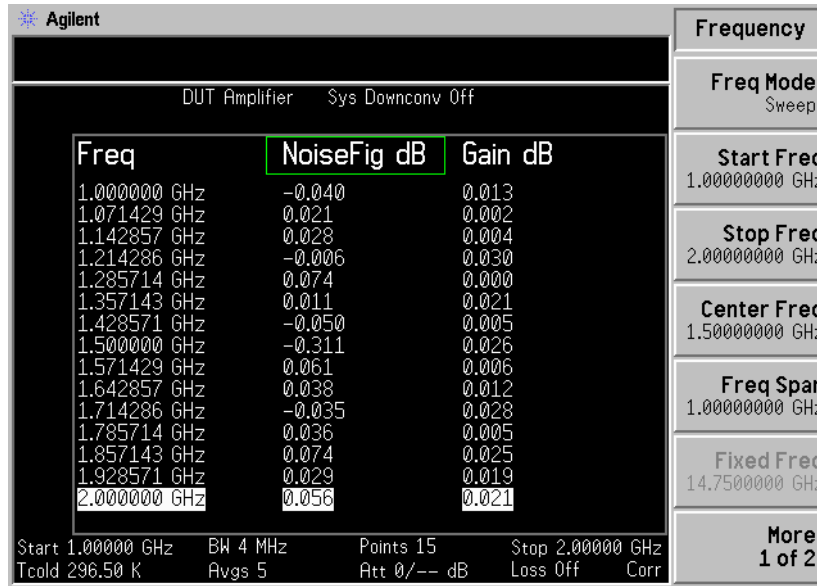

Making Measurements

To make noise figure measurements once calibration is complete:

- Step 1.** Disconnect the noise source from the 50Ω input of the NFA
- Step 2.** Connect the DUT to the 50Ω input of the NFA.
- Step 3.** Connect the noise source to the DUT as shown in Figure 2-28.

Figure 2-28 Connecting the DUT to make a measurement

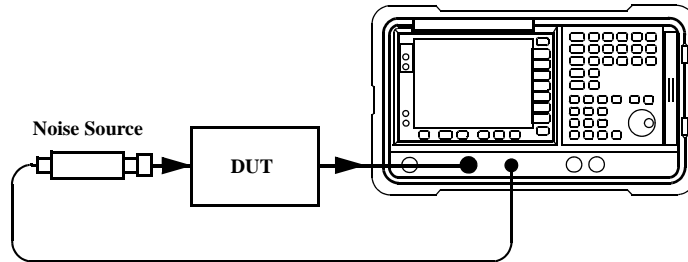

After the DUT and noise source are connected, the measurement result appears on the NFA's display. If it does not, press **Restart**. If you want to get a continuous update ensure **Sweep(Cont)** is enabled. This is the default setting.

A result similar to Figure 2-30 is now displayed.

Figure 2-29 Typical Tabulated Results after Measurement

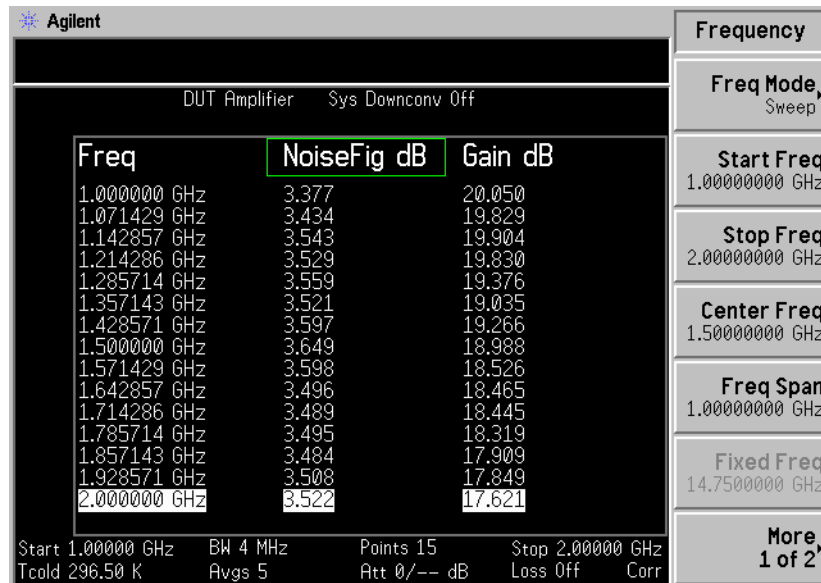

Making Basic Measurements

Example of a Basic Amplifier Measurement

- Step 4.** Press the **Format** key to select **Format** menu key to **Graph**. A graphical result similar to Figure 2-29 is now displayed.

Figure 2-30 Typical Graphical Results after Measurement

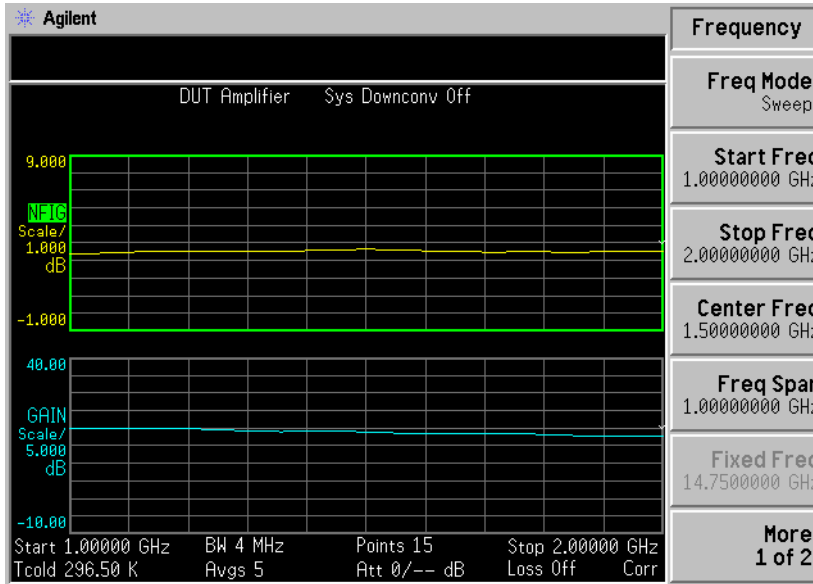

The results shown in Figure 2-29 and Figure 2-30 shows the DUT has an average noise figure of 3.35 dB and a gain of 18.50 dB. The device under test therefore meets its manufacturer's specification over the frequency range of interest.

3 **Advanced Features**

This chapter describes how to use the Limit Lines and Loss Compensation features on your Noise Figure Analyzer. It also covers how to make manual measurements.

What You will Find in this Chapter

This chapter covers:

- Setting up Limit Lines and using them for pass/fail testing of the measurements.
- Using Loss Compensation and using this to correct for system losses in cabling, switches, or connectors and so forth. Also, the use of S2P file formats to create Loss Compensation Tables.
- Making Manual Measurements.

Setting up Limit Lines

Limit lines can be set to mark lower or upper boundaries of the active traces and they can also be set to notify you of a failure when a trace passes over a limit line. Two limit lines can be applied to a single trace, for example, allowing an upper and lower boundary limit to be specified.

The NFA features four independent Limit Lines. The **Limit Line(1)** and **Limit Line(2)** are applied to the upper graph, and **Limit Line(3fl)** and **Limit Line(4fl)** are associated with the lower graph.

To change the Limit Line

The default limit line setting is **Limit(1)**. To change the active indicator, press the **Limit Line** menu key. This moves the active indicator from **Limit Line(1)** to **Limit Line(2)**, press it again and it moves the active indicator from **Limit Line(2)** to **Limit Line(3fl)**. This process is repeated until it returns to the **Limit Line(1)**.

Setting the Type of Limit Line

You can set the Limit Line to be an upper limit or lower limit and test the trace against this limit line setting.

To set the limit line type, choose **Type(Upper)** if you want it to be above the trace or **Type(Lower)** if you want it to be below the trace. Each of the four limit line needs to be set up separately.

NOTE

There can be instances when you want to have two limit lines on a screen configured as Upper or Lower type, where one limit line could be a tolerance limit fail and the other an absolute limit fail.

Enabling Testing against a Limit Line

You can set the Limit Line to test against the trace. If a result fails testing it is reported in the upper left hand corner of the display as shown in Figure 3-1. In table mode you also see the reported result failure.

To set the testing of the trace against the limit line, choose **Test(On)** if you want the result reported or **Test(Off)** if you do not want the result reported. Each of the four limit lines need to be set up separately.

NOTE After a failure the LIMITS FAIL: indicator remains displayed until you either switch **Test(Off)**, change the limit line type, or press **Restart**.

Figure 3-1 Limit Fail Indicator

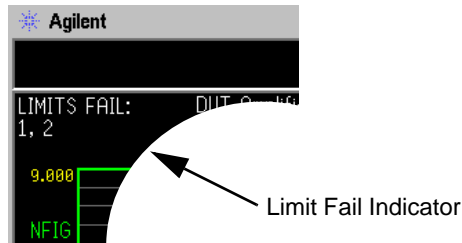

To Display a Limit Line You can choose to display a Limit Line.

To display the limit line on the graph, choose **Display(On)**. To not display the limit line on the graph, choose **Display(Off)**. Each of the four limit line needs to be set up separately.

To Switch all the Limit Lines Off To switch all the Limit Lines off, press **Limit Lines All Off**. This simultaneously switches off all Limit Lines, regardless of what graph or trace they are associated with and setting both **Test(Off)** and **Display(Off)**.

NOTE When a limit line is switched off the limit line data is not affected.

Creating a Limit Line

To set up limit lines, you need to specify the frequencies, the Y-axis value and whether it is to be connected to the previous limit line point or not. The limit line consists of a table of entries each of which is a frequency-limit-connected group.

The **Limit** or Y-axis value is a dimensionless unit, hence you need to know what Y-axis scale you are working in before you set this.

NOTE

When you change the result parameter, the **Limit** or Y-axis value is not converted. This is due to the value being dimensionless.

To create a limit line:

- Step 1.** Press the **Limit Lines** key and select the limit line you want to create.
- Step 2.** Press the Editor menu key.

You are presented with a Limit Line table.

Figure 3-2

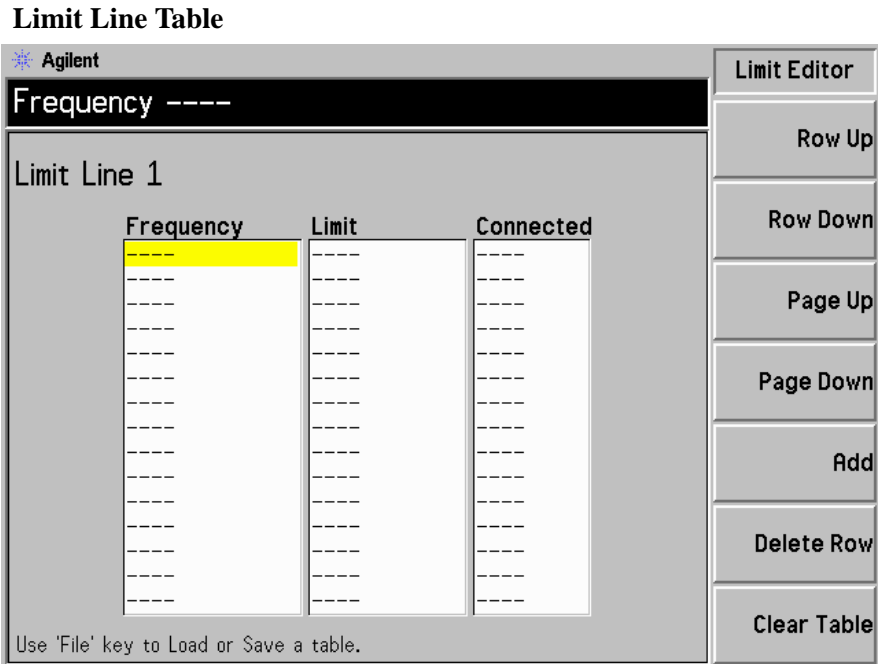

Step 3. Enter the first Frequency value. Press the **Tab** key.

Step 4. Enter the first **Limit** or Y-axis unit value. Press the **Tab** key.

For a limit line value to be useful, it should be derived from the scale values you are using to display the trace.

Step 5. Press the arrow key to change **Connected** to either **Yes** or **No**.

When **Connected** is set to **Yes** it connects the point to the previous point to form a continuous line. To disconnect a point, set **Connected** to **No**, this disconnects it from the previous point. Figure 3-3 shows the connections and Figure 3-4 shows the graphical result with limit line **Display(On)**.

NOTE

When the Limit Line is set to **Test(On)**, and a trace crosses over the limit line, the test is only performed between connected points. Also, if you are making a fixed frequency measurement you only need to specify that frequency value and the limit line can be tested on the single point.

Step 6. Repeat this process until the limit line is defined. Limit line tables can have a maximum of 201 entries.

The limit line is now defined. Press the **Prev** key or **Limit Line** key to return to the limit line menu. When saving a limit line table you need to specify which limit line number. See [“Saving a File” on page 41](#).

For a greater explanation of table use, See [“Working with Tables” on page 45](#).

NOTE

You can load a previously saved Limit Line table. However, you need to specify which limit line number you want loaded. See [“Loading a File” on page 42](#).

Figure 3-3 Typical Limit Line Connections in Table

Limit Line 1

Frequency	Limit	Connected
10.0000000 MHz	2.40000	Yes
100.000000 MHz	2.45000	Yes
300.000000 MHz	2.50000	Yes
400.000000 MHz	2.40000	Yes
1.00000000 GHz	2.50000	No
1.50000000 GHz	2.70000	Yes
2.00000000 GHz	2.85000	Yes
2.10000000 GHz	2.80000	Yes
----	----	----
----	----	----
----	----	----
----	----	----
----	----	----
----	----	----

Use 'File' key to Load or Save a table.

Figure 3-4 Limit Line Connections Displayed

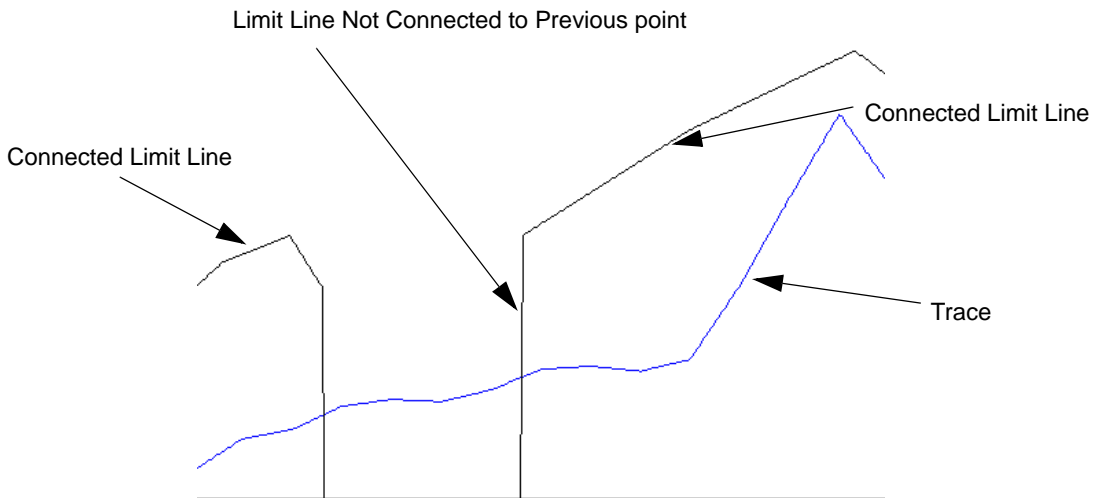

Using Loss Compensation

You can configure the NFA to compensate for losses due to cabling, connectors and temperature effects that occur in the measurement setup. These can be between the Noise Source and the DUT, **Before DUT**, and/or between the DUT and the NFA input, **After DUT**. Loss compensation can be set either by specifying a single, fixed loss value which gets applied at all frequencies, or using various loss values, specified in a table, applied across the frequency span. In the table mode, linearly interpolated values are used between each table entry. You can also specify a temperature value which is applied at all frequencies.

You can also use S2P data file formats output from a Network Analyzer to create Loss Compensation tables. The NFA converts the S2P file format to a Loss Compensation table.

Examples where Loss Compensation is applied

This is important in cases such as:

1. Amplifiers with waveguide input, where a lossy waveguide-to-coax adapter is needed.
2. Transistors, where input and output tuners are required.
3. Non-50 Ω converters (such as TV tuners and amplifiers) where matching pads or transformers are required.
4. Compensation for fixed attenuators used to improve SWR.
5. Double sideband measurement modification (of receivers and mixers) to approximate single sideband results.

Configuring Fixed Loss Compensation

To configure fixed loss compensation follow the example below:

Step 1. Press the **Loss Comp** key.

Advanced Features
Using Loss Compensation

- Step 2.** Press the **Setup** menu key to access the Loss Compensation Setup form, see Figure 3-5.

Figure 3-5 Loss Compensation Setup Form

Agilent

Before DUT Off

Loss Compensation Setup

Before DUT Off

Before DUT Fixed Value 0.000 dB

Before Temperature 0.00 K

After DUT Off

After DUT Fixed Value 0.000 dB

After Temperature 0.00 K

Before Comp

Off

Fixed

Table

Move the highlight to select a field using the 'Tab' keys.

- Step 3.** When configuring loss compensation before the DUT, use the **Tab** key to navigate to the **Before DUT** field and set before DUT to fixed by selecting the **Fixed** menu key to highlight it.

NOTE

A fixed loss compensation value cannot be entered or changed if the **Before DUT** field or the **After DUT** field is not set to fixed. It is selected by highlighting the **Fixed** menu key.

- Step 4.** To set the loss compensation value before the DUT, use the **Tab** key to navigate to the **Before DUT Fixed Value** field and input the required value for the loss occurring before the DUT, see Figure 3-6.

Enter a value using the numerical keypad and terminate it using the unit keys presented to you, linear or dB.

The lower limit is -100.000 dB, the upper limit is 100.000 dB, and the default is 0.000 dB.

Step 5. When configuring loss compensation after the DUT, use the **Tab** key to navigate to the **After DUT** field and set after DUT to fixed by selecting the **Fixed** menu key to highlight it, see Figure 3-6.

Step 6. To set the loss compensation value after the DUT, use the Tab key to navigate to the After DUT Fixed Value field and input the required value for the loss occurring after the DUT.

Enter a value using the numerical keypad and terminate it using the unit keys presented to you, linear or dB.

The lower limit is -100.000 dB, the upper limit is 100.000 dB and the default is 0.000 dB.

Figure 3-6

Loss Compensation Setup Form with **Fixed** Selected

The screenshot shows the Agilent Loss Compensation Setup Form. The title bar reads "Agilent" and "After DUT Fixed". The main area is titled "Loss Compensation Setup" and contains the following fields:

Before DUT	Fixed
Before DUT Fixed Value	5.000 dB
Before Temperature	0.00 K
After DUT	Fixed
After DUT Fixed Value	-3.000 dB
After Temperature	0.00 K

At the bottom of the form, it says: "Move the highlight to select a field using the 'Tab' keys." On the right side, there is a vertical menu with options: "After Comp", "Off", "Fixed", and "Table". The "Fixed" option is currently selected and highlighted.

Configuring Table Loss Compensation

To configure table loss compensation proceed as follows.

- Step 1.** Press the **Loss Comp** key.
- Step 2.** Press the Setup menu key to access the Loss Compensation Setup form, see Figure 3-7.

Figure 3-7

Loss Compensation Setup Form

Agilent

Before DUT Off

Loss Compensation Setup

Before DUT

Before DUT Fixed Value

Before Temperature

After DUT

After DUT Fixed Value

After Temperature

Before Comp

Off

Fixed

Table

Move the highlight to select a field using the 'Tab' keys.

- Step 3.** When configuring table loss compensation before the DUT, use the **Tab** key to navigate to the **Before DUT** field and select the **Table** menu key to highlight it, see Figure 3-8.

The table loss compensation used is as specified in the Loss Compensation Before DUT Table. See “Creating a Loss Compensation Table” on page 124.

- Step 4.** When configuring table loss compensation after the DUT, use the **Tab** key to navigate to the **After DUT** field and select the **Table** menu key to highlight it, see Figure 3-8.

The table loss compensation used is as specified in the Loss Compensation After DUT Table. See “Creating a Loss Compensation Table” on page 124.

Figure 3-8

Loss Compensation Setup Form with Table Selected

The screenshot shows the Agilent Loss Compensation Setup Form. The title bar reads "Agilent" and "After DUT Table". The main area is titled "Loss Compensation Setup" and contains two sections: "Before DUT" and "After DUT". Each section has three fields: "Before DUT Fixed Value" (5.000 dB), "Before DUT Temperature" (0.00 K), and "After DUT Fixed Value" (-3.000 dB), "After DUT Temperature" (0.00 K). The "After DUT" section's "Table" field is highlighted in yellow. To the right of the main area is a vertical menu with options: "After Comp", "Off", "Fixed", and "Table". The "Table" option is selected. At the bottom of the form, a note reads: "Move the highlight to select a field using the 'Tab' keys."

NOTE

You can load a previously saved Loss Compensation table. However, you need to specify whether the Loss Compensation table is an **After Table** or a **Before Table**. See [“Loading a File” on page 42](#).

Creating a Loss Compensation Table

Loss Compensation tables can have a maximum of 201 entries. To create a loss compensation table proceed as follows:

NOTE The example shows how to enter a Before DUT Table. If you want to enter an After DUT Table follow the procedure, changing the **Before Table** key presses to **After Table** key presses.

NOTE If you want to enter new loss compensation data and there is previous loss compensation data in the NFA, you can delete the previous data by pressing **Clear Table**. An empty table is shown in Figure 3-9.

NOTE The Loss Compensation table frequency limits in the **Before DUT Table** are specified in terms of the DUT's input frequencies and the **After DUT Table** are specified in terms of the DUT's output frequencies. This is important when making frequency-converting DUT measurements or using a system downconverter.

Step 1. Press the Loss Comp key, and the Before Table menu key.

A Loss Compensation Before DUT Table appears on the display with the first loss frequency point in the table highlighted, see Figure 3-9. The table editing and navigation menu items now appear. For details on working with tables, see [“Working with Tables” on page 45](#).

Figure 3-9

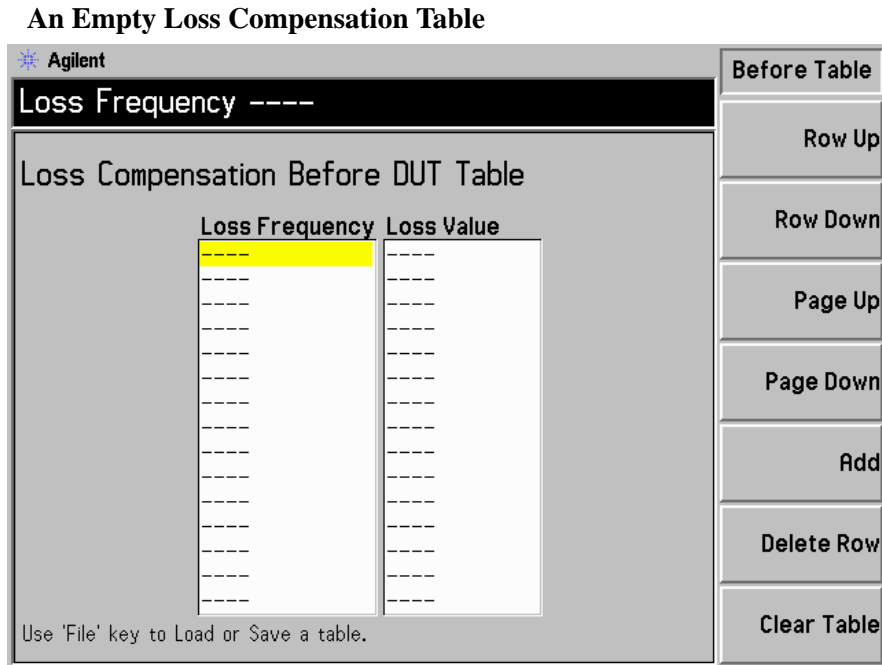

- Step 2.** Enter the Loss Frequency value in the table using the numeric keys. Terminate it using the unit menu keys.
- Step 3.** Press the **Tab** key to move the highlight to the Loss Value column and enter the corresponding Loss Value.

When terminating the Loss Value you can use either **dB** or **linear** menu keys. However, the result appears in the table in dB.
- Step 4.** Press the **Tab** key to move the highlight to the Loss Frequency column and enter the next Loss Frequency Value.
- Step 5.** Repeat steps 2 to 4 until all the Loss Frequency and Loss Values you need are entered.
- Step 6.** After completing the Loss Compensation table entries, press the **Prev** key or **Loss Comp** key to return to the Loss Compensation menu.
- Step 7.** Once you have completed entering the Loss Compensation data, save the Loss Compensation table using the **File** key.

Advanced Features
Using Loss Compensation

For details on saving files, See “Saving a File” on page 41.

NOTE If you do not save the Loss Compensation table, you may lose the data. This depends on your Power On/Preset condition. See “Defining the Power-On/Preset Conditions” on page 232 for an explanation of these.

NOTE You can insert the Loss Frequency/Loss Values in the Loss Compensation Table entry in any order, as the NFA automatically sorts the table list into ascending frequency order.

Working with S2P, S1, and S2 File Formats

The S2P data file formats are described as frequency dependent linear network parameters for 2 port components. The S2P file is output from a Network Analyzer in the standard ASCII Touchstone S2P format. The output format includes frequency values, S11, S21, S12, and S22 network parameters. Not all these parameters are used by the NFA. The NFA uses the frequency parameter which it reads as a loss frequency and the S21 parameter which it converts to a loss value.

NOTE

When saving S2P data format from a Network Analyzer you need to ensure the data is saved in an ascending frequency order.

The S2P file format is loaded as a Loss Compensation table in the NFA, either as a Before DUT or an After DUT Table. The NFA accepts any files with the following extensions: S2P, S1, and S2.

The NFA can only load S2P file formats, it cannot save them. However, they can be copied, deleted and renamed using the NFA's file manager functions.

NOTE

If saving a previously loaded S2P file in the NFA, it is saved as a LOS file.

Loading an S2P, S1, or S2 File

To load a S2P format file into the NFA, the process is identical to loading a loss compensation (LOS) file which has been stored previously on a diskette. The choice needs to be made using the file manager's list of available file formats of LOS, S2P, S1, and S2.

Step 1. Insert the diskette into the floppy drive of the NFA.

For more details on loading files, see [“Loading a File” on page 42](#).

Step 2. Press the **File** key.

Step 3. Press the **Load** menu key to access the file system.

Step 4. Press the **Loss** menu key.

Advanced Features
Using Loss Compensation

Step 5. Press either the **Before Table** or **After Table** menu key.

A list of available files on the [-A-] drive is displayed. Use the arrow keys to access the appropriate file. The options have the following file extensions S2P, S1, and S2

Step 6. Press the **Enter** key.

A Loading file prompt appears on the display and when this disappears the file has been successfully loaded.

NOTE

To verify a successful loading of the S2P file as loss compensation table data, view the Loss Compensation Before or After DUT Table form.

Setting Temperature of Loss

To set temperature of loss proceed as follows:

- Step 1.** Press the **Loss Comp** key.
- Step 2.** Press the **Setup** menu key to access the Loss Compensation Setup form, see Figure 3-10.

Figure 3-10

Loss Compensation Setup Form with Temperature Selected

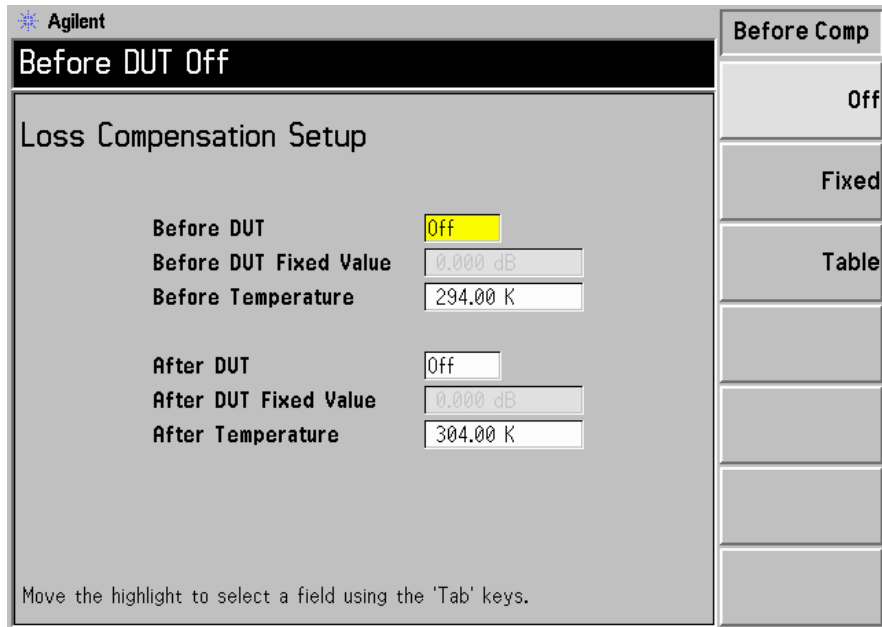

Agilent

Before DUT Off

Loss Compensation Setup

Before DUT

Before DUT Fixed Value

Before Temperature

After DUT

After DUT Fixed Value

After Temperature

Before Comp

Off

Fixed

Table

Move the highlight to select a field using the 'Tab' keys.

- Step 3.** To set the temperature value before the DUT, use the **Tab** key to navigate to the **Before Temperature** field and input the required temperature of loss value occurring before the DUT.

Enter a value using the numerical keypad and terminate it using the unit keys presented to you, either in degrees **K**, **C** or **F**. Entries terminated using the **C** or **F** menu keys are converted to **K**.

The lower limit is 0.0 K, the upper limit is 29,650,000.0 K and the default is 0.0 K.

Advanced Features
Using Loss Compensation

Step 4. To set the temperature value after the DUT, use the **Tab** key to navigate to the **After Temperature** field and input the required temperature of loss value occurring after the DUT.

Enter a value using the numerical keypad and terminate it using the unit keys presented to you, either in degrees **K**, **C** or **F**. Entries terminated using the C or F menu keys are converted to K.

The lower limit is 0.0 K, the upper limit is 29,650,000.0 K and the default is 0.0 K.

Making Manual Measurements

This feature is for making manual measurements with a hot/cold noise source. It is primarily for users who do not use SNS or 346 Series noise sources. These measurements are more difficult and slower than those made automatically using a Noise Source with the NFA. The technique can be applied using either a normal or SNS noise source to make Phot and Pcold measurements by turning the noise source on and off.

The measurement is similar to one made using a Noise Source, except that a hot source and a cold source must be physically connected for each noise power reading. The difficulty in working with a cold source, for example, liquid nitrogen, is in correcting for temperature gradients, condensation, and so forth. This can introduce errors unless the measurement is very carefully performed. If a normal noise source is used it can act as the hot/cold source. The Noise Source is turned on or off by the appropriate **Noise Source(On)** and **Noise Source(Off)**, for example, **Noise Source(On)** provides Phot.

The following paragraphs give a step-by-step procedure for making the measurement. Several steps are required for measurements at each frequency point.

NOTE

The N8972A and the N8973A models do not have microwave hardware installed and the menu keys are also different. Hence, in the following procedures the **RF/mW Att** menu key should be referred to as the **RF Att** menu key. Also the **Fixed mW Att** menu key is unavailable.

Making Manual Measurements

Four important details you need to note when making manual measurements:

1. A stable reading must be stored in the NFA memory before any change is made to the physical connections.

A reading is stored by pressing the **Accept** menu key in the sequence before changing connections.

2. The DUT must first be connected to the measurement system and then the NFA's input attenuators set. The input attenuators must be fixed for the entire manual measurement by selecting either **RF/mW Att(Hold)** or **RF/mW Att(Fixed)**. When using the fixed mode the fixed attenuator values are specified using the **Fixed RF Att/Fixed mW Att** menu keys.
3. The IF attenuators must be allowed to autorange between calibration and measurement.
4. The IF attenuators must be held fixed for both calibration readings (noise source on and off) and also for both measurement readings (noise source on and off) by selecting either **IF Att(Hold)** or **IF Att(Fixed)**. When using the fixed IF mode the fixed IF attenuator value is specified using the **Fixed IF Att** menu key.

NOTE

When calibrating a series of frequency points and an error is made on one of the points, you need to start calibrating the series of frequency points again. Press the **Calibrate** key to reset the calibration.

NOTE

When measuring a series of frequency points and an error is made on one of the points, you need to start measuring the series of frequency points again. Press the **Restart** key to reset the measurement.

Figure 3-11 Manual Measurement Display in Meter Format



Manual Measurements Procedure

NOTE

Between each stage of this procedure, ensure you wait until the data invalid indicator has disappeared before you proceed.

The steps of a typical measurement are as follows:

Step 1. Find and hold RF/μW attenuators.

1. Connect the hot source, T_h , to the DUT input, and the DUT output to the NFA.
2. Press **Noise Source(On)** to measure noise power with the source at T_h .
3. Press **RF/mW Att(Hold)** to hold RF attenuators for the entire measurement.

Advanced Features
Making Manual Measurements

Step 2. Calibrate.

1. Remove the DUT and connect the noise source to the NFA
2. Press **Calibration (On)** to calibrate with noise source at Phot.
3. Press **IF Att(Hold)** to hold the IF attenuators fixed at the new value or use the previously defined **IF Att(Fixed)** value.
4. Press **Accept** to store the Phot calibration reading.
5. Press **Noise Source(Off)** to select the Pcold calibration reading.
6. Press **Accept** to store the Pcold calibration reading.

Step 3. Measure.

1. Press **Calibration (Off)**.
2. Connect Noise Source to the DUT and the DUT to the NFA.
3. Press **Noise Source(On)** to select the Phot reading.
4. Press **IF Att(Auto)** to allow the IF attenuators to autorange.
5. Press **IF Att(Hold)** to hold the IF attenuators fixed at the new value or use the previously defined **IF Att(Fixed)** value.
6. Press **Accept** to store Phot measurement result.
7. Press **Noise Source(Off)** and press **Accept** to store Pcold measurement.

NOTE

If you have set up to measure a number of points over a frequency range. You need to change the point number by pressing the **Point** menu key and entering the point number and repeat the procedure from the next measurement point. Repeat this until all the points have been measured.

The points need not be measured sequentially.

4 **Making Extended Frequency Measurements**

This chapter describes how to make measurements outside the baseband frequency range of your Noise Figure Analyzer.

What You will Find in this Chapter

This chapter covers:

- Overview of Configuring Extended Frequency Measurements
- An overview of the Measurement Modes
- Comparison of the 8970B and the NFA Series Measurement Modes
- Choosing and Setting Up the Local Oscillator
- Connecting the System
- A description of Measuring a Frequency-Converting DUT
- Making Frequency-Converting DUT Measurements using examples
- A description of Measurements with a System Downconverter
- Making System Downconverter Measurements using examples
- Frequency Restrictions

Overview of Configuring Extended Frequency Measurements

Configuring extended frequency measurements involves four steps.

- Step 1.** Press the **System** key and configure the measurement system parameters as required using the **GPIB** and **External LO** menu items.

Table 4-1 System Parameters

Parameter	Description
NFA Address	This sets the NFA's GPIB address. Valid addresses are from 0 to 30. The default address is 8.
External LO Address	This sets the GPIB address of the External LO attached to the LO GPIB port. Valid addresses are from 0 to 30. The default address is 19.
LO GPIB Address	This sets the address through which other devices, attached to the LO GPIB, communicate with the NFA. Valid addresses are from 0 to 30. The default address is 8.
Command Set	This sets the External LO command language. The default setting is Command Set(SCPI) to operate a SCPI compliant LO. Command Set(Custom) is used when the External LO is not SCPI compliant and operated using the custom command strings.
LO Commands	This accesses the External LO Commands Form. The form is used to enter the commands used to control a non-SCPI-compliant External LO.

Making Extended Frequency Measurements
Overview of Configuring Extended Frequency Measurements

Table 4-1 **System Parameters**

Parameter	Description
Settling Time	This sets the settling time of the External LO. This is used as a settling period after the External LO frequency is changed.
Min and Max Frequency	This sets the minimum and maximum frequencies of the External LO.
Multiplier	This sets the multiplier value of the External LO frequency.

Step 2. Press the **Meas Mode** key to configure the measurement mode of the Noise Figure Analyzer.

For more details on the available measurement modes, see “Measurement Modes” on page 139.

Step 3. Press the **Mode Setup** key to configure the measurement mode parameters for the specific measurement mode you have selected.

Step 4. Configure the measurement (measurement frequency range, number of measurement points and averages and so forth) using the **Frequency/Points** and **Averaging/Bandwidth** keys.

For more details on configuring measurements, including calibration, see Chapter 2 , “Making Basic Measurements,” on page 49.

Measurement Modes

Available modes The Noise Figure Analyzer offers the following measurement modes through the **Meas Mode** key on the front panel:

- The DUT is an amplifier-type device with no frequency conversion. This is the basic measurement mode where the measurement frequency is within the NFA's frequency range. It is described in "Example of a Basic Amplifier Measurement" on page 104.
- The DUT is an amplifier-type device with frequency downconversion occurring in the measurement test setup (system downconversion). The LO can be either fixed or variable in this case.
- The DUT is a frequency downconverter (that is, frequency downconversion occurs in the DUT itself and not in the measurement test setup). The LO can be fixed or variable.
- The DUT is a frequency upconverter (that is, frequency up conversion occurs in the DUT itself and not in the measurement test setup). The LO can be fixed or variable.

NOTE The **Amplifier** measurement mode is for any DUT that does not perform frequency conversion and includes amplifiers, filters, attenuators and so forth.

Noise figure measurements involving mixers are necessary when:

- The frequency conversion is part of the DUT. For example, the DUT is a mixer or a receiver.
- The frequency conversion is part of the measurement test set-up. The DUT is to be measured at a higher frequency than the NFA's frequency range covers, hence an external mixer and local oscillator are added to the measurement test set-up to convert this frequency to a frequency within the NFA's range.

Making Extended Frequency Measurements Measurement Modes

The NFA can make a single frequency conversion, either in the DUT, or as an added **System Downconverter**, which configures the NFA as a frequency range extender. The NFA can also control an LO source remotely using the SCPI commands or the custom commands. Under this control the LO can be swept.

Basic Measurement — No Frequency Conversion

The basic measurement setup is shown in Figure 4-1, allowing you to compare more complex setups with it.

Figure 4-1

Basic Noise Figure Measurement — No Frequency Conversion

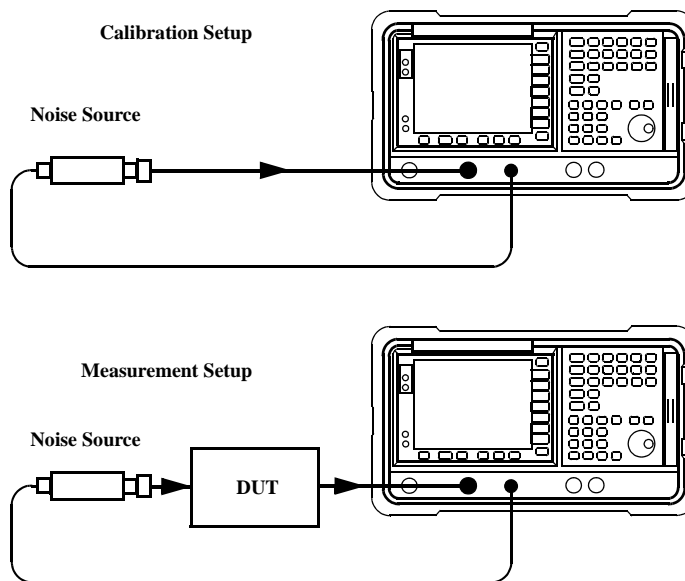

When an uncorrected measurement is performed, the result is the measured Noise Figure of all of the components after the noise source. When the calibration setup is connected and the calibration performed, the NFA measures its own noise figure and the connection set up. When a corrected measurement is performed, the contribution of the calibration setup is removed from the uncorrected result, giving a corrected measurement of the DUT only.

For these measurements the NFA mode is set to

DUT	Amplifier
System Downconverter	Off

NOTE

The RF input section on all NFA models has a built-in 3.0 GHz Low Pass Filter. This filter needs to be accounted for when planning your filter requirements during calibration and measurement.

NOTE

On the N8974A and the N8975A models the microwave input section has no filtering. This needs to be accounted for when planning your filter requirements for calibration and measurement. This is also important when making measurements which cross over the 3.0 GHz switch.

Frequency Down-converting DUT

In this mode, the DUT contains a frequency down-converting device, for example, a mixer or receiver.

There are two modes to choose from:

1. A variable frequency LO and fixed IF.

Making this measurement, the NFA remains locked at one frequency and the LO sweeps.

2. A fixed frequency LO and variable IF.

Making this measurement, the LO remains locked at one frequency and the NFA sweeps.

NOTE

Filtering is needed to remove the unwanted sideband when making single-sideband measurements in both modes. Ideally these filters should be included in the calibration path and measurement path. However, if it is not in the path, you can enter loss compensation to account for any additional error.

Fixed IF Variable LO (8970B Mode 1.3)

This is an overview of the key presses needed to set up the mode. See “Frequency Restrictions” on page 207, for the restrictions applicable to this mode. See “Making Frequency-Converting DUT Measurements” on page 172 for an example of this mode. This shows a procedure for making an LSB, Fixed IF and Variable LO measurement. However, you need to change the settings and apply the appropriate filtering. For greater detail on this see “Measuring a Frequency-Converting DUT” on page 159.

In the Measurement Mode Form set the following:

DUT	Downconv
System Downconverter	No Access
LO Mode	Variable

In the Mode Setup Form set the following:

IF Frequency	Enter a value
Sideband	LSB, USB or DSB
LO Control	On
External LO Power Level	Enter value and terminate using either dBm or W

NOTE

The External LO Power Level is displayed on the NFA as dBm.

In the **Frequency** menu, frequencies are specified as RF (input to DUT) frequencies.

Making Extended Frequency Measurements Measurement Modes

Variable IF Fixed LO (8970B Mode 1.4)

These are an overview of the key presses needed to set up the mode. See “Frequency Restrictions” on page 207, for the restrictions applicable to this mode. See “Making Frequency-Converting DUT Measurements” on page 172 for an example of this mode. This shows how to make an LSB, Fixed IF and Variable LO measurement. However, you need to change the settings and apply the appropriate filtering. For greater detail on this see “Measuring a Frequency-Converting DUT” on page 159.

In the Measurement Mode Form set the following:

DUT	Downconv
System Downconverter	No Access
LO Mode	Fixed

In the Mode Setup Form set the following:

LO Frequency	Enter a value
Sideband	LSB, USB or DSB
LO Control	Off or On
External LO Power Level	Enter value and terminate using either dBm or W

NOTE

The External LO Power Level is displayed on the NFA as dBm.

In the **Frequency** menu, frequencies are specified as IF (output from DUT) frequencies.

Frequency Up-converting DUT

In this mode, the DUT contains a frequency up-converting device, for example, a transmitter.

There are two modes to choose from:

1. A variable frequency LO and fixed IF.

Making this measurement, the NFA remains locked at one frequency and the LO sweeps.

2. A fixed frequency LO and variable IF.

Making this measurement, the LO remains locked at one frequency and the NFA sweeps.

Making Extended Frequency Measurements Measurement Modes

Fixed IF Variable LO (8970B Mode 1.3 with SUM Sideband)

These are an overview of the key presses needed to setup using this mode. See “Frequency Restrictions” on page 207, for the restrictions applicable to this mode. See “Making Frequency-Converting DUT Measurements” on page 172 for an example of this mode. This shows a procedure how to make an LSB, Fixed IF and Variable LO measurement. However, you need to change the settings and apply the appropriate filtering. For greater detail on this see “Measuring a Frequency-Converting DUT” on page 159. In this mode, the DSB measurement is not allowed.

In the Measurement Mode Form set the following:

DUT	Upconv
System Downconverter	No Access
LO Mode	Variable

In the Mode Setup Form set the following:

IF Frequency	Enter a value
Sideband	LSB or USB
LO Control	On
External LO Power Level	Enter value and terminate using either dBm or W

NOTE

The External LO Power Level is displayed on the NFA as dBm.

In the **Frequency** menu, frequencies are specified as RF (input to DUT) frequencies.

Variable IF Fixed LO (8970B Mode 1.4 with SUM Sideband)

These are an overview of the key presses needed to set up using this mode. See “Frequency Restrictions” on page 207, for the restrictions applicable to this mode. See “Making Frequency-Converting DUT Measurements” on page 172 for an example of this mode. This shows a procedure how to make an LSB, Fixed IF and Variable LO measurement. However, you need to change the settings and apply the appropriate filtering. For greater detail on this see “Measuring a Frequency-Converting DUT” on page 159. In this mode, the DSB measurement is not allowed.

In the Measurement Mode Form set the following:

DUT	Upconverter
System Downconverter	No Access
LO Mode	Fixed

In the Mode Setup Form set the following:

LO Frequency	Enter a value
Sideband	LSB or USB
LO Control	Off or On
External LO Power Level	Enter value and terminate using either dBm or W

NOTE

The External LO Power Level is displayed on the NFA as dBm.

In the **Frequency** menu, frequencies are specified as IF (output from DUT) frequencies.

System Downconverter

The DUT is a non-frequency converting device, for example an amplifier or filter, and its frequency is higher than the NFA's measurement range. Frequency down-conversion is required within the measurement system, using a mixer, external to the DUT, to convert the signal of interest to the frequency range of the NFA.

There are two modes to choose from:

1. A variable frequency LO and fixed IF.

Making this measurement, the NFA remains locked at one frequency and the LO sweeps.

2. A fixed frequency LO and variable IF.

Making this measurement, the LO remains locked at one frequency and the NFA sweeps.

NOTE

Filtering is needed to remove the unwanted sideband when making single-sideband measurements in both modes. Ideally any filtering is included in the calibration path and measurement path. However, if it is not in the path, you can enter loss compensation to account for any additional error.

Fixed IF Variable LO (8970B Mode 1.1)

These are an overview of the key presses needed to set up using this mode. See “Frequency Restrictions” on page 207, for the restrictions applicable to this mode. See “Making System Downconverter Measurements” on page 194 for an example of this mode. This shows a procedure how to make a DSB, Fixed IF and Variable LO measurement. However, you need to change the settings and apply the appropriate filtering. For greater detail on this see “Measurements with a System Downconverter” on page 184.

In the Measurement Mode Form set the following:

DUT	Amplifier
System Downconverter	On
LO Mode	Variable

In the Mode Setup Form set the following:

IF Frequency	Enter a value
Sideband	LSB, USB or DSB
LO Control	On
External LO Power Level	Enter value and terminate using either dBm or W

NOTE

The External LO Power Level is displayed on the NFA as dBm.

In the **Frequency** menu, frequencies are specified as RF (input to DUT) frequencies.

Making Extended Frequency Measurements Measurement Modes

Variable IF Fixed LO (8970B Mode 1.2)

These are an overview of the key presses needed to set up using this mode. See “Frequency Restrictions” on page 207, for the restrictions applicable to this mode. See “Making System Downconverter Measurements” on page 194 for an example of this mode. In this mode, a DSB measurement is not allowed. This shows a procedure how to make a DSB, Fixed IF and Variable LO measurement. However, you need to change the settings and apply the appropriate filtering. For greater detail on this see “Measurements with a System Downconverter” on page 184.

In the Measurement Mode Form set the following:

DUT	Amplifier
System Downconverter	On
LO Mode	Fixed

In the Mode Setup Form set the following:

LO Frequency	Enter a value
Sideband	LSB or USB
LO Control	Off or On
External LO Power Level	Enter value and terminate using either dBm or W

NOTE

The External LO Power Level is displayed on the NFA as dBm.

In the **Frequency** menu, frequencies are specified as RF (input to DUT) frequencies.

Comparison of the 8970B and the NFA Series Measurement Modes

Table 4-2 is to assist 8970B users map the 8970B measurement modes to the NFA Series measurement modes.

Table 4-2 8970B Mode Comparison

8970B	NFA Series
Mode 1.1: Swept LO	System Downconverter Fixed IF Variable LO
Mode 1.2: Fixed LO	System Downconverter Variable IF Fixed LO
Mode 1.3: Swept LO	Downconverting Fixed IF Variable LO
Mode 1.4: Fixed LO	Downconverting Variable IF Fixed LO
Mode 1.3 with SUM Sideband: Swept LO	Upconverting Fixed IF Variable LO, USB
Mode 1.4 with SUM Sideband: Fixed LO	Upconverting Variable IF Fixed LO, USB

Choosing and Setting Up the Local Oscillator

Selecting a Local Oscillator for Extended Frequency measurements with the NFA

Because of reciprocal mixing, noise components in the LO are converted into the IF band applied to the NFA. This converted LO noise causes the measured noise figure to be higher than the actual noise figure of the mixer.

If the mixer is to be used with a particular LO in its final application, its noise figure should be measured with that LO. The measurement then gives the actual noise figure of the extended frequency device - LO combination in the final system.

For testing of extended frequency measurements, the LO must have a low noise floor over frequencies equal to the $LO \pm IF$.

Effect of high LO spurious signals and noise on mixer measurements with low L-to-I rejection.

The LO's spurious level also has to be low. At frequencies where there is a high spurious signal the noise figure measured will have a peak at that IF. For example, ideally the LO's noise, including spurious, needs to be below -90 dBm. If a mixer has higher isolation, then the LO's noise can be higher since the mixer will be better able to reject the LO's noise.

This is especially necessary if the mixer has a poor balance, or L-to-I isolation. With low isolation, the mixer is more likely to pass the LO noise through and thus increase the measured noise figure.

NOTE

L-to-I rejection is the mixers ability to reject the LO's spurious signals and not allow them to pass through to the IF output.

Selecting a Local Oscillator for the NFA

Here are several criteria that must be met when choosing the LO:

1. It should have a frequency range appropriate to the DUT's frequency range, IF range, and sideband chosen.
2. It should be controllable over GPIB if variable LO measurements are to be made.
3. It should have sufficient power to drive mixers (typically, +7 dBm)
4. It should have excellent frequency accuracy and repeatability (typically, the same as the NFA you are using.)

The last point, frequency accuracy, deserves further comment. There are three frequency-dependent components in an NFA measurement that must all be aligned to make an accurate measurement at the IF. The need for frequency accuracy is the main reason for recommending a synthesized source for the LO, such as the Agilent 83712B Synthesized CW Generator.

Other LOs may be used, but should be tested to determine that their noise is sufficiently low, as LO noise can cause an increase in noise figure for the mixer/LO combination, and calibration of the system may not be possible. A broadband, high gain amplifier at the LO output usually generates unacceptable noise. This is almost always the case when a heterodyne-type sweep oscillator or signal generator is used.

Setting up the NFA to drive the Local Oscillator

The following procedures are general to all the measurement mode settings. These can be done independently of setting up the measurement.

- Setting the External LO address
- Setting the Minimum and Maximum LO Frequencies
- Setting the Settling Time

Setting the External LO address

Step 1. Press the **System** key, the **GPIB** menu key.

The System GPIB Form appears on the display.

Step 2. Using the Tab key, highlight the **External LO Address** field, Figure 4-2 shows the form and the selected address. Set the External LO Address using the numeric keypad and terminate it using the **Enter** key.

Figure 4-2

External LO Address

The screenshot shows the Agilent System GPIB Form. At the top, the Agilent logo is visible. The main title of the form is "External LO Address 19". Below this, the text "System GPIB Form" is displayed. There are three input fields: "Noise Figure Analyzer Address" with the value 8, "External LO Address" with the value 19 (highlighted in yellow), and "LO GPIB Address" with the value 8. To the right of the main form area is a vertical stack of buttons, with the top one labeled "Ext. LO Addr" and the second one labeled "Ext. LO Addr 19". At the bottom of the form, a note reads: "Move the highlight to select a field using the 'Tab' keys."

NOTE

If an error message `GPIB Error, Write command timeout` appears in the NFA's display status line, this indicates the external LO cannot be written to. The problem is most likely one of the following:

- The GPIB cable is either not attached or is not making proper contact.
 - The external LO is not turned on.
 - The NFA has the wrong address for the external LO.
-

If the NFA does not appear to be controlling the LO as described above, check your setup to make sure all connections are properly made. Also check for any bad connections or cables and that the LO is working properly.

Setting the Minimum and Maximum LO Frequencies

Step 1. Press the **System** key, the **External LO** menu key.

Step 2. Press the **Min Freq** menu key and enter the minimum frequency value.

Using the numeric keypad, terminate it using the unit menu keys, or use the RPG and rotate it to the required value. Set the External LO to have a minimum frequency equivalent to the LO you are using. The default value is 10 MHz.

Step 3. Press the **Max Freq** menu key and enter the maximum frequency value.

Using the numeric keypad, terminate it using the unit menu keys, or use the RPG and rotate it to the required value. Set the External LO to have a maximum frequency equivalent to the LO you are using. The default value is 40.0 GHz.

Figure 4-3 Setting Maximum and Minimum Frequencies and Settling Time and Multiplier of the External LO

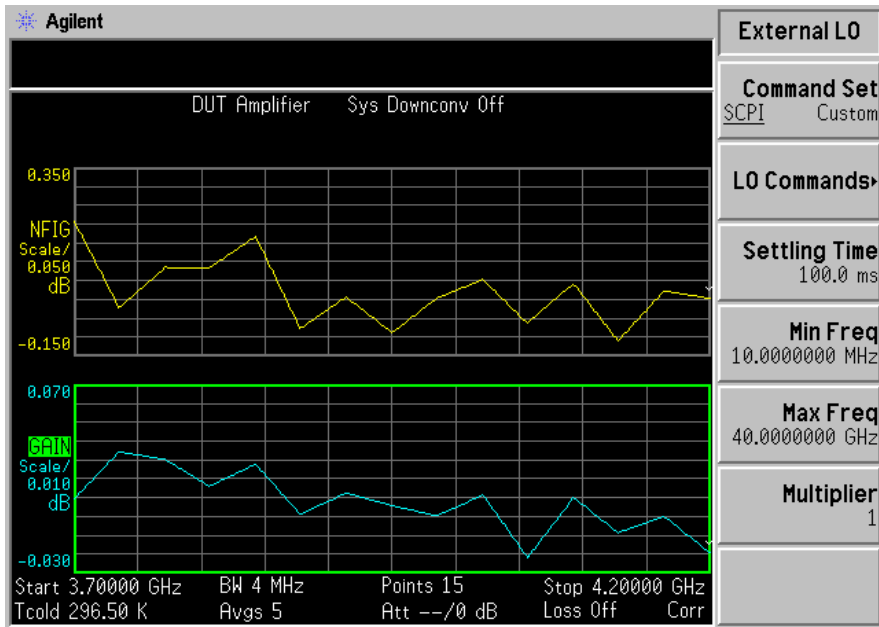

Setting the Settling Time

- Step 1.** Press the **System** key, the **External LO** menu key.
- Step 2.** Press the **Settling Time** menu key and enter the Settling Time value.

Using the numeric keypad, terminate it using the unit menu keys, or use the front panel knob and rotate it to the required value. The default value is 100 mS.

Setting the Multiplier

- Step 1.** Press the **System** key, the **External LO** menu key.
- Step 2.** Press the **Multiplier** menu key and enter the multiplier value.

Using the numeric keypad, terminate it using the Enter key, or use the front panel knob and rotate it to the required value. The default value is 1. The maximum value is 1000000000.

Connecting the System

Figure 4-4 and Figure 4-5 show the connection diagram options you can use to calibrate the NFA and after calibration, to measure a DUT, whether it is a down-converter mixer, up-converter mixer, amplifier, or filter. It does not show where to place a filter to remove any unwanted sideband or input noise.

Setting Up the Noise Figure Analyzer

NOTE

You may connect the 10 MHz timebase frequency reference. Hence, the NFA and the LO are locked at the same frequency reference. This can be done from the NFA's 10 MHz Ref Out to the LO's 10 MHz Ref In or the LO's 10 MHz Ref Out to the NFA's 10 MHz Ref In. It can also be provided by an external reference. Ideally use the best standard reference available.

To connect the NFA to make measurements.

- Step 1.** Connect a GPIB cable between the NFA's LO GPIB rear panel connector and the Local Oscillator's GPIB connector.
- Step 2.** Turn on both instruments and press the **Preset** key to return the NFA to a known state.

The NFA can control the Local Oscillator, over its General Purpose Interface Bus (LO GPIB) without the need for an external controller. The NFA does not send LO controlling commands over its main GPIB. LO control is only done over its LO GPIB.

- Step 3.** Enter the ENR values in to the NFA. See "Entering Excess Noise Ratio (ENR) Data" on page 51 for the procedures to do this.
- Step 4.** Follow the procedure to calibrate the system, and measure the DUT, in the mode to suit your needs.

Figure 4-4 System Downconverter Mode

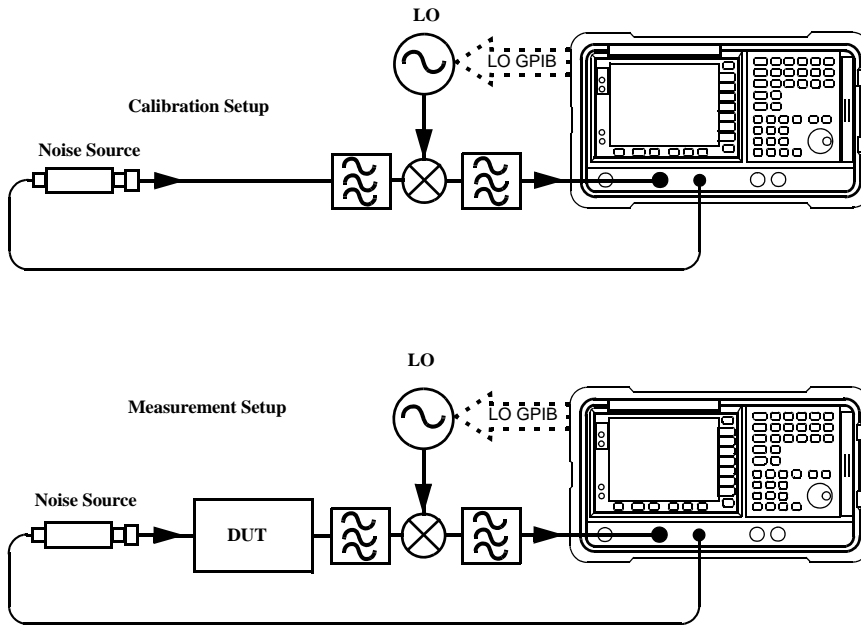
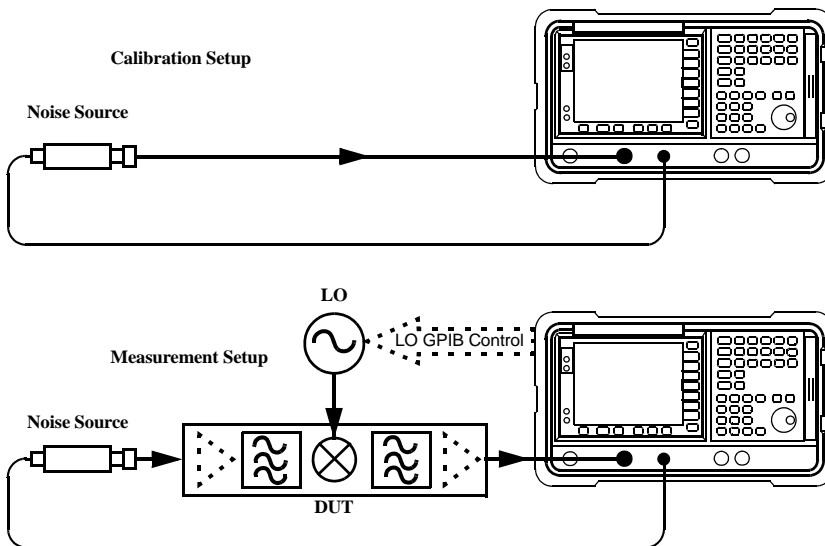
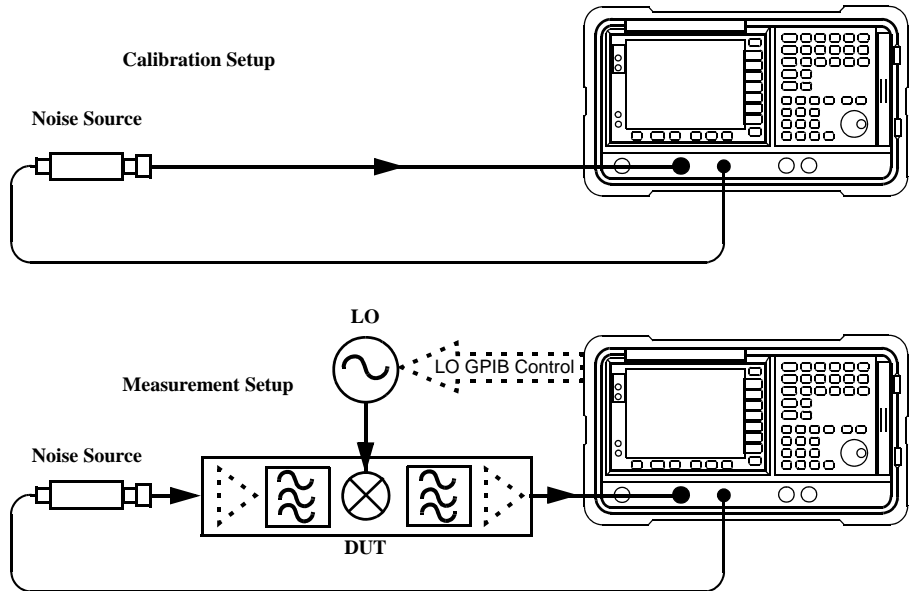

Figure 4-5 Frequency Converting DUT Measurement Modes



Measuring a Frequency-Converting DUT

Figure 4-6 Frequency Converting DUT Measurement Modes



In this mode, the DUT has frequency conversion in the measurement setup. However, there is no frequency conversion in the calibration setup, this is shown in Figure 4-6. The purpose of the calibration setup is to allow the NFA to measure its own noise figure and sensitivity with the noise source. This must be performed across the frequency range the NFA will tune over in the measurement setup. When the measurement is made, the NFA calculates the input frequency to the DUT, and using the appropriate values from the noise source ENR table, interpolating as necessary, measures the DUT.

Making Extended Frequency Measurements

Measuring a Frequency-Converting DUT

To allow the frequencies in the measurement setup to be calculated, the frequency parameters for the measurement are entered into the NFA. There are two possible sweep options:

1. The DUT LO is swept and the NFA is set to a fixed IF for the DUT.
2. The DUT LO is fixed and the NFA tuned frequency is swept.

If the DUT includes a fixed LO, then only option two is possible. If the DUT uses an external LO, then either option is possible. The frequency parameters for the measurement are entered into the NFA, hence it is convenient to allow the NFA to perform all the frequency calculations and control the LO.

For these measurements the NFA mode is set to

- **DUT: Upconv** or **Downconv**

NOTE

The Upconverter and Downconverter modes include any DUT performing frequency conversion, whether a simple single mixer or a complex receiver structure.

Sidebands and Images

For any measurement involving frequency conversion, you need to consider the exact frequency ranges involved, and make decisions about the filtering requirements for the specific measurement. For example, there may be several different methods of measuring a mixer, and the method chosen may be set by the choice of available filters.

Figure 4-7 Sidebands and Images

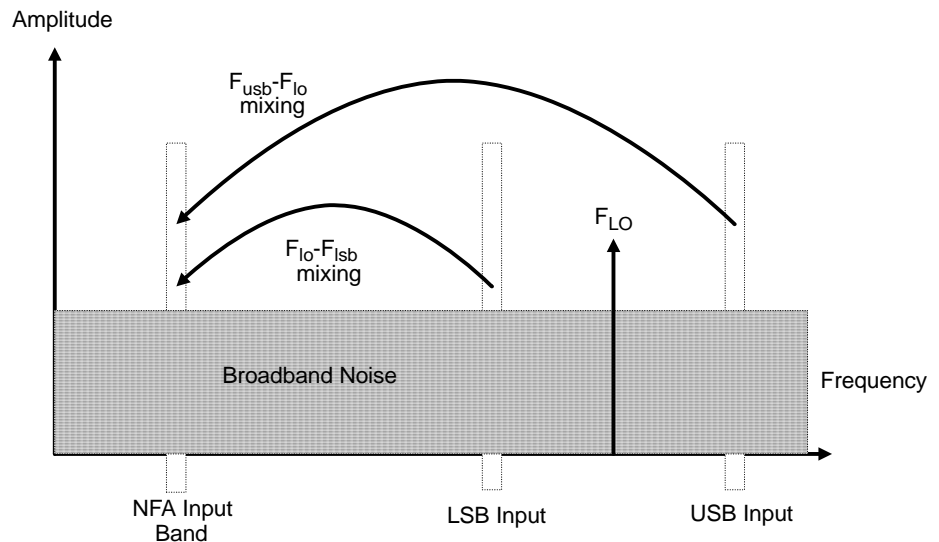

Simple, ideal, mixers output signals on both the sum and difference of their RF and LO frequencies. Hence, for a fixed output frequency and a fixed LO frequency, there are two different input frequencies that are converted to the output frequency. This is shown in Figure 4-7.

The noise sources used in noise figure measurements are broad-band, hence, there is a probability that noise will be presented to a simple mixer in both the upper and lower input frequency bands that are converted into the same IF output band that the NFA is tuned to. The NFA receives mixer-created noise from the two frequency bands superimposed. The noise is random, hence the two power levels combine by simple addition. Similarly, the NFA receives noise-source-created noise from the two frequency bands combined as added power. Any measurement where two mixing products are combined like this is usually termed Double-Sideband, DSB.

Making Extended Frequency Measurements

Measuring a Frequency-Converting DUT

It is conventional to call the higher frequency band of an image pair the Upper-Sideband, USB, and the lower frequency band of an image pair the Lower-Sideband, LSB.

Non-ideal mixers exhibit some unwanted behaviors:

1. Some of the input signal leaks directly to the output.
2. Some of the LO signal, and its harmonics, leak directly to the output.
3. Mixing products are created between the input signal and the harmonics of the LO.

There are other unwanted products involving input signal harmonics, but these tend to be less troublesome than those above, provided the mixer is operated at a level within its linear range.

Signal Leakage

Direct signal leakage of input signal through to a mixer's output can occur, because the noise sources cover a broad frequency range. Signal leakage is not normally a problem unless the noise source has a large variation in ENR, or the mixer's RF-to-IF leakage is high.

LO Leakage

The LO power is normally greater than the largest input signal that a mixer is intended to operate with. The LO power leaking from the mixer's output is at a high level compared to the signal levels involved in the noise figure measurement. Hence, LO leakage needs to be considered when measuring noise figure of a frequency converting DUT.

If the LO frequency is low enough to be passed by the NFA's RF section's input filter (a 3.0 GHz Low Pass Filter), the LO leakage will force the NFA's RF input attenuator to autorange onto a very insensitive range. This will prevent successful measurement of the DUT noise figure. Desensitization by LO leakage can be avoided by adding a filter between the DUT and the NFA to remove the LO frequency component.

LO Harmonics

Many mixers are operated by sinusoidal LO signals, LO harmonics can be formed in the mixer at significantly high levels. It is common for the specified LO input level for a diode mixer to be chosen to operate the diodes between saturation and off conditions, hence making the mixer act as a switch. LO harmonic derived products from industry standard double-balanced mixers may be similar in level to what they would have been with a square-wave LO signal. Instead of just being sensitive at one pair of frequencies $[F_{LO} \pm F_{IF}]$, the mixer input is sensitive at a series of pairs:

Equation 4-1

$$[F_{LO} \pm F_{IF}] + [2F_{LO} \pm F_{IF}] + [3F_{LO} \pm F_{IF}] + [4F_{LO} \pm F_{IF}] + [5F_{LO} \pm F_{IF}] + \dots$$

Filtering is needed to eliminate the noise input to the DUT at these higher order frequencies. However, their frequencies may be great enough that the mixer attenuates them, making them insignificant.

Other signals from the DUT

NFA RF input attenuator auto-ranging has already been covered in “LO Leakage” on page 162. However, signals close to the tuned frequency can de-sensitize the NFA measurements by forcing auto-ranging of the NFA's IF gain control. The NFA has a similar, internal, limitation set by the LO leakage of its own first mixer, and the requirement for the NFA to tune down to 10 MHz. The NFA's analogue IF filter is designed for high rejection for signals more than 10 MHz away from the tuned frequency. This is not changed when narrow bandwidths are selected. An unwanted signal within 10 MHz of the tuned frequency could corrupt a noise figure measurement.

Single Sideband Measurements

Most mixer applications involve single sideband (SSB) mixing - either LSB or USB, hence it is ideal to make noise figure measurements on a mixer in the circumstances in which it is used. Making an SSB measurement requires suitable filters to remove the unwanted image, any LO leakage, and other unwanted mixer products. This may require filters that are not available, or expensive, and a DSB measurement may be chosen as a compromise. There is no general guidance on what filtering is needed. Each case needs individual consideration.

Items to be considered are:

1. Decide the frequency ranges that must be covered; Input, LO, and Output.
2. Calculate the frequency range that the unwanted image will cover.
3. Calculate the frequency range that the LO harmonic modes will cover.
4. Choose a filter to go between the noise source and the DUT, that will pass the wanted input band and stop the unwanted input bands.
5. Consider the LO frequency range (and harmonics), is a filter needed to protect the NFA input being desensitized by LO leakage in the 0 - 3.5 GHz range?
6. Choose a filter, if necessary to go between the DUT and the NFA

If any of these ranges conflict, making the filter requirements impossible, the measurement could be split into a group of smaller ranges, with different filters for each.

If the DUT is a complicated mixer, it may already contain filters to operate the mixer in single sideband mode over the frequency range of interest. A mixer in its final application exhibits the same problems that make noise figure measurement difficult, hence the application will need similar filtering to that needed during noise figure measurement.

Figure 4-8 Single Sideband Mixer Measurements

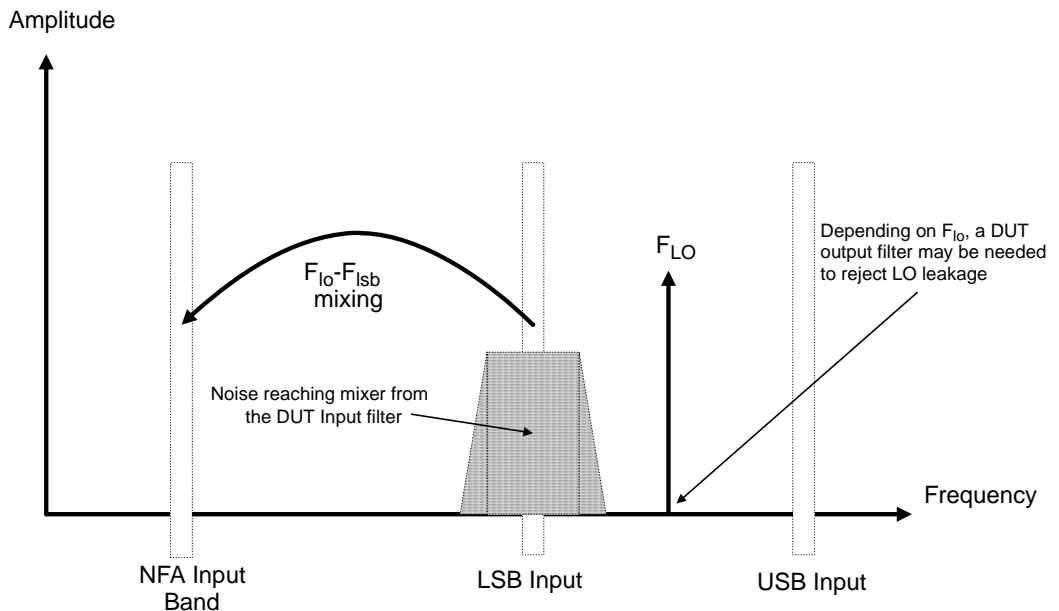

Figure 4-8 shows an SSB mixer measurement (Downconverter, LSB) where a filter makes it single sideband. If the IF frequency is lowered - the NFA is tuned to a lower frequency, the USB and LSB bands will move closer to the LO frequency. This makes filtering more difficult, and if the IF is lowered further, a point is reached where filtering is not possible and SSB measurements cannot be made. The width of the filter limits where the LO or IF frequencies sweep to make a measurement.

The NFA performs frequency calculations, controls the NFA frequency, and the LO frequency, for a variety of mixer modes. However, you have to determine the filter requirements, and provide those filters in the measurement setup.

Downconverter means that the output frequency, (IF) is lower than the input, (RF).

Upconverter means that the output frequency, (IF) is higher than the input (RF).

Making Extended Frequency Measurements

Measuring a Frequency-Converting DUT

The NFA can handle SSB mixer measurements in modes defined by the following combinational choices:

- **DUT: Upconverter** or **Downconverter**
- **LO Mode: Fixed** or **Variable**.
- **Sideband: LSB** or **USB**.

Double Sideband Measurements

DSB techniques can make useful noise figure measurements. Consider the following:

- What if adequate filters for image-free SSB measurements are not available?
- What if frequency ranges have to be covered that make SSB filters impractical or impossible?

DSB measurements do not eliminate the need for filtering, however, it can greatly simplify the filtering needed. This benefit is achieved at the loss of frequency resolution.

Figure 4-9 Double Sideband Measurements

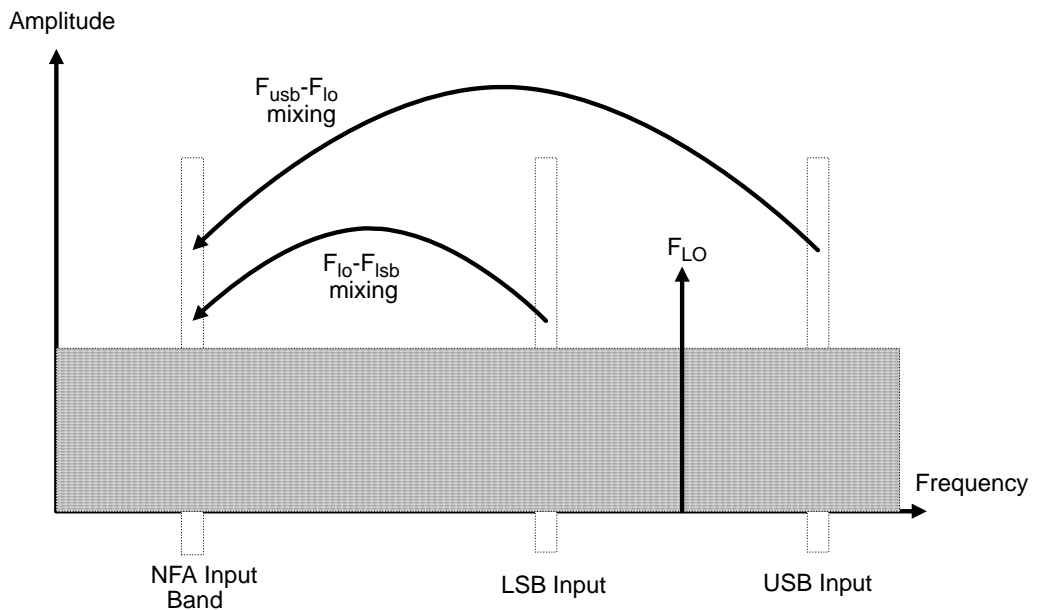

Figure 4-9 shows a double sideband, downconversion, mixing. Noise from two separated RF bands are mixed into the IF band, where the power addition takes place.

DSB measurements are made with the noise from a pair of separate bands, symmetrically arranged about the LO frequency. The selection of the IF frequency value should be a low frequency. Hence this technique maintains the two bands close together. The reason is to justify making the assumption that the variations in noise source ENR, gain and noise figure are linear between the two bands. This means that the averaging of results for the two bands, due to the power summation, gives a result which can be assigned to the centre frequency - the LO frequency.

Figure 4-9 shows that noise from two bands are combined during the measurement, while during calibration, when the DUT was not connected, only one band (at the IF frequency) was used.

If the assumptions about the parameters being flat over frequency between the two sidebands are valid, this causes a doubling in power (3 dB increase) in noise level during the measurement. This does not happen during calibration. This can be corrected for, using the **Loss Compensation**

Making Extended Frequency Measurements

Measuring a Frequency-Converting DUT

facility, and entering **Before DUT Value** of -3 dB and selecting **Fixed** in the **Before DUT** field. The DSB power addition occurs for both the *Hot* and *Cold* noise from the noise source, and the noise created in the input of the DUT. A temperature value can be assigned to this loss using the **Before Temperature**. Using the *Cold* temperature of the noise source (often assumed to be 290 Kelvin) corrects for this, and the NFA will give corrected results comparable to those that would have been given by an SSB measurement.

If you must use a high IF frequency, or if it has variations in performance over frequency, then the assumption is invalid.

DSB measurements are not appropriate for making measurements where DUT performance, or noise source ENR, have significant variation over the frequency range $[F_{LO} \pm F_{IF}]$

DSB measurements need care to determine their filtering needs.

LO Leakage (with specific DSB information)

LO leakage is a problem and is avoided by tuning the LO at frequencies greater than 3.5 GHz. Below 3.0 GHz, the LO leakage drives the NFA to add input attenuation to prevent overload, making the NFA insufficiently sensitive to measure the noise component at the input. Above 3.0 GHz, the NFA's input filter progressively attenuates the LO signal. For a DSB downconverter measurement with the LO going below about 3.5 GHz, a lowpass filter will be needed. The cutoff frequency must be chosen to pass the IF frequency of the measurement. The amount of attenuation over the LO frequency range has to be sufficient to reduce the LO leakage down to the broadband (10.0 MHz - 3 GHz) noise level presented to the NFA input.

With most DSB Downconverter measurements, the IF is made low, with respect to, the RF and LO frequencies, so filter needs are not complex.

NOTE

Low pass filters with cutoffs at low frequencies, may exhibit spurious resonances and leakage at low microwave frequencies. It may be necessary to use a pair of lowpass filters, one microwave, one RF, in order to assure a stopband attenuation over a wide frequency range.

LO Harmonics (with specific DSB information)

Many mixers have product pairs associated with harmonics of the LO. Depending on the mixer, these could be at a sufficient level to distort the measured noise figure results. To avoid this insert an input filter between the noise source and the DUT. A Highpass filter may also be needed in this location if signal leakage is a problem.

There is no general guidance on what filtering is needed. Each case needs individual consideration:

1. Decide the frequency ranges that have to be covered; Input, LO, and Output.
2. Calculate the frequency range that the LO harmonic modes will cover.
3. If LO harmonic related products are a problem, choose a filter to go between the noise source and the DUT, that will pass the wanted input band and stop the LO harmonic modes. If the frequency ranges are wide, the measurement may have to be split into frequency ranges with different filters for each.
4. Consider the LO frequency range (and harmonics), is a filter needed to protect the NFA input being desensitized by LO leakage in the 0-3.5GHz range?
5. Choose a filter, if necessary to go between the DUT and the NFA

The NFA can handle DSB mixer measurements in modes defined by the following combinational choices:

- **DUT: Upconverter** or **Downconverter**
- **LO Mode: Fixed** or **Variable**.
- **Sideband: DSB**.

Fixed IF

In the fixed IF mode, the IF frequency at the NFA's input is constant, and the LO frequency is swept to perform the measurement.

Figure 4-10 Fixed IF Measurements

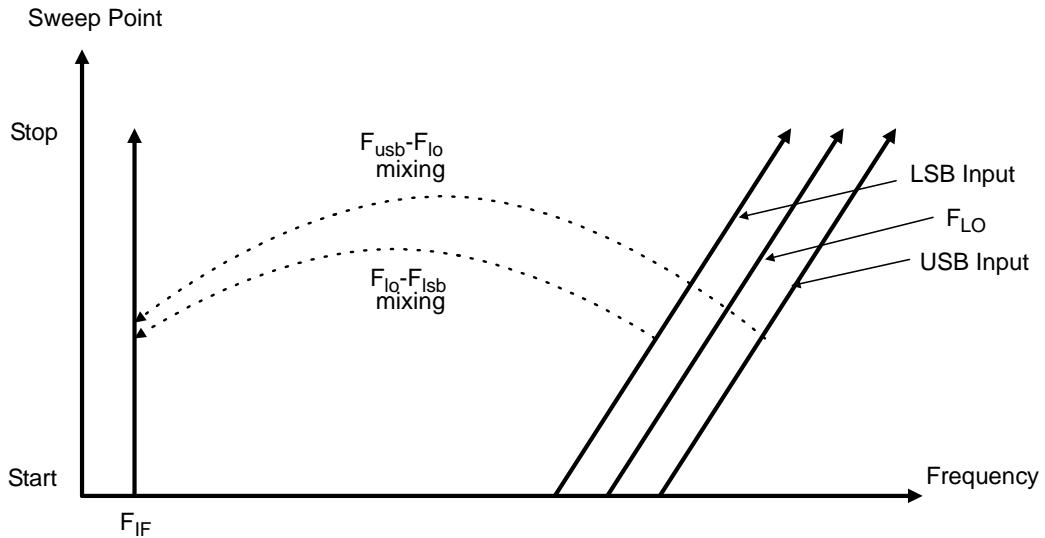

Figure 4-10 shows how the different frequencies in a DSB, downconverter, fixed IF, measurement vary as the measurement sweep proceeds. This mode measures the DUT's noise figure across a range of DUT input frequencies. This is the main use of the DSB mode.

A similar diagram could be drawn, if needed, showing the LO harmonic mixing modes at higher frequencies, with flatter slopes due to frequency multiplication.

Fixed LO

The fixed LO mode produces no sweep at the DUT input, as the two sideband input pairs diverge their average remains fixed. This mode could be useful for measuring a complex DUT where the effect of variation of performance of the post-mixer stage over IF frequency is of interest.

Because the LO frequency is held constant it is the IF frequency at the NFA input that is swept. Figure 4-11 illustrates this mode.

Figure 4-11 Fixed LO Measurements

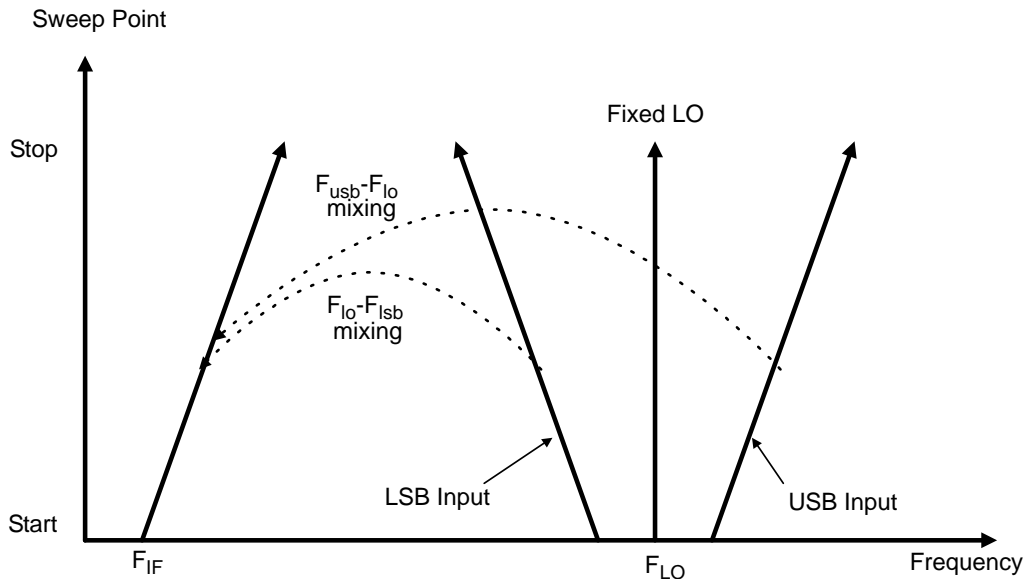

Making Frequency-Converting DUT Measurements

An example is provided where the NFA remains locked at one frequency and the LO sweeps. A lower sideband measurement of a mixer is made. The example can be modified to make measurements using a fixed LO where the IF is swept. Also, from the example, upper and double side band measurements can be made. The changes in the example's procedure are explained in each case.

Calibration of the measurement system is similar to a basic calibration, the noise source is connected directly to the RF input of the NFA and a calibration is made. The DUT is then placed between the noise source and the NFA, and a corrected measurement is made.

NOTE The RF input section on all NFA models has a built-in 3.0 GHz Low Pass Filter. This filter needs to be accounted for when planning your filter requirements during calibration and measurement.

NOTE On the N8974A and the N8975A models the microwave input section has no filtering. This needs to be accounted for when planning your filter requirements for calibration and measurement. This is also important when making swept IF measurements which cross over the 3.0 GHz switch.

Making Down-Converting DUT Measurements using a Fixed IF and Variable LO (8970B Mode 1.3)

Lower Sideband Measurement (Fixed IF and Variable LO)

The example lower sideband measurement is made using a N8973A model. The result is obtained by using a fixed IF of 1.0 GHz. Setting the RF frequency of interest to be 3.7 GHz to 4.2 GHz, giving an LO sweep from 4.7 to 5.2 GHz. This also meets with the need to maintain the LO frequency out of the NFA's passband.

The example uses a Signal Generator as a local oscillator. The system is used to measure a mixer over a 3.7 to 4.2 GHz frequency range. The noise figure for this mixer typically varies from 7 to 15 dB and the gain (conversion loss) from -5 to -15 dB over this frequency band. See Figure 4-12.

NOTE In the example, a 4.4 GHz Low Pass Filter with an out of band rejection by 4.6 GHz is used to remove the upper sideband. (see Figure 4-12).

Figure 4-12 Fixed IF and Variable LO, LSB Spectrum

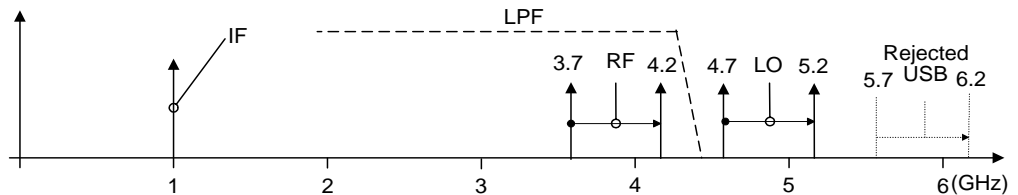

Initial Setup Procedure Follow the overview procedure of the initial set up.

- Step 1.** Power Up the NFA and the LO. You need to wait for the recommended warm up time to get accurate measurement results
- Step 2.** Connect the GPIB cables and the 10 MHz reference, if required. See “Connecting the System” on page 157 for more detail.
- Step 3.** Load the ENR values. See “Entering Excess Noise Ratio (ENR) Data” on page 51 for more detail.
- Step 4.** Set up the LO and the NFA’s LO settings. See “Choosing and Setting Up the Local Oscillator” on page 152 for more detail.
- Step 5.** Set the LO address
- Step 6.** Connect the system and add filtering where required. Figure 4-5 on page 158 shows the connections

Selecting Measurement Mode

Figure 4-13

Measurement Mode Form

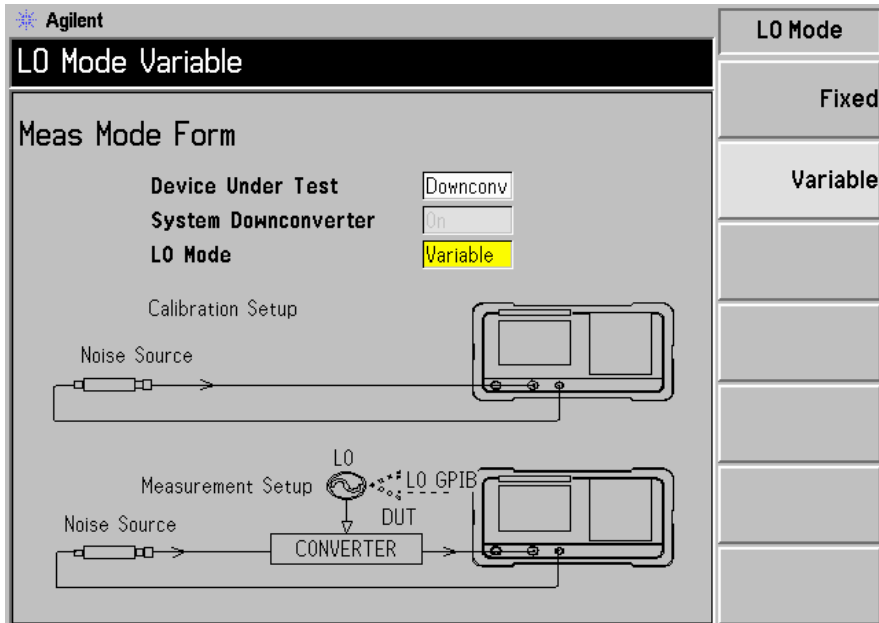

Step 1. Press the **Meas Mode** key. A Meas Mode Form is displayed (Figure 4-13). Confirm that the **Device Under Test** field is set to **Downconv** (select the **Downconv** menu key to highlight it).

The default **Device Under Test** setting is **Amplifier**.

NOTE

The **System Downconverter** field is no longer accessible to you in this measurement mode.

Step 2. Press the **Tab** key to navigate to the **LO Mode** field and press the **Variable** menu key for a variable LO setup.

Selecting Mode Setup

Figure 4-14

Mode Setup Form

The screenshot shows the Agilent Mode Setup Form. At the top left, the Agilent logo is visible. The main title is "LO Control On". Below this, the "Mode Setup Form" is displayed with the following fields and values:

IF Frequency	1.00000000 GHz
LO Frequency	10.00000000 GHz
Sideband	LSB
LO Control	On
External LO Power Level	10.000 dBm

At the bottom of the form, a note reads: "Move the highlight to select a field using the 'Tab' keys." To the right of the main form is a vertical sidebar with a "LO Control" header and two buttons: "Off" and "On". The "On" button is currently selected and highlighted in yellow.

Step 1. Press the **Mode Setup** key. A Mode Setup Form is displayed (Figure 4-14).

This form allows you to enter values for the IF frequency, setup the LO parameters and choose the sideband required.

Step 2. Press the **Tab** key to navigate to the **IF Frequency** field. Set the IF Frequency.

In the example, enter 1.0 GHz using the numeric keypad and terminate it using the unit keys which are presented to you.

Step 3. Press the **Tab** key to navigate to the **Sideband** field. Set the Sideband.

In the example, enter **LSB** using the menu keys which are presented to you.

Step 4. Press the **Tab** key to navigate to the **LO Control** field. Set the LO Control.

In the example, enter on by pressing the **On** menu key which is presented to you.

Making Extended Frequency Measurements
Making Frequency-Converting DUT Measurements

Step 5. Press the **Tab** key to navigate to the **External LO Power Level** field. Set the External LO Power Level.

In this example, enter 10 dBm using the numeric keypad and terminate it using the unit keys which are presented to you.

Setting Frequency, Point, Bandwidth, Averaging

Step 1. Configure the measurement with the **Frequency/Points** and **Averaging/Bandwidth** keys. For a description of these keys “Setting the Measurement Frequencies” on page 65 and “Setting the Bandwidth and Averaging” on page 71.

Set start and stop frequencies and number of points for the amplifier to be tested. For the example microwave amplifier, the appropriate figures are:

- Start: 3700 MHz
- Stop: 4200 MHz
- Points: 15
- Averaging: On
- Averages: 5
- Average Mode: Point

NOTE

The N8972A Average Mode is set to point by default, as sweep mode is only available on the other NFA models.

Calibration of the Microwave Setup Calibration of the microwave measurement system is similar to a basic RF calibration. If not done already, connect the Noise Source output to the NFA input, see Figure 4-15.

Figure 4-15 Frequency Converting DUT Measurement Modes

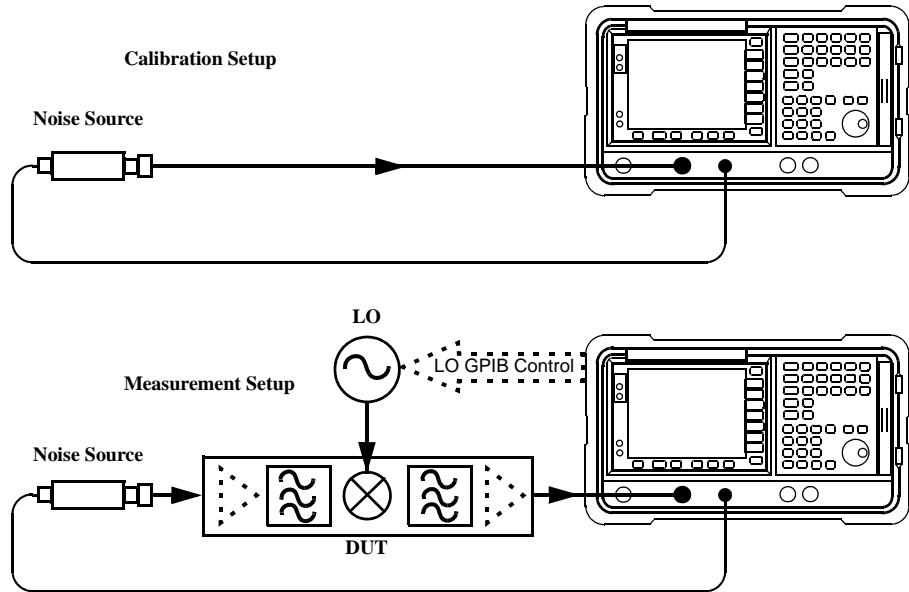

Step 1. Press the **Calibrate** key twice

The first time you press the key you are prompted to press it again. This two-stroke calibration is a safety feature to prevent you from accidentally pressing **Calibrate** and erasing the calibration data.

When calibration is complete the measurement system is calibrated at the mixer input. The white **Uncorr** text changes to **Corr** text in the lower right hand side of the display.

NOTE

The calibration is only made at the fixed IF frequency.

Calibration of the Microwave Setup

Step 1. Figure 4-16 shows typical results in table format after calibration.

Figure 4-16 Typical Calibration Results after a Restart is Pressed

Freq	NoiseFig dB	Gain dB
3.700000 GHz	-0.267	0.314
3.735714 GHz	-0.303	0.318
3.771429 GHz	-0.296	0.320
3.807143 GHz	-0.316	0.324
3.842857 GHz	-0.309	0.328
3.878571 GHz	-0.302	0.330
3.914286 GHz	-0.300	0.343
3.950000 GHz	-0.313	0.354
3.985714 GHz	-0.378	0.357
4.021429 GHz	-0.373	0.363
4.057143 GHz	-0.365	0.360
4.092857 GHz	-0.367	0.367
4.128571 GHz	-0.367	0.352
4.164286 GHz	-0.322	0.368
4.200000 GHz	-0.321	0.365

NOTE

After calibration the instrument will not show 0 dB + jitter with no DUT inserted. This is because the instrument is now using the microwave frequency ENR, while the input is tuned to the IF. When DUT is added, the NFA measures the noise figure of the DUT. If the configuration is arranged to reject one sideband, the SSB result is displayed. If both sidebands are converted by the mixer the DSB result is displayed.

Making the Corrected Noise Figure and Gain Measurement A measurement corrected for the second stage contribution may now be made. Insert the DUT into the system as shown in Figure 4-15. The results are displayed on the display using the same steps as those described in “Displaying the Measurement Results” on page 81. A typical display of noise figure and gain (conversion loss) is shown in Figure 4-17.

Figure 4-17 Typical Microwave Results

Freq	NoiseFig dB	Gain dB
3.700000 GHz	8.129	-8.205
3.735714 GHz	8.278	-8.315
3.771429 GHz	8.469	-8.527
3.807143 GHz	8.706	-8.770
3.842857 GHz	8.989	-9.134
3.878571 GHz	9.616	-9.789
3.914286 GHz	10.072	-10.270
3.950000 GHz	10.333	-10.494
3.985714 GHz	11.121	-11.374
4.021429 GHz	11.198	-11.574
4.057143 GHz	10.059	-10.660
4.092857 GHz	10.649	-11.577
4.128571 GHz	12.154	-13.298
4.164286 GHz	12.273	-13.255
4.200000 GHz	13.123	-14.037

NOTE Once you have successfully made your measurement you may want to save the set up for future measurements. This can be done by saving the state. See “Saving a File” on page 41 for more details.

Upper Sideband Measurement (Fixed IF and Variable LO)

The upper single sideband measurement set up is similar to the LSB measurement procedure described in “Lower Sideband Measurement (Fixed IF and Variable LO)” on page 172. However, you need to provide filtering to remove the LSB image. Follow the LSB procedure, and in the Mode Setup Form select the **USB** in the sideband option.

NOTE

During measurement with the DUT inserted, it is important that the filter is placed on the mixer input. Otherwise some added noise from the device under test will likely be in the unwanted sideband and create a measurement error. The filter must be in place for both calibration and measurement.

Double Sideband Measurement (Fixed IF and Variable LO)

The double sideband measurement set up is similar to the LSB measurement described in “Lower Sideband Measurement (Fixed IF and Variable LO)” on page 172. However, you need to provide filtering. Follow the LSB procedure, and in the Mode Setup Form select the **DSB** in the sideband option.

NOTE

During measurement with the DUT inserted, it is important that the filter is placed on the mixer input. Otherwise some added noise from the device under test will likely be in the unwanted sideband and create a measurement error. The filter must be in place for both calibration and measurement.

NOTE

The calibration is only made at the IF frequency

Making Down-converting DUT Measurements using a Variable IF and Fixed LO (8970B Mode 1.4)

Both double and single sideband measurements may be made in this mode. This measurement may be useful to choose the optimum IF for a mixer or receiver, or to measure how a mixer's or a receiver's noise figure and gain vary with IF.

Double Sideband Measurement (Variable IF and Fixed LO)

The double sideband measurement set up is similar to the LSB measurement procedure described in “Lower Sideband Measurement (Fixed IF and Variable LO)” on page 172. Follow the LSB procedure, and in the Mode Setup Form select the **DSB** in the sideband option. On the Meas Mode Form set the LO Mode to **Fixed**.

Lower Sideband Measurement (Variable IF and Fixed LO)

The lower sideband measurement set up is similar to the LSB measurement procedure described in “Lower Sideband Measurement (Fixed IF and Variable LO)” on page 172. However, you need to provide filtering. Follow the LSB procedure, and in the Mode Setup Form select the **LSB** in the sideband option. On the Meas Mode Form set the LO Mode to **Fixed**.

Upper Sideband Measurement (Variable IF and Fixed LO)

The upper sideband measurement set up is similar to the LSB measurement procedure described in “Lower Sideband Measurement (Fixed IF and Variable LO)” on page 172. However, you need to provide filtering. Follow the LSB procedure, and in the Mode Setup Form select the **USB** in the sideband option. On the Meas Mode Form set the LO Mode to **Fixed**.

Making Up-converting DUT Measurements using a Fixed IF and Variable LO (8970B Mode1.3 with SUM)

Making an up-converter measurement is similar to measuring down converters. The terminology is the same as the downconverter mode, the input to the NFA is called the IF and the noise source output is called the RF.

In the Meas Mode Form set the **Device Under Test** to **Upconv**.

Lower Sideband Measurement (Fixed IF and Variable LO)

The lower sideband measurement set up is similar to the LSB measurement procedure described in “Lower Sideband Measurement (Fixed IF and Variable LO)” on page 172. However, you need to provide filtering. Follow the LSB procedure, and in the Mode Setup Form ensure the **LSB** in the sideband option is selected. On the Meas Mode Form set the LO Mode to **Variable**.

Upper Sideband Measurement (Fixed IF and Variable LO)

The upper sideband measurement set up is similar to the LSB measurement procedure described in “Lower Sideband Measurement (Fixed IF and Variable LO)” on page 172. However, you need to provide filtering. Follow the LSB procedure, and in the Mode Setup Form select the **USB** in the sideband option. On the Meas Mode Form set the LO Mode to **Variable**.

Making Up-converting DUT Measurements using a Variable IF and Fixed LO (8970B Model 1.4 with SUM)

Lower Sideband Measurement (Variable IF and Fixed LO)

The lower sideband measurement set up is similar to the LSB measurement procedure described in “Lower Sideband Measurement (Fixed IF and Variable LO)” on page 172. However, you need to provide filtering. Follow the LSB procedure, and in the Mode Setup Form ensure the **LSB** in the sideband option is selected. On the Meas Mode Form set the LO Mode to **Fixed**.

Upper Sideband Measurement (Variable IF and Fixed LO)

The upper sideband measurement set up is similar to the LSB measurement procedure described in “Lower Sideband Measurement (Fixed IF and Variable LO)” on page 172. However, you need to provide filtering. Follow the LSB procedure, and in the Mode Setup Form select the **USB** in the sideband option. On the Meas Mode Form set the LO Mode to **Fixed**.

Measurements with a System Downconverter

A system downconverter can be thought of as a frequency extender for the NFA, to allow measurements to be made on DUTs at frequencies the NFA does not cover with its frequency range.

Figure 4-18 System Downconverter Mode

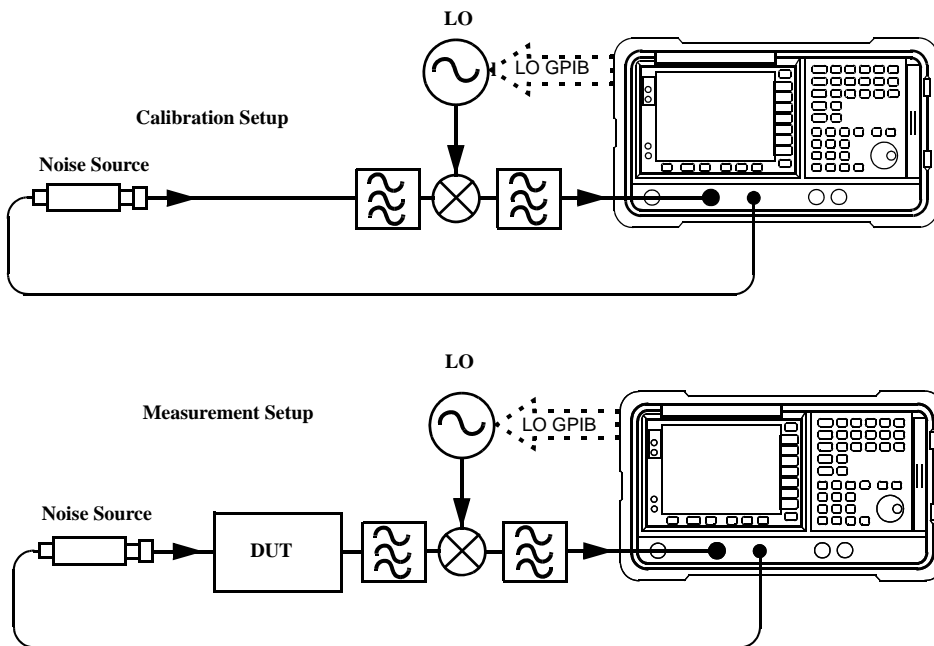

A system downconverter is part of the measuring system, and is present in both the calibration setup and the measurement setup, see Figure 4-18. During calibration the noise performance of both the NFA and the system downconverter are measured. Because of this, when corrected measurements are performed, the results apply to the DUT only. ENR data for the same frequency range is used for both calibration and measurements

The NFA has the capability to control a single frequency conversion, so system downconverter measurements under the NFA's control are limited to non-frequency converting DUTs.

The NFA can be used in much more complex systems, with multiple frequency conversions between the DUT and measurement system. However, the control of such systems is application-specific. You need to perform frequency calculations to suit that particular system, account for the effects of any DSB conversions, determine filter requirements, and calculate the appropriate ENR values for calibration and measurement.

USB, LSB or DSB?

If the DUT is broadband, a system downconverter could operate in USB, LSB, or DSB mode, and the same circumstances occur in both calibration and measurements, hence DSB sideband power addition corrections are not needed. Corrected measurements cancel any sideband summation effects.

If the DUT is narrowband and a DSB system downconverter is used, the calibration setup will operate in true DSB mode. However, the measurement setup mode will be influenced by the DUT's selectivity.

The possibilities fit into two groups and a third situation which should be avoided:

1. The DUT bandwidth is much greater than the LSB-USB separation, so a normal DSB measurement results.
2. The DUT bandwidth is much less than the LSB-USB separation, and the sweep width is less than the USB-LSB separation, so an SSB measurement results. This needs a gain correction factor due to the DSB calibration

NOTE

There is a third situation and this must be avoided. Where the DUT selectivity can resolve the individual sidebands of the DSB measurement and the sweep is wide enough to scan the DUT across them. Different parts of the measurement plot are in different modes. USB, LSB and DSB could occur in different places on the same plot, with gradual changes between them, set by the shape of the DUT's frequency response. Variable gain correction would be needed across the plot and the corrections needed would change if adjustments to the DUT changed its shape.

Measurement Modes with a DSB System Downconverter

The NFA supports only one DSB System Downconverter mode; where the IF is fixed and the system downconverter LO is swept. The benefits of a DSB measurement are, minimal filter requirements, and wide frequency coverage. DSB measurements are appropriate for wideband DUTs. Their disadvantages, covered in the “USB, LSB or DSB?” section, make them inappropriate for narrowband DUTs. The usual aim is to choose as low a frequency IF as possible, in order to minimize the separation between the sidebands, thus get the optimum resolution possible. Figure 4-19 shows this.

Figure 4-19 DSB System Downconverter Measurements

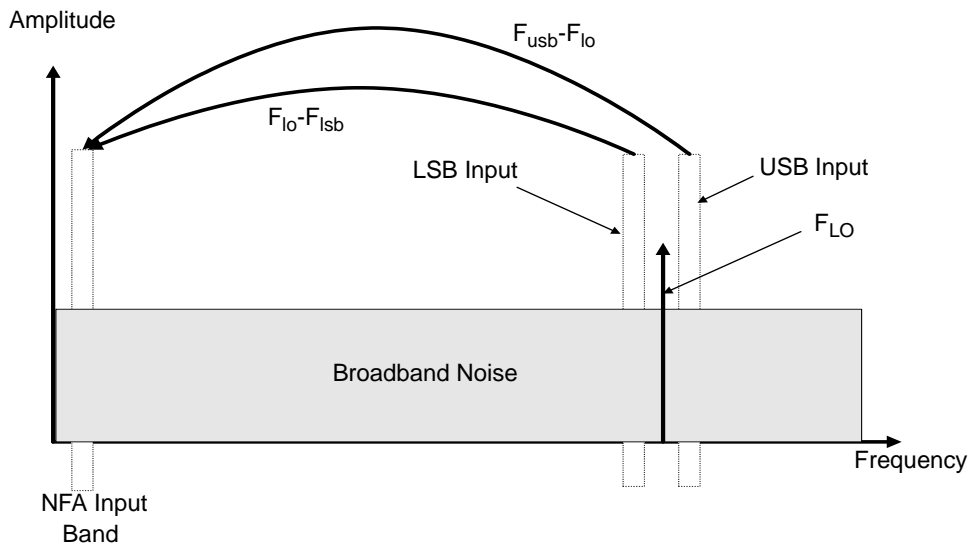

DSB system downconverter measurements have implicit linear averaging of DUT characteristics and ENR values between the USB and LSB frequencies. Results are made against the average frequency of the two bands - the LO frequency.

Figure 4-20 DSB System Downconverter Measurements

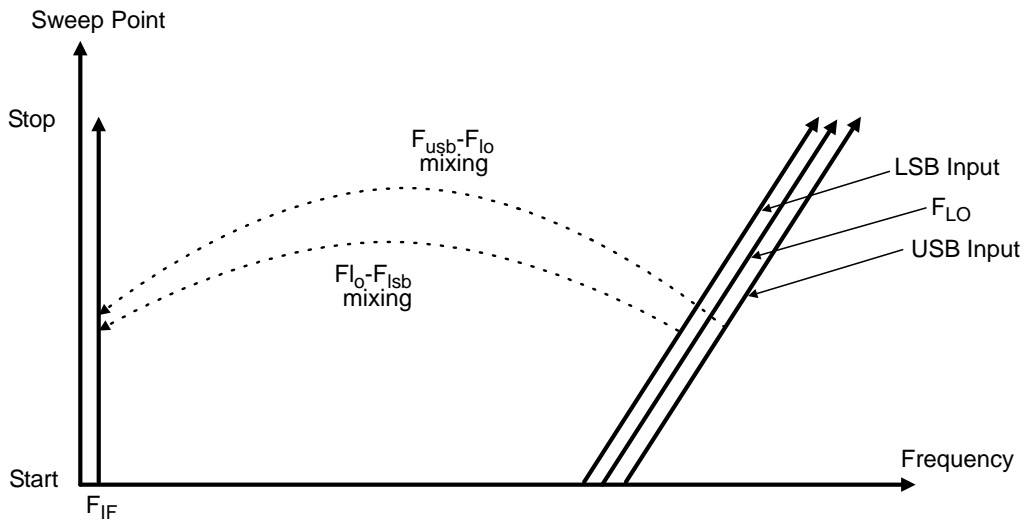

For microwave measurements, above 3.5 GHz, the NFA's input filter will reject LO leakage from the downconverter, otherwise a filter is needed between the system downconverter and the NFA. Also, considerations about mixer LO harmonic modes apply.

Measurement Modes with an SSB System Downconverter

The NFA can perform frequency calculations and LO control for either USB or LSB system downconverter conversions. It is the provision of filtering that makes a mode USB or LSB.

The filtering requirements will be measurement-specific.

Figure 4-21 shows how filtering makes an LSB measurement, and Figure 4-22 shows a USB downconversion measurement.

Making Extended Frequency Measurements
Measurements with a System Downconverter

Figure 4-21 LSB System Downconverter Measurements

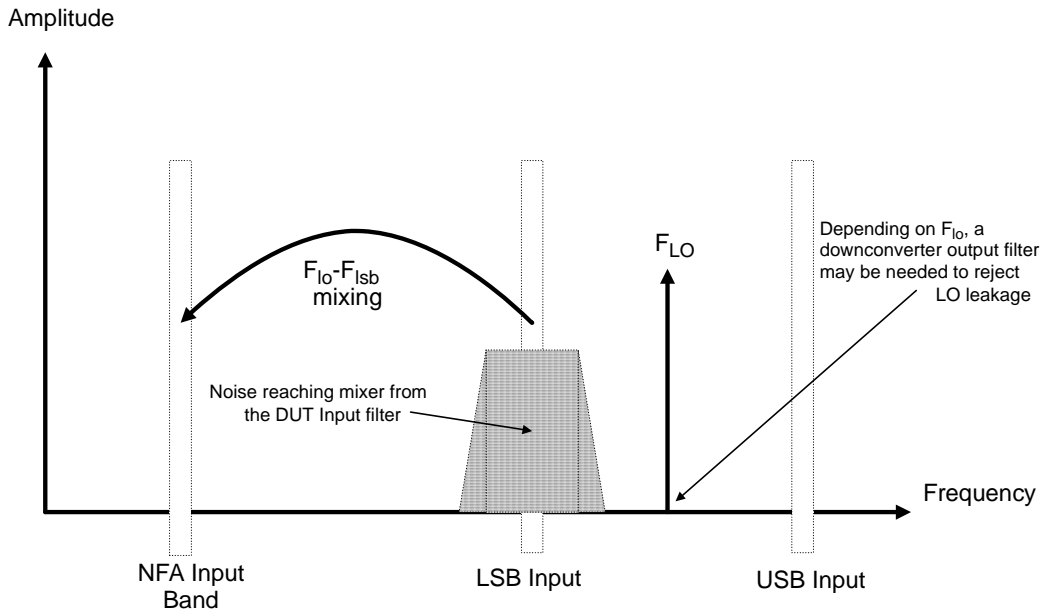
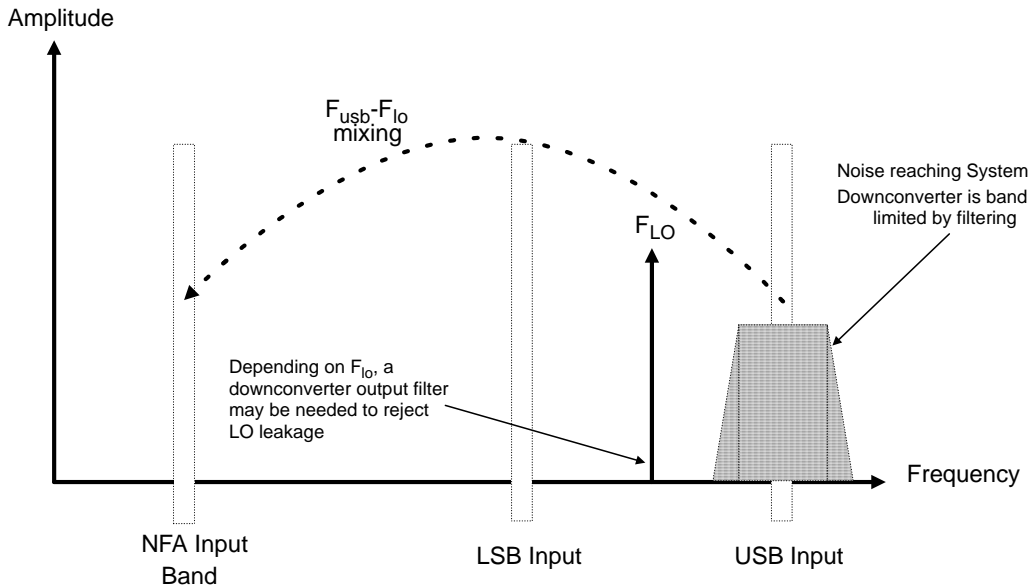

Figure 4-22 USB System Downconverter Measurements



Ideally choose a high IF frequency for the conversion to separate the USB and LSB bands, thus reducing the filter requirements.

The filter needed to make an SSB measurement could be part of the DUT, or a measurement-specific filter must be obtained and applied at the input to the system downconverter.

The bandwidth of the SSB filter limits the maximum frequency range that a measurement can be swept over. Therefore SSB measurements are not suited to very wideband DUTs. However, variable LO (Fixed IF) SSB measurements can be made over wider sweep widths than variable IF (Fixed LO) measurements can be.

The NFA can perform frequency calculations and LO control for both USB and LSB. It can perform both variable LO (NFA frequency fixed) and fixed LO (NFA frequency swept). The fixed LO mode is useful where the downconverter, has a fixed LO system. The sweep of the NFA's tuned frequency causes the frequencies at which the system downconverter is sensitive to sweep. Filtering is needed to select the wanted sideband. A swept noise figure measurement is then possible even if the system LO cannot be swept.

FIXED IF, LSB:

Figure 4-23 **LSB Measurements**

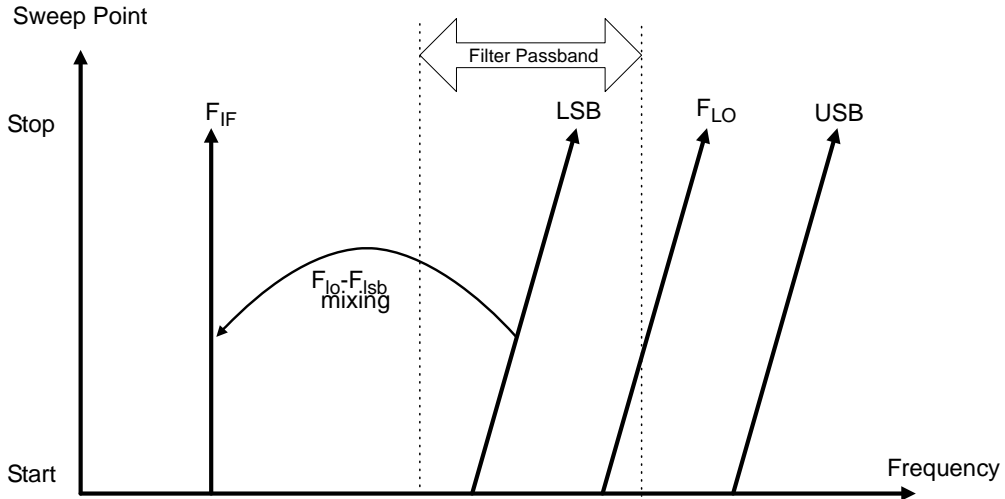

Figure 4-23 shows a fixed-IF, LSB, system downconverter where the NFA steps the LO through the sweep.

A filter is used to pass the LSB and reject the USB. Manufactured filters cannot have infinite transition-band slopes, hence some margin is needed between the maximum frequency of the LSB component (at the end of the sweep) and the minimum frequency of the USB component (at the start of the sweep). Choosing a high IF separates the USB and LSB frequencies more, and allows a wider sweep, or a simpler filter. The filter could be a lowpass or a bandpass, it must pass the range that the LSB frequency sweeps over, while rejecting the range that the USB frequency sweeps over. Figure 4-23 shows that the sweep width cannot exceed twice the IF frequency.

You need to make an allowance for the filter's transition band.

FIXED IF, USB:

Figure 4-24 USB Measurements

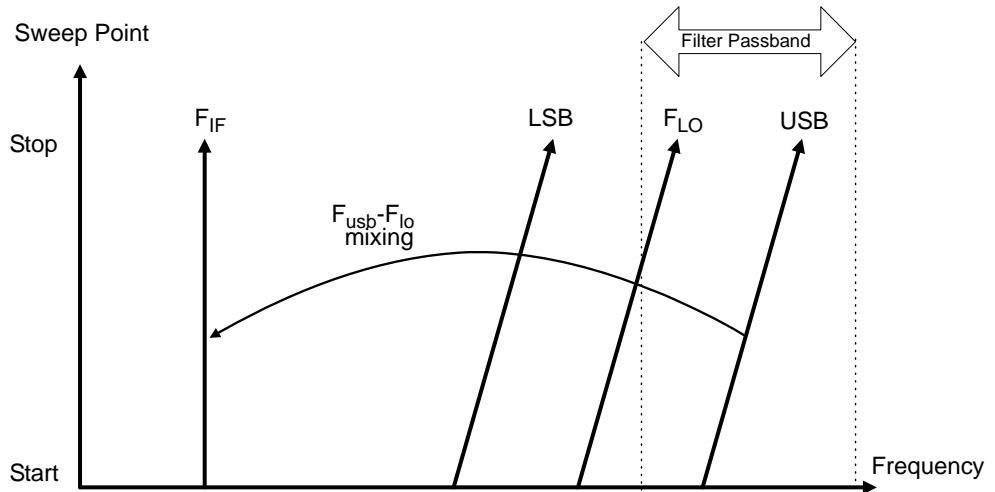

The fixed IF, USB mode is similar to the fixed IF, LSB mode. It allows the measurement to extend up to 3.0 GHz higher than the maximum LO frequency (1.5GHz with N8972A). The filter needs to be a bandpass or highpass. A bandpass filter has an advantage in rejecting LO harmonic mixing modes. This mode is shown in Figure 4-24, again, the sweep width is limited to less than twice the IF frequency, less an allowance for the filter transition band.

FIXED LO, LSB

The main benefit of the fixed LO system downconverter modes is that a programmable synthesized LO is not needed. The disadvantage is the limited sweep width available, and the increased demands placed on the sideband selection filters. These modes are suited to the measurement of DUTs with narrow frequency bands of less than 4 MHz.

Figure 4-25 LSB Measurements

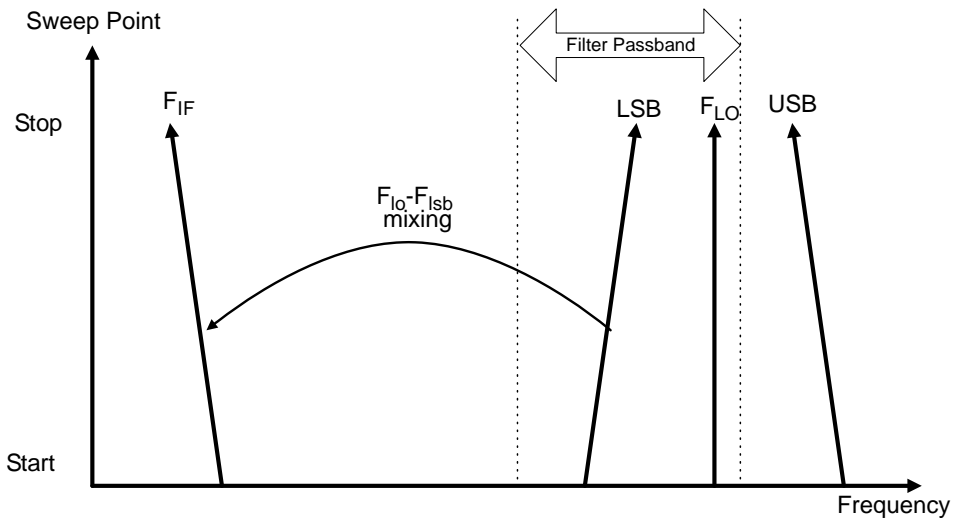

Figure 4-25 shows how the NFA sweeps its own input frequency backwards from high to low frequency so that as the LSB tunes, the frequency increases across the sweep. The filter required is either; a lowpass or a bandpass. The maximum sweep width is now limited to the maximum IF frequency, less an allowance for the filter transition band.

FIXED LO, USB

Figure 4-26 USB Measurements

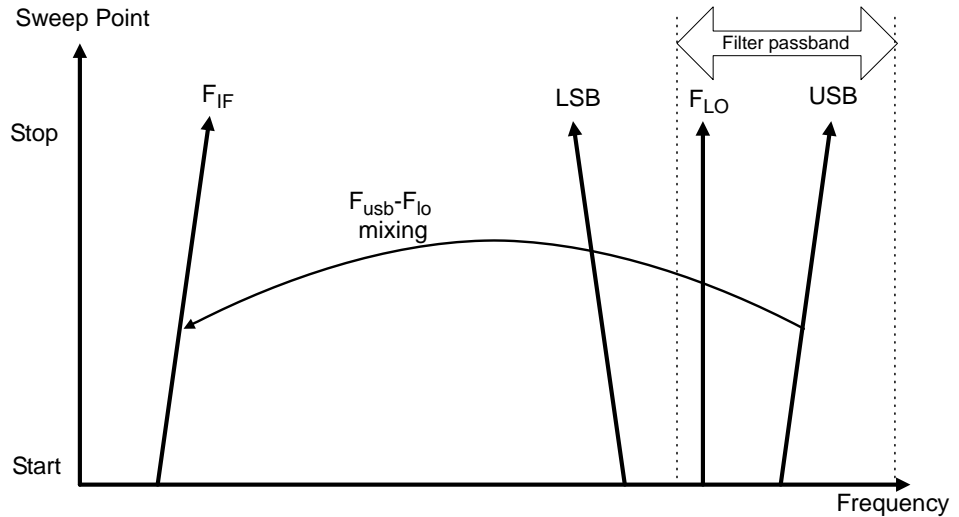

Figure 4-26 shows as the NFA tunes in the normal direction for the fixed LO USB mode. The filter can be a bandpass or highpass, and the sweep width is again limited to the maximum IF frequency, less an allowance for the filter transition band.

Making System Downconverter Measurements

To make a System Downconverter measurement requires an external mixer and local oscillator. In this mode the frequency conversion is in the measurement system, not in device under test.

An example is provided where the NFA remains locked at one frequency and the LO sweeps with the noise source input frequency. A double sideband measurement of an amplifier is made. The example can be modified to make measurements using a fixed LO where the IF is swept. Also, from the example, upper and lower side band measurements can be made. The changes in the example's procedure are explained in each method.

NOTE The RF input section on all NFA models has a built-in 3.0 GHz Low Pass Filter. This filter needs to be accounted for when planning your filter requirements during calibration and measurement.

NOTE On the N8974A and the N8975A models the microwave input section has no filtering. This needs to be accounted for when planning your filter requirements for calibration and measurement. This is also important when making measurements which cross over the 3.0 GHz switch.

Using a Fixed IF and Variable LO (8970B Model1.1)

In this mode the LO sweeps with the input frequency and the NFA is set at a fixed IF frequency. The IF frequency and the measurement input frequency range values are entered into the analyzer. The NFA calculates the set of frequencies that the LO will be swept over.

Double Sideband Measurement (Fixed IF and Variable LO)

The example double sideband measurement is made using a N8973A model. The result is obtained, by using a fixed IF of 1.0 GHz. Setting the frequency of interest to be 3.6 GHz to 4.0 GHz, giving an LO sweep from 3.6 GHz to 4.0 GHz. This also meets with the need to maintain the LO frequency out of the NFA's passband.

NOTE

Typically select an low IF, as there may be differences in ENR values. Also, differences in gain performance at the two sidebands.

The example uses the a Signal Generator as a local oscillator, and a mixer to downconvert to the frequency range of the NFA. The system is used to measure a 2000 to 4300 MHz amplifier over a 3.6 to 4.0 GHz frequency range. The noise figure for this amplifier typically varies from 6 to 10 dB and the gain from 15 to 5 dB over this reduced frequency band. Figure 4-27 shows the frequencies involved.

NOTE

Filtering is not needed in the DSB mode. Ensure the LO frequencies are out of the passband range of the NFA, Hence, LO sweep is always greater than 3.5 GHz over its swept range.

Figure 4-27 Variable LO, Fixed IF, DSB Spectrum

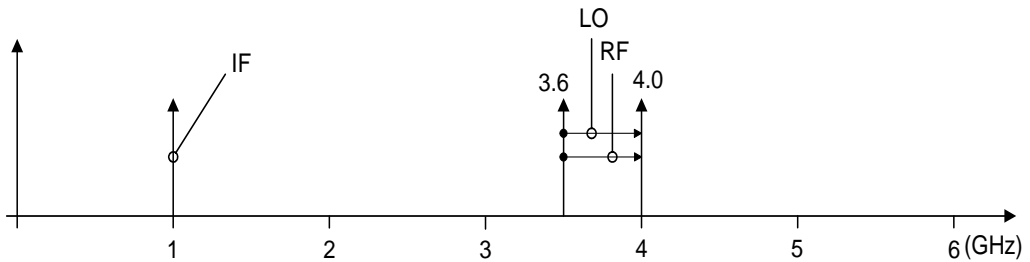

Initial Setup Procedure

Follow the overview procedure of the initial set up.

- Step 1.** Power Up the NFA and the LO. You need to wait for the recommended warm up time to get accurate measurement results
- Step 2.** Connect the GPIB cables and the 10 MHz reference, if required. See “Connecting the System” on page 157 for more detail.
- Step 3.** Load the ENR values. See “Entering Excess Noise Ratio (ENR) Data” on page 51 for more detail.
- Step 4.** Set up the LO and the NFA’s LO settings. See “Choosing and Setting Up the Local Oscillator” on page 152 for more detail.
- Step 5.** Set the LO address
- Step 6.** Connect the system and add filtering where required. Figure 4-4 on page 158 shows the connections

NOTE

The **LO GPIB** menu key accesses the System LO GPIB Form. This feature is currently not supported, as currently only the NFA can act as GPIB controller. Hence, if the **LO Control** is set to **On** in the Mode Set Up Form, the NFA controls the LO.

Selecting Measurement Mode

Figure 4-28 Measurement Mode Form

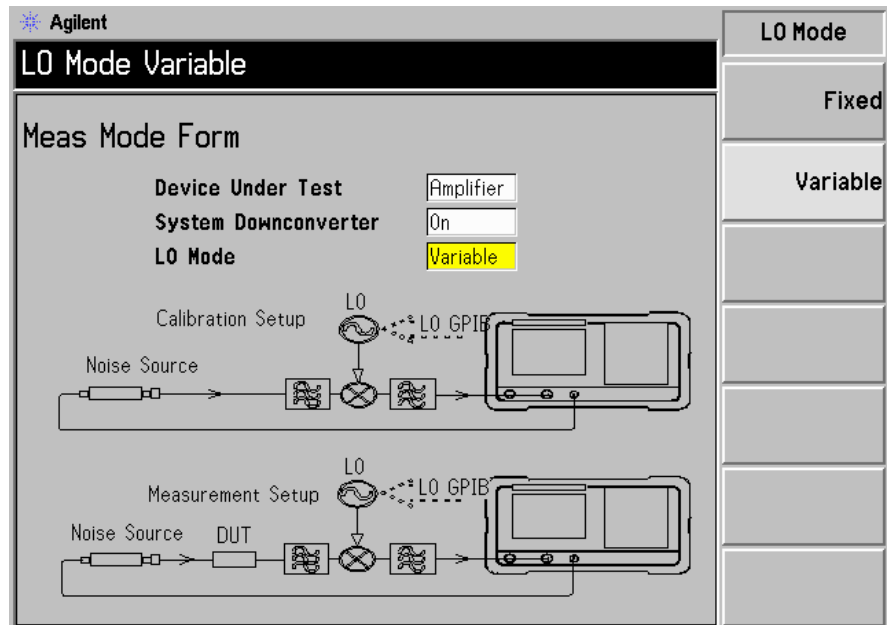

Step 1. Press the **Meas Mode** key. A Meas Mode Form is displayed (Figure 4-28). Confirm that the **Device Under Test** field is set to **Amplifier**.

Use the **Tab** key to move round the form and in the **Device Under Test** field select the **Amplifier** menu key to highlight it. The default **Device Under Test** setting is **Amplifier**.

Step 2. Press the **Tab** key to navigate to the **System Downconverter** field and press the **On** menu key to turn on system down conversion.

Step 3. Press the **Tab** key to navigate to the **LO Mode** field and press the **Variable** menu key for a variable LO setup.

Selecting Mode Setup

Figure 4-29

Mode Setup Form

Agilent

Sideband DSB

Mode Setup Form

IF Frequency	1.00000000 GHz
LO Frequency	10.00000000 GHz
Sideband	DSB
LO Control	0n
External LO Power Level	10.000 dBm

Move the highlight to select a field using the 'Tab' keys.

Sideband

- LSB
- USB
- DSB

- Step 1.** Press the **Mode Setup** key. A Mode Setup Form is displayed (Figure 4-29).

This form allows you to enter values for the IF frequency, setup the LO parameters and choose the sideband required.

- Step 2.** Press the **Tab** key to navigate to the **IF Frequency** field. Set the IF Frequency.

In the example, enter 1.0 GHz using the numeric keypad and terminate it using the unit keys which are presented to you.

- Step 3.** Press the **Tab** key to navigate to the **Sideband** field. Set the Sideband.

In the example, enter **DSB** using the menu keys which are presented to you.

Step 4. Press the **Tab** key to navigate to the **LO Control** field. Set the LO Control.

In the example, enter on by pressing the **On** menu key which is presented to you.

Step 5. Press the **Tab** key to navigate to the **External LO Power Level** field. Set the External LO Power Level.

In this example, enter 10 dBm using the numeric keypad and terminate it using the unit keys which are presented to you.

Setting Frequency, Point, Bandwidth, Averaging

Step 1. Configure the measurement with the **Frequency/Points** and **Averaging/Bandwidth** keys. For a greater description of these keys, see “Setting the Measurement Frequencies” on page 65 and “Setting the Bandwidth and Averaging” on page 71.

Set start and stop frequencies and number of points for the amplifier to be tested. For the example amplifier, the appropriate figures are:

- Start: 3600 MHz
- Stop: 4000 MHz
- Points: 15
- Averaging: On
- Averages: 5
- Average Mode: Point
- Bandwidth: 4 MHz

NOTE

The N8972A Average Mode is set to point by default, as sweep mode is only available on the other NFA models.

Calibration of the DSB Setup Calibration of the DSB measurement setup requires, if not done already, you to attach the mixer LO port to the output of the LO, connect the Noise Source output to the mixer RF input, and connect the mixer IF output to the NFA input, see Figure 4-30.

Figure 4-30 System Downconverter Mode

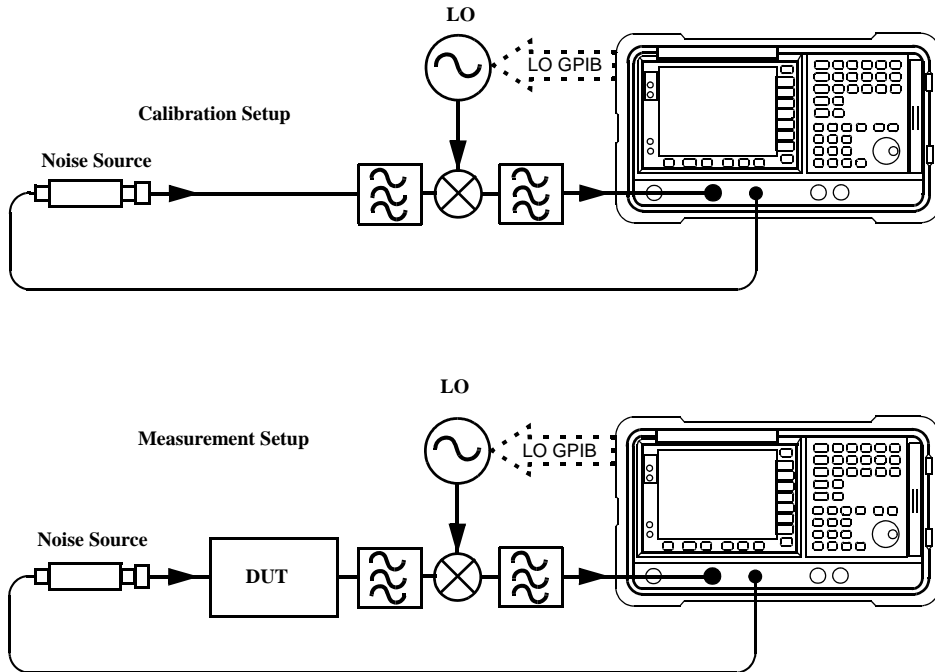

Step 1. Press the **Calibrate** key twice

The first time you press the key you are prompted to press it again. This two-stroke calibration is a safety feature to prevent you from accidentally pressing **Calibrate** and erasing the calibration data.

When the calibration is complete the measurement set up is calibrated at the mixer input. The white **Uncorr** text changes to yellow **Corr** text in the lower right hand side of the display. The second stage calibration now includes the mixer, the LO, the cables, adapters, and the NFA.

Figure 4-31 shows typical results in table format after calibration. It is good practice to measure the gain and noise figure of the direct connection before the DUT is inserted.

Figure 4-31 Typical Calibration Results after a Restart is Pressed

Freq	NoiseFig dB	Gain dB
3.600000 GHz	-0.002	0.034
3.642857 GHz	0.129	0.008
3.685714 GHz	0.076	0.032
3.728571 GHz	0.122	0.016
3.771429 GHz	0.163	0.000
3.814286 GHz	0.141	0.005
3.857143 GHz	0.108	-0.013
3.900000 GHz	-0.329	-0.007
3.942857 GHz	-0.141	0.047
3.985714 GHz	0.216	0.022
4.028571 GHz	-0.082	0.015
4.071429 GHz	0.347	-0.004
4.114286 GHz	0.046	0.024
4.157143 GHz	0.437	0.013
4.200000 GHz	0.219	0.011

Making the Corrected Noise Figure and Gain Measurement A measurement corrected for the second stage contribution may now be made. Insert the DUT into the system as shown in Figure 4-30. The results are displayed on the display using the same steps as those described in “Displaying the Measurement Results” on page 81. A typical display of noise figure and gain is shown in Figure 4-32.

Figure 4-32 Typical DUT Results

Freq	NoiseFig dB	Gain dB
3.600000 GHz	9.164	19.475
3.642857 GHz	9.344	19.477
3.685714 GHz	9.461	19.490
3.728571 GHz	9.682	19.519
3.771429 GHz	9.818	19.441
3.814286 GHz	10.047	19.612
3.857143 GHz	10.190	19.657
3.900000 GHz	10.415	19.794
3.942857 GHz	10.564	19.906
3.985714 GHz	10.772	19.890
4.028571 GHz	10.815	19.807
4.071429 GHz	10.915	19.796
4.114286 GHz	10.964	19.730
4.157143 GHz	11.105	19.499
4.200000 GHz	11.089	19.218

NOTE Once you have successfully made your measurement you may want to save the set up for future measurements. This can be done by saving the state. See “Saving a File” on page 41 for more details.

Lower Single Sideband Measurement (Fixed IF and Variable LO)

The lower single sideband measurement set up is similar to the DSB measurement. However, you need to provide filtering to remove the USB image. Follow the DSB procedure, however in the Mode Setup Form select the **LSB** in the sideband option.

NOTE

During measurement with the DUT inserted, it is important that the filter be on the mixer input rather than the noise source output. Otherwise some added noise from the device under test will likely be in the unwanted sideband and create a measurement error. The filter must be in place for both calibration and measurement.

Upper Single Sideband Measurement (Fixed IF and Variable LO)

The upper single sideband measurement set up is similar to the DSB measurement. However, you need to provide filtering to remove the LSB image. Follow the DSB procedure, however in the Mode Setup Form select the **USB** in the sideband option.

NOTE

During measurement with the DUT inserted, it is important that the filter be on the mixer input rather than the noise source output. Otherwise some added noise from the device under test will likely be in the unwanted sideband and create a measurement error. The filter must be in place for both calibration and measurement.

Using a Variable IF and Fixed LO (8970B Mode1.2)

In this mode the NFA sweeps with the input frequency and the LO is set to a fixed frequency. The LO frequency and the measurement input frequency range values are entered into the analyzer. The NFA calculates the set of frequencies that the IF is swept over.

NOTE

Even if the LO is not controlled by the NFA the LO's frequency value must be entered in the Mode Setup Form.

A measurement with a variable IF, always requires a single-sideband measurement. Hence the need to filter the unwanted sideband in the measurement setup.

Calibration in this mode is the same as for the variable LO single-sideband modes, and you need to ensure that the filter is in place for both the calibration and the measurement.

Connecting the System

To connect the calibration and measurement set up for this mode see Figure 4-33. If the NFA is the controller as in the previous section, and the LO is one that can respond over GPIB, this automatically sets the LO frequency.

If the LO cannot respond over GPIB or using the custom commands, you can set the frequency and amplitude manually to a fixed value. However, the frequency value must be entered in the Mode Setup Form in the NFA.

Figure 4-33

System Downconverter Mode

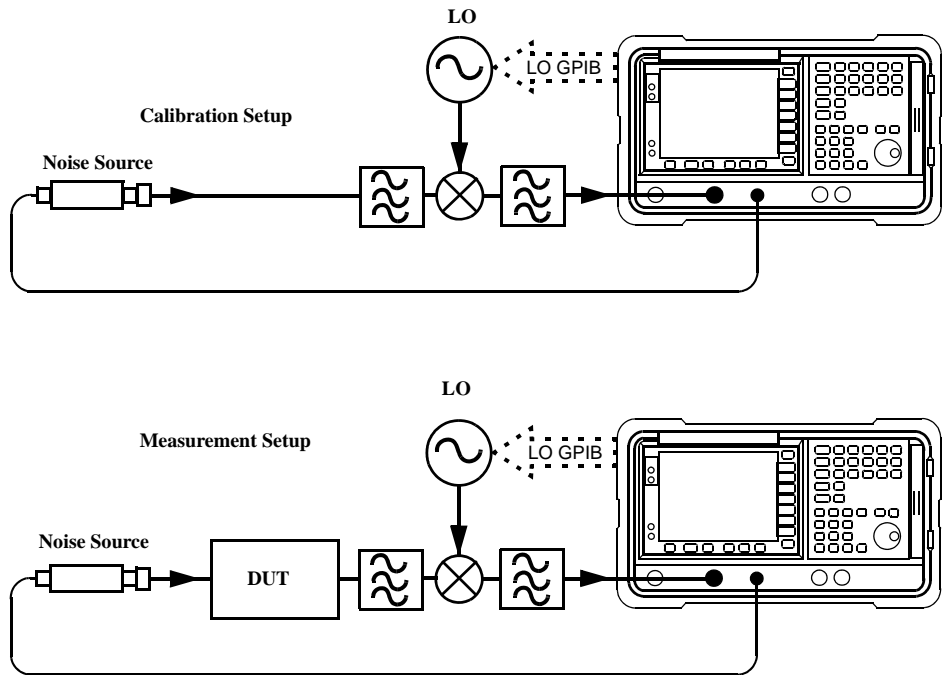

Lower Sideband Measurement (Variable IF and Fixed LO)

The lower single sideband measurement set up is similar to the DSB measurement example, see “Double Sideband Measurement (Fixed IF and Variable LO)” on page 195. However, you need to provide filtering to remove the USB image. Follow the DSB procedure, and the Mode Setup Form select the **LSB** in the sideband option. On the Meas Mode Form select the LO Mode to **Fixed**.

NOTE

During measurement with the DUT inserted, it is important that the filter be on the mixer input rather than the noise source output. Otherwise some added noise from the device under test will likely be in the unwanted sideband and create a measurement error. The filter must be in place for both calibration and measurement.

Upper Sideband Measurement (Variable IF and Fixed LO)

The upper single sideband measurement set up is similar to the DSB measurement example, see “Double Sideband Measurement (Fixed IF and Variable LO)” on page 195. However, you need to provide filtering to remove the LSB image. Follow the DSB procedure, and the Mode Setup Form select the **USB** in the sideband option. On the Meas Mode Form select the LO Mode to **Fixed**.

NOTE

During measurement with the DUT inserted, it is important that the filter be on the mixer input rather than the noise source output. Otherwise some added noise from the device under test will likely be in the unwanted sideband and create a measurement error. The filter must be in place for both calibration and measurement.

Frequency Restrictions

To assist you troubleshoot problems encountered when setting up these measurement modes, there are restrictions that apply to the mode of operation.

Glossary of Restricted Terms

Table 4-3 is a description of the terms used in the restrictions

Table 4-3 Restricted Terms

Term	Description
f_{FIF}	Fixed IF
f_{FLO}	Fixed LO frequency
f_{LO}	External LO frequency
f_{SIF}	System input frequency
f_{START}	Start frequency
f_{STOP}	Stop frequency
IF	The output from DUT frequency or the tuned frequency of the NFA
RF	The input to DUT frequencies

General Restrictions

In the measurement modes the following general restrictions apply:

- The Fixed IF frequency, f_{FIF} , limits are defined by the NFA's minimum and maximum system input frequencies, $f_{\text{SIF(MIN)}}$ and $f_{\text{SIF(MAX)}}$ respectively. For example, the N8973A has $f_{\text{SIF(MIN)}} = 10 \text{ MHz}$ and $f_{\text{SIF(MAX)}} = 3 \text{ GHz}$.
- Fixed LO frequency, f_{FLO} , limits are defined by the external LO's minimum and maximum frequencies, $f_{\text{LO(MIN)}}$ and $f_{\text{LO(MAX)}}$ respectively, as entered in the **System?**⇒**External LO** menu.

NOTE

Whether the input frequencies are RF or IF frequencies, the Frequency menu is used to enter these frequency values.

- For modes with a fixed IF, the frequency span, f_{SPAN} , is limited to $f_{\text{STOP}} - f_{\text{START}}$.
- For modes with a variable IF, the frequency span, f_{SPAN} , is limited to $f_{\text{SIF(MAX)}} - f_{\text{SIF(MIN)}}$.

Frequency-Downconverting DUT

In this mode, the DUT contains a frequency down-converting device. For example, a mixer or receiver.

Fixed IF Variable LO

These are the restrictions applicable to this mode.

LSB Restrictions In the LSB, Fixed IF Variable LO mode the following restrictions apply:

- $f_{\text{RF(START)}} > f_{\text{FIF}}$

If this restriction is broken, Mode setup error; Start freq must be greater than fixed IF freq is generated.

To resolve this error condition, decrease f_{FIF} or increase $f_{\text{RF(START)}}$.

USB Restrictions In the USB, Fixed IF Variable LO mode the following restrictions apply:

- $f_{\text{LO(START)}} > f_{\text{FIF}}$

If this restriction is broken, Mode setup error; Start LO freq must be greater than fixed IF freq is generated.

To resolve this error condition, decrease f_{FIF} or increase $f_{\text{RF(START)}}$.

DSB Restrictions In the DSB, Fixed IF Variable LO mode the following restrictions apply:

- $f_{\text{RF(START)}} > f_{\text{FIF}}$

If this restriction is broken, Mode setup error; Start freq must be greater than fixed IF freq is generated.

To resolve this error condition, decrease f_{FIF} or increase $f_{\text{RF(START)}}$.

Variable IF Fixed LO

These are the restrictions applicable to this mode.

LSB Restrictions In the LSB, Variable IF Fixed LO mode the following restrictions apply:

- $f_{IF(STOP)} < f_{RF(STOP)}$

If this restriction is broken, Mode setup error; Stop freq must be less than stop RF freq is generated.

To resolve this error condition, increase f_{FLO} or decrease $f_{IF(STOP)}$.

USB Restrictions In the USB, Variable IF Fixed LO mode the following restrictions apply:

- $f_{IF(STOP)} < f_{FLO}$

If this restriction is broken, Mode setup error; Stop freq must be less than fixed LO freq is generated.

To resolve this error condition, increase f_{FLO} or decrease $f_{IF(STOP)}$.

DSB Restrictions In the DSB, Variable IF Fixed LO mode the following restrictions apply:

- $f_{IF(STOP)} < f_{RF(STOP)}$

If this restriction is broken, Mode setup error; Stop freq must be less than stop RF freq is generated.

To resolve this error condition, increase f_{FLO} or decrease $f_{IF(STOP)}$.

Frequency Up-converting DUT

In this mode, the DUT contains a frequency up-converting device. For example, a transmitter.

Fixed IF Variable LO

These are the restrictions applicable to this mode.

LSB Restrictions In the LSB, Fixed IF Variable LO mode the following restrictions apply:

- $f_{\text{RF}(\text{STOP})} < f_{\text{FIF}}$

If this restriction is broken, Mode setup error; Stop freq must be less than fixed IF freq is generated.

To resolve this error condition, increase f_{FIF} or decrease $f_{\text{RF}(\text{STOP})}$.

USB Restrictions In the USB, Fixed IF Variable LO mode the following restrictions apply:

- $f_{\text{RF}(\text{STOP})} < f_{\text{LO}(\text{STOP})}$

If this restriction is broken, Mode setup error; Stop freq must be less than stop LO freq is generated.

To resolve this error condition, increase f_{FIF} or decrease $f_{\text{RF}(\text{STOP})}$.

Variable IF Fixed LO

These are the restrictions applicable to this mode.

LSB Restrictions In the LSB, Variable IF Fixed LO mode the following restrictions apply:

- $f_{\text{IF}(\text{STOP})} < f_{\text{FLO}}$

If this restriction is broken, Mode setup error; Stop freq must be less than fixed LO freq is generated.

To resolve this error condition, increase f_{FLO} or decrease $f_{\text{IF}(\text{STOP})}$.

- $f_{\text{IF}(\text{START})} > f_{\text{RF}(\text{START})}$

If this restriction is broken, Mode setup error; Start freq must be greater than start RF freq is generated.

To resolve this error condition, decrease f_{FLO} or increase $f_{\text{IF}(\text{START})}$.

USB Restrictions In the USB, Variable IF Fixed LO mode the following restrictions apply:

- $f_{\text{IF}(\text{START})} > f_{\text{FLO}}$

If this restriction is broken, Mode setup error; Start freq must be greater than fixed LO freq is generated.

To resolve this error condition, decrease f_{FLO} or increase $f_{\text{IF}(\text{START})}$.

- $f_{\text{RF}(\text{STOP})} < f_{\text{FLO}}$

If this restriction is broken, Mode setup error; Stop RF freq must be less than fixed LO freq is generated.

To resolve this error condition, increase f_{FLO} or decrease $f_{\text{IF}(\text{STOP})}$.

System Downconverter

The DUT is a non-frequency converting device, for example an amplifier or filter measurement, and its frequency is outside the NFA's measurement range (frequencies less than 10 MHz or greater than 3.0 GHz). Frequency down-conversion is required within the measurement system, in other words, using a mixer, external to the DUT, to convert the signal of interest to the frequency range of the NFA.

Fixed IF Variable LO

These are the restrictions that apply to this mode.

DSB Restrictions

In the DSB, Fixed IF Variable LO mode the following restrictions apply:

- $f_{\text{RF}(\text{START})} > f_{\text{FIF}}$

If this restriction is broken, Mode setup error; Start freq must be greater than fixed IF freq is generated.

To resolve this error condition, decrease f_{FIF} or increase $f_{\text{RF}(\text{START})}$.

LSB Restrictions

In the LSB, Fixed IF Variable LO mode the following restrictions apply to the set up:

- $f_{\text{RF}(\text{START})} > f_{\text{FIF}}$

If this restriction is broken, Mode setup error; Start freq must be greater than fixed IF freq is generated.

To resolve this error condition, decrease f_{FIF} or increase $f_{\text{RF}(\text{START})}$.

Making Extended Frequency Measurements

Frequency Restrictions

USB Restrictions

In the USB, Fixed IF Variable LO mode the following restrictions apply to the set up:

- $f_{\text{RF(START)}} > f_{\text{FIF}}$

If this restriction is broken, Mode setup error; Start freq must be greater than fixed IF freq is generated.

To resolve this error condition, decrease f_{FIF} or increase $f_{\text{RF(START)}}$.

Variable IF Fixed LO

These are the restrictions applicable to this mode.

LSB Restrictions

In the LSB, Variable IF Fixed LO mode the following restrictions apply:

- $f_{RF(STOP)} < f_{FLO}$

If this restriction is broken, Mode setup error; Stop freq must be less than fixed LO freq is generated.

To resolve this error condition, increase f_{FLO} or decrease $f_{RF(STOP)}$.

- $f_{RF(START)} > f_{IF(START)}$

If this restriction is broken, Mode setup error; Start freq must be greater than start IF freq is generated.

To resolve this error condition, decrease f_{FLO} or increase $f_{RF(START)}$

- $f_{FLO} - f_{RF(STOP)} > f_{SIF(MIN)}$

If this restriction is broken, Mode setup error; LO - Stop freq must be \geq min system input freq is generated.

To resolve this error condition, increase f_{FLO} or decrease $f_{RF(STOP)}$

Making Extended Frequency Measurements

Frequency Restrictions

USB Restrictions

In the LSB, Variable IF Fixed LO mode the following restrictions apply:

- $f_{\text{RF}(\text{START})} > f_{\text{FLO}}$

If this restriction is broken, Mode setup error; Start freq must be greater than fixed LO freq is generated.

To resolve this error condition, decrease f_{FLO} or increase $f_{\text{RF}(\text{START})}$.

- $f_{\text{IF}(\text{STOP})} < f_{\text{FLO}}$

If this restriction is broken, Mode setup error; Stop IF freq must be less than fixed LO freq is generated.

To resolve this error condition, increase f_{FLO} or decrease $f_{\text{RF}(\text{STOP})}$.

- $f_{\text{RF}(\text{START})} - f_{\text{FLO}} > f_{\text{SIF}(\text{MIN})}$

If this restriction is broken, Mode setup error; Start - LO freq must be \geq min system input freq is generated.

To resolve this error condition, decrease f_{FLO} or increase $f_{\text{RF}(\text{START})}$.

5 **Performing System Operations**

This chapter describes how to perform the system-level tasks, such as configuring the Noise Figure Analyzer's GPIB address, defining the preset conditions and so forth.

What You will Find in this Chapter

This chapter covers:

- Setting the GPIB Addresses
- Configuring the Serial Port
- Configuring the Characteristics of an External LO
- Configuring the Internal Alignment
- Displaying Error, System and Hardware Information
- Presetting the Noise Figure Analyzer
- Defining the Power-On/Preset Conditions
- Restoring System Defaults
- Setting the Time and Date
- Configuring a Printer with the NFA

Setting the GPIB Addresses

Purpose of the GPIB and LO GPIB

The NFA has two GPIB connectors on its rear panel. One connector is used for communicating with a computer using the remote command set and the other connector, the LO GPIB, is used by the NFA to control an external local oscillator. The NFA acts as the **controller** over the LO GPIB.

To Set the GPIB Addresses

- Step 1.** Press the **System** key
- Step 2.** Press the **GPIB** menu key.

The System GPIB Form now appears in the display. See Figure 5-1.

Figure 5-1

System GPIB Form

Noise Figure Analyzer Address 8		NFA Address
System GPIB Form		NFA Address 8
Noise Figure Analyzer Address	8	
External LO Address	19	
LO GPIB Address	8	
Move the highlight to select a field using the 'Tab' keys.		

- Step 3.** Using the **Tab** key to navigate through the form configure the GPIB parameters as required.

Performing System Operations
Setting the GPIB Addresses

The System GPIB parameters are described in Table 5-1.

Table 5-1 System GPIB parameters

Parameter	Description
Noise Figure Analyzer Address	The instrument's GPIB address. Valid addresses are from 0 to 30. Default is 8.
External LO Address	The GPIB address of the External LO attached to the LO GPIB. Valid addresses are from 0 to 30. Default is 19.
LO GPIB Address	The address through which devices, attached to the LO GPIB, communicate with the instrument. Valid addresses are from 0 to 30. Default is 8

NOTE

Ensure the **Remote Port** menu key is set **Remote Port(GPIB)**.

Configuring the Serial Port

The NFA has a serial port on the rear panel to allow the it to communicate using the remote command set.

To configure the serial port:

- Step 1.** Press the **System** key
- Step 2.** Press the **Serial** menu key.

The System Serial Form now appears. See Figure 5-2

Figure 5-2

System Serial Form

The screenshot shows a terminal window titled "System Serial Form". At the top left, it displays "Baud 9600". On the right side, there is a vertical list of baud rate options: 1200, 2400, 4800, 9600, 19200, and 38400. The "9600" option is highlighted. In the main area of the form, there are five configuration items, each with a corresponding input field:

Data Terminal Ready	OFF
Request To Send	OFF
Baud	9600
Receive Pacing	XON/XOFF
Transmit Pacing	XON/XOFF

At the bottom of the form, there is a instruction: "Move the highlight to select a field using the 'Tab' keys."

- Step 3.** Use the **Tab** keys to navigate through the form and the menu keys to configure the serial parameters as required.

Performing System Operations

Configuring the Serial Port

The System serial port parameters are described in Table 5-2.

Table 5-2 Serial port parameters

Parameter	Description
Data Terminal Ready	Sets the DTR line control. <ul style="list-style-type: none">• OFF de-asserts DTR, hence disabling the serial port• ON asserts DTR, hence enabling the serial port• IBF tells the driver to use DTR for data pacing
Request To Send	Sets the RTS line control. <ul style="list-style-type: none">• OFF de-asserts RTS, hence disabling the serial port• ON asserts RTS, hence enabling the serial port• IBF tells the driver to use RTS for data pacing
Baud	Sets the Baud rate of the NFA's serial port. Note: The value you set here must match the Baud rate of the connected device.
Receive Pacing	Sets the receive pacing handshake characters. <ul style="list-style-type: none">• NONE• XON/XOFF
Transmit Pacing	Sets the transmit pacing handshake characters. <ul style="list-style-type: none">• NONE• XON/XOFF

NOTE

Ensure the **Remote Port** menu key is set **Remote Port(Serial)**. The NFA needs a power cycle to take effect if you changed it from **Remote Port(GPIB)**.

Configuring the Characteristics of an External LO

The NFA can control an external LO using its LO GPIB port. The **External LO** menu allows you to configure the following characteristics of the external LO:

- Type of command set used: the default is SCPI, however, the NFA also allows you to create and use custom command sequences for LOs that do not use SCPI commands.
- The minimum and maximum input frequencies of the LO: [See “Minimum and Maximum Frequencies” on page 226.](#)
- The settling time of the LO: [See “Settling Time” on page 226.](#)
- The frequency multiplier of the LO: [See “Multiplier” on page 227.](#)
- Auxiliary command, if any used, for example, Continuous Wave (CW) or Modulation type.

NOTE

The custom command sequence is stored as part of the “persistent” instrument state.

Custom Command Set

The custom command set allow you to customize a command set to define the operation of a non-SCPI compliant LO.

The custom command set supports an LO that could use a maximum of seventy-nine characters in the prefix and suffix. These characters include the prefix characters and the suffix characters.

The purpose of the frequency prefix and suffix is to correctly format the commands from the NFA to the LO. The format is different for different LOs. The frequency information is determined by the frequency parameters entered into the NFA during the measurement setup and by the measurement mode in which the NFA is operating.

Performing System Operations

Configuring the Characteristics of an External LO

The purpose of the Power prefix and suffix is to set the output signal power level of the LO. The allowable range is from -100 to +100 dBm. The actual output signal power level is limited by the output signal power level capability of the LO.

The purpose of the auxiliary command is to set other features in the LO, for example, enable RF output (OUTP:STAT ON).

To access the menu to configure the command characteristics of an external LO follow the procedure:

- Step 1.** Press the **System** key.
- Step 2.** Select the **External LO** menu key.
- Step 3.** Select the **LO Commands** menu key.

You are presented with an External LO Commands Form.

Figure 5-3 External LO Commands Form

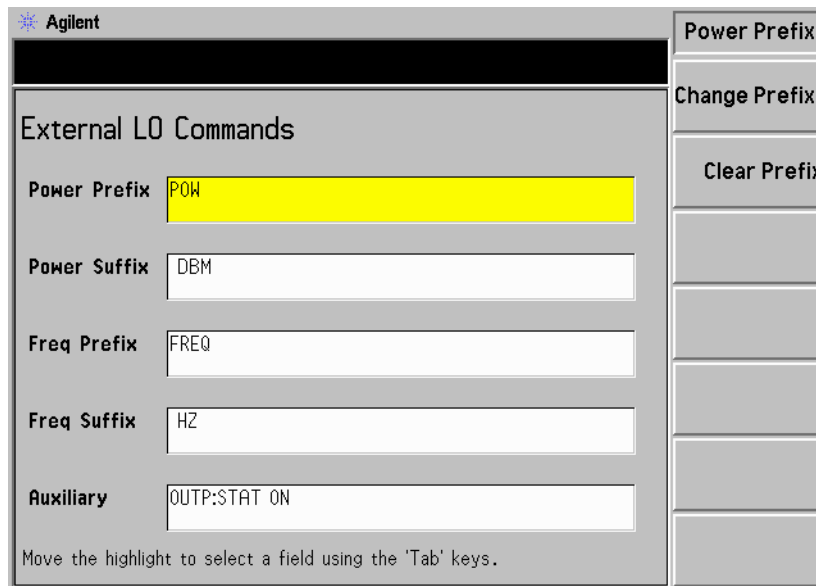

Agilent		Power Prefix
External LO Commands		Change Prefix>
Power Prefix	POW	Clear Prefix
Power Suffix	DBM	
Freq Prefix	FREQ	
Freq Suffix	HZ	
Auxiliary	OUTP:STAT ON	
Move the highlight to select a field using the 'Tab' keys.		

NOTE

The default suffix commands have an intentional space inserted.

Step 4. Press the **Tab** key to move the highlight to the required position in the form.

You can choose to enter the Prefix and Suffix of the power commands and frequency commands. Also you can enter an auxiliary command. This procedure explains this process using the auxiliary commands.

Figure 5-4

External LO Auxiliary Menu Keys

The screenshot shows the 'External LO Auxiliary Menu Keys' interface. At the top left is the 'Agilent' logo. The main area is titled 'External LO Commands' and contains five input fields: 'Power Prefix' (containing 'POW' and highlighted in yellow), 'Power Suffix' (containing 'DBM'), 'Freq Prefix' (containing 'FREQ'), 'Freq Suffix' (containing 'HZ'), and 'Auxilliary' (containing 'OUTP:STAT ON'). Below these fields is a note: 'Move the highlight to select a field using the 'Tab' keys.' To the right of the input fields is a vertical menu with two buttons: 'Change Command' and 'Clear Command'.

- Selecting the **Clear Command** menu key, clears the current command. See Figure 5-4 showing the Auxiliary menu keys.
- Selecting the **Change Command** menu key, you are presented with an Alpha Editor. This and the numeric keys allows you to enter a command string, see Figure 5-5. Press the **Prev** key to enter the command. The command string can have up to a maximum of seventy-nine characters.

Figure 5-5 External LO Auxiliary Command Changes

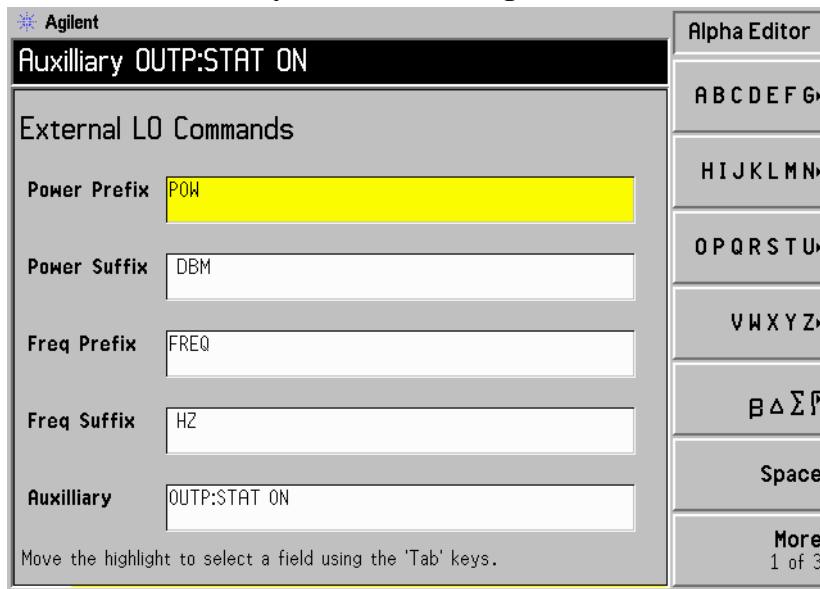

Settling Time

The purpose of the settling time is to ensure that the NFA waits a sufficient amount of time after issuing a frequency or power command to allow the LO's output to stabilize.

Pressing the **Settling Time** menu key allows you to set the settling time of NFA. Valid settling times are between 0 ms and 100 s. The default value is 100 ms.

Minimum and Maximum Frequencies

The minimum and maximum frequencies represent the frequency capability of the LO. They are only used by the NFA to determine if the frequencies needed by the measurement are acceptable.

Pressing the **Min Freq** menu key allows you to set the minimum frequency the NFA expects the External LO to have. The default value is 10 MHz.

Pressing the **Max Freq** menu key allows you to set the maximum frequency the NFA expects the External LO to have. The default value is 40.0 GHz.

Multiplier

The external LO frequency multiplier value sets the frequency multiplying factor of the external LO.

Pressing the **Multiplier** menu key allows you to set the multiplier frequency of the External LO. The default value is 1.

NOTE

When using the multiplier feature and setting the minimum and maximum frequencies capabilities of the external LO, note that these limits refer to the multiplied frequency input to the DUT. For example, with a multiplier of 4, and an external LO which can operate from 10 MHz to 20 GHz, the limits should be set to 40 MHz and 80 GHz.

Configuring the Internal Alignment

Data from the internal alignment routine is necessary for accurate NFA operation. When enabled, the internal alignment routine runs continuously to ensure that the NFA is using current alignment data which improves the NFA's accuracy.

Alignment is the process of routing a known internally generated signal through a selected signal path and measuring the signal. This measured value is then compared with the expected value in order to derive the correction needed to convert the measured value to the expected value.

No external connections are needed.

Turning Alignment Off and On

- Step 1.** Press the **System** key.
- Step 2.** Press the **Alignment** menu key to access the Alignment menu.
- Step 3.** Press the **Alignment** menu key selecting **Alignment(On)** or **Alignment(Off)** as required.

The default setting is **Alignment(On)**.

Changing Alignment Mode

- Step 1.** Press the **System** key.
- Step 2.** Press the **Alignment** menu key to access the Alignment menu.
- Step 3.** Press the **Alignmnt Mode** menu key selecting **Alignmnt Mode(Point)** or **Alignmnt Mode(Sweep)** as required.

The default mode setting is **Alignmnt(Sweep)**.

Alignment of the YIG Tuned Filter (YTF)

NOTE The YTF alignment feature only applies to the N8974A and the N8975A models.

Step 1. Press the **System** key.

Step 2. Press the **Alignment** menu key to access the Alignment menu.

Step 3. Press the **Align YTF** menu key to set the YTF alignment.

You are prompted to press this key again. This feature ensures you do not accidentally erase the current YTF alignment data.

Step 4. Wait until the Alignment routine has completed.

Step 5. Press the **Save YTF Alignment** menu key to store the Alignment data.

Displaying Error, System and Hardware Information

Displaying the Error History

The 10 most recent errors are stored in an error queue which you can display as a full size table. The most recent messages appear at the top of the table. To display the error queue:

- Step 1.** Press the **System** key and the **More 1 of 3** menu key.
 - Step 2.** Press **Show Errors** menu key to view the error queue.
- To clear the error screen, press **Clear Error Queue**.

Displaying System Information

You can display the instrument product number, serial number, memory, loaded firmware details and fitted options.

- Step 1.** Press the **System** key and the **More 1 of 3** menu key.
- Step 2.** Press **Show System** menu key to view system information.

Displaying Hardware Information

- Step 1.** Press the **System** key and the **More 1 of 3** menu key.
- Step 2.** Press **Show Hdwr** menu key to view hardware information.

The name and version numbers of the hardware modules in the instrument are now displayed.

Presetting the Noise Figure Analyzer

Pressing the **Preset** key places the NFA in a known state and provides a convenient starting point for making most measurements. You can specify the preset state with the **Preset** menu key located under the **System** key.

To preset the analyzer using its factory defaults:

- Step 1.** Turn the NFA on by pressing the **On** key and wait for the power on process to complete.
- Step 2.** Press **System** key, **More 1 of 3**, **Power On/Preset**, **Preset (Factory)** menu keys.
- Step 3.** Press the green **Preset** key.

The instrument preset function performs a processor test but does not affect alignment data. Pressing **Preset** clears both the input and output buffers. The status byte is set to 0.

NOTE

Turning on the analyzer performs an instrument preset. Turning on the analyzer also fetches alignment data; clears both the input and output buffers; and sets the status byte to 0. The last state of the analyzer before it was turned off is recalled when **Power On(Last)** is selected (under the **System** key).

Defining the Power-On/Preset Conditions

The power up and preset conditions can be different if required. You can set the NFA to return it to a user-defined state after a power on or preset.

Setting the Power On Conditions

- Step 1.** Press the **System** key and the **More 1 of 3** menu key.
- Step 2.** Press the **Power On/Preset** menu key.
- Step 3.** Set **Power On** to **Power On(Last)** or **Power On(Preset)** as required.
 - ‘Last’ means that the instrument, upon power on returns to the state it was in when it was powered off.
 - ‘Preset’ means the instrument returns to its defined preset state.

Setting the Preset Conditions

You can set the NFA to return to its factory default state or a user defined state upon preset. The configured user defined state is provided by pressing the **Save User Preset** menu key to save the current NFA state

To set the preset conditions to factory default

- Step 1.** Press the **System** key and the **More 1 of 3** menu key.
- Step 2.** Press the **Power On/Preset** menu key.
- Step 3.** Enable the **Preset(Factory)** menu key.

To set the preset conditions to user defined

- Step 1.** Configure the NFA to the desired state.
- Step 2.** Press the **System** key and the **More 1 of 3** menu key.
- Step 3.** Press the **Power On/Preset** menu key.
- Step 4.** Enable the **Preset(User)** menu key.
- Step 5.** Press the **Save User Preset** menu key to save the current NFA state.

Restoring System Defaults

This will reset the NFA to the original factory default settings. It will also clear the non-volatile memory of ENR tables, limit lines, address setting, and so forth.

To restore the system defaults:

- Step 1.** Press the **System** key
- Step 2.** Press the **More 1 of 3** menu key.
- Step 3.** Press the **Restore Sys Defaults** menu key.

Press the **Restore Sys Defaults** menu key again.

NOTE

You are prompted to press this key again. This feature ensures you do not accidentally restore the original factory default settings.

Setting the Time and Date

The NFA allows you to set and display the time and date. The date can be set in US or European format as required.

To turn the time and date on and off

- Step 1.** Press the **System** key.
- Step 2.** Press the **More 1 of 3** menu key.
- Step 3.** Press the **Time/Date** menu key.
- Step 4.** Press the **Time/Date** menu key to select **Time/Date(On)** or **Time/Date(Off)** as required.

The default is **Time/Date(On)**.

To set the time and date

- Step 1.** Press the **System** key.
- Step 2.** Press the **More 1 of 3** menu key.
- Step 3.** Press the **Time/Date** menu key.
- Step 4.** Set the **Date Mode** to either US format **MDY** (Month/Day/Year) or European format **DMY** (Day/Month/Year).

US format is the default setting.

- Step 5.** Enter the time in hhmmss (hours, minutes, seconds) format.
- Step 6.** Enter the date in yyyyymmdd (year, month, day) format.

Configuring a Printer with the NFA

Printer requirements

- IEEE 1284 compliant printer cable.
- Supported printer equipped with a parallel interface. A supported printer is one that accepts Printer Control Language Level 3 or 5.
 - PCL3 printers include most HP DeskJet printers.
 - PCL5 printers include most HP LaserJet printers and the HP 1600C DeskJet printer.

Printer connection

To connect your printer to the NFA, connect the printer to the parallel I/O interface connector of the NFA using an IEEE 1284 compliant parallel printer cable.

If appropriate, configure your printer (see your printer documentation for more details on configuring your printer).

To Configure a Printer with the NFA

- Step 1.** Power on the NFA and the printer.
- Step 2.** Press the **Print Setup** key and then press the **Printer Type** menu key.
- Step 3.** Press **Printer Type** to access the **Printer Type** menu keys and press **Auto** to make the NFA attempt to identify the connected printer.

When you select **Auto** as the **Printer Type**, the NFA responds in one of the following three ways:

- The **Print Setup** menu is displayed with the **Auto** key selected and no new message is displayed in the display status line. This indicates that the NFA recognizes the connected printer and no further setup is required. As long as **Auto** remains selected in the **Printer Type** menu, the NFA attempts to identify the printer when you press the front panel **Print** key. The selected printer is displayed by pressing **System, More 1 of 3, Show System**.

Performing System Operations

Configuring a Printer with the NFA

- The **Print Setup** menu is displayed with the **Custom** key selected and one of the following diagnostic messages is displayed in the display status line:

Unknown printer, Define Custom to set up printer

No printer response, Define Custom to set up printer

Invalid printer response, Define Custom to set up printer

This indicates that the NFA is unable to automatically identify the connected printer, and **Custom** is selected in the **Printer Type** menu. Press **Print Setup, Define Custom** to select specific printer characteristics such as the printer language (PCL3 or PCL5) and color printing capability. Once you have set these characteristics to match those of your connected printer, the printer setup process is complete. As long as **Custom** remains selected in the **Printer Type** menu, the NFA does not attempt to automatically identify the connected printer when you press the front panel **Print** key.

- The **Print Setup** menu is displayed with the **None** key selected and the following message appears in the display status line:

Unsupported printer, Printer Type set to None

This indicates that the NFA recognizes the connected printer, but the printer is not supported by the NFA. As long as **None** is selected in the **Printer Type** menu, the NFA responds to any print command by displaying the message `Printer Type is None` in the display status line.

The **Printer Type** accesses the following keys:

- | | |
|---------------|--|
| None | None disables the NFA from attempting to print to a printer. This is the appropriate setting if no printer is connected to the NFA. |
| Custom | Custom allows you to access the Define Custom menu keys. The Define Custom menu keys allow you to specify printer characteristics such as PCL Level and printer color capability. |

Auto

Auto enables the NFA to automatically attempt to identify the connected printer when the **Print** key is pressed or when **Printer Type** is set to **Auto**.

Testing Correct Printer Operation

When printer setup is complete test correct printer operation by pressing **Print Setup, Print (Screen)** and then pressing the **Print** key to print a test page.

If the printer is ready and printer setup is successful, a printout of the NFA display is printed. If the printer is not ready, the message `Printer Timeout` appears on the NFA display. `Printer Timeout` remains on the display until the printer is ready or until you press **ESC** to cancel the printout request.

6 **Front Panel Key Reference**

This chapter describes each key and menu item contained within the user interface of the NFA. The keys are listed in their key groupings and are listed with their corresponding menu keys as they appear in the key menus.

MEASURE Keys

Figure 6-1 Measure Key Group



Frequency/Points

This accesses the menu keys that control the measurement frequency range and the number of discrete measurement points in the frequency range. It also accesses the menus allowing you to set a spot measurement frequency and create frequency lists.

The center frequency and frequency span, or start and stop frequency values appear in the lower annotation on the display. This is dependent on which of these options you have selected.

When entering a frequency value you specify units of Hz, kHz, MHz, or GHz using the menu keys presented.

NOTE

The frequency range upper limits are model dependent. All models have a lower limit of 10 MHz and each model's upper limit is as follows:

- The N8972A upper limit is 1.5 GHz.
 - The N8973A upper limit is 3.0 GHz.
 - The N8974A upper limit is 6.7 GHz.
 - The N8975A upper limit is 26.5 GHz.
-

NOTE Models, N8974A and N8975A have their default frequency ranges set to avoid crossing the 3.0 GHz switch. See “3.0 GHz Mechanical Switch” on page 18 for an explanation of this.

NOTE When varying the External LO, the frequency limits are specified by you. The limits applied depend on whether the LO or IF is being varied. See “Making Extended Frequency Measurements” on page 135 for a further explanation of this.

Figure 6-2 A Typical Frequency/Points Menu Map

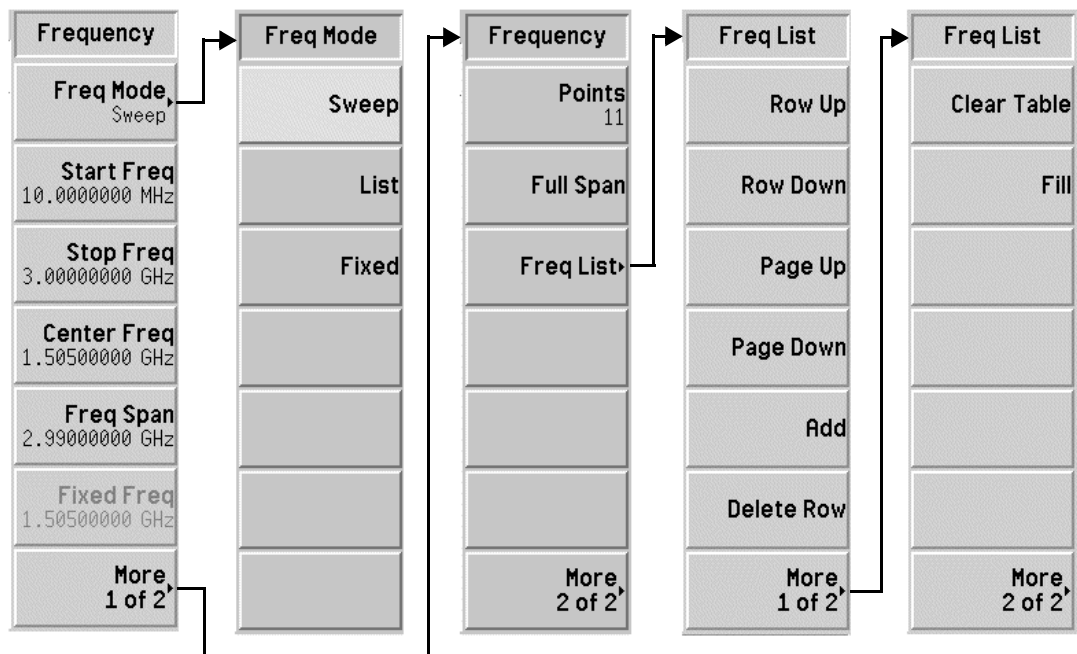

Freq Mode	<p>This selects between swept, list and fixed frequency modes. The frequency mode which is selected is displayed in the menu key.</p> <p>The frequency modes available are:</p> <ul style="list-style-type: none">• Sweep where the frequencies are generated from the frequency range selected and the number of measurement points.• List where the frequencies are taken from the frequency list.• Fixed where the measurement is taken at the fixed frequency.
Start Freq	<p>This allows you to set the frequency at which the measurement sweep starts. In the graphical format, the trace starts at the left side of the graticule. When Start Freq is selected its value is displayed in the lower annotation.</p>
Stop Freq	<p>This allows you to set the frequency at which the measurement sweep stops. In the graphical format, the trace stops at the right side of the graticule. When Stop Freq is selected its value is displayed in the lower annotation.</p>
Center Freq	<p>This allows you to set the center frequency at which the measurement frequency range is centered. When Center Freq is selected its value is displayed in the left lower annotation.</p>
Freq Span	<p>This allows you to set the frequency range symmetrically about the centre frequency. When Freq Span is selected its value is displayed in the right lower annotation.</p>
Fixed Freq	<p>This allows you to set the frequency point used in fixed frequency measurements. When Fixed Freq is selected its value is displayed in the left and right lower annotation as start and stop values respectively.</p>

Points This allows you to set the number of discrete equidistant measurement frequency points at which measurements are made during **Sweep** frequency mode. The maximum number of points allowed is 401. Default value is 11. The number of points are shown at the bottom of the display.

NOTE The maximum number of 401 points are conditional, as they are limited by the frequency span. This is because the minimum resolution between any two points is set at 10 KHz. Hence, to achieve 401 points, the frequencies measurement range must be greater than 4 MHz.

Full Span This changes the measurement span to the full span of the NFA showing the full frequency range. The full span of the NFA is model dependant. See “The Noise Figure Analyzer Features” on page 18 for your model’s frequency range.

Freq List This allows you access to a form to enter or edit a frequency list.

The frequency list allows you to enter a list of frequencies at which measurements are to be made. Frequency lists are limited to 401 entry points. The number of points are shown at the bottom of the display. The frequencies are automatically sorted in ascending order.

Row Up This allows you to select a particular entry in the table by pressing this menu key to move up to its position in the table one entry at a time.

Row Down This allows you to select a particular entry in the table by pressing this menu key to move down to its position in the table one entry at a time.

Page Up This allows you to move up the table entries in page blocks.

Page Down This allows you to move down the table entries in page blocks.

MEASURE Keys

- Add** This allows you to add a new entry. It adds the entry to the bottom of the table after the last valid entry. It sequences the entry in the correct ascending order when the entry is terminated. To terminate an entry use the frequency unit value keys presented to you.
- Delete Row** This removes the highlighted row entry from the table.
- Clear Table** This removes all entries from the table. You need to press this menu key twice.
- The first time you press the key you are prompted to press it again. This two-stroke key press is a safety feature to prevent you from accidentally pressing **Clear Table** and erasing the table data.
- Fill** This clears then fills the frequency list with current frequencies generated by swept frequency mode.

Averaging/Bandwidth

This accesses the menu keys that control the measurement averaging and bandwidth parameters.

Figure 6-3 Averaging/Bandwidth Menu Map

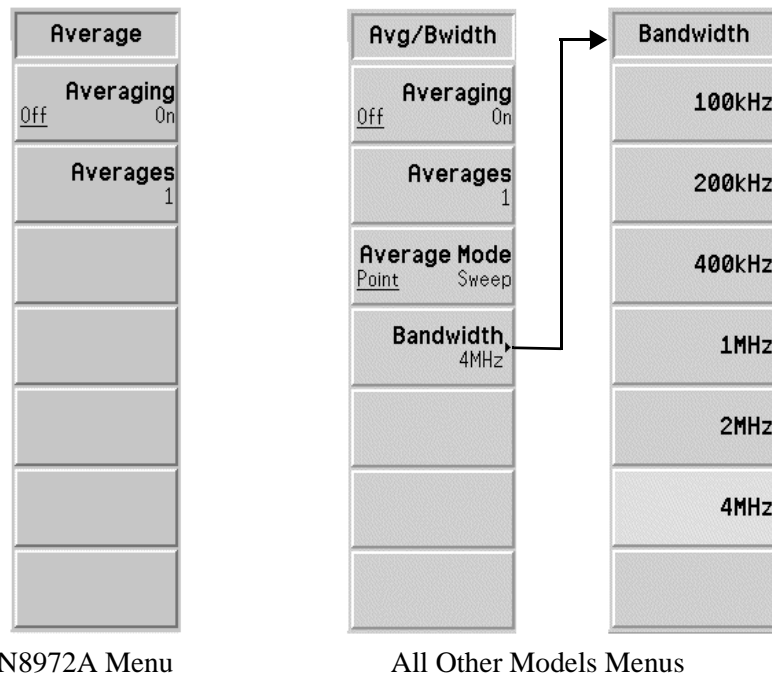

Averaging

This allows you to enable or disable the averaging function. To enable the averaging set the **Averaging(On)** function. To disable the averaging set the **Averaging(Off)** function.

NOTE

If the averaging number is set to 1 and averaging is enabled, this gives the same result as averaging disabled.

MEASURE Keys

Averages This sets the number of times each data points is to be averaged. This is a value between 1 and 999. The default value is 1, meaning that no averaging is performed. You can either scroll using the RPG to the average value you want, or enter the numerical value you want with the numerical keypad and press **Enter** to terminate it. The value is annotated in the bottom of the display.

Average Mode This allows you to choose the type of averaging mode. To average at each point enable the **Average Mode(Point)** function. To average at each sweep enable the **Average Mode(Sweep)** function. See “Selecting the Averaging Mode” on page 72 for an explanation on the difference between the two modes.

NOTE The sweep average function is not available on the N8972A.

Bandwidth This allows you to set the measurement bandwidth to one of the following values listed below. See page 71 for an explanation of measurement bandwidth.

- **100kHz**
- **200kHz**
- **400kHz**
- **1MHz**
- **2MHz**
- **4MHz**

NOTE The bandwidth menu key is unavailable on the N8972A and its bandwidth value is set at the default 4MHz.

Calibrate

This performs the internal calibration routine. The calibration is similar to a measurement except that the device under test is not in the measurement path. It is used to correct any noise added by the second stage test system.

You must press the **Calibrate** key twice before calibration starts. After the first press you are presented with a popup dialogue box that prompts you to press the calibrate key a second time to start the calibration, or to press **Escape** to abandon the calibration.

The values generated during a calibration are used to correct subsequent measurements as long as the calibration remains valid or until the next calibration.

Figure 6-4

Calibration Warning Pop Up Box

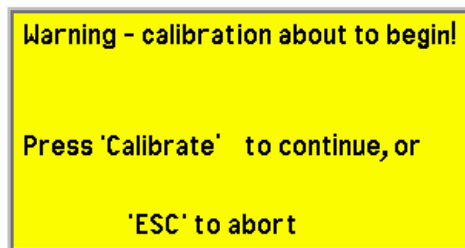

Meas Mode

This key accesses the Meas Mode Form, which allows you to select the measurement mode of the NFA. You can choose which type of Device Under Test and, if applicable, whether the LO is fixed or variable using this form.

Use the **Tab** keys to highlight items in the form. When an item is highlighted you can change its value. Its value is displayed in the highlighted area and in the active function area.

Device Under Test This selects which type of DUT you want to measure.

- **Amplifier**
- **Downconv**
- **Upconv**

System Downconverter This selects whether or not the downconverter is **On** or **Off**. This is only accessible if the Device Under Test is set to **Amplifier**.

LO Mode This selects whether the LO mode is **Fixed** or **Variable**.

Figure 6-5

Meas Mode Menu Maps

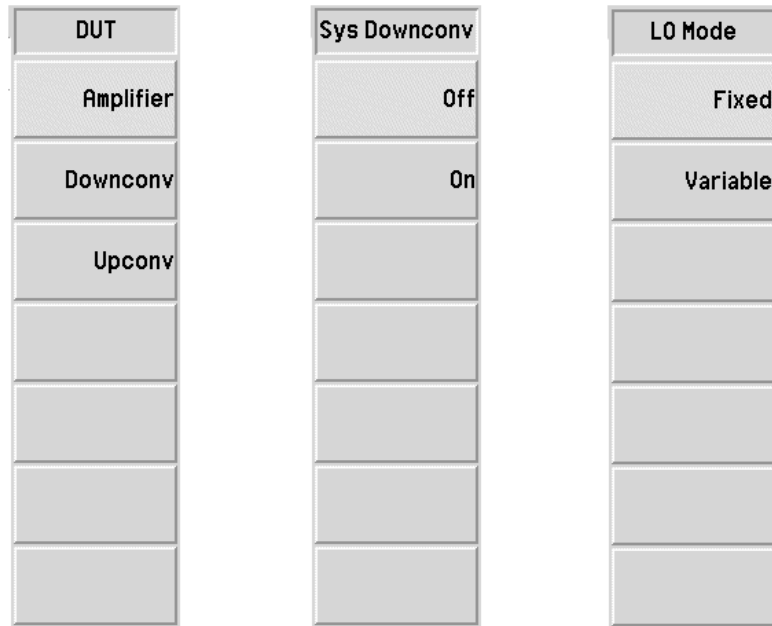

Mode Setup

This key accesses the Mode Setup Form, which allow you to setup the measurement mode of the NFA you selected under the **Meas Mode** key. This allows you to choose the fixed frequency value, sideband, the NFA control of the LO, and the LO power level to be used.

Use the **Tab** keys to highlight items in the form. When an item is highlighted you can change it's value. Its value is displayed in the highlighted area and in the active function area.

- | | |
|--------------------------------|--|
| IF Frequency | This allows you to set a fixed IF frequency when the LO Mode is set to variable. |
| LO Frequency | This allows you to set a fixed LO frequency when the LO Mode is set to fixed. |
| Sideband | This allows you to set the measurement side-band selection, where the selected measurement mode allows, to either lower side-band (LSB), upper side-band (USB), double side-band (DSB). |
| LO Control | This allows you to set whether the external LO is controlled by the NFA, LO Control(On) , or if the LO is set up manually, LO Control(Off) . If you are working with a fixed LO, you can set up the LO manually, however you are required to enter the LO's frequency value in the LO Frequency . |
| External LO Power Level | This allows you to set the power level of the external LO. It only functions if the NFA's LO control is set to LO Control(On) . To enter a value, you can either scroll using the RPG to the value you want, or enter the numerical value you want with the numerical keypad. Press the units menu keys presented to you to terminate it. |

Figure 6-6

Mode Setup Form with Sideband Menu Map Displayed

Agilent

Sideband DSB

Mode Setup Form

IF Frequency	30.0000000 MHz
LO Frequency	30.0000000 GHz
Sideband	DSB
LO Control	Off
External LO Power Level	0.0000 dBm

Move the highlight to select a field using the 'Tab' keys.

Sideband

- LSB
- USB
- DSB**
-
-
-
-

ENR

This accesses a menu which allows you to select a noise source preference, enter the ENR tables, specify a T_{cold} temperature, specify a spot T_{hot} temperature, and select a spot frequency ENR value.

Figure 6-7 ENR Menu Maps

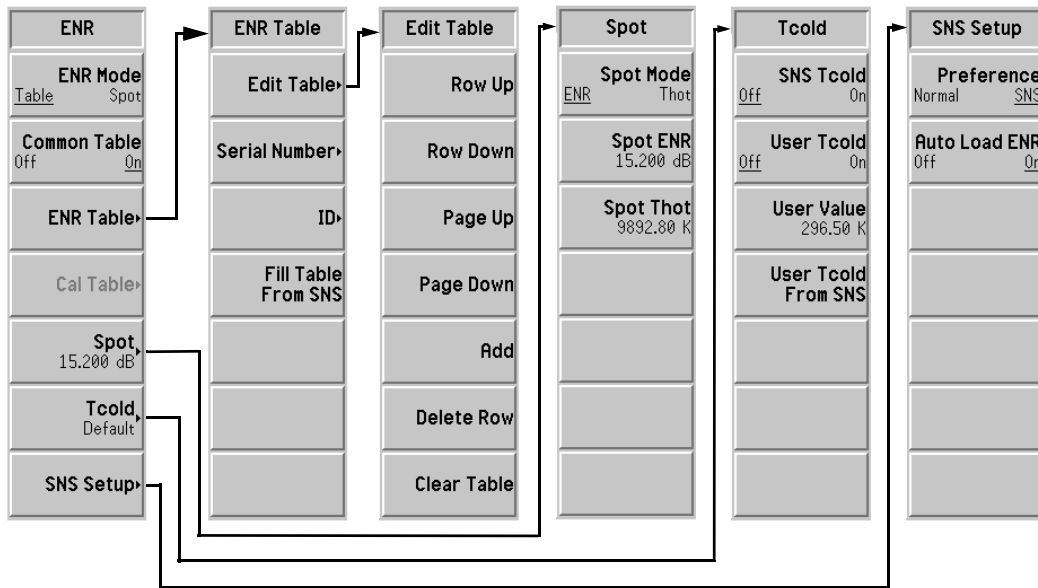

ENR Mode This switches between **ENR Mode(Table)** and **ENR Mode(Spot)** modes. The default is **ENR Mode(Table)**.

When **ENR Mode(Spot)** is enabled the ENR table data is ignored and a single value specified by **Spot ENR** or **Spot Thot** is used.

Common Table This switches between **Common Table(On)** and **Common Table(Off)** modes. The default is **Common Table(On)**.

When **Common Table(On)** is enabled, the same noise source ENR data is used during both the measurement and calibration. When **Common Table(Off)** is enabled, separate noise source ENR data is used for the measurement and calibration.

ENR Table

This allows you to enter, alter, or check data in the ENR table.

Edit Table

The allows you to enter or edit an ENR table of frequency/ENR pairs from which ENR values are interpolated. See [“Working with Tables” on page 45](#).

- **Row Up** This allows you to select a particular entry in the table, by pressing this menu key you move up to its position in the table one row at a time.
- **Row Down** This allows you to select a particular entry in the table, by pressing this menu key you move down to its position in the table one row at a time.
- **Page Up** This allows you to move up the table entries in page blocks.
- **Page Down** This allows you to move down the table entries in page blocks.
- **Add** This allows you to add a new entry. It adds the entry to the bottom of the table and sequences it in the correct ascending frequency order when the row is complete. To terminate the ENR Value entry use the unit keys presented to you. You can also terminate using the **Enter** key and it uses the dB unit value by default.
- **Delete Row** This removes the single row which is highlighted from the table.
- **Clear Table** This removes all entries from the table. You need to press this menu key twice.

The first time you press the key you are prompted to press it again. This two-stroke key press is a safety feature to prevent you from accidentally pressing **Clear Table** and erasing the table data.

Serial Number

This allows you to enter the serial number of the noise source associated with the ENR table. To enter a value, you use the Alpha Editor which is presented and the numerical keypad. To complete the entry press the **Prev** key. Its value is displayed in the highlighted area and in the active function area.

Front Panel Key Reference

MEASURE Keys

ID This allows you to enter the model number of the noise source associated with the ENR table. To enter a value, you use the Alpha Editor which is presented and the numerical keypad. To complete the entry press the **Prev** key. Its value is displayed in the highlighted area and in the active function area.

Fill Table From SNS

This allows you to automatically upload the ENR Table information from a SNS. This menu key is only active when an SNS is connected. This information may already be present, if the **Auto Load ENR(On)** is set.

Meas Table This allows you to enter, alter, or check data in the measurement ENR table.

Cal Table This allows you to enter, alter, or check data in the calibration ENR table.

NOTE An ENR table can have a maximum of 81 entries.

Figure 6-8

Typical ENR Table with Table Entry Menu Map Displayed

The screenshot shows the Agilent ENR Table interface. At the top, it displays "ENR Value 15.400 dB". Below this is the "ENR Table" section, which includes input fields for "Noise Source Serial Number" (3318A14197) and "Noise Source Model ID" (346B). The main table has two columns: "Frequency" and "ENR Value". The table contains 13 rows of data, with the 12th row (12.00000000 GHz, 15.400 dB) highlighted in yellow. To the right of the table is a "Table Entry Menu Map" with buttons for "Edit Table", "Row Up", "Row Down", "Page Up", "Page Down", "Add", "Delete Row", and "Clear Table". At the bottom of the interface, it says "Use 'File' key to Load or Save a table."

Frequency	ENR Value
10.00000000 MHz	15.330 dB
100.00000000 MHz	15.560 dB
1.000000000 GHz	15.360 dB
2.000000000 GHz	15.120 dB
3.000000000 GHz	14.970 dB
4.000000000 GHz	14.910 dB
5.000000000 GHz	14.850 dB
6.000000000 GHz	14.900 dB
7.000000000 GHz	14.860 dB
8.000000000 GHz	14.890 dB
9.000000000 GHz	15.010 dB
10.00000000 GHz	15.110 dB
11.00000000 GHz	15.260 dB
12.00000000 GHz	15.400 dB
13.00000000 GHz	15.440 dB

Spot

This allows you to select a specific ENR value or T_{hot} value. The selected value is applied across the entire frequency range during calibration and measurement. To operate **ENR Mode(Spot)** must be enabled. The default setting is **Spot ENR(15.200 dB)**.

Spot Mode This switches between the **Spot Mode(ENR)** and the **Spot Mode(Thot)** modes. The default is **Spot Mode(ENR)**.

Spot ENR This allows you to enter a spot ENR value which is applied across the entire frequency range during calibration and measurement. The value is applied when **Spot Mode(ENR)** and **ENR Mode(Spot)** are enabled. The default value is 15.200 dB.

The ENR value is entered using the numeric key pad and terminated by selecting unit menu keys.

NOTE

The **dB** limits have a lower limit of -7.0 dB and an upper limit of 50.0 dB.
The **K**, **C**, and **F** limits are converted to the dB limits.

Spot Thot This allows you to enter a spot T_{hot} value which is applied across the entire frequency range during calibration and measurement. The value is applied when **Spot Mode(Thot)** and **ENR Mode(Spot)** are enabled. The default value is 9892.80 K.

The T_{hot} value is entered using the numeric key pad and terminated by selecting unit menu keys.

NOTE

The **K** limits have a lower limit of 0.00K and an upper limit of 29000290.0 K.

The **C** and **F** limits are converted to the K limits.

Tcold

This menu key give access to the T_{cold} functions. When no T_{cold} functions are enabled the default T_{cold} value of 296.50 K is used and the menu key is set to **Tcold(Default)**. When **Tcold(User)** is enabled, it uses your entered **User Value**, or if an SNS is connected, the **User Tcold From SNS** value is used. When **Tcold(Auto)** is enabled, it uses the SNS ambient temperature value and updates this value after every measurement sweep. These SNS features use the built-in SNS temperature sensor. The NFA can upload this value and use it to calculate an accurate T_{cold} value.

SNS Tcold This allows you to automatically upload the T_{cold} value from the SNS built-in temperature sensor. The value updates after every sweep. This feature is only enabled when a SNS is connected.

When **SNS Tcold(On)** is selected the NFA uploads the T_{cold} values from the attached SNS. Also, when **SNS Tcold(On)** is selected the other **Tcold** menu keys are unavailable. When the default **SNS Tcold(Off)** is selected no automatic T_{cold} upload occurs.

User Tcold This allows you to change the T_{cold} value. When **User Tcold(On)** is selected it uses the value set in the **User Value**. When the **User Tcold(Off)** is selected, the NFA uses the default 296.50 K value.

User Value This allows you to enter either a T_{cold} value manually, or if an SNS is connected, by pressing the **User Tcold From SNS** the value is automatically uploaded from the SNS built-in temperature sensor. The value is only valid when **User Tcold(On)** is enabled. When entering a value manually use the numeric key pad and terminated using one of the menu keys which are presented to you.

User Tcold From SNS Pressing this menu key allows you to upload the T_{cold} value from the SNS built-in temperature sensor. The value is only valid when **User Tcold(On)** is enabled. This feature is only enabled when a SNS is connected.

SNS Setup

This allows you to select which type of noise source you prefer to use. Also, if you are using an SNS, it allows you to choose to load it's ENR values automatically.

Preference Selecting **Preference(Normal)** uses the +28V NOISE SOURCE OUTPUT PORT and selecting **Preference(SNS)** uses the SNS PORT, if an SNS is connected. It is possible to have both an SNS and a +28V driven normal noise source connected to the NFA at the same time. However, the NFA's +28V drive can only drive one noise source at a time. Hence, you need to select which noise source should be used. The default setting is **Preference(SNS)** as this is typically expected to be the preferred option. However, if an SNS is not connected the NFA uses the +28V NOISE SOURCE OUTPUT PORT even when **Preference(SNS)** is selected.

Auto Load ENR Selecting **Auto Load ENR(On)** enables the SNS to automatically upload it's ENR values and associated data to the Common ENR Table. This happens when the NFA is powered on or an SNS is connected to the SNS port. Selecting **Auto Load ENR(Off)** disables the automatic loading of the SNS data.

NOTE

When an SNS is connected and **Auto Load ENR(On)** enabled, the **Common Table(On)** is set automatically. Hence, the SNS ENR data is loaded into the common ENR table.

DISPLAY Keys

Figure 6-9 **Display Key Group**



Scale

This key allows you to specify the units and limits for each active measurement result type. The units are available in all display formats, however, the limits only apply to the graph format.

Only the active measurement result graph units and limits are displayed. The scale menu displayed is dependent on the active measurement result selected. See Figure 6-10 showing the six measurement parameter scale menu keys.

The graph limits and levels only affect how the data is displayed and do not affect the measurement process or results.

Autoscale Creates the graph limits to provide an optimum view of the result data.

NOTE **Autoscale** does not scale a memory trace only the current data trace.

Figure 6-10 Scale Menu Keys

Noise Figure	Gain	Y-Factor	Teffective	PHot	PCold
Autoscale	Autoscale	Autoscale	Autoscale	Autoscale	Autoscale
Units dB Linear	Units dB Linear	Units dB Linear	Units K C F	Units dB Linear	Units dB Linear
Upper Limit 9.000	Upper Limit 40.000	Upper Limit 10.000	Upper Limit 2000.0 K	Upper Limit 10.000	Upper Limit 10.000
Lower Limit -1.000	Lower Limit -10.000	Lower Limit 0.000	Lower Limit 0.0 K	Lower Limit 0.000	Lower Limit 0.000
Ref Level 4.000	Ref Level 15.000	Ref Level 5.000	Ref Level 1000.0 K	Ref Level 5.000	Ref Level 5.000
Display Ref Off On	Display Ref Off On	Display Ref Off On	Display Ref Off On	Display Ref Off On	Display Ref Off On
Scale/Div 1.000	Scale/Div 5.000	Scale/Div 1.000	Scale/Div 200.0 K	Scale/Div 1.000	Scale/Div 1.000

Units

This sets the units used to display the data. It is dependent on which result parameter you selected. The options are displayed in Table 6-1

Table 6-1 Result Parameter and Unit, Limit, and Scale/Div Type

Result Parameter	Units, Limits, and Scale/Div
Noise Figure	dB or Linear
Gain	dB or Linear
Y Factor	dB or Linear
Teffective	K, C or F
Phot	dB or Linear
Pcold	dB or Linear

DISPLAY Keys

Upper Limit This sets the upper graph limit on the y-axis. The linear scale values use engineering multipliers to terminate the entry, see Figure 6-11. As the scale per division values are coupled to the upper limit, setting the upper limit causes the scale per division value to be adjusted.

Lower Limit This sets the lower graph limit on the y-axis. The linear scale values use engineering multipliers to terminate the entry, see Figure 6-11. As the scale per division values are coupled to the lower limit, setting the lower limit causes the scale per division value to be adjusted.

Ref Level This allows you to enter a reference level value. The linear scale values use engineering multipliers to terminate the entry, see Figure 6-11. It is displayed as a horizontal line in the graph, if the **Display Ref(On)** is **enabled**. To enter a value, use the numerical keypad.

NOTE The **Ref Level** value can only be set within the **Upper Limit** value and **Lower Limit** value.

Display Ref This allows you to show or hide the reference level on the graph. To show the reference level set **Display Ref(On)**. To hide the reference level set **Display Ref(Off)**, this is the default setting.

Scale/Div This sets the units per division on the y-axis. The linear scale values use engineering multipliers to terminate the entry, see Figure 6-11. Setting this causes the upper and lower limits to be adjusted as the items are coupled.

Figure 6-11 **Scale Linear Termination Menu Keys**

x1e9 (G)
x1e6 (M)
x1e3 (k)
x1
x1e-3 (m)
x1e-6 (μ)
x1e-9 (n)

Format

This accesses menu keys to select which display format you want the measurement data presented. You can choose between graph, table and meter format.

When **Format** is set to **Graph**, you can combine the two graphs, save a trace to volatile memory and recall it later. Also, the annotation and graticules can be switched off or on.

Figure 6-12 **Format Menu Keys**

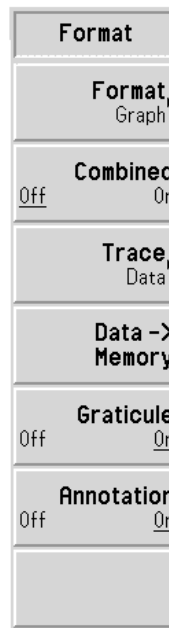

Format This selects between **Format(Graph)** where a graphical display is shown, **Format(Table)** where the measurement results are shown in tabular form, or **Format(Meter)** where the measurement results are shown in single frequency point result display format. The default setting is Graph.

Combined When **Combined(On)** is enabled it combines the upper and lower graphs from a dual graph display into a single graphical display. It overlays both upper and lower graphs simultaneously. When **Combined(Off)** is enabled the graphs are not combined, this is the default setting.

- Trace** The **Trace** menu key only becomes available after you have pressed the **Data->Memory** menu key.
- When **Trace(Data)** is enabled, it displays the current measurement trace. This is the default setting.
- When **Trace(Memory)** is enabled, it displays the measurement trace you saved to memory when the **Data->Memory** menu key was pressed.
- When **Trace(Data&Memory)** is enabled, it displays the measurement trace you saved to memory when the **Data->Memory** menu key was pressed and the current measurement trace. This allows you to compare two traces.
- Data->Memory** When the **Data->Memory** menu key is pressed the current trace is stored in volatile memory and remains there until change the measurement parameter, you switch the NFA off, preset it, or press the **Data->Memory** menu key again saving another trace. After you have pressed the **Data->Memory** menu key the **Trace** menu key becomes available. The **Data->Memory** menu key is only available after a complete sweep of data is made.
- Graticule** When **Graticule(On)** is enabled, it switches the graph graticule on. This is the default setting. When **Graticule(Off)** is enabled, it switches the graph graticule off and the graticule is removed from the graph.
- Annotation** When **Annotation(On)** is enabled it switches the screen annotation surrounding the graphs on, and the annotations are displayed. This is the default setting. When **Annotation(Off)** is enabled it switches the screen annotation surrounding the graphs off and the annotations are removed from the display. However, menu key annotation remains on the screen.

Result

This key allows you to specify which measurement result parameter you want to display in the active measurement. This is applicable to all display formats.

NOTE You cannot make the same two measurement result active, as each measurement result type selected must differ from the other.

NOTE The result menu shows the current, active measurement result. To obtain the other result parameter use the  key.

Figure 6-13 **Result Menu Key**



Noise Figure This selects noise figure as the measurement result.

Gain This selects gain as the measurement result.

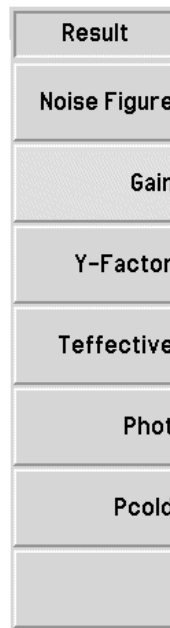
NOTE This gain measurement result is only valid after a calibration has been performed and **Corrected(On)** is selected.

Y Factor This selects Y-Factor as the measurement result.

Teffective This selects equivalent temperature as the measurement result.

Phot This selects hot power density as the measurement result.

Pcold This selects cold power density as the measurement result.

Marker

This accesses the marker control keys which select the marker type, placement, number, and switch them on and off. Markers are diamond-shaped characters that identify points of traces. Up to four pairs of markers are available. They can be distributed on the various traces and may appear on the display simultaneously; only one pair can be controlled at a time. The marker that is controlled is called the “active” marker.

Above the graph, all the enabled marker’s results are displayed. When a marker is activated, its frequency value is displayed in the active function area.

Figure 6-14 **Marker Menu Maps**

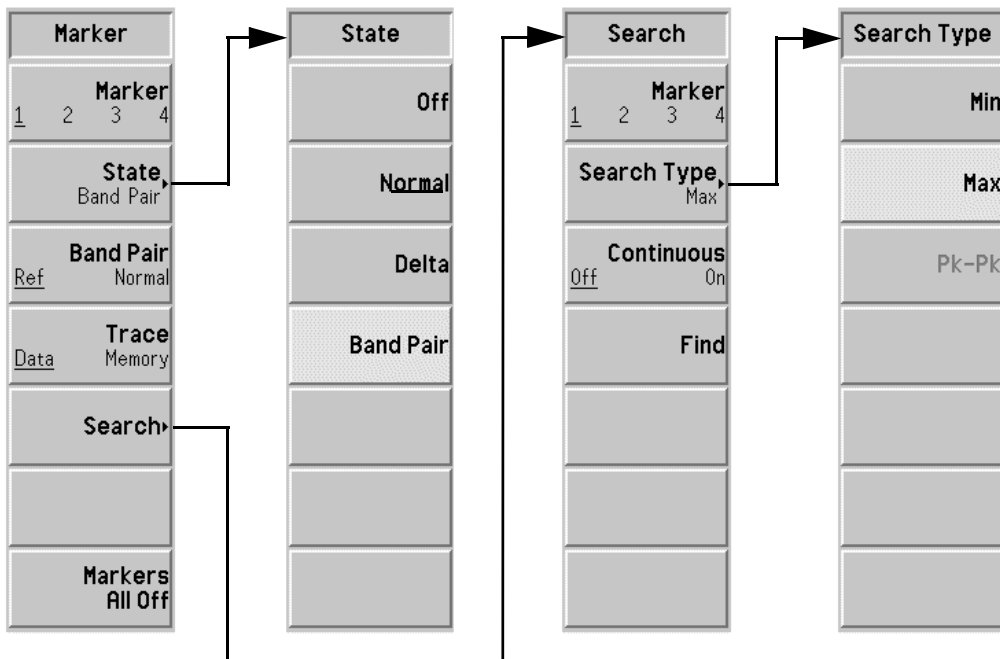

Marker		Selects one of the four possible marker pairs, Marker(1) , Marker(2) , Marker(3) , and Marker(4) . Only one of the markers can be active, although they can, if required, all be enabled. To make a marker active, you need to underline the marker, for example, Marker(1) is active and while active it's frequency value is displayed in the active function area.
State	Off	This switches off an active marker and removes it from the graph. It also removes the marker annotation from the display. This is the default state.
	Normal	<p>Places a single marker on the graph's trace. If a marker has been displayed previously and is reactivated, the marker is enabled at the marker's previously selected position. The marker number is indicated above the marker.</p> <p>Use the RPG to control the position of the marker. Its frequency value is displayed in the active function area and frequency and measurement parameter values are reported above the graph.</p> <p>Pressing Normal when the Delta or Band Pair function is enabled, switches off the reference marker.</p>
	Delta	<p>Activates a second marker at the position of the first marker. It is identified as a reference marker and its position is fixed. (If no marker is present, the marker appears at the center of the graph, or if the marker has been previously active it appears in the last marker position) The marker number is indicated above the delta marker, and the same number is indicated with an R (for example, 1R) above the reference marker. Use the RPG to position the delta marker.</p> <p>The delta marker's frequency value is displayed in the active function area. Also frequency and measurement parameter values are reported above the graph to indicate the difference between the two markers. The reference marker's position remains fixed until delta is disabled.</p>

Band Pair Enters a mode that allows adjustment of the two markers independently. It is similar to the delta marker mode, except you can choose to move the normal marker or the reference marker. Pressing **Band Pair(Ref)** and **Band Pair(Normal)** menu keys, switches between the reference and normal markers. The reference marker number is indicated with a number and an R (for example, 1R) and the normal marker is indicated with a marker number.

The band pair marker's frequency value is displayed in the active function area. Also the frequency and measurement parameter values are reported above the graph to indicate the difference between the two markers.

Band Pair This menu key is only accessible when **State(Band Pair)** has been selected. **Band Pair(Ref)** and **Band Pair(Normal)** menu keys, switch between the reference and normal markers. The reference marker number is indicated with a number and an R (for example, 1R) and the normal marker is indicated with a marker number. Use the RPG to position the currently selected marker.

Trace This menu key becomes active after **Data->Memory** has been pressed. It is used to place a marker on either the data or memory trace. **Trace(Data)** places a marker on the active trace. This is the default setting. **Trace(Memory)** places a marker on the memory trace.

For example, when the recalled and active traces are both displayed, pressing this key causes the marker to hop from the data trace to the memory trace.

NOTE If you disable the memory trace display with a marker on, the marker disappears

Search

This menu key allows you access to a further menu where you can configure a marker search on the trace. The type of search is dependent on the setting type.

Marker

The **Marker** menu key allows you to change the active marker. See “Marker” on page 267 for an explanation.

Search Type

When the **Search Type** menu key is pressed a further optional choice can be made. The options are: -

- When **Search Type(Min)** is enabled, the active marker is placed at the minimum point of the trace.

This key is not accessible when the Marker state is **Band Pair**.

- When **Search Type(Max)** is enabled, the active marker is placed at the maximum point of the trace.

This key is not accessible when the Marker state is **Band Pair**.

- When **Search Type(Pk-Pk)** is enabled, the active band pair markers are placed on the highest and lowest trace points. The reference marker is placed on the highest peak while the normal marker is placed on the lowest trough. Its frequency and measurement parameter values are reported above the graph to indicate the difference between the two markers.

This key is only accessible when the Marker state is **Band Pair**.

Continuous When **Continuous(On)** is enabled, the active marker continuously finds the maximum, minimum, or peak-to-peak on the trace as successive sweep results are reported. This is dependent on which search type is selected. When **Continuous(Off)** is enabled, the marker search is controlled by the **Find** menu key.

NOTE

If you are searching continuously the markers have additional annotation which identifies which marker is the minimum and the maximum. The annotation is “v” a minimum, “^” a maximum. If you change the active graph the annotation remains on the original graph.

Find Pressing the **Find** menu key manually places an active search marker. This functions when **Continuous(Off)** and a **Marker** is enabled. The annotation displays the frequency and measurement parameter differences. Also in the **Find** mode the marker’s frequency value is displayed in the active function area.

Markers All Off This switches off all of the markers, including the marker annotation.

CONTROL Keys

Figure 6-15 Control Key Group



Loss Comp

This key accesses features which allow the NFA to compensate for losses, for example, due to additional cabling, before and/or after the DUT's measurement, by allowing you to specify the compensation loss. This loss can either be the same fixed value over the whole frequency span or it can vary across the frequency span using values specified in a table.

Figure 6-16 Loss Compensation Menu Keys

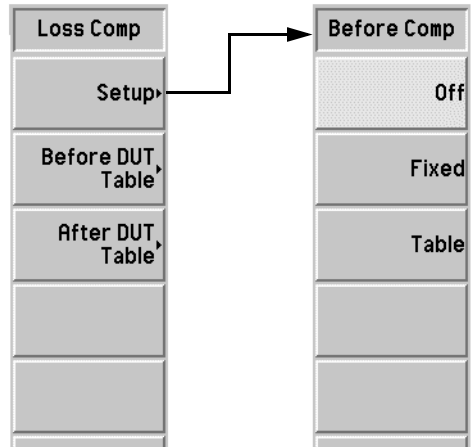

Setup This accesses the Loss Compensation Setup form.

Figure 6-17 Loss Compensation Setup Form

The screenshot shows the 'Loss Compensation Setup' form. At the top left is the Agilent logo. The title bar reads 'Before DUT Off'. The main area is titled 'Loss Compensation Setup' and contains the following fields:

Before DUT	<input type="text" value="Off"/>
Before DUT Fixed Value	<input type="text" value="0.000 dB"/>
Before Temperature	<input type="text" value="0.00 K"/>
After DUT	<input type="text" value="Off"/>
After DUT Fixed Value	<input type="text" value="0.000 dB"/>
After Temperature	<input type="text" value="0.00 K"/>

At the bottom of the form, a note reads: 'Move the highlight to select a field using the 'Tab' keys.'

On the right side of the form, there is a vertical stack of menu items: 'Before Comp', 'Off', 'Fixed', and 'Table'.

You use the **Tab** keys to highlight items in the form. When an item is highlighted its value or option is also displayed in the menu key, allowing you to change its status or value.

Before DUT This controls the compensation before the device under test. It is either,

- **Off**, where there is no compensation before device under test. The default status is **Off**.
- **Fixed**, where the **Before DUT Fixed Value** compensation is used.
- **Table** where the values in the Before DUT Table are used.

**Before DUT
Fixed Value**

This sets the amount of compensation, before the device under test, as a fixed value. This is only valid if the **Before DUT(Fixed)** is enabled. You can enter the value as dB or linear. However, the linear value is converted to dB. The lower limit is -100.000 dB and the upper limit is 100.000 dB. The default value is 0.000 dB.

**Before
Temperature**

This sets the temperature of loss compensation, before the device under test, as a fixed value. This is only valid if **Before DUT** is enabled. You can enter the value as **K**, **C**, or **F**. However, the **C** and **F** values are converted to **K**. The lower limit is 0.00K and the upper limit is 29,650,000.0K. The default value is 0.00K.

After DUT

This controls the compensation after the device under test. It is either,

- **Off**, where there is no compensation after device under test. The default status is **Off**.
- **Fixed**, where the **After DUT Fixed Value** compensation is used.
- **Table** where the values in the After DUT Table are used.

CONTROL Keys

After DUT

Fixed Value

This sets the amount of compensation, after the device under test, as a fixed value. This is only valid if **After DUT(Fixed)** is enabled. You can enter the value as dB or linear. However, the linear value is converted to dB. The limit and default values are the same as **Before DUT**.

After

Temperature

This sets the temperature of loss compensation, after the device under test, as a fixed value. This is only valid if **After DUT** is enabled. You can enter the value as **K**, **C**, or **F**. However, the **C** and **F** values are converted to **K**. The limit and default values are the same as **Before DUT**.

Before DUT Table

This accesses the Loss Compensation Before DUT Table form.

This allows you to enter a Loss table of frequency/value pairs from which loss values are interpolated. See [“Working with Tables” on page 45](#) or the following description.

Figure 6-18 Loss Compensation Before DUT Table

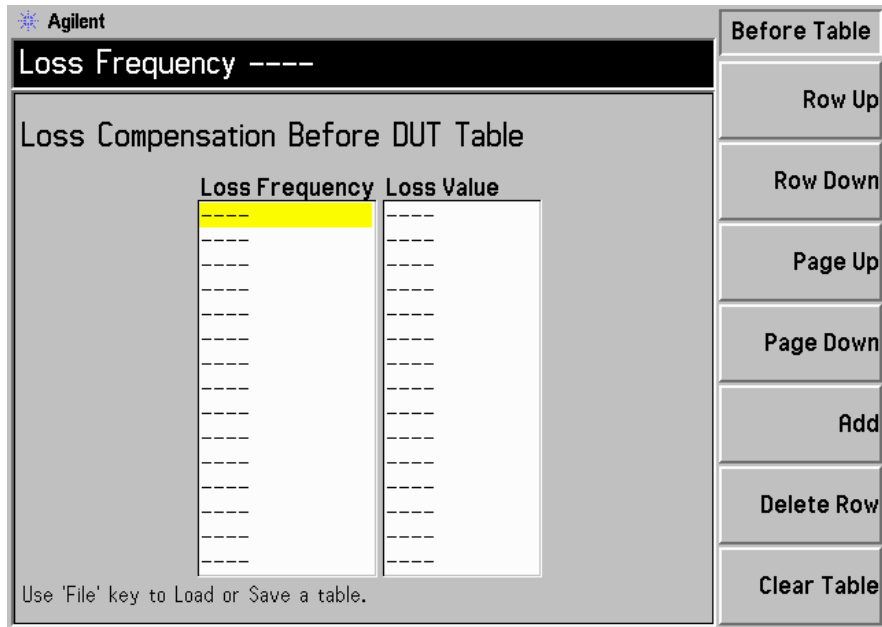

You use the **Tab** keys to highlight items in the form. When an item is highlighted it is also displayed in the menu key, allowing you to change its status or value.

Row Up This allows you to select a particular row in the table, by pressing this menu key you move up to its position in the table one entry at a time.

Row Down This allows you to select a particular row in the table, by pressing this menu key you move down to its position in the table one entry at a time.

Page Up This allows you to move up the table entries in page blocks.

Front Panel Key Reference

CONTROL Keys

Page Down	This allows you to move down the table entries in page blocks.
Add	<p>This allows you to add a new entry. It adds the entry to the bottom of the table and sequences it in the correct ascending order of frequency when it is terminated.</p> <p>To terminate the value entry use the unit keys presented to you. You can also terminate the loss value using the Enter key and it uses the dB unit value by default.</p>
Delete Row	This removes the highlighted single row entry from the table.
Clear Table	<p>This removes all entries from the table. You need to press this menu key twice.</p> <p>The first time you press the key you are prompted to press it again. This two-stroke key press is a safety feature to prevent you from accidentally pressing Clear Table and erasing the table data.</p>

After DUT Table This accesses the Loss Compensation After DUT Table form.

This allows you to enter an Loss table of frequency/value pairs from which loss values are interpolated. See [“Working with Tables” on page 45](#) or the descriptions under the “Before DUT Table” on page 275.

NOTE

A Loss Compensation table can have a maximum of 201 entries.

Limit Lines

The limit lines mark boundary limits of a trace. Limit lines feature four independent lines numbered from 1 to 4. Limit line 1 and 2 are associated with the upper graph, and limit line 3 and 4 are associated with the lower graph. The limit lines can be set to inform you when the trace of interest crosses one of the limit lines. The limit lines can be set as an upper or lower limit. They can also be displayed on the their associated graph.

Figure 6-19 Typical Limit Line Menu Map



Limit Line Selects one of the four possible limit lines. **Limit Line(1)** and **Limit Line(2)** are associated with the upper graph trace, and **Limit Line(3)** and **Limit Line(4)** are associated with the lower graph trace. The selected limit line is underlined and the other limit line menu items apply to it.

Type This menu key sets the selected limit line to, either **Type(Upper)** or **Type(Lower)**. The limit line is tested against the trace if **Test(On)** is enabled.

Front Panel Key Reference

CONTROL Keys

Test This menu key becomes active after limit line data has been entered. It sets the selected limit line to test against the trace. To enable the test, set **Test(On)**. If a limit line failure occurs, the result is reported in the upper left hand corner of the display annotation. To disable the test, set **Test(Off)**. This is the default setting.

Editor This accesses a Limit Line editor which allows you to enter or edit the selected limit line. Figure 6-20 shows the editor.

Limit lines are limited to 201 frequencies. The limit line entries are automatically sorted in ascending frequency order, after the point has been entered. The limit unit is the unit of the selected graph.

Figure 6-20

Limit Line Editor with Table Entry Menu Map

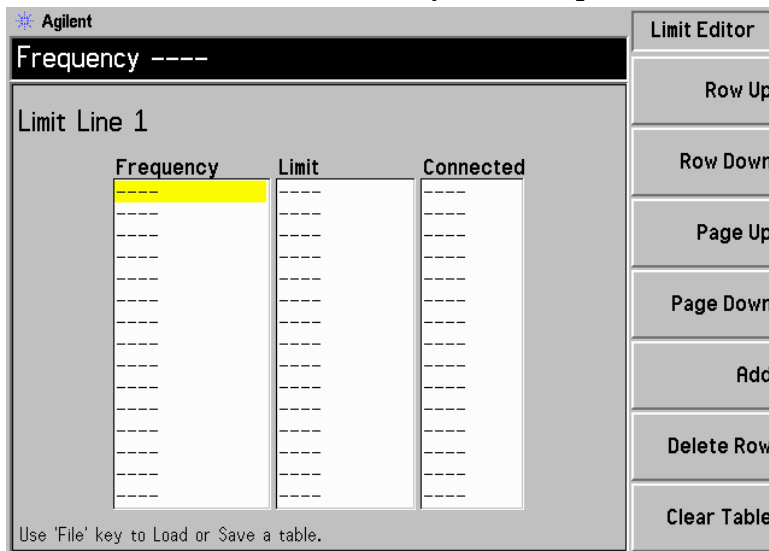

Frequency This sets the frequency value of the current entry.

Limit This sets the limit value of the current entry. The limit line is a unitless value. The values are dependent on the associated graphical limits.

Connected This is used to connect the current point to, or disconnect the current point from the previous point. Setting it to **Yes**, connects the point to the previous point. Setting it to **No**, the point is not connected to the previous point.

See [“Working with Tables” on page 45](#) or the following descriptions on how to enter values into a table.

- **Row Up** This allows you to select a particular entry in the table, by pressing this menu key you move up to its position in the table one row at a time.
- **Row Down** This allows you to select a particular entry in the table, by pressing this menu key you move down to its position in the table one row at a time.
- **Page Up** This allows you to move up the table entries in page blocks.
- **Page Down** This allows you to move down the table entries in page blocks.
- **Add** This allows you to add a new entry. It adds the entry to the bottom of the table and sequences it in the correct ascending frequency order when the row is complete.
- **Delete Row** This removes the single row which is highlighted from the table.
- **Clear Table** This removes all entries from the table. You need to press this menu key twice.

The first time you press the key you are prompted to press it again. This two-stroke key press is a safety feature to prevent you from accidentally pressing **Clear Table** and erasing the table data.

Display This menu key becomes active after limit line data has been entered. It displays the selected limit line on the graph. To enable the limit line display, set **Display(On)**. To disable the limit line display, set **Display(Off)**, this is the default setting.

Limit Lines All Off This switches off all of the limit lines, including any limit line test result and annotation.

NOTE When a limit line is switched off the limit line data is unchanged and can be retrieved if the limit line is switched on again.

Full Screen

This allows the measurement window to expand over the entire display removing the menu keys, the active window annotation, and the display status line annotation. This functions in all formats, graph, table and meter. Press the **Full Screen** key again to return to the previous display. All other key presses are ignored except; **Zoom, Next Window, Save Trace, Help, Preset, Print, Power Standby**, and the Viewing Angle keys.

Corr

This key allows you to switch corrected measurements off or on. The default status is dependent on whether a calibration has been made previously.

You can change the choice of input attenuation of the NFA used during calibration, allowing you to make the calibration faster, or measure higher gain DUTs.

Figure 6-21

N8972A and N8973A Corrected Menu Maps

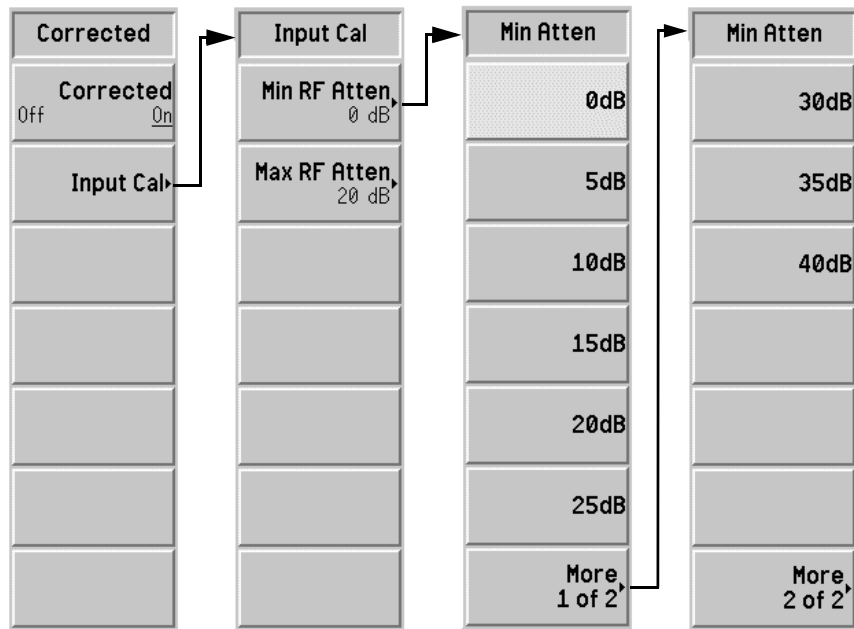

Corrected

This allows you to select between corrected and uncorrected results.

You have the option of doing the measurement with the **Corrected(On)** or the **Corrected(Off)**. The correction uses the calibration data of the second stage and accounts for errors associated with this.

After you have made a calibration the annotation **Corr** is displayed at the bottom right corner of the display.

NOTE If you change the frequency range to greater than the current calibration, the NFA changes to Uncorr. If you want corrected measurements over a greater range, you need to re-calibrate the NFA again before making this measurement. If you change the frequency range to less than the current calibration, the NFA changes to a yellow Corr. This demonstrates the NFA is using interpolated results and interpolated errors may be introduced.

Input Cal The menu key gives you access to menu keys allowing you to set the maximum and minimum attenuator values.

Figure 6-22 N8974A and N8975A Microwave Attenuator Menu Maps

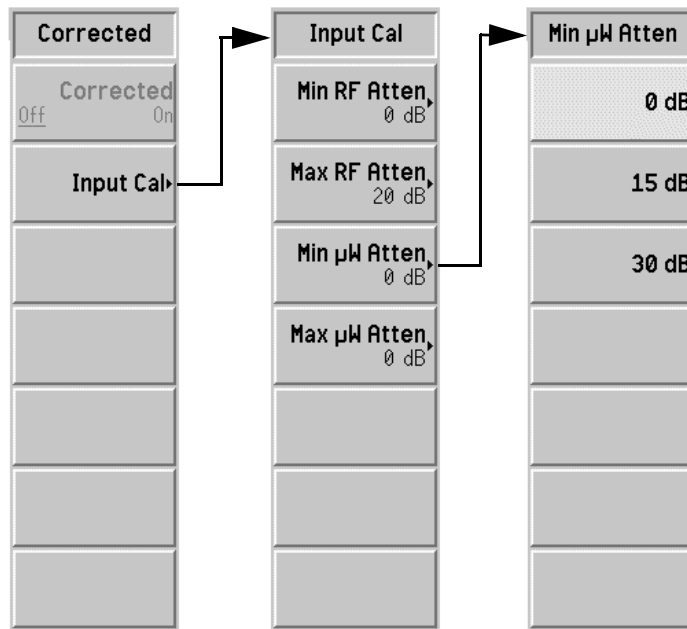

NOTE

On the N8972A and N8973A models there are no **Min mW Atten** and **Max mW Atten** menu keys. The microwave attenuator is only available on the N8974A and N8975A models.

- | | |
|---------------------|---|
| Min Atten | This menu key allows you to change the RF attenuator's minimum input attenuation during calibration. The RF attenuator's frequency range is less than or equal to 3.0 GHz. The choice is from 0dB to 40dB in 5 dB steps. The default value is 0dB . |
| Max Atten | This menu key allows you to change the RF attenuator's maximum input attenuation during calibration. The RF attenuator's frequency range is less than or equal to 3.0 GHz. The choice is from 0dB to 40dB in 5 dB steps. The default value is 20dB . |
| Min mW Atten | This menu key allows you to change the microwave attenuator's minimum input attenuation during calibration. The microwave attenuator's frequency is greater than 3.0 GHz. The choice is from 0dB to 30dB in 15 dB steps. The default value is 0dB . |
| Max mW Atten | This menu key allows you to change the microwave attenuator's maximum input attenuation during calibration. The microwave attenuator's frequency is greater than 3.0 GHz. The choice is from 0dB to 30dB in 15 dB steps. The default value is 0dB . |

Sweep

Sweep Mode

This menu key is used to control the NFA's measurement repetition, so that it is performed once or multiple times.

To set the measurement to perform once, enable **Sweep Mode(Single)**. To set the measurement to repeat continuously, enable **Sweep Mode(Cont)**, this is the default setting.

Figure 6-23 Sweep Menu Map (N8974/5A Models)

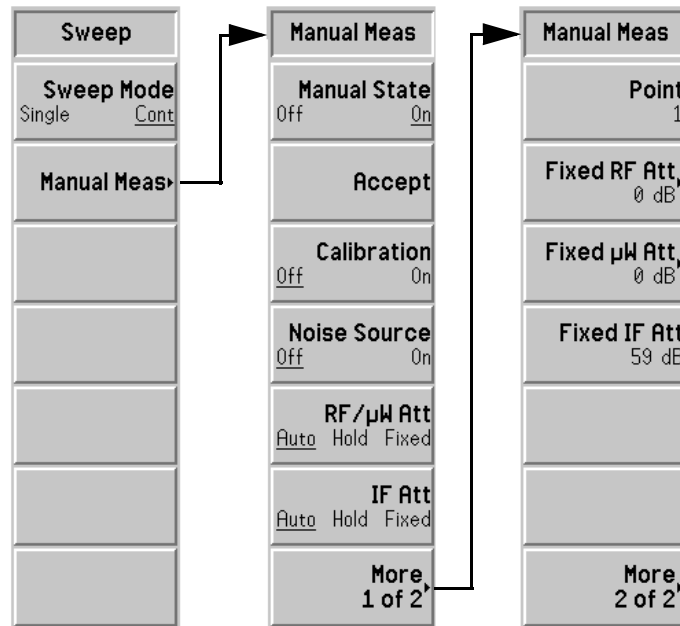

Manual Meas

This allows you access to the Manual Measurement menu keys. This also allows you to manually set the RF attenuator, the IF attenuator, and the microwave attenuator on the N8974/5A models. See “Manual Measurements Procedure” on page 133.

NOTE

The microwave attenuator is only available on the N8974A and N8975A models.

NOTE

On the N8972A and N8973A models the **RF/mW Att** menu key is labelled **RF Att**. Also, there is not a **Fixed mW Att** menu key.

Manual State This allows you to either enable the **Manual State(On)** or disable the **Manual State(Off)** in the Manual Measurement Mode. The default status is **Manual State(Off)** and the other menu keys in the Manual Measurement Menu are disabled, except the RF attenuator, microwave attenuator, and IF attenuator keys.

Accept Press this menu key when you are satisfied that the reading is sufficiently settled to be used in the manual measurement calculations. When pressed, the NFA will use the current power reading in the manual measurement calculations.

This menu key is disabled when **Manual Meas(Off)** is selected.

Calibration This menu key allows you to control whether the NFA is performing a calibration or measurement. Selecting **Calibration(On)** a calibration is performed at a selected frequency point. Selecting **Calibration(Off)** a measurement is performed at a selected frequency point. The default status is **Calibration(Off)**.

This menu key is disabled when **Manual Meas(Off)** is selected.

Noise Source This allows you to switch the noise source on and off. Selecting **Noise Source(On)** a Phot measurement is performed at a selected frequency point. Selecting **Noise Source(Off)** a Pcold measurement is performed at a selected frequency point. The default status is **Noise Source(Off)**.

This menu key is disabled when **Manual Meas(Off)** is selected.

CONTROL Keys

- RF/mW Att** This is used to control the RF and microwave attenuator setting. Selecting **RF/mW Att(Auto)** enables the RF and/or microwave attenuator auto-ranging. This is the default value. Selecting **RF/mW Att(Hold)** enables the current RF attenuator setting to be held until the selection is changed. Selecting **RF/mW Att(Fixed)** enables the values specified in **Fixed RF Att** value or **Fixed mW Att** value to be used.
- IF Att** This is used to control the IF attenuator setting. Selecting **IF Att(Auto)** enables the IF attenuator auto-ranging. This is the default value. Selecting **IF Att(Hold)** enables the current IF attenuator setting to be held until the selection is changed. Selecting **IF Att(Fixed)** enables the values specified in **Fixed IF Att** value to be used.
- Point** This allows you to specify the frequency point at which you want to make the measurement. The points are the number of sweep points in the frequency settings.
- This menu key is disabled when **Fixed Freq** or **Manual Meas(Off)** is selected.
- Fixed RF Att** This allows you to specify a fixed value of the RF attenuator, where the frequency is less than or equal to 3.0 GHz. It is applied when **RF/mW Att(Fixed)** is enabled.
- The choice is from **0dB** to **40dB** with a 5 dB step option. The default value is **0dB**.

NOTE

The **Fixed mW Att** menu key is only available on the N8974A and N8975A models.

Fixed mW Att This allows you to specify a fixed value of the microwave attenuator, where the frequency is greater than 3.0 GHz. It is applied when **RF/mW Att(Fixed)** is enabled.

The choice is from **0dB** to **30dB** with a 15 dB step option. The default value is **0dB**.

Fixed IF Att This allows you to specify a fixed value of the IF attenuator. It is applied when **IF Att(Fixed)** is enabled.

The maximum attenuation allowed is 70 dB. The default value is 59 dB.

Restart

When a measurement is in progress and the **Restart** key is pressed, it stops the measurement and a new one is started. Depending on the sweep setting, the measurement is either made once or continuously.

When in Manual Measurement Mode pressing **Restart** causes the measurement to start again and all the previous data is lost.

NOTE

The **Restart** key can also be used to stop a calibration routine.

SYSTEM Keys

Figure 6-24 System Key Group



System (Local)

This key has two functions. When the instrument is in remote mode pressing this key returns it to local mode.

Pressing **System (Local)** after the NFA has been placed in the remote mode, places the NFA in the local mode and enables front panel control. During remote operation, R appears in the upper-right corner of the screen. A T, L or S may appear during remote operation, indicating talk, listen, or service request. Pressing the **System (Local)** key removes the R symbol in the upper-right corner.

Figure 6-25 System(Local) Menu Maps

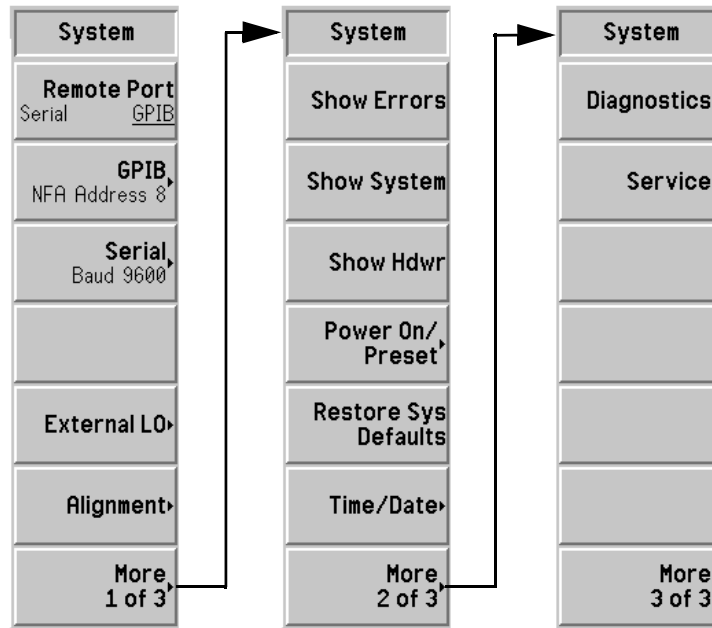

Remote Port This allows you to select between Serial and GPIB remote modes. You have the option of using the **Remote Port(Serial)** or the **Remote Port(GPIB)**

NOTE The NFA needs to be power cycled before the remote port change takes effect.

GPIB

The GPIB menu key accesses the System GPIB Form. This allows access to the GPIB address of the NFA and the LO GPIB related addresses.

Figure 6-26 System GPIB Form with a Menu Displayed

The screenshot shows a graphical user interface for the System GPIB Form. At the top, a black header bar contains the text "Noise Figure Analyzer Address 8" in white. Below this, the main area is titled "System GPIB Form" and contains three input fields: "Noise Figure Analyzer Address" with the value "8" highlighted in yellow, "External LO Address" with the value "19", and "LO GPIB Address" with the value "8". To the right of the main form is a vertical menu with several grey buttons. The top button is labeled "NFA Address" and is currently selected, with the value "8" displayed below it. At the bottom of the main form area, there is a small instruction: "Move the highlight to select a field using the 'Tab' keys."

You use the **Tab** keys to highlight items in the form. When an item is highlighted it is also displayed in the menu allowing you to change its value.

Noise Figure

Analyzer Address This sets the instrument GPIB address. Valid addresses are from 0 to 29. The default address is 8.

External LO

Address This sets the GPIB address of the External LO attached to the LO GPIB. Valid addresses are from 0 to 30. The default address is 19

LO GPIB Address This sets the address through which devices, attached to the LO GPIB, communicate with the NFA. Valid addresses are from 0 to 30. The default address is 8.

Front Panel Key Reference

SYSTEM Keys

Serial

The Serial menu key accesses the System Serial Form. This allows access to the Serial port configuration of the NFA.

You use the **Tab** keys to highlight items in the form. When an item is highlighted it is also displayed in the menu allowing you to change its value.

Figure 6-27

System Serial Form with Baud Rate Menu Map Displayed

The screenshot shows a terminal window with a dark header bar displaying "Baud 9600". Below the header is the "System Serial Form" with the following fields:

Data Terminal Ready	<input type="text" value="OFF"/>
Request To Send	<input type="text" value="OFF"/>
Baud	<input type="text" value="9600"/>
Receive Pacing	<input type="text" value="XON/XOFF"/>
Transmit Pacing	<input type="text" value="XON/XOFF"/>

At the bottom of the form, it says: "Move the highlight to select a field using the 'Tab' keys."

To the right of the form is a vertical menu titled "Baud" with the following options:

- 1200
- 2400
- 4800
- 9600 (highlighted)
- 19200
- 38400

Data Terminal Ready

This sets the DTR line control. To disable the serial port and de-assert the DTR, press **OFF**, this is the default setting. To enable the serial port and assert the DTR, press **ON**. To enable the driver to use the DTR for receive data pacing, press **IBF**.

Request To Send

This sets the RTS line control. To disable the serial port and de-assert the RTS, press **OFF**, this is the default setting. To enable the serial port and assert the RTS, press **ON**. To enable the driver to use the RTS for receive data pacing, press **IBF**.

- Baud** This sets the baud rate. The following list is the Baud rate values. The default setting is 9600.
- **1200**
 - **2400**
 - **4800**
 - **9600**
 - **19200**
 - **38400**
- Receive Pacing** This sets the receive pacing handshake characters. To disable the software receive pacing, press **NONE**, this is the default setting. To enable the XON/XOFF characters, press **XON/XOFF**.
- Transmit Pacing** This sets the transmit pacing handshake characters. To disable the software transmit pacing, press **NONE**, this is the default setting. To enable the XON/XOFF characters, press **XON/XOFF**.

SYSTEM Keys

External LO

This menu is used to set the External LO limits and commands. The frequency and power limits that are included in the system LO menu to stop the External LO from being controlled outside its working range. The NFA is unable to check the validity of the inputs.

Figure 6-28

External LO Menu Map

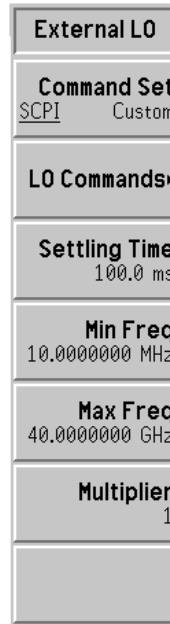

Command Set This sets the External LO command language. Set the **Command Set(SCPI)** to use the built in commands to drive an LO which is SCPI compliant. Set the **Command Set(Custom)** when the External LO is not SCPI compliant and enter the custom command strings.

LO Commands This accesses the External LO Commands Form. This form allows you to enter the commands used to control a non-SCPI-compliant External LO. To enter a command use the Alpha Editor and the numeric keypad.

NOTE When entering an External LO Command, spaces after the prefix and before the suffix may be important.

Figure 6-29 External LO Commands Form with Menu Keys

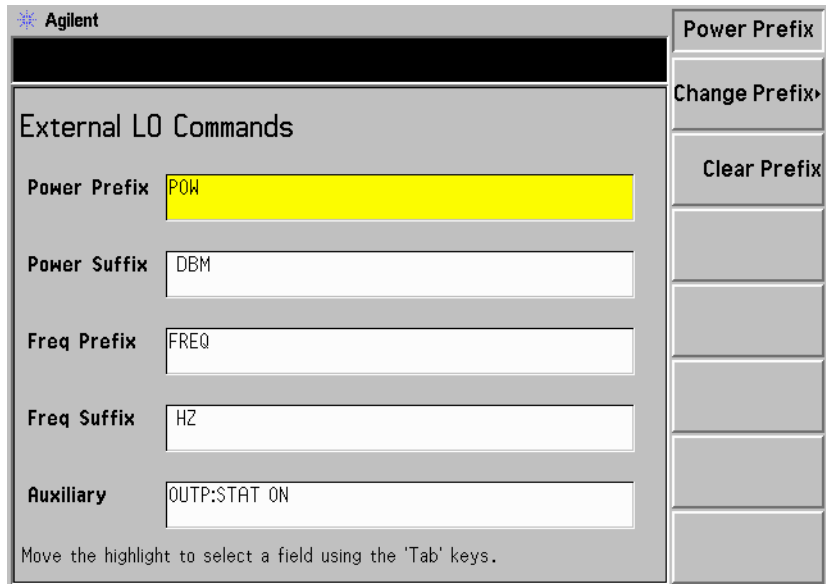

Agilent

External LO Commands

Power Prefix POW

Power Suffix DBM

Freq Prefix FREQ

Freq Suffix HZ

Auxiliary OUTP:STAT ON

Move the highlight to select a field using the 'Tab' keys.

Power Prefix

Change Prefix>

Clear Prefix

- **Power Prefix**, sets the prefix for the command used to set the External LO's power level.
- **Power Suffix**, sets the suffix for the command used to set the External LO's power level.
- **Freq Prefix**, sets the prefix for the command used to set the External LO's frequency.
- **Freq Suffix**, sets the suffix for the command used to set the External LO's frequency.
- **Auxiliary**, other commands required to properly control the External LO (for example, to preset the LO or to put the LO in a CW operation).

SYSTEM Keys

- Settling Time** This sets the settling time of the NFA's command to the External LO. This is used as a settling period after commands are sent to the LO. Valid settling times are between 0 ms and 100 s. The default value is 100 ms.
- Min Freq** This sets the minimum frequency the NFA expects the External LO to have. The default value is 10 MHz.
- Max Freq** This sets the maximum frequency the NFA expects the External LO to have. The default value is 40.0 GHz.
- Multiplier** This sets the value of the External LO frequency multiplier. The default value is 1.

Alignment Accesses the Alignment menu keys which align the internal circuitry of the NFA and allow you to choose the alignment mode.

Figure 6-30 Alignment Menu Map



Alignment Selecting **Alignment(On)** enables the automatic alignment of the NFA, this is the default setting. Selecting **Alignment(Off)** disables automatic alignment.

IMPORTANT In unstable temperature environments or where a lot of averaging is being applied, it is better to align more often. Hence, point mode should be more accurate.

Alignmnt Mode Selecting **Alignmnt Mode(Sweep)** enables the alignment of the NFA to align at the beginning of a sweep. This is the default setting. Selecting **Alignmnt Mode(Point)** enables alignment to align at each point of the sweep.

Align YTF This aligns the tuning current of the YIG Tuned Filter (YTF) against frequency. To avoid an accidental key press you need to press **Align YTF** menu key again.

Save YTF Alignment This saves the YTF alignment data to persistent memory. This is stored in the NFA's non-volatile RAM and remains there after a preset or a power cycle. It also remains in memory after **Restore Sys Defaults** menu key is pressed. To avoid an accidental key press you need to press **Save YTF Alignment** menu key again.

NOTE On N8972A and N8973A models the **Align YTF** and **Save YTF Alignment** menu keys are unavailable.

Show Errors Accesses a display of the last 10 errors reported. The most recent errors appear at the top of the list.

Clear Error Queue Clears the error queue in the **Show Errors** display.

Show System Displays the instrument model name, product number, serial number, host ID, firmware revision number, bootrom revision, and amount of RAM and ROM. Also displayed are the hardware modules in each card slot, options fitted, the printer type, and a time counter.

SYSTEM Keys

- Show Hdw** Displays the instrument model name, product number, serial number, firmware revision number, bootrom revision, and amount of RAM and ROM. Also, displayed are the assembly name and where appropriate the part number, serial number and version numbers of the hardware modules in your NFA.
- Power On/Pres** Accesses menu keys to change the setting of the NFA state which is recalled at power on. The power on preset system controls the power on state of the NFA.

Figure 6-31 Power On/Pres

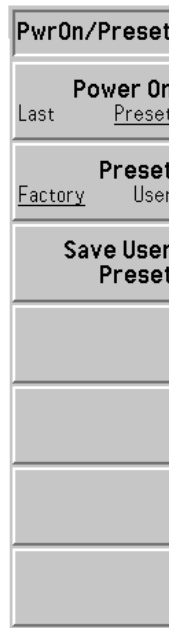

Power On Determines the preferred state of the NFA when the NFA is powered on. If the function is set to **Power On(Preset)**, the power on state of the NFA is the same as it is after the **Pres** is pressed. If the function is set to **Power On(Last)**, then the state that the NFA was in when it was powered off is recalled when it is powered on.

NOTE

The setting **Power On** is not changed by pressing **Preset**.

Preset This sets the preset state to be used when **Power On(Preset)** is the selected state. The NFA is put in the preset state by pressing the **Preset** key. Selecting **Preset (Factory)** allows the NFA to be in the default configuration originally set at the factory. Selecting **Preset (User)** allows the NFA to be in the settings defined by the **Save User Preset** key. See [“Preset” on page 309](#) in this chapter.

Save User Preset Saves the current instrument active state of the NFA into your Preset register for recall on **Preset** if **Preset(User)** is selected.

Restore Sys Defaults

Pressing this menu key restores the NFA to the factory default settings. This key needs to be pressed twice, as it has this safety feature to stop you accidentally pressing this key.

The restored items are, for example, the GPIB address, that are unaffected by a power cycle or a preset.

Time/Date Accesses menu keys used to set and display the real-time clock in the Date Window.

Figure 6-32 **Time/Date Menu Map**



- Time/Date** Enable **Time/Date(On)** to switch the display of the real-time clock on, or enable **Time/Date(Off)** to switch the display of the real-time clock off.
- Date Mode** Enable **Date Mode(MDY)** to display the date in a month-day-year format, or enable **Date Mode(DMY)** to display the date in a day-month-year format.
- Set Time** This allows you to set the time of the real-time clock. Enter the time in 24 hour HHMMSS format, using the numeric keypad and pressing **Enter** to terminate it. Valid hour (HH) values are from 00 to 23. Valid minute (MM) and second (SS) values are from 00 to 59.
- Set Date** This allows you to set the date of the real-time clock. Enter the date in the YYYYMMDD format using the numeric keypad and press **Enter**. Valid year (YYYY) values are 0000 through 9999. Valid month (MM) values are from 01 to 12, and valid day values are from 01 to 31.

Diagnostics

Accesses the **Front Panel Test** menu key.

Front Panel Test Allows you to verify the functionality of each front panel key (except **Preset**). The number next to each key name increments once each time the key is pressed. Rotating the RPG causes the number of pulses to be counted. Press **Esc** to exit.

Service

Accesses the Service menu keys which requires a password for further access. For information, refer to the *Noise Figure Analyzers NFA Series Performance Verification and Calibration Guide*.

File

This accesses the menu keys used to load, save, and manage data on a floppy disk or the internal NFA drives. The file system consists of two DOS compatible volumes. The first, volume A, is the floppy disk. The second, volume C, is the internal flash file system.

The file menu keys also access dialog boxes appropriate for the selected function. You can store and retrieve information to and from files in the file systems and perform file system management functions. The **Tab** keys allow you to move between the dialog box fields and set up a desired operation. Press the **Enter** key to execute an operation.

The file select submenu changes in format depending on where it was entered from. From the Load File and File Manager menus it has a single softkey which is used to select a file name from a scrollable list of files. From the Save File menu it uses the Alpha Editor to enter new file names. It also numbers the files with default names sequentially.

Load

Accesses menu keys that allow you to load ENR values, states, limits, frequency lists, loss compensation tables into the NFA from a floppy (A:) drive or internal flash (C:) drive. To load a file, use the following steps:

1. Select the type of data you wish to load by pressing the appropriate menu key. For example, if you select **Limits**, you also have to select which limit line **1**, **2**, **3**, or **4**.
2. The drive letter name is activated in the Path dialog box. Select the source of the data. Select the desired drive with the **Select** key. If you are already in a drive, press **Select** while “.” is active to select a different drive. Use the \uparrow and \downarrow keys or the RPG to activate the desired drive. Press **Select**.
3. When you are ready to load the data, press **Enter**.

ENR	ENR files contain tables of ENR/frequency pairs used to characterize a noise sources. Files of this type have the three letter suffix (ENR). You need to decide whether the ENR file is either, a Meas Table or a Cal Table by pressing the appropriate menu key.
State	State files contain the instrument settings. Loading a state file restores the settings to the previously saved values. Files of this type have the three letter suffix (STA).
Limits	Limits files contain limit line specifications and provides data sets to determine whether a trace has crossed the limit line specifications. You need to decide whether the limits file is either, a limit line 1 , 2 , 3 , or 4 , by pressing the appropriate menu key. Files of this type have the three letter suffix (LIM).
Frequency List	Frequency list files contain specified list of frequencies at which measurements are to be made. Files of this type have the three letter suffix (LST).
Loss	Loss files contain loss compensation data. You need to decide whether the loss file is either a Before Table or After Table by pressing the appropriate menu key. Files of this type have the three letter suffix (LOS). The NFA can also load S2P file formats. The NFA accepts any files with the following extensions: S2P, S1, and S2.

Save

Accesses menu keys that allow you to save the NFA's ENR, states, traces, limits, frequency lists, loss compensation tables, and screen data to a floppy (A:) drive or internal flash (C:) drive.

NOTE

The Save Menu is similar to the Load Menu, except that it supports two additional file types, these are, trace and screen. It also only allows you to save loss compensation as .LOS files. The S2P formats are only available to load into the NFA.

To save a file, use the following steps:

1. Select the type of data you wish to save by pressing the appropriate menu key. For example, if you select **ENR**, you need to select either **Meas Table** or **Cal Table**.
2. If appropriate, in the Format dialog box, select the desired format.
3. If the auto-selected name is not acceptable, enter a name using the Alpha Editor menu keys. File names are limited to eight characters.
4. The Path dialog box becomes active, allowing you to change the destination drive of the data. Select the desired drive with the **Select** key. If you are already in a drive, press the **Select** key while “..” is activated to select a different drive. Use the ↑ and ↓ keys or the RPG to activate the desired drive. Press **Select**.
5. When you are ready to save, press **Enter**.

ENR	ENR files contain tables of ENR/frequency pairs used to characterize a noise sources. ENR allows you to save an ENR table in memory. You need to decide whether the ENR file is a Meas Table , a Cal Table , or an SNS table by pressing the appropriate menu key.
State	State files contain the instrument settings. State allows you to save an NFA state in memory.
Trace	A trace is saved in a Comma Separated Value (CSV) format, and is readable by a spreadsheet on your PC. However, it cannot be loaded back into the NFA.
Limits	Provides data sets to determine whether a trace has exceeded allowed specified limits. You need to decide whether the limits file is either, a limit line 1 , 2 , 3 , or 4 by pressing the appropriate menu key. Limits can only be saved individually.
Frequency List	Frequency list files contain your specified list of frequencies at which measurements are to be made.
Loss	Loss files contain loss compensation data. You need to decide whether the loss file is either a Before Table or After Table by pressing the appropriate menu key. Files of this type have the three letter suffix (LOS).
Screen	Saves the screen image to a file and allows you to choose between bitmap and metafile formats. The Bitmap saves the screen image in Graphics Interchange Format (GIF) and the Metafile saves the screen image in Windows Metafile (WMF) format. Also, the screen images can be saved as reverse images where the colors are reversed. Press Reverse Bitmap or Reverse Metafile menu key to save a reverse image. Screen images cannot be loaded back into the NFA.

File Manager

Accesses menu keys that allow you to perform functions such as copying, deleting, and renaming files.

The file manager allows you to perform house keeping functions on saved data.

Copy

Allows you to copy a file to another file with a different name or to a different drive (in which case the same name is acceptable).

Copy accesses the following menu keys:

ENR

Allows you to copy ENR files.

State

Allows you to copy state files.

Trace

Allows you to copy trace files.

Limits

Allows you to copy limits files.

Frequency List

Allows you to copy frequency list files.

Loss

Allows you to copy loss compensation files.

Screen

Allows you to copy screen files.

Delete

Allows you to delete a file from a floppy disk or the NFA's internal memory.

ENR

Allows you to delete ENR files.

State

Allows you to delete state files.

Trace

Allows you to delete trace files.

Limits

Allows you to delete limits files.

Frequency List

Allows you to delete frequency list files.

Loss

Allows you to delete loss compensation files.

Screen

Allows you to delete screen files.

SYSTEM Keys

Rename	Allows you to rename a file. File names are limited to eight (8) characters.
	ENR
	Allows you to rename ENR files.
	State
	Allows you to rename state files.
	Trace
	Allows you to rename trace files.
	Limits
	Allows you to rename limits files.
	Frequency List
	Allows you to rename frequency list files.
	Loss
	Allows you to rename loss compensation files.
	Screen
	Allows you to rename screen files.
Format	Formats a double-density floppy disk to 1.44 MB format. 760 KB disks are not supported.

Save Trace

This is an action key which saves what is set-up under File. When you need to change the parameters to be saved, press **File** and change them. See [“File” on page 302](#) for an explanation of setting up of saving files.

Preset

This key provides a convenient starting point for making most measurements. Pressing the **Preset** key sets the instrument into a preset state, the actual state depends on the Power On/Preset menu selections. See the [“Preset/Power Up Groups” on page 317](#), for the conditions established by pressing **Preset**.

The instrument preset function performs a processor test, but does not affect alignment data. Pressing **Preset** clears both the input and output buffers and sets the status byte is set to 0. See [“Preset/Power Up Groups” on page 317](#) for a description of the preset states.

NOTE

Switching on the NFA performs an instrument preset, and also fetches alignment data. The last state of the NFA (before it was powered off) is recalled when **Power On (Last)** is selected (under the **System** key).

Print Setup

Accesses the menu keys which allow you to define a printer and select the printer options.

This menu allows you choose the information to be printed, the layout of that information on the printed page, and the type of printer.

Figure 6-33

Print Setup Menu Maps

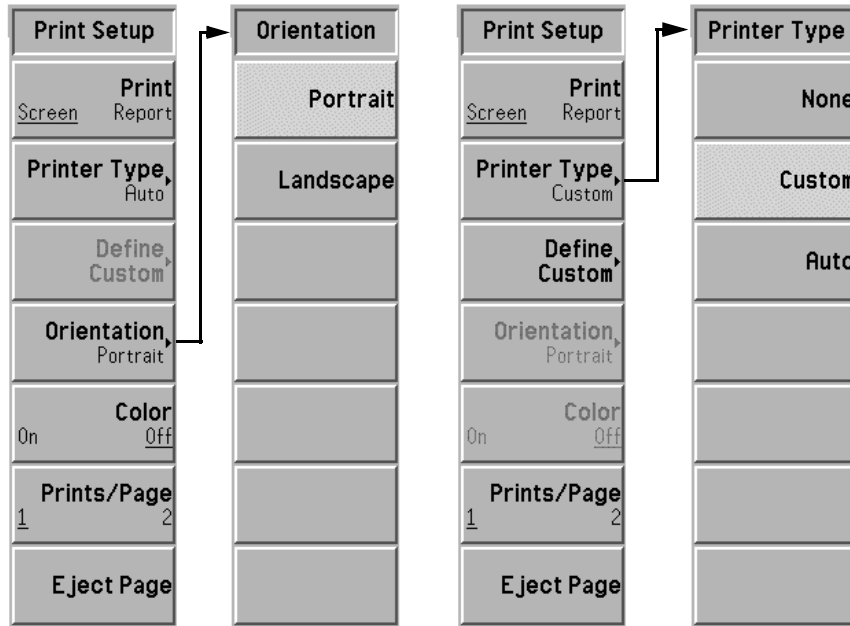

Print

Pressing **Print (Screen)** and then the **Print** action key, prints out what is on the NFA display. Pressing **Print (Report)** and then the **Print** action key, prints out the NFA information displayed under the **Show System** menu key. Show System information includes the NFA's product number, serial number, firmware revision, and installed options.

Printer Type

Accesses the Printer Type menu keys. When you connect your printer and press the **Print** key, the NFA attempts to identify your printer. If identification is unsuccessful, **None** or **Custom** are automatically set in the Printer Type menu. You can select one of the following options:

- None** The Printer Type is automatically set to **None** when you press the **Print** key and there is no attached printer or an unsupported printer is connected to your NFA.
- Custom** When you press the **Print** key and the NFA cannot identify your printer, **Custom** is automatically set in the Printer Type menu. Setting the Printer Type menu key to **Custom** allows you to define your printer using the **Define Custom** menu keys.
- Auto** When **Auto** is selected, and the **Print** key is pressed, the NFA attempts to communicate with the printer and obtain its identification. If the printer is identified, the print is successful and no message appears on the display. If the NFA is not able to identify the printer, the Printer Type is automatically set to **Custom** and an error message asking you to press **Define Custom** to set up your printer is displayed. If the printer is not supported, the Printer Type is automatically set to **None** and an error message informs you that your printer is unsupported.

Define Custom

Allows you to define your printer.

- Language** Allows you to define your printer as a **Language(PCL3)**, Deskjet type printer, or **Language(PCL5)**, Laserjet type printer.
- Color Capable** Allows you to define the color capability of your printer. When **Color Capable(Yes)** is enabled, the printer is color capable. When **Color Capable(No)** is enabled, the printer is not color capable.

Orientation

Allows you to select either **Portrait** or **Landscape** printing. Landscape is not available with a PCL3 (Deskjet) printer.

SYSTEM Keys

- Color** Allows you to select between color or black and white printing. This key does not function when pressed unless the connected printer supports color. When **Color(Off)** is set color printing is disabled. When **Color(On)** is set color printing is enabled.
- Prints/Page** Selects the number of prints per page when orientation is set to **Portrait**. In **Landscape** printing, **Prints/Page** is always set to 1.
- When **Prints/Page(1)** is enabled, the printer ejects the page after making a single printout. When **Prints/Page(2)** is enabled, the printer ejects the page after making a second printout.
- Eject Page** This causes the printer to eject the current page.

Print

Pressing the **Print** key initiates an output of the display data to a previously specified graphics printer. See [“Configuring a Printer with the NFA” on page 235](#) of this manual for detailed information about printing.

Press the **Print** key to immediately print the screen to the currently-defined printer. The screen remains frozen (no further sweeps are taken) until the data transfer to the printer is complete. Refer to the [“Print Setup”](#) key description in this chapter for more information about the structure and definitions of the printer keys.

If you need to abort a print in progress, use the **Esc** (escape) key.

Data Entry Keys

Numeric Keys

These keys are used to enter numeric data. After each complete numerical entry you need to terminate it using the units menu keys when presented to you or the **Enter** key.

Back Space

Used to correct front panel numeric input value or an Alpha Editor entry. Press the **Bk Sp** ← key and tab back to where you need the correction over written.

Enter

Terminates and enters into the NFA a numerical value that has been entered from the front panel using the numeric keypad.

NOTE

For certain applications, you must use the units menu keys to terminate an entry.

When using the **File** key menus, the **Enter** key is also used to save, load, copy, delete, or rename a file.

Up/Down Arrow Keys

These keys are used to increment and decrement active function values, and also to move up and down file selection lists.

Display and Menu Control Keys

Viewing Angle

Controls the optimum viewing angle of the display. The viewing angle keys are located next to each other at the upper left-hand corner of the NFA, bordering the display. These two keys allow you to adjust the intensity of the display so that it can be optimally viewed from different angles.

The **Viewing Angle** keys automatically repeat when they are continually pressed down.

On

This powers up the NFA.

Standby

Removes power from the NFA, except for a small portion of circuitry inside the power supply. No internal timebase circuitry, or any other function outside of the power supply is powered when the NFA is in **Standby** mode.

To remove power from the small portion of circuitry inside the power supply which remains powered when the NFA is in **Standby** mode, you need to disconnect the power cord from the rear of the NFA.

Next Window 

The *Next Window* key is used to switch the selection between the upper and lower windows in dual and single graph display layout. The active window has a green border.

NOTE

The *Next Window* key is also used in table and meter formats to change the active measurement parameter. The active measurement parameter title has a green border.

Zoom 

Allows you to switch between the dual graph split-screen and full-sized display of the active window.

The graph selected by the next window key is the one that is expanded to create the single graph display.

NOTE

The *Zoom* key is only active when in graph format.

Help

This accesses a short description of any front panel key or menu key. After pressing **Help**, an explanation of the next key pressed appears on the display.

The help key provides on-line help for other keys on the front panel. The help is context sensitive so that the key's help is specific to its current function.

NOTE

After the help text is displayed, pressing any key, except **Preset**, removes the help window. Pressing **ESC** allows you to remove the help window without changing functions.

Tab Keys

These are three **Tab** keys that are used to select entries in tables when editing or viewing them. They are used in the forms to select the entry to allow you to edit it. Also, these keys move between entry fields in the file selection menus.

- The up-left arrow moves to the first entry in the table.
- The left arrow moves to the previous table entry.
- The right arrow moves to the next table entry.

⇐Prev

Returns you to the previous menu. Repeated presses of this key move back through previously selected menus. When a menu requiring a yes or no key press has been accessed, the **Prev** key does not respond.

Esc

Deactivates the active function and clears the active function text from the display. This ensures that no data can be accidentally entered using the RPG, front panel keys, or numeric keypad.

Pressing **Esc** also aborts a print, clear input or output overloads, and clear error messages from the status line along the bottom of the display.

Preset/Power Up Groups

The NFA has preset and power up settings which are allocated into four groupings. These occur on Preset/Power Up and recalling a State file. These are as follows: -

- A persistent group which remains in memory after a preset or a power cycle and is not saved as part of a State file.
- A “survive preset” group which remains in memory after a preset or a power cycle and can be saved as part of a State file.
- A No Save group which does not remain in memory after a preset or a power cycle. It is not saved or recalled as part of a State file.
- A State group which remains in memory after a preset or a power cycle. It contains data which is reset by preset or a power cycle and is stored and recalled as a State file.

Preset/Power Up — “Persistent” Group Items

The “persistent” group is stored in the NFA’s non-volatile RAM and remains there after a preset or a power cycle. It is not stored as part of a State file, hence is not affected when a State file is recalled. It is reset to its initial value by **Restore Sys Default**, which is under the **System** key.

The “persistent” group items are listed in the following list: -

- Automatic Filename Counter
- Viewing Angle
- **Remote Port** (Serial) or (GPIB)
- **GPIB** (Noise Figure Analyzer Address)
- **GPIB** (External LO Address)
- **GPIB** (LO GPIB Address)
- **Serial** (Data Terminal Ready)
- **Serial** (Request To Send)

Front Panel Key Reference

Preset/Power Up Groups

- **Serial** (Baud)
- **Serial** (Receive Pacing)
- **Serial** (Transmit Pacing)
- **Power On** (Last) or (Preset)
- **Preset** (Factory) or (User)
- **Time/Date** (On) or (Off)
- **Date Mode** (MDY) or (DMY)
- **Printer Type**
- **Orientation** (Portrait) or (Landscape)
- **Color** (On) or (Off)
- **Prints/Page** (1) or (2)
- **Language** (PCL3) or (PCL5)
- **Color Capable** (No) or (Yes)

Preset/Power Up - “Survive Preset” Group Items

The “survive preset” group is stored in the NFA’s non-volatile RAM and remains there after a preset or a power cycle. It typically contains table data which you do not want to re-enter when the NFA is preset or power cycled.

The group can also be stored as part of a `State` file, hence it is refreshed when a `State` file is recalled. It is reset to its initial value by **Restore Sys Default**, which is under the **System** key.

These group items are detailed in the following list: -

- **Limit Lines**
This also includes **Type**. However, it does not include Test (On) or (Off) and Display (On) or (Off)
- **Freq List** data
- **Before DUT Table** and **After DUT Table** Loss Compensation data
- **LO Commands**
The custom command strings (Power Prefix, Power Suffix, Freq Prefix, Freq Suffix, Auxiliary)
- **External LO**, Settling Time
- **External LO**, Min Freq
- **External LO**, Max Freq

NOTE

The **ENR Table** data, both **Meas Table** and **Cal Table**, is part of the “survive preset” group. However, it is not stored as part of this group in a `State` file.

Unsaved Items

This data does not need to remain after a preset or a power cycle. It contains data which is not saved or recalled from a State file. The data is reset on power up or preset

These unsaved items are listed in the following list:

- The current menu
- The editing position within a table
- The marker selection number
- The limit line selection number
- The file type

State Items

State saved items are stored in the NFA's non-volatile RAM and remain there after a power cycle. These contain data which is normally reset by preset or a power cycle. They are stored as part of a State file. It contains all menu/remote settings except those listed in the [“Unsaved Items”](#) section.

NOTE An NFA's State file also stores the Calibration Data and Marker Memory Trace Data. Hence, this data is recalled with a State file.

NOTE Calibration Data is volatile and is lost after a power cycle. However, it is not lost after a preset.

NOTE Memory Trace Data is volatile and is lost after a preset or a power cycle.

Default States

Table 6-2 shows the NFA's system default states. Where the value is initially not active, its activated default state is shown in parenthesis

Table 6-2 Default States

Menu Key	Default States
After DUT	Off
After DUT Fixed Value	Inactive (0.000 dB)
After Temperature	0.00 K
Alignment	On
Alignment Mode	Sweep
Annotation	On
Auto Load ENR	On
Average Mode (Key not available on the N8972A)	Point
Averages	1
Averaging	Off
Band Pair	Inactive (Ref)
Bandwidth	4 MHz
Baud	9600
Before DUT	Off
Before DUT Fixed Value	Inactive (0.000 dB)
Before Temperature	0.00 K
Cal Table	Inactive
Center Freq (N8972A)	755.0 MHz
Center Freq (N8973A)	1.505 GHz
Center Freq (N8974A)	1.505 GHz

Front Panel Key Reference
Preset/Power Up Groups

Table 6-2 Default States

Menu Key	Default States
Center Freq (N8975A)	14.75 GHz
Color	Off
Combined	Off
Command Set	SCPI
Common Table	On
Continuous	Inactive (Off)
Corrected	Inactive (Off)
Define Custom	Inactive
Data->Memory	Inactive
Date Mode	MDY
Data Terminal Ready	OFF
Device Under Test	Amplifier
Display	Inactive (Off)
Display Ref	Off
ENR Mode	Table
ENR Table	Active
External LO Address	19
External LO Power Level	0.0000 dB
Find	Inactive (Off)
Fixed Freq	Inactive
Format	Graph
Freq Span (N8972A)	1.490 GHz
Freq Span (N8973A)	2.990 GHz

Table 6-2 Default States

Menu Key	Default States
Freq Span (N8974A)	2.990 GHz
Freq Span (N8975A)	23.50 GHz
Freq. Mode	Sweep
Graticule	On
IF Frequency	Inactive (30.0 MHz)
Limit Line	1↑
LO Control	Off
LO Frequency	30.0 GHz
LO GPIB Address	8
LO Mode	Inactive
Marker	1↑
Manual State	Off
Meas Table	Inactive
Min RF Atten	0 dB
Max RF Atten	20 dB
Min μ W Atten (Key selection not on the N8972/3A)	0 dB
Max μ W Atten (Key selection not on the N8972/3A)	0 dB
Multiplier	1
Noise Figure Analyzer Address	8
Orientation	Inactive (Portrait)
Points	11
Power On	Preset

Front Panel Key Reference
Preset/Power Up Groups

Table 6-2 Default States

Menu Key	Default States
Preference	SNS
Preset	Factory
Print	Screen
Printer Type	Auto
Prints/Page	1
Receive Pacing	XON/XOFF
Ref. Level	4.000
Request To Send	OFF
Remote Port	GPIB
Search Type	Inactive (Max)
Sideband	LSB
Spot ENR	15.200 dB
Spot Mode	ENR
Spot Thot	9892.80 K
SNS Tcold	Inactive (On)
Start Freq (not N8975A model)	10.00 MHz
Start Freq (only N8975A model)	3.000000001 GHz
State	Off
Stop Freq (N8972A)	1.50 GHz
Stop Freq (N8973A)	3.00 GHz
Stop Freq (N8974A)	3.00 GHz
Stop Freq (N8975A)	26.50 GHz
Sweep Mode	Cont

Table 6-2 Default States

Menu Key	Default States
System Downconverter	Off
Tcold	SNS (if connected) Default (if SNS not connected)
Test	Inactive (Off)
Time/Date	On
Trace	Inactive (Data)
Transmit Pacing	XON/XOFF
Type	Upper
Units (Default Noise Figure)	dB
User Tcold	Off
User Tcold from SNS	Inactive
User Value	296.50K

Front Panel Key Reference
Preset/Power Up Groups

What You'll Find in This Chapter

This chapter includes information on how to check for a problem with your Noise Figure Analyzer, and how to return it for service. It also includes descriptions of all of the analyzer built-in messages.

Your analyzer is built to provide dependable service. However, if you experience a problem, or if you desire additional information or wish to order parts, options, or accessories, Agilent's worldwide sales and service organization is ready to provide the support you need.

In general, a problem can be caused by a hardware failure, a software error, or a user error. Follow these general steps to determine the cause and to resolve the problem.

1. Perform the quick checks listed in "Check the Basics" in this chapter. It is possible that a quick check may eliminate your problem altogether.
2. If the problem is a hardware problem, you have several options:
 - Repair it yourself; see the "[Service Options](#)" section in this chapter.
 - Return the analyzer to Agilent Technologies for repair; if the analyzer is still under warranty or is covered by an Agilent maintenance contract, it is repaired under the terms of the warranty or plan (the warranty is at the front of this manual).

If the analyzer is no longer under warranty or is not covered by an Agilent maintenance plan, Agilent Technologies notifies you of the cost of the repair after examining the instrument. See "[Contacting Agilent Technologies](#)" and "[How to Return Your Analyzer for Service](#)" for more information.

WARNING

No operator serviceable parts inside the analyzer. Refer servicing to qualified personnel. To prevent electrical shock do not remove covers.

Before You Call Agilent Technologies

Check the Basics

A problem can often be resolved by repeating the procedure you were following when the problem occurred. Before calling Agilent Technologies or returning the analyzer for service, please make the following checks:

- ? Check the line fuse.
- ? Is there power at the receptacle?
- ? Is the analyzer turned on? Make sure the fan is running, which indicates that the power supply is on.
- ? If the display is dark or dim, press the upper **Viewing Angle** key in the upper-left corner of the front panel. If the display is too bright, adjust the lower **Viewing Angle** key in the upper-left corner of the front panel.
- ? If other equipment, cables, and connectors are being used with your Noise Figure Analyzer, make sure they are connected properly and operating correctly.
- ? Review the procedure for the measurement being performed when the problem appeared. Are all the settings correct?
- ? If the analyzer is not functioning as expected, return the analyzer to a known state by pressing the **Preset** key.

Some analyzer settings are not affected by a Preset. If you wish to reset the analyzer configuration to the state it was in when it was originally sent from the factory, press **System, Power On/Preset, Preset (Factory)**.

- ? Is the measurement being performed, and the results that are expected, within the specifications and capabilities of the analyzer? Refer to the “Technical Specifications” chapter in the *Agilent NFA Series Performance Verification and Calibration Guide* for the NFA specifications.
- ? In order to meet specifications, the analyzer must be aligned. Press

System, Alignment and enable **Alignment(On)**. If **Alignment(Off)** is enabled the analyzer must be aligned whenever the temperature changes more than 3° centigrade.

- ? Is the analyzer displaying an error message? If so, refer to [“Error Messages”](#) in this chapter.
- ? If the necessary test equipment is available, perform the performance verification tests in the *Agilent NFA Series Performance Verification and Calibration Guide*. Record all results on a Performance Verification Test Record form which follows the tests.

Read the Warranty

The warranty for your analyzer is at the front of this manual. Please read it and become familiar with its terms.

If your analyzer is covered by a separate maintenance agreement, please be familiar with its terms.

Service Options

Agilent Technologies offers several optional maintenance plans to service your analyzer after the warranty has expired. Call your Agilent Technologies sales and service office for full details.

Connector Care

Cleaning connectors with alcohol shall only be done with the instruments power cord removed, and in a well-ventilated area. Allow all residual alcohol moisture to evaporate, and the fumes to dissipate prior to energizing the instrument.

WARNING

If flammable cleaning materials are used, the material shall not be stored, or left open in the area of the equipment. Adequate ventilation shall be assured to prevent the combustion of fumes, or vapors.

For information on proper connector care and cleaning, go to the following URL:

<http://cp.literature.agilent.com/litweb/pdf/08510-90360.pdf>

Contacting Agilent Technologies

For assistance, contact your nearest Agilent Technologies Sales and Service Office. To find your local Agilent office access the following URL, or if in the United States, call the following telephone number:

<http://www.agilent.com/find/assist>

1-800-829-4444 (8 am - 8 pm ET, Monday - Friday)

In any correspondence or telephone conversations, refer to your analyzer by its product number, full serial number, and firmware revision.

Press **System, More (1 of 3), Show System**, and the product number, serial number, and firmware revision information will be displayed on your analyzer screen. A serial number label is also attached to the rear panel of the analyzer.

How to Return Your Analyzer for Service

Detailing the Problem

If you are returning your analyzer to Agilent Technologies for servicing, enter details of the problem and send them with the analyzer. Please be as specific as possible about the nature of the problem. If you have recorded any error messages that appeared on the display, or have completed a Performance Test Record, or have any other specific data on the performance of your analyzer, please send a copy of this information with your analyzer.

Original Packaging

Before shipping, pack the unit in the original factory packaging materials if they are available. If the original materials were not retained, see [“Other Packaging”](#).

NOTE Ensure that the instrument handle is in the rear-facing position in order to reduce the possibility of damage during shipping. Refer to Figure 7-1.

NOTE Install the transportation disk into the floppy drive to reduce the possibility of damage during shipping. If the original transportation disk is not available, a blank floppy may be substituted.

Figure 7-1

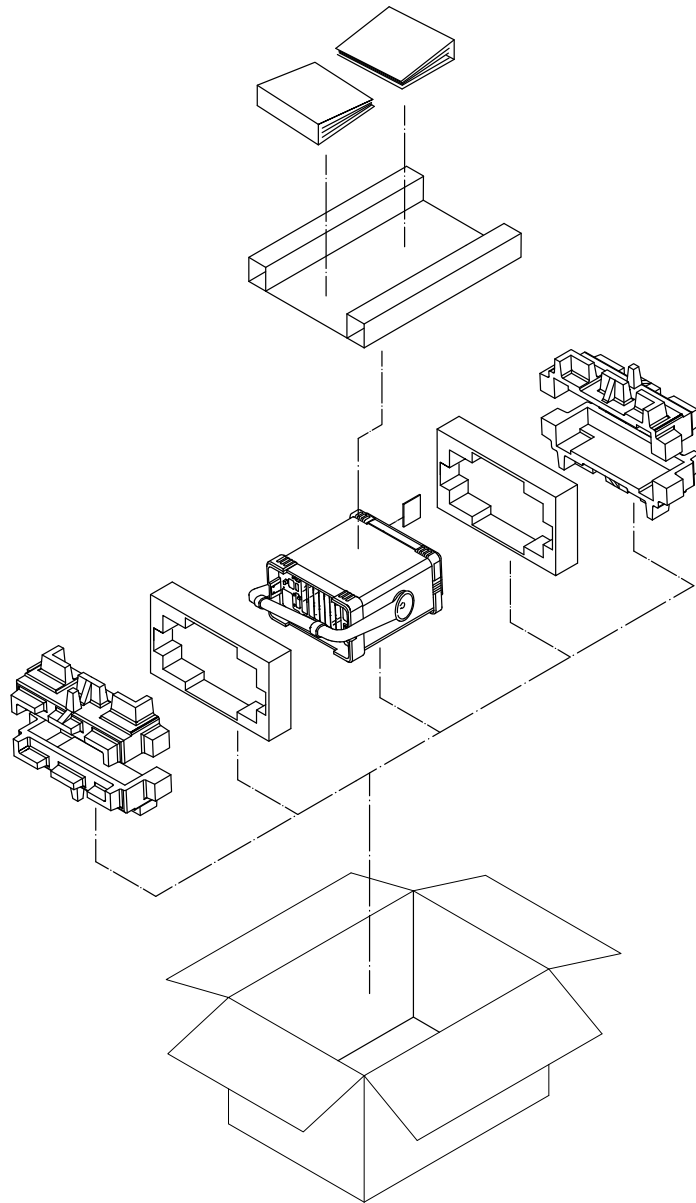

form122

Other Packaging

CAUTION

Analyzer damage can result from using packaging materials other than those specified. Never use styrene pellets in any shape as packaging materials. They do not adequately cushion the equipment or prevent it from shifting in the carton. They cause equipment damage by generating static electricity and by lodging in the analyzer louvers, blocking airflow.

You can repackage the instrument with commercially available materials, as follows:

1. Attach the details of the problem to the instrument.
2. Install the transportation disk or a blank floppy disk into the disk drive.
3. If you have a front-panel cover, install it on the instrument. If you do not have a front panel cover, make sure the instrument handle is in the forward-facing position to protect the control panel.
4. Wrap the instrument in antistatic plastic to reduce the possibility of damage caused by electrostatic discharge.
5. Use a strong shipping container. The carton must be both large enough and strong enough to accommodate the analyzer. A double-walled, corrugated cardboard carton with 159 kg (350 lb) bursting strength is adequate. Allow at least 3 to 4 inches on all sides of the analyzer for packing material.
6. Surround the equipment with three to four inches of packing material and prevent the equipment from moving in the carton. If packing foam is not available, the best alternative is S.D.-240 Air Cap™ from Sealed Air Corporation (Hayward, California, 94545). Air Cap looks like a plastic sheet filled with 1-1/4 inch air bubbles. Use the pink-colored Air Cap to reduce static electricity. Wrapping the equipment several times in this material should both protect the equipment and prevent it from moving in the carton.
7. Seal the shipping container securely with strong nylon adhesive tape.
8. Mark the shipping container “FRAGILE, HANDLE WITH CARE” to assure careful handling.
9. Retain copies of all shipping papers.

NFA Battery Information

The NFA uses a single 3V lithium battery to enable the internal memory to retain data. The date when the battery was installed is on a label on the rear panel of the NFA.

The minimum life expectancy of the battery is 7 years at 25°C, or 1 year at 55°C. If you experience problems with the battery or the recommended time period for battery replacement has elapsed, contact Agilent Technologies. Refer to [“Contacting Agilent Technologies” on page 331](#).

If you wish to replace the battery yourself, you can by following the service documentation that provides all necessary test and maintenance information.

You can order the service documentation for an Agilent NFA through your Agilent Sales and Service office.

After replacing the NFA battery, write the date of battery replacement on the rear panel label.

WARNING

Danger of explosion if battery is incorrectly replaced. Replace only with the same or equivalent type recommended. Discard used batteries according to the manufacturer’s instructions.

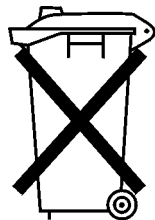

**DO NOT THROW BATTERIES AWAY BUT
COLLECT AS SMALL CHEMICAL WASTE.**

sk780a

Error Messages

The analyzer can generate various messages that appear on the display during operation. There are three types of messages.

- Informational Messages provide information that requires no intervention. These messages appear in the status line at the bottom of the display, in green if you have a color display. The message remains until you preset the analyzer, press **ESC**, or another message is displayed in the status line.
- User Error Messages appear when an attempt has been made to set a parameter incorrectly or an operation has failed (such as saving a file). These messages are often generated during remote operation when an invalid programming command has been entered. These messages appear in the status line at the bottom of the display, in yellow if you have a color display. The message remains until you preset the analyzer, press **ESC**, or another message is displayed in the status line. A summary of the last 10 error messages may be viewed by pressing, **System** then **Show Errors**. When generated by activity on the remote interface, the messages are output to the remote bus. When output to the remote interface, they are preceded by an error number. Note that the error number is not displayed under the **System, Show Errors** key sequence.
- Pop-up Messages indicate a condition that may require intervention. They display in the middle of the display in a framed box. The message remains until the appropriate intervention has taken place or the condition is corrected.

Informational Messages

The following messages provide information that requires no intervention. These type of messages are in green. The information provided in brackets, for example <filename> or <name> is a variable that represents a specific input provided previously.

```
<filename> file loaded
```

The filename indicated has been successfully loaded.

```
<filename> file saved
```

The filename indicated has been successfully saved.

```
<filename> file copied
```

The filename indicated has been successfully copied.

```
<filename> file deleted
```

The filename indicated has been successfully deleted.

```
<filename1> file renamed to <filename2>
```

Filename1 has been successfully renamed to filename2.

```
Duplicate frequency entered in table,  
old entry replaced
```

A duplicate entry was made in either the ENR table, frequency list, limit line table or loss table. The previous entry is replaced with the new entry.

Troubleshooting

Error Messages

Each result type selected must differ from all others

An attempt was made to select the same result type for both of the two displayed result types.

Volume <name> formatted

The indicated disk has been successfully formatted.

Zoom active in graph mode only

The  key is only active when display format is set to **Graph**.

Zoom inactive when showing combined graph

The  key is not active if the display format is set to **Combined**.

User cal now valid

Previously invalidated user cal is now valid due to change of instrument parameter(s).

Invalid frequency list for measurement mode

A frequency within the frequency list cannot be used to make a measurement in the current mode.

ENR table will be extrapolated

The measurement requires ENR values beyond the limits of the existing ENR table.

User cal will be interpolated

For a corrected measurement, the measurement frequencies do not coincide with the user cal frequencies.

Memory trace invalidated

A change of instrument parameter has caused the memory trace to be invalidated (removed from screen and no longer selectable).

Maximum number of entries in table reached

The maximum number of entries in the ENR table, frequency list or limit line table has been reached.

Error Queues

When a user-error condition occurs in the instrument as a result of SCPI activity, it is reported to both the front-panel display-error queue and the SCPI (remote interface) error queue. If it is a result of front-panel activity it reports to the front panel display error queue, and may also report to the SCPI error queue depending on the error. These two queues are viewed and managed separately.

Error messages have a signed error number followed by some error text in double quotes. Negative error numbers are for predefined SCPI errors, for example error -350, “Queue overflow” which is issued if an error occurs when the error queue is already full. Positive errors are instrument specific.

The query used to get the head of the error queue is `SYSTEM:ERROR:NEXT?`. It can only retrieve one error at a time.

The special error message +0, “No error” indicates that the error queue is empty. You can query the error queue as often as you like, when it is empty you just keep getting +0, “No error”.

A single command or query can generate more than one error message. For this reason it is best to drain the error queue after each command or query. If not, you will lose track of what commands caused what errors.

Errors can occur that are not directly related to the last command issued. You can use status information to find out if your command generated an error. Status information can also tell you if some other type of error has occurred. However, if the status information indicates there are different types of error in the error queue, you cannot know which of the errors was caused by the last command unless it is obvious from the error itself.

Table 7-1 **Characteristics of the Error Queues**

Characteristic	Front Panel Display Error Queue	SCPI Remote Interface Error Queue
Capacity (#errors)	10	30
Overflow Handling	Circular (rotating). Drops oldest error as new error comes in.	Linear, first-in/first-out. Replaces newest error with: -350, Queue overflow
Viewing Entries	Press: System, Show Errors	Use SCPI query SYSTem:ERRor?
Clearing the Queue	Press: System, Show Errors, Clear Error Queue	Power up Send a *CLS command Read last item in the queue

Error Message Format

The system-defined error numbers are chosen on an enumerated (“1 of N”) basis. The error messages are listed in alphabetical order within each error message type section.

In this chapter, an explanation is included with each error to further clarify its meaning. The last error described in each class (for example, -400, -300, -200, -100) is a “generic” error.

Error messages appear at the bottom of the display.

Error Message Types

Events do not generate more than one type of error. For example, an event that generates a query error will not generate a device-specific, execution, or command error.

-499 to -400: Query Errors

These errors indicate that the instrument output queue control has detected a problem with the message exchange protocol described in IEEE 488.2, Chapter 6. Errors in this class set the query error bit (bit 2) in the event status register (IEEE 488.2, section 11.5.1). These errors correspond to message exchange protocol errors described in IEEE 488.2, 6.5. In this case:

- Either an attempt is being made to read data from the output queue when no output is either present or pending, or
- data in the output queue has been lost.

-199 to -100: Command Errors

These errors indicate that the instrument parser detected an IEEE 488.2 syntax error. Errors in this class set the command error bit (bit 5) in the event status register (IEEE 488.2, section 11.5.1). In this case:

- Either an IEEE 488.2 syntax error has been detected by the parser (a control-to-device message was received that is in violation of the IEEE 488.2 standard. Possible violations include a data element which violates device listening formats or whose type is unacceptable to the device.), or
- an unrecognized header was received. These include incorrect device-specific headers and incorrect or non-implemented IEEE 488.2 common commands.

-399 to -300 and 201 to 799: Device-Spe cific Errors

These errors indicate that a device operation did not properly complete, possibly due to an abnormal hardware or firmware condition. These codes are also used for self-test response errors. Errors in this class set the device-specific error bit (bit 3) in the event status register (IEEE 488.2, section 11.5.1).

The <error_message> string for a positive error is not defined by SCPI.

**-299 to -200:
Execution Errors**

These errors indicate that an error has been detected by the instrument's execution control block. The occurrence of any error in this class shall cause the execution error bit (bit 4) in the event status register (IEEE 488.2, section 11.5.1) to be set. One of the following events has occurred:

- A <PROGRAM DATA> element following a header was evaluated by the device as outside of its legal input range or is otherwise inconsistent with the device's capabilities.
- A valid program message could not be properly executed due to some device condition.

Execution errors shall be reported by the device after rounding and expression evaluation operations have taken place. Rounding a numeric data element shall not be reported as an execution error. Events that generate execution errors shall not generate Command errors, device-specific errors, or Query errors.

0: No Error

0

No error

The queue is empty. Every error in the queue has been read or the queue was purposely cleared by power-on or *CLS.

-499 to -400: Query Errors

The instrument output queue control has detected a problem with the message exchange protocol described in IEEE 488.2, Chapter 6. Errors in this class set the query error bit (bit 2) in the event status register (IEEE 488.2, section 11.5.1). These errors correspond to message exchange protocol errors described in IEEE 488.2, 6.5.

In this case, either an attempt is being made to read data from the output queue when no output is either present or pending, or data in the output queue has been lost.

- | | | |
|------|--------------------|---|
| -430 | Query DEADLOCKED | Indicates that a SCPI output queue has filled, preventing further SCPI command execution, and there is no more room left in the corresponding SCPI input queue to accept a query to read from the output queue. The system automatically discards output to correct the deadlock. |
| -400 | Query Error | This is a generic query error for devices that cannot detect more specific errors. The code indicates only that a query error as defined in IEEE 488.2, 11.5.1.1.7 and 6.3 has occurred. |
| -410 | Query INTERRUPTED | Indicates that a condition causing an INTERRUPTED query error occurred (see IEEE 488.2, 6.3.2.7). For example, a query was followed by DAB or GET before a response was completely sent. |
| -420 | Query UNTERMINATED | Indicates that a condition causing an UNTERMINATED query error occurred (see IEEE 488.2, 6.3.2.2). For example, the device was addressed to talk and an incomplete program message was received. |

-440

Query UNTERMINATED after indefinite response

Indicates that a query was received in the same program message after a query requesting an indefinite response was executed (see IEEE 488.2, 6.3.7.5).

-199 to -100: Command Errors

The instrument parser detected an IEEE 488.2 syntax error. Errors in this class set the command error bit (bit 5) in the event status register (IEEE 488.2, section 11.5.1). In this case:

- Either an IEEE 488.2 syntax error has been detected by the parser (a control-to-device message was received that is in violation of the IEEE 488.2 standard. Possible violations include a data element which violates device listening formats or whose type is unacceptable to the device.), or
- an unrecognized header was received. These include incorrect device-specific headers and incorrect or non-implemented IEEE 488.2 common commands.

-160 Block data error

This error, and also error -168, is generated when parsing a block data element. This particular error message is used if the device cannot detect a more specific error.

-168 Block data not allowed

A legal block data element was encountered, but not allowed by the device at this point in the parsing.

-140 Character data error

This error, as well as errors -144 and -148, are generated when parsing a character data element. This particular error message is used if the device cannot detect a more specific error.

-148 Character data not allowed

A legal character data element was encountered where prohibited by the device.

- 144 Character data too long
The character data element contains more than twelve characters (see IEEE 488.2, 7.7.1.4).
- 100 Command error
This is a generic syntax error for devices that cannot detect more specific errors. The code indicates only that a command error as defined in IEEE 488.2, 11.5.1.1.4 has occurred.
- 110 Command header error
An error was detected in the header. This message is used when the device cannot detect the more specific errors described for errors -111 through -119.
- 104 Data type error
The parser recognized a data element that is not allowed. For example, numeric or string data was expected, but block data was encountered.
- 123 Exponent too large
The magnitude of an exponent was greater than 32000 (see IEEE 488.2, 7.7.2.4.1).
- 170 Expression error
This error, as well as error -178, is generated when parsing an expression data element. This particular error message is used if the device cannot detect a more specific error.

Troubleshooting

Error Messages

- 178 Expression data not allowed
- A legal expression data was encountered, but was not allowed by the device at this point in parsing.
- 105 GET not allowed
- A Group Execute Trigger was received within a program message (see IEEE 488.2, 7.7). Correct the GPIB controller program so that the GET does not occur within a line of GPIB program code.
- 111 Header separator error
- A character which is not a legal header separator was encountered while parsing the header.
- 114 Header suffix out of range
- The value of a header suffix attached to a program mnemonic makes the header invalid.
- 161 Invalid block data
- A block data element was expected, but was invalid (see IEEE 488.2, 7.7.6.2). For example, an END message was received before the end length was satisfied.
- 101 Invalid character
- A syntactic command contains a character which is invalid for that type. For example, a header containing an ampersand, SETUP&. This error might be used in place of error numbers -114, -121, -141 and some others.

- 141 Invalid character data
Either the character data element contains an invalid character or the particular element received is not valid for the header.
- 121 Invalid character in number
An invalid character for the data type being parsed was encountered. For example, an alpha in a decimal numeric or a “9” in octal data.
- 171 Invalid expression
The expression data element was invalid (see IEEE 488.2, 7.7.7.2). For example, unmatched parentheses or an illegal character.
- 103 Invalid separator
The parser was expecting a separator and encountered an illegal character. For example, the semicolon was omitted after a program message unit.
- 151 Invalid string data
A string data element was expected, but was invalid (see IEEE 488.2, 7.7.5.2). For example, an END message was received before the terminal quote character.
- 131 Invalid suffix
The suffix does not follow the syntax described in IEEE 488.2, 7.7.3.2, or the suffix is inappropriate for this device.

Troubleshooting

Error Messages

- 109 Missing parameter
- Fewer parameters were received than required for the header. For example, the *ESE common command requires one parameter, so receiving *ESE is not allowed.
- 120 Numeric data error
- This error, as well as error -128, is generated when parsing a data element which appears to be numeric, including non-decimal numeric types. This particular error message is used if the device cannot detect a more specific error.
- 128 Numeric data not allowed
- A legal numeric data element was received, but the device does not accept one in this position for the header.
- 108 Parameter not allowed
- More parameters were received than expected for the header. For example, the *ESE common command only accepts one parameter, so receiving *ESE 0, 1 is not allowed.
- 112 Program mnemonic too long
- The header contains more than twelve characters (see IEEE 488.2, 7.6.1.4.1).
- 150 String data error
- This error, as well as error -158, is generated when parsing a string data element. This particular error message is used if the device cannot detect a more specific error.

- 158 String data not allowed
A string data element was encountered, but not allowed by the device at this point in the parsing.
- 130 Suffix error
This error, as well as errors -134 and -138, are generated when parsing a suffix. This particular error message is used if the device cannot detect a more specific error.
- 138 Suffix not allowed
A suffix was encountered after a numeric element which does not allow suffixes.
- 134 Suffix too long
The suffix contained more than twelve characters (see IEEE 488.2, 7.7.3.4).
- 102 Syntax error
An unrecognized command or data type was encountered. For example, a string was received when the device does not accept strings.
- 124 Too many digits
The mantissa of a decimal-numeric data element contained more than 255 digits excluding leading zeros (see IEEE 488.2, 7.7.2.4.1).
- 113 Undefined header
The header is syntactically correct, but it is undefined for this specific device. For example, *XYZ is not defined for any device.

-399 to -300 and 201 to 799: Device-Specific Errors

Some device operations did not properly complete, possibly due to an abnormal hardware or firmware condition. These codes are also used for self-test response errors. Errors in this class set the device-specific error bit (bit 3) in the event status register (IEEE 488.2, section 11.5.1).

The <error_message> string for a *positive* error is not defined by SCPI.

304 Alignment failed

The alignment failed because of one of the following reasons:

- Gain less than 0

During alignment, the measured value of the IF section gain was less than 0.

- Microwave noise greater than signal

The alignment failed at the current microwave frequency because the reading at the IF detector was greater when only the noise floor of the instrument was present compared to when the alignment noise source was on.

NOTE This error can occur if the YTF alignment has not been performed at the current operating temperature.

NOTE This error applies only to the N8974A and N8975A.

- Noise greater than signal

The reading at the IF detector was greater when only the noise floor of the instrument was present compared to when the alignment CW signal was present.

- 614 Bad or missing disk
The floppy is not inserted or the directory could not be read. Insert a known good disk and try again.
- 219 Command not valid in this model
Indicates that the command sent from the remote interface does not apply to this model number.
- 615 Corrupted file
The file that you were trying to load is corrupt.
- 768 Failed to load ENR data
A problem occurred when attempting to load an ENR table.
- 771 Failed to load Freq list
A problem occurred when attempting to load a frequency list.
- 774 Failed to load Limit Line
A problem occurred when attempting to load a limit line.
- 779 Failed to load Loss data
A problem occurred when attempting to load loss data.
- 772 Failed to store Freq list
A problem occurred when attempting to save a frequency list.

Troubleshooting

Error Messages

- 769 Failed to store ENR data
A problem occurred when attempting to save an ENR table.
- 775 Failed to store Limit Line
A problem occurred when attempting to save a limit line.
- 780 Failed to save Loss data
A problem occurred when attempting to save loss data.
- 778 Failed to store Trace
A problem occurred when attempting to save a trace.
- 610 File access is denied
The file is protected or hidden and cannot be accessed.
- 604 File already exists
Attempt to save to a file that already exists. Delete or rename the old file and try again.
- 607 File name error
An invalid file name has been specified. Use filenames with a maximum of 8 characters (letters and digits only) and use a 3 character extension. Note that lowercase and uppercase are perceived as the same.

- 612 File does not exist
The analyzer could not find the specified file.
- 754 File does not exist
The state file you were trying to recall does not exist.
- 500 Hardware config error
A hardware configuration error occurred due to one of the following reasons:
- Unknown product number
During start-up, an attempt to match the hardware found against the NFA's product number could not be made because the product number was unknown. This is a fatal hardware configuration error.
 - HW ID x in slot y not required
A card with ID x was found in slot y but for this product number is not required. This is a non-fatal hardware configuration error.
 - HW ID x must be in slot y, not z
A card with ID x was found in slot z but was expected to be found in slot y for this product number. This is a fatal hardware configuration error.
 - HW ID x is missing
A card with ID x was expected for this product number but was not found. This is a fatal hardware configuration error.
 - Measurement not possible
An attempt was made to perform a measurement but a previous fatal hardware configuration error has occurred, preventing measurements.

Troubleshooting

Error Messages

- Option 'x' not installed

Software option 'x' must be enabled for this product number, but was not installed. The NFA will attempt to enable this option, requiring a power cycle. This is a fatal hardware configuration error. (until the option is reinstalled).

300

IF autorange failed

The IF section could not be autoranged because of one of the following:

- RF att. is fixed

The RF front-end attenuation is fixed.

- RF att. limit reached

The RF front-end attenuation limit is reached.

313

IF over range req. RF re-range: Meas. restarted

During a continuous measurement, a IF section over range condition occurred, requiring a change of RF front-end attenuation. To do this the measurement needs to be restarted.

302

IF PLD error;Power detector read timed out

A read of the IF section power detector timed out.

603

Illegal MSDOS name given

An invalid file name has been specified. Use filenames with a maximum of 8 characters (letters and digits only) and use a 3 character extension. Note that lowercase and uppercase are perceived as the same.

- 770 Incorrect filename, allowable extension
ENR

Attempt to save an ENR table to a file with an incorrect
extension.
- 763 Incorrect filename, allowable extensions
are GIF or WMF

Attempt to save a screen image to a file with an incorrect
extension.
- 776 Incorrect filename, allowable extensions
LIM

Attempt to save limit line data to a file with an incorrect
extension.
- 781 Incorrect filename, allowable extension
LOS

An attempt was made to save loss data using an extension
other than LOS.
- 773 Incorrect filename, allowable extension
LST

Attempt to save frequency list data to a file with an
incorrect extension.
- 777 Incorrect filename, allowable extension
STA

Attempt to save the instrument state to a file with an
incorrect extension.

Troubleshooting
Error Messages

- 762 Incorrect filename, allowable extension
CSV

Attempt to save a trace to a file with an incorrect
extension.
- 782 Incorrect SNS data format

An attempt to read SNS data failed either because the
device attached was not an SNS or because the data was
corrupt.
- 307 Input attenuation x dB not calibrated

Corrected measurements have been requested and the
required RF front-end attenuation setting of x dB has not
been calibrated.
- 751 Instrument state may be corrupt, state has
been reset to initial values

An attempt was made to load a possibly corrupt state. The
instrument state is reset to the state prior to the attempt to
load. If the state load was for a user preset, then the
instrument state is reset to the factory state.
- 216 Invalid baud rate

Attempt to use invalid baud rate. Refer to “Baud” on
page 293 of User’s Guide for valid rates.
- 308 Invalid frequency list for measurement
mode

A frequency within the frequency list cannot be used to
make a measurement in the current mode.

- 306 Invalid input attenuation
An attempt was made to set an invalid RF front-end attenuation limit for calibration.
- 701 Invalid printer response
In attempting to identify the printer an invalid response was received. Check that you are using a supported printer. Be sure you are using the proper cable and that it is securely fastened.
- 301 LO GPIB error
An LO GPIB error occurred because of one of the following:
- Did not become system controller
An attempt to become system controller failed, possibly because another controller is present on the LO GPIB bus.
 - Need to be system controller
To perform the required action, the NFA needs to be the system controller on the LO GPIB bus and is not because a prior attempt to become the system controller failed.
 - Controller collision
Another controller on the LO GPIB has attempted to use the bus concurrently with the NFA.
 - Address bus timeout
Attempted to address bus and failed — check cabling connections.
 - Write command timeout
Attempt to write command to device failed — check device address is correct.

Troubleshooting

Error Messages

- Read response timeout
Attempt to read response from device failed - check device address is not the same as the LO GPIB address.
- 606 Media is not writable
A save was attempted to a read-only device.
- 605 Media is protected
A save was attempted to a write-protected device.
- 315 Microwave input attenuation x dB not calibrated
Corrected measurements have been requested and the required microwave front-end attenuation setting of x dB has not been calibrated.
- 305 Mode setup error
A mode setup error occurred because of one of the following:
- System input frequency out of range
One or more system input frequencies are out of range. If using a frequency list, check that all entries are valid for current measurement mode.
 - External LO frequency out of range
One or more external LO frequencies are out of range. Check that the LO frequency limits are set correctly and check the entered measurement frequencies and measurement mode.

- Stop freq must be less than fixed LO freq

The current measurement mode requires that the stop frequency must be less than the fixed LO frequency.

- Start freq must be greater than start IF freq

The current measurement mode requires that the start RF (input to DUT) frequency must be greater than the start IF (output from DUT) frequency.

- LO - Stop freq must be \geq min system input freq

The current measurement mode requires that the difference between the fixed LO frequency and the stop RF (input to DUT) frequency must be more than the minimum system input frequency.

- Start freq must be greater than fixed LO freq

The current measurement mode requires that the start frequency must be greater than the fixed LO frequency.

- Stop IF freq must be less than fixed LO freq

The current measurement mode requires that the stop IF (output from DUT) frequency must be less than the fixed LO frequency.

- Start - LO freq must be \geq min system input freq

The current measurement mode requires that the start RF (input to DUT) frequency must be more than the minimum system input frequency away from the fixed LO frequency.

- Stop freq must be less than stop RF freq

The current measurement mode requires that the stop IF (output from DUT) frequency must be less than the stop RF (input to DUT) frequency.

- Start freq must be greater than start RF freq

The current measurement mode requires that the start IF (output from DUT) frequency must be greater than the start RF (input to DUT) frequency.

- Stop RF freq must be less than fixed LO freq

The current measurement mode requires that the stop RF (input to DUT) frequency must be less than the fixed LO frequency.

- Start freq must be greater than fixed IF freq

The current measurement mode requires that the start RF (input to DUT) frequency must be greater than the fixed IF frequency.

- Start LO freq must be greater than fixed IF freq

The current measurement mode requires that the start LO frequency must be greater than the fixed IF frequency.

- Stop freq must be less than fixed IF freq

The current measurement mode requires that the stop RF (input to DUT) frequency must be less than the fixed IF frequency.

- Stop freq must be less than stop LO freq

The current measurement mode requires that the stop RF (input to DUT) frequency must be less than the stop LO frequency.

310

No entries in ENR table

A measurement was attempted or a SCPI query of an ENR table was made and there were no entries in the relevant ENR table (Common, Meas or Cal).

309

No entries in frequency list

A measurement was attempted with List frequency mode or a SCPI query of the frequency list table was made and the frequency list table is empty.

311

No entries in limit line table

A measurement was attempted using a limit line table, or a SCPI query of an limit line table was made and there were no entries in the relevant limit line table.

Troubleshooting
Error Messages

- 314 No entries in loss table
A measurement was attempted or a SCPI query of a loss table was made and there were no entries in the relevant loss table (either Before or After table).
- 700 No printer response
An attempt to identify the printer failed.
- 704 Printer interface error
An error occurred while trying to print. Make sure the printer is turned on and properly connected.
- 705 Printer type is none
The current printer type is set to **None**, so no print operations are possible. Change the type in the **Print Setup** menu and try again.
- 350 Queue Overflow
There is no room in the error queue and an error occurred but was not recorded.
- 312 RF re-range required: Meas. restarted
During a continuous measurement, a change of RF front-end attenuation was required. To do this the measurement needs to be restarted.

217

RS-232 Interface Error

An error occurred on the serial interface due to one of the following reasons:

- Input data overrun
An error occurred on the serial interface.
- Input data parity
An error occurred on the serial interface.
- Input data framing
An error occurred on the serial interface.
- Output data timeout
An error occurred on the serial interface
- Command input timeout
An error occurred on the serial interface.

-330

Self-Test Failed

A self-test error occurred due to one of the following reasons:

- IF test [x] [y] failure
- RF test [x] failure
- RF gain (x) out of range
- IF gain out of range
- RF cal x out of range amp[y]
- RF amp[x] floor too high
- Tuner EEPROM cal value out of range
- IF filter offset x out of range

Troubleshooting Error Messages

- 501 SNS read failure
An attempt to read from the SNS failed. This could be due to SNS cable problems such as poor connection or disconnection while reading.
- 502 SNS write failure
An attempt to write to the SNS failed. This could be due to SNS cable problems such as poor connection or disconnection while writing.
- 316 Thot must be greater than Tcold
A spot Thot temperature has been specified which is not greater than Tcold temperature.
- 766 Unable to format drive
A problem occurred when attempting to format a drive.
- 765 Unable to load file
A problem occurred when attempting to load a file.
- 759 Unable to load state file into instrument with older firmware date
A saved state file from a newer firmware revision was attempted to be loaded into an older instrument.
- 752 Unable to load state from file
An attempt to load a state from the File Manager or through MMEM:LOAD:STAT failed. Preceding error messages may indicate the cause of failure.

- 755 Unable to load state from register
- An attempt to load a state from a register using the *RCL command failed. Preceding error messages may indicate the cause of failure.
- 757 Unable to load user state, factory preset was done
- An attempt to perform a **User Preset** failed, so the **Factory Preset** values were used. Save a valid state into **User Preset** and try again.
- 760 Unable to query state from the remote
- A problem occurred while trying to query the instrument state as part of a *LRN command.
- 764 Unable to save file
- A failure occurred while saving a file; the file was not saved.
- 753 Unable to save state to file
- An attempt to save a state from the File Manager or through MMEM:STOR:STAT failed. Preceding error messages may indicate the cause of failure.
- 756 Unable to save state to register
- An attempt to save a state to a register using the *SAV command failed. Preceding error messages may indicate the cause of failure.

Troubleshooting
Error Messages

- 758 Unable to save user state
An attempt to save the **User Preset** state failed.
- 761 Unable to set state from the remote
A problem occurred while trying to set the instrument state as part of a `SYST:SET` command.
- 703 Unknown printer
In attempting to identify the printer, a valid response was received but the printer is not known to the analyzer. Use the **Custom** printer menu under **Print Setup** to configure the printer.
- 702 Unsupported printer
A printer which is recognized, but known to be unsupported was identified. This printer cannot be used with the analyzer. For example, a printer only supported by Microsoft Windows generates this error.

303

User cal invalidated

The existing user cal has been invalidated because of one of the following reasons:

- Meas mode changed

The measurement mode has been changed from that used for user cal.

- Freq outside cal range

The current measurement frequencies lie partially or wholly outside the range of frequencies used for user cal.

- Fixed IF changed

The fixed IF frequency has been changed from that used for user cal.

- Fixed LO changed

The fixed LO frequency has been changed from that used for user cal.

- Sideband changed

The sideband has been changed from that used for user cal.

660

YTF align error

The alignment failed because of one of the following reasons:

- Peak / floor too small

During a YTF alignment the level of a peak above the noise floor was too small. If this error occurs then the quality of the YTF alignment is questionable.

- Image / floor too small

During a YTF alignment the level of an image response above the noise floor was too small. If this error occurs then the quality of the YTF alignment is questionable.

-299 to -200:
Execution Errors

-222	Data out of range	A parameter of a command or query was outside the defined range for that command or query.
-224	Illegal parameter value	An unexpected value was entered. (for example, a value other than the available options)
-225	Out of memory	The analyzer has insufficient memory to perform the requested operation.
-221	Settings conflict	A legal program data element was parsed but could not be executed due to the current device state.
-223	Too much data	A block, expression or string parameter of a command or query contained more data than the analyzer could handle due to memory constraints.
-213	Init ignored	Indicates that a request for a measurement initiation was ignored as another measurement was in progress.

NOTE

The front panel **Restart** key does not generate this error, only the remote command `INIT:IMM`.

Troubleshooting
Error Messages

-230 Data corrupt or stale
Possibly invalid data; new reading started but not
completed since last access.

Symbols

(Local) key, 289

Numerics

10 MHz ref connection, 157
10 MHz ref in, 26
10 MHz ref out, 26
3.0 GHz switch, 18
3.5 mm connector, 18

A

active function, 28
active marker, 93, 266
address GPIB, 219
After DUT Table menu key, 276
Agilent Technologies, contacting, 331
Align YTF (saving) menu key, 297
Align YTF menu key, 297
alignment, 228
Alignment (internal) menu key, 296
Alignmnt Mode (internal) menu key, 297
alpha editor, 46
annotation, 30, 89
Annotation menu key, 263
arrow keys, 23
Auto menu key, 311
Autoscale menu key, 258
AUX IN (TTL), 26
AUX OUT (TTL), 26
Auxiliary menu key, 295
Average Mode menu key, 246
Averages menu key, 246
Averaging, 71
Averaging menu key, 245
Averaging/Bandwidth key, 245

B

Back Space keys, 313

Band Pair (State) menu key, 268
band pair marker, 96
Band Pair menu key, 268
Bandwidth, 71
Bandwidth menu key, 246
battery, 335
Baud menu key, 293
Before DUT Table menu key, 275
Bitmap menu key, 305

C

Cal Table menu key, 254
Calibrate key, 247
calibration, 74
 input attenuation range, 78
 performing, 76
 reasons to, 74
 using interpolated results, 75
Center Freq menu key, 242
checking the basics, 329
Clear Error Queue, 297
clock
 setup, 300
Color Capable Yes No, 311
Color menu key, 312
Color On Off, 312
Combined menu key, 262
command error messages, 346
Command Set menu key, 294
Common Table menu key, 252
Configuring
 Extended Frequency Measurements, 137
configuring
 alignment, 228
 alignment mode, 228
 alignment YTF, 229
 external LO, 223
 GPIB address, 219
 loss compensation
 fixed value, 119
 table value, 122

 serial port, 221
 temperature loss, 129
connect
 10 MHz timebase, 157
Connecting
 NFA for extended measurements, 157
connector
 10 MHz ref in, 26
 10 MHz ref out, 26
 50 ohm input, 23
 APC 3.5 mm, 23
 AUX IN (TTL), 26
 AUX OUT (TTL), 26
 external keyboard, 23
 GPIB, 26
 LO GBIB, 26
 noise source output, 23
 parallel port, 26
 probe power, 23
 RS-232 port, 26
 service, 26
 SNS, 24
 Type-N, 23
 VGA, 26
Continuous menu key, 270
CONTROL functions, 22
copy files, 43
Copy menu key, 306
Corr key, 281
Corrected menu key, 281
creating
 frequency list, 67
 limit line, 115
custom command, 223
Custom menu key, 311

D

Data Entry Keys, 313
data invalid indicator, 31
Data Terminal Ready menu key, 292
Data->Memory menu key, 263

- date
 - setting, 234
- date display, 300
- Datemode MDY DMY, 300
- Default States, 321
- Define Custom menu key, 311
- delete files, 44
- Delete menu key, 307
- Delta (State) menu key, 267
- delta marker, 95
- Device Under Test menu key, 248
- device-specific error messages
 - 201 to 799, 352
 - 399 to -300, 352
- Diagnostics menu key, 301
- disk format, 39
- display
 - annotation, 89
 - combining graph, 86
 - display reference, 92
 - format, 81
 - full screen, 83
 - graticule, 88
 - markers, 93
 - memory trace, 87
 - result type, 84
 - scaling, 90
 - single graph, 85
- Display and Menu Control Keys, 314
- display annotation, 30
- DISPLAY functions, 22
- Display menu key, 279
- Display Ref menu key, 260
- Displaying
 - Error History, 230
- displaying
 - hardware information, 230
 - system information, 230
- displaying results, 81
- Downconverter description, 165
- Downconverting
 - Fixed IF Variable LO, 143
 - Variable IF Fixed LO, 144
- E**
 - Edit Table menu key, 253
 - editor
 - limit line, 115
 - Editor (limit line) menu key, 278
 - Eject Page menu key, 312
 - ENR, 51
 - ENR key, 252
 - ENR Mode menu key, 252
 - ENR spot value, 58
 - ENR table calibrate, 52
 - ENR table common, 51
 - ENR table measurement, 52
 - ENR Table menu key, 253
 - ENR table normal data entry, 52
 - Enter key, 313
 - entering normal ENR data, 52
 - error messages
 - 199 to -100, 346
 - 201 to 799, 352
 - 399 to -300, 352
 - 499 to -400, 344
 - command, 346
 - device-specific (201 to 799), 352
 - device-specific (-399 to -300), 352
 - empty error queue, 343
 - format, 341
 - query, 344
 - types, 342
 - Error queue
 - clearing, 230
 - displaying, 230
 - error queue, 230
 - error queues
 - empty message, 343
 - front panel, 341
 - SCPI remote interface, 341
 - Esc key, 21, 316
 - Escape, 316
 - Example
 - Down-Convertor Measurements, 172
 - System Downconverter
 - Measurements, 194
- example
 - making a basic amplifier measurement, 104
 - making a fixed frequency measurement, 34
- Excess Noise Ratio, 51
- external keyboard connector, 23
- external LO
 - configuring, 223
 - custom commands, 223
 - min and max freq, 226
 - multiplier freq, 227
 - settling time, 226
- External LO Address menu key, 291
- External LO menu key, 294
- External LO Power Level menu key, 250
- F**
 - file copying, 43
 - file deleting, 44
 - file format S2P, 127
 - File key, 302
 - file loading, 42
 - File Manager menu key, 306
 - file menu functions
 - copy, 43
 - delete, 44
 - format, 39
 - load, 42
 - rename, 42
 - save, 41
 - file renaming, 42
 - file saving, 41
 - Fill Table From SNS menu key, 254
 - filter requirements, 165
 - Find menu key, 270
 - fixed ENR, 58
 - Fixed Freq menu key, 242
 - Fixed value loss compensation, 119

- floppy disk format, 39
- format, 81
- format a disk, 39
- Format key, 262
- Format menu key, 262
- Freq List menu key, 243
- freq mode
 - fixed, 65
 - list, 65
 - sweep, 65
- Freq Mode menu key, 242
- Freq Prefix menu key, 295
- Freq Span menu key, 242
- Freq Suffix menu key, 295
- frequency list
 - creating, 67
 - using swept points, 69
 - using the fill, 69
- Frequency Restrictions, 207
- Frequency/Points key, 240
- Frequency-Converting description, 159
- front panel
 - error queue characteristics, 341
- front panel input connector, precision 3.5 mm connector, 18
- front panel overview, 21
- Front Panel Test, 301
- full screen, 83
- Full Screen key, 280
- full span, 65
- Full Span menu key, 243
- fuse, 26

- G**
- Gain menu key, 265
- GPIB address, 219
 - setting, 219
- GPIB annunciators, 31
- GPIB menu key, 291
- graticule, 88
- Graticule menu key, 263

- H**
- hardware information
 - displaying, 230
- hardware problems, 328
- Help key, 315
- help key, 24
- how to return your analyzer for service, 332

- I**
- ID menu key, 254
- IF Frequency menu key, 250
- IF Input Over Range Condition, 103
- IF Under Range Conditions, 103
- IFO, 103
- IFU, 103
- indicator IFO, 103
- indicator IFU, 103
- indicator RFO, 102, 103
- indicator RFU, 102, 103
- input
 - power, 25
- INPUT 50 OHM, 23
- input attenuation range microwave, 79
- Input Attenuation Range RF, 78
- Input Cal menu key, 282
- input calibration, 78
- instrument preset, 231, 309
- intensity
 - viewing angle, 21
- internal alignment
 - configuring, 228
- interpolated corrected state, 74
- invalid result, 102

- K**
- key
 - Averaging/Bandwidth, 245
 - Back Space, 313
 - Calibrate, 247
 - Corr, 281
 - ENR, 252
 - Enter, 313
 - Esc, 316
 - File, 302
 - Format, 262
 - Frequency/Points, 240
 - Full Screen, 280
 - Help, 315
 - Limit Lines, 277
 - Local, 289
 - Loss Comp, 271
 - Marker, 266
 - Meas Mode, 248
 - Mode Setup, 250
 - Next Window, 315
 - Numeric, 313
 - On, 314
 - Preset, 309
 - Prev, 316
 - Print, 312
 - Print Setup, 310
 - Restart, 288
 - Result, 264
 - Save Trace, 309
 - Scale, 258
 - Standby, 314
 - Sweep, 284
 - System, 289
 - System (Local), 289
 - Tab, 316
 - Up/Down Arrow, 313
 - viewing angle, 314
 - Zoom, 315
- key group
 - control, 271
 - display, 258
 - measure, 240
 - system, 289
- key overview, 28
- key presses
 - Fixed IF Variable LO (Downconvert), 143

-
- Fixed IF Variable LO (System Downconvert), 149, 150
 - Fixed IF Variable LO (Upconvert), 146
 - Variable IF Fixed LO (Downconvert), 144
 - Variable IF Fixed LO (Upconvert), 147
- L**
- Language PCL3 PCL5, 311
 - limit line
 - editor, 115
 - limit line 1, 113
 - limit line 2, 113
 - limit line 3, 113
 - limit line 4, 113
 - Limit Line menu key, 277
 - Limit Lines All Off menu key, 279
 - Limit Lines key, 277
 - limit lines use, 113
 - Limits (file) menu key, 303
 - lithium battery, 335
 - LO Commands menu key, 294
 - LO Control menu key, 250
 - LO Frequency menu key, 250
 - LO frequency multiplier, 227
 - LO frequency setting, 226
 - LO GBIB, 26
 - LO GPIB Address menu key, 291
 - LO Mode menu key, 248
 - load files, 42
 - Load menu key, 302
 - Loading S2P files, 127
 - Loss Comp key, 271
 - loss compensation configuring, 119, 122
 - loss compensation use, 119
 - Lower Limit menu key, 260
- M**
- MAIN GPIB, 26
 - Manual Meas menu key, 284
 - manual measurement procedure, 133
 - manual measurements, 131
 - Marker 1, 93
 - Marker 2, 93
 - Marker 3, 93
 - Marker 4, 93
 - Marker key, 266
 - Marker menu key, 267
 - marker state
 - delta, 95, 96
 - memory, 99
 - markers, 93
 - band pair, 96
 - memory traces, 99
 - searching, 100
 - selecting, 93
 - states, 95
 - Markers All Off menu key, 270
 - marking memory traces, 99
 - Max Freq menu key, 296
 - maximum frequency, 226
 - Meas Mode key, 248
 - Meas Table menu key, 254
 - MEASURE functions, 22
 - measurement
 - fixed, 34
 - sweep, 104
 - Measurement Modes
 - Frequency-Downconverting, 142
 - Frequency-Upconverting, 145
 - N8970B comparison, 151
 - Overview, 139
 - System Downconverter, 148
 - mechanical 3.0 GHz switch, 18
 - memory marker, 99
 - menu keys, 22
 - Metafile menu key, 305
 - methods of normal ENR data entry, 52
 - microwave front panel connector, 18
 - microwave input attenuation range, 79
 - Min Freq menu key, 296
 - minimum LO frequency, 226
 - mode
 - fixed frequency, 70
 - Mode Setup key, 250
 - monitor output, 26
 - multiplier LO frequency, 227
 - Multiplier menu key, 296
- N**
- N8970B Mode Comparison, 151
 - N8970B Modes, 151
 - next window, 24
 - Next Window key, 315
 - NFA features, 18, 19
 - Noise Figure Analyzer Address menu key, 291
 - Noise Figure menu key, 265
 - noise source
 - model number, 54
 - serial number, 54
 - noise source normal, 51
 - noise source output, 23
 - noise source smart, 51
 - None menu key, 311
 - Normal (State) menu key, 267
 - normal noise source, 51
 - Numeric Keys, 313
 - numeric keys, 23
- O**
- Off (State) menu key, 267
 - On key, 314
 - Option 1D5, 19
 - options, 19
 - Orientation, 311
 - Orientation menu key, 311
 - Overview
 - Extended Frequency Measurements, 137
 - Measurement Modes, 139

P

- packaging, 332
- parallel connector, 26
- Pcold menu key, 265
- persistent, 317
- Phot menu key, 265
- Points menu key, 243
- power input, 25
- Power On(Last) menu key, 298
- Power On(Preset) menu key, 298
- Power On/Preset menu key, 298
- Power Prefix menu key, 295
- Power Suffix menu key, 295
- Power-On conditions
 - defining, 232
- Preset, 231
 - defining conditions, 232
- preset
 - system defaults, 233
- Preset (Factory) menu key, 299
- Preset (User) menu key, 299
- Preset key, 22, 309
- Presetting, 231
- pressing full span, 65
- Prev, 316
- Print key, 312
- Print menu key, 310
- Print Screen Report, 310
- Print Setup key, 310
- printer output, 26
- Printer Type menu key, 311
- printing, 312
- printing, parallel
 - deskjet, 235
 - epson, 235
 - laserjet, 235
 - paintjet, 235
 - thinkjet, 235
- Prints/Page 1 2, 312
- Prints/Page menu key, 312
- probe power connector, 23
- product family, 18
- product options, 19

Q

- queries
 - error messages, 344

R

- real-time clock
 - set date, 300
 - set time, 300
- rear panel features, 25
- rear panel overview, 25
- Receive Pacing menu key, 293
- ref level, 92
- Ref. Level menu key, 260
- remote
 - interface (SCPI) error queue, 341
- Remote Port menu key, 290
- rename files, 42
- Rename menu key, 308
- Request To Send menu key, 292
- Restart key, 288
- Restore System Defaults menu key, 299
- Restricted Terms, 207
- result invalid, 102
- Result key, 264
- result type, 84
- results displaying, 81
- returning your analyzer for service, 332
- Reverse Bitmap menu key, 305
- Reverse Metafile menu key, 305
- RF Input Attenuation Range, 78
- RF Input Over Range Condition, 102, 103
- RF Under Range Conditions, 102, 103
- RFO, 102, 103
- RFU, 102, 103
- RPG, 23
- RS-232 connector, 26

S

- S1 file format, 127
- S2 file format, 127
- S2P file format, 127
- save files, 41
- Save menu key, 304
- Save Trace key, 309
- Save User Preset menu key, 299
- save YTF alignment, 297
- saving
 - ENR table data, 58
- Scale key, 258
- Scale/Div menu key, 260
- scaling, 90
- SCPI remote interface error queue
 - characteristics, 341
- Search menu key, 269
- Search Type menu key, 269
- searching markers, 100
- selecting a fixed freq, 70
- selecting a freq list, 67
- selecting a freq sweep, 65
- selecting averaging, 72
- selecting bandwidth, 71
- selecting markers, 93
- serial data output, 26
- Serial menu key, 292
- Serial Number menu key, 253
- serial port
 - setting up, 221
- Service menu key, 301
- service options, 330
- Set Date menu key, 300
- Set Time menu key, 300
- Setting
 - Maximum LO Frequencies, 155
 - Minimum LO Frequencies, 155
 - Multiplier, 156
 - Settling Time, 156
- setting
 - external LO, 223
 - GPIB address, 219
 - serial port, 221

setting date, 234
setting Tcold, 62
setting the microwave input
 attenuation, 80
setting Thot, 59
setting time, 234
Setting up
 NFA for extended measurements,
 157
setting up limit lines, 113
settling time, 226
Settling Time menu key, 296
Setup (loss comp) menu key, 272
Show Errors menu key, 297
Show Hdwr menu key, 298
Show System menu key, 297
Sideband menu key, 250
single sideband (SSB), 164
Smart Noise Source (SNS), 51
SNS connector, 24
SNS Setup menu key, 257
SNS Tcold menu key, 256
spot ENR, 58
Spot ENR menu key, 255
spot Thot, 59
Standby key, 314
Start Freq menu key, 242
State (file) menu key, 303
State menu key, 267
Stop Freq menu key, 242
survive preset, 319
Sweep key, 284
Sweep Mode menu key, 284
switch reliability, 18
System (Local) key, 289
System Downconverter description,
 184
System Downconverter
 Fixed IF Variable LO, 149, 150
System Downconverter menu key,
 248
SYSTEM functions, 22
system information

 displaying, 230
System key, 289

T

Tab Keys, 23, 316
table value loss compensation, 122
tcold data changing, 62, 63, 64
Tcold menu key, 256
Tcold setting, 62
Teffective menu key, 265
temperature correction, 62, 63, 64
temperature loss configuring, 129
Test (limit line) menu key, 278
Thot spot value, 59
time
 setting, 234
Time/Date menu key, 300
Time/Date On Off, 300
torque value, 18
Trace menu key, 263, 268
Transmit Pacing menu key, 293
turning off markers, 270
Type (limit line) menu key, 277

U

uncorrected state, 74
Units menu key, 259
Up/Down Arrow Keys, 313
Upconverter description, 165
Upconverting
 Fixed IF Variable LO, 146
 Variable IF Fixed LO, 147
Upper Limit menu key, 260
User Tcold From SNS menu key, 256
User Tcold menu key, 256
User Value menu key, 256
using alpha editor, 46
using tables, 45

V

VGA connector, 26
video connector, 26

viewing angle, 21
Viewing Angle key, 314

W

warm-up time, 24
warranty, 330
working with tables, 45

Y

Y Factor menu key, 265
YTF alignment, 229

Z

zoom, 24
Zoom key, 315