

Smart Noise Sources SNS Series

Operating and Service Guide

N4000A, N4001A, and N4002A



Agilent Technologies

Manufacturing Part Number: N4000-90001

March 2001

© Copyright 2001 Agilent Technologies

Notice

Information contained in this document is subject to change without notice. Agilent Technologies makes no warranty of any kind with regard to this material, including, but not limited to, the implied warranties of merchantability and fitness for a particular purpose. Agilent Technologies shall not be liable for errors contained herein or for incidental or consequential damages in connection with the furnishings, performance, or use of this material. No part of this document may be photocopied, reproduced, or translated to another language without the prior written consent of Agilent Technologies.

Certification

Agilent Technologies certifies that this product met its published specifications at the time of shipment from the factory. Agilent Technologies further certifies that its calibration measurements are traceable to the United States National Institute of Standards and Technology, to the extent allowed by the Institute's calibration facility, and to the calibration facilities of other International Standards Organization members.

Warranty

This Agilent Technologies instrument product is warranted against defects in material and workmanship for a period of one year from date of shipment. During the warranty period, Agilent Technologies will at its option, either repair or replace products which prove to be defective. For warranty service or repair, this product must be returned to a service facility designated by Agilent Technologies. Buyer shall prepay shipping charges to Agilent Technologies and Agilent Technologies shall pay shipping charges, duties, and taxes for products returned to Agilent Technologies from another country. Agilent Technologies warrants that

its software and firmware designated by Agilent Technologies for use with an instrument will execute its programming instructions when properly installed on that instrument. Agilent Technologies does not warrant that the operation of the instrument, or firmware will be uninterrupted or error free.

Limitation of Warranty

The foregoing warranty shall not apply to defects resulting from improper or inadequate maintenance by Buyer, Buyer-supplied software or interfacing, unauthorized modification or misuse, operation outside of the environmental specifications for the product, or improper site preparation or maintenance.

NO OTHER WARRANTY IS EXPRESSED OR IMPLIED. AGILENT TECHNOLOGIES SPECIFICALLY DISCLAIMS THE IMPLIED WARRANTIES OF MERCHANTABILITY AND FITNESS FOR A PARTICULAR PURPOSE.

Exclusive Remedies

THE REMEDIES PROVIDED HEREIN ARE BUYER'S SOLE AND EXCLUSIVE REMEDIES. AGILENT TECHNOLOGIES SHALL NOT BE LIABLE FOR ANY DIRECT, INDIRECT, SPECIAL, INCIDENTAL, OR CONSEQUENTIAL DAMAGES, WHETHER BASED ON CONTRACT, TORT, OR ANY OTHER LEGAL THEORY.

Safety Notices

This guide uses warnings and cautions to denote hazards.

WARNING

***Warning* denotes a hazard. It calls attention to a procedure which, if not correctly performed or adhered to, could result in injury or loss of life. Do not proceed beyond a warning note until the indicated conditions are fully understood and met.**

CAUTION

Caution denotes a hazard. It calls attention to a procedure that, if not correctly performed or adhered to, could result in damage to or destruction of the instrument. Do not proceed beyond a caution sign until the indicated conditions are fully understood and met.



NOTE

Note calls out special information for the user's attention. It provides operational information or additional instructions of which the user should be aware.

Safety Symbols

The following symbols on the instrument and in the manual indicate precautions which must be taken to maintain safe operation of the instrument.

Table 1 Safety Symbols

	The Instruction Documentation Symbol. The product is marked with this symbol when it is necessary for the user to refer to the instructions in the supplied documentation.
	This symbol indicates that a device, or part of a device, may be susceptible to electrostatic discharges (ESD) which can result in damage to the product. Observe ESD precautions given on the product, or its user documentation, when handling equipment bearing this mark.

Electromagnetic Compatibility

This product conforms with the protection requirements of European Council Directive 89/336/EEC for Electromagnetic Compatibility (EMC).

The conformity assessment requirements have been met using the technical Construction file route to compliance, using EMC test specifications EN 55011:1991 (Group 1, Class A) and EN 50082-1:1992.

In order to preserve the EMC performance of the product, any cable which becomes worn or damaged must be replaced with the same type and specification. See the Declaration of Conformity on page vi.

Radio-Frequency Electromagnetic Field Immunity

When a 3 Vm-1 radio-frequency electromagnetic field is applied to the Smart Noise Source according to IEC 61000-4-3:1995, degradation of performance may be observed. When the frequency of the incident field falls within the bandwidth of a measured noise figure or gain, the values displayed will deviate from those expected. This phenomenon will only affect that specific frequency, and the SNS will continue to perform to specification at all other frequency sample points.

The NFA may be unable to calibrate a chosen frequency sample point, if the frequency matches that of an incident electromagnetic field.

Where to Find the Latest Information

Documentation is updated periodically. For the latest information about Agilent SNS Smart Noise Sources, please visit the following Internet URL:

<http://www.agilent.com/find/nf/>

Declaration of Conformity

DECLARATION OF CONFORMITY	
According to ISO/IEC Guide 22 and CEN/CENELEC EN 45014	
Manufacturer's Name:	Agilent Technologies, Inc.
Manufacturer's Address:	1400 Fountaingrove Parkway Santa Rosa, CA 95403-1799 USA
Declares that the products	
Product Name:	Noise Source
Model Number:	N4000A, N4001A, N4002A
Product Options:	This declaration covers all options of the above products.
Conform to the following product specifications:	
EMC: IEC 61326-1:1997+A1:1998 / EN 61326-1:1997+A1:1998	
<u>Standard</u>	<u>Limit</u>
CISPR 11:1990 / EN 55011-1991	Group 1, Class A
IEC 61000-4-2:1995+A1998 / EN 61000-4-2:1995	4 kV CD, 8 kV AD
IEC 61000-4-3:1995 / EN 61000-4-3:1995	3 V/m, 80 - 1000 MHz
IEC 61000-4-4:1995 / EN 61000-4-4:1995	0.5 kV sig., 1 kV power
IEC 61000-4-5:1995 / EN 61000-4-5:1996	0.5 kV L-L, 1 kV L-G
IEC 61000-4-6:1996 / EN 61000-4-6:1998	3 V, 0.15 - 80 MHz
IEC 61000-4-11:1994 / EN 61000-4-11:1998	1 cycle, 100%
Safety: IEC 61010-1:1990 + A1:1992 + A2:1995 / EN 61010-1:1993 +A2:1995 CAN/CSA-C22.2 No. 1010.1-92	
Supplementary Information: The products herewith comply with the requirements of the Low Voltage Directive 73/23/EEC and the EMC Directive 89/336/EEC and carry the CE-marking accordingly.	
	
Santa Rosa, CA, USA	22 Feb. 2001
Greg Pfeiffer/Quality Engineering Manager	
For further information, please contact your local Agilent Technologies sales office, agent or distributor.	

Contents

1. General Information

Introduction	2
Specifications	2
Specifications - Table 1-1	3
Excess Noise Ratio Expanded Uncertainty (U(Y)) - Table 1-2	6
Supplemental Characteristics - Table 1-3	8
Description	9
Warranty	9
Equipment Supplied with the NFA	9
Equipment Available But Not Supplied	10
Options	10
Recommended Test Equipment	10
Installation	11
Handling Precautions	11
Initial Inspection	11
Returning an SNS to Agilent for Repair	12
Mating Connectors	12
Connectors That Can Be Mated With the Noise Sources	12
Storage and Shipping Environment	12
Operation	13
Operating Environment	14
Operator's Maintenance	14
Operator's Check	14
Operator's Check for Data Communication	15
Operator's Check for Tcold Communication	18
Operator's Check for Switching Noise Source Off and On	21
Performance Tests	24
Adjustments	24
Replaceable Parts	25

Contents

Replaceable Parts List	25
Replaceable Parts List	25
Chassis Parts	26
Documentation	26
Service	29
Principles of Operation	29
Troubleshooting	30
Repair of Defective Noise Source	30
Disassembly Procedure	30
Reassembly Procedure	31
Returning a Noise Source for Calibration	31
Agilent Technologies Sales and Service Offices	32
2. ENR File Format	
Format Details	34
Format	34
Comment Records	34
Header Fields	35
ENR Data	37
Viewing the Smart Noise Source ENR Data	39
Examples	40
A. Caring for Connectors	
Introduction	44
Connector Part Numbers	44
Handling and Storage	44
Visual Inspection	45
Obvious Defects and Damage	45
Mating Plane Surfaces	45
Precision 7 mm Connectors	46

Contents

Sexed Connectors	47
Cleaning	49
Compressed Air	49
Cleaning Alcohol	49
Precision 7 mm Connectors	50
Cleaning Interior Surfaces	51
Drying Connectors	52
Mechanical Inspection: Connector Gages	53
Mechanical Specifications	54
Precision 7mm Connectors	54
Sexed Connectors	55
50 Ohm Type-N Connectors	55
75 Ohm Type-N Connectors	56
Using Connector Gages	57
Inspecting and Cleaning the Gage	57
Zeroing the Gage	57
Measuring Connectors	59
Making Connections	60
Align Connectors Carefully	60
To Make a Preliminary Connection	61
Final Connection Using a Torque Wrench	62
Disconnection	63
Adapters	65
Principles of Microwave Connector Care	67

Contents

Introduction

This manual contains operating and service information for the Agilent SNS Series Smart Noise Sources, models; N4000A, N4001A, and N4002A.

The Agilent SNS Series Smart Noise Sources have been designed to work with the Agilent NFA Series Noise Figure Analyzers.

Figure 1-1

An Agilent SNS Smart Noise Source



Specifications

The “Specifications - Table 1-1” on page 3, page 4, and page 5 are performance standards or limits against which the noise source may be tested. These specifications for the noise source are ONLY valid if the analyzer has been allowed to meet its specified warm up time of 60 minutes.

ENR expanded uncertainty analysis for noise source calibration in “Excess Noise Ratio Expanded Uncertainty (U(Y)) - Table 1-2” on page 6 and page 7. The “Supplemental Characteristics - Table 1-3” on page 8 are not specifications but are typical characteristics included as additional information for the user.

Specifications - Table 1-1

NOTE

Specifications are valid at ambient temperature 23 °Celsius only (296 K).

Frequency Range

N4000A and N4001A	10 MHz - 18 GHz
N4002A	10 MHz - 26.5 GHz

Excess Noise Ratio (ENR) Range¹

N4000A	4.5 - 6.5 dB
N4001A	14 - 16 dB
N4002A	12 - 17 dB

Impedance

50 ohm nominal

Operating Temperature

0 °C to 55 °C

Maximum reverse power

1 Watt

-
1. ENR values are given at cardinal frequency points over the frequency range of each noise source. These values are stored within the noise source's internal EEPROM and documented on the calibration report.

Specifications - Table 1-1 Continued

**Maximum
Standing Wave
Ratio (SWR) and
Reflection
Coefficient (ρ)
Source ON/OFF
States**

Instrument model	Frequency Range (GHz)	Maximum Standing Wave Ratio (SWR)	Reflection Coefficient (Rho) (ρ)
N4000A¹	0.01-1.5	<1.06:1	0.03
	1.5 - 3.0	<1.06:1	0.03
	3.0 - 7.0	<1.13:1	0.06
	7.0 - 18.0	<1.22:1	0.10
N4001A	0.01-1.5	<1.15:1	0.07
	1.5 - 3.0	<1.15:1	0.07
	3.0 - 7.0	<1.20:1	0.09
	7.0 - 18.0	<1.25:1	0.11
N4002A	0.01-1.5	<1.22:1	0.10
	1.5 - 3.0	<1.22:1	0.10
	3.0 - 7.0	<1.22:1	0.10
	7.0 - 18.0	<1.25:1	0.11
	18.0 - 26.5	<1.35:1	0.15

1. Maximum change in complex reflection coefficient between source ON and source OFF at all frequencies for N4000A only: 0.01.

Specifications - Table 1-1 Continued

Figure 1-2 Characteristic¹ SWR at 23 °C

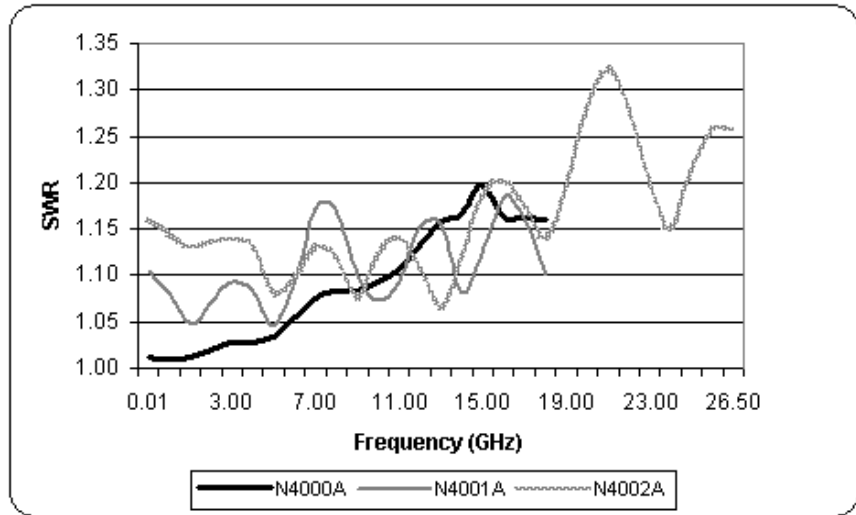

Connectors²

SNS Output	APC-3.5 (male) standard or Type-N (male) Option 001 ¹
SNS Input	Interconnect with 11730A/B/C cable to use with NFA.

1. Type-N connector (option 001) only available on the N4000A and N4001A models.

Dimensions

112 x 38 x 30 mm (4.4 x 1.5 x 1.2 in)

Net Weight

0.160 kg (5.64 oz.)

1. Characteristic values are met or bettered by 90% of instruments with 90% confidence.
2. For correct connector usage, refer Table A-2 for the torque settings.

Introduction

Excess Noise Ratio Expanded Uncertainty (U(Y)) - Table 1-2

ENR values are given at cardinal frequency points over the frequency range of each noise source. These values are stored within the noise sources internal EEPROM and documented on the calibration report.

The uncertainty analysis for the calibration of the noise sources is in accordance with the ISO/TAG4 Guide. The uncertainty data reported on the calibration report is the expanded uncertainty (U(Y)) with 95% confidence level and a coverage factor of 2. This uncertainty analysis is valid for APC 3.5mm and Type-N (option 001) connector types.

A significant proportion of the expanded uncertainty (U(Y)) is based on the uncertainties provided by the National Standards Institutes. Agilent therefore reserve the right to change the overall expanded uncertainties based on changes in uncertainty values within the National Standards Institutes.

Uncertainties are valid at ambient temperature $23^{\circ}\text{C} \pm 1^{\circ}\text{C}$ (296K) only.

A typical characteristic plot of ENR (U(Y)) versus each cardinal frequency point is shown in Figure 1-3.

Figure 1-3

Characteristic¹ENR Plot versus Cardinal Frequency Points

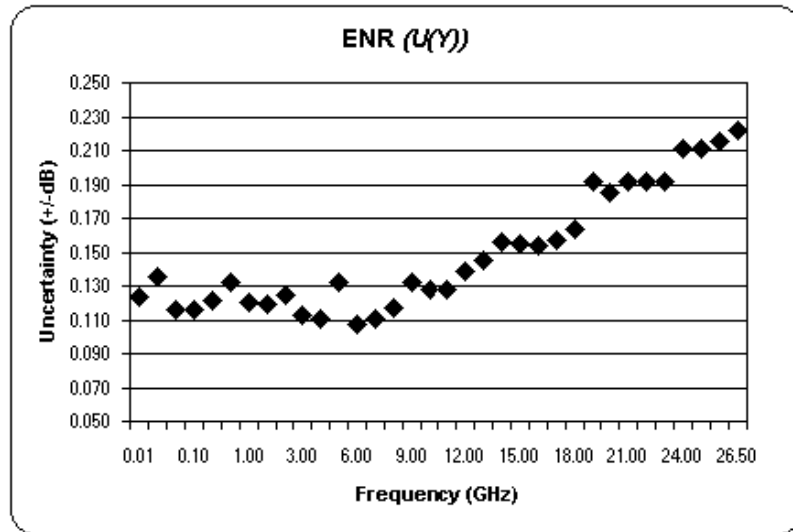

1. Characteristic values are met or bettered by 90% of instruments with 90% confidence.

**Excess Noise Ratio Expanded Uncertainty (U(Y)) - Table 1-2
Continued**

**Characteristic
ENR (U(Y))
Specification**

Instrument model	Frequency (GHz)	ENR Uncertainty (\pmdB)¹
N4000A	0.01-1.5	0.16
	1.5 - 3.0	0.15
	3.0 - 7.0	0.15
	7.0 - 18.0	0.16
N4001A	0.01-1.5	0.14
	1.5 - 3.0	0.13
	3.0 - 7.0	0.13
	7.0 - 18.0	0.16
N4002A	0.01-1.5	0.15
	1.5 - 3.0	0.13
	3.0 - 7.0	0.13
	7.0 - 18.0	0.15
	18.0 - 26.5	0.22

1. Characteristic values are met or bettered by 90% of instruments with 90% confidence.

Supplemental Characteristics - Table 1-3

**Supplemental
Characteristics**

ENR variation with temperature:	<0.01 dB/°C for 30 MHz to 26.5 GHz	
Temperature Sensing Accuracy	Range	0 to 55 °C
	Resolution	0.25 °C
	Accuracy	± 1° at 25 °C ± 2° over 0 °C to 55 °C

Description

The Smart Noise Source, when commanded “Off” produces RF noise due to thermal agitation of its RF components at a level appropriate to its physical temperature. When commanded “On” it still produces this noise and produces additional noise component, referred to as EXCESS NOISE. These two noise levels are used to measure the gain and added noise of the device under test, and consequently, its noise figure.

The Excess Noise Ratio (ENR) for each SNS has been measured at cardinal frequencies and these frequency/ENR pair values are stored in the SNS’s internal EEPROM. The ENR of the source relates the level of excess noise in dB to the noise level appropriate to the standard temperature; 296 K. ENR does not include the “Off” noise component.

Also included in the EEPROM calibration data is the measurement uncertainty and the complex reflection coefficient in both the “On” and “Off” states for each SNS.

The SNS has a built in thermometer which monitors the ambient temperature. This value can be transferred to the NFA and control the calculation of the T_{cold} value.

All models are provided with a twelve pin connector for power input and data transfer. The output connector is a male APC-3.5 on the standard noise sources. Type-N connectors are available as options for the Agilent SNS models N4000A and N4001A.

Warranty

The noise sources are warranted and certified as indicated in this manual. Connector damage resulting from improper use is not covered under warranty.

Equipment Supplied with the NFA

The following equipment is supplied from Agilent Technologies with the N8974A and the N8975A Noise Figure Analyzer models for use with the Precision APC 3.5 mm Smart Noise Sources:

- 8710-1761: 7.0 mm Wrench
- 83059B: Precision 3.5mm Coaxial Adaptor

Description

Equipment Available But Not Supplied

The following equipment is available from Agilent Technologies for use with the noise sources:

- 8710-1764: 20mm 8lb-in Torque Wrench
- 8710-1765: 5/16" 8lb-in Torque Wrench
- 8710-1766: 3/4" 12lb-in Torque Wrench (for use with option 001)

Options

The Agilent N4000A and N4001A Noise Sources are available with the following output connector options:

- Option 001, Type-N (male)

Since the Type-N connectors are not suitable for use above 18.0 GHz, no output connector options are available for the Agilent N4002A.

Recommended Test Equipment

All of the operator's checks are performed using an Agilent Noise Figure Analyzer with firmware version A.01.01 and above. This can be used to perform an operational verification check.

Installation

Handling Precautions

CAUTION

The diode module is static sensitive and can be damaged or the calibration can be altered.

CAUTION

Do not rotate the Smart Noise Source body when connecting to the Noise Figure Analyzer, or internal damage may result.

CAUTION

Do not drop the noise source. Dropping can damage the unit or alter the calibration.

Proper connector care is essential. See Operator's Maintenance in the Operation section of this manual for more information.

Initial Inspection

Inspect the shipping container for damage. Inspect the noise source for mechanical damage incurred in transit. If the shipping container or cushioning material is damaged, it should be kept until the contents of the shipment have been checked for completeness and the noise source has been mechanically and electrically checked. If the contents are incomplete, if there is mechanical damage or a defect, or if the noise source does not work electrically, notify the nearest Agilent Technologies office. If the shipping container is damaged, or the cushioning material shows signs of unusual stress, notify the carrier as well as the Agilent Technologies office. Keep the shipping materials for the carrier's inspection.

Returning an SNS to Agilent for Repair

Container and materials identical to those used in factory packaging are available through Agilent Technologies offices. If the noise source is being returned to Agilent Technologies for servicing, attach a tag indicating the name and address of the company, the technical contact person, phone number and extension, the model number, serial number, type of service being requested, and failure symptoms if applicable. For this purpose, blue service tags have been provided at the back of this manual. Mark the shipping container FRAGILE. In any correspondence, refer to the noise sources by model number and serial number.

Mating Connectors

The noise sources can be mated with other instrumentation having the connectors listed in Table 1-4.

Table 1-4

Connectors That Can Be Mated With the Noise Sources

Configuration	Mating Connector
Input: all units	multi-pin connector ¹
Output: standard	APC-3.5 female
Opt.001	Type-N female ²

1. This is designed to operate with the NFA using the 11730 cable. A 11730A cable is supplied with the NFA.
2. Must comply with U.S. Military Standard MII,C-39012

Storage and Shipping Environment

The noise sources must be stored in a clean, dry environment. The following environmental limitations apply to both storage and shipment:

- Temperature: -55 °C to +75 °C
- Humidity: <95% relative
- Altitude: <15300 meters (50000 feet)

Operation

This section refers to operation with the Agilent NFA Series Noise Figure Analyzers. The Agilent SNS Series Smart Noise Sources have been designed to work specifically with these analyzers. For more detailed operating instructions, refer to the *Agilent NFA Series Noise Figure Analyzers User's Guide*.

CAUTION

Use a dc blocking capacitor to protect the noise source from damage when connected to any system where a dc voltage is present on the output center conductor.

Noise figure measurements of devices (such as amplifiers, mixers, transistors, and receivers) can be made using the Smart Noise Sources with a Noise Figure Analyzers. Figure 1-4 shows a simple test setup for a noise figure measurement.

Figure 1-4 Typical Noise Figure Measurement Test Setup



Operating Environment

The operating environment of the noise sources must be within the following limitations:

- Temperature: 0 °C to +55 °C
- Humidity: <95% relative
- Altitude: <4600 metres (15 000 feet)

Operator's Maintenance

Proper connector care is a vital part of the maintenance which should be performed by the user. The life of the connector can be greatly extended by following the general connector care practices outlined in Appendix A , "Caring for Connectors," on page 43.

Operator's Check

The operator's checks in this section should be performed if failure of the noise source is suspected. The checks can be used only to verify that the noise sources are producing a broadband noise spectrum. They can not be used to check the units against specifications.

NOTE

The operator's checks are designed to find a fault in the SNS. However, the fault could equally be with the cable and this should also be checked.

NOTE

All of the operator's checks are performed using a Noise Figure Analyzer with firmware version A.01.01 and above. This can be used to perform an operational verification check.

Operator's Check for Data Communication

The following procedure checks that the SNS can transfer the ENR data to the NFA.

Step 1. Remove any cables from the NFA input and SNS drive.

Step 2. Press the **Preset** key.

Wait until the preset routine is complete before proceeding.

NOTE

The preset condition used is the NFA default of **Preset (Factory)**.

Step 3. Press the **ENR** key.

Step 4. Press the **SNS Setup** menu key.

Step 5. Press the **Preference** menu key and set it to **Preference (SNS)**.

Step 6. Press the **Auto Load ENR** menu key and set it to **Auto Load ENR (Off)**.

Step 7. Connect the SNS to the NFA Port using the multi-pin 11730 cable, as shown in Figure 1-5.

Figure 1-5 **Operator's Check Test Setup for Data Communication**



General Information
Operation

- Step 8.** Press the **ENR** key.
- Step 9.** Press the **ENR Mode** menu key and set it to **ENR Mode (Table)**.
- Step 10.** Press the **Common Table** menu key and set it to **Common Table (On)**.
- Step 11.** Press the **ENR Table** menu key.
- Step 12.** Press the **Edit Table** menu key and press the **Clear Table** menu key if there is data in the **ENR Table**.

You are prompted to press this key again. This feature ensures you do not accidentally clear a valid Frequency list table. Press the **Clear Table** menu key again. Figure 1-6 shows a typical cleared ENR table.

Figure 1-6 A Typical Cleared ENR Table

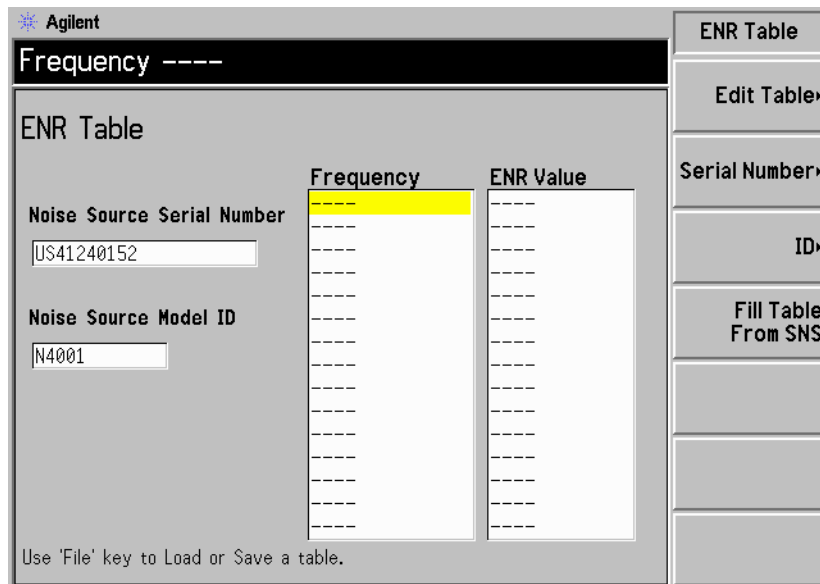

Step 13. Press the **Prev** key.

Step 14. Press the **Fill Table From SNS** menu key.

Wait until the data is uploaded from the SNS before proceeding.

Step 15. Verify the data has been transferred from the SNS to the NFA.

The data transfer should be similar to Figure 1-7. If it is not, return the SNS to Agilent Technologies for repair.

Figure 1-7 A Typical ENR Table after data entry

The screenshot shows the Agilent ENR Table interface. At the top, it displays 'Agilent' and 'Frequency 10.00000000 MHz'. Below this is the 'ENR Table' section, which includes two input fields: 'Noise Source Serial Number' with the value 'US41240152' and 'Noise Source Model ID' with the value 'N4001'. To the right of these fields is a table with two columns: 'Frequency' and 'ENR Value'. The table contains 14 rows of data, with the first row highlighted in yellow. The table data is as follows:

Frequency	ENR Value
10.00000000 MHz	15.330 dB
100.0000000 MHz	15.560 dB
1.000000000 GHz	15.360 dB
2.000000000 GHz	15.120 dB
3.000000000 GHz	14.970 dB
4.000000000 GHz	14.910 dB
5.000000000 GHz	14.850 dB
6.000000000 GHz	14.900 dB
7.000000000 GHz	14.860 dB
8.000000000 GHz	14.890 dB
9.000000000 GHz	15.010 dB
10.00000000 GHz	15.110 dB
11.00000000 GHz	15.260 dB
12.00000000 GHz	15.400 dB
13.00000000 GHz	15.440 dB

At the bottom of the interface, there is a note: 'Use 'File' key to Load or Save a table.' On the right side of the screen, there is a vertical menu with several options: 'ENR Table', 'Edit Table', 'Serial Number', 'ID', 'Fill Table From SNS', and two empty buttons. The 'Fill Table From SNS' option is highlighted.

Operator's Check for T_{cold} Communication

The following procedure checks that the SNS can transfer the T_{cold} data to the NFA.

Step 1. Remove any cables from the NFA input and SNS drive.

Step 2. Press the **Preset** key.

Wait until the preset routine is complete before proceeding.

NOTE

The preset condition used is the NFA default of **Preset (Factory)**.

Step 3. Press the **ENR** key.

Step 4. Press the **Tcold** menu key.

Step 5. Connect the SNS to the NFA Port using the multi-pin 11730 cable, as shown in Figure 1-8

Figure 1-8 Operator's Check Test Setup for T_{cold} Communication



Step 6. Press the **SNS Tcold** menu key and set it to **SNS Tcold (Off)**.

Step 7. Press the **User Tcold** menu key and set it to **User Tcold (On)**.

NOTE The value displayed in the **User Value** menu key, typically 296.50 K. Figure 1-9 shows a typical NFA menu map.

Figure 1-9 Typical User Value

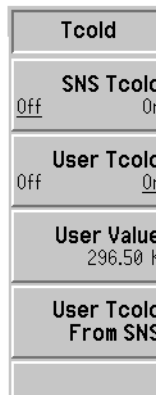

Step 8. Press the **User Tcold From SNS** menu key.

In the **User Value** menu key, the new ambient temperature value is displayed. Figure 1-10 shows a typical NFA menu map.

Figure 1-10 Typical User Value after Uploading SNS Value

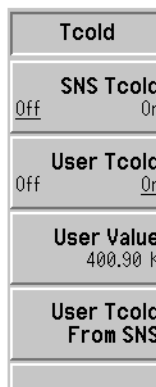

General Information
Operation

Step 9. If this value has not changed, warm the SNS by wrapping your hand around its bulkhead as shown in Figure 1-11 for 20 seconds. This gives the SNS thermometer time to change its ambient value. Then press the **User T_{cold} From SNS** menu key again. The new ambient temperature value is displayed.

Figure 1-11 **Operator's Check for T_{cold} Upload From SNS**



Step 10. If the value does not change, return the SNS to Agilent Technologies for repair.

Operator's Check for Switching Noise Source Off and On

The following procedure checks that the SNS can switch the noise source off and on. This ensures the excess noise switches.

Step 1. Remove any cables from the NFA input and SNS drive.

Step 2. Press the **Preset** key.

Wait until the preset routine has completed before proceeding.

NOTE

The preset condition used is the NFA default of **Preset (Factory)**.

Step 3. Connect the SNS to the NFA Port using the multi-pin 11730 cable, as shown in Figure 1-12.

Figure 1-12 SNS connected to NFA graphic



Step 4. Press the **Frequency/Points** key.

Step 5. Press the **Frequency Mode** menu key.

Step 6. Press the **Fixed** menu key.

General Information
Operation

Step 7. Press the **Fixed Frequency** menu key.

Enter 1.0 GHz as a fixed frequency value, by pressing the 1 numeric key followed by pressing the **GHz** menu key.

Step 8. Press the **Sweep** key.

Step 9. Press the **Manual Meas** menu key.

Step 10. Press the **Manual State** menu key and set it to **Manual State (On)**.

Step 11. Press the **Noise Source** menu key and set it to **Noise Source (On)**.

Step 12. Press the **IF Att** menu key and set it to **IF Att (Hold)**.

Step 13. Monitor the power value which appears in the manual measurement screen. Figure 1-13 shows a typical example of this.

Figure 1-13

Typical example of power reading with Noise Source On

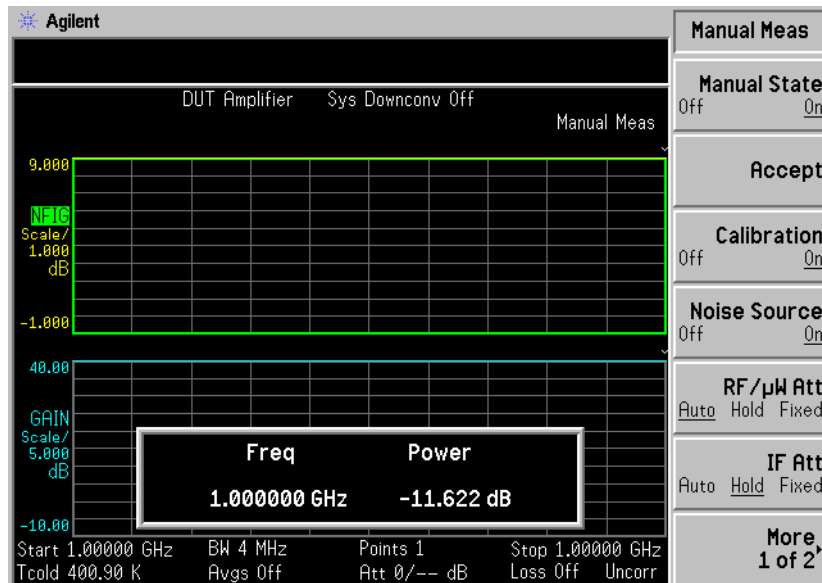

Step 14. Press the **Noise Source** menu key and set it to **Noise Source (Off)**.

Step 15. Monitor the power value which appears in the manual measurement screen. Figure 1-14 shows a typical example of this.

NOTE The monitored value is only to be used to indicate if the SNS is switching the Excess Noise “On” and “Off” by showing a change in power value.

Figure 1-14 Typical example of power reading with Noise Source Off

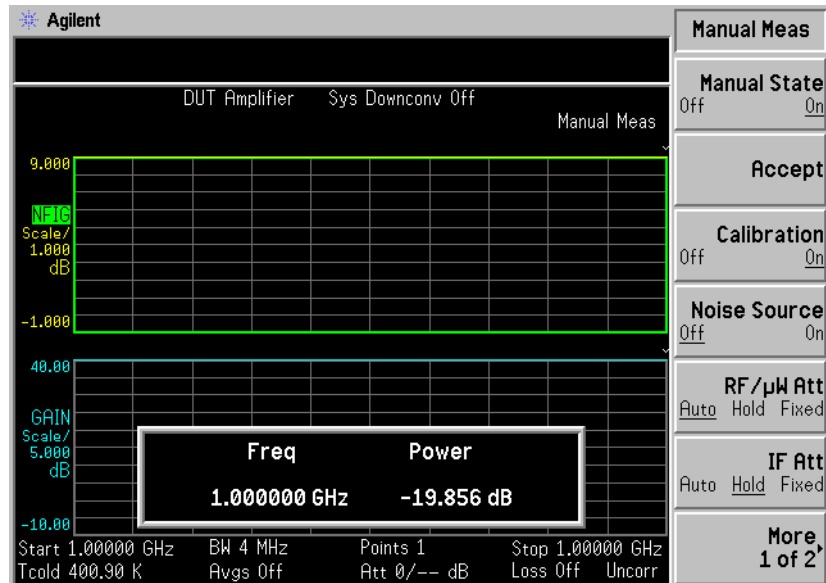

Step 16. If there is not a change in value, return the SNS to Agilent Technologies for repair.

Performance Tests

Due to the specialized test equipment involved, there are no recommended performance tests for the user to perform. Return the noise sources to Agilent Technologies when tests are required to verify its performance and for periodic re-calibration. The calibration must be traceable to the national standards laboratories. The suggested interval before initial re-calibration is one year.

Adjustments

The user cannot make adjustments to the noise sources.

Replaceable Parts

Table 1-5 and Table 1-6 lists all replaceable parts available for the Agilent N400XA Smart Noise Sources. Figure 1-15 shows a typical Smart Noise Source being prepared for parts replacement at the assembly level by removing the four end screws (two at each end).

To order parts contact your local Agilent Technologies Sales and Service Office.

NOTE If the Agilent Smart Noise Source is opened and parts replaced, it requires re-calibration.

Table 1-5 Replaceable Parts List¹

Model/ Option	Replacement Bulkhead Assembly	Replacement Noise Cartridge	Attenuator Replacement Kit	PC Board Assembly
N4000A	N4000-60014	00346-60154	00346-60156	N4000-60001
N4000A Opt 001	N4000-60015	00346-60154	00346-60156	N4000-60001
N4001A	N4001-60003	00346-60154	00346-60027	N4000-60001
N4001A Opt 001	N4001-60004	00346-60154	00346-60027	N4000-60001
N4002A	N4002-60004	00346-60155	00346-60027	N4002-60001

1. Only replace these parts if you have calibration facilities to verify the SNS.

General Information
Replaceable Parts

Table 1-6 Chassis Parts

Model	Agilent Part Number	Reference Designator	Description
N4000A, N4001A, N4002A	E9321-20002	MP1, MP2	Machined Casting
N4000A, N4001A, N4002A	E9321-00001	MP3, MP4	Shield
N4000A, N4001A, N4002A	E9321-40001	MP5, MP6	Plastic Shell
N4000A, N4001A, N4002A	0460-1919	MP7, MP8	Copper Roll Shielding Tape
N4000A, N4001A, N4002A	N4000-80002	MP9	Label- Caution
N4000A, N4001A, N4002A	N4000-80003	MP10, MP11	Label- SNS Series
N4000A	N4000-80001	MP12	Label- N4000A
N4001A	N4001-80001	MP12	Label- N4001A
N4002A	N4002-80001	MP12	Label- N4002A
N4000A, N4001A, N4002A	00346-80011	MP13	Label- Caution

Table 1-7 Documentation

Model	Agilent Part Number	Description
N4000A, N4001A, N4002A	N4000-90001	Operating and Service Manual

Figure 1-15 **Illustrated Parts Break Down**

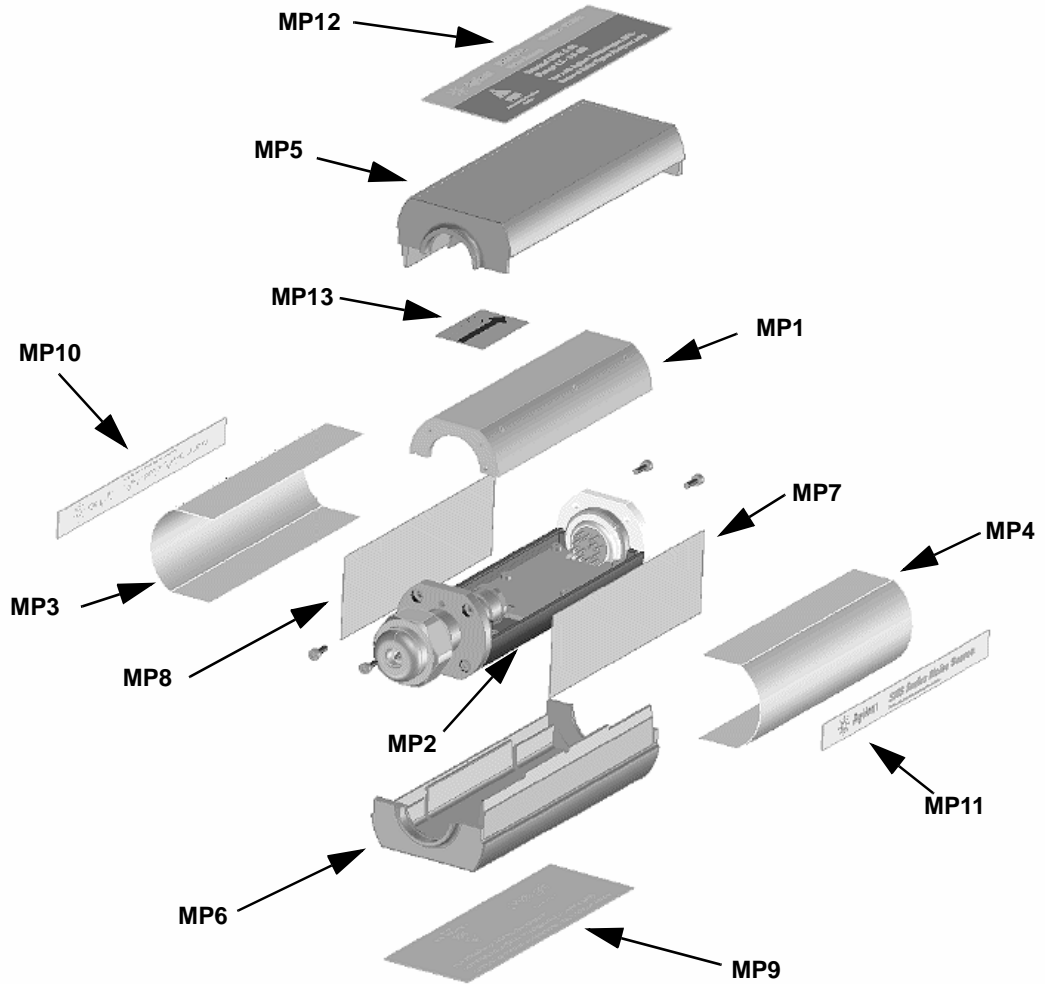
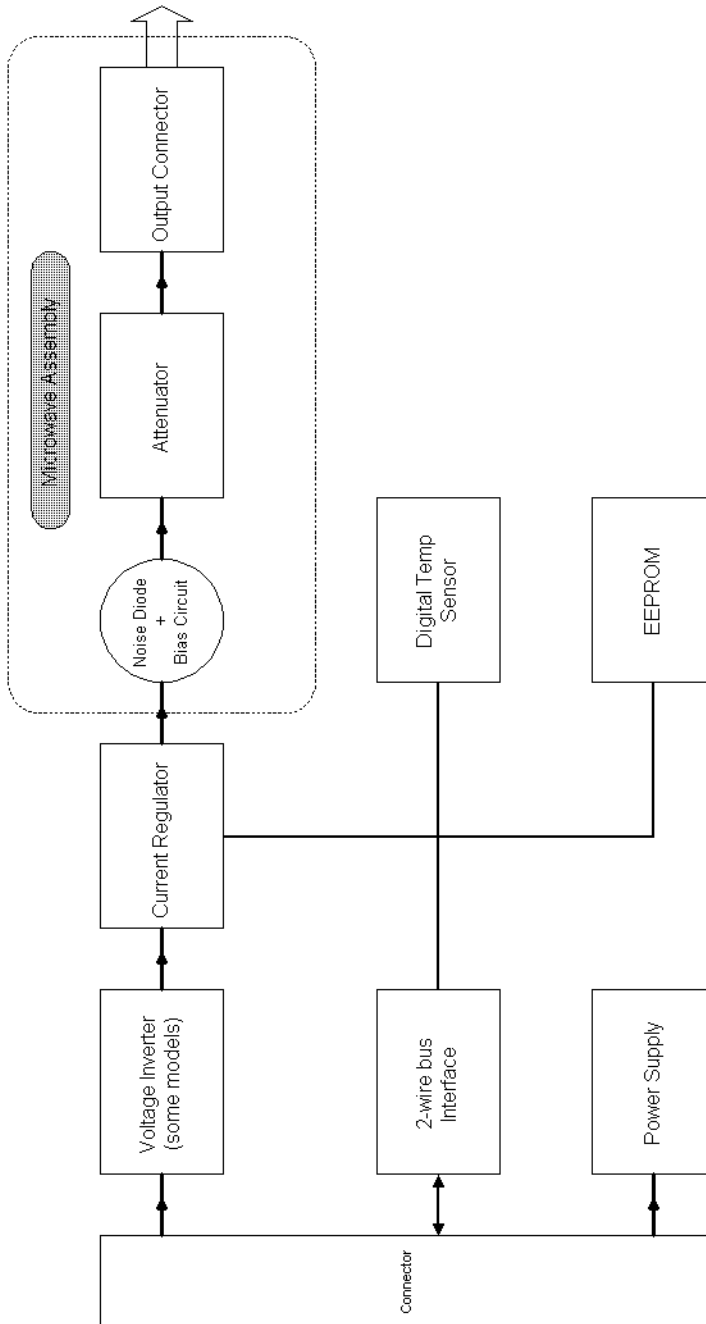

Figure 1-16 Smart Noise Source Block Diagram



Service

Principles of Operation

Referring to the SNS block diagram in Figure 1-16, a constant +28V is supplied from the NFA through the multi-pin “Connector” block when the SNS is connected to the Noise Figure Analyzer. A voltage inverter is used in the N4000A and N4001A to input approximately -25V to the Current Regulator.

The Current Regulator applies a negative bias current to the noise diode for the N4000A and N4001A models. The N4002A utilizes a positive bias, so the voltage inverter is not necessary. The current regulator block also provides the switching necessary to produce the noise “On” and “Off” states.

The two-wire bus interface allows for data transfer to and from the noise source. The data stored in the EEPROM includes model, serial number, diode current setting and SNS calibration data.

The Power Supply provides +5V to the Two Wire Bus Interface, EEPROM and Digital Temperature Sensor.

The Digital Temperature Sensor is a digital thermometer, thermally coupled to the Microwave Assembly.

When the Smart Noise Source is in its “On” state, the noise diode produces broadband noise which is input to the attenuator.

The attenuator sets the final Excess Noise Ratio (ENR) and output impedance of the Smart Noise Source. A 16dB attenuator is used in the N4000A to provide nominal ENR values of 5dB. A 6dB attenuator is used in the N4001A and N4002A models for nominal ENR values of 15 dB.

The standard output connector is a Precision 3.5mm. A Type-N connector is optional.

Troubleshooting

Check the connectors and perform the Operator Check described in the Operation section of this manual. If the Operator Check results indicate a problem, or if the connectors are damaged, please contact Agilent Technologies. Our representatives can help isolate the problem and make arrangements for repairs if necessary.

Repair of Defective Noise Source

Repair by the user is not recommended because of the complex equipment required for test and calibration. However, a number of replacement parts are available for customers with repair and calibration capabilities. See “Replaceable Parts List” on page 25 and “Chassis Parts” on page 26.

NOTE

This manual does not include specific repair procedures covering the replacement of parts listed in Table 1-5.

Disassembly Procedure

NOTE

If the Agilent Smart Noise Source is opened and parts are replaced, it requires re-calibration.

CAUTION

Disassemble the noise source only in a static free work area. Electrostatic discharge can damage the noise source.

Figure 1-17 **Removing the Smart Noise Source Plastic Shell**

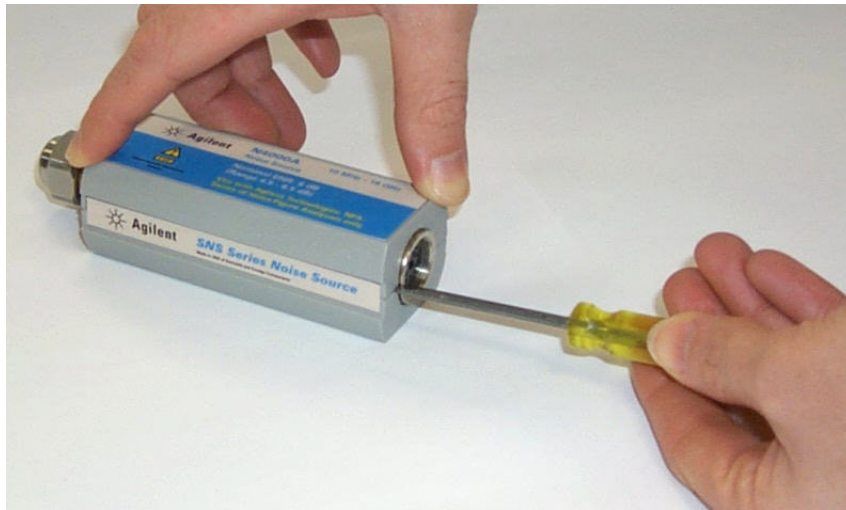

Disassemble the Smart Noise Source by performing the following steps.

- Step 1.** At the rear of the noise source, insert the blade of a screwdriver between the plastic shells (see Figure 1-17). To prevent damage to the shells, use a screwdriver blade as wide as the slot between the two shells.
- Step 2.** Pry alternately at both sides of the connector (see Figure 1-17) until the plastic shells are apart. Remove the shells and the magnetic shields.

Reassembly Procedure

- Step 1.** Replace the magnetic shields and plastic shells as shown in Figure 1-15.
- Step 2.** Snap the plastic shells together.

Returning a Noise Source for Calibration

When returning a Smart Noise Source to Agilent Technologies for calibration send it to your nearest Sales and Service Office. These are listed in Table 1-8.

Table 1-8

Agilent Technologies Sales and Service Offices

UNITED STATES
Agilent Technologies (tel) 1 800 452 4844
CANADA
Agilent Technologies Canada Inc. Test & Measurement (tel) 1 877 894 4414
EUROPE
Agilent Technologies Test & Measurement European Marketing Organization (tel) (31 20) 547 2000
JAPAN
Agilent Technologies Japan Ltd. (tel) (81) 426 56 7832 (fax) (81) 426 56 7840
LATIN AMERICA
Agilent Technologies Latin America Region Headquarters, USA (tel) (305) 267 4245 (fax) (305) 267 4286
AUSTRALIA/NEW ZEALAND
Agilent Technologies Australia Pty Ltd. (tel) 1-800 629 4852 (Australia) (fax) (61 3) 9272 0749 (Australia) (tel) 0-800 738 378 (New Zealand) (fax) (64 4) 802 6881 (New Zealand)
ASIA PACIFIC
Agilent Technologies, Hong Kong (tel) (852) 3197 7777 (fax) (852) 2506 9284

2

ENR File Format

Format Details

An SNS ENR file:

- Includes all data currently supplied on the printed noise source calibration report.
- Can be viewed and edited using a standard text editor (for example, Wordpad).
- Is simple to create and interpret.
- Is easily printable.
- Is easily imported into Excel.

Format

The ENR file is read line by line. Each line is terminated by a linefeed character, or a carriage-return linefeed pair. Each line must be less than 100 characters long, excluding the terminator.

Lines containing only whitespace (tab or space character) are ignored. Each line is interpreted as one of three types of record:

- Comment.
- Header Field.
- ENR Data.

Comment Records

A comment record must have either a "#" or "!" as the first character in the line. The entire line is ignored. Comment records can appear at any point within the file.

Header Fields

General form Header fields must have a "[" as the first character in the line. Each header field has the general form:

- [FieldName OptionalValue]
- The "[" must be the first character on the line.
- The FieldName and OptionalValue, if present, must be separated by whitespace.
- Whitespace following the "]" is ignored.
- The file must start with one or more header fields (ignoring comments and blank lines).

All header fields must appear at the beginning of the file before the ENR data records. Mixing header fields and ENR data is not permitted.

Mandatory header fields Certain header fields must be present. These are:

Table 2-1 Mandatory header fields

FieldName	Description	OptionalValue	Description	Example
Filetype	Indicates the type of file.	ENR	Only 'ENR' is allowed for ENR data files.	[Filetype ENR]
Version	Indicates the version of the file format which applies to this file.	versionnumber (formatted as major.minor)	Allows for future changes in the file format.	[Version 1.0]

NOTE All mandatory fields must appear in the file before any optional header fields.

Optional header fields The following header fields are also allowed.

ENR File Format
Format Details

NOTE Only the first two fields, `Serialnumber` and `Model`, are currently used by the Noise Figure Analyzer.

Table 2-2 Optional header fields

FieldName	Description	Optional-Value	Description	Example
Serialnumber	The serial number of the noise source	serialtext	a string containing the serial number	[Serialnumber 3318A14223]
Model	Identifies the noise source model number	modelcode	model code string	[Model 346B]
Option	Identifies any model code option	optioncode	option code string	[Option 001]
Caldate	Date of calibration of noise source	date&time	formatted date and optional time	[Caldate 19991202.09:15:30]
Calduedate	Indicates date when next calibration of noise source is due	date&time	formatted date and optional time	[Calduedate 20001225]
Temperature	Calibration temperature	value	number followed by unit. Valid units are C,F,K	[Temperature 24C]
Humidity	Calibration relative humidity	value	number followed by optional '%'	[Humidity 40%]
Placeofcal	Name of calibration site	placetext	string containing the place of calibration	[Placeofcal SouthQueensferry]
Trackingnum	Tracking number used during manufacture	value	number	[Trackingnum 100]

Table 2-2 Optional header fields

FieldName	Description	Optional-Value	Description	Example
Current	Calibrated value of SNS current DAC value	value	number	[Current 3000]

The format of date&time parameters is YYYYMMDD[.hh:mm:ss], i.e. a four digit year, two digit month and two digit date, optionally followed by a "." then two digit hour ":" two digit minutes ":" two digit seconds.

Unknown header fields are ignored by the Noise Figure Analyzer. This allows for future expansion.

ENR Data

ENR data records must be ordered from lowest to highest frequency.

General form

The Noise Figure Analyzer attempts to interpret lines which are not comments or header fields as ENR data. ENR data has the general form:

```
Freq [Funit] ENR [Eunit] [Euncert [on_mag on_phase
off_mag off_phase [on_mag_uncert [on_phase_uncert
off_mag_uncert off_phase_uncert]]]]
```

NOTE

Square brackets signify optional fields.

Field separator

Each field is separated by whitespace. A single "," is allowed within or instead of the whitespace.

Numeric fields

With the exception of the two optional value fields, the other fields are numeric. Numbers are formatted as an optional sign, followed by a sequence of one or more digits (which can include a single decimal point within the sequence), followed by an optional exponent. The exponent consists of the "e" or "E" followed by an optional sign followed by between one and three digits, for example, "10e6" to represent 10 MHz.

Format Details

Frequency fields The frequency field (*F_{freq}*) is the frequency at which the ENR amplitude was measured.

The frequency unit field (*F_{unit}*) is optional. The default unit is Hz.

Valid units are Hz, kHz, MHz, GHz, THz. Units are not case sensitive.

ENR fields The ENR amplitude (*E_{NR}*) is the measured ENR at the specified frequency.

The ENR unit field (*E_{unit}*) is optional. The default unit is dB. Currently, the only allowed unit is dB. Note that units K, C, F (temperature) are reserved for possible future use, but are not supported by the NFA at this time.

The uncertainty field for the ENR amplitude (*E_{uncert}*) is optional. However, this field must be present if reflection coefficient data is supplied.

Reflection coefficient data The reflection coefficient data is optional and is formatted as four fields (*on_mag*, *on_phase*, *off_mag*, *off_phase*):

- Reflection magnitude with noise source on.
- Reflection angle (in degrees) with noise source on.
- Reflection magnitude with noise source off.
- Reflection angle (in degrees) with noise source off.

If any reflection coefficient data is supplied, then all four fields must be present.

NOTE The file format requires the ENR uncertainty field to be present before any reflection data.

The reflection coefficient uncertainty (*on_mag_uncert*) is an optional parameter. Either one or four reflection uncertainties are allowed. If one value is supplied, it is assumed to apply to all reflection parameters. Alternatively, uncertainties can be supplied for all four reflection parameters independently. Reflection coefficient data must be present if this field is supplied.

Viewing the Smart Noise Source ENR Data

To view the ENR data you need a Noise Figure Analyzer and a diskette.

NOTE

For an explanation of saving a file to a diskette using the NFA, see the *Noise Figure Analyzer User's Guide*.

Step 1. Connect the SNS to the NFA Port using the multi-pin 11730 cable, as shown in Figure 1-5 on page 15.

NOTE

Ensure the NFA is set to read the SNS data. See "Operator's Check for Data Communication" on page 15, for further information.

Step 2. Press the **File** key.

Step 3. Press the **Save** menu key.

Step 4. Press the **ENR** menu key.

Step 5. Press the **SNS** menu key.

Step 6. Press the **Tab** key to highlight the Path: C:
Ensure ". ." "^{UP}" is highlighted.

Step 7. Press the **Select** menu key.
Ensure the "[-A-]" directory is highlighted.

Step 8. Press **Select** menu key.

Step 9. Press the **Enter** key.

Wait until the data is saved to the diskette.

Step 10. You can now view the data on a PC using, for example, Wordpad as shown in "Examples" on page 40.

The data is presented using Comma Separated Values (CSV). This allows you to view it in a Spreadsheet.

Examples

Example 1

This first example shows a simple ENR file where the Frequency and ENR values have been entered manually into the Noise Figure Analyzer:

```
# ENR Data File
# Created by N8973A Agilent NFA Series Noise Figure Analyzer
# Serial Number GB40390000 Firmware Revision A.01.01
# 13:37:07 Mar 28, 2001
# Format is: Frequency (Hz), ENR (dB)

[Filetype ENR]
[Version 1.0]
10000000, 15.3500
100000000, 15.4230
1000000000, 15.2280
2000000000, 15.0900
3000000000, 14.9600
4000000000, 14.8400
5000000000, 14.7890
6000000000, 14.7500
7000000000, 14.7720
8000000000, 14.8570
9000000000, 14.9580
10000000000, 15.0600
11000000000, 15.0830
12000000000, 15.1950
13000000000, 15.2710
14000000000, 15.3430
15000000000, 15.4800
16000000000, 15.6750
17000000000, 15.8400
18000000000, 15.8940
```

Example 2

The second example is an SNS ENR file saved to a diskette:

```
# ENR Data File
# Created by N8975A NFA Series Noise Figure Analyzer
# Serial Number GB40390000 Firmware Revision A.01.01
# 13:37:07 Mar 28, 2001
# Format is: Frequency (Hz), ENR (dB), ENR Unc (dB),
# On Refl.Mag (lin), On Refl.Phase (deg),
# Off Refl.Mag (lin), Off Refl.Phase (deg),
# On Refl.Mag Unc (lin), On Refl.Phase Unc (deg),
# Off Refl.Mag Unc (lin), Off Refl.Phase Unc (deg)

[Filetype ENR]
[Version 1.1]
[Serialnumber US41240152]
[Model N4001A]
[Option 001]
[Caldate 20000727]
[Calduedate 20010727]
[Placeofcal EPSGQ]
[Trackingnum 10]
[Temperature 296.5K]
[Humidity 65%]
[Current 36272]

10000000,15.281,0.193,0.0450,-136.0,0.0450,-136.0,0.0030,
-6.0, 0.0070, +6.0

100000000, 15.291, 0.190, 0.0358, +168.0, 0.0358, +168.0,
0.0040, +4.6, 0.0050, -4.6

1000000000, 15.118, 0.151, 0.0398, +39.6, 0.0398, +39.6,
0.0100, +4.5, 0.0067, +1.5

2000000000, 14.999, 0.168, 0.0377, 0.168, 0.0377, -85.7,
0.0056, +0.9, 0.0086, +1.9

3000000000, 14.879, 0.172, 0.0267, +150.6, 0.0267, +150.6,
0.0080, -9.2, 0.0090, -1.2

4000000000, 14.795, 0.173, 0.0130, -18.1, 0.0130, -18.1,
0.0013, +16.0, 0.0063, +10.0

5000000000, 14.818, 0.179, 0.0359, +169.5, 0.0359, +169.5,
0.0024, -9.3, 0.0035, -0.3

6000000000, 14.846, 0.181, 0.0556, +63.7, 0.0556, +63.7,
0.0041, +10.3, 0.0067, -4.3

7000000000, 14.895, 0.180, 0.0430, -37.0, 0.0430, -27.0,
0.0079, -2.3, 0.0049, -2.3
```

ENR File Format

Examples

8000000000, 15.016, 0.198, 0.0232, -160.3, 0.0232, -160.3,
0.0091, -3.8, 0.0053, -1.8

9000000000, 15.134, 0.201, 0.0122, +71.4, 0.0122, +71.4,
0.0037, +17.3, 0.0057, +7.3

10000000000, 15.253, 0.194, 0.0080, +116.2, 0.0080, +116.2,
0.0048, -1.4, 0.0056, -5.4

11000000000, 15.249, 0.243, 0.0241, +65.7, 0.0241, +65.7,
0.0059, +1.5, 0.0049, +44.5

12000000000, 15.349, 0.240, 0.0196, +8.8, 0.0196, +8.8, 0.0057,
+3.2, 0.0077, +2.2

13000000000, 15.383, 0.188, 0.0217, -5.4, 0.0217, -5.4, 0.0062,
-6.9, 0.0045, -1.9

14000000000, 15.355, 0.178, 0.0228, -66.6, 0.0228, -66.6,
0.0075, +11.2, 0.0065, +1.2

15000000000, 15.367, 0.187, 0.0141, +141.6, 0.0141, +141.6,
0.0036, -3.2, 0.0029, -1.2

16000000000, 15.421, 0.182, 0.0251, +6.4, 0.0251, +6.4, 0.0030,
+7.2, 0.0042, -1.2

17000000000, 15.418, 0.174, 0.0242, -100.5, 0.0242, -100.5,
0.0048, -2.7, 0.0050, +9.7

18000000000, 15.464, 0.179, 0.0183, +124.4, 0.0183, +124.4,
0.0098, -1.1, 0.0100, +9.1

NOTE

The values shown in Example 2 are representative of their position in the file. Therefore, they may not be numerically accurate.

A **Caring for Connectors**

The material contained in this appendix may not be apply to the connector you are using on the instrument.

Introduction

Recent advances in measurement capabilities have made connectors and connection techniques more important than ever before. Damage to the connectors on calibration and verification devices, test ports, cables, and other devices represent an increasing burden in downtime and expense.

This Appendix will help you get the best performance from all coaxial microwave connectors:

- To know what to look for when cleaning and inspecting them, in order to preserve their precision and extend their life.
- To make the best possible microwave connections, improving the accuracy and repeatability of all of your measurements, saving both time and money.

Connector Part Numbers

Refer to the latest edition of the HP RF & Microwave Test Accessories Catalog for connector part numbers.

Handling and Storage

Microwave connectors must be handled carefully, inspected before use and when not in use, stored in a way that gives them maximum protection. Avoid touching the connector mating plane surfaces and avoid setting the connectors contact-end down, especially on a hard surface.

Never store connectors with the contact end exposed. Plastic end caps are provided with all Agilent connectors and these should be retained after unpacking and placed over the ends of the connectors whenever they are not in use. Extend the threads of connectors that have a retractable sleeve or sliding connector nut, then put the plastic end cap over the end of the connector.

Above all, never store any devices loose in a box or in a desk or a bench drawer. Careless handling of this kind is the most common cause of connector damage during storage.

Visual Inspection

Visual inspection and, if necessary, cleaning should be done every time a connection is made.

Metal and metal by-product particles from the connector threads often find their way onto the mating plane surfaces when a connection is disconnected and even one connection made with a dirty or damaged connector can damage both connectors beyond repair.

Magnification is helpful when inspecting connectors, but it is not required and may actually be misleading. Defects and damage that cannot be seen without magnification generally have no effect on electrical or mechanical performance. Magnification is of great use in analyzing the nature and cause of damage and in cleaning connectors, but it is not required for inspection.

Obvious Defects and Damage

Examine the connectors first for obvious defects or damage: badly worn plating, deformed threads or bent, broken, or misaligned center conductors. Connector nuts should move smoothly and be free of burrs, loose metal particles, and rough spots.

Immediately discard, or mark for identification and send away for repair, any connector that has obvious defects like these.

Mating Plane Surfaces

Flat contact between the connectors at all points on their mating plane surfaces is required for a good connection. Therefore, particular attention should be paid to deep scratches or dents, and to dirt and metal or metal by-product particles on the connector mating plane surfaces.

Also look for bent or rounded edges on the mating plane surfaces of the center and outer conductors and for any signs of damage due to excessive or uneven wear or misalignment.

Visual Inspection

Light burnishing of the mating plane surfaces is normal, and is evident as light scratches or shallow circular marks distributed more or less uniformly over the mating plane surface. Other small defects and cosmetic imperfections are also normal. None of these affect electrical or mechanical performance.

If a connector shows deep scratches or dents, particles clinging to the mating plane surfaces, or uneven wear, clean it and inspect it again. Damage or defects like dents or scratches, which are deep enough to displace metal on the mating plane surface of the connector, may indicate that the connector itself is damaged and should not be used. Try to determine the cause of the damage before making further connections.

Precision 7 mm Connectors

Precision 7mm connectors, among them APC-7[®] connectors, should be inspected visually with the center conductor collets in place, and whenever the collet has been removed. See Figure A-1.

The collet itself should be inspected for edge or surface damage and for any signs that the spring contacts are bent or twisted. If they are, replace the collet. When the collet has been re-inserted, verify that it springs back immediately when pressed with a blunt plastic rod or with the rounded plastic handle of the collet removing tool. Never use a pencil or your finger for this purpose.

Figure A-1

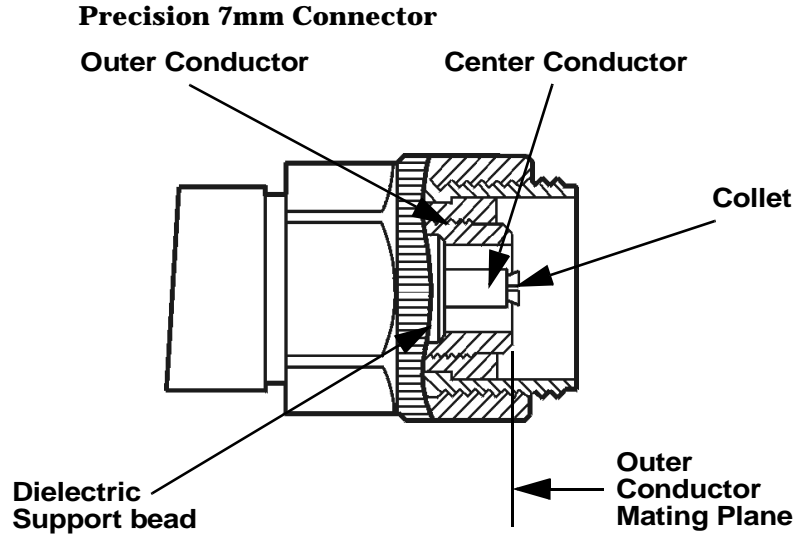

Sexed Connectors

On sexed connectors, especially precision 3.5mm and SMA connectors, pay special attention to the female center conductor contact fingers (Figure A-2 and Figure A-3). These are very easily bent or broken, and damage to them is not always easy to see. Any connector with damaged contact fingers will not make good electrical contact and must be replaced.

Figure A-2

Precision 3.5mm connectors

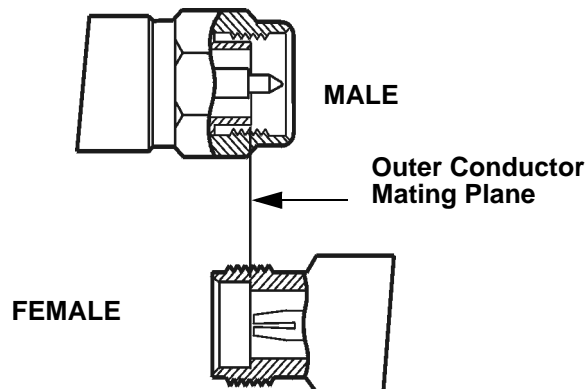

Caring for Connectors
Visual Inspection

Figure A-3

SMA connectors

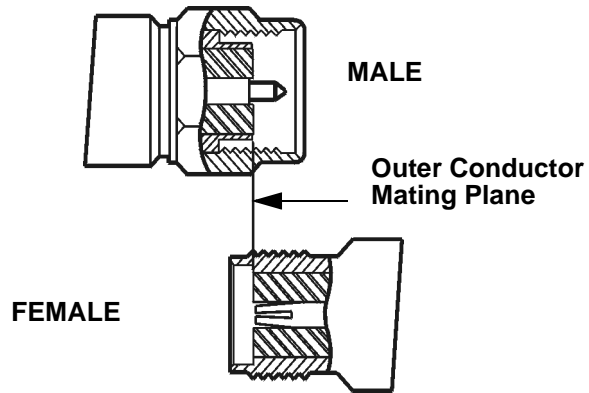

Cleaning

Careful cleaning of all connectors is essential to assure long, reliable connector life, to prevent accidental damage to connectors, and to obtain maximum measurement accuracy and repeatability. Yet it is the one step most often neglected or done improperly. Supplies recommended for cleaning microwave connectors are as follows:

- Compressed Air.
- Alcohol.
- Cotton Swabs.
- Lint-Free Cleaning Cloth.

Compressed Air

Loose particles on the connector mating plane surfaces can usually be removed with a quick blast of compressed air. This is very easy to do and should always be tried first using compressed air from a small pressurized can. The stream of air can be directed exactly where it is wanted through a plastic (not metal) nozzle. No hoses or other connections are needed. Hold the can upright, to avoid spraying liquid along with the vapor.

Cleaning Alcohol

Dirt and stubborn contaminants that cannot be removed with compressed air can often be removed with a cotton swab or lint free cleaning cloth moistened with alcohol.

NOTE

Use the least amount of alcohol possible, and avoid wetting any plastic parts in the connectors with the alcohol.

Cleaning

Alcohol should be used in liquid rather than spray form. If a spray must be used, always spray the alcohol onto a cloth or swab, never directly into a connector.

Very dirty connectors can be cleaned with pure alcohol. Other solutions that contain additives should not be used.

Carefully avoid wetting the plastic support bead (which is easily damaged by alcohol) inside the connector and blow the connector dry immediately with a gentle stream of compressed air.

Precision 7 mm Connectors

When precision 7mm connectors have been cleaned with the center conductor collet removed, insert the collet and clean the mating plane surfaces again.

When the connector is attached to a small component, or to a cable, calibration, or verification standard, the easiest way to do this is to put a lint-free cleaning cloth flat on a table and put a couple of drops of alcohol in the center of the cloth. It should be noted that it is not necessary to remove the collet to use this cleaning method.

Retract the connector sleeve threads so that the connector interface is exposed. Gently press the contact end of the connector into the cloth moistened with alcohol, then turn the connector.

Dirt on the connector interface will be scrubbed away by the cloth without damaging the connector. Blow the connector dry with a gentle stream of compressed air.

This cleaning method can be adapted even for fixed connectors such as those attached to test ports. Simply fold the cloth into several layers of thickness, moisten it, press it against the connector interface, and turn it to clean the connector. Blow the connector dry with a gentle stream of compressed air.

Cleaning Interior Surfaces

Interior surfaces, especially on precision 3.5mm connectors, are very difficult to reach, and it is easy to damage connectors in trying to clean them. The openings are very small, and generally the center conductor is supported only at the inner end, by a plastic dielectric support bead. This makes it very easy to bend or break the center conductor.

One suitable method (Figure A-4) is to cut off the sharp tip of a round wooden toothpick, or a smaller diameter wooden rod, and then to wrap it with a single layer of lint-free cleaning cloth.

Figure A-4

Cleaning interior surfaces



NOTE

Metal must never be used (it will scratch the plated surfaces), and in cleaning precision 3.5mm connectors the diameter must not exceed 0.070 in. (1.7 mm). The wooden handle of a cotton swab, for example, is too large for this purpose. Even though the handle can sometimes be inserted into the connector, even when wrapped in lint-free cloth, movement of the handle against the center conductor can exert enough force on the center conductor to damage it severely.

Cleaning

Moisten the cloth with a small amount of alcohol and carefully insert it into the connector to clean the interior surfaces. Use an illuminated magnifying glass or microscope to see clearly the areas you wish to clean.

Drying Connectors

When you have cleaned a connector, always be sure that it is completely dry before reassembling or using it. Blow the connector dry with a gentle stream of clean compressed air and inspect it again under a magnifying glass to be sure that no particles or alcohol residues remain.

Mechanical Inspection: Connector Gages

Even a perfectly clean, unused connector can cause problems if it is mechanically out of specification. Since the critical tolerances in microwave connectors are on the order of a few ten-thousandths of an inch, using a connector gage is essential.

Before using any connector for the first time, inspect it mechanically using a connector gage. How often connectors should be gaged after that depends upon usage.

In general, connectors should be gaged whenever visual inspection or electrical performance suggests that the connector interface may be out of specification, for example due to wear or damage. Connectors on calibration and verification devices should also be gaged whenever they have been used by someone else or on another system or piece of equipment.

Precision 3.5mm and SMA connectors should be gaged relatively more often than other connectors, owing to the ease with which the center pins can be pulled out of specification during disconnection.

Connectors should also be gaged as a matter of routine - after every 100 connections and disconnections initially, more or less often after that as experience suggests.

Table A-1 Recommended connector gages

Connector gage kits containing all of the items required are included in many Agilent calibration kits. They are also available separately. Part numbers are as follows.	
Type	Part Number/Ordering Information
Precision 7mm (APC-7)	85050-80012
Precision 3.5mm	11752D
Precision 2.4mm	11752E
Type-N	85054-60047

Mechanical Specifications

The critical dimension to be measured, regardless of connector type, is the position (generally, the recession or setback) of the center conductor relative to the outer conductor mating plane.

Mechanical specifications for connectors specify a maximum distance and a minimum distance that the center conductor can be positioned behind (or, in female Type-N connectors, in front of) the outer conductor mating plane. Nominal specifications for each connector type exist, but the allowable tolerances (and sometimes the dimensions themselves) differ from manufacturer to manufacturer and from device to device. Therefore, before gaging any connector, consult the mechanical specifications provided with the connector or the device itself.

Precision 7mm Connectors

In precision 7mm connectors, contact between the center conductors is made by spring-loaded contacts called collets. These protrude slightly in front of the outer conductor mating plane when the connectors are apart. When the connection is tightened, the collets are compressed into the same plane as the outer conductors.

For this reason, two mechanical specifications are generally given for precision 7mm connectors: the maximum recession of the center conductor behind the outer conductor mating plane with the center conductor collet removed; and a minimum and maximum allowable protrusion of the center conductor collet in front of the outer conductor mating plane with the collet in place.

The center conductor collet should also spring back immediately when pressed with a blunt plastic rod or with the rounded plastic handle of the collet removing tool. Never use a pencil or your finger for this purpose.

With the center conductor collet removed, no protrusion of the center conductor in front of the outer conductor mating plane is allowable, and sometimes a minimum recession is required. Consult the mechanical specifications provided with the connector or the device itself.

Sexed Connectors

In Type-N and precision 3.5mm connectors, the position of the center conductor in the male connector is defined as the position of the shoulder of the male contact pin - not the position of the tip. The male contact pin slides into the female contact fingers and electrical contact is made by the inside surfaces of the tip of the female contact fingers on the sides of the male contact pin.

50 Ohm Type-N Connectors

NOTE

No Type-N connector should ever be used when there is any possibility of interference between the shoulder of the male contact pin and the tip of the female contact fingers when the connectors are mated. In practice this means that no Type-N connector pair should be mated when the separation between the tip of the female contact fingers and the shoulder of the male contact pin could be less than zero when the connectors are mated. Gage Type-N connectors carefully to avoid damage.

Type-N connectors differ from other connector types in that the outer conductor mating plane is offset from the mating plane of the center conductors. The outer conductor sleeve in the male connector extends in front of the shoulder of the male contact pin. When the connection is made, this outer conductor sleeve fits into a recess in the female outer conductor behind the tip of the female contact fingers (Figure A-5).

Figure A-5

Type-N connectors

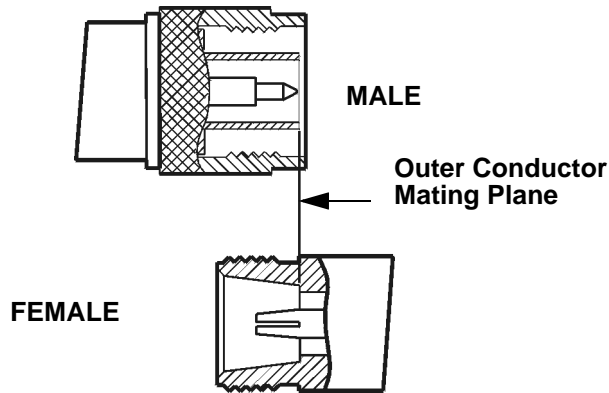

Therefore the mechanical specifications of Type-N connectors give a maximum protrusion of the female contact fingers in front of the outer conductor mating plane and a minimum recession of the shoulder of the male contact pin behind the outer conductor mating plane.

As Type-N connectors wear, the protrusion of the female contact fingers generally increases, due to wear of the outer conductor mating plane inside the female connector. This decreases the total center conductor contact separation and should be monitored carefully.

75 Ohm Type-N Connectors

75 Ω Type-N connectors differ from 50 Ω Type-N connectors most significantly in that the center conductor, male contact pin, and female contact hole are smaller. Therefore, mating a male 50 Ω Type-N connector with a female 75 Ω Type-N connector will destroy the female 75 Ω connector by spreading the female contact fingers apart permanently or even breaking them.

NOTE

If both 75 Ω and 50 Ω Type-N connectors are among those on the devices you are using, identify the 75 Ω Type-N connectors to be sure that they are never mated with any 50 Ω Type-N connectors.

Using Connector Gages

Before a connector gage is used, it must be inspected, cleaned, and zeroed.

Inspecting and Cleaning the Gage

Inspect the connector gage and the gage calibration block carefully, exactly as you have inspected the connector itself. Clean or replace the gage or the block if necessary (dirt on the gage or block will make the gage measurements of the connectors inaccurate and can transfer dirt to the connectors themselves, damaging them during gaging or when the connection is made).

Zeroing the Gage

Zero the gage by following the steps described below. Be sure that you are using the correct connector gage and correct end of the gage calibration block for the connector being measured.

- Hold the gage by the plunger barrel (not the dial housing or cap) and, for male connectors, slip the protruding end of the calibration block into the circular bushing on the connector gage. For precision 7mm, female precision 3.5mm use the flat end of the gage calibration block. For female Type-N connectors, use the recessed end of calibration block.
- Hold the gage by the plunger barrel only (Figure A-6). Doing so will prevent errors in gage readings due to the application of stresses to the gage plunger mechanism through the dial indicator housing.
- Carefully bring the gage and gage block together, applying only enough pressure to the gage and gage block to result in the dial indicator pointer settling at a reading.

Caring for Connectors
Using Connector Gages

- Gently rock the two surfaces together, to make sure that they have come together flatly. The gage pointer should now line up exactly with the zero mark on the gage. If it does not, inspect and clean the gage and gage calibration block again and repeat this process. If the gage pointer still does not line up with the zero mark on the gage, loosen the dial lock screw and turn the graduated dial until the gage pointer exactly lines up with zero. Then retighten the lock screw.

Figure A-6 **Using the connector gage**



NOTE

Gages should be checked often, to make sure that the zero setting has not changed. Generally, when the gage pointer on a gage that has been zeroed recently does not line up exactly with the zero mark, the gage or calibration block needs cleaning. Clean carefully and check the zero setting again.

Measuring Connectors

Measuring the recession of the center conductor behind the outer conductor mating plane in a connector is done in exactly the same way as zeroing the gage, except of course that the graduated dial is not re-set when the measurement is made.

If the connector has a retractable sleeve or sliding connector nut - precision 7mm connectors, for example - extend the sleeve or nut fully. This makes it easier to keep the gage centered in the connector.

Hold the gage by the plunger barrel and slip the gage into the connector so that the gage plunger rests against the center conductor. Carefully bring the gage into firm contact with the outer conductor mating plane.

Apply only enough pressure to the gage so that the gage pointer settles at a reading.

Gently rock the connector gage within the connector, to make sure that the gage and the outer conductor have come together flatly. Read the recession (or protrusion) from the gage dial. (For maximum accuracy, measure the connector several times and take an average of the readings.)

Rotate the gage relative to the connector between each measurement. To monitor connector wear, record the readings for each connector over time.

Making Connections

Making good connections is easy if a few simple principles are kept in mind:

- All connectors must be undamaged, clean, and within mechanical specification.
- The connectors must be precisely aligned with one another and in flat physical contact at all points on the mating plane surfaces.
- The connection must not be too tight or too loose.
- Lateral or horizontal (bending) force must not be applied to the connection, nor should any connection ever be twisted.

Align Connectors Carefully

Careful alignment of the connectors is critical in making a good connection, both to avoid damaging connectors and devices and to assure accurate measurements.

As you bring one connector up to the other and as you make the actual connection, be alert for any sign that the two connectors are not aligned perfectly. If you suspect that misalignment has occurred, stop and begin again.

Alignment is especially important in the case of sexed connectors, such as precision 3.5mm and SMA connectors, to avoid bending or breaking the contact pins. The center pin on the male connector must slip concentrically into the contact fingers of the female connector. This requires great care in aligning the two connectors before and as they are mated.

When they have been aligned, the center conductors must be pushed straight together, not twisted or screwed together, and only the connector nut (not the device itself) should then be rotated to make the connection. (slight resistance is generally felt as the center conductors mate).

Alignment of precision 7mm connectors is made easier by the fact that the connector sleeve on one of the connectors must be extended fully (and the sleeve on the other connector retracted fully) in order to make the connection. Extending the sleeve creates a cylinder into which the other connector fits.

If one of the connectors is fixed, as on a test port, extend that connector sleeve and spin its knurled connector nut to make sure that the threads are fully extended, while on the other connector, fully retract the connector sleeve.

To Make a Preliminary Connection

Align the two connectors carefully and engage the connector nut over the exposed connector sleeve threads on the other connector.

Gently turn the connector nut until a preliminary connection is made. Let the connector nut pull the two connectors straight together. Do not twist one connector body into the other (as you might drive a screw or insert a light bulb) as this is extremely harmful and can damage the connectors.

When the mating plane surfaces make uniform, light contact, the preliminary connection is tight enough. Do not overtighten this connection.

NOTE

At this stage all you want is a connection in which the outer conductors make gentle contact at all points on both mating surfaces. Very light finger pressure (no more than 2 inch-ounces of torque) is enough.

Final Connection Using a Torque Wrench

When the preliminary connection has been made, use a torque wrench to make the final connection. Tighten the connection only until the “break” point of the wrench is reached, when the wrench handle gives way at its internal pivot point. Do not tighten the connection further.

Also make sure that torque actually is being applied to the connection through the torque wrench, not only to the wrench handle or in any way that prevents the break point of the wrench from controlling the torque applied to the connection. Suggestions to ensure that torque is actually being applied are given in Table A-2 on page 63.

Using a torque wrench guarantees that the connection will not be too tight, thus preventing possible damage to the connectors and impaired electrical performance. It also guarantees that all connections will be made with the same degree of tightness every time they are made.

Torque wrenches pre-set to the correct value for each connector type are included in many Agilent calibration kits, and they are also available separately. Torque settings are detailed in Table A-2.

When using a torque wrench, prevent rotation of anything other than the connector nut that is being tightened with the torque wrench. Generally this is easy to do by hand (all the more so if one of the connectors is fixed) as on a test port. In other situations, an open-end wrench can be used to keep the bodies of the connectors from turning.

Hold the torque wrench lightly by the knurled end of the handle only. Apply force at the end of the torque wrench only, perpendicular to the wrench and always in a plane parallel to the outer conductor mating planes. This will result in torque being applied to the connection through the wrench until the break point of the wrench is reached.

Avoid pivoting the wrench handle on the thumb or other fingers. This results in an unknown amount of torque being applied to the connection when the break point of the wrench is reached. Avoid twisting the head of the wrench relative to the outer conductor mating plane. This results in applying more than the recommended torque.

Table A-2 Recommended Torque Settings

Type	Description
Precision 7mm	12 lb-in (136 N-cm.)
Precision 3.5mm	8 lb-in (90 N-cm)
SMA	5 lb-in (56 N-cm) Use the SMA wrench to connect male SMA connectors to female precision 3.5mm connectors. Connections of male precision 3.5mm. connectors to female SMA connectors can be made with the precision 3.5mm torque wrench (8 lb-in).
Type-N	Type-N connectors may be connected finger tight. If a torque wrench is used, 12 lb-in (136 N-cm) is recommended.

To reiterate the main do's and do not's detailed previously:

- Avoid holding the wrench tightly, in such a way that the handle is not pivoted but simply pushed downward the same amount throughout its length. If this is done, an unlimited amount of torque can be applied.
- Hold the wrench at the same point near the end of the handle every time, and always in the same orientation. Whenever possible, begin tightening the connection with the wrench held horizontally

Disconnection

Disconnect connectors by first loosening the connector nut that was tightened in order to make the connection. If necessary, use the torque wrench or an open-end wrench to start the process, but leave the connection finger tight. At all times support the devices and the connection to avoid putting lateral (bending) force on the connectors.

Complete the disconnection by disconnecting the connector nut completely.

NOTE

Never disconnect connectors by twisting one connector or device out of the other as one might remove a screw or a light bulb. This is extremely harmful and connector damage can occur whenever the device body rather than the nut alone is being turned.

If the connection is between sexed connectors, pull the connectors straight apart and be especially careful not to twist the body of any device as you do so. Twisting the connection can damage the connector by damaging the center conductors or the interior component parts to which the connectors themselves are attached. It can also scrape the plating from the male contact pin or even (in rare instances) unscrew the male or female contact pin slightly from its interior mounting, bringing it out of specification (this can also occur if the female contact fingers are unusually tight).

Adapters

Adapters are used to connect a device with one connector interface to a device or to test equipment that has another interface, or to reduce wear on connectors that may be difficult or expensive to replace. Reducing wear is possibly the most important use of adapters, especially when devices that have SMA connectors are being used.

SMA connectors are low-cost connectors generally used up to about 23GHz. They are not precision mechanical devices and are not designed for repeated connections and disconnections as they wear out quickly and are very often found, upon assembly, to be out of specification, even before they have been used. This makes them potentially destructive to any precision 3.5mm connectors with which they might be mated.

CAUTION

Worn, damaged, or out-of-specification SMA connectors can destroy a precision 3.5mm connector even on the very first connection. For this reason it is recommended that you use high-quality precision adapters, sometimes called “connector savers”, whenever more than a few connections are to be made between SMA and precision 3.5mm connectors.

In most applications two adapters will be required, one each at the input and the output of the device. Male-female adapters cause no change in the sex of the interface. The same interface is presented when the adapter is in place as is presented in the original setup.

Same-sex adapters (male-male, female-female) change the sex of the interface. For example, if the original interface presents a male connector, attaching a female-female adapter will result in a female interface to which devices or cables that have male SMA (or male precision 3.5mm) connectors can be connected.

Adapters are included in many Agilent calibration kits and with many Agilent devices, or they may be ordered separately.

Caring for Connectors
Adapters

Table A-3 Adapters

Type	Description
Precision 7mm and Type-N	Precision 7mm/male 3.5mm Precision 7mm/female 3.5 mm Precision 7mm/male 50Ω Type-N Precision 7mm/female 50Ω Type-N
Precision 3.5mm and SMA	Male 3.5mm/female 3.5mm Male 3.5mm/female 3.5 mm Female 3.5mm/female 3.5mm Precision 7mm/male 3.5mm Precision 7mm/female 3.5mm “Connector saver” male 3.5mm/female 3.5 mm “Connector saver” male 3.5mm/male 3.5mm

Principles of Microwave Connector Care

Table A-4 Principles of Microwave Connector Care

Handling and Storage	
DO	DO NOT
<ul style="list-style-type: none"> • Keep connectors clean. • Extend sleeve or connector nut. • Use plastic end caps during storage. 	<ul style="list-style-type: none"> • Touch mating plane surfaces. • Set connectors contact-end down.
Visual Inspection	
DO	DO NOT
<ul style="list-style-type: none"> • Inspect each connector carefully before every connection. • Look for metal particles, scratches and dents. 	<ul style="list-style-type: none"> • Use a damaged connector - EVER.
Cleaning	
DO	DO NOT
<ul style="list-style-type: none"> • Try compressed air first. • Clean connector threads. 	<ul style="list-style-type: none"> • Use any abrasives. • Get liquid onto plastic support beads.

Caring for Connectors
Principles of Microwave Connector Care

Table A-4 Principles of Microwave Connector Care

Gaging	
DO	DO NOT
<ul style="list-style-type: none"> • Clean and zero the gage before using. • Use correct gage type. • Use correct end of calibration block. • Gage all connectors before first use. 	<ul style="list-style-type: none"> • Use an out-of-spec connector.
Making Connections	
DO	DO NOT
<ul style="list-style-type: none"> • Align connectors carefully. • Make preliminary connection lightly. • Turn connector nut only to tighten. • Use a torque wrench for final connection. 	<ul style="list-style-type: none"> • Apply bending force to connection. • Overtighten preliminary connection. • Twist or screw in connectors. • Tighten past “break” point of torque wrench.