

R&S®ZVL

Vector Network Analyzer

Operating Manual



1303.6580.32 – 08

The Operating Manual describes all R&S®ZVL models:

- R&S® ZVL3 (frequency range up to 3 GHz), stock no. 1303.6509K03
- R&S® ZVL6 (frequency range up to 6 GHz), stock no. 1303.6509K06
- R&S® ZVL3-75 (frequency range up to 3 GHz), stock no. 1303.6509K75
- R&S® ZVL13 (frequency range up to 15 GHz), stock no. 1303.6509K13

© 2009 Rohde & Schwarz GmbH & Co. KG

81671 Munich, Germany

Printed in Germany – Subject to change – Data without tolerance limits is not binding.

R&S® is a registered trademark of Rohde & Schwarz GmbH & Co. KG.

Trade names are trademarks of the owners.

The following abbreviations are used throughout this manual:

R&S®ZVL is abbreviated as R&S ZVL.

R&S® FSL-xxx as R&S FSL-xxx.

R&S ZVL Documentation Map

Standard Documentation

The following documentation is supplied with the instrument.



The help systems are embedded in the instrument, offering quick, context-sensitive reference to the information needed for operation and programming. The help systems contain the complete user documentation for the network analyzer including all optional features. The instrument provides two help files for the network analyzer modes and for the spectrum analyzer mode.

You can also transfer the help files RSZVLhelp.chm (network analyzer mode plus basic functions) and RSFSLhelp.chm (spectrum analyzer mode plus supplementary spectrum analyzer options) to your PC and use them as standalone help files.



The quick start guide contains the data sheet (“Product Brochure” and “Specifications”), describes everything that is needed to put the instrument into operation and helps you get familiar with the analyzer. The quick start guide gives an introduction to the instrument’s functionality and provides procedures for typical measurement tasks.

For an overview and a short description of R&S ZVL options refer to section “Optional Extensions” in the “System Overview” chapter at the end of the quick start guide.

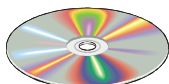

The CD-ROM provides the complete user documentation for the network analyzer:

- The online help system in two different HTML-based formats (*.chm for transfer to the hard disk and WebHelp for viewing from the CD).
- Printable (*.pdf) versions of the online help systems. The R&S ZVL operating manual describes the R&S ZVL instrument including network analyzer mode. A separate manual describes the spectrum analyzer mode (with option R&S ZVL-K1) and the supplementary spectrum analyzer options.
- The quick start manual in printable form.
- The service manual in printable form.
- Links to different useful sites in the R&S internet.

Glossary of Terms

A

- Active channel:** Channel belonging to the active trace. The active channel is highlighted in the channel list below the diagram. The active channel is not relevant in remote control where each channel can contain an active trace.
- Active marker:** Marker that can be changed using the settings of the Marker menu (Delta Mode, Ref. Mkr -> Mkr, Mkr Format). The active marker is also used for the Marker Functions. It appears in the diagram with an enlarged marker symbol and font size and with a dot placed in front of the marker line in the info field.
- Active menu:** The menu containing the last executed command. If the softkey bar is displayed (Nwa Setup - Display Config - Softkey Labels on), then the active menu is indicated on top of the softkey bar.
- Active trace (manual control):** Trace that is selected to apply the settings in the Trace menu. The active trace is highlighted in the trace list of the active diagram area. It can be different from the active trace in remote control.
- Active trace (remote control):** One trace of each channel that has been selected as the active trace (CALCulate[Ch]:PARAMeter:SElect <Trace Name>). Many commands (e.g. TRACE...) act on the active trace. It can be different from the active trace in manual control.

C

- Cal pool:** The cal pool is a collection of correction data sets (cal groups) that the analyzer stores in a common directory. Cal groups in the pool can be applied to different channels and setups.
- Calibration:** The process of removing systematic errors from the measurement (system error correction). See also TOSM.
- Calibration kit:** Set of physical calibration standards for a particular connector family.
- Calibration standard:** Physical device that has a known or predictable magnitude and phase response within a given frequency range. Calibration standards are grouped into several types (open, through, match,...) corresponding to the different input quantities for the analyzer's error models.
- Channel:** A channel contains hardware-related settings to specify how the network analyzer collects data. Each channel is stored in an independent data set. The channel settings complement the definitions of the Trace menu; they apply to all traces assigned to the channel.
- Compression point:** The x-dB compression point of an S-parameter is the stimulus signal level where the magnitude of the measured quantity has dropped by x dB compared to its value at small stimulus signal levels (small-signal value).
- Confirmation dialog box:** Standard dialog box that pops up to display an error message or a warning. The current action can be either continued (OK) or cancelled (Cancel) on closing the dialog box.
- Crosstalk:** The occurrence of a signal at the receive port of the analyzer which did not travel through the test setup and the DUT but leaks through other internal

paths. Crosstalk causes an isolation error in the measurement which can be corrected by means of a calibration.

CW frequency: Continuous Wave frequency; fixed stimulus frequency.

D

Data trace: Trace filled with measurement data and updated after each sweep (dynamic trace).

Diagram area: Rectangular portion of the screen used to display traces. Diagram areas are arranged in windows; they are independent of trace and channel settings.

Directivity error: Measurement error caused by a coupler or bridge in the analyzer's source port causing part of the generated signal to leak through the forward path into the receive path instead of being transmitted towards the DUT. The directivity error can be corrected by means of a full one port calibration or one of the two-port calibration methods (except normalization).

Discrete marker: The stimulus value of a discrete marker always coincides with a sweep point so that the marker does not show interpolated measurement values.

E

Excursion: Difference between the response values at a local maximum (minimum) of the trace and at the two closest local minima (maxima) to the left and to the right.

F

Forward: A measurement on a two-port DUT is said to be in forward direction if the source signal (stimulus) is applied to port 1 of the DUT.

I

Isolation error: Measurement error caused by a crosstalk between the source and receive port of the analyzer.

L

Limit check: Comparison of the measurement results with the limit lines and display of a pass/fail indication.

Limit line: A limit line is a set of data to specify the allowed range for some or all points of a trace. Typically, limit lines are used to check whether a DUT conforms to the rated specifications (conformance testing).

Load match error: Measurement error caused by a mismatch of the analyzer's receive (load) port causing part of the signal transmitted through the DUT to be reflected off the receive port so that it is not measured there. The load match error can be corrected by means of a two-port calibration (except normalization).

M

Marker: Tool for selecting points on the trace and for numerical readout of measured data. A marker is displayed with a symbol (a triangle, a crossbar or a line) on the trace; its coordinates are shown in the marker info field.

Mathematical trace: Trace that is calculated according to a mathematical expression. The expression is a mathematical relation between a data and a memory trace of the active setup.

Measurement point: Result of the measurement at a specified stimulus value (frequency).

Measurement result: Set of all measurement points acquired in a measurement (e.g. a sweep). The measurement result is displayed in a diagram area and forms a trace.

Memory trace: Trace that is associated to a data trace and stored in the memory. Data traces and the associated memory traces share the same channel and scale settings. Alternatively, memory traces can be imported from a file.

P

Partial measurement: Measurement at a specified stimulus value maintaining definite hardware settings. Depending on the measurement type, several partial measurements may be needed to obtain a measurement point. A full n-port S-parameter measurement requires n partial measurements with n different drive ports.

Peak: Local maximum or local minimum (dip) on the trace. In the Trace - Marker-> - Marker Search menu, it is possible to define a minimum excursion that both types of peaks must have to be considered valid.

R

Reflection tracking error: Frequency-dependent variation of the ratio of the reflected wave to the reference wave at a test port when an ideal reflection coefficient (= 1) is measured. The reflection tracking error can be corrected by means of a reflection normalization or one of the more sophisticated calibration methods.

Reverse: A measurement on a two-port DUT is said to be in reverse direction if the source signal (stimulus) is applied to port 2 of the DUT.

Ripple test: A special type of limit test where the maximum difference between the largest and the smallest response value of the trace must not exceed the specified limit. This test is suitable e.g. to check whether the passband ripple of a filter is within acceptable limits, irrespective of the actual transmitted power in the passband.

S

Setup: A setup comprises a set of diagram areas with all displayed information that can be stored to a NWA setup file (*.nwa). Each setup is displayed in an independent window.

Source match error: Measurement error caused by a mismatch of the analyzer's source port causing part of the signal reflected of the DUT to be reflected again of the source port so that it is not measured there. The source match

error can be corrected by means of a full one-port calibration or a two-port calibration (except normalization).

Stimulus value: Value of the sweep variable (frequency) where a measurement is taken. Also termed sweep point.

Sweep: Series of consecutive measurements taken at a specified sequence of stimulus values = series of consecutive measurement points.

Sweep point: Value of the sweep variable (stimulus value: frequency) where a measurement is taken.

Sweep range: Continuous range of the sweep variable (frequency) containing the sweep points where the analyzer takes measurements. In a Segmented Frequency sweep the sweep range can be composed of several parameter ranges or single points.

Sweep segment: Continuous frequency range or single frequency point where the analyzer measures at specified instrument settings (generator power, IF bandwidth etc.). In the Segmented Frequency sweep type the entire sweep range can be composed of several sweep segments.

T

TOSM: A calibration type using four known standards (through, open, short, match), also called SOLT or 12-term error correction model.

Trace: A trace is a set of data points that can be displayed together on the screen. The trace settings specify the mathematical operations used to obtain traces from the collected data. They complement the definitions of the Channel menu. Each trace is assigned to a channel. The channel settings apply to all traces assigned to the channel.

Trace point: Point on the screen which is an element of the displayed trace.

Transmission tracking error: Frequency-dependent variation of the ratio of the transmitted wave to the reference wave at a test port when an ideal transmission coefficient ($= 1$) is measured. The transmission tracking error can be corrected by means of a transmission normalization or one of the more sophisticated calibration methods.

W

Window: Rectangular portion of the screen showing all diagram areas of a particular setup. Windows are limited by a blue frame with several icons. The analyzer uses standard windows provided by the operating system.



ROHDE & SCHWARZ

EC Certificate of Conformity



Certificate No.: 2007-12

This is to certify that:

Equipment type	Stock No.	Designation
ZVL3	1303.6509.03	Vector Network Analyzer 9 kHz - 3 GHz
ZVL3-75	1303.6509.75	Vector Network Analyzer 9 kHz - 3 GHz
ZVL6	1303.6509.06	Vector Network Analyzer 9 kHz - 6 GHz
ZVL13	1303.6509.13	Vector Network Analyzer 9 kHz - 13,6 GHz

complies with the provisions of the Directive of the Council of the European Union on the approximation of the laws of the Member States

- relating to electrical equipment for use within defined voltage limits (2006/95/EC)
- relating to electromagnetic compatibility (2004/108/EC)

Conformity is proven by compliance with the following standards:

EN 61010-1: 2001
EN 55011: 2007 + A2: 2007
EN 61326-1: 2006
EN 61326-2-1: 2006
EN 61000-3-2: 2006
EN 61000-3-3: 1995 + A1: 2001 + A2: 2005

For the assessment of electromagnetic compatibility, the limits of radio interference for Class A equipment as well as the immunity to interference for operation in industry have been used as a basis.

ROHDE & SCHWARZ GmbH & Co. KG
Mühdorfstr. 15, D-81671 München

Munich, 2009-06-25

Central Quality Management MF-QZ / Radde

Basic Safety Instructions

Always read through and comply with the following safety instructions!









All plants and locations of the Rohde & Schwarz group of companies make every effort to keep the safety standards of our products up to date and to offer our customers the highest possible degree of safety. Our products and the auxiliary equipment they require are designed, built and tested in accordance with the safety standards that apply in each case. Compliance with these standards is continuously monitored by our quality assurance system. The product described here has been designed, built and tested in accordance with the attached EC Certificate of Conformity and has left the manufacturer's plant in a condition fully complying with safety standards. To maintain this condition and to ensure safe operation, you must observe all instructions and warnings provided in this manual. If you have any questions regarding these safety instructions, the Rohde & Schwarz group of companies will be happy to answer them.







Furthermore, it is your responsibility to use the product in an appropriate manner. This product is designed for use solely in industrial and laboratory environments or, if expressly permitted, also in the field and must not be used in any way that may cause personal injury or property damage. You are responsible if the product is used for any intention other than its designated purpose or in disregard of the manufacturer's instructions. The manufacturer shall assume no responsibility for such use of the product.

The product is used for its designated purpose if it is used in accordance with its product documentation and within its performance limits (see data sheet, documentation, the following safety instructions). Using the product requires technical skills and a basic knowledge of English. It is therefore essential that only skilled and specialized staff or thoroughly trained personnel with the required skills be allowed to use the product. If personal safety gear is required for using Rohde & Schwarz products, this will be indicated at the appropriate place in the product documentation. Keep the basic safety instructions and the product documentation in a safe place and pass them on to the subsequent users.

Observing the safety instructions will help prevent personal injury or damage of any kind caused by dangerous situations. Therefore, carefully read through and adhere to the following safety instructions before and when using the product. It is also absolutely essential to observe the additional safety instructions on personal safety, for example, that appear in relevant parts of the product documentation. In these safety instructions, the word "product" refers to all merchandise sold and distributed by the Rohde & Schwarz group of companies, including instruments, systems and all accessories.





Symbols and safety labels

							
Notice, general danger location Observe product documentation	Caution when handling heavy equipment	Danger of electric shock	Warning! Hot surface	PE terminal	Ground	Ground terminal	Be careful when handling electrostatic sensitive devices

					
ON/OFF supply voltage	Standby indication	Direct current (DC)	Alternating current (AC)	Direct/alternating current (DC/AC)	Device fully protected by double (reinforced) insulation

Tags and their meaning

The following signal words are used in the product documentation in order to warn the reader about risks and dangers.

	indicates a hazardous situation which, if not avoided, will result in death or serious injury.
	indicates a hazardous situation which, if not avoided, could result in death or serious injury.
	indicates a hazardous situation which, if not avoided, could result in minor or moderate injury.
	indicates the possibility of incorrect operation which can result in damage to the product. In the product documentation, the word ATTENTION is used synonymously.

These tags are in accordance with the standard definition for civil applications in the European Economic Area. Definitions that deviate from the standard definition may also exist in other economic areas or military applications. It is therefore essential to make sure that the tags described here are always used only in connection with the related product documentation and the related product. The use of tags in connection with unrelated products or documentation can result in misinterpretation and in personal injury or material damage.

Operating states and operating positions

The product may be operated only under the operating conditions and in the positions specified by the manufacturer, without the product's ventilation being obstructed. If the manufacturer's specifications are not observed, this can result in electric shock, fire and/or serious personal injury or death. Applicable local or national safety regulations and rules for the prevention of accidents must be observed in all work performed.

1. Unless otherwise specified, the following requirements apply to Rohde & Schwarz products: predefined operating position is always with the housing floor facing down, IP protection 2X, pollution severity 2, overvoltage category 2, use only indoors, max. operating altitude 2000 m above sea level, max. transport altitude 4500 m above sea level. A tolerance of $\pm 10\%$ shall apply to the nominal voltage and $\pm 5\%$ to the nominal frequency.
2. Do not place the product on surfaces, vehicles, cabinets or tables that for reasons of weight or stability are unsuitable for this purpose. Always follow the manufacturer's installation instructions when installing the product and fastening it to objects or structures (e.g. walls and shelves). An installation that is not carried out as described in the product documentation could result in personal injury or death.
3. Do not place the product on heat-generating devices such as radiators or fan heaters. The ambient temperature must not exceed the maximum temperature specified in the product documentation or in the data sheet. Product overheating can cause electric shock, fire and/or serious personal injury or death.

Electrical safety

If the information on electrical safety is not observed either at all to the extent necessary, electric shock, fire and/or serious personal injury or death may occur.

1. Prior to switching on the product, always ensure that the nominal voltage setting on the product matches the nominal voltage of the AC supply network. If a different voltage is to be set, the power fuse of the product may have to be changed accordingly.
2. In the case of products of safety class I with movable power cord and connector, operation is permitted only on sockets with an earthing contact and protective earth connection.
3. Intentionally breaking the protective earth connection either in the feed line or in the product itself is not permitted. Doing so can result in the danger of an electric shock from the product. If extension cords or connector strips are implemented, they must be checked on a regular basis to ensure that they are safe to use.
4. If the product does not have a power switch for disconnection from the AC supply network, the plug of the connecting cable is regarded as the disconnecting device. In such cases, always ensure that the power plug is easily reachable and accessible at all times (corresponding to the length of connecting cable, approx. 2 m). Functional or electronic switches are not suitable for providing disconnection from the AC supply network. If products without power switches are integrated into racks or systems, a disconnecting device must be provided at the system level.
5. Never use the product if the power cable is damaged. Check the power cable on a regular basis to ensure that it is in proper operating condition. By taking appropriate safety measures and carefully laying the power cable, you can ensure that the cable will not be damaged and that no one can be hurt by, for example, tripping over the cable or suffering an electric shock.
6. The product may be operated only from TN/TT supply networks fused with max. 16 A (higher fuse only after consulting with the Rohde & Schwarz group of companies).
7. Do not insert the plug into sockets that are dusty or dirty. Insert the plug firmly and all the way into the socket. Otherwise, sparks that result in fire and/or injuries may occur.
8. Do not overload any sockets, extension cords or connector strips; doing so can cause fire or electric shocks.
9. For measurements in circuits with voltages $V_{\text{rms}} > 30 \text{ V}$, suitable measures (e.g. appropriate measuring equipment, fusing, current limiting, electrical separation, insulation) should be taken to avoid any hazards.
10. Ensure that the connections with information technology equipment, e.g. PCs or other industrial computers, comply with the IEC60950-1/EN60950-1 or IEC61010-1/EN 61010-1 standards that apply in each case.
11. Unless expressly permitted, never remove the cover or any part of the housing while the product is in operation. Doing so will expose circuits and components and can lead to injuries, fire or damage to the product.
12. If a product is to be permanently installed, the connection between the PE terminal on site and the product's PE conductor must be made first before any other connection is made. The product may be installed and connected only by a licensed electrician.
13. For permanently installed equipment without built-in fuses, circuit breakers or similar protective devices, the supply circuit must be fused in such a way that anyone who has access to the product, as well as the product itself, is adequately protected from injury or damage.

Basic Safety Instructions

14. Use suitable overvoltage protection to ensure that no overvoltage (such as that caused by a bolt of lightning) can reach the product. Otherwise, the person operating the product will be exposed to the danger of an electric shock.
15. Any object that is not designed to be placed in the openings of the housing must not be used for this purpose. Doing so can cause short circuits inside the product and/or electric shocks, fire or injuries.
16. Unless specified otherwise, products are not liquid-proof (see also section "Operating states and operating positions", item 1. Therefore, the equipment must be protected against penetration by liquids. If the necessary precautions are not taken, the user may suffer electric shock or the product itself may be damaged, which can also lead to personal injury.
17. Never use the product under conditions in which condensation has formed or can form in or on the product, e.g. if the product has been moved from a cold to a warm environment. Penetration by water increases the risk of electric shock.
18. Prior to cleaning the product, disconnect it completely from the power supply (e.g. AC supply network or battery). Use a soft, non-linting cloth to clean the product. Never use chemical cleaning agents such as alcohol, acetone or diluents for cellulose lacquers.

Operation

1. Operating the products requires special training and intense concentration. Make sure that persons who use the products are physically, mentally and emotionally fit enough to do so; otherwise, injuries or material damage may occur. It is the responsibility of the employer/operator to select suitable personnel for operating the products.
2. Before you move or transport the product, read and observe the section titled "Transport".
3. As with all industrially manufactured goods, the use of substances that induce an allergic reaction (allergens) such as nickel cannot be generally excluded. If you develop an allergic reaction (such as a skin rash, frequent sneezing, red eyes or respiratory difficulties) when using a Rohde & Schwarz product, consult a physician immediately to determine the cause and to prevent health problems or stress.
4. Before you start processing the product mechanically and/or thermally, or before you take it apart, be sure to read and pay special attention to the section titled "Waste disposal", item 1.
5. Depending on the function, certain products such as RF radio equipment can produce an elevated level of electromagnetic radiation. Considering that unborn babies require increased protection, pregnant women must be protected by appropriate measures. Persons with pacemakers may also be exposed to risks from electromagnetic radiation. The employer/operator must evaluate workplaces where there is a special risk of exposure to radiation and, if necessary, take measures to avert the potential danger.
6. Should a fire occur, the product may release hazardous substances (gases, fluids, etc.) that can cause health problems. Therefore, suitable measures must be taken, e.g. protective masks and protective clothing must be worn.
7. If a laser product (e.g. a CD/DVD drive) is integrated into a Rohde & Schwarz product, absolutely no other settings or functions may be used as described in the product documentation. The objective is to prevent personal injury (e.g. due to laser beams).

Repair and service

1. The product may be opened only by authorized, specially trained personnel. Before any work is performed on the product or before the product is opened, it must be disconnected from the AC supply network. Otherwise, personnel will be exposed to the risk of an electric shock.
2. Adjustments, replacement of parts, maintenance and repair may be performed only by electrical experts authorized by Rohde & Schwarz. Only original parts may be used for replacing parts relevant to safety (e.g. power switches, power transformers, fuses). A safety test must always be performed after parts relevant to safety have been replaced (visual inspection, PE conductor test, insulation resistance measurement, leakage current measurement, functional test). This helps ensure the continued safety of the product.

Batteries and rechargeable batteries/cells

If the information regarding batteries and rechargeable batteries/cells is not observed either at all or to the extent necessary, product users may be exposed to the risk of explosions, fire and/or serious personal injury, and, in some cases, death. Batteries and rechargeable batteries with alkaline electrolytes (e.g. lithium cells) must be handled in accordance with the EN 62133 standard.

1. Cells must not be taken apart or crushed.
2. Cells or batteries must not be exposed to heat or fire. Storage in direct sunlight must be avoided. Keep cells and batteries clean and dry. Clean soiled connectors using a dry, clean cloth.
3. Cells or batteries must not be short-circuited. Cells or batteries must not be stored in a box or in a drawer where they can short-circuit each other, or where they can be short-circuited by other conductive materials. Cells and batteries must not be removed from their original packaging until they are ready to be used.
4. Keep cells and batteries out of the hands of children. If a cell or a battery has been swallowed, seek medical aid immediately.
5. Cells and batteries must not be exposed to any mechanical shocks that are stronger than permitted.
6. If a cell develops a leak, the fluid must not be allowed to come into contact with the skin or eyes. If contact occurs, wash the affected area with plenty of water and seek medical aid.
7. Improperly replacing or charging cells or batteries that contain alkaline electrolytes (e.g. lithium cells) can cause explosions. Replace cells or batteries only with the matching Rohde & Schwarz type (see parts list) in order to ensure the safety of the product.
8. Cells and batteries must be recycled and kept separate from residual waste. Rechargeable batteries and normal batteries that contain lead, mercury or cadmium are hazardous waste. Observe the national regulations regarding waste disposal and recycling.

Transport

1. The product may be very heavy. Therefore, the product must be handled with care. In some cases, the user may require a suitable means of lifting or moving the product (e.g. with a lift-truck) to avoid back or other physical injuries.

2. Handles on the products are designed exclusively to enable personnel to transport the product. It is therefore not permissible to use handles to fasten the product to or on transport equipment such as cranes, fork lifts, wagons, etc. The user is responsible for securely fastening the products to or on the means of transport or lifting. Observe the safety regulations of the manufacturer of the means of transport or lifting. Noncompliance can result in personal injury or material damage.
3. If you use the product in a vehicle, it is the sole responsibility of the driver to drive the vehicle safely and properly. The manufacturer assumes no responsibility for accidents or collisions. Never use the product in a moving vehicle if doing so could distract the driver of the vehicle. Adequately secure the product in the vehicle to prevent injuries or other damage in the event of an accident.

Waste disposal

1. If products or their components are mechanically and/or thermally processed in a manner that goes beyond their intended use, hazardous substances (heavy-metal dust such as lead, beryllium, nickel) may be released. For this reason, the product may only be disassembled by specially trained personnel. Improper disassembly may be hazardous to your health. National waste disposal regulations must be observed.
2. If handling the product releases hazardous substances or fuels that must be disposed of in a special way, e.g. coolants or engine oils that must be replenished regularly, the safety instructions of the manufacturer of the hazardous substances or fuels and the applicable regional waste disposal regulations must be observed. Also observe the relevant safety instructions in the product documentation. The improper disposal of hazardous substances or fuels can cause health problems and lead to environmental damage.

Informaciones elementales de seguridad

Es imprescindible leer y observar las siguientes instrucciones e informaciones de seguridad!

El principio del grupo de empresas Rohde & Schwarz consiste en tener nuestros productos siempre al día con los estándares de seguridad y de ofrecer a nuestros clientes el máximo grado de seguridad. Nuestros productos y todos los equipos adicionales son siempre fabricados y examinados según las normas de seguridad vigentes. Nuestro sistema de garantía de calidad controla constantemente que sean cumplidas estas normas. El presente producto ha sido fabricado y examinado según el certificado de conformidad adjunto de la UE y ha salido de nuestra planta en estado impecable según los estándares técnicos de seguridad. Para poder preservar este estado y garantizar un funcionamiento libre de peligros, el usuario deberá atenerse a todas las indicaciones, informaciones de seguridad y notas de alerta. El grupo de empresas Rohde & Schwarz está siempre a su disposición en caso de que tengan preguntas referentes a estas informaciones de seguridad.

Además queda en la responsabilidad del usuario utilizar el producto en la forma debida. Este producto está destinado exclusivamente al uso en la industria y el laboratorio o, si ha sido expresamente autorizado, para aplicaciones de campo y de ninguna manera deberá ser utilizado de modo que alguna persona/cosa pueda sufrir daño. El uso del producto fuera de sus fines definidos o sin tener en cuenta las instrucciones del fabricante queda en la responsabilidad del usuario. El fabricante no se hace en ninguna forma responsable de consecuencias a causa del mal uso del producto.







Informaciones elementales de seguridad

Se parte del uso correcto del producto para los fines definidos si el producto es utilizado conforme a las indicaciones de la correspondiente documentación del producto y dentro del margen de rendimiento definido (ver hoja de datos, documentación, informaciones de seguridad que siguen). El uso del producto hace necesarios conocimientos técnicos y ciertos conocimientos del idioma inglés. Por eso se debe tener en cuenta que el producto solo pueda ser operado por personal especializado o personas instruidas en profundidad con las capacidades correspondientes. Si fuera necesaria indumentaria de seguridad para el uso de productos de Rohde & Schwarz, encontraría la información debida en la documentación del producto en el capítulo correspondiente. Guarde bien las informaciones de seguridad elementales, así como la documentación del producto, y entréguelas a usuarios posteriores.

Tener en cuenta las informaciones de seguridad sirve para evitar en lo posible lesiones o daños por peligros de toda clase. Por eso es imprescindible leer detalladamente y comprender por completo las siguientes informaciones de seguridad antes de usar el producto, y respetarlas durante el uso del producto. Deberán tenerse en cuenta todas las demás informaciones de seguridad, como p. ej. las referentes a la protección de personas, que encontrarán en el capítulo correspondiente de la documentación del producto y que también son de obligado cumplimiento. En las presentes informaciones de seguridad se recogen todos los objetos que distribuye el grupo de empresas Rohde & Schwarz bajo la denominación de "producto", entre ellos también aparatos, instalaciones así como toda clase de accesorios.

Símbolos y definiciones de seguridad

							
Aviso: punto de peligro general Observar la documentación del producto	Atención en el manejo de dispositivos de peso elevado	Peligro de choque eléctrico	Advertencia: superficie caliente	Conexión a conductor de protección	Conexión a tierra	Conexión a masa	Aviso: Cuidado en el manejo de dispositivos sensibles a la electrostática (ESD)

					
Tensión de alimentación de PUESTA EN MARCHA / PARADA	Indicación de estado de espera (Standby)	Corriente continua (DC)	Corriente alterna (AC)	Corriente continua / Corriente alterna (DC/AC)	El aparato está protegido en su totalidad por un aislamiento doble (reforzado)

Palabras de señal y su significado

En la documentación del producto se utilizan las siguientes palabras de señal con el fin de advertir contra riesgos y peligros.



PELIGRO identifica un peligro inminente con riesgo elevado que provocará muerte o lesiones graves si no se evita.



ADVERTENCIA identifica un posible peligro con riesgo medio de provocar muerte o lesiones (graves) si no se evita.



ATENCIÓN identifica un peligro con riesgo reducido de provocar lesiones leves o moderadas si no se evita.



AVISO indica la posibilidad de utilizar mal el producto y, como consecuencia, dañarlo.

En la documentación del producto se emplea de forma sinónima el término CUIDADO.

Las palabras de señal corresponden a la definición habitual para aplicaciones civiles en el área económica europea. Pueden existir definiciones diferentes a esta definición en otras áreas económicas o en aplicaciones militares. Por eso se deberá tener en cuenta que las palabras de señal aquí descritas sean utilizadas siempre solamente en combinación con la correspondiente documentación del producto y solamente en combinación con el producto correspondiente. La utilización de las palabras de señal en combinación con productos o documentaciones que no les correspondan puede llevar a interpretaciones equivocadas y tener por consecuencia daños en personas u objetos.

Estados operativos y posiciones de funcionamiento

El producto solamente debe ser utilizado según lo indicado por el fabricante respecto a los estados operativos y posiciones de funcionamiento sin que se obstruya la ventilación. Si no se siguen las indicaciones del fabricante, pueden producirse choques eléctricos, incendios y/o lesiones graves con posible consecuencia de muerte. En todos los trabajos deberán ser tenidas en cuenta las normas nacionales y locales de seguridad del trabajo y de prevención de accidentes.

1. Si no se convino de otra manera, es para los productos Rohde & Schwarz válido lo que sigue: como posición de funcionamiento se define por principio la posición con el suelo de la caja para abajo, modo de protección IP 2X, grado de suciedad 2, categoría de sobrecarga eléctrica 2, uso solamente en estancias interiores, utilización hasta 2000 m sobre el nivel del mar, transporte hasta 4500 m sobre el nivel del mar. Se aplicará una tolerancia de $\pm 10\%$ sobre el voltaje nominal y de $\pm 5\%$ sobre la frecuencia nominal.
2. No sitúe el producto encima de superficies, vehículos, estantes o mesas, que por sus características de peso o de estabilidad no sean aptos para él. Siga siempre las instrucciones de instalación del fabricante cuando instale y asegure el producto en objetos o estructuras (p. ej. paredes y estantes). Si se realiza la instalación de modo distinto al indicado en la documentación del producto, pueden causarse lesiones o incluso la muerte.
3. No ponga el producto sobre aparatos que generen calor (p. ej. radiadores o calefactores). La temperatura ambiente no debe superar la temperatura máxima especificada en la documentación del producto o en la hoja de datos. En caso de sobrecalentamiento del producto, pueden producirse choques eléctricos, incendios y/o lesiones graves con posible consecuencia de muerte.

Seguridad eléctrica

Si no se siguen (o se siguen de modo insuficiente) las indicaciones del fabricante en cuanto a seguridad eléctrica, pueden producirse choques eléctricos, incendios y/o lesiones graves con posible consecuencia de muerte.

1. Antes de la puesta en marcha del producto se deberá comprobar siempre que la tensión preseleccionada en el producto coincida con la de la red de alimentación eléctrica. Si es necesario modificar el ajuste de tensión, también se deberán cambiar en caso dado los fusibles correspondientes del producto.
2. Los productos de la clase de protección I con alimentación móvil y enchufe individual solamente podrán enchufarse a tomas de corriente con contacto de seguridad y con conductor de protección conectado.
3. Queda prohibida la interrupción intencionada del conductor de protección, tanto en la toma de corriente como en el mismo producto. La interrupción puede tener como consecuencia el riesgo de que el producto sea fuente de choques eléctricos. Si se utilizan cables alargadores o regletas de enchufe, deberá garantizarse la realización de un examen regular de los mismos en cuanto a su estado técnico de seguridad.
4. Si el producto no está equipado con un interruptor para desconectarlo de la red, se deberá considerar el enchufe del cable de conexión como interruptor. En estos casos se deberá asegurar que el enchufe siempre sea de fácil acceso (de acuerdo con la longitud del cable de conexión, aproximadamente 2 m). Los interruptores de función o electrónicos no son aptos para el corte de la red eléctrica. Si los productos sin interruptor están integrados en bastidores o instalaciones, se deberá colocar el interruptor en el nivel de la instalación.
5. No utilice nunca el producto si está dañado el cable de conexión a red. Compruebe regularmente el correcto estado de los cables de conexión a red. Asegúrese, mediante las medidas de protección y de instalación adecuadas, de que el cable de conexión a red no pueda ser dañado o de que nadie pueda ser dañado por él, p. ej. al tropezar o por un choque eléctrico.
6. Solamente está permitido el funcionamiento en redes de alimentación TN/TT aseguradas con fusibles de 16 A como máximo (utilización de fusibles de mayor amperaje solo previa consulta con el grupo de empresas Rohde & Schwarz).
7. Nunca conecte el enchufe en tomas de corriente sucias o llenas de polvo. Introduzca el enchufe por completo y fuertemente en la toma de corriente. La no observación de estas medidas puede provocar chispas, fuego y/o lesiones.
8. No sobrecargue las tomas de corriente, los cables alargadores o las regletas de enchufe ya que esto podría causar fuego o choques eléctricos.
9. En las mediciones en circuitos de corriente con una tensión $U_{\text{eff}} > 30 \text{ V}$ se deberán tomar las medidas apropiadas para impedir cualquier peligro (p. ej. medios de medición adecuados, seguros, limitación de tensión, corte protector, aislamiento etc.).
10. Para la conexión con dispositivos informáticos como un PC o un ordenador industrial, debe comprobarse que éstos cumplan los estándares IEC60950-1/EN60950-1 o IEC61010-1/EN 61010-1 válidos en cada caso.
11. A menos que esté permitido expresamente, no retire nunca la tapa ni componentes de la carcasa mientras el producto esté en servicio. Esto pone a descubierto los cables y componentes eléctricos y puede causar lesiones, fuego o daños en el producto.

Informaciones elementales de seguridad

12. Si un producto se instala en un lugar fijo, se deberá primero conectar el conductor de protección fijo con el conductor de protección del producto antes de hacer cualquier otra conexión. La instalación y la conexión deberán ser efectuadas por un electricista especializado.
13. En el caso de dispositivos fijos que no estén provistos de fusibles, interruptor automático ni otros mecanismos de seguridad similares, el circuito de alimentación debe estar protegido de modo que todas las personas que puedan acceder al producto, así como el producto mismo, estén a salvo de posibles daños.
14. Todo producto debe estar protegido contra sobretensión (debida p. ej. a una caída del rayo) mediante los correspondientes sistemas de protección. Si no, el personal que lo utilice quedará expuesto al peligro de choque eléctrico.
15. No debe introducirse en los orificios de la caja del aparato ningún objeto que no esté destinado a ello. Esto puede producir cortocircuitos en el producto y/o puede causar choques eléctricos, fuego o lesiones.
16. Salvo indicación contraria, los productos no están impermeabilizados (ver también el capítulo "Estados operativos y posiciones de funcionamiento", punto 1). Por eso es necesario tomar las medidas necesarias para evitar la entrada de líquidos. En caso contrario, existe peligro de choque eléctrico para el usuario o de daños en el producto, que también pueden redundar en peligro para las personas.
17. No utilice el producto en condiciones en las que pueda producirse o ya se hayan producido condensaciones sobre el producto o en el interior de éste, como p. ej. al desplazarlo de un lugar frío a otro caliente. La entrada de agua aumenta el riesgo de choque eléctrico.
18. Antes de la limpieza, desconecte por completo el producto de la alimentación de tensión (p. ej. red de alimentación o batería). Realice la limpieza de los aparatos con un paño suave, que no se deshilache. No utilice bajo ningún concepto productos de limpieza químicos como alcohol, acetona o diluyentes para lacas nitrocelulósicas.

Funcionamiento

1. El uso del producto requiere instrucciones especiales y una alta concentración durante el manejo. Debe asegurarse que las personas que manejen el producto estén a la altura de los requerimientos necesarios en cuanto a aptitudes físicas, psíquicas y emocionales, ya que de otra manera no se pueden excluir lesiones o daños de objetos. El empresario u operador es responsable de seleccionar el personal usuario apto para el manejo del producto.
2. Antes de desplazar o transportar el producto, lea y tenga en cuenta el capítulo "Transporte".
3. Como con todo producto de fabricación industrial no puede quedar excluida en general la posibilidad de que se produzcan alergias provocadas por algunos materiales empleados, los llamados alérgenos (p. ej. el níquel). Si durante el manejo de productos Rohde & Schwarz se producen reacciones alérgicas, como p. ej. irritaciones cutáneas, estornudos continuos, enrojecimiento de la conjuntiva o dificultades respiratorias, debe avisarse inmediatamente a un médico para investigar las causas y evitar cualquier molestia o daño a la salud.
4. Antes de la manipulación mecánica y/o térmica o el desmontaje del producto, debe tenerse en cuenta imprescindiblemente el capítulo "Eliminación", punto 1.

5. Ciertos productos, como p. ej. las instalaciones de radiocomunicación RF, pueden a causa de su función natural, emitir una radiación electromagnética aumentada. Deben tomarse todas las medidas necesarias para la protección de las mujeres embarazadas. También las personas con marcapasos pueden correr peligro a causa de la radiación electromagnética. El empresario/operador tiene la obligación de evaluar y señalar las áreas de trabajo en las que exista un riesgo elevado de exposición a radiaciones.
6. Tenga en cuenta que en caso de incendio pueden desprenderse del producto sustancias tóxicas (gases, líquidos etc.) que pueden generar daños a la salud. Por eso, en caso de incendio deben usarse medidas adecuadas, como p. ej. máscaras antigás e indumentaria de protección.
7. En caso de que un producto Rohde & Schwarz contenga un producto láser (p. ej. un lector de CD/DVD), no debe usarse ninguna otra configuración o función aparte de las descritas en la documentación del producto, a fin de evitar lesiones (p. ej. debidas a irradiación láser).

Reparación y mantenimiento

1. El producto solamente debe ser abierto por personal especializado con autorización para ello. Antes de manipular el producto o abrirlo, es obligatorio desconectarlo de la tensión de alimentación, para evitar toda posibilidad de choque eléctrico.
2. El ajuste, el cambio de partes, el mantenimiento y la reparación deberán ser efectuadas solamente por electricistas autorizados por Rohde & Schwarz. Si se reponen partes con importancia para los aspectos de seguridad (p. ej. el enchufe, los transformadores o los fusibles), solamente podrán ser sustituidos por partes originales. Después de cada cambio de partes relevantes para la seguridad deberá realizarse un control de seguridad (control a primera vista, control del conductor de protección, medición de resistencia de aislamiento, medición de la corriente de fuga, control de funcionamiento). Con esto queda garantizada la seguridad del producto.

Baterías y acumuladores o celdas

Si no se siguen (o se siguen de modo insuficiente) las indicaciones en cuanto a las baterías y acumuladores o celdas, pueden producirse explosiones, incendios y/o lesiones graves con posible consecuencia de muerte. El manejo de baterías y acumuladores con electrolitos alcalinos (p. ej. celdas de litio) debe seguir el estándar EN 62133.

1. No deben desmontarse, abrirse ni triturarse las celdas.
2. Las celdas o baterías no deben someterse a calor ni fuego. Debe evitarse el almacenamiento a la luz directa del sol. Las celdas y baterías deben mantenerse limpias y secas. Limpiar las conexiones sucias con un paño seco y limpio.
3. Las celdas o baterías no deben cortocircuitarse. Es peligroso almacenar las celdas o baterías en estuches o cajones en cuyo interior puedan cortocircuitarse por contacto recíproco o por contacto con otros materiales conductores. No deben extraerse las celdas o baterías de sus embalajes originales hasta el momento en que vayan a utilizarse.
4. Mantener baterías y celdas fuera del alcance de los niños. En caso de ingestión de una celda o batería, avisar inmediatamente a un médico.
5. Las celdas o baterías no deben someterse a impactos mecánicos fuertes indebidos.

Informaciones elementales de seguridad

6. En caso de falta de estanqueidad de una celda, el líquido vertido no debe entrar en contacto con la piel ni los ojos. Si se produce contacto, lavar con agua abundante la zona afectada y avisar a un médico.
7. En caso de cambio o recarga inadecuados, las celdas o baterías que contienen electrolitos alcalinos (p. ej. las celdas de litio) pueden explotar. Para garantizar la seguridad del producto, las celdas o baterías solo deben ser sustituidas por el tipo Rohde & Schwarz correspondiente (ver lista de recambios).
8. Las baterías y celdas deben reciclarse y no deben tirarse a la basura doméstica. Las baterías o acumuladores que contienen plomo, mercurio o cadmio deben tratarse como residuos especiales. Respete en esta relación las normas nacionales de eliminación y reciclaje.

Transporte

1. El producto puede tener un peso elevado. Por eso es necesario desplazarlo o transportarlo con precaución y, si es necesario, usando un sistema de elevación adecuado (p. ej. una carretilla elevadora), a fin de evitar lesiones en la espalda u otros daños personales.
2. Las asas instaladas en los productos sirven solamente de ayuda para el transporte del producto por personas. Por eso no está permitido utilizar las asas para la sujeción en o sobre medios de transporte como p. ej. grúas, carretillas elevadoras de horquilla, carros etc. Es responsabilidad suya fijar los productos de manera segura a los medios de transporte o elevación. Para evitar daños personales o daños en el producto, siga las instrucciones de seguridad del fabricante del medio de transporte o elevación utilizado.
3. Si se utiliza el producto dentro de un vehículo, recae de manera exclusiva en el conductor la responsabilidad de conducir el vehículo de manera segura y adecuada. El fabricante no asumirá ninguna responsabilidad por accidentes o colisiones. No utilice nunca el producto dentro de un vehículo en movimiento si esto pudiera distraer al conductor. Asegure el producto dentro del vehículo debidamente para evitar, en caso de un accidente, lesiones u otra clase de daños.

Eliminación

1. Si se trabaja de manera mecánica y/o térmica cualquier producto o componente más allá del funcionamiento previsto, pueden liberarse sustancias peligrosas (polveros con contenido de metales pesados como p. ej. plomo, berilio o níquel). Por eso el producto solo debe ser desmontado por personal especializado con formación adecuada. Un desmontaje inadecuado puede ocasionar daños para la salud. Se deben tener en cuenta las directivas nacionales referentes a la eliminación de residuos.
2. En caso de que durante el trato del producto se formen sustancias peligrosas o combustibles que deban tratarse como residuos especiales (p. ej. refrigerantes o aceites de motor con intervalos de cambio definidos), deben tenerse en cuenta las indicaciones de seguridad del fabricante de dichas sustancias y las normas regionales de eliminación de residuos. Tenga en cuenta también en caso necesario las indicaciones de seguridad especiales contenidas en la documentación del producto. La eliminación incorrecta de sustancias peligrosas o combustibles puede causar daños a la salud o daños al medio ambiente.

Kundeninformation zur Batterieverordnung (BattV)

Dieses Gerät enthält eine schadstoffhaltige Batterie. Diese darf nicht mit dem Hausmüll entsorgt werden.

Nach Ende der Lebensdauer darf die Entsorgung nur über eine Rohde&Schwarz-Kundendienststelle oder eine geeignete Sammelstelle erfolgen.

Safety Regulations for Batteries (according to BattV)

This equipment houses a battery containing harmful substances that must not be disposed of as normal household waste.

After its useful life, the battery may only be disposed of at a Rohde & Schwarz service center or at a suitable depot.

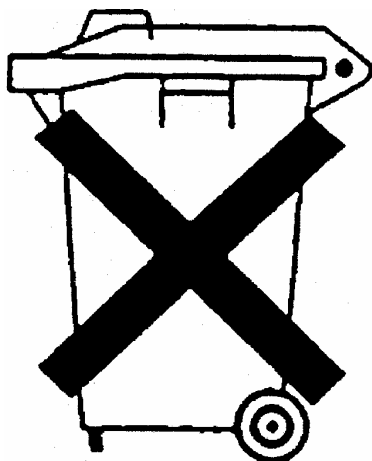

Normas de Seguridad para Baterías (Según BattV)

Este equipo lleva una batería que contiene sustancias perjudiciales, que no se debe desechar en los contenedores de basura domésticos.

Después de la vida útil, la batería sólo se podrá eliminar en un centro de servicio de Rohde & Schwarz o en un depósito apropiado.

Consignes de sécurité pour batteries (selon BattV)

Cet appareil est équipé d'une pile comprenant des substances nocives. Ne jamais la jeter dans une poubelle pour ordures ménagères.

Une pile usagée doit uniquement être éliminée par un centre de service client de Rohde & Schwarz ou peut être collectée pour être traitée spécialement comme déchets dangereux.

Customer Information Regarding Product Disposal

The German Electrical and Electronic Equipment (ElektroG) Act is an implementation of the following EC directives:

- 2002/96/EC on waste electrical and electronic equipment (WEEE) and
- 2002/95/EC on the restriction of the use of certain hazardous substances in electrical and electronic equipment (RoHS).

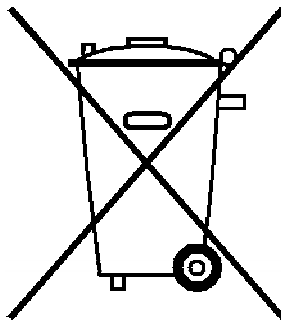

Product labeling in accordance with EN 50419

Once the lifetime of a product has ended, this product must not be disposed of in the standard domestic refuse. Even disposal via the municipal collection points for waste electrical and electronic equipment is not permitted.

Rohde & Schwarz GmbH & Co. KG has developed a disposal concept for the environmental-friendly disposal or recycling of waste material and fully assumes its obligation as a producer to take back and dispose of electrical and electronic waste in accordance with the ElektroG Act.

Please contact your local service representative to dispose of the product.



Certified Quality System

DIN EN ISO 9001 : 2000
DIN EN 9100 : 2003
DIN EN ISO 14001 : 2004

DQS REG. NO 001954 QM UM

QUALITÄTSZERTIFIKAT

Sehr geehrter Kunde,
Sie haben sich für den Kauf eines Rohde & Schwarz-Produktes entschieden. Hiermit erhalten Sie ein nach modernsten Fertigungsmethoden hergestelltes Produkt. Es wurde nach den Regeln unseres Managementsystems entwickelt, gefertigt und geprüft.
Das Rohde & Schwarz Managementsystem ist zertifiziert nach:

DIN EN ISO 9001:2000
DIN EN 9100:2003
DIN EN ISO 14001:2004

CERTIFICATE OF QUALITY

Dear Customer,
you have decided to buy a Rohde & Schwarz product. You are thus assured of receiving a product that is manufactured using the most modern methods available. This product was developed, manufactured and tested in compliance with our quality management system standards.
The Rohde & Schwarz quality management system is certified according to:

DIN EN ISO 9001:2000
DIN EN 9100:2003
DIN EN ISO 14001:2004

CERTIFICAT DE QUALITÉ

Cher Client,
vous avez choisi d'acheter un produit Rohde & Schwarz. Vous disposez donc d'un produit fabriqué d'après les méthodes les plus avancées. Le développement, la fabrication et les tests respectent nos normes de gestion qualité.
Le système de gestion qualité de Rohde & Schwarz a été homologué conformément aux normes:

DIN EN ISO 9001:2000
DIN EN 9100:2003
DIN EN ISO 14001:2004



Customer Support

Technical support – where and when you need it

For quick, expert help with any Rohde & Schwarz equipment, contact one of our Customer Support Centers. A team of highly qualified engineers provides telephone support and will work with you to find a solution to your query on any aspect of the operation, programming or applications of Rohde & Schwarz equipment.

Up-to-date information and upgrades

To keep your instrument up-to-date and to be informed about new application notes related to your instrument, please send an e-mail to the Customer Support Center stating your instrument and your wish. We will take care that you will get the right information.

Europe, Africa, Middle East

Phone +49 89 4129 12345
customersupport@rohde-schwarz.com

North America

Phone 1-888-TEST-RSA (1-888-837-8772)
customer.support@rsa.rohde-schwarz.com

Latin America

Phone +1-410-910-7988
customersupport.la@rohde-schwarz.com

Asia/Pacific

Phone +65 65 13 04 88
customersupport.asia@rohde-schwarz.com



Table of Contents

1	Preparing for Use	11
1.1	Front Panel Tour	11
1.1.1	Display	12
1.1.2	Setup Keys.....	12
1.1.3	Function Keys	13
1.1.4	Navigation Keys.....	14
1.1.5	Data Entry Keys.....	15
1.1.6	Rotary Knob	16
1.1.7	Power On/Off Key.....	16
1.1.8	Test Ports	17
1.1.9	USB Connectors	17
1.1.10	PROBE POWER.....	18
1.2	Rear Panel Tour	19
1.3	Putting the Instrument into Operation	21
1.3.1	Unpacking the Instrument and Checking the Shipment	21
1.3.2	Instrument Setup.....	22
1.3.3	Bench Top Operation	22
1.3.4	Mounting in a 19" Rack.....	23
1.3.5	EMI Protective Measures.....	23
1.3.6	Power Supply Options	23
1.3.7	Connecting the Instrument to the AC Supply.....	24
1.3.8	Power on and off.....	24
1.3.9	Instrument States with AC Power Supply	24
1.3.10	Replacing Fuses	25
1.3.11	DC Power Supply and Battery	26
1.3.12	Charging the Battery	27
1.4	Maintenance	28
1.4.1	Storing and Packing.....	28
1.5	Starting and Shutting down the Analyzer	29
1.6	Connecting External Accessories	30
1.6.1	Connecting a Mouse	30

1.6.2	Connecting a Keyboard	30
1.6.3	Connecting a Printer	31
1.6.4	Connecting a Monitor	32
1.6.5	Connecting a LAN Cable	32
1.7	Remote Control in a LAN	34
1.7.1	Assigning an IP Address	34
1.7.2	Remote Desktop Connection	36
1.8	Windows XP	37
1.8.1	Accessing Windows XP's Start Menu	37
1.9	Firmware Update	38
1.9.1	Operation with and without Administrator Rights	39

1 Preparing for Use

This chapter gives an overview of the front panel controls and connectors of the network analyzer and gives all information that is necessary to put the instrument into operation and connect external devices. Notes on reinstallation of the analyzer software appear at the end of the chapter.

CAUTION

Please make sure to observe the instructions of the following sections so that you cannot endanger people or cause damage to the instrument. This is of particular importance when you use the instrument for the first time. Also observe the general safety instructions at the beginning of this manual.

Chapter 2 of this manual provides an introduction to the operation of the analyzer by means of typical configuration and measurement examples; for a description of the operating concept and an overview of the instrument's capabilities refer to Chapter 3. For all reference information concerning manual and remote control of the instrument refer to the online help system or its printed/printable version. A more detailed description of the hardware connectors and interfaces is also part of the help system.

1.1 Front Panel Tour

The front panel of the network analyzer consists of the VGA display with the softkey area, the hardkey areas, and the connectors area. Brief explanations on the controls and connectors, the hardkey area and the rear panel can be found on the next pages.

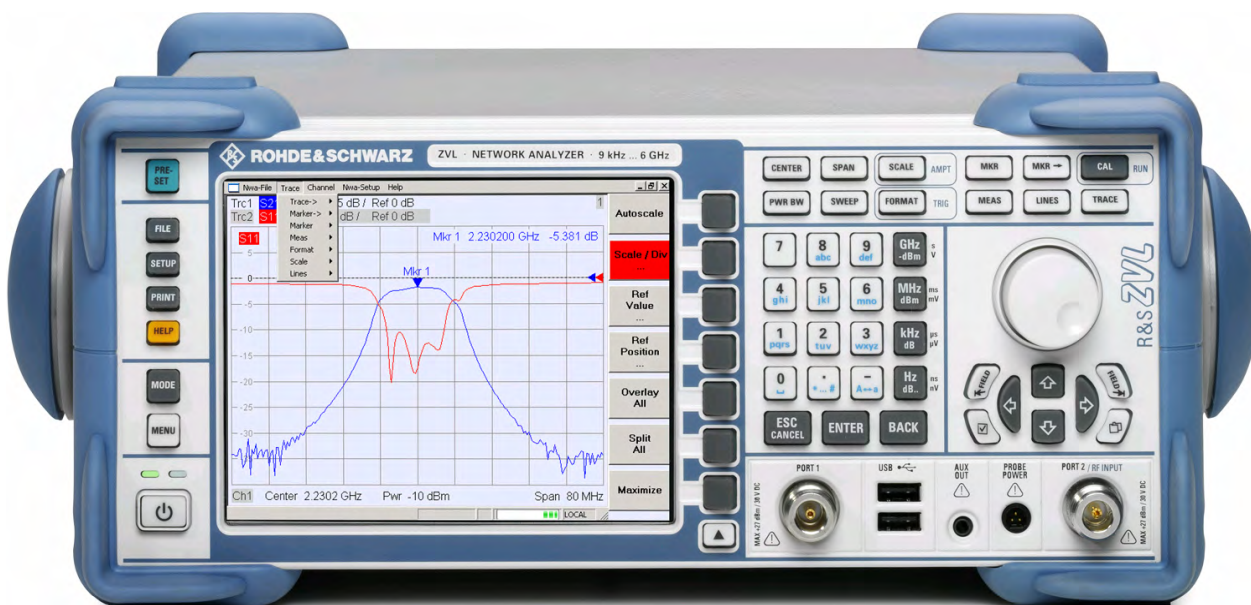

1.1.1 Display

The analyzer is equipped with a color display providing all control elements for the measurements and the diagram areas for the results.

- Refer to section *Navigation Tools of the Screen* in Chapter 3 to learn how to use menus, keys and softkeys.
- Refer to section *Display Elements* in Chapter 3 to obtain information about the results in the diagram area.
- Refer to section *Display Menu* in the online help system and learn how to customize the screen.
- Refer to the data sheet for the technical specifications of the display.



Screen saver

The screen saver function of the operating system switches off the display if the analyzer receives no command for more than a specified period of time. It is switched on again if any front panel key is pressed. To change the screen saver properties, press *SETUP – General Setup – More – Open Start Menu* (or connect an external keyboard and press CTRL + ESC) to open the start menu, and click Control Panel – Display – Screen Saver.

1.1.2 Setup Keys

The front panel keys to the left of the display provide utility functions, assistance, and alternative measurement modes. Some of the keys are related to the spectrum analyzer mode (with option R&S ZVL-K1), irrespective of the active mode.

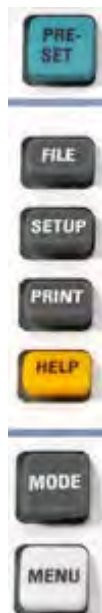

- PRESET performs a general factory preset or user preset, depending on the "Preset Scope" selected in the System Configuration menu.
- FILE provides standard Windows™ functions to create, save, and recall spectrum analyzer settings and results. For detailed information refer to the spectrum analyzer help system (HELP). Alternatively, use the functions in the Nwa-File menu of the network analyzer mode.
- SETUP provides basic instrument configurations. For detailed information refer to the spectrum analyzer help system (HELP). Alternatively, use the functions in the Nwa-Setup menu of the network analyzer mode, in particular the System Config. settings.
- PRINT customizes the printout, selects and configures the printer. For detailed information refer to the spectrum analyzer help system (HELP). Alternatively, use the functions in the Nwa-File menu of the network analyzer mode
- HELP calls the help system, depending on the active context. The network analyzer and spectrum analyzer modes are

described in two separate help systems.

- MODE opens a dialog to switch between the network analyzer and spectrum analyzer modes.
- MENU activates the highest softkey menu level of the current spectrum analyzer context. For detailed information refer to the spectrum analyzer help system (HELP). In network analyzer mode, use the Function Keys or the menus across the top of the main application window.

1.1.3 Function Keys

The keys in the upper right part of the front panel provide direct access to the most important measurement settings. Each key opens a drop-down menu (softkey menu) or activates a menu command (softkey) of the graphical user interface. The softkeys are hidden after a while to make room for the display and the measurement results.

The links in the short descriptions below will take you to the detailed description for the network analyzer mode. If the spectrum analyzer option (R&S ZVL-K1) is active, the keys have a similar function. The network analyzer keys SCALE, FORMAT, and CAL have no direct equivalent in spectrum analysis; they are replaced by the AMPT, TRIG, and RUN keys, respectively.



- CENTER or SPAN define the center frequency and the width of the sweep range.
- SCALE defines how the current trace is presented in the diagram. If the spectrum analyzer option (R&S ZVL-K1) is active, the key provides additional functions affecting the displayed signal amplitude (AMPT).
- PWR BW defines the power of the internal signal source, sets the step attenuators and the IF bandwidths.
- SWEEP defines the scope of measurement, including the sweep type, the number of points, the measurement delay and the periodicity of the measurement.
- FORMAT defines how the measured data is presented in the graphical display. If the spectrum analyzer option (R&S ZVL-K1) is active, the key provides trigger settings (TRIG).



- MKR positions markers on a trace, configures their properties and selects the format of the numerical readout.
- MARKER-> provides marker functions that allow you to search for values on traces, define the sweep range, scale the diagram, and introduce an electrical length offset.

- CAL provides all functions that are necessary to perform a system error correction (calibration). If the spectrum analyzer option (R&S ZVL-K1) is active, the key starts a new measurement (RUN).
- MEAS selects the quantity to be measured and displayed.
- LINES defines limits for measured values and activates the limit check.
- TRACE provides functions to handle traces in diagram areas, evaluate trace statistics, and store trace data.

1.1.4 Navigation Keys

The navigation keys below the rotary knob are used to navigate within the analyzer screen and the Help system, to access and control active elements.

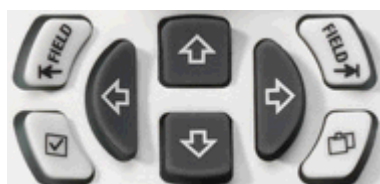

The *Left Field* (= Tab) or *Right Field* (= Shift Tab) keys switch between several active elements in dialogs and panes, e.g. in order to access:



- All control elements (e.g. buttons, numerical or text input fields, radio buttons, checkmarks, combo boxes etc.) in a dialog
- All links in a Help topic (not possible with the rotary knob)



The *Cursor Up* and *Cursor Down* keys are used to:

- Scroll up and down in lists, e.g. in pull-down lists, among menu items, in a list of keywords, in the Help table of contents, or in the Help topic text



- Increase and decrease numeric input values

Cursor Up (*Down*) become inactive or switches to the previous (next) dialog element as soon as the beginning of the list is reached. *Cursor Up* (*Down*) is equivalent to a rotation of the rotary knob to the right (left).



The *Cursor Left* and *Cursor Right* keys are used to:

- Move the cursor to the left or right within input fields
- Compress or expand menus or the Help table of contents
- Access the previous (next) menu in the menu bar



The *Checkmark* (= Space) key can be used to

- Insert a space character into character entry fields
- Switch a checkmark control in a dialog on or off
- Activate the selected active control element, e.g. a button in a

dialog or a link in the Help system

- Scroll down in Help topic

The *Next Tab* key opens the next tab of a dialog, e.g. in the Help navigation pane or in some of the spectrum analyzer dialogs.

1.1.5 Data Entry Keys

The data entry keys are used to enter numbers and units.



Key activation

The data entry keys are only enabled while the cursor is placed on a data input field in a dialog or in the Help navigation pane.



The keys 0 to 9 enter the corresponding numbers. In addition, these keys can be used to insert characters in character input fields; see section Data Entry in chapter 2.



The function of the . and – keys depends on the data type of the active input field:

- In numeric input fields, the keys enter the decimal point and change the sign of the entered numeric value. Multiple decimal points are not allowed; pressing – for a second time cancels the effect of the first entry.
- In character input fields, the keys enter a dot and a hyphen, respectively. Both entries can be repeated as often as desired.



The function of the four unit keys depends on the data type of the active input field; see Data Entry section in Chapter 3.

- In numeric input fields (e.g. in the numeric entry bar), the *GHz / -dBm*, *MHz / dBm*, *kHz / dB* or *Hz / dB..* keys multiply the entered value with factors of $10^{(-)9}$, $10^{(-)6}$, $10^{(-)3}$ or 1 and add the appropriate physical unit.



- In character input fields, the keys are inactive.

ENTER is used to:

- Activate the selected active control element, e.g. a button in a dialog or a link in the Help
- Confirm selections and entries made and close dialogs



ENTER is equivalent to pressing the rotary knob.



The ESC CANCEL key is used to:

- Close dialogs without activating the entries made (equivalent to the *Close* button)
- Close the Help



BACK deletes the last character before the cursor position or the selected character sequence. If an entire numeric value is selected, BACK deletes the whole entry.

1.1.6 Rotary Knob

The rotary knob can be turned in both directions or pressed.



Turning the rotary knob is equivalent to the action of the cursor up and down keys. Turn the knob in order to

- Increase or decrease numerical values
- Scroll within lists
- Switch to the previous or next dialog element
- Pressing the rotary knob is equivalent to the action of the ENTER key. Press the knob in order to:
 - Activate the selected active control element, e.g. a button in a dialog or a link in the Help
 - Confirm selections and entries made and close dialogs

1.1.7 Power On/Off Key

The power on/off toggle switch is located in the bottom left corner of the front panel.



The key serves two main purposes:

- Save settings, shut down and switch off.

- Toggle between standby and ready state, if the instrument is AC-supplied and appropriately configured.

1.1.8 Test Ports

N-connectors labelled PORT 1 and PORT 2/ RF INPUT. The test ports serve as outputs for the RF stimulus signal and as inputs for the measured RF signals from the DUT (response signals).

- With a single test port, it is possible to generate a stimulus signal and measure the response signal in reflection.
- With 2 test ports, it is possible to perform full two-port measurements; see S-Parameters section in Chapter 3.
- The two network analyzer ports are equivalent. If the Spectrum Analysis option (R&S ZVL-K1) is active, test port PORT 2 serves as an AC-coupled input for the analyzed RF signal; PORT 1 is not used.



NOTICE

Input levels

The maximum input levels at all test ports according to the front panel labeling or the data sheet must not be exceeded.

In addition, the maximum input voltages of the other input connectors at the front and rear panel must not be exceeded.

1.1.9 USB Connectors

Two single Universal Serial Bus connectors of type A (master USB), used to connect a keyboard (recommended: PSL-Z2, order number 1157.6870.03), mouse (recommended: PSL-Z10, order number 1157.7060.03) or other pointing devices, the Calibration Unit (accessory R&S ZV-Z5x), a printer or an external storage device (USB stick, CD-ROM drive etc.).

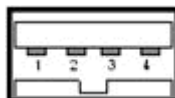

Using an adapter cable (R&S NRP-Z4), a power sensor can be connected, as an alternative to the power sensor connector on the rear panel that is only available with option Additional Interfaces, R&S FSL-B5.

**EMI conformity, cable length**

For maintaining the EMI conformity of the R&S ZVL only appropriate USB accessories may be used.

Passive connecting USB cables should not exceed 4 m in length. Use the original USB connecting cable or another high-quality cable. The maximum current per USB port is 500 mA.

1.1.10 PROBE POWER

Connector for supply voltages of +15 V to –12 V and ground for active probes and preamplifiers. A maximum current of 140 mA is available. This connector is suitable as power supply for high-impedance probes from Agilent.

1.2 Rear Panel Tour

This section gives an overview of the rear panel controls and connectors of the network analyzer.



The following rear panel connectors require special attention:

- The (fuse-protected) mains connector in the lower left corner is used to connect the analyzer to the AC power supply; see *Power on and off*.
- The *DC power supply* connector and the *Battery Pack* are alternatives for the AC power supply via the mains connector; see *DC Power Supply and Battery*.
- *LAN* is used to connect the analyzer to a Local Area Network; see *Remote Operation in a LAN*.

The remaining rear connectors are described in detail in the annex *Hardware Interfaces* in the online help system.

- *EXT. TRIGGER / GATE IN* is an input for external TTL trigger signals.
- *EXT REF* serves as an input for an external 10 MHz reference signal.

The following connectors require additional hardware options (see rear panel labeling):

- *POWER SENSOR* is used for connecting power sensors of the R&S NRP-Zxy family.
- *Noise Source Control* provides the supply voltage for an external noise source.
- *IF/VIDEO OUT* is an output for the IF signal or video signal.
- *AUX PORT* provides control signals for external devices.
- *OCXO* provides the internal 10 MHz reference signal, which may be used to synchronize external devices. The connector can be used as an input for external reference signals, too.
- *IEC Bus* is the GPIB bus connector (according to standard IEEE 488 / IEC 625).

NOTICE**Input levels, AUX PORT**

The maximum input levels and voltages of the input connectors at the front and rear panel must not be exceeded.

When using the AUX PORT, watch the pin assignment carefully. A short-circuit may damage the instrument.

1.3 Putting the Instrument into Operation

This section describes the basic steps to be taken when setting up the analyzer for the first time.

NOTICE

General safety instructions

Before turning on the instrument, please make sure that the following conditions are fulfilled:

- Instrument covers are in place and all fasteners are tightened.
- Fan openings are free from obstructions.
- Signal levels at the input connectors are all within the specified maxima.
- Signal outputs are correctly connected and not overloaded.
- The instrument is dry and shows no condensation.

Non-observance may cause damage to the instrument!

1.3.1 Unpacking the Instrument and Checking the Shipment

The instrument is shipped together with its mandatory accessories in a cardboard box. In order to unpack its contents proceed as follows:

1. Open the cardboard box.
2. Remove the accessories packed into the box and take the instrument out of the packaging.
3. Check the shipment against the list of accessories to ensure that all items are included.
4. Remove the two protective caps from the front and rear and carefully inspect the analyzer to make sure that it was not damaged during shipment.

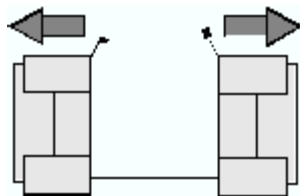

Should the instrument be damaged, immediately notify the forwarder who shipped the instrument to you and keep the container and packing material.

Equipment returned or sent in for repair must be packed in the original container or packing with electrostatic protection. It is recommended to keep at least the two protective caps for front and rear side in order to prevent damage to the controls and connectors.

1.3.2 Instrument Setup

The network analyzer is designed for use under laboratory conditions, either on a bench top or in a rack. The general ambient conditions required at the operating site are as follows:

- The ambient temperature must be in the ranges specified for operation and for compliance with specifications (see data sheet).
- All fan openings including the rear panel perforations must be unobstructed. The distance to the wall should be at least 10 cm.

NOTICE

Electrostatic discharge

To avoid damage of electronic components of the DUT and the analyzer, the operating site must be protected against electrostatic discharge (ESD). ESD is most likely to occur when you connect or disconnect a DUT or test fixture to the analyzer's test ports. To prevent ESD damage use a wrist strap and grounding cord and connect yourself to ground.

1.3.3 Bench Top Operation

If the analyzer is operated on a bench top, the surface should be flat.

In order to move the handle into the desired position, pull at both side knobs and turn the handle.

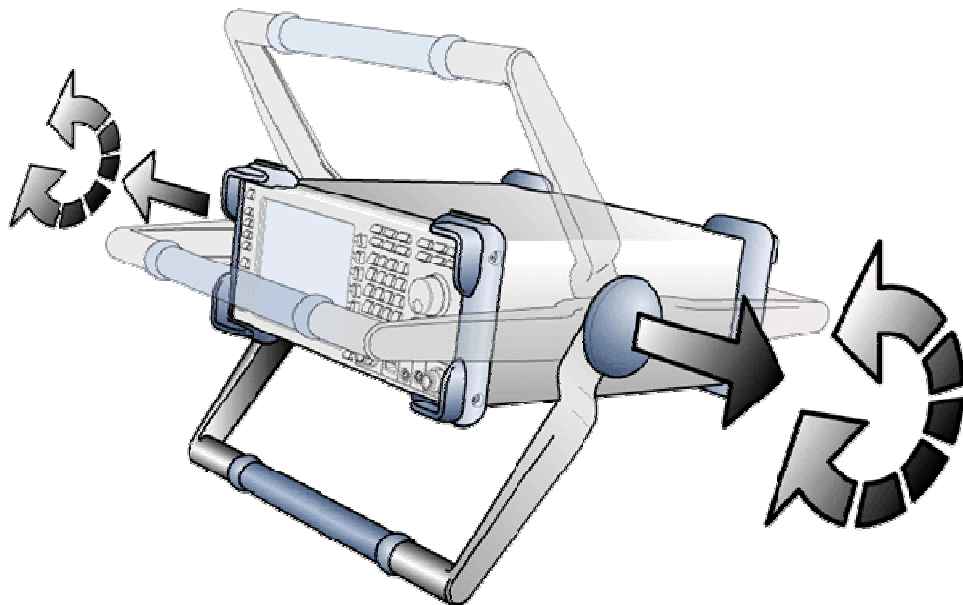

WARNING**Danger of injury**

To avoid injuries, place the instrument on a stable surface and do not stack other instruments or material on top of it.

1.3.4 Mounting in a 19" Rack

Using the adapter R&S ZZA-S334 (order no. 1109.4487.00) the instrument can be mounted in 19" racks according to the mounting instructions supplied with the rack adapter.

NOTICE

- Allow for sufficient air supply in the rack.
- Make sure that there is sufficient space between the ventilation holes and the rack casing.

1.3.5 EMI Protective Measures

In order to avoid electromagnetic interference, the instrument may only be operated when it is closed and with all shielding covers fitted. Only appropriate shielded signal and control cables may be used.

1.3.6 Power Supply Options

The R&S ZVL is equipped with an AC power supply connector. In order to use the analyzer independently from an AC power supply, it can be fitted with a DC power supply connector (option DC Power Supply, R&S FSL-B30) and/or a battery pack (option NIMH Battery Pack, R&S FSL-B31). Refer to DC Power Supply and Battery for further information.

From the available power supplies, the R&S ZVL selects the one to use according to the following priority scheme:

Priority	Power Supply
1	AC power supply
2	DC power supply
3	Battery

For example, if the R&S ZVL is connected to both an AC and a DC power supply, it uses the AC power supply. If it is suddenly disconnected from the AC power supply, it switches to the DC power supply.

1.3.7 Connecting the Instrument to the AC Supply

The network analyzer is automatically adapted to the AC supply voltage supplied. The supply voltage must be in the range 100 V to 240 V; 50 Hz to 60 Hz (see also the *General Data* section in the "Specifications"). The mains connector is located at the bottom left corner of the rear panel.

- ▶ Connect the network analyzer to the AC power source using the AC power cable delivered with the instrument.

Since the instrument is assembled in line with the specifications for safety class EN61010, it may only be connected to an outlet that has a ground contact.

The power consumption of the analyzer depends on the installed options (see "Specifications").

1.3.8 Power on and off

The mains connector is located at the bottom left corner of the rear panel.



- ▶ To turn the power on or off, press the AC power switch to position I (On) or 0 (Off). After power-on, the analyzer is booted and reaches its ready state.



The AC power switch can be permanently on. Switching off is required only if the instrument must be completely removed from the AC power supply.

1.3.9 Instrument States with AC Power Supply

The power on/off key is located in the bottom left corner of the front panel.



If the R&S ZVL is AC supplied the power on/off key switches between the following states:

- In the switched off state, both LEDs are off. The analyzer is completely disconnected from the power supply. The instrument is re-started using the mains power switch on the rear panel.
- In standby state, the right, amber LED is on. The standby power only supplies the power switch circuits, the optional oven quartz (OCXO, 10 MHz reference oscillator, option ZVL-B4, order no. 1164.1757.02), the battery (option NIMH Battery Pack, R&S FSL-B31), and the fan. The network adapter remains active, too. The power consumption of the R&S ZVL is much reduced. In this state it is safe to switch off the AC power and disconnect the instrument from the power supply.
- In ready state, the left, green LED is on, indicating that all modules are power-supplied. After performing its startup procedure, the analyzer is ready for operation.

The *SETUP* -> *More* -> *Shutdown Off/Standby* softkey determines the behavior of the power on/off key:

- In the default setting (*Shutdown: Off*), the standby state is blocked. The power on/off key switches the R&S ZVL from ready to off state. Use this instrument configuration if you want to avoid any power consumption while you do not use your instrument.
- If *Shutdown: Standby* is selected, you can use the power on/off key to toggle between standby and ready state. Use this configuration if you want to be able to resume your measurements quickly, avoiding the complete startup procedure and the system check.

If the R&S ZVL is DC or battery supplied, the *Shutdown:Standby* option is not effective, see section DC Power Supply and Battery below.

⚠ CAUTION

Power supply in standby mode

The instrument is still power-supplied while it is in standby mode.

1.3.10 Replacing Fuses

The instrument is protected by two fuses (IEC 127 – T 3.15 H / 250 V) located on the rear panel at the right side of the AC power switch.

DANGER**Shock hazard**

For fuse replacement, ensure that the instrument is switched off and disconnected from the power supply by removing the plug from the AC and DC power connector.

To replace the fuses

1. Open the lid of the AC power connector.
2. Lift the fuse holder out of its slot.
3. Exchange the two fuses.
4. Put the fuse holder back in its slot and close the lid.

1.3.11 DC Power Supply and Battery

While the R&S ZVL is disconnected from the AC power supply, it can be supplied either by a DC power (option DC Power Supply, R&S FSL-B30) or a battery (option NIMH Battery Pack, R&S FSL-B31); see Power Supply Options. With DC power or battery supply, the AC power switch on the rear panel is disabled. The power on/off key on the front panel is used to switch the analyzer on or off, irrespective of the *SETUP -> More -> Shutdown Off/Standby* setting.



- While the R&S ZVL is switched off, press the power on/off key to initiate the startup procedure until the R&S ZVL enters its ready state. The left, green LED is on.
- While the R&S ZVL is switched on (ready), press the power on/off key to switch the analyzer off. Both LEDs are off.

When using the DC power supply or battery, note the safety instructions below. Please also refer to the detailed information about DC Power Supply and the Battery Pack.

**Battery low**

The battery symbol in the status bar changes to "battery low" when the battery needs to be charged. At the same time, a message box is displayed where you can either shut down the instrument or continue measuring.

⚠ CAUTION**DC power supply**

The power supply (SELV) that is used must fulfill the requirements for reinforced/double insulation for main supply circuits in accordance to DIN/EN/IEC 61010 (UL 61010B-1, CSA C22.2 No. 1010.1) or DIN/EN/IEC 60950 (UL 1950, CSA C22.2 No. 950). It is recommended to fuse the DC power supply appropriately. Before switching on the instrument check the connection for correct polarity.

⚠ CAUTION**Battery pack**

The power supply that is used must fulfill the requirements for reinforced/double insulation for main supply circuits in accordance to DIN/EN/IEC 61010 (UL 61010B-1, CSA C22.2 No. 1010.1) or DIN/EN/IEC 60950 (UL 1950, CSA C22.2 No. 950).

Note: If the battery is not to be used for a longer time, it is recommended to remove it and store it separately.

1.3.12 Charging the Battery

The battery can be charged via the AC or the DC power supply without being removed:

- To charge the battery using the AC power supply, connect the instrument to the mains supply and switch on the AC power on the rear panel. The power on/off key on the front panel can be set either way.
- To charge the battery using the DC power supply, connect the instrument to the DC power supply.

If you have more than one battery packs in use, you can also charge them outside the instrument using the power supply unit of option R&S FSL-Z4 (DC Supply for FSL-B31, stock no. 4052.3041.00). An LED with the inscription "Charge" is switched on during charging.

Charging conditions	Approximate duration
AC power supply, standby mode	5 h
AC power supply, instrument is switched on	9 h
DC power supply, instrument is switched off	5 h
DC power supply, instrument is switched on	9 h
External charging (battery removed)	5 h

1.4 Maintenance

The network analyzer does not require any special maintenance. Make sure that the air vents are not obstructed. The outside of the instrument is suitably cleaned using a soft, line-free dust cloth.

NOTICE

Instrument damage caused by cleaning agents. Cleaning agents contain substances that may damage the instrument, e.g. solvent-containing cleaning agents may damage the front panel labeling or plastic parts.

Never use cleaning agents such as solvents (thinners, acetone, etc), acids, bases, or other substances.

The address of our support center and a list of useful contact addresses can be found on the *Contact* page.

1.4.1 Storing and Packing

The network analyzer can be stored at the temperature range quoted in the data sheet. When it is stored for a longer period of time the instrument should be protected against dust.

The original packing should be used, particularly the protective caps at the front and rear, when the instrument is to be transported or dispatched. If the original packing is no longer available, use a sturdy cardboard box of suitable size and carefully wrap the instrument to protect it against mechanical damage.

1.5 Starting and Shutting down the Analyzer

To start the analyzer, proceed as follows:

- If you use the AC power supply, make sure that the instrument is connected to the mains supply and switch the power switch on the rear panel to position I (On).
- If you use the DC power supply, make sure that the instrument is connected and press the power on/off key on the front panel.

The analyzer automatically performs a system check, boots the Windows XP operating system and then starts the analyzer (NWA) application. If the last analyzer session was terminated regularly, the NWA application uses the last setup with all instrument settings.

To shut down the analyzer, proceed as follows:

- With AC power supply, press the power on/off key to save the current setup, close the NWA application, shut down Windows XP and set the instrument to standby or off state, depending on the *SETUP -> More -> Shutdown Off/Standby* settings. Refer to section *Instrument States with AC Power Supply*. From the standby state, you can set the AC power switch to position 0 (Off) to turn the analyzer completely off..
- With DC power supply or battery, press the power on/off key to switch the analyzer off.



Power on/off key, OCXO

Do not press the power on/off key longer than 3 seconds.

The AC power switch also interrupts the power supply of the OCXO (option OCXO Reference Frequency, R&S FSL-B4). When you switch the instrument back on, be sure to comply with the extended warm-up phase specified in the data sheet.

NOTICE

Saving instrument settings

When using the AC power supply, it is strongly recommended to press the power on/off key on the front panel before disconnecting the power. If you set the power switch on the rear panel to 0 while the NWA application is still running, you will lose the current settings. Moreover, loss of program data can not be excluded if the application is terminated improperly.

With DC power supply or battery, it is safe to switch off the instrument using the power on/off key on the front panel.

1.6 Connecting External Accessories

The equivalent USB ports on the front panel of the analyzer can be used to connect a variety of accessories:

- A mouse simplifies operation of the instrument using the controls and dialogs of the Graphical User Interface (GUI).
- A keyboard simplifies the entry of data.
- A printer generates hard copies of the screen contents.

In addition the analyzer provides an interface for network integration:

- An external monitor shows the magnified GUI with all diagram areas, measurement results and control elements.
- A LAN connection can be established in order to access the hard disk or control the analyzer from an external PC.

1.6.1 Connecting a Mouse

A USB mouse can be connected to one of the Universal Serial Bus connectors on the front panel.

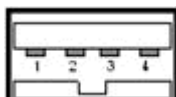

The mouse is detected automatically when it is connected. It is safe to connect or disconnect the mouse during the measurement.



Mouse configuration

Use the *Start – Control Panel – Mouse* menu of Windows XP to configure the mouse properties. To access Windows XP, press *SETUP – General Setup – More – Open Start Menu* (or connect an external keyboard and press CTRL + ESC).

Operating the analyzer does not require a mouse. You can access all essential functions using the keys on the front panel.

1.6.2 Connecting a Keyboard

A keyboard can be connected to one of the Universal Serial Bus connectors on the front panel.

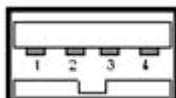

The keyboard is detected automatically when it is connected. The default input language is English – US. It is safe to connect or disconnect the external keyboard during the measurement.



Keyboard configuration

Use the Start – Control Panel – Keyboard or Regional and Language Options menu of Windows XP to configure the keyboard properties. To access Windows XP, press *SETUP – General Setup – More – Open Start Menu* (or connect an external keyboard and press CTRL + ESC).

Operating the analyzer does not require a keyboard. You can access all essential functions using the keys on the front panel. In combination with a mouse, the front panel keys provide access to all instrument functions.

1.6.3 Connecting a Printer

A printer can be connected to one of the Universal Serial Bus connectors on the front panel.

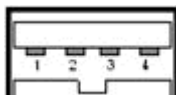

It is safe to connect or disconnect the printer during the measurement. When printing a copy (PRINT), the analyzer checks whether a printer is connected and turned on and whether the appropriate printer driver is installed. If required, printer driver installation is initiated using Windows XP's *Add Printer Wizard*. The wizard is self-explanatory. A printer driver needs to be installed only once, even though the printer may be temporarily removed from the analyzer.

Printer driver installation

A great variety of printer drivers is available on the analyzer. To obtain the complete list, access Windows XP (press the *Windows* key) and open the Add Printer Wizard in the *Start – Control Panel – Printer and Faxes* menu.

You can load updated and improved driver versions or new drivers from an installation disk, USB memory stick or another external storage medium. Alternatively, if the analyzer is integrated in a network, you can install driver data stored in a network directory. In either case, use the *Add Printer Wizard* to complete the installation.



Printer configuration

Use the *Page Setup* dialog or the *Start – Control Panel – Printers and Faxes* menu of Windows XP to configure the printer properties. To access Windows XP, press *SETUP – General Setup – More – Open Start Menu* (or connect an external keyboard and press CTRL + ESC).

1.6.4 Connecting a Monitor

A standard DVI monitor can be connected to the DVI-D connector in the lower right corner of the rear panel. The monitor displays the magnified R&S ZVL screen with all diagram areas, measurement results and control elements. Connection of an analog VGA monitor is not supported.

After connecting the monitor, use the *SETUP – General Setup – More – Monitor Int/Ext* softkey to display the screen contents on the external monitor. To display the screen contents on the R&S ZVL and on the external monitor simultaneously, proceed as follows:

1. Connect an external keyboard to the instrument and press CTRL + ESC to access the operating system.
2. On the right side of the task bar, click the monitor icon.
3. Select *Graphics Options – Output To – Intel(R) Dual Display Clone – Monitor + Digital Display*.



Instrument control from the external monitor

With an additional mouse or keyboard connected to the analyzer, you can control the measurement from the external monitor. If desired, press *SETUP – General Setup – More – Soft Frontpanel* to add the soft frontpanel (front panel key emulation) to the analyzer screen.

1.6.5 Connecting a LAN Cable

A LAN cable can be connected to the LAN connector on the rear panel of the analyzer.



To establish a LAN connection proceed as follows:

1. Refer to section *Assigning an IP Address* and learn how to avoid connection errors.
2. Connect an appropriate LAN cable to the LAN port. Use a commercial RJ-45 cable to establish a non-dedicated network connection, or a cross-over RJ-45 cable to establish a dedicated connection between the analyzer and a single PC.

Dedicated vs. non-dedicated network connections

There are two methods to establish a LAN connection of the analyzer:

- A non-dedicated network (Ethernet) connection from the analyzer to an existing network made with an ordinary RJ-45 network cable. The analyzer is assigned an IP address and can coexist with a computer and with other hosts on the same network.

- A dedicated network connection between the analyzer and a single computer made with a cross-over RJ-45 network cable. The computer must be equipped with a network adapter and is directly connected to the analyzer. The use of hubs, switches, or gateways is not needed, however, data transfer is still made using the TCP/IP protocol.

The IP address information is displayed in the *Info – Setup Info* dialog.

1.7 Remote Control in a LAN

A LAN connection is used to integrate the analyzer into a home/company network. This offers several applications:

- Transfer data between a controller and the analyzer, e.g. in order run a remote control program.
- Control the measurement from a remote computer using the *Remote Desktop* application.
- Use external network devices (e.g. printers).

NOTICE

Virus protection

An efficient virus protection is a prerequisite for secure operation in the network. Never connect your analyzer to an unprotected network because this may cause damage to the instrument software.

To establish the connection proceed as follows:

1. Access Windows XP, e.g. by pressing *SETUP – General Setup – More – Open Start Menu* (see section Accessing Windows XP's Start Menu on p. 37).
2. Open Windows XP's control panel.
3. Select System and open the *Remote* tab in the *System Properties* dialog. Enable *Allow users to connect remotely to this computer*.
4. Assign an IP address to the analyzer following the directions below and connect the analyzer to the network as described in *Connecting a LAN Cable*.
5. Create a *Remote Desktop Connection* using the analyzer's IP address.



Password protection

The analyzer uses a user name and password as credentials for remote access. In the factory configuration, instrument is preset for both the user name and the password. To protect the analyzer from unauthorized access, it is recommended to change the factory setting.

1.7.1 Assigning an IP Address

Depending on the network capacities, the TCP/IP address information for the analyzer can be obtained in different ways.

- If the network supports dynamic TCP/IP configuration using the Dynamic Host Configuration Protocol (DHCP), all address information can be assigned automatically.

- If the network does not support DHCP, or if the analyzer is set to use *alternate TCP/IP* configuration, the addresses must be set manually.

By default, the analyzer is configured to use dynamic TCP/IP configuration and obtain all address information automatically. This means that it is safe to establish a physical connection to the LAN without any previous analyzer configuration.

NOTICE**Address selection**

If your network does not support DHCP, or if you choose to disable dynamic TCP/IP configuration, you must assign valid address information before connecting the analyzer to the LAN. Contact your network administrator to obtain a valid IP address, because connection errors can affect the entire network.

Manual TCP/IP configuration

To disable dynamic TCP/IP configuration and enter the TCP/IP address information manually proceed as follows:

1. Obtain the IP address and subnet mask for the analyzer and the IP address for the local default gateway from your network administrator. If needed, also obtain the name of your DNS domain and the IP addresses of the DNS and WINS servers on your network.
2. Press the SETUP front panel key to the left of the analyzer's display.
3. In the softkey menu opened, press General Setup – Network Address– DHCP: Off.
4. Enter your IP-Address and Subnet Mask.

To enter additional IP address information, you have to access the operating system of the R&S ZVL.

1. Access Windows XP using an external keyboard; see Accessing Window XP's Start Menu.
2. Open the *Control Panel – Network Connections – Local Area Connection Status – Local Area Connection Properties – Internet Protocol (TCP/IP) Properties* dialog and enter the complete address information, e.g.:

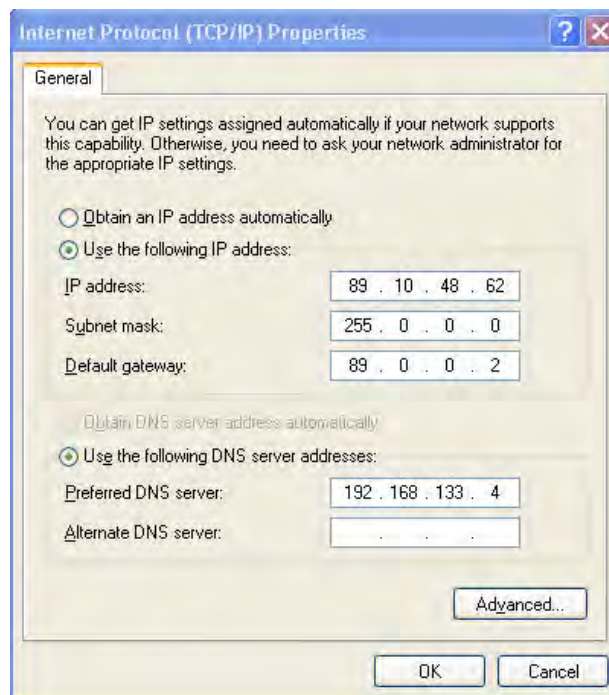

For more information refer to the Windows XP Help.

1.7.2 Remote Desktop Connection

Remote Desktop is a Windows application which can be used to access and control the analyzer from a remote computer through a LAN connection. While the measurement is running, the analyzer screen contents are displayed on the remote computer, and *Remote Desktop* provides access to all of the applications, files, and network resources of the analyzer.

To set up a *Remote Desktop* connection

1. Connect the analyzer to a LAN and determine its IP address; see *Remote Control in a LAN*.
2. Set up your remote computer (integrated in the LAN) to use *Remote Desktop* and create the *Remote Desktop* connection to the analyzer.

For detailed information about *Remote Desktop* and the connection refer to the Windows XP Help.

1.8 Windows XP

The analyzer is equipped with a Windows XP operating system which has been configured according to the instrument's features and needs. Changes in the system configuration can be necessary in order to

- Establish a LAN connection
- Customize the properties of the external accessories connected to the analyzer
- Call up additional software tools

NOTICE

Operating system settings

The operating system is adapted to the network analyzer. To avoid impairment of instrument functions, only change the settings described in this manual. Existing software must be modified only with update software released by Rohde & Schwarz. Likewise, only programs authorized by Rohde & Schwarz for use on the instrument must be executed.

The *Start* menu of the operating system is accessed as described below. All necessary settings can be accessed from the Start menu, in particular from the Control Panel.

1.8.1 Accessing Windows XP's Start Menu

The Windows XP Start menu provides access to the Windows XP functionality and installed programs. From the Start menu, you can navigate to the submenus by using the mouse or the cursor keys of the keyboard.

The simplest way to access the Start menu is by pressing *SETUP – General Setup – More – Open Start Menu*. This will not close the measurement application.

If you find it more convenient, you can also use an external keyboard to access the Start menu,

- ▶ On your keyboard, press the Windows key or the CTRL+ESC key combination.

To return to the measurement screen use one of the following methods:

1. Press the ALT+TAB key combination to switch to the analyzer application.
2. In the Windows task bar (opened via ALT + Tab), click the "R&S Analyzer Interface" icon.

1.9 Firmware Update

Upgrade versions of the analyzer firmware are supplied as setup files (*.msi). To perform a firmware update, you can either use the softkeys associated with the SETUP front panel key or the Instrument_Update_Tool. The latter procedure is recommended if installation via SETUP is not practicable.



Setup files

To prepare the installation, copy the setup file to any storage medium accessible from the analyzer. This may be the internal hard disk, an external storage medium (USB memory stick, CD-ROM with external drive) or a network connection (LAN, GPIB bus).

NOTICE

Calibration unit

The Calibration Unit (accessory R&S ZV-Z5x) must be disconnected during a firmware update.

To install new firmware using the SETUP menu,

1. Press SETUP > More > Firmware Update and open the Firmware Update dialog box.
2. Enter the update path of your firmware, depending on the installation medium that you use. You can also Browse... the update path in the dialog.
3. Click Execute to start the installation.

The installation program will guide you through the installation. If installation fails, use the Instrument_Update_Tool as described below.

Setup files can be stored and installed again. The default drive name of the USB interfaces is C:. External storage devices are automatically mapped to the next free drive, i.e. D:, E: etc.

Remote control: `SYST:FIRM:UPD 'D:\FW_UPDATE'`

To install new firmware using the update tool,

4. Close all applications.
5. Access Windows XP's startup menu, e.g. by pressing *SETUP – General Setup – More – Open Start Menu* (see section Accessing Windows XP's Start Menu on p. 37).
6. Select Programs > Accessories > Instrument_Update_Tool.
7. In the dialog box opened, select the ZVL.package file and click Open.
8. In the Install Manager dialog box opened, click Install.

1.9.1 Operation with and without Administrator Rights

With firmware version V3.xx (image version 3.11) and higher, the network analyzer may be operated with or without administrator rights. Some administrative tasks (e.g. a firmware update) do require administrator rights; refer to the detailed description of the SETUP softkeys in chapter 4 of the operating manual.

In the default configuration, auto login is enabled, and an account with administrator rights is active. This means that no password is required, and the full functionality of the analyzer is available to any user. An additional user account without administrator rights is pre-defined.

To install new firmware using the update tool,

To change the user account, access Windows XP's Start menu, e.g. by pressing *SETUP – General Setup – More – Open Start Menu* (see section Accessing Windows XP's Start Menu on p. 37) and click *Settings – Control Panel – User Accounts*. In the dialog opened, you can also change the passwords for the user accounts. User accounts with the following user names and passwords are pre-defined::

Description	User name	Password
Default account, with administrator rights	Instrument	894129
Account without administrator rights	NormalUser	894129

(De)activating auto login

After being turned off, the R&S ZVL will return to the *Instrument* account without prompting for a password. To de-activate the automatic login mechanism,

1. Access the Start menu and select *Run...*
2. In the dialog box opened, enter `C:\R_S\INSTR\USER\NO_AUTOLOGIN.REG` and confirm.

Auto login is deactivated. The next time you switch on the R&S ZVL, you will have to enter a user name and a password. Proceed in the same way, using the `C:\R_S\INSTR\USER\AUTOLOGIN.REG` file, to re-activate automatic login.

Firmware upgrade and downgrade

An update from a firmware version <V3.xx to version V3.xx or higher does not replace the image. To replace the image version, contact your R&S service representative. The image upgrade is possible on instruments with a DVI-D connector on the rear panel.

A downgrade of the firmware from V3.xx or higher to version <V3.xx requires the *BackGrade* program, which can be accessed from the Windows XP Start menu of the analyzer:

1. Access the Start menu.
2. Click *Programs – Accessories – BackGrade* and confirm with OK.
3. Perform the firmware update using the *Instrument Update Tool* described above.

**LXI**

The LXI functionality including the home page is unavailable while the instrument is operated without administrator rights.

Table of Contents

2	Getting Started	43
2.1	Reflection Measurements	43
2.1.1	Instrument Setup for Reflection Measurements	43
2.1.2	Parameter and Sweep Range Selection	44
2.1.3	Instrument Calibration	45
2.1.4	Evaluation of Data	47
2.1.5	Saving and Printing Data	48
2.2	Transmission Measurements	49
2.3	Basic Tasks	50
2.3.1	Control via Front Panel Keys	50
2.3.2	Data Entry	52
2.3.3	Scaling Diagrams	54

2 Getting Started

The following chapter presents a sample session with a R&S ZVL network analyzer and explains how to solve basic tasks that you will frequently encounter when working with the instrument.

CAUTION

General safety instructions

Before starting any measurement on your network analyzer, please note the instructions given in Chapter *Preparing for Use*.

In the *System Overview* you will find detailed information on customizing the instrument and the display according to your personal preferences. For a systematic explanation of all menus, functions and parameters and background information refer to the reference chapters in the online help system.



Windows operation

In the following we assume that you are familiar with standard Windows dialogs and mouse operation. Refer to sections *Using Front Panel Keys* and *Data Entry* to learn how to access instrument functions and control dialogs without a mouse and keyboard.

2.1 Reflection Measurements

In a reflection measurement, the analyzer transmits a stimulus signal to the input port of the device under test (DUT) and measures the reflected wave. A number of trace formats allow you to express and display the results. depending on what you want to learn from the data. Only one analyzer test port is required for reflection measurements.

In the following example, the analyzer is set up for a reflection measurement, a frequency sweep range and measurement parameter is selected, the instrument is calibrated and the result is evaluated using various formats.

2.1.1 Instrument Setup for Reflection Measurements

In order to prepare a reflection measurement, you have to connect your DUT (which is assumed to have a male N 50 Ω connector) to one of the (equivalent) analyzer test ports. Besides, it is recommended to preset the instrument in order to set it to a definite, known state.



1. Proceed as described in section *Starting the Analyzer and Shutting Down* in Chapter 1 to switch on the instrument and start the NWA application.
2. Connect the input port of your DUT to test port 1 of the network analyzer.
3. Press the PRESET key in the upper left corner of the front panel to perform a factory preset of the analyzer.



The analyzer is now set to its default state. The default measured quantity is the transmission S-parameter S_{21} . This quantity is zero in the current test setup, so the trace shows the noise level.

2.1.2 Parameter and Sweep Range Selection

After preset the display shows a diagram with a dB Mag scale. The sweep range (scale of the horizontal axis) is equal to the maximum frequency range of the analyzer, and the S-parameter S_{12} is selected as a measurement parameter.

To obtain information about the reflection characteristics of your DUT you have to select an appropriate measurement parameter and specify the sweep range.

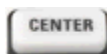

1. Press the CENTER function key to the right of the display to open the associated numeric entry bar (Center Frequency). Enter the center of your desired frequency range in (e.g. 5.25 GHz).

If you use the data keys at the front panel for data entry, simply type 5.25 and terminate the entry with the *G/n* key. Refer to section *Data Entry* to learn more about entering numeric values and characters.



2. Press SPAN and enter the width of the frequency range you want to measure (e.g. 0.5 GHz).

In addition to the linear frequency sweep considered in this example the analyzer provides frequency sweeps with a logarithmic or segmented frequency axis. Refer to *Setting up a Sweep* for more application examples.



3. Press MEAS and select the forward reflection coefficient S_{11} as a measurement parameter.

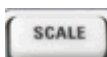

4. Press SCALE and activate the *Autoscale* function.

The analyzer adjusts the scale of the diagram to fit in the entire S_{11} trace,

leaving an appropriate display margin.

Refer to section *Scaling Diagrams* to learn more about the different methods and tools for diagram scaling.

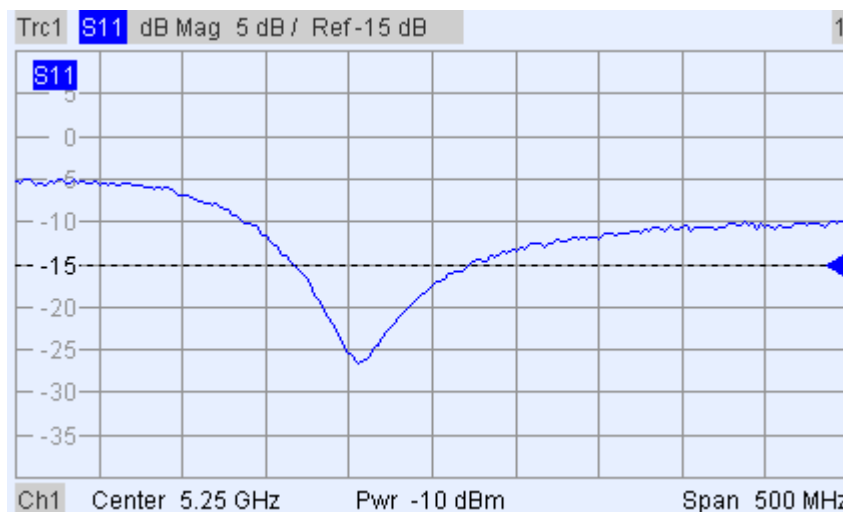

2.1.3 Instrument Calibration

The analyzer provides sophisticated calibration methods for all types of measurements. Which calibration method is selected depends on the expected system errors, the accuracy requirements of the measurement, on the test setup and on the types of calibration standards available.

In the following we assume that the calibration kit ZV-Z21 contains an appropriate male short standard with known physical properties. With a single short standard, it is possible to perform a normalization, compensating for a frequency-dependent attenuation and phase shift in the signal path.

Due to the analyzer's calibration wizard, calibration is a straightforward, menu-guided process.



1. Unscrew the DUT and connect the male short standard from calibration kit ZV-Z21.
2. Press the CAL function key to open the calibration menu.
3. Activate *Start Cal – One Port P1 – Normalization (Short)* to open the calibration wizard for the selected calibration type.

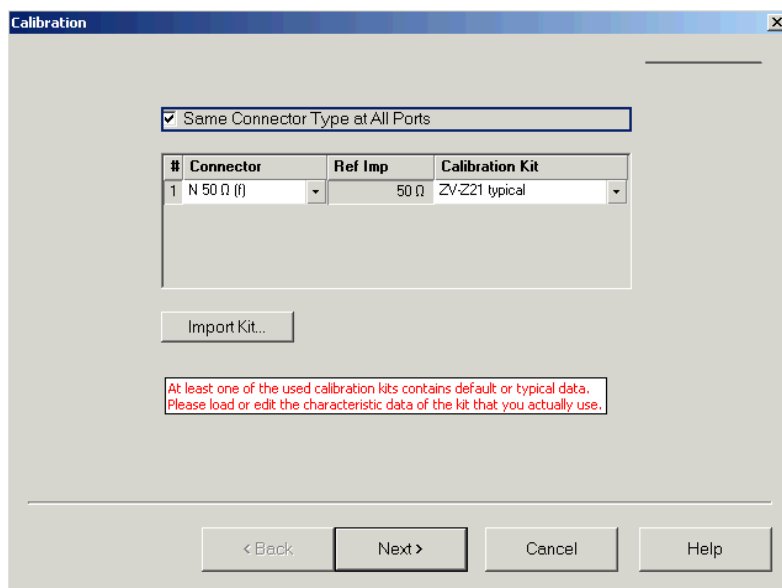

4. In the first dialog of the wizard, select the calibration kit (here: ZV-Z21) and the test port connector (here: N 50 Ω (f), corresponding to a male calibration standard), and click *Next*.

If you have not yet imported the exact cal kit data of your calibration kit, you can use the typical data as shown above. Typical data provide an approximate description of a calibration kit mode. To import the actual (accurate) data of your kit, press *Import Kit...* and select the appropriate cal kit file.

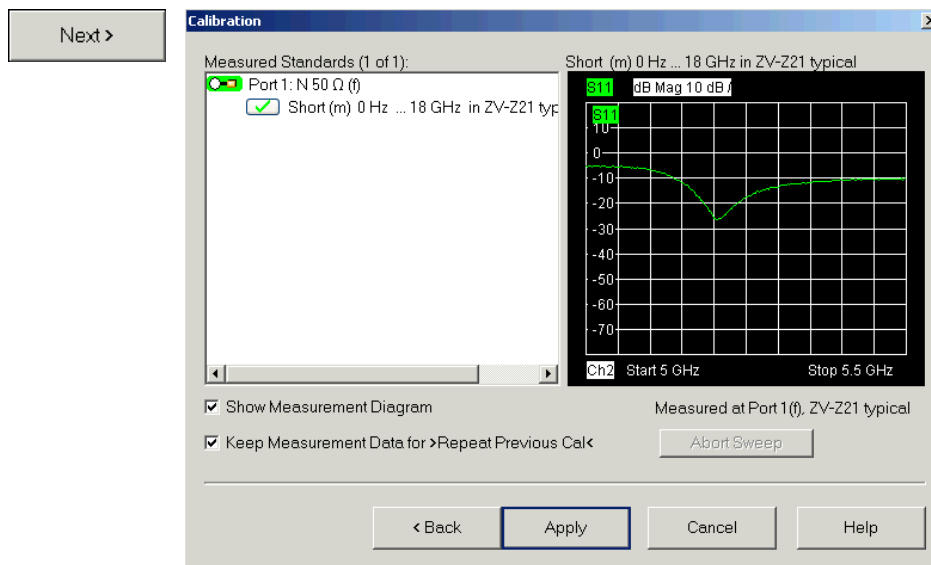

The next dialog of the calibration wizard shows that only a single calibration standard needs to be measured.

5. Click the box *Short (m)...* to initiate the measurement of the connected short standard.

The analyzer performs a calibration sweep and displays a message

box with a progress bar. After completing the sweep the analyzer generates a short sound and a green checkmark appears in the checkbox.

Apply

6. Click *Apply* to close the wizard, calculate and store the system error correction data and apply them to the current measurement.
7. Remove the short standard and connect the DUT again.

2.1.4 Evaluation of Data

The analyzer provides various tools to optimize the display and analyze the measurement data. For instance, you can use markers determine the maximum of the reflection coefficient, and change the display format to obtain information about the phase shift of the reflected wave and the impedance of your DUT.

MKR

1. Press the MKR function key. This places Marker 1 to its default position (center of the sweep range).

A marker symbol (triangle) appears on the trace. The stimulus value (frequency) and response value (magnitude of the reflection coefficient converted to a dB value) at the marker position is displayed in the *marker info field* in the upper right corner of the diagram.

MKR →

2. Press the MKR → function key, open the *Marker Search* submenu and activate *Min Search*.

The marker jumps to the absolute minimum of the curve in the entire sweep range. The *marker info field* shows the coordinates of the new marker position.

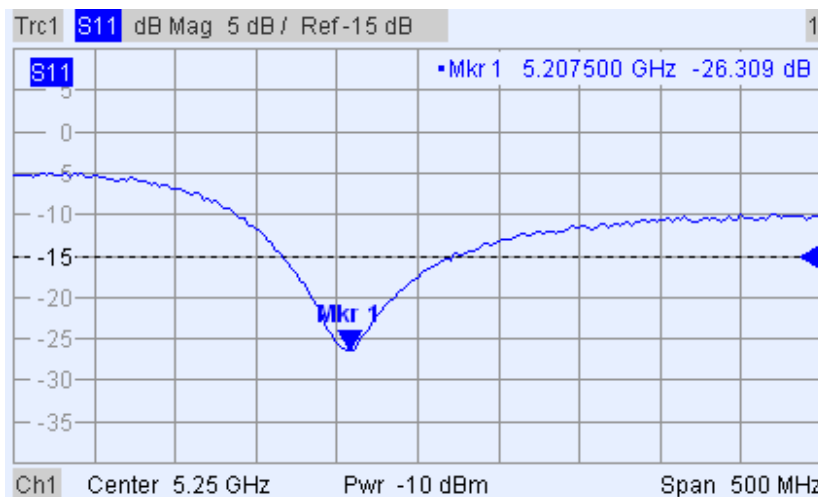

FORMAT

3. In the TRACE keypad, press FORMAT and select the *Phase* of the reflection coefficient to be displayed.

The phase is shown in a Cartesian diagram with a default vertical scale of -225 deg to $+225$ deg. The *marker info field* shows the frequency and phase at the marker position.

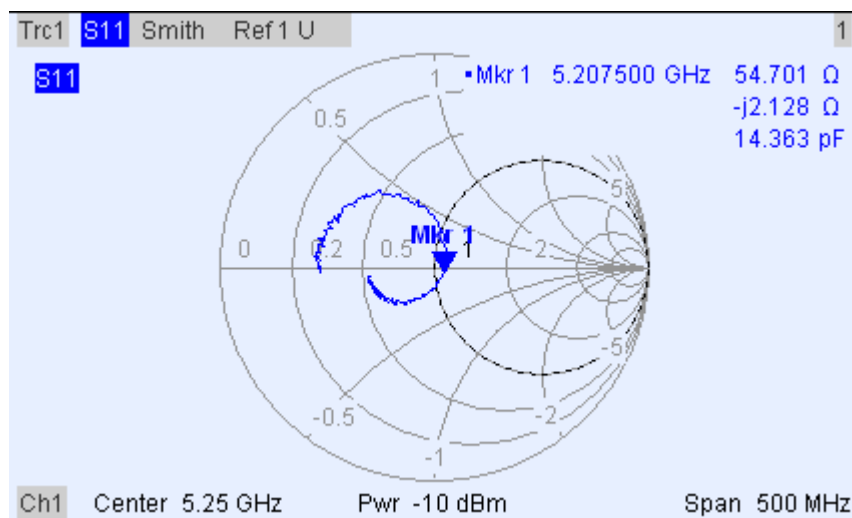

4. Still in the **FORMAT** menu, select *Smith*.

The Smith chart shows lines of constant real and imaginary part of the impedance in the reflection coefficient plane.

Refer to section *Display Formats and Diagram Types* in Chapter 3 to learn more about the diagram properties.

2.1.5 Saving and Printing Data

The analyzer provides standard functions for saving measurement settings and for printing the results. You can use these functions as if you were working on a standard PC. Moreover you can export your trace data to an ASCII file and reuse it in a later session or in an external application.

Data transfer is made easier if external accessories are connected to the analyzer or if the instrument is integrated into a LAN. Refer to sections *External Accessories* and *Remote Control in a LAN* in Chapter 1 to obtain information about the necessary steps.

1. Press **TRACE** and activate *More 1/3 – Import/Export Data – Export Data*.
2. In the *Export Complex Data* dialog opened, select a file location, format and name and activate *Save*.

The active trace data is written to an ASCII file.

Refer to section *Trace File Formats* to learn more about trace files and their use.

3. Press the **PRINT** key to the left of the display; then press *Device Setup*.
4. In the *Hardcopy Setup* dialog opened, select *Printer*.
5. Close the dialog and press *Print Screen* to create a hardcopy of your diagram.

6. Press *Device Setup* again and select a file format or *Clipboard*.
7. Close the dialog and press *Print Screen* again to copy the diagram to a file or an external application.

Nwa-File

8. Open the *Nwa-File* menu and select *Save NWA As...*
9. In the *Save As* dialog opened, select a file location, format and name and activate *Save*.

The active setup is stored to a file and can be reused in a later session.

Proceed as described in section *Starting the Analyzer, Shutdown* to shut down your analyzer.

2.2 Transmission Measurements

A transmission measurement involves the same steps as a reflection measurement.

Note the following differences:

- The test setup for transmission measurements involves two DUT and analyzer ports. You can connect the input of your DUT to port 1 of the analyzer, the output to port 2. After a preset, the analyzer will measure the forward transmission S-parameter S_{21} .
- The analyzer provides special calibration types for transmission measurements. Use the calibration wizard and select an appropriate type. A TOSM calibration will correct the system errors for all transmission and reflection S-parameters.

2.3 Basic Tasks

The following sections describe how to solve basic tasks that you will frequently encounter when working with the instrument. In particular you can learn how to access instrument functions and control dialogs without a mouse and keyboard.

2.3.1 Control via Front Panel Keys

Although a mouse and external keyboard simplify the operation of the instrument, you can access all essential functions using the keys on the front panel. The following examples are intended to make you familiar with front panel key operation.

To Access a Particular Menu Command ...



1. Press the MENU key to the left of the display to access the menu bar and open the *Nwa-File* menu.



2. Use the keys in the NAVIGATION keypad or the rotary knob to navigate between and within the menus.
 - Use the *Cursor Left* and *Cursor Right* keys to change between the different menus in the menu bar. When the first option in a pull-down menu is a submenu, the submenu will be opened first before proceeding to the next option in the menu bar.



- Use the *Cursor Up* and *Cursor Down* keys to scroll up and down in a menu.

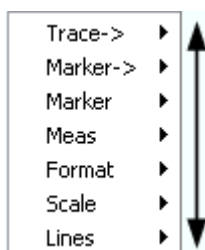

- ENTER, the *Cursor Right* key or the rotary knob (if pressed) expand a submenu, open a dialog or initiate an action, depending on the selected command type.



- ESC CANCEL or the *Cursor Left* key compress the current submenu and move the cursor one menu level up or close the active dialog, depending on the selected softkey type.

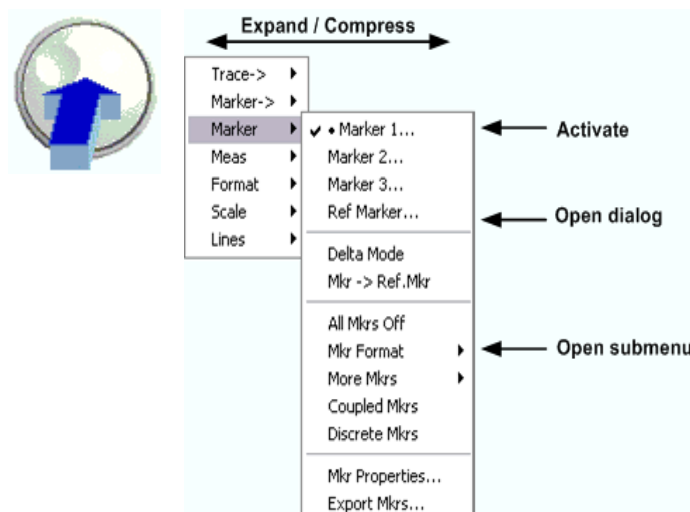

3. As soon as you reach the desired menu command (which must not be one opening a submenu) press ENTER or press the rotary knob to initiate an action or open a dialog.

After command execution or after closing the dialog, the menu bar is deactivated and the cursor returns to the diagram/softkey area.

To Make a Selection in a Dialog...



1. Press a softkey or a menu item followed by three dots to open a dialog.
 2. Use the navigation keys and/or the rotary knob to access the controls in the dialog.
- Press *Left Field* or *Right Field* or the cursor keys to switch between the control elements in a dialog.



- Press the cursor keys to switch between several entries in a list of alternative or independent settings.

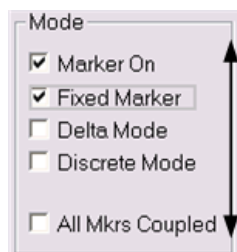



3. Use the data entry keys or the rotary knob to enter numbers. Use the on-screen keyboard for character entry. For more details refer to Data Entry.
4. Press ENTER, ESC CANCEL or press the rotary knob to close the active dialog.

2.3.2 Data Entry

The analyzer provides dialogs with various types of input fields where you can enter numeric values and character data. Data entry with a mouse and an external keyboard is a standard procedure known from other Windows applications. However, there are various alternative ways to enter data.

Using Front Panel Keys

If no mouse and no external keyboard is connected to the analyzer, you can use the data entry keys to enter numbers and units.

To enter a numeric value

1. Place the cursor into a numeric data input field in a dialog or in the numeric entry bar.
2. Press the data entry keys.



- Use 0 to 9 enter the corresponding numbers.



- Use . and - to enter a decimal point or change the sign of the value.



- Use *GHz* / *-dBm*, *MHz* / *dBm*, *kHz* / *dB*, or *Hz* / *dB*.. to multiply the entered value with factors of $10^{(-)9}$, $10^{(-)6}$, $10^{(-)3}$ or 1 and/or add the appropriate physical unit.

To enter a character string

1. Place the cursor into a character data input field in a dialog.
2. Press the data entry keys as if you were writing a short message on your mobile phone.

The different characters assigned to each key are displayed in a popup dialog.



- Press 0 to 9 once to enter the corresponding numbers.
- Press the keys repeatedly to select one of the other characters assigned to the key.
- Wait 2 seconds to confirm an entry.



- Use . or – to enter a dot or a hyphen.
- Use the sign key to change from upper case to lower case and vice versa.



- Use the checkmark key to enter a space.
- Use the BACK key to correct wrong entries, deleting the character to the left of the current cursor position.



- Press ENTER to complete an entry.

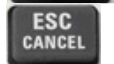

- Press ESC CANCEL to close the popup dialog, discarding the entries made.

3. To enter letters you can also use one of the following methods:

- If the active input field has a  symbol, then use the analyzer's on-screen keyboard.
- Otherwise, use an external keyboard or a mouse and Windows XP's on-screen keyboard.

Using the Analyzer's On-Screen Keyboard

The on-screen keyboard allows you to enter characters, in particular letters, without an external keyboard. It is available for all character input fields which have a  symbol.

Operation with front panel keys

1. Place the cursor into a character data input field in a dialog or in the numeric entry bar.
2. Press ENTER or the *Checkmark* key to open the on-screen keyboard.
3. Use the cursor keys or turn the rotary knob to move the cursor to a character.
4. Press ENTER or the rotary knob to select the character for the input string.
5. After completing the input string use the *Right Field* key to move to the OK button.
6. Press ENTER or the rotary knob to apply your selection and close the keyboard.

Operation with a mouse

1. Click the keyboard symbol to open the on-screen keyboard.
2. Click a sequence of characters and OK to apply your selection and close the keyboard.

You can also access Windows XP's on-screen keyboard from the start menu. Press *SETUP – General Setup – More – Open Start Menu* (or connect an external keyboard and press CTRL + ESC) to open the start menu, and click *Programs – Accessories – Accessibility – On-Screen Keyboard*. From the start menu, you can also access other useful software accessories.



2.3.3 Scaling Diagrams

The analyzer provides several alternative tools for setting the sweep range and customizing the diagrams. Pick the method that is most convenient for you.

Setting the Sweep Range

The sweep range for all channels is displayed in the channel list across the bottom of the diagram area:

Ch1	Center	5.1 GHz	—	Pwr	-10 dBm	Span	500 MHz
Ch2	Start	1 GHz	—	Pwr	-10 dBm	Stop	2.5 GHz

To change the sweep range, use one of the following methods:

- Press the CENTER or SPAN function keys on the front panel.
- Right-click the start or stop value in the channel list and select *Start*, *Stop*, *Center*, *Span* from the context menu.
- Select *Start*, *Stop*, *Center*, *Span* from the *Channel – Center* or *Channel– Span* menus.
- Use the marker functions (MARKER → function key).

Reference Value and Position

The analyzer provides three parameters for changing the scale of the vertical (response) axis:

- Changing the *Ref Value* or *Ref Position* shifts the trace in vertical direction and adjusts the labels of the vertical axis. *Ref Value* also works for radial diagrams.
- Changing the *Scale/Div* modifies the value of the vertical or radial diagram divisions and thus the entire range of response values displayed.
- The *Scale/Div* and the *Ref Value* is indicated in the scale section of the trace list.

Trc2	S21	dB Mag	40 dB / Ref -200 dB	Ch1	Invisible
Trc3	S21	Phase	45° / Ref 0°	Ch2	
Trc7	S21	dB Mag	10 dB / Ref 0 dB	Ch2	Math
Mem8[Trc7]	S21	dB Mag	10 dB / Ref 0 dB	Ch2	

To change one of the parameters use one of the following methods:

- Press the SCALE function key on the front panel.
- Right-click the scale section in the trace list and select the parameters from the context menu.
- Select the parameters from the *Trace – Scale* menu.
- Use the marker functions (MARKER → function key).

Autoscale

The *Autoscale* function adjusts the scale divisions and the reference value so that the entire trace fits into the diagram area. To access *Autoscale*, use one of the following methods:

- Press the SCALE function key on the front panel.
- Right-click the scale section in the trace list and select *Autoscale* from the context menu.
- Select *Autoscale* from the *Trace – Scale* menu.

Circular Diagrams

The radial scale of a circular (*Polar*, *Smith* or *Inverted Smith*) diagram can be changed with a single linear parameter, the *Ref Value*. The reference value defines the radius of the outer circumference.

- Increasing the *Reference Value* scales down the polar diagram.
- Decreasing the *Reference Value* magnifies the polar diagram.

The *Reference Value* is indicated in the scale section of the trace list.

Trc1	S21	Polar	0.26 U / Ref 1.3 U
Trc3	S21	Smith	0.2 U / Ref 1 U

To change the *Reference Value* use one of the following methods:

- Press the SCALE function key on the front panel.
- Right-click the scale section in the trace list and select the parameter from the context menu.
- Select the parameter from the *Trace – Scale* menu.
- Use the marker functions.

The *Autoscale* function also works for polar diagrams.

Using Marker Functions

Marker functions are a convenient tool for scaling (in particular: magnifying) diagrams without entering explicit numeric values. You simply place a marker to a trace point and use the marker values to change the sweep range or move the trace relative to the vertical axis. A mouse makes it easier to activate (click) or move (drag and drop) markers.

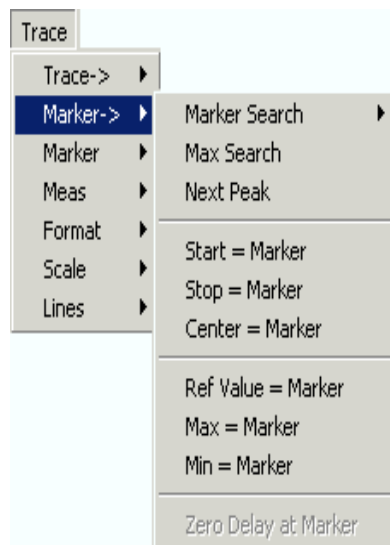

To set the sweep range use one of the following methods:

- **Define Start and Stop values**

1. Create two normal markers, e.g. the markers *Mkr 1* and *Mkr 2*, and place them to the desired start and stop values of the sweep range.
2. Activate *Mkr 1* and click *Trace – Marker --> – Start = Marker*.
3. Activate *Mkr 2* and click *Trace – Marker --> – Stop = Marker*.

- **Use a definite Span**

1. Create a marker and set it to delta mode.
2. The analyzer automatically creates a reference marker in addition to the delta marker.
3. Place the reference marker to the desired start value of the sweep range.
4. Set the value of the delta marker equal to the desired (positive or negative) span.
5. Activate the delta marker and click *Trace – Marker --> – Span = Marker*.

To move the trace relative to the vertical axis proceed as follows:

1. Create a normal marker, e.g. the marker *Mkr 1*, and place it to a particular trace point. E.g. you can use the marker *Search* functions to locate a maximum or minimum on the trace.
2. Click *Trace – Marker --> – Max = Marker* to move the trace towards the upper diagram edge, leaving the values of the vertical divisions (*Scale Div.*) and the overall vertical scale unchanged. Analogously, click *Min = Marker* to move the trace towards the lower diagram edge, or click *Ref Value = Marker* to move the trace towards the Reference Value.

Enlarging the Diagram Area

The analyzer provides different tools for customizing the contents and size of the diagram areas:

- *Maximize* allows you to enlarge the active diagram area to occupy the whole window. A double-click on any point in the diagram area is equivalent to the *Maximize* function.
- The *Title*, the *Softkey Labels*, the *Status Bar* and the *Front Panel Keys* are optional display elements which you can hide in order to gain space for the diagram.
- Use the context menu of the diagram area or the Nwa-Setup – Display menu to access the scaling functions above.

Table of Contents

3	System Overview	61
3.1	Basic Concepts	61
3.1.1	Global Resources	62
3.1.1.1	Setups	62
3.1.2	Traces, Channels, and Diagram Areas	62
3.1.2.1	Trace Settings	63
3.1.2.2	Channel Settings.....	64
3.1.3	Data Flow	64
3.1.4	Navigation Tools of the Screen	66
3.1.4.1	Menu Bar	66
3.1.4.2	Menu Structure.....	67
3.1.4.3	Softkey Bar	68
3.1.4.4	Front Panel Key Bar.....	69
3.1.4.5	Status Bar	70
3.1.5	Display Elements in the Diagram Area	70
3.1.5.1	Title	71
3.1.5.2	Traces	71
3.1.5.3	Trace Types	72
3.1.5.4	Trace List and Trace Settings	73
3.1.5.5	Markers	74
3.1.5.6	Marker Info Field	75
3.1.5.7	Channel Settings.....	76
3.1.5.8	Context Menus.....	77
3.1.6	Dialogs	77
3.1.6.1	Immediate vs. Confirmed Settings.....	78
3.1.6.2	On-Screen Keyboard	78
3.1.6.3	Paste Marker List.....	79
3.1.6.4	Numeric Entry Bar.....	79
3.1.7	Display Formats and Diagram Types.....	80
3.1.7.1	Cartesian Diagrams	80
3.1.7.2	Conversion of Complex into Real Quantities	81

3.1.7.3	Polar Diagrams	82
3.1.7.4	Smith Chart	83
3.1.7.5	Inverted Smith Chart	85
3.1.7.6	Measured Quantities and Display Formats	87
3.2	Measured Quantities	89
3.2.1	S-Parameters	89
3.2.2	Impedance Parameters	90
3.2.3	Admittance Parameters	91
3.3	Calibration Overview	93
3.3.1	Calibration Standards and Calibration Kits	94
3.3.2	Calibration Types	94
3.3.2.1	Normalization	95
3.3.2.2	Full One-Port Calibration	95
3.3.2.3	One-Path Two-Port Calibration	96
3.3.2.4	TOSM Calibration	96
3.3.3	Automatic Calibration (Introduction)	97
3.4	Optional R&S ZVL Extensions	98
3.4.1	Distance-to-Fault (R&S ZVL-K2)	100
3.4.2	Time Domain (R&S ZVL-K3).....	100
3.4.3	Spectrum Analysis (R&S ZVL-K1)	100
3.4.4	TV Trigger (R&S FSL-B6).....	101
3.4.5	Gated Sweep (R&S FSL-B8).....	101
3.4.6	AM/FM/ϕM Measurement Demodulator (R&S FSL-K7)	101
3.4.7	Bluetooth Measurements (R&S FSL-K8).....	101
3.4.8	Spectrogram Measurements (R&S FSL-K14)	101
3.4.9	Noise Figure and Gain Measurements (R&S FSL-K30).....	101
3.4.10	WCDMA Measurements (3GPP/FDD BTS) (R&S FSL-K72).....	102
3.4.11	WLAN OFDM Analysis (R&S FSL-K91).....	102
3.4.12	WiMAX OFDM/OFDMA Analysis (R&S FSL-K93)	102

3 System Overview

The following chapter provides an overview of the analyzer's capabilities and their use. This includes a description of the basic concepts that the analyzer uses to organize, process and display measurement data, of the screen contents, possible measured quantities, and calibration methods.

For a systematic explanation of all menus, functions and parameters and background information refer to the reference description on the graphical user interface (GUI Reference) in the online help system.

3.1 Basic Concepts

The analyzer provides a variety of functions to perform a particular measurement and to customize and optimize the evaluation of results. To ensure that the instrument resources are easily accessible and that user-defined configurations can be conveniently implemented, stored and reused the instrument uses a hierarchy of structures:

- *Global resources* can be used for all measurements, irrespective of the current measurement session or setup.
- A *setup* comprises a set of *diagram areas* with all displayed information that can be stored to a setup file.
- The diagram areas show traces which are assigned to channels. See section Traces, Channels and Diagram Areas.

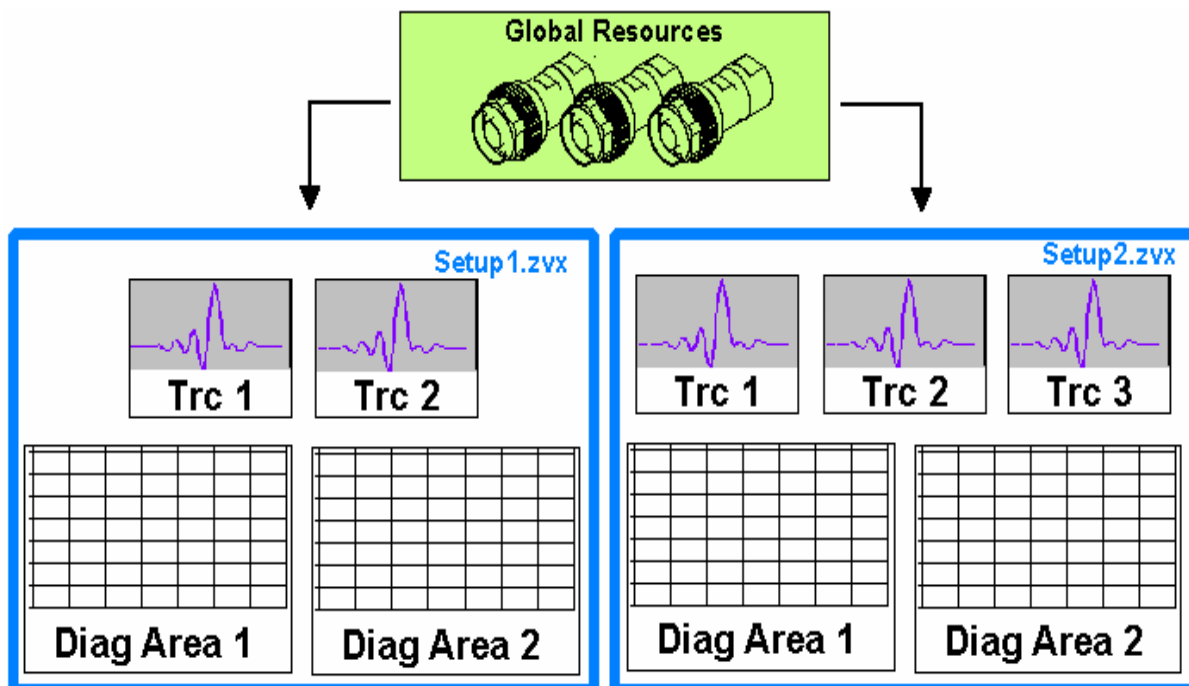

3.1.1 Global Resources

The analyzer provides global settings that are mostly hardware-related and can be used for all measurements, irrespective of the current measurement session or setup. The settings are stored in independent files and do not enter into any of the setup files. The following settings correspond to global resources:

- Calibration kits
- Connector types
- Cal pool data including system error correction and power correction data
- Color schemes

The data related to global resources are not affected by a *Preset* of the analyzer. However, it is possible to delete or reset global resource data using the *Resets* tab in the *System Config* dialog.

3.1.1.1 Setups

A setup comprises a set of *diagram areas* with all displayed information that can be stored to a NWA setup file (*.nwa) and reused. Each setup is displayed in an independent window. The setup file contains the following information:

- General settings related to the setup
- The trace settings for all traces in the diagram areas
- The channel settings for all channels associated to the traces
- The display settings for each diagram area

The *Nwa-File* menu is used to organize setups.



Demo setups

In the *System – External Tools* submenu, you can find demo setups *.vbs for various measurement scenarios. You can modify the demo setups and store them to a *.nwa file for later use.

3.1.2 Traces, Channels, and Diagram Areas

The analyzer arranges, displays or stores the measured data in *traces* which are assigned to *channels* and displayed in *diagram areas*. To understand the menu structure of the instrument and quickly find the appropriate settings, it is important to understand the exact meaning of the three terms.

- A trace is a set of data points that can be displayed together in a diagram area. The trace settings specify the mathematical operations used in order to obtain traces from the measured or stored data and to display them.
- A channel contains hardware-related settings to specify how the network analyzer collects data.

- A diagram area is a rectangular portion of the screen used to display traces. Diagram areas belonging to the same setup are arranged in a common window. The settings for diagram areas are described in section *Display Elements* in this chapter.

A diagram area can contain a practically unlimited number of traces, assigned to different channels. Diagram areas and channels are completely independent from each other.

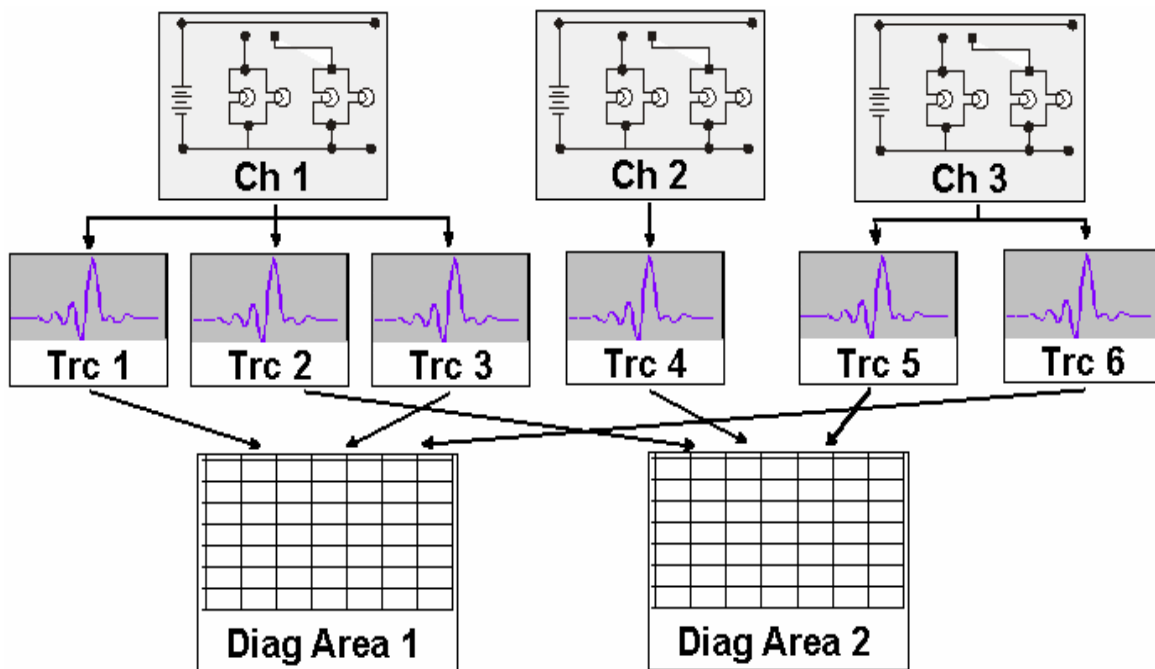

3.1.2.1 Trace Settings

The trace settings specify the mathematical operations used in order to obtain traces from the measured or stored data. They can be divided into several main groups:

- Selection of the measured quantity (S-parameters, impedances,...)
- Conversion into the appropriate display format and selection of the diagram type
- Scaling of the diagram and selection of the traces associated to the same channel
- Readout and search of particular values on the trace by means of markers
- Limit check

The *Trace* menu provides all trace settings. They complement the definitions of the *Channel* menu. Each trace is assigned to a channel. The channel settings apply to all traces assigned to the channel.



Active Traces

If a trace is selected in order to apply the trace settings, it becomes the active trace. In manual control there is always exactly one active trace, irrespective of the number of channels and traces defined. The active channel contains the active trace. In remote control, each channel contains an active trace; see section Active Traces in Remote Control in the help system.

3.1.2.2 Channel Settings

A channel contains hardware-related settings to specify how the network analyzer collects data. The channel settings can be divided into three main groups:

- Control of the measurement process (*Sweep*)
- Description of the test setup (*Power* of the internal source, IF filter *Bandwidth* and *Step Attenuators*, *Port Configuration*)
- Correction data (Calibration, Port Extensions)

The *Channel* menu provides all channel settings.



Sweep initialization

After changing the channel settings or selecting another measured quantity, the analyzer needs some time to initialize the new sweep. This preparation period increases with the number of points and the number of partial measurements involved. It is visualized by a Preparing Sweep symbol in the status bar:

All analyzer settings can still be changed during sweep initialization. If necessary, the analyzer terminates the current initialization and starts a new preparation period. During the first sweep after a change of the channel settings, an additional red asterisk symbol appears in the status bar:

3.1.3 Data Flow

The analyzer processes the raw measurement data in a sequence of stages in order to obtain the displayed trace. The following diagram gives an overview.

The diagram consists of an upper and a lower part, corresponding to the data processing stages for the entire channel and for the individual traces. All stages in the diagram are configurable.

All stages are described in detail in Chapter 4 of the help system, *GUI Reference*.

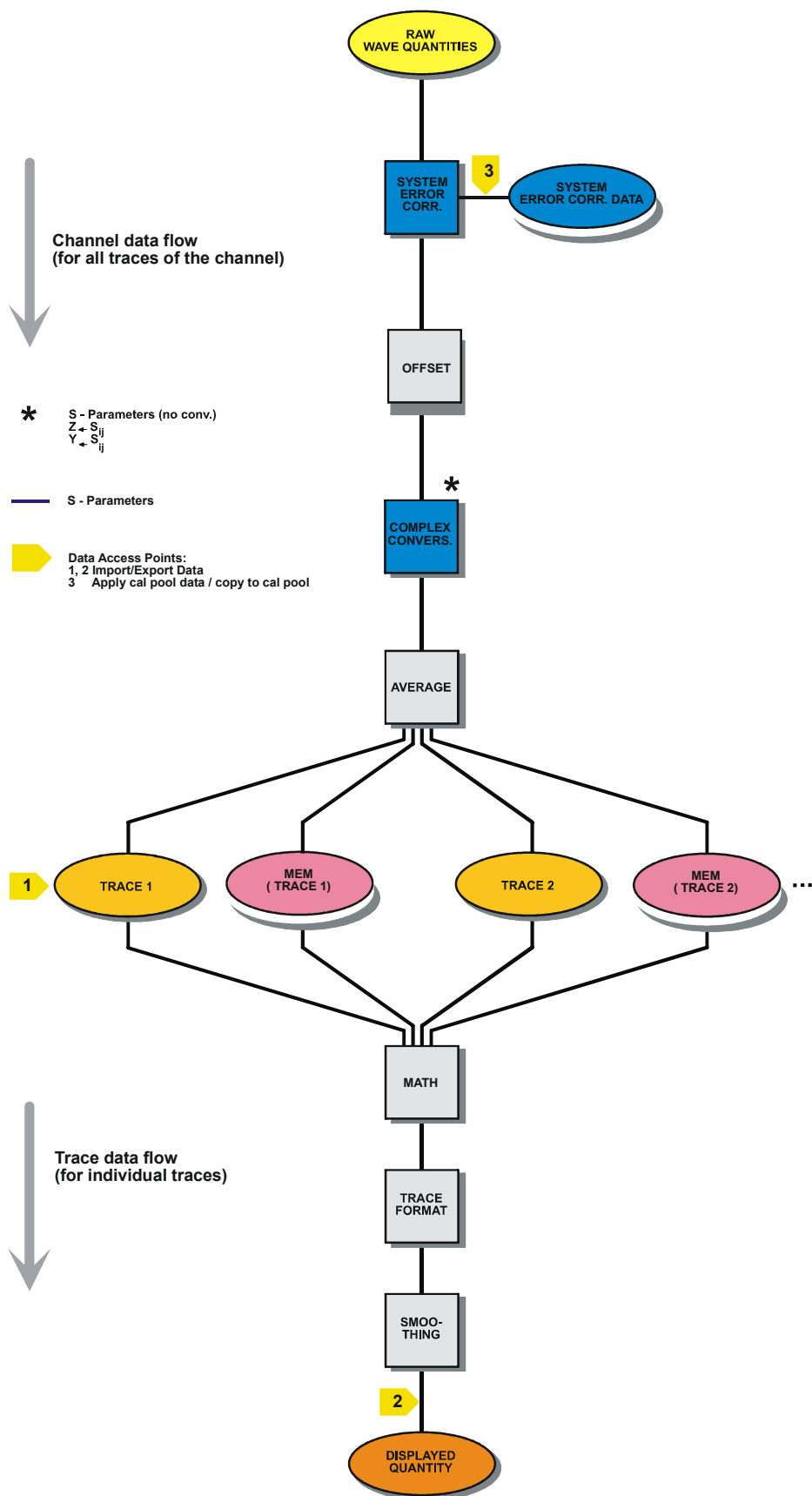

3.1.4 Navigation Tools of the Screen

This section describes the operating concept of the network analyzer, including the alternative navigation tools for mouse and hardkey operation, the trace settings, markers and diagram areas. For a description of the different quantities measured by the analyzer refer to the *Measured Quantities* section.

The main window of the analyzer provides all control elements for the measurements and contains the diagram areas for the results. There are several alternative ways to access an instrument function:

- Using the menus and submenus of the menu bar (provides all settings)
- Using the softkeys of the softkey bar (alternative to the previous method)
- Using the hardkey bar (preselection of the most important menus)

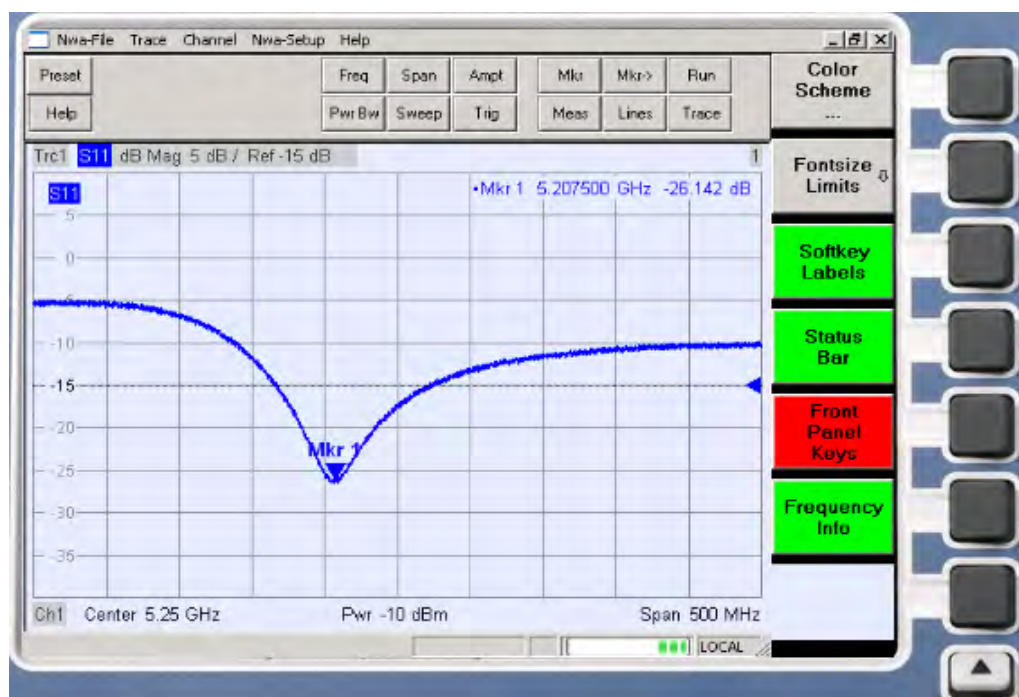

- Refer to section *Display Elements* to obtain information about the results in the diagram area.
- Refer to section *Display Menu* in the reference chapter and learn how to customize the screen.

3.1.4.1 Menu Bar

All analyzer functions are arranged in drop-down menus. The menu bar is located across the top of the diagram area:



Menus can be controlled in different ways:

- With a mouse, like the menus in any Windows application. A left mouse click expands a menu or submenu. If a menu command has no submenu assigned, a left mouse click opens a dialog or directly activates the menu command.
- Using the front panel keys.
- With a combination of the previous methods, using the hardkey bar (front panel key bar, activated via *Setup/Display Config./Front Panel Keys*).

The active menu is the menu containing the last executed command.

When you select a command in a new menu the softkey bar is updated to reflect the new active menu with all commands. You can continue operation using the softkeys.

Overview of menu functions

- The *Control*  menus provide standard Windows functions to control windows.
- The *File* menu provides standard Windows functions to create, save or recall setups and to shut down the application.
- The *Trace* menu provides all trace settings and the functions to create, select, modify and store different traces. In addition the menu provides the marker, search and limit check functions.
- The *Channel* menu provides all channel settings and the functions to create, select, modify and store different channels. This includes the functions for calibration.
- The *Display* menu provides all display settings and the functions to create, select, modify and arrange different diagram areas.
- The *NWA-Setup* menu provides standard Windows™ functions to arrange different windows on the screen, display options, reverse operations, return to a defined instrument state, and retrieve information on the instrument. Besides, it provides configurations for the user interface and for remote control operation.
- The *Help* menu provides assistance with the network analyzer and its operation.

3.1.4.2 Menu Structure

All menus show an analogous structure.

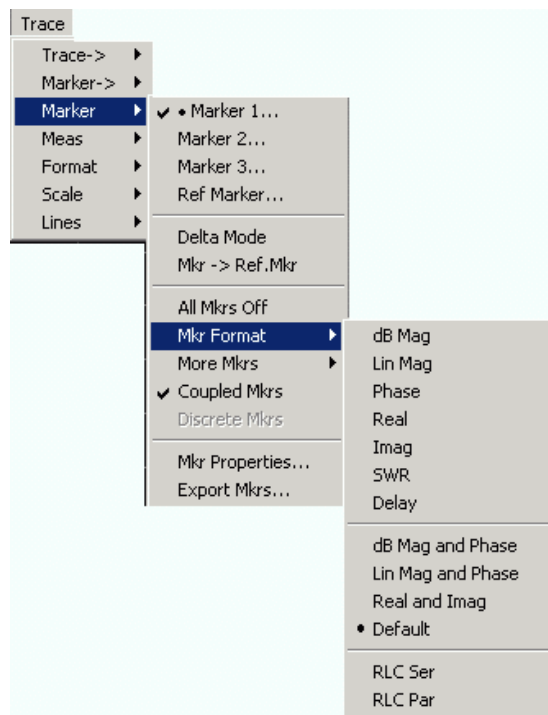

- A menu command with a right arrow ▶ expands a submenu with further related settings. **Example:** *Marker* ▶ expands a submenu to position markers on a trace and configure their properties.
- A menu command with three dots appended calls up an input field or a dialog providing several related settings. **Example:** *Marker 1...* opens an input field to enter the frequency of marker 1.
- A menu command with no arrow or dots directly initiates an action. **Example:** *Delta Mode* converts the active marker to a delta marker.
- A dot preceding the menu command indicates the current selection in a list of alternative settings. **Example:** In the figure above, the default format is selected as marker format.

3.1.4.3 Softkey Bar

The softkey bar displays the commands of the active menu so that they can be activated by hitting the associated keys on the front panel. It contains two different softkey types:

Function softkeys



Up to 7 softkeys, each corresponding to a command of the active menu. The function of the softkeys and their labels are strictly equivalent to the corresponding menu commands.

- Three dots indicate that the softkey calls up a dialog providing several related settings.
- A down arrow  indicates a submenu with further related settings.
- A softkey with no arrow or dots directly initiates an action.

...

Navigation softkey (optional)



Softkey no. 7 is reserved for navigation:

More 1/2, More 2/2 etc. toggle between groups of softkeys which belong to the same menu. The softkeys are provided whenever the active menu contains more than 6 commands.



The lowest front panel key to the right of the display activates the higher-level menu. This works in all menus except the top-level one listing the main menus in the menu bar.

The softkey bar is automatically updated when the active menu is changed.



Hiding display elements

You can hide the softkey bar and gain screen space for the diagram areas if you use a mouse to control the analyzer (see *Setup/Display Config.*). All settings are accessible from the menus listed in the menu bar across the top of the screen. Moreover, you don't have to display the softkey bar permanently in order to make use of its functionality. Hitting any of the keys associated to the softkey bar will make it visible for a period of time sufficient to select the next instrument function.

3.1.4.4 Front Panel Key Bar

The front panel key bar (hardkey bar, *Setup/Display Config.*) displays the most commonly used setup and function keys of the analyzer. Clicking a key symbol executes the action of the corresponding key.



The front panel key bar provides access to the basic groups of settings with a single mouse click. It is particularly useful if the analyzer is controlled with a mouse or via *Remote Desktop*. Alternatively the settings are accessible from the menus of the menu bar or from the softkey bar.

The front panel key bar is hidden by default to gain screen space for the diagram areas.

3.1.4.5 Status Bar

The status bar (Setup/Display Config.) shows the statistics for the sweep average (if sweep average is on), the progress of the sweep, a symbol for the current power supply option (AC, DC, battery, battery low), and the control mode of the analyzer (LOCAL or REMOTE).



During sweep initialization, the progress bar for the sweep is replaced by a **Preparing Sweep** symbol. During the first sweep after a change of the channel settings, an additional red asterisk symbol appears:



You can hide the status bar and gain screen space for the diagram areas.

3.1.5 Display Elements in the Diagram Area

The central part of the screen is occupied by one or several diagram areas.

Diagram Areas

A diagram area is a rectangular portion of the screen used to display traces. Diagram areas are arranged in windows; they are independent of trace and channel settings. A diagram area can contain a practically unlimited number of traces, assigned to different channels (overlay mode).

Diagram areas are controlled and configured by means of the functions in the *Display* menu and the following additional settings:

- The settings in the *Nwa-Setup – Display* submenu arrange several windows containing one or more diagram areas within the entire screen. Each window corresponds to a setup. Only one setup can be active at a time, and only the traces of the active setup are updated by the current measurements.
- Various settings to assign traces to diagram areas are provided in the *Trace – Trace-> – Traces* submenu.

Diagram areas may contain:

- Measurement results, in particular the traces and marker values
- An indication of the basic channel and trace settings
- Context menus providing settings related to the current screen

The examples in this section have been taken from Cartesian diagrams. All other diagram types provide the same display elements.

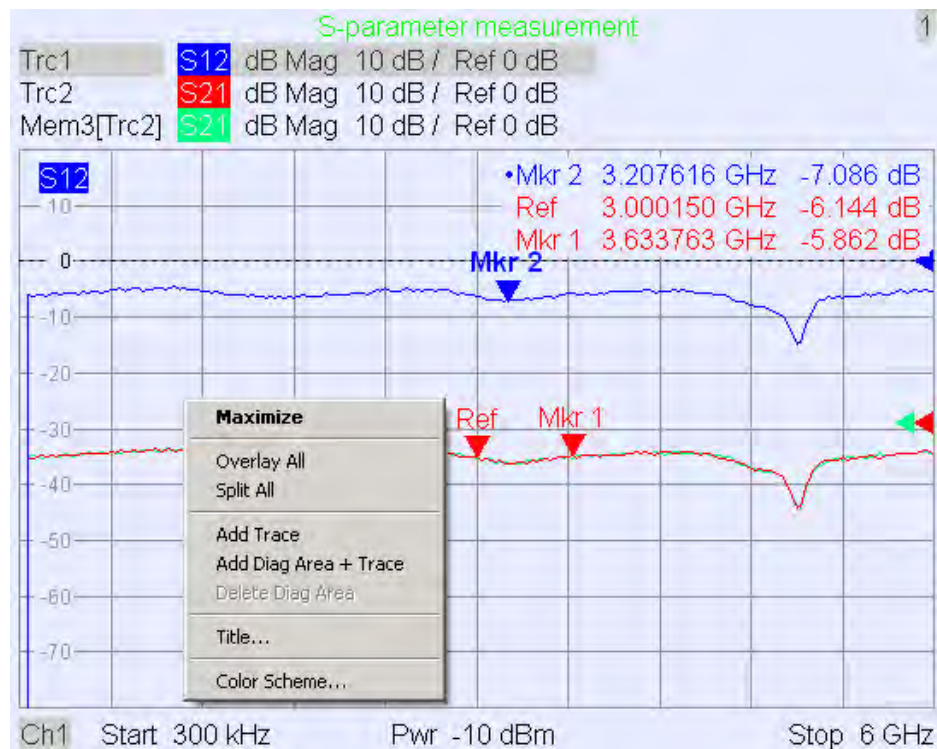

3.1.5.1 Title

Across the top of the diagram area, an optional title describes the contents of the area. Different areas within a setup are distinguished by area numbers in the upper right corner.

Measurement of S-Parameters

1

Use the context menu or the functions in the *Display* menu to display, hide or change the title and to add and customize diagram areas.

3.1.5.2 Traces

A trace is a set of data points displayed together in the diagram area. The individual data points are connected so that each trace forms a continuous line.

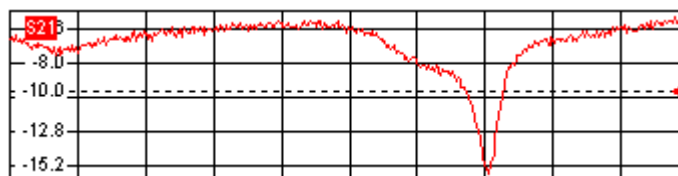

The trace can be complemented by the following display elements, plotted with the same color:

- **Reference value** (for all traces): The *Reference Value* is indicated with a triangle at the right edge of the diagram and a dashed, horizontal line. The value and position of the triangle can be changed in order to modify the diagram scale and shift the trace vertically.
- **Measured quantity** (for the active trace): The measured quantity is indicated in the left upper corner of the diagram.

A trace can be either a data trace, a memory trace, or a mathematical trace; see *Trace Types* below.

Context menu of the diagram area

A right mouse click on any point of the diagram area (except the marker info field and the measured quantity info) opens a context menu:

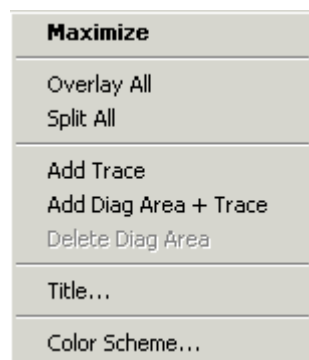

The settings correspond to the most common commands in the *Nwa-Setup – Display* and *Nwa-Setup – Display Config* menus.

3.1.5.3 Trace Types

The analyzer uses traces to display the current measurement result in a diagram area but is also capable of storing traces to the memory, recalling stored traces, and defining mathematical relations between different traces. There are three basic trace types:

- **Data traces** show the current measurement data and are continuously updated as the measurement goes on. Data traces are dynamic traces.
- **Memory traces** are generated by storing the data trace to the memory. It represents the state of the data trace at the moment when it was stored. Memory traces are static traces which can be stored to a file and recalled.
- **Mathematical traces** are calculated according to a mathematical relation between constants and the data or memory traces of the active setup. A mathematical trace that is based on the active data trace is dynamic.

It is possible to generate an unlimited number of memory traces from a data trace and display them together, see *Data -> Mem*. Markers and marker functions are available for all trace types.

The trace type of each trace in a diagram area is indicated in the trace list. You can also make each trace *Invisible* without deleting it.

3.1.5.4 Trace List and Trace Settings

The main properties of all traces assigned to the diagram area are displayed in the trace list in the upper left corner.

Trc2	S21	dB Mag	40 dB / Ref -200 dB	Ch1	Invisible
Trc3	S21	Phase	45° / Ref 0°	Ch2	
Trc7	S21	dB Mag	10 dB / Ref 0 dB	Ch2	Math
Mem8[Trc7]	S21	dB Mag	10 dB / Ref 0 dB	Ch2	

Each line in the trace list describes a single trace. The active trace is highlighted. The lines are divided into several sections with the following contents (from left to right):

- Trace name indicates the current trace name. The default names for new traces are Trc<n> where <n> is a current number. A *Mem...* preceding the trace name indicates a memory trace. Right-click the section and call the *Trace Manager* from the context menu to change the trace name.
- Measured quantity indicates the measured quantity, e.g. an S-parameter or an impedance. The measured quantity of the active trace is also displayed in the diagram area below the trace list.
- Format shows how the measured data is presented in the graphical display (trace format).
- Scale shows the value of the vertical or radial diagram divisions (Scale Div.) and the Reference Value.
- Channel shows the channel that each trace is assigned to. The channel section is omitted if the all traces in the diagram area are assigned to the same channel.
- Type shows *Invisible* if a trace is hidden and *Math* if the trace is a mathematical trace. *GAT* indicates that a time gate is active for the trace. Right-click the trace name and click *Show Data* or *Show Mem* from the context menu to display and hide data and memory traces. Use the *Trace Funct(ions)* to define mathematical traces. Right-click any of the sections in the trace list (except *Type*) to open a context menu and access the most common tasks related to the section.

Context menus of the trace list

A right mouse click on the trace name, the measured quantity, and the format and scale section of the trace list opens the following context menus, respectively:

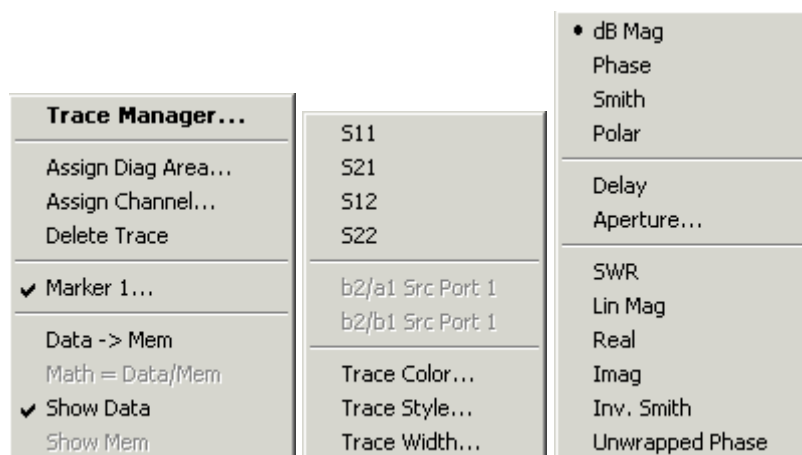



The settings correspond to the most common commands in the *Trace – Trace Select*, *Trace – Trace Funct*, *Trace – Meas*, *Trace – Format* and *Trace – Scale* menus.

A red label Cal Off ! appears behind the trace list if the system error correction no longer applies to one or more traces; see Calibration Overview.

3.1.5.5 Markers

Markers are tools for selecting points on the trace and for numerical readout of measured data. The analyzer provides three different basic marker types.

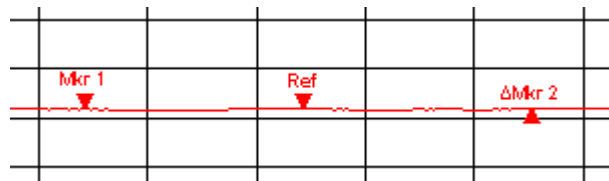

- A (normal) marker (*Mkr 1*, *Mkr 2*, ...) determines the coordinates of a measurement point on the trace. Up to 10 different normal markers can be assigned to a trace.
- A reference marker (*Ref*) defines the reference value for all delta markers.
- A delta marker (Δ) indicates the coordinates relative to the reference marker.
- The stimulus value of a *discrete marker* always coincides with a sweep point so that the marker does not show interpolated measurement values.

The markers 1 to 4 are also used for bandfilter search mode. The examples below show a bandpass search and a bandstop search, respectively.



- *Mkr 1* indicates the maximum (minimum) of the peak.
- *Mkr 2* and *Mkr 3* indicate the lower and upper band edge where the trace value has decreased (increased) by a definite *Level* value.
- *Mkr 4* indicates the center of the peak, calculated as the arithmetic mean value of the *LBE* and *UBE* positions.

3.1.5.6 Marker Info Field

The coordinates of all markers defined in a diagram area are displayed in the info field, which by default is located in the upper right corner.

Ref	6.838279 GHz	-1.954 dB
Mkr 1	6.088307 GHz	-0.160 dB
ΔMkr 2	779.38254 MHz	0.521 dB

The list contains the following information:

- *Mkr 1*, *Mkr2*, ... denote the marker numbers.
- Markers are displayed with the same color as the associated trace.
- The marker coordinates are expressed in one of the marker formats selected via *Marker Format*. The formats of the markers assigned to a trace are independent of each other and of the trace format settings.
- The active marker has a dot placed in front of the marker line.
- A Δ sign placed in front of the marker line indicates that the marker is in *Delta Mode*.

Customizing the marker info field

To change the position, appearance or contents of the marker info field use one of the following methods:

- Double-click the info field to open the Marker Properties dialog with extended settings for all markers of the active trace. Select the options in the Show Info panel to customize the information in the info field (Active Trace Only, Stimulus Info Off).
- Right-click the info field to open a context menu providing frequently used marker settings.
- To change the position of the marker info field, select *Movable Marker Info* from the context menu. Drag-and-drop the info field to any position in the active diagram area.
- To change the format of the active marker, select *Mkr Format*.
- To express the coordinates of the active marker relative to the reference marker, activate the *Delta Mode*.
- Open the *Nwa-Setup* dialog and open the *System Configuration* dialog to toggle between non-transparent and transparent info fields.

For more information: Show Info Table

In addition to the marker info field, the analyzer provides an info table with extended marker information.

Marker	Trace	Stimulus	Response	Delta	Discr	Fixed	Tracking	Search Range
Ref	Trc1	3.440171000 GHz	-6.426 dB	<input type="checkbox"/>	<input checked="" type="checkbox"/>	<input checked="" type="checkbox"/>	Off	Full Range
Mkr 1	Trc1	4.000150000 GHz	-5.364 dB	<input type="checkbox"/>	<input type="checkbox"/>	<input type="checkbox"/>	Off	Full Range

The table is hidden by default. To display the table double-click the marker info field to open the *Marker Properties* dialog.

Context menu of the marker info field

A right mouse click on the marker info field opens a context menu:

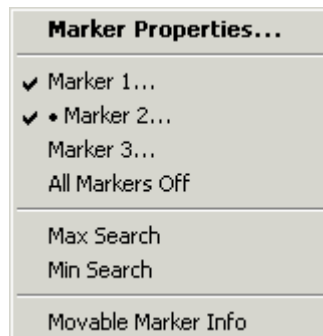

Movable Marker Info allows the marker info field to be placed to any position in the diagram area. The remaining settings correspond to the most common commands in the *Trace – Marker* and *Trace – Search* menus.

3.1.5.7 Channel Settings

The main properties of all channels assigned to the traces in the diagram area are displayed in the channel list below the diagram.

Ch1	Center	5.1 GHz	—	Pwr	-10 dBm	Span	500 MHz
Ch2	Start	1 GHz	—	Pwr	-10 dBm	Stop	2.5 GHz

Each line in the channel list describes a single channel. The channel of the active trace is highlighted. The lines are divided into several sections with the following contents (from left to right):

- Channel name indicates the current channel name. The default names for new channels are Ch<n> where <n> is a current number. Right-click the section and call the *Channel Manager* from the context menu to change the channel name.
- Start value of the sweep indicates the lowest value of the sweep variable (e.g. the lowest frequency measured), corresponding to the left edge of the Cartesian diagram.
- Color legend shows the display color of all traces assigned to the channel. The colors are different, so the number of colors is equal to the numbers of traces assigned to the channel.
- Additional stimulus parameter shows either the power of the internal signal source (for frequency sweeps and time sweeps) or the CW frequency (for power sweeps).
- Stop value of the sweep indicates the highest value of the sweep variable (e.g. the highest frequency measured), corresponding to the right edge of the Cartesian diagram. Right-click any of the sections in the trace list (except *Color legend*) to open a context menu and access the most common tasks related to the section.

Context menus of the channel list

A right mouse click on the channel name, the sweep range, and the additional parameter section of the channel list opens the following context menus, respectively:

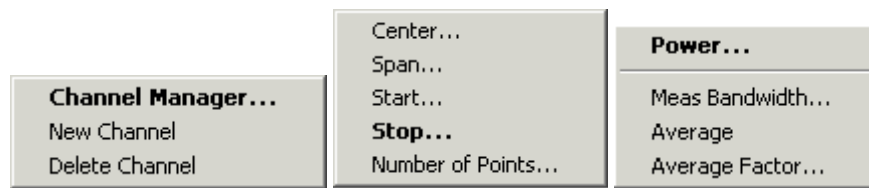

The settings correspond to the most common commands in the *Channel – Channel Select*, *Channel – Center*, *Span* and *Channel – Pwr Bw* menus.

3.1.5.8 Context Menus

To provide access to the most common tasks and speed up the operation, the analyzer offers context menus (right-click menus) for the following display elements:

- Diagram area
- Marker info field
- Trace list (separate context menus for trace name section, measured quantity section, format section, scale section, and channel section)
- Channel list (separate context menus for channel name section, sweep range section, additional parameter section)

Working with context menus requires a mouse. Click inside the display element that you want to work with using the **right** mouse button.

Except from some particular screen configurations, anything you can do from a context menu you can also do from the menu bar using front panel keys and softkeys. Use whatever method is most convenient for you.

3.1.6 Dialogs

Dialogs provide groups of related settings and allow to make selections and enter data in an organized way. All softkeys with three dots behind their labeling (as in *Mkr Properties...*) call up a dialog. The dialogs of the analyzer have an analogous structure and a number of common control elements.



Dialog Transparency

The *Dialog Transparency* function (*Nwa-Setup – System Config* menu) varies the transparency of all dialogs. With an appropriate setting, you can control the dialogs and at the same time view the underlying traces and display elements.

We assume that you are familiar with standard Windows dialogs and mouse operation. Refer to *Using Front Panel Keys* to learn how to control dialogs without a mouse and keyboard.



3.1.6.1 Immediate vs. Confirmed Settings

In some dialogs, the settings take effect immediately so that the effect on the measurement is observable while the dialog is still open. This is especially convenient when a numeric value is incremented or decremented, e.g. via the rotary knob.

In most dialogs, however, it is possible to cancel an erroneous input before it takes effect. The settings in such dialogs must be confirmed explicitly.

The two types of dialogs are easy to distinguish:

- Dialogs with immediate settings provide a *Close* button but no *OK* button.
Example: *Step Size* dialog.
- Dialogs with confirmed settings provide both an *OK* button and a *Cancel* button.
Example: On-screen keyboard.

You can also cancel an immediate setting using *Setup – Undo*.

3.1.6.2 On-Screen Keyboard

A keyboard  symbol next to a character input field opens the analyzer's on-screen keyboard.

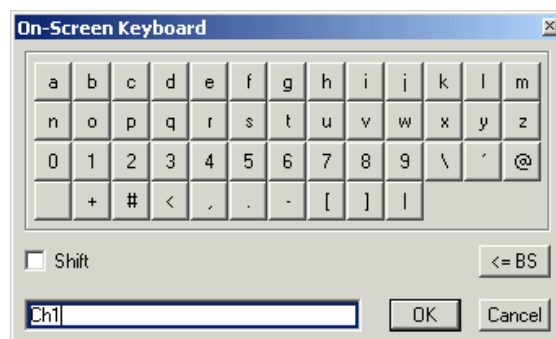

The on-screen keyboard contains two sets of characters plus the following additional controls:

- *Shift* changes between the two character sets containing lower case letters/numbers and upper case letters/special characters, respectively.
- *<= BS* deletes the current string in the alphanumeric input field.
- *OK* applies the current selection and closes the keyboard. The current string is written into the input field of the calling dialog. See also *Immediate vs. Confirmed Settings*.
- *Cancel* discards the current selection and closes the keyboard. The input field of the calling dialog is left unchanged.

The on-screen keyboard allows you to enter characters, in particular letters, without an external keyboard; see *Data Entry*. To enter numbers and units, you can also use the DATA ENTRY keys on the front panel of the instrument.

3.1.6.3 Paste Marker List

A pull-down list symbol next to a numeric input field opens a list of all current stimulus and response marker values of the active trace. Any of the marker values can be selected as a numeric entry. If the physical unit of the selected marker value is inconsistent (mismatch of stimulus and response values) then the numeric value is used without the unit.

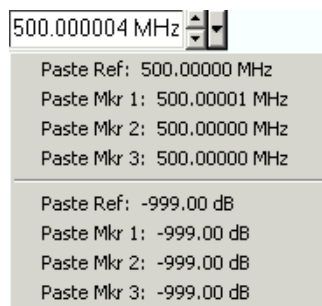

The response values in the paste marker list are not updated as the analyzer continues measuring, so they may differ from the values in the marker info field.

To open the paste marker list you can also click on the input field and use the space bar of your keyboard or the checkmark key in the navigation area at the front panel of the analyzer.

3.1.6.4 Numeric Entry Bar

Single numeric values can be entered using the input field of the numeric entry bar. The numeric entry bar appears just below the menu bar as soon as a function implying a single numeric entry is activated. In contrast to dialogs, it does not hide any of the display elements in the diagram area.

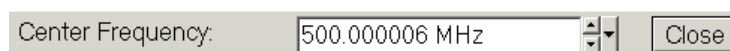

The numeric entry bar contains the name of the calling function, a numeric input field including the Cursor Up/Down buttons for data variation and a *Close* button. Besides it is closed automatically as soon as an active display element in the diagram area is clicked or a new menu command is activated.

3.1.7 Display Formats and Diagram Types

A display format defines how the set of (complex) measurement points is converted and displayed in a diagram. The display formats in the *Trace – Format* menu use the following basic diagram types:

- Cartesian (rectangular) diagrams are used for all display formats involving a conversion of the measurement data into a real (scalar) quantity, i.e. for *dB Mag*, *Phase*, *Group Delay*, *SWR*, *Lin Mag*, *Real*, *Imag* and *Unwrapped Phase*.
- Polar diagrams are used for the display format *Polar* and show a complex quantity as a vector in a single trace.
- Smith charts are used for the display format *Smith* and show vector like polar diagrams but with grid lines of constant real and imaginary part of the impedance.
- Inverted Smith charts are used for the display format *Inverted Smith* and show vector like polar diagrams but with grid lines of constant real and imaginary part of the admittance.



Trace formats and measured quantities

The analyzer allows arbitrary combinations of display formats and measured quantities (Trace – Meas). Nevertheless, in order to extract useful information from the data, it is important to select a display format which is appropriate to the analysis of a particular measured quantity; see Measured Quantities and Display Formats.

3.1.7.1 Cartesian Diagrams

Cartesian diagrams are rectangular diagrams used to display a scalar quantity as a function of the stimulus variable (frequency).

- The stimulus variable appears on the horizontal axis (x-axis), scaled linearly (sweep type *Lin Frequency*) or logarithmically (sweep type *Log Frequency*).
- The measured data (response values) appears on the vertical axis (y-axis). The scale of the y-axis is linear with equidistant grid lines although the y-axis values may be obtained from the measured data by non-linear conversions.

The following examples show the same trace in Cartesian diagrams with linear and logarithmic x-axis scaling.

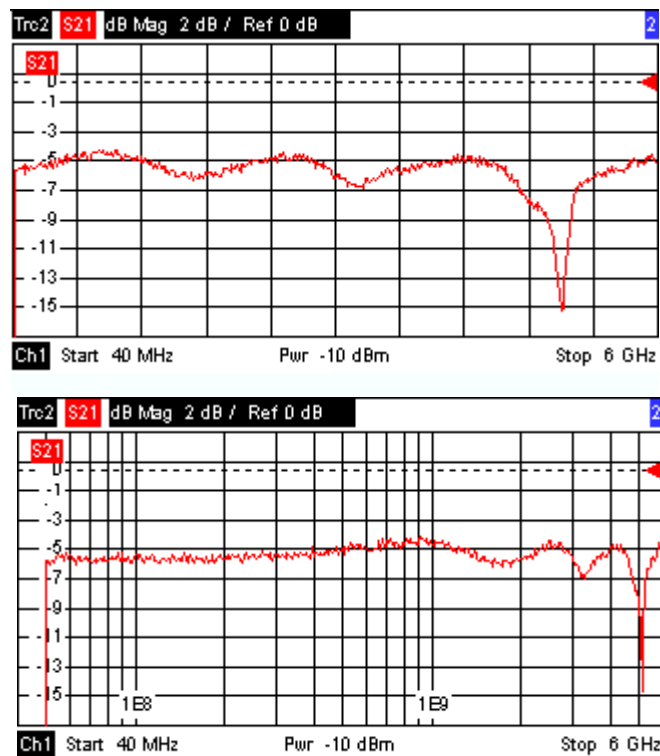

3.1.7.2 Conversion of Complex into Real Quantities

The results to be selected in the *Trace – Meas* menu can be divided into two groups:

- S-Parameters, Impedances, and Admittances are complex.
- Stability Factors are real.

The following table shows how the response values in the different Cartesian diagrams are calculated from the complex measurement values $z = x + jy$ (where x , y , z are functions of the sweep variable). The formulas also hold for real results, which are treated as complex values with zero imaginary part ($y = 0$).

Trace Format	Description	Formula
dB Mag	Magnitude of z in dB	$ z = \sqrt{x^2 + y^2}$ $\text{dB Mag}(z) = 20 * \log z \text{ dB}$
Lin Mag	Magnitude of z , unconverted	$ z = \sqrt{x^2 + y^2}$
Phase	Phase of z	$\phi(z) = \arctan(y/x)$
Real	Real part of z	$\text{Re}(z) = x$
Imag	Imaginary part of z	$\text{Im}(z) = y$
SWR	(Voltage) Standing Wave Ratio	$\text{SWR} = (1 + z) / (1 - z)$
Group Delay	Group delay, neg. derivative of the phase response	$-d\phi(z) / d\omega$ ($\omega = 2\pi * f$)

An extended range of formats and conversion formulas is available for markers. To convert any point on a trace, create a marker and select the appropriate marker format. Marker and trace formats can be selected independently.

3.1.7.3 Polar Diagrams

Polar diagrams show the measured data (response values) in the complex plane with a horizontal real axis and a vertical imaginary axis. The grid lines correspond to points of equal magnitude and phase.

- The magnitude of the response values corresponds to their distance from the center. Values with the same magnitude are located on circles.
- The phase of the response values is given by the angle from the positive horizontal axis. Values with the same phase on straight lines originating at the center.

The following example shows a polar diagram with a marker used to display a pair of stimulus and response values.

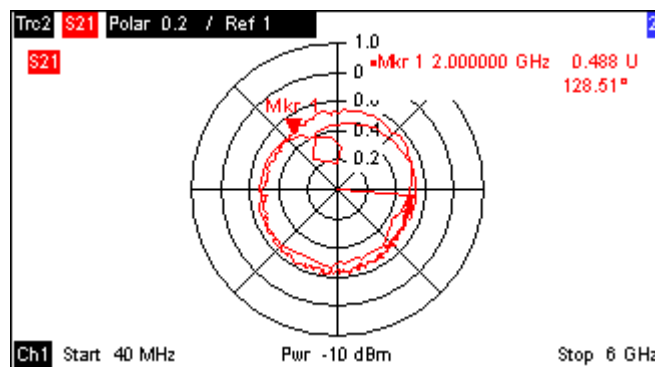

Example: Reflection coefficients in polar diagrams

If the measured quantity is a complex reflection coefficient (S_{11} , S_{22} etc.), then the center of the polar diagram corresponds to a perfect load Z_0 at the input test port of the DUT (no reflection, matched input), whereas the outer circumference ($|S_{ii}| = 1$) represents a totally reflected signal.

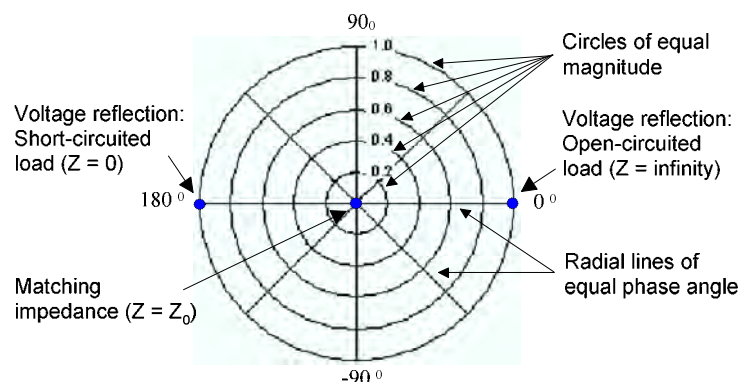

Examples for definite magnitudes and phase angles:

- The magnitude of the reflection coefficient of an open circuit ($Z = \text{infinity}$, $\Gamma = 0$) is one, its phase is zero.

- The magnitude of the reflection coefficient of a short circuit ($Z = 0$, $U = 0$) is one, its phase is -180° .

3.1.7.4 Smith Chart

The Smith chart is a circular diagram that maps the complex reflection coefficients S_{ij} to normalized impedance values. In contrast to the polar diagram, the scaling of the diagram is not linear. The grid lines correspond to points of constant resistance and reactance.

- Points with the same resistance are located on circles.
- Points with the same reactance produce arcs.

The following example shows a Smith chart with a marker used to display the stimulus value, the complex impedance $Z = R + jX$ and the equivalent inductance L (see marker format description in the help system).

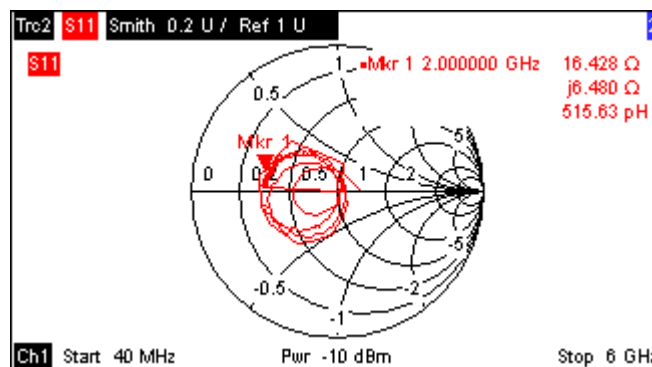

Polar diagram types

A comparison of the Smith chart, the inverted Smith chart and the polar diagram reveals many similarities between the two representations. In fact the shape of a trace does not change at all if the display format is switched from *Polar* to *Smith* or *Inverted Smith* – the analyzer simply replaces the underlying grid and the default marker format.

Smith chart construction

In a Smith chart, the impedance plane is reshaped so that the area with positive resistance is mapped into a unit circle.

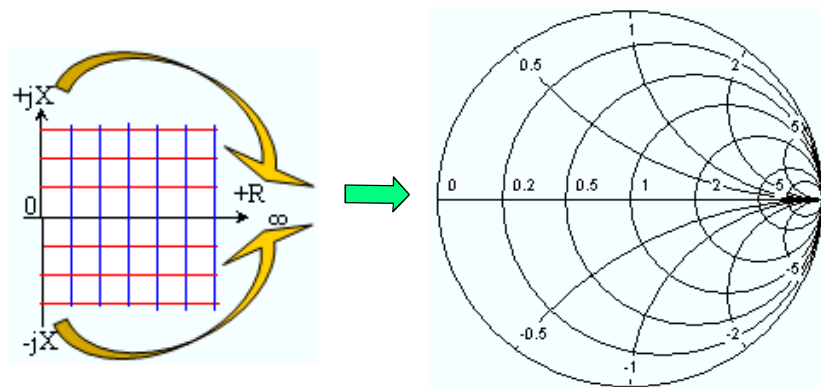

The basic properties of the Smith chart follow from this construction:

- The central horizontal axis corresponds to zero reactance (real impedance). The center of the diagram represents $Z/Z_0 = 1$ which is the reference impedance of the system (zero reflection). At the left and right intersection points between the horizontal axis and the outer circle, the impedance is zero (short) and infinity (open).
- The outer circle corresponds to zero resistance (purely imaginary impedance). Points outside the outer circle indicate an active component.
- The upper and lower half of the diagram correspond to positive (inductive) and negative (capacitive) reactive components of the impedance, respectively.

Example: Reflection coefficients in the Smith chart

If the measured quantity is a complex reflection coefficient Γ (e.g. S_{11} , S_{22}), then the unit Smith chart can be used to read the normalized impedance of the DUT. The coordinates in the normalized impedance plane and in the reflection coefficient plane are related as follows (see also: definition of matched-circuit (converted) impedances):

$$Z / Z_0 = (1 + \Gamma) / (1 - \Gamma)$$

From this equation it is easy to relate the real and imaginary components of the complex resistance to the real and imaginary parts of Γ :

$$R = \operatorname{Re}(Z / Z_0) = \frac{1 - \operatorname{Re}(\Gamma)^2 - \operatorname{Im}(\Gamma)^2}{[1 - \operatorname{Re}(\Gamma)]^2 + \operatorname{Im}(\Gamma)^2}, \quad X = \operatorname{Im}(Z / Z_0) = \frac{2 \cdot \operatorname{Im}(\Gamma)}{[1 - \operatorname{Re}(\Gamma)]^2 + \operatorname{Im}(\Gamma)^2},$$

in order to deduce the following properties of the graphical representation in a Smith chart:

- Real reflection coefficients are mapped to real impedances (resistances).
- The center of the Γ plane ($\Gamma = 0$) is mapped to the reference impedance Z_0 , whereas the circle with $|\Gamma| = 1$ is mapped to the imaginary axis of the Z plane.
- The circles for the points of equal resistance are centered on the real axis and intersect at $Z = \text{infinity}$. The arcs for the points of equal reactance also belong to circles intersecting at $Z = \text{infinity}$ (open circuit point $(1,0)$), centered on a straight vertical line.

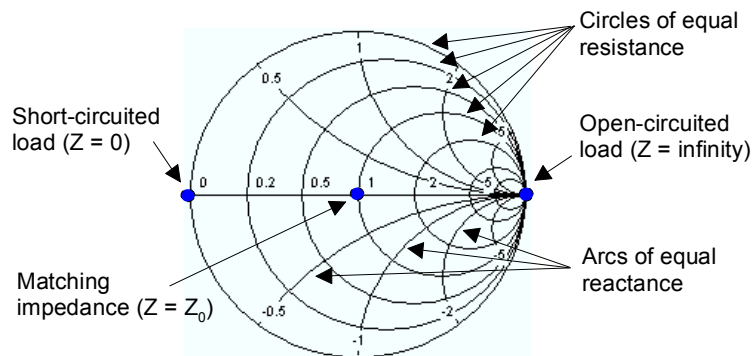

Examples for special points in the Smith chart:

- The magnitude of the reflection coefficient of an open circuit ($Z = \text{infinity}$, $\Gamma = 0$) is one, its phase is zero.
- The magnitude of the reflection coefficient of a short circuit ($Z = 0$, $\Gamma = 0$) is one, its phase is -180° .

3.1.7.5 Inverted Smith Chart

The inverted Smith chart is a circular diagram that maps the complex reflection coefficients S_{ij} to normalized admittance values. In contrast to the polar diagram, the scaling of the diagram is not linear. The grid lines correspond to points of constant conductance and susceptance.

- Points with the same conductance are located on circles.
- Points with the same susceptance produce arcs.

The following example shows an inverted Smith chart with a marker used to display the stimulus value, the complex admittance $Y = G + jB$ and the equivalent inductance L (see marker format description in the help system).

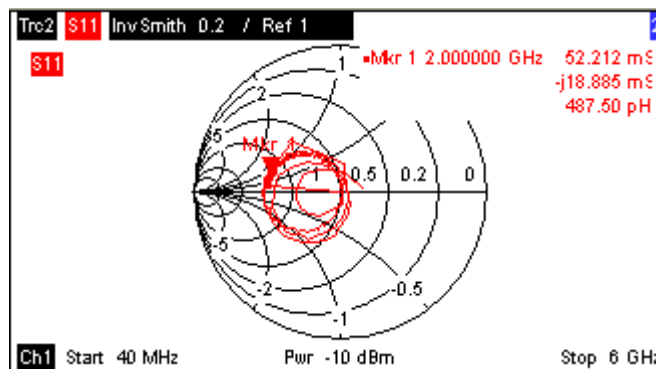

Polar diagram types

A comparison of the Smith chart, the inverted Smith chart and the polar diagram reveals many similarities between the two representations. In fact the shape of a trace does not change at all if the display format is switched from *Polar* to *Smith* or *Inverted Smith* – the analyzer simply replaces the underlying grid and the default marker format.

Inverted Smith chart construction

The inverted Smith chart is point-symmetric to the Smith chart:

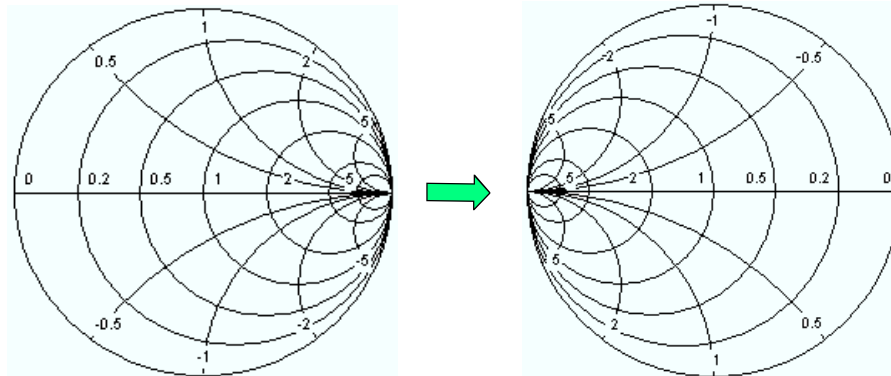

The basic properties of the inverted Smith chart follow from this construction:

- The central horizontal axis corresponds to zero susceptance (real admittance). The center of the diagram represents $Y/Y_0 = 1$, where Y_0 is the reference admittance of the system (zero reflection). At the left and right intersection points between the horizontal axis and the outer circle, the admittance is infinity (short) and zero (open).
- The outer circle corresponds to zero conductance (purely imaginary admittance). Points outside the outer circle indicate an active component.
- The upper and lower half of the diagram correspond to negative (inductive) and positive (capacitive) susceptive components of the admittance, respectively.

Example: Reflection coefficients in the inverted Smith chart

If the measured quantity is a complex reflection coefficient Γ (e.g. S_{11} , S_{22}), then the unit inverted Smith chart can be used to read the normalized admittance of the DUT. The coordinates in the normalized admittance plane and in the reflection coefficient plane are related as follows (see also: definition of matched-circuit (converted) admittances):

$$Y / Y_0 = (1 - \Gamma) / (1 + \Gamma)$$

From this equation it is easy to relate the real and imaginary components of the complex admittance to the real and imaginary parts of Γ

$$G = \text{Re}(Y / Y_0) = \frac{1 - \text{Re}(\Gamma)^2 - \text{Im}(\Gamma)^2}{[1 + \text{Re}(\Gamma)]^2 + \text{Im}(\Gamma)^2}, \quad B = \text{Im}(Y / Y_0) = \frac{-2 \cdot \text{Im}(\Gamma)}{[1 + \text{Re}(\Gamma)]^2 + \text{Im}(\Gamma)^2},$$

in order to deduce the following properties of the graphical representation in an inverted Smith chart:

- Real reflection coefficients are mapped to real admittances (conductances).
- The center of the Γ plane ($\Gamma = 0$) is mapped to the reference admittance Y_0 , whereas the circle with $|\Gamma| = 1$ is mapped to the imaginary axis of the Y plane.
- The circles for the points of equal conductance are centered on the real axis and intersect at $Y = \text{infinity}$. The arcs for the points of equal susceptance also belong to circles intersecting at $Y = \text{infinity}$ (short circuit point $(-1, 0)$), centered on a straight vertical line.

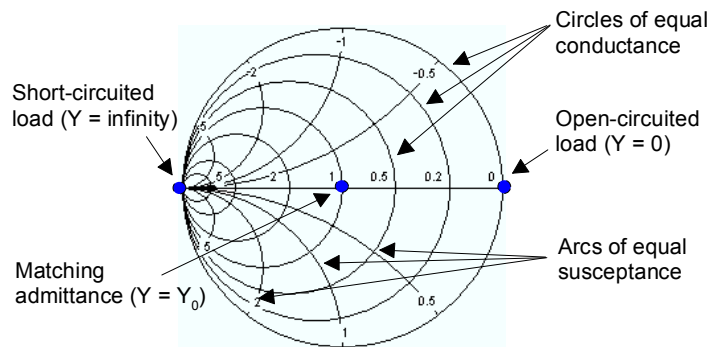

Examples for special points in the inverted Smith chart:

- The magnitude of the reflection coefficient of a short circuit ($Y = \infty, U = 0$) is one, its phase is -180° .
- The magnitude of the reflection coefficient of an open circuit ($Y = 0, I = 0$) is one, its phase is zero.

3.1.7.6 Measured Quantities and Display Formats

The analyzer allows any combination of a display format and a measured quantity. The following rules can help to avoid inappropriate formats and find the format that is ideally suited to the measurement task.

- All formats are suitable for the analysis of reflection coefficients S_{ij} . The formats *SWR*, *Smith* and *Inverted Smith* lose their original meaning (standing wave ratio, normalized impedance or admittance) if they are used for transmission *S-parameters*.
- The complex *Impedances*, and *Admittances* are generally displayed in one of the Cartesian diagrams with linear vertical axis scale or in a polar diagram.
- The real *Stability Factors* are generally displayed in a linear Cartesian diagram (*Lin Mag* or *Real*). In complex formats, real numbers represent complex numbers with zero imaginary part.

The following table gives an overview of recommended display formats.

	Complex dimensionless quantities: S-parameters	Complex quantities with dimensions: impedances, admittances	Real quantities: Stability Factors
Lin Mag	<input checked="" type="checkbox"/>	<input checked="" type="checkbox"/> (default for impedances, admittances)	<input checked="" type="checkbox"/> (default)
dB Mag	<input checked="" type="checkbox"/> (default)	<input checked="" type="checkbox"/>	–
Phase	<input checked="" type="checkbox"/>	<input checked="" type="checkbox"/>	–
Real	<input checked="" type="checkbox"/>	<input checked="" type="checkbox"/>	<input checked="" type="checkbox"/>
Imag	<input checked="" type="checkbox"/>	<input checked="" type="checkbox"/>	–
Unwrapped Phase	<input checked="" type="checkbox"/>	<input checked="" type="checkbox"/>	–
Smith	<input checked="" type="checkbox"/> (reflection coefficients S_{ij})	–	–
Polar	<input checked="" type="checkbox"/>	–	–

	Complex dimensionless quantities: S-parameters	Complex quantities with dimensions: impedances, admittances	Real quantities: Stability Factors
Inverted Smith	<input checked="" type="checkbox"/> (reflection coefficients S_{ij})	–	–
SWR	<input checked="" type="checkbox"/> (reflection coefficients S_{ij})	–	–
Group Delay	<input checked="" type="checkbox"/> (transmission coefficients S_{ij})	–	–

The default formats are activated automatically when the measured quantity is changed.

3.2 Measured Quantities

This section gives an overview of the measurement results of the network analyzer and the meaning of the different measured quantities. All quantities can be selected in the *Trace – Meas* submenu.

3.2.1 S-Parameters

S-parameters are the basic measured quantities of a network analyzer. They describe how the DUT modifies a signal that is transmitted or reflected in forward or reverse direction. For a 2-port measurement the signal flow is as follows.

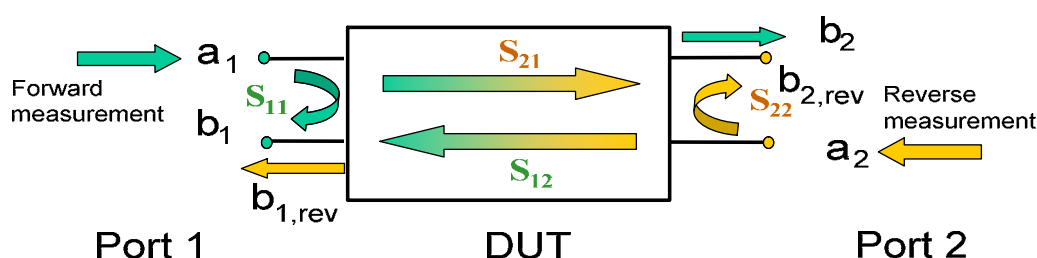

Extensions to the signal flow

The figure above is sufficient for the definition of S-parameters but does not necessarily show the complete signal flow. In fact, if the source and load ports are not ideally matched, part of the transmitted waves are reflected off the receiver ports so that an additional a_2 contribution occurs in forward measurements, an a_1 contribution occurs in reverse measurements.

The scattering matrix links the incident waves a_1 , a_2 to the outgoing waves b_1 , b_2 according to the following linear equation:

$$\begin{bmatrix} b_1 \\ b_2 \end{bmatrix} = \begin{bmatrix} S_{11} & S_{12} \\ S_{21} & S_{22} \end{bmatrix} * \begin{bmatrix} a_1 \\ a_2 \end{bmatrix}$$

The equation shows that the S-parameters are expressed as $S_{\langle out \rangle \langle in \rangle}$, where $\langle out \rangle$ and $\langle in \rangle$ denote the output and input port numbers of the DUT.

Meaning of 2-port S-parameters

The four 2-port S-parameters can be interpreted as follows:

- S_{11} is the input reflection coefficient, defined as the ratio of the wave quantities b_1/a_1 , measured at PORT 1 (forward measurement with matched output and $a_2 = 0$).
- S_{21} is the forward transmission coefficient, defined as the ratio of the wave quantities b_2/a_1 (forward measurement with matched output and $a_2 = 0$).

- S_{12} is the reverse transmission coefficient, defined as the ratio of the wave quantities b_1 (reverse measurement with matched input, $b_{1,rev}$ in the figure above and $a_1 = 0$) to a_2 .
- S_{22} is the output reflection coefficient, defined as the ratio of the wave quantities b_2 (reverse measurement with matched input, $b_{2,rev}$ in the figure above and $a_1 = 0$) to a_2 , measured at PORT 2.

Meaning of squared amplitudes

The squared amplitudes of the incident and outgoing waves and of the matrix elements have a simple meaning:

$ a_1 ^2$	Available incident power at the input of a two-port (= the power provided by a generator with a source impedance equal to the reference impedance Z_0)
$ a_2 ^2$	Available incident power at the output
$ b_1 ^2$	Reflected power at the input of a two-port
$ b_2 ^2$	Reflected power at the output
$10 \cdot \log S_{11} ^2 (= 20 \cdot \log S_{11})$	Reflection loss at the input
$10 \cdot \log S_{22} ^2$	Reflection loss at the output
$10 \cdot \log S_{21} ^2$	Insertion loss at the input
$10 \cdot \log S_{12} ^2$	Insertion loss at the output

3.2.2 Impedance Parameters

An impedance is the complex ratio between a voltage and a current. The analyzer provides converted impedances: each impedance parameter is obtained from a single S-parameter.

The converted, matched-circuit impedances describe the impedances of a DUT that is terminated at its outputs with the reference impedance Z_{0i} . i numbers the analyzer/DUT port.

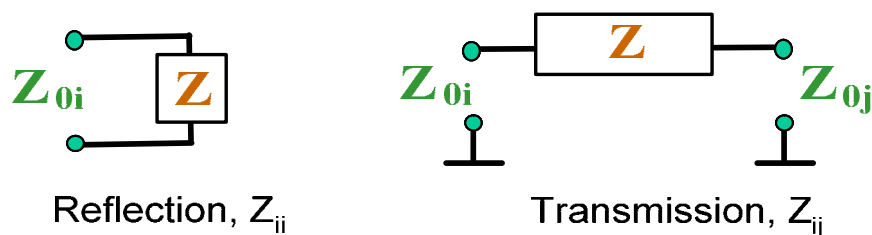

The analyzer converts a **single** measured S-parameter to determine the corresponding converted impedance. As a result, converted Z-parameters cannot completely describe general n-port DUTs:

- A reflection parameter Z_{ii} completely describes a one-port DUT. For n-port DUTs ($n > 1$) the reflection parameters Z_{ii} describe the input impedances at ports i ($i = 1$ to n) under the condition that each of the other ports is terminated with its reference impedance (matched-circuit parameters).

- A two-port transmission parameter Z_{ij} ($i \neq j$) can describe a pure serial impedance between the two ports.

Relation with S-parameters

The converted impedances Z_{ii} are calculated from the reflection S-parameters S_{ii} according to:

$$Z_{ii} = Z_{0i} \frac{1 + S_{ii}}{1 - S_{ii}},$$

The transmission parameters are calculated according to:

$$Z_{ij} = 2 \cdot \frac{\sqrt{Z_{0i} \cdot Z_{0j}}}{S_{ij}} - (Z_{0i} + Z_{0j}), \quad i \neq j,$$

The converted admittances are defined as the inverse of the impedances.

Example:

Z_{11} is the input impedance of a 2-port DUT that is terminated at its output with the reference impedance Z_0 (matched -circuit impedance measured in a forward reflection measurement).

Tip: You can also read the converted impedances in a reflection coefficient measurement from the Smith chart.

3.2.3 Admittance Parameters

An admittance is the complex ratio between a current and a voltage. The analyzer provides converted admittances: each admittance parameter is obtained from a single S-parameter.

The converted admittance parameters describe the input admittances of a DUT with fully matched outputs. The converted admittances are the inverse of the converted impedances.

The analyzer converts a **single** measured S-parameter to determine the corresponding converted admittance. As a result, converted Y-parameters cannot completely describe general n-port DUTs:

- A reflection parameter Y_{ii} completely describes a one-port DUT. For n-port DUTs ($n > 1$) the reflection parameters Y_{ii} describe the input admittances at ports i ($i = 1$ to n) under the condition that each of the other ports is terminated with its reference impedance (matched-circuit parameters).
- A two-port transmission parameter Y_{ij} ($i \neq j$) can describe a pure serial impedance between the two ports.

Relation with S-parameters

The converted admittances Y_{ii} are calculated from the reflection S-parameters S_{ii} according to:

$$Y_{ii} = \frac{1}{Z_{0i}} \frac{1 - S_{ii}}{1 + S_{ii}} = 1/Z_{ii} ,$$

where i numbers the analyzer/DUT port. The transmission parameters are calculated according to:

$$Y_{ij} = \frac{S_{ij}}{2 \cdot \sqrt{Z_{0i} \cdot Z_{0j}} - S_{ij} \cdot (Z_{0i} + Z_{0j})} = 1/Z_{ij}, \quad i \neq j, \quad i, j = 1, \dots, 99$$

Example:

Y_{11} is the input admittance of a 2-port DUT that is terminated at its output with the reference impedance Z_0 (matched-circuit admittance measured in a forward reflection measurement).



You can also read the converted admittances in a reflection coefficient measurement from the inverted Smith chart.

3.3 Calibration Overview

Calibration is the process of eliminating systematic, reproducible errors from the measurement results (system error correction). The process involves the following stages:

1. A set of calibration standards is selected and measured over the required sweep range. For many calibration types the magnitude and phase response of each calibration standard (i.e. its S-parameters if no system errors occur) must be known within the entire sweep range.
2. The analyzer compares the measurement data of the standards with their known, ideal response. The difference is used to calculate the system errors using a particular error model (calibration type) and derive a set of system error correction data.
3. The system error correction data is used to correct the measurement results of a DUT that is measured instead of the standards.

Calibration is always channel-specific because it depends on the hardware settings, in particular on the sweep range. This means that a system error correction data set is stored with the calibrated channel.

The analyzer provides a wide range of sophisticated calibration methods for all types of measurements. Which calibration method is selected depends on the expected system errors, the accuracy requirements of the measurement, on the test setup and on the types of calibration standards available.

Due to the analyzer's calibration wizard, calibration is a straightforward, menu-guided process. Moreover, it is possible to perform the entire calibration process automatically using a calibration unit (accessory R&S ZV-Z5x).



Storing system error correction data

The system error correction data determined in a calibration procedure is stored on the analyzer. You can read this correction data using the remote control command `[SENSe<Ch>:]CORRection:CDATa`. You can also replace the correction data of the analyzer by your own correction data sets.

A label *Cal Off!* appears behind the trace list if the system error correction no longer applies to one or more traces:

Trc1	S21	dB Mag	10 dB / Ref 0 dB	Cal Off !
Trc2	S21	dB Mag	10 dB / Ref 0 dB	Cal Off !

This may happen for the one of the following reasons:

- The sweep range is outside the calibrated frequency range.
- The channel calibration is not sufficient for the measured quantity (e.g. a one-port calibration has been performed, but the measured quantity is a transmission parameter).
- The system error correction has been switched off deliberately (Correction Off).

3.3.1 Calibration Standards and Calibration Kits

A calibration kit is a set of physical calibration standards for a particular connector type. The magnitude and phase response of the calibration standards (i.e. their S-parameters) must be known or predictable within a given frequency range.

The standards are grouped into several types (open, through, match,...) corresponding to the different input quantities for the analyzer's error models. The standard type also determines the equivalent circuit model used to describe its properties. The circuit model depends on several parameters that are stored in the cal kit file associated with the calibration kit.

As an alternative to using circuit models, it is possible to describe the standards by means of S-parameter tables stored in a file.

The analyzer provides a large number of predefined cal kits but can also import cal kit files and create new kits:

- A selection of predefined kits is available for all connector types. The parameters of these kits are displayed in the *Add/Modify Standards* dialog, however, it is not possible to change or delete the kits.
- Imported and user-defined kits can be changed in the *Calibration Kits* dialog and its various sub-dialogs.

Calibration kits and connector types are global resources; the parameters are stored independently and are available irrespective of the current setup.

3.3.2 Calibration Types

The analyzer provides a wide range of calibration types for one, two or more ports. The calibration types differ in the number and types of standards used, the error terms, i.e. the type of systematic errors corrected and the general accuracy. The following table gives an overview.

Calibration Type	Standards	Parameters	Error Terms	General Accuracy	Application
Reflection Normalization	Open or Short	S_{11} (or S_{22}, \dots)	Reflection tracking	Low to medium	Reflection measurements on any port.
Transmission Normalization	Through	S_{12}, S_{21}	Transmission tracking	Medium	Transmission measurements in any direction and between any combination of ports.
Full One-Port	Open, Short, Match ¹⁾	S_{11} (or S_{22}, \dots)	Reflection tracking, Source match Directivity,	High	Reflection measurements on any port.
One-Path Two-Port	Open, Short, Match ¹⁾ (at source port), Through ²⁾	S_{11}, S_{21} (or S_{22}, \dots)	Reflection tracking, Source match, Directivity, Transmission tracking	Medium to high	Unidirectional transmission measurements in any direction and between any combination of ports.

Calibration Type	Standards	Parameters	Error Terms	General Accuracy	Application
TOSM	Open, Short, Match ¹⁾ (at each port), Through ²⁾ (between the 2 ports)	All	Reflection tracking, Source match, Directivity, Load match, Transmission tracking	High	Reflection and transmission measurements on DUTs with 2 ports.

1) Or any other 3 known one-port standards. To be used in a guided calibration, the known standards must be declared to be open, short, and match irrespective of their properties.

2) Or any other known two-port standard. See remark above.

- The calibration type must be selected in accordance with the test setup. Select the calibration type for which you can obtain or design the most accurate standards and for which you can measure the required parameters with best accuracy.

3.3.2.1 Normalization

A normalization is the simplest calibration type since it requires the measurement of only one standard for each calibrated S-parameter:

- One-port (reflection) S-parameters (S_{11} , S_{22} , ...) are calibrated with an open or a short standard providing the **reflection tracking** error term.
- Two-port (transmission) S-parameters (S_{12} , S_{21} , ...) are calibrated with a through standard providing the **transmission tracking** error term.

Normalization means that the measured S-parameter at each sweep point is divided by the corresponding S-parameter of the standard. A normalization eliminates the frequency-dependent attenuation and phase shift in the measurement path (reflection or transmission tracking error). It does not compensate for directivity or mismatch errors. This limits the accuracy of a normalization.

3.3.2.2 Full One-Port Calibration

A full one-port calibration requires a short, an open and a match standard to be connected to a single test port. The three standard measurements are used to derive all three reflection error terms:

- The short and open standards are used to derive the **source match** and the **reflection tracking** error terms.
- The match standard is used to derive the **directivity** error.

A full one-port calibration is more accurate than a normalization but is only applicable for reflection measurements.

3.3.2.3 One-Path Two-Port Calibration

A one-path two-port calibration combines a full one-port calibration with a transmission normalization, so it requires a short, an open and a match standard to be connected to a single test port plus a through standard between this calibrated source port and a second load port. The four standard measurements are used to derive the following error terms:

- The short and open standards are used to derive the **source match** and the **reflection tracking error** terms at the source port.
- The match standard is used to derive the **directivity error** at the source port.
- The through standard provides the **transmission tracking error** term.

A one-path two-port calibration requires only four standards to be connected (instead of 7 for a full two-port TOSM calibration) and is suitable when only the forward (e.g. S_{11} and S_{21}) or reverse S-parameters (e.g. S_{22} and S_{12}) are to be measured and the DUT is well matched, especially at the load port.

3.3.2.4 TOSM Calibration

A TOSM (Through – Open – Short – Match) calibration requires the same standards as the one-path two-port calibration, however, all measurements are performed in the forward and reverse direction. TOSM is also referred to as SOLT (Short – Open – Load = Match – Through) calibration. The four standards are used to derive 6 error terms for each signal direction:

- In addition to the **source match** and **reflection tracking** error terms provided by the one-path two-port calibration, TOSM also provides the **load match**.
- The **directivity** error is determined at both source ports.
- The **transmission tracking** is determined for each direction.

The number of required standard measurements and of error terms for 2-port measurements is shown in the following table.

Number of ports	Number of standards to be connected	Number of standard measurements	Number of error terms
2	$2 * 3$ $+1 = 7$	$2 * 3$ $+2 * 1 = 8$	$2 * 3$ $+ 2 * 2 = 10$

An open, through and match measurement is required at each port; in addition, a through must be measured between the two ports and in both directions.

The analyzer automatically performs each through measurement in both directions, so the number of connected standards is smaller than the number of measurements.

3.3.3 Automatic Calibration (Introduction)

A Calibration Unit is an integrated solution for automatic system error correction of vector network analyzers. For R&S ZVL3-75 analyzers (75 Ω variant of R&S ZVL3), Rohde & Schwarz offers the calibration unit R&S ZV-Z53, stock number 1164.0473.75. This calibration unit supports a frequency range between 300 kHz and 3 GHz. With its two N 75 Ω (f) connectors, it is suited for one-port and two-port calibration.

The unit contains calibration standards that are electronically switched when a calibration is performed. The calibration kit data for the internal standards are also stored in the calibration unit, so that the analyzer can calculate the error terms and apply the calibration without any further input.

Advantages of automatic calibration

- Automatic calibration is generally faster and more secure than manual calibration, because:
- There is no need to connect several standards manually.
- Invalid calibrations due to operator errors (e.g. wrong standards or improper connections) are almost excluded.
- No need to handle calibration kit data.
- The internal standards don't wear out because they are switched electronically.

Automatic calibration is less flexible than manual calibration, because it is cannot be performed for segmented sweep.

NOTICE

Connection and use of the calibration unit

Please observe the safety instructions in the "Technical Information" provided with the calibration unit to avoid any damage to the unit and the network analyzer. Safety-related aspects of the connection and operation of the units are also reported in chapter 5 (GUI Reference) of the operating manual or in the network analyzer's help system.

3.4 Optional R&S ZVL Extensions

The R&S ZVL network analyzer can be upgraded with various hardware and software options, providing enhanced flexibility and an extended measurement functionality. The available options are listed in the *SETUP – More – System Info – Versions + Options* dialog. Options can be enabled by means of a license key, to be entered in the SETUP menu after an appropriate firmware version has been installed. The new supported options for each firmware version are listed in the "What's New..." section of the network analyzer help system.

The R&S ZVL options can be grouped as follows:

- **Measurement modes:** The option enables a special operating mode. Only one measurement mode can be active at a given time. The basic instrument modes are *Network Analyzer* (NWA, no option required) and *Spectrum Analyzer* (SAN, with option R&S ZVL-K1). The SAN mode provides a number of supplementary measurement modes, e.g. *WiMAX OFDM/OFDMA Analysis mode* (with option R&S FSL.K93). The supplementary SAN modes also require option R&S ZVL-K1.
- **Additional measurements:** The option extends a particular measurement mode, providing additional measurement functionality. The analyzer provides additional measurements for the NWA and the SAN modes.

The relationship between the R&S ZVL options and measurement modes is shown below.

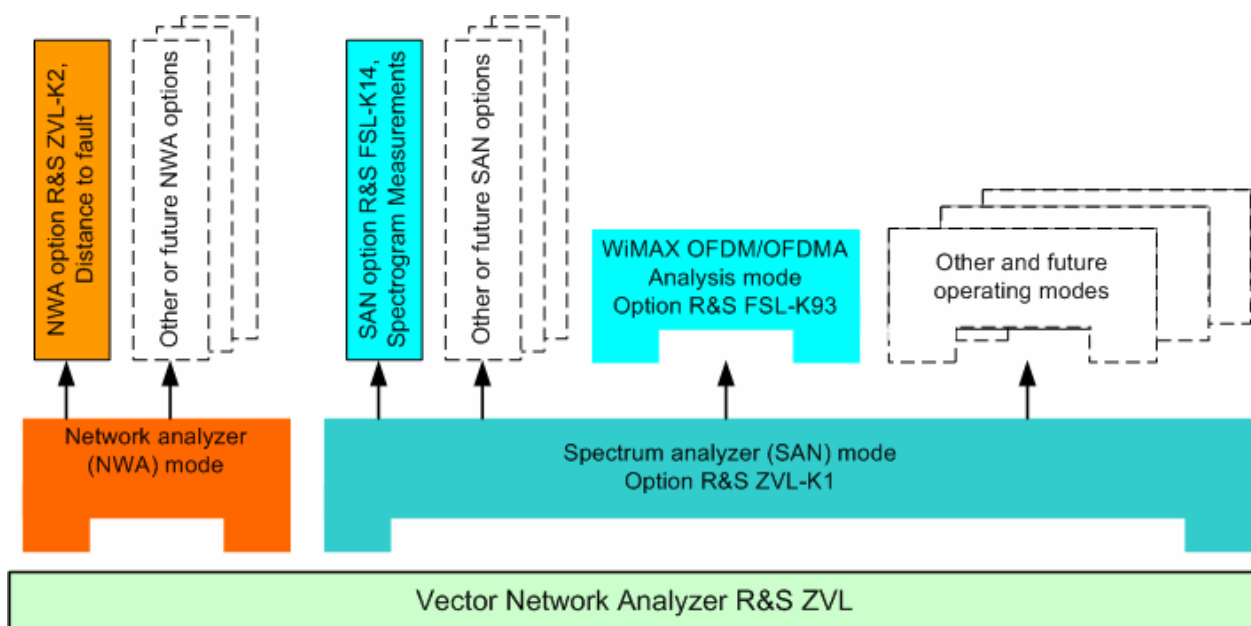

Accessing measurement modes, remote control

All measurement modes are accessed by means of the MODE front panel key. When a new mode is selected, the appearance of the user interface and the control elements change. At the same time, the instrument adjusts its remote-control command set to the functionality of the selected operating mode.

While a particular measurement mode is active, the functionality of the other modes is generally not available. The same applies to the remote-control commands. Basic instrument functions, i.e. the softkeys associated with the FILE, SETUP, PRINT, and MODE front panel keys and the related commands, are available in all operating modes.

The R&S ZVL options listed below are described in detail in the reference chapters of the NWA help system (NWA options) or in the separate SAN help system (SAN options). For a complete list of options, accessories, and extras refer to the R&S ZVL product brochure.

Option	Option Type	Functionality
ZVL-K2, Distance-to-Fault	NWA option	Transformation of the trace to time domain in order to analyze the impulse response and locate faults and discontinuities on cables
ZVL-K3 Time Domain	NWA option	Transformation of the trace to time domain in order to analyze responses, transformation back to the frequency domain
ZVL-K1, Spectrum Analysis	SAN option, measurement mode	Basis spectrum analyzer functions providing the frequency spectrum of the measured RF signal. The option also provides a wide range of pre-configured power measurements.
FSL-B6, TV Trigger	SAN option	TV trigger, especially for service in the analog TV field.
FSK-B8, Gated Sweep	SAN option	Gated sweep, especially for the modulation spectrum of GSM signals or bursted WLAN signals.
FSL-K7, AM/FM/φM Measurement Demodulator	SAN option	Analog modulation analysis for amplitude, frequency or phase modulated signals.
FSL-K8, Bluetooth Measurements	SAN option	Bluetooth transmitter (TX) tests in line with the Bluetooth® RF test specification, including EDR tests.
FSL-K14, Spectrogram Measurements	SAN option	Spectrogram display and trace recording for general spectrum measurements.
FSL-K30, Noise Figure and Gain Measurements)	SAN option, measurement mode	Noise figure and noise temperature measurements, especially suited for manufacturers of amplifiers.
FSL-K72, WCDMA Measurements (3GPP/FDD BTS)	SAN option, measurement mode	Transmitter (TX) tests on 3GPP/FDD downlink signals including HSDPA and HSUPA channels.
FSL-K91, WLAN OFDM Analysis	SAN option, measurement mode	Transmitter (TX) tests on WLAN signals in line with the WLAN standards IEEE 802.11a/b/g/j.
FSL-K93, WiMAX OFDM/OFDMA Analysis	SAN option, measurement mode	Transmitter (TX) tests on WLAN signals in line with standard IEEE 802.16-2004 and IEEE 802.16e-2005 for mobile WiMAX-Signals including WiBro.

The following sections provide a short introduction to the software options.

3.4.1 Distance-to-Fault (R&S ZVL-K2)

The network analyzer measures and displays complex S-parameters and other quantities as a function of the frequency. The measurement results can be filtered and mathematically transformed in order to obtain the impulse response, which often gives a clearer insight into the characteristics of the DUT.

The impulse response is special type of a time-domain representation. A fault (discontinuity) on a transmission line causing reflection results in a spike on the impulse response trace of the reflection coefficient. With option R&S ZVL-K2, the analyzer can display the impulse response trace and calculate the distance between the reference plane and the fault from the propagation time, taking into account the electrical properties of the transmission line (Cable Type). Moreover it is possible to define which of the peaks will be considered as being due to a fault, and to draw up and export a list of the detected peaks.

3.4.2 Time Domain (R&S ZVL-K3)

The network analyzer measures and displays complex S-parameters and other quantities as a function of the frequency. The measurement results can be filtered and mathematically transformed in order to obtain the time domain representation, which often gives a clearer insight into the characteristics of the DUT.

Time domain transforms can be calculated in band pass or low pass mode. For the latter the analyzer offers the impulse and step response as two alternative transformation types. A wide selection of windows can be used to optimize the time domain response and suppress sidelobes due to the finite sweep range. Moreover, it is possible to eliminate unwanted responses by means of a time gate and transform the gated result back into the frequency domain.

3.4.3 Spectrum Analysis (R&S ZVL-K1)

The spectrum analysis option provides the basic functionality for measuring an arbitrary RF signal in the frequency domain. Evaluation tools such as markers and limit lines allow a refined analysis of the measurement results. A wide range of predefined power measurements cover typical RF measurement tasks, in particular:

- Zero span power measurements
- Channel and adjacent channel power measurement
- Measurement of occupied bandwidth
- CCDF measurement (amplitude statistics of signals)

Option R&S ZVL-K1 is a prerequisite for all supplementary spectrum analyzer (SAN) options; see table and figure above.

3.4.4 TV Trigger (R&S FSL-B6)

Option R&S FSL-B6 adds a TV trigger to option ZVL-K1, in order to select different sections of a TV video signal for display and facilitate the analysis. This option is especially suited for all doing any service in the analog TV field.

3.4.5 Gated Sweep (R&S FSL-B8)

The gated sweep mode removes switching transients from the spectrum. This is advantageous for the analysis of pulsed-carrier signals, e. g. to investigate the modulation spectrum of GSM signals or WLAN signals.

3.4.6 AM/FM/φM Measurement Demodulator (R&S FSL-K7)

The AM/FM/φM Measurement Demodulator option R&S FSL-K7 converts the ZVL into an analog modulation analyzer for amplitude, frequency or phase modulated signals. It measures not only characteristics of the useful modulation, but also factors such as residual FM or synchronous modulation.

3.4.7 Bluetooth Measurements (R&S FSL-K8)

Option R&S FSL-K8 provides measurements on Bluetooth transmitters. All measurements are carried out in line with the Bluetooth® RF test specification Rev. 2.0+DER and cover basic rate as well as Enhanced Data Rate (EDR) packets.

3.4.8 Spectrogram Measurements (R&S FSL-K14)

Option FSL-K14 adds a spectrogram display and trace recording to the ZVL. The spectrogram view gives a history of the spectrum and helps to analyze intermittent problems or variations in frequency and level versus time.

3.4.9 Noise Figure and Gain Measurements (R&S FSL-K30)

Option R&S FSL-K30 adds the capability to measure noise figure and noise temperature. This enables manufacturers of amplifiers to analyze all necessary characteristics, e.g. noise figure, nonlinear parameters such as harmonics, intermodulation or ACPR, as well as S-parameters.

In addition to the spectrum analyzer option R&S ZVL-K1, option R&S FSL-K30 also requires option R&S FSL-B5, Additional Interfaces (providing the noise source control voltage), and an external preamplifier to specify the measurement uncertainties. DC supply for the external preamplifier can be derived from the probe power socket; a matching connector can be ordered as spare part (1065.9480.00).

Noise source: E.g. NC 346 types from Noisecom.

3.4.10 WCDMA Measurements (3GPP/FDD BTS) (R&S FSL-K72)

The R&S FSL-K72 adds transmitter (TX) measurements on 3GPP downlink signals including HSDPA/HSUPA signals. The measurement types comprise code domain power, signal channel power, adjacent channel power, and spectrum emission mask.

3.4.11 WLAN OFDM Analysis (R&S FSL-K91)

Option R&S FSL-K91 provides transmitter (TX) tests, especially spectrum and modulation measurements, on signals in line with the WLAN standards IEEE 802.11a/b/g/j.

3.4.12 WiMAX OFDM/OFDMA Analysis (R&S FSL-K93)

Option R&S FSL-K93 provides transmitter (TX) tests, especially spectrum and modulation measurements on signals in line with IEEE 802.16-2004 and IEEE 802.16e-2005 for mobile WiMAX-Signals including WiBro.

Table of Contents

4 Measurement Examples	104
Basic Measurement Tasks	104
Display Configuration	104
Screen Control	105
Data Transfer.....	105
Setting up a Sweep	106
Optimization	108
Optimizing the Measurement Speed	108
Calibrating a Measurement Channel	109
Advanced Tasks	110
Time Domain Measurements	110
Distance-to-Fault Measurements	110
Network (De-)embedding	112

4 Measurement Examples

This chapter provides examples for typical measurement tasks to be performed on the network analyzer:

To make yourself familiar with the instrument, use the simple measurement examples outlined in the Getting Started chapter. For a systematic explanation of all menus, functions and parameters and background information refer to the Manual Control reference.

Basic Measurement Tasks

Display Configuration

The analyzer provides various tools that you can use to customize the diagram areas and control elements. The following examples show how to change the display colors.

To select or define a color scheme for the diagrams and their display elements ...

- Click Nwa-Setup — Display Config — Color Scheme... to open the Color Scheme dialog.
- Select the *Predefined Scheme* that is most appropriate for your needs.
- Click Define User Scheme... to open the Define User Color Scheme dialog.
- Select a display element from the *Element* drop-down list.
- Click the *Color* field to open a standard *Color* dialog and assign the color.

You can repeat the last 2 steps for as many elements as you like. For traces, you can also select a *Trace Style* and *Trace Width*. Your settings apply to all setups, they are permanent even after you close the network analyzer application.

- If you wish to use several color schemes in parallel, click *Save* to save your current color scheme to a file.
- If you wish to restore the original Predefined Scheme, click Setup — System Config... — Resets — Reset Colors.

To change the marker colors...

When you create markers, their color is the same as the color of the associated trace. You can change the marker colors using the *Color Scheme* dialog.

- Click Nwa-Setup — Display Config — Color Scheme...
- Click Define User Scheme... to open the Define User Color Scheme dialog.
- Select Same Color for all Markers from the Element drop-down list.
- Click the *Color* field to open a standard *Color* dialog and assign the color.
- Click Use same Color for all Markers.

All markers are displayed with the same color, irrespective of the trace colors.

Screen Control

Control of the analyzer's display elements is based on the standard Windows™ functionality. The following examples show you how to make efficient use of the functions.

To move an active setup window within the available space ...

- Make sure that the window is not maximized.
- Click the  icon in the title bar to open the setup control menu.
- Click *Move*.

After the pointer changes to the four-headed arrow:

- Press one of the direction keys (left, right, up, or down arrow key) to move the entire window without changing its size.
- Press *ENTER* or left-click the window when it is at the position you want.

To size the active setup window ...

- Make sure that the window is not maximized.
- Click the  icon in the title bar to open the setup control menu.
- Click *Size*.

After the pointer changes to the four-headed arrow:

- Press one of the direction keys (left, right, up, or down arrow key) to move the pointer to the border you want to move.
- Press a direction key to move the border.

Press *ENTER* or left-click the window when it is the size you want.

Data Transfer

The following examples show you how to perform basic tasks related to data transfer from and to the analyzer.

To copy the active setup ...

- Connect a storage device like an USB stick or a CD-ROM drive to an USB connector.
- Click *Nwa-File — Save Nwa As* to open the *Save As* dialog.
- Open the *Save in* drop-down list and select the storage device and a folder.
- Select a *File name* and click *Save* to store the data on the storage device and to close the *Save As* dialog.

The default extension for setup files (*.nwa) is appended automatically.

To load a setup stored on an external device...

- Connect the storage device to an USB connector.
- Click Nwa-File — Recall Nwa to open the Open dialog.
- Open the *Look in* drop-down list and select the storage device.
- In the center of the dialog, select the folder containing the setup files.
- Select a file and click *Open* to load the setup as the active setup.

Setting up a Sweep

Configurations of the different sweep types require different procedures. The following examples list the essential settings for various sweep types.

To Set up a Lin Frequency Sweep...

- Press the *Sweep* key or click *Channel - Sweep* to access the Sweep submenu.
- Click Sweep Type – Lin Frequency.
- Click *Channel – Center* or *Span* to access the submenu defining the sweep range.
- To define a sweep range confined by a start and a stop frequency, use *Start* and *Stop*. Alternatively, to define a sweep range of definite width around a known center frequency (e.g. an expected peak), use *Center* and *Span*.
- To vary the number of measurement points (e.g. to improve the resolution of the sweep or reduce the sweep time), click *Channel – Sweep – Number of Points*.

If the active diagram is a Cartesian diagram, the x-axis is linearly scaled and labeled with the *Start* and *Stop* frequencies.

To Set up a Log Frequency Sweep...

- Press the *Sweep* key or click *Channel - Sweep* to access the Sweep submenu.
- Click Sweep Type - Log Frequency.
- Click *Channel - Center* or *Span* to access the submenu defining the sweep range.
- To define a sweep range confined by a start and a stop frequency, use *Start* and *Stop*. Alternatively, to define a sweep range of definite width around a known center frequency (e.g. an expected peak), use *Center* and *Span*.
- To vary the number of measurement points (e.g. to improve the resolution of the sweep or reduce the sweep time), click *Channel - Sweep - Number of Points*.

If the active diagram is a Cartesian diagram, the x-axis is logarithmically scaled and labeled with the *Start* and *Stop* frequencies.

To Set up a Segmented Frequency Sweep...

- Press the *Sweep* key or click *Channel - Sweep* to access the Sweep submenu.
- Click *Sweep Type - Define Segments* to call up the dialog defining the individual sweep segments. Proceed as described in Define Segments to customize your sweep range. Make sure to define at least 2 distinct sweep frequencies.
- Use the controls in the *Individual Settings* panel to define the internal generator power, measurement (IF) bandwidth and other measurement settings for each sweep segment.
- Close the *Define Segments* dialog.
- Click *Sweep Type - Segmented Frequency*.

If the active diagram is a Cartesian diagram, the x-axis is linearly scaled and ranges from the lowest to the highest frequency in all segments.

Optimization

Optimizing the Measurement Speed

Minimizing the measurement time per sweep contributes to a high measurement throughput. The following parameters have an influence on the sweep time:

To find the best set of sweep points...

Limit the measurement to the stimulus range that you need for your device:

- Click *Channel - Center* or *Span* to access the submenu defining the sweep range.
- To define a sweep range confined by a start and a stop frequency, use *Start* and *Stop*. Alternatively, to define a sweep range of definite width around a known center frequency (e.g. an expected peak), use *Center* and *Span*.
- Alternatively, use the marker functions to define the sweep range.

Use the minimum number of points that will produce an acceptable resolution:

- Click *Channel – Sweep – Number of Points* and reduce the number of sweep points.

Use the segmented sweep to focus on different subranges of the sweep, using optimized channel settings for each subrange:

- Set up a segmented frequency sweep as described in *Segmented Frequency*.
- Optimize the number of points and the noise reduction settings for each individual sweep segment.



The sweep time increases with the *Frequency Step Size*.

To find the appropriate noise reduction settings...

Use the fastest IF filter that will produce acceptable dynamic range:

- Press the *PWR BW* key or click *Channel – Pwr Bw* to access the corresponding submenu.
- Select the widest bandwidth compatible with your measurement task.
- If possible, click *Fine Adjust* to further increase the bandwidth. Select the *Fast* filter type unless a *Normal* filter is required for your measurement.

Reduce the number of repeated measurements made to obtain an averaged result. Averaging does not slow down the measurement, however, several consecutive sweeps must be performed until an average result is available.

- If averaging is not necessary, open the *Channel – Power Bandwidth Average* menu and make sure that *Average On* is not active.
- Alternatively, click *Average Factor* and reduce the factor to a minimum.

Calibrating a Measurement Channel

Calibration is the process of eliminating systematic, reproducible errors from the measurement results (system error correction). A measurement channel can be calibrated either manually or automatically using a calibration unit (accessory R&S ZV-Z5x).

Select and perform a manual calibration

In the following example a 2-port TOSM calibration is performed using the Calibration Wizard. Other calibrations can be performed in an analogous way.

- Perform all channel settings for your measurement.
- Click *Channel – Cal – Start Cal – Two-Port P1 P2 – TOSM* to open the calibration wizard for the desired calibration type.
- In the first dialog of the calibration wizard, select the connector type that you use at port 1 and 2 (both connector types must be equal) and the calibration kit. Click *Next >* to access the next dialog of the wizard.
- Connect an open standard to port 1 and click the corresponding box in the *Measured Standards* list to initiate the calibration sweep and acquire the calibration data for this standard.
- Repeat the last step for a short and a match connected to port 1, an open, short and match connected to port 2, and for a through between both ports.
- Click *Apply* to start the calculation of the system error correction data, apply them to the current channel and close the calibration wizard.
- Replace the last measured standard with your DUT and perform calibrated measurements without changing the channel settings used for calibration.

You can also access manual calibration from the *S-Parameter Wizard*.

Perform an automatic calibration

In the following example a 2-port TOSM calibration is performed using the calibration unit (accessory R&S ZV-Z53). The calibration of a single port is analogous; see *Performing an Automatic Calibration*.

Connect the calibration unit:

- Switch on and start-up your network analyzer and establish a USB connection to the calibration unit; see *Connecting the calibration unit*.
- Connect port 1 of the unit to port 1 of the analyzer; repeat this for port 2.

Perform the calibration:

- Click *Channel – Cal – Start Cal – Two-Port P1 P2 – Calibration Unit* and wait until the calibration is completed.
- Remove the connecting cables from the unit, connect your DUT instead and perform calibrated measurements.

You can also access automatic calibration from the *S-Parameter Wizard*.

Advanced Tasks

Time Domain Measurements

With option ZVL-K3, *Time Domain*, you can view the measurement results as a function of time.

To set up a time domain measurement...

- Reset the analyzer to ensure that the following operating mode is set: Channel - Sweep - Sweep Type: Lin. Frequency, Trace - Meas.: S21, Trace - Format: dB Mag.
- Open the *Trace - Meas* menu and select the measured quantity to be transformed (preferably: an S-parameter or ratio).
- Click *Trace - Traces - Time Domain Transform - Time Domain* to transform the active trace to the time domain.

The transformed trace is displayed in the active diagram area. To refine the analysis, you can modify the number and position of the sweep points (*Channel - Sweep - Number of Points, Channel - Stimulus*), select a different transform type and window for profiling (*Trace - Traces - Time Domain Transform - Define Transform...*) and vary the time range (*Trace - Traces - Time Domain Transform - Stimulus Transform*).

To eliminate an unwanted response from the measured trace...

- Calculate a time domain transform as described above, Setting up a time domain measurement.
- Click *Trace - Traces - Time Domain Transform - Define Time Gate* and place a time gate on the transformed trace. To remove a single response use a *Notch* gate type. To remove everything outside a specified area, use a *Bandpass* gate type.
- Click *Trace - Traces - Time Domain Transform - Time Gate* to enable the time gate. If necessary, go back to the *Define Time Gate* dialog to correct your time gate settings.
- Click *Trace - Trace Func - Transform - Frequency Domain*.

The frequency domain trace now corresponds to the modified time domain trace which is transformed back into the frequency domain.

Distance-to-Fault Measurements

With option ZVL-K2, *Distance-to-Fault*, the analyzer can locate faults and discontinuities on cables and transmission lines. The faults produce spikes on the trace; the x-axis shows the distance from the calibrated reference plane. Most conveniently the reference plane is set to the analyzer test port PORT 2.

Preparing a Distance-to-Fault Measurement

Consider two RG141A cables of different length. The first cable can be connected to PORT 2 of the analyzer using a suitable adapter. The second cable is connected to the first cable using a second adapter and either left open or terminated with a matched load. The first cable contains a fault which is to be located by the network analyzer. The lengths of the cables and adapters are shown below.

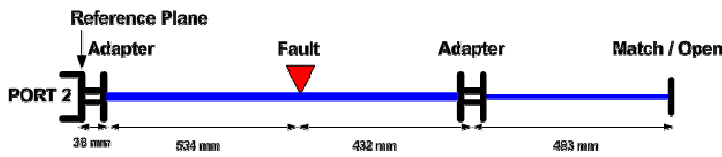

To prepare the distance-to-fault measurement, first perform a full one-port calibration at PORT 2:

- Press the *Preset* key to restore standard analyzer settings, in particular a linear frequency sweep with a relatively wide sweep range and a sufficiently large number of points.
- Click *Trace – Meas – Distance-to-Fault* to switch on the distance-to-fault measurement, display the distance scale and select S22 as measured quantity.
- Click *Trace – Meas – Distance-to-Fault – Full One-Port P2 Cal...* to open the calibration wizard and perform a full one-port calibration at the analyzer test port. Proceed in analogy to section *Manual_calibration*, connecting the required Open, Short, and Match standards directly to PORT 2.
- Click *Cable Type* to open the *Cable Type* dialog. In the list of cables, select your cable type (*RG 141A*). Press *OK* to close the dialog.
- Adjust the *Stop Distance* to 3 m, according to the dimensions of your cables (approx. twice the total length in order to view multiple reflections).
- Observe the measurement result in the diagram area (see *Analysis of Distance-to-Fault Results*). If desired, vary the diagram scale (*Trace – Scale...*).



If the second cable is of different type, you can still correctly locate the fault on the first cable using the described settings. If your cable type is not in the list, you can easily add your own cable type with arbitrary properties.

Analysis of Distance-to-Fault Results

The position of the spikes indicating faults and discontinuities is most easily monitored using markers which are placed onto the peaks of the trace (*Trace – Marker – Marker Search – Peak Search >*). With a matched termination at the end of the second cable, the following result is obtained:

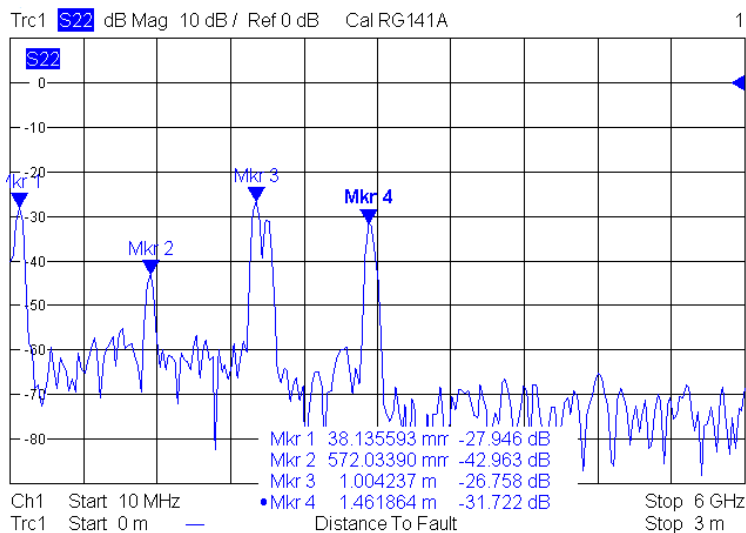

The spikes can be interpreted as follows:

- *Mkr 1* shows the position of the first adapter between the analyzer port and the first cable.

- *Mkr 2* shows the position of the fault in the first cable.
- *Mkr 3* shows the position of the second adapter between the first and the second cable, causing a reflection at either side. The distance between the two maxima of this spike corresponds to the length of the adapter.
- *Mkr 4* shows the reflection at the end of the second cable due to a small residual mismatch.
- With an open second cable, the result looks a little more complex:

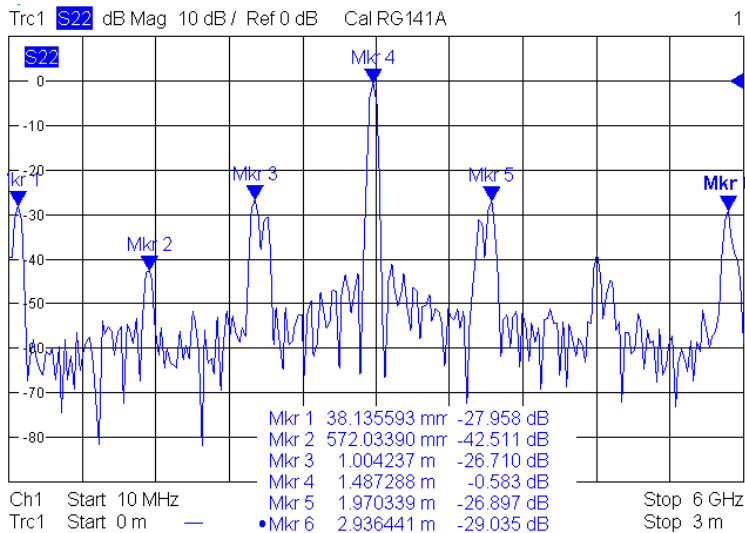

- Compared to the situation with matched termination, the spikes at the positions of *Mkr 1*, *Mkr 2*, and *Mkr 3* are virtually unchanged.
- *Mkr 4* shows the reflection at the end of the second cable. The open cable reflects almost the entire signal power; full one-port calibration normalizes the trace so that the maximum of the spike is close to 0 dB.
- The spikes beyond *Mkr 4* indicate multiple reflections. E.g. the double spike at the position of *Mkr 5* corresponds to a signal that has once traveled through the first cable (in both directions) and twice traveled through the second line due to bouncing between open end and adapter.

Network (De-)embedding

The *Virtual Transform* menu provides the functions for network embedding and deembedding. The following examples show how to use the functions.

To add a virtual transformation network to a port...

Suppose that your DUT is a 2-port DUT.

- Connect the DUT to your analyzer: For a two-port measurement, connect the DUT between test ports 1 and 2 of the analyzer.
- Establish the necessary *Channel* settings (port configuration, sweep range and type etc.) and select the measured quantities (*Trace – Meas*).
- Click *Channel – Cal – Port Extension – Embedding* to open the *Embedding...* dialog.
- In the dialog, select the *Port* to which you want to add a virtual transformation network (e.g. *Port 1*) and do one of the following:

- If you wish to define the added network by an imported set of 2-port S-parameters, select the *2-Port* transformation network, click *Read Data From File*, and load the parameters from a 2-port (*.s2p) Touchstone file.
- If you wish to define the added network by an equivalent circuit, select the circuit type and adjust the parameters R, C, and L displayed in the right half of the dialog.
- Click *Embed DUT* and *Close* the dialog.

The traces of the active channel show the characteristics of the DUT including the virtual transformation network inserted between port 1 of the analyzer and the DUT.

To remove a real transformation network from a port...

Suppose that your 2-port DUT has a real, known 2-port transformation network at port 1.

- Connect the DUT (including the transformation network) between test ports 1 and 2 of the analyzer so that the transformation network is placed between port 1 of the analyzer and the DUT.
- Establish the necessary *Channel* settings (port configuration, sweep range and type etc.) and select the measured quantities (*Trace – Measure*).
- Click *Channel – Cal – Port Extension – Deembedding* to open the *Deembedding...* dialog.
- In the dialog, select the *Port* connected to the physical transformation network (e.g. *Port 1*) and do one of the following:
 - If your transformation network is described by an imported set of 2-port S-parameters, select the *2-Port* transformation network, click *Read Data From File*, and load the data from a 2-port (*.s2p) Touchstone file.
 - If your transformation network can be described by an equivalent circuit, select the circuit type and adjust the parameters R, C, and L displayed in the right half of the dialog.
- Click *Deembed DUT* and *Close* the dialog.

The traces of the active channel show the characteristics of the DUT without the effects of the removed physical transformation network.

Table of Contents

5 GUI Reference	124
Nwa-File Menu	124
New	124
Close	125
Recall Nwa	125
Open Dialog	125
Save Nwa	126
Save Nwa As	126
Save As Dialog	126
Page Setup	127
Page Setup Dialog	127
Recent File	127
Exit Firmware	127
Trace Menu	128
Trace ->	128
Data -> Mem	129
Math = Data/Mem	130
Math = Data-Mem	130
Show Data	131
Show Mem	131
Traces	131
Trace Statistics	136
Smoothing On	139
Smoothing Aperture	139
Time Domain Transform	140
Import/Export Data	150
Shift Response Value	157
Shift Stimulus Value	158

Max Hold On	158
Restart Hold	158
Marker ->	159
Next Peak	159
Start = Marker	160
Stop = Marker	160
Center = Marker	160
Ref Value = Marker	160
Max = Marker	160
Min = Marker	160
Zero Delay at Marker	160
Marker Search	161
Marker Tracking	170
Def Peak	170
Search Range	171
Marker	172
Marker 1, 2, 3	174
Ref Marker	174
Delta Mode	175
Ref.Marker -> Marker	175
All Mkrs Off	175
Mkr Format	175
More Mkrs	177
Coupled Mkrs	177
Discrete Mkrs	178
Mkr Properties	178
Export Mkrs	179
Meas	179
S11, S12, S21, S22	180
S-Parameter Wizard	181

Distance-to-Fault	182
Impedance	189
Admittance	190
Stability Factors	191
Format	192
dB Mag	193
Phase	193
Smith	194
Polar	194
Group Delay	194
Aperture	195
SWR	196
Lin Mag	197
Real	197
Imag	197
Inv Smith	198
Unwrapped Phase	198
Scale	198
Autoscale	199
Autoscale All	200
Scale / Div	200
Ref Value	200
Ref Position	200
Maximize	201
Overlay All	201
Split All	202
Lines	202
Show Limit Line	203
Limit Check On	204
Define Limit Line	204

Horizontal Line	209
Global Limit Check On.....	209
Ripple Test	209
Ripple Test.....	209
Global Check	210
Show Ripple Limits	210
Ripple Check On	211
Define Ripple Test.....	211
Channel Menu	214
Stimulus	215
Pwr Bw	216
Power	216
Step Atten b1..., Step Atten b2.....	217
RF Off	217
Meas Bandwidth	217
Cal	218
Start Cal	219
Repeat Prev Cal	226
Correction Off	226
Port Extensions	226
Cal Manager	235
Recall Last Cal Set	236
Automatic Calibration (Procedure)	237
Cal Kits	240
Sweep	251
Sweep Type	252
Number of Points	258
Frequency Step Size	258
Meas Delay	259
Restart	259

Single (All Chans).....	259
Define Restart.....	260
Trigger.....	260
Average Factor	262
Channel Select.....	263
Next Channel	264
Select Channel	265
Add Chan + Trace.....	265
Add Chan + Trace + Diag Area.....	265
Delete Channel.....	266
Channel Manager	266
Nwa-Setup Menu	267
Display.....	267
Delete Diag Area	268
Dual Split.....	269
Triple Split	269
Quad Split	270
Split Manager.....	270
Title	272
Display Config	272
Color Scheme	273
Define User Color Scheme.....	273
Softkey Labels	275
Status Bar	275
Front Panel Keys	275
Frequency Info.....	275
Undo.....	276
Redo.....	276
Setup Info.....	276
System Config.....	276

External Tools	278
Help Menu	278
Help Topics	279
About NWA	279
FILE Key	279
Navigation in the dialog boxes for saving and loading settings files	281
Save	282
Save File / Recall File	282
Select Path	282
Select File	283
Edit File Name	283
Edit Comment	283
Select Items	283
Enable All Items / Disable All Items	283
Delete File	283
Recall	284
Startup Recall	284
Startup Recall Setup	284
File Manager	284
Recall Shortcuts	284
Export / Import	284
Hardcopy	285
File Manager	285
Edit Path	286
New Folder	286
Copy	286
Rename	286
Cut	286
Paste	287
Delete	287

Sort Mode	287
Name	287
Date	287
Extension	287
Size	287
File Lists 1/2	287
Current File List 1/2	287
Network Drive	287
Map Network Drive	288
Disconnect Network Drive	288
SETUP Key	288
Reference Int/Ext	290
Firmware Update	290
Firmware Update	290
Option Licenses	290
Install Option	291
Shutdown Off/Standby	291
Preset Network	291
Preset Spectrum	291
General Setup	291
Configure Network	292
Time+Date	292
Meas Display	292
Monitor Int/Ext	292
Soft Frontpanel	292
Open Start Menu	292
Network Address	293
Computer Name	293
IP Address	293
Subnet Mask	293

DHCP On/Off	293
LXI Configuration Menu	293
LAN Status On/Off	294
Info	294
Password	294
Description	294
LAN Reset	295
LXI Browser Interface	295
GPIB (option GPIB Interface, with option R&S FSL-B10 only)	300
GPIB Address	301
ID String Factory	301
ID String User	301
GPIB Language	301
Display Update On/Off	301
GPIB Terminator LFE0I/EOI	301
*IDN Format Leg./ZVL	302
I/O Logging On/Off	302
System Info	302
Hardware Info	302
Versions+Options	302
System Messages	302
Clear All Messages	303
Service	303
Input RF/Cal/TG	304
Comb Frequency	304
Reset Password	304
Selftest	304
Selftest Results	304
Password	305
Service Function	305

PRINT Key	305
Print Screen.....	305
Device Setup.....	306
Device 1/2	306
Comment.....	306
Install Printer	306
MODE Key	306
Control Menus	307
Restore.....	308
Move.....	308
Size	308
Minimize	308
Maximize	308
Close	308
Next.....	309

5 GUI Reference

This chapter explains in detail all functions of the analyzer and their application. It is organized according to the menus/softkey groups of the user interface.

All topics in this chapter can be called up directly using the HELP key in the menus or the *Help* buttons in the dialogs. A link at the end of each function description leads to the corresponding remote control command.

For a general overview of the analyzer's capabilities and their use refer to the *System Overview*.

Nwa-File Menu

The *Nwa-File* menu provides standard Windows™ functions to create, save, and recall setups, and to shut down the application.



Setups

A setup comprises a set of diagram areas with all displayed information that can be stored to a NWA setup file (*.zvx). Each setup is displayed in an independent window.

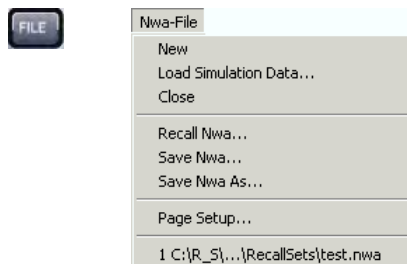

The *File* menu contains the following functions:

- *New* creates a new setup and opens a new setup window.
- *Close* closes an opened setup window.
- *Page Setup...* selects print options.
- *Save Nwa* saves an opened setup.
- *Save Nwa As...* saves an opened setup to a specific file.
- *Recall Nwa* recalls an existing setup from a file.
- *1 Set<n>.nwa* etc. is a list of the last 4 setups stored in the current or in previous sessions.
- *Exit Firmware* closes the application.

New

Creates a new setup and opens a new setup window. The new setup is named *Setup<n>* where <n> is the current number for all created setups.



To open an existing setup, select *File – Recall Nwa*. To rename a setup, use *File – Save As*.

Remote control: `MEMory:DEFine "<setup_name>"`

Close

Closes an opened setup window. The analyzer suggests to save changes to the setup before closing it. If a setup is closed without saving, all changes made since the last time it was saved are lost.

Remote control: `MEMory:DELeTe[:NAME] "<setup_name>"`

Recall Nwa

Recalls an existing setup from a file. The analyzer opens a standard Windows™ *Open* dialog box to select the file from all NWA setup files (*.nwa) stored on the file system.

It is not possible to open the same setup in different windows. If an opened setup is changed and an attempt is made to open the same setup again the analyzer displays a warning:

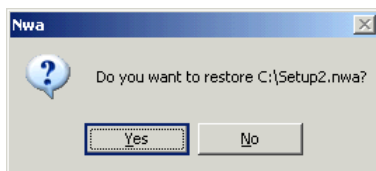

Yes overwrites the changes in the opened setup, No closes the message box, leaving the opened setup unchanged.



It is possible to create and open several setup files with the same contents but different names or locations. To open/recall a setup file (*.nwa) you can also use the Windows Explorer and simply double-click the file or drag and drop the file into the NWA application. The imported setup becomes the active setup.



Setups for different network analyzer models

It is possible to transfer setups between different R&S ZVL network analyzers, even if they belong to different analyzer types. To be loaded into an R&S ZVL13 network analyzer, a test setup file created with an R&S ZVL3 or R&S ZVL-6 must not use the following setting:

- A point trigger (Channel – Sweep – Trigger – Trigger Settings:Point)
- A measurement delay (Channel – Sweep – Meas Delay)

Remote control: `MMEMory:LOAD:NWANalyzer 1,"<file_name>"`

Open Dialog

Specifies the name and location of a particular file (e.g. a NWA setup file) to open:

- *Look in* specifies the drive and directory in which the file to open is stored. The icons to the right of the pull-down list are provided for easy navigation in the file system (place the cursor on the icons to obtain *What's this?* help).
- *File Name* specifies a file name (e.g. a setup file, *.nwa) to open. The file can be selected by clicking on the directory overview above.
- *Open* opens selected file and closes the dialog.

- *Cancel* closes the dialog without opening a setup file.

Save Nwa

Saves an opened setup to its current name and directory. On saving a setup for the first time, the analyzer displays the *Save As* dialog box in order to name the setup file.



To change the name and directory of an existing setup before saving it, choose the *Save As* command. If you store device settings file to the `C:\R_S\Instr\RecallShortCut` directory, you can recall them using the *FILE – Recall Shortcuts* submenu.

Save Nwa As

Saves and names the active setup. The analyzer opens a standard Windows™ *Save As* dialog box to select a NWA setup file name (*.nwa) and location for the setup file.



To save a document with its existing name and directory, use the *Save* command. If you store device settings file to the `C:\R_S\Instr\RecallShortCut` directory, you can recall them using the *FILE – Recall Shortcuts* submenu.

Remote control: `MMEMory:STORe:NWANalyzer 1, "<file_name>"`

Save As Dialog

Specifies the name and location of a particular file (e.g. a NWA setup file) to save:

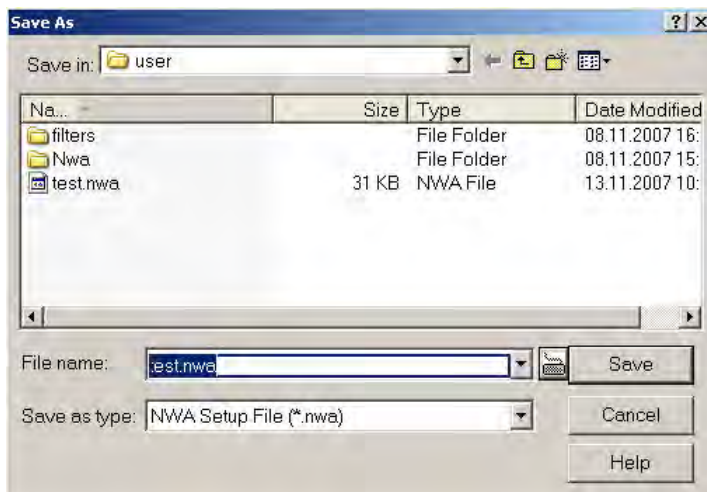

- *File Name* specifies a file name to save the current data (e.g. the setup). The analyzer adds the extension (e.g. *.nwa) in the *Save As Type* box.
- *Save in* specifies the drive and directory in which the data is stored. The icons to the right of the pull-down list are provided for easy navigation in the file system (place the cursor on the icons to obtain *What's this?* help).
- *Save* saves the data (e.g. the active setup) in the selected file and directory and closes the dialog.
- *Cancel* closes the dialog without saving the data.



The *Save As* dialog is used to store various data types (e.g. cal kit data, limit lines, sweep segment lists, ...). Depending on its use the dialog is opened with different file locations and data types. File locations (directories) are remembered when the dialog is closed. To restore default directories use the *System – System Configuration – Resets* dialog.

Page Setup

Opens the Page Setup dialog box to select print options.

Page Setup Dialog

Provides options to specify how the document should be printed. *Page Setup* is opened by means of the *Nwa-File – Page Setup...* command.

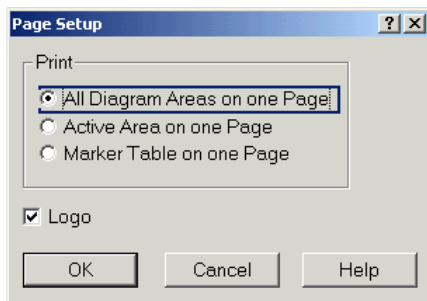

- The radio buttons in the *Print* panel specify whether or not different diagram areas are printed on different pages.
- The *Logo* check box specifies if the R&S logo is included in the printed document.

Additional print settings are available via the PRINT key (see section Setup Keys).

Recent File

Is a placeholder which is replaced by a list of the last 4 setups stored in the current or in previous sessions. Clicking an item in the list opens the corresponding setup.



Use the setup list in the *Window* menu to switch between different open setups.

Remote control: `MEMory:CAT?` (returns a list of the loaded files).

Exit Firmware

Ends the analyzer session. The analyzer prompts you to save setups with unsaved changes.



This command is equivalent to the *Close* command on the application Control menu.

Trace Menu

The *Trace* menu provides all trace settings and the functions to select, modify and store different traces. In addition the menu provides the marker, search and limit check functions.



A trace is a set of data points that can be displayed together in a diagram area. The trace settings specify the mathematical operations used in order to obtain traces from the collected data. They can be divided into several main groups:

- Selection of the measured quantity (S-parameters, wave quantities, ratios, impedances,...)
- Conversion into the appropriate display format and selection of the diagram type
- Scaling of the diagram and selection of the traces associated with the same channel
- Readout and search of particular values on the trace by means of markers
- Limit check

The trace settings complement the definitions of the *Channel* menu. Each trace is assigned to a channel; see *Traces, Channels and Diagram Areas*. The channel settings apply to all traces assigned to the channel.

(No direct access via front panel keys)



The *Trace* menu contains the following functions and submenus:

- *Trace ->* stores traces to the memory and performs mathematical operations on traces.
- *Marker ->* defines the sweep range, scales the diagram and introduces an electrical length offset using the active marker.
- *Marker* positions markers on a trace, configures their properties and selects the format of the numerical readout.
- *Meas* selects the quantity to be measured and displayed.
- *Format* defines how the measured data is presented in the graphical display.
- *Scale* defines how the current trace is presented in the diagram selected in the *Format* submenu.
- *Lines* defines limits for measured values and activates the limit check.

Trace ->

The *Trace ->* submenu stores traces to the memory and performs mathematical operations on traces.



Refer to section *Trace Types* in the *System Overview* chapter to learn more about data traces, memory traces, and mathematical traces.

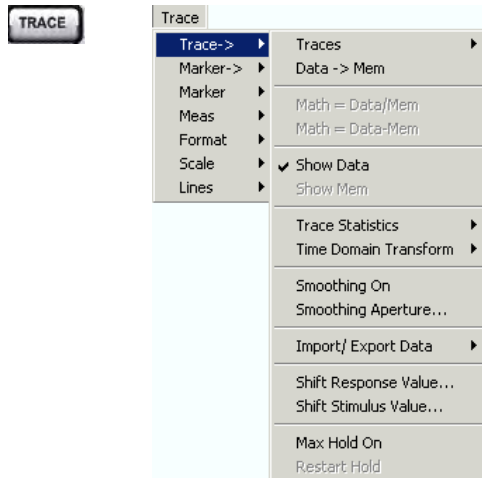

- Traces opens a submenu with functions to handle traces and diagram areas, and assign traces to channels.
- *Data -> Mem* stores the active data trace as a memory trace.
- *Math = Data/Mem* activates the mathematical mode where the data trace is divided by the memory trace.
- *Math = Data-Mem* activates the mathematical mode where the memory trace is subtracted from the data trace.
- *Show Data* shows or hides the active data trace.
- *Show Mem* shows or hides the active memory trace.
- *Trace Statistics* opens a submenu to evaluate statistical and phase information of the trace.
- *Time Domain Transform* opens a submenu to view the measurement results as a function of time (with option ZVAB-K3, *Time Domain*).
- *Smoothing On* activates the smoothing function for the active trace.
- *Smoothing Aperture...* defines how many measurement points are averaged to smooth the trace.
- *Import/Export Data* stores the active trace to a file or loads a memory trace from a file.
- *Shift Response Value...* opens a dialog to define a user-correction to the measured values.
- *Shift Stimulus Value...* shifts a memory trace in horizontal direction.
- *Max Hold On* enables or disables the max hold (peak hold) function for the active trace.
- *Restart Hold* restarts the max hold (peak hold) function for the active trace, discarding the old maximum measurement results.

Many of the functions of the *Trace Funct* menu act on the active trace. Data traces and the associated memory traces share many of their properties; see coupling of memory traces.

Data -> Mem

Stores the current state of the active trace as a memory trace. The memory trace is displayed in the active diagram area with another color, and its properties are indicated in the trace list:

Trc1	521	dB Mag	10 dB /	Ref 0 dB
Mem2[Trc1]	521	dB Mag	10 dB /	Ref 0 dB

Memory traces are named *Mem<n>[<Data_Trace>]* where <n> counts all data and memory traces in the active setup in chronological order, and <Data_Trace> is the name of the associated data trace. Trace names can be changed in the *Trace Manager* dialog.

The exact function of *Data* -> *Mem* depends on the number of memory traces associated with the active data trace:

- If no memory trace is associated with the active trace, a new memory trace is generated.
- If several memory traces are associated with the active trace, the current measurement data overwrites the last generated or changed memory trace.



Coupling of data and memory traces

When a memory trace is generated from a data trace, it is displayed in the same diagram area and inherits all channel and trace settings from the data trace.

The following display settings of a data trace and the associated memory traces are **fully coupled**. Changing a property of one trace affects the properties of all other traces.

- All settings in the *Trace – Format* menu
- All settings in the *Trace – Scale* menu

Selection of the measured quantity (*Trace – Meas*) is possible for the data trace but disabled for the memory traces.

Channel settings made for a memory trace act on the associated data trace. Some of the channel settings for a data trace (e.g. the *Stimulus* range) also affect the display of the memory traces.



If the sweep type of a data trace is changed so that the stimulus ranges of the data traces and the memory traces become incompatible, all coupled memory traces are removed from the diagram area and deleted.

Remote control: `CALCulate<Chn>:MATH:MEMorize`

Math = Data/Mem

Activates the mathematical mode where the active data trace is divided by the last generated memory trace. The division is calculated on a point-to-point basis: Each measurement point of the active trace is divided by the corresponding measurement point of the memory trace. The result of the division is a mathematical trace and replaces the active data trace in the diagram area. The mathematical trace is updated as the measurement goes on and the analyzer provides new active trace data.

This function is disabled unless a memory trace is coupled to the active data trace. Trace coupling ensures that the two traces have the same number of points and that the mathematical trace Data/Mem is well-defined.

Remote control: `CALCulate<Chn>:MATH:FUNction DIVide`

Math = Data-Mem

Activates the mathematical mode where the last generated memory trace is subtracted from the active data trace. The subtraction is calculated on a point-to-point basis: Each measurement point of the memory trace is subtracted from the corresponding measurement point of the active trace. The result of the subtraction is a mathematical trace and replaces the active data trace in the diagram area. The mathematical trace is updated as the measurement goes on and the analyzer provides new active trace data.

This function is disabled unless a memory trace is coupled to the active data trace. Trace coupling ensures that the two traces have the same number of points and that the mathematical trace Data-Mem is

well-defined.

Remote control: `CALCulate<Chn>:MATH:FUNCTION SUBTRACT`

Show Data

Displays or hides the active data trace in the diagram area. If the mathematical option *Math = Data/Mem* or *Math = Data-Mem* is active, then the active mathematical trace is displayed or hidden.

Remote control: No command, display configuration only.

Show Mem

Displays or hides the active memory trace in the diagram area or the memory trace associated with the active data trace.

If no memory trace is associated with the active data trace, *Show Mem* is disabled.

Remote control: No command, display configuration only.

Traces

The *Traces* submenu provides functions to handle traces and diagram areas, and assign traces to channels.

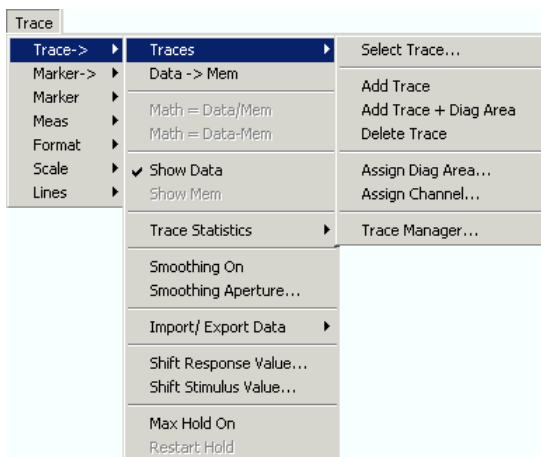

- *Select Trace* opens a box to select an arbitrary trace of the active setup as the active trace (disabled if only one trace is defined).
- *Add Trace* creates a new trace in the current diagram area.
- *Add Trace + Diag. Area* generates a new trace in a new diagram area.
- *Delete Trace* deletes the active trace.
- *Assign Diag. Area* assigns the active trace to another diagram area.
- *Assign Channel* assigns the active trace to another channel.
- *Trace Manager* opens a dialog to perform the previous actions systematically for all traces and diagram areas.



Active and inactive traces

The screen can display several diagram areas simultaneously, each with a variable number of traces.

- In an active diagram area one of these traces is the active trace. The active trace is highlighted in the trace list on top of the diagram area (Trc 3 in the figure below):

Trc2	S21	dB Mag	40 dB / Ref-200 dB	Ch1	Invisible
Trc3	S21	Phase	45° / Ref0°	Ch2	
Trc7	S21	dB Mag	10 dB / Ref0 dB	Ch2	Math
Mem8[Trc7]	S21	dB Mag	10 dB / Ref0 dB	Ch2	

- If an inactive area is selected as the active area, the trace that was active last time when the area was active will again become the active trace. It is highlighted in the trace list of the inactive diagram area as shown for Trc6 in the figure below:

Trc3	S21	dB Mag	10 dB / Ref0 dB		
Trc6	S21	dB Mag	10 dB / Ref0 dB		

All settings in the *Trace* menu except the *Trace Functions* involving a memory trace apply to the active trace in the active diagram area.



In remote control each channel can contain an active trace. The active remote traces and the active manual trace are independent of each other; see Active Traces in Remote Control.

Select Trace

Opens a box to select an arbitrary trace of the active setup as the active trace. This function is disabled if only one trace is defined.

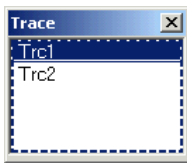

Remote control: The numeric suffix <Ch / Tr> appended to the first-level mnemonic of a command selects a trace as active trace.

Add Trace

Creates a new trace in the current diagram area and assigns it to the current channel. The new trace is created with the trace and channel settings of the former active trace but displayed with another color. The former and the new active trace are superimposed but can be easily separated, e.g. by changing the *Reference Position*.

The new trace is named Trc <n>, where <n> is the largest of all existing trace numbers plus one. The name can be changed in the *Trace Manager*.



To create a new trace in a new channel, use *Channel – Channel Select – Add Chan + Trace*.

Remote control: `CALCulate<Ch>:PARAmeter:SDEFine <Trace Name>, < Meas Parameter>`
control: `DISPlay:WINDow<Wnd>:TRACe<WndTr>:FEED`

Add Trace + Diag. Area

Creates a new trace in a new diagram area and assigns the trace to the current channel. The new trace is created with the trace and channel settings of the former active trace but displayed with another color.

The new trace is named Trc <n>, where <n> is the largest of all existing trace numbers plus one. The name can be changed in the *Trace Manager*.

Remote control: CALCulate<Ch>:PARAmeter:SDEFine <Trace Name>, < Meas Parameter>
DISPlay:WINDow<Wnd>:STATe ON
DISPlay:WINDow<Wnd>:TRACe<WndTr>:FEED

Delete Trace

Deletes the current trace and removes it from the diagram area. *Delete Trace* is disabled if the setup contains only one trace: In manual control, each setup must contain at least one diagram area with one channel and one trace.



To restore a trace that was unintentionally deleted, use *Undo*.

Remote control: CALCulate<Ch>:PARAmeter:DELEte <Trace Name>

Assign Diag Area

Assigns the active trace to another diagram area. A popup window offers a list of all areas available:

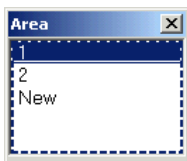

- Selecting one of the existing area numbers assigns the active trace to the existing diagram area: The active trace is removed from the previous area and displayed in the new diagram area.
- Selecting *New* creates a new diagram area and assigns the active trace to the new area. The new area is numbered <n>, where <n> is the largest of all existing area numbers plus one.



Assign Diag. Area is disabled if the current setup contains only one area. To create an additional area, click *Display – Area Select – New Diag. Area*.



To go to another diagram area and activate the last active trace in this area, simply click a point inside the new area.

Remote control: DISPlay:WINDow<Wnd>:TRACe<WndTr>:FEED <Trace Name>

Assign Channel

Assigns the active trace to another channel. A popup window offers a list of all channels available:

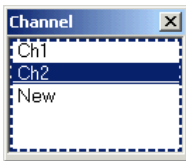

- Selecting one of the existing channel names assigns the current trace to the existing channel.
- Selecting *New* creates a new channel and assigns the current trace to the new channel. The new channel is named Ch <n>, where <n> is the largest of all existing channel numbers plus one. The name can be changed in the Channel Manager.

Remote control: `CALCulate<Ch>:PARAmeter:SDEFine <Trace Name>, < Meas Parameter>`

Trace Manager

Opens a dialog to perform the actions in the *Trace Select* menu systematically for all traces and diagram areas.

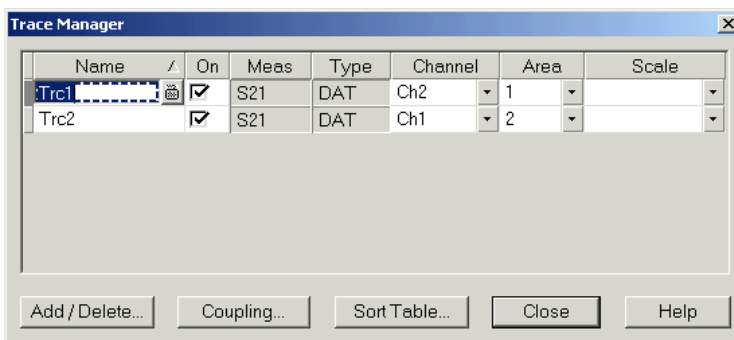

All existing traces of the current setup are listed in a table with several editable (white) or non-editable (gray) columns. Below the table the *Trace Manager* provides the following buttons:

- *Add/Delete...* opens a dialog to add a new trace or delete a trace.
- *Coupling* opens a dialog to define coupling criteria (channel, scale) for all traces in the table.
- *Sort Table* opens a dialog to change the order of the traces (rows) in the table.



Columns in the Trace Manager table

- *Name* indicates the current trace name. The default names for new traces are Trc<n> where <n> is a current number. Current numbers in the trace names are necessary to make automatic assignments, e.g. decouple the channel settings in the *Coupling* dialog.
- *On* indicates whether the trace is displayed on the screen (*On*) or invisible.
- *Meas* indicates the measured parameter.
- *Type* indicates whether the trace is a data trace (*DAT*), displaying the current measurement data, or a memory trace (*MEM*).
- *Channel* indicates the channel of each trace.
- *Area* indicates the diagram area of each trace.
- *Scale* shows which traces use common scaling and format settings.



Rules for trace names

For trace names, the following restrictions apply:

- The first character of a trace name can be either one of the upper case letters A to Z, one of the lower case letters a to z, an underscore _ or a square bracket [or].
- For all other characters of a trace name, the numbers 0 to 9 can be used in addition.

Furthermore, trace names must be unique across different channels and windows.

The analyzer does not accept illegal trace names. If an illegal name is specified, the input field in the *Trace Manager* turns red.

Remote control: `CALCulate<Ch>:PARAmeter:SDEFine <Trace Name>, < Meas Parameter>`

Add/Delete

Opens a dialog to add a new trace or delete a trace.

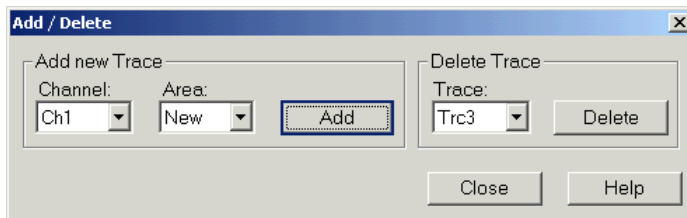

- *Add* creates a new trace and adds it to the list in the *Trace Manager*, assigning it to the channel and diagram area selected in the drop-down lists. It is possible to create a *New* channel and/or diagram area for the new trace.
- *Delete* deletes the selected trace, removing it from the list in the *Trace Manager* and from the screen. This button is disabled if the setup contains only one trace: In manual control, each setup must contain at least one diagram area with one channel and one trace.

Remote control: `CALCulate<Ch>:PARAmeter:SDEFine <Trace Name>, < Meas Parameter>`
`DISPlay:WINDow<Wnd>:TRACe<WndTr>:FEED <Trace Name>`
`DISPlay:WINDow<Wnd>:TRACe<WndTr>:EFEed <Trace Name>`
`CALCulate<Ch>:PARAmeter:DELEte <Trace Name>`

Coupling

Selects common channel or scale settings for all traces in the *Trace Manager* dialog.

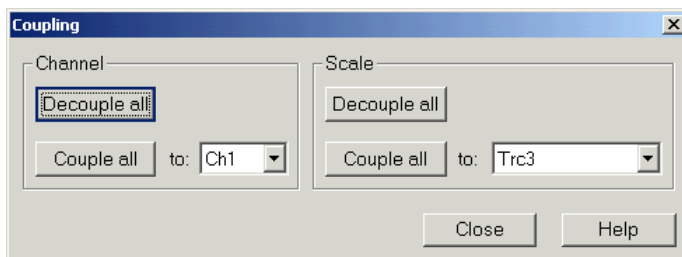

The channel and scale coupling is set in two independent panels.

- *Decouple All* assigns independent channel or scale settings to all traces in the *Trace Manager*. If the channel and trace names include numbers, the trace with the lowest number is assigned to the channel with the lowest number and so forth. Measurement or data traces and their associated memory traces are assigned to the same channel.

- *Couple All* assigns all traces to the channel or scale settings selected in the corresponding drop-down lists. All channel or scale settings except the selected ones are lost. The analyzer displays a confirmation dialog box before deleting the unused channels.

Remote control: –

Sort Table

Changes the order of the traces (table rows) in the *Trace Manager* dialog.

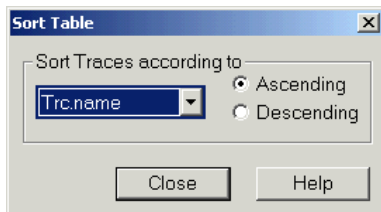

- The drop-down list contains all trace properties that can provide the sorting criterion. The properties correspond to the column headers in the *Trace Manager*.
- The two radio buttons qualify whether the traces in the table are sorted in ascending or descending order, according to the property selected in the pull-down list.

Remote control: No command, display configuration only.

Trace Statistics

Opens a submenu to evaluate and display statistical and phase information of the entire trace or of a specific evaluation range.

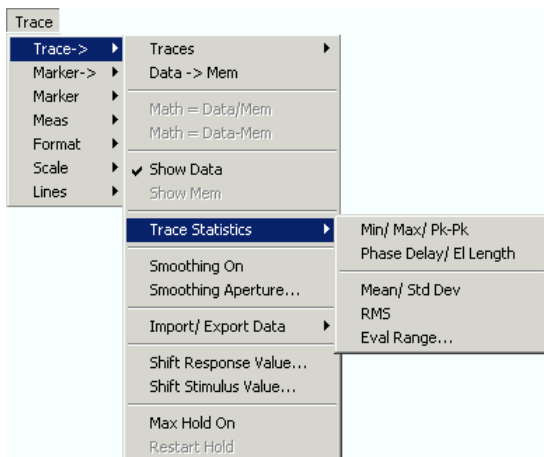

- *Min/Max/Pk-Pk* displays or hides the essential statistical parameters of the trace in the selected evaluation range.
- *Phase Delay/El Length* displays or hides the phase delay and the electrical length of the trace in the selected evaluation range (*Eval Range...*).
- *Mean/Std Dev* displays or hides the arithmetic mean value and the standard deviation of the trace in the selected evaluation range.
- *RMS* displays or hides the RMS value of the trace in the selected evaluation range.

- *Eval Range...* opens a dialog to define the range for the statistical and phase evaluation.

Statistical Evaluation

The *Min/Max/Pk-Pk*, *Mean/Std Dev*, and *RMS* commands in the *Trace Statistics* submenu display or hide the maximum (*Max*), minimum (*Min*), the peak-to-peak value (*Pk-Pk*), arithmetic mean value (*Mean*), the standard deviation (*Std Dev*), and the *RMS* value of all response values of the trace in the selected evaluation range (*Eval Range...*).

```
Min: -175.6754 °
Max: 123.3545 °
Pk-Pk: 299.0299 °
Mean: -0.6765 °
SDev: 25.6680 °
RMS: -16.3608 °
```



Open the *Nwa-Setup* dialog and open the *System Configuration* dialog to toggle between non-transparent and transparent info fields.



Definition of statistical quantities

The statistical quantities are calculated from all response values in the selected evaluation range. Suppose that the trace in the evaluation range contains n stimulus values x_i and n corresponding response values y_i (measurement points).

- *Mean* is the arithmetic mean value of all response values:

$$\text{Mean} = \frac{1}{n} \sum_{i=1}^n y_i$$

- *Std. Deviation* is the standard deviation of all response values:

$$\text{Std. Dev.} = \sqrt{\frac{1}{n} \sum_{i=1}^n (y_i - \frac{1}{n} \sum_{i=1}^n y_i)^2}$$

- *Max.* and *Min.* are the largest and the smallest of all response values y_i .
- *RMS* is the root mean square (effective value) of all response values:

$$\text{RMS} = \sqrt{\frac{1}{n} \sum_{i=1}^n y_i^2}$$

- *P-P* is the peak-to-peak value and is equal to the difference *Max.* – *Min.*



The definitions given above apply to all linear, scalar trace formats. For a *dB Mag* trace, the *Mean*, *Std. Dev.* and *RMS* are calculated before logarithmation.

```
Remote      CALCulate<Chn>:STATistics[:STATE]
control:    CALCulate<Chn>:STATistics:RESult? MIN | MAX | PEAK2P | MEAN |
           STDDev | RMS
           CALCulate<Chn>:STATistics:MMPTpeak[:STATE]
           CALCulate<Chn>:STATistics:MSTDev[:STATE]
           CALCulate<Chn>:STATistics:RMS[:STATE]
```

Phase Delay/EI. Length

Displays or hides the phase delay (*Phs Dly*) and the electrical length (*EI Len*) of the trace in the selected evaluation range (*Eval Range...*). The parameters are only available for trace formats that contain phase information, i.e. for the formats *Phase*, *Unwrapped Phase*, and the polar diagram formats *Polar*, *Smith*,

Inverted Smith. Moreover, the sweep type must be a *frequency sweep*.

Delay: 39.2764 ps
EL: 11.7748 mm



Definition of phase parameters

The phase parameters are obtained from an approximation to the derivative of the phase with respect to frequency in the selected evaluation range.

- *Delay* is the phase delay, which is an approximation to the group delay and calculated as follows:

$$PD = -\frac{\Delta \phi_{deg}}{360^\circ \cdot \Delta f},$$

where Δf is the width of the evaluation range and $\Delta\Phi$ is the corresponding phase change. See also note on transmission and reflection parameters below.

- *EL* is the electrical length, which is product of the phase delay times the speed of light in the vacuum.

If no dispersion occurs the phase delay is equal to the group delay. For more information see mathematical relations.

If a dispersive connector type (i.e. a waveguide; see *Offset Model* dialog) is assigned to a test port related to a particular quantity, then the dispersion effects of the connector are taken into account for the calculation of the phase delay and the electrical length.



To account for the propagation in both directions, the delay and the electrical length of a reflection parameter is only half the delay and the electrical length of a transmission parameter. The formula for PD above is for transmission parameters. See also introduction to section *Channel – Offset*.



The phase parameters are available only if the evaluation range contains at least 3 measurement points.



The phase evaluation can cause misleading results if the evaluation range contains a ± 360 deg phase jump. The trace format *Unwrapped Phase* avoids this behavior.

Remote control: CALCulate<Chn>:STATistics[:STATe]
CALCulate<Chn>:STATistics:RESult? ELENgth | PDELay
CALCulate<Chn>:STATistics:EPDelay[:STATe]

Eval Range

Opens a dialog to define the range for the statistical and phase evaluation. The evaluation range is a continuous interval of the sweep variable.

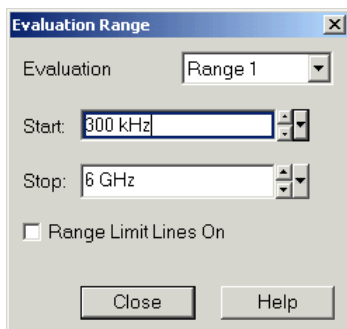

It is possible to select, define and display up to ten different evaluation ranges for each setup. *Full Span* means that the search range is equal to the *sweep range*. The statistical and phase evaluation take into account all measurement points with stimulus values x_i between the *Start* and *Stop* value of the evaluation range:

$$\text{Start} \leq x_i \leq \text{Stop}$$



The evaluation ranges are identical to the marker search ranges. For more information see *Search Range Dialog*.

Remote control: `CALCulate<Chn>:STATistics:DOMain:USER <numeric_value>`
`CALCulate<Chn>:STATistics:DOMain:USER:START <numeric_value>`
`CALCulate<Chn>:STATistics:DOMain:USER:STOP <numeric_value>`

Smoothing On

Activates the smoothing function for the active trace, which may be a data or a memory trace. With active smoothing function, each measurement point is replaced by the arithmetic mean value of all measurement points located in a symmetric interval centered on the stimulus value. The width of the smoothing interval is referred to as the *Smoothing Aperture* and can be adjusted according to the properties of the trace.



The sweep average is an alternative method of compensating for random effects on the trace by averaging consecutive traces. Compared to smoothing, the sweep average requires a longer measurement time but does not have the drawback of averaging out quick variations of the measured values.

Remote control: `CALCulate<Chn>:SMOothing[:STATe] <Boolean>`

Smoothing Aperture

Defines how many measurement points are averaged to smooth the trace if smoothing is switched on. The *Smoothing Aperture* is entered as a percentage of the total sweep span.



An aperture of $n\%$ means that the smoothing interval for each sweep point i with stimulus value x_i is equal to $[x_i - \text{span} \cdot n/200, x_i + \text{span} \cdot n/200]$, and that the result of i is replaced by the arithmetic mean value of all measurement points in this interval. The average is calculated for every measurement point. Smoothing does not significantly increase the measurement time.



Finding the appropriate aperture

A large smoothing aperture enhances the smoothing effect but may also average out quick variations of the measured values and thus produce misleading results. To avoid errors, observe the following recommendations.

- Start with a small aperture and increase it only as long as you are certain that the trace is still correctly reproduced.
- As a general rule, the smoothing aperture should be small compared to the width of the observed structures (e.g. the resonance peaks of a filter). If necessary, restrict the sweep range or switch smoothing off to analyze narrow structures.

Remote control: `CALCulate<Chn>:SMOothing:APERTure <numeric_value>`

Time Domain Transform

Opens a submenu to view the measurement results as a function of time. The time domain transformation requires option ZVL-K3 , *Time Domain*.



Time domain transformation

The network analyzer measures and displays complex S-parameters and other quantities as a function of the frequency. The measurement results can be filtered and mathematically transformed in order to obtain the time domain representation, which often gives a clearer insight into the characteristics of the DUT.

Time domain transforms can be calculated in band pass or low pass mode. For the latter the analyzer offers the impulse and step response as two alternative transformation types. A wide selection of windows can be used to optimize the time domain response and suppress sidelobes due to the finite sweep range. Moreover, it is possible to eliminate unwanted responses by means of a time gate and transform the gated result back into the frequency domain.

The distance-to-fault measurement is a special application of a time transformation.

For a detailed discussion of the time domain transformation including many examples refer to the application note 1EZ44_OE which is posted on the R&S internet.

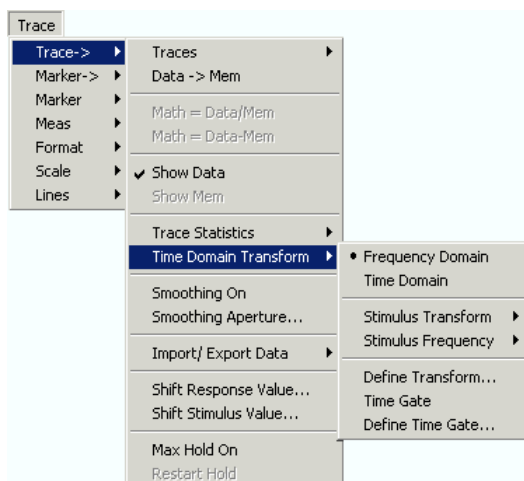

- *Frequency Domain* and *Time Domain* select frequency domain or time domain representation of the active trace.
- *Stimulus Transform* opens a submenu to define the stimulus axis range for the time domain representation.
- *Stimulus Frequency* opens a submenu to change the stimulus axis in the frequency domain.
- *Define Transform...* opens a dialog to define the transformation type and the frequency domain window used to optimize the time domain response.
- *Time Gate* switches the time gate defined with *Define Time Gate...* on or off.
- *Define Time Gate...* opens a dialog to select the time gate and define its parameters.

Frequency Domain

Selects the frequency domain representation for the active trace. The softkey is enabled if option ZVL-K3, *Time Domain*, is available, and if a linear frequency sweep (*Channel – Sweep – Sweep Type – Lin Frequency*) is active.

In frequency domain representation the diagram shows the measured trace as a function of the stimulus frequency applied to the DUT. The trace corresponds to the results obtained during the frequency sweep, however, the effect of a time gate is taken into account as long as the *Time Gate* function is active. The x-axis corresponds to the sweep range (stimulus range) selected via *Channel – Center / Span*.



In time domain representation, you can use the *Time Gate* settings in order to eliminate unwanted responses in your signal. After switching back to the frequency domain, you will receive the frequency response of your DUT without the contribution of the unwanted responses.



Gated and ungated state of the frequency domain representation

The trace in the frequency domain depends on the state of the *Time Gate*:

- If the gate is disabled, the frequency domain (FD) trace corresponds to the sweep results prior to the transformation.
- If the gate is enabled, the frequency domain trace shown is calculated from the time domain (TD) trace which is gated and transformed back into the frequency domain.
- The analyzer uses modified window and time gate settings to calculate the gated FD trace:

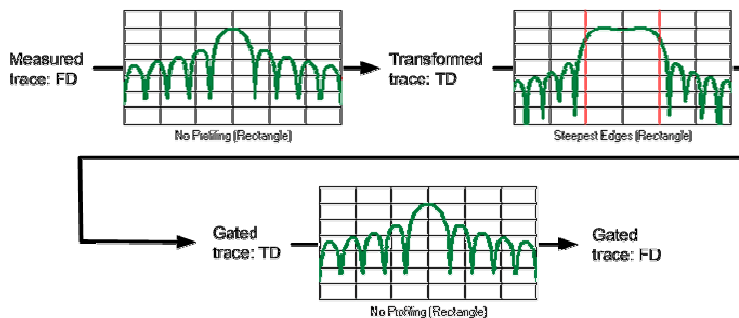

- All windows are rectangular, however, the width and position of the time gate affect the gated frequency domain trace. The window type selections in the *Define Transform* and *Define Time Gate* dialogs are ignored. The selected windows are used again when the TD trace is displayed (*Time Domain: On*).
- The rectangular *No Profiling (Rectangle)* windows minimize numerical inaccuracies near the boundaries of the measured frequency span. In the limit where the effect of the time gate vanishes (e.g. a gate of type *Notch* and a very small width), the time gated trace is equal to the original measured trace.

Remote control: `CALCulate<Chn>:TRANSform:TIME:STATe OFF`

Time Domain

Selects the time domain representation for the active diagram area. The softkey is enabled if option ZVL-K3, *Time Domain*, is available, and if a linear frequency sweep (*Channel – Sweep – Sweep Type – Lin. Frequency*) is active. The analyzer automatically quits time domain representation as soon as a different sweep type is selected.

In time domain representation the diagram shows the measurement results as a function of time. The results are obtained by transforming the measured frequency sweep data into the time domain using an appropriate mathematical transformation type and frequency window (*Define Transform...*). The sweep range and the output power for the active channel is still displayed below the diagram; the displayed time interval is shown in a second line:

Ch1	Start 300 kHz	—Pwr	0 dBm	Stop 8 GHz
Trc2	Start -1 ns	—Time Domain		Stop 4 ns



Trace settings in time domain representation

While the time domain representation is active the trace settings behave as follows:

- The settings in the *Stimulus Transform* submenu configure the time axis.
- All Trace Formats including the circular diagrams are available.
- Limit lines can be defined like the limit lines for time sweeps.
- The bandfilter search functions are available for the transformed trace.
- If marker coupling is active, then the markers in the time domain and in the frequency domain are coupled with each other.

The analyzer places no restriction on the measured quantities to be transformed into the time domain. Impedances and admittances are first converted back into the equivalent S-parameter, transformed, and restored after the transformation.



Properties of the Chirp z-transformation

The Chirp z-transformation that the analyzer uses to compute the time domain response is an extension of the (inverse) Fast Fourier Transform (FFT). Compared to the FFT, the number of sweep points is arbitrary (not necessarily an integer power of 2), but the computation time is increased by approx. a factor of 2. This increased computation time is usually negligible compared to the sweep times of the analyzer.

The following properties of the Chirp z-transformation are relevant for the analyzer settings:

- The frequency points must be equidistant. If a *Log Frequency* or *Segmented Frequency* sweep is active, the measurement points are interpolated.
- The time domain response is repeated after a time interval which is equal to $\Delta t = 1/\Delta f$, where Δf is the spacing between two consecutive sweep points in the frequency domain. For a sweep span of 4 GHz and 201 equidistant sweep points, $\Delta f = 4 \text{ GHz}/200 = 2 \cdot 10^7 \text{ Hz}$, so that $\Delta t = 50 \text{ ns}$. Δt is termed measurement range (in time domain) or unambiguous range.

Additional constraints apply if the selected Chirp z-transformation is a lowpass transformation.

Remote control: `CALCulate<Chn>:TRANSform:TIME:STATe ON`

Stimulus Transform

Opens a submenu to define the stimulus axis range for time domain representation.

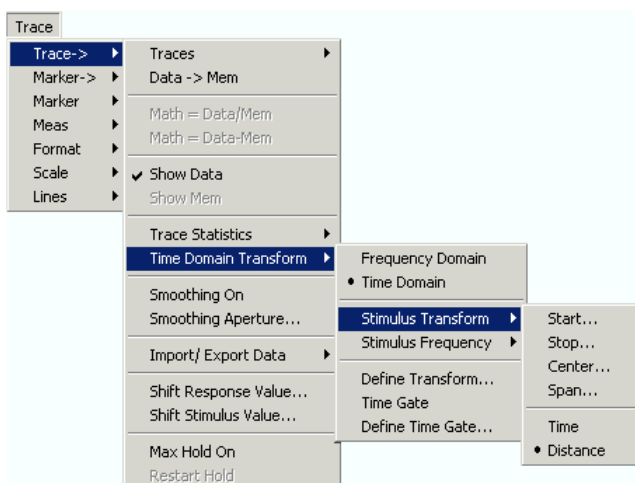

- *Start* is the lowest displayed time and corresponds to the left edge of the Cartesian diagram.
- *Stop* is the highest displayed time and corresponds to the right edge of the Cartesian diagram.
- *Center* corresponds to the center of the Cartesian diagram, i.e. $(Start + Stop)/2$.
- *Span* corresponds to the diagram width, i.e. $(Stop - Start)$.
- *Time* and *Distance* switch over between the x-axis scaling in time units or distance units.



Use the paste marker list for convenient entry of *Start* and *Stop* values.



Distance units for transmission and reflection parameters

The interpretation of time and distance depends on the measurement type. For reflection measurements, the time axis represents the propagation time of a signal from the source to the DUT and back. For transmission measurement, it represents the propagation time from the source through the device to the receiver. The *Distance* calculation is consistent with this interpretation:

- For reflection measurements (S-parameters S_{ii} or ratios with equal port indices) the distance between the source and the DUT is half the propagation time multiplied by the velocity of light in the vacuum times the velocity factor of the receiving port defined in the *Channel Offset* menu ($Distance = 1/2 * Time * c_0 * Velocity Factor$). The factor 1/2 accounts for the return trip from the DUT to the receiver.
- For transmission measurements, the distance is calculated as the propagation time times the velocity of light in the vacuum times the velocity factor of the receiving port defined in the *Channel Offset* menu ($Distance = Time * c_0 * Velocity Factor$).



Due to the properties of the Chirp z-transformation the trace is periodic in time and repeats after an unambiguous range of $\Delta t = 1/\Delta f$, where Δf is the spacing between two consecutive frequency points. To extend the unambiguous range, either reduce the sweep span ($Channel - Center / Span$) or increase the number of sweep points.

Remote control: `CALCulate<Chn>:TRANSform:TIME:START`
`CALCulate<Chn>:TRANSform:TIME:STOP`
`CALCulate<Chn>:TRANSform:TIME:CENTER`
`CALCulate<Chn>:TRANSform:TIME:SPAN`
`CALCulate<Chn>:TRANSform:TIME:XAXIS TIME | DISTANCE`

Stimulus Frequency

Opens a submenu to change the stimulus axis in the frequency domain. The settings are identical with the *Channel - Stimulus* settings.

Remote control: `[SENSe<Ch>:]FREQuency:START`
`[SENSe<Ch>:]FREQuency:STOP`
`[SENSe<Ch>:]FREQuency:CENTER`
`[SENSe<Ch>:]FREQuency:SPAN`

Define Transform

The *Define Transform* dialog selects the transformation type and the frequency domain window which is applied to the trace in order to optimize its time domain response.

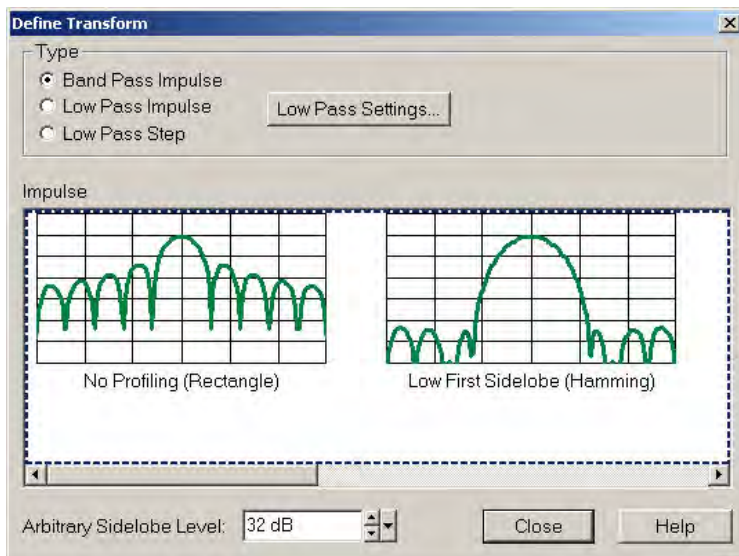

- The radio buttons in the *Type* panel select a band pass or low pass transform. To calculate a low pass transform the sweep points must be on a harmonic grid (otherwise the analyzer will only be able to calculate an approximate result and generate a warning). *Low Pass Settings...* opens a dialog to establish or change a harmonic grid (not available for memory traces).
- The *Impulse* panel shows the impulse response of a constant trace over a finite sweep range (i.e. a rectangular function) that was filtered in the frequency domain using different windows. The selected window is applied to the active trace. The analyzer always uses a *No Profiling (Rectangle)* window to calculate the time-gated frequency domain trace, see background information in section *Frequency Domain*.
- If an *Arbitrary Sidelobes (Dolph-Chebyshev)* window is selected, the *Arbitrary Sidelobe Level* (sidelobe suppression) can be set below the *Impulse Response* diagrams.

For a comparison of the different transformation types and windows and for application examples please also refer to the application note 1EZ44_OE which is posted on the R&S internet.



The frequency domain window is used to filter the trace prior to the time domain transformation. An independent *Time Gate* can be used after the transformation in order to eliminate unwanted responses.

Remote control: `CALCulate<Chn>:TRANSform:TIME[:TYPE]`
`CALCulate<Chn>:TRANSform:TIME:STIMulus`
`CALCulate<Chn>:TRANSform:TIME:WINDow`
`CALCulate<Chn>:TRANSform:TIME:DCHebyshev`

Band Pass and Low Pass Mode

The analyzer provides two essentially different types of time domain transforms:

- **Band pass mode** : The time domain transform is based on the measurement results obtained in the sweep range between any set of positive start and stop values. The sweep points must be equidistant. No assumption is made about the measurement point at zero frequency (DC value). The time domain result is complex with a generally undetermined phase depending on the delay of the signal.
- **Low pass mode** : The measurement results are continued towards $f = 0$ (DC value) and mirrored at the frequency origin so that the effective sweep range (and thus the response resolution) is more than doubled. Together with the DC value, the condition of equidistant sweep points implies

that the frequency grid must be harmonic. Due to the symmetry of the trace in the frequency domain, the time domain result is harmonic.

The band pass and low pass modes are compared below.

Transform type	Band pass	Low pass
Advantages	Easiest to use: works with any set of equidistant sweep points	Higher response resolution (doubled) Includes information about DC value Real result Impulse and step response
Restrictions	No step response Undetermined phase	Needs harmonic grid
Use for...	Scalar measurements where the phase is not needed DUTs that don't operate down to $f = 0$ (e.g. pass band or high pass filters)	Scalar measurements where the sign is of interest DUT's with known DC value

Remote control:

`CALCulate<Chn>:TRANSform:TIME[:TYPE]`

Impulse and Step Response

In low pass mode, the analyzer can calculate two different types of responses:

- The impulse response corresponds to the response of a DUT that is stimulated with a short pulse.
- The step response corresponds to the response of a DUT that is stimulated with a voltage waveform that transitions from zero to unity.

The two alternative responses are mathematically equivalent; the step response can be obtained by integrating the impulse response:



Integrate impulse response



Obtain step response



The step response is recommended for impedance measurements and for the analysis of discontinuities (especially inductive and capacitive discontinuities). The impulse response has an unambiguous magnitude and is therefore recommended for most other applications.

Remote control: `CALCulate<Chn>:TRANSform:TIME:STIMulus`

Windows in the Frequency Domain

The finite sweep range in a frequency domain measurement with the discontinuous transitions at the start and stop frequency broadens the impulses and causes sidelobes (ringing) in the time domain response. The windows offered in the *Define Transform* dialog can reduce this effect and optimize the time domain response. The windows have the following characteristics:

Window	Sidelobe suppression	Relative impulse width	Best for...
No Profiling (Rectangle)	13 dB	1	–
Low First Sidelobe (Hamming)	43 dB	1.4	Response resolution: separation of closely spaced responses with comparable amplitude

Normal Profile (Hann)	32 dB	1.6	Good compromise between pulse width and sidelobe suppression
Steep Falloff (Bohman)	46 dB	1.9	Dynamic range: separation of distant responses with different amplitude
Arbitrary Sidelobes (Dolph-Chebyshev)	User defined between 10 dB and 120 dB	1.2 (at 32 dB sidelobe suppression)	Adjustment to individual needs; tradeoff between sidelobe suppression and impulse width

Remote control: CALCulate<Chn>:TRANSform:TIME:WINDow
 CALCulate<Chn>:TRANSform:TIME:DCHebyshev

Low Pass Settings

The *Low Pass Settings* dialog defines the harmonic grid for low pass time domain transforms.



Harmonic grid

A harmonic grid is formed by a set of equidistant frequency points f_i ($i = 1 \dots n$) with spacing Δf and the additional condition that $f_1 = \Delta f$. In other words, all frequencies f_i are set to harmonics of the start frequency f_1 .

If a harmonic grid, including the DC value ($f = 0$) is mirrored to the negative frequency range, the result is again an equidistant grid.

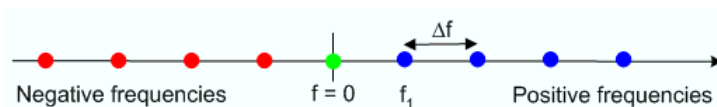

The point symmetry with respect to the DC value makes harmonic grids suitable for lowpass time domain transformations.



The dialog can be used to change the present grid of sweep points, which may or may not be harmonic.

- The three buttons in the *Set Harmonic Grid...* panel provide alternative algorithms for calculation of a harmonic grid, based on the current sweep points.
- The control elements in the *DC Value* panel define the measurement result at zero frequency and in the interpolation/extrapolation range between $f = 0$ and $f = f_{\min}$. They are enabled after a harmonic grid has been established.



Defining the low frequency sweep points

After calculating a harmonic grid, the analyzer must determine the value of the measured quantity at zero frequency and possibly at additional points in the range between $f = 0$ and $f = f_{\min}$.

The following figure shows a scenario where the harmonic grid was calculated with fixed *Stop Frequency and Number of Points*. The DC value and the values at the two additional red points must be extrapolated or interpolated according to the measured sweep points (blue dots) and the properties of the DUT.

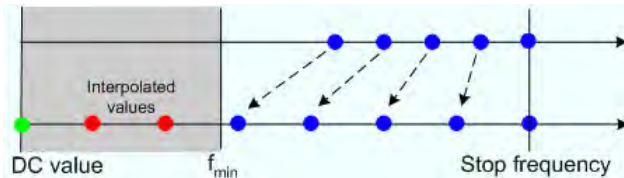

- If the properties of the DUT at $f = 0$ are sufficiently well known, then it is recommendable to enter the DC value manually (*Manual Entry*) and let the analyzer calculate the remaining values (red dots) by linear interpolation of the magnitude and phase (Examples: At $f = 0$ the reflection factor of an open-ended cable is 1. It is -1 for a short-circuited cable and 0 for a cable with matched termination. If a cable with known termination is measured, then these real numbers should be entered as DC values.). Clicking the *Extrapolate* button will initiate an extrapolation of the measured trace towards $f = 0$ and overwrite the current DC value. This can be used for a consistency check.
- *Continuous Extrapolation* initiates an extrapolation of the measured trace towards lower frequencies, so that the missing values (green and red dots) are obtained without any additional input. The extrapolation is repeated after each sweep.

Remote control: `CALCulate<Chn>:TRANSform:TIME:LPASs:KFSTop | KDFrequency | KSDFrequency`
`CALCulate<Chn>:TRANSform:TIME:LPASs:DCSParam`
`CALCulate<Chn>:TRANSform:TIME:LPASs:DCSParam:CONTinuous`
`CALCulate<Chn>:TRANSform:TIME:LPASs:DCSParam:EXTRapolate`
`CALCulate<Chn>:TRANSform:TIME:LPFRequency`

Set Harmonic Grid

In the *Set Harmonic Grid...* panel of the *Low Pass Settings* dialog, a harmonic grid can be calculated in three alternative ways:

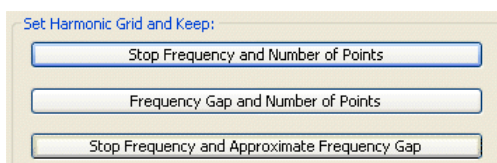

- Keep *Stop Frequency and Number of Points* calculates a harmonic grid based on the current stop frequency ($Channel - Center / Span - Stop$) and the current number of sweep points ($Channel - Sweep - Number of Points$). This may increase the step width, narrowing the unambiguous range but improving the time domain resolution.
- Keep *Frequency Gap and Number of Points* calculates a harmonic grid based on the current stop frequency ($Channel - Center / Span - Stop$) and the current frequency gap (the spacing between the equidistant sweep points, i.e. the sweep Span divided by the Number of Points minus one). This leaves the unambiguous range unchanged but may lower the stop frequency and therefore deteriorate the time domain resolution.
- Keep *Stop Frequency and Approximate Frequency Gap* calculates a harmonic grid based on the current stop frequency ($Channel - Center / Span - Stop$), increasing the number of points ($Channel - Sweep - Number of Points$) in such a way that the frequency gap remains approximately the same. This leaves both the time domain resolution and the unambiguous range

unchanged but may increase the sweep time, due to the additional sweep points introduced.

The three grids can be calculated repeatedly in any order; the analyzer always starts from the original set of sweep points.

-  **Visualization of the harmonic grid algorithms**

The three types of harmonic grids have the following characteristics:

- **Keep Stop Frequency and Number of Points** means that the stop frequency and the number of sweep points is maintained. The sweep points are re-distributed across the range between the minimum frequency of the analyzer and the stop frequency; the step width may be increased.

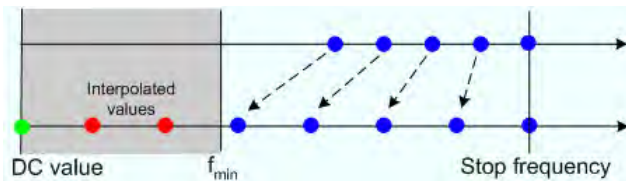

- **Keep Frequency Gap and Number of Points** means that the number of sweep points and their relative spacing is maintained. The entire set of sweep points is shifted towards lower frequencies so that the stop frequency is decreased.

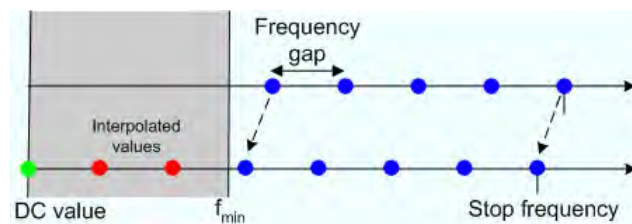

- **Keep Stop Frequency and Approximate Frequency Gap** means that the stop frequency is maintained and the number of sweep points is increased until the range between f_{min} and the stop frequency is filled. The frequency gap is approximately maintained.

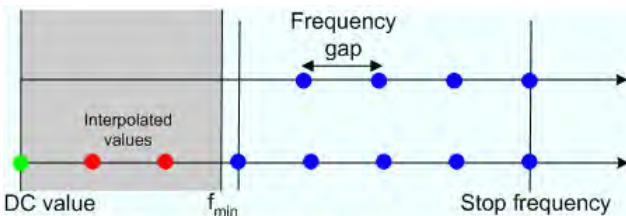

The figures above are schematic and do not comply with the conditions placed on the number of sweep points and interpolated/extrapolated values.



The harmonic grids can not be calculated for any set of sweep points. If the minimum number of sweep points is smaller than 5, then the interpolation/extrapolation algorithm for additional sweep points will not work. The same is true if the number of sweep points or stop frequency exceeds the upper limit. Besides, the ratio between the sweep range and the interpolation range between $f = 0$ and $f = f_{min}$ must be large enough to ensure accurate results. If the sweep range for the harmonic grid exceeds the frequency range of the current system error correction, a warning is displayed.



Finding the appropriate algorithm

The three types of harmonic grids have different advantages and drawbacks. The following table helps you to find the appropriate grid.

Grid type: Keep	Sweep time	Time domain resolution	Unambiguous range
Stop freq. and no. of points	→	↑	↓
Freq. gap and no. of points	→	↓	→
Stop freq. and approx. freq. gap	↑	→	→

Remote control:

CALCulate<Chn>:TRANSform:TIME:LPASs KFSTop |
KDFrequency | KSDFrequency

Time Gate

Switches the time gate defined via *Define Time Gate* on or off. An active time gate acts on the trace in time domain as well as in frequency domain representation. *Gat* is displayed in the trace list while the time gate is active.

Trc1 Sss22 Delay 1 ns/ Ref 0 s Gat



The time gate is independent of the frequency window used to filter the trace prior to the time domain transformation.



In time domain representation, you can use the time gate settings in order to eliminate unwanted responses in your signal. After switching back to the frequency domain, you will receive the frequency response of your DUT without the contribution of the unwanted responses.

Remote control: CALCulate<Chn>:FILTer[:GATE]:TIME:STATE <Boolean>

Define Time Gate

The *Define Time Gate* defines the properties of the time gate used to eliminate unwanted responses that appear on the time domain transform.

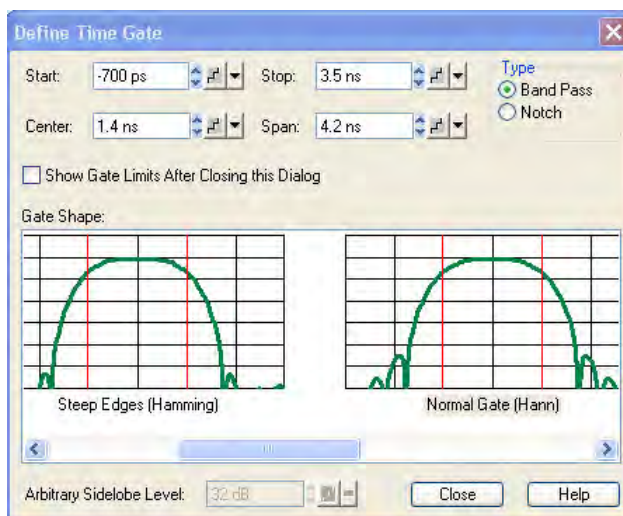

- *Start* and *Stop* or *Center* and *Span* define the size of the time gate. The analyzer generates a warning if the selected time span exceeds the unambiguous range which is given by $\Delta t = 1/\Delta f$, where Δf is the spacing between two consecutive frequency points. Simply reduce the time span until the warning disappears.
- The filter *Type* defines what occurs to the data in the specific time region. A *Band Pass* filter passes all information in the specified time region and rejects everything else. A *Notch* filter rejects all information in the specified time region and passes everything else.
- If the *Show Gate Limits after Closing this Dialog* check box is selected two red lines indicating the start and stop of the time gate are permanently displayed in the diagram area.
- The *Gate Shape* panel visualizes how the time gate will affect a constant function after transformation back into the frequency domain. The selected window is applied to the active trace. The two red vertical lines represent the *Start* and *Stop* values defining the size of the time gate. The analyzer always uses a *Steepest Edges (Rectangle)* window to calculate the time-gated frequency domain trace, see background information in section *Frequency Domain*.
- If an *Arbitrary Gate Shape (Dolph-Chebyshev)* window is selected, the *Arbitrary Sidelobe Level* can be set below the *Gate Shape* diagrams.



Use the paste marker list for convenient entry of *Start* and *Stop* values.

-  **Comparison of time gates**

The properties of the time gates are analogous to the properties of the frequency domain windows. The following table gives an overview:

Window	Sidelobe suppression	Passband ripple	Best for...
Steepest Edges (Rectangle)	13 dB	0.547 dB	Eliminate small distortions in the vicinity of the useful signal, if demands on amplitude accuracy are low
Steep Edges (Hamming)	43 dB	0.019 dB	Good compromise between edge steepness and sidelobe suppression
Normal Gate (Hann)	32 dB	0.032 dB	Good compromise between edge steepness and sidelobe suppression
Maximum Flatness (Bohman)	46 dB	0 dB	Maximum attenuation of responses outside the gate span
Arbitrary Gate Shape (Dolph-Chebyshev)	User defined between 10 dB and 120 dB	0.071 dB	Adjustment to individual needs; tradeoff between sidelobe suppression and edge steepness

Remote control:

```

CALCulate<Chn>:FILTer[:GATE]:TIME:START
CALCulate<Chn>:FILTer[:GATE]:TIME:STOP
CALCulate<Chn>:FILTer[:GATE]:TIME:CENTer
CALCulate<Chn>:FILTer[:GATE]:TIME:SPAN
CALCulate<Chn>:FILTer[:GATE]:TIME[:TYPE] BPASs | NOTCh
CALCulate<Chn>:FILTer[:GATE]:TIME:SHOW
CALCulate<Chn>:FILTer[:GATE]:TIME:WINDow RECT | HAMMING | HANN
| BOHMan | DCHebyshev
CALCulate<Chn>:FILTer[:GATE]:TIME:DCHebyshev

```

Import/Export Data

Stores one or several data or memory traces to a file or loads a memory trace from a file. Import or export is selected from a submenu:

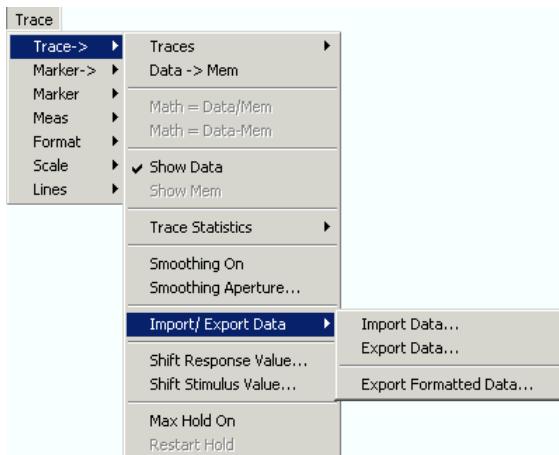

- *Import Data...* calls up an *Open File* dialog to load a memory trace from a trace file.
- *Export Data...* calls up a *Save As...* dialog to store data or memory traces to a trace file.
- *Export Formatted Data...* calls up a *Save As...* dialog to store data or memory traces with their current trace format and stimulus values to a trace file.

Import Data...

Calls up a dialog to load a memory trace from a trace file. Trace files are ASCII files with selectable file format.

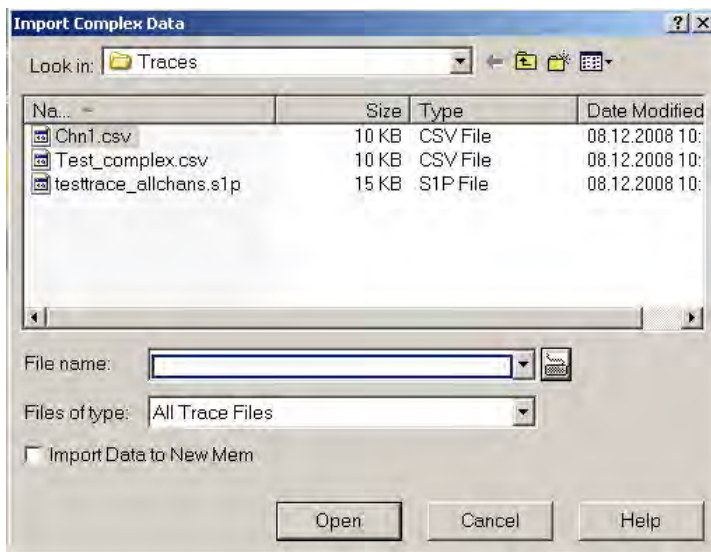

The loaded trace data is used to generate a memory trace which is coupled to the active data trace. *Import Data* corresponds to a standard *Open File* dialog with an additional checkbox:

- *Import Data to New Mem* qualifies whether the loaded data overwrite the active memory trace (box unchecked, analogous to *Data -> Mem*) or whether they are used to generate a new memory trace (box checked, analogous to *Data -> New Mem*).



Trace file import and import conditions

On loading data from a trace file, the analyzer displays a list box to select one of the traces stored in the file. The example below shows a *Touchstone* (*.s2p) file, containing all four 2-port S-parameters; see *Trace File Formats*.

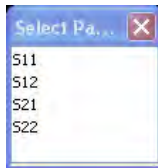

Coupling between the imported memory trace and the active data trace implies that the stimulus values of the imported data and of the active trace must be compatible. Compatibility means that the Sweep Type of the two traces must match; the position and number of the sweep points do not have to be the same.

The analyzer checks for compatibility before importing data. The *Select Parameter* box remains empty if the selected files contains no compatible data.



When a *.s1p file is opened the *Select Parameter* box indicates the 1-port (reflection) parameter S11, irrespective of the actual S-parameter stored in the file.



To import a trace file (*.snp or *.csv) you can also use the Windows Explorer and simply double-click the file or drag and drop the file into the NWA application. The imported data generates a memory trace which is coupled to the active data trace.

Remote control: `MMEemory:LOAD:TRACe "<trc_name>","<file_name>"`

Export Data...

Calls up a dialog to store data or memory traces to a trace file. Trace files are ASCII files with selectable file format.

Data export can serve many purposes, e.g.:

- To process and evaluate measurement data in an external application.
- To store measurement data and re-import it in a future measurement session.

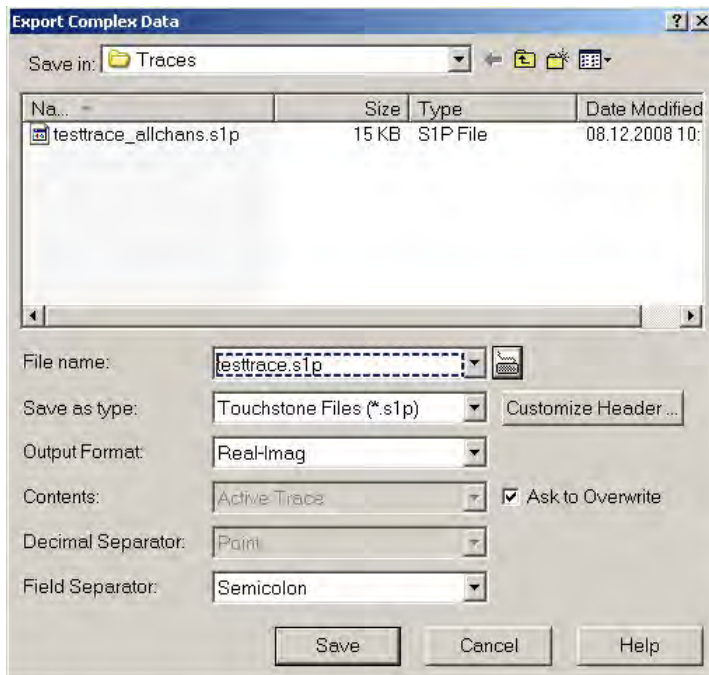

Export Complex Data corresponds to a standard *Save As...* dialog with an additional panel to specify the export options. The export options are remembered when the dialog is closed. The *Dec. Separator* export

option is not available for Matlab (*.dat) file export. Touchstone files *.s<n>p contain either a single trace (*.s1p) or the complete set of S-parameters of an n-port and use the point as *Dec. Separator*; see *Trace File Formats*. Some of the following output options also depend on the trace format.

- Output Format selects the format for the exported trace data. In the Real-Imag format, each complex measurement value is represented by its real and imaginary part. It is also possible to store the linear magnitude and phase (Lin Mag-Phase) or dB magnitude and phase (dB Mag-Phase) of each value.
- Content selects only the Active Trace or All Traces of (the) Active Channel (including all data and memory traces) for data export to an ASCII (*.csv) file.
- Dec. Separator selects either the Point or the Comma (if needed to process the exported data with an external application) as a separator for decimal numbers exported to an ASCII (*.csv) file.
- Ask to Overwrite activates a message box to be displayed before an older trace file with the same file name and directory is overwritten.
- Customize Header... opens the Customize Header dialog to define a custom header for the generated trace file.



Selecting an appropriate file format

Use a **Touchstone** file format to export a fixed number of S-parameter data traces to a file that can be evaluated with applications such as Agilent's Microwave Design System (MDS) and Advanced Design System (ADS). The data must be acquired in a frequency sweep.

- *.s1p files are intended for a 1-port S-parameter (the reflection coefficient S₁₁) but can be used as well to store any single S-parameter. Note that any S-parameter will be labeled S₁₁ in the file and in the *Select Parameter* box.
- *.s2p files are intended for a complete set of 2-port S-parameters. Data export fails if the active channel does not contain the full set of 4 traces.

Use the **ASCII (*.csv)** format if you want to do one of the following:

- Import the created file into a spreadsheet application such as Microsoft Excel.
- Export an arbitrary number of traces, multiple traces with the same parameter or memory traces.
- Use export options.

Use a the **Matlab (*.dat)** format if you want to import and process the trace data in Matlab.

For more information see Trace File Formats.

```
Remote          MMEMemory:STORe:TRACe
control:        "<trc_name>", "<file_name>"[,UNFormatted,...]
```

Export Formatted Data...

Calls up a dialog to store data or memory traces with their current trace format and stimulus values to a trace file using a *.csv or *.dat file format. Only the displayed values of the trace (e.g. the logarithmic magnitude, if trace format *dB Mag* is selected) are exported. Therefore the trace file doesn't necessarily contain the full (complex) information about the trace.



The exported formatted values correspond to the results in the marker info field. For trace formats involving Cartesian diagrams (dB Mag, Real, Imag...), the stimulus value and a single real response value is exported. For circular diagrams, both the real and imaginary part of the response value is exported. See also Complex vs. Formatted Data.

An exported formatted trace can be processed and evaluated in an external application. Re-import into the

analyzer is only possible if the complex trace values are available.

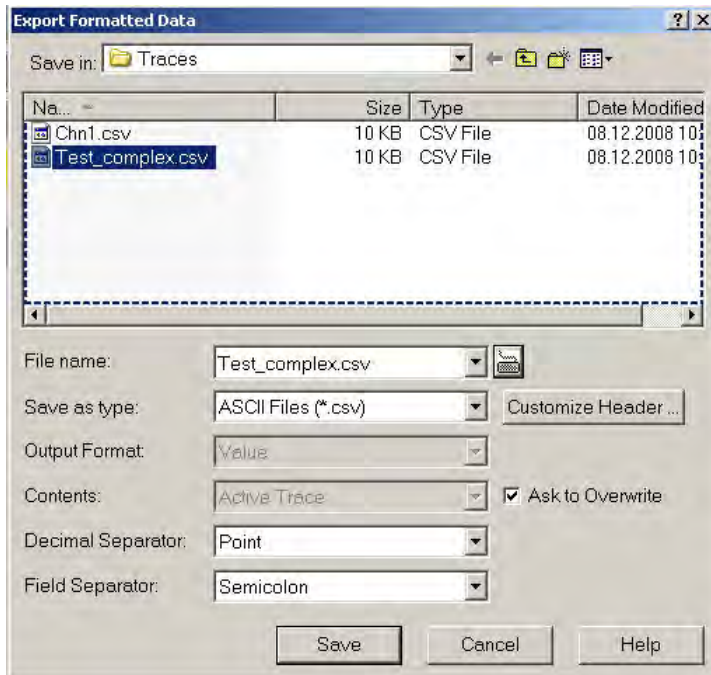

Export Formatted Data corresponds to a standard *Save As...* dialog with an additional panel to specify the export *Options*. The *Dec. Separator* export option is not available for Matlab (*.dat) file export. Touchstone files *.s<n>p contain either a single trace (*.s1p) or the complete set of S-parameters of an n-port and use the point as *Dec. Separator*; see *Trace File Formats*; they are only available if complex trace values are exported (trace formats *Polar*, *Smith*, *Inverted Smith*). Some of the following output options also depend on the trace format.

- Output Format selects the format for the exported trace data. In the Re/Im format, each complex measurement value is represented by its real and imaginary part. It is also possible to store the linear magnitude and phase (lin Mag-Phase) or dB magnitude and phase (dB Mag-Phase) of each value.
- Content selects only the Active Trace or All Traces of (the) Active Channel (including all data and memory traces) for data export to an ASCII (*.csv) file.
- Dec. Separator selects either the Point or the Comma (if needed to process the exported data with an external application) as a separator for decimal numbers exported to an ASCII (*.csv) file.
- Ask to Overwrite activates a message box to be displayed before an older trace file with the same file name and directory is overwritten.
- Customize Header... opens the Customize Header dialog to define a custom header for the generated trace file.



Selecting an appropriate file format

Use a **Touchstone** file format to export a fixed number of S-parameter data traces to a file that can be evaluated with applications such as Agilent's Microwave Design System (MDS) and Advanced Design System (ADS). The data must be acquired in a frequency sweep.

- *.s1p files are intended for a 1-port S-parameter (the reflection coefficient S_{11}) but can be used as well to store any single S-parameter. Note that any S-parameter will be labeled S_{11} in the file and in the *Select Parameter* box.
- *.s2p files are intended for a complete set of 2-port S-parameters. Data export fails if the active channel does not contain the full set of 4 traces.

Use the **ASCII (*.csv)** format if you want to do one of the following:

- Import the created file into a spreadsheet application such as Microsoft Excel.
- Export an arbitrary number of traces, multiple traces with the same parameter or memory traces.
- Use export options.

Use a the **Matlab (*.dat)** format if you want to import and process the trace data in Matlab.

For more information see Trace File Formats.

Remote control: `MMEMemory:STORe:TRACe "<trc_name>","<file_name>","FORMatted,...`

Customize Header

Adds a custom header to a trace file. The dialog is opened from the *Export Complex Data* or *Export Formatted Data* dialogs.

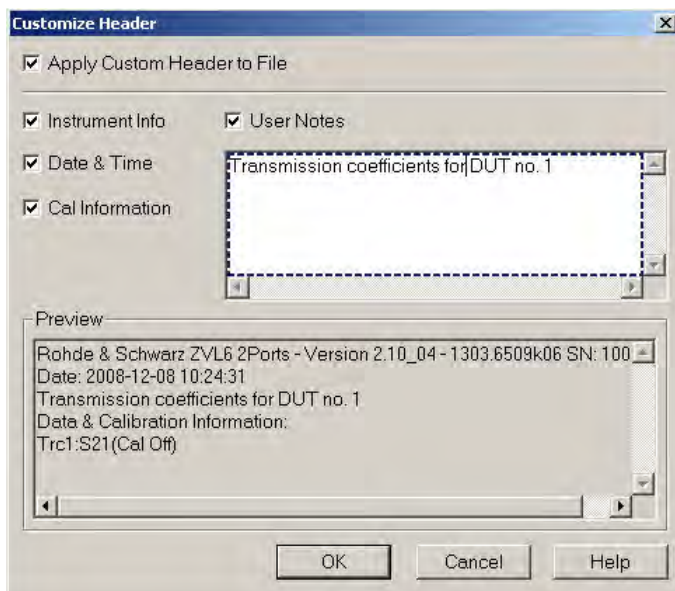

Select *Apply Custom Header to File* to insert the header in the *Preview* section at the beginning of the generated trace file. The *Instrument Info*, *Date & Time*, and *Cal Information* are generated automatically. The *Cal Information* contains the calibration for each exported trace. *User Notes* are additional, optional comments.



A preset does not change the custom header settings. Press the *Use Default Directories* button in the *System Configuration* dialog (*Nwa-Setup – System Config.*) to reset the settings.

Remote control: `MMEMemory:STORe:TRACe:USER:CINformation`
`MMEMemory:STORe:TRACe:USER:DATE`
`MMEMemory:STORe:TRACe:USER:IINformation`
`MMEMemory:STORe:TRACe:USER:STATE`
`MMEMemory:STORe:TRACe:USER:TEXT`
`MMEMemory:STORe:TRACe:USER:TEXT:STATE`

Trace File Formats

Trace files are ASCII files with selectable file format. The analyzer provides two classes of trace files:

- Touchstone (*.s<n>p) files
- ASCII (*.csv) files
- Matlab (*.dat) files are ASCII files which can be imported and processed in Matlab.

The trace file formats complement each other; see *Selecting an appropriate file format*.

Touchstone files

All Touchstone files contain a header, a comment section, and the actual trace data:

```
# HZ S RI R 50.0000
! Rohde & Schwarz ZVL
! Measurement: S11
! 2003-07-07
!
60297750.000000      0.498113 -0.054290
80297000.000000      0.504888 -0.081229
...
```

The header consists of the following data elements:

specifies beginning of header line (required at top of file). <Frequency unit> HZ / KHZ / MHZ / GHZ allowed for imported files. The analyzer always uses HZ for exported data.
 <Data file type> at present: S for S-parameter files.
 <Data format> RI for Re/Im, MA for lin. Mag-Phase, DB for dB Mag-Phase. The data format for export files can be selected in the Export Data dialog.
 <Normalizing impedance> Impedance system in which the data was defined. The analyzer uses 50.0000 Ω.

Comment lines start with the exclamation mark (!) and may contain any text used for documentation of the trace data file. Any number of comment lines may be inserted before or after the header line.

The trace data section depends on the number of ports <n> and the data format. For real and imaginary values (data format = RI) the trace data for each stimulus frequency is arranged as follows:

- **1-port files (*.s1p)**
 - Freq Re(S11) Im(S11)
 - S11 can be replaced by any S-parameter, so the *s1p format is suitable for exporting an arbitrary data trace representing an S-parameter.
- **2-port files (*.s2p)**
 - Freq Re(S11) Im(S11) Re(S21) Im(S21) Re(S12) Im(S12) Re(S22) Im(S22)
 - (all values arranged in 1 line)

The stimulus frequencies are arranged in ascending order. If a *lin. Mag-Phase (MA)* or *dB Mag-Phase (DB)* data format is selected the real and imaginary S-parameter values $\text{Re}(S_{ij})$, $\text{Im}(S_{ij})$ are replaced by *lin Mag(S_{ij})*, *phase(S_{ij})* or *dB Mag(S_{ij})*, *phase(S_{ij})*, respectively.

According to Touchstone file specifications, no more than four pairs of network data are allowed per data line. The entries in the data lines are separated by white space, and a data line is terminated by a new line character. All data sets are arranged in increasing order of frequency.

ASCII (*.csv) files

An ASCII file contains a header and the actual trace data:

```
freq;reTrc1_S21;imTrc1_S21;reMem2[Trc1]_S21;imMem2[Trc1]_S21;
300000.000000;0.000000;0.000000;0.000000;0.000000;0.000000;
40499497.487437;0.000000;0.000000;0.000000;0.000000;
80698994.974874;0.494927;-0.065174;0.500833;-0.074866;
120898492.462312;0.497959;-0.111724;0.488029;-0.107375;
```

...

The header consists of the following data elements:

<Stimulus> stimulus variable: freq for Frequency sweep.

<reTrace1> first response value of first trace: re<Trace_Name>, mag<Trace_Name> or db<Trace_Name> for output format Real-Imag, Lin. Mag-Phase or dB Mag-Phase, respectively. The data format for export files can be selected in the Export Data dialog.

<imTrace1> second response value of first trace: im<Trace_Name> for output format Real-Imag, ang<Trace_Name> for output formats Lin. Mag-Phase or dB Mag-Phase. The data format for export files can be selected in the Export Data dialog.

<reTrace2> first response value of second trace: re<Trace_Name>, mag<Trace_Name> or db<Trace_Name> for output format Real-Imag, Lin. Mag-Phase or dB Mag-Phase, respectively. The data format for export files can be selected in the Export Data dialog.

<imTrace2>... second response value of first trace: im<Trace_Name> for output format Real-Imag, ang<Trace_Name> for output formats Lin. Mag-Phase or dB Mag-Phase. The data format for export files can be selected in the Export Data dialog. first response value of second trace. HZ / KHZ / MHZ / GHZ allowed for imported files. The analyzer always uses HZ for exported data. second response value of first trace: im<Trace_Name> for output format Re/Im, ang<Trace_Name> for output formats lin. Mag-Phase or dB Mag-Phase. The data format for export files can be selected in the Export Data dialog.

The trace data is arranged as described in the header. Different values are separated by semicolons. A semicolon is also inserted before the end of each line.

The stimulus values are arranged in ascending order.

Shift Response Value...

Modifies all points of the active trace by means of an added and/or a multiplied complex constant. The constant complex values are entered in the four input fields of the *Shift Response Value* dialog.

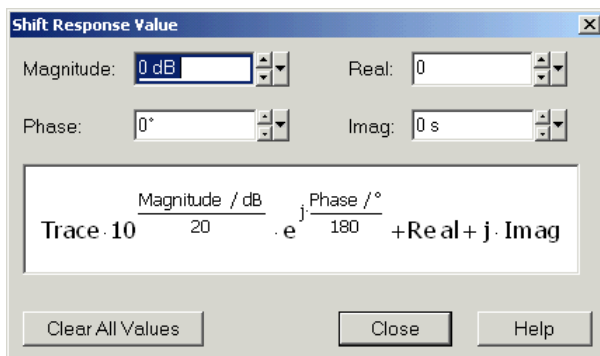

The units of the constants are adjusted to the format of the active trace. Setting all values to zero (*Clear All Values*) restores the original trace.



Effect of the constants

The trace points are modified according to the formula displayed in the lower part of the dialog:

$$M_{new} = M_{old} \cdot 10^{<Magnitude>/20 \text{ dB}} \cdot e^{j \cdot <Phase>/180^\circ} + <Real> + j \cdot <Imag>$$

The formula and the different constants are adjusted to the different display formats of a trace:

- The *Magnitude* factor shifts a *dB Mag* trace in vertical direction, leaving the phase of a complex parameter unchanged.
- The *Phase* factor rotates a trace that is displayed in a polar diagram around the origin, leaving the

magnitude unchanged.

- The *Real* added constant shifts a real trace in vertical direction, leaving the imaginary part unchanged.
- The *Imaginary* added constant shifts a imaginary trace in vertical direction, leaving the real part unchanged.



Shifting the trace by means of constant values is a simple case of trace mathematics. Use the *Define Math* dialog to define more complicated mathematical operations.

Remote control: `DISPlay:WINDow<Wnd>:TRACe<WndTr>:Y:OFFset <Magnitude>[, <Phase>, <Real>, <Imag>]`

Remote control: `CALCulate<Chn>:MATH:WUNit:STATe ON | OFF`

Shift Stimulus Value...

Shifts the active trace in horizontal direction, leaving the positions of all markers unchanged. The positive or negative offset value for the stimulus variable is entered into an input field. The unit depends on the sweep type.



Shift Stimulus Value can be used in Cartesian as well as in polar diagrams. The visible effect depends on the diagram type:

- In Cartesian diagrams, the trace is shifted relative to the markers and the x-axis.
- In polar diagrams, the trace is not affected, however, markers change their position.



Use a negative offset value to reset a shifted trace to its original position.

Remote control: `DISPlay:WINDow<Wnd>:TRACe<WndTr>:X:OFFset <numeric_value>`

Max Hold On

Enables (if selected) or disables the max hold (peak hold) function for the active trace. With enabled max hold function, the displayed trace shows the maximum values that the analyzer acquired since the start of the measurement.

The max hold process can be restarted any time using *Restart Hold*. It is also restarted automatically when the channel or trace settings are changed so that the previous measurement results are no longer valid.

Remote control: `CALCulate<Chn>:PHOLd MAX | OFF`

Restart Hold

Restarts the max hold (peak hold) function for the active trace, discarding the old maximum measurement results. This softkey has no effect unless *Max Hold On* is active.

Remote control: CALCulate<Chn>:PHOLd MAX | OFF

Marker ->

The *Marker ->* submenu uses the active marker to define the sweep range, scale the diagram and introduce an electrical length offset.

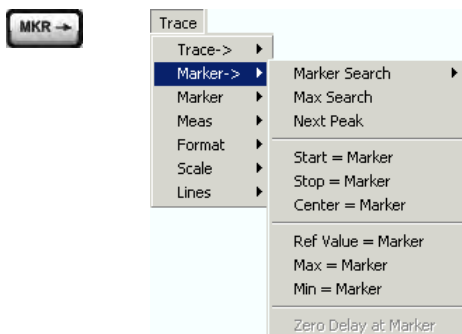

The functions in the upper section provide search functions to locate specific points on the trace.

- *Marker Search* opens a submenu with all marker search functions.
- *Max Search* sets the active marker to the absolute maximum in the search range.
- *Next Peak* sets the active marker to the next maximum or minimum in the search range, depending on the current search criterion.

The following functions use the stimulus value of the active marker to define the sweep range:

- *Start = Marker* sets the beginning of the sweep range equal to the marker value.
- *Stop = Marker* sets the end of the sweep range equal to the marker value.
- *Center = Marker* sets the center of the sweep range equal to the marker value.

The following functions use the response value of the active marker to scale the y-axis of the diagram:

- *Ref. Value = Marker* sets the reference value equal to the marker value.
- *Max = Marker* sets the upper edge of the diagram equal to the marker value.
- *Min = Marker* sets the lower edge of the diagram equal to the marker value.
- *Zero Delay at Marker* corrects the measurement result by adding or subtracting a constant group delay.

Next Peak

Sets the active marker to the next maximum or minimum in the search range, depending on the current search criterion.

- If a *Max Search* or a *Bandpass Search* is active, then the marker is set to the next maximum. The next maximum is the maximum with the largest response value that is below the current marker response value.
- If a *Min Search* or a *Bandstop Search* is active, then the marker is set to the next minimum. The next minimum is the minimum with the smallest response value that is above the current marker response value.

By default the search range coincides with the sweep range. If the active trace contains no markers, a marker *Mkr 1* is created to indicate the search result. *Next Peak* is disabled while a *Target Search* is active.

Remote control: `CALCulate<Chn>:MARKer<Mk>:FUNction:EXECute NPEak`
`CALCulate<Chn>:MARKer<Mk>:FUNction:RESult?`

Start = Marker

Sets the beginning (start) of the sweep range equal to the stimulus value of the active marker, leaving the end (stop) value unchanged. The active marker appears at the left edge of the diagram.

Remote control: `CALCulate<Chn>:MARKer<Mk>:FUNction:START`

Stop = Marker

Sets the end (stop) of the sweep range equal to the stimulus value of the active marker, leaving the beginning (start) unchanged. The active marker appears at the right edge of the diagram.

Remote control: `CALCulate<Chn>:MARKer<Mk>:FUNction:STOP`

Center = Marker

Sets the center of the sweep range equal to the stimulus value of the active marker, leaving the span unchanged. The active marker appears in the center of the diagram.

Remote control: `CALCulate<Chn>:MARKer<Mk>:FUNction:CENTer`

Ref Value = Marker

Sets the reference value equal to the response value of the active marker, leaving the values of the vertical divisions (*Scale Div.*) unchanged.

Max = Marker

Sets the upper edge of the diagram equal to the response value of the active marker, leaving the values of the vertical divisions (*Scale Div.*) unchanged.

Min = Marker

Sets the lower edge of the diagram equal to the response value of the active marker, leaving the values of the vertical divisions (*Scale Div.*) unchanged.

Zero Delay at Marker

Corrects the measurement result by adding or subtracting a constant group delay. This function must be applied to a trace which is displayed in group delay format. The trace is shifted in vertical direction so that

the delay at the marker position vanishes.

The delay represents the propagation time of the wave across the DUT, so this operation corresponds to a electrical length compensation, i.e. to a shift of the reference plane by adding to or subtracting from the test port a simulated lossless transmission line of variable length. The correction must be carried out on the *Delay* trace but has an impact on all trace formats.

A standard application of *Zero Delay at Marker* is correction of the constant delay caused by the interconnecting cables between the analyzer test ports and the DUT (line stretch).



The Zero Delay at Marker function modifies the Offset parameters and therefore influences the entire channel.

Marker Search

The *Marker Search* menu uses markers to locate specific points on the trace.



Search functions

The search functions are tools for searching measurement data according to specific criteria. A search consists of analyzing the measurement points of the current trace (or of a user-defined subrange termed the *Search Range*) in order to find one of the following:

- Absolute or relative (local) maxima and minima (minimum/maximum search).
- Trace points with a specific response value (target search).
- Trace segments with a shape that is characteristic for bandpass or bandstop filters (bandfilter search).

When the search is activated, the active marker is moved to the (next) point that meets the search criteria. If the trace contains no markers, a *Mkr 1* is created and used for the search. The search result is displayed in the marker info field. If no search result can be found, the marker remains at its original position.

Some search functions can be activated repeatedly in order to find all possible search results. Moreover the analyzer provides a *Tracking* mode where the search is repeated after each sweep.

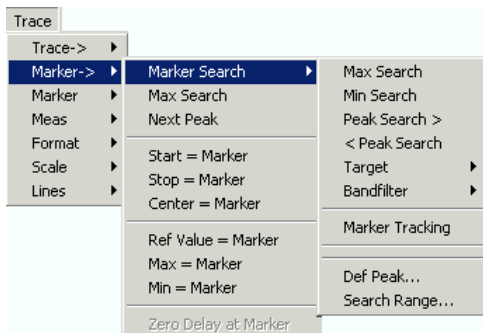

- *Max Search* sets the active marker to the absolute maximum in the search range.
- *Min Search* sets the active marker to the absolute minimum in the search range.
- *Peak Search >* sets the active marker to the next peak with higher stimulus value.
- *< Peak Search* sets the active marker to the next peak with lower stimulus value.
- *Target* opens a submenu to search for a specific value on the trace.
- *Bandfilter* opens a submenu to search for trace segments with characteristic bandfilter shape and calculate the filter parameters.

- *Marker Tracking* causes the search to be repeated after each sweep.
- *Def Peak* defines the criteria for the peak search.
- *Search Range...* assigns a search range to each marker of the current trace.



The search functions are available in all Cartesian and polar diagram types (see Trace – Format). In polar diagrams (*Polar*, *Smith*, *Inverted Smith*), where complex values are displayed, the magnitude of the response values provides the search criterion.

Max Search

Sets the active marker to the absolute maximum in the search range, i.e. to the largest of all response values. If a complex trace format (e.g. a polar diagram) is active, the marker is set to the measurement point with the maximum magnitude.

By default the search range coincides with the sweep range. If the active trace contains no markers, a marker *Mkr 1* is created to indicate the search result.

Remote control: `CALCulate<Chn>:MARKer<Mk>:FUNction:EXECute MAXimum
CALCulate<Chn>:MARKer<Mk>:FUNction:RESult?`

Min Search

Sets the active marker to the absolute minimum in the search range, i.e. to the smallest of all response values. If a complex trace format (e.g. a polar diagram) is active, the marker is set to the measurement point with the minimum magnitude.

By default the search range coincides with the sweep range. If the active trace contains no markers, a marker *Mkr 1* is created to indicate the search result.

Remote control: `CALCulate<Chn>:MARKer<Mk>:FUNction:EXECute MINimum
CALCulate<Chn>:MARKer<Mk>:FUNction:RESult?`

Peak Search >

Sets the active marker to the next peak with higher stimulus value. If the active trace contains no markers, a marker *Mkr 1* is created to indicate the search result. The peak criteria are defined via Define Peak.

Remote control: `CALCulate<Chn>:MARKer<Mk>:FUNction:EXECute RPEak
CALCulate<Chn>:MARKer<Mk>:FUNction:RESult?`

< Peak Search

Sets the active marker to the next peak with lower stimulus value. If the active trace contains no markers, a marker *Mkr 1* is created to indicate the search result. The peak criteria are defined via Define Peak.

Remote control: `CALCulate<Chn>:MARKer<Mk>:FUNction:EXECute LPEak
CALCulate<Chn>:MARKer<Mk>:FUNction:RESult?`

Target

Opens a submenu to search for a specific value on the trace.

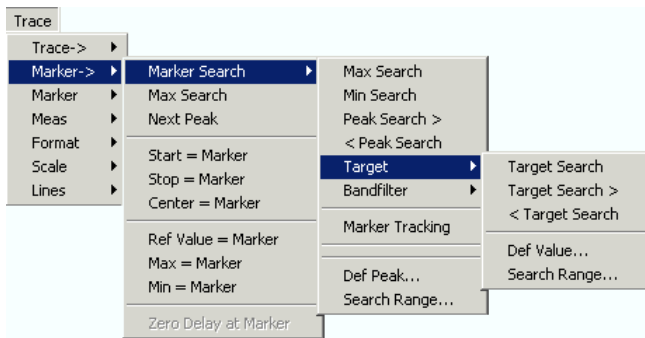

- *Target Search* activates the search for the target value.
- *Target Search >* activates the search for the target value to the right of the active marker.
- *< Target Search* activates the search for the target value to the left of the active marker.
- *Def Value* specifies the target value.
- *Search Range* confines the search to a subrange of the sweep.

Target Search

Activates the search and sets the active marker to the defined target value. If the active trace contains no markers, a marker *Mkr 1* is created to indicate the search result.

If the target value occurs at several stimulus values, the marker is placed to the search result with the smallest stimulus value. The other measurement points with the same target value can be located using the *Target Search >* function.

If the target is not found (e.g. because the active trace doesn't contain the target value), then the active marker is not moved away from its original position.

Remote control: `CALCulate<Chn>:MARKer<Mk>:FUNction:EXECute TARGET
CALCulate<Chn>:MARKer<Mk>:FUNction:RESult?`

Target Search >

Activates the search to the right of the active marker position and sets the active marker to the defined target value. The target search range is between the active marker position and the end (Stop) of the sweep range. If the active trace contains no markers, a marker *Mkr 1* is created to indicate the search result, and the target search range starts at the beginning (Start) of the sweep range.

If the target value occurs at several stimulus values, the marker is placed to the search result with the smallest stimulus value. The other measurement points with the same target value can be located using *Target Search >* repeatedly.

If the target is not found (e.g. because the active trace doesn't contain the target value), then the active marker is not moved away from its original position.

Remote control: `CALCulate<Chn>:MARKer<Mk>:FUNction:EXECute RTARGET
CALCulate<Chn>:MARKer<Mk>:FUNction:RESult?`

< Target Search

Activates the search to the left of the active marker position and sets the active marker to the defined

target value. The target search range is between the (Start) of the sweep range and the active marker position. If the active trace contains no markers, a marker *Mkr 1* is created to indicate the search result, and the target search range starts at the end (Stop) of the sweep range.

If the target value occurs at several stimulus values, the marker is placed to the search result with the smallest stimulus value. The other measurement points with the same target value can be located using *Target Search* > repeatedly.

If the target is not found (e.g. because the active trace doesn't contain the target value), then the active marker is not moved away from its original position.

Remote control: `CALCulate<Chn>:MARKer<Mk>:FUNction:EXECute LTARget`
`CALCulate<Chn>:MARKer<Mk>:FUNction:RESult?`

Def Value

Opens an dialog to select a marker for the target search and define the target value.

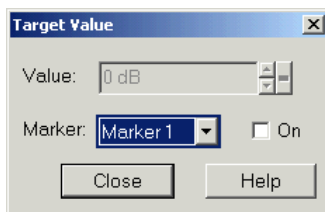

It is possible to define up to ten different target values for each trace and assign them to the markers no. 1 to 10. The input fields in the *Target Search* dialog are used to select the markers and define the associated search ranges:

- *Marker* selects one of the ten markers that can be assigned to the trace. If a selected marker does not exist, it is created as soon as *On* is checked. A created marker is displayed in the center of the search range.
- *Value* selects the target value to be assigned to the selected marker. The target Value is entered with the unit of the active trace.

Remote control: `CALCulate<Chn>:MARKer<Mk>:TARget`

Search Range...

Opens the *Search Range Dialog* to confine the target search to a subrange of the sweep.

Bandfilter

Opens a submenu to search for trace segments with a bandpass or bandstop shape and determine characteristic filter parameters.



Bandfilter search and filter parameters

Bandpass and bandstop regions can be described with the same parameter set:

- A bandpass region contains a local maximum around which the magnitude of the trace falls off by more than a specified *x dB Bandwidth*.
- A bandstop region contains a local minimum around which the magnitude of the trace increases by more than a specified *x dB Bandwidth*.

The analyzer locates bandpass and bandstop regions and determines their position (*Center* frequency) and shape (*Bandwidth*, *LBE*, *UBE*, Quality factor *Q*; see *Show Results*). For a meaningful definition of the *x dB Bandwidth* criterion, the trace format must be *dB Mag*.

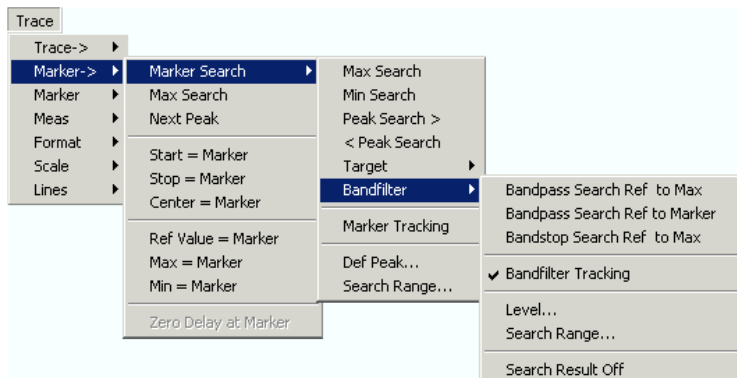

- *Bandpass Search Ref to Max* activates the search for a bandpass region in the active trace, starting at the absolute maximum of the active trace within the search range.
- *Bandpass Search Ref to Marker* activates the search for a bandpass region in the active trace, starting at the position of the active marker.
- *Bandstop Search Ref to Max* activates the search for a bandstop region in the active trace, starting at the absolute minimum of the active trace within the search range.
- *Bandfilter Tracking* causes the bandfilter search to be repeated after each sweep.
- *Level...* sets the level defining the filter bandwidth.
- *Search Range...* confines the search to a subrange of the sweep.
- *Search Result Off* hides the display of the bandfilter parameters in the diagram area.



Bandfilter mode can be selected for a broad range of measured quantities (Trace – Measure), provided that the display format is dB Mag. To obtain real filter parameters, the measured quantity must be a transmission S-parameter and a frequency sweep must be performed. For other quantities (e.g reflection parameters), the Bandfilter functions are still useful to analyze general trace properties. In some display formats (e.g. Phase) the bandfilter search is disabled.

Bandpass Search Ref to Max

Activates the search for a bandpass region on the active trace and activates bandfilter *Tracking*. A bandpass region is the tallest peak in the search range with a minimum excursion specified by means of the *x dB Bandwidth* parameter.

When *Bandpass Search* is activated the analyzer uses (or creates) the four markers *Mkr 1* to *Mkr 4* to locate the **bandpass region**.

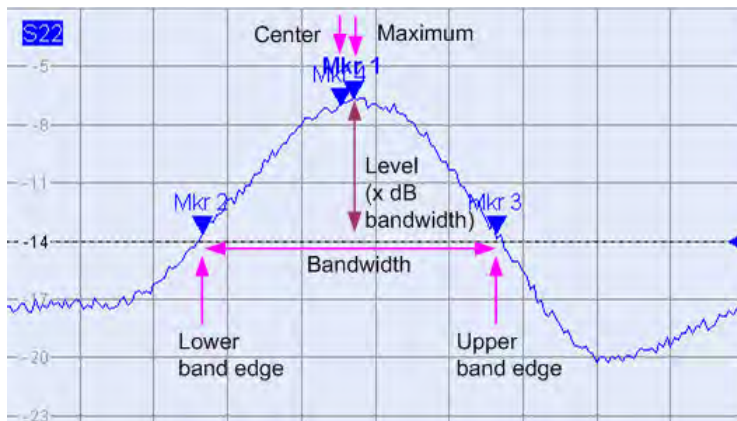

- *Mkr 1* indicates the maximum of the peak (*Max*).
- *Mkr 2* indicates the point on the left edge of the peak where the trace value is equal to the maximum minus *x dB Bandwidth* (*Lower Band Edge, LBE*).
- *Mkr 3* indicates the point on the right edge of the peak where the trace value is equal to the maximum minus *x dB Bandwidth* (*Upper Band Edge, UBE*).
- *Mkr 4* indicates the center of the peak, calculated as the geometric mean value of the *LBE* and *UBE* positions: $f_{\text{Center}} = \sqrt{f_{\text{LBE}} \cdot f_{\text{UBE}}}$.

The band filter search results are displayed in the bandfilter info field.



To search for a bandpass region in the vicinity of the active marker, use *Bandpass Search Ref to Marker*. Use *Bandfilter Tracking* to select other search modes.

Remote control: `CALCulate<Chn>:MARKer<Mk>:FUNction:BWIDth:MODE BPASS`
`CALCulate<Chn>:MARKer<Mk>:FUNction:EXECute BFILter`

Bandpass Search Ref to Marker

Activates the search for a bandpass region on the active trace and activates bandfilter *Tracking*, starting at the position of the active marker. A bandpass region is the closest peak in the search range with a minimum excursion specified by means of the *x dB Bandwidth* parameter.

In contrast to a *Bandpass Search*, the *Bandpass Search Ref to Marker* does not change the position of the active markers. The band filter search results are displayed in the bandfilter info field.



To search for a bandstop region in the vicinity of the active marker, use *Bandfilter Tracking – Bandstop Search Ref to Marker*. Use *Bandfilter Tracking* to select other search modes.

Remote control: `CALCulate<Chn>:MARKer<Mk>:FUNction:BWIDth:MODE BPRMarker |`
`BSRMarker`
`CALCulate<Chn>:MARKer<Mk>:FUNction:EXECute BFILter`

Bandstop Search Ref to Max

Activates the search for a bandstop region on the active trace and activates bandfilter *Tracking*. A bandstop region is the lowest peak (local minimum) in the search range, provided that its level is at least *<x dB Bandwidth>* below the maximum (passband value).

When *Bandstop Search* is activated the analyzer uses (or creates) the four markers *Mkr 1* to *Mkr 4* to locate the **bandstop region**.

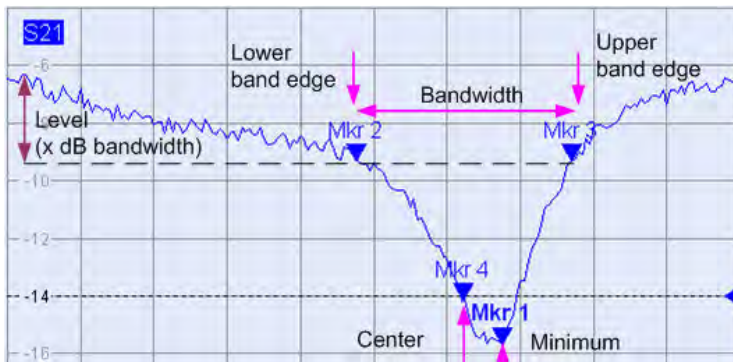

- *Mkr 1* indicates the minimum of the peak (*Min*).
- *Mkr 2* indicates the point on the left edge of the peak where the trace value is equal to the maximum in the search range (passband value) minus *x dB Bandwidth* (*Lower Band Edge, LBE*).
- *Mkr 3* indicates the point on the right edge of the peak where the trace value is equal to the maximum in the search range (passband value) minus *x dB Bandwidth* (*Upper Band Edge, UBE*).
- *Mkr 4* indicates the center of the peak, calculated as the geometric mean value of the *LBE* and *UBE* positions: $f_{\text{Center}} = \sqrt{f_{\text{LBE}} \cdot f_{\text{UBE}}}$.

The band filter search results are displayed in the bandfilter info field.



Use *Bandfilter Tracking* to select other search modes.

Remote control: `CALCulate<Chn>:MARKER<Mk>:FUNction:BWIDth:MODE BStOP`
`CALCulate<Chn>:MARKER<Mk>:FUNction:EXECute BFILter`

Bandfilter Tracking

Causes the bandfilter search to be repeated after each sweep: When tracking mode is active the markers typically change their horizontal and their vertical positions as the measurement goes on.

Tracking for the different bandfilter search modes is enabled or disabled in a selection box. Selecting a search mode for tracking also activates this mode.



The search modes have the following effect:

- *Bandpass Ref to Max / Bandstop Ref to Min*: The bandpass / bandstop is the tallest / lowest peak in the search range.
- *Bandpass / Bandstop Ref to Marker*: The bandpass / bandstop is the tallest / lowest peak in the search range. The response value for the lower and upper band edges is calculated as the response value at the active marker position plus / minus *x dB*, where *x* is equal to the *<x dB Bandwidth>* value. To be valid the peak must be above / below the response value for the band edges.

- **Bandpass / Bandstop Absolute Level:** The bandpass / bandstop is the tallest/lowest peak in the search range. To be valid, the peak must be above / below $-x$ dB, where x is numerically equal to the $\langle x \text{ dB Bandwidth} \rangle$ value. The Lower Band Edge and Upper Band Edge values are given by the frequencies where the trace is equal to $-x$ dB.

Tracking is a toggle function: Selecting the function repeatedly switches the tracking mode on and off.

Remote control: `CALCulate<Chn>:MARKer<Mk>:FUNction:BWIDth:MODE`
`CALCulate<Chn>:MARKer<Mk>:FUNction:EXECute BFILter`
`CALCulate<Chn>:MARKer<Mk>:SEARch:TRACking`

Level

Opens the numeric entry bar for the minimum excursion of the bandpass and bandstop peaks.



- A bandpass peak must fall off on both sides by the specified x dB Bandwidth to be considered a valid peak.
- A bandstop peak must be x dB Bandwidth below the maximum level in the search range (bandpass value) to be considered a valid peak.

Remote control: `CALCulate<Chn>:MARKer<Mk>:BWIDth <Level>`

Search Range...

Opens the *Search Range Dialog* to confine the bandfilter search to a subrange of the sweep.

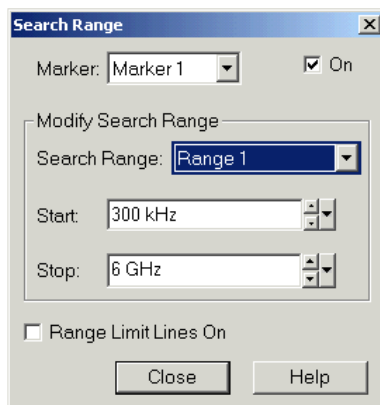

It is possible to define and store up to ten different search ranges for each trace. The bandfilter search is performed using the markers *Mkr 1*, ..., *Mkr 4*, irrespective of the selected search range.

- **Search Range** Selects a search range for the bandfilter search. Full Span means that the search range is equal to the sweep range. Besides, it is possible to store up to 10 customized search ranges.
- **Start** defines the beginning of the search range. Start must be smaller than the Stop value, otherwise the search will not be initiated.
- **Stop** defines the end of the search range. Stop must be larger than the Start value, otherwise the search will not be initiated.
- **Range Limit Lines On** displays two vertical lines indicating the Start and the Stop value of the current bandfilter search range in the diagram area. This function is enabled as soon as one of the

search ranges 1 to 10 is selected.

Search range properties

In contrast to the marker properties defined in the *Marker* and *Search* menus, the ten search ranges are valid for the entire setup. This means that, once defined, each of them can be used for any trace in the setup, irrespective of the channel that the trace belongs to.

The default search range of each new marker is *Full Span*. The analyzer provides greatest flexibility in defining search ranges. In particular, two search ranges may overlap or even be identical. The search is confined to the part of the search range that belongs to the sweep range.

The following example shows how search ranges can be used to search a trace for several bandpass regions.

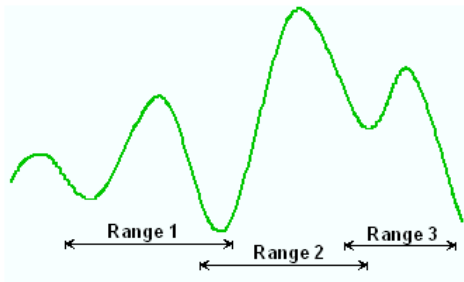

Remote control: `CALCulate<Chn>:MARKer<Mk>:FUNction:DOMain:USER`
`CALCulate<Chn>:MARKer<Mk>:FUNction:DOMain:USER:START`
`CALCulate<Chn>:MARKer<Mk>:FUNction:DOMain:USER:STOP`

Search Result Off

Hides the info field with the results of a bandpass or a bandstop search and disables bandfilter *Tracking*. The info field is displayed again (and tracking re-enabled) when a new bandfilter search is performed.

Bandpass Ref to Max Parameters		tracking...
Bandwidth:		932.103853 MHz
Center:		1.813672673 GHz
Lower Band Edge:		1.347620747 GHz
Upper Band Edge:		2.279724600 GHz
Quality Factor:		1.9458 U
Loss:		5.604 dB

Bandfilter parameters

The info field contains the following search results:

- *Bandwidth* is the n-dB bandwidth of the bandpass/bandstop region, where n is the selected x dB *Bandwidth*. The bandwidth is equal to the difference between the Upper Bandwidth Edge (UBE) and the Lower Bandwidth Edge (LBE).
- *Center* is calculated as the geometric mean value of the *LBE* and *UBE* positions: $f_{\text{Center}} = \sqrt{f_{\text{LBE}} \cdot f_{\text{UBE}}}$.
- *Lower Band Edge* is the closest frequency below the center frequency where the trace is equal to the center value minus n dB.
- *Upper Band Edge* is the closest frequency above the center frequency where the trace is equal to the center value minus n dB.
- The *Quality Factor* is the ratio between the *Center* frequency and the 3-dB *Bandwidth*; it does not depend on the selected x dB *Bandwidth*. The *Quality Factor* is not available for bandstop

measurements.

- *Loss* is the loss of the filter at its center frequency and is equal to the response value of marker no. 4. For an ideal bandpass filter the loss is zero (0 dB), for an ideal bandstop filter it is $-\infty$ dB.

The info field contains the following search results:

- *Bandwidth* is the n-dB bandwidth of the bandpass/bandstop region, where n is the selected *x dB Bandwidth*. The bandwidth is equal to the difference between the Upper Bandwidth Edge (UBE) and the Lower Bandwidth Edge (LBE).
- *Center* is the stimulus frequency where the trace reaches its absolute maximum (minimum) within the bandpass (bandstop) region.
- *Lower Band Edge* is the closest frequency below the center frequency where the trace is equal to the center value minus n dB.
- *Upper Band Edge* is the closest frequency above the center frequency where the trace is equal to the center value minus n dB.
- The *Quality Factor* is the ratio between the *Center* frequency and the 3-dB *Bandwidth*; it does not depend on the selected *x dB Bandwidth*.
- *Loss* is the loss of the filter at its center frequency and is equal to the response value of marker no. 4. For an ideal bandpass filter the loss is zero (0 dB), for an ideal bandstop filter it is $-\infty$ dB.

Remote control: `CALCulate<Chn>:MARKer<Mk>:BWIDth?`
`CALCulate<Chn>:MARKer<Mk>SEARch:BFILter:RESult[:StAtE]`

Marker Tracking

Causes the active minimum/maximum or target search of the active marker to be repeated after each sweep: When tracking mode is active the marker typically changes its horizontal and its vertical position as the measurement goes on.

Tracking mode properties

The tracking mode is available for all search modes, i.e. for minimum/maximum search, target search and bandfilter search. The *Marker Tracking* function in the *Search* submenu is valid for an active minimum/maximum and target search; bandfilter tracking can be activated separately. Tracking is marker-specific but can be switched on for several markers simultaneously.

Switching between *Max Search* and *Min Search* does not affect the tracking mode. Tracking is switched off though when one of the following actions is performed:

- Redefinition of the active marker position by means of the functions in the *Marker* menu or drag-and-drop of the active marker symbol.
- Change of the active marker's search mode, e.g. from a minimum/maximum search to a target search.

Tracking is a toggle function: Selecting the function repeatedly switches the tracking mode on and off.

Remote control: `CALCulate<Chn>:MARKer<Mk>:SEARch:TRACking`

Def Peak

Opens a dialog to define the peak type to be searched for.

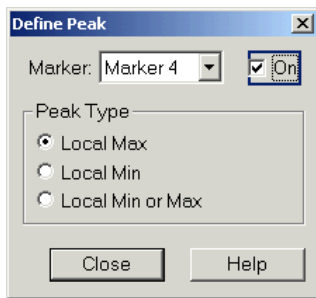

It is possible to select the peak type up to ten times for each trace and assign the selection to the markers no. 1 to 10.

- **Marker** Selects one of the ten markers that can be assigned to the trace. If a selected marker does not exist, it is created as soon as On is checked. A created marker is displayed in the center of the search range.

The radio buttons in the *Peak Type* panel offer the following alternative peak types:

- **Local Max** activates the peak search for local maxima only. The response value at a local maximum is larger than the values in the vicinity.
- **Local Min** activates the peak search for local minima only. The response value at a local minimum is smaller than the values in the vicinity.
- **Local Min or Max** activates the peak search for both local maxima and minima.

Search Range

Opens the *Search Range Dialog* to confine the minimum/maximum search to a subrange of the sweep.

Search Range Dialog

Defines search ranges for the maximum/minimum or target search.

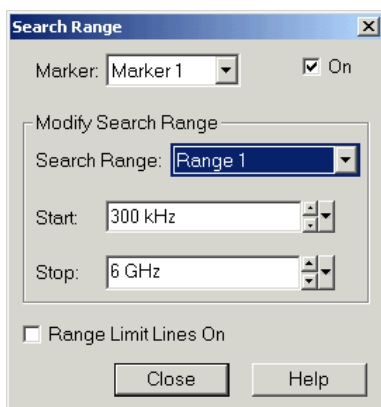

It is possible to define up to ten different search ranges for each setup and assign them to the markers no. 1 to 10. The input fields in the *Search Range* dialog are used to select the markers and define the associated search ranges:

- **Marker** Selects one of the ten markers that can be assigned to a trace in the current setup. If a selected marker does not exist, it is created as soon as On is checked. A created marker is displayed in the center of the search range.
- **Search Range** Selects the search range to be assigned to the selected marker. Full Span means that the search range is equal to the sweep range. Besides, it is possible to store up to 10

customized search ranges.

- *Start* defines the beginning of the search range. Start must be smaller than the Stop value, otherwise the search will not be initiated.
- *Stop* defines the end of the search range. Stop must be larger than the Start value, otherwise the search will not be initiated.
- *Range Limit Lines On* displays two vertical lines indicating the Start and the Stop value of the current search range in the diagram area. This function is enabled as soon as one of the search ranges 1 to 10 is selected.

Search range properties

In contrast to the marker properties defined in the *Marker* and *Search* menus, the ten search ranges are valid for the entire setup. This means that, once defined, each of them can be assigned to any marker in the setup, irrespective of the trace and channel that the marker belongs to.

The default search range of each new marker is *Full Span*. The analyzer provides the greatest flexibility in defining search ranges. In particular, two search ranges may overlap or even be identical. The search is confined to the part of the search range that belongs to the sweep range.

The following example shows how search ranges can be used to search a trace for several local maxima.

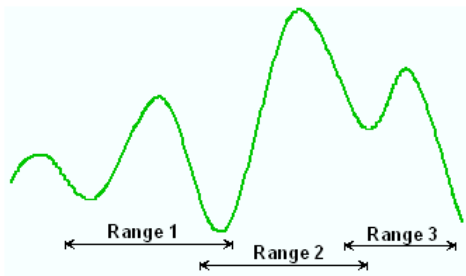

Use the paste marker list for convenient entry of *Start* and *Stop* values.

Remote control: `CALCulate<Chn>:MARKer<Mk>:FUNction:DOMain:USER`
`CALCulate<Chn>:MARKer<Mk>:FUNction:DOMain:USER:START`
`CALCulate<Chn>:MARKer<Mk>:FUNction:DOMain:USER:STOP`

Marker

The functions in the *Marker* submenu are used to position markers on a trace, configure their properties and select the format of the numerical readout.

Markers

Markers are tools for selecting points on the trace and for numerical readout of measured data. A marker is displayed with a symbol (a triangle, a crossbar or a line) on the trace, which may be a data trace or a memory trace. At the same time, the coordinates are displayed in a marker info field or in a table. Each marker can be defined as a normal marker, reference marker, delta marker or discrete marker.

Marker types

- A (normal) marker (*Mkr 1*, *Mkr 2*, ...) determines the coordinates of a measurement point on the trace. Up to 10 different normal markers can be assigned to a trace.

- A reference marker (*Ref*) defines the reference value for all delta markers.
- A delta marker (Δ) indicates the coordinates relative to the reference marker.
- The stimulus value of a *discrete marker* always coincides with a sweep point.

A special set of markers Mk1 to Mkr4 is provided for bandfilter search mode.

The most common tasks to be performed with markers can be achieved using the *Marker* menu functions:

- Determine the coordinates of a measurement point on the trace. In polar diagrams where no x-axis is displayed, markers can be used to retrieve the stimulus value of specific points.
- Determine the difference between two trace points or the relative measurement result (*Delta Mode*).
- Convert a complex measurement result into other formats.

Markers also play an important role in performing the following advanced tasks:

- Change the sweep range and the diagram scale (*Marker Funct.*).
- Search for specific points on the trace (*Search*).

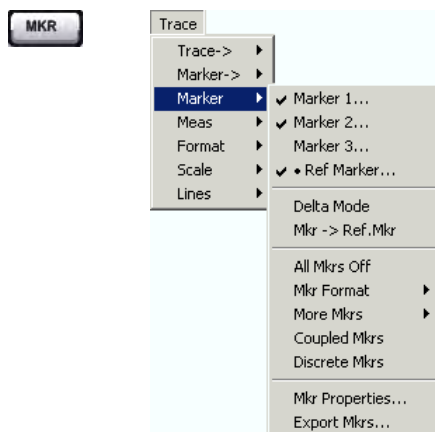

The *Marker* menu contains the following functions:

- *Marker 1, 2, 3* creates the markers numbered 1, 2, and 3.
- *Ref Marker...* creates the reference marker which is used to measure relative values and distances.
- *Delta Mode* activates the display of the active marker values relative to the reference marker.
- *Ref.Marker -> Marker* places the reference marker to the position of the active marker.
- *All Mkrs Off* removes all markers from all traces of the active setup.
- *Mkr Format* defines an output format for the (complex) marker values.
- *More Mkrs* opens a submenu to create the markers numbered 4 to 10.
- *Coupled Mkrs* couples the markers on different traces.
- *Discrete Mkrs* turns the active marker into a discrete marker and vice versa.
- *Mkr Properties...* opens a dialog with extended marker settings.
- *Export Mkrs...* exports the marker values to an ASCII file.



Toggle functions in the Marker menu

Some of the *Marker* functions toggle between two alternative states when they are pressed repeatedly:

- *Delta Mode* switches the delta mode for the active marker on or off.
- *Coupled Mkrs* activates or deactivates marker coupling.
- *Marker 1, ..., Marker 10* and *Ref. Marker* create a marker or remove it from the display. A removed marker remembers its properties (stimulus value, format, delta mode, number) and will be restored with these properties when *Marker <n>* or *Ref. Marker* is selected again. The marker properties are definitely lost if the associated trace is deleted.

Markers are available for all diagram types (Trace – Format).

Marker 1, 2, 3

Creates the markers numbered 1, 2, and 3, respectively, and assigns them to the active trace (toggle function). *Marker 1/2/3* opens the numeric entry bar to define the marker position (*Stimulus Mkr 1/2/3*). The default position is the center of the sweep range.

Stimulus Mkr 1:

On closing the *Stimulus Mkr 1/2/3* numeric entry bar a marker symbol (triangle) labeled *Mkr <n>* is positioned on the trace and the marker coordinates are displayed in the *Info Field*.



Activating and moving markers

To select one of several markers as an active marker, do one of the following:

- Click the marker symbol.
- Click the marker line in the marker info field.

To change the position of the active marker on the trace use one of the following methods:

- Drag-and-drop the marker symbol to the desired position.
- Click the *Marker <n>* or *Ref. Marker* softkey to call up the entry bar for the new stimulus value.
- Right-click the diagram area or select *Mkr. Properties* to call up the *Marker Properties* dialog and select the new stimulus value.
- Use the *Search* functions to place the marker to a specific point on the trace.



If the marker position is defined explicitly by entering a numeric value, the marker position can be outside the sweep range. If it is just varied using the rollkey, the mouse or the cursor keys, it always remains within the sweep range. If the position of a marker outside the sweep range is varied, it is automatically moved to the start or stop value of the sweep range, whichever is closer.

Remote control: CALCulate<Chn>:MARKer<Mk>[:STATe] ON
CALCulate<Chn>:MARKer<Mk>:Y?

Ref Marker

Creates a reference marker and assigns it to the active trace (toggle function). *Ref Marker* opens the numeric entry bar to define the marker position (*Stim. Ref.Mkr.*). The default position is the center of the sweep range.

Stim. Ref.Mkr.:

On closing the *Stimulus Ref Mkr* numeric entry bar a marker symbol (triangle) labeled *Ref* is positioned on the trace and a line indicating *Ref* plus the marker coordinates is inserted in the marker *info field*.

The reference marker defines the reference value for all markers that are in *Delta Mode*.

Remote control: CALCulate<Chn>:MARKer<Mk>:REFerence[:STATe] ON
CALCulate<Chn>:MARKer<Mk>:REFerence:Y?

Delta Mode

Converts the active marker to a delta marker so that its values are measured and indicated relative to the reference marker (toggle function). A Δ sign placed in front of the marker line indicates that the marker is in *Delta Mode*.

The reference marker itself can not be set to delta mode but must be present when another marker is set to delta mode. The analyzer takes into account these conditions when *Delta Mode* is selected:

- If *Delta Mode* is selected while the reference marker is active, the marker in the info list after the reference marker is activated and set to delta mode. If the current trace contains the reference marker only, a new *Mkr 1* is created and set to delta mode.
- If *Delta Mode* is selected for a normal marker while the current trace contains no reference marker, a reference marker is created.

Remote control: CALCulate<Chn>:MARKer<Mk>:DELta[:STATe] ON

Ref.Marker -> Marker

Places the reference marker to the position of the active marker. As a consequence, the active marker takes the role of a reference marker.

Ref.Marker -> Marker is not active if the active marker is a reference marker.

Remote control: -

All Mkrs Off

Removes all markers from all traces of the active setup. The removed markers remember their properties (stimulus value, format, delta mode, number) when they are restored. The marker properties are definitely lost if the associated trace is deleted.

Remote control: CALCulate<Chn>:MARKer<Mk>:AOFF

Mkr Format

Opens a submenu to select an output format for the (complex) active marker value in the marker info field. The default marker format is the format of the associated trace. The current format is indicated with a ●.

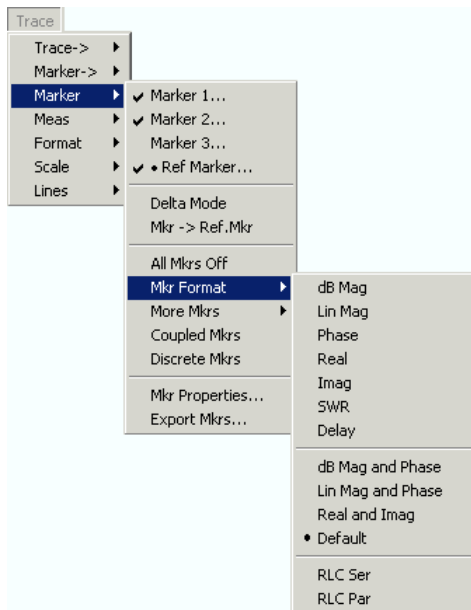

All marker formats are available irrespective of the measured quantity. The output values are calculated by a simple conversion of a complex measurement result, where the marker format defines the conversion rules. This flexibility in the calculation must be kept in mind when interpreting the results and physical units displayed; see also Measured Quantities and Display Formats.



Short description of marker formats

The formats of the markers assigned to a trace are independent of each other and of the trace format settings. The following table gives an overview on how a complex marker value $z = x + jy$ is converted.

Marker Format	Description	Formula
dB Mag	Magnitude of z in dB	$ z = \sqrt{x^2 + y^2}$ $\text{dB Mag}(z) = 20 * \log z \text{ dB}$
Lin Mag	Magnitude of z , unconverted	$ z = \sqrt{x^2 + y^2}$
Phase	Phase of z	$\Phi(z) = \arctan(y/x)$
Real	Real part of z	$\text{Re}(z) = x$
Imag	Imaginary part of z	$\text{Im}(z) = y$
SWR	(Voltage) Standing Wave Ratio	$\text{SWR} = (1 + z) / (1 - z)$
Delay	Group delay, neg. derivative of the phase response*)	$-d \Phi(z) / d \omega$
dB Mag and Phase	Magnitude of z in dB and phase in two lines	$20 * \log z \text{ dB}$ $\arctan(\text{Im}(z) / \text{Re}(z))$
Lin Mag and Phase	Magnitude of z (unconverted) and phase in two lines	$ z $ $\arctan(\text{Im}(z) / \text{Re}(z))$
Real and Imag	Real and imaginary part of z in two lines	x y
Default (Trace)	Marker format identical with trace format	–
R + j X	Unnormalized resistance and reactance; L or C in three lines (Smith diagram)	R X L or C**)
G + j B	Unnormalized conductance and susceptance; L or C in three lines	G

	(Inverted Smith diagram)	B L or C**)
--	--------------------------	----------------

*) The delay aperture is defined in the Trace – Format menu.

**The equivalent inductances or capacitances L or C are calculated from the imaginary part of the impedance according to

$$L = \frac{1}{\omega} X \quad \text{if } X \geq 0$$

$$C = \frac{1}{\omega \cdot X} \quad \text{if } X < 0$$

Remote control: CALCulate<Chn>:MARKer<Mk>:FORMat ...

More Mkrs

Opens a submenu to create the markers numbered 4 to 10. The markers are analogous to marker no. 1 to 3.

Remote control: CALCulate<Chn>:MARKer<Mk>[:STATe] ON

Coupled Mkrs

Couples the markers of all traces in the active setup to the markers of the active trace (toggle function). While marker coupling is active, the active trace markers assume the role of master markers; the other markers behave as slave markers, following any change of position of the master marker.



Effects of marker coupling

The concept of marker coupling means that corresponding markers on different traces (i.e. markers with the same number or reference markers) are positioned to the same stimulus values but keep their independent format and type settings. When a trace with markers is selected as the active trace and marker coupling is switched on, the following happens:

- The active trace and all associated markers are left unchanged. The active trace markers become the master markers of the setup.
- Markers on the other traces which have no corresponding master marker are removed but remember their properties and can be re-activated after the coupling is released.
- The remaining markers on the other traces become slave markers and are moved to the position of the corresponding master markers. "Missing" slave markers are created so that each trace has the same number of markers placed at the same position.
- If the position of a master marker is outside the sweep range of the slave trace, the slave marker is displayed at the edge of the diagram. The marker info field indicates an invalid measurement result: `Mkr 1 1.768901 GHz -----`

While marker coupling is active, it is possible to:

- Move a master marker and thus change the position of all corresponding slave markers.
- Activate another trace in order to make the associated markers the new master markers.



NOTE Marker coupling makes sense only if the master and the slave traces use the same stimulus variable. Channels with a different stimulus variable (sweep type) are not coupled.

Remote control: `CALCulate<Chn>:MARKer<Mk>:COUPled[:STATe] ON`

Discrete Mkrs

Turns the active marker into a discrete marker and vice versa.



The stimulus value of a discrete marker always coincides with a sweep point. Use discrete markers in order to avoid that the marker indicates an interpolated measurement value.

Remote control: `CALCulate<Chn>:MARKer<Mk>:MODE`
`CALCulate<Chn>:MARKer<Mk>:REFerence:MODE`

Mkr Properties...

Opens a dialog to define the properties of all markers of the active trace.

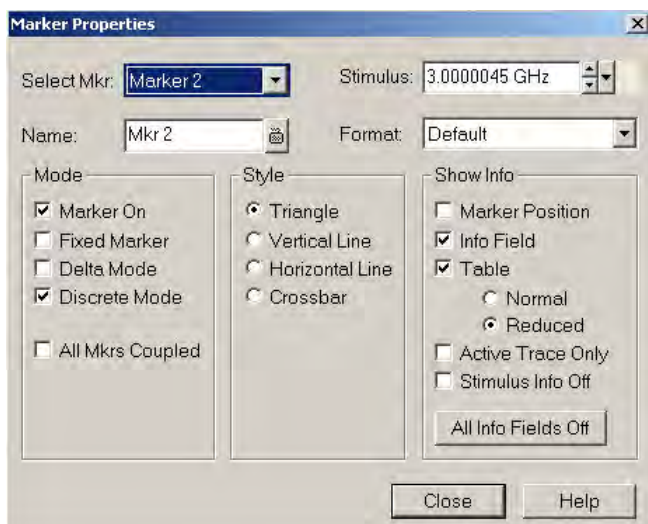

In the left part the dialog contains four input fields and drop-down lists to select a marker and define the basic properties of a selected marker which is switched on in the *Mode* panel.

- *Select Mkr.* opens a drop-down list to select the Ref. Marker or one of the Marker 1, ... 10 that may be associated with the active trace.
- *Name* defines a marker name which may exceed the length of the input box and contain letters, numbers, blanks and special characters.
- *Stimulus* defines the stimulus value (in Cartesian diagrams: the x-axis position) of the marker.
- *Format* defines the output format of the marker value.

The *Mode* panel contains check boxes to select properties that are related to the marker positions. All properties can be combined.

- *Marker On* displays the selected marker in the diagram and in the marker info field or removes it. Marker configurations are only available while the marker is switched On. A removed marker remembers its properties (stimulus value, format, delta mode, number ...) when it is switched on again. The marker properties are definitely lost if the associated trace is deleted.
- *Fixed Marker* freezes the current response value of the selected marker. The marker can still be shifted horizontally but the vertical position remains fixed if the other marker settings are changed.

Markers must be inside the sweep range and have a valid response value when they are fixed.

- *Delta Mode* sets the selected marker to delta mode and displays its values relative to the reference marker.
- *Discrete Mode* means that a marker can be set to discrete sweep points only. If discrete mode is switched off, the marker can be positioned on any point of the trace, and its response values are obtained by interpolation.
- *All Mkrs Coupled* couples the markers of all traces in the active setup to the markers of the active trace; see Coupled Markers.

The *Style* settings qualify how the selected marker is displayed on the screen.

The *Show Info* settings select the marker info to be displayed at the *Marker Position*, in the marker *info field* or in a separate *Table* below the diagram area. The display options may be selected simultaneously or all switched off. The table provides more information than the marker info field:

Marker	Trace	Stimulus	Response	Delta	Discr	Fixed	Tracking	Search Range
Ref	Trc1	3.440171000 GHz	-6.426 dB	<input type="checkbox"/>	<input checked="" type="checkbox"/>	<input checked="" type="checkbox"/>	Off	Full Range
Mkr 1	Trc1	4.000150000 GHz	-5.364 dB	<input type="checkbox"/>	<input type="checkbox"/>	<input type="checkbox"/>	Off	Full Range

The *Reduced* table provides a condensed overview with less entries.

```
Remote control: CALCulate<Chn>:MARKer<Mk>[:STATe] ON
                CALCulate<Chn>:MARKer<Mk>:TYPE NORMAl | FIXed
                CALCulate<Chn>:MARKer<Mk>:REFerence:TYPE NORMAl | FIXed
                CALCulate<Chn>:MARKer<Mk>:DELTA[:STATe] ON
                CALCulate<Chn>:MARKer<Mk>:MODE CONTInuous | DISCrete
                CALCulate<Chn>:MARKer<Mk>:COUPled[:STATe] ON
```

Export Mkrs...

Calls up a *Save As...* dialog to store the current marker values to a marker file.

The analyzer uses a simple ASCII format to export marker values. By default, the marker file extension is *.txt. The file contains all traces in the active setup together with their names and measured quantities. Below each trace, the file shows a list of all markers with their names, stimulus and response values.

The following example of a marker file describes a setup with two traces *Trc1* and its memory trace. *Trc1* has no markers assigned, the memory trace has four markers named *Mkr 1*, ..., *Mkr 4*.

```
Trc1 s21
No Markers

Mem2[Trc1] s21
Mkr 1 969.60000 MHz -4.896 dB
Mkr 2 129.72115 MHz -7.896 dB
Mkr 3 4.793734 GHz -7.896 dB
Mkr 4 2.461727 GHz -5.192 dB
```

```
Remote control: MMEMory:STORe:MARKer "file_name"
```

Meas

The *Measure* submenu selects the quantity to be measured and displayed.

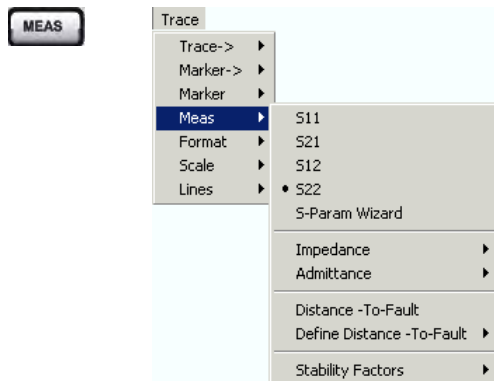

- *S11, S12, S21, S22* select the four elements of the standard 2-port scattering matrix (S-parameters).
- *S-Param Wizard* opens a series of dialogs providing the settings for a standard S-parameter measurement.
- *Distance-to-Fault* enables or disables the location of a discontinuity on a transmission line (with option R&S ZVL-K2).
- *Define Distance-to-Fault* opens a submenu to configure the *Distance-to-Fault* measurement.
- *Impedance* opens a submenu to convert reflection S-parameters into matched-circuit impedances (converted Z-parameters).
- *Admittance* opens a submenu to convert reflection S-parameters into matched-circuit admittances (converted Y-parameters).
- *Stability Factor* selects one of the three factors K , μ_1 or μ_2 to assess the stability of linear circuits (e.g. amplifiers).

Port assignments of the DUT and the analyzer

S-parameters $S_{\langle out \rangle \langle in \rangle}$ characterize the Device Under Test, so the indices $\langle out \rangle$ and $\langle in \rangle$ denote the output and input ports of the DUT. Analogously the waves a_1 and a_2 are referred to as incident waves, b_1 and b_2 to as outgoing waves.

The analyzer measures the waves a_1, b_1, \dots at its own test ports in order to obtain S-parameters, ratios and other derived quantities. The test ports of the analyzer are numbered, so it is convenient to use them as a reference, defining port number n of the DUT as the port connected to test port n of the analyzer. With this convention the waves a_n and b_n have the following meaning:

- a_n is the wave transmitted at test port no. n of the analyzer (stimulus signal) and fed to port number n of the DUT (incident wave).
- b_n is the wave transmitted at port number n of the DUT (response signal) and received at test port no. n of the analyzer (received wave).



The analyzer offers various diagrams and display formats to visualize the results. The analyzer places no restriction on the formats that are available for each measured quantity. However, to keep the interpretation simple, it is recommended to select an appropriate display format; see Trace - Format.

S11, S12, S21, S22

Select one of the four elements of the standard 2-port scattering matrix (S-parameters).

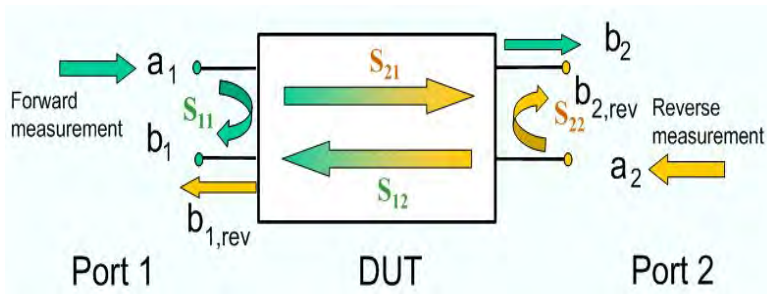

The S-parameters are the basic measured quantities of a network analyzer. They describe how the DUT modifies a signal that is transmitted or reflected in forward or reverse direction. S-parameters are expressed as $S_{\langle out \rangle \langle in \rangle}$, where $\langle out \rangle$ and $\langle in \rangle$ denote the output and input port numbers of the DUT.

A full 2-port S-parameter measurement involves 2 stages (referred to as partial measurements) with interchanged drive and receive ports. The analyzer automatically switches the internal power sources and the receivers to obtain the desired S-parameters.

Remote control:

```
CALCulate<Ch>:PARAmeter:MEASure "<Trace_Name>", "S11" | "S12" | "S21" | "S22"
[SENSe<Chn>:]FUNctIon[:ON] "...:POWer:S<11 | 12 | 21 | 22>"
```

Create new trace and select name and measurement parameter:

```
CALCulate<Ch>:PARAmeter:SDEFine "<Trace_Name>", "S11" | "S12" | "S21" | "S22"
```

S-Parameter Wizard

The *S-Parameter Wizard* consists of a series of dialogs providing the settings for a standard S-parameter measurement.

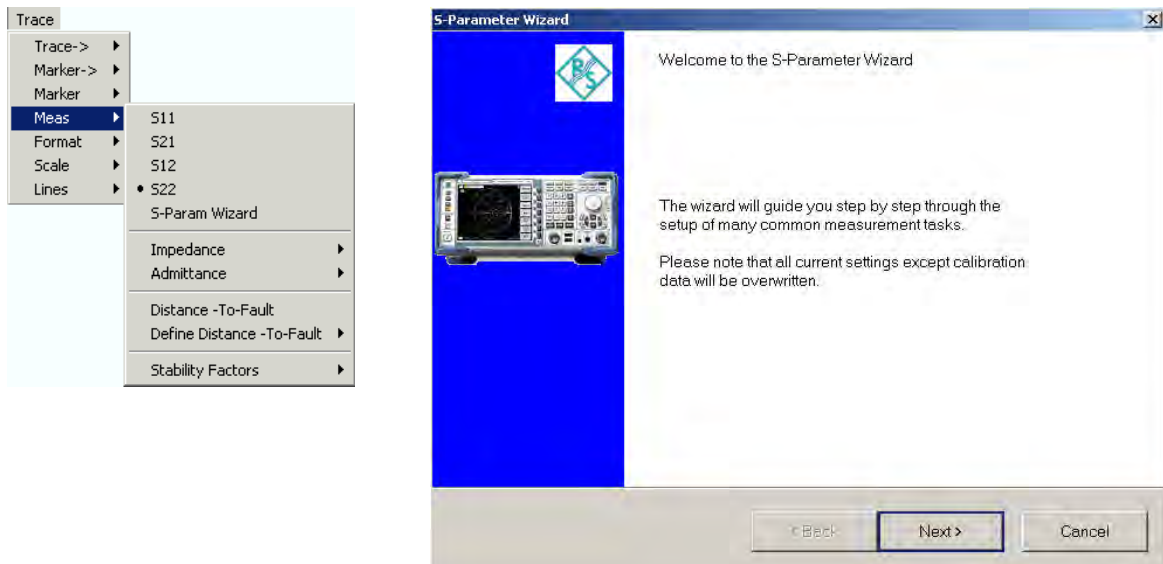

The measurement comprises the following stages:

➤ Select the measurement parameters and the diagram areas

Choose an S-parameter or a group of S-parameters to be measured and displayed. The measurement parameters are displayed in separate diagram areas: Cartesian diagram areas are

used for transmission S-parameters, Cartesian or Smith diagrams for reflection parameters.

➤ Select the sweep settings

Choose the frequency range and the number of measurement points per sweep. The sweep range is defined by two values (start and stop frequency or center frequency and span). The measurement points are equidistant across the sweep range. Increasing the number of points also increases the measurement time per single sweep.

➤ Select the measurement bandwidth and source power

Choose a typical measurement bandwidth and one of two typical source power values. A smaller measurement bandwidth increases the dynamic range but slows down the measurement. A smaller source power protects the input port of the analyzer from being overdriven, if an active DUT with high gain is measured.

➤ Perform a calibration (optional)

Call up the calibration wizard and perform a calibration. The calibration type is a full 2-port (TOSM) calibration. This calibration can be performed as well using automatic calibration (if accessory R&S ZV-Z5x, Calibration Unit, is available).



You can skip the automatic calibration stage (select *Finish without Calibration*) if

- A valid calibration is already assigned to the active channel
- You want to apply a valid calibration stored in the cal pool
- You want to perform the calibration manually, e.g. because you wish to select another calibration type.
- You don't want to use a calibration, e.g. because the factory calibration is accurate enough for your measurement.



In order to obtain a predictable result the measurement wizard has to reset all settings except the current calibration data. Store your setup if you don't want to lose the current configuration.

Distance-to-Fault

Opens a submenu to locate faults and discontinuities on cables. The measurement requires option ZVL-K2, *Distance-to-Fault*.



Distance-to-fault measurement

The network analyzer measures and displays complex S-parameters and other quantities as a function of the frequency. The measurement results can be filtered and mathematically transformed in order to obtain the **impulse response**, which often gives a clearer insight into the characteristics of the DUT.

The impulse response is special type of a time-domain representation. A fault (discontinuity) on a transmission line causing reflection results in a spike on the impulse response trace of the reflection coefficient. The distance between the reference plane and the fault can be calculated from the propagation time, taking into account the electrical properties of the transmission line (*Cable Type*). The following example shows the reflection at the end of an open cable with a length of approx. 959 mm (Mkr 2 position). The cable is connected to the test port no. 2 of the analyzer. A full one-port calibration ensures that the distance is measured from the test port position (reference plane = distance zero). The additional peak at the position of Mkr 1 is due to the connection between the cable and the test port.

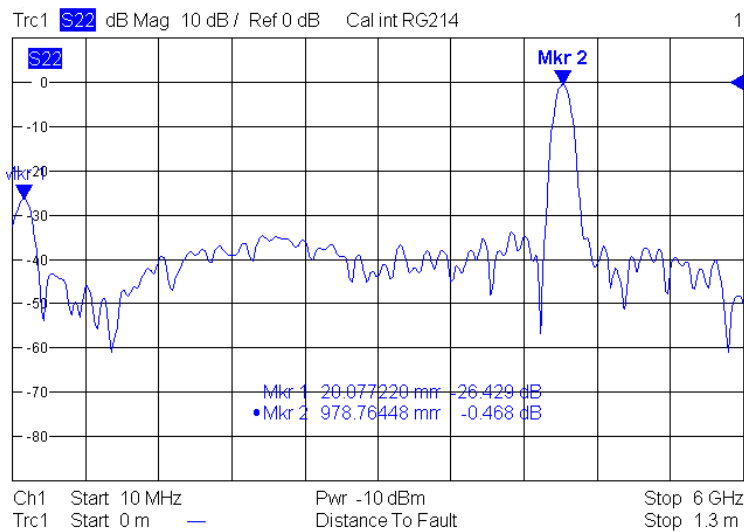

The parameters of the impulse response and frequency-domain representation are related due to the mathematical properties of the time-domain transform. In practice, this means that the sweep points may have to be adjusted to the length of the transmission line and the expected distance-to-fault:

- The impulse-response resolution is proportional to the measured sweep range: The larger the sweep range (span), the better the resolution.
- At fixed frequency span, the maximum distance that can be measured is proportional to the number of sweep points (i.e. inversely proportional to the *Frequency Step Size*). The larger the *Number of Points*, the longer the maximum distance between the calibrated reference plane (most conveniently, PORT 2 of the analyzer) and the located fault.
- The R&S ZVL can automatically determine a suitable number of sweep points (*Auto Number of Points*). Moreover it is possible to define which of the peaks will be considered as being due to a fault, and to draw up and export a list of the detected peaks.

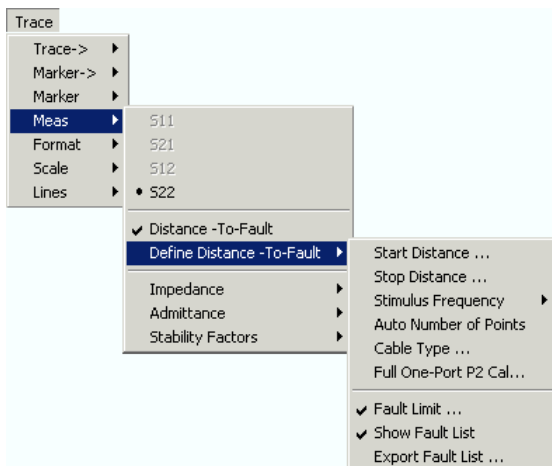

- *Start Distance* and *Stop Distance* define the distance window for the distance-to-fault measurement.
- *Stimulus Frequency* opens a submenu to define the frequency stimulus axis.
- *Auto Number of Points* adjusts the number of sweep points in order to provide an unambiguous display of the fault locations.
- *Cable Type* opens a dialog to select a standard (predefined) cable type or add a cable with arbitrary permittivity.

- *Full One-Port P2 Cal* opens the calibration wizard to perform a full one-port calibration at port no. 2 and re-adjust the reference plane (distance zero).
- *Fault Limit* defines a minimum response value in dB for a trace maximum to be considered as being due to a fault.
- *Show Fault List* displays a list of all peaks that fulfil the *Fault Limit* condition.
- *Export Fault List* opens a *Save As...* dialog to write the fault list data to an ASCII file.

Distance-to-Fault

Enables or disables the location of a discontinuity on a transmission line (with option R&S ZVL-K2). The distance-to-fault measurement requires a linear frequency sweep (*Channel – Sweep – Sweep Type – Lin. Frequency*). The analyzer automatically disables the distance-to-fault measurement as soon as a different sweep type is selected.



Default settings for distance-to-fault

The following settings are performed automatically when a distance-to-fault measurement is enabled (*Trace – Meas – Distance-to-Fault: On*):

- The reflection coefficient S_{22} is selected as measured quantity.
- The stimulus axis shows a distance window. The start and stop distance is displayed below the channel settings.
- The cable type (e.g. *Ideal Air Line*) is displayed in the trace list. A context menu opens the *Cable Type* dialog.
- The number of points is increased, if necessary. See *Auto Number of Points*.

Remote control: `CALCulate<Chn>:TRANSform:DTFault:STATE`

Start Distance..., Stop Distance...

Defines the distance range (x-axis range) for the distance-to-fault measurement. The *Start Distance* and the *Stop Distance* correspond to the left and right edge of the diagram area; they are shown below the channel settings:

Ch1	Start 10 MHz	Pwr -10 dBm	Stop 3 GHz
Trc1	Start 0 m	Distance To Fault	Stop 10 m



Distance trace settings

While a distance-to-fault measurement is active the trace settings behave as follows:

- *Start Distance...* and *Stop Distance...* configure the distance axis.
- *dB Mag* is the recommended Trace Format, although other formats are available.
- Limit lines can be defined like the limit lines for time sweeps.
- The marker and bandfilter search functions are available for the transformed trace.

Note that only the reflection coefficient S_{22} (and the corresponding impedance and admittance parameters) are available as measured quantities.

Remote control: `CALCulate<Chn>:TRANSform:DTFault:START`
`CALCulate<Chn>:TRANSform:DTFault:STOP`
`CALCulate<Chn>:TRANSform:DTFault:CENTER`
`CALCulate<Chn>:TRANSform:DTFault:SPAN`

Stimulus Frequency

Opens a submenu which gives access to the frequency stimulus axis settings for the active channel.

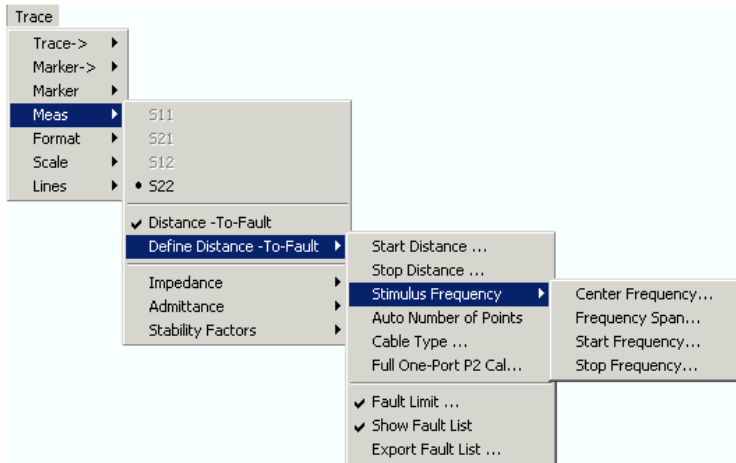

The stimulus frequency settings that the R&S ZVL uses for the distance-to-fault measurement are identical with the general *Channel – Stimulus* settings. Previous settings are not restored when the distance-to-fault measurement is switched off.

Remote control: [SENSe<Ch>:] FREQuency:START
 [SENSe<Ch>:] FREQuency:STOP
 [SENSe<Ch>:] FREQuency:CENTer
 [SENSe<Ch>:] FREQuency:SPAN

Auto Number of Points

Adjusts the number of sweep points in a way that guarantees **unambiguous display** of the fault locations.

Since the behavior of the DUT is measured at discrete frequency points, the impulse response resulting from a transformation to the time/distance domain is periodic. By settings the number of points to the value shown below, the frequency interval between the measured points (*Frequency Step Size*) is small enough to ensure that all faults in the distance domain belong to the same period.

The required number of points depends on the frequency span ($f_{\text{stop}} - f_{\text{start}}$), the stop distance d_{stop} , and the velocity factor v of the transmission line (see *Cable Type*). The analyzer sets the number of points N as the nearest integer greater than or equal to the following expression:

$$2.6 * d_{\text{stop}} * (f_{\text{stop}} - f_{\text{start}}) / (v * c_0)$$

The minimum number of points set by *Auto Number of Points* is 201. If the calculated minimum number of points is larger than the maximum number of points of the R&S ZVL, the analyzer generates a notice message and also reduces the frequency span, at the expense of distance resolution.



Use *Auto Number of Points* to reduce the number of points and speed up the measurement, e.g. after setting a smaller frequency span or stop distance.

Remote control: CALCulate:TRANSform:DTFault:POINTs

Cable Type...

Opens a dialog to select a standard (predefined) cable type or add a cable type with arbitrary parameters.

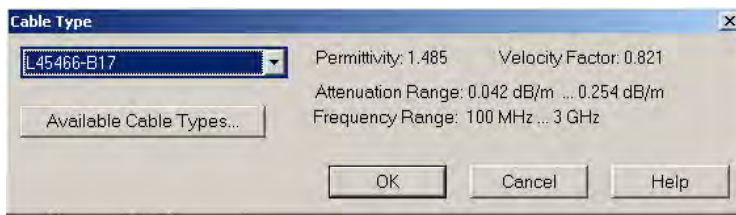

The pull-down list in the *Cable Type* dialog contains an ideal air line (with a relative permittivity of 1, a corresponding velocity factor of 1, and zero attenuation) and a wide range of standard cable types. Click *Available Cable Types* to open a second dialog where you can view the parameters of the predefined cable types and add new types.

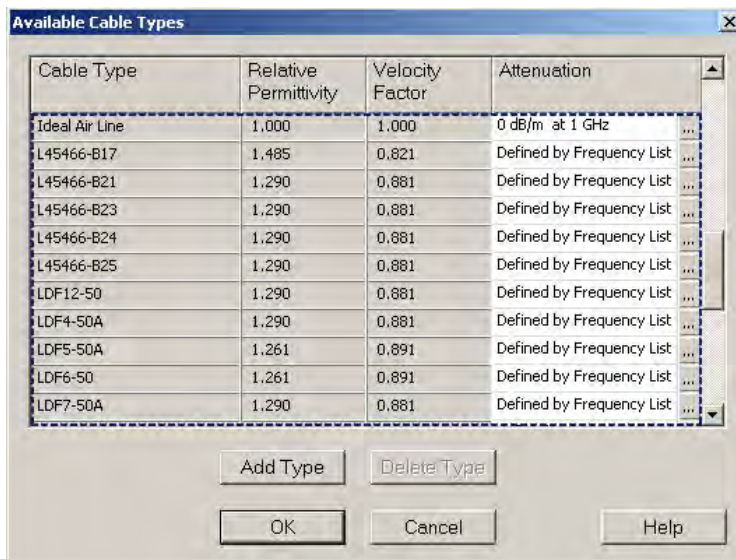

In the *Available Cable Types* dialog, added cables must be defined with their relative permittivity ϵ_r and the attenuation at a particular frequency or in a frequency range. The velocity factor $1/\sqrt{\epsilon_r}$ is a measure for the velocity of light in a dielectric with permittivity ϵ_r relative to the velocity of light in the vacuum; see *Length offset parameters: Definition*. This parameter is needed to convert the propagation times in the cable into distances. Permittivity and velocity factor are coupled parameters.



Cable description files, *.rsc

The R&S ZVL provides a wide range of pre-installed cable types. The properties of each cable are stored in an ASCII file with the default file extension *.RSC, the cable type forming the file name, e.g.:

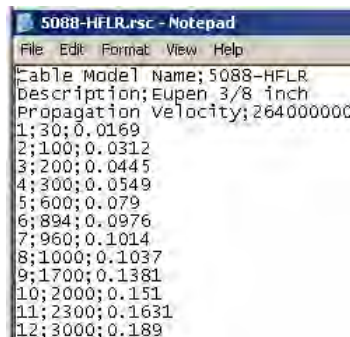

Pre-installed cable description files are stored in the `C:\R_S\Instr\Resources\Nwa\CableTypes` directory. A new, user-defined cable type is stored under `C:\R_S\Instr\user\Nwa\CableTypes`.



Use the `MMEMemory...` commands to store or re-load all cable specifications including the user-defined ones to/from a separate directory.

Remote control: `CALCulate:TRANSform:DTFault:DEFine`
`CALCulate:TRANSform:DTFault:SELEct`
`CALCulate:TRANSform:DTFault:DELEte`

`MMEMemory:LOAD:CABLe`
`MMEMemory:SAVE:CABLe`

Attenuation Factors for Cables

The measured cables are assumed to be homogenous so that the attenuation per length unit is constant. This means that the attenuation can be expressed in units of dB/m or dB/ft, depending on the *Distance Unit* selected in the *System Configuration* dialog. Due to the skin effect and various other factors, the attenuation is generally frequency-dependent.

The *Attenuation* dialog defines the frequency dependence of the cable attenuation. A click on an entry in the *Attenuation* column of the *Available Cable Types* dialog opens this dialog.

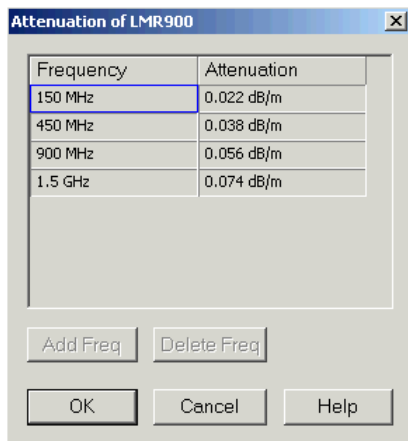

For user-defined cables, the *Frequency* and *Attenuation* columns in the dialog are editable. The frequency dependence can be defined in two alternative ways:

- **Single reference frequency**

If the cable attenuation is specified at a single frequency, the R&S ZVL calculates the attenuation factor at the center frequency of the sweep range, assuming that $Attenuation(f_{const}) / Attenuation(f_{center}) = \sqrt{f_{const} / f_{center}}$. This frequency dependence accounts for the impact of the skin effect.

The impulse response trace is corrected with the calculated attenuation factor $Attenuation(f_{center})$.

- **Frequency list**

If the cable attenuation is specified at several frequency points, the R&S ZVL calculates the attenuation factor f_{center} at the center frequency of the sweep range by linear interpolation. If f_{center} is outside the specified frequency range, then the frequency dependence is linearly extrapolated, using the two first or the last two specified frequency points.

The impulse response trace is corrected with the calculated attenuation factor $Attenuation(f_{center})$.

It is recommended to specify the cable attenuation as accurately as possible. The correction due to the attenuation factor is proportional to the measured distance between the fault and the reference plane: The larger the distance, the larger the correction.

Remote control: `CALCulate:TRANSform:DTFault:DEFine`

Full One-Port Cal...

Opens the calibration wizard to perform a full one-port calibration at port no. 2. The calibration serves several purposes:

- Define the reference plane (zero distance).
- Normalize the trace (total reflection of the signal corresponds to a 0 dB peak).
- Avoid spurious effects, e.g. peaks on the impulse response trace that are not due to a fault.

If necessary, the analyzer also increases the number of points; see *Auto Number of Points*.

Remote control: `SENSe:CORRection:COLLect:METhod:DEFine 'Test Full One Port',
FOPort, 2
SENSe:CORRection:COLLect:ACQuire:SELEcted OPEN, 2
SENSe:CORRection:COLLect:ACQuire:SELEcted SHORt, 2
SENSe:CORRection:COLLect:ACQuire:SELEcted MATCh, 2
SENSe:CORRection:COLLect:SAVE:SELEcted`

Fault Limit...

Defines a minimum response value in dB for a trace maximum to be considered as being due to a fault. The fault limit is defined relative to the 0 dB-line in the test diagram, i.e. the peak response value for total reflection after proper calibration. The fault limit is handled like any other trace limit:

- Defining a fault limit overwrites the previously defined limit lines for the active trace. The fault limit forms a new upper line segment which is displayed in the *Define Limit Line* dialog.
- If *Trace – Lines – Show Limit Line* is enabled, the fault limit is displayed as a horizontal limit line.
- If the limit check is enabled (*Limit Check On*), peaks above the fault limit can change their color, and a *PASS* or *FAIL* message is displayed.

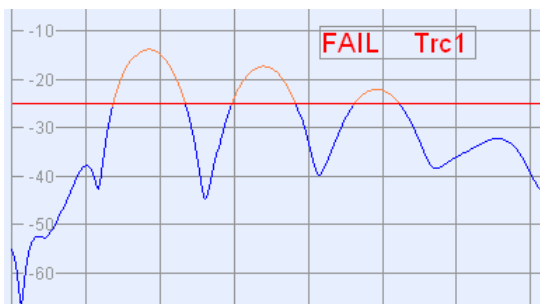

Remote control: `CALCulate:TRANSform:DTFault:PEAK:THReshold`

Show Fault List

Displays a list of all peaks that fulfil the *Fault Limit* condition.

Fault	Trace	Distance	Peak Response
1	Trc1	11 mm	-13.90 dB
2	Trc1	104 mm	-17.36 dB
3	Trc1	195 mm	-22.18 dB

Remote control: `CALCulate:TRANSform:DTFault:PEAK:STATE ON | OFF`
`CALCulate:TRANSform:DTFault:PEAK:COUNT?`
`CALCulate:TRANSform:DTFault:PEAK:DATA<nr>?`

Export Fault List...

Opens a *Save As...* dialog to write the fault list data to an ASCII file.

Example: The fault list:

Fault	Trace	Distance	Peak Response
1	Trc1	11 mm	-13.90 dB
2	Trc1	104 mm	-17.36 dB
3	Trc1	195 mm	-22.18 dB

is described by the file:

```
1      Trc1      11 mm      -13.91 dB
2      Trc1     104 mm     -17.37 dB
3      Trc1     195 mm     -22.18 dB
```

Remote control: –

Impedance

The *Impedance* submenu contains the functions to convert S-parameters into matched-circuit impedances. The matched-circuit impedances describe the impedances of a DUT that is terminated at its outputs with the reference impedance Z_0 .

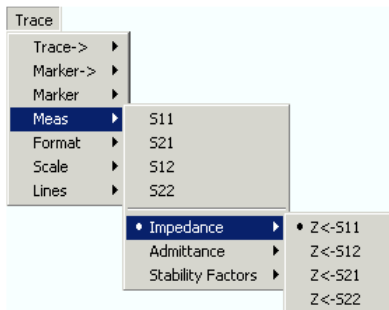

$Z \leftarrow S11$, $Z \leftarrow S12$, $Z \leftarrow S21$, $Z \leftarrow S22$ select the forward and reverse matched-circuit impedances of a 2-port DUT.

$Z \leftarrow S11$, $Z \leftarrow S12$, $Z \leftarrow S21$, $Z \leftarrow S22$

Selects the 2-port matched-circuit, converted impedances. The parameters describe the impedances of a 2-port DUT, obtained in forward and reverse transmission and reflection measurements:

- Z_{11} is the input impedance of a 2-port DUT that is terminated at its output with the reference impedance Z_0 (matched-circuit impedance measured in a forward reflection measurement).
- Z_{22} is the output impedance of a 2-port DUT that is terminated at its input with the reference impedance Z_0 (matched-circuit impedance measured in a reverse reflection measurement).
- Z_{12} and Z_{21} denote the forward and reverse transfer impedances, respectively.



Use the Smith chart to obtain an alternative, graphical representation of the converted impedances in

a reflection measurement.

Remote control: `CALCulate<Ch>:PARAmeter:MEASure "<Trace_Name>", "Z-S11" | "Z-S12" | "Z-S21" | "Z-S22"`
`[SENSE<Chn>:]FUNction[:ON] "...:POWer:Z<11 | 12 | 21 | 22>"`

Create new trace and select name and measurement parameter:

`CALCulate<Ch>:PARAmeter:SDEFine "<Trace_Name>", "Z-S11" | "Z-S12" | "Z-S21" | "Z-S22"`

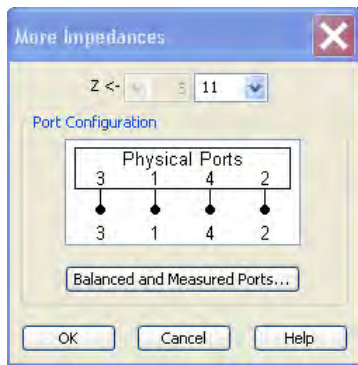

Admittance

The *Admittance* submenu contains the functions to convert reflection S-parameters into matched-circuit admittances. The matched-circuit admittances describe the admittances of a DUT that is terminated at its outputs with the reference impedance Z_0 .

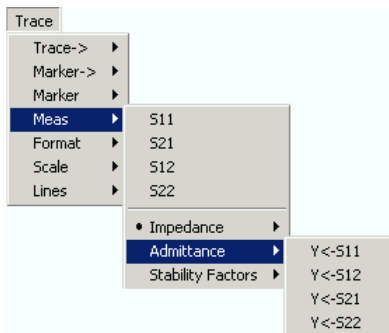

$Y \leftarrow S11$, $Y \leftarrow S12$, $Y \leftarrow S21$, $Y \leftarrow S22$ select the forward or reverse matched-circuit admittances of a 2-port DUT.

$Y \leftarrow S11$, $Y \leftarrow S12$, $Y \leftarrow S21$, $Y \leftarrow S22$

Selects the 2-port converted matched-circuit admittance parameters. The parameters describe the admittances of a 2-port DUT, obtained in forward and reverse transmission and reflection measurements:

- Y_{11} is the input admittance of a 2-port DUT that is terminated at its output with the reference impedance Z_0 (matched -circuit admittance measured in a forward reflection measurement).
- Y_{22} is the output admittance of a 2-port DUT that is terminated at its input with the reference impedance Z_0 (matched -circuit admittance measured in a reverse reflection measurement).
- Y_{12} and Y_{21} denote the forward and reverse transfer admittances, respectively.



Use the Inverted Smith chart to obtain an alternative, graphical representation of the converted admittances in a reflection measurement.

Remote control: `CALCulate<Ch>:PARAmeter:MEASure "<Trace_Name>", "Y-S11" | "Y-S12" | "Y-S21" | "Y-S22" [SENSE<Chn>:]FUNCTion[:ON] "...:POWEr:Y<11 | 12 | 21 | 22>"`

Create new trace and select name and measurement parameter:

`CALCulate<Ch>:PARAmeter:SDEFine "<Trace_Name>", "Y-S11" | "Y-S12" | "Y-S21" | "Y-S22"`

Stability Factors

The *Stability Factors* submenu selects stability factors to be measured and displayed.

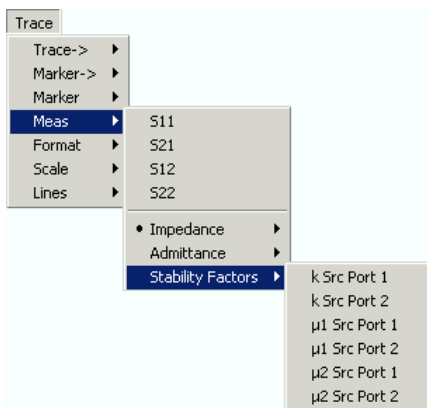

The three two port stability factors K, μ_1 or μ_2 are available.



Definition of stability factors and stability criteria

The stability factors K, μ_1 and μ_2 are real functions of the (complex) S-parameters, defined as follows:

$$K := \frac{1 - |S_{11}|^2 - |S_{22}|^2 + |S_{11} \cdot S_{22} - S_{12} \cdot S_{21}|^2}{2 \cdot |S_{12} \cdot S_{21}|}$$

$$\mu_1 := \frac{1 - |S_{11}|^2}{|S_{22} - \overline{S_{11}} \cdot (S_{11} \cdot S_{22} - S_{12} \cdot S_{21})| + |S_{12} \cdot S_{21}|}$$

$$\mu_2 := \frac{1 - |S_{22}|^2}{|S_{11} - \overline{S_{22}} \cdot (S_{11} \cdot S_{22} - S_{12} \cdot S_{21})| + |S_{12} \cdot S_{21}|}$$

where \bar{s} denotes the complex conjugate of S.

Stability factors are calculated as functions of the frequency or another stimulus parameter. They provide criteria for linear stability of two-ports such as amplifiers. A linear circuit is said to be unconditionally stable if no combination of passive source or load can cause the circuit to oscillate.

- The K-factor provides a necessary condition for unconditional stability: A circuit is unconditionally stable if $K > 1$ and an additional condition is met. The additional condition can be tested by means of the stability factors μ_1 and μ_2 .
- The μ_1 and μ_2 factors both provide a necessary and sufficient condition for unconditional stability: The conditions $\mu_1 > 1$ or $\mu_2 > 1$ are both equivalent to unconditional stability. This means that μ_1 and μ_2 provide direct insight into the degree of stability or potential instability of linear circuits.

References: Marion Lee Edwards and Jeffrey H. Sinsky, "A New Criterion for Linear 2-Port Stability Using a Single Geometrically Derived Parameter", IEEE Trans. MTT, vol. 40, No. 12, pp. 2303-2311, Dec. 1992.

Remote control:

```
CALCulate<Ch>:PARAmeter:MEASure "<Trace_Name>", "KFAC21" |
"MUF121" | "MUF221" | ...
[SENSe<Chn>:]FUNctioN[:ON] "...:POWer:KFACtor | MUFactor1 |
MUFactor2"
```

Create new trace and select name and measurement parameter:

```
CALCulate<Ch>:PARAmeter:SDEFine "<Trace_Name>", "SY11" | "SY12" |
"SY21" | "SY22"
```

Format

The *Format* submenu defines how the measured data is presented in the graphical display.

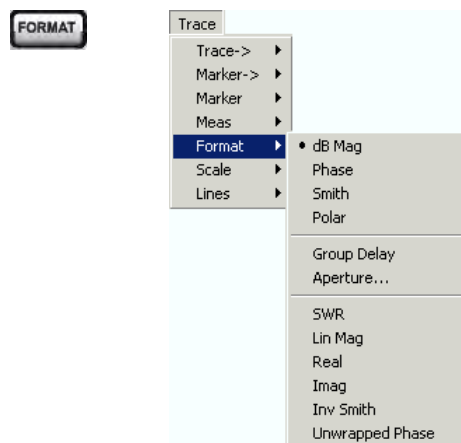

- *dB Mag* selects a Cartesian diagram with a logarithmic scale of the vertical axis to display the magnitude of a complex measured quantity.
- *Phase* selects a Cartesian diagram with a linear vertical axis to display the phase of a complex measured quantity in the range between -180 degrees and $+180$ degrees.
- *Smith* selects a Smith diagram to display an S-parameter or ratio.
- *Polar* selects a polar diagram to display an S-parameter or ratio.
- *Group Delay* calculates the group delay from an S-parameter or ratio and displays it in a Cartesian diagram.
- *Aperture* sets a delay aperture for the delay calculation.
- *SWR* calculates the Standing Wave Ratio from the measured reflection S-parameters and displays it in a Cartesian diagram.
- *Lin Mag* selects a Cartesian diagram with a linear scale of the vertical axis to display the magnitude of the measured quantity.
- *Real* selects a Cartesian diagram to display the real part of a complex measured quantity.
- *Imag* selects a Cartesian diagram to display the imaginary part of a complex measured quantity.
- *Inv Smith* selects an inverted Smith diagram to display an S-parameter or ratio.
- *Unwrapped Phase* selects a Cartesian diagram with a linear vertical axis to display the phase of the measured quantity in an arbitrary phase range.

The *Format* settings are closely related to the settings in the *Scale* submenu and in the *Display* menu. All

of them have an influence on the way the analyzer presents data on the screen.



The analyzer allows arbitrary combinations of display formats and measured quantities (Trace – Measure). Nevertheless, in order to extract useful information from the data, it is important to select a display format which is appropriate to the analysis of a particular measured quantity; see Measured Quantities and Display Formats.



An extended range of formats is available for markers. To convert any point on a trace, create a marker and select the appropriate marker format. Marker and trace formats can be applied independently.

dB Mag

Selects a Cartesian diagram with a logarithmic scale of the vertical axis to display the magnitude of the complex measured quantity.

Properties: The stimulus variable appears on the horizontal axis, scaled linearly. The magnitude of the complex quantity C , i.e. $|C| = \sqrt{\text{Re}(C)^2 + \text{Im}(C)^2}$, appears on the vertical axis, scaled in dB. The decibel conversion is calculated according to $\text{dB Mag}(C) = 20 * \log(|C|)$ dB.

Application: dB Mag is the default format for the complex, dimensionless S-parameters. The dB-scale is the natural scale for measurements related to power ratios (insertion loss, gain etc.).



Alternative Formats

The magnitude of each complex quantity can be displayed on a linear scale. It is possible to view the real and imaginary parts instead of the magnitude and phase. Both the magnitude and phase are displayed in the polar diagram.

Remote control: `CALCulate<Chn>:FORMat MLOGarithmic`

Phase

Selects a Cartesian diagram with a linear vertical axis to display the phase of a complex measured quantity in the range between -180 degrees and $+180$ degrees.

Properties: The stimulus variable appears on the horizontal axis, scaled linearly. The phase of the complex quantity C , i.e. $\Phi(C) = \arctan(\text{Im}(C) / \text{Re}(C))$, appears on the vertical axis. $\Phi(C)$ is measured relative to the phase at the start of the sweep (reference phase = 0°). If $\Phi(C)$ exceeds $+180^\circ$ the curve jumps by -360° ; if it falls below -180° , the trace jumps by $+360^\circ$. The result is a trace with a typical sawtooth shape. The alternative *Phase Unwrapped* format avoids this behavior.

Application: Phase measurements, e.g. phase distortion, deviation from linearity.



Alternative Formats:

The magnitude of each complex quantity can be displayed on a linear scale or on a logarithmic scale. It is possible to view the real and imaginary parts instead of the magnitude and phase. Both the magnitude and phase are displayed in the polar diagram. As an alternative to direct phase measurements, the analyzer provides the derivative of the phase response for a frequency sweep (Delay).

Remote control: `CALCulate<Chn>:FORMat PHASe`

Smith

Selects a Smith chart to display a complex quantity, primarily a reflection S-parameter.

Properties: The Smith chart is a circular diagram obtained by mapping the positive complex semi-plane into a unit circle. Points with the same resistance are located on circles, points with the same reactance produce arcs. If the measured quantity is a complex reflection coefficient (S_{11} , S_{22} etc.), then the unit Smith chart represents the normalized impedance. In contrast to the polar diagram, the scaling of the diagram is not linear.

Application: Reflection measurements, see application example.



The axis for the sweep variable is lost in Smith charts but the marker functions easily provide the stimulus value of any measurement point. dB values for the magnitude and other conversions can be obtained by means of the *Marker Format* functions.

Remote control: `CALCulate<Chn>:FORMat SMITh`

Polar

Selects a polar diagram to display a complex quantity, primarily an S-parameter or ratio.

Properties: The polar diagram shows the measured data (response values) in the complex plane with a horizontal real axis and a vertical imaginary axis. The magnitude of a complex value is determined by its distance from the center, its phase is given by the angle from the positive horizontal axis. In contrast to the Smith chart, the scaling of the axes is linear.

Application: Reflection or transmission measurements, see application example.



The axis for the sweep variable is lost in polar diagrams but the marker functions easily provide the stimulus value of any measurement point. dB values for the magnitude and other conversions can be obtained by means of the *Marker Format* functions.

Remote control: `CALCulate<Chn>:FORMat POLar`

Group Delay

Calculates the (group) delay from the measured quantity (primarily: from a transmission S-parameter) and displays it in a Cartesian diagram.

Properties: The group delay τ_g represents the propagation time of wave through a device. τ_g is a real quantity and is calculated as the negative of the derivative of its phase response. A non-dispersive DUT shows a linear phase response, which produces a constant delay (a constant ratio of phase difference to frequency difference).



Mathematical relations: Delay, Aperture, Electrical Length

The group delay is defined as:

$$\tau_g = -\frac{d\phi_{rad}}{d\omega} = -\frac{d\phi_{deg}}{360^\circ df}$$

where

$\Phi_{rad/deg}$ = Phase response in radians or degrees

ω = Frequency/angular velocity in radians/s

f = Frequency in Hz

In practice, the analyzer calculates an approximation to the derivative of the phase response, taking a small frequency interval Δf and determining the corresponding phase change $\Delta\phi$. The delay is thus computed as:

$$\tau_{g,meas} = -\frac{\Delta\phi_{deg}}{360^\circ\Delta f}$$

The aperture Δf must be adjusted to the conditions of the measurement.

If the delay is constant over the considered frequency range (non-dispersive DUT, e.g. a cable), then τ_g and $\tau_{g,meas}$ are identical and

$$\tau_g = \frac{d(360^\circ f \cdot \Delta t)}{360^\circ \Delta f} = \Delta t = \frac{L_{mech} \cdot \sqrt{\epsilon}}{c}$$

where Δt is the propagation time of the wave across the DUT, which often can be expressed in terms of its mechanical length L_{mech} , the permittivity ϵ , and the velocity of light c . The product of $L_{mech} \cdot \sqrt{\epsilon}$ is termed the electrical length of the DUT and is always larger or equal than the mechanical length ($\epsilon > 1$ for all dielectrics and $\epsilon = 1$ for the vacuum).

Application: Transmission measurements, especially with the purpose of investigating deviations from linear phase response and phase distortions. To obtain the delay a frequency sweep must be active.



The cables connecting the analyzer test ports to the DUT introduce an unwanted delay, which often can be assumed to be constant. Use the *Zero Delay at Marker* function, define a numeric length *Offset* or use the *Auto Length* function to mathematically compensate for this effect in the measurement results. To compensate for a frequency-dependent delay in the test setup, a system error correction is required.

Remote control: CALCulate<Chn>:FORMat GDElay

Aperture

Sets a delay aperture for the delay calculation. The aperture Δf is entered as an integer number of *Aperture Steps*:

Aperture Steps:

The analyzer calculates the aperture from the sweep points of the current frequency sweep.

Properties: The delay at each sweep point is computed as:

$$\tau_{g,meas} = -\frac{\Delta\phi_{deg}}{360^\circ\Delta f}$$

where the aperture Δf is a finite frequency interval around the sweep point f_0 and the analyzer measures the corresponding phase change $\Delta\phi$.

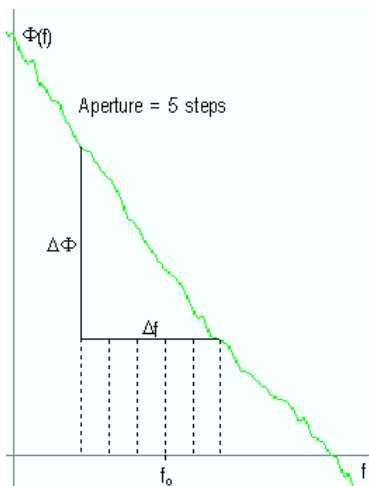

Calculation of Δf and $\Delta\phi$

With a given number of aperture steps n the delay at sweep point no. m is calculated as follows:

- If n is even ($n = 2k$), then $\Delta f(m) = f(m+k) - f(m-k)$ and $\Delta\phi(m) = \Delta\phi(m+k) - \Delta\phi(m-k)$.
- If n is odd ($n = 2k+1$), then $\Delta f(m) = f(m+k) - f(m-k-1)$ and $\Delta\phi(m) = \Delta\phi(m+k) - \Delta\phi(m-k-1)$.

The delay calculation is based on the already measured sweep points and does not slow down the measurement.

Δf is constant over the entire sweep range, if the sweep type is a Lin. Frequency sweep. For Log. Frequency and Segmented Frequency sweeps, it varies with the sweep point number m .

Application The aperture must be adjusted to the conditions of the measurement. A small aperture increases the noise in the group delay; a large aperture tends to minimize the noise effects, but at the expense of frequency resolution. Phase perturbations which are narrower in frequency than the aperture tend to be smeared over and can not be measured.

Remote control: `CALCulate<Chn>:GDAPerture:SCount`

SWR

Calculates the Standing Wave Ratio (SWR) from the measured quantity (primarily: from a reflection S-parameter) and displays it in a Cartesian diagram.

Properties: The SWR (or Voltage Standing Wave Ratio, VSWR) is a measure of the power reflected at the input of the DUT. It is calculated from the magnitude of the reflection coefficients S_{ii} (where i denotes the port number of the DUT) according to:

$$SWR = \frac{1 + |S_{ii}|}{1 - |S_{ii}|}$$

The superposition of the incident and the reflected wave on the transmission line connecting the analyzer and the DUT causes an interference pattern with variable envelope voltage. The SWR is the ratio of the maximum voltage to the minimum envelope voltage along the line.

Interpretation of the SWR

The superposition of the incident wave I and the reflected wave R on the transmission line connecting the analyzer and the DUT causes an interference pattern with variable envelope voltage. The SWR is the ratio of the maximum voltage to the minimum envelope voltage along the line:

$$SWR = V_{Max}/V_{Min} = (|V_i| + |V_R|) / (|V_i| - |V_R|) = (1 + |S_{ii}|) / (1 - |S_{ii}|)$$

Application: Reflection measurements with conversion of the complex S-parameter to a real SWR.

Remote control: `CALCulate<Chn>:FORMat SWR`

Lin Mag

Selects a Cartesian diagram with a linear vertical axis scale to display the magnitude of the measured quantity.

Properties: The stimulus variable appears on the horizontal axis, scaled linearly. The magnitude of the complex quantity C, i.e. $|C| = \sqrt{\text{Re}(C)^2 + \text{Im}(C)^2}$, appears on the vertical axis, also scaled linearly.

Application: Real measurement data (i.e. the Stability Factors, DC Input 1/2, and the PAE) are always displayed in a Lin Mag diagram.



Alternative Formats

The magnitude of each complex quantity can be displayed on a logarithmic scale. It is possible to view the real and imaginary parts instead of the magnitude and phase.

Remote control: `CALCulate<Chn>:FORMat MLINear`

Real

Selects a Cartesian diagram to display the real part of a complex measured quantity.

Properties: The stimulus variable appears on the horizontal axis, scaled linearly. The real part $\text{Re}(C)$ of the complex quantity $C = \text{Re}(C) + j \text{Im}(C)$, appears on the vertical axis, also scaled linearly.

Application: The real part of an impedance corresponds to its resistive portion.



Alternative Formats

It is possible to view the magnitude and phase of a complex quantity instead of the real and imaginary part. The magnitude can be displayed on a linear scale or on a logarithmic scale. Both the real and imaginary parts are displayed in the polar diagram.

Remote control: `CALCulate<Chn>:FORMat REAL`

Imag

Selects a Cartesian diagram to display the imaginary part of a complex measured quantity.

Properties: The stimulus variable appears on the horizontal axis, scaled linearly. The imaginary part $\text{Im}(C)$ of the complex quantity $C = \text{Re}(C) + j \text{Im}(C)$, appears on the vertical axis, also scaled linearly.

Application: The imaginary part of an impedance corresponds to its reactive portion. Positive (negative) values represent inductive (capacitive) reactance.



Alternative Formats

It is possible to view the magnitude and phase of a complex quantity instead of the real and imaginary part. The magnitude can be displayed on a linear scale or on a logarithmic scale. Both the real and

imaginary parts are displayed in the polar diagram.

Remote control: `CALCulate<Chn>:FORMat IMAGinary`

Inv Smith

Selects an inverted Smith chart to display a complex quantity, primarily a reflection S-parameter.

Properties: The Inverted Smith chart is a circular diagram obtained by mapping the positive complex semi-plane into a unit circle. If the measured quantity is a complex reflection coefficient (S_{11} , S_{22} etc.), then the unit Inverted Smith chart represents the normalized admittance. In contrast to the polar diagram, the scaling of the diagram is not linear.

Application: Reflection measurements, see application example.



The axis for the sweep variable is lost in Smith charts but the marker functions easily provide the stimulus value of any measurement point. dB values for the magnitude and other conversions can be obtained by means of the *Marker Format* functions.

Remote control: `CALCulate<Chn>:FORMat ISmith`

Unwrapped Phase

Selects a Cartesian diagram with an arbitrarily scaled linear vertical axis to display the phase of the measured quantity.

Properties: The stimulus variable appears on the horizontal axis, scaled linearly. The phase of the complex quantity C , i.e. $\Phi(C) = \arctan(\text{Im}(C) / \text{Re}(C))$, appears on the vertical axis. $\Phi(C)$ is measured relative to the phase at the start of the sweep (reference phase = 0°). In contrast to the normal Phase format, the display range is not limited to values between -180° and $+180^\circ$. This avoids artificial jumps of the trace but can entail a relatively wide phase range if the sweep span is large.

Application: Phase measurements, e.g. phase distortion, deviation from linearity.



After changing to the *Unwrapped Phase* format, use *Trace – Scale – Autoscale* to re-scale the vertical axis and view the entire trace.

Remote control: `CALCulate<Chn>:FORMat UPHase`

Scale

The *Scale* settings define how the current trace is presented in the diagram selected in the *Format* submenu.

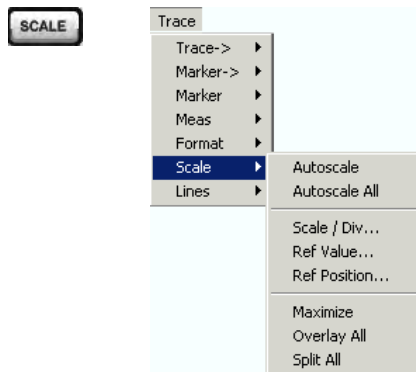

- *Autoscale* adjusts the diagram scale in order to display the entire active trace in the diagram area.
- *Autoscale All* adjusts the diagram scale in order to display all traces in the diagram area.
- *Scale/Div* sets the value of the vertical diagram divisions.
- *Ref Value* sets the reference line of a Cartesian diagram or the outer circumference of a polar diagram.
- *Ref Position* defines the position of the reference line in a Cartesian diagram.
- *Maximize* maximizes the active diagram area.
- *Overlay All* displays all traces in one diagram area.
- *Split All* displays every trace in a separate diagram area.

The *Scale* settings are closely related to the settings in the *Format* submenu and in the *Display* menu. All of them have an influence on the way the analyzer presents data on the screen.

The *Scale* settings depend on the diagram type (Trace – Format) because not all diagrams can be scaled in the same way:

- In Cartesian diagrams, all scale settings are available.
- In circular diagrams, no *Scale/Div.*, no *Ref. Position*, and no *Max* and *Min* values can be defined.

The default scale is activated automatically when a display format (diagram type) is selected. Scale settings that are not compatible with the current display format are disabled (grayed).



Relations between the scaling parameters

The scaling parameters *Scale / Div*, *Ref Value*, *Ref Position*, *Max*, *Min* are coupled together in the following manner:

$$\begin{aligned} \text{Max} - \text{Min} &= \text{Scale} / \text{Div} * \langle \text{Number of graticule divisions} \rangle \\ \text{Max} &= \text{Ref Value} \text{ when Ref Position is } 10 \\ \text{Min} &= \text{Ref Value} \text{ when Ref Position is } 0 \end{aligned}$$



The Marker -> provide a convenient alternative to manual diagram scaling.

Autoscale

Adjusts the *Scale Divisions* and the *Ref. Value* in order to display the entire active trace in the diagram area, leaving an appropriate display margin.

- In Cartesian diagrams, the analyzer re-calculates the values of the vertical divisions so that the trace fits onto 80% of the vertical grid. The reference value is chosen to center the trace in the diagram.

- In circular diagrams (*Polar, Smith, Inverted Smith*), the analyzer re-calculates the values of the radial divisions so that the diagram is confined to approx. 80% of the outer circumference. The reference value is set to the value of the outer circumference.

Autoscale does not affect the stimulus values and the horizontal axis.

Remote control: `DISPlay[:WINDow<Wnd>]:TRACe<WndTr>:Y[:SCALE]:AUTO ONCE`

Autoscale All

Adjusts the *Scale Divisions* and the *Ref. Value* in order to display all traces in the diagram area, leaving an appropriate display margin. This scale settings are analogous to the *Autoscale* function. The traces in the active diagram area are taken into account irrespective of their channel assignment.

Scale / Div

Sets the value of the vertical diagram divisions in Cartesian diagrams.

Scale / Div:

Scale / Div corresponds to the increment between two consecutive grid lines. The unit depends on the display format: dB for display format *dB Mag*, degrees for *Phase* and *Unwrapped Phase*, ns for *Delay*, U (units) for all other (dimensionless) formats.

Scale / Div is not available (grayed) for circular diagrams (*Polar, Smith, Inverted Smith*).

Remote control: `DISPlay[:WINDow<Wnd>]:TRACe<WndTr>:Y:PDIVision`

Ref Value

Sets the reference line of a Cartesian diagram or the outer circumference of a circular diagram.

Ref Value:

- In Cartesian diagrams *Ref. Value* defines the value of the reference line, indicated by a  symbol at the right edge of the diagram area. The color of the symbol corresponds to the trace color. As the *Ref. Value* is varied, the position of the reference line (Ref. Position) is left unchanged, so that the current trace is shifted in vertical direction. The unit of the *Ref. Value* depends on the display format: dB for display format *dB Mag*, degrees for *Phase* and *Unwrapped Phase*, ns for *Delay*, U (units) for all other (dimensionless) formats.
- In circular diagrams (*Polar, Smith, Inverted Smith*), *Ref. Value* defines the value of the outer circumference. Changing *Ref. Value* enlarges or scales down the diagram, leaving the center unchanged. The unit is U (units) for all circular diagrams.



Use the paste marker list for convenient entry of the reference value.

Remote control: `DISPlay[:WINDow<Wnd>]:TRACe<WndTr>:Y:RLEVel`

Ref Position

Defines the position of the reference line in a Cartesian diagram.

Ref Position:

The reference line is indicated by a  symbol at the right edge of the diagram area. The color of the symbol corresponds to the trace color. *Ref. Position* is defined on a linear scale between 0 (bottom line of the diagram) and 10 (top line of the diagram). As the *Ref. Position* is varied, the value of the reference line (*Ref. Value*) is left unchanged, so the current trace is shifted together with the *Ref. Position*.

Ref. Position is not available (grayed) for polar diagrams (*Polar, Smith, Inverted Smith*).



Use the analyzer's drag-and-drop functionality to move the reference line symbol to the desired position.

Remote control: `DISPlay[:WINDow<Wnd>]:TRACe<WndTr>:Y:RPOSition`

Maximize

Maximizes all diagram areas of the active setup to occupy the whole window, placing the active diagram area on top. Clicking *Maximize* again restores the previous display configuration.

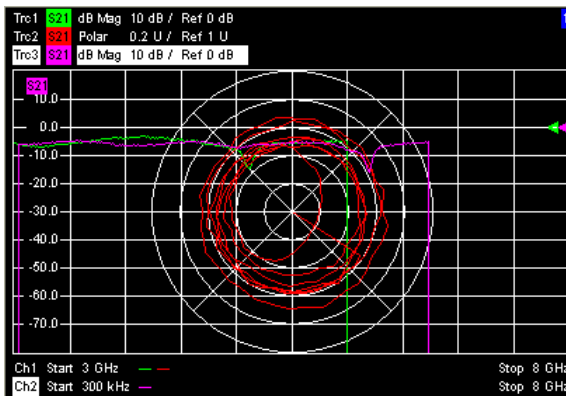

A double-click into any point in the diagram area is equivalent to the *Maximize* function. To view all traces in a common, maximized diagram area, select *Overlay all*.

Remote control: `DISPlay:WINDow<Wnd>:MAXimize ON | OFF`

Overlay All

Places all traces in a single diagram area which is maximized to occupy the whole window. This function is available irrespective of the trace Format and the Channel settings; it is even possible to overlay Cartesian and polar diagrams.

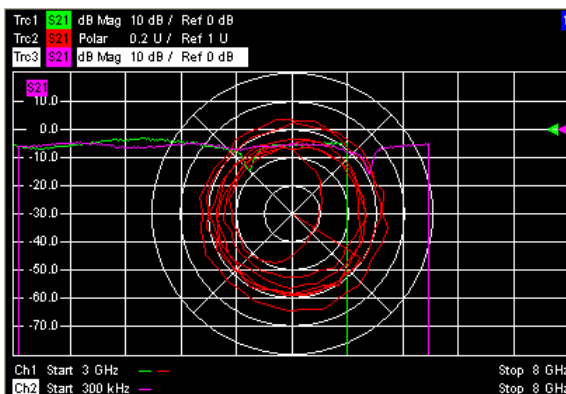

The active trace and active channel is highlighted. The scaling of the axes corresponds to the active trace.



To hide all traces except the active one, select *Split All* and *Maximize*.

Remote control: No command, display configuration only.

Split All

Splits the active window into as many diagram areas as there are traces and assigns a single trace to each area.

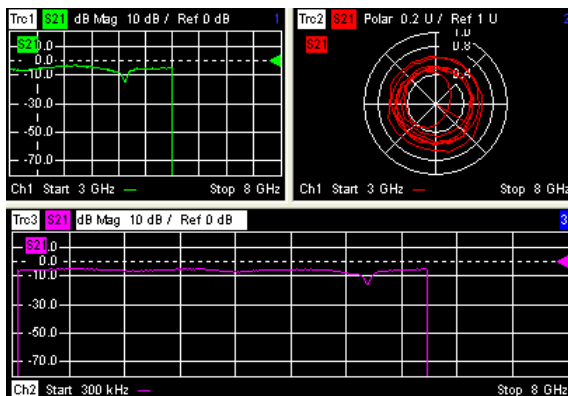

Remote control: No command, display configuration only.

Lines

The commands in the *Lines* submenu define limits for the measurement results, visualize them in the diagrams and activate/deactivate the limit check. Besides the menu provides a horizontal line for each trace.



Limit Lines

A limit line is a set of data to specify the allowed range for some or all points of a trace. Typically, limit lines are used to check whether a DUT conforms to the rated specifications (conformance testing).

- The *upper* limit line defines the maximum value for the trace points.
- The *lower* limit line defines the minimum value for the trace points.

A limit check consists of comparing the measurement results to the limit lines and display a pass/fail indication.

Upper and lower limit lines are both defined as a combination of segments with a linear dependence between the measured quantity and the sweep variable (stimulus variable). The limit lines can be stored to a file and recalled. Data or memory traces can be used to define the segments of a limit line. Moreover it is possible to modify the limit lines globally by adding an offset to the stimulus or response values.

(No direct access via front panel keys)

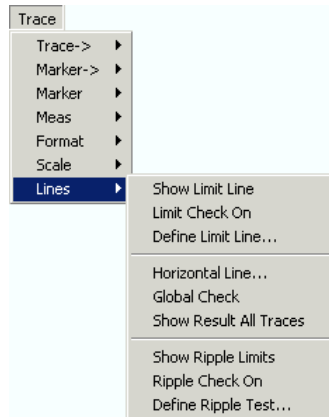

- *Show Limit Line* displays or hides the limit line associated with the active trace.
- *Limit Check On* activates or deactivates the limit check.
- *Define Limit Line* opens a dialog to define, save or recall limit lines.
- *Horizontal Line* displays or hides the horizontal line of the active trace and changes its position.
- *Global Limit Check* activates a global (composite) limit check on all traces in the active setup.

Limit lines are available for all Cartesian diagram types (Trace – Format). For polar diagrams, the functions of the *Lines* submenu are grayed. The limit lines are hidden and the limit check is disabled when a Cartesian trace format is replaced by a polar diagram.

Show Limit Line

Shows or hides the limit line associated with the active trace in a Cartesian diagram area. A checkmark appears next to the menu item when the limit line is shown.

In the diagram, upper and lower limit lines can be displayed with different colors. Limit line segments with disabled limit check (see *Define Limit Line*) can also be colored differently. The limit line colors are defined in the *Define User Color Scheme* dialog (*Display – Display Config. – Color Scheme...*).

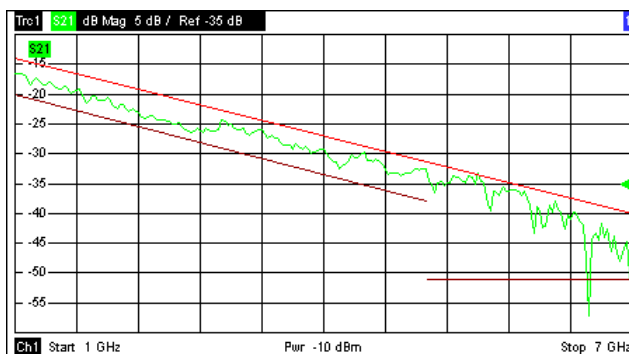

Display of the limit line and limit check are independent of each other: Hiding the limit line does not switch off the limit check.

Remote control: `CALCulate<Chn>:LIMit:DISPlay[:STATe] ON | OFF`

Limit Check On

Switches the limit check of the active trace on or off. A checkmark appears next to the menu item when the limit check is enabled.

When the limit check is switched on, a *PASS* or *FAIL* message is displayed in the center of the diagram. If the limit check fails at a measurement point, the two trace segments to the left and right of the point can change their color. The *Limit Fail Trace* color is defined in the *Define User Color Scheme* dialog (*Display – Display Config. – Color Scheme...*).

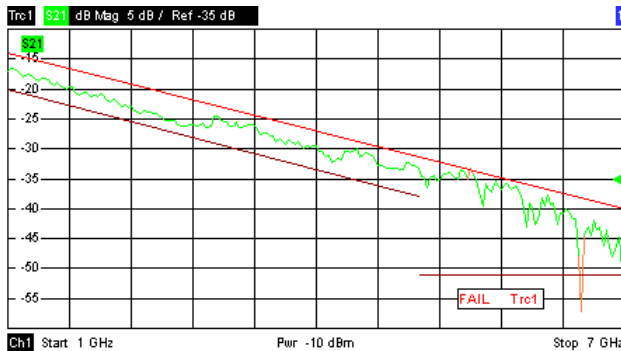

Limit check and display of the limit lines are independent of each other: With disabled limit check, the limit line can still be displayed, however, no display elements indicating a limit failure will appear.

If no limit lines are defined for the active trace, the limit check can be switched on but will always PASS the trace.

Limits are checked at the actual measurement points, whereas a limit failure is indicated for the trace segments on both sides of a failed point. A small number of points causes wide trace segments so that the out-of-tolerance regions can appear wider as they are.

Markers show interpolated values. As a consequence, a trace segment can be failed, whereas a marker placed on the segment may show a response value within the allowed range. This is shown in the example below, with an upper limit line at 26 dB, and a marker response value of 25.968 dB. The small circles correspond to the sweep points; the orange part of the trace is failed.

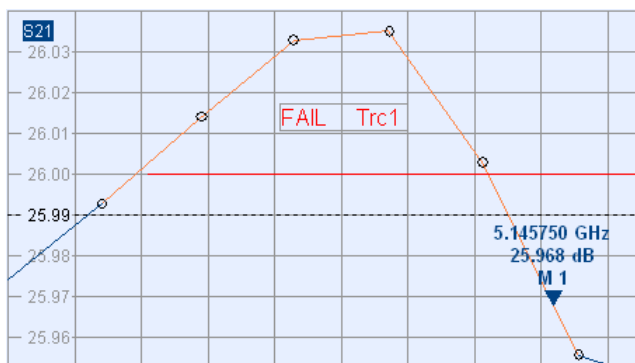

Remote control: `CALCulate<Chn>:LIMit:STATe ON | OFF`
`CALCulate<Chn>:LIMit:LOWer:STATe ON | OFF`
`CALCulate<Chn>:LIMit:UPPer:STATe ON | OFF`
`CALCulate<Chn>:LIMit:FAIL?`

Define Limit Line

Opens a dialog to define the limit line for the active trace on a segment-by-segment basis. In each

segment the limit line is defined as a straight line connecting two points.



Creating limit lines with minimum effort

Choose one of the following methods to efficiently create and handle limit lines:

- To define a limit line with only a few segments, use *Add Segment* and edit each segment in the segment table individually.
- Use the multiselection feature to edit several limit line segments at the same time.
- Select a data or memory trace as a limit line (*Import Trace*) or import a trace stored in a file (*Import File*).
- Save your limit lines to a file so you can re-use or modify them later sessions (*Save Limit Line*, *Recall Limit Line*).

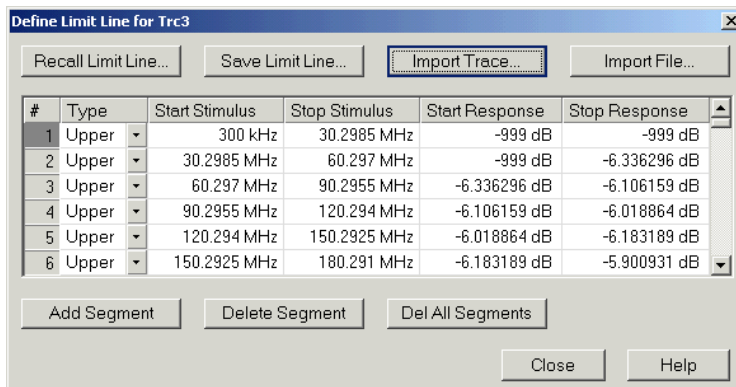

The *Define Limit Line* dialog contains a table to edit the individual segments of the limit line; see below. The active trace is indicated in the title bar of the dialog. The three buttons below the table extend or shorten the segment list.

- *Add Segment* adds a new segment to the list. The new segment is a copy of the previously active segment and inserted after that segment. The current segment numbers are adapted. The analyzer places no restriction on the number of segments in a limit line.
- *Delete Segment* removes the selected segment from the list.
- *Del All Segments* clears the entire segment list so it is possible to define or load a new limit line.

The buttons to the right of the table are used to import and export limit line data.

- *Recall Limit Line...* calls up an Open File dialog to load a limit line from a limit line file. Limit line files are ASCII files with the default extension *.limit and a special file format.
- *Save Limit Line...* calls up a Save As... dialog to store the current limit line configuration to a limit line file. Limit line files are ASCII files with the default extension *.limit and a special file format.

- **Import Trace**

opens a box to select a trace that can be used to define a limit line.

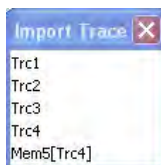

The box contains all data or memory traces of the active channel. As soon as a trace is selected, the *Properties of Imported Segments* dialog with further global import options is opened.

- **Import File**

Calls up a standard *Import File* dialog to load a limit line from a trace file. The limit line import is analogous to the import of traces. Trace files are ASCII files with selectable file format. After the trace file is selected, the *Properties of Imported Segments* dialog with further global import options is opened.

Imported traces are polygonal curves with n points and $n - 1$ segments. The number of points n is set via *Channel – Sweep – Number of Points*. The $n - 1$ segments are appended to the current segment table for further editing. Existing limit line segments are not overwritten.



To import a limit line file (*.limit) you can also use the Windows Explorer and simply double-click the file or drag and drop the file into the NWA application. You have to switch on the limit check separately. Use the paste marker list for convenient entry of *Start* and *Stop* values.



Columns in the segment table

The table contains an automatically assigned current number for each segment plus the following editable columns:

- *Type* indicates whether the segment belongs to an *Upper* or a *Lower* limit line, or if the limit check at the segment is switched *Off*. Switching off the limit check does not delete the segment but changes its screen color.
- *Start Stimulus* is the stimulus (x-axis) value of the first point of the segment (not necessarily smaller than *Stop Stimulus*).
- *Stop Stimulus* is the stimulus (x-axis) value of the last point of the segment (not necessarily larger than *Start Stimulus*).
- *Start Response* is the response (y-axis) value of the first point of the segment.
- *Stop Response* is the response (y-axis) value of the last point of the segment.

The limit line segment is calculated as a straight line connecting the two points (<Start Stimulus>, <Start Response>) and (<Stop Stimulus>, <Stop Response>); see *Rules for Limit Line Definition*.

Remote control: CALCulate<Chn>:LIMit:CONTRol[:DATA]
 CALCulate<Chn>:LIMit:DATA
 CALCulate<Chn>:LIMit:SEGment<Seg>...
 CALCulate<Chn>:LIMit:UPPer...
 CALCulate<Chn>:LIMit:LOWer...
 CALCulate<Chn>:LIMit:DElete:ALL
 CALCulate<Ch>:LIMit:SEGment:COUNT?
 MMEMory:STORe:LIMit
 MMEMory:LOAD:LIMit

Multi-Selection of Limit Line Segments

In the *Define Limit Line* dialog it is possible to edit several limit line segments at the same time. Selection of two or more segments (use the left mouse key and the *Shift* key of an external keyboard) and a right-click on the dark grey *Seg.* area opens a context menu:

Seg.	Type	Start Stimulus	Stop Stimulus
1	Upper	300 kHz	8 GHz
2	Upper		
3	Lower		
4	Off		
5		.040148 GHz	

Context menu options:

- Type
 - Upper
 - Lower
 - Off
- Delete Segments
- Add Response Offset...
- Add Stimulus Offset...
- Start Response...
- Stop Response...
- Start Stimulus...
- Stop Stimulus...
- Merge Segments

The context menu provides the following functions:

- Modification of all entries in the segment table: Type, start and stop values for the stimulus and response variable.
- Definition of an offset for response and stimulus values in analogy to the *Properties of Imported Segments* dialog.
- *Delete* the selected segments.
- *Merge* the selected segments to a single new segment. The start and stop values of the new segment are given by the start values of the first selected segment and the stop value of the last selected segment. The type is taken from the first selected segment. The new segment replaces the selected segments.

Remote control: `CALCulate<Chn>:LIMit:UPPer...`
`CALCulate<Chn>:LIMit:LOWer...`

Rules for Limit Line Definition

The analyzer places very few restrictions on the definition of limit line segments. The following rules ensure a maximum of flexibility:

- Segments don't have to be sorted in ascending or descending order (e.g. the *Start Stimulus* value of segment no. n doesn't have to be smaller than the *Start Stimulus* value of segment no. n+1).
- Overlapping segments are allowed. The limit check in the overlapping area refers to the tighter limit (the pass test involves a logical AND operation).
- Gaps between segments are allowed and equivalent to switching off an intermediate limit line segment.
- Limit lines can be partially or entirely outside the sweep range, however, the limits are only checked at the measurement points.

The following figure shows a limit line consisting of 3 upper and 2 lower limit line segments. To pass the limit check, the trace must be confined to the shaded area.

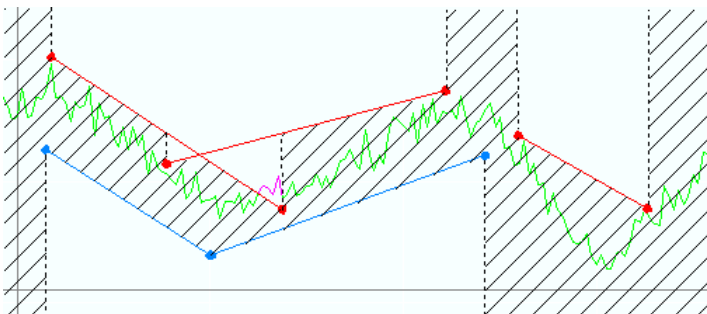

As a consequence of the limit line rules, the limit check will always pass a DUT if no limit lines are defined.

File Import Settings

The *Properties of Imported Segments* dialog appears before a trace is imported into the *Define Limit Line* dialog.

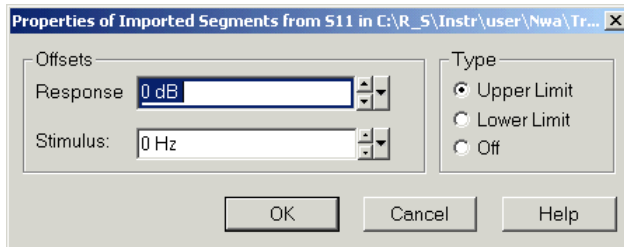

The dialog assigns common properties to all limit line segments generated by the imported trace.

- *Offsets* contains two input fields to define constant offset values for all imported segments. The Response offset shifts all segments in vertical direction, the Stimulus offset shifts them in horizontal direction. The offsets are added to the start and stop values of all segments.
- *Type* defines whether the imported segments belong to the Upper or Lower limit line. A third option is to import the segments but disable the limit check (Off).

Remote control: CALCulate<Chn>:LIMit:LOWer:FEED
<stimulus_offset>,<response_offset>[,<trace_name>]
CALCulate<Chn>:LIMit:UPPer:FEED
<stimulus_offset>,<response_offset>[,<trace_name>]
MMEMory:LOAD:LIMit

File Format for Limit Lines

The analyzer uses a simple ASCII format to export limit line data. By default, the limit line file has the extension *.limit and is stored in the directory shown in the *Export Limit Line* and *Import Limit Line* dialogs. The file starts with a preamble containing the channel and trace name and the header of the segment list. The following lines contain the entries of all editable columns of the list.



Example of a limit line file

The limit line:

Seg.	Type	Start Stimulus	Stop Stimulus	Start Response	Stop Response
1	Upper	1 GHz	3 GHz	2 dB	2 dB
2	Lower	3 GHz	8 GHz	3 dB	4 dB
3	Off	300 kHz	1 GHz	1 dB	1 dB

is described by the limit line file:

```
# Version 1.00
#
# Channel 2
# Trace 2
en:Type; Start Stimulus[MHz]; Stop Stimulus[MHz]; Start Response[db]; Stop Response[db];
Upper; 1.0000000000000000E+003; 3.0000000000000000E+003; 2.0000000000000000E+000; 2.0000000000000000E+000;
Lower; 3.0000000000000000E+006; 8.0000000000000000E+003; 3.0000000000000000E+000; 4.0000000000000000E+000;
Off; 3.0000000000000000E-001; 1.0000000000000000E+003; 1.0000000000000000E+000; 1.0000000000000000E+000;
```

Remote control: MMEMory:LOAD:LIMit "Trc_name","file_name"
MMEMory:STORe:LIMit "Trc_name","file_name"

Horizontal Line

Shows or hides the horizontal line associated with the active trace in a Cartesian diagram area. A checkmark appears next to the menu item when the horizontal line is shown.

The horizontal line (or display line) is a red line which can be moved to particular trace points in order to retrieve the response values.

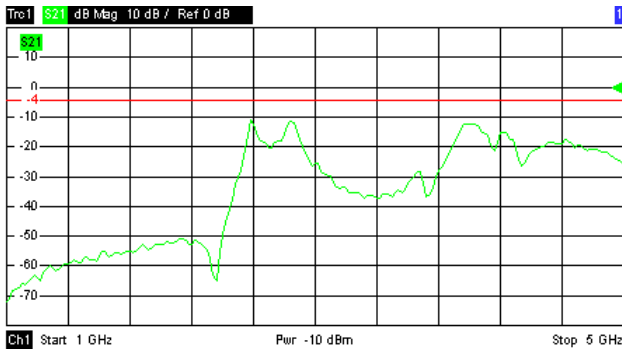

- Pressing *Horizontal Line* for a first time shows the line for the active trace and opens the numeric entry bar to define its position (response value). The (rounded) position is displayed near the left edge of the screen.
- Pressing *Horizontal Line* for a second time hides the horizontal line for the active trace.



Use the analyzer's drag-and-drop functionality to move the horizontal line symbol to the desired position.

Remote control: `CALCulate<Chn>:DLINe:STATe ON | OFF`
`CALCulate<Chn>:DLINe`

Global Limit Check On

Performs a composite limit check on all traces of the current setup. The result of the global check appears in a pop up box whenever *Global Limit Check* is pressed.

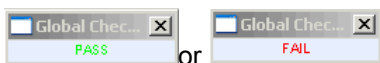

- *PASS* represents pass for all traces for which the limit check is enabled. A trace without limit lines or with disabled individual limit check always passes the composite limit check.
- *FAIL* means that the limit checks for one or more traces failed.

Remote control: `CALCulate<Chn>:CLIMits:FAIL?`

Ripple Test

Ripple Test

The commands in the second section of the *Lines* submenu define the ripple test. A ripple test is a special type of limit test where the maximum **difference** between the largest and the smallest response value of

the trace must not exceed the specified limit. This test is suitable e.g. to check whether the passband ripple of a filter is within acceptable limits, irrespective of the actual transmitted power in the passband. See also background information for Limit Lines.

(No direct access via front panel keys)

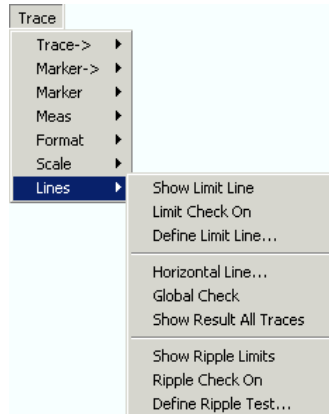

- Global Check activates a global (composite) limit check on all traces in the active setup.
- Show Ripple Limits displays or hides the limit line associated to the active trace.
- Ripple Check On activates or deactivates the ripple limit check.
- *Define Ripple Test...* opens a dialog to define, save or recall limit lines.

Ripple limit lines are available for all Cartesian diagram types (Trace – Format). For polar diagrams, the functions of the ripple check (except the *Global Check*) are grayed. The limit lines are hidden and the ripple limit check (except the global check) is disabled when a Cartesian trace format is replaced by a polar diagram.

Global Check

Activates or deactivates the global limit check including upper/lower limits and ripple limits. The global limit check is a composite limit check over all traces of the current setup. The result of the global check appears in a popup box whenever *Global Limit Check* is pressed.

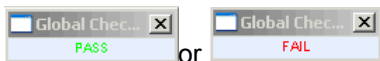

- *PASS* represents pass for all traces with enabled limit check. A trace without limit lines or with disabled individual limit check always passes the global check.
- *FAIL* means that the limit check for one or more traces failed.

Remote control: CALCulate<Chn>:CLIMits:FAIL?

Show Ripple Limits

Shows or hides the ripple limit lines associated with the active trace in a Cartesian diagram area. A checkmark appears next to the menu item when the limit line is shown.

The vertical positions of the ripple lines are re-calculated after each sweep; only their stimulus range and distance (the ripple limit) if fixed. The limit line colors are defined in the *Define User Color Scheme* dialog (*Nwa-Setup – Display Config. – Color Scheme...*).



Display of the ripple limits and limit check are independent of each other: Hiding the limits does not switch off the limit check.

Remote control: `CALCulate<Chn>:RIPPlE:DISPlay[:STATe] ON | OFF`

Ripple Check On

Switches the ripple limit check of the active trace on or off. A checkmark appears next to the menu item when the limit check is enabled.

When the limit check is switched on, an info field shows the pass/fail information and the measured ripple in each ripple limit range. If the limit check fails in a particular ripple line range, the trace within the range can change its color. The *Limit Fail Trace* color is defined in the *Define User Color Scheme* dialog (*Display – Display Config. – Color Scheme...*).



TIP Ripple limit check and display of the limit lines are independent of each other: With disabled limit check, the limit line can still be displayed.
If no limit lines are defined for the active trace, the limit check can be switched on but will always PASS the trace.

Remote control: `CALCulate<Chn>:RIPPlE:STATe ON | OFF`
`CALCulate<Chn>:RIPPlE:FAIL?`
`CALCulate<Chn>:RIPPlE:SEGment<Seg>:STATe ON | OFF`
`CALCulate<Chn>:RIPPlE:SEGment<Seg>:RESult?`

Define Ripple Test...

Opens a dialog to define the ripple limits for the active trace on a range-by-range basis. A separate ripple limit can be assigned to each range.

TIP Defining ripple limits with minimum effort

Choose one of the following methods to efficiently create and handle ripple limit ranges:

- To configure a limit test with only a few ranges, use *Add Range* and edit each range in the table individually.
- Use the *Align All Ranges* button to create non-overlapping, contiguous ranges of equal width.
- Use the multiselection feature to edit several ranges at the same time.
- Save your ripple ranges to a file so you can re-use or modify them later sessions (*Save Ripple Limit...*, *Recall Ripple Limit...*).

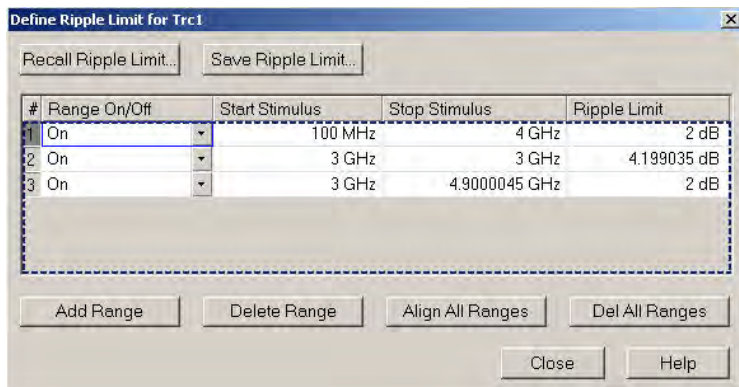

The *Define Ripple Limit* dialog contains a table to edit the individual ripple check ranges; see below. The active trace is indicated in the title bar of the dialog. The buttons below the table extend, shorten, or re-order the range list.

- *Add Range* adds a new range to the list. The new range is inserted after the previously selected range. The current range numbers are adapted; the start and stop stimulus values are set so that an overlap is avoided. Moreover, the ripple limit is estimated according to the measured ripple of the trace in the created range. The analyzer places no restriction on the number of ranges assigned to each trace.
- *Del. Range* removes the selected range from the list.
- *Align All Ranges* subdivides the entire sweep range into contiguous ripple limit ranges of equal width. The ripple limits are estimated according to the measured ripple of the trace in the created ranges.
- *Del All Ranges* clears the entire range list so it is possible to define or load a new ripple limit line.

The buttons to the right of the table are used to import and export limit line data.

- *Recall Ripple Limit...* calls up an Open File dialog to load a ripple limit line from a file. Ripple limit files are ASCII files with the default extension *.ripple and a special file format.
- *Save Ripple Limit...* calls up a Save As... dialog to store the current ripple limit configuration to a ripple limit file. Ripple limit files are ASCII files with the default extension *.ripple and a special file format.



To import a ripple limit file (*.limit) you can also use the Windows Explorer and simply double-click the file or drag and drop the file into the NWA application. You have to switch on the limit check separately. Use the paste marker list for convenient entry of *Start* and *Stop* values.



Columns in the range table

The table contains an automatically assigned current number for each range plus the following editable columns:

- *Range On/Off* indicates whether the ripple limit check in the range is enabled (*On*) or *Off*. Switching off the ripple limit check does not delete the range but hides the entry in the info field.
- *Start Stimulus* is the smallest stimulus (x-axis) value of the range.
- *Stop Stimulus* is the largest stimulus (x-axis) value of the range.
- *Ripple Limit* is the maximum allowed difference between the largest and the smallest trace value in the range.

The ripple limit range is displayed as two parallel, horizontal lines in the diagram. *Stop Stimulus – Start Stimulus* is the length of both lines; *Ripple Limit* is their distance; see *Rules for Limit Line Definition*.

Remote control: CALCulate<Chn>:RIPPlE:CONTRol:DOMain
 CALCulate<Chn>:RIPPlE:DATA
 CALCulate<Chn>:RIPPlE:SEGment<Seg>...
 CALCulate<Chn>:RIPPlE:DELEte:ALL
 MMEMory:STORE:RIPPlE
 MMEMory:LOAD:RIPPlE

Multi-Selection of Ripple Limit Ranges

In the *Define Ripple Limit* dialog it is possible to edit several limit ripple ranges at the same time. Selection of one or more ranges (use the left mouse key and the *Shift* key of an external keyboard) and a right-click on the dark grey *Seg.* area opens a context menu:

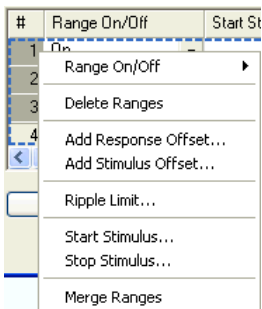

The context menu provides the following functions:

- Modification of all entries in the range table: Range On/Off, stimulus start and stop values, ripple limit.
- Definition of an offset for response and stimulus values in analogy to the *Properties of Imported Ranges* dialog.
- *Delete* the selected ranges.
- *Merge* the selected ranges to a single new range. The start and stop values of the new range are given by the start values of the first selected range and the stop value of the last selected range. The first range also provides the ripple limit and the information whether the merged range is on or off. The new, merged range replaces the selected ranges.

Remote control: CALCulate<Chn>:RIPPlE:SEGment<Seg>...

Rules for Ripple Limit Definition

The analyzer places very few restrictions on the definition of ripple limit ranges. The following rules ensure a maximum of flexibility:

- Ranges do not have to be sorted in ascending or descending order (e.g. the *Start Stimulus* value of range no. n doesn't have to be smaller than the *Start Stimulus* value of range no. n+1).
- Overlapping ranges are allowed. The limit check in the overlapping area is related to the tighter limit (the pass test involves a logical AND operation).
- Gaps between ranges are allowed and equivalent to switching off an intermediate ripple limit range.
- Ripple limit ranges can be partially or entirely outside the sweep range, however, the limits are only checked at the measurement points.

The following figure shows a ripple limit test involving 3 ranges.

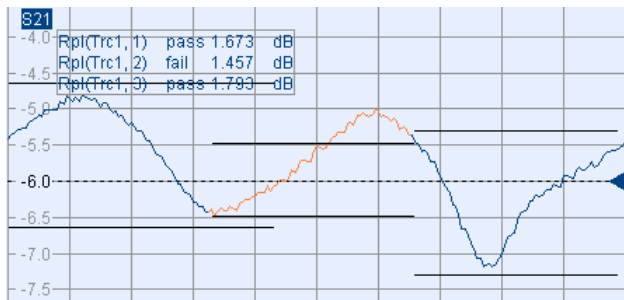

As a consequence of the limit line rules, the limit check will always pass a DUT if no limit lines are defined.

File Format for Ripple Limit Lines

The analyzer uses a simple ASCII format to export ripple limit data. By default, the limit line file has the extension *.ripple and is stored in the directory shown in the *Save Ripple Limit* and *Recall Ripple Limit* dialogs. The file starts with a preamble containing the channel and trace name and the header of the range list. The following lines contain the entries of all editable columns of the list.



Example of a limit line file

The ripple limit list:

#	Range On/Off	Start Stimulus	Stop Stimulus	Ripple Limit
1	On	500 MHz	2 GHz	2 dB
2	On	1.65 GHz	2.8 GHz	1 dB
3	On	2.8 GHz	3.95 GHz	2 dB

is described by the ripple limit file:

```
# Version 1.00
#
# Channel 1
# Trace 1
bo:Range on/off;start stimulus[MHz];stop stimulus[MHz];Ripple Limit[dB];
true;5.000000000000000E+002;2.000000000000000E+003;2.000000000000000E+000;
true;1.650000000000000E+003;2.800000000000000E+003;5.000000000000000E+000;
true;2.800000000000000E+003;3.950000000000000E+003;2.000000000000000E+000;
```

Remote control: MMEMory:LOAD:RIPPLE "Trc_name","file_name"
MMEMory:STORe:RIPPLE "Trc_name","file_name"

Channel Menu

The *Channel* menu provides all channel settings and the functions to activate, modify and store different channels.



Channels

A channel contains hardware-related settings to specify how the network analyzer collects data. The channel settings can be divided into three main groups:

- Control of the measurement process (*Sweep, Trigger, Average*)
- Description of the test setup (*internal source power, IF filters and step attenuators*)
- Correction data (*Calibration, Offset*)

The channel settings complement the definitions of the *Trace* menu. Each trace is assigned to a channel, see Traces, Channels and Diagram Areas. The channel settings apply to all traces assigned to the channel.

(No direct access via front panel keys)

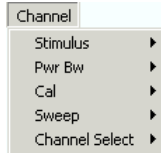

The *Channel* menu contains the following functions and submenus:

- *Stimulus* defines the sweep range, depending on the sweep type.
- *Pwr Bw* defines the power of the internal signal source, sets the step attenuators and the IF bandwidths, and configures the sweep average.
- *Cal* provides all functions that are necessary to perform a system error correction (calibration).
- *Sweep* defines the scope of measurement, including the sweep type and the periodicity of the measurement.
- *Channel Select* provides functions to handle and activate channels.

Stimulus

The *Stimulus* submenu defines the frequency sweep range in the current channel.

- In Cartesian diagrams, the sweep range corresponds to the diagram width and defines the scaling of the *x*-axis.
- In polar diagrams and Smith charts the stimulus axis is lost but the marker functions easily provide the stimulus value of any measurement point.

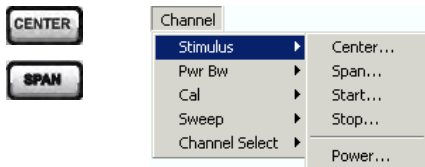

- *Center* opens the input field for the center frequency. It corresponds to the center of the Cartesian diagram, i.e. $(Start + Stop)/2$.
- *Span* opens the input field for the frequency span. It corresponds to the diagram width, i.e. $(Stop - Start)$.
- *Start* opens the input field for the the lowest frequency to be measured. It corresponds to the left edge of the Cartesian diagram.
- *Stop* opens the input field for the highest frequency to be measured. It corresponds to the right edge of the Cartesian diagram.
- *Power* defines the power of the internal signal source.



The Marker Functions provide a convenient alternative to the manual entry of the sweep range parameters. Use the paste marker list for convenient entry of *Start* and *Stop* values.

Equivalence of settings: For a frequency sweep the *Start* and *Stop* frequencies or the *Center* frequency and *Span* are alternative settings:



Remote control:

```
[SENSe<Ch>:] FREQUency: START
[SENSe<Ch>:] FREQUency: STOP
[SENSe<Ch>:] FREQUency: CENTer
[SENSe<Ch>:] FREQUency: SPAN
```

Pwr Bw

The *Pwr Bw* submenu defines the power of the internal signal source and sets the step attenuators and the IF bandwidths.

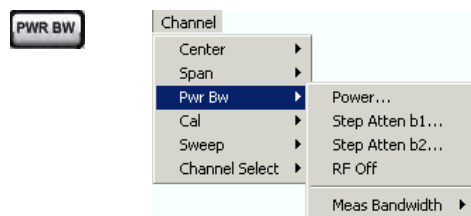

- *Power* defines the power of the internal signal source.
- *Step Atten b1/b2...* sets the attenuation for the received wave b1 or b2 respectively.
- *RF Off* switches the internal and external power sources on (if checked) or off.
- *Meas Bandwidth* selects the bandwidth of the IF measurement filter.

Power

Opens the numeric entry bar to set the power of the internal signal source (channel power).

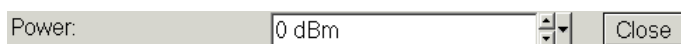

The channel power determines the output power at the test ports; see info below.



The selected channel power applies to all source ports used in the active channel.

Remote control: `SOURce<Ch>:POWer[:LEVel][:IMMediate][:AMPLitude]`

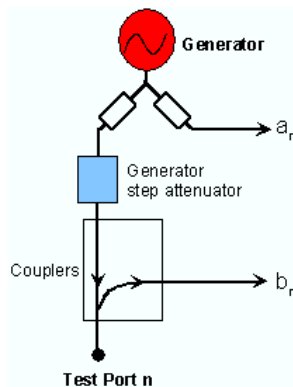

Step Atten b1..., Step Atten b2...

Opens the numeric entry bar to set the attenuation for the received wave b1 or b2 respectively.



The attenuation is used to adjust the received signal level at the port to the input level range of the analyzer in order to avoid damage to the instrument, e.g. if the DUT is a power amplifier. The range of values depends on the analyzer model.

Using a single step attenuation b1 or b2 corresponds to a standard test setup with 0 dB generator attenuation and attenuation of the (amplified) wave received at test port 1/2.

Remote control: `INPut<Pt>:ATTenuation
[SENSe<Ch>:]POWer:ATTenuation ARECeiver | BRECeiver,
<attenuation>`

RF Off

RF Off switches the internal and external power sources on (if checked) or off. Switching off the RF power helps to prevent overheating of a connected DUT while not measurement results are taken.

Remote control: `OUTPut<Ch>[:STATe] ON | OFF`

Meas Bandwidth

Sets the measurement bandwidth of the IF filter. *Meas Bandwidth* opens a submenu (and displays a range of softkeys) to directly select bandwidths between 10 Hz and 500 kHz:

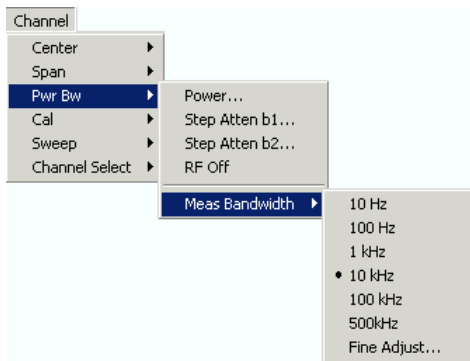

Fine Adjust... opens a dialog to modify the selected measurement bandwidth and the selectivity of the IF filter.

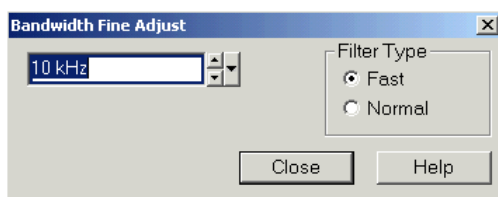

- The input field shows the last IF filter bandwidth selected. The arrow buttons increment and decrement the bandwidth in 1-2-5 steps for each decade. Entered values between the steps will be rounded up, values exceeding the maximum bandwidth rounded down.
- *Filter Type* selects between two types of IF filters: *Fast* filters with short settling time and *Normal* filters with longer settling time but higher selectivity.

The selected bandwidth and selectivity applies to all filters used in the current channel. This makes sense because the measurement speed is limited by the slowest filter in the channel. In *Segmented Frequency* sweeps, the bandwidth and selectivity can be set independently for each segment; see *Define Segments*.



Optimizing the filter settings

A high selectivity (*Filter Type: Normal*) and a small filter bandwidth both suppress the noise level around the measurement frequency and thus increase the dynamic range. On the other hand the time needed to acquire a single measurement point increases for small filter bandwidths and high selectivity. For small bandwidths, the filter settling time, which is inversely proportional to the bandwidth, is responsible for the predominant part of the measurement time.



In general, the system error correction is no longer valid after a change of the IF filter bandwidth. The message Cal? appears in the trace list.

Remote control: [SENSe<Ch>:]BANDwidth|BWIDth[:RESolution]
[SENSe<Ch>:]BANDwidth[:RESolution]SELect

Cal

The *Cal* submenu provides all functions that are necessary to perform a system error correction (calibration).



For an introduction to calibration and calibration types refer to section Calibration Overview in the *System Overview* chapter. See also the *Data Flow* overview in the *System Overview* chapter.

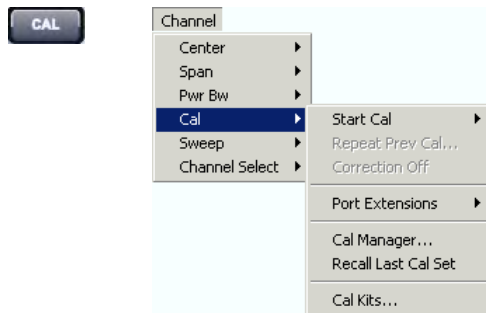

- *Start Cal* opens a submenu to select a new calibration and start the calibration wizard.
- *Repeat Prev Cal* reopens the wizard to repeat and optimize the previous calibration.
- *Correction Off* activates or deactivates the system error correction in the active channel.
- *Port Extensions* provides a selection of length offset parameters to shift the measurement plane.
- *Cal Manager* opens a dialog to store system error correction data to a Cal Pool and to assign correction data to channels.
- *Recall Last Cal Set* loads and activates the setup for which the last calibration was performed.
- *Cal Kits* opens a dialog to manage the calibration kits in use, add new kits and import or export kits.

Start Cal

The *Start Cal* submenu selects the calibrated ports and the calibration type.

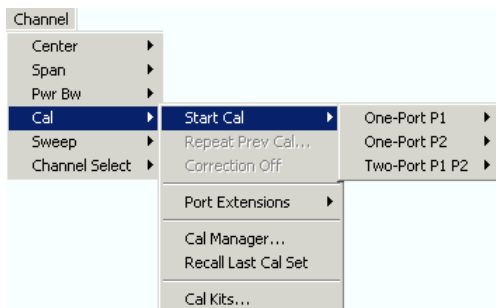

The calibration types depend on the number of test ports of the analyzer. For a four-port unit:

- *One-Port P1* and *One-Port P2* open submenus to select a one-port calibration at test ports PORT 1 and PORT 2, respectively.
- *Two-Port P1 P2* opens a submenu to select a two-port calibration at test ports PORT 1 and PORT 2.

Calibrations can be performed automatically using the Calibration Unit (accessory R&S ZV-Z5x).

Remote control: [SENSe<Ch>:]CORRection:COLLect:METHod:DEFine

One-Port P1, One-Port P2

Opens a submenu to select a one-port calibration at test ports PORT 1 or PORT 2. The two submenus are identical:

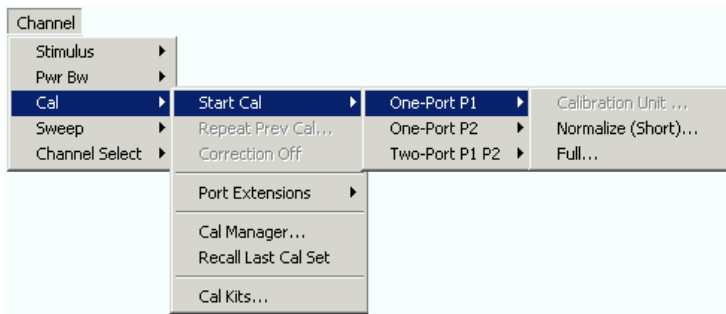

One-port calibrations can be performed automatically or manually.

- *Calibration Unit 75 Ω* starts an automatic full one-port calibration. This function is enabled while the Calibration Unit is connected.

The following menu commands calls up the start dialog of the calibration wizard to start a manual calibration:

- *Normalize (Short)* initiates a normalization using a short standard.
- *Full* initiates a full one-port calibration.

Remote control: [SENSe<Ch>:]CORRection:COLLect:AUTO ' ', <port_no> (for matching analyzer and cal unit ports)
 [SENSe<Ch>:]CORRection:COLLect:AUTO:PORTs (for arbitrary pairs of ports)
 [SENSe<Ch>:]CORRection:COLLect:METhod:DEFine

Two-Port P1 P2

Opens a submenu to select a two-port calibration at test ports PORT 1 and PORT 2:

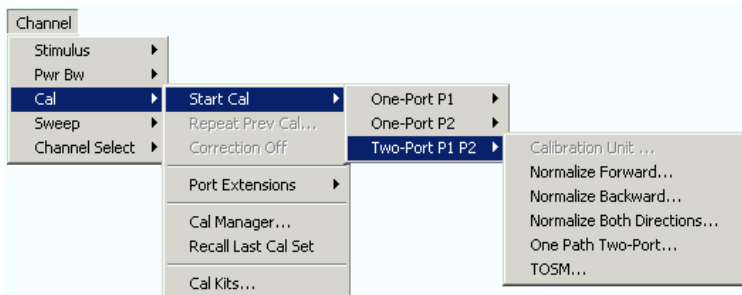

One-port calibrations can be performed automatically or manually.

- *Calibration Unit 75 Ω* starts an automatic tow-port TOSM calibration. This function is enabled while the Calibration Unit is connected.

The following menu commands calls up the start dialog of the calibration wizard to start a manual calibration:

- *Normalization Forward...* initiates a normalization in forward direction (using PORT 1 as a source port and a through standard). This calibration type is preferable (compared to a normalization in both directions), if only forward transmission parameters (S_{21}) are measured.
- *Normalization Backward...* initiates a normalization in backward (reverse) direction (using PORT 2 as a source port and a through standard). This calibration type is preferable (compared to a normalization in both directions), if only reverse transmission parameters (S_{12}) are measured.
- *Normalization Both Directions...* initiates a normalization in forward and backward direction (using

a through standard). This calibration type is preferable (compared to a unidirectional normalization), if both transmission parameters (S_{21} and S_{12}) are measured.

- *One Path Two-Port* initiates a full one-port calibration.
- *TOSM* initiates a Through-Open-Short-Match (12-term) calibration

Remote control: [SENSe<Ch>:]CORRection:COLLect:AUTO ' ', <port_no> (for matching analyzer and cal unit ports)
 [SENSe<Ch>:]CORRection:COLLect:AUTO:PORTs (for arbitrary pairs of ports)
 [SENSe<Ch>:]CORRection:COLLect:METhod:DEFine

Guided Calibration

The analyzer provides a calibration wizard for each calibration type. The guided calibration consists of the following steps:

- *Select Physical Port Connectors* and calibration kits at all calibrated ports.
- *Measure Standards*: Acquire measurement data for all standards required for the selected calibration type.
- Calculate the system error correction data (error terms) from the measurement data of the standards and apply the result to the active channel.



A successful calibration will supersede the previous calibration, discarding all previous system error correction data. To keep older correction data you can transfer them into a *Cal Pool* using the *Calibration Manager*.

The system error correction data determined in a calibration procedure are stored on the analyzer. You can read these correction data using the remote control command [SENSe<Ch>:]CORRection:CDATa. You can also replace the correction data of the analyzer by your own correction data sets.

Select Connectors

The first dialog of the calibration wizard displays a table to select the connectors and calibration kits for all calibrated physical ports.

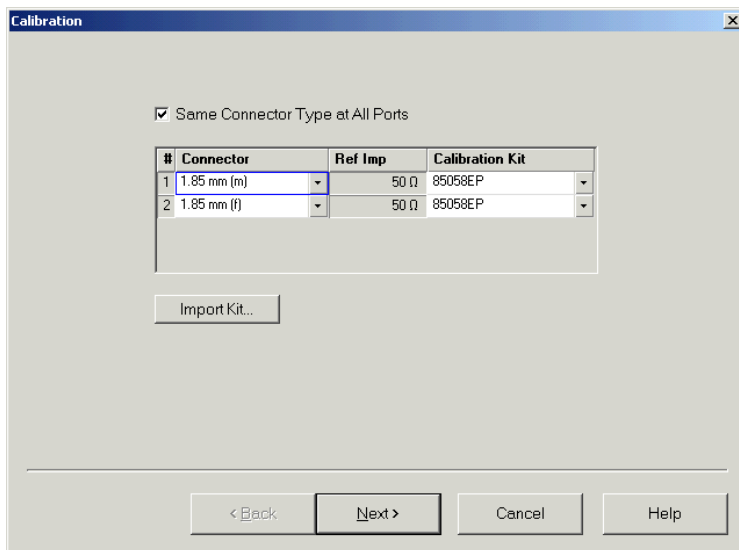

The table contains the following rows:

- **Physical Port Number #**

The ports (and therefore the number of table rows) are determined by the active calibration type selected in the *Start Cal* submenu.

- **Connector**

provides a drop-down list to select the connector type An (f) behind the connector type denotes female connectors, an (m) denotes male connectors. Symmetric (sexless) connectors (e.g. PC7) are not labeled. User-defined connectors can be added or removed in the Available Connector Types dialog, which is opened from the Channel – Cal – Cal Kits dialog. at the port and its gender. If *Same Connector at All Ports in Table* is active, the connector types at all ports (but not their gender) are always adjusted to the current selection. The default selection depends on the analyzer model, e.g. on the reference impedance (50 Ω / 75 Ω).

- *Ref Imp* shows the reference impedance for the selected connector.

- **Calibration Kits**

provides a drop-down list to select a calibration kit. The list contains all calibration kits available for the selected connector type. The assignment of a calibration kit to a connector type must be the same for all physical ports: If a calibration kit is changed, the analyzer automatically assigns the new kit to all ports with the same connector type.



Completeness: *The selected calibration kit must contain all standards needed for the active calibration type. If it doesn't the analyzer displays an error message.*



Waveguide cutoff: *If a user-defined waveguide connector is assigned to one of the calibrated ports, then the start frequency of the active channel must be above the waveguide cutoff. Otherwise the analyzer displays an error message.*

Import Kit opens the *Import Calibration Kit* dialog to load and (if desired) activate a cal kit file.

Next > opens the second dialog of the wizard to continue the calibration procedure.



If the calibrated channel has already been assigned to a cal group, the correction data overwrites the cal group data, so the new calibration will affect all channels assigned to the cal group. The network analyzer generates a notice message "New calibration will overwrite cal pool!" when opening the calibration wizard.



Checks on switching to the next dialog

When the *Next>* button is pressed the analyzer checks the calibration kits and the matching of the calibration standards and possibly displays a notice box (confirm with OK). This happens if one of the calibration kits is described by ideal kit parameters or typical values.

Remote control: [SENSe<Ch>:]CORRection:COLLect:CONNection<port_no>
 [SENSe<Ch>:]CORRection:COLLect:SCONNection<port_no>
 [SENSe<Ch>:]CORRection:CKIT:<conn_type>:SELEct "<Ckit_Name>"

Measure Standards

The last dialog of the calibration wizard is used to perform the necessary measurements of standards and to calculate the correction data.

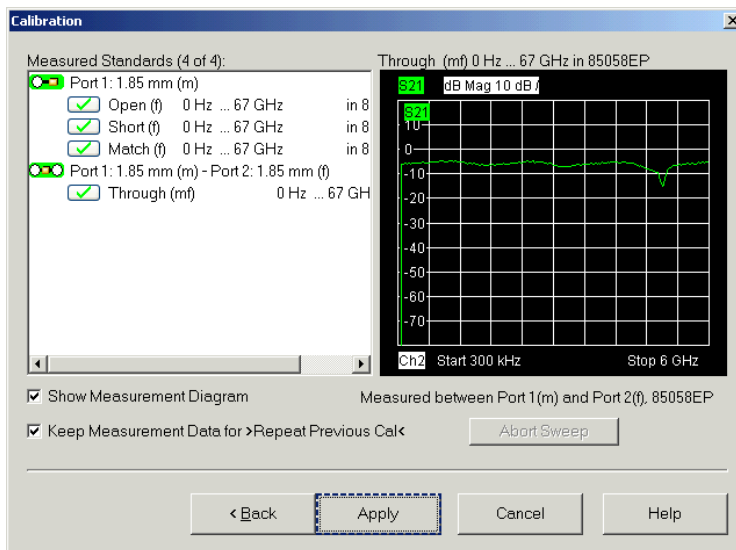

The dialog displays the list of measured standards compiled in the previous dialog. The list is complete: All standards must be measured to perform the selected calibrations.



Structure of the Measured Standards list

The list of measured standards has a tree structure.

- The first level contains all physical ports where one-port (reflection) measurements are required and all physical port combinations where two-port (transmission) measurements must be performed.
- The second level contains check boxes for the standards to be measured at each port or port combination.
- For a sliding match, a third level contains check boxes for the different positions of the sliding element.



To expand the list of a physical port symbol, click the symbol, to collapse the list, double-click the symbol.

Calibrations using a match or sliding match

If the calibration kit contains a sliding match standard, the *Sliding Match* appears in the *Measured*

Standards list whenever the selected calibration type requires a *Match*. A click on the node expands the check boxes for the different positions of the load element. The number of different positions is defined in the *User Interface* tab of the *System Configuration* dialog.

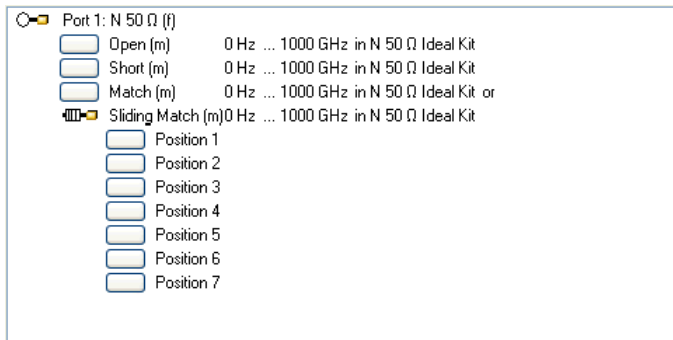

The sliding match is a one-port standard consisting of an air line with a movable, low-reflection load element (sliding load). This standard is used because a no perfect match is available over a wide frequency range. However, a series of measurements at a given frequency with equal mismatch and varying phase yields reflection factors that are located on a circle in the Smith chart. The center of this circle corresponds to perfect match. The network analyzer determines and further corrects this match point following I. Kása's circle-fitting algorithm.

To obtain the reflection coefficient for a perfectly matched calibration standard, the sliding load must be measured at least at 3 positions which should be unequally spaced to avoid overlapping data points. Increasing the number of positions to 4 – 6 can improve the accuracy. Moreover it is recommended to use the predefined load positions of the standard.

The calibration is valid (*Apply* is available) if either the match or three positions of the sliding match have been measured. However, it is often desirable to acquire calibration data from both standards. The analyzer combines the data in an appropriate manner:

- The match results are used up to the lower edge of the specified frequency range of the sliding match (Min Freq).
- The sliding match results are used for frequencies above the Min Freq. In general, the sliding match will provide better results than the match within its specified frequency range.

Checking one of the boxes in the list causes the analyzer to stop the measurement in all channels except the active one and measure the standard according to the active channel settings. The progress of the calibration sweep and the result can be monitored in the diagram. In case of an error (e.g. if the measurement result shows that the calibration standard was not connected properly), *Abort Sweep* immediately terminates the sweep.

When the sweep is completed, a green checkmark appears in the checkbox. Measurements can be repeated as often as desired. Newer results overwrite older measurement data.



Most channel settings remain valid for calibration sweeps.



Checks for the calibration sweep

If the sweep range of the active channel exceeds the validity range of the standard model (defined by *Min Freq* and *Max Freq* in the *Add/Modify Standard* dialog) the analyzer displays a notice box (confirm with *OK*).

The dialog provides further controls:

- *Show Measurement Diagram* displays or hides the diagram to the right of the list of Measured

Standards. Hiding the diagram leaves more space for displaying the characteristics of the measured standards.

- *Keep Measurement Data for >Repeat Previous Cal<* causes the raw measurement data of the standards to be stored after the calibration is completed. This enables the Repeat Prev Cal... command, which can be used to optimize a previous calibration without repeating the measurement of all standards. If Keep Measurement Data... is not active, then the raw measurement data of the standards is deleted and the analyzer only stores the system error correction data. Deleting the raw data saves disk space.
- *Apply* is enabled as soon as data has been acquired for all standards. The button starts the calculation of the system error correction data and closes the calibration wizard. The current instrument settings are stored with the correction data. To avoid incompatibilities, older system error correction data is deleted unless it has been transferred into a Cal Pool using the Calibration Manager.



The *Keep Measurement Data for >Repeat Previous Cal<* setting is valid for the current calibration only. To activate this function in general, use the parameter in the *User Interface* tab of the *System Configuration* dialog (menu *Nwa-Setup – System Config*).



Checks during the calculation of correction data

Incompatibilities between the selected calibration type, the standards and the channel settings may cause the calibration to be inaccurate. The analyzer auto-detects potential sources of errors and displays appropriate, self-explanatory notice boxes.

Remote control: [SENSe<Ch>:]CORRection:COLLect[:ACQuire]:RSAVE
 [SENSe<Ch>:]CORRection:COLLect[:ACQuire]:SElected
 [SENSe<Ch>:]CORRection:COLLect:SAVE
 [SENSe<Ch>:]CORRection:COLLect:DElete ["<cal_name>"]

Calibration Labels

The following labels in the trace list inform you about the status or type of the current calibration.

Label	Meaning
Cal	The system error correction is applied without interpolation. This means that a set of measured correction data is available at each sweep point.
Cal int	The system error correction is applied, however, the correction data for at least one sweep point is interpolated from the measured values. This means that the channel settings have been changed so that a current sweep point is different from the calibrated sweep points. It is not possible to disable interpolation.
Cav	The system error correction uses variable calibration methods to calculate a measurement parameter. This happens for example, if a Z-parameter is calculated from S-parameters which are partly factory calibrated and partly normalized. This can also happen, if the analyzer uses a one port calibration at port 1 and a normalization at port 2.
Ca?	The system error correction is applied, however, the accuracy is questionable because of of the following applies: <ul style="list-style-type: none"> • The attenuator settings during the calibration differ from the attenuator settings during the measurement.

	<ul style="list-style-type: none"> The bandwidth settings during the calibration differ from the bandwidth settings during the measurement. The point delay settings during the calibration differ from the point delay settings during the measurement.
Cal Off !	The system error correction is no longer applied (e.g. turned off by the user). See also Calibration Overview.

Repeat Prev Cal

Reopens the *Measure Standards* dialog of the calibration wizard to repeat and optimize the previous calibration without necessarily repeating the measurement of all standards.

Repeat Prev Cal is active only if *Keep Measurement Data for >Repeat Cal<* in the *Measure Standards* dialog was enabled when the last calibration for the active channel was successfully completed.



Additional conditions for repeating a calibration

Changing the channel settings can cause incompatibilities between the current instrument state and the previous calibration. In particular the following conditions must be met:

- The configuration of all ports needed must be correct (see *Select Connector– Physical Port Number #*).
- The *Sweep Type* must be unchanged.

If incompatible settings occur the analyzer displays an error message and does not repeat the calibration.

Correction Off

Activates or deactivates the system error correction in the active channel. *Correction Off* is active only if a valid system error correction is assigned to the active channel; see *Cal State* in the *Calibration Manager*.



A red label *Cal Off !* appears behind the trace list if the system error correction is switched off; see also *Calibration Overview*.

Remote control: [:SENSe<Ch>]:CORRection:STATe ON | OFF

Port Extensions

The *Port Extensions* submenu defines a length offset and a loss for the test ports. The offset parameters complement the system error correction, compensating for the known length and loss of a (non-dispersive and perfectly matched) transmission line between the calibrated reference plane and the DUT.



Length offset parameters: Definition

The *Delay* is the propagation time of a wave traveling through the transmission line. The *Electrical Length* is equal to the *Delay* times the speed of light in the vacuum and is a measure for the length of transmission line between the standard and the actual calibration plane. For a line with permittivity ϵ_r and mechanical length L_{mech} the delay and the electrical length are calculated as follows:

$$\text{Delay} = \frac{L_{\text{mech}} \cdot \sqrt{\epsilon_r}}{c}; \quad \text{Electrical Length} = L_{\text{mech}} \cdot \sqrt{\epsilon_r}$$

Electrical Length, *Mechanical Length* or *Delay* are coupled parameters. When one of them is changed, the other two follow.

The velocity factor is $1/\sqrt{\epsilon_r}$ and is a measure for the velocity of light in a dielectric with permittivity ϵ_r relative to the velocity of light in the vacuum (velocity factor < 1). Permittivity and velocity factor are coupled parameters.

For a non-dispersive DUT, the delay defined above is constant over the considered frequency range and equal to the negative derivative of the phase response with respect to the frequency (see mathematical relations). The length offset parameters compensate for a constant delay, which is equivalent to a linear phase response.

If a dispersive connector type (i.e. a waveguide; see *Offset Model* dialog) is assigned to a test port that is related to a particular quantity, then the phase of the quantity is calculated taking dispersion effects into account.

Loss parameters: Definition

The loss L is the attenuation of a wave traveling through the offset transmission line. In logarithmic representation, the loss can be modeled as the sum of a constant and a frequency-dependent part. The frequency dependence is essentially due to the skin effect; the total loss can be approximated by an expression of the following form:

$$\text{Loss}(f) = [\text{Loss}(f_{\text{ref}}) - \text{Loss}_{\text{DC}}] \cdot \sqrt{\frac{f}{f_{\text{ref}}}} + \text{Loss}_{\text{DC}}$$

The DC loss Loss_{DC} , the reference frequency f_{ref} , and the loss at the reference frequency $\text{Loss}(f_{\text{ref}})$ are empirical parameters for the transmission lines connected to each port which can be entered into any of the dialogs in the *Offset* menu. For a lossless transmission line, both Loss_{DC} and $\text{Loss}(f_{\text{ref}})$ are zero. In practice, $\text{Loss}(f_{\text{ref}})$ often represents the dominant contribution so that Loss_{DC} can be set to zero.

Offset parameters: Application and effect

Offset parameters can be particularly useful if the reference plane of the calibration cannot be placed directly at the DUT ports, e.g. because the DUT has non-coaxial ports and can only be measured in a test fixture. Offset parameters can also help to avoid a new complete system error correction if a cable with known properties has to be included in the test setup.

A positive length offset moves the reference plane of the port towards the DUT, a negative offset moves the reference plane away from the DUT. The offset parameters cannot compensate for a possible mismatch in the test setup.

- A positive length offset moves the reference plane of the port towards the DUT, which is equivalent to deembedding the DUT from a (perfectly matched) transmission line at that port.
- A negative offset moves the reference plane away from the DUT, which is equivalent to embedding the DUT into a (perfectly matched) transmission line at that port.

In contrast to the embedding/deembedding procedure, the offset parameters cannot compensate for a possible mismatch in the test setup.

Each offset parameter is assigned to a particular port. The delay parameters affect the phase of all measured quantities related to this port; the loss parameters affect their magnitude. An offset at port 1 affects the S-parameters S_{11} , S_{21} , S_{12} . Some quantities depend on the whole of all S-parameters, so they are all more or less affected when one S-parameter changes due to the addition of an offset length.



To account for the propagation in both directions, the phase shift of a reflection parameter due to a given length offset is twice the phase shift of a transmission parameter. If, at a frequency of 300 MHz, the electrical length is increased by 250 mm ($\lambda/4$), then the phase of S_{21} increases by 90 deg, whereas the phase of S_{11} increases by 180 deg. Equivalent relations hold for the loss.

If the trace is displayed in *Delay* format, changing the offset parameters simply shifts the whole trace in vertical direction. The sign of the phase shift is determined as follows:

- A positive offset parameter causes a positive phase shift of the measured parameter and therefore reduces the calculated group delay.
- A negative offset parameter causes a negative phase shift of the measured parameter and therefore increases the calculated group delay.

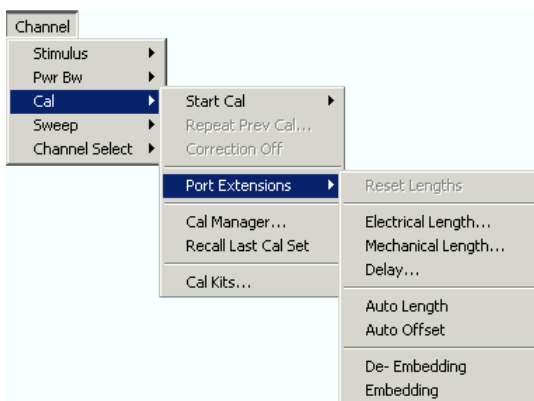

The offset parameters can be defined separately for each port.

- *Reset Lengths* restores the default values for all length offsets, i.e. it resets all values to zero. The (de-)embedding parameters are left unchanged.
- *Electrical Length* defines electrical length offsets and loss parameters at all test ports.
- *Mechanical Length* defines mechanical length offsets and loss parameters at all test ports.
- *Delay* defines delay times and loss parameters at all test ports.
- *Auto Length* determines a length offset for the receiving port of the active measured quantity with the condition that the residual group delay of the active trace is minimized.
- *Auto Offset* determines a length offset and loss for the receiving port of the active measured quantity with the condition that the residual group delay of the active trace is minimized and the measured loss is minimized as far as possible across the entire sweep range.
- *De-Embedding* and *Embedding* open configuration dialogs for (de-)embedding transformation networks.



The Zero Delay at Marker function overwrites the Offset parameters.

Remote control (for Reset Offsets): `[SENSe<Ch>:]CORRection:OFFSet<port_no>[:STATe] <numeric _value>`

Electrical Length

Opens a dialog to define the length offset parameters for the physical test ports as electrical lengths. The dialog also contains the DC loss, the loss at the reference frequency $\text{Loss}(f_{\text{ref}})$; and the reference frequency f_{ref} , see *Loss parameters: Definition* above.

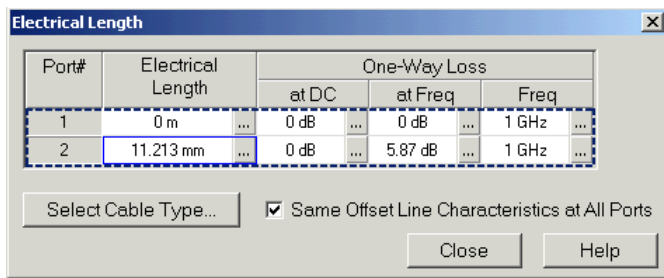

The dialog provides the following additional control elements:

- *Select Cable Type* opens a dialog to use the parameters of a standard (predefined) cable type or add a cable type with arbitrary parameters.
- If *Same Offset Line Characteristics at All Ports* is selected, the selected cable type is applied to all ports.

Remote control: [SENSE<Ch>:]CORRection:EDElay<port_no>:ELEngth
 [SENSE<Ch>:]CORRection:LOSS<port_no>
 [SENSE<Ch>:]CORRection:LOSS<port_no>:FREQuency
 [SENSE<Ch>:]CORRection:LOSS<port_no>:OFFSet

Mechanical Length

Opens a dialog to define length offset parameters for the physical test ports as mechanical lengths and permittivities. The dialog also contains the DC loss, the loss at the reference frequency Loss(f_{ref}); and the reference frequency f_{ref} ; see *Loss parameters: Definition* above.

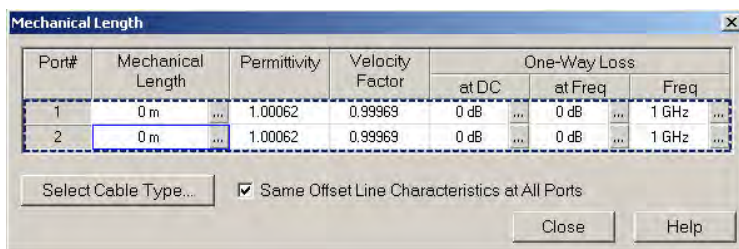

The *Mechanical Length* dialog contains the three editable columns *Mech. Length*, *Permittivity* (ϵ_r) and *Velocity Fact* $1/\sqrt{\epsilon_r}$; see *Offset parameters: Definition* above. Permittivity and velocity factor are coupled parameters. The dialog provides the following additional control elements:

- *Select Cable Type* opens a dialog to use the parameters of a standard (predefined) cable type or add a cable type with arbitrary parameters.
- If *Same Offset Line Characteristics at All Ports* is selected, the selected cable type is applied to all ports.



Select *Same Offset Line Characteristics at All Ports* to change the permittivity or velocity factor for all ports by entering a single value.

Remote control: [SENSE<Ch>:]CORRection:EDElay<port_no>:DISTance
 [SENSE<Ch>:]CORRection:EDElay<port_no>:DIElectric
 [SENSE<Ch>:]CORRection:LOSS<port_no>
 [SENSE<Ch>:]CORRection:LOSS<port_no>:FREQuency
 [SENSE<Ch>:]CORRection:LOSS<port_no>:OFFSet

Delay

Opens a dialog to define the length offset parameters for the physical test ports as delays. The dialog also contains the DC loss, the loss at the reference frequency $\text{Loss}(f_{\text{ref}})$; and the reference frequency f_{ref} ; see *Loss parameters: Definition* above.

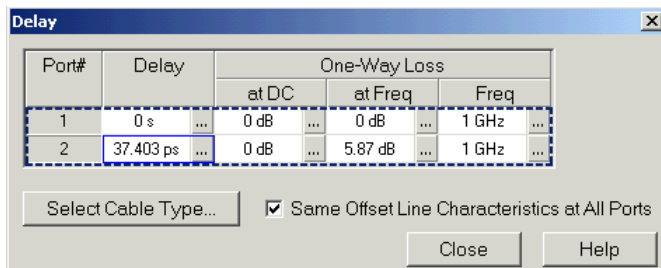

The dialog provides the following additional control elements:

- *Select Cable Type* opens a dialog to use the parameters of a standard (predefined) cable type or add a cable type with arbitrary parameters.
- If *Same Offset Line Characteristics at All Ports* is selected, the selected cable type is applied to all ports.

Remote control: [SENSE<Ch>:]CORREction:EDElay<port_no>[:TIME]
 [SENSE<Ch>:]CORREction:LOSS<port_no>
 [SENSE<Ch>:]CORREction:LOSS<port_no>:FREQuency
 [SENSE<Ch>:]CORREction:LOSS<port_no>:OFFSet

Auto Length

Adds an electrical length offset to the active test port with the condition that the residual delay of the active trace (defined as the negative derivative of the phase response) is minimized across the entire sweep range. If *Delay* is the selected trace format, the entire trace is shifted in vertical direction and centered around zero. In phase format, the *Auto Length* corrected trace shows the deviation from linear phase. The effect of a dispersive connector type (i.e. a waveguide; see *Offset Model* dialog) assigned to the receiving port of the measured quantity is taken into account.

If the active trace shows an S-parameter S_{ij} , then *Auto Length* adds a length offset at port i .



Preconditions for Auto Length, effect on measured quantities and exceptions

Auto Length is enabled if the measured quantity contains the necessary phase information as a function of frequency, and if the interpretation of the results is unambiguous:

- A frequency sweep must be active.
- The measured quantity must be an S-parameter, a converted impedance or a converted admittance.

The effect of *Auto Length* on S-parameters is to eliminate a linear phase response as described above. The magnitude of the measured quantity is not affected. Converted admittances or impedances are calculated from the corresponding *Auto Length* corrected S-parameters. Stability factors are not derived from a single S-parameter, therefore *Auto Length* is disabled.



Use *Zero Delay at Marker* to set the delay at a special trace point to zero.

Remote control: [SENSE<Ch>:]CORREction:EDElay<port_no>:AUTO ONCE

Auto Offset

Determines all offset parameters such that the residual group delay of the active trace (defined as the negative derivative of the phase response) is minimized and the measured loss is minimized as far as possible across the entire sweep range. *Auto Offset* involves a two-step procedure:

- An *Auto Length* correction modifies the phase of the measured quantity, minimizing the residual group delay. The magnitude of the measured quantity is not affected.
- The auto loss correction modifies the magnitude of the measured quantity, leaving the (auto length-corrected) phase unchanged.



Preconditions for Auto Offset, effect on measured quantities and exceptions

Auto Offset is enabled if the measured quantity contains the necessary phase information as a function of the frequency, and if the interpretation of the results is unambiguous:

- A frequency sweep must be active.
- The measured quantity must be an S-parameter, a converted impedance or a converted admittance.

The effect of *Auto Offset* on S-parameters is to eliminate a linear phase response and account for a loss as described above. Converted admittances or impedances are calculated from the corresponding *Auto Offset* corrected S-parameters. Stability factors are not derived from a single S-parameter, therefore *Auto Offset* is disabled.

Calculation of loss parameters

The loss is assumed to be given in terms of the DC loss Loss_{DC} , the reference frequency f_{ref} , and the loss at the reference frequency $\text{Loss}(f_{\text{ref}})$. The formula used in the *Auto Loss* algorithm is similar to the formula for manual entry of the loss parameters (see *Loss parameters: Definition*). The result is calculated according to the following rules:

- The reference frequency f_{ref} is kept at its previously defined value (default: 1 GHz).
- The DC loss c is zero except for S-parameters with maximum dB magnitude larger than -0.01 dB.
- Auto Offset for S-parameters centers the corrected dB magnitude as close as possible around 0 dB.

The resulting offset parameters are displayed in the *Electrical Length*, *Mechanical Length*, and *Delay* dialogs.

Remote control: [SENSE<Ch>:]CORRection:LOSS<port_no>:AUTO ONCE

Deembedding and Embedding

The *Embedding...* and *Deembedding...* dialogs define virtual networks (transformation networks) to be added to/removed from the measurement circuit for a DUT.



Embedding a DUT into a matching network

To be integrated in application circuits, high-impedance components like Surface Acoustic Wave (SAW) filters are often combined with a matching network. To obtain the characteristics of a component with an added matching network, both must be integrated in the measurement circuit of the network analyzer. The figure below shows a 2-port DUT that is combined with a real matching circuit consisting of a serial capacitor and a shunt inductor.

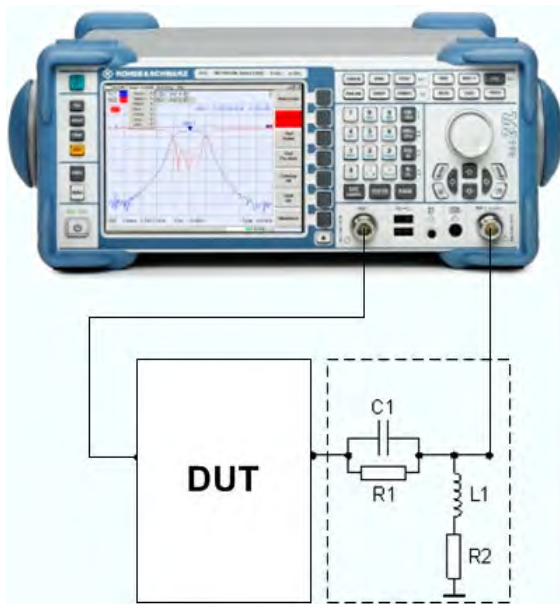

The idea of virtual embedding is to simulate the matching network and avoid using physical circuitry so that the analyzer ports can be directly connected to the input and output ports of the DUT. The matching circuit is taken into account numerically. The analyzer measures the DUT alone but provides the characteristics of the DUT, including the desired matching circuit. This method provides a number of advantages:

- The measurement uncertainty is not impaired by the tolerances of real test fixtures.
- There is no need to fabricate test fixtures with integrated matching circuits for each type of DUT.
- Calibration can be performed at the DUT's ports. If necessary (e.g. for compensating for the effect of a test fixture) it is possible to shift the calibration plane using length offset parameters.



Deembedding a DUT

Deembedding and embedding are inverse operations: A deembedding problem is given if an arbitrary real network connected to the DUT is to be virtually removed in order to obtain the characteristics of the DUT alone. Deembedding is typically used for DUTs which are not directly accessible because they are inseparably connected to other components, e.g. for MMICs in a package or connectors soldered to an adapter board.

To be numerically removed, the real network must be described by a set of S-parameters or by an equivalent circuit of lumped elements. Deembedding the DUT effectively extends the calibration plane towards the DUT ports, enabling a realistic evaluation of the DUT without the distorting network. Deembedding can be combined with length offset parameters.

The simplest case of one-port deembedding can be depicted as follows:

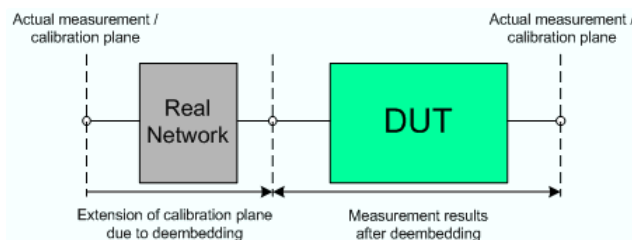

The embedding/deembedding function in the *Virtual Transform* menu has the following characteristics:

- Two-port networks can be applied to any of the DUT ports 1 or 2.

- Transformation networks can be defined by a set of S-parameters stored in a Touchstone file or by an equivalent circuit with lumped elements.
- The same networks are available for embedding and deembedding.

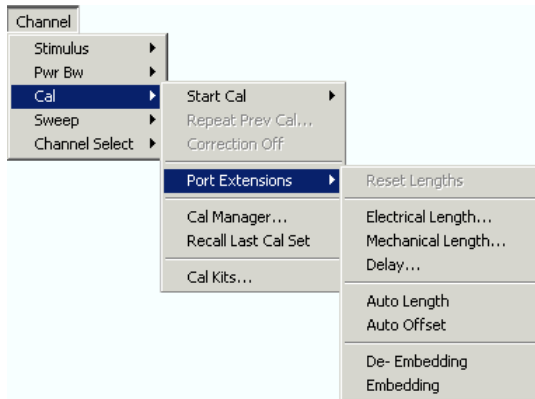

- *De-embedding* opens the configuration dialog and activates or deactivates deembedding.
- *Embedding* opens the configuration dialog and activates or deactivates embedding.

Embedding/Deembedding

Selects a 2-port transformation network for (de-)embedding, defines its parameters, assigns it to a physical port and enables (de-)embedding. The two dialogs for deembedding and embedding are identical except for their inverse effect.

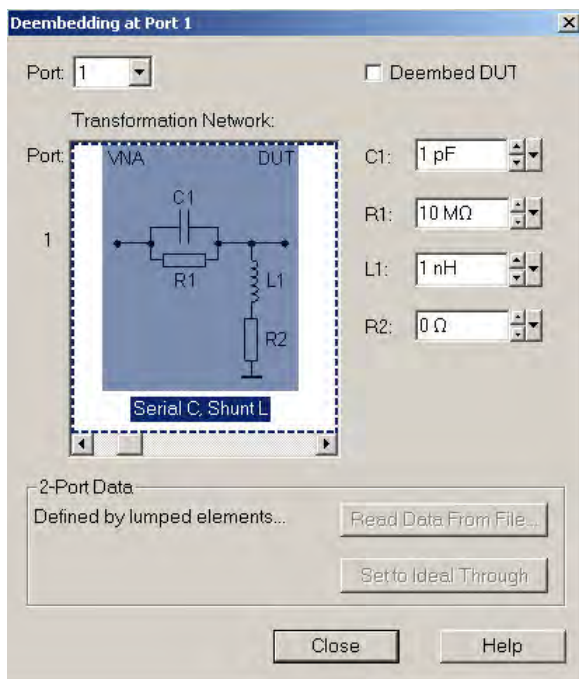

The dialogs contain the following control elements:

- *Port* is the analyzer port for the added or removed circuit. The transformation networks are defined such that the analyzer test port is connected to the left of the circuit; the DUT port is on the right side.
- *(De-)embed DUT* enables or disables the (de-)embedding function.

- *Transformation Network* contains all available 2-port networks (see below). Networks are either defined by lumped elements or by means of imported S-parameter data. The active network appears in inverse colors. The element parameters (C, R, L) for the selected network are displayed on the right side.
- *Read Data From File...* is enabled as long as the *2-Port Data* network is active. This network is defined by its S-parameters stored in a two-port Touchstone file (*.s2p). No additional parameters are required.
- *Set to Ideal Through* is enabled as long as the *2-Port Data* network is active. An imported S-parameter set is replaced by the S-parameters of an ideal through connection, which eliminates the transformation network.



Circuit models for 2-port networks

The lumped element 2-port transformation networks for (de-)embedding consist of the following two basic circuit blocks:

- A capacitor C connected in parallel with a resistor.
- An inductor L connected in series with a resistor.

The 2-port transformation networks comprise all possible combinations of 2 basic blocks, where one block represents a serial, the other a shunt element. In the default setting the resistors are not effective, since the serial Rs are set to 0 Ω , the shunt Rs are set to 10 M Ω .

- The first network is defined by its S-parameters stored in an imported two-port Touchstone file (*.s2p). No additional parameters are required.

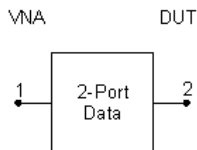

The following networks are composed of a serial C or L (as seen from the test port), followed by a shunt C or L. They are named *Serial C*, *Shunt C / Serial C*, *Shunt L / Serial L*, *Shunt C / Serial L*, *Shunt L*.

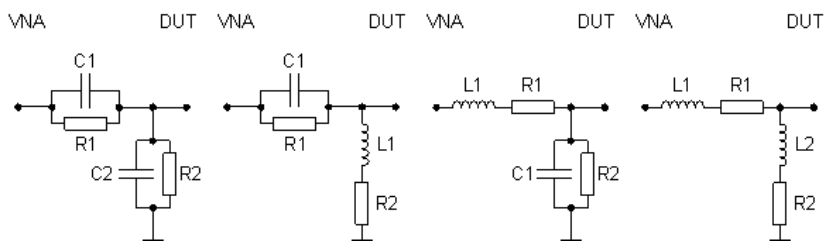

- The following networks are composed of a shunt C or L (as seen from the analyzer port), followed by a serial C or L. They are named *Shunt C*, *Serial C / Shunt C*, *Serial L / Shunt L*, *Serial C / Shunt L*, *Serial L*.

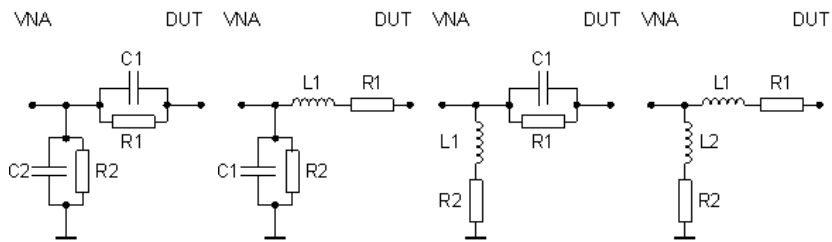
**Remote control:**

```
CALCulate<Ch>:TRANSform:VNETwork:SENDED...
MMEMemory:LOAD:VNETworks<Ch>:SENDED:DEEMbedding<Ph_pt>
'<file_name>'
MMEMemory:LOAD:VNETworks<Ch>:SENDED:EMBedding<Ph_pt> '<file_name>'
```

Cal Manager

Opens a dialog to store system error correction and power correction data to the cal pool and to assign stored correction data to channels.



Cal pool

The cal pool is a collection of correction data sets (cal groups) that the analyzer stores in a common directory *C:\Rohde&Schwarz\NWA\Calibration\Data*. Cal groups in the pool can be applied to different channels and setups. Each cal group is stored in a separate file named *<CalGroup_name>.cal*. The cal group name can be changed in the *Calibration Manager* dialog.

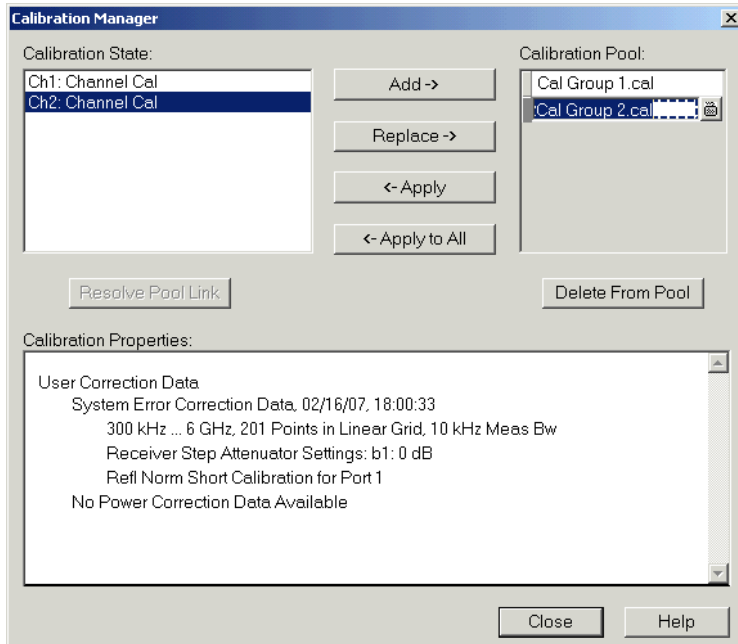

The *Calibration Manager* dialog contains three main panels:

- *Calibration State* lists all channels and their current calibration state.
- *Calibration Pool* contains a list of all stored correction data sets.
- *Calibration Properties* displays the basic channel settings, the *System Error Correction Data*, and

the *Power Correction Data* available for the channel selection in the *Calibration State* panel.



Calibration states

One of the following calibration states is assigned to each of the channels listed in the *Cal State* table:

- No Calibration No specific channel correction data is available. The factory system error correction is used. This is the default situation when a new setup is created (Nwa-File – New).
- Channel Cal A system error correction and/or power correction with channel-specific correction data is active. A new calibration of the channel affects the channel-specific correction data only.
- Uses <CalGroup> A system error correction with one of the correction data sets (cal groups) stored in the cal pool is active. A new calibration of the channel replaces the correction data in the cal pool and may affect several channels, see below.

The channel calibration of the active channel is also applied to a new channel created via *New Add Chan + Trace* indicates that the system error correction for the channel has been deactivated using *Correction Off*.



If a new calibration is performed for a channel assigned to a cal group (marked as Uses <CalGroup>), the correction data overwrites the cal group data, so the new calibration will affect all channels assigned to the cal group. The network analyzer generates a notice message "New calibration will overwrite cal pool!" when opening the first dialog of the calibration wizard.

The buttons in the upper half of the dialog are used to modify the Cal Pool and apply pool data to channels:

- *Copy >>* copies the correction data (*Channel Cal*) of the selected channel to the cal pool, generating a new pool member (cal group).
- *Apply* assigns the selected cal group to the selected channel.
- *Apply All* assigns the selected cal group to all channels in the *Cal State* table.
- *Resolve Pool Link* deletes the assignment between the selected channel (*Ch<n>: Uses <CalGroup_name>*) and the cal group. The correction data from the cal group *<CalGroup_name>* is used as a channel calibration for *<Ch1>*, the *Calibration State* list displays *Ch<n>: Channel Cal*.
- *Delete From Pool* deletes the selected cal group.



You can apply any correction data set (cal group) from the Cal Pool to several channels, which may belong to different setups. When doing make sure that the port configuration of the channels (connectors, state, ...) and the cal group are compatible. You can also use a cal group stored in the Cal Pool to define a channel-specific calibration. Apply the cal group to the channel and click Resolve Pool Link.

```
Remote control: MMEMory:STORe:CORRection <Ch>, "<file_name>"
MMEMory:LOAD:CORRection <Ch>, "<file_name>"
MMEMory:LOAD:CORRection:RESolve <Ch>, "<file_name>"
MMEMory:DELeTe
"C:\R_S\Instr\user\Nwa\Calibration\Data\<file_name>"
MMEMory:DELeTe:CORRection "<file_name>"
[SENSe<Ch>:]CORRection:DATE?
[SENSe<Ch>:]CORRection:DATA:PARAmeter?
[SENSe<Ch>:]CORRection:SState?
```

Recall Last Cal Set

- Loads and activates the setup for which the last calibration was performed. If the last calibrated

setup is already active, nothing is changed.

- The calibrated setups are automatically stored in the `C:\R_S\Instr\user\Nwa\Calibration\RecallSets` directory. A message box pops up if the directory is empty, e.g. because no calibration was performed yet.

Automatic Calibration (Procedure)

A *Calibration Unit* is an integrated solution for automatic system error correction of vector network analyzers. For an overview of available types refer to section Automatic Calibration (Introduction). The use of the calibration units is described below.



Attention!

Please observe the safety instructions in the "Technical Information" provided with the calibration unit to avoid any damage to the unit and the network analyzer. Safety-related aspects of the connection and operation of the units are also reported in the sections below.

Connecting the Calibration Unit to the Network Analyzer

The calibration unit provides two N 75 Ω (f) connectors.

To connect the unit...

- Switch on and start-up your network analyzer.
- To protect your equipment against ESD damage use the wrist strap and grounding cord supplied with the instrument and connect yourself to ground. GND
- Connect the USB type A connector of the USB cable to any of the USB type A connectors on the front panel of the analyzer. Connect the USB type B connector of the USB cable to the USB type B connector of the calibration unit. You can also connect the unit before switching on the analyzer.
- Wait until the operating system has recognized and initialized the new hardware. When the unit is connected for the first time, this may take longer than in normal use.

The unit is ready to be used, see *Performing an Automatic Calibration* below.

**Note:**

- The calibration unit is intended for direct connection to ZVB network analyzers following the procedure described above. You can also connect the unit before switching on the analyzer. Do not connect the unit to other USB hosts, e.g. a PC, or insert any USB hubs between the analyzer and the unit, as this may cause damage to the unit or the host.
- You can connect only one calibration unit at a time. However, you can simultaneously connect a cal unit and another device (mouse, USB memory stick etc.) to the USB connectors of the analyzer.
- An unused calibration unit may remain connected to the USB port while the network analyzer is performing measurements. It must be disconnected during a firmware update.
- It is safe to connect or disconnect the calibration unit while the network analyzer is operating. Never connect or disconnect the unit while data is being transferred between the analyzer and the unit. Never connect the unit during a firmware update.

Performing an Automatic Calibration

After connection and initialization, you can use the calibration unit as follows:

- Connect the analyzer ports you wish to calibrate (one/two ports for a one/two-port calibration) to arbitrary ports of the calibration unit. If you connect just one cal unit port, terminate the other port with a 50 Ω match.
- Perform the automatic calibration for the selected number of ports using the *S-Parameter Wizard* or the *Start Calibration* menu.
- Remove the test cables from the unit, connect your DUT instead and perform calibrated measurements.



The assignment between the analyzer ports and the cal unit ports is detected automatically. If auto-detection fails (e.g. because of a high attenuation in the signal path), connect matching port numbers and click *Default Port Assignment* at the beginning of the calibration process.



Accuracy considerations

To ensure an accurate calibration, please observe the following items:

- Unused ports of the calibration unit must be terminated with a 50 Ω match.
- No adaptors must be inserted between the calibration unit and the test ports.
- After connecting the unit to the USB port, allow for a sufficient warm-up time (see "*Specifications*") before starting the calibration.
- Highest accuracy is achieved if the input power at the cal unit ports is approx. -10 dBm. This corresponds to the source power of the R&S ZVL after a preset of the instrument. If the test setup contains a large attenuation, increase the source power to compensate for the attenuation.

**Attention!**

The maximum RF input power of the calibration unit is beyond the RF output power range of the analyzer, so there is no risk of damage if the device is directly connected to the test ports. If you use an external power amplifier, make sure that the maximum RF input power of the calibration unit quoted in the data sheet is never exceeded.

The calibration type depends on the number of ports. If a single port is calibrated, the analyzer uses full one-port calibration. For 2 ports, the analyzer provides the following options:

- A TOSM calibration for the two ports.
- One or two full one-port calibrations.

```
Remote control [SENSe<Ch>:]CORRection:COLLect:AUTO
: [SENSe<Ch>:]CORRection:COLLect:AUTO:CKIT
: [SENSe<Ch>:]CORRection:COLLect:AUTO:PORTs
: [SENSe<Ch>:]CORRection:COLLect:AUTO:PORTs:CONNectiOn?
```

Calibration Procedure

The automatic calibration is started on clicking *Calibration Unit* in the *Start Calibration* menu. The *Calibration Unit* dialog shows the parameters of the cal unit, the port assignment, and the progress of the calibration procedure.

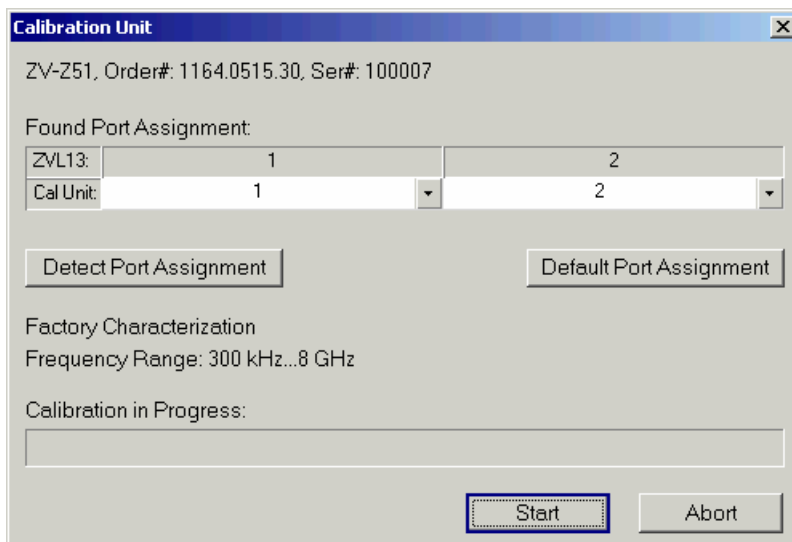

In the dialog, you can:

- *Detect* the current *Port Assignment* between the analyzer and the connected calibration unit.
- Restore the *Default Port Assignment* (port 1 / 2 of the analyzer to port 1 / 2 of the cal unit). This is important if the automatic detection of the port assignment fails.
- *Start* the necessary calibration sweeps. The calibration is started automatically if automatic port detection is successful and the cal unit temperature is within the validity range.

- Restore the *Default Port Assignment* (port 1 / 2 of the analyzer to port 1 / 2 of the cal unit). This is important if the automatic detection of the port assignment fails.
- *Start* the necessary calibration sweeps. The calibration is started automatically if automatic port detection is successful and the cal unit temperature is within the validity range.
- *Abort* an ongoing calibration sweep.

The *Calibration Unit* dialog is closed automatically when all standards have been measured, the system error correction data has been calculated, and the result is applied to the active channel. The network analyzer is ready to perform calibrated measurements.



If you accidentally connect a calibration unit which is not suited for R&S ZVL network analyzers (e.g. one of the cal unit types for R&S ZVA/B analyzers) the analyzer generates an error message, stating that the characterization of the cal unit is not sufficient.

```
Remote control [SENSe<Ch>:]CORRection:COLLect:AUTO
: [SENSe<Ch>:]CORRection:COLLect:AUTO:CKIT
: [SENSe<Ch>:]CORRection:COLLect:AUTO:PORTs
: [SENSe<Ch>:]CORRection:COLLect:AUTO:PORTs:CONNection?

SYSTem:COMMUnicate:RDEVice:AKAL:ADDReSS
SYSTem:COMMUnicate:RDEVice:AKAL:ADDReSS:ALL?

SYSTem:COMMUnicate:AKAL:CONNection
SYSTem:COMMUnicate:AKAL:MMEMory[:STATe]

MMEMory:AKAL:FACTory:CONVeRSion
```

Cal Kits

- Opens a dialog to manage the calibration kits in use, add new kits and import or export kits.



Calibration kits

A calibration kit is a set of physical calibration standards for a particular connector type. The magnitude and phase response of the calibration standards (i.e. their S-parameters) must be known or predictable within a given frequency range.

The standards are grouped into several types (open, through, match,...) corresponding to the different input quantities for the analyzer's error models. The standard type also determines the equivalent circuit model used to describe its properties. The circuit model depends on several parameters that are stored in the cal kit file associated with the calibration kit.

As an alternative to using circuit models, it is possible to describe the standards by means of S-parameter tables stored in a file.

The analyzer provides a large number of predefined cal kits but can also import cal kit files and create new kits:

- A selection of predefined kits with different types of parameters is available for all connector types. The parameters of these kits are displayed in the *Add/Modify Standards* dialog, however, it is not possible to change or delete the kits.
- Imported and user-defined kits can be changed in the *Calibration Kits* dialog and its various sub-dialogs.

Calibration kits and connector types are global resources; the parameters are stored independently and available irrespective of the current setup.

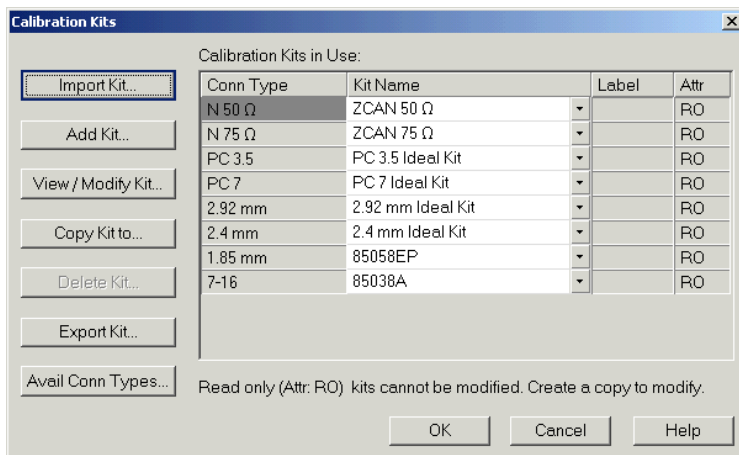

The *Calibration Kits* dialog contains a series of buttons, each of them opening a dialog:

- *Import Kit* imports a cal kit file containing the parameters for a new calibration kit. It is possible to load several kits, so the analyzer asks whether to set the imported calibration kit active.
- *Add Kit* combines different standards to form a new calibration kit.
- *View/ Modify Kit* adds or deletes standards in an imported or user-defined calibration kit and/or changes their parameters.
- *Copy Kit to...* creates a copy of the selected calibration kit. The cal kit data is stored in the internal memory and can be exported to a cal kit file using *Export Kit*.
- *Delete Kit* removes an imported or user-defined kit from the list of *Calibration Kits in Use*.
- *Export Kit* exports calibration kit data to a cal kit file.
- *Avail Conn Types* adds or deletes connector types.

The *Calibration Kits in Use:* table is used to select a calibration kit for each connector type. The pull-down lists contain all kits for the individual connector types.

Remote control: [SENSE<Ch>:]CORRection:CKIT:<conn_type>:SElect '<ckit_name>'
[SENSE<Ch>:]CORRection:CKIT:SElect '<conn_type>', '<ckit_name>'

Cal Kit Parameter Types

The analyzer uses three types of parameters to describe the calibration standards. The parameter type is the same for all standards in a kit and therefore annexed to the kit name:

```
New_Kit
85032B/E
85032F
85054B
85054D
N 50 Ω Ideal Kit
ZCAN 50 Ω
ZV-Z21 typical
```

- **Universal** parameters (no label) describe calibration kit models with highly standardized components so that the parameters are valid for all calibration kits of the model.
- **Typical** parameters (labelled *typical*) approximately describe a calibration kit model. To correct for deviations between the standards, each kit of the model is individually measured and delivered with an additional, kit-specific parameter set. Therefore each typical parameter set <kit_name> typical is complemented by an additional parameter set <kit_name> containing optimized parameters for an individual kit.
- **Ideal** parameters (labelled *Ideal Kit*) describe an idealized calibration kit for each connector type;

see below.



Make sure to use universal or individual parameter sets if you need to obtain high-precision results. The precision of the calibration kit parameters determine the accuracy of the system error correction and of the measurements. The calibration wizard displays a warning if you use a typical or ideal parameter set to calibrate a channel.

Calibration kits can be obtained as network analyzer accessories; refer to the data sheet for the relevant ordering information. The name of all parameter sets is equal to the name of the corresponding calibration kit model.



Ideal parameters

All ideal kits contain the following standards:

Standard (Gender)	R (Load)	Electrical Length (Offset)
Open (f, m)	$\infty \Omega$	0 mm (Delay: 0 s)
Short (f, m)	0 Ω	0 mm
Offset Short (f, m)	0 Ω	10 mm
Match (f, m)	Z_0 (reference impedance of the connector type)	0 mm
Sliding Match (f, m)	–	0 mm
Reflect (f, m)	$\infty \Omega$	0 mm
Through (ff, mm, mf)	–	0 mm
Line (ff, mm, mf)	–	10 mm
Attenuation (ff, mm, mf)	–	0 mm
Symm. Network (ff, mm, mf)	–	0 mm

The following additional parameters are used:

- Characteristic impedance: Z_0 (reference impedance of the connector type)
- Loss: 0 dB / sqrt(GHz) (0 G Ω / s)
- All inductance and capacitance parameters are set to zero.

Cal Kit Files

Calibration kit files can be used to store the parameters of a particular calibration kit, to reuse the data and to exchange calibration kits from one network analyzer to another.



Cal kit file contents

Cal kit files are independent of the current setup and contain the following information:

- Name and label of the calibration kit
- Connector type including all connector type parameters (name, polarity, offset model, reference impedance)
- Type, gender and label of all standards in the kit together with the circuit model parameters (offsets, load) or S-parameter tables (.snp file) that are necessary to determine its magnitude and phase response.
- To **export** cal kit data, the analyzer uses a specific binary file format *.calkit.
- Three different **import** file formats are supported: ZVL-specific binary cal kit files (*.calkit), ZVR-specific binary cal kit files (*.ck), cal kit files in Agilent-specific ASCII formats (*.csv, *.prn; see notes below).

By default cal kit files are stored in the C:\R_S\Instr\user\Nwa\Calibration\Kits directory.



To import a ZVL-specific or ZVR-specific cal kit file (*.ck or *.calkit) you can also use the Windows Explorer and simply double-click the file or drag and drop the file into the NWA application. The imported cal kit file is automatically set active.



Importing older ZVR cal kit files

On loading some older ZVR-specific *.ck files, e.g. the ZV-Z23 cal kit file, the ZVL generates the message *File does not comply with instrument calibration kit file format*. The files must be converted using a ZVR network analyzer equipped with a firmware version V3.52 or higher. Proceed as follows:

- On the ZVR, press *CAL – CAL KITS – MODIFY KITS – INSTALL NEW KIT* to import the *.ck file.
- Press *CREATE INST FILE* in the same submenu to export the *.ck file in a ZVL-compatible format.
- Import the converted file into the ZVL.

*.csv cal kit files: VNA Cal Kit Manager 2.1

The *VNA Cal Kit Manager* is a free, Windows-based software tool intended to import, edit, and export *.csv cal kit files. The software is available for download at <http://www.vnahelp.com/products.html>. The decimal separator used by the *VNA Cal Kit Manager V2.1* depends on the language version of the Windows operating system: Cal kit files generated on an English operating system contain dots, the ones generated on a German system contain commas.

The network analyzer expects the dot as a separator and displays an error message when a *.csv file with commas is loaded. Please install the *VNA Cal Kit Manager V2.1* on an appropriate (e.g. English) Windows version to avoid trouble.

*.prn cal kit files: PNA Cal Kit Editor

The network analyzer can import and process cal kit files created with the *PNA Cal Kit Editor*. The files use the extension *.prn; the data format is identical to the *.csv format.

The decimal separator used by the *PNA Cal Kit Editor* depends on the language version of the Windows operating system: Cal kit files generated on an English operating system contain dots, the ones generated on a German system contain commas.

The network analyzer expects the dot as a separator and displays an error message when a *.prn file with commas is loaded. Please install the *PNA Cal Kit Editor* on an appropriate (e.g. English) Windows version to avoid trouble.

Remote control: `MMEMemory:LOAD:CKIT "file_name"`
`MMEMemory:STORE:CKIT "kit_name", "file_name"`
`[SENSE<Ch>:]CORREction:CKIT:INSTall "<file_name>"`

Add or View / Modify Calibration Kit

Combines different standards to form a new calibration kit, assigning a connector type and further attributes (name, labels). This dialog is opened from the *Calibration Kits* dialog: If the *Add Kit...* button is selected, the dialog title is *Add Calibration Kit*; if the *View / Modify Kit...* button is selected, the dialog title is *View / Modify Calibration Kit*. The functionality of both dialog versions is the same.



If *Add Kit* is used for a predefined calibration kit, the *View / Modify Standard...* button can be used to

open the *View / Modify Standard in <kit_name>* dialog check the standard parameters. All other controls are inactive.

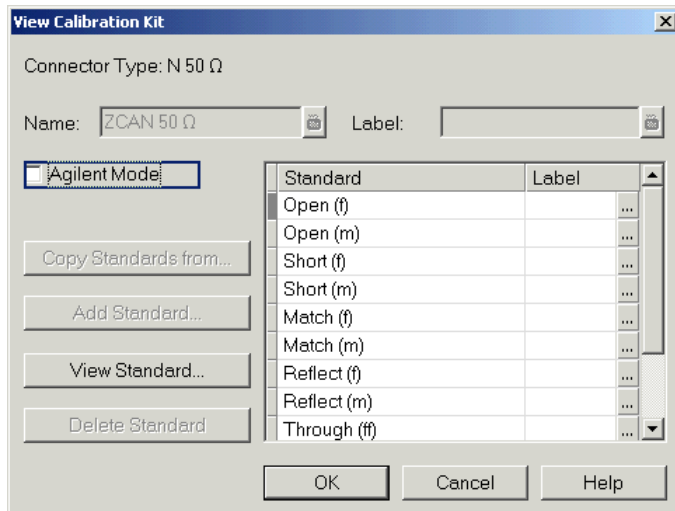

In its upper part the *Add or View / Modify Calibration Kit* dialog contains several controls to do the following:

- Select a predefined or user-defined *Connector Type*.
- Insert the (unique) *Name* of the new kit and assign a *Label*.
- Qualify whether or not the *Offset* and *Load* parameters for the standards are defined and displayed in *Agilent Mode*.



Assigning a label to user-defined calibration kits is optional. However, the label is displayed in many dialogs and can provide useful information about the kit, e.g. its serial number.

The table in the center of the dialog lists all standards in the new kit together with either their gender or their port assignment (see *Restrict Port Assignment*) and the label (if defined). Clicking a standard opens the *View / Modify Standard in <kit_name>* dialog where it is possible to change the parameters. Four buttons can be used to **change the entries in the list**.

- *Copy Standards from...* opens a dialog to copy standards from another calibration kit to the new kit.
- *Add Standard...* selects, defines and adds a new standard to the kit. A calibration kit may only contain a single standard of each type.
- *View / Modify Standard...* displays or changes the properties of the selected standard.
- *Delete Standard* removes the selected standard from the list and from the calibration kit.



Use *Copy Standards from...* to avoid the (re-)definition of their properties. Standards are copied together with their parameters and their label, which you can modify once they belong to the new kit.

Copy Standards from

Copies standards together with their parameters from a calibration kit in use to a new calibration kit. This dialog is opened from the *View Calibration Kit* dialog (*Copy Standards from...* button).

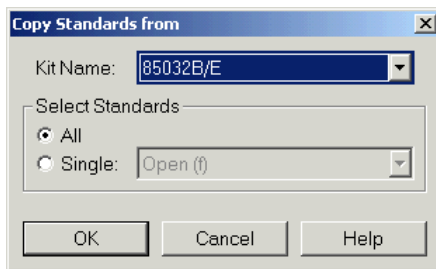

In the dialog, it is possible to select one of the calibration kits in use (*Kit Name*) and select either all or a single standard to be copied. A calibration kit may only contain a single standard of each type.

Available Connector Types

Displays and modifies the list of available connector types. This dialog is opened from the *Calibration Kits* dialog (*Avail Conn Types...* button).

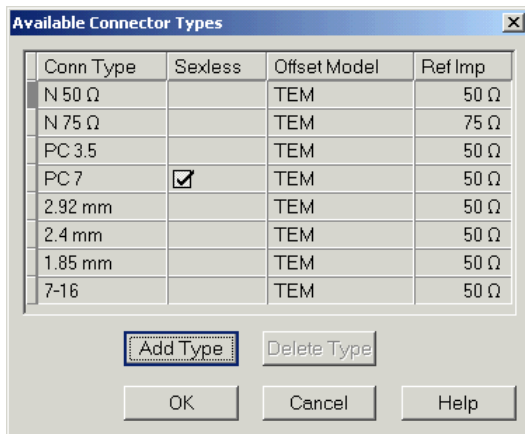

The list shows the available connector types with their name (*Conn Type*), polarity (*Sexless*) and reference impedance (*Ref Imp*). The *Offset Model* describes the mode of wave propagation in the transmission lines of the standards associated with the connector type. The buttons below are used to add and delete user-defined connector types. Deleting a connector type will also delete all calibration or adapter kits assigned to it.



Impact of reference impedance

The reference impedance (*Ref Imp*) Z_0 for the connectors is a critical value that represents an input value for various parameter conversions. Z_0 enters into:

- The calculation of the S-parameters for the calibration standards associated with the connector type, provided that they are derived from a circuit model (*Add/Modify Standard* dialog).
- The calculation of impedance and admittance parameters.



Storing connector type settings

Calibration kits and connector types are global resources; the parameters are stored independently and available irrespective of the current setup. The connector type settings are always stored together with the associated calibration kit parameters. It is possible to export and import the connector settings using *Export Kit...* and *Import Kit...* in the *Calibration Kits* dialog.

The name, polarity and reference impedance of a user-defined connector can be changed in the table. The  button in the *Offset Model* column opens the *Offset Model* dialog to define the propagation mode in detail.



After assigning a calibration or adapter kit to a user-defined connector type, you can still change its name, offset model and reference impedance. Switching between sexed and sexless will delete all kits assigned to the connector type.

Remote control: [SENSe<Ch>:]CORRection:CONNection
[SENSe<Ch>:]CORRection:CONNection:DELeTe

Offset Model Dialog

Defines the mode of wave propagation in the lines of the standards associated with the connector type. This dialog is opened from the *Available Connector Types* dialog (... button in the table).

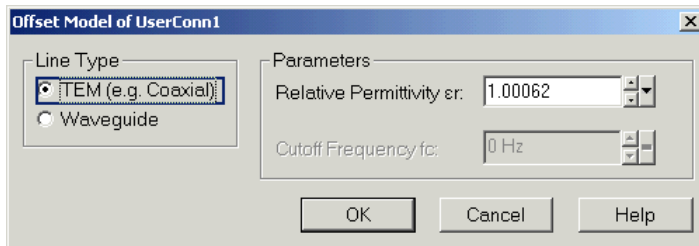

The *Parameters* to be selected depend on the *Line Type*:

- If the calibration kit standards contain lines with transverse electric propagation mode (TEM), then the *Relative Permittivity* ϵ_r of the dielectric can be defined. The default permittivity is the value for air. TEM-type lines have not cutoff frequency.
- If the calibration kit standards contain waveguides, then the lowest frequency where a wave propagation is possible (*Cutoff Frequency* f_c) can be defined. The default cutoff frequency is 0 Hz (propagation at all frequencies). No relative permittivity is needed for waveguides.



The impedance for waveguides is frequency-dependent. If a waveguide line type is selected, various dialogs (e.g. *Add Standard...*) will indicate varies instead of a definite impedance value.



Impact of offset model parameters

The offset model parameters are used for the calculation of the S-parameters for the calibration standards associated with the connector type, provided that they are derived from a circuit model (*Add/Modify Standard* dialog).

- For TEM-type lines, the relative permittivity ϵ_r is needed for the conversion of and ZVR-type *Loss* (in units of dB/sqrt(GHz)) into an Agilent-type *Offset Loss* (in units of GΩ/s) and vice versa (see *Offset* and *Load* parameters). The *Electrical Length* and *Delay* values in the *Modify Offset* dialog are directly entered and therefore independent of ϵ_r .
- For waveguides, the low frequency cutoff frequency f_c is important because no wave propagation is possible at frequencies below f_c . If a standard is measured in order to acquire calibration data, the analyzer checks the low frequency cutoff. If the start frequency of the sweep range is below f_c , then the calibration wizard generates an error message.

The offset model parameters are not used except in the context of calibration. The offset parameter definitions (see *Mechanical Length*) are based on independent ϵ_r values.

Remote control: [SENSe<Ch>:]CORRection:CONNection

Add or View / Modify Standard

Defines, displays or modifies the properties of the calibration standards in a particular calibration kit. This dialog is opened from the *Add or View / Modify Calibration Kit* dialog (*Add Standard...* or *View / Modify Standard...* buttons). Depending on the title, some control elements may not be active.



For an overview of calibration standards and their properties refer to section Calibration standard types below.

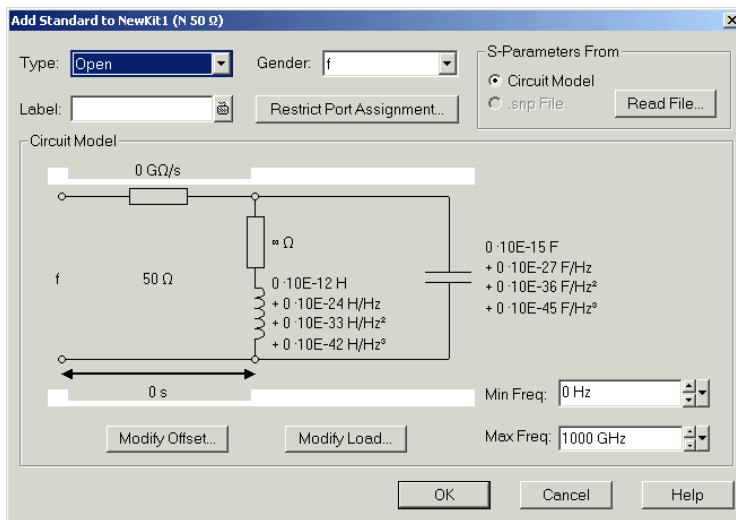

In its upper part the *Add Standard* or *View / Modify Standard* dialog contains several controls to do the following:

- Select a standard *Type* and its *Gender* (for polarized/not sexless connector types and if the port assignment is not restricted) and assign a *Label*.
- *Restrict Port Assignment*
- **Select S-Params From**

Qualify whether the standard is described by a *Circuit Model* from which the analyzer can calculate the S-parameters or by a table of measured or simulated S-parameters stored in a Touchstone file. Pressing the *Read Data from File...* button opens a file selection dialog where the appropriate file type (*.s1p for one-port standards and *.s2p for two-port standards) is automatically selected.



The *Sliding Match* and *Attenuation* are special standard types which must be described by a circuit model. The controls in the *S-Params From* panel are disabled.

For two-port standards described by a *.s2p file, the implicit ports 1 and 2 (given by the order of S-parameters $\text{Re}(S_{11})$ $\text{Im}(S_{11})$ $\text{Re}(S_{21})$ $\text{Im}(S_{21})$ $\text{Re}(S_{12})$ $\text{Im}(S_{12})$ $\text{Re}(S_{22})$ $\text{Im}(S_{22})$ in the file) are assigned to the test ports that the analyzer actually calibrates as follows: Port 1 is always assigned to the lower-numbered calibrated test port, port 2 to the other (higher-numbered) calibrated test port.



Assigning a label to standards is optional. However, the label is displayed in many dialogs and can provide useful information about the standard, e.g. its serial number.

If *Circuit Model* is selected in the *S-params From* panel, then the controls in the central panel of the dialog are enabled. The circuit diagram is adjusted to the selected standard type. The following parameters can be set:

- Frequency range (*Min. Freq.* to *Max. Freq.*) for which the circuit model is valid. During calibration, the analyzer checks whether the sweep range is contained in the validity range of all measured standards and possibly generates a warning (see *Measure Standards* dialog).
- *Offset* and *Load* parameters of the circuit model.



The impedance for waveguides is frequency-dependent. If a waveguide line type is selected in the *Offset Model* dialog, the circuit model indicates varies instead of a definite impedance value.

Remote control: [SENSe<Ch>:]CORRection:CKIT:<std_type>
[SENSe<Ch>:]CORRection:CKIT:<conn_type>:<std_type>
MMEMoRY:LOAD:CKIT:SDATa

Restrict Port Assignment

Opens a dialog to define whether the standard can be connected to any port of the analyzer or to just one port (for one-port standards) or a pair of ports (for two-port standards).

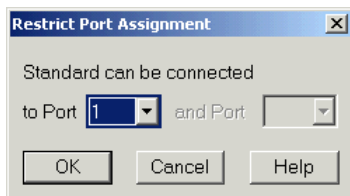

The port assignment is displayed in the *Add or View / Modify Calibration Kit* dialogs.



Port assignment and gender

The standards are handled differently, depending on their port assignment:

- If the port assignment is not restricted, the gender belongs to the definition of polarized standards. When the connector type and calibration kit is selected in the calibration wizard, the analyzer checks whether the kit contains the necessary standard types and whether the standards have the right gender.
- Standards with restricted port assignment are assumed to have the right gender (the one required for this port). In the *View Modify Standard* dialog, the *Gender:* input field is disabled. In the calibration wizard, the analyzer checks whether the kit contains the necessary standard types for the required ports. Instead of the gender, the port assignment is stored in the calibration kit file.

This approach simplifies the definition of standards and helps to avoid inconsistencies.

Remote control: [SENSe<Ch>:]CORRection:CKIT:<std_type>

Modify Offset

Specifies the offset parameters for the transmission lines of a particular calibration standard. This dialog is opened from the *Add or View / Modify Standard...* dialog (*Modify Offset...* button).

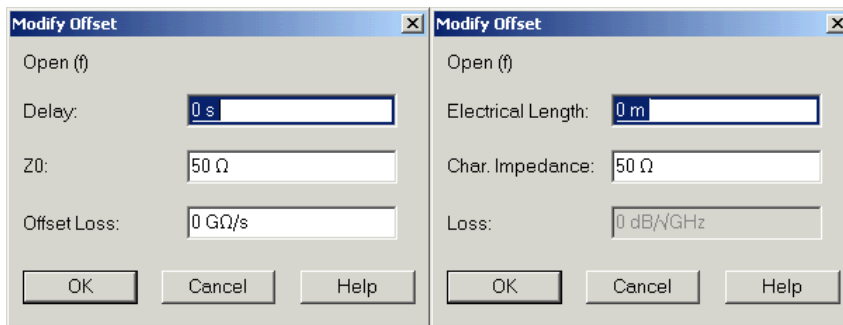

The offset parameters depend on whether or not the circuit model is defined in *Agilent Mode* (see *Add/Modify Calibration Kit* dialog):

- If *Agilent Mode* is active, then the standard is characterized by its *Delay* (in s), its characteristic impedance Z_0 (in Ω) and its *Offset Loss* (in $\text{G}\Omega/\text{s}$).
- If *Agilent Mode* is switched off, then the standard is characterized by the ZVR-compatible parameters *Electrical Length* (in m or foot (ft), depending on the *Distance Unit* selected in the *System Configuration* dialog), its *Char. Impedance* (in Ω) and its *Loss* (in $\text{dB}/\sqrt{\text{GHz}}$). The loss is zero and not editable as long as the electrical length is zero.

Both parameter sets are closely related. The *Electrical Length* is proportional to the *Delay*; Z_0 corresponds to the *Char. Impedance*. Moreover the analyzer converts an Agilent-type *Offset Loss* into a ZVR-type *Loss* and vice versa using the *Relative Permittivity* ϵ_r for the connector type defined in the *Offset Model...* dialog.



Offset parameters

The offset parameters have the following physical meaning:

- The *Delay* is the propagation time of a wave traveling through the standard. The *Electrical Length* is equal to the *Delay* times the speed of light in the vacuum and is a measure for the length of transmission line between the standard and the actual calibration plane. For a waveguide with permittivity ϵ_r and mechanical length L_{mech} the following relations hold:

$$\text{Delay} = \frac{L_{\text{mech}} \cdot \sqrt{\epsilon_r}}{c}; \quad \text{Electrical Length} = L_{\text{mech}} \cdot \sqrt{\epsilon_r}$$

The default delay is 0 s, the default step width is 1 ns, corresponding to a step width of 299.792 mm for the electrical length. The relations hold for one-port and 2-port standards.

- Z_0 is the *Characteristic Impedance* of the standard. If the standard is terminated with Z_0 , then its input impedance is also equal to Z_0 . Z_0 is not necessarily equal to the reference impedance of the system (depending on the *Connector Type*) or the terminal impedance of the standard. The characteristic impedance of the standard is only used in the context of calibration.

The default characteristic impedance is equal to the reference impedance of the system.

- The *Loss* is the energy loss along the transmission line due to the skin effect. For resistive lines and at RF frequencies the loss is approximately proportional to the square root of the frequency.

In Agilent mode the *Offset Loss* is expressed in units of Ω/s at a frequency of 1 GHz. The following formula holds:

$$\text{Offset Loss} [\Omega/\text{s}] = \frac{\text{Loss} [\text{dB}] \cdot Z_0 [\Omega]}{4.3429 [\text{dB}] \cdot \text{delay} [\text{s}]}$$

To determine an offset loss value experimentally, measure the delay in seconds and the loss in dB at 1 GHz and use the formula above.

The default *Loss* or *Offset Loss* is zero.



The impedance for waveguides is frequency-dependent. If a waveguide line type is selected in the Offset Model dialog, the Char. Impedance field is disabled and indicates "varies" instead of a definite impedance value. Moreover no Loss or Offset Loss can be set.



Offset parameters and standard types

Offset parameters are used to describe all types of standards except the *Sliding Match* and the *Attenuation*.

- The *Sliding Match* is a one-port standard with variable load parameters (sliding load) and unspecified length. The reference impedance is fixed and equal to the characteristic impedance of the connector type. No load and offset parameters need to be set.
- The *Attenuation* is a two-port standard which is fully matched in both directions (the reflection factor at both ports is zero). No load and offset parameters need to be set.

Remote control: [SENSE<Ch>:]CORRection:CKIT:<conn_type>:<std_type>

Modify Load

Specifies the load parameters for a particular calibration standard describing its terminal impedance. This dialog is opened from the *Add or View / Modify Standard...* dialog (*Modify Load...* button).

The circuit model for the load consists of capacitance C which is connected in parallel to an inductance L and a resistance R, both connected in series.

- R is the constant resistive contribution. It is possible to select a special value (*Open* for $\infty \text{ } \Omega$, *Short* for $0 \text{ } \Omega$, *Match* for the reference impedance of the current connector type) or set any resistance R.
- The fringing capacitance C and the residual inductance L are both assumed to be frequency-dependent and approximated by the first four terms of the Taylor series around $f = 0 \text{ Hz}$.



Load parameters and standard types

Load parameters are used to describe all types of standards except a *Through*, a *Sliding Match*, a *Line* and an *Attenuation*.

- The *Through* standard is a through-connection between two ports with minimum loss which is taken into account by the *Offset Parameters*.
- The *Sliding Match* is a one-port standard with variable load parameters (sliding load), so there is no fixed load model.
- The *Line* standard is a line of variable length with minimum loss which is taken into account by the *Offset Parameters*.
- The *Attenuation* is a two-port standard which is fully matched in both directions (the reflection

factor at both ports is zero). No load and offset parameters need to be set.

Remote control: [SENSE<Ch>:]CORRection:CKIT:<conn_type>:<std_type>

Calibration Standard Types

The following table gives an overview of the different standards and their offset and load models:

Standard Type	Characteristics	Ideal Standard	Offset Model	Load Model
Open	Open circuit (one-port)	$\infty \Omega$	<input checked="" type="checkbox"/>	<input checked="" type="checkbox"/>
Short	Short circuit (one-port)	0Ω	<input checked="" type="checkbox"/>	<input checked="" type="checkbox"/>
Offset short	Short circuit with added electrical length offset, for waveguide calibration (one-port)	0Ω	<input checked="" type="checkbox"/>	<input checked="" type="checkbox"/>
Match	Matched broadband termination (one-port)	Z_0 (reference impedance of the connector type)	<input checked="" type="checkbox"/>	<input checked="" type="checkbox"/>
Sliding match	One-port standard consisting of an air line with a movable, low-reflection load element (sliding load).	–	–	–
Reflect	Unknown mismatched standard (one-port)	$\infty \Omega$	<input checked="" type="checkbox"/>	<input checked="" type="checkbox"/>
Through	Through-connection with minimum loss (two-port)	–	<input checked="" type="checkbox"/>	–
Line1, Line 2	Line(s) for TRL calibration with minimum loss (two-port)	–	<input checked="" type="checkbox"/>	–
Attenuation	Fully matched standard in both directions (two-port; the reflection factor at both ports is zero).	–	–	–
Symm. network	Unknown mismatched reflection-symmetric standard (two-port)	–	<input checked="" type="checkbox"/>	<input checked="" type="checkbox"/>

Remote control: For an overview of standard parameters see also
[SENSE<Ch>:]CORRection:CKIT:<conn_type>:<std_type>

Sweep

The *Sweep* submenu defines the scope of measurement in the current channel. This includes the sweep type with various parameters, the periodicity of the measurement, and the sweep average.

Sweeps

A sweep is a series of consecutive measurements taken over a specified sequence of stimulus values. It represents the basic measurement cycle of the analyzer.

The analyzer can perform sweeps at constant power but variable frequency (frequency sweeps); see Sweep Type.

The sweeps are further specified by the number of measurement points, the total measurement time and the trigger mode. A measurement may consist of a single sweep or a series of sweeps repeated continuously.

On the other hand, depending on the measurement task and the measured quantity, the measurement at each point can consist of several partial measurements with definite hardware settings.

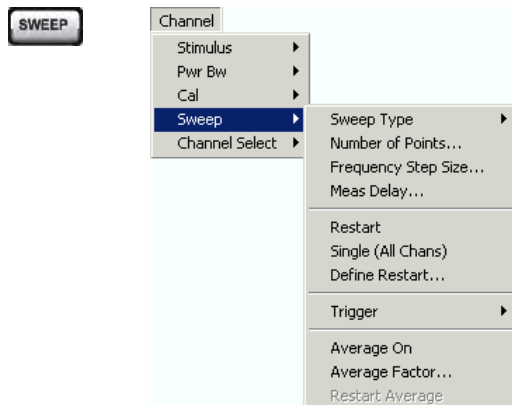

The *Sweep* menu provides the following settings:

- *Sweep Type* defines the position of sweep points (frequency values) in the sweep range.
- *Number of Points* sets the total number of measurement points over the sweep range.
- *Frequency Step Size* sets the distance between two consecutive frequency sweep points.
- *Meas Delay* delays the start of each sweep.
- *Trigger* selects the trigger mode for the measurement.
- *Restart* aborts the current measurement and restarts a new sweep sequence.
- If *Single (All Chans)* is selected the measurement is terminated after a single sweep or a group of single sweeps defined in the *Define Restart* dialog.
- *Define Restart* opens a dialog to specify which channels are affected and how many sweeps are repeated.
- *Average On* activates or de-activates the sweep average. With average on the measurement results are averaged over a selected number of consecutive sweeps (*Average Factor*).
- *Average Factor* defines the number of consecutive sweeps to be averaged.
- *Restart Average* starts a new average cycle, clearing all previous results and thus eliminating their effect on the new cycle. The new cycle is started as fast as possible; an ongoing sweep is terminated immediately.

Sweep Type

The *Sweep Type* submenu defines the frequency sweep type and the position of the sweep points across the sweep range.

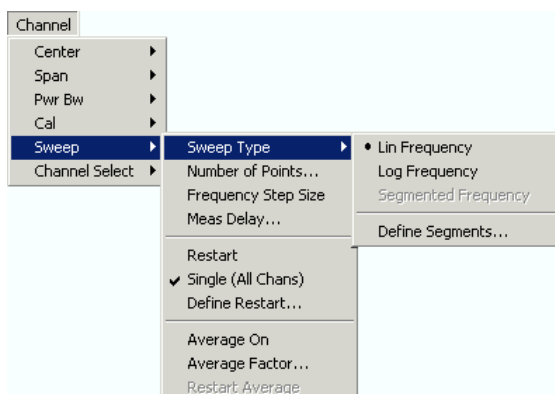

- *Lin Frequency* is the default sweep type. The stimulus frequency is swept in equidistant steps

over the continuous frequency range. In a Cartesian diagram, the x-axis is a linear frequency axis.

- *Log Frequency* is analogous to *Lin. Frequency*, however, the frequency is swept in equidistant steps on a logarithmic scale. In a Cartesian diagram, the x-axis is a logarithmic frequency axis.
- *Segmented Frequency* is analogous to *Lin. Frequency* but uses a sweep range that can be composed of several continuous frequency ranges or single frequency points defined via Define Segments. A valid segment list must be defined before activating *Segment Frequency*.

Lin Frequency

In a *Lin. Frequency* sweep the stimulus frequency is swept in equidistant steps over the continuous frequency range. The frequency range (sweep range) is defined with the Stimulus settings. The step width between two consecutive sweep points is constant and given by $\langle \text{Span} \rangle / (n - 1)$ where n is the specified Number of Points ($n > 1$). The internal generator power can be set, if so desired, in the Power Bandwidth Average submenu.

A *Lin. Frequency* sweep corresponds to the analysis of a signal over the frequency, as obtained e.g. by means of a spectrum analyzer. This is the default sweep type. In a Cartesian diagram the measurement result is displayed as a trace over a linear frequency scale (spectral representation). The following example shows a *Lin. Frequency* sweep with a stimulus range between 4.5 GHz and 6 GHz, the forward transmission parameter S_{12} as measured quantity, and a *dB Mag* scaled y-axis.

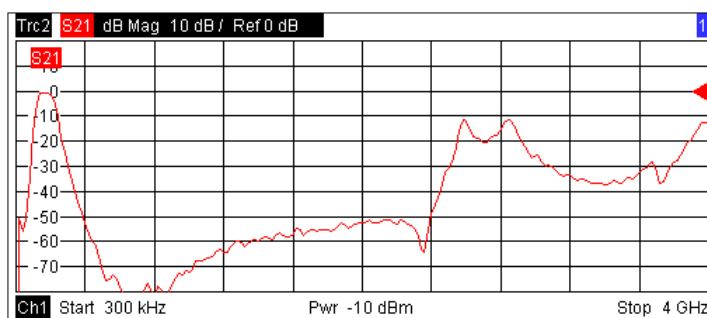

Remote control: [SENSE<Ch>:]SWEep:TPYE LINear
[SENSE<Chn>:]FUNctIon[:ON] "XFrequency:..."

Log Frequency

In a *Log. Frequency* sweep the stimulus frequency is swept on a logarithmic scale over the continuous frequency range. The frequency range (sweep range) is defined with the Stimulus settings. The sweep points are calculated from the Span and the specified Number of Points ($n > 1$) with the condition that the step width is constant on the logarithmic scale. The internal generator power can be set, if so desired, in the Power Bandwidth Average submenu.

Log Frequency sweeps are suitable for the analysis of a DUT over a large frequency range, e.g. over several octaves. In a Cartesian diagram the measurement result is displayed as a trace over a logarithmic frequency scale. The following example shows a *Log. Frequency* sweep with a stimulus range between 50 MHz and 6 GHz, the forward transmission parameter S_{12} as measured quantity, and a *dB Mag* scaled y-axis

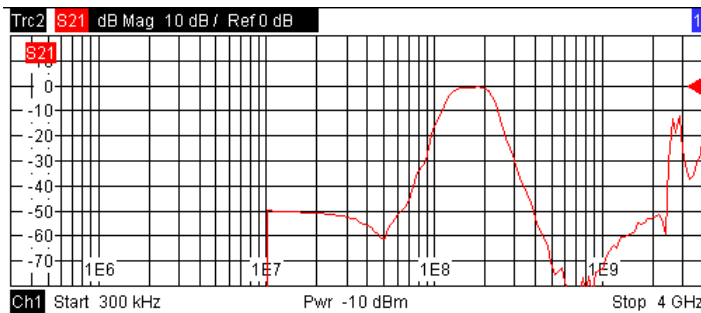

Remote control: [SENSe<Ch>:]SWEep:TPYE LOGarithmic
[SENSe<Chn>:]FUNction[:ON] "XFRequency:..."

Segmented Frequency

In a *Segmented Frequency* sweep the sweep range can be composed of several continuous, non-overlapping frequency sub-ranges or single frequency points. The sub-ranges are termed sweep segments and defined in the Define Segments dialog. The segment list must contain at least 2 distinct frequency points before a *Segmented Frequency* sweep can be started.

Instrument settings such as the internal generator power, the measurement (IF) bandwidth, the selectivity of the measurement filter, the frequency band of the local oscillator, and the measurement time can be set independently for the individual segments.

Due to this flexibility *Segmented Frequency* sweeps are suitable for any detailed analysis of a DUT at specified frequencies. In a Cartesian diagram the measurement result is displayed as a trace over a linear frequency scale ranging from the lowest to the highest frequency point of all segments. The following example shows a *Segmented Frequency* sweep with 3 segments in the stimulus range between 50 MHz and 6 GHz, the forward transmission parameter S12 as measured quantity, and a *dB Mag* scaled y-axis. In the frequency ranges between the sweep segments the trace is displayed as a straight line.

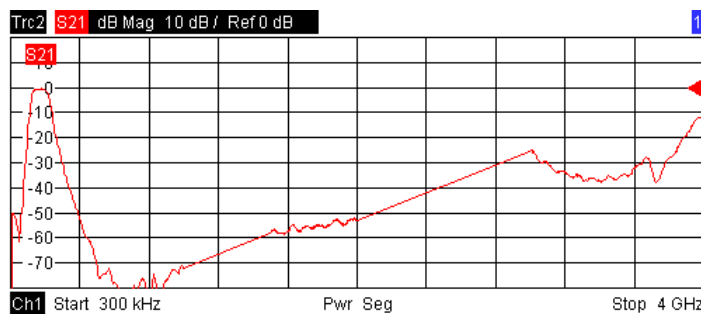

The segmented sweep is not compatible with automatic calibration using a Calibration Unit.

Remote control: [SENSe<Ch>:]SWEep:TPYE SEGment
[SENSe<Chn>:]FUNction[:ON] "XFRequency:..."

Define Segments

Opens a dialog to define all channel settings for a *Segmented Frequency* sweep and to import and export segmented sweep settings.

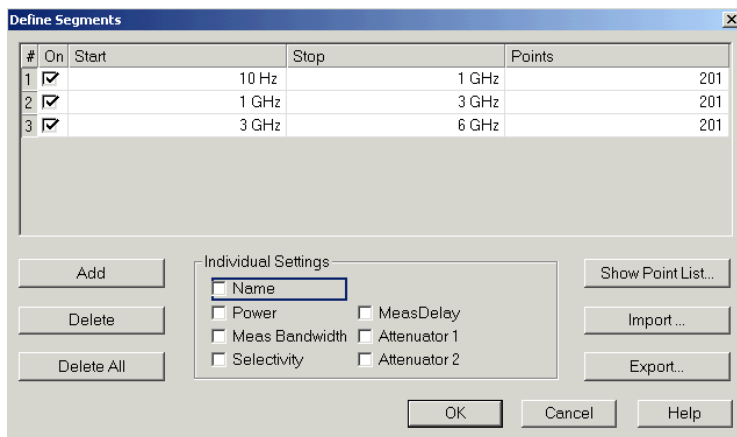

The *Define Segments* dialog contains a table to edit the individual segments of the sweep range. Sweep segments must not overlap, however, two adjacent segments can have one common point; see *Columns in the Define Limit Line table*.

Below the table, three groups of controls provide additional settings. Refer to the following sections below:

- Inserting and Deleting Segments
- Individual Settings
- Point List, Segment Import and Export



Columns in the Define Limit Line table

The table contains an automatically assigned current number for each segment plus the following editable or non-editable columns:

#	On	Start	Stop	Points
1	<input checked="" type="checkbox"/>	300 kHz	19.999999996 GHz	201
2	<input checked="" type="checkbox"/>	19.999999996 GHz	20 GHz	201

- *On* provides check boxes to activate or deactivate each individual segment. Sweep points belonging to inactive segments only are not measured and not listed in the *Point List*.
- *Start* is the stimulus (x-axis) value of the first point of the segment. If the segment contains more than one *Point*, then *Start* must be smaller than the *Stop* value. If a *Start* value equal to or larger than the current *Stop* value is set, *Stop* is adjusted to the new *Start* value plus 1 Hz.
- *Stop* is the stimulus (x-axis) value of the last point of the segment. If the segment contains more than one *Point*, then *Stop* must be larger or equal than the *Start* value. If a *Stop* value equal to or smaller than the current *Start* value is set, *Start* is adjusted to the new *Stop* value minus 1 Hz.
- *Points* is the number of sweep points in the segment. A single segment can consist of only one point, however, the entire sweep range must contain at least 2 distinct frequency points. If *Points* is set to 1, then the *Stop* frequency is set equal to the *Start* frequency.
- The remaining columns show the channel settings for each segment. They are displayed only if they are selected in the *Individual Segment Settings* panel.



*When a new segment is defined or when the stimulus range of a segment is modified, the analyzer automatically checks whether it is compatible with the existing segments. The *Start* and *Stop* values of the existing segments are modified so that there is no overlap between any of the segments. If this is not possible (e.g. because of the limited frequency range of the analyzer), the entry of the new *Start* or *Stop* value is denied.*



Use the paste marker list for convenient entry of *Start* and *Stop* values.

Remote control: The commands in the `[SENSe<Chn>:] SEGMENT...` subsystem define all sweep segment settings.

Inserting and Deleting Segments

Three buttons on the left side below the table in the *Define Segments* dialog extend or shorten the segment list:

- **Insert New Segment**

adds a new segment to the list. The new segment is inserted after the active segment. The segment numbers (#) of all segments after the new segment are adapted.

To avoid overlapping segments, the new segment ranges from the *Stop* value of the previously active segment to either the *Start* value of the next segment or the maximum frequency of the analyzer. The analyzer places no restriction on the number of segments in a sweep range.

- Delete Segment removes the selected segment from the list.
- Del All Segments clears the entire segment list so it is possible to define or load a new segmented sweep range.

Remote control: `[SENSe<Chn>:] SEGMENT<Seg>:INSert`
`[SENSe<Chn>:] SEGMENT<Seg>:DELeTe`
`[SENSe<Chn>:] SEGMENT<Seg>:DELeTe:ALL`

Individual Settings

The options in the *Individual Settings* panel can be used to vary the channel settings of every individual segment in the list.

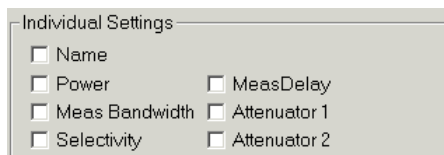

The first sweep segment is created with the channel settings defined for general sweep types. When any further sweep segment created, it uses the channel settings of the previously active segment. Each selected (checked) option adds a column to the segment list.

- Name adds a column to assign a name to each segment. A segment name is a string that may contain letters, numbers and special characters.
- Power defines the internal source Power for each individual sweep segment.
- Meas Bandwidth defines the Meas Bandwidth for each individual sweep segment.
- Filter Type defines the Filter Type(selectivity) of the IF filter used for each sweep segment.
- *MeasDelay* sets a delay time allowing the DUT to settle before the hardware settings of the analyzer are changed and a new partial measurement is started. [This setting is not available on R&S ZVL13 analyzers.](#)
- Attenuator 1/2 select the attenuation factors for the received waves b1 and b2, respectively.

Remote control: `[SENSe<Chn>:] SEGMENT<Seg>:POWer[:LEVel]`
`[SENSe<Chn>:] SEGMENT<Seg>:BWIDth[RESolution]`
`[SENSe<Chn>:] SEGMENT<Seg>:BWIDth[RESolution]:SELeCt`



```
[SENSE<Chn>:] SEGMENT<Seg>:DEFine
[SENSE<Chn>:] SEGMENT<Seg>:INSert
[SENSE<Chn>:] SEGMENT<Seg>:SWEep:DWELL
[SENSE<Chn>:] SEGMENT<Seg>:ATTenuation<Pt>
```

Point List, Segment Import and Export

The buttons on the right side below the table in the *Define Segments* dialog are used to retrieve the position of the defined sweep points import and export limit line data.

- **Show Point List**

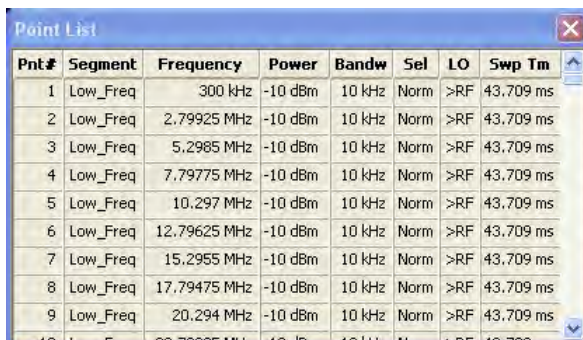
opens a list of all active sweep points and their channel settings.



Pnt#	Segment	Frequency	Power	Bandw	Sel	LO	Swp Tm
1	Low_Freq	300 kHz	-10 dBm	10 kHz	Norm	>RF	43.709 ms
2	Low_Freq	2.79925 MHz	-10 dBm	10 kHz	Norm	>RF	43.709 ms
3	Low_Freq	5.2985 MHz	-10 dBm	10 kHz	Norm	>RF	43.709 ms
4	Low_Freq	7.79775 MHz	-10 dBm	10 kHz	Norm	>RF	43.709 ms
5	Low_Freq	10.297 MHz	-10 dBm	10 kHz	Norm	>RF	43.709 ms
6	Low_Freq	12.79625 MHz	-10 dBm	10 kHz	Norm	>RF	43.709 ms
7	Low_Freq	15.2955 MHz	-10 dBm	10 kHz	Norm	>RF	43.709 ms
8	Low_Freq	17.79475 MHz	-10 dBm	10 kHz	Norm	>RF	43.709 ms
9	Low_Freq	20.294 MHz	-10 dBm	10 kHz	Norm	>RF	43.709 ms

Points in inactive sweep segments (i.e. segments that are not switched *On* in the segment table) are not shown. The table provides a check of the settings made and can not be edited.

- *Import Segment List...* calls up an Open File dialog to load a sweep segment list from a sweep segment file. Sweep segment files are ASCII files with the default extension *.seglist and a special file format.
- *Export Segment List...* calls up a Save As... dialog to store the current sweep segments to a sweep segment file. Sweep segment files are ASCII files with the default extension *.seglist and a special file format.



To import a segment list file (*.seglist) you can also use the Windows Explorer and simply double-click the file or drag and drop the file into the NWA application. You must enable the segmented sweep separately.

Remote control: `MMEMemory:LOAD:SEGMENT <Ch_no>,"file_name"`
`MMEMemory:STORe:SEGMENT <Ch_no>,"file_name"`

File Format for Sweep Segments

The analyzer uses a simple ASCII format to export sweep segment data. By default, the sweep segment file extension is *.seglist. The file starts with two comment lines containing the version and a third line reproducing the header of the segment list. The following lines contain the entries of all columns of the segment list, including the *Individual Segment Settings* that may be actually hidden.



Example of a sweep segment file

The segmented sweep range:

#	On	Start	Stop	Points
1	<input checked="" type="checkbox"/>	300 kHz	300.002 kHz	401
2	<input checked="" type="checkbox"/>	300.002 kHz	300.004 kHz	401
3	<input checked="" type="checkbox"/>	4.5 GHz	8 GHz	401

is described by the following sweep segment file:

```
# Version 0
#
boState;      strName;      Start_Frequency[MHz];  Stop_Frequency[MHz];  intNo_of_Points;
true;        >;          0.300000;             2000.000000;401;     -10.000000;
true;        >;          2000.000000;          3000.000000;401;     -10.000000;
true;        >;          4500.000000;          8000.000000;401;     -10.000000;
```



The sweep segment file actually contains more columns listing all channel settings of the individual sweep segments. The headings of the additional columns read:

Source Power [dBm]; IF Bandwidth [Hz]; enIF Selectivity; en IF Sideband; Meas Delay [μ s]; boSweep Time Auto;

Number of Points

Sets the total number of measurement points per sweep. The minimum number of points is 2.

Number of Points:

Together with the sweep range defined with the *Center*, *Span* settings, this parameter defines the grid of sweep points. The sweep points are equidistantly distributed over the entire sweep range: The step width between two consecutive sweep points is constant on a linear scale (sweep type *Lin. Frequency*) or on a logarithmic scale (sweep type *Log. Frequency*).

In *Segmented Frequency* sweeps, the number of points can be set independently for each segment; see *Define Segments*.

As an alternative to the *Number of Points*, the *Stimulus Step Size* can be set.



Measurement time and screen resolution

A large number of points improves the resolution of the trace but increases the measurement time.

The overall measurement time is composed of a hardware settling time at the beginning of the sweep plus the sum of the measurement times at each individual sweep point. This implies that the measurement time increases roughly linearly with the number of points.



After changing the channel settings or selecting another measured quantity, the analyzer needs some time to initialize the new sweep. This preparation period increases with the number of points and the number of partial measurements involved. It is visualized by a *Preparing Sweep* symbol in the status bar:

All analyzer settings can still be changed during sweep initialization. If necessary, the analyzer terminates the current initialization and starts a new preparation period.

Remote control: [SENSe<Ch>:] SWEp: POINTs

Frequency Step Size

Sets the distance between two consecutive frequency sweep points.

Stimulus Step Size:

The step size is an alternative to the *Number of Points* setting:

- If the sweep range is defined by means of the *Start* and *Stop* variables, both the *Stop* value and the *Number of Points* can vary as the *Stimulus Step Size* is changed. The *Stop* value is changed as little as possible so that the condition $Stimulus\ Step\ Size = (Stop - Start) / (Number\ of\ Points - 1)$ can be fulfilled. Changing the *Start* and *Stop* values modifies the *Stimulus Step Size*.
- If the sweep range is defined by means of the *Center* and *Span* variables, both the *Span* value and the *Number of Points* can vary as the *Stimulus Step Size* is changed. The *Span* is reduced as little as possible so that the condition $Stimulus\ Step\ Size = (Stop - Start) / (Number\ of\ Points - 1)$ can be fulfilled. Changing the *Span* modifies the *Stimulus Step Size*.



This setting is valid for linear frequency sweeps only. It does not apply to logarithmic and segmented sweeps. Increasing the Frequency Step Size generally increases the measurement time.

Remote control: [SENSE<Ch>:]SWEep:STEP

Meas Delay

Sets a delay time before the start of each partial measurement. This setting is not available on R&S ZVL13 network analyzers.



A measurement delay time increases the accuracy, in particular in measurements on DUTs with long settling times (e.g. quartzes, SAW filters).

Remote control: [SENSE<Ch>:]SWEep:DWELL

Restart

Stops the current measurement and restarts a measurement sequence. In *Single* sweep mode a new single sweep sequence is started.

Remote control:
INITiate<Ch>[:IMMEDIATE]

Single (All Chans)

Toggles between single sweep and continuous sweep mode.

- In continuous mode (*Single (All Chans)* not selected), the analyzer measures continuously, repeating the current sweep.
- In single sweep mode, the measurement is stopped after the number of sweeps selected in the *Define Restart* dialog.



Press *Single* to activate the single sweep mode and start a single sweep sequence. To start further sweep sequences press *Restart*.

Remote control: INITiate<Ch>:CONTinuous ON | OFF

Define Restart

Opens a dialog to configure the *Single* sweep mode.

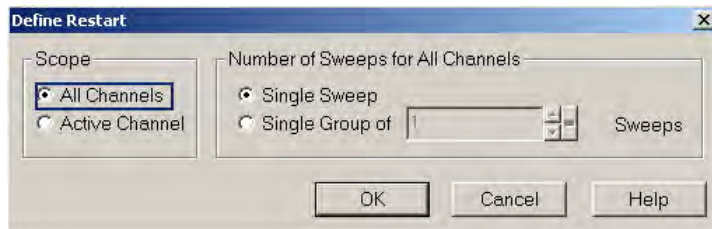

- *Number of Sweeps* selects the number of sweeps to be measured in single sweep mode: either one (*Single Sweep*) or a group of consecutive sweeps.
- *Scope* defines whether the active sweep mode (single or continuous) and the *Number of Sweeps* are valid in the *Active Channel* only or for *All Channels* in the active setup. If *All Channels* is selected, the number of sweeps in the single sweep sequence is equal to the selected *Number of Sweeps* times the number of channels. The sequence starts with the first sweep in channel no. 1.



In remote control, it is possible to retrieve the results acquired in any of the sweeps within a single sweep group; see *Sweep History*.

Remote control: [SENSE<Ch>:]SWEep:COUNT
INITiate<Ch>:IMMediate:SCOPE

Trigger

The *Trigger* submenu selects the source of the trigger signal and provides additional *Trigger Settings*.



Trigger system of the analyzer

The trigger system is used to synchronize the analyzer's actions with events that can be provided by an external signal. Triggered measurements are an alternative to the default mode (*Free Run, Continuous Sweep*), where the measurement is continuously repeated without fixed time reference.

A trigger event may start an entire sweep or a single sweep point. Moreover, it is possible to define a delay between trigger events and the measurement sequences.



The trigger settings are also valid for calibration sweeps (see Measure Standards dialog). This means that, in external trigger mode, the external trigger signal must be available during the system error correction, too. To start the calibration sweeps without delay, use the Free Run trigger type.

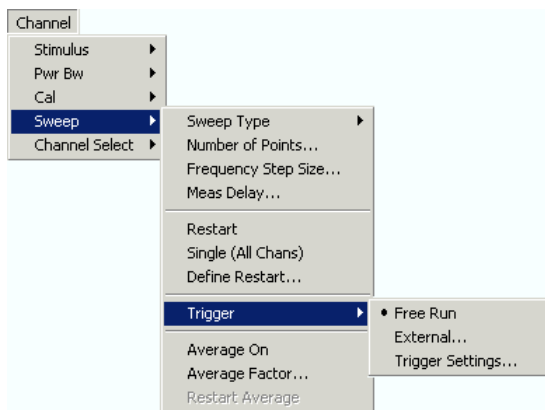

- *Free Run* is the default trigger mode. A new measurement is started immediately without waiting for a trigger signal and without fixed time reference.
- The *External* trigger signal is applied to the *EXT TRIGGER / GATE IN* connector on the rear panel.
- *Trigger Settings* opens a dialog to specify the operation that the analyzer carries out after receiving a trigger event.

Free Run

In *Free Run* mode a new measurement is started immediately without waiting for a trigger event and without fixed time reference. The *Trigger Settings* are not valid.

Free Run means that a measurement in *Continuous Sweep* mode is repeated as fast as possible.

Remote control: TRIGger[:SEquence]:SOURce IMMEDIATE

External

In *External* trigger mode the measurement is triggered by an external TTL signal applied to the BNC connector *EXT TRIGGER / GATE IN* on the rear panel. No additional setting for signal routing is required.

Selecting *External...* opens a dialog to select whether the rising or the falling edge of the external trigger signal provides the trigger event.

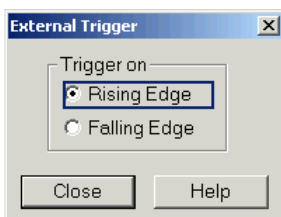

The period of the external trigger signal should be adjusted to the triggered measurement sequence. If the analyzer receives a trigger event while the last sequence is still running, the trigger event is skipped and a message Trigger event missed is displayed.

Remote control: TRIGger[:SEquence]:SOURce EXTERNAL
TRIGger[:SEquence]:SLOPe

Trigger Settings

Trigger Settings opens a dialog to specify the operation that the analyzer carries out after receiving a trigger event.

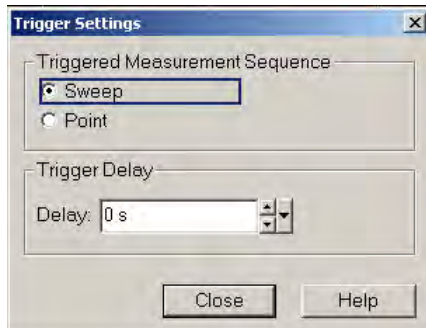

The dialog is divided into the following panels (for a detailed description refer to the following sections):

- *Triggered Measurement Sequence* selects the measurement cycle to be triggered.
- *Trigger Delay* specifies a delay time between the trigger event and the start of the measurement.



The Trigger Settings are not valid for Free Run measurements.

Triggered Measurement Sequence

Selects the measurement cycle to be triggered.

- *Sweep* means that each trigger event starts an entire sweep, according to the current sweep configuration.
- *Point* means that each trigger event starts the measurement at the next sweep point. This mode is not available on R&S ZVL13 network analyzers.



The period of the trigger events should be adjusted to the triggered measurement sequence. If the analyzer receives a trigger event while the last sequence is still running, the trigger event is skipped and a message Trigger event missed is displayed.

Remote control: TRIGger[:SEquence]:LINK

Trigger Delay

Specifies a delay time between the trigger event and the start of the measurement.

The delay time entered must be zero or positive so that the trigger event precedes the start of the measurement (post-trigger).

Remote control: TRIGger[:SEquence]:HOLDoff

Average Factor

Opens the numeric entry bar to define the number of consecutive sweeps to be averaged.



An average over several sweeps reduces the influence of random effects in the measurement and therefore minimizes the noise level. The effect increases with the average factor, however, obtaining an averaged result requires several sweeps and therefore increases the measurement time.



The average factor is also valid for calibration sweeps: The calculation of system correction data is based on the averaged trace.



Smoothing is an alternative method of compensating for random effects on the trace by averaging adjacent measurement points. Compared to the sweep average, smoothing does not significantly increase the measurement time but can eliminate narrow peaks and thus produce misleading results.

The sweep average is not frequency selective. To eliminate a spurious signal in the vicinity of the measurement frequency, alternative techniques (e.g. a smaller filter bandwidth) must be used.



Calculation of sweep average

The average trace is obtained as follows:

Let c be the Average Factor and assume that n sweeps have been measured since the start of the average cycle (start of the measurement or *Restart Average*). The following two situations are distinguished:

- $n < c$: At each sweep point, the average trace no. n is calculated from the average trace no. $n - 1$ and the current trace no. n according to the following recurrence:

$$Avg(n) = \frac{n-1}{n} Avg(n-1) + \frac{1}{n} Curr(n) \quad (n = 1, \dots, c)$$

The average trace represents the arithmetic mean value over all n sweeps.

- $n > c$: At each sweep point, the average trace no. n is calculated from the average trace no. $n - 1$ and the current trace no. n according to:

$$Avg(n) = \frac{c-1}{c} Avg(n-1) + \frac{1}{c} Curr(n) \quad (n > c)$$

The formulas hold for Average Factor $n = 1$ where the average trace becomes equal to the current trace.

Remote control: [SENSE<Ch>:]AVERAge[:STATe] ON | OFF
 [SENSE<Ch>:]AVERAge:COUNT
 [SENSE<Ch>:]AVERAge:CLEAr

Channel Select

The *Channel Select* submenu provides functions to create and delete channels and select a channel as the active channel.

(No direct access via front panel keys)

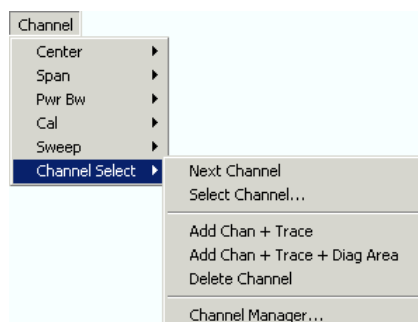

- *Next Channel* selects the next channel as the active channel (disabled if only one channel is defined).
- *Select Channel* opens a box to select an arbitrary channel of the active setup as the active channel (disabled if only one channel is defined).
- *Add Chan + Trace* creates a new channel and a new trace in the active diagram area.
- *Add Chan + Trace + Diag Area* creates a new channel and a new trace in a new diagram area.
- *Delete Channel* deletes the active channel.
- *Channel Manager* opens a dialog to perform the previous actions systematically, rename channels.



Active and inactive traces and channels

A window can display several diagram areas simultaneously, each with a variable number of traces. One of these traces is active at each time. The active trace is highlighted in the trace list on top of the active diagram area (Trc 4 in the figure below):

Trc1	S21	dB Mag	10 dB /	Ref 0 dB
Trc2	S11	Phase	45° /	Ref 0°
Trc3	a1	Lin Mag	10 dB /	Ref 0 dBm
Trc4	S21	Phase	45° /	Ref 0°

A mouse click onto a trace in the list selects the trace as the active trace. Alternatively, use the functions of the *Trace – Traces* menu.

The active channel is the channel belonging to the active trace. The channels of all traces in a diagram area are listed at the bottom of the diagram, together with the *Stimulus* values and the display colors of all traces. The active channel is highlighted (Ch1 in the example below, with two associated traces).

Ch1	Start	300 kHz	—
Ch2	Start	500 kHz	—
Ch3	Start	5 MHz	—

A mouse click onto a trace in the trace list selects the channel associated to the trace as the active channel. Channels with no traces are not indicated in the diagram areas but can be accessed via the *Channel Manager*.

Next Channel

Selects the next channel in a list of defined channels as the active channel. This function is disabled if the current setup contains only one channel.

Ch1	Start	300 kHz	—
Ch2	Start	500 kHz	—
Ch3	Start	5 MHz	—

If one or several traces are assigned to the next channel, one of these traces becomes the active trace.

The order of all channels belonging to a setup is given by the channels' creation time. By default, the channels are named Ch1, Ch2, ... so that Ch<n> follows Ch<n – 1>. This order is always maintained, even if channels are renamed, invisible (because no traces are assigned to them) or distributed over several diagram areas.

Remote control: The numeric suffix <Ch> appended to the first-level mnemonic of a command selects a channel as active channel.

Select Channel

- Opens a box to select an arbitrary trace of the active setup as the active trace. This function is disabled if the current setup contains only one channel.



If one or several traces are assigned to the selected channel, one of these traces becomes the active trace.

The order of all channels belonging to a setup is given by the channels' creation time. By default, the channels are named Ch1, Ch2, ... so that Ch<n – 1> precedes Ch<n>. This order is always maintained, even if channels are renamed, invisible (because no traces are assigned to them) or distributed over several diagram areas.

Remote control: The numeric suffix <Ch> appended to the first-level mnemonic of a command selects a channel as active channel.

Add Chan + Trace

Creates a new channel and a new trace, which is displayed in the active diagram area. The new channel settings (including a possible channel calibration) are identical to the previous channel settings; the trace is created with the trace settings of the former active trace but displayed with another color. The former and the new active trace are superimposed but can be easily separated, e.g. by changing the *Reference Position*.

The new channel is named Ch<n>, where <n> is the largest of all existing channel numbers plus one. The name can be changed in the Channel Manager.



To create a new trace in the active channel, use the *Trace – Traces – Add Trace* function. To create a new channel and a new trace and display it in a new diagram area, use *Add Chan + Trace + Diag Area*.

Remote control: `CONFigure:CHANnel<Ch>[:STATe] ON`
`CALCulate<Ch>:PARAmeter:SDEFine "<Trc_name>", "<Parameter>"`
`DISPlay:WINDow<No>:TRACe:FEED "<Trc_name>"`

Add Chan + Trace + Diag Area

Creates a new channel and a new trace, which is displayed in a new diagram area. The new channel settings (including a possible channel calibration) are identical to the previous channel settings; the trace is created with the trace settings of the former active trace but displayed with another color.

The new channel is named Ch<n>, where <n> is the largest of all existing channel numbers plus one. The name can be changed in the Channel Manager.



To create a new trace in the active channel, use the *Trace – Traces – Add Trace* function. To create a new channel and a new trace and display it in the active diagram area, use *Add Chan + Trace*.

Remote control: `CONFigure:CHANnel<Ch>[:STATe] ON`

```
CALCulate<Ch>:PARAmeter:SDEFine "<Trc_name>", "<Parameter>"
DISPlay:WINDow<No>:STATe ON
DISPlay:WINDow<No>:TRACe:FEED "<Trc_name>"
```

Delete Channel

Deletes the current channel including all traces assigned to the channel and removes all display elements related to the channel from the diagram area. *Delete Channel* is disabled if the setup contains only one channel: In manual control, each setup must contain at least one diagram area with one channel and one trace.



To restore a channel that was unintentionally deleted, use the *Undo* function.

Remote control: CONFigure:CHANnel<Ch>[:STATe] OFF

Channel Manager

Opens a dialog to perform the actions in the *Channel Select* menu systematically and rename channels.

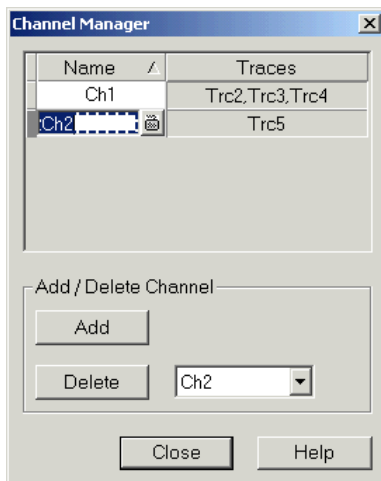

All existing channels of the current setup are listed in a table; see below. Below the table the *Trace Manager* provides the following buttons:

- *Add Channel* adds a new channel to the list. The new channel is named Ch<n>, where <n> is the largest of all existing channel numbers plus one.
- *Delete Channel* deletes the channel selected in the drop-down menu. This button is disabled if the setup contains only one channel: In manual control, each setup must contain at least one diagram area with one channel and one trace.



Columns in the Channel Manager table

The channel table contains several editable (white) or non-editable (gray) columns.

Name	Traces
Ch2	Trc4
Ch3	None

- *Channel* indicates the current channel name. The default names for new channels are Ch<n> where <n> is a current number.

- *Traces* indicates the names of all traces assigned to the channel.

Remote control: CONFigure:CHANnel<Ch>:CATalog?
 CONFigure:CHANnel<Ch>:NAME
 CONFigure:CHANnel<Ch>:NAME:ID?
 CONFigure:CHANnel<Ch>[:STATe]

Nwa-Setup Menu

The *Nwa-Setup* menu provides all display settings and the functions to activate, modify and arrange different diagram areas.



Diagram Areas

A diagram area is a rectangular portion of the screen used to display traces. Diagram areas are arranged in windows; they are independent of trace and channel settings.

- A diagram area can contain a practically unlimited number of traces, assigned to different channels (overlay mode); see *Traces*, *Channels* and *Diagram Areas*.
- The traces displayed in the diagram area are listed in the upper left corner.
- The channels for all traces are listed in the lower left corner.

The contents of the diagram areas are explained in section *Display Elements*. Diagram areas are controlled and configured by means of the functions in the *Nwa-Setup – Display* submenu. Moreover the size of the entire window can be changed by an easy drag-and-drop operation, which is especially useful if the network analyzer is controlled via *Remote Desktop*.

(No direct access via front panel keys)

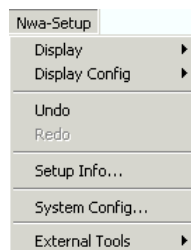

The *Nwa-Setup* menu contains the following functions and submenus:

- *Display* provides functions to delete diagram areas, arrange traces to diagram areas and arrange the diagram areas in the active window.
- *Display Config* configures the entire screen and the individual diagram areas.
- *Undo* reverses the previous operation.
- *Redo* reverses the action of the *Undo* command.
- *Setup Info* displays information on the active setup.
- *System Config* opens a dialog to define various system-related settings.
- *External Tools* opens a submenu with various demo setups and editing tools.

Display

The *Display* submenu provides functions to delete diagram areas, and arrange areas in the active window.



Active and inactive traces and diagram areas

The active window can display several diagram areas simultaneously, each with a variable number of traces. One of these areas and traces is active at each time. The area number in the upper right corner of the active area is highlighted. At the same time the active trace is highlighted in the trace list on top of the active diagram area (Trc 4 in the figure below):

Trc1	S21	dB Mag	10 dB / Ref 0 dB
Trc2	S11	Phase	45° / Ref 0°
Trc3	a1	Lin Mag	10 dB / Ref 0 dBm
Trc4	S21	Phase	45° / Ref 0°

The analyzer provides several tools to activate a diagram area:

- A left mouse click on a point in the diagram activates the diagram including the last active trace in the diagram.
- A left mouse click on a trace list activates the trace including the corresponding diagram.
- Some of the functions of the *Trace – Traces* menu activate a particular trace including the corresponding diagram.

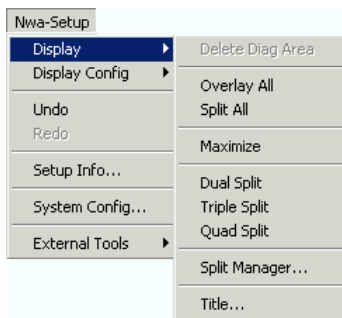

- *Delete Diag Area* deletes the active diagram area.
- *Overlay All* places all traces in a single diagram area which occupies the whole window.
- *Split All* splits the active window into as many diagram areas as there are traces and assigns a single trace to each area.
- *Maximize* maximizes the active diagram area to occupy the whole window.
- *Dual Split* splits the active window into two diagram areas and distributes the traces among the two areas.
- *Triple Split* splits the active window into three diagram areas and distributes the traces among the three areas.
- *Quad Split* splits the active window into four diagram areas and distributes the traces among the four areas.
- *Split Manager* opens a dialog to arrange the diagram areas in the active window.
- *Title* opens a dialog to define a title and display it in one of the diagram areas.

Delete Diag Area

Deletes the current diagram area including all traces displayed in the diagram area. *Delete Diag Area* is disabled if the setup contains only one diagram area: In manual control, each setup must contain at least one diagram area with one channel and one trace.



To restore a diagram area that was unintentionally deleted, use the *Undo* function.

Remote control: DISPlay:WINDow<Wnd>:STATe OFF

Dual Split

Splits the window horizontally into two diagram areas and distributes the traces among the two areas, separating diagrams with different trace Format and Channel settings (e.g. Cartesian and polar diagrams).

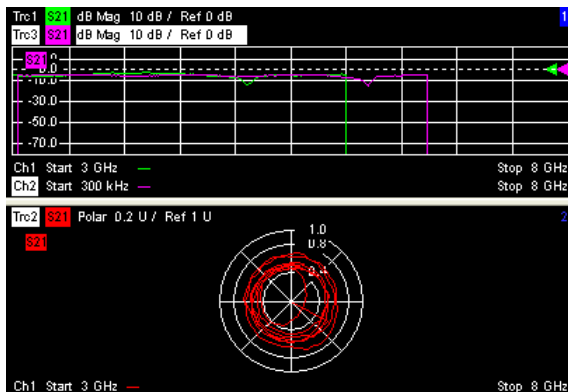

To vary the size and position of the two diagram areas, drag and drop the separating frames or use the *Split Manager*.

Remote control: No command, display configuration only.

Triple Split

Splits the active window into three diagram areas and distributes the traces among the three areas, separating diagrams with different trace Format and Channel settings (e.g. Cartesian and polar diagrams).

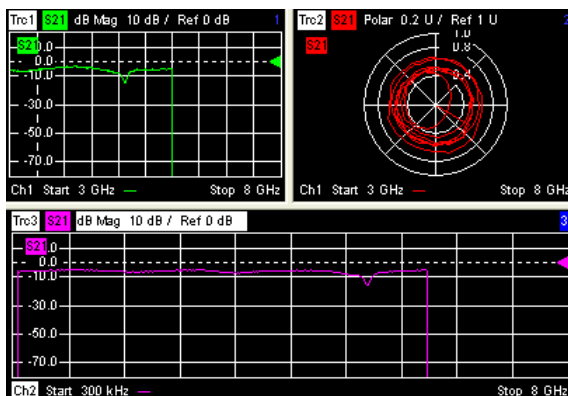

If less than three traces are available, some diagram areas are empty and display *No Trace*.



To vary the size and position of the diagram areas, drag and drop the separating frames or use the *Split Manager*.

Remote control: No command, display configuration only.

Quad Split

Splits the active window into four diagram areas and distributes the traces among the four areas, separating diagrams with different trace Format and the Channel settings (e.g. Cartesian and polar diagrams).

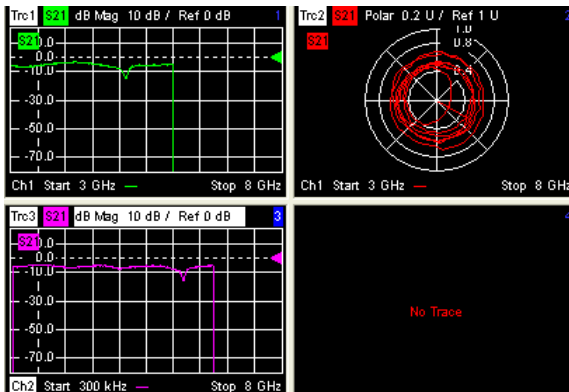

If less than four traces are available, some diagram areas are empty and display *No Trace*.



To vary the size and position of the diagram areas, drag and drop the separating frames or use the *Split Manager*.

Remote control: No command, display configuration only.

Split Manager

Opens a dialog to arrange the diagram areas in the active window.

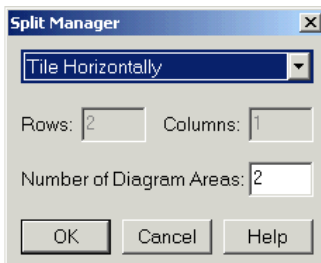

- *Split Mode* provides a drop-down list to select alternative display schemes for the diagram areas (see examples for split modes below).
- *Number of Diagram Areas* indicates the total number of diagram areas. Increasing/decreasing the number creates new diagram areas or deletes diagram areas.



Examples for split modes

- The following examples were obtained with 3 diagram areas, each with 1 trace.

Nwa-Setup Menu

Lineup

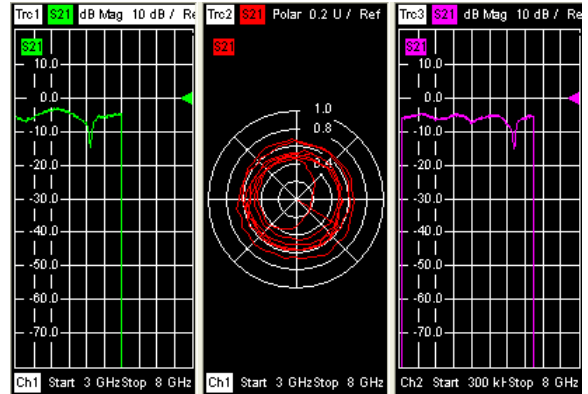

Stack

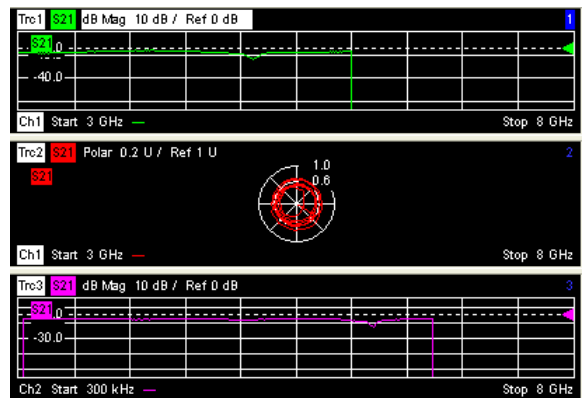

Tile Horizontally

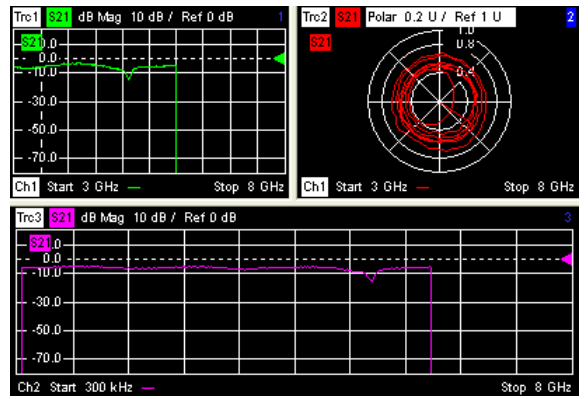

Tile Vertically

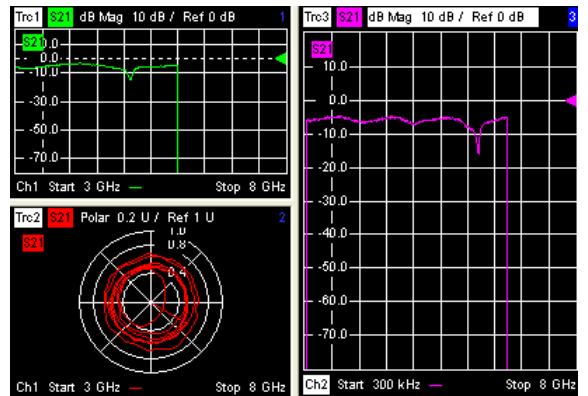

Rows and Columns (2 | 1): the 3rd trace is displayed in overlay mode.

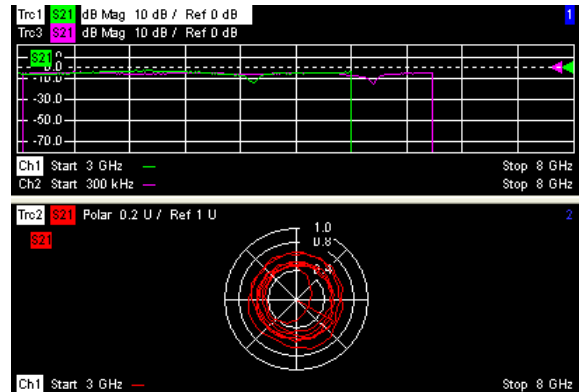

Remote control:

No command, display configuration only.

Title

Opens a dialog to opens a dialog to define a title and display it in one of the diagram areas.



- *Title* provides an input field for the title string. The title may comprise a practically unlimited number of characters and is centered in a line below the top of the diagram area.
- *Diagram Area* provides a drop-down list of all diagram areas of the current setup. The title is assigned to the selected area.
- *All Titles Off* removes the titles from all diagram areas. The titles are hidden but not deleted: Unchecking *All Titles Off* displays the titles again.

Remote control: `DISPlay:WINDow<Wnd>:TITLe:DATA '<title>'`
`DISPlay:WINDow<Wnd>:TITLe:STATe <Boolean>`

Display Config

The *Display Config* submenu configures the screen by showing or hiding controls and information elements and controls the appearance of the individual diagrams.

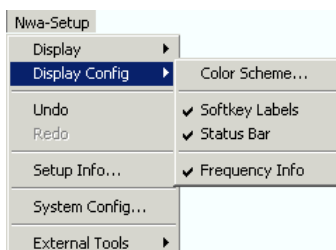

The *Display Config* menu contains the following functions:

- *Color Scheme* controls the colors in all diagram areas.
- *Softkey Labels* shows or hides the softkey bar at the right edge of the screen.
- *Status Bar* shows or hides the status bar across the bottom of the screen.
- *Front Panel Keys* shows or hides the hardkey bar at the top of the screen.
- *Frequency Info* shows or hides the frequency values in the diagram areas.

Hiding the controls and information elements leaves more space for the diagram areas. All elements may be shown or hidden simultaneously. A checkmark next to the menu item indicates that the view element is displayed.

Color Scheme

Controls the colors in the diagram areas. Color schemes are global settings and apply to all active setups.

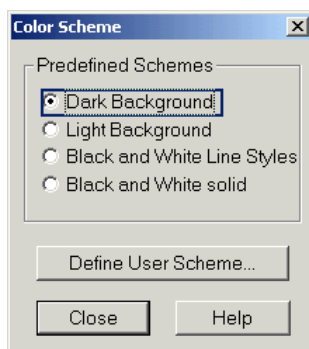

The following *Predefined Schemes* are optimized for the analyzer screen and for color hardcopies, respectively:

- *Dark Background* sets a black background color. The traces and information elements in the diagram areas are displayed in different colors. This setting is usually suitable for observing results on the analyzer screen.
- *Light Background* sets a light background color. The traces and information elements in the diagram areas are displayed in different colors. This setting is suitable for generating color hardcopies of the screen.

The following *Predefined Schemes* can be appropriate for generating black-and-white hardcopies of the screen:

- *Black and White Line Styles* sets a white background color. All traces and information elements in the diagram areas are black, however, the traces are drawn in different line styles.
- *Black and White Solid* sets a white background color. All traces and information elements in the diagram areas are black. All traces are drawn with solid lines.

Define User Scheme... opens a dialog to modify the predefined schemes, changing the colors and styles of the individual display elements.



Use *Define User Scheme* to create, save and recall your own color scheme.

Remote control: `SYSTem:DISPlay:COLor`

Define User Color Scheme

The *Define User Color Scheme* dialog modifies the predefined color schemes, changing the colors and

styles of the individual display elements. User-defined color schemes can be saved to a file for later reuse.

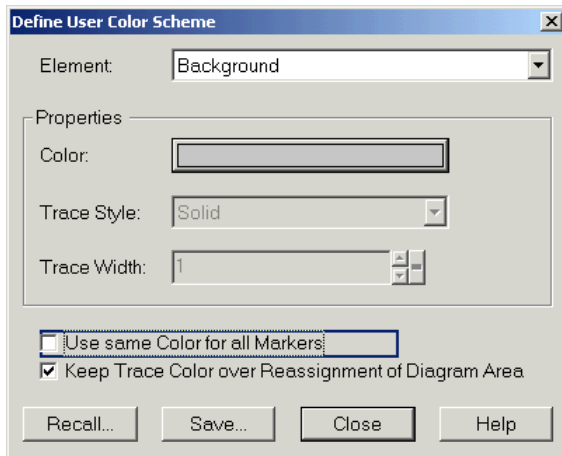

The following control elements change the current color scheme:

- The screen element to be modified is selected from the *Element* drop-down list. The list contains the background and all traces, text elements and lines in the diagrams.
- *Color* opens a standard color dialog to assign a color to the selected element. Use the *What's This?* help button  in the dialog to obtain detailed information.
- *Trace Style* and *Trace Width* are enabled if the selected element is a trace.
- *Use same Color for all Markers* allows to select a common marker color, which is independent of the trace colors. To define the common color, select the *Same Color for all Markers* element.
- *Keep Trace Color over Reassignment of Diagram Area* controls the color of traces that are assigned to another diagram area or created together with a new diagram areas; see background information below.



Effects of Keep Trace Color...

The analyzer assigns trace colors according to a predefined scheme, starting with the colors that are easiest to distinguish. On one hand it is advantageous to use the colors at the beginning of the scheme. On the other hand, it is often desirable to use different colors in different diagram areas so that any trace that is moved from one diagram area to another can keep its color.

Keep Trace Color... changed between these two alternative color modes as shown below.

Keep Trace Color	Move trace to another diagram area (Trace Manager)	Add Trace + Diag. Area (Trace – Trace Select...)
<input type="checkbox"/>	Trace color changed according to the new diagram area's color scheme	Color scheme of the new diagram area is independent, restarts with the first colors. Consequently the new trace is displayed with a color that has been already used.
<input checked="" type="checkbox"/>	Trace keeps its color	Color scheme of the new diagram area continues color scheme of the previously active area. The new trace is displayed with a new color.

See also program example for `DISPlay:CMAP<Element>:TRACe:COLor[:STATe]`.

Two buttons at the bottom of the dialog are used to save or recall user-defined color schemes.

- *Save...* opens a *Save As...* dialog to select a color scheme file and save the current settings. Color scheme files are non-editable files with the extension **ColorScheme*; the default directory is `C:\R_S\Instr\user\Nwa\ColorSchemes`.
- *Recall...* opens an *Open File...* dialog to load and apply a color scheme saved before.



To recall a color scheme file (*.ColorScheme) you can also use the Windows Explorer and simply double-click the file or drag and drop the file into the NWA application.

Remote control:

```

DISPlay:CMAP<Element>:RGB <red>, <green>, <blue> [,<trace_style>,
<trace_width>]
DISPlay:CMAP<Element>:MARKer[:STATE] ON | OFF
DISPlay:CMAP<Element>:TRACe:COLor[:STATE] ON | OFF
MMEMoRY:LOAD:CMAP
MMEMoRY:STORE:CMAP

```

Softkey Labels

Shows or hides the softkey bar at the right edge of the screen.

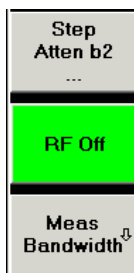

The softkey bar shows up to 7 commands of the active menu indicated above softkey no. 1. The figure above shows the upper part of the softkey bar corresponding to the *Trace – Meas* submenu. Pressing the key to the right of a softkey directly activates a submenu, calls up the numeric entry bar or a dialog or initiates an action. See *Softkey Bar* in the introductory chapter for more information.

Status Bar

Shows or hides the status bar across the bottom of the screen.



The status bar describes the current channel (if the setup contains only one channel), the progress of the sweep and the control mode of the analyzer (*LOCAL* or *REMOTE*).

Front Panel Keys

Shows or hides the hardkey bar (front panel key bar) at the top of the screen (to the left of the softkey bar).



The hardkey bar represents the most commonly used front panel keys of the analyzer. Clicking a key symbol executes the action of the corresponding key.

See *Hardkey Bar* in the introductory chapter for more information.

Frequency Info

Shows or hides all frequency stimulus values in the diagrams. This comprises:

- The frequency stimulus ranges below the diagram area.
- The frequency stimulus values in the marker info field, at the marker position and in the marker table.

The *Frequency Info* setting is valid for frequency and segmented frequency sweeps only.

Remote control: `DISPlay:ANNotation:FREQuency[:STATe] ON | OFF`

Undo

Reverses the last action, if possible. Otherwise, *Undo* is disabled (grayed).



You can use *Undo* even after a *Preset*, in order to restore your own instrument settings.

Redo

Reverses the action of the *Undo* command. If *Undo* was not used before, *Redo* is disabled (grayed).

Setup Info

Displays the channel and trace settings of the active setup. See also section Obtaining Technical Support.

System Config

Opens a dialog to define various system-related settings.

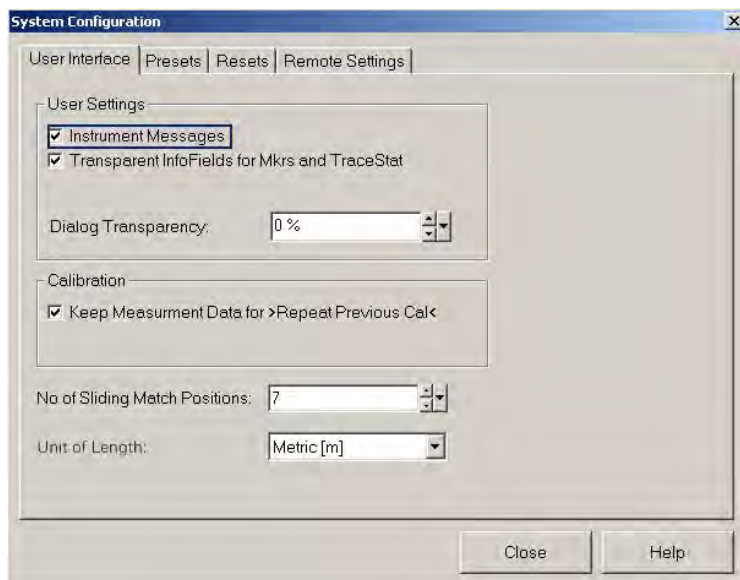

The *System Configuration* dialog is divided into the following tabs:

- **User Interface**

The two check boxes in the *User Settings* panel switch the instrument messages or transparent info fields on or off. The *Instrument Messages* setting is also valid if the instrument is remote-controlled. With transparent info fields the grid and traces underneath are still visible.

Dialog Transparency varies the transparency of all dialogs on a scale between 0% and 100%. 0% transparency means that dialogs completely hide the diagram area in the background. With a maximum transparency of 100%, the dialogs are still visible but clearly show the underlying traces and display elements.

Keep Measurement Data for >Repeat Previous Cal< causes the raw measurement data of the standards to be stored after the calibration is completed. This function is equivalent to the parameter in the *Measured Standards* dialog of the calibration wizard (see detailed description there) but applies to all calibrations.

No of Sliding Match Positions defines the maximum number of different positions to be measured if a sliding match standard (sliding load) is used for calibration. The different positions appear in the *Measure Standards* dialog of the calibration wizard. A sliding match calibration is valid after three calibration sweeps at different match positions; however, calibration sweeps at additional positions can still improve the accuracy. In general 4 to 6 positions are recommended.

Unit of Length selects the physical unit for lengths/distances, e.g. for distance-to-fault measurements. The selected unit (metric units/m or feet) is also used as a default length unit for remote control; see e.g. `CALCulate<Chn>:TRANSform:DTFault:CENTer`.

- **Presets**

The tab specifies whether a *Preset* affects the *Active Setup* or all open setups (*Instrument*). A preset does not change any of the properties listed in the *Resets* tab of the *System Configuration* dialog.

In the *Preset Configuration* panel, it is possible to specify whether the *Preset* command will perform a factory preset or restore the settings stored to a user preset file. A user preset file is an arbitrary setup (.zvx) file, to be stored using the *Nwa File – Save Network Analysis...* command. If the current user preset file is not found (e.g. because it was deleted or moved), the analyzer performs a factory preset.



*In remote control, a user-defined preset must be initiated using the commands in the SYSTem:PRESet:USER... subsystem. *RST and SYSTem:PRESet always restore the factory preset settings.*

- **Resets**

Provides several buttons to reset global instrument settings and properties. Global settings (e.g. the data related to global resources) are not affected by an instrument *Preset*.

Use Default Directories also resets the custom header for trace files.

- **Remote Settings**

Specifies the *Remote Language* for the analyzer.

- The *DEFAULT* language corresponds to the instrument control commands reported in this help system; see *SCPI Command Lists*.
- *PNA, HP8510, HP8720, HP8753* denote command sets for network analyzers from other manufacturers.

The *ID String* and the *OPT String* of the analyzer are adjusted to the selected *Remote Language*. The strings can be queried via `*IDN?` and `*OPT?`, respectively.

- If the *DEFAULT* language is activated, the factory ID string *Rohde&Schwarz,ZVL<Max. Freq.-Ports>Port,<Serial_no>,<FW_Version>* (e.g. *Rohde&Schwarz,ZVL6-2Port,1145101010100001,1.70.5*) is set. The bit order for transferred binary data is

swapped (FORMat:BORDER SWAPped).

- If the PNA language is activated, Agilent-compatible ID and OPT strings are set. The bit order for transferred binary data is normal.
- If one of the *HP xxxx* languages is activated, HP xxxx-compatible ID and OPT strings are set. Binary data is transferred in a device-specific bit order, however, the bit order can be changed using HP xxxx-specific commands.

The ID string can be changed or reset by using the SETUP key.

Show Error Messages activates a information popup box (tooltip) to be displayed whenever the parser encounters an remote control command error. The tooltip appears at the bottom of the remote or manual screen; it is **not** displayed for SCPI errors no. –113, *Undefined header*:

```
Remote Error : -222, "Data out of range;FREQ:STAR 1"
```

The tooltip is to provide information that can be useful for program development and optimization; it does not necessarily indicate that a remote control script is faulty or non-executable.

Remote control (for *Unit of Length*)

UNIT:LENGth

for *Keep Measurement Data...*

[SENSE<Ch>:]CORRection:COLLect[:ACQuire]:RSAVe:DEFault

for preset scope:

SYSTem:PRESet:SCOPE SINGLE | ALL

for GPIB:

FORMat:BORDER NORMAl | SWAPped
SYSTem:ERRor:DISPlay

External Tools

Opens a submenu with various demo setups: *Demo*.vbs*: Shows how to perform the settings for typical measurement tasks.



After running a **vbs* file you can modify the demo setup according to your own needs and store it to a **.nwa* file for later reuse.

Help Menu

The *Help* menu provides assistance with the network analyzer and its operation.



The *Help* menu contains the following functions:

- *Help Topics* opens this help system.
- *About NWA...* opens a dialog to retrieve information about the network analyzer and the current firmware version.

Help Topics

Opens this help system. The help file is opened with the *Welcome* topic and remembers its last size, position and default navigation tab (*Contents, Index,...*). For more information see *About this Help*.

About NWA...

Opens a dialog to retrieve information about the network analyzer and the current firmware version. *OK* closes the dialog.

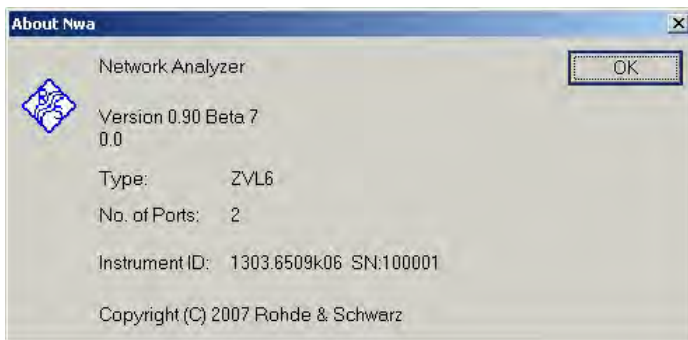

FILE Key

The FILE key is used to store and load instrument settings and to manage stored files.

The file menu includes functions for storing (*Save* softkey) instrument settings such as instrument configurations (measurement/display settings, etc) and measurement results on permanent storage media, or to load (*Recall* softkey) stored data back onto the instrument.

Functions for management of storage media (*File Manager* softkey) include among others functions for listing, copying, and deleting/renaming files.

The R&S ZVL is capable of internally storing complete instrument settings with instrument configurations and measurement data in the form of settings files. The respective data are stored on the internal flash disk or, if selected, on a memory stick or network drive. The mass storage media are assigned to the volume names as follows:

Drive	Designation	Comment
C	operating system, firmware and stored instrument settings	for customer data
A	USB floppy drive	if connected
D	USB memory stick or USB CD ROM	if connected
E ...Z	additional USB mass storage devices or mounted LAN volumes	if connected



Navigation in the dialog boxes for saving and loading settings files

The following table shows all softkeys available in the file menu. It is possible that your instrument configuration does not provide all softkeys. If a softkey is only available with a special option, model or (measurement) mode, this information is delivered in the corresponding softkey description.

Submenu / Command	Submenu / Command	Command
Save	Save File	
	Select Path	
	Select File	
	Edit File Name	
	Edit Comment	
	Select Items	Select Items
		Enable All Items
		Disable All Items
	Delete File	
Recall	Recall File	
	Select Path	
	Select File	
	Edit File Name	
	Edit Comment	
	Select Items	Select Items
		Enable All Items
		Disable All Items
	Delete File	
Startup Recall		
File Manager ▼	Edit Path	
	New Folder	
	Copy	

	Rename	
	Cut	
	Paste	
	More ▼	
	Delete	
	Sort Mode ▼	Name
		Date
		Extension
		Size
	File Lists 1/2	
	Current File List 1/2	
	Network Drive	Map Network Drive
		Disconnect Network Drive
Recall Shortcuts ▼	<File Names>	
More ▼	Hardcopy	

Navigation in the dialog boxes for saving and loading settings files

The *Save*, *Recall* and *Startup Recall* dialog boxes are used to save and recall settings files and use the same navigation principle. Press the *Save* or *Recall* softkey to open the corresponding dialog box.

- *Path* field
 - To change the directory, press the *Edit Path* softkey.
 - To select a folder, use the rotary knob or the *Cursor Up* and *Cursor Down* keys. To open a subfolder, press the *Cursor Right* key. To close subfolders, press the *Cursor Left* key. To confirm the selection, press the rotary knob or the ENTER key.
- *Files* list
 - If the *Startup Recall* dialog box is opened, the focus is on the *File Name* field. To set the focus on the *Files* list, press the *Select File* softkey.
 - To select a folder, use the rotary knob or the *Cursor Up* and *Cursor Down* keys. To open a subfolder, press the ENTER key. To select a file, use the rotary knob or the *Cursor Up* and *Cursor Down* keys. To load the selected file, press the rotary knob or the ENTER key. To delete the selected file, press the softkey.

- *File Name* field
- If the *Save* or *Recall* dialog box is opened, the focus is on the *File Name* field. Enter the name in the *File Name* field. The extension of the data name is ignored.
- *Comment* field
- To enter a comment, press the *Edit Comment* softkey.
- Items saved in the settings file
- To select a special item, set the focus on the entry using the arrow keys or the rotary knob. To confirm the selection, press the CHECKMARK key. To deselect the item, press the CHECKMARK key again.

Save

Opens the *Save* dialog box to define and store the settings file. To navigate in the dialog box and define/enter settings use the corresponding softkeys.

<i>Path</i>	Directory in which the settings file is stored. The default path for user settings files is C:\R_S\Instr\user
<i>Files</i>	List of settings files already stored.
<i>File Name</i>	Alphanumeric name of settings file.
<i>Comment</i>	Comment regarding the settings file.
[Items]	Selection of items to be saved in the settings file.

Save File / Recall File

Saves the settings file with the defined file name (*Save* dialog box), or recalls the selected settings file (*Recall* dialog box). If the file name already exists upon saving, a message is displayed. Selecting *Yes* overwrites the existing file, selecting *No* aborts the saving process.

For details on the file name conventions refer to the *Edit File Name* softkey description.



If you store device settings file to the C:\R_S\Instr\RecallShortCut directory, you can recall them using the *Recall Shortcuts* submenu.

Remote Control:

```
MMEM:STOR:STAT 1, 'TEST'
MMEM:STOR:STAT:NEXT
MMEM:LOAD:STAT 1, 'C:\R_S\Instr\user\TEST01'
```

Select Path

Opens the directory list to select the folder in which the device configuration is to be stored or loaded. The default path is C:\R_S\Instr\user.

Select File

Sets the focus on the *Files* list.

Edit File Name

Sets the focus on the *File Name* field.

In the *Save* dialog box, the field already contains a suggestion for a new name: the file name used in the last saving process is counted up to the next unused name. For example, if the name last used was "test_004", the new name "test_005" is suggested, but only if this name is not in use. If the name "test_005" is already in use, the next free name is suggested, e.g. "test_006". You can change the suggested name to any name conform to the following naming conventions.

The name of a settings file consists of a base name followed by an underscore and three numbers, e.g. limit_lines_005. In this example, the base name is "limit_lines". The base name can contain characters, numbers and underscores. The file extension is added automatically.

Edit Comment

Sets the focus on the *Comment* field to enter a comment concerning the current settings file. Max. 60 characters are allowed.

Select Items

Displays the softkey submenu for selecting the items to be stored or loaded. The *Select Items* softkey in the submenu sets the focus on the items list.

In the *Save* dialog box, all items that can be saved are displayed. The number of displayed items depends on the installed options, as for some options additional items can be stored.

In the *Recall* dialog box, the items saved in the selected file are displayed.

Remote Control: MMEM:SEL[:ITEM]:DEFault
 MMEM:SEL[:ITEM]:HWSettings
 MMEM:SEL[:ITEM]:LINes[:ALL]
 MMEM:SEL[:ITEM]:TRACe[ACTive]

Enable All Items / Disable All Items

Selects all items / none of the items for saving or loading.

Remote Control: MMEM:SEL[:ITEM]:ALL
 MMEM:SEL[:ITEM]:NONE

Delete File

Deletes the selected settings file.

Remote Control: `M MEM:CLE:STAT 1, 'Test'`

Recall

Opens the *Recall* dialog box to load a settings file. For details on the dialog box see *Save* softkey. To navigate in the dialog box and define/enter settings use the corresponding softkeys.

Remote Control: `M MEM:LOAD:STAT 1, 'C:\R_S\Instr\user\TEST01'`

Startup Recall

Activates or deactivates the startup recall function. If activated, the settings stored in the settings file selected via the *Startup Recall Setup* softkey are loaded when booting or for preset. If deactivated, the default settings are loaded.

Remote Control: `M MEM:LOAD:AUTO 1, 'C:\R_S\Instr\user\TEST'`

Startup Recall Setup

Opens the *Startup Recall* dialog box to select the settings file for the startup recall function (see also *Startup Recall* softkey).

Remote Control: `M MEM:LOAD:AUTO 1, 'C:\R_S\Instr\user\TEST'`

File Manager

Opens the *File Manager* dialog and submenu.

Recall Shortcuts

Opens a submenu providing access to all settings files stored in the `C:\R_S\Instr\RecallShortCut` directory. The file extensions `*.zvl.dfl` do not appear on the softkeys of the submenu, and every blank in the filename causes a line break.

By pressing a softkey with a file name, you can load the corresponding device settings. *Recall Shortcuts* is equivalent to *Recall* but faster.

Remote Control: `M MEM:LOAD:STAT 1, 'C:\R_S\Instr\user\TEST01'`

Export / Import

These softkeys are currently unavailable.



Use the *Trace – Trace – Import/Export Data* submenu to export or import trace data in *Network Analyzer* mode.

Hardcopy

Opens the PRINT menu.

File Manager

Opens the *File Manager* dialog box and a submenu to manage mass storage media and files. In the upper left corner, the current drive is displayed. Below the folders and subfolders of the current directory are displayed.

The following tasks can be performed:

- to copy files from flash disk to other media
- to copy files into another directory
- to rename and delete files



Navigation in the File Manager

- To change from one subfolder to another, use the ENTER key.
- To change to the next higher directory, select the dots "..".
- To change into a subfolder, use the *Cursor Right* and *Cursor Left* keys.
- To select a file or a folder, use the *Cursor Up* and *Cursor Down* keys.
- To confirm the selection of a file or folder, press the ENTER key.

Menu (Key)	Submenu	Submenu / Command	Command
FILE ▼	File Manager ▼	Edit Path	
		New Folder	
		Copy	
		Rename	
		Cut	
		Paste	
		More ▼	
		Delete	
		Sort Mode ▼	Name

			Date
			Extension
			Size
		File Lists 1/2	
		Current File List 1/2	
		Network Drive	Map Network Drive
			Disconnect Network Drive

Edit Path

Opens the directory list to select the folder in which the device configuration is to be stored or loaded. The default path is C:\R_S\Instr\user. For details see also Navigation in the dialog boxes for saving and loading data sets.

Remote Control: MMEM:MSIS "D:"
 MMEM:CDIR "C:\R_S\Instr\user"

New Folder

Creates a new folder and opens an edit dialog box to enter name and path (absolute or relative to the current directory) of the new folder.

Remote Control: MMEM:MDIR "C:\R_S\Instr\user\TEST"

Copy

Copies the selected item to the clipboard. The item can be copied later using the *Paste* softkey.

Remote Control: MMEM:COPY "C:\R_S\Instr\user\set.cfg", "E:"

Rename

Opens an edit dialog box to enter a new file or folder name.

Remote Control: MMEM:MOVE "test02.cfg", "set2.cfg"

Cut

Copies the selected file to the clipboard. If the file is later copied to a different directory using the *Paste*

softkey, it is deleted in the current directory.

Paste

Copies a file from the clipboard to the currently selected directory.

Delete

Deletes the selected item after confirmation.

Remote Control: MMEM:DEL "test01.hcp"
 MMEM:RDIR "C:\R_S\Instr\user\TEST"

Sort Mode

Opens a submenu to select the sorting mode for the displayed files. The entry for the next higher directory level ("..") and the folders are always located at the top of the list.

Name

Sorts the displayed files in alphabetical order of the file names.

Date

Sorts the displayed files in respect to the date.

Extension

Sorts the displayed files in respect to the extension.

Size

Sorts the displayed files in respect to the size.

File Lists 1/2

Splits the screen to copy files from one directory to the other. The focus between the two panes is switched using the FIELD RIGHT and FIELD LEFT keys.

Current File List 1/2

Changes the focus to the selected file list.

Network Drive

Opens a dialog to map a drive to a server or server folder of the network. As a prerequisite in Microsoft networks, sharing of this server or server folder must be enabled.

Remote Control: MMEM:NETW:USED
MMEM:NETW:UNUS?

Map Network Drive

Changes the focus to the *Drive* list.

Remote Control: MMEM:NETW:MAP

Disconnect Network Drive

Opens a dialog to disconnect a (previously connected) network drive.

Remote Control: MMEM:NETW:DISC

SETUP Key

The SETUP key is used to set or display the default settings of the instrument: reference frequency, date, time, LAN interface, firmware update and enabling of options, information about instrument configuration and service support functions.

The following table shows all softkeys available in the setup menu. It is possible that your instrument configuration does not provide all softkeys. If a softkey is only available with a special option, model or (measurement) mode, this information is delivered in the corresponding softkey description.

Submenu / Command	Submenu / Command	Submenu / Command
Reference Int/Ext		
General Setup ▼	Configure Network	
	Network Address ▼	Computer Name
		IP Address
		Subnet Mask
		DHCP On/Off
	LXI ▼	LAN Status On/Off
		Info
		Password
		Description

		LAN Reset
	GPIB ▼	GPIB Address
		ID String Factory
		ID String User
		GPIB Language
		Display Update On/Off
		More ▼
		GPIB Terminator LFEOI/EOI
		*IDN Format Leg./ZVL
		I/O Logging On/Off
	Time+Date	
	Meas Display ▼	Display Pwr Save On/Off
	More ▼	Monitor Int/Ext
		Soft Frontpanel
		Open Start Menu
More ▼		
	Firmware Update ▼	Firmware Update
	Option Licenses ▼	Install Option
	Shutdown Off/Standby	
	Preset Network	
	Preset Spectrum	
	System Info ▼	Hardware Info
		Versions+Options
		System Messages
		Clear All Messages

	Service ▼	Reset Password
		Selftest
		Selftest Results
		Password
		Service Function

Reference Int/Ext

Switches between the internal and external reference signal source. The default setting is internal reference. It is important, that the external reference signal is deactivated when switching from external to internal reference to avoid interactions.

If the reference signal is missing when switching to external reference, the message *EXREF* is displayed to indicate that no synchronization is possible.

The R&S ZVL can use the internal reference source or an external reference source as frequency standard from which all internal oscillators are derived. A 10 MHz crystal oscillator is used as internal reference source. In the external reference setting, all internal oscillators of the R&S ZVL are synchronized to the external reference frequency (also 10 MHz).

Remote Control: `ROSC:SOUR INT`

Firmware Update

Opens a submenu to install firmware versions. The installation of a new firmware version can be performed via USB or LAN interface; see *Firmware Update*. With firmware versions V3.00 and higher, a user account with administrator rights is necessary to install a printer (see *Operation with and without Administrator Rights*).

Firmware Update

Opens the *Firmware Update* dialog box. The update path is changed by entering the new path or via the *Browse* button. The installation is started via the *Execute* button; see *Firmware Update*.

Remote Control: `SYST:FIRM:UPD 'D:\FW_UPDATE'`

Option Licenses

Opens a submenu to install options. With firmware versions V3.00 and higher, a user account with administrator rights is necessary to install a printer (see *Operation with and without Administrator Rights*).

Install Option

Opens an edit dialog box to enter the license key for the option that you want to install. A message box opens if an option is about to expire or has already expired (in which case all functions (including remote control) are unavailable until the R&S ZVL is rebooted). For more information about the option in question refer to the System Info softkey in the setup menu.

Shutdown Off/Standby

Defines the effect of the power on/off key on the front panel, if the R&S ZVL is AC-supplied (see *Instrument States with AC Power Supply*):

- Off: The instrument is completely turned off. To prevent the instrument from overheating, the fan remains active.
- Standby: The instrument is switched to standby mode.

Preset Network

Sets the preset mode to network analyzer. The instrument is set to this mode when a preset is performed (PRESET key or *RST command).

Preset Spectrum

Sets the preset mode to spectrum analyzer. The instrument is set to this mode when a preset is performed (PRESET key or *RST command).

General Setup

Opens a submenu for all general settings such as IP address and LAN settings, date and time, remote control (optional) and MEAS display.

Menu (Key)	Submenu	Submenu / Command	Submenu / Command
SETUP ▼	General Setup ▼	Configure Network	
		Network Address ▼	
		LXI ▼	
		GPIB ▼	
		Time+Date	
		Meas Display ▼	
		More ▼	Monitor Int / Ext
			Soft Frontpanel

			Open Start Menu
--	--	--	-----------------

Configure Network

Opens the *Network Connections* dialog box to change the LAN settings. See *Remote Control in a LAN*.

Time+Date

Opens an edit dialog box to enter time and date for the internal real time clock.

Remote Control: SYST:TIME 12,30
 SYST:DATE 2004,10,01

Meas Display

Opens a submenu with the *Display Pwr Save On/Off* softkey.

The *Display Pwr Save On/Off* softkey switches the power–save mode for the display on/off and opens an edit dialog box to enter the time for the power–save function to respond. After the elapse of this time the display is completely switched off, i.e. including backlighting. This mode is recommended when the instrument is exclusively operated in remote control.

Remote Control: DISP:PSAV ON
 DISP:PSAV:HOLD 15

Monitor Int/Ext

Activates the R&S ZVL front panel display (Int) or an external monitor to display the screen contents. An external monitor must be connected to the DVI connector on the rear panel of the instrument.

Soft Frontpanel

Activates or deactivates the display of the front panel keys on the screen. The soft frontpanel is recommended for control of the instrument from an external monitor or a Remote Desktop connection.

Alternatively, F6 enables or disables the soft frontpanel.

Remote Control: SYST:DISP:FPAN ON

Open Start Menu

Opens Windows XP's start menu from where you can access program utilities such as Windows XP's on-screen keyboard. The R&S ZVL application is not closed.

Network Address

Opens a submenu to configure the internet protocol properties and the computer name.

Menu (Key)	Submenu	Submenu	Command
SETUP ▼	General Setup ▼	Network Address ▼	Computer Name
			IP Address
			Subnet Mask
			DHCP On/Off

Computer Name

Opens an edit dialog box to enter the computer name via the keypad. The naming conventions of Windows apply. If too many characters and/or numbers are entered, in the status line, a message is displayed.

IP Address

Opens an edit dialog box to enter the IP address via the keypad. The TCP/IP protocol is preinstalled with the IP address 10.0.0.10. If the DHCP server is available (*DHCP On*), the dialog box entry is read-only.

The IP address consists of four number blocks separated by dots. Each block contains 3 numbers in maximum (e.g. 100.100.100.100), but also one or two numbers are allowed in a block (as an example see the preinstalled address).

Subnet Mask

Opens an edit dialog box to enter the subnet mask via the keypad. The TCP/IP protocol is preinstalled with the subnet mask 255.255.255.0. If the DHCP server is available (*DHCP On*), the dialog box entry is read-only.

The subnet mask consists of four number blocks separated by dots. Each block contains 3 numbers in maximum (e.g. 100.100.100.100), but also one or two numbers are allowed in a block (as an example see the preinstalled address).

DHCP On/Off

Switches between DHCP server available (On) or not available (Off). If a DHCP server is available in the network, the IP address and subnet mask of the instrument are obtained automatically from the DHCP server.

LXI Configuration Menu

Opens the LXI submenu containing the following softkeys:

Menu (Key)	Submenu	Submenu / Command	Submenu / Command
SETUP ▼	General Setup ▼	LXI ▼	LAN Status On/Off
			Info
			Password
			Description
			LAN Reset

For a description of the LXI browser interface of the R&S ZVL refer to LXI Configuration.

LAN Status On/Off

Activates the LAN status bar that shows the current status of the LAN connection. Depending on the status of the connection, the LXI logo assumes the following states:

- Red: no connection is established
- Green: connection established
- Blinking: the device could not be identified

Info

Shows the current LXI parameters of the analyzer. The R&S ZVL displays the current LXI version, LXI class and various system parameters like computer name or IP adress.

While active, the dialog is not updated.

Remote control: SYSTem:LXI:INFO?

Password

Shows the current LXI password. You can also change the current password using this softkey. Some settings in the LXI web browser (e.g. IP parameters) are password-protected. An empty password is not valid, i.e. you must enter a password.

By default, the password is LxiWebIfc.

Remote control: SYSTem:LXI:PASSword

Description

Opens a dialog box to view or change the LXI instrument description. This description appears on the LXI browser interface. By default, the description contains the serial number of the network analyzer.

Remote control: SYSTem:LXI:MDEscription

LAN Reset

Initiates the network configuration reset mechanism (Lan Configure Initialize, LCI) for the instrument.



Default state of the network settings

According to the LXI standard, an LCI must place the following parameters to a default state.

Parameter	Value
TCP/IP Mode	DHCP + Auto IP Address
Dynamic DNS	Enabled
ICMP Ping	Enabled
Password for LAN configuration	LxiWebIfc

The LCI for the network analyzer also resets the following parameters:

Parameter	Value
Description	Rohde & Schwarz Vector Network Analyzer / ZVL / <serial no.>
Negotiation	Auto Detect
VXI-11 Discovery	Enabled

The LAN settings are configured using the instrument's LXI Browser Interface. With firmware versions V3.00 and higher, a user account with administrator rights is necessary for the LXI functionality (see *Operation with and without Administrator Rights* in chapter 1).

Remote control: SYSTem:LXI:LANReset

LXI Browser Interface

LAN eXtensions for Instrumentation (LXI) is an instrumentation platform for measuring instruments and test systems that is based on standard Ethernet technology. LXI is intended to be the LAN-based successor to GPIB, combining the advantages of Ethernet with the simplicity and familiarity of GPIB.



LXI classes and LXI functionality

LXI-compliant instruments are divided into three classes, A, B and C, with the functionality of the classes hierarchically based one upon the other:

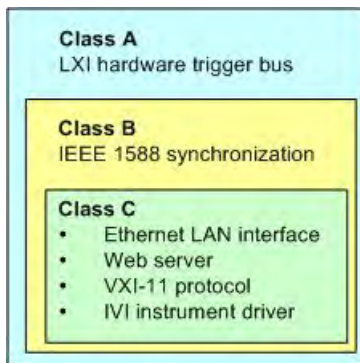

- **Class C** instruments are characterized by a common LAN implementation, including an ICMP ping responder for diagnostics. The instruments can be configured via a web browser; a LAN Configuration Initialize (LCI) mechanism resets the LAN configuration. The LXI class C instruments shall also support automatic detection in a LAN via the VXI-11 discovery protocol and programming by means of IVI drivers.
- **Class B** adds IEEE 1588 Precision Time Protocol (PTP) and peer-to-peer communication to the base class. IEEE 1588 allows all instruments on the same network to automatically synchronize to the most accurate clock available and then provide time stamps or time-based synchronization signals to all instruments with exceptional accuracy.
- **Class A** instruments are additionally equipped with the eight-channel hardware trigger bus (LVDS interface) defined in the LXI standard.

Instruments of classes A and B can generate and receive software triggers via LAN messages and communicate with each other without involving the controller.

The network analyzer complies with LXI class C. In addition to the general class C features described above, it provides the following LXI-related functionality:

- Integrated *LXI* menu for LXI activation and reset of the LAN configuration (LAN Configuration Initialize, LCI)



The LXI functionality requires a Windows XP operating system that has been upgraded to service pack 2. Please contact your Rohde & Schwarz service representative if your network analyzer's operating system needs an upgrade. To check the version of your operating system, open the System – General dialog in the Control Panel.

To upgrade an R&S ZVL which already supports LXI to a newer firmware version, the old LXI version must be de-installed first. This is done automatically by the setup file. Do not prevent de-installation to avoid problems.

After a firmware update, use the standby key to shut-down and re-start the instrument in order to enable the full LXI functionality.

The LXI functionality including the home page is unavailable while the instrument is operated without administrator rights.



For information about the LXI standard refer to the LXI website at <http://www.lxistandard.org>. See also "News from Rohde & Schwarz, article 2006/II - 190".

LXI Browser Interface

The instrument's LXI browser interface works correctly with all W3C compliant browsers. Typing the instrument's host name or IP address in the address field of the browser on your PC, e.g.

<http://10.113.10.203>

opens the *Instrument Home Page* (welcome page).



The instrument home page displays the device information required by the LXI standard including the VISA resource string in read-only format. The *Device Indicator* toggle button causes the LXI symbol in the status bar of the analyzer to blink (if active). A green LXI status symbol indicates that a LAN connection has been established; a red symbol indicates that no LAN cable is connected. The *Device Indicator* setting is not password-protected.



The navigation pane of the browser interface contains the following control elements:

- *Lan Configuration* opens the LAN Configuration page.
- *Status* displays information about the LXI status of the instrument.
- *Glossary* opens a document with a glossary of terms related to the LXI standard.
- *www.rohde-schwarz.com* opens the Rohde & Schwarz homepage.

LAN Configuration

The *Lan Configuration* web page displays all mandatory LAN parameters and allows their modification.

The screenshot displays the 'LAN Parameters' configuration page in the LXI web interface. The left sidebar contains navigation links for Home, Lan Configuration (with sub-links for IP Configuration, Advanced Config, and Ping Client), Status, and Help (with links for Glossary and www.rohde-schwarz.com). The main content area is titled 'LAN Parameters' and contains the following fields:

- Hostname: 10.110.10.118
- Domain: (empty)
- Description: Rohde & Schwarz Vector Network Analyzer / :
- TCP/IP Mode: DHCP + Auto IP Address (dropdown menu)
- IP Address: 10.110.10.118
- Subnet Mask: 255.255.0.0
- Default Gateway: 10.110.0.1
- DNS Server(s): 10.0.23.159, 10.0.2.166
- Dynamic DNS: Disabled, Enabled

At the bottom of the form, there is a 'Submit' button and a password field with the label '(Password required!)'. Below the form, a 'Status' section shows 'No error'. The footer of the page contains the copyright notice: '© 2008 ROHDE&SCHWARZ. All rights reserved.'

The *TCP/IP Mode* configuration field controls how the IP address for the instrument gets assigned (see also *Assigning an IP Address*). For the manual configuration mode, the static IP address, subnet mask, and default gateway are used to configure the LAN. The automatic configuration mode uses DHCP server or Dynamic Link Local Addressing (Automatic IP) to obtain the instrument IP address.



NOTE Changing the LAN configuration is password-protected. The default password reads *LxiWebIfc* (notice upper and lower case characters). This password can be changed in the LXI configuration menu. This password is restored by a Lan Reset (LCI).

The subentries of the *Lan Configuration* menu open other pages:

- *Ping Client* provides the ping utility to verify the connection between the instrument and other devices.
- *Advanced LAN Configuration* provides LAN settings that are not declared mandatory by the LXI standard.



The *Advanced LAN Configuration* parameters are used as follows:

- The *Negotiation* configuration field provides different Ethernet speed and duplex mode settings. In general, the *Auto Detect* mode is sufficient.
- *ICMP Ping* must be enabled to use the ping utility.
- *VXI-11* is the protocol that is used for discovery of the instrument in the LAN. According to the standard, LXI devices must use VXI-11 to provide a discovery mechanism; other additional discovery mechanisms are permitted.

Ping

Ping is a utility that verifies the connection between the analyzer and another device. The ping command uses the ICMP echo request and echo reply packets to determine whether the LAN connection is functional. Ping is useful for diagnosing IP network or router failures.

The ping utility is not password-protected. To initiate a ping between the analyzer and a second connected device,

- Enable *ICMP Ping* on the *Advanced LAN Configuration* page (enabled after an LCI).
- Enter the IP address of the second device **without the ping command and without any further parameters** into the *Destination Address* field (e.g. *10.113.10.203*).
- Click *Submit*.

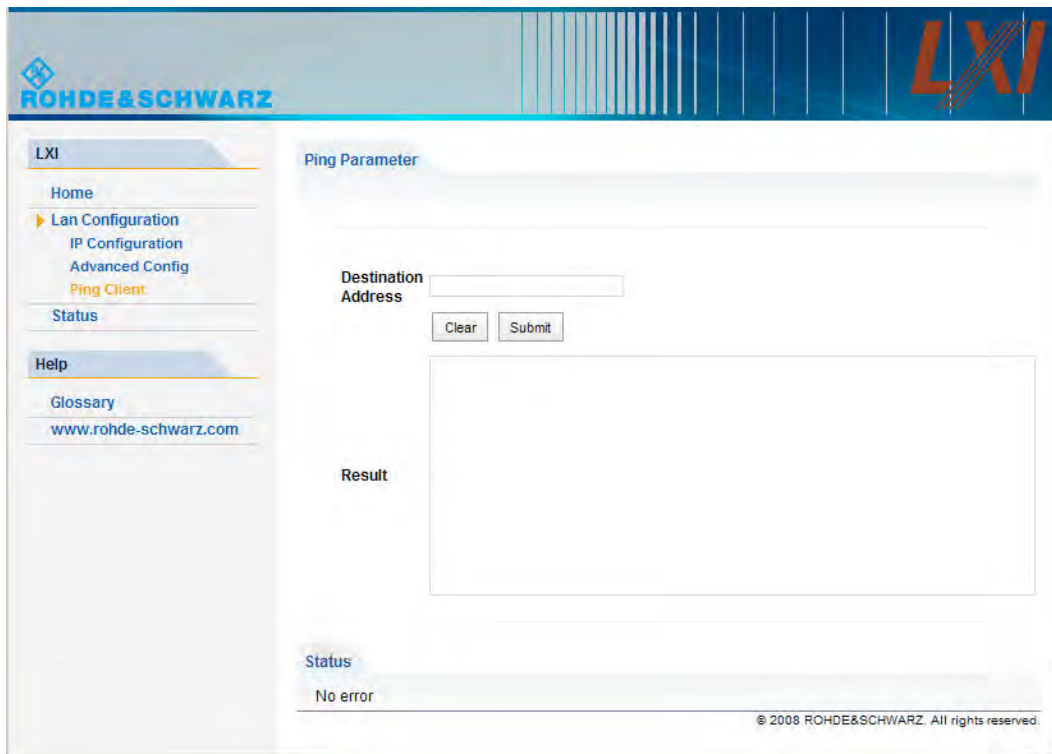

GPIOB (option GPIOB Interface, with option R&S FSL-B10 only)

Opens a submenu to set the parameters of the remote control interface.

Menu (Key)	Submenu	Submenu	Command
SETUP ▼	General Setup ▼	GPIOB ▼	GPIOB Address
			ID String Factory
			ID String User
			GPIOB Language
			Display Update On/Off
			More ▼
			GPIOB Terminator LFEOI/EOI
			*IDN Format Leg./ZVL
			I/O Logging On/Off

GPIB Address

Opens an edit dialog box to enter the GPIB address. Values from 0 to 30 are allowed. The default address is 20.

If, e.g. after a firmware update, the R&S ZVL does not maintain the GPIB address after reboot, the shutdown file needs to be recreated. Perform the following steps:

- Set the GPIB address.
- Create a shutdown file by switching the R&S FSL in the standby mode:
- Press the ON/STANDBY key on the front panel and wait until the yellow LED is on. With the battery pack option, use a USB keyboard and terminate the R&S ZV firmware with ALT+F4 to create the shutdown file.

If the shutdown file was created once, the R&S ZVL boots with exactly those settings after a reboot with the main switch on the rear panel. During a firmware update or cold boot for service reasons the shutdown file is deleted, and the setup is necessary once again.

Remote Control: `SYST:COMM:GPIB:ADDR 20`

ID String Factory

Selects the default response to the *IDN? query.

ID String User

Opens an edit dialog box to enter a user-defined response to the *IDN? query. Max. 36 characters are allowed.

GPIB Language

Only the remote control language SCPI is available for the R&S ZVL and is set by default.

Display Update On/Off

Defines whether the instrument display is switched off when changing from manual operation to remote control. In remote control mode, this softkey is displayed in the local menu.

Remote Control: `SYST:DISP:UPD`

GPIB Terminator LFEOI/EOI

Changes the GPIB receive terminator.

According to the standard the terminator in ASCII is <LF> and/or <EOI>. For binary data transfers (e.g. trace data) from the control computer to the instrument, the binary code used for <LF> might be included in the binary data block, and therefore should not be interpreted as a terminator in this particular case. This can be avoided by changing the receive terminator to EOI.

Remote Control: `SYST:COMM:GPIB:RTER`

*IDN Format Leg./ZVL

If set to *Leg.*, provides the response to the *IDN? remote command in a format that is compatible to the R&S FSP/FSU/FSQ family (e.g. "Rohde&Schwarz,ZVL-6,100007/006,1.10"). This function is intended for re-use of existing control programs together with the R&S ZVL. The ZVL-compliant ID string contains the order number of the instrument; e.g. "Rohde&Schwarz,ZVL-6,1303.6509K06/100007,1.10".

The *IDN format is not changed upon a reset/preset of the analyzer settings.

I/O Logging On/Off

Activates logging all remote control commands received by the ZVL in the log file ScpiLog.txt for debug purposes. Logging the commands may be useful in order to find misspelled keywords in control programs. The corresponding log file will be stored in folder C:\R_S\instr\ScpiLogging.

System Info

Opens a submenu to display detailed information on module data, device statistics and system messages.

Menu (Key)	Submenu	Command
SETUP ▼	System Info ▼	Hardware Info
		Versions+Options
		System Messages
		Clear All Messages

Hardware Info

Opens a dialog box in which all modules (installed hardware components) are listed together with the serial numbers, order numbers, model information, hardware codes, and hardware revisions.

Versions+Options

Opens a dialog box that displays hardware and firmware information, e.g. the firmware version, the image version, BIOS version, data sheet version of the basic device, installed options (hardware and firmware options).

Remote Control: *IDN? (instrument identification)
 *OPT? (installed options)

System Messages

Opens the *System Messages* dialog box that displays the generated system messages in the order of their occurrence. The most recent messages are placed at the top of the list. Messages that have occurred since the last display of system messages menu are marked with an asterisk '*'. The following

information is available:

<i>No</i>	device-specific error code
<i>Message</i>	brief description of the message
<i>Component</i>	hardware messages: name of the affected module software messages: name of the affected software
<i>Date/Time</i>	date and time of the occurrence of the message

If the number of error messages exceeds the capacity of the error buffer, *Message buffer overflow* is displayed. To delete messages see *Clear All Messages* softkey.

Remote Control: `SYST:ERR:LIST?`

Clear All Messages

Deletes all system messages. The softkey is only available if the *System Messages* dialog box is displayed.

Remote Control: `SYST:ERR:CLE:ALL?`

Service

Opens a submenu that contains additional functions for maintenance and/or trouble shooting.

Menu (Key)	Submenu	Command
SETUP ▼	Service ▼	Input RF/Cal/TG
		Comb Frequency
		Reset Password
		Selftest
		Selftest Results
		Password
		Service Function

**Attention!**

The service functions are not necessary for normal measurement operation. However, incorrect use can affect correct operation and/or data integrity of the R&S ZVL.

Therefore, many of the functions can only be used after entering a password. They are described in the instrument service manual.

Input RF/Cal/TG

Selects the source signal for the RF input path in spectrum analysis mode (with option R&S ZVL-K1).

- *RF* switches the RF path to the input connector for spectrum analyzer mode (PORT 2). The R&S ZVL measures the RF input signal fed in via PORT 2.
- *Cal* switches the RF path to the internal calibration source (65.8333 MHz; see *Comb Frequency*) and activates the data entry of the output level of the calibration source. Possible values are 0 dB and -30 dB.
- *TG* is for future extensions.

The *Input RF/Cal/TG* softkey is available in spectrum analyzer mode only.

Comb Frequency

Opens a dialog box to set the comb generator frequency for the internal calibration (see *Input Cal*):

- *Comb/1*: 65.8333 MHz / 1
- *Comb/64*: 65.8333 MHz / 64
- *Comb/65*: 65.8333 MHz / 65

The *Comb Frequency* is available in spectrum analyzer mode only, provided that *Input Cal* is active.

Reset Password

Deactivates all set passwords.

Remote Control: `SYST:PASS:RES`

Selftest

Initiates the self test of the instrument modules to identify a defective module in case of failure. All modules are checked consecutively and the test result is displayed.

Remote Control: `*TST?`

Selftest Results

Opens the *Selftest Result* dialog box that contains the test results. In case of failure a short description of the failed test, the defective module, the associated value range and the corresponding test results are

indicated.

Password

Opens an edit dialog box to enter the password. This ensures that the service functions are only used by authorized personnel.

Remote Control: `SYST:PASS "Password"`

Service Function

Opens the *Service Function* dialog box to start special service functions. For further information refer to the service manual.

PRINT Key

The PRINT key is used to select and configure the printer and to customize the screen printout. For detailed information on printer selection and installation refer to the Quick Start Guide.

The following table shows all softkeys available in the *PRINT* menu. It is possible that your instrument configuration does not provide all softkeys. If a softkey is only available with a special option, model or (measurement) mode, this information is delivered in the corresponding softkey description.

Command
Print Screen
Device Setup
Device 1/2
Comment
Install Printer

Print Screen

Starts to printout all test results displayed on the screen: diagrams, traces, markers, marker lists, limit lines etc. Comments, title, date, and time are included at the bottom margin of the printout. All displayed items belonging to the instrument software (softkeys, tables, dialog boxes) are not printed out.

Starts to printout all test results displayed on the screen: diagrams, traces, markers, marker lists, limit lines etc. Comments, title, date, and time are included at the bottom margin of the printout. All displayed items belonging to the instrument software (softkeys, tables, dialog boxes) are not printed out. The date and time can be excluded from the printout via the *Device Setup* softkey.

The output is defined via the *Device Setup* softkey. If the output is saved in a file, the file name used in the

last saving process is counted up to the next unused name. If you use a file name that already exists, upon saving, a message is displayed. Selecting Yes overwrites the existing file, selecting No aborts the saving process. For further details on the file name and an example, refer to the file menu, *Edit File Name* softkey.

Remote Control: HCOP:ITEM:ALL
HCOP
HCOP:NEXT

Device Setup

Opens the *Device Setup* dialog box to select file format and the printer. The dialog box consists of two tabs which are selected via the *Device 1/2* softkey.

Remote Control: HCOP:DEV:LANG GDI
SYST:COMM:PRIN:ENUM:FIRS?
SYST:COMM:PRIN:ENUM:NEXT?
SYST:COMM:PRIN:SEL <Printer>
HCOP:PAGE:ORI PORT
HCOP:DEST "SYST:COMM:PRIN"

Device 1/2

Selects the tab of the device in the *Device Setup* dialog box. The analyzer is able to manage two print settings independently of each other. For each device the print setting is displayed on the corresponding tab of the *Device Setup* dialog box (*Device Setup* softkey).

Comment

Opens dialog box to enter a comment. Max. 120 characters are allowed. 60 characters fit in one line. In the first line, at any point a manual line-feed can be forced by entering "@".

Date and time are inserted automatically. The comment is printed below the diagram area, but not displayed on the screen. If a comment should not be printed, it must be deleted.

Install Printer

Opens the *Printers and Faxes* window to install a new printer. All printers that are already installed are displayed.

With firmware versions V3.00 and higher, a user account with administrator rights is necessary to install a printer (see *Operation with and without Administrator Rights*).

MODE Key

The MODE key selects the operating mode of the analyzer. The operating mode is stored when the

analyzer is shut down and restored in the next session. MODE opens a selection dialog for the basic measurement modes (Network Analyzer, Spectrum Analyzer) and the supplementary, optional spectrum analyzer modes which are enabled on the instrument; see Optional Extensions. An example is shown below. For a complete list of R&S ZVL options and ordering information refer to the R&S ZVL product brochure.

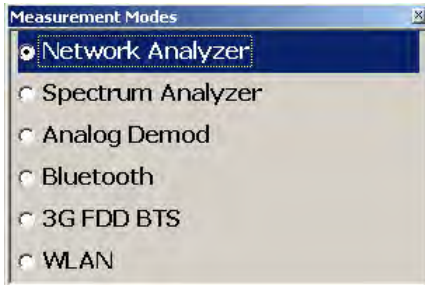

The spectrum analyzer mode and the supplementary modes require option R&S ZVL-K1.





GUI and remote control of the R&S ZVL is mode-dependent. This help system and the Quick Start Guide describe the GUI elements in Network Analyzer mode. The Spectrum Analyzer mode does not provide a Windows®-type menu structure; operation is based on softkeys and dialogs. The functionality of the Spectrum Analyzer mode and of all supplementary spectrum analyzer options is described in a separate context-sensitive help system. For an overview of the remote control structure refer to Network Analyzer and Spectrum Analyzer Mode.

Remote Control: INST:SEL NWA | SAN

Control Menus

The *Control* menus provide standard Windows™ functions to control windows. The analyzer provides two types of *Control* menus with analogous function:

- Clicking the  icon opens the *Control* menu for the main application window. To access this icon the *Title Bar* of the main application window must be open.
- Clicking a  icon opens the *Control* menu for an individual setup window. If a setup window is maximized, the icon is placed to the left of the *File* menu.

Double-clicking a control icon is the same as clicking the  icon or the *Close* menu command.

(No direct access via front panel keys)

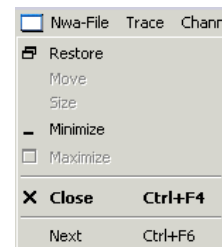
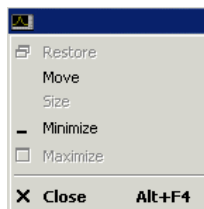

The *Control* menu contains the following functions:

- *Restore* returns the active window to its size and position.
- *Move* displays a cursor symbol to moves the active window within the available space.

- *Size* displays a cursor symbol to size the active window.
- *Minimize* reduces the active window to an icon.
- *Maximize* enlarges the active window to fill the available space.
- *Close* closes the application.
- *Next* switches to the next open setup window.

Restore

Returns the maximized or minimized active window to its size and position. *Restore* is available after a *Maximize* or *Minimize* command only.

Move

Displays a four-headed arrow to move the active window with the arrow keys.



This command is unavailable for maximized windows.

Size

Returns the maximized or minimized active window to its size and position. *Restore* is available after a *Maximize* or *Minimize* command only.



This command is unavailable for maximized windows.

Minimize

Reduces the active window to an icon.

Maximize

Enlarges the active window to fill the available space.

Close

Closes the active setup window (setup control menu) or ends the analyzer session (application control menu).

- In a setup window the analyzer suggests to save changes to the setup before closing it. If a setup is closed without saving, all changes made since the last time it was saved are lost.
- In the application window the analyzer prompts you to save documents with unsaved changes.



The *Close* application command is equivalent to the *Exit* command in the *File* menu. Moreover *Close* is the same as double-clicking a *Control* menu icon or clicking the  icon in the title bar of the active window.

Next

Selects the next diagram area as the active diagram area. This command is available in setup control menus only and is disabled if only one setup is defined.

Table of Contents

6 Remote Control	313
Network Analyzer and Spectrum Analyzer Mode	313
Remote Control Operation	314
Remote Control: Introduction	314
GPIB Explorer	314
Switchover to Remote Control	316
Setting the Device Address	318
Return to Manual Operation.....	318
Combining Manual and Remote Control.....	319
Messages	320
GPIB Interface Messages.....	320
RSIB and VXI-11 Interface Messages	320
Device Messages (Commands and Device Responses).....	320
SCPI Command Structure and Syntax	321
Common Commands.....	321
Instrument-Control Commands	321
Structure of a Command Line.....	323
Responses to Queries	324
SCPI Parameters	324
Numeric Values.....	324
Boolean Parameters.....	325
Text Parameters	325
Strings.....	326
Block Data Format.....	326
Overview of Syntax Elements.....	326
Basic Remote Control Concepts	327
Traces, Channels, and Diagram Areas	327
Active Traces in Remote Control.....	328

Initiating Measurements, Speed Considerations.....	329
Command Processing.....	330
Input Unit.....	330
Command Recognition.....	330
Data Base and Instrument Hardware.....	331
Status Reporting System.....	331
Output Unit.....	331
Command Sequence and Command Synchronization.....	332
Status Reporting System.....	333
Overview of Status Registers.....	334
Structure of an SCPI Status Register.....	335
Status Registers.....	337
Contents of the Status Registers.....	337
STB and SRE.....	337
IST Flag and PPE.....	338
ESR and ESE.....	338
STATus:OPERation.....	339
STATus:QUEStionable.....	339
STATus:QUEStionable:LIMit1<1 2>.....	339
STATus:QUEStionable:INTEgrity.....	340
Application of the Status Reporting System.....	341
Service Request.....	341
Serial Poll.....	342
Parallel Poll.....	343
Query of an Instrument Status.....	343
Error Queue.....	344
Reset Values of the Status Reporting System.....	344

6 Remote Control

This chapter provides instructions on how to set up the analyzer for remote control, a general introduction to remote control of programmable instruments, and the description of the analyzer's remote control concept. For reference information about all remote control commands implemented by the instrument, complemented by comprehensive program examples, refer to the SCPI Reference chapter.

Network Analyzer and Spectrum Analyzer Mode

GUI and remote control of the R&S ZVL is mode-dependent; see MODE key. The analyzer provides different sets of remote-control commands:

- Commands for general device settings are available in all modes. They correspond to the softkeys associated with the FILE, SETUP, PRINT, and MODE front panel keys.
- Network analyzer commands are available while the Network Analyzer (NWA) mode is active. In NWA mode, the R&S ZVL also supports the commands for supplementary NWA options, e.g. R&S ZVL-K2 (Distance-to-Fault).
The NWA commands have been implemented for compatibility with network analyzers of the R&S ZVA/ZVB/ZVT family. Using a NWA command in spectrum analysis will generally cause and SCPI error no. -113, "Undefined header...".
- Spectrum analyzer (SAN) commands are available while the SAN mode is active. In SAN mode, the R&S ZVL also supports commands for the following supplementary spectrum analyzer options: R&S FSL-K7 (AM/FM/ϕM Measurement Demodulator / "Analog Demod"), R&S FSL-K8 (Bluetooth Measurements), R&S FSL-B6 (TV Trigger), R&S FSK-B8 (Gated Sweep), R&S FSL-K14 (Spectrogram Measurements)
The SAN commands have been implemented for compatibility with the R&S FSL spectrum analyzer. Using a SAN command in network analysis will generally cause and SCPI error no. -113, "Undefined header...".
- Commands for supplementary spectrum analyzer modes, e.g. WCDMA, WLAN, WiMax, ..., are available only while the supplementary mode is active. The *Bluetooth* and *Analog Demod* modes are exceptions because their commands are also available in SAN mode.
- In view of the SCPI compatibility of all instrument-control commands, some NWA and SAN commands have the same syntax, however, their function may not necessarily be identical.



Use `INST:SEL NWA | SAN ...` to select the operating mode of your R&S ZVL. Alternatively, use `INST:NSEL ...`

Examples:

```
*RST; FREQ:STAR 1GHz
```

Reset the analyzer, activating the NWA mode and select a start frequency of 1 GHz.

```
CALC:TRAN:DTF:STAT ON
```

Enable the distance-to-fault measurement.

```
INST:SEL SAN; FREQ:STAR?
```

Switch to SAN mode and query the start frequency. The response is "0"; the SAN and NWA settings are independent.

```
CALC:TRAN:DTF:STAT?
```

Query the state of the distance-to-fault measurement. The response is -113,"Undefined header;CALC:TRAN:DTF:STAT?", because `CALCulate :TRANSform:DTFault:STATe` does not belong to the SAN command set.

Remote Control Operation

Remote Control: Introduction

The instrument is equipped with different interfaces for remote control:

- A GPIB bus interface according to standard IEC 625.1/IEEE 488.1. The GPIB bus connector for direct connection to a controller is located on the rear panel of the instrument.
- Instruments connected to a Local Area Network can be controlled via the RSIB or VX 11 protocol. Two connectors for LAN connection are located on the rear panel.



The GPIB Explorer is a easy-to-use program tool that allows you to obtain an overview of all implemented remote control programs, test programs, compile and run test scripts.

This section assumes basic knowledge of GPIB bus programming and operation of the controller. A description of the interface commands can be found in the *Annexes* sections *GPIB Bus Interface* and *RSIB Interface Functions* respectively.



SCPI compatibility

The analyzers are compatible to the final SCPI version 1999.0. Not all of the commands supported by the instrument are taken from the SCPI standard (*Standard Commands for Programmable Instruments*), however, their syntax follows SCPI rules. The SCPI standard is based on standard IEEE 488.2 and aims at the standardization of instrument-control commands, error handling and the status registers.

The requirements that the SCPI standard places on command syntax, error handling and configuration of the status registers are explained in detail in the following sections. Tables provide a fast overview of the bit assignment in the status registers. The tables are supplemented by a comprehensive description of the status registers.



Reset values

In contrast to instruments with manual control, which are designed for maximum possible operating convenience, the priority of remote control is the "predictability" of the device status. This means that when incompatible settings are attempted, the command is ignored and the device status remains unchanged, i.e. other settings are not automatically adapted. Therefore, GPIB bus control programs should always define an initial device status (e.g. with the command `*RST`) and then implement the required settings.

GPIB Explorer

The *GPIB Explorer* is a easy-to-use program tool that allows you to obtain an overview of all implemented remote control programs, test programs, compile and run test scripts. The program can be opened by starting the executable file `iecw32.exe` in the program directory of the network analyzer (e.g.

`C:\R_S\Instr\Bin`).

After the *GPIB Explorer* is started, the interface for the connection to the instrument can be selected in a dialog:

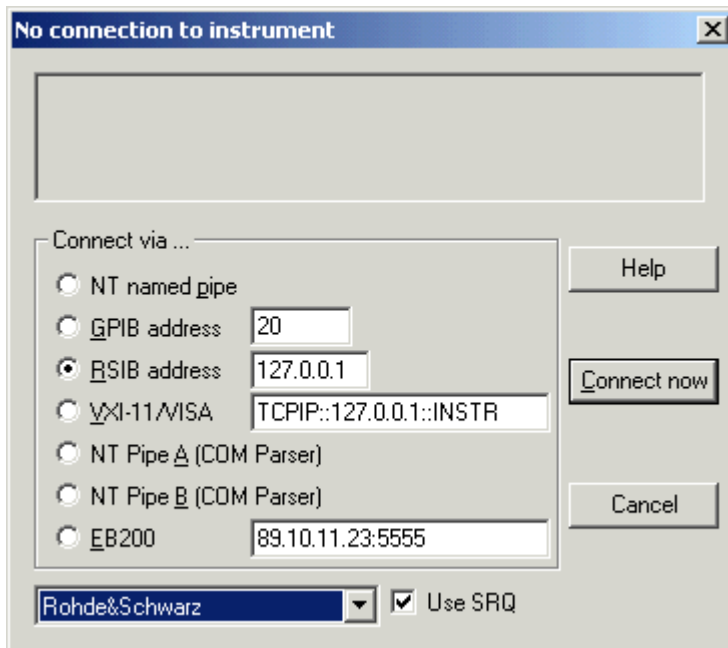

The following options are provided:

- NT named pipe (not supported at present)
- GPIB address (for connection to controllers equipped with a National Instrument GPIB interface using the GPIB bus connector)
- RSIB address (for LAN connection via RSIB protocol, requires an appropriate IP or local host address; see *LAN Connection* sections in Chapter 1)
- VXI-11/VISA (for LAN connections via the VXI-11 protocol; requires an installed VISA library)
- NT pipe A/B (only for local connection on the analyzer, recommended for remote test on the instrument)
- EB200 (not supported at present)



A connection requires the default settings "Rohde & Schwarz" (for the SCPI command set) and "Use SRQ: On". Select Nwa-Setup – Setup Info to look up the IP address information of your analyzer.

After the connection is established, the GPIB explorer displays a tree view of all commands included in the current firmware version of the network analyzer. The programs can be selected for execution by a single mouse click.

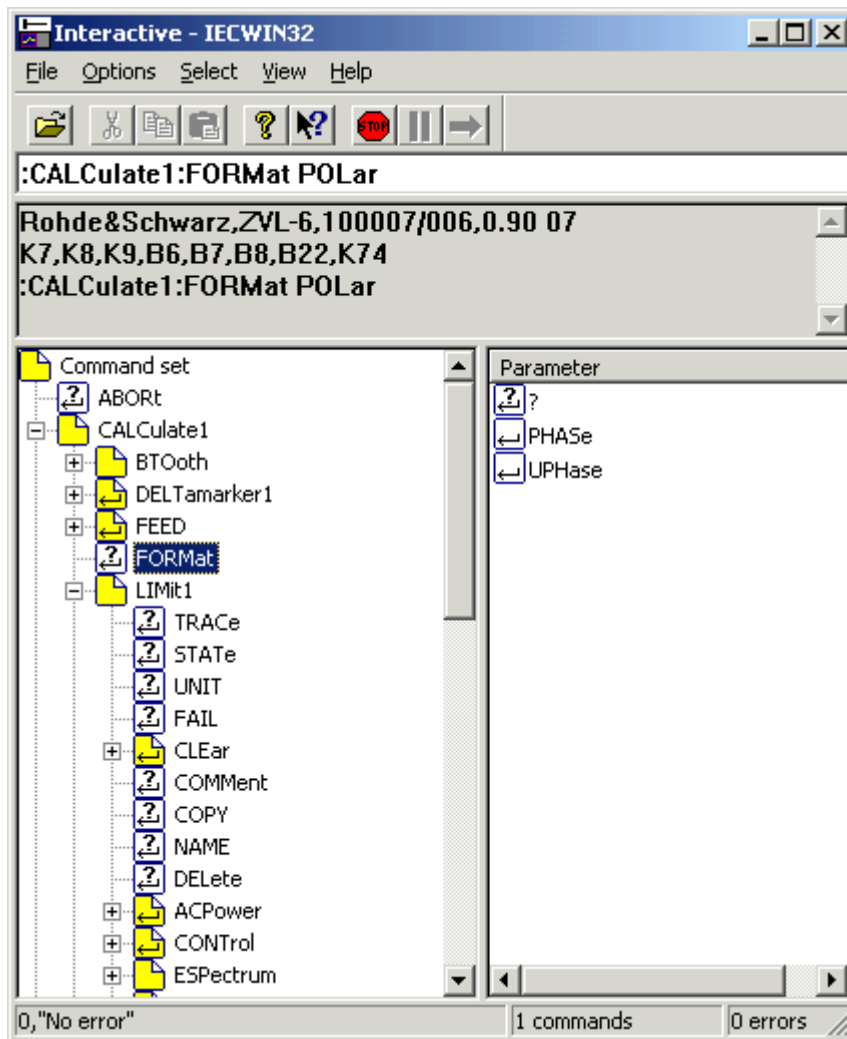

Refer to the GPIB explorer's help system for more information.

Switchover to Remote Control

On power-up, the instrument is always in the manual operating state and can be operated via the front panel controls. The instrument is switched to remote control as soon as it receives a command from the controller. If the instrument is controlled via RSIB or VX 11 protocol, the alternative commands *@REM* and *@LOC* can be used to switch from manual to remote control and back.

Remote Control Operation

While remote control is active, operation via the front panel is disabled with the exception of two softkeys. The instrument settings are optimized for maximum measurement speed; the display is switched off:



The two softkeys in the remote screen are used to modify or quit the remote state:

- *Display Update On/Off* switches the display on or off; see background information below.
- *Local* switches the instrument back to local state.



Display On/Off states

Switching on the display means that the analyzer shows the measurement screen with the current setups, diagram areas and traces without leaving the remote state. In this operating mode, it is possible to observe the screen while a remote control script is executed and the control elements on the front panel are still disabled:

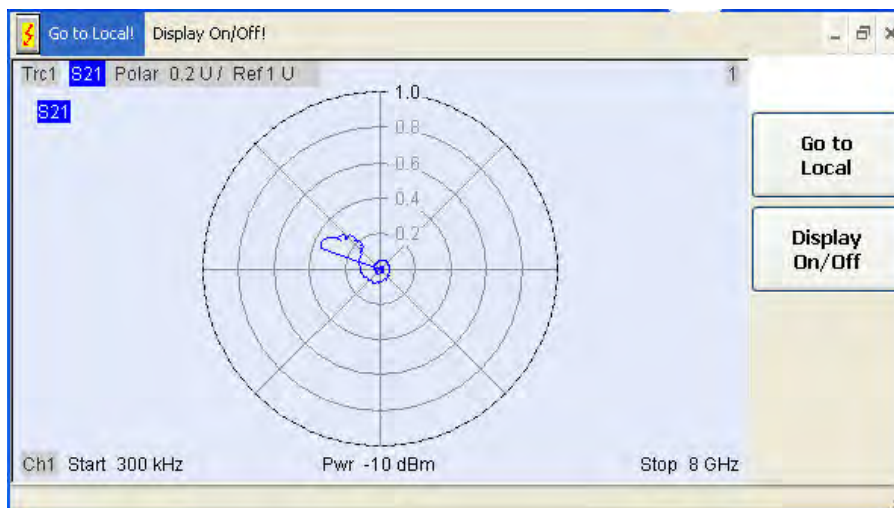

Switching on the display is ideal for program test purposes but tends to slow down the measurement. Therefore it is recommended to switch off the display in real measurement applications where a tested program script is to be executed repeatedly.



The analyzer provides a third display option where the measurement screen is only updated when this is triggered by a remote control command; see `SYSTem:DISPlay:UPDate ONCE`.

The instrument remains in the remote state until it is reset to the manual state via the GUI or via GPIB bus (see section *Return to Manual Operation*).



You can create your own keys to replace the two default softkeys *Go to Local* and *Display On/Off*. See *Combining Manual and Remote Control*.

A tooltip across the bottom of the remote screen indicates a remote command error, e.g.

`Remote Error : -222,"Data out of range;FREQ:STAR 1"`. You can switch off this tooltip using

`SYSTem:ERRor:DISPlay OFF`.

Remote control: `@REM`
 `SYSTem:DISPlay:UPDate`
 `SYSTem:USER:DISPlay:TITLe` (define a title for the remote display)
 `SYSTem:ERRor:DISPlay` (switch tooltip on or off)

Setting the Device Address

The GPIB address (primary address) of the instrument is factory-set to 20. It can be changed manually in the *System* menu or via GPIB bus. For remote control, addresses 0 through 30 are permissible. The GPIB address is maintained after a reset of the instrument settings.

Remote control: `SYSTem:COMMunicate:GPIB[:SELF]:ADDRess`

Return to Manual Operation

Return to manual operation can be initiated via the front panel or via remote control.

- Manually: Click the *Local* softkey in the remote screen.
- Via GPIB bus: `CALL IBLOC(device%)`
- Via RSIB or VX 11 protocol: `@LOC` and `@REM` can be used to switch from remote to manual control and back.



Local lockout

Before returning to manual control, command processing must be completed. If this is not the case, the analyzer switches back to remote control immediately.

Returning to manual control by pressing the *Local* softkey can be disabled by the GPIB Local Lockout Message (LLO; see *GPIB Bus Interface, Universal Commands*) which is also included in the NI commands `SetRWLS` (Set Remote With Lockout State) or `SendLLO`. This prevents unintentional switch-over, i.e. return to manual control is possible via the GPIB bus only.

Returning to manual control via the front panel keys can be enabled again by deactivating the REN control line of the GPIB bus.

Combining Manual and Remote Control

Using a remote control script is the quickest and easiest way of performing complicated tasks which need to be repeated many times. On the other hand, it is often preferable to control a previously configured measurement manually in order to observe the result on the screen.

The analyzer provides a number of tools for combining manual and remote control:

- **User Keys**

The remote control commands `SYSTEM:USER:KEY...` place up to 8 softkeys with arbitrary functionality on the remote screen. The softkeys replace the default softkeys *Go to Local* and *Display On/Off*.

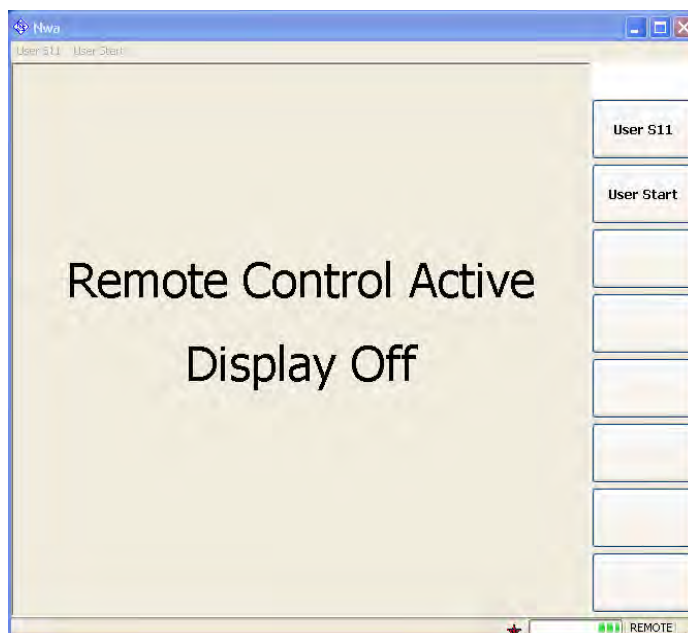

Pressing a user softkey or clicking the corresponding command across the top of the remote screen executes the assigned functionality.



If you want to use more than 8 user keys, you can easily introduce additional levels: Simply reserve one key for re-defining the entire user key bar. If you press or click the key, your remote script should re-assign the labels and functions of the existing keys. If you use this procedure repeatedly, you can emulate an arbitrary number of manual control features on your remote screen.

- **Menu key commands**

The commands in the `DISPlay:MENU:KEY...` subsystem open the manual control screen, activate menus or submenus for manual control, or execute a specified menu command.

`DISPlay:MENU:KEY:EXECute '<menu_key>'` can be used in different ways:

- If the menu key causes an event (e.g. selection of the measured quantity: S11, S12 etc.), the function is executed immediately. No further action is required; the instrument remains in remote control mode.
- If the menu key requires a numeric entry (e.g. entry of the sweep range: Start, Stop etc.) the command opens the numeric entry bar. The instrument is switched back to remote control mode as soon as the entry has been made manually.

- If the menu key requires several entries to be made in a dialog or in a wizard (e.g. the S-Param Wizard), the command opens this dialog/wizard. All entries can be made manually. The instrument is switched back to remote control mode as soon as the dialog or wizard is closed.



DISPlay:MENU:KEY:EXECute '<menu_key>' works for all menu keys, even though the analyzer may not provide an equivalent remote control command.

Remote control:

```

SYSTEM:USER:KEY
SYSTEM:USER:KEY:FUNCTION
DISPlay:MENU:KEY:EXECute
DISPlay:MENU:KEY:SElect

```

Messages

The messages transferred on the data lines of the GPIB bus or via the RSIB / VXI-11 interface can be either interface messages or device messages.

GPIB Interface Messages

GPIB interface messages are transferred on the data lines of the GPIB bus, the ATN control line being active. They are used for communication between controller and instrument and can only be sent by a computer which has the function of an GPIB bus controller.

GPIB interface messages can be further subdivided into

- Universal commands act on all devices connected to the GPIB bus without previous addressing.
- Addressed commands only act on devices previously addressed as listeners.

The interface messages relevant to the instrument are listed in the GPIB bus section.

RSIB and VXI-11 Interface Messages

The RSIB and VXI-11 interfaces allow the instrument to be controlled in a Local Area Network. For a short introduction and a list of interface functions refer to the following sections:

- *RSIB Interface*
- *VXI-11 Interface*

Device Messages (Commands and Device Responses)

Device messages are transferred via the data lines of the GPIB bus, the "ATN" control line not being active. The ASCII character set is used. A distinction is made according to the direction in which device messages are transferred:

- Commands are messages the controller sends to the instrument. They operate the device functions and request information.

- Device responses are messages the instrument sends to the controller after a query. They can contain measurement results, instrument settings and information on the instrument status.

Commands are subdivided according to two criteria:

1. According to the effect they have on the instrument:

- Setting commands cause instrument settings such as a reset of the instrument or setting the output level to some value.
- Queries cause data to be provided for output on the GPIB bus, e.g. for identification of the device or polling the active input.

2. According to their definition in standard IEEE 488.2:

- Common commands have a function and syntax that is exactly defined in standard IEEE 488.2. Typical tasks are the management of the standardized status registers, reset and selftest.
- Instrument-control commands are functions that depend on the features of the instrument such as frequency settings. A majority of these commands has also been standardized by the SCPI consortium.

The device messages have a characteristic structure and syntax. In the SCPI reference chapter all commands are listed and explained in detail.

SCPI Command Structure and Syntax

SCPI commands consist of a so-called header and, in most cases, one or more parameters. The header and the parameters are separated by a "white space" (ASCII code 0 to 9, 11 to 32 decimal, e.g. blank). The headers may consist of several key words. Queries are formed by directly appending a question mark to the header.

Common commands and device-specific commands differ in their syntax.

Common Commands

Common (=device-independent) commands consist of a header preceded by an asterisk "*" and possibly one or more parameters.

Examples:

*RST	RESET, resets the instrument.
*ESE 253	EVENT STATUS ENABLE, sets the bits of the event status enable registers.
*ESR?	EVENT STATUS QUERY, queries the contents of the event status register.

Instrument-Control Commands

Instrument-control commands are based on a hierarchical structure and can be represented in a command tree. The command headers are built with one or several mnemonics (keywords). The first level (root level) mnemonic identifies a complete command system.

Example:

`SENSe` This mnemonic identifies the command system `SENSe`.

For commands of lower levels, the complete path has to be specified, starting on the left with the highest level, the individual key words being separated by a colon ":".

Example:

`SENSe:FREQuency:STARt 1GHZ`

This command is located on the third level of the `SENSe` system. It defines the start frequency of the sweep.

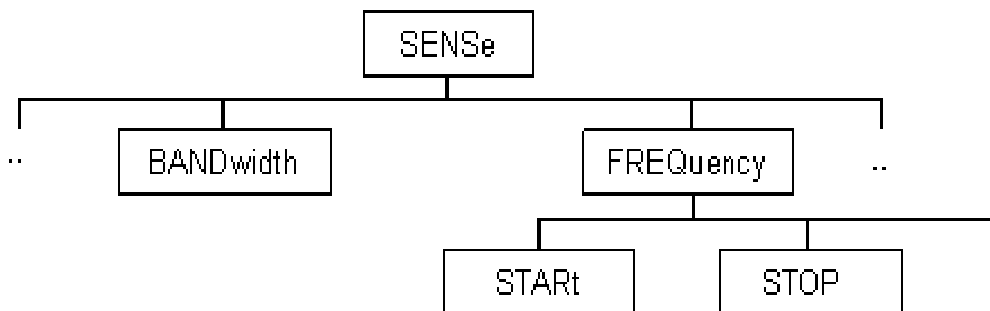

The following rules simplify and abbreviate the command syntax:

- **Multiple mnemonics**

Some mnemonics occur on several levels within one command system. Their effect depends on the structure of the command, i. e. on the position in the command header they are inserted in.

Example:

`SOURce:FREQuency:CW 1GHZ`

This command contains the key word `SOURce` in the first command level. It defines the frequency for sweep types operating at fixed frequency.

`TRIGger:SOURce EXTernal`

This command contains the key word `SOURce` in the second command level. It defines the trigger source "external trigger".

- **Optional mnemonics**

Some command systems permit certain mnemonics to be optionally inserted into the header or omitted. These mnemonics are marked by square brackets in this manual. The full command length must be recognized by the instrument for reasons of compatibility with the SCPI standard. Some commands are considerably shortened by omitting optional mnemonics.

Example:

`TRIGger[:SEQuence]:SOURce EXTernal`

This command defines the trigger source "external trigger". The following command has the same effect:

`TRIGger:SOURce EXTernal`



An optional mnemonic must not be omitted if its effect is additionally specified by a numeric suffix.

- **Long and short form**

The key words feature a long form and a short form. Either the short form or the long form can be entered; other abbreviations are not permitted.

Example:

```
TRIGger:SOURce EXTernal
TRIG:SOUR EXT
```



The short form is marked by upper case letters, the long form corresponds to the complete word. Upper case and lower case notation only serves to distinguish the two forms in the manual, the instrument itself is case-insensitive.

- **Parameters**

Parameters must be separated from the header by a "white space". If several parameters are specified in a command, they are separated by a comma ",". For a description of the parameter types, refer to section Parameters.

Example:

```
SOURce:GROup 1,1
```

This command defines a group of measured ports.

- **Numeric suffix**

If a device features several functions or features of the same kind, e.g. several channels or test ports, the desired function can be selected by a suffix added to the command. Entries without suffix are interpreted like entries with the suffix 1.

Example:

```
SOURce:GROup2 1,1
```

This command defines a second group (group no 2) of measured ports.

Structure of a Command Line

A command line may consist of one or several commands. It is terminated by a <New Line>, a <New Line> with EOI or an EOI together with the last data byte. Visual BASIC automatically produces an EOI together with the last data byte.

Several commands in a command line must be separated by a semicolon ";". If the next command belongs to a different command system, the semicolon is followed by a colon.

Example: CALL IBWRT(device%, "TRIGger:SOURce EXTernal;:SENSe:FREQUENCY:START 1GHZ")

This command line contains two commands. The first command belongs to the TRIGger system and defines the trigger source (external trigger). The second command belongs to the SENSe system and defines the start frequency of the sweep.

If the successive commands belong to the same system, having one or several levels in common, the command line can be abbreviated. To this end, the second command after the semicolon starts with the level that lies below the common levels. The colon following the semicolon must be omitted in this case.

Example: CALL IBWRT(device%, "TRIG:SOUR EXT;:TRIG:TIM 0.1")

This command line is represented in its full length and contains two commands separated from each other by the semicolon. Both commands are part of the TRIGger command system, i.e. they have one level in common.

When abbreviating the command line, the second command begins with the level below TRIG. The colon after the semicolon is omitted. The abbreviated form of the command line reads as follows:

```
CALL IBWRT(device%, "TRIG:SOUR EXT; TIM 0.1")
```

However, a new command line always begins with the complete path.

Example:

```
CALL IBWRT(device%, "TRIG:SOUR EXT ")
CALL IBWRT(device%, "TRIG:THR LOW ")
```

Responses to Queries

A query is defined for each setting command unless explicitly specified otherwise. It is formed by adding a question mark to the associated setting command. According to SCPI, the responses to queries are partly subject to stricter rules than in standard IEEE 488.2.

1. The requested parameter is transmitted without header.

Example: TRIGger:SOURce? Response: IMM

2. Maximum values, minimum values and all further quantities which are requested via a special text parameter are returned as numerical values.

Example: SENSE:FREQuency:STOP? MAX Response: 8000000000

3. Numerical values are output without their unit. The default unit for each command is reported in the SCPI command description.

Example: SENSE:FREQuency:STOP? MAX Response: 8000000000 for 8 GHz

4. Boolean values are returned as 0 (for OFF) and 1 (for ON).

Example: SWEp:TIME:AUTO? Response: 1

5. Text (character data) is returned in short form (see also next section).

Example: TRIGger:SOURce? Response: IMM

SCPI Parameters

Most commands require a parameter to be specified. The parameters must be separated from the header by a "white space". Permissible parameters are numerical values, Boolean parameters, text, character strings and block data. The type of parameter required for the respective command and the permissible range of values are specified in the command description.

Numeric Values

Numeric values can be entered in any form, i.e. with sign, decimal point and exponent. Values exceeding the resolution of the instrument are rounded up or down. The mantissa may comprise up to 255 characters, the values must be in the value range $-9.9E37$ to $9.9E37$. The exponent is introduced by an "E" or "e". Entry of the exponent alone is not allowed. In the case of physical quantities, the unit can be entered. Permissible unit prefixes are G (giga), MA (mega), MOHM and MHZ are also permissible), K (kilo), M (milli), U (micro) and N (nano). If the unit is missing, the default unit is used.

Example:

SOUR:RFQ:FREQ 1.5GHz is equivalent to
SOUR:RFQ:FREQ 1.5E9

Special numeric values

The texts MINimum, MAXimum, DEFault, UP and DOWN are interpreted as special numeric values. A query returns the associated numerical value.

Example:

Setting command: SENSE:FREQuency:STARt MINimum

The query SENSE:FREQuency:STARt? returns 300000 (the exact value depends on the analyzer model).

The following special values can be used:

- MIN/MAX MINimum and MAXimum denote the minimum and maximum value of a range of numeric values.
- DEF DEFault denotes the preset value. This value is set by the *RST command.
- UP/DOWN UP, DOWN increases or reduces the numeric value by one step. The step width is reported in the detailed command description.
- INF/NINF Negative INFINITY (NINF) represent the numerical values $-9.9E37$ or $+9.9E37$, respectively. INF and NINF are only sent as device responses.
- NAN Not a Number (NAN) represents the value $9.91E37$. NAN is only sent as device response. This value is not defined. Possible causes are division by zero, subtraction or addition of infinite and the representation of missing values.



Unless it is explicitly stated in the command description you can use the special numeric parameters for all commands of the analyzer.

Boolean Parameters

Boolean parameters represent two states. The ON state (logically true) is represented by ON or a numerical value different from 0. The OFF state (logically false) is represented by OFF or the numerical value 0. A query responds with 0 or 1.

Example: Setting command: SWEep:TIME:AUTO ON

Query: SWEep:TIME:AUTO? returns 1

Text Parameters

Text parameters observe the syntax rules for key words, i.e. they can be entered using a short or long form. Like any parameter, they have to be separated from the header by a white space. In the case of a query, the short form of the text is provided.

Example: Setting command: TRIGger:SOURce EXTernal

Query: TRIGger:SOURce? returns EXT

Strings

Strings must always be entered within single or double quotation marks (' or ").

Example: CONFigure:CHANnel:NAME "Channel 4" or
CONFigure:CHANnel:NAME 'Channel 4'

Block Data Format

Block data is a transmission format which is suitable for the transmission of large amounts of data. A command using a block data parameter with definite length has the following structure:

Example: HEADer:HEADer #45168xxxxxxxx

The hash symbol # introduces the data block. The next number indicates how many of the following digits describe the length of the data block. In the example the 4 following digits indicate the length to be 5168 bytes. The data bytes follow. During the transmission of these data bytes all End or other control signs are ignored until all bytes are transmitted.

A #0 combination introduces a data block of indefinite length. The use of the indefinite format requires a NL^END message to terminate the data block. This format is useful when the length of the transmission is not known or if speed or other considerations prevent segmentation of the data into blocks of definite length.

Overview of Syntax Elements

- : The colon separates the key words of a command. In a command line the separating semicolon marks the uppermost command level.
 - ;; The semicolon separates two commands of a command line. It does not alter the path.
 - ,
 - ? The question mark forms a query.
 - *
 - '
,
" Quotation marks introduce a string and terminate it.
 - # The hash sign # introduces binary, octal, hexadecimal and block data.
Binary: #B10110
Octal: #O7612
Hexadecimal: #HF3A7
Block: #21312
- A "white space" (ASCII-Code 0 to 9, 11 to 32 decimal, e.g. blank) separates header and parameter.

Basic Remote Control Concepts

The functionality of the network analyzer's remote control commands has been defined in close analogy to the menu commands and control elements of the graphical user interface (GUI). The basic concepts of setups, traces, channels, and diagram areas remain valid in remote control. Moreover, all commands follow SCPI syntax rules, and SCPI-confirmed commands have been used whenever possible. These principles largely simplify the development of remote control scripts.

The GUI and the remote control command set both aim at maximum operating convenience. In manual control this generally means that the control elements are easy to find and intuitive to handle, and that the effect of each operation is easy to verify on the screen. Convenient remote control operation depends on a simple and systematic program syntax and on a predictable instrument state; the display of results is secondary.

These differences suggest the peculiarities in the analyzer's remote control concept discussed in the following sections.

Traces, Channels, and Diagram Areas

Like in manual control, traces can be assigned to a channel and displayed in diagram areas (see section *Traces, Channels and Diagram Areas* in Chapter 3). There are two main differences between manual and remote control:

- A trace can be created without being displayed on the screen.
- A channel must not necessarily contain a trace. Channel and trace configurations are independent of each other.

The following frequently used commands create and delete traces, channels, and diagram areas:

Create new trace and new channel (if channel <Ch> does not exist yet)	CALCulate<Ch>:PARAmeter:SDEFine '<Trace Name>', '< Meas Parameter>
Delete trace	CALCulate<Ch>:PARAmeter:DELEte <Trace Name>
Create or delete channel	CONFigure:CHANnel<Ch>[:STATe] ON OFF
Create or delete diagram area	DISPlay:WINDow<Wnd>:STATe ON OFF
Display trace in diagram area	DISPlay:WINDow<Wnd>:TRACe<WndTr>:FEED

The assignment between traces, channels, and diagram areas is defined via numeric suffixes as illustrated in the following example:

```
CALC4:PAR:SDEF 'Ch4Tr1', 'S11'
```

Create channel 4 (channel suffix 4) and a trace named *Ch4Tr1* to measure the input reflection coefficient S_{11} . The trace is created but not displayed.

DISP:WIND2:STAT ON

Create diagram area no. 2 (window suffix 2).

DISP:WIND2:TRAC9:FEED 'CH4TR1'

Display the generated trace (identified by its name *Ch4Tr1*) in diagram area no. 2 (window suffix 2), assigning the trace number 9 (trace suffix 9) to it.

Active Traces in Remote Control

In manual control there is always exactly one active trace, irrespective of the number of channels and traces defined. The *active channel* contains the active trace; see section *Trace Settings* in Chapter 3.

In remote control, each channel contains an active trace (unless the channel contains no trace at all), so the notion of *active channel* is meaningless. This principle actually simplifies the remote control command syntax, because it allows the active trace in a particular channel to be referenced by means of the channel suffix. No additional trace identifier is needed; there is no need either to distinguish channel and trace settings using mnemonics or suffixes.

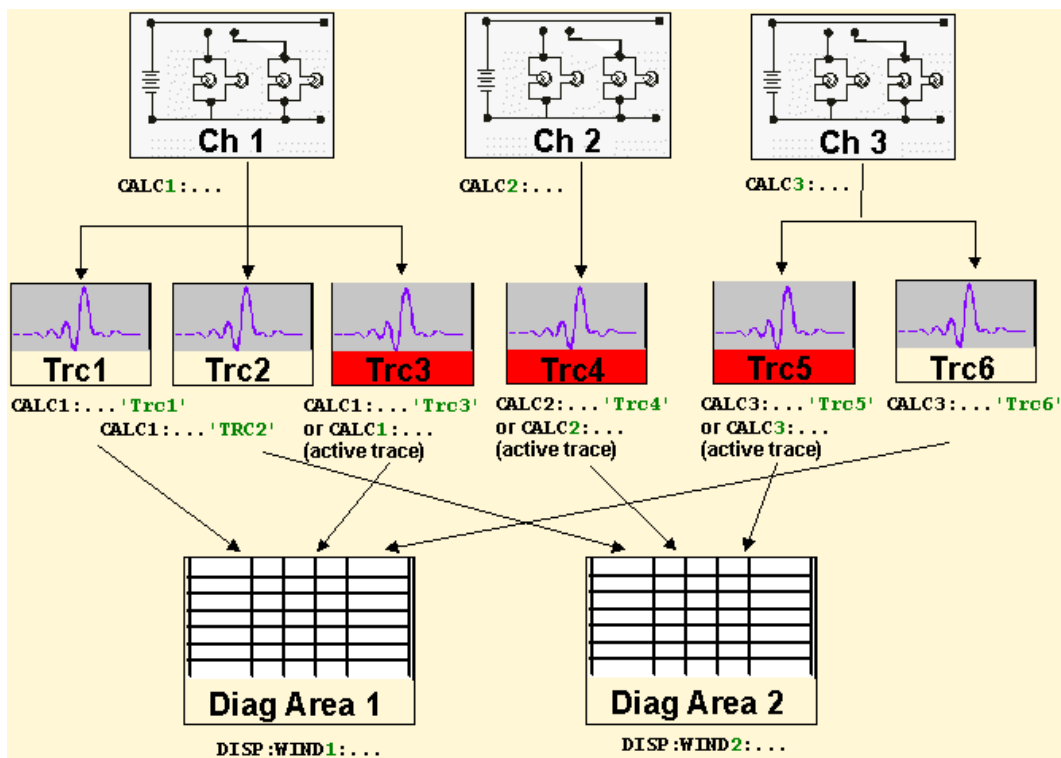

The active traces are handled as follows:

- After a preset (*RST), the analyzer displays a single diagram area with the default trace no. 1 named *TRC1*. The trace is active in manual and in remote control.
- In manual control, a new, added trace automatically becomes the active trace. To select another trace as the active trace, click inside the trace list.
- In remote control, a new trace added via `CALCulate<Ch>:PARAmeter:SDEFine '<trace_name>', '<parameter>'` also becomes the active trace. To select another trace as the active trace, use `(CALCulate<Ch>:PARAmeter:SElect '<trace_name>')`.
- The active traces for manual and remote control may be different.

The following program example illustrates how to create, select and reference traces. It is instructive to observe the analyzer screen in order to check the effect of each step.

```
*RST
```

Reset the analyzer, creating channel no. 1 with the default trace *Trc1*. The trace is displayed in diagram area no. 1.

```
CALC1:PAR:SDEF 'Trc2', 'S11'; DISP:WIND:TRAC2:FEED 'Trc2'
```

Create a new trace named *Trc2*, assigned to channel no. 1 (the suffix 1 after `CALC`, may be omitted), and display the trace. The new trace automatically becomes the active trace for manual and for remote control. To check this, click *Trace – Marker – Marker 1* to create a marker. The marker is assigned to *Trc2*. Delete all markers (*Trace – Marker – All Markers Off*).

```
CALC1:MARK ON
```

To verify that *Trc2* is also active for remote control, use the channel suffix 1 after `CALC` (may be omitted) to reference the active trace in channel 1 and create a marker *Mkr 1*. The marker is assigned to *Trc2*.

```
CALC:PAR:SEL 'Trc1'; CALC1:MARK ON
```

Select the old default trace *Trc1* as the active trace for remote control. Create a new marker to verify that *Trc1* is now the active trace in channel 1.



In the SCPI command description, the numeric suffix <Ch> is used for channel settings (it denotes the configured channel), whereas <Chn> is used for trace settings (it denotes the active trace in the channel).

Initiating Measurements, Speed Considerations

After a reset the network analyzer measures in continuous mode. The displayed trace shows the result of the last sweep and is continuously updated. This provides a permanent visual control over the measurement and the effect of any analyzer settings.

In remote control, it is advisable to follow a different approach in order use the analyzer's resources to full capacity and gain measurement speed. The following principles can help to optimize a remote control program (see also programming example *Typical Stages of a Measurement*):

- Switch off the measurement while configuring your instrument.
- Use a minimum number of suitably positioned sweep points.
- Start a single sweep, observing proper command synchronization, and retrieve your results.

The following command sequence performs a single sweep in a single channel.

```
*RST; INITiate:CONTinuous OFF
```

Activate single sweep mode for all channels (including the channels created later).

```
INITiate:SCOPE SING
```

State that a single sweep will be performed in the active channel only.

```
INITiate[:IMMediate]; *WAI
```

Start a single sweep in channel no. 2, wait until the sweep is terminated before proceeding to the next command (see *Command Synchronization*).

Command Processing

The block diagram below shows how GPIB bus commands are serviced in the instrument.

The individual components work independently and simultaneously. They communicate with each other by means of so-called "messages".

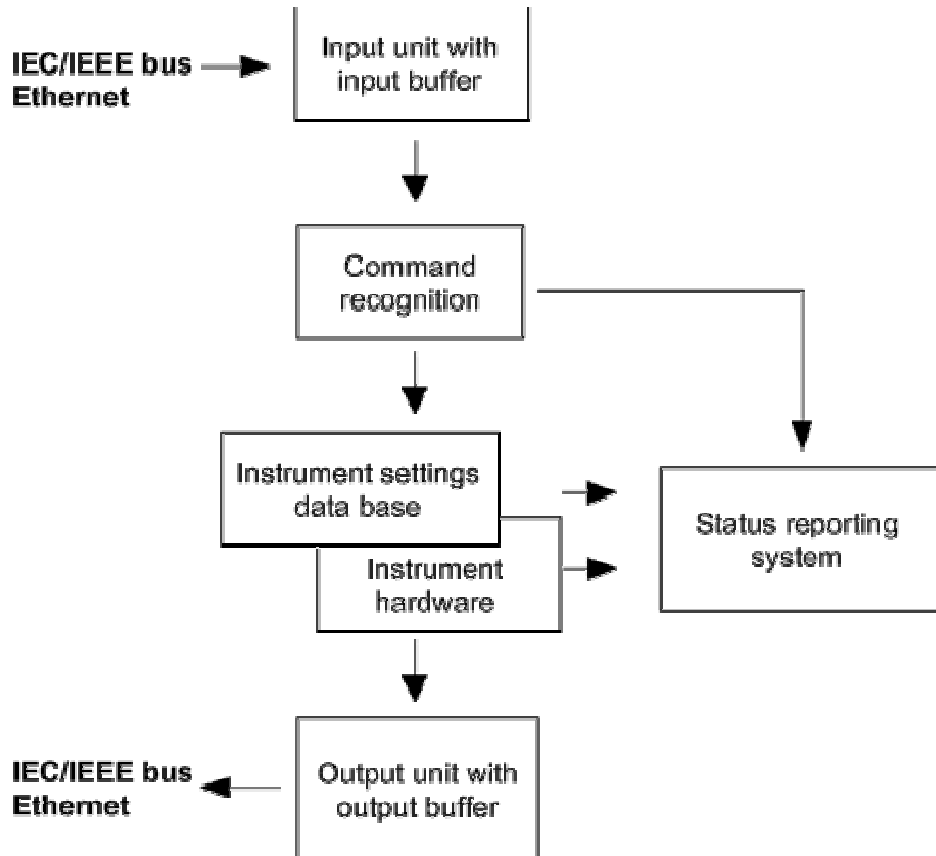

Input Unit

The input unit receives commands character by character from the controller and collects them in the input buffer. The input unit sends a message to the command recognition as soon as the input buffer is full or as soon as it receives a delimiter, <PROGRAM MESSAGE TERMINATOR>, as defined in IEEE 488.2, or the interface message DCL.

If the input buffer is full, the message data traffic is stopped and the data received up to then is processed. Subsequently the traffic is continued. If, however, the buffer is not yet full when receiving the delimiter, the input unit can already receive the next command during command recognition and execution. The receipt of a DCL clears the input buffer and immediately initiates a message to the command recognition.

Command Recognition

The command recognition stage analyzes the data received from the input unit. It proceeds in the order in which it receives the data. Only a DCL is serviced with priority, e.g. a GET (Group Execute Trigger) is only executed after the commands received before. Each recognized command is immediately transferred to the data set but not executed immediately.

The command recognition detects syntax errors in the commands and transfers them to the status reporting system. The rest of a command line after a syntax error is still executed, if possible. After the syntax check, the range of the numerical parameters is checked, if required.

If the command recognition detects a delimiter or a `DCL`, it also requests the data set to perform the necessary instrument hardware settings. Subsequently it is immediately prepared to process further commands. This means that new commands can already be serviced while the hardware is still being set ("overlapping execution").

Data Base and Instrument Hardware

The expression "instrument hardware" denotes the part of the instrument fulfilling the actual instrument function – signal generation, measurement etc. The controller is not included. The data base manages all the parameters and associated settings required for the instrument hardware.

Setting commands lead to an alteration in the data set. The data set management enters the new values (e.g. frequency) into the data set, however, it only passes them on to the hardware when requested by the command recognition. This can only occur at the end of a command line, therefore the order of the setting commands in the command line is not relevant.

The commands are only checked for their compatibility among each other and with the instrument hardware immediately before they are transmitted to the instrument hardware. If the instrument detects that execution is not possible, an "execution error" is signalled to the status reporting system. All alterations of the data set are cancelled, the instrument hardware is not reset. Due to the delayed checking and hardware setting, however, impermissible instrument states can be set for a short period of time within one command line without this leading to an error message (example: simultaneous activation of a frequency and a power sweep). At the end of the command line, however, a permissible instrument state must have been reached again.

Before passing on the data to the hardware, the settling bit in the `STATUS:OPERation` register is set (cf. section *STATUS:OPERation Register*). The hardware executes the settings and resets the bit again as soon as the new state has settled. This fact can be used to synchronize command servicing.

Queries induce the data set management to send the desired data to the output unit.

Status Reporting System

The status reporting system collects information on the instrument state and makes it available to the output unit on request. The exact structure and function are described in section Status Reporting System.

Output Unit

The output unit collects the information requested by the controller, which it receives from the data set management. It processes it according to the SCPI rules and makes it available in the output buffer. If the information requested is longer, it is made available "in portions" without this being recognized by the controller.

If the instrument is addressed as a talker without the output buffer containing data or awaiting data from the data set management, the output unit sends the error message "Query UNTERMINATED" to the status reporting system. No data is sent on the GPIB bus or via the Ethernet, the controller waits until it has reached its time limit. This behavior is specified by SCPI.

Command Sequence and Command Synchronization

IEEE 488.2 defines a distinction between overlapped and sequential commands:

- A sequential command is one which finishes executing before the next command starts executing. Commands that are processed quickly are usually implemented as sequential commands.
- An overlapping command is one which does not automatically finish executing before the next command starts executing. Usually, overlapping commands take longer to process and allow the program to do other tasks while being executed. If overlapping commands do have to be executed in a defined order, e.g. in order to avoid wrong measurement results, they must be serviced sequentially. This is called synchronization between the controller and the analyzer.

According to section *Data Set and Instrument Hardware*, setting commands within one command line, even though they may be implemented as sequential commands, are not necessarily serviced in the order in which they have been received. In order to make sure that commands are actually carried out in a certain order, each command must be sent in a separate command line. **Examples:**

Example 1: Commands and queries in one message

The response to a query combined in a program message with commands that affect the queried value is not predictable. Sending

```
:FREQ:STAR 1GHZ;SPAN 100
```

```
:FREQ:STAR?
```

always returns 1000000000 (1 GHz). When:

```
:FREQ:STAR 1GHZ;STAR?;SPAN 1000000
```

is sent, however, the result is not specified by SCPI. The result could be the value of `START` before the command was sent since the instrument might defer executing the individual commands until a program message terminator is received. The result could also be 1 GHz if the instrument executes commands as they are received.

As a general rule, send commands and queries in different program messages.

Example 2: Overlapping command with *OPC

The analyzer implements `INITiate[:IMMEDIATE]` as an overlapped command. Assuming that `INITiate[:IMMEDIATE]` takes longer to execute than `*OPC`, sending the command sequence `INIT; *OPC`.

results in initiating a sweep and, after some time, setting the OPC bit in the ESR. Sending the commands:

```
INIT; *OPC; *CLS
```

still initiates a sweep. Since the operation is still pending when the analyzer executes `*CLS`, forcing it into the Operation Complete Command Idle State (OCIS), `*OPC` is effectively skipped. The OPC bit is not set until the analyzer executes another `*OPC` command.



The analyzer provides only one overlapped command, `INITiate<Ch>[:IMMEDIATE]`. What is said below is not relevant for the other (sequential) SCPI commands.



Preventing overlapping execution

To prevent an overlapping execution of commands, one of the commands *OPC, *OPC? or *WAI can be used. For a programming example refer to section *Command Synchronization* in Chapter *Programming Examples*.

Command	Action after the hardware has settled	Programming the controller
*WAI	Stops further command processing until all commands sent before *WAI have been executed Note: The GPIB bus handshake is not stopped	Send *WAI directly after the command which should be terminated before the next command is executed.
*OPC?	Stops command processing until 1 is returned, i.e. until the Operation Complete bit has been set in the ESR. This bit indicates that the previous commands have been completed.	Send *OPC? directly after the command which should be terminated before the next command is executed.
*OPC	Sets the operation complete bit in the ESR after all previous commands have been executed.	<ul style="list-style-type: none"> – Set bit 0 in the ESE – Set bit 5 in the SRE – Wait for service request (SRQ)

Status Reporting System

The status reporting system stores all information on the present operating state of the instrument, and on errors which have occurred. This information is stored in the status registers and in the error queue. Both can be queried via GPIB bus or Ethernet (STATus... commands).



Hierarchy of status registers

As shown in the graphical overview, the status information is of hierarchical structure.

- **STB, SRE** The STatus Byte (STB) register and its associated mask register Service Request Enable (SRE) form the highest level of the status reporting system. The STB provides a rough overview of the instrument status, collecting the information of the lower-level registers.
- **ESR, SCPI registers**
The STB receives its information from the following registers:
 - The Event Status Register (ESR) with the associated mask register standard event status enable (ESE).
 - The STATus:OPERation and STATus:QUEStionable registers which are defined by SCPI and contain detailed information on the instrument.
- **IST, PPE** The IST flag ("Individual STatus"), like the SRQ, combines the entire instrument status in a single bit. The PPE is associated to the IST flag. It fulfills an analogous function for the IST flag as the SRE does for the service request.
- **Output buffer** contains the messages the instrument returns to the controller. It is not part of the status reporting system but determines the value of the MAV bit in the STB and thus is represented in the overview.

All status registers have the same internal structure.



The service request enable register SRE can be used as ENABLE part of the STB if the STB is structured according to SCPI. By analogy, the ESE can be used as the ENABLE part of the ESR.

Overview of Status Registers

The status registers of the network analyzer are implemented as shown below.

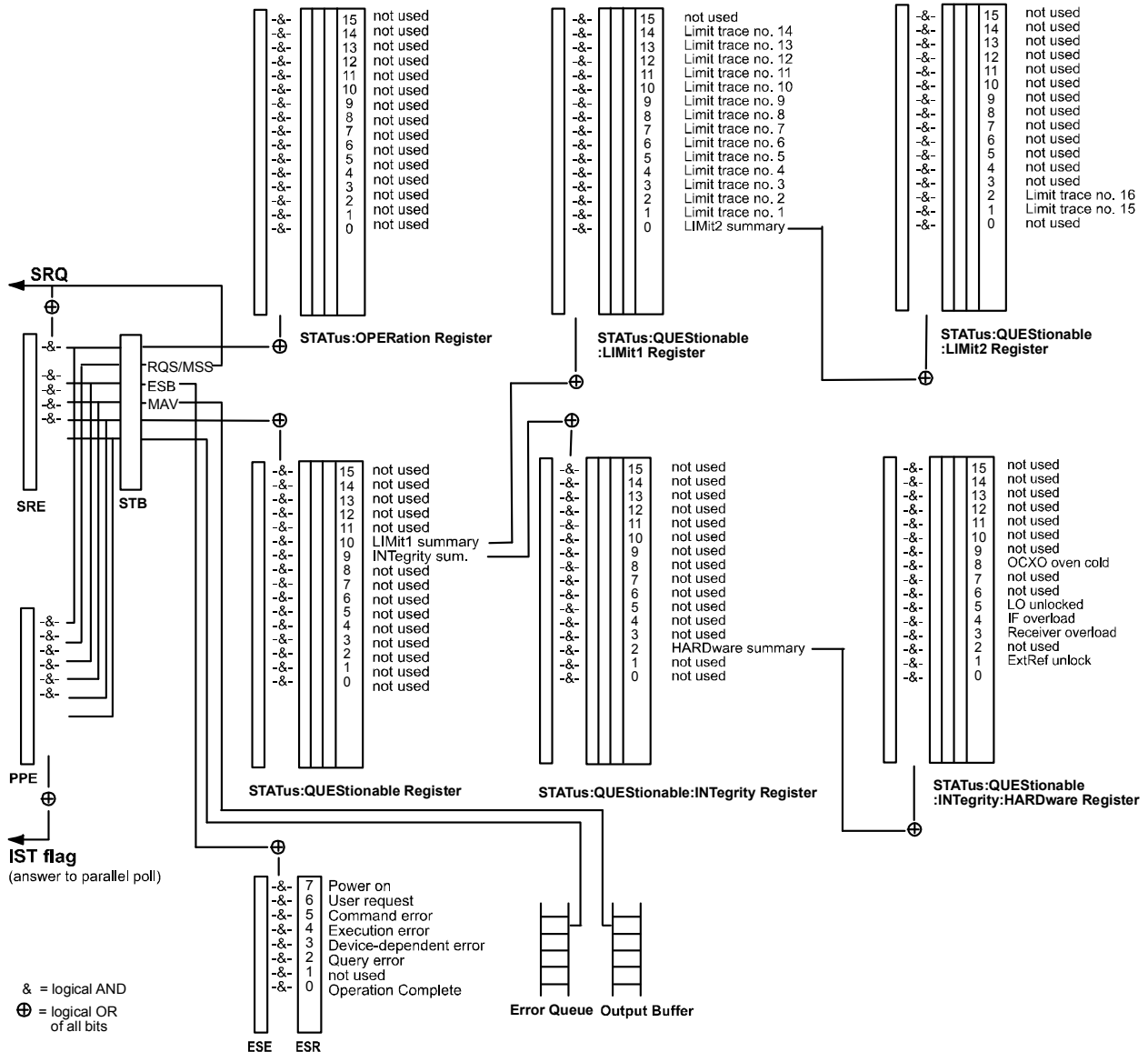

Structure of an SCPI Status Register

Each standard SCPI register consists of 5 parts which each have a width of 16 bits and have different functions. The individual bits are independent of each other, i.e. each hardware status is assigned a bit number which is valid for all five parts. Bit 15 (the most significant bit) is set to zero for all parts. Thus the contents of the register parts can be processed by the controller as positive integer.

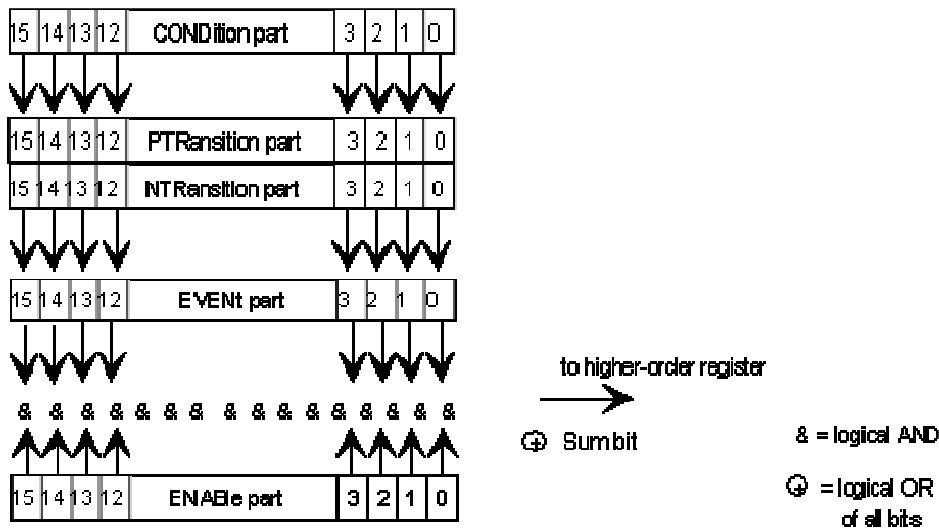

Description of the five status register parts

The five parts of an SCPI register have different properties and function:

- **CONDition**

The CONDition part is permanently overwritten by the hardware or the sum bit of the next lower register. Its contents always reflect the current instrument state.

This register part can only be read, but not overwritten or cleared. Reading the CONDition register is nondestructive.

- **PTRansition**

The two transition register parts define which state transition of the condition part (none, 0 to 1, 1 to 0 or both) is stored in the EVENT part.

The Positive TRansition part acts as a transition filter. When a bit of the CONDition part is changed from 0 to 1, the associated PTR bit decides whether the EVENT bit is set to 1:

- PTR bit =1: the EVENT bit is set.
- PTR bit =0: the EVENT bit is not set.

This status register part can be overwritten and read at will. Reading the PTRansition register is nondestructive.

- **NTRansition**

The Negative TRansition part also acts as a transition filter. When a bit of the CONDition part is changed from 1 to 0, the associated NTR bit decides whether the EVENT bit is set to 1.

NTR bit =1: the EVENT bit is set.

NTR bit =0: the EVENT bit is not set.

This part can be overwritten and read at will. Reading the PTRansition register is nondestructive.

- **EVENT**

The EVENT part indicates whether an event has occurred since the last reading, it is the "memory" of the condition part. It only indicates events passed on by the transition filters. It is permanently updated by the instrument. This part can only be read by the user. Reading the register clears it. This part is often equated with the entire register.

- **ENABLE**

The ENABLE part determines whether the associated EVENT bit contributes to the sum bit (cf. below). Each bit of the EVENT part is ANDed with the associated ENABLE bit (symbol '&'). The results of all logical operations of this part are passed on to the sum bit via an OR function (symbol '+').

- ENAB bit =0: The associated EVENT bit does not contribute to the sum bit.
- ENAB bit =1: If the associated EVENT bit is "1", the sum bit is set to "1" as well.

This part can be overwritten and read by the user at will. Its contents are not affected by reading.

As shown in the graphical overview, the status information is of hierarchical structure.

- **STB, SRE** The register SStatus Byte (STB) defined in IEEE 488.2 and its associated mask register Service Request Enable (SRE) form the highest level of the status reporting system. The STB provides a rough overview of the instrument status, collecting the information of the lower-level registers.
- **ESR, SCPI registers**
The STB receives its information from the following registers:
 - The standard IEEE 488.2 Event Status Register (ESR) with the associated mask register standard event status enable (ESE).
 - The STATus:OPERation and STATus:QUESTionable registers which are defined by SCPI and contain detailed information on the instrument.
- **IST, PPE** The IST flag ("Individual SStatus"), like the SRQ, combines the entire instrument status in a single bit. The PPE is associated to the IST flag. It fulfills an analogous function for the IST flag as the SRE does for the service request.
- **Output buffer** contains the messages the instrument returns to the controller. It is not part of the status reporting system but determines the value of the MAV bit in the STB and thus is represented in the overview.

The **sum bit** is obtained from the EVENT and ENABLE part for each register. The result is then entered into a bit of the CONDition part of the higher-order register.

The instrument automatically generates the sum bit for each register. Thus an event can lead to a service request throughout all levels of the hierarchy.

Status Registers

Contents of the Status Registers

The individual status registers are used to report different classes of instrument states or errors. The following status registers belong to the general model described in IEEE 488.2:

- The STatus Byte (STB) gives a rough overview of the instrument status.
- The IST flag combines the entire status information into a single bit that can be queried in a parallel poll.
- The Event Status Register (ESR) indicates general instrument states.

The status registers below belong to the device-dependent SCPI register model:

- The STATus:OPERation register contains conditions which are part of the instrument's normal operation.
- The STATus:QUESTionable register indicates whether the data currently being acquired is of questionable quality.
- The STATus:QUESTionable:LIMit<1|2> register indicates the result of the limit check.

STB and SRE

The STatus Byte (STB) provides a rough overview of the instrument status by collecting the pieces of information of the lower registers. The STB represents the highest level within the SCPI hierarchy. A special feature is that bit 6 acts as the summary bit of the remaining bits of the status byte.



SRE and Service Request

The STatus Byte (STB) is linked to the Service Request Enable (SRE) register on a bit-by-bit basis.

- The STB corresponds to the CONDition part of an SCPI register, indicating the current instrument state.
- The SRE corresponds to the ENABle part of an SCPI register. If a bit is set in the SRE and the associated bit in the STB changes from 0 to 1, a Service Request (SRQ) is generated on the GPIB bus.

Bit 6 of the SRE is ignored, because it corresponds to the summary bit of the STB.



Related common commands

The STB is read out using the command `*STB?` or a serial poll.

The SRE can be set using command `*SRE` and read using `*SRE?`.

The bits in the STB are defined as follows:

Bit No.	Meaning

3	<p>QUESTIONable status summary bit</p> <p>This bit is set if an EVENT bit is set in the QUESTIONable register and the associated ENABLE bit is set to 1.</p> <p>The bit indicates a questionable instrument status, which can be further pinned down by polling the QUESTIONable register.</p>
5	<p>ESB bit</p> <p>Sum bit of the event status register. It is set if one of the bits in the event status register is set and enabled in the event status enable register.</p> <p>Setting of this bit implies an error or an event which can be further pinned down by polling the event status register.</p>

IST Flag and PPE

In analogy to the Service Request (SRQ), the IST flag combines the entire status information in a single bit. It can be queried by means of a parallel poll.

The Parallel Poll Enable (PPE) register determines which bits of the STB contribute to the IST flag. The bits of the STB are ANDed with the corresponding bits of the PPE, with bit 6 being used as well in contrast to the SRE. The IST flag results from the ORing of all results.



Related common commands

The IST flag is queried using the command **IST?*.

The PPE can be set using **PRE* and read using command **PRE?*.

ESR and ESE

The Event Status Register (ESR) indicates general instrument states. It is linked to the Event Status Enable (ESE) register on a bit-by-bit basis.

- The ESR corresponds to the CONDition part of an SCPI register, indicating the current instrument state.
- The ESE corresponds to the ENABle part of an SCPI register. If a bit is set in the ESE and the associated bit in the ESR changes from 0 to 1, the ESB bit in the SStatus Byte is set.



Related common commands

The Event Status Register (ESR) can be queried using *ESR?*.

The Event Status Enable (ESE) register can be set using the command **ESE* and read using **ESE?*.

The bits in the ESR are defined as follows:

Bit No.	Meaning
0	<p>Operation Complete</p> <p>This bit is set on receipt of the command <i>*OPC</i> after all previous commands have been executed.</p>

STATus:OPERation

The STATus:OPERation register contains conditions which are part of the instrument's normal operation.

The analyzer does not use the STATus:OPERation register:

STATus:QUEStionable

The STATus:QUEStionable register indicates whether the acquired data is of questionable quality and monitors hardware failures of the analyzer. It can be queried using the commands `STATus:QUEStionable:CONDition?` or `STATus:QUEStionable[:EVENT]?`

The bits in the STATus:QUEStionable register are defined as follows:

Bit No.	Meaning
9	Integrity Register summary This bit is set if a bit is set in the STATus:QUEStionable:INTegrity register and the associated ENABLE bit is set to 1.
10	Limit Register summary This bit is set if a bit is set in the STATus:QUEStionable:LIMit1 register and the associated ENABLE bit is set to 1.

STATus:QUEStionable:LIMit1<1|2>

The STATus:QUEStionable:LIMit<1|2> registers indicate the result of the limit check. They can be queried using the commands `STATus:QUEStionable:LIMit<1|2>:CONDition?` or `STATus:QUEStionable:LIMit<1|2>[:EVENT]?` STATus:QUEStionable:LIMit1 is also the summary register of the lower-level STATus:QUEStionable:LIMit2 register.

The bits in the STATus:QUEStionable:LIMit1 register are defined as follows:

Bit No.	Meaning
0	LIMit2 Register summary This bit is set if a bit is set in the STATus:QUEStionable:LIMit2 register and the associated ENABLE bit is set to 1.
1	Failed Limit Check for Trace no. 1 This bit is set if any point on trace no. 1 fails the limit check.
...	...
14	Failed Limit Check for Trace no. 14 This bit is set if any point on trace no. 14 fails the limit check.

The bits in the STATus:QUEStionable:LIMit2 register are defined as follows:

Bit No.	Meaning
0	Not used
1	Failed Limit Check for Trace no. 15 This bit is set if any point on trace no. 15 fails the limit check.

2	<p>Failed Limit Check for Trace no. 16</p> <p>This bit is set if any point on trace no. 16 fails the limit check.</p>
---	--



Numbering of traces

The traces numbers 1 to 16 are assigned as follows:

- Traces assigned to channels with smaller channel numbers have smaller trace numbers.
- Within a channel, the order of traces reflects their creation time: The oldest trace has the smallest, the newest trace has the largest trace number. This is equivalent to the order of traces in the response string of the `CALCulate<Ch>:PARAmeter:CATalog?` query.
- The number of traces monitored cannot exceed 16. If a setup contains more traces, the newest traces are not monitored.

STATus:QUESTionable:INTegrity...

The `STATus:QUESTionable:INTegrity` register monitors hardware failures of the analyzer. It can be queried using the commands `STATus:QUESTionable:INTegrity:CONDition?` or `STATus:QUESTionable:INTegrity[:EVENT]?` `STATus:QUESTionable:INTegrity` is also the summary register of the lower-level `STATus:QUESTionable:INTegrity:HARDware` register.



Refer to the *Error Messages* section for a detailed description of hardware errors including possible remedies.

The bits in the `STATus:QUESTionable:INTegrity` register are defined as follows:

Bit No.	Meaning
2	<p>HARDware Register summary</p> <p>This bit is set if a bit is set in the <code>STATus:QUESTionable:INTegrity:HARDware</code> register and the associated <code>ENABLE</code> bit is set to 1.</p>

The `STATus:QUESTionable:INTegrity:HARDware` register can be queried using the commands `STATus:QUESTionable:INTegrity:HARDware:CONDition?` or `STATus:QUESTionable:INTegrity:HARDware[:EVENT]?`

The bits in the `STATus:QUESTionable:INTegrity:HARDware` register are defined as follows:

Bit No.	Meaning
0	Not used
1	<p>ExtRef unlock</p> <p>With external reference signal (System – External Reference active) or option ZVAB-B4 (oven quartz), the reference oscillator is phase locked to a 10 MHz signal. This bit is set if this phase locked loop (PLL) fails.</p> <p>For external reference: check frequency and level of the supplied reference signal.</p>
3	<p>Receiver overload</p> <p>This bit is set if the analyzer detects an excessive input level at one of the ports.</p> <p>Reduce RF input level at the port. Check amplifiers in the external test setup.</p>

4	IF overload The internal local oscillator (LO) signal is phase locked to a 10 MHz signal. This message appears when the internal phase locked loop (PLL) fails. Reduce RF input level at the port. Check amplifiers in the external test setup.
5	LO unlocked This bit is set if the analyzer detects that the instrument temperature is too high. Shut down and restart the analyzer.
8	OCXO oven cold This bit is set if the oven for the optional oven quartz (OCXO, option FSL-B4) is not at its operating temperature. Wait until the oven has been heated up.
9 ...	Not used

Application of the Status Reporting System

The purpose of the status reporting system is to monitor the status of one or several devices in a measuring system. To do this and react appropriately, the controller must receive and evaluate the information of all devices. The following standard methods are used:

- Service request (SRQ) initiated by the measuring device
- Serial poll of all devices in the bus system, initiated by the controller in order to find out who sent a SRQ and why
- Parallel poll of all devices
- Query of a specific instrument status by means of commands
- Query of the error queue

Service Request

The measuring device can send a service request (SRQ) to the controller. Usually this service request causes an interrupt, to which the control program can react appropriately.



Initiating an SRQ

As shown in the graphical overview, an SRQ is initiated if one or several of bits 2, 3, 4, 5 or 7 of the status byte are set and enabled in the SRE. Each of these bits summarizes the information of a further register, the error queue or the output buffer.

The ENABLE parts of the status registers can be set such that arbitrary bits in an arbitrary status register initiate an SRQ. To use the possibilities of the service request effectively, all bits in the enable registers SRE and ESE should be set to "1".

Examples:

- **Use *OPC to generate an SRQ**
 1. Set bit 0 in the ESE (Operation Complete).
 2. Set bit 5 in the SRE (ESB).
 3. Insert *OPC in the command sequence (e.g. at the end of a sweep).

As soon as all commands preceding *OPC have been completed, the instrument generates an SRQ.

- **Generate an SRQ when a limit is exceeded**

1. Set bit 3 in the SRE (summary bit of the STATus:QUEStionable register, set after STATus:PRESet)
2. Set bit 10 in the STATus:QUEStionable:ENABle register (summary bit of the STATus:QUEStionable:LIMit1 register)
3. Set bit 1 in the STATus:QUEStionable:LIMit1:ENABle register

The analyzer generates a SRQ when the event associated with bit 1 of the STATus:QUEStionable:LIMit1:ENABle register occurs, i.e. when any point on the first trace fails the limit check.

- **Find out which event caused an SRQ**

The procedure to find out which event caused an SRQ is analogous to the procedure to generate an SRQ:

1. STB? (query the contents of the status byte in decimal form)

If bit 3 (QUEStionable summary bit) is set, then:

2. STAT:QUES:EVENT? (query STATus:QUEStionable register)

If bit 10 (QUEStionable:LIMit1 summary bit) is set, then:

3. Query STAT:QUES:LIMit1:EVENT? (query STATus:QUEStionable:LIMit1 register)

If bit 1 is set, then the first trace failed the limit check.



The SRQ is the only possibility for the instrument to become active on its own. Each controller program should set the instrument such that a service request is initiated in the case of malfunction. The program should react appropriately to the service request.

Serial Poll

In a serial poll, the controller queries the SStatus Bytes of the devices in the bus system one after another. The query is made via interface messages, so it is faster than a poll by means of *STB?.



Serial poll procedure

The serial poll method is defined in IEEE 488.1 and used to be the only standard possibility for different instruments to poll the status byte. The method also works for instruments which do not adhere to SCPI or IEEE 488.2.

The Visual BASIC command for executing a serial poll is "IBRSP()".

The serial poll is mainly used to obtain a fast overview of the state of several instruments connected to the controller.

Parallel Poll

In a parallel poll, up to eight instruments are simultaneously requested by the controller by means of a single command to transmit 1 bit of information each on the data lines, i.e., to set the data line allocated to each instrument to a logical "0" or "1".



Parallel poll procedure

In addition to the SRE register, which determines the conditions under which an SRQ is generated, there is a Parallel Poll Enable register (PPE) which is ANDed with the STB bit by bit, considering bit 6 – AND as well. This register is ANDed with the STB bit by bit, considering bit 6 as well. The results are ORed, the result is possibly inverted and then sent as a response to the parallel poll of the controller. The result can also be queried without parallel poll by means of the command "*IST?".

The instrument first has to be set for the parallel poll using the Visual BASIC command "IBPPC()". This command allocates a data line to the instrument and determines whether the response is to be inverted. The parallel poll itself is executed using "IBRPP()".

The parallel poll method is mainly used to find out quickly which one of the instruments connected to the controller has sent a service request. To this effect, SRE and PPE must be set to the same value.

Query of an Instrument Status

Each part of any status register can be read by means of queries. There are two types of commands:

- The common commands *ESR?, *IDN?, *IST?, *STB? query the higher-level registers.
- The commands of the STATus system query the SCPI registers (STATus:QUESTIONable...)

All queries return a decimal number which represents the bit pattern of the status register. This number is evaluated by the controller program.



Decimal representation of a bit pattern

The STB and ESR registers contain 8 bits, the SCPI registers 16 bits. The contents of a status register is keyed and transferred as a single decimal number. To make this possible, each bit is assigned a weighted value. The decimal number is calculated as the sum of the weighted values of all bits in the register that are set to 1.

Bits	0	1	2	3	4	5	6	7	...
Weight	1	2	4	8	16	32	64	128	...

Example: The decimal value $40 = 32 + 8$ indicates that bits no. 3 and 5 in the status register (e.g. the QUESTIONable status summary bit and the ESB bit in the SStatus Byte) are set.

Queries are usually used after an SRQ in order to obtain more detailed information on the cause of the SRQ.

Error Queue

Each error state in the instrument leads to an entry in the error queue. The entries of the error queue are detailed plain text error messages that can be looked up in the *Error Log* or queried via remote control using `SYSTem:ERRor[:NEXT]?` or `SYSTem:ERRor:ALL?`. Each call of `SYSTem:ERRor[:NEXT]?` provides one entry from the error queue. If no error messages are stored there any more, the instrument responds with 0, "No error".

The error queue should be queried after every SRQ in the controller program as the entries describe the cause of an error more precisely than the status registers. Especially in the test phase of a controller program the error queue should be queried regularly since faulty commands from the controller to the instrument are recorded there as well.

Reset Values of the Status Reporting System

The table below indicates the effects of various commands upon the status reporting system of the analyzer.

Event	Switching on supply voltage Power-On-Status-Clear		DCL,SDC(Device Clear, Selected Device Clear)	*RST or SYSTem:PRESet	STATus:PRESet	*CLS
	0	1				
Effect	0	1				
Clear STB,ESR		yes				yes
Clear SRE,ESE		yes				
Clear PPE		yes				
Clear EVENT parts of the registers		yes				yes
Clear ENABLE parts of all OPERation-and QUESTionable registers, Fill ENABLE parts of all other registers with "1".		yes			yes	
Fill PTRansition parts with „1“ Clear NTRansition parts		yes			yes	
Clear error queue	yes	yes				yes
Clear output buffer	yes	yes	yes	1)	1)	1)
Clear command processing and input buffer	yes	yes	yes			

1) Every command being the first in a command line, i.e. immediately following a <PROGRAM MESSAGE TERMINATOR> clears the output buffer.

Table of Contents

7 Command Reference	346
Special Terms and Notation	346
Common Commands	348
Instrument-Control Commands	350
CALCulate	350
CONFigure.....	424
DIAGnostic:SERvice.....	426
DISPlay.....	427
FORMat.....	442
HCOPY.....	444
INITiate<Ch>.....	451
INPut.....	452
INSTrument.....	453
MEMory.....	454
MMEMory.....	456
OUTPut<Pt>.....	481
PROGram.....	482
[SENSe...].	483
SOURce<Ch>:.....	532
STATus.....	533
SYSTem.....	537
TRACe.....	549
TRIGger<Ch>.....	554
UNIT.....	555

7 Command Reference

This chapter lists all common commands and SCPI commands implemented by the analyzer.

Special Terms and Notation

This section explains the meaning of special syntax elements used in the SCPI command reference sections. A general description of the SCPI command syntax can be found in section *SCPI Command Structure and Syntax* in Chapter *Remote Control*.



Compatibility with ZVR and other instruments

The SCPI command set for the R&S ZVL vector network analyzer has been designed for compatibility with older R&S network analyzers of the ZVR type. A special class of commands, marked with the symbol ZVR☑, has been implemented primarily for compatibility reasons. Use these commands if you want to maintain compatibility with ZVR analyzers. If you want to make full use of the ZVL features and don't need ZVR compatibility, you should use the generalized, R&S ZVL-specific commands. A link to a generalized command is provided in the description of each ZVR-specific command.

Similar considerations also hold for other commands that have been "implemented for compatibility reasons".

*Commands for spectrum analyzer mode are reported in the separate R&S ZVL-K1 manual; see section *Network Analyzer and Spectrum Analyzer Mode* in chapter 6.*

- **Information in the command tables**

All commands are described according to the same scheme. The following information is provided:

- Complete command syntax and parameter list
- Description of the command and its relationship with other commands
- List and description of the parameters with their numerical ranges, default values and default units
- SCPI conformance information, supported command types (setting command, query)
- Program example

- **Order of commands**

The commands are arranged in alphabetical order. SCPI systems or subsystems are arranged in one topic.

- **Parameters**

Many commands are supplemented by a parameter or a list of parameters. Parameters either provide alternative options (setting a or setting b or setting c ..., see special character "|"), or they form a list separated by commas (setting x,y).

- **<Par_Name>** In the command tables and lists, parameters are generally described by a name (literal) written in angle brackets (<>). This literal merely serves as a parameters description; in an application program it must be replaced by one of the possible settings reported in the detailed parameter description.

- **Example:** CONTrol:AUXiliary:C[:DATA] <numeric_value>

with <numeric_value> = 0 to 15

possible command syntax: CONT:AUX:C 1

- **NAN** (Not A Number) is generally used to represent missing data, e.g. if a portion of a trace has not been acquired yet. It is also returned after invalid mathematical operations such as division by zero. As defined in the SCPI standard, NAN is represented as 9.91 E 37.
- **INV** (invalid) is returned e.g. if a limit check is performed without defining the appropriate tolerance values.

- **Upper/lower case**

Upper/lower case characters characterize the long and short form of the mnemonics in a command. The short form consists of all upper-case characters, the long form of all upper case plus all lower case characters. On the ZVL, either the short form or the long form are allowed; mixed forms will generally not be recognized. The instrument itself does not distinguish upper case and lower case characters.

- **Special characters**

- | A vertical stroke in the parameter list characterizes alternative parameter settings. Only one of the parameters separated by | must be selected.

- **Example:** The following command has two alternative settings:

```
FORMat[:DATA] ASCii | REAL
```

- [] Key words in square brackets can be omitted when composing the command header (see *SCPI Command Structure and Syntax*). The complete command must be recognized by the instrument for reasons of compatibility with the SCPI standard. Parameters in square brackets are optional as well. They may be entered in the command or omitted.
- { } Braces or curly brackets enclose one or more parameters that may be included zero or more times.
- **Numeric suffixes**

Symbols in angular brackets (<Ch>, <Chn>, <Mk>,...) denote numeric suffixes. Numeric suffixes are replaced by integer numbers to distinguish various items of the same type. The analyzer provides numeric suffixes for channels, traces, ports, markers etc. If unspecified, a numeric suffix is replaced by 1.

The marker suffix must be in the range between 1 and 10, the number of ports depends on the analyzer model. No restrictions apply to channel, trace, and diagram area suffixes.

In remote control, one active trace can be selected for each channel; see *Active Traces in Remote Control*. This concept simplifies the remote control command syntax, because it allows the active trace in a particular channel to be referenced by means of the channel suffix. To keep the syntax transparent, <Ch> is used for channel settings (it denotes the configured channel), whereas <Chn> is used for trace settings (it denotes the active trace in the channel).

Common Commands

Common commands are described in the IEEE 488.2 (IEC 625-2) standard. These commands have the same effect on different devices. The headers of these commands consist of "*" followed by three letters. Many common commands are related to the status reporting system.

Command	Parameters	Short Description
*CLS CLear Status sets the status byte (STB), the standard event register (ESR) and the EVENT -part of the QUEStionable and the OPERation registers to zero. The command does not alter the mask and transition parts of the registers. It clears the output buffer and the tooltip for remote error messages.		Clear Status;
no query		
*ESE Event Status Enable sets the event status enable register to the value indicated. The query *ESE? returns the contents of the event status enable register in decimal form.	0...255	Event Status Enable
*ESR? Event Status Read returns the contents of the event status register in decimal form (0 to 255) and subsequently sets the register to zero.		Standard Event Status Query; query only
*IDN? IDeNtification returns the instrument identification. The (default) response is of the form "Rohde&Schwarz,ZVL-6,1303.6509K06/100007,1.10", where: ZVL-6 is the analyzer type 1303.6509K06 is the order number of the analyzer 100007 is the serial number of the analyzer 1.10 is the firmware version number.		
The ID string can be configured in the System Config dialog or in via SETUP – General Setup – GPIB – More – *IDN? Format.		Identification Query; query only
*IST? Individual STatus query returns the contents of the IST flag in decimal form (0 1). The IST-flag is the status bit which is sent during a parallel poll.		Individual Status Query; query only
*OPC OPERATION Complete sets bit 0 in the event status register when all preceding commands have been executed. This bit can be used to initiate a service request.		
The query form writes a "1" into the output buffer as soon as all preceding commands have been executed. This is used for command synchronization.		Operation Complete
*OPT? OPTion identification query queries the options included in the instrument and returns a list of the options installed. The response consists of arbitrary ASCII response data according to IEEE 488.2. The options are returned at fixed positions in a comma-separated string. A zero is returned for options that are not installed.		Option Identification Query; query only
*PCB Pass Control Back indicates the controller address to which GPIB bus control is returned after termination of the triggered action.	0...30	Pass Control Back; no query
*PRE Parallel poll Register Enable sets parallel poll enable register to the value indicated. The query *PRE? returns the contents of the parallel poll enable register in decimal form.	0...255	Parallel Poll Register Enable
*PSC Power on Status Clear determines whether the contents of the ENABLE registers is maintained or reset when the analyzer is switched on.		
*PSC = 0 causes the contents of the status registers to be maintained. Thus a service request can be triggered on switching on in the case of a corresponding configuration of status registers ESE and SRE.		
*PSC ≠ 0 resets the registers.	0 1	Power On Status Clear
*RST ReSeT sets the instrument to a defined default status. The command resets all setups, restoring the factory default values defined for remote control operation. In contrast the command SYSTem:PRESet resets the active setup only. The default settings are indicated in the description of commands.		Reset;no query
*SRE Service Request Enable sets the service request enable register to the value	0...255	Service Request

Common Commands

Command	Parameters	Short Description
indicated. Bit 6 (MSS mask bit) remains 0. This command determines under which conditions a service request is triggered. The query *SRE? returns the contents of the service request enable register in decimal form. Bit 6 is always 0.		Enable
* STB? S T atus Byte query reads the contents of the status byte in decimal form.		Status Byte Query; query only
* TRG TRIGger triggers all actions waiting for a trigger event. In particular *TRG generates a manual trigger signal (Manual Trigger). This common command complements the commands of the TRIGger subsystem.		Trigger;
no query		
* TST? self Te S T query triggers selftests of the instrument and returns an error code in decimal form.		Self Test Query; query only
* WAI WA I t to continue prevents servicing of the subsequent commands until all preceding commands have been executed and all signals have settled (see also command synchronization and *OPC).		Wait to continue; no query

Instrument-Control Commands

The remainder of this chapter lists the SCPI commands of the R&S ZVL in alphabetical order.

CALCulate

CALCulate<Chn>:CLIMits...

This subsystem controls the composite limit check.

CALCulate<Chn>:CLIMits:FAIL?

Returns a 0 or 1, to indicate whether or not a composite limit or ripple limit check on several traces has failed.

<Chn>	Channel number used to identify the active trace. This suffix is not relevant because the command provides a summary of all individual limit fails.
Response	0 1 - 0 represents pass for all individual limit checks (also returned if no limit check is active at all), 1 means that the limit checks for one or more traces failed.
*RST value	0
SCPI, Command Types	Device-specific, query only.
Example:	<pre>*RST; CALC:LIM:CONT 1 GHZ, 2 GHZ</pre> <p>Define an upper limit line segment in the stimulus range between 1 GHz and 2 GHz, using default response values.</p> <pre>CALC:LIM:STAT ON; FAIL?</pre> <p>Switch the limit check on and query the result.</p> <pre>CALC:CLIM:FAIL?</pre> <p>Query the result for the composite limit check. As only one trace is tested, the response should be equal to the previous response..</p>

CALCulate<Chn>:DATA...

This subsystem provides access to the results of a measurement.



The trace data is transferred in either ASCII or block data (REAL) format, depending on the FORMat[:DATA] setting. If the block data format is used, it is recommended to select EOI as receive terminator (SYSTem:COMMunicate:GPIB[:SELF]:RTERminator EOI).

CALCulate<Chn>:DATA SCORr1 | ... | SCORr27**CALCulate<Chn>:DATA SDATa, <data>**

Reads the current response values of the active data trace, reads or writes error terms, or reads or writes a memory trace.

<Chn> Channel number used to identify the active trace. If unspecified the numeric suffix is set to 1.

Parameters See list of parameters below.
Range [def. unit] The data format is parameter-dependent; see below. The unit is the default unit of the measured parameter; see `CALCulate<Ch>:PARameter:SDEFine`.
***RST value** –

<data> Unformatted trace data in ASCII or block data format, depending on `FORMat[:DATA]` setting. This parameter is only used for writing memory traces; see example 2 below.

SCPI, Command Types Confirmed, command (for memory traces or error terms) or query.

Example 1:

```
*RST; SWE:POIN 20
```

Create a trace with 20 sweep points, making the created trace the active trace of channel 1 (omitted optional mnemonic `SENSe1`).

```
CALC:DATA? FDAT
```

Query the 20 response values of the created trace. In the `FDATa` setting, 20 comma-separated ASCII values are returned.

```
CALC:DATA:STIM?
```

Query the 20 stimulus values of the created trace. 20 comma-separated ASCII values are returned.

```
CALC2:PAR:SDEF 'Trc2', 'S11'
```

Create a second trace in a new channel no. 2.

```
CALC:DATA:ALL? FDAT
```

Query the response values of all traces. 40 comma-separated ASCII values are returned.

**Example 2:
Write memory
trace**

```
*RST; SWE:POIN 3
```

Create a data trace 'Trc1' with 3 sweep points, making the created trace the active trace of channel 1 (omitted optional mnemonic `SENSe1`).

```
TRAC:COPY 'MemTrc1','Trc1'; :CALC:PAR:SEL 'MemTrc1'
```

Copy the data trace to a memory trace and select the memory trace as an active trace.

```
CALC:DATA SDAT, 1,2, 3,4, 5,6
```

Write numbers (1,2), (3,4), (5,6) to the memory trace.

```
CALC:DATA? SDAT
```

Query the memory trace. The response is 1, 2, 3, 4, 5, 6.

```
FORM REAL,32
```

Change the data format to 4-byte block data.

```
CALC:DATA SDAT, #224123456789012345678901234
```

Write 24 bytes (= 4 * 2 * 3 bytes) of data to the memory trace.

The following parameters are related to trace data (see also *Data Flow* diagram):

FDATa	Formatted trace data, according to the selected trace format (CALCulate<Chn>:FORMat). 1 value per trace point for Cartesian diagrams, 2 values for polar diagrams.
SDATa	Unformatted trace data: Real and imaginary part of each measurement point. 2 values per trace point irrespective of the selected trace format. The trace mathematics is not taken into account.
MDATa	Unformatted trace data (see SDATa) after evaluation of the trace mathematics.

The following parameters denote the error terms generated during a calibration:

Error Term	Description	Receive Ports (S-parameter)
SCORr1, ... SCORr12	2-port error terms; see [SENSe<Ch>:]CORRection:DATA.	1 and 2 (S11, S12, S21, S22)
SCORr13	Directivity	3 (S33)
SCORr14	Source match	3 (S33)
SCORr15	Reflection tracking	3 (S33)
SCORr16	Isolation	3 (S31)
SCORr17	Load match	3 (S31)
SCORr18	Transmission tracking	3 (S13)
SCORr19	Isolation	1 (S13)
SCORr20	Load match	1 (S13)
SCORr21	Transmission tracking	1 (S13)
SCORr22	Isolation	3 (S32)
SCORr23	Load match	3 (S32)
SCORr24	Transmission tracking	3 (S32)
SCORr25	Isolation	2 (S23)
SCORr26	Load match	2 (S23)
SCORr27	Transmission tracking	2 (S23)



Use the generalized command [SENSe<Ch>:]CORRection:COLLect:CDATa to read or write error terms for arbitrary analyzer ports.

CALCulate<Chn>:DATA:NSWeep? SDATa, <Trace_Hist_Count>

Reads the response values of a trace acquired in single sweep mode (INITiate<Ch>:CONTInuous OFF). The trace can be any of the traces acquired during the single sweep cycle.

<Chn>

Channel number used to identify the active trace.

SDATa

Read unformatted sweep data (fixed parameter): Returns the real and imaginary part of each measurement point (2 values per trace point)

<Trace_Hist_Count>	irrespective of the selected trace format). Number of sweep to be read. 1 denotes the last sweep acquired, 2 denotes the second-last and so forth.
Range [def. unit]	1 to sweep count defined via [SENSe<Ch>:] SWEep:COUNT [-]
*RST value	–
SCPI, Command Types	Device-specific, query only
Example (see also Sweep History):	<pre>SWE:COUN 10</pre> <p>Define the number of sweeps (10) to be measured in single sweep mode.</p> <pre>INIT:CONT OFF; INIT</pre> <p>Activate single sweep mode and start a single sweep in channel no. 1.</p> <pre>CALC:DATA:NSW? SDAT, 5</pre> <p>Query the results of the 5th sweep.</p>

CALCulate<Chn>:DATA:STIMulus?

Reads the stimulus values of the active data or memory trace.

<Chn>	Channel number used to identify the active trace.
Parameters	–
Range [def. unit]	The data is transferred in the data format defined via FORMat[:DATA]. The unit is the default unit of the sweep variable (Hz or dBm or s).
*RST value	–
SCPI, Command Types	Device-specific, query only
Example:	See CALCulate<Chn>:DATA?

CALCulate<Chn>:DLINe...

This subsystem controls the horizontal line used to mark and retrieve response values (display line).

CALCulate<Chn>:DLINe <numeric_value>

Defines the position (response value) of the horizontal line.

<Chn>	Channel number used to identify the active trace. If unspecified the numeric suffix is set to 1.
Parameters	See list of parameters below.
Range [def. unit]	The data is transferred in the data format defined via FORMat[:DATA]. The unit is the default unit of the measured parameter; see CALCulate<Ch>:PARAmeter:SDEFine.

*RST value	–
SCPI, Command Types	Device-specific, command or query.
Example:	<pre>*RST; CALC:DLIN 10</pre> <p>Define the position of the horizontal line in the default dB Mag diagram at +10 dBm.</p> <pre>CALC:DLIN:STAT ON</pre> <p>Display the defined horizontal line.</p>

CALCulate<Chn>:DLINe:STATe <Boolean>

Switches the horizontal line on or off.

<Chn>	Channel number used to identify the active trace.
<Boolean>	ON OFF - Horizontal line on or off.
*RST value	OFF
SCPI, Command Types	Device-specific, command or query.
Example:	See <code>CALC:DLIN</code> .

CALCulate<Chn>:FORMat...

This subsystem determines a post-processing of the measured data in order to obtain various display formats.

CALCulate<Chn>:FORMat MLINear | MLOGarithmic | PHASe | UPHase | POLar | SMITH | ISMith | GDELaY | REAL | IMAGinary | SWR | COMPLex | MAGNitude

Defines how the measured result at any sweep point is post-processed and presented in the graphical display.

Note: *The analyzer allows arbitrary combinations of display formats and measured quantities; see Trace - Format and CALCulate<Chn>:PARAmeter commands. Nevertheless, it is advisable to check which display formats are generally appropriate for an analysis of a particular measured quantity; see Measured Quantities and Display Formats.*

<Chn>	Channel number used to identify the active trace. If unspecified the numeric suffix is set to 1.
Parameters	See list of parameters below.
*RST value	MLOGarithmic
SCPI, Command Types	Confirmed, command or query
Example:	<pre>CALC4:PAR:SDEF 'Ch4Tr1', 'S11'</pre>

Create channel 4 and a trace named *Ch4Tr1* to measure the input reflection coefficient S11. The trace becomes the active trace in channel 4.

```
CALC4:FORM MLIN; DISP:WIND:TRAC:FEED 'CH4TR1'
```

Calculate the magnitude of S11 and display it in a linearly scaled Cartesian diagram.

Assume that the result at a sweep point is given by the complex quantity $z = x + jy$. The meaning of the parameters is as follows (see also table in `CALCulate<Chn>:MARKer<Mk>:FORMat` description):

MLINear	Calculate the magnitude of z, to be displayed in a Cartesian diagram with a linear scale
MLOGarithmic	Calculate the magnitude of z, displayed in a Cartesian diagram with a logarithmic scale
PHASe	Phase of z, displayed in a Cartesian diagram with a linear vertical axis
UPHase	Unwrapped phase of z, displayed in a Cartesian diagram with a linear vertical axis
POLar	Magnitude and phase, displayed in a polar diagram
SMITH	Magnitude and phase, displayed in a Smith chart
ISMith	Magnitude and phase, displayed in an inverted Smith chart
GDELay	Group delay, displayed in a Cartesian diagram
REAL	Real part (x), displayed in a Cartesian diagram
IMAGinary	Imaginary part (y), displayed in a Cartesian diagram
SWR	Standing Wave Ratio (SWR), displayed in a Cartesian diagram
ZVR <input checked="" type="checkbox"/> COMPLex	x, y, displayed in a polar diagram
ZVR <input checked="" type="checkbox"/> MAGNitude	Magnitude ($\sqrt{x^2 + y^2}$), displayed in a Cartesian diagram with a logarithmic scale

CALCulate<Chn>:FILTer[:GATE]...

This subsystem defines the properties of the time gate optimize the time domain response (with option ZVL-K3, *Time Domain*).

CALCulate<Chn>:FILTer[:GATE]:TIME:CENTer <numeric_value>

Defines the center time of the time gate.

<Chn>	Channel number used to identify the active trace
<numeric_value>	Center time of the time gate
Range [def. unit]	-99.8999999 s to +99.8999999 s. The increment (parameters UP or DOWN) is 0.1 ns. [s]
*RST value	1.5E-009 s

SCPI, Command Types Confirmed, command or query

Example:

```
*RST; CALC:TRAN:TIME:STAT ON; CALC:FILT:TIME:STAT ON
```

Reset the instrument and enable the time domain representation and the time gate.

```
CALC:FILT:TIME:CENT 0; SPAN 5ns
```

set the center time to 0 ns and the time span to 5 ns.

CALCulate<Chn>:FILTer[:GATE]:TIME:DCHebyshev <numeric_value>

Sets the sideband suppression for the Dolph-Chebyshev time gate. The command is only available if a Dolph-Chebyshev time gate is active (CALCulate<Chn>:FILTer[:GATE]:TIME:WINDow DCHebyshev).

<Chn>	Channel number used to identify the active trace
<numeric_value>	Sideband suppression
Range [def. unit]	10 dB to 120 dB. The increment (parameters UP or DOWN) is 10 dB. [dB]
*RST value	32 dB

SCPI, Command Types Device-specific, command or query

Example:

```
*RST; CALC:FILT:TIME:WIND DCH
```

Reset the instrument and select a Dolph-Chebyshev time gate for filtering the data in the frequency domain.

```
CALC:FILT:TIME:DCH 25
```

set the sideband suppression to 25 dB.

CALCulate<Chn>:FILTer[:GATE]:TIME:SHAPE MAXimum | WIDE | NORMal | MINimum

Selects the time gate to be applied to the time domain transform.



Use the generalized command CALCulate<Chn>:FILTer[:GATE]:TIME:WINDow if you wish to select a Dolph-Chebyshev time gate.

<Chn>	Channel number used to identify the active trace
Parameters	MINimum – Steepest edges (rectangle) WIDE – Normal gate (Hann) NORM – Steep edges (Hamming) Maximum – Maximum flatness (Bohman)
*RST value	WIDE

SCPI, Command Types Device-specific, command or query

Example:

```
*RST; CALC:FILT:TIME:SHAP?
```

Reset the instrument and query the type of time gate used. The response is WIDE.

CALCulate<Chn>:FILTer[:GATE]:TIME:SHOW <Boolean>

Enables or disables permanent display of the gate limits.

<Chn>	Channel number used to identify the active trace
<Boolean>	ON – Time gate permanently displayed OFF – Time gate hidden
*RST value	OFF [-]
SCPI, Command Types	Device-specific, command or query

Example:

```
See CALCulate<Chn>:FILTer[:GATE]:TIME:CENTer
```

**CALCulate<Chn>:FILTer[:GATE]:TIME:SPAN **

Defines the span of the time gate.

<Chn>	Channel number used to identify the active trace
	Span of the time gate.
Range [def. unit]	2E-012 s to 200 s. The increment (parameters UP or DOWN) is 0.1 ns. [s]
*RST value	5E-009 s
SCPI, Command Types	Confirmed, command or query

Example:

```
See CALCulate<Chn>:FILTer[:GATE]:TIME:CENTer
```

CALCulate<Chn>:FILTer[:GATE]:TIME:START <start>

Defines the start time of the time gate.

<Chn>	Channel number used to identify the active trace
<start>	Start time of the time gate.
Range [def. unit]	-100 s to +99.999999999998 s. The increment (parameters UP or DOWN) is 0.1 ns. [s]
*RST value	-1E-009 s
SCPI, Command Types	Confirmed, command or query

Example:

```
*RST; CALC:TRAN:TIME:STAT ON; :CALC:FILT:TIME:STAT ON
```

Reset the instrument and enable the time domain representation and the time gate.

```
CALC:FILT:TIME:STAR 0; STOP 10ns; SHOW ON
```

Set the start time to 0 ns and the stop time to 10 ns and display the time gate permanently.

Note: If the start frequency entered is greater than the current stop frequency

(CALCulate<Chn>:FILTer[:GATE]:TIME:STOP), the stop frequency is set to the start frequency plus the minimum frequency span (CALCulate<Chn>:FILTer[:GATE]:TIME:SPAN).

CALCulate<Chn>:FILTer[:GATE]:TIME:STATe <Boolean>

Determines whether the time gate for trace no. <Chn> is enabled.

<Chn> Channel number used to identify the active trace

<Boolean> ON – Time gate enabled
OFF – Time gate disabled

*RST value OFF [-]

SCPI, Command Types Confirmed, command or query

Example: *RST; CALC:TRAN:TIME:STAT?; CALC:FILT:TIME:STAT?

Reset the instrument, activating a frequency sweep, and query whether the default trace is displayed in the time domain and whether the time gate is enabled. The response is 0;0.

CALCulate<Chn>:FILTer[:GATE]:TIME:STOP <numeric_value>

Defines the stop time of the time gate.

<Chn> Channel number used to identify the active trace

<numeric_value> Stop time of the time gate.
Range [def. unit] –99.999999999998 s to +100 s. The increment (parameters UP or DOWN) is 0.1 ns. [s]

*RST value +4E-009 s

SCPI, Command Types Confirmed, command or query

Example: See CALCulate<Chn>:FILTer[:GATE]:TIME:START.

Note: If the stop frequency entered is smaller than the current start frequency (*CALCulate<Chn>:FILTer[:GATE]:TIME:START*), the start frequency is set to the stop frequency minus the minimum frequency span (*CALCulate<Chn>:FILTer[:GATE]:TIME:SPAN*).

CALCulate<Chn>:FILTer[:GATE]:TIME[:TYPE] BPASs | NOTCh

Selects the time gate filter type, defining what occurs to the data in the specific time region.

<Chn> Channel number used to identify the active trace

Parameters BPASs – Band pass filter: pass all information in specified time region and reject all else
NOTCh – Notch filter: reject all information in specified time region and pass all else.

*RST value BPASs

SCPI, Command Confirmed, command or query

Types**Example:**

```
*RST; CALC:FILT:TIME:STAT ON
```

Reset the instrument and enable the time gate.

```
CALC:FILT:TIME NOTCh
```

Select a notch filter in order to reject unwanted pulses.

CALCulate<Chn>:FILTer[:GATE]:TIME:WINDow RECT | HAMMING | HANN | BOHMan | DCHebyshev

Selects the time gate to be applied to the time domain transform.

<Chn>	Channel number used to identify the active trace
Parameters	RECT – Steepest edges (rectangle) HANN – Normal gate (Hann) HAMMING – Steep edges (Hamming) BOHMan – Minimum flatness (Bohman) DCHebyshev – Arbitrary gate shape (Dolph-Chebyshev)
*RST value	HANN
SCPI, Command Types	Confirmed (with some device-specific parameters), command or query
Example:	See CALCulate<Chn>:FILTer[:GATE]:TIME:DCHebyshev

CALCulate<Chn>:GDAPerture...

This subsystem defines parameters for the group delay calculation.

CALCulate<Chn>:GDAPerture:SCOut <steps>

Defines the number of aperture steps for the group delay calculation.

<Chn>	Channel number used to identify the active trace. If unspecified the numeric suffix is set to 1.
<steps>	Aperture steps
Range [def. unit]	1 to 10000
*RST value	10
SCPI, Command Types	Device-specific (last keyword), with query
Example:	*RST; CALC:FORMat GDELay

Select group delay format for the default trace.

```
CALC:GDAP:SCO 12
```

Select 12 aperture steps for the calculation of the delay at each sweep point.

CALCulate<Chn>:LIMit...

This subsystem defines the limit lines and controls the limit check.

CALCulate<Chn>:LIMit:CONTRol[:DATA] <start>,<stop>{,<start>,<stop>}

Defines the stimulus values of the limit line and/or creates new limit line segments.

**Rules for creating segments**

The following rules apply to an active trace with n existing limit line segments:

- An odd number of values is rejected; an error message –109,"Missing parameter..." is generated.
- An even number of 2*k values updates or generates k limit line segments.
- For n > k the stimulus values of all existing limit line segments no. 1 to k are updated, the existing limit line segments no. k+1, ..., n are deleted.
- For n < k the stimulus values of the limit line segments no. 1 to n are updated, the limit line segments n+1, ..., k are generated with default response values (see `CALCulate<Chn>:LIMit:UPPer[:DATA]`, `CALCulate<Chn>:LIMit:LOWer[:DATA]`).



The generated segments are upper or lower limit line segments, depending on the `CALCulate<Chn>:LIMit:SEGment<Seg>:TYPE` setting.

`CALCulate<Chn>:LIMit:CONTRol[:DATA]` does not overwrite the type setting.



To define additional new limit line segments without overwriting the old segments use `CALCulate<Chn>:LIMit:DATA`.

<Chn>	Channel number used to identify the active trace.
<start>, <stop>	Pair(s) of frequency values.
Range [def. unit]	Almost no restriction for limit segments; see <i>Rules for Limit Line Definition</i> . [Hz. For distance-to-fault traces the default unit is the length unit defined via <code>UNIT:LENGTH</code> .]
*RST value	– A segment that is created implicitly, e.g. by means of <code>CALCulate<Chn>:LIMit:UPPer[:DATA]</code> or <code>CALCulate<Chn>:LIMit:LOWer[:DATA,]</code> , covers the maximum sweep range of the analyzer.
SCPI, Command Types	Confirmed, with query.
Example:	<pre>*RST; CALC:LIM:CONT 1 GHZ, 2 GHZ</pre> <p>Define an upper limit line segment in the stimulus range between 1 GHz and 2 GHz, using default response values.</p> <pre>CALC:LIM:DISP ON</pre> <p>Show the limit line segment in the active diagram.</p>

CALCulate<Chn>:LIMit:CONTRol:SHIFt <offset>

Shifts the limit line in horizontal direction.

<Chn>	Channel number used to identify the active trace.
<offset>	Amount that the limit line is shifted.
Range [def. unit]	Almost no restriction for limit segments; see <i>Rules for Limit Line Definition</i> . [Hz. For distance-to-fault traces the default unit is the length unit defined via <code>UNIT:LENGth.</code>]]
*RST value	–
SCPI, Command Types	Device-specific, no query.

Example:

```
*RST; CALC:LIM:CONT 1 GHZ, 2 GHZ
```

Define a limit line segment in the stimulus range between 1 GHz and 2 GHz, using default response values.

```
CALC:LIM:CONT:SHIF 1; CALC:LIM:CONT?
```

Shift the segment by 1 Hz. The modified limit line segment extends from 1000000001 (Hz) to 2000000001 (Hz).

CALCulate<Chn>:LIMit:DATA <type>, <start stim>, <stop stim>, <start resp>, <stop resp>{,<type>, <start stim>, <stop stim>, <start resp>, <stop resp>}

Defines the limit line type, the stimulus and response values for a limit line with an arbitrary number of limit line segments.



In contrast to `CALCulate<Chn>:LIMit:CONTRol[:DATA]`, this command does not overwrite existing limit line segments. The defined segments are appended to the segment list as new segments.

<Chn>	Channel number used to identify the active trace.
<type>	Identifier for the type of the limit line segment.
Range [def. unit]	0 – Limit line segment off, segment defined but no limit check performed 1 – Upper limit line segment 2 – Lower limit line segment
<start stim>,
<stop stim>,
<start resp>,
<stop resp>	Stimulus and response values of the first and last points of the limit line segment.
Range [def. unit]	Almost no restriction for limit segments; see <i>Rules for Limit Line Definition</i> . [no unit entries accepted, the default unit is Hz. For distance-to-fault traces the default unit is the length unit defined via <code>UNIT:LENGth.</code>]]
*RST values	– (no limit line defined after *RST)
SCPI, Command Types	Device-specific, with query.

Example:

```
*RST; CALC:LIM:CONT 1 GHZ, 1.5 GHZ
```

Define an upper limit line segment in the stimulus range between 1 GHz and 1.5

GHz, using default response values.

```
CALC:LIM:DATA 1,1500000000, 2000000000,2,3
```

Define an upper limit line segment in the stimulus range between 1.5 GHz and 2 GHz, assigning response values of +2 dBm and +3 dBm.

```
CALC:LIM:DISP ON
```

Show the limit line segment in the active diagram.

CALCulate<Chn>:LIMit:DELeTe:ALL

Deletes all limit line segments.

<Chn> Channel number used to identify the active trace.

*RST value –

SCPI, Command Device-specific, no query.

Types

Example:

```
*RST; CALC:LIM:CONT 1 GHz, 1.5 GHz
```

Define an upper limit line segment in the stimulus range between 1 GHz and 1.5 GHz, using default response values.

```
CALC:LIM:DATA 1,1500000000, 2000000000,2,3
```

Define an upper limit line segment in the stimulus range between 1.5 GHz and 2 GHz, assigning response values of +2 dBm and +3 dBm.

```
CALC:LIM:DEL:ALL
```

Delete both created limit line segments.

CALCulate<Chn>:LIMit:DISPlay[:STATe] <Boolean>

Displays or hides the entire limit line (including all segments) associated with the active trace.

<Chn> Channel number used to identify the active trace.

<Boolean> ON | OFF - Limit line on or off.

*RST value OFF

SCPI, Command Device-specific, command or query.

Types

Example:

```
*RST; CALC:LIM:CONT 1 GHz, 2 GHz
```

Define an upper limit line segment in the stimulus range between 1 GHz and 2 GHz, using default response values.

```
CALC:LIM:DISP ON
```

Show the limit line segment in the active diagram.

CALCulate<Chn>:LIMit:FAIL?

Returns a 0 or 1, to indicate whether or not the limit check has failed.



Use `CALCulate<Chn>:CLIMits:FAIL?` to perform a composite (global) limit check.

<Chn> Channel number used to identify the active trace.

Response 0 | 1 - 0 represents pass, 1 represents fail.
***RST value** 0

SCPI, Command Types Confirmed, query only.

Example: `*RST; CALC:LIM:CONT 1 GHZ, 2 GHZ`

Define an upper limit line segment in the stimulus range between 1 GHz and 2 GHz, using default response values.

`CALC:LIM:STAT ON; FAIL?`

Switch the limit check on and query the result.

CALCulate<Chn>:LIMit:LOWer[:DATA] <start resp>, <stop resp>{, <start resp>, <stop resp>}

Defines the response (y-axis) values of the lower limit line and/or creates new limit line segments.



The commands `CALCulate<Chn>:LIMit:LOWer[:DATA]` and `CALCulate<Chn>:LIMit:UPPer[:DATA]` use a fixed numbering scheme for limit line segments: Upper limit line segments are assigned odd numbers (1, 3, 5,...), lower limit line segments are assigned even numbers (2, 4, 6,...).

**Rules for creating segments**

The following rules apply to an active trace with n existing upper and n existing lower limit line segments:

- An odd number of values is rejected; an error message –109, "Missing parameter..." is generated.
- An even number of 2^k values updates or generates k lower limit line segments.
- For $n > k$ the response values of all existing lower limit line segments no. 2, 4, ..., 2^k are updated, the existing upper and lower limit line segments no. 2^k+1 , ..., 2^n are deleted. The existing upper limit line segments no. 1, 3, 2^k-1 are not affected.
- For $n < k$ the response values of the lower limit line segments no. 2, 4 to 2^n are updated, the lower limit line segments 2^n+2 , 2^n+4 , ..., 2^k are generated with default stimulus values (see `CALCulate<Chn>:LIMit:CONTRol[:DATA]`). In addition, the missing upper limit line segments 2^n+1 , 2^n+3 , ..., 2^k-1 are generated with default stimulus and response values

<Chn> Channel number used to identify the active trace.

<start resp>, <stop resp> Pair(s) of response values.

Range [def. unit] Almost no restriction for limit segments; see *Rules for Limit Line Definition*. [dB]

***RST value** –
 The response value of a segment that is created implicitly, e.g. an upper limit line segment, is –20 dB.

SCPI, Command Types

Confirmed, with query.

Example:

```
CALC:LIM:LOW -10, 0, 0, -10
```

Define the following lower and (default) upper limit line segments:

Seg.	Type	Start Stimulus	Stop Stimulus	Start Response	Stop Response
1	Upper	300 kHz	8 GHz	-20 dB	-20 dB
2	Lower	300 kHz	8 GHz	-10 dB	0 dB
3	Upper	300 kHz	8 GHz	-20 dB	-20 dB
4	Lower	300 kHz	8 GHz	0 dB	-10 dB

```
CALC:LIM:DISP ON
```

Show the limit line segments in the active diagram.

CALCulate<Chn>:LIMit:LOWer:FEED <stimulus offset>,<response offset>[,<trace name>]

Generates a lower limit line using the stimulus values of a data or memory trace and specified offset values.

<Chn>

Channel number used to identify the active trace. This trace provides the stimulus data for the limit line unless another trace <trace_name> is specified.

<stimulus offset>

Stimulus offset value, used to shift all imported limit line segments in horizontal direction.

Range [def. unit]

-1000 GHz to +1000 GHz [Hz. For distance-to-fault traces the default unit is the length unit defined via *UNIT:LENGth.*]

*RST value

0 Hz

<response offset>

Response offset value, used to shift all imported limit line segments in vertical direction.

Range [def. unit]

-10¹² dB to +10¹² dB [dB]

*RST value

0 dB

<trace name>Name of the selected trace as used e.g. in *CALCulate<Ch>:PARAmeter:SDEFine.* If no trace name is specified the analyzer uses the active trace no. <Chn>.**SCPI, Command Types**

Device-specific, no query.

Example:

```
CALC:LIM:LOW:FEED 1 GHz, -10
```

Use the stimulus values of the active trace, shifted by 1 GHz to the right and decreased by 10 dB, to create a lower limit line.

```
CALC:LIM:LOW:SHIF -3; CALC:LIM:CONT:SHIF 1 GHz
```

Shift the limit line by an additional -3 dB in vertical and by 1 GHz in horizontal direction. If an upper limit line exists it is also shifted.

CALCulate<Chn>:LIMit:LOWer:SHIFt <offset>

Shifts all lower and upper limit line segments assigned to the active trace in vertical direction.



This command is identical with CALCulate<Chn>:LIMit:UPPer:SHIFt.

<Chn>	Channel number used to identify the active trace.
<offset>	Response offset value for all limit line segments.
Range [def. unit]	Almost no restriction for limit segments; see Rules for Limit Line Definition. [dB]
*RST value	–
SCPI, Command Types	Device-specific, no query.
Example:	See CALCulate<Chn>:LIMit:LOWer:FEED.

CALCulate<Chn>:LIMit:LOWer:STATe <Boolean>

Switches the lower limit check on or off. Lower limit line segments are assigned even numbers; see CALCulate<Chn>:LIMit:LOWer[:DATA]. The command does not affect segments with odd numbers.



Use CALCulate<Chn>:LIMit:STATe to switch on or off the entire limit check, including upper and lower limit lines.

<Chn>	Channel number used to identify the active trace.
<Boolean>	ON OFF - Limit check on or off.
*RST value	OFF
SCPI, Command Types	Confirmed, command or query.

Example: CALC:LIM:LOW -10, 0, 0, -10

Define the following lower and (default) upper limit line segments:

Seg.	Type	Start Stimulus	Stop Stimulus	Start Response	Stop Response
1	Upper	300 kHz	8 GHz	-20 dB	-20 dB
2	Lower	300 kHz	8 GHz	-10 dB	0 dB
3	Upper	300 kHz	8 GHz	-20 dB	-20 dB
4	Lower	300 kHz	8 GHz	0 dB	-10 dB

CALC:LIM:LOW:STAT ON; CALC:LIM:FAIL?

Switch the limit check on and query the result.

CALCulate<Chn>:LIMit:RDOMain:COMPLex S | SINV | Y | Z | YREL | ZREL

Deletes the existing limit line and (re-)defines the physical units of the response values of the limit line. The units of the stimulus values are defined via CALCulate<Chn>:LIMit:CONTRol:DOMain.



This command is complemented by CALCulate<Chn>:LIMit:RDOMain:FORMat and CALCulate<Chn>:LIMit:RDOMain:SPACing.

<Chn>	Channel number used to identify the active trace.
--------------------	---

Parameters	Keyword for the physical unit of the response values.
Range [def. unit]	The parameters form four groups: <ul style="list-style-type: none"> ▪ S and SINV select relative units (dB) for the limit line. ▪ Y selects admittance units (S/Siemens). ▪ Z selects impedance units (Ω). ▪ YREL and ZREL select dimensionless numbers (U).
	[-]
*RST value	-
SCPI, Command Types	Device-specific, no query.

CALCulate<Chn>:LIMit:RDOMain:FORMat COMPLex | MAGNitude | PHASe | REAL | IMAGinary | SWR | GDELay | L | C

Deletes the existing limit line and (re-)defines the physical units of the response values of the limit line. The units of the stimulus values are defined via `CALCulate<Chn>:LIMit:CONTrol:DOMain`.



This command is complemented by `CALCulate<Chn>:LIMit:RDOMain:COMPLex` and `CALCulate<Chn>:LIMit:RDOMain:SPACing`.

<Chn>	Channel number used to identify the active trace.
Parameters	Keyword for the physical unit of the response values.
Range [def. unit]	The parameters form four groups: <ul style="list-style-type: none"> ▪ COMPLex, REAL, IMAGinary, and SWR select dimensionless numbers (U) for the limit line. ▪ MAGNitude selects relative units (dB). ▪ PHASe selects phase units (deg). ▪ GDELay selects time units (s). ▪ L selects inductance units (H/Henry). ▪ C selects capacitance units (F/Farad).
	[-]
*RST value	-
SCPI, Command Types	Device-specific, no query.

CALCulate<Chn>:LIMit:RDOMain:SPACing LINear | LOGarithmic | dB | SIC

Deletes the existing limit line and (re-)defines the physical units of the response values of the limit line. The units of the stimulus values are defined via `CALCulate<Chn>:LIMit:CONTrol:DOMain`.



This command is complemented by `CALCulate<Chn>:LIMit:RDOMain:COMPLex` and `CALCulate<Chn>:LIMit:RDOMain:FORMat`.

<Chn>	Channel number used to identify the active trace.
--------------------	---

Parameters	Keyword for the physical unit of the response values.
Range [def. unit]	The analyzer uses dB units, irrespective of the parameter selected. [-]
*RST value	-
SCPI, Command Types	Device-specific, no query.

CALCulate<Chn>:LIMit:SEGMent<Seg>:AMPLitude:STARt <response>

Changes the start response value (i.e. the response value assigned to the start stimulus value) of a limit line segment. A segment must be created first to enable this command (e.g. `CALC:LIM:DATA`).



To define the response values of several limit line segments with a single command, use `CALCulate<Chn>:LIMit:LOWer[:DATA]` or `CALCulate<Chn>:LIMit:UPPer[:DATA]`.

<Chn>	Channel number used to identify the active trace.
<Seg>	Segment number
<response>	Response value
Range [def. unit]	Almost no restriction for limit segments; see <i>Rules for Limit Line Definition</i> . [dB]
*RST value	- The default response values of a segment that is created by defining its stimulus values only (e.g. by means of <code>CALCulate<Chn>:LIMit:CONTRol[:DATA]</code>), is -20 dB.
SCPI, Command Types	Device-specific, with query.

Example:

```
CALC:LIM:DATA 1,1500000000,2000000000,2,3
```

Define an upper limit line segment (segment no. 1) in the stimulus range between 1.5 GHz and 2 GHz, assigning response values of +2 dBm and +3 dBm.

```
:CALC:LIM:SEGM:AMPL:STAR 5; STOP 5; CALC:LIM:SEGM:TYPE LMIN
```

Change the segment to a lower limit line segment with a constant response value of +5 dB.

```
CALC:LIM:DATA?
```

Query the type, the stimulus and response values of the created segment with a single command. The response is `2,1000000,2000000,5,5`.

CALCulate<Chn>:LIMit:SEGMent<Seg>:AMPLitude:STOP <response>

Changes the stop response value (i.e. the response value assigned to the stop stimulus value) of a limit line segment. A segment must be created first to enable this command (e.g. `CALC:LIM:DATA`).



To define the response values of several limit line segments with a single command, use `CALCulate<Chn>:LIMit:LOWer[:DATA]` or `CALCulate<Chn>:LIMit:UPPer[:DATA]`.

<Chn>	Channel number used to identify the active trace.
<Seg>	Segment number
<response>	Response value
Range [def. unit]	Almost no restriction for limit segments; see <i>Rules for Limit Line Definition</i> . [dB]
*RST value	– The default response values of a segment that is created by defining its stimulus values only (e.g. by means of <code>CALCulate<Chn>:LIMit:CONTRol[:DATA]</code>), is –20 dB.
SCPI, Command Types	Device-specific, with query.
Example:	See <code>CALCulate<Chn>:LIMit:SEGment<Seg>:AMPLitude:START.</code>

CALCulate<Chn>:LIMit:SEGment<Seg>:COUNT?

Queries the number of limit line segments.

<Chn>	Channel number used to identify the active trace.
<Seg>	Limit line segment number. This suffix is ignored; the command counts all ranges.
Response	0 1 ...- number of (enabled or disabled) limit line segments.
*RST value	0
SCPI, Command Types	Device-specific, query only.
Example:	<code>CALC:LIM:DATA 1,1500000000, 2000000000,2,3</code>

Define an upper limit line segment (segment no. 1) in the stimulus range between 1.5 GHz and 2 GHz, assigning response values of +2 dBm and +3 dBm.

`CALC:LIM:SEGM:COUNT?`

Query the number of segments. The response is 1.

CALCulate<Chn>:LIMit:SEGment<Seg>:STIMulus:START <start>

Changes the start stimulus value (i.e. the largest or smallest stimulus value) of a limit line segment. A segment must be created first to enable this command (e.g. `CALC:LIM:DATA`).



To define the stimulus values of several limit line segments with a single command, use `CALCulate<Chn>:LIMit:CONTRol[:DATA]`.

<Chn>	Channel number used to identify the active trace.
<Seg>	Segment number
<start>	Frequency value.
Range [def. unit]	Almost no restriction for limit segments; see <i>Rules for Limit Line Definition</i> . In particular, the start value can be larger than the stop value

	<code>CALCulate<Chn>:LIMit:SEGment<Seg>:STIMulus:STOP.</code> [Hz. For distance-to-fault traces the default unit is the length unit defined via <code>UNIT:LENGth.</code>]
*RST value	– A segment that is created implicitly, e.g. by means of <code>CALCulate<Chn>:LIMit:UPPer[:DATA]</code> or <code>CALCulate<Chn>:LIMit:LOWer[:DATA,]</code> , covers the maximum sweep range of the analyzer.
SCPI, Command Types	Device-specific, with query.
Example:	<pre>CALC:LIM:DATA 1,1500000000, 2000000000,2,3</pre> Define an upper limit line segment (segment no. 1) in the stimulus range between 1.5 GHz and 2 GHz, assigning response values of +2 dBm and +3 dBm. <pre>CALC:LIM:SEGM:STIM:STAR 1GHZ; STOP 2 GHz; CALC:LIM:SEGM:TYPE LMIN</pre> Change the segment to a lower limit line segment with a stimulus range between 1 GHz and 2 GHz. <pre>CALC:LIM:DATA?</pre> Query the type, the stimulus and response values of the created segment with a single command. The response is <code>2,1000000,2000000,2,3.</code>

CALCulate<Chn>:LIMit:SEGment<Seg>:STIMulus:STOP <stop>

Changes the stop stimulus value (i.e. the largest or smallest stimulus value) of a limit line segment. A segment must be created first to enable this command (e.g. `CALC:LIM:DATA`).



To define the stimulus values of several limit line segments with a single command, use `CALCulate<Chn>:LIMit:CONTRol[:DATA]`.

<Chn>	Channel number used to identify the active trace.
<Seg>	Segment number
<stop>	Frequency value.
Range [def. unit]	Almost no restriction for limit segments; see <i>Rules for Limit Line Definition</i> . In particular, the stop value can be smaller than the start value <code>CALCulate<Chn>:LIMit:SEGment<Seg>:STIMulus:START.</code> [Hz. For distance-to-fault traces the default unit is the length unit defined via <code>UNIT:LENGth.</code>]
*RST value	– A segment that is created implicitly, e.g. by means of <code>CALCulate<Chn>:LIMit:UPPer[:DATA]</code> or <code>CALCulate<Chn>:LIMit:LOWer[:DATA,]</code> , covers the maximum sweep range of the analyzer.
SCPI, Command Types	Device-specific, with query.
Example:	<pre>See CALCulate<Chn>:LIMit:SEGment<Seg>:STIMulus:START.</pre>

CALCulate<Chn>:LIMit:SEGment<Seg>:TYPE LMIN | LMAX | OFF

Selects the limit line type for a limit line segment. This can be done before or after defining the stimulus and response values of the segment, however, a segment must be created first to enable this command (e.g. `CALC:LIM:DATA`).



The type command overwrites the `CALCulate<Chn>:LIMit:DATA` settings and is overwritten by them. It is not affected by the other commands in the LIMit subsystem defining stimulus and response values of limit lines.

<Chn>	Channel number used to identify the active trace.
<Seg>	Segment number
Parameters	Limit line type
Range [def. unit]	LMAX (upper limit line segment), LMIN (lower limit line segment), OFF (limit check switched off, limit line segment not deleted) [-]
*RST value	LMAX
SCPI, Command Types	Device-specific, with query.

Example:

```
*RST; CALC:LIM:UPP 1 GHZ, 2 GHZ
```

Define an upper limit line segment in the stimulus range between 1 GHz and 2 GHz, using default response values.

```
CALC:LIM:SEG:TYPE LMIN
```

Turn the defined limit line segment into a lower limit line segment.

CALCulate<Chn>:LIMit:STATe

Switches the limit check (including upper and lower limits) on or off.



Use `CALCulate<Chn>:LIMit:UPPer:STATe` or `CALCulate<Chn>:LIMit:LOWer:STATe` to switch on or off the individual limit checks for upper or lower limit lines.

<Chn>	Channel number used to identify the active trace.
<Boolean>	ON OFF - Limit check on or off.
*RST value	OFF

SCPI, Command Types Confirmed, command or query.

Example:

```
*RST; CALC:LIM:CONT 1 GHZ, 2 GHZ
```

Define an upper limit line segment in the stimulus range between 1 GHz and 2 GHz, using default response values.

```
CALC:LIM:STAT ON; CALC:LIM:FAIL?
```

Switch the limit check on and query the result.

CALCulate<Chn>:LIMit:UPPer[:DATA] <start resp>,<stop resp>{,<start resp>,<stop resp>}

Defines the response (y-axis) values of the upper limit line and/or creates new limit line segments.



The commands `CALCulate<Chn>:LIMit:LOWer[:DATA]` and `CALCulate<Chn>:LIMit:UPPer[:DATA]` use a fixed numbering scheme for limit line segments: Upper limit line segments are assigned odd numbers (1, 3, 5,...), lower limit line segments are assigned even numbers (2, 4, 6,...).



Rules for creating segments

The following rules apply to an active trace with n existing upper and n existing lower limit line segments:

- An odd number of values is rejected; an error message –109,"Missing parameter..." is generated.
- An even number of $2*k$ values updates or generates k upper limit line segments.
- For $n > k$ the response values of all existing upper limit line segments no. 1, 3, ..., $2*k-1$ are updated, the existing upper and lower limit line segments no. $2*k+1$, ..., $2*n$ are deleted. The existing lower limit line segments no. 2, 4, $2*k$ are not affected.
- For $n < k$ the response values of the upper limit line segments no. 1, 3 to $2*n-1$ are updated, the upper limit line segments $2*n+1$, $2*n+3$, ..., $2*k-1$ are generated with default stimulus values (see `CALCulate<Chn>:LIMit:CONTRol[:DATA]`). In addition, the missing lower limit line segments $2*n+2$, $2*n+4$, ..., $2*k$ are generated with default stimulus and response values

<Chn>	Channel number used to identify the active trace.
<start resp>, <stop resp>	Pair(s) of response values.
Range [def. unit]	Almost no restriction for limit segments; see <i>Rules for Limit Line Definition</i> . [dB]
*RST value	– The response value of a segment that is created implicitly, e.g. an lower limit line segment, is –20 dB.

SCPI, Command Types Confirmed, with query.

Example:

```
CALC:LIM:UPP -10, 0, 0, -10
```

Define the following upper and (default) lower limit line segments:

Seg.	Type	Start Stimulus	Stop Stimulus	Start Response	Stop Response
1	Upper	300 kHz	8 GHz	-10 dB	0 dB
2	Lower	300 kHz	8 GHz	-20 dB	-20 dB
3	Upper	300 kHz	8 GHz	0 dB	-10 dB
4	Lower	300 kHz	8 GHz	-20 dB	-20 dB

```
CALC:LIM:DISP ON
```

Show the limit line segments in the active diagram.

CALCulate<Chn>:LIMit:UPPer:FEED

Generates an upper limit line using the stimulus values of a data or memory trace and specified offset values.

<Chn> Channel number used to identify the active trace. This trace provides the

	stimulus data for the limit line unless another trace <trace_name> is specified.
<stimulus_offset>	Stimulus offset value, used to shift all imported limit line segments in horizontal direction.
Range [def. unit]	-1000 GHz to +1000 GHz [Hz. For distance-to-fault traces the default unit is the length unit defined via <code>UNIT:LENGTH</code> .]
*RST value	0 Hz
<response_offset>	Response offset value, used to shift all imported limit line segments in vertical direction.
Range [def. unit]	-10 ¹² dB to +10 ¹² dB [dB]
*RST value	0 dB
<trace_name>	Name of the selected trace as used e.g. in <code>CALCulate<Ch>:PARAmeter:SDEFine</code> . If no trace name is specified the analyzer uses the active trace no. <Chn>.
SCPI, Command Types	Device-specific, no query.
Example:	<code>CALC:LIM:UPP:FEED 1 GHz, 10</code>
	Use the stimulus values of the active trace, shifted by 1 GHz to the right and increased by 10 dB, to create an upper limit line.
	<code>CALC:LIM:UPP:SHIF 3; CALC:LIM:CONT:SHIF 1 GHz</code>
	Shift the limit line by an additional 3 dB in vertical and by 1 GHz in horizontal direction. If a lower limit line exists it is also shifted.

CALCulate<Chn>:LIMit:UPPer:SHIFt <offset>

Shifts all lower and upper limit line segments assigned to the active trace in vertical direction.



This command is identical with `CALCulate<Chn>:LIMit:LOWer:SHIFt`.

<Chn>	Channel number used to identify the active trace.
<offset>	Response offset value for all limit line segments.
Range [def. unit]	Almost no restriction for limit segments; see Rules for Limit Line Definition. [dB]
*RST value	–
SCPI, Command Types	Device-specific, no query.
Example:	See <code>CALCulate<Chn>:LIMit:UPPer:FEED</code> .

CALCulate<Chn>:LIMit:UPPer:STATe <Boolean>

Switches the upper limit check on or off. Upper limit line segments are assigned odd numbers; see `CALCulate<Chn>:LIMit:UPPer[:DATA]`. The command does not affect segments with even numbers.



Use `CALCulate<Chn>:LIMit:STATe` to switch on or off the entire limit check, including upper and lower limit lines.

<Chn> Channel number used to identify the active trace.

<Boolean> ON | OFF - Limit check on or off.

***RST value** OFF

SCPI, Command Types Confirmed, command or query.

Example:

```
CALC:LIM:UPP -10, 0, 0, -10
```

Define the following upper and (default) lower limit line segments:

Seg.	Type	Start Stimulus	Stop Stimulus	Start Response	Stop Response
1	Upper	300 kHz	8 GHz	-10 dB	0 dB
2	Lower	300 kHz	8 GHz	-20 dB	-20 dB
3	Upper	300 kHz	8 GHz	0 dB	-10 dB
4	Lower	300 kHz	8 GHz	-20 dB	-20 dB

```
CALC:LIM:UPP:STAT ON; CALC:LIM:FAIL?
```

Switch the limit check on and query the result.

CALCulate<Chn>:MARKer<Mk>...

This subsystem controls the marker functions. The commands are device-specific and beyond what is specified in the SCPI subsystem `SOURCE:MARKer`.

CALCulate<Chn>:MARKer<Mk>:AOFF

Removes all markers from all traces of the active setup. The removed markers remember their properties (stimulus value, format, delta mode, number) when they are restored (`CALC<Chn>:MARK<Mk> ON`). The marker properties are definitely lost if the associated trace is deleted.

<Chn> Channel number used to identify the active trace. If unspecified the numeric suffix is set to 1.

<Mk> Marker number in the range 1 to 10. This numeric suffix is ignored and may be set to any value.

***RST value** —

SCPI, Command Types Device-specific, no query.

Example:

Suppose that the active setup contains an active trace no. 1.

```
CALC:MARK1 ON; MARK2 ON
```

Create markers 1 and 2 and assign them to the trace no. 1.

```
CALC:MARK:AOFF
```

Remove both markers.

CALCulate<Chn>:MARKer<Mk>:BWIDth <x_dB_Bandwidth>

Sets the bandfilter level for a bandfilter search or returns the results. The command is only available after a bandfilter search has been executed (`CALCulate<Chn>:MARKer<Mk>:FUNCTION:EXECute BFILter`; see example below).

<Chn>	Channel number used to identify the active trace.
<Mk>	Marker number in the range 1 to 10. This numeric suffix is ignored and may be set to any value because the bandfilter search functions always use markers Mkr1 to Mkr4.
<x_dB_Bandwidth>	<i>x dB Bandwidth</i> parameter. The <i>x dB Bandwidth</i> is the difference between the band edges and the center response value of a bandfilter peak; it must be negative for a bandpass search and positive for a bandstop search.
Range [def. unit]	For bandpass: -100.00 dB to -0.01 dB, the increment (UP/DOWN) is 0.3 dB. [dB] For bandstop: +0.01 dB to +100.00 dB, the increment (UP/DOWN) is 0.3 dB. [dB]
*RST value	-3 dB
Response for query:	Search result in the format <Bandwidth>, <Center_Stimulus>, <Q>, <Loss>, <LBE>, <UBE> where:
<Bandwidth>	n-dB bandwidth of the bandpass/bandstop region, where n is the selected <i>x dB Bandwidth</i> (setting command <code>CALCulate<Chn>:MARKer<Mk>:BWIDth <x dB Bandwidth></code>).
<Center_Stimulus>	Stimulus frequency at the center of the bandpass/bandstop region (the stimulus value of marker no. 4).
<Q>	Quality factor, i.e. the ratio between the center frequency and the 3-dB bandwidth. The <i>Quality Factor</i> is not available for bandstop measurements; where the command returns a dash (-).
<Loss>	Loss at the center of the bandpass/bandstop region (the response value of marker no. 4 at the time of the bandfilter search).
<LBE>	Lower band edge
<UBE>	Upper band edge
Range [def. unit]	Depending on the measurement parameter. [units depending on the sweep type and the marker format; see <code>CALCulate<Chn>:MARKer<Mk>:FORMat</code>]
*RST value	-

SCPI, Command Types Device-specific, query only.

Example:

```
CALC:MARK:FUNC:BWID:MODE BST
```

Select a bandstop filter search.

```
CALC:MARK:FUNC:EXEC BFIL
```

Initiate the bandpass filter search for the current trace. Create markers 1 to 4.

```
CALC:MARK:SEAR:BFIL:RES ON
```

Display the marker info field in the diaram area.

```
CALC:MARK:BWID 6
```

Select a 6-dB bandwidth for the bandstop.

```
CALC:MARK:BWID?
```

Query the results of the bandfilter search. An error message is generated if the bandfilter search fails so that no valid results are available.

CALCulate<Chn>:MARKer<Mk>:COUPlEd[:STATe] <Boolean>

Couples the markers of all traces in the active setup to the markers of trace no. <Chn>, provided that they have the same sweep type (SENSe<Chn>:FUNctIon).

<Chn>	Channel number used to identify the active trace. The effects of marker coupling depend on the active trace number; see <i>Coupled Markers</i> in the GUI Reference chapter.
<Mk>	Marker number in the range 1 to 10. This suffix is ignored because the command affects all markers.
<Boolean> *RST value	ON OFF - Enables or disables marker coupling. OFF

SCPI, Command

Types

Example:

Suppose that the active setup contains two traces Trc1 and Trc2, assigned to channels no. 1 and 2, respectively.

```
:CALC1:PAR:SEL 'TRC1'; CALC1:MARK1 ON; MARK2 ON
```

Select Trc1 as the active trace and create the two markers no. 1 and 2. The default position for both markers is the center of the sweep range.

```
CALC1:MARK:COUP ON
```

Create two markers no. 1 and 2 on Trc 2 and couple them to the markers of Trc 1.

CALCulate<Chn>:MARKer<Mk>:DELTA[:STATe] <Boolean>

Switches the delta mode for marker <Mk> on trace no. <Chn> on or off. The marker must be created before using CALCulate<Chn>:MARKer<Mk>[:STATe] ON. If the active trace contains no reference marker, the command also creates a reference marker.

<Chn>	Channel number used to identify the active trace.
<Mk>	Marker number in the range 1 to 10.
<Boolean> *RST value	ON OFF - Enables or disables the delta mode. OFF

SCPI, Command

Types

Example:

Suppose that the active setup contains an active trace no. 1.

```
CALC:MARK ON
```

Create marker no. 1 and set it to the center of the sweep range.

```
CALC:MARK:DELT ON
```

Create a reference marker at the center of the sweep range and set marker 1 to delta mode.

CALCulate<Chn>:MARKer<Mk>:FORMat DEFault | MLINear | MLOGarithmic | PHASe | POLar | COMPLex | GDElay | REAL | IMAGinary | SWR | LINPhase | LOGPhase | IMPedance | ADMittance | MDB | MLPHase | MDPHase

Defines the output format for the (complex) value of marker <Mk> on trace no. <Chn>.

Note: The formats of the markers assigned to a trace are independent of each other and of the trace format settings; see *CALCulate<Chn>:FORMat*.

<Chn> Channel number used to identify the active trace.

<Mk> Marker number in the range 1 to 10.

Parameters See list of parameters below.

*RST value DEFault

SCPI, Command Types Device-specific, command or query

Example:

Suppose that the active setup contains an active trace no. 1.

```
CALC:MARK ON; CALC:MARK:FORM?
```

Create marker 1, assign it to the trace no. 1 and query its format. The analyzer returns the format of the active trace.

Assume that the marker result is given by the complex quantity $z = x + jy$. The meaning of the parameters is as follows:

DEFault	The format of the trace no. <Chn> (MLOG after *RST); see <i>CALCulate<Chn>:FORMat</i> .
MLINear	$ z = \sqrt{x^2 + y^2}$
MLOGarithmic ZVR <input checked="" type="checkbox"/> MDB	$ z = \sqrt{x^2 + y^2}$ dB Mag(z) = $20 \cdot \log z $ dB
PHASe	$\Phi(z) = \arctan(\text{Im}(z) / \text{Re}(z))$
POLar ZVR <input checked="" type="checkbox"/> COMPLex	x, y (Real and Imag)
GDElay	Group Delay, $-d\phi(z)/d\omega$
REAL	x
IMAGinary	y
SWR	Standing Wave Ratio, $SWR = (1 + z) / (1 - z)$
LINPhase ZVR <input checked="" type="checkbox"/> MLPhase	Lin Mag and Phase, $ z $, $\arctan(\text{Im}(z) / \text{Re}(z))$
LOGPhase ZVR <input checked="" type="checkbox"/> MDPHase	dB Mag and Phase, $20 \cdot \log z $ dB, $\arctan(\text{Im}(z) / \text{Re}(z))$
IMPedance	R, X, L or C (depending on sign(X))
ADMittance	G, B, L/C (depending on sign(X))

CALCulate<Chn>:MARKer<Mk>:FUNCtion:BWIDth <x dB Bandwidth>

Defines the bandfilter level, i.e. the minimum excursion for the bandpass and bandstop peaks.



Use `CALCulate<Chn>:MARKer<Mk>:BWIDth` to set the *x dB Bandwidth* and query the results of a bandfilter search. Note the sign convention for input values.

<Chn>	Channel number used to identify the active trace.
<Mk>	Marker number in the range 1 to 10. This numeric suffix is ignored and may be set to any value because the bandfilter search functions always use markers Mkr1 to Mkr4.
<x dB Bandwidth>	<i>x dB Bandwidth</i> parameter.
Range [def. unit]	0.01 dB to 100.00 dB, the increment (UP. DOWN) is 0.3 dB. [dB]
*RST value	3 dB.
SCPI, Command Types	Device-specific, command or query.
Example:	See <code>CALCulate<Chn>:MARKer<Mk>:BWIDth</code> .

CALCulate<Chn>:MARKer<Mk>:FUNCtion:BWIDth:MODE BPASs | BSTop | BPRMarker | BSRMarker | BPAB | BSAB

Selects the bandfilter search mode.

<Chn>	Channel number used to identify the active trace.
<Mk>	Marker number in the range 1 to 10. This numeric suffix is ignored and may be set to any value because the bandfilter search functions always use markers Mkr1 to Mkr4.
Parameters	Bandfilter search type: BPASs: Bandpass Search Ref to Max BSTop: Bandstop Search Ref to Max BPRMarker: Bandpass Search Ref to Marker BSRMarker: Bandstop Search Ref to Marker BPAB: Bandpass Absolute Level BSAB: Bandstop Absolute Level
*RST value	BPASs
SCPI, Command Types	Device-specific, command or query.
Example:	See <code>CALCulate<Chn>:MARKer<Mk>:BWIDth</code> .

CALCulate<Chn>:MARKer<Mk>:FUNCtion:CENTER

Sets the center of the sweep range equal to the stimulus value of the marker <Mk> on trace no. <Chn>.

<Chn>	Channel number used to identify the active trace.
--------------------	---

<Mk>	Marker number in the range 1 to 10.
Range [def. unit]	– [–]
*RST value	–
SCPI, Command Types	Device-specific, no query.
Example:	<pre>*RST; CALC:MARK ON</pre> <p>Create marker 1 in the center of the current sweep range and assign it to trace no. 1.</p> <pre>CALC:MARK:FUNC:CENT</pre> <p>Leave the sweep range unchanged.</p>

CALCulate<Chn>:MARKer<Mk>:FUNCtion:DELTA[:STATE] <Boolean>

Switches the delta mode for marker <Mk> on trace no. <Chn> on or off.

Note: This command is the ZVR-compatible equivalent of
CALCulate<Chn>:MARKer<Mk>:DELTA[:STATE].

<Chn>	Channel number used to identify the active trace.
<Mk>	Marker number in the range 1 to 10.
<Boolean>	ON OFF - Enables or disables the delta mode.
*RST value	OFF
SCPI, Command Types	Device-specific, command or query.

CALCulate<Chn>:MARKer<Mk>:FUNCtion:DOMain:USER <numeric_value>

Assigns a search range no. <numeric_value> to marker no <Mk> and selects the search range, e.g. in order to define the start and stop values.

<Chn>	Channel number used to identify the active trace.
<Mk>	Marker number in the range 1 to 10.
<numeric_value>	Number of the search range.
Range [def. unit]	0 – fixed full span search range (equal to the sweep range) 1 to 10 – user-definable search ranges; see example
*RST value	0 (reserved for full span search range)
SCPI, Command Types	Device-specific, command or query.

Example:	<pre>CALC1:MARK1:FUNC:DOM:USER 2</pre> <p>Select the search range no. 2, assigned to marker no. 1 and trace no. 1.</p> <pre>CALC:MARK:FUNC:DOM:USER:START 1GHz</pre> <p>Set the start frequency of the search range to 1 GHz.</p> <pre>CALC:MARK:FUNC:DOM:USER:STOP 1.2GHz</pre> <p>Set the stop frequency of the search range to 1.2 GHz.</p>
-----------------	--

CALCulate<Chn>:MARKer<Mk>:FUNction:DOMain:USER:START <numeric_value>

Defines the start value of the search range selected with

CALCulate<Chn>:MARKer<Mk>:FUNction:DOMain:USER <numeric_value>.

<Chn>	Channel number used to identify the active trace.
<Mk>	Marker number in the range 1 to 10.
<numeric_value>	Beginning of the search range.
Range [def. unit]	Maximum allowed sweep range, depending on the instrument model and on the sweep type. [Hz, dBm or s, depending on the sweep type]
*RST value	0 Hz
SCPI, Command Types	Device-specific, command or query.
Example:	See CALCulate<Chn>:MARKer<Mk>:FUNction:DOMain:USER <numeric_value>

CALCulate<Chn>:MARKer<Mk>:FUNction:DOMain:USER:STOP <numeric_value>

Defines the stop value of the search range selected with

CALCulate<Chn>:MARKer<Mk>:FUNction:DOMain:USER <numeric_value>.

<Chn>	Channel number used to identify the active trace.
<Mk>	Marker number in the range 1 to 10.
<numeric_value>	End of the search range.
Range [def. unit]	Maximum allowed sweep range, depending on the instrument model and on the sweep type. [Hz, dBm or s, depending on the sweep type]
*RST value	0 Hz
SCPI, Command Types	Device-specific, command or query.
Example:	See CALCulate<Chn>:MARKer<Mk>:FUNction:DOMain:USER <numeric_value>

CALCulate<Chn>:MARKer<Mk>:FUNction:EXECute MAXimum | MINimum | RPEak | LPEak | NPEak | TARGet | LTARGet | RTARGet | BFILter

Selects a search mode for marker no. <Mk> and initiates the search. The marker must be created before using CALCulate<Chn>:MARKer<Mk>[:STATe] ON (exception: bandfilter search).

<Chn>	Channel number used to identify the active trace.
<Mk>	Marker number in the range 1 to 10. For a bandfilter search (BFILter) this numeric suffix is ignored and may be set to any value because the bandfilter search functions always use markers Mkr1 to Mkr4.
Parameters	See list of parameters below.
*RST value	–
SCPI, Command Types	Device-specific, no query.
Example:	

Suppose that the active setup contains an active trace no. 1.

```
CALC:MARK ON
```

Create marker 1 and assign it to trace no. 1.

```
CALC:MARK:FUNC:EXEC MAX; RES?
```

Move the created marker to the absolute maximum of the trace and query the stimulus and response value of the search result.

The analyzer provides the following search modes:

Mode	Find...
MAXimum	Absolute maximum in the search range (see <code>CALCulate<Chn>:MARKer<Mk>:FUNction:DOMain:USER <numeric_value></code>)
MINimum	Absolute maximum in the search range
RPEak	Next valid peak to the right of the current marker position
LPEak	Next valid peak to the left
NPEak	Next highest or lowest value among the valid peaks (next peak)
TARGet	Target value (see <code>CALCulate<Chn>:MARKer<Mk>:TARget</code>)
RTARget	Next target value to the right of the current marker position
LTARget	Next target value to the left
BFILter	Bandfilter search. The results are queried using <code>CALCulate<Chn>:MARKer<Mk>:BWIDth</code> .

CALCulate<Chn>:MARKer<Mk>:FUNction:RESult?

Returns the result (stimulus and response value) of a search started by means of `CALCulate<Chn>:MARKer<Mk>:FUNction:EXECute`. The search must be executed before the command is enabled.

<Chn>	Channel number used to identify the active trace.
<Mk>	Marker number in the range 1 to 10. This numeric suffix is ignored and may be set to any value.
Response	Search result in the format <code><Stimulus value>, <Response_value></code> .
Range [def. unit]	Depending on the measurement parameter. [unit depending on the sweep type and the marker format; see <code>CALCulate<Chn>:MARKer<Mk>:FORMat</code>]
*RST value	–
SCPI, Command Types	Device-specific, query only.
Example:	See <code>CALCulate<Chn>:MARKer<Mk>:FUNction:EXECute</code> .

CALCulate<Chn>:MARKer<Mk>:FUNction[:SElect] MAXimum | MINimum | RPEak | LPEak | NPEak | TARGet | LTARget | RTARget | BFILter

Selects a search mode for marker no. `<Mk>`, which can then be initiated using one of the `CALCulate<Chn>:MARKer<Mk>:SEARch...`, `CALCulate<Chn>:MARKer<Mk>:MAXimum` or `CALCulate<Chn>:MARKer<Mk>:MINimum` functions. The marker must be created before using `CALCulate<Chn>:MARKer<Mk>[:STATE] ON`.

Note: This command is not needed expect for compatibility with ZVR programs. Use `CALCulate<Chn>:MARKer<Mk>:FUNction:EXECute` to select a search mode and at the same time initiate the search. The `CALCulate<Chn>:MARKer<Mk>:SEARCh...`, `CALCulate<Chn>:MARKer<Mk>:MAXimum` or `CALCulate<Chn>:MARKer<Mk>:MINimum` functions also select the search mode.

<Chn> Channel number used to identify the active trace.

<Mk> Marker number in the range 1 to 10. For a bandfilter search (`BFIlter`) this numeric suffix is ignored and may be set to any value because the bandfilter search functions always use markers Mkr1 to Mkr4.

Parameters See list of parameters below.

*RST value –

SCPI, Command Device-specific, command or query.

Types

The analyzer provides the following search modes:

Mode	Selected search mode
MAXimum	Absolute maximum in the search range (see <code>CALCulate<Chn>:MARKer<Mk>:FUNction:DOMain:USER<numeric_value></code>)
MINimum	Absolute maximum in the search range
RPEak	Next valid peak to the right of the current marker position
LPEak	Next valid peak to the left
NPEak	Next highest value among the valid peaks
TARGet	Target value (see <code>CALCulate<Chn>:MARKer<Mk>:TARGet</code>)
RTARGet	Next target value to the right of the current marker position
LTARGet	Next target value to the left
BFIlter	Bandfilter search. Bandfilter search. The results are queried using <code>CALCulate<Chn>:MARKer<Mk>:BWIDth</code> .

CALCulate<Chn>:MARKer<Mk>:FUNction:STARt

Sets the beginning (start) of the sweep range equal to the stimulus value of the marker <Mk> on trace no. <Chn>.

<Chn> Channel number used to identify the active trace.

<Mk> Marker number in the range 1 to 10.

Range [def. unit] – [-]

*RST value –

SCPI, Command Device-specific, no query.

Types

Example:

```
*RST; CALC:MARK ON
```

Create marker 1 in the center of the current sweep range and assign it to trace no. 1.

```
CALC:MARK:FUNC:STAR
```

Divide the sweep range in half, starting at the current marker position.

CALCulate<Chn>:MARKer<Mk>:FUNCtion:STOP

Sets the end (stop) of the sweep range equal to the stimulus value of the marker <Mk> on trace no. <Chn>.

<Chn> Channel number used to identify the active trace.

<Mk> Marker number in the range 1 to 10.

Range [def. unit] – [-]

*RST value –

SCPI, Command Types Device-specific, no query.

Example:

```
*RST; CALC:MARK ON
```

Create marker 1 in the center of the current sweep range and assign it to trace no. 1.

```
CALC:MARK:FUNC:STOP
```

Divide the sweep range in half, ending at the current marker position.

CALCulate<Chn>:MARKer<Mk>:FUNCtion:TARget <numeric_value>

Defines the target value for the target search of marker no. <Mk>, which can be activated using `CALCulate<Chn>:MARKer<Mk>:FUNCtion:EXECute TARget`.

Note: This command is the ZVR-compatible equivalent of `CALCulate<Chn>:MARKer<Mk>:TARget`.

<Chn> Channel number used to identify the active trace.

<Mk> Marker number in the range 1 to 10.

<numeric_value> Target search value of marker no. <Mk>.

Range [def. unit] Depending on the format of the active trace (`CALCulate<Chn>:FORMat`). For a dB Mag trace the range is –300 dB to +200 dB, the increment (UP. DOWN) is 0.1 dB. [dB, deg etc., depending on the trace format]

*RST value Depending on the trace format; 0 dB for a dB Mag trace.

SCPI, Command Types Device-specific, command or query.

CALCulate<Chn>:MARKer<Mk>:MAXimum

Selects a search mode for marker no. <Mk> and initiates a maximum search. The marker must be created before using `CALCulate<Chn>:MARKer<Mk>[:STATe] ON`.

Note: This command is the ZVR-compatible equivalent of

`CALCulate<Chn>:MARKer<Mk>:FUNCtion:EXECute MAXimum`.

<Chn> Channel number used to identify the active trace.

<Mk> Marker number in the range 1 to 10.

Range [def. unit] – [-]

*RST value –

SCPI, Command Types Device-specific, no query.

CALCulate<Chn>:MARKer<Mk>:MINimum

Selects a search mode for marker no. <Mk> and initiates a minimum search. The marker must be created before using `CALCulate<Chn>:MARKer<Mk>[:STATe] ON`.

Note: This command is the ZVR-compatible equivalent of

`CALCulate<Chn>:MARKer<Mk>:FUNctioN:EXECute MAXimum`.

<Chn>	Channel number used to identify the active trace.
<Mk>	Marker number in the range 1 to 10.
Range [def. unit]	– [–]
*RST value	–
SCPI, Command Types	Device-specific, no query.

CALCulate<Chn>:MARKer<Mk>:MODE CONTinuous | DISCrete

Sets marker no. <Mk> to continuous or discrete mode. The marker doesn't have to be created before (`CALCulate<Chn>:MARKer<Mk>[:STATe] ON`), the mode can be assigned in advance.

<Chn>	Channel number used to identify the active trace.
<Mk>	Marker number in the range 1 to 10.
Parameters	CONTinuous – marker can be positioned on any point of the trace, and its response values are obtained by interpolation. DISCrete – marker can be set to discrete sweep points only.
*RST value	CONT
SCPI, Command Types	Device-specific, command or query.
Example:	

Suppose that the active setup contains an active trace no. 1.

```
CALC:MARK:MODE DISC; MARK2 CONT
```

Create marker 1 in discrete mode and marker 2 in continuous mode.

```
CALC:MARK ON; MARK2 ON
```

Display the two markers. Due to the different modes the horizontal position can be different.

CALCulate<Chn>:MARKer<Mk>:REFerence:MODE CONTinuous | DISCrete

Sets the reference marker to continuous or discrete mode. The marker doesn't have to be created before (`CALCulate<Chn>:MARKer<Mk>:REFerence[:STATe] ON`), the mode can be assigned in advance.

<Chn>	Channel number used to identify the active trace.
<Mk>	Marker number in the range 1 to 10. This numeric suffix is ignored and may be set to any value.
Parameters	CONTinuous – marker can be positioned on any point of the trace, and its response values are obtained by interpolation. DISCrete – marker can be set to discrete sweep points only.

*RST value CONT

SCPI, Command Device-specific, command or query.

Types

Example:

Suppose that the active setup contains an active trace no. 1.

```
CALC:MARK:REF:MODE DISC; :CALC:MARK2:REF:MODE CONT
```

Create the reference marker in discrete mode and marker 2 in continuous mode.

```
CALC:MARK:REF ON; :CALC:MARK2 ON
```

Display the two markers. Due to the different modes the horizontal position can be different.

CALCulate<Chn>:MARKer<Mk>:REFerence[:STATe] <Boolean>

Creates the reference marker and assigns it to trace no. <Chn>.

<Chn> Channel number used to identify the active trace.

<Mk> Marker number in the range 1 to 10. This numeric suffix is ignored and may be set to any value.

<Boolean> ON | OFF - Creates or removes the marker.

*RST value OFF

SCPI, Command Device-specific, command or query.

Types

Example:

Suppose that the active setup contains an active trace no. 1.

```
CALC:MARK:REF ON; CALC:MARK ON
```

Create the reference marker and marker 1 and assign them to trace no. 1. The default position of both markers is the center of the sweep range.

CALCulate<Chn>:MARKer<Mk>:REFerence:TYPE NORMal | FIXed

Sets the reference to normal or fixed mode. The marker must be created before using

CALCulate<Chn>:MARKer<Mk>:REFerence[:STATe] ON.

<Chn> Channel number used to identify the active trace.

<Mk> Marker number in the range 1 to 10. This numeric suffix is ignored and may be set to any value.

Parameters NORMal – response value changes according to the measurement result.
FIXed – marker keeps its current response value.

*RST value NORMal

SCPI, Command Device-specific, command or query.

Types

Example:

```
CALC:MARK:REF ON; CALC:MARK:REF:TYPE FIX
```

Create the reference marker and display it in the center of the sweep range

as a fixed marker.

```
CALC:MARK:REF:X 1GHz
```

Shift the marker horizontally. The response value remains fixed.

CALCulate<Chn>:MARKer<Mk>:REFerence:X <numeric_value>

Defines the stimulus (in Cartesian diagrams: x-axis) value of the reference marker, which can (but doesn't have to) be displayed using `CALCulate<Chn>:MARKer<Mk>:REFerence[:STATe] ON`.

<Chn>	Channel number used to identify the active trace.
<Mk>	Marker number in the range 1 to 10. This numeric suffix is ignored and may be set to any value.
<numeric_value>	Stimulus value of the reference marker.
Range [def. unit]	–9.9E+11 Hz to +9.9E+11 Hz [Hz]
*RST value	0 Hz

SCPI, Command Types Device-specific, command or query.

Example:

Suppose that the active setup contains an active trace no. 1 and that the sweep range for a frequency sweep starts at 1 GHz.

```
CALC:MARK:REF ON
```

Create the reference marker and display it in the center of the sweep range.

```
CALC:MARK:REF:X 1GHz
```

Set the reference marker to the beginning of the sweep range.

CALCulate<Chn>:MARKer<Mk>:REFerence:Y?

Returns the response (in Cartesian diagrams: y-axis) value of the reference marker. The reference marker must be created before using `CALCulate<Chn>:MARKer<Mk>:REFerence[:STATe] ON`.

<Chn>	Channel number used to identify the active trace.
<Mk>	Marker number in the range 1 to 10. This numeric suffix is ignored and may be set to any value.
Response	Response value of the reference marker.
Range [def. unit]	Depending on the measured quantity. [unit depending on the marker format; see <code>CALCulate<Chn>:MARKer<Mk>:FORMat</code>]
*RST value	–

SCPI, Command Types Device-specific, query only.

Example:

Suppose that the active setup contains an active trace no. 1.

```
CALC:MARK:REF ON
```

Create the reference marker and display it in the center of the sweep range.

```
CALC:MARK:REF:Y?
```

Query the measurement value at the reference marker position.

CALCulate<Chn>:MARKer<Mk>SEARch:BFILter:RESult[:STATe] <Boolean>

Shows or hides the bandfilter search results in the diagram area.

<Chn>	Channel number used to identify the active trace.
<Mk>	Marker number in the range 1 to 10. This numeric suffix is ignored and may be set to any value.
<Boolean>	ON - Show the bandfilter search results. If no bandfilter search has been initiated before (CALCulate<Chn>:MARKer<Mk>:FUNction:EXECute BFILter), nothing is displayed. OFF - hide the bandfilter search results.
*RST value	OFF
SCPI, Command Types	Device-specific, command or query.

Example:

```
See CALCulate<Chn>:MARKer<Mk>:BWIDth.
```

CALCulate<Chn>:MARKer<Mk>:SEARch[:IMMediate]

Initiates a search according to the search function selected with CALCulate<Chn>:MARKer<Mk>:FUNction[:SElect]. The marker must be created before using CALCulate<Chn>:MARKer<Mk>[:STATe] ON.

Note: Together with CALCulate<Chn>:MARKer<Mk>:FUNction[:SElect] this command is the ZVR-compatible equivalent of CALCulate<Chn>:MARKer<Mk>:FUNction:EXECute

<Chn>	Channel number used to identify the active trace.
<Mk>	Marker number in the range 1 to 10. For a bandfilter search (BFILter) this numeric suffix is ignored and may be set to any value because the bandfilter search functions always use markers Mkr1 to Mkr4.
Range [def. unit]	– [–]
*RST value	–
SCPI, Command Types	Device-specific, no query.

CALCulate<Chn>:MARKer<Mk>:SEARch:LEFT

Selects a search mode for marker no. <Mk> and initiates a search for the next valid peak to the left. The marker must be created before using CALCulate<Chn>:MARKer<Mk>[:STATe] ON.

Note: This command is the ZVR-compatible equivalent of

CALCulate<Chn>:MARKer<Mk>:FUNction:EXECute LPEak.

<Chn>	Channel number used to identify the active trace.
<Mk>	Marker number in the range 1 to 10.
Range [def. unit]	– [–]
*RST value	–
SCPI, Command Types	Device-specific, no query.

CALCulate<Chn>:MARKer<Mk>:SEARch:NEXT

Selects a search mode for marker no. <Mk> and initiates a search for the next highest or lowest value among the valid peaks. The marker must be created before using

CALCulate<Chn>:MARKer<Mk>[:STATe] ON.

Note: This command is the ZVR-compatible equivalent of

CALCulate<Chn>:MARKer<Mk>:FUNction:EXECute NPEak.

<Chn>	Channel number used to identify the active trace.
<Mk>	Marker number in the range 1 to 10.
Range [def. unit]	– [–]
*RST value	–
SCPI, Command Types	Device-specific, no query.

CALCulate<Chn>:MARKer<Mk>:SEARch:RIGHT

Selects a search mode for marker no. <Mk> and initiates a search for the next valid peak to the right. The marker must be created before using *CALCulate<Chn>:MARKer<Mk>[:STATe] ON.*

Note: This command is the ZVR-compatible equivalent of

CALCulate<Chn>:MARKer<Mk>:FUNction:EXECute RPEak.

<Chn>	Channel number used to identify the active trace.
<Mk>	Marker number in the range 1 to 10.
Range [def. unit]	– [–]
*RST value	–
SCPI, Command Types	Device-specific, no query.

CALCulate<Chn>:MARKer<Mk>:SEARch:TRACking <Boolean>

Enables or disables the marker tracking mode for marker no. <Mk>. Tracking mode causes the active minimum/maximum or target search of the active marker to be repeated after each sweep. A marker must be created and a search mode must be active (*CALCulate<Chn>:MARKer<Mk>:FUNction:EXECute . . .*) to use this command.



If the current search mode is a bandfilter search this command enables or disables bandfilter tracking.

<Chn>	Channel number used to identify the active trace.
--------------------	---

Instrument-Control Commands

<Mk> Marker number in the range 1 to 10. For a bandfilter search (**BFI**lter) this numeric suffix is ignored and may be set to any value because the bandfilter search functions always use markers Mkr1 to Mkr4.

<Boolean> ON | OFF - Enables or disables the marker tracking mode.

*RST value OFF

SCPI, Command Types Device-specific, command or query.

Example:

Suppose that the active setup contains an active trace no. 1.

```
CALC:MARK ON; FUNC:EXEC MAXimum
```

Create marker no. 1 and assign them to trace no. 1. Activate a maximum search for marker no. 1.

```
CALC:MARK:SEAR:TRAC ON
```

Enable the tracking mode for the created marker.

CALCulate<Chn>:MARKer<Mk>[:STATe] <Boolean>

Creates the marker numbered <Mk> and assigns it to trace no. <Chn>.

<Chn> Channel number used to identify the active trace.

<Mk> Marker number in the range 1 to 10. If unspecified the numeric suffix is set to 1.

<Boolean> ON | OFF - Creates or removes the marker.

*RST value OFF

SCPI, Command Types Device-specific, command or query.

Example:

Suppose that the active setup contains an active trace no. 1.

```
CALC:MARK ON; MARK2 ON
```

Create markers 1 and 2 and assign them to trace no. 1. The default position of both markers is the center of the sweep range.

CALCulate<Chn>:MARKer<Mk>:TARget <numeric_value>

Defines the target value for the target search of marker no. <Mk>, which can be activated using `CALCulate<Chn>:MARKer<Mk>:FUCTION:EXECute TARGet`.

<Chn> Channel number used to identify the active trace.

<Mk> Marker number in the range 1 to 10.

<numeric_value> Target search value of marker no. <Mk>.

Range [def. unit] Depending on the format of the active trace (`CALCulate<Chn>:FORMat`). For a dB Mag trace the range is -300 dB to +200 dB, the increment (UP. DOWN) is 0.1 dB. [dB, deg etc., depending on the trace format]

*RST value Depending on the trace format; 0 dB for a dB Mag trace.

SCPI, Command Device-specific, command or query.

Types

Example:

```
CALC:MARK ON
```

Create marker no. 1 and display it in the center of the sweep range.

```
:CALC:MARK:TARG -10; FUNC:EXEC TARG
```

Define a target search value of –10 dB and start the target search.

```
CALC:MARK:X?
```

Query the stimulus value corresponding to the target search result.

CALCulate<Chn>:MARKer<Mk>:TYPE NORMal | FIXed

Sets marker no. <Mk> to normal or fixed mode. The marker must be created before using CALCulate<Chn>:MARKer<Mk>[:STATe] ON.

<Chn> Channel number used to identify the active trace.

<Mk> Marker number in the range 1 to 10.

Parameters NORMal – response value changes according to the measurement result.
FIXed – marker keeps its current response value.

*RST value NORMal

SCPI, Command Device-specific, command or query.

Types

Example:

```
CALC:MARK ON; CALC:MARK:TYPE FIX
```

Create marker 1 and display it in the center of the sweep range as a fixed marker.

```
CALC:MARK:X 1GHz
```

Shift the marker horizontally. The response value remains fixed.

CALCulate<Chn>:MARKer<Mk>:X <numeric_value>

Defines the stimulus (in Cartesian diagrams: x-axis) value of the marker no. <Mk>, which can (but doesn't have to) be created using CALCulate<Chn>:MARKer<Mk>[:STATe] ON.

<Chn> Channel number used to identify the active trace.

<Mk> Marker number in the range 1 to 10.

<numeric_value> Stimulus value of marker no. <Mk>.

Range [def. unit] –9.9E+11 Hz to +9.9E+11 Hz [Hz] (for frequency sweeps)

*RST value 0 Hz

SCPI, Command Device-specific, command or query.

Types

Example:

Suppose that the active setup contains an active trace no. 1 and the sweep range for a frequency sweep starts at 1 GHz.

```
CALC:MARK ON
```

Create marker no. 1 and display it in the center of the sweep range.

```
CALC:MARK:X 1GHz
```

Set the marker to the beginning of the sweep range.

CALCulate<Chn>:MARKer<Mk>:Y?

Returns the response (in Cartesian diagrams: y-axis) value of marker no. <Mk>. The marker must be created before using CALCulate<Chn>:MARKer<Mk>[:STATe] ON.

<Chn>	Channel number used to identify the active trace.
<Mk>	Marker number in the range 1 to 10.
Response	Response value of marker no. <Mk>.
Range [def. unit]	Depending on the measured quantity. [unit depending on the marker format; see CALCulate<Chn>:MARKer<Mk>:FORMat]
*RST value	–
SCPI, Command Types	Device-specific, query only.

Example:

Suppose that the active setup contains an active trace no. 1.

```
CALC:MARK ON
```

Create marker no. 1 and display it in the center of the sweep range.

```
CALC:MARK:Y?
```

Query the measurement value at the marker position.

CALCulate<Chn>:MATH...

This subsystem permits processing of measured data in numerical expression format. The operators are -, / and use of constants and data arrays are permitted.

CALCulate<Chn>:MATH:FUNCTION NORMAL | SUBTRACT | DIVIDE

Defines a simple mathematical relation between the active trace and the active memory trace to calculate a new mathematical trace and displays the mathematical trace.



This command places some restrictions on the mathematical expression and the operands. Use CALCulate<Chn>:MATH[:EXPReSSion]:SDEFine to define general expressions.

<Chn>	Channel number used to identify the active trace. If unspecified the numeric suffix is set to 1.
NORMAL	Math. trace = active data trace
SUBTRACT	Math. trace = data – memory
DIVIDE	Math. trace = data / memory
*RST value	NORMAL
SCPI,	Confirmed, with query.

Command Types**Example:**

```
*RST; CALC:MATH:MEM
```

Copy the current state of the default trace *Trc1* to a memory trace named 'Mem2[Trc1]'. The memory trace is not displayed.

```
CALC:MATH:FUNC DIV
```

Define a mathematical trace, dividing the data trace by the stored memory trace. The mathematical trace is displayed instead of the active data trace.

```
CALC:MATH:STAT?
```

The response is 1 (mathematical mode switched on, mathematical trace displayed).

CALCulate<Chn>:MATH:MEMorize

Copies the current state of the active data trace to a memory trace. If a mathematical trace is active, the data trace associated with the mathematical trace is copied. The memory trace is named *Mem<n>[<Data_Trace>]* where *<n>* counts all data and memory traces in the active setup in chronological order, and *<Data_Trace>* is the name of the associated (copied) data trace.

The exact function of the command depends on the number of memory traces associated with the active data trace:

- If no memory trace is associated to the active trace, a new memory trace is generated.
- If several memory traces are associated with the active trace, the current measurement data overwrites the last generated or changed memory trace.



To copy a trace to the memory without overwriting an existing memory trace or define a memory trace name, use TRACe:COPIY <memory_trc>,<data_trc>. To copy an active mathematical trace use TRACe:COPIY:MATH <memory_trc>,<data_trc>

<Chn> Channel number used to identify the active trace.

***RST value** –

SCPI, Command Types Device-specific, no query

Example:

```
*RST; CALC:MATH:MEM
```

Copy the current state of the default trace *Trc1* to a memory trace named 'Mem2[Trc1]'. The memory trace is not displayed.

```
DISP:WIND:TRAC2:FEED 'Mem2[Trc1]'
```

Display the created memory trace in the active diagram area (diagram area no. 1).

CALCulate<Ch>:PARAmeter...

This subsystem assigns names and measurement parameters to traces. The commands are device-specific.

CALCulate<Ch>:PARAmeter:CATalog?

Returns the trace names and measurement parameters of all traces assigned to a particular channel.

<Ch> Channel number. If unspecified the numeric suffix is set to 1.

Response String parameter with comma-separated list of trace names and measurement parameters, e.g. 'CH4TR1, S11, CH4TR2, S12'. The measurement parameters are returned according to the naming convention of CALCulate<Ch>:PARAmeter:SDEFine. The order of traces in the list reflects their creation time: The oldest trace is the first, the newest trace is the last trace in the list.

*RST value –

SCPI, Command Types Device-specific, query only.

Example:

```
CALC4:PAR:SDEF 'Ch4Tr1', 'S11'
```

Create channel 4 and a trace named *Ch4Tr1* to measure the input reflection coefficient S11.

```
CALC4:PAR:CAT?
```

Query the traces assigned to channel 4. If *Ch4Tr1* is the only trace assigned to channel 4, the response is 'CH4TR1, S11'.

CALCulate<Ch>:PARAmeter:DEFine '<string>', S11 | S12 | S21 | S22

Creates a trace and assigns a channel number, a name and a measurement parameter to it. The trace is not displayed. To display a trace defined via CALCulate<Ch>:PARAmeter:DEFine, a window must be created (DISPlay:WINDow<Wnd>[:STATe] ON) and the trace must be assigned to this window (DISPlay:WINDow<Wnd>:TRACe:FEED); see example below.

Traces must be selected to become active traces; see CALCulate:PARAmeter:SElect.



This command has been implemented for compatibility reasons. The parameter names in this command differ from ZVL conventions; moreover the parameter list is not complete. The alternative command CALCulate<Ch>:PARAmeter:SDEFine uses a complete parameter list with compatible names.

<Ch> Channel number. <Ch> may be used to reference a previously defined channel. If <Ch> does not exist, it is generated with default channel settings.

'<string>' Trace name, e.g. 'Trc4'. See *Rules for trace names* in the *Trace Manager* description.

S11, S12, S21, S22 Measurement parameter

*RST value –

SCPI, Command Types Device-specific, no query. CALCulate<Ch>:PARAmeter:CATalog? returns a list of all defined traces.

Example:

```
CALC4:PAR:DEF 'Ch4Tr1', S11
```

Create channel 4 and a trace named *Ch4Tr1* to measure the input reflection coefficient S11.

```
DISP:WIND:STAT ON
```

Create diagram area no. 1.

```
DISP:WIND:TRAC:FEED 'CH4TR1'
```

Display the generated trace in diagram area no. 1.

CALCulate<Ch>:PARAmeter:DELeTe '<string>'

Deletes a trace with a specified trace name and channel.

<Ch>	Channel number.
'<string>'	Trace name, e.g. 'Trc4'. See <i>Rules for trace names</i> in the <i>Trace Manager</i> description.
*RST value	–

SCPI, Command Types Device-specific, no query.

Example:

```
CALC4:PAR:SDEF 'Ch4Tr1', 'S11'
```

Create channel 4 and a trace named *Ch4Tr1* to measure the input reflection coefficient S11.

```
CALC4:PAR:CAT?
```

Query the traces assigned to channel 4. If *Ch4Tr1* is the only trace assigned to channel 4, the response is 'CH4TR1,S11'.

```
CALC4:PAR:DEL 'CH4TR1'
```

Delete the created trace.

CALCulate<Ch>:PARAmeter:MEASure '<string>', 'S11' | 'Y-S11' | ... | 'Z-S11'

Assigns a measurement parameter to an **existing** trace.

Note: To create a new trace and at the same time assign the attributes, use

CALCulate<Ch>:PARAmeter:SDEFine. To display the trace, create a window (*DISPlay:WINDow<Wnd>[:STATe] ON*) and assign the trace to this window (*DISPlay:WINDow<Wnd>:TRACe:FEED*); see example below.

Traces must be selected to become active traces; see *CALCulate:PARAmeter:SElect*.

CALCulate<Ch>:PARAmeter:CATalog? returns a list of all defined traces. You can open the trace manager (*DISPlay:MENU:KEY:EXECute 'Trace Manager'*) to obtain an overview of all channels and traces, including the traces that are not displayed.

<Ch>	Channel number of an existing channel containing the referenced trace.
'<string>'	Trace name, e.g. 'Trc4'. See <i>Rules for trace names</i> in the <i>Trace Manager</i> description.

'S11', ...	Measurement parameter (string variable); see list of in the <code>CALCulate<Ch>:PARAmeter:SDEFine</code> command description.
*RST value	–
SCPI, Command Types	Device-specific, with query (see 'S11',... parameter description above).
Example:	

```
CALC4:PAR:SDEF 'Ch4Tr1', 'S11'
```

Create channel 4 and a trace named *Ch4Tr1* to measure the input reflection coefficient S_{11} .

```
CALC4:PAR:MEAS 'Ch4Tr1', 'S12'
```

Change the measurement parameter of the trace and measure the transmission coefficient S_{12} .

```
CALC4:PAR:MEAS? 'Ch4Tr1'
```

Query the measured quantity. The response is 'S12'.

`CALCulate<Ch>:PARAmeter:SDEFine '<string>', 'S11' | ... | 'Y-S11' | ... | 'Z-S11' | ...`

Creates a trace and assigns a channel number, a name and a measurement parameter to it. The trace becomes the active trace in the channel but is not displayed.



To display the trace defined via `CALCulate<Ch>:PARAmeter:SDEFine`, create a window (`DISPlay:WINDow<Wnd>[:STATE] ON`) and assign the trace to this window (`DISPlay:WINDow<Wnd>:TRACe:FEED`); see example below.
`CALCulate<Ch>:PARAmeter:MEASure` changes the measurement parameter of an existing trace.

To select an existing trace as the active trace, use `CALCulate:PARAmeter:SElect`. You can open the trace manager (`DISPlay:MENU:KEY:EXECute 'Trace Manager'`) to obtain an overview of all channels and traces, including the traces that are not displayed.



In FW versions <V1.90, traces created with `CALCulate<Ch>:PARAmeter:SDEFine` must be selected explicitly (`CALCulate:PARAmeter:SElect`) in order to become active traces.

<Ch>	Channel number. <Ch> may be used to reference a previously defined channel. If <Ch> does not exist, it is generated with default channel settings.
'<string>'	Trace name, e.g. 'Trc4'. See <i>Rules for trace names</i> in the <i>Trace Manager</i> description.
'S11', ...	Measurement parameter (string variable); see list of parameters below.
*RST value	–
SCPI, Command Types	Device-specific, no query. <code>CALCulate<Ch>:PARAmeter:MEASure? '<Trc_name>'</code> queries the measurement parameter of the trace. <code>CALCulate<Ch>:PARAmeter:CATalog?</code> returns a list of all defined traces.
Example:	
	<pre>CALC4:PAR:SDEF 'Ch4Tr1', 'S11'</pre>
	Create channel 4 and a trace named <i>Ch4Tr1</i> to measure the input reflection coefficient S_{11} .
	<pre>DISP:WIND2:STAT ON</pre>

Create diagram area no. 2.

```
DISP:WIND2:TRAC:FEED 'CH4TR1'
```

Display the generated trace in diagram area no. 2.

The measurement parameter is selected by means of the following keywords (the selection depends on the number of test ports of the analyzer, e.g. S44 is not available on 2-port analyzers):

'S11' 'S12' ...	Normal mode S-parameters S<out><in>, where <out> and <in> denote the output and input port numbers of the DUT.
'Y-S11' ... 'Z-S11' ...	S-parameters converted to matched-circuit admittances and impedances with port numbers like for normal mode S-parameters.
'KFAC21' 'KFAC12' ...	Stability factor K (for unbalanced ports only)
'MUF121' 'MUF112' ...	Stability factor μ_1 (for unbalanced ports only)
'MUF221' 'MUF212' ...	Stability factor μ_2 (for unbalanced ports only)

*Selecting a parameter Y...<n><m> or Z...<n><m> sets the range of port numbers to be considered for the Y and Z-parameter measurement to <n>:<m>.

CALCulate<Ch>:PARAmeter:SElect <string>

Selects an existing trace as the active trace of the channel. All trace commands without explicit reference to the trace name act on the active trace (e.g. CALCulate<Ch>:FORMat).

CALCulate<Ch>:PARAmeter:SElect is also necessary if the active trace of a channel has been deleted.

<Ch> Channel number.

<string> Trace name, e.g. 'Trc4'. See *Rules for trace names* in the *Trace Manager* description.

*RST value –

SCPI, Command Types Device-specific, with query (returns the name of the active trace).

Example:

```
CALC4:PAR:SDEF 'Ch4Tr1', 'S11'
```

Create channel 4 and a trace named *Ch4Tr1* to measure the input reflection coefficient S11. The trace is the active trace in channel 4.

```
CALC4:PAR:SDEF 'Ch4Tr2', 'S22'
```

Create another trace named *Ch4Tr2* to measure the output reflection coefficient S22. Again this new trace becomes the active trace in channel 4.

```
CALC4:PAR:SEL 'Ch4Tr1'
```

Select the first trace *Ch4Tr1* as the active trace.

```
CALC4:FORM MLIN
```

Calculate the magnitude of S11 and display it in a linearly scaled Cartesian diagram.

CALCulate<Chn>:PHOLd

This subsystem controls the max hold (peak hold) function.

CALCulate<Chn>:PHOLd MAX | OFF

Enables, disables, or restarts the max hold function.

<Chn> Channel number used to identify the active trace.

Parameters MAX - Enable the max hold function
OFF - Disables the max hold function

***RST value** OFF

SCPI, Command Types Device-specific, command or query.

Example:

```
*RST; CALC:PHOL MAX
```

Reset the instrument and enable the max hold function.

```
CALC:PHOL OFF; PHOL MAX
```

Restart max hold.

CALCulate<Chn>:RIPPLe...

This subsystem defines the ripple limits and controls the ripple check.

CALCulate<Chn>:RIPPLe:DATA <type>, <start_stim>, <stop_stim>, <limit>{,<type>, <start_stim>, <stop_stim>, <limit>}

Adds and enables/disables an arbitrary number of ripple limit ranges, assigning the stimulus values and the ripple limits.



This command does not overwrite existing ripple limit ranges. The defined ranges are appended to the range list as new ranges.

<Chn> Channel number used to identify the active trace.

<type> Identifier for the type of the ripple limit range.

Range [def. unit] **0** – Ripple limit range off, range defined but no limit check result displayed. The result is still available via `CALCulate<Chn>:RIPPLe:SEGMENT<Seg>:RESult?`
1 – Ripple limit range on (with limit check)

<start_stim>, <stop_stim>, <limit> Stimulus values of the first and last points of the ripple limit range and associated ripple limit.

Range [def. unit] Almost no restriction for limit ranges; see *Rules for Limit Line Definition*. [no unit entries accepted, the default unit is Hz. For distance-to-fault traces the default unit is the length unit defined via `UNIT:LENGth.`]

***RST values** – (no ripple limit line defined after *RST)

SCPI, Command Device-specific, with query.

Types**Example:**

```
*RST; CALC:RIPP:DATA 1,1500000000, 2000000000,3, 1, 2000000000, 3000000000, 5
```

Define and enable a ripple limit range in the stimulus range between 1.5 GHz and 2 GHz, assigning a ripple limit of +3 dBm. Define and enable a second ripple limit range in the stimulus range between 2 GHz and 3 GHz, assigning a ripple limit of +5 dBm.

```
CALC:RIPP:DISP ON
```

Show the ripple limit ranges in the active diagram.

CALCulate<Chn>:RIPple:DElete:ALL

Deletes all ripple limit ranges.

<Chn> Channel number used to identify the active trace.

***RST value** –

SCPI, Command Types Device-specific, no query.

Example:

```
*RST; CALC:RIPP:DATA 1,1500000000, 2000000000,3, 1, 2000000000, 3000000000, 5
```

Define and enable a ripple limit range in the stimulus range between 1.5 GHz and 2 GHz, assigning a ripple limit of +3 dBm. Define and enable a second ripple limit range in the stimulus range between 2 GHz and 3 GHz, assigning a ripple limit of +5 dBm.

```
CALC:RIPP:DEL:ALL
```

Delete both created ripple limit ranges.

CALCulate<Chn>:RIPple:DISPlay[:STATe] <Boolean>

Displays or hides all ripple limit lines (including all ranges) associated to the active trace.

<Chn> Channel number used to identify the active trace.

<Boolean> ON | OFF - Limit line on or off.

***RST value** OFF

SCPI, Command Types Device-specific, command or query.

Example:

```
*RST; CALC:RIPP:DATA 1,1500000000, 2000000000,3
```

Define and enable a ripple limit range in the stimulus range between 1.5 GHz and 2 GHz, assigning a ripple limit of +3 dBm.

```
CALC:RIPP:DISP ON
```

Show the ripple limit range in the active diagram.

CALCulate<Chn>:RIPPlE:FAIL?

Returns a 0 or 1, to indicate whether or not the global ripple limit check has failed.



Use `CALCulate<Chn>:RIPPlE:SEGment<Seg>:RESult?` to query the result for a single ripple limit range.

<Chn>	Channel number used to identify the active trace.
Response	0 1 - 0 represents pass (or a disabled limit check), 1 represents fail in at least one ripple limit range.
*RST value	0
SCPI, Command Types	Device-specific, query only.

Example:

```
*RST; CALC:RIPP:DATA 1,1500000000, 2000000000,3
```

Define and enable a ripple limit range in the stimulus range between 1.5 GHz and 2 GHz, assigning a ripple limit of +3 dBm.

```
CALC:RIPP:STAT ON; FAIL?
```

Switch the limit check on and query the result.

CALCulate<Chn>:RIPPlE:RDOMain:FORMat COMPlEx | MAGNitude | PHASe | REAL | IMAGinary | SWR | GDELay | L | C

Deletes the existing ripple limit ranges and (re-)defines the physical unit of the ripple limit. The units of the stimulus values are defined via `CALCulate<Chn>:RIPPlE:CONTRol:DOMain`.

<Chn>	Channel number used to identify the active trace.
Parameters	Keyword for the physical unit of the response values.
Range [def. unit]	The parameters form four groups: <ul style="list-style-type: none"> ▪ COMPlEx, REAL, IMAGinary, and SWR select dimensionless numbers (U) for the ripple limit. ▪ MAGNitude selects relative units (dB). ▪ PHASe selects phase units (deg). ▪ GDELay selects time units (s). ▪ L selects inductance units (H/Henry). ▪ C selects capacitance units (F/Farad).

[–]

*RST value –

SCPI, Command Types Device-specific, no query.

Example

```
*RST; CALC:RIPP:DATA 1,1500000000, 2000000000,3
```

Define and enable a ripple limit range in the stimulus range between 1.5 GHz and 2 GHz, assigning a ripple limit of +3 dBm.

```
CALC:RIPP:RDOM:FORM COMP
```

Delete the ripple limit range, select complex units for the ripple limit.

CALCulate<Chn>:RIPPlE:SEGMent<Seg>:COUNT?

Queries the number of ripple limit ranges.

<Chn> Channel number used to identify the active trace.

<Seg> Ripple limit range number. This suffix is ignored; the command counts all ranges.

Response 0 | 1 | ...- number of (enabled or disabled) ripple limit ranges.

***RST value** 0

SCPI, Command Types Device-specific, query only.

Example:

```
*RST; CALC:RIPP:DATA 1,1500000000, 2000000000,3, 1, 2000000000, 3000000000, 5
```

Define and enable a ripple limit range in the stimulus range between 1.5 GHz and 2 GHz, assigning a ripple limit of +3 dBm. Define and enable a second ripple limit range in the stimulus range between 2 GHz and 3 GHz, assigning a ripple limit of +5 dBm.

```
CALC:RIPP:SEGM:COUNT?
```

Query the number of ranges. The response is 2.

CALCulate<Chn>:RIPPlE:SEGMent<Seg>:LIMit <limit_value>

Defines the ripple limit for ripple limit range no. <Seg>. A range must be created first to enable this command (e.g. CALCulate<Chn>:RIPPlE:DATA).



To define several ripple limit ranges with a single command, use CALCulate<Chn>:RIPPlE:DATA.

<Chn> Channel number used to identify the active trace.

<Seg> Segment number

<limit_value> Limit value, to be defined in accordance with the selected format (CALCulate<Chn>:RIPPlE:RDOMain:FORMat).

Range [def. unit] Almost no restriction for limit ranges; see *Rules for Limit Line Definition*. [Hz]

***RST value** – (no ripple limit line defined after *RST)

SCPI, Command Types Device-specific, with query.

Example:

```
See CALCulate<Chn>:RIPPlE:SEGMent<Seg>:STIMulus:START.
```

CALCulate<Chn>:RIPPlE:SEGMent<Seg>:RESult?

Returns the result of the ripple limit check in the previously defined limit range no. <Seg>.



Use `CALCulate<Chn>:RIPPlE:FAIL?` to query the result for global ripple limit check.

<Chn>	Channel number used to identify the active trace.
<Seg>	Ripple limit range number
Response:	
<Fail>	0 1 - 0 represents pass, 1 represents fail
<Limit>	Measured ripple in the limit range. A result is returned even if the limit check in the range no. <Seg> is disabled; see example below.
*RST value	– (a reset deletes all ripple limit ranges)
SCPI, Command Types	Device-specific, query only
Example:	<pre>*RST; CALC:RIPP:DATA 1,1500000000, 2000000000,3</pre> <p>Define and enable a ripple limit range in the stimulus range between 1.5 GHz and 2 GHz, assigning a ripple limit of +3 dBm.</p> <pre>CALC:RIPP:STAT ON; SEGM:RES?</pre> <p>Enable the limit check and query the result for the created range. Possible response: 0,0.3529814004.</p> <pre>CALC:RIPP:DATA 0,2500000000, 3000000000,3</pre> <p>Define a second ripple limit range with disabled limit check (no limit check results are displayed in the diagram area).</p> <pre>CALC:RIPP:SEGM2:RES?</pre> <p>Query the result for the second range. Possible response: 0,1.149071925.</p>

CALCulate<Chn>:RIPPlE:SEGMENT<Seg>:STIMulus:STARt <start_value>

Changes the start stimulus value (i.e. the smallest stimulus value) of a ripple limit range. A range must be created first to enable this command (e.g `CALCulate<Chn>:RIPPlE:DATA`).



To define several ripple limit ranges with a single command, use `CALCulate<Chn>:RIPPlE:DATA`.

<Chn>	Channel number used to identify the active trace.
<Seg>	Ripple limit range number
<start_value>	Frequency value.
Range [def. unit]	Almost no restriction for limit ranges; see <i>Rules for Limit Line Definition</i> . [Hz. For distance-to-fault traces the default unit is the length unit defined via <code>UNIT:LENGth</code> .]
*RST value	– (no ripple limit line defined after *RST)
SCPI, Command Types	Device-specific, with query.
Example:	<pre>*RST; CALC:RIPP:DATA 1,1500000000, 2000000000,3</pre> <p>Define and enable a ripple limit range in the stimulus range between 1.5 GHz and 2 GHz, assigning a ripple limit of +3 dBm.</p> <pre>CALC:RIPP:SEGM:STIM:STAR 1GHZ; STOP 2.5 GHZ; :CALC:RIPP:SEGM:LIM 5</pre> <p>Change the range to a stimulus range between 1 GHz and 2.5 GHz and a limit</p>

of 5 dB.

```
CALC:RIPP:SEGM:STAT OF
```

Disable the limit check in the modified stimulus range.

CALCulate<Chn>:RIPPlE:SEGMENT<Seg>:STIMulus:STOP <stop_value>

Changes the stop stimulus value (i.e. the largest stimulus value) of a ripple limit range. A range must be created first to enable this command (e.g. CALCulate<Chn>:RIPPlE:DATA).



To define several ripple limit ranges with a single command, use CALCulate<Chn>:RIPPlE:DATA.

<Chn>	Channel number used to identify the active trace.
<Seg>	Segment number
<stop_value>	Frequency value.
Range [def. unit]	Almost no restriction for limit ranges; see <i>Rules for Limit Line Definition</i> . [Hz. For distance-to-fault traces the default unit is the length unit defined via UNIT:LENGth.]
*RST value	– (no ripple limit line defined after *RST)
SCPI, Command Types	Device-specific, with query.
Example:	See CALCulate<Chn>:RIPPlE:SEGMENT<Seg>:STIMulus:START.

CALCulate<Chn>:RIPPlE:SEGMENT<Seg>[:STATe] <Boolean>

Enables or disables the limit check in the ripple limit range no. <Seg>.

<Chn>	Channel number used to identify the active trace.
<Seg>	Segment number
<Boolean>	ON OFF - Limit check on or off. A result is available even if the limit check is disabled; see example for CALCulate<Chn>:RIPPlE:SEGMENT<Seg>:RESult?.
*RST value	– (no ripple limit line defined after *RST)
SCPI, Command Types	Device-specific, command or query.
Example:	See CALCulate<Chn>:RIPPlE:SEGMENT<Seg>:STIMulus:START.

CALCulate<Chn>:RIPPlE:STATe <Boolean>

Switches the global ripple limit check on or off. This check covers all traces in the active setup.



Use CALCulate<Chn>:RIPPlE:SEGMENT<Seg>[:STATe] to switch the limit check for a single ripple limit range on or off.

<Chn>	Channel number used to identify the active trace.
--------------------	---

<Boolean>	ON OFF - Limit check on or off.
*RST value	OFF
SCPI, Command Types	Device-specific, command or query.
Example:	See CALCulate<Chn>:RIPPLe:FAIL?

CALCulate<Chn>:SMOothing...

This subsystem provides the settings for trace smoothing.

CALCulate<Chn>:SMOothing:APERture <numeric_value>

Defines how many measurement points are averaged to smooth the trace.

<Chn>	Channel number used to identify the active trace. If unspecified the numeric suffix is set to 1.
<numeric_value> Range [def. unit]	Smoothing aperture. 0.05% to 100%. A smoothing aperture of n % means that the smoothing interval for each sweep point i with stimulus value x_i is equal to $[x_i - \text{span} * n / 200, x_i + \text{span} * n / 200]$, and that the result of i is replaced by the arithmetic mean value of all measurement points in this interval. [%]
*RST value	1
SCPI, Command Types	Device-specific, command or query.
Example:	<pre>*RST; CALC:SMO ON</pre> <p>Activate smoothing for the default trace.</p> <pre>CALC:SMO:APER 0.5</pre> <p>Reduce the smoothing aperture to 0.5 %.</p>

CALCulate<Chn>:SMOothing[:STATe] <Boolean>

Enables or disables smoothing for trace no. <Chn>.

<Chn>	Channel number used to identify the active trace.
<Boolean>	ON OFF - Smoothing on or off.
*RST value	OFF
SCPI, Command Types	Device-specific, command or query.
Example:	See CALCulate<Chn>:STATistics:SMOothing:APERture

CALCulate<Chn>:STATistics...

This subsystem evaluates and displays statistical and phase information of the trace.

CALCulate<Chn>:STATistics:DOMain:USER <numeric_value>

Selects one out of 10 evaluation ranges to be configured with the `CALCulate<Chn>:STATistics:DOMain:USER:START` and `CALCulate<Chn>:STATistics:DOMain:USER:STOP` commands.

<Chn> Channel number used to identify the active trace. If unspecified the numeric suffix is set to 1.

<numeric_value> Number of the evaluation range.
Range [def. unit] 1 to 10. In addition, 0 denotes the (non-configurable) *Full Span* evaluation range. [-]

*RST value 0

SCPI, Command Types Device-specific, command or query.

Example:

```
*RST; CALC:STAT:DOM:USER?
```

Query the default evaluation range. The response is zero, i.e. the evaluation range is equal to the complete sweep range

```
CALC:STAT:DOM:USER 1; :CALC:STAT:DOM:USER:START 1GHZ; STOP 2GHZ
```

Select evaluation range no. 1 and define the evaluation range between 1 GHz and 2 GHz.

CALCulate<Chn>:STATistics:DOMain:USER:START <numeric_value>

Defines the start value of the evaluation range selected via `CALCulate<Chn>:STATistics:DOMain:USER`.

<Chn> Channel number used to identify the active trace.

<numeric_value> Start value of the evaluation range.
Range [def. unit] -1000 GHz to 999.999999999 GHz. [Hz]
*RST value Lowest frequency of the analyzer, depending on the analyzer model.

SCPI, Command Types Device-specific, command or query.

Example:

```
See CALCulate<Chn>:STATistics:DOMain:USER
```

CALCulate<Chn>:STATistics:DOMain:USER:STOP <numeric_value>

Defines the stop value of the evaluation range selected via `CALCulate<Chn>:STATistics:DOMain:USER`.

<Chn> Channel number used to identify the active trace.

<numeric_value> Stop value of the evaluation range.

Range [def. unit]	–999.999999999 GHz to 1000 GHz. [Hz]
*RST value	Highest frequency of the analyzer, depending on the analyzer model.
SCPI, Command Types	Device-specific, command or query.
Example:	See CALCulate<Chn>:STATistics:DOMain:USER

CALCulate<Chn>:STATistics:EPDelay[:STATe] <Boolean>

Displays or hides the *Phase Delay/EI Length* results in the diagram area of trace no. <Chn>.

<Chn>	Channel number used to identify the active trace.
<Boolean>	ON OFF - Statistical info field on or off.
*RST value	OFF
SCPI, Command Types	Device-specific, command or query.
Example:	See CALCulate<Chn>:STATistics[:STATe]

CALCulate<Chn>:STATistics:MMPTpeak[:STATe] <Boolean>

Displays or hides the *Min/Max/Peak-Peak* results in the diagram area of trace no. <Chn>.

<Chn>	Channel number used to identify the active trace.
<Boolean>	ON OFF - Statistical info field on or off.
*RST value	OFF
SCPI, Command Types	Device-specific, command or query.
Example:	See CALCulate<Chn>:STATistics[:STATe]

CALCulate<Chn>:STATistics:MSTDev[:STATe] <Boolean>

Displays or hides the *Mean/Std Dev* results in the diagram area of trace no. <Chn>.

<Chn>	Channel number used to identify the active trace.
<Boolean>	ON OFF - Statistical info field on or off.
*RST value	OFF
SCPI, Command Types	Device-specific, command or query.
Example:	See CALCulate<Chn>:STATistics[:STATe]

CALCulate<Chn>:STATistics:RESult? MEAN | STDDev | MAX | MIN | RMS | PTPeak | ELENgth | PDELay | ALL

Returns a single statistical parameters of the trace no. <Chn> or all parameters. It is not necessary to display the info field (CALCulate<Chn>:STATistics[:STATe] ON) before using this command.

<Chn> Channel number used to identify the active trace.

Parameters

- MEAN – Return arithmetic mean value of all response values of the trace in the entire sweep range (or in the evaluation range defined in manual control)
- STDDev – Return standard deviation of all response values
- MAX – Return the maximum of all response values
- MIN – Return the minimum of all response values
- RMS – Return the root mean square of all response values
- PTPeak – Return the peak-to-peak value (MAX – MIN)
- ELENgth – Return the electrical length
- PDELay – Return the phase delay
- ALL – Return all statistical values, observing the order used above

Range [def. unit] The data is returned as a comma-separated list of real numbers. The unit is the default unit of the measured parameter; see CALCulate<Ch>:PARAmeter:SDEFine but also depends on the trace format (linear or logarithmic scale, see CALCulate<Chn>:FORMat). If a polar trace format is selected, then the statistical parameters are calculated from the linear magnitude of the measurement parameter. [-]

*RST value –

SCPI, Command Types Device-specific, query only.

Example:

```
*RST; CALC:STAT:RES? MAX
```

Calculate and return the maximum of the default trace showing an S-parameter on a dB Mag scale.

```
:CALC:FORM POL; STAT:RES? MAX
```

Display the trace in a polar diagram and re-calculate the maximum. The result corresponds to the previous result but is converted to a unitless linear value.

CALCulate<Chn>:STATistics:RMS[:STATe] <Boolean>

Displays or hides the *RMS* results in the diagram area of trace no. <Chn>.

<Chn> Channel number used to identify the active trace.

<Boolean> ON | OFF - Statistical info field on or off.

*RST value OFF

SCPI, Command Types Device-specific, command or query.

Example: See CALCulate<Chn>:STATistics[:STATe]

CALCulate<Chn>:STATistics[:STATe] <Boolean>

Displays or hides all statistical results in the diagram area of trace no. <Chn>.



You can display or hide the *Min/Max/Peak-Peak*, *Mean/Std Dev*, *RMS*, and the *Phase Delay/EI Length* results separately; see example below.

<Chn>	Channel number used to identify the active trace.
<Boolean>	ON OFF - Statistical info field on or off.
*RST value	OFF
SCPI, Command Types	Device-specific, command or query.
Example:	<pre>*RST; CALC:STAT:MMPT ON</pre> <p>Reset the instrument, hiding all statistical results. Display the <i>Min/Max/Peak-Peak</i> results.</p> <pre>CALC:STAT:MSTD ON</pre> <p>Display the <i>Mean/Std Dev</i> results in addition.</p> <pre>CALC:STAT:RMS ON</pre> <p>Display the <i>RMS</i> results in addition.</p> <pre>CALC:STAT:EPD ON</pre> <p>Display the <i>Phase Delay/EI Length</i> results in addition.</p> <pre>CALC:STAT OFF</pre> <p>Hide all results.</p>

CALCulate<Chn>:TRANSform...

This subsystem converts measured data from one representation to another and controls the transformation into the time domain (with option ZVL-K3, *Time Domain*).

CALCulate<Chn>:TRANSform:COMPLex S | Y | Z

Converts S-parameters into matched-circuit (converted) Y-parameters or Z-parameters and vice versa, assuming that port no. i is terminated with Z_{0i} so that the three parameter sets are equivalent and the following formulas apply:

$$Z_{\langle out \rangle \langle in \rangle ii} = Z_0 \frac{1 + S_{\langle out \rangle \langle in \rangle ii}}{1 - S_{\langle out \rangle \langle in \rangle ii}}, \quad \langle out \rangle = \langle in \rangle,$$

$$Z_{\langle out \rangle \langle in \rangle ij} = 2 \cdot \frac{\sqrt{Z_{0i} \cdot Z_{0j}}}{S_{\langle out \rangle \langle in \rangle ij}} - (Z_{0i} + Z_{0j}), \quad i \neq j,$$

$$Y_{ii} = \frac{1}{Z_{0i}} \frac{1 - S_{ii}}{1 + S_{ii}} = 1 / Z_{ii},$$

$$Y_{ij} = \frac{S_{ij}}{2 \cdot \sqrt{Z_{0i} \cdot Z_{0j}} - S_{ij} \cdot (Z_{0i} + Z_{0j})} = 1/Z_{ij}, \quad i \neq j,$$

<Chn> Channel number used to identify the active trace. If unspecified the numeric suffix is set to 1.

S | Y | P S-parameters, Y-parameters, Z-parameters
***RST value** – (The initial representation of the trace is determined by means of CALCulate<Ch>:PARAmeter:SDEFine)

SCPI, Command Types Device-specific, command or query.

Example:

```
*RST; CALC:PAR:MEAS 'Trc1', '"Y-S22'
```

Select the converted admittance Y<-S22 as measurement parameter of the default trace.

```
CALC:TRAN:COMP S
```

Convert the converted Y-parameter into an S-parameter.

CALCulate<Chn>:TRANSform:TIME:CENTER <numeric_value>

Defines the center time of the diagram in time domain.

<Chn> Channel number used to identify the active trace

<numeric_value> Center time of the diagram in time domain
 Range [def. unit] -99.9999999999 s to +99.9999999999 s. The increment (parameters UP or DOWN) is 0.1 ns. [s]

***RST value** 1.5E-009 s

SCPI, Command Types Confirmed, command or query

Example:

```
*RST; CALC:TRAN:TIME:STAT ON
```

Reset the instrument, activating a frequency sweep, and enable the time domain transformation for the default trace.

```
CALC:TRAN:TIME:CENT 0; SPAN 5ns
```

set the center time to 0 ns and the time span to 5 ns.

Note: If the x-axis is scaled in distance units (CALCulate<Chn>:TRANSform:TIME:XAXis DISTance), then the center value is entered in m or foot (ft), depending on the Distance Unit selected in the System Configuration dialog. The range and default value changes accordingly.

CALCulate<Chn>:TRANSform:TIME:DCHebyshev <numeric_value>

Sets the sideband suppression for the Dolph-Chebyshev window. The command is only available if a Dolph-Chebyshev window is active (CALCulate<Chn>:TRANSform:TIME:WINDow DCHebyshev).

<Chn>	Channel number used to identify the active trace
<numeric_value>	Sideband suppression
Range [def. unit]	10 dB to 120 dB. The increment (parameters UP or DOWN) is 10 dB. [dB]
*RST value	32 dB

SCPI, Command Types Device-specific, command or query

Example:

```
*RST; CALC:TRAN:TIME:WIND DCH
```

Reset the instrument and select a Dolph-Chebyshev window for filtering the data in the frequency domain.

```
CALC:TRAN:TIME:DCH 25
```

set the sideband suppression to 25 dB.

CALCulate<Chn>:TRANSform:TIME:LPASs KFSTop | KDFrequency | KSDFrequency

Calculates the harmonic grid for low pass time domain transforms according to one of the three alternative algorithms.

<Chn>	Channel number used to identify the active trace
Parameters	KFSTop – Keep stop frequency and number of points KDFrequency – Keep frequency gap and number of points KSDFrequency – Keep stop frequency and approximate frequency gap
*RST value	–

SCPI, Command Types Device-specific, no query (the command causes an event)

Example:

```
See CALCulate<Chn>:TRANSform:TIME[:TYPE]
```

CALCulate<Chn>:TRANSform:TIME:LPASs:DCSPParam <numeric_value>

Defines the DC value for low pass transforms. The command is enabled only if the sweep points are on a harmonic grid (to be set explicitly or using CALCulate<Chn>:TRANSform:TIME:LPASs).

<Chn>	Channel number used to identify the active trace
<numeric_value>	DC value of the measured quantity
Range [def. unit]	Depending on the measured quantity (–1 to +1 for S-parameters)
*RST value	0

SCPI, Command Types Device-specific, command or query

Example:

```
*RST; CALC:TRAN:TIME:STAT ON
```

Reset the instrument, activating a frequency sweep with S_{21} as measured quantity, and enable the time domain transformation for the default trace.

```
CALC:TRAN:TIME LPAS; TIME:STIM STEP
```

Select a low pass step transformation.

```
CALC:TRAN:TIME:LPAS KFST
```

Calculate a harmonic grid, keeping the stop frequency and the number of points.

```
CALC:TRAN:TIME:LPAS:DCSP 0.2
```

Set the DC value.

```
CALC:TRAN:TIME:LPAS:DCSP:EXTR; CALC:TRAN:TIME:LPAS:DCSP?
```

Extrapolate the measured trace, overwrite the defined DC value, and query the new value.

```
CALC:TRAN:TIME:LPAS:DCSP:CONT ON
```

Switch over to continuous extrapolation (e.g. because you noticed a discrepancy between the manually entered DC value and the extrapolation and assume the extrapolation to be more trustworthy).

CALCulate<Chn>:TRANSform:TIME:LPASs:DCSPParam:CONTInuous <Boolean>

Determines whether continuous extrapolation for the DC value is enabled.

<Chn>	Channel number used to identify the active trace
<Boolean>	ON – Continuous extrapolation enabled OFF – Continuous extrapolation disabled
*RST value	OFF [-]
SCPI, Command Types	Device-specific, command or query

Example: See `CALCulate<Chn>:TRANSform:TIME:LPASs:DCSPParam`

CALCulate<Chn>:TRANSform:TIME:LPASs:DCSPParam:EXTRapolate

Extrapolates the measured trace towards $f = 0$ and overwrites the current DC value (`CALCulate<Chn>:TRANSform:TIME:LPASs:DCSPParam`). The command is relevant for low pass time domain transforms.

<Chn>	Channel number used to identify the active trace
Parameters	None
*RST value	–
SCPI, Command Types	Device-specific, no query (the command causes an event)

Example: See `CALCulate<Chn>:TRANSform:TIME:LPASs:DCSPParam`

CALCulate<Chn>:TRANSform:TIME:LPFRequency

Calculates the harmonic grid for low pass time domain transforms, keeping the stop frequency and the number of points.



Use `CALCulate<Chn>:TRANSform:TIME:LPASs` if you wish to use one of the other algorithms for calculating the grid.

<Chn>	Channel number used to identify the active trace
Parameters	None
*RST value	–
SCPI, Command Types	Device-specific, no query (the command causes an event)
Example:	<code>See CALCulate<Chn>:TRANSform:TIME[:TYPE]</code>

CALCulate<Chn>:TRANSform:TIME:SPAN <numeric_value>

Defines the time span of the diagram in time domain.

<Chn>	Channel number used to identify the active trace
<numeric_value>	Time span of the diagram in time domain.
Range [def. unit]	2E-012 s to 200 s. The increment (parameters UP or DOWN) is 0.1 ns. [s]
*RST value	5E-009 s
SCPI, Command Types	Confirmed, command or query
Example:	<code>See CALCulate<Chn>:TRANSform:TIME:CENTer</code>

Note: If the x-axis is scaled in distance units (`CALCulate<Chn>:TRANSform:TIME:XAXis DISTance`), then the span is entered in m; the range and default value changes accordingly.

CALCulate<Chn>:TRANSform:TIME:START <numeric_value>

Defines the start time of the diagram in time domain.

<Chn>	Channel number used to identify the active trace
<numeric_value>	Start time of the diagram.
Range [def. unit]	–100 s to +99.999999999998 s. The increment (parameters UP or DOWN) is 0.1 ns. [s]
*RST value	–1E-009 s
SCPI, Command Types	Confirmed, command or query
Example:	<code>*RST; CALC:TRAN:TIME:STAT ON</code>

Reset the instrument, activating a frequency sweep, and enable the time domain transformation for the default trace.

```
CALC:TRAN:TIME:STAR 0; STOP 10 ns
```

set the start time to 0 ns and the stop time to 10 ns.

Note: If the start frequency entered is greater than the current stop frequency (`CALCulate<Chn>:TRANSform:TIME:STOP`), the stop frequency is set to the start frequency plus the minimum frequency span (`CALCulate<Chn>:TRANSform:TIME:SPAN`).

If the x-axis is scaled in distance units (CALCulate<Chn>:TRANSform:TIME:XAXis DISTance), then the start value is entered in m; the range and default value changes accordingly.

CALCulate<Chn>:TRANSform:TIME:STATe <Boolean>

Determines whether the time domain transformation for trace no. <Chn> is enabled.

<Chn> Channel number used to identify the active trace

<Boolean> ON – Time domain representation active
OFF – Frequency domain representation active

***RST value** OFF [-]

SCPI, Command Types Confirmed, command or query

Example: *RST; CALC:TRAN:TIME:STAT?

Reset the instrument, activating a frequency sweep, and query whether the default trace is displayed in the time domain. The response is 0.

CALCulate<Chn>:TRANSform:TIME:STIMulus STEP | IMPulse

Selects the type of stimulus to be simulated in the low pass transformation process.

<Chn> Channel number used to identify the active trace

Parameters IMPulse – Impulse response, in bandpass or lowpass mode
STEP – Step response, only in lowpass mode (a bandpass mode setting
CALCulate<Chn>:TRANSform:TIME[:TYPE] BPASs is automatically changed to lowpass)

***RST value** IMP

SCPI, Command Types Confirmed, command or query

Example: See CALCulate<Chn>:TRANSform:TIME[:TYPE]

CALCulate<Chn>:TRANSform:TIME:STOP <numeric_value>

Defines the stop time of the diagram in time domain.

<Chn> Channel number used to identify the active trace

<numeric_value> Stop time of the diagram.

Range [def. unit] –99.99999999998 s to +100 s. The increment (parameters UP or DOWN) is 0.1 ns. [s]

***RST value** +4E-009 s

SCPI, Command Types Confirmed, command or query

Example: See CALCulate<Chn>:TRANSform:TIME:START.

Note: If the stop frequency entered is smaller than the current start frequency (`CALCulate<Chn>:TRANSform:TIME:START`), the start frequency is set to the stop frequency minus the minimum frequency span (`CALCulate<Chn>:TRANSform:TIME:SPAN`).
If the x-axis is scaled in distance units (`CALCulate<Chn>:TRANSform:TIME:XAXisDISTance`), then the stop value is entered in m; the range and default value changes accordingly.

CALCulate<Chn>:TRANSform:TIME[:TYPE] BPASs | LPASs

Selects the time domain transformation type.

<Chn>	Channel number used to identify the active trace
Parameters	BPASs – Band pass impulse (only impulse response; a step response <code>CALCulate<Chn>:TRANSform:TIME:STIMulus STEP</code> is automatically changed to impulse response) LPASs – Low pass (impulse or step response, depending on <code>CALCulate<Chn>:TRANSform:TIME:STIMulus</code> setting)
*RST value	BPASs

SCPI, Command Types
Confirmed, command or query

Example:

```
*RST; CALC:TRAN:TIME:STAT ON
```

Reset the instrument, activating a frequency sweep, and enable the time domain transformation for the default trace.

```
CALC:TRAN:TIME LPAS; TIME:STIM STEP
```

Select a low pass step transformation.

```
CALC:TRAN:TIME:LPAS KFST
```

Calculate a harmonic grid, keeping the stop frequency and the number of points.

CALCulate<Chn>:TRANSform:TIME:WINDow RECT | HAMMing | HANN | BOHMan | DCHebyshev

Selects the window type for filtering the data in the frequency domain prior to the time domain transformation.

<Chn>	Channel number used to identify the active trace
Parameters	RECT – No profiling (rectangle) HANN – Normal profile (Hann) HAMMing – Low first sidelobe (Hamming) BOHMan – Steep falloff (Bohman) DCHebyshev – Arbitrary sidelobes (Dolph-Chebyshev)
*RST value	HANN
SCPI, Command Types	Confirmed (with some device-specific parameters), command or query
Example:	See <code>CALCulate<Chn>:TRANSform:TIME:DCHebychev</code>

CALCulate<Chn>:TRANSform:TIME:XAXis TIME | DISTance

Switches over between the x-axis scaling in time units or distance units.

<Chn>	Channel number used to identify the active trace
TIME	x-axis scaled in time units
DISTance	x-axis scaled in distance units ($Distance = Time * c_0 * Velocity\ Factor$)
*RST value	OFF [-]

SCPI, Command Types Device-specific, command or query

Example:

```
*RST; CALC:TRAN:TIME:STAT ON
```

Reset the instrument, activating a frequency sweep, and enable the time domain transformation for the default trace.

```
CALC:TRAN:TIME:XAX DIST
```

Convert the x-axis scaling to distance units.

CALCulate<Chn>:TRANSform:DTFault...

This subsystem controls the distance-to-fault measurement (with option ZVL-K2, *Distance-to-Fault*).

CALCulate<Chn>:TRANSform:DTFault:CENTER <distance>

Defines the center distance of the distance-to-fault diagram.

<Chn>	Channel number used to identify the active trace
<distance>	Center distance
Range [def. unit]	–4.999 m to +9.999 m. The increment (parameters UP or DOWN) is 1 mm. [m or foot (ft), depending on the <i>Distance Unit</i> selected in the <i>System Configuration</i> dialog]
*RST value	5 m

SCPI, Command Types Device-specific, command or query

Example:

```
CALC:TRAN:DTF:CENT 3; SPAN 5
```

Define a distance range between –0.5 m and +5.5 m.

```
CALC:TRAN:DTF:STAR?; STOP?
```

Query the distance range. The response is 0.5;5.5.

CALCulate<Ch>:TRANSform:DTFault:DEFine '<cable name>', <permittivity>, <attenuation>, <frequency>

Adds a new, user-defined cable.

<Ch>	Channel number. Note that the cable type is channel-specific (rather than trace-specific).
'<cable name>'	Cable name to identify the cable, string parameter
<permittivity>	Permittivity of the cable
Range [def. unit]	1 to 100 [-]
*RST value	–
<attenuation>	Attenuation per length unit
Range [def. unit]	0 dB/m to 1000 dB/m [dB/m or dB/ft, depending on the <i>Distance Unit</i> selected in the <i>System Configuration</i> dialog]
*RST value	–
<frequency>	Frequency reference for the attenuation value
Range [def. unit]	0 Hz to 6 GHz
*RST value	–

SCPI, Command Types Device-specific, command or query

Example:

```
CALC:TRAN:DTF:DEF 'User 1', 1.1, 0.2, 1GHz
```

Add a new cable named *User 1* with permittivity 1.1 and an attenuation of 0.2 dB/m at 1 GHz.

```
CALC:TRAN:DTF:SEL 'User 1'
```

Select the added cable for the distance-to-fault measurement.

```
CALC:TRAN:DTF:DEL 'User 1'
```

Delete the added cable.

CALCulate<Ch>:TRANSform:DTFault:DELeTe '<cable name>'

Deletes a previously defined cable identified by its name.

<Ch>	Channel number. Note that the cable type is channel-specific (rather than trace-specific).
'<cable name>'	Cable name used to identify the cable
*RST value	–

SCPI, Command Types Device-specific, command or query

Example:

```
See CALCulate<Chn>:TRANSform:DTFault:DEFine
```

CALCulate<Chn>:TRANSform:DTFault:PEAK:COUNT?

Returns the number of peaks on the active distance trace which are above the fault limit (CALCulate<Chn>:TRANSform:DTFault:PEAK:THReshold).

<Chn>	Channel number used to identify the active trace
Response	Number of peaks, integer value
*RST value	N/a
SCPI, Command Types	Device-specific, query only

Example: See `CALCulate<Chn>:TRANSform:DTFault:PEAK:THReshold`

CALCulate<Chn>:TRANSform:DTFault:PEAK:DATA<nr>?

Returns the distance and peak response values of the detected fault no. <nr>. If the number of detected faults (`CALCulate<Chn>:TRANSform:DTFault:PEAK:COUNT?`) is smaller than <nr>, an error message is returned.

<Chn>	Channel number used to identify the active trace
<nr>	Current number of the fault. Faults are numbered according to their distance (fault no. 1 has the smallest distance)
Response	Distance and peak response value of the fault, separated by a comma; see example.
*RST value	N/a
SCPI, Command Types	Device-specific, query only

Example: See `CALCulate<Chn>:TRANSform:DTFault:PEAK:THReshold`

CALCulate<Chn>:TRANSform:DTFault:PEAK:STATE <Boolean>

Enables or disables the fault limit check.

<Chn>	Channel number used to identify the active trace.
<Boolean>	ON OFF - Limit check on or off.
*RST value	OFF
SCPI, Command Types	Device-specific, command or query.

Example: See `CALCulate<Chn>:TRANSform:DTFault:PEAK:THReshold`

CALCulate<Chn>:TRANSform:DTFault:PEAK:THReshold

Starts the automatic calculation of the number of points.

<Chn>	Channel number used to identify the active trace
Parameters	N/a
*RST value	–
SCPI, Command Types	Device-specific, query only

Example: `*RST; :CALC:TRAN:DTF:STAT ON`

Enable distance-to-fault measurement with default settings.

`CALC:TRAN:DTF:PEAK:THR -20`

Specify a fault limit of –20 dB relative for the absolute maximum of the active trace in channel 1.

```
CALC:TRAN:DTF:PEAK:STAT ON
```

Enable the fault limit check for the active trace.

```
CALC:TRAN:DTF:PEAK:COUN?
```

Query the number of detected faults. The network analyzer responds with an integer number, e.g. 2.

```
CALC:TRAN:DTF:PEAK:DATA2?
```

Query the distance and peak response values of the second detected fault. Possible response: *0.09615384615,-18.07471664* (for a distance of 0.09615384615 units of length and a peak response value of -18.07471664 dB).

CALCulate<Chn>:TRANSform:DTFault:POINTs

Starts the automatic calculation of the number of points.

<Chn>	Channel number used to identify the active trace
Parameters	N/a
*RST value	–
SCPI, Command Types	Device-specific, no query
Example:	See CALCulate<Chn>:TRANSform:DTFault:STATe

CALCulate<Ch>:TRANSform:DTFault:SELEct '<cable name>'

Selects a standard cable or a previously defined cable identified by its name.

<Ch>	Channel number. Note that the cable type is channel-specific (rather than trace-specific).
'<cable name>'	Cable name used to identify the cable
*RST value	–
SCPI, Command Types	Device-specific, command or query
Example:	See CALCulate<Chn>:TRANSform:DTFault:DEFine

CALCulate<Chn>:TRANSform:DTFault:SPAN <numeric_value>

Defines the span of the distance-to-fault diagram.

<Chn>	Channel number used to identify the active trace
<numeric_value>	Distance span
Range [def. unit]	1 mm to +15 m. The increment (parameters UP or DOWN) is 1 mm. [m or foot (ft), depending on the <i>Distance Unit</i> selected in the <i>System Configuration</i> dialog]
*RST value	10 m
SCPI, Command	Device-specific, command or query

Types

Example: See `CALCulate<Chn>:TRANSform:DTFault:CENTer`

CALCulate<Chn>:TRANSform:DTFault:START <numeric_value>

Defines the start distance of the distance-to-fault diagram.

<Chn>	Channel number used to identify the active trace
<numeric_value>	Start distance
Range [def. unit]	–5 m to +9.999 m. The increment (parameters UP or DOWN) is 1 mm. [m or foot (ft), depending on the <i>Distance Unit</i> selected in the <i>System Configuration</i> dialog]
*RST value	0 m
SCPI, Command Types	Device-specific, command or query
Example:	See <code>CALCulate<Chn>:TRANSform:DTFault:CENTer</code>

Note: If the start frequency entered is greater than the current stop frequency (`CALCulate<Chn>:TRANSform:DTFault:STOP`), the stop frequency is set to the start frequency plus the minimum frequency span (`CALCulate<Chn>:TRANSform:DTFault:SPAN`).

CALCulate<Chn>:TRANSform:DTFault:STATE <Boolean>

Enables or disables the distance-to-fault measurement. In contrast to manual control, the number of points is not automatically re-adjusted (`CALCulate<Chn>:TRANSform:DTFault:POINTs`).

<Chn>	Channel number used to identify the active trace
<Boolean>	ON – Distance-to-fault measurement active OFF – Distance-to-fault measurement active
*RST value	OFF [–]
SCPI, Command Types	Device-specific, command or query
Example:	<code>*RST; :CALC:TRAN:DTF:STAT ON; :SWE:POIN?</code>

Enable distance-to-fault measurement with default settings. The number of sweep points is equal to the default value 201.

```
CALC:TRAN:DTF:POIN; :SWE:POIN?
```

Adjust the number of sweep points to the default channel settings. For an R&S ZVL network analyzer, the result is 519.

```
CALC:TRAN:DTF:STAR -1; STOP 5
```

Select a distance range between -1 m and +5 m.

```
CALC:TRAN:DTF:SEL 'RG214'
```

Select a RF214 cable type for the distance-to-fault measurement.

```
FREQ:SPAN 2GHz; :CALC:TRAN:DTF:POIN; :SWE:POIN?
```

Reduce the frequency span, re-calculate the number of points. The query returns 201.

```

CORR:COLL:METH:DEF 'DTF Cal', FOPort, 2
CORR:COLL:ACQ:SEL OPEN, 2
CORR:COLL:ACQ:SEL SHOR, 2
CORR:COLL:ACQ:SEL MATC, 2
CORR:COLL:SAVE:SEL

```

Perform a full one-port calibration for the distance-to-fault measurement.

CALCulate<Chn>:TRANSform:DTFault:STOP <numeric_value>

Defines the stop distance of the distance-to-fault diagram.

<Chn>	Channel number used to identify the active trace
<numeric_value>	Stop distance
Range [def. unit]	–4.999 m to +10 m. The increment (parameters UP or DOWN) is 1 mm. [m or foot (ft), depending on the <i>Distance Unit</i> selected in the <i>System Configuration</i> dialog]
*RST value	+10 m
SCPI, Command Types	Device-specific, command or query
Example:	See CALCulate<Chn>:TRANSform:DTFault:CENTer

Note: If the stop frequency entered is smaller than the current start frequency (*CALCulate<Chn>:TRANSform:DTFault:START*), the start frequency is set to the stop frequency minus the minimum distance span of 1 mm (*CALCulate<Chn>:TRANSform:DTFault:SPAN*).

CALCulate<Ch>:TRANSform:VNETworks...

This subsystem defines the circuit models for single ended and balanced port (de-)embedding and activates the (de-)embedding function.

The circuit models are referenced by means of predefined character data parameters.

Circuit models for embedding/deembedding:

Parameter	Circuit model	Capacitances	Resistances	Inductances
FIMPort	File import, no circuit model	–	–	–
CSL	Serial C, shunt L	C1	R1, R2	L1
LSC	Serial L, shunt C	C1	R1, R2	L1
CSC	Serial C, shunt C	C1, C2	R1, R2	–

LSL	Serial L, shunt L	–	R1, R2	L1, L2
SLC	Shunt L, serial C	C1	R1, R2	L1
SCL	Shunt C, serial L	C1	R1, R2	L1
SCC	Shunt C, serial C	C1, C2	R1, R2	–
SLL	Shunt L, serial L	–	R1, R2	L1, L2

CALCulate<Ch>:TRANSform:VNETworks:SENDEd:DEEMbedding<Ph_pt>:PARame ters:C<no> CSL | LSC | CSC | SLC | SCL | SCC,<numeric_value>

Specifies the capacitance values C1, C2 in the different circuit models for deembedding.

<Ch>	Channel number
<Ph_pt>	Physical port number
<no>	Number of capacitance in circuit model. If unspecified the numeric suffix is set to 1.
Range [def. unit]	1 to 2 [–] The number of capacitances depends on the selected circuit model.
Parameters	Possible circuit models (character data); see circuit models.
*RST value	– (see command type description below)
<numeric_value>	Capitance C<no> for the specified circuit model.
Range [def. unit]	–1mF to 1 mF [F]. The increment is 1 fF (10^{-15} F).
*RST value	1 pF (10^{-12} F)
SCPI, Command Types	Device-specific, command or query. In the query form, the <numeric_value> parameter must be omitted. The command returns the capacitance value for the specified circuit model.

Example:

```
*RST; CALC:TRAN:VNET:SEND:DEEM:PAR:C2? CSC
```

Query the default capacitance C2 for the *Serial C*, *shunt C* circuit model. The response is 1E-012 (1 pF).

```
CALC:TRAN:VNET:SEND:DEEM:PAR:C2 CSC, 2.2E-12
```

Increase the capacitance to 2.2 pF.

CALCulate<Ch>:TRANSform:VNETworks:SENDEd:DEEMbedding<Ph_pt>:PARame ters:L<no> CSL | LSC | LSL | SLC | SCL | SLL,<numeric_value>

Specifies the inductance values L1, L2, L3 in the different circuit models for deembedding.

<Ch>	Channel number.
<Ph_pt>	Physical port number
<no>	Number of inductance in circuit model. If unspecified the numeric suffix is set to 1.

Instrument-Control Commands

Range [def. unit]	1 to 3 [–] The number of inductances depends on the selected circuit model.
Parameters	Possible circuit models (character data); see circuit models.
*RST value	– (see command type description below)
<numeric_value>	Inductance L<no> for the specified circuit model.
Range [def. unit]	–1H to 1 H [H]. The increment is 1 pH (10^{-12} H).
*RST value	1 nH (10^{-9} H)
SCPI, Command Types	Device-specific, command or query. In the query form, the <numeric_value> parameter must be omitted. The command returns the inductance value for the specified circuit model.

Example:

```
*RST; CALC:TRAN:VNET:SEND:DEEM:PAR:L1? SLL
```

Query the default inductance L1 for the *Shunt L*, *serial L* circuit model. The response is 1E-009 (1 nH).

```
CALC:TRAN:VNET:SEND:DEEM:PAR:L1 SLL, 2.2E-9
```

Increase the inductance to 2.2 nH.

CALCulate<Ch>:TRANSform:VNETworks:SENDEd:DEEMbedding<Ph_pt>:PARameters:R<no> CSL | LSC | CSC | LSL | SLC | SCL | SCC | SLL,<numeric_value>

Specifies the resistance values R1, R2, R3 in the different circuit models for deembedding.

<Ch>	Channel number.
<Ph_pt>	Physical port number
<no>	Number of resistance in circuit model. If unspecified the numeric suffix is set to 1.
Range [def. unit]	1 to 3 [–] The number of resistances depends on the selected circuit model.
Parameters	Possible circuit models (character data); see circuit models.
*RST value	– (see command type description below)
<numeric_value>	Resistance R<no> for the specified circuit model.
Range [def. unit]	–10 MΩ to 10 MΩ [Ω]. The increment is 1 mΩ (10^{-3} Ω).
*RST value	0 Ω for all resistances connected in series with an inductance 10 MΩ for all resistances connected in parallel with a capacitance
SCPI, Command Types	Device-specific, command or query. In the query form, the <numeric_value> parameter must be omitted. The command returns the resistance value for the specified circuit model.

Example:

```
*RST; CALC:TRAN:VNET:SEND:DEEM:PAR:R1? CSL; R2? CSL
```

Query the default resistances for the *Serial C*, *shunt L* circuit model. The response is 10000000; 0.

```
CALC:TRAN:VNET:SEND:DEEM:PAR:R2 CSL, 2.2E+3
```

Increase the resistance R2 to 2.2 kΩ.

CALCulate<Ch>:TRANSform:VNETworks:SENDEd:DEEMbedding<Ph_pt>[:STATe]

<Boolean>

Enables or disables the deembedding function. It is allowed to change the circuit model and its parameters while deembedding is enabled.

<Ch>	Channel number.
<Ph_pt>	Physical port number
<Boolean>	ON – Deembedding active OFF – Deembedding inactive
*RST value	OFF [-]
SCPI, Command Types	Device-specific, command or query

Example:

```
CALC:TRAN:VNET:SEND:DEEM:TND CSL
```

Select the *Serial C, shunt L* circuit model for deembedding.

```
CALC:TRAN:VNET:SEND:DEEM:PAR:R2 CSL, 2.2E+3; CALC:TRAN:VNET:SEND:DEEM ON
```

Increase the resistance R2 for the *Serial C, shunt L* circuit model to 2.2 kΩ and enable deembedding.

CALCulate<Ch>:TRANSform:VNETworks:SENDED:DEEMbedding<Ph_pt>:TNDefini tion FIMPort | CSL | LSC | CSC | LSL | SLC | SCL | SCC | SLL

Selects the circuit model for deembedding.

<Ch>	Channel number.
<Ph_pt>	Physical port number
Parameters	Possible circuit models (character data); see circuit models.
*RST value	CSL
SCPI, Command Types	Device-specific, command or query.

Example:

```
See CALCulate<Ch>:TRANSform:VNETworks:SENDED:DEEMbedding[:STATe]
```

CALCulate<Ch>:TRANSform:VNETworks:SENDED:EMBedding<Ph_pt>:PARAmeter s:C<no> CSL | LSC | CSC | SLC | SCL | SCC,<numeric_value>

Specifies the capacitance values C1, C2 in the different circuit models.

<Ch>	Channel number.
<Ph_pt>	Physical port number
<no>	Number of capacitance in circuit model. If unspecified the numeric suffix is set to 1.
Range [def. unit]	1 to 2 [-] The number of capacitances depends on the selected circuit model.
Parameters	Possible circuit models (character data); see circuit models.
*RST value	– (see command type description below)

Instrument-Control Commands

<numeric_value>	Capacitance C<no> for the specified circuit model.
Range [def. unit]	–1mF to 1 mF [F]. The increment is 1 fF (10^{-15} F).
*RST value	1 pF (10^{-12} F)
SCPI, Command Types	Device-specific, command or query. In the query form, the <numeric_value> parameter must be omitted. The command returns the capacitance value for the specified circuit model.

Example:

```
*RST; CALC:TRAN:VNET:SEND:EMB:PAR:C2? CSC
```

Query the default capacitance C2 for the *Serial C*, *shunt C* circuit model. The response is 1E-012 (1 pF).

```
CALC:TRAN:VNET:SEND:EMB:PAR:C2 CSC, 2.2E-12
```

Increase the capacitance to 2.2 pF.

CALCulate<Ch>:TRANSform:VNETworks:SENDEd:EMBedding<Ph_pt>:PARAmeter s:L<no> CSL | LSC | LSL | SLC | SCL | SLL,<numeric_value>

Specifies the inductance values L1, L2, L3 in the different circuit models.

<Ch>	Channel number.
<Ph_pt>	Physical port number
<no>	Number of inductance in circuit model. If unspecified the numeric suffix is set to 1.
Range [def. unit]	1 to 3 [–] The number of inductances depends on the selected circuit model.
Parameters	Possible circuit models (character data); see circuit models.
*RST value	– (see command type description below)
<numeric_value>	Inductance L<no> for the specified circuit model.
Range [def. unit]	–1H to 1 H [H]. The increment is 1 pH (10^{-12} H).
*RST value	1 nH (10^{-9} H)
SCPI, Command Types	Device-specific, command or query. In the query form, the <numeric_value> parameter must be omitted. The command returns the inductance value for the specified circuit model.

Example:

```
*RST; CALC:TRAN:VNET:SEND:EMB:PAR:L1? SLL
```

Query the default inductance L1 for the *Shunt L*, *serial L* circuit model. The response is 1E-009 (1 nH).

```
CALC:TRAN:VNET:SEND:EMB:PAR:L1 SLL, 2.2E-9
```

Increase the inductance to 2.2 nH.

CALCulate<Ch>:TRANSform:VNETworks:SENDEd:EMBedding<Ph_pt>:PARAmeter s:R<no> CSL | LSC | CSC | LSL | SLC | SCL | SCC | SLL,<numeric_value>

Specifies the resistance values R1, R2, R3 in the different circuit models.

<Ch>	Channel number.
-------------------	-----------------

Instrument-Control Commands

<Ph_pt>	Physical port number
<no>	Number of resistance in circuit model. If unspecified the numeric suffix is set to 1.
Range [def. unit]	1 to 3 [-] The number of resistances depends on the selected circuit model.
Parameters	Possible circuit models (character data); see circuit models.
*RST value	– (see command type description below)
<numeric_value>	Resistance R<no> for the specified circuit model.
Range [def. unit]	–10 MΩ to 10 MΩ [Ω]. The increment is 1 mΩ (10 ⁻³ Ω).
*RST value	0 Ω for all resistances connected in series with an inductance 10 MΩ for all resistances connected in parallel with a capacitance
SCPI, Command Types	Device-specific, command or query. In the query form, the <numeric_value> parameter must be omitted. The command returns the resistance value for the specified circuit model.

Example:

```
*RST; CALC:TRAN:VNET:SEND:EMB:PAR:R1? CSL; R2? CSL
```

Query the default resistances for the *Serial C*, *shunt L* circuit model. The response is 10000000; 0.

```
CALC:TRAN:VNET:SEND:EMB:PAR:R2 CSL, 2.2E+3
```

Increase the resistance R2 to 2.2 kΩ.

CALCulate<Ch>:TRANSform:VNETworks:SENDEd:EMBedding<Ph_pt>[:STATE] <Boolean>

Enables or disables the embedding function. It is allowed to change the circuit model and its parameters while embedding is enabled.

<Ch>	Channel number.
<Ph_pt>	Physical port number
<Boolean>	ON – Embedding active OFF – Embedding inactive
*RST value	OFF [-]
SCPI, Command Types	Device-specific, command or query

Example:

```
CALC:TRAN:VNET:SEND:EMB:TND CSL
```

Select the *Serial C*, *shunt L* circuit model for embedding.

```
CALC:TRAN:VNET:SEND:EMB:PAR:R2 CSL, 2.2E+3; CALC:TRAN:VNET:SEND:EMB ON
```

Increase the resistance R2 for the *Serial C*, *shunt L* circuit model to 2.2 kΩ and enable embedding.

CALCulate<Ch>:TRANSform:VNETworks:SENDEd:EMBedding<Ph_pt>:TNDefinitio n FIMPort | CSL | LSC | CSC | LSL | SLC | SCL | SCC | SLL

Selects the circuit model for sembedding.

<Ch>	Channel number.
<Ph_pt>	Physical port number
Parameters	Possible circuit models (character data); see circuit models.
*RST value	CSL
SCPI, Command Types	Device-specific, command or query.
Example:	See <code>CALCulate<Ch>:TRANSform:VNETworks:SENDED:EMBedding[:STATe]</code>

CONFigure...

This subsystem creates and deletes channels and assigns names to channels. The commands are device-specific.

CONFigure:CHANnel<Ch>:CATalog?

Returns the numbers and names of all channels in the current setup.

<Ch>	Channel number. This parameter is ignored because the command returns all channels.
Response	String with comma-separated list of channel numbers and names, see example below. If all channels have been deleted the response is an empty string ("").
*RST value	–
SCPI, Command Types	Device-specific, query only.
Example:	<pre>*RST; CONF:CHAN2:STAT ON; NAME 'New Channel'</pre>

Create channel 2 and assign the channel name "New Channel".

```
CONF:CHAN:CAT?
```

Query all channels and their names. As a default channel no. 1 is created on *RST, the response is '1, Ch1, 2, New_Channel'.

```
CONF:CHAN:NAME:ID? 'New Channel'
```

Query the channel number for the channel named "New Channel". The response is 2.

CONFigure:CHANnel<Ch>:NAME '<Ch_name>'

Assigns a name to channel number <Ch>. The channel must be created before (CONFigure:CHANnel<Ch>[:STATe] ON). Moreover it is not possible to assign the same name to two different channels. CONFigure:CHANnel<Ch>:CATalog? returns a list of all defined channels with their names.

<Ch>	Number of an existing channel.
-------------------	--------------------------------

'<Ch_name>'	Channel name, e.g. 'Channel 4'.
*RST value	'Ch1'
SCPI, Command Types	Device-specific, command or query.
Example:	See <code>CONFigure:CHANnel<Ch>:CATalog?</code>

CONFigure:CHANnel<Ch>:NAME:ID? '<Ch_name>'

Queries the channel number (numeric suffix) of a channel with known channel name. A channel name must be assigned before (`CONFigure:CHANnel<Ch>NAME '<Ch_name>'`).

`CONFigure:CHANnel<Ch>:CATalog?` returns a list of all defined channels with their names.

<Ch>	Channel number. This suffix is not relevant and may be omitted (the command returns the right channel number).
'<Ch_name>'	Channel name, e.g. 'Channel 4'.
*RST value	–
SCPI, Command Types	Device-specific, command or query.
Example:	See <code>CONFigure:CHANnel<Ch>:CATalog?</code>

CONFigure:CHANnel<Ch>[:STATe] <Boolean>

Creates or deletes channel no. <Ch> and selects it as the active channel.

`CONFigure:CHANnel<Ch>:NAME` defines the channel name.



A channel created with `CONFigure:CHANnel<Ch>[:STATe] ON` can be configured but has no trace assigned so that no measurement can be initiated. Use `CALCulate<Ch>:PARAMeter:SDEFine "<Trace_name>," "<Parameter>"` to create a new channel and a new trace.

In remote control it is possible to remove all channels. This is in contrast to manual control where at least one channel with one diagram area and one trace must be available.

<Ch>	Number of the channel to be created or deleted.
<Boolean>	ON - Create channel no. <Ch>. If the channel no. <Ch> exists already, it is not modified but selected as the active channel OFF - Delete channel no. <Ch>.
*RST value	ON for channel no. 1 (created on *RST), OFF for all other channels.
SCPI, Command Types	Device-specific, command or query.
Example:	See <code>CONFigure:CHANnel<Ch>:CATalog?</code>

<Ch>	Number of the channel to be created or deleted.
<Boolean>	ON - Create channel no. <Ch>. If the channel no. <Ch> exists already, it is not modified but selected as the active channel

*RST value OFF - Delete channel no. <Ch>
ON for channel no. 1 (created on *RST), OFF for all other channels.

SCPI, Command Types Device-specific, command or query.

Example: See CONFigure:CHANnel<Ch>:CATalog?

CONFigure:TRACe<Trc>:CATalog?

Returns the numbers and names of all traces in the current setup.

<Trc> Trace number. This suffix is ignored; the command returns a list of all traces.

Response String with comma-separated list of trace numbers and names, see example below. If all traces have been deleted the response is an empty string ("").

*RST value –

SCPI, Command Types Device-specific, query only.

Example: *RST; CALC2:PAR:SDEF 'Ch2Trc2', 'S11'

Create channel 2 and a new trace named *Ch2Trc2*.

CONF:TRAC:CAT?

Query all traces and their names. As a default trace no. 1 is created upon *RST, the response is '1, TRC1, 2, Ch2Trc2'.

CONF:TRAC:NAME:ID? 'Ch2Trc2'

Query the trace number for the trace named "Ch2Trc2". The response is 2.

CONF:TRAC2:NAME?

Query the trace name for trace no. 2. The response is 'Ch2Trc2'.

CONF:TRAC:CHAN:NAME? 'Ch2Trc2'

Query the channel name for trace *Ch2Trc2*. The response is 'Ch2'.

CONF:TRAC:CHAN:ID? 'Ch2Trc2'

Query the channel number for trace *Ch2Trc2*. The response is 2.

DIAGnostic:SERVICE...

This subsystem provides access to service and diagnostic routines used in service, maintenance and repair. In accordance with the SCPI standard all commands are device-specific.

Service functions are password-protected (SYSTEM:PASSword[:CENable]) and should be used by a R&S service representative only. Refer to the service manual for more information.

DIAGnostic:SERVice:SFUNction '<string>',...

Activates a service function (for internal use only).

DISPlay...

This subsystem controls the selection and presentation of graphical and trace information on the screen.

Note: *Traces are generally identified by a string parameter defining the trace name (e.g. CALCulate<Ch>:PARAmeter:SElect <Trace_Name>). In the DISPlay... subsystem, traces are assigned to diagram areas (DISPlay:WINDow<Wnd>:TRACe<WndTr>:FEED <Trace_Name>). While this assignment is valid, the trace is identified by the numeric suffix <WndTr> and the trace name is not needed.*

DISPlay:CMAP<Element>:MARKer[:STATe] <Boolean>

Displays all markers with the same color or display each marker with the color of the associated trace. The colors of all display elements are defined via DISPlay:CMAP<Element>:RGB <red>, <green>, <blue>,

<Element>	Numeric suffix, not used in this command. Implemented for compatibility with DISPlay:CMAP<Element>:RGB.
<Boolean>	ON – All markers have the same color, to be defined via DISPlay:CMAP6:RGB <red>, <green>, <blue>. The marker color is independent of the trace colors. OFF - Each marker has the color of the associated trace.
*RST value	*RST does not affect the color settings; see also description of the Preset command.
SCPI, Command Types	Device-specific, command or query
Example:	See DISPlay:CMAP<Element>:RGB.

DISPlay:CMAP<Element>:RGB <red>, <green>, <blue> [,<trace_style>, <trace_width>]

Defines the color of all display elements based on the Red/Green/Blue color model.

<Element>	Number of the display element. The display elements corresponding to the numbers 1 to 28 are listed below.
<red> <green> <blue>	Red, green, and blue content of the defined color.
Range [def. unit]	0 (zero intensity, corresponding to a 0 in the 24-bit color model) to 1 (full intensity, corresponding to 255 in the 24-bit color model) [-]
<trace_style>	Optional trace style, only for traces (<Element> > 12): One of the string

<trace_width>
 Range [def. unit]
 *RST values

parameters SOLid | DASHed | DOTTed | DDOTted | DDDotted.
 Optional trace width, only for traces (<Element> > 12).
 1 to 20 [-]
 *RST does not affect the color settings; see also description of the Preset command.

SCPI, Command Types

Confirmed (with device-specific numeric suffix and parameters), command or query. The query returns three values between 0 and one, separated by commas, corresponding to the red, green, and blue color content.

Example:

```
*RST; DISP:CMAP:MARK ON; CALC:MARK ON
```

Create diagram area no. 1 (with default trace showing the S-parameter S_{21}) and a marker *Mkr 1*.

```
CALC:PAR:SDEF 'TRC2', 'S11'; DISP:WIND:TRAC2:FEED 'TRC2'
```

Create a new trace named *TRC2* and display the trace in diagram area no. 1. Note that the new trace automatically becomes the active trace.

```
CALC:MARK2 ON
```

Assign a marker *Mkr 2* to the trace. Both markers are displayed with the same color.

```
DISP:CMAP13:RGB 1,0,0; DISP:CMAP14:RGB 0,1,0
```

Color the first trace red, the second trace green.

```
DISP:CMAP6:RGB?
```

Query the marker color. The marker color depends on the settings made in previous sessions; it is not reset. A possible response is *0,0,0* for black markers.

```
DISP:CMAP:MARK OFF
```

Change the marker colors: *Mkr 1* turns red, *Mkr 2* turns green.

The numeric suffixes <Element> denote the following display elements:

<Element>	Display Element
1	Background
2	Text
3	Selected Text
4	Grid
5	Reference Line
6	Same Color for all Markers
7	Horizontal Line / Vertical Range Lines
8	Diagram Title

9	Limit Fail Trace Color
10	Limit Line Type Off
11	Limit Line Type Upper
12	Limit Line Type Lower
13	Trace 1
14	Trace 2
15	Trace 3
16	Trace 4
17	Trace 5
18	Trace 6
19	Trace 7
20	Trace 8
21	Trace 9
22	Trace 10
23	Trace 11
24	Trace 12
25	Trace 13
26	Trace 14
27	Trace 15
28	Trace 16

DISPlay:CMAP<Element>:TRACe:COLor[:STATe] <Boolean>

Defines the trace color schemes in different diagram areas.

Instrument-Control Commands

<Element>	Numeric suffix, not used in this command. Implemented for compatibility with DISPLAY:CMAP<Element>:RGB.
<Boolean>	OFF – Independent color scheme in new diagram area. Moved traces change their color. ON – Color scheme in new diagram area continues the previous color scheme. Moved traces keep their color.
*RST value	*RST does not affect the color settings; see also description of the Preset command.
SCPI, Command Types	Device-specific, command or query
Example:	<pre>*RST; DISP:CMAP13:RGB 1,0,0</pre> <p>Create diagram area no. 1 (with default trace showing the S-parameter S_{21}) and color the trace red.</p> <pre>DISP:CMAP:TRAC:COL OFF; DISP:WIND2:STAT ON</pre> <p>Select independent color schemes for new diagram areas. Create a new diagram area no. 2.</p> <pre>CALC:PAR:SDEF 'TRC2', 'S11'; DISP:WIND2:TRAC2:FEED 'TRC2'</pre> <p>Create a new trace named <i>TRC2</i> and display the trace in a new diagram area no. 2. The new trace is red like the first trace.</p> <pre>DISP:CMAP:TRAC:COL ON; DISP:WIND3:STAT ON</pre> <p>Continue the same color scheme in new diagram areas. Create a new diagram area no. 3.</p> <pre>CALC:PAR:SDEF 'TRC3', 'S22'; DISP:WIND3:TRAC3:FEED 'TRC3'</pre> <p>Create a new trace named <i>TRC3</i> and display the trace in a new diagram area no. 3. The new trace is not red.</p>

DISPlay:MENU:KEY:EXECute '<menu_key>'

Executes the function of a key with a specified name and switches to the local screen.



You can use this command to execute part of your measurement task manually; see *Combining Manual and Remote Control*. Menu keys that initiate events are executed immediately, because no additional input is necessary. However, DISPLAY:MENU:KEY:EXECute can be used as well for manual entries in numeric entry bars, dialogs or wizards.

'<menu_key>'	Name of the key as shown in the analyzer's softkey bar (case-sensitive string variable, may contain blanks but no dots). If the name is not unique, the complete menu path can be specified, e.g. 'Trace:Format:Phase'. Menus, submenus and menu function must be separated by colons.
*RST value	–
SCPI, Command Types	Device-specific, no query
Example:	<pre>*RST; DISP:MENU:KEY:EXEC 'S11'; EXEC 'Trace:Format:Phase'</pre>

Assign the S-parameter S_{11} to the default trace, open the local analyzer screen, then display the phase of the measured quantity. The commands are executed immediately without any manual entry.

```
DISP:MENU:KEY:EXEC 'Start'
```

Open the numeric input bar for the start frequency of the sweep. The frequency can be entered manually.

```
DISP:MENU:KEY:EXEC 'About Nwa'
```

Display information about your network analyzer and the firmware version. The info box is closed when you click the analyzer screen or if you send another command.

DISPlay:MENU:KEY:SElect '<menu_key>'

Activates the menu or submenu of the specified key.

'<menu_key>' Name of the key as shown in the analyzer's softkey bar (case-sensitive string variable).

*RST value –

SCPI, Command Types Device-specific, no query

Example: *RST; DISP:MENU:KEY:SEL 'S11'

Open the *Trace – Meas* menu in order to select a measured quantity.

DISPlay:PSAVe:HOLDoff <holdoff time>

Sets the holdoff time for the powersave mode of the display.

<holdoff time> Holdoff time for the powersave mode.

Range [def. unit] 1 to 60 minutes, the resolution is 1 minute. The entry is dimensionless.

*RST value 15

SCPI, Command Types Device-specific, command or query

Example: *RST; DISP:PSAV:HOLD 30

Sets the holdoff time to 30 minutes.

DISPlay:PSAVe[:STATe] <Boolean>

This command switches on or off the powersave mode of the display. With the powersave mode activated the display including backlight is completely switched off after the elapse of the response time (see DISPlay:PSAVe:HOLDoff command).



This mode is recommended for preserving the display especially if the instrument is exclusively operated via remote control.

<Boolean> ON | OFF - Switching the power-save mode on or off.

*RST value OFF

SCPI, Command Types Device-specific, command or query

Example: *RST; DISP:PSAVe ON

Switches on the powersave mode.

DISPlay[:WINDow<Wnd>]:MAXimize <Boolean>

Maximizes all diagram areas in the active setup or restores the previous display configuration.

<Wnd> Number of the diagram area to become the active diagram area.
DISPlay:WINDow<Wnd>:MAXimize acts on all diagrams of the current setup, however, the diagram no. <Wnd> is displayed on top of the others.

<Boolean> ON | OFF - Maximize all diagram areas or restore the previous display configuration.

*RST value OFF

SCPI, Command Types Device-specific, command or query (returns whether or not the diagrams are maximized).

Example: *RST; DISP:WIND2:STAT ON

Create diagram areas no. 1 (with default trace) and 2 (with no trace).

DISP:WIND2:MAXimize ON

Maximize the diagram areas, placing area no. 2 on top.

DISPlay[:WINDow<Wnd>]:STATe <Boolean>

Creates or deletes a diagram area, identified by its area number <Wnd>.

<Wnd> Number of the diagram area to be created or deleted.

<Boolean> ON | OFF - Creates or deletes diagram area no. <Wnd>.

*RST value –

SCPI, Command Types Device-specific, command or query (returns whether or not a particular diagram area exists).

Example: CALC4:PAR:SDEF 'Ch4Tr1', 'S11'

Create channel 4 and a trace named *Ch4Tr1* to measure the input reflection coefficient S11.

DISP:WIND2:STAT ON

Create diagram area no. 2.

```
DISP:WIND2:TRAC9:FEED 'CH4TR1'
```

Display the generated trace in diagram area no. 2, assigning the trace number 9 to it.

DISPlay[:WINDow<Wnd>]:TITLe:DATA '<string>'

Defines a title for diagram area <Wnd>.

<Wnd> Number of the diagram area.

'<string>' String variable for the title. The length of the title is practically unlimited but should be kept short enough to be displayed in the diagrams.

*RST value ' '

SCPI, Command Types Device-specific, command or query

Example:

```
*RST; :DISP:WIND:TITL:DATA 'S21 Test Diagram'
```

Define a title for the default diagram area. The title is displayed below the top of the diagram area.

```
DISP:WIND:TITL OFF; TITL:DATA?
```

Hide the title. The title is no longer displayed but still defined so it can be displayed again.

DISPlay[:WINDow<Wnd>]:TITLe[:STATe] <Boolean>

Displays or hides the title for area number <Wnd>, defined by means of DISPlay:WINDow<Wnd>:TITLe:DATA.

<Wnd> Number of the diagram area.

<Boolean> ON | OFF - Displays or hides the title.

*RST value ON

SCPI, Command Types Device-specific, command or query

Example:

```
See DISPlay:WINDow<Wnd>:TITLe:DATA.
```

DISPlay[:WINDow<Wnd>]:TRACe<WndTr>:DELeTe

Releases the assignment between a trace and a diagram area, as defined by means of DISPlay:WINDow<Wnd>:TRACe<WndTr>:FEED <Trace_Name> and expressed by the <WndTr> suffix. The trace itself is not deleted; this must be done via CALCulate<Ch>:PARAmeter:DELeTe <Trace_Name>.

Instrument-Control Commands

<Wnd>	Number of an existing diagram area (defined by means of <code>DISPlay:WINDow<Wnd>:STATe ON</code>).
<WndTr>	Trace number used to distinguish the traces of the same diagram area <Wnd>.
*RST value	–
SCPI, Command Types	Device-specific, no query.
Example:	<pre>CALC4:PAR:SDEF 'Ch4Tr1', 'S11'</pre> <p>Create channel 4 and a trace named <i>Ch4Tr1</i> to measure the input reflection coefficient S11.</p> <pre>DISP:WIND2:STAT ON</pre> <p>Create diagram area no. 2.</p> <pre>DISP:WIND2:TRAC9:FEED 'CH4TR1'</pre> <p>Display the generated trace in diagram area no. 2, assigning the trace number 9 to it.</p> <pre>DISP:WIND2:TRAC9:DELeTe</pre> <p>Release the assignment between trace no. 9 and window no. 2. The trace can still be referenced with its trace name <i>Ch4Tr1</i>.</p>

DISPlay[:WINDow<Wnd>]:TRACe<WndTr>:EFEed '<trace_name>'

Assigns an existing trace (`CALCulate<Ch>:PARAMeter:SDEFine <Trace_Name>`) to a diagram area <Wnd>, and displays the trace. Use `DISPlay[:WINDow<Wnd>]:TRACe<WndTr>:FEED` to assign the trace to a diagram area using a numeric suffix (e.g. in order to use the `DISPlay[:WINDow<Wnd>]:TRACe<WndTr>:Y:OFFSet` command).



You can open the trace manager (`DISPlay:MENU:KEY:EXECute 'Trace Manager'`) to obtain an overview of all channels and traces, including the traces that are not displayed.

<Wnd>	Number of an existing diagram area (defined by means of <code>DISPlay:WINDow<Wnd>:STATe ON</code>).
<WndTr>	Trace number. This suffix is ignored; the trace is referenced by its name.
'<trace_name>'	String parameter for the trace name, e.g. 'Trc4'.
*RST value	–
SCPI, Command Types	Device-specific, no query.
Example:	<pre>CALC4:PAR:SDEF 'Ch4Tr1', 'S11'</pre> <p>Create channel 4 and a trace named <i>Ch4Tr1</i> to measure the input reflection coefficient S11.</p> <pre>DISP:WIND2:STAT ON</pre> <p>Create diagram area no. 2.</p> <pre>DISP:WIND2:TRAC:EFE 'CH4TR1'</pre> <p>Display the generated trace in diagram area no. 2. No trace number is</p>

assigned.

DISPlay[:WINDow<Wnd>]:TRACe<WndTr>:FEED '<trace_name>'

Assigns an existing trace (`CALCulate<Ch>:PARAmeter:SDEFine <Trace_Name>`) to a diagram area, using the `<WndTr>` suffix, and displays the trace. Use `DISPlay[:WINDow<Wnd>]:TRACe:EFEEed` to assign the trace to a diagram area without using a numeric suffix.



A trace can be assigned to a diagram only once. If a attempt is made to assign the same trace a second time (e.g. by typing `DISP:WIND2:TRAC8:FEED 'CH4TR1'` after executing the program example below) an error message –114, "Header suffix out of range is generated. You can open the trace manager (`DISPlay:MENU:KEY:EXECute 'Trace Manager'`) to obtain an overview of all channels and traces, including the traces that are not displayed.

<Wnd>	Number of an existing diagram area (defined by means of <code>DISPlay:WINDow<Wnd>:STATe ON</code>).
<WndTr>	Trace number used to distinguish the traces of the same diagram area <code><Wnd></code> .
'<trace_name>'	String parameter for the trace name, e.g. 'Trc4'.
*RST value	–

SCPI, Command Types Device-specific, no query.

Example:

```
CALC4:PAR:SDEF 'Ch4Tr1', 'S11'
```

Create channel 4 and a trace named *Ch4Tr1* to measure the input reflection coefficient S11.

```
DISP:WIND2:STAT ON
```

Create diagram area no. 2.

```
DISP:WIND2:TRAC9:FEED 'CH4TR1'
```

Display the generated trace in diagram area no. 2, assigning the trace number 9 to it.

DISPlay[:WINDow<Wnd>]:TRACe<WndTr>:SHOW DALL | MALL | '<trace_name>', <Boolean>

Displays or hides an existing trace, identified by its trace name (`CALCulate<Ch>:PARAmeter:SDEFine <Trace_Name>`), or a group of traces.



You can open the trace manager (`DISPlay:MENU:KEY:EXECute 'Trace Manager'`) to obtain an overview of all channels and traces, including the traces that are not displayed.

<Wnd>	Number of a diagram area. This suffix is ignored; the command affects traces in all diagram areas.
<WndTr>	Trace number. This suffix is ignored; the trace is referenced by its name.

DALL	All data traces
MALL	All memory traces
'<trace_name>'	Single trace identified by its trace name (string parameter), e.g. 'Trc4'.
*RST value	–
<Boolean>	ON OFF – display or hide trace(s)
*RST value	1 (for the default trace 'Trc1')
SCPI, Command Types	Device-specific, command or query. The query must be sent with the first parameter; see example below.

Example:

```
*RST; :DISP:TRAC:SHOW? 'Trc1'
```

Reset the analyzer, creating the default trace 'Trc1'. The trace is displayed; the query returns *1*.

```
CALC4:PAR:SDEF 'Ch4Tr1', 'S11'
```

Create channel 4 and a trace named Ch4Tr1 to measure the input reflection coefficient S_{11} .

```
DISP:WIND2:STAT ON; :DISP:WIND2:TRAC:FEED 'CH4TR1'
```

Create diagram area no. 2 and display the generated trace in the diagram area.

```
DISP:TRAC:SHOW DALL, OFF
```

Hide both traces in both diagrams.

```
DISP:TRAC:SHOW? DALL
```

Query whether all data traces are displayed. The response *0* means that at least one trace is hidden.

DISPlay[:WINDow<Wnd>]:TRACe<WndTr>:X:OFFSet <offset>

Shifts the trace <WndTr> in horizontal direction, leaving the positions of all markers unchanged.

<Wnd>	Number of an existing diagram area (defined by means of DISPlay:WINDow<Wnd>:STATe ON).
<WndTr>	Existing trace number, assigned by means of DISPlay:WINDow<Wnd>:TRACe<WndTr>:FEED.
<offset>	Stimulus offset value.
Range [def. unit]	–1000 GHz to +1000 GHz [Hz, for frequency sweeps]. The range and unit depends on the sweep type ([SENSe<Ch>:] SWEep:TYPE).
*RST value	0.
SCPI, Command Types	Device-specific, with query.

Example:

```
*RST; :DISP:WIND:TRAC:X:OFFS 1MHZ; :DISP:WIND:TRAC:Y:OFFS 10
```

Create the default trace and shift it horizontally by 1 MHz, vertically by 10 dB.

DISPlay[:WINDow<Wnd>]:TRACe<WndTr>:Y:OFFSet <Magnitude>[,<Phase>, <Real>, <Imaginary>]

Modifies all points of the trace <WndTr> by means of an added and/or a multiplied complex constant. The response values M of the trace are transformed according to:

$$M_{new} = M_{old} \cdot 10^{<Magnitude>/20 \text{ dB}} \cdot e^{j \cdot <Phase>/180^\circ} + <Real> + j \cdot <Imag>$$

<Wnd>	Number of an existing diagram area (defined by means of DISPlay:WINDow<Wnd>:STATe ON).
<WndTr>	Existing trace number, assigned by means of DISPlay:WINDow<Wnd>:TRACe<WndTr>:FEED.
<Magnitude>	Multiplied magnitude factor
Range [def. unit]	-300 dB to + 300 dB [dB]
*RST value	0 dB
<Phase>	Multiplied phase factor, optional for setting command but returned by query
Range [def. unit]	-3.4*10 ³⁸ deg to +3.4*10 ³⁸ deg [deg]
*RST value	0 deg
<Real>, <Imaginary>	Real and imaginary part of added complex constant, optional for setting command but returned by query
Range [def. unit]	-3.4*10 ³⁸ to +3.4*10 ³⁸ [-]
*RST value	0.

SCPI, Command Types Device-specific, with query.

Example:

```
*RST; :DISP:WIND:TRAC:X:OFFS 1MHZ; :DISP:WIND:TRAC:Y:OFFS 10
```

Create the default trace and shift it horizontally by 1 MHz, vertically by 10 dB.

```
DISP:WIND:TRAC:Y:OFFS?
```

Query all response offset values. The response is 10,0,0,0.

DISPlay[:WINDow<Wnd>]:TRACe<WndTr>:Y[:SCALE]:AUTO ONCE[, '<trace_name>']

Displays the entire trace in the diagram area, leaving an appropriate display margin. The trace can be referenced either by its number <WndTr> or by its name <trace_name>.

<Wnd>	Number of an existing diagram area (defined by means of DISPlay:WINDow<Wnd>:STATe ON). This suffix is ignored if the optional <trace_name> parameter is used.
<WndTr>	Existing trace number, assigned by means of DISPlay:WINDow<Wnd>:TRACe<WndTr>:FEED. This suffix is ignored if the optional <trace_name> parameter is used.
ONCE	Activate the autoscale function.
'<trace_name>'	Optional string parameter for the trace name, e.g. 'Trc4'. If this optional parameter is present, both numeric suffixes are ignored (trace names must be unique across different channels and windows).

*RST value	–
SCPI, Command Types	Confirmed, no query.
Example:	<pre>*RST; DISP:WIND:TRAC:Y:PDIV?; RLEV?</pre> <p>Query the value between two grid gratitudes and the reference value for the default trace. The response is <i>10;0</i>.</p> <pre>DISP:WIND:TRAC:Y:AUTO ONCE; PDIV?; RLEV? or: DISP:WIND:TRAC:Y:AUTO ONCE, 'Trc1'; PDIV?; RLEV?</pre> <p>Autoscale the default trace and query the scaling parameters again. In general both values have changed.</p>

DISPlay[:WINDow<Wnd>]:TRACe<WndTr>:Y[:SCALE]:BOTTom <lower_value>[, '<trace_name>']

Sets the lower (minimum) edge of the diagram area <Wnd>.

<Wnd>	Number of an existing diagram area (defined by means of <code>DISPlay:WINDow<Wnd>:STATe ON</code>). This suffix is ignored if the optional <trace_name> parameter is used.
<WndTr>	Existing trace number, assigned by means of <code>DISPlay:WINDow<Wnd>:TRACe<WndTr>:FEED</code> . This suffix is ignored if the optional <trace_name> parameter is used.
<lower_value>	Value and unit for the lower diagram edge.
Range [def. unit]	Range and unit depend on the measured quantity, see <i>Units for DISPlay... Commands</i> .
*RST value	Depending on the measured quantity. The default lower edge for a <i>dB Mag</i> diagram is –80 dB.
'<trace_name>'	Optional string parameter for the trace name, e.g. 'Trc4'. both numeric suffixes are ignored (trace names must be unique across different channels and windows).
*RST value	–
SCPI, Command Types	Confirmed, with query.
Example:	<pre>CALC4:PAR:SDEF 'Ch4Tr1', 'S11'</pre> <p>Create channel 4 and a trace named <i>Ch4Tr1</i> to measure the input reflection coefficient S11.</p> <pre>DISP:WIND2:STAT ON</pre> <p>Create diagram area no. 2.</p> <pre>DISP:WIND2:TRAC9:FEED 'CH4TR1'</pre> <p>Display the generated trace in diagram area no. 2, assigning the trace number 9 to it.</p> <pre>DISP:WIND2:TRAC9:Y:BOTT -40; TOP 10 or: DISP:WIND2:TRAC:Y:BOTT -40, 'CH4TR1'; TOP 10, 'CH4TR1'</pre>

Scale the diagram between -40 dB and +10 dB.

DISPlay[:WINDow<Wnd>]:TRACe<WndTr>:Y[:SCALe]:PDIVision <divisions>[, '<trace_name>']

Sets the value between two grid graticules (value per division) for the diagram area <Wnd>. When a new PDIVision value is entered, the current RLEVEL is kept the same, while the top and bottom scaling is adjusted for the new PDIVision value.

<Wnd>	Number of an existing diagram area (defined by means of DISPlay:WINDow<Wnd>:STATe ON). This suffix is ignored if the optional <trace_name> parameter is used.
<WndTr>	Existing trace number, assigned by means of DISPlay:WINDow<Wnd>:TRACe<WndTr>:FEED. This suffix is ignored if the optional <trace_name> parameter is used.
<divisions>	Value and unit for the vertical diagram divisions.
Range [def. unit]	Range and unit depend on the measured quantity, see <i>Units for DISPlay... Commands</i> .
*RST value	Depending on the measured quantity. The default reference level for an S-parameter displayed in a <i>dB Mag</i> diagram is 10 dB.
'<trace_name>'	Optional string parameter for the trace name, e.g. 'Trc4'. If this optional parameter is present, both numeric suffixes are ignored (trace names must be unique across different channels and windows).
*RST value	–
SCPI, Command Types	Confirmed, with query.
Example:	

```
CALC4:PAR:SDEF 'Ch4Tr1', 'S11'
```

Create channel 4 and a trace named *Ch4Tr1* to measure the input reflection coefficient S11.

```
DISP:WIND2:STAT ON
```

Create diagram area no. 2.

```
DISP:WIND2:TRAC9:FEED 'CH4TR1'
```

Display the generated trace in diagram area no. 2, assigning the trace number 9 to it.

```
DISP:WIND2:TRAC9:Y:PDIV 5  
or: DISP:WIND2:TRAC:Y:PDIV 5, 'CH4TR1'
```

Set the value per division to 5 dB.

DISPlay[:WINDow<Wnd>]:TRACe<WndTr>:Y[:SCALe]:RLEVEL <level>[, '<trace_name>']

Sets the reference level (or reference value) for a particular displayed trace. Setting a new reference level

does not affect the value of PDIVision. The trace can be referenced either by its number <WndTr> or by its name <trace_name>.

<Wnd>	Number of an existing diagram area (defined by means of DISPLAY:WINDow<Wnd>:STATe ON). This suffix is ignored if the optional <trace_name> parameter is used.
<WndTr>	Existing trace number, assigned by means of DISPLAY:WINDow<Wnd>:TRACe<WndTr>:FEED. This suffix is ignored if the optional <trace_name> parameter is used.
<level>	Value and unit for the reference level (or reference value, if the trace does not show a level).
Range [def. unit]	Range and unit depend on the measured quantity, see <i>Units for DISPLAY... Commands</i> .
*RST value	Depending on the measured quantity. The default reference level for an S-parameter displayed in a <i>dB Mag</i> diagram is 0 dB.
'<trace_name>'	Optional string parameter for the trace name, e.g. 'Trc4'. If this optional parameter is present, both numeric suffixes are ignored (trace names must be unique across different channels and windows).
*RST value	–

SCPI, Command Types
Confirmed, with query.

Example:

```
CALC4:PAR:SDEF 'Ch4Tr1', 'S11'
```

Create channel 4 and a trace named *Ch4Tr1* to measure the input reflection coefficient S11.

```
DISP:WIND2:STAT ON
```

Create diagram area no. 2.

```
DISP:WIND2:TRAC9:FEED 'CH4TR1'
```

Display the generated trace in diagram area no. 2, assigning the trace number 9 to it.

```
DISP:WIND2:TRAC9:Y:RLEV -10  
or: DISP:WIND2:TRAC:Y:RLEV -10, 'CH4TR1'
```

Change the reference level to –10 dB.

DISPlay[:WINDow<Wnd>]:TRACe<WndTr>:Y[:SCALE]:RPOSITION <reference>[, '<trace_name>']

Sets the point on the y-axis to be used as the reference position as a percentage of the length of the y-axis. The reference position is the point on the y-axis which should equal the RLEVel.

<Wnd>	Number of an existing diagram area (defined by means of DISPLAY:WINDow<Wnd>:STATe ON). This suffix is ignored if the optional <trace_name> parameter is used.
<WndTr>	Existing trace number, assigned by means of DISPLAY:WINDow<Wnd>:TRACe<WndTr>:FEED. This suffix is ignored if the optional <trace_name> parameter is used.

Instrument-Control Commands

<reference> Value of the reference position in percent. The top of the y-axis is defined to have a reference position of 100%, while the bottom of the y-axis is defined to have a reference position of 0%.

Range [def. unit] 0 to 100 [PCT].

*RST value 80 PCT.

'<trace_name>' Optional string parameter for the trace name, e.g. 'Trc4'. If this optional parameter is present, both numeric suffixes are ignored (trace names must be unique across different channels and windows).

*RST value –

SCPI, Command Confirmed, with query.

Types

Example:

```
CALC4:PAR:SDEF 'Ch4Tr1', 'S11'
```

Create channel 4 and a trace named *Ch4Tr1* to measure the input reflection coefficient S11.

```
DISP:WIND2:STAT ON
```

Create diagram area no. 2.

```
DISP:WIND2:TRAC9:FEED 'CH4TR1'
```

Display the generated trace in diagram area no. 2, assigning the trace number 9 to it.

```
DISP:WIND2:TRAC9:Y:RPOS 50
or: DISP:WIND2:TRAC:Y:RPOS 50, 'CH4TR1'
```

Set the reference position to the center of the diagram area.

DISPlay[:WINDow<Wnd>]:TRACe<WndTr>:Y[:SCALe]:TOP <upper_value>[, '<trace_name>']

Sets the upper (maximum) edge of the diagram area <Wnd>.

<Wnd> Number of an existing diagram area (defined by means of `DISPlay:WINDow<Wnd>:STATe ON`). This suffix is ignored if the optional `<trace_name>` parameter is used.

<WndTr> Existing trace number, assigned by means of `DISPlay:WINDow<Wnd>:TRACe<WndTr>:FEED`. This suffix is ignored if the optional `<trace_name>` parameter is used.

<upper_value> Value and unit for the upper diagram edge.

Range [def. unit] Range and unit depend on the measured quantity, see *Units for DISPlay... Commands*.

*RST value Depending on the measured quantity. The default upper edge for a *dB Mag* diagram is +20 dB.

'<trace_name>' Optional string parameter for the trace name, e.g. 'Trc4'. If this optional parameter is present, both numeric suffixes are ignored (trace names must be unique across different channels and windows).

*RST value –

SCPI, Command Confirmed, with query.

Types**Example:**

```
See DISPLAY:WINDow<Wnd>:TRACe<WndTr>:Y[:SCALE]:BOTTom
```

Units for DISPLAY... Commands

The DISPLAY... subsystem contains commands to define particular points in the diagram, e.g. to set the scale or a reference value. This requires the entry of a numeric value and a physical unit, depending on the parameter type displayed. The following table lists the physical units accepted by the analyzer.

Power	DBM, DB, DBW, W, MW, UW, NW, PW
Voltage	V, MV, UV, NV, PV, DBV, DBMV, DBUV
Phase	DEG, KDEG, MDEG, UDEG, NDEG, PDEG
Group delay	S, MS, US, NS, PS
Impedance	OHM, GOHM, MOHM, KOHM
Admittance	SIE, MSIE, USIE, NSIE
Inductance	H, MH, UH, NH, PH, FH
Capacitance	F, MF, UF, NF, PF, FF
Dimensionless	UNIT, MUNIT, UUNIT, NUNIT, PUNIT, FUNIT

FORMat...

This subsystem sets a data format for transferring numeric and array information from and to the analyzer.

FORMat:BORDER NORMal | SWAPped

Controls whether binary data is transferred in normal or swapped byte order.

Parameters

SWAPped – The least significant bit is transferred first (little endian)
 NORMal – The most significant bit is transferred first (big endian)

***RST value**

SWAPped (if the *GPiB Language* is set to *PNA* or *HP xxxx*, then the order is NORMal)

SCPI, Command Types

Confirmed, command or query

Example:

```
FORM:BORD NORM
```

Change the bit order to normal mode.

FORMat[:DATA] ASCii | REAL [,<length>]

Selects the format for numeric data transferred to and from the analyzer.



The format setting is only valid for commands and queries whose description states that the response is formatted as described by FORMat [:DATA]. In particular, it affects trace data transferred by means of the commands in the TRACe: . . . system.

ASCII Numeric data is transferred as ASCII bytes. The numbers are separated by commas as specified in IEEE 488.2.

REAL Data is transferred in a definite length block as IEEE floating point numbers of the specified <length>. See block data format.



If binary data is transferred to the analyzer, the receive terminator should be set to EOI (SYSTem:COMMunicate:GPIB[:SELF]:RTERminator EOI) to avoid inadvertent interruption of the data transfer.

<length> The optional <length> parameter is needed for REAL format only. It defines the length of the floating point numbers in bits. Valid values are 32 and 64.

***RST value** ASCII. The default length of REAL data is 32 bits (single precision).

SCPI, Command Types Confirmed, command or query

Example:

```
FORM REAL, 32
```

Select real data format.

```
SYST:COMM:GPIB:RTER EOI
```

Set the terminator to EOI.

```
(During a calibration) ... CORR:CDAT? 'REFLTRACK',1,0
```

Query a system error correction term. The data is transferred in a definite length block which can be written to a file; the analyzer displays the message <no_of_bytes> bytes binary data received.

FORMat:DEXPort:SOURce FDATA | SDATA | MDATA

Defines the format for traces retrieved with the ZVR-compatible command

TRACe [:DATA] [:RESPonse] [:ALL] ?



This command is not relevant for results read with the CALCulate:DATA . . . commands.

Parameters See list of parameters below.

Range [def. unit] Depending on the measured parameter and format. The unit is the default unit of the measured parameter; see CALCulate<Ch>:PARAmeter:SDEFine.

***RST value** SDATA

SCPI, Command Types Device-specific, command or query.

Example: See TRACe[:DATA][:RESPonse][:ALL]?

The following parameters are related to trace data (see also *Data Flow* diagram):

FDATa	Formatted trace data, according to the selected trace format (CALCulate<Chn>:FORMat). 1 value per trace point for Cartesian diagrams, 2 values for polar diagrams.
SDATa	Unformatted trace data: Real and imaginary part of each measurement point. 2 values per trace point irrespective of the selected trace format. The trace mathematics is not taken into account.
MDATa	Unformatted trace data (see SDATa) after evaluation of the trace mathematics.

HCOPY...

The HCOPY system controls the output of screen information to an external device. The instrument allows two independent printer configurations which can be set separately with the numeric suffix <1|2>. Part of the functionality of this system is included in the *File* menu.

HCOPY[:IMMEDIATE<config>] <numeric_value>

Starts a hardcopy output.

<config>	1 2 - Printer configuration to be used for the hardcopy output. If there is no suffix, configuration 1 is automatically selected.
<numeric_value>	1 2 - Starts the hardcopy output to device 1 (default) or 2.
*RST value	-
SCPI, Command Types	Confirmed, no query
Example:	See HCOpy[:IMMEDIATE<config>]:NEXT

HCOPY[:IMMEDIATE<config>]:NEXT <numeric_value>

Starts a hardcopy output. If the output is printed to a file (see HCOpy:DESTination<1|2>), the file name used in the last saving process is automatically counted up to the next unused name.

<config>	1 2 - Printer configuration to be used for the hardcopy output. If there is no suffix, configuration 1 is automatically selected.
<numeric_value>	1 2 - Starts the hardcopy output to device 1 (default) or 2.
*RST value	-
SCPI, Command Types	Confirmed, no query
Example:	HCOP:DEV:LANG BMP Select the data format HCOP:DEST 'MMEM' Direct the hardcopy to a file.

Instrument-Control Commands

```
MMEM:NAME 'C:\R_S\instr\user\Print.bmp'; HCOP
```

Select a file name and start printing to the file Print.bmp.

```
HCOP:NEXT
```

Save the hardcopy output into the file Print_001.bmp.

```
HCOP:NEXT
```

Save the hardcopy output into the file Print_002.bmp.

HCOPY:ABORT

Aborts a running hardcopy output.

Parameters	None.
*RST value	-
SCPI, Command Types	Confirmed, no query
Example:	<pre>HCOP:ABOR</pre> Abort printing.

HCOPY:CMAP<Element>:DEFault<numeric_value>

Resets the colors for a hardcopy to the selected default settings.

<Element>	Numeric suffix, not used in this command.
<numeric_value>	DEFault1 – SCREEN COLORS, but background white DEFault2 – OPTIMIZED COLOR SET DEFault3 – USER DEFINED color set
*RST value	-
SCPI, Command Types	Confirmed, no query
Example:	<pre>HCOP:CMAP:DEF2</pre> Selects the optimized color set for the color settings of a hardcopy.

HCOPY:CMAP<Element>:HSL <hue>,<sat>,<lum>

Defines the color table in user defined colors. To each numeric suffix of CMAP is assigned one or several picture elements which can be modified by varying the corresponding color setting.

<Element>	Number of the display element. The display elements corresponding to the numbers 1 to 27 are listed below.
<hue>	tint
<sat>	saturation
<lum>	brightness

Range [def. unit] 0 to 1 for all parameters.

*RST value -

Note: *The values set are not changed by *RST.*

SCPI, Command Types Confirmed, no query

Example:

```
HCOP:CMAP2:HSL 0.3,0.8,1.0
```

Changes the grid color.

The numeric suffixes *<Element>* denote the following display elements:

<i><Element></i>	Display Element
1	Background
2	Grid
3	Function field + status field + data entry text
4	Function field LED on
5	Function field LED warn
6	Enhancement label text
7	Status field background
8	Trace 1
9	Trace 2
10	Trace 3
11	Marker
12	Lines
13	Measurement status + limit check pass
14	Limit check fail
15	Reserved
16	Reserved

17	Table selected field text
18	Table selected field background
19	Reserved
20	Reserved
21	Reserved
22	Reserved
23	Reserved
24	Reserved
25	Reserved
26	Logo
27	Trace 4

HCOPY:CMAP<Element>:PDEFined BLACK | BLUE | BROWn | GREen | CYAN | RED | MAGenta | YELLow | WHITE | DGRAY | LGRAY | LBLUe | LGREen | LCYan | LRED | LMAGenta

Defines the color table in user defined colors using predefined color values. To each numeric suffix of CMAP is assigned one or several picture elements which can be modified by varying the corresponding color setting.

<Element>	Number of the display element. For details on the CMAP assignment refer to HCOPY:CMAP<Element>:HSL.
Range [def. unit]	1 to 27
BLACK ...	Predefined colors.
LMAGenta	
*RST value	-

Note: The values set are not changed by *RST.

SCPI, Command Confirmed, no query

Types

Example:

```
HCOPY:CMAP2:PDEF GRE
```

HCOPY:DESTination<config> 'MMEM' | 'SYST:COMM:PRIN' | 'SYST:COMM:CLIP'

Selects the printer output medium (Disk, Printer or Clipboard) associated with configuration 1 or 2.



The type of instrument is selected with `SYSTem:COMMunicate:PRINter:SElect`, which will automatically select a default output medium. Therefore the `HCOPY:DESTination` command should always be sent after setting the device type.

<config>	1 2 - Printer configuration to be used for the hardcopy output. If there is no suffix, configuration 1 is automatically selected.
'MMEM'	Directs the hardcopy to a file. The <code>MMEMory:NAME</code> command defines the file name. All formats can be selected for <code>HCOPY:DEvice:LANGUage</code> .
'SYST:COMM:PRIN'	Directs the hardcopy to the printer. The printer is selected with the <code>SYSTem:COMMunicate:PRINter:SElect</code> command. GDI should be selected for <code>HCOPY:DEvice:LANGUage</code> .
'SYST:COMM:CLIP'	Directs the hardcopy to the clipboard. EWMF should be selected for <code>HCOPY:DEvice:LANGUage</code> .
*RST value	–
	Note: *RST does not overwrite the printer destination.

SCPI, Command Types Confirmed, command or query.

Example:

```
SYST:COMM:PRIN:SEL2 'LASER on LPT1'
```

Selects the printer and output medium for device 2.

```
HCOP:DEST2 'SYST:COMM:PRIN'
```

Selects the printer interface as device 2.

HCOPY:DEvice:COLor <Boolean>

Selects between color and monochrome hardcopy of the screen.

<Boolean>	ON - Selects the color hardcopy mode. OFF - Selects the monochrome hardcopy mode.
*RST value	OFF
SCPI, Command Types	Confirmed, command or query

Example:

```
HCOP:DEV:COL ON
```

Select color hardcopy.

HCOPY:DEvice:LANGUage GDI | WMF | EWMF | BMP

Selects a file format for printer files. Selecting the format is recommended to ensure that the file defined via `MMEMory:NAME` can be read or imported by an external application. See also `HCOPY:DESTination` command.

GDI	Graphics Device Interface: Default format for the output to a printer configured under Windows. Must be selected for the output to the printer interface. Can be used for the output to a file. The printer driver configured under Windows is used in this case and a printer-specific file format is thus generated.
WMF, EWMF	Windows Metafile and Enhanced Metafile Format:

Data formats for output files which can be integrated in corresponding programs for documentation purposes at a later time. WMF can only be used for output to a file and EWMF also for the output to the clipboard.

BMP, JPG, PNG
Windows Bitmap:
Data format for output to files only.

*RST value -

SCPI, Command Types
Confirmed, command or query.

Example:

```
HCOP:DEV:LANG BMP
```

Select Windows bitmap format for printer files.

```
MMEM:NAME 'C:\Screenshots\PLOT1.BMP'
```

Define a printer file name and specify an existing directory (without creating the file).

```
HCOP:DEST 'MMEM'; HCOP
```

Select 'Print to file' and create the printer file specified before.

HCOPY:ITEM:ALL

Selects the complete screen to be output. The hardcopy output is always provided with comments, title, time and date. As an alternative to the whole screen, e.g. only traces (HCOPY:ITEM:WINDOW:TRACE:STATE command) can be output.

*RST value After a reset, the complete information is printed.

SCPI, Command Types Confirmed, no query.

Example:

```
HCOPY:ITEM:ALL
```

Select the complete information to be printed.

```
HCOPY
```

Start printing.

HCOPY:ITEM:LOGO[:STATE] <Boolean>

Qualifies whether or not the printed output contains the logo. The default R&S logo (file Logo.gif) is stored in the Resources\Images subdirectory of the NWA program directory and can be replaced by another logo.

<Boolean> ON | OFF - Logo is included or excluded.

*RST value OFF

SCPI, Command Types Device-specific, command or query

Example:

```
HCOPY:ITEM:ALL
```

Select the complete information to be printed.

```
HCOP:ITEM:LOGO ON; HCOP
```

Include the logo in the printed output and start printing.

HCOPy:ITEM:WINDow<numeric_suffix>:TEXT <string>

Defines the comment text for the printout.

<numeric_suffix> The numeric suffixes <1|2> are irrelevant for this command.
<string> Text with a maximum of 100 characters; line feed by means of character @.
 *RST value -

SCPI, Command Types Device-specific, command or query

Example:

```
HCOP:ITEM:WIND:TEXT 'comment'
```

HCOPy:ITEM:WINDow<numeric_suffix>:TRACe:STATe <Boolean>

Selects the output of the currently displayed trace.

Both the `HCOPy:ITEM:WINDow:TRACe:STATe` command and the `HCOPy:ITEM:ALL` command enable the output of the whole screen.

<numeric_suffix> The numeric suffixes <1|2> are irrelevant for this command.
<Boolean> ON | OFF - Selects or deselects the output of the currently displayed trace.
 *RST value OFF

SCPI, Command Types Device-specific, command or query

Example:

```
HCOP:ITEM:WIND:TRACe:STAT ON
```

HCOPy:PAGE:ORientation<device> PORTRait | LANDscape

Defines the orientation of the printed page. Switching between LANDscape and PORTRait rotates the hardcopy result by 90 degrees. No other settings are changed.



The command is only available provided that the output medium "printer" (HCOPy:DESTination) has been selected.

<device> 1 | 2 - Hardcopy device 1 or 2.
PORTRait Short edge of the paper is the top of the page.
LANDscape Long edge of the paper is the top of the page.
 *RST value PORTRait

SCPI, Command Types Confirmed, command or query

Example:

```
HCOP:PAGE:ORI LAND; HCOP
```

Select landscape page orientation and start printing.

HCOPY:PAGE:WINDow ACTIVE | ALL | SINGLE

Defines the number of diagram areas per printed page.

ACTIVE	Print only active diagram area.
ALL	All diagram areas are printed on one page.
SINGLE	One diagram area per page.
*RST value	ALL

SCPI, Command Types Confirmed, command or query

Example:

```
HCOP:PAGE:WIND SING; HCOP
```

Select one diagram area per page and start printing.

INITiate<Ch>...

This subsystem controls the initiation of the trigger system and defines the scope of the triggered measurement.

INITiate<Ch>:CONTInuous <Boolean>

Qualifies whether the analyzer measures in single sweep or in continuous sweep mode.

<Ch>	Channel number. The channel is ignored because the command affects all channels.
<Boolean>	ON - The analyzer measures continuously, repeating the current sweep. OFF - The measurement is stopped after the number of sweeps defined via [SENSe<Ch>:]SWEep:COUNT. INITiate<Ch>[:IMMEDIATE] initiates a new measurement cycle.
*RST value	ON
SCPI, Command Types	Confirmed, command or query

Example:

```
*RST; INIT:CONT OFF
```

Activate single sweep mode for all channels (including channel no. 2 created later).

```
INIT:SCOP SING
```

State that a single sweep will be performed in the active channel only.

```
CALC2:PAR:SDEF 'TRC2','S11'; INIT2
```

Create channel no. 2 with a new trace and start a single sweep in channel no. 2.

INITiate<Ch>[:IMMEDIATE]

Starts a new single sweep sequence. This command is available in single sweep mode only (INITiate<Ch>:CONTInuous OFF). The data of the last sweep (or previous sweeps, see *Sweep History*) can be read using CALCulate<Ch>:DATA:NSWEEP? SDATA, <history_count>.



In contrast to all other commands of the analyzer, INITiate<Ch>[:IMMEDIATE] has been implemented for overlapped execution; see Command Synchronization.

<Ch> Channel number. If the channel number does not exist the analyzer returns an error message. If INITiate<Ch>[:IMMEDIATE]:SCOPE ALL is active, this suffix is ignored.

*RST value –

SCPI, Command Types Confirmed, no query

Example: See INITiate<Ch>:CONTInuous

INITiate<Ch>[:IMMEDIATE]:SCOPE ALL | SINGLE

Selects the scope of the single sweep sequence. The setting is applied in single sweep mode only (INITiate<Ch>:CONTInuous OFF).

<Ch> Channel number. The channel is ignored because the command affects all channels.

ALL INITiate<Ch>[:IMMEDIATE] starts a single sweep in all channels.

SINGLE INITiate<Ch>[:IMMEDIATE] starts a single sweep in the referenced channel <Ch> only.

*RST value ALL

SCPI, Command Types Device-specific, command or query

Example: See INITiate<Ch>:CONTInuous

INPut...

This subsystem controls the characteristics of the analyzer's input ports.

INPut<port_no>:ATTenuation <numeric_value>

Sets the attenuation for the received waves.

Note: INPut<port_no>:ATTenuation is not channel-specific; the value is valid for all channels. Use

[SENSe<Ch>:]POWer:ATTenuation to set or query a channel-specific attenuation value.

<port_no>	Test port number of the analyzer, 1 or 2. If unspecified the numeric suffix is set to 1.
<numeric_value> Range [def. unit]	Attenuation factor for the received wave. 0 dB to 30 dB. UP and DOWN increment/decrement the attenuation in 5 dB steps. The analyzer rounds any entered value below the maximum attenuation to the closest step.
*RST value	+10 dB (0 dB for R&S ZVL13)
SCPI, Command Types	Confirmed, no query (query cannot return channel-specific settings, would be misleading).

Example:

```
INP2:ATT 10
```

Set the step attenuator for the wave received at port 2 and for all channels to 10 dB. The waves at the other test ports are not affected.

```
SENS1:POW:ATT? BREC
```

Query the receiver step attenuator setting at port 2 and for channel no. 1. The response is 10.

INSTrument...

This subsystem identifies and selects particular resources (SCPI: logical instruments) of the analyzer.

INSTrument:NSElect <code_no>

This command switches between the measurement modes by means of numbers.

<code_no>	<ul style="list-style-type: none"> 2 - Network analyzer mode 1 - Spectrum analyzer mode (option R&S ZVL-K1, also enables the commands with code numbers 3 and 12) 19 - Noise figure and gain measurements (option FSL-K30) 8 - WCDMA measurements (3GPP/FDD BTS, option FSL-K72) 16 - WLAN OFDM analysis (option FSL-K91) 6 - WiMAX OFDM/OFDMA analysis (option FSL-K93) <ul style="list-style-type: none"> 3 - AM/FM/φM measurement demodulator (option FSL-K7) 12 - Bluetooth measurements (option FSL-K8) <p>The codes for the different spectrum analyzer options are also included in the option descriptions.</p>
------------------------	--

*RST value 2

SCPI, Command Types Confirmed, command or query.

Example:

```
INST:NSEL 2
```

Switch the instrument to network analyzer mode.

INSTrument:PORT:COUNT?

Returns the number of test ports of the analyzer.

Response	Number of ports (integer number).
Range [def. unit]	2
*RST value	–

SCPI, Command Types Device-specific, query only.

Example:

```
INST:PORT:COUN?
```

Return the number of test ports. The response is 2.

INSTrument[:SElect] NWA | SAN | NOISe | BWCD | WLAN | WiMAX | ADEM | BTO

Switches between the measurement modes by means of text parameters.

Parameters	NWA - Network analyzer mode SAN - Spectrum analyzer mode (option R&S ZVL-K1, also enables the ADEM and BTO commands) NOISe - Noise figure and gain measurements (option FSL-K30) BWCD - WCDMA measurements (3GPP/FDD BTS, option FSL-K72) WLAN - WLAN OFDM analysis (option FSL-K91) WiMAX - WiMAX OFDM/OFDMA analysis (option FSL-K93)
	ADEM - AM/FM/φM measurement demodulator (option FSL-K7) BTO - Bluetooth measurements (option FSL-K8)
*RST value	NWA

SCPI, Command Types Confirmed, command or query.

Example:

```
INST SAN
```

Switch the instrument to spectrum analyzer mode.

MEMory...

The MEMory system controls the loaded setups of the analyzer.



The MEMory... command don't affect any stored files. Use the MEMory... commands to store and load data and to manage files stored on a mass storage device.

MEMory:CATalog?

Returns the names of all loaded setups.

Response	Comma-separated list of all setups.
*RST value	'Set1' (the default setup is created after each *RST).

SCPI, Command Types Confirmed (with device-specific response), query only.

Example:

```
*RST; MEM:DEF 'SETUP_2'
```

Create a setup named 'Setup_2' and make it the active setup.

```
MEM:CAT?
```

Query all setups. The response is 'Set1,Setup_2'.

```
MMEM:STOR:STAT 1, 'C:\R_S\Instr\user\Nwa\RecallSets\Setup_2.nwa';
MEM:DEL 'Setup_2.nwa'
```

Store the active setup Setup_2 to a file, renaming it Setup_2.nwa. Close the setup.

MEMory:DEFine '<setup_name>'

Creates a new setup <setup_name> using default settings for the traces, channels and diagram areas. The created setup becomes the active setup.

'<setup_name>' String parameter to specify the name of the created setup.

*RST value –

SCPI, Command Types Device-specific, no query.

Example:

```
See MEM:CAT?.
```

MEMory:DELeTe[:NAME] '<file_name>'

Closes the specified setup.

'<setup_name>' String parameter to specify the name of the setup to be closed.

*RST value –

SCPI, Command Types Confirmed, no query.

Example:

```
See MEM:CAT?.
```

MEMory:SELeCt '<setup_name>'

Selects a setup as the active setup.

'<setup_name>' String parameter to specify the setup.

*RST value –

SCPI, Command Types Device-specific, no query.

Example:

```
*RST; MEM:DEF 'SETUP_2'
```

Create a setup named 'Setup_2' and make it the active setup.

```
MEM:SEL 'Set1'
```

Activate the default setup Set1.

```
MMEM:STOR:STAT 1, 'C:\R_S\Instr\user\Nwa\RecallSets\Set1.nwa'; MEM:DEL 'Set1.nwa'
```

Store the active setup Set1 to a file, renaming it Set1.nwa. Close the setup.

MMEMory...

The MMEMory system provides mass storage capabilities for the analyzer.



Internal and external mass storage

The mass storage of the analyzer may be internal or external. The internal mass storage device can be any section of the internal hard disk (mapped to drive C:\). The external mass storage device can be a floppy disk inserted into the drive at the front panel of the instrument, which is mapped to drive a:\ (see MMEMory:MSIS), a USB memory stick connected to one of the USB ports (mapped to any free drive letter) or a network connection.



File and directory names

The <file_name> and <directory_name> parameters are strings. Some commands use a fixed directory; for others the <file_name> can contain the complete path including the drive name and all subdirectories, e.g. 'C:\TEMP\TRASH\test.txt' for the file named test.txt in the TEMP\TRASH subdirectory of the internal hard disk drive C:\. If no complete path is specified, the file location is relative to the current directory (queried with MMEMory:CDIRectory?). The file name itself may contain the period as a separator for extensions.

File and directory names can be chosen according to Windows™ conventions; the restrictions placed on file names known from DOS systems do not apply. All letters and numbers are allowed, as well as the special characters "_", "^", "\$", "~", "!", "#", "%", "&", "-", "{", "}", "(", ")", "@", and "'". Reserved file names are CON, AUX, COM1, ..., COM4, LPT1, ..., LPT3, NUL and PRN.

The use of wildcards ? and * is not allowed.

MMEMory:AKAL:FACTory:CONVersion '<directory_name>'

Converts the calibration data of the standards in the active calibration unit (SYSTEM:COMMunicate:RDEvice:AKAL:ADDRess) to Touchstone format and copies it to the specified directory.

'<directory_name>' String parameter to specify the directory.
*RST value –

SCPI, Command Types Device-specific, command or query (returns the current directory).

Example: MMEM:AKAL:FACTory:CONVersion 'C:\AKAL\Touchstone'

Convert and copy the calibration data of the standards

to the specified directory.

MMEMemory:CATalog? '<directory_name>'

Returns the contents of a specified directory.

'<directory_name>'	String parameter to specify the directory.
Response	Comma-separated list of all file names in the directory (string parameters).
*RST value	–
SCPI, Command Types	Confirmed, query only.

Example:

```
MMEM:CAT? 'C:\R_S\Instr\user'
Response: 'autolog.txt','autologin.reg','no_autologin.reg'
```

MMEMemory:CDIRectory '<directory_name>'

Changes the default directory for mass memory storage.

'<directory_name>'	String parameter to specify the directory.
*RST value	– (A *RST does not change the current directory)
SCPI, Command Types	Confirmed, command or query (without parameter, returns the current directory).

Example:

```
MMEM:CDIR 'C:\Documents and
Settings\NetworkService\Application Data'
```

Change to the specified directory.

MMEMemory:CLEar:ALL

Deletes all device settings in the current directory. The current directory can be selected with the MMEMemory:CDIRectory command. The default directory is C:\R_S\instr\user\Nwa.

*RST value	–
SCPI, Command Types	Device-specific, no query.

Example:

```
MMEM:CLE:ALL
```

Delete all device settings files.

MMEMemory:CLEar:STAtE 1,<file_name>

Deletes the instrument setting selected by <file_name>. All associated files on the mass memory storage are cleared.

<file_name>	File name of the settings file. The file extension can be omitted. If the file is not stored in the C:\R_S\Instr\user directory, the full path has to be specified.
*RST value	–
SCPI, Command Types	Device-specific, no query.
Example:	<code>MMEM:CLE:STAT 1,'TEST.ZVL.DFL'</code> Delete file TEST.zvl.dfl.

MMEMory:COPY '<file_source>','<file_destination>'

Copies an existing file to a new file or directory.

'<file_source>','<file_destination>'	String parameters to specify the name of the file to be copied and the name of the new file or directory.
*RST value	–
SCPI, Command Types	Confirmed, no query.
Example:	<code>MMEM:COPY 'C:\USER\DATA\SETUP.ZVL.DFL','E:'</code> Copy file Setup.zvl.dfl in directory C:\USER\DATA to the external storage medium, mapped to drive E:\.

MMEMory:DATA '<file_name>', <data>

Loads <data> into the file <file_name>. The delimiter must be set to EOI (SYSTEM:COMMunicate:GPIB[:SELF]:RTERminator EOI) to obtain error-free data transfer.

'<file_name>'	String parameter to specify the name of the file.
<data>	Data in 488.2 block data format. The delimiter EOI must be selected to achieve correct data transfer.
*RST value	–
SCPI, Command Types	Confirmed, with query. The query form <code>MMEMory:DATA? <file_name></code> returns the associated <data> in block format (the delimiter setting is irrelevant for the query).
Example:	<code>MMEM:DATA? 'C:\TEMP\TEST01.HCP'</code> Query the block data contained in file TEST01.HCP.

MMEMory:DELeTe '<file_name>'

Removes a file from the specified directory.

'<file_name>'	String parameter to specify the name and path of the file to be removed. If the
----------------------------	---

path is omitted, the current directory is used (see `MMEMemory:CDIRectory`).

*RST value

–

SCPI, Command Types

Confirmed, no query.

Example:

```
MMEMemory:DEL 'C:\TEMP\TEST01.HCP'
```

Remove TEST01.HCP from the directory C:\TEMP.

MMEMemory:DELeTe:CORRection <file_name>

Deletes a system error correction data set stored in the cal pool (cal group file).

'<file_name>'

String parameter to specify the name of the cal group file to be deleted. Cal group files must have the extension *.cal. The directory path must not be specified; the analyzer always uses the default cal pool directory `C:\R_S\Instr\user\Nwa\Calibration\Data`.

*RST value

–

SCPI, Command Types

Device-specific, no query.

Example:

```
See MMEMemory:LOAD:CORRection
```

MMEMemory:LOAD:AUTO 1,'FACTORY | <file_name>

Defines which device settings are automatically loaded after the device is switched on. The contents of the file are read after switching on the device and used to define the new device state.

The data set defined as auto recall set can also be restored by the *RST command.

FACTORY

Deactivates the startup recall function.

'<file_name>'

Activates the startup recall function and defines the device settings to be loaded.

*RST value

–

SCPI, Command Types

Device-specific, no query.

Example:

```
MMEMemory:LOAD:AUTO 1,'C:\R_S\Instr\user\TEST'
```

Define the TEST file as startup recall file and activate the function.

MMEMemory:LOAD:CABLe '<source_directory>

Loads all cable description files (*.rsc) from a specified directory. The default source directories for cable description files (`C:\R_S\Instr\resources\Nwa\CableTypes` for predefined,

C:\R_S\Instr\user\Nwa\CableTypes for user-defined cables) are not affected; see example.

'<source_directory>' String parameter to specify the source directory.

*RST value –

SCPI, Command Types Device-specific, no query.

Example: See `MMEMoRY:STORe:CABLe`

MMEMoRY:LOAD:CKIT '<file_name>'

Loads cal kit data from a specified NWA cal kit file.

'<file_name>' String parameter to specify the name and directory of the cal kit file to be loaded. If no path is specified the analyzer searches the current directory, to be queried with `MMEMoRY:CDIRectory?`.

*Note: The loaded file must be a NWA-specific cal kit file with the extension *.calkit. ZVR cal kit files can be imported using the [SENSe<Ch>:]CORRection:CKIT:INSTAll command. Agilent cal kit files can be imported manually and converted into *.calkit files.*

*RST value –

SCPI, Command Types Device-specific, no query.

Example:

```
MMEMoRY:LOAD:CKIT
'C:\R_S\Instr\user\Nwa\Calibration\Kits\New_kit.calkit'
```

Load the previously created cal kit file New_kit.calkit from the default cal kit directory.

```
... :MMEMoRY:STOR:CKIT 'New_kit',
'C:\R_S\Instr\user\Nwa\Calibration\Kits\New_kit.calkit'
```

Store the data for the user-defined cal kit Newkit and overwrite the cal kit file New_kit.calkit.

MMEMoRY:LOAD:CKIT:SDATa '<conn_name>', '<ckit_name>', MMThrough | MFThrough | FFThrough | MMLine | MFLine | FFLine | MMATten | MFATten | FFATten | MMSNetwork | MFSNetwork | FFSNetwork | MOPen | FOPen | MSHort | FSHort | MOShort | FOShort | MREFlect | FRElect | MMTCh | FMTCh | MSMATCH | FSMATCH, '<stdlabel_name>', '<file_name>' [,<port1_no>][,<port2_no>]

Loads cal kit data for a specific connector type, cal kit, and calibration standard from a specified Touchstone file, assigning a label for the cal data. A restriction on the port assignment may be defined in addition.

'<conn_name>' String parameters containing the name of the connector type.

'<ckit_name>' String parameters containing the name of a calibration kit available on the analyzer.

Parameters	Standard type; for a description refer to the table of standard types.
'<stdlabel_name>'	String parameter defining a label for the cal kit data. An empty string means that no label is defined.
'<file_name>'	String parameter to specify the name and directory of the Touchstone file to be loaded. A *.s1p file must be used for one-port standards, a *.s2p file for two-port standards. If no path is specified the analyzer searches the current directory, to be queried with <code>MMEMemory:CDIRectory?</code> .
<port1_no>, <port2_no>	Port assignment: One port number for one-port standards, two port number for two-port standards. If the port numbers are omitted, the cal kit data is valid for all ports.
*RST value	–
SCPI, Command Types	Device-specific, no query.

Example:

```
MME:LOAD:CKIT:SDAT 'N 50 Ohm','Default Kit',MOPEN,'Test data','test.slp',1
```

Load the file *Test.slp* from the current directory in order to define the properties of an Open (m) standard in the cal kit named *Default Kit* for the *N 50 Ω* connector type. Assign the label *Test data* and specify that the data standard data is only valid for port no. 1.

**Connector and cal kit naming conventions**

Connector and calibration kit names must be entered as string parameters. The strings contain the connector and cal kit names used in the *Calibration Kits* dialog; a Ω in the name must be replaced by 'Ohm', e.g.:

- 'NewKit1' denotes the user-defined calibration kit *NewKit1*.
- 'N 50 Ohm Ideal Kit' denotes the *N 50 Ω Dummy Kit*.
- 'ZV-Z21 typical' denotes the cal kit *ZV-Z21 typical*.

MMEMemory:LOAD:CMAP '<file_name>'

Loads a color scheme from a specified NWA color scheme file.

'<file_name>'	String parameter to specify the name and directory of the cal kit file to be loaded. The default extension (manual control) for color scheme files is *.ColorScheme, although other extensions are allowed.
---------------	---

*RST value	–
------------	---

SCPI, Command Types	Device-specific, no query.
----------------------------	----------------------------

Example:

```
MME:LOAD:CMAP 'C:\R_S\Instr\user\Nwa\ColorSchemes\Test.ColorScheme'
```

Load the previously created color scheme file

Instrument-Control Commands

Test.ColorScheme from the default color scheme directory.

```
DISP:CMAP13:RGB 1,0,0; DISP:CMAP14:RGB 0,1,0
```

Color the first trace red, the second trace green.

```
MMEM:STOR:CMAP
```

```
'C:\R_S\Instr\user\Nwa\ColorSchemes\Test.ColorScheme'
```

Store the data for the user-defined cal kit Newkit and overwrite the cal kit file New_kit.calkit.

MMEMory:LOAD:CORRection <Ch>,'<file_name>'

Applies a system error correction data set stored in the cal pool (cal group file) to channel no. <Ch>.

<Ch>	Channel number of an existing channel
<file_name>	String parameter to specify the name of the cal group file to be loaded. Cal group files must have the extension *.cal. The directory path must not be specified; the analyzer always uses the default cal pool directory C:\R_S\Instr\user\Nwa\Calibration\Data.
*RST value	–
SCPI, Command Types	Device-specific, no query.

Example:

```
MMEM:STOR:CORR 1,'Calgroup1.cal'
```

Copy the current correction data set of channel 1 to a cal group file Calgroup1.cal.

```
CONF:CHAN2:STAT ON; :MMEM:LOAD:CORR 2,'Calgroup1.cal'
```

Apply the stored correction data to channel 2.

```
MMEM:LOAD:CORR:RES 2,'Calgroup1.cal'
```

Undo the previous action: Resolve the link, causing channel 2 to use its previous correction data.

```
MMEM:DEL:CORR 'Calgroup1.cal'
```

Delete the created cal group file.

MMEMory:LOAD:CORRection:RESolve <Ch>['<file_name>']

Resolves the link between channel <Ch> and the correction data set (cal group file) so that the channel uses its previous correction data.

<Ch>	Channel number
'<file_name>'	Optional string parameter to specify the name of the cal group file. Cal group files must have the extension *.cal. The directory path must not be specified. If there is no link between <Ch> and the specified file, the command has no effect. If no file is specified, the command resolves any link between <Ch> and

an arbitrary cal group file.

*RST value –

SCPI, Command Types Device-specific, no query.

Example: See `MMEMemory:LOAD:CORRection`

MMEMemory:LOAD:LIMit '<trc_name>','<file_name>','<param_name>', <x_offset>, <y_offset>, <type>]

Loads a limit line definition from a specified file and assigns it to a trace with a specified name. Limit lines are created using the `CALCulate<Chn>:LIMit...` commands.



Limit lines can be loaded from Touchstone files (.s<n>p, where <n> denotes the number of ports). The optional parameters '<param_name>', <x_offset>, <y_offset>, <type> are only relevant for Touchstone files. For *.limit files, no optional parameters can be set.*

'<trc_name>' Name of an existing trace in the active setup (string parameter). The imported limit line is assigned to this trace, irrespective of the trace information in the limit line file.

*RST value –

'<file_name>' String parameter to specify the name and directory of the limit line file to be loaded. The default extension (manual control) for limit line files is *.limit, although other extensions are allowed. If no path is specified the analyzer searches the current directory, to be queried with `MMEMemory:CDIRectory?`. See also note on Touchstone files above.

*RST value –

'<param_name>' String parameter, selects an S-parameter from a Touchstone file. The parameter must be compatible with the file type (e.g. for one-port Touchstone files *.s1p, only the parameter name 'S11' is allowed).

*RST value 'S11' (if all optional parameters are omitted)

<x_offset> Stimulus offset for limit lines loaded from a Touchstone file. A 1 GHz offset shifts the limit line by 1 GHz in (positive) horizontal direction.

Range [def. unit] Depending on the sweep range of the analyzer. [Hz]

*RST value 0

<y_offset> Response offset for limit lines loaded from a Touchstone file. A 1 dB offset shifts the limit line by 1 dB in (positive) vertical direction.

Range [def. unit] Depending on the measured quantity. [dB]

*RST value 0

<type> Limit line type :
LMAX – upper limit line
LMIN – lower limit line
OFF – limit line off

*RST value LMAX (if all optional parameters are omitted)

SCPI, Command Types Device-specific, no query.

Example:

Assume that the current setup contains two traces named Trc1 and Trc2, respectively, and that limit lines have been defined for Trc1.

```
MMEM:STOR:LIM 'TRC1',
'C:\R_S\Instr\user\Nwa\LIMitLines\Lim_Trcl.limit'
```

Store the limit line definition of Trc1 to a limit line file.

```
MMEM:LOAD:LIM 'TRC2',
'C:\R_S\Instr\user\Nwa\LIMitLines\Lim_Trcl.limit'
```

Load the previously created limit line file and assign the limit lines to Trc2.

```
MMEM:STOR:TRAC 'TRC1',
'C:\R_S\Instr\user\Nwa\LIMitLines\Trcl.slp'
```

Store the current trace data of Trc1 to a limit line file in Touchstone format.

```
MMEM:LOAD:LIM 'TRC1',
'C:\R_S\Instr\user\Nwa\LIMitLines\Trcl.slp', 'S11', 0, 2,
LMAX
```

Load the previously created Touchstone limit line file and assign the limit lines to Trc1, applying a response offset of 2 dB.

```
CALC:LIMit:DISPlay ON
```

Show the limit line in the diagram.

MMEMory:LOAD:NWANalyzer <numeric_value>,'<file_name>'

Loads configuration data from a specified setup file and sets the analyzer to the corresponding instrument state.

<numeric_value> 1 (the <numeric_value> is used for compatibility with the SCPI standard but is ignored).

<file_name> String parameter to specify the name and directory of the setup file to be loaded. The default extension (manual control) for setup files is *.nwa, although other extensions are allowed. If no path is specified the analyzer searches the current directory, to be queried with MMEMory:CDIRectory?.

*RST value –

SCPI, Command Types Confirmed, no query.

Example:

```
MMEM:STOR:NWAN 1,'C:\R_S\Instr\user\Nwa\Setup_0413.nwa'
```

Store the current setup configuration in the file Setup_0413.NWA in the default directory for setup files.

```
MMEM:LOAD:NWAN 1,'C:\R_S\Instr\user\Nwa\Setup_0413.nwa'
```

Load the settings stored in Setup_0413.NWA.

MMEMory:LOAD:RIPPlE '<trc_name>','<file_name>'

Loads a ripple limit definition from a specified file and assigns it to a trace with a specified name. Ripple limits are created using the `CALCulate<Chn>:RIPPlE...` commands.

'<trc_name>' Name of an existing trace in the active setup (string parameter). The imported ripple limit line is assigned to this trace, irrespective of the trace information in the ripple limit file.

*RST value –

'<file_name>' String parameter to specify the name and directory of the ripple limit file to be loaded. The default extension (manual control) for ripple limit files is *.ripple, although other extensions are allowed. If no path is specified the analyzer searches the current directory, to be queried with `MMEMory:CDIRectory?`.

*RST value –

SCPI, Device-specific, no query.

Command Types

Example:

Assume that the current setup contains two traces named Trc1 and Trc2, respectively, and that ripple limits have been defined for Trc1.

```
MMEM:STOR:RIPP 'TRC1',
'C:\Rohde&Schwarz\NWA\LIMitLines\Lim_Trcl.limit'
```

Store the ripple limit definition of Trc1 to a ripple limit file.

```
MMEM:LOAD:RIPP 'TRC2',
'C:\Rohde&Schwarz\NWA\LIMitLines\Lim_Trcl.limit'
```

Load the previously created ripple limit file and assign the limits to Trc2.

```
CALC:RIPP:DISPlay ON
```

Show the ripple limit line for the active trace in the diagram.

MMEMory:LOAD:SEGMENT <Ch>,'<file_name>'

Loads a sweep segment definition from a specified file and assigns it to a specified channel. Sweep segments are defined using the `[SENSe<Ch>:]SEGMENT<Seg>...` commands.

<Ch> Channel number.

'<file_name>' String parameter to specify the name and directory of the sweep segment file to be loaded. The default extension (manual control) for sweep segment files is *.seglist, although other extensions are allowed. If no path is specified the analyzer searches the current directory, to be queried with `MMEMory:CDIRectory?`.

*RST value –

SCPI, Command Device-specific, no query.

Types

Example:

Assume that the current setup contains two channels numbered 1 and 2, respectively, and that sweep segments have been defined for channel no. 1.

```
:MMEM:STOR:SEGM 1,
'C:\R_S\Instr\user\Nwa\SweepSegments\Seg_Ch1.seglist'
```

Store the sweep segment definition of channel 1 to a sweep segment file.

```
MMEM:LOAD:SEGM 2,
'C:\R_S\Instr\user\Nwa\SweepSegments\Seg_Ch1.seglist'
```

Load the previously created sweep segment file and use the sweep segments for channel 2.

MMEMory:LOAD:STATe <numeric_value>,'<file_name>'

Loads configuration data from a specified device settings file and sets the analyzer to the corresponding instrument state.

<numeric_value> 1 (the <numeric_value> is used for compatibility with the SCPI standard but is ignored).

<file_name> String parameter to specify the name and directory of the settings file to be loaded. The default extension for settings files is *.zvl.dfl (see `MMEMory:STOR:STATe`). This extension may be omitted when a settings file is loaded. If no path is specified the analyzer searches the current directory, to be queried with `MMEMory:CDIRECTory?`.

*RST value –

SCPI, Command Confirmed, no query.

Types

Example:

```
MMEM:STOR:STAT 1, 'C:\R_S\Instr\user\Setup_0413.zvl.dfl'
```

Store the current configuration to the file Setup_0413.zvl.dfl in the default directory for settings files.

```
MMEM:STOR:STAT:NEXT
```

Store the current configuration to the file Setup_0414.zvl.dfl in the default directory for settings files.

```
MMEM:LOAD:STAT 1, 'C:\R_S\Instr\user\Setup_0413.zvl.dfl'
```

Load the settings stored in Setup_0413.zvl.dfl.

MMEMory:LOAD:TRACe '<trc_name>','<file_name>',['<parameter_name>']

Loads trace data from a specified trace file and assigns it to a trace with a specified name. Traces are created using the `CALCulate<Ch>:PARAmeter:SDEFine...` command.

'<trc_name>'	Name of an existing data trace in the active setup (string parameter). The trace data is loaded into a memory trace associated with the specified data trace. If one or more memory traces are already associated with the specified data trace, the last generated memory trace is overwritten.
'<file_name>'	String parameter to specify the name and directory of the trace file to be loaded. Several file formats for trace files are supported. If no path is specified the analyzer searches the current directory, to be queried with <code>MMEMory:CDIRectory?</code> . The file extensions <code>*.s<n>p</code> , <code>*.csv</code> , and <code>*.dat</code> for Touchstone, ASCII, and Matlab files are mandatory.
'<parameter_name>'	Optional string parameter for imported Touchstone files for more than one port (<code>*.s2p</code> , <code>*.s3p</code> , <code>*.s4p</code>), denotes the imported S-parameter ('S11', 'S12', ...). If nothing is specified, the first trace in the specified file is imported.
*RST value	–

SCPI, Command Types

Confirmed, no query.

Example:

Assume that the current setup contains a trace named Trc1.

```
MMEM:STOR:TRAC 'TRC1',
'C:\R_S\Instr\user\Nwa\Traces\Trc1.s1p'
```

Store the current trace data of Trc1 to a trace file.

```
MMEM:LOAD:TRAC 'TRC1',
'C:\R_S\Instr\user\Nwa\Traces\Trc1.s1p'
```

Load the previously created trace file and create a memory trace assigned to Trc1.

```
CALC:PAR:DEF:SGR 1,2
```

Create four traces to measure the two-port S-parameters S_{11} , S_{12} , S_{21} , S_{22} . The traces are not displayed.

```
MMEM:STOR:TRAC 'TRC1',
'C:\R_S\Instr\user\Nwa\Traces\Trc1.s2p'
```

Store the four S-parameter traces to a two-port Touchstone file.

```
MMEM:LOAD:TRAC 'TRC1',
'C:\R_S\Instr\user\Nwa\Traces\Trc1.s2p'
```

Load the previously created Touchstone file and overwrite the previously generated memory trace assigned to Trc1 with the S_{11} trace.

MMEMory:LOAD:VNETworks<Ch>:SENDED:DEEMbedding<Ph_pt> '<file_name>'

Loads data from a specified two-port (*.sp2) Touchstone file defining the characteristics of the current deembedded single ended port circuit model. The single ended port circuit model involving file import (FIMPport) must be selected before using the command.

<Ch>	Channel number.
<Ph_pt>	Physical port number
'<file_name>'	String parameter to specify the name and directory of the loaded Touchstone file. If no path is specified the analyzer searches the current directory, to be queried with MMEMory:CDIRECTORY?.
*RST value	–
SCPI, Command Types	Device-specific, no query.

Example:

```
CALC:TRAN:VNET:SEND:DEEM:TND FIMP
```

Select the *Serial .s2p data, shunt L* circuit model.

```
MMEM:LOAD:VNET:SEND:DEEM2
```

```
'C:\Rohde&Schwarz\NWA\VNETWORKS\Test.s2p'
```

Load a Touchstone file and assign it to the physical port no. 2.

MMEMory:LOAD:VNETworks<Ch>:SENDED:EMBedding<Ph_pt> '<file_name>'

Loads data from a specified two-port (*.sp2) Touchstone file defining the characteristics of the current embedded single ended port circuit model. The single ended port circuit model involving file import (FIMPport) must be selected before using the command.

<Ch>	Channel number.
<Ph_pt>	
'<file_name>'	String parameter to specify the name and directory of the loaded Touchstone file. If no path is specified the analyzer searches the current directory, to be queried with MMEMory:CDIRECTORY?.
*RST value	–
SCPI, Command Types	Device-specific, no query.

Example:

```
CALC:TRAN:VNET:SEND:EMB:TND FIMP
```

Select the *Serial .s2p data, shunt L* circuit model.

```
MMEM:LOAD:VNET:SEND:EMB2
```

```
'C:\Rohde&Schwarz\NWA\VNETWORKS\Test.s2p'
```

Load a Touchstone file and assign it to the physical port no. 2.

MMEemory:MDIRectory '<directory_name>'

Creates a new subdirectory for mass memory storage in an existing directory.

'<directory_name>' String parameter to specify the new directory. Either the full path or a subdirectory for the current directory (see MMEemory:CDIRectory).
***RST value** –

SCPI, Command Types Device-specific, no query.

Example:

```
MMEemory:MDIR 'C:\Documents and Settings\New_Directory'
```

Create the specified directory. The parent directory 'C:\Documents and Settings' must have been created before.

```
MMEemory:MDIR 'C:\Documents and Settings\New_Directory\New_Subdirectory'
```

Create an additional subdirectory.

```
MMEemory:CDIR 'C: '; MDIR 'New_Rootdirectory'
```

Create an additional directory C:\New_Rootdirectory.

MMEemory:MOVE '<file_source>','<file_destination>'

Moves a file to the indicated directory and stores it under the file name specified, if any. If <file_destination> contains no path indication, the command renames the file without moving it.

'<file_source>','<file_destination>' String parameters to specify the name and the path of the file to be copied and the name and the path of the new file.
***RST value** –

SCPI, Command Types Confirmed, no query.

Example:

```
MMEemory:MOVE 'C:\USER\DATA\SETUP.ZVL.DFL','E: '
```

Move file Setup.zvl.dfl in directory C:\USER\DATA to the external storage medium, mapped to drive E:\.

MMEemory:MSIS '<drive_name>'

Selects a default mass storage device which is used by some of the MMEemory commands. The command does not reset the current directory (MMEemory:CDIRectory).

'<drive_name>' String parameter to specify the drive. 'c:' for the internal hard disk. Other external storage devices (e.g. a memory stick connected to one of the USB ports, a network connection) are mapped to any free drive letter.
***RST value** C:

SCPI, Command Types Confirmed, with query.

Example:

```
MMEM:MSIS 'C:'
Select internal hard disk..
```

MMEMory:NAME '<file_name>'

Defines a name for a file which can be used to store the printer output. The file is created when it is selected as a printer destination (HCOPY:DESTINATION 'MMEM').

'<file_name>' String parameter to specify the file name. The supported file formats are *.gdi, *.wmf, *.ewmf, *.bmp, *.jpg, *.png; see command HCOPI:DEVICE:LANGUAGE. The specified directory must exist, otherwise no file can be generated. If no path is specified the analyzer uses the current directory, to be queried with MMEMory:CDIRECTORY?.

***RST value** 'C:\R_S\Instr\user\Print'

SCPI, Command Types Device-specific, with query.

Example:

```
MMEM:NAME 'C:\Screenshots\PLOT1.BMP'
```

Define a printer file name, to be stored in the existing directory C:\Screenshots (without creating the file).

```
HCOPY:DEST 'MMEM'; HCOPI
```

Select 'Print to file' and create the printer file specified before.

MMEMory:NETWork:DISConnect '<drive_name>'

Disconnects the selected (and previously mapped) network drive.

'<drive_name>' String parameter to specify the drive.

***RST value** -

SCPI, Command Types Device-specific, no query.

Example:

```
MMEM:NETW:USED ON
```

List all mapped network drives including the folder information.

```
MMEM:NETW:UNUS?
```

List all unused network drive names.

```
MMEM:NETW:MAP 'T:', '\\server\folder'
```

Map drive T: to folder on server.

```
MMEM:NETW:DISC 'T:'
```

Disconnect drive T:.

MMEmory:NETWork:MAP '<drive_name>', '<host_name>',['<user_name>', '<password>'][,<Boolean>]

Maps a drive to a server or server folder of the network. As a prerequisite in Microsoft networks, sharing of this server or server folder must be enabled.

'<drive_name>'	String parameter to specify the drive.
'<host_name>'	String parameter in the format '\\<host name or IP address>\<share name>'
'<user_name>'	String parameter to specify a user name
'<password>'	String parameter to specify a password
<Boolean>	ON OFF – Enable/disable reconnect at logon
*RST value	–

SCPI, Command Types Device-specific, no query.

Example: See `MMEmory:NETWork:DISConnect`

MMEmory:NETWork:UNUSeddrives?

Lists all unused network drive names.

*RST value	–
SCPI, Command Types	Device-specific, query only.

Example: See `MMEmory:NETWork:DISConnect`

MMEmory:NETWork:USEDdrives <Boolean>

List all used network drives.

<Boolean>	ON – include folder information OFF – list of drive names only
*RST value	–
SCPI, Command Types	Device-specific, command or query. The query returns the list of drive names without folder information.

Example: See `MMEmory:NETWork:DISConnect`

MMEmory:RDIRECTory '<directory_name>'

Removes an existing directory from the mass memory storage system.

'<directory_name>'	String parameter to specify the directory.
*RST value	–

SCPI, Command Types Device-specific, no query.

Example:

```
MMEM:RDIR 'C:\Documents and
Settings\NetworkService\Application Data'
```

Remove the specified directory.

MMEMory:SElect[:ITEM]:ALL

Includes all data subsets in the list of device settings to be stored/loaded.

*RST value –

SCPI, Command Types Device-specific, no query.

Example:

```
MMEM:SEL:ALL
```

Select all data subsets.

MMEMory:SElect[:ITEM]:DEFault

Sets the default list of device settings to be stored/loaded. For details on hardware settings refer to the MMEMory:SElect[:ITEM]:HWSettings command.

*RST value –

SCPI, Command Types Device-specific, no query.

Example:

```
MMEM:SEL:DEFault
```

Set the default list of device settings.

MMEMory:SElect[:ITEM]:HWSettings <Boolean>

Includes the hardware settings in the list of data subsets of a device setting to be stored/loaded.

The hardware settings include:

- current configuration of general device parameters (general setup)
- current setting of the measurement hardware including markers
- activated limit lines
A data set may include 8 limit lines at maximum. This number includes the activated limit lines and, if available, the deactivated limit lines last used.
Therefore the combination of the non-activated restored limit lines depends on the sequence of use with the MMEMory:LOAD:STATe command.
- user-defined color setting
- configuration for the hardcopy output

<Boolean> ON | OFF – Includes the hardware settings in the list of data subsets or

	excludes them.
*RST value	ON
SCPI, Command Types	Device-specific, command or query.
Example:	<code>MMEM:SEL:HWS ON</code>
	Select the hardware settings.

MMEMory:SElect[:ITEM]:LINEs:ALL <Boolean>

Adds all limit lines (activated and deactivated) to the list of device settings to be stored/loaded.

<Boolean>	ON OFF – Includes the limit lines in the list of data subsets or excludes them.
*RST value	ON
SCPI, Command Types	Device-specific, no query.
Example:	<code>MMEM:SEL:LIN:ALL ON</code>
	Select the limit lines.

MMEMory:SElect[:ITEM]:NONE

Deletes all data subsets from the list of device settings to be stored/loaded.

*RST value	–
SCPI, Command Types	Device-specific, no query.
Example:	<code>MMEM:SEL:NONE</code>
	Exclude all data subsets.

MMEMory:SElect[:ITEM]:TRACe[:ACTive] <Boolean>

Adds the active traces to the list of data subsets of a save/recall device setting. Active traces are all traces whose state is not blank.

<Boolean>	ON – Includes the active traces in the list of data subsets. OFF – No traces will be stored.
*RST value	OFF
SCPI, Command Types	Device-specific, no query.
Example:	<code>MMEM:SEL:TRAC ON</code>
	Select the active traces.

MMEMory:STOR:CABL '<target_directory>'

Copies all pre-defined and user-defined cable description files (*.rsc) to a specified directory. The contents of the source directories for cable description files (C:\R_S\Instr\resources\Nwa\CableTypes for predefined, C:\R_S\Instr\user\Nwa\CableTypes for user-defined cables) are not affected.

'<target_directory>' String parameter to specify the target directory.

*RST value –

SCPI, Command Types Device-specific, no query.

Example:

```
MMEM:STOR:CABL 'c:\temp'
```

Copy all *.rsc files from the source directories (see above) to C:\temp.

After a possible modification of the *.rsc files in c:\temp:

```
MMEM:LOAD:CABL 'c:\temp'
```

Re-load all *.rsc files from C:\temp. The files remain in c:\temp; they are not copied to the default directories for cable description files.

MMEMory:STOR:CKIT '<kit_name>', '<file_name>'

Stores the data of a calibration kit to a specified file.

'<kit_name>' Name of a user-defined calibration kit available on the analyzer.



It is not possible to modify or store predefined or ideal kits.

'<file_name>' String parameter to specify the name and directory of the cal kit file to be created. The file is a NWA-specific cal kit file with the extension *.calkit. If no path is specified the analyzer uses the current directory, to be queried with MMEMory:CDIRectory?.

*RST value –

SCPI, Command Types Device-specific, no query.

Example:

```
MMEM:LOAD:CKIT  
'C:\R_S\Instr\user\Nwa\Calibration\Kits\New_kit.calkit'
```

Load the previously created cal kit file New_kit.calkit from the default cal kit directory.

```
... :MMEM:STOR:CKIT 'New_kit',  
'C:\R_S\Instr\user\Nwa\Calibration\Kits\New_kit.calkit'
```

Store the data for the user-defined cal kit Newkit and overwrite the cal kit file New_kit.calkit.

MMEMory:STORe:CMAP '<file_name>'

Stores a color scheme to a specified NWA color scheme file.

'<file_name>' String parameter to specify the name and directory of the color scheme file to be created. If no path is specified the analyzer uses the current directory, to be queried with `MMEMory:CDIRectory?`. The default extension (manual control) for color scheme files is `*.ColorScheme`, although other extensions are allowed.

*RST value –

**SCPI,
Command
Types** Device-specific, no query.

Example: See `MMEMory:LOAD:CMAP`

MMEMory:STORe:CORRection <Ch>,'<file_name>'

Copies the correction data of channel <Ch> to the cal pool, generating a new correction data file (cal group). The file has the extension `*.calkit` and is stored in the `C:\R_S\Inst\user\Nwa\Calibration\Data` directory.

<Ch> Channel number

'<file_name>' String parameter to specify the name of the created cal group file. The directory path must not be specified; the analyzer always uses the default cal pool directory `C:\R_S\Inst\user\Nwa\Calibration\Data`.

*RST value –

**SCPI,
Command
Types** Device-specific, no query.

Example: See `MMEMory:LOAD:CORRection`

MMEMory:STORe:LIMit '<trc_name>', '<file_name>'

Saves the limit lines associated with a specified trace to a limit line file. Limit lines are created using the `CALCulte<Chn>:LIMit...` commands.

'<trc_name>' Name of an existing trace in the active setup (string parameter) for which a limit line definition exists.

'<file_name>' String parameter to specify the name and directory of the created limit line file. The default extension (manual control) for limit line files is `*.limit`, although other extensions are allowed. If no path is specified the analyzer uses the current directory, to be queried with `MMEMory:CDIRectory?`.

*RST value –

**SCPI,
Command
Types** Device-specific, no query.

Example: See `MMEMemory:LOAD:LIMit`.

MMEMemory:STOR:MARKer '<file_name>'

Saves the values of all markers to a ASCII file.

'<file_name>' String parameter to specify the name and directory of the created ASCII file. The default extension (manual control) for marker files is *.txt, although other extensions are allowed. If no path is specified the analyzer uses the current directory, to be queried with `MMEMemory:CDIRectory?`. An example for the file contents is given below.

*RST value –

SCPI, Command Types Device-specific, no query.

Example:

```
*RST
```

Reset the analyzer, creating the default trace no. 1 in channel no. 1.

```
CALC:MARK ON; MARK:X 1GHz
```

Create marker no. 1 and place it to 1 GHz.

```
CALC:MARK2 ON; MARK2:X 2GHz
```

Create a second marker and place it to 2 GHz.

```
MMEM:STOR:MARK 'Marker.txt'
```

Store the marker values to an ASCII file. The file contains both marker values:

```
Trc1 521
Mkr 1 1.000000 GHz -4.900 dB
Mkr 2 2.000000 GHz -6.087 dB
```

MMEMemory:STOR:NWANalyzer <numeric_value>,<file_name>'

Stores the configuration data of the current setup to a specified setup file.



MMEMemory:STOR:NWANalyzer renames the current setup, appending a .nwa extension. See *example for MMEMemory:LOAD:NWANalyzer*.

<numeric_value> 1 (the <numeric_value> is used for compatibility with the SCPI standard but is ignored).

'<file_name>' String parameter to specify the name and directory of the created setup file. The default extension (manual control) for setup files is *.nwa, although other extensions are allowed. If no path is specified the analyzer uses the current directory, to be queried with `MMEMemory:CDIRectory?`.

*RST value –

SCPI, Command Confirmed, no query.

Types**Example:**

See `MMEMemory:LOAD:NWAnalyzer`.

MMEMemory:STORe:RIPPlE '<trc_name>', '<file_name>'

Saves the ripple limits associated with a specified trace to a ripple limit file. Ripple limit definitions are created using the `CALCulte<Chn>:RIPPlE...` commands.

'<trc_name>' Name of an existing trace in the active setup (string parameter) for which a ripple limit definition exists.

'<file_name>' String parameter to specify the name and directory of the created ripple limit file. The default extension (manual control) for ripple limit files is `*.ripple`, although other extensions are allowed. If no path is specified the analyzer uses the current directory, to be queried with `MMEMemory:CDIRectory?`.

*RST value –

**SCPI,
Command
Types**

Example:

See `MMEMemory:LOAD:LIMit`.

MMEMemory:STORe:SEGMENT <Ch>, '<file_name>'

Saves the sweep segment definition of a specified channel to a sweep segment file. Sweep segments are defined using the `[SENSe<Ch>:]SEGMENT<Seg>...` commands.

<Ch> Channel number.

'<file_name>' String parameter to specify the name and directory of the created sweep segment file. The default extension (manual control) for sweep segment files is `*.seglist`, although other extensions are allowed. If no path is specified the analyzer uses the current directory, to be queried with `MMEMemory:CDIRectory?`.

*RST value –

**SCPI,
Command
Types**

Example:

See `MMEMemory:LOAD:SEGMENT`.

MMEMemory:STORe:STATe <numeric_value>,'<file_name>'

Stores the configuration data of the current device settings to a specified settings file.

<numeric_value> 1 (the `<numeric_value>` is used for compatibility with the SCPI standard but is ignored).

'<file_name>' String parameter to specify the name and directory of the created settings file.

Instrument-Control Commands

The default extension for settings files is *.zvl.dfl. `MMEMemory:STORe:STATe` automatically appends the default extension, if a file name without extension (or with a different extension) is specified. It is allowed though to re-name settings files using other extensions. If no path is specified the analyzer uses the current directory, to be queried with `MMEMemory:CDIRectory?`.

*RST value	–
SCPI, Command Types	Confirmed, no query.
Example:	See <code>MMEMemory:LOAD:STATe</code> .

MMEMemory:STORe:STATe:NEXT

Stores the configuration data of the current data set to a data set file using the file name used in the last saving process. This file name is automatically counted up to the next unused name.

*RST value	–
SCPI, Command Types	Device-specific, no query.
Example:	See <code>MMEMemory:LOAD:STATe</code> .

MMEMemory:STORe:TRACe '<trc_name>','<file_name>',[UNFormatted | FORMatted, COMPLex | LINPhase | LOGPhase, POINT | COMMa, SEMicolon | COMMa | TABulator | SPACE]

Stores the trace data of a specified trace to a trace file. Traces are created using the `CALCulte<Ch>:PARAmeter:SDEFine...` command.



*.s<n>p Touchstone files (<n> = 1, 2, 3, ...) are intended for a complete set of <n>-port S-parameters. Data export fails if the active channel does not contain the full set of <n>² traces. If the necessary trace are available, '<trc_name>' can be the name of any of the traces.

'<trc_name>'	Name of an existing data trace in the active setup (string parameter).
'<file_name>'	String parameter to specify the name and directory of the created trace file. Several file formats for trace files are supported. The file extensions *.s<n>p, *.csv, and *.dat for Touchstone, ASCII, and Matlab files are mandatory. To generate a multiport Touchstone file *.s2p, *.s3p..., the channel must contain traces for the full set of S-parameters; the '<trc_name>' is ignored. If no path is specified the analyzer uses the current directory, to be queried with <code>MMEMemory:CDIRectory?</code> .

Optional parameters	<p>UNFormatted – Unformatted data export specified by the second optional parameter</p> <p>FORMatted – Formatted data export (for *.csv and *.dat files only)</p> <p>If the first optional parameter is omitted the command stores unformatted data.</p> <p>COMPLex – Complex values (real and imaginary part)</p> <p>LINPhase – Linear magnitude and phase</p> <p>LOGPhase – dB-magnitude and phase</p> <p>If the second optional parameter is omitted the command stores complex data.</p>
----------------------------	--

	POINT – Decimal separator: point COMMa – Decimal separator: comma If the third optional parameter is omitted, points are used. SEMicolon – Field separator: semicolon COMMa – Field separator: comma TABulator – Field separator: tabulator SPACe – Field separator: space If the fourth optional parameter is omitted, semicolons are used.
*RST value	– (the default export format is UNFormatted)
SCPI, Command Types	Confirmed, no query.
Example:	See <code>MMEMemory:LOAD:TRACe.</code>

MMEMemory:STORE:TRACe:USER...

The `MMEMemory:STORE:TRACe:USER...` subsystem configures the custom header for trace files.



A *RST does not change the custom header settings. Press the Use Default Directories button in the System Configuration dialog (Nwa-Setup – System Config.) to reset the settings.

MMEMemory:STORE:TRACe:USER:CINformation <Boolean>

Qualifies whether the calibration information is included in the custom header.

<Boolean>	ON OFF – calibration information included/omitted
*RST value	ON (after <i>Use Default Directories</i>)
SCPI, Command Types	Device-specific, command or query.
Example:	<code>MMEMemory:STORE:TRACe:USER:IINF OFF; DATE OFF; CINF OFF</code>

Omit instrument information, date and time, and calibration information in the custom header.

```
MMEMemory:STORE:TRACe:USER:TEXT:STAT ON
```

Include user notes in the custom header.

```
MMEMemory:STORE:TRACe:USER:TEXT 'Transmission coefficient S21 for DUT no. 1'
```

Define user notes.

```
MMEMemory:STORE:TRACe:USER:STAT ON
```

Apply custom header to all trace files created subsequently.

```
MMEMemory:STORE:TRACe 'TRC1', 'C:\R_S\Instr\user\Nwa\Traces\Trc1.s1p'
```

Store the current trace (named *Trc1*) to a file, including the custom header. The custom header consists of a single line: *! Transmission coefficient S21 for DUT no. 1*

MMEMory:STORe:TRACe:USER:DATE <Boolean>

Qualifies whether the date and time is included in the custom header.

<Boolean> ON | OFF – date and time included/omitted

*RST value ON (after *Use Default Directories*)

SCPI, Command Types Device-specific, command or query.

Example: See `MMEMory:STORe:TRACe:USER:CINFormation`

MMEMory:STORe:TRACe:USER:IINFormation <Boolean>

Qualifies whether the instrument information is included in the custom header.

<Boolean> ON | OFF – instrument information included/omitted

*RST value ON (after *Use Default Directories*)

SCPI, Command Types Device-specific, command or query.

Example: See `MMEMory:STORe:TRACe:USER:CINFormation`

MMEMory:STORe:TRACe:USER:STATe <Boolean>

Qualifies whether the custom header is written to the trace file.

<Boolean> ON | OFF – custom header used/not used

*RST value OFF (after *Use Default Directories*)

SCPI, Command Types Device-specific, command or query.

Example: See `MMEMory:STORe:TRACe:USER:CINFormation`

MMEMory:STORe:TRACe:USER:TEXT '<text>'

Defines the user notes for the custom header.

'<target_directory>' String parameter to specify the user notes

*RST value '' (empty string, after *Use Default Directories*)

SCPI, Command Types Device-specific, no query.

Example: See `MMEMory:STORe:TRACe:USER:CINFormation`

MMEMory:STORe:TRACe:USER:TEXT:STATe <Boolean>

Qualifies whether the user notes are included in the custom header.

<Boolean> ON | OFF – user notes used/not used

*RST value ON (after *Use Default Directories*)

SCPI, Command Types Device-specific, command or query.

Example: See `MMEMory:STORe:TRACe:USER:CINFormation`

OUTPut<Pt>...

This subsystem controls the characteristics of the analyzer's output ports.

OUTPut<Chn>:DPORt PORT1 | PORT2

Selects a source port for the stimulus signal (drive port). The setting acts on the active trace. The effect of the drive port selection depends on the measurement parameter associated with the active trace:

- If an S-parameter $S_{\text{out}<\text{in}>}$ is measured, the second port number index <in> (input port of the DUT = drive port of the analyzer) is set equal to the selected drive port: Drive port selection affects the measured quantity.
- If a wave quantity or a ratio is measured, the drive port is independent from the measured quantity:

Note: This command is equivalent to `[SENSe<Chn>:]SWEep:SRCPort`.

<Chn> Channel number used to identify the active trace. If unspecified the numeric suffix is set to 1.

PORT1 ... Test port number of the analyzer, 1 to 2.

*RST value PORT1

SCPI, Command Types Device-specific, with query.

Example: `CALC4:PAR:SDEF 'Ch4Tr1', 'A1'`

Create channel 4 and a trace named *Ch4Tr1* to measure the wave quantity a1. The trace automatically becomes the active trace.

`OUTP4:DPOR PORT2`

Select drive port 2 for the active trace.

OUTPut<Ch>[:STATe] <Boolean>

Turns the internal source power at all ports and the power of all external generators on or off.

<Ch> Channel number. This suffix is ignored; the setting is valid for all channels.

<Boolean> ON | OFF - Switches the power on or off.

*RST value ON

SCPI, Command Types Device-specific, command or query

Example: `OUTP OFF`

Turn off the RF source power.

PROGram...

This subsystem controls external application programs that can be run on the analyzer.

PROGram[:SELEcted]:EXECute '<file_name>[<command>]'

Starts an application program or open a file using an application available on the analyzer.

'<file_name>' Name and path of an application program to be executed or of a file to be opened. The path can be defined as an absolute path (e.g. 'c:\...') or relative to the current directory (MMEMory:CDIRectory). Blanks in the file name are not allowed because everything after a blank is interpreted as a <command>.

<command> Command name in the selected application <file_name> (optional).
*RST value –

SCPI, Command Types Confirmed, no query.

Example:

```
PROG:SEL:NAME PROG
```

Selects general program execution on the analyzer.

```
MMEM:CDIR 'C:\Program Files\Rohde&Schwarz\Network Analyzer\Bin'
```

Go to the program directory.

```
PROG:EXEC 'iecin32.exe'
```

Start the application iecin32.

```
PROG:EXEC:WAIT
```

Lock command execution and manual control of the analyzer until iecin32 is paused or stopped.

PROGram[:SELEcted]:NAME PROG

Selects the application to be run on the analyzer. At present, only the general parameter PROG is available: PROGram[:SELEcted]:EXECute can start any program.



Use this command in order to avoid problems should the default value change in future firmware versions.

PROG Any program running under Windows XP or any file that can be opened with an application program available on the analyzer.

*RST value	PROG
SCPI, Command Types	Confirmed, command or query.
Example:	See <code>PROGram[:SElected]:EXECute.</code>

PROGram[:SElected]:WAIT

Locks command execution and manual control of the analyzer while a program started via `PROGram[:SElected]:EXECute` is running. The analyzer does not execute any further commands or queries until the program is stopped or paused.

Parameters	None.
*RST value	–
SCPI, Command Types	Confirmed, command or query. The query also locks command execution; it returns 1 when the executed program is stopped or paused.
Example:	See <code>PROGram[:SElected]:EXECute.</code>

[SENSe...]

[SENSe<Ch>:]AVERAge...

This subsystem sets sweep averaging parameters. The sweep average is a noise-reduction technique which consists of calculating each measurement point as an average of the same measurement point over several consecutive sweeps.

[SENSe<Ch>:]AVERAge:CLEAr

Starts a new average cycle, clearing all previous results and thus eliminating their effect on the new cycle.

<Ch>	Channel number. If unspecified the numeric suffix is set to 1.
*RST value	–
SCPI, Command Types	Confirmed, no query
Example:	<code>AVER:COUN 15; AVER ON</code> Set the average factor for channel 1 to 15 and enable the sweep average.
	<code>AVER:COUN 5; CLE</code> Reduce the average factor and restart the average.

[SENSe<Ch>:]AVERAge:COUNT <numeric_value>

Defines the number of consecutive sweeps to be combined for the sweep average (*Average Factor*).

<Ch>	Channel number.
<numeric_value>	Average factor
Range [def. unit]	1 to 1000 [1]
*RST value	10
SCPI, Command Types	Confirmed, command or query

Example:

```
AVER:COUN 15
```

Set the average factor for channel 1 to 15.

```
AVER ON
```

Enable the sweep average.

[SENSe<Ch>:]AVERAge[:STATe] <Boolean>

Enable or disable the sweep average.

<Ch>	Channel number.
<Boolean>	ON OFF - Enables or disables the automatic calculation of the sweep average over the specified number of sweeps ([SENSe<Ch>:]AVERAge:COUNT).
*RST value	ON
SCPI, Command Types	Confirmed, command or query

Example:

```
AVER:COUN 15
```

Set the average factor for channel 1 to 15.

```
AVER ON
```

Enable the sweep average over the defined number of sweeps.

[SENSe<Ch>:]BANDwidth...

This subsystem sets the bandwidth of the IF measurement filter (resolution bandwidth) and the filter type. The forms `BANDwidth` and `BWIDth` are equivalent.

[SENSe<Ch>:]BANDwidth|BWIDth[:RESolution] <bandwidth>

Defines the resolution bandwidth of the analyzer (*Meas Bandwidth*).

<Ch>	Channel number. If unspecified the numeric suffix is set to 1.
<bandwidth>	Resolution bandwidth
Range [def. unit]	10 Hz to 500 kHz. UP and DOWN increment/decrement the bandwidth in 1-2-5

	steps for each decade. The analyzer rounds up any entered value between these steps and rounds down values exceeding the maximum bandwidth.
*RST value	10 kHz
SCPI, Command Types	Confirmed, command or query
Example:	<code>BAND 1.1</code>
	Set a resolution bandwidth of approx. 1.1 Hz for channel 1.
	<code>BAND?</code>
	The analyzer returns the rounded bandwidth of 2 Hz.

[SENSe<Ch>:]BANDwidth|BWIDth[:RESolution]:SElect FAST | NORMal

Defines the selectivity of the IF filter for an unsegmented sweep. The value is also used for all segments of a segmented sweep, provided that separate selectivity setting is disabled ([SENSe<Ch>:]SEGment<Seg>:BWIDth[:RESolution]:SElect:CONTRol OFF).

<Ch>	Channel number.
FAST	Use IF filter short settling time.
NORMal	Use IF filter with higher selectivity but larger settling time.
*RST value	FAST
SCPI, Command Types	Device-specific, command or query
Example:	See [SENSe<Ch>:]SEGment<Seg>:BWIDth[:RESolution]:SElect:CONTRol

[SENSe<Ch>:]CORRection...

This subsystem controls system error correction and recording of correction data.

[SENSe<Ch>:]CORRection:CDATa 'DIRECTIVITY' | 'SRCMATCH' | 'REFLTRACK' | 'ISOLATION' | 'LOADMATCH' | 'TRANSTRACK', <port1_no>, <port2_no>

Writes or reads system error correction data for a specific channel <Ch>, calibration method ([SENSe<Ch>:]CORRection:COLlect:METHod:DEFine), and port combination <Port1_no>, <Port2_no>. The setting command can be used to transfer user-defined correction data to the analyzer; the query returns the current correction data set. ASCII or block data can be transferred, depending on the selected data transfer format (FORMat[:DATA]).



The sweep must be stopped to transfer calibration data; see program example for [SENSe<Ch>:]CORRection:COLlect:SAVE:DEFault.



For an overview of calibration methods and error terms refer to section Calibration Types.

<Ch>	Channel number of the calibrated channel. If unspecified the numeric suffix is set to
------	---

1.

Error term parameters	String parameters describing the different error terms, depending on the current calibration method; see table below. Each term contains one complex value (real and imaginary part) for each sweep point.
Range [def. unit]	The error terms consist of dimensionless complex numbers. The parameters must be transferred in full length and have the following meaning: 'DIRECTIVITY' – Directivity at port <port1_no> 'SRCMATCH' – Source match at port <port1_no> 'REFLTRACK' – Reflection tracking at port <port1_no> 'ISOLATION' – Isolation between port <port1_no> and <port2_no> 'LOADMATCH' – Load match at <port2_no> 'TRANSTRACK' – Transmission tracking between port <port1_no> and <port2_no>
*RST value	– The analyzer provides a default calibration corresponding to a test setup which does not introduce any systematic errors; see [SENSe<Ch>:]CORRection:COLLect:SAVE:SElected:DEFault.
<port1_no>	Source port number.
<port2_no>	Load port number. If the error term is not related to the load port, a dummy number can be used; e.g. CORR:CDAT 'REFLTRACK', 1, 0
SCPI, Command Types	Device-specific, command or query
Example:	See [SENSe<Ch>:]CORRection:COLLect:SAVE:SElected:DEFault.

The different calibration types of the analyzer provide the following error terms:

Calibration type	Parameters in [SENSe<Ch>:]CORRection:COLLect:METHod:DEFine	Available error terms (depending on port numbers)
One-port normalization (reflection) using an open or a short standard	REFL, RSHort	'REFLTRACK'
Full one port	FOPort	'DIRECTIVITY', 'SRCMATCH', 'REFLTRACK'
Two-port normalization	FRTRans	'TRANSTRACK'
One path two port	OPTPort	'DIRECTIVITY', 'SRCMATCH', 'REFLTRACK', 'TRANSTRACK'
TOSM	TOSM	'DIRECTIVITY', 'SRCMATCH', 'REFLTRACK', 'LOADMATCH', 'TRANSTRACK' (at present the 'ISOLATION' terms are not included)

[SENSe<Ch>:]CORRection:CKIT...

This subsystem controls system error correction and recording of correction data.

[SENSe<Ch>:]CORRection:CKIT:<std_type>

'<Conn_Name>', '<Ckit_Name>', '<Std_No>', <Min_Freq>, <Max_Freq>, <EI_Length>, <Loss>, <Z0>, <C0>, <C1>, <C2>, <C3>, <L0>, <L1>, <L2>, <L3>[, OPEN | SHORT | MATCH, <Resistance>, <Port_1>, <Port_2>]

Defines the parameters of a non-ideal 1 port or 2-port calibration standard <std_type>. A particular physical standard can be selected by specifying the name of the calibration kit and its serial number. Depending on the standard type, only a subset of the parameters may be used; see table below.

<Ch>	Channel number. This suffix is ignored because calibration kits are channel-independent.
<std_type>	Standard type. For reflection standards, the first character denotes the gender, e.g.: FOPEN, MOPEN: Open (f) or Open (m) standard. The following reflection standards are supported: MOPen, FOPen, MShort, FShort, OShort, MOShort, FOShort, MMTCh, FFTCh, MREFlect, FREFLect For transmission standards, the first two characters denotes the genders on both ends, e.g.: FFSNetwork, MFSNetwork, MMSNetwork: Symm. network (ff), symm. network (mf) or symm. network (mm) standard. For a complete list of standard types refer to the table of standard types below.

Parameter list String parameters to specify the configured standard ('<Conn_Name>', '<Ckit_Name>', '<Std_No>') and numeric parameters defining its properties. See detailed description below.



The following transmission standards have only 8 parameters (until <Z0>):

MMTHrough, MFTHrough, FFTHrough, MMLine, MFLine, FFLine

The following reflection and transmission standards have only 5 parameters (until <Max_Freq>):

MSMatch, FSMatch, MMATten, MFATten, FFATten

*RST value –

SCPI, Command Types Device-specific, command or query (see examples below)

Example:

```
CORR:CKIT:FOP 'N 50 Ohm','Test Kit',...
```

Define the properties of the open (f) standard for a N 50 Ω connector type in cal kit 'Test Kit'. See also example for

```
[SENSe<Ch>:]CORRection:CKIT:<conn_type>:<std_type>.
```

```
CORR:CKIT:FOP? 'N 50 Ohm'
```

Query the properties of the open (f) standard for a N 50 Ω connector type in the active cal kit.

```
CORR:CKIT:FOP? 'N 50 Ohm','Test Kit'
```

Query the properties of the open (f) standard for a N 50 Ω connector type in cal kit 'Test Kit'.

[SENSE<Ch>:]CORRection:CKIT:<conn_type>:<std_type>
'<Ckit_Name>','<Std_No>','<Min_Freq>','<Max_Freq>','<El_Length>','<Loss>','<C0> |
<L0>,<C1> | <L1>,<C2> | <L2>,<C3> | <L3>, OPEN | SHORT

Defines the parameters of a calibration standard <std_type> for a specified connector type <conn_type>. A particular physical standard can be selected by specifying the name of the calibration kit and its serial number. Depending on the standard type, only a subset of the parameters may be used; see table below.

<Ch> Channel number. This suffix is ignored because calibration kits are channel-independent.

<conn_type> Connector type, one of the following identifiers:
 N50, N75: N 50 Ω or N 75 Ω connectors
 PC7, PC35, PC292: PC 7, PC 3.5 or 2.92 mm connectors
 USER<no>: User-defined connectors UserConn1, UserConn2



This command only supports ZVR-compatible connector types. For general definitions use [SENSE<Ch>:]CORRection:CKIT:<std_type>.

<std_type> Standard type. For reflection standards, the first character denotes the gender, e.g.: FOPEN, MOPEN: Open (f) or Open (m) standard.
 For transmission standards, the first two characters denotes the genders on both ends, e.g.: FFThrough, MFThrough, MMThrough: Through (ff), Through (mf) or Through (mm) standard.
 For a complete list of standard types refer to the table of standard types below.

Parameter list String parameters to specify the configured standard ('<Ckit_Name>','<Std_No>') and numeric parameters defining its properties. See detailed description below.

*RST value

–

SCPI, Command Types Device-specific, command or query

Example:

```
CORR:CKIT:N50:FOPEN 'ZV-Z21',",0,1.8E+010,0.0151,0,0,0.22,-0.22,0.0022
```

Define the properties of the open (f) standard for the N 50 Ω connector type contained in the ZV-Z21 calibration kit: Assign a valid frequency range of 0 Hz to 18 GHz, an electrical length of 15.1 mm, 0 dB loss and define the polynomial coefficients of the fringing capacitance as 0 fF, 0.22 fF/GHz, –0.22 fF/(GHz)², 0.0022 fF/(GHz)³.

The parameters in the [SENSE<Ch>:]CORRection:CKIT:<std_type> and [SENSE<Ch>:]CORRection:CKIT:<conn_type>:<std_type> commands have the following meaning:

Parameter	Meaning	Comment/Unit
'<Conn_Name>'	Name of the connector type	String parameter
'<Ckit_Name>'	Name of the calibration kit	String parameter
'<Std_No>'	Label (e.g. the serial number) of the standard	String parameter

Instrument-Control Commands

<Min_Freq>	Min. frequency for which the circuit model is valid	Default unit is Hz
<Max_Freq>	Max. frequency for which the circuit model is valid	Default unit is Hz
<EI_Length>	Electrical length (offset parameter) of the standard	Default unit is m or ft, depending on the <i>Distance Unit</i> setting in the <i>System Configuration</i> dialog
<Loss>	Loss (offset parameter) of the standard	To be specified without unit (implicit unit is dB)
<Z0>	Reference impedance (no unit)	To be specified without unit (implicit unit is Ω)
<C0> <L0>	Polynomial coefficients C_0 or L_0 for the fringing capacitance or residual inductance of the standard (load parameter)	To be specified without unit (implicit unit is fF or pH)
<C1> <L1>	Polynomial coefficients C_1 or L_1 for the fringing capacitance or residual inductance of the standard (load parameter)	To be specified without unit (implicit unit is fF /GHz or pH /GHz)
<C2> <L2>	Polynomial coefficients C_2 or L_2 for the fringing capacitance or residual inductance of the standard (load parameter)	To be specified without unit (implicit unit is fF/GHz ² or pH/GHz ²)
<C3> <L3>	Polynomial coefficients C_3 or L_3 for the fringing capacitance or residual inductance of the standard (load parameter)	To be specified without unit (implicit unit is fF/GHz ³ or pH/GHz ³)
OPEN SHORT MATCH	Simplified modelling as an open or short or match standard. The load circuit model generally consists of capacitance C which is connected in parallel to an inductance L and a resistance R, both connected in series. OPEN means that R is infinite so that the standard behaves like a capacitor (no inductance, the polynomial coefficients specify C). SHORT means that R is zero so that the standard behaves like an inductance (no capacitance, the polynomial coefficients specify L). MATCH means that the standard behaves like a match with the specified <Resistance>	Character data
<Resistance>	Optional resistance for the MATCH standard	Numeric value
, <Port_1>, <Port_2>	Optional port restriction: one port number for one port standards, two port numbers for two port standards	Integer value

The different standard types are defined by the following parameters:

<std_type>	Meaning	Parameters
MOPen FOPen	Open (m) or open (f)	'<Ckit_Name>' ... <C3>[, <Port_1>] complete parameter list with capacitance coefficients, no OPEN SHORT MATCH
MShort FShort	Short (m) or short (f)	'<Ckit_Name>' ... <L3>[, <Port_1>] complete parameter list with inductance

Instrument-Control Commands

		coefficients, no OPEN SHORT MATCH
OShort MOShort FOShort	Offset short (sexless) or offset short (m) or offset short (f) (for user-defined connector types only)	'<Ckit_Name>' ... <L3>[, <Port_1>] complete parameter list with inductance coefficients, no OPEN SHORT MATCH
MMTCh FMTCh	Match (m) or match (f)	'<Ckit_Name>' ... <Max_Freq>[, <Port_1>] no offset parameters, no polynomial coefficients, no OPEN SHORT MATCH
MREFlect FRElect	Reflect (m) or reflect (f)	'<Ckit_Name>' ... OPEN SHORT[, <Port_1>] no loss, otherwise complete parameter list
MMThrough MFThrough FFThrough	Through (m - m) or through (m - f) or through (f - f)	'<Ckit_Name>' ... <Loss>[, <Port_1>, <Port_2>] no load parameters (polynomial coefficients), no OPEN SHORT MATCH
MMLine1 MFLine1 FFLine1 (suffix 1 optional)	Line1 (m - m) or line1 (m - f) or line1 (f - f)	'<Ckit_Name>' ... <Loss>[, <Port_1>, <Port_2>] no load parameters (polynomial coefficients), no OPEN SHORT MATCH
MMLine2 MFLine2 FFLine2	Line1 (m - m) or line2 (m - f) or line2 (f - f)	'<Ckit_Name>' ... <Loss>[, <Port_1>, <Port_2>] no load parameters (polynomial coefficients), no OPEN SHORT MATCH
MMATten MFATten FFATten	Attenuation (m - m) or attenuation (m - f) or attenuation (f - f)	'<Ckit_Name>' ... <Max_Freq>[, <Port_1>, <Port_2>] no offset parameters, no load parameters (polynomial coefficients), no OPEN SHORT MATCH
MMSNetwork MFSNetwork FFSNetwork	Symmetric network (m - m) or symmetric network (m - f) or symmetric network (f - f)	'<Ckit_Name>' ... OPEN SHORT MATCH[, <Port_1>, <Port_2>] no loss, otherwise complete parameter list

[SENSe<Ch>:]CORRection:CKIT:<conn_type>:SElect '<ckit_name>'

Selects the calibration kit to be used for a specified connector type <conn_type>.



For connector types with arbitrary, user-defined names you can use the command [SENSe<Ch>:]CORRection:CKIT:SElect '<conn_name>', '<ckit_name>'.

<Ch>	Channel number. This suffix is ignored because calibration kits are channel-independent.
<conn_type>	Connector type, one of the following identifiers: N50, N75: N 50 Ω or N 75 Ω connectors PC7, PC35, PC292: PC 7, PC 3.5 or 2.92 mm connectors USER<no>: User-defined connectors UserConn1, UserConn2
'<ckit_name>'	String parameters containing the name of a calibration kit available on the analyzer.
*RST value	– (A *RST does not change the assignment between connector types and calibration kits.)

SCPI, Device-specific, command or query

Command Types

Example:

```
MMEM:LOAD:CKIT
'C:\R_S\Instr\user\Nwa\Calibration\Kits\New_kit.calkit'
```

Load the previously created cal kit file `New_kit.calkit` from the default cal kit directory.

```
CORR:CKIT:N50:SEL 'New_kit'
```

Assign the imported kit to the N 50 Ω connector type (assuming that the cal kit name stored in `New_kit.calkit` reads `New_kit`).



Cal kit naming conventions

Calibration kit names must be entered as string parameters. The string contains the cal kit name used in the *Calibration Kits* dialog; a Ω in the name must be replaced by 'Ohm', e.g.:

- 'NewKit1' denotes the user-defined calibration kit *NewKit1*.
- 'N 50 Ohm Ideal Kit' denotes the *N 50 Ω Ideal Kit*.
- 'ZV-Z21 typical' denotes the cal kit *ZV-Z21 typical*.

[SENSe<Ch>:]CORRection:CKIT:SElect '<conn_name>', '<ckit_name>'

Selects the calibration kit to be used for a specified connector type <conn_type>.



The command is suitable for connector types with arbitrary, user-defined names. For standard connector types you can use the command

```
[SENSe<Ch>:]CORRection:CKIT:<conn_type>:SElect.
```

<Ch>	Channel number. This suffix is ignored because calibration kits are channel-independent.
'<conn_name>'	Connector type, e.g. a user-defined connector type (string variable)
'<ckit_name>'	String parameters containing the name of a calibration kit available on the analyzer.
*RST value	– (A *RST does not change the assignment between connector types and calibration kits.)

SCPI, Device-specific, command or query (the query requires the first string parameter only)

Command Types

Example:

```
MMEM:LOAD:CKIT
'C:\R_S\Instr\user\Nwa\Calibration\Kits\New_kit.calkit'
```

Load the previously created cal kit file `New_kit.calkit` from the default cal kit directory.

```
CORR:CKIT:SEL 'N 50 Ohm', 'New_kit'
```

Assign the imported kit to the N 50 Ω connector type (assuming that the cal kit name stored in `New_kit.calkit` reads `New_kit`).

[SENSe<Ch>:]CORRection:CKIT:INSTall '<file_name>'

Loads cal kit data from a specified ZVR cal kit file.

<Ch> Channel number. This suffix is ignored because calibration kits are channel-independent.

'<file_name>' String parameter to specify the name and directory of the cal kit file to be loaded.
*Note: The loaded file must be a ZVR-specific cal kit file with the extension *.ck. NWA cal kit files (*.calkit) can be imported using the MMEMory:LOAD:CKIT command. Agilent cal kit files can be imported manually and converted into *.calkit files.*

*RST value –

SCPI, Command Types Device-specific, no query.

Example:

```
CORR:CKIT:INST
'C:\R_S\Instr\user\Nwa\Calibration\Kits\ZCAN.ck'
```

Load the previously created ZVR cal kit file ZCAN.ck from the default cal kit directory.

```
MMEM:STOR:CKIT 'ZCAN',
'C:\R_S\Instr\user\Nwa\Calibration\Kits\ZCAN.calkit'
```

Store the imported cal kit data to a NWA cal kit file ZCAN.calkit (assuming that the cal kit name stored in ZCAN.ck reads ZCAN).

[SENSe<Ch>:]CORRection:COLLect...

This subsystem controls the system error correction and manages calibration kits.

[SENSe<Ch>:]CORRection:COLLect[:ACQuire] THROugh | OPEN1 | OPEN2 | OPEN12 | SHORT1 | SHORT2 | SHORT12 | MATCH1 | MATCH2 | MATCH12 | NET | ATT | IMATCH12 | REFL1 | REFL2 | SLIDe1 | SLIDE2 | SLIDE12 | LINE1 | LINE2 | M1O2 | O1M2 | M1S2 | S1M2 | OSHORT1 | OSHORT2

Starts a calibration measurement in order to acquire measurement data for the selected standards. The standards are reflection or transmission standards and must be connected to port 1 or 2 of the analyzer.



Use the generalized command [SENSe<Ch>:]CORRection:COLLect[:ACQuire]:SELected to obtain measurement data at arbitrary analyzer ports.

<Ch> Channel number of the calibrated channel. If unspecified the numeric suffix is set to 1.

THROugh ... OSHORT2 Standard types: *Through, Open, Short, Match (MATCH12 and IMATCH12 are synonymous), Symmetric Network (NET), Attenuation (ATT), Reflect, Sliding Match (SLIDe), Line1 (LINE1 and LINE are synonymous), Line2, Match/Open (M1O2, O1M2), Match/Short (M1S2, S1M2), Offset Short (OSHOrt).*
 The numbers in the parameters denote the analyzer ports. Two numbers 12 mean that

	two separate calibrations are performed at ports 1 and 2.
*RST value	ON
AUTO <delay phase>	Optional entry of delay time or phase for UTHRough standard: AUTO – The analyzer determines the delay time or phase during the calibration sweep <delay or phase> – entry of the delay time in ps (for non-dispersive standards) or of an estimate of the phase at the start frequency of the sweep in deg (for dispersive standards). If an estimate of the start phase is entered, the analyzer uses the calculated value which is closest to the estimate.
*RST value	AUTO
SCPI, Command Types	Confirmed (with device-specific standards), no query
Example:	See [SENSe<Ch>:]CORRection:COLLect:SAVE.

[SENSe<Ch>:]CORRection:COLLect[:ACQuire]:RSAVe <Boolean>

Activates or deactivates the calibration mode where the raw measurement data of the standards is stored after the calibration is completed. The setting is valid for the current calibration, where it overwrites the global setting ([SENSe<Ch>:]CORRection:COLLect[:ACQuire]:RSAVe:DEFault). A new calibration deletes the calibration data acquired in previous calibrations.

<Ch>	Channel number of the calibrated channel.
<Boolean>	ON OFF - Keep measurement data on or off.
*RST value	OFF
SCPI, Command Types	Device-specific, command or query
Example:	<pre>CORR:COLL:RSAB:DEF ON</pre> <p>Generally keep the raw measurement data of the standards after the calibration is completed.</p> <pre>CORR:COLL:METH:DEF 'Test',RSHort,1</pre> <p>Select a one-port normalization at port 1 with a short standard as calibration type.</p> <pre>CORR:COLL:SEL SHOR,1</pre> <p>Measure a short standard connected to port 1 and store the raw measurement results of this standard.</p> <pre>CORR:COLL:RSAB OFF</pre> <p>To save disk space, delete the current raw calibration data after the calibration is completed.</p> <pre>CORR:COLL:SAVE:SEL</pre> <p>Calculate the system error correction data and apply them to the active channel.</p>

[SENSe<Ch>:]CORRection:COLLect[:ACQuire]:RSAVE:DEFault <Boolean>

Activates or deactivates the calibration mode where the raw measurement data of the standards is stored after the calibration is completed. The setting remains valid for all subsequent calibrations until it is changed explicitly. A new calibration deletes the calibration data acquired in previous calibrations.

<Ch> Channel number of the calibrated channel.

<Boolean> ON | OFF - Keep measurement data on or off.

***RST value** OFF

SCPI, Command Types Device-specific, command or query

Example:

See `[SENSe<Ch>:]CORRection:COLLect[:ACQuire]:RSAVE.`

[SENSe<Ch>:]CORRection:COLLect[:ACQuire]:SELected THROugh | OPEN | SHORt | MATCh | NET | ATT | REFL | SLIDE | LINE1 | LINE2,<port_no>,<port_no>

Starts a calibration measurement in order to acquire measurement data for the selected standards. The standards are reflection or transmission standards and can be connected to arbitrary analyzer ports.

<Ch> Channel number of the calibrated channel.

THROugh ... LINE2 Standard types: *Through, Open, Short, Match, Symmetric Network (NET), Attenuation (ATT), Reflect, Sliding Match (SLIDE), Line1 (LINE1 and LINE are synonymous), Line2.*

<port_no> Port numbers of the analyzer. For a transmission standard (through, line, attenuation, symmetric network) the input and output port numbers must be specified, for reflection standards, only one port number is required.

***RST value** –

AUTO | <delay | phase> Optional entry of delay time or phase for UTHROUGH standard:
 AUTO – The analyzer determines the delay time or phase during the calibration sweep
 <delay or phase> – entry of the delay time in ps (for non-dispersive standards) or of the phase at the start frequency of the sweep in deg (for dispersive standards)

***RST value** AUTO

SCPI, Command Types Device-specific, no query

Example:

See `[SENSe<Ch>:]CORRection:COLLect:SAVE:SELected.`

[SENSe<Ch>:]CORRection:COLLect:AUTO '<file_name>',<port_no>{,<port_no>}

Selects and initiates a one-port or two-port automatic calibration at arbitrary analyzer and cal unit ports.



If the test setup contains a high attenuation the analyzer may fail to detect the cal unit ports connected to each of its ports. In this case use the extended command

`[SENSe<Ch>:]CORRection:COLLect:AUTO:PORTs.`

If several calibration units are connected, use `SYSTem:COMMunicate:RDEvice:AKAL:ADDRess` to

select a unit for the calibration.

<Ch>	Channel number of the calibrated channel.
'<file_name>'	Name and (possibly) directory of the cal kit file to be used for the automatic calibration (string parameter): <ul style="list-style-type: none"> ▪ If nothing is specified (empty string ' '), the default cal kit file stored in the calibration unit is used. This file is also used in manual control. ▪ A NWA cal kit file name *.calkit without path denotes a specific cal kit file stored in the Calibration Unit. ▪ A NWA cal kit file name *.calkit with path denotes a specific cal kit file stored in an arbitrary directory.

<port_no> Port number(s) of the analyzer. For a 2-port automatic calibration, either 1, 2 or 2, 1 may be entered. The analyzer automatically detects the calibration unit ports connected to each analyzer port.

*RST value –

SCPI, Command Types Device-specific, no query

Example:

```
CORR:COLL:AUTO ", 1, 2
```

Perform an automatic 2-port TOSM calibration using the calibration unit's default calibration kit file and arbitrary test ports of the cal unit.

[SENSe<Ch>:]CORRection:COLLect:AUTO:CKIT '<file_name>'

Generate a cal kit file with the specified name containing the cal kit data of the active calibration unit (SYSTem:COMMunicate:RDEvice:AKAL:ADDRess). The cal kit file can be stored in the calibration unit or written to a directory on the analyzer.

<Ch> Channel number of the calibrated channel (not relevant for this command).

'<file_name>' Name and (possibly) directory of the created cal kit file (string parameter, extension *.calkit):

- If no path and directory is specified, the file is stored in the calibration unit (see also [SENSe<Ch>:]CORRection:COLLect:AUTO). The factory calibration data on the unit is not overwritten.
- If a path and directory is specified, the file is stored in the directory on the analyzer's hard disk.

The default directory (MMEMory:CDIRectory) is not used.

*RST value –

SCPI, Command Types Device-specific, no query

Example:

```
CORR:COLL:AUTO:CKIT 'AutoCalChar.calkit'
```

Generate a cal kit file AutoCalChar.calkit for the active calibration unit and store it internally.

[SENSe<Ch>:]CORRection:COLLect:AUTO:PORTs

'<file_name>',<analyzer_port_no>,<cal_unit_port_no>{,<analyzer_port_no>,<cal_unit_port_no>}

Selects and initiates a one-port or two-port automatic calibration at arbitrary analyzer and calibration unit ports.



This command is necessary if the analyzer fails to detect the cal unit ports connected to each of its ports (e.g. because of a high attenuation in the test setup). If auto-detection works you can use the simpler command [SENSe<Ch>:]CORRection:COLLect:AUTO.

<Ch>	Channel number of the calibrated channel.
'<file_name>'	Name and (possibly) directory of the cal kit file to be used for the automatic calibration (string parameter): <ul style="list-style-type: none"> ▪ If nothing is specified (empty string ' '), the default cal kit file stored in the calibration unit is used. This file should be used to operate the calibration unit like in manual control; specifying another cal kit file is primarily for service purposes. ▪ A NWA cal kit file name *.calkit without path denotes a specific cal kit file stored in the Calibration Unit. ▪ A NWA cal kit file name *.calkit with path denotes a specific cal kit file stored in an arbitrary directory.
<analyzer_port_no>	Port number(s) of the analyzer. For a 2-port automatic calibration, either 1, 2 or 2, 1 may be entered.
<cal_unit__port_no>	Port number(s) of the cal unit. For a 2-port automatic calibration, either 1, 2 or 2, 1 may be entered. It is possible to combine arbitrary (not necessarily matching) pairs of analyzer and cal unit ports.
*RST value	–

SCPI, Command Types Device-specific, no query

Example:

```
CORR:COLL:AUTO:PORT ", 1, 2, 2, 1
```

Perform an automatic 2-port TOSM calibration at the analyzer test ports 1 and 2 using the calibration unit's default calibration kit file and ports 2 and 1 of the cal unit.

[SENSe<Ch>:]CORRection:COLLect:AUTO:PORTs:CONNection?

Returns the assignment between the network analyzer ports and the ports of the connected automatic calibration unit.

<Ch> Channel number of the calibrated channel (not relevant for this command).

*RST value –

SCPI, Command Types Device-specific, query only

Example:

```
CORR:COLL:AUTO:PORT ", 1, 2, 2, 1
```

Perform an automatic 2-port TOSM calibration at the analyzer test ports 1 and 2 using the calibration unit's default calibration kit file and ports 2 and 1 of the cal unit.

```
CORR:COLL:AUTO:PORT:CONN?
```

Query the actual port assignment. If the cal unit is properly connected according to the previous command, the response is *1,2,2,1*. A zero would mean that the corresponding analyzer port is not connected to any port of the calibration unit.

[SENSe<Ch>:]CORRection:COLLect:CONNectiOn<port_no> N50FEMALE | N50MALE | N75FEMALE | N75MALE | PC7 | PC35FEMALE | PC35MALE | PC292FEMALE | PC292MALE

Additional parameters (): UFEMALE1 | UMALE1 | UFEMALE2 | UMALE2

Selects a connector type at a specified port <port_no> and its gender.



Use [SENSe<Ch>:]CORRection:COLLect:SCONnectiOn<port_no> to select an arbitrary connector type using a string variable.

<Ch> Channel number of the calibrated channel.

<port_no> Port numbers of the analyzer.

Note: *If the analyzer is set to use the same connectors at all ports*

([SENSe<Ch>:]CORRection:COLLect:CONNectiOn<port_no>:PORTs ALL), then a change of a connector type is valid for all ports. The gender of the connectors can still be different.

Parameters Connector type and gender of the connectors (omitted for query). UFEMALE1 and UMALE1 denote the user-defined connector type *UserConn1*, UFEMALE2 and UMALE2 denote the user-defined connector type *UserConn2*. The user-defined connector types must be defined before being addressed by [SENSe<Ch>:]CORRection:COLLect:CONNectiOn<port_no>.

*RST value N50FEMALE for all ports.

SCPI, Command Types Device-specific, command or query.

Example:

```
*RST; CORR:COLL:CONN1 N75MALE; CONN4?
```

Change the connector type at port 1 from N50FEMALE to N75MALE. The connector type at the other ports is also changed to N75, however, the gender (female) is

maintained. `CORR:COLL:CONN4?` returns `N75FEMALE`.

[SENSE<Ch>:]CORREction:COLLect:CONNect:PORTs ALL | SINGLE

Qualifies whether the connector types at the analyzer ports (but not their gender) are equal or independent.



*In the present firmware version, a **calibration** must be performed using the same connector type at all ports. Use [SENSE<Ch>:]CORREction:COLLect:CONNect<port_no>:PORTs SINGle if you want to perform a **measurement** with independent port connectors.*

<Ch>	Channel number of the calibrated channel.
Parameters	ALL: Equal (uniform) connector types. If the connector type at one port is changed, the connector type at all other ports is changed accordingly. SINGle: Independent (possibly non-uniform) connector types at the ports.
<port_no>	Port numbers of the analyzer. This parameter has no effect because the setting affects all ports.
*RST value	ALL
SCPI, Command Types	Device-specific, command or query.
Example:	<pre>CORR:COLL:CONN:PORTS SING</pre> <p>Select independent connector types at the ports.</p> <pre>CORR:COLL:CONN1 N50MALE; CONN4 N75FEMALE; CONN2?</pre> <p>Select independent connector types at ports 1 and 4. The connector type at port 2 is not changed; the query returns <code>N50FEMALE</code>.</p>

[SENSE<Ch>:]CORREction:COLLect:DELeTe ['<cal_name>']

Deletes system error correction data generated and stored previously.

<Ch>	Channel number of the calibrated channel.
'<cal_name>'	Name of the calibration (string parameter) defined together with calibration type [SENSE<Ch>:]CORREction:COLLect:METhod:DEFine. If nothing is specified the analyzer deletes the last system error correction stored by means of [SENSE<Ch>:]CORREction:COLLect:SAVE.
*RST value	–
SCPI, Command Types	Device-specific, no query
Example:	<pre>CORR:COLL:METh:DEF 'Test',RShort,1</pre> <p>Select a one-port normalization at port 1 with a short standard as calibration type.</p> <pre>CORR:COLL:SEL SHOR,1</pre> <p>Measure a short standard connected to port 1 and store the measurement results of this standard.</p>

CORR:COLL:SAVE; DEL

Calculate the system error correction data and apply them to the active channel, then delete the data.

[SENSE<Ch>:]CORREction:COLLect:METHod REFL1 | REFL2 | REFL12 | FTRans | RTRans | FRTRans | FOPort1 | FOPort2 | FOPort12 | FOPTport | ROPTport | TPORT | TOSM

Selects a one-port or two-port calibration type at ports 1/2.



Use the generalized command [SENSE<Ch>:]CORREction:COLLect:METHod:DEFine to select the calibration type for arbitrary analyzer ports or a multipoint calibration type.

<Ch>	Channel number of the calibrated channel.
Parameters	Calibration types: <i>Normalization</i> (REFL1, REFL2 and REFL12 for one-port normalization, FTRans, RTRans and FRTRans for forward, reverse, and bidirectional two-port/transmission normalization), <i>Full One Port, One Path Two Port</i> (FOPTport and ROPTport are equivalent, the query returns OPT12), <i>TOSM</i> . <i>T</i> The numbers in the parameters denote the analyzer ports. Parameters for two-port calibration types contain no numbers because the command is only valid for ports 1 and 2.
*RST value	–
SCPI, Command Types	Confirmed (with device-specific calibration types), command or query. If several calibration types are assigned to channel <Ch>, the query returns a list of all calibration types.
Example:	See [SENSE<Ch>:]CORREction:COLLect:SAVE.

[SENSE<Ch>:]CORREction:COLLect:METHod:DEFine '<cal_name>', REFL | RSHort | FOPort | FTRans | RTRans | FRTRans | OPTPort | TOSM, <port_no>[,<port_no>]

Selects a one-port or two-port calibration type at arbitrary analyzer ports.

<Ch>	Channel number of the calibrated channel.
'<cal_name>'	Name of the calibration (string parameter). The name serves as a reference to delete a particular set of system correction data ([SENSE<Ch>:]CORREction:COLLect:DElete).
Parameters	Calibration types: <i>One-port Normalization (reflection), using an open</i> (REFL) <i>or a short (RSHort) standard, Full One Port, Two-port Normalization</i> (FTRans, RTRans and FRTRans for forward, reverse, and bidirectional two-port/transmission normalization), <i>One Path Two Port, TOSM</i> , .
<port_no>	Port numbers of the analyzer. For an n-port calibration type (n = 1 to 2), n port numbers must be specified. If more than n numbers are defined, the spare numbers (the last ones in the list) are ignored. Entering less than n numbers causes an error message.
*RST value	–

SCPI, Command Types Device-specific, no query. Use `[SENSE<Ch>:]CORREction:COLLect:METHOD?` to obtain a list of all calibration types for channel <Ch>.

Example: See `[SENSE<Ch>:]CORREction:COLLect:SAVE:SElected.`

`[SENSE<Ch>:]CORREction:COLLect:SAVE`

Calculates the system error correction data from the acquired one or two-port measurement results (`[SENSE<Ch>:]CORREction:COLLect[:ACquire]`), stores them and applies them to the calibrated channel <Ch>. To avoid incompatibilities, older system error correction data is deleted unless it has been transferred into a cal pool (`MMEMory:STORe:CORREction <Ch>, '<file_name>'`).



This command is the ZVR-compatible equivalent of `[SENSE<Ch>:]CORREction:COLLect:SAVE:SElected`. It must be used in combination with the ZVR-compatible commands for calibration method and standard selection; see example below.

<Ch> Channel number of the calibrated channel.

***RST value** –

SCPI, Command Types Confirmed, no query

Example: `CORR:COLL:METH REFL1`

Select a one-port normalization at port 1 as calibration type.

`CORR:COLL OPEN1`

Measure an open standard connected to port 1 and store the measurement results of this standard.

`CORR:COLL:SAVE`

Calculate the system error correction data and apply them to the active channel.

`[SENSE<Ch>:]CORREction:COLLect:SAVE:DEFault`

Generates a set of default system error correction data for the selected ports and calibration type. The default data set corresponds to a test setup which does not introduce any systematic errors; none of the measurement results acquired previously (`[SENSE<Ch>:]CORREction:COLLect[:ACquire]`) is taken into account.



The main purpose of the default correction data set is to provide a dummy system error correction which you can replace with your own, external correction data. You may have acquired the external data in a previous session or even on an other instrument. If you want to use the external correction data on the analyzer, simply generate the default data set corresponding to your port configuration and calibration type and overwrite the default data. For details refer to the program example below.



This command must be used in combination with the ZVR-compatible commands `[SENSE<Ch>:]CORREction:COLLect:METHOD` and `[SENSE<Ch>:]CORREction:DATA`. Use `[SENSE<Ch>:]CORREction:COLLect:SAVE:SElected:DEFault` if you want to use ZVL-specific calibration commands or if you want to calibrate more than 2 ports.

<Ch> Channel number of the calibrated channel.

*RST value –

SCPI, Command Types Device-specific, no query

Example:

```
CORR:COLL:METH REFL1
```

Select a one-port normalization at port 1 with an open standard as calibration type.

```
CORR:COLL:SAVE:DEF
```

Calculate a dummy system error correction for the normalization at port 1. The dummy system error correction provides the reflection tracking error term 'SCORR3'.

```
CORR:DATA? 'SCORR3'
```

Query the dummy system error correction term. The response is a 1 (written as 1,0 for the real and imaginary part) for each sweep point (no attenuation and no phase shift between the analyzer and the calibration plane).

```
CORR:DATA 'SCORR3',<ASCII_data>
```

Replace the dummy system error correction term with your own correction data, transferred in ASCII format.

[SENSe<Ch>:]CORRection:COLLect:SAVE:SELeCted

Calculates the system error correction data from the acquired measurement results ([SENSe<Ch>:]CORRection:COLLect[:ACQuire]:SELeCted), stores them and applies them to the calibrated channel <Ch>. To avoid incompatibilities, older system error correction data is deleted unless it has been transferred into a cal pool (MMEMory:STORe:CORRection <Ch>, '<file_name>').

<Ch> Channel number of the calibrated channel.

*RST value –

SCPI, Command Types Confirmed, no query

Example:

```
CORR:COLL:METH:DEF 'Test',RSHort,1
```

Select a one-port normalization at port 1 with a short standard as calibration type.

```
CORR:COLL:SEL SHOR,1
```

Measure a short standard connected to port 1 and store the measurement results of this standard.

```
CORR:COLL:SAVE:SEL
```

Calculate the system error correction data and apply them to the active channel.

[SENSe<Ch>:]CORRection:COLLect:SAVE:SELEcted:DEFault

Generates a set of default system error correction data for the selected ports and calibration type. The default data set corresponds to a test setup which does not introduce any systematic errors; none of the measurement results acquired previously

([SENSe<Ch>:]CORRection:COLLect[:ACQuire]:SELEcted) is taken into account.



The main purpose of the default correction data set is to provide a dummy system error correction which you can replace with your own, external correction data. You may have acquired the external data in a previous session or even on an other instrument. If you want to use the external correction data on the analyzer, simply generate the default data set corresponding to your port configuration and calibration type and overwrite the default data. For details refer to the program example below.

<Ch> Channel number of the calibrated channel.

***RST value** –

SCPI, Command Types Device-specific, no query

Example:

```
CORR:COLL:METH:DEF 'Test',RSHort,1
```

Select a one-port normalization at port 1 with a short standard as calibration type.

```
CORR:COLL:SAVE:SEL:DEF
```

Calculate a dummy system error correction for the normalization at port 1. The dummy system error correction provides the reflection tracking error term 'REFLTRACK'.

```
CORR:CDAT? 'REFLTRACK',1,0
```

Query the dummy system error correction term. The response is a 1 (written as 1,0 for the real and imaginary part) for each sweep point (no attenuation and no phase shift between the analyzer and the calibration plane).

```
CORR:CDAT 'REFLTRACK',1,0,<ASCII_data>
```

Replace the dummy system error correction term with your own correction data, transferred in ASCII format.

[SENSe<Ch>:]CORRection:COLLect:SCONnection<port_no> '<conn_name>', MALE | FEMale

Selects a connector type at a specified port <port_no> and its gender. In contrast to [SENSe<Ch>:]CORRection:COLLect:CONNECTION<port_no>, this command uses a string variable to identify the connector type.

<Ch> Channel number of the calibrated channel.

<port_no> Port numbers of the analyzer.

Note: If the analyzer is set to use the same connectors at all ports

([SENSe<Ch>:]CORRection:COLLect:CONNECTION<port_no>:PORTs ALL), then a change of a connector type is valid for all ports. The gender of the connectors can still be different.

Parameters Connector type (string parameter) and gender of the connectors. The gender designation MALE | FEMale is not necessary (and ignored) for sexless connector

	types.
*RST value	'N 50 Ohm', FEM for all ports.
SCPI, Command Types	Device-specific, command or query.
Example:	<pre>*RST; CORR:COLL:SCON1 'N 75 Ohm', MALE; SCON4?</pre> <p>Change the connector type at port 1 from 'N 50 Ohm', FEM to 'N 75 Ohm', MALE. The connector type at the other ports is also changed to N 75 Ohm, however, the gender (female) is maintained. CORR:COLL:SCON4? returns 'N 75 Ohm', FEM.</p>

[SENSE<Ch>:]CORREction:CONNECTION '<conn_name>', TEM | WGUide, GENDER | NGENDER, <perm_rel>, <imped>

Configures the user-defined connector types.

<Ch>	Channel number
'<conn_name>'	Name of the user-defined connectors, string parameter
TEM WGUide GENDER NGENDER	Transverse electric or waveguide type propagation mode Polar connector type (m/f) Sexless connector type
<perm_rel>	Relative permittivity
Range [def. unit]	0.000000001 to 1000. [-] UP/DOWN/MIN/MAX parameters are not available for this command
*RST value	–
<imped>	For TEM type connectors: reference impedance in Ω (without unit), For WGUide type connectors: cutoff frequency in Hz (without unit)
Range [def. unit]	Ref. impedance: $1\mu\Omega$ to 1000 M Ω Cutoff frequency: 0 Hz to 1000 GHz
*RST value	–
SCPI, Command Types	Device-specific, command or query
Example:	<pre>CORR:CONN 'USERCON', TEM, GEND, 1.00000, 50</pre> <p>Define a TEM type connector type names USERCON.</p> <pre>CORR:CONN? 'USERCON'</pre> <p>Query the properties of the configured connector type.</p> <pre>CORR:CONN:DEL 'USERCON'</pre> <p>Delete the configured connector type.</p>

[SENSE<Ch>:]CORREction:CONNECTION:DELeTE '<conn_name>'

Deletes a user-defined connector type named '<conn_name>'.

<Ch>	Channel number
-------------------	----------------

'<conn_name>' Name of the user-defined connectors, string parameter

SCPI, Command Types Device-specific, no query

Example: See [SENSe<Ch>:]CORRection:CONNection

[SENSe<Ch>:]CORRection:DATA 'SCORR1' | ... | 'SCORR12'

Writes or reads system error correction data for a specific channel <Ch> and calibration method ([SENSe<Ch>:]CORRection:COLLect:MEtHod). The analyzer test ports 1 or 2 are implicitly specified with the correction terms. The setting command can be used to transfer user-defined correction data to the analyzer; the query returns the current correction data set. ASCII or block data can be transferred, depending on the selected data transfer format (FORMat [:DATA]).



The sweep must be stopped to transfer calibration data; see program example for [SENSe<Ch>:]CORRection:COLLect:SAVE:DEFault.



Use the generalized command [SENSe<Ch>:]CORRection:COLLect:CDATa to transfer calibration data for arbitrary analyzer ports.

<Ch> Channel number of the calibrated channel. If unspecified the numeric suffix is set to 1.

Error term parameters String parameters describing the different error terms, depending on the current calibration method; see table below. Each term contains one complex value (real and imaginary part) for each sweep point.

Range [def. unit] The error terms consist of dimensionless complex numbers. The parameters must be transferred in full length and have the following meaning:

'SCORR1' – Directivity at port 1
 'SCORR2' – Source match at port 1
 'SCORR3' – Reflection tracking at port 1
 'SCORR4' – Forward isolation between port 1 and port 2
 'SCORR5' – Load match at port 2
 'SCORR6' – Forward transmission tracking between port 1 and port 2
 'SCORR7' – Directivity at port 2
 'SCORR8' – Source match at port 2
 'SCORR9' – Reflection tracking at port 2
 'SCORR10' – Reverse isolation between port 2 and port 1
 'SCORR11' – Load match at port 1
 'SCORR12' – Reverse transmission tracking between port 2 and port 1

***RST value** –
 The analyzer provides a default calibration corresponding to a test setup which does not introduce any systematic errors; see [SENSe<Ch>:]CORRection:COLLect:SAVE:DEFault.

SCPI, Command Types Device-specific, command or query

Example: See [SENSe<Ch>:]CORRection:COLLect:SAVE:DEFault.

The different calibration types of the analyzer provide the following error terms:

Calibration type	Parameter in	Available error terms (depending
------------------	--------------	----------------------------------

Instrument-Control Commands

	[SENSe<Ch>:]CORRection:COLLect:MEthod	on port numbers)
One-port normalization (reflection) using an open standard	REFL1 REFL2 REFL12	'SCORR3' 'SCORR9' 'SCORR3' and 'SCORR9'
Full one port	FOPort1 FOPort2 FOPort12	'SCORR1' to 'SCORR3' 'SCORR7' to 'SCORR9' 'SCORR1' to 'SCORR3' and 'SCORR7' to 'SCORR9'
Two-port normalization	FTRans RTRans FRTRans	'SCORR6' 'SCORR12' 'SCORR6' and 'SCORR12'
One path two port	FOPTport ROPTport	'SCORR1' to 'SCORR3', 'SCORR6' 'SCORR7' to 'SCORR9', 'SCORR12'
TOSM	TOSM	'SCORR1' to 'SCORR12' (at present the isolation terms 'SCORR4' and 'SCORR10' are not included)

[SENSe<Ch>:]CORRection:DATA:PARAmeter?

Returns the sweep settings of the active system error correction for channel <Ch>.

<Ch>	Channel number of the calibrated channel.
Response	Five values, corresponding to the start and stop frequency of the calibration sweep, the number of points, the source power, and the sweep type (LIN LOG SEGM).
*RST value	– (the command generates an execution error if no system error correction is active)
SCPI, Command Types	Device-specific, query only
Example:	See [SENSe<Ch>:]CORRection:DATE?

[SENSe<Ch>:]CORRection:DATE?

Returns the date and time when the active system error correction data for channel <Ch> was acquired.

<Ch>	Channel number of the calibrated channel.
*RST value	– (the command generates an execution error if no system error correction is active)
SCPI, Command Types	Device-specific, query only
Example:	<pre>CORR:COLL:METH REFL1</pre> <p>Select a one-port normalization at port 1 as calibration type.</p> <pre>CORR:COLL OPEN1</pre> <p>Measure an open standard connected to port 1 and store the measurement results of this standard.</p> <pre>CORR:COLL:SAVE</pre>

Calculate the system error correction data and apply them to the active channel.

CORR:DATE?

Query the time when the system error correction became active. The analyzer returns the data and time, e.g. '03/20/06,18:30:39'.

CORR:DATA:PAR?

Query the sweep settings for the calibration sweep. The analyzer returns the start and stop frequency, the number of points, source power, and the sweep type, e.g. 300000,8000000000,201,0,LIN.

CORR:SST?

Query the calibration status. The analyzer returns 'CAL OFF' (because the performed one-port calibration is not sufficient for the measured transmission S-parameter S_{21}).

[SENSE<Ch>:]CORREction:EDELay<port_no>:AUTO ONCE

Defines the offset parameter for the active test port such that the residual delay of the active trace (defined as the negative derivative of the phase response) is minimized across the entire sweep range.

<Ch>	Channel number of the offset-corrected channel.
<port_no>	Port number of the analyzer. This numeric suffix is ignored; the active port is determined by the active trace.
ONCE	Applies the <i>Auto Length</i> function.
*RST value	–
SCPI, Command Types	Device-specific, no query
Example:	<pre>*RST; CORR:EDEL:AUTO ONCE</pre>

Reset the instrument and apply the auto length function to the default trace (*Trc1* in channel 1).

[SENSE<Ch>:]CORREction:EDELay<port_no>:DIElectric <permittivity>

Defines the permittivity for the offset correction at test port <port_no>.

<Ch>	Channel number of the offset-corrected channel
<port_no>	Port number of the analyzer
<permittivity>	Permittivity
Range [def. unit]	1 to +1E+6 []
*RST value	1.00062 [–]
SCPI, Command Types	Device-specific, command or query
Example:	See [SENSE<Ch>:]CORREction:EDELay<port_no>:ELENgth

[SENSe<Ch>:]CORRection:EDELay<port_no>:DISTance <length>

Defines the offset parameter for test port <port_no> as a mechanical length.

<Ch>	Channel number of the offset-corrected channel
<port_no>	Port number of the analyzer
<length>	Mechanical length
Range [def. unit]	–3.402823466E+038 m to +3.4028234664E+038 m.
*RST value	0 m [m or foot (ft), depending on the <i>Distance Unit</i> selected in the <i>System Configuration</i> dialog]

SCPI, Command Types Device-specific, command or query

Example: See [SENSe<Ch>:]CORRection:EDELay<port_no>:ELENgth

[SENSe<Ch>:]CORRection:EDELay<port_no>:ELENgth <length>

Defines the offset parameter for test port <port_no> as an electrical length.

<Ch>	Channel number of the offset-corrected channel
<port_no>	Port number of the analyzer
<length>	Electrical length
Range [def. unit]	–1E+9 m to +1E+9 m [m or foot (ft), depending on the <i>Distance Unit</i> selected in the <i>System Configuration</i> dialog]. The increment (UP, DOWN) is 1 mm.
*RST value	0 m

SCPI, Command Types Device-specific, command or query

Example: `CORR:EDEL2:ELEN 0.3`

Define an electrical length of 30 cm for channel 1 and port no. 2.

`CORR:EDEL2:DIST?; DIEL?`

Query the values of the mechanical length and the permittivity at port 2. The mechanical length is equal to the electrical length divided by the square root of the permittivity; the latter is set to its default value. The response is `0.29990704322;1.00062`.

`CORR:EDEL2?`

Query the value of the delay at port 2. The delay is equal to the electrical length divided by the speed of light in the vacuum, so the response is `1.0006922856E-009`.

`CORR:LOSS2 2; LOSS2:FREQ 1.5 GHz; OFFS 3 dB`

Define the offset loss parameters at port 2.

[SENSe<Ch>:]CORRection:EDELay<port_no>[:TIME] <delay>

Defines the offset parameter for test port <port_no> as a delay time.

<Ch>	Channel number of the offset-corrected channel
<port_no>	Port number of the analyzer
<delay>	Delay
Range [def. unit]	-3.40282346638529E+038 s to +3.40282346638529E+038 s [s].
*RST value	0 s
SCPI, Command Types	Device-specific, command or query
Example:	See <code>[SENSe<Ch>:]CORRection:EDELay<port_no>:ELENgth</code>

[SENSe<Ch>:]CORRection:FACTory[:STATe] <Boolean>

Enables or disables the factory calibration for a particular channel.

<Ch>	Channel number of the calibrated channel
<Boolean>	Enable or disable factory calibration
*RST value	ON
SCPI, Command Types	Device-specific, command or query
Example:	<code>*RST; CORR:FACT?</code> Reset the instrument and query whether the factory calibration for channel 1 is enabled. The response is <code>1</code> .

[SENSe<Ch>:]CORRection:LOSS<port_no> <ref_loss>

Defines the offset loss at the reference frequency
(`[SENSe<Ch>:]CORRection:LOSS<port_no>:FREQuency`).

<Ch>	Channel number of the offset-corrected channel
<port_no>	Port number of the analyzer
<ref_loss>	Frequency-dependent part of the offset loss
Range [def. unit]	-200 dB to +200 dB [dB]. The increment (UP/DOWN) is 0.001 dB.
*RST value	0 dB
SCPI, Command Types	Device-specific, command or query
Example:	See <code>[SENSe<Ch>:]CORRection:EDELay<port no>:ELENgth</code>

[SENSe<Ch>:]CORRection:LOSS<port_no>:AUTO ONCE

Defines the offset parameters for the active test port such that the residual delay of the active trace (defined as the negative derivative of the phase response) is minimized and the measured loss is reproduced as far as possible across the entire sweep range.

<Ch>	Channel number of the offset-corrected channel.
-------------------	---

<port_no>	Port number of the analyzer. This numeric suffix is ignored; the active port is determined by the active trace.
ONCE	Applies the <i>Auto Length and Loss</i> function.
*RST value	–
SCPI, Command Types	Device-specific, no query
Example:	<pre>*RST; CORR:LOSS:AUTO ONCE</pre>
	Reset the instrument and apply the <i>Auto Length and Loss</i> function to the default trace (<i>Trc1</i> in channel 1).

[SENSe<Ch>:]CORRection:LOSS<port_no>:FREQuency <ref_frequency>

Defines the reference frequency for the frequency-dependent part of the offset loss ([SENSe<Ch>:]CORRection:LOSS<port_no>:OFFSet).

<Ch>	Channel number of the offset-corrected channel
<port_no>	Port number of the analyzer
<ref_frequency>	Reference frequency
Range [def. unit]	Frequency range of the analyzer model [Hz]. The increment (UP/DOWN) is 1 MHz.
*RST value	1000000000 Hz (= 1 GHz)
SCPI, Command Types	Device-specific, command or query
Example:	See [SENSe<Ch>:]CORRection:EDELay<port_no>:ELENgth

[SENSe<Ch>:]CORRection:LOSS<port_no>:OFFSet <DC_loss>

Defines the frequency-independent part (DC value) of the offset loss.

<Ch>	Channel number of the offset-corrected channel
<port_no>	Port number of the analyzer
<DC_loss>	Frequency-independent part of the offset loss
Range [def. unit]	-200 dB to +200 dB [dB]. The increment (UP/DOWN) is 0.001 dB.
*RST value	0 dB
SCPI, Command Types	Confirmed, command or query
Example:	See [SENSe<Ch>:]CORRection:EDELay<port no>:ELENgth

[SENSe<Ch>:]CORRection:OFFSet<port_no>[:STATe] <Boolean>

Resets the offset parameters for all test ports to zero or queries whether any of the offset parameters are different from zero.

<Ch>	Channel number of the offset-corrected channel
-------------------	--

<port_no>	Port number of the analyzer. This numeric suffix is ignored; the command affects the parameters of all ports.
<Boolean>	The parameter function depends on whether the command is used as a setting command or as a query: For setting command: ON – no effect OFF – resets all length offsets to zero For query: 1 – at least one length offset is different from zero 0 – all length offsets are zero
*RST value	OFF
SCPI, Command Types	Device-specific, command or query
Example:	<pre>*RST; CORR:OFFS?</pre> Reset the instrument and query whether the length offset parameters have been reset as well. The response is 0.

[SENSe<Ch>:]CORRection:OFFSet<port_no>:MAGNitude <DC_loss>

Defines the frequency-independent part (DC value) of the offset loss.



Use the [SENSe<Ch>:]CORRection:LOSS<port_no>... commands to define the complete set of loss offset parameters. [SENSe<Ch>:]CORRection:OFFSet<port_no>:MAGNitude is equivalent to [SENSe<Ch>:]CORRection:LOSS<port_no>:OFFSet

<Ch>	Channel number of the offset-corrected channel
<port_no>	Port number of the analyzer
<DC_loss>	Frequency-independent part of the offset loss
Range [def. unit]	-200 dB to +200 dB [dB]. The increment (UP/DOWN) is 0.001 dB.
*RST value	0 dB
SCPI, Command Types	Confirmed, command or query

[SENSe<Ch>:]CORRection:SState?

Returns the state of the active system error correction for channel <Ch>.

<Ch>	Channel number of the calibrated channel.
Response	String variable containing the calibration state label in the trace list ('Cal', 'Cai', 'Ca?', 'Cav', 'Cal Off').
*RST value	" (empty string)
SCPI, Command Types	Device-specific, query only
Example:	See [SENSe<Ch>:]CORRection:DATE?

[SENSe<Ch>:]CORRection[:STATe] <Boolean>

Enables or disables the system error correction for channel <Ch>.

<Ch> Calibrated channel number

<Boolean> Enables (ON) or disables (OFF) the correction.
*RST value ON [-]

SCPI, Command Types Confirmed, command or query

Example:

```
*RST; CORR?
```

Reset the instrument and query whether channel 1 is system error corrected. The response is 1.

[SENSe<Ch>:]FREQUency...

This subsystem sets frequency-related parameters, especially the measurement and display ranges for the different sweep types.

The frequency ranges for the different instrument models are listed below. The specified frequency ranges start at 9 kHz; see data sheet.

	R&S ZVL3 and R&S ZVL3-75	R&S ZVL6	R&S ZVL13
Start, Stop	10 Hz to 3 GHz	10 Hz to 6 GHz	5 kHz to 15 GHz The stop freq. is preset to 13.6 GHz; see data sheet
Center	> 10 Hz to < 3 GHz	> 10 Hz to < 6 GHz	> 5 kHz to < 15 GHz
Span	10 Hz to 2.99999999 GHz	10 Hz to 5.99999999 GHz	10 Hz to 14.99999999 GHz

Note: The sweep range can be defined alternatively by a combination of Start/Stop frequencies or a Center frequency and Span.

[SENSe<Ch>:]FREQUency:CENTer <center_frequency>

Defines the center of the measurement and display range for a frequency sweep.

<Ch> Channel number. If unspecified the numeric suffix is set to 1.

<center_frequency> Center frequency of the sweep.
Range [def. unit] Depending on the instrument model [Hz]. The increment (parameters UP or DOWN) is 0.1 kHz.

*RST value Center of the analyzer's default frequency range: $(f_{\text{start}} + f_{\text{stop}})/2$

SCPI, Command Types Confirmed, command or query.

Example:

```
FUNC "XFR:POW:RAT B1, A2"
```

Activate a frequency sweep and select the ratio B1/A2 as measured parameter for channel and trace no. 1.

```
FREQ:CENT 100MHz
```

Set center frequency to 100 MHz.

```
FREQ:SPAN 50000
```

Set frequency span to 50 kHz.



The measurement range defined by means of the center frequency and the current span ([SENSE<Ch>:]FREQUENCY:SPAN) must not exceed the allowed frequency range of the analyzer. If necessary, the span is reduced to $\min(\text{Center} - f_{\text{MIN}}, f_{\text{MAX}} - \text{Center})$.

[SENSE<Ch>:]FREQUENCY:MODE SWEep | SEGment

Selects the sweep type and defines which set of commands controls the stimulus frequency.



The command [SENSE<Ch>:]SWEep:TYPE provides a complete list of sweep types.

<Ch>	Channel number.
SWEep	Linear or logarithmic frequency sweep, depending on the selected spacing ([SENSE<Ch>:]SWEep:SPACing LINear LOGarithmic). The frequency range is set via [SENSE<Ch>:]FREQUENCY:START etc.
SEGment	Segmented frequency sweep. The sweep range is composed of several continuous frequency ranges or single frequency points defined by means of the commands in the [SENSE<Ch>:]SEGment<Seg>... subsystem.
SCPI, Command Types	Confirmed (with device-specific *RST value and parameters), command or query.

Example:

```
FREQ:MODE SWE
```

Activate a frequency sweep.

```
SWE:TYPE LOG
```

Set the sweep type *Log Frequency*.

[SENSE<Ch>:]FREQUENCY:SPAN

Defines the width of the measurement and display range for a frequency sweep.

<Ch>	Channel number.
	Frequency span of the sweep.
Range [def. unit]	Depending on the instrument model [Hz]. The increment (parameters UP or DOWN) is 0.1 kHz.
*RST value	Default stop value (depending on the analyzer model) minus default start value (9 kHz); $f_{\text{start}} - f_{\text{stop}}$.
SCPI, Command Types	Confirmed, command or query.

Example:

```
FUNC "XFR:POW:RAT B1, A2"
```

Activate a frequency sweep and select the ratio B1/A2 as measured parameter for channel and trace no. 1.

```
FREQ:CENT 100MHz
```

Set center frequency to 100 MHz.

```
FREQ:SPAN 50000
```

Set frequency span to 50 kHz, leaving the center frequency unchanged.

Note: The measurement range defined by means of the span and the current center frequency ([SENSe<Ch>:]FREQUency:CENTer), must not exceed the allowed frequency range of the analyzer. If necessary, the center frequency is adjusted to $f_{MIN} + \text{Span}/2$ or $f_{MAX} - \text{Span}/2$.

[SENSe<Ch>:]FREQUency:STARt <start_frequency>

Defines the start frequency for a frequency sweep which is equal to the left edge of a Cartesian diagram.

<Ch>	Channel number.
<start_frequency>	Start frequency of the sweep.
Range [def. unit]	Depending on the instrument model [Hz]. The increment (parameters UP or DOWN) is 0.1 kHz.
*RST value	9 kHz (larger than the minimum frequency of the analyzer).
SCPI, Command Types	Confirmed, command or query.

Example:

```
FUNC "XFR:POW:RAT B1, A2"
```

Activate a frequency sweep and select the ratio B1/A2 as measured parameter for channel and trace no. 1.

```
FREQ:STAR 100000
```

Set start frequency to 100 kHz.

```
FREQ:STOP 10MHz
```

Set stop frequency to 10 MHz.

Note: If the start frequency entered is greater than the current stop frequency ([SENSe<Ch>:]FREQUency:STOP), the stop frequency is set to the start frequency plus the minimum frequency span ([SENSe<Ch>:]FREQUency:SPAN).

[SENSe<Ch>:]FREQUency:STOP <stop_frequency>

Defines the stop frequency for a frequency sweep which is equal to the right edge of a Cartesian diagram.

<Ch>	Channel number.
<stop_frequency>	Stop frequency of the sweep.
Range [def. unit]	Depending on the instrument model [Hz]. The increment (parameters UP or DOWN) is 0.1 kHz.
*RST value	Maximum frequency of the analyzer: MAX
SCPI, Command	Confirmed, command or query.

Types**Example:**

```
FUNC "XFR:POW:RAT B1, A2"
```

Activate a frequency sweep and select the ratio B1/A2 as measured parameter for channel and trace no. 1.

```
FREQ:STAR 100000
```

Set start frequency to 100 kHz.

```
FREQ:STOP 10MHz
```

Set stop frequency to 10 MHz.

Note: If the stop frequency entered is smaller than the current start frequency ([SENSe<Ch>:]FREQuency:STARt), the start frequency is set to the stop frequency minus the minimum frequency span ([SENSe<Ch>:]FREQuency:SPAN).

[SENSe<Chn>:]FUNctIon...

This subsystem selects the sweep type and the measurement parameter.

[SENSe<Chn>:]FUNctIon[:ON] '<string>'

Defines the sweep type and the measurement parameter in a single string.

Note: To select a measurement parameter without changing the sweep type, use CALCulate<Ch>:PARAmeter:MEASure. Use the other commands in the CALCulate<Ch>:PARAmeter... subsystem to create or delete traces and select measurement parameters.

<Chn> Channel number used to identify the active trace. If [SENSe<Chn>:]FUNctIon[:ON] is not used as a query, the number must be 1.

'<string>' Single string parameter defining the sweep type and the parameter to be measured: <string> = "<sweep_type>:<parameter>".

Range [def. unit] See list of strings below [-].

*RST value "XFR:S21" '

SCPI, Command Confirmed, command or query

Types**Example:**

```
CALC4:PAR:SDEF "Ch4Tr1", "S11"
```

Create channel 4 and a trace named *Ch4Tr1* to measure the input reflection coefficient S11. The trace automatically becomes the active trace.

```
SENS4:FUNC?
```

Check (query) the sweep type and measurement parameter of the active trace. The result is 'XFR:POW:S11'.

The following keyword defines the sweep type (see SCPI command reference: presentation layer):

XFRequency	Frequency sweep (<i>Lin. Frequency/Log. Frequency/Segmented Frequency</i>)
------------	--

The following keywords define the measurement parameter (see SCPI command reference: function name):

POWer:S<Pt _{out} ><Pt _{in} >	S-parameter with output and input port number of the DUT, e.g. S ₁₁ , S ₂₁ .
POWer:KFACTOR	Stability factor K
POWer:MUFACTOR<1 2>	Stability factors μ_1 or μ_2

[SENSE<Ch>:]POWER...

This subsystem controls the power at the input ports of the analyzer.

[SENSE<Ch>:]POWER:ATTenuation ARECeiver | BRECeiver, <numeric_value>

Sets an attenuation factor for the received waves b_1 and b_2 .

<Ch>	Channel number. If unspecified the numeric suffix is set to 1.
	Test port of the analyzer:
ARECeiver BRECeiver 	Test port 1
	Test port 2
<numeric_value>	Attenuation factor for the received wave.
Range [def. unit]	0 dB to 30 dB. UP and DOWN increment/decrement the attenuation in 5 dB steps. The analyzer rounds any entered value below the maximum attenuation to the closest step.
*RST value	+10 dB (0 dB for R&S ZVL13)

SCPI, Command Types Confirmed, command or query

Example:

```
POW:ATT AREC, 15
```

Set an attenuation factor of 15 dB for the waves received at test port 1 and channel no. 1. The other test ports and channels are not affected.

[SENSE<Ch>:]ROSCillator...

This subsystem controls the frequency reference oscillator.

[SENSE<Ch>:]ROSCillator[:SOURce] INTernal | EXTernal

Selects the source of the reference oscillator signal.

<Ch>	Channel number. This suffix is ignored in the ROSCillator subsystem and can be set to any value.
INTernal	Select internal 10 MHz reference oscillator.
EXTernal	Select external reference clock. The frequency of the external reference clock is specified via [SENSE<Chn>:]ROSCillator:EXTernal:FREQUENCY.
*RST value	INTernal

SCPI, Command Types Confirmed, command or query

Example:

```
ROSC EXT
```

Select external reference oscillator.

```
ROSC:EXT:FREQ?
```

Query the frequency of the external reference oscillator. The response is 10000000 Hz, i.e. the frequency of the external reference oscillator must be 10 MHz.

[SENSe<Ch>:]ROSCillator:EXTernal:FREQuency <numeric_value>

Specifies or queries the frequency of the external reference oscillator.

<Ch>	Channel number. This suffix is ignored in the <code>ROSCillator</code> subsystem and can be set to any value.
<numeric_value>	Frequency of the external reference clock signal. The frequency must be 10 MHz; any other setting is ignored.
Range [def. unit]	10 MHz [Hz].
*RST value	10 MHz
SCPI, Command Types	Confirmed, command or query
Example:	See [SENSe<Ch>:]ROSCillator[:SOURce].

[SENSe<Ch>:]SEGMENT<Seg>...

This subsystem defines all channel settings for a *Segmented Frequency* sweep. A segmented sweep is activated via [SENSe<Ch>:]SWEep:TPYE SEGMENT.



The commands in the [SENSe<Ch>:]SEGMENT<Seg>... subsystem do not accept the step parameters UP and DOWN. Numeric values can be entered directly or using the DEFAULT, MINimum, MAXimum parameters.

[SENSe<Ch>:]SEGMENT<Seg>:ADD

Inserts a new sweep segment using default channel settings (*Insert New Segment*). The added segment covers the frequency interval between the maximum frequency of the existing sweep segments and the stop frequency of the entire sweep range.



Use [SENSe<Ch>:]SEGMENT<Seg>:INSert to create a segment with specific channel settings.

<Ch>	Channel number. If unspecified the numeric suffix is set to 1.
<Seg>	Sweep segment number. Segment numbers must be sequential. If n segments already exist, the added segment must have the segment number n+1.
*RST value	–
SCPI, Command	Device-specific, no query.

Types**Example:**

```
SEGM:INS 1MHZ, 1.5MHZ, 111, -21DBM, 0.5S, 0, 10KHZ
```

Create a sweep segment with a sweep range between 1.0 MHz and 1.5 MHz.

```
SEGM2:ADD
```

Create a second sweep segment. The frequency range of the second segment will be between 1.5 MHz and the maximum frequency of the analyzer.

[SENSE<Ch>:]SEGMENT<Seg>:ATTenuation<port_no> <Attenuation>

Defines the attenuation factors for the received waves b_1 and b_2 in segment no. <Seg> . .

<Ch> Channel number.

<Seg> Sweep segment number.

<port_no> Test port number of the analyzer, 1 (wave b_1) or 2 (wave b_2). If unspecified the numeric suffix is set to 1.

<Attenuation> Attenuation factor for the received wave.

Range [def. unit] 0 dB to +30 dB. UP and DOWN increment/decrement the attenuation in 5 dB steps. The analyzer rounds any entered value below the maximum attenuation to the closest step.

*RST value +10 dB

SCPI, Command Device-specific, with query.

Types**Example:**

```
SEGM:INS 1MHZ, 1.5MHZ, 111, -21DBM, 0.5S, 0, 10KHZ
```

Create a sweep segment with a sweep range between 1.0 MHz and 1.5 MHz.

```
SEGM:ATT1 5; ATT2 15
```

Define an input attenuation of 5 dB for the b_1 wave, 15 dB for the b_2 wave.

[SENSE<Ch>:]SEGMENT<Seg>:BWIDth[:RESolution] <Bandwidth>

Defines the resolution bandwidth of the analyzer (*Meas Bandwidth*) in sweep segment no. <Seg>. At the same time, the command activates separate bandwidth setting in all sweep segments

([SENSE<Ch>:]SEGMENT<Seg>:BWIDth[:RESolution]:CONTRol ON).

<Ch> Channel number.

<Seg> Sweep segment number.

<Bandwidth> Internal source power.

Range [def. unit] 1.0E-6 Hz to 5 MHz [Hz]. UP and DOWN increment/decrement the bandwidth in 1-2-5 steps for each decade. The analyzer rounds up any entered value between these steps and rounds down values exceeding the maximum bandwidth.

*RST value 10 kHz

SCPI, Command Device-specific, command or query

Types

Example:

```
SEGM:ADD
```

Create a new sweep segment no. 1 in channel no. 1 using default settings and thus 10 kHz measurement bandwidth.

```
SEGM:BWID 1 MHZ
```

Increase the resolution bandwidth to 1 MHz.

[SENSe<Ch>:]SEGMent<Seg>:BWIDth[:RESolution]:CONTrol <Boolean>

Qualifies whether or not the *Meas Bandwidth* can be set independently for each sweep segment.

<Ch>	Channel number.
<Seg>	Sweep segment number.
<Boolean>	ON: The bandwidth can be set independently for each sweep segment. OFF: The bandwidth in all sweep segments is equal to the bandwidth for unsegmented sweeps set via <code>SENSe<Ch>:BWIDth[:RESolution]</code> .
*RST value	OFF. The parameter is automatically switched to ON when a bandwidth is entered using <code>[SENSe<Ch>:]SEGMent<Seg>:BWIDth[:RESolution]</code> .
SCPI, Command Types	Device-specific, command or query

Example:

```
SEGM:ADD
```

Create a new sweep segment no. 1 in channel no. 1 using default settings and thus 10 kHz measurement bandwidth.

```
SEGM:BWID 1 MHZ
```

Increase the resolution bandwidth to 1 MHz.

```
SEGM:BWID:CONT OFF
```

Couple the bandwidths in all segments and reset the bandwidth in segment no. 1 to the initial value.

[SENSe<Ch>:]SEGMent<Seg>:BWIDth[:RESolution]:SELEct FAST | NORMal

Defines the *Filter Type* (selectivity) in sweep segment no. <Seg>. At the same time, the command activates separate filter type settings in all sweep segments

(`[SENSe<Ch>:]SEGMent<Seg>:BWIDth[:RESolution]SELEct:CONTrol ON`).

<Ch>	Channel number.
<Seg>	Sweep segment number.
FAST	Use IF filter with normal selectivity and short settling time.
NORMal	Use IF filter with higher selectivity but larger settling time.
*RST value	FAST
SCPI, Command Types	Device-specific, command or query

Example:

```
SEGM:ADD
```

Create a new sweep segment no. 1 in channel no. 1 using default settings and thus the *Fast* filter type.

```
SEGM:BWID:SEL NORM
```

Activate an IF filter with high selectivity.

[SENSe<Ch>:]SEGMENT<Seg>:BWIDth[:RESolution]:SElect:CONTRol <Boolean>

Qualifies whether or not the *Filter Type* (selectivity) can be set independently for each sweep segment.

<Ch> Channel number.

<Seg> Sweep segment number.

<Boolean> ON – The filter type can be set independently for each sweep segment.
OFF – The filter type in all sweep segments is equal to the filter type for unsegmented sweeps set via `SENSe<Ch>:BWIDth[:RESolution]:SElect`.

***RST value** OFF. The parameter is automatically switched to ON when a bandwidth is entered using `[SENSe<Ch>:]SEGMENT<Seg>:BWIDth[:RESolution]:SElect`.

SCPI, Command Types Device-specific, command or query

Example:

```
*RST; SEGM:ADD
```

Create a new sweep segment no. 1 in channel no. 1 using default settings and thus the *Fast* filter type.

```
SEGM:BWID:SEL NORM
```

Change the filter type to *Normal*.

```
BWID:SEL?
```

Query the (default) filter type for unsegmented sweeps. The response is `FAST`.

```
SEGM:BWID:SEL:CONT OFF
```

Couple the filter type in all segments and reset the filter type in segment no. 1 to the unsegmented value `FAST`.

[SENSe<Ch>:]SEGMENT:CLEAr

Deletes all sweep segments in the channel. The command is equivalent to

```
[SENSe<Ch>:]SEGMENT:DELEt:ALL.
```

[SENSe<Ch>:]SEGMENT<Seg>:COUNT?

Returns the number of sweep segments in the channel including all segments that are switched off

```
([SENSe<Ch>:]SEGMENT<Seg>[:STATe] OFF).
```

<Ch> Channel number.

*RST value	–
SCPI, Command Types	Device-specific, query only.
Example:	<pre>SEGM:ADD</pre> <p>Create a new sweep segment no. 1 in channel no. 1 using default settings.</p> <pre>SEGM OFF</pre> <p>Disable the measurement in the created sweep segment.</p> <pre>SEGM:COUN?</pre> <p>Query the number of segments.</p>

[SENSe<Ch>:]SEGMent<Seg>:DEFine <Start>,<Stop>,<Points>,<Power>,<Point Delay>,<Unused>,<Meas. Bandwidth>[,<LO>]

Re-defines a sweep segment with specific channel settings (*Insert New Segment*). The segment replaces an existing segment <Seg> in the segment list. The modified segment must not overlap with any of the existing segments.

Entry of the first seven numeric parameters is mandatory; no default values are provided. All settings except <LO> can be changed for existing segments using other commands of the [SENSe<Ch>:]SEGMent<Seg>... subsystem.

Note: Use [SENSe<Ch>:]SEGMent<Seg>:Add to create a segment with default channel settings. Use [SENSe<Ch>:]SEGMent<Seg>:INSert (no query) to insert a new segment into the current segment list.

<Ch>	Channel number.
<Seg>	Sweep segment number. Segment numbers must be sequential. The specified segment number must be smaller or equal to the number of existing segments plus 1. If segment number <Seg> already exists, it is replaced by the new segment.
<Start>, <Stop>	Start and stop frequency of the segment. See [SENSe<Ch>:]SEGMent<Seg>:FREQuency:START and [SENSe<Ch>:]SEGMent<Seg>:FREQuency:STOP.
Range [def. unit]	A new segment must not overlap with any of the existing segments. Besides the frequency range depends on the analyzer model. [Hz]
<Points>	Number of sweep points in the segment. See [SENSe<Ch>:]SEGMent<Seg>:SWEep:POINTs.
Range [def. unit]	1 to 2147483647. [1] 1 is allowed if start and stop frequencies are equal.
<Power>	Internal source power in the segment. See [SENSe<Ch>:]SEGMent<Seg>:POWer.
Range [def. unit]	–40 dBm to +10 dBm. The exact range depends on the analyzer model; refer to the data sheet [dBm]. UP and DOWN increment/decrement the source power in 1-dB steps.
<Point Delay>	Delay for each partial measurement in the segment. See [SENSe<Ch>:]SEGMent<Seg>:SWEep:DWELL. In the setting [SENSe<Ch>:]SEGMent<Seg>:INSert:SElect SWTime, this parameter is replaced by <Time>. On R&S ZVL13 network analyzers, no point delay can be

Range [def. unit]	set: the value must be 0. 0 s to 2.5E+003 s. [s] AUTO activates automatic sweep time setting in the segment, which is equivalent to a meas. delay of 0 s.
ZVR <input checked="" type="checkbox"/> <Unused> <Meas. Bandwidth>	Ignored parameter, should be set to the default value 0. Resolution bandwidth in the segment. See [SENSe<Ch>:] SEGMENT<Seg>: BWIDth[:RESolution].
Range [def. unit]	1.0E-6 Hz to 5 MHz [Hz].
<LO>	Position of the local oscillator frequency LO relative to the RF frequency (<i>Spur Avoid</i>). In remote control this parameter must be set when a sweep segment is created.
Range [def. unit]	POSitive: LO > RF
SCPI, Command Types	Device-specific, with query (used to retrieve the channel settings for a particular sweep segment).
Example:	<pre>SEGM:ADD</pre> <p>Create a new sweep segment no. 1 in channel no. 1 using default settings.</p> <pre>SEGM:DEF?</pre> <p>Query the channel settings for the new segment.</p>

[SENSe<Ch>:]SEGMENT<Seg>:DELEte

Deletes the specified (single) sweep segment (*Del. Selected Segment*).

[SENSe<Ch>:] SEGMENT<Seg>: DELEte: ALL deletes all segments in the channel.

<Ch>	Channel number.
<Seg>	Sweep segment number. If unspecified, the value is set to 1.
*RST value	–
SCPI, Command Types	Device-specific, no query.
Example:	<pre>SEGM:ADD</pre> <p>Create a new sweep segment no. 1 in channel no. 1 using default settings and thus NORMAl selectivity.</p> <pre>SEGM:DEL</pre> <p>Delete the created segment.</p>

[SENSe<Ch>:]SEGMENT:DELEte:ALL

Deletes all sweep segments in the channel (*Del. All Segments*). [SENSe<Ch>:] SEGMENT<Seg>: DELEte deletes a single segment.

<Ch>	Channel number.
*RST value	–

SCPI, Command Types

Device-specific, no query.

Example:

SEGM:ADD

Create a new sweep segment no. 1 in channel no. 1 using default settings and thus NORMal selectivity.

SEGM:ALL

Delete the created segment and all segments in the channel created before.

[SENSE<Ch>:]SEGMENT<Seg>:FREQUENCY:CENTER?

Returns the center frequency of sweep segment no. <Seg>.

<Ch> Channel number.**<Seg>** Sweep segment number.**Response** Center frequency of the sweep.

Range [def. unit] Depending on the instrument model [Hz].

*RST value –

SCPI, Command Types

Device specific, query only.

Example:

SEGM:INS 1MHZ, 1.5MHZ, 111, -21DBM, 0.5S, 0, 10KHZ

Create a sweep segment with a sweep range between 1.0 MHz and 1.5 MHz.

SEGM:FREQ:CENT?

Query the center frequency of the created segment. The response is 1.2500000000E+006.

Note: The frequency range of the sweep segment can be changed via

[SENSE<Ch>:]SEGMENT<Seg>:FREQUENCY:START and

[SENSE<Ch>:]SEGMENT<Seg>:FREQUENCY:STOP.

[SENSE<Ch>:]SEGMENT<Seg>:FREQUENCY:SPAN?

Returns the width of the frequency range of sweep segment no. <Seg>.

<Ch> Channel number.**<Seg>** Sweep segment number.**Response** Frequency span of the sweep.

Range [def. unit] Depending on the instrument model [Hz].

*RST value –

SCPI, Command Types

Device specific, query only.

Example:

SEGM:INS 1MHZ, 1.5MHZ, 111, -21DBM, 0.5S, 0, 10KHZ

Create a sweep segment with a sweep range between 1.0 MHz and 1.5

MHz.

```
SEGM:FREQ:SPAN?
```

Query the span of the created segment. The response is 5.0000000000E+005.

Note: The frequency range of the sweep segment can be changed via [SENSe<Ch>:]SEGMent<Seg>:FREQuency:STARt and [SENSe<Ch>:]SEGMent<Seg>:FREQuency:STOP.

[SENSe<Ch>:]SEGMent<Seg>:FREQuency:STARt <Start>

Defines the *Start* frequency of sweep segment no. <Seg>.

<Ch> Channel number.
<Seg> Sweep segment number.
<Start> Start frequency of the sweep.
 Range [def. unit] Depending on the instrument model [Hz]. The increment is 0.1 kHz.
 *RST value – (no sweep segment defined after reset)

SCPI, Command Types Device-specific, command or query

Example:

```
SEGM:INS 1MHZ, 1.5MHZ, 111, -21DBM, 0.5S, 0, 10KHZ
```

Create a sweep segment with a sweep range between 1.0 MHz and 1.5 MHz.

```
SEGM:FREQ:STAR?
```

Query the start frequency of the created segment. The response is 1.0000000000E+006.

Note: If the start frequency entered is greater than the current stop frequency ([SENSe<Ch>:]SEGMent<Seg>:FREQuency:STOP), the stop frequency is set to the start frequency plus the minimum frequency span of 1 Hz.

[SENSe<Ch>:]SEGMent<Seg>:FREQuency:STOP <Stop>

Defines the *Stop* frequency of sweep segment no. <Seg>.

<Ch> Channel number.
<Seg> Sweep segment number.
<Stop> Stop frequency of the sweep.
 Range [def. unit] Depending on the instrument model [Hz]. The increment is 0.1 kHz.
 *RST value – (no sweep segment defined after reset)

SCPI, Command Types Device-specific, command or query

Example:

```
SEGM:INS 1MHZ, 1.5MHZ, 111, -21DBM, 0.5S, 0, 10KHZ
```

Create a sweep segment with a sweep range between 1.0 MHz and 1.5 MHz.

SEGM:FREQ:STOP?

Query the stop frequency of the created segment. The response is 1.500000000E+006.

Note: If the stop frequency entered is smaller than the current start frequency ([SENSe<Ch>:]SEGMent<Seg>:FREQUency:START), the start frequency is set to the stop frequency minus the minimum frequency span ([SENSe<Ch>:]SEGMent<Seg>:FREQUency:SPAN).

[SENSe<Ch>:]SEGMent<Seg>:INSert <Start>,<Stop>,<Points>,<Power>,<Point Delay>,<Unused>,<Meas. Bandwidth>

Inserts a new sweep segment with specific channel settings (*Define Segments - Add*). The new segment must not overlap with any of the existing segments.

Entry of the first seven numeric parameters is mandatory; no default values are provided. All settings except <LO> can be changed for existing segments using other commands of the [SENSe<Ch>:]SEGMent<Seg>... subsystem.

Note: Use [SENSe<Ch>:]SEGMent<Seg>:Add to create a segment with default channel settings. Use [SENSe<Ch>:]SEGMent<Seg>:DEFine to change or query all settings of an existing segment.

<Ch> Channel number.

<Seg> Sweep segment number. Segment numbers must be sequential. The specified segment number must be smaller or equal to the number of existing segments plus 1. Moreover, segment numbers must be selected such that the corresponding frequency ranges are in ascending order.
If one or more sweep segments with segment numbers <Seg> or larger exist in the current channel, then all these existing segment numbers are incremented by 1 and the new segment is inserted as segment no. <Seg>.

<Start>, <Stop> Start and stop frequency of the segment. See [SENSe<Ch>:]SEGMent<Seg>:FREQUency:START and [SENSe<Ch>:]SEGMent<Seg>:FREQUency:STOP.

Range [def. unit] A new segment must not overlap with any of the existing segments. Besides the frequency range depends on the analyzer model. [Hz]

<Points> Number of sweep points in the segment. See [SENSe<Ch>:]SEGMent<Seg>:SWEep:POINTs.

Range [def. unit] 1 to 2147483647. [1] 1 is allowed if start and stop frequencies are equal.

<Power> Internal source power in the segment. See [SENSe<Ch>:]SEGMent<Seg>:POWER.

Range [def. unit] -40 dBm to +10 dBm. The exact range depends on the analyzer model; refer to the data sheet [dBm]. UP and DOWN increment/decrement the source power in 1-dB steps.

<Point Delay> Delay for each partial measurement in the segment. See [SENSe<Ch>:]SEGMent<Seg>:SWEep:DWELL. In the setting [SENSe<Ch>:]SEGMent<Seg>:INSert:SELEc SWTime, this parameter is replaced by <Time>. On R&S ZVL13 network analyzers, no point delay can be set: the value must be 0.

Range [def. unit] 0 s to 2.5E+003 s. [s] AUTO activates automatic sweep time setting in the segment, which is equivalent to a meas. delay of 0 s.

ZVR <input checked="" type="checkbox"/> <Unused>	Ignored parameter, should be set to the default value 0.
<Meas. Bandwidth>	Resolution bandwidth in the segment. See [SENSE<Ch>:]SEGMENT<Seg>:BWIDTh[:RESolution].
Range [def. unit]	1.0E-6 Hz to 5 MHz [Hz].
SCPI, Command Types	Device-specific, no query.
Example:	<pre>SEGM:INS 1MHZ, 1.5MHZ, 111, -21DBM, 0.5S, 0, 10KHZ</pre> <p>Create a sweep segment with a sweep range between 1.0 MHz and 1.5 MHz.</p> <pre>SEGM2:ADD</pre> <p>Create a second sweep segment. The frequency range of the second segment will be between 1.5 MHz and the maximum frequency of the analyzer.</p>

[SENSE<Ch>:]SEGMENT<Seg>:OVERlap <Boolean>

Queries whether the analyzer supports overlapping sweep segments.

<Ch>	Channel number.
<Seg>	Sweep segment number.
<Boolean>	ON OFF: No effect.
*RST value	OFF. If used as a query, the command returns the information that overlapping sweep segments are not supported (<i>OFF</i>).
SCPI, Command Types	Device-specific, command (no effect) or query

[SENSE<Ch>:]SEGMENT<Seg>:POWER[:LEVEL] <Power>

Defines the *Power* of the internal signal source in sweep segment no. <Seg>. At the same time, the command activates separate power control in all sweep segments ([SENSE<Ch>:]SEGMENT<Seg>:POWER[:Level]:CONTROL ON).

<Ch>	Channel number.
<Seg>	Sweep segment number.
<Power>	Internal source power.
Range [def. unit]	–40 dBm to +10 dBm. The exact range depends on the analyzer model; refer to the data sheet [dBm].
*RST value	–10 dBm.
SCPI, Command Types	Device-specific, command or query
Example:	<pre>SEGM:ADD</pre> <p>Create a new sweep segment no. 1 in channel no. 1 using default settings and thus –10 dBm internal source power.</p> <pre>SEGM:POW -20</pre>

Decrease the power to –20 dBm.

[SENSE<Ch>:]SEGMENT<Seg>:POWER[:LEVEL]:CONTROL <Boolean>

Qualifies whether or not the *Power* of the internal signal source can be set independently for each sweep segment.

<Ch>	Channel number.
<Seg>	Sweep segment number.
<Boolean>	ON: The power can be set independently for each sweep segment. OFF: The power in all sweep segments is equal to the internal source power for unsegmented sweeps set via SOURCE<Ch>:POWER[:LEVEL] [:IMMEDIATE] [:AMPLITUDE].
*RST value	OFF. The parameter is automatically switched to ON when a segment level is entered using [SENSE<Ch>:]SEGMENT<Seg>:POWER[:LEVEL].
SCPI, Command Types	Device-specific, command or query

Example:

```
SEGM:ADD
```

Create a new sweep segment no. 1 in channel no. 1 using default settings and thus –10 dBm internal source power.

```
SEGM:POW -20
```

Decrease the power to –20 dBm.

```
SEGM:POW:CONT OFF
```

Couple the powers in all segments and reset the power in segment no. 1 to the initial value.

[SENSE<Ch>:]SEGMENT<Seg>[:STATE] <Boolean>

Activates or deactivates the sweep segment <Seg>. Sweep points belonging to inactive segments only are not measured

<Ch>	Channel number.
<Seg>	Sweep segment number.
<Boolean>	ON OFF - Activates or deactivates the measurement in sweep segment <Seg>.
*RST value	ON
SCPI, Command Types	Device-specific, command or query

Example:

```
SEGM:ADD
```

Create a new sweep segment no. 1 in channel no. 1 using default settings.

```
SEGM OFF
```

Disable the measurement in the created sweep segment.

[SENSE<Ch>:]SEGMENT<Seg>:SWEep:DWELI <Meas. Delay>

Defines the delay time for each partial measurement in sweep segment no. <Seg> (*Meas. Delay*). If coupling of the segments is switched on ([SENSE<Ch>:]SEGMENT<Seg>:SWEep:DWELI:CONTROL ON) the delay is valid for all sweep segments in the current channel. This command is not available on R&S ZVL13 network analyzers.

<Ch>	Channel number.
<Seg>	Sweep segment number.
<Meas. Delay>	Meas. delay before each partial measurement.
Range [def. unit]	0 s to 2.5E+003 s. [s] Changing the delay leaves the number of points unchanged but has an impact on the duration of the sweep ([SENSE<Ch>:]SEGMENT<Seg>:SWEep:TIME).
*RST value	0 s
SCPI, Command Types	Device-specific, command or query. This default value corresponds to automatic sweep time setting in manual control.

Example:

```
SEGM:ADD
```

Create a new sweep segment no. 1 in channel no. 1 using default settings.

```
SEGM:SWE:DWEL 1 MS
```

Set the meas. delay in segment no. 1 to 1 ms.

```
SEGM:DEF? Response: 300000,8000000000,51,-300,0.056559,0,10000,POS,NORM
```

Query the channel parameters for sweep segment 1. The response value for the segment sweep time (olive) implicitly contains the defined meas. delay.

[SENSE<Ch>:]SEGMENT<Seg>:SWEep:DWELI:CONTROL <Boolean>

Qualifies whether or not the *Meas. Delay* defined via [SENSE<Ch>:]SEGMENT<Seg>:SWEep:DWELI can be set independently for each sweep segment.

<Ch>	Channel number.
<Seg>	Sweep segment number. This suffix is ignored; the command controls the whole segmented sweep.
<Boolean>	ON: The meas. delay can be set independently for each sweep segment. OFF: The meas. delay in all sweep segments is equal to the <i>Meas. Delay</i> measurements for unsegmented sweeps set via [SENSE<Ch>:]SWEep:DWELI.
*RST value	OFF. The parameter is automatically switched to ON when a meas. delay time is entered using [SENSE<Ch>:]SEGMENT<Seg>:SWEep:DWELI.
SCPI, Command Types	Device-specific, command or query.

Example:

```
SEGM:ADD
```

Create a new sweep segment no. 1 in channel no. 1 using default settings and thus 0 s meas. delay.

```
SEGM:SWE:DWELI 0.1
```

Increase the meas. delay to 0.1 s.

```
SEGM:SWE:DWEL1:CONT OFF
```

Couple the meas. delay in all segments and reset the delay in segment no. 1 to the initial value of 0 s.

[SENSe<Ch>:]SEGMENT<Seg>:SWEep:POINTs <Points>

Defines the total number of measurement *Points* in sweep segment no. <Seg>.

<Ch>	Channel number.
<Seg>	Sweep segment number.
<Points>	Number of points in the segment.
Range [def. unit]	1 to 2147483647. [1] 1 is allowed if start and stop frequencies are equal.
*RST value	51

SCPI, Command Types Device-specific, command or query

Example:

```
SEGM:ADD
```

Create a new sweep segment no. 1 in channel no. 1 using default settings and thus 51 sweep points.

```
SEGM:SWE:POIN 401
```

Increase the number of points to 401.

[SENSe<Ch>:]SWEep...

This subsystem provides general settings to control the sweep . Most of the settings are related to the sweep time.



The [SENSe<Ch>:]SWEep... settings apply to non-segmented sweep types. Segmented sweeps are selected via [SENSe<Ch>:]SWEep:TPYE SEGMENT and configured in the [SENSe<Ch>:]SEGMENT<Seg>... subsystem.

[SENSe<Ch>:]SWEep:COUNt <No_of_Sweeps>

Defines the number of sweeps to be measured in single sweep mode (INITiate<Ch>:CONTinuous OFF).

<Ch>	Channel number.
<No_of_Sweeps>	Number of consecutive sweeps to be measured.

Range [def. unit]	1 to 999. [-]
*RST value	1
SCPI, Command Types	Confirmed, command or query

Example: See `CALCulate<Chn>:DATA:NSweep?`.

[SENSe<Ch>:]SWEep:DWELI <delay>

Defines the *Meas. Delay* time for each partial measurement. This command is not available on R&S ZVL13 network analyzers.

<Ch>	Channel number.
<delay>	Meas. delay before each partial measurement.
Range [def. unit]	0 s to 3.179551E+002 s. [s] Changing the delay leaves the number of points unchanged but has an impact on the duration of the sweep.
*RST value	0 s
SCPI, Command Types	Confirmed, command or query

Example: `FUNC "XFR:POW:S12"`

Activate a frequency sweep and select the S-parameter S12 as measured parameter for channel and trace no. 1.

`SWE:TIME?`

Query total sweep time.

`SWE:DWEL 1`

Set a delay of 1 s for each partial measurement.

`SWE:TIME?`

Query total sweep time. The time is extended by the delay times the total number of partial measurements per sweep.

[SENSe<Ch>:]SWEep:POINTS <no_points>

Defines the total number of measurement points per sweep (*Number of Points*).

<Ch>	Channel number 1.
<no_points>	Number of points per sweep.
Range [def. unit]	2 to 4001. [1]
*RST value	201

SCPI, Command Types Confirmed, command or query

Example: `FUNC "XFR:POW:S12"`

Activate a frequency sweep and select the S-parameter S12 as measured parameter for channel and trace no. 1.

`SWE:TIME?`

Query total sweep time.

```
SWE:POIN 2010
```

Multiply the (default) number of points by 10.

```
SWE:TIME?
```

Query total sweep time again. The analyzer estimates a sweep time that is also multiplied by 10.

[SENSe<Ch>:]SWEep:SPACing LINear | LOGarithmic

Defines the frequency vs. time characteristics of a frequency sweep (*Lin Frequency* or *Log Frequency*). The command has no effect on segmented frequency sweeps.

Note: Use [SENSe<Ch>:]SWEep:TPYE to select sweep types other than Lin Frequency or Log Frequency.

<Ch>	Channel number.
LINear	The stimulus frequency is swept in equidistant steps over the frequency range. In a Cartesian diagram, the x-axis is a linear frequency axis.
LOGarithmic	The frequency is swept in equidistant steps on a logarithmic scale. In a Cartesian diagram, the x-axis is a logarithmic frequency axis.
*RST value	LINear
SCPI, Command Types	Confirmed, command or query
Example:	<pre>FUNC "XFR:POW:S12"</pre> <p>Activate a frequency sweep and select the S-parameter S12 as measured parameter for channel and trace no. 1.</p> <pre>SWE:SPAC LOG</pre> <p>Change to sweep type <i>Log Frequency</i>.</p>

[SENSe<Chn>:]SWEep:SRCPort 1 | 2

Selects a source port for the stimulus signal (*Drive Port*). The setting acts on the active trace.

If an S-parameter $S_{\text{out}<\text{in}>}$ is measured, the second port number index <in> (input port of the DUT = drive port of the analyzer) is set equal to the selected drive port: Drive port selection affects the measured quantity.

<Chn>	Channel number used to identify the active trace. If unspecified the numeric suffix is set to 1.
1 ...	Test port number of the analyzer, 1 to 2.
*RST value	1 (test port 1)
SCPI, Command Types	Device-specific, with query.
Example:	<pre>CALC4:PAR:SDEF "Ch4Tr1", "A1"</pre> <p>Create channel 4 and a trace named <i>Ch4Tr1</i> to measure the wave quantity a1.</p>

The trace automatically becomes the active trace.

```
SENS4:SWE:SRCP 2
```

Select drive port 2 for the active trace.

[SENSe<Ch>:]SWEep:STEP <step_size>

Sets the distance between two consecutive sweep points.



This setting is valid for sweep types with equidistant sweep points only. It does not apply to logarithmic and segmented sweeps.

<Ch>	Channel number.
<step_size>	Stimulus step size.
Range [def. unit]	Depending on the other channel settings. The minimum step size is equal to the sweep span divided by the maximum number of points minus one ([SENSe<Ch>:]SWEep:POINts), the maximum step size is equal to the sweep span ([SENSe<Ch>:]FREQuency:SPAN). See also description of manual control and program example below. [-]
*RST value	The default step size is equal to the default sweep span of the analyzer divided by the default number of points minus one.

**SCPI,
Command
Types**

Confirmed, with query.

Example:

```
*RST;SWE:STEP?
```

Query the default step size. For a 6 GHz analyzer, the response is 29998500.
29998500 Hz = (6 GHz – 300 kHz) / 200.

```
SWE:STEP UP
```

Increase the step size.

```
FREQ:STOP?; :SWE:POIN?
```

Query the stop frequency of the sweep and the number of points. Increasing the step size has changed both values.

[SENSe<Ch>:]SWEep:TYPE LINear | LOGarithmic | SEGment

Selects the sweep type (frequency) and the position of the sweep points across the sweep range.

<Ch>	Channel number.
LINear	Lin. frequency sweep at constant source power (SOURce<Ch>:POWer<Pt>[:LEVel] [:IMMediate] [:AMPlitude]). The stimulus frequency ([SENSe<Ch>:]FREQuency:...) is swept in equidistant steps over the frequency range. In a Cartesian diagram, the x-axis is a linear frequency axis.
LOGarithmic	Log. frequency sweep. The frequency is swept in equidistant steps on a logarithmic scale. In a Cartesian diagram, the x-axis is a logarithmic frequency axis.
SEGment	Segmented frequency sweep. The sweep range is composed of several continuous frequency ranges or single frequency points defined by means of the commands in

	the [SENSe<Ch>:] SEGMENT<Seg> . . . subsystem.
*RST value	LINear
SCPI, Command Types	Device-specific, command or query
Example:	<pre>FUNC "XFR:POW:S12"</pre> <p>Activate a frequency sweep and select the S-parameter S12 as measured parameter for channel and trace no. 1.</p> <pre>SWE:TYPE LOG</pre> <p>Change to sweep type <i>Log Frequency</i>.</p>

SOURce<Ch>:...

This subsystem controls the power of the internal signal source and controls the output signals of the instrument.

SOURce<numeric_suffix>:EXTernal<numeric_suffix>:ROSCillator[:SOURce] INTernal | EXTernal

Switches between external and internal reference oscillator.

<numeric_suffix>	1 2 - The numeric suffixes are ignored.
INTernal	Select internal 10 MHz reference oscillator.
EXTernal	Select external reference clock. The frequency of the external reference clock is specified via [SENSe<Chn>:]ROSCillator:EXTernal:FREQuency.
*RST value	INT
SCPI, Command Types	Device-specific, command or query
Example:	<pre>SOUR:EXT:ROSC EXT</pre> <p>Switches to external reference oscillator.</p>

SOURce<Ch>:POWER<Pt>[:LEVel][:IMMediate][:AMPLitude] <numeric_value>

Defines the power of the internal signal source (channel power). The setting is valid for all sweep types.

<Ch>	Channel number.
<Pt>	Test port number of the analyzer. This suffix is ignored because the selected channel power applies to all source ports used in the active channel.
<numeric_value>	Internal source power.
Range [def. unit]	-70 dBm to +20 dBm (to 0 dBm for R&S ZVL13 analyzers). The exact range for all analyzer models is quoted in the data sheet [dBm]. UP and DOWN

*RST value	increment/decrement the source power in 0.1-dB steps. -10 dBm
SCPI, Command Types	Confirmed, command or query
Example:	<pre>FUNC "XFR:POW:RAT B1, A2"</pre> <p>Activate a frequency sweep and select the ratio B1/A2 as measured parameter for channel and trace no. 1.</p> <pre>SOUR:POW -6</pre> <p>Set the internal source power for channel 1 to -6 dBm.</p>

STATus...

This subsystem controls the Status Reporting System. Note that *RST does not influence the status registers.

STATus:PRESet

Configures the status reporting system such that device-dependent events are reported at a higher level.

The command affects only the transition filter registers, the ENABLE registers, and queue enabling:

- The ENABLE parts of the STATus:OPERation and STATus:QUESTionable... registers are set to all 1's.
- The PTRansition parts are set all 1's, the NTRansition parts are set to all 0's, so that only positive transitions in the CONDition part are recognized.

The status reporting system is also affected by other commands, see *Reset Values of the Status Reporting System*.

*RST value	–
SCPI, Command Types	Confirmed, no query
Example:	<pre>STAT:PRES</pre> <p>Preset the status registers.</p>

STATus:QUESTionable:CONDition?

Returns the contents of the CONDition part of the QUESTionable register. Reading the CONDition registers is nondestructive.

*RST value	–
SCPI, Command Types	Confirmed, query only
Example:	<pre>STAT:QUES:COND?</pre> <p>Query the CONDition part of the QUESTionable register to check for</p>

questionable instrument states.

STATus:QUESTionable:ENABLE

Sets the enable mask which allows true conditions in the EVENT part of the QUESTionable register to be reported in the summary bit. If a bit is 1 in the enable register and its associated event bit transitions to true, a positive transition will occur in the summary bit (bit 3 of the SStatus Byte).

<NRf>	0 to 65535 (decimal representation)
*RST value	– (see also <i>Reset Values of the Status Reporting System</i>)
SCPI, Command Types	Confirmed, command or query
Example:	STAT:QUES:ENABle 1536 Set bits no. 9 and 10 of the QUESTionable:ENABLE register

STATus:QUESTionable[:EVENT]?

Returns the contents of the EVENT part of the QUESTionable register. Reading an EVENT register clears it.

*RST value	–
SCPI, Command Types	Confirmed, query only
Example:	STAT:OPER? Query the EVENT part of the OPERation register to check whether an event has occurred since the last reading.

STATus:QUESTionable:NTRansition

Sets the negative transition filter. Setting a bit causes a 1 to 0 transition in the corresponding bit of the associated condition register to cause a 1 to be written in the associated bit of the corresponding event register.

<NRf>	0 to 65535 (decimal representation)
*RST value	– (see also <i>Reset Values of the Status Reporting System</i>)
SCPI, Command Types	Confirmed, command or query
Example:	STAT:QUES:NTR 1536 Set bits no. 9 and 10 of the QUESTionable:NTRansition register

STATus:QUEStionable:PTRansition

Sets the positive transition filter. Setting a bit causes a 0 to 1 transition in the corresponding bit of the associated condition register to cause a 1 to be written in the associated bit of the corresponding event register.

<NRf> 0 to 65535 (decimal representation)
***RST value** – (see also *Reset Values of the Status Reporting System*)

SCPI, Command Types Confirmed, command or query

Example: `STAT:QUES:PTR 1536`
 Set bits no. 9 and 10 of the QUEStionable:PTRansition register

STATus:QUEStionable:LIMit<1|2>:CONDition?

Returns the contents of the CONDition part of the QUEStionable:LIMit<1|2> register. Reading the CONDition registers is nondestructive.

***RST value** –

SCPI, Command Types Confirmed, query only

Example: `STAT:QUES:LIMit:COND?`
 Query the CONDition part of the QUEStionable:LIMit1 register to retrieve the current status of the limit check.

STATus:QUEStionable:LIMit<1|2>:ENABLE

Sets the enable mask which allows true conditions in the EVENt part of the QUEStionable:LIMit<1|2> register to be reported in the summary bit. If a bit is 1 in the enable register and its associated event bit transitions to true, a positive transition will occur in the summary bit (bit 10 of the QUEStionable register for the LIMit1 register, bit 0 of the LIMit1 register for the LIMit2 register).

<NRf> 0 to 65535 (decimal representation)
***RST value** – (see also *Reset Values of the status reporting system*)

SCPI, Command Types Confirmed, command or query

Example: `STAT:QUES:LIM2:ENAB 6`
 Set bits no. 1 and 2 of the QUEStionable:LIMit2:ENABLE register

STATus:QUEStionable:LIMit<1|2>[:EVENT]?

Returns the contents of the EVENt part of the QUEStionable:LIMit<1|2> register. Reading an EVENt register clears it.

*RST value	–
SCPI, Command Types	Confirmed, query only
Example:	STAT:QUES:LIM1?
	Query the EVENT part of the QUESTIONable:LIMit1 register to check whether an event has occurred since the last reading.

STATus:QUESTIONable:LIMit<1|2>:NTRansition

Sets the negative transition filter. Setting a bit causes a 1 to 0 transition in the corresponding bit of the associated condition register to cause a 1 to be written in the associated bit of the corresponding event register.

<NRf>	0 to 65535 (decimal representation)
*RST value	– (see also <i>Reset Values of the Status Reporting System</i>)
SCPI, Command Types	Confirmed, command or query
Example:	STAT:QUES:LIM2:NTR 6
	Set bits no. 1 and 2 of the QUESTIONable:LIMit2:NTRansition register

STATus:QUESTIONable:LIMit<1|2>:PTRansition

Sets the positive transition filter. Setting a bit causes a 0 to 1 transition in the corresponding bit of the associated condition register to cause a 1 to be written in the associated bit of the corresponding event register.

<NRf>	0 to 65535 (decimal representation)
*RST value	– (see also <i>Reset Values of the Status Reporting System</i>)
SCPI, Command Types	Confirmed, command or query
Example:	STAT:QUES:LIM2:PTR 6
	Set bits no. 1 and 2 of the QUESTIONable:LIMit2:PTRansition register

STATus:QUEue[:NEXT]?

Queries and at the same time deletes the oldest entry in the error queue. Operation is identical to that of SYSTem:ERRor[:NEXT]?

The entry consists of an error number and a short description of the error. Positive error numbers are instrument-dependent. Negative error numbers are reserved by the SCPI standard; see section Error Messages.

*RST value	–
SCPI, Command	Confirmed, query only

Types**Example:**

STAT:QUE?

Query the oldest entry in the error queue. 0, "No error" is returned if the error queue is empty.

SYSTEM...

This subsystem collects the functions that are not related to instrument performance, such as function for general housekeeping and function related to global configurations.

SYSTEM:COMMunicate:AKAL:CONNectiOn THROugh | OPEN | SHORt | MATCh, <port_1>, <port_2>

Connects the selected calibration standard to one or two ports of the active calibration unit (see `SYSTEM:COMMunicate:RDEvice:AKAL:ADDRESS`).

THROugh | OPEN | SHORt | MATCh

Connected one or two-port standard

<port_1>

Port number of the calibration unit, for one and two-port standards

<port_2>

Second port number of the calibration unit, for two-port standards (THROugh) only, omitted for the one-port standards

*RST value

–

SCPI, Command Types

Device-specific, command or query

Example:

SYST:COMM:AKAL:CONN THR, 1, 2

Connect a trough standard between ports 1 and 2 of the cal unit.

SYSTEM:COMMunicate:AKAL:MMEMory[:STATe] <Boolean>

Shows or hides the memory of the active calibration unit (see `SYSTEM:COMMunicate:RDEvice:AKAL:ADDRESS`).

<Boolean>

ON – memory is shown in a separate drive

OFF – memory is not shown

*RST value

OFF

SCPI, Command Types

Device-specific, command or query

Example:

SYST:COMM:AKAL:MMEM ON

Show the memory of the active calibration unit.

SYSTem:COMMunicate:GPIB[:SELF]:ADDRess <address_no>

Sets the GPIB address of the analyzer.

<address_no>	GPIB address (integer number)
Range [def. unit]	0 to 30 [-].
*RST value	The GPIB address is factory-preset (value 20). *RST has no effect on the value.

SCPI, Command Types Confirmed, command or query

Example:

```
SYST:COMM:GPIB:ADDR 10
```

Set the GPIB address to 10.

```
*RST; SYST:COMM:GPIB:ADDR?
```

After a reset, the address is maintained (the response is 10).

SYSTem:COMMunicate:GPIB[:SELF]:RTERminator LFEoi | EOI

Sets the receive terminator of the analyzer. The receive terminator indicates the end of a command or a data block.

The receive terminator setting is relevant if block data is transferred to the analyzer (`FORMat [:DATA] REAL`). In the default setting LFEoi, the analyzer recognizes an LF character sequence with or without the EOI control bus message as a receive terminator. An accidental LF in a data block can be recognized as a terminator and cause an interruption of the data transfer.

The EOI setting is especially important if commands are transferred in block data format, because it ensures that the parser for command decoding is activated by the terminator only after the command has been completely transferred. Readout of binary data does not require a change of the receive terminator.

LFEoi LF character sequence with or without EOI recognized

EOI EOI recognized only

*RST value LFEoi.

SCPI, Command Types Device-specific, command or query

Example:

```
SYST:COMM:GPIB:RTER EOI
```

Set the terminator to EOI.

SYSTem:COMMunicate:PRINter:ENUMerate[:NEXT]?

Queries the name of the next printer installed under Windows XP.

The `SYSTem:COMMunicate:PRINter:ENUMerate:FIRSt?` command should be sent previously to return to the beginning of the printer list and query the name of the first printer.

The names of other printers can then be queried with the `SYSTem:COMMunicate:PRINter:ENUMerate[:NEXT]?` command. After all available printer names have been output, an empty string enclosed by quotation marks (") is output for the next query. Further

queries are answered by a query error.

*RST value	–
SCPI, Command Types	Device-specific, query only
Example:	<code>SYST:COMM:PRIN:ENUM:NEXT?</code>

SYSTem:COMMunicate:PRINter:ENUMerate:FIRSt?

Queries the name of the first printer (in the list of printers) available under Windows XP. The names of other installed printers can be queried with the `SYSTem:COMMunicate:PRINter:ENUMerate[:NEXT]? command`.

If no printer is configured an empty string is output.

*RST value	–
SCPI, Command Types	Device-specific, query only
Example:	<code>SYST:COMM:PRIN:ENUM:FIRS?</code>

SYSTem:COMMunicate:PRINter:SElect <config> <printer name>

Selects one of the printers configured under Windows XP including the associated output destination.



The `HCOPY:DESTination` command is used to select an output medium other than the default one.

<config>	1 2 - Printer configuration 1 or 2. If there is no suffix, configuration 1 is automatically selected.
<printer name>	Printer name as returned by the commands <code>SYSTem:COMMunicate:PRINter:ENUMerate:FIRSt?</code> or <code>SYSTem:COMMunicate:PRINter:ENUMerate[:NEXT]?</code>
*RST value	–
SCPI, Command Types	Device-specific, command or query
Example:	<code>SYST:COMM:PRIN:SEL LASER on LPT1</code> Select printer LASER on LPT1.

SYSTem:COMMunicate:RDEvice:AKAL:ADDRess '<cal_unit_name>'

Selects one of the USB-connected calibration units for calibration (see commands `SENSE<Ch>:CORRection:COLlect:AUTO...`). This command is not necessary if only one cal unit is connected.

<cal_unit_name>	Name (USB address) of a connected calibration unit (string)
------------------------------	---

variable). The names of all connected cal units can be queried using `SYSTem:COMMunicate:RDEvice:AKAL:ADDRess:ALL?` (empty string; *RST has no effect on external devices).

SCPI, Command Types Device-specific, command or query

Example:

```
SYST:COMM:RDEV:AKAL:ADDR:ALL?
```

Query the names of all connected calibration units.

```
SYST:COMM:RDEV:AKAL:ADDR 'ZV-Z52::1234'
```

Select the cal unit named 'ZV-Z52::1234' for calibration.

```
CORR:COLL:AUTO ", 1, 2, 4
```

Perform an automatic 3-port TOSM calibration at test ports 1, 2, and 4 using the calibration unit's default calibration kit file and arbitrary test ports of the cal unit.

SYSTem:COMMunicate:RDEvice:AKAL:ADDRess:ALL?

Queries the names (USB addresses) of all connected calibration units.

Response Names (USB addresses) of all connected calibration units (comma-separated list of string variables).

*RST values " (empty string; *RST has no effect on external devices).

SCPI, Command Types Device-specific, query only

Example:

```
See SYSTem:COMMunicate:RDEvice:AKAL:ADDRess
```

SYSTem:DATA:SIZE ALL | AUTO

Defines the block size for the data transfer between the instrument hardware and the software. The block size has an impact on the display of traces and on the readout of trace data using the commands of the `TRACe...` or `CALCulate<Chn>:DATA...` subsystems.

ALL Data transfer with full buffer size. The data for each sweep are transferred together so that each displayed trace contains the data of exactly one sweep. The same is true for queried trace data. The trace is displayed or updated at once, the sweep progress is not visible on the screen.



To make sure that all queried trace points stem from the same sweep you can also use single sweep mode (`INITiate<Ch>:CONTinuous OFF`) and the common command `*OPC?`

AUTO Data transfer with an automatically determined block size. In general the data blocks comprise only part of a trace, therefore the sweep progress is visible on the screen. On the other hand the displayed trace can show the results of two consecutive sweeps.

*RST value AUTO

SCPI, Device-specific, command or query

Command Types**Example:** SYST:DATA:SIZE ALL

Select data transfer with full buffer size in order to view the trace data from a single sweep..

SYSTem:DATE <year>,<month>,<day>

Sets the date for the internal calendar.

<year>,<month>,<day> Date; the sequence of entry is year, month, day.

Range [def. unit] 1980 to 2099, 1 to 12, 1 to 31.

*RST value –

SCPI, Command Types Confirmed, command or query

Example: SYST:DATE 2007,6,1

SYSTem:DISPlay:COLor DBACKground | LBACKground | BWLStyles | BWSolid

Selects the color scheme for all diagram areas in the active setup.

DBACKground Dark background
LBACKground Light background
BWLStyles Black and white line styles
BWSolid Black and white solid

*RST value –
 *RST does not affect the color settings; see also description of the Preset command.

SCPI, Command Types Device-specific, command or query

Example: SYST:DISP:COL LBAC
 Select a light background, e.g. to generate color hardcopies.

SYSTem:DISPlay:FPANel <Boolean>

Activates or deactivates the display of the front panel keys on the screen. With the display activated, the instrument can be operated on the screen using the mouse by pressing the corresponding buttons.

<Boolean> ON | OFF – Activates or deactivates the display.

*RST value –

SCPI, Command Types Device-specific, command or query

Example: `SYST:DISP:FPAN ON`
Activates the display.

SYSTem:DISPlay:UPDate <Boolean> | ONCE

Switches the display on or off while the analyzer is in the remote state. The command has no effect while the analyzer is in the *Local* operating state.



Switching off the display speeds up the measurement. This command may have an impact on the update of trace and channel settings; see `SYSTem:SETTings:UPDate`.

<Boolean> ON | OFF – Switch the display on or off. If the display is switched on, the analyzer shows the diagrams and traces like in manual control.

ONCE Switch the display on and show the current trace. This parameter can be used for occasional checks of the measurement results or settings. The measurement is continued, however, the measurement results are not updated. Compared to the ON setting, ONCE does not slow down the measurement speed.

***RST value** OFF

SCPI, Command Types Device-specific, command or query

Example: `SYST:DISP:UPD ON`
Switch the display on to view the traces and diagrams.

SYSTem:ERRor[:NEXT]?

Queries and at the same time deletes the oldest entry in the error queue. Operation is identical to that of `STATus:QUEue[:NEXT]?`

The entry consists of an error number and a short description of the error. Positive error numbers are instrument-dependent. Negative error numbers are reserved by the SCPI standard; see section Error Messages. If the error queue is empty, the error number 0, "No error", is returned.

***RST value** –

SCPI, Command Types Confirmed, query only

Example: `SYST:ERR?`
Query the oldest entry in the error queue. 0, "No error" is returned if the error queue is empty.

SYSTem:ERRor:ALL?

Queries and at the same time deletes all entries in the error queue.

The entries consist of an error number and a short description of the error. Positive error numbers are instrument-dependent. Negative error numbers are reserved by the SCPI standard; see section Error Messages.

***RST value** –

SCPI, Command Types Confirmed, command or query

Example: SYST:ERR:ALL?

Query all entries in the error queue. 0, "No error" is returned if the error queue is empty.

SYSTem:ERRor:CLEar:ALL

Deletes all entries in the table SYSTEM MESSAGES.

***RST value** –

SCPI, Command Types Device-specific, no query

Example: SYST:ERR:CLE:ALL

Delete all entries in the table.

SYSTem:ERRor:DISPlay <Boolean>

Switches the display of a tooltip for remote command errors on or off. The tooltip appears at the bottom of the remote screen and of the manual screen; it is **not** displayed for SCPI errors no. –113, *Undefined header*.

<Boolean> ON | OFF – Switch the tooltip on or off.

***RST value** OFF

SCPI, Command Types Device-specific, command or query

Example: SYST:ERR:DISP ON

Switch the display of the tooltip for remote command errors on.

FREQ:STAR 1

Remote Error : -222, "Data out of range;FREQ:STAR 1"

SYSTem:ERRor:LIST?

Reads all system messages and returns a list of comma separated strings. Each string corresponds to an

entry in the table SYSTEM MESSAGES. If the error list is empty, an empty string "" will be returned.

*RST value

–

SCPI, Command Types Device-specific, query only

Example:

```
SYST:ERR:LIST?
```

Read system messages and display them in a list.

SYSTem:FIRMware:UPDate '<file_name>'

Installs a firmware version stored in a NWA setup file (*.msi) on the analyzer. The installation is automatic and does not require any further action to be taken.

'<file_name>'

String variable for the name and directory of a NWA setup file (*.msi).

*RST value

–

SCPI, Command Types Device-specific, no query

Example:

```
SYST:FIRM:UPD 'C:\Setup\ZVL_01.10.msi
```

Install the firmware version 01.10 from the setup file stored in the *Setup* directory of the analyzer's internal hard disk.

SYSTem:FORMat:IDENt ZVL | LEGacy

Adapts the return value of the *IDN? command to the R&S FSP/FSU/FSQ family. This function is intended for re-use of existing FSP/FSU/FSQ control programs together with the R&S ZVL.

ZVL

Switches the FSP adaptation off. Example *IDN? return string: 'Rohde&Schwarz,ZVL-6,1303.6509K06/100007,1.10'.

LEGacy

Adapts the return value to the R&S FSP. Example *IDN? return string: 'Rohde&Schwarz,ZVL-6,100007/006,1.10'.

*RST value

FSL

SCPI, Command Types Device-specific, command or query

Example:

```
SYST:FORM:IDEN FSL
```

Adapts the return value of *IDN? to the FSP.

SYSTem:PASSword[:CENable] '<password>'

Sends a password to the analyzer enabling a class of service functions to function (Command ENable). Service functions are activated with the commands of the DIAGnostic system and should be used by a R&S service representative only. Refer to the service manual for more information.

'<password>'

Case-sensitive string variable. Sending an invalid password generates error -

*RST value	221, (settings conflict). – (neither the password nor the protection of service functions is affected by *RST)
SCPI, Command Types	Confirmed, no query
Example:	<code>SYST:PASS "XXXX"</code> Enter password.

SYSTem:PASSword:RESet

This command resets the service password.

*RST value	–
SCPI, Command Types	Confirmed, no query
Example:	<code>SYST:PASS:RES</code> Reset password.

SYSTem:PRESet

Performs a factory preset of all instrument settings (i.e. all open setups) or of the active setup, depending on the `SYSTem:PRESet:SCOPE` settings. The command is equivalent to *RST and to the action of the **PRESET** key on the front panel.



*If a user-defined preset is active (`SYSTem:PRESet:USER[:STATe] ON`), the **PRESET** key initiates a user-defined preset, while `SYSTem:PRESet` and *RST still activate the factory preset.*

*RST value	–
SCPI, Command Types	Confirmed, no query
Example:	<code>SYST:PRE:SCOPE SING</code> Define the scope of a preset: the active setup is reset only. <code>SYST:PRE</code> Reset the parameters of the current setup.

SYSTem:PRESet:SCOPE ALL | SINGLE

Specifies whether a preset (`SYSTem:PRESet`; *RST) affects the active setup only or all open setups.

This command is effective in the Network Analyzer mode only and returns an error in other modes.

ALL	All open setups are deleted and the setup <i>Set1</i> is created with default trace and channel settings.
------------	---

SINGLE	The settings of the active setup are reset; the name of the active setup and the parameters of all other setups remain unchanged.
*RST value	– (*RST does not affect the preset scope setting)
SCPI, Command Types	Device-specific, command or query
Example:	See SYSTem:PRESet

SYSTem:PRESet:USER[:STATe] <Boolean>

Selects a factory preset or a user-defined preset.



*The user-defined preset can be initiated using System – Preset (manual control) or MMEMory:LOAD:STATe. *RST and SYSTem:PRESet always initiate a factory preset.*

<Boolean>	OFF - User-defined preset switched off (factory preset is used) ON - User-defined preset switched on
*RST value	– (*RST does not affect the preset state setting)
SCPI, Command Types	Device-specific, command or query
Example:	<pre>SYST:PRESet:USER ON</pre> <p>Enable a user-defined preset.</p> <pre>SYST:PRESet:USER:NAME 'C:\R_S\Instr\user\Nwa\RecallSets\Setup_2.nwa'</pre> <p>Select a setup file for the user-defined preset.</p> <p>Press <i>System – Preset</i> (manual control) or use</p> <pre>MMEM:LOAD:STAT 1, 'C:\R_S\Instr\user\Nwa\RecallSets\Setup_2.nwa'</pre> <p>Carry out the use-defined preset.</p>

SYSTem:PRESet:USER:NAME '<Setup_file>'

Specifies the name of a setup file (.nwa) to be used for a user-defined preset.

'<Setup_file>'	String parameter to specify the name and directory of the setup file to be loaded. The default extension (manual control) for setup files is *.nwa, although other extensions are allowed. If no path is specified the analyzer searches the default directory (subdirectory . . .RecallSets)
*RST value	– (*RST does not affect the preset settings)
SCPI, Command Types	Device-specific, command or query
Example:	See SYSTem:PRESet:USER[:STATe]

SYSTem:SETTings:UPDate ONCE

Initiates an immediate update of the channel or trace settings.

The command has an effect if the analyzer operates in single sweep mode (INITiate<Ch>:CONTinuous OFF) and if the display update is switched off (SYSTem:DISPlay:UPDate OFF). In this scenario, a change of the channel or trace settings is usually not taken into account immediately. The analyzer waits until the end of the current sweep sequence and changes all settings made during the last sweep period when the next single sweep sequence is initiated. Several settings can be made en bloc, which generally saves time.

SYSTem:SETTings:UPDate ONCE causes the analyzer to apply the settings at once without waiting for the end of the current single sweep sequence. The command has no effect in continuous sweep mode or if the display update is switched on.



The settings are also updated when the continuous sweep mode is activated (INITiate<Ch>:CONTinuous ON).

ONCE Causes an immediate update of the settings.
*RST value –

SCPI, Command Types Confirmed, no query

Example:

```
INIT:CONT OFF
Activate single sweep mode.
SYST:SETT:UPD ONCE
```

Update the settings made during the current single sweep period.

SYSTem:TIME <hour>,<minute>,<second>

Sets the internal clock.

<hour>,<minute>,<second> Time; the sequence of entry is hour, minute, second.

Range [def. unit] 0 to 23, 0 to 59, 0 to 59.

*RST value –

SCPI, Command Types Confirmed, command or query

Example: SYST:TIME 12,30,30

SYSTem:UNIT:LENGth '<unit>'

Defines a title for the remote display.

'<title>' Title (string variable)
*RST value – (*RST does not affect the title)

SCPI, Command Types Device-specific, command or query.

Example: SYST:USER:DISP:TITL 'Remote test running'

Define a title for the remote display.

SYSTem:USER:DISPlay:TITLe '<title>'

Defines a title for the remote display.

'<title>'	Title (string variable)
*RST value	– (*RST does not affect the title)
SCPI, Command Types	Device-specific, command or query.

Example: `SYST:USER:DISP:TITL 'Remote test running'`
 Define a title for the remote display.

SYSTem:USER:KEY <ukey_no>[, '<ukey_name>']

Labels a user-defined key in the remote display. In the query form the command returns whether or not a user-defined key was used.

<ukey_no>	Number of the user key
Range [def. unit]	0 – Delete all user keys and restore the default keys (<i>Go to Local, Display Off</i>) 1 to 8 – user key numbers
*RST value	0
'<ukey_name>'	Label for user key no. 1 to 8 (string variable)
*RST value	" (empty string)
SCPI, Command Types	Device-specific, command or query.

Example: `SYST:USER:KEY 1, 'User S11'`
 Define a user key no. 1 labeled S11. The user key is only labeled, no functionality has been assigned yet.

`SYST:USER:KEY:FUNC 1, 'S11'`
 Assign the functionality 'S11' (select S11 as a measured quantity for the active trace) to the created user key.

`SYST:USER:KEY?`
 The query returns `0,"`, indicating that no user key has been pressed. If you press the user softkey no. 1, the response is `1, 'User S11'`.

`CALC:PAR:MEAS? 'Trc1'`
 The query returns `'S11',"`, indicating that the measured quantity for trace 'Trc1' has been changed.

`SYST:USER:KEY 0`
 Delete the user key and restore the default keys..

SYSTem:USER:KEY:FUNCTion <ukey_no>[, '<ukey_name>']

Labels the functionality of a function key to a user-defined key in the remote display.



You can use this command to execute part of your measurement task manually; see *Combining*

Manual and Remote Control.

<ukey_no>	Number of the user key
Range [def. unit]	1 to 8 – user key numbers
*RST value	– (the parameter is also needed in the query form)
'<ukey_name>'	Name of a function key, e.g. 'S11', 'Start' etc. (string variable)
*RST value	" (empty string)
SCPI, Command Types	Device-specific, command or query.

Example:See `SYST:USER:KEY`**SYSTem:VERSion?**

Returns the SCPI version number to which the analyzer complies. The analyzer complies to the final SCPI version 1999.0.

*RST value	–
SCPI, Command Types	Confirmed, query only

Example:`SYST:VERS?`Query the SCPI version. The response is *1999.0*.**TRACe...**

This subsystem handles active trace data and trace data stored in the analyzer's internal memory.



Trace data is transferred in either ASCII or block data (REAL) format, depending on the `FORMat[:DATA]` setting. If the block data format is used, it is recommended to select EOI as receive terminator (`SYSTem:COMMunicate:GPIB[:SELF]:RTERminator EOI`).

Reserved Trace Names

The commands in the `TRACe . . .` menu use the following ZVR-compatible parameters to specify traces:

Parameter	Meaning	Used in
CH1Data, CH2Data, CH3Data, CH4Data	Active data trace of channels 1 to 4	<code>TRACe:COPI</code> <code>TRACe[:DATA][:RESPonse][:ALL]?</code> <code>TRACe[:DATA][:STIMulus][:ALL]?</code> <code>CALCulate<Chn>:MATH[:EXPReSSion][:DEFine]</code>
CH1Mem, CH2Mem, CH3Mem, CH4Mem	Active memory trace associated with the active data trace CH1DATA, CH2DATA, CH3DATA, CH4DATA, respectively.	<code>TRACe[:DATA][:RESPonse][:ALL]?</code> <code>TRACe[:DATA][:STIMulus][:ALL]?</code>
IMPLied	Active data trace, addressed with <Chn>	<code>CALCulate<Chn>:MATH[:EXPReSSion][:DEFine]</code>
CHMem	Active memory trace assigned to the	<code>CALCulate<Chn>:MATH[:EXPReSSion][:DEFine]</code>

	IMPlIed trace	
MDATa1, MDATa2, MDATa3, MDATa4, MDATa5, MDATa6, MDATa7, MDATa8	Memory trace named <i>Mem<n>[Trc<m>]</i> . The trace name is unique because <n> counts all data and memory traces in the active setup.	TRACe:CLEAr TRACe:COpy TRACe[:DATA][:RESPOuse][:ALL]? TRACe[:DATA][:STIMulus][:ALL]? CALCulate<Chn>:MATH[:EXPRession][:DEFine]

TRACe:CLEAr MDATA1 | MDATA2 | MDATA3 | MDATA4 | MDATA5 | MDATA6 | MDATA7 | MDATA8

Deletes one of the memory traces *Mem<n>[Trc<m>]*, where $n = 1, \dots, 8$.

Parameters Identifier for the memory trace; see list of trace names. .
Range [def. unit] MDATA<n> where <n> = 1 to 8. [-]
***RST value** -

SCPI, Command Types Device-specific, no query

Example:

```
SWE:POIN 20
```

Create a trace with 20 sweep points, making the created trace the active trace of channel 1 (omitted optional mnemonic *SENSe1*).

```
TRAC:COpy "Mem_Pt20",CH1DATA
```

Copy the current state of the created trace to a memory trace named "Mem_Pt20". The memory trace is not displayed.

```
DISP:WIND:TRAC2:FEED "MEM_PT20"
```

Display the created memory trace in the active diagram area (diagram area no. 1).

TRACe:COpy <memory_trc>,<data_trc>

Copies a data trace to a memory trace. The trace to be copied can be specified by two alternative methods:

- As the active data trace of channels 1 to 4 (CH1DATA, CH2DATA, CH3DATA, CH4DATA). If a mathematical trace is active, the associated data trace is copied.
- As a trace with a name (string variable)

The created memory trace can be specified as follows:

- As the memory trace named *Mem<n>[Trc<m>]*, where $n = 1, \dots, 8$ and *Trc<m>* is the name of the copied data trace (MDATA1, MDATA2, MDATA3, MDATA4, MDATA5, MDATA6, MDATA7, MDATA8)
- As a memory trace with an arbitrary name (string variable)

An existing memory trace with the same name is overwritten.



The copied trace is the data trace which is not modified by any mathematical operations. To copy a mathematical trace to a memory trace, use `TRACe:COpy:MATH`. To copy the active trace to the memory using an automatic memory trace name, use `CALCulate<Chn>:MATH:MEMorize`.

<memory_trc>	Name of the memory trace.
Range [def. unit]	<memory_trace> is either a string variable (enclosed in single or double quotes) or one of the following reserved names (no string variables): ZVR ✓ MDATA1 MDATA2 MDATA3 MDATA4 MDATA5 MDATA6 MDATA7 MDATA8 (only for memory traces <i>Mem<n>[Trc<m>]</i> , where n = 1, ... 8; see list of trace names). [-]
*RST value	–
<data_trc>	Name of the data trace
Range [def. unit]	<data_trace> is either a string variable (enclosed in single or double quotes) or one of the following reserved names (no string variables): ZVR ✓ CH1DATA CH2DATA CH3DATA CH4DATA (only for the active data trace in channels Ch1, Ch2, Ch3, Ch4; see list of trace names). [-]
*RST value	–
SCPI, Command Types	Confirmed, no query
Example:	<pre>*RST; SWE:POIN 20</pre> <p>Create a trace with 20 sweep points, making the created trace the active trace of channel 1 (omitted optional mnemonic <i>SENSe1</i>).</p> <pre>TRAC:COPY "Mem_Pt20",CH1DATA</pre> <p>Copy the current state of the created trace to a memory trace named "Mem_Pt20". The memory trace is not displayed.</p> <pre>DISP:WIND:TRAC2:FEED "MEM_PT20"</pre> <p>Display the created memory trace in the active diagram area (diagram area no. 1).</p>

TRACe:COPIY:MATH <memory_trc>,<data_trc>

Copies a mathematical trace to a memory trace. The trace to be copied can be specified by two alternative methods:

- As the active mathematical trace of channels 1 to 4 (CH1DATA, CH2DATA, CH3DATA, CH4DATA)
- As a trace with a name (string variable)

The created memory trace can be specified as follows:

- As the memory trace named *Mem<n>[Trc<m>]*, where n = 1, ... 8 and *Trc<m>* is the name of the copied data trace (MDATA1, MDATA2, MDATA3, MDATA4, MDATA5, MDATA6, MDATA7, MDATA8)
- As a memory trace with an arbitrary name (string variable)

An existing memory trace with the same name is overwritten.



To copy a data trace which is not modified by any mathematical operations, use TRACe:COPIY.

<memory_trc>	Name of the memory trace.
Range [def. unit]	<memory_trace> is either a string variable (enclosed in single or double quotes) or one of the following reserved names (no string variables): ZVR ✓ MDATA1 MDATA2 MDATA3 MDATA4 MDATA5 MDATA6

Instrument-Control Commands

	MDATA7 MDATA8 (only for memory traces <i>Mem<n></i> [<i>Trc<m></i>], where n = 1, ... 8; see list of trace names). [-]
*RST value	–
<data_trc>	Name of the data trace
Range [def. unit]	<data_trace> is either a string variable (enclosed in single or double quotes) or one of the following reserved names (no string variables): ZVR CH1DATA CH2DATA CH3DATA CH4DATA (only for the active data trace in channels Ch1, Ch2, Ch3, Ch4; see list of trace names). [-]
*RST value	–
SCPI, Command Types	Confirmed, no query
Example:	*RST; SWE:POIN 20
	Create a trace with 20 sweep points, making the created trace the active trace of channel 1 (omitted optional mnemonic <i>SENSe1</i>).
	CALC:MATH:SDEF 'Trc1 / 2'; CALC:MATH:STAT ON
	Define a mathematical trace, dividing the data trace by 2. Activate the mathematical mode and display the mathematical trace instead of the data trace.
	TRAC:COPY:MATH 'Mem_Pt20',CH1DATA; CALC:MATH:STAT OFF
	Copy the current state of the mathematical trace to a memory trace named "Mem_Pt20". The memory trace is not displayed. Switch the display back to the data trace.
	DISP:WIND:TRAC2:FEED 'MEM_PT20'
	Display the created memory trace together with the data trace.

TRACe[:DATA][:RESPonse][:ALL]? CH1Data | CH2Data | CH3Data | CH4Data | CH1Mem | CH2Mem | CH3Mem | CH4Mem | MDATa1 | MDATa2 | MDATa3 | MDATa4 | MDATa5 | MDATa6 | MDATa7 | MDATa8 | CH1Fdata ... CH4Fdata | CH1Sdata ... CH4Sdata | CH1FMEM ... CH4FMEM | CH1SMEM ... CH4SMEM |

Returns the response values of the active data trace or memory trace (see trace names).



*To read the response values of an arbitrary data or memory trace, use **CALCulate<Chn>:DATA?** To read the response values of a trace acquired in single sweep mode (**INITiate<Ch>:CONTinuous OFF**), use **CALCulate<Chn>:DATA:NSweep?***

<Response>	Response data of the selected trace, see list of trace names.
Range [def. unit]	The data format is parameter-dependent; see below. The unit is the default unit of the measured parameter; see CALCulate<Ch>:PARAMeter:SDEFine .
*RST value	–
SCPI, Command Types	Device-specific, query only
Example:	SWE:POIN 20
	Create a trace with 20 sweep points, making the created trace the active trace of

channel 1 (omitted optional mnemonic `SENSe1`).

```
CALC:FORM MLIN; :FORM ASCII; FORM:DEXP:SOUR FDAT
```

Select the trace data format: linear magnitude values, ASCII format and formatted trace data (1 value per sweep point).

```
TRAC? CH1DATA
```

Query the 20 response values of the created trace according to the previous format settings.

The following parameters are related to trace data (see also *Data Flow* diagram):

CH<nr>Data	Response values of the data trace for channels 1 to 4. The data is transferred in the data format defined via <code>FORMat[:DATA]</code> and <code>FORMat:DEXPort:SOURce</code> .
MDATa<nr>	Response values for the memory trace named "Mem<nr>...". The data is transferred in the data format defined via <code>FORMat[:DATA]</code> and <code>FORMat:DEXPort:SOURce</code> .
CH<nr>Mem, MDATa	Response values of the memory trace for channels 1 to 4 (8). The data is transferred in the data format defined via <code>FORMat[:DATA]</code> and <code>FORMat:DEXPort:SOURce</code> .
CH<nr>Fdata, CH<nr>FMEM	Formatted trace data, according to the selected trace format (<code>CALCulate<Chn>:FORMat</code>). 1 value per trace point for Cartesian diagrams, 2 values for polar diagrams.
CH<nr>Sdata, CH<nr>SMEM	Unformatted trace data: Real and imaginary part of each measurement point. 2 values per trace point irrespective of the selected trace format. The trace mathematics is not taken into account.

TRACe[:DATA]:STIMulus[:ALL]? CH1Data | CH2Data | CH3Data | CH4Data | CH1Mem | CH2Mem | CH3Mem | CH4Mem | MDATa1 | MDATa2 | MDATa3 | MDATa4 | MDATa5 | MDATa6 | MDATa7 | MDATa8

Returns the stimulus values of the active data trace or memory trace (see trace names).



To read the stimulus values of an arbitrary data or memory trace, use `CALCulate<Chn>:DATA:STIMulus?`

<Response> Response data of the selected trace, see list of trace names.
Range [def. unit] The data is transferred in the data format defined via `FORMat[:DATA]`. The numeric values are expressed in the default unit of the stimulus variable. [Hz, dBm or s, depending on the sweep type]

***RST value** –

SCPI, Command Types Device-specific, query only

Example:

```
SWE:POIN 20
```

Create a trace with 20 sweep points, making the created trace the active trace of channel 1 (omitted optional mnemonic `SENSe1`).

```
TRAC:STIM? CH1DATA
```

Query the 20 stimulus values of the created trace. In the default format setting, the data is returned as a comma-separated list of 10-digit ASCII values.

TRIGger<Ch>...

This subsystem is used to synchronize the analyzer's actions (in particular, the start of a measurement sequence) with events.

TRIGger<Ch>[:SEQUENCE]:HOLDoff <numeric_value>

Sets a delay time between the trigger event and the start of the measurement (*Trigger Delay*).

<Ch>	Channel number. If unspecified the numeric suffix is set to 1.
<numeric_value>	Delay time.
Range [def. unit]	0 s to 13680 s [s]. UP and DOWN increment/decrement the trigger delay in 10 ms steps.
*RST value	0 s
SCPI, Command Types	Confirmed, command or query
Example:	<pre>TRIG:SOUR TIM</pre> <p>Activate internal timer as trigger source.</p> <pre>TRIG:HOLD UP</pre> <p>Set a delay time of 10 ms.</p>

TRIGger<Ch>[:SEQUENCE]:LINK 'POINT' | 'SWEep'

Selects the *Triggered Meas. Sequence*. The identifier for the sequence is a string variable.

<Ch>	Channel number.
'SWEep' 'POINT' 	Trigger event starts an entire sweep.
'POINT' 	Trigger event starts measurement at the next sweep point. This mode is not available on R&S ZVL13 network analyzers.
*RST value	'SWEep'
SCPI, Command Types	Confirmed, command or query
Example:	<pre>TRIG:LINK 'POIN'</pre> <p>Select a sweep point as triggered measurement sequence.</p>

TRIGger<Ch>[:SEQUENCE]:SLOPe POSitive | NEGative

Qualifies whether the trigger event occurs on the rising or on the falling edge of the external TTL trigger signal.

<Ch>	Channel number.
POSitive 	Rising edge.
NEGative	Falling edge.

*RST value	POSitive
SCPI, Command Types	Confirmed, command or query
Example:	<code>TRIG:SOUR EXT</code> Activate external signal as trigger source.
	<code>TRIG:SLOP NEG</code> Trigger on the negative edge of the (external TTL) trigger signal.

TRIGger<Ch>[:SEQUence]:SOURce IMMEDIATE | EXTernal

Selects the source for the events that the analyzer uses to start a sweep.

<Ch>	Channel number.
IMMEDIATE	Free run measurement without waiting for trigger events
EXTernal	Trigger by external signal applied to the <i>EXT TRIGGER / GATE IN</i> connector on the rear panel.
*RST value	IMMEDIATE
SCPI, Command Types	Confirmed, command or query.
Example:	<code>TRIG:SOUR EXT</code> Activate external trigger mode.

UNIT...

This subsystem defines default units for all SCPI commands and queries implemented by the network analyzer.

UNIT:LENGTH <unit>

Defines the default unit of length. The command affects all SCPI commands defining a parameter with a physical unit that is related to a length, in particular:

- Length offset parameters (`[SENSe:]CORRection:EDElay...`)
- Parameters of the distance-to fault measurement (`CALCulate<Chn>:TRANSform:DTFault...`)
- Derived units, e.g. the attenuation per unit of length defined via `CALCulate<Ch>:TRANSform:DTFault:DEFine`
- Stimulus values for limit lines and ripple limit lines for the distance-to fault trace (e.g. `CALCulate<Chn>:LIMit:DATA`)

<unit>	METer– metric units FOOT – foot (ft). 1 foot corresponds to 0.3048 m (1 m = 3.28084 ft).
---------------------	---

*RST value
SCPI, Command
Types

Example:

– (a *RST does not affect the default unit of length)
Device-specific, command or query.

```
UNIT:LENG METer; :CORR:EDEL:DIST 1
```

Define a mechanical length offset of 1 m.

```
UNIT:LENG FOOT; :CORR:EDEL:DIST?
```

Change the default unit of length and query the mechanical length. The response is 3.2808400526.

Table of Contents

8 Programming Examples.....	558
Basic Tasks	558
Typical Stages of a Remote Control Program.....	558
Basic Instrument Settings.....	558
Adjusting the Test Setup.....	559
Start of the Measurement and Command Synchronization.....	559
Retrieving Measurement Results	560
Handling of Channels, Traces and Diagram Areas	561
Several Traces with Equal Channel Settings	561
Several Traces with Different Channel Settings.....	566
Markers and Limit Lines... ..	570
Condensed Programming Examples.....	575
Calibration	575
Modeling a Max Hold Function.....	577
Retrieving the Results of Previous Sweeps	578

8 Programming Examples

This chapter contains detailed program examples.

The syntax and use of all SCPI commands is described in the *SCPI Reference* chapter. For a general introduction to remote control of the analyzer refer to chapter *Remote Control*. For an overview of special remote control features of the network analyzers refer to section *NWA Remote Control Features* in Chapter 5.

Basic Tasks

Typical Stages of a Remote Control Program

A typical remote control program comprises the following stages:

Very often, steps 3 and 4 (or steps 2 to 4) must be repeated several times.



All example programs in this section have been developed and tested by means of the GPIB Explorer provided with the network analyzer. No extra programming environment is needed.

Basic Instrument Settings

Programming task: Adjust the basic network analyzer settings to your measurement tasks, optimizing the instrument for fast measurements.



Considerations for high measurement speed

The measurement speed depends on the sweep time but also on an efficient preparation of the instrument and on proper command synchronization. The following items should be kept in mind:

- For maximum speed the basic channel settings should be set while the sweep is stopped and with a minimum of sweep points. It is advisable to increase the number of points after all instrument settings have been performed, and to initiate the sweep after the test setup has been completed.
- Execution of the `INITiate[:IMMEDIATE]` command is fastest in synchronized mode. Insertion of fixed waiting periods into the command sequence is possible but generally less efficient.
- The sweep time depends on several parameters discussed in section *Optimizing the Measurement Speed*. In particular it is recommended to select the best set of sweep points, e.g. using the segmented sweep.

```
// Reset the instrument, switch off the measurement (after one sweep),
```

```
// reduce the number of sweep points.
```

```
*RST
```

```
INITiate1:CONTinuous OFF
```

```
SENSe1:SWEep:POINts 2
```

```
//
```

// Avoid a delay time between different partial measurements and before the start of the sweeps (is default setting).

```
SENSe1:SWEp:TIME:AUTO ON
```

```
TRIGger1:SEQuence:SOURce IMMEDIATE
```

```
//
```

// Select the widest bandwidth compatible with your measurement.

```
SENSe1:BANDwidth:RESolution 10
```

```
//
```

// Adjust your sweep points to your measurement task, e.g. using a segmented sweep.

```
SENSe1:SEGMENT...
```

Adjusting the Test Setup

In general the preparatives described above can be used for a series of measurements. In-between the measurements it is often necessary to change the test setup, e.g. in order to replace the DUT, change the connected ports, connect external devices etc.

Start of the Measurement and Command Synchronization

Programming task: Start a measurement in single sweep mode. Wait until all single sweep data has been acquired before you proceed to the next stage of the measurement.

`INITiate<Ch>[:IMMEDIATE]` is used to start a single sweep or a group of single sweeps. This command has been implemented for overlapped execution. The advantage of an overlapped command is that they allow the program to do other tasks while being executed.

In the present example the sweep must be completed before measurement results can be retrieved. To prevent wrong results (e.g. a mix-up of results from consecutive sweeps) the controller must synchronize its operation to the execution of `INITiate<Ch>[:IMMEDIATE]`. IEEE 488.2 defines three common commands (`*WAI`, `*OPC?`, `*OPC`) for synchronization.

```
//
```

// 1. Start single sweep, use *WAI

// *WAI is the easiest method of synchronization. It has no effect when sent after sequential commands.

// If *WAI follows `INITiate<Ch>[:IMMEDIATE]` (overlapped command),

// the analyzer executes no further commands or queries until the sweep is terminated.

// *WAI does prevent the controller from sending other commands to the analyzer or other devices

// on the GPIB bus

```
INITiate1:SCOPE SINGLE // Single sweep will be started in the referenced channel only
```

```
INITiate1:IMMEDIATE; *WAI // Start single sweep in channel no. 1, wait until the end of the sweep
```

```
<Continue program sequence>
```

```
//
```

// 2. Start single sweep, use *OPC?

// If *OPC follows INITiate<Ch>[:IMMEDIATE], it places a 1 into the output queue when the sweep is terminated.

// An appropriate condition in the remote control program must cause the controller to wait until *OPC? returns one.

// The controller is stopped from the moment when the condition is set.

INITiate1:IMMEDIATE; *OPC? // Start single sweep in channel no. 1, indicate the end of the sweep by a 1 in the output queue.

// So far the controller may still send messages to other devices on the GPIB bus.

<Condition OPC=1> // Stop the controller until *OPC? returns one (program syntax depends on your programming environment).

<Continue program sequence>

//

// 3. Start single sweep, use *OPC

// If *OPC follows INITiate<Ch>[:IMMEDIATE], it sets the OPC bit in the ESR after the sweep is terminated.

// This event can be polled or used to trigger a service request of the analyzer.

// The advantage of *OPC synchronization is that both the controller and the analyzer can continue

// processing commands while the sweep is in progress.

*SRE 32 / Enable a service request for the ESR

*ESE 1 / Set event enable bit for operation complete bit

INITiate1::IMMEDIATE; *OPC // Start single sweep in channel no. 1, set the OPC bit in the ESR after the sweep is terminated.

// The controller may still send messages, the analyzer continues to parse and execute commands.

<Wait for service request> // Controller waits for service request from the analyzer (program syntax depends on your programming environment).

<Continue program sequence>

Retrieving Measurement Results

Programming task: Read the results acquired in a single sweep.

//

// 1. Read single values (-> Markers)

// Markers are the most convenient tool for determining and retrieving single values on traces.

// The analyzer provides up to ten markers; see *Markers and Limit Lines*.

//

// 2. Read complete trace

// Select a trace format and read formatted trace data.

CALCulate1:FORMat MLINear / Calculate the linear magnitude of z

```
CALCulate1:DATA? FDATA / Read the formatted trace data
```

```
//
```



Use `CALCulate<Chn>:DATA:NSweep` to retrieve a particular trace within a group of sweeps.

Handling of Channels, Traces and Diagram Areas

The following examples show you how to perform basic tasks related to channel and trace definition and to the display of traces in diagram areas.



All example programs in this section have been developed and tested by means of the GPIB Explorer provided with the network analyzer. No extra programming environment is needed.

Several Traces with Equal Channel Settings

Programming task: Create up to four different traces with equal channel settings, assign the four 2-port standard S-parameters to the traces and display them in up to four diagram areas.

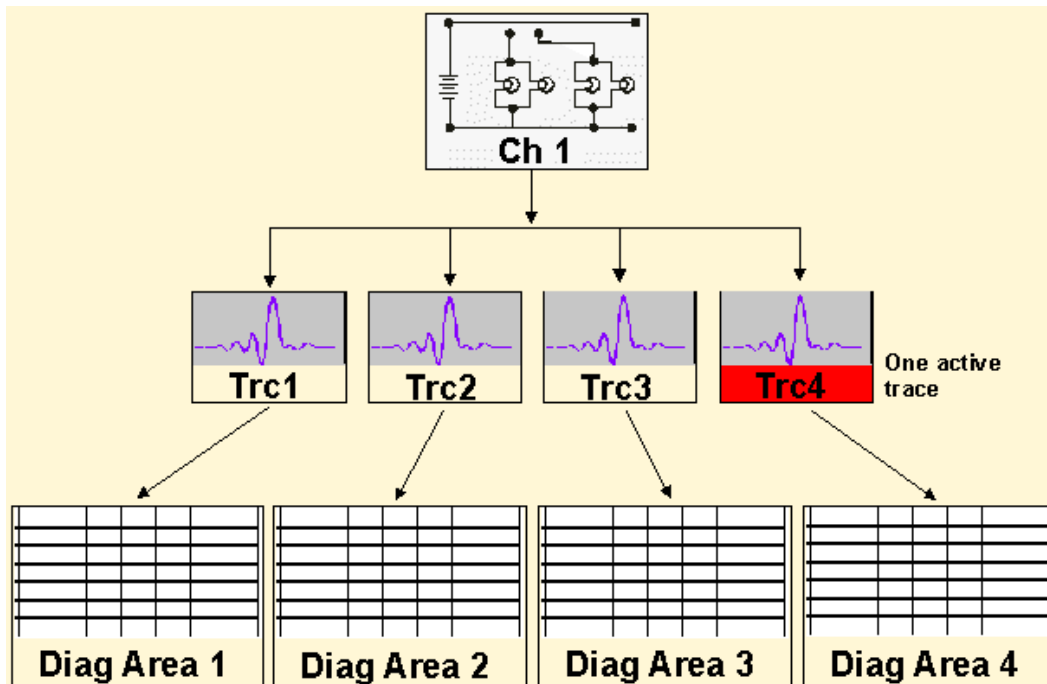

Important remote control features for this program example

The following command sequence illustrates the structure of the remote commands discussed in section *Basic Remote Control Concepts*. In particular it shows that:

- A trace can be created and handled without being displayed.
- Traces are referenced by trace names. The active trace of a channel is often referenced by the

channel suffix.

- Diagram areas are referenced by a window suffix <Wnd>. An additional suffix <WndTr> in the `DISPlay:WINDow<Wnd>:TRACe<WndTr>...` commands numbers the different traces in a diagram area.
- In remote control, it is possible to display the same trace in several diagram areas.
- The analyzer provides several commands allowing a smooth transition between remote and manual control.

//

// 1. One channel, two traces, one diagram area

// Reset the instrument, creating the default trace Trc1 in channel 1.

// The default measured quantity is the forward transmission S-parameter S21.

// The default format is dB Mag.

*RST

//

// Create a second trace in channel 1, assign the format *Phase*,

// and display the new trace in the same diagram area.

`CALCulate1:PARAmeter:SDEFine 'Trc2', 'S21'` // the trace becomes the active trace but is not displayed

`CALCulate1:FORMat PHASe` // the trace is referenced by the channel suffix 1

`DISPlay:WINDow1:TRACe2:FEED 'Trc2'` // display the second trace, numbering it the second trace in diagram area no. 1

//

// **▶ Check the result on the local screen**

// Go to local

`SYSTem:DISPlay:UPDate ONCE`



//

//

// 2. One channel, two traces, two diagram areas

// Create a second diagram area, assign Trc2 to the new area, and remove it from the first area.

DISPlay:WINDow2:STATe ON

DISPlay:WINDow2:TRACe2:FEED 'Trc2' // Trc2 is now displayed in both diagram areas

DISPlay:WINDow1:TRACe2:DELeTe

//

// ▶ Check the result on the local screen

// Go to local

SYSTem:DISPlay:UPDate ONCE



```
//
```

```
//
```

// 3. One channel, four traces, four diagram areas

```
// Reset the instrument, add diagram areas no. 2, 3, 4.
```

```
*RST; :DISPlay:WINDow2:STATe ON
```

```
DISPlay:WINDow3:STATe ON
```

```
DISPlay:WINDow4:STATe ON
```

```
//
```

```
// Assign the reflection parameter S11 to the default trace.
```

```
:CALCulate1:PARAmeter:MEASure 'Trc1', 'S11'
```

```
//
```

```
// Assign the remaining S-parameters to new traces Trc2, Trc3, Tr4;
```

```
// select the Smith chart format for the reflection parameters.
```

```
CALCulate1:FORMat SMITH // Smith chart for the active trace Trc1
```

```
CALCulate1:PARAmeter:SDEFine 'Trc2', 'S21'
```

```
CALCulate1:PARAmeter:SDEFine 'Trc3', 'S12'
```

```
CALCulate1:PARAmeter:SDEFine 'Trc4', 'S22'
```

```
CALCulate1:FORMat SMITH // Smith chart for the active trace Trc4, referenced by the channel number
```

```
//
```

```
// Display the new traces in diagram areas no. 2 to 4.
```

```
DISPlay:WINDow2:TRACe2:FEED 'Trc2'
```

```
DISPlay:WINDow3:TRACe3:FEED 'Trc3'
```

```
DISPlay:WINDow4:TRACe4:FEED 'Trc4'
```

```
//
```

```
// ▶ Check the result on the local screen
```

```
// Go to local
```

```
SYSTem:DISPlay:UPDate ONCE
```

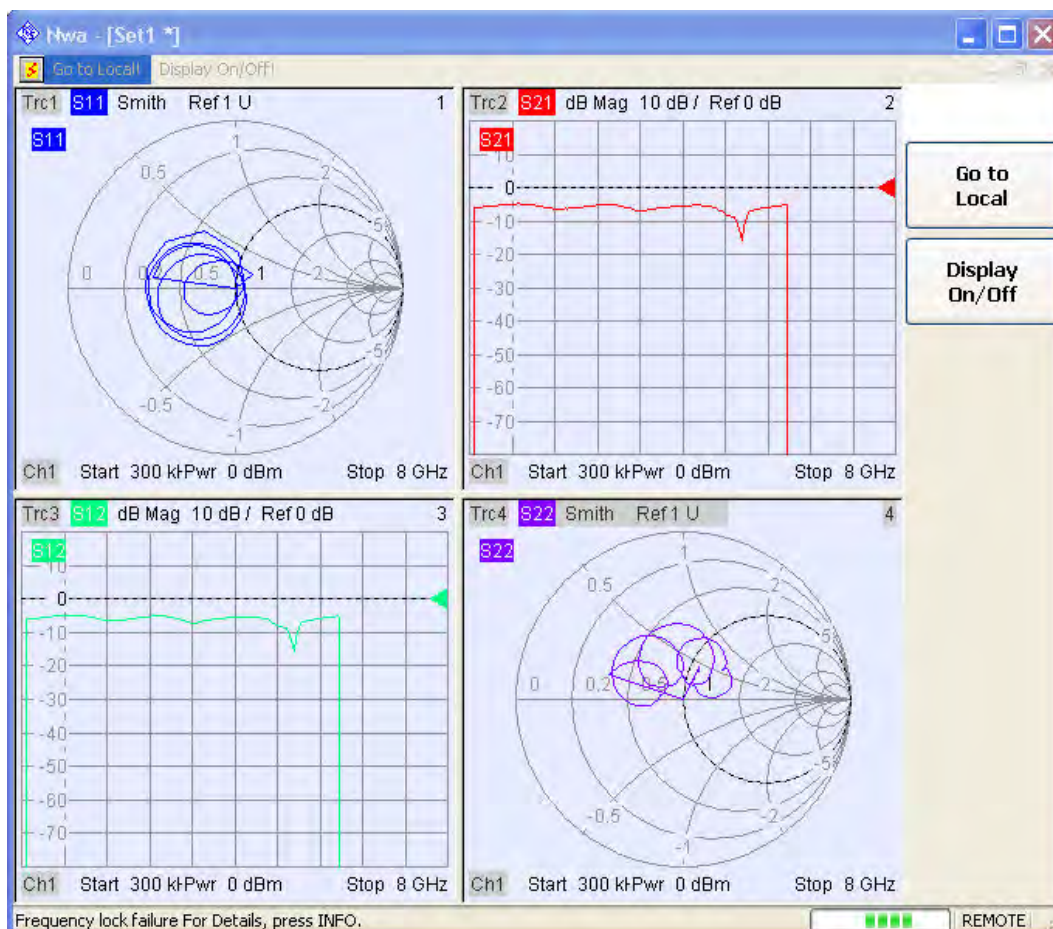

```
//
```

```
// ▶ Check the result in the trace manager
```

```
// The trace manager gives an overview of the current channel/trace configuration
```

```
DISPlay:MENU:KEY:EXECute 'Trace Manager'
```

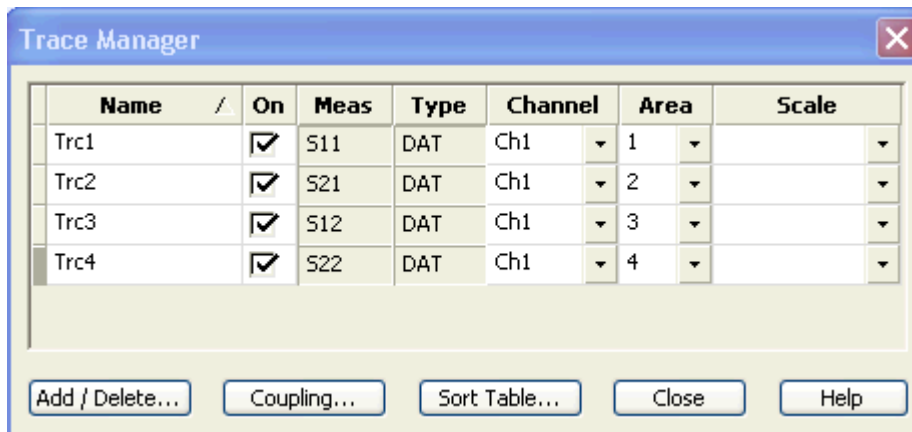

Several Traces with Different Channel Settings...

Programming task: Create three channels with 3, 1 and 2 traces, respectively, and display the traces in two diagram areas.

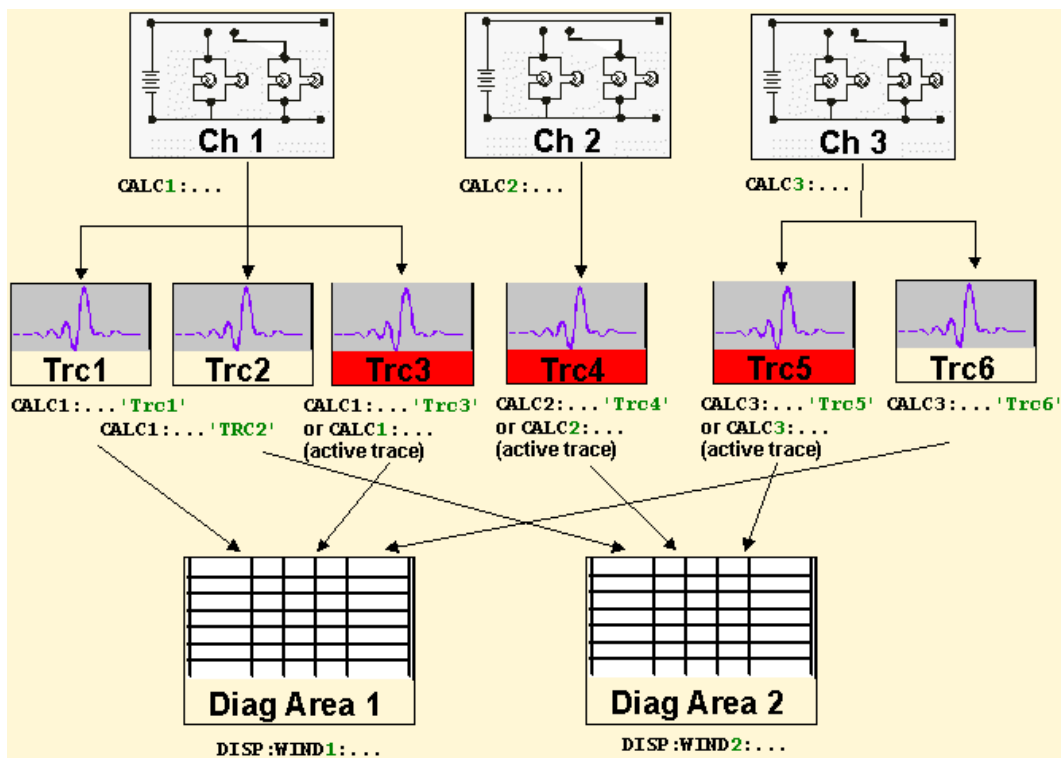

Important remote control features for this program example

The following command sequence illustrates the structure of the remote commands discussed in section *Basic Remote Control Concepts*. In particular it shows that:

- Channels are always referenced by a channel suffix.
- Traces are referenced by trace names. The active trace of a channel is often referenced by the channel suffix.

- Diagram areas are referenced by a window suffix <Wnd>. An additional suffix <WndTr> in the `DISPlay:WINDow<Wnd>:TRACe<WndTr>...` commands numbers the different traces in a diagram area.
- The analyzer provides several commands allowing a smooth transition between remote and manual control.

```
//
```

```
// 1. Create all channels and traces
```

```
// Reset the instrument, creating the default trace Trc1 in channel 1.
```

```
// The default measured quantity is the forward transmission S-parameter S21.
```

```
// The default format is dB Mag.
```

```
*RST
```

```
//
```

```
// Create two more traces in channel 1, assigning a trace name and a measured quantity
```

```
// to each of them. Choose descriptive trace names (instead of the short default names used above).
```

```
CALCulate1:PARAmeter:SDEFine 'Impedance_trace', 'Z-S21' // the trace becomes the active trace  
for channel 1 but is not displayed
```

```
CALCulate1:PARAmeter:SDEFine 'Admittance_trace', 'Y-S21' // the trace becomes the active trace  
for channel 1
```

```
//
```

```
// Create channel 2 with one new trace, channel 3 with two new traces.
```

```
CALCulate2:PARAmeter:SDEFine 'Ratio_trace', 'B1/B2'
```

```
CALCulate3:PARAmeter:SDEFine 'Z_trace', 'Z21'
```

```
CALCulate3:PARAmeter:SDEFine 'Y_trace', 'Y21'
```

```
CALCulate3:PARAmeter:SELEct 'Z_trace' // the trace created previously becomes the active  
trace for channel 3
```

```
// So far, only the default trace is displayed.
```

```
//
```

```
// ▶ Check the result in the trace manager
```

```
// The trace manager gives an overview of the current channel/trace configuration
```

```
DISPlay:MENU:KEY:EXECute 'Trace Manager'
```

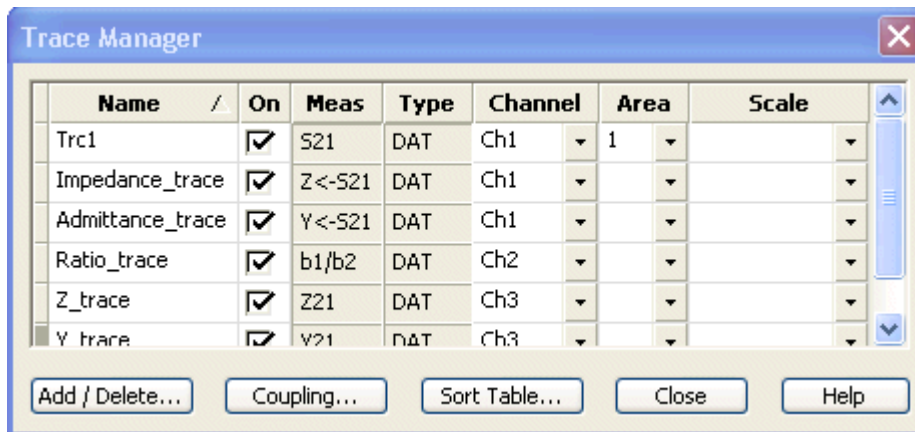

//

// ▶ Check the result on the local screen

// Go to local

SYSTem:DISPlay:UPDate ONCE

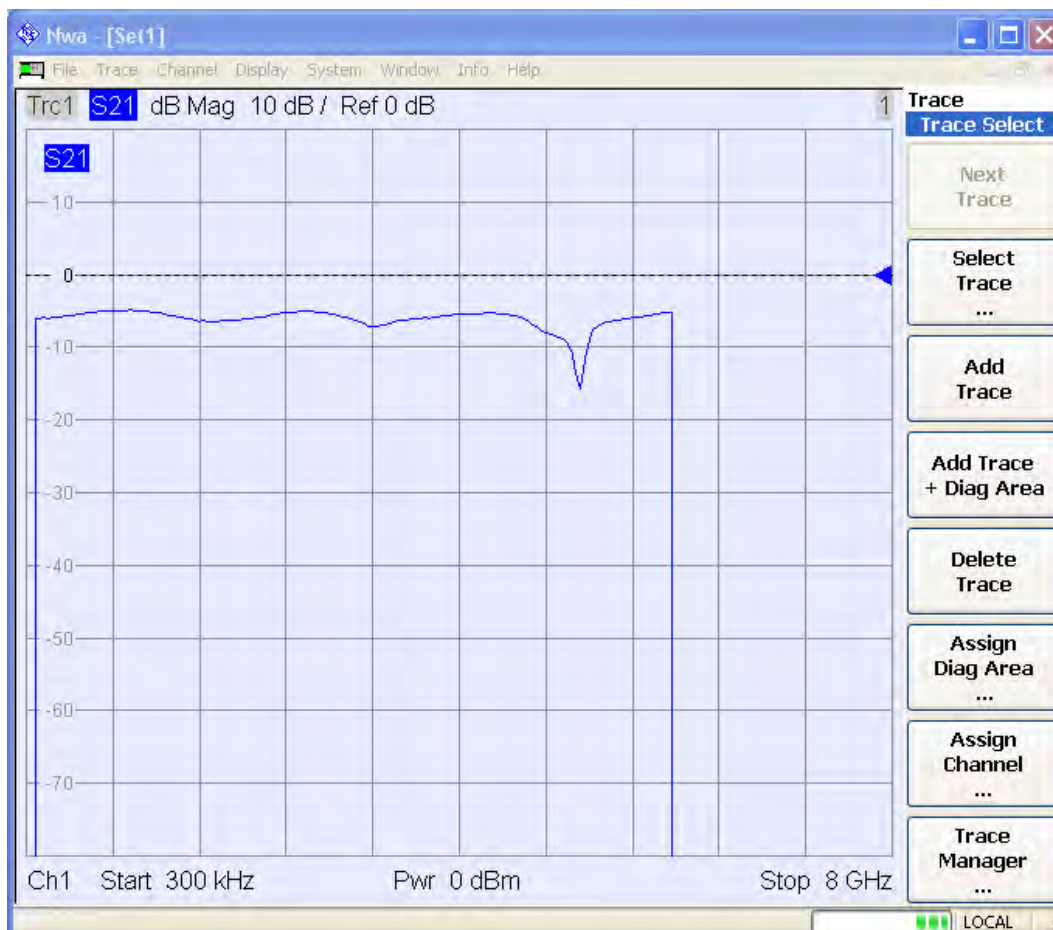

//

//

// 2. Create second diagram area and display traces

DISPlay:WINDow2:STATe ON

DISPlay:WINDow1:TRACe2:FEED 'Admittance_trace'

DISPlay:WINDow1:TRACe3:FEED 'Y_trace'

DISPlay:WINDow2:TRACe1:FEED 'Impedance_trace'

DISPlay:WINDow2:TRACe2:FEED 'Ratio_trace'

DISPlay:WINDow2:TRACe3:FEED 'Z_trace'

//

// ▶ Check the result on the local screen

// Go to local

SYSTem:DISPlay:UPDate ONCE

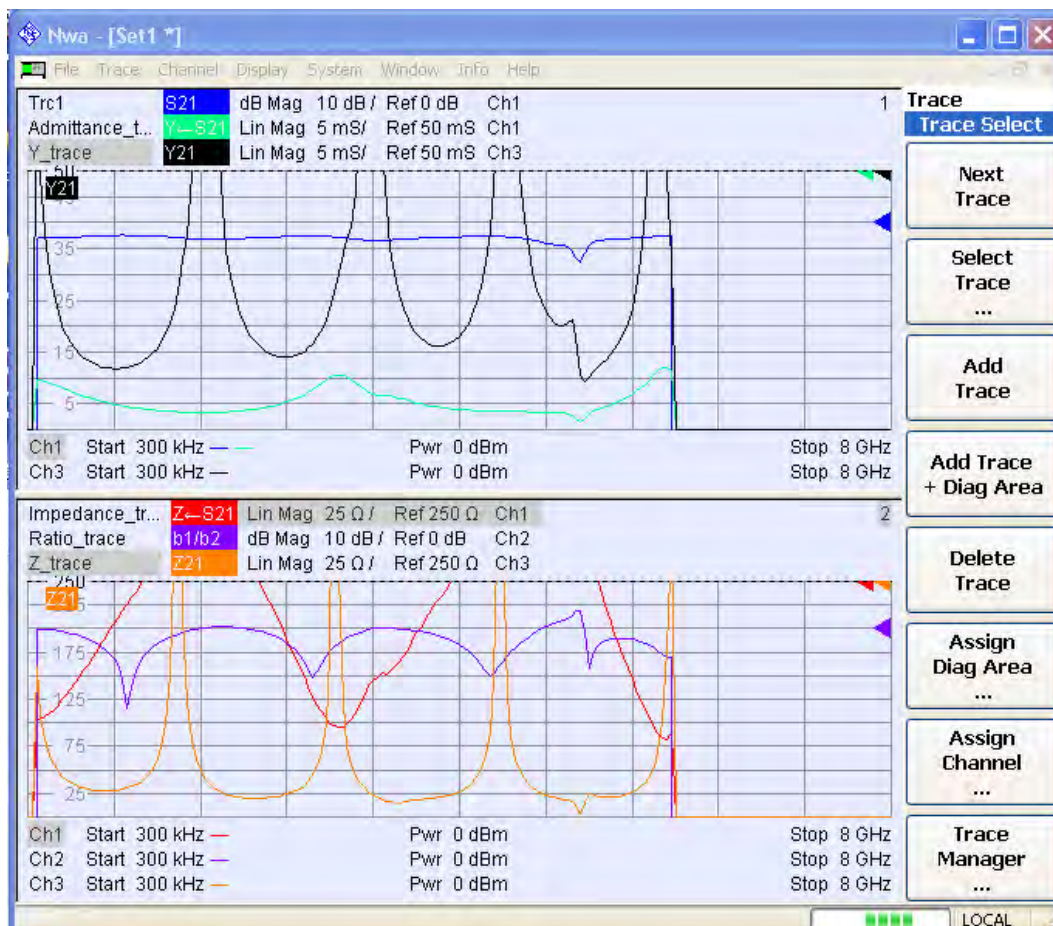

//

//

// 3. Check and modify your configuration

// Query the traces in channel 1.

CALCulate1:PARAmeter:CATalog?

```
// The response is 'Trc1,S21,Impedance_trace,Z-S21,Admittance_trace,Y-S21'
//
// Query the reference level for the 'Z_trace'.
// The trace is referenced by its number in diagram area no. 2.
DISPlay:WINDow2:TRACe3:Y:RLEVel?
//
// Change the display format for the 'Z_trace'. The trace is the active trace in channel 3,
// so it is referenced by the channel suffix 3.
CALCulate3:FORMat PHASe
```

Markers and Limit Lines...

Programming task: Display two traces in a single diagram area, use markers to read results, and perform a limit check.

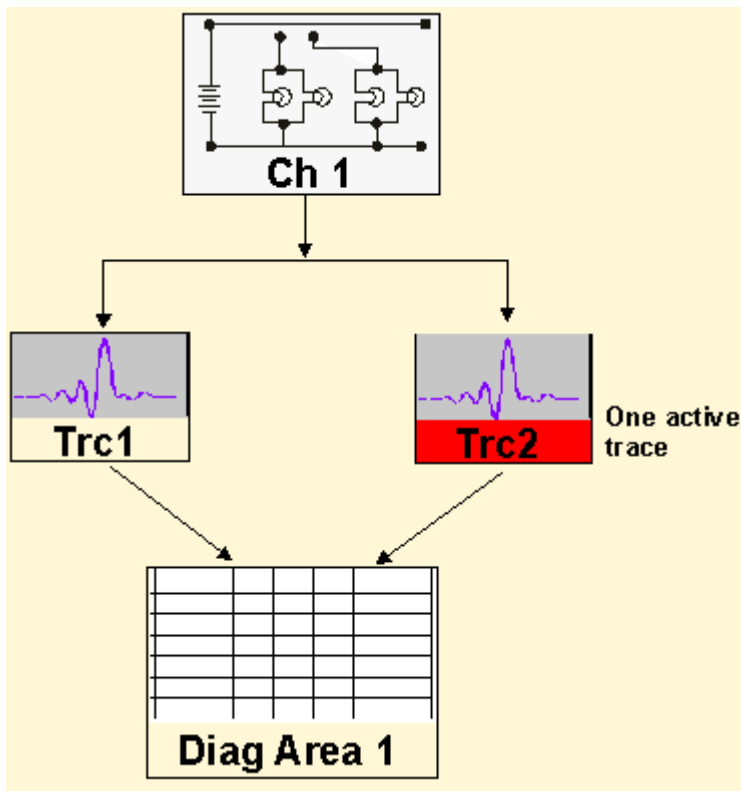

Important remote control features for this program example

The following command sequence illustrates the structure of the remote commands discussed in section *Basic Remote Control Concepts*. In particular it shows that:

- Traces are referenced by trace names. The active trace of a channel is often referenced by the channel suffix. This simplifies the program syntax, e.g. in the commands for marker settings and for the limit check.

- Diagram areas are referenced by a window suffix <Wnd>. An additional suffix <WndTr> in the `DISPlay:WINDow<Wnd>:TRACe<WndTr>...` commands numbers the different traces in a diagram area.
- The analyzer provides several commands allowing a smooth transition between remote and manual control.

```
//
```

```
//
```

```
// 1. Create one channel, two traces, one diagram area
```

```
// Reset the instrument, creating the default trace Trc1 in channel 1.
```

```
// The default measured quantity is the forward transmission S-parameter S21.
```

```
// The default format is dB Mag.
```

```
*RST
```

```
//
```

```
// Create a second trace in channel 1, assign the format Phase,
```

```
// and display the new trace in the same diagram area.
```

```
CALCulate1:PARAmeter:SDEFine 'Trc2', 'S21' // the trace becomes the active trace but is not displayed
```

```
CALCulate1:FORMat PHASe // the trace is referenced by the channel suffix 1
```

```
DISPlay:WINDow1:TRACe2:FEED 'Trc2' // display the second trace, numbering it the second trace in diagram area no. 1
```

```
//
```

```
// ▶ Check the result on the local screen
```

```
// Go to local
```

```
SYSTem:DISPlay:UPDate ONCE
```



```
//
```

```
//
```

// 2. Marker settings

```
// Adjust the sweep range to consider an interesting segment of the trace and re-scale the diagram.
```

```
SENSe1:FREQUency:STARt 4.5 GHz; STOP 5.5 GHz
```

```
DISPlay:WINDow1:TRACe1:Y:SCALE:AUTO ONCE / in the autoscale command the trace is  
referenced by its number in the diagram
```

```
//
```

```
// Select trace Trc1 as the active trace of the channel, define a reference marker and a delta marker.
```

```
// In the marker commands the active trace is referenced by the channel suffix.
```

```
CALCulate1:PARAmeter:SELEct 'Trc1'
```

```
CALCulate1:MARKer1:STATe ON // the marker is set to the center of the sweep range
```

```
CALCulate1:MARKer1:DELTA:STATe ON // this command also creates the reference marker
```

```
CALCulate1:MARKer1:REFerence:X 4.5 GHz // set the reference marker to the beginning  
of the sweep range
```

```
//
```

```
// Use the delta marker to search for the minimum of the trace and query the result.
```

CALCulate1:MARKer1:FUNCTION:EXECute MIN; RES? // the query returns the stimulus and the response value at the marker position

//

// ▶ **Check the result on the local screen**

// Go to local

SYSTem:DISPlay:UPDate ONCE

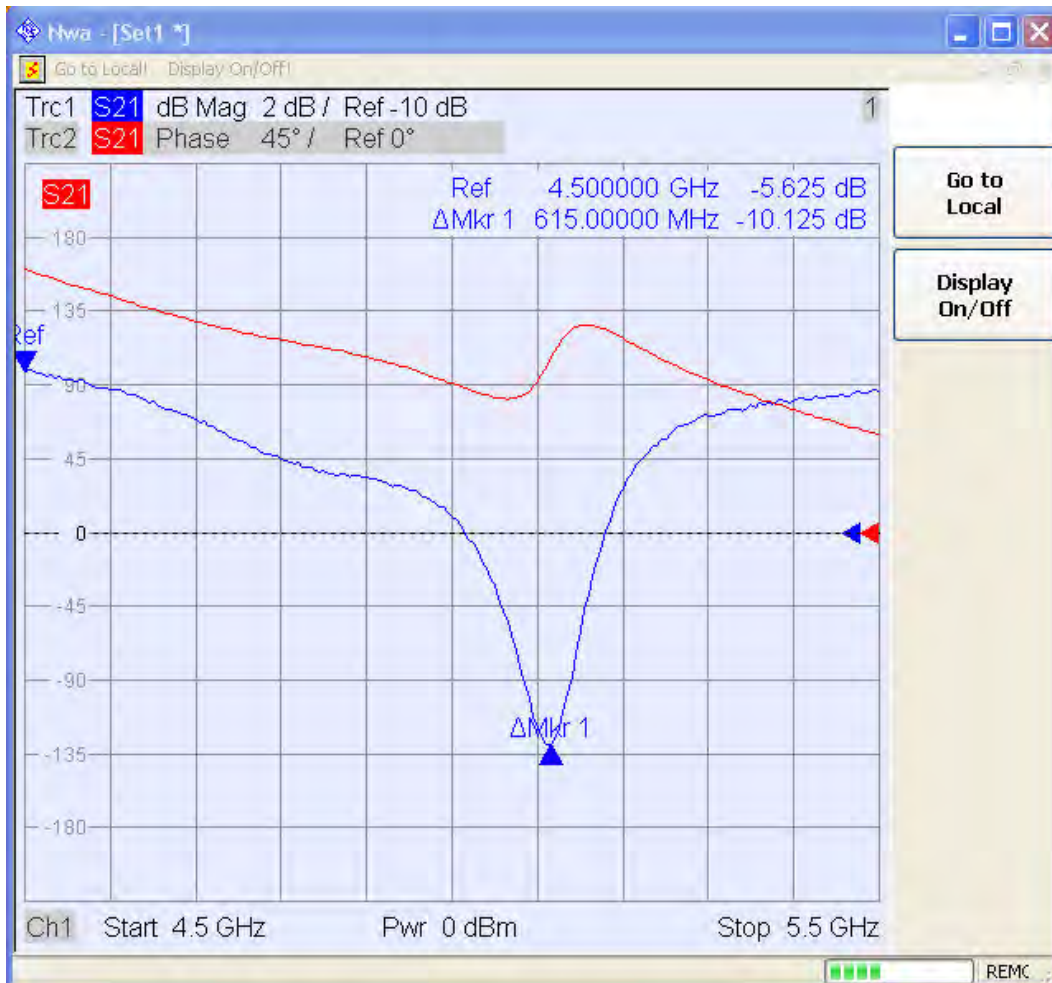

//



*Use the `CALCulate<Chn>:DATA...` commands to retrieve the complete trace; see *Retrieving Measurement Results*.*

//

//

// 2. Limit lines and limit check

// Remove all markers and define a limit line for the active trace.

CALCulate1:MARKer1:AOff

CALCulate1:LIMit:DATA 1, 4500000000, 5500000000, -5, -5 // define an upper limit line across the

entire sweep range

```
CALCulate1:LIMit:DATA 2, 4500000000, 5000000000, -10, -15
```

```
CALCulate1:LIMit:DATA 2, 5000000000, 5500000000, -15, -10 // define two segments for the lower limit line
```

```
//
```

```
// Display the limit line and perform the limit check.
```

```
CALCulate1:LIMit:DISPlay:STATe ON
```

```
CALCulate1:LIMit:STATe ON; FAIL? / if the trace is failed; the response is 1.
```

```
//
```

```
// ▶ Check the result on the local screen
```

```
// Go to local
```

```
SYSTem:DISPlay:UPDate ONCE
```

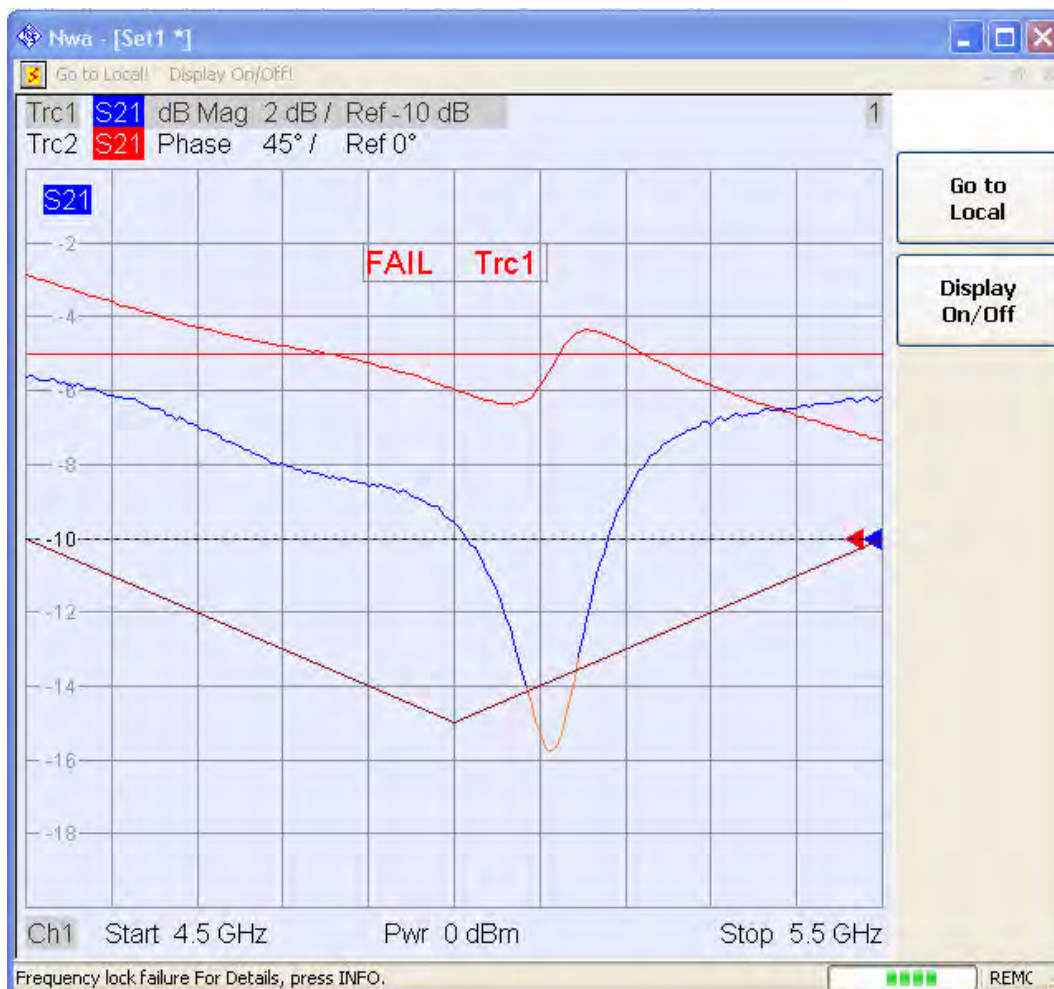

```
//
```

```
// ▶ Check the result in the Define Limit Line dialog
```

```
// The Define Limit Line dialog gives an overview of the limit line segments of the active trace.
```

DISPlay:MENU:KEY:EXECute 'Define Limit Line'

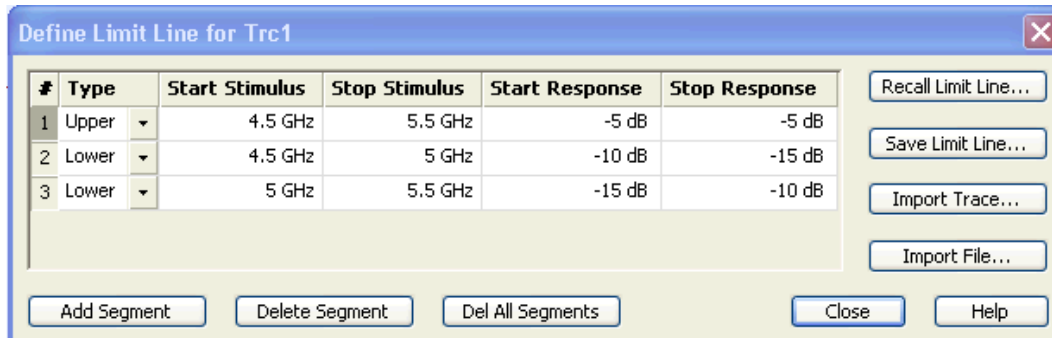

Condensed Programming Examples

Calibration

The following example shows you how to perform a multiport calibration of the analyzer.

```
// Reset the analyzer
*RST
//
// Set cal kit as active kit for N50
:SENSE:CORRECTION:CKIT:N50:SELECT 'N 50 Ohm Ideal Kit'
//
// Select connectors for the ports
:SENSE1:CORRECTION:COLLECT:CONNECTION1 N50MALE
:SENSE1:CORRECTION:COLLECT:CONNECTION2 N50MALE
//
// Don't save the cal standard measurements with apply cal, i.e. with the commands
// :SENSE1:CORRECTION:COLLECT:SAVE or
// :SENSe1:CORRection:COLLect:SAVE:SELected
// Instead, use the global, channel-independent setting:
:SENSe:CORRection:COLLect:ACQuire:RSAVe:DEFault OFF
//
//
// Full one port = OSM
// Select cal procedure
:SENSe1:CORRection:COLLect:METhod:DEFine 'Test SFK OSM 1', FOPORT, 1
//
```

```
// Measure Standards
:SENSe1:CORRection:COLLect:ACQuire:SElected OPEN, 1
:SENSe1:CORRection:COLLect:ACQuire:SElected SHORT, 1
:SENSe1:CORRection:COLLect:ACQuire:SElected MATCH, 1
//
// Apply cal
:SENSe1:CORRection:COLLect:SAVE:SElected
//
//
// 2 port TOSM
// Select cal procedure
:SENSe1:CORRection:COLLect:MEthod:DEFine 'Test SFK TOSM 12', TOSM, 1, 2
//
// Measure Standards
:SENSe1:CORRection:COLLect:ACQuire:SElected THROUGH, 1, 2
:SENSe1:CORRection:COLLect:ACQuire:SElected OPEN, 1
:SENSe1:CORRection:COLLect:ACQuire:SElected SHORT, 1
:SENSe1:CORRection:COLLect:ACQuire:SElected MATCH, 1
:SENSe1:CORRection:COLLect:ACQuire:SElected OPEN, 2
:SENSe1:CORRection:COLLect:ACQuire:SElected SHORT, 2
:SENSe1:CORRection:COLLect:ACQuire:SElected MATCH, 2
//
// Apply calibration
:SENSe1:CORRection:COLLect:SAVE:SElected
//
// Save / load cal files
// Save calibration in calibration file pool in directory
// C:\Rohde&Schwarz\Nwa\Calibration\Data
// the file name in the commands must not contain the path !
:MMEMORY:STORE:CORRection 1, 'OSM1 TOSM12.cal'
//
// load cal file from calibration file pool
:MMEMORY:LOAD:CORRection 1, 'OSM1 TOSM12.cal'
```

Modeling a Max Hold Function

The following example shows you how to emulate a max hold function.

```
// Reset the analyzer
*RST
:DISPlay:WINDow1:TITLe:DATA 'Max Hold Function Emulation'

// Create a trace with the last extremum as memory trace.
:TRACe:COPIY 'LastExtr', 'Trc1'

// Display this last extremum trace.
// Because it's a memory trace it must be displayed in the same diagram as the mother trace.
:DISPlay:WINDow1:TRACe2:FEED 'LastExtr'
:CALCulate1:MATH:SDEFine 'Max (Data, Mem)'
:CALCulate1:MATH:STATe ON

// Single sweep mode
:INITIATE:CONTINUOUS OFF

// Do a single sweep and update trace with the current extremum.
// This is the last extremum for the next sweep
:INITIATE:IMMEDIATE; *WAI
:TRACe:COPIY:MATH 'LastExtr', 'Trc1'

// Loop over these 2 commands
:INITIATE:IMMEDIATE; *WAI
:TRACe:COPIY:MATH 'LastExtr', 'Trc1'
:INITIATE:IMMEDIATE; *WAI
:TRACe:COPIY:MATH 'LastExtr', 'Trc1'
// .....
// Continous sweep mode
:INITIATE:CONTINUOUS ON
//
```

Retrieving the Results of Previous Sweeps

The command `CALCulate<Ch>:DATA:NSweep? SDATa, <Trace_Hist_Count>` retrieves the results of any sweep within a previously defined single sweep group. This means that, in single sweep mode, you can first measure a specified number of sweeps (`SENSe<Ch>:SWEep:COUNT <sweeps>`) and then read any of the data traces acquired.

This feature has no equivalent in manual control where always the last data trace is displayed.

```
// Reset the analyzer
```

```
*RST
```

```
:SYSTEM:DISPLAY:UPDATE ON
```

```
// Create a second channel with a second trace.
```

```
:CALCULATE2:PARAMETER:SDEFINE "Trc2","S11"
```

```
:CALCULATE2:PARAMETER:SELECT "Trc2"
```

```
:DISPLAY:WINDOW2:STATE ON
```

```
:DISPLAY:WINDOW2:TRACE1:FEED 'Trc2'
```

```
// Select active trace for the created channel 2. Adjust the number of sweep points.
```

```
:CALCULATE2:PARAMETER:SELECT "Trc2"
```

```
:SENSE1:SWEEP:POINTS 3
```

```
:SENSE2:SWEEP:POINTS 4
```

```
// Set sweep count for the channels
```

```
// (3 traces per single sweep in channel 1, 4 traces in channel 2)
```

```
:SENSE1:SWEEP:COUNT 3
```

```
:SENSE2:SWEEP:COUNT 4
```

```
// State that INITIATE<Ch>:IMMEDIATE will start a single sweep for the
```

```
// referenced channel <Ch> only, not for all channels
```

```
:INITIATE:IMMEDIATE:SCOPE SINGLE
```

```
// Select single sweep mode and measure a single sweep group for channels no. 1 and 2
```

```
:INITIATE:IMMEDIATE:SCOPE SINGLE
```

```
:INITIATE1:IMMEDIATE; *WAI
```

```
:INITIATE2:IMMEDIATE; *WAI
```

```
// Read trace data (without history, i.e. the last trace acquired in each channel)
```

```
:CALCULATE1:DATA? SDATA
```

```
:CALCULATE2:DATA? SDATA
```

```
// Read last and previous trace data in channel 1 and 2
```

```
:CALCULATE1:DATA:NSWEEP? SDATA, 1      // last trace data  
:CALCULATE1:DATA:NSWEEP? SDATA, 3      // previous trace data  
:CALCULATE2:DATA:NSWEEP? SDATA, 1      // last trace data  
:CALCULATE2:DATA:NSWEEP? SDATA, 4      // previous trace data
```

Table of Contents

9 Interfaces and Connectors	583
Front Panel Connectors	583
Test Ports	583
USB Connectors	583
PROBE POWER	584
Rear Panel Connectors	584
LAN	584
EXT TRIGGER	584
EXT REF	585
POWER SENSOR (Option R&S FSL-B5, Additional Interfaces)	585
NOISE SOURCE CONTROL (Option R&S FSL-B5, Additional Interfaces)	585
IF/VIDEO OUT (Option R&S FSL-B5, Additional Interfaces)	586
AUX PORT (Option R&S FSL-B5, Additional Interfaces)	586
GPIB Interface (Option R&S FSL-B10)	587
DC Power Supply (Option R&S FSL-B30)	587
Battery Pack (Option R&S FSL-B31)	588
IEC/IEEE Bus Interface	588
Interface Functions	589
Interface Messages	590
Instrument Messages	591
VXI-11 Protocol	591
VXI-11 Interface Messages	592

RSIB Interface Functions	593
Variables ibsta, iberr, ibcntl	593
Error variable iberr	593
Count variable - ibcntl	594
Overview of Interface Functions	594
Description of Interface Functions	595

9 Interfaces and Connectors

This chapter provides a detailed description of the hardware interfaces and connectors of the instrument. For a graphical overview of the front panel and rear panel connectors and their use refer to chapter *Preparing for Use*.

Front Panel Connectors

Test Ports

N-connectors labelled PORT 1 and PORT 2/ RF INPUT. The test ports serve as outputs for the RF stimulus signal and as inputs for the measured RF signals from the DUT (response signals).

- With a single test port, it is possible to generate a stimulus signal and measure the response signal in reflection.
- With 2 test ports, it is possible to perform full two-port measurements; see S-Parameters section in Chapter 3.
- The two network analyzer ports are equivalent. If the Spectrum Analysis option (R&S ZVL-K1) is active, test port PORT 2 serves as an AC-coupled input for the analyzed RF signal; PORT 1 is not used.



Attention!



The maximum input levels at all test ports according to the front panel labeling or the data sheet must not be exceeded.

In addition, the maximum input voltages of the other input connectors at the front and rear panel must not be exceeded.

USB Connectors

Two single Universal Serial Bus connectors of type A (master USB), used to connect a keyboard (recommended: PSL-Z2, order number 1157.6870.03), mouse (recommended: PSL-Z10, order number 1157.7060.03) or other pointing devices, a calibration unit (accessory R&S ZV-Z5x), a printer or an external storage device (USB stick, CD-ROM drive etc.).

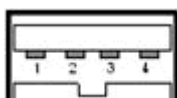

Using an adapter cable (R&S NRP-Z4), a power sensor can be connected, as an alternative to the power sensor connector on the rear panel that is only available with option Additional Interfaces, R&S FSL-B5.



For maintaining the EMI conformity of the R&S ZVL only appropriate USB accessories may be used.

Passive connecting USB cables should not exceed 4 m in length. Use the original USB connecting cable or another high-quality cable. The maximum current per USB port is 500 mA.

PROBE POWER

Connector for supply voltages of +15 V to -12 V and ground for active probes and preamplifiers. A maximum current of 140 mA is available. This connector is suitable as power supply for high-impedance probes from Agilent.

Rear Panel Connectors

LAN

8-pin connector RJ-45, used to connect the analyzer to a Local Area Network (LAN); see Remote Control in a LAN. The pin assignment of the RJ-45 connector supports category 5 UTP/STP (Unshielded/Shielded Twisted Pair) cables.



EXT TRIGGER

BNC female connector, used as an input for external TTL trigger signals. Input levels <0.7 V are interpreted as logic low; input levels >1.4 V as logic high. The typical input impedance is 10 k Ω .



EXT REF

BNC female connector, used as an input or output for the 10 MHz reference clock signal.

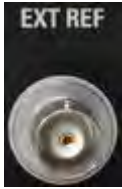

The function of the 10 MHz REF connector depends on the *Int. Reference* or *Ext. Reference* setting in the *SETUP* menu:

- If *Int. Reference* is active, 10 MHz REF is used as an output connector for the 10 MHz internal reference clock signal of the analyzer. This configuration requires the OCXO option (R&S FSL–B4, OCXO Reference Frequency).
- If *Ext. Reference* is active, 10 MHz REF is used as an input connector for an external 10 MHz reference clock signal. The external reference signal must meet the specifications of the data sheet. The internal reference signal is synchronized to the external signal.



The AC power switch also interrupts the power supply of the OCXO. When you switch the instrument back on, be sure to comply with the extended warm-up phase specified in the data sheet.

POWER SENSOR (Option R&S FSL–B5, Additional Interfaces)

LEMOSA female connector, used for connecting power sensors of the R&S NRP–Zxy family. With an adapter cable R&S NRP–Z4, the USB port on the front panel can be used for this purpose.



NOISE SOURCE CONTROL (Option R&S FSL–B5, Additional Interfaces)

BNC female connector, provides the supply voltage for an external noise source, e.g. to measure the noise figure and gain of amplifiers and frequency converting DUTs.



Conventional noise sources require a voltage of +28 V in order to be switched on and 0 V to be switched off. The output supports a maximum load of 100 mA.

IF/VIDEO OUT (Option R&S FSL–B5, Additional Interfaces)

BNC female connector, used as an intermediate frequency (IF) output of approximately 20 MHz or as a video output at the selected video and resolution bandwidth (with spectrum analyzer option R&S ZVL-K1).



This connector cannot be used simultaneously with the AF output connector on the front panel unless it is configured as a video output.

AUX PORT (Option R&S FSL–B5, Additional Interfaces)

9-pole SUB–D male connector, provides output signals for controlling external devices. The voltage levels are of TTL type (max. 5 V). The pin assignment is shown below.

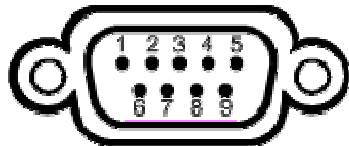

Pin No.	Name	Input (I) or Output (O) or Bidirectional (B)	Voltage Range	Function
1	SUPPLY	O	+ 5 V / max. 250 mA	Supply voltage for external circuits
2 to 7	I/O	–		Reserved for future use
8	GND	–		Ground
9	READY FOR TRIGGER	O	0 V	Signal indicating that the instrument is ready to receive trigger signal.



Attention!

Watch the pin assignment carefully. A short-circuit may damage the instrument.

GPIB Interface (Option R&S FSL-B10)

GPIB interface in compliance with IEEE488 and SCPI. A computer for remote control can be connected via this interface. To set up the connection, a shielded cable is recommended. See GPIB Bus Interface above in this chapter.



DC Power Supply (Option R&S FSL-B30)

A DC power supply can be connected alternatively to the AC power supply; see DC Power Supply and Battery in chapter 1. The connector is supplied with the other accessories of the option and is connected according to the following diagram:

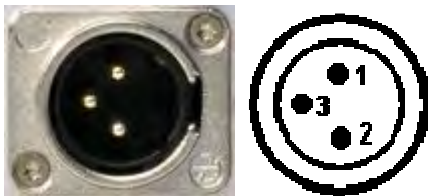

Pin No.	Input (I) or Output (O) or Bidirectional (B)	Voltage Range	Function
1	I	+11 V to +28 V 7 A to 2.7 A	Positive voltage
2	–	–	Ground
3	–	–	Not used



Caution!

DC power supply

The power supply (SELV) that is used must fulfill the requirements for reinforced/double insulation for main supply circuits in accordance to DIN/EN/IEC 61010 (UL 61010B-1, CSA C22.2 No. 1010.1) or DIN/EN/IEC 60950 (UL 1950, CSA C22.2 No. 950). It is recommended to fuse the DC power supply according to the table below. Before switching on the instrument check the connection for correct polarity.

In continuous operation the actual breaking current can differ from the rated breaking current. For fuse selection take the characteristics of the fuse into account.

Input Voltage	Max. Current or Power
11 V to 12.5 V	125 VA
12.5 V to 18.7 V	10 A
18.7 V to 28 V	200 VA

The instrument is switched on or off using the standby key on the front panel; see sections Power Supply Options and DC Power Supply and Battery in chapter 1.

Battery Pack (Option R&S FSL-B31)

The battery pack can be used alternatively as power supply. If the battery runs low during operation, a message is displayed. In this case, use another power supply or switch off the instrument. For an overview on available power supplies refer to section Power Supply Options in chapter 1. The power supply can be changed during operation.

The instrument is switched on or off using the ON/STANDBY function key on the front panel. For details refer to section DC Power Supply and Battery in chapter 1.

The battery pack can be reloaded via the AC or DC power supply. For details on charging refer to section Charging the Battery in chapter 1.



If the battery is not to be used for a longer time, it is recommended to remove it and store it separately.

IEC/IEEE Bus Interface

The standard instrument is equipped with a GPIB bus (IEC/IEEE bus) connection. The two interface connectors labeled *IEC BUS* and *IEC SYSTEM BUS* are located on the rear panel of the instrument.

- The *IEC BUS* connector is intended for remote control of the analyzer from a controller.
- The *IEC SYSTEM BUS* can be used to control further devices from the analyzer.



Always use a shielded cable to connect the GPIB bus interfaces.



Characteristics of the interface

- 8-bit parallel data transfer
- Bidirectional data transfer
- Three-line handshake
- High data transfer rate of max. 1 MByte/s
- Up to 15 devices can be connected
- Maximum length of the connecting cables 15 m. The length of a single connecting cable should not exceed 2 m, if many devices are used, it should not exceed 1 m.
- Wired OR if several instruments are connected in parallel

Pin assignment

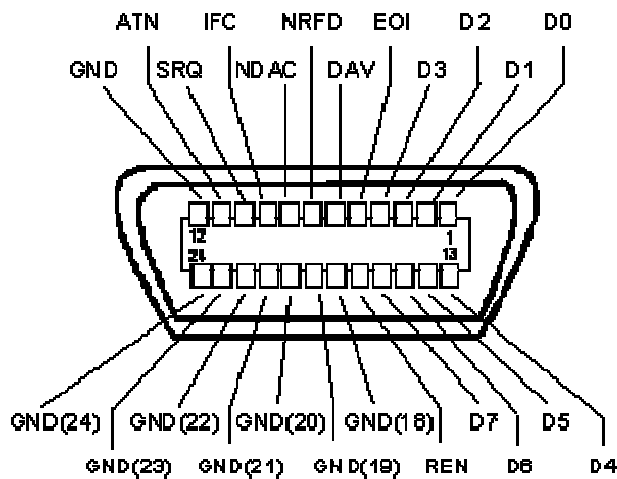

Bus lines

1. Data bus with 8 lines D0 to D7 The transmission is bit-parallel and byte-serial in the ASCII/ISO code. D0 is the least significant bit, D7 the most significant bit.

2. Control bus with five lines

IFC (Interface Clear): active LOW resets the interfaces of the instruments connected to the default setting.

ATN (Attention): active LOW signals the transmission of interface messages, inactive HIGH signals the transmission of device messages.

SRQ (Service Request): active LOW enables the connected device to send a service request to the controller.

REN (Remote Enable): active LOW permits switchover to remote control.

EOI (End or Identify): has two functions in connection with ATN:
 ATN=HIGH active LOW marks the end of data transmission.
 ATN=LOW active LOW triggers a parallel poll.

3. Handshake bus with three lines

DAV (Data Valid): active LOW signals a valid data byte on the data bus.

NRFD (Not Ready For Data): active LOW signals that one of the connected devices is not ready for data transfer.

NDAC (Not Data Accepted): active LOW signals that the instrument connected is accepting the data on the data bus.

The analyzer provides the following functions to communicate via GPIB bus:

- Interface functions
- Interface messages
- Instrument messages

Interface Functions

Instruments which can be controlled via GPIB bus can be equipped with different interface functions. The interface function for the network analyzer are listed in the following table.

Control character	Interface function
SH1	Handshake source function (source handshake), full capability
AH1	Handshake sink function (acceptor handshake), full capability
L4	Listener function, full capability, de-addressed by MTA.
T6	Talker function, full capability, ability to respond to serial poll, deaddressed by MLA
SR1	Service request function (Service Request), full capability
PP1	Parallel poll function, full capability
RL1	Remote/Local switch over function, full capability
DC1	Reset function (Device Clear), full capability
DT1	Trigger function (Device Trigger), full capability

Interface Messages

Interface messages are transmitted to the instrument on the data lines, with the attention line being active (LOW). They serve to communicate between controller and instrument.

Universal Commands

Universal commands are encoded in the range 10 through 1F hex. They are effective for all instruments connected to the bus without previous addressing.

Command	QuickBASIC command	Effect on the instrument
DCL (Device Clear)	IBCMD (controller%, CHR\$(20))	Aborts the processing of the commands just received and sets the command processing software to a defined initial state. Does not change the instrument settings.
IFC (Interface Clear)	IBSIC (controller%)	Resets the interfaces to the default setting.
LLO (Local Lockout)	IBCMD (controller%, CHR\$(17))	The LOC/IEC ADDR key is disabled.
SPE (Serial Poll Enable)	IBCMD (controller%, CHR\$(24))	Ready for serial poll.
SPD (Serial Poll Disable)	IBCMD (controller%, CHR\$(25))	End of serial poll.
PPU (Parallel Poll Unconfigure)	IBCMD (controller%, CHR\$(21))	End of the parallel-poll state.

Addressed Commands

Addressed commands are encoded in the range 00 through 0F hex. They are only effective for instruments addressed as listeners.

Command	QuickBASIC command	Effect on the instrument
GET (Group Execute Trigger)	IBTRG (device%)	Triggers a previously active device function (e.g. a sweep). The effect of the command is the same as with that of a pulse at the external trigger signal input.
GTL (Go to Local)	IBLOC (device%)	Transition to the "Local" state (manual control).

Command	QuickBASIC command	Effect on the instrument
PPC (Parallel Poll Configure)	IBPPC (device%, data%)	Configures the instrument for parallel poll. Additionally, the QuickBASIC command executes PPE/PPD.
SDC (Selected Device Clear)	IBCLR (device%)	Aborts the processing of the commands just received and sets the command processing software to a defined initial state. Does not change the instrument setting.

Instrument Messages

Instrument messages (commands) are transferred on the data lines of the GPIB bus while the ATN line is not active. ASCII code is used.

Structure and syntax of the instrument messages are described the SCPI Reference chapter. The chapter also provides a detailed description of all messages implemented by the analyzers.

VXI-11 Protocol

The VXI-11 standard is based on the RPC protocol which in turn relies on TCP/IP as the network/transport layer. The TCP/IP network protocol and the associated network services are pre-configured. TCP/IP ensures connection-oriented communication, where the order of the exchanged messages is adhered to and interrupted links are identified. With this protocol, messages cannot be lost.

Remote control of an instrument via a network is based on standardized protocols which follow the OSI reference model (see Fig. below).

Application	SCPI
Presentation	XDR (VXI-11)
Session	ONC-RPC
Transport	TCP / UDP
Network	IP
Data Link	Ethernet/802.3
Physical	802.3/10BASE-

Based on TCP/UDP, messages between the controller and the instrument are exchanged via open network computing (ONC) – remote procedure calls (RPC). With XDR (VXI-11), legal RPC messages are known as VXI-11 standard. Based on this standard, messages are exchanged between the controller and the instrument. The messages are identical with SCPI commands. They can be organized in four groups:

- Program messages (control command to the instrument)
- Response messages (values returned by the instrument)
- Service request (spontaneous queries of the instrument)
- Low-level control messages (interface messages)

A VXI-11 link between a controller and an instrument uses three channels: core, abort and interrupt

channel. Instrument control is mainly performed on the core channel (program, response and low-level control messages). The abort channel is used for immediate abort of the core channel; the interrupt channel transmits spontaneous service requests of the instrument. Link setup itself is very complex. For more details refer to the VXI-11 specification.

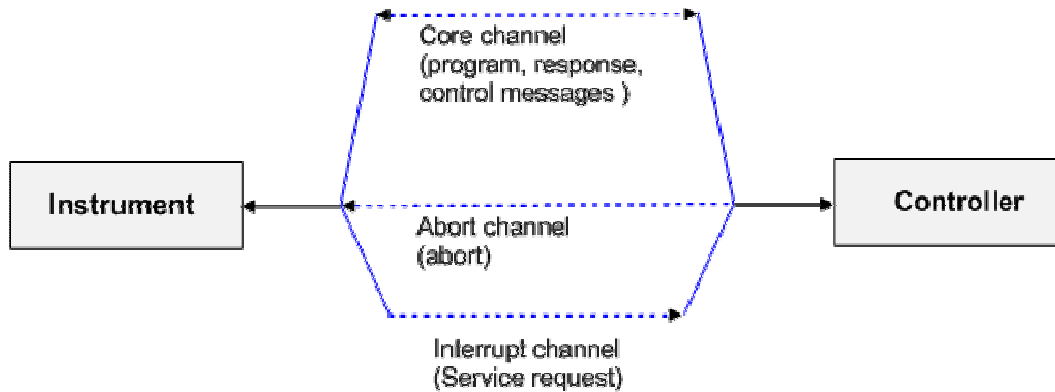

The number of controllers that can address an instrument is practically unlimited in the network. In the instrument, the individual controllers are clearly distinguished. This distinction continues up to the application level in the controller, i.e. two applications on a computer are identified by the instrument as two different controllers.

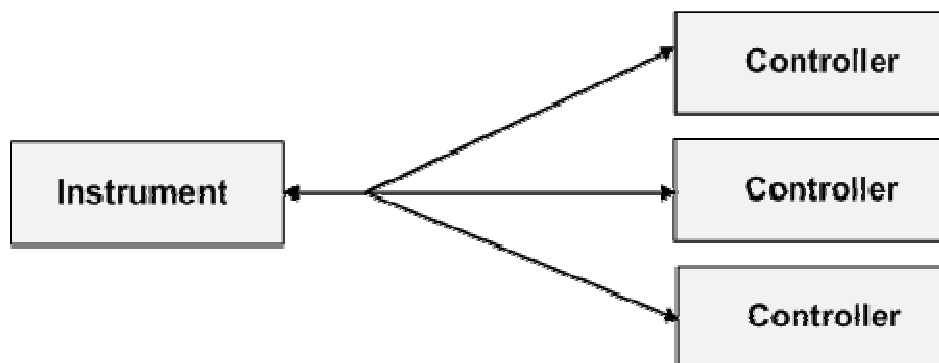

The controllers can lock and unlock the instrument for exclusive access. This regulates access to the instrument of several controllers.

VXI-11 Interface Messages

On the Ethernet link, the interface messages are called low-level control messages. These messages can be used to emulate interface messages of the IEC/IEEE bus.

Command		Effect on the instrument
&ABO	(Abort)	Aborts processing of the commands just received.
&DCL	(Device Clear)	Aborts processing of the commands just received and sets the command processing software to a defined initial state. Does not change the instrument setting.
>L	(Go to Local)	Transition to the "Local" state (manual control).
>R	(Go to Remote)	Transition to the "Remote" state (remote control).
&GET	(Group Execute Trigger)	Triggers a previously active device function (e.g. a sweep). The effect of the command is the same as with that of a pulse at the external trigger signal input.

Command		Effect on the instrument
&LLO	(Local Lockout)	Disables switchover from remote control to manual control by means of the front panel keys.
&POL	(Serial Poll)	Starts a serial poll.
&NREN	(Not Remote Enable)	Enables switchover from remote control to manual control by means of the front panel keys.

RSIB Interface Functions

This section lists all functions of the DLL "RSIB.DLL" or "RSIB32.DLL" or "librsib.so", which allow to produce control applications.

- Variables
- Interface Functions

Variables `ibsta`, `iberr`, `ibcntl`

Same as with the National Instruments interface, successful execution of a command can be checked by means of the variables `ibsta`, `iberr` and `ibcntl`. To this end, references to the three variables are transferred to all RSIB functions. In addition, the status word `ibsta` is returned as a function value by all functions.

Status word `ibsta`

All functions send back a status word that provides information on the status of the RSIB interface. The following bits are defined:

Bit name	Bit	Hex code	Description
ERR	15	8000	This bit is set if an error occurs during a function call. If this bit is set, <code>iberr</code> contains an error code which specifies the error.
TIMO	14	4000	This bit is set if a timeout occurs during a function call. A timeout may occur in the following situations: - while waiting for an SRQ with the function <code>RSDLLWaitSrq()</code> . - if no acknowledgment is received for data sent to an instrument with <code>RSDLLibwrt()</code> or <code>RSDLLilwrt()</code> . - if no response from server to a data request with function <code>RSDLLibrd()</code> or <code>RSDLLilrd()</code> .
CMPL	8	0100	This bit is set if the reply of the IEC/IEEE-bus parser is completely read. If a reply of the parser is read with the function <code>RSDLLilrd()</code> and the buffer length is not sufficient, the bit is cleared.

Error variable `iberr`

If the ERR bit (8000h) is set in the status word, `iberr` contains an error code that specifies the error. The RSIB has error codes of its own independent of the National Instrument interface.

Error	Error code	Description
IBERR_DEVICE_REGISTER	1	RSIB.DLL cannot register any new device.

Error	Error code	Description
IBERR_CONNECT	2	Link to the device has failed.
IBERR_NO_DEVICE	3	An interface function was called with an invalid device handle.
IBERR_MEM	4	No free memory available.
IBERR_TIMEOUT	5	Timeout has occurred.
IBERR_BUSY	6	The RSIB interface is blocked by a function not yet completed. Windows is not blocked, for example, by function RSDLLibrd() if data is still to be transmitted in response to this function. In this case a new call is possible. Further calls are however rejected by RSIB.DLL with error code <code>IBERR_BUSY</code> .
IBERR_FILE	7	Error in reading from or writing to a file.
IBERR_SEMA	8	Error upon creating or assigning a semaphore (only under Unix)

Count variable - `ibcntl`

The variable `ibcntl` is updated with the number of bytes transmitted on every read and write function call.

Overview of Interface Functions

The library functions are adapted to the interface functions of National Instruments for GPIB programming. The functions supported by the libraries are listed in the following table.

Function	Description
RSDLLibfind()	Provides a handle for access to a device.
RSDLLibwrt()	Sends a zero-terminated string to a device.
RSDLLilwrt()	Sends a certain number of bytes to a device.
RSDLLibwrtf()	Sends the contents of a file to a device.
RSDLLibrd()	Reads data from a device into a string.
RSDLLilrd()	Reads a certain number of bytes from a device.
RSDLLibrdf()	Reads data from a device into a file.
RSDLLibtmo()	Sets timeout for RSIB functions
RSDLLibsre()	Switches a device into the local or remote state
RSDLLibloc()	Temporarily switches a device into the local state
RSDLLibeot()	Enables/disables the END message for write operations.
RSDLLibrsp()	Performs a serial poll and provides the status byte.
RSDLLibclr	Sends the command SDC (Device Clear) to the instrument.
RSDLLibonl()	Sets the device On/Offline.
RSDLLTestSrQ()	Checks whether a device has generated an SRQ.
RSDLLWaitSrQ()	Waits until a device generates an SRQ.
RSDLLSwapBytes	Swaps the byte sequence for binary numeric display (only required for non-Intel platforms)

Description of Interface Functions

RSDLLibfind()

The function provides a handle for access to the device with the name `udName`.

VB format	Function RSDLLibfind (ByVal udName\$, ibsta%, iberr%, ibcntl&) As Integer
C-format	short WINAPI RSDLLibfind(char far *udName, short far *ibsta, short far *iberr, unsigned long far *ibcntl)
C format (Unix)	short RSDLLibfind(char *udName, short *ibsta, short *iberr, unsigned long *ibcntl)
Parameter	udName // IP address of device
Example	ud = RSDLLibfind ("89.10.38.97", ibsta, iberr, ibcntl)

The function must be called prior to all other functions of the interface.

As return value, the function provides a handle that must be indicated in all functions for access to the device. If the device with the name `udName` is not found, the handle has a negative value.

RSDLLibwrt

This function sends data to the device with the handle `ud`.

VB format	Function RSDLLibwrt (ByVal ud%, ByVal Wrt\$, ibsta%, iberr%, ibcntl&) As Integer
C-format	short WINAPI RSDLLibwrt(short ud, char far *Wrt, short far *ibsta, short far *iberr, unsigned long far *ibcntl)
C format (Unix)	short RSDLLibwrt(short ud, char *Wrt, short *ibsta, short *iberr, unsigned long *ibcntl)
Parameters	ud // Device handle Wrt // String sent to the device
Example	RSDLLibwrt(ud, "SENS:FREQ:STAR?", ibsta, iberr, ibcntl)

This function allows to send setting and query commands to the measuring instruments. Whether the data is interpreted as a complete command can be set using the function `RSDLLibeot()`.

RSDLLilwrt

This function sends `Cnt` bytes to a device with the handle `ud`.

VB format	Function RSDLLilwrt (ByVal ud%, ByVal Wrt\$, ByVal Cnt&, ibsta%, iberr%, ibcntl&) As Integer
C-format	short WINAPI RSDLLilwrt(short ud, char far *Wrt, unsigned long Cnt, short far *ibsta, short far *iberr, unsigned long far *ibcntl)
C format (Unix)	short RSDLLilwrt(short ud, char *Wrt, unsigned long Cnt, short *ibsta, short *iberr, unsigned long *ibcntl)
Parameters	ud // Device handle Wrt // String sent to the device Cnt // Number of bytes sent to the device
Example	RSDLLilwrt (ud, '.....', 100, ibsta, iberr, ibcntl)

Like RSDLLibwrt() this function sends data to a device. The only difference is that binary data can be sent as well. The length of the data is not determined by a zero-terminated string, but by the indication of Cnt bytes. If the data is to be terminated with EOS (0Ah), the EOS byte must be appended to the string.

RSDLLibwrtf

This function sends the contents of a file file\$ to the device with the handle ud.

VB format	Function RSDLLibwrtf (ByVal ud%, ByVal file\$, ibsta%, iberr%, ibcntl&) As Integer
C-format	short WINAPI RSDLLibwrtf(short ud, char far *Wrt, short far *ibsta, short far *iberr, unsigned long far *ibcntl)
C format (Unix)	short RSDLLibwrtf(short ud, char *Wrt, short *ibsta, short *iberr, unsigned long *ibcntl)
Parameters	ud // Device handle file // File the contents of which are sent to the device
Example	RSDLLibwrtf(ud, "C:\db.sav", ibsta, iberr, ibcntl)

This function allows to send setting and query commands to the measuring instruments. Whether the data is interpreted as complete command can be set using the function RSDLLibeot().

RSDLLibrd()

The function reads data from the device with the handle ud into the string Rd.

VB format	Function RSDLLibrd (ByVal ud%, ByVal Rd\$, ibsta%, iberr%, ibcntl&) As Integer
C-format	short WINAPI RSDLLibrd(short ud, char far *Rd, short far *ibsta, short far *iberr, unsigned long far *ibcntl)

C format (Unix)	<code>short RSDLLibrd(short ud, char *Rd, short *ibsta, short *iberr, unsigned long *ibcntl)</code>
Parameters	<code>ud</code> // Device handle <code>Rd</code> // String into which the read data is copied
Example	<code>RSDLLibrd (ud, Rd, ibsta, iberr, ibcntl)</code>

This function fetches the responses of the GPIB parser to a query.

In the case of Visual Basic programming, a string of sufficient length must be generated before. This can be done during the definition of the string or using the command `Space$()`.

Generation of a string of the length 100:

```
- Dim Rd as String * 100
- Dim Rd as String
Rd = Space$(100)
```

RSDLLlird

This function reads `Cnt` bytes from the device with the handle `ud`.

VB format	Function <code>RSDLLlird (ByVal ud%, ByVal Rd\$, ByVal Cnt&, ibsta%, iberr%, ibcntl&) As Integer</code>
C-format	<code>short WINAPI RSDLLlird(short ud, char far *Rd, unsigned long Cnt, short far *ibsta, short far *iberr, unsigned long far *ibcntl)</code>
C format (Unix)	<code>short RSDLLlird(short ud, char *Rd, unsigned long Cnt, short *ibsta, short *iberr, unsigned long *ibcntl)</code>
Parameters	<code>ud</code> // Device handle <code>cnt</code> // Maximum number of bytes copied from the DLL into the target // string <code>Rd</code> .
Example	<code>RSDLLlird (ud, RD, 100, ibsta, iberr, ibcntl)</code>

Like the function `RSDLLibrd()`, this function reads data from a device. The only difference is that in this case the maximum number of bytes to be copied into the target string `Rd` can be indicated by means of `Cnt`. This function prevents writing beyond the end of the string.

RSDLLibrdf()

Reads data from the device with the handle `ud` into the file `file`.

VB format	Function <code>RSDLLibrdf (ByVal ud%, ByVal file\$, ibsta%, iberr%, ibcntl&) As Integer</code>
C-format	<code>short WINAPI RSDLLibrdf(short ud, char far *file, short far *ibsta, short far *iberr, unsigned long far *ibcntl)</code>

C format (Unix)	<code>short RSDLLibrd(short ud, char *file, short *ibsta, short *iberr, unsigned long *ibcntl)</code>
Parameters	<code>ud</code> // Device handle <code>file</code> // File into which the read data is written
Example	<code>RSDLLibrdf (ud, "c:\db.sav", ibsta, iberr, ibcntl)</code>

The file name may as well include a drive or path specification.

RSDLLibtmo

This function defines the timeout for a device. The default value for the timeout is set to 5 seconds.

VB format	Function <code>RSDLLibtmo (ByVal ud%, ByVal tmo%, ibsta%, iberr%, ibcntl&)</code> As Integer
C-format	<code>short WINAPI RSDLLibtmo(short ud, short tmo, short far *ibsta, short far *iberr, unsigned long far *ibcntl)</code>
C format (Unix)	<code>short RSDLLibtmo(short ud, short tmo, short *ibsta, short *iberr, unsigned long *ibcntl)</code>
Parameters	<code>ud</code> // Device handle <code>tmo</code> // Timeout in seconds
Example	<code>RSDLLibtmo (ud, 10, ibsta, iberr, ibcntl)</code>

RSDLLibsre

This function sets the device to the 'LOCAL' or 'REMOTE' state.

VB format	Function <code>RSDLLibsre (ByVal ud%, ByVal v%, ibsta%, iberr%, ibcntl&)</code> As Integer
C-format	<code>short WINAPI RSDLLibsre(short ud, short v, short far *ibsta, short far *iberr, unsigned long far *ibcntl)</code>
C format (Unix)	<code>short RSDLLibsre(short ud, short v, short *ibsta, short *iberr, unsigned long *ibcntl)</code>
Parameters	<code>ud</code> // Device handle <code>v</code> // State of device (0 - local or 1 - remote)
Example	<code>RSDLLibsre (ud, 0, ibsta, iberr, ibcntl)</code>

RSDLLibloc

This function temporarily switches the device to the 'LOCAL' state.

VB format	Function RSDLLibloc (ByVal ud%, ibsta%, iberr%, ibcntl&) As Integer
C-format	short WINAPI RSDLLibloc(short ud, short far *ibsta, short far *iberr, unsigned long far *ibcntl)
C format (Unix)	short RSDLLibloc(short ud, short *ibsta, short *iberr, unsigned long *ibcntl)
Parameter	ud // Device handle
Example	RSDLLibloc (ud, ibsta, iberr, ibcntl)

After switchover to LOCAL state, the instrument can be manually operated via the GUI. On the next access to the instrument by means of one of the functions of the library the instrument is switched again to the REMOTE state.

RSDLLibeot

This function enables or disables the END message after write operations.

VB format	Function RSDLLibeot (ByVal ud%, ByVal v%, ibsta%, iberr%, ibcntl&) As Integer
C-format	short WINAPI RSDLLibsre(short ud, short v, short far *ibsta, short far *iberr, unsigned long far *ibcntl)
C format (Unix)	short RSDLLibsre(short ud, short v, short *ibsta, short *iberr, unsigned long *ibcntl)
Parameters	ud // Device handle v // State of END message (0 - no END message or 1 - send END message)
Example	RSDLLibeot (ud, 1, ibsta, iberr, ibcntl)

If the END message is disabled, the data of a command can be sent with several successive calls of write functions. The END message must be enabled again before sending the last data block.

RSDLLibrsp

This function performs a serial poll and provides the status byte of the device.

VB format	Function RSDLLibrsp(ByVal ud%, spr%, ibsta%, iberr%, ibcntl&) As Integer
C-format	short WINAPI RSDLLibrsp(short ud, char far* spr, short far *ibsta, short far *iberr, unsigned long far *ibcntl)

C format (Unix)	<code>short RSDLLibrsp(short ud, char *spr, short *ibsta, short *iberr, unsigned long *ibcntl)</code>
Parameters	<code>ud // Device handle</code> <code>spr // Pointer to status byte</code>
Example	<code>RSDLLibrsp(ud, spr, ibsta, iberr, ibcntl)</code>

RSDLLibclr

Sends the command SDC (Device Clear) to the instrument.

VB format	Function <code>RSDLLibclr(ByVal ud%, spr%, ibsta%, iberr%, ibcntl%) As Integer</code>
C-format	<code>short WINAPI RSDLLibclr(short ud, short far *ibsta, short far *iberr, unsigned long far *ibcntl)</code>
C format (Unix)	<code>short RSDLLibclr(short ud, short *ibsta, short *iberr, unsigned long *ibcntl)</code>
Parameter	<code>ud // Device handle</code>
Example	<code>RSDLLibclr(ud, ibsta, iberr, ibcntl)</code>

RSDLLibonl

This function switches the device to 'online' or 'offline' mode. When it is switched to 'offline' mode, the interface is released and the device handle becomes invalid. By calling `RSDLLibfind` again, the communication is set up again.

VB format	Function <code>RSDLLibonl (ByVal ud%, ByVal v%, ibsta%, iberr%, ibcntl%) As Integer</code>
C-format	<code>short WINAPI RSDLLibonl(short ud, short v, short far *ibsta, short far *iberr, unsigned long far *ibcntl)</code>
C format (Unix)	<code>short RSDLLibonl(short ud, short v, short *ibsta, short *iberr, unsigned long *ibcntl)</code>
Parameters	<code>ud // Device handle</code> <code>v // State of device (0 - local or 1 - remote)</code>
Example	<code>RSDLLibonl(ud, 0, ibsta, iberr, ibcntl)</code>

RSDLLTestSRQ

This function checks the status of the SRQ bit.

VB format	Function RSDLLTestSrq (ByVal ud%, Result%, ibsta%, iberr%, ibcntl&) As Integer
C-format	short WINAPI RSDLLTestSrq(short ud, short far *result, short far *ibsta, short far *iberr, unsigned long far *ibcntl)
C format (Unix)	short RSDLLTestSrq(short ud, short *result, short *ibsta, short *iberr, unsigned long *ibcntl)
Parameters	ud // Device handle result // Reference to an integer value in which the library returns the status of the SRQ bit (0 - no SRQ, or 1 - SRQ active, device requests service)
Example	RSDLLTestSrq (ud, result%, ibsta, iberr, ibcntl)

This function corresponds to the function RSDLLWaitSrq. The only difference is that RSDLLTestSRQ immediately returns the current status of the SRQ bit, whereas RSDLLWaitSrq waits for an SRQ to occur.

RSDLLWaitSrq

This function waits until the device triggers an SRQ with the handle ud.

VB format	Function RSDLLWaitSrq (ByVal ud%, Result%, ibsta%, iberr%, ibcntl&) As Integer
C-format	short WINAPI RSDLLWaitSrq(short ud, short far *result, short far *ibsta, short far *iberr, unsigned long far *ibcntl)
C format (Unix)	short RSDLLWaitSrq(short ud, short *result, short *ibsta, short *iberr, unsigned long *ibcntl)
Parameters	ud // Device handle result // Reference to an integer value in which the library returns the status of the SRQ bit (0 - No SRQ has occurred during the timeout, or 1 - SRQ has occurred during the timeout)
Example	RSDLLWaitSrq(ud, result, ibsta, iberr, ibcntl); The function waits until one of the following two events occurs: <ul style="list-style-type: none"> ▪ The measuring instrument triggers an SRQ ▪ No SRQ occurs during the timeout defined with RSDLLibtm()

RSDLLSwapBytes

This function changes the display of binary numbers on non-Intel platforms.

VB format	Not provided at present since it is required only on non-Intel platforms.
C-format	void WINAPI RSDLLSwapBytes(void far *pArray, const long size, const long count)

C format (Unix)	<code>void RSDLLSwapBytes(void *pArray, const long size, const long count)</code>
Parameters	<code>pArray // Array in which modifications are made</code> <code>size // Size of a single element in pArray</code> <code>count // Number of elements in pArray</code>
Example	<code>RSDLLSwapBytes(Buffer, sizeof(float), ibcntl/sizeof(float))</code>

This function swaps the display of various elements from *Big Endian* to *Little Endian* and vice versa. It is expected that a coherent storage area of elements of the same file type (`size` byte) is transferred to `pArray`. This function has no effect on Intel platforms.

Different types of processor architecture store data in different byte sequences. For example, Intel processors store data in the reverse order of Motorola processors. Comparison of byte sequences:

Byte sequence	Use in	Display in memory	Description
Big Endian	Motorola processors, network standard	Most significant byte at least significant address	The <i>most significant</i> byte is at the left end of the word.
Little Endian	Intel processors	Least significant byte at least significant address	The <i>most significant</i> byte is at the right end of the word.

Table of Contents

10 Error Messages	604
Asynchronous Errors	604
Obtaining Technical Support	605

10 Error Messages

An error generally causes the analyzer to display a tooltip across the lower part of the screen. The tooltip provides a textual description of the error, e. g.:

Remote Error : -222, "Data out of range;FREQ:STAR 1"

The errors can be divided into three categories:

- Remote errors (SCPI errors) may occur during the execution of a remote control program. They include an error code, followed by the short description of the error. Remote errors are specified and described in the SCPI standard; they are cleared upon *CLS.
- Software errors (setting errors) can occur e.g. if numeric entries in an analyzer dialog are incompatible with each other or with the current analyzer state. These errors are generally self-explanatory and easy to correct.
- Hardware errors indicate an incorrect hardware state. Hardware errors with possible causes and remedies are listed below.



Hardware error categories

Hardware errors can be detected at various stages of the start-up or measurement procedure.

- Configuration errors occur on start-up of the analyzer, e.g. if a hardware module or configuration file cannot be detected. Configuration errors cause an entry in the error log (*Info – Error Log*).
- Asynchronous errors can occur any time while the analyzer is operating. The analyzer is checked periodically for asynchronous errors.

Asynchronous Errors

Asynchronous errors can occur any time while the analyzer is operating. The analyzer is checked periodically for asynchronous errors. Many of these errors also cause an entry in the status reporting system.

Error	Description	Remedy	Bit no.*)
Receiver overload	The analyzer detects an excessive input level at one of the ports.	Reduce RF input level at the port. Check amplifiers in the external test setup.	3
IF overload	The level in the IF path (input signal of the analog to digital converter (ADC) is too high.	Reduce RF input level at the port. Check amplifiers in the external test setup.	4
LO unlocked	The internal local oscillator (LO) signal is phase locked to a 10 MHz signal. This message appears when the internal phase locked loop (PLL) fails.	Shut down and restart the analyzer.	5
ExtRef unlock	With external reference signal (<i>SETUP – Reference Ext</i> active) or option FSL-B4 (oven quartz), the reference oscillator is phase locked to a 10 MHz signal. The message appears when this phase locked loop (PLL) fails.	For external reference: check frequency and level of the supplied reference signal.	1
OVCXO oven cold	With option R&S FSL-B4, oven quartz: The oven temperature is too low.	Wait until the oven has been heated up	8

*) The following bits in the `STATUS:QUESTIONABLE:INTEGRITY:HARDWARE` register are set when the error occurs.

The order of the errors in the table above corresponds to their priority: Errors in the upper rows are displayed with higher priority.

Obtaining Technical Support

Our customer support centers are there to assist you in solving any problems that you may encounter with your network analyzer. We will find solutions more quickly and efficiently if you provide us with the information listed below.

- **Setup Info:** The instrument setup information (*Nwa-Setup – Setup Info*) contains your instrument settings. You can also send us the NWA setup file (*.zvx) that you generate after the fault occurs (*File – Save...*).
- If possible, list the operating sequence (after the last preset of the instrument) that caused the fault.

Index

*.msi	38	Close	307
*CLS	344	Command	
2-port	179	common	321, 348
2-port S-parameters	179	device-specific	321
a1	179	structure and syntax	321
a2	179	Command description (notation)	346
AC power	21	CONDition	333
Add Channel	263	Continuous Sweep	251
Add Diag. Area	263	Control bus	588
Add Diag. Area + Trace	263	Control lines (GPIB bus)	588
Add Standard	246	Control menu	307
Administrator rights	39	Coupled Markers	373
Admittance	91	Crosstalk	251
AM/FM/φM Measurement Demodulator	101	Data bus (GPIB)	588
ATN	588	Data entry keys	15
Attention	588	Data entry	52
Automatic calibration	97	Data Flow	
Average Factor	483	S-parameters	64
Average On	251, 483	wave quantities	64
b1	179	Data Flow	64
b2	179	Data processing	64
Bandfilter search	164	Data trace	128
Bandpass Search Ref to Marker	164	Data Valid	588
Bandpass Search Ref to Max	164	DAV	588
Bandstop Search Ref to Marker	164	DCL, SDC	344
Bandstop Search Ref to Max	164	Decouple	263
Bandwidth	216	Deembedding	231
Basic Concepts	61	DEFault	324
Block data format	324	Define Distance-to-Fault	182
Bluetooth Measurements	101	Define Segments	254, 516
Boolean parameter	324	Delete	
Brace	346	Delete Channel	263
Bracket, square	346	Delete Segment	254
Buffered Sweep	578	Delta Mode	373
Cal pool	235	Diagram area	62, 70
Calibration	93	programming examples	561
guided	221	Diagrams	80
kit	94	scaling	54
measurement examples	109	Dialogs (general description)	77
program example	575	Discrete Mode	373
wizard	221	Dispersion	226
Calibration	575	Display	12
Calibration Manager	235	Display Line	353
Calibration standard	94	Distance-to-Fault	100
Calibration types	94	analysis	110
Calibration unit	97	measurement example	110
Cartesian diagrams	192	Distance-to-Fault	182
Center	215, 511	DOWN	324
Channel	62, 214	DVI monitor	32
data flow	64	Embedding	231
menu	214	ENABLE	333
programming examples	561	EOI	588
Sweep	251	Error queue	333
Channel Cal	235	ESE	333
Channel Manager	263	ESR	333
Circuit Model	246	Examples	

Reflection measurement.....	43	K-factor.....	191
Transmission measurement.....	49	LAN, remote control.....	34
Excursion.....	373	Limit line.....	62, 202, 360
External Accessories.....	30	Lin. Frequency.....	106, 528
FILE key.....	279	Linear 2-port.....	191
File Manager.....	285	Local Max.....	373
Firmware update.....	38	Local Min.....	373
Fixed Marker.....	373	Log. Frequency.....	106, 528
Format.....	192, 354	Lower limit.....	202
Frequency.....	108	LXI configuration menu.....	293
Frequency sweep.....	252	Maintenance.....	28
Front panel.....	11	Marker.....	172
Front panel keys.....	50	format.....	373
FSL-B6.....	101	menu.....	172, 373
FSL-B8.....	101	programming examples.....	62
FSL-K14.....	101	properties.....	373
FSL-K30.....	101	switch on.....	373
FSL-K7.....	101	Marker Funct.....	159
FSL-K72.....	102	Mathematical trace.....	128
FSL-K8.....	101	Max Freq.....	246
FSL-K91.....	102	Max Search.....	373
FSL-K93.....	102	Maximize.....	307
Full one-port calibration.....	95	MAXimum.....	324
Gated Sweep.....	101	Meas Delay.....	254
General Setup.....	291	MEAS key.....	179
GPIO Address.....	314	Meas. Bandwidth.....	484
GPIO bus interface.....	588	Meas. Delay.....	528
GPIO Explorer.....	314	Measure S-parameters.....	179
Guided calibration.....	221	Measure.....	179
Handshake bus.....	588	Measurement Mode.....	98
Hardcopy.....	444	Measurement Speed.....	108
Help menu.....	278	Measurement Wizard.....	181
Horizontal Line.....	353	Memory trace.....	128
IEC BUS.....	588	Min Freq.....	246
IEC SYSTEM BUS.....	588	Min Search.....	373
IEC/IEEE Bus Interface.....	588	Minimize.....	307
lecwin32.exe.....	314	MINimum.....	324
IEEE 488.2.....	333	Mode.....	98
IFC.....	588	MODE key.....	306
Impedance.....	90	Modify Standard.....	246
Import/Export Data.....	150	Monitor connection.....	32
Impulse Response.....	182	More Markers.....	373
INFintiy.....	324	Move.....	307
Instrument Messages.....	588	mu1-factor.....	191
Instrument Setup.....	21	mu2-factor.....	191
Instrument-control commands.....	321	NAN (not a number).....	324
Interface Clear.....	588	Navigation.....	285
INV.....	346	Navigation keys.....	14
IP address, assign.....	34	Navigation tools (screen).....	66
IST flag.....	333	NDAC.....	588
Keyboard, on-screen.....	52	Network Address.....	293
Keys.....	11	Network Analyzer.....	306
data entry.....	15	New (setup).....	124
file.....	279	New Channel.....	263
navigation.....	14	Next Channel.....	263
power on/off.....	16	NINF (negative infinity).....	324
print.....	306	No Cal.....	235
rotary knob.....	16	Noise Figure and Gain Measurements.....	101
setup.....	12, 288	Normal.....	179
Keyword (SCPI command).....	321	Normalization.....	95

NRFD	588	Screen saver	12
NT named pipe	314	Search	161, 373
NT pipe A/B	314	Segmented Frequency.....	106, 251, 254
NTR	333	Selectivity (Define Segments).....	254
NTRansition	333	Service	303
Number of Points	251, 258, 528	Service Request Enable	333
Numeric suffix	346	Setup file	38
NWA application	29	SETUP key	288
Nwa-File menu.....	124	Setup keys.....	12
Offset	226	Shut down.....	29
One-path two-port calibration.....	96	Single	259
OPERation register.....	333	Single Sweep.....	251
Options	98	Size (Control menus)	307
ZVL-K2, Distance-to-Fault	140	Socket interface	314
Parameter selection	514	Source Port.....	528
Peak Search	373	Source Power	216, 252
Points	258	Span.....	215, 511
Define Segments	254	S-Parameter Wizard	181
Number	258	S-parameters	
Power on/off key	16	data flow	64
PPE	333	meaning	89, 179
Preset	344	measuring.....	179
PRINT key	305	multiport	179
Program examples.....	575	Spectrogram Measurements.....	101
PTR	333	Spectrum Analysis	100
Query.....	321	Spectrum Analyzer	306
QUEStionable register	333	SRE	333
R&S ZV-Z53	97	SRQ.....	333, 588
Rear panel	19	Stability factors	191
Ref. Position	427	Standby	16
Ref. Value.....	427	Start.....	170, 215, 511
Reference marker	373	Start Cal	219
Reference oscillator.....	515	Startup procedure	29
Reflection measurement example.....	43	Status Byte.....	333
Remote Control		Status Registers	333
basic concepts.....	327	Status reporting system (reset values).....	344
combine with manual control	319	STB	333
Remote Control.....	313	Stimulus.....	202, 215
REN.....	588	Stop.....	170, 215, 511
Replacing fuses	21	String.....	324
Reset Lengths.....	226	Sweep History	578
Reset Values	314	SWEEP key	251
Status Reporting System	344	Sweep Time.....	108, 528
Resolution bandwidth.....	484	Sweep Type.....	252, 514
Response (to queries).....	321	SWR.....	192
Restore	307	Syntax elements (SCPI, overview).....	324
Restrict Port Assignment.....	246	System Configuration.....	276
Ripple test.....	209	System Info.....	302
Rotary knob	16	Target Search.....	373
RPC protocol	591	Target Value	373
RSIB address.....	314	TCP/IP for VXI-11	591
RSIB interface functions.....	593	Text parameter	324
S11/S12/S21/S22	179	Threshold.....	373
Save As	124	Time Domain	140
Scale Div	427	TOSM calibration	96
Scaling diagrams	54	Trace	62
Scc/SCD/Sdc/Sdd/Sds/Ssc/Ssd/Sss	179	data	128
SCPI commands.....	321	data flow	64
SCPI compatibility.....	314	mathematical.....	128
SCPI Status Register	333	memory	128

programming examples	561	WCDMA Measurements	102
Trace Funct	128	WiMAX OFDM/OFDMA Analysis	102
Trace Statistics	136	Windows XP	37
Tracking	164, 373	Wizard	181
Transform	140	WLAN OFDM Analysis.....	102
Transformation Network.....	231	Y-parameter.....	91
Transmission measurement example	49	Y-parameter.....	189
TV Trigger.....	101	Zoom	198
UP	324	Z-parameter.....	90, 189
Upper limit	202	ZVL-K1	100
Upper/lower case.....	346	ZVL-K2	100
Virtual Networks.....	418	ZVL-K2, Distance-to-Fault.....	140
VXI-11 interface	591	ZVR compatibility.....	346