

Keysight Technologies

PNA-X Series

Microwave Network Analyzers

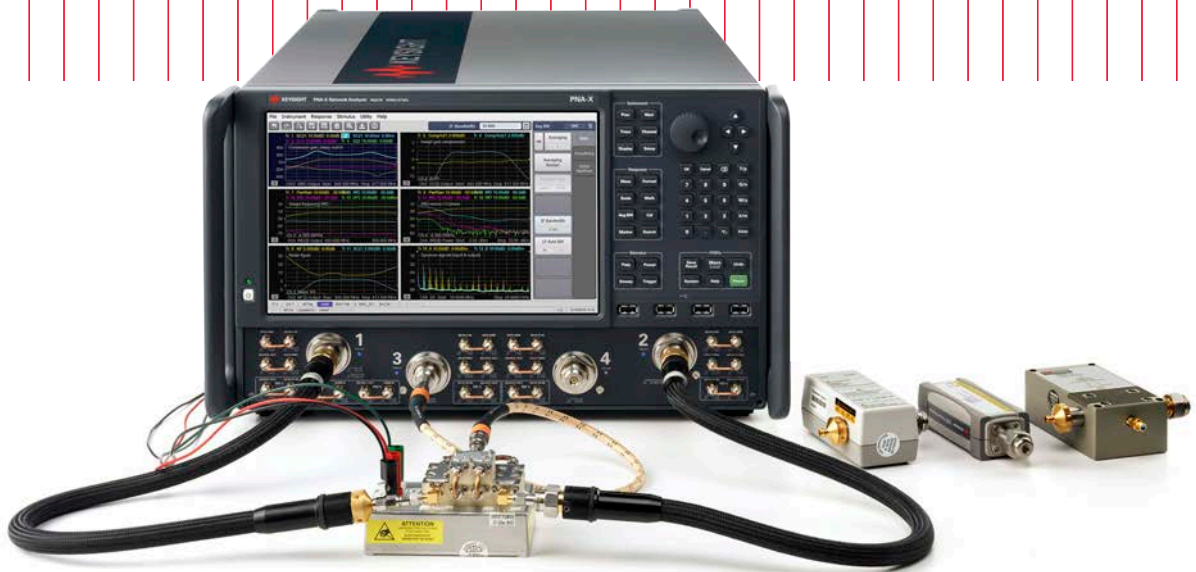

Industry's Most Advanced RF Test Solution

Reach for unrivaled excellence

Choose the leader in network analysis

The PNA-X Series of microwave network analyzers are the culmination of Keysight Technologies, Inc. 40-year legacy of technical leadership and innovation in radio frequency (RF) network analysis. More than just a vector network analyzer, the PNA-X is the world's most integrated and flexible microwave test engine for measuring active devices like amplifiers, mixers, and frequency converters.

The combination of two internal signal sources, a signal combiner, S-parameter and noise receivers, pulse modulators and generators, and a flexible set of switches and RF access points provide a powerful hardware core for a broad range of linear and nonlinear measurements, all with a single set of connections to your device-under-test (DUT).

When you're characterizing active devices, the right mix of speed and performance gives you an edge. In R&D, the PNA family provides a level of measurement integrity that helps you transform deeper understanding into better designs. On the production line, our PNAs deliver the throughput and repeatability you need to transform great designs into competitive products. Every Keysight VNA is the ultimate expression of our expertise in linear and nonlinear device characterization. Choose a PNA --and reach for unrivaled excellence in your measurements and your designs.

World's widest range of measurement applications

PNA-X applications bring speed, accuracy, and ease-of-use to common RF measurements, in coaxial, fixtured, and on-wafer environments. Applications include:

- S-parameters (CW and pulsed)
- Noise figure
- Gain compression
- Intermodulation and harmonic distortion
- Conversion gain/loss
- True-differential stimulus
- Nonlinear waveform and X-parameter* characterization
- Antenna test

Network analysis technology down to the nanoscale

The PNA-X is also compatible with these Keysight measurement solutions:

- **Physical layer test system (PLTS) software** to calibrate, measure, and analyze linear passive interconnects, such as cables, connectors, backplanes, and printed circuit boards.
- **Materials test equipment and accessories** to help determine how your materials interact with electromagnetic fields, by calculating permittivity and permeability.
- **Award-winning scanning microwave microscope** to create a powerful and unique combination for topography measurements of calibrated capacitance and dopant densities at nanoscale dimensions.



All of the PNA-X's powerful measurement applications can be used for on-wafer devices.

The right frequency for your application

N5249B	10 MHz to 8.5 GHz
N5241B	10 MHz to 13.5 GHz
N5242B	10 MHz** to 26.5 GHz
N5244B	10 MHz to 43.5 GHz
N5245B	10 MHz to 50 GHz
N5247B	10 MHz** to 67 GHz
PNA-X with mm-wave modules	10 MHz to 1.5 THz

** Some configuration options allow operation down to 900 Hz

Build your optimal test system by selecting the frequency range for your specific device-test needs without paying for functionality you don't need.

Multiple measurements with a single instrument

Replace racks and stacks

With its highly integrated and versatile hardware and re-configurable measurement paths, the PNA-X replaces racks and stacks of equipment – with a single instrument.

One PNA-X can take the place of the following test gear:

- Network analyzer
- Spectrum analyzer
- Two signal sources
- Noise figure meter/analyzer
- Power meters
- Switch matrix
- Digital voltmeter



Benefits of a PNA-X-based solution

- **Simpler test systems for...**
 - ...lower hardware and software costs
 - ...quicker development time and faster time to manufacturing
 - ...less downtime and lower maintenance costs
 - ...smaller size and lower power consumption
- **Faster test times for...**
 - ...improved throughput
- **Higher accuracy for...**
 - ...better yields and better specifications
- **Flexible hardware for...**
 - ...greater adaptability to future test requirements

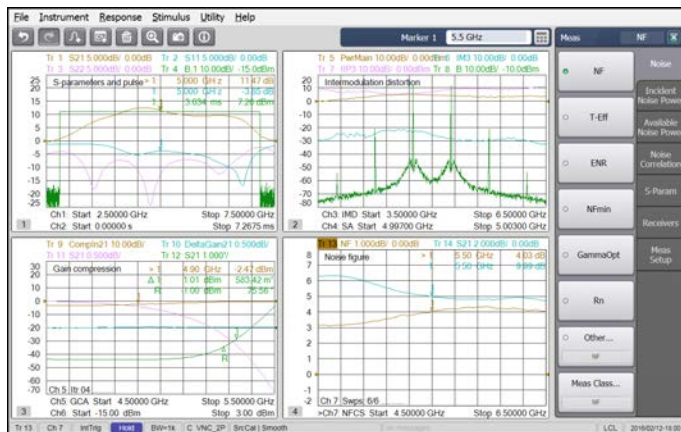

With a single set of connections to an amplifier or frequency converter, the PNA-X can measure CW and pulsed S-parameters, intermodulation distortion, gain and phase compression versus frequency, noise figure, and more.



Bottom Line Results – PNA-X Case Studies

“We selected Keysight’s PNA-X because it eliminated unnecessary cable swaps between measurements and it makes more active measurements than any other network analyzer out there. We used to make S-parameter, vector-signal, and noise-figure measurements with separate test equipment—and now with the PNA-X, we can perform all of our active measurements in one box.”

Test Engineering Manager

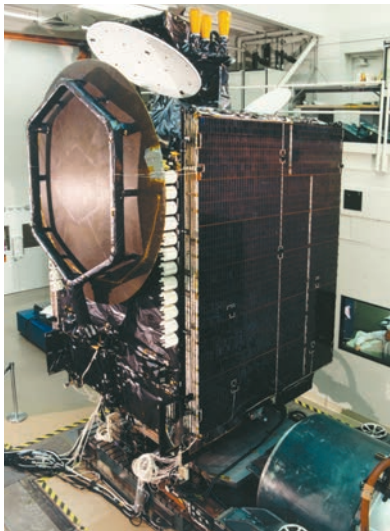

Case Study 1

Aerospace/defense component supplier reduces test time by 95%

Challenges

This customer manufactures over 4600 RF components, with typically 1000 devices in the manufacturing process at any given time. Devices included filters, multipliers, amplifiers, and switches, from 10 MHz to 60 GHz. They needed to simplify the test system for one particular multiport device, so they set out to develop an operator independent automated test system (ATS). Key challenges included:

- Complicated and expensive test systems with multiple racks of equipment and miles of test cables
- Multiple cable swaps and recalibrations required with extensive operator intervention and downtime
- Significant retesting of devices and high system downtime

Results

The PNA-X’s ability to incorporate more active measurements into a single instrument than any other product on the market provided:

- **Faster test times:** Reduced test times from four hours per temperature to 24 minutes when compared to the prior ATS, resulting in a test-time reduction of 95%
- **Reduced equipment count:** Replaced nine racks of equipment with three, 12-port PNA-X network analyzers
- **Increased operator productivity:** Enabled operators to monitor four test stations simultaneously and eliminated the need for single-operator test stations
- **Reduced re-testing and cable swaps**

Case Study 2

Satellite designer and manufacturer reduces test time from three hours to three minutes

Challenges

This aerospace company was conducting a specific panel-level test and wanted to modernize its test systems and improve its test productivity and throughput. Its legacy satellite payload test systems utilized a large amount of rack and stack equipment accompanied by a big test overhead. The company was required to exert a great deal of time and effort to program and maintain the test systems.

Results

Initially the aerospace company purchased four PNA-Xs (26.5 and 50 GHz models). They were so impressed with the throughput and test productivity results, that they purchased eight more analyzers. In one test case, the level of improvement exceeded expectations—taking a 20-minute gain-transfer test to just under a minute. Replacing their test system with the PNA-X effectively modernized and simplified their test system which enabled:

- **Faster test times:** Complete test suite cut measurement times from three hours to three minutes
- **Reduced equipment count:** Replaced a two-rack payload test system with a single four-port PNA-X
- **Smaller test system:** Reduced the amount of equipment space and power consumption

Case Study 3

Wireless networking systems manufacturer reduces throughput from 30 to 10 minutes

Challenges

The manufacturer was developing a new broadband wireless network system and needed a faster test system. Its existing test system consisted of two sources, a spectrum analyzer, and power meters. Using this system, they estimated their new product would take 30 minutes to test; however their speed goal was 15 minutes. In addition to needing a faster test solution, the company also needed better noise figure and distortion measurements, and it required single-connection measurements on both up and down converters.

Results

Replacing their existing multi-instrument test system with a single four-port 50 GHz PNA-X enabled the company to realize:

- **Faster test times:** Complete test suite cut test throughput from an estimated 30 minutes to under ten minutes
- **Less downtime and reduced maintenance costs:** Reducing the equipment count reduced the setup time, as well as the headaches associated with multiple equipment faults, and resulted in lowered annual calibration costs
- **Cost savings on equipment:** The cost of a four-port PNA-X was substantially less expensive than the legacy multi-instrument test system.

Case Study 4

Global security company speeds test and improves measurement accuracy

Challenges

The company needed to upgrade its legacy test systems, which consisted of large switch matrices with network analyzers. They required technicians to keep connecting and disconnecting the device-under-test (DUT) to multiple instruments to make a range of different measurements. This approach was slow, costly, prone to inaccuracy, and required a good deal of user intervention and additional hardware. The company sought a solution that was easy to set up and use, decreased test time and cost, minimized measurement inaccuracy, and offered a smaller footprint

Results

The company decided to purchase PNA-Xs rather than simply upgrade to newer, code-compatible, drop-in instruments offered by the provider of its legacy test equipment. This decision was made despite the fact that it meant significant rewrite of legacy software. The company saved time over their existing test solutions and realized:

- **Easy setup and use:** Technicians were able to easily connect to a DUT and measure all different parameters in one pass—without additional hardware
- **Faster and more accurate tests:** Using just one instrument technicians were able to conduct their required tests in significantly less time and improve accuracy
- **Smaller test system:** A single four-port PNA-X reduced their initial capital expense, equipment count, floor space, and power consumption, which resulted in lower overall test costs

“We chose the PNA-X for its unique single-connection, multiple-measurement capability. The PNA-X is also the only solution we found that can make accurate nonlinear measurements by using its extended NVNA software option. This saves us an amazing amount of design time because it means we can quickly and accurately characterize the nonlinear behavior of our devices even at crazy high power levels.”

Test Engineering Manager

Intuitive, Speed-Driven Features

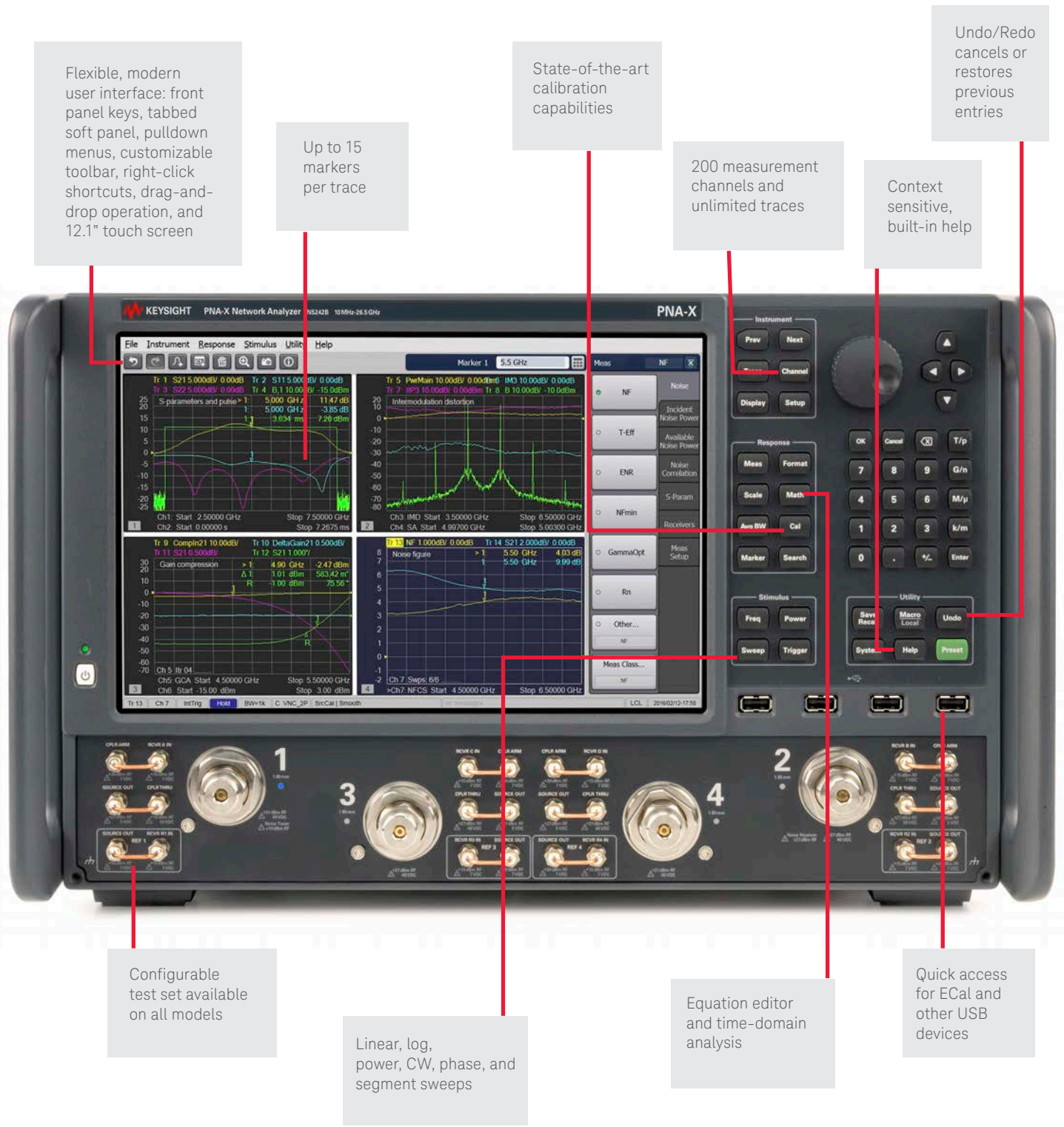

Flexible, modern user interface: front panel keys, tabbed soft panel, pulldown menus, customizable toolbar, right-click shortcuts, drag-and-drop operation, and 12.1" touch screen

Up to 15 markers per trace

State-of-the-art calibration capabilities

200 measurement channels and unlimited traces

Context sensitive, built-in help

Undo/Redo cancels or restores previous entries

Configurable test set available on all models

Linear, log, power, CW, phase, and segment sweeps

Equation editor and time-domain analysis

Quick access for ECal and other USB devices

Hardware for Exceptional Flexibility

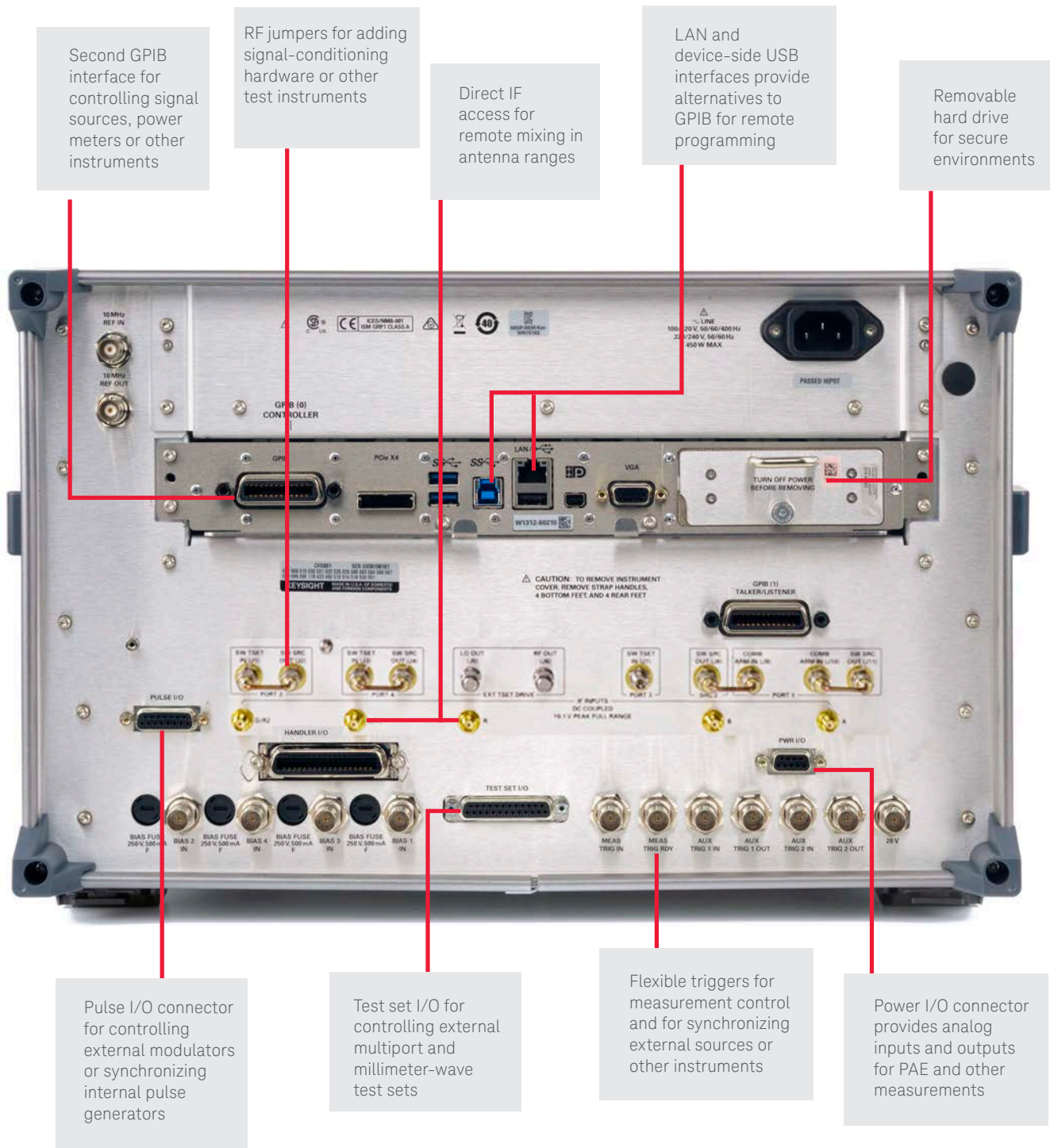

Second GPIB interface for controlling signal sources, power meters or other instruments

RF jumpers for adding signal-conditioning hardware or other test instruments

Direct IF access for remote mixing in antenna ranges

LAN and device-side USB interfaces provide alternatives to GPIB for remote programming

Removable hard drive for secure environments

Pulse I/O connector for controlling external modulators or synchronizing internal pulse generators

Test set I/O for controlling external multiport and millimeter-wave test sets

Flexible triggers for measurement control and for synchronizing external sources or other instruments

Power I/O connector provides analog inputs and outputs for PAE and other measurements

Flexible Architecture

1. Each test port includes test and reference couplers and receivers, source and receiver attenuators, and a bias tee, for maximum accuracy and flexibility.
2. The built-in signal combiner greatly simplifies the setup for intermodulation distortion and X-parameter measurements.
3. Internal pulse modulators enable integrated pulsed-RF testing over the full frequency range of the instrument, eliminating expensive and bulky external modulators.

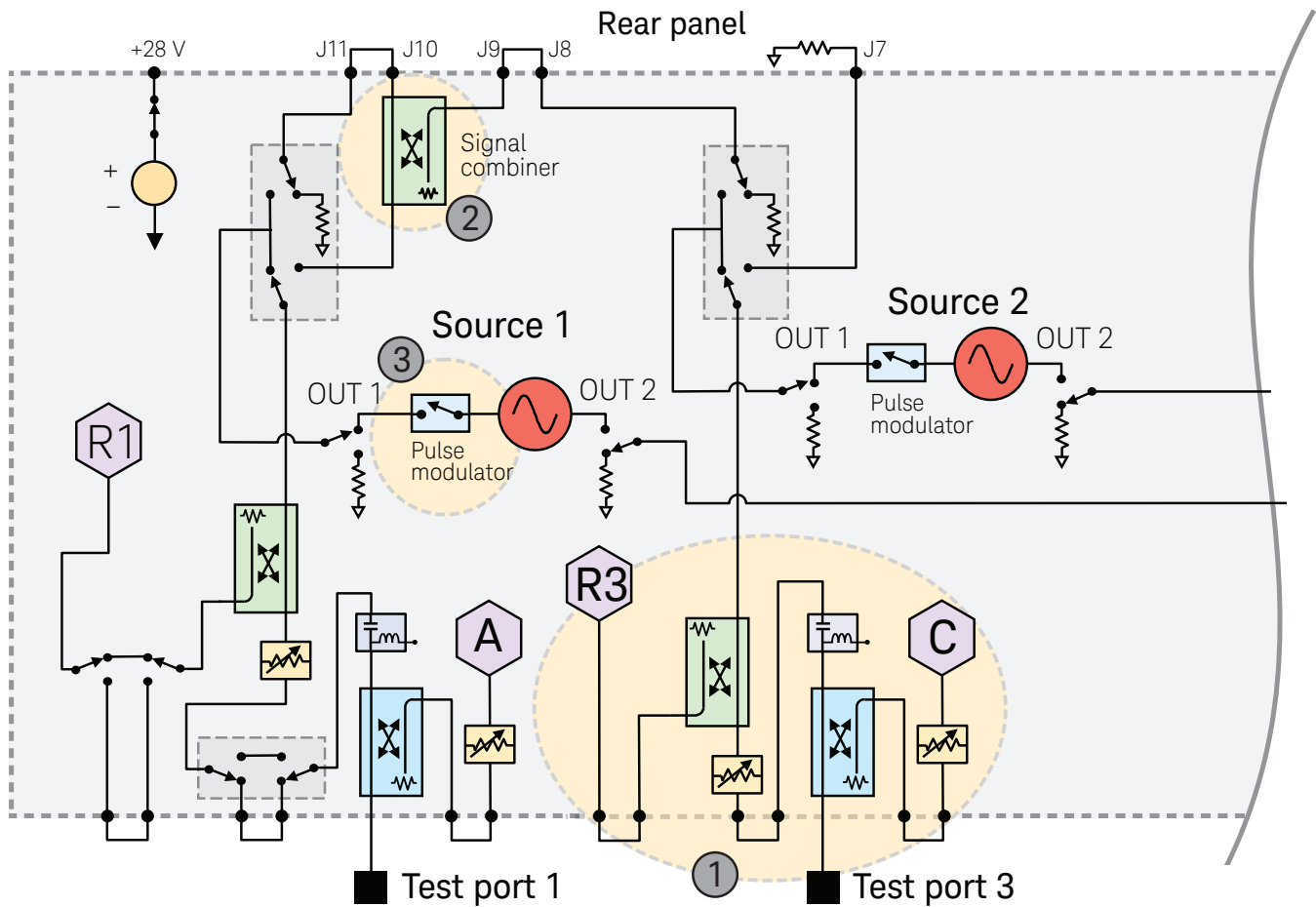

4. Switchable rear-panel jumpers provide the flexibility to add signal-conditioning hardware or route additional test equipment to the DUT without moving test cables.
5. Setting up pulse timing for the pulse modulators and internal IF gates is easy using the built-in pulse generators.
6. Internal low-noise receivers, along with advanced calibration and measurement algorithms, provide the industry's most accurate noise figure measurements.

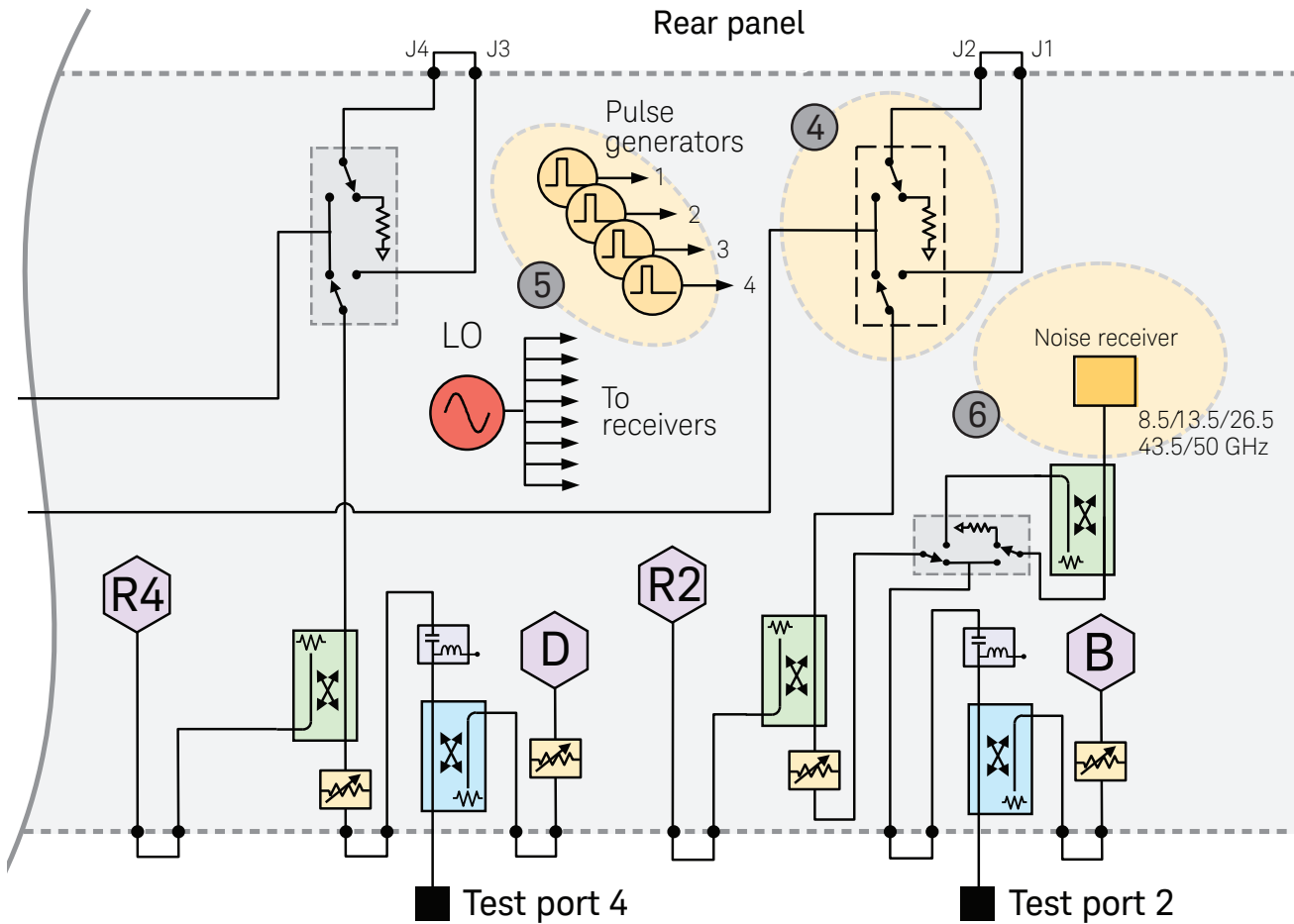

Innovative Applications

Simple, fast and accurate pulsed-RF measurements

(S93025/026A, Options 021, 022)

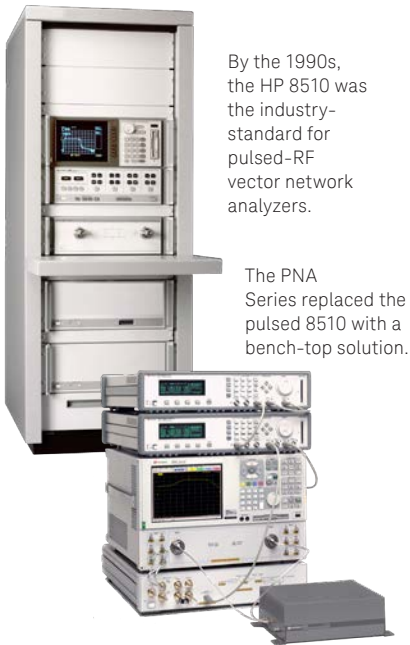

By the 1990s, the HP 8510 was the industry-standard for pulsed-RF vector network analyzers.

The PNA Series replaced the pulsed 8510 with a bench-top solution.

Pulsed-RF measurement challenges

- Pulse generators and modulators required for pulsed-RF measurements add complexity in test setups
- For narrow pulses:
 - Maximum IF bandwidth of analyzer is often too small for wideband detection
 - Narrowband detection is slow, and measurements are noisy for low-duty-cycle pulses

PNA-X pulsed-RF measurements provide:

- S93025A provides a simple user interface for full control of two internal pulse modulators (Options 021 and 022), four internal independent pulse generators, and point-in-pulse measurements with pulse widths as narrow as 200 ns, and pulse-profile measurements with 50 ns minimum resolution
- S93026A adds point-in-pulse measurements with 20 ns minimum pulse width, and pulse profile measurements with 10 ns minimum resolution
- Improved measurement speed and accuracy for narrowband detection using hardware filters and patented spectral-nulling and software IF-gating techniques
- Measurements using wideband detection with pulse widths as narrow as 100 ns
- Pulse I/O connector on rear panel for synchronization with external equipment and DUT
- Accurate active-component characterization using unique application measurement classes for gain compression, swept-frequency/power IMD, and noise figure



Providing the first one-box pulsed-RF test system, the PNA-X sets a new standard for simplicity, speed, and accuracy.

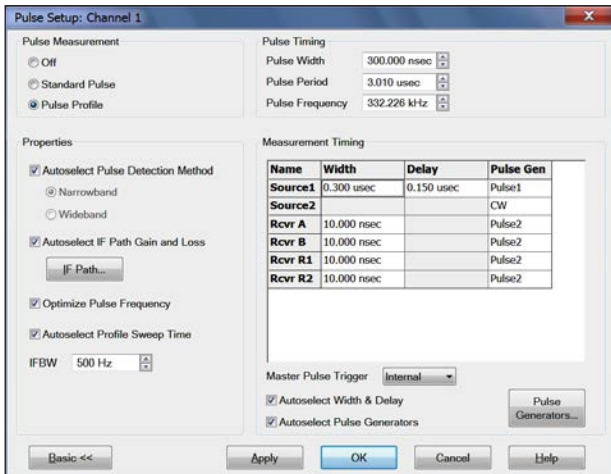

Pulsed-RF measurement application automatically optimizes internal hardware configuration for specified pulse conditions to dramatically simplify test setups. Alternately, users can choose to manually set up the hardware for unique test requirements.

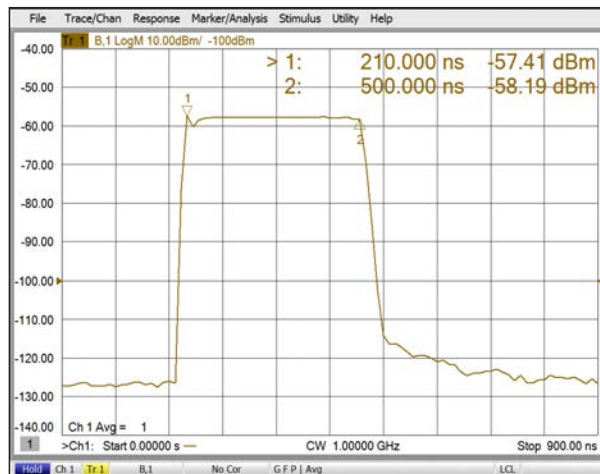

Pulse profile measurement using narrowband detection technique allows 30 measurement points within 300 ns pulse, with 10 ns timing resolution.

Tips from the experts

- Compared to sweep averaging, point averaging typically provides faster results when averaging is needed to lower noise and improve accuracy of measurements using wideband detection.
- During source power calibrations, power sensors read the average power, while the analyzer sets the peak power of the pulsed stimulus. To compensate for the difference between the peak and average power, use the power offset feature with the value of $10 \log(\text{duty cycle})$.
- The minimum pulse width for point-in-pulse measurements using wideband detection is determined by the number

of samples required for the IF bandwidth (IFBW). For example, the minimum pulse width is 100 ns with 15 MHz IFBW, 300 ns with 5 MHz IFBW, and 1.44 μs with 1 MHz IFBW. When working at the minimum pulse width for a particular IFBW, it is important to precisely set the measurement delay (with 10 ns resolution) to align the pulse modulation and the data acquisition period.

- In pulse mode, it is important to use receiver leveling to maintain power-level accuracy for power-dependent measurements, such as output power, compression, and intermodulation distortion.

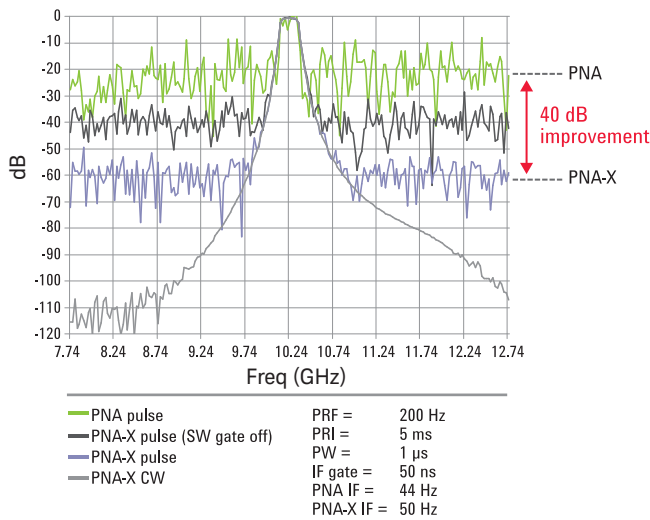

PNA-X's narrowband detection method used for narrow pulse widths (< 267 ns) employs special hardware and patented software-gating techniques to improve system dynamic range for low-duty-cycle measurements by 40 dB compared to PNA-based pulsed-RF systems.

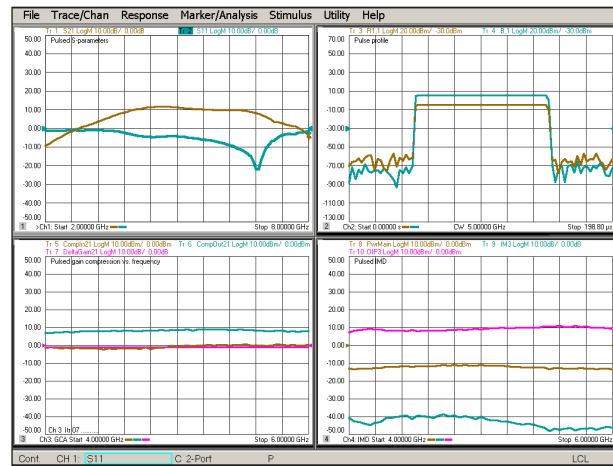

The PNA-X accurately characterizes active devices under pulsed operation with a single set of connections to the DUT—pulsed S-parameters, pulse profile (input and output power in the time domain), gain compression versus frequency, and swept-frequency IMD are measured in this example.

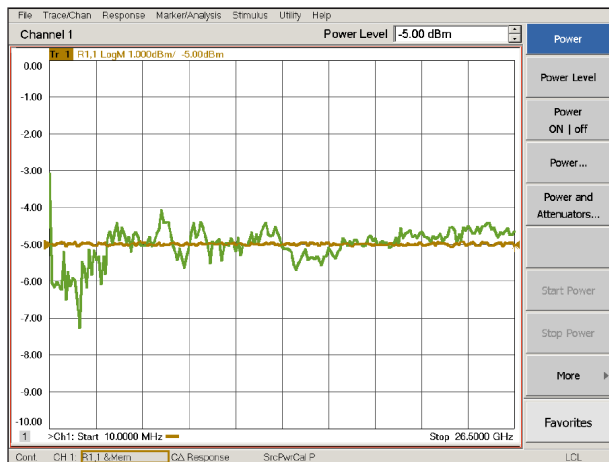

Using receiver leveling improves the pulsed-RF power accuracy from ± 1 dB to less than 0.05 dB.

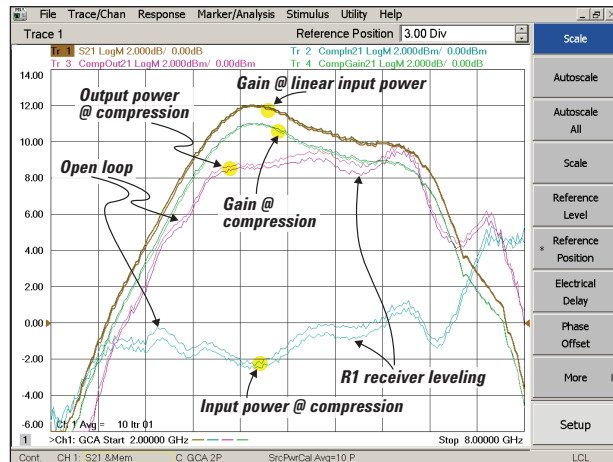

Above measurements compare the results with and without receiver leveling in GCA measurements. Inaccurate stimulus causes large errors in power-dependent measurements such as input and output power at the compression point versus frequency.

Innovative Applications

Fast and accurate noise figure measurements
(S93029A, Option 029)

Noise figure measurement challenges with traditional, Y-factor approach

- Multiple instruments and multiple connections required to fully characterize DUT
- Measurement accuracy degrades in-fixture, on-wafer, and automated-test environments, where noise source cannot be connected directly to DUT
- Measurements are slow, often leading to fewer measured data points and misleading results due to under-sampling



PNA-X noise figure solution provides:

- Amplifier and frequency converter measurements with the highest accuracy in the industry, using advanced error-correction methods
- Fast measurements: typically 4 to 10 times faster than Keysight's NFA Series noise figure analyzers
- Ultra-fast noise-parameter measurements when used with Maury Microwave automated tuners, giving 200 to 300 times speed improvements

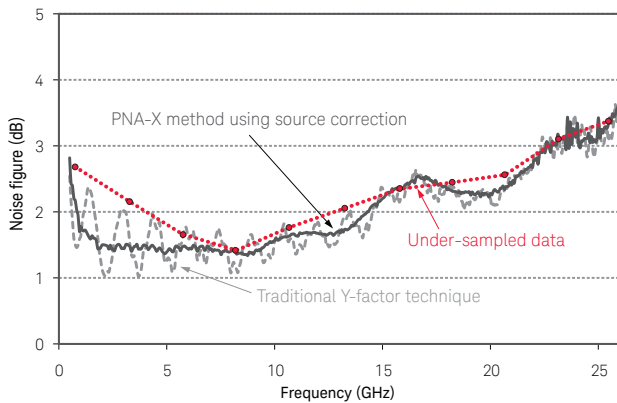

For this 401 point measurement of an unmatched transistor, the PNA-X exhibits much less ripple compared to the Y-factor method. The NFA default of 11 trace points would give under-sampled and therefore misleading results of the amplifier's performance.

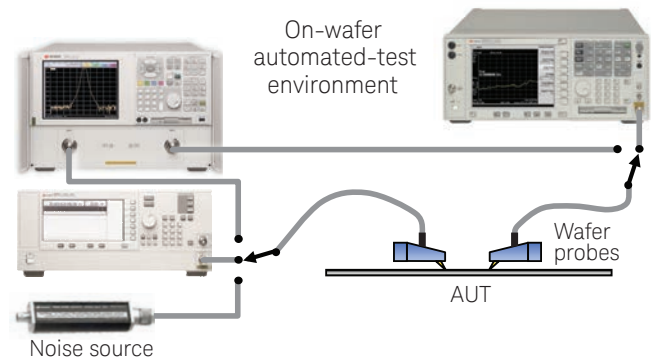

For Y-factor measurements, any electrical network connected between the noise source and the DUT, such as cables, switch matrices, and wafer probes, causes significant accuracy degradation.

"I have several instruments in my equipment pool that can measure noise figure— 8970s, NFAs, and spectrum analyzers. My biggest problem for noise figure measurements was lack of correlation—I'd get different answers depending on which instrument I used. Now, with the PNA-X's high accuracy, I know I'll get the right answer every time, no matter which PNA-X I use."

Test Engineering Manager

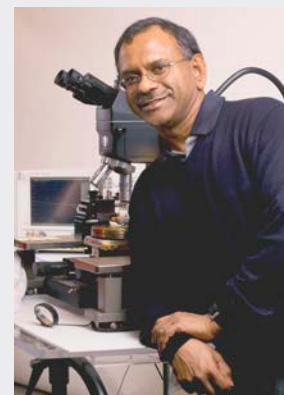

Noise-parameter measurements in minutes rather than days

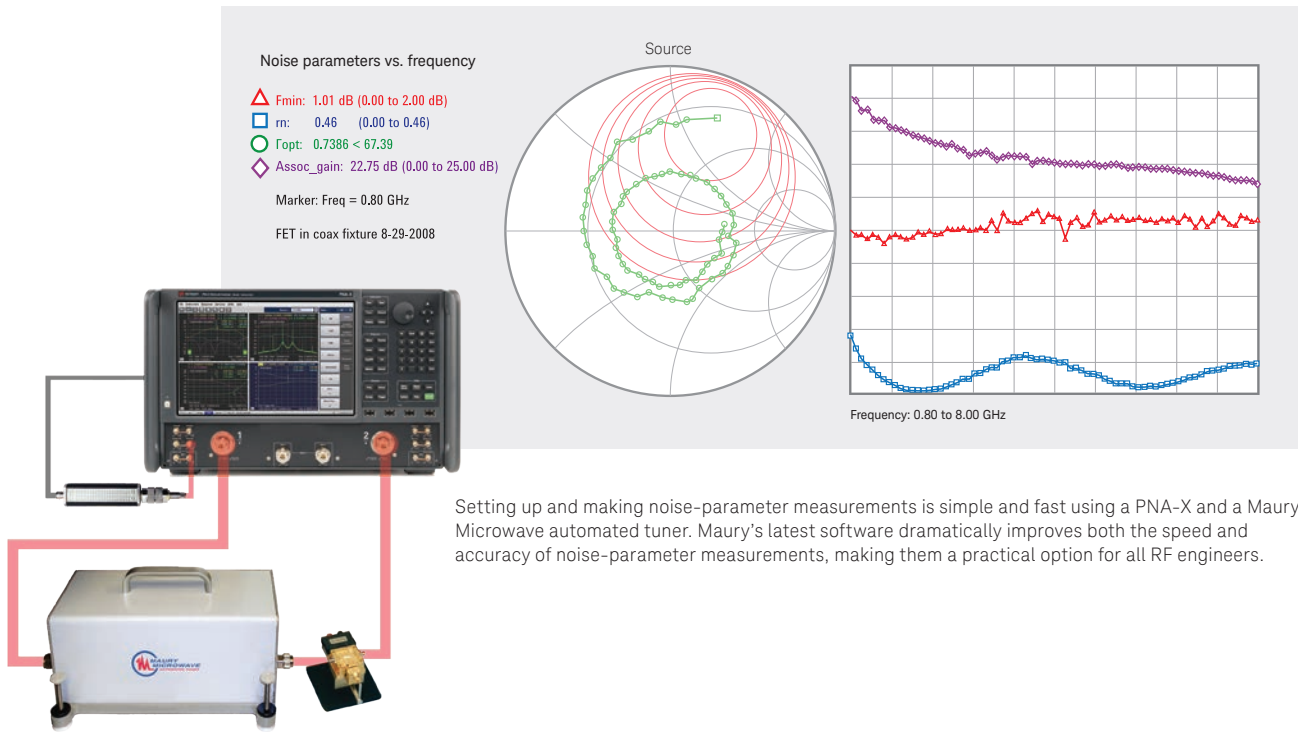

Setting up and making noise-parameter measurements is simple and fast using a PNA-X and a Maury Microwave automated tuner. Maury's latest software dramatically improves both the speed and accuracy of noise-parameter measurements, making them a practical option for all RF engineers.

Noise figure measurement methods

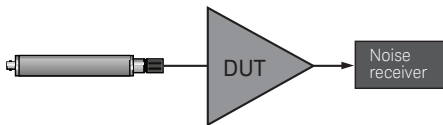

Y-factor: The most prevalent method for measuring noise figure is the Y-factor technique. It relies on a noise source connected to the input of the device under test (DUT). When the noise source is turned off, it presents a room temperature (cold) source termination. When the noise source is turned on, it creates excess noise, equivalent to a hot source termination. Under these two conditions, noise power is measured at the output of the DUT, and the scalar gain and noise figure of the amplifier is calculated. The Y-factor method is used by Keysight's NFA Series and by spectrum analyzers with preamplifiers and a noise figure personality option.

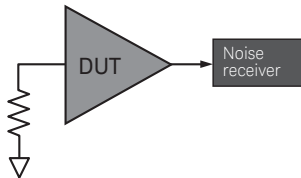

Cold Source: An alternate method for measuring noise figure is the cold source or direct noise technique. With this method, only one noise power measurement is made at the output of the DUT, with the input of the amplifier terminated with a room temperature source impedance. The cold source technique requires an independent measurement of the amplifier's gain. This technique is well suited for vector network analyzers (VNAs) because VNAs can measure gain (S21) extremely accurately by utilizing vector error correction. The other advantage of the cold source method is that both S-parameter and noise figure measurements can be made with a single connection to the DUT.

Innovative Applications

Fast and accurate noise figure measurements (S93029A, Option 029, continued)

PNA-X's unique source-corrected noise figure solution

- Uses modified cold-source method, eliminating need for noise source when measuring DUT
- Corrects for imperfect system source match by using vector correction to remove mismatch errors plus an ECal module used as an impedance tuner to remove noise-parameter-induced errors
- Maintains high measurement accuracy in fixtured, on-wafer, or automated-test environments
- Accurately measures differential devices using vector de-embedding of baluns or hybrids

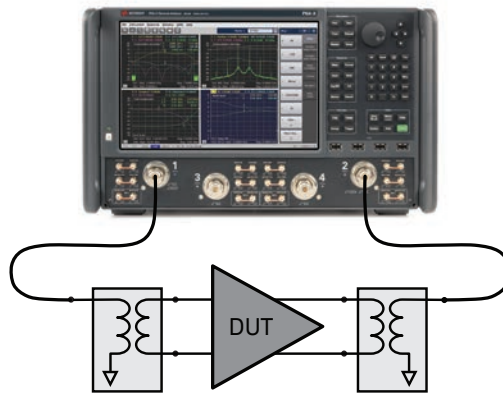

Measure differential devices by de-embedding baluns or hybrids.

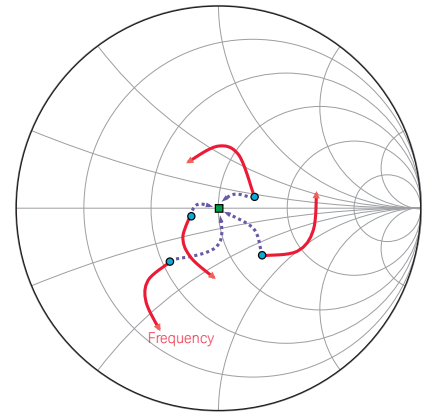

At each test frequency, four or more noise measurements are made with known, non-50-ohm source impedances. From these measurements, 50-ohm noise figure is accurately calculated.

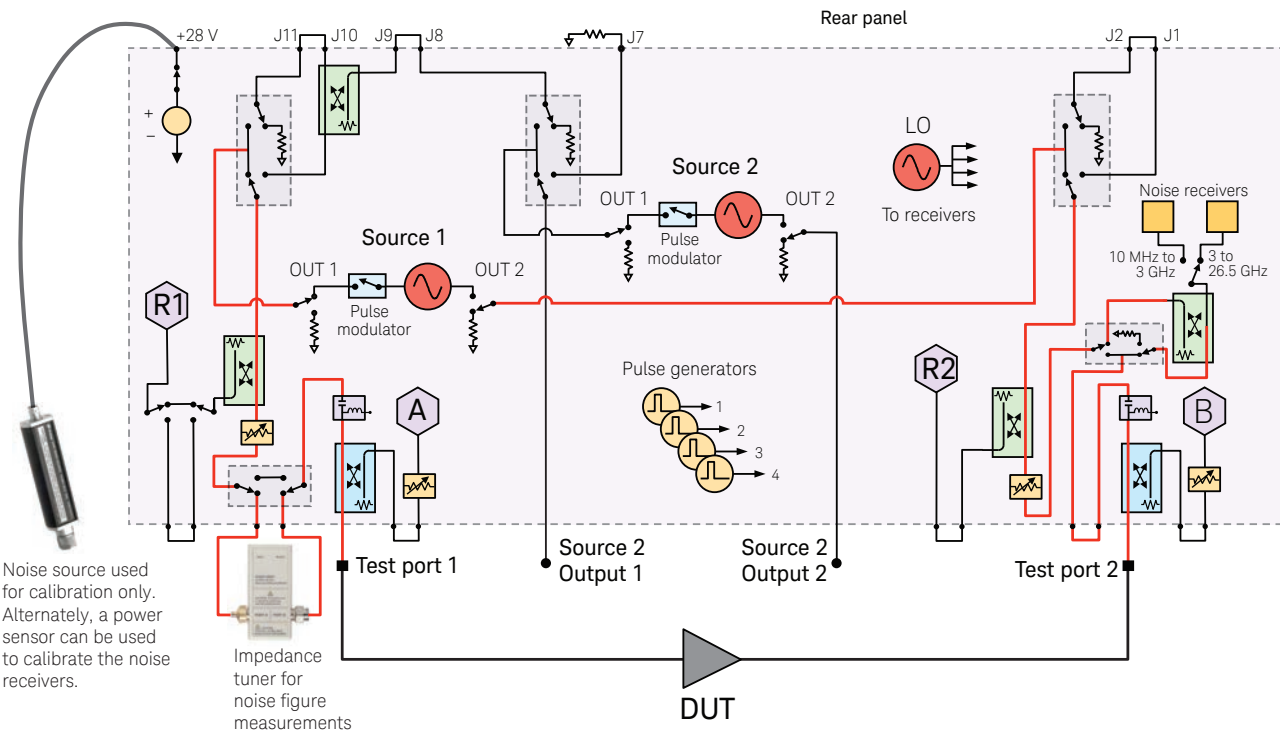

Noise source used for calibration only. Alternately, a power sensor can be used to calibrate the noise receivers.

Impedance tuner for noise figure measurements

Block diagram of a two-port N5242B PNA-X with test set option 224, and low-noise receiver option 029. A standard ECal module is used as an impedance tuner to help remove the effects of imperfect system source match. N5244/45/47B models include a built-in impedance tuner.

Tips from the experts

- Noise figure measurements are best done in a screen room to eliminate spurious interference from mobile phones, wireless LAN, handheld transceivers, etc.
- Batteries are sometimes used instead of mains-based power supplies to eliminate conducted interference from sensitive LNA measurements
- Overall measurement accuracy can be estimated by using Keysight's Monte-Carlo-based noise figure uncertainty calculator

Keysight's PNA-X noise figure uncertainty calculator (www.keysight.com/find/nfcalc) includes the effects of mismatch and noise-parameter-induced errors caused by imperfect system source match.

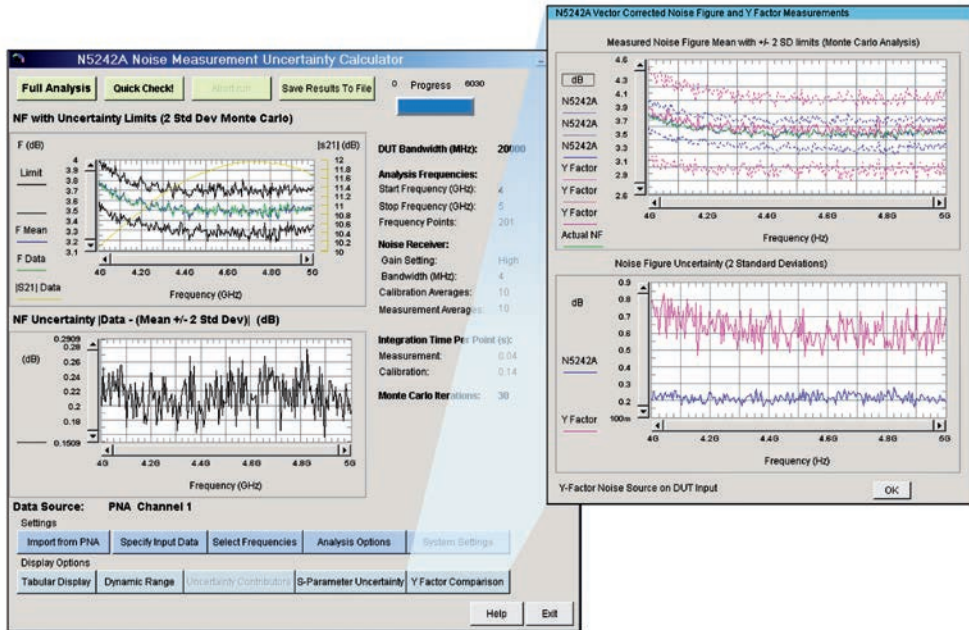

Noise figure measurement uncertainty example in an automated test environment (ATE). The PNA-X's source corrected technique is considerably more accurate than the Y-factor method.

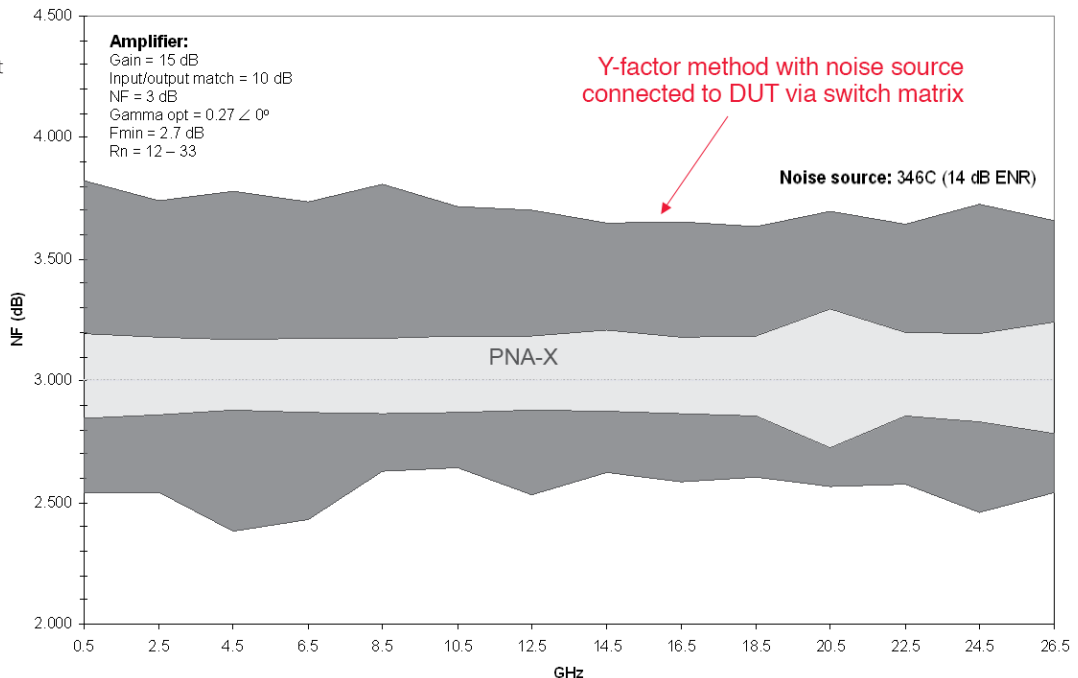

Innovative Applications

Fast and accurate gain compression versus frequency measurements of amplifiers and converters

(S93086A)

Gain compression measurement challenges

- Characterizing amplifier or frequency converter compression over its operating frequency range requires measurements at many frequency and power points, so setting up the measurements, calibration, and data manipulation takes a lot of time and effort
- A variety of errors degrade measurement accuracy, such as mismatch between the test port and the power sensor and DUT during absolute power measurements, and using linear S-parameter error correction in nonlinear compression measurements

PNA-X gain compression application (GCA) provides:

- Fast and convenient measurements with SMART Sweep
- Highly accurate results using a guided calibration that provides power and mismatch correction
- Complete device characterization with two-dimensional (2D) sweeps, with the choice of sweeping power per frequency, or sweeping frequency per power
- Flexibility with a variety of compression methods—compression from linear gain, maximum gain, X/Y compression, compression from back-off, or compression from saturation

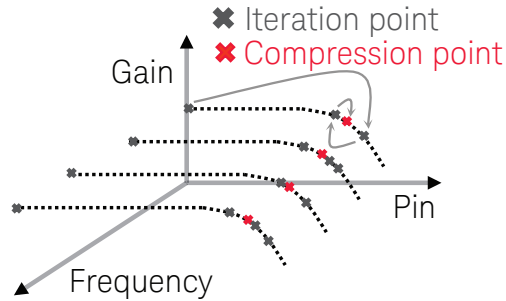
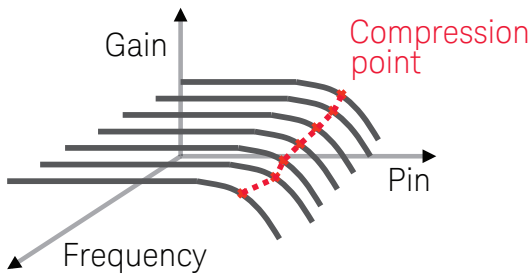

A network analyzer is commonly used for gain compression measurements by performing power sweeps at multiple CW frequencies. The PNA-X's GCA makes it easy to characterize compression over the DUT's operating frequency range with extreme speed and accuracy, and a simple setup.

Instead of a linear power sweep with many points, GCA's SMART Sweep uses an adaptive algorithm to find the desired compression point at each frequency with just a few power measurements, thus significantly reducing test times.

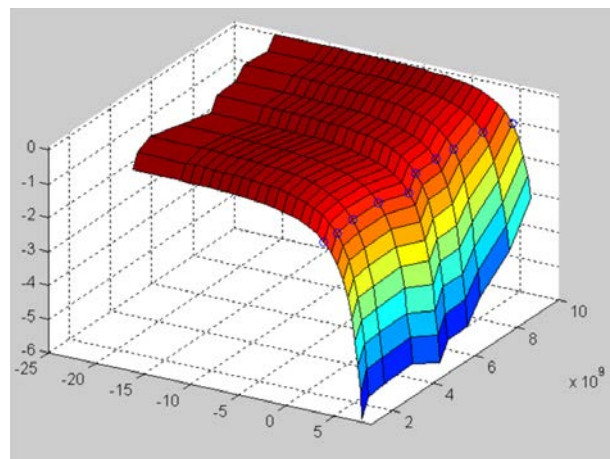
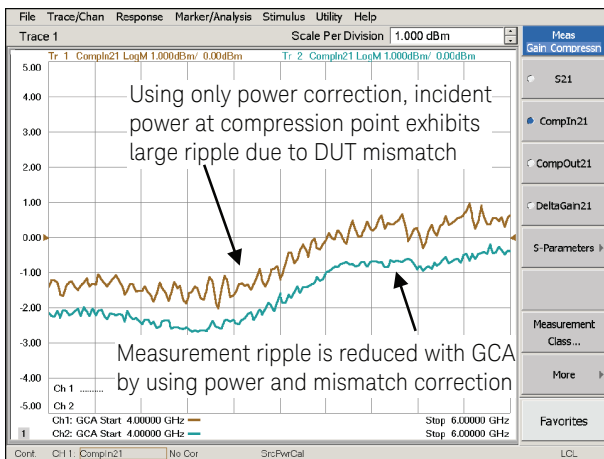

Complete device response to 2D sweeps—gain versus frequency and power—can be extracted for device modeling.

Available compression methods

Compression from linear gain	The linear gain is measured using the specified linear (input) power level. The compression point is calculated as the linear gain minus the specified compression level.	
Compression from max gain	The highest gain value that is found at each frequency is used as the max gain. The compression point is calculated as the max gain minus the specified compression level.	
Compression from back off	The gains at two input powers that are different with the specified back off level are compared. The compression point is found as the highest input power with the gain difference of the specified compression level.	
X/Y compression	The output powers at two input powers that are different with the specified delta X are compared. The compression point is found as the highest input power with the output power difference of the specified delta Y.	
Compression from saturation	The compression point is found at the highest output power minus the value specified as "From Max Pout".	

Tips from the experts

- Use the safe mode in SMART Sweep to increment the input power first with coarse and then with fine steps to prevent over driving the DUT
- When the DUT's hysteresis or thermal effects are in doubt, it is recommended to sweep frequency per power rather than power per frequency, or to add dwell time to lower the effects from previous measurements
- Compression analysis capability extracts the DUT response over the power range at a specified frequency point on any of the compression traces
- Use the CompAI1 and CompAI2 internal voltmeter readings that are synchronized to the compression point to measure power-added efficiency (PAE) at compression for each frequency

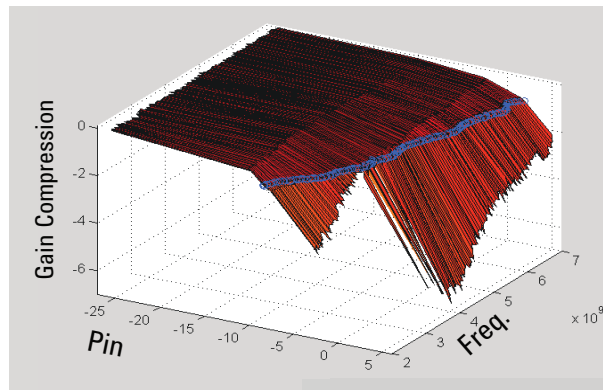

Measured background data in SMART Sweep with Safe Mode Off (above) and On (below)—more iterations are used as the gain becomes closer to the 1 dB compression point with Safe Mode On, which minimizes excess drive power.

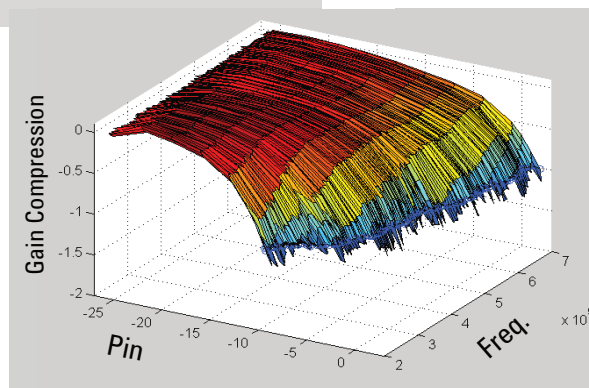

Innovative Applications

Fast two-tone intermodulation distortion (IMD) measurements with simple setup (S93087A)



IMD application measures third order IMD and IP3 at 201 frequency (or power) points in a matter of seconds, compared to several minutes using signal generators and a spectrum analyzer.

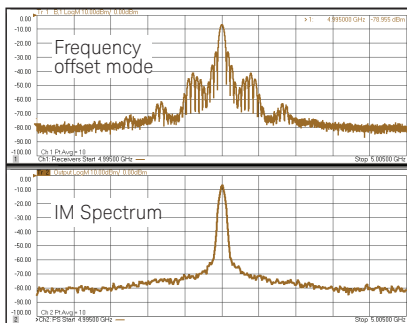

Frequency-offset mode is commonly available in VNA's, but conventional IF filter responses exhibit high side lobes. The IM Spectrum mode employs an optimized digital IF filter and provides true spectrum measurement capability in the PNA-X.

IMD measurement challenges

- Two signal generators, a spectrum analyzer, and an external combiner are most commonly used, requiring manual setup of all instruments and accessories
- Test times are slow when swept-frequency or swept-power IMD is measured
- Instruments and test setups often cause significant measurement errors due to source-generated harmonics, cross-modulation, and phase noise, plus receiver compression and noise floor

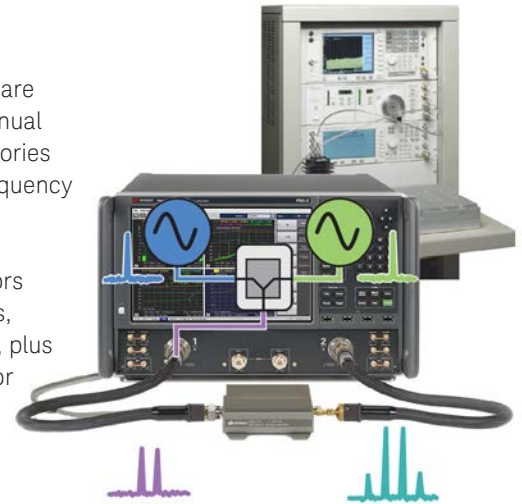

PNA-X with IMD application provides:

- Fast swept IMD measurements of amplifiers and frequency converters, using internal combiner and two internal sources
- Quick and easy measurements with simplified hardware setup and intuitive user interface
- Guided calibration that simplifies the calibration procedure and provides high measurement accuracy
- Spectrum analyzer mode for troubleshooting or making spurious measurements, eliminating the need for a separate spectrum analyzer
- Very clean internal sources and wide receiver dynamic range, minimizing the measurement errors caused by other instruments

The PNA-X with IMD application replaces two signal generators and a spectrum analyzer in the system rack, simplifying the system configuration and increasing test throughput.

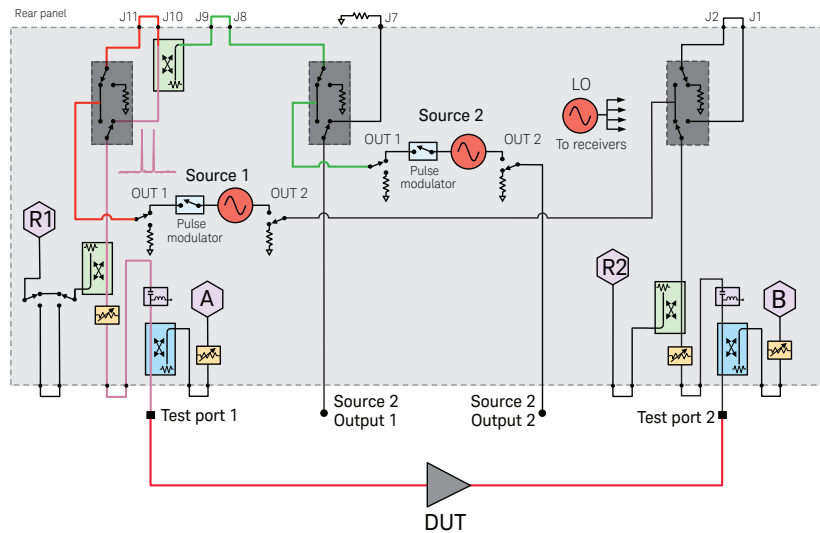

Two internal sources with high output power, wide ALC range, -60 dBc harmonics, and a high-isolation combiner, make the PNA-X an ideal instrument to drive the DUT for two-tone IMD measurements. Wide dynamic-range receivers with high compression points enable accurate measurements of low-power IMD products while the higher power main tones are present.

Swept IMD sweep types

	Sweep fc	Sweep Delta F	Power Sweep	CW	LO Power Sweep	Segments
Center Frequency	Swept	Fixed	Fixed	Fixed	Fixed	Swept (as defined by segment table)
Tone Spacing	Fixed	Swept	Fixed	Fixed	Fixed	Fixed
Tone Powers	Fixed	Fixed	Swept (coupled or uncoupled)	Fixed	Fixed	Fixed
Diagram						

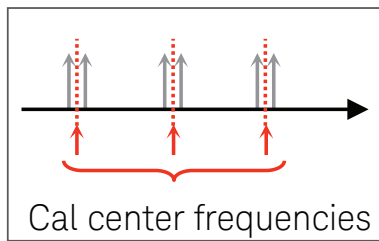
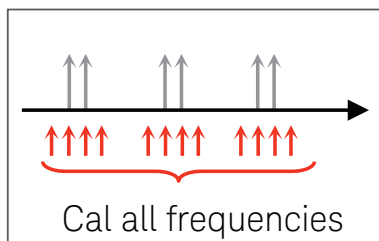

Tips from the experts

- Calibrate at all measurement frequencies or at center frequencies only, trading off productivity and accuracy
- Let the PNA-X control external signal generators to greatly simplify swept IMD measurements of mixers and converters
- Use the Marker to IM Spectrum feature to show the spectrum at a specified point on the swept IMD trace
- Use point averaging with IM Spectrum, especially when using a wide resolution bandwidth, to reduce the noise deviation of the noise floor with minimum speed impact

Calibrating all frequencies is recommended for wide tone spacing. Although the calibration takes longer with "all frequencies", measurement speed is not affected.

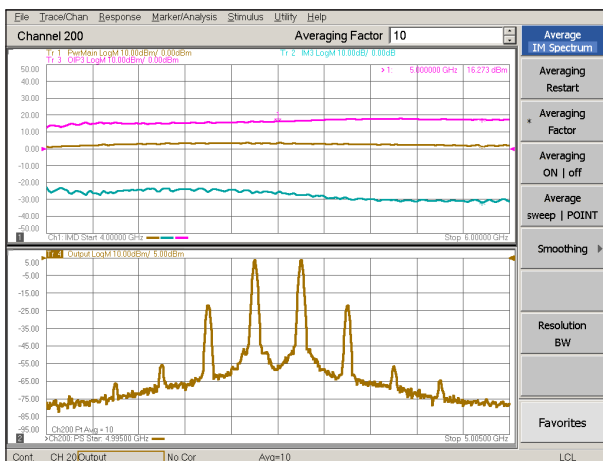

The IM Spectrum in the lower window shows the spectrum corresponding to the Swept IMD marker at the center of the trace in the upper window. Point averaging is applied to the IM Spectrum to reduce the noise deviation.

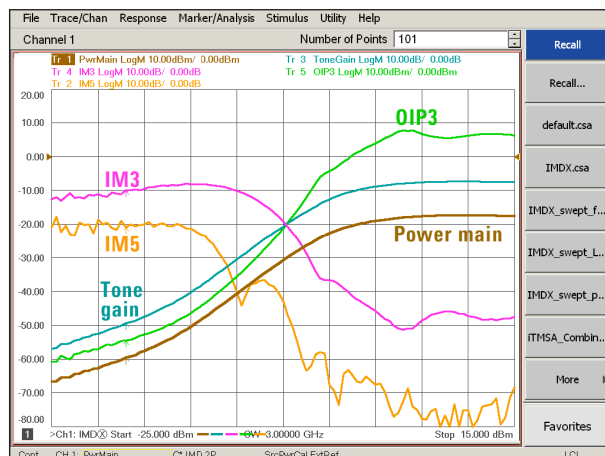

IMD and IP3 versus LO power yields maximum IP3 with lowest possible LO drive power. This helps specify the mixer setup to achieve maximum efficiency while minimizing power consumption.

Innovative Applications

Accurate characterization of mixers and converters

(S93082/083/084A)

Mixer and converter measurement challenges

- Traditional approach with spectrum analyzer and external signal sources is cumbersome, slow, and does not provide phase or group delay information
- Conventional VNAs require an external signal source, which degrades sweep speed
- Conventional VNAs provide phase or group delay data relative to a "golden" device
- Attenuators are often used to minimize ripple due to input and output mismatch, at the expense of dynamic range and calibration stability

SMC+Phase



S93083A's Scalar Mixer/Converter plus Phase (SMC+Phase) makes mixer and converter measurements simple to set up since reference and calibration mixers are not required. Calibration is easy to perform using three broadband standards: a power meter as a magnitude standard, a comb generator as a phase standard, and an S-parameter calibration kit (mechanical or ECal module).

PNA-X frequency converter applications provide:

- Simple setup using internal second signal source as a local oscillator (LO) signal
- Typical measurement time improvement of 100x compared to spectrum analyzer-based approach
- High measurement accuracy using two patented techniques:
 - Scalar Mixer/Converter (SMC) provides match and most accurate conversion loss/gain measurements by combining two-port and power-meter calibrations (S93082A), and with (S93083A), calibrated absolute group delay measurements without a reference or calibration mixer
 - Vector Mixer/Converter (VMC) provides measurements of match, conversion loss/gain, delay, phase difference between multiple paths or devices, and phase shifts within a device, using a vector-calibrated through mixer (S93083A)
- Input and output mismatch correction reduces ripple and eliminates the need for attenuators
- Embedded-LO feature (S93084A) extends SMC and VMC measurements to converters with embedded LOs without access to internal time bases

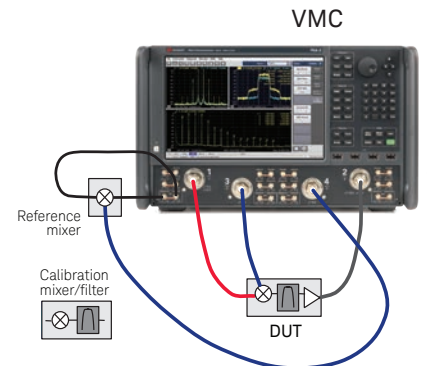

The Vector Mixer/Converter technique provides measurements of match, conversion loss/gain, delay, phase difference between multiple paths or devices, and phase shifts within a device.

Calibration mixer/filter pair

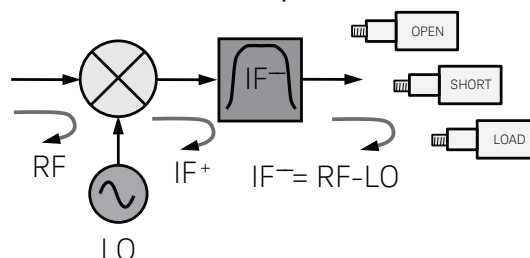

Keysight's patented Vector Mixer/Converter calibration method uses open, short, and load standards to create a characterized-mixer through standard.

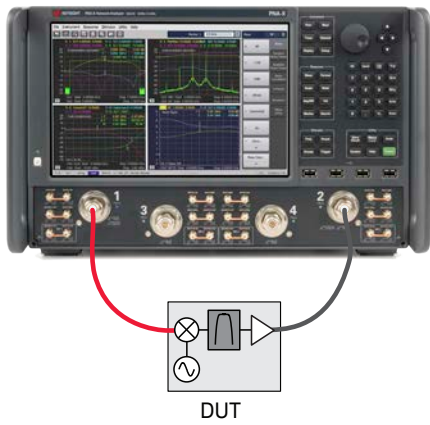

Both SMC and VMC can be used to measure converters with embedded LOs, without need for access to internal time bases.

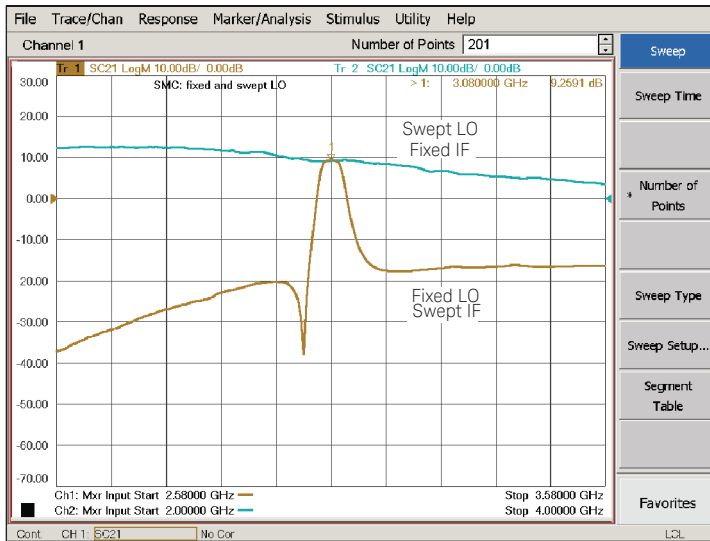

With two internal signal sources, the PNA-X provides fast measurements of both fixed and swept IF responses.

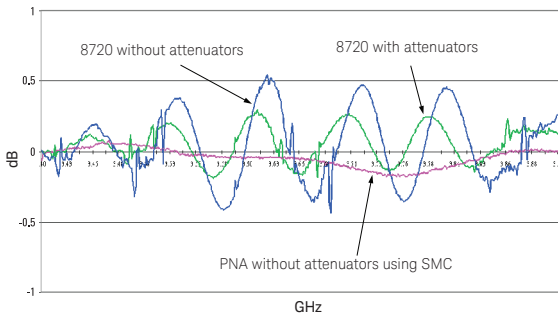

SMC's match correction greatly reduces mismatch errors in conversion loss/gain measurements, eliminating the need for attenuators at the ends of the test cables.

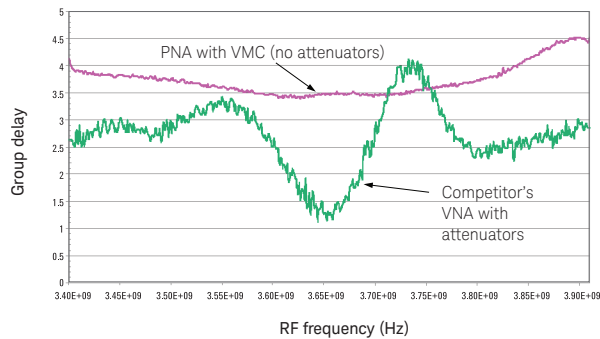

VMC's match correction greatly reduces mismatch errors in group delay measurements, eliminating the need for attenuators at the ends of the test cables.

Tips from the experts

- Narrowing the IF bandwidth helps eliminate spikes on the measurement trace that result from LO feed through and other spurious signals from the DUT
- To prevent source-unleveled errors when measuring devices with high-level spurious outputs (such as unfiltered mixers), it is often helpful to increase the amount of source attenuation to provide better isolation between the DUT and the PNA-X
- When making VMC measurements on multistage converters, it is best to create a single "meta-LO" signal that can be used to drive the reference and calibration mixers
- When measuring unfiltered mixers, time-domain gating can be a useful tool to reduce ripple by removing undesired, time-delayed responses due to spurious signals

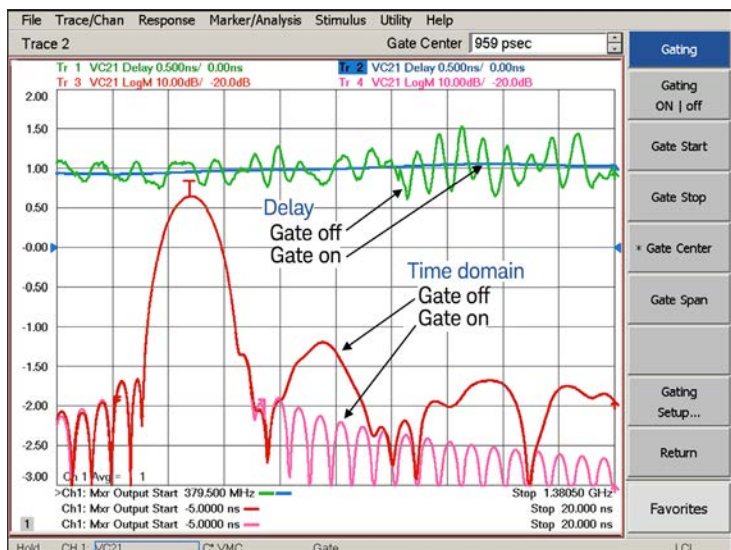

Time-domain gating can remove ripple by removing unwanted, time-delayed responses due to spurious signals.

Innovative Applications

Fast multi-channel spectrum analyzer for component characterization

(S93090x/093/094A)

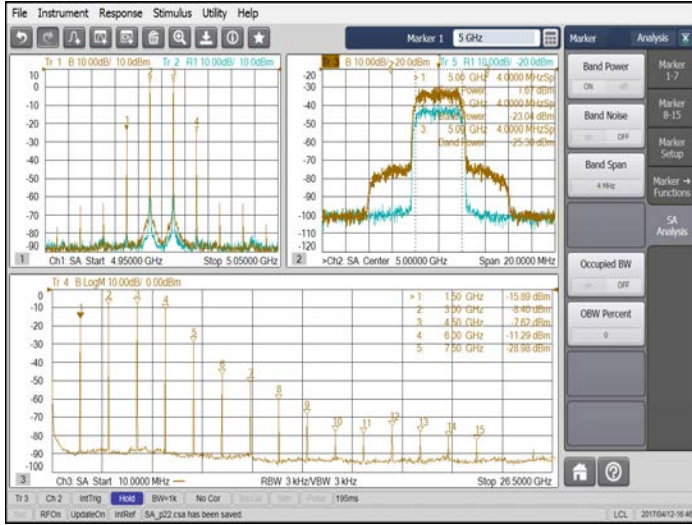

Spectrum analyzer option adds fast spur search capability to the PNA-X, replacing a standalone spectrum analyzer and switch matrix in component-characterization test systems.

Spectrum analysis challenges for component testing

- Measuring spurious performance is time consuming, especially when searching for low-level spurs over a broad frequency range
- Long measurement times may force insufficient test coverage
- Characterizing spurs over operating range of the DUT is tedious to accomplish or requires external control software

PNA-X spectrum analyzer (SA) application provides:

- Fast spurious searches over broad frequency ranges
- A multi-channel SA with internal swept-signal generators for efficient spurious analysis of mixers and converters
- In-fixture spectrum measurements using VNA calibration and de-embedding techniques
- Fast band- and noise-power measurements
- SA capability to the PNA-X's single-connection, multiple-measurement suite

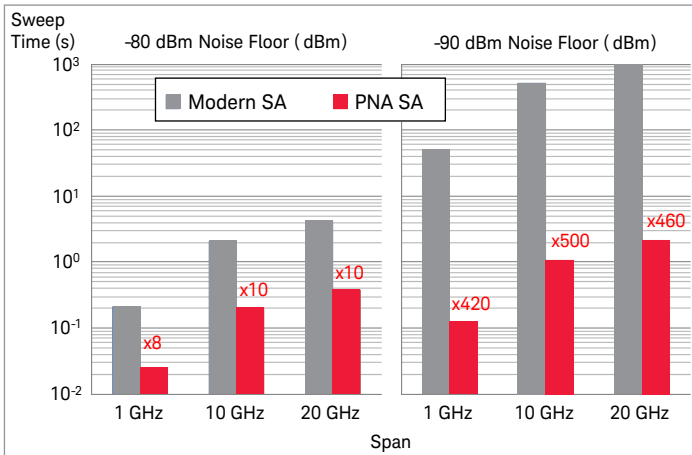

Sweep time versus span with 12 GHz center frequency for -80 dBm and -90 dBm noise floor. The receiver attenuator is set to avoid compression with a +10 dBm signal.

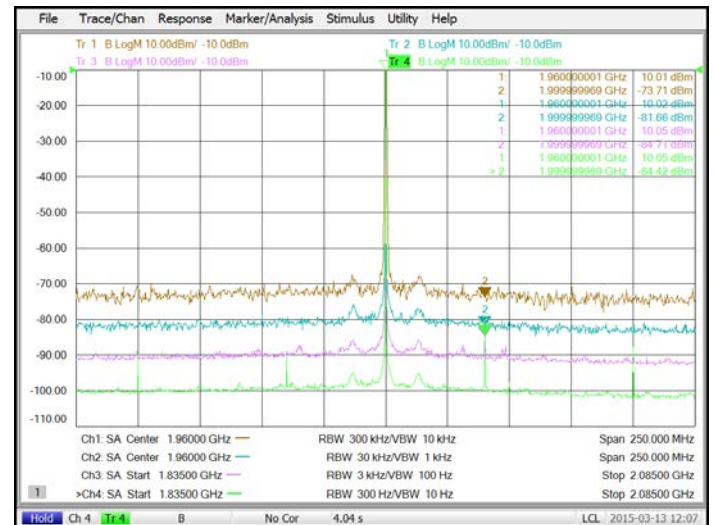

Above plot shows -84 dBm spurious measurements in the presence of a +10 dBm signal, with (from top to bottom) approximate S/N (at RBW) of 80 dB (300 kHz), 90 dB (30 kHz), 100 dB (3 kHz), and 110 dB (300 Hz)

Providing multi-channel spectrum analysis

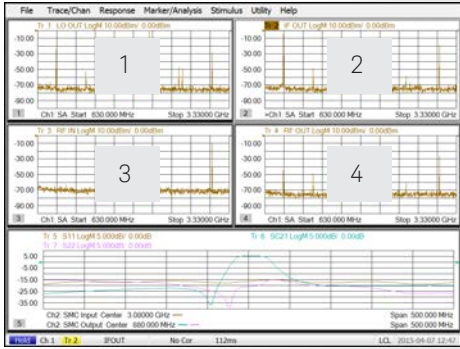

Having spectrum analyzers on all ports of a mixer or converter provides unparalleled insight into the performance of the device. With a single set of connections, the spurious content emanating from all ports is readily apparent during operation with fixed or swept stimuli. Measured spurs can include LO, RF, and IF feedthrough, harmonics, intermodulation products, and other higher-order mixing products. Conversion loss and match versus frequency is easily seen in a companion SMC channel (bottom).

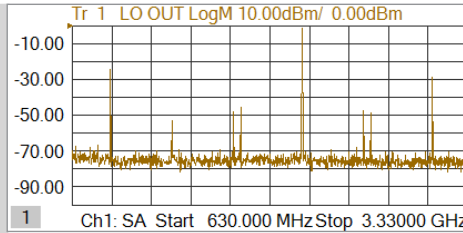
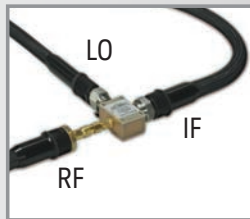

Output spectrum on LO port

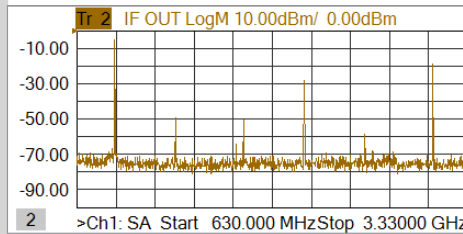

Output spectrum on IF port

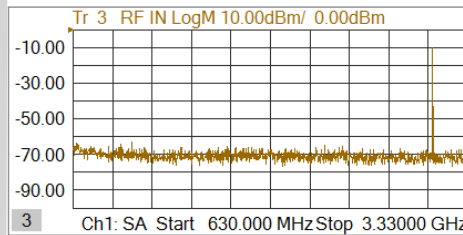

Input spectrum on RF port

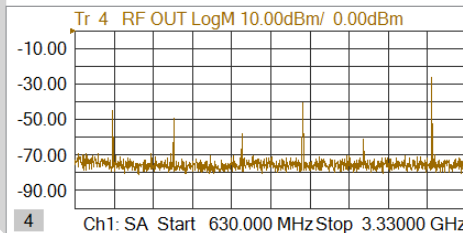

Output spectrum on RF port

Unlock true performance with VNA calibration

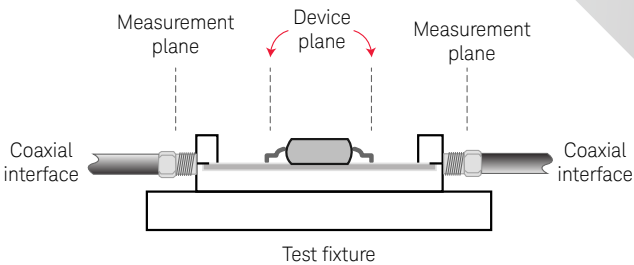

Tips from the experts

- Choose different levels of software-image rejection to trade-off measurement speed with thoroughness, based on the spectral density of the measurement
- For harmonics measurements, add a separate SA channel for each harmonic with a narrow frequency span and RBW to optimize speed and sensitivity, and with enough receiver attenuation to avoid internally-generated harmonics
- To help identify spurious signals that might be interfering with a measurement, use the Marker-to-SA feature to easily create a spectrum display with the same stimulus conditions at the marker position in SMC, swept-IMD, or standard channels
- When using de-embedding to measure in-fixture or on-wafer devices, use the power-compensation feature to overcome the loss of the fixture or probes, thereby delivering a known stimulus power to the DUT

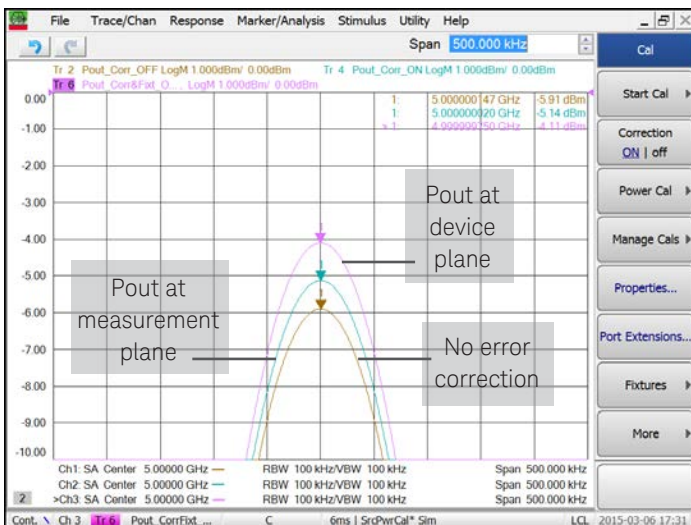

VNA calibration and fixture de-embedding remove cable and fixture effects and correct receiver response errors, providing calibrated in-fixture spectrum analysis.

Innovative Applications continued

Control relative magnitude and phase between two sources for active output-load control

(S93088A)

Amplifier load-pull measurement challenges

- Amplifier gain, output power, and power efficiency are commonly measured under different output-load conditions to determine the optimum large-signal match
- Traditional approach uses mechanical tuners which can handle high power, but are slow and cannot supply highly reflective loads

PNA-X with source-phase control provides

- Control of second source to electronically tune reflection coefficient at output of amplifier
- Fast tuning speed and full reflection
- Match correction for accurate amplitude and phase control
- Measurements of amplifier output power, match, gain, and PAE under different load conditions

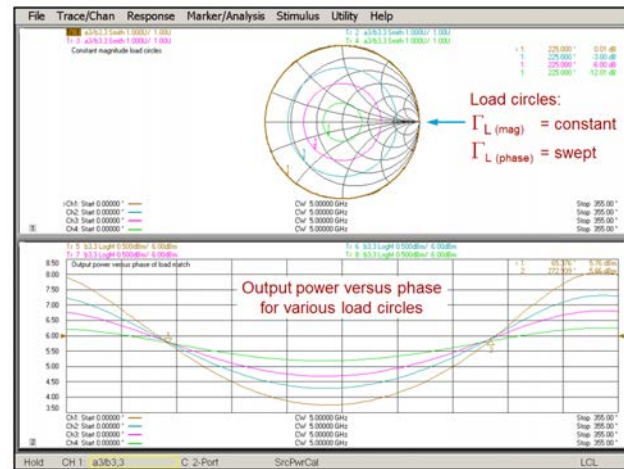
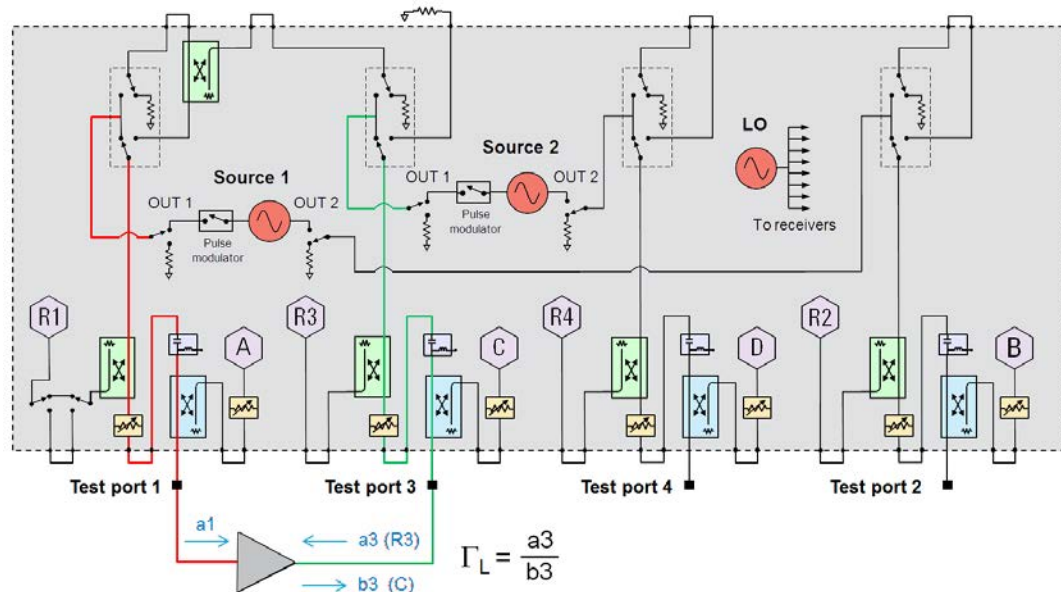

Example of load circles generated by keeping the magnitude of Γ_L constant while sweeping phase

Tips from the experts

- Measurement setups can use receiver (R3, C...) or wave (a3, b3...) terminology
- Use the equation editor to calculate the power delivered to the load (forward power - reverse power) as $\sqrt{\text{pow}(\text{mag}(b3_3),2) - \text{pow}(\text{mag}(a3_3),2)}$
- Use mechanical tuners and external software for hybrid load-pull systems that can handle high output power and achieve full reflection
- When using external signal sources, connect instruments to a common 10 MHz frequency reference

Innovative Applications

Simplified test of I/Q converters and modulators, and differential mixers

(S93089A)

I/Q and differential converter measurement challenges

- Requires signals with 90° or 180° phase difference
- Traditional approach uses hybrid couplers and/or baluns which are:
 - Inherently band-limited, requiring multiple components for broadband measurements
 - Limited to fixed phase offsets, preventing phase sweeps to determine optimum alignment
 - Lossy and inaccurate (+/- 3° to 12° typically)
 - Difficult to use with on-wafer setups

PNA-X differential and I/Q devices application

- Provides accurate phase control of internal and external sources, eliminating the need for hybrid couplers and baluns
- Tunes receivers to all user-specified output frequencies needed to fully characterize the DUT
- Sweeps frequency to measure operating bandwidth or sweeps phase and power at a fixed frequency to measure quadrature or differential imbalance
- Includes match-corrected power measurements for highest accuracy

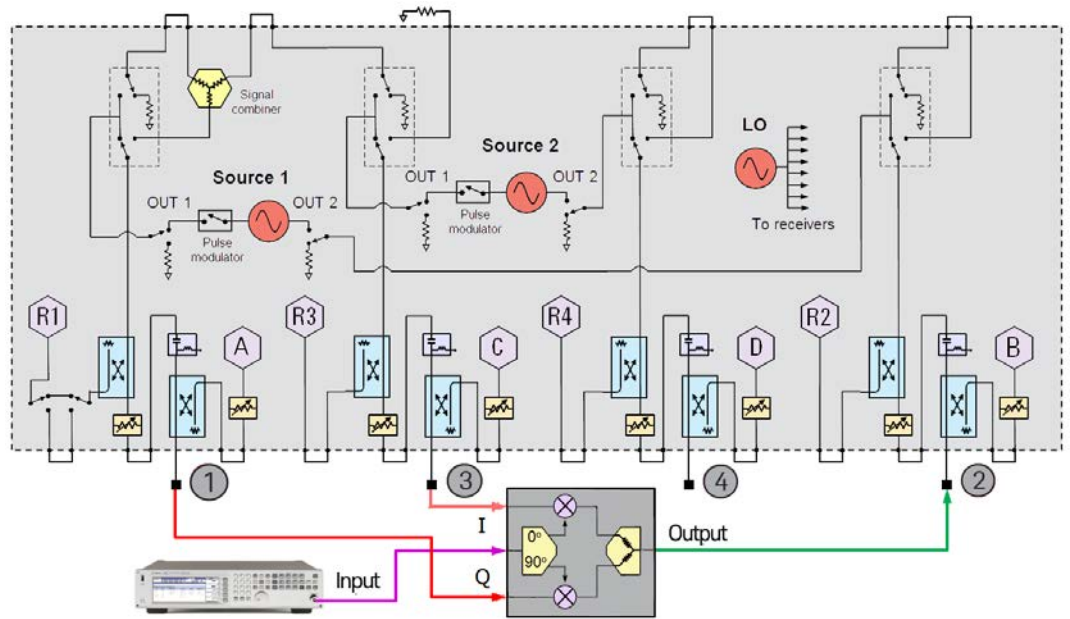

The I/Q inputs of this modulator can be directly driven with the internal sources of the PNA-X, eliminating the need for a 90° hybrid coupler

Tips from the experts

- Two additional external sources can be used to create differential I/Q drive signals. The external sources must be routed through the PNA-X test set to measurement receivers in order to achieve the desired phase offsets.
- For I/Q modulators, DC power supplies or source-measurement units (SMUs) can be routed through the bias tees to the I/Q inputs of the DUT. Voltage sweeps can then be performed to help find the optimum I/Q-voltage offsets for the greatest amount of LO suppression.
- Measure harmonics and total-harmonic distortion (THD) of differential amplifiers by establishing a true-differential drive and tuning the PNA-X receivers to all desired harmonics
- Measure compression of differential mixers using power sweeps

Innovative Applications

Testing differential amplifiers under real operating conditions (S93460A)

Differential amplifier measurement challenges

- Conventional two-port VNAs with baluns do not provide common-mode, differential to common-mode, and common to differential-mode responses
- Baluns are inherently band-limited devices, which forces multiple test setups for broad frequency coverage
- Phase errors of baluns provide inaccurate differential responses
- Modern four-port VNAs provide mixed-mode S-parameter measurements with single-ended stimulus, but differential amplifiers may respond differently when in compression during real operating environments

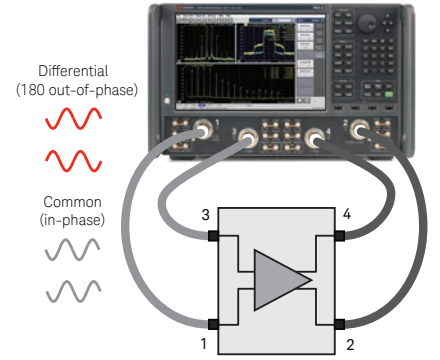

Using the PNA-X's two internal sources, iTMSA drives the differential amplifier under real world conditions, providing accurate mixed-mode S-parameters in all operating environments.

PNA-X integrated true-mode stimulus application (iTMSA) provides:

- Mixed-mode S-parameters of differential amplifiers driven by true differential and common-mode signals
- Mismatch correction at the DUT input to minimize phase errors between two sources
- Input-only drive mode that prevents damage on amplifiers caused by stimulus on the output port
- In-fixture arbitrary phase offset and phase-offset sweeps to optimize input matching network for maximum amplifier gain

$$\begin{bmatrix} S_{DD11} & S_{DD12} & S_{DC11} & S_{DC12} \\ S_{DD21} & S_{DD22} & S_{DC21} & S_{DC22} \\ S_{CD11} & S_{CD12} & S_{CC11} & S_{CC12} \\ S_{CD21} & S_{CD22} & S_{CC21} & S_{CC22} \end{bmatrix}$$

Mixed-mode S-parameters.

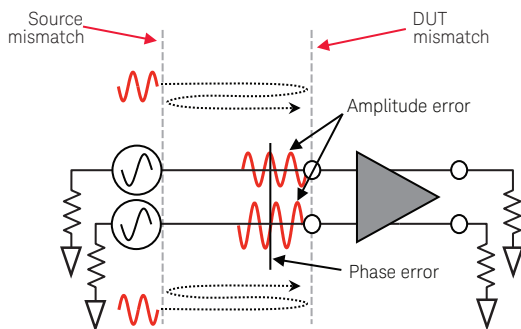

Without mismatch correction, the delivered signals to the DUT will not be truly differential due to reflection from the DUT input and the subsequent re-reflection from the sources. The reflected signals overlay the original signals, causing phase and amplitude imbalance. This effect can be corrected with mismatch correction.

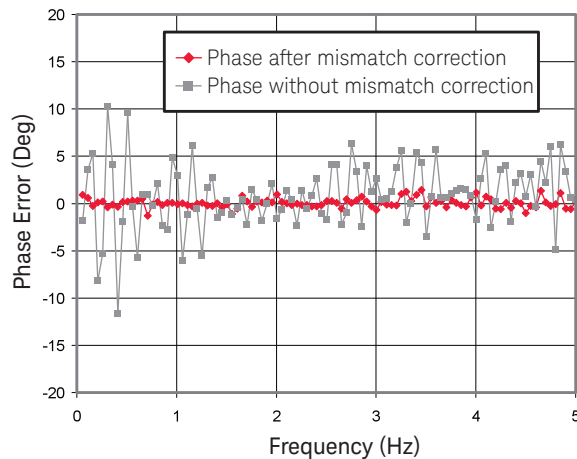

iTMSA compensates for mismatch errors by measuring the raw matches of the VNA and DUT, and precisely adjusting the amplitude and phase of the two signals at the reference plane to achieve ideal true-mode signals.

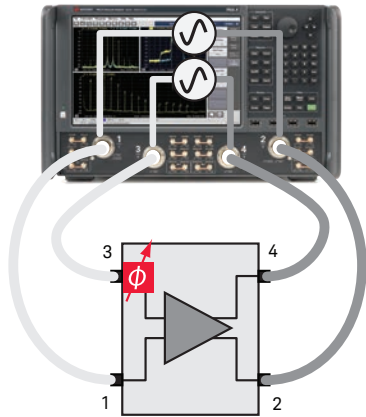

Phase-offset sweeps change the phase-offset value as if it were added in the fixture, enabling input-matching circuit validation.

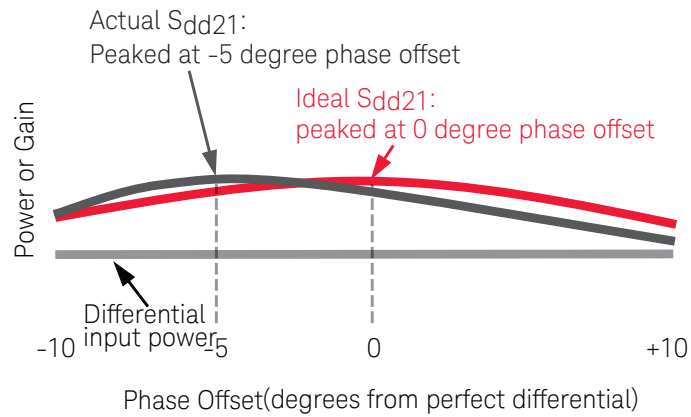

In-fixture phase-offset sweeps reveal the optimal phase offset to achieve the highest amplifier gain, which is essential to the design of the input matching circuit.

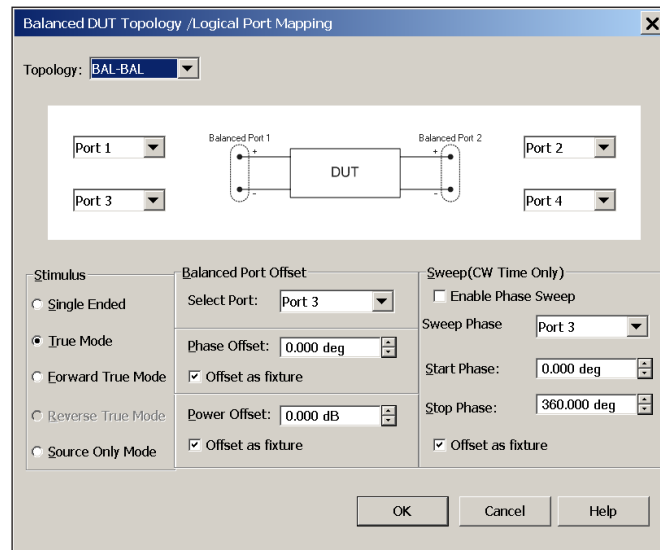

Various stimulus and sweep settings are available in the Balanced DUT Topology dialog, allowing you to select the right configuration for all of your balanced devices.

Tips from the experts

- Input-only true-mode drive assumes a perfect match between the DUT output and the VNA's test ports, which is a good assumption when the DUT's reverse isolation is high. When the reverse isolation is low, adding attenuators on the output port improves the system match and reduces mismatch errors.
- When comparing the test results between single-ended and true-mode drive conditions with the same effective delivered differential power, the individual port powers with true-differential drive must be set 6 dB lower than the port powers used with single-ended drive.

Single-ended drive

0 dBm port power = -3 dBm differential power + -3 dBm common-mode power

True differential drive

-3 dBm port power = -6 dBm port 1 single-ended power + -6 dBm port 3 single-ended power

Innovative Applications

Powerful, fast and accurate automatic fixture removal (AFR)

(S93007A)

Powerful AFR features can handle a variety of measurement needs

- Single ended and differential devices
- Left and right side of fixture can be asymmetrical
- Through lengths can be specified or determined from open or short measurements
- Band-pass time-domain mode for band-limited devices
- Extrapolation to match DUT frequency range
- Power correction compensates for fixture loss versus frequency
- De-embed files can be saved in a variety of formats for later use in PNA, ADS, and PLTS

AFR is the fastest way to de-embed a fixture from the measurement

Measurement Challenge:

Many of today's devices do not have coaxial connectors and are put in fixtures in order to measure them in a coaxial environment. Accurately removing the effects of the fixture is required to get a good measurement of the device under test (DUT).

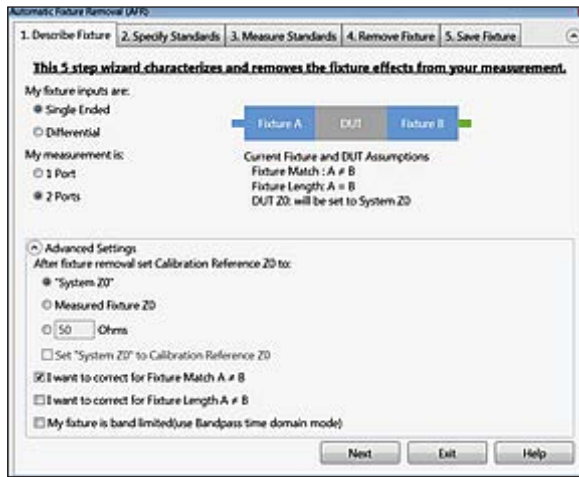

A five-step wizard guides you through the process to characterize your fixture and remove it from your measurement.

Yesterday without AFR

Complicated modeling in EM simulation software or multiple calibration standards fabricated on board were needed to characterize and remove a fixture.

Today with AFR

First calibrate in coax with the reference planes at the inputs to your fixture. Then measure one or more standards designed as a replica of the fixture's 2-port through, or fixture half terminated with an open or short.

Or, even faster: just measure the actual fixture itself before the DUT is installed for the open standard. AFR automatically characterizes and removes your fixture from the measurement.

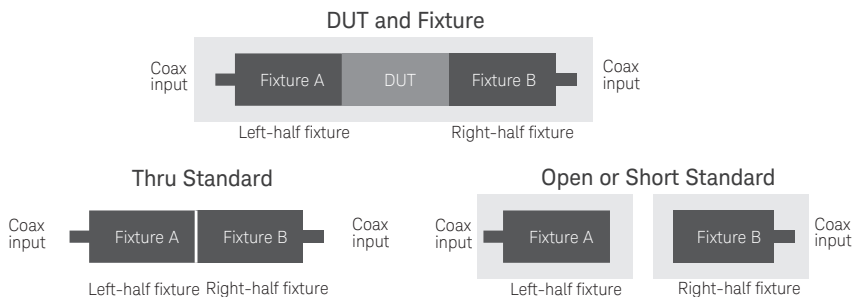

AFR accuracy is comparable to on-board TRL calibration, but much easier to accomplish.

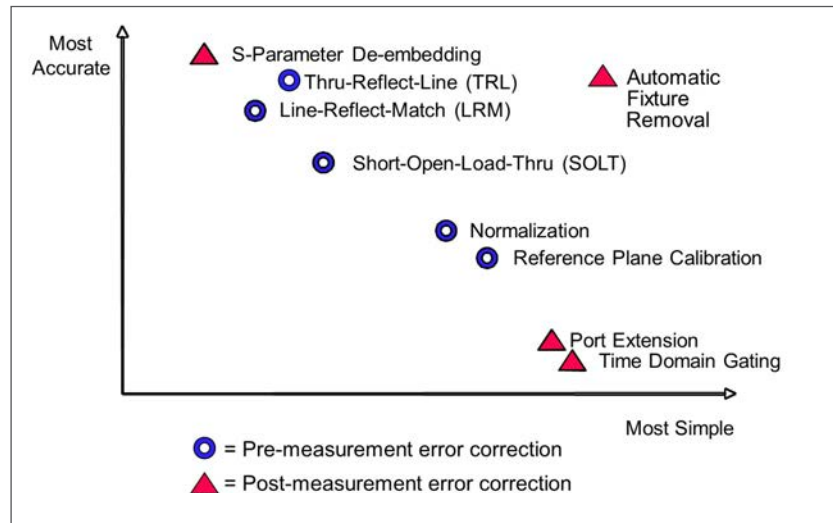

Measurement example

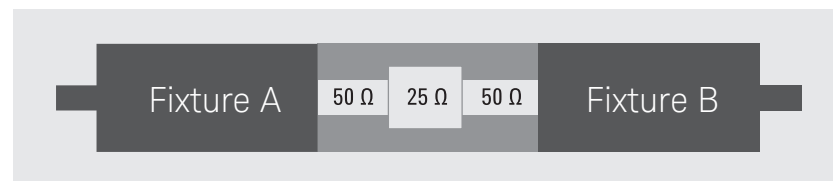

Beatty Standard DUT
 In the plots below, the green trace is a measurement of a Beatty Standard DUT before AFR fixture removal. The red trace is the DUT with AFR open-standard fixture removal. The blue trace is the DUT with AFR thru-standard fixture removal. The effects of fixture mismatch and length are removed from the DUT measurements. Good correlation is shown between the AFR open- and thru-standard fixture characterizations.

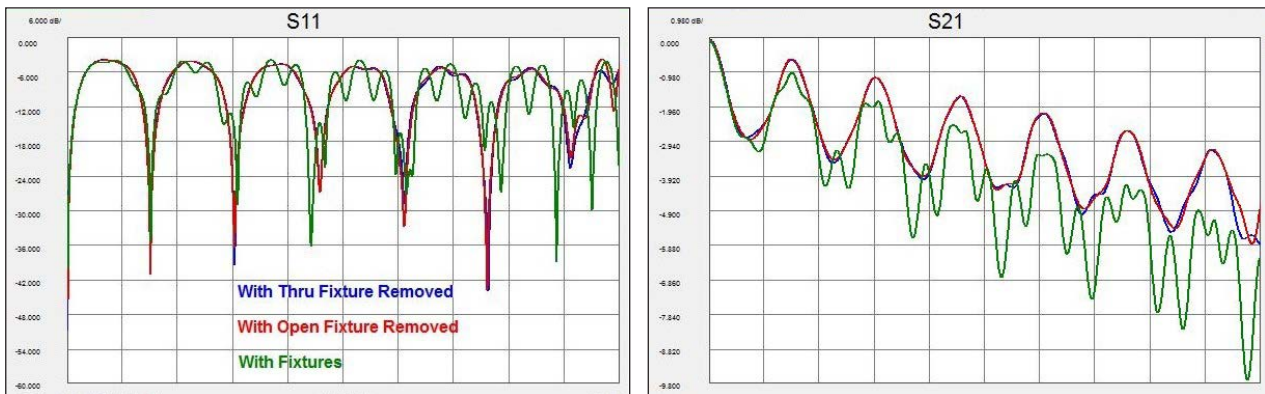

S11 and S21 in frequency domain

Innovative Applications

Extending the PNA-X to millimeter-wave frequencies

PNA-X's unique hardware architecture provides:

- Single-sweep millimeter-wave network analyzer configurations with frequency coverage from 900 Hz to 120 GHz
- Two- and four-port solutions for measurements on a wide variety of single-ended and balanced millimeter-wave devices
- Differential and I/Q measurements at millimeter-wave frequencies using two, phase-controlled internal sources
- Fully integrated solution for millimeter-wave pulsed-RF measurements using built-in pulse modulators and pulse generators
- Accurate leveled power at millimeter-wave frequencies with advanced source-power calibration methods
- Two internal sources allow direct connection of THz frequency-extender modules

Two- and four-port broadband, single-sweep solutions, 900 Hz to 120 GHz



N5290/91A PNA-X based 120 GHz millimeter-wave network analyzers are only available in four-port configurations. Two-port solutions are available using a two-port PNA network analyzer. N5290/91A broadband systems provide test capability to fully characterize passive, active, and frequency converting devices. These systems are compact replacements for N5251A systems, with superior performance and wider frequency range.

Two- and four-port banded configurations



The N5262A millimeter-wave test-set controller connects four millimeter-wave test modules to the PNA-X. For two-port measurements, the N5261A millimeter-wave test-set controller is available.

Terahertz measurements

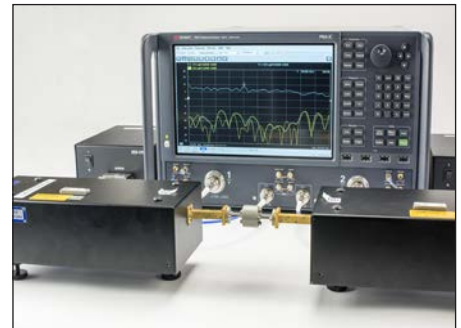

Direct connection of VDI modules to a four-port PNA-X enables S-parameter measurements to 1.5 THz.

Two-port direct connect system architecture

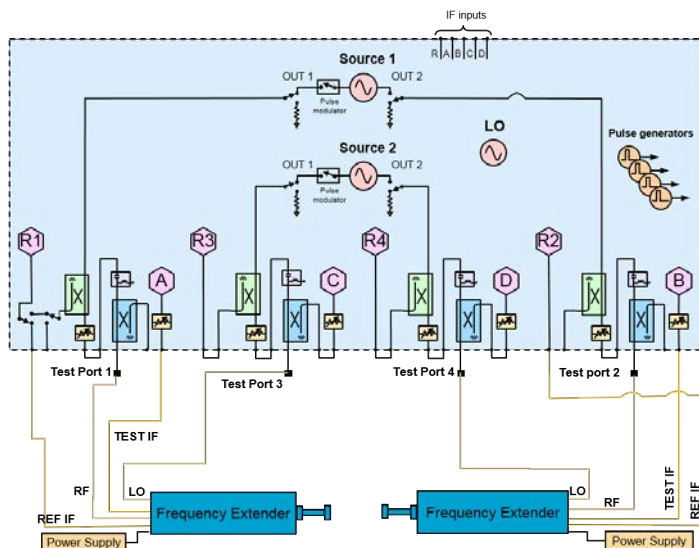

Block diagram of a two-port millimeter-wave system using a four-port PNA and two millimeter-wave frequency extenders.

Millimeter-wave applications with the PNA-X

Tips from the experts

- For repeatable calibrations, always use a torque wrench for the 1.0 mm calibration standards along with another wrench that prevents rotation of the test-port or test-cable connectors.
- For repeatable measurements, ensure the cables between the instrument and extender modules are physically supported along their length.
- Use Keysight's downloadable macro for easy configuration of direct-connect, banded millimeter-wave setups that don't require a test-set controller.
- For multi-channel setups, use the Cal All Channels feature to simplify the calibration process.

Millimeter-wave spectrum analysis

PNA-based millimeter-wave systems can take full advantage of spectrum analysis applications. This capability enables high-order harmonic and spur measurements at millimeter-wave frequencies.

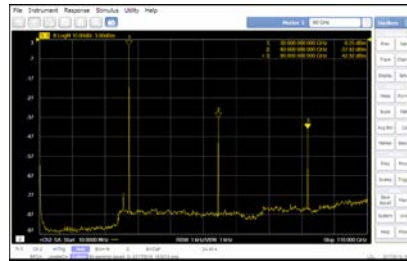

The PNA's spectrum analyzer application is used to measure the harmonics of a millimeter-wave amplifier.

Multi-channel measurements at millimeter-wave frequencies

Fully characterize active devices at millimeter-wave frequencies using multiple PNA software applications, with a single set of connections or wafer touch-downs. Calibration of multi-channel setups is easy using the Cal All Channels feature.



In addition to S-parameters, the spectrum analysis, gain compression, and differential I/Q applications are used to characterize a 10 MHz to 125 GHz amplifier.

Scalar mixer measurements

Measure conversion loss or gain plus input and output matches of mixers and frequency converters at millimeter-wave frequencies.

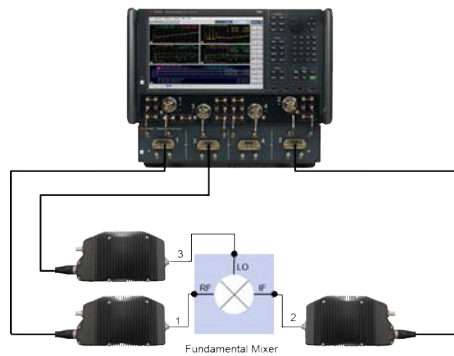

A dual-source PNA with an N5292A four-port controller and broadband frequency-extender modules characterize mixers and converters at millimeter wave frequencies. The PNA's second source can be used to provide an LO signal to a mixer.

Differential and I/Q measurements at millimeter-wave frequencies

- Highest measurement accuracy in the industry using advanced error-correction methods
- Integrated phase sweeps with power control

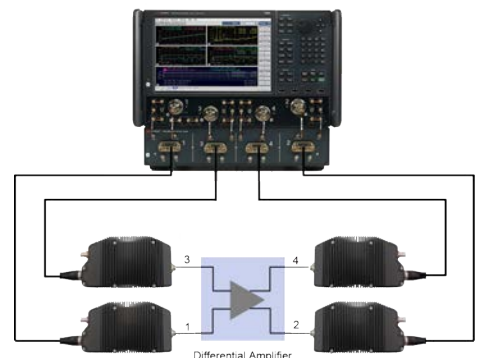

True-differential measurement of a balanced trans-impedance amplifier using a four-port PNA, the N5292A controller, and N5293A frequency extenders.

Innovative Applications

Nonlinear waveform and X-parameter characterization

(S94510/514/518/520/521A)

High-power design challenges

- Active devices are commonly driven into nonlinear regions, often by design to increase power efficiency, information capacity, and output power
- Under large-signal drive conditions, active devices distort time-domain waveforms, generating harmonics, intermodulation distortion, and spectral regrowth
- Current circuit simulation tools that rely on S-parameters and limited nonlinear behavioral models are no longer sufficient to fully analyze and predict nonlinear behavior of devices and systems
- Fewer design iterations are required to meet current time-to-market demands

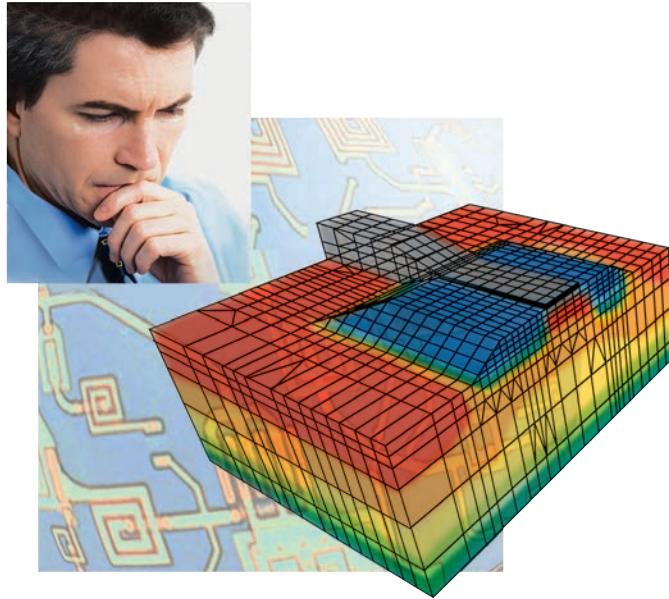

S-parameters in a nonlinear world

In the past, when designing systems with high-power amplifiers (HPAs), designers measured amplifier S-parameters using a vector network analyzer, loaded the results into an RF simulator, added other measured or modeled circuit elements, and then ran a simulation to predict system performance such as gain and power-efficiency under various loads.

Since S-parameters assume that all elements in the system are linear, this approach does not work well when attempting to simulate performance when the amplifier is in compression or saturation, as real-world HPAs often are. The errors are particularly apparent when simulating the combined performance of two cascaded devices that exhibit nonlinear behavior. While engineers may live with this inaccuracy, it invariably results in extensive and costly empirical-based iterations of the design, adding substantial time and cost to the design and verification process.

Breakthrough technology accurately characterizes nonlinear behaviors

Testing today's high-power devices demands an alternate solution—one that quickly and accurately measures and displays the device's nonlinear behavior under large signal conditions, and provides an accurate behavioral model that can be used for linear and nonlinear circuit simulations. The Keysight nonlinear vector network analyzer (NVNA) and X-parameters provide that solution.

Keysight's award-winning NVNA goes beyond S-parameters to:

- Efficiently and accurately analyze and design active devices and systems under real-world operating conditions, to reduce design cycles by as much as 50%
- Gain valuable insight into device behavior with full nonlinear component characterization (S94510A)
 - Display calibrated time-domain waveforms of incident, reflected, and transmitted waves of the DUT in coaxial, in-fixture, or on-wafer environments
 - Show the amplitude and phase of all harmonic and distortion spectral products to design optimal matching circuits
 - Create user-defined displays such as dynamic load lines
 - Measure with full traceability to the National Institute of Science and Technology (NIST)
- Provide fast and powerful measurements of DUT nonlinear behavior using X-parameters (S94514A)
 - Extend linear S-parameters into nonlinear operating regions for accurate predictions of cascaded nonlinear device behavior using measurement-based data
 - Easily import the NVNA's X-parameters into Keysight's Advanced Design System (ADS) to quickly and accurately simulate and design nonlinear components, modules and systems
- Measure memory effects such as self heating and signal-dependent bias changes (S94518A)
- Adds load-dependent nonlinear component behavior to X-parameters from external sources or external impedance tuners* (S94520A)
- Adds direct control of external sources or impedance tuners for load-dependent nonlinear X-parameters (S94521A)

*Requires an additional load-control application.

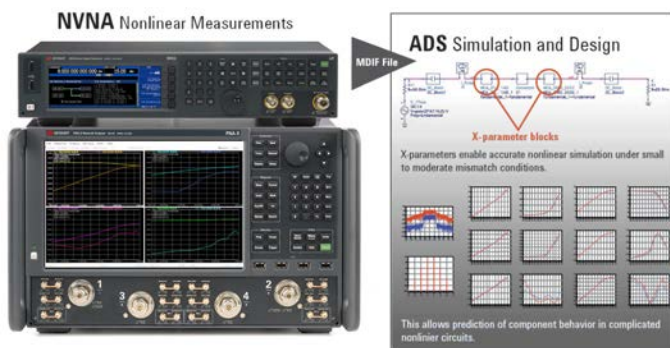

Measure complete linear and nonlinear component behavior with the Keysight NVNA, and then accurately perform simulations and optimizations with Keysight's Advanced Design System.



Keysight's NVNA software applications and accessories convert a Keysight 4-port PNA-X network analyzer into a high-performance nonlinear vector network analyzer.

Innovative Applications

Fast and accurate RF subsystem for antenna measurements

Challenges of antenna and radar cross-section (RCS) measurements

- Many data points must be collected, resulting in long test times
- In far-field and RCS measurements, signals can be close to the noise floor of the test receiver, resulting in noisy measurements
- Large installed-software base exists for 8530A antenna receivers, which have been discontinued and are no longer supported

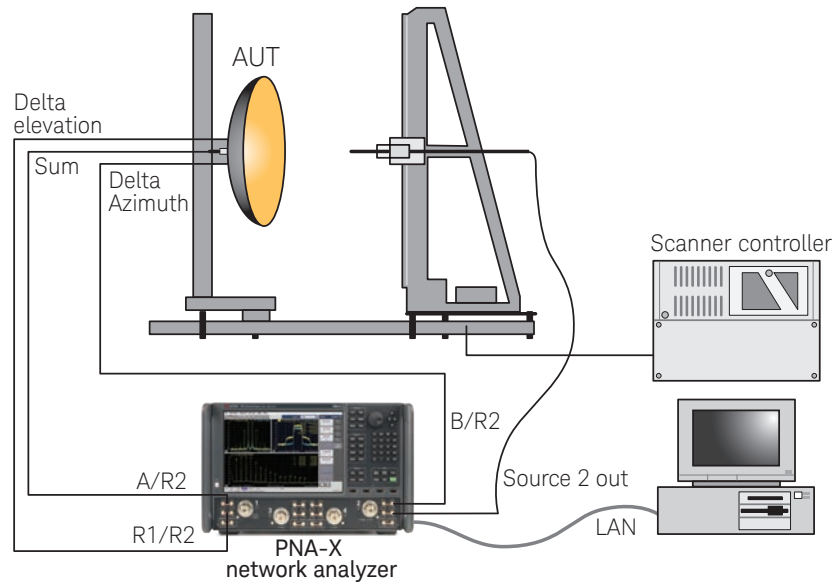

PNA-X configured for near-field measurements.

PNA-X-based antenna solutions provide:

- Flexibility in system design: choose a standard PNA-X or an N5264B low-cost dedicated measurement receiver based on PNA-X hardware
- Fast measurements: 400,000 data points per second simultaneously on five receivers, yielding three to five times improvement in test times compared to the 8530A
- Large data collections with 500 million-point circular FIFO data buffer
- Excellent measurement sensitivity via selectable IF bandwidths and point-averaging mode
- Built-in 8530A code emulation for easy migration

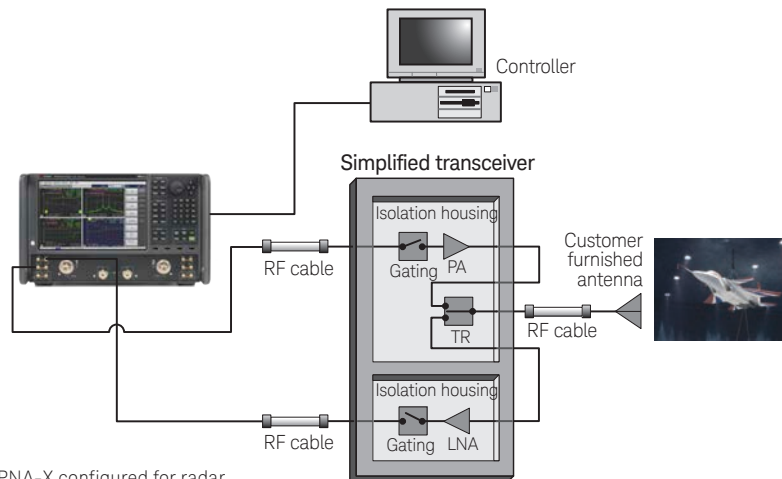

PNA-X configured for radar cross-section measurements.

Why should I migrate my 8530A system to the new PNA-X measurement receiver?



- 8530A is no longer supported, so maintaining existing systems is getting harder and harder
- PNA-X measurement receiver...
 - Offers built-in 8530A code emulation for full reuse of existing measurement software
 - Is fully compatible with your existing 8530A system components
 - Features 80 times improvement in data acquisition time
 - Contains an optional built-in high-output-power source (Option 108) that can be used as an LO for remote mixers or frequency converters

What is the best choice for an antenna receiver?

Application	N5264B measurement receiver	N524xB PNA-X	Comments
Near-field	No (requires external source)	Yes	Achieve faster measurement throughput with internal source Can use VNA for general-purpose component test
Compact range	Yes	Yes	Choice depends on the size of the antenna range
Far-field	Yes	No (higher cost)	Distributed approach increases measurement sensitivity by strategic placement of system components
Pulsed RF	No	Yes	PNA-X offers built-in pulse generators and modulators that simplify the system configuration

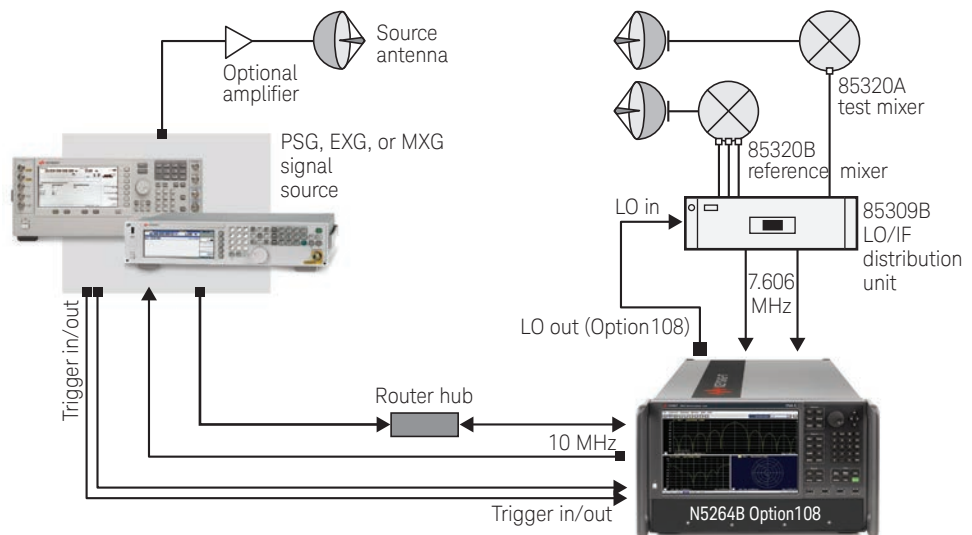

PNA-X measurement receiver configured for far-field measurements (PNA-X Option 020 with IF inputs can also be used).

Innovative Applications

Fast and accurate RF subsystem for antenna measurements (continued)

Tips from the experts

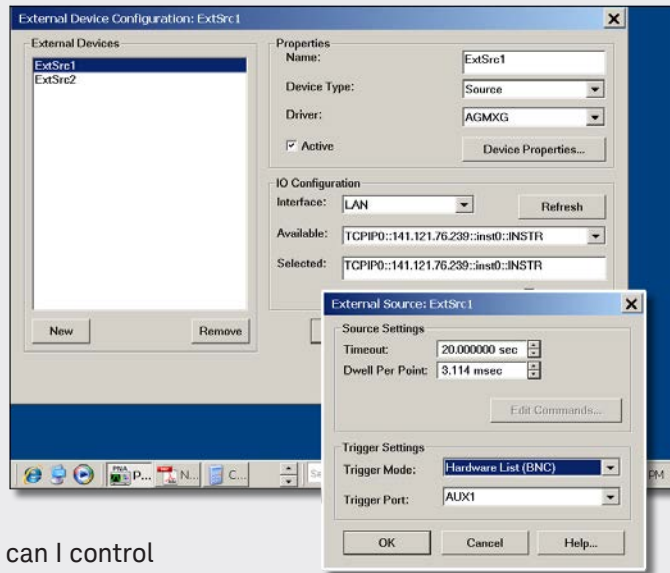

How can I control external sources?

1. Connect PNA-X to source via LAN or GPIB
2. Use External Device Configuration feature
3. Under Properties section:
 - Type name of external source, change Device Type to Source, and choose appropriate driver
 - Under Device Properties, choose between two trigger modes: Software CW (trigger cables not needed, but slow), or Hardware List (fast, but requires TTL triggers)
 - When the distance between the PNA-X and source is too far to use BNC trigger cables (> 40 meters), then a Keysight E5818A trigger box with LAN hub offers a good alternative

How do I get a common 10 MHz reference signal to my source and PNA-X when it's too far to use BNC cables?

- Use low-cost GPS-based satellite receivers to obtain high-accuracy 10 MHz reference signals
- Place a GPS receiver near the transmit source, and one near the PNA-X
- This approach works for arbitrary distances, from 100's of meters to many kilometers

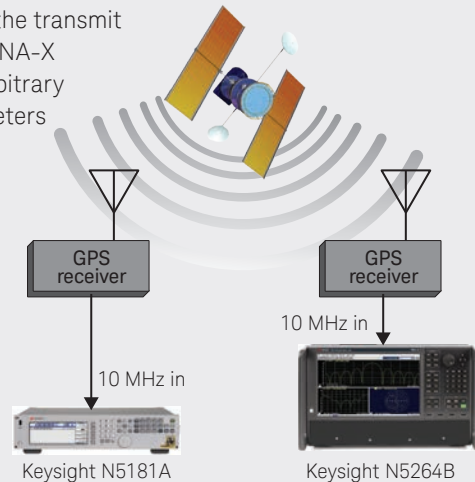

Outstanding Performance

Specification and Feature Comparison

	N5249B N5241B N5242B	N5244B N5245B	N5247B
Frequency range	10 MHz to 8.5 GHz 10 MHz to 13.5 GHz 10 MHz to 26.5 GHz ¹	10 MHz to 43.5 GHz 10 MHz to 50 GHz	10 MHz to 67 GHz ¹
System dynamic range (at 20 GHz)	121 to 130 dB depending on configuration 124 to 141 dB with direct receiver access (typical)	121 to 125 dB depending on configuration 133 to 137 dB with direct receiver access (typical)	122 to 129 dB depending on configuration 136 to 140 dB with direct receiver access (typical)
Maximum output power at test port (at 20 GHz)	+13 dBm (Option 201, 401) +10 dBm (Option 21x, 41x) +15 dBm (Option 22x) +10 dBm (Option 42x)	+13 dBm (Option 201, 401) +10 dBm (Option 21x, 41x) +10 dBm (Option 22x, 42x)	+11 dBm (Option 201, 401) +8 dBm (Option 219, 419) +7 dBm (Option 224, 423)
Maximum power sweep range	38 dB		
Corrected specifications ²	(2-port cal, 3.5 mm) Dir 44 to 48 dB SM 31 to 40 dB LM 44 to 48 dB Refl trk \pm 0.003 to 0.006 dB Trans trk \pm 0.015 to 0.104 dB	(2-port cal, 2.4 mm) Dir 36 to 42 dB SM 31 to 41 dB LM 35 to 42 dB Refl trk \pm 0.001 to 0.027 dB Trans trk \pm 0.020 to 0.182 dB	(2-port cal, 1.85 mm) Dir 34 to 41 dB SM 34 to 44 dB LM 33 to 41 Refl trk 0.01 to 0.33 Trans trk 0.061 to 0.17 dB
Trace noise	0.002 dB rms (1 kHz BW)		
Harmonics (ports 1, 3) 10 MHz to 2 GHz > 2 GHz	-51 dBc typical -60 dBc typical		
Bias tees, maximum current, voltage	\pm 200 mA, \pm 40 VDC		
Dimensions, H x W x D (with feet, handles)	280 x 459 x 578 mm	280 x 459 x 649 mm	280 x 459 x 649 mm
Weight (nominal net), 2-port 4-port	27 kg 37 kg	46 kg 49 kg	46 kg 49 kg

1. The following model configurations work down to 900 Hz: N5242B Option 425 with or without Option 029, and N5247B Option 425 with Option 029.

2. Dir = directivity; SM = source match; LM = load match; Refl trk = reflection tracking; Trans trk = transmission tracking

PNA-X Configuration Information

PNA-X Network Analyzers

Available options

Test set	Description	Additional information
Option 201	2-ports, single source, and configurable test set	
Option 217 ²	2-ports, single source, configurable test set, and receiver attenuators	Not available on N5247B
Option 219	2-ports, single source, configurable test set, receiver attenuators, and bias tees	
Option 222 ²	2-ports, dual sources, configurable test set, receiver attenuators, combiner, and mechanical switches	Includes additional RF jumpers for maximum setup flexibility
Option 224	2-ports, dual sources, configurable test set, receiver attenuators, combiner, mechanical switches, and bias tees	Includes additional RF jumpers for maximum setup flexibility
Option 401 ¹	4-ports, dual sources, and configurable test set	
Option 417 ^{1,2}	4-ports, dual sources, configurable test set, and receiver attenuators	Not available on N5247B
Option 419 ¹	4-ports, dual sources, configurable test set, receiver attenuators, and bias tees	
Option 422 ^{1,2}	4-ports, dual sources, configurable test set, receiver attenuators, combiner, and mechanical switches	Includes additional RF jumpers for maximum setup flexibility
Option 423 ¹	4-ports, dual sources, configurable test set, receiver attenuators, combiner, mechanical switches, and bias tees	Includes additional RF jumpers for maximum setup flexibility
Option 425 ¹	4-ports, dual sources, configurable test set, receiver attenuators, combiner, mechanical switches, bias tees, and low-frequency extension	Includes additional RF jumpers for maximum setup flexibility. Only available for N5242B with or without low-noise receiver Option 029, and for N5247B with Option 029.
Additional hardware		
Option 020	Add IF inputs	Used for antenna measurements and mm-wave extenders
Option 021	Add pulse modulator to first source	
Option 022	Add pulse modulator to second source	Requires one of Option 22x, 40x, 41x, or 42x
Option 029	Add low-noise receiver	S93029A application software is needed to control the noise receiver for noise figure and noise power measurements. For N5241/42/49B, requires one of options 21x, 22x, 41x, or 42x. For N5244/45/47B, requires one of options 22x or 42x. On N5247B, noise receiver works up to 50 GHz only.

1. To independently control the frequency of the second internal source, one of the following software applications is required: S93080/029/082/083/084/086/087/089/090x/093/094A

2. Recommended for high-power setups. The maximum power rating on the test port couplers is +43 dBm (additional attenuators or isolators are typically required to protect other components inside the instrument).

PNA-X Configuration Information (continued)

For PNA-X Series	Description	Additional Information
Application software¹		
S93007A	Automatic fixture removal	
S93010A	Time domain analysis	
S93025A	Basic pulsed-RF measurements	Includes control of internal pulse generators and provides pulse widths to 200 ns using wideband detection
S93026A	Advanced pulsed-RF measurements	Includes control of internal pulse generators, and provides pulse widths to 100 ns using wideband detection, and 20 ns using narrowband detection
S93029A	Noise figure measurements with vector correction ²	Standard receivers are used if hardware option N524xB-029 is not present
S93080A	Frequency-offset measurements	Provides ability to independently set the frequency of internal sources and receivers, and to configure external sources. This functionality is included with S93029/082/083/084/086/087/089/090x/093/094A.
S93082A	Scalar mixer/converter measurements	Provides SMC measurement class. S93082A is a subset of S93083A.
S93083A	Vector and scalar mixer/converter measurements ³	Provides SMC+Phase and VMC measurement classes
S93084A	Embedded-LO capability	Works with S93029/082/083/086/087A
S93086A	Gain-compression measurements	
S93087A	Intermodulation distortion measurements ⁴	Not available with PNA test set options 200, 210, 400, and 410
S93088A	Source phase control	
S93089A	Differential and I/Q device measurements	Requires a 4-port test set option (4xx)
S930900A	Spectrum analysis, up to 8.5 GHz ⁵	
S930901A	Spectrum analysis, up to 13.5 GHz ⁵	
S930902A	Spectrum analysis, up to 26.5 GHz ⁵	
S930904A	Spectrum analysis, up to 43.5 GHz ⁵	
S930905A	Spectrum analysis, up to 50 GHz ⁵	
S930907A	Spectrum analysis, up to 67 GHz ⁵	
S930909A	Spectrum analysis, up to 90 GHz ⁵	
S93093A	Spectrum analysis, up to 110 GHz	
S93094A	Spectrum analysis, beyond 110 GHz	
S93118A	Fast CW measurements	
S93460A	True-mode stimulus	Requires a 4-port test set option (4xx)
S93551A	N-port measurements ^{6,7}	Not available with test set options 200, 210, 400, and 410

1. Supported software license types: fixed-perpetual (1FP), transportable-perpetual (1TP), fixed-1-year (1FY), and transportable-1-year (1TY) (note: S93093A, S93094A, S93898A, and S94510A have fixed-license types only).
2. For N522xB and N5241/42/49B, vector-noise-corrected measurements require an ECal for use as an impedance tuner. For N5244/45/47B with Option 029, an internal tuner is included. Noise calibration requires a power meter when using a standard receiver. When using the low-noise receiver (Option 029), either a power meter or a 346-series noise source is required (Keysight 346C or 346C-K01 recommended). A power meter is required for measuring mixers and converters.
3. A configurable test set is required for VMC measurements to connect a reference mixer, or for SMC+Phase measurements using the comb-generator-based calibration. When ordered with PNA test set Options 200, 210, 400, or 410 (no front-panel jumpers), phase and delay measurements can only be done using SMC+Phase with a calibration mixer.
4. S93087A can be used without PNA-X Options 22x or 42x, but external equipment such as a signal generator and a combiner may be required.
5. A test set with internal receiver attenuators is recommended to avoid receiver compression when measuring large input signals.
6. When ordering a test set, select an appropriate interface kit.
7. When configured as a multipoint analyzer using S93551A and a multipoint test set, the combiner feature of Option 22x or 42x is temporarily disabled. When configured as a standalone analyzer, the combiner feature is enabled.

PNA-X Configuration Information (continued)

For PNA-X Series	Description	Additional Information
Nonlinear vector network analysis¹		
S94510A ²	Nonlinear component characterization	Requires test set option 41x or 42x
S94511A ²	Nonlinear component characterization	Export-control version. Requires test set option 41x or 42x
S94514A ³	Nonlinear X-parameters ^{4,5}	Requires test set option 42x and application software S94510A
S94518A	Nonlinear pulse-envelope domain	Requires hardware option 021 and application software S94510A, and S93025A or S93026A
S94520A	Arbitrary load-impedance X-parameters ^{4,5}	Requires application software S94514A
S94521A	Arbitrary load-control X-parameters ^{4,5}	Requires application software S94520A
Required NVNA accessories		
<ul style="list-style-type: none"> – U9391C 10 MHz to 26.5 GHz or U9391F 10 MHz to 50 GHz or U9391G 10 MHz to 67 GHz comb generator (two required for nonlinear measurements) – Keysight power meter and sensor or USB power sensor – Keysight calibration kit, mechanical or ECal – Keysight signal generator, EXG, MXG, or PSG, used for X-parameter extraction (the PNA-X's 10 MHz reference output can be used for 10 MHz tone spacing applications) 		

Accessories, calibration options

For PNA-X Series	Description	Additional Information
Accessories		
N524xB-1CM	Rack mount kit for use without handles	
N524xB-1CP	Rack mount kit for use with handles	
N1966A	Pulse I/O adapter	
U9391C/F/G	Comb generator ¹	
Calibration Software		
S93898A	Built-in performance test software for standard compliant calibration ⁶	
Calibration Documentation		
N524xB-1A7	ISO 17025 compliant calibration	
N524xB-UK6	Commercial calibration certificate with test data	
N524xB-A6J	ANSI Z540 compliant calibration	
Required NVNA accessories		
<ul style="list-style-type: none"> – U9391C 10 MHz to 26.5 GHz or U9391F 10 MHz to 50 GHz or U9391G 10 MHz to 67 GHz comb generator (two required for nonlinear measurements) – Keysight power meter and sensor or USB power sensor – Keysight calibration kit, mechanical or ECal – Keysight signal generator, MXG or PSG used for X-parameter extraction (internal 10 MHz reference output can be used for 10 MHz tone spacing applications) 		

1. A fully configured NVNA system requires two comb generators with power supplies, Keysight calibration kits (mechanical or ECal), and a power meter and sensor or USB power sensor.
2. Pulse capability requires option 021 and S93025A or S93026A.
3. Pulse capability requires option 021, 022 and S93025A or S93026A.
4. Requires EXG, MXG, or PSG signal generator for X-parameter extraction (the PNA-X's 10 MHz reference output can be used for 10 MHz tone-spacing applications).
5. X-parameters is a trademark and registered trademark of Keysight Technologies in the U.S., Europe, Japan, and elsewhere. The X-parameters format and underlying equations are open and documented. For more information, visit www.keysight.com/find/eesof-x-parameters-info.
6. Additional hardware required. Please refer to the analyzer's service guide for required service-test equipment.

Additional Information

Download the latest PNA-X application notes:

Bookmark this page to download the latest PNA-X application notes to gain in-depth measurement knowledge.

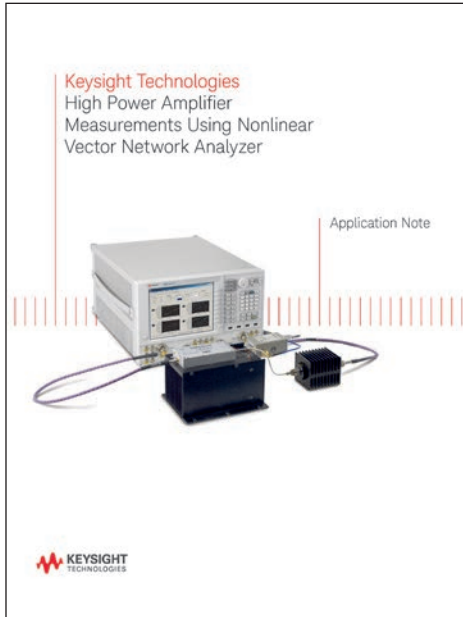

www.keysight.com/find/pnaxapps

Get answers online from factory experts:

Discuss calibration, applications, product, and programming topics at Keysight's online network analyzer discussion forum. Get answers to your toughest measurement and design challenges and browse prior discussion topics.

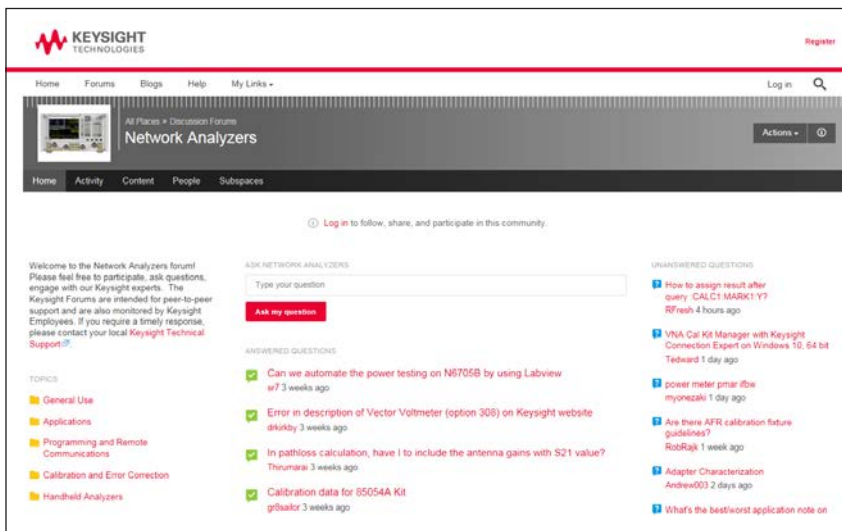

www.keysight.com/find/na_forum

Evolving Since 1939

Our unique combination of hardware, software, services, and people can help you reach your next breakthrough. We are unlocking the future of technology.
From Hewlett-Packard to Agilent to Keysight.

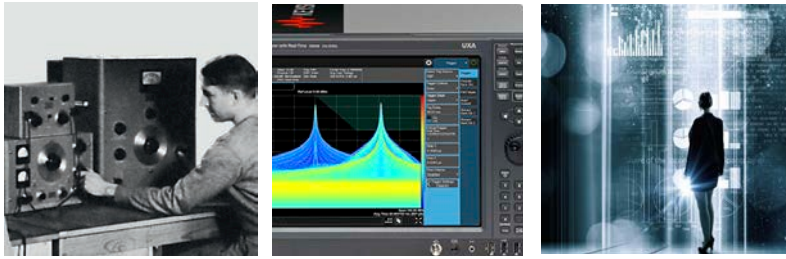

myKeysight

myKeysight

www.keysight.com/find/mykeysight

A personalized view into the information most relevant to you.

http://www.keysight.com/find/emt_product_registration

Register your products to get up-to-date product information and find warranty information.

KEYSIGHT SERVICES

*Accelerate Technology Adoption.
Lower costs.*

Keysight Services

www.keysight.com/find/service

Keysight Services can help from acquisition to renewal across your instrument's lifecycle. Our comprehensive service offerings—one-stop calibration, repair, asset management, technology refresh, consulting, training and more—helps you improve product quality and lower costs.



Keysight Assurance Plans

www.keysight.com/find/AssurancePlans

Up to ten years of protection and no budgetary surprises to ensure your instruments are operating to specification, so you can rely on accurate measurements.

Keysight Channel Partners

www.keysight.com/find/channelpartners

Get the best of both worlds: Keysight's measurement expertise and product breadth, combined with channel partner convenience.

www.keysight.com/find/pna

www.keysight.com/find/na_forum

For more information on Keysight Technologies' products, applications or services, please contact your local Keysight office. The complete list is available at:
www.keysight.com/find/contactus

Americas

Canada	(877) 894 4414
Brazil	55 11 3351 7010
Mexico	001 800 254 2440
United States	(800) 829 4444

Asia Pacific

Australia	1 800 629 485
China	800 810 0189
Hong Kong	800 938 693
India	1 800 11 2626
Japan	0120 (421) 345
Korea	080 769 0800
Malaysia	1 800 888 848
Singapore	1 800 375 8100
Taiwan	0800 047 866
Other AP Countries	(65) 6375 8100

Europe & Middle East

Austria	0800 001122
Belgium	0800 58580
Finland	0800 523252
France	0805 980333
Germany	0800 6270999
Ireland	1800 832700
Israel	1 809 343051
Italy	800 599100
Luxembourg	+32 800 58580
Netherlands	0800 0233200
Russia	8800 5009286
Spain	800 000154
Sweden	0200 882255
Switzerland	0800 805353
	Opt. 1 (DE)
	Opt. 2 (FR)
	Opt. 3 (IT)
United Kingdom	0800 0260637

For other unlisted countries:
www.keysight.com/find/contactus
 (BP-9-7-17)

DEKRA Certified
ISO 9001 Quality Management System

www.keysight.com/go/quality

Keysight Technologies, Inc.
 DEKRA Certified ISO 9001:2015
 Quality Management System

This information is subject to change without notice.
 © Keysight Technologies, 2017
 Published in USA, December 1, 2017
 5990-4592EN
www.keysight.com