

Keysight 2-Port and 4-Port PNA-L Network Analyzer

N5239A 300 kHz to 8.5 GHz

N5231A 300 kHz to 13.5 GHz

N5232A 300 kHz to 20 GHz

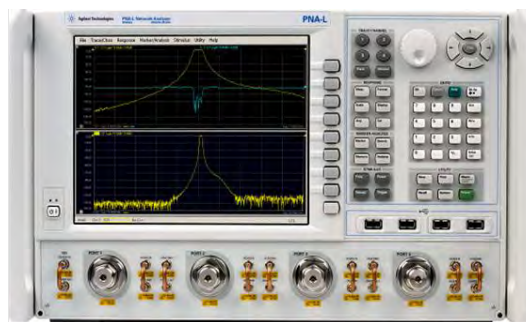
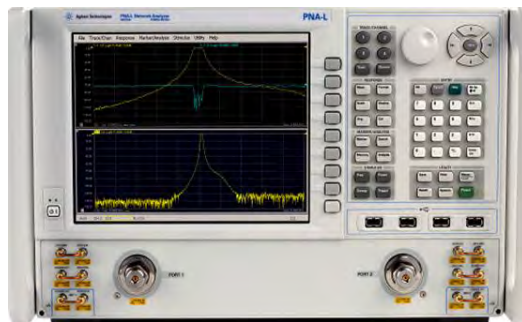

Data Sheet and
Technical
Specifications

Documentation Warranty

THE MATERIAL CONTAINED IN THIS DOCUMENT IS PROVIDED "AS IS," AND IS SUBJECT TO BEING CHANGED, WITHOUT NOTICE, IN FUTURE EDITIONS. FURTHER, TO THE MAXIMUM EXTENT PERMITTED BY APPLICABLE LAW, KEYSIGHT DISCLAIMS ALL WARRANTIES, EITHER EXPRESS OR IMPLIED WITH REGARD TO THIS MANUAL AND ANY INFORMATION CONTAINED HEREIN, INCLUDING BUT NOT LIMITED TO THE IMPLIED WARRANTIES OF MERCHANTABILITY AND FITNESS FOR A PARTICULAR PURPOSE. KEYSIGHT SHALL NOT BE LIABLE FOR ERRORS OR FOR INCIDENTAL OR CONSEQUENTIAL DAMAGES IN CONNECTION WITH THE FURNISHING, USE, OR PERFORMANCE OF THIS DOCUMENT OR ANY INFORMATION CONTAINED HEREIN. SHOULD KEYSIGHT AND THE USER HAVE A SEPARATE WRITTEN AGREEMENT WITH WARRANTY TERMS COVERING THE MATERIAL IN THIS DOCUMENT THAT CONFLICT WITH THESE TERMS, THE WARRANTY TERMS IN THE SEPARATE AGREEMENT WILL CONTROL.

DFARS/Restricted Rights Notice

If software is for use in the performance of a U.S. Government prime contract or subcontract, Software is delivered and licensed as "Commercial computer software" as defined in DFAR 252.227-7014 (June 1995), or as a "commercial item" as defined in FAR 2.101(a) or as "Restricted computer software" as defined in FAR 52.227-19 (June 1987) or any equivalent agency regulation or contract clause. Use, duplication or disclosure of Software is subject to Keysight Technologies' standard commercial license terms, and non-DOD Departments and Agencies of the U.S. Government will receive no greater than Restricted Rights as defined in FAR 52.227-19(c)(1-2) (June 1987). U.S. Government users will receive no greater than Limited Rights as defined in FAR 52.227-14 (June 1987) or DFAR 252.227-7015 (b)(2) (November 1995), as applicable in any technical data.

DFARS/Restricted Rights Notice	2
Definitions	5
Corrected System Performance	6
System Dynamic Range and Receiver Dynamic Range	6
Table 1a. System Dynamic Range (dB), All Models	7
Table 1b. System Dynamic Range (dB), N5231A or N5232A.....	7
Table 2. Receiver Dynamic Range (dB), N5239A, N5231A or N5232A - Typical.....	8
N5239A, N5231A and N5232A Corrected System Performance, All Options.....	8
Table 3. 85052B Calibration Kit.....	9
Table 4. N4691B 2-Port Electronic Calibration Module	10
Table 5. N4433A 4-Port Electronic Calibration Module.....	11
Uncorrected System Performance.....	12
Table 6a. Error Terms (dB), N5239A/31A/32A , All Ports, Option 200, 216 - Specifications	12
Table 6b. Error Terms (dB), N5239A/31A/32A, All Ports, Option 200, 216 - Typical.....	12
Table 6c. Error Terms (dB), N5231A, N5232A, All Ports, Option 400, 416 - Specifications.....	13
Table 6d. Error Terms (dB), N5231A, N5232A, All Ports, Option 400, 416 - Typical	13
Test Port Output.....	14
Table 7. Frequency Information, All Options	14
Table 8a. Maximum Leveled Power (dBm), All Models, All Ports ¹	14
Table 8b. Maximum Leveled Power (dBm), N5231A or N5232A, All Ports ¹	14
Table 9a. Power Level Accuracy (dB) at Nominal Power ¹ , All Models, Options 200 or 216, All Ports ²	15
Table 9b. Power Level Accuracy (dB) at Nominal Power ¹ , N5231A or N5232A, Options 400 or 416, All Ports ²	15
Table 10a. Power Level Linearity ¹ (dB), All Models, Options 200 or 216, All Ports ² - Specification16	
Table 10b. Power Level Linearity ¹ (dB), N5231A, N5232A Option 400, 416, All Ports ² - Specification	16
Table 11a. Power Sweep Range (dB), All Models, Option 200 or 216, All Ports ¹	16
Table 11b. Power Sweep Range (dB), N5231A or N5232A, Option 400 or 416, All Ports ¹	17
Table 12. Nominal Power (Preset, dBm), All Models, All Ports ¹	17
Table 13. Power Resolution and Maximum/Minimum Settable Power, All Models, All Ports ¹	17
Table 14. 2 nd and 3 rd Harmonics at Max Specified Power (dBc), All Ports ¹ - Typical.....	18
Table 15 Non-Harmonic Spurs at Nominal Power (dBc), All Models, All Options - Typical.....	18
Table 16. Phase Noise (dBc/Hz), All Models, All Options - Typical.....	18
Test Port Input	19
Table 17. Test Port Noise Floor ¹ (dBm) @ 10 Hz IFBW, All Models, All Ports	19
Table 18. Direct Receiver Access Input Noise Floor ¹ (dBm), All Models, All Ports.....	19
Table 19. 0.1 dB Receiver Compression at Test Port (dBm), All Models, All Options, All Ports - Typical	20
Table 20. Receiver Compression at Test Port Power, All Models, All Ports - Specification.....	20
Table 21a. Trace Noise ¹ Magnitude (dB rms)/Phase (deg rms), All Models, Option 200 or 216	20

Table 21b. Trace Noise ¹ Magnitude (dB rms) / Phase (deg rms), N5231A or N5232A, Option 40021	
Table 21c. Trace Noise ¹ Magnitude (dB rms) / Phase (deg rms), N5231A or N5232A, Option 41621	
Table 22. Reference Level Magnitude, All Models, All Options - Specification	21
Table 23a. Stability ¹ , All Models, Options 200 or 216 - Typical	21
Table 23b. Stability ¹ , N5231A, N5232A, Options 400, 416 - Typical	22
Table 24a. Damage Level, All Models - Specification.....	22
Table 24b. Damage Level, All Models - Specification	22
Dynamic Accuracy	23
Table 25. Dynamic Accuracy - Specification.....	23
Table 26. Group Delay ¹	25
General Information	26
Table 27. Miscellaneous Information	26
Table 28. Front Panel Information, All Options	26
Table 28. (Continued) Front Panel Information, All Options	27
Table 29. Rear Panel Information, All Options.....	27
Table 29. (Continued) Rear Panel Information, All Options.....	28
Table 30. Analyzer Dimensions and Weight.....	29
Regulatory and Environmental Information	29
Measurement Throughput Summary.....	30
Table 31a. Cycle Time (ms) for Measurement Completion, All Models, All Options - Typical	30
Table 31b. N5239A Cycle Time (ms) for Full-Span Measurement Completion - Typical.....	30
Table 31c. N5231A Cycle Time (ms) for Full-Span Measurement Completion- Typical.....	31
Table 31d. N5232A Cycle Time (ms) for Full-Span Measurement Completion- Typical.....	31
Table 32. Cycle Time vs. IF Bandwidth - Typical	32
Table 33. Cycle Time vs. Number of Points - Typical.....	33
Table 34. Data Transfer Times - Typical.....	34
Specifications: Front-Panel Jumpers.....	35
Table 35. Measurement Receiver Inputs (dBm) - Typical.....	35
Table 36. Reference Receiver Inputs and Reference Source Outputs (dBm) - Typical.....	35
Table 37. Source Outputs (dBm) - Typical	36
Table 38. Coupler Inputs (dB), All Options - Typical	36
Test Set Block Diagrams.....	37
N5239A, N5231A and N5232A Option 200 (2-port base model).....	37
N5239A, N5231A and N5232A Option 216.....	37
N5231A and N5232A Option 400 (4-port base model).....	38
N5231A and N5232A Option 416	38
Receiver Block Diagram	39

This is a complete list of the technical specifications for the N5239A, N5231A and N5232A PNA-L Series network analyzers with the following options:

2-Port, All Models

Option 200 - 2-port base model with standard test set.

Option 216 - To base model, adds front-panel jumpers, and source attenuators (extended power range).

4-Port N5231A or N5232A

Option 400 - 4-port base model with standard test set.

Option 416 - To base model, adds front-panel jumpers, and source attenuators (extended power range).

See block diagrams for all models and options beginning on page 37.

Definitions

All specifications and characteristics apply over a 25 °C \pm 5 °C range (unless otherwise stated) and 90 minutes after the instrument has been turned on.

Specification (spec.): Warranted performance. Specifications include guardbands to account for the expected statistical performance distribution, measurement uncertainties, and changes in performance due to environmental conditions.

Characteristic (char.): A performance parameter that the product is expected to meet before it leaves the factory, but that is not verified in the field and is not covered by the product warranty. A characteristic includes the same guardbands as a specification.

Typical (typ.): Expected performance of an average unit which does not include guardbands. It is not covered by the product warranty. Typical values are produced by averaging the measured data across each frequency band.

Nominal (nom.): A general, descriptive term that does not imply a level of performance. It is not covered by the product warranty.

Calibration: The process of measuring known standards to characterize a network analyzer's systematic (repeatable) errors.

Corrected (residual): Indicates performance after error correction (calibration). It is determined by the quality of calibration standards and how well "known" they are, plus system repeatability, stability, and noise.

Uncorrected (raw): Indicates instrument performance without error correction. The uncorrected performance affects the stability of a calibration.

Standard: When referring to the analyzer, this includes no options unless noted otherwise.

Notes

This document provides technical specifications for the 85052B, N4691B and N4433A calibration kits.

Please download our free Uncertainty Calculator from http://www.keysight.com/find/na_calculator to generate the curves for your calibration kit and PNA setup.

Corrected System Performance

The specifications in this section apply for measurements made with the N5231A and N5232A PNA network analyzers with the following conditions:

- 10 Hz IF bandwidth
- No averaging applied to data
- Isolation calibration with an averaging factor of 8

System Dynamic Range and Receiver Dynamic Range

- **System Dynamic Range** is defined as the specified source maximum output power (spec) minus the noise floor (spec).
- **Extended Dynamic Range at Direct Access Input** is defined as the specified source maximum output power (spec) minus the direct receiver access input noise floor (spec).
- **Receiver Dynamic Range** is defined as the test port compression at 0.1 dB (typical) minus the noise floor (typical).

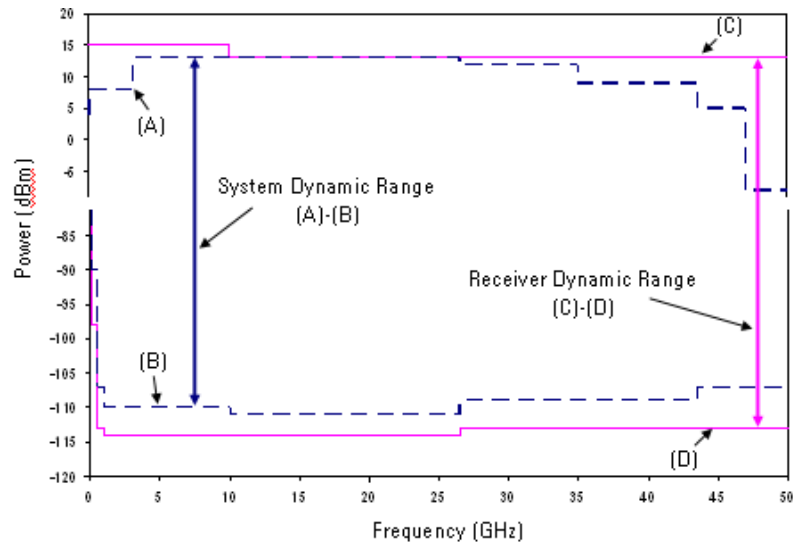

NOTE:

The effective dynamic range must take measurement uncertainties and interfering signals into account.

The direct receiver access input extended dynamic range is calculated as the difference between the direct receiver access input noise floor and the source maximum output power. This set-up should only be used when the receiver input will never exceed its maximum receiver input. When the analyzer is in segment sweep mode, it can have predefined frequency segments which will output a higher power level when the extended dynamic range is required (i.e. devices with high insertion loss), and reduced power when the maximum receiver input level will occur (i.e. devices with low insertion loss). The extended range is only available in one-path transmission measurements.

It may typically be degraded at particular frequencies below 500 MHz due to spurious receiver residuals.

Table 1a. System Dynamic Range (dB), All Models

Description	Specification			Typical		
	Option 200		Option 216	Option 200		Option 216
	Test Port	Test Port	Direct Receiver Access Port	Test Port	Test Port	Direct Receiver Access Port
300 kHz to 3 MHz	105	104	117	136	137	153
3 MHz to 10 MHz	115	114	127	138	139	155
10 MHz to 500 MHz	131	129	142	139	140	156
500 MHz to 2 GHz	133	131	144	141	140	156
2 GHz to 6 GHz	133	131	144	141	141	157
6 GHz to 8.5 GHz	133	131	144	140	139	155
8.5 GHz to 10.5 GHz	128	126	139	139	137	153
10.5 GHz to 12.5 GHz	127	125	138	139	137	153
12.5 GHz to 13.51 GHz	125	122	135	138	136	152
13.51 GHz to 15 GHz	115	112	125	129	127	143
15 GHz to 20 GHz	114	111	124	129	127	143

Table 1b. System Dynamic Range (dB), N5231A or N5232A

Description	Specification			Typical		
	Option 400		Option 416	Option 400		Option 416
	Test Port	Test Port	Direct Receiver Access Port	Test Port	Test Port	Direct Receiver Access Port
300 kHz to 3 MHz	102	101	114	135	134	150
3 MHz to 10 MHz	112	111	124	138	137	153
10 MHz to 500 MHz	128	128	141	138	137	153
500 MHz to 4 GHz	128	128	141	139	138	154
4 GHz to 6 GHz	127	126	139	138	137	153
6 GHz to 8.5 GHz	124	122	135	137	135	151
8.5 GHz to 10.5 GHz	122	120	133	136	134	150
10.5 GHz to 12.5 GHz	118	116	129	133	130	146

12.5 GHz to 13.51 GHz	118	106	119	133	121	137
13.51 GHz to 15 GHz	108	101	114	124	118	134
15 GHz to 20 GHz	105	101	114	121	134	150

Table 2. Receiver Dynamic Range (dB), N5239A, N5231A or N5232A - Typical

Description	Options 200, 216	Options 400, 416
300 kHz to 3 MHz	125	125
3 MHz to 10 MHz	127	128
10 MHz to 500 MHz	132	133
500 MHz to 2 GHz	133	135
2 GHz to 4 GHz	134	135
4 GHz to 8.5 GHz	134	136
8.5 GHz to 10.5 GHz	134	135
10.5 GHz to 13.5 GHz	134	134
13.51 GHz to 15 GHz	125	125
15 GHz to 20 GHz	124	124

N5239A, N5231A and N5232A Corrected System Performance, All Options

Note: For any S_{ii} reflection measurement:

- $S_{jj} = 0$.

For any S_{ij} transmission measurement:

- $S_{ji} = S_{ij}$ when $S_{ij} \leq 1$
- $S_{ji} = 1/S_{ij}$ when $S_{ij} > 1$
- $S_{kk} = 0$ for all k

Applies to the N5239A/1A/2A Option 200, 216, 400, 416 analyzers, 85131F flexible test port cable set, and a full 2-port calibration. Also applies to the following condition:

Environmental temperature $23^\circ \pm 3^\circ \text{C}$, with $< 1^\circ \text{C}$ deviation from calibration temperature

Table 3. 85052B Calibration Kit

Description	Specification (dB)					
	300 kHz to 50 MHz	50 MHz to 500 MHz	500 MHz to 2 GHz	2 GHz to 8.5 GHz	8.5 GHz to 13.5 GHz	13.5 GHz to 20 GHz
Directivity	48	48	48	44	44	44
Source Match	40	40	40	31	31	31
Load Match	48	48	48	44	44	44
Reflection Tracking ¹						
Mag	±0.003	±0.003	±0.003	±0.006	±0.006	±0.006
Phase (°/°C)	±0.020	±0.020	±0.020	±0.040	±0.040	±0.040
Transmission Tracking ¹						
Mag	±0.067	±0.017	±0.017	±0.078	±0.134	±0.131
Phase (°/°C)	±0.441	±0.115	±0.115	±0.518	±0.884	±0.866

¹Temperature deviation is a characteristic value.

Transmission Uncertainty, All Options

Magnitude

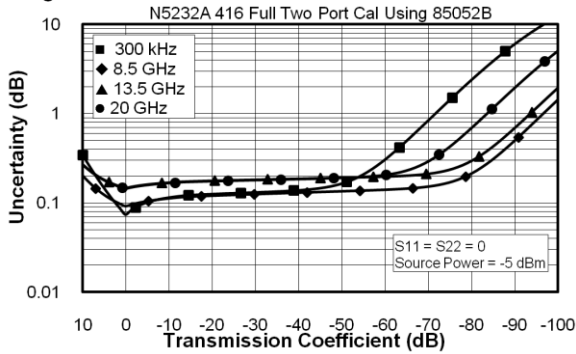

Phase

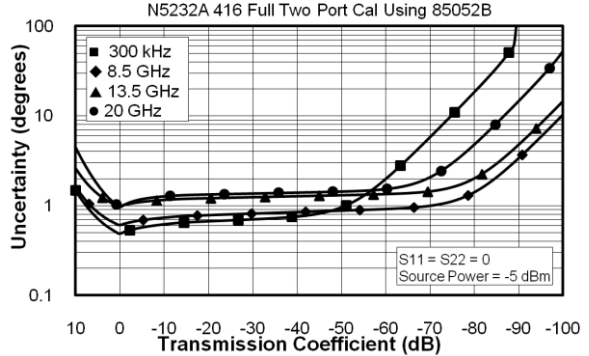

Reflection Uncertainty, All Options

Magnitude

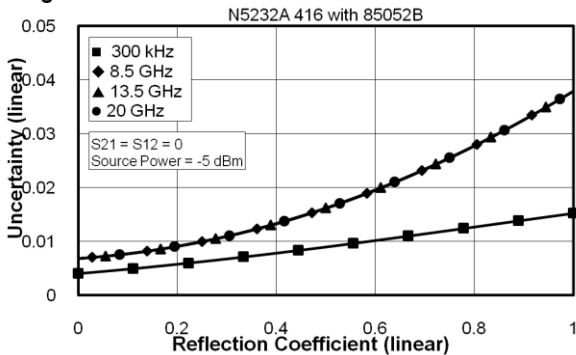

Phase

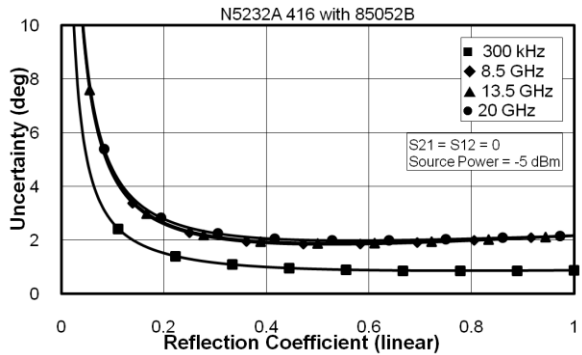
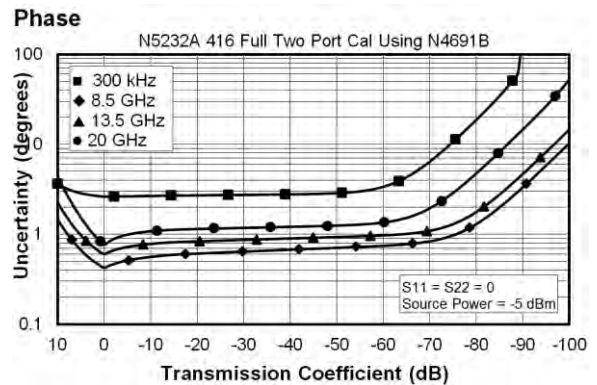
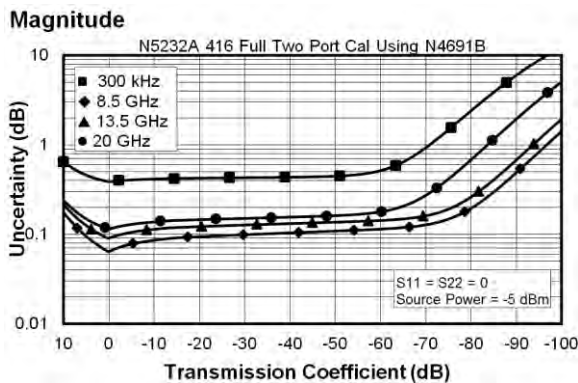

Table 4. N4691B 2-Port Electronic Calibration Module

Description	Specification (dB)					
	300 kHz to 50 MHz	50 MHz to 500 MHz	500 MHz to 2 GHz	2 GHz to 8.5 GHz	8.5 GHz to 13.5 GHz	13.5 GHz to 20 GHz
Directivity	31	46	52	48	46	46
Source Match	29	41	47	45	42	42
Load Match	27	42	47	42	40	39
Reflection Tracking ¹						
Mag	±0.110	±0.050	±0.020	±0.030	±0.040	±0.040
Phase (°/°C)	±0.726	±0.330	±0.132	±0.198	±0.264	±0.264
Transmission Tracking ¹						
Mag	±0.368	±0.036	±0.026	±0.052	±0.078	±0.102
Phase (°/°C)	±2.430	±0.235	±0.174	±0.343	±0.516	±0.674

¹Temperature deviation is a characteristic value.

Transmission Uncertainty, All Options



Reflection Uncertainty, All Options

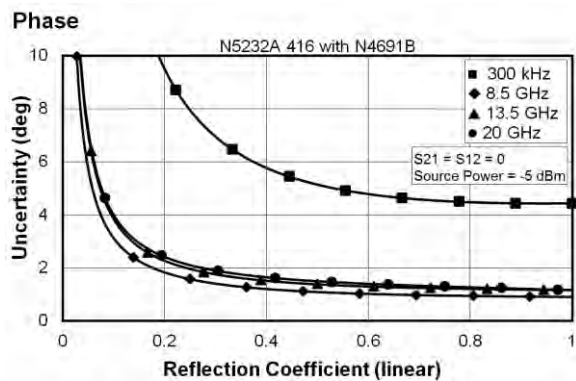
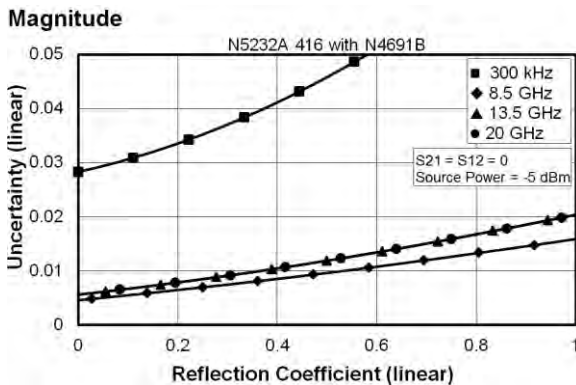

Table 5. N4433A 4-Port Electronic Calibration Module

Note: Uncertainty curves for the N4433A are created using a 2-port calibration. Multiport uncertainties are not supported at this time.

Description	Specification (dB)					
	300 kHz to 50 MHz	50 MHz to 500 MHz	500 MHz to 2 GHz	2 GHz to 8.5 GHz	8.5 GHz to 13.5 GHz	13.5 GHz to 20 GHz
Directivity	45	50	50	47	45	40
Source Match	36	42	42	39	37	31
Load Match	36	43	43	40	38	33
Reflection Tracking ¹						
Mag	±0.100	±0.060	±0.060	±0.090	±0.100	±0.180
Phase (°/°C)	±0.660	±0.396	±0.396	±0.594	±0.660	±1.188
Transmission Tracking ¹						
Mag	±0.176	±0.039	±0.042	±0.078	±0.118	±0.221
Phase (°/°C)	±1.161	±0.260	±0.275	±0.513	±0.776	±1.458

¹ Temperature deviation is a characteristic value.

Transmission Uncertainty, All Options

Magnitude

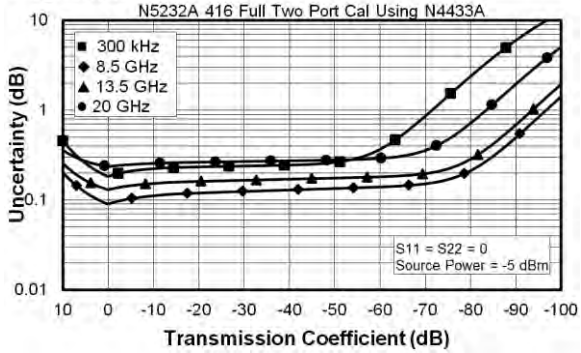

Phase

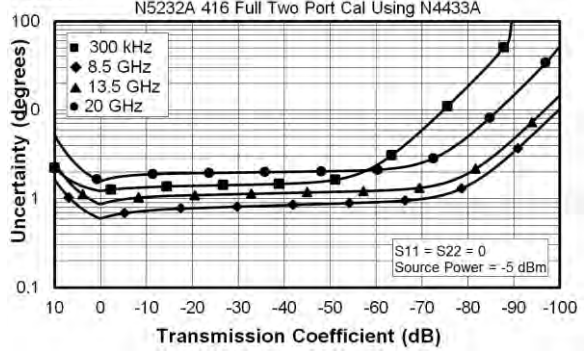

Reflection Uncertainty, All Options

Magnitude

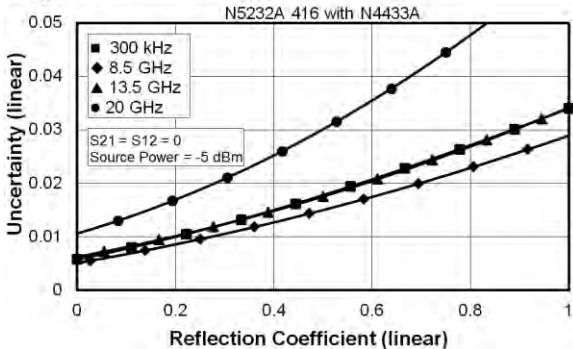

Phase

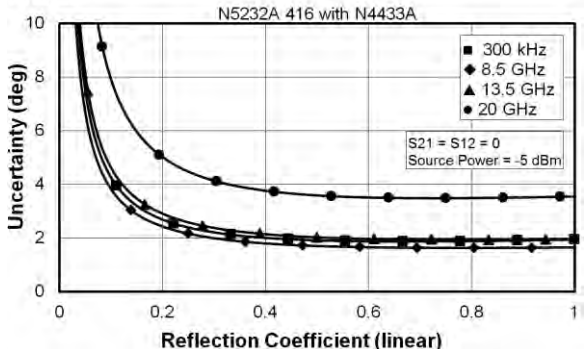

Uncorrected System Performance

Specifications apply to following conditions:

- Over environmental temperature of 25 °C ±5 °C,
- Cable loss not included in Transmission Tracking.
- Crosstalk measurement conditions: normalized to a thru, measured with shorts on all ports, 10 Hz IF bandwidth, averaging factor of 8, alternate mode, source power set to the specified maximum power.

Table 6a. Error Terms (dB), N5239A/31A/32A , All Ports, Option 200, 216 - Specifications

Description	Directivity	Source Match	Load Match	Transmission Tracking	Reflection Tracking	Crosstalk
300 kHz to 1 MHz	12	6	6	--	--	--
1 MHz to 45 MHz	12	9	9	--	--	--
45 MHz to 500 MHz	24	17	22	--	--	--
500 MHz to 2 GHz	27	15	16	--	--	--
2 GHz to 8.5 GHz	19	10	10	--	--	--
8.5 GHz to 12.5 GHz	15	8	8	--	--	--
12.5 GHz to 20 GHz	15	8	9	--	--	--

Table 6b. Error Terms (dB), N5239A/31A/32A, All Ports, Option 200, 216 - Typical

Description	Directivity	Source Match	Load Match	Transmission Tracking	Reflection Tracking	Crosstalk
300 kHz to 1 MHz	16	8	8	+/-2.0	+/-1.5	-80
1 MHz to 5 MHz	16	17	17	+/-2.0	+/-1.5	-85
5 MHz to 45 MHz	16	17	17	+/-2.0	+/-1.5	-95
45 MHz to 500 MHz	35	21	28	+/-2.0	+/-1.5	-110
500 MHz to 2 GHz	35	19	22	+/-2.0	+/-1.5	-122
2 GHz to 8.5 GHz	23	17	17	+/-2.0	+/-1.5	-122
8.5 GHz to 10.5 GHz	20	12	12	+/-2.0	+/-1.5	-122
10.5 GHz to 12.5 GHz	20	12	12	+/-2.0	+/-1.5	-115
12.5 GHz to 13.5GHz	20	12	14	+/-2.5	+/-2.0	-115
13.5 GHz to 20 GHz	20	12	14	+/-2.5	+/-2.0	-108

Table 6c. Error Terms (dB), N5231A, N5232A, All Ports, Option 400, 416 - Specifications

Description	Directivity	Source Match	Load Match	Transmission Tracking	Reflection Tracking	Crosstalk
300 kHz to 1 MHz	10	6	5	--	--	--
1 MHz to 10 MHz	10	9	14	--	--	--
10 MHz to 1 GHz	28	12	20	--	--	--
1 GHz to 3 GHz	25	10	18	--	--	--
3 GHz to 5 GHz	20	10	14	--	--	--
5 GHz to 8.5 GHz	17	10	12	--	--	--
8.5 GHz to 11.5 GHz	15	10	12	--	--	--
11.5 GHz to 16 GHz	15	7	7	--	--	--
16 GHz to 20 GHz	15	8	7	--	--	--

Table 6d. Error Terms (dB), N5231A, N5232A, All Ports, Option 400, 416 - Typical

Description	Directivity	Source Match	Load Match	Transmission Tracking	Reflection Tracking	Crosstalk
300 kHz to 1 MHz	16	8	8	+/-2.0	+/-1.5	-80
1 MHz to 5 MHz	16	17	17	+/-2.0	+/-1.5	-85
5 MHz to 10 MHz	16	17	17	+/-2.0	+/-1.5	-95
10 MHz to 45 MHz	35	24	30	+/-2.0	+/-1.5	-95
45 MHz to 500 MHz	35	24	30	+/-2.0	+/-1.5	-110
500 MHz to 1 GHz	35	24	30	+/-2.0	+/-1.5	-122
1 GHz to 3 GHz	31	24	25	+/-2.0	+/-1.5	-122
3 GHz to 5 GHz	25	19	21	+/-2.0	+/-1.5	-122
5 GHz to 8.5 GHz	19	16	16	+/-2.0	+/-1.5	-122
8.5 GHz to 10.5 GHz	18	16	16	+/-2.0	+/-1.5	-122
10.5 GHz to 11.5 GHz	18	16	19	+/-2.0	+/-1.5	-115
11.5 GHz to 12.5 GHz	18	13	13	+/-2.0	+/-1.5	-115
12.5 GHz to 13.5 GHz	18	13	13	+/-2.5	+/-2.0	-115
13.5 GHz to 16 GHz	18	13	13	+/-2.5	+/-2.0	-108
16 GHz to 20 GHz	18	13	15	+/-2.5	+/-2.0	-108

Test Port Output

Table 7. Frequency Information, All Options

Description	Specification		Typical	
	Option 200	Option 216	Option 200	Option 216
N5239A Frequency Range	300 kHz to 8.5 GHz		--	
N5231A Frequency Range	300 kHz to 13.5 GHz		--	
N5232A Frequency Range	300 kHz to 20 GHz		--	
Frequency Resolution	1 Hz		--	
Frequency Accuracy	+/- 1 ppm		--	
Frequency Stability	--		+/-0.05 ppm, -10° to 70° C ¹ +/-0.1 ppm/yr maximum ²	

¹ Assumes no variation in time.

² Assumes no variation in temperature.

Table 8a. Maximum Leveled Power (dBm), All Models, All Ports¹

Description	Specification		Typical	
	Option 200	Option 216	Option 200	Option 216
300 kHz to 10 MHz	10	9	16	16
10 MHz to 500 MHz	13	11	16	16
500 MHz to 6 GHz	13	11	17	17
6 GHz to 8.5 GHz	13	11	16	15
8.5 GHz to 12.5 GHz	10	8	15	13
12.5 GHz to 20 GHz	8	5	14	12

¹ Any port can be used as the source port.

Table 8b. Maximum Leveled Power (dBm), N5231A or N5232A, All Ports¹

Description	Specification		Typical	
	Option 400	Option 416	Option 400	Option 416
300 kHz to 10 MHz	7	6	15	14
10 MHz to 4 GHz	8	8	14	13
4 GHz to 6 GHz	7	6	12	11
6 GHz to 10.5 GHz	4	2	11	9
10.5 GHz to 15 GHz	1	-1	9	6
15 GHz to 20 GHz	-2	-6	6	3

¹ Any port can be used as the source port.

Table 9a. Power Level Accuracy (dB) at Nominal Power¹, All Models, Options 200 or 216, All Ports²

Description	Specification	Typical
300 kHz to 10 MHz	+/- 1.8	+/- 0.09
10 MHz to 45 MHz	+/- 1.5	+/- 0.06
45 MHz to 500 MHz	+/- 1.0	+/- 0.07
500 MHz to 2 GHz	+/- 1.0	+/- 0.08
2 GHz to 8.5 GHz	+/- 1.0	+/- 0.09
8.5 GHz to 13.5 GHz	+/- 1.5	+/- 0.14
13.5 GHz to 16 GHz	+/- 1.5	+/- 0.18
16 GHz to 20 GHz	+/- 1.5	+/- 0.14

¹ Level accuracy at power other than nominal power, Power Level Accuracy (dB) at Nominal Power + Power Level Linearity (dB)

² Any port can be used as the source port.

Table 9b. Power Level Accuracy (dB) at Nominal Power¹, N5231A or N5232A, Options 400 or 416, All Ports²

Description	Specification	Typical
300 kHz to 10 MHz	+/- 1.5	+/- 0.07
10 MHz to 45 MHz	+/- 1.0	+/- 0.12
45 MHz to 500 MHz	+/- 1.0	+/- 0.18
500 MHz to 2 GHz	+/- 1.0	+/- 0.10
2 GHz to 8.5 GHz	+/- 1.25	+/- 0.27
8.5 GHz to 10.5 GHz	+/- 1.5	+/- 0.21
10.5 GHz to 12.5 GHz	+/- 2.0	+/- 0.43
12.5 GHz to 16 GHz	+/- 2.5	+/- 0.65
16 GHz to 20 GHz	+/- 2.8	+/- 0.72

¹ Level accuracy at power other than nominal power, Power Level Accuracy (dB) at Nominal Power + Power Level Linearity (dB)

² Any port can be used as the source port.

Table 10a. Power Level Linearity¹ (dB), All Models, Options 200 or 216, All Ports² - Specification

Description	Specification		P ≥ -15 dBm
	-25 dBm ≤ P < -20 dBm	-20 dBm ≤ P < -15 dBm	
300 kHz to 10 MHz	+/-2.0	+/-1.5	+/-1.5
10 MHz to 20 GHz	+/-1.5	+/-1.5	+/-1.5

¹ Referenced to nominal power.

² Any port can be used as the source port.

Table 10b. Power Level Linearity¹ (dB), N5231A, N5232A Option 400, 416, All Ports² - Specification

Description	Specification		P ≥ -15 dBm
	-25 dBm ≤ P < -20 dBm	-20 dBm ≤ P < -15 dBm	
300 kHz to 10 MHz	+/-2.5	+/-1.5	+/-1.5
10 MHz to 20 GHz	+/-1.5	+/-1.5	+/-1.5

¹ Referenced to nominal power.

² Any port can be used as the source port.

Table 11a. Power Sweep Range (dB), All Models, Option 200 or 216, All Ports¹

Description	Specification		Typical	
	Option 200	Option 216	Option 200	Option 216
300 kHz to 10 MHz	35	34	43	43
10 MHz to 50 MHz	38	36	43	43
50 MHz to 6 GHz	38	36	44	44
6 GHz to 8.5 GHz	38	36	43	42
8.5 GHz to 12.5 GHz	35	33	42	40
12.5 GHz to 20 GHz	33	30	41	39

¹ Any port can be used as the source port.

Table 11b. Power Sweep Range (dB), N5231A or N5232A, Option 400 or 416, All Ports¹

Description	Specification		Typical	
	Option 400	Option 416	Option 400	Option 416
300 kHz to 10 MHz	32	31	42	41
10 MHz to 4 GHz	33	33	41	40
4 GHz to 6 GHz	32	31	39	38
6 GHz to 10.5 GHz	29	27	38	36
10.5 GHz to 15 GHz	26	24	36	33
15 GHz to 20 GHz	23	19	33	30

¹ Any port can be used as the source port.

Table 12. Nominal Power (Preset, dBm), All Models, All Ports¹

Description	Options 200, 216	Option 400	Option 416
Preset Power	0	-5	-8

¹ Any port can be used as the source port.

Table 13. Power Resolution and Maximum/Minimum Settable Power, All Models, All Ports¹

Description	Specification (dB)	Typical (dBm)		
		All Options	Options 200, 400	Options 216, 416
Power Resolution	0.01	--	--	--
Maximum Settable Power		30	--	--
Minimum Settable Power	--	--	-30	-90

¹ Any port can be used as the source port.

Table 14. 2nd and 3rd Harmonics at Max Specified Power (dBc), All Ports¹ - Typical

Description ²	N5239A		N5231A		N5232A	
	Options 200, 216	Options 200, 216	Options 400, 416	Options 200, 216	Options 400, 416	Options 400, 416
600 kHz to 500 MHz	-15	-15	-18	-15	-18	-18
500 MHz to 1 GHz	-17	-17	-18	-17	-18	-18
1 GHz to 3 GHz	-17	-17	-17	-17	-17	-17
3 GHz to 4 GHz	-17	-17	-25	-17	-25	-25
4 GHz to 8.5 GHz	-18	-18	-25	-18	-25	-25
8.5 GHz to 13.5 GHz	--	-18	-25	-18	-25	-25
13.5 GHz to 20 GHz	--	--	--	-18	-22	-22

¹ Any port can be used as the source port.

² Listed frequency is harmonic frequency; test at max specified power

Table 15 Non-Harmonic Spurs at Nominal Power (dBc), All Models, All Options - Typical

Description	Based on 8 kHz offset Frac-N	Based on 100 kHz offset Frac-N
300 kHz to 500 MHz	-50	-50
500 MHz to 2 GHz	-60	-42
2 GHz to 4 GHz	-57	-45
4 GHz to 8 GHz	-51	-39
8 GHz to 16 GHz	-45	-33
16 GHz to 20 GHz	-39	-27

Table 16. Phase Noise (dBc/Hz), All Models, All Options - Typical

Description	1 kHz Offset	10 kHz Offset	100 kHz Offset	1 MHz Offset
300 kHz to 50 MHz	-95	-101	-101	-117
50 MHz to 1 GHz	-96	-101	-101	-119
1 GHz to 2 GHz	-91	-105	-102	-121
2 GHz to 4 GHz	-85	-99	-96	-115
4 GHz to 8 GHz	-79	-93	-90	-109
8 GHz to 16 GHz	-73	-87	-84	-103

16 GHz to 20 GHz	-67	-81	-78	-97
------------------	-----	-----	-----	-----

Test Port Input

Table 17. Test Port Noise Floor¹ (dBm) @ 10 Hz IFBW, All Models, All Ports

Description	Specification		Typical	
	Options 200, 216	Options 400, 416	Options 200, 216	Options 400, 416
300 kHz to 3 MHz ²	-95	-95	-120	-120
3 MHz to 10 MHz ²	-105	-105	-122	-123
10 MHz to 500 MHz ²	-118	-120	-123	-124
500 MHz to 2 GHz	-120	-120	-123	-125
2 GHz to 4 GHz	-120	-120	-124	-125
4 GHz to 8.5 GHz	-120	-120	-124	-126
8.5 GHz to 10.5 GHz	-118	-118	-124	-125
10.5 GHz to 13.51 GHz	-117	-117	-124	-124
13.51 GHz to 15 GHz	-107	-107	-115	-115
15 GHz to 20 GHz	-106	-107	-115	-115

¹ Total average (rms) noise power calculated as the mean value of a linear magnitude trace expressed in dBm.

² May typically be degraded at particular frequencies below 500 MHz due to spurious receiver residuals.

Table 18. Direct Receiver Access Input Noise Floor¹ (dBm), All Models, All Ports

Description	Specification		Typical	
	Option 216	Option 416	Option 216	Option 416
300 kHz to 3 MHz ²	-108	-108	-136	-136
3 MHz to 10 MHz ²	-118	-118	-138	-139
10 MHz to 500 MHz ²	-131	-133	-139	-140
500 MHz to 2 GHz	-133	-133	-139	-141
2 GHz to 4 GHz	-120	-120	-124	-125
4 GHz to 8.5 GHz	-131	-131	-140	-142
8.5 GHz to 10.5 GHz	-131	-131	-140	-141
10.5 GHz to 13.51 GHz	-130	-130	-140	-140
13.51 GHz to 15 GHz	-120	-120	-131	-131
15 GHz to 20 GHz	-119	-120	-131	-131

¹ Total average (rms) noise power calculated as the mean value of a linear magnitude trace expressed in dBm.

² May typically be degraded at particular frequencies below 500 MHz due to spurious receiver residuals.

Table 19. 0.1 dB Receiver Compression at Test Port (dBm), All Models, All Options, All Ports - Typical

Description	Typical
300 kHz to 10 MHz	5
10 MHz to 500MHz	9
500 MHz to 15GHz	10
15 GHz to 20 GHz	9

Table 20. Receiver Compression at Test Port Power, All Models, All Ports - Specification

Description	Test Port Power (dBm)	Options 200, 216		Options 400, 416	
		Magnitude (dB)	Phase (degrees)	Magnitude (dB)	Phase (degrees)
300 kHz to 10 MHz	8 ¹	0.4	1.5	0.4	1.5
10 MHz to 50 MHz	8	0.15	1.0	0.15	1.0
50 MHz to 2 GHz	8	0.25	2.0	0.25	2.0
2 GHz to 8.5 GHz	8	0.25	2.5	0.25	2.5
8.5 GHz to 10 GHz	8	0.25	3.0	0.25	3.0
10 GHz to 13.5 GHz	8	0.25	4.5	0.28	4.0
13.5 GHz to 16 GHz	8	0.25	6.5	0.28	6.0
16 GHz to 20 GHz	8	0.35	11.0	0.28	9.0

¹ 6 dBm with Option 400 or 416.

Table 21a. Trace Noise¹ Magnitude (dB rms)/Phase (deg rms), All Models, Option 200 or 216

Description	Specification	Typical		
		1 kHz IFBW	100 kHz IFBW	600 kHz IFBW
300 kHz to 10 MHz	0.004 / 0.060	0.001 / 0.001	0.015 / 0.350	0.040 / 0.300
10 MHz to 45 MHz	0.004 / 0.060	0.004 / 0.024	0.006 / 0.350	0.105 / 0.670
45 MHz to 500 MHz	0.004 / 0.060	0.004 / 0.024	0.006 / 0.060	0.105 / 0.670
500 MHz to 13.51 GHz	0.004 / 0.060	0.001 / 0.005	0.006 / 0.060	0.015 / 0.090
13.51 GHz to 20 GHz	0.006 / 0.060	0.001 / 0.005	0.010 / 0.080	0.020 / 0.120

¹ Ratioed measurement, nominal power at test port.

Table 21b. Trace Noise¹ Magnitude (dB rms) / Phase (deg rms), N5231A or N5232A, Option 400

Description	Specification	Typical		
		1 kHz IFBW	100 kHz IFBW	600 kHz IFBW
300 kHz to 10 MHz	0.015 / 0.050	0.001 / 0.003	0.055 / 0.350	0.070 / 0.663
10 MHz to 45 MHz	0.007 / 0.050	0.004 / 0.024	0.055 / 0.350	0.110 / 0.663
45 MHz to 500 MHz	0.007 / 0.020	0.004 / 0.005	0.007 / 0.080	0.110 / 0.080
500 MHz to 13.51 GHz	0.007 / 0.020	0.001 / 0.005	0.007 / 0.080	0.015 / 0.080
13.51 GHz to 20 GHz	0.010 / 0.045	0.001 / 0.006	0.010 / 0.100	0.020 / 0.130

¹ Ratioed measurement, nominal power at test port.

Table 21c. Trace Noise¹ Magnitude (dB rms) / Phase (deg rms), N5231A or N5232A, Option 416

Description	Specification	Typical		
		1 kHz IFBW	100 kHz IFBW	600 kHz IFBW
300 kHz to 10 MHz	0.007 / 0.052	0.001 / 0.003	0.053 / 0.350	0.110 / 0.300
10 MHz to 45 MHz	0.002 / 0.052	0.004 / 0.024	0.053 / 0.350	0.110 / 0.670
45 MHz to 500 MHz	0.002 / 0.052	0.001 / 0.005	0.053 / 0.350	0.110 / 0.670
500 MHz to 13.51 GHz	0.002 / 0.020	0.001 / 0.005	0.015 / 0.100	0.020 / 0.100
13.51 GHz to 20 GHz	0.003 / 0.045	0.001 / 0.007	0.025 / 0.150	0.030 / 0.160

¹ Ratioed measurement, nominal power at test port.

Table 22. Reference Level Magnitude, All Models, All Options - Specification

Description	Magnitude (dB)	Phase (degrees)
Range	+/-500	+/-500
Resolution	0.001	0.01

Table 23a, Stability¹, All Models, Options 200 or 216 - Typical

Description	Magnitude (dB/°C)	Phase (°/°C)
300 kHz to 10 MHz	0.04	0.40
10 MHz to 45 MHz	0.01	0.15
45 MHz to 2 GHz	0.01	0.10
2 GHz to 4 GHz	0.01	0.15
4 GHz to 8.5 GHz	0.01	0.35
8.5 GHz to 13.5 GHz	0.02	0.75
13.5 GHz to 20 GHz	0.03	0.95

¹ Stability is defined as a ratio measurement made at the test port.

Table 23b. Stability¹, N5231A, N5232A, Options 400, 416 - Typical

Description	Magnitude (dB/°C)	Phase (°/°C)
300 kHz to 10 MHz	0.03	0.40
10 MHz to 2 GHz	0.01	0.07
2 GHz to 4 GHz	0.01	0.10
4 GHz to 13.5 GHz	0.03	0.50
13.5 GHz to 16 GHz	0.02	0.50
16 GHz to 19 GHz	0.02	0.60
19 GHz to 20 GHz	0.03	0.70

¹ Stability is defined as a ratio measurement made at the test port.

Table 24a. Damage Level, All Models - Specification

Description	Option 200		Option 400	
	RF (dBm)	DC (VDC)	RF (dBm)	DC (VDC)
Ports 1, 2	30	40	27	16
Ports 3, 4	--	--	27	16

Table 24b. Damage Level, All Models - Specification

Description	Option 216		Option 416	
	RF (dBm)	DC (VDC)	RF (dBm)	DC (VDC)
Ports 1, 2, 3, 4	27	7	27	16
RCVR A, B, C, D IN	15	16	15	16
REF RCVR R1 IN	15	16	15	16
REF SOURCE OUT	20	16	20	16
PORT 1, 2, 3, 4 SOURCE OUT	27	7	27	16
PORT 1, 2, 3, 4 CPLR THRU	27	7	27	16
PORT 1, 2, 3, 4 CPLR ARM	15	5	15	5

Dynamic Accuracy

Standard receiver accuracy of the test port input power reading relative to the reference input power level. It is verified with the following measurements:

- Compression over frequency
- IF linearity at a single frequency of 1.998765GHz using a reference level of -20 dBm for an input power range of 0 to -60 dBm. For values below -60 dBm, refer to "[VNA Receiver Dynamic Accuracy Specifications and Uncertainties](#)"

Table 25. Dynamic Accuracy - Specification

Dynamic Accuracy, 50 MHz

Magnitude

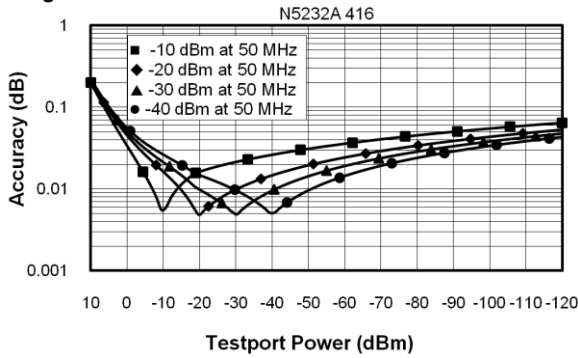

Phase

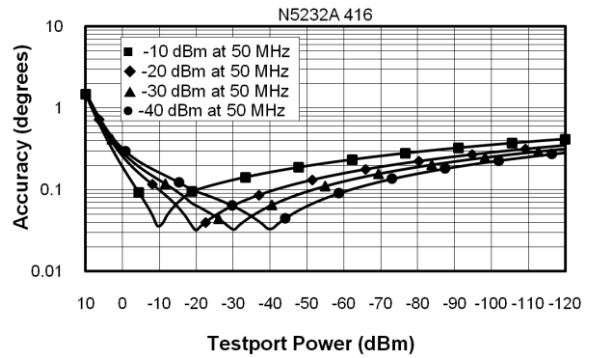

Dynamic Accuracy, 500 MHz

Magnitude

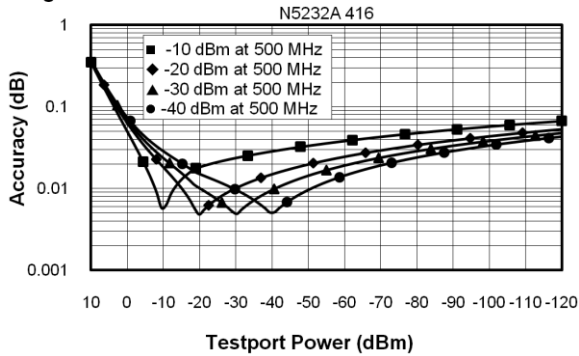

Phase

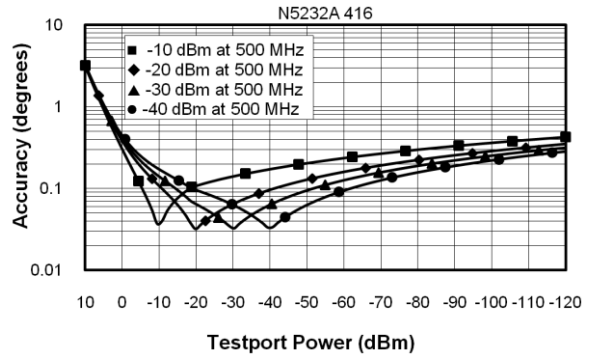

Dynamic Accuracy, 1 GHz

Magnitude

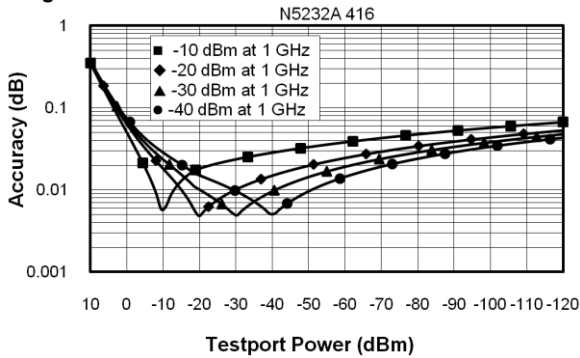

Phase

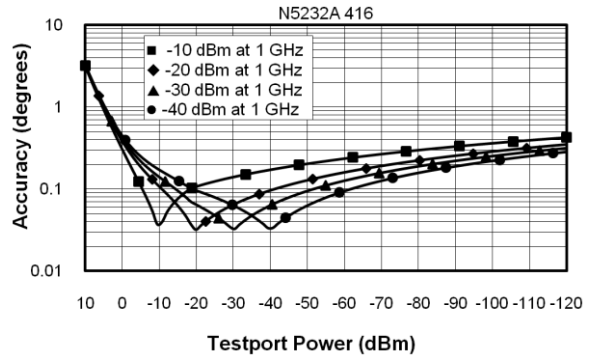

Dynamic Accuracy, 2 GHz

Magnitude

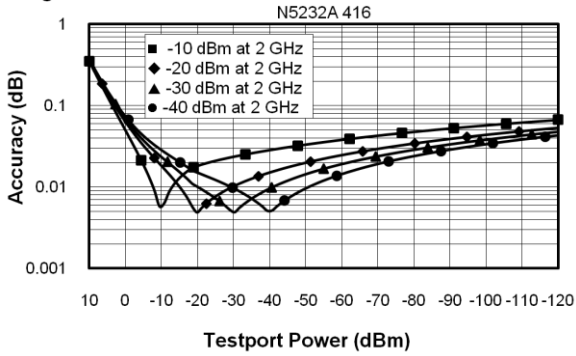

Phase

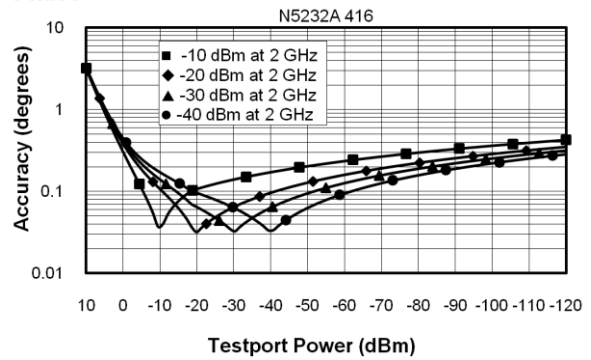

Dynamic Accuracy, 20 GHz

Magnitude

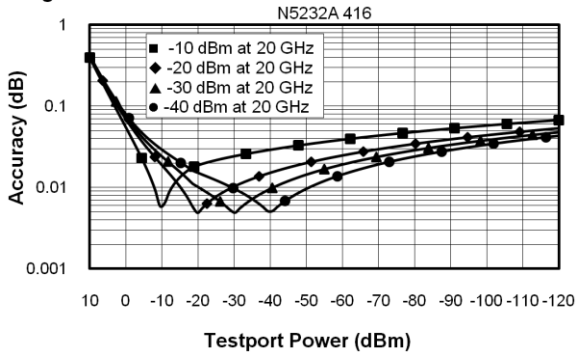

Phase

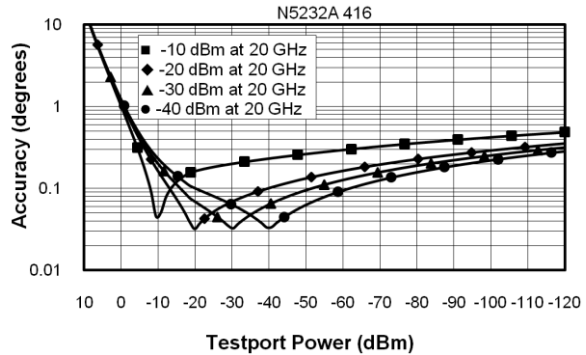

Table 26. Group Delay¹

Description	Typical Performance
Aperture (selectable)	(frequency span)/(number of points -1)
Maximum Aperture	20% of frequency span
Range	0.5 x (1/minimum aperture)
Maximum Delay	Limited to measuring no more than 180° of phase change within the minimum aperture.)

The following graphs show characteristic group delay accuracy with full 2-port calibration and a 10 Hz IF bandwidth. Insertion loss is assumed to be < 2 dB and electrical length to be ten meters.

For any S_{ij} Group Delay measurement, $S_{ii} = 0$, $S_{ij} = 1$, $S_{ji} = 0$, $S_{kl} = 0$ for all $kl \neq lij$

Group Delay (Typical)

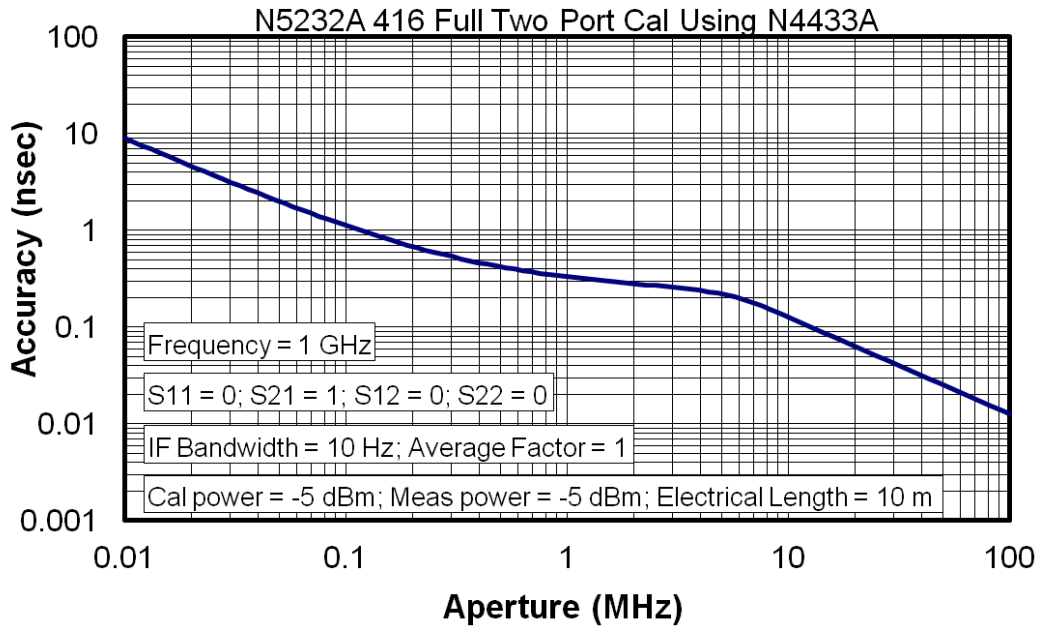

In general, the following formula can be used to determine the accuracy, in seconds, of specific group delay measurement:

$$\pm \text{Phase Accuracy (deg)} / [360 \times \text{Aperture (Hz)}]$$

Depending on the aperture and device length, the phase accuracy used is either incremental phase accuracy or worst-case phase accuracy.

¹ Group delay is computed by measuring the phase change within a specified frequency step (determined by the frequency span and the number of points per sweep).

General Information

- [Miscellaneous Information](#)
- [Front Panel](#)
- [Rear Panel](#)
- [Environment and Dimensions](#)

Table 27. Miscellaneous Information

Description	Supplemental Information
System IF Bandwidth Range	1 Hz to 15 MHz, nominal
CPU	Intel® 1.87 GHz Celeron® with 4 GByte RAM
LXI	Class C

Table 28. Front Panel Information, All Options

Description	Typical Performance
RF Connectors	
Test Ports	3.5 mm (male), 50 ohm (nominal), 0.002 in. Center Pin Recession (characteristic)
Jumpers (Options 216, 416)	SMA (female) connectors with SMA (male) jumper cables
USB 2.0 Ports - Master (4 ports)	
Standard	Compatible with USB 2.0
Connector	USB Type-A female
Display	
Size	26.3 cm (10.4 in) diagonal color active matrix LCD; 1024 (horizontal) X 768 (vertical) resolution
Refresh Rate	Vertical 60 Hz; Horizontal 46.08 kHz
Pixels	<p>Any of the following would cause a display to be considered faulty:</p> <ul style="list-style-type: none"> • A complete row or column consists of "stuck" or "dark" pixels. • More than six "stuck on" pixels (but not more than three green) or more than 0.002% of the total pixels are within the LCD specifications. • More than twelve "dark" pixels (but no more than seven of the same color) or more than 0.004% of the total pixels are within the LCD specifications. • Two or more consecutive "stuck on" pixels or three or more consecutive "dark" pixel (but no more than one set of two consecutive dark pixels) • "Stuck on" "dark" pixels are less than 6.5 mm apart (excluding consecutive pixels)

Table 28. (Continued) Front Panel Information, All Options

Description	Typical Performance
Display Range	
Magnitude	+/-2500 dB (at 500 dB/div), max
Phase	+/-2500° (at 500 dB/div), max
Polar	10 pUnits, min 10,000 Units, max
Display Resolution	
Magnitude	0.001 dB/div, min
Phase	0.01°/div, min
Marker Resolution	
Magnitude	0.001 dB, min
Phase	0.01°, min
Polar	10 pUnit, min

Table 29. Rear Panel Information, All Options

Description	Typical Performance
10 MHz Reference In	
Connector	BNC, female
Input Frequency	10 MHz \pm 10 ppm
Input Level	-15 dBm to +20 dBm
Input Impedance	200 Ω , nom.
10 MHz Reference Out	
Connector	BNC, female
Output Frequency	10 MHz \pm 1 ppm
Signal Type	Sine Wave
Output Level	+10 dBm \pm 4 dB into 50 Ω
Output Impedance	50 Ω , nominal
Harmonics	<-40 dBc, typical

Table 29. (Continued) Rear Panel Information, All Options

Description	Typical Performance
VGA Video Output	
Connector	15-pin mini D-Sub; Drives VGA compatible monitors
Devices Supported	Resolutions
Flat Panel (TFT)	1024 X 768, 800 X 600, 640 X 480
Flat Panel (DSTN)	800 X 600, 640 X 480
CRT Monitor	1280 X 1024, 1024 X 768, 800 X 600, 640 X 480
Simultaneous operation of the internal and external displays is allowed, but with 640 X 480 resolution only. If you change resolution, you can only view the external display (internal display will "white out").	
Trigger Inputs/Outputs	BNC(f), TTL/CMOS compatible
Test Set IO	25-pin D-Sub connector, available for external test set control.
Power IO	9-pin D-Sub, female; analog and digital IO
Handler IO	36-pin parallel I/O port; all input/output signals are default set to negative logic; can be reset to positive logic via GPIB command.
GPIB	Two ports - dedicated controller and dedicated talker/listener. 24-pin D-sub (Type D-24), female; compatible with IEEE-488.
Parallel Port (LPT1)	25-pin D-Sub miniature connector, female; provides connection to printers or any other parallel port peripherals
USB Ports	Four ports on front panel (all Host) and five ports (four Host and one Device) on rear panel. Type A configuration (eight Host) and Type B configuration (one Device), USB 2.0 compatible. The total current limit for all rear panel USB ports is 2.0 amps. The total current limit for all front panel USB is 0.9 amps.
LAN	10/100BaseT Ethernet, 8-pin configuration; auto selects between the two data rates
Line Power	
Frequency, Voltage	50/60/400 Hz for 100 to 120 VAC 50/60 Hz for 220 to 240 VAC
	Power supply is auto switching
Max	350 watts

Table 30. Analyzer Dimensions and Weight

All models are shipped with bottom feet, handles and front and rear hardware.

See detailed PNA dimension drawings at: <http://na.tm.keysight.com/pna/PNADimensions.pdf>

Cabinet Dimensions	Metric (mm)	Imperial (inches)
Height		
Without bottom feet: EIA RU ¹ = 6	266.1	10.5
With bottom feet	279.1	11
Width		
Without handles or rack-mount flanges	425.6	16.8
With handles, without rack-mount flanges	458.7	18.1
With handles and rack-mount flanges	482.9	19.0
Depth		
Without front and rear panel hardware	445.7	17.5
With front and rear panel hardware, handles	497.2	19.6
Weight (nominal)		
	Net	Shipping
2-port models (Option 216)	23.6 kg (52 lb)	34.9 kg (77 lb)
4-port models (Option 416)	24 kg (53 lb)	35.4 kg (78 lb)

¹Electronics Industry Association rack units. 1 RU = 1.75 in.

Regulatory and Environmental Information

For Regulatory and Environmental information, refer to the PNA Series Installation and Quick Start Guide, located online at <http://literature.cdn.keysight.com/litweb/pdf/E8356-90001.pdf>.

Measurement Throughput Summary

- [Typical Cycle Time for Measurement Completion](#)
- [Cycle Time vs. IF Bandwidth](#)
- [Cycle Time vs. Number of Points](#)
- [Data Transfer Time](#)

Cycle time includes sweep time, retrace time and band-crossing time. Analyzer display turned off with DISPLAY:ENABLE OFF. Add 21 ms for display on. Data for one trace (S₁₁) measurement.

Table 31a. Cycle Time (ms) for Measurement Completion, All Models, All Options - Typical

Sweep Range	IF Bandwidth		Number of Points				
			201	401	1601	16001	32001
9 GHz to 10 GHz	600 kHz	Uncorrected	6	6	9	55	106
		2-Port cal	7	9	17	111	216
	10 kHz	Uncorrected	29.1	54	204	1990	3980
		2-Port cal	56	106	404	3600	6390
	1 kHz	Uncorrected	227	445	1742	17010	33780
		2-Port cal	451	888	3482	27231	54100

Table 31b. N5239A Cycle Time (ms) for Full-Span Measurement Completion - Typical

300 kHz to 8.5 GHz		Number of Points				
IF Bandwidth		201	401	1601	16001	32001
600 kHz	Uncorrected	24.22	27.5	46	113	257
	2-Port cal	46	53	89	226	515
10 kHz	Uncorrected	70	126	228	2120	4088
	2-Port cal	137	249	453	4120	8020
1 kHz	Uncorrected	235	456	1768	17170	34098
	2-Port cal	468	910	3417	32057	54584

Table 31c. N5231A Cycle Time (ms) for Full-Span Measurement Completion- Typical

300 kHz to 13.5 GHz		Number of Points				
IF Bandwidth		201	401	1601	16001	32001
600 kHz	Uncorrected	27	29	44	108	258
	2-Port cal	52	56	85	219	518
10 kHz	Uncorrected	72	130	236	2073	4103
	2-Port cal	141	257	470	4146	7397
1 kHz	Uncorrected	237	460	1781	17312	34381
	2-Port cal	472	917	3559	34626	45875

Table 31d. N5232A Cycle Time (ms) for Full-Span Measurement Completion- Typical

300 kHz to 20 GHz		Number of Points				
IF Bandwidth		201	401	1601	16001	32001
600 kHz	Uncorrected	34	37	49	115	170
	2-Port cal	67	72	95	228	346
10 kHz	Uncorrected	75	134	337	2152	4079
	2-Port cal	147	266	672	3971	7621
1 kHz	Uncorrected	240	464	1790	17405	34568
	2-Port cal	478	926	3510	33651	55331

Table 32. Cycle Time vs. IF Bandwidth - Typical

Applies to the Preset condition (201 points, correction off) except for the following changes:

- CF = 7 GHz
- Span = 100 MHz
- Display off (add 21 ms for display on)

Cycle time includes sweep and retrace time.

Description		Option 200, 216, 400, 416	
IF Bandwidth (Hz)	Cycle Time (ms)	Trace Noise Magnitude (dB rms)	
600,000	5.75	0.006	
100,000	5.78	0.005	
30,000	8.83	0.001	
10,000	28.80	0.0003	
3,000	71	0.0001	
1,000	220	0.0001	
300	638	0.0001	
100	1822	0.0001	
30	5981	0.0001	
10	17828	0.0001	
3	59273	0.0001	

Table 33. Cycle Time vs. Number of Points - Typical

Applies to the Preset condition (correction off) except for the following changes:

- CF = 7 GHz
- Span = 100 MHz
- Display off (add 21 ms for display on)

Cycle time includes sweep and retrace time.

Description	IF Bandwidth (Hz)			
	1,000	10,000	30,000	600,000
3	6.80	5.62	5.51	5.50
11	15.80	5.72	5.53	5.53
51	59	10	5.57	5.59
101	113	16	6.33	5.63
201	220	29	8.83	5.75
401	443	54	13.90	6.00
801	853	103	23.80	6.52
1,601	1693	203	43.80	9
6,401	6672	798	164	25
16,001	16531	1990	403	56
32,001	32828	3977	803	108

Table 34. Data Transfer Times - Typical

- Values are for Real & Imaginary pairs (two values per point)
- Results measured with the analyzer display off. Values will increase slightly if the analyzer display is on.
- LAN values assume a gigabit connection and are highly dependent upon both LAN conditions and the computer used
- All values are approximate. Example values shown are actual averaged measured results and include the time required to send the command to request the data

Description	General Formula	Example for 1601 Points	Example for 32001 Points
SCPI over GPIB¹ (Program executed on external PC)			
32-bit floating point	1mS + .024 mS/point	39 mS	755 mS
ASCII	1mS + 0.185mS/point	300 mS	5850 mS
SICL over LAN (Program executed on external PC)			
32-bit floating point	0.5 mS + 0.18 μ S/point	0.78 mS	6.4 mS
ASCII	0.5 mS + .012 mS/point	20.4 mS	390 mS
SICL (Program executed within the analyzer)			
32-bit floating point	0.3 mS + 0.18 μ S/point	0.64 mS	6.2 mS
ASCII	0.3 mS + .012 mS/point	20.2 mS	388 mS
COM (Program executed within the analyzer)			
32-bit floating point	130 μ S + .012 μ S/point	0.14 mS	0.5 mS
Variant type	130 μ S + 1.7 μ S/point	2.7 mS	56 mS
DCOM over LAN (Program executed on external PC)			
32-bit floating point	350 μ S + 0.17 μ S/point	0.55 mS	5.7 mS
Variant type	350 μ S + 3.4 μ S/point	5.8 mS	108 mS

¹ Values obtained using USB-to-GPIB adapter (82357B)

Note: Internally, the PNA measurement data is handled in 32-bit (single-precision) format. Therefore, there is no need to use 64-bit transfers for most data. Frequency values however, may be rounded slightly with 32-bit transfers since there is insufficient resolution in this format to represent higher frequencies with 1 Hz accuracy. If this type of accuracy is needed for frequencies, then you should use 64-bit transfers. Specifications for Recall & Sweep Speed are not provided for the N523xA analyzers.

Specifications: Front-Panel Jumpers

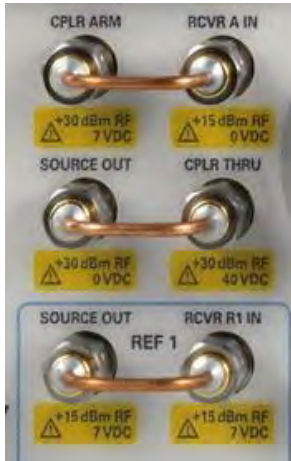

The following options have front-panel jumpers for each port:

Options 216, 416

- [Measurement Receiver Inputs](#)
- [Reference Receiver Inputs and Reference Source Outputs](#)
- [Source Outputs](#)
- [Coupler Inputs](#)

**Table 35. Measurement Receiver Inputs (dBm) - Typical
(RCVR A, B, C, D IN) @ 0.1dB Typical Compression**

Description	Option 216	Option 416
300 kHz to 10 MHz	-9	-11
10 MHz to 500 MHz	-9	-7
500 MHz to 8.5 GHz	-4	-6
8.5 GHz to 12.5 GHz	-4	-6
12.5 GHz to 13.5 GHz	-4	-7
13.5 GHz to 20 GHz	-5	-7

**Table 36. Reference Receiver Inputs and Reference Source Outputs (dBm) - Typical
(REF RCVR R1, R2¹ IN, REF 1, 2¹ SOURCE OUT) @ Specified Maximum Levelled Power**

Description	Option 216	Option 416
300 kHz to 10 MHz	-11	-18
10 MHz to 2 GHz	-9	-15
2 GHz to 8.5 GHz	-10	-16
8.5 GHz to 12.5 GHz	-13	-19
12.5 GHz to 13.5 GHz	-16	-21
13.5 GHz to 15 GHz	-15	-21
15 GHz to 20 GHz	-15	-26

¹ Not available with Option 416.

Table 37. Source Outputs (dBm) - Typical**(PORT 1, 2, 3, 4 SOURCE OUT) @ Specified Maximum Leveled Power**

Description	Option 216	Option 416
300 kHz to 10 MHz	11	7
10 MHz to 2 GHz	13	10
2 GHz to 8.5 GHz	13	9
8.5 GHz to 12.5 GHz	10	4
12.5 GHz to 13.5 GHz	7	1
13.5 GHz to 15 GHz	8	1
15 GHz to 20 GHz	8	-3

Table 38. Coupler Inputs (dB), All Options - Typical**(PORT 1, 2, 3, 4 CPLR THRU) Insertion Loss of Coupler Thru**

Description	Insertion Loss
300 kHz to 8.5 GHz	2.0
8.5 GHz to 10.5 GHz	2.3
10.5 GHz to 13.5 GHz	2.5
13.5 GHz to 20 GHz	3.0

Test Set Block Diagrams

NOTE: For best readability, use a color printer for printing the following graphics.

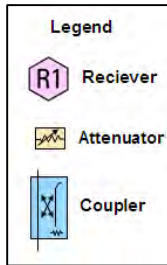

N5239A, N5231A and N5232A Option 200 (2-port base model)

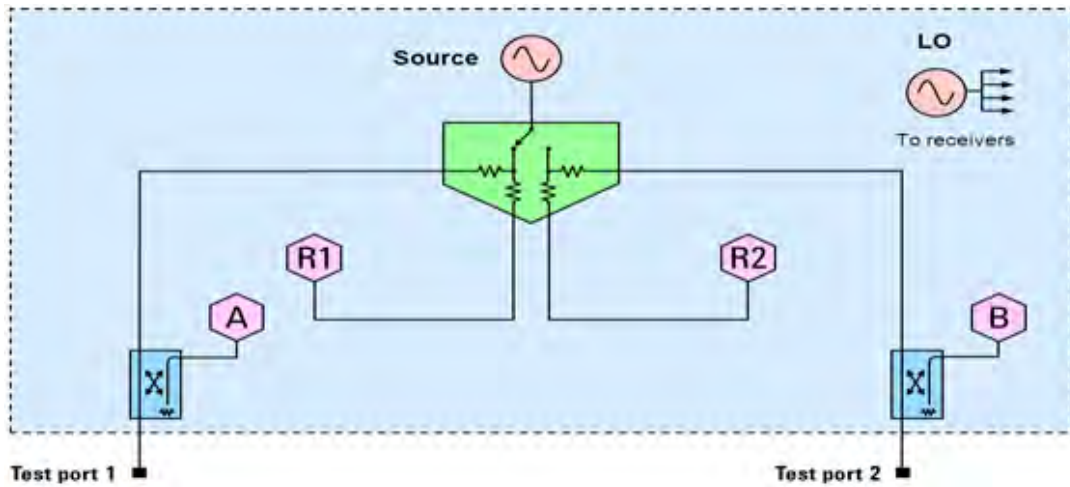

N5239A, N5231A and N5232A Option 216

To base model, adds front-panel jumpers and source attenuators (extended power range).

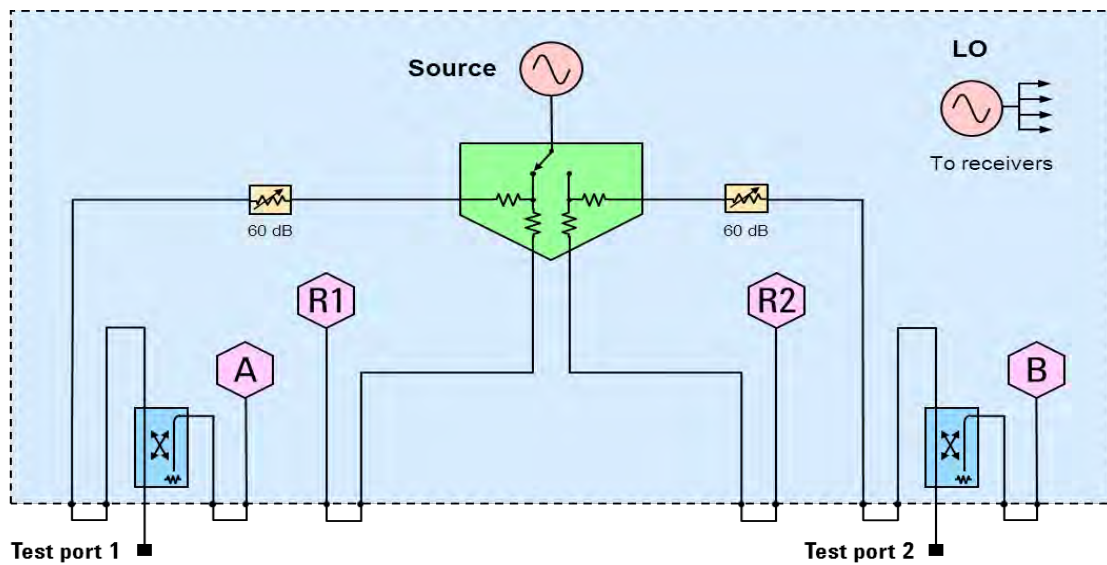

N5231A and N5232A Option 400 (4-port base model)

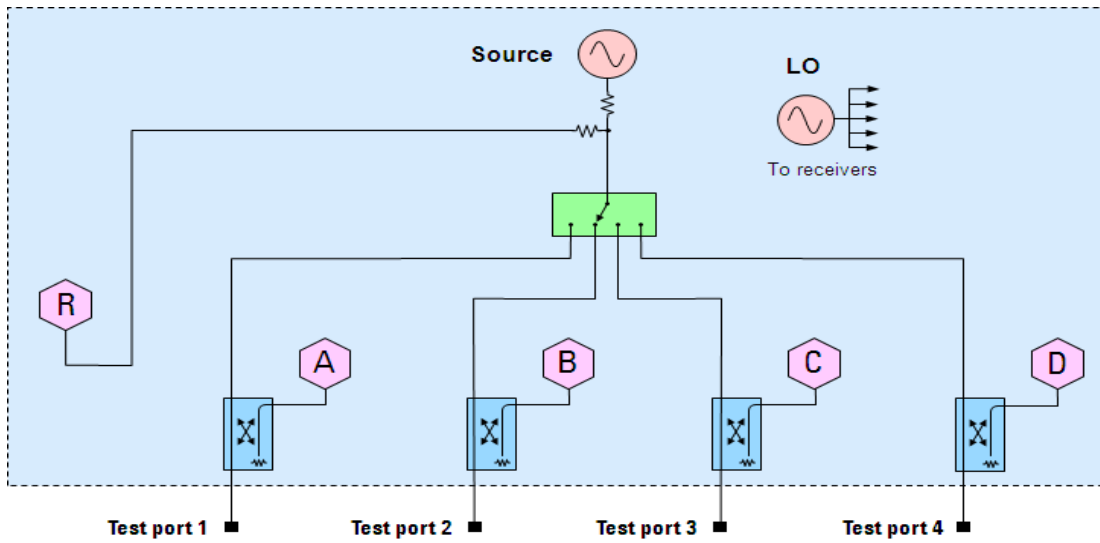

N5231A and N5232A Option 416

To base model, adds front-panel jumpers and source attenuators (extended power range).

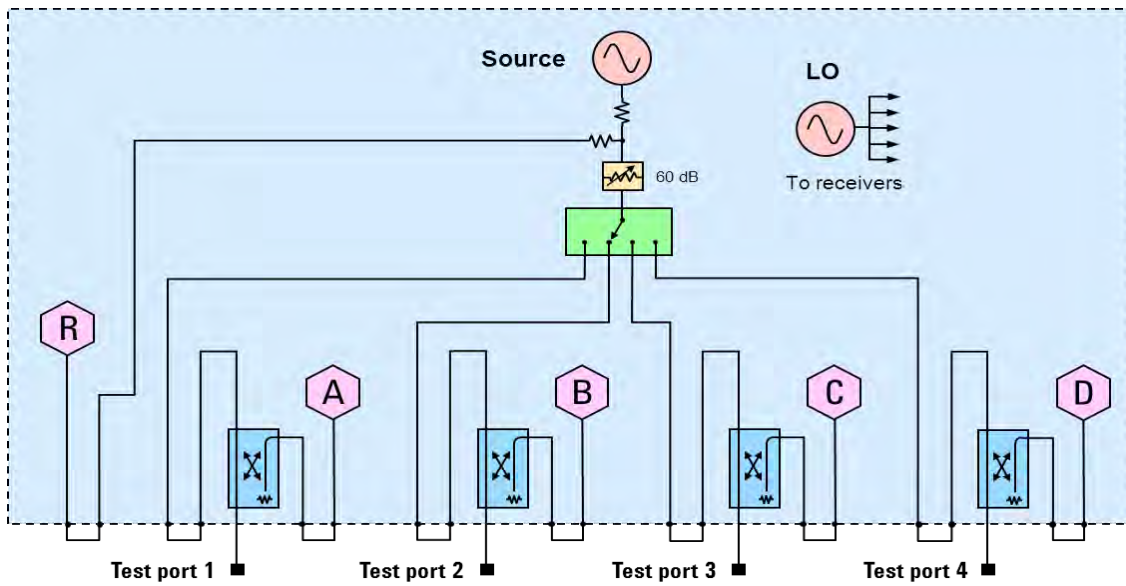

Receiver Block Diagram

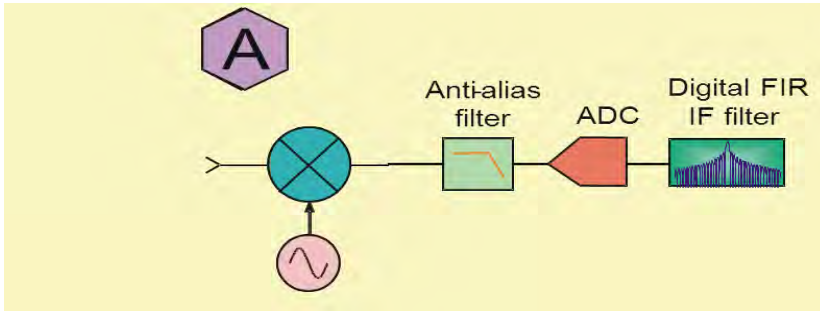

www.keysight.com/find/myKeysight

A personalized view into the information most relevant to you.



www.axistandard.org

AdvancedTCA® Extensions for Instrumentation and Test (AXIe) is an open standard that extends the AdvancedTCA for general purpose and semiconductor test. Keysight is a founding member of the AXIe consortium.



www.lxistandard.org

LAN eXtensions for Instruments puts the power of Ethernet and the Web inside your test systems. Keysight is a founding member of the LXI consortium.



www.pxisa.org

PCI eXtensions for Instrumentation (PXI) modular instrumentation delivers a rugged, PC-based high-performance measurement and automation system.



Three-Year Warranty

www.keysight.com/find/ThreeYearWarranty

Keysight's combination of product reliability and three-year warranty coverage is another way we help you achieve your business goals: increased confidence in uptime, reduced cost of ownership and greater convenience.



Keysight Assurance Plans

Keysight Advantage Services

www.keysight.com/find/AssurancePlans

Five years of protection and no budgetary surprises to ensure your instruments are operating to specifications and you can continually rely on accurate measurements



www.keysight.com/go/quality

Keysight Electronic Measurement Group
DEKRA Certified ISO 9001:2008
Quality Management System

Keysight Channel Partners

www.keysight.com/find/channelpartners

Get the best of both worlds: Keysight's measurement expertise and product breadth, combined with channel partner convenience.

www.keysight.com/find/pnax

For more information on Keysight Technologies' products, applications or services, please contact your local Keysight office. The complete list is available at:

www.keysight.com/find/contactus

Americas

Canada	(877) 894-4414
Brazil	(11) 4197 3500
Mexico	01800 5064 800
United States	(800) 829-4444

Asia Pacific

Australia	1 800 629 485
China	800 810 0189
Hong Kong	800 938 693
India	1 800 112 929
Japan	0120 (421) 345
Korea	080 769 0800
Malaysia	1 800 888 848
Singapore	1 800 375 8100
Taiwan	0800 047 866
Other AP Countries	(65) 375 8100

Europe & Middle East

Belgium	32 (0) 2 404 93 40
Denmark	45 70 13 15 15
Finland	358 (0) 10 855 2100
France	0825 010 700*
	*0.125 €/minute
Germany	49 (0) 7031 464
Ireland	6333
Israel	1890 924 204
Italy	972-3-9288-504/544
Netherlands	39 02 92 60 8 484
Spain	31 (0) 20 547 2111
Sweden	34 (91) 631 3300
United Kingdom	0200-88 22 55
	44 (0) 118 9276201

For other unlisted countries:

www.keysight.com/find/contactus



This information is subject to change without notice.

© Keysight Technologies 2014

Print Date: September 15, 2014

Supersedes: July 2, 2014

N5235-90004

www.keysight.com