

Keysight 2-Port PNA-L Network Analyzer

N5234B (10 MHz to 43.5 GHz)

N5235B (10 MHz to 50 GHz)

Data Sheet and
Technical
Specifications

Documentation Warranty

THE MATERIAL CONTAINED IN THIS DOCUMENT IS PROVIDED "AS IS," AND IS SUBJECT TO BEING CHANGED, WITHOUT NOTICE, IN FUTURE EDITIONS. FURTHER, TO THE MAXIMUM EXTENT PERMITTED BY APPLICABLE LAW, KEYSIGHT DISCLAIMS ALL WARRANTIES, EITHER EXPRESS OR IMPLIED WITH REGARD TO THIS MANUAL AND ANY INFORMATION CONTAINED HEREIN, INCLUDING BUT NOT LIMITED TO THE IMPLIED WARRANTIES OF MERCHANTABILITY AND FITNESS FOR A PARTICULAR PURPOSE. KEYSIGHT SHALL NOT BE LIABLE FOR ERRORS OR FOR INCIDENTAL OR CONSEQUENTIAL DAMAGES IN CONNECTION WITH THE FURNISHING, USE, OR PERFORMANCE OF THIS DOCUMENT OR ANY INFORMATION CONTAINED HEREIN. SHOULD KEYSIGHT AND THE USER HAVE A SEPARATE WRITTEN AGREEMENT WITH WARRANTY TERMS COVERING THE MATERIAL IN THIS DOCUMENT THAT CONFLICT WITH THESE TERMS, THE WARRANTY TERMS IN THE SEPARATE AGREEMENT WILL CONTROL.

U.S. Government Rights

U.S. Government Rights. The Software is "commercial computer software," as defined by Federal Acquisition Regulation ("FAR") 2.101. Pursuant to FAR 12.212 and 27.405-3 and Department of Defense FAR Supplement ("DFARS") 227.7202, the U.S. government acquires commercial computer software under the same terms by which the software is customarily provided to the public. Accordingly, Keysight provides the Software to U.S. government customers under its standard commercial license, which is embodied in its End User License Agreement (EULA), a copy of which can be found at <http://www.keysight.com/find/sweula>. The license set forth in the EULA represents the exclusive authority by which the U.S. government may use, modify, distribute, or disclose the Software. The EULA and the license set forth therein, does not require or permit, among other things, that Keysight: (1) Furnish technical information related to commercial computer software or commercial computer software documentation that is not customarily provided to the public; or (2) Relinquish to, or otherwise provide, the government rights in excess of these rights customarily provided to the public to use, modify, reproduce, release, perform, display, or disclose commercial computer software or commercial computer software documentation. No additional government requirements beyond those set forth in the EULA shall apply, except to the extent that those terms, rights, or licenses are explicitly required from all providers of commercial computer software pursuant to the FAR and the DFARS and are set forth specifically in writing elsewhere in the EULA. Keysight shall be under no obligation to update, revise or otherwise modify the Software. With respect to any technical data as defined by FAR 2.101, pursuant to FAR 12.211 and 27.404.2 and DFARS 227.7102, the U.S. government acquires no greater than Limited Rights as defined in FAR 27.401 or DFAR 227.7103-5 (c), as applicable in any technical data.

U.S. Government Rights	2
Definitions	5
Corrected System Performance.....	6
System Dynamic Range and Receiver Dynamic Range.....	6
Table 1a. System Dynamic Range (dB), N5234B.....	7
Table 1b. System Dynamic Range (dB), N5235B.....	7
Table 2. Receiver Dynamic Range (dB), All Models, All Options - Typical	8
N5234B and N5235B Corrected System Performance, All Options	8
Table 3. 85056A Calibration Kit	9
Table 4. N4693A 2-Port Electronic Calibration Module	11
Uncorrected System Performance.....	13
Table 5a. Error Terms (dB), All Models, All Ports, All Options - Specifications	13
Table 5b. Error Terms (dB), All Models, All Ports, All Options - Typical.....	13
Test Port Output.....	14
Table 6. Frequency Information, All Options.....	14
Table 7a. Maximum Leveled Power (dBm), N5234B, All Ports ¹	14
Table 7b. Maximum Leveled Power (dBm), N5235B, All Ports ¹	14
Table 8. Power Level Accuracy (dB) at Nominal Power ¹ , All Models, All Options, All Ports ²	15
Table 9. Power Level Linearity ¹ (dB), All Models, All Options, All Ports ² - Specification.....	15
Table 10. Power Sweep Range (dB), All Models, All Ports ¹	15
Table 11. Nominal Power (Preset,dBm), All Ports ¹ , All Options.....	16
Table 12. Power Resolution and Maximum/Minimum Settable Power, All Models, All Ports ¹	16
Table 13. 2 nd and 3 rd Harmonics at Max Specified Power (dBc) All Options, All Ports ¹ - Typical.....	16
Table 14. Non-Harmonic Spurs at Nominal Power (dBc), All Models,All Options - Typical	16
Table 15. Phase Noise (dBc/Hz), All Models, All Options - Typical.....	17
Test Port Input	18
Table 16. Noise Floor ¹ (dBm) @ 10 Hz IFBW, All Models, All Ports	18
Table 17. 0.1 dB Receiver Compression at Test Port (dBm), All Models, All Options, All Ports - Typical.....	18
Table 18. Receiver Compression at Test Port Power, All Models, All Options, All Ports - Specification	19
Table 19a. Trace Noise ¹ Magnitude (dB rms), All Models, All Options.....	19
Table 19b. Trace Noise ¹ Phase (deg rms), All Models, All Options.....	19
Table 20. Reference Level Magnitude, All Models and Options - Specification.....	20
Table 21. Stability ¹ , All Models, All Options - Typical.....	20
Table 22a. Damage Level, All Models, Option 200 - Typical.....	20
Table 22b. Damage Level, All Models, Option 216 - Typical.....	20
Dynamic Accuracy.....	21
Table 23. Dynamic Accuracy - Specification	21
Table 24. Group Delay ¹	24
General Information	25

Table 25. Miscellaneous Information	25
Table 26. Front Panel Information, All Options.....	25
Table 26 (Continued) Front Panel Information, All Options	26
Table 27. Rear Panel Information, All Options	26
Table 27. (Continued) Rear Panel Information, All Options	27
Table 28. Analyzer Dimensions and Weight	28
Regulatory and Environmental Information	28
Measurement Throughput Summary	29
Table 29. Cycle Time (ms) for Measurement Completion, All Options - Typical	29
Table 30. Cycle Time vs. IF Bandwidth - Typical	30
Table 31. Cycle Time vs. Number of Points - Typical	31
Table 32. Data Transfer Times - Typical	32
Specifications: Front-Panel Jumpers.....	33
Table 33. Measurement Receiver Inputs (dBm), Option 216 - Typical.....	33
Table 34. Reference Receiver Inputs and Reference Source Outputs (dBm) - Typical.....	33
Table 35. Source Outputs (dBm) - Typical.....	34
Table 36. Coupler Inputs (dB) - Typical	34
Test Set Block Diagrams	35
N5234B and N5235B Option 200 (2-port base model)	35
N5234B and N5235B Option 216	35
Receiver Block Diagram	36

This is a complete list of the technical specifications for the N5234B and N5235B PNA-L network analyzers with the following options:

All Models

Option 200 - 2-port base model with standard test set.

Option 216 - To base model, adds front-panel jumpers and source attenuators (extended power range).

See block diagrams for all models and options beginning on page 35.

Definitions

All specifications and characteristics apply over a 25 °C \pm 5 °C range (unless otherwise stated) and 90 minutes after the instrument has been turned on.

Specification (spec.): Warranted performance. Specifications include guardbands to account for the expected statistical performance distribution, measurement uncertainties, and changes in performance due to environmental conditions.

Characteristic (char.): A performance parameter that the product is expected to meet before it leaves the factory, but that is not verified in the field and is not covered by the product warranty. A characteristic includes the same guardbands as a specification.

Typical (typ.): Expected performance of an average unit which does not include guardbands. It is not covered by the product warranty. Typical values are produced by averaging the measured data across each frequency band.

Nominal (nom.): A general, descriptive term that does not imply a level of performance. It is not covered by the product warranty.

Calibration: The process of measuring known standards to characterize a network analyzer's systematic (repeatable) errors.

Corrected (residual): Indicates performance after error correction (calibration). It is determined by the quality of calibration standards and how well "known" they are, plus system repeatability, stability, and noise.

Uncorrected (raw): Indicates instrument performance without error correction. The uncorrected performance affects the stability of a calibration.

Standard: When referring to the analyzer, this includes no options unless noted otherwise.

Notes:

This document provides technical specifications for the 85056A and N4693A calibration kits.

Please download our free Uncertainty Calculator from http://www.keysight.com/find/na_calculator to generate the curves for your calibration kit and PNA-L setup.

Corrected System Performance

The specifications in this section apply for measurements made with the N5234B and N5235B PNA-L network analyzers with the following conditions:

- 10 Hz IF bandwidth
- No averaging applied to data
- Isolation calibration with an averaging factor of 8

System Dynamic Range and Receiver Dynamic Range

- **System Dynamic Range** is defined as the specified source maximum output power (spec) minus the noise floor (spec).
- **Extended Dynamic Range at Direct Access Input** is defined as the specified source maximum output power (spec) minus the direct receiver access input noise floor (spec).
- **Receiver Dynamic Range** is defined as the test port compression at 0.1 dB (typical) minus the noise floor (typical).

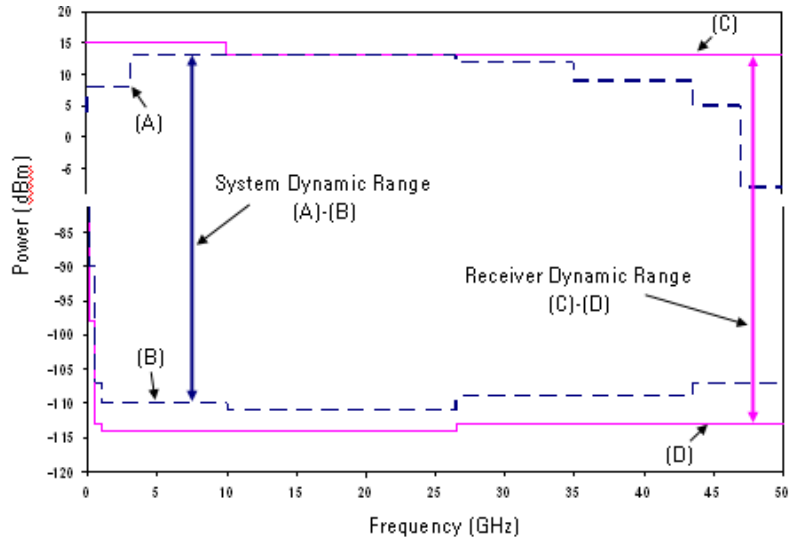

NOTE

The effective dynamic range must take measurement uncertainties and interfering signals into account.

The direct receiver access input extended dynamic range is calculated as the difference between the direct receiver access input noise floor and the source maximum output power. This set-up should only be used when the receiver input will never exceed its maximum receiver input. When the analyzer is in segment sweep mode, it can have predefined frequency segments which will output a higher power level when the extended dynamic range is required (i.e. devices with high insertion loss), and reduced power when the maximum receiver input level will occur (i.e. devices with low insertion loss). The extended range is only available in one-path transmission measurements.

It may typically be degraded at particular frequencies below 500 MHz due to spurious receiver residuals.

Table 1a. System Dynamic Range (dB), N5234B

Description	Specification			Typical		
	Option 200	Option 216		Option 200	Option 216	
	Test Port	Test Port	Direct Receiver Access port	Test Port	Test Port	Direct Receiver Access port
10 MHz to 45 MHz	75	75	110	94	94	138
45 MHz to 500 MHz	90	90	102	117	117	132
500 MHz to 2 GHz	114	112	124	129	129	144
2 GHz to 8.5 GHz	120	118	130	131	130	145
8.5 GHz to 12.5 GHz	122	120	132	132	131	146
12.5 GHz to 13.51 GHz	118	116	128	131	129	144
13.51 GHz to 20 GHz	108	106	118	120	118	133
20 GHz to 35 GHz	100	97	107	116	113	126
35 GHz to 40 GHz	100	97	107	116	113	126
40 GHz to 43.5 GHz	85	85	93	104	100	111

Table 1b. System Dynamic Range (dB), N5235B

Description	Specification			Typical		
	Option 200	Option 216		Option 200	Option 216	
	Test Port	Test Port	Direct Receiver Access port	Test Port	Test Port	Direct Receiver Access port
10 MHz to 45 MHz	75	75	110	94	94	138
45 MHz to 500 MHz	90	90	102	117	117	132
500 MHz to 2 GHz	114	112	124	129	129	144
2 GHz to 8.5 GHz	120	118	130	131	130	145
8.5 GHz to 12.5 GHz	122	120	132	132	131	146
12.5 GHz to 13.51 GHz	118	116	128	131	129	144
13.51 GHz to 20 GHz	108	106	118	120	118	133
20 GHz to 35 GHz	100	97	107	116	113	126
35 GHz to 40 GHz	100	97	107	116	113	126
40 GHz to 50 GHz	84	80	88	104	100	111

Table 2. Receiver Dynamic Range (dB), All Models, All Options - Typical

Description	Typical
10 MHz to 45 MHz	100
45 MHz to 500 MHz	120
500 MHz to 2 GHz	127
2 GHz to 8.5 GHz	128
8.5 GHz to 13.5 GHz	129
13.5 GHz to 20 GHz	117
20 GHz to 35 GHz	116
35 GHz to 40 GHz	114
40 GHz to 43.5 GHz	105
43.5 GHz to 47 GHz	104
47 GHz to 50 GHz	103

N5234B and N5235B Corrected System Performance, All Options

Note: For any S_{ii} reflection measurement:

- $S_{jj} = 0$.

For any S_{ij} transmission measurement:

- $S_{ji} = S_{ij}$ when $S_{ij} \leq 1$
- $S_{ji} = 1/S_{ij}$ when $S_{ij} > 1$
- $S_{kk} = 0$ for all k

Applies to the N5234B/5A Option 200 or 216 analyzers, 85133F flexible test port cable set, and a full 2-port calibration. Also applies to the following condition:

Environmental temperature $23^\circ \pm 3^\circ \text{C}$, with $< 1^\circ \text{C}$ deviation from calibration temperature

Table 3. 85056A Calibration Kit

Description	Specification (dB)						
	10 MHz to 50 MHz	50 MHz to 2 GHz	2 GHz to 10 GHz	10 GHz to 20 GHz	20 GHz to 30 GHz	30 GHz to 40 GHz	40 GHz to 50 GHz
Directivity	42	42	42	42	38	38	36
Source Match	41	41	38	38	33	33	31
Load Match	42	42	42	42	37	37	35
Reflection Tracking ¹							
Mag	±0.001	±0.001	±0.008	±0.008	±0.020	±0.020	±0.027
Phase (°/°C)	±0.009	±0.009	±0.054	±0.054	±0.133	±0.133	±0.180
Transmission Tracking ¹							
Mag	±0.019	±0.019	±0.051	±0.060	±0.129	±0.129	±0.220
Phase (°/°C)	±0.126	±0.126	±0.335	±0.393	±0.848	±0.848	±1.453

¹ Temperature deviation is a characteristic value.

Transmission Uncertainty, All Options

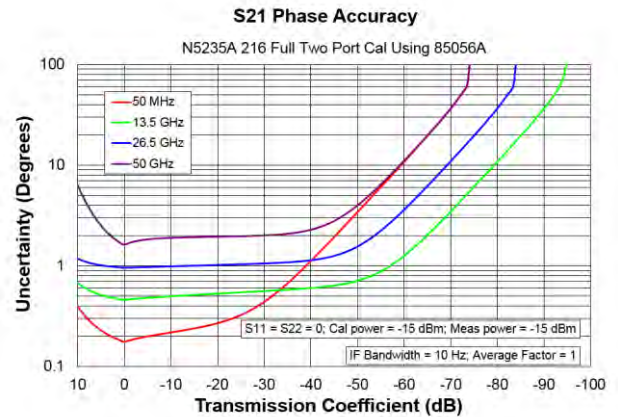
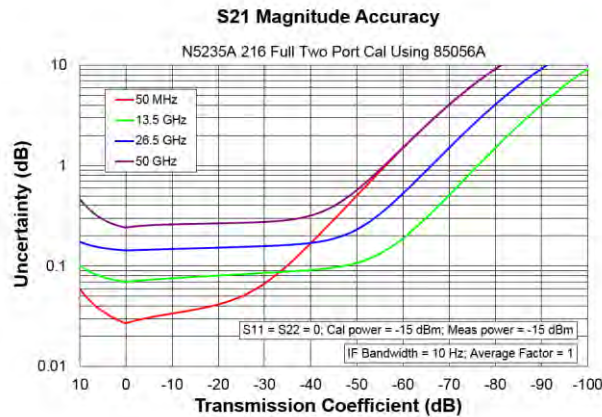
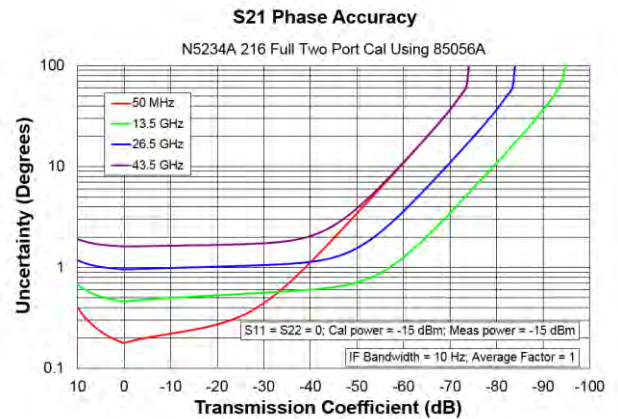
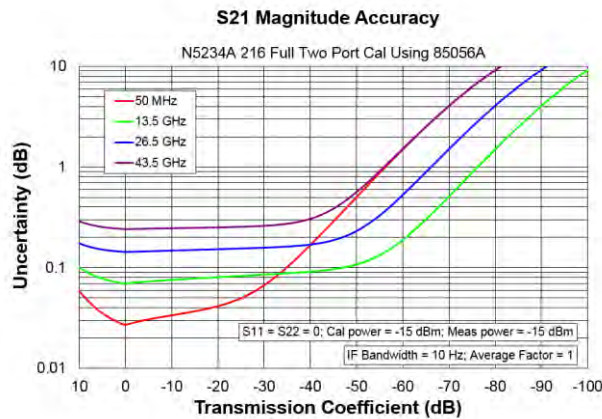

Reflection Uncertainty, All Options

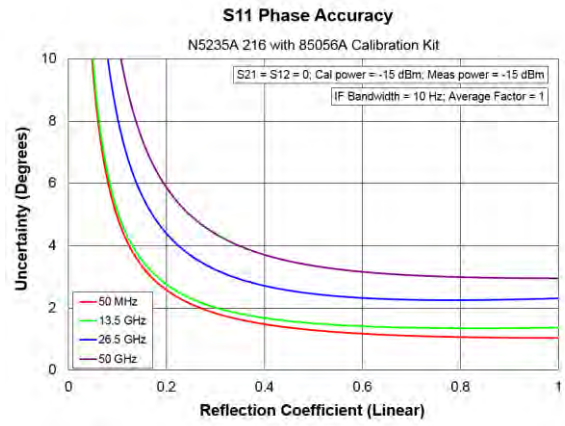
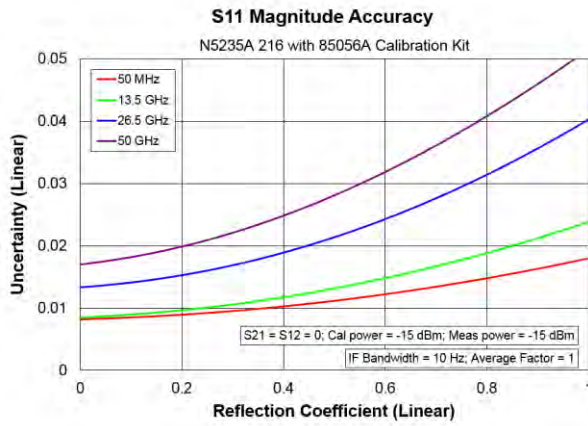
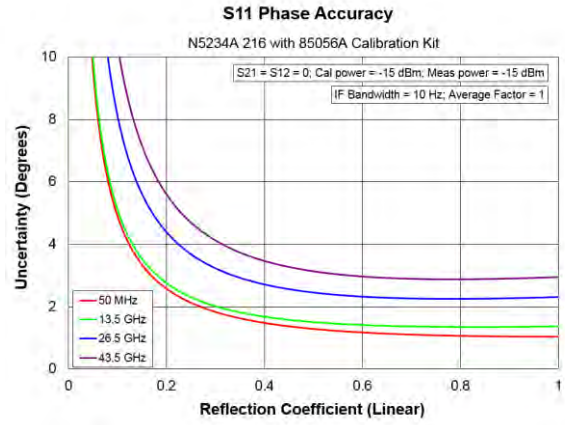
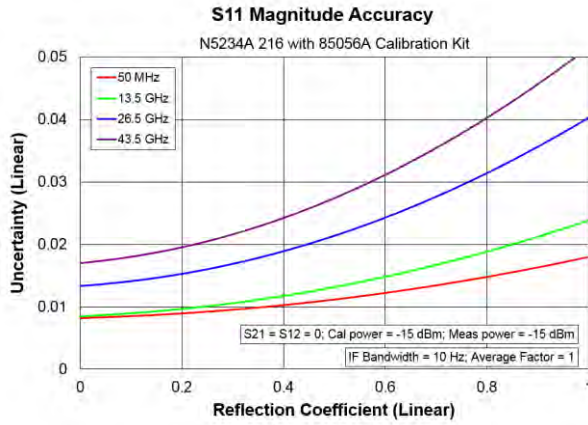
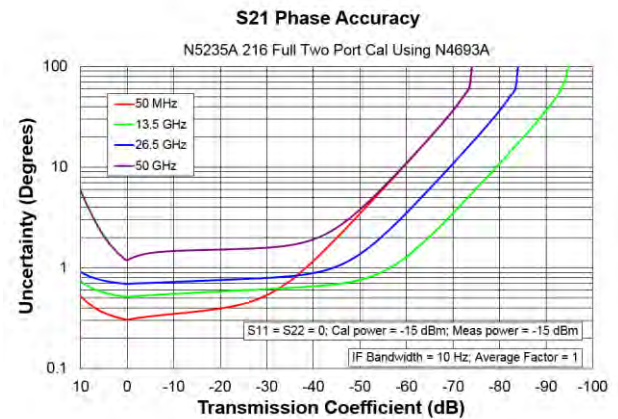
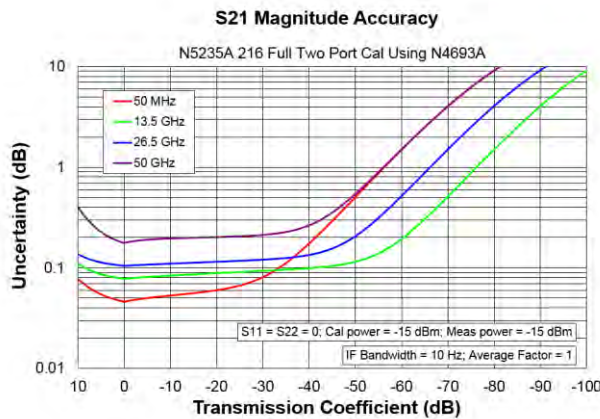
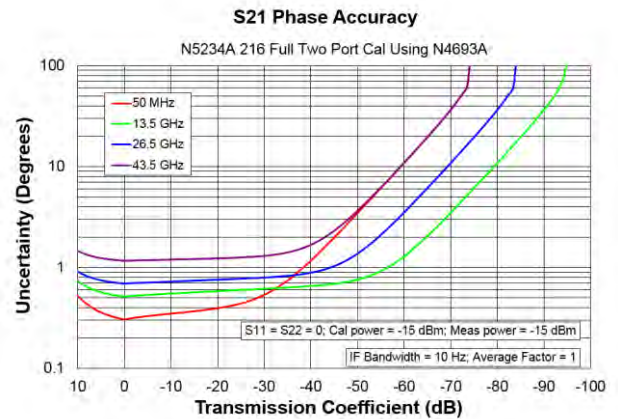
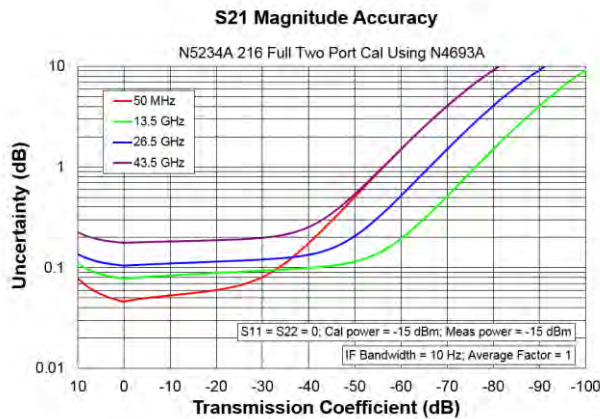

Table 4. N4693A 2-Port Electronic Calibration Module

Description	Specification (dB)						
	10 MHz to 50 MHz	50 MHz to 2 GHz	2 GHz to 10 GHz	10 GHz to 20 GHz	20 GHz to 30 GHz	30 GHz to 40 GHz	40 GHz to 50 GHz
Directivity	32	42	49	45	41	41	36
Source Match	25	44	42	37	35	35	32
Load Match	28	38	43	40	35	35	30
Reflection Tracking ¹							
Mag	±0.050	±0.030	±0.040	±0.050	±0.060	±0.060	±0.080
Phase (°/°C)	±0.330	±0.198	±0.264	±0.330	±0.396	±0.396	±0.528
Transmission Tracking ¹							
Mag	±0.345	±0.061	±0.052	±0.093	±0.112	±0.149	±0.284
Phase (°/°C)	±2.274	±0.404	±0.345	±0.615	±0.739	±0.980	±1.875

¹ Temperature deviation is a characteristic value.

Transmission Uncertainty, All Options



Reflection Uncertainty, All Options

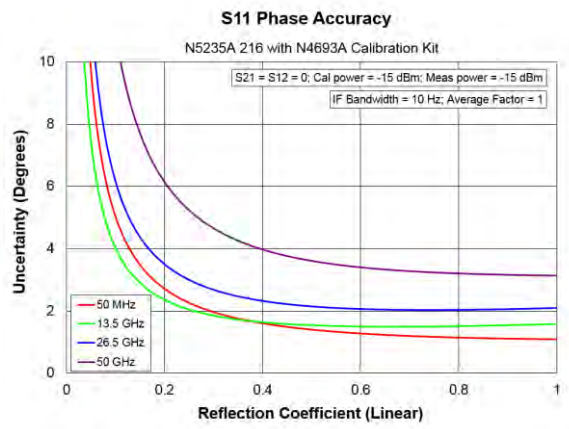
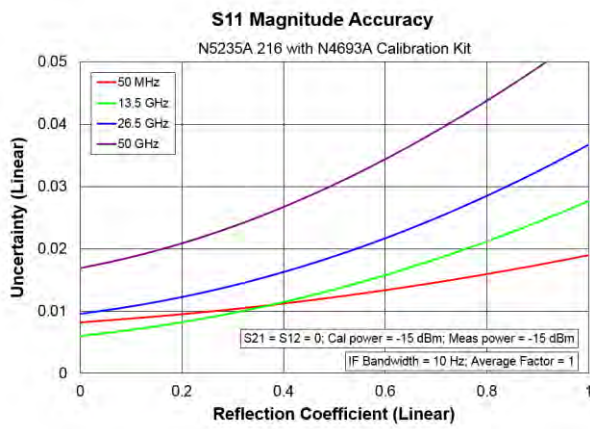
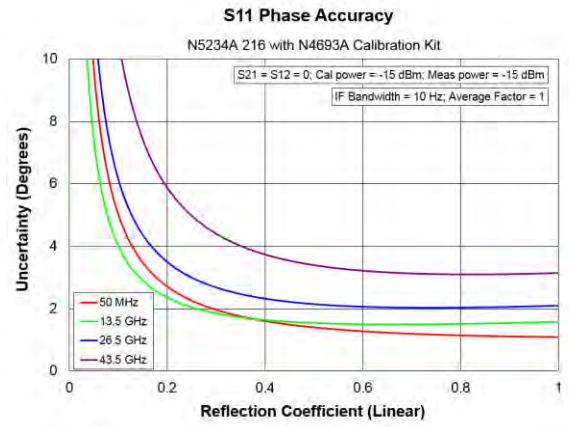
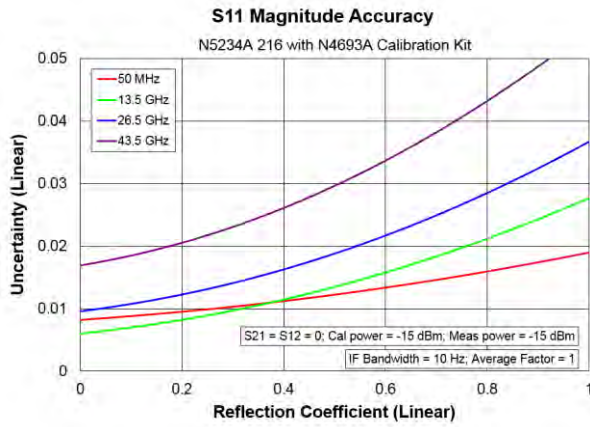

Uncorrected System Performance

Specifications apply to following conditions:

- Over environmental temperature of 25 °C \pm 5 °C, with less than 1°C variation from the calibration temperature.
- Cable loss not included in Transmission Tracking.
- Crosstalk measurement conditions: normalized to a thru, measured with shorts on all ports, 10 Hz IF bandwidth, averaging factor of 8, alternate mode, source power set to the specified maximum power.

Table 5a. Error Terms (dB), All Models, All Ports, All Options - Specifications

Description	Directivity	Source Match	Load Match	Transmission Tracking	Reflection Tracking	Crosstalk
10 MHz to 45 MHz	15	9	10	--	--	--
45 MHz to 2 GHz	23	17	18	--	--	--
2 GHz to 8.5 GHz	21	12	13	--	--	--
8.5 GHz to 12.5 GHz	16	11	11	--	--	--
12.5 GHz to 20 GHz	16	11	9	--	--	--
20 GHz to 40 GHz	15	7	8	--	--	--
40 GHz to 50 GHz	13	5	5	--	--	--

Table 5b. Error Terms (dB), All Models, All Ports, All Options - Typical

Description	Directivity	Source Match	Load Match	Transmission Tracking	Reflection Tracking	Crosstalk
10 MHz to 45 MHz	21	13	14	+/- 2.5	+/- 1.5	-86
45 MHz to 200 MHz	27	25	26	+/- 2.5	+/- 1.5	-94
200 MHz to 500 MHz	30	25	22	+/- 2.5	+/- 1.5	-94
500 MHz to 2GHz	30	25	22	+/- 2.5	+/- 1.5	-95
2 GHz to 8.5 GHz	25	20	17	+/- 2.5	+/- 1.5	-105
8.5 GHz to 12.5 GHz	22	16	15	+/- 3.0	+/- 1.5	-110
12.5 GHz to 13.51GHz	19	16	14	+/- 3.0	+/- 1.5	-110
13.51 GHz to 20 GHz	19	16	14	+/- 3.0	+/- 1.5	-108
20 GHz to 26.5 GHz	20	14	13	+/- 5.0	+/- 2.0	-97
26.5 GHz to 40 GHz	19	14	13	+/- 5.0	+/- 2.0	-97
40 GHz to 43.5 GHz	19	10	10	+/- 5.0	+/- 2.5	-89
43.5 GHz to 50 GHz	18	10	10	+/- 5.0	+/- 2.5	-89

Test Port Output

Table 6. Frequency Information, All Options

Description	Specification	Typical
N5234B Frequency Range	10 MHz to 43.5 GHz	--
N5235B Frequency Range	10 MHz to 50 GHz	--
Frequency Resolution	1 Hz	--
Frequency Accuracy	+/- 1 ppm	--
Frequency Stability	--	+/-0.05 ppm, -10° to 70° C ¹ +/-0.1 ppm/yr maximum ²

¹ Assumes no variation in time.

² Assumes no variation in temperature.

Table 7a. Maximum Levelled Power (dBm), N5234B, All Ports¹

Description	Specification		Typical	
	Option 200	Option 216	Option 200	Option 216
10 MHz to 45 MHz	0.000	0.000	4	4
45 MHz to 500 MHz	0.000	0.000	7	7
500 MHz to 8 GHz	4.000	2.000	9	9
8 GHz to 12.5 GHz	6.000	4.000	10	9
12.5 GHz to 20 GHz	2.000	0.000	9	7
20 GHz to 40 GHz	-5.000	-8.000	5	2
40 GHz to 43.5 GHz	-10.000	-10.000	0	-4

¹ Any port can be used as the source port.

Table 7b. Maximum Levelled Power (dBm), N5235B, All Ports¹

Description	Specification		Typical	
	Option 200	Option 216	Option 200	Option 216
10 MHz to 45 MHz	0.000	0.000	4	4
45 MHz to 500 MHz	0.000	0.000	7	7
500 MHz to 8 GHz	4.000	2.000	9	9
8 GHz to 12.5 GHz	6.000	4.000	10	9
12.5 GHz to 20 GHz	2.000	0.000	9	7
20 GHz to 40 GHz	-5.000	-8.000	5	2
40 GHz to 50 GHz	-11.000	-15.000	0	-4

¹ Any port can be used as the source port.

Table 8. Power Level Accuracy (dB) at Nominal Power¹, All Models, All Options, All Ports²

Description	Specification	Typical
10 MHz to 45 MHz	+/-1.5	+/-0.18
45 MHz to 500 MHz	+/-1.5	+/-0.13
500 MHz to 10.5 GHz	+/-1.5	+/-0.07
10.5 GHz to 20 GHz	+/-1.5	+/-0.08
20 GHz to 40GHz	+/-1.5	+/-0.11
40 GHz to 43.5 GHz	+/-2.5	+/-0.14
43.5 GHz to 50 GHz	+/-3.0	+/-0.23

¹ Level accuracy at power other than nominal power, Power Level Accuracy (dB) at Nominal Power + Power Level Linearity (dB)

² Either port can be used as the source port.

Table 9. Power Level Linearity¹ (dB), All Models, All Options, All Ports² - Specification

Description	-25 dBm ≤ P < -20 dBm	-20 dBm ≤ P < -15 dBm	P ≥ -15 dBm
10 MHz to 45 MHz	+/-2.0	+/-1.5	+/-1.5
45 MHz to 50 GHz	+/-1.5	+/-1.5	+/-1.5

¹ Referenced to nominal power.

² Either port can be used as the source port.

Table 10. Power Sweep Range (dB), All Models, All Ports¹

Description	Specification		Typical	
	Option 200	Option 216	Option 200	Option 216
10 MHz to 45 MHz	25	25	31	31
45 MHz to 500 MHz	25	25	34	34
500 MHz to 2 GHz	29	27	36	36
2 GHz to 12.5 GHz	31	29	37	36
12.5 GHz to 20 GHz	27	25	36	34
20 GHz to 40 GHz	20	17	32	29
40 GHz to 50 GHz	14	10	27	23

¹ Either port can be used as the source port.

Table 11. Nominal Power (Preset,dBm), All Ports¹, All Options

Description	N5234B	N5235B
Preset Power	-10	-15

¹ Either port can be used as the source port.

Table 12. Power Resolution and Maximum/Minimum Settable Power, All Models, All Ports¹

Description	Specification (dB)	Typical (dBm)		
		All Options	Option 200	Option 216
Power Resolution	0.01	--	--	--
Maximum Settable Power	--	30	--	--
Minimum Settable Power	--	--	-30	-90

¹ Either port can be used as the source port.

Table 13. 2nd and 3rd Harmonics at Max Specified Power (dBc) All Options, All Ports¹ - Typical

Description ²	N5234B	N5235B
20 MHz to 500 MHz	-22	-22
500 MHz to 2 GHz	-23	-23
2 GHz to 15 GHz	-28	-28
15 GHz to 20 GHz	-33	-33
20 GHz to 40 GHz	-30	-30
40 GHz to 43.5 GHz	-29	-29
43.5 GHz to 50 GHz	--	-29

¹ Either port can be used as the source port.

² Listed frequency is harmonic frequency; test at max specified power.

Table 14. Non-Harmonic Spurs at Nominal Power (dBc), All Models, All Options - Typical

Description	Based on 8 kHz offset Frac-N	Based on 100 kHz offset Frac-N
10 MHz to 500 MHz	-50	-50
500 MHz to 2 GHz	-60	-42
2 GHz to 4 GHz	-57	-45
4 GHz to 8 GHz	-51	-39
8 GHz to 16 GHz	-45	-33
16 GHz to 32 GHz	-39	-27
32 GHz to 50 GHz	-33	-21

Table 15. Phase Noise (dBc/Hz), All Models, All Options - Typical

Description	1 kHz Offset	10 kHz Offset	100 kHz Offset	1 MHz Offset
10 MHz to 50 MHz	-95	-101	-101	-117
50 MHz to 1 GHz	-96	-101	-101	-119
1 GHz to 2 GHz	-91	-105	-102	-121
2 GHz to 4 GHz	-85	-99	-96	-115
4 GHz to 8 GHz	-79	-93	-90	-109
8 GHz to 16 GHz	-73	-87	-84	-103
16 GHz to 32 GHz	-67	-81	-78	-97
32 GHz to 50 GHz	-61	-75	-72	-91

Test Port Input

Table 16. Noise Floor¹ (dBm) @ 10 Hz IFBW, All Models, All Ports

Total average (rms) noise power calculated as the mean value of a linear magnitude trace expressed in dBm. May typically be degraded at particular frequencies below 500 MHz due to spurious receiver residuals.

Description	Specification		Typical	
	Options 200, 216	Option 216	Options 200, 216	Option 216
	Test Port	Direct Receiver Access Port	Test Port	Direct Receiver Access Port
10 MHz to 45 MHz ²	-75	-110	-90	-134
45 MHz to 500 MHz ²	-90	-102	-110	-125
500 MHz to 2 GHz	-110	-122	-120	-135
2 GHz to 8.5 GHz	-116	-128	-121	-136
8.5 GHz to 12.5 GHz	-116	-128	-122	-137
12.5 GHz to 13.51 GHz	-116	-128	-122	-137
13.51 GHz to 20 GHz	-106	-118	-111	-126
20 GHz to 40 GHz	-105	-115	-111	-124
40 GHz to 50 GHz	-95	-103	-104	-115

¹Total average (rms) noise power calculated as the mean value of a linear magnitude trace expressed in dBm.

²May typically be degraded at particular frequencies below 500 MHz due to spurious receiver residuals.

Table 17. 0.1 dB Receiver Compression at Test Port (dBm), All Models, All Options, All Ports - Typical

Description	Typical
10 MHz to 500 MHz	10
500 MHz to 13.51 GHz	7
13.51 GHz to 20 GHz	6
20 GHz to 35 GHz	5
35 GHz to 40 GHz	3
40 GHz to 43.5 GHz	1
43.5 GHz to 47 GHz	0
47 GHz to 50 GHz	-1

Table 18. Receiver Compression at Test Port Power, All Models, All Options, All Ports - Specification

Description	Test Port Power (dBm)	Magnitude (dB)	Phase (degrees)
10 MHz to 50 MHz ¹	-	-	-
50 MHz to 30 GHz	5	0.40	3.5
30 GHz to 35 GHz	5	0.40	5.0
35 GHz to 40 GHz	5	0.60	5.0
40 GHz to 43.5 GHz	5	0.65	5.0
43.5 GHz to 47 GHz	1	0.55	5.0
47 GHz to 50 GHz	-5	0.25	5.0

¹Test port receiver compression at specified input levels below 50 MHz is negligible due to coupler roll off in this frequency range.

Table 19a. Trace Noise¹ Magnitude (dB rms), All Models, All Options

Description	Specification	Typical		
		1 kHz IFBW	100 kHz IFBW	600 kHz IFBW
10 MHz to 45 MHz	0.200	0.071	0.700	2.000
45 MHz to 100 MHz	0.020	0.009	0.130	0.400
100 MHz to 500 MHz	0.020	0.004	0.130	0.200
500 MHz to 13.51 GHz	0.003	0.001	0.035	0.090
13.51 GHz to 40 GHz	0.007	0.003	0.075	0.200
40 GHz to 50 GHz	0.010	0.004	0.100	0.300

¹Ratioed measurement, nominal power at test port.

Table 19b. Trace Noise¹ Phase (deg rms), All Models, All Options

Description	Specification	Typical		
		1 kHz IFBW	100 kHz IFBW	600 kHz IFBW
10 MHz to 45 MHz	1.000	0.490	4.700	12.000
45 MHz to 100 MHz	0.100	0.029	1.500	3.000
100 MHz to 500 MHz	0.100	0.010	0.500	1.500
500 MHz to 13.51 GHz	0.025	0.008	0.500	0.700
13.51 GHz to 40 GHz	0.060	0.021	0.700	1.300
40 GHz to 50 GHz	0.090	0.030	1.000	2.000

¹Ratioed measurement, nominal power at test port.

Table 20. Reference Level Magnitude, All Models and Options - Specification

Description	Magnitude (dB)	Phase (degrees)
Range	+/- 500	+/- 500
Resolution	0.001	0.01

Table 21. Stability¹, All Models, All Options - Typical

Description	Magnitude (dB/°C)	Phase (°/°C)
10 MHz to 45 MHz	0.02	0.25
45 MHz to 500 MHz	0.01	0.05
500 MHz to 2 GHz	0.01	0.03
2 GHz to 4 GHz	0.01	0.05
4 GHz to 8 GHz	0.01	0.09
8 GHz to 13.5 GHz	0.01	0.15
13.5 GHz to 20 GHz	0.01	0.20
20 GHz to 40 GHz	0.03	0.45
40 GHz to 50 GHz	0.03	0.55

¹ Stability is defined as a ratio measurement made at the test port.

Table 22a. Damage Level, All Models, Option 200 - Typical

Description	RF (dBm)	DC (VDC)
Ports 1, 2	30	40

Table 22b. Damage Level, All Models, Option 216 - Typical

Description	RF (dBm)	DC (VDC)
Ports 1, 2	30	7
RCVR A, B IN	15	7
REF RCVR R1, R2 IN	15	7
REF 1, 2 SOURCE OUT	20	7
PORT 1, 2 SOURCE OUT	30	7
PORT 1, 2 CPLR THRU	30	7
PORT 1, 2 CPLR ARM	30	7

Dynamic Accuracy

Dynamic accuracy is verified with the following measurements:

- Compression over frequency
- IF linearity at a single frequency of 1.998765GHz using a reference level of -20 dBm for an input power range of 0 to -60 dBm. For values below -60 dBm, refer to "[VNA Receiver Dynamic Accuracy Specifications and Uncertainties](#)"

Table 23. Dynamic Accuracy - Specification

Dynamic Accuracy, 50 MHz

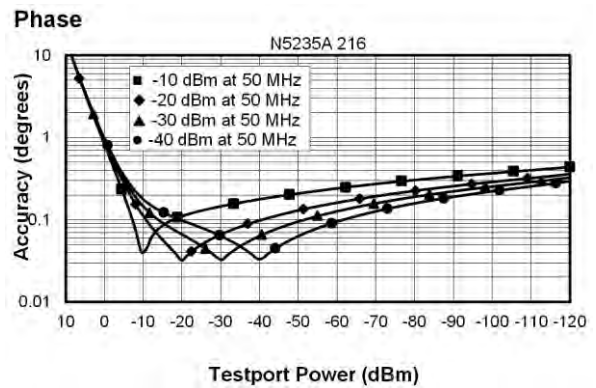
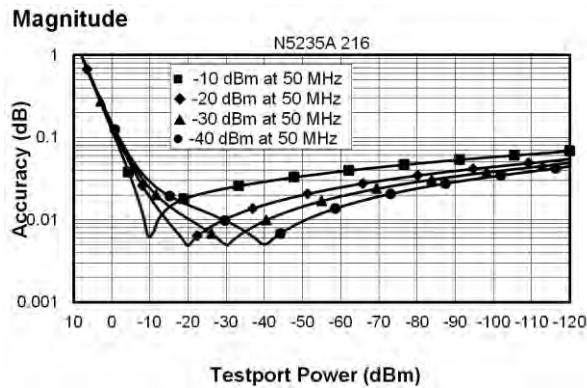

Dynamic Accuracy, 500 MHz

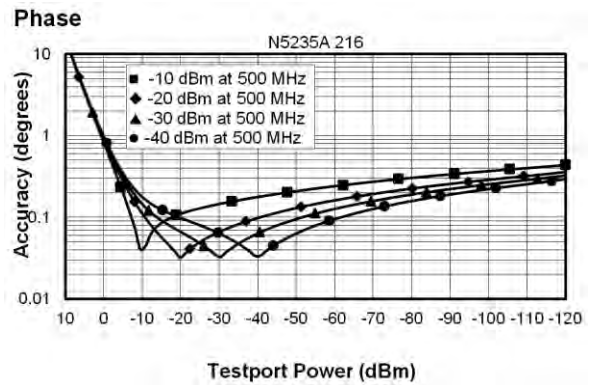
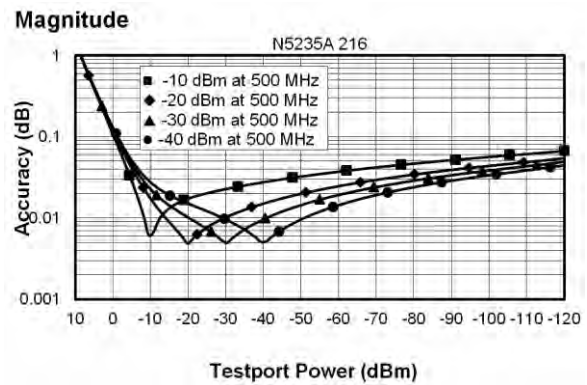

Dynamic Accuracy, 1 GHz

Magnitude

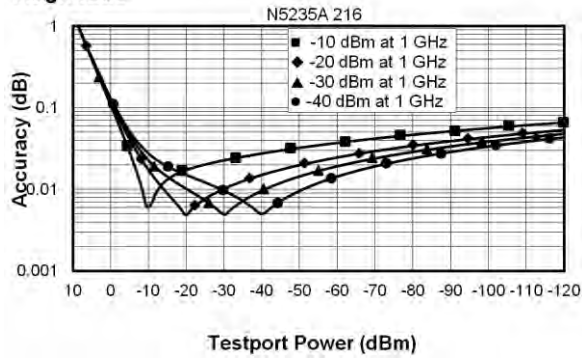

Phase

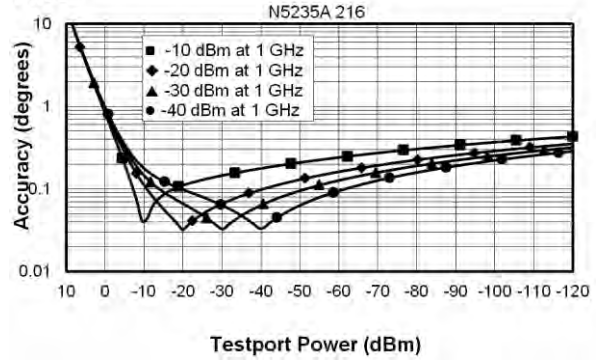

Dynamic Accuracy, 2 GHz

Magnitude

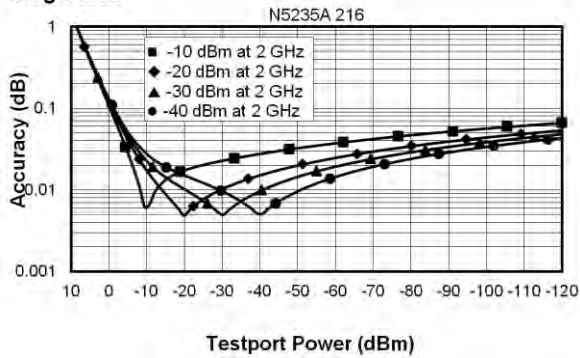

Phase

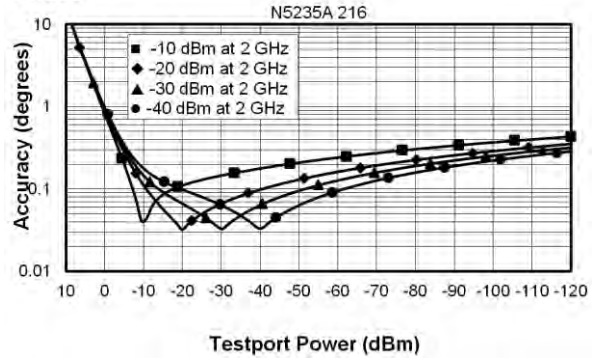

Dynamic Accuracy, 20 GHz

Magnitude

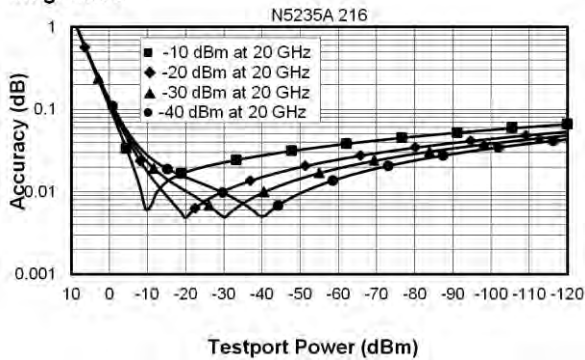

Phase

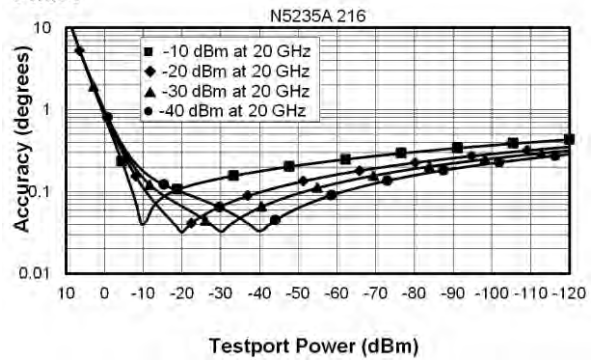

Dynamic Accuracy, 35 GHz

Magnitude

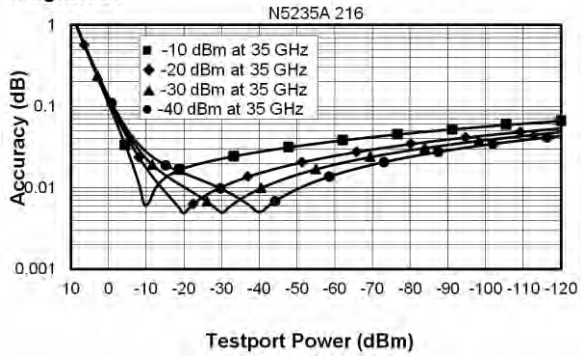

Phase

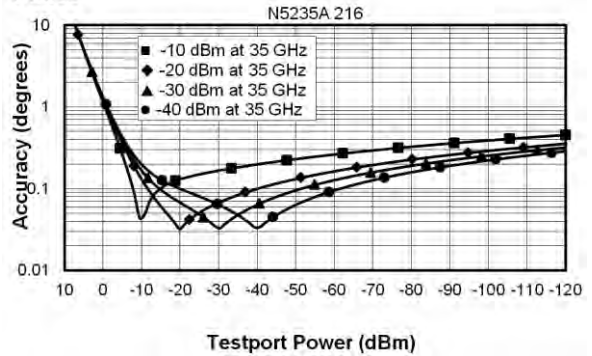

Dynamic Accuracy, 40 GHz

Magnitude

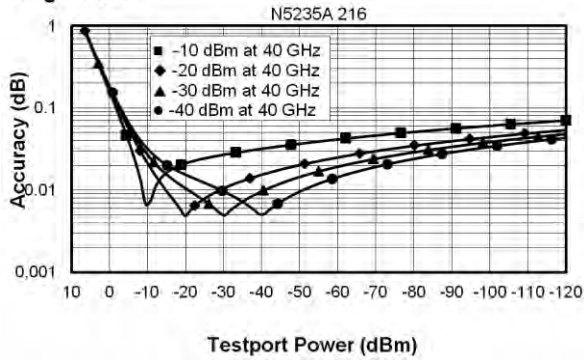

Phase

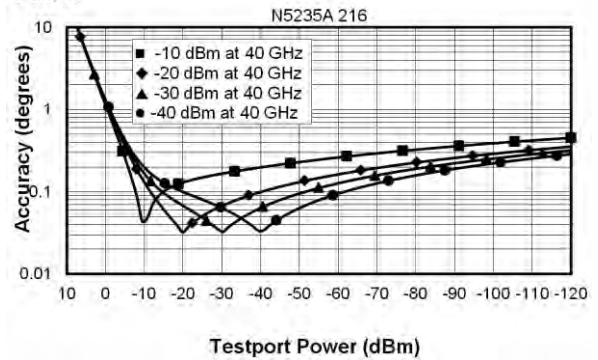

Dynamic Accuracy, 50 GHz

Magnitude

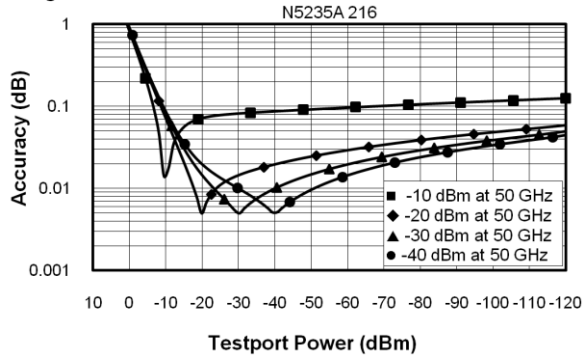

Phase

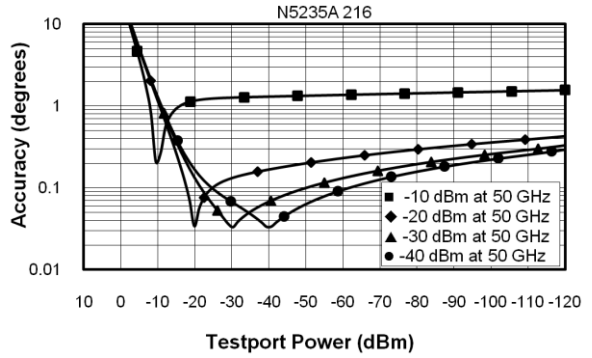

Table 24. Group Delay¹

In general, the following formula can be used to determine the accuracy, in seconds, of specific group delay measurement:

$$\pm \text{Phase Accuracy (deg)} / [360 \times \text{Aperture (Hz)}]$$

Depending on the aperture and device length, the phase accuracy used is either incremental phase accuracy or worst-case phase accuracy

Description	Typical Performance
Aperture (selectable)	(frequency span)/(number of points -1)
Maximum Aperture	20% of frequency span
Range	0.5 x (1/minimum aperture)
Maximum Delay	Limited to measuring no more than 180° of phase change within the minimum aperture.)

The following graphs show characteristic group delay accuracy with full 2-port calibration and a 10 Hz IF bandwidth. Insertion loss is assumed to be < 2 dB and electrical length to be ten meters.

For any S_{ij} Group Delay measurement, $S_{ii} = 0$, $S_{ij} = 1$, $S_{ji} = 0$, $S_{kl} = 0$ for all $kl \neq ij$

Group Delay (Typical)

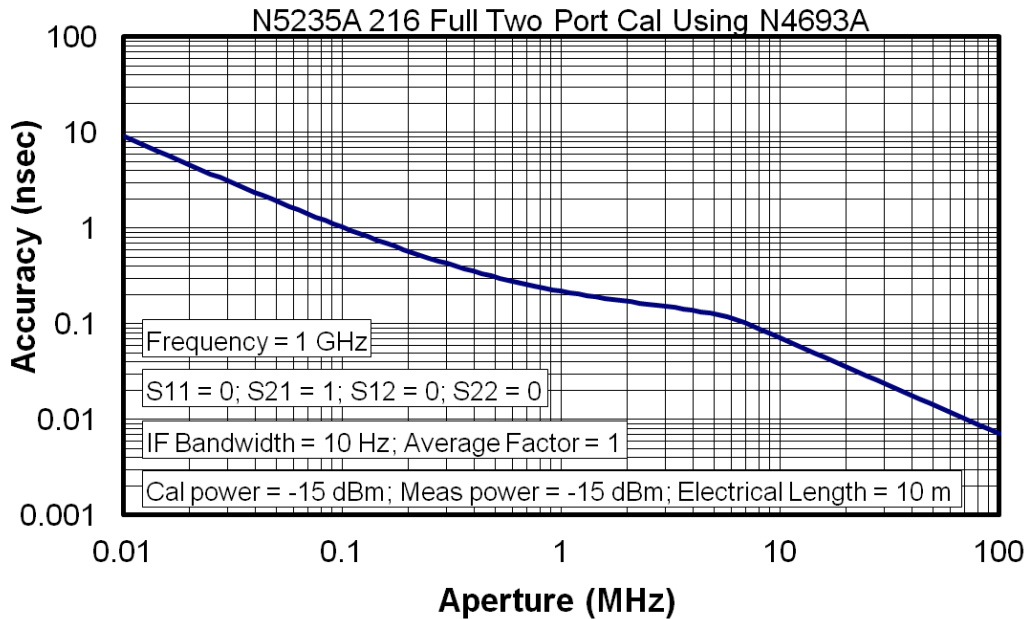

In general, the following formula can be used to determine the accuracy, in seconds, of specific group delay measurement:

$$\pm \text{Phase Accuracy (deg)} / [360 \times \text{Aperture (Hz)}]$$

Depending on the aperture and device length, the phase accuracy used is either incremental phase accuracy or worst-case phase accuracy

¹Group delay is computed by measuring the phase change within a specified frequency step (determined by the frequency span and the number of points per sweep).

General Information

- [Miscellaneous Information](#)
- [Front Panel](#)
- [Rear Panel](#)
- [Environment and Dimensions](#)

Table 25. Miscellaneous Information

Description	Supplemental Information
System IF Bandwidth Range	1 Hz to 15 MHz, nominal
CPU	For the latest information on CPUs and associated hard drives, visit: http://na.support.keysight.com/pna/hdnumbers.html
LXI	Class C

Table 26. Front Panel Information, All Options

Description	Typical Performance
RF Connectors	
Test Ports	2.4 mm (male), 50 ohm, (nominal), 0.002 in. (characteristic)
Jumpers (Option 216)	2.4 mm (female) connectors with 2.4 mm (male) jumper cables
USB 2.0 Ports - Master (4 ports)	
Standard	Compatible with USB 2.0
Connector	USB Type-A female
Display	
Size	31 cm (12.1 in) diagonal color active matrix LCD; 1280 (horizontal) X 800 (vertical) resolution
Refresh Rate	Vertical 60 Hz; Horizontal 49.31 kHz
Pixels	Any of the following would cause a display to be considered faulty: <ul style="list-style-type: none"> • A complete row or column consists of “stuck” or “dark” pixels. • More than six “stuck on” pixels (but not more than three green) or more than 0.002% of the total pixels are within the LCD specifications. • More than twelve “dark” pixels (but no more than seven of the same color) or more than 0.004% of the total pixels are within the LCD specifications. • Two or more consecutive "stuck on" pixels or three or more consecutive "dark" pixel (but no more than one set of two consecutive dark pixels). • “Stuck on” pixels or more than two “dark” pixels less than 6.5 mm apart (excluding consecutive pixels).

Table 26 (Continued) Front Panel Information, All Options

Description	Typical Performance
Display Range	
Magnitude	+/-2500 dB (at 500 dB/div), max
Phase	+/-2500° (at 500 dB/div), max
Polar	10 pUnits, min 10,000 Units, max
Display Resolution	
Magnitude	0.001 dB/div, min
Phase	0.01°/div, min
Marker Resolution	
Magnitude	0.001 dB, min
Phase	0.01°, min
Polar	10 pUnit, min

Table 27. Rear Panel Information, All Options

Description	Typical Performance
10 MHz Reference In	
Connector	BNC, female
Input Frequency	10 MHz ± 10 ppm
Input Level	-15 dBm to +20 dBm
Input Impedance	200 Ω, nom.
10 MHz Reference Out	
Connector	BNC, female
Output Frequency	10 MHz ± 1 ppm
Signal Type	Sine Wave
Output Level	+10 dBm ± 4 dB into 50 Ω
Output Impedance	50 Ω, nominal
Harmonics	<-40 dBc, typical

Table 27. (Continued) Rear Panel Information, All Options

Description	Typical Performance
Devices Supported	Resolutions
Flat Panel (TFT)	1024 X 768, 800 X 600, 640 X 480
Flat Panel (DSTN)	800 X 600, 640 X 480
CRT Monitor	1280 X 1024, 1024 X 768, 800 X 600, 640 X 480
Simultaneous operation of the internal and external displays is allowed, but with 640 X 480 resolution only. If you change resolution, you can only view the external display (internal display will "white out").	
Trigger Inputs/Outputs	BNC(f), TTL/CMOS compatible
Test Set IO	25-pin D-Sub connector, available for external test set control
Power IO	9-pin D-Sub, female; analog and digital IO
Handler IO	36-pin parallel I/O port; all input/output signals are default set to negative logic; can be reset to positive logic via GPIB command
GPIB	Two ports - dedicated controller and dedicated talker/listener. 24-pin D-sub (Type D-24), female; compatible with IEEE-488
PCIe	Cabled PCIe x4 connector is a 4-lane slot (not currently used)
USB Ports	Two SuperSpeed USB ports (900 mA each), one USB port below LAN connector, and one USB device port. There are also four USB ports (500 mA each) on the front panel. The total current limit for all rear panel USB ports is 2.3 amps. The total current limit for all front panel USB ports is 2 amps.
LAN	10/100/1000 BaseT Ethernet, 8-pin configuration; auto selects between the data rates
VGA Video Output	15-pin mini D-Sub; Drives VGA compatible monitors
Mini DisplayPort	Miniature DisplayPort connector for connection to external displays
Line Power	
Frequency, Voltage	50/60/ Hz for 100 to 120 VAC 50/60 Hz for 220 to 240 VAC
	Power supply is auto switching
Max	350 watts

Table 28. Analyzer Dimensions and Weight

All models are shipped with bottom feet, handles and front and rear hardware.

See detailed PNA dimension drawings at: <http://na.tm.keysight.com/pna/PNADimensions.pdf>

Cabinet Dimensions	Metric (mm)	Imperial (inches)
Height		
Without bottom feet: EIA RU ¹ = 6	266.1	10.5
With bottom feet	279.1	11
Width		
Without handles or rack-mount flanges	425.6	16.8
With handles, without rack-mount flanges	458.7	18.1
With handles and rack-mount flanges	482.9	19.0
Depth		
Without front and rear panel hardware	445.7	17.5
With front and rear panel hardware, handles	497.2	19.6
Weight (nominal)		
	Net	Shipping
2-port model (Option 216)	24.6 kg (52 lb)	34.9 kg (77 lb)

¹Electronics Industry Association rack units. 1 RU = 1.75 in.

Regulatory and Environmental Information

For Regulatory and Environmental information, refer to the PNA-L Series Installation and Quick Start Guide, located online at <http://literature.cdn.keysight.com/litweb/pdf/E8356-90001.pdf>.

Measurement Throughput Summary

- Typical Cycle Time for Measurement Completion
- Cycle Time vs. IF Bandwidth
- Cycle Time vs. Number of Points
- Data Transfer Time

Cycle time Includes sweep time, retrace time and band-crossing time. Analyzer display turned off with DISPLAY:ENABLE OFF. Add 21 ms for display on. Data for one trace (S₁₁) measurement.

Table 29. Cycle Time (ms) for Measurement Completion, All Options - Typical

Sweep Range	IF Bandwidth		Number of Points				
			201	401	1601	16001	32001
9 GHz to 10 GHz, All Models	600 kHz	Uncorrected	6	6	9	55	106
		2-Port cal	10	11	19	115	216
	10 kHz	Uncorrected	29.1	54	203	1992	3978
		2-Port cal	59	109	408	3595	6397
	1 kHz	Uncorrected	227	453	1743	17011	33792
		2-Port cal	460	904	3423	27238	45100
10 MHz to 43.5 GHz, N5234B	600 kHz	Uncorrected	47	51	61	149	194
		2-Port cal	93	101	121	300	392
	10 kHz	Uncorrected	80	142	497	2037	4042
		2-Port cal	161	285	995	4078	8094
	1 kHz	Uncorrected	246	472	1813	17592	34938
		2-Port cal	497	950	3633	35194	46620
10 MHz to 50 GHz, N5235B	600 kHz	Uncorrected	48	54	63	151	197
		2-Port cal	99	108	127	304	399
	10 kHz	Uncorrected	80	142	500	2034	4040
		2-Port cal	161	285	998	4080	8089
	1 kHz	Uncorrected	246	472	1814	17612	34979
		2-Port cal	497	950	3277	28203	55994

Table 30. Cycle Time vs. IF Bandwidth - Typical

Applies to the **Preset condition** (201 points, correction off) except for the following changes:

- CF = 10 GHz
- Span = 100 MHz
- Display off (add 21 ms for display on)

Cycle time includes sweep and retrace time.

Description		N5234B/35B	
IF Bandwidth (Hz)	Cycle Time (ms)	Trace Noise Magnitude (dB rms)	
600,000	6	0.0035	
100,000	7	0.0016	
30,000	9	0.0010	
10,000	29	0.0005	
3,000	71	0.0004	
1,000	222	0.0001	
300	640	0.0001	
100	1823	0.00006	
30	5980	0.00006	
10	17828	0.00006	
3	59273	0.00006	

Table 31. Cycle Time vs. Number of Points - Typical

Applies to the **Preset condition** (correction off) except for the following changes:

- CF = 10 GHz
- Span = 100 MHz
- Display off (add 21 ms for display on)

Cycle time includes sweep and retrace time.

Description	IF Bandwidth (Hz)			
	1,000	10,000	30,000	600,000
3	7	6	6	6
11	16	6	6	6
51	60	10.4	6	6
101	114	17	7	6
201	222	29	9	6
401	436	54	14	6
801	861	104	24	7
1,601	1706	203	44	9
6,401	6718	799	164	25
16,001	16641	1991	403	55
32,001	33057	3974	803	106

Table 32. Data Transfer Times - Typical

- Values are for Real & Imaginary pairs (two values per point)
- Results measured with the analyzer display off. Values will increase slightly if the analyzer display is on.
- LAN values assume a gigabit connection and are highly dependent upon both LAN conditions and the computer used
- All values are approximate. Example values shown are actual averaged measured results and include the time required to send the command to request the data

Description	General Formula	Example for 1601 Points	Example for 32001 Points
SCPI over GPIB¹ (Program executed on external PC)			
32-bit floating point	1mS + .024 mS/point	39 mS	755 mS
ASCII	1mS + 0.185mS/point	300 mS	5850 mS
SICL over LAN (Program executed on external PC)			
32-bit floating point	0.5 mS + 0.18 μS/point	0.78 mS	6.4 mS
ASCII	0.5 mS + .012 mS/point	20.4 mS	390 mS
SICL (Program executed within the analyzer)			
32-bit floating point	0.3 mS + 0.18 μS/point	0.64 mS	6.2 mS
ASCII	0.3 mS + .012 mS/point	20.2 mS	388 mS
COM (Program executed within the analyzer)			
32-bit floating point	130 μS + .012 μS/point	0.14 mS	0.5 mS
Variant type	130 μS + 1.7 μS/point	2.7 mS	56 mS
DCOM over LAN (Program executed on external PC)			
32-bit floating point	350 μS + 0.17 μS/point	0.55 mS	5.7 mS
Variant type	350 μS + 3.4 μS/point	5.8 mS	108 mS

¹ Values obtained using USB-to-GPIB adapter (82357B)

NOTE

Internally, the PNA measurement data is handled in 32-bit (single-precision) format. Therefore, there is no need to use 64-bit transfers for most data. Frequency values however, may be rounded slightly with 32-bit transfers since there is insufficient resolution in this format to represent higher frequencies with 1 Hz accuracy. If this type of accuracy is needed for frequencies, then you should use 64-bit transfers. Specifications for Recall & Sweep Speed are not provided for the N532xB analyzers.

Specifications: Front-Panel Jumpers

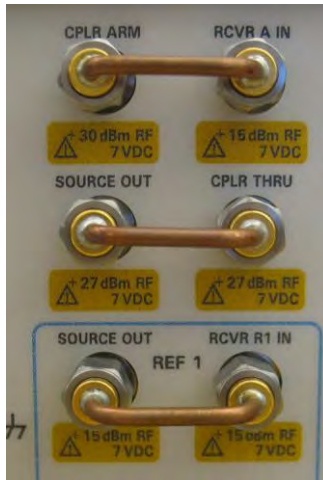

The following options have front-panel jumpers for each port:

Option 216

- Measurement Receiver Inputs
- Reference Receiver Inputs and Reference Source Outputs
- Source Outputs
- Coupler Inputs

Table 33. Measurement Receiver Inputs (dBm), Option 216 – Typical

(RCVR A, B IN) @ 0.1dB Typical Compression

Description	Option 216
10 MHz to 45 MHz	-34
45 MHz to 500 MHz	-20
500 MHz to 35 GHz	-9
35 GHz to 43.5 GHz	-11
43.5 GHz to 47GHz	-12
47 GHz to 50 GHz	-13

Table 34. Reference Receiver Inputs and Reference Source Outputs (dBm) – Typical

(RCVR R1, R2 IN, REF 1, 2 SOURCE OUT) @ Specified Maximum Leveled Power

Description	Option 216
10 MHz to 8.5 GHz	-28
8.5 GHz to 20 GHz	-26
20 GHz to 35 GHz	-30
35 GHz to 40 GHz	-27
40 GHz to 43.5 GHz	-29
43.5 GHz to 50 GHz	-28

Table 35. Source Outputs (dBm) - Typical

(PORT 1, 2 SOURCE OUT) @ Specified Maximum Leveled Power

Description	Option 216
10 MHz to 12.5 GHz	1
12.5 GHz to 20 GHz	3
20 GHz to 40 GHz	-4
40 GHz to 50 GHz	-11

Table 36. Coupler Inputs (dB) - Typical

(PORT 1, 2 CPLR THRU) Insertion Loss of Coupler Thru

Description	Option 216
10 MHz to 500 MHz	0.6
500 MHz to 2 GHz	0.8
2 GHz to 20 GHz	2.0
20 GHz to 40 GHz	2.5
40 GHz to 50 GHz	3.0

Test Set Block Diagrams

NOTE

For best readability, use a color printer for printing the following graphics.

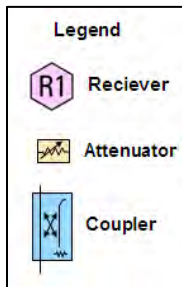

N5234B and N5235B Option 200 (2-port base model)

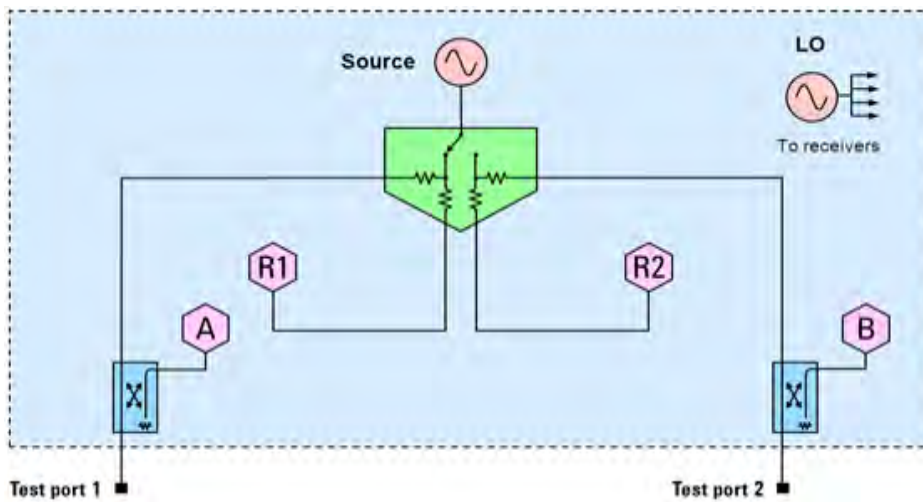

N5234B and N5235B Option 216

To base model, adds front-panel jumpers and source attenuators

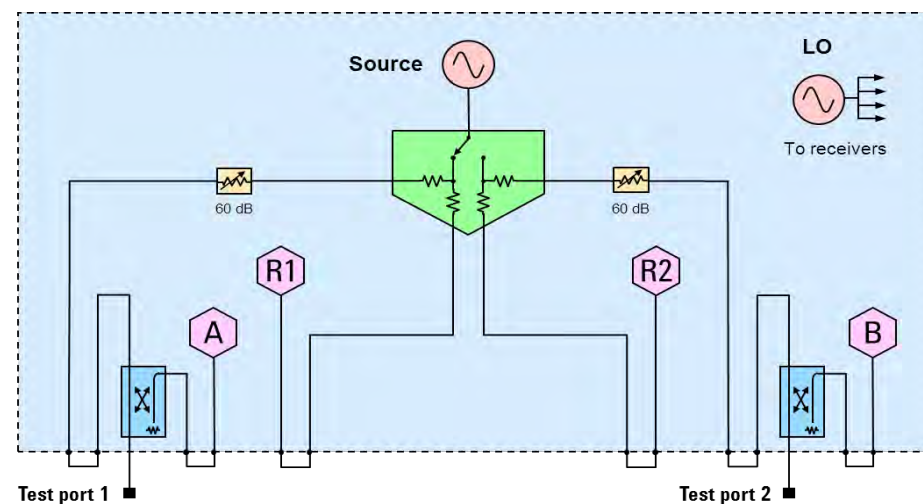

Receiver Block Diagram

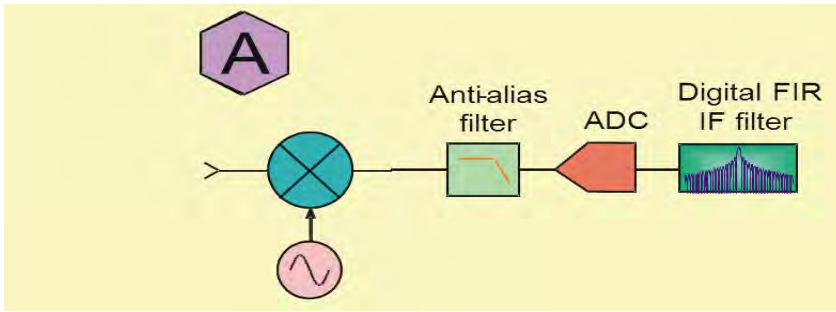



This information is subject to change without notice.

© Keysight Technologies 2017

Print Date: May 1, 2017



N5235-90005

www.keysight.com