

# VNA Master™

MS2026B Vector Network Analyzer 5 kHz to 6 GHz

MS2028B Vector Network Analyzer 5 kHz to 20 GHz

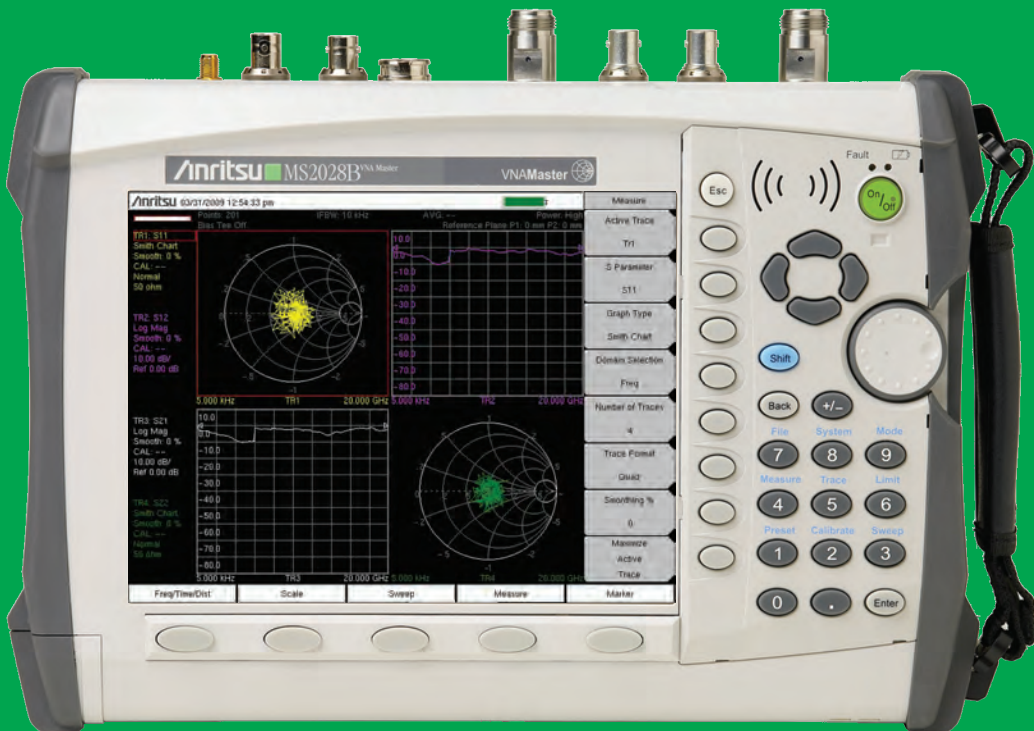



**User Guide**

# **VNA Master™**

## **Model MS202xB**

**MS2026B Vector Network Analyzer 5 kHz to 6 GHz**

**MS2028B Vector Network Analyzer 5 kHz to 20 GHz**

The Anritsu logo is located in the bottom right corner of the page. It consists of the word "Anritsu" in a bold, sans-serif font. The letter "A" is stylized with a diagonal slash through it.

## **WARRANTY**

The Anritsu product(s) listed on the title page is (are) warranted against defects in materials and workmanship for one year from the date of shipment.

Anritsu's obligation covers repairing or replacing products which prove to be defective during the warranty period. Buyers shall prepay transportation charges for equipment returned to Anritsu for warranty repairs. Obligation is limited to the original purchaser. Anritsu is not liable for consequential damages.

## **LIMITATION OF WARRANTY**

The foregoing warranty does not apply to Anritsu connectors that have failed due to normal wear. Also, the warranty does not apply to defects resulting from improper or inadequate maintenance by the Buyer, unauthorized modification or misuse, or operation outside of the environmental specifications of the product. No other warranty is expressed or implied, and the remedies provided herein are the Buyer's sole and exclusive remedies.

## **DISCLAIMER OF WARRANTY**

DISCLAIMER OF WARRANTIES. TO THE MAXIMUM EXTENT PERMITTED BY APPLICABLE LAW, ANRITSU COMPANY AND ITS SUPPLIERS DISCLAIM ALL WARRANTIES, EITHER EXPRESSED OR IMPLIED, INCLUDING, BUT NOT LIMITED TO, IMPLIED WARRANTIES OF MERCHANTABILITY AND FITNESS FOR A PARTICULAR PURPOSE, WITH REGARD TO THE PRODUCT. THE USER ASSUMES THE ENTIRE RISK OF USING THE PRODUCT. ANY LIABILITY OF PROVIDER OR MANUFACTURER WILL BE LIMITED EXCLUSIVELY TO PRODUCT REPLACEMENT.

NO LIABILITY FOR CONSEQUENTIAL DAMAGES. TO THE MAXIMUM EXTENT PERMITTED BY APPLICABLE LAW, IN NO EVENT SHALL ANRITSU COMPANY OR ITS SUPPLIERS BE LIABLE FOR ANY SPECIAL, INCIDENTAL, INDIRECT, OR CONSEQUENTIAL DAMAGES WHATSOEVER (INCLUDING, WITHOUT LIMITATION, DAMAGES FOR LOSS OF BUSINESS PROFITS, BUSINESS INTERRUPTION, LOSS OF BUSINESS INFORMATION, OR ANY OTHER PECUNIARY LOSS) ARISING OUT OF THE USE OF OR INABILITY TO USE THE PRODUCT, EVEN IF ANRITSU COMPANY HAS BEEN ADVISED OF THE POSSIBILITY OF SUCH DAMAGES. BECAUSE SOME STATES AND JURISDICTIONS DO NOT ALLOW THE EXCLUSION OR LIMITATION OF LIABILITY FOR CONSEQUENTIAL OR INCIDENTAL DAMAGES, THE ABOVE LIMITATION MAY NOT APPLY TO YOU.

## **TRADEMARK ACKNOWLEDGMENTS**

VNA Master is a trademarks of Anritsu Company.

Acrobat Reader is a registered trademark of Adobe Corporation.

## **NOTICE**

Anritsu Company has prepared this manual for use by Anritsu Company personnel and customers as a guide for the proper installation, operation and maintenance of Anritsu Company equipment and computer programs. The drawings, specifications, and information contained herein are the property of Anritsu Company, and any unauthorized use or disclosure of these drawings, specifications, and information is prohibited; they shall not be reproduced, copied, or used in whole or in part as the basis for manufacture or sale of the equipment or software programs without the prior written consent of Anritsu Company.

## **UPDATES**

Updates, if any, can be downloaded from the Documents area of the Anritsu web site at:

<http://www.anritsu.com>

For the latest service and sales contact information in your area, please visit:

<http://www.anritsu.com/contact.asp>

# DECLARATION OF CONFORMITY

**Manufacturer's Name:** ANRITSU COMPANY

**Manufacturer's Address:** Microwave Measurements Division  
490 Jarvis Drive  
Morgan Hill, CA 95037-2809  
USA

declares that the product specified below:

**Product Name:** VNA Master

**Model Number:** MS202xB

conforms to the requirement of:

EMC Directive: 2004/108/EC  
Low Voltage Directive: 2006/95/EC

## **Electromagnetic Compatibility: EN61326:2006**

Emissions: EN55011: 2007 Group 1 Class A

Immunity: EN 61000-4-2:1995 +A1:1998 +A2:2001 4kV CD, 8kV AD  
EN 61000-4-3:2006 +A1:2008 3V/m  
EN 61000-4-4:2004 0.5kV SL, 1kV PL  
EN 61000-4-5:2006 0.5kV L-L, 1kV L-E  
EN 61000-4-6: 2007 3V  
EN 61000-4-11: 2004 100% @ 20msec

## **Electrical Safety Requirement:**

Product Safety: EN 61010-1:2001

  
Eric McLean, Corporate Quality Director

Morgan Hill, CA

12 MAR 2009  
Date

European Contact: For Anritsu product EMC & LVD information, contact Anritsu LTD, Rutherford Close, Stevenage Herts, SG1 2EF UK, (FAX 44-1438-740202)

## CE Conformity Marking

Anritsu affixes the CE Conformity marking onto its conforming products in accordance with Council Directives of The Council Of The European Communities in order to indicate that these products conform to the EMC and LVD directive of the European Union (EU).



## C-tick Conformity Marking

Anritsu affixes the C-tick marking onto its conforming products in accordance with the electromagnetic compliance regulations of Australia and New Zealand in order to indicate that these products conform to the EMC regulations of Australia and New Zealand.



## Notes On Export Management

This product and its manuals may require an Export License or approval by the government of the product country of origin for re-export from your country.

Before you export this product or any of its manuals, please contact Anritsu Company to confirm whether or not these items are export-controlled.

When disposing of export-controlled items, the products and manuals need to be broken or shredded to such a degree that they cannot be unlawfully used for military purposes.

## Mercury Notification

This product uses an LCD backlight lamp that contains mercury. Disposal may be regulated due to environmental considerations. Please contact your local authorities or, within the United States, the Electronics Industries Alliance ([www.eiae.org](http://www.eiae.org)) for disposal or recycling information.



产品中有毒有害物质或元素的名称及含量

For Chinese Customers Only YLYB

部件名称	有毒有害物质或元素					
	铅 (Pb)	汞 (Hg)	镉 (Cd)	六价铬 [Cr(VI)]	多溴联苯 (PBB)	多溴二苯醚 (PBDE)
印刷线路板 (PCA)	×	○	×	×	○	○
机壳、支架 (Chassis)	×	○	×	×	○	○
LCD	×	×	×	×	○	○
其他(电缆、风扇、 连接器等) (Appended goods)	×	○	×	×	○	○

○：表示该有毒有害物质在该部件所有均质材料中的含量均在 SJ/T11363-2006 标准规定的限量要求以下。  
 ×：表示该有毒有害物质至少在该部件的某一均质材料中的含量超出 SJ/T11363-2006 标准规定的限量要求。

环保使用期限



这个标记是根据 2006/2/28 公布的「电子信息产品污染控制管理办法」以及 SJ/T 11364-2006 「电子信息产品污染控制标识要求」的规定，适用于在中国销售的电子信息产品的环保使用期限。仅限于在遵守该产品的安全规范及使用注意事项的基础上，从生产日起算的该年限内，不会因产品所含有害物质的泄漏或突发性变异，而对环境污染，人身及财产产生深刻地影响。

注) 电池的环保使用期限是 5 年。生产日期标于产品序号的前四码 (如 S/N 0728XXXX 为 07 年第 28 周生产)。





## Safety Symbols

To prevent the risk of personal injury or loss related to equipment malfunction, Anritsu Company uses the following symbols to indicate safety-related information. For your own safety, please read the information carefully *before* operating the equipment.

### Symbols Used in Manuals

#### Danger



This indicates a risk from a very dangerous condition or procedure that could result in serious injury or death and possible loss related to equipment malfunction. Follow all precautions and procedures to minimize this risk.

#### Warning



This indicates a risk from a hazardous condition or procedure that could result in light-to-severe injury or loss related to equipment malfunction. Follow all precautions and procedures to minimize this risk.

#### Caution



This indicates a risk from a hazardous procedure that could result in loss related to equipment malfunction. Follow all precautions and procedures to minimize this risk.

### Safety Symbols Used on Equipment and in Manuals

The following safety symbols are used inside or on the equipment near operation locations to provide information about safety items and operation precautions. Ensure that you clearly understand the meanings of the symbols and take the necessary precautions *before* operating the equipment. Some or all of the following five symbols may or may not be used on all Anritsu equipment. In addition, there may be other labels attached to products that are not shown in the diagrams in this manual.



This indicates a prohibited operation. The prohibited operation is indicated symbolically in or near the barred circle.



This indicates a compulsory safety precaution. The required operation is indicated symbolically in or near the circle.



This indicates a warning or caution. The contents are indicated symbolically in or near the triangle.



This indicates a note. The contents are described in the box.



These indicate that the marked part should be recycled.

## For Safety

### Warning



Always refer to the operation manual when working near locations at which the alert mark, shown on the left, is attached. If the operation, etc., is performed without heeding the advice in the operation manual, there is a risk of personal injury. In addition, the equipment performance may be reduced. Moreover, this alert mark is sometimes used with other marks and descriptions indicating other dangers.

### Warning

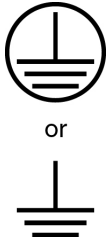

When supplying power to this equipment, connect the accessory 3-pin power cord to a 3-pin grounded power outlet. If a grounded 3-pin outlet is not available, use a conversion adapter and ground the green wire, or connect the frame ground on the rear panel of the equipment to ground. If power is supplied without grounding the equipment, there is a risk of receiving a severe or fatal electric shock.

### Warning



This equipment can not be repaired by the operator. Do not attempt to remove the equipment covers or to disassemble internal components. Only qualified service technicians with a knowledge of electrical fire and shock hazards should service this equipment. There are high-voltage parts in this equipment presenting a risk of severe injury or fatal electric shock to untrained personnel. In addition, there is a risk of damage to precision components.

### Caution



Electrostatic Discharge (ESD) can damage the highly sensitive circuits in the instrument. ESD is most likely to occur as test devices are being connected to, or disconnected from, the instrument's front and rear panel ports and connectors. You can protect the instrument and test devices by wearing a static-discharge wristband. Alternatively, you can ground yourself to discharge any static charge by touching the outer chassis of the grounded instrument before touching the instrument's front and rear panel ports and connectors. Avoid touching the test port center conductors unless you are properly grounded and have eliminated the possibility of static discharge.

Repair of damage that is found to be caused by electrostatic discharge is not covered under warranty.

### Warning



This product is supplied with a rechargeable battery that could potentially leak hazardous compounds into the environment. These hazardous compounds present a risk of injury or loss due to exposure. Anritsu Company recommends removing the battery for long-term storage of the instrument and storing the battery in a leak-proof, plastic container. Follow the environmental storage requirements specified in the product technical data sheet.

# Table of Contents

---

## Chapter 1—General Information

- 1-1 Introduction . . . . . 1-1
- 1-2 Identifying the Connections . . . . . 1-1
- 1-3 Description . . . . . 1-1
  - Model MS202xB measurement capabilities: . . . . . 1-2
- 1-4 Soft Carrying Case and Tilt Bail . . . . . 1-2
  - VNA Master Soft Carrying Case . . . . . 1-2
  - VNA Master Tilt Bail Stand . . . . . 1-4
- 1-5 Preventive Maintenance . . . . . 1-5
- 1-6 Calibration Requirements – Vector Network Analyzer . . . . . 1-5
- 1-7 Annual Verification . . . . . 1-5
- 1-8 ESD Cautions . . . . . 1-6
- 1-9 Battery Replacement . . . . . 1-6
- 1-10 Anritsu Service Centers . . . . . 1-7

## Chapter 2—Quick Start Guide

- 2-1 Introduction . . . . . 2-1
- 2-2 Turning the VNA Master On for the First Time . . . . . 2-1
- 2-3 Front Panel Overview . . . . . 2-3
  - Battery Charge LED (Green) . . . . . 2-5
  - Charge Fault LED (Red) . . . . . 2-5
  - Fan Inlet and Exhaust Ports . . . . . 2-5
- 2-4 Typical Vector Network Analyzer Display . . . . . 2-6
  - Instrument Settings Summary . . . . . 2-9
- 2-5 Front Panel Keys . . . . . 2-10
  - Esc Key . . . . . 2-10
  - Enter Key . . . . . 2-10
  - Arrow Keys . . . . . 2-10
  - Shift Key . . . . . 2-10
  - Back Key . . . . . 2-11
  - Plus/Minus (+/-) Key . . . . . 2-11
  - Number Keypad . . . . . 2-11
  - Rotary Knob . . . . . 2-11
  - Function Hard Keys . . . . . 2-11
  - Soft Keys . . . . . 2-11

2-6	Soft Key Types .....	2-11
	Select .....	2-11
	Input .....	2-12
	Toggle .....	2-12
	Switching .....	2-12
2-7	Parameter Setting .....	2-13
2-8	Text Entry .....	2-13
2-9	Mode Selector .....	2-16
2-10	Test Panel Connectors .....	2-17
	MS202xB Test Panel Connectors .....	2-17
	External Power .....	2-18
	LAN Connection .....	2-19
	USB Interface - USB Type Mini-B .....	2-20
	USB Interface - USB Type A .....	2-21
	Headset Jack .....	2-21
	Ext Trigger .....	2-21
	Ext Freq Ref .....	2-21
	RF Detector .....	2-21
	Port 1 (50 Ohm) .....	2-22
	Port 2 (50 Ohm) .....	2-22
	Bias Input Port 1 .....	2-22
	Bias Input Port 2 .....	2-22
	Bias Status LED .....	2-22
	GPS Antenna Connector .....	2-22
2-11	Symbols and Indicators .....	2-23
	Battery Symbol .....	2-23
	Hold .....	2-24
	Single Sweep .....	2-24
2-12	Memory Profile and Security Issues .....	2-25
2-13	System Settings .....	2-27
	Application Options .....	2-28
	System Options .....	2-29
2-14	File Types .....	2-31

## **Chapter 3—VNA Display Overview**

3-1	Introduction .....	3-1
-----	--------------------	-----

3-2	Powerful Display Capabilities . . . . .	3-1
	Flexible Features For Displaying Results . . . . .	3-1
	Active Trace . . . . .	3-2
	Changing the Active Trace . . . . .	3-2
	Trace Description . . . . .	3-3
	Example Measurement Displays . . . . .	3-4
3-3	Marker and Limit Capabilities . . . . .	3-7
	Marker Description . . . . .	3-7
	Selecting the Readout Style for Each Marker . . . . .	3-7
	Displaying Markers on the Screen . . . . .	3-7
	Setting Up Delta Markers . . . . .	3-8
	Setting Up Limits . . . . .	3-8
3-4	Trace Math Capabilities . . . . .	3-8

## Chapter 4—VNA Fundamentals

4-1	Introduction . . . . .	4-1
4-2	S-Parameters . . . . .	4-1
	Additional Examples: . . . . .	4-2
4-3	MS202xB VNA Master Architecture . . . . .	4-2
4-4	Calculating and Displaying S-Parameters . . . . .	4-4
4-5	Extracting More Information by Using Markers. . . . .	4-6
4-6	How Bias is Generated . . . . .	4-7

## Chapter 5—VNA Measurements

5-1	Introduction . . . . .	5-1
5-2	1-Port Cable Measurement . . . . .	5-1
	Introduction . . . . .	5-1
	Setup Considerations . . . . .	5-1
	Measurement Readout and Interpretation . . . . .	5-1
5-3	1-Port Smith Chart Tuning Example . . . . .	5-4
5-4	2-Port Filter Measurement . . . . .	5-6
	Introduction . . . . .	5-6
	Setup Considerations . . . . .	5-6
	Measurement Readout and Interpretation . . . . .	5-6
5-5	2-Port Amplifier Measurement . . . . .	5-9
	Introduction . . . . .	5-9
	Setup Considerations . . . . .	5-9
	Measurement Readout and Interpretation . . . . .	5-9

5-6	Waveguide Considerations	5-12
	Introduction	5-12
	Setup Considerations	5-12
	Measurement Readout and Interpretation	5-12
5-7	Calibration Considerations	5-13
	Cal Type	5-16

## Chapter 6—VNA Menus

6-1	Introduction	6-1
6-2	VNA Key Functions	6-1
	Introduction	6-1
6-3	Frequency Menus	6-3
	Freq Menu	6-4
	Setup Domain Menu	6-5
	Time Menu	6-6
	Windowing Menu	6-7
	Distance Setup Menu	6-8
	Additional Dist Setup Menu (Coax)	6-9
	Additional Dist Setup Menu (Waveguide)	6-10
	Distance Info List Box for Cable	6-11
	Distance Info List Box for Waveguide	6-11
6-4	Calibration Menus	6-12
	Calibration Menu	6-13
	Existing Calibration Information List Box	6-14
	Additional Calibration Considerations	6-14
	DUT Port Setup Menu (Coax)	6-15
	Cal Kit Definition Menus for Coax	6-16
	DUT Connector Selector List Box for Coax	6-17
	DUT Port Setup Menu (Waveguide)	6-18
	Cal Kit Definition Menus for Waveguide	6-19
	DUT Connector Selector List Box for Waveguide	6-20
	Calibration Types	6-21
6-5	File Menus	6-22
	File Menu	6-23
	Screen Capture Feature	6-24
	Save (Text Entry) Menu	6-25
	File Types	6-27
	Save Location Menu	6-28
	Abbreviated Text Entry Menu	6-29
	Text Entry Letters Menu	6-30
	Recall Menu	6-31
	Delete Menu	6-32
	Copy Menu	6-34

6-6	Limit Menus	6-36
	Limit Menu	6-37
	Limit Edit Menu	6-38
6-7	Marker Menus	6-39
	Marker Menu	6-40
	Marker Search Menu	6-41
	Readout Format Menu	6-42
6-8	Measurement Menus	6-43
	Measure Menu	6-44
	S-Parameter Menu	6-46
	Domain Menu	6-47
	Number of Traces Menu	6-48
	Trace Format Menu	6-49
	Sweep Menu	6-50
	Configure Ports Menu	6-51
	Bias Tee Setup Menu	6-52
	Bias Tee Menu	6-53
	Source Power Menu	6-53
	Preset Menu	6-54
6-9	Scale Menu	6-55
	Smith Scale Menu	6-56
6-10	System Menus	6-57
	System Menu	6-58
	Application Options	6-59
	System Options	6-60
	Reset Menu	6-61
	Trace Menu	6-61
	Display Menu (Trace)	6-62
	Trace Math Menu	6-63

## Chapter 7—Time Domain, Option 2

7-1	Introduction	7-1
7-2	Time Domain Measurements	7-1
7-3	VNA Master Implementation	7-2
	One Way versus Round Trip	7-2
	Waveguide Dispersion Compensation	7-4
7-4	Windowing	7-6
7-5	Distance-to-Fault Measurement Example	7-7
	In the Measure Menu:	7-7
	In the Sweep Menu:	7-7
	In the Freq/Time/Dist Menu:	7-7
	In the Additional Dist Setup submenu:	7-7

7-6	Time and Distance Information .....	7-9
<b>Chapter 8—Power Monitor, Option 5</b>		
8-1	Introduction .....	8-1
8-2	Procedure .....	8-1
	Zeroing the Power Monitor .....	8-1
	Measuring High Input Power Levels .....	8-1
	Displaying Power in dBm or in Watts .....	8-2
	Setting Relative Power .....	8-2
8-3	Power Monitor Display .....	8-3
8-4	Power Monitor Menu .....	8-3
<b>Chapter 9—Secure Data Option 7</b>		
9-1	Introduction .....	9-1
9-2	Procedure .....	9-1
9-3	Calibration Setup .....	9-2
9-4	Memory Profile and Security Issues .....	9-3
9-5	.....	9-4
<b>Chapter 10—Bias Tee, Option 10</b>		
10-1	Introduction .....	10-1
10-2	Bias Tee Fundamentals .....	10-1
10-3	How Bias is Generated .....	10-2
10-4	Bias Tee when Making 2-Port Gain Measurements .....	10-4
10-5	Bias Tee Menus .....	10-6
	Bias Tee Setup Menu .....	10-7
	Bias Tee Menu .....	10-8
<b>Chapter 11—Vector Voltmeter, Option 15</b>		
11-1	Introduction .....	11-1
11-2	Getting Started .....	11-2
11-3	Using Vector Voltmeter Mode for the First Time .....	11-3
11-4	How the VVM Function Works .....	11-3
11-5	Simple Measurement Using CW Display .....	11-4
11-6	Simple Relative Measurements using CW Display .....	11-9
11-7	Measurements Using Comparison Table Display .....	11-10
11-8	Vector Voltmeter Menus .....	11-12
	CW Menu .....	11-12
	Table Menu .....	11-13
	Save/Recall Menu .....	11-14
	Calibration Menu .....	11-14



---

## Chapter 12—High Accuracy Power Meter, Option 19

12-1	Introduction	12-1
12-2	High Accuracy Power Meter (HAPM) Display	12-1
12-3	HAPM General Operating Procedure	12-2
	Turn On the VNA Master and the Sensor	12-2
	Zero/Cal (Calibration) and Cal Factor	12-3
	Change the Analog Scale Display	12-5
	Using Attenuators	12-5
	Displaying Relative Power	12-6
	Averaging/Max Hold/Run Hold	12-6
	Limits	12-7
	Saving the Measurement	12-8
12-4	Menus	12-8
12-5	Zero/Cal and Cal Factor Menus	12-9
12-6	Amplitude and Units Menus	12-10
12-7	Averages Menu	12-11
12-8	Limits Menu	12-12

## Chapter 13—GPS Receiver, Option 31

13-1	Introduction	13-1
13-2	Activating the GPS Feature	13-1
13-3	GPS Menu	13-3
13-4	GPS Info Window	13-4
	Tracked Satellites	13-4
	Latitude and Longitude	13-4
	Altitude	13-4
	UTC	13-4
	Fix Available	13-5
	Almanac Complete	13-5
	Antenna Status	13-5
	Receiver Status	13-5
	Other Status Messages	13-6
	GPS Antenna Voltage	13-6
	GPS Antenna Current	13-6
13-5	Saving and Recalling Traces with GPS Information	13-6
	Saving Traces with GPS Information	13-6
	Recalling GPS Information	13-6

## Chapter 14—Balanced Ports, Option 77

14-1	Introduction	14-1
14-2	Procedure	14-1

---

14-3	Typical Measurements . . . . .	14-3
------	--------------------------------	------

## **Chapter 15—Anritsu PC Software Tools**

15-1	Introduction . . . . .	15-1
15-2	Anritsu Tool Box . . . . .	15-1
15-3	Line Sweep Tools . . . . .	15-2
15-4	Master Software Tools . . . . .	15-3
15-5	easyMap Tools . . . . .	15-4

## **Appendix A—Signal Standards**

A-1	Introduction . . . . .	A-1
-----	------------------------	-----

## **Appendix B—Error Messages**

B-1	Introduction . . . . .	B-1
B-2	Reset Options . . . . .	B-1
	Reset Via Instrument Menus . . . . .	B-1
	Reset from OFF Condition . . . . .	B-1
B-3	Self Test or Application Self Test Error Messages . . . . .	B-1
	Self Test . . . . .	B-1
	Application Self Test . . . . .	B-3
B-4	Operation Error Messages . . . . .	B-5
	Fan Failure . . . . .	B-5
	High Temp Warning . . . . .	B-5
	Operation not Permitted in Recall Mode . . . . .	B-5
	PMON PLD Fail . . . . .	B-6
	Power Supply . . . . .	B-6

## **Appendix C—Windowing**

C-1	Introduction . . . . .	C-1
	Rectangular Windowing . . . . .	C-2
	Nominal Side Lobe Windowing . . . . .	C-3
	Low Side Lobe Windowing . . . . .	C-4
	Minimum Side Lobe Windowing . . . . .	C-5

## **Appendix D—Tower Mounted Amplifiers**

D-1	Introduction . . . . .	D-1
-----	------------------------	-----

## **Appendix E—Coaxial Cable Technical Data**

E-1	Coaxial Cable Technical Data . . . . .	E-1
-----	--	-----

## **Appendix F—Waveguide Data**

F-1	Introduction . . . . .	F-1
F-2	Calibration Components . . . . .	F-1
F-3	Waveguide-to-Coaxial Adapters . . . . .	F-2

F-4	Flange Compatibility . . . . .	F-3
	Universal Flange Compatibility . . . . .	F-4
	Universal Flange Compatibility . . . . .	F-6
F-5	Waveguide Technical Data . . . . .	F-7
	Waveguide Technical Data . . . . .	F-8
	Waveguide Technical Data . . . . .	F-9

## Appendix G—More About DHCP

G-1	Introduction . . . . .	G-1
G-2	Using DHCP . . . . .	G-1
G-3	Static IP Address . . . . .	G-1
	IP Address . . . . .	G-1
	Default Gateway . . . . .	G-1
	Subnet Mask . . . . .	G-1
	Example 1 . . . . .	G-2
	Example 2 . . . . .	G-2
G-4	Operating System Tools . . . . .	G-2
	Ipconfig Tool . . . . .	G-2
	Ping Tool . . . . .	G-2

## Appendix H—Formulas

H-1	VNA Master Formulas . . . . .	H-1
	Reflection Coefficient. . . . .	H-1
	Return Loss . . . . .	H-1
	VSWR . . . . .	H-1
	Smith Chart . . . . .	H-1
	Electrical Length . . . . .	H-1
	Propagation . . . . .	H-2
	Cable Loss . . . . .	H-2
	Fault Resolution. . . . .	H-2
	Maximum Horizontal Distance. . . . .	H-2
	Suggested Span . . . . .	H-3

## Index



# Chapter 1 — General Information

## 1-1 Introduction

This chapter covers general information that includes a description, optional accessories, preventive maintenance, ESD verifications, and calibration requirements for the VNA Master model MS202xB. Throughout this manual, the terms VNA Master and MS202xB refer to the Anritsu MS2026B and the Anritsu MS2028B Vector Network Analyzers.

MS2026B Frequency Range: 5 kHz to 6 GHz

MS2028B Frequency Range: 5 kHz to 20 GHz

## 1-2 Identifying the Connections

The MS202xB has the connectors shown in [Figure 1-1](#). For details, refer to [Figure 2-12](#) on [page 2-17](#).



**Figure 1-1.** MS202xB Connectors

Model MS202xB physical characteristics:

**Size:** 31.5 x 21.1 x 7.82 cm (12.4 x 8.3 x 3.1 in.)

**Weight:** 4.5 kg (9.9 lbs)

## 1-3 Description

The Anritsu VNA Master instruments are portable handheld vector network analyzers (VNAs) featuring precise performance and essential RF capabilities. These VNA Master instruments are designed to conduct accurate vector-corrected 1-port magnitude, phase, and fault location measurements and 2-port magnitude, phase, and group delay measurements from 5 kHz to 20 GHz.

This one instrument provides all essential RF capabilities in a portable, high-performance platform.

**Model MS202xB measurement capabilities:****MS2026B VNA Frequency:**

5 kHz to 6 GHz

**MS2028B VNA Frequency:**

5 kHz to 20 GHz

**Measurements:**

S-parameters, magnitude, phase, real, imaginary, SWR, Cable Loss, group delay, Smith Chart, time domain, distance domain.

## 1-4 Soft Carrying Case and Tilt Bail

The tilt bail is factory-installed on the VNA Master for use with or without the soft carrying case.

### VNA Master Soft Carrying Case

The MS202xB can be operated while in the soft carrying case. On the back of the case is a large storage pouch for accessories and supplies.

To install the MS202xB into the soft carrying case, perform the following:

1. The front panel of the case is secured with hook and loop fasteners. Fully open the front panel of the case.
2. Place the soft carrying case face down on a stable surface, with the front panel fully open and laying flat.
3. Fully open the zippered back of the case.

**Note**

Two zippers are located around the back of the case. The zipper closer to the MS202xB compartment of the case opens the case back and allows access to install and remove the MS202xB. The other zipper closer to the back of the case opens a support panel that can be used to provide support for improved stability and air flow while in the case. This support panel also contains the storage pouch.

4. Insert the MS202xB face down into the case, taking care that the connectors are properly situated in the case top opening. [Figure 1-2](#) shows the MS202xB in the case.



**Figure 1-2.** Instrument Inserted Into the Soft Carrying Case

5. Close the back panel and secure it with the zipper .



**Figure 1-3.** VNA Master Installed in Soft Case

The soft carrying case includes a detachable shoulder strap that can be connected to the D-rings on the upper corners of the case as required for comfort or convenience. The velcro strap acts as a tilt bail when using the soft case as shown in [Figure 1-3](#).

## VNA Master Tilt Bail Stand

The supplied Tilt Bail can be used for desktop operation. The tilt bail provides a backward tilt for improved stability and air flow. Refer to [Figure 1-4](#).

To deploy the tilt bail, pull the bottom of the tilt bail away from the back of the unit.



**Figure 1-4.** Tilt Bail Extended on VNA Master

To store the tilt bail, push the bottom of the bail toward the back of the unit and snap the bottom of the bail into the clip on the back of the unit.



## 1-5 Preventive Maintenance

VNA Master preventive maintenance consists of cleaning the unit and inspecting and cleaning the RF connector on the instrument and all accessories. Clean the VNA Master with a soft, lint-free cloth dampened with water or water and a mild cleaning solution.

<b>Caution</b>	To avoid damaging the display or case, do not use solvents or abrasive cleaners.
----------------	--

Clean the RF connectors and center pins with a cotton swab dampened with denatured alcohol. Visually inspect the connectors. The fingers of N(f) and K(f) connectors and the pins of N(m) and K(m) connectors should be unbroken and uniform in appearance. If you are unsure whether the connectors are good, then gauge the connectors to confirm that their dimensions are correct. Type K(f) test port connectors are available with Option 11.

Visually inspect the test port cables. The test port cable should be uniform in appearance, not stretched, kinked, dented, or broken.

## 1-6 Calibration Requirements – Vector Network Analyzer

The VNA Master is a field portable unit operating in the rigors of the test environment. In order to ensure measurement accuracy, RF calibration (OSLT or SSLT, for example) must be performed prior to making a measurement in the field.

The VNA Master has no field-adjustable components. The RF (OSLT, SSLT, and SSST) calibration components, however, are crucial to the integrity of the calibration and should be periodically verified to ensure their performance. This is especially important if the components have been dropped or over-torqued.

<b>Note</b>	For best calibration results (compensation for all measurement uncertainties), ensure that the calibration is performed at the end of the test port or optional extension cable; that is, at the same point that the device that is to be tested will be connected.
-------------	---

<b>Caution</b>	For best results, use an Anritsu phase stable Test Port Extension Cable. Use of a typical laboratory cable to extend the VNA Master test port to the device under test, or any bending of the cable subsequent to the OSL or OSLT calibration, may cause uncompensated phase reflections inside the cable. Reflections of this type cause measurement errors, which are more pronounced at higher frequencies.
----------------	--

## 1-7 Annual Verification

Anritsu recommends an annual calibration and performance verification of the VNA Master and the calibration components by local Anritsu service centers. Anritsu service centers are listed our web site at [www.anritsu.com](http://www.anritsu.com).

## 1-8 ESD Cautions

The MS202xB, like other high performance instruments, is susceptible to ESD damage. Coaxial cables and antennas can easily build up a static charge, which (if allowed to discharge by connecting directly to the MS202xB without first discharging the static charge) may damage the instrument input circuitry. Operators must be aware of the potential for ESD damage and must take all necessary precautions.

Operators should exercise practices outlined within industry standards such as JEDEC-625 (EIA-625), MIL-HDBK-263, and MIL-STD-1686, which pertain to ESD and ESDS devices, equipment, and practices. Because these standards apply to the MS202xB, Anritsu Company recommends that any static charges that may be present be dissipated before connecting coaxial cables or antennas to the MS202xB. This may be as simple as temporarily attaching a short or load device to the cable or antenna prior to attaching to the MS202xB. Remember that the operator may also carry a static charge that can cause damage. Following the practices outlined in the above standards will help to ensure that a safe environment exists for both personnel and equipment.

## 1-9 Battery Replacement

The battery can be replaced without the use of tools. The battery compartment is located on the lower left side of the instrument. Slide the battery door down (towards the bottom of the instrument) to remove the door. Remove the battery pack from the instrument by pulling straight out on the battery lanyard. Replacement is the opposite of removal.



1 | Battery Compartment Door

**Figure 1-5.** MS202xB VNA Master Battery Compartment Door

The battery that is supplied with the VNA Master may need charging before use. The battery can be charged in the VNA Master by using either the AC-DC Adapter (40-168-R) or the 12 Volt DC adapter (806-141-R), or can be charged separately in the optional Dual Battery Charger (2000-1374).

**Caution**

When using the Automotive Cigarette Lighter 12 VDC Adapter, always verify that the supply is rated for a minimum of 60 Watts at 12 VDC, and that the socket is clear of any dirt or debris. If the adapter plug becomes hot to the touch during operation, then discontinue use immediately.

**Caution**

Use only Anritsu approved batteries, adapters and chargers with these instruments.

## 1-10 Anritsu Service Centers

Use the following URL to find your local Anritsu service Center:

<http://www.anritsu.com/Contact.asp>



# Chapter 2 — Quick Start Guide

## 2-1 Introduction

This chapter provides a brief overview of the Anritsu MS202xB VNA Master handheld Vector Network Analyzer. The intent of this chapter is to provide you with a starting point for making basic measurements. For more detailed information, refer to the specific measurement mode chapters in this manual.

## 2-2 Turning the VNA Master On for the First Time

The Anritsu VNA Master is capable of greater than two hours of continuous operation from a fully charged, field-replaceable battery (refer to [“Battery Replacement” on page 1-6 in Chapter 1, “General Information”](#)). The VNA Master can also be operated from a 12 VDC source (which also simultaneously charges the battery). This can be achieved with either the Anritsu AC-DC Adapter or 12 VDC Automotive Cigarette Lighter Adapter. Both items are included as standard accessories.

**Caution**

When using the Automotive Cigarette Lighter 12 VDC Adapter, always verify that the supply is rated for a minimum of 60 Watts at 12 VDC, and that the socket is clear of any dirt or debris. If the adapter plug becomes hot to the touch during operation, then discontinue use immediately.

To turn on the VNA Master, press the **On/Off** front panel button (Figure 2-1).

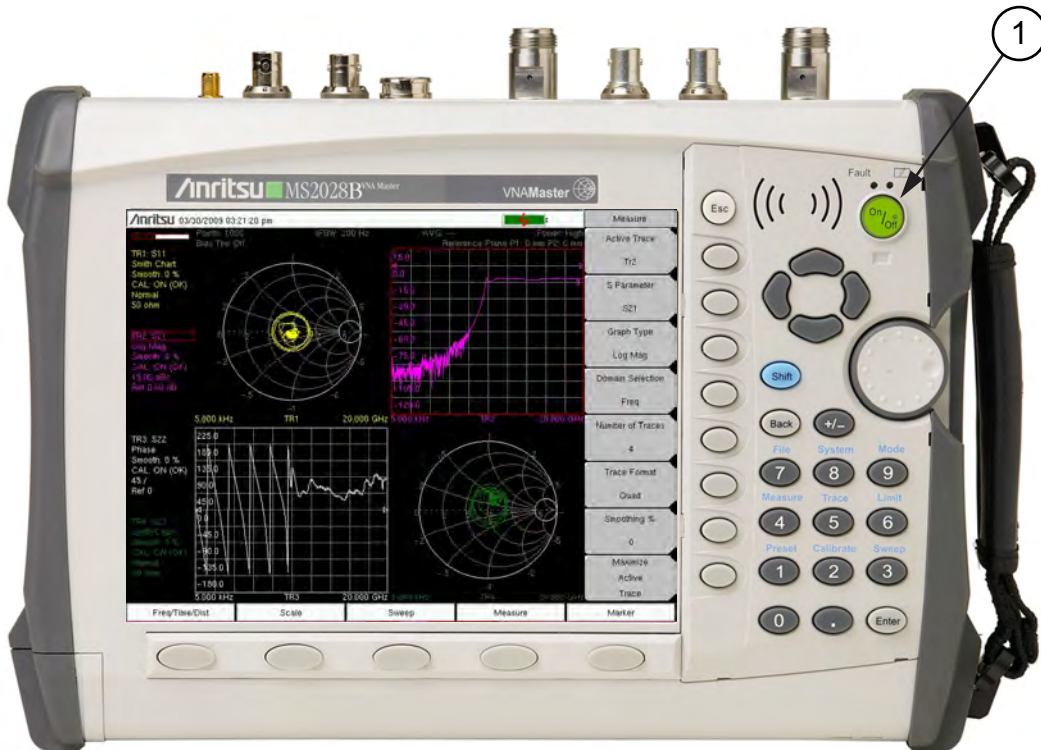

1 On/Off Button

**Figure 2-1.** VNA Master On/Off Button (MS202xB shown)

The VNA Master requires approximately thirty-five seconds to complete the power-on cycle and load the application software. At the completion of this process, the instrument is ready to use.

The VNA Master performs a self test during each power-on cycle. If the self test fails, then refer to “[Self Test or Application Self Test Error Messages](#)” on page B-1 in [Appendix B, “Error Messages”](#). For maximum accuracy, letting the instrument warm up for approximately 15 minutes is a good practice before performing a calibration.

## 2-3 Front Panel Overview

The VNA Master menu-driven flexible interface is intuitive and easy to use. Hard keys on the front panel are used to initiate function-specific menus. Five function hard keys (unlabeled) are located below the display. These keys vary in function depending upon the current mode of operation. If a function hard key has no function in the current mode, then the key label in the measurement display area is blank adjacent to that key.

**Note**

Users who are familiar with the operation of previous VNA Master instruments will find that those menus are quite different from the menus for this current MS202xB VNA Master. Some menus are the same, but those related to measurement setups and sweeps are very different. The intent with the MS202xB is to provide you with more flexibility and choice in measurement configurations even if these choices result in configurations that are not very practical (such as the overlay of a Smith Chart on top of a rectilinear chart).

Located to the right of the display, the VNA Master has eight soft keys (unlabeled buttons), hard keys, arrow keys, and a rotary knob. The locations of all of the keys are shown in [Figure 2-2](#).

Nine of these hard keys (the number keys 1 through 9) are dual purpose, depending upon the current mode of operation. The dual-purpose keys are labeled with a number on the key itself and with the alternate function printed in blue (same color as the **Shift** key) on the panel above the key. Use the **Shift** key to access the functions printed on the panel above the number keys.

The eight soft keys (unlabeled buttons) are located adjacent to the right edge of the measurement display screen (or sweep window). These eight soft keys change function depending upon the current mode of operation and the menu selection. The current soft key function is indicated at the top of the active function block, which is located within the measurement display screen (or sweep window). The active function block displays a label for each active soft key. If a soft key has no function in the current mode, then the active function block display is blank adjacent to that soft key.

The **Escape** key (labeled **Esc** and used for aborting data entry) is the round button located above the eight (unlabeled) soft keys.

The rotary knob and the keypad (and sometimes the arrow keys) can be used to change the value of an active parameter. The rotary knob can also be pressed to duplicate the action of the **Enter** key.

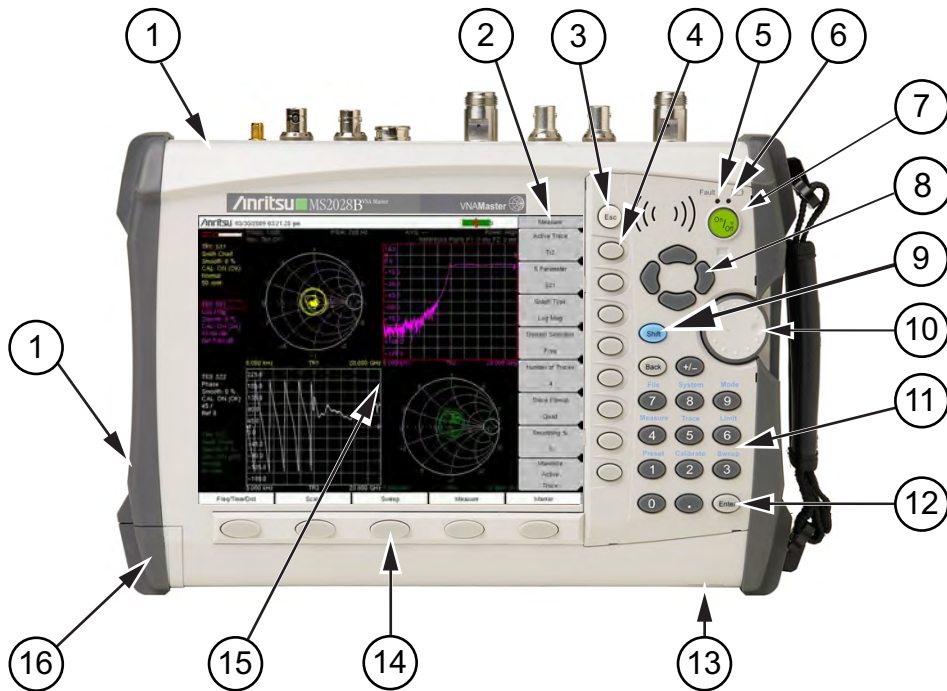

1	Fan Exhaust Ports
2	Active Function Block
3	Escape Key
4	Soft Keys (8 buttons)
5	Charge Fault LED
6	Battery Charge LED
7	On/Off Key
8	Directional Arrow Keys
9	Shift Key
10	Rotary Knob
11	Keypad
12	Enter Key
13	Fan Inlet
14	Function Hard Keys (5 buttons)
15	Measurement Display Screen (or Sweep Window)
16	Battery Compartment

**Figure 2-2.** Front Panel Overview



## Other Features on the Front Panel

### Battery Charge LED (Green)

The green Battery Charge LED (Figure 2-2, item 6) will flash if the battery is charging and will remain on and steady when the battery is fully charged.

### Charge Fault LED (Red)

The red Charge Fault LED (Figure 2-2, item 5) will remain on and steady under a battery charger fault condition. Fault conditions include a battery cell voltage that is too low to charge, or a battery temperature outside the acceptable temperature range ( $-5^{\circ}\text{C}$  to  $+50^{\circ}\text{C}$ ) to charge.

### Fan Inlet and Exhaust Ports

The fan inlet (Figure 2-2, item 13) and exhaust ports (Figure 2-2, item 1) must be kept clear of obstructions at all times for proper ventilation and cooling of the instrument.

## 2-4 Typical Vector Network Analyzer Display

Figure 2-3 illustrates some of the key information areas of the vector network analyzer display screen on the VNA Master MS202xB. The measurement and the display type that are illustrated here may not be the same as currently shown on your instrument. The purpose of the figure is to show the general areas of the display, which are labeled in the figure. Refer to Chapter 6, “VNA Menus” for more detailed soft key descriptions.

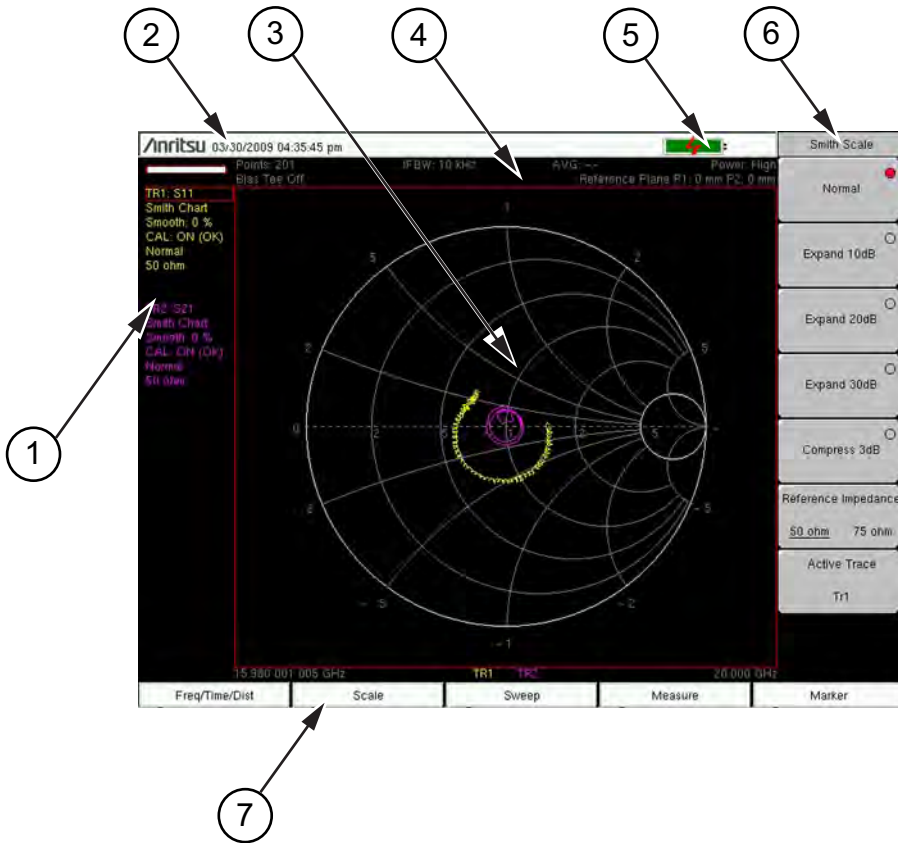

1	Instrument Settings Summary (unique to each trace)
2	Real Time Clock
3	Measurement Display Area (or Sweep Window)
4	Instrument Settings Summary (applies to all traces)
5	Battery Charge Indicator
6	Soft Key Labels (or Active Function Block)
7	Function Hard Key Labels

**Figure 2-3.** Vector Network Analyzer Smith Chart Display

The MS202xB features a versatile new display option for better measurement convenience. Because the VNA Master measures all four S-parameters simultaneously, with fully-reversing test signals at both Port 1 and Port 2, the measurement display provides up to 4 simultaneous window images. As shown in Figure 2-4, each one of the S-parameters could be displayed in its own quarter window. Additionally, the display could be divided into three, two, or one graph areas. An example of four S-parameters overlaid onto one graph area is shown in Figure 2-5.

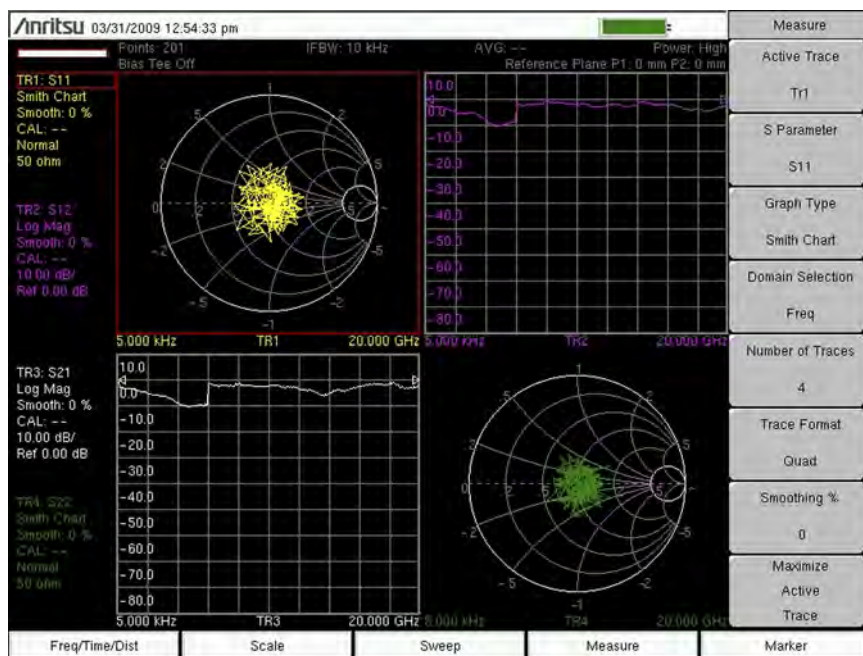

Figure 2-4. 4 Traces in 4 Window Images (Quad Trace Format)

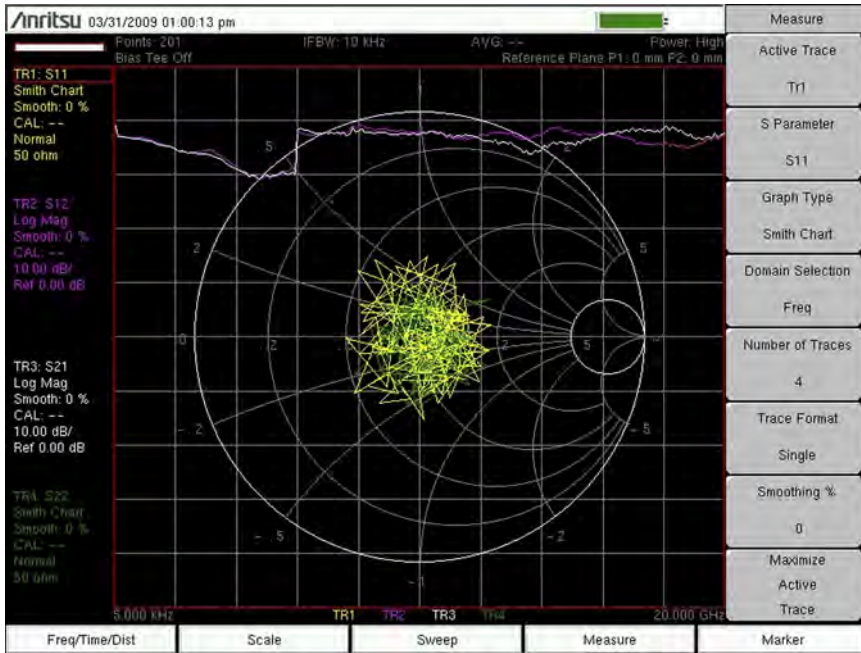
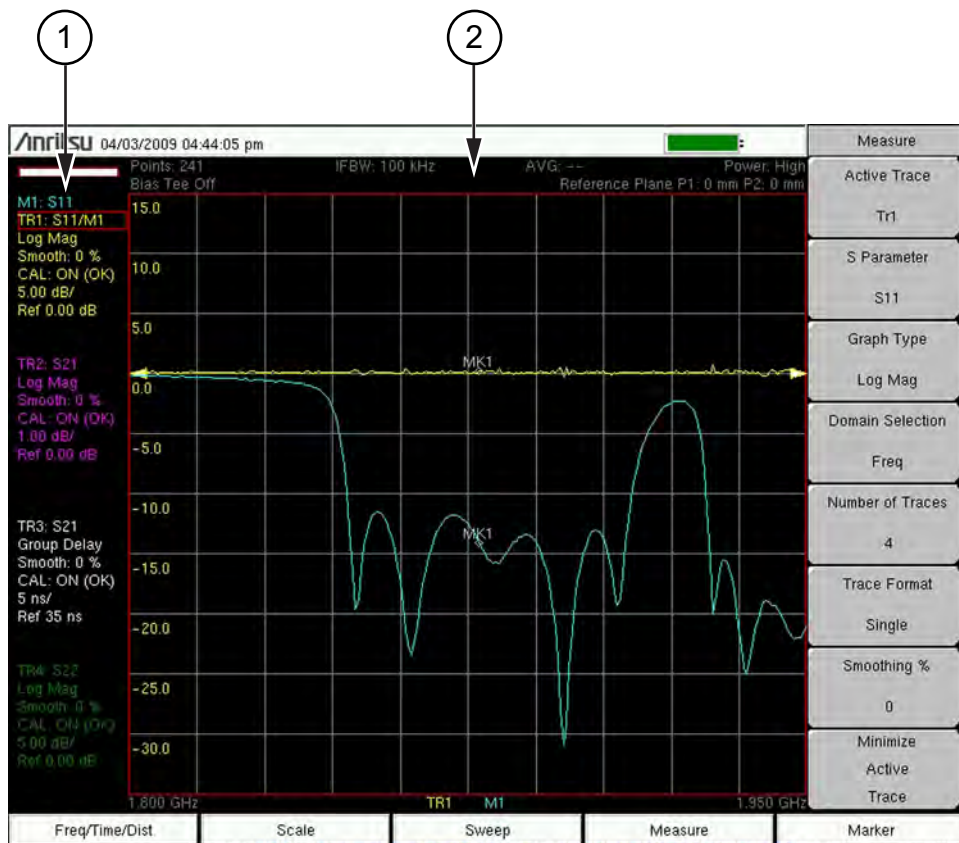

Figure 2-5. 4 Traces in 1 Window Image (Single Trace Format)

## Instrument Settings Summary

The instrument settings that apply to all traces are summarized in the top two rows of the measurement display screen (refer to item 2 in Figure 2-6). The summary includes the Number of Points, the IF Bandwidth, the Averaging count, the Port Power level, and the Bias Tee status, all of which apply to both ports. The summary also includes the Reference Plane Extension values, which differ for each port.



- 1 Instrument Settings Summary (unique to each trace)
- 2 Instrument Settings Summary (applies to all traces)

**Figure 2-6.** Instrument Settings Summary on Measurement Display Screen

The instrument settings that are unique to each trace are summarized in an information block on the left side of the measurement display screen (refer to item 1 in [Figure 2-6](#)). Each block contains the trace number followed by the S-parameter that is assigned to that trace (**TR4: S22**, for example). If the trace has Trace Math applied to it, then the math function is also displayed on that line (**TR1: S11/M1**, for example), where M1 is the memory that is associated with TR1, and the math function is Trace/Memory). The S-parameter that is assigned to the trace memory is shown (if enabled) at the top of each trace information block (**M1: S11**, for example). Each trace block also includes the Graph type, the smoothing percentage, the calibration status, and the scale (Resolution per Division and the Reference Value). The calibration status indicates whether the calibration is ON, OFF, or non-existent (-) for the specific S-parameter that is assigned to each trace. If the Calibration is ON, then its validity is also displayed (**OK, ?, or X**).

## 2-5 Front Panel Keys

The term hard key refers to all of the buttons on the instrument face except for the vertical row of gray buttons adjacent to the measurement display. These eight gray buttons are called soft keys, and they are used to activate virtual soft key buttons within the measurement display screen. This area is also called the active function block. Refer to [Figure 2-2](#) (item 2) and [Figure 2-3](#) (item 6).

### Esc Key

Pressing this key cancels any setting that is currently being made. Refer to [Figure 2-2](#) (item 3). The **Esc** key is located directly above the eight soft keys.

### Enter Key

Press this key to finalize data input. Pressing the rotary knob performs this same function. Refer to [Figure 2-1](#) (item 1) and [Figure 2-2](#) (item 12). The **Enter** key is located directly below the Number 3 key.

### Arrow Keys

The four arrow keys (between the rotary knob and the **Esc** key) are used to scroll up, down, left, or right. Refer to [Figure 2-2](#) (item 8). The arrow keys can often be used to change a value or to change a selection from a list. This function is similar to the function of the rotary knob. The arrow keys are also used to move markers.

### Shift Key

Pressing the **Shift** key (refer to [Figure 2-2](#), item 9 and [Figure 2-7](#)) and then a number key executes the function that is indicated in blue text above the number key. When the **Shift** key is active, its icon is displayed in the upper right corner of the measurement display area between the battery charge indicator and the soft key menu label.



**Figure 2-7.** Shift Key Icon

## Back Key

Press this key to delete only one character, one number, or the range that is specified by the cursor. The **Back** key is located directly above the Number **7** key.

## Plus/Minus (+/-) Key

Press this key to change the sign of numbers that are entered with the number keys. The **Plus/Minus (+/-)** key is located directly above the Number **8** key.

## Number Keypad

These keys are used to directly input numbers.

## Rotary Knob

Turning the rotary knob (refer to [Figure 2-2](#), item 10) changes numerical values, scrolls through selectable items from a list, and moves markers. Values or items may be within a dialog box or an edit window.

Pressing this knob finalizes the input function in the same manner as pressing the **Enter** key.

## Function Hard Keys

These five function keys (refer to [Figure 2-2](#), item 14) are horizontally arranged adjacent to the measurement display screen along the lower edge. These buttons have no labels. As with the soft keys, they are positioned to accompany virtual key labels that are displayed to match instrument modes and functions. These function hard key labels change to match specific instrument Mode settings. Each Mode has a specific set of Function Hard Keys. For details about selecting the Mode, refer to the Section “[Mode Selector](#)” on page 2-16.

## Soft Keys

These eight gray keys have no labels (refer to [Figure 2-2](#), item 4). They are arranged adjacent to the measurement display screen along the right-hand edge. They are positioned to accompany virtual soft key labels that are displayed to match instrument modes and measurement functions. These soft key labels (also called the Active Function Block) change as instrument measurement settings change. The following soft key descriptions describe how these keys are used:

## 2-6 Soft Key Types

### Select

A **Select** soft key has a small circle in the upper right corner of the virtual key face and is used to select the function or item that is displayed on the virtual soft key label. When not selected, the circle is gray. When selected, the circle is red to indicate that the function is active.

Press the key to make the selection. Press a different key to make a different selection.

A **Select** soft key may also be a **Switching** soft key. These keys show both a gray circle and an arrow mark (->).

A **Select** soft key may change to a **Switching** soft key when active. These keys show only the gray circle when not active, but show the arrow mark as well as the red circle when active. Refer to section “Switching” on this page.

## Input

An **Input** soft key is used to select an item or a value. This type of soft key displays the setting parameter and the setting value on the virtual key face. When the key is pressed, a select box or edit box may open on the display screen, or the key face may turn a darker gray color to show that the setting is being made. At any time before finalizing the input, press the escape (**Esc**) key to abort the change and retain the previously existing setting.

To set or select an item or a value, use the number keys, the arrow keys, or the rotary knob. Press the rotary knob or the **Enter** key to finalize data input. If a value is being selected or entered, then the soft key Active Function Block may change to provide one or more soft keys for units, such as Hz or dB. Pressing a unit soft key sometimes finalizes the data input in the same manner as pressing the **Enter** key. If more than one unit key is displayed, then pressing the **Enter** key without first pressing a unit key selects a specific unit by default.

With some functions, only a specific set of values are valid. When scrolling with the **Up/Down** arrow keys or the rotary knob, only valid values are offered. If different values are set with the number keypad, then those values might not be accepted. Even if different values are accepted on the soft key face, the values may not be valid for the selected measurement.

## Toggle

A **Toggle** soft key displays the setup item and the toggle states. Toggle states may be On and Off or may be a selection of types or values such as Reference Impedance: 50 ohm or 75 ohm.

Each press of the **Toggle** soft key moves the selection to the next value or item in sequence. The selected item or value is underlined on the virtual key face.

## Switching

A **Switching** soft key is used to open an additional soft key menu, and it has an arrow mark (-->) in the lower right corner of the virtual key face.

Some **Select** soft keys become **Switching** soft keys after being pressed (after becoming active). These keys do not display the arrow mark until their circle is red. An additional press, after the circle is red and the arrow mark is displayed, opens the additional soft key menu. Refer to section “Select” on page 2-11.

The **Switching** soft key that is labeled **More** opens a menu with additional soft key functions. The **Switching** soft key that is labeled **Back** returns to a previous soft key menu. The **Back** key has the arrow mark (<-- ) in the lower left corner of the virtual key face.



## 2-7 Parameter Setting

Pop-up list boxes or edit boxes are used to provide selection lists and selection editors. Scroll through a list of items or parameters with the arrow keys or the rotary knob. Select numerical values by scrolling with the arrow keys or rotary knob or by entering the digits directly from the number keypad. These list boxes and edit boxes frequently display a range of possible values or limits for possible values.

Finalize the input by pressing the rotary knob or the **Enter** key. At any time before finalizing the input, press the escape (**Esc**) key to abort the change and retain the previously existing setting.

## 2-8 Text Entry

When entering text (as when saving a measurement) the soft key menu for **Text Entry** displays the characters (alphabet, hyphen, and underscore) in 6 letters per soft key. Characters can be entered by using the rotary knob or by using the soft keys.

The rotary knob scrolls through the characters in a pop-up window and is pressed to select each character in sequence.

Alternatively, press the **a b c / d e f** soft key (for example) to open another soft key menu with a separate key for each of these letters. The menu returns to the complete character set after each individual letter is entered.

Use the arrow keys to navigate within a name or character string. Use the **Shift** key for capital letters. Press the **Enter** key or the rotary knob to finalize a text entry.

Refer to [Figure 2-8](#), [Figure 2-9](#), and [Figure 2-10](#).

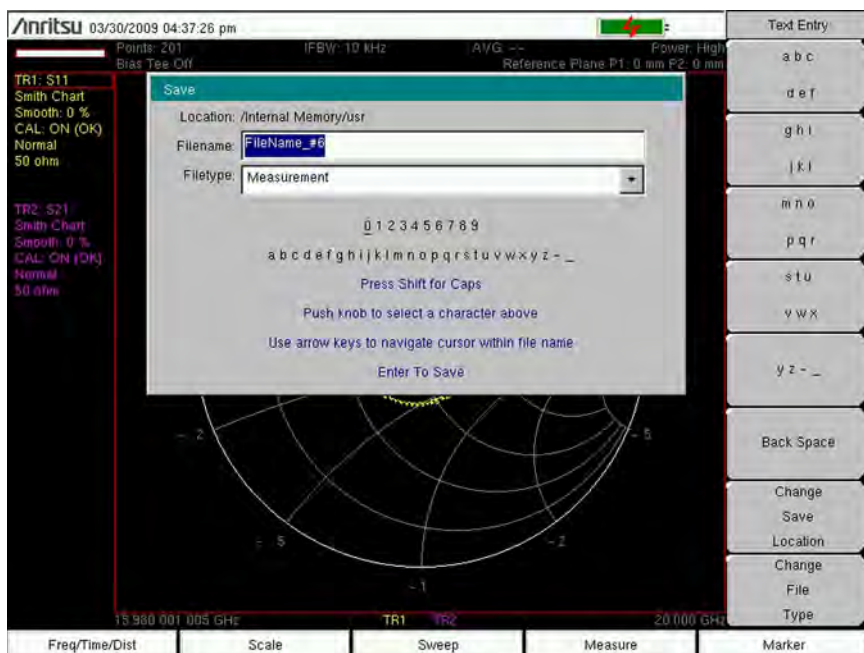

**Figure 2-8.** Text Entry Menu – Lower Case

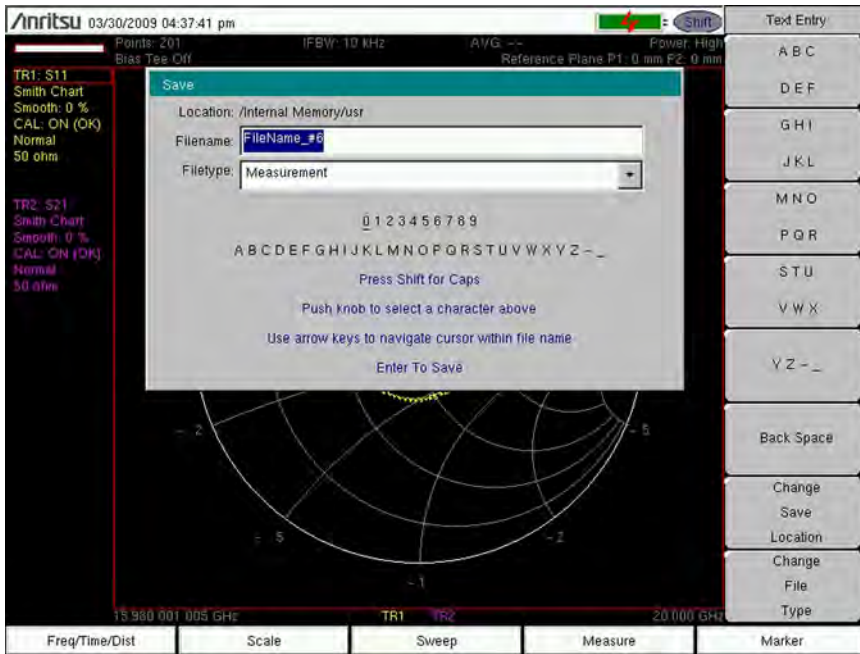

Figure 2-9. Text Entry Menu – Upper Case

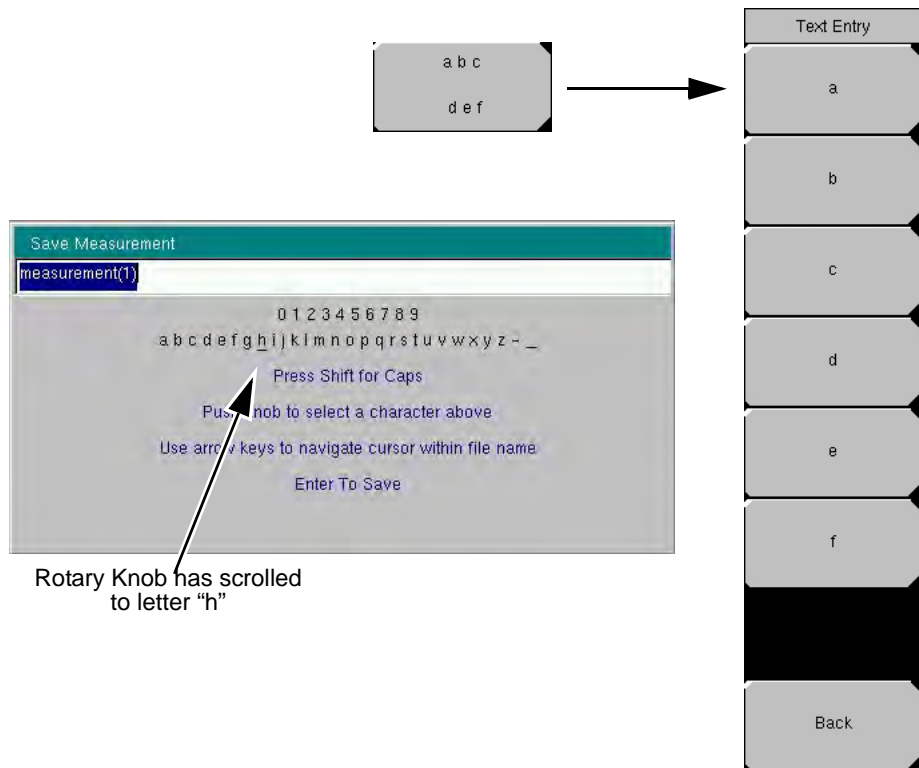
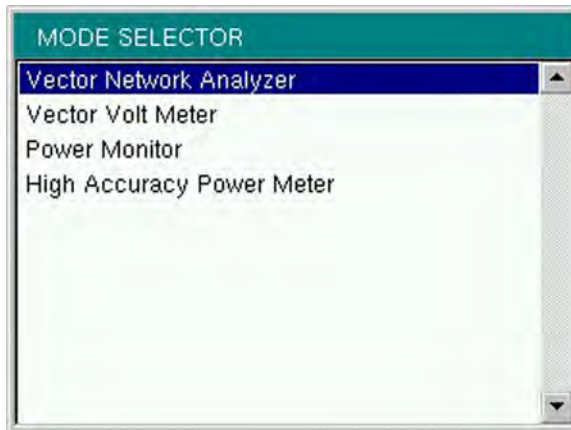

Figure 2-10. Text Entry Menu – Selecting Characters

## 2-9 Mode Selector

Select a VNA Master measurement mode (such as Vector Network Analyzer or Vector Volt Meter) by opening the Mode Selector List Box. Press the **Shift** key, then the **Mode** (9) key, and choose a mode from the menu. Use the directional arrow keys or the rotary knob to highlight your selection and press the **Enter** key.

The modes that are available on your VNA Master depend upon the options that are installed and activated. Your instrument may not show the same list as [Figure 2-11](#).



**Figure 2-11.** Mode Selector List Box

## 2-10 Test Panel Connectors

The connectors and indicators that are located on the test panel of the MS202xB are shown in [Figure 2-10 on page 2-15](#) and are described in the following section.

### MS202xB Test Panel Connectors

The connectors and indicators that are located on the test panel of the MS202xB are shown in [Figure 2-12](#) and are described in the following text.

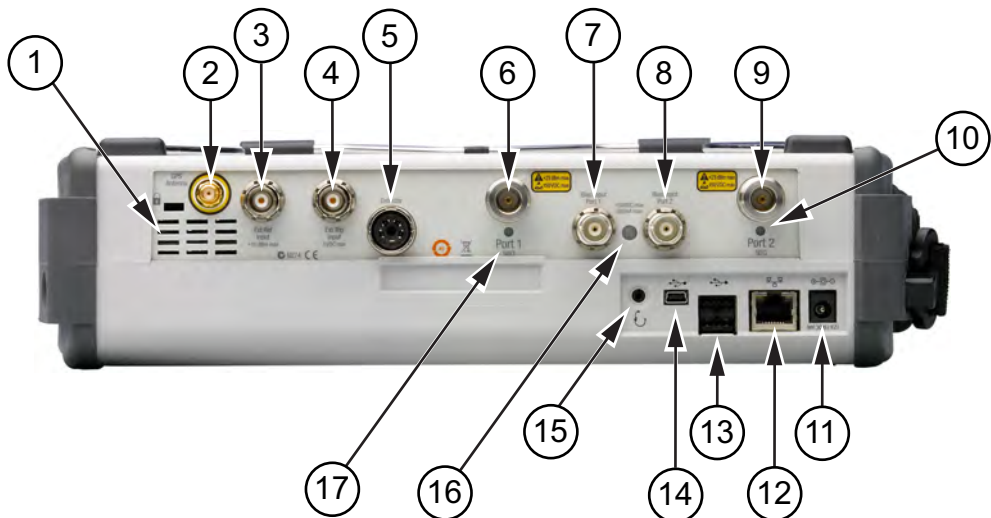

1	Fan Exhaust Port
2	GPS Antenna Input for Option 31
3	External Reference Input
4	External Trigger Input
5	RF Detector Interface (for Option 5)
6	Test Port 1 (50 Ohm) The corresponding LED turns green when the port is transmitting.
7	Bias Input Port 1
8	Bias Input Port 2
9	Test Port 2 (50 Ohm) The corresponding LED turns green when the port is transmitting.
10	Port 2 LED
11	External Power Input
12	LAN Connection
13	USB Interface, Type A (2 connectors, Full Speed USB 2.0)
14	USB Interface, Type Mini-B (Full Speed USB 2.0)
15	Headset Jack
16	Bias Status LED
17	Port 1 LED

**Figure 2-12.** MS202xB Test Panel Connectors

In [Figure 2-13](#), a waveguide-coax adaptor at Test Port 1 provides test connections, and typical waveguide calibration components are shown below the VNA Master.

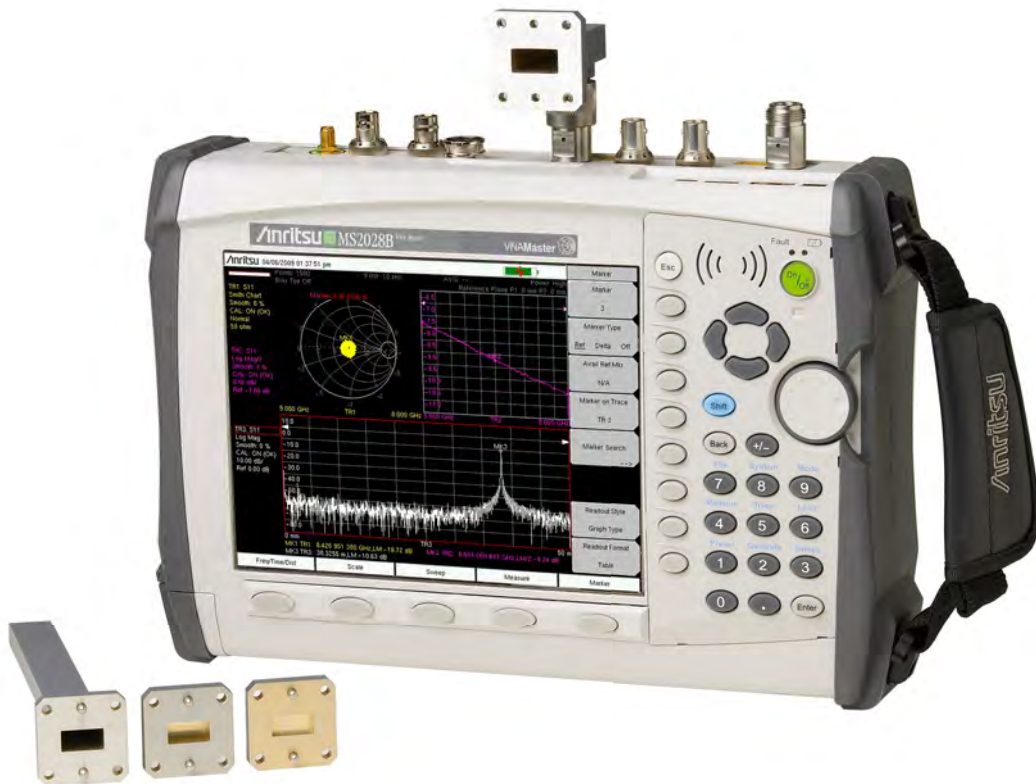

**Figure 2-13.** Waveguide-Coax Adaptor and Waveguide Calibration Components

## External Power

The external power connector is used to power the unit and for battery charging. Refer to [Figure 2-12](#), item 11. Input is 12 VDC to 15 VDC at up to 5.0 A. A green flashing indicator light near the power switch shows that the instrument battery is being charged by the external charging unit. The indicator is steadily illuminated when the battery is fully charged.

### Warning

When using the AC-DC Adapter, always use a three-wire power cable connected to a three-wire power line outlet. If power is supplied without grounding the equipment in this manner, then the user is at risk of receiving a severe or fatal electric shock.

### Note

If the battery is completely depleted, then the VNA Master may not turn on even when the external power supply is plugged into the unit. In that case, allow the battery to charge while the instrument is turned off before attempting to turn on the instrument.

## LAN Connection

The RJ-45 connector is used to connect the VNA Master to a local area network. Refer to [Figure 2-12](#), item 12. Integrated into this connector are two LEDs. The amber LED indicates the speed of the LAN connection (ON for 10 Mb/s and OFF for 100 Mb/s), and the green LED flashes to show that LAN traffic is present. The instrument IP address is set by pressing the **Shift** key, then the **System** (8) key followed by the **System Options** soft key and the **Ethernet Config** soft key. The instrument Ethernet address can be set automatically using DHCP, or manually by entering the desired IP address, gateway address, and subnet mask. These settings are described in more detail in [Appendix G, “More About DHCP”](#).

<b>Note</b>	<p>An active Ethernet cable must be connected to the MS202xB before it is turned ON in order to enable the Ethernet port for DHCP or for a static IP address.</p> <p>Depending upon local conditions, the port may remain enabled when changing from DHCP to static IP address, when changing from static IP address to DHCP, or when temporarily disconnecting the Ethernet cable.</p> <p>If the port becomes disabled, then ensure that an active Ethernet cable is attached to the MS271xB before cycling the power OFF and back ON.</p>
-------------	---

Dynamic Host Configuration Protocol (DHCP) is an Internet protocol that automates the process of setting IP addresses for devices that use TCP/IP and is the most common method of configuring a device for network use. To determine if a network is set up for DHCP, connect the VNA Master to the network and select DHCP protocol in the Ethernet Config menu.

Turn the VNA Master off, and then on. If the network is set up for DHCP, then the assigned IP address should be displayed briefly after the power-on sequence.

<b>Note</b>	<p>In order to acquire an address from a DHCP protocol network, the VNA Master <b>MUST</b> be connected to the network <b>BEFORE</b> being switched on.</p>
-------------	---

To display the IP address with the instrument on, press the **Shift** key, then the **System** (8) key, then the System Options soft key and the Ethernet Config soft key. The IP address is displayed as shown in [Figure 2-14](#). For more information about DHCP, refer to [Appendix G, “More About DHCP”](#).

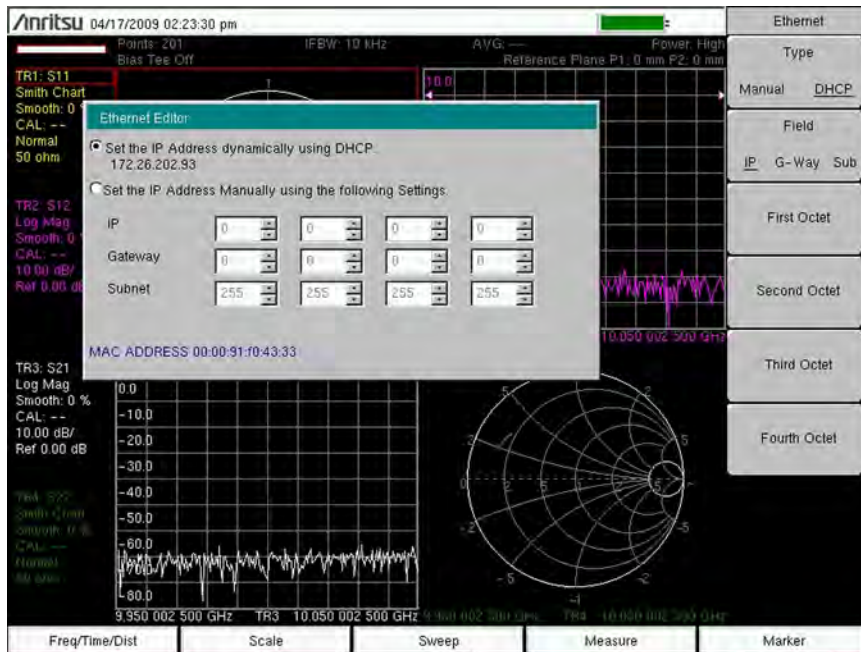

**Figure 2-14.** IP Address Assigned Using DHCP

## USB Interface - USB Type Mini-B

The USB 2.0 interface can be used to connect the VNA Master directly to a PC. Refer to [Figure 2-12](#), item 14 for the USB connector location. Refer to [Figure 2-15](#) for an example of a PC connection that is also using Master Software Tools. The first time that the VNA Master is connected to a PC, the normal USB device detection will be performed by the computer operating system. The CD-ROM that is shipped with the instrument contains a driver (for Windows 2000 and Windows XP) that is installed when Master Software Tools is installed. Drivers are not available for earlier versions of the Windows operating system. During the driver installation process, place the CD-ROM in the computer drive and specify that the installation wizard should search the CD-ROM for the driver.

<b>Note</b>	For proper detection, either Line Sweep Tools (LST) or Master Software Tools (MST) must be installed on the PC prior to connecting the VNA Master to the PC USB port.
-------------	---



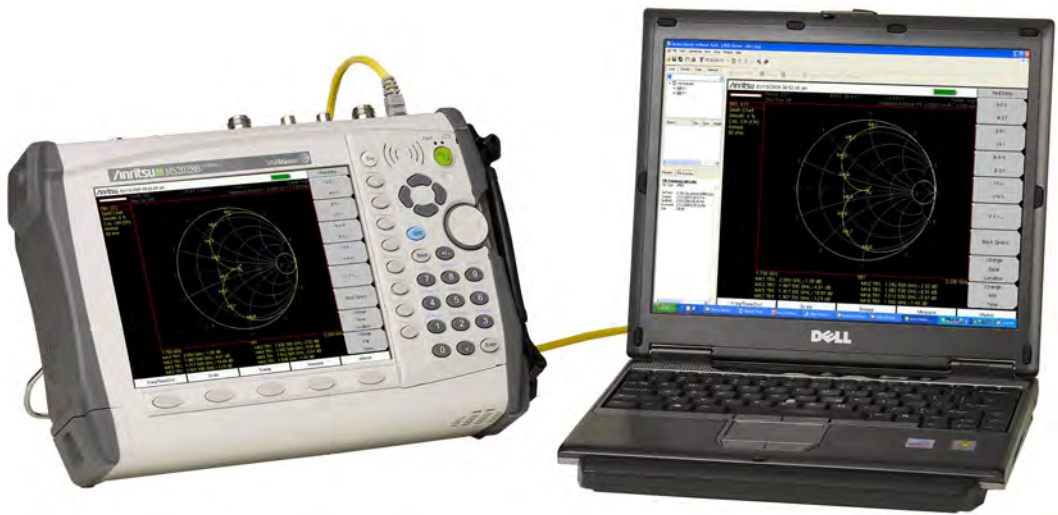

**Figure 2-15.** MS2028B Connected to PC via Ethernet

## USB Interface - USB Type A

The VNA Master can also act as a USB Host, which allows various USB Flash Memory devices to be connected to the instrument for storing measurements and setups. Refer to [Figure 2-12](#), item 13.

## Headset Jack

This connector (refer to [Figure 2-12](#), item 15) is not currently in service. The headset jack accepts a 2.5 mm 3-wire miniature phone plug such as those commonly used with cellular telephones.

## Ext Trigger

Refer to [Figure 2-12](#), item 4. This connector is not currently supported. It will be supported in a future release.

## Ext Freq Ref

The BNC female connector (refer to [Figure 2-12](#), item 3) is used for connection of an external frequency reference or external trigger. Press the **External Reference** soft key under the **System** menu and then the **Application Options** menu to set the reference to external (10 MHz). The amplitude of the External Reference should be between  $-10$  dBm and  $+10$  dBm.

## RF Detector

The RF detector connector (refer to [Figure 2-12](#), item 5) is used for Power Monitor measurements (Option 5).

## Port 1 (50 Ohm)

This connector (refer to [Figure 2-12](#), item 6) provides the input/output 50 ohm interface for transmission and reflection measurements at Port 1. Maximum input is +23 dBm at  $\pm 50$  VDC. Bias Tee output is also available from this port (with Option 0010). The Port 1 green LED (refer to [Figure 2-12](#), item 17) indicates when the port is transmitting power.

## Port 2 (50 Ohm)

This connector (refer to [Figure 2-12](#), item 9) provides the input/output 50 ohm interface for transmission and reflection measurements at Port 2. Maximum input is +23 dBm at  $\pm 50$  VDC. Bias Tee output is also available from this port (with Option 0010). The Port 2 green LED (refer to [Figure 2-12](#), item 10) indicates when the port is transmitting power.

## Bias Input Port 1

The BNC female connector (refer to [Figure 2-12](#), item 7) is used for external bias tee input that will be routed to Port 1. Maximum input is  $\pm 50$  VDC and 500 mA.

## Bias Input Port 2

The BNC female connector (refer to [Figure 2-12](#), item 8) is used for external bias tee input that will be routed to Port 1. Maximum input is  $\pm 50$  VDC and 500 mA.

## Bias Status LED

This LED (refer to [Figure 2-12](#), item 16) illuminates green when Internal or External Bias is selected. It illuminates red for any overload condition (current or voltage).

## GPS Antenna Connector

This GPS antenna connection is for GPS only (Option 31 only). Refer to [Figure 2-12](#), item 2.

**Note**

The GPS antenna connection on the VNA Master is fitted with an SMA connector. A DC voltage (3.3 V or 5.0 V) is present on this connector to support active GPS antennas. Connect only supported antennas, such as the Anritsu GPS antennas listed in the technical data sheet, to this port.

## 2-11 Symbols and Indicators

The symbols and indicators that appear on the display screen convey the instrument status or condition on the display.

### Battery Symbol

The battery symbol ([Figure 2-16](#)) above the display indicates the charge remaining in the battery. The colored section that is inside the symbol changes size and color with the charge level.



**Figure 2-16.** Battery Symbol

- Green: Battery is 30% to 100% charged.
- Yellow: Battery is 10% to 30% charged.
- Red: Battery is 0% to 10% charged. When the Battery Indicator is red, approximately 8 to 10 minutes of battery life remain.

When the battery is charging, either from the AC-DC Adapter (40-168-R) or the 12 Volt DC adapter (806-141-R), the symbol will change to that shown in [Figure 2-17](#):



**Figure 2-17.** Battery Symbol While charging

The Battery Charge LED flashes when the battery is charging and remains on and steady when the battery is fully charged.

<b>Note</b> Use only Anritsu approved batteries, adapters, and chargers with this instrument.
---

The battery symbol is replaced by a red plug body to indicate that the instrument is running from external power and is not charging the battery (or the battery is not present). When the external AC adaptor is connected, the battery automatically receives a charge, and the battery symbol with the lightning bolt is displayed ([Figure 2-17](#)). When the battery is fully charged, the charging circuit shuts off and the red plug body is displayed, as shown in [Figure 2-18](#).



**Figure 2-18.** Battery Not Charging or Not Available

**Hold**

The Hold symbol is displayed when the VNA Master is on hold. To resume sweeping, toggle from Hold to Run in the Sweep menu.

**Single Sweep**

The Single Sweep symbol is displayed when Single Sweep is selected. Single or Continuous sweep can be selected under the Sweep Menu.

## 2-12 Memory Profile and Security Issues

This section describes the profiles of the various types of memory that are used in the MS202xB VNA Master and the associated security issues that are related to those memory devices.

The MS202xB has 1 GB of Flash non-volatile memory, has EEPROM memory, and has sufficient DRAM volatile memory for normal operation. The instrument is supplied with a USB memory device that plugs into the USB Type A connector. The MS202xB does not have a hard drive or any other type of volatile or non-volatile memory.

The following sections describe how memory is used in the VNA Master and how it can be erased.

### Internal Flash Memory

This memory space is used to store the instrument firmware and factory calibration, and can be used to store measurements and setups that are saved by the user.

Saved measurements and setups that are stored in the Flash memory are all deleted by the master reset process that is described in Section “MS202xB Master Reset Instructions” in Chapter 2.

<b>Note</b>	With Option 7 enabled, the user is not able to store any measurements or setups to this internal flash memory.
-------------	--

### USB Memory Device

The USB memory device is not required for proper operation of the instrument. The instrument may be directed to store measurements and setups directly to the USB memory device, or you may transfer the contents of the internal flash memory into the USB memory device for storage or data transfer purposes. The device is removable and therefore does not pose a security risk because it can remain in a secured area, can be externally erased by a computer, or can be destroyed.

<b>Note</b>	With Option 7 enabled, the user does not have access to the internal flash memory and, therefore, cannot transfer any contents of the internal flash memory into the USB memory device.
-------------	---

### RAM Memory

This is volatile memory that is used to store many parameters that are needed for the normal operation of the MS202xB along with current measurements. This memory is reset whenever the instrument is restarted.

### EEPROM

This memory holds information such as the model number, serial number, and calibration data for the instrument. Also stored here are the operating parameters, such as frequency range, that are set by the user. During the master reset process, all operating parameters that are stored in the EEPROM are set to standard factory default values.

**MS202xB Master Reset Instructions**

1. Turn the MS2026B or MS2028B On.
2. Press the **Shift** key then the **System** (8) key.
3. Press the System Options soft key.
4. Press the Reset soft key.
5. Press the Master Reset soft key.
6. A dialog box is displayed on the instrument screen to warn that all settings will be returned to factory default values, and that all user files will be deleted.
7. Press the **Enter** key to complete the master reset, or press the **Esc** key to abort.
8. After several seconds (which can grow to several minutes if a very large number of measurements have been saved in the instrument), the instrument reboots.

## 2-13 System Settings

To access the System menu (refer also to [Figure 6-57 on page 6-58](#)), press the **Shift** key, then the **System** (8) key. System Status, Self Test, Application Self Test, Application Options, and System Options can be found in this menu.

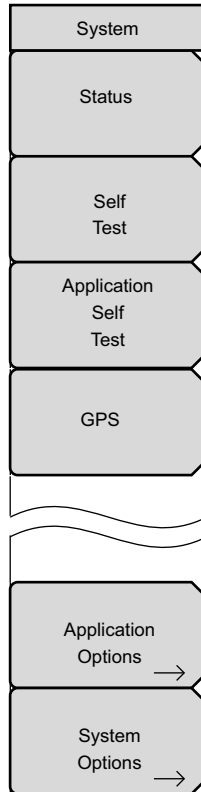

**Figure 2-19.** System Menu

The functions of these soft keys are described in the following paragraphs.

### Status

Pressing this soft key displays the current system status, including the operating system and versions, temperatures, and other details such as current battery information. Press Esc or Enter to return to normal operation.

## Self Test

At power on, the VNA Master runs through a series of quick checks to ensure that the system is functioning properly. The system Self Test runs a series of tests that are related to the instrument. In the MS202xB, the Application Self Test runs a series of tests related to the VNA portion of the instrument. If the self test fails, although the battery is fully charged and the VNA Master is within the specified operating temperature range, then contact your Anritsu Service Center (refer to [“Anritsu Service Centers” on page 1-7](#)). To initiate a self test when the system is already powered up, perform the following:

1. Press the **Shift** key and then the **System** (8) key.
2. Select the Self Test soft key. The Self Test results are displayed.
3. Press the **Esc** key to continue.

## Application Self Test

Press this soft key to initiate a series of diagnostic tests that are related to the performance of the VNA Master. a display lists the individual test with a pass or fail indication. Press **Esc** or **Enter** to return to normal operation.

## GPS

Pressing this soft key opens the GPS Menu. (This soft key appears only if the GPS option is enabled in your VNA Master. Refer to [Figure 13-4 in Chapter 13, “GPS Receiver, Option 31”](#)).

## Application Options

The Application Options menu contains the selections for Units, External Reference, and Trace Label. Press the **Back** soft key to return to the System menu.

### Units

Press this soft key to toggle the measurement units between meters and feet.

### External Reference

Press this soft key to toggle between turning **Off** the external reference or selecting the external reference.

### Trace Label

Press this soft key to toggle the trace label **On** and **Off**. When **On**, a label is shown next to each trace (TR1 next to Trace 1, and so forth).



## System Options

The System Options menu includes basic instrument settings and reset options. On your instrument, the function hard keys may differ from those shown in [Figure 2-20](#) depending upon selected instrument options.

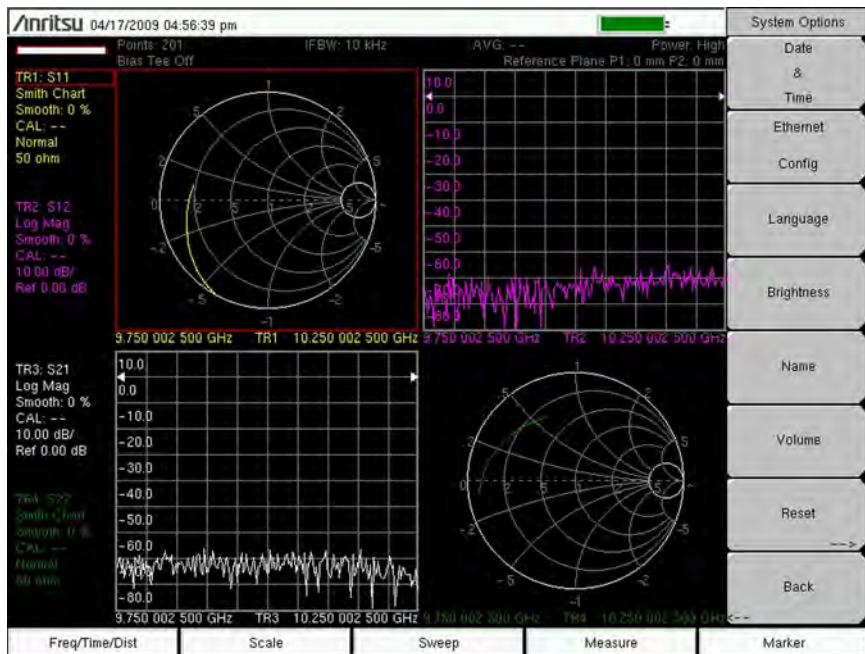

**Figure 2-20.** System Options Soft Key Menu

The System Options soft keys perform as described in the following paragraphs:

### Date and Time

This soft key brings up a dialog box for setting the current date and time. Use the keypad, the arrows, or the rotary knob to select the date and time.

### Ethernet Configuration

This soft key brings up a dialog box to set the IP address of the instrument. Use the Type: Manual/DHCP soft key to select whether the address will be entered manually or will be supplied automatically by a network DHCP server. If manual is selected, then use the soft keys or the arrow keys to select the field to be modified. For more information about LAN connections and DHCP, refer to [“LAN Connection” on page 2-19](#) and [Appendix G, “More About DHCP”](#).

## Language

This soft key allows selection from a list of built-in languages. Use the rotary knob or Up/Down arrow keys to highlight a selection and press **Enter** to select. The languages currently available are English, French, German, Spanish, Japanese, Chinese, Korean, and Italian. In addition, two custom languages may be selected if they have been defined in the Master Software Tools Software Language Editor and loaded into the unit. For more information about how to create custom defined languages, refer to the Master Software Tools user guide.

## Brightness

The brightness of the display can be adjusted to optimize viewing under a variety of lighting conditions. Use the keypad, the **Up/Down** arrow keys, or the rotary knob to select a brightness level from 1 to 9, and press **Enter** to select.

## Name

The VNA Master can be named. For more information about entering a name, refer to section [“Text Entry” on page 2-13](#).

## Volume

Opens a dialog box to change the speaker volume of the unit. Use the keypad, the **Up/Down** arrow keys, or the rotary knob to select a volume level from 0 to 90, and press **Enter** to select.

## Reset

Opens a menu of reset and update options.

## Factory Defaults

Press this soft key to restore the instrument to the factory default values, including mode of operation, sweep settings, Ethernet, language, and brightness settings. Press the Factory Defaults soft key to initiate the reset. A dialog box opens with the following message:

Attention.

This will apply factory default settings. The following will be reset to default values: Ethernet settings, Language, Volume and Brightness. The instrument will power cycle when the operation is complete. Press **ENTER** to continue, **ESC** to abort.

### Master Reset

Press this soft key to restore factory settings to all system parameters, including Time/Date, Ethernet, language, and brightness settings. Also, all user files in the internal memory are deleted, and the original language and antenna files are restored. Press the Master Reset soft key to initiate the reset. A dialog box opens with the following message:

Attention.

This will perform a Master Reset. All settings will return to factory defaults and all user files will be deleted. The instrument will power cycle when the operation is complete. Press **ENTER** to continue, **ESC** to abort.

Press the **Enter** key to initiate the reset, and turn the unit off, then on again to complete.

### Update Firmware

Press this soft key to update the instrument via an external USB memory device. After you press this key, the instrument loads a default application screen. Press the **Load** soft key that appears in the bottom left side corner of the display. Connect an external USB device with the appropriate package to the Type A USB input. Press the **Update Application** soft key that appears in the top right hand corner of the display. A pop-up selection window appears. Select one of the three options: Save none, Save user data, Save & restore user data. Each selection is explained in that selection window. After a selection has been made, initiate the update by pressing the **Update from USB Memory** soft key that appears in the top right hand corner of the display. Verify the selection that is shown in the window, and press **Enter** to proceed.

This update takes several minutes. The MS202xB VNA Master automatically reboots when it is completed. An hourglass symbol slowly rotates while it is downloading the code.

### Back

Returns to the previous menu.

## 2-14 File Types

Filename extensions that are used in the VNA Master:

- \*.jpg JPEG images, filename.jpg
- \*.mna Measurements, filename.mna
- \*.stp Setups, filename.stp
- \*.s2p S2P (SnP), filename.s2p
- \*.csv Text file with Comma Separated Values (CSV), filename.csv
- \*.txt Text file with tab separated values, filename.txt

S2P is a standard ASCII text file format that is used for scattering parameters from a 2-Port measurement. This is a subset of SnP (where n equals the number of ports). An S2P file can be used as input for signal analysis.

**Note**

The CSV and Text files contain setup information and final formatted data that are shown on the instrument display screen. This file information includes any post-processing that was done on the data (smoothing, trace math, time domain, and so forth). These files contain the data for any traces that are displayed, including the memory traces. They also contain the markers that are turned on when the file is saved.

# Chapter 3 — VNA Display Overview

## 3-1 Introduction

This chapter provides an overview of the display features that are found in the MS202xB VNA Master. The topics include active traces, trace format, number of traces, markers, and limits.

## 3-2 Powerful Display Capabilities

The VNA Master has a flexible display capable of single, dual, tri, and quad displays, meaning that you can subdivide the measurement display area into 2, 3, or 4 sections. In addition, the VNA Master supports the display of up to four traces in each single, dual, tri, or quad display. Becoming familiar with these flexible display capabilities is important before you begin any calibrations and measurements.

The function hard keys in Vector Network Analyzer mode without Option 2 (Time Domain) are:

**Freq, Scale, Sweep, Measure, Marker**

The function hard keys in Vector Network Analyzer mode with Option 2 (Time Domain) are:

**Freq/Time/Dist, Scale, Sweep, Measure, Marker**

### Flexible Features For Displaying Results

If you are not yet familiar with the menus that control trace display, refer to the [“Measure Menu” on page 6-44](#), to the [“Number of Traces Menu” on page 6-48](#), and to the [“Trace Format Menu” on page 6-49](#). To select the Measure soft key menu on the VNA Master, press the **Measure** function hard key (you must be in Vector Network Analyzer mode for this example). To change instrument modes, refer to Section [“Mode Selector” on page 2-16](#).

Perform the following steps to observe the trace format features:

1. The default view uses Trace Format = Quad with Number of Traces = 4. Refer to [Figure 3-1 on page 3-4](#).
2. Beginning with the default view, set Trace Format = Single. Notice how all 4 traces are overlaid on a single graph. Refer to [Figure 3-2 on page 3-4](#).
3. Next, set Trace Format = Dual. Note how the 4 traces are assigned to the split display. TR1 (Trace 1) and TR3 are assigned to the top graph. TR2 and TR4 are assigned to the bottom graph. Refer to [Figure 3-3 on page 3-5](#).
4. Next change Trace Format to Tri. Note how the 4 traces are assigned on this display. TR3 and TR4 are now overlaid in the bottom half of the display area. Refer to [Figure 3-4 on page 3-5](#).
5. Now return to the default display of Trace Format = Quad. Change the Number of traces from 4 to 1. Note how the top left quadrant is filled, while the other three quadrants have no data. Refer to [Figure 3-5 on page 3-6](#).

6. Increment the number of traces from 1 back to 4 and note how the VNA Master adds the additional traces to the display. Refer to [Figure 3-6 on page 3-6](#). (Note that [Figure 3-1](#) and [Figure 3-6](#) are the same measurement illustration.)
7. At this point, the display is back to the default setting of Quad with 4 traces.

Regardless of the Trace Format that is selected, the number of traces that are displayed is controlled by the **Number of Traces** soft key. For a brief description, refer to the examples that accompany [Figure 6-47, “Trace Format Menu” on page 6-49](#).

## Active Trace

Notice on the Quad trace format that one trace has a red outline box on the graph, and the trace number in the [Instrument Settings Summary](#) (on the left side of the sweep window) is outlined with a red rectangle. This is the active trace, and only one trace is active at a time. Any display or format selection is applied only to the active trace.

## Changing the Active Trace

You can change the active trace in three ways:

1. In the Measure menu, press the **Active Trace** soft key to select the trace that you want to be active. The pop-up list box displays the active traces (TR1 through TR4) and parenthetically also lists the unique attributes that are associated with each trace (in other words, S-parameter, graph type, domain, and smoothing percentage). After a selection, notice how the active trace indicator on the display has changed. For example, if the active trace changed from TR1 to TR3, then the red highlight box moved from the upper left quadrant to the lower left quadrant.

Not only does the graph get highlighted in red, but the Instrument Settings Summary legend on the left side of the sweep window also highlights the active trace. This becomes important when you are trying to distinguish between active traces and other traces when they are all overlaid on one graph.

2. In the Measure menu, turn the rotary knob clockwise, and the active trace indicator moves clockwise on the quad trace format display. If you turn the rotary knob counterclockwise (CCW), then the active trace indicator moves in a CCW direction on the display.
3. In the Measure menu, use the **Up/Down/Left/Right** arrow keys to select the active trace.

In any menu, when no active parameter is selected, the rotary knob or the arrow keys allow you to select an active trace.

Another powerful feature to become acquainted with is the ability to Maximize and Minimize an active trace. On the quad default display, select **Maximize Active Trace** from the Measure menu, and note how this feature zooms in on the active trace and uses maximum area to display the measurement results. Next, select **Minimize Active Trace** to return to the original trace format of quad display.

Combining the previously described active trace selection techniques with this Maximize and Minimize active trace feature allows for maximum flexibility in extracting the measurement results from the display.

## Trace Description

A trace is a measurement result that can have user-defined attributes assigned to it for display purposes. You can assign the following attributes for a trace: S-parameter, Graph Type, Domain, and Smoothing. Using the Scale menu, you can independently set the scale for each trace.

Example Measurement Displays

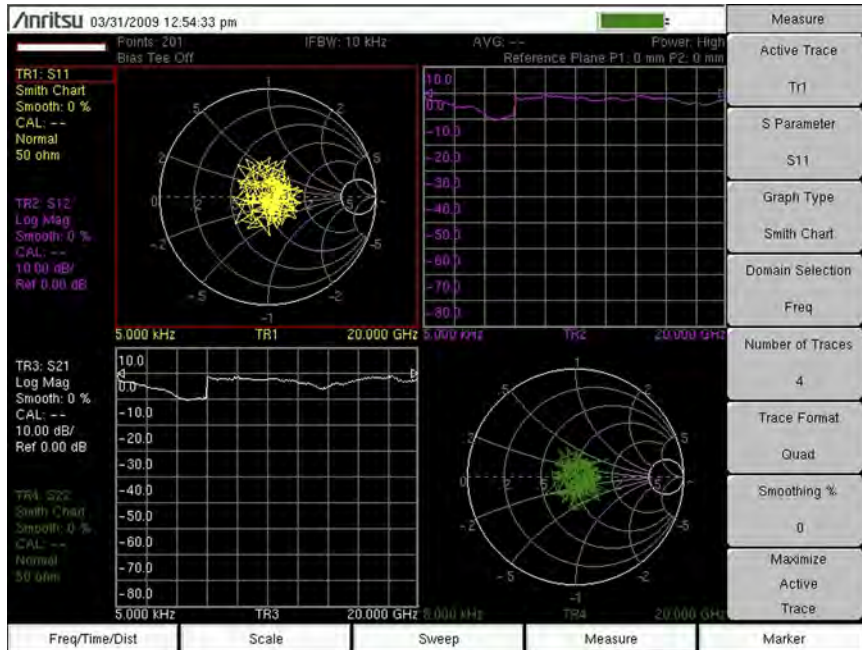

Figure 3-1. Format = Quad, Traces = 4

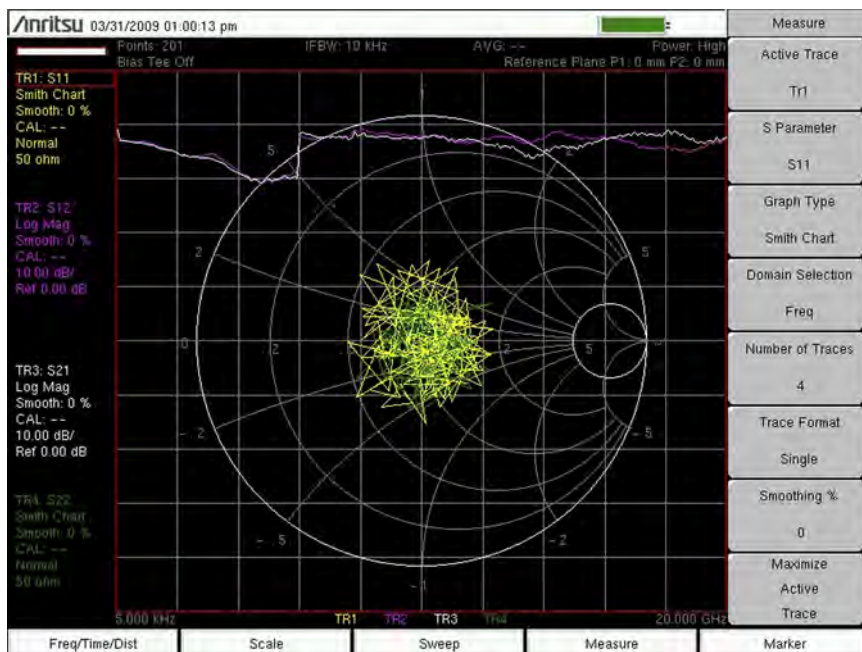

Figure 3-2. Format = Single, Traces = 4



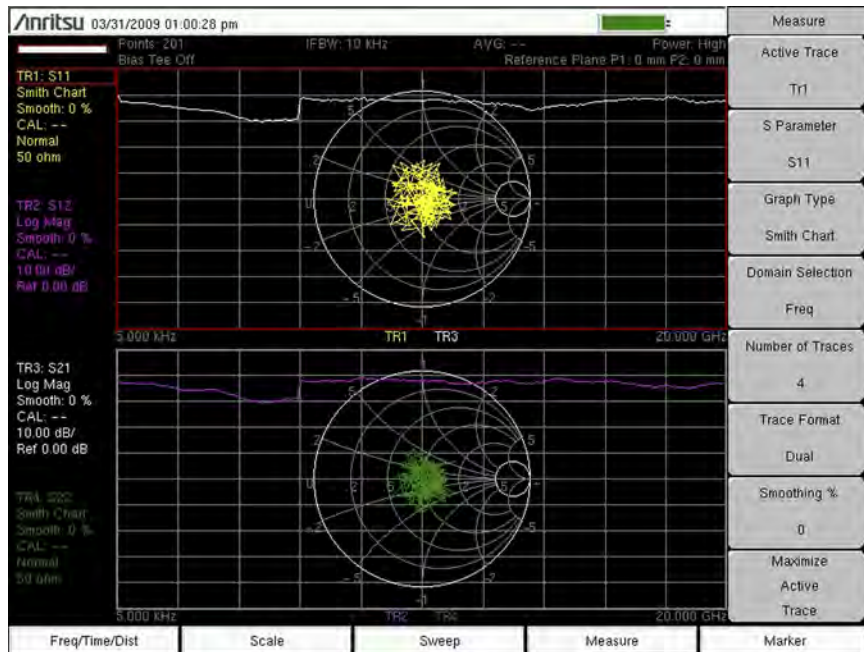

Figure 3-3. Format = Dual, Traces = 4

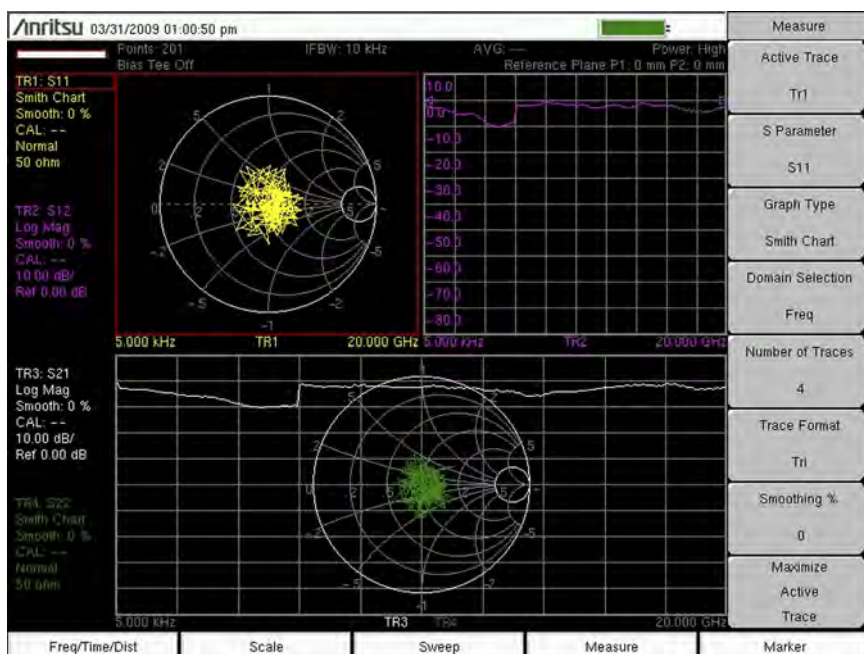

Figure 3-4. Format = Tri, Traces = 4

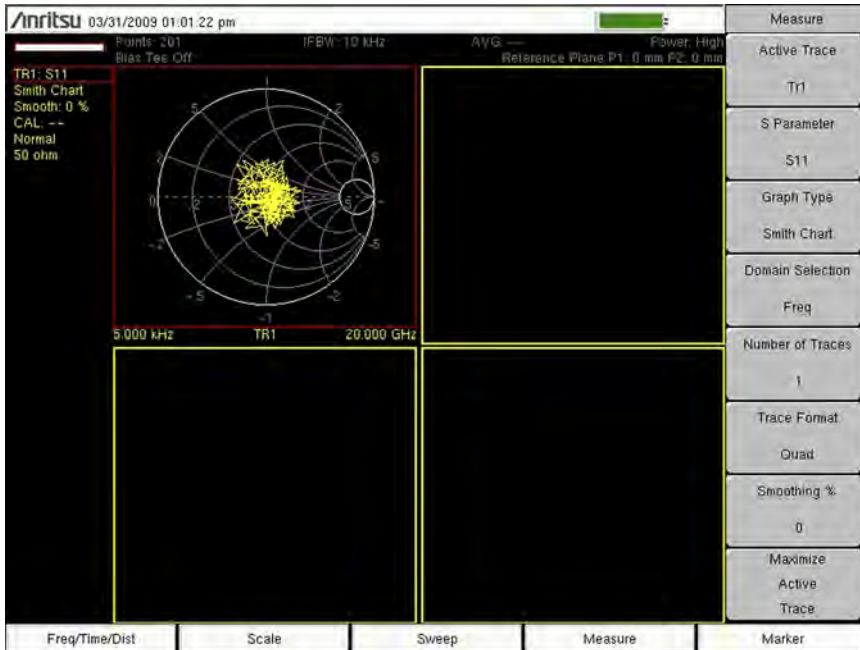

Figure 3-5. Format = Quad, Traces = 1



Figure 3-6. Format = Quad, Traces = 4

## 3-3 Marker and Limit Capabilities

### Marker Description

A marker is a tool for extracting results from traces (or from trace memory). Eight independent markers can be assigned to any one trace (or to all traces). User-defined attributes for a marker include: Marker Type (reference or delta) and Readout Style.

In the marker menu, the markers are selected by using the Marker soft key. Select an active marker with the rotary knob, arrow keys, or key pad (by pressing the marker number). If you select a marker that is Off, then this action will automatically turn On the marker and assign it to the current active trace as a reference marker. After a marker is selected from the Select Marker List Box, an input parameter window (located in the upper left-hand corner of the display and using red font text) displays the current location (frequency, time, or distance) of the marker. The input parameter accepts keypad, rotary knob, or arrow key input to move the marker to the desired location on the active trace.

### Selecting the Readout Style for Each Marker

In the Marker menu, press Readout Style to specify a readout style that differs from the current graph type. For example, if active trace graph type is Log Magnitude, then default Readout Style is Log Magnitude. You can use Readout Style, however, to select any of the available styles for your preferences. These Readout Style selections include: Log Mag, Log Mag and Phase, Phase, Real and Imaginary, SWR, Impedance, Admittance, Normalized Impedance, Normalized Admittance, Polar Impedance, Group Delay, and Log Mag/2.

### Displaying Markers on the Screen

By default, the active marker is displayed on the active trace. Location can be manipulated by keypad, rotary knob, or arrow key input. Additional flexibility is offered either to display the marker readout on the Trace, Screen, or Table, or to turn Off the display of marker readout information (displaying only the marker symbol on the trace). Press the Readout Format soft key to make your choice (refer to [“Readout Format Menu” on page 6-42](#)).

1. Pressing Trace to select marker readout on the trace overlays the active marker readout directly on the active trace.
2. Pressing Screen to select marker readout on the screen overlays the active marker readout on the active trace in the bottom of the graph.
3. Pressing Table to select marker readout on the table shrinks the display and lists marker readouts in the bottom of the display. This selection allows easy viewing of not only the active marker, but of all markers. Note that the color of the marker readout in the table corresponds to the color of the trace to which it is assigned. If a marker is set to be on all traces, then the table listing shows the marker readout for the active trace only.

If multiple markers are displayed in the table, and if the marker data is displayed with overlapping text, then the readout format can be set to Small with the Marker Text Size soft key in the Readout Format menu. To see an example of overlapping text that is made more clear with this feature, refer to [Figure 14-4](#) and [Figure 14-5 on page 14-5](#).

## Setting Up Delta Markers

If the intent is to conduct a delta measurement, then two markers are necessary: one for the reference and one for the delta. As an example:

1. Turn on Marker 1 (the Ref marker) and assign it either to one trace or to All traces.
2. Turn on Marker 2 and toggle the Marker Type from Ref to Delta.
3. Assign Marker 2 to Marker 1 by specifying the Avail Ref Mkr to Marker 1.

The third step allows you to specify marker delta on one trace, and it also allows you to specify marker delta between two traces.

Note that the marker pop-up list includes the current location and readout style, if they exist; otherwise, it indicates Off.

## Setting Up Limits

The following description is a brief reminder. For a more detailed description of limits, refer to section “Limit Menu” on page 6-36.

Each trace can be assigned both an upper limit and a lower limit. The limits can apply to the entire trace or to a portion of the trace, as desired. To set up a simple limit, select the limit menu (refer to “Limit Menu” on page 6-37) by pressing the **Shift** key and the **Limit** (6) key, and then select the active trace. Choose **Upper** or **Lower** by pressing the Limit soft key. Next, press the **Limit State** soft key to toggle the limit line from Off to On (Notice how the limit line is now displayed on the active trace). Adjust limit values by using the Limit Edit submenu, which allows you to adjust the entire limit line or each point of the limit line. Limit Alarm and Pass Fail Message can be separately assigned for each limit line or for each limit point.

## 3-4 Trace Math Capabilities

Trace math is a powerful tool for comparing two traces to each other by using mathematical operations. To perform trace math, select the trace menu (by pressing the **Shift** key and the **Trace** (5) key), and then select the active trace. Press the **Save Trace to Memory** soft key to save a copy of the trace into the instrument memory. When trace TR1 is saved to memory, an M1 memory trace is produced. Each trace can have one associated memory trace.

You can display Trace Only, Memory Only, or Trace and Memory. Press the **Display** soft key in the Trace menu to open the Display menu. Then press the desired soft key to select trace or trace memory, or both. To make distinguishing traces easier, the memory trace is assigned a different color than the original trace. The corresponding memory trace number (shown in the [Instrument Settings Summary](#)) uses a matching color. When viewing **Memory Only**, the Instrument Settings Summary displays the information for M1. When viewing **Trace and Memory**, the M1 information is displayed above the TR1 information.

At this point, the trace has been saved only to memory, and no trace math has been applied to it. Click on the **Trace Math** soft key to apply one of the following functions: subtraction, addition, multiplication, or division. The mathematical function operates on the complex numbers for each of the traces. When dividing TR1 by M1, the result is the point-by-point division of the complex numbers for each trace. Note that when trace math is applied to a trace, the function is displayed in the instrument status window. In the above example, assuming that  $S_{11}$  is the S-parameter that is associated with TR1, the status would display TR1:  $S_{11}/M1$ .

If a trace is saved to memory, and if some settings on the trace are then changed (such as S-parameters, frequency, or number of points), then a mismatch occurs between the trace and memory. The VNA Master allows you to change these trace settings, but it places an asterisk next to the memory trace name in the instrument status window to point out the mismatch. In the previous example, if a setting is changed on TR1 (relative to the memory trace M1), then the listed filename is displayed as: M1: S11\*. A similar mismatch occurs if you save a measurement when trace math is applied (TR1: S11/M1, for example). When that measurement is recalled, the result of the trace math is still stored in the memory location. The trace math function, however, is no longer valid, and the memory trace contains only the resulting S-parameter (S<sub>11</sub> in this example). To indicate that the data that are stored in the memory location is based on previous measurements and calculations, the ^ sign is placed next to the memory name: M1: S11^.



# Chapter 4 — VNA Fundamentals

## 4-1 Introduction

This chapter includes Vector Network Analyzer (VNA) measurement capabilities and instrument architecture information. It also describes calculating and displaying S-parameters, and describes using markers to provide additional measurement information.

The function hard keys in this mode are:

**Freq/Time/Dist, Scale, Sweep, Measure, Marker**

VNA is Vector Network Analyzer or Vector Network Analysis. The VNA Master is a Vector Network Analyzer that measures the magnitude and phase characteristics of 1-port or 2-port networks, including cables, antennas, filters, isolators, attenuators, and amplifiers. It compares the signal that leaves the analyzer port (the reference signal) with either the signal that is transmitted through the test device (the transmitted signal) or the signal that is reflected from the input or the output of the test device (the reflected signal).

Compared to a Scalar Network Analyzer (SNA), a VNA has the added capability for measuring phase characteristics. While phase measurements are important in themselves, the availability of this phase information unlocks many new features for complex measurements. These features include Smith Charts, Time Domain, and Group Delay. Phase information also allows greater accuracy through vector error correction of the measured signal.

A VNA can have 1-port only, in which case it measures only reflection signals. A VNA can have 2-ports, in which case it can measure both reflection and transmission. A 2-port VNA can also have two different capabilities: 1-path 2-port, or full-reversing. The 1-path 2-port design allows reflection measurements only at one of the two ports and allows transmission measurements only in one direction. The MS202xB VNA Master is a full-reversing VNA that allows reflection measurements from both ports and allows transmission measurements in both directions.

## 4-2 S-Parameters

To simplify the description of the types of measurements a VNA can make, the reflection and transmission measurements are defined in terms of scattering parameters, or S-parameters. For a 2-port network, four fundamental S-parameters can be measured, and they are defined as  $S_{XY}$ . For a 2-port VNA, measurements of signals leaving Port 1 are called forward measurements, and those leaving Port 2 are called reverse measurements. Signals that leave and return to the same port are designated reflection measurements, and those that leave one port and return to another port are designated transmission measurements. S-parameters are an abbreviated designation for these measurements, and are used as shown in the following list:

- $S_{11}$ : Forward Reflection
- $S_{21}$ : Forward Transmission
- $S_{12}$ : Reverse Transmission
- $S_{22}$ : Reverse Reflection

The first number (X) in  $S_{XY}$  is the port number into which the signal is being injected, and the second number (Y) is the port number from which the signal is leaving. The S-parameter is a ratio of the two signals.

### Additional Examples:

**$S_{11}$ : Forward Reflection** represents the measurement in which the signal leaves port 1 and is reflected back to port 1.

**$S_{21}$ : Forward Transmission** represents the measurement in which the signal leaves port 1 and is transmitted to port 2.

**$S_{12}$ : Reverse Transmission** represents the measurement in which the signal leaves port 2 and is transmitted to port 1.

**$S_{22}$ : Reverse Reflection** represents the measurement in which the signal leaves port 2 and is reflected back to port 2.

## 4-3 MS202xB VNA Master Architecture

The MS202xB VNA Master has an architecture that automatically measures the four S-parameters with a single connection. Three receivers are used, so the forward sweep from Port 1 simultaneously yields  $S_{11}$  and  $S_{21}$ , and the reverse sweep from Port 2 simultaneously yields  $S_{22}$  and  $S_{12}$ . Thus, measurement of the four S-parameters for a two-port DUT requires only two sweeps, the forward and reverse transmission.

Figure 4-1 and Figure 4-2 show a general block diagram of the three-receiver architecture that is used in the VNA Master and show how the S-parameters are related to the signals that are being transmitted and received by the ports. From Figure 4-1, you can see how  $S_{11}$  and  $S_{21}$  are generated by a forward sweep (signal directed from Port 1). Figure 4-2 shows how  $S_{22}$  and  $S_{12}$  are generated by a reverse sweep (signal directed from Port 2).

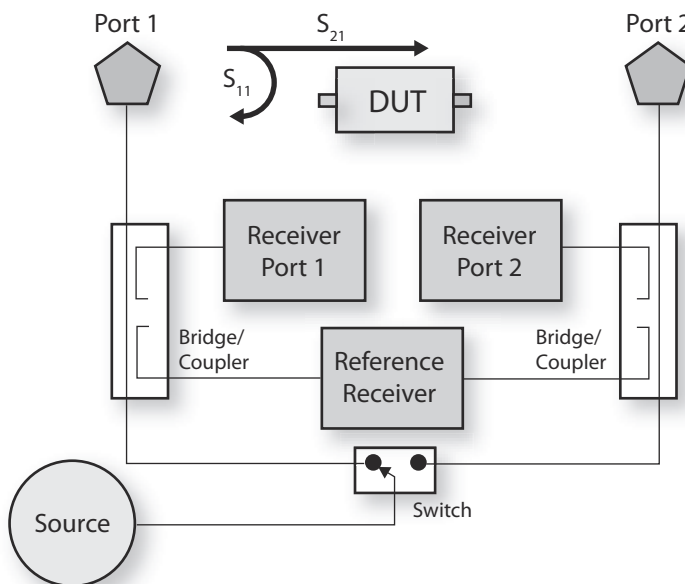
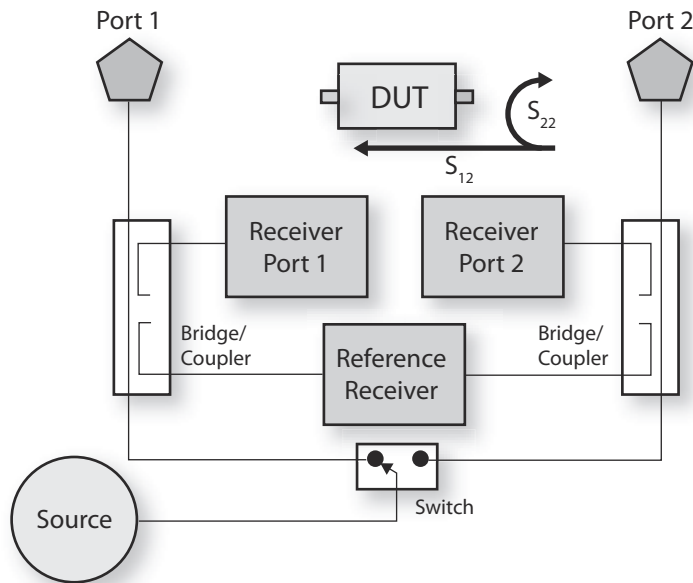

Figure 4-1. MS202xB VNA Master Block Diagram During Forward Sweep





**Figure 4-2.** MS202xB VNA Master Block Diagram During Reverse Sweep

The MS202xB VNA Master, when equipped with Option 77, can calculate the differential  $S_{11}$  S-parameter ( $S_{d1d1}$ ) using the 4 measured S-parameters ( $S_{11}$ ,  $S_{21}$ ,  $S_{12}$ , and  $S_{22}$ ).

**Note**

This additional S-parameter ( $S_{d1d1}$ ) can be used to measure reflections from differential cables when the two ends of the cable are connected to Port 1 and Port 2 of the VNA Master. Because  $S_{d1d1}$  is a function of all 4 S-parameters, it requires both a forward and reverse sweep to complete the calculation.

For more information about the  $S_{d1d1}$  S-parameter, refer to [Chapter 14, “Balanced Ports, Option 77”](#).

## 4-4 Calculating and Displaying S-Parameters

S-parameters are a measure of the ratio of two complex voltage levels, one measured by the port receiver, and one measured by the reference receiver. S-parameters therefore consist of unitless complex numbers.

Depending on the application, S-parameters can be displayed in many ways and can be used to calculate other parameters. S-parameters consist of real and imaginary numbers. More typically, however, they are represented as magnitude and phase. In most cases, the magnitude is displayed in dB (this term is often called log magnitude). We can display phase as “linear phase”. With phase, we cannot tell the difference between one cycle and the next. After going through 360 degrees, we are back to where we began. We can display the measurement from –180 degrees to +180 degrees, which keeps the display discontinuity removed from the important 0 degrees area used as the phase reference.

The MS202xB VNA Master supports the following display types. Each type is associated with a particular S-parameter,  $S_{xy} = S_{\text{Real}} + jS_{\text{Imaginary}}$  (where  $j$  is the square root of  $-1$ ).

---

$$\text{LogMagnitude(dB)} = 20\text{Log}_{10}|S_{xy}|$$

---

### Application Notes

To measure return loss at Port 1 (or Port 2), use the Log Mag display with  $S_{11}$  (or  $S_{22}$ ).

To measure the gain or loss in a DUT that is connected between Port 1 and Port 2, use the Log Mag display with  $S_{21}$  or  $S_{12}$ .

---

---

$$\frac{\text{LogMagnitude}}{2}(\text{dB}) = 0.5 \times 20\text{Log}_{10}|S_{xy}|$$

---

### Application Note

For measuring 1-port cable loss, use  $S_{11}$  or  $S_{22}$  with the Log Mag/2 display type to account for the round trip signal path through the cable. When using reflection data to measure cable loss, the end of the cable must be shorted or must be a perfect open.

---

---

$$\text{Phase(degrees)} = \text{Tan}^{-1} \left| \frac{S_{\text{Imaginary}}}{S_{\text{Real}}} \right| \times \left( \frac{180}{\pi} \right)$$

---

$S_{\text{Real}}$  = Real S-parameter

$S_{\text{Imaginary}}$  = Imaginary S-parameter

---

---

$$\text{SWR} = \frac{(1 + |S_{xx}|)}{(1 - |S_{xx}|)}$$

---

**Application Note**

SWR, or Standing Wave Ratio, is a measure of the **reflection** from the DUT input port or output port, and it must be used, therefore, with  $S_{11}$  or  $S_{22}$ .

---

Group Delay (sec) = rate of change of phase over a specified frequency aperture

---

**Application Note**

Group Delay is a measure of the time delay of the signals that are propagating through the DUT versus frequency (using  $S_{21}$  or  $S_{12}$ ). Group delay is a good measure of phase distortion through the DUT.

---

Smith Chart = graphical tool for plotting impedance or admittance data versus frequency

---

**Application Note**

Use Smith Chart with  $S_{11}$  or  $S_{22}$  to plot the input or output impedance of the DUT.

---

## 4-5 Extracting More Information by Using Markers

An S-parameter can be displayed in different formats, as already described. The MS202xB VNA Master also allows you to extract information from the trace by using markers. By default, the marker presents the trace point information using the graph type format, thereby providing additional flexibility in analyzing S-parameter VNA data. For example, if the graph type is SWR, then the marker readout is in SWR. You can set the marker type to be something other than the graph type. For any graph type that the trace may have, the markers can be used to extract data in any of the following formats:

- Log Magnitude (dB)
- Log Magnitude/2 (dB)
- Log Magnitude (dB) and Phase (deg)
- Phase (deg)
- Real and Imaginary
- SWR
- Group Delay (sec)
- Impedance:  $Z_{in} = R + jX$
- Admittance:  $Y_{in} = G + jB$
- Normalized Impedance:  $Z_{in}/Z_o = (R + jX)/Z_o$
- Normalized Admittance:  $Y_{in}/Y_o = (G + jB)Y_o$
- Polar Impedance

## 4-6 How Bias is Generated

Another important feature of a VNA is the ability to provide DC bias voltage at the RF port. Bias on the RF cable is useful for operating TMA components that are being tested. The architecture of the MS202xB VNA Master, when equipped with Option 10, allows for internal and external bias at both RF ports. Figure 4-3 shows how an internal source can provide a voltage between 12 volts and 32 volts that can be switched between Port 1 and Port 2. That voltage would be available at the port along with the RF signals. Alternatively, an external voltage source could be connected to the Bias Tee input ports in order to provide a bias voltage between +50 volts and -50 volts at both ports simultaneously, if desired.

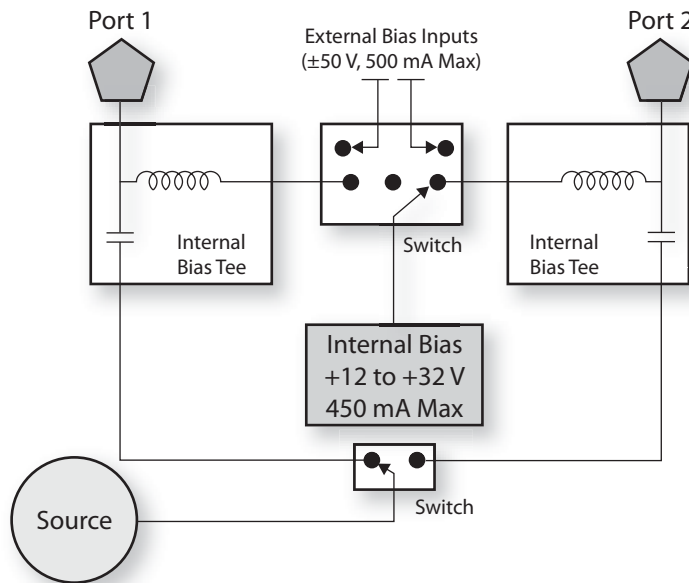

Figure 4-3. Internal or External Bias



# Chapter 5 — VNA Measurements

## 5-1 Introduction

This chapter describes some of the VNA measurements that can be made with the MS202xB VNA Master. It includes both 1-port and 2-port measurements (coaxial and waveguide) and features the key considerations that you are required to make regarding calibration types, IF Bandwidth (IFBW), power levels, graph types, and graph formats.

## 5-2 1-Port Cable Measurement

### Introduction

When cables are installed in the field, one end of the cable is often too far away to allow you to conduct a full 2-port measurement. The 1-port measurement is an ideal technique for this situation.

### Setup Considerations

To conduct a 1-port cable measurement, the first step is to set the frequency range of interest and the desired number of points in the sweep. Then set the test port power to high and perform a full  $S_{11}$  Open-Short-Load (OSL) calibration by using the appropriate connector type. Connect the easily accessible side of the cable to Port 1 of the VNA Master, and connect a short or an open to the far end of the cable. Finally, set up the instrument to display the measurement results in the desired format.

### Measurement Readout and Interpretation

The screen-captured measurement that is shown in [Figure 5-1](#) uses a four-trace display to show  $S_{11}$ , a smoothed version of  $S_{11}/2$ , a distance-to-fault (DTF) measurement using return loss, and another distance-to-fault measurement using SWR. Note that these four measurements are displayed in Quad format as Trace 1 (upper left quadrant), Trace 2 (upper right quadrant), Trace 3 (lower left quadrant), and Trace 4 (lower right quadrant). For an explanation of trace format versus the number of traces that are displayed, refer to section [“Trace Format Menu”](#) on page 6-49.

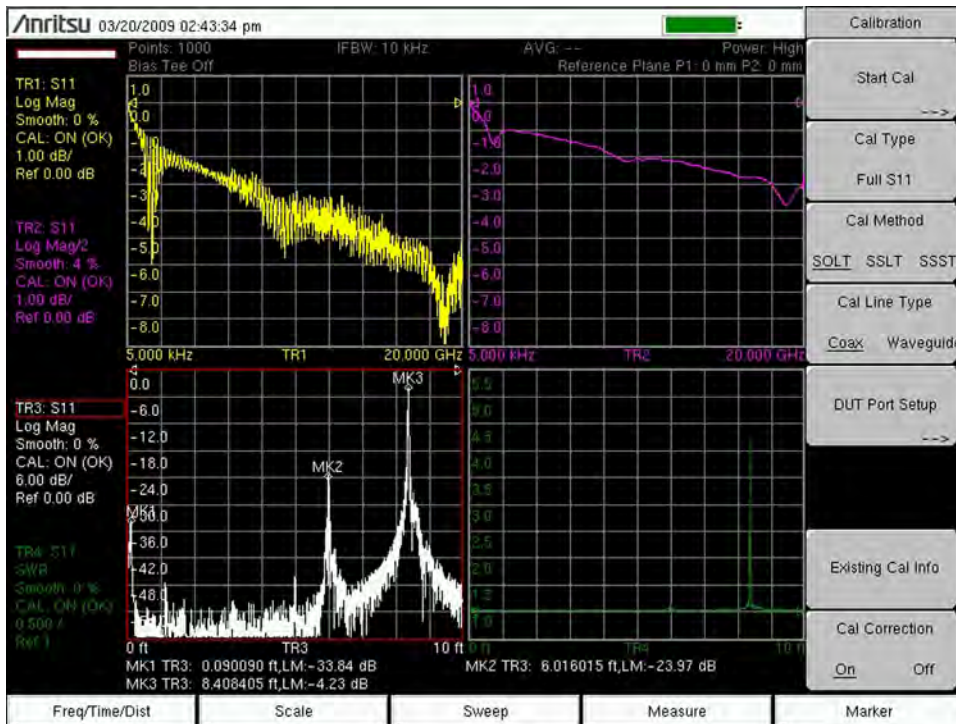

Figure 5-1. Four-Trace  $S_{11}$  Display

SWR as a good tool for identifying major discontinuities, and Return Loss is better for identifying minor discontinuities.

To calculate cable loss, the far end of the cable is shorted, and the resulting  $S_{11}$  return loss measurement is divided by two ( $S_{11}/2$ ) to compensate for the round-trip loss of the cable. Smoothing can be applied to remove any ripples in the 1-port cable loss response. The ripples that are seen in TR1 (Trace 1) are caused by the phase interactions of the large reflection at the short at the end of the cable and the small reflection of the connector at the near end of the cable. In normal cable use, the far end of the cable is terminated with some device, which would eliminate the large reflection in the image with the short. To accurately measure the loss in the cable, however, the signal must be fully reflected from the far end of the cable, which is why a short or an open is used. The resulting undesired ripple can be removed by using smoothing. A smoothing setting of 2% to 5% is usually sufficient to remove the ripples.

**Note**

If you apply smoothing when the sweep has more than 2000 points, the smoothing may slow the sweep time of the trace and the responsiveness of the VNA Master. This slowing can be significant, and it increases as the number of sweep points is increased.

This particular cable shows (at MK2) unwanted dips (troughs) in the insertion loss frequency sweep. The optional time domain or distance-to-fault measurement can reveal potential causes for the poor frequency response of the cable.



In this example, a loose connector that is located 6 feet down the cable was causing a sizable degradation in performance. Marker 1 shows the mismatch of the near end cable connector, Marker 2 highlights the loose connection, and Marker 3 shows the full reflection of the short at the end of the cable. (MK3 is not a full 0 dB reflection, but somewhat less. This can be attributed to the loss of the cable and the previous smaller reflections at MK1 and MK2, which both contribute to the reduced magnitude of the reflected signal at the far-end short.)

After tightening the connector, the insertion loss becomes well behaved, and the mismatch from the connector is significantly reduced, as shown in Figure 5-2.

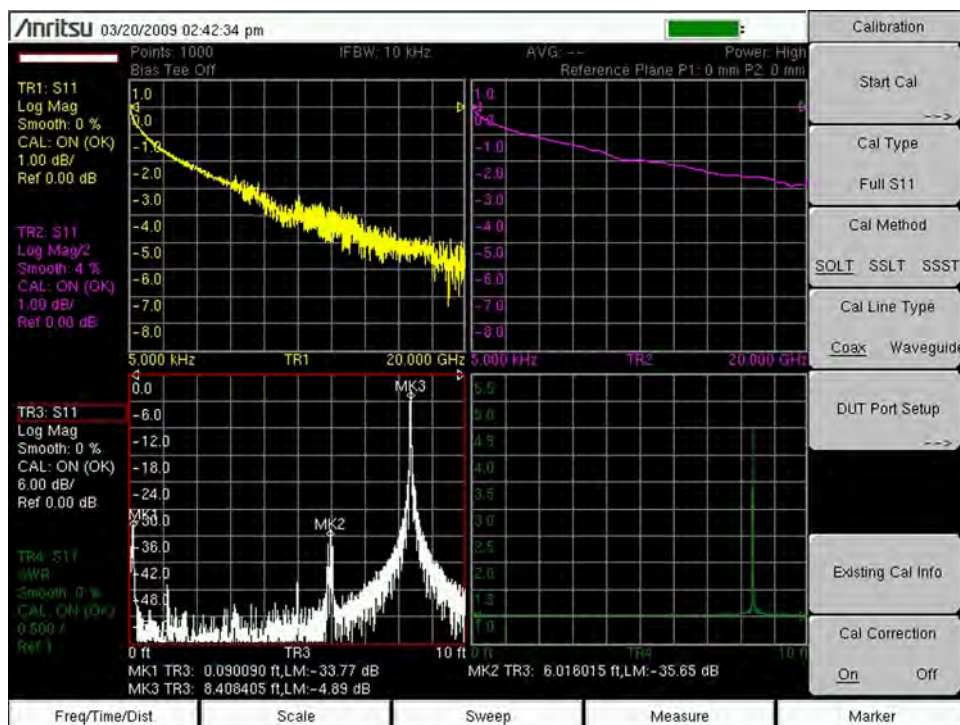

**Figure 5-2.** Improved Trace with Connector Tightened

The 1-port measurement approach is useful for deployed cables, but does have a practical limitation. Uncertainties become large as the round-trip cable loss exceeds 15 dB. This threshold is easy to surpass for long cable lengths or for high operating frequencies. For longer cables and higher frequencies, a 2-port measurement is required for improved accuracy.

## 5-3 1-Port Smith Chart Tuning Example

The Smith Chart is a useful tool for tuning input match. This complex impedance plot reveals which matching elements are necessary to match a device under test to the reference impedance (usually 50 ohms). Selecting “Smith Chart” as the graph type provides this tuning-friendly graph.

In [Figure 5-3](#), the untuned blue trace is overlaid on the tuned yellow trace. The untuned response resembles a series capacitance and series resistance (starts as open circuit at low frequency, and approaches center of chart towards higher frequencies). This series capacitance is tuned out at 375 MHz by placing a shunt inductance in the circuit.

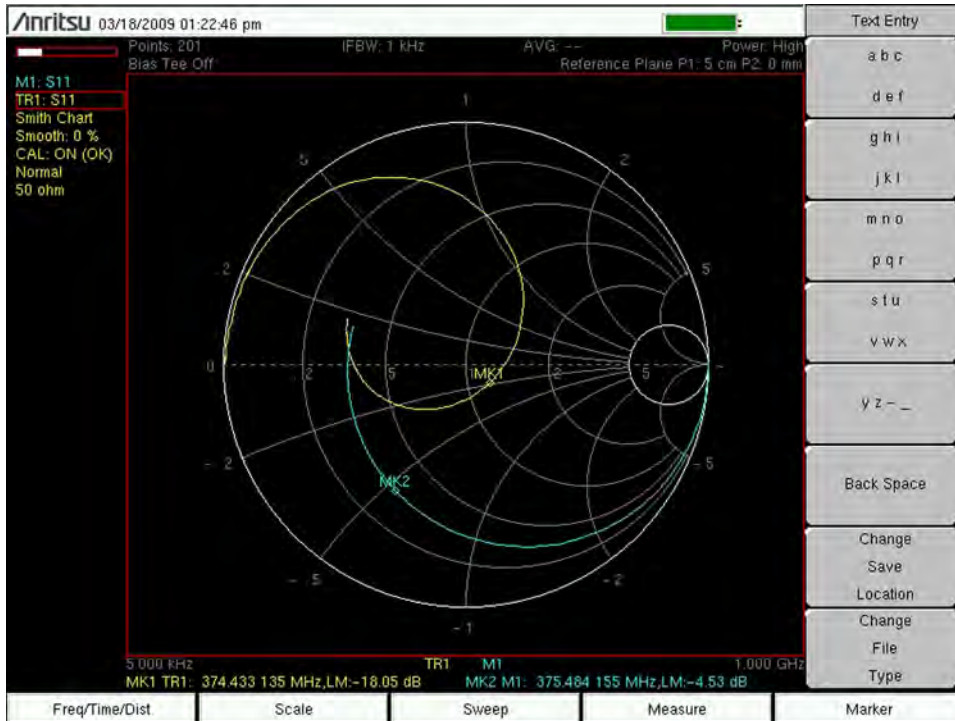

**Figure 5-3.** Smith Chart Tuning Example

In [Figure 5-4](#), the more familiar log magnitude response is showing the input match improvement at 375 MHz. Trace 1 (shown in yellow with marker MK1) is the trace of the tuned circuit.



**Figure 5-4.** Log Magnitude at 375 MHz

#### Figure 5-4

In the electronic (PDF) file of this user guide, the traces are shown in color, and are therefore easier to distinguish.

#### Note

In the printed grayscale images, M1 drops smoothly from approximately 0 dB to approximately -6 dB and utilizes marker MK2. Trace 1 (TR1) has nearly the same end points, but dips to -18.05 dB, as shown at marker MK1.

## 5-4 2-Port Filter Measurement

### Introduction

Filters are 2-port devices that lend themselves well to a full 2-port measurement. They are usually compact devices with both sides of the component being easily accessible.

### Setup Considerations

To perform the measurement, set the frequency to the range of interest, and set the power level to high. Perform a 2-port calibration by using the appropriate connector type. Also refer to section “[Calibration Considerations](#)” on page 5-13.

### Measurement Readout and Interpretation

The screen-captured measurement that is shown in [Figure 5-5](#) is an overlay of  $S_{11}$  and  $S_{21}$  of a highpass filter. This measurement is comparing the transmission response calibration and the full 2-port calibration. The full 2-port calibration offers a dramatic improvement in return loss accuracy. The transmission response calibration is sufficient for a rough measurement of insertion loss.

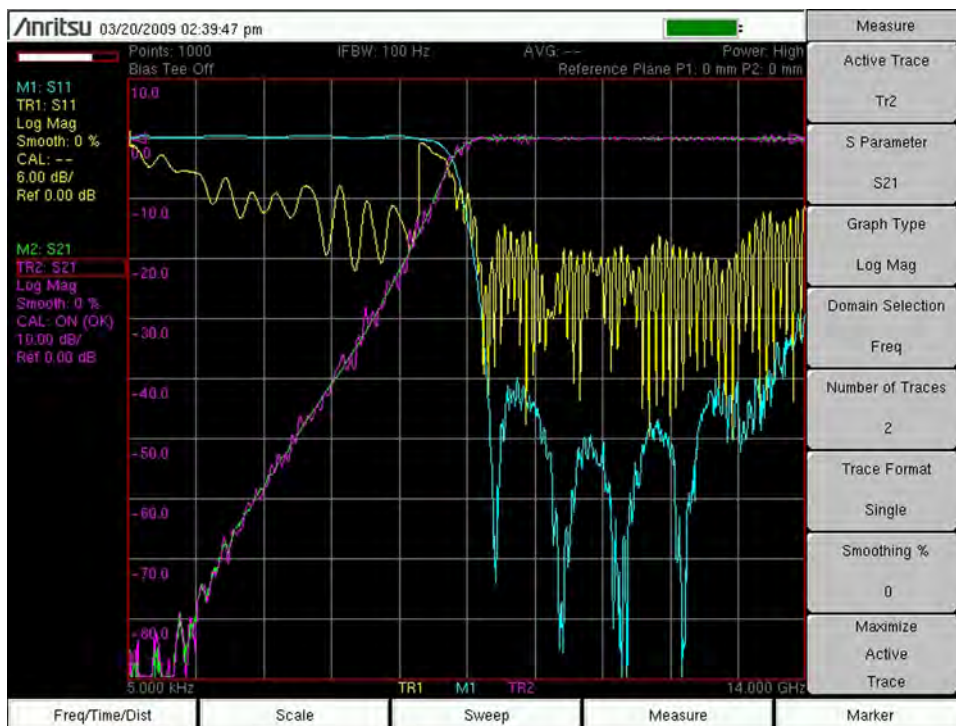

**Figure 5-5.** High Pass Filter with 2-Port Calibration

M1 and M2 are the full 12-term calibration responses. TR1 and TR2 are the responses from the transmission response calibration.

### Figure 5-5

In the electronic (PDF) file of this user guide, the traces are shown in color, and are therefore easier to distinguish.

In the printed grayscale images, M1 and M2 are smoother than traces TR1 and TR2.

**Note** M1 and TR1 begin at the low end of the frequency range at approximately 0 dB and continue above  $-20$  dB until mid frequency range. Then TR1 ranges between approximately  $-10$  dB and  $-50$  dB, while M1 ranges to the bottom of the sweep window, mostly below  $-30$  dB.

M2 and TR2 begin at the low end of the frequency range below  $-60$  dB and sweep upward to approximately 0 dB at mid frequency range. They continue at approximately 0 dB to the high end of the frequency range.

Because of the increased accuracy, full 2-port calibrations are generally the preferred approach. Figure 5-6 shows a 4-trace display of the same filter (as illustrated in Figure 5-5) showing  $S_{11}$  and  $S_{21}$  on 10 dB/div and 1 dB/div scales, highlighting the passband, the reject band, and roll-off of the filter.

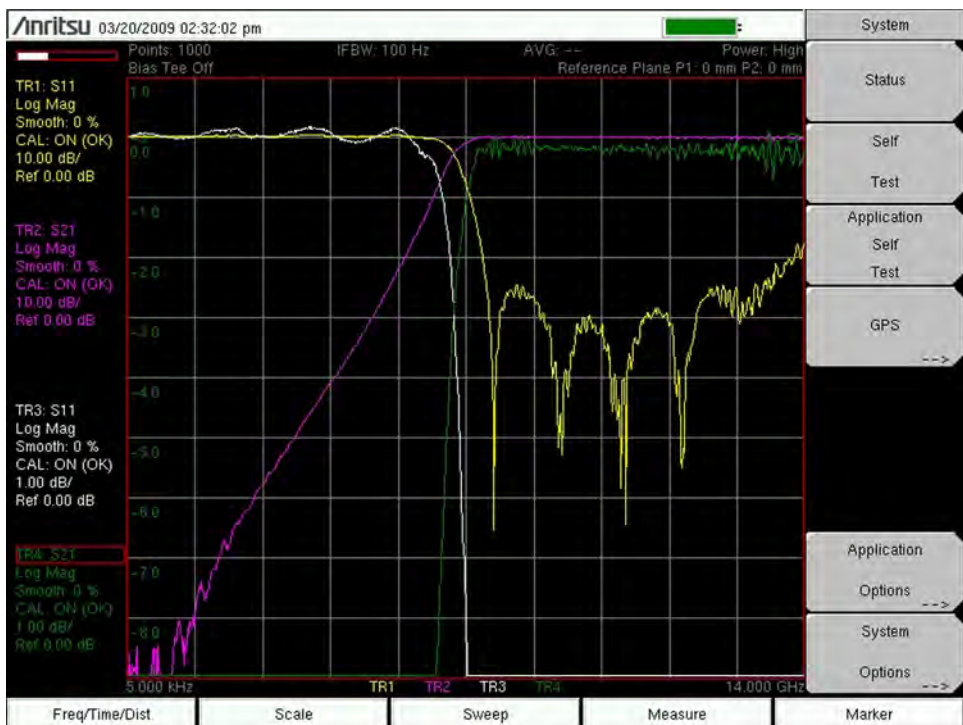

Figure 5-6. Highpass Filter with 2-Port Calibration, 10 dB/div and 1 dB/div

IF-bandwidth can be reduced to lower the noise floor of the instrument. The screen-captured measurement that is shown in Figure 5-7 uses trace memory to show the same measurement taken with a 100 Hz IF-bandwidth on top of a 100 kHz IFBW measurement. Narrower IF bandwidths slow down the measurement speed, but provide a lower measurement noise floor.

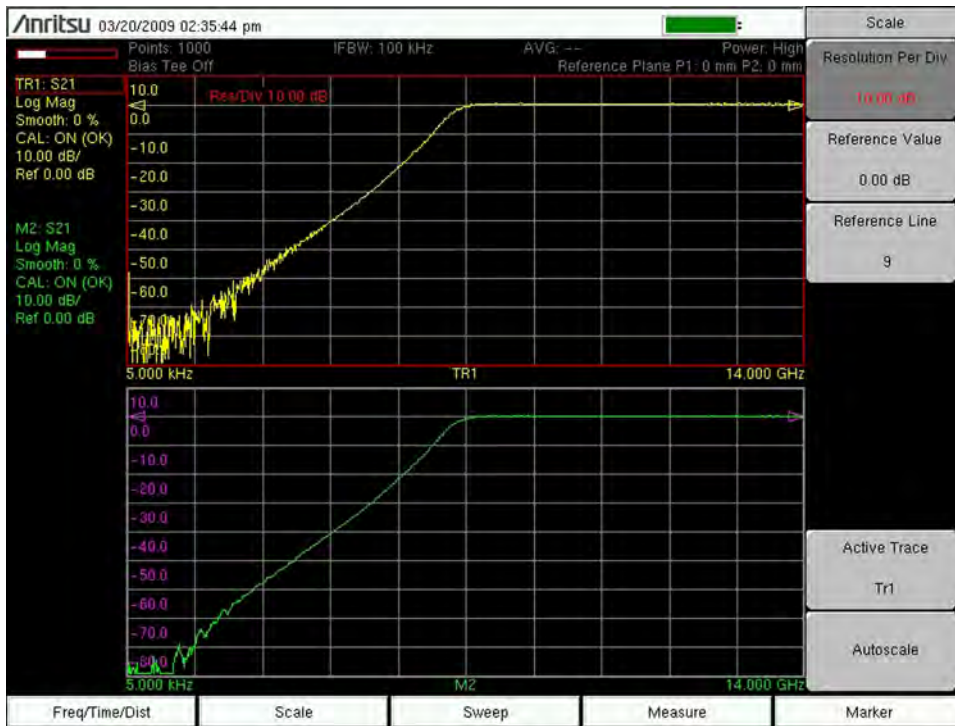

Figure 5-7. 100 Hz (top trace) and 100 kHz IFBW

## 5-5 2-Port Amplifier Measurement

### Introduction

Another popular 2-port device is the amplifier. For amplifier measurements, configuring the instrument to low power mode is an important step. This reduces the source power to ensure that the amplifier and the VNA Master do not go into compression.

### Setup Considerations

To measure the amplifier, set source power to low and perform a full 2-port calibration by using the appropriate connector type. Connect the amplifier between the test ports, and bias the amplifier. The VNA Master offers both internal and external test port bias supplies. These can be utilized to power devices that accept bias through their test ports. Also refer to section “[Calibration Considerations](#)” on page 5-13.

### Measurement Readout and Interpretation

The screen-captured measurement that is illustrated in [Figure 5-8](#) shows gain ( $S_{21} = TR2$ ), input match ( $S_{11} = TR1$ ), output match ( $S_{22} = TR4$ ), and isolation ( $S_{12} = TR3$ ) of an amplifier all at the same time on different graphs.



**Figure 5-8.** Gain, Input Match, Output Match, Isolation of an Amplifier

Group delay is another popular measurement with broadband amplifiers. The two plots that are illustrated in [Figure 5-9](#) and [Figure 5-10](#) show the group delay of the amplifier with 2% aperture and 10% aperture. Increasing the group delay aperture makes the measurement less susceptible to noise, but provides less fine detail in phase linearity.

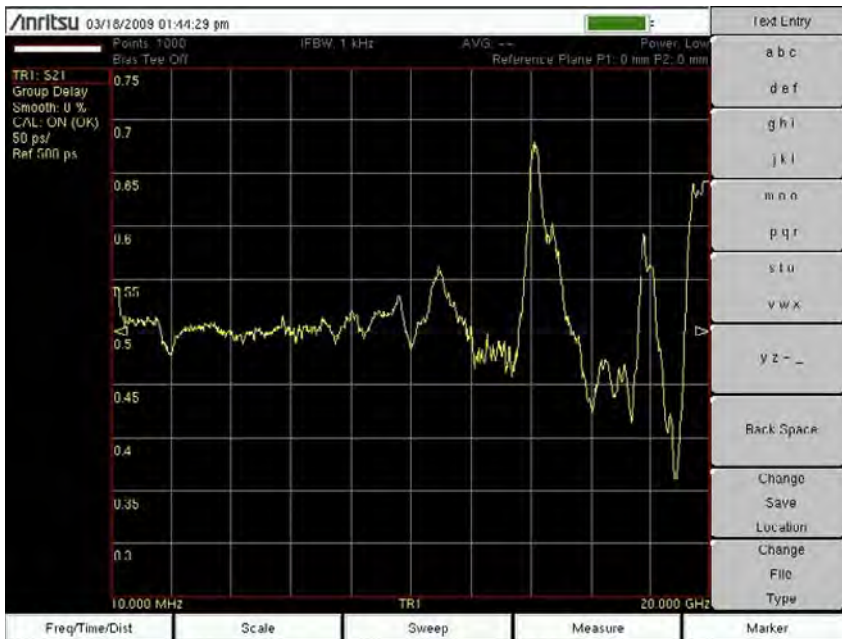

Figure 5-9. 2% Aperture

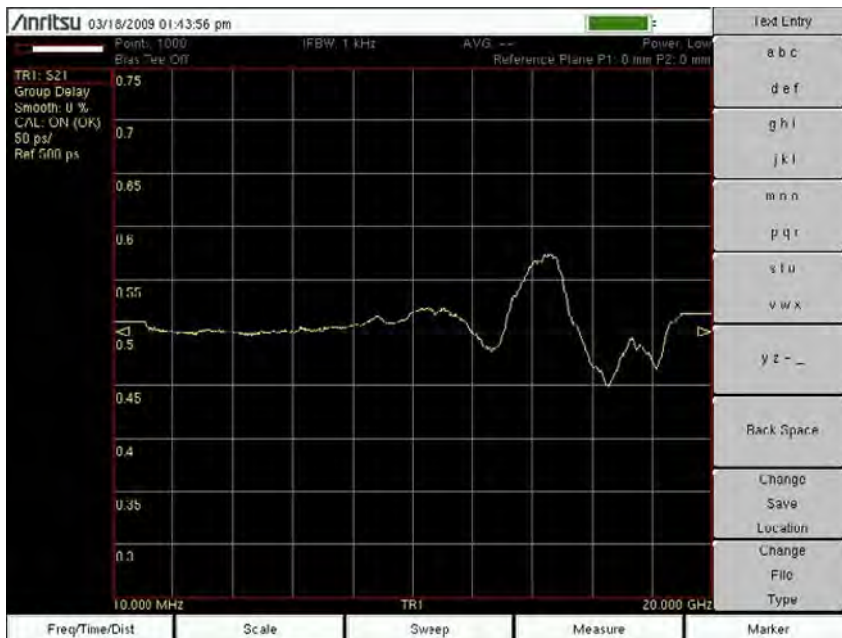
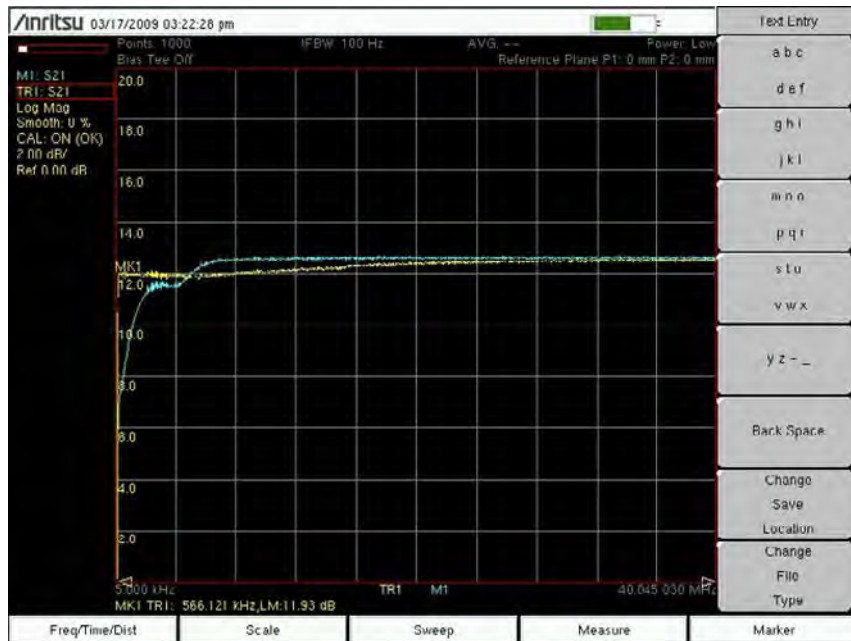

Figure 5-10. 10% Aperture



The 5 kHz low end of the VNA Master facilitates the characterization of low frequency resonances that are commonly caused by bias networks. The screen-captured measurement that is illustrated in Figure 5-11 shows the difference between an amplifier with proper low frequency biasing (TR1) and one with a defective bias inductor (M1).



**Figure 5-11.** Proper Biasing versus Defective Bias Inductor

## 5-6 Waveguide Considerations

### Introduction

The VNA Master accommodates waveguide measurements in addition to the previously discussed coaxial measurements.

### Setup Considerations

The primary difference between waveguide and coax measurements is the calibration. Coax is typically calibrated by using an open, short, load, and through line. Waveguide calibration components do not include an open because the open end of a waveguide is actually an effective radiator and does not reflect much of the signal back to the test port. Offset shorts are typically used to replace the open. Short, offset-Short, Load, Through (SSLT) is a common waveguide calibration that is supported by the VNA Master. Triple offset short (SSST) is another calibration option. Because this calibration avoids having a load standard, it can lead to better ultimate directivity. It is, however, more band-limited and is more susceptible to wear on the calibration components. Also refer to section [“Calibration Considerations”](#) on page 5-13.

### Measurement Readout and Interpretation

In the Distance Domain, the VNA Master includes waveguide dispersion correction to account for different propagation speeds of signals in the waveguide. Dispersion correction is not applied in Time Domain. The  $S_{11}$  measurement of a 15 cm shorted waveguide section (Figure 5-12) shows how dispersion compensation improves distance domain resolution.

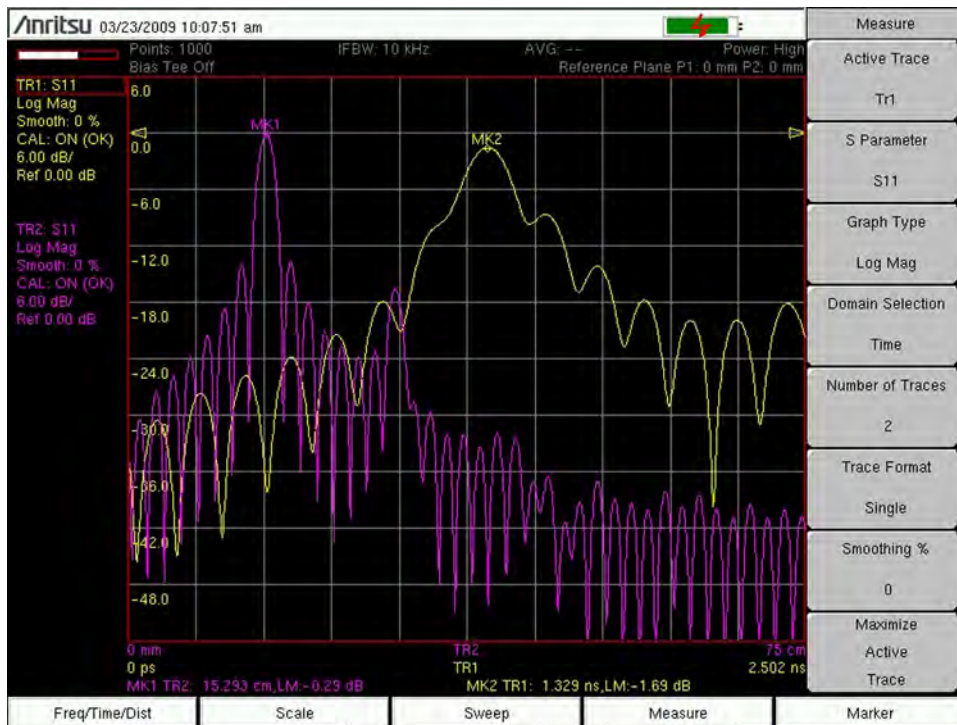

Figure 5-12.  $S_{11}$  on 15 cm Shorted Waveguide Section

Trace TR1 (yellow trace) is in the time domain without dispersion correction. Trace TR2 (purple trace) is in the distance domain. Peaks and troughs are better defined in the distance domain (TR2) than in the time domain (TR1).

#### Figure 5-12

In the electronic (PDF) file of this user guide, the traces are shown in color, and are therefore easier to distinguish.

#### Note

In the printed grayscale image, Trace 1 (TR1) is smoother than Trace 2 (TR2). Both traces begin at the low end of the frequency range at approximately  $-35$  dB. TR1 (time domain) peaks at  $1.329$  ns and  $-1.69$  dB as shown by Marker MK2. TR2 (distance domain) peaks at  $15.293$  cm and  $-0.29$  dB as shown by Marker MK1.

#### Note

When measuring reflection parameters (such as  $S_{11}$  in the [Figure 5-12](#) example) the distance domain measurement is adjusted so that the peak of the signal is at the end of the cable or waveguide (a length of  $15$  cm in the example). The signal itself travels round-trip to the end of the cable and then back to the port. If the VNA Master does not adjust for the round-trip condition, then the peak of the signal will be at a distance that is twice the length of the cable. In the time domain, the VNA Master does not compensate for the round-trip condition. The peak of the signal in the time domain therefore represents the time that is taken for the signal to reach the end of the cable and reflect back to the port ( $1.3$  ns in the example).

## 5-7 Calibration Considerations

Various 2-port calibrations are available in the VNA Master. Transmission response is the simplest and requires only one connection during calibration, but it does not correct for test port match errors. 1-Path 2-Port calibration requires four calibration connections and corrects for the transmit port match, but does not correct for the receive port. Full 2-port calibration requires seven calibration connections and corrects for both test port match errors (refer to [Figure 5-13](#)). The full 2-port calibration technique offers the most accuracy.

#### Note

The previously described calibration considerations omit isolation steps in which loads are connected to each test port. During the isolation step of the calibration procedure, the VNA Master measures the isolation between test ports in order to achieve best dynamic range performance.

Specifications may be model specific. Anritsu recommends allowing the instrument to warm up for 15 minutes to typical operation temperature ( $\sim 40$  °C) before calibrating. The instrument will require a new OSL calibration if the internal instrument temperature changes more than  $15$  °C after calibration.

The Vector Network Analyzer Calibration menu is the same one that is used in the Vector Voltmeter menu. Refer to section "[Calibration Menu](#)" on [page 6-13](#) for more information about the calibration menu. Note that some calibration parameters are shared between the Vector Network Analyzer and Vector Voltmeter mode, and that some parameters are different because they were optimized for the specific mode application.

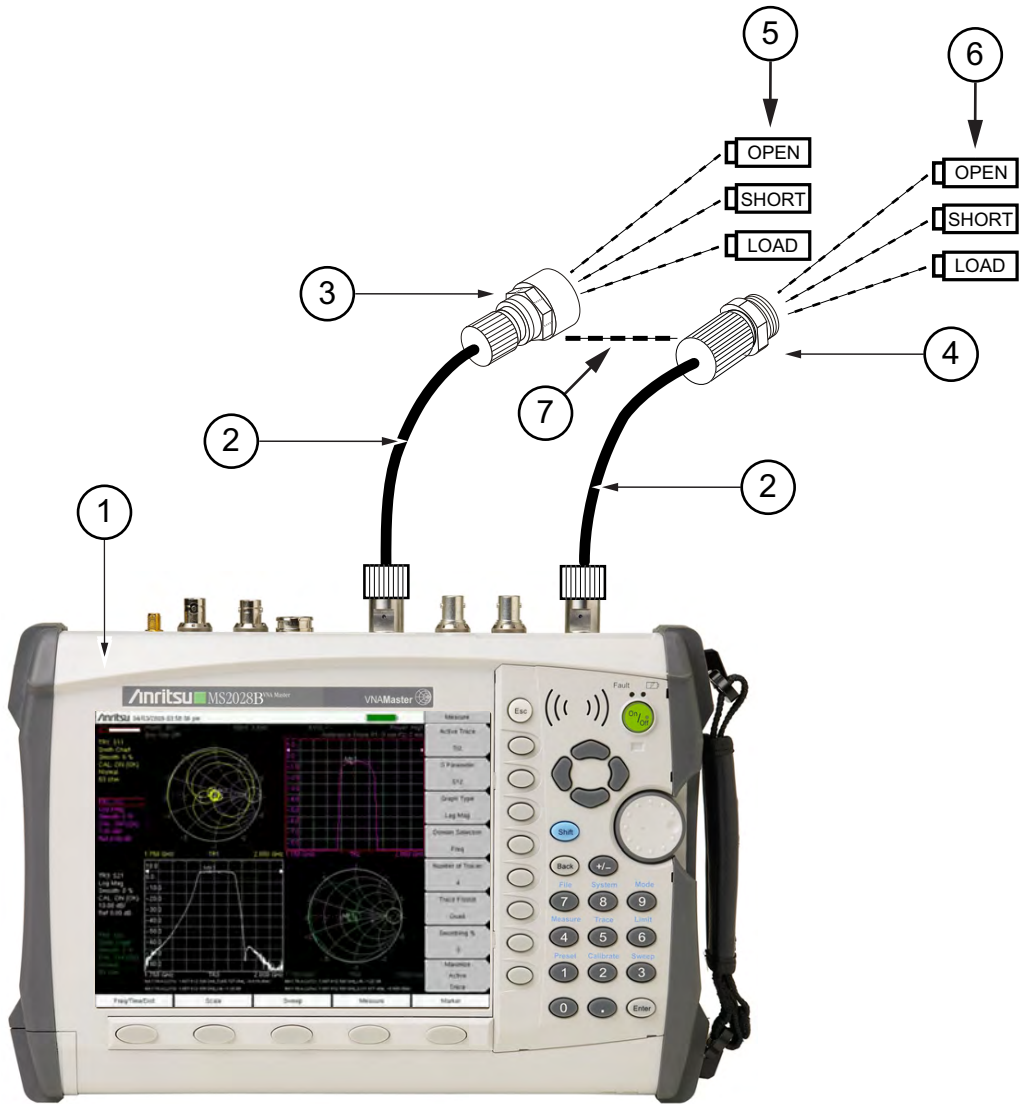

- |   |  |
|---|--|
| 1 | The VNA Master   |
| 2 | Optional Test Port Cable   |
| 3 | Male Connector   |
| 4 | Female Connector   |
| 5 | OSL (Open, Short, Load) Precision Calibration Components, Female |
| 6 | OSL (Open, Short, Load) Precision Calibration Components, Male   |
| 7 | Through Connection (Item 3 Connects to Item 4)                   |

**Figure 5-13.** 2-Port Calibration

**Note** For a “Through” connection, connect the ends of the Male and Female cables together.

When you perform a calibration, the correction coefficients are calculated for specific S-parameters (depending on the type of calibration chosen) and for instrument settings (frequency range, number of points, and power level). The term “calibration correction” refers to the measurement correction coefficients that are applied to measurements as a result of your calibration.

When calibration correction is On, the correction is applied to all applicable S-parameters. For example, if a Full  $S_{11}$  (1-port) calibration is performed, then only traces that measure  $S_{11}$  have a valid calibration. For those traces, the calibration information data in the “[Instrument Settings Summary](#)” (described on page 2-9) shows “**CAL: ON (OK)**”. All other traces that do not measure  $S_{11}$  will display “**CAL: --**” to indicate that no valid calibration is available for those traces. The calibration correction can also be turned off manually under the Calibration menu by toggling the Cal Correction soft key from On to Off. In that case, the display will show “**CAL: OFF**” for all traces that have valid correction data available.

Note that “**CAL: OFF**” means that a calibration correction has been created, but it is not currently being used. This is different from “**CAL: --**”, which means that no valid calibration correction is available for the current setting.

When you have Cal Correction on, you cannot increase the frequency range or the number of points. You can, however, reduce the frequency range or decrease the number of points without forcing the calibration to become invalid. When reducing the frequency range, the MS202xB VNA Master uses the appropriate points within the new frequency range that have correction coefficients applied to them. In that case, you can observe that the number of points that are being used for calibration correction are automatically reduced.

If you reduce only the number of points, then the frequency range is not changed. The VNA Master finds a subset of the original points in the sweep that can be used. You can therefore notice that the instrument may not use the exact number of points that you have entered. It picks a specific number of points that allow the calibration correction to continue to be valid. If you use the rotary knob, you will more easily find the available number of points that can be set. For example, if you calibrated with 201 points, then you can observe that you can reduce the number of points to 101, 68, 51, 41, and so forth.

If you change the source power setting, the calibration status will be changed to “**CAL: ON (?P)**”, which indicates that source power has changed since the instrument was calibrated (from Low to High, or from High to Low). Refer to “[Source Power Menu](#)” on page 6-53. In this case, the calibration may still be valid, but a new calibration is recommended.

Another status information display that you may see is “**CAL: ON (?T)**” which indicates that the instrument temperature has deviated by more than a set amount since the time that the calibration was conducted. The calibration is most likely still valid, but a new calibration is recommended. If you see “**CAL: ON (X)**” on the display, this indicates that the instrument temperature has deviated (since the time the calibration was conducted) by an amount that has more than likely rendered the calibration invalid. When this occurs, a new calibration is highly recommended before further measurements are conducted.

Only one calibration is available at one time. Performing a new calibration overwrites any existing calibration. You can, however, store a measurement setup (with CAL), which also stores the calibration. You can therefore have multiple calibrations available (as long as the calibration settings and conditions continue to apply).

## Cal Type

The Cal Type soft key is found in the “[Calibration Menu](#)” (shown [on page 6-13](#)). The Calibration Type list box provides the complete selection of available calibration types. Refer to section “[Calibration Types](#)” [on page 6-21](#)

# Chapter 6 — VNA Menus

## 6-1 Introduction

The menus that are shown in this chapter are found on the MS202xB VNA Master.

## 6-2 VNA Key Functions

### Introduction

The following section is a quick reference to the principal menus in the VNA Master. For more specific information on a particular measurement, refer to the related chapter for the measurement being made. The key function menus are presented in the following order:

- “Freq Menu” on page 6-4
- “Setup Domain Menu” on page 6-5
- “Time Menu” on page 6-6
- “Windowing Menu” on page 6-7
- “Distance Setup Menu” on page 6-8
- “Additional Dist Setup Menu (Coax)” on page 6-9
- “Additional Dist Setup Menu (Waveguide)” on page 6-10
- “Distance Info List Box for Cable” on page 6-11
- “Distance Info List Box for Waveguide” on page 6-11
- “Calibration Menu” on page 6-13
- “DUT Port Setup Menu (Coax)” on page 6-15
- “File Menu” on page 6-23
- “Save (Text Entry) Menu” on page 6-25
- “Save Location Menu” on page 6-28
- “Abbreviated Text Entry Menu” on page 6-29
- “Text Entry Letters Menu” on page 6-30
- “Recall Menu” on page 6-31
- “Delete Menu” on page 6-32
- “Copy Menu” on page 6-34
- “Limit Menu” on page 6-37
- “Limit Edit Menu” on page 6-38
- “Marker Menu” on page 6-40

- “Marker Search Menu” on page 6-41
- “Readout Format Menu” on page 6-42
- “Measure Menu” on page 6-44
- “S-Parameter Menu” on page 6-46
- “Domain Menu” on page 6-47
- “Number of Traces Menu” on page 6-48
- “Trace Format Menu” on page 6-49
- “Sweep Menu” on page 6-50
- “Configure Ports Menu” on page 6-51
- “Bias Tee Setup Menu” on page 6-52
- “Bias Tee Menu” on page 6-53
- “Source Power Menu” on page 6-53
- “Preset Menu” on page 6-54
- “Smith Scale Menu” on page 6-56
- “System Menu” on page 6-58
- “Application Options” on page 6-59
- “System Options” on page 6-60
- “Reset Menu” on page 6-61
- “Trace Menu” on page 6-61
- “Display Menu (Trace)” on page 6-62
- “Trace Math Menu” on page 6-63



# 6-3 Frequency Menus

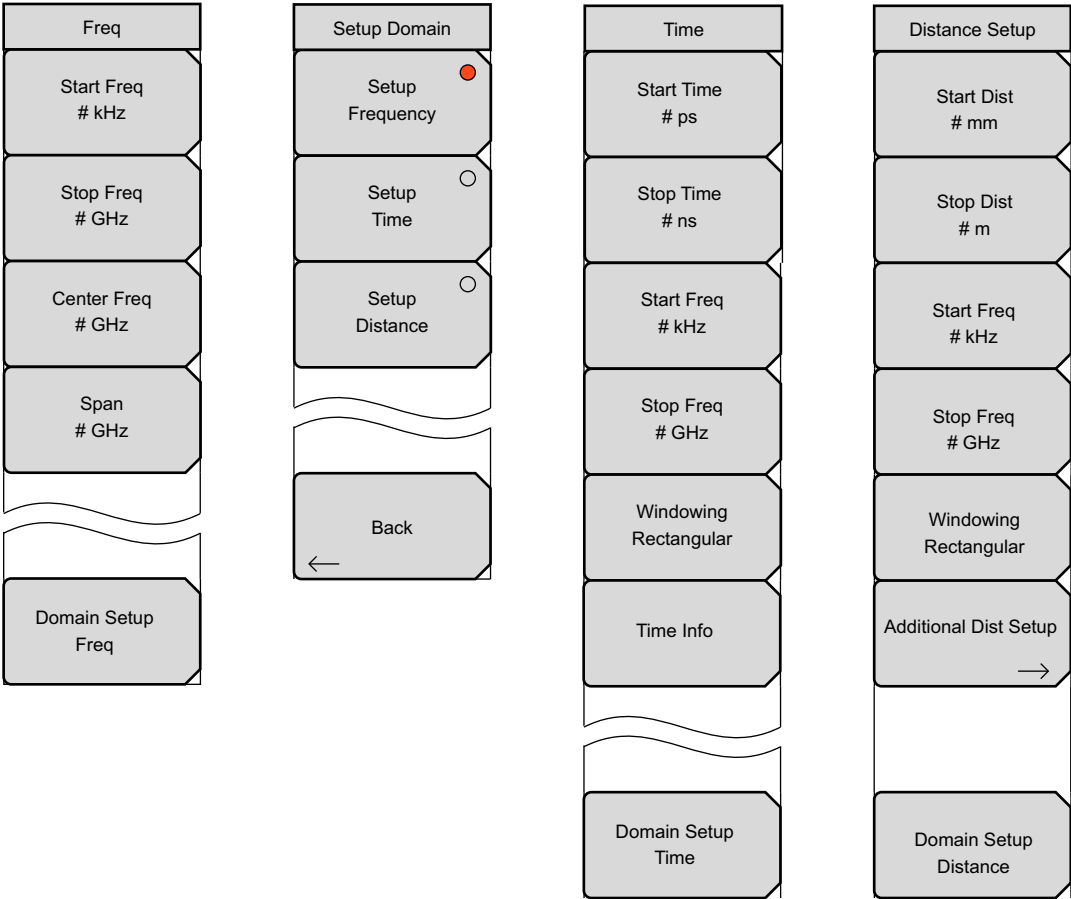

Figure 6-1. Frequency Menus Group

## Freq Menu

Freq	<p><b>Start Freq:</b> Press this soft key to set the start frequency in units of Hz, kHz, MHz, or GHz. If you enter a start frequency that is higher than the currently-set stop frequency, and if CAL = On, then the start frequency is set to the same value as the stop frequency. If you enter a start frequency that is higher than the currently-set stop frequency, and if CAL = Off, then both start and stop frequency are set to the new frequency.</p>
Start Freq # kHz	<p><b>Stop Freq:</b> Press this soft key to set the stop frequency in units of Hz, kHz, MHz, or GHz. If you enter a stop frequency that is lower than the currently-set start frequency, and if CAL = On, then the stop frequency is set to the same value as the start frequency. If you enter a stop frequency that is lower than the currently-set start frequency, and if CAL = Off, then both stop and start frequency are set to the new frequency.</p>
Stop Freq # GHz	<p><b>Center Freq:</b> Press this soft key to set the center frequency in units of Hz, kHz, MHz, or GHz. The center frequency can be set with the arrow keys, the rotary knob, or the number keypad. When using the number keypad, the menu displays soft keys with Hz, kHz, MHz, and GHz units. Pressing the <b>Enter</b> key has the same effect as pressing the MHz soft key.</p>
Center Freq # GHz	<p><b>Span:</b> Press this soft key to set the span in units of Hz, kHz, MHz, or GHz. The span setting determines the frequency range over which the instrument sweeps. The span may be set from 0 (zero) to the maximum frequency of the instrument.</p>
Span # GHz	<p><b>Domain Setup:</b> Press this soft key to open the <a href="#">“Setup Domain Menu”</a>. The message on the key face reflects the setup feature (Freq) that is in use.</p>
Domain Setup Freq	

**Figure 6-2.** Freq (Frequency) Menu

## Setup Domain Menu

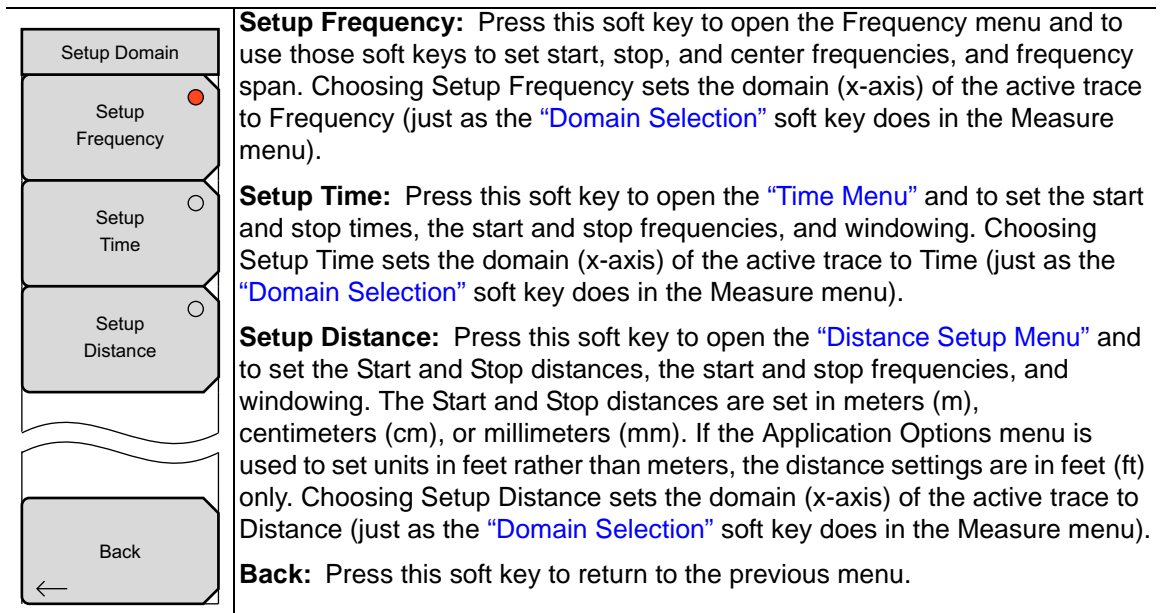

**Figure 6-3.** Setup Domain Menu

## Time Menu

Time	
Start Time # ps	<b>Start Time:</b> Press this soft key to set the start time in seconds (s), milliseconds (ms), microseconds ( $\mu$ s), nanoseconds (ns), or picoseconds (ps). Use the arrow keys, the rotary knob, or the number keypad to set a time value. When using the number keypad, the menu displays soft keys with s, ms, $\mu$ s, ns, and ps units. Pressing the <b>Enter</b> key has the same effect as pressing the ps soft key. The set value is displayed on the key face.
Stop Time # ns	
Start Freq # kHz	<b>Stop Time:</b> Press this soft key to set the stop time in seconds (s), milliseconds (ms), microseconds ( $\mu$ s), nanoseconds (ns), or picoseconds (ps). The maximum setting is 500 $\mu$ s.
Stop Freq # GHz	<b>Start Freq:</b> Press this soft key to set the start frequency in units of Hz, kHz, MHz, or GHz.
Windowing Rectangular	<b>Stop Freq:</b> Press this soft key to set the stop frequency in units of Hz, kHz, MHz, or GHz.
Time Info	<b>Windowing:</b> Press this soft key to open the <a href="#">"Windowing Menu"</a> . The Side value is displayed on the key face, and may be Rectangular (as in this example), Nominal Side Lobe, Low Side Lobe, or Minimum Side Lobe.
	<b>Time Info:</b> Press this soft key to display the Time Info List Box. This list box displays useful information and suggestions regarding the time domain setup.
	<b>Domain Setup:</b> Press this soft key to return to the <a href="#">"Setup Domain Menu"</a> . The message on the key face reflects the setup feature (Time, in this example image) that is in use.

**Figure 6-4.** Time Menu

## Windowing Menu

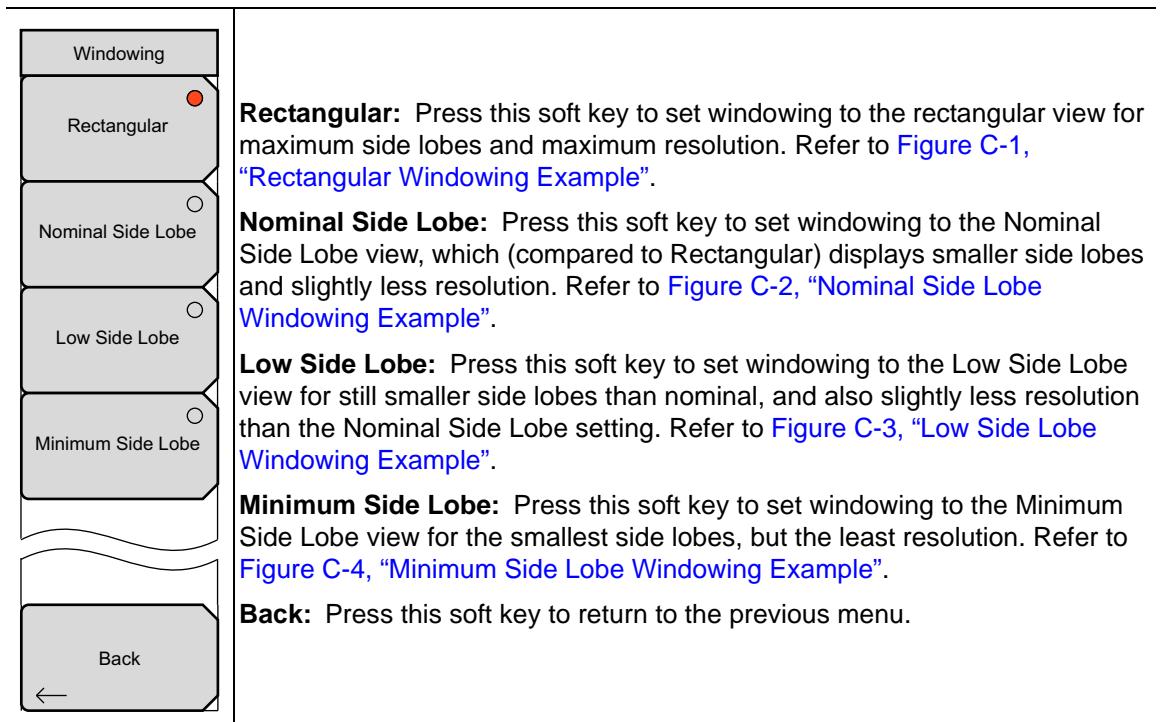

**Figure 6-5.** Windowing Menu

## Distance Setup Menu

Distance Setup	<p><b>Start Dist:</b> Press this soft key to set the start distance. Use the arrow keys, the rotary knob, or the number keypad to set a distance value. When using the number keypad, the menu displays soft keys with meters (m), centimeters (cm), or millimeters (mm) as units. Pressing the <b>Enter</b> key has the same effect as pressing the meter (m) soft key. If the Application Options menu is used to set units in feet rather than meters, the distance settings are in feet (ft) only, and pressing the Enter key sets the units to feet.</p>
Start Dist # mm	
Stop Dist # m	
Start Freq # kHz	<p><b>Stop Dist:</b> Press this soft key to set the stop distance in meters (m), centimeters (cm), or millimeters (mm). If the Application Options menu is used to set units in feet rather than meters, the distance settings are in feet (ft) only.</p>
Stop Freq # GHz	<p><b>Start Freq:</b> Press this soft key to set the start frequency in units of Hz, kHz, MHz, or GHz.</p>
Windowing Rectangular	<p><b>Stop Freq:</b> Press this soft key to set the stop frequency in units of Hz, kHz, MHz, or GHz.</p>
Additional Dist Setup →	<p><b>Windowing:</b> Press this soft key to open the <a href="#">“Windowing Menu”</a>.</p> <p><b>Additional Dist Setup:</b> Press this soft key to open the <a href="#">“Additional Dist Setup Menu (Coax)”</a> or the <a href="#">“Additional Dist Setup Menu (Waveguide)”</a>.</p>
	<p><b>Domain Setup:</b> Press this soft key to return to the <a href="#">“Setup Domain Menu”</a>. The message on the key face reflects the setup feature (Distance) that is in use.</p>
Domain Setup Distance	

**Figure 6-6.** Distance Setup Menu

## Additional Dist Setup Menu (Coax)

Additional Dist Setup	<b>Distance Info:</b> Press this soft key to open the Distance Info List Box to find helpful distance and parameter information. For a view of the list box information, refer to <a href="#">Figure 6-9</a> . The list box contains information such as the start and stop frequencies, start and stop distances, number of data points, and distance resolution.
Distance Info	
DUT Line Type Coax Waveguide	<b>DUT Line Type:</b> Press this soft key to toggle the line type between coaxial cable and waveguide.
Cable List →	
Propagation Velocity #	<b>Cable List:</b> Press this soft key to open a list box and select a cable type. The Cable List menu provides quick navigation aids to search through the list.
Cable Loss(dB/m) #	<b>Propagation Velocity:</b> Press this soft key to set the fraction of propagation velocity from 0.001 to 1.000. For any fraction less than 1.000, press the decimal key before entering the decimal digits.
Units m ft	<b>Cable Loss:</b> Press this soft key to set the cable loss coefficient from 0.000 dB/m to 5.000 dB/m. (The units are dB/ft if units are set to US units.)
Back ←	<b>Units:</b> Press this soft key to toggle the units setting between metric units (meters) and US units (feet).
Back ←	<b>Back:</b> Press this soft key to return to the <a href="#">“Distance Setup Menu”</a> .
Cable List	
Top of List	
Page Up	
Page Down	
Bottom of List	

**Figure 6-7.** Additional Dist Setup Menu (Coax)

## Additional Dist Setup Menu (Waveguide)

Additional Dist Setup	<b>Distance Info:</b> Press this soft key to open the Distance Info List Box to find helpful distance and parameter information. For a view of the list box information, refer to <a href="#">Figure 6-10</a> . The list box contains information such as the start and stop frequencies, start and stop distances, number of data points, and distance resolution.
Distance Info	
DUT Line Type Coax <u>Waveguide</u>	<b>DUT Line Type:</b> Press this soft key to toggle the line type between coaxial cable and waveguide.
Waveguide List →	<b>Waveguide List:</b> Press this soft key to open a list box and select a waveguide type. The Waveguide List menu provides quick navigation aids to search through the list.
Cutoff Freq # Hz	<b>Cutoff Freq:</b> Press this soft key to set the cutoff frequency of the waveguide that is in use.
Waveguide Loss(dB/m) #	<b>Waveguide Loss:</b> Press this soft key to set the waveguide loss coefficient from 0.000 dB/m to 5.000 dB/m. (The units are dB/ft if units are set to US units.).
Units <u>m</u> ft	<b>Units:</b> Press this soft key to toggle the units setting between metric units (meters) and US units (feet).
Back ←	<b>Back:</b> Press this soft key to return to the <a href="#">“Distance Setup Menu”</a> .
Back ←	
Waveguide List	
Top of List	
Page Up	
Page Down	
Bottom of List	

**Figure 6-8.** Additional Dist Setup Menu (Waveguide)



### Distance Info List Box for Cable



Figure 6-9. Distance Information List Box for Cable

### Distance Info List Box for Waveguide



Figure 6-10. Distance Information List Box for Waveguide

(Refer to “Time and Distance Information” on page 7-9.)

## 6-4 Calibration Menus

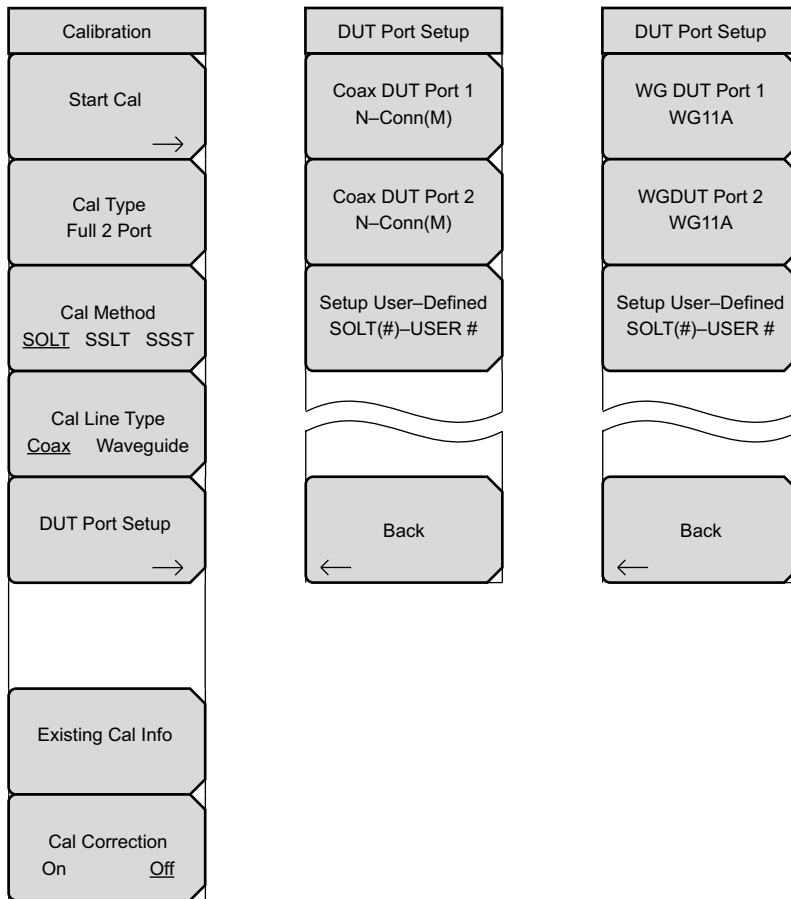

Figure 6-11. Calibration Menus Group

## Calibration Menu

To access the Calibration Menu, press the **Shift** key, then the **Calibrate** (2) key.

Calibration	<p><b>Start Cal:</b> Press this soft key to open the “Next Step” List Box, which contains the instructions: “Connect cal component, select step, and press <b>Enter</b> to measure:”</p>
Start Cal →	<p><b>Example for <math>S_{11}</math>:</b></p> <p>Open, Port 1 Short, Port 1 Load, Port 1 Calculate and Finish Cal Exit to Setup Abort Cal</p>
Cal Type Full 2 Port	<p><b>Cal Type:</b> Press this soft key to open the “Select One” List Box, then select a calibration type. Refer to Section “<a href="#">Calibration Types</a>” on page 6-21.</p>
Cal Method SOLT SSLT SSST	<p><b>Example:</b></p> <p>Full 2 Port – (<math>S_{11}</math>, <math>S_{21}</math>, <math>S_{12}</math>, <math>S_{22}</math>) Full <math>S_{11}</math> – Port 1 (<math>S_{11}</math>)</p>
Cal Line Type Coax Waveguide	<p>Response <math>S_{11}</math> &amp; <math>S_{22}</math> – Refl Resp – Both Ports (<math>S_{11}</math>, <math>S_{22}</math>) 1P2P <math>S_{11}</math>, <math>S_{21}</math> – 1 Path 2 Port Forward Path (<math>S_{11}</math>, <math>S_{21}</math>) 1P2P <math>S_{22}</math>, <math>S_{12}</math> – 1 Path 2 Port Reverse Path (<math>S_{22}</math>, <math>S_{12}</math>)</p>
DUT Port Setup →	<p><b>Cal Method:</b> Press this soft key to toggle through the calibration method options: SOLT, SSLT, and SSST.</p>
Existing Cal Info	<p>SOLT is the most common type of calibration for coaxial devices. SOLT calibrations use a Short, Open, Load, and Through-line.</p>
Cal Correction On Off	<p>SSLT and SSST calibrations are commonly used for waveguide devices. These calibrations use two Shorts, a Load, and a Through-line for SSLT, or three Shorts and a Through-line for SSST.</p>
	<p><b>Cal Line Type:</b> Press this soft key to toggle the line type to Coaxial or Waveguide.</p>
	<p><b>DUT Port Setup:</b> Press this soft key to open the “<a href="#">DUT Port Setup Menu (Coax)</a>”.</p>
	<p><b>Existing Cal Info:</b> Press this soft key to open the “Existing Calibration Information” List Box. Press <b>Enter</b> or <b>Esc</b> to close the list box.</p>
	<p><b>Cal Correction:</b> Press this soft key to toggle calibration correction On and Off.</p>

**Figure 6-12.** Calibration Menu

## Existing Calibration Information List Box

Existing Calibration Information		
Type	Current Settings	Active Cal Settings
Time	04/22/2009 04:50:47 p.m.	04/22/2009 04:49:52 p.m.
Internal Temp	52.0 C	51.8 C
# points	201	201
Start Frequency	290.000 MHz	290.000 MHz
Stop Frequency	310.000 MHz	310.000 MHz
Source Power	High	High
IFBW	10 kHz	10 kHz
AVG Factor	1	1
Ref Plane 1	0 mm	0 mm
Ref Plane 2	0 mm	0 mm
Cal Type	Response S11 & S22	Response S11 & S22
Cal Method	SOLT	SOLT
Cal Line Type	Coax	Coax
DUT Port 1	K-Conn(M)	K-Conn(M)
DUT Port 2	K-Conn(M)	K-Conn(M)
Cal Status	OK: Accuracy High	--

**Figure 6-13.** Existing Calibration Information List Box

The Existing Calibration Information list box shows the various sweep setting types for the active calibration and compares this information to the current sweep settings. It also displays the Cal Status information and the associated level of accuracy.

### Additional Calibration Considerations

In Vector Network Analyzer mode, refer to section “[Calibration Considerations](#)” on page 5-13. In Vector Voltmeter mode, refer to the Note on page 11-5.

## DUT Port Setup Menu (Coax)

	<p><b>Coax DUT Port 1:</b> Press this soft key to open the “DUT Connector Selector” List Box for Port 1. Choose the connector type that matches the calibration components that are to be used on Port 1. The standard calibration coefficients are displayed for the calibration kit that is associated with the selected connector type.</p> <p><b>Examples:</b></p> <ul style="list-style-type: none"> <li>N-Conn(M)</li> <li>N-Conn(F)</li> <li>K-Conn(M)</li> <li>TNC(F)</li> <li>SMA(M)</li> <li>SSST(1) – USER 1</li> <li>SSST(4) – USER 4</li> </ul> <p><b>Coax DUT Port 2:</b> Press this soft key to open the “DUT Connector Selector” List Box for Port 2. Choose the connector type that matches the calibration components that are to be used on Port 2. The calibration coefficients are displayed for the calibration kit that is associated with the selected connector type.</p> <p><b>Setup User-Defined:</b> Press this soft key to open the “User-Defined Cal Kit Selector” List Box (Figure 6-16). Format: SSST(#) – USER #.</p> <p>Selecting a user-defined cal kit brings up the cal kit definition menu (Figure 6-15). In this menu, you may enter the calibration coefficients for the specific calibration kit.</p> <p><b>Back:</b> Press this soft key to return to the “Calibration Menu”.</p>
--	---

**Figure 6-14.** DUT Port Setup Menu

Cal Kit Definition Menus for Coax

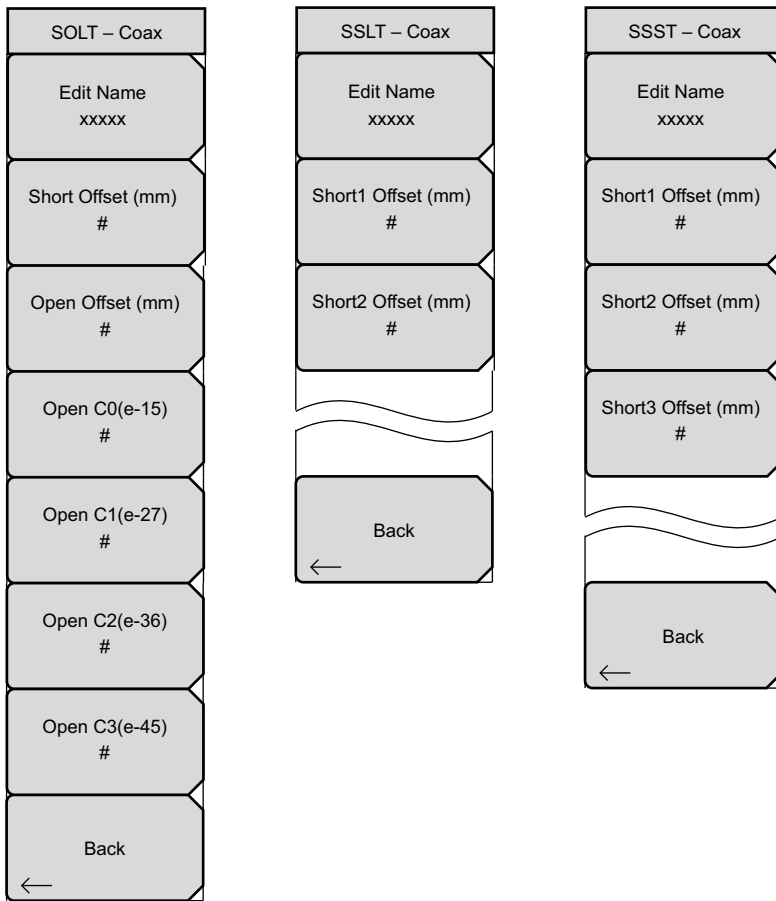
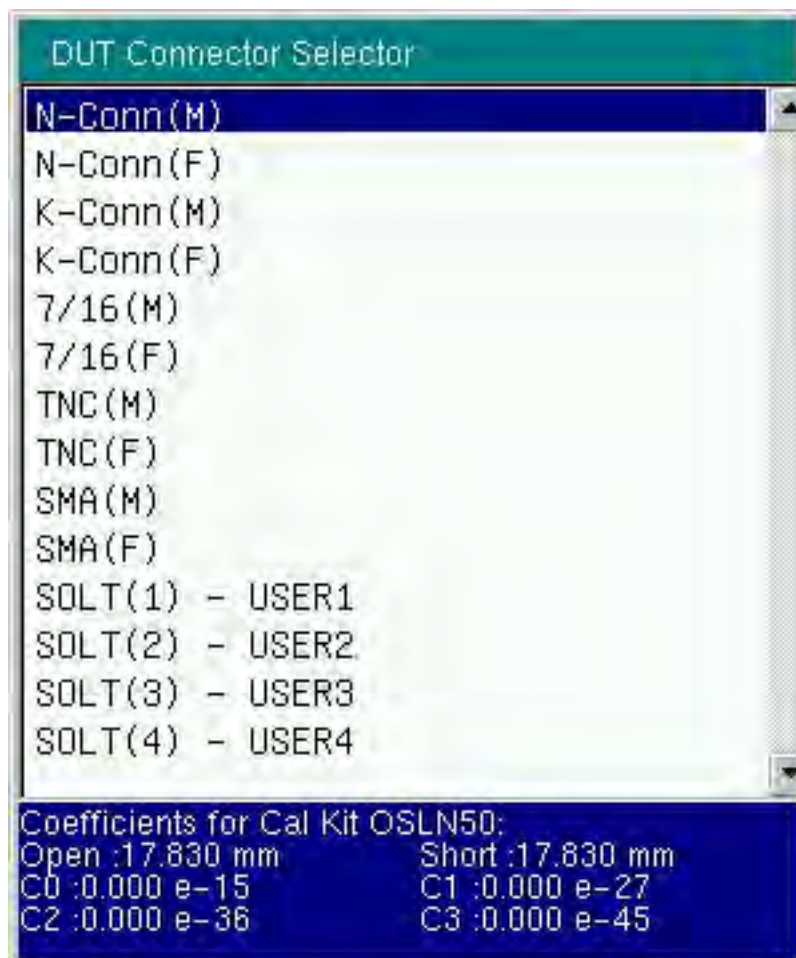

Figure 6-15. Cal Kit Definition Menus for Coax

## DUT Connector Selector List Box for Coax



**Figure 6-16.** DUT Connector Selector List Box for Cable

This list box is opened by the Coax DUT Port # soft key.

## DUT Port Setup Menu (Waveguide)

DUT Port Setup	<b>WG DUT Port 1:</b> Press this soft key to open the “DUT Connector Selector” List Box for Port 1. Choose the connector type that matches the DUT connection on Port 1. This indicates that you are using the matching calibration kit, and the VNA Master displays the corresponding calibration coefficients that will be used during the calibration procedure.
WG DUT Port 1 WG11A	<b>Examples:</b> WG11A WG12 WG20 SSLT(1) – USER 1 SSLT(4) – USER 4
WGDUT Port 2 WG11A	<b>WG DUT Port 2:</b> Press this soft key to open the “DUT Connector Selector” List Box for Port 2. Choose the connector type that matches the DUT connection on Port 2. This indicates that you are using the matching calibration kit, and the VNA Master displays the corresponding calibration coefficients that will be used during the calibration procedure.
Setup User-Defined SOLT(#)-USER #	<b>Setup User-Defined:</b> Press this soft key to open the “User-Defined Cal Kit Selector” List Box (Figure 6-19). Format: SSST(#) – USER #. Selecting a user-defined cal kit brings up the cal kit definition menu (Figure 6-18). In this menu, you may enter the calibration coefficients for their specific calibration kit.
Back ←	<b>Back:</b> Press this soft key to return to the “Calibration Menu”.

Figure 6-17. DUT Port Setup Menu



## Cal Kit Definition Menus for Waveguide

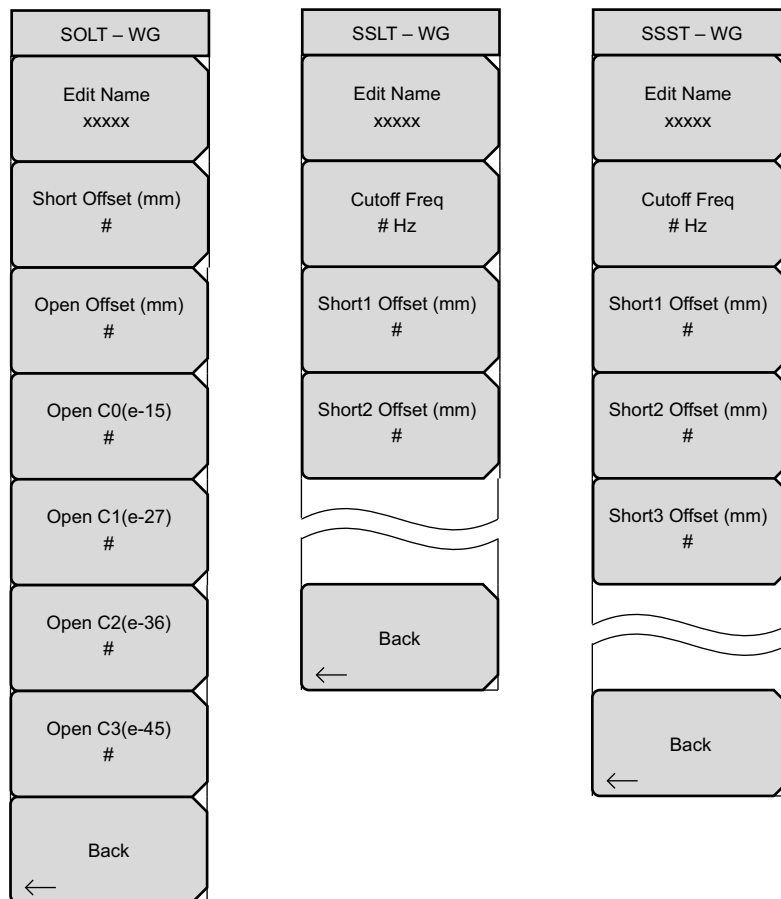

**Figure 6-18.** Cal Kit Definition Menus for Waveguide

## DUT Connector Selector List Box for Waveguide



**Figure 6-19.** DUT Connector Selector List Box for Waveguide

This list box is opened by the WG DUT Port # soft key.

## Calibration Types

The Calibration Type list box provides the complete selection of available calibration types. The following list describes each calibration type:

- Full 2-Port ( $S_{11}$ ,  $S_{21}$ ,  $S_{12}$ ,  $S_{22}$ ) calibrates both ports for measurements in both directions, and provides the most accuracy for two-port devices. It requires three calibration components and a through-line.
- Full  $S_{11}$  (Port 1) calibrates Port 1 for reflection measurements only. It requires three calibration components.
- Full  $S_{22}$  (Port 2) calibrates Port 2 for reflection measurements only. It requires three calibration components.
- Full  $S_{11}$  and  $S_{22}$  (both Ports) calibrates both ports for reflection measurements only. It requires six calibration components: three calibration components for each port.
- Response  $S_{21}$  (Transmission Response Forward Path) performs simple normalization for  $S_{21}$  measurements. It requires a through-line.
- Response  $S_{12}$  (Transmission Response Reverse Path) performs simple normalization for  $S_{12}$  measurements. It requires a through-line.
- Response  $S_{21}$  and  $S_{12}$  (Transmission Response Both Paths) performs simple normalization for both  $S_{21}$  and  $S_{12}$  measurements. It requires a through-line.
- Response  $S_{11}$  (Reflection Response, Port 1) performs simple normalization for Port 1 reflection measurements only. It requires one short or open.
- Response  $S_{22}$  (Reflection Response, Port 2) performs simple normalization for Port 2 reflection measurements only. It requires one short or open.
- Response  $S_{11}$  and  $S_{22}$  (Reflection Response, Both Ports) performs simple normalization for both ports for reflection measurements only. It requires two components: one short or open for each port.
- 1P2P  $S_{11}$ ,  $S_{21}$  (1 Path, 2 Port Forward Path) calibrates Port 1 for reflection measurements and  $S_{21}$  measurements only. It requires three calibration components and a through-line.
- 1P2P  $S_{22}$ ,  $S_{12}$  (1 Path, 2 Port Reverse Path) calibrates Port 2 for reflection measurements and  $S_{12}$  measurements only. It requires three calibration components and a through-line.

# 6-5 File Menus

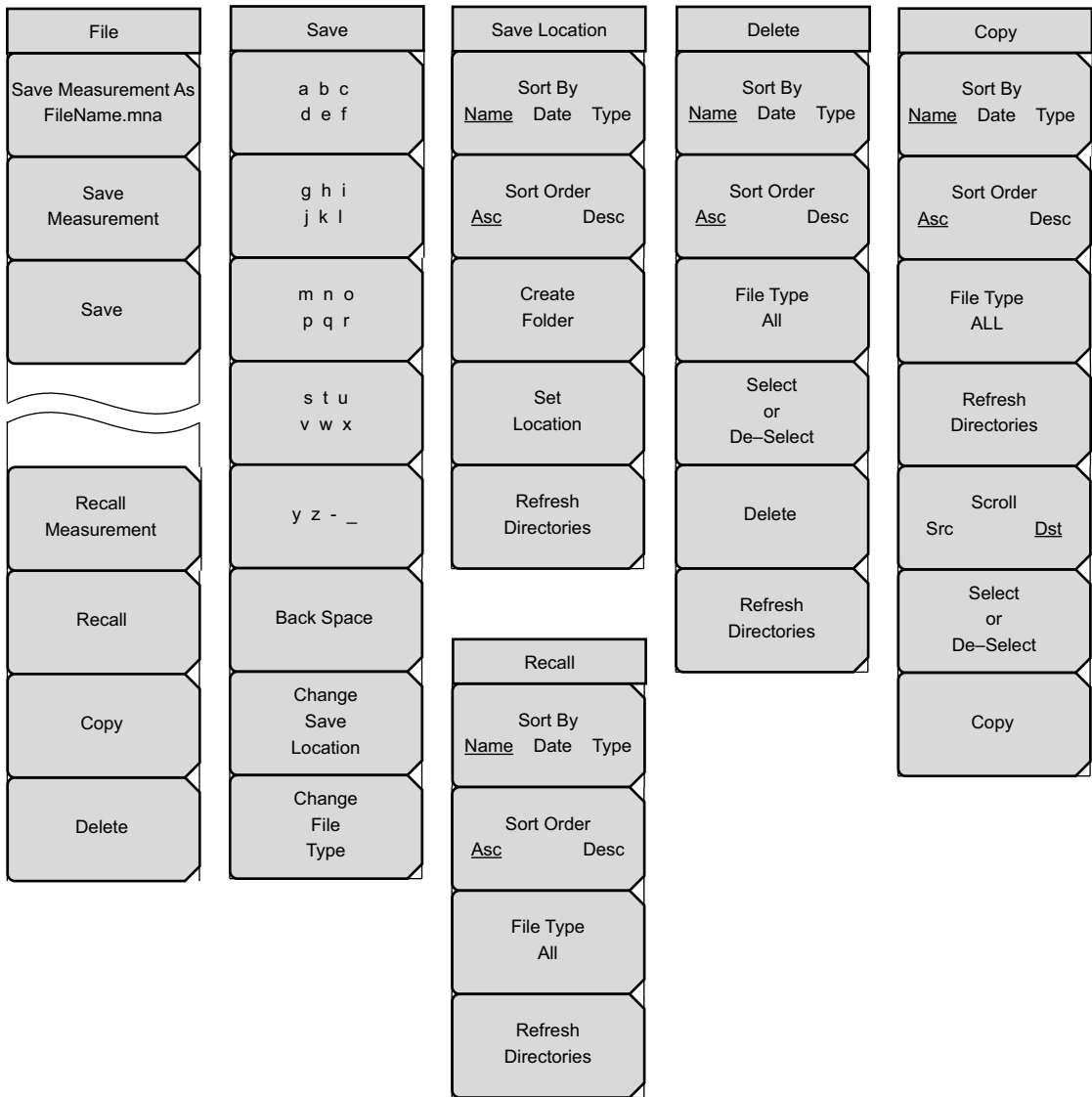

Figure 6-20. File Menus Group

## File Menu

To access the File Menu, press the **Shift** key, then the **File** (7) key.

File	<b>Save Measurement As FileName.mna:</b> Press this soft key to quickly save the current measurement data using the filename that is shown. The filename root is based on the most recently saved measurement file, and the file number is automatically incremented.
Save Measurement As FileName.mna	
Save Measurement	<b>Save Measurement:</b> Press this soft key to quickly save the current measurement using the filename that is chosen by default. This is similar to the top soft key, but you are allowed to change the filename and the file type.
Save	<b>Save:</b> Press this soft key to enter a filename and save a file. The “ <a href="#">Save (Text Entry) Menu</a> ” opens to allow creating a filename. The file name, file type, and location can be set. The default file type is the same as the last file that was saved.
~~~~~	
Recall Measurement	<b>Recall Measurement:</b> Press this soft key to open the “ <a href="#">Recall Menu</a> ” (refer to page 6-31) and the Recall List Box ( <a href="#">Figure 6-30 on page 6-31</a> ). This soft key chooses the measurement file type by default.
Recall	
Copy	<b>Recall:</b> Press this soft key to recall a file. The last file type that was recalled is offered by default.
Delete	<b>Copy:</b> Press this soft key to open the “ <a href="#">Copy Menu</a> ” (refer to page 6-34) and the Copy List Box ( <a href="#">Figure 6-34 on page 6-35</a> ).
	<b>Delete:</b> Press this soft key to open the “ <a href="#">Delete Menu</a> ” (refer to page 6-32) and the Delete List Box ( <a href="#">Figure 6-32 on page 6-33</a> ).

**Figure 6-21.** File Menu

## Screen Capture Feature

A front-panel JPEG screen capture feature is available. To initiate, press the following keys in order (not simultaneously), as shown in [Figure 6-22](#): **Shift**, **Period**, **Plus/Minus (+/-)**. When these 3 keys are pressed in this sequence, the VNA Master saves the current screen to a file in the default file location (refer to [“Change Save Location” on page 6-25](#) and [“Select Save Location List Box” on page 6-26](#)) with a filename constructed from the date and time code as follows: MMDDYYYYHHMMSS.jpg

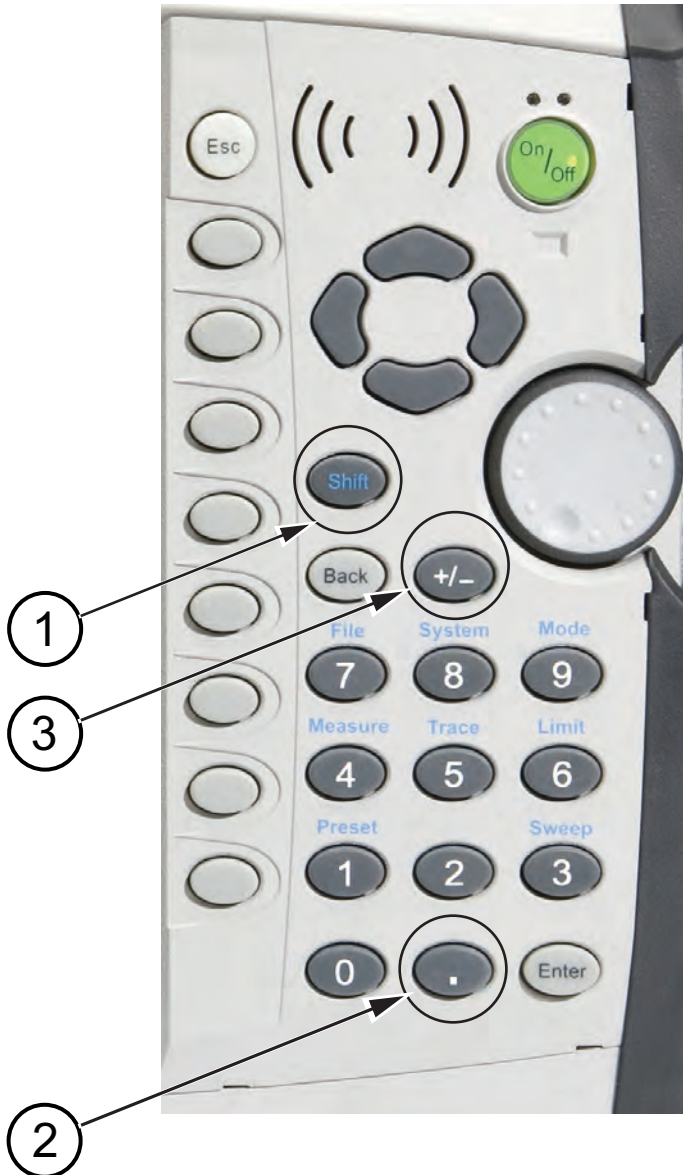

**Figure 6-22.** Screen Capture Feature

## Save (Text Entry) Menu

Save	
a b c d e f	<b>a b c d e f:</b> Press this soft key to open the A through F menu of letters ( <a href="#">“Text Entry Letters Menu”</a> ). Press the shift key to toggle the letters to uppercase and lowercase (before or after pressing this soft key).
g h i j k l	<b>g h i j k l:</b> Press this soft key to open the G through L menu of letters.
m n o p q r	<b>m n o p q r:</b> Press this soft key to open the M through R menu of letters.
s t u v w x	<b>s t u v w x:</b> Press this soft key to open the S through X menu of letters.
y z - _	<b>y z - _:</b> Press this soft key to open the Y, Z, dash, and underline menu of characters.
Back Space	<b>Back Space:</b> Press the Back Space soft key to move the cursor backward in the filename text box. Back Space deletes characters. Use the <b>Left/Right</b> arrow keys to navigate without deleting.
Change Save Location	<b>Change Save Location:</b> Press this soft key to open the Save Location menu. The “Select Save Location” List Box is opened and provides a directory and file tree. Refer to <a href="#">Figure 6-24 on page 6-26</a> for an example of the list box.
Change Type Setup/JPG/...	<b>Change File Type:</b> Press this soft key to open the <a href="#">Select File Type List Box on page 6-26</a> . Use the arrow keys or the rotary knob to select a file type, and then press the rotary knob or the <b>Enter</b> key to select. Press the <b>Esc</b> key to return to the Text Entry menu without changing the file type.

**Figure 6-23.** Save (Text Entry) Menu

### Select Save Location List Box

The example screen shown in [Figure 6-24](#) shows a sample file structure with various user-generated measurement files in the subdirectories. The image may not match any screen displayed on your instrument.

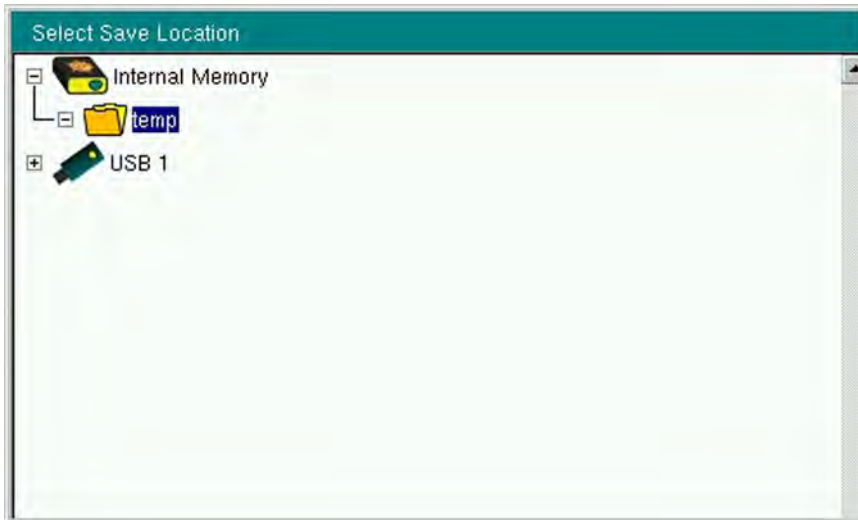

**Figure 6-24.** Select Save Location List Box

### Select File Type List Box

The image may not match any screen displayed on your instrument. The file types are described in the next section.



**Figure 6-25.** Select File Type List Box



## File Types

### Measurement (\*.mna):

This is a file that contains the current setup, measurement, and calibration data. This file type should be used to save measurements that will be recalled back into the instrument. Upon recall, the saved measurement files are placed into the respective memory traces (TR1 into M1, TR2 into M2, and so forth).

### Setup (with CAL) (\*.stp):

This is a file that contains the setup and user calibration data. This file should be used to save and recall the current setup and calibration data. Memory traces also get saved and recalled back into the instrument as memory traces.

### Setup (without CAL) (\*.stp):

This file type is the same as with CAL, except that the calibration data are not stored in this file. This file should be used when you are not required to store or reuse the user calibration data. The file will be smaller in size than the Setup (with CAL) file.

### S2P (Real/Imag) (\*.s2p):

This is a file that contains standard S2P data in real and imaginary format. S2P is a standard ASCII text file format that is used for scattering parameters from a 2-Port measurement. The file header contains the calibration setup information (the same information that is found in the [“Existing Calibration Information List Box”](#) on page 6-14). The file contains data for all 4 S-parameters ( $S_{11}$ ,  $S_{12}$ ,  $S_{21}$ , and  $S_{22}$ ). If certain S-parameters are not available ( $S_{21}$  and  $S_{22}$  will not be available if the instrument is sweeping in only one direction), then the data for that S-parameter will be set to 0.

### S2P (Lin Mag/Phase) (\*.s2p):

This file type is the same as the S2P (Real/Imag) file, except that the S-parameter data are produced in Linear Magnitude and Phase format.

### S2P (Log Mag/Phase) (\*.s2p):

This file type is the same as the S2P (Real/Imag) file, except that the S-parameter data are produced in Log Magnitude and Phase format.

### CSV (\*.csv):

This is a text file in comma separated value (CSV) format that contains setup and final formatted data, as shown on the instrument display. The file includes any post-processing that was done on the data (smoothing, trace math, time domain, and so forth). The file header contains all of the calibration and setup information, as well as the markers that were set to ON when the file was saved. Following the header, the file contains data for all traces that are displayed, including the memory traces (up to a total of 8 traces). Each trace contains one column for the x-axis data (frequency, time, or distance) and one column or two columns for the y-axis data. This file format is currently available only in VNA mode.

### Text (\*.txt):

This file type is the same as a CSV file, except that the data are tab delimited.

## Save Location Menu

Save Location	
Sort By <u>Name</u> Date Type	<b>Sort By</b> <b>Name Date Type:</b> Press this soft key to toggle through the 3 sorting choices: Name, Date, and Type. The selected sort method is underlined on the key face.
Sort Order <u>Asc</u> Desc	<b>Sort Order</b> <b>Asc Desc:</b> Press this soft key to toggle the sort order to ascending or descending. The selected sort order is underlined on the key face.
Create Folder	<b>Create Folder:</b> Press this soft key to open the “Create Directory” List Box and the “ <a href="#">Abbreviated Text Entry Menu</a> ”. Enter a directory name in the directory edit box and press the <b>Enter</b> key to save the directory. Press the <b>Esc</b> key to return to the “ <a href="#">Save Location Menu</a> ” without creating a new folder.
Set Location	<b>Set Location:</b> Use the arrow keys or the rotary knob to select a directory (or folder). Press the Set Location soft key to return to the “Save” List Box and the “ <a href="#">Save (Text Entry Menu)</a> ”.
Refresh Directories	<b>Refresh Directories:</b> Press this soft key to refresh the list of files and directories

**Figure 6-26.** Save Location Menu

## Abbreviated Text Entry Menu

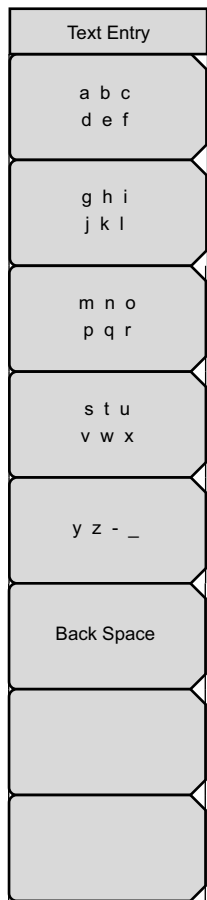

This menu functions in the same manner as the [“Save \(Text Entry\) Menu” on page 6-25](#), but it does not have the soft keys for Change Save Location and Change File Type.

This soft key menu opens when the Create Folder soft key is pressed. The Create Folder soft key is in the Save Location menu (refer to [Figure 6-26](#)).

**Figure 6-27.** Abbreviated Text Entry Menu

## Text Entry Letters Menu

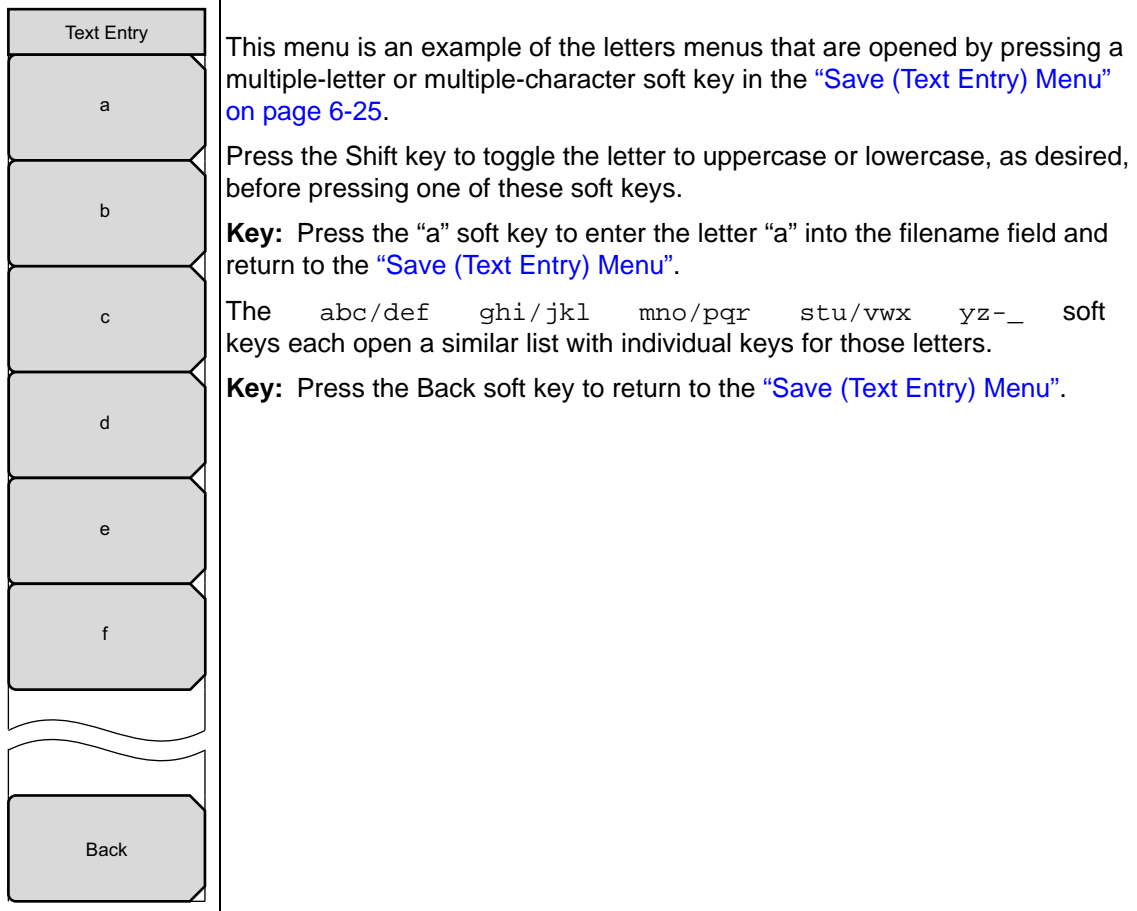

**Figure 6-28.** Text Entry Letters Menu

## Recall Menu

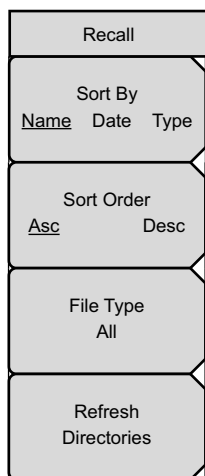

### Sort By

**Name Date Type:** Press this soft key to toggle through the 3 sorting choices: Name, Date, and Type. The selected sort method is underlined on the key face.

### Sort Order

**Asc Desc:** Press this soft key to toggle the sort order to ascending or descending. The selected sort order is underlined on the key face.

**File Type:** Press this soft key to open the [Select File Type List Box](#) (refer to the example list box [on page 6-26](#)). You can choose from measurement files, setup files (with and without CAL), and All file types.

**Refresh Directories:** Press this soft key to refresh the list of files and directories.

**Figure 6-29.** Recall Menu



**Figure 6-30.** Recall List Box

## Delete Menu

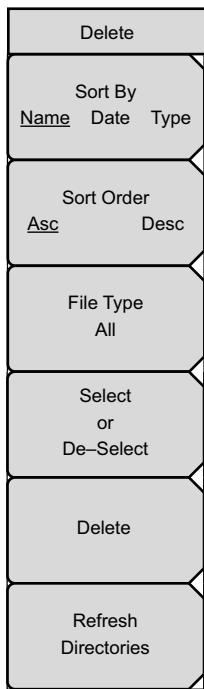
**Sort By**

**Name Date Type:** Press this soft key to toggle through the 3 sorting choices: Name, Date, and Type. The selected sort method is underlined on the key face.

**Sort Order**

**Asc Desc:** Press this soft key to toggle the sort order to ascending or descending. The selected sort order is underlined on the key face.

**File type:** Press this soft key to open the [Select File Type List Box](#) (refer to the example list box [on page 6-26](#)). Use the arrow keys or the rotary knob to choose a file type, and then press the rotary knob or the **Enter** key to select. Press the **Esc** key to return to the Delete menu without changing the file type.

**Select or De-Select:** Scroll through the files in the “Delete” List Box, and then press this soft key to select the indicated file, which is then marked with blue highlighting. Press the soft key again to remove a selection. Continue selecting files until you have selected all desired files to be deleted. When you have finished selecting files, press the Delete soft key to delete the file or group of files. Pressing the Refresh Directories soft key removes selection highlighting from any files that may have been selected.

**Delete:** Press this soft key to prepare to delete the files that you have selected in the “Delete” List Box. A message is displayed in the “Delete” List Box: Press the **Enter** key to confirm that you want to delete the selected files, or press the **Esc** key to cancel the selection. Focus returns to the “Delete” List Box. Press the **Esc** key to return to the [“File Menu”](#).

**Refresh Directories:** Press this soft key to refresh the list of directories. Pressing the Refresh Directories soft key removes selection highlighting from any files that may have been selected.

Figure 6-31. Delete Menu

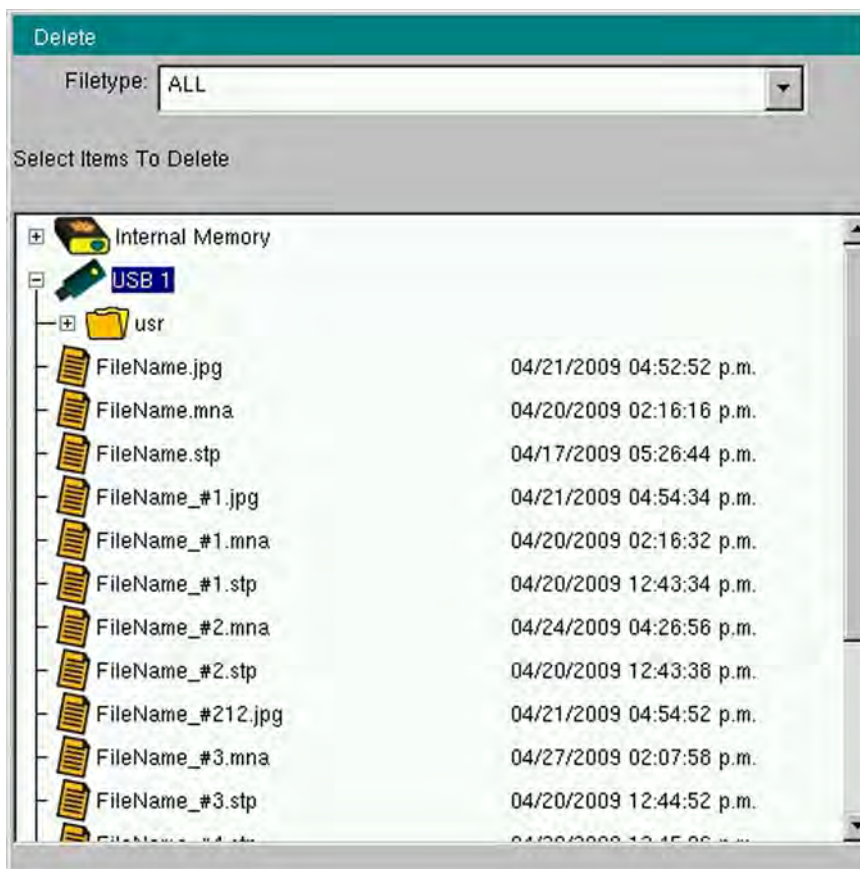

Figure 6-32. Delete List Box

## Copy Menu

The “Copy” List Box displays 2 lists: a list of directories and files that can be copied, and a list of directories and files from which you can select a copy destination.

Copy	<p><b>Sort By</b>  <b>Name Date Type:</b> Press this soft key to toggle through the 3 sorting choices: Name, Date, and Type. The selected sort method is underlined on the key face.</p>
Sort By Name Date Type	<p><b>Sort Order</b>  <b>Asc Desc:</b> Press this soft key to toggle the sort order to ascending or descending. The selected sort order is underlined on the key face.</p>
Sort Order Asc Desc	<p><b>File Type:</b> Press this soft key to open the <a href="#">Select File Type List Box</a> (refer to the example list box <a href="#">on page 6-26</a>). Use the arrow keys or the rotary knob to choose a file type, and then press the rotary knob or the <b>Enter</b> key to select. Press the <b>Esc</b> key to return to the Delete menu without changing the file type.</p>
File Type ALL	<p><b>Refresh Directories:</b> Press this soft key to refresh the list of directories and files. Any files or directory that were selected are released from selection.</p>
Refresh Directories	<p><b>Scroll</b>  <b>Src Dst:</b> Press this soft key to place focus on the “Select Files or Directory to Copy” list or the “Select Destination” list. To open or close a source directory or destination directory, scroll with the arrow keys or the rotary knob, and then press the rotary knob or the <b>Enter</b> key to open (or close) the directory tree.</p>
Scroll Src Dst	<p>First, choose a file or directory to copy, then press the Select or De-Select soft key to highlight the file or directory.</p>
Select or De-Select	<p>Next, press the Scroll soft key again to select a destination directory (or folder), then press the Select or De-Select soft key to highlight the directory as the destination directory.</p>
Copy	<p>Press the Copy soft key to complete the copy operation. If you are selecting more than one file, then all files in a single copy operation must reside within the same directory.</p>
	<p><b>Select or De-Select:</b> Scroll through the directories and files in the <a href="#">Copy List Box</a> (refer to <a href="#">page 6-35</a>), and then press this soft key to select the indicated file and the indicated destination, which is then marked with blue highlighting. Press this soft key again to remove a selection. When you have finished selecting files and a destination directory, press the Copy soft key to copy the file or group of files. Pressing the Refresh Directories soft key removes selection highlighting from any files they may have been selected.</p>
	<p><b>Copy:</b> Press this soft key to complete the copy operation. Press the <b>Esc</b> key to return to the <a href="#">“File Menu”</a>.</p>

**Figure 6-33.** Copy Menu



### Copy List Box



Figure 6-34. Copy List Box

## 6-6 Limit Menus

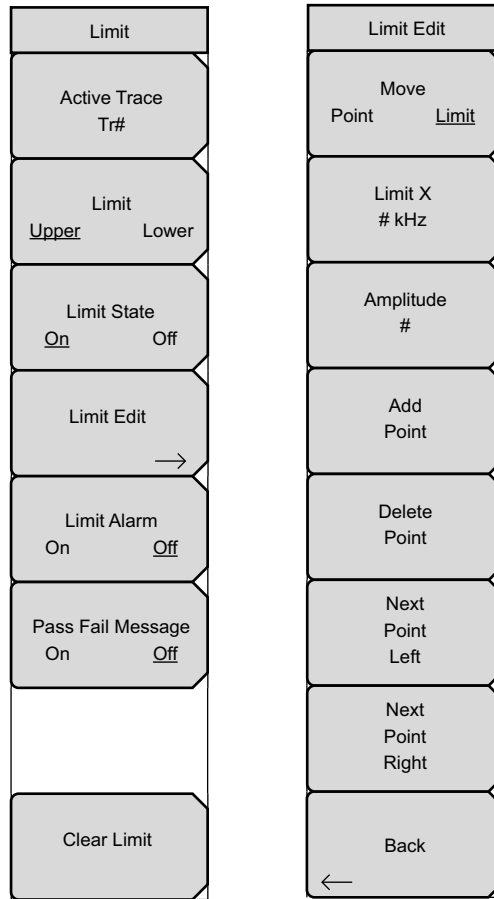

**Figure 6-35.** Limit Menu Group

To access the Limit Menu, press the **Shift** key, then the **Limit** (6) key.

Two types of limit lines can be specified, lower limit lines and upper limit lines. Limit lines can be used for visual reference only, or for pass/fail criteria using the limit alarm. Limit alarm failures are reported whenever a signal is above the upper limit line or below the lower limit line.

Each limit line can consist of a single segment, or as many as 40 segments across the entire frequency span of the instrument. These limit segments are retained regardless of the current frequency span of the instrument. Limit segments allow the configuring of specific limit envelopes at various frequencies of interest without having to reconfigure them each time that the frequency is changed. To clear the current limit setup configuration and return to a single limit segment (starting at the current start frequency and ending at the current stop frequency), press the Clear Limit soft key.

## Limit Menu

Limit	<p><b>Active Trace:</b> Press this soft key to open the “Active Trace Selector” List Box and select a trace. The selected trace number is displayed on the soft key face. Scroll through the list with the arrow keys or the rotary knob, and press the rotary knob or the <b>Enter</b> key to select a trace. Press the <b>Esc</b> key to cancel and close the list box without changing the previously-selected trace.</p>
Active Trace Tr#	<p><b>Limit</b></p>
Limit <u>Upper</u> Lower	<p><b>Upper Lower:</b> Press this soft key to toggle the active limit to be the upper or lower limit. The limit line that is currently selected for editing is <u>underlined</u> on the soft key face.</p>
Limit State <u>On</u> Off	<p><b>Limit State</b></p>
Limit Edit →	<p><b>On Off:</b> Press this soft key to toggle the Limit State On and Off.</p>
Limit Alarm On <u>Off</u>	<p><b>Limit Edit:</b> Press this soft key to open the “Limit Edit Menu”. The “Limit Edit Menu” has soft keys for the creating or editing of single limit lines or multi-segment limit lines. The currently active limit point is marked by a red circle on the measurement display.</p>
Pass Fail Message On <u>Off</u>	<p><b>Limit Alarm</b></p>
	<p><b>On Off:</b> Press this soft key to toggle the Limit Alarm On and Off. For the currently-active limit line, this soft key determines whether an alarm beep occurs when a data point exceeds the limit.</p>
	<p><b>Pass Fail Message</b></p>
Clear Limit	<p><b>On Off:</b> Press this soft key to toggle the Pass Fail Message feature On and Off. The message indicates “FAIL(Up)” and “FAIL(Low)” for upper and lower limit failures, and it indicates “PASS” for passing measurements. The pass and fail messages are displayed in the same color as the measurement trace. If more than one trace is displayed in a single measurement display window, the message color helps distinguish the trace with which the message is associated.</p>
	<p><b>Clear Limit:</b> Press this soft key to delete all limit points for the currently active limit line. A segmented limit line changes to the default, which is a single limit whose amplitude value is adjusted to make it visible in the sweep window. The other (non active) limit line is not altered.</p>

Figure 6-36. Limit Menu

## Limit Edit Menu

Limit Edit	<b>Move</b>
Move Point <u>Limit</u>	<b>Point Limit:</b> Press this soft key to select a single limit point or an entire limit line. Changes in limit frequency or amplitude affect the limit point or limit line that is selected by this soft key. The selected feature is <u>underlined</u> on the key.
Limit X # kHz	<b>Limit X:</b> Press this soft key to change the frequency setting of the limit point or limit line, as determined by the <u>underlined</u> selection on the Move soft key. The current frequency setting is shown on the soft key face.
Amplitude #	<b>Amplitude:</b> Press this soft key to change the amplitude setting of the limit point or limit line, as determined by the <u>underlined</u> selection on the Move soft key. The amplitude of each limit point can be individually set. By default, when a new point is added, it takes on the amplitude that is on the limit line at the frequency where the point was added. Use the number keypad, the arrow keys, or the rotary knob to move the point to the desired value. When using the number keypad, use the <b>+/-</b> key for entering a minus sign. The unit of the amplitude limit is the same as the current vertical amplitude unit. Refer to the Add Point soft key description for more details. The current amplitude setting is shown on the soft key face.
Add Point	<b>Add Point:</b> Press this soft key to add a limit point. The precise behavior of this soft key depends upon which limit point is active at the time that the key is pressed. If the active limit point is somewhere in the middle of a multi-segment limit line, then a new limit point will be added halfway between the currently active point and the point immediately to its right. The amplitude of the point will be such that it falls on the limit line. For example, if a limit point is at 2.0 GHz with an amplitude of $-30$ dBm, and if the next point to its right is 3.0 GHz with an amplitude of $-50$ dBm, then the added point will be at 2.5 GHz with an amplitude of $-40$ dBm. The frequency and amplitude values of the new point can be adjusted as needed with the Frequency (Limit X) and Amplitude soft keys.
Delete Point	If the last (furthest right) limit point is active (assuming that it is not at the right edge of the display), then the new limit point will be placed at the right edge of the display at the same amplitude as the point immediately to its left.
Next Point Left	Points may not be added beyond the current sweep limits of the instrument.
Next Point Right	<b>Delete Point:</b> Press this soft key to delete the active (selected) limit point. The active point becomes the point immediately to the left of the deleted point.
Back ←	<b>Next Point Left:</b> Press this soft key to select the limit point immediately to the left of the active point, making this point active for editing or deletion. With each key press, the indicator (of which point is active) moves one limit point to the left until it reaches the left edge of the sweep window.
	<b>Next Point Right:</b> Press this soft key to select the limit point immediately to the right of the active point, making this point active for editing or deletion. With each key press, the indicator (of which point is active) moves one limit point to the right until it reaches the right edge of the sweep window.
	<b>Back:</b> Press this soft key to return to the "Limit Menu".

Figure 6-37. Limit Edit Menu

## 6-7 Marker Menus

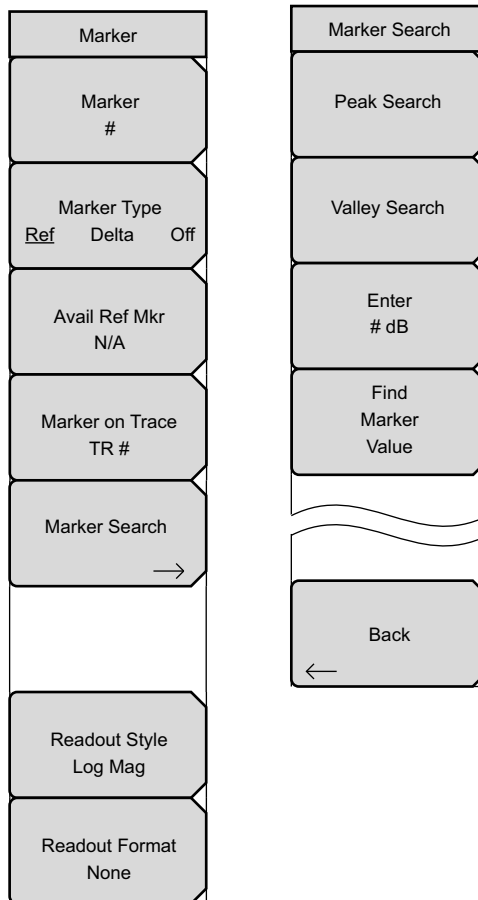

**Figure 6-38.** Marker Menu Group

To access the functions under the Marker menu, press the **Marker** function hard key.

## Marker Menu

Marker	<b>Marker:</b> Press this soft key to open the Select Marker List Box and select a marker. The active marker number is displayed on the soft key face.
Marker #	<b>Marker Type</b>
Marker Type Ref Delta Off	<b>Ref Delta Off:</b> Press this soft key to toggle the Marker Type selection. The active marker becomes a Reference marker or a Delta marker, or it can be turned off.
Avail Ref Mkr N/A	<b>Avail Ref Marker:</b> Press this soft key to open a list box and select a reference marker, if one is available.
Marker on Trace TR #	<b>Marker on Trace:</b> Press this soft key to open a list box and select the trace upon which the marker is located. The active trace number is displayed on the soft key face. Choose from the 4 current traces or 4 memory traces, or all traces.
Marker Search →	<b>Marker Search:</b> Press this soft key to open the “ <a href="#">Marker Search Menu</a> ” and to select a search type.
Readout Style Log Mag	<b>Readout Style:</b> Press this soft key to open a list box and select a chart style. Choose a graph type from the list: Log Mag, Log Mag and Phase, Phase, Real and Imaginary, SWR, Impedance, Admittance, Normalized Impedance, Normalized Admittance, Polar Impedance, and Group Delay, and Log Mag/2. Scroll with the arrow keys or the rotary knob. Press the rotary knob or the <b>Enter</b> key to select. Press the <b>Esc</b> key to cancel and return to the “ <a href="#">Marker Menu</a> ” without changing the readout style.
Readout Format None	<b>Readout Format:</b> Press this soft key to open the “ <a href="#">Readout Format Menu</a> ”.

**Figure 6-39.** Marker Menu

## Marker Search Menu

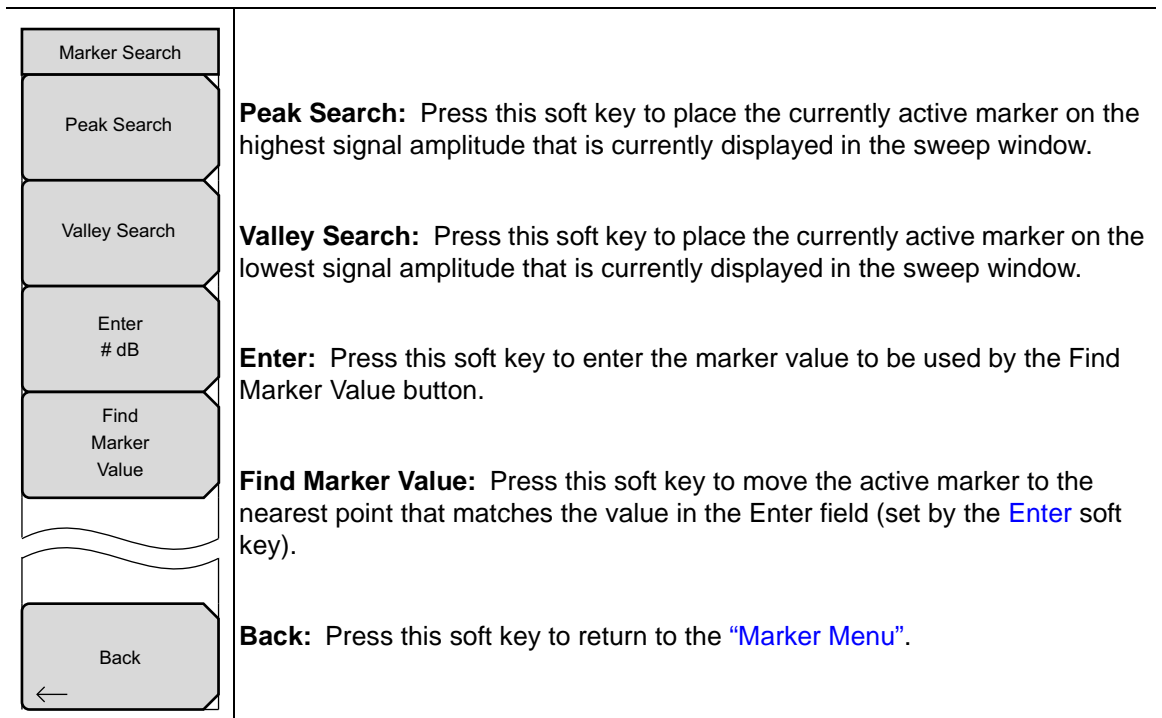

**Figure 6-40.** Marker Search Menu

## Readout Format Menu

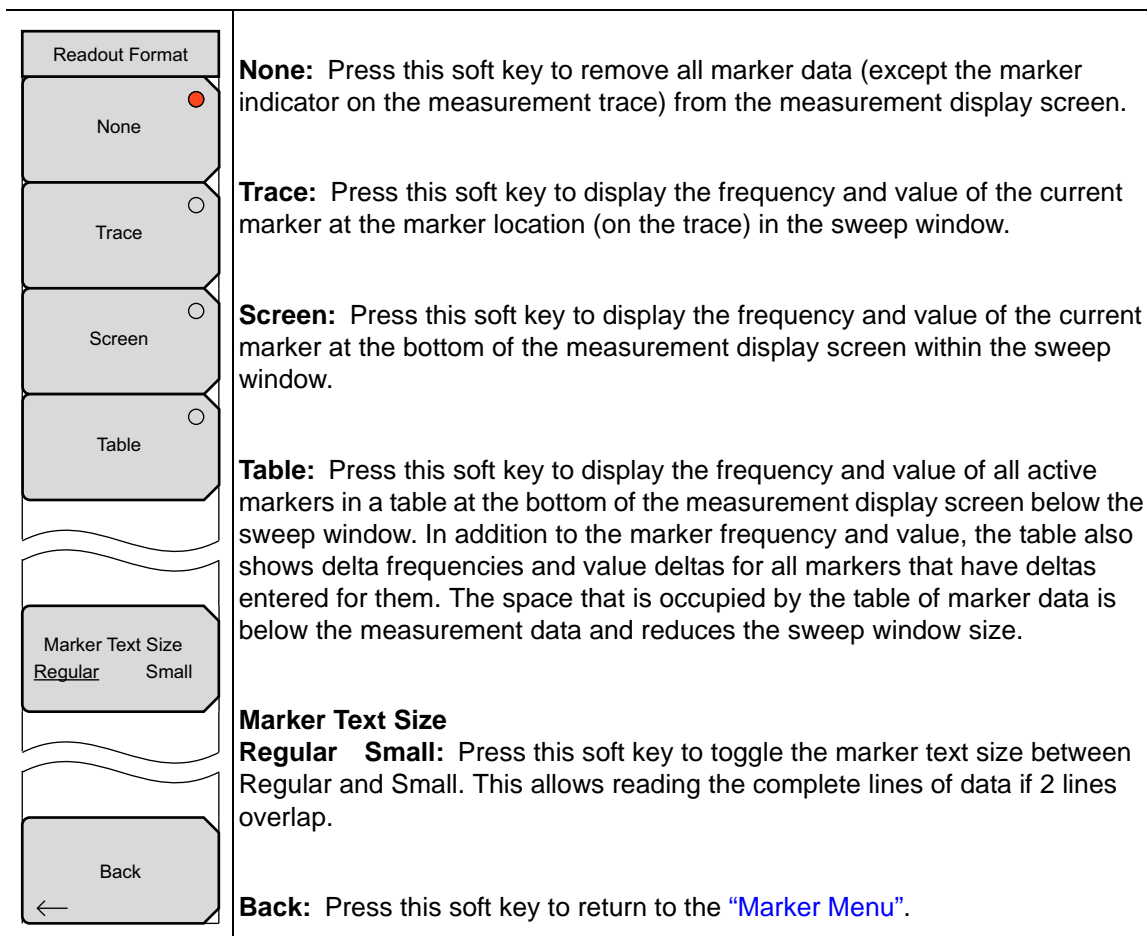

**Figure 6-41.** Readout Format Menu



## 6-8 Measurement Menus

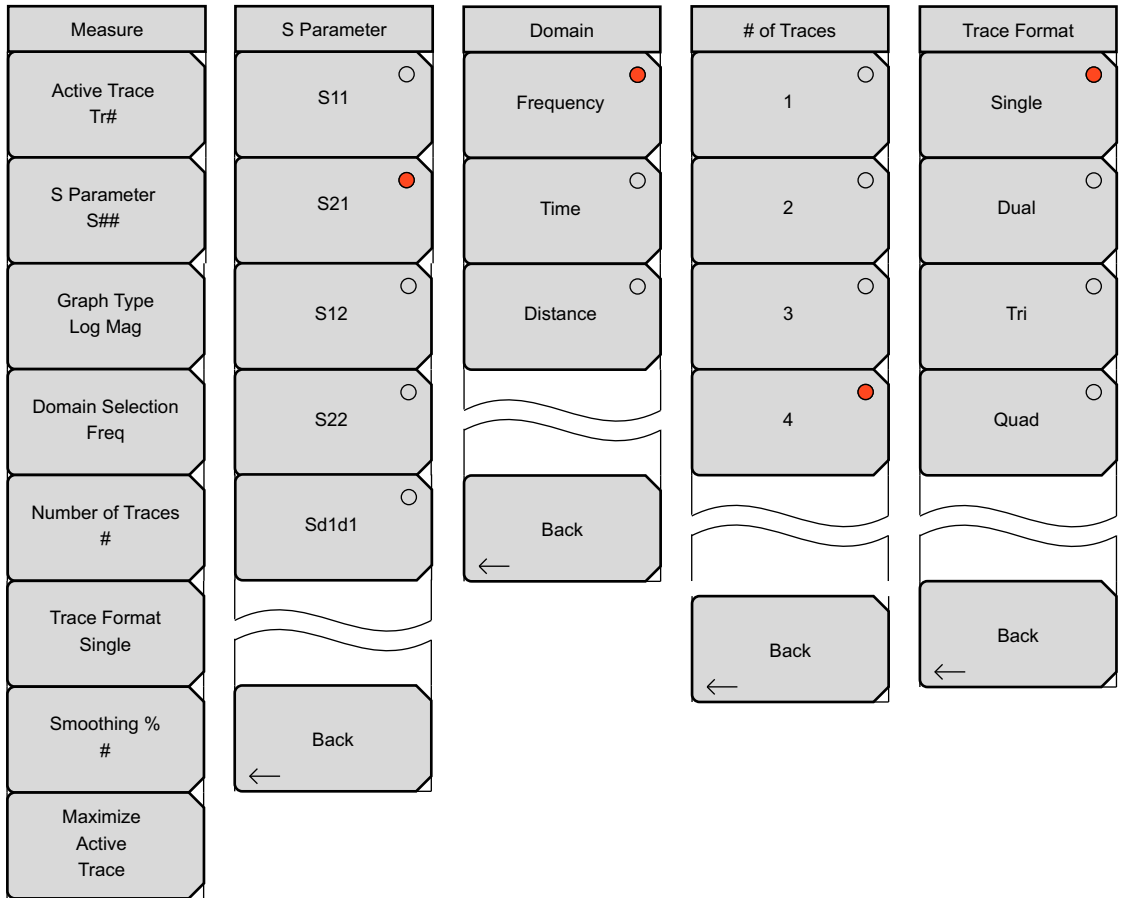

Figure 6-42. Measurement Menus Group

## Measure Menu

Measure	<b>Active Trace:</b> Press this soft key to open the “Active Trace Selector” List Box and choose a trace. Use the arrow keys or the rotary knob to scroll through the list. Press the rotary knob or the <b>Enter</b> key to select a trace. Press the <b>Esc</b> key to close the list box and return to the “Measure Menu” without changing the trace selection.
Active Trace Tr#	
S Parameter S##	<b>S-Parameter:</b> Press this soft key to open the “S-Parameter Menu” and select a measurement type. Refer to Section “S-Parameters” on page 4-1 for a description of the S-Parameter settings.
Graph Type Log Mag	<b>Graph Type:</b> Press this soft key to open the “Graph Type Selector” List Box and choose a graph (trace display) type. Examples of graph type are: Log Mag, Real, Imaginary, and Smith Chart.
Domain Selection Freq	<b>Domain Selection:</b> Press this soft key to open the “Domain Menu” and select Frequency, Time, or Distance as the measurement domain. Each trace can use a different domain.
Number of Traces #	<b>Number of Traces:</b> Press this soft key to open the “Number of Traces Menu” and select the number of traces (1, 2, 3, or 4) to be simultaneously displayed in the sweep window.
Trace Format Single	<b>Trace Format:</b> Press this soft key to open the “Trace Format Menu” and choose the screen format for trace display. The selected Trace Format is shown on the soft key face.
Smoothing % #	<b>Smoothing %:</b> Press this soft key to add a smoothing percentage from 0 (zero) to 20%. Use the arrow keys, the rotary knob, or the number keypad to input the value, and then press the rotary knob or the <b>Enter</b> key.
Maximize Active Trace	<b>Maximize Active Trace:</b> Press this soft key to toggle the display between the active trace at full size in the sweep window and the minimized trace. The Trace Format soft key continues to show the selected Trace Format on the soft key face, and this soft key label changes between Maximize and Minimize Active Trace.

**Figure 6-43.** Measure Menu

If no other feature is currently enabled, then the rotary knob and arrow keys can change the active trace selection.

### Note

If you apply smoothing when the sweep has more than 2000 points, the smoothing may slow the sweep time of the trace and the responsiveness of the VNA Master. This slowing can be significant, and it increases as the number of sweep points is increased.

Within the individual menus that are activated from the Measure menu, such as the S-Parameter menu, you can select a setting by pressing a soft key or by using the arrow keys or the rotary knob or a number key. Pressing number key 1 in the S-Parameter menu activates the first (top) soft key parameter ( $S_{11}$  for example), and pressing number key 4 activates the fourth soft key parameter ( $S_{22}$  for example). The Back soft key cannot be selected with the arrow keys, rotary knob, or number keys. Pressing a number key makes the selection and returns focus to the Measure menu. When using the arrow keys or the rotary knob, make your selection and then press the rotary knob or the **Enter** key.

## S-Parameter Menu

S Parameter	For a visual depiction of S-Parameter measurements, refer to <a href="#">Chapter 4</a> .
S <sub>11</sub>	<b>S<sub>11</sub></b> : Press this soft key to set the measurement to S <sub>11</sub> Forward Reflection (receive at Port 1, transmit from Port 1).
S <sub>21</sub>	<b>S<sub>21</sub></b> : Press this soft key to set the measurement to S <sub>21</sub> Forward Transmission (receive at Port 2, transmit from Port 1).
S <sub>12</sub>	<b>S<sub>12</sub></b> : Press this soft key to set the measurement to S <sub>12</sub> Reverse Transmission (receive at Port 1, transmit from Port 2).
S <sub>22</sub>	<b>S<sub>22</sub></b> : Press this soft key to set the measurement to S <sub>22</sub> Reverse Reflection (receive at Port 2, transmit from Port 2).
S <sub>d1d1</sub>	<b>S<sub>d1d1</sub></b> : This soft key appears in the S-Parameter menu only if Option 77 is enabled. Press this soft key to set the measurement to S <sub>d1d1</sub> (differential S <sub>11</sub> ). For more information about the S <sub>d1d1</sub> parameter, refer to <a href="#">Chapter 14, "Balanced Ports, Option 77"</a> .
Back	<b>Back</b> : Press this soft key to return to the <a href="#">"Measure Menu"</a> .

**Figure 6-44.** S-Parameter Menu

## Domain Menu

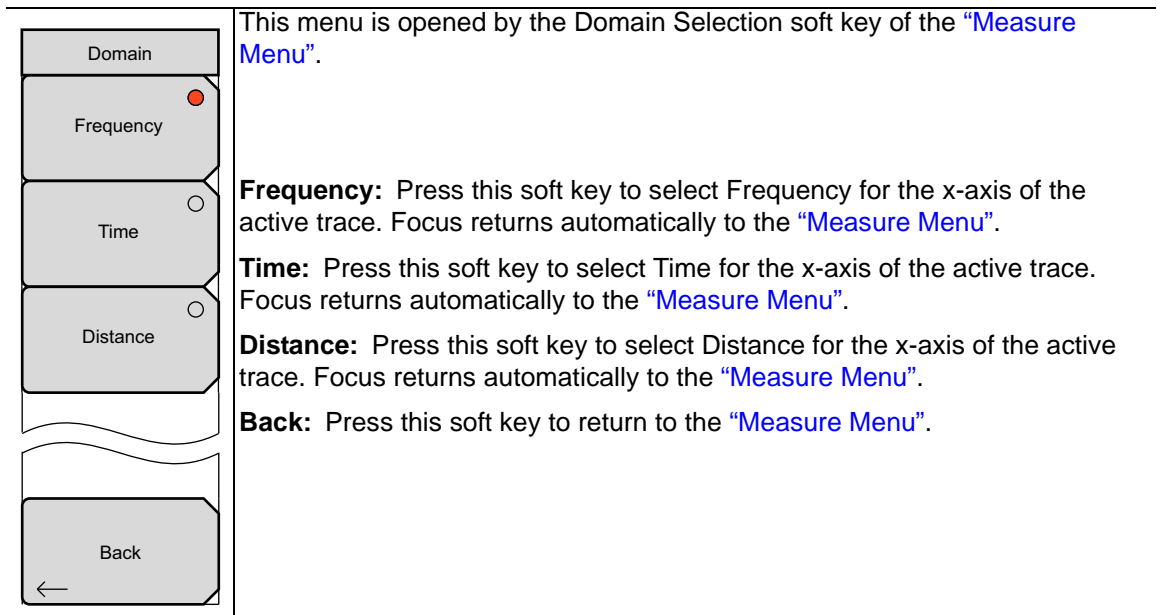

**Figure 6-45.** Domain Menu

## Number of Traces Menu

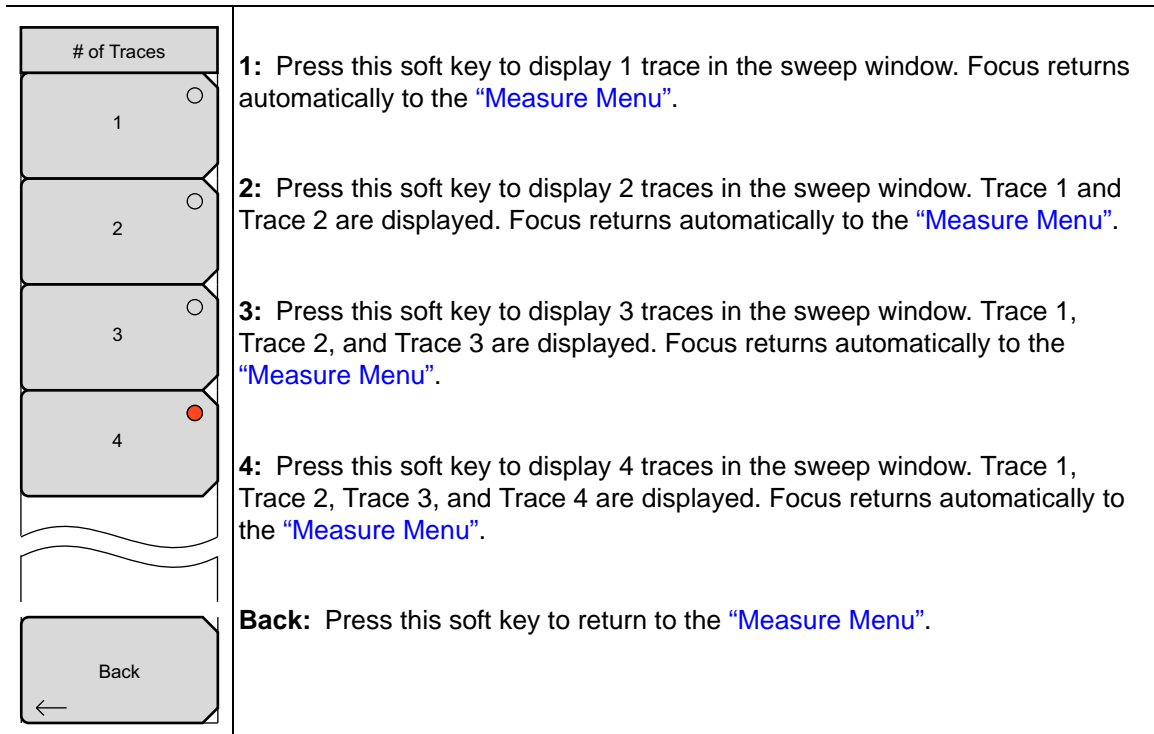

**Figure 6-46.** Number of Traces Menu

## Trace Format Menu

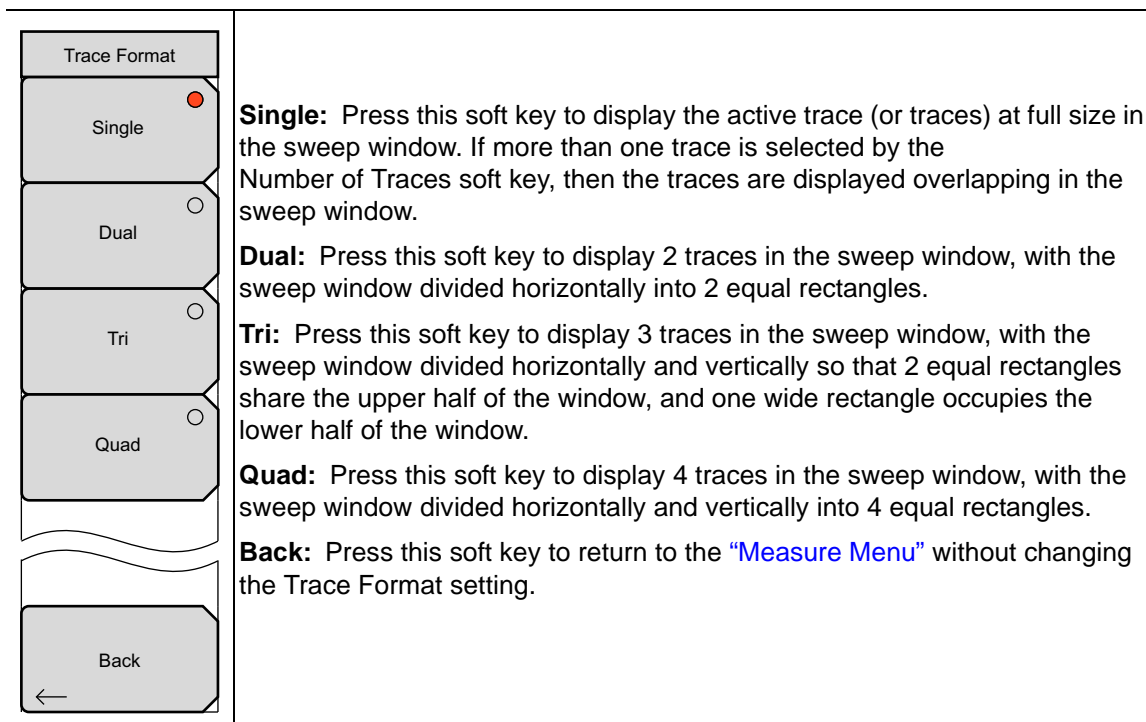

**Figure 6-47.** Trace Format Menu

Regardless of the Trace Format that is selected, the number of traces that are displayed is controlled by the Number of Traces soft key.

### Examples:

If 4 traces are displayed in Single Trace Format mode, then all 4 traces are displayed overlapping in the sweep window.

If 4 traces are displayed in Dual Trace Format mode, then traces 1 and 3 are displayed overlapping in the upper sweep window, and traces 2 and 4 are displayed overlapping in the lower sweep window.

If 4 traces are displayed in Tri Trace Format mode, then traces 1 and 2 are displayed individually in the upper half of the sweep window, and traces 3 and 4 are displayed overlapping in the lower sweep window.

If 4 traces are displayed in Quad Trace Format mode, then all 4 traces are displayed individually in the sweep window, each trace occupying one quarter of the sweep window.

If 1 trace is displayed in Dual, Tri, or Quad format, then that trace is displayed in the first section of the sweep window, and any other sections are blank.

## Sweep Menu

Sweep	
Run/Hold Run      Hold	<b>Run/Hold</b> <b>Run Hold:</b> Press this soft key to toggle the sweep to Run or Hold.
Sweep Type Single <u>Cont</u> Ext	<b>Sweep Type</b> <b>Single Cont Ext:</b> Press this soft key to toggle the sweep type to Single, Continuous, or External. Single sweep sets the VNA Master to make a single sweep and then wait for additional commands. The Continuous mode sweeps continuously. The External mode will set the sweep trigger to an external signal in a later software release.
Data Points ###	<b>Data Points:</b> Press this soft key to set the number of data points from 2 to 4001.
IFBW # Hz	<b>IFBW:</b> Press this soft key to open a list box and set the Intermediate Frequency bandwidth. The default is 10 kHz. Select 10 Hz for the maximum dynamic range, and select 100 kHz for the maximum speed.
Sweep Averaging #	<b>Sweep Averaging:</b> Press this soft key to set the number of sweeps to use for averaging. the minimum number is 1.
Configure Ports →	<b>Configure Ports:</b> Press this soft key to open the <a href="#">"Configure Ports Menu"</a> .

**Figure 6-48.** Sweep Menu

To access the Sweep Menu, press the **Sweep** function hard key or press the **Shift** key then the **Sweep** (3) key. All of the variables that affect the sweep can be found in this menu.



## Configure Ports Menu

Access to this menu is from the Configure Ports soft key in the “[Sweep Menu](#)”.

Configure Ports	
Auto Reference Plane Extension	<b>Auto Reference Plane Extension:</b> Press this soft key to use the active trace data to automatically determine the best length to mathematically extend the reference plane (plane of calibration) in order to remove cable length from the measurement, based on the current value of Propagation Velocity (refer to the description for the “ <a href="#">Propagation Velocity</a> ” soft key). The resultant display will “unwrap” phase displays to allow a better view of the phase properties of the DUT.
Port 1 Ref Plane Length # mm	<b>Port 1 Ref Plane Length:</b> Press this soft key to manually enter a distance to which the Reference Plane (Plane of Calibration) is extended. This action calculates and removes (from the measurement data) an appropriate amount of linear phase rotation based on Propagation Velocity and the distance that is entered here.
Port 2 Ref Plane Length # mm	<b>Port 2 Ref Plane Length:</b> Press this soft key to enter reference plane extension distance for Port 2.
DUT Line Type Coax      Waveguide	<b>DUT Line Type:</b> Press this soft key to toggle the line type to coaxial cable or to waveguide.
Propagation Velocity #	<b>Propagation Velocity:</b> This value is used by the Reference Plane Extension functions. Press this soft key to enter the propagation velocity of electrical signals in the length of cable that is being removed by the Reference Plane Extension calculations. Values are expressed as a decimal ratio compared to the speed of light in a vacuum (examples: 1 = speed of light, and 0.5 = 1/2 the speed of light).
Bias Tee Setup →	<b>Bias Tee Setup:</b> Press this soft key to open the “ <a href="#">Bias Tee Setup Menu</a> ”.
Source Power High	<b>Source Power:</b> Press this soft key to open the “ <a href="#">Source Power Menu</a> ”.
Back ←	<b>Back:</b> Press this soft key to return to the “ <a href="#">Sweep Menu</a> ”.

**Figure 6-49.** Configure Ports Menu

## Bias Tee Setup Menu

Access to this menu is from the Bias Tee Setup soft key in the “Configure Ports Menu”.

Bias Tee Setup	<b>Bias Tee:</b> Press this soft key to open the “Bias Tee Menu” to select External, Internal, or Off.
Bias Tee Off	<b>Int Port Selection</b> <b>1 2:</b> Press this soft key to toggle the internal port selection to Port 1 or Port 2.
Int Port Selection 1      2	<b>Int voltage P1:</b> Press this soft key to set the internal bias tee voltage that is directed onto the center conductor of port 1. The available range is from 12.0 V to 32.0 V in increments of 0.1 V. Use the arrow keys, the rotary knob, or the number keypad to change the setting. When using the number keypad, press the soft key for voltage units (V), or press the <b>Enter</b> key. Press the <b>Esc</b> key to exit without changing the setting.
Int Voltage P1 ##.# V	<b>Int Current Limit P1:</b> Press this soft key to set the internal bias tee current limit for the voltage that is set at Port 1. The available range is from 0 mA to 450 mA in steps of 1 mA. This current limit sets the trip point for the bias tee for this port. When using the number keypad, the soft key menu displays 2 choices for units: A or mA. Use the arrow keys, the rotary knob, or the number keypad to change the setting. When using the number keypad, press the soft key for current units (A or mA), or press the <b>Enter</b> key to use mA. Press the <b>Esc</b> key to exit without changing the setting.
Int Current Limit P1 ## mA	<b>Int voltage P2:</b> Press this soft key to set the internal bias tee voltage that is directed onto the center conductor of Port 2. The available range is from 12.0 V to 32.0 V in increments of 0.1 . Use the arrow keys, the rotary knob, or the number keypad to change the setting. When using the number keypad, press the soft key for voltage units (V), or press the <b>Enter</b> key. Press the <b>Esc</b> key to exit without changing the setting.
Int Voltage P2 ##.# V	<b>Int Current Limit P2:</b> Press this soft key to set the internal bias tee current limit for the voltage that is set at Port 2. The available range is from 0 mA to 450 mA in steps of 1 mA. This current limit sets the trip point for the bias tee for this port. When using the number keypad, the soft key menu displays 2 choices for units: A or mA. Use the arrow keys, the rotary knob, or the number keypad to change the setting. When using the number keypad, press the soft key for current units (A or mA), or press the <b>Enter</b> key to use mA. Press the <b>Esc</b> key to exit without changing the setting.
Int Current Limit P2 ## mA	<b>Back:</b> Press this soft key to return to the Configure Ports menu.
Back ←	

**Figure 6-50.** Bias Tee Setup Menu

## Bias Tee Menu

Access to this menu is from the Bias Tee soft key in the [“Bias Tee Setup Menu”](#).

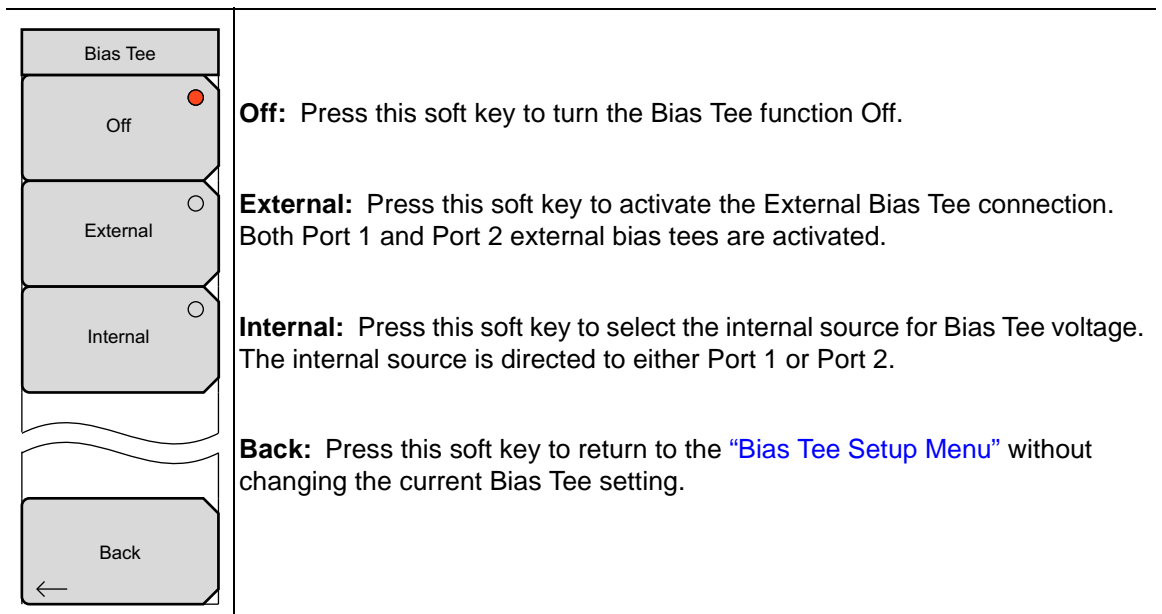

**Figure 6-51.** Bias Tee Menu

## Source Power Menu

Access to this menu is from the Source Power soft key in the [“Configure Ports Menu”](#).

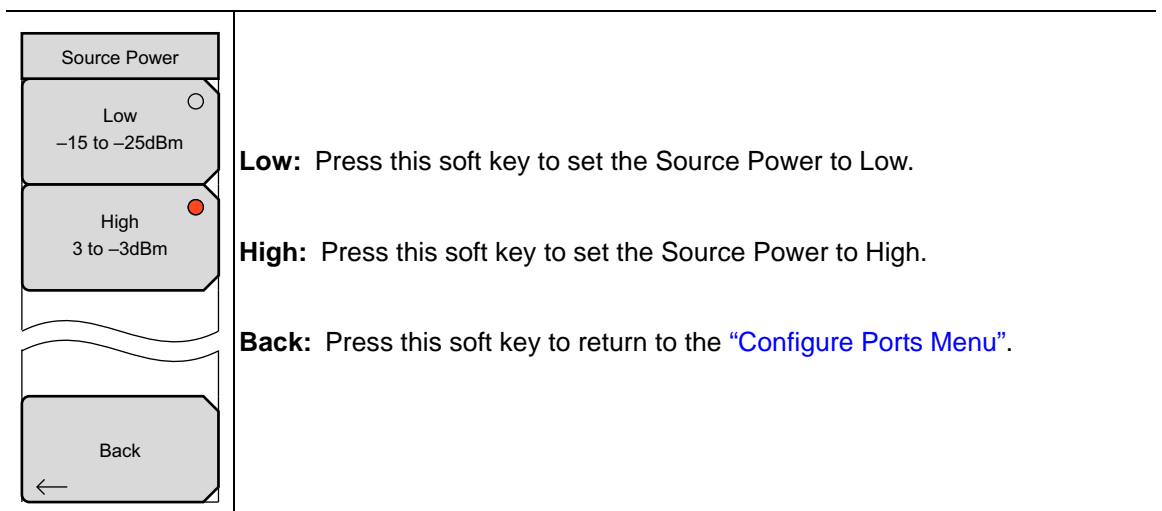

**Figure 6-52.** Source Power Menu

## Preset Menu

Preset	<p><b>Preset:</b> Press this soft key to preset sweep conditions to the default state of full band sweep, 201 data points, Quad display, 4 traces (<math>S_{11}</math> Smith, <math>S_{21}</math> Log Mag, <math>S_{12}</math> Log Mag, <math>S_{22}</math> Smith), 10 kHz IFBW, <math>S_{21}</math> Log Mag display, High output power, continuous sweep. This also turns off markers, limits, and calibration.</p>
Preset	<p><b>Save:</b> Press this soft key to open a dialog box to name and save the current operating settings, allowing them to be recalled later in order to return the instrument to the state it was in at the time that the setup was saved.</p>
Save	<p><b>Caution:</b> Use the Change File Type soft key (in the <a href="#">“Save (Text Entry) Menu”</a>, as shown on page 6-25) to set the file type to “Setup (with CAL)”, if it is currently set to another file type. Also refer to the <a href="#">“Select File Type List Box”</a> on page 6-26.</p>
Recall	<p>The saved setup is named by entering text as described in section <a href="#">“Text Entry”</a> on page 2-13. Use the <b>Shift</b> key to select an upper case letter. Use the <b>Left/Right</b> directional arrows to move the cursor position. Press <b>Enter</b> to save the setup.</p>
	<p><b>Recall</b> Press this soft key to open a selection box that allows selection and recall of a previously stored instrument setup. The <a href="#">“Recall Menu”</a> on page 6-31 also opens. Use the Recall menu soft keys to work within the selection box. All current instrument settings are replaced by the stored setup information. Press the <b>Esc</b> key to cancel the recall.</p>

**Figure 6-53.** Preset Menu

To access the Preset Menu, press the **Shift** key, then the **Preset** (1) key. The Preset menu is used to preset the VNA Master.

## 6-9 Scale Menu

Scale	<p><b>Resolution Per Div:</b> Press this soft key to set the number of units that are displayed between horizontal graticules. Units depend upon frequency, time, and distance settings. Use the <b>Up/Down</b> arrow keys, the keypad, or the rotary knob to set this parameter, then press the <b>Enter</b> key or the rotary knob.</p>
Resolution Per Div #	<p><b>Reference Value:</b> Press this soft key to set the value of the Reference Line. Use the <b>Up/Down</b> arrow keys, the keypad, or the rotary knob to set this parameter, then press the <b>Enter</b> key or the rotary knob.</p>
Reference Value #	<p><b>Reference Line:</b> Press this soft key to set which horizontal graph graticule is at the reference value. The reference line is indicated by a small colored triangle along the right edge of the graph. Use the <b>Up/Down</b> arrow keys, the keypad, or the rotary knob to set this parameter, then press the <b>Enter</b> key or the rotary knob.</p>
Reference Line #	<p><b>Aperture (Group Delay measurements only):</b> Press this soft key to set the aperture from 2% to 20% of the display. This soft key appears only when Group Delay has been selected in the measurement menu. Group delay is a measurement of “Change in phase / change in frequency.” The aperture setting is used by the VNA Master to determine how large a change in frequency to use in this calculation.</p>
Aperture % #	<p>Use the <b>Up/Down</b> arrow keys, the keypad, or the rotary knob to set this parameter. When using the keypad to enter a value, an Enter soft key appears in the active function block. The value can be set by pressing this soft key, the <b>Enter</b> key, or the rotary knob. Press the <b>Esc</b> key to exit without changing the aperture.</p>
Active Trace Tr#	<p><b>Active Trace:</b> Press this soft key to open the Active Trace Selector List Box and choose a trace.</p>
Autoscale	<p><b>Autoscale:</b> Press the Autoscale soft key to automatically adjust the Resolution Per Div and Reference Value so that the trace for the current measurement is shown in the middle of the display.</p>

**Figure 6-54.** Scale Menu

Press the **Scale** function key to access the Scale menu. The Scale menu is used to set the measurement display for optimum viewing.

## Smith Scale Menu

Smith Scale	
Normal <span style="float: right;">●</span>	<b>Normal:</b> Press this soft key to display the normal Smith Chart.
Expand 10dB <span style="float: right;">○</span>	<b>Expand 10 dB:</b> Press this soft key to display the Smith Chart expanded by 10 dB.
Expand 20dB <span style="float: right;">○</span>	<b>Expand 20 dB:</b> Press this soft key to display the Smith Chart expanded by 20 dB.
Expand 30dB <span style="float: right;">○</span>	<b>Expand 30 dB:</b> Press this soft key to display the Smith Chart expanded by 30 dB.
Compress 3dB <span style="float: right;">○</span>	<b>Compress 3 dB:</b> Press this soft key to display the Smith Chart compressed by 3 dB.
Reference Impedance 50 ohm    75 ohm	<b>Reference Impedance</b> <b>50 ohm 75 ohm:</b> Press this soft key to toggle the reference impedance to 50 ohms or 75 ohms.
Active Trace Tr#	<b>Active Trace:</b> Press this soft key to open the “Active Trace Selector” List Box and choose a trace.

**Figure 6-55.** Smith Scale Menu

## 6-10 System Menus

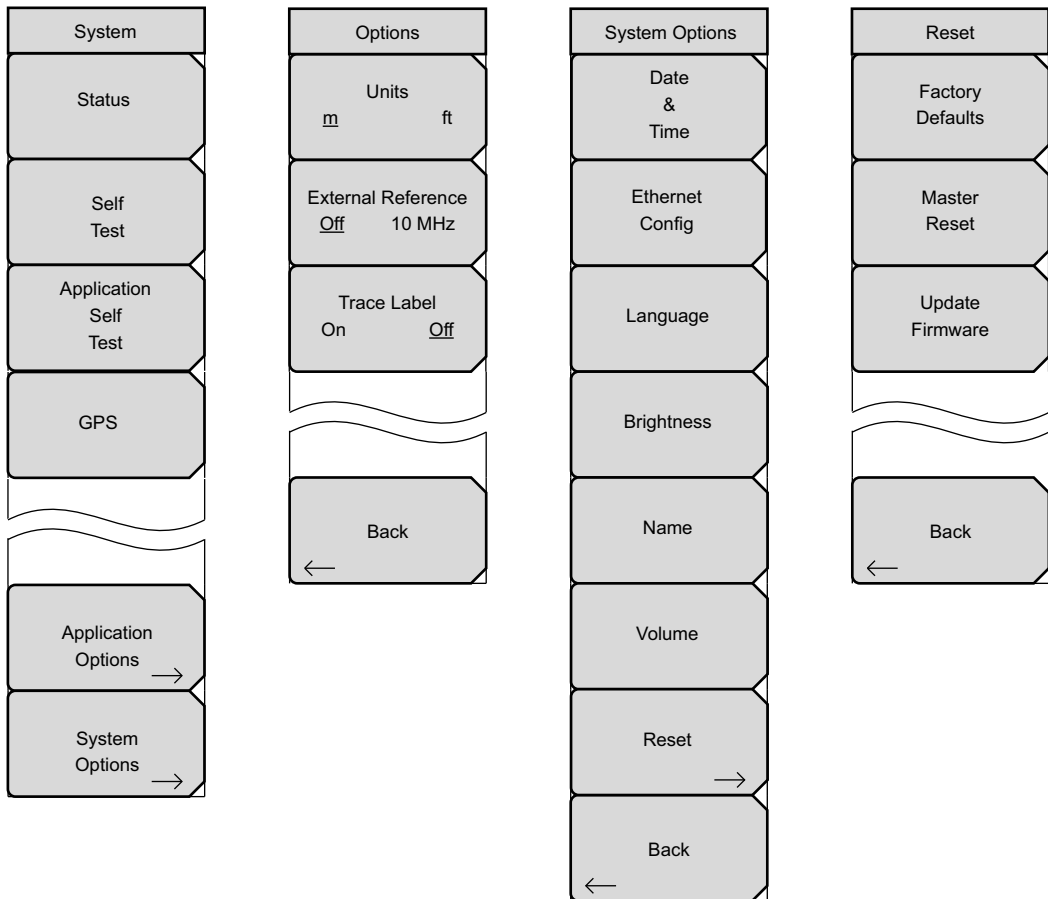

**Figure 6-56.** System Menu Group

To access the System Menu, press the **Shift** key, then the **System** (8) key. The System menu is used to interact with the system attributes of the VNA Master. Self Test, GPS, Application Options, and System Options can be found in this menu.

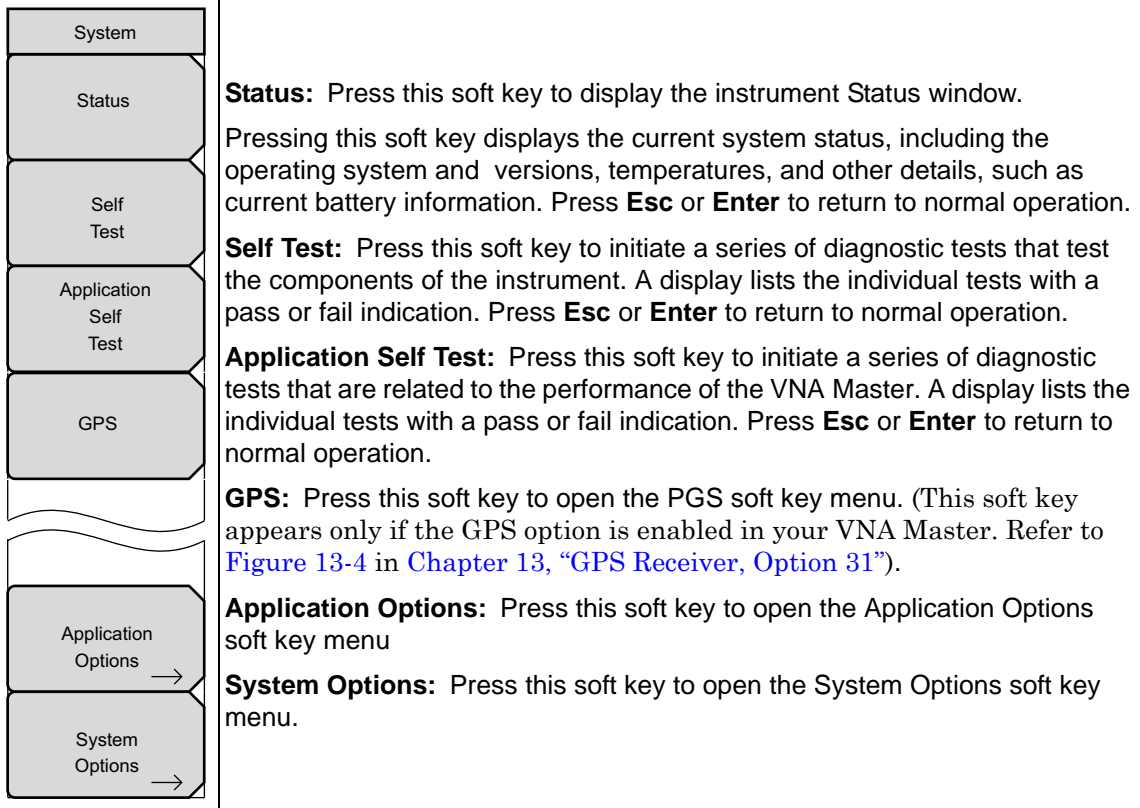

## System Menu



**Figure 6-57.** System Menu

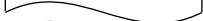
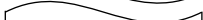

## Application Options

Options	
Units <u>m</u> ft	<b>Units</b> <b>m ft:</b> Press this soft key to toggle the measurement units between meters and feet.
External Reference <u>Off</u> 10 MHz	<b>External Reference</b> <b>Off 10 MHz:</b> Press this soft key to toggle between turning Off the external reference or selecting the external reference.
Trace Label On <u>Off</u>	<b>Trace Label</b> <b>On Off:</b> Press this soft key to toggle the trace label On and Off. When On, a label is shown next to each trace (TR1 next to Trace 1, and so forth).
	
	
Back 	<b>Back:</b> Press this soft key to return to the System soft key menu.

**Figure 6-58.** Application Options Menu

## System Options

System Options	<p><b>Date &amp; Time:</b> Press this soft key to display a dialog box for setting the current date and time. Use the keypad, the arrows, or the rotary knob to set the date and time.</p>
Date & Time	<p><b>Ethernet Config:</b> Press this soft key to display a dialog box to set the IP address of the instrument. Use the Manual/DHCP soft key to select whether the address will be entered manually or supplied automatically by a network DHCP server. If manual is selected, then use the soft keys or the arrow keys to select the field to be modified. For more information on LAN connections and DHCP, refer to “LAN Connection” on page 2-12 in Chapter 2, “Quick Start Guide”.</p>
Ethernet Config	<p><b>Language:</b> Press this soft key to selection from a list of built-in languages. Use the rotary knob or <b>Up/Down</b> arrow keys to highlight a selection and press <b>Enter</b> to select. The languages that are currently available are: English, French, German, Spanish, Japanese, Chinese, Korean, and Italian. In addition, two custom languages may be selected if they have been defined in the Master Software Tools Software Language Editor and have been loaded into the unit. For more information about creating custom defined languages, refer to the Master Software Tools user guide.</p>
Language	<p><b>Brightness:</b> The brightness of the display can be adjusted to optimize viewing under a variety of lighting conditions. Use the keypad, the <b>Up/Down</b> arrow keys, or the rotary knob to select a brightness level from 1 through 9 and press <b>Enter</b> to select.</p>
Brightness	<p><b>Name:</b> The VNA Master can be named by using the keypad to select numbers, the rotary knob to highlight a number or character (pressing the knob to select), or by pressing the soft key for each letter. Use the <b>Shift</b> key to select an upper case letter. Use the <b>Left/ Right</b> directional arrows to move the cursor position. Press <b>Enter</b> to save the name.</p>
Name	<p><b>Volume:</b> Press this soft key to open a dialog box to change the speaker volume of the unit. Use the keypad, the <b>Up/Down</b> arrow keys, or the rotary knob to select a volume level from 0 through 90 and press <b>Enter</b> to select.</p>
Volume	<p><b>Reset:</b> Press this soft key to open the Reset soft key menu.</p>
Reset	<p><b>Center Freq Share All Modes Not Shared:</b> This soft key is not used by the VNA Master.</p>
Center Freq Share All Modes Not Shared	

**Figure 6-59.** System Options Menu

## Reset Menu

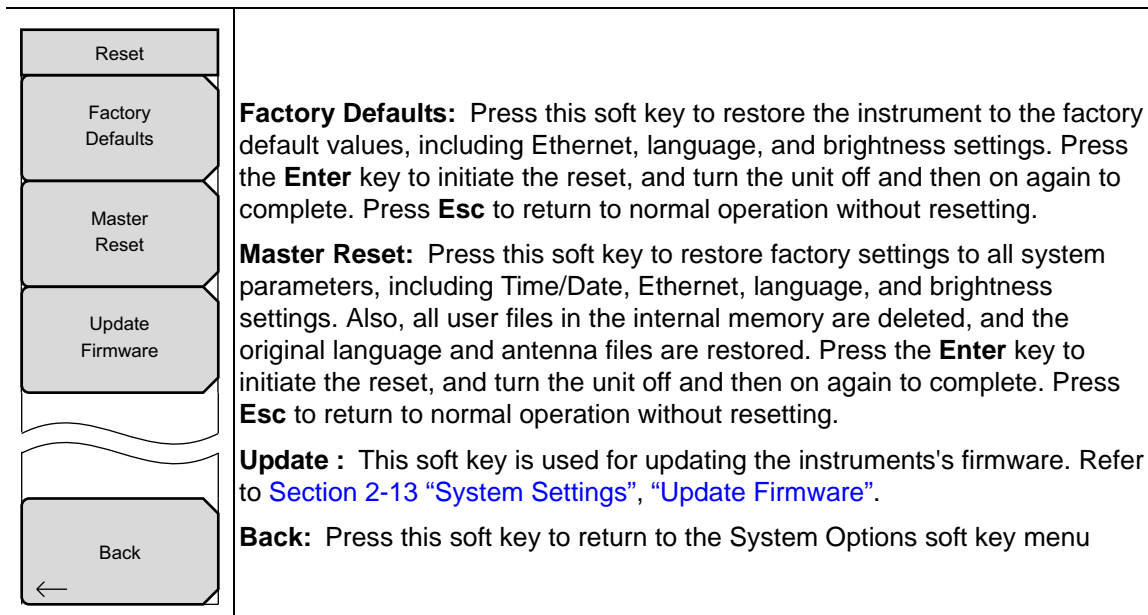

**Figure 6-60.** Reset Menu

## Trace Menu

To access the Trace Menu, press the **Shift** key, then the **Trace** (5) key.

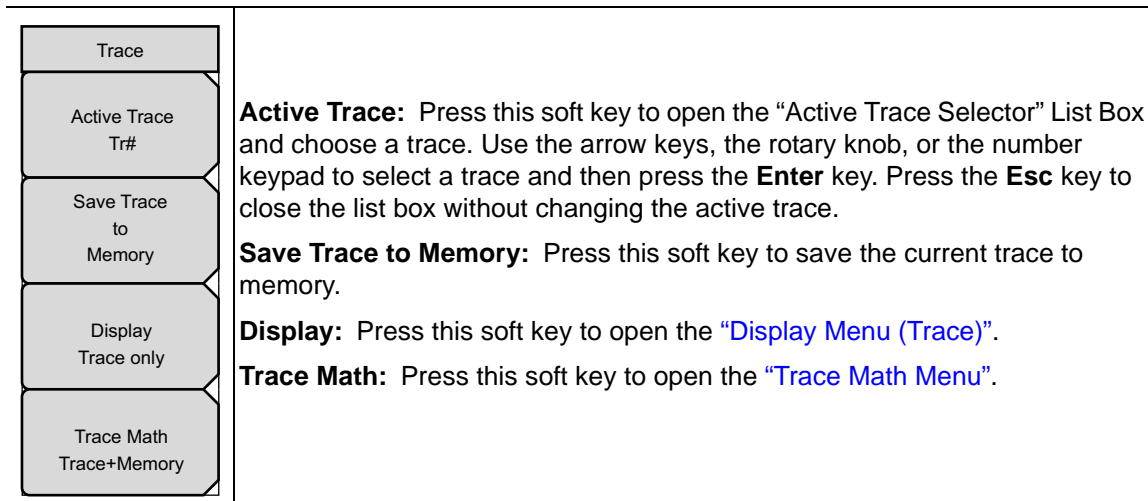

**Figure 6-61.** Trace Menu

## Display Menu (Trace)

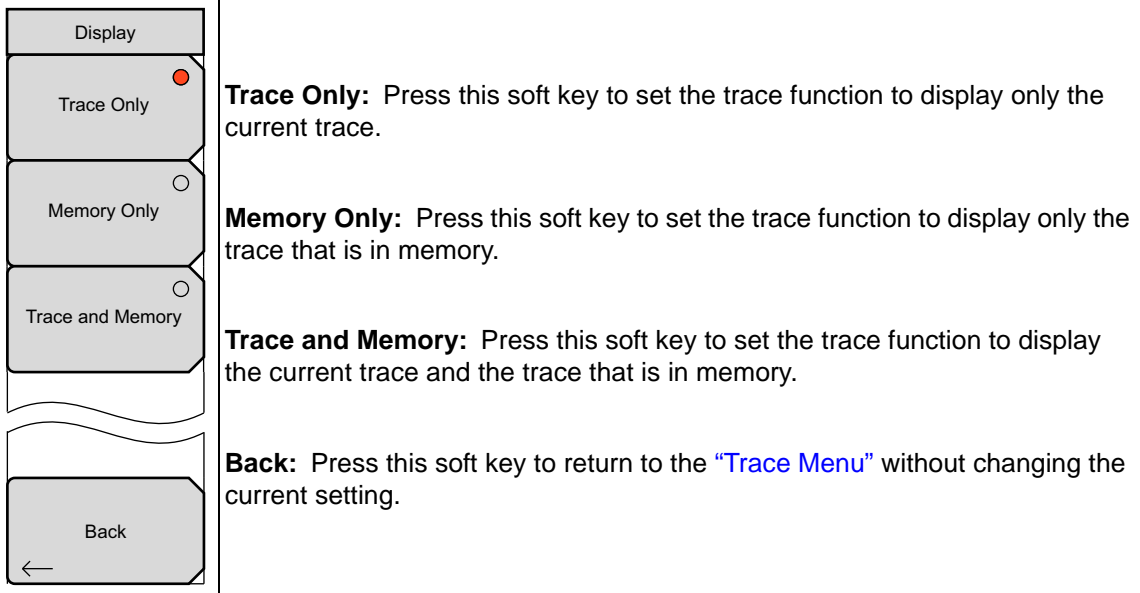

**Figure 6-62.** Display Menu

## Trace Math Menu

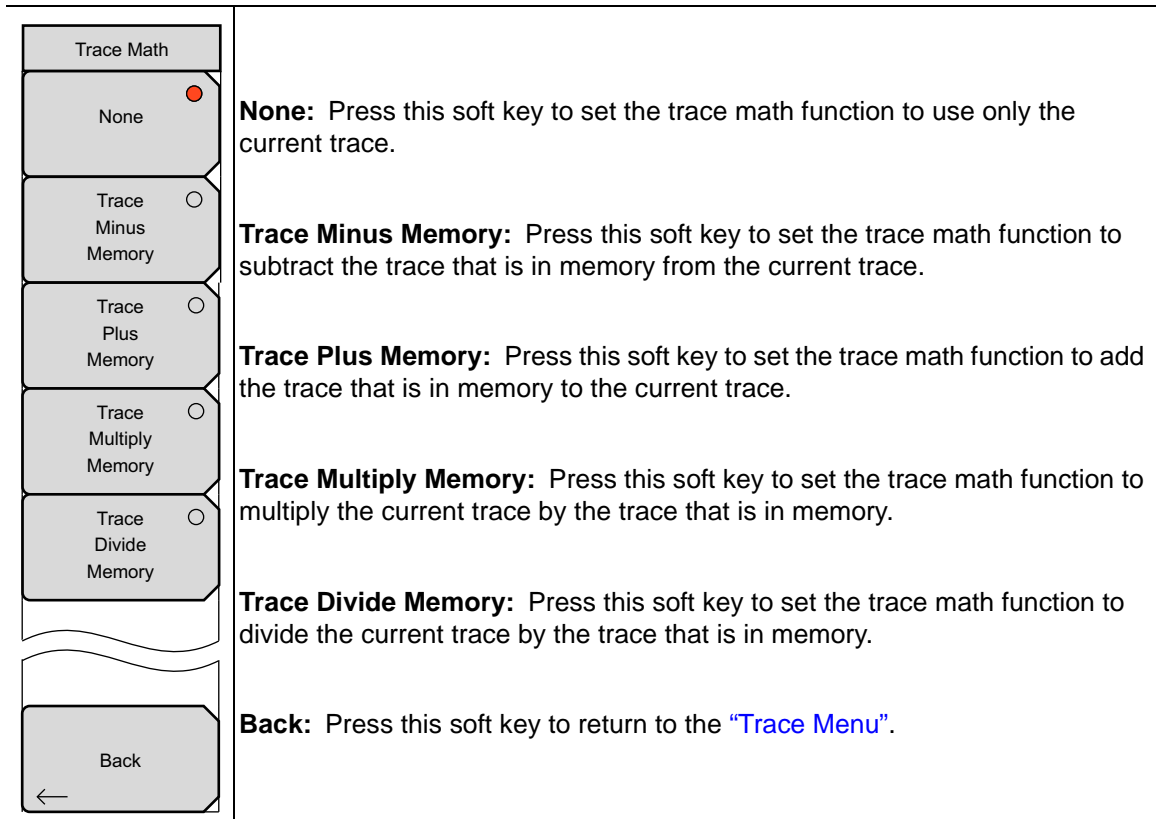

**Figure 6-63.** Trace Math Menu



# Chapter 7 — Time Domain, Option 2

## 7-1 Introduction

This chapter describes the optional Time Domain feature in the MS202xB VNA Master. General descriptions, key concepts, and examples are presented for time and distance measurements for both coaxial and waveguide media.

The function hard keys in Vector Network Analyzer mode with Option 2 are:

**Freq/Time/Dist, Scale, Sweep, Measure, Marker**

## 7-2 Time Domain Measurements

The Option 2 Time Domain feature provides the ability to transform the native frequency domain data (that is measured by the VNA Master) into time domain or distance domain information to help in determining the location of impedance discontinuities. Some typical applications are: distance-to-fault (DTF) in cables and waveguides, characterizing antennas, isolating and analyzing a desired response in a one-port or two-port network, and identifying and analyzing circuit elements.

The relationship between the frequency-domain response and the time-domain response of a network is described mathematically by the Fourier transform. The MS202xB VNA Master makes measurements in the frequency domain, then transforms that data into its time-domain response, which can be displayed as a function of time or distance. This computational technique benefits from the wide dynamic range of the VNA Master (and its measurement data) and from the error correction of the frequency-domain data.

The transformation technique that is used by the VNA Master (in most cases) is the chirp-Z transform of the available frequency domain data for that parameter. Because the transform simply treats the frequency domain values as input data, any S-parameter can be transformed (including differential S-parameters). The chirp-Z transform is (in a macro sense) very similar to the Fast Fourier Transform with the exception that the output range can be variable. This permits you to zoom in on a specific time (distance) range of interest for the data display. A different algorithm is used with the waveguide dispersive media, where the time-frequency relationship is more complex, but the functionality remains the same.

Two of the fundamental properties of time-domain conversion are resolution and maximum (alias-free) range. Resolution is the ability to resolve one discontinuity from another. Resolution is limited by the frequency span of the measurement. Maximum range defines how far you can see discontinuities on the media you are measuring. Beyond the maximum range, the data just repeats itself, and you start seeing the same discontinuities from closer ranges. The maximum range is determined by the frequency step size.

For more details about time domain fundamentals, refer to the following application notes:

- [Reflectometer Measurements — Revisited](#)  
- Anritsu Application Note 11410-00214
- [Time Domain Measurements Using Vector Network Analyzers](#)  
- Anritsu Application Note 11410-00206
- [Distance to Fault](#)  
- Anritsu Application Note 11410-00373

## 7-3 VNA Master Implementation

The Time Domain implementation in the VNA Master is trace based, which makes it very flexible to use. Each of the four traces in the VNA Master can be configured independently and can be in the frequency, time, or distance domain. Each trace can also be configured to represent any of the S-parameters. The VNA Master (as an example) can simultaneously view  $S_{11}$  in the frequency, distance, and time domains using three traces. Alternatively, you can view all four of the S-parameters in the distance domain or the time domain or both. This flexibility could be useful when tuning complex filters or analyzing long cable problems with multiple discontinuities.

### One Way versus Round Trip

With the ability to transform any S-parameter, one question that arises is whether the time or distance that is plotted represents a one-way or a round-trip propagation. The one-way propagation represents the transmission (or 2-port) measurement, in which the signal is transmitted from one port, propagates through the device under test, and is received on the second port. One-way propagation occurs when transforming  $S_{21}$  or  $S_{12}$ .

The round trip propagation represents a reflection (1-port) measurement, in which the signal is transmitted from one port, propagates through the device under test, fully reflects at the end of the device, and is received back at the same port. One-way propagation occurs when transforming  $S_{11}$  or  $S_{22}$ .

The VNA Master handles the two cases of one-way and round-trip propagation differently in the time and distance domains. In the time domain, the VNA Master plots the response against the actual time the signal travels from the transmission port to the receiving port, without accounting for whether the measurement is transmission (2-port) or reflection (1-port). In the distance domain, however, the VNA Master compensates for the round trip propagation by showing the actual length of the device under test (essentially dividing the distance by 2 for the reflection measurements).

For example, look at the results of measuring a cable that is 3.05 meters (10 ft) long. For a transmission measurement, approximately 14.4 ns are taken by a signal when traveling from one end of the cable to the other end of the cable. For a reflection measurement, the time is twice as long, or approximately 29 ns are taken by a signal when traveling from one end of the cable, reflecting from the far end, and returning. [Figure 7-1](#) shows a measured time domain response of a cable of this length for both reflection ( $S_{11}$ ) and transmission ( $S_{21}$ ). The top trace is the  $S_{11}$  plot showing the reflections from both ends of the cable (MK1 at the near end and MK2 at the far end). You can see that the far end peak at MK2 is at approximately 29 ns. Looking at the bottom trace, you can see that the peak at MK3 (which represents the signal received at the end of the cable) is at approximately 14.4 ns.



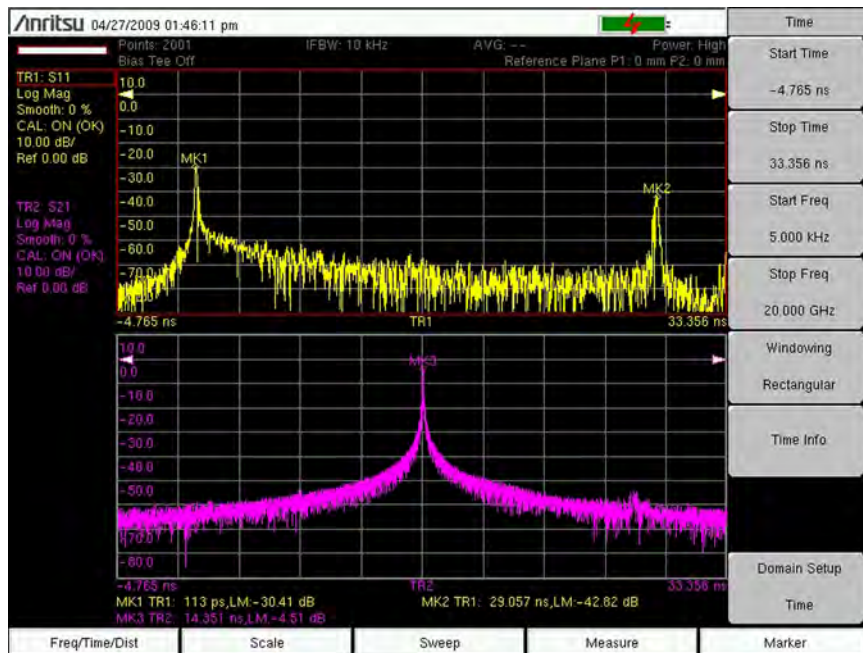

**Figure 7-1.** Time Domain Measurements of a 3.05 m Cable Showing  $S_{11}$  and  $S_{21}$

Take a look at what happens in the distance domain for the same cable. As a user, you want the reflection and transmission measurements to show you where the end of the cable is located. [Figure 7-2](#) shows a measured distance domain response of this cable for both reflection ( $S_{11}$ ) and transmission ( $S_{21}$ ). The top trace is the  $S_{11}$  plot showing the reflections from both ends of the cable (MK1 at the near end and MK2 at the far end). The bottom trace shows the transmission  $S_{21}$  measurement with the peak representing the signal received at the end of the cable (MK3). Looking at the signal at MK2 and MK3, you can see that the reflection and transmission measurements produced the same result for the length of the cable. The VNA Master compensated for the round-trip condition in the  $S_{11}$  measurement so that the distance information matches the physical length of the cable, just as it does in the  $S_{21}$  measurement.

**Caution**

The measured cable had a propagation velocity of 70%, which was entered into the VNA Master. Measurements in the distance domain use the entered propagation velocity value to calculate the actual physical length of cables. If the default value of 100% were used, then the measured cable length would be wrong (4.4 meters in the above example). Time domain measurements are not dependent on the propagation velocity values.

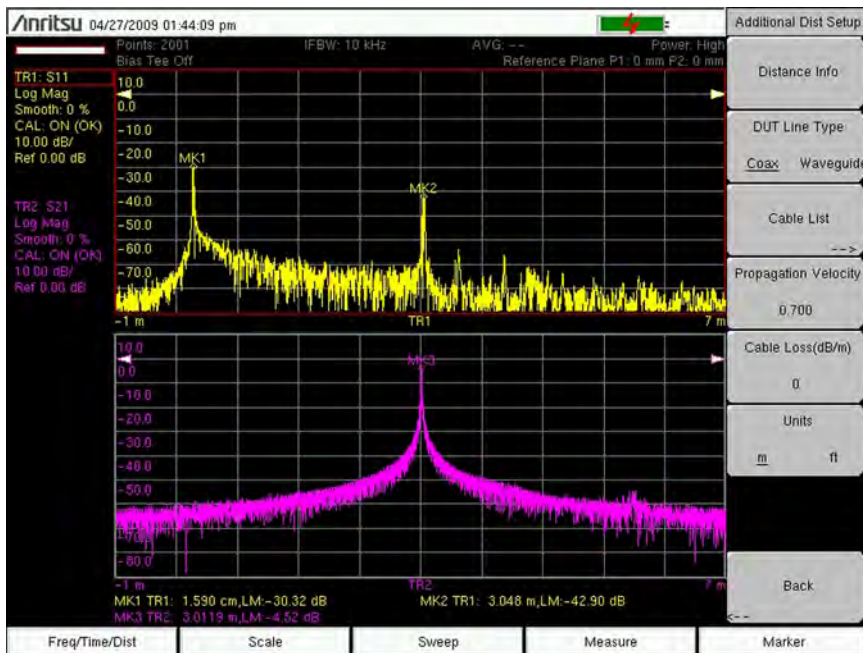

Figure 7-2. Distance Domain Measurements of a 3.05 m Cable Showing  $S_{11}$  and  $S_{21}$

## Waveguide Dispersion Compensation

Waveguide media suffers from frequency dispersion, which basically means that signals at different frequencies that are launched at the same time into a waveguide will arrive at different times at the output of that waveguide. This phenomenon is not evident when looking at the frequency response of the waveguide. When looking at the time or distance response, however, you will see the effect of this dispersion. The VNA Master uses a special frequency-to-time conversion technique to compensate for this dispersion in waveguide media. This compensation is applied only in the distance domain.

Figure 7-3 shows the reflection response ( $S_{11}$ ) from a 15 cm long WG18 waveguide. The distance response shows a sharp peak at 15 cm, as expected. The time domain response shows a spread-out peak at approximately 1.33 ns, which is the equivalent of 40 cm. Ideally, the  $S_{11}$  time domain response should be equivalent to twice the distance, or 30 cm (due to the round trip compensation in distance). Because of the dispersion, however, the time domain response is spread out and inaccurate. The distance domain response, which has dispersion compensation, produces the correct response.

Similarly, the effect of the dispersion compensation can be seen in the transmission response ( $S_{21}$ ) of the same waveguide, as shown in Figure 7-4. Note how the distance response is sharp and centered at 15 cm, whereas the time response is spread out and inaccurate.

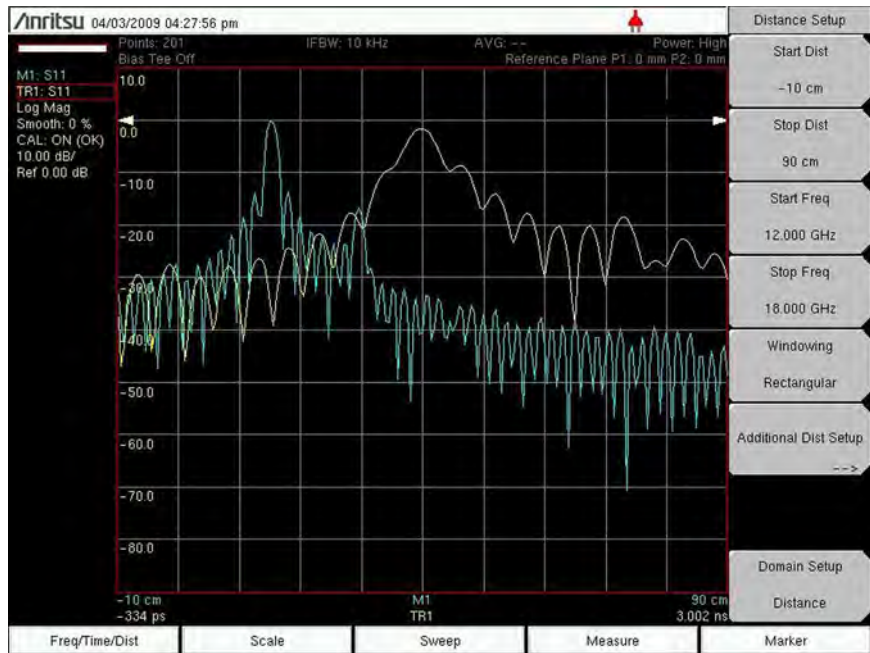

Figure 7-3.  $S_{11}$  Measurement of 15 cm Long Waveguide Showing Dispersion Compensation

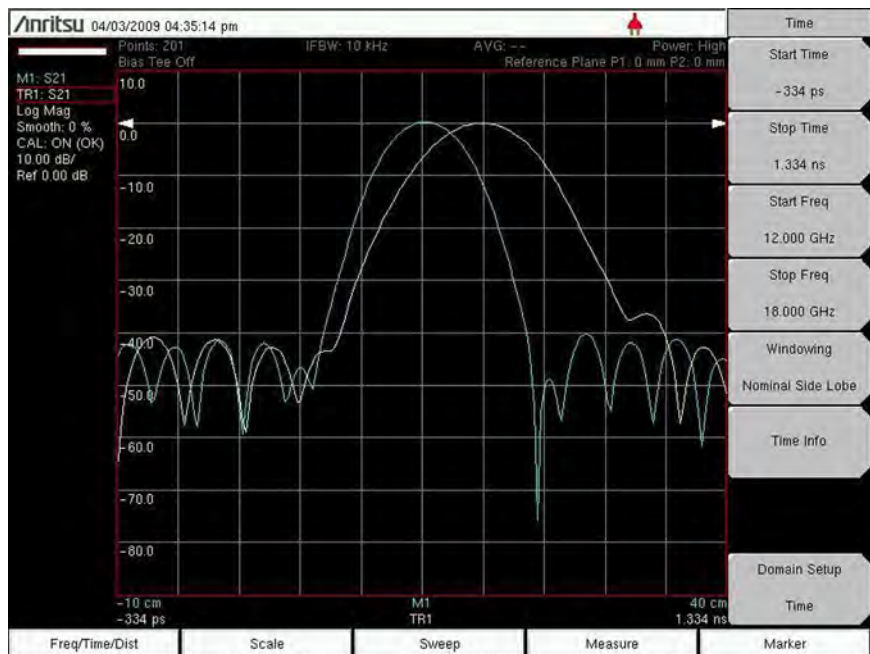

Figure 7-4.  $S_{21}$  Measurement of 15 cm Long Waveguide Showing Dispersion Compensation

**Note**

In both examples of these examples (round-trip compensation for reflection measurements and dispersion compensation for waveguide), the VNA Master **does not alter** the time domain measurement (this provides a pure unmodified measurement for sophisticated users). This is consistent with display selections on equivalent bench-top instruments. In the distance domain, the VNA Master performs both compensations to provide the user with more practical and easy-to-interpret results.

## 7-4 Windowing

Windowing is a frequency filter that is applied to the frequency-domain data when it is converted to time-domain data. This filtering rolls off the abrupt transition that occurs at the start and stop frequencies. This effectively produces a time-domain response with lower sidelobes. Windowing allows a limited degree of control over the pulse shape, trading ringing (sidelobes) for pulse width. Four different windows are available: Rectangular, Nominal Sidelobe, Low Sidelobe, and Minimum Sidelobe. The Rectangular option provides the narrowest pulse width, and the Minimum Sidelobe option provides the least ringing (fewest sidelobes). For more details on Windowing, refer to [Appendix C](#).

## 7-5 Distance-to-Fault Measurement Example

The most common time domain and distance domain measurement that is made by using a handheld VNA is distance-to-fault (DTF). Using this measurement, you can find the location of faults (or discontinuities) along the length of a cable or waveguide. This measurement is typically performed as a reflection measurement ( $S_{11}$  or  $S_{22}$ ).

The VNA Master can be easily set to perform distance-to-fault measurements. Following are the key parameters that need to be set for these types of measurements:

### In the Measure Menu:

- S-parameter = set to  $S_{11}$  if the cable or waveguide is connected to Port 1 (or  $S_{22}$  for Port 2)
- Domain Selection = Distance
- Graph Type = Log Mag, SWR, or Real (depending on preference)

### In the Sweep Menu:

- Number of Points (Data Points) = the larger the number, the longer the maximum distance (at the expense of a slower sweep speed)

### In the Freq/Time/Dist Menu:

- Start Freq/Stop Freq = set to within the frequency range of the device under test (the wider the frequency range, the better the distance resolution, but the shorter the maximum distance)
- Start Dist/Stop Dist = set to view the specific length that you want to view
- Windowing = Rectangular is the default window (set to other windows if sidelobe levels are too high)

### In the Additional Dist Setup submenu:

#### (under Freq/Time/Dist Menu)

- DUT Line Type = set to Coax or Waveguide
- Cable List/Waveguide List = pick a cable or waveguide from a list to capture its propagation velocity and cable loss (if it is coax) or its cutoff frequency and waveguide loss (if it is waveguide). Alternatively, just enter these parameters directly if the specific cable or waveguide that you are testing is not in the list. Note that you can add coax entries into the list via the Line Sweep Tools program.
- Units = choose between m (meters) or ft (feet)

Figure 7-5 shows a typical distance-to-fault measurement result. The device under test is a 3.7 m long cable with a discontinuity close to the end of the cable, at 3.1 m. The display shows the Log Mag (top) and SWR (bottom) responses. In both results, the ends of the cable and the discontinuity are all clearly identifiable.

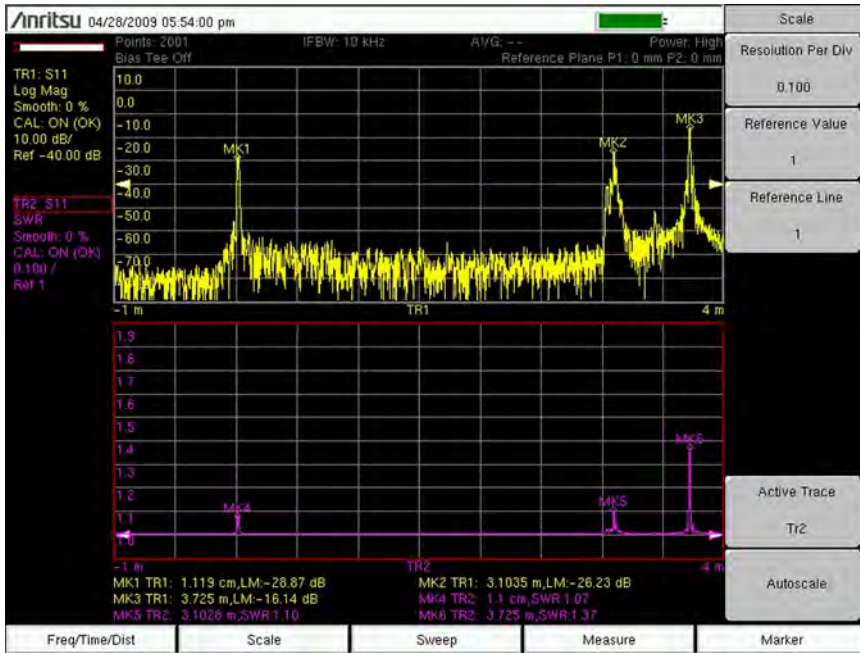

Figure 7-5. Distance Domain Measurements of a 3.05 m Cable Showing  $S_{11}$  and  $S_{21}$

## 7-6 Time and Distance Information

To help you with the time and distance setup, the VNA Master provides a helpful aid that provides information on the resolution and maximum range.

Figure 7-6 shows the Distance Info window (which can be displayed from the Additional Dist Setup submenu under the Distance Setup menu). This window provides information to help you with the distance domain setup. The top portion of the window displays information about the selected Cable or Waveguide. If you select a cable from the cable list (or a waveguide from the waveguide list), then the name of the cable and its associated parameters are displayed under the heading CABLE INFO (or WAVEGUIDE INFO). Below that heading is the CURRENT INFO section, which summarizes the actual parameters being used in the measurements. For cables, the parameters are propagation velocity and cable loss. For waveguide, they are cut-off frequency and waveguide loss. These current parameters are either the values that are associated with the chosen cable or waveguide from the list, or they are the values that are entered directly by the user.

The bottom part of the list provides information about the settings and suggestions for meeting the maximum required distance. This section is divided into three columns, headed: PARAMETER, ROUND TRIP, and ONE WAY for one-way measurements. The key parameters that are displayed are the Distance Resolution and the Distance Max. The following list includes all of the items in the Distance Info window with a brief description of each item:

**Fstart:** the start frequency

**Fstop:** the stop frequency

**Distance Resolution:** the calculated distance resolution based on the frequency range

**No. of Data Points:** number of points in the sweep

**Distance Max:** maximum usable distance based on frequency span and number of points

**Dstart:** the start distance

**Dstop:** the stop distance (when set greater than Dmax, the following suggestions can be used to increase Dmax to make it equal to Dstop)

**Suggestion 1:** Adjust Freq span to meet Dstop

**Max Span:** suggested frequency span (within allowable range) to make  $D_{max} = D_{stop}$

**Suggested Start Freq:** typically equal to the Fstart that was set by user

**Suggested Stop Freq:** suggested stop frequency based on calculated Max Span and Fstart

**Resulting Distance Resolution:** resulting resolution if new Fstart and Fstop are used

**Maximum Usable Range (Dmax):** resulting Dmax if new Fstart and Fstop are used

**Suggestion 2:** Adjust No. of pts to meet Dstop (using current Fstart and Fstop)

**Min Number of points to get Dstop:** suggested number of points to make  $D_{max} = D_{stop}$

**Maximum Usable Range (Dmax):** resulting Dmax if the new number of points are used

Distance Info		
CABLE INFO		
Name: FSJ1-50A (6 GHz)		
Vp: 0.840		
Frequency	Cable Loss	
1.000 GHz	0.196	
2.500 GHz	0.322	
6.000 GHz	0.527 (current)	
CURRENT INFO		
Vp: 0.840		
Loss: 0.527 dB/m		
PARAMETER	ROUND TRIP (REFLECTION)	ONE WAY (TRANSMISSION)
Fstart	5.000 kHz	5.000 kHz
Fstop	20.000 GHz	20.000 GHz
Distance Resolution	6.300 mm	1.260 cm
No. of Data Points	2001	2001
Distance Max	12.6000 m	25.2000 m
Dstart	0 mm	0 mm
Dstop	35 m	35 m
Suggestion 1: Adjust Freq span to meet Dstop		
Max Span	7.199 999 918 GHz	14.399 999 836 GHz
Suggested Start Freq	5.000 kHz	5.000 kHz
Suggested Stop Freq	7.200 004 918 GHz	14.400 004 836 GHz
Resulting Distance Resolution	1.750 cm	1.750 cm
Maximum Usable Range (Dmax)	34.998 m	34.998 m
Suggestion 2: Adjust No. of pts to meet Dstop		
Min Number of points to get Dstop	4001	2779
Maximum Usable Range (Dmax)	25.2126 m	35.0028 m

Figure 7-6. Distance Info Window



**Note**

As you can see in [Figure 7-6](#), the user has entered a Dstop value of 35 m, whereas the calculated maximum usable range (Distance max) is 12.6 m for a reflection measurement and is 25.2 m for a transmission measurement. As the user, you need to make some adjustments either to the frequency range or to the number of data points in order to increase Dmax to 35 m. Suggestion 1 (of the Distance Info) tells you that you need to reduce your frequency span to 7.199 GHz (14.399 GHz for transmission). You can do that by changing just the stop frequency, or you can change both the start and stop frequencies such that the difference between them equals the calculated Max Span. By making that adjustment, you can achieve a Dmax of 35 m. What you give up is distance resolution. In the example in [Figure 7-6](#), the resolution will degrade to 17.5 mm. To avoid changing the frequency span (and thereby degrading the resolution), you can increase the number of points (at the expense of slower sweep speed). In the example in [Figure 7-6](#), however, even if you increase the number of points to the maximum allowable number of 4001 (for reflection), you can achieve only a Dmax of 25.2 m. For a transmission measurement, 2779 points will let you achieve 35 m. In this case, you should either use a transmission measurement or adjust the frequency span to meet your goal

**Note**

The Time Info window does not contain any cable or waveguide information because those parameters affect only the distance setup. Also, in the Time Info window, the two columns for round trip and one way are identical because the time domain has no round trip compensation.



# Chapter 8 — Power Monitor, Option 5

## 8-1 Introduction

When equipped with Option 5, Power Monitor, the VNA Master can be used for making power measurements with broadband RF detectors. The power monitor displays the measured power results in dBm or Watts.

The function hard keys that are displayed in this mode are:

**Freq, Scale, Save/Recall, Measure, Marker**

Only the **Save/Recall** and **Measure** function hard keys are functional in this mode. The other three function hard keys provide no valid functions.

## 8-2 Procedure

1. On the VNA Master, press the **Shift** key, then the **Mode** (9) key.
2. Use the directional arrow keys or the rotary knob to highlight Power Monitor and then press the **Enter** key.
3. Connect the power sensor to the VNA Master RF Detector port.

### Zeroing the Power Monitor

1. With no power applied to the Power Detector input, press the **Zero** soft key. Wait for a few seconds while the VNA Master accumulates data samples of the quiescent power.
2. When complete, Zero: On is displayed in the message area.

### Measuring High Input Power Levels

1. Insert an attenuator between the DUT and the RF Detector to protect the VNA Master so that the power level is less than or equal to +16 dBm.
2. Press the **Offset** soft key and enter the attenuation by using the keypad, the arrow keys, or the rotary knob.
3. Press the **Enter** key to complete the entry.

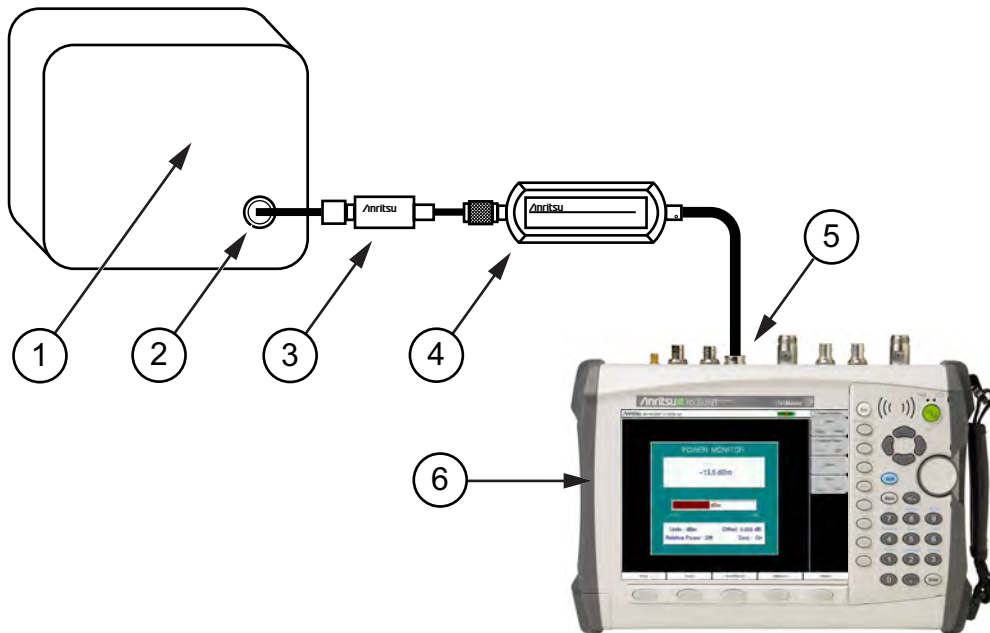

1	DUT (Device Under Test)
2	RF Out
3	Attenuator
4	RF Detector (Power Sensor)
5	RF Detector Interface (for Option 5)
6	VNA Master

**Figure 8-1.** Power Measurement Setup With Attenuator

## Displaying Power in dBm or in Watts

Press the Units soft key to toggle between dBm and Watts.

## Setting Relative Power

1. With the desired base power level input to the VNA Master, press the **Relative** soft key. The power reading shows 100% because it is measuring the same power level.
2. If the power is lowered by 3 dB, then the relative power will show 50%.
3. If the power in Watts is increased from 1 Watt to 2 Watts, then the relative power will show 200%.

In [Figure 8-2](#), the Units are set for dBm, the Relative Power function is Off, the Offset is 1 dBm, and the Zero function is set to Off. The figure is intended to illustrate the general layout of the Power Monitor display. The displayed image on your instrument may be different.

## 8-3 Power Monitor Display

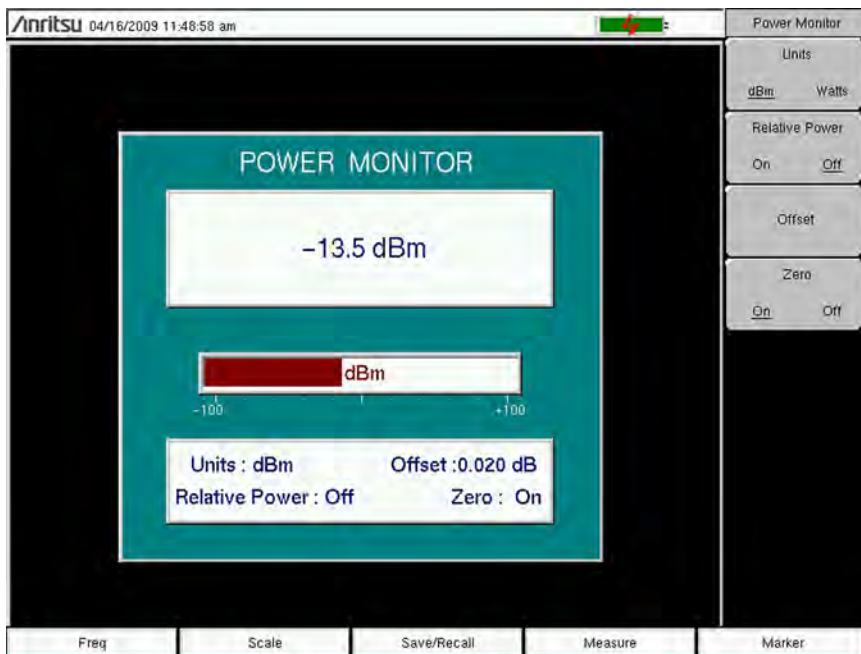

Figure 8-2. Power Monitor Display

## 8-4 Power Monitor Menu

Power Monitor	
Units <u>dBm</u> Watts	<b>Units</b> <b>dBm    Watts:</b> Press this soft key to toggle units between dBm and Watts.
Relative Power On <u>Off</u>	<b>Relative Power</b> <b>On    Off:</b> Press this soft key to turn relative power On or Off.
Offset	<b>Offset:</b> Press this soft key to enter an offset value to account for any external attenuator that is used during a measurement.
Zero <u>On</u> Off	<b>Zero</b> <b>On    Off:</b> Press this soft key to toggle zeroing On in order to perform Zeroing of the power monitor detector.

Figure 8-3. Power Monitor Menu



# Chapter 9 — Secure Data Option 7

## 9-1 Introduction

When equipped with Option 7, the MS202xB VNA Master provides for careful management of confidential data for both the setup parameters and the resulting measured data.

Highly sophisticated systems and equipment have technical applications that must remain secure in their operations. The particular parameters that must remain secure usually involve operating frequencies and a variety of other setup configurations.

To accommodate the measurements and yet preserve the data as confidential, Option 7 can be used to prevent any setup data or measured data from being stored on any internal memory location of the VNA Master. Instead, all such data are forced to be stored on removable memory such as an external USB memory device.

<b>Caution</b>	Note that even with Option 7 enabled, operating parameters (such as frequency range, power level, number of points) that are set by the user are stored in the VNA Master EEPROM when the VNA Master is turned OFF. These parameters can be erased, however, via a Master Reset operation, as described later in this chapter.
----------------	--------------------------------------------------------------------------------------------------------------------------------------------------------------------------------------------------------------------------------------------------------------------------------------------------------------------------------

## 9-2 Procedure

When saving data (setups, measurements, JPEG, and so forth) in a VNA Master with Option 7, the save location must be an external USB memory device. If a USB memory device is not connected to the instrument, then you cannot perform the save function.

You can use the following steps to change the save location while saving a file:

1. Press the **Shift** key, then the **File** (7) key.
2. Press the **Save** soft key.
3. Press the **Change Save Location** soft key.
4. Use the rotary knob or arrow keys to highlight the external USB memory device or any desired folder on that device.
5. Press the **Create Folder** soft key to create a new folder, if desired.
6. Press the **Set Location** soft key to set the highlighted folder or drive as the target location.
7. Press the **Change File Type** soft key to pick a different file type, if desired.
8. Use the **Text Entry** soft keys to enter the desired file name.
9. Press **Enter** to save the file.

## 9-3 Calibration Setup

After any user calibration, the VNA Master automatically writes the calibration file to internal memory. This is done so that when the instrument is turned Off and then back On, the user calibration data are recalled, and the calibration can be applied.

With Option 7 enabled, however, the VNA Master cannot write to internal memory. Therefore, the user calibration file is not automatically saved. With Option 7 enabled, when the instrument is turned Off and then back On, the user calibration data are not recalled, and the calibration cannot be applied. To save and recall the calibration, use the file save menu to save the setup with calibration. Then use the file recall menu to retrieve the calibration.



## 9-4 Memory Profile and Security Issues

This section describes the profiles of the various types of memory that are used in the MS202xB VNA Master and the associated security issues that are related to those memory devices.

The MS202xB has 1 GB of Flash non-volatile memory, has EEPROM memory, and has sufficient DRAM volatile memory for normal operation. The instrument is supplied with a USB memory device that plugs into the USB Type A connector. The MS202xB does not have a hard drive or any other type of volatile or non-volatile memory.

The following sections describe how memory is used in the VNA Master and how it can be erased.

### Internal Flash Memory

This memory space is used to store the instrument firmware and factory calibration, and can be used to store measurements and setups that are saved by the user.

Saved measurements and setups that are stored in the Flash memory are all deleted by the master reset process that is described in Section “MS202xB Master Reset Instructions” in Chapter 2.

<b>Note</b>	With Option 7 enabled, the user is not able to store any measurements or setups to this internal flash memory.
-------------	----------------------------------------------------------------------------------------------------------------

### USB Memory Device

The USB memory device is not required for proper operation of the instrument. The instrument may be directed to store measurements and setups directly to the USB memory device, or you may transfer the contents of the internal flash memory into the USB memory device for storage or data transfer purposes. The device is removable and therefore does not pose a security risk because it can remain in a secured area, can be externally erased by a computer, or can be destroyed.

<b>Note</b>	With Option 7 enabled, the user does not have access to the internal flash memory and, therefore, cannot transfer any contents of the internal flash memory into the USB memory device.
-------------	-----------------------------------------------------------------------------------------------------------------------------------------------------------------------------------------

### RAM Memory

This is volatile memory that is used to store many parameters that are needed for the normal operation of the MS202xB along with current measurements. This memory is reset whenever the instrument is restarted.

### EEPROM

This memory holds information such as the model number, serial number, and calibration data for the instrument. Also stored here are the operating parameters, such as frequency range, that are set by the user. During the master reset process, all operating parameters that are stored in the EEPROM are set to standard factory default values.

**MS202xB Master Reset Instructions**

1. Turn the MS2026B or MS2028B On.
2. Press the **Shift** key then the **System (8)** key.
3. Press the System Options soft key.
4. Press the Reset soft key.
5. Press the Master Reset soft key.
6. A dialog box is displayed on the instrument screen to warn that all settings will be returned to factory default values, and that all user files will be deleted.
7. Press the **Enter** key to complete the master reset, or press the **Esc** key to abort.
8. After several seconds (which can grow to several minutes if a very large number of measurements have been saved in the instrument), the instrument reboots.

**9-5**

# Chapter 10 — Bias Tee, Option 10

## 10-1 Introduction

Option 10 provides a bias tee that is installed inside the VNA Master, which permits testing of amplifiers that require their system power to be supplied from their RF signal port. In addition to the internal bias tee, the MS202xB VNA Master features two input ports (BNC(f)) that offer you the ability to supply external bias current to the unit under test.

To access the Bias Tee menu, press the **Sweep** function hard key to open the Sweep menu (refer to “[Bias Tee Menus](#)” on page 10-6), then the Configure Ports soft key, then the Bias Tee Setup soft key. The Bias Tee menu (“[Bias Tee Menu](#)” on page 10-8), which has keys for Off, External, and Internal, is opened with the Bias Tee soft key in the Bias Tee Setup menu (“[Bias Tee Setup Menu](#)” on page 10-7).

## 10-2 Bias Tee Fundamentals

For the internal function, the bias arm is connected to an internal power source that can be turned on as needed to place the voltage on the center conductor of the RF ports. Because the MS202xB features full S-parameter testing at both Port 1 and Port 2, the bias voltage is also available from either port upon selection by the user. This voltage can be used to provide power to block down-converters in satellite receivers and can be used to power some tower-mounted amplifiers.

The bias can be turned on only when the instrument is in vector network analyzer mode and when the lowest frequency is set greater than or equal to 2 MHz. Below 2 MHz, both internal and external bias tee are not supported. When bias is turned on, the LED indicator on the connector panel turns green, and the actual bias voltage and current are displayed in the upper left corner of the measurement display screen. The display shows the voltage and current for the selected port when using internal bias tee, and for both ports when using external bias tee.

### Caution

Depending on the load that is presented by the device under test, the bias voltage value that is displayed on the screen may be different than the value that was set using the soft key menu. The value that is displayed on the screen is the actual measured value of the voltage that is being delivered to the device under test.

The internal bias tee is designed to continuously deliver a maximum of 450 mA between 12 VDC and 32 VDC in steps of 0.1 V.

### Warning

When using external bias tee, a maximum of  $\pm 50$  VDC at 500 mA is supported.

[Figure 10-1](#) shows the bias tee architecture within the VNA Master. [Figure 10-2](#) shows a variable bias tee on a Tower Mounted Amplifier (TMA-DD).

## 10-3 How Bias is Generated

The ability to provide DC bias voltage at the RF port is an important feature of a VNA. The architecture of the MS202xB VNA Master, when equipped with Option 10, allows for internal and external bias at both RF ports. [Figure 10-1](#) shows how an internal source can provide a voltage between 12 volts and 32 volts that can be switched between Port 1 and Port 2. That voltage would be available at the port along with the RF signals. Alternatively, an external voltage source could be connected to the Bias Tee input ports in order to provide a bias voltage between +50 volts and –50 volts at both ports simultaneously, if desired.

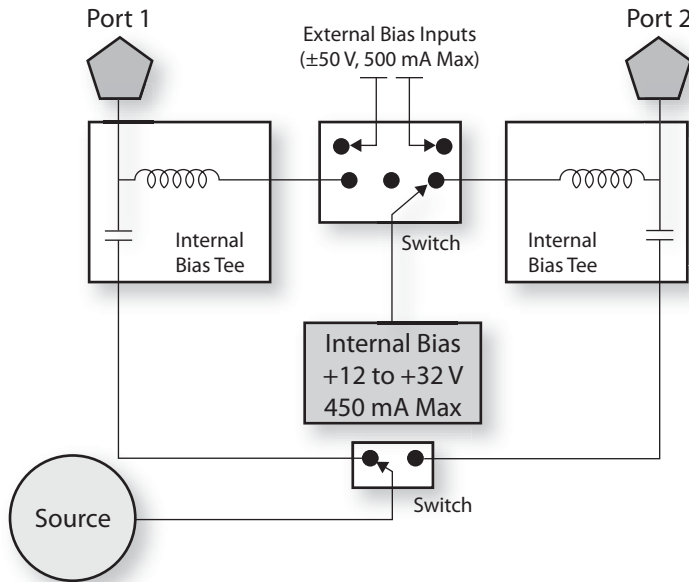

**Figure 10-1.** Internal or External Bias

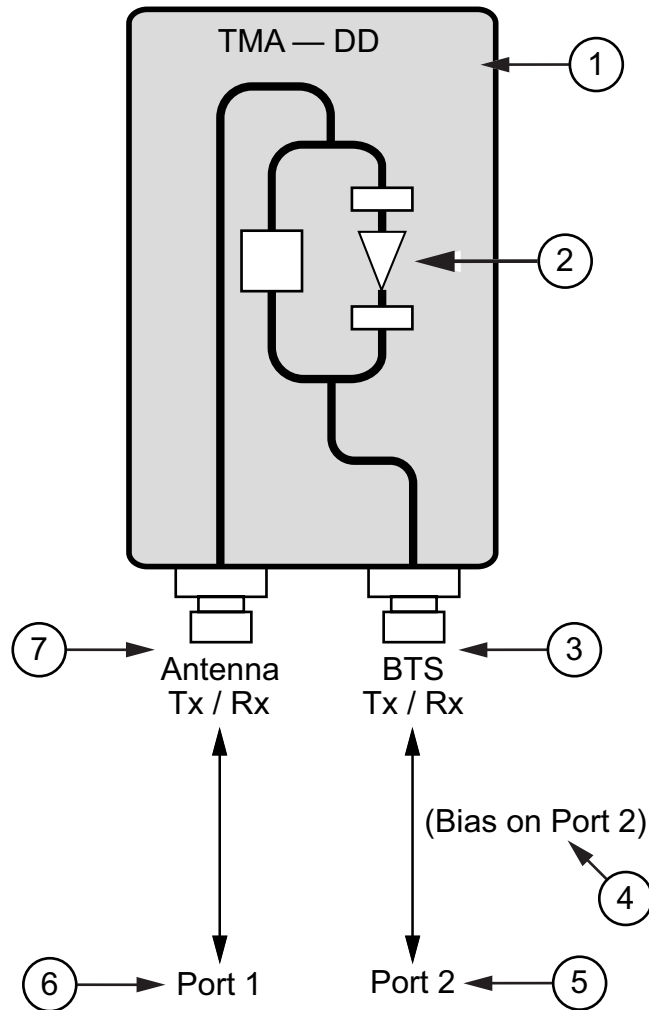

1	TMA-DD (Tower Mounted Amplifier – Dual Duplex)
2	Internal Components
3	Base Station Transmit and Receive Connection
4	Bias voltage is on Port 2
5	Port 2 of VNA Master
6	Port 1 of VNA Master
7	Antenna Transmit and Receive Connection

**Figure 10-2.** Variable Bias Tee on TMA-DD

Figure 10-2 shows a variable bias tee supplying bias power out of Port 2 to the test unit, which is a dual duplex tower-mounted amplifier.

## 10-4 Bias Tee when Making 2-Port Gain Measurements

Two power levels are available with 2-port measurements: High and Low. The Low Port Power setting should be used when making direct gain measurements of amplifiers. This will ensure that the amplifier is operating in the linear region. The High Port Power setting (default setting) is ideal when characterizing passive devices but can also be used when making relative gain or antenna-to-antenna isolation measurements in the field. For performance details and measurement uncertainties, refer to the Technical Data Sheet (Anritsu part number 11410-00501).

The internal bias tee is typically used to put voltage on the RF port that is feeding the bias to the amplifier under test. Because of its full reversing architecture, the MS202xB VNA Master can support amplifier measurements with the amplifier input connected either to Port 1 or to Port 2. To support this flexibility, the internal bias tee can be directed to either port via a user selection. Each port selection has its own Voltage setting and Current Limit setting that can be saved with the setup (refer to [Figure 10-3](#)).

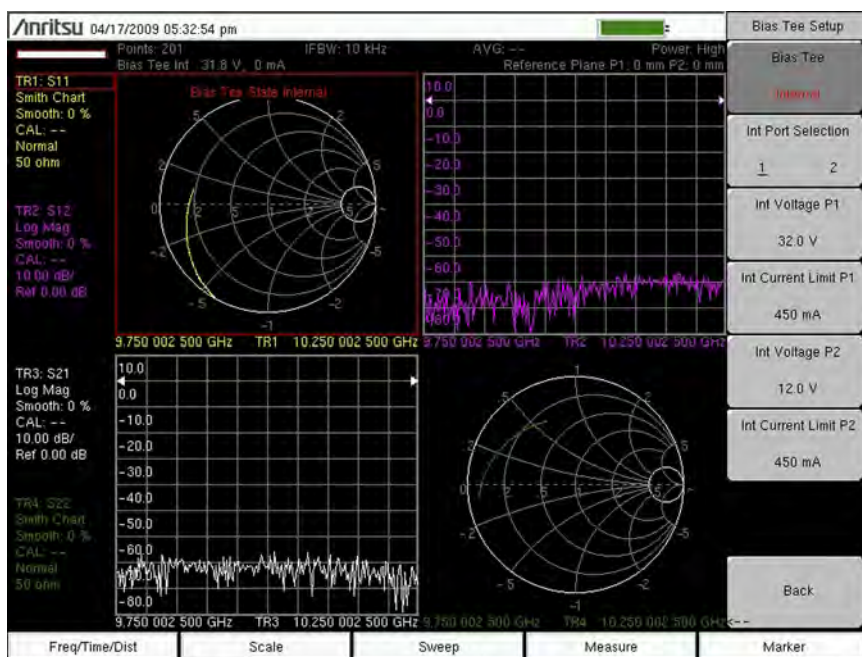

**Figure 10-3.** S21 Log Magnitude (VNA Measurement Menu)

The voltage setting for the internal bias tee, when selected for either port, can be set from 12.0 VDC to 32.0 VDC in steps of 0.1 V. The Current Limit value, with a maximum setting of 450 mA, sets the trip point. If the current draw of the device under test exceeds this trip point level, then the VNA Master shuts off the internal bias tee, the LED indicator on the connector panel turns from green to flashing red, and the actual voltage and current readings that are displayed on the screen turn red.

With external bias tee voltage input, you can connect an external voltage of  $\pm 50$  VDC to both ports simultaneously, although for most applications biasing is required on only one port. When the bias tee is set to External, the actual measured voltage and current at both ports are displayed on the screen, as shown in Figure 10-4. The maximum current that is allowed when using external bias tee is 500 mA. If that current level is exceeded, then the VNA Master switches the external bias tee away from the ports, the LED indicator on the connector panel turns from green to flashing red, and the actual voltage and current readings that are displayed on the screen turn red.

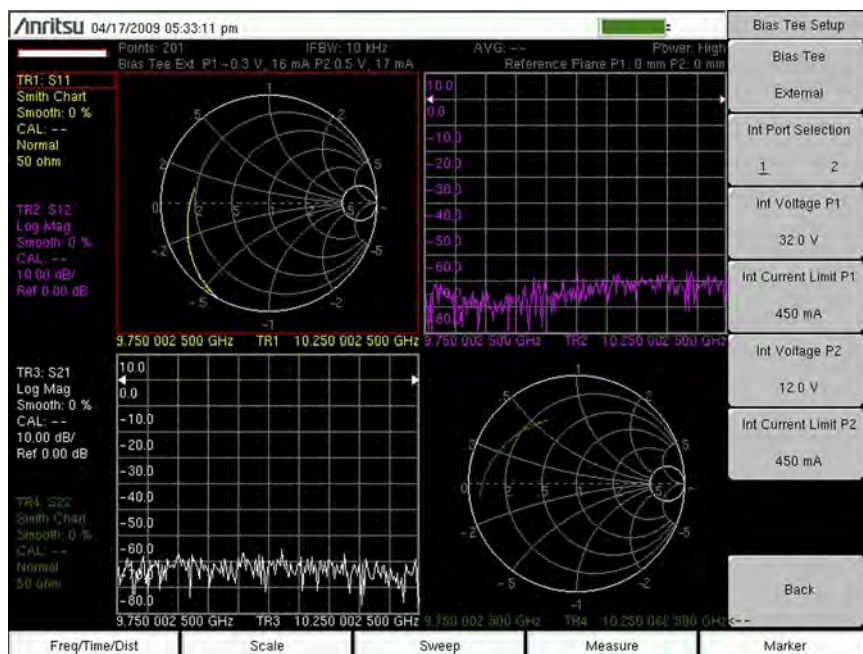
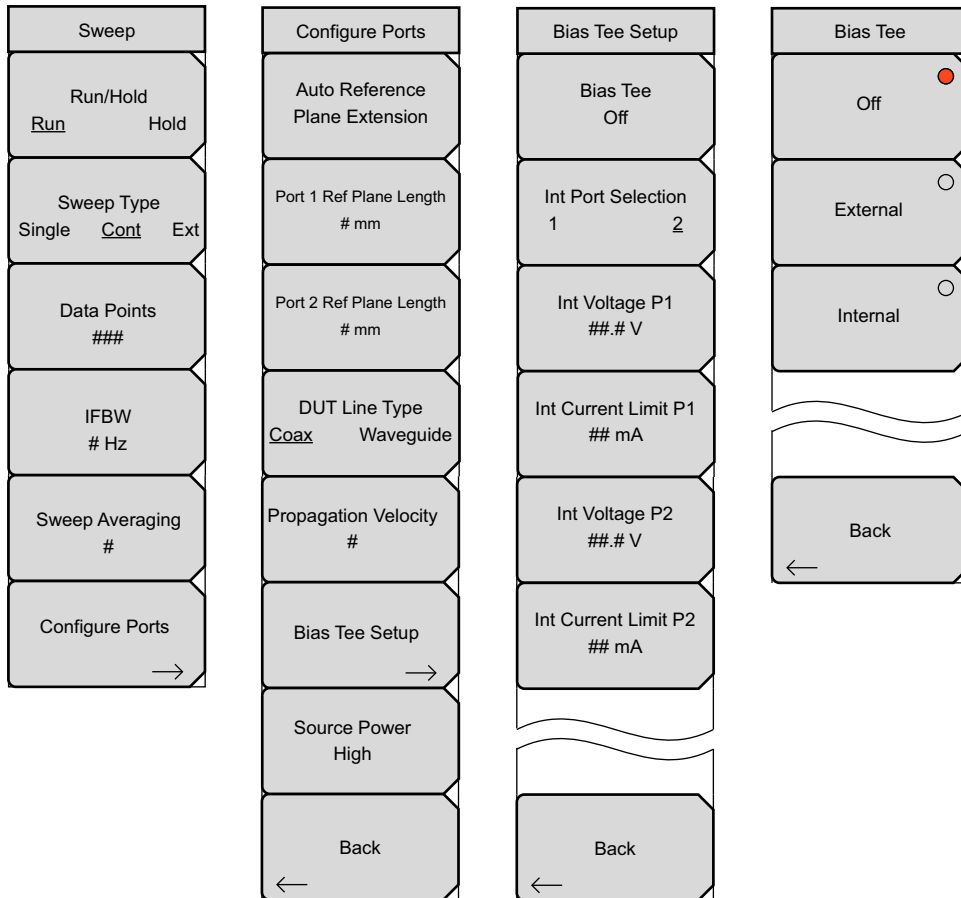

Figure 10-4. Bias Tee Set to External

## 10-5 Bias Tee Menus

To access the Bias Tee menu, press the **Sweep** function hard key (or press the **Shift** key then the **Sweep** (3) key). Press the **Configure Ports** soft key, and then press the **Bias Tee Setup** soft key to open the Bias Tee Setup menu. Press the **Bias Tee** soft key to select Internal, External, or Off.



**Figure 10-5.** Bias Tee Menu Group

For additional information about the Sweep menu, refer to [“Sweep Menu” on page 6-50](#).



## Bias Tee Setup Menu

Bias Tee Setup	<b>Bias Tee (On/Off):</b> Press this soft key to open the “Bias Tee Menu” to select External, Internal, or Off.
Bias Tee Off	<b>Int Port Selection</b>
Int Port Selection 1      2	<b>1 2:</b> Press this soft key to toggle the internal port selection to Port 1 or Port 2.
Int Voltage P1 ##.# V	<b>Int voltage P1:</b> Press this soft key to set the internal bias tee voltage that is directed onto the center conductor of port 1. The available range is from 12.0 V to 32.0 V in increments of 0.1 V. Use the arrow keys, the rotary knob, or the number keypad to change the setting. When using the number keypad, press the soft key for voltage units (V), or press the <b>Enter</b> key. Press the <b>Esc</b> key to exit without changing the setting.
Int Current Limit P1 ## mA	<b>Int Current Limit P1:</b> Press this soft key to set the internal bias tee current limit for the voltage that is set at Port 1. The available range is from 0 mA to 450 mA in steps of 1 mA. This current limit sets the trip point for the bias tee for this port. When using the number keypad, the soft key menu displays 2 choices for units: A or mA. Use the arrow keys, the rotary knob, or the number keypad to change the setting. When using the number keypad, press the soft key for current units (A or mA), or press the <b>Enter</b> key to use mA. Press the <b>Esc</b> key to exit without changing the setting.
Int Voltage P2 ##.# V	<b>Int voltage P2:</b> Press this soft key to set the internal bias tee voltage that is directed onto the center conductor of Port 2. The available range is from 12.0 V to 32.0 V in increments of 0.1 . Use the arrow keys, the rotary knob, or the number keypad to change the setting. When using the number keypad, press the soft key for voltage units (V), or press the <b>Enter</b> key. Press the <b>Esc</b> key to exit without changing the setting.
Int Current Limit P2 ## mA	<b>Int Current Limit P2:</b> Press this soft key to set the internal bias tee current limit for the voltage that is set at Port 2. The available range is from 0 mA to 450 mA in steps of 1 mA. This current limit sets the trip point for the bias tee for this port. When using the number keypad, the soft key menu displays 2 choices for units: A or mA. Use the arrow keys, the rotary knob, or the number keypad to change the setting. When using the number keypad, press the soft key for current units (A or mA), or press the <b>Enter</b> key to use mA. Press the <b>Esc</b> key to exit without changing the setting.
Back ←	<b>Back:</b> Press this soft key to the Sweep menu.

Figure 10-6. Bias Tee Setup Menu

## Bias Tee Menu

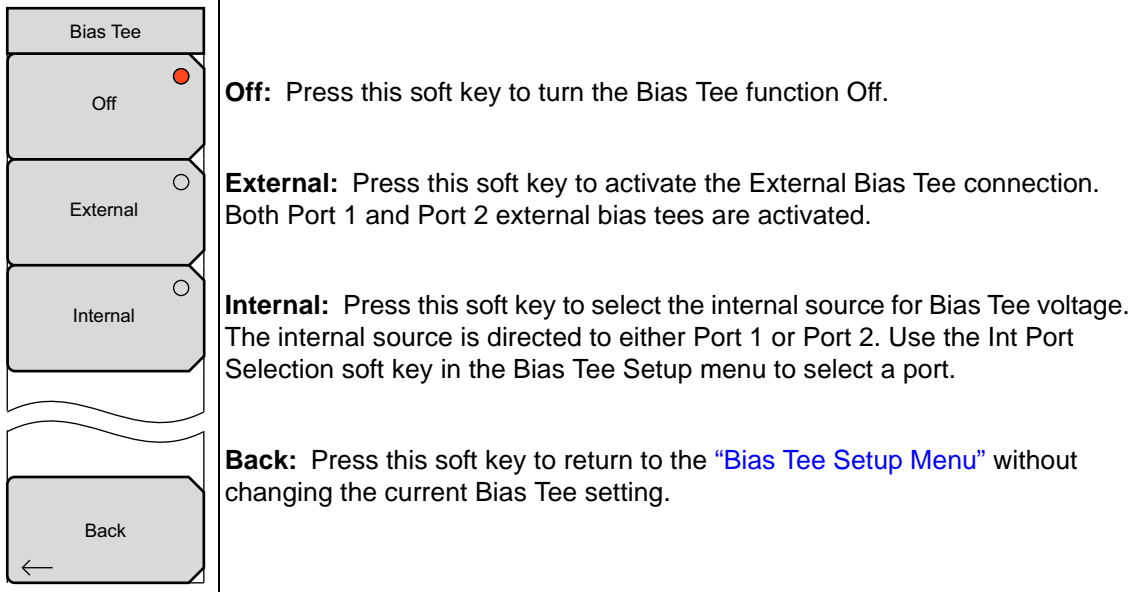

**Figure 10-7.** Bias Tee Menu

# Chapter 11 — Vector Voltmeter, Option 15

## 11-1 Introduction

When equipped with Option 15, the MS202xB VNA Master is a convenient tool for ensuring phase match between RF cables, especially in the field where access to AC power is typically limited. This mode is called Vector Voltmeter mode (VVM) because it can replace a vector voltmeter, which is becoming obsolete. With the convenience of a user interface that is similar to a vector voltmeter, an engineer or technician can use a familiar display and highly integrated solution for phase matching cables.

The function hard keys in Vector Voltmeter mode are:

**CW, Table, Save/Recall, Cal, [BLANK]**

The fifth key is not used in Vector Voltmeter mode.

## 11-2 Getting Started

Figure 11-1 shows a block diagram comparison of the test configuration for the Vector Voltmeter instrument method (left) and the VNA Master (right) when used for an  $S_{11}$  measurement. The VNA Master (when equipped with Option 15) contains not only the Vector Voltmeter receiver, but also the signal source and couplers that are necessary for conducting both 1-port and 2-port measurements at a selected CW frequency.

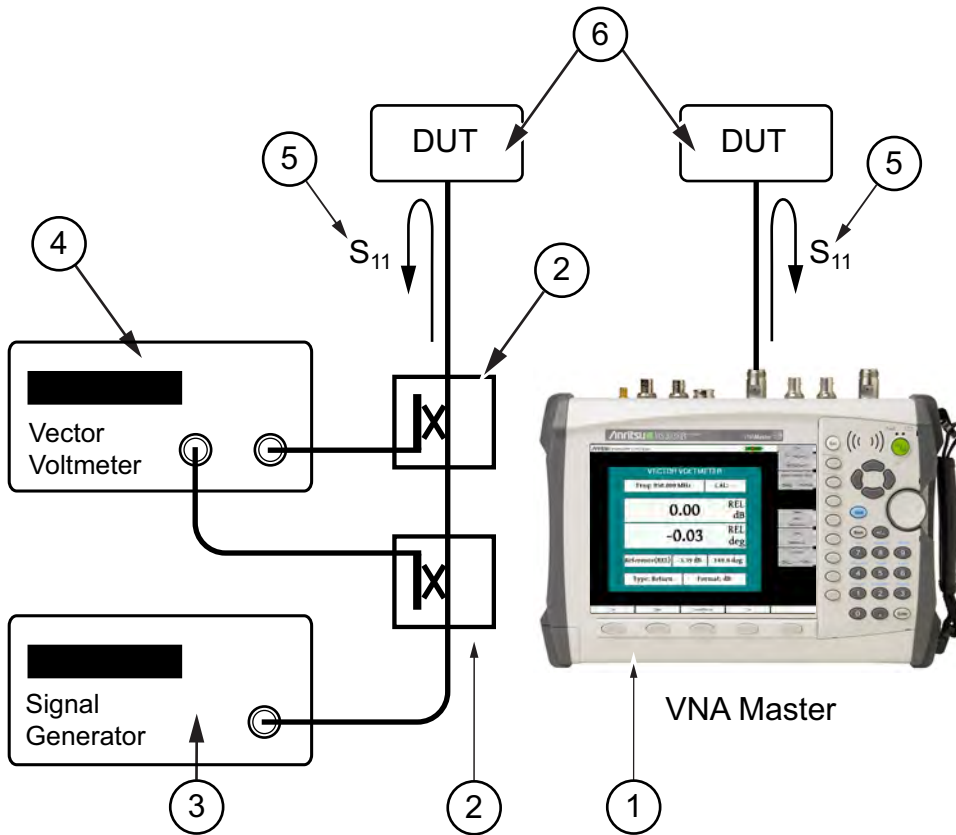

1	VNA Master
2	Couplers
3	Signal Generator
4	Vector Voltmeter
5	$S_{11}$ Reflection Measurement
6	DUT (Device Under Test)

**Figure 11-1.** Vector Voltmeter within VNA Master

While phase sensitive cabling is used primarily in lower frequency applications that are typical in air navigation systems such as VOR (VHF Omnidirectional Range), the Option 15 software VVM procedures are applicable for the entire frequency coverage of the MS202xB.

**Note**

Disclaimer (an important distinction): The Anritsu VNA Master Vector Voltmeter Option 15 does not measure RF voltages. The traditional vector voltmeter function of probing RF voltages (A and B) in two channels, and displaying A, B, A/B, B/A, and the phase difference between them is now obsolete, and those instruments are no longer available. The VNA Master has replaced the ratio functions of the vector voltmeters. The VNA Master measures those amplitude and phase ratios very accurately. Thus it is a suitable replacement for the most used ratio function of VVMs, that of measuring component parameters.

### 11-3 Using Vector Voltmeter Mode for the First Time

Before conducting a measurement in Vector Voltmeter mode, select a CW frequency and perform a calibration. During calibration, choose between a 1-port or 2-port calibration depending upon whether return or insertion type measurements (respectively) are desired.

The choice of whether to use a 1-port or a 2-port measurement is usually dictated by the physical site configuration. If the DUT (device under test) is compact, such as cables or amplifiers or filters, then the 2-port measurement may be used because both ends are available near the VNA Master. If a cable is already installed permanently, then the 1-port methods are indicated because only the one end of the DUT is convenient to the test port.

When making a 1-port connection to the DUT, select the Return measurement type and perform a 1-port calibration. When making a 2-port connection to the DUT, select the Insertion measurement type and perform a 2-port calibration. The following paragraphs further explain these steps.

### 11-4 How the VVM Function Works

1. Insertion technique (2-port). One technique, probably the preferable one, uses the VNA Master in a straightforward manner with its 2-port setup. By characterizing the insertion phase delay of a signal by measuring  $S_{21}$  or  $S_{12}$  through the cable, the operator can determine the phase shift of the component or cable from input connector to output connector. The VNA Master, Option 15 display presents those  $S_{21}$  or  $S_{12}$  data as insertion loss in dB and insertion phase in degrees.
2. Reflection technique (1-port). The second technique (using the VNA Master) measures the  $S_{11}$  or  $S_{22}$  reflected signal on a component or cable, and depends upon the procedure in which the far end of the cable is deliberately mismatched, either shorted or left open-circuited. This reflects virtually 100% of the input signal, and the phase delay of the measured reflected signal is therefore equal to twice the one-way phase of the cable. Likewise, the cable attenuation is twice the one-way loss. This technique is especially useful for situations in which you must manually create multiple phase matched cables. This would be done by carefully snipping small amounts of cable with a diagonal cutters, perhaps 1/8th inch at a time, and re-measuring the effect on the 2-way phase.

**Note**

The standard MS202xB VNA Master features a fully-reversing architecture, which allows for measurements (on Port 1 and Port 2) of all four S-parameters without reconnecting the DUT. With Option 15 VVM, you can make a Return measurement type (amplitude and phase) on either Port 1 ( $S_{11}$ ) or Port 2 ( $S_{22}$ ). Similarly, you can make an Insertion measurement type (amplitude and phase) either with Port 1 transmitting ( $S_{21}$ ) or with Port 2 transmitting ( $S_{12}$ ). You select the Port using the Cal Port soft key under the CW menu. When making Return measurements, you can connect two cables (one to each port) and then toggle the Cal Port setting to look at the Return results of both cables without having to disconnect and reconnect.

## 11-5 Simple Measurement Using CW Display

1. Press **Shift** and **Mode** and **Enter** to use the Vector Voltmeter function.
2. Press the **CW** function hard key.
3. Press CW Frequency soft key and enter the desired frequency.
4. Press the **Cal** function hard key.
5. Press the Cal Type soft key and select the type of calibration from the selection list box.

**Note**

The VVM Calibration menu is the same one that is used in the Vector Network Analyzer menu. Refer to section “[Calibration Menu](#)” on page 6-13 for more information about the calibration menu. For typical VVM Return measurements, choose Full  $S_{11}$  for Port 1, Full  $S_{22}$  for Port 2, or Full  $S_{11}$  and  $S_{22}$  for both ports. For typical VVM Insertion measurements, choose Full 2 Port for the highest accuracy measurement, or any of the transmission response or 1-path 2-port calibrations for the appropriate port selection. Note that some calibration parameters are shared between the Vector Network Analyzer and VVM mode, and that some parameters are different because they were optimized for the VVM application.

6. For typical VVM applications, the Cal Method should be SOLT, and the Cal Line Type should be Coax.
7. Press the DUT Port Setup soft key to select a specific connector type for each port. Select (from the list) the connector type of the device under test (or equivalently, the calibration component connector type).
8. Press the Start Cal soft key to begin the calibration. [Figure 11-2 on page 11-6](#) shows a typical setup for a 1-port Open-Short-Load calibration at Port 1.  
  
For two-port measurements, refer to [Figure 11-3 on page 11-7](#), which shows a setup for 2-port calibration using Open-Short-Load-Isolation-Through. In order to ensure a good calibration, be careful to follow the on-screen instructions for connecting the calibration components.
9. After calibration, press the **CW** function hard key to display the CW menu.
10. Connect the DUT for measurement at the desired Port. The display should appear similar to the image in [Figure 11-4 on page 11-8](#). The measurements and display parameters on your instrument display may differ from those in this user guide.

11. Specify Measurement Type to be Return for a 1-port DUT. After a 2-port calibration, both Return and Insertion measurement types can be viewed.
12. Choose to view the measurement results for the return measurement as dB, VSWR, or Impedance by pressing the Return Meas. Format soft key. For insertion measurements, only the dB selection is available.
13. Choose the Cal Port to be Port 1 or Port 2. If you performed a Full  $S_{11}$  calibration, then choose Port 1 to have that calibration apply. If you performed a Full  $S_{22}$  calibration, then choose Port 2 to have that calibration apply. If you performed a Full  $S_{11}$  and  $S_{22}$  calibration, or a full 2-Port calibration, then you will be able to make calibrated measurements using both Port 1 and Port 2. For Insertion measurements on a symmetric cable with a full 2-Port calibration, using Cal Port 1 or Cal Port 2 should give you the same results.

This completes the procedure for performing a simple measurement using the Vector Voltmeter mode.

When you choose the Measurement Type and the Cal Port, the VNA Master matches these measurement settings with the current calibration. If a match is found, then the current calibration is applied to the measured data, and the Cal info box on the display (refer to [Figure 11-4 on page 11-8](#)) shows “**CAL: ON (OK)**”. If no match is found (for example, the calibration was for  $S_{11}$ , but the Cal Port is set to Port 2), then the display shows “**CAL: --**”. Adjusting the setting (the Measurement Type or the Cal Port) to match the calibration will automatically apply the correction. The calibration correction can also be turned off manually under the Calibration menu by toggling the Cal Correction soft key from On to Off. In that case, the display will show “**CAL: OFF**”.

**Note**

Note that “**CAL: OFF**” means that a calibration correction has been created, but it is not currently being used. This is different from “**CAL: --**”, which means that no valid calibration correction is available for the current setting.

Another status information display that you may see is “**CAL: ON (?T)**” which indicates that the instrument temperature has deviated by more than a set amount since the time the calibration was conducted. The calibration is most likely still valid, but a new calibration is recommended. If you see “**CAL: ON (X)**” on the display, this indicates that the instrument temperature has deviated (since the time that the calibration was conducted) by an amount that has more than likely rendered the calibration invalid. When this occurs, a new calibration is highly recommended before further measurements are conducted.

Only one calibration is available at one time. Performing a new calibration overwrites any existing calibration. You can, however, store a measurement setup, which also stores the calibration. You can therefore have multiple calibrations available (as long as the calibration settings and conditions continue to apply).



- |   |                                                          |
|---|----------------------------------------------------------|
| 1 | The VNA Master                                           |
| 2 | Optional Test Port Cable                                 |
| 3 | OSL (Open, Short, Load) Precision Calibration Components |

**Figure 11-2.** 1-Port Calibration



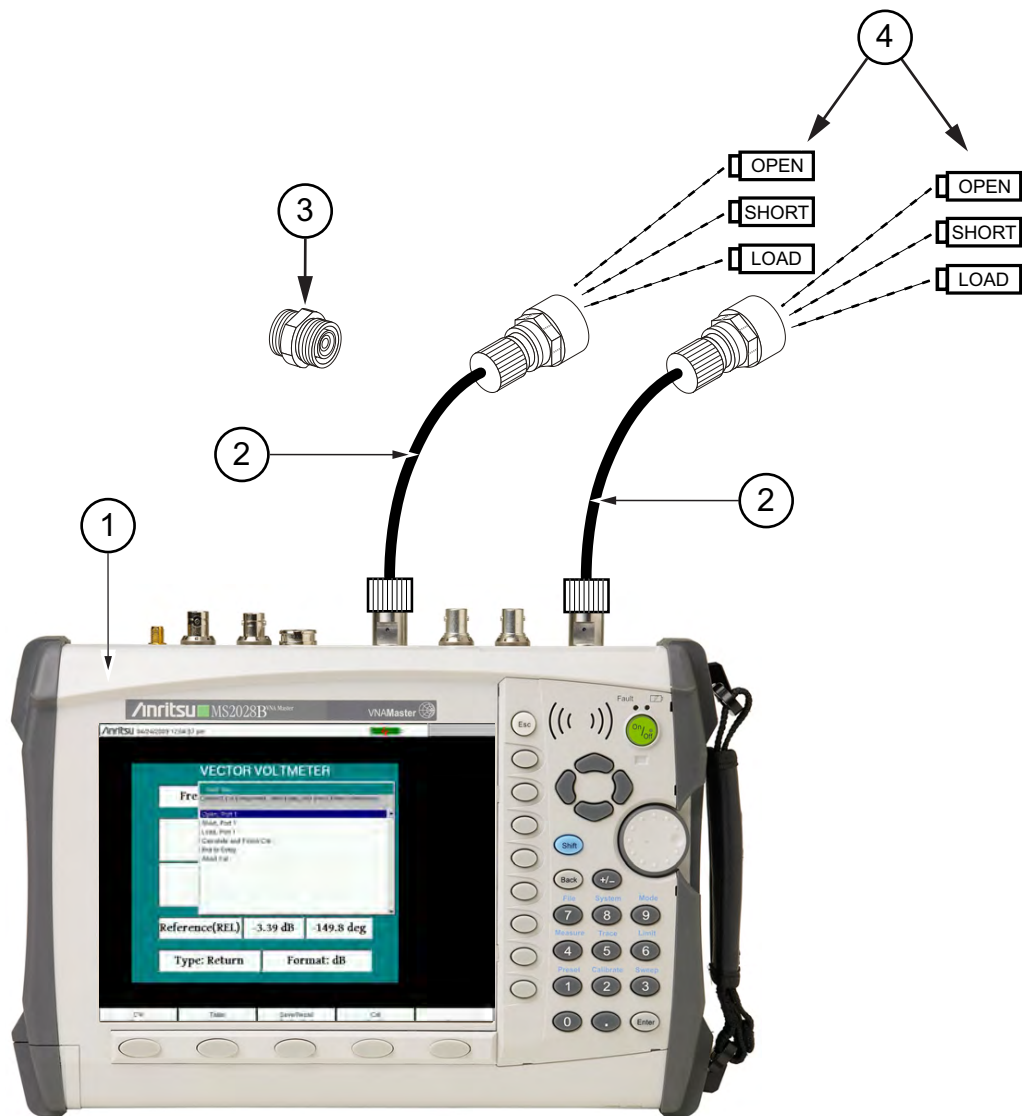

- |   |                                                          |
|---|----------------------------------------------------------|
| 1 | The VNA Master                                           |
| 2 | Optional Test Port Cable                                 |
| 3 | Optional Adapter for Through Connection                  |
| 4 | OSL (Open, Short, Load) Precision Calibration Components |

**Figure 11-3.** 2-Port Calibration

**Note**

Figure 11-3 shows an optional adapter for the Through connection. If you are using test port cables, and if you have sufficient calibration components, then using male OSL standards on one port and female OSL standards on the other port allows you to connect the cable ends together without the adapter. This becomes more important at higher frequencies.

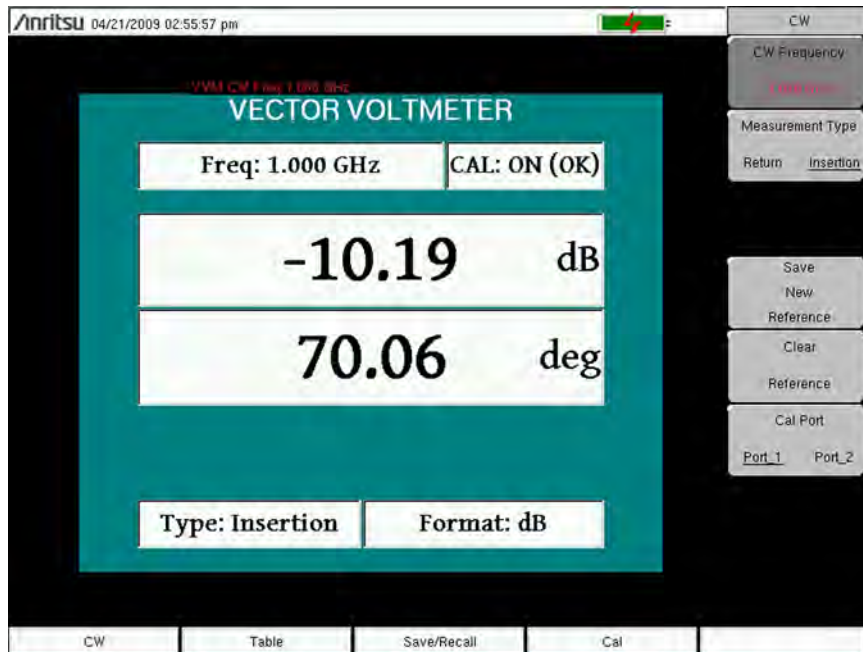

Figure 11-4. Continuous Wave Menu

## 11-6 Simple Relative Measurements using CW Display

For many phase-sensitive applications, absolute phase shift of a cable is not as critical as the phase matching among multiple cables. For this application, the VNA Master relative phase measurement is preferred.

The operations for relative measurements are described in the following steps.

1. From the **CW** menu, preset the Vector Voltmeter for relative (by an amount) measurements by pressing the Clear Reference soft key.
2. Connect the first DUT (device under test).
3. Save the measurement result of the first DUT by pressing the Save New Reference soft key.
4. As shown in [Figure 11-5](#), the Vector Voltmeter saves the current measurement in a new reference window and converts the main measurement window to display the difference between the current measurement and the saved reference. In other words, saving a reference will normalize the results to the current measurement. When relative measurements are displayed, REL is indicated in the main measurement window.

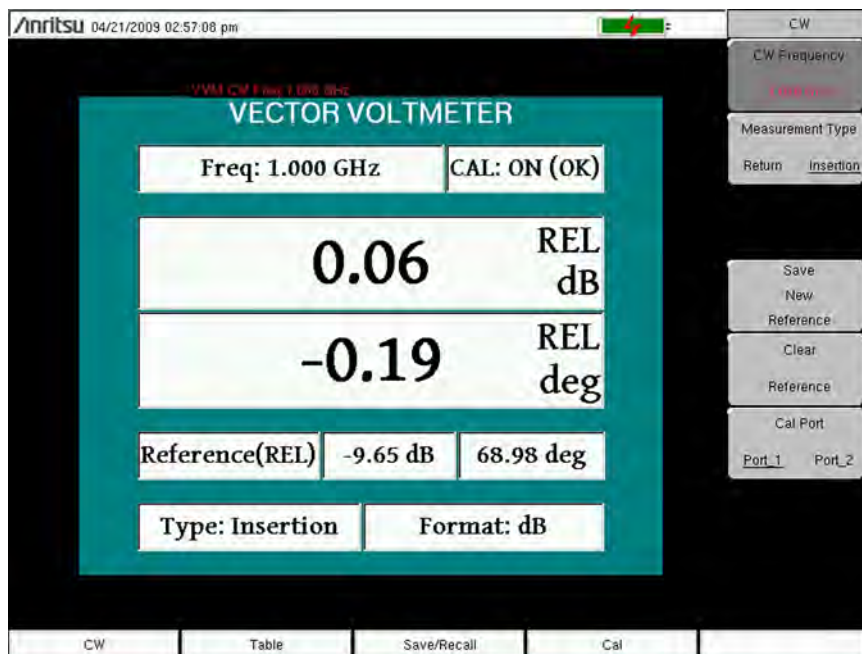

**Figure 11-5.** Continuous Wave Menu with Relative Measurements

5. Connect the second DUT and view the difference between the first and second DUT measurements.
6. To create a new reference, press the Clear Reference soft key followed by the Save New Reference soft key

This completes the procedure for relative measurements.

## 11-7 Measurements Using Comparison Table Display

The Vector Voltmeter procedure includes a convenient table display for comparing up to twelve cables. With this feature, the user can save the first cable measurement as a reference, can view the differences among the other cables, and can output a final report showing both absolute and relative values of all the cables. The following steps describe an overview of the procedure for using this feature.

1. Press the **Table** function hard key.
2. The setup procedure, including calibration, is the same as Step 4 through Step 9. in the procedure described in section “[Simple Measurement Using CW Display](#)” on page 11-4. Specify CW Frequency and perform the appropriate 1-port or 2-port calibration.
3. After calibration, press the **Table** function hard key.
4. Preset the Vector Voltmeter Mode for relative measurements by pressing the Clear Reference soft key.
5. Connect the DUT for measurement. The display appears similar to that shown in [Figure 11-6](#).

The screenshot shows the 'VECTOR VOLTMETER TABLE' interface. At the top, it displays 'Freq: 1.000 GHz' and 'CAL: ON (OK)'. The main table contains the following data:

Cable	Amp	REL Amp	Phase	REL Phase
1	-10.79 dB		71.13 deg	
2	-10.78 dB		71.18 deg	
3	-10.58 dB		70.88 deg	
4	-10.37 dB		70.40 deg	
5	-10.32 dB		70.45 deg	
6	0.00 dB		0.00 deg	
7	0.00 dB		0.00 deg	
8	0.00 dB		0.00 deg	
9	0.00 dB		0.00 deg	
10	0.00 dB		0.00 deg	
11	0.00 dB		0.00 deg	
12	0.00 dB		0.00 deg	

Below the table, it shows 'Type: Insertion' and 'Format: dB'. On the right side, there are soft keys for 'Table', 'CW Frequency', 'Measurement Type', 'Return Insertion', 'Select Cable', '5', 'Save New Reference', 'Clear Reference', 'Cal Port', 'Port\_1', and 'Port\_2'. At the bottom, there are hard keys for 'CW', 'Table', 'Save/Recall', and 'Cal'.

**Figure 11-6.** Vector Voltmeter Measurement Table

6. Save the measurement result of the first DUT by pressing the Save New Reference soft key.

- As shown in Figure 11-7, the VNA Master saves the current measurement in a new reference window above the table and updates the REL Amp and REL Phase columns to display the difference between the current measurement and the saved reference measurement.

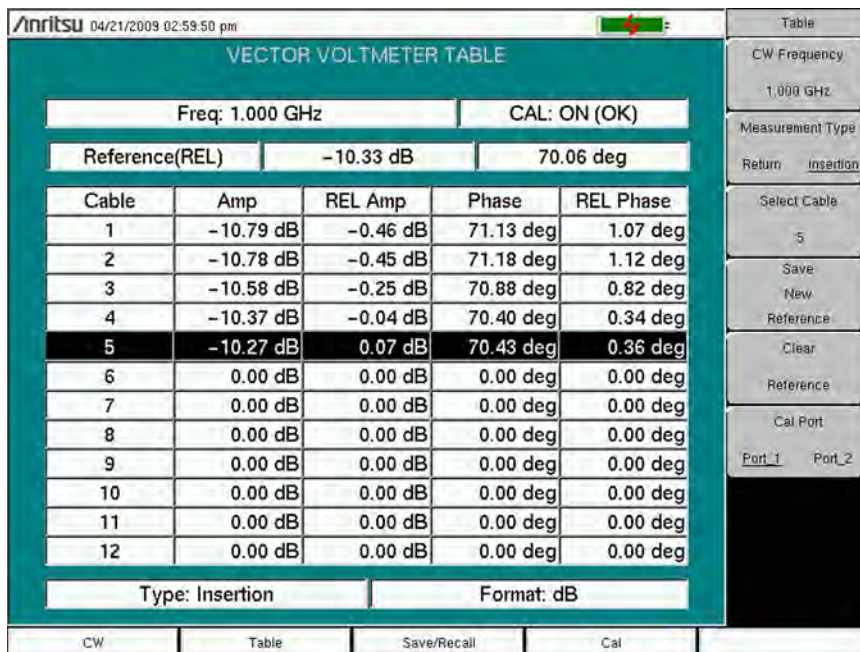

Figure 11-7. Vector Voltmeter Relative Measurement Table

- Before disconnecting the first DUT, save the results in the current row by using the Select Cable soft key to move to another row in the table. When selecting a new cable, the VNA Master saves the results and updates measurements for the next cable in the table.

**Note** Be sure to keep the DUT connected until a new cable has been selected in order to ensure that the proper values are saved in the table for the final report.

- Connect the second DUT and view the difference between the first and second DUT measurements. Be careful to avoid selecting another cable when you are done with the measurement. Saved data can be overwritten.
- To create a new reference, press the Clear Reference soft key followed by the Save New Reference soft key. Consider the possibility of changing the reference by using Select Cable to choose cable 1 again.

This completes the procedure for relative measurements using the table display.

## 11-8 Vector Voltmeter Menus

In the Vector Voltmeter mode, the function hard keys display the following labels: “**CW**”, “**Table**”, “**Save/Recall**”, and “**Cal**”. The fifth function hard key has no function in the Vector Volt Meter mode.

### CW Menu

CW	<b>CW Frequency:</b> Press this soft key to set the desired measurement frequency. Enter the desired frequency using the keypad, the arrow keys, or the rotary knob. If entering a frequency using the keypad, then the soft key labels change to GHz, MHz, kHz, and Hz. Press the appropriate units key. Pressing the <b>Enter</b> key has the same affect as using the MHz soft key.
CW Frequency # GHz	
Measurement type Return    Insertion	<b>Measurement Type</b> <b>Return    Insertion:</b> Press this soft key to toggle between return and insertion measurements.
Return Meas Format dB    VSWR    Imped	<b>Return Meas Format</b> <b>dB    VSWR    Imped:</b> Press this soft key to toggle among dB, VSWR, and Imped (impedance) measurements formats
Save New Reference	<b>Save New Reference:</b> Press this soft key to save the current measurement as the reference measurement. Entering a reference puts the Vector Voltmeter in relative measurement mode.
Clear Reference	<b>Clear Reference:</b> Press this soft key to remove the reference measurement from memory. The Vector Voltmeter exits the relative measurement mode.
Cal Port Port_1    Port_2	<b>Cal Port</b> <b>Port_1    Port_2:</b> Press this soft key to set the transmission port for subsequent measurements. For making $S_{11}$ or $S_{21}$ measurements, set this to Port 1. For $S_{22}$ or $S_{12}$ measurements, set this to Port 2.

**Figure 11-8.** CW Menu

In Continuous Wave, the meter displays the selected frequency and indicates if calibration is On or Off for that specific frequency. The instrument must be calibrated for each chosen frequency.

The return measurement format units are displayed near the center of the Vector Voltmeter window. For dB format, the units are dB and deg (degrees). For VSWR format, the voltage standing wave ratio values are unitless. For Imped (impedance) format, the units are Ohms and jOhms.

The measurement type and format are displayed at the bottom of the Vector Voltmeter window.

## Table Menu

Table	<b>CW Frequency:</b> Press this soft key to set the desired measurement frequency. Enter the desired frequency using the keypad, the arrow keys, or the rotary knob. If entering a frequency using the keypad, then the soft key labels change to GHz, MHz, kHz, and Hz. Press the appropriate units key. Pressing the <b>Enter</b> key has the same affect as using the MHz soft key.
CW Frequency # GHz	
Measurement type <u>Return</u> Insertion	<b>Measurement Type</b> <b>Return – Insertion:</b> Press the Measurement Type soft key to toggle between return and insertion.
Select Cable #	<b>Select Cable:</b> Press this soft key to open the Select Cable List Box. One of the twelve cable numbers is underlined to indicate which cable is selected. Change to a different cable by pressing the Select Cable soft key. The data for the selected cable is highlighted in that cable row within the displayed table.
Save New Reference	<b>Save New Reference:</b> Press this soft key to save the current measurement as the reference measurement. Entering a reference puts the Vector Voltmeter in relative measurement mode.
Clear Reference	<b>Clear Reference:</b> Press this soft key to remove the reference measurement from memory. The Vector Voltmeter exits the relative measurement mode.
Cal Port <u>Port_1</u> Port_2	<b>Cal Port</b> <b>Port_1 Port_2:</b> Press this soft key to set the transmission port for subsequent measurements. For making $S_{11}$ or $S_{21}$ measurements, set this to Port 1. For making $S_{22}$ or $S_{12}$ measurements, set this to Port 2.

**Figure 11-9.** Table Menu

## Save/Recall Menu

Pressing the **Save/Recall** function hard key opens the File menu. For a description of the soft keys in the File menu, refer to [“File Menu” on page 6-23](#).

## Calibration Menu

For description of the Calibration menu items and options, refer to [“Calibration Menu” on page 6-13](#).

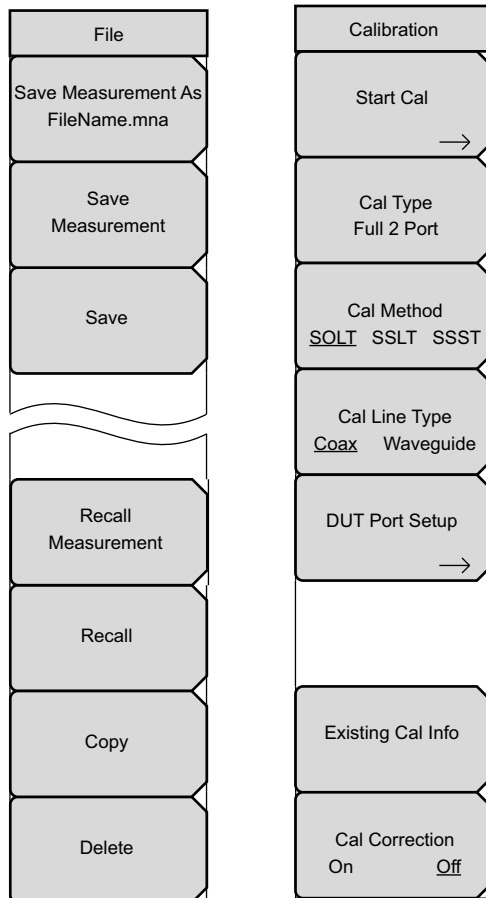

**Figure 11-10.** File and Calibration Menus



# Chapter 12 — High Accuracy Power Meter, Option 19

## 12-1 Introduction

Option 19 is available on all VNA Master models, with several sensors available to make high accuracy power measurements from 10 MHz to 18 GHz. This high performance sensor option provides true RMS measurements with accurate measurements for both CW and complex digitally modulated signals.

**Note**

A power sensor is not included with Option 19. The sensors must be ordered separately.

## 12-2 High Accuracy Power Meter (HAPM) Display

The display shows the power values in both dBm and Watts. The Relative Power feature allows the display of power changes with respect to a desired reference value in both dB and % (percent). Limit values can be turned on as needed to indicate if a measurement is within or outside specified limits. Running averaging and a Max/Hold feature are also available.

The VNA Master connects to the High Accuracy Power Sensor with a USB cable.

The zeroing feature improves the accuracy between  $-20$  dBm and  $-30$  dBm by removing measured system noise. Calibration factors can be used to correct both efficiency and mismatch loss.

Attenuators can be used to ensure that the power does not exceed the specified measurement range. The Enter Offset feature allows entering offset values for any cables and attenuators.

### Required Equipment

- VNA Master
- High Accuracy Power Sensor
- USB cable, Type A/Mini-B or Type A/Micro-B, as required by the sensor.
- 30 dB, 50 W, bi-directional, DC-8.5 GHz, N(m)-N(f), Attenuator (or other similar attenuators that are appropriate for the frequency band of interest)

**Note**

For more information about cable accessories, options, and their Anritsu part numbers, refer to [Chapter 1](#).

## 12-3 HAPM General Operating Procedure

### Turn On the VNA Master and the Sensor

1. Connect the USB cable between the High Accuracy Power Sensor and the VNA Master.

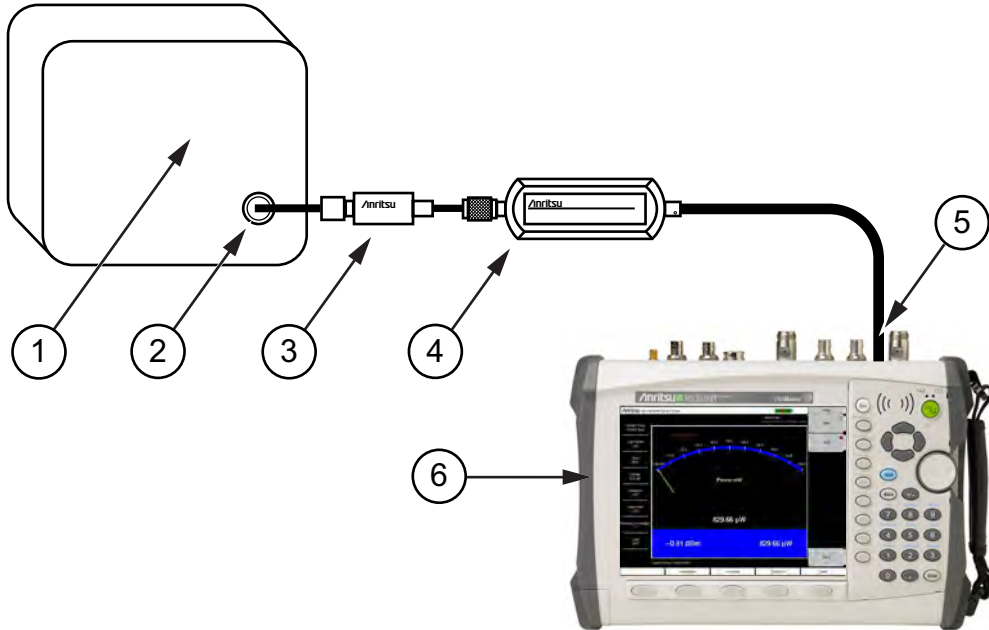

1	DUT (Device Under Test)
2	RF Out
3	Attenuator
4	High Accuracy Power Sensor
5	USB Port
6	VNA Master

**Figure 12-1.** High Accuracy Power Meter Setup Example

2. Press the **ON/OFF** key on the VNA Master.
3. Press the **Shift** and **Mode** (9) keys. Use the **Up/Down** arrow keys or rotary knob to select High Accuracy Power Meter mode and press **Enter**.

## Zero/Cal (Calibration) and Cal Factor

1. Press the **Zero/Cal** key, the Zero/Cal menu appears, and press the Cal Factor soft key. The Cal Factor submenu appears.
2. For a description of the Zero/Cal and Cal Factor menu soft keys, refer to section [“Zero/Cal and Cal Factor Menus”](#) on page 12-9.

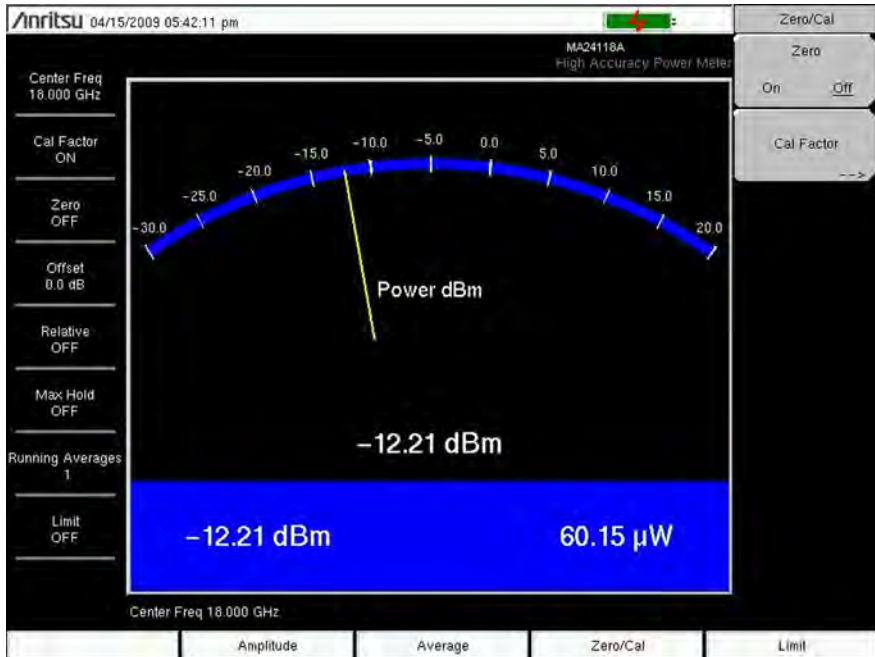

**Figure 12-2.** Power Meter Display and Zero/Cal Menu

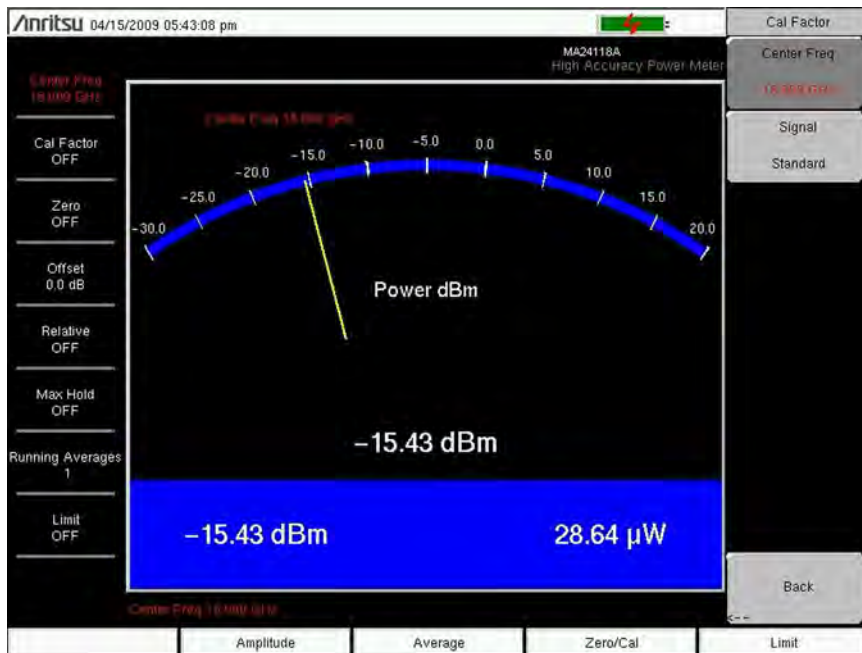

**Figure 12-3.** Power Meter Display and Cal Factor Menu

3. Enter the Center Frequency or press the Signal Standard key and the **Up/Down** arrows to select a particular standard. The Cal Factors will be derived for the corresponding center frequency. The channel number is not required because the Cal Factor frequencies are rounded to the nearest 500 MHz. The Cal Factor message in the display window will show ON if the Cal Factor command has been properly sent to the sensor.
4. With no power applied to the sensor, press the **Zero** soft key to zero the sensor. This step is recommended when making power measurements below  $-20$  dBm.

## Change the Analog Scale Display

1. Press the **Amplitude** key. The Amplitude menu appears.

For a description of the Amplitude menu soft keys, refer to section “[Amplitude and Units Menus](#)” on page 12-10.



**Figure 12-4.** Amplitude Menu

2. Press the Auto Scale soft key to align the needle in the middle of the analog display. The maximum and minimum values will align accordingly.
3. Press the Max soft key and use the key pad to manually set the maximum value of the analog display.
4. Press the Min soft key and use the key pad to manually set the minimum value of the analog display.

### Note

With no offset, the maximum value for the display is the upper measurement range, which is +20 dBm. With an offset, such as with 10 dB of attenuation, the upper value can be set to +30 dBm. With an offset of XX dB, the upper value can be set to +20 dBm plus xx dB.

## Using Attenuators

1. Press the **Amplitude** key and press the Enter Offset soft key.
2. Enter the offset value for the attenuator at the frequency of operation.

## Displaying Relative Power

1. Press the **Amplitude** key.
2. With the desired base power level input to the sensor, press the **Relative** soft key. The power reading will show 0 dB and 100%. If measuring a 10 dBm signal, and if the **Relative** key is selected, then a drop to 7 dBm will show  $-3$  dB and 50%.

## Averaging/Max Hold/Run Hold

1. Press the **Average** key. The Averages soft menu appears.

For a description of the Average menu soft keys, refer to section [“Averages Menu”](#) on page 12-11.

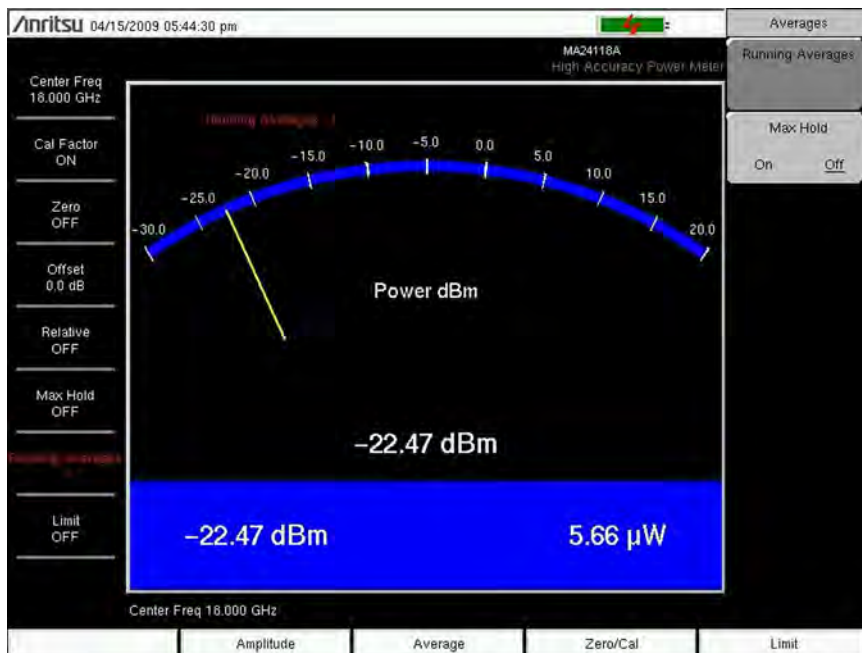
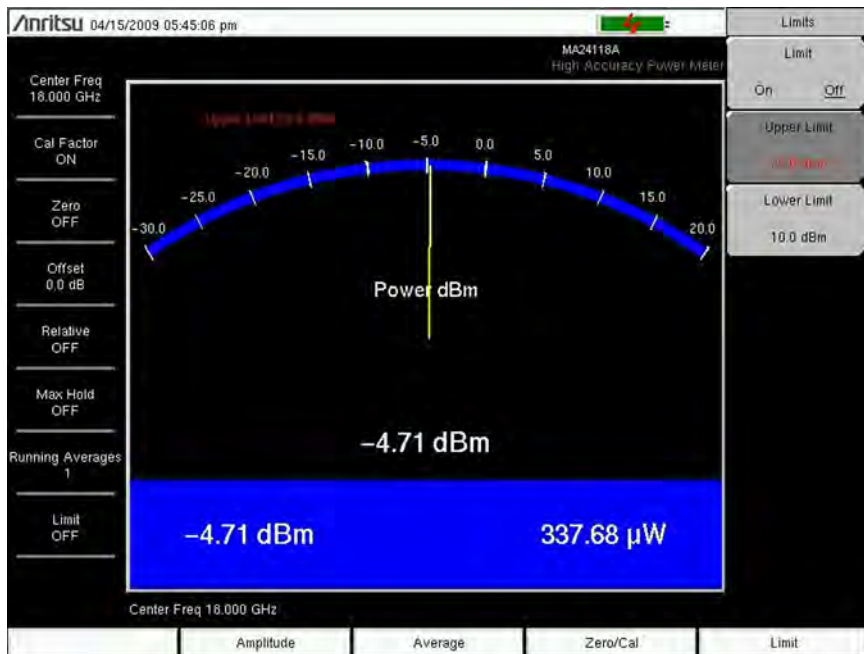

**Figure 12-5.** Averages Menu

2. Press the **Running Averages** key. Use the keypad to enter the desired number of averages.
3. Press the **Max Hold (toggle)** soft key to alternate between Max Hold On and Max Hold Off. If averaging is selected, then Max Hold will display the maximum value of the non-averaged data.

## Limits

Press the **Limit** key. The Limits menu appears. For a description of the Limits menu soft keys, refer to section “Limits Menu” on page 12-12.



**Figure 12-6.** Limits Menu

4. Press the Lower Limit soft key. Enter the lower limit value in dBm or in Watts.
5. Press the Upper Limit soft key. Enter the upper limit value in dBm or in Watts.
6. Press the Limit On/Off soft key to turn the Limits ON and OFF. The number display will turn green or red if the measurement is passing or failing.

Press the **Amplitude** key and press the Units soft key to change between dBm and Watts.

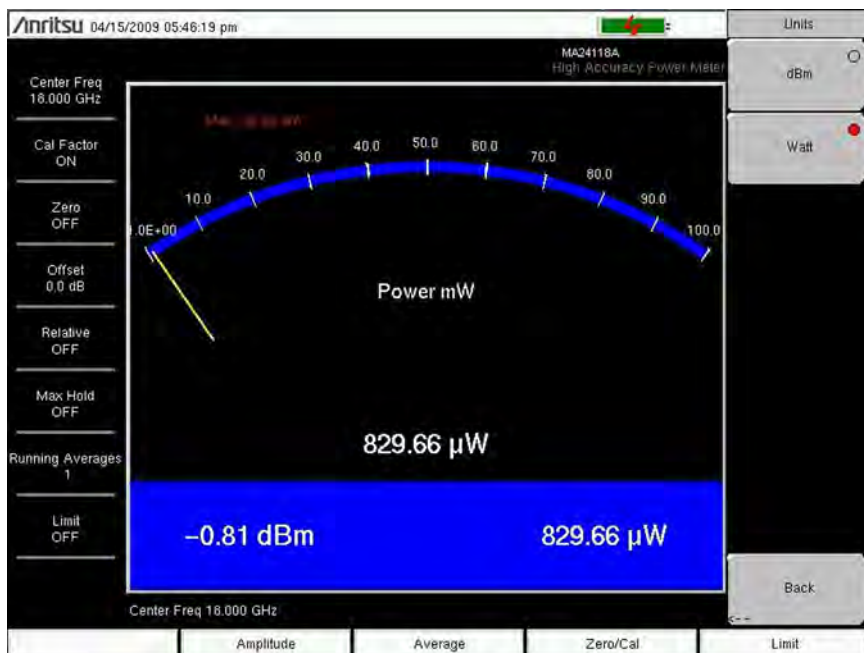

Figure 12-7. Units Menu

## Saving the Measurement

1. Press the **Shift** key and the **File (7)** key.
2. Press the **Save** soft key.
3. Chose the save location and the file type.
4. Use the **Text Entry** soft keys to enter the desired file name and then press **Enter** to save the file.

## 12-4 Menus

The High Accuracy Power Meter is controlled by menus available from the hard keys at the bottom of the screen.

- Zero/Cal menu and the Cal Factor submenu
- Amplitude menu and the Units submenu
- Averages menu
- Limit menu



## 12-5 Zero/Cal and Cal Factor Menus

Zero/Cal and Cal Factor Menus are displayed in [Figure 12-8](#). Access the Zero/Cal menu by pressing the **Zero/Cal** hard key, which is below the measurement display screen.

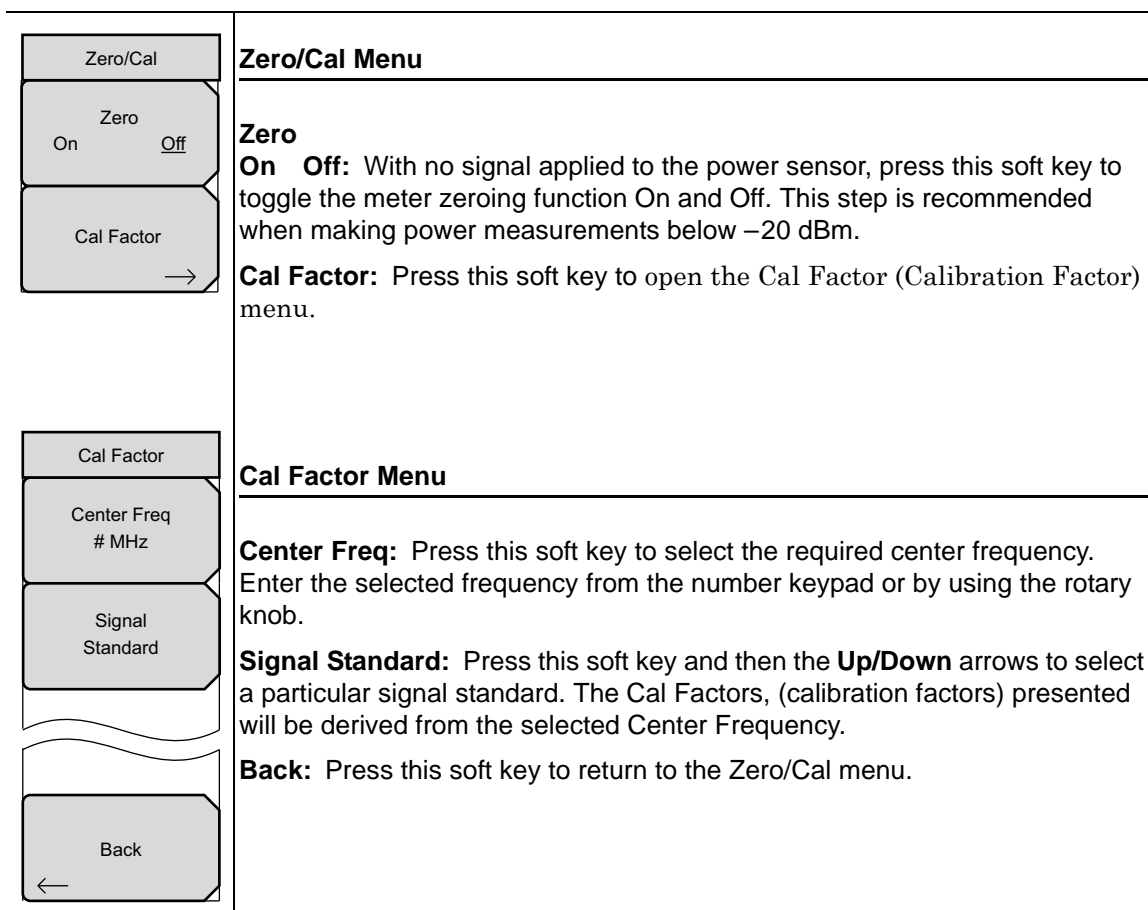

**Figure 12-8.** Zero/Cal and Cal Factor Soft Key Menus

## 12-6 Amplitude and Units Menus

The Amplitude and Units Menus are displayed in [Figure 12-9](#). Access the Amplitude menu by pressing the **Amplitude** hard key, which is below the measurement display screen.

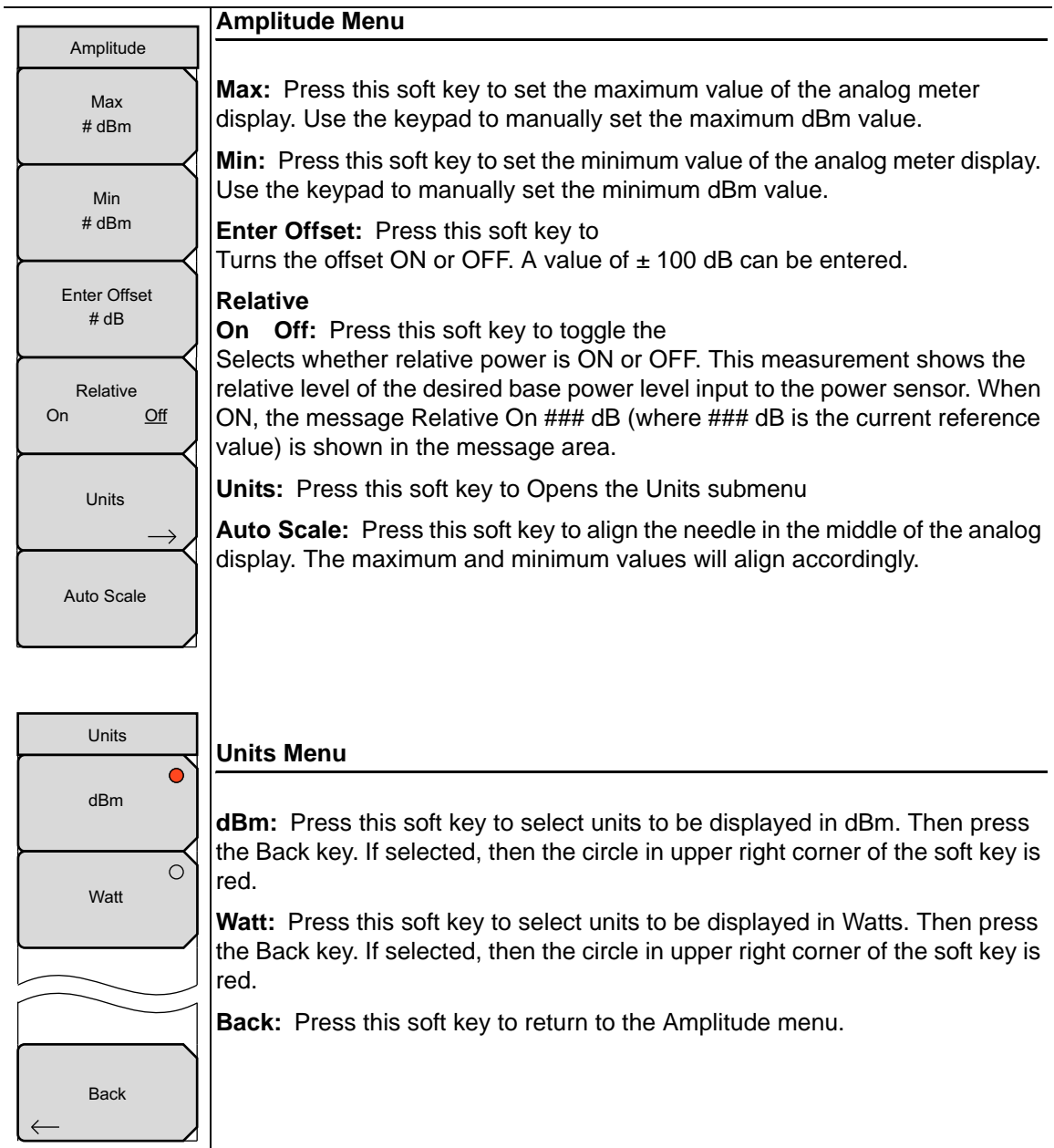

**Figure 12-9.** Amplitude and Units Soft Key Menus

## 12-7 Averages Menu

The Averages menu is displayed in [Figure 12-10](#). Access the Averages menu by pressing the **Average** hard key, which is below the measurement display screen.

Averages	<b>Running Averages:</b> Press this soft key to select the number of averages that will be used to calculate the running average. Use the keypad numbers to enter the required number.
Running Averages #	<b>Max Hold</b> <b>On Off:</b> Press this soft key to toggle between Max Hold On and Max Hold Off. If averaging is selected, then the Max Hold displays the maximum value of the non-averaged data.
Max Hold On      Off	

**Figure 12-10.** Averages Soft Key Menu

## 12-8 Limits Menu

The Limits menu is displayed in [Figure 12-11](#). Access the Limits menu by pressing the **Limits** hard key, which is below the measurement display screen.

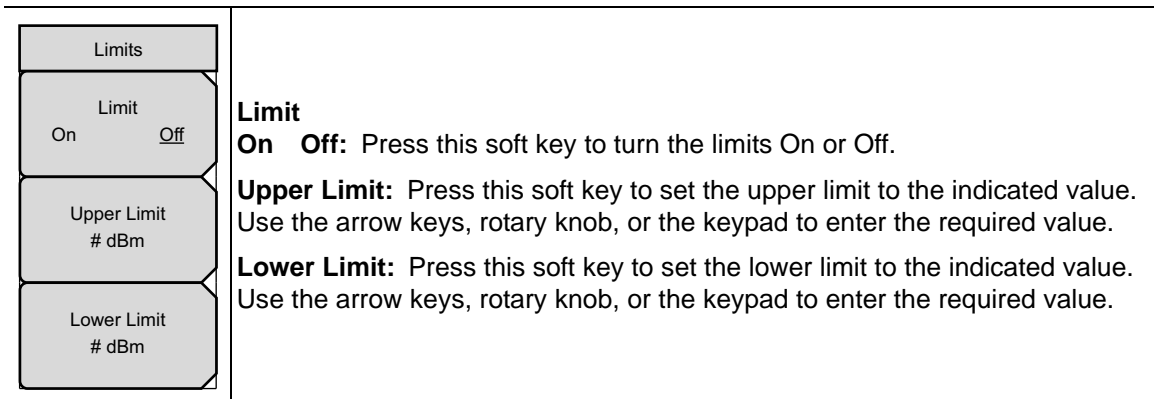

**Figure 12-11.** Amplitude and Units Soft Key Menus

# Chapter 13 — GPS Receiver, Option 31

## 13-1 Introduction

The VNA Master is available with a built-in GPS receiver feature (Option 31) that can provide latitude, longitude, altitude, and UTC timing information. A GPS antenna is not included with Option 31. The antenna must be ordered separately.

In order to acquire data from the GPS satellites, the user must have line-of-sight to the satellites or the antenna must be placed outside without any obstructions. The following GPS antenna must be ordered separately:

2000-1528-R Magnet Mount GPS Antenna with 4.6 m (15 ft) cable

## 13-2 Activating the GPS Feature

Install the Anritsu GPS antenna onto the GPS Antenna connector on the VNA Master.

**Note**

The GPS antenna connection on the VNA Master is fitted with an SMA female connector. A DC voltage is present on this connector. Do not connect anything other than the Anritsu GPS antenna to this port.

1. Press the **Shift** key, then the **System** (8) key.
2. Press the GPS soft key.
3. Press the GPS On/Off soft key to toggle the GPS feature On or Off. When GPS is first turned on, a RED GPS icon appears at the top of the display.



---

**Figure 13-1.** GPS - Red

4. When the GPS receiver has tracked at least three satellites, the GPS icon changes to GREEN. Latitude and Longitude information is displayed in the white bar on top of the measurement display screen. Acquiring satellites may take as long as three minutes.
- 



**Figure 13-2.** GPS - Green

5. Press the GPS Info soft key to view the number of tracked satellites, latitude, longitude, altitude, and UTC timing information, and so forth.
  6. Press the Reset soft key to reset the GPS.
  7. The GREEN GPS icon with a RED CROSS through it, as shown below, appears when GPS satellite tracking is lost (after actively tracking 3 or more satellites). The GPS longitude and latitude are saved in the instrument memory until the VNA Master is turned off or until GPS is turned off by using the GPS On/Off soft key.
- 



**Figure 13-3.** GPS - Crossed

## 13-3 GPS Menu

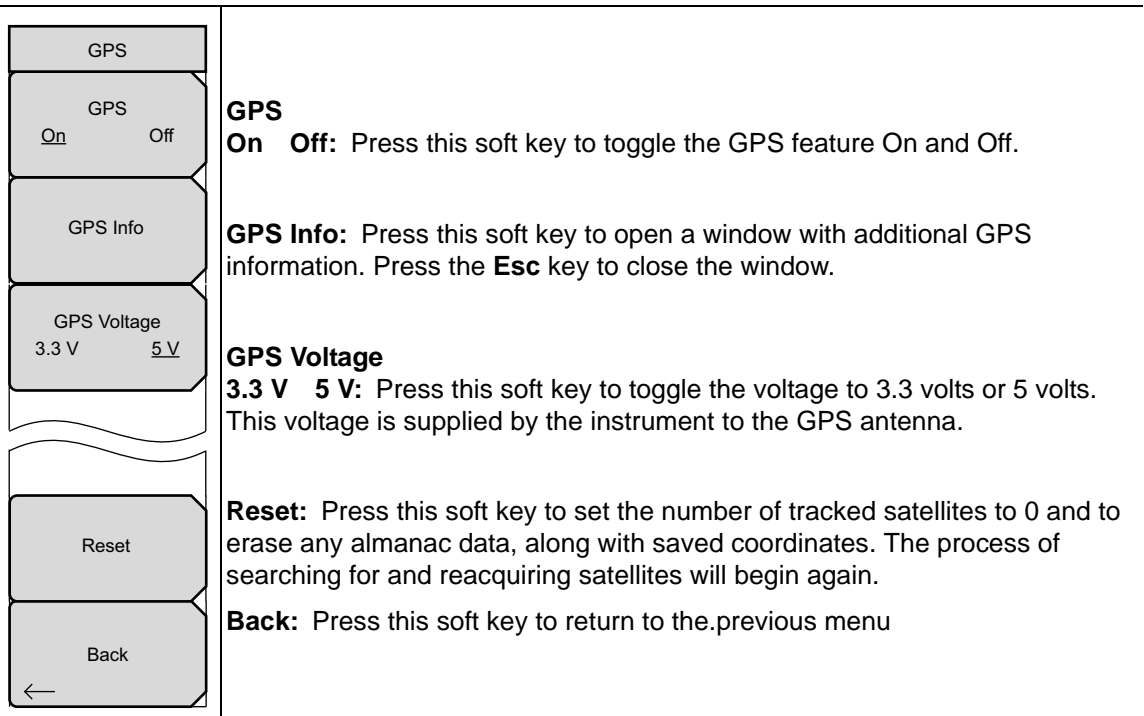

Figure 13-4. GPS Menu

## 13-4 GPS Info Window

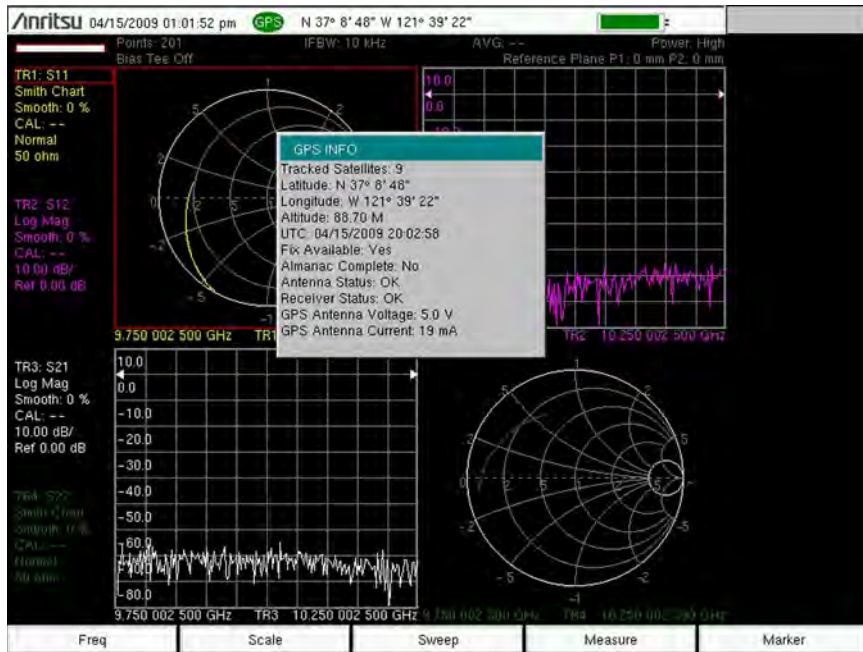

Figure 13-5. GPS Info Window

The GPS Info window provides the following GPS information:

### Tracked Satellites

Shows the number of tracked satellites (three are required to retrieve latitude and longitude, four are required to resolve altitude). Generally, the larger the number of satellites tracked, the more accurate the information.

### Latitude and Longitude

Shows location in degrees, minutes, and seconds.

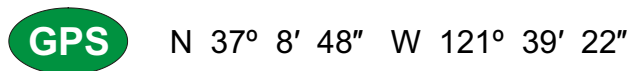

Figure 13-6. GPS Latitude and Longitude

### Altitude

Shows altitude information in meters.

### UTC

Universal Coordinated Time.



## Fix Available

The cold start search sets are established to ensure that at least three satellites are acquired within the first couple minutes of GPS activation. When three satellites are found, the receiver computes an initial fix (typically in less than two minutes). Fix Not Available means that the initial position has not been established.

## Almanac Complete

The system Almanac contains information about the satellites in the constellation, ionospheric data, and special system messages. In a cold start, the GPS receiver does not have any navigation data, so the receiver does not have a current almanac. A complete system almanac is not required to achieve a first position fix. The availability of the almanac, however, can significantly reduce the time to first fix.

## Antenna Status

### OK:

Antenna is connected properly, and antenna is working properly.

### Short/Open:

A short or open exists between the antenna and the connection. If this message is displayed, then remove and replace the GPS antenna. If the message persists, then try another Anritsu GPS antenna. If the message still persists, then contact your nearest Anritsu Service Center (refer to section [“Anritsu Service Centers”](#) on page 1-7).

## Receiver Status

### OK:

Receiver is working properly.

### No GPS Time Yet:

The receiver does not have any input signal, which is usually the case when the antenna status is not OK. Check the antenna connection. If the antenna status is OK and if this message persists, then contact your nearest Anritsu Service Center.

## Other Status Messages

If any of the status messages (in the following list) persist, then the GPS receiver may be not working properly. In that case, contact your nearest Anritsu Service Center.

- Only 1 Satellite
- Only 2 Satellites
- Only 3 Satellites
- No Usable Satellites
- Satellite unusable
- Need Initialization
- PDOP is Too Hi
- Undecoded Error

## GPS Antenna Voltage

Lists the voltage that is being used by the GPS antenna (3.3 V or 5 V).

## GPS Antenna Current

Lists the current draw from the GPS antenna when the voltage is applied.

## 13-5 Saving and Recalling Traces with GPS Information

### Saving Traces with GPS Information

The GPS coordinates of a location can be saved along with a measurement trace. Refer to the [“File Menu” on page 6-23](#) for Save and Recall menu information.

The current GPS coordinates are saved with the measurement traces whenever GPS is On and actively tracking satellites.

### Recalling GPS Information

If the GPS coordinates were saved with a measurement trace, then when the trace is recalled, the coordinates that were saved are recalled as well. Refer to the [“Recall Menu” on page 6-31](#) for more information about recalling a saved trace.

# Chapter 14 — Balanced Ports, Option 77

## 14-1 Introduction

When equipped with Option 77, the MS202xB VNA Master is able to leverage both of its test ports in order to measure the S-parameters of balanced and differential test configurations. Using mathematical transformations, the VNA Master can convert single-ended S-Parameters into the equivalent balanced differential, common, and mixed mode S-parameters:  $S_{d1d1}$ ,  $S_{c1c1}$ ,  $S_{c1d1}$ ,  $S_{d1c1}$ . This approach provides accurate results for passive measurements. Note that the VNA Master is **not** simultaneously transmitting from both Port 1 and Port 2 during this measurement. This measurement can be used as an alternative to a sampling oscilloscope for verifying performance and discontinuities in differential cables.

## 14-2 Procedure

With Option 77, the VNA Master enables measurements with four additional S-parameters: the differential reflection coefficient ( $S_{d1d1}$ ), the common mode reflection coefficient ( $S_{c1c1}$ ), and the mixed mode reflection coefficients ( $S_{c1d1}$  and  $S_{d1c1}$ ). These S-parameters can be applied to any trace with any graph type, in the same manner as the other standard S-parameters.

1. Press the **Measure** function hard key.
2. Choose the desired active trace.
3. Press the S-parameter soft key and then choose the desired S-parameter from the pop-up list box.
4. Choose the desired Graph Type and Domain.

**Note**

A full 2-Port calibration is required for balanced or differential S-parameter measurements.

Markers, limits, and all other features that can be used with the standard S-parameters also can be used with the balanced or differential S-parameters.

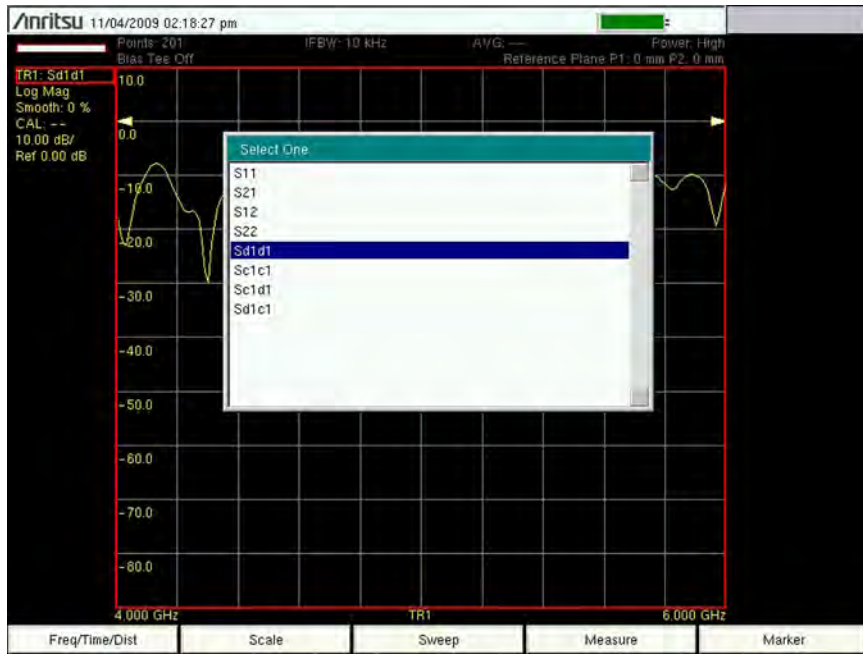

**Figure 14-1.** Differential S-Parameter Selection List Box (no soft key menu)

With Option 77, the S-parameter submenu uses the selection list box instead of the standard soft keys for choosing the desired S-parameter, even for non-differential S-parameters.

## 14-3 Typical Measurements

The following description uses  $S_{d1d1}$  as an example. The same measurements can be made on any of the other parameters:  $S_{c1c1}$ ,  $S_{c1d1}$ , or  $S_{d1c1}$ .

The differential match, or  $S_{d1d1}$ , can be viewed in the frequency domain. It represents the reflections from the differential port of the device under test. Figure 14-2 shows the Log Magnitude display of  $S_{d1d1}$  (essentially the return loss) of a differential cable. A segmented limit line with pass/fail alarm is used to verify that this cable meets its specifications.

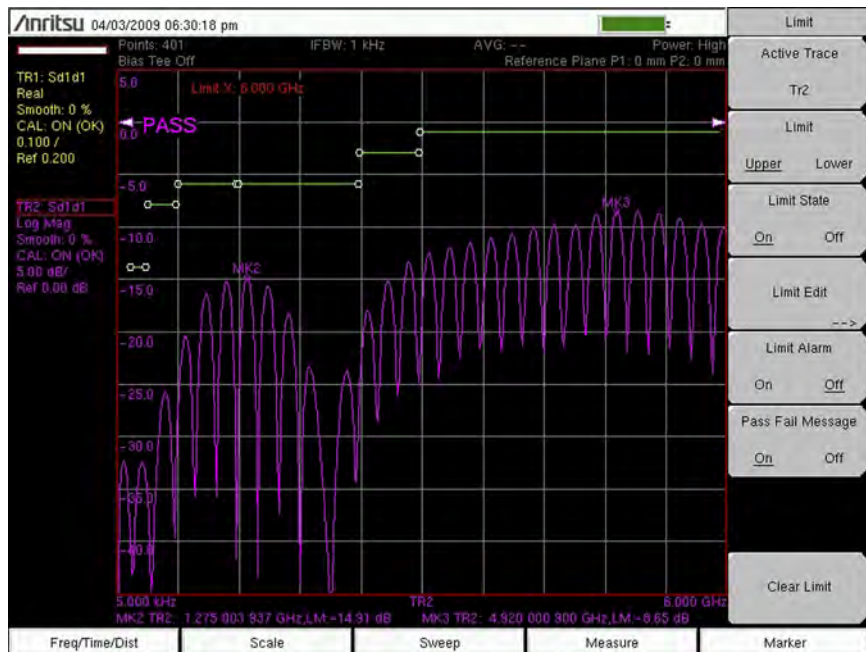

Figure 14-2. Differential  $S_{11}$  Log Magnitude Display of  $S_{d1d1}$

In addition to looking at the frequency response of  $S_{d1d1}$ , the VNA Master (when equipped with Option 2) can display the time or distance domain response (or both) of  $S_{d1d1}$ . This powerful display allows you to check for impedance discontinuities on the differential line.

Figure 14-3 shows both the frequency and distance domain responses of the differential cable under test. Markers are used in the frequency domain to check for the return loss values at different frequency points. In the distance domain, a marker is used to check the impedance value at the end of the cable under test. The marker readout can be set independently of the graph type, and in this case (Figure 14-3), it was set to Impedance. In the example in Figure 14-3, the impedance readout at the end of that cable is 115 ohm, which is a good termination for this 100 ohm differential cable.

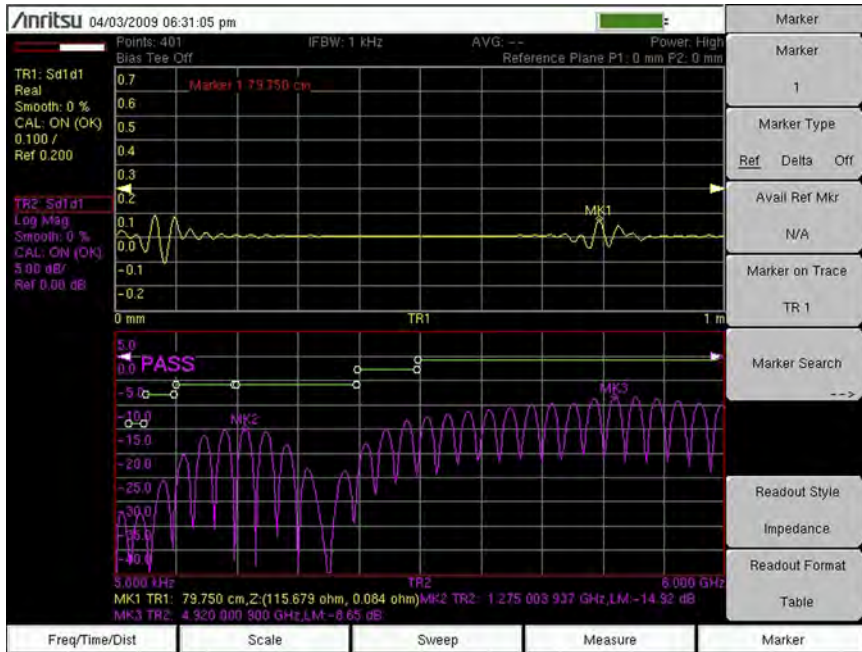

Figure 14-3. Frequency and Distance Domain Responses of Differential Cable

Figure 14-4 shows a cable that fails its return loss specification limits. Looking at the distance domain plot, you can see that the cable has a large mismatch at the end of the cable. The marker reading validates this by providing the impedance value at the end of the cable. In this case, the results point to an open condition at the end of the cable. With its flexible, yet powerful display, and with marker and limits capabilities, the VNA Master is able to test differential cables against their specifications, and also it is able to troubleshoot any failures that are identified.

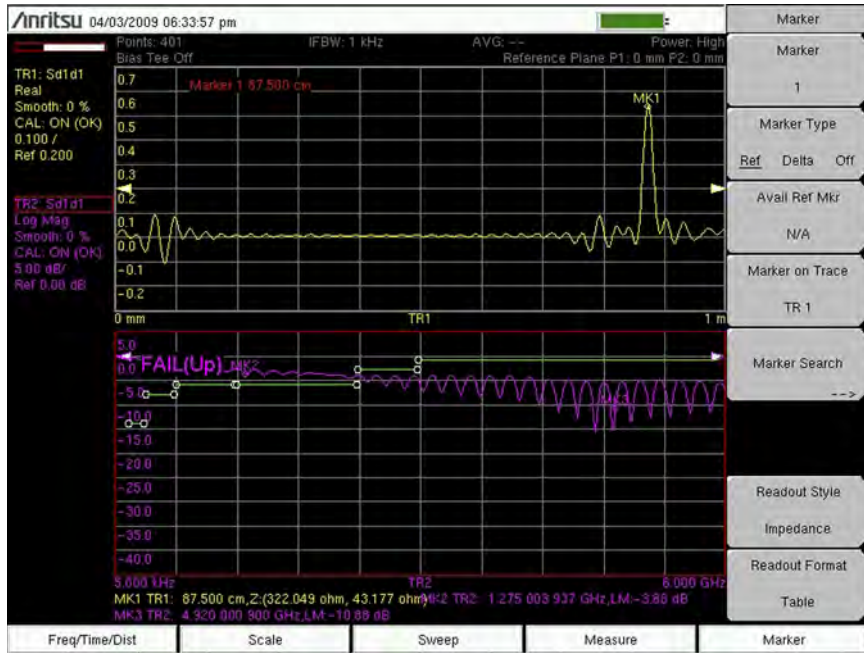

Figure 14-4. Cable with Failing Return Loss (Marker Text Size = Regular)

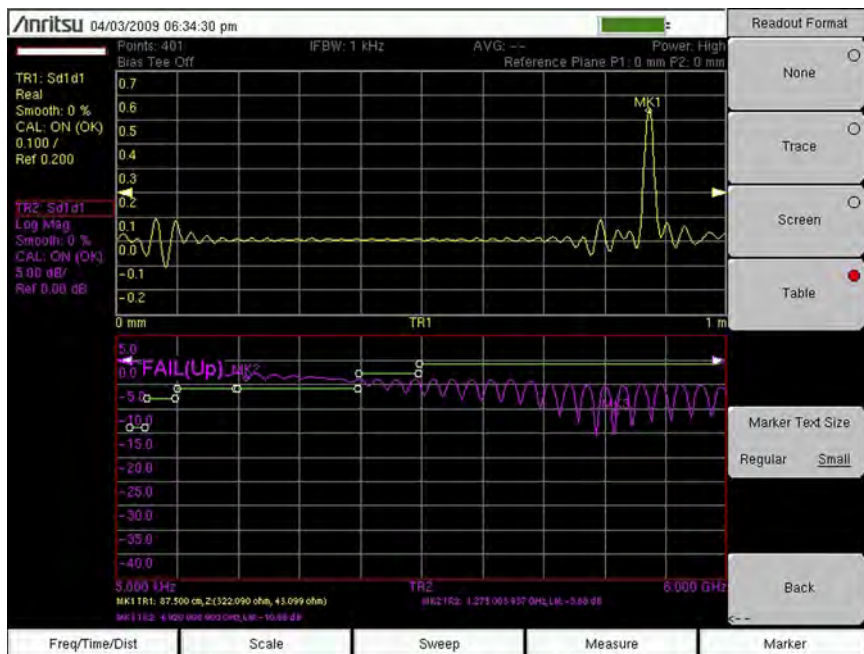

Figure 14-5. Cable with Failing Return Loss (Marker Text Size = Small)

Compare the table of marker data at the bottom of the sweep windows in [Figure 14-4](#) and [Figure 14-5](#). [Figure 14-5](#) shows marker text size set to small (the Marker Text Size soft key is shown in the figure). The key path to this setting is:

**Marker** — Readout Format — Marker Text Size (Regular or Small)



# Chapter 15 — Anritsu PC Software Tools

## 15-1 Introduction

This chapter provides a brief overview of the available PC software tools from Anritsu. For detailed information about specific software, refer to the Anritsu web site or the program's built-in Help. Software is included with the instrument and is also available from the Anritsu web site: <http://www.anritsu.com/en-US/Services-Support/Handheld-Tools-Tool-Box.aspx>.

## 15-2 Anritsu Tool Box

The Anritsu Tool Box is a central location to open an Anritsu measurement, visit the Anritsu web site, or launch several Anritsu applications. To open the Anritsu Tool Box, either click on the shortcut icon on the desktop or click **Start** and navigate through the Programs folder to the Anritsu folder and select Anritsu Tool Box.

Once the Tool Box is open, move the mouse pointer over any of the application icons to view a short description of the application. The following pages describe three software programs that can be launched from the Tool Box, Line Sweep Tools (LST), Master Software Tools (MST), and easyMap Tools™.



Figure 15-1. Anritsu Tool Box

The Anritsu PC Software tools do not support all of Anritsu's handheld instruments or all of their measurements. Compatibility information is provided in the program's Help.

**Note** Line Sweep Tools (LST) can be used for downloading and post-processing of certain VNA measurements and cable & antenna analysis sweeps.

Master Software Tools (MST) is primarily used for spectrum analysis measurements.

## 15-3 Line Sweep Tools

Line Sweep Tools is a program designed to increase productivity for people who work with dozens of Cable traces, Antenna traces, and Passive Intermodulation (PIM) traces every day. Line Sweep Tools will:

- Collect sweeps from Anritsu PIM and Line Sweep gear.
- Help verify that those sweeps are done properly and that the Cable, Antenna and PIM sweeps meet specifications.
- Help create reports of the findings quickly and to a professional standard.



Figure 15-2. Line Sweep Tools

## 15-4 Master Software Tools

Anritsu Master Software Tools is a PC program for transferring and editing saved measurements, markers, and limit lines to a PC. MST is recommended for Spectrum Analyzer instruments or instruments that perform spectrum analysis measurements.

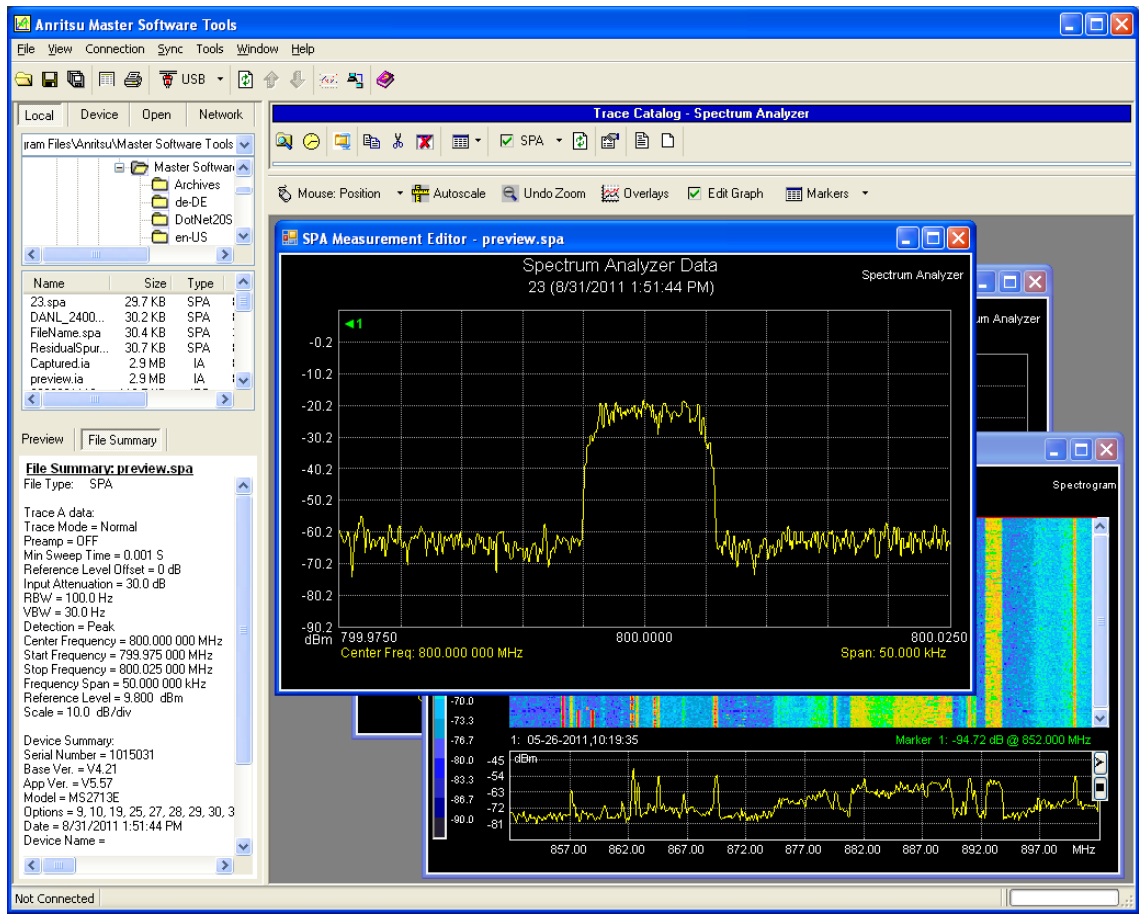
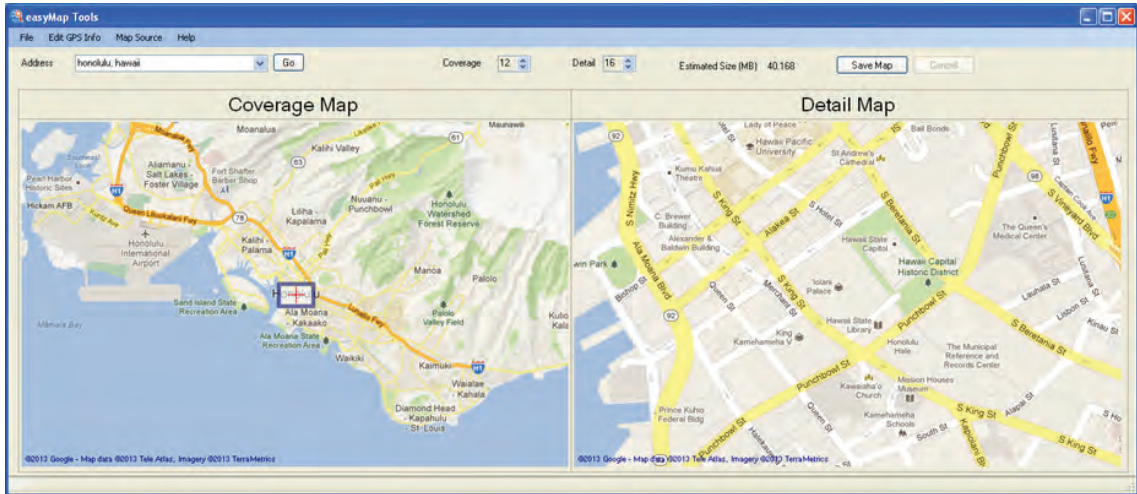

Figure 15-3. Master Software Tools

## 15-5 easyMap Tools

easyMap Tools creates geo-referenced maps and can also convert floor plans for use by Anritsu mapping spectrum analyzers. It can also create single panel maps (.map) for legacy instruments or pan and zoom maps (.azm) for current instruments. Mapping of both interference and coverage is available while indoors or outdoors.



**Figure 15-4.** Captured Geo-referenced Map Ready for the Analyzer

# Appendix A — Signal Standards

## A-1 Introduction

This appendix provides a sample list of signal standards. This list can be used as a reference when making measurements with the VNA Master.

**Table A-1.** Signal Standards

Signal Standard	Center (MHz)	Span (MHz)	Valid Channels
AMPS / EIA 553 - Uplink	859	70	1-799, 990-1023
AMPS / EIA 553 - Downlink	859	70	1-799, 990-1023
C-450 (P) - Uplink	463.5	21	1-800
C-450 (P) - Downlink	463.5	21	1-800
C-450 (SA) - Uplink	462.5	15	1-247
C-450 (SA) - Downlink	462.5	15	1-247
CDMA US Cellular - Uplink	859	70	1-799, 990-1023
CDMA US Cellular - Downlink	859	70	1-799, 990-1023
CDMA US PCS - Uplink	1920	140	1-1199
CDMA US PCS - Downlink	1920	140	1-1199
CDMA Korea PCS - Uplink	1810	120	1-599
CDMA Korea PCS - Downlink	1810	120	1-599
CDMA Japan / ARIB - Uplink	878.5	93	1-799, 801-1039, 1041-1199
CDMA Japan / ARIB - Downlink	878.5	93	1-799, 801-1039, 1041-1199
CDMA China - 1 - Uplink	916	88	0-1000, 1329-2047
CDMA China - 1 - Downlink	916	88	0-1000, 1329-2047
CDMA China - 2 - Uplink	910	76	0-1000
CDMA China - 2 - Downlink	910	76	0-1000
cdma2000 Class 0, Korea Cellular - Uplink	859	70	1-799, 990-1023
cdma2000 Class 0, Korea Cellular - Downlink	859	70	1-799, 990-1023
cdma2000 Class 0, N.A. Cellular - Uplink	859	70	1-799, 990-1023
cdma2000 Class 0, N.A. Cellular - Downlink	859	70	1-799, 990-1023
cdma2000 Class 1, N.A. PCS - Uplink	1920	140	0-1199
cdma2000 Class 1, N.A. PCS - Downlink	1920	140	0-1199
cdma2000 Class 2, (TACS Band) - Uplink	916	88	0-1100, 1329-2047
cdma2000 Class 2, (TACS Band) - Downlink	916	88	0-1100, 1329-2047
cdma2000 Class 3, (JTACS Band) - Uplink	878.5	93	1-799, 801-1039, 1041-1199
cdma2000 Class 3, (JTACS Band) - Downlink	878.5	93	1-799, 801-1039, 1041-1199
cdma2000 Class 4, Korea PCS - Uplink	1810	120	0-599
cdma2000 Class 4, Korea PCS - Downlink	1810	120	0-599
cdma2000 Class 5, (NMT-450-20 kHz) - Uplink	472.5	43	1039-1473, 1792-2016

**Table A-1.** Signal Standards

Signal Standard	Center (MHz)	Span (MHz)	Valid Channels
cdma2000 Class 5, (NMT-450-20 kHz) - Downlink	472.5	43	1039-1473, 1792-2016
cdma2000 Class 5, (NMT-450-25 kHz) - Uplink	439.5	57	1-300, 539-871
cdma2000 Class 5, (NMT-450-25 kHz) - Downlink	439.5	57	1-300, 539-871
cdma2000 Class 6, IMT-2000 - Uplink	2045	250	0-1199
cdma2000 Class 6, IMT-2000 - Downlink	2045	250	0-1199
cdma2000 Class 7, N.A. 700 MHz Cellular - Uplink	770	48	0-359
cdma2000 Class 7, N.A. 700 MHz Cellular - Downlink	770	48	0-359
ETACS - Uplink	916	88	0-1000, 1329-2047
ETACS - Downlink	916	88	0-1000, 1329-2047
GSM 900 - Uplink	897.4	40	1-124, 975-1023
GSM 900 - Downlink	942.4	40	1-124, 975-1023
GSM 1800 - Uplink	1747.4	80	512-885
GSM 1800 - Downlink	1842.4	80	512-885
GSM 1900 - Uplink	1879.8	80	512-810
GSM 1900 - Downlink	1959.8	80	512-810
JTACS - Uplink	878.5	93	0-1198 (even numbers only)
JTACS - Downlink	878.5	93	0-1198 (even numbers only)
MATS-E - Uplink	925	70	1-1000
MATS-E - Downlink	925	70	1-1000
N-AMPS / IS-88L - Uplink	859	70	1-799, 990-1023
N-AMPS / IS-88L - Downlink	859	70	1-799, 990-1023
N-AMPS / IS-88M - Uplink	859	70	1-799, 990-1023
N-AMPS / IS-88M - Downlink	859	70	1-799, 990-1023
N-AMPS / IS-88U - Uplink	897.5	147	1-799, 990-1023
N-AMPS / IS-88U - Downlink	897.5	147	1-799, 990-1023
NADC IS136 Cellular - Uplink	859	70	1-799, 990-1023
NADC IS136 Cellular - Downlink	859	70	1-799, 990-1023
NADC IS136 PCS - Uplink	1920	140	1-1199
NADC IS136 PCS - Downlink	1920	140	1-1199
NMT-411-25 kHz - Uplink	420.5	19	539-871
NMT-411-25 kHz - Downlink	420.5	19	539-871
NMT-450-20 kHz - Uplink	460.5	19	1039-1473
NMT-450-20 kHz - Downlink	460.5	19	1039-1473
NMT-450-25 kHz - Uplink	459	18	1-300

Table A-1. Signal Standards

Signal Standard	Center (MHz)	Span (MHz)	Valid Channels
NMT-450-25 kHz - Downlink	459	18	1-300
NMT-470-20 kHz - Uplink	486.5	15	1972-2016
NMT-470-20 kHz - Downlink	486.5	15	1972-2016
NMT-900 - Uplink	925	70	1-1000
NMT-900 - Downlink	925	70	1-1000
NMT-900 (Offset) - Uplink	925	70	1025-2023
NMT-900 (Offset) - Downlink	925	70	1025-2023
NTACS - Uplink	878.5	93	1-1199
NTACS - Downlink	878.5	93	1-1199
PDC 800 Analog - Uplink	891.5	97	0-1680
PDC 800 Analog - Downlink	891.5	97	0-1680
PDC 1500 (JDC) - Uplink	1513	72	0-960
PDC 1500 (JDC) - Downlink	1513	72	0-960
PHS - Uplink	1906.5	23	1-77
PHS - Downlink	1906.5	23	1-77
SMR 800 - 12.5 kHz - Uplink	836	60	1-1199
SMR 800 - 12.5 kHz - Downlink	836	60	1-1199
SMR 800 - 25 kHz - Uplink	836	60	1-600
SMR 800 - 25 kHz - Downlink	836	60	1-600
SMR 1500 - Uplink	1483	60	1-479
SMR 1500 - Downlink	1483	60	1-479
TACS - Uplink	925	70	1-1000
TACS - Downlink	925	70	1-1000
UMTS/WCDMA - Uplink	1920	70	9600-9900
UMTS/WCDMA - Downlink	2110	70	10550-10850
UMTS/Region 2 - Uplink	1850	70	9250-9550
UMTS/Region 2 - Downlink	1930	70	9650-9950
802.11a	5170	84	34-161 (not all valid)
802.11b	2442	84	1-14
802.11 DS	2448	72	1-14
802.11 FH	2448.5	93	2-95
802.11g	2442	84	1-14





# Appendix B — Error Messages

## B-1 Introduction

This appendix provides a list of information and error messages that could be displayed on the VNA Master. If any error condition persists, then contact your local Anritsu Service Center.

## B-2 Reset Options

You can reset your VNA Master to Factory Defaults or use a Master Reset to return to the FULL Factory Default condition from the menu system or from the Off condition.

### Reset Via Instrument Menus

From the VNA Master menu system, press the **Shift** key, then the **System** (8) key to open the System menu. Then press the System Options soft key to open the System Options menu. Then press the Reset soft key to open the Reset menu (refer to section “[Reset Menu](#)” on page 6-61). From the Reset menu, press either the Factory Defaults soft key or the Master Reset soft key.

### Reset from OFF Condition

You can also reset the VNA Master by turning it Off and then restarting under one of the following conditions:

#### Factory Defaults Reset:

Hold the **Esc** button while pressing the **On/Off** button. Continue holding the **Esc** button until the Anritsu splash screen appears. You can then release the button. The VNA Master starts up with many Factory Default settings (refer to section “[Factory Defaults](#)” on page 2-30). Throughout this appendix, this sequence is abbreviated as Factory Defaults (**Esc+On**).

#### Master Reset:

Hold the **8** key in the number keypad (also referred to as the **System** (8) key) while pressing the **On/Off** button. Continue holding the **8** key until the Anritsu splash screen appears. You can then release the key. The VNA Master starts up in FULL Factory Default condition (refer to section “[Master Reset](#)” on page 2-31). Throughout this appendix, this sequence is abbreviated as Master Reset (**System+On**).

## B-3 Self Test or Application Self Test Error Messages

### Self Test

To run self test, press **Shift** and **System** (8) and then Self Test. Refer to the results window in [Figure B-1](#), which summarizes the status of several key functions in the instrument that are common to all applications (note that your instrument display may differ from this image). If any subtest shows FAILED, then check that the battery level is adequate for operation, or check that the temperature is within acceptable limits. Reset to factory defaults with either Factory Defaults (**Esc+On**), or Master Reset (**System+On**).

**Caution**

Use of Master Reset (**System+On**), will erase all user saved setups and measurement traces and will return the VNA Master to a full Factory Default condition. If the error persists, then contact your Anritsu Service Center.

```
SELF TEST
USB: PASSED
NET: PASSED
Disk-on-Chip: PASSED
EEPROM: PASSED
Temperature: PASSED
DSP: PASSED
RTC: PASSED
Display: PASSED
Battery: PASSED
Power: PASSED
  vSys= 11.673 V
  3.3 V= 3.330 V
  3.3OPT V = 3.339 V

  5.0 V= 4.955 V
  4.0 V= 4.192 V
  5.8 V= 6.023 V
  13.2 V= 13.355 V
  24 V= 24.366 V
  -5.8 V= -6.014 V

  RTC backup= 3.510 V
CPU FPGA Version: 4.12

Decode PLD Version: 4.07
Motherboard ID: 192
```

**Figure B-1.** Self Test Results Window

## Application Self Test

To run the application self test, press **Shift** and **System** (8) and then Application Self Test from within the desired mode. When you are in Vector Network Analyzer mode, you will see the results window that is shown in [Figure B-2](#) (note that your instrument display may differ from this image), which summarizes the status of several key functions that are specific to this application.

If the Overall Status shows Failed, then one or more elements of the Application Self Test have failed. This self test consists of 4 subtests:

**Power Supply Test:** Lists any power supply voltages that are not meeting tolerance specification

**VCO Calibration:** Lists any frequency range over which the VCO calibration is failing

**Frequency Sweep:** Lists any frequency range over which errors in the sweep are occurring

**EEPROM:** Indicates whether reading or writing (or both) to the EEPROM has failed

If any of the subtests shows FAILED, then check that the battery level is adequate for operation or that temperature is within acceptable limits. Reset to factory defaults with either Factory Defaults (**Esc+On**), or Master Reset (**System+On**).

**Caution**

Use of Master Reset (**System+On**), will erase all user saved setups and measurement traces and will return the VNA Master to a full Factory Default condition. If the error persists, then contact your Anritsu Service Center.

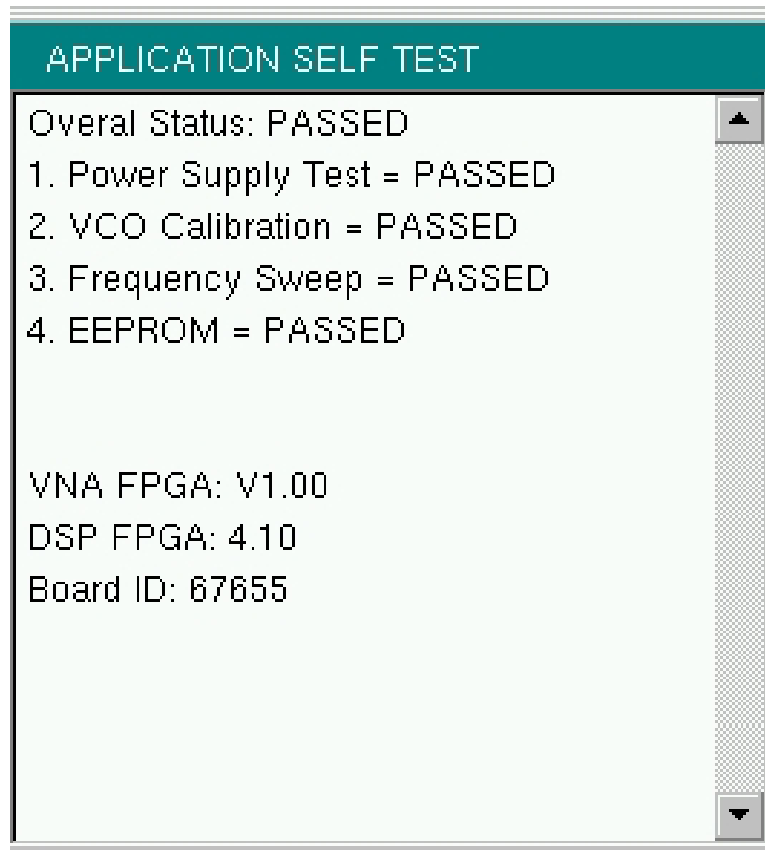

**Figure B-2.** Application Self Test Results Window (VNA mode)

## B-4 Operation Error Messages

### Fan Failure

The system has determined that the fan should be running due to the internal temperature of the unit, but cannot detect that the fan is actually running.

It is important to keep the fan inlet and exhaust ports clear of obstructions. The cooling fan will vary the speed in relation to the internal temperature of the instrument (refer to [Figure B-3](#)). The fan will turn on at low speed when the internal temperature of the instrument reaches 44°C, and will increase the fan speed to maximum at 54°C. As the internal temperature of the instrument decreases, the fan will reduce speed until the temperature reaches 39°C, at which point the fan will turn off.

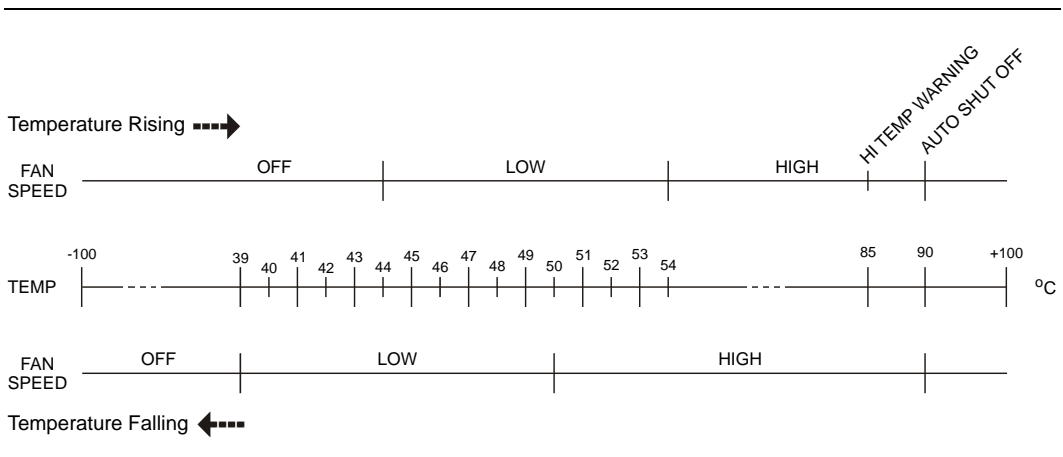

**Figure B-3.** Fan Speed vs. Temperature

### High Temp Warning

The internal temperature has reached an excessive level, 85°C. Verify that the ventilation openings are unobstructed and that the fan is running. Internal temperatures may be manually verified by using the SELF TEST function. Turn off the unit and allow the temperature to cool down. If the fault is not resolved and the internal temperature reaches 90°C, then a countdown of 10 seconds will begin. The countdown gives the user a chance to save the current setup before the instrument turns itself off (before internal temperatures can cause any damage). If the error persists after removing any obstructions and allowing the unit to cool, then reset to the factory defaults with **Factory Defaults (Esc+On)**, or **Master Reset (System+On)**.

<b>Caution</b>	Use of Master Reset ( <b>System+On</b> ), will erase all user saved setups and measurement traces and will return the VNA Master to a full Factory Default condition. If the error persists, then contact your Anritsu Service Center.
----------------	----------------------------------------------------------------------------------------------------------------------------------------------------------------------------------------------------------------------------------------

### Operation not Permitted in Recall Mode

Attempted to perform an operation on a recalled trace. Many operations are valid only on a live or active trace.

**PMON PLD Fail**

Unable to communicate with the Power Monitor PCBA.

**Power Supply**

Power Supply failed. Charge the battery.

# Appendix C — Windowing

## C-1 Introduction

The theoretical requirement for inverse FFT is for the data to extend from zero frequency to infinity. Side lobes appear around a discontinuity because the spectrum is cut off at a finite frequency. Windowing reduces the side lobes by smoothing out the sharp transitions at the beginning and the end of the frequency sweep. As the side lobes are reduced, the main lobe widens, thereby reducing the resolution.

In situations where a small discontinuity may be close to a large one, side lobe reduction windowing helps to reveal the discrete discontinuities. If distance resolution is critical, then reduce the windowing for greater signal resolution.

If strong interfering frequency components are present, but are distant from the frequency of interest, then use a windowing format with higher side lobes, such as **Rectangular Windowing** or **Nominal Side Lobe Windowing**.

If strong interfering signals are present and are near the frequency of interest, then use a windowing format with lower side lobes, such as **Low Side Lobe Windowing** or **Minimum Side Lobe Windowing**.

If two or more signals are very near to each other, then spectral resolution is important. In this case, use **Rectangular Windowing** for the sharpest main lobe (the best resolution).

If the amplitude accuracy of a single frequency component is more important than the exact location of the component in a given frequency bin, then choose a windowing format with a wide main lobe.

If you are examining a single frequency, and if the amplitude accuracy is more important than the exact frequency, then use **Low Side Lobe Windowing** or **Minimum Side Lobe Windowing**.

## Rectangular Windowing

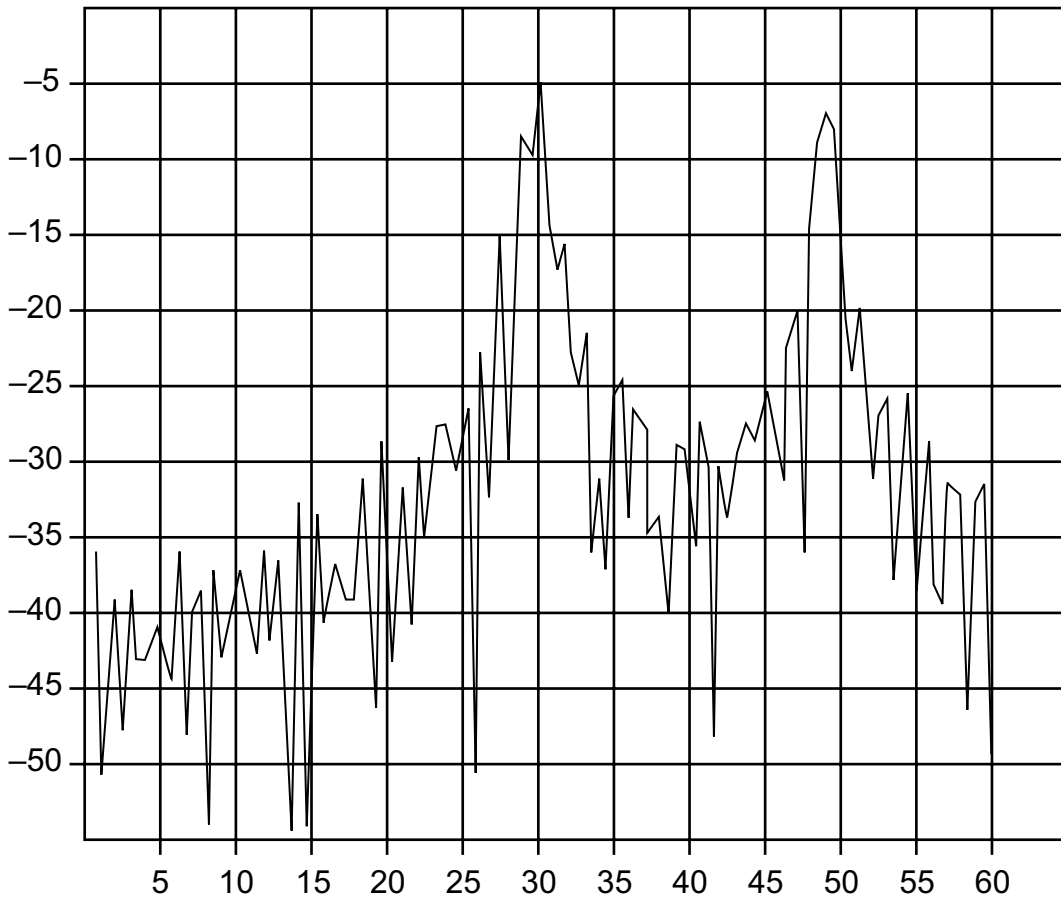

**Figure C-1.** Rectangular Windowing Example

This Distance To Fault graph has Return Loss (dB) on the vertical scale (y-axis) and distance in feet on the horizontal scale (x-axis).

This view of Rectangular Windowing shows the maximum side lobe display and the greatest waveform resolution.



## Nominal Side Lobe Windowing

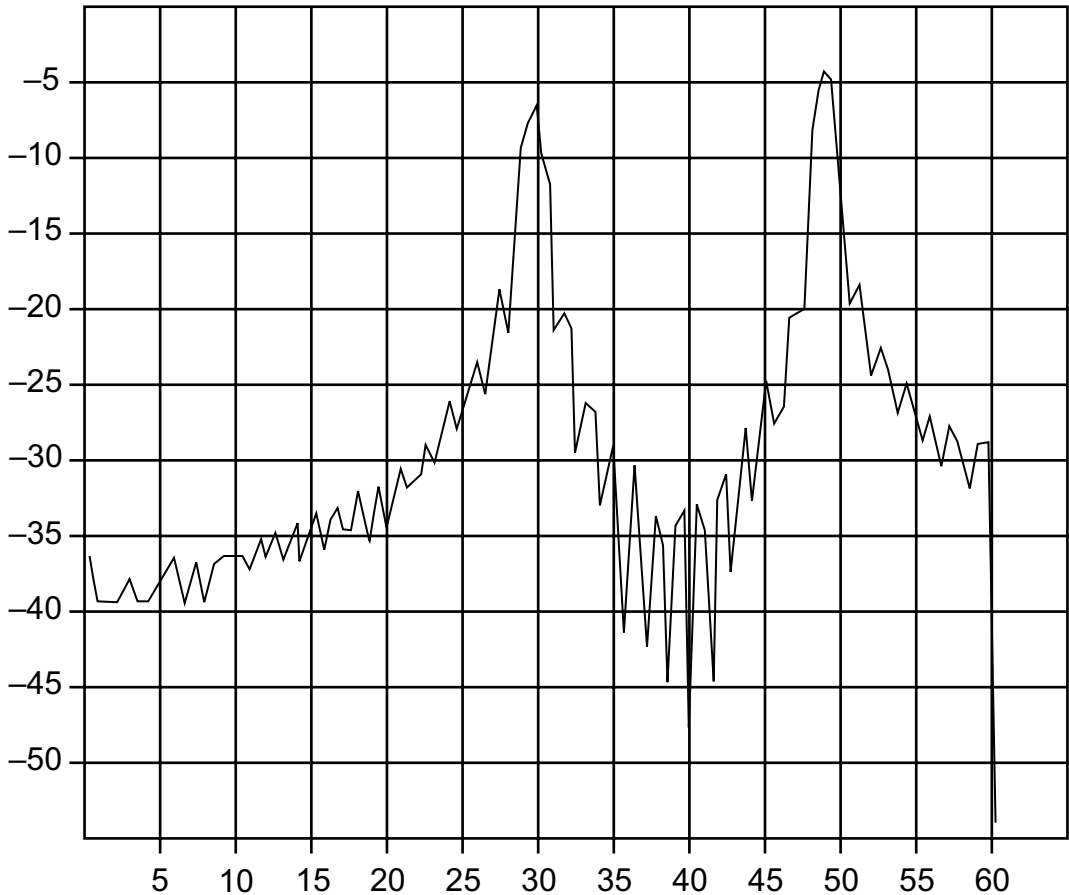
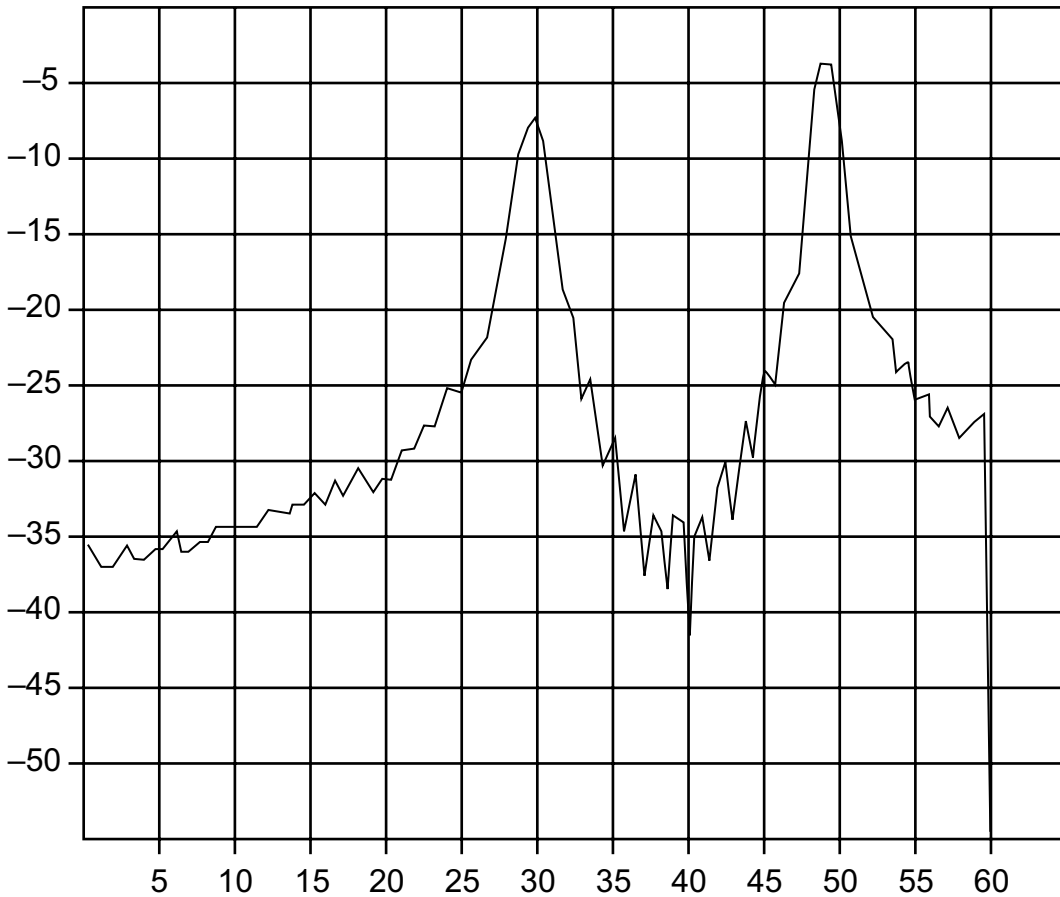

**Figure C-2.** Nominal Side Lobe Windowing Example

This Distance To Fault graph has Return Loss (dB) on the vertical scale (y-axis) and distance in feet on the horizontal scale (x-axis).

This view of Nominal Side Lobe Windowing shows less side lobe resolution than Rectangular Windowing and more side lobe resolution than Low Side Lobe Windowing. This level of windowing displays intermediate resolution.

## Low Side Lobe Windowing

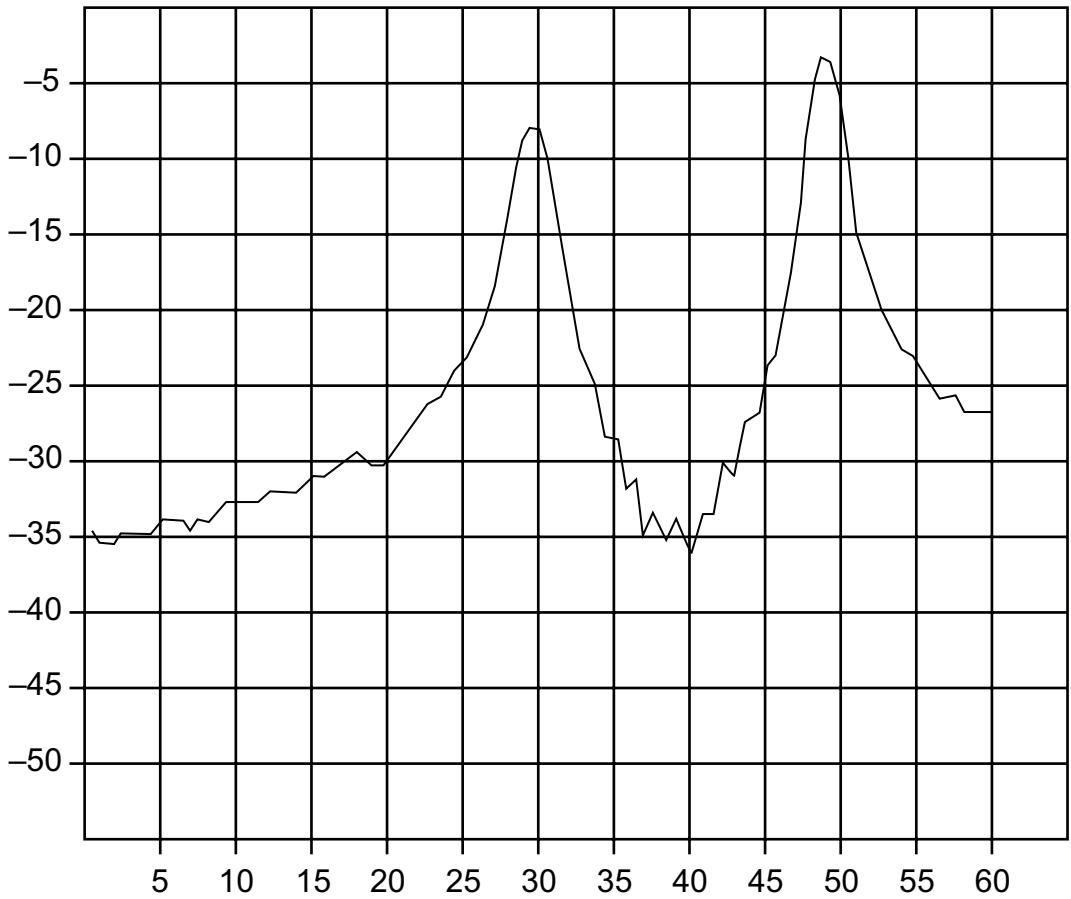

**Figure C-3.** Low Side Lobe Windowing Example

This Distance To Fault graph has Return Loss (dB) on the vertical scale (y-axis) and distance in feet on the horizontal scale (x-axis).

This view of Low Side Lobe Windowing shows less side lobe resolution than Nominal Side Lobe Windowing and more side lobe resolution than Minimum Side Lobe Windowing. This level of windowing displays intermediate resolution.

Minimum Side Lobe Windowing



**Figure C-4.** Minimum Side Lobe Windowing Example

This Distance To Fault graph has Return Loss (dB) on the vertical scale (y-axis) and distance in feet on the horizontal scale (x-axis).

This view of Minimum Side Lobe Windowing shows less side lobe resolution than Low Side Lobe Windowing and displays the lowest side lobe and waveform resolution.



# Appendix D — Tower Mounted Amplifiers

## D-1 Introduction

A Tower Mounted Amplifier (TMA) can be used to amplify the received signal. There are different types of TMA depending on the system requirements. Three commonly used types are:

- TMA-D - A duplex tower mounted amplifier that combines transmit and receive ports from the radio system and connects to a single antenna. This configuration is specific to systems that use a single antenna configuration.
- TMA-S - A receive-only tower mounted amplifier is installed between the receiving antenna and the radio to boost weak signals. This configuration is common on systems that implement separate antennas for transmitting and receiving.
- TMA-DD - A dual-duplex tower mounted amplifier used for radios systems with a single transmission line connection for transmit and receive. These systems are commonly called transceivers.

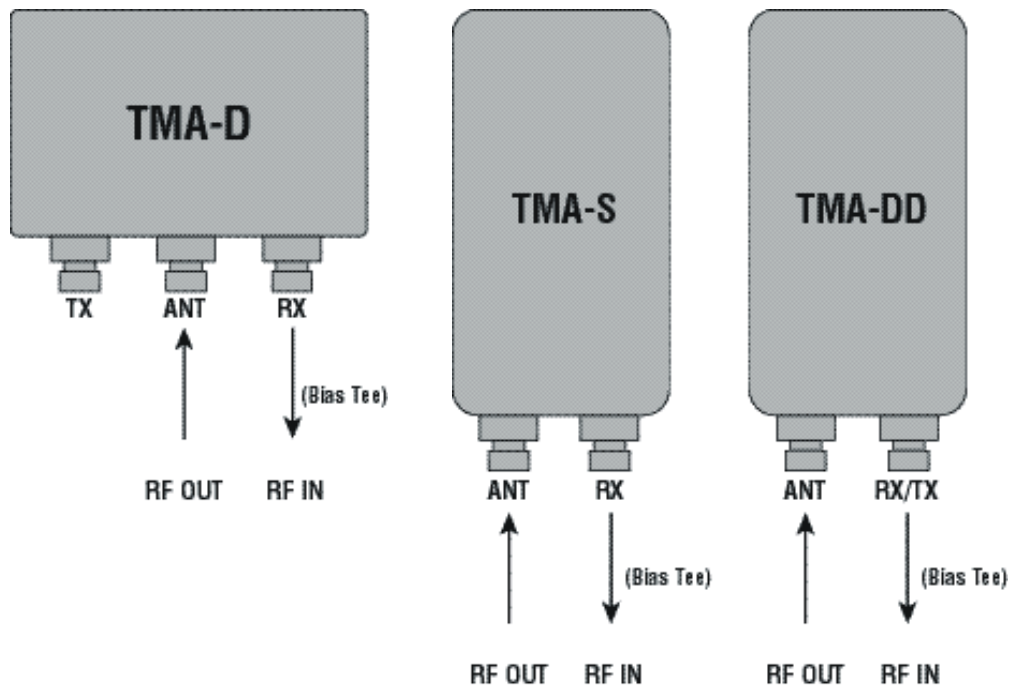

Figure D-1. Tower Mounted Amplifiers



# Appendix E — Coaxial Cable Technical Data

## E-1 Coaxial Cable Technical Data

The table below provides a list of common coaxial cables.

**Table E-1.** Coaxial Cable Technical Data (Sheet 1 of 4)

Manufacturer	Cable	Prop. Vel.	Freq 1	Loss 1	Freq 2	Loss 2	Freq 3	Loss 3
Andrew	FSJ1-50A (6 GHz)	0.84	1000	0.196	2500	0.313	6000	0.532
Andrew	FSJ2-50 (6 GHz)	0.83	1000	0.133	2500	0.223	6000	0.374
Andrew	FSJ4-50B (6 GHz)	0.81	1000	0.118	2500	0.201	6000	0.348
Andrew	EFX2-50 (6 GHz)	0.85	1000	0.121	2500	0.202	6000	0.341
Andrew	LDF1-50 (6 GHz)	0.86	6000	0.306	6000	0.306	6000	0.306
Andrew	LDF2-50 (6 GHz)	0.88	6000	0.323	6000	0.323	6000	0.323
Andrew	LDF4-50A (6 GHz)	0.88	1000	0.073	2500	0.121	6000	0.218
Andrew	HJ4-50 (6 GHz)	0.914	1000	0.092	2500	0.156	6000	0.257
Andrew	HJ4.5-50 (6 GHz)	0.92	1000	0.054	2500	0.089	6000	0.148
Andrew	AVA5-50 7/8	0.91	1000	0.038	2000	0.055	2500	0.063
Andrew	AVA7-50 1-5/8	0.92	1000	0.022	2000	0.034	2500	0.038
Andrew	EFX2-50	0.85	1000	0.121	2000	0.177	2500	0.202
Andrew	FLC 12-50J	0.88	1000	0.075	2000	0.11	2500	0.134
Andrew	FLC 38-50J	0.88	1000	0.115	2000	0.169	2500	0.19
Andrew	FLC 78-50J	0.88	1000	0.041	2000	0.061	2500	0.072
Andrew	FLC 114-50J	0.88	1000	0.033	2000	0.05	2500	0.059
Andrew	FLC 158-50J	0.88	1000	0.025	2000	0.038	2500	0.042
Andrew	FSJ1-50A	0.84	1000	0.196	2000	0.285	2500	0.313
Andrew	FSJ2-50	0.83	1000	0.133	2000	0.196	2500	0.223
Andrew	FSJ4-50B	0.81	1000	0.118	2000	0.176	2500	0.201
Andrew	HJ4-50	0.91	1000	0.092	2000	0.137	2500	0.156
Andrew	HJ4.5-50	0.92	1000	0.054	2000	0.079	2500	0.089
Andrew	HJ5-50	0.916	1000	0.042	2000	0.063	2500	0.071
Andrew	HJ7-50A	0.921	1000	0.023	2000	0.034	2500	0.039
Andrew	HJ12-50	0.931	1000	0.019	2000	0.029	2000	0.029
Andrew	HL4RP-50A	0.88	1000	0.074	2000	0.109	2500	0.123
Andrew	LDF4-50A	0.88	1000	0.073	2000	0.107	2500	0.12

Table E-1. Coaxial Cable Technical Data (Sheet 2 of 4)

Manufacturer	Cable	Prop. Vel.	Freq 1	Loss 1	Freq 2	Loss 2	Freq 3	Loss 3
Andrew	LDF4.5-50	0.89	1000	0.054	2000	0.08	2500	0.091
Andrew	LDF5-50A	0.89	1000	0.041	2000	0.061	2500	0.07
Andrew	LDF5-50B	0.91	1000	0.041	2000	0.061	2500	0.07
Andrew	LDF6-50	0.89	1000	0.028	2000	0.042	2500	0.048
Andrew	LDF7-50A	0.88	1000	0.024	2000	0.037	2500	0.043
Andrew	LDF12-50	0.88	1000	0.021	2000	0.033	2000	0.033
Andrew	VXL5-50 7/8	0.88	1000	0.045	2000	0.066	2500	0.075
Andrew	VXL6-50 1-1/4	0.88	1000	0.032	2000	0.048	2500	0.055
Andrew	VXL7-50 1-5/8	0.88	1000	0.024	2000	0.037	2500	0.043
Belden	RG-8/8A	0.86	1000	0.132	2000	0.33	2500	0.22
Belden	RG-9/9A	0.659	1000	0.289	1000	0.289	1000	0.289
Belden	RG-17/17A	0.659	1000	0.18	1000	0.18	1000	0.18
Belden	RG-55/55A/55B	0.659	1000	0.541	1000	0.541	1000	0.541
Belden	RG-58/58B	0.77	1000	0.356	2000	0.528	2500	0.6
Belden	RG-58A/58C	0.73	1000	0.594	1000	0.594	1000	0.594
Belden	RG-142	0.7	1000	0.43	2000	0.663	2500	0.713
Belden	RG-174	0.66	1000	1.115	1000	1.115	1000	1.115
Belden	RG-178B	0.695	1000	1.509	1000	1.509	1000	1.509
Belden	RG-188	0.69	1000	0.951	1000	0.951	1000	0.951
Belden	RG-213	0.66	1000	0.262	1000	0.269	1000	0.269
Belden	RG-214	0.659	1000	0.229	1000	0.292	1000	0.292
Belden	RG-223	0.66	1000	0.476	1000	0.478	1000	0.478
Cablewave	HCC 12-50J	0.915	1000	0.087	2000	0.126	2500	0.137
Cablewave	HCC 78-50J	0.915	1000	0.041	2000	0.061	2500	0.066
Cablewave	HCC 158-50J	0.95	1000	0.022	2000	0.031	2500	0.033
Cablewave	HCC 300-50J	0.96	1000	0.015	1000	0.015	1000	0.015
Cablewave	HCC 312-50J	0.96	1000	0.013	1000	0.013	1000	0.013
Cablewave	HF 4 1/8 Cu2Y	0.97	1000	0.01	1000	0.01	1000	0.01
Cablewave	HF 5 Cu2Y	0.96	1000	0.007	1000	0.007	1000	0.007
Cablewave	HF 6 1/8 Cu2Y	0.97	1000	0.006	1000	0.006	1000	0.006
Cellflex	LCF78-50JA	0.9	1000	0.039	2000	0.058	2500	0.066
Cellflex	LCFS114-50JA	0.9	1000	0.029	2000	0.044	2500	0.051
Cellflex	LCF158-50JA	0.9	1000	0.024	2000	0.036	2500	0.042
Cellflex	LCF214-50JA	0.88	1000	0.021	2000	0.033	2000	0.033
Cellflex	UCF114-50JA	0.89	1000	0.031	2000	0.047	2000	0.047



Table E-1. Coaxial Cable Technical Data (Sheet 3 of 4)

Manufacturer	Cable	Prop. Vel.	Freq 1	Loss 1	Freq 2	Loss 2	Freq 3	Loss 3
Comscope	CR50 540PE	0.88	1000	0.069	2000	0.103	2500	0.116
Comscope	CR50 1070PE	0.88	1000	0.037	2000	0.055	2500	0.064
Comscope	CR50 1873PE	0.88	1000	0.022	2000	0.034	2500	0.04
Eupen	EC4-50-HF 1/2	0.82	1000	0.108	2000	0.161	2500	0.183
Eupen	EC4-50 1/2	0.88	1000	0.074	2000	0.109	2500	0.121
Eupen	EC4.5-50 5/8	0.88	1000	0.056	2000	0.083	2500	0.094
Eupen	EC5-50 7/8	0.88	1000	0.04	2000	0.058	2500	0.066
Eupen	EC6-50 1-1/4	0.88	1000	0.028	2000	0.043	2500	0.048
Eupen	EC7-50 1-5/8	0.88	1000	0.024	2000	0.037	2500	0.042
Eupen	EC7-50A 1-5/8	0.89	1000	0.023	2000	0.035	2500	0.039
Eupen	EC12-50 2-1/4	0.88	1000	0.022	2000	0.034	2500	0.039
Nk Cables	RF1/2-50	0.88	1000	0.073	2000	0.107	2500	0.127
Nk Cables	RF1/2-50GHF	0.88	1000	0.073	2000	0.107	2500	0.127
Nk Cables	RF1/2-50BHF	0.88	1000	0.073	2000	0.107	2500	0.127
Nk Cables	RF5/8-50	0.88	1000	0.051	2000	0.075	2500	0.087
Nk Cables	RF5/8-50GHF	0.88	1000	0.051	2000	0.075	2500	0.087
Nk Cables	RF5/8-50BHF	0.88	1000	0.051	2000	0.075	2500	0.087
Nk Cables	RF7/8-50	0.88	1000	0.04	2000	0.059	2500	0.07
Nk Cables	RF7/8-50GHF	0.88	1000	0.04	2000	0.059	2500	0.07
Nk Cables	RF7/8-50BHF	0.88	1000	0.04	2000	0.059	2500	0.07
Nk Cables	RF1 5/8-50	0.88	1000	0.024	2000	0.036	2500	0.042
Nk Cables	RF1 5/8-50GHF	0.88	1000	0.024	2000	0.036	2500	0.042
Nk Cables	RF1 5/8-50BHF	0.88	1000	0.024	2000	0.036	2500	0.042
Nk Cables	RF2 1/4-50	0.88	1000	0.021	2000	0.032	2500	0.041
Nk Cables	RF2 1/4-50GHF	0.88	1000	0.021	2000	0.032	2500	0.041
Nk Cables	RF2 1/4-50BHF	0.88	1000	0.021	2000	0.032	2500	0.041
Nk Cables	RFF3/8-50	0.81	1000	0.147	2000	0.218	2500	0.25
Nk Cables	RFF3/8-50GHF	0.81	1000	0.147	2000	0.218	2500	0.25
Nk Cables	RFF3/8-50BHF	0.81	1000	0.147	2000	0.218	2500	0.25
Nk Cables	RFF1/2-50	0.82	1000	0.112	2000	0.167	2500	0.19
Nk Cables	RFF1/2-50GHF	0.82	1000	0.112	2000	0.167	2500	0.19
Nk Cables	RFF1/2-50BHF	0.82	1000	0.112	2000	0.167	2500	0.19
Nk Cables	RFF7/8-50	0.88	1000	0.04	2000	0.066	2500	0.076
Nk Cables	RFF7/8-50GHF	0.88	1000	0.04	2000	0.066	2500	0.076
Nk Cables	RFF7/8-50BHF	0.88	1000	0.04	2000	0.066	2500	0.076

**Table E-1.** Coaxial Cable Technical Data (Sheet 4 of 4)

<b>Manufacturer</b>	<b>Cable</b>	<b>Prop. Vel.</b>	<b>Freq 1</b>	<b>Loss 1</b>	<b>Freq 2</b>	<b>Loss 2</b>	<b>Freq 3</b>	<b>Loss 3</b>
Times	LMR100	0.66	1000	0.789	2000	1.15	2500	1.31
Times	LMR200	0.83	1000	0.342	2000	0.49	2500	0.554
Times	LMR240	0.84	1000	0.261	2000	0.377	2500	0.424
Times	LMR400	0.85	1000	0.135	2000	0.196	2500	0.222
Times	LMR500	0.86	1000	0.109	2000	0.159	2500	0.18
Times	LMR600	0.87	1000	0.087	2000	0.128	2500	0.145
Times	LMR900	0.87	1000	0.059	2000	0.086	2500	0.098
Times	LMR1200	0.88	1000	0.044	2000	0.065	2500	0.074
Times	LMR1700	0.89	1000	0.033	2000	0.049	2500	0.057
	310801	0.821	1000	0.115	1000	0.115	1000	0.115
	311201	0.82	1000	0.18	1000	0.18	1000	0.18
	311501	0.8	1000	0.23	1000	0.23	1000	0.23
	311601	0.8	1000	0.262	1000	0.262	1000	0.262
	311901	0.8	1000	0.377	1000	0.377	1000	0.377
	352001	0.8	1000	0.377	1000	0.377	1000	0.377

# Appendix F — Waveguide Data

## F-1 Introduction

This appendix provides lists of waveguide components and their characteristics.

## F-2 Calibration Components

The calibration components part numbers in the following table are broken down as follows, where the **xx** in the part number column (as in **xxUM70**) is replaced as follows:

xx:     23 = 1/8 Offset Short  
           24 = 3/8 Offset Short  
           26 = Precision Load

**Table F-1.** Precision Waveguide Calibration Components

Part Number	Freq. Range (GHz)	Waveguide Type	Compatible Flanges
xxUM70	5.85 to 8.20	WR137, WG14	CAR70, PAR70, UAR 70, PDR70
xxUM84	7.05 to 10.00	WR112, WG15	CBR84, UBR84, PBR84, PDR84
xxUM100	8.20 to 12.40	WR90, WG16	CBR100, UBR100, PBR100, PDR100
xxUM120	10.00 to 15.00	WR75, WG17	CBR120, UBR120, PBR120, PDR120
xxUA187	3.95 to 5.85	WR187, WG12	CPR187F, CPR187G, UG-1352/U, UG-1353/U, UG-1728/U, UG-1729/U, UG-148/U, UG-149A/U
xxUA137	5.85 to 8.20	WR137, WG14	CPR137F, CPR137G, UG-1356/U, UG-1357/U, UG-1732/U, UG-1733/U, UG-343B/U, UG-344/U, UG-440B/U, UG-441/U
xxUA112	7.05 to 10.00	WR112, WG15	CPR112F, CPR112G, UG-1358/U, UG-1359/U, UG-1734/U, UG-1735/U, UG-52B/U, UG-51/U, UG-137B/U, UG-138/U
xxUA90	8.20 to 12.40	WR90, WG16	CPR90F, CPR90G, UG-1360/U, UG-1361/U, UG-1736/U, UG-1737/U, UG-40B/U, UG-39/U, UG-135/U, UG-136B/U
xxUA62	12.40 to 18.00	WR62, WG18	UG-541A/U, UG-419/U, UG-1665/U, UG1666/U

**Table F-1.** Precision Waveguide Calibration Components (Continued)

Part Number	Freq. Range (GHz)	Waveguide Type	Compatible Flanges
xxUA42	17.00 to 26.50	WR42, WG20	UG-596A/U, UG-595/U, UG-597/U, UG-598A/U

## F-3 Waveguide-to-Coaxial Adapters

Part numbers that end with N have Type N connectors, part numbers that end with K have K Connectors.

**Table F-2.** Coaxial to Universal Waveguide Adapters

Part Number	Freq. Range (GHz)	Waveguide Type	Compatible Flanges
35UM70N	5.85 to 8.20	WR137, WG14	CAR70, PAR70, UAR 70, PDR70
35UM84N	7.05 to 10.00	WR112, WG15	CBR84, UBR84, PBR84, PDR84
35UM100N	8.20 to 12.40	WR90, WG16	CBR100, UBR100, PBR100, PDR100
35UM120N	10.00 to 15.00	WR75, WG17	CBR120, UBR120, PBR120, PDR120
35UA187N	3.95 to 5.85	WR187, WG12	CPR187F, CPR187G, UG-1352/U, UG-1353/U, UG-1728/U, UG-1729/U, UG-148/U, UG-149A/U
35UA137N	5.85 to 8.20	WR137, WG14	CPR137F, CPR137G, UG-1356/U, UG-1357/U, UG-1732/U, UG-1733/U, UG-343B/U, UG-344/U, UG-440B/U, UG-441/U
35UA112N	7.05 to 10.00	WR112, WG15	CPR112F, CPR112G, UG-1358/U, UG-1359/U, UG-1734/U, UG-1735/U, UG-52B/U, UG-51/U, UG-137B/U, UG-138/U
35UA90N	8.20 to 12.40	WR90, WG16	CPR90F, CPR90G, UG-1360/U, UG-1361/U, UG-1736/U, UG-1737/U, UG-40B/U, UG-39/U, UG-135/U, UG-136B/U
35UA62N	12.40 to 18.00	WR62, WG18	UG-541A/U, UG-419/U, UG-1665/U, UG1666/U
35UA42K	7.00 to 26.50	WR42, WG20	UG-596A/U, UG-595/U, UG-597/U, UG-598A/U

## F-4 Flange Compatibility

**Table F-3.** Universal Flange Compatibility (1 of 3)

Calibration Component Part Number	Start Frequency (GHz)	Stop Frequency (GHz)	Waveguide Type	Flange Type	Compatible Flanges
xxUM40	3.300	4.900	WR229 WG11A	UnivM-229	PDR40
xxUM48	3.950	5.850	WR187 WG12	UnivM-187	CAR48 PAR48 UAR48 PDR48
xxUM58	4.900	7.050	WR159 WG13	UnivM-159	CAR58 PAR58 UAR58 PDR58
xxUM70	5.850	8.200	WR137 WG14	UnivM-137	CAR70 PAR70 UAR70 PDR70
xxUM84	7.050	10.000	WR112 WG15	UnivM-112	CBR84 UBR84 PBR84 PDR84
xxUM100	8.200	12.400	WR90 WG16	UnivM-90	CBR100 UBR100 PBR100 PDR100
xxUM120	10.000	15.000	WR75 WG17	UnivM-75	CBR120 UBR120 PBR120 PDR120
xxUM140	12.400	18.000	WR62 WG18	UnivM-62	CBR140 UBR140 PBR140 PDR140
xxUM220	17.000	26.500	WR42 WG20	UnivM-42	CBR220 UBR220 PBR220 PDR220
xxUA229	3.300	4.900	WR229 WG11A	UnivUS-229	CPR229F CPR229G UG-1350/U UG-1351/U UG-1726/U UG-1727/U

## Universal Flange Compatibility

**Table F-4.** Universal Flange Compatibility (2 of 3)

Calibration Component Part Number	Start Frequency (GHz)	Stop Frequency (GHz)	Waveguide Type	Flange Type	Compatible Flanges
xxUA187	3.950	5.850	WR187 WG12	UnivUS-187	CPR187F CPR187G UG-1352/U UG-1353/U UG-1728/U UG-1729/U UG-148/U UG-149A/U
xxUA159	4.900	7.050	WR159 WG13	UnivUS-159	CPR159F CPR159G UG-1354/U UG-1355/U UG-1730/U UG-1731/U
xxUA137	5.850	8.200	WR137 WG14	UnivUS-137	CPR137F CPR137G UG-1356/U UG-1357/U UG-1732/U UG-1733/U UG-343B/U UG-344/U UG-440B/U UG-441/U
xxUA112	7.050	10.00	WR112 WG15	UnivUS-112	CPR112F CPR112G UG-1358/U UG-1359/U UG-1734/U UG-1735/U UG-52B/U UG-51/U UG-137B/U UG-138/U

**Table F-4.** Universal Flange Compatibility (2 of 3) (Continued)

<b>Calibration Component Part Number</b>	<b>Start Frequency (GHz)</b>	<b>Stop Frequency (GHz)</b>	<b>Waveguide Type</b>	<b>Flange Type</b>	<b>Compatible Flanges</b>
xxUA90	8.200	12.400	WR90 WG16	UnivUS-90	CPR90F CPR90G UG-1360/U UG-1361/U UG-1736/U UG-1737/U UG-40B/U UG-39/U UG-135/U UG-136B/U
xxUA75	10.000	15.000	WR75 WG17	UnivUS-75	WR75

## Universal Flange Compatibility

**Table F-5.** Universal Flange Compatibility (3 of 3)

Calibration Component Part Number	Start Frequency (GHz)	Stop Frequency (GHz)	Waveguide Type	Flange Type	Compatible Flanges
xxUA62	12.400	18.000	WR62 WG18	UnivUS-62	UG-541A/U UG-419/U UG-1665/U UG-1666/U
xxUA42	17.000	26.500	WR42 WG20	UnivUS-42	UG-596A/U UG-595/U UG-597/U UG-598A/U
xxCMR229	3.300	4.900	WR229 WG11A	CMR229	CMR229
xxCMR187	3.950	5.850	WR187 WG12	CMR187	CMR187 UG-1475/U UG-1480/U
xxCMR159	4.900	7.050	WR159 WG13	CMR159	CMR159
xxCMR137	5.850	8.200	WR137 WG14	CMR137	CMR137 UG-1476/U UG-1481/U
xxCMR112	7.050	10.000	WR112 WG15	CMR112	CMR112 UG-1477/U UG-1482/U
xxCMR90	8.200	12.400	WR90 WG16	CMR90	CMR90 UG-1478/U UG-1483/U
xxUER40	3.300	4.900	WR229 WG11A	UER40	UER40
xxUER48	3.950	5.850	WR187 WG12	UER48	UER48
xxUER58	4.900	7.050	WR159 WG13	UER58	UER58
xxUER70	5.850	8.200	WR137 WG14	UER70	UER70
xxUER84	7.050	10.000	WR112 WG15	UER84	UER84
xxUER100	8.200	12.400	WR90 WG16	UER100	UER100



## F-5 Waveguide Technical Data

**Table F-6.** Waveguide Offset Short<sup>a</sup> Specifications

Offset Short P/N	Frequency (GHz)	Length (mm)
24UM70	6.926	20,710 +/- 0.08
24UM84	8.396	17,040 +/- 0.05
24UM100	10.084	14,675 +/- 0.05
24UM120	12.247	11,978 +/- 0.04
24UA187	4.807	30,979 +/- 0.11
24UA137	6.926	20,710 +/- 0.08
24UA112	8.396	17,040 +/- 0.05
24UA90	10.084	14,675 +/- 0.05
24UA62	14.940	9,742 +/- 0.04
24UA42	21.225	7,067 +/- 0.03
24CMR187	4.807	30,979 +/- 0.11
24CMR137	6.926	20,710 +/- 0.08
24CMR112	8.396	17,040 +/- 0.05
24CMR90	10.084	14,675 +/- 0.05
24UER70	6.926	20,710 +/- 0.08
24UER84	8.396	17,040 +/- 0.05
24UER100	10.084	14,675 +/- 0.05

a. Offset shorts are 3/8 wave at the geometric mean frequency waveguide band and dimensionally accurate to <0.5 degree at the maximum operating frequency of the corresponding wavelength.

**Waveguide Technical Data****Table F-7.** Waveguide Technical Data (1 of 2)

<b>Waveguide Type/Model</b>	<b>Start Frequency (GHz)</b>	<b>Stop Frequency (GHz)</b>	<b>Cutoff Frequency (GHz)</b>	<b>Mid-Band Loss (dB/m, GHz)</b>
WR229, WG11A	3.300	4.900	2.577	0.0374
WR187, WG12	3.950	5.850	3.152	0.0515
WR159, WG13	4.900	7.050	3.711	0.0591
WR137, WG14	5.850	8.200	4.301	0.0738
WR112, WG15	7.050	10.000	5.259	0.1024
WR102	7.000	11.000	5.786	0.1083
WR90, WG16	8.200	12.400	6.557	0.1578
WR75, WG17	10.000	15.000	7.868	0.1913
WR67	11.000	17.000	8.578	0.2159
WR62, WG18	12.400	18.000	9.486	0.2411
WR51, WG19	15.000	22.000	11.574	0.3691
WR42, WG20	17.000	26.500	14.047	0.5200
<b>Andrew</b>				
EW17	1.700	2.400	1.364	0.012
EW20	1.900	2.700	1.57	0.015
EW28	2.600	3.400	2.2	0.021
EW34	3.100	4.200	2.376	0.0223
EW37	3.300	4.300	2.790	0.0292
EW43	4.400	5.000	2.780	0.0289
EW52	4.600	6.425	3.650	0.042
EW63	5.580	7.125	4.000	0.0453
EW64	5.300	7.750	4.320	0.052
EW77	6.100	8.500	4.720	0.061
EW85	7.700	9.800	6.460	0.1086
EW90	8.300	11.700	6.500	0.108
EW127	10.000	13.250	7.670	0.124

## Waveguide Technical Data

**Table F-8.** Waveguide Technical Data (2 of 2)

Waveguide Type/Model	Start Frequency (GHz)	Stop Frequency (GHz)	Cutoff Frequency (GHz)	Mid-Band Loss (dB/m, GHz)
EW132	11.000	15.350	9.220	0.17
EW180	14.000	19.700	11.150	0.1939
EW220	17.000	23.600	13.340	0.2822
<b>Cablewave</b>				
WE37	3.600	4.200	2.830	0.0269
WE46	4.400	5.000	3.000	0.0354
WE61	5.925	6.425	3.600	0.0390
WE65	6.425	7.125	4.000	0.0453
WE70	7.125	7.750	4.300	0.0404
WE78	7.125	8.500	4.670	0.0446
WE108	10.500	11.700	6.570	0.0978
WE130	11.700	13.250	7.430	0.1142
WE150	14.000	15.350	8.600	0.1398
WE191	17.700	19.700	10.680	0.1952
<b>RFS Cablewave</b>				
E20	1.700	2.300	1.38	0.012
E30	2.300	3.100	1.8	0.016
E38	3.000	4.200	2.4	0.025
E46	3.650	5.000	2.88	0.028
ES46	3.900	5.000	3.08	0.036
E60	4.500	6.425	3.65	0.045
E65	5.000	7.125	4.01	0.05
E78	5.900	8.500	4.72	0.06
E105	8.100	11.700	6.49	0.09
E130	9.300	13.250	7.43	0.12
E150	10.800	15.350	8.64	0.15
E185	13.700	19.700	11.06	0.2
E220	16.700	23.600	13.36	0.29



# Appendix G — More About DHCP

## G-1 Introduction

DHCP stands for Dynamic Host Configuration Protocol. This protocol allows a server to dynamically assign IP addresses to devices that are connected to the network. Most networks include a DHCP server to manage IP addresses. When a DHCP server is available on the network, DHCP is the preferred IP address mode.

## G-2 Using DHCP

When using DHCP, no setup is required to lease and use a dynamic IP address. In a dynamic IP operation, the assigned IP address may change from use to use. The DHCP server assigns IP addresses on a time rotation basis. As soon as the device is disconnected from the network, the IP address that it was using becomes available to lease to the next unit requesting an IP address. Normally, some amount of lag time occurs on the DHCP server end, so if the device is connected again reasonably soon, it may receive the same address.

<b>Note</b>	The VNA Master must be connected to the network <i>before</i> it is turned on in order to allow DHCP to work. Key elements of the DHCP lease are performed only during the instrument startup operations or when switching from manual to DHCP.
-------------	-------------------------------------------------------------------------------------------------------------------------------------------------------------------------------------------------------------------------------------------------

## G-3 Static IP Address

When a DHCP server is not available, a Static IP address can be used. A Static IP address is a fixed address. After being set, it will always remain the same, and care must be taken to avoid conflict with other equipment on the network.

When using a static IP address on an established network, always request a Static IP address from the network administrator. Randomly choosing a Static IP address on an established network may result in duplicate IP addresses or other conflicts.

Three parameters must be set prior to using a Static IP address:

### IP Address

This is the Static IP address on the network.

### Default Gateway

Often when a static IP address is assigned, a default gateway is also identified. If the default gateway is unknown, then type in the Static IP address so that the Static IP address and Default Gateway are the same number.

### Subnet Mask

This parameter is usually extracted from the Static IP address based upon the class of the address. It determines the destination of any broadcast messages that might be sent from the instrument. It can be customized if necessary. The subnet mask may also be provided with the Static IP address.

## Example 1

In this example, a Static IP address has been chosen because no network is available. The instrument is connected to the network port on the PC with a crossover Ethernet cable (not included). This is also referred to as Direct Connect:

```
IP Address: 10.0.0.2
Default Gateway: 10.0.0.2
Subnet Mask: 255.255.0.0
```

## Example 2

In this example, the Static IP address has been assigned with an associated gateway and subnet mask:

```
IP Address: 153.56.100.42
Default Gateway: 153.56.100.1
Subnet Mask: 255.255.252.0
```

## G-4 Operating System Tools

A few tools that are built into the Microsoft Windows operating system can assist in making some determinations about the network that the PC is plugged into.

### Ipconfig Tool

Typing `ipconfig` at a command prompt will display information about the in-use parameters of the PC and its network connection. Below is an example of the typical results expected.

<b>Note</b>	The <code>ipconfig</code> display does not report if the information is from a DHCP server or a Static IP setup
-------------	-----------------------------------------------------------------------------------------------------------------

```
Y:\>ipconfig
Windows 2000 IP Configuration
Ethernet adapter Local Area Connection:
Connection-specific DNS Suffix. : us.anritsu.com
IP Address . . . . . : 172.26.202.172
Subnet Mask . . . . . : 255.255.252.0
Default Gateway . . . . . : 172.26.200.1
```

### Ping Tool

Another tool that can find out if a selected IP address is already on the network is `ping`. Ping is a harmless way to determine if an address is found on the network and, if it is found, for it to reply. Greatly simplified, ping sends out a request to a specific address to determine if it is there. If the specific address is found, then it will respond by sending back the same message that was received. If it is not found, then the response will be “request timed out.” This means that no reply was received from that IP address.

```
Y:\>ping 172.26.202.172
Pinging 172.26.202.172 with 32 bytes of data:
Reply from 172.26.202.172: bytes=32 time<10ms TTL=128
Reply from 172.26.202.172: bytes=32 time<10ms TTL=128
Reply from 172.26.202.172: bytes=32 time<10ms TTL=128
```

```
Reply from 172.26.202.172: bytes=32 time<10ms TTL=128
Ping statistics for 172.26.202.172:
Packets: Sent = 4, Received = 4, Lost = 0 (0% loss),
Approximate round trip times in milliseconds:
Minimum = 0ms, Maximum = 0ms, Average = 0ms
```





# Appendix H — Formulas

## H-1 VNA Master Formulas

The following formulas can be used with the VNA Master.

### Reflection Coefficient

Reflection coefficient is the ratio of the amplitude of the reflected wave to the amplitude of incident wave.

$$\text{Reflection Coefficient} = \rho$$

$$\text{where: } 0 \leq \rho \leq 1$$

### Return Loss

$$\text{Return Loss (dB)} = -20\log|\rho|$$

$$\text{where: } 0 \leq \text{Return Loss} < \infty$$

### VSWR

$$\text{VSWR} = \frac{(1 + \rho)}{(1 - \rho)}$$

$$\text{where: } 1 \leq \text{VSWR} < \infty$$

### Smith Chart

$$\text{Smith Chart: } z = r + jx$$

$$\rho = \frac{(z - 1)}{(z + 1)}$$

### Electrical Length

The length of the cable as seen by the electrical signal. The electrical length is always greater than 1 for practical dielectric materials.

$$\text{Electrical Length} = L_{el} = L_{mech} \times \sqrt{\epsilon}$$

## Propagation

Propagation is the propagation velocity expressed as a ratio to the speed of light.

$$\text{Propagation Constant} = v_p = \frac{1}{\sqrt{\epsilon}}$$

$$\text{where: } 0 \leq v < 1$$

## Cable Loss

$$\text{Cable Loss} = \frac{\text{Return Loss (dB)}}{2}$$

$$\text{Cable Loss Average} = \frac{(\text{Peak} + \text{Valley})}{2}$$

## Fault Resolution

Fault resolution (in the distance domain) is the ability of the system to separate two closely-spaced discontinuities. Calculations for distance utilize the speed of light ( $c$ ), which is  $2.99792458 \times 10^8$  meters per second (for light in vacuum).  $F$  is frequency (in Hertz).

$$\text{Fault Resolution Round-Trip (m)} = \frac{0.5 \times c \times v_p}{\Delta F}$$

$$\text{Fault Resolution One-Way (m)} = \frac{c \times v_p}{\Delta F}$$

## Maximum Horizontal Distance

$D_{\max}$  is the maximum horizontal distance that can be analyzed in DTF.

$$D_{\max(m)} = (\text{Datapoints} - 1) \times \text{Fault Resolution}$$

## Suggested Span

Suggested Span is the span needed to get Max Distance to equal Stop Distance.

$$\text{Suggested Span Round-Trip (Hz)} = \frac{(\text{Datapoints} - 1) \times 0.5 \times c \times vp}{\text{Stop Distance}}$$

$$\text{Suggested Span One-Way (Hz)} = \frac{(\text{Datapoints} - 1) \times c \times vp}{\text{Stop Distance}}$$



# Index

## Numerics

- 1-port
  - cable measurement ..... 5-1
  - tuning example ..... 5-4
- 2-port
  - amplifier measurement ..... 5-9
  - filter example ..... 5-6
- 560 series detectors ..... 1-8

## A

- accessories, list ..... 1-3
- activating GPS ..... 13-1
- active trace
  - defined ..... 3-2
  - identify or select ..... 3-2
- adapter
  - AC-DC ..... 1-14
- Additional Dist Setup
  - coax menu ..... 6-9
  - waveguide menu ..... 6-10
- almanac
  - complete, GPS ..... 13-5
- amplifier
  - measurement, 2-port ..... 5-9
- antenna
  - connection, GPS ..... 2-23
  - GPS ..... 13-1
  - status ..... 13-5
- application options
  - menu described ..... 6-59
  - menu group ..... 6-57
  - system settings ..... 2-29
- architecture of MS202xB ..... 4-2
- attenuation
  - attenuator part numbers ..... 1-6
  - high input power ..... 8-1
- attributes of a trace ..... 3-3

## B

- balanced ports, Option 77, main topic 14-1
- balanced test configuration ..... 14-1
- battery
  - charging ..... 1-14, 2-19
  - replacement ..... 1-13
  - status information ..... 6-58
  - symbol ..... 2-24

## bias

- Bias Input Port 1, BNC ..... 2-23
- Bias Input Port 2, BNC ..... 2-23
- external ..... 4-7, 10-2
- internal ..... 4-7, 10-2
- networks, low frequency resonances 5-11
- Status LED ..... 2-23

## bias tee

- 2-port gain, VNA measurement . 10-4
- block diagram, TMA-DD ..... 10-3
- freq limitation ..... 10-1
- if current level is exceeded ..... 10-5
- internal, max current ..... 10-1
- menu ..... 10-6
- MS202xB architecture ..... 4-7, 10-2
- Option 10, main topic ..... 10-1
- power to block down-converters . 10-1
- power to some TMAs ..... 10-1
- setup menu ..... 6-52

## block diagram

- forward sweep ..... 4-2
- HAPM setup ..... 12-2
- internal/external bias ..... 4-7, 10-2
- reverse sweep ..... 4-3
- TMA ..... D-1
- TMA-DD with bias ..... 10-3
- VNA vs vector voltmeter ..... 11-2

## brightness

- system settings ..... 2-31

## C

### cable loss

- example ..... 5-2

### cables, differential, S-parameter ..... 4-3

### calculating S-parameters ..... 4-4

### calibration

- 2 port, considerations ..... 5-13
- before field measurement ..... 1-12
- comparing S11 and S21 ..... 5-6
- High Accuracy Power Meter .... 12-3
- menu, functions overview ..... 6-12
- requirements ..... 1-12
- transmission response vs full 2-port 5-6
- waveguide, considerations ..... 5-12

cautions

- approved batteries . . . . . 1-14
- automotive 12 VDC adapter .1-14, 2-1
- bias voltage . . . . . 10-1
- ESD damage . . . . . 1-12, 1-13
- propagation velocity of cable . . . . . 7-3
- safety symbols . . . . . Safety-1

charging the battery . . . . . 1-14

chirp-Z transform, time domain . . . . . 7-1

comma separated value file type . . . . . 6-27

common mode reflection coefficient . . 14-1

compensation, dispersion in waveguide 7-4

complex numbers, S-parameters . . . . . 4-4

configure ports menu . . . . . 6-51

connectors

- 50 ohm, port 1 . . . . . 2-23
- 50 ohm, port 2 . . . . . 2-23
- bias input . . . . . 2-23
- Bias Tee LED indication . . . . . 10-1
- component part numbers . . . . . 1-3
- DUT Connector Selector . . . . . 6-18
- example - detecting loose connector 5-3
- Ext Freq Ref . . . . . 2-22
- external power . . . . . 2-19
- function overview . . . . . 2-18
- GPS antenna (SMA) . . . . . 2-23, 13-1
- headset . . . . . 2-22
- identifying on VNA Master . . . . . 1-1
- LAN . . . . . 2-20
- list box, for Coax . . . . . 6-17
- list box, for waveguide . . . . . 6-20
- preventive maintenance . . . . . 1-12
- RF detector . . . . . 2-22
- USB . . . . . 2-21
- waveguide-coax adapter . . . . . 2-19

copy menu . . . . . 6-34

csv file type description . . . . . 6-27

current

- maximum exceeded for bias tee . . 10-5
- maximum for bias tee . . . . . 10-1

CW menu . . . . . 11-12

**D**

date and time, system settings . . . . . 2-30

default gateway

- functions overview . . . . . H-1

defaults

- factory . . . . . 6-61
- factory, resetting . . . . . 2-31

delete menu . . . . . 6-32

delta marker

- setup . . . . . 3-8

detector

- RF . . . . . 2-22
- RF, power monitor . . . . . 8-1

DHCP Ethernet address . . . . . 2-20

- system settings . . . . . 2-30
- VNA configuration . . . . . 6-60

differential reflection coefficient . . . . 14-1

differential S-parameter, Sd1d1

- defined . . . . . 4-3
- Option 2 . . . . . 7-1
- Option 77 . . . . . 4-3

differential test configuration . . . . . 14-1

diodes, Schottky, 560 series detectors . 1-8

dip, DTF, loose connector . . . . . 5-2

dispersion compensation in waveguide 7-4

dispersion correction, waveguide . . . . 5-12

dispersion, frequency, time domain . . . 7-4

display menu . . . . . 6-62

display overview . . . . . 2-6

distance

- resolution, windowing . . . . . C-1
- setup menu . . . . . 6-8
- stop, span formula . . . . . G-3

distance-to-fault (DTF)

- dip, loose connector . . . . . 5-2
- example, time domain . . . . . 7-7
- mismatch (example) . . . . . 5-3
- reading and interpreting . . . . . 5-1
- ripples (example) . . . . . 5-2
- smoothing (example) . . . . . 5-2
- time domain . . . . . 7-1

domain menu . . . . . 6-47

**E**

EEPROM memory . . . . . 2-26, 9-3

enabling Ethernet . . . . . 2-20

ESD damage, cautions . . . . . 1-13

Ethernet

- address functions overview . . . . . 2-20
- address, system settings . . . . . 2-30
- enabling . . . . . 2-20

examples	
cable loss	5-2
DTF in time domain	7-7
DTF, 1-port	5-1
S11	5-1
Smith Chart, 1-port	5-4
smoothing	5-2
S-parameters	4-2
tuning, 1-port	5-4
external bias	4-7, 10-2

## F

fault resolution	
DTF, example formula	G-2
file menu	6-23
file menu group	6-22
file types, described	6-27
flash memory, internal	2-26, 9-3
formula	
a list	G-1
Group delay	4-5
Log Mag	4-4
Log Mag/2	4-4
Phase in degrees	4-4
SImaginary	4-4
SReal	4-4
SWR	4-5
Fourier transform, time domain	7-1

frequency	
1-port cable measurement	5-1
2-Port amplifier measurement	5-11
2-Port filter measurement	5-6
additional dist setup menu (WG)	6-10
calibration considerations	5-15
dispersion, time domain	7-4
distance setup menu	6-8
domain menu	6-47
external reference	2-22
freq menu	6-4
group delay calculation	4-5
IFBW in sweep menu	6-50
insertion loss sweep example	5-2
limit edit menu	6-38
limit line and freq span	6-36
marker capabilities	3-7
measure menu, domain	6-44
range of detectors (table)	1-7
range of instrument	1-1
setup domain menu	6-5
Smith Chart calculation	4-5
Smith Chart tuning example	5-4
time menu	6-6
trace math	3-9
front panel keys	2-10
full 2-port calibration	
amplifier measurement	5-9
calibration considerations	5-13
filter measurement	5-6
increased accuracy	5-7
vector voltmeter	11-5
functions overview	
battery	2-19
DHCP	2-20
headset	2-22
IP address	2-20
LAN	2-20
subnet mask	2-20
USB	2-21

## G

gain	
2-port, bias tee	10-4
2-port, S21	5-9
calculating	4-4
gateway address	
LAN connection	2-20

general instrument specs  
 battery . . . . . 1-13  
 calibration . . . . . 1-12  
 ESD damage . . . . . 1-13  
 maintenance . . . . . 1-12  
 verification . . . . . 1-12  
**GPS**  
 activating . . . . . 13-1  
 antenna . . . . . 13-1  
 option 31, main topic . . . . . 13-1  
**group delay**  
 2-port amplifier measurement . . . . . 5-10  
 formula . . . . . 4-5

**H**

headset jack . . . . . 2-22  
**High Accuracy Power Meter**  
 analog display . . . . . 12-5  
 averaging . . . . . 12-6  
 basic setup . . . . . 12-2  
 calibration . . . . . 12-3  
 limits . . . . . 12-7  
 menus . . . . . 12-8  
 Option 19, main topic . . . . . 12-1  
 relative power . . . . . 12-6  
 relative power feature . . . . . 12-1  
 required equipment . . . . . 12-1  
**High Port Power setting** . . . . . 10-4  
**hold symbol, VNA Master** . . . . . 2-25

**I**

imaginary numbers, S-parameters . . . . . 4-4  
 instrument mode . . . . . 2-17  
 internal bias . . . . . 4-7, 10-2  
 internal flash memory . . . . . 2-26, 9-3  
 Internal, Bias Tee soft key . . . . . 10-8  
**interpretation**  
 1-port cable meas . . . . . 5-1  
 2-port amplifier measurement . . . . . 5-9  
 waveguide measurements . . . . . 5-12  
**IP address** . . . . . 2-20  
 system settings . . . . . 2-30  
 VNA configuration . . . . . 6-60

**J**

**JPEG screen capture feature** . . . . . 6-24

**K**

key presses to select a setting . . . . . 6-45  
**keys** . . . . . 2-10  
 front panel keys . . . . . 2-10  
 soft key types . . . . . 2-11

**L**

**LAN connection** . . . . . 2-20  
 system settings . . . . . 2-30  
 VNA configuration . . . . . 6-60  
**language**  
 system settings . . . . . 2-31  
**LED, Bias Status** . . . . . 2-23  
**limit**  
 alarm, on/off soft key . . . . . 6-37  
 High Accuracy Power Meter . . . . . 12-7  
 limit edit menu . . . . . 6-38  
 menu . . . . . 6-37  
 menu group . . . . . 6-36  
 menu, functions overview . . . . . 6-36  
 setting up . . . . . 3-8  
 line of sight, GPS . . . . . 13-1  
 linear magnitude S2P file type . . . . . 6-27  
 log magnitude S2P file type . . . . . 6-27  
 loose connector, dip, DTF . . . . . 5-3  
**Low Port Power setting** . . . . . 10-4

**M**

**maintenance, preventive** . . . . . 1-12  
**marker**  
 defined . . . . . 3-7  
 delta, setup . . . . . 3-8  
 marker search menu . . . . . 6-41  
 menu . . . . . 6-40  
 menu group . . . . . 6-39  
 readout format . . . . . 3-7  
 readout style . . . . . 3-7  
**master reset**  
 described . . . . . 2-32  
 instructions . . . . . 2-27, 9-4  
**maximize an active trace** . . . . . 3-2  
**measurement**  
 1-port cable measurement . . . . . 5-1  
 2-port amplifier . . . . . 5-9  
 capabilities . . . . . 1-2  
 menu . . . . . 6-44  
 menu group . . . . . 6-43  
 time domain . . . . . 7-1  
 trace description . . . . . 3-3  
 measurement file type . . . . . 6-27  
**memory**  
 EEPROM . . . . . 2-26, 9-3  
 flash, internal . . . . . 2-26, 9-3  
 profile and security . . . . . 2-26, 9-3  
 RAM . . . . . 2-26, 9-3  
 USB . . . . . 2-26, 9-3



menu

- additional dist setup (coax) . . . . . 6-9
- additional dist setup (waveguide) 6-10
- amplitude (HAPM) . . . . . 12-10
- application options . . . . . 6-57, 6-59
- bias tee . . . . . 10-6
- bias tee setup . . . . . 6-52
- cal factor . . . . . 12-9
- configure ports . . . . . 6-51
- copy . . . . . 6-34
- CW menu . . . . . 11-12
- delete . . . . . 6-32
- display . . . . . 6-62
- distance setup . . . . . 6-8
- domain . . . . . 6-47
- file . . . . . 6-23
- freq . . . . . 6-4
- limit . . . . . 6-37
- limit edit . . . . . 6-38
- marker . . . . . 6-40
- marker search . . . . . 6-41
- measurement . . . . . 6-44
- number of traces . . . . . 6-48
- preset . . . . . 6-54
- recall . . . . . 6-31
- reset . . . . . 6-61
- scale . . . . . 6-55
- setup domain . . . . . 6-5
- system . . . . . 6-57, 6-58
- system options . . . . . 6-57, 6-60
- table . . . . . 11-13
- time . . . . . 6-6
- trace . . . . . 6-61
- trace format . . . . . 6-49
- trace math . . . . . 6-63
- units (HAPM) . . . . . 12-10
- windowing . . . . . 6-7
- Zero/Cal . . . . . 12-9

menu groups

- file . . . . . 6-22
- limit . . . . . 6-36
- marker . . . . . 6-39
- measurement . . . . . 6-43

minimize an active trace . . . . . 3-2

mismatch, DTF example . . . . . 5-3

mixed mode reflection coefficients Sc1d1 and Sd1c1 . . . . . 14-1

mna file type description . . . . . 6-27

mode selection . . . . . 2-17

**N**

- name (for instrument), system settings 2-31
- number of traces menu . . . . . 6-48

**O**

- offset short . . . . . 5-12
- operating mode . . . . . 2-17
- option
  - 02, time domain . . . . . 7-1
  - 05, power monitor . . . . . 8-1
  - 07, secure data . . . . . 9-1
  - 10, bias tee . . . . . 10-1
  - 15, vector voltmeter . . . . . 11-1
  - 19, high accuracy power meter . . 12-1
  - 31, GPS . . . . . 13-1
  - 77, balanced ports . . . . . 14-1
  - list of available options . . . . . 1-2
- Option 7, no access to USB memory 2-26, 9-3

**P**

- panel, keys on front panel . . . . . 2-10
- phase format S2P file type . . . . . 6-27
- plane of calibration
  - reference plane extension values . . 2-9
  - reference plane soft keys . . . . . 6-51
- Port 1, 50 Ohm . . . . . 2-23
- Port 2, 50 Ohm . . . . . 2-23
- port, enabling Ethernet . . . . . 2-20
- power
  - external . . . . . 2-19
  - High Port Power . . . . . 10-4
  - level, 2-port gain, bias tee . . . . . 10-4
  - Low Port Power . . . . . 10-4
  - monitor, Option 5, main topic . . . . 8-1
  - power-on cycle . . . . . 2-2
  - relative . . . . . 8-2
  - relative soft key, power monitor . . 8-2
  - RF detector . . . . . 2-22
  - supply failure . . . . . B-6
- preset menu . . . . . 6-54
  - functions overview . . . . . 6-54
- preventive maintenance . . . . . 1-12
- profile, memory profile and security 2-26, 9-3
- propagation velocity caution . . . . . 7-3

**R**

- RAM Memory . . . . . 2-26, 9-3
- real and imaginary numbers
  - S-parameters . . . . . 4-4
- Real/Imag S2P file type . . . . . 6-27

recall  
     GPS information . . . . . 13-6  
     menu . . . . . 6-31  
 reference plane  
     extension values, displayed . . . . . 2-9  
     soft keys in configure ports menu 6-51  
 reflection coefficients . . . . . 14-1  
 relative power, HAPM . . . . . 12-1  
 reset  
     factory default settings . . . . . 2-31  
     master reset instructions . . . 2-27, 9-4  
     master reset soft key . . . . . 6-61  
     master, system settings described 2-32  
     menu . . . . . 6-61  
     RAM during instrument restart 2-26, 9-3  
     USB memory not affected . . . 2-26, 9-3  
 resolution  
     time domain . . . . . 7-1  
     windowing . . . . . C-1  
 resonances, low frequency  
     in bias networks . . . . . 5-11  
 return loss versus SWR . . . . . 5-2  
 ripples, phase interactions . . . . . 5-2

**S**

s2p file type description . . . . . 6-27  
 Safety Symbols  
     For Safety . . . . . Safety-2  
     In Manuals . . . . . Safety-1  
     On Equipment  
         large and small . . . . . Safety-1  
 sampling oscilloscope alternative . . . 14-1  
 satellites, GPS . . . . . 13-1  
 save current screen image to JPEG . . 6-24  
 Sclc1 reflection coefficient . . . . . 14-1  
 Scalar Network Analyzer (SNA) . . . . 4-1  
 scale menu . . . . . 6-55  
 Schottky diodes, 560 series detectors . 1-8  
 screen capture feature, JPEG . . . . . 6-24  
 Sd1d1 reflection coefficient . . . . . 14-1  
 Sd1d1, differential S-parameter  
     defined . . . . . 4-1  
     Option 2 . . . . . 7-1  
     Option 77 . . . . . 4-3, 14-1  
 secure data, option 7, main topic . . . . 9-1  
 security, memory content . . . . . 2-26, 9-3  
 selecting a setting, key presses . . . . 6-45  
 self test  
     VNA Master . . . . . 2-29  
 setting IP Address . . . . . 2-20  
 setup domain menu . . . . . 6-5

setup file type with CAL . . . . . 6-27  
 setup file type without CAL . . . . . 6-27  
 Single Sweep symbol . . . . . 2-25  
 Smith Chart example, 1-port . . . . . 5-4  
 smoothing  
     example . . . . . 5-2  
     greater than 2000 sweep pts . 5-2, 6-44  
 soft key types . . . . . 2-11  
 S-parameters  
     calculating and displaying . . . . . 4-4  
     defined . . . . . 4-1  
     differential, Option 77 . . . . . 14-1  
     differential, Sd1d1, Option 2 . . . . 7-1  
     differential, Sd1d1, Option 77 . . . . 4-3  
     examples . . . . . 4-2  
 SSLT  
     waveguide calibration . . . . . 5-12  
 SSST  
     waveguide calibration . . . . . 5-12  
 status  
     information, System status . . . . . 2-28  
 stp file type description . . . . . 6-27  
 subnet mask . . . . . 2-20  
 sweep  
     external trigger . . . . . 2-22  
     menu, VNA . . . . . 6-50  
     power monitor detectors . . . . . 1-8  
     preset resets sweep conditions . . 6-54  
 SWR formula . . . . . 4-5  
 SWR versus return loss . . . . . 5-2  
 symbols and indicators . . . . . 2-24  
 system  
     GPS . . . . . 2-29  
     menu . . . . . 6-58  
     menu group . . . . . 6-57  
     menu, access . . . . . 2-28  
     menu, functions overview . . . . . 6-57  
     options menu . . . . . 6-57  
     options soft key . . . . . 2-20  
     settings . . . . . 2-28  
     status . . . . . 2-28  
 system options  
     description . . . . . 2-30  
     menu . . . . . 6-60

**T**

table menu . . . . . 11-13  
 test panel connectors  
     function overview . . . . . 2-18  
 text file type . . . . . 6-27

- tilt bail  
 MS2028A use and storage . . . . . 1-11
- time domain measurements . . . . . 7-1
- time domain, Option 2, main topic . . . 7-1
- time menu . . . . . 6-6
- TMA (Tower Mounted Amplifier) . . . . D-1
- trace  
 active, identify or select . . . . . 3-2  
 format menu . . . . . 6-49  
 math menu . . . . . 6-63  
 measurement description . . . . . 3-3  
 menu . . . . . 6-61  
 trace math, described . . . . . 3-8
- trace labels, on and off . . . . . 2-29
- transmission response calibration . . . . 5-6
- trigger  
 external connector . . . . . 2-22  
 external sweep . . . . . 2-22
- triple offset short (SSST) . . . . . 5-12
- tuning example, 1-port . . . . . 5-4
- txt file type description . . . . . 6-27
- U**
- units of measurement, setting . . . . . 2-29
- update OS . . . . . 6-61
- USB memory device  
 interface . . . . . 2-21  
 no access with Option 7 . . . . . 2-26, 9-3  
 security . . . . . 2-26, 9-3
- use of phase stable Cable . . . . . 1-12
- UTC . . . . . 13-4
- V**
- vector network analyzer  
 display overview . . . . . 2-6
- vector voltmeter, Option 15, main topic 11-1
- verification  
 performance, annual . . . . . 1-12
- VNA defined . . . . . 4-1
- volatile (RAM) memory . . . . . 2-26, 9-3
- voltage  
 bias tee . . . . . 10-1
- volume, speaker, system settings . . . . 2-31
- W**
- warnings  
 external bias tee power . . . . . 10-1  
 safety symbols . . . . . Safety-1  
 shock hazard, adapter ground . . . . . 2-19
- waveguide  
 dispersion compensation . . . . . 7-4  
 dispersion correction . . . . . 5-12  
 frequency dispersion, time domain 7-4  
 measurement considerations . . . . . 5-12
- windowing  
 menu . . . . . 6-7  
 resolution . . . . . C-1  
 time domain . . . . . 7-6
- Z**
- zero . . . . . 8-1
- Numerics
- 1-port  
 cable measurement 1  
 tuning example 4
- 2-port  
 amplifier measurement 9  
 filter example 6
- A**
- activating GPS 1
- active trace  
 defined 2  
 identify or select 2
- adapter  
 AC-DC 7
- Additional Dist Setup  
 coax menu 9  
 waveguide menu 10
- almanac  
 complete, GPS 5
- amplifier  
 measurement, 2-port 9
- antenna  
 connection, GPS 22  
 GPS 1  
 status 5
- application options  
 menu described 59  
 menu group 57  
 system settings 28
- architecture of MS202xB 2
- attenuation  
 high input power 1
- attributes of a trace 3

---

## B

balanced ports, Option 77, main topic 1

balanced test configuration 1

battery

charging 7, 18

replacement 6

status information 58

symbol 23

bias

Bias Input Port 1, BNC 22

Bias Input Port 2, BNC 22

external 7, 2

internal 7, 2

networks, low frequency resonances 11

Status LED 22

bias tee

2-port gain, VNA measurement 4

block diagram, TMA-DD 3

freq limitation 1

if current level is exceeded 5

internal, max current 1

menu 6

MS202xB architecture 7, 2

Option 10, main topic 1

power to block down-converters 1

power to some TMAs 1

setup menu 52

block diagram

forward sweep 2

HAPM setup 2

internal/external bias 7, 2

reverse sweep 3

TMA 1

TMA-DD with bias 3

VNA vs vector voltmeter 2

brightness

system settings 30

## C

cable loss

example 2

cables, differential, S-parameter 3

calculating S-parameters 4

calibration

---

- 2 port, considerations 13
- before field measurement 5
- comparing S11 and S21 6
- High Accuracy Power Meter 3
- menu, functions overview 12
- requirements 5
- transmission response vs full 2-port 6
- waveguide, considerations 12
- cautions
  - approved batteries 7
  - automotive 12 VDC adapter 7, 1
  - bias voltage 1
  - ESD damage 5, 6
  - propagation velocity of cable 3
- charging the battery 7
- chirp-Z transform, time domain 1
- comma separated value file type 27
- common mode reflection coefficient 1
- compensation, dispersion in waveguide 4
- complex numbers, S-parameters 4
- configure ports menu 51
- connectors
  - 50 ohm, port 1 22
  - 50 ohm, port 2 22
  - bias input 22
  - Bias Tee LED indication 1
  - DUT Connector Selector 18
  - example - detecting loose connector 3
  - Ext Freq Ref 21
  - external power 18
  - function overview 17
  - GPS antenna (SMA) 22, 1
  - headset 21
  - identifying on VNA Master 1
  - LAN 19
  - list box, for Coax 17
  - list box, for waveguide 20
  - preventive maintenance 5
  - RF detector 21
  - USB 20
  - waveguide-coax adapter 18
- copy menu 34
- csv file type description 27

---

current  
    maximum exceeded for bias tee 5  
    maximum for bias tee 1

CW menu 12

D

date and time, system settings 29

default gateway  
    functions overview 1

defaults  
    factory 61  
    factory, resetting 30

delete menu 32

delta marker  
    setup 8

detector  
    RF 21  
    RF, power monitor 1

DHCP Ethernet address 19  
    system settings 29  
    VNA configuration 60

differential reflection coefficient 1

differential S-parameter, Sd1d1  
    defined 3  
    Option 2 1  
    Option 77 3

differential test configuration 1

dip, DTF, loose connector 2

dispersion compensation in waveguide 4

dispersion correction, waveguide 12

dispersion, frequency, time domain 4

display menu 62

display overview 6

distance  
    resolution, windowing 1  
    setup menu 8  
    stop, span formula 3

distance-to-fault (DTF)  
    dip, loose connector 2  
    example, time domain 7  
    mismatch (example) 3  
    reading and interpreting 1  
    ripples (example) 2  
    smoothing (example) 2

---

- time domain 1
- domain menu 47
- E
- EEPROM memory 25, 3
- enabling Ethernet 19
- ESD damage, cautions 6
- Ethernet
  - address functions overview 19
  - address, system settings 29
  - enabling 19
- examples
  - cable loss 2
  - DTF in time domain 7
  - DTF, 1-port 1
  - S11 1
  - Smith Chart, 1-port 4
  - smoothing 2
  - S-parameters 2
  - tuning, 1-port 4
- external bias 7, 2
- F
- fault resolution
  - DTF, example formula 2
- file menu 23
- file menu group 22
- file types, described 27
- flash memory, internal 25, 3
- formula
  - a list 1
  - Group delay 5
  - Log Mag 4
  - Log Mag/2 4
  - Phase in degrees 4
  - SImaginary 4
  - SReal 4
  - SWR 5
- Fourier transform, time domain 1
- frequency
  - 1-port cable measurement 1
  - 2-Port amplifier measurement 11
  - 2-Port filter measurement 6
  - additional dist setup menu (WG) 10
  - calibration considerations 15

---

- dispersion, time domain 4
- distance setup menu 8
- domain menu 47
- external reference 21
- freq menu 4
- group delay calculation 5
- IFBW in sweep menu 50
- insertion loss sweep example 2
- limit edit menu 38
- limit line and freq span 36
- marker capabilities 7
- measure menu, domain 44
- range of instrument 1
- setup domain menu 5
- Smith Chart calculation 5
- Smith Chart tuning example 4
- time menu 6
- trace math 9

front panel keys 10

full 2-port calibration

- amplifier measurement 9
- calibration considerations 13
- filter measurement 6
- increased accuracy 7
- vector voltmeter 5

functions overview

- battery 18
- DHCP 19
- headset 21
- IP address 19
- LAN 19
- subnet mask 19
- USB 20

G

gain

- 2-port, bias tee 4
- 2-port, S<sub>21</sub> 9
- calculating 4

gateway address

- LAN connection 19

general instrument specs

- battery 6
- calibration 5



---

- ESD damage 6
- maintenance 5
- verification 5
- GPS
- activating 1
- antenna 1
- option 31, main topic 1
- group delay
- 2-port amplifier measurement 10
- formula 5
- H
- headset jack 21
- High Accuracy Power Meter
- analog display 5
- averaging 6
- basic setup 2
- calibration 3
- limits 7
- menus 8
- Option 19, main topic 1
- relative power 6
- relative power feature 1
- required equipment 1
- High Port Power setting 4
- hold symbol, VNA Master 24
- I
- imaginary numbers, S-parameters 4
- instrument mode 16
- internal bias 7, 2
- internal flash memory 25, 3
- Internal, Bias Tee soft key 8
- interpretation
- 1-port cable meas 1
- 2-port amplifier measurement 9
- waveguide measurements 12
- IP address 19
- system settings 29
- VNA configuration 60
- J
- JPEG screen capture feature 24
- K
- key presses to select a setting 45
- keys 10

---

front panel keys 10

soft key types 11

## L

LAN connection 19

system settings 29

VNA configuration 60

language

system settings 30

LED, Bias Status 22

limit

alarm, on/off soft key 37

High Accuracy Power Meter 7

limit edit menu 38

menu 37

menu group 36

menu, functions overview 36

setting up 8

line of sight, GPS 1

linear magnitude S2P file type 27

log magnitude S2P file type 27

loose connector, dip, DTF 3

Low Port Power setting 4

## M

maintenance, preventive 5

marker

defined 7

delta, setup 8

marker search menu 41

menu 40

menu group 39

readout format 7

readout style 7

master reset

described 31

instructions 26, 4

maximize an active trace 2

measurement

1-port cable measurement 1

2-port amplifier 9

capabilities 2

menu 44

menu group 43

time domain 1

---

- trace description 3
- measurement file type 27
- memory
  - EEPROM 25, 3
  - flash, internal 25, 3
  - profile and security 25, 3
  - RAM 25, 3
  - USB 25, 3
- menu
  - additional dist setup (coax) 9
  - additional dist setup (waveguide) 10
  - amplitude (HAPM) 10
  - application options 57, 59
  - bias tee 6
  - bias tee setup 52
  - cal factor 9
  - configure ports 51
  - copy 34
  - CW menu 12
  - delete 32
  - display 62
  - distance setup 8
  - domain 47
  - file 23
  - freq 4
  - limit 37
  - limit edit 38
  - marker 40
  - marker search 41
  - measurement 44
  - number of traces 48
  - preset 54
  - recall 31
  - reset 61
  - scale 55
  - setup domain 5
  - system 57, 58
  - system options 57, 60
  - table 13
  - time 6
  - trace 61
  - trace format 49
  - trace math 63

---

units (HAPM) 10  
windowing 7  
ZeroCal 9

menu groups  
file 22  
limit 36  
marker 39  
measurement 43

minimize an active trace 2

mismatch, DTF example 3

mixed mode reflection coefficients Sc1d1 and Sd1c1 1

mna file type description 27

mode selection 16

N

name (for instrument), system settings 30

number of traces menu 48

O

offset short 12

operating mode 16

option

- 02, time domain 1
- 05, power monitor 1
- 07, secure data 1
- 10, bias tee 1
- 15, vector voltmeter 1
- 19, high accuracy power meter 1
- 31, GPS 1
- 77, balanced ports 1

Option 7, no access to USB memory 25, 3

P

panel, keys on front panel 10

phase format S2P file type 27

plane of calibration

- reference plane extension values 9
- reference plane soft keys 51

Port 1, 50 Ohm 22

Port 2, 50 Ohm 22

port, enabling Ethernet 19

power

- external 18
- High Port Power 4
- level, 2-port gain, bias tee 4
- Low Port Power 4

---

- monitor, Option 5, main topic 1
- power-on cycle 2
- relative 2
- relative soft key, power monitor 2
- RF detector 21
- supply failure 6
- preset menu 54
  - functions overview 54
- preventive maintenance 5
- profile, memory profile and security 25, 3
- propagation velocity caution 3
- R
- RAM Memory 25, 3
- real and imaginary numbers
  - S-parameters 4
- Real/Imag S2P file type 27
- recall
  - GPS information 6
  - menu 31
- reference plane
  - extension values, displayed 9
  - soft keys in configure ports menu 51
- reflection coefficients 1
- relative power, HAPM 1
- reset
  - factory default settings 30
  - master reset instructions 26, 4
  - master reset soft key 61
  - master, system settings described 31
  - menu 61
  - RAM during instrument restart 25, 3
  - USB memory not affected 25, 3
- resolution
  - time domain 1
  - windowing 1
- resonances, low frequency
  - in bias networks 11
- return loss versus SWR 2
- ripples, phase interactions 2
- S
- s2p file type description 27
- Safety Symbols
  - For Safety 2

---

- In Manuals 1
- On Equipment 1
- sampling oscilloscope alternative 1
- satellites, GPS 1
- save current screen image to JPEG 24
- Sc1c1 reflection coefficient 1
- Scalar Network Analyzer (SNA) 1
- scale menu 55
- screen capture feature, JPEG 24
- Sd1d1 reflection coefficient 1
- Sd1d1, differential S-parameter
  - defined 1
  - Option 2 1
  - Option 77 3, 1
- secure data, option 7, main topic 1
- security, memory content 25, 3
- selecting a setting, key presses 45
- self test
  - VNA Master 28
- setting IP Address 19
- setup domain menu 5
- setup file type with CAL 27
- setup file type without CAL 27
- Single Sweep symbol 24
- Smith Chart example, 1-port 4
- smoothing
  - example 2
  - greater than 2000 sweep pts 2, 44
- soft key types 11
- S-parameters
  - calculating and displaying 4
  - defined 1
  - differential, Option 77 1
  - differential, Sd1d1, Option 2 1
  - differential, Sd1d1, Option 77 3
  - examples 2
- SSLT
  - waveguide calibration 12
- SSST
  - waveguide calibration 12
- status
  - information, System status 27
- stp file type description 27

---

subnet mask 19

sweep

- external trigger 21
- menu, VNA 50
- preset resets sweep conditions 54

SWR formula 5

SWR versus return loss 2

symbols and indicators 23

system

- GPS 28
- menu 58
- menu group 57
- menu, access 27
- menu, functions overview 57
- options menu 57
- options soft key 19
- settings 27
- status 27

system options

- description 29
- menu 60

T

table menu 13

test panel connectors

- function overview 17

text file type 27

tilt bail

- MS2028A use and storage 4

time domain measurements 1

time domain, Option 2, main topic 1

time menu 6

TMA (Tower Mounted Amplifier) 1

trace

- active, identify or select 2
- format menu 49
- math menu 63
- measurement description 3
- menu 61
- trace math, described 8

trace labels, on and off 28

transmission response calibration 6

trigger

- external connector 21

---

- external sweep 21
- triple offset short (SSST) 12
- tuning example, 1-port 4
- txt file type description 27
- U
- units of measurement, setting 28
- update OS 61
- USB memory device
  - interface 20
  - no access with Option 7 25, 3
  - security 25, 3
- use of phase stable Cable 5
- UTC 4
- V
- vector network analyzer
  - display overview 6
- vector voltmeter, Option 15, main topic 1
- verification
  - performance, annual 5
- VNA defined 1
- volatile (RAM) memory 25, 3
- voltage
  - bias tee 1
- volume, speaker, system settings 30
- W
- warnings
  - external bias tee power 1
  - shock hazard, adapter ground 18
- waveguide
  - dispersion compensation 4
  - dispersion correction 12
  - frequency dispersion, time domain 4
  - measurement considerations 12
- windowing
  - menu 7
  - resolution 1
  - time domain 6
- Z
- zero 1





# Anritsu



Anritsu prints on recycled paper with vegetable soybean oil ink.

Anritsu Company  
490 Jarvis Drive  
Morgan Hill, CA 95037-2809  
USA  
<http://www.anritsu.com>