

VNA Master™

High Performance Handheld Vector Network Analyzer

MS2026B
5 kHz to 6 GHz

MS2028B
5 kHz to 20 GHz

Introduction

Anritsu introduces the industry's broadest frequency, highest performance, handheld solution to address cable and antenna measurement needs in the field. The MS2026/28B VNA Master covers applications up to 20 GHz, which contains a wide variety of RF and microwave systems, both coax and waveguide. Equally impressive, this measurement tool offers the industry's first 12-term error correction algorithm in a handheld VNA. With typical measurement speed of 750 $\mu\text{sec}/\text{point}$, the VNA Master is also ideally suited for transmission measurements anytime, anywhere.

Performance Highlights

- Broadband coverage of 5 kHz to 6 GHz and 20 GHz
- True 2-port Vector Network Analyzer (VNA)
- Arbitrary data points up to 4001
- IF Bandwidth selections of 10 Hz to 100 kHz
- 65 dB dynamic range to 20 GHz
- Supports waveguide measurements
- 750 $\mu\text{s}/\text{data point}$ sweep speed
- Greater than 2 hour battery life
- USB/Ethernet for data transfer
- Automate repetitive tasks via Ethernet
- Store more than 4000 traces and setups in memory
- Light weight: 9.9 lbs (4.5 kg)
- Full Speed USB Memory support
- High resolution daylight viewable TFT color display
- Time Domain option for Distance-to-Fault diagnostics
- Internal Bias Tee option
- Vector Voltmeter option
- Power Monitor option
- High Accuracy Power Meter option
- Differential (S_{D1D1}) option
- Secure Data Operation option
- GPS Receiver option



Handheld Vector Network Analyzers achieve a new standard of performance, speed, and accuracy in the MS2026/28B VNA Master which covers applications to 20 GHz.

Specifications

Definitions

All specifications and characteristics apply under the following conditions, unless otherwise stated:

- After 30 minutes of warm-up time, where the instrument is left in the ON state.
- Temperature range is $23\text{ }^{\circ}\text{C} \pm 5\text{ }^{\circ}\text{C}$.
- All specifications apply when using internal reference.
- All specifications subject to change without notice. Please visit www.us.anritsu.com for most current data sheet.
- Typical performance is the measured performance of an average unit.
- Recommended calibration cycle is 12 months.

Frequency

VNA Master Frequency Range:

MS2026B: 5 kHz to 6 GHz

MS2028B: 5 kHz to 20 GHz

Frequency Accuracy: 1.5 ppm

Frequency Resolution: 1 kHz

Typical Test Port Power

VNA Master supports selection of either High (default) or Low test port power. Changing power after calibration can degrade the calibrated performance. Typical power by bands is shown in the following table.

Frequency Range (GHz)	High Port Power (dBm)	Low Port Power (dBm)
5 kHz to \leq 3 GHz	+3	-25 dBm
3 GHz to \leq 6 GHz	-3	-25 dBm
6 GHz to \leq 20 GHz	-3	-15 dBm

Transmission Dynamic Range

The transmission dynamic range (the difference between test port power and noise floor) using 10 Hz IF Bandwidth and High Port Power is shown in the following table.

Frequency Range (GHz)	Dynamic Range (dB)
5 kHz to \leq 3 GHz	80
3 GHz to \leq 6 GHz	75
6 GHz to \leq 20 GHz	65

Block Diagram

As shown in the following block diagram, the VNA Master has an architecture that automatically measures four S-parameters with a single connection.

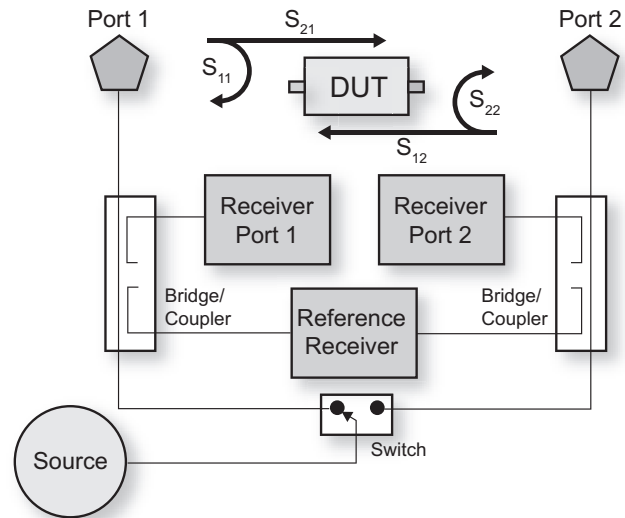

The above illustration is a simplified block diagram of VNA Master's architecture.

Typical Sweep Speed

The typical sweep speed for IF Bandwidth of 100 kHz, 1001 data points, and single display is shown in the following table. The three receiver architecture will simultaneously collect S_{21} and S_{11} (or S_{12} and S_{22}) in a single sweep.

Frequency Range (GHz)	Typical Sweep Speed ($\mu\text{s}/\text{point}$)
5 kHz to 6 GHz	525
5 kHz to 20 GHz	750

Round Trip Cable Loss Measurements using Reflection Measurements (1-Port)

One-Port Technique Simplifies Cable Loss Measurements on Long Cable Runs

Round-trip cable loss measurements are convenient for field personnel testing installed cable or waveguide runs. In this scenario, the two ends of the cable are typically separated by a considerable distance with one end on the ground near the transmit/receive hardware and the other end on an elevated structure near the antenna. This class of measurement is fairly precise when properly applied during site installation and maintenance activities.

As shown in the following illustration of a typical cable run, the VNA Master can determine cable loss (or insertion loss of other devices) from a one-port reflection measurement. After calibration, this round-trip technique involves connecting a short at the far end of the cable and measuring reflections at the near end of the cable. Since the test signal traverses the cable twice, a simple divide-by-two on the reflection measurement (e.g., $\text{Log Mag} / 2$) corrects for the round-trip.

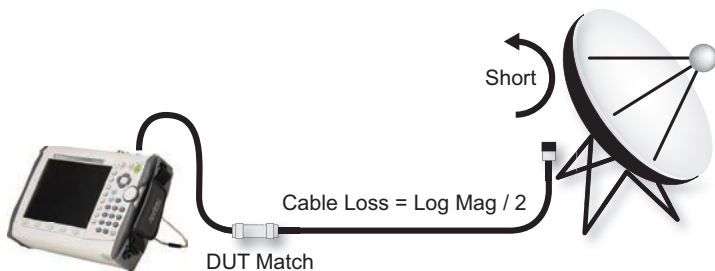

This illustration shows the popular setup for conducting round-trip cable loss measurements. This technique involves using a short at the far end and measuring reflections at the near end of the cable. The test signal traverses the cable twice so cable loss is one-half of the reflection measurement.

This one-port technique provides adequate results so long as there is a sufficient test signal level for VNA Master to measure after twice traversing the cable. This technique also assumes a well-matched setup so you are measuring mostly loss from the cable instead of reflections from other discontinuities in the cable. Mismatch of the cable connectors or adapters can distort this measurement and leads to more uncertainty. To better understand how these assumptions interact with your results, the following uncertainty curves are provided as tools to help optimize your setups for cable measurements using the one-port technique.

Use Uncertainty Curves to Analyze Practical Limitations of Round-Trip Cable Loss Measurements

You can understand the practical limitation of this round-trip measurement technique by evaluating the uncertainty of your measurements. The following two sets of uncertainty curves, less than 6 GHz on the left and greater than 6 GHz on the right, present worst-case uncertainty by DUT Match (i.e., Log Mag) when using VNA Master for one-port cable loss measurements. As a practical tip, consider using a two-port transmission measurement technique to improve upon these one-port cable loss uncertainties.

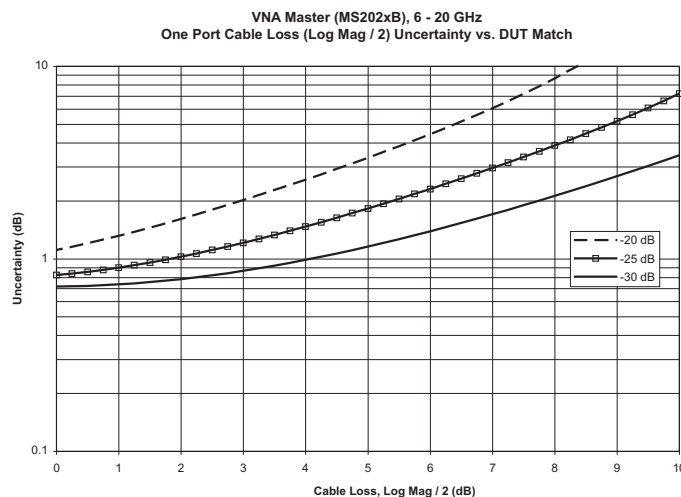
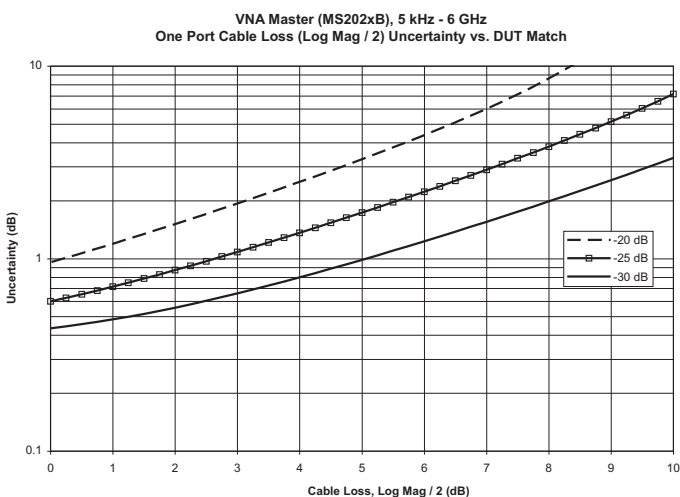

These uncertainty curves show how frequency range, DUT Match, and cable loss impact worst-case uncertainty of round-trip cable loss measurements. The uncertainty curves, separated by frequency range, are shown for DUT Match conditions of 20, 25, and 30 dB. For DUT Match of 30 dB and cable loss of 4-5 dB (reflection measurement of 8-10 dB) the worst-case uncertainties are approximately ± 1 dB.

High Port Power

OSLxx50 Calibration Components

Corrected System Performance and Uncertainties:

MS202xB Model with 12-term SOLT calibration including isolation using either OSLN50 & OSLNF50 or OSLK50 & OSLKF50 Calibration Kits.



Frequency Range (GHz)	Directivity (dB)
≤ 5	> 42
≤ 15	> 36
≤ 20*	> 32

*N-Connector guaranteed to 18 GHz, Typical >18 GHz

Frequency Range (GHz)	Typical High Port Power (dBm)
≤ 3	+3
≤ 6	-3
≤ 20	-3

Measurement Uncertainties

The following graphs provide measurement uncertainty at 23 °C ± 5 °C for the above indicated connector type and calibration. Errors are worst-case contributions of residual directivity, source match, frequency response, network analyzer dynamic range, and connector repeatability. For two-port measurements, transmission tracking, crosstalk, and physical load match termination were added. Isolation calibration and an IF Bandwidth of 10 Hz is used.

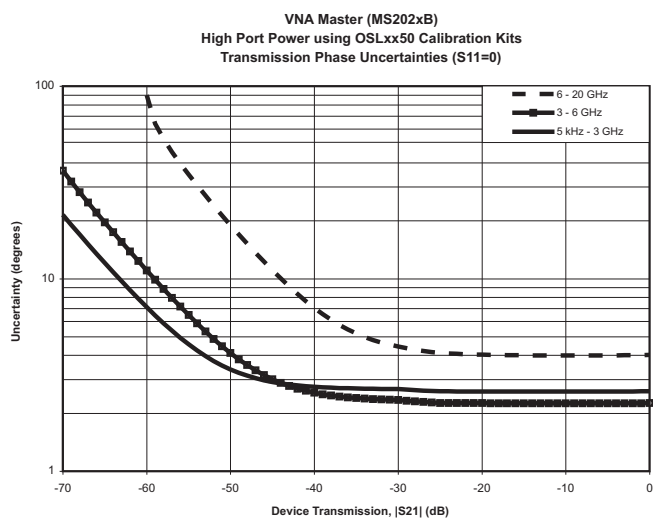
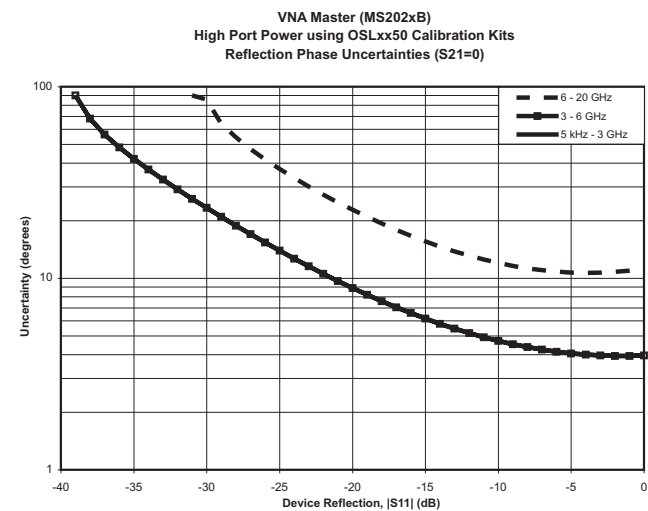
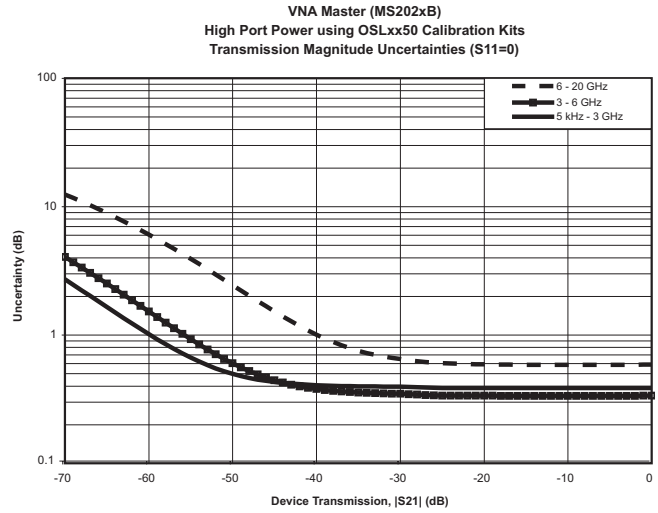
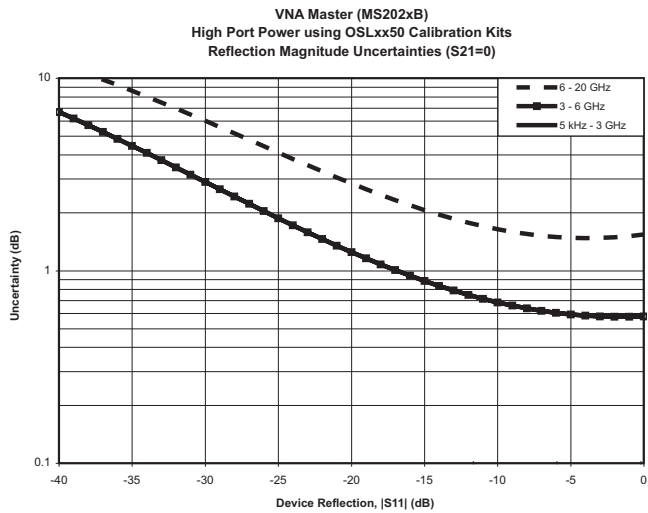

Low Port Power

OSLxx50 Calibration Components

Corrected System Performance and Uncertainties:

MS202xB Model with 12-term SOLT calibration including isolation using either OSLN50 & OSLNF50 or OSLK50 & OSLKF50 Calibration Kits.



Frequency Range (GHz)	Directivity (dB)
≤ 5	> 42
≤ 15	> 36
≤ 20*	> 32

*N-Connector guaranteed to 18 GHz, Typical >18 GHz

Frequency Range (GHz)	Typical Low Port Power (dBm)
≤ 3	-25
≤ 6	-25
≤ 20	-15

Measurement Uncertainties

The following graphs provide measurement uncertainty at 23 °C ± 5 °C for the above indicated connector type and calibration. Errors are worst-case contributions of residual directivity, source match, frequency response, network analyzer dynamic range, and connector repeatability. For two-port measurements, transmission tracking, crosstalk, and physical load match termination were added. Isolation calibration and an IF Bandwidth of 10 Hz is used.

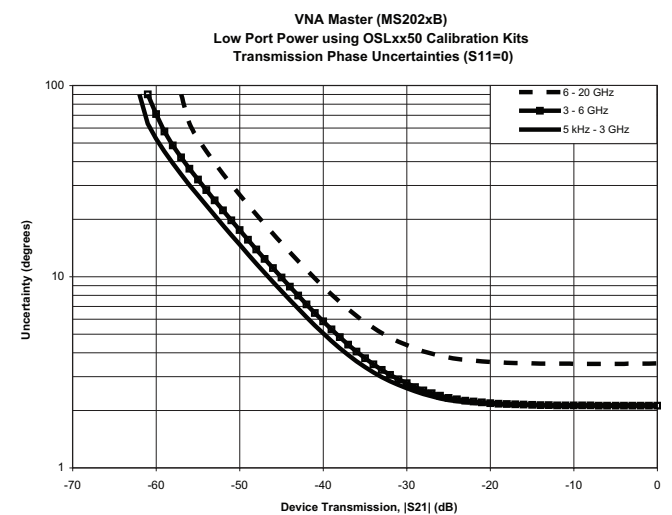
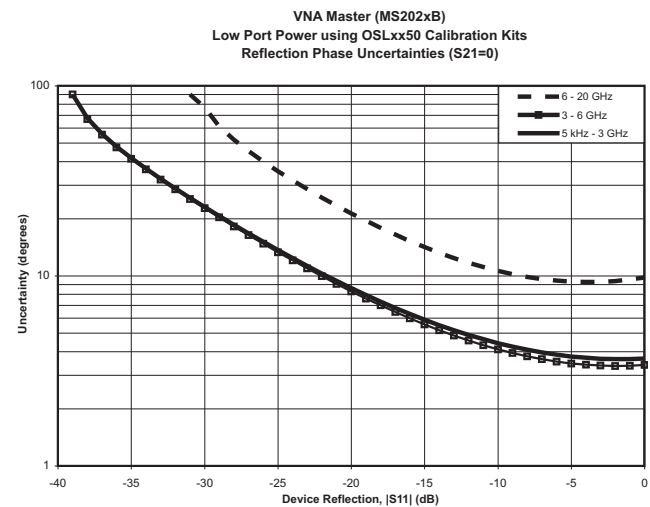
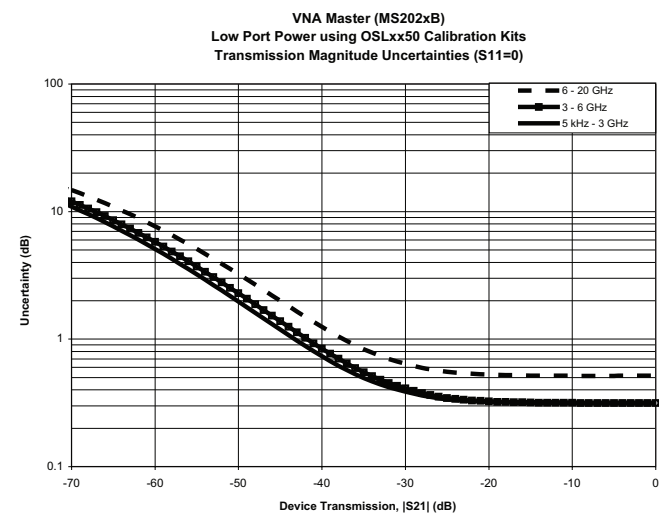
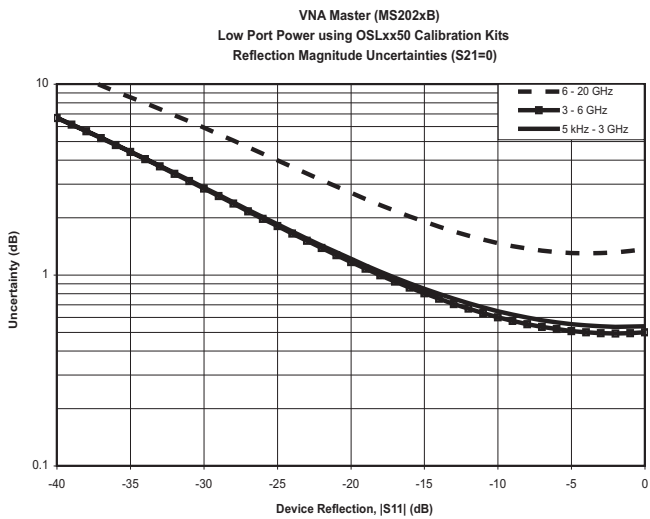

High Port Power

3652A Calibration Kit (K-Connector)

Corrected System Performance and Uncertainties:

MS202xB Model with 12-term SOLT calibration including isolation using 3652A Calibration Kit.



Frequency Range (GHz)	Directivity (dB)
≤ 5	> 42
≤ 15	> 36
≤ 20	> 32

Frequency Range (GHz)	Typical High Port Power (dBm)
≤ 3	+3
≤ 6	-3
≤ 20	-3

Measurement Uncertainties

The following graphs provide measurement uncertainty at 23 °C ± 5 °C for the above indicated connector type and calibration. Errors are worse-case contributions of residual directivity, source match, frequency response, network analyzer dynamic range, and connector repeatability. For two-port measurements, transmission tracking, crosstalk, and physical load match termination were added. Isolation calibration and an IF Bandwidth of 10 Hz is used.

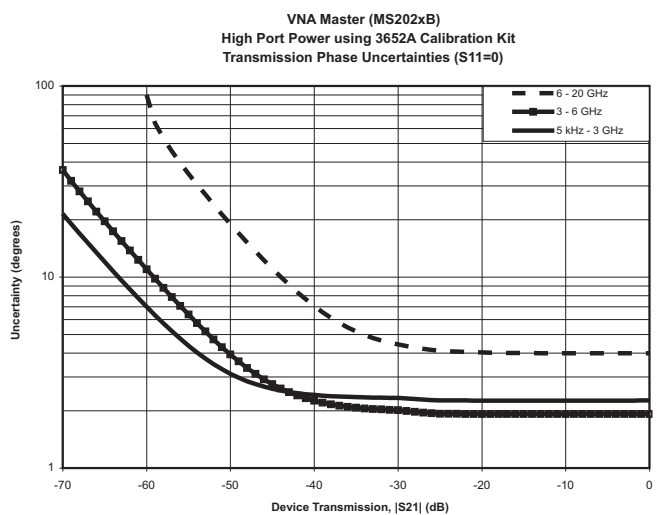
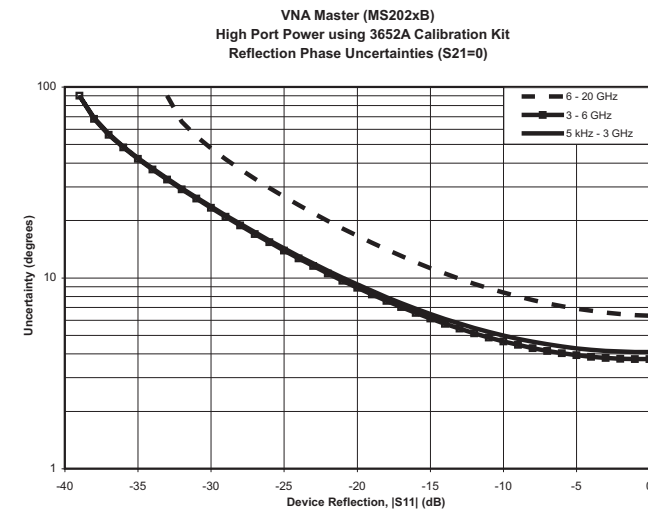
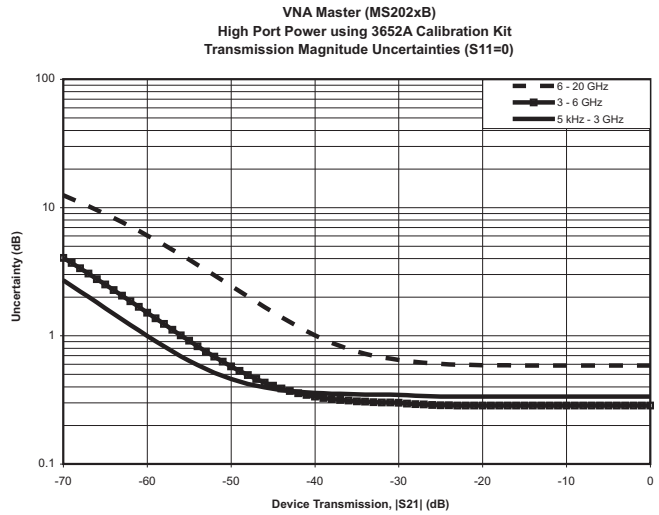
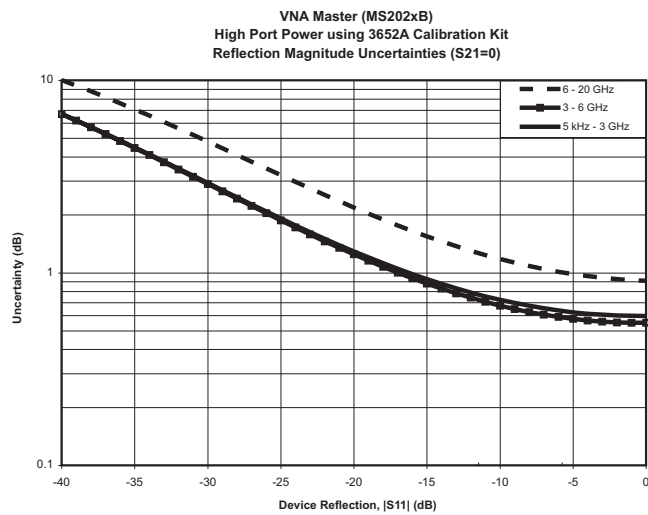

Low Port Power

3652A Calibration Kit (K-Connector)

Corrected System Performance and Uncertainties:

MS202xB Model with 12-term SOLT calibration including isolation using 3652A Calibration Kit.



Frequency Range (GHz)	Directivity (dB)
≤ 5	> 42
≤ 15	> 36
≤ 20	> 32

Frequency Range (GHz)	Typical Low Port Power (dBm)
≤ 3	-25
≤ 6	-25
≤ 20	-15

Measurement Uncertainties

The following graphs provide measurement uncertainty at 23 °C ± 5 °C for the above indicated connector type and calibration. Errors are worse-case contributions of residual directivity, source match, frequency response, network analyzer dynamic range, and connector repeatability. For two-port measurements, transmission tracking, crosstalk, and physical load match termination were added. Isolation calibration and an IF Bandwidth of 10 Hz is used.

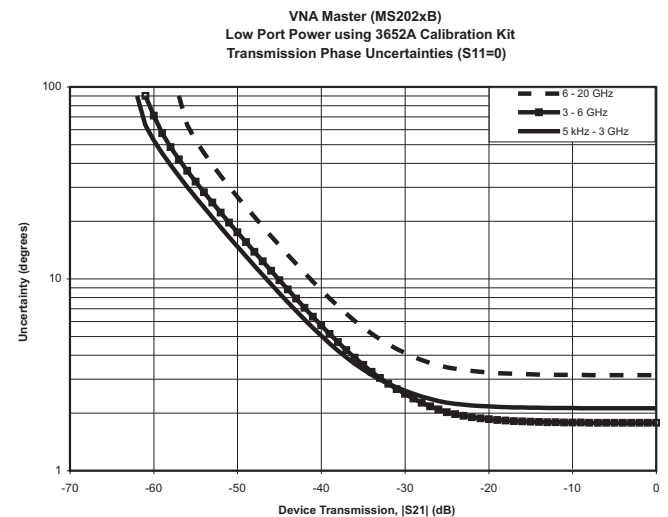
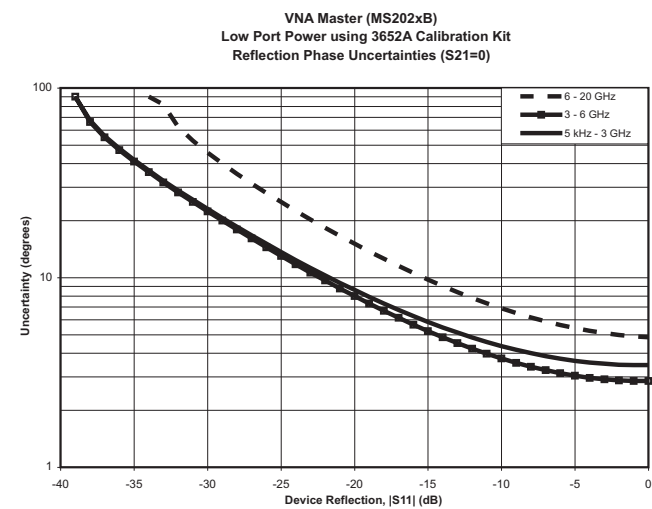
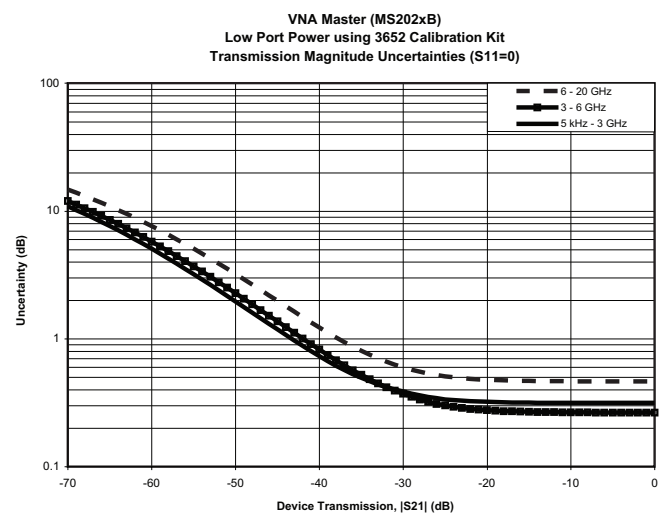
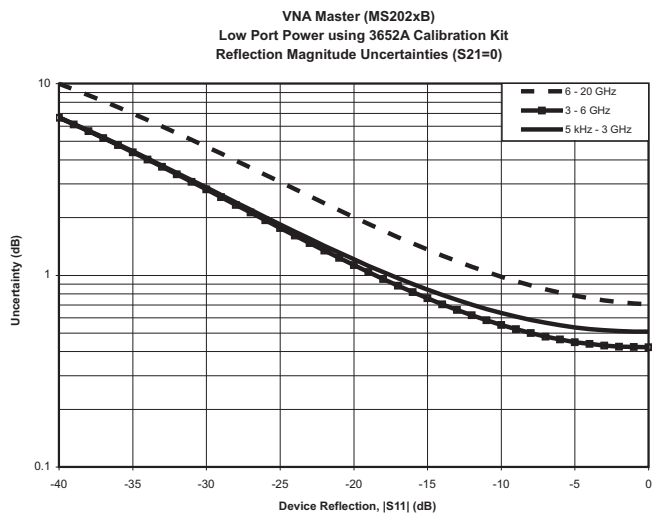

VNA Master's Optional Capabilities

Time Domain (Option 0002)

The VNA Master can also display the S-parameter measurements in the time or distance domain using bandpass processing analysis mode. The broadband frequency coverage coupled with 4001 data points means you can measure discontinuities both near and far with unprecedented clarity for a handheld tool. With this option, you can simultaneously view S-parameters in frequency, time, and distance domain to quickly identify faults in the field. Further enhance the Distance-to-Fault (DTF) results by compensating for cable loss, relative velocity of propagation, and dispersion compensation in waveguide.

Distance-To-Fault	Round-Trip (reflection) Fault Resolution (meters):	$(0.5 \times c \times Vp) / \Delta F$; (c is speed of light = 3E8 m/s, ΔF is $F2 - F1$ in Hz)
	One-Way (transmission) Fault Resolution (meters):	$(c \times Vp) / \Delta F$; (c is speed of light = 3E8 m/s, ΔF is $F2 - F1$ in Hz)
	Horizontal Range (meters):	0 to (data points - 1) x Fault Resolution to a maximum of 3000 m (9843 ft.)
	Windowing	Rectangular, Nominal Side Lobe (NSL), Low Side Lobe (LSL), and Minimum Side Lobe (MSL)

Power Monitor (Option 0005), Requires external detector

Transmitter measurements in the field are possible when using this VNA Master software mode with a separately purchased Anritsu 560 series detector. A variety of detectors are available to 50 GHz, but the popular 560-7N50B covers 10 MHz to 20 GHz with a measurement range of -50 to +20 dBm with better than 0.5 dB flatness to 18 GHz. After zeroing the detector to ensure accuracy at low power levels, the software offers intuitive operation for absolute and relative readouts in dBm or Watts.

Display Range	-80 to +80 dBm (10 pW to 100 kW)
Measurement Range	-50 to +20 dBm (10 nW to 40 mW)
Offset Range	0 to +60 dB
Resolution	0.1 dB, 0.1 xW (x = n, μ , m based on detector power)
Accuracy	± 1 dB maximum for > -40 dBm using 560-7N50B detector

Power Monitor Detectors* (Ordered separately):

Part Numbers	560-7N50B	560-7S50B
Frequency Range	0.01 to 20 GHz	0.01 to 20 GHz
Impedance	50 Ω	50 Ω
Power Range	-55 dBm to +16 dBm	-55 dBm to +16 dBm
Return Loss	15 dB, <0.04 GHz 22 dB, <8 GHz 17 dB, <18 GHz 14 dB, <20 GHz	15 dB, <0.04 GHz 22 dB, <8 GHz 17 dB, <18 GHz 14 dB, <20 GHz
Input Connector	N(m)	WSMA(m)
Frequency Response	± 0.5 dB, <18 GHz ± 1.25 dB, <20 GHz	± 0.5 dB, <18 GHz ± 1.25 dB, <20 GHz

*See www.us.anritsu.com for additional detectors

Secure Data Operation (Option 0007)

For highly secure data handling requirements, this software option prevents the storing of measurement setup or data information onto any internal file storage location. Instead, setup and measurement information is stored ONLY to the external USB memory location. A simple factory preset prepares the VNA Master for transportation while the USB memory remains behind in the secure environment. The VNA Master cannot be switched between secure and non-secure operation by the user once configured for secure data operation.

Bias Tee (Option 0010)

For tower mounted amplifier tests, the MS202xB series with optional internal bias tees can supply both DC and RF signals on the center conductor of the cable during measurements. For frequency sweeps in excess of 2 MHz, the VNA Master can supply internal voltage control from +12 to +32 V in 0.1 V steps up to 450 mA. To extend battery life, an external power supply can substitute for the internal supply by using the external bias inputs instead. Both test ports can be configured to supply voltage via this integrated bias tees option.

Frequency Range	2 MHz to 6 GHz (MS2026B) 2 MHz to 20 GHz (MS2028B)
Internal Voltage/Current	+12 V to +32 V at 450 mA steady rate
Internal Resolution	0.1 V
External Voltage/Current	± 50 V at 500 mA steady rate
Bias Tee Selections	Internal, External, Off

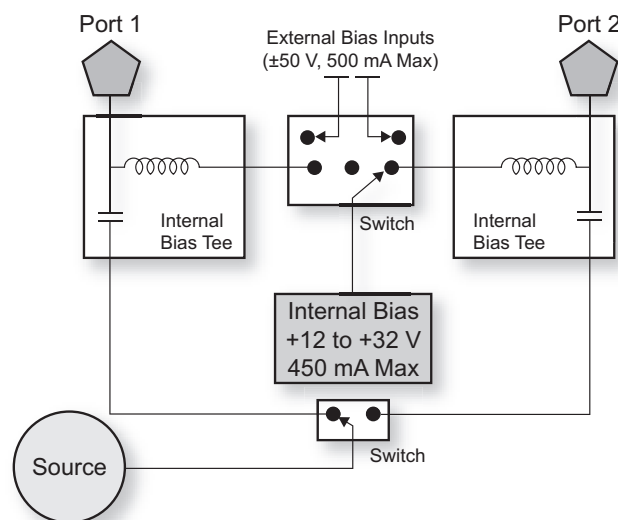

The VNA Master offers optional integrated bias tee for supplying DC plus RF to the DUT as shown in this simplified block diagram. Connectivity is also provided for external supply (instead of internal) to preserve battery consumption.

VNA Master's Optional Capabilities (continued)

Vector Voltmeter (Option 0015)

A phased array system relies on phase matched cables for nominal performance. For this class of application, the VNA Master offers this special software mode to simplify phase matching cables at a single frequency. The similarity between the popular vector voltmeter and this software mode ensures minimal training is required to phase match cables. Operation is as simple as configuring the display for absolute or relative measurements. The easy-to-read large fonts show either reflection or transmission measurements using impedance, magnitude, or VSWR readouts. For instrument landing system (ILS) or VHF Omni-directional Range (VOR) applications, a table view improves operator efficiency when phase matching up to twelve cables. The MS202xB solution is superior because the signal source is included internally, precluding the need for an external signal generator.

CW Frequency Range	5 kHz to 20 GHz
Measurement Display	CW, Table (Twelve Entries, Plus Reference)
Measurement Types	Return Loss, Insertion
Measurement Format	dB/VSWR/Impedance

High Accuracy Power Meter (Option 0019), Requires external USB power sensor.

Conduct precise measurements of CW and digitally modulated transmitters in the field using this VNA Master software mode with a separately purchased Anritsu USB power sensor. After specifying the center frequency and zeroing the sensor to ensure accuracy at low power levels, the software offers intuitive operation for absolute and relative readouts in dBm or Watts.

Option 0019 supports the USB Power Sensors in the following table.

USB Power Sensors (Ordered separately):

	PSN50	MA24104A	MA24106A	MA24108A	MA24118A
Frequency Range:	50 MHz to 6 GHz	600 MHz to 4 GHz	50 MHz to 6 GHz	10 MHz to 8 GHz	10 MHz to 18 GHz
Description	High Accuracy RF Power Sensor	Inline High Power Sensor	High Accuracy RF Power Sensor	Microwave USB Power Sensor	Microwave USB Power Sensor
Connector	Type N, male, 50 Ω	Type N, female, Ω	Type N, male, 50 Ω	Type N, male, 50 Ω	Type N, male, 50 Ω
Dynamic Range:	-30 dBm to +20 dBm (0.001 mW to 100 mW)	+3 dBm to +51.76 dBm (2 mW to 150 W)	-40 dBm to +23 dBm (0.1 μ W to 200 mW)	-40 dBm to +20 dBm (0.1 μ W to 100 mW)	-40 dBm to +20 dBm (0.1 μ W to 100 mW)
VBW	100 Hz	100 Hz	100 Hz	50 kHz	50 kHz
Measurand:	True-RMS	True-RMS	True-RMS	True-RMS, Slot Power, Burst Average Power	True-RMS, Slot power, Burst Average power
Measurement Uncertainty	± 0.16 dB ¹	± 0.17 dB ²	± 0.16 dB ¹	± 0.18 dB ³	± 0.18 dB ³
Datasheet for Additional Specifications	11410-00414	11410-00483	11410-00424	11410-00504	11410-00504

Notes:

- 1) Total RSS measurement uncertainty (0 $^{\circ}$ C to 50 $^{\circ}$ C) for power measurements of a CW signal greater than -20 dBm with zero mismatch errors
- 2) Expanded uncertainty with K=2 for power measurements of a CW signal greater than +20 dBm with a matched load. Measurement results referenced to the input side of the sensor.
- 3) Expanded uncertainty with K=2 for power measurements of a CW signal greater than -20 dBm with zero mismatch errors

GPS (Option 0031), Requires external GPS antenna

Built-in GPS provides location information (latitude, longitude, altitude) and Universal Time (UT) information for storage along with trace data so you can later verify that measurements were taken at the right location. The GPS option requires a separately ordered magnet mount GPS antenna (2000-1528-R), which is configured with a 15 foot (~5 m) cable to mount outside on a metallic surface.

GPS Location Indicator	Latitude, Longitude, Altitude, and Universal Time
GPS Readout	Both Display and Trace Storage

Balanced/Differential S-Parameters, 1-port (Option 0077)

As an alternative to a sampling oscilloscope, verifying the performance and identifying discontinuities in differential cables is now possible with the VNA Master. After a full two-port calibration, connect your differential cable directly to the two test ports and reveal the S_{DID1} performance, which is essentially differential return loss. With optional time domain, you can convert frequency sweeps to distance. This capability is especially valuable for applications in high data rate cables where balanced data formats are used to isolate noise and interference.

Standard and Optional Capabilities

Measurement Parameters	$S_{11}, S_{21}, S_{22}, S_{12}, S_{D1D1}$		
Number of Traces	Four: TR1, TR2, TR3, TR4		
Trace Format	Single, Dual, Tri, Quad. When used with Number of Traces, overlays are possible including a Single Format with Four trace overlays.		
Graph Types	Log Magnitude	Range --Resolution	-200 to +200 dB 0.01 dB
	SWR	Range --Resolution	1 to 91 0.01 dB
	Phase	Range --Resolution	-450° to +450° 0.01°
	Real	Range --Resolution	-1300 to +1300 0.001
	Imaginary	Range --Resolution	-1300 to +1300 0.001
	Group Delay	Range --Resolution	-1300 to +1300 ns 0.001 ns
	Smith Chart	Range --Resolution	1; compress 3dB; expand 10dB, 20dB, 30dB 0.001 Ω
	Log Mag / 2 (1-Port Cable Loss)	Range --Resolution	40 to -360 dB 0.01 dB
Domains	Frequency Domain, Time Domain, Distance Domain		
Frequency	Start Frequency, Stop Frequency, Center Frequency, Span		
Distance	Start Distance, Stop Distance		
Time	Start Time, Stop Time		
Frequency Sweep Type: Linear	Single Sweep, Continuous		
Data Points	2 to 4001 (arbitrary setting); data points can be reduced without recalibration.		
Limit Lines	Upper, Lower, 10 segmented Upper, 10 segmented Lower		
Test Limits	Pass/Fail for Upper, Pass/Fail for Lower, Limit Audible Alarm		
Data Averaging	Sweep-by-sweep		
Smoothing	0 to 20%		
IF Bandwidth	10, 30, 100, 300, 1k, 3k, 10k, 30k, 100k (Hz)		
Reference Plane	The reference planes of a calibration (or other normalization) can be changed by entering a line length. Assumes no loss, flat magnitude, linear phase, and constant impedance.		
Auto Reference Plane Extension	Instead of manually entering a line length, this feature automatically adjusts phase shift from the current calibration (or other normalization) to compensate for external cables (or test fixtures). Assumes no loss, flat magnitude, linear phase, and constant impedance.		
Frequency Range	Frequency range of the measurement can be narrowed within the calibration range without recalibration.		
Group Delay Aperture	Defined as the frequency span over which the phase change is computed at a given frequency point. The aperture can be changed without recalibration. The minimum aperture is the frequency range divided by the number of points in calibration and can be increased to 20% of the frequency range.		
Group Delay Range	< 180° of phase change within the aperture		
Trace Memory	A separate memory for each trace can be used to store measurement data for later display. The trace data can be saved and recalled.		
Trace Math	Complex trace math operations of subtraction, addition, multiplication, or division are provided.		
Number of Markers	Eight, arbitrary assignments to any trace		
Marker Types	Reference, Delta		
Marker Readout Styles	Log Mag, Cable Loss (Log Mag / 2), Log Mag and Phase, Phase, Real and Imaginary, SWR, Impedance, Admittance, Normalized Impedance, Normalized Admittance, Polar Impedance, and Group Delay		
Marker Search	Peak Search, Valley Search, Find Marker Value		
Correction Models	Full 2-Port, Full S_{11} , Full S_{22} , Full S_{11} & S_{22} , Response S_{21} , Response S_{12} , Response S_{21} & S_{12} , Response S_{11} , Response S_{22} , Response S_{11} & S_{22} , One-Path Two-Port (S_{11}, S_{21}), One-Path Two-Port (S_{22}, S_{12})		
Calibration Methods	Short-Open-Load-Through (SOLT), Offset-Short (SSLT), and Triple-Offset-Short (SSST)		
Calibration Standards' Coefficients	Coax: N-Connector, K-Connector, 7/16, TNC, SMA, and four User Defined Waveguide: WG11A, WG12, WG13, WG14, WG15, WG16, WG17, WG18, WG20, and four User Defined		
Cal Correction Toggle	On/Off		
Dispersion Compensation	Waveguide correction that improves accuracy of distance-to-fault data by compensating for different wavelengths propagating at different speeds.		
Impedance Conversion	Support for 50 Ω and 75 Ω are provided.		
Units	Meters, Feet		
Bias Tee Settings	Internal, External, Off		
Timebase Reference	Internal, External (10 MHz)		
File Storage Types	Measurement, Setup (with CAL), Setup (without CAL), S2P (Real/Imag), S2P (Lin Mag/Phase), S2P (Log Mag/Phase), JPEG		
Ethernet Configuration	DHCP or Manual (Static); IP, Gateway, Subnet entries		
Languages	English, French, German, Spanish, Chinese, Japanese, Korean, Italian, plus two User Defined		

General Specifications

Product Overview

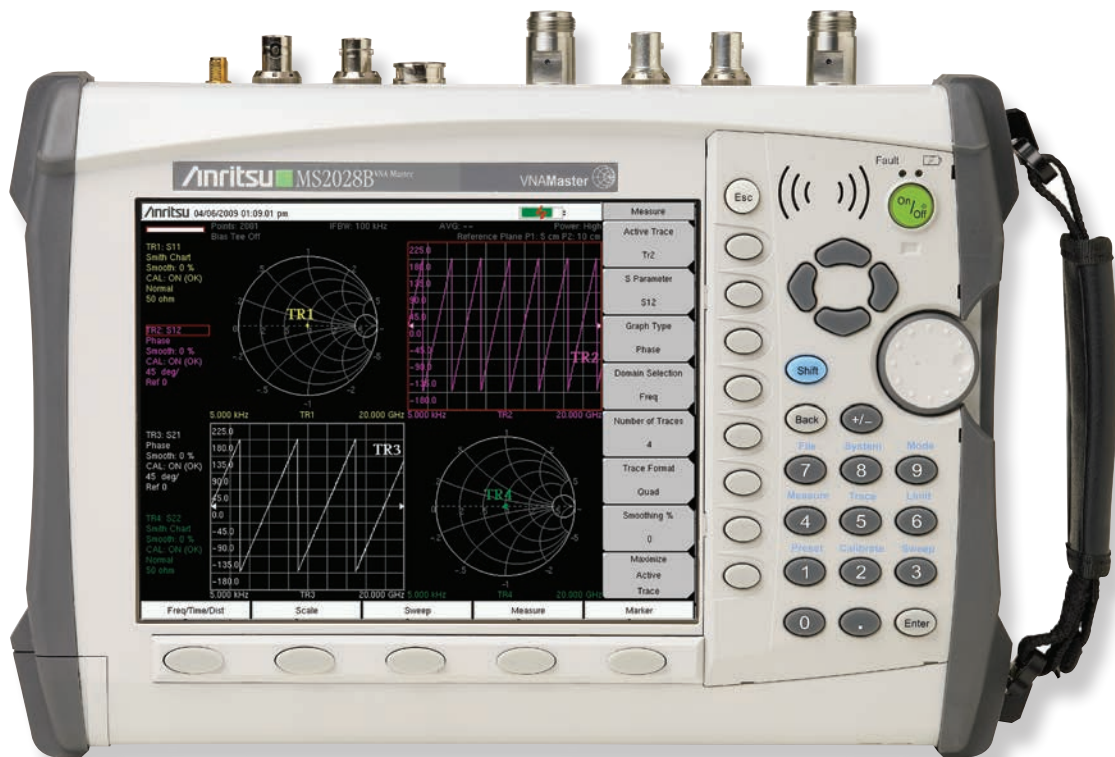

Maximum Input (Damage Level) into Vector Network Analyzer	+23 dBm, ±50 VDC
Interfaces	<ul style="list-style-type: none"> Type N female (or K female with opt 0011, MS2028B only) VNA port (x2) Type BNC female Bias Tee port (enabled with opt 0010) (x2) Type BNC female Trigger In port Type BNC female External Reference In port Type SMA female GPS port supports +3.3 V or +5 V external antenna (available with opt 0031) 4-pin DIN connector for RF detector (available with opt 0005) USB Interface, Type A (2 connectors) USB Interface, Type Mini-B RJ45 connector for Ethernet 10/100-Base T 2.5 mm 3-wire cellular headset connector

General Specifications (continued)

Mechanical:

Dimensions	Height	211 mm (8.3 in)
	Width	315 mm (12.4 in)
	Depth	78 mm (3.1 in)
Weight, Including Battery	4.5 kg (9.9 lbs)	

Environmental:

MIL-PRF-28800F, Class 2 Environmental Conditions	MS2026/28B
Temperature, operating (°C) (3.8.2.1 & 4.5.5.14)	Passed, -10 °C to 55 °C, Humidity 85%
Temperature, not operating (°C) (3.8.2.2 & 4.5.5.1)	Passed, -51 °C to 71 °C
Relative humidity (3.8.2.3 & 4.5.5.1)	Passed
Altitude, not operating (3.8.3 & 4.5.5.2)	Passed*, 4600 m
Altitude, operating (3.8.3 & 4.5.5.2)	Passed*, 4600 m
Vibration limits (3.8.4.1 & 4.5.5.3.1)	Passed
Shock, functional (3.8.5.1 & 4.5.5.4.1)	Passed
Transit Drop (3.8.5.2 & 4.5.5.4.2)	Passed
Bench handling (3.8.5.3 & 4.5.5.4.3)	Passed
Shock, high impact (3.8.5.4 & 4.5.5.4.4)	Not Required**
Salt exposure structural parts (3.8.8.2 & 4.5.6.2.2)	Not Required***

* Qualified by similarity (tested on a similar product)

** Not defined in standard; must be invoked and defined by purchase description

*** Not required for Class 2 equipment

Safety:

Safety	Conforms to EN 61010-1 for Class 1 portable equipment
--------	---

Electromagnetic Compatibility:

EMI	Meets European Community requirements for CE marking
-----	--

Power:

Field replaceable Li-Ion Battery (633-44: 6600 mAh, 4.5 Amps)	40 Watts on battery power only
DC power from Universal 110/220V AC/DC Adapter	55 Watts running off AC/DC adaptor while charging battery
Life time charging cycles (Li-Ion Battery, 633-44)	>300 (80% of initial capacity)

Remote Programming

SCPI available via Ethernet. Refer to VNA Master Programming Manual (10580-00221) for additional information.

Master Software Tools (2300-498)

A free software utility for Windows 2000/XP/Vista that provides additional post-processing and archiving features when connected via Ethernet or USB interface. In addition, this utility enables the free download and installation of firmware revisions.



Connect VNA Master to a PC for archiving and additional analysis.

Ordering Information

VNA Master™

MS2026B	VNA Master, 2-port, 5 kHz to 6 GHz
MS2028B	VNA Master, 2-port, 5 kHz to 20 GHz

The instrument includes standard one-year warranty and Certificate of Calibration and Conformance

MS2026B VNA Master Options

MS2026B-0002	Time Domain (includes DTF capability)
MS2026B-0005	Power Monitor (requires external detector)
MS2026B-0007	Secure Data Operation
MS2026B-0010	Built-in Bias-Tee
MS2026B-0015	Vector Voltmeter
MS2026B-0019	High Accuracy Power Meter (requires external USB sensor)
MS2026B-0031	GPS Receiver (requires GPS antenna, 2000-1528-R)
MS2026B-0077	Balanced/Differential S-Parameters, 1-port
MS2026B-0098	Z-540 Calibration
MS2026B-0099	Premium Calibration

MS2028B VNA Master Options

MS2028B-0002	Time Domain (includes DTF capability)
MS2028B-0005	Power Monitor (requires external detector)
MS2028B-0007	Secure Data Operation
MS2028B-0010	Built-in Bias-Tee
MS2028B-0011	K(f) Test Port Connectors
MS2028B-0015	Vector Voltmeter
MS2028B-0019	High Accuracy Power Meter (requires external USB sensor)
MS2028B-0031	GPS Receiver (requires GPS antenna, 2000-1528-R)
MS2028B-0077	Balanced/Differential S-Parameters, 1-port
MS2028B-0098	Z-540 Calibration
MS2028B-0099	Premium Calibration

MS202xB Standard Accessories

10580-00220	VNA Master User's Guide
65729	Soft Carrying Case
2300-498	Master Software Tools CD ROM
633-44	Rechargeable Battery, Li-Ion, 6.6 Ah
40-168-R	AC-DC Adapter
806-141-R	Automotive Cigarette Lighter 12 V DC adapter
3-2000-1498	USB A-to mini B cable, 3.05 m (10 ft.)
2000-1371-R	Ethernet cable, 2.13 m (7 ft.)
3-806-152	Ethernet Crossover Cable, 2.13 m (7 ft.)
2000-1520-R	USB Flash Drive

Coaxial Calibration Components

K Connector Components

OSLK50	Precision integrated Open/Short/Load K(m), DC to 20 GHz, 50 Ω
OSLKF50	Precision integrated Open/Short/Load K(f), DC to 20 GHz, 50 Ω
22K50	Precision K(m) Short/Open, 40 GHz
22KF50	Precision K(f) Short/Open, 40 GHz
28K50	Precision Termination, DC to 40 GHz, 50 Ω , K(m)
28KF50	Precision Termination, DC to 40 GHz, 50 Ω , K(f)
3652A	K Calibration Kit, DC to 40 GHz

N-Type Connectors

OSLN50	Precision Integrated Open/Short/Load N(m), DC to 18 GHz, 50 Ω
OSLNF50	Precision Integrated Open/Short/Load N(f), DC to 18 GHz, 50 Ω
22N50	Precision N(m) Short/Open, 18 GHz
22NF50	Precision N(f) Short/Open, 18 GHz
28N50-2	Precision Termination, DC to 18 GHz, 50 Ω , N(m)
28NF50-2	Precision Termination, DC to 18 GHz, 50 Ω , N(f)
OSLN50-1	Precision N(m) Open/Short/Load, 42 dB, 6 GHz
OSLNF50-1	Precision N(f) Open/Short/Load, 42 dB, 6 GHz
SM/PL-1	Precision N(m) Load, 42 dB, 6 GHz
SM/PLNF-1	Precision N(f) Load, 42 dB, 6 GHz

TNC Connector Components

1091-53-R	Precision TNC(m) Open, 18 GHz, 50 Ω
1091-54-R	Precision TNC(m) Short, 18 GHz, 50 Ω
1015-55-R	Precision TNC(m) Load, 18 GHz, 50 Ω
1091-55-R	Precision TNC(f) Open, 18 GHz, 50 Ω
1091-56-R	Precision TNC(f) Short, 18 GHz, 50 Ω
1015-54-R	Precision TNC(f) Load, 18 GHz, 50 Ω

7/16 Connector Components

2000-767-R	Precision Open/Short/Load, 7/16(m), 4.0 GHz
2000-768-R	Precision Open/Short/Load, 7/16(f), 4.0 GHz

Ordering Information (continued)

Waveguide Calibration Components

In addition to coaxial measurements, VNA Master supports waveguide measurements. Use the following table to add waveguide adapters and calibration component accessories according to the desired flange type.

In the next table, the 'xx' denotes the following waveguide components:

23 = 1/8 Offset Short

24 = 3/8 Offset Short

26 = Precision Load

Example: 23UA90, 24UA90, 26UA90, and 35UM90N

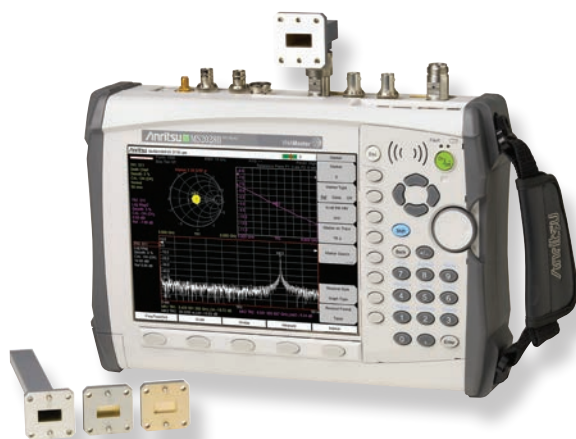

Precision waveguide-to-coaxial adapters enable VNA Master to conduct calibration and measurement in a variety of popular waveguide flange types.

Precision Waveguide Calibration Components¹

Part Number	Freq. Range	Waveguide Type	Compatible Flanges
xxUM70	5.85 to 8.20 GHz	WR137, WG14	CAR70, PAR70, UAR 70, PDR70
xxUM84	7.05 to 10.00 GHz	WR112, WG15	CBR84, UBR84, PBR84, PDR84
xxUM100	8.20 to 12.40 GHz	WR90, WG16	CBR100, UBR100, PBR100, PDR100
xxUM120	10.00 to 15.00 GHz	WR75, WG17	CBR120, UBR120, PBR120, PDR120
xxUA187	3.95 to 5.85 GHz	WR187, WG12	CPR187F, CPR187G, UG-1352/U, UG-1353/U, UG-1728/U, UG-1729/U, UG-148/U, UG-149A/U
xxUA137	5.85 to 8.20 GHz	WR137, WG14	CPR137F, CPR137G, UG-1356/U, UG-1357/U, UG-1732/U, UG-1733/U, UG-343B/U, UG-344/U, UG-440B/U, UG-441/U
xxUA112	7.05 to 10.00 GHz	WR112, WG15	CPR112F, CPR112G, UG-1358/U, UG-1359/U, UG-1734/U, UG-1735/U, UG-52B/U, UG-51/U, UG-137B/U, UG-138/U
xxUA90	8.20 to 12.40 GHz	WR90, WG16	CPR90F, CPR90G, UG-1360/U, UG-1361/U, UG-1736/U, UG-1737/U, UG-40B/U, UG-39/U, UG-135/U, UG-136B/U
xxUA62	12.40 to 18.00 GHz	WR62, WG18	UG-541A/U, UG-419/U, UG-1665/U, UG1666/U
xxUA42	17.00 to 26.50 GHz	WR42, WG20	UG-596A/U, UG-595/U, UG-597/U, UG-598A/U

Coaxial to Universal Waveguide Adapters¹

Part Number	Freq. Range	Waveguide	Type Compatible Flanges
35UM70N	5.85 to 8.20 GHz	WR137, WG14	CAR70, PAR70, UAR 70, PDR70
35UM84N	7.05 to 10.00 GHz	WR112, WG15	CBR84, UBR84, PBR84, PDR84
35UM100N	8.20 to 12.40 GHz	WR90, WG16	CBR100, UBR100, PBR100, PDR100
35UM120N	10.00 to 15.00 GHz	WR75, WG17	CBR120, UBR120, PBR120, PDR120
35UA187N	3.95 to 5.85 GHz	WR187, WG12	CPR187F, CPR187G, UG-1352/U, UG-1353/U, UG-1728/U, UG-1729/U, UG-148/U, UG-149A/U
35UA137N	5.85 to 8.20 GHz	WR137, WG14	CPR137F, CPR137G, UG-1356/U, UG-1357/U, UG-1732/U, UG-1733/U, UG-343B/U, UG-344/U, UG-440B/U, UG-441/U
35UA112N	7.05 to 10.00 GHz	WR112, WG15	CPR112F, CPR112G, UG-1358/U, UG-1359/U, UG-1734/U, UG-1735/U, UG-52B/U, UG-51/U, UG-137B/U, UG-138/U
35UA90N	8.20 to 12.40 GHz	WR90, WG16	CPR90F, CPR90G, UG-1360/U, UG-1361/U, UG-1736/U, UG-1737/U, UG-40B/U, UG-39/U, UG-135/U, UG-136B/U
35UA62N	12.40 to 18.00 GHz	WR62, WG18	UG-541A/U, UG-419/U, UG-1665/U, UG1666/U
35UA42K	7.00 to 26.50 GHz	WR42, WG20	UG-596A/U, UG-595/U, UG-597/U, UG-598A/U

¹Contact an Anritsu sales representative for availability of waveguide calibration components and waveguide-to-coaxial adapters not listed in the table.

Optional Accessories

High Accuracy Power Sensor

PSN50	High Accuracy Power Sensor, 50 MHz to 6 GHz
MA24104A	Inline High Power Sensor, 600 MHz to 4 GHz, True RMS
MA24106A	High Accuracy Power Sensor, 50 MHz to 6 GHz, True RMS
MA24108A	High Accuracy Power Sensor, 10 MHz to 8 GHz, True RMS
MA24118A	High Accuracy Power Sensor, 10 MHz to 18 GHz, True RMS

Power Monitor Detectors

560-7N50B	RF Detector, 0.01 to 20 GHz, Type-N(m)
560-7S50B	RF Detector, 0.01 to 20 GHz, W-SMA(m)

Detector Extender Cables

800-109	Detector Extender Cable, 7.6m (25 ft)
800-111	Detector Extender Cable, 30.5m (100 ft.)

Adapters

1091-26-R	N(m)-SMA(m), DC to 18 GHz, 50 Ω
1091-27-R	N(m)-SMA(f), DC to 18 GHz, 50 Ω
1091-80-R	N(f)-SMA(m), DC to 18 GHz, 50 Ω
1091-81-R	N(f)-SMA(f), DC to 18 GHz, 50 Ω
510-102-R	N(m)-N(m), 90° right angle, DC to 11 GHz, 50 Ω
510-90-R	7/16 DIN(f)-N(m), DC to 7.5 GHz, 50 Ω
510-91-R	7/16 DIN(f)-N(f), DC to 7.5 GHz, 50 Ω
510-92-R	7/16 DIN(m)-N(m), DC to 7.5 GHz, 50 Ω
510-93-R	7/16 DIN(m)-N(f), DC to 7.5 GHz, 50 Ω
510-96-R	7/16 DIN(m)-7/16 DIN(m), DC to 7.5 GHz, 50 Ω
510-97-R	7/16 DIN(f)-7/16 DIN(f), DC to 7.5 GHz, 50 Ω
513-62-R	Adapter, TNC(f) to N(f), 18 GHz, 50 Ω
1091-315-R	Adapter, TNC(m) to N(f), 18 GHz, 50 Ω
1091-324-R	Adapter, TNC(f) to N(m), 18 GHz, 50 Ω
1091-325-R	Adapter, TNC(m) to N(m), 18 GHz, 50 Ω
1091-317-R	Adapter, TNC(m) to SMA(f), 18 GHz, 50 Ω
1091-318-R	Adapter, TNC(m) to SMA(m), 18 GHz, 50 Ω
1091-323-R	Adapter, TNC(f) to TNC(f), 18 GHz, 50 Ω
1091-326-R	Adapter, TNC(m) to TNC(m), 18 GHz, 50 Ω
K220B	K(m)-K(m), DC to 40 GHz, 50 Ω
K222B	K(f)-K(f), DC to 40 GHz, 50 Ω
K224B	K(f)-K(m), DC to 40 GHz, 50 Ω

Precision Adapters

34NN50A	N(m)-N(m), DC to 18 GHz, 50 Ω
34NFN50	N(f)-N(f), DC to 18 GHz, 50 Ω
34NKF50	N(m)-K(f), DC to 18 GHz, 50 Ω
34NK50	N(m)-K(m), DC to 18 GHz, 50 Ω
34NFK50	N(f)-K(f), DC to 18 GHz, 50 Ω
34NFK50	N(f)-K(m), DC to 18 GHz, 50 Ω
34RKRK50	Ruggedized RK(m)-RK(m), DC to 40 GHz, 50 Ω
34RKNF50	Ruggedized RK(m)-N(f), DC to 18 GHz, 50 Ω

Limiter

1N50C	Limiter, N(m) to N(f), 50 W, 0.01 to 18 GHz
-------	---

Attenuator

42N50-20	Attenuator, 20 dB, 5 W, DC to 18 GHz, N(m)-N(f)
42N50A-30	Attenuator, 30 dB, 5 W, DC to 18 GHz, N(m)-N(f)

Test Port Cables Armored

15NN50-1.5C	1.5 m, N(m)-N(m), 6 GHz, 50 Ω
15NN50-3.0C	3.0 m, N(m)-N(m), 6 GHz, 50 Ω
15NN50-5.0C	5.0 m, N(m)-N(m), 6 GHz, 50 Ω
15NNF50-1.5C	1.5 m, N(m)-N(f), 6 GHz, 50 Ω
15NNF50-3.0C	3.0 m, N(m)-N(f), 6 GHz, 50 Ω
15NNF50-5.0C	5.0 m, N(m)-N(f), 6 GHz, 50 Ω
15ND50-1.5C	1.5 m, N(m)-7/16 DIN(m), 6 GHz, 50 Ω
15NDF50-1.5C	1.5 m, N(m)-7/16 DIN(f), 6 GHz, 50 Ω
15KKF50-0.6A	Armored Test Port Cable, 0.6 meter, K(m) to K(f), 20 GHz
15KK50-0.6A	Armored Test Port Cable, 0.6 meter, K(m) to K(m), 20 GHz
15KKF50-1.5A	Armored Test Port Cable, 1.5 meter, K(m) to K(f), 20 GHz
15RKKF50-1.5A	Ruggedized Armored Test Port Cable, 1.5 meter, K(m) to K(f), 20 GHz
15NN50-0.6B	Armored Test Port Cable, 0.6 meter, N(m) to N(m), 18 GHz
15NNF50-0.6B	Armored Test Port Cable, 0.6 meter, N(m) to N(f), 18 GHz
15NNF50-1.5B	Armored Test Port Cable, 1.5 meter, N(m) to N(f), 18 GHz

Battery Accessories

633-44	Rechargeable Battery, Li-Ion, 6.6 Ah
2000-1374	Dual Battery Charger, Li-Ion with Universal Power Supply

GPS Antenna

2000-1528-R	Magnet Mount GPS Antenna (active 3-5V) with SMA connector and 4.6 m (15 ft.) extension cable
-------------	--

Flash Drive

2000-1520-R	USB Flash Drive
-------------	-----------------

Hard Transit Case

760-243-R	Hard Transit Case with wheels and retracting handle for Anritsu Handheld Master products
-----------	--

Rack Mount Kit

66864	Rack Mount Kit, Master Platform
-------	---------------------------------

Backpack

67135	Anritsu Backpack (for Handheld Products)
-------	--

Technical Data Sheet

10580-00500	VNA Master Brochure
10580-00501	VNA Master Technical Data Sheet

Manuals

10580-00220	VNA Master User's Guide
10580-00221	VNA Master Programming Manual

Related Literature, Application Notes

11410-00214	Reflectometer Measurements – Revisited
11410-00206	Time Domain for Vector Network Analyzers
11410-00270	What is Your Measurement Accuracy?
11410-00373	Distance-to-Fault
11410-00414	High Accuracy Power Meter, PSN50
11410-00424	USB Power Sensor MA24106A
11410-00483	Inline High Power Sensor MA24104A
11410-00504	Microwave USB Power Sensor MA241x8A

Anritsu

Anritsu Corporation

5-1-1 Onna, Atsugi-shi, Kanagawa, 243-8555 Japan
Phone: +81-46-223-1111
Fax: +81-46-296-1264

• U.S.A.

Anritsu Company

1155 East Collins Boulevard, Suite 100,
Richardson, Texas 75081 U.S.A.
Toll Free: 1-800-ANRITSU (267-4878)
Phone: +1-972-644-1777
Fax: +1-972-671-1877

• Canada

Anritsu Electronics Ltd.

700 Silver Seven Road, Suite 120, Kanata,
Ontario K2V 1C3, Canada
Phone: +1-613-591-2003
Fax: +1-613-591-1006

• Brazil

Anritsu Eletrônica Ltda.

Praca Amadeu Amaral, 27-1 Andar
01327-010 - Paraisópolis, São Paulo, Brazil
Phone: +55-11-3283-2511
Fax: +55-11-3886940

• Mexico

Anritsu Company, S.A. de C.V.

Av. Ejército Nacional No. 579 Piso 9, Col. Granada
11520 México, D.F., México
Phone: +52-55-1101-2370
Fax: +52-55-5254-3147

• U.K.

Anritsu EMEA Ltd.

200 Capability Green, Luton, Bedfordshire LU1 3LU, U.K.
Phone: +44-1582-433200
Fax: +44-1582-731303

• France

Anritsu S.A.

16/18 Avenue du Québec-SILIC 720
91961 COURTABOEUF CEDEX, France
Phone: +33-1-60-92-15-50
Fax: +33-1-64-46-10-65

• Germany

Anritsu GmbH

Nemetschek Haus, Konrad-Zuse-Platz 1
81829 München, Germany
Phone: +49 (0) 89 442308-0
Fax: +49 (0) 89 442308-55

• Italy

Anritsu S.p.A.

Via Elio Vittorini, 129, 00144 Roma, Italy
Phone: +39-06-509-9711
Fax: +39-06-502-2425

• Sweden

Anritsu AB

Borgafjordsgatan 13, 164 40 Kista, Sweden
Phone: +46-8-534-707-00
Fax: +46-8-534-707-30

• Finland

Anritsu AB

Teknobulevardi 3-5, FI-01530 Vantaa, Finland
Phone: +358-20-741-8100
Fax: +358-20-741-8111

• Denmark

Anritsu A/S

Kirkebjerg Allé 90 DK-2605 Brøndby, Denmark
Phone: +45-72112200
Fax: +45-72112210

• Spain

Anritsu EMEA Ltd.

Oficina de Representación en España

Edificio Veganova
Avda de la Vega, n° 1 (edf 8, pl1, of 8)
28108 ALCOBENDAS - Madrid, Spain
Phone: +34-914905761
Fax: +34-914905762

• Russia

Anritsu EMEA Ltd.

Representation Office in Russia

Tverskaya str. 16/2, bld. 1, 7th floor.
Russia, 125009, Moscow
Phone: +7-495-363-1694
Fax: +7-495-935-8962

• United Arab Emirates

Anritsu EMEA Ltd.

Dubai Liaison Office

P O Box 500413 - Dubai Internet City
Al Thuraya Building, Tower 1, Suite 701, 7th Floor
Dubai, United Arab Emirates
Phone: +971-4-3670352
Fax: +971-4-3688460

• Singapore

Anritsu Pte. Ltd.

60 Alexandra Terrace, #02-08, The Comtech (Lobby A)
Singapore 118502
Phone: +65-6282-2400
Fax: +65-6282-2533

• India

Anritsu Pte. Ltd.

India Branch Office

3rd Floor, Shri Lakshminarayan Niwas,
#2726, 80 ft Road, HAL 3rd Stage, Bangalore - 560 075, India
Phone: +91-80-4058-1300
Fax: +91-80-4058-1301

• P. R. China (Hong Kong)

Anritsu Company Ltd.

Units 4 & 5, 28th Floor, Greenfield Tower, Concordia Plaza,
No. 1 Science Museum Road, Tsim Sha Tsui East,
Kowloon, Hong Kong, P.R. China
Phone: +852-2301-4980
Fax: +852-2301-3545

• P. R. China (Beijing)

Anritsu Company Ltd.

Beijing Representative Office

Room 2008, Beijing Fortune Building,
No. 5, Dong-San-Huan Bei Road,
Chao-Yang District, Beijing 100004, P.R. China
Phone: +86-10-6590-9230
Fax: +82-10-6590-9235

• Korea

Anritsu Corporation, Ltd.

8F Hyunjuk Bldg. 832-41, Yeoksam-Dong,
Kangnam-ku, Seoul, 135-080, Korea
Phone: +82-2-553-6603
Fax: +82-2-553-6604

• Australia

Anritsu Pty Ltd.

Unit 21/270 Ferntree Gully Road, Notting Hill
Victoria, 3168, Australia
Phone: +61-3-9558-8177
Fax: +61-3-9558-8255

• Taiwan

Anritsu Company Inc.

7F, No. 316, Sec. 1, Neihu Rd., Taipei 114, Taiwan
Phone: +886-2-8751-1816
Fax: +886-2-8751-1817

