

Technical Specifications

Agilent Technologies PNA Series Network Analyzers E8362B/C, E8363B/C, and E8364B/C



Manufacturing Part Number: E8364-90031

Printed in USA

Print Date: October 3, 2008

Supersedes: September 8, 2008

© Agilent Technologies, Inc. 2004, 2006 - 2008 All rights reserved.

Documentation Warranty

THE MATERIAL CONTAINED IN THIS DOCUMENT IS PROVIDED "AS IS," AND IS SUBJECT TO BEING CHANGED, WITHOUT NOTICE, IN FUTURE EDITIONS. FURTHER, TO THE MAXIMUM EXTENT PERMITTED BY APPLICABLE LAW, AGILENT DISCLAIMS ALL WARRANTIES, EITHER EXPRESS OR IMPLIED WITH REGARD TO THIS MANUAL AND ANY INFORMATION CONTAINED HEREIN, INCLUDING BUT NOT LIMITED TO THE IMPLIED WARRANTIES OF MERCHANTABILITY AND FITNESS FOR A PARTICULAR PURPOSE. AGILENT SHALL NOT BE LIABLE FOR ERRORS OR FOR INCIDENTAL OR CONSEQUENTIAL DAMAGES IN CONNECTION WITH THE FURNISHING, USE, OR PERFORMANCE OF THIS DOCUMENT OR ANY INFORMATION CONTAINED HEREIN. SHOULD AGILENT AND THE USER HAVE A SEPARATE WRITTEN AGREEMENT WITH WARRANTY TERMS COVERING THE MATERIAL IN THIS DOCUMENT THAT CONFLICT WITH THESE TERMS, THE WARRANTY TERMS IN THE SEPARATE AGREEMENT WILL CONTROL.

DFARS/Restricted Rights Notice

If software is for use in the performance of a U.S. Government prime contract or subcontract, Software is delivered and licensed as "Commercial computer software" as defined in DFAR 252.227-7014 (June 1995), or as a "commercial item" as defined in FAR 2.101(a) or as "Restricted computer software" as defined in FAR 52.227-19 (June 1987) or any equivalent agency regulation or contract clause. Use, duplication or disclosure of Software is subject to Agilent Technologies' standard commercial license terms, and non-DOD Departments and Agencies of the U.S. Government will receive no greater than Restricted Rights as defined in FAR 52.227-19(c)(1-2) (June 1987). U.S. Government users will receive no greater than Limited Rights as defined in FAR 52.227-14 (June 1987) or DFAR 252.227-7015 (b)(2) (November 1995), as applicable in any technical data.

Printing Copies of Documentation from the Web

To print copies of documentation from the Web, download the PDF file from the Agilent web site:

- Go to www.agilent.com.
 - Enter the document's part number (located on the title page) in the **Search** box.
 - Click **SEARCH**.
 - Click on the hyperlink for the document.
 - Click the printer icon located in the tool bar.
-

Contacting Agilent

Assistance with test and measurement needs and information on finding a local Agilent office are available on the Web at:

www.agilent.com/find/assist

If you do not have access to the Internet, please contact your Agilent field engineer.

NOTE In any correspondence or telephone conversation, refer to the Agilent product by its model number and full serial number. With this information, the Agilent representative can determine whether your product is still within its warranty period.

This page intentionally left blank.

Technical Specifications for the E8362B/C, E8363B/C, E8364B/C (Rev. 2008-10-03)

| | |
|---|----|
| Definitions | 4 |
| Corrected System Performance | 4 |
| Table 1. System Dynamic Range..... | 5 |
| Table 2. Receiver Dynamic Range..... | 7 |
| E8363B/C AND E8364B/C Corrected System Performance with 2.4mm Connectors | 9 |
| Table 3. 85056A Calibration Kit Standard Configuration and Standard Power Range (E8363B/C AND E8364B/C)..... | 9 |
| Table 4. 85056A Calibration Kit Fully Optioned (E836xB/C - Option 014, UNL, 016, 080, and 081)..... | 12 |
| Table 5. 85056D Calibration Kit Standard Configuration and Standard Power Range (E8363B/C AND E8364B/C)..... | 15 |
| Table 6. 85056D Calibration Kit Fully Optioned (E836xB/C - Option 014, UNL, 016, 080, and 081)..... | 18 |
| E8363B/C AND E8364B/C Corrected System Performance with 2.92mm Connectors | 21 |
| Table 7. 85056K Calibration Kit Standard Configuration and Standard Power Range (E8363B/C AND E8364B/C)..... | 21 |
| Table 8. 85056K Calibration Kit Fully Optioned (E836xB/C - Option 014, UNL, 016, 080, and 081)..... | 24 |
| E836xB/C Corrected System Performance with 3.5mm Connectors | 27 |
| Table 9. 85052B Calibration Kit Standard Configuration and Standard Power Range (E836xB/C)..... | 27 |
| Table 10. 85052B Calibration Kit Fully Optioned (E836xB/C - Option 014, UNL, 016, 080, and 081)..... | 30 |
| Table 11. 85052C Calibration Kit Standard Configuration and Standard Power Range (E836xB/C)..... | 33 |
| Table 12. 85052C Calibration Kit Fully Optioned (E836xB/C - Option 014, UNL, 016, 080, and 081)..... | 36 |
| Table 13. 85052D Calibration Kit Standard Configuration and Standard Power Range (E836xB/C)..... | 39 |
| Table 14. 85052D Calibration Kit Fully Optioned (E836xB/C - Option 014, UNL, 016, 080, and 081)..... | 42 |
| E836xB/C Corrected System Performance with 7mm Connectors | 45 |
| Table 15. 85050B Calibration Kit Standard Configuration and Standard Power Range (E836xB/C)..... | 45 |
| Table 16. 85050B Calibration Kit Fully Optioned (E836xB/C - Option 014, UNL, 016, 080, and 081)..... | 48 |
| Table 17. 85050C Calibration Kit Standard Configuration and Standard Power Range (E836xB/C)..... | 51 |
| Table 18. 85050C Calibration Kit Fully Optioned (E836xB/C - Option 014, UNL, 016, 080, and 081)..... | 54 |
| Table 19. 85050D Calibration Kit Standard Configuration and Standard Power Range (E836xB/C)..... | 57 |
| Table 20. 85050D Calibration Kit Fully Optioned (E836xB/C - Option 014, UNL, 016, 080, and 081)..... | 60 |
| E836xB/C Corrected System Performance with Type-N Connectors | 63 |
| Table 21. 85054B Calibration Kit Standard Configuration and | |

| | |
|--|-----|
| Standard Power Range (E836xB/C)..... | 63 |
| Table 22. 85054B Calibration Kit Fully Optioned (E836xB/C - Option 014, UNL, 016, 080, and 081) | 66 |
| Table 23. 85054D Calibration Kit Standard Configuration and Standard Power Range (E836xB/C)..... | 69 |
| Table 24. 85054D Calibration Kit Fully Optioned (E836xB/C - Option 014, UNL, 016, 080, and 081)..... | 72 |
| E8363B/C AND E8364B/C Corrected System Performance with WR-28 Connectors | 75 |
| Table 25. R11644A Calibration Kit Standard Configuration and Standard Power Range (E8363B/C AND E8364B/C) | 75 |
| Table 26. R11644A Calibration Kit Fully Optioned (E836xB/C - Option 014, UNL, 016, 080, and 081)..... | 78 |
| E8363B/C AND E8364B/C Corrected System Performance with WR-42 Connectors | 81 |
| Table 27. K11644A Calibration Kit Standard Configuration and Standard Power Range (E8363B/C AND E8364B/C) | 81 |
| Table 28. K11644A Calibration Kit Fully Optioned (E836xB/C - Option 014, UNL, 016, 080, and 081)..... | 84 |
| E836xB/C Corrected System Performance with WR-62 Connectors | 87 |
| Table 29. P11644A Calibration Kit Standard Configuration and Standard Power Range (E836xB/C)..... | 87 |
| Table 30. P11644A Calibration Kit Fully Optioned (E836xB/C - Option 014, UNL, 016, 080, and 081)..... | 90 |
| E836xB/C Corrected System Performance with WR-90 Connectors | 93 |
| Table 31. X11644A Calibration Kit Standard Configuration and Standard Power Range (E836xB/C)..... | 93 |
| Table 32. X11644A Calibration Kit Fully Optioned (E836xB/C - Option 014, UNL, 016, 080, and 081) | 96 |
| Table 33. Uncorrected System Performance | 99 |
| Table 34. Test Port Output | 102 |
| Table 35: Test Port Input..... | 106 |
| Table 36. Dynamic Accuracy (Specification)..... | 113 |
| Table 37. Test Port Input (Group Delay)..... | 117 |
| General Information | 118 |
| Table 38. Miscellaneous Information | 118 |
| Table 39. Front Panel Information..... | 118 |
| Table 40. Rear Panel Information..... | 119 |
| Table 41. Analyzer Dimensions and Weight | 122 |
| Measurement Throughput Summary | 123 |
| Table 42 Typical Cycle Time (ms) for Measurement Completion | 123 |
| Table 43. Cycle Time vs IF Bandwidth..... | 124 |
| Table 44. Cycle Time vs Number of Points..... | 124 |
| Table 45. Frequency Converter Application (option 083) Cycle Time for Fixed-IF Measurements | 125 |
| Table 46. Data Transfer Time (ms) | 125 |
| Specifications: Front-Panel Jumpers | 126 |
| Table 47: Measurement Receiver Inputs (Rcvr A In, Rcvr B In)..... | 126 |

| | |
|---|-----|
| Table 48: Reference Receiver Inputs (Rcvr R1, Rcvr R2) | 128 |
| Table 49: Reference Outputs (Reference 1 Source Out, Reference 2 Source Out) | 129 |
| Table 50: Source Outputs (Port 1 Source Out, Port 2 Source Out) | 130 |
| Table 51: Coupler Inputs (Port 1 Cplr Thru, Port 2 Cplr Thru)..... | 132 |
| Table 52: Coupler Outputs (Port 1 Cplr Arm, Port 2 Cplr Arm)..... | 133 |
| Test Set Block Diagrams | 134 |
| E836xB/C - Standard Configuration and Standard Power Range | 134 |
| E836xB/C - Option UNL Standard Configuration with Extended Power Range and Bias - Tees | 134 |
| E836xB/C - Option UNL Standard Configuration with Extended Power Range and Bias - Tees, and Option 016, Receiver Attenuators | 135 |
| Test Set with Option 014 Block Diagrams | 136 |
| E836xB/C - Option 014 Configurable Test Set and Standard Power Range..... | 136 |
| E836xB/C - Option 014 Configurable Test Set and Standard Power Range, and Option 081 Reference Channel Transfer Switch..... | 137 |
| E836xB/C - Option 014 Configurable Test Set, and Option UNL Extended Power Range and Bias - Tees..... | 138 |
| E836xB/C - Option 014 Configurable Test Set, and Option UNL Extended Power Range and Bias - Tees, and Option 081 Reference Channel Transfer Switch | 139 |
| E836xB/C - Option 014 Configurable Test Set and Option UNL, Extended Power Range and Bias - Tees and Option 016 Receiver Attenuators | 140 |
| E836xB/C - Option 014 Configurable Test Set, and Option UNL Extended Power Range and Bias - Tees, and Option 016 Receiver Attenuators, and Option 081 Reference Channel Transfer Switch | 141 |

Definitions

All specifications and characteristics apply over a $25\text{ }^{\circ}\text{C} \pm 5\text{ }^{\circ}\text{C}$ range (unless otherwise stated) and 90 minutes after the instrument has been turned on.

Specification (spec.): Warranted performance. Specifications include guardbands to account for the expected statistical performance distribution, measurement uncertainties, and changes in performance due to environmental conditions.

Characteristic (char.): A performance parameter that the product is expected to meet before it leaves the factory, but that is not verified in the field and is not covered by the product warranty. A characteristic includes the same guardbands as a specification.

Typical (typ.): Expected performance of an average unit which does not include guardbands. It is not covered by the product warranty.

Nominal (nom.): A general, descriptive term that does not imply a level of performance. It is not covered by the product warranty.

Calibration: The process of measuring known standards to characterize a network analyzer's systematic (repeatable) errors.

Corrected (residual): Indicates performance after **error correction** (calibration). It is determined by the quality of calibration standards and how well "known" they are, plus system repeatability, stability, and noise.

Uncorrected (raw): Indicates instrument performance without error correction. The uncorrected performance affects the stability of a **calibration**.

Standard: When referring to the analyzer, this includes no options unless noted otherwise.

Corrected System Performance

The specifications in this section apply for measurements made with the E836xB/C analyzer with the following conditions:

- 10 Hz IF bandwidth
- No averaging applied to data
- Isolation calibration with an averaging factor of 8

Table 1. System Dynamic Range^a

| Description | Specification (dB) at Test Port ^b | Typical (dB) at Direct Receiver Access Input ^c | Supplemental Information |
|---|--|---|--|
| Dynamic Range (in a 10 Hz BW) | | | |
| Standard Configuration and Standard Power Range (E836xB/C - Standard) | | | |
| 10 MHz to 45 MHz ^d | 79 (typical) | NA | -- |
| 45 MHz to 500 MHz ^e | 94 | NA | -- |
| 500 MHz to 2 GHz | 119 | NA | -- |
| 2 GHz to 10 GHz | 122 | NA | -- |
| 10 GHz to 20 GHz | 123 | NA | -- |
| 20 GHz to 30 GHz | 114 | NA | -- |
| 30 GHz to 40 GHz | 110 | NA | -- |
| 40 GHz to 45 GHz | 109 | NA | -- |
| 45 GHz to 50 GHz | 104 | NA | -- |
| Configurable Test Set and Standard Power Range (E836xB/C - Option 014) | | | |
| 10 MHz to 45 MHz ^d | 79 (typical) | 129 | Option 016 degrades performance by 2 dB. |
| 45 MHz to 500 MHz ^e | 94 | 132 | |
| 500 MHz to 2 GHz | 119 | 138 | |
| 2 GHz to 10 GHz | 122 | 137 | |
| 10 GHz to 20 GHz | 121 | 136 | |
| 20 GHz to 30 GHz | 111 | 123 | |
| 30 GHz to 40 GHz | 107 | 119 | |
| 40 GHz to 45 GHz | 105 | 116 | |
| 45 GHz to 50 GHz | 100 | 111 | |
| Standard Configuration and Extended Power Range & Bias-Tees (E836xB/C - Option UNL) | | | |
| 10 MHz to 45 MHz ^d | 79 (typical) | NA | Option 016 degrades performance by 2 dB. |
| 45 MHz to 500 MHz ^e | 92 | NA | |
| 500 MHz to 2 GHz | 117 | NA | |
| 2 GHz to 10 GHz | 120 | NA | |
| 10 GHz to 20 GHz | 121 | NA | |
| 20 GHz to 30 GHz | 112 | NA | |
| 30 GHz to 40 GHz | 108 | NA | |
| 40 GHz to 45 GHz | 105 | NA | |
| 45 GHz to 50 GHz | 99 | NA | |
| Configurable Test Set and Extended Power Range & Bias-Tees (E836xB/C - Option 014/UNL) | | | |
| 10 MHz to 45 MHz ^d | 79 (typical) | 129 | Option 016 degrades performance by 2 dB. |
| 45 MHz to 500 MHz ^{e, f} | 92 | 130 | |
| 500 MHz to 2 GHz ^g | 117 | 136 | |
| 2 GHz to 10 GHz ^h | 120 | 135 | |
| 10 GHz to 20 GHz ^g | 119 | 134 | |
| 20 GHz to 30 GHz | 109 | 121 | |
| 30 GHz to 40 GHz | 105 | 117 | |
| 40 GHz to 45 GHz | 101 | 112 | |
| 45 GHz to 50 GHz | 95 | 106 | |

^a The system dynamic range is calculated as the difference between the noise floor and the source maximum output power. System dynamic range is a specification when the source is set to Port 1, and a characteristic when the source is set to Port 2. The effective dynamic range must take measurement uncertainties and interfering signals into account as well as the insertion loss resulting from a thru cable connected between Port 1 and Port 2..

^b The test port system dynamic range is calculated as the difference between the test port noise floor and the source maximum output power. The effective dynamic range must take measurement uncertainties and interfering signals into account as well as the insertion loss resulting from a thru cable connected between Port 1 and Port 2..

^c The direct receiver access input system dynamic range is calculated as the difference between the receiver access input noise floor and the source maximum output power. The effective dynamic range must take measurement uncertainties and interfering signals into account. This set-up should only be used when the receiver input will never exceed its damage level. When the analyzer is in segment sweep mode,

the analyzer can have predefined frequency segments which will output a higher power level when the extended dynamic range is required (i.e. devices with high insertion loss), and reduced power when receiver damage may occur (i.e. devices with low insertion loss). The extended range is only available in one-path transmission measurements.

^d Typical performance.

^e May be limited to 100 dB at particular frequencies below 500 MHz due to spurious receiver residuals. Methods are available to regain the full dynamic range.

^f E8362B/C only: Option H11 decreases value by 1 dB.

^g E8362B/C only: Option H11 decreases value by 2 dB.

Table 2. Receiver Dynamic Range^a

| Description | Specification (dB) at Test Port ^b | Typical (dB) at Direct Receiver Access Input ^c | |
|---|--|---|--|
| Dynamic Range (in a 10 Hz BW) | | | |
| Standard Configuration and Standard Power Range (E836xB/C - Standard) | | | |
| OR | | | |
| Standard Configuration and Extended Power Range & Bias Tees (E836xB/C - Option UNL) | | | |
| 10 MHz to 45 MHz ^d | 82 (typical) | NA | -- |
| 45 MHz to 500 MHz ^e | 94 | NA | -- |
| 500 MHz to 2 GHz | 119 | NA | -- |
| 2 GHz to 10 GHz | 122 | NA | -- |
| 10 GHz to 20 GHz | 125 | NA | -- |
| 20 GHz to 30 GHz | 114 | NA | Option 016 degrades performance by 2 dB. |
| 30 GHz to 40 GHz | 111 | NA | |
| 40 GHz to 50 GHz | 111 | NA | |
| Configurable Test Set and Standard Power Range (E836xB/C - Option 014) | | | |
| OR | | | |
| Configurable Test Set and Extended Power Range & Bias Tees (E836xB/C - Option 014/UNL) | | | |
| 10 MHz to 45 MHz ^d | 82 (typical) | 132 | -- |
| 45 MHz to 500 MHz ^e | 94 | 132 | -- |
| 500 MHz to 2 GHz | 119 | 138 | -- |
| 2 GHz to 10 GHz | 122 | 137 | -- |
| 10 GHz to 20 GHz | 124 | 139 | -- |
| 20 GHz to 30 GHz | 113 | 125 | Option 016 degrades performance by 2 dB. |
| 30 GHz to 40 GHz | 110 | 122 | |
| 40 GHz to 50 GHz | 109 | 120 | |

^a The receiver dynamic range is calculated as the difference between the noise floor and the receiver maximum output power. The effective dynamic range must take measurement uncertainties and interfering signals into account.

^b The test port receiver dynamic range is calculated as the difference between the test port noise floor and the receiver maximum input level. The effective dynamic range must take measurement uncertainties and interfering signals into account.

^c The direct receiver access input receiver dynamic range is calculated as the difference between the direct receiver access input noise floor and the receiver maximum input level. The effective dynamic range must take measurement uncertainties and interfering signals into account. This set-up should only be used when the receiver input will never exceed its compression or damage level. When the analyzer is in segment sweep mode, the analyzer can have predefined frequency segments which will output a higher power level when the extended dynamic range is required (i.e. devices with high insertion loss), and reduced power when compression or receiver damage may occur (i.e. devices with low insertion loss). The extended range is only available in one-path transmission measurements.

^d Typical performance.

^e May be degraded by 10 dB at particular frequencies (multiples of 5 MHz) below 500 MHz due to spurious receiver residuals. Methods are available to regain the full dynamic range.

Note: This E836xB/C document provides technical specifications for the following calibration kits only: 85056A, 85056D, 85056K, 85052B, 85052C, 85052D, 85050B, 85050C, 85050D, 85054B, 85054D, K11644A, P11644A, R11644A, and the X11644A.

Table 2 (Continued). Receiver Dynamic Range^a

| Description | Specification (dB) at Test Port ^b | Typical (dB) at Direct Receiver Access Input ^c | |
|---|--|---|--|
| Dynamic Range (in a 10 Hz BW) | | | |
| Standard Configuration and Standard Power Range (E836xB/C - Standard) | | | |
| OR | | | |
| Standard Configuration and Extended Power Range & Bias Tees (E836xB/C - Option UNL) | | | |
| 10 MHz to 45 MHz ^d | 82 (typical) | NA | -- |
| 45 MHz to 500 MHz ^e | 94 | NA | -- |
| 500 MHz to 2 GHz | 119 | NA | -- |
| 2 GHz to 10 GHz | 122 | NA | -- |
| 10 GHz to 20 GHz | 125 | NA | -- |
| 20 GHz to 30 GHz | 114 | NA | Option 016 degrades performance by 2 dB. |
| 30 GHz to 40 GHz | 111 | NA | |
| 40 GHz to 50 GHz | 111 | NA | |
| Configurable Test Set and Standard Power Range (E836xB/C - Option 014) | | | |
| OR | | | |
| Configurable Test Set and Extended Power Range & Bias Tees (E836xB/C - Option 014/UNL) | | | |
| 10 MHz to 45 MHz ^d | 82 (typical) | 132 | -- |
| 45 MHz to 500 MHz ^e | 94 | 132 | -- |
| 500 MHz to 2 GHz | 119 | 138 | -- |
| 2 GHz to 10 GHz | 122 | 137 | -- |
| 10 GHz to 20 GHz | 124 | 139 | -- |
| 20 GHz to 30 GHz | 113 | 125 | Option 016 degrades performance by 2 dB. |
| 30 GHz to 40 GHz | 110 | 122 | |
| 40 GHz to 50 GHz | 109 | 120 | |

^a The receiver dynamic range is calculated as the difference between the noise floor and the receiver maximum output power. The effective dynamic range must take measurement uncertainties and interfering signals into account.

^b The test port receiver dynamic range is calculated as the difference between the test port noise floor and the receiver maximum input level. The effective dynamic range must take measurement uncertainties and interfering signals into account.

^c The direct receiver access input receiver dynamic range is calculated as the difference between the direct receiver access input noise floor and the receiver maximum input level. The effective dynamic range must take measurement uncertainties and interfering signals into account. This set-up should only be used when the receiver input will never exceed its compression or damage level. When the analyzer is in segment sweep mode, the analyzer can have predefined frequency segments which will output a higher power level when the extended dynamic range is required (i.e. devices with high insertion loss), and reduced power when compression or receiver damage may occur (i.e. devices with low insertion loss). The extended range is only available in one-path transmission measurements.

^d Typical performance.

^e May be degraded by 10 dB at particular frequencies (multiples of 5 MHz) below 500 MHz due to spurious receiver residuals. Methods are available to regain the full dynamic range.

Note: This E836xB/C document provides technical specifications for the following calibration kits only: 85056A, 85056D, 85056K, 85052B, 85052C, 85052D, 85050B, 85050C, 85050D, 85054B, 85054D, K11644A, P11644A, R11644A, and the X11644A.

E8363B/C AND E8364B/C Corrected System Performance with 2.4mm Connectors

Table 3. 85056A Calibration Kit
Standard Configuration and Standard Power Range
(E8363B/C AND E8364B/C)

Applies to the E8363B/C AND E8364B/C analyzers, 85056A (2.4mm) calibration kit, 85133F flexible test port cable set, and a full 2-port calibration. Also applies to the following condition:

Environmental temperature 23° ±3 °C, with < 1 °C deviation from calibration temperature

| Description | Specification (dB) | | | |
|-----------------------|--------------------|--------------------|--------------------|--------------------|
| | 45 MHz to 2 GHz | 2 to 20 GHz | 20 to 40 GHz | 40 to 50 GHz |
| Directivity | 42 | 42 | 38 | 36 |
| Source Match | 41 | 38 | 33 | 31 |
| Load Match | 42 | 42 | 37 | 35 |
| Reflection Tracking | ±0.001 +0.02/°C | ±0.008 +0.02/°C | ±0.020 +0.02/°C | ±0.027 +0.03/°C |
| Transmission Tracking | ±0.010 +0.02/°C | ±0.049 +0.02/°C | ±0.105 +0.02/°C | ±0.170 +0.03/°C |

NOTE: The following graphs also apply to the "C" model of the analyzers.

Transmission Uncertainty (Specifications)

Magnitude

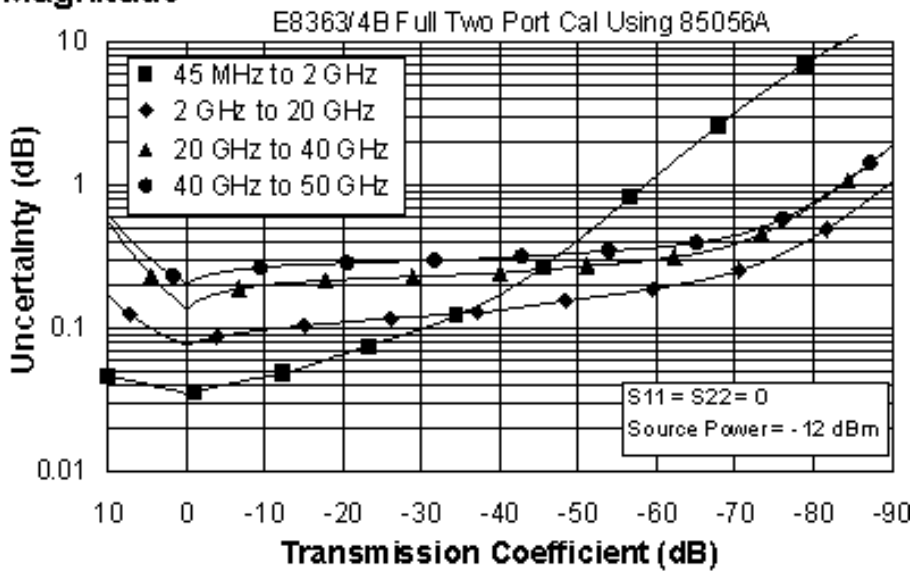

Phase

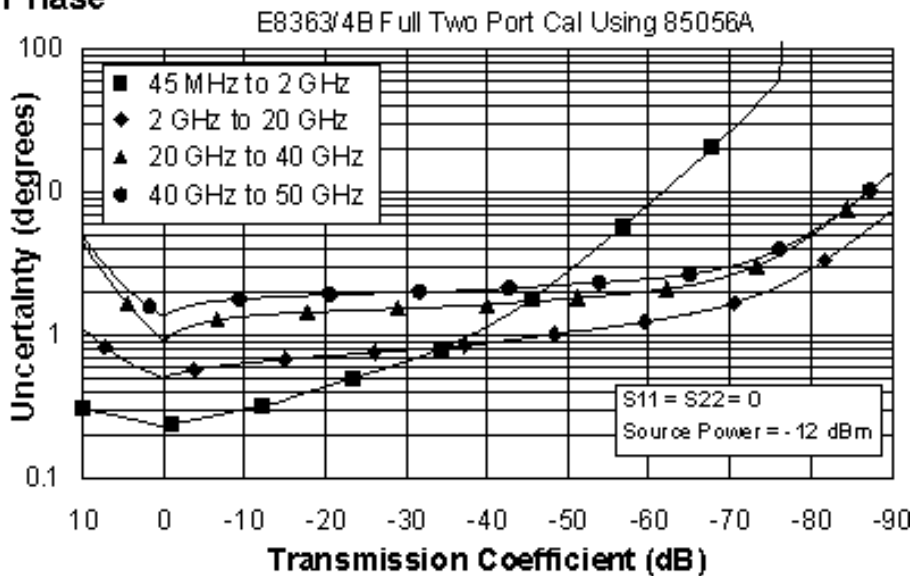

Reflection Uncertainty (Specifications)

Magnitude

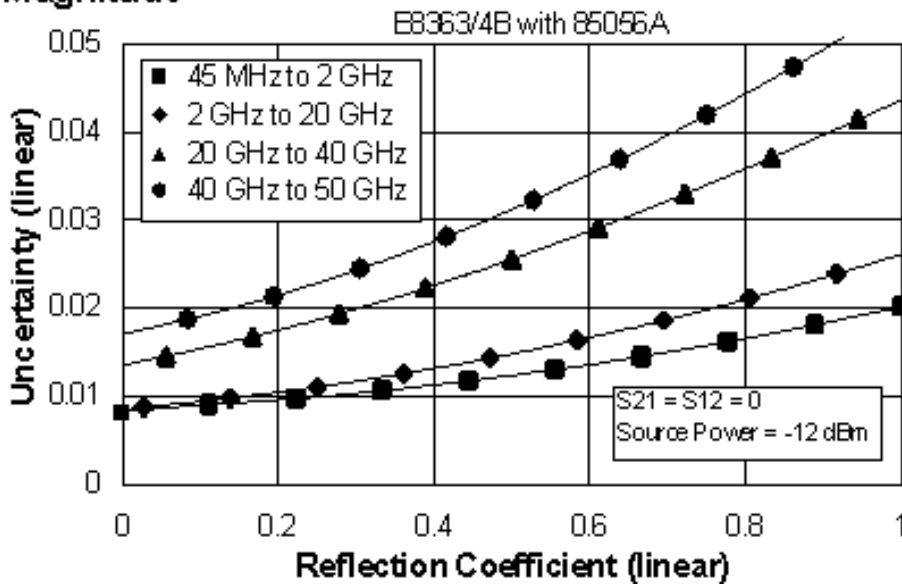

Phase

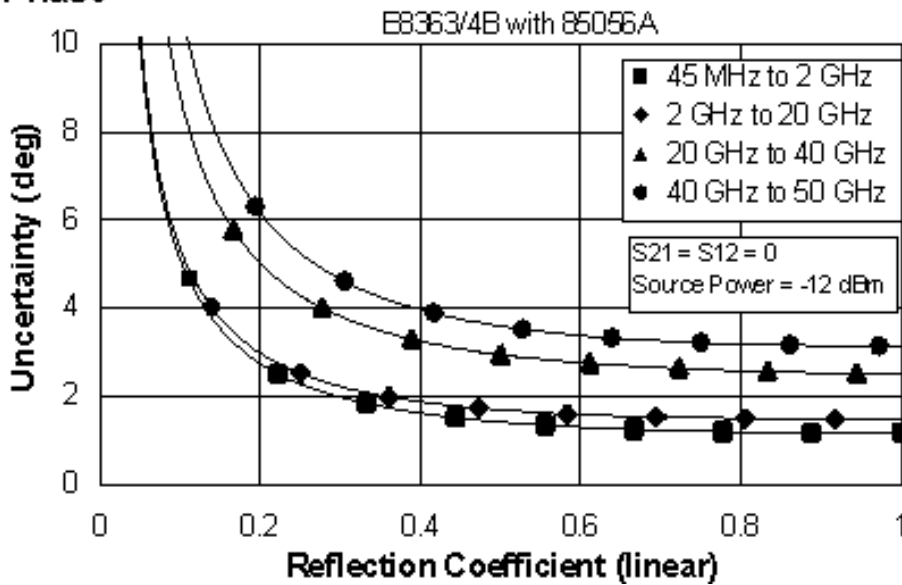

Table 4. 85056A Calibration Kit

Fully Optioned (E836xB/C - Option 014, UNL, 016, 080, and 081)

Configurable Test Set, Extended Power Range & Bias-Tees, Receiver Attenuators, Frequency Offset Mode, and Reference Channel Transfer Switch

Applies to the, E8363B/C AND E8364B/C analyzers, 85056A (2.4mm) calibration kit, 85133F flexible test port cable set, and a full 2-port calibration. Also applies to the following condition:

Environmental temperature 23° ±3 °C, with < 1 °C deviation from calibration temperature

| Description | Specification (dB) | | | |
|-----------------------|--------------------|--------------------|--------------------|--------------------|
| | 45 MHz to 2 GHz | 2 to 20 GHz | 20 to 40 GHz | 40 to 50 GHz |
| Directivity | 42 | 42 | 38 | 36 |
| Source Match | 41 | 38 | 33 | 31 |
| Load Match | 42 | 42 | 37 | 35 |
| Reflection Tracking | ±0.001 +0.02/°C | ±0.008 +0.02/°C | ±0.020 +0.02/°C | ±0.027 +0.03/°C |
| Transmission Tracking | ±0.019 +0.02/°C | ±0.053 +0.02/°C | ±0.109 +0.02/°C | ±0.182 +0.03/°C |

NOTE: The following graphs also apply to the “C” model of the analyzers.

Transmission Uncertainty (Specifications)

Magnitude

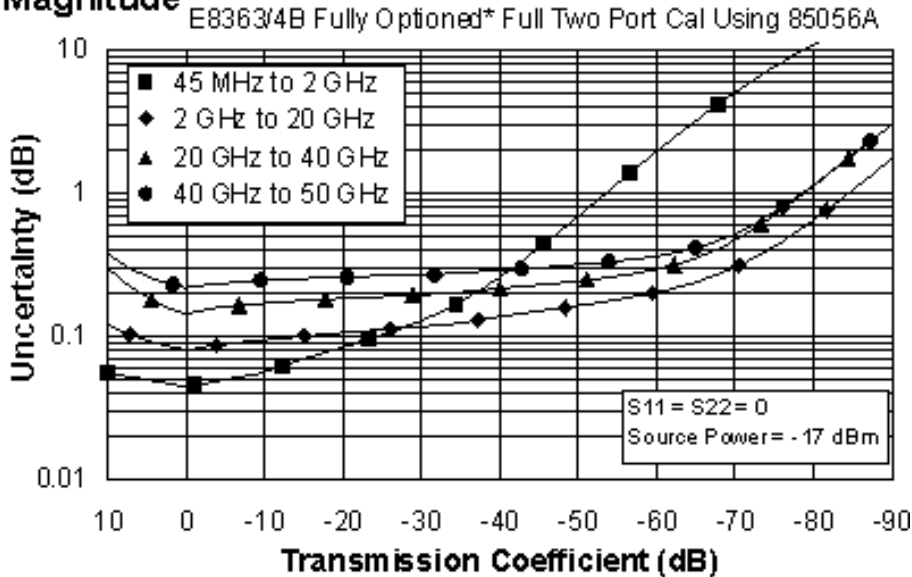

Phase

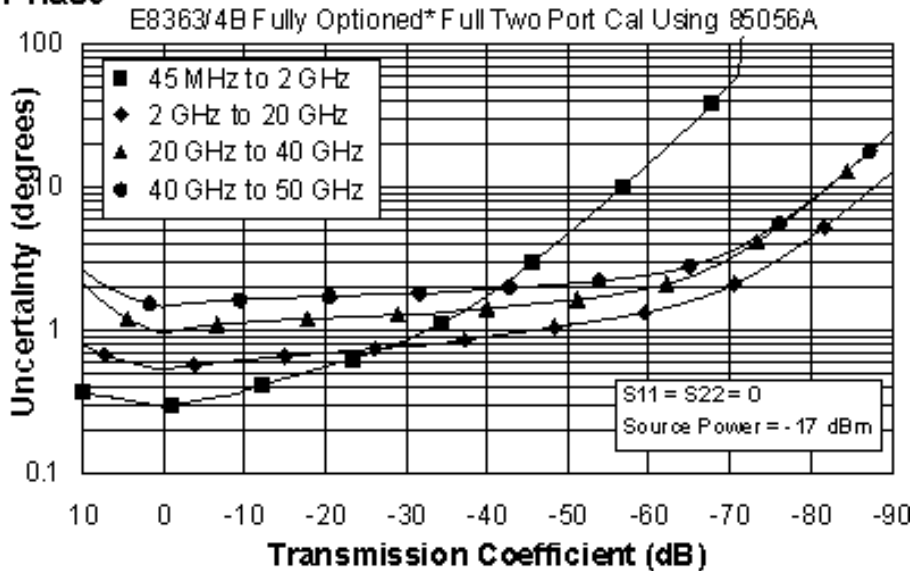

* Configurable Test Set, Extended Power Range & Bias-Tees, Receiver Attenuators, Frequency Offset Mode, and Reference Channel Transfer Switch (E836xB/C - Option 014, UNL, 016, 080, and 081)

Reflection Uncertainty (Specifications)

Magnitude

E8363/4B Fully Optioned* with 85056A

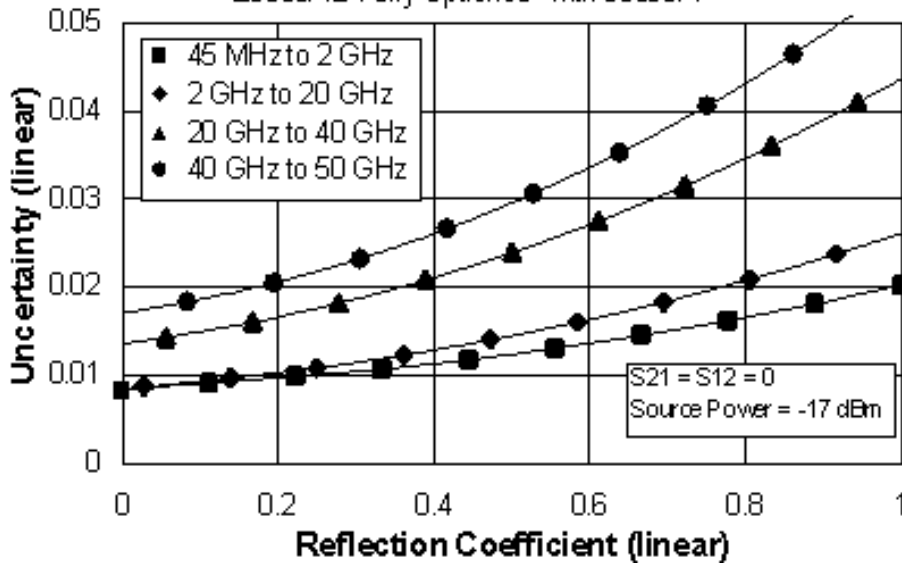

Phase

E8363/4B Fully Optioned* with 85056A

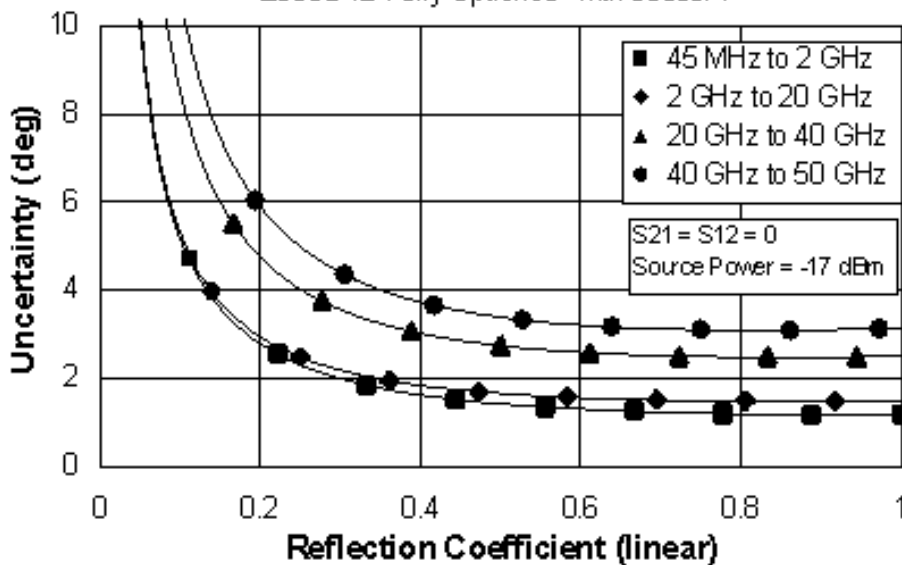

* Configurable Test Set, Extended Power Range & Bias-Tees, Receiver Attenuators, Frequency Offset Mode, and Reference Channel Transfer Switch (E836xB/C - Option 014, UNL, 016, 080, and 081)

Table 5. 85056D Calibration Kit
Standard Configuration and Standard Power Range
(E8363B/C AND E8364B/C)

Applies to the, E8363B/C AND E8364B/C analyzers, 85056D (2.4mm) calibration kit, 85133F flexible test port cable set, and a full 2-port calibration. Also applies to the following condition:

Environmental temperature 23° ±3 °C, with < 1 °C deviation from calibration temperature

| Description | Specification (dB) | | | |
|-----------------------|--------------------|--------------------|--------------------|--------------------|
| | 45 MHz to 2 GHz | 2 to 20 GHz | 20 to 40 GHz | 40 to 50 GHz |
| Directivity | 42 | 34 | 26 | 26 |
| Source Match | 40 | 30 | 24 | 23 |
| Load Match | 42 | 33 | 25 | 25 |
| Reflection Tracking | ±0.002 +0.02/°C | ±0.029 +0.02/°C | ±0.079 +0.02/°C | ±0.075 +0.03/°C |
| Transmission Tracking | ±0.011 +0.02/°C | ±0.121 +0.02/°C | ±0.347 +0.02/°C | ±0.462 +0.03/°C |

NOTE: The following graphs also apply to the "C" model of the analyzers.

Transmission Uncertainty (Specifications)

Magnitude

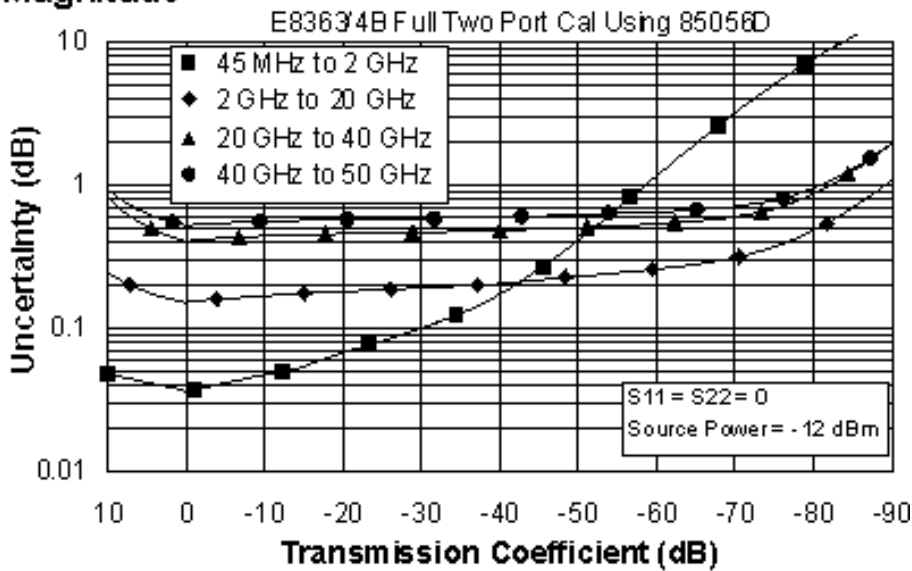

Phase

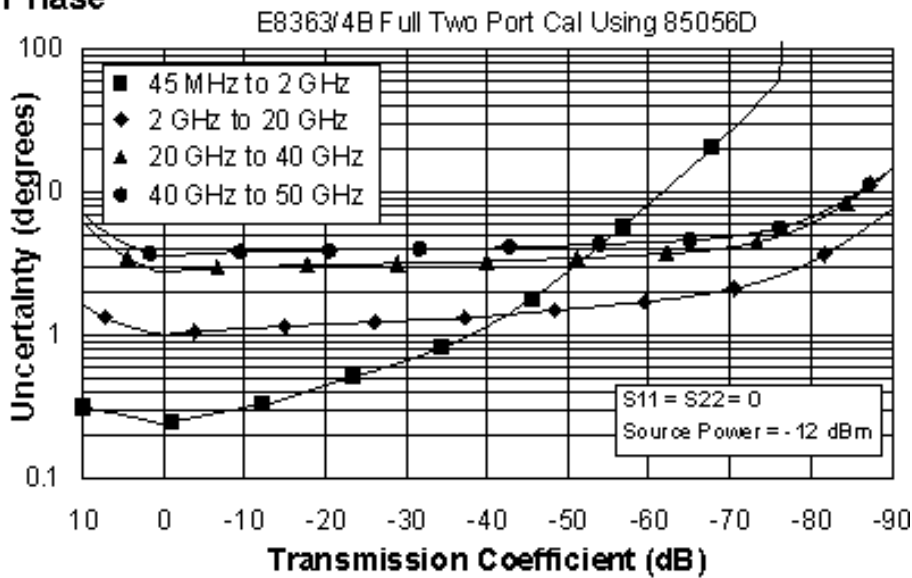

Reflection Uncertainty (Specifications)

Magnitude

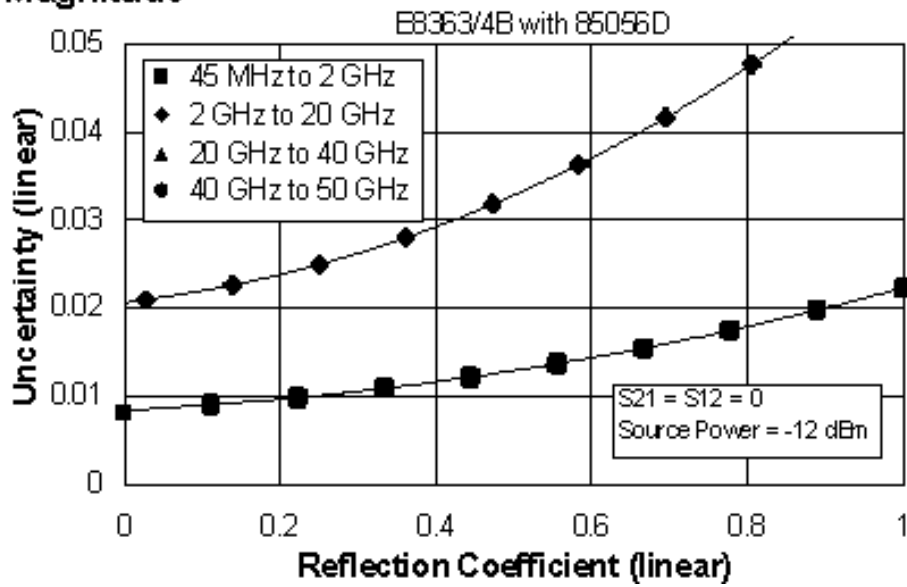

Phase

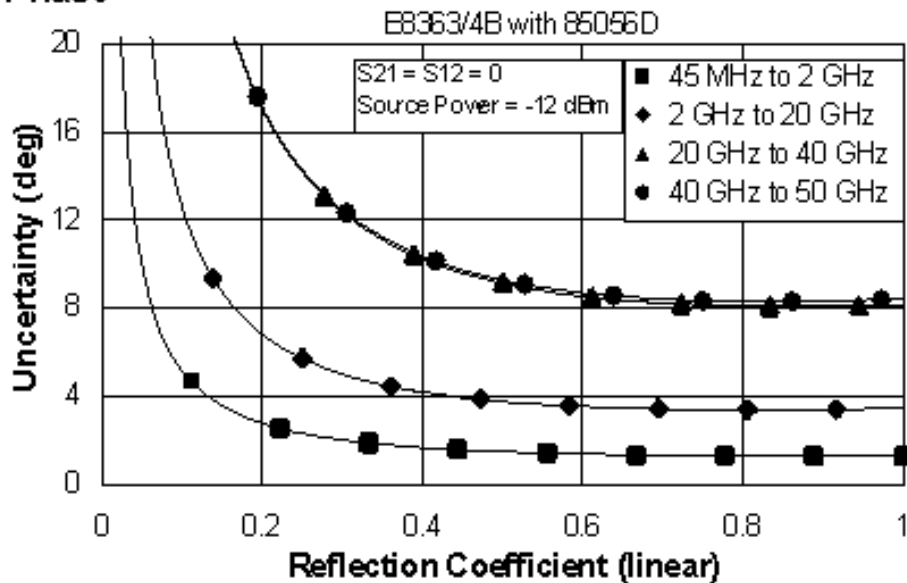

Table 6. 85056D Calibration Kit

Fully Optioned (E836xB/C - Option 014, UNL, 016, 080, and 081)

Configurable Test Set, Extended Power Range & Bias-Tees, Receiver Attenuators, Frequency Offset Mode, and Reference Channel Transfer Switch

Applies to the, E8363B/C AND E8364B/C analyzers, 85056D (2.4mm) calibration kit, 85133F flexible test port cable set, and a full 2-port calibration. Also applies to the following condition:

Environmental temperature 23° ±3 °C, with < 1 °C deviation from calibration temperature

| Description | Specification (dB) | | | |
|-----------------------|--------------------|--------------------|--------------------|--------------------|
| | 45 MHz to 2 GHz | 2 to 20 GHz | 20 to 40 GHz | 40 to 50 GHz |
| Directivity | 42 | 34 | 26 | 26 |
| Source Match | 40 | 30 | 24 | 23 |
| Load Match | 42 | 33 | 25 | 25 |
| Reflection Tracking | ±0.002 +0.02/°C | ±0.029 +0.02/°C | ±0.079 +0.02/°C | ±0.075 +0.03/°C |
| Transmission Tracking | ±0.022 +0.02/°C | ±0.130 +0.02/°C | ±0.365 +0.02/°C | ±0.498 +0.03/°C |

NOTE: The following graphs also apply to the “C” model of the analyzers.

Transmission Uncertainty (Specifications)

Magnitude

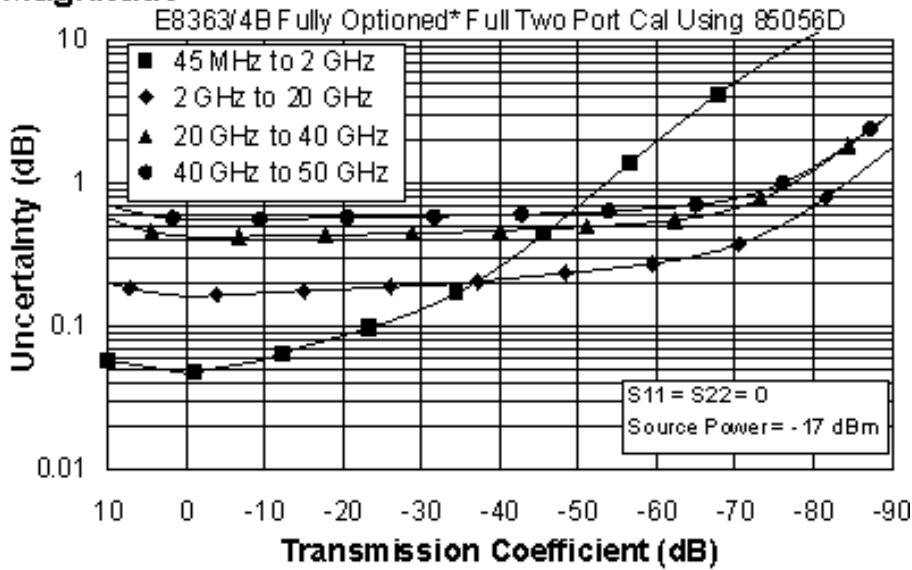

Phase

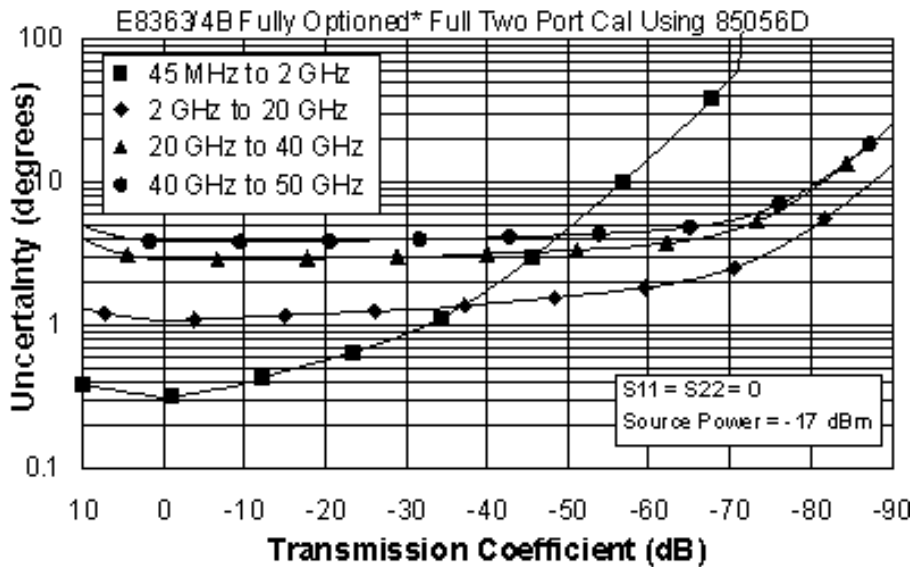

* Configurable Test Set, Extended Power Range & Bias-Tees, Receiver Attenuators, Frequency Offset Mode, and Reference Channel Transfer Switch (E836xB/C - Option 014, UNL, 016, 080, and 081)

Reflection Uncertainty (Specifications)

Magnitude

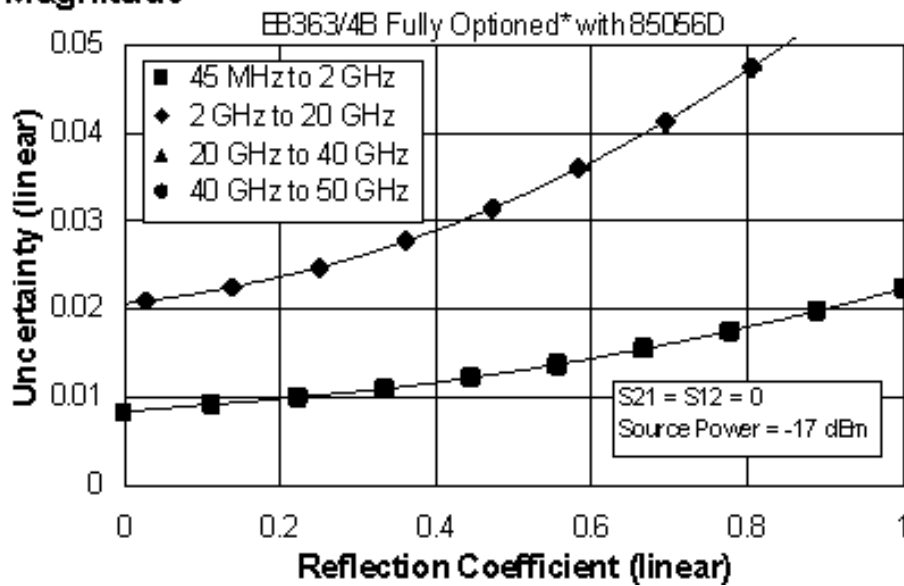

Phase

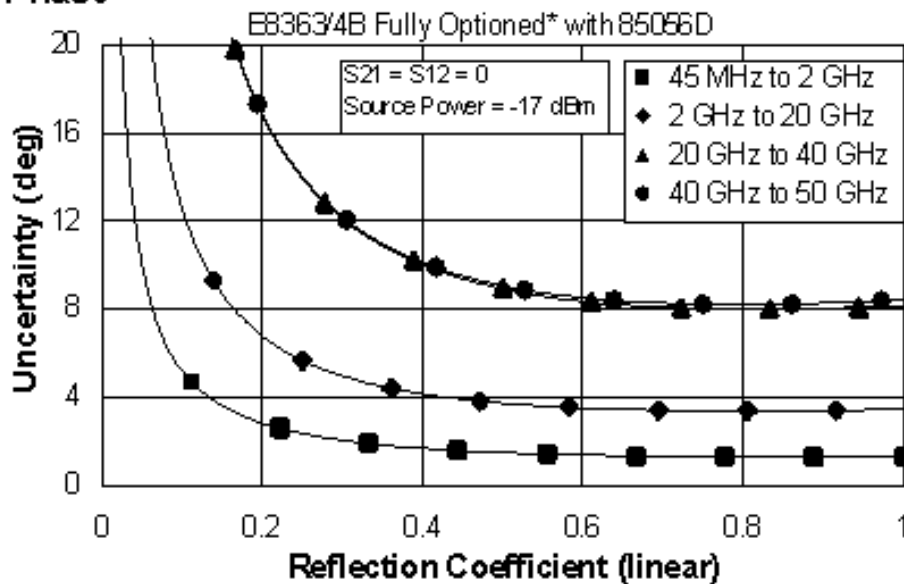

* Configurable Test Set, Extended Power Range & Bias-Tees, Receiver Attenuators, Frequency Offset Mode, and Reference Channel Transfer Switch (E836xB/C - Option 014, UNL, 016, 080, and 081)

E8363B/C AND E8364B/C Corrected System Performance with 2.92mm Connectors

Table 7. 85056K Calibration Kit

Standard Configuration and Standard Power Range

(E8363B/C AND E8364B/C)

Applies to the, E8363B/C AND E8364B/C analyzers, 85056K (2.92mm) calibration kit, 85133F flexible test port cable set, and a full 2-port calibration. Also applies to the following condition:

Environmental temperature 23° ±3 °C, with < 1 °C deviation from calibration temperature

| Description | Specification (dB) | | |
|-----------------------|--------------------|--------------------|--------------------|
| | 0.045 to 2 GHz | 2 to 20 GHz | 20 to 40 GHz |
| Directivity | 42 | 42 | 40 |
| Source Match | 40 | 40 | 35 |
| Load Match | 42 | 41 | 38 |
| Reflection Tracking | ±0.018 +0.02/°C | ±0.018 +0.02/°C | ±0.067 +0.03/°C |
| Transmission Tracking | ±0.011 +0.02/°C | ±0.042 +0.02/°C | ±0.089 +0.03/°C |

NOTE: The following graphs also apply to the "C" model of the analyzers.

Transmission Uncertainty (Specifications)

Magnitude

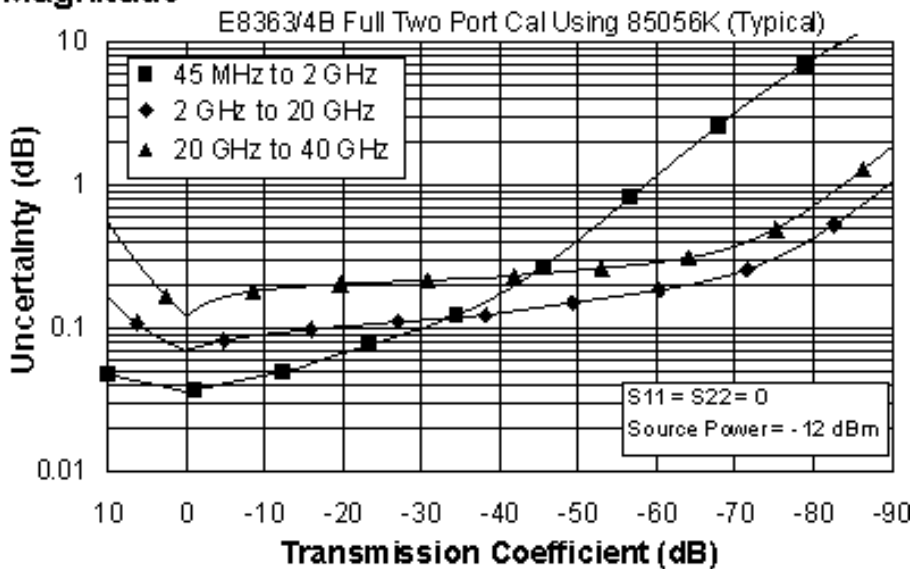

Phase

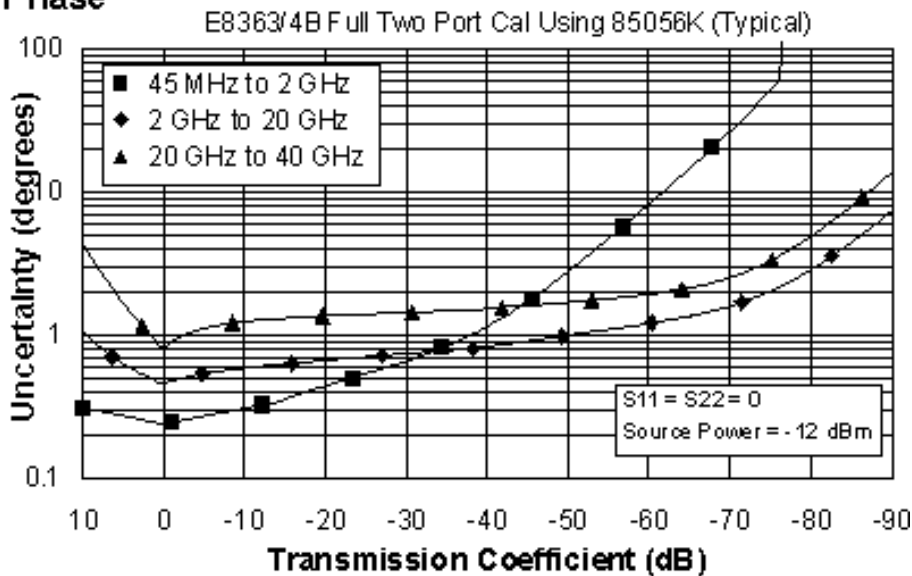

Reflection Uncertainty (Specifications)

Magnitude

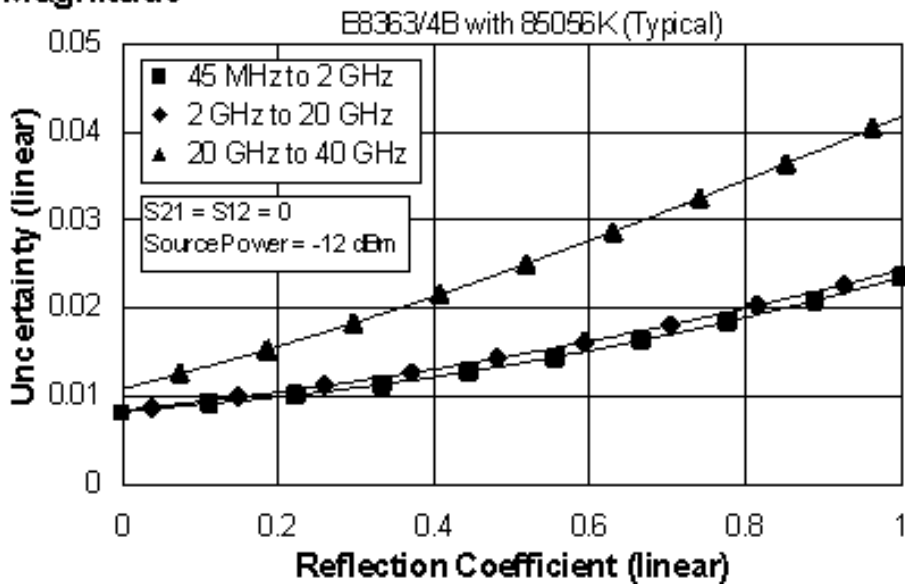

Phase

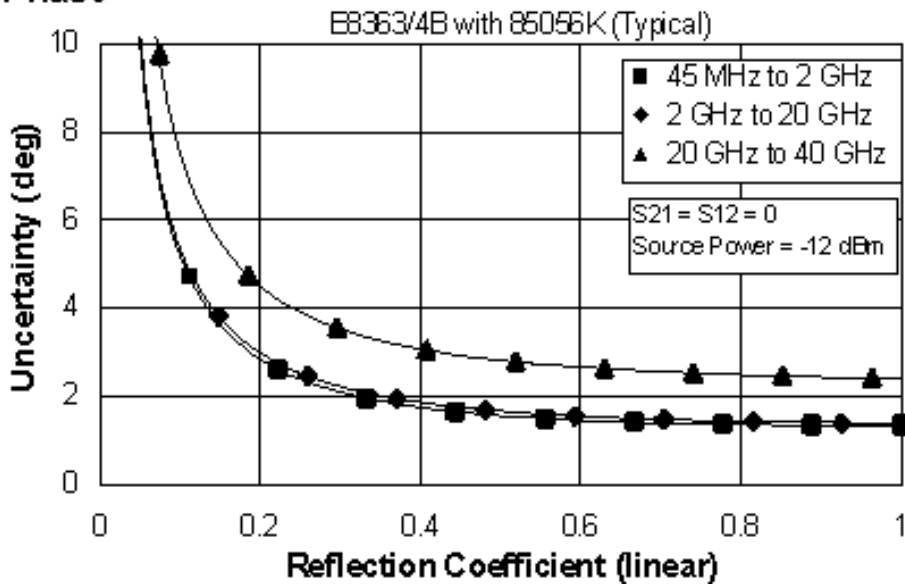

Table 8. 85056K Calibration Kit

Fully Optioned (E836xB/C - Option 014, UNL, 016, 080, and 081)

Configurable Test Set, Extended Power Range & Bias-Tees, Receiver Attenuators, Frequency Offset Mode, and Reference Channel Transfer Switch

Applies to the, E8363B/C AND E8364B/C analyzers, 85056K (2.92mm) calibration kit, 85133F flexible test port cable set, and a full 2-port calibration. Also applies to the following condition:

Environmental temperature 23° ±3 °C, with < 1 °C deviation from calibration temperature

| Description | Specification (dB) | | |
|-----------------------|--------------------|--------------------|--------------------|
| | 0.045 to 2 GHz | 2 to 20 GHz | 20 to 40 GHz |
| Directivity | 42 | 42 | 40 |
| Source Match | 40 | 40 | 35 |
| Load Match | 42 | 41 | 38 |
| Reflection Tracking | ±0.018 +0.02/°C | ±0.018 +0.02/°C | ±0.067 +0.03/°C |
| Transmission Tracking | ±0.021 +0.02/°C | ±0.046 +0.02/°C | ±0.094 +0.03/°C |

NOTE: The following graphs also apply to the “C” model of the analyzers.

Transmission Uncertainty (Specifications)

Magnitude

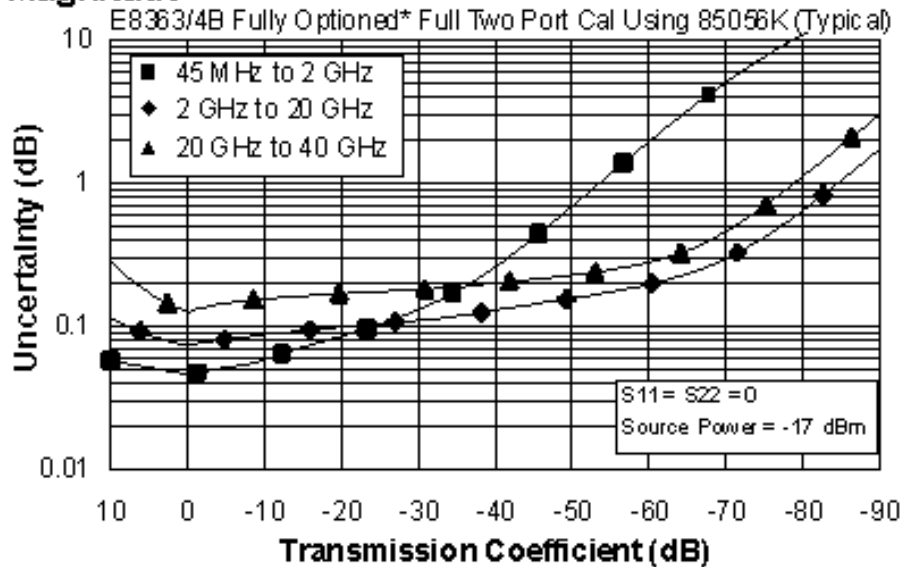

Phase

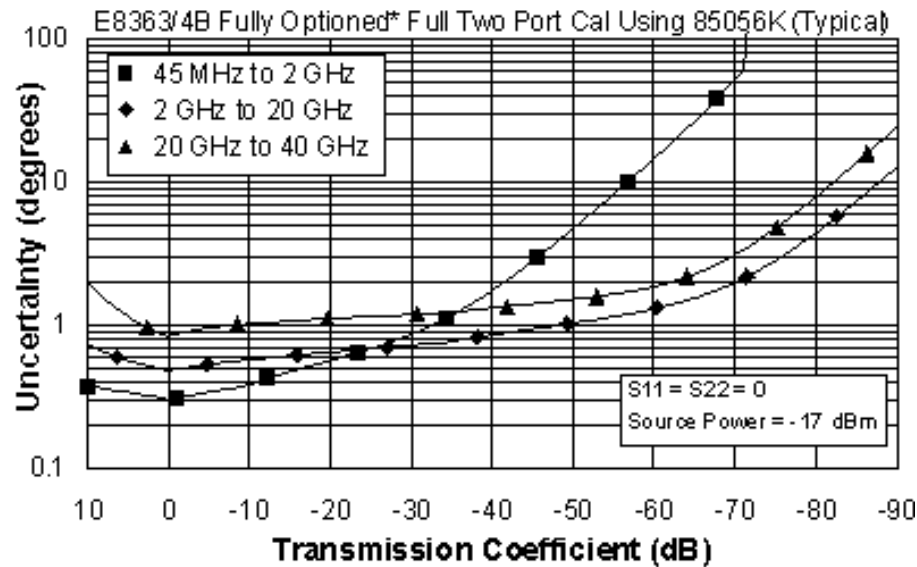

* Configurable Test Set, Extended Power Range & Bias-Tees, Receiver Attenuators, Frequency Offset Mode, and Reference Channel Transfer Switch (E836xB/C - Option 014, UNL, 016, 080, and 081)

Reflection Uncertainty (Specifications)

Magnitude

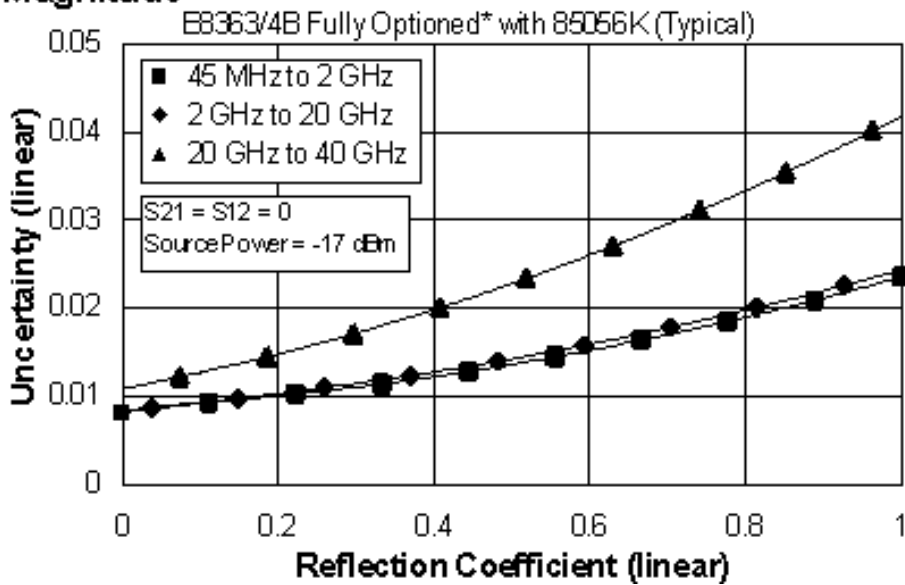

Phase

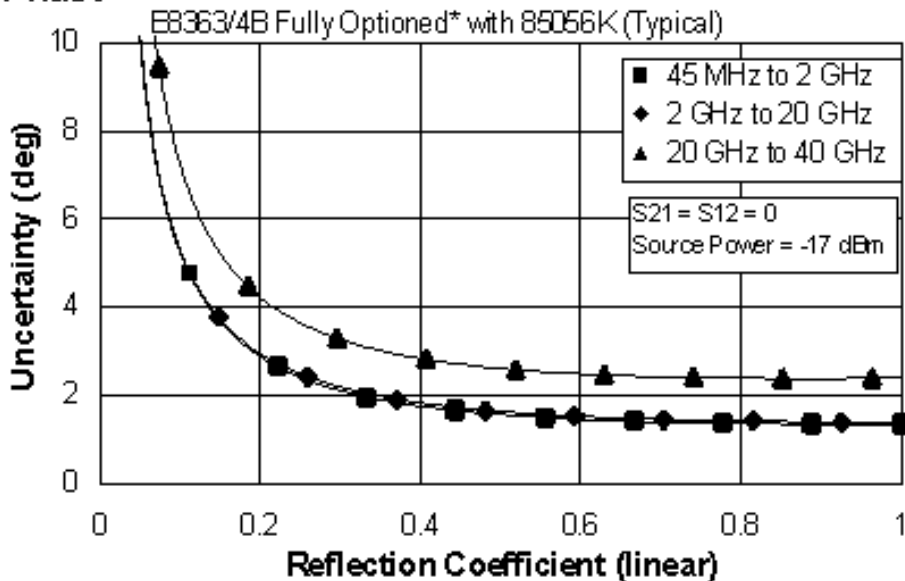

* Configurable Test Set, Extended Power Range & Bias-Tees, Receiver Attenuators, Frequency Offset Mode, and Reference Channel Transfer Switch (E836xB/C - Option 014, UNL, 016, 080, and 081)

E836xB/C Corrected System Performance with 3.5mm Connectors

Table 9. 85052B Calibration Kit
Standard Configuration and Standard Power Range
 (E836xB/C)

Applies to the, E836xB/C analyzers, 85052B (3.5mm) calibration kit, 85131F flexible test port cable set, and a full 2-port calibration. Data and traces above 20 GHz are not applicable to the E8362C. Also applies to the following condition:

Environmental temperature 23° ±3 °C, with < 1 °C deviation from calibration temperature

| Description | Specification (dB) | | |
|-----------------------|--------------------|--------------------|--------------------|
| | 45 MHz to 2 GHz | 2 to 20 GHz | 20 to 26.5 GHz |
| Directivity | 48 | 44 | 44 |
| Source Match | 40 | 31 | 31 |
| Load Match | 48 | 44 | 44 |
| Reflection Tracking | ±0.003 +0.02/°C | ±0.006 +0.02/°C | ±0.006 +0.03/°C |
| Transmission Tracking | ±0.009 +0.02/°C | ±0.088 +0.02/°C | ±0.104 +0.03/°C |

NOTE: The following graphs also apply to the “C” model of the analyzers.

Transmission Uncertainty (Specifications)

Magnitude

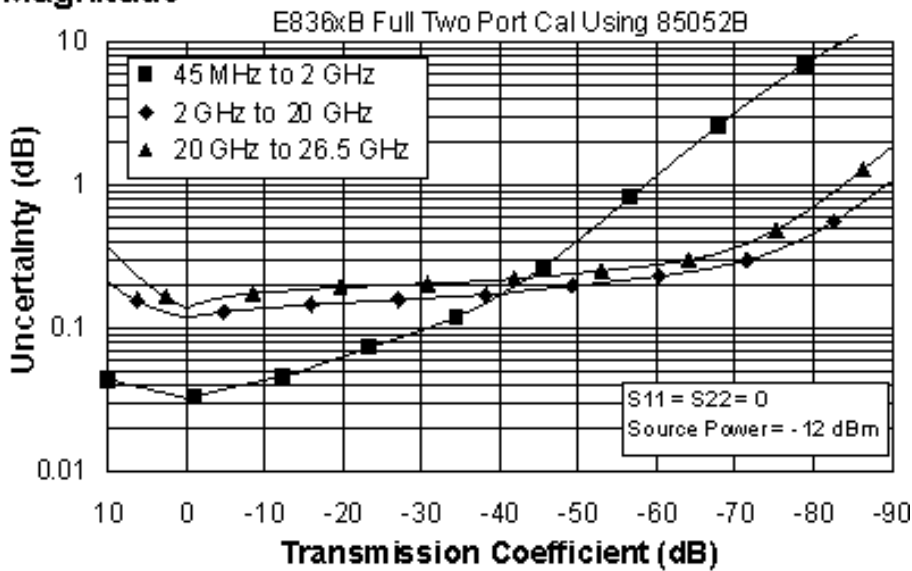

Phase

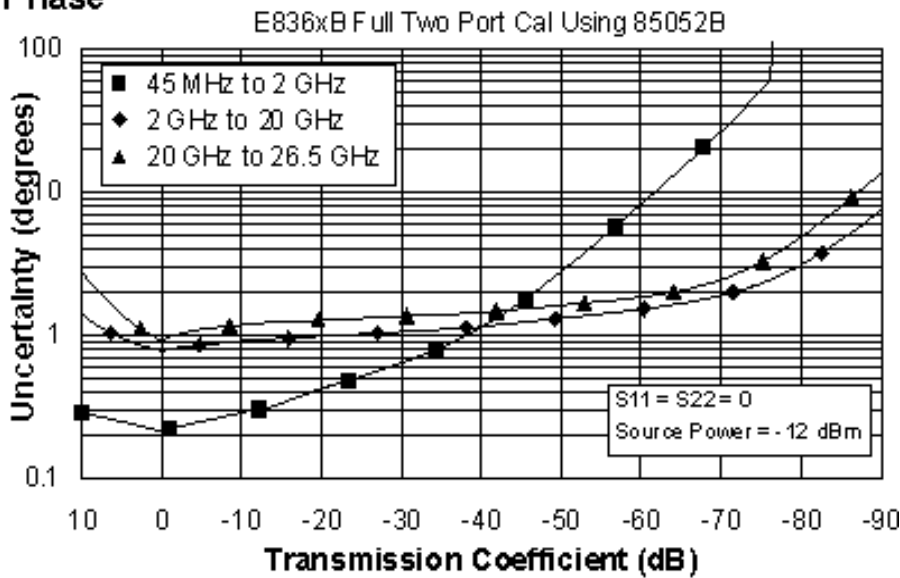

Reflection Uncertainty (Specifications)

Magnitude

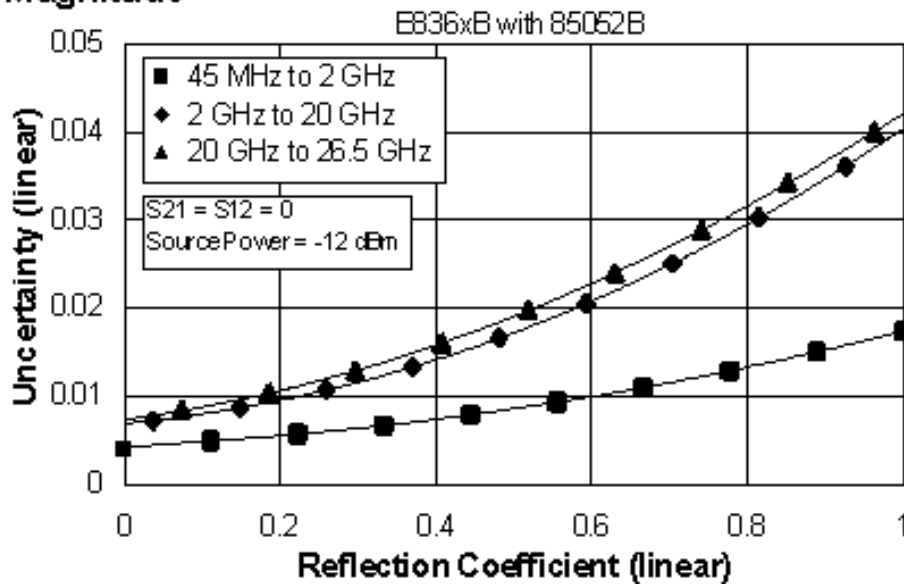

Phase

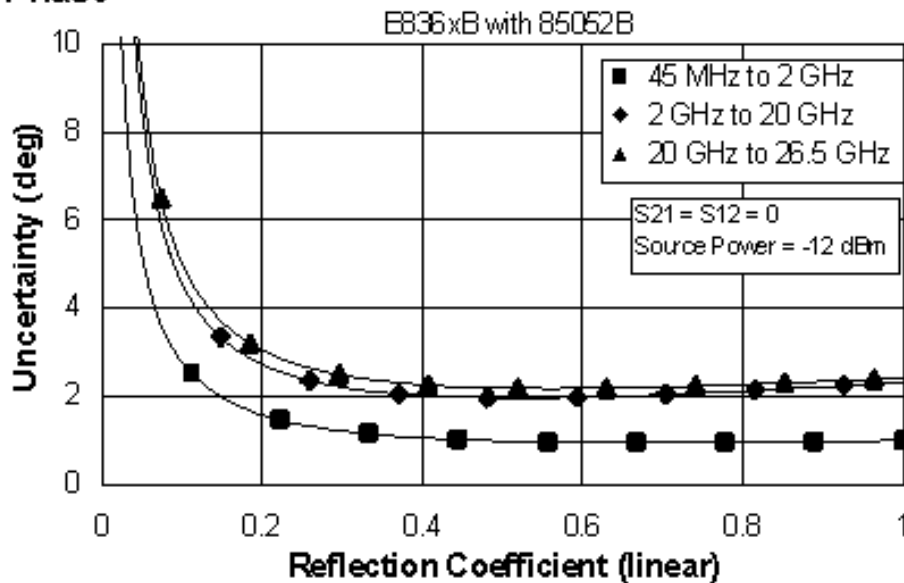

Table 10. 85052B Calibration Kit

Fully Optioned (E836xB/C - Option 014, UNL, 016, 080, and 081)

Configurable Test Set, Extended Power Range & Bias-Tees, Receiver Attenuators, Frequency Offset Mode, and Reference Channel Transfer Switch

Applies to the, E836xB/C analyzers, 85052B (3.5mm) calibration kit, 85131F flexible test port cable set, and a full 2-port calibration. Data and traces above 20 GHz are not applicable to the E8362C. Also applies to the following condition:

Environmental temperature 23° ±3 °C, with < 1 °C deviation from calibration temperature

| Description | Specification (dB) | | |
|-----------------------|--------------------|--------------------|--------------------|
| | 45 MHz to 2 GHz | 2 to 20 GHz | 20 to 26.5 GHz |
| Directivity | 48 | 44 | 44 |
| Source Match | 40 | 31 | 31 |
| Load Match | 48 | 44 | 44 |
| Reflection Tracking | ±0.003 +0.02/°C | ±0.006 +0.02/°C | ±0.006 +0.03/°C |
| Transmission Tracking | ±0.017 +0.02/°C | ±0.091 +0.02/°C | ±0.106 +0.03/°C |

NOTE: The following graphs also apply to the “C” model of the analyzers.

Transmission Uncertainty (Specifications)

Magnitude

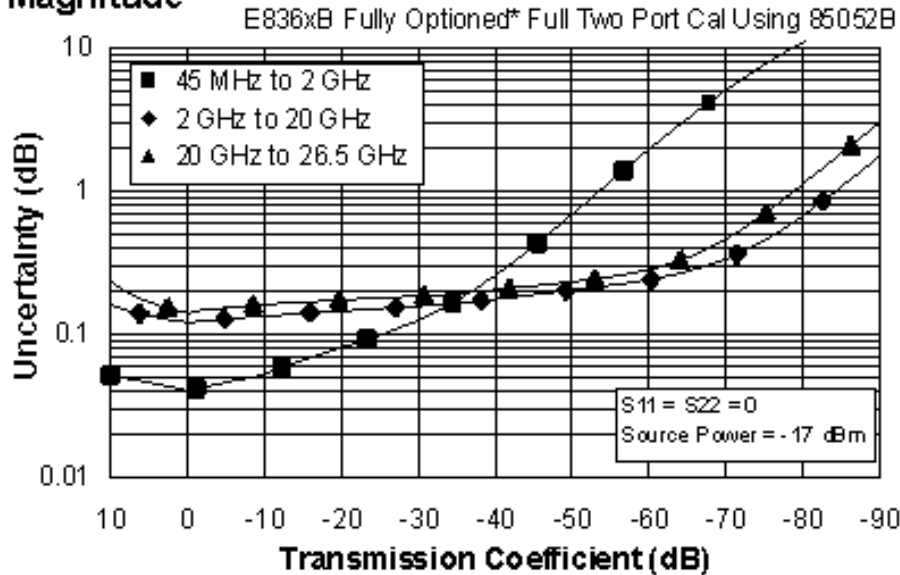

Phase

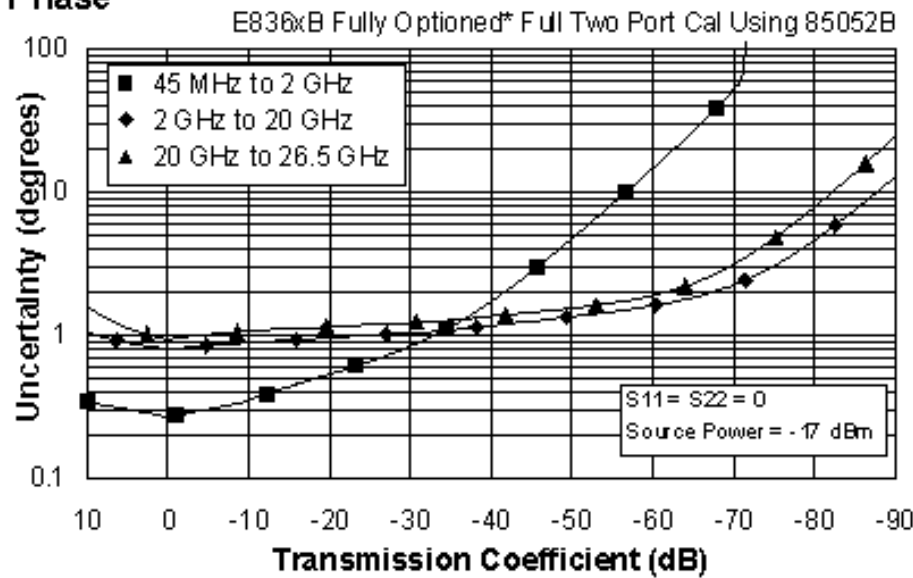

* Configurable Test Set, Extended Power Range & Bias-Tees, Receiver Attenuators, Frequency Offset Mode, and Reference Channel Transfer Switch
 (E836xB/C - Option 014, UNL, 016, 080, and 081)

Reflection Uncertainty (Specifications)

Magnitude

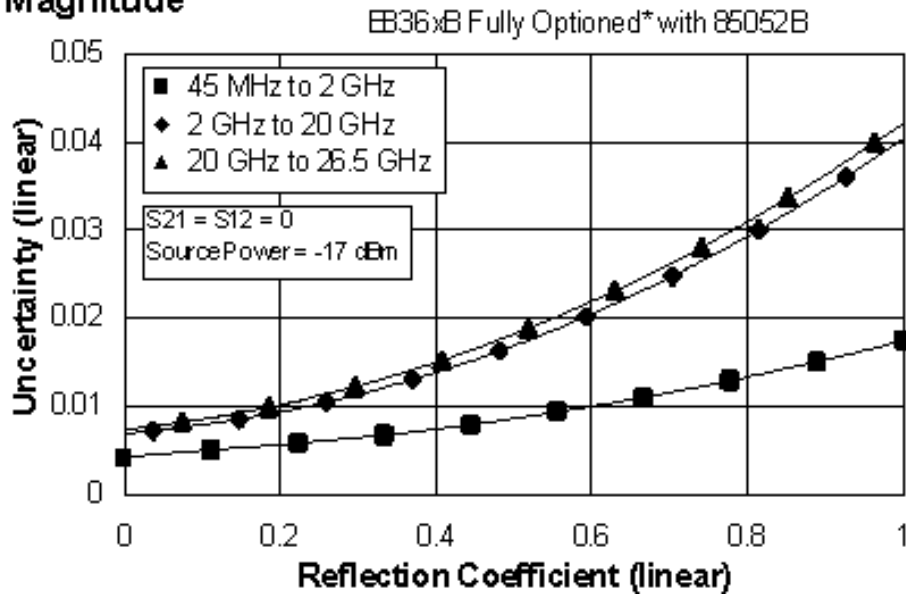

Phase

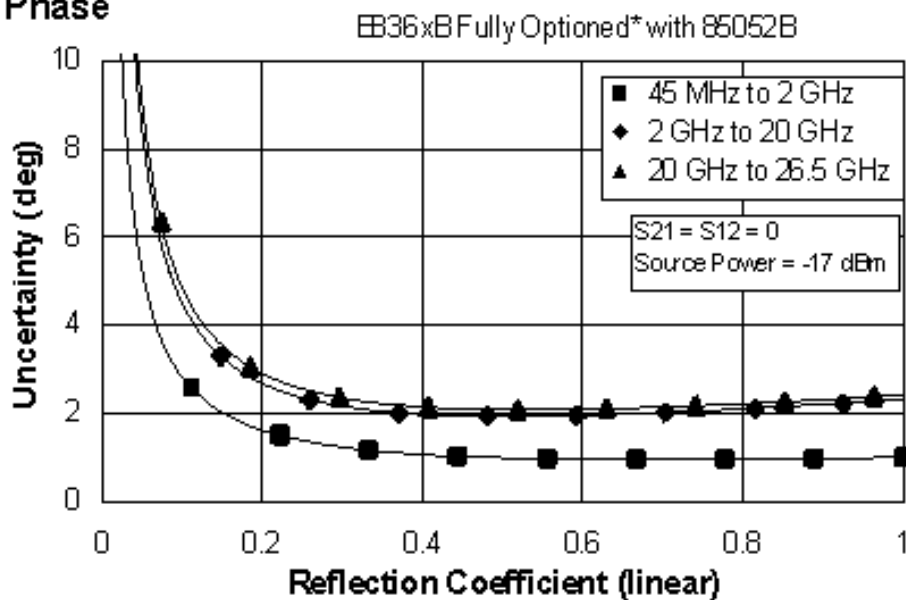

* Configurable Test Set, Extended Power Range & Bias-Tees, Receiver Attenuators, Frequency Offset Mode, and Reference Channel Transfer Switch
(E836xB/C - Option 014, UNL, 016, 080, and 081)

Table 11. 85052C Calibration Kit
Standard Configuration and Standard Power Range
 (E836xB/C)

Applies to the, E836xB/C analyzers, 85052C (3.5mm) calibration kit, 85131F flexible test port cable set, and a full 2-port calibration. Data and traces above 20 GHz are not applicable to the E8362C. Also applies to the following condition:

Environmental temperature 23° ±3 °C, with < 1 °C deviation from calibration temperature

| Description | Specification (dB) | | |
|-----------------------|--------------------|--------------------|--------------------|
| | 45 MHz to 2 GHz | 2 to 20 GHz | 20 to 26.5 GHz |
| Directivity | 48 | 50 | 50 |
| Source Match | 40 | 50 | 50 |
| Load Match | 48 | 50 | 50 |
| Reflection Tracking | ±0.003 +0.02/°C | ±0.000 +0.02/°C | ±0.000 +0.03/°C |
| Transmission Tracking | ±0.009 +0.02/°C | ±0.014 +0.02/°C | ±0.018 +0.03/°C |

NOTE: The following graphs also apply to the “C” model of the analyzers.

Transmission Uncertainty (Specifications)

Magnitude

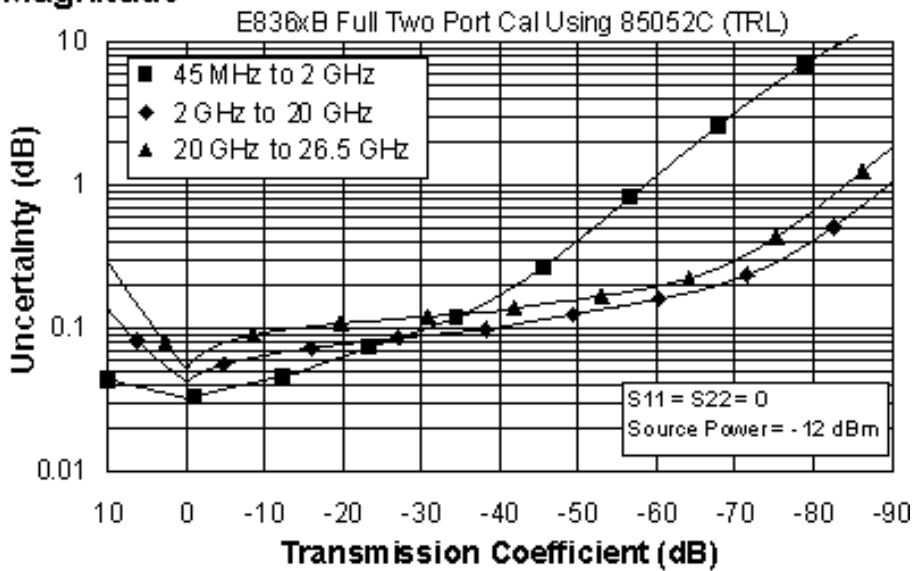

Phase

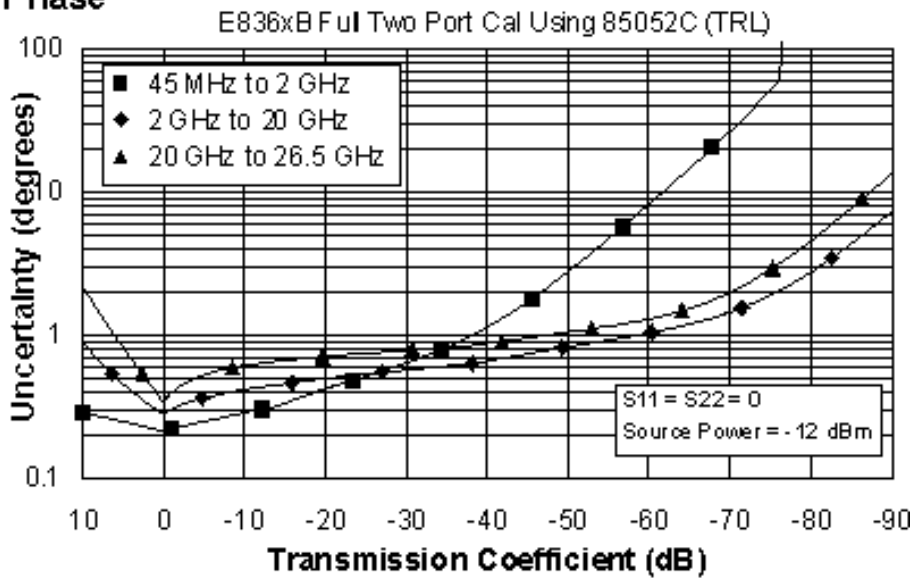

Reflection Uncertainty (Specifications)

Magnitude

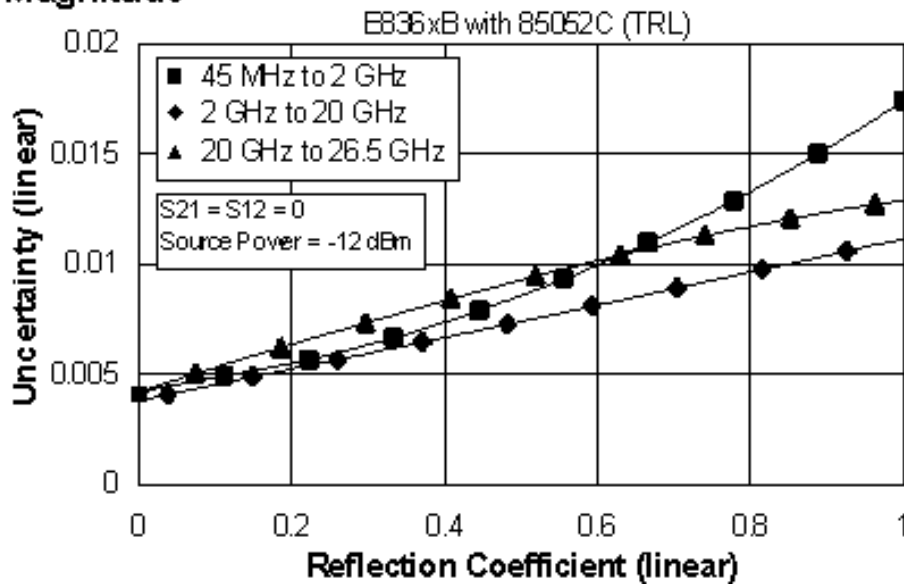

Phase

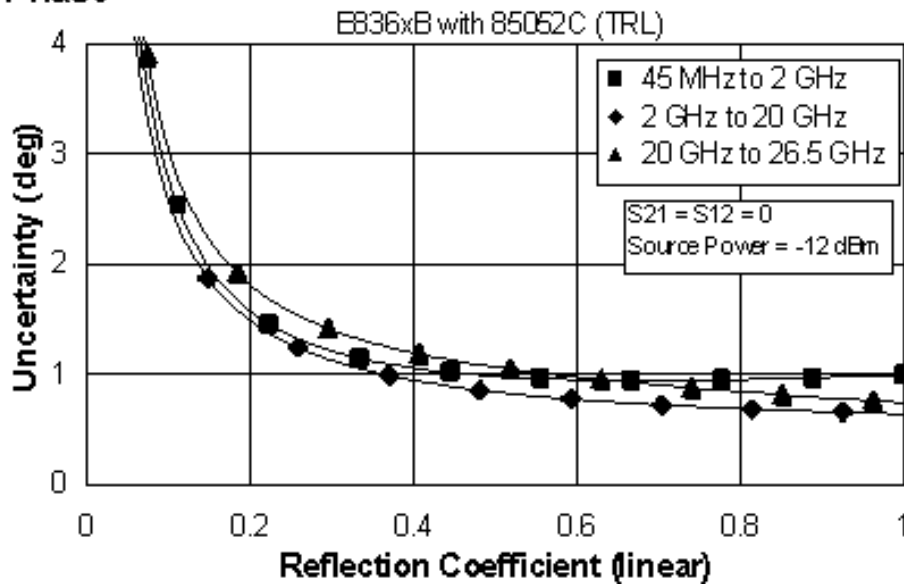

Table 12. 85052C Calibration Kit

Fully Optioned (E836xB/C - Option 014, UNL, 016, 080, and 081)

Configurable Test Set, Extended Power Range & Bias-Tees, Receiver Attenuators, Frequency Offset Mode, and Reference Channel Transfer Switch

Applies to the, E836xB/C analyzers, 85052C (3.5mm) calibration kit, 85131F flexible test port cable set, and a full 2-port calibration. Data and traces above 20 GHz are not applicable to the E8362C. Also applies to the following condition:

Environmental temperature 23° ±3 °C, with < 1 °C deviation from calibration temperature

| Description | Specification (dB) | | |
|-----------------------|--------------------|--------------------|--------------------|
| | 45 MHz to 2 GHz | 2 to 20 GHz | 20 to 26.5 GHz |
| Directivity | 48 | 50 | 50 |
| Source Match | 40 | 50 | 50 |
| Load Match | 48 | 50 | 50 |
| Reflection Tracking | ±0.003 +0.02/°C | ±0.000 +0.02/°C | ±0.000 +0.03/°C |
| Transmission Tracking | ±0.017 +0.02/°C | ±0.016 +0.02/°C | ±0.019 +0.03/°C |

NOTE: The following graphs also apply to the “C” model of the analyzers.

Transmission Uncertainty (Specifications)

Magnitude

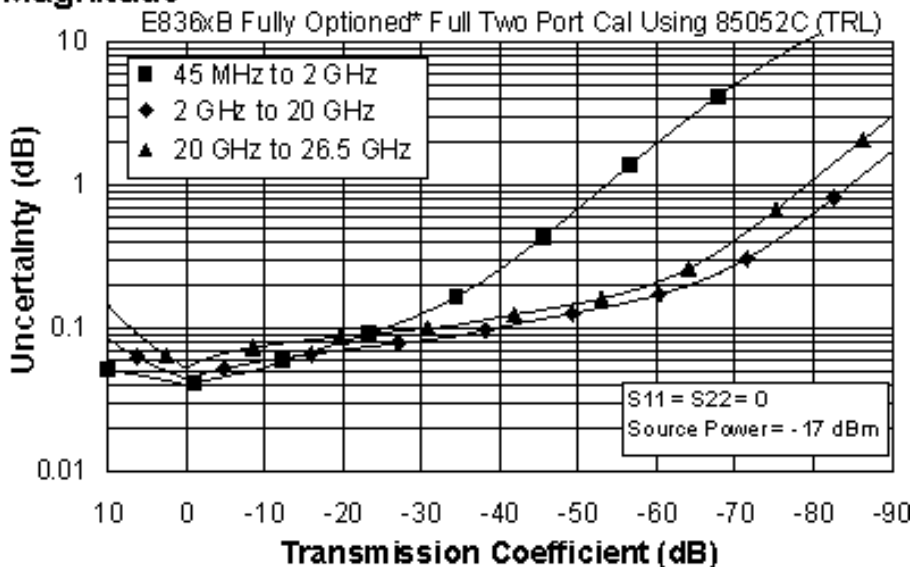

Phase

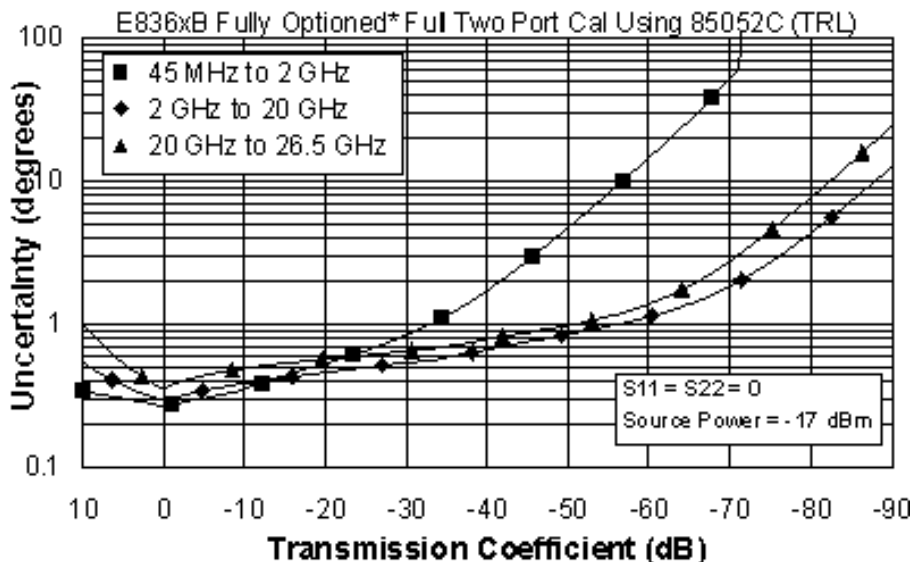

* Configurable Test Set, Extended Power Range & Bias-Tees, Receiver Attenuators, Frequency Offset Mode, and Reference Channel Transfer Switch
 (E836xB/C - Option 014, UNL, 016, 080, and 081)

Reflection Uncertainty (Specifications)

Magnitude

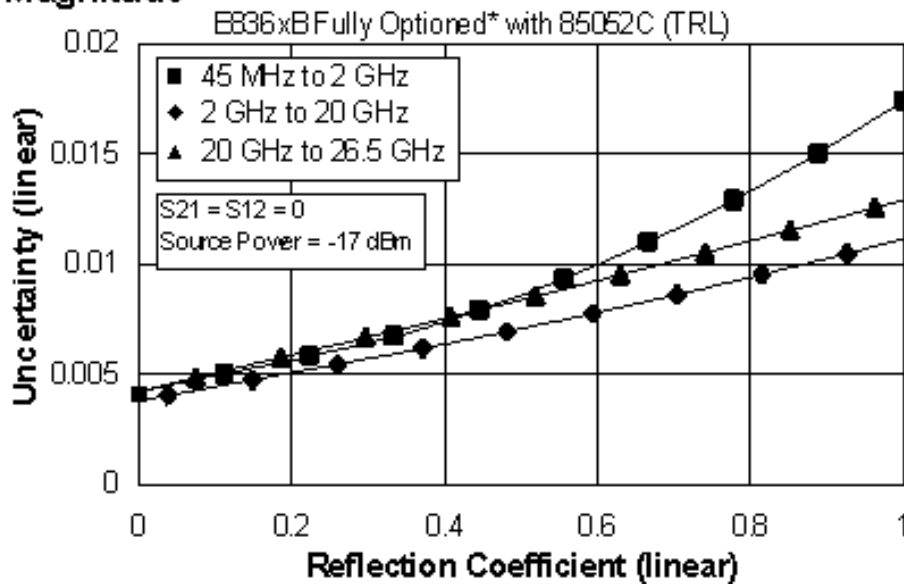

Phase

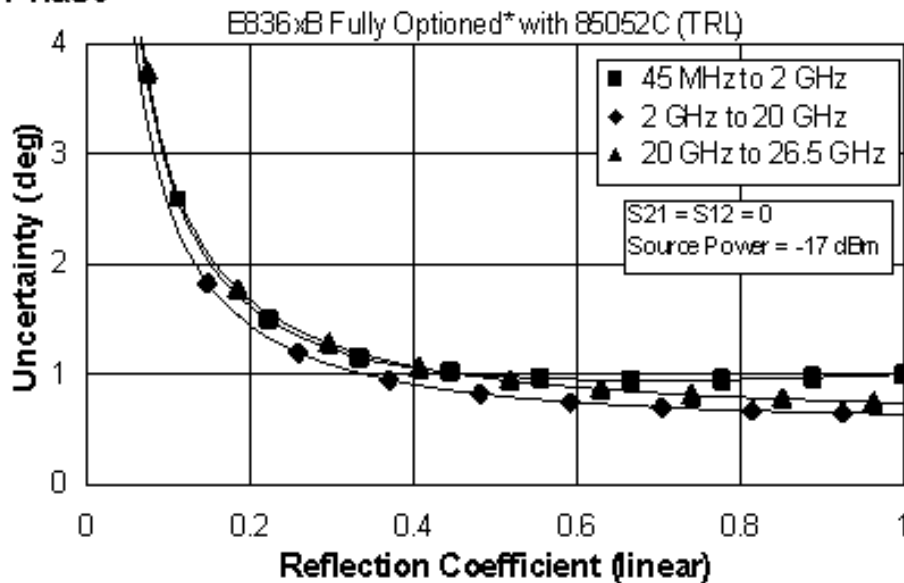

* Configurable Test Set, Extended Power Range & Bias-Tees, Receiver Attenuators, Frequency Offset Mode, and Reference Channel Transfer Switch
(E836xB/C - Option 014, UNL, 016, 080, and 081)

Table 13. 85052D Calibration Kit
Standard Configuration and Standard Power Range
 (E836xB/C)

Applies to the, E836xB/C analyzers, 85052D (3.5mm) calibration kit, 85131F flexible test port cable set, and a full 2-port calibration. Data and traces above 20 GHz are not applicable to the E8362C. Also applies to the following condition:

Environmental temperature 23° ±3 °C, with < 1 °C deviation from calibration temperature

| Description | Specification (dB) | | |
|-----------------------|--------------------|--------------------|--------------------|
| | 45 MHz to 2 GHz | 2 to 20 GHz | 20 to 26.5 GHz |
| Directivity | 42 | 36 | 30 |
| Source Match | 37 | 28 | 25 |
| Load Match | 42 | 36 | 30 |
| Reflection Tracking | ±0.003 +0.02/°C | ±0.008 +0.02/°C | ±0.011 +0.03/°C |
| Transmission Tracking | ±0.014 +0.02/°C | ±0.131 +0.02/°C | ±0.250 +0.03/°C |

NOTE: The following graphs also apply to the "C" model of the analyzers.

Transmission Uncertainty (Specifications)

Magnitude

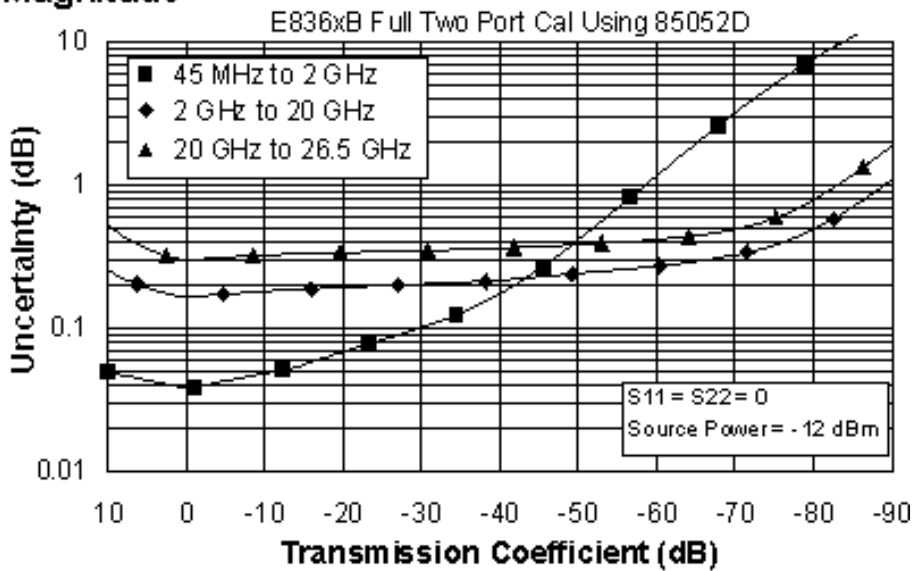

Phase

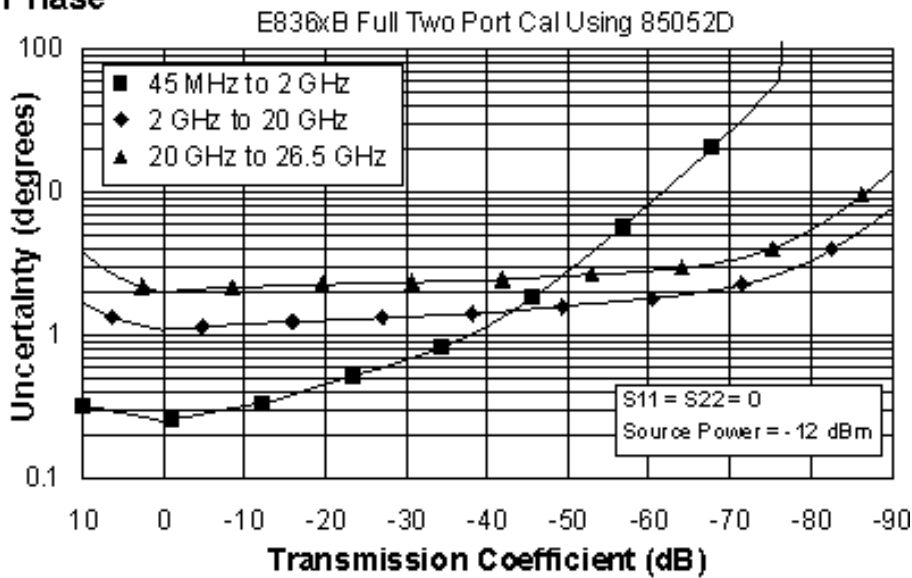

Reflection Uncertainty (Specifications)

Magnitude

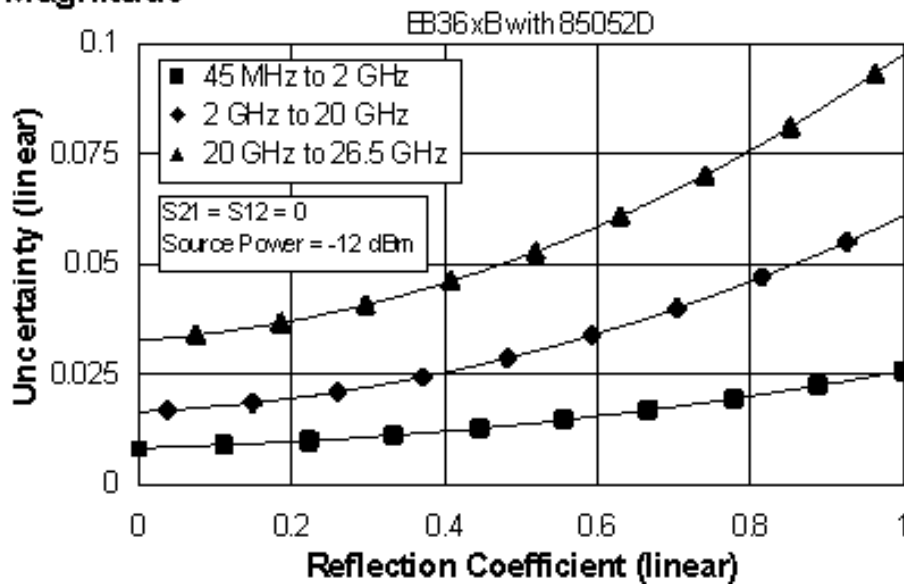

Phase

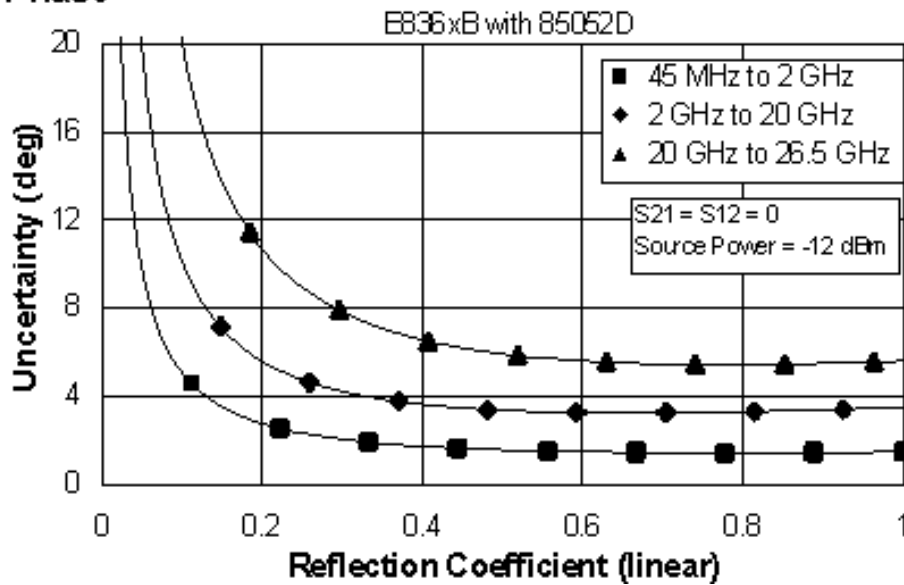

Table 14. 85052D Calibration Kit

Fully Optioned (E836xB/C - Option 014, UNL, 016, 080, and 081)

Configurable Test Set, Extended Power Range & Bias-Tees, Receiver Attenuators, Frequency Offset Mode, and Reference Channel Transfer Switch

Applies to the, E836xB/C analyzers, 85052D (3.5mm) calibration kit, 85131F flexible test port cable set, and a full 2-port calibration. Data and traces above 20 GHz are not applicable to the E8362C. Also applies to the following condition:

Environmental temperature 23° ±3 °C, with < 1 °C deviation from calibration temperature

| Description | Specification (dB) | | |
|-----------------------|--------------------|--------------------|--------------------|
| | 45 MHz to 2 GHz | 2 to 20 GHz | 20 to 26.5 GHz |
| Directivity | 42 | 36 | 30 |
| Source Match | 37 | 28 | 25 |
| Load Match | 42 | 36 | 30 |
| Reflection Tracking | ±0.003 +0.02/°C | ±0.008 +0.02/°C | ±0.011 +0.03/°C |
| Transmission Tracking | ±0.026 +0.02/°C | ±0.138 +0.02/°C | ±0.261 +0.03/°C |

NOTE: The following graphs also apply to the “C” model of the analyzers.

Transmission Uncertainty (Specifications)

Magnitude

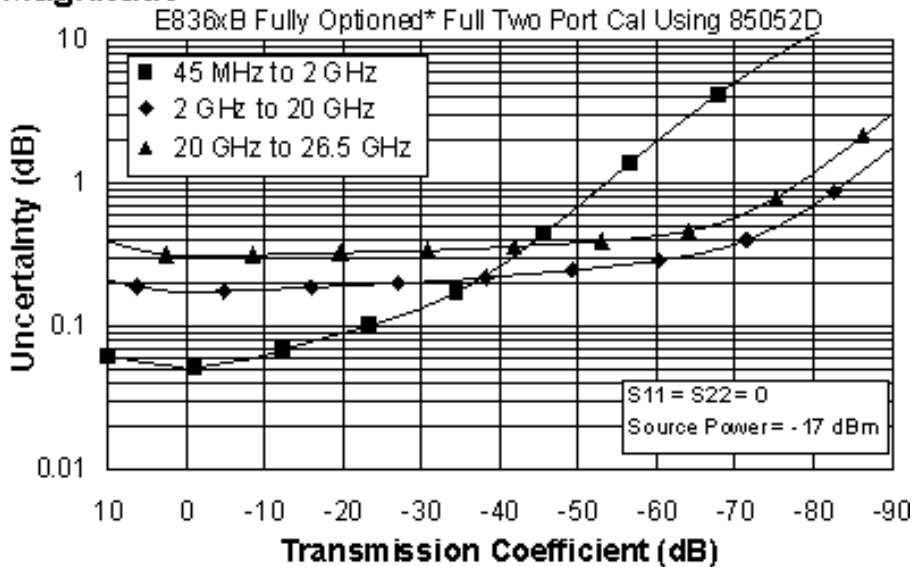

Phase

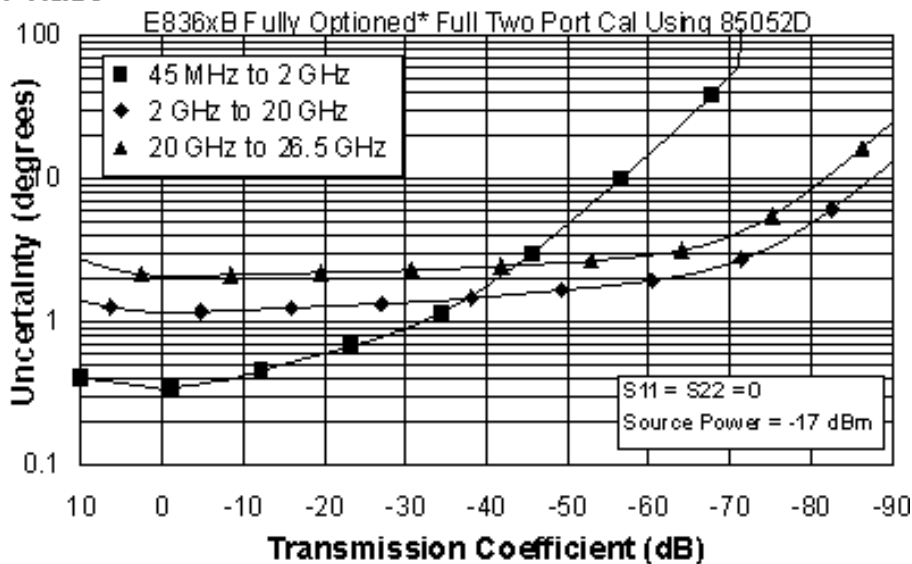

* Configurable Test Set, Extended Power Range & Bias-Tees, Receiver Attenuators, Frequency Offset Mode, and Reference Channel Transfer Switch (E836xB/C - Option 014, UNL, 016, 080, and 081)

Reflection Uncertainty (Specifications)

Magnitude

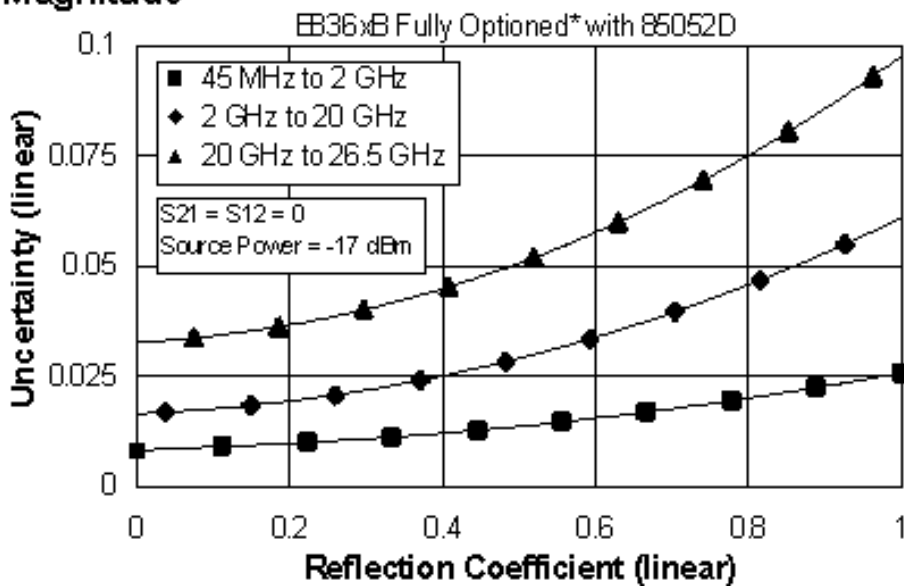

Phase

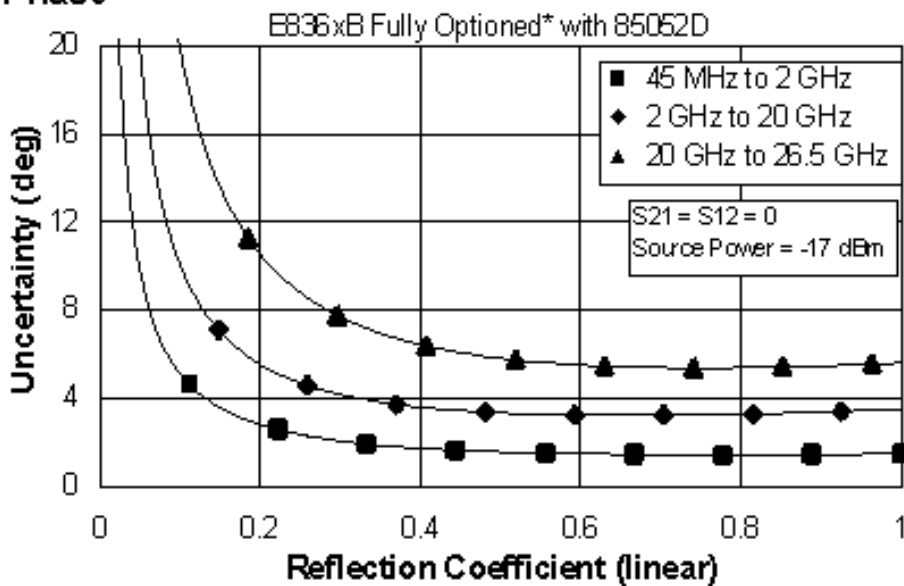

* Configurable Test Set, Extended Power Range & Bias-Tees, Receiver Attenuators, Frequency Offset Mode, and Reference Channel Transfer Switch (E836xB/C - Option 014, UNL, 016, 080, and 081)

E836xB/C Corrected System Performance with 7mm Connectors

Table 15. 85050B Calibration Kit
Standard Configuration and Standard Power Range
(E836xB/C)

Applies to the, E836xB/C analyzers, 85050B (7mm) calibration kit, 85132F flexible test port cable set, and a full 2-port calibration. Also applies to the following condition:

Environmental temperature 23° ±3 °C, with < 1 °C deviation from calibration temperature

| Description | Specification (dB) | |
|-----------------------|--------------------|--------------------|
| | 0.045 to 2 GHz | 2 to 18 GHz |
| Directivity | 52 | 52 |
| Source Match | 48 | 41 |
| Load Match | 52 | 47 |
| Reflection Tracking | ±0.003 +0.02/°C | ±0.047 +0.02/°C |
| Transmission Tracking | ±0.004 +0.02/°C | ±0.032 +0.02/°C |

NOTE: The following graphs also apply to the “C” model of the analyzers.

Transmission Uncertainty (Specifications)

Magnitude

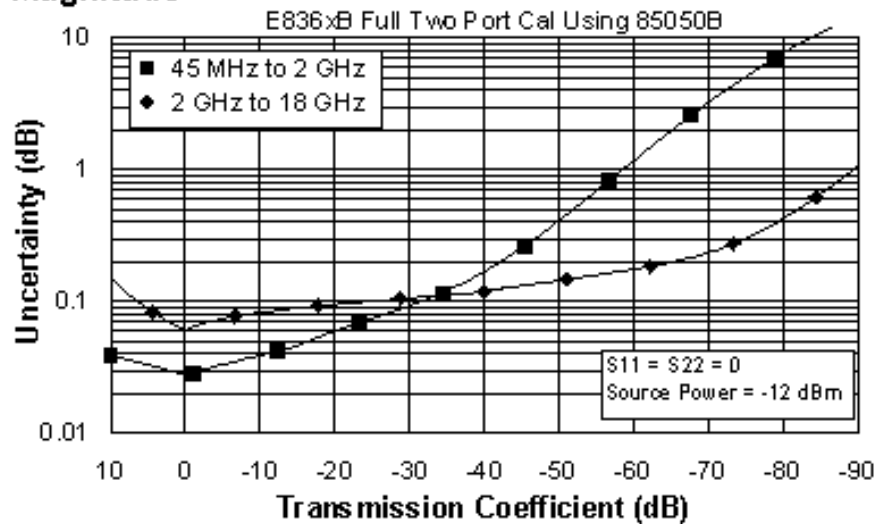

Phase

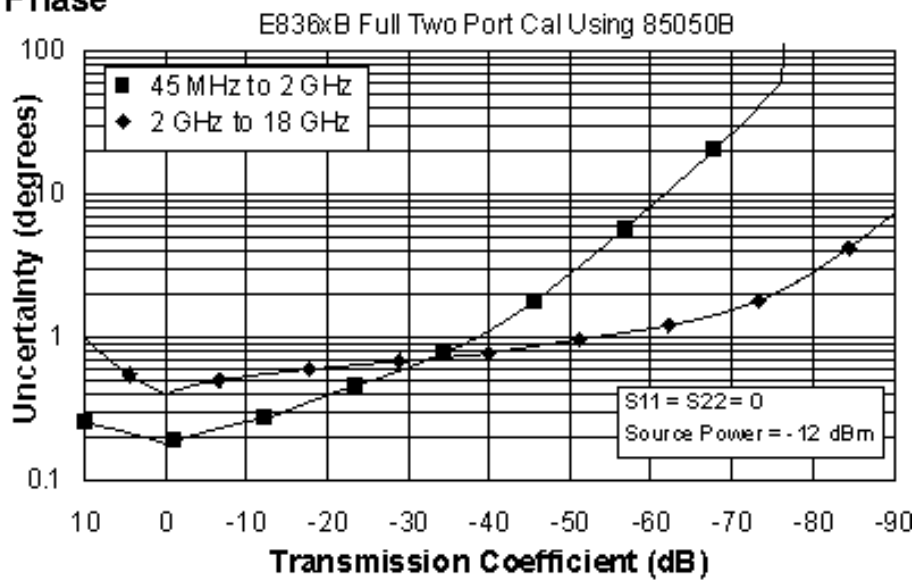

Reflection Uncertainty (Specifications)

Magnitude

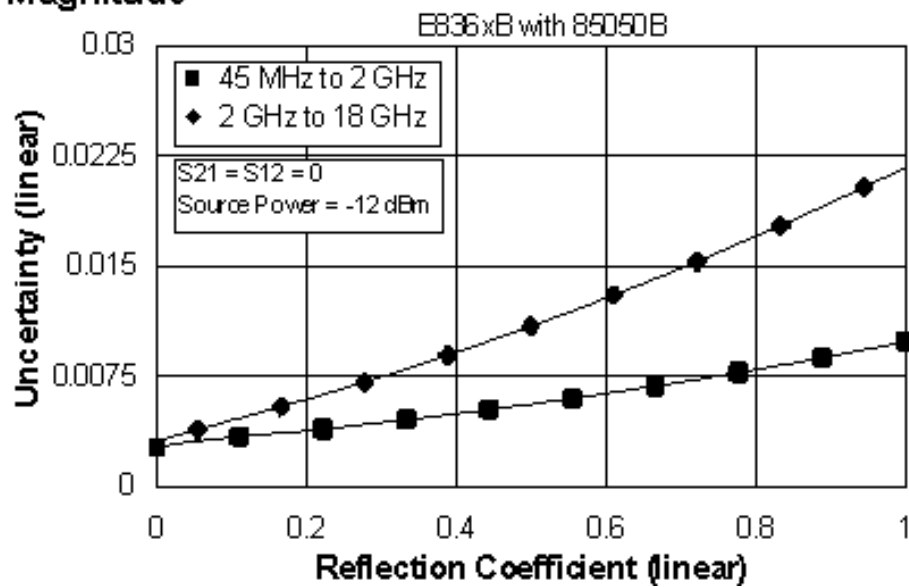

Phase

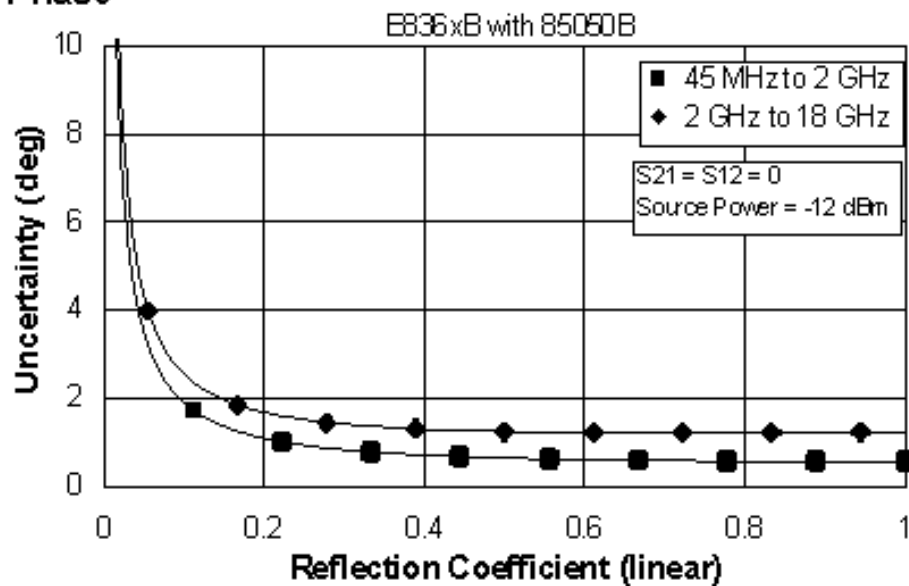

Table 16. 85050B Calibration Kit

Fully Optioned (E836xB/C - Option 014, UNL, 016, 080, and 081)

Configurable Test Set, Extended Power Range & Bias-Tees, Receiver Attenuators, Frequency Offset Mode, and Reference Channel Transfer Switch

Applies to the, E836xB/C analyzers, 85050B (7mm) calibration kit, 85132F flexible test port cable set, and a full 2-port calibration. Also applies to the following condition:

Environmental temperature 23° ±3 °C, with < 1 °C deviation from calibration temperature

| Description | Specification (dB) | |
|-----------------------|--------------------|--------------------|
| | 0.045 to 2 GHz | 2 to 18 GHz |
| Directivity | 52 | 52 |
| Source Match | 48 | 41 |
| Load Match | 52 | 47 |
| Reflection Tracking | ±0.003 +0.02/°C | ±0.047 +0.02/°C |
| Transmission Tracking | ±0.008 +0.02/°C | ±0.034 +0.02/°C |

NOTE: The following graphs also apply to the “C” model of the analyzers.

Transmission Uncertainty (Specifications)

Magnitude

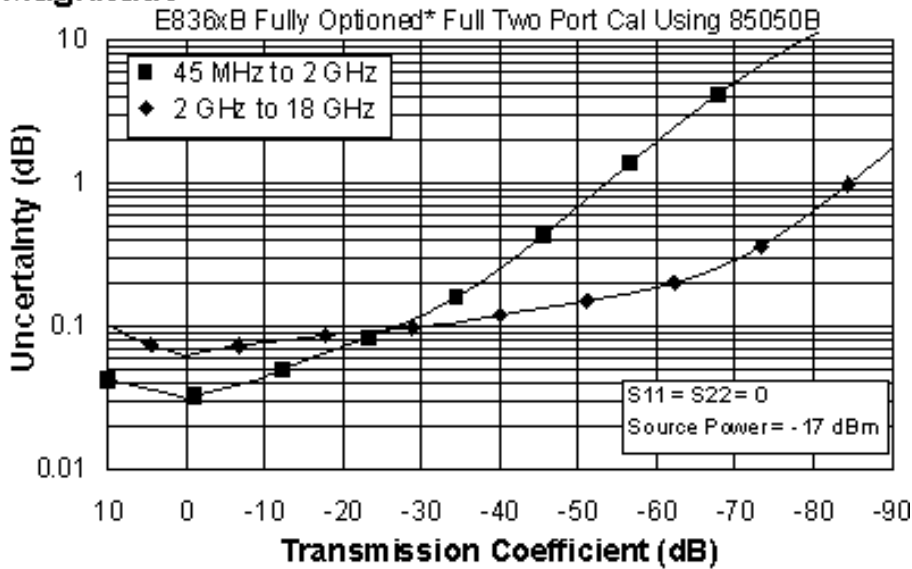

Phase

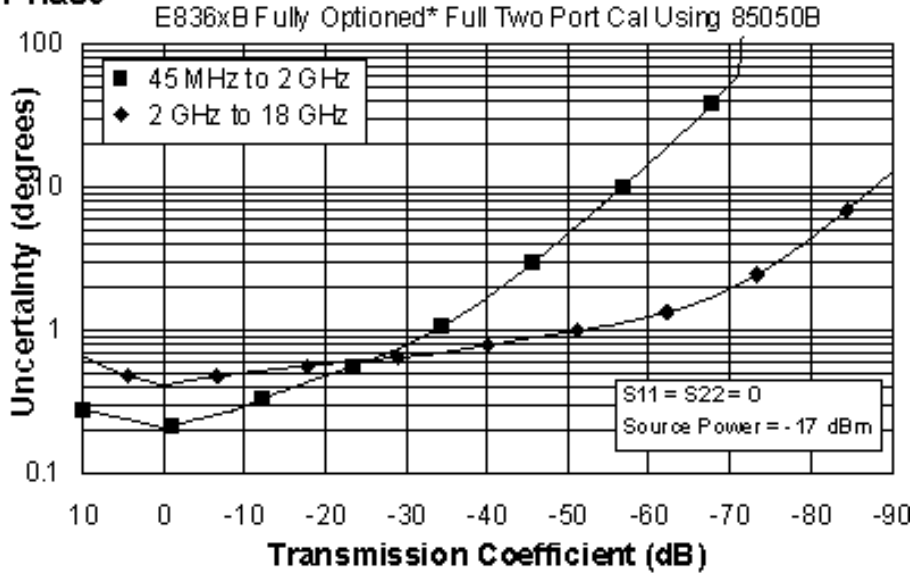

*Configurable Test Set, Extended Power Range & Bias-Tees, Receiver Attenuators, Frequency Offset Mode, and Reference Channel Transfer Switch (E836xB/C - Option 014, UNL, 016, 080, and 081)

Reflection Uncertainty (Specifications)

Magnitude

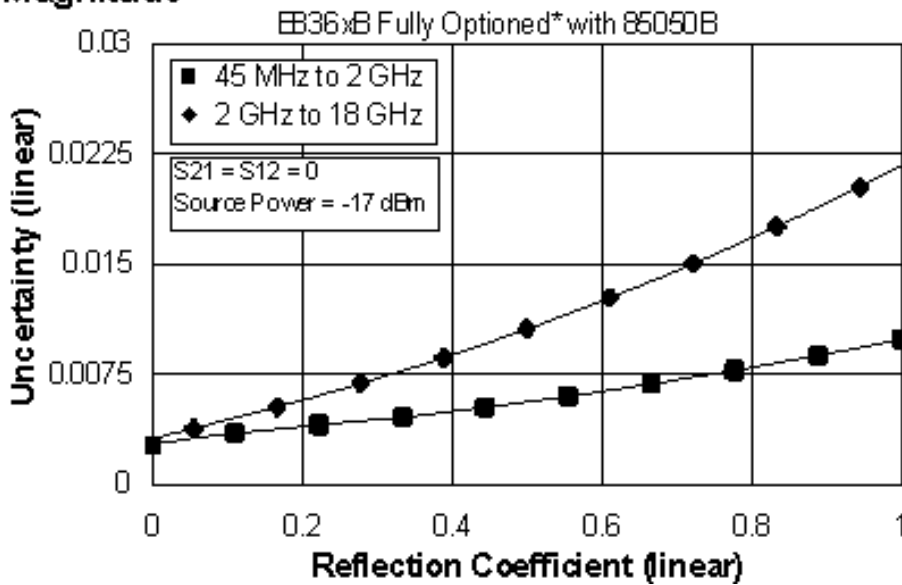

Phase

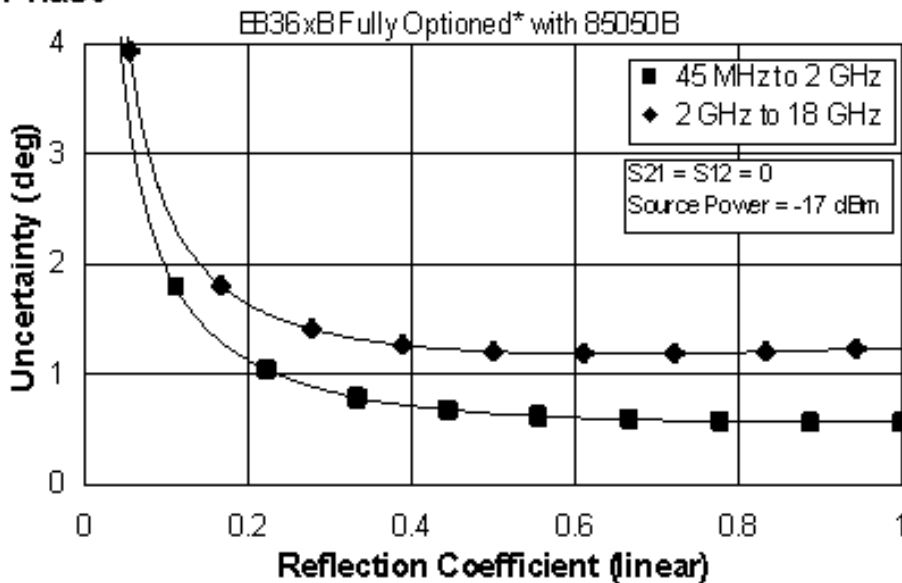

*Configurable Test Set, Extended Power Range & Bias-Tees, Receiver Attenuators, Frequency Offset Mode, and Reference Channel Transfer Switch (E836xB/C - Option 014, UNL, 016, 080, and 081)

Table 17. 85050C Calibration Kit
Standard Configuration and Standard Power Range
(E836xB/C)

Applies to the, E836xB/C analyzers, 85050C (7mm) calibration kit, 85132F flexible test port cable set, and a full 2-port calibration. Also applies to the following condition:

Environmental temperature 23° ±3 °C, with < 1 °C deviation from calibration temperature

| Description | Specification (dB) | |
|-----------------------|--------------------|--------------------|
| | 0.045 to 2 GHz | 2 to 18 GHz |
| Directivity | 52 | 60 |
| Source Match | 48 | 60 |
| Load Match | 52 | 60 |
| Reflection Tracking | ±0.003 +0.02/°C | ±0.000 +0.02/°C |
| Transmission Tracking | ±0.004 +0.02/°C | ±0.004 +0.02/°C |

NOTE: The following graphs also apply to the "C" model of the analyzers.

Transmission Uncertainty (Specifications)

Magnitude

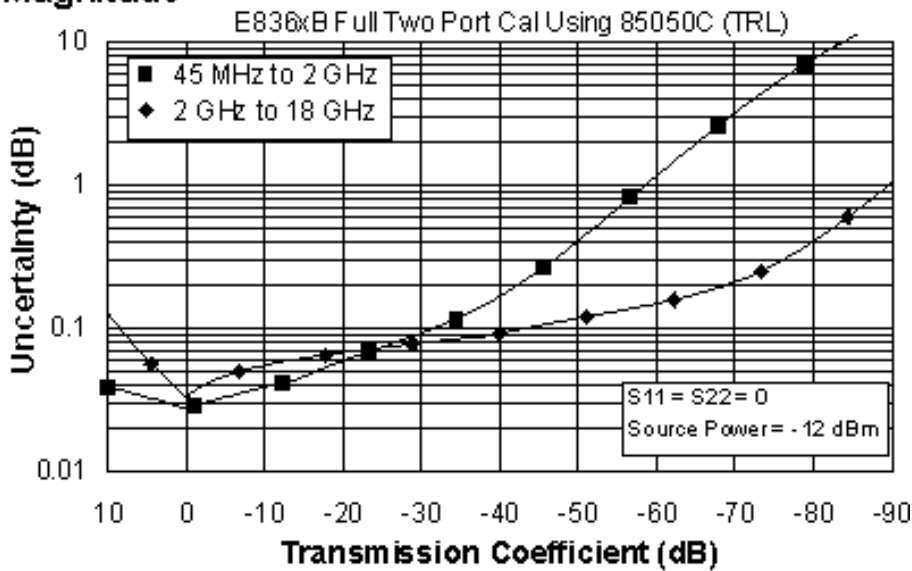

Phase

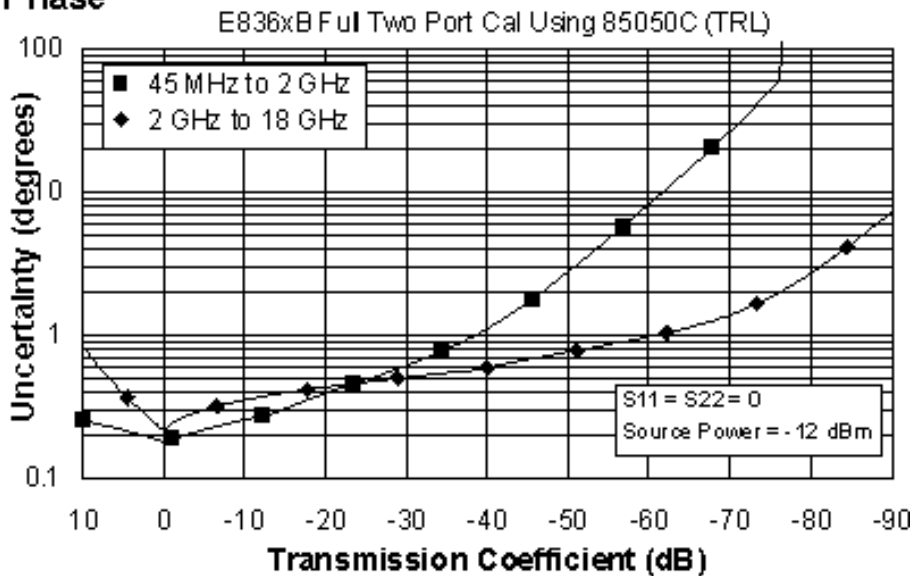

Reflection Uncertainty (Specifications)

Magnitude

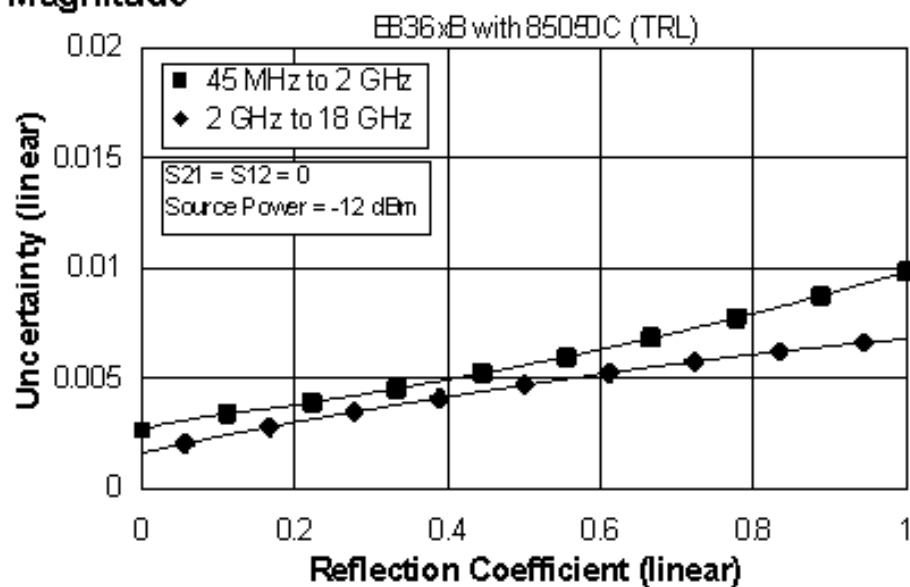

Phase

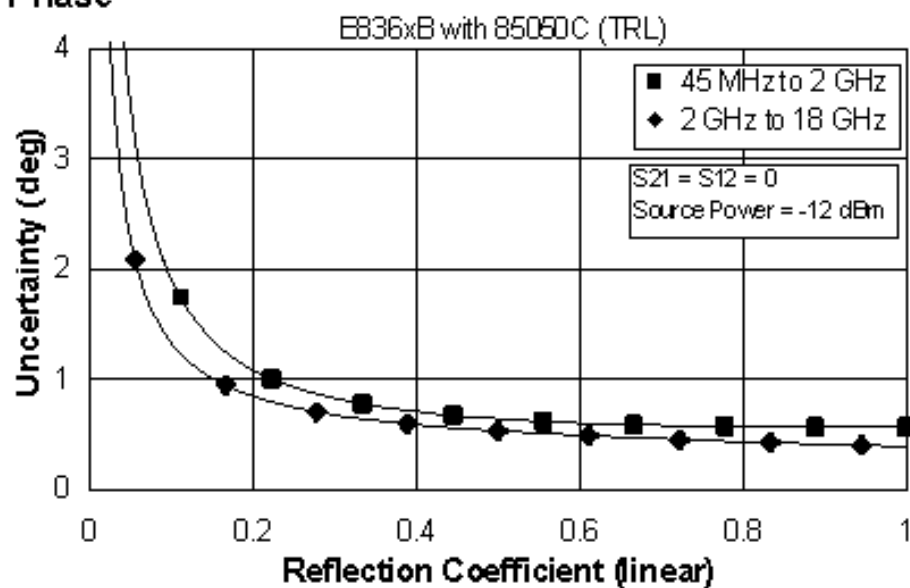

Table 18. 85050C Calibration Kit
Fully Optioned (E836xB/C - Option 014, UNL, 016, 080, and 081)

Configurable Test Set, Extended Power Range & Bias-Tees, Receiver Attenuators, Frequency Offset Mode, and Reference Channel Transfer Switch

Applies to the, E836xB/C analyzers, 85050C (7mm) calibration kit, 85132F flexible test port cable set, and a full 2-port calibration. Also applies to the following condition:

Environmental temperature 23° ±3 °C, with < 1 °C deviation from calibration temperature

| Description | Specification (dB) | |
|-----------------------|--------------------|--------------------|
| | 0.045 to 2 GHz | 2 to 18 GHz |
| Directivity | 52 | 60 |
| Source Match | 48 | 60 |
| Load Match | 52 | 60 |
| Reflection Tracking | ±0.003 +0.02/°C | ±0.000 +0.02/°C |
| Transmission Tracking | ±0.008 +0.02/°C | ±0.005 +0.02/°C |

NOTE: The following graphs also apply to the “C” model of the analyzers.

Transmission Uncertainty (Specifications)

Magnitude

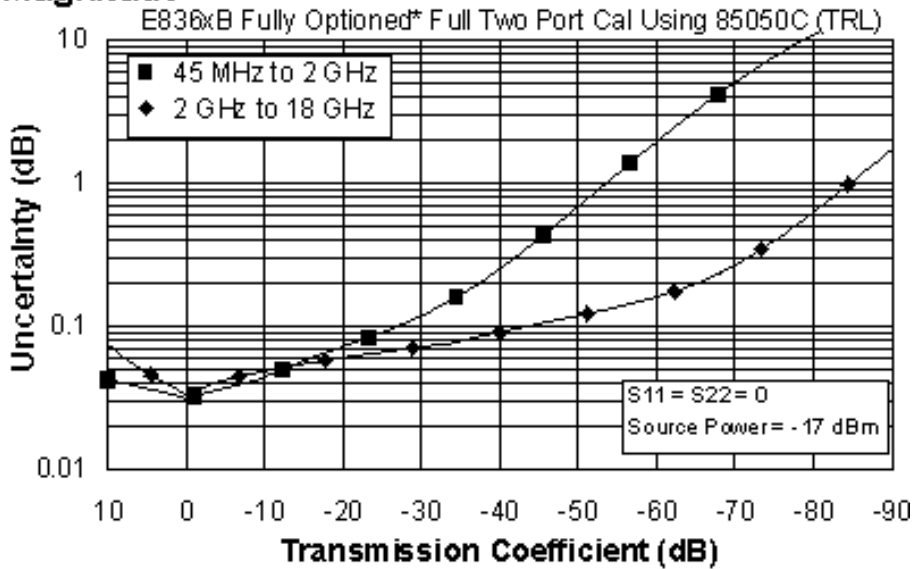

Phase

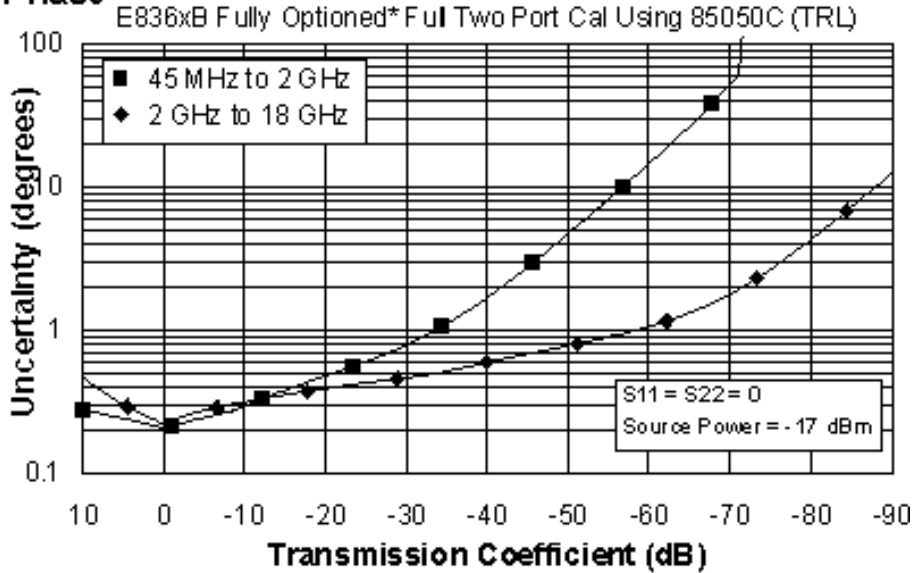

*Configurable Test Set, Extended Power Range & Bias-Tees, Receiver Attenuators, Frequency Offset Mode, and Reference Channel Transfer Switch (E836xB/C - Option 014, UNL, 016, 080, and 081)

Reflection Uncertainty (Specifications)

Magnitude

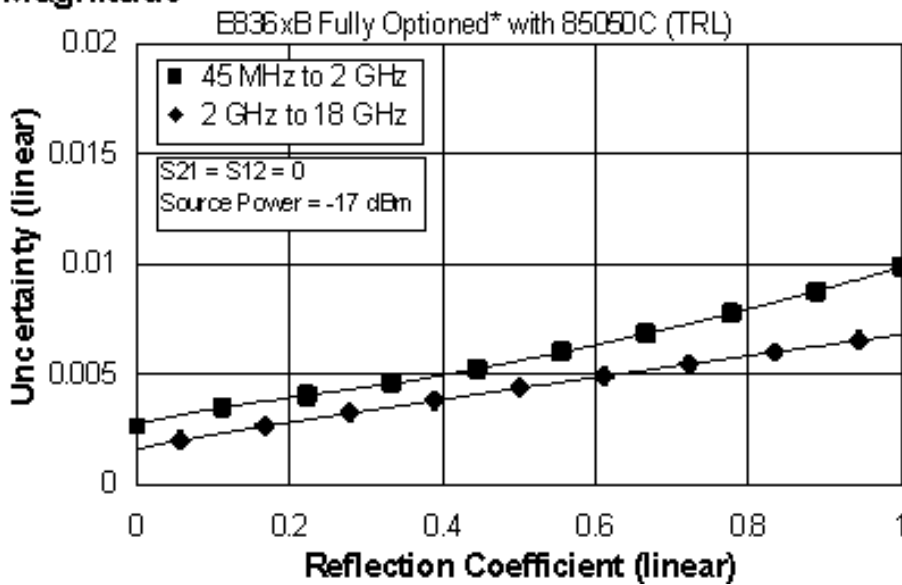

Phase

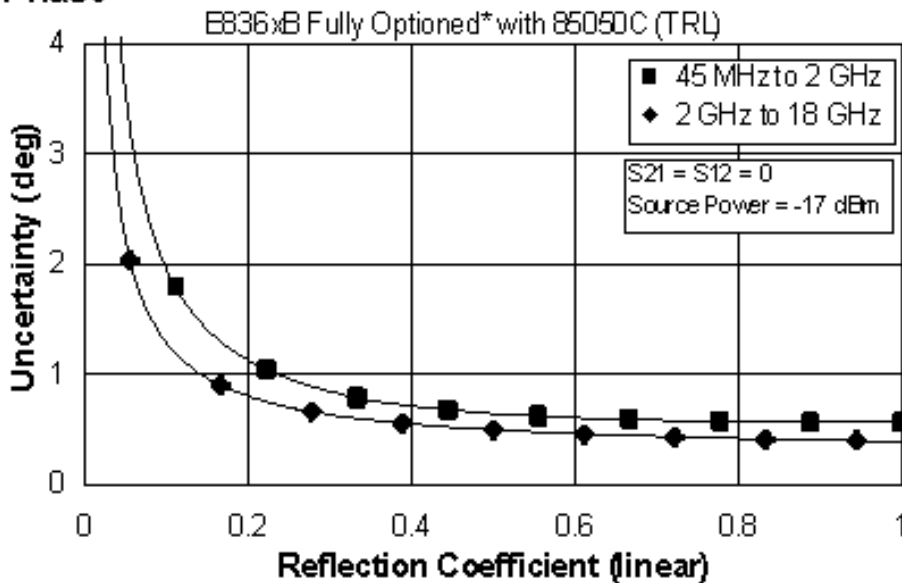

*Configurable Test Set, Extended Power Range & Bias-Tees, Receiver Attenuators, Frequency Offset Mode, and Reference Channel Transfer Switch (E836xB/C - Option 014, UNL, 016, 080, and 081)

Table 19. 85050D Calibration Kit
Standard Configuration and Standard Power Range
(E836xB/C)

Applies to the, E836xB/C analyzers, 85050D (7mm) calibration kit, 85132F flexible test port cable set, and a full 2-port calibration. Also applies to the following condition:

Environmental temperature $23^{\circ} \pm 3^{\circ} \text{C}$, with $< 1^{\circ} \text{C}$ deviation from calibration temperature

| Description | Specification (dB) | |
|-----------------------|---|---|
| | 0.045 to 2 GHz | 2 to 18 GHz |
| Directivity | 40 | 40 |
| Source Match | 39 | 35 |
| Load Match | 40 | 37 |
| Reflection Tracking | ± 0.010 $+0.02/^{\circ}\text{C}$ | ± 0.100 $+0.02/^{\circ}\text{C}$ |
| Transmission Tracking | ± 0.013 $+0.02/^{\circ}\text{C}$ | ± 0.072 $+0.02/^{\circ}\text{C}$ |

NOTE: The following graphs also apply to the “C” model of the analyzers.

Transmission Uncertainty (Specifications)

Magnitude

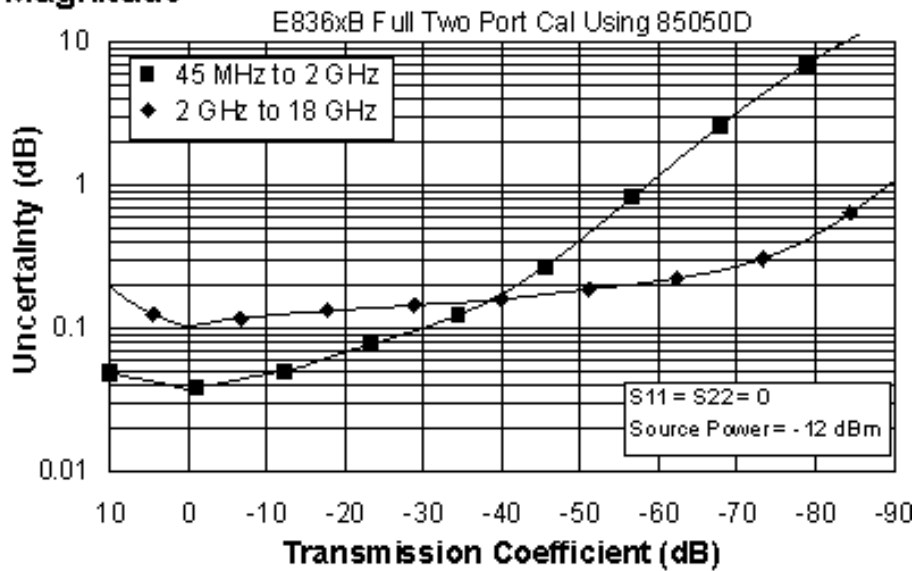

Phase

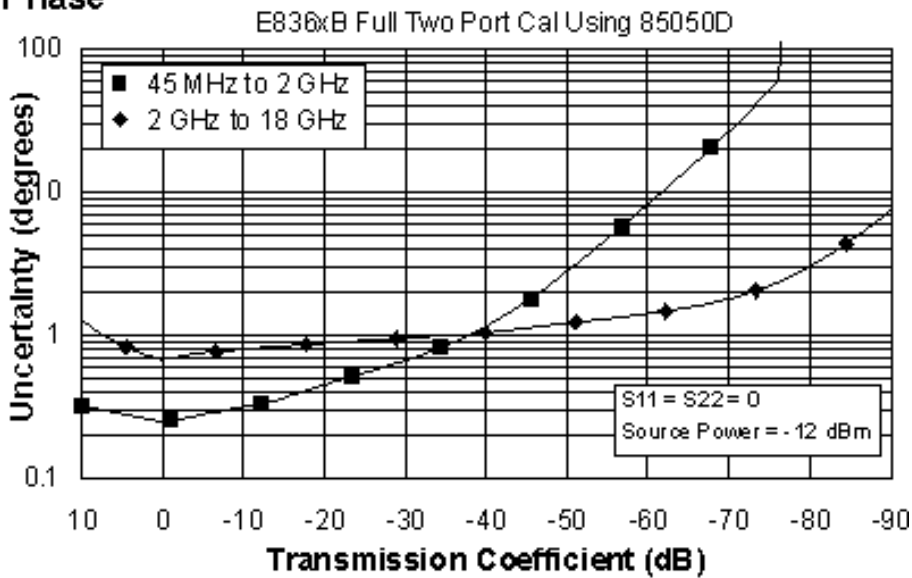

Reflection Uncertainty (Specifications)

Magnitude

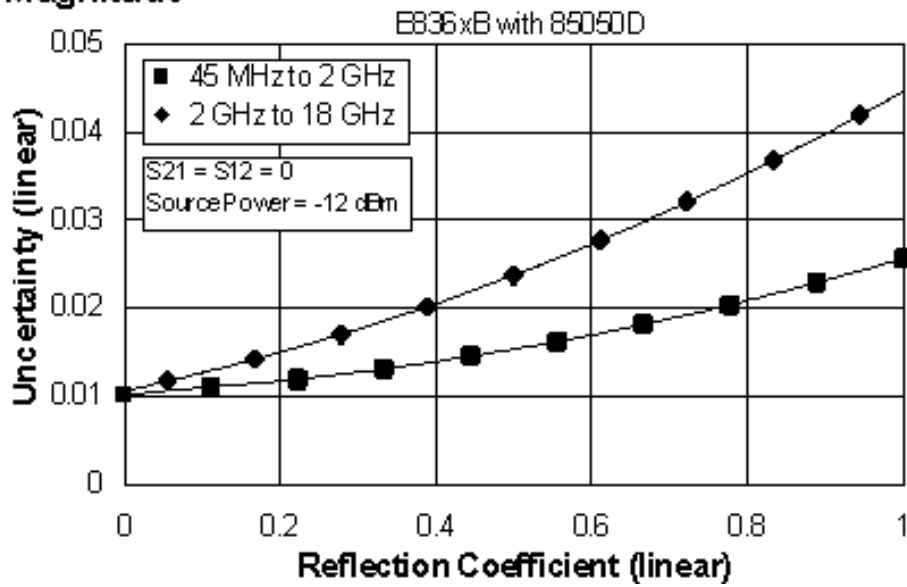

Phase

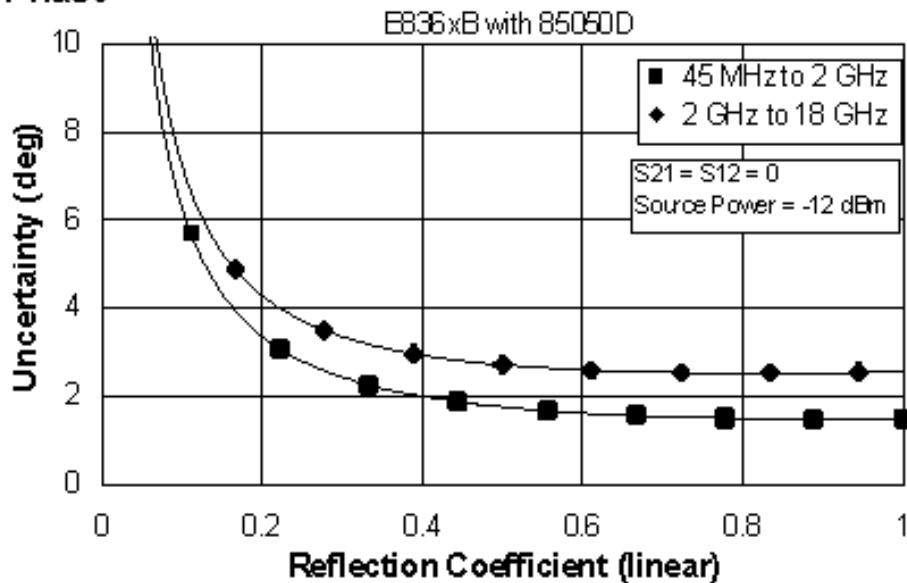

Table 20. 85050D Calibration Kit
Fully Optioned (E836xB/C - Option 014, UNL, 016, 080, and 081)

Configurable Test Set, Extended Power Range & Bias-Tees, Receiver Attenuators, Frequency Offset Mode, and Reference Channel Transfer Switch

Applies to the, E836xB/C analyzers, 85050D (7mm) calibration kit, 85132F flexible test port cable set, and a full 2-port calibration. Also applies to the following condition:

Environmental temperature 23° ±3 °C, with < 1 °C deviation from calibration temperature

| Description | Specification (dB) | |
|-----------------------|--------------------|--------------------|
| | 0.045 to 2 GHz | 2 to 18 GHz |
| Directivity | 40 | 40 |
| Source Match | 39 | 35 |
| Load Match | 40 | 37 |
| Reflection Tracking | ±0.010 +0.02/°C | ±0.100 +0.02/°C |
| Transmission Tracking | ±0.025 +0.02/°C | ±0.078 +0.02/°C |

NOTE: The following graphs also apply to the “C” model of the analyzers.

Transmission Uncertainty (Specifications)

Magnitude

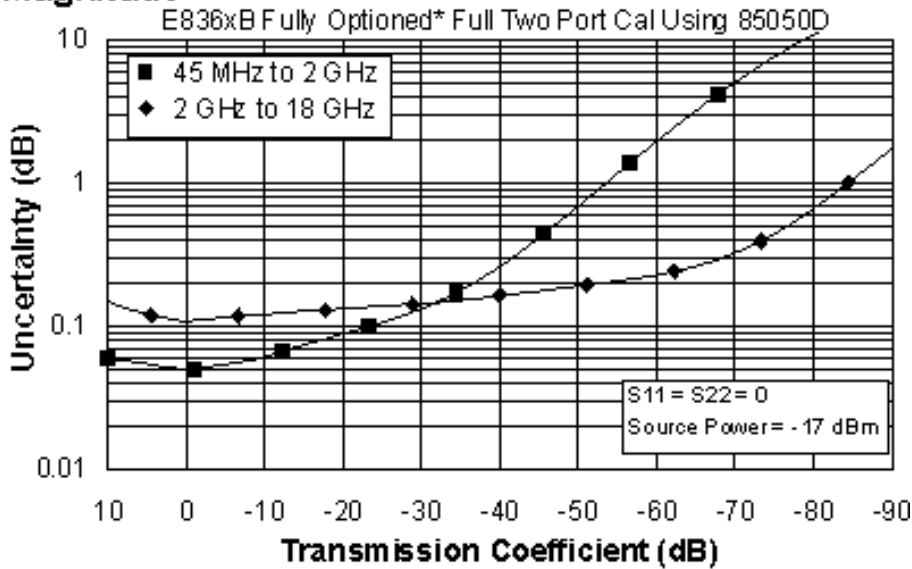

Phase

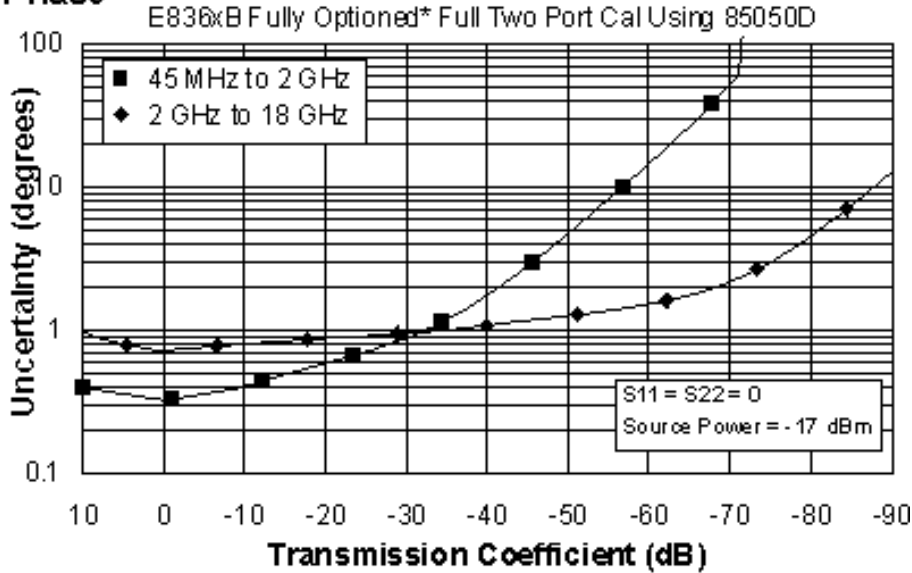

*Configurable Test Set, Extended Power Range & Bias-Tees, Receiver Attenuators, Frequency Offset Mode, and Reference Channel Transfer Switch (E836xB/C - Option 014, UNL, 016, 080, and 081)

Reflection Uncertainty (Specifications)

Magnitude

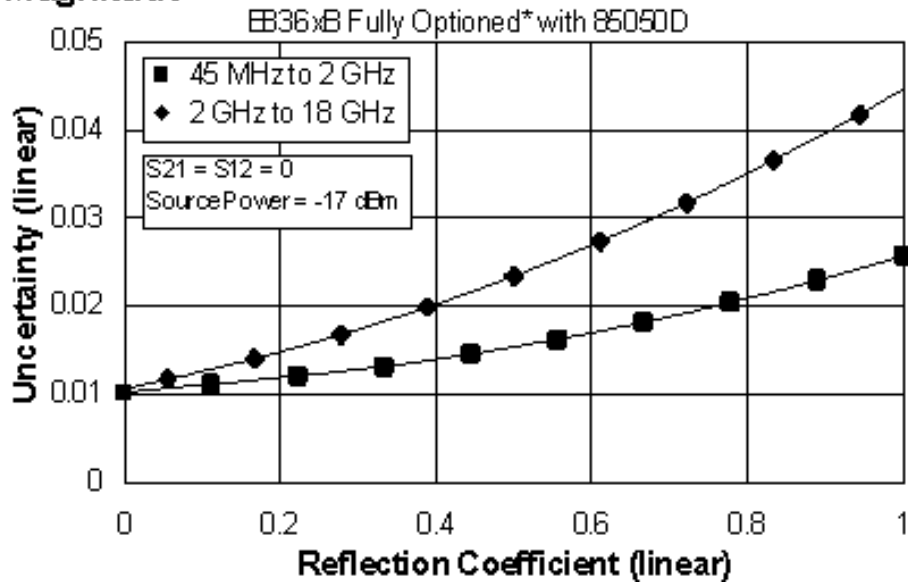

Phase

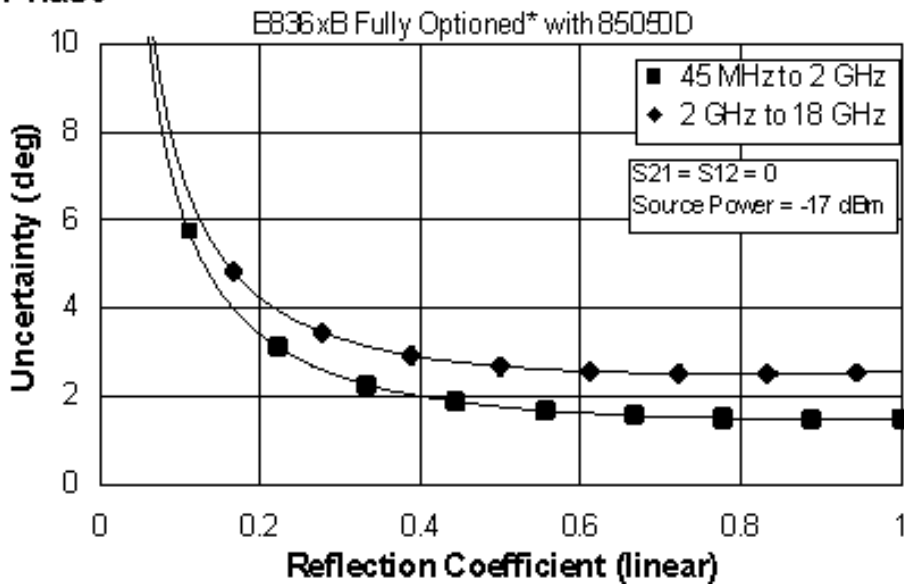

*Configurable Test Set, Extended Power Range & Bias-Tees, Receiver Attenuators, Frequency Offset Mode, and Reference Channel Transfer Switch (E836xB/C - Option 014, UNL, 016, 080, and 081)

E836xB/C Corrected System Performance with Type-N Connectors

Table 21. 85054B Calibration Kit
Standard Configuration and Standard Power Range
(E836xB/C)

Applies to the, E836xB/C analyzers, 85054B (Type-N) calibration kit, 85132F flexible test port cable set with 85130C adapter set, and a full 2-port calibration. Also applies to the following condition:

Environmental temperature $23^{\circ} \pm 3^{\circ} \text{C}$, with $< 1^{\circ} \text{C}$ deviation from calibration temperature

| Description | Specification (dB) | |
|-----------------------|---|---|
| | 0.045 to 2 GHz | 2 to 18 GHz |
| Directivity | 48 | 42 |
| Source Match | 45 | 33 |
| Load Match | 48 | 41 |
| Reflection Tracking | ± 0.001 $+0.02/^{\circ}\text{C}$ | ± 0.015 $+0.02/^{\circ}\text{C}$ |
| Transmission Tracking | ± 0.006 $+0.02/^{\circ}\text{C}$ | ± 0.079 $+0.02/^{\circ}\text{C}$ |

NOTE: The following graphs also apply to the “C” model of the analyzers.

Transmission Uncertainty (Specifications)

Magnitude

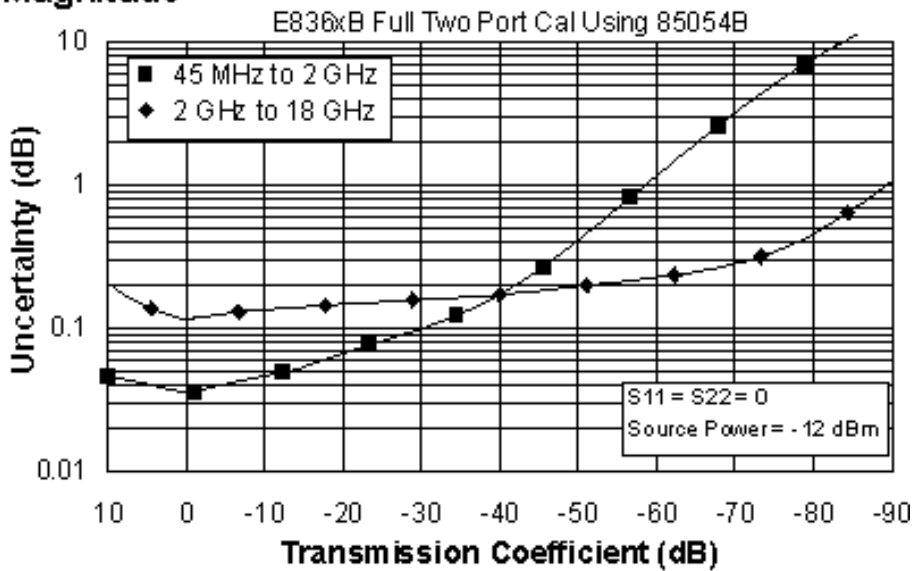

Phase

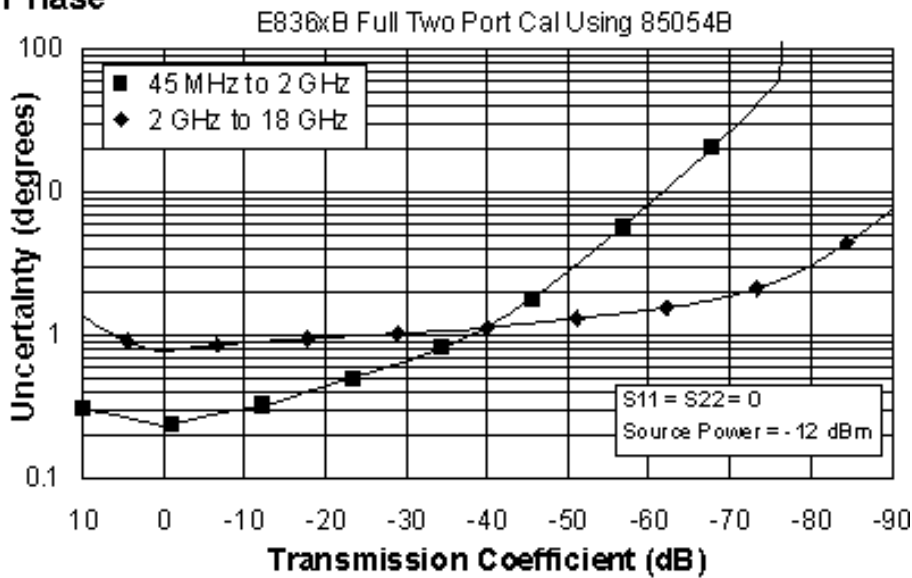

Reflection Uncertainty (Specifications)

Magnitude

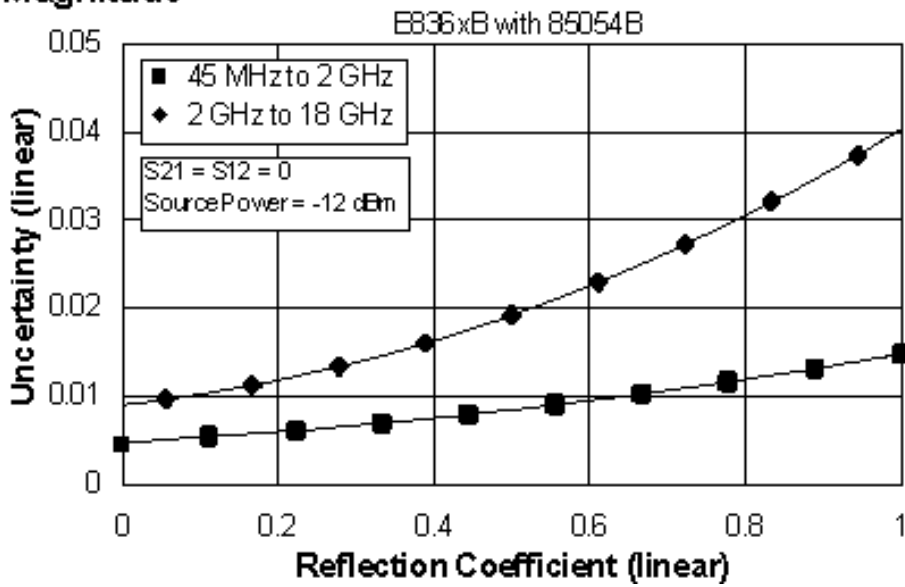

Phase

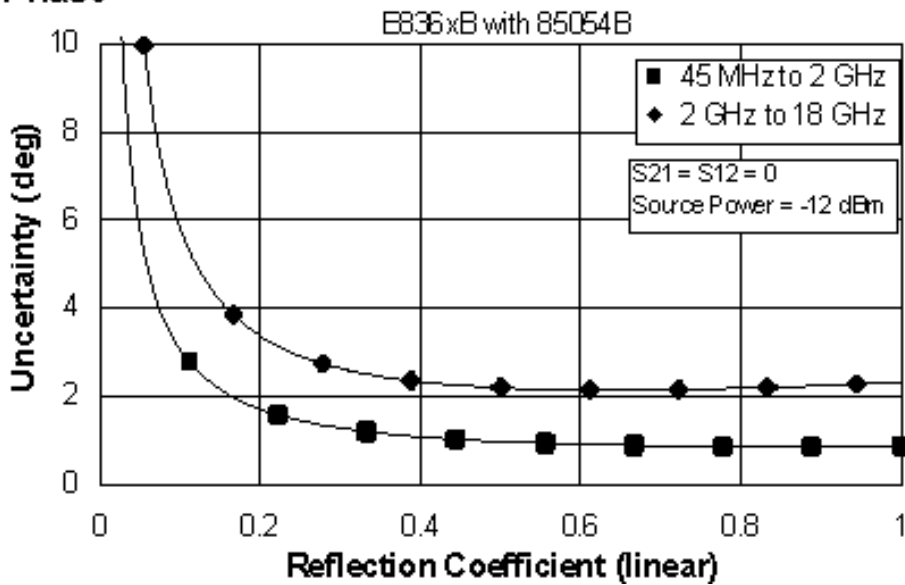

Table 22. 85054B Calibration Kit

Fully Optioned (E836xB/C - Option 014, UNL, 016, 080, and 081)

Configurable Test Set, Extended Power Range & Bias-Tees, Receiver Attenuators, Frequency Offset Mode, and Reference Channel Transfer Switch

Applies to the, E836xB/C analyzers, 85054B (Type-N) calibration kit, 85132F flexible test port cable set with 85130C adapter set, and a full 2-port calibration. Also applies to the following condition:

Environmental temperature 23° ±3 °C, with < 1 °C deviation from calibration temperature

| Description | Specification (dB) | |
|-----------------------|--------------------|--------------------|
| | 0.045 to 2 GHz | 2 to 18 GHz |
| Directivity | 48 | 42 |
| Source Match | 45 | 33 |
| Load Match | 48 | 41 |
| Reflection Tracking | ±0.001 +0.02/°C | ±0.015 +0.02/°C |
| Transmission Tracking | ±0.011 +0.02/°C | ±0.083 +0.02/°C |

NOTE: The following graphs also apply to the “C” model of the analyzers.

Transmission Uncertainty (Specifications)

Magnitude

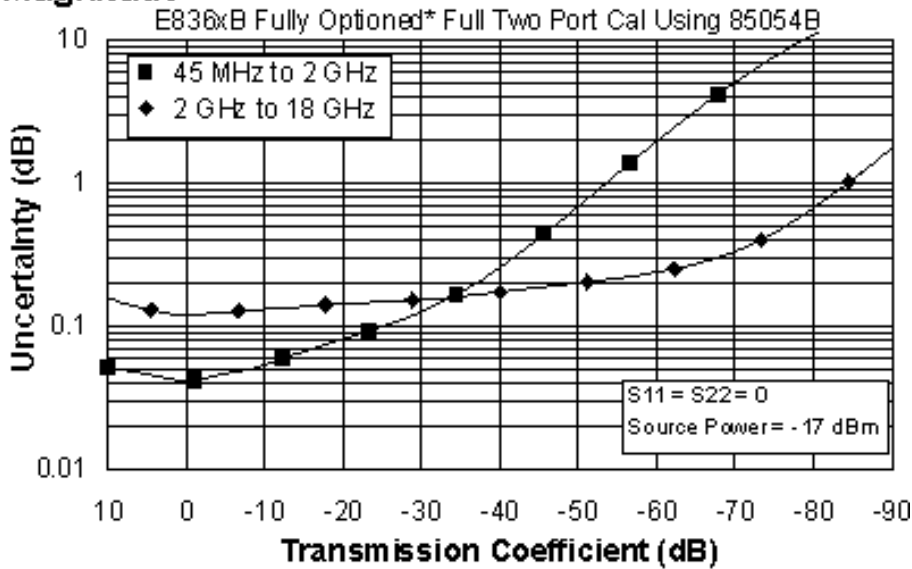

Phase

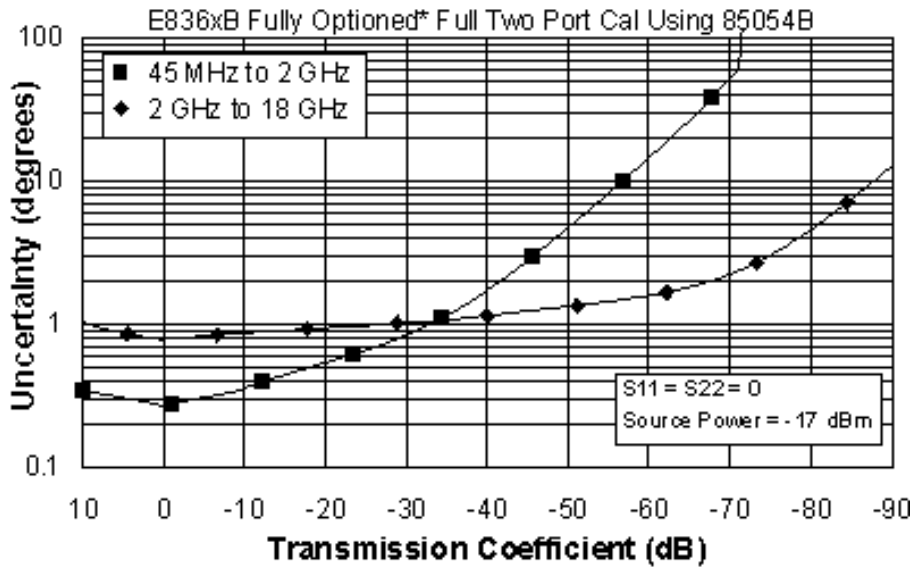

* Configurable Test Set, Extended Power Range & Bias-Tees, Receiver Attenuators, Frequency Offset Mode, and Reference Channel Transfer Switch
(E836xB/C - Option 014, UNL, 016, 080, and 081)

Reflection Uncertainty (Specifications)

Magnitude

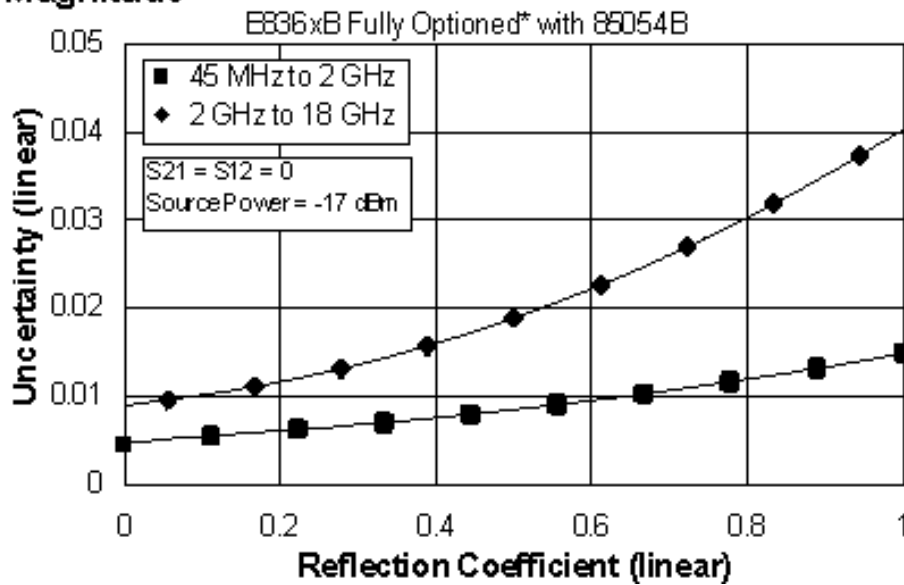

Phase

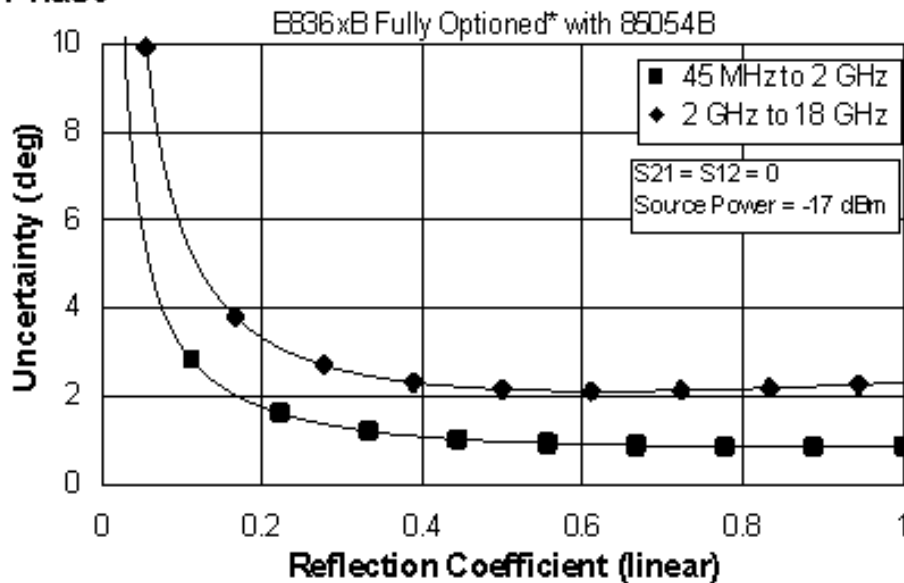

* Configurable Test Set, Extended Power Range & Bias-Tees, Receiver Attenuators, Frequency Offset Mode, and Reference Channel Transfer Switch
 (E836xB/C - Option 014, UNL, 016, 080, and 081)

Table 23. 85054D Calibration Kit
Standard Configuration and Standard Power Range
(E836xB/C)

Applies to the, E836xB/C analyzers, 85054D (Type-N) calibration kit, 85132F flexible test port cable set with 85130C adapter set, and a full 2-port calibration. Also applies to the following condition:

Environmental temperature 23° ±3 °C, with < 1 °C deviation from calibration temperature

| Description | Specification (dB) | |
|-----------------------|--------------------|--------------------|
| | 0.045 to 2 GHz | 2 to 18 GHz |
| Directivity | 40 | 34 |
| Source Match | 39 | 29 |
| Load Match | 40 | 34 |
| Reflection Tracking | ±0.003 +0.02/°C | ±0.027 +0.02/°C |
| Transmission Tracking | ±0.013 +0.02/°C | ±0.136 +0.02/°C |

NOTE: The following graphs also apply to the “C” model of the analyzers.

Transmission Uncertainty (Specifications)

Magnitude

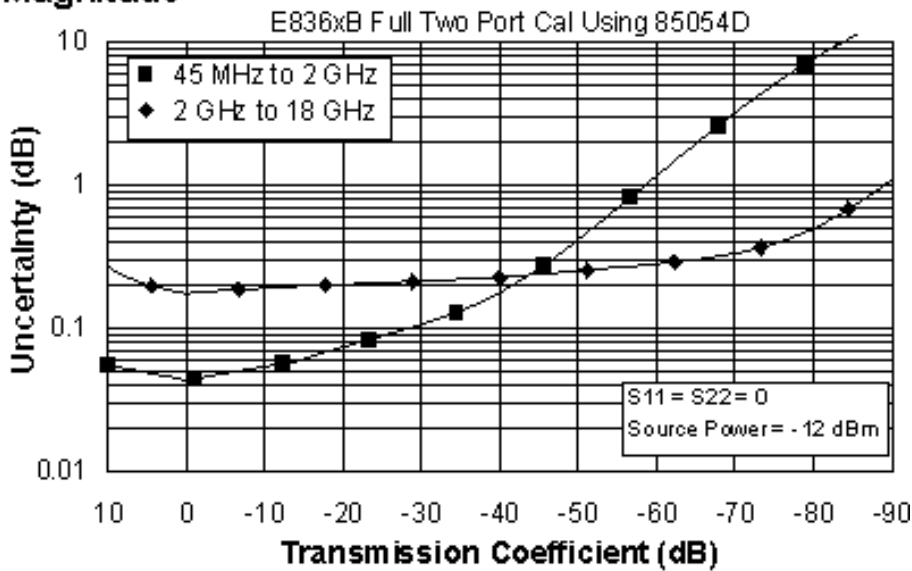

Phase

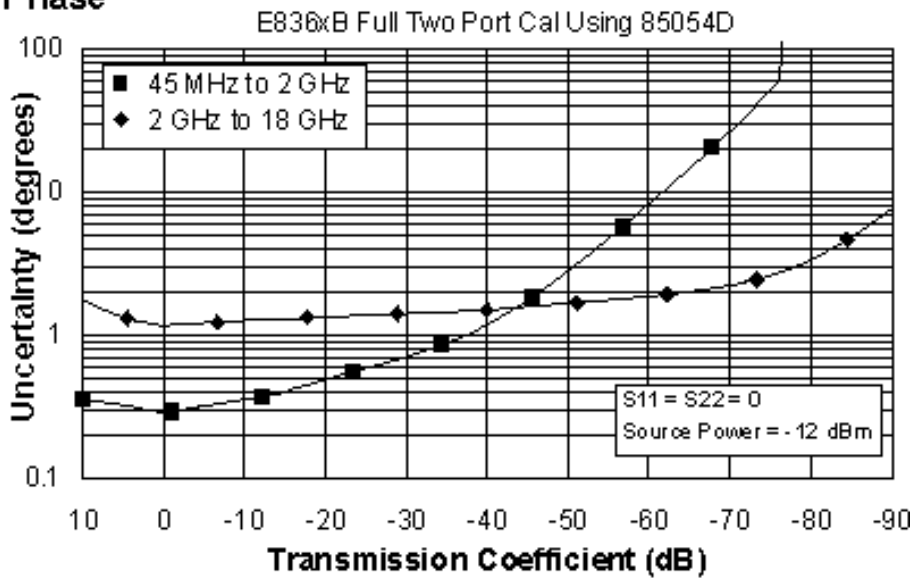

Reflection Uncertainty (Specifications)

Magnitude

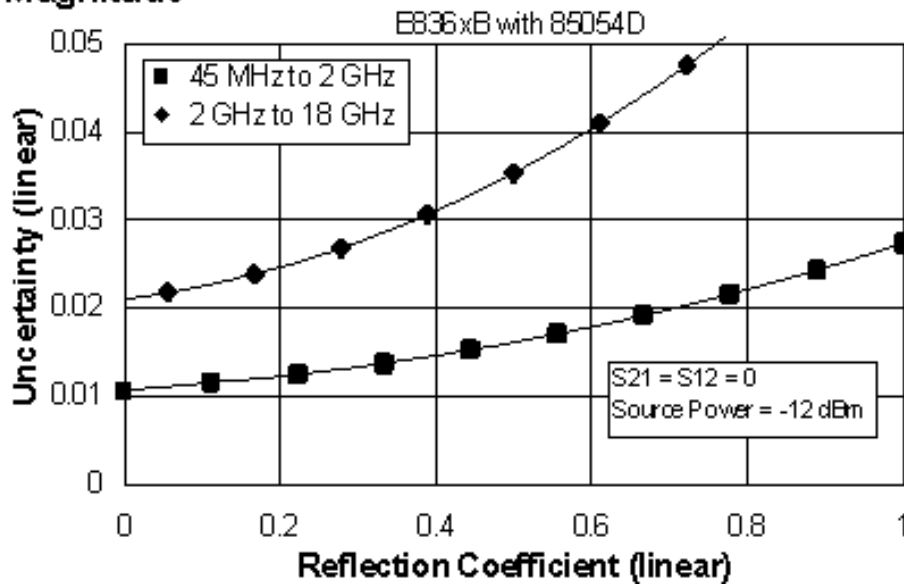

Phase

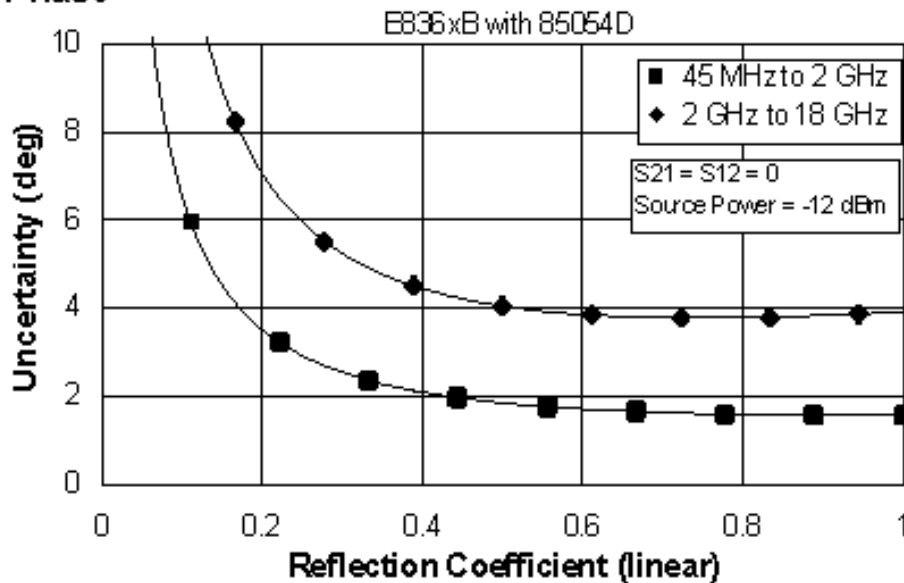

Table 24. 85054D Calibration Kit

Fully Optioned (E836xB/C - Option 014, UNL, 016, 080, and 081)

Configurable Test Set, Extended Power Range & Bias-Tees, Receiver Attenuators, Frequency Offset Mode, and Reference Channel Transfer Switch

Applies to the, E836xB/C analyzers, 85054D (Type-N) calibration kit, 85132F flexible test port cable set with 85130C adapter set, and a full 2-port calibration. Also applies to the following condition:

Environmental temperature 23° ±3 °C, with < 1 °C deviation from calibration temperature

| Description | Specification (dB) | |
|-----------------------|--------------------|--------------------|
| | 0.045 to 2 GHz | 2 to 18 GHz |
| Directivity | 40 | 34 |
| Source Match | 39 | 29 |
| Load Match | 40 | 34 |
| Reflection Tracking | ±0.003 +0.02/°C | ±0.027 +0.02/°C |
| Transmission Tracking | ±0.025 +0.02/°C | ±0.145 +0.02/°C |

NOTE: The following graphs also apply to the “C” model of the analyzers.

Transmission Uncertainty (Specifications)

Magnitude

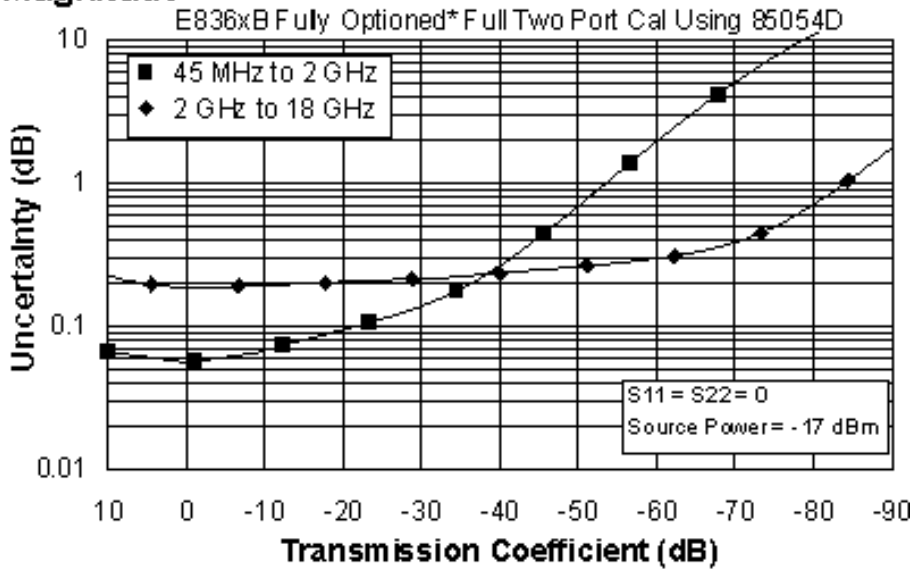

Phase

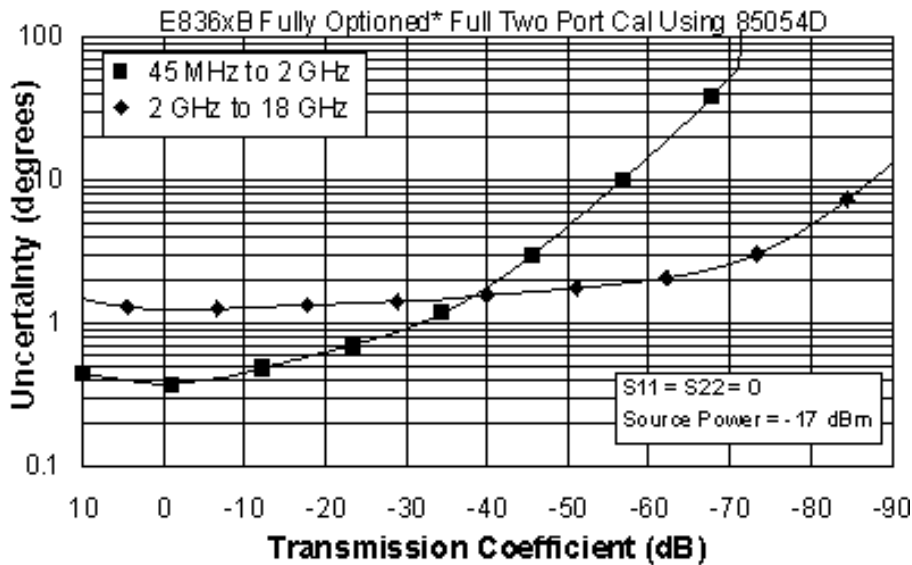

* Configurable Test Set, Extended Power Range & Bias-Tees, Receiver Attenuators, Frequency Offset Mode, and Reference Channel Transfer Switch (E836xB/C - Option 014, UNL, 016, 080, and 081)

Reflection Uncertainty (Specifications)

Magnitude

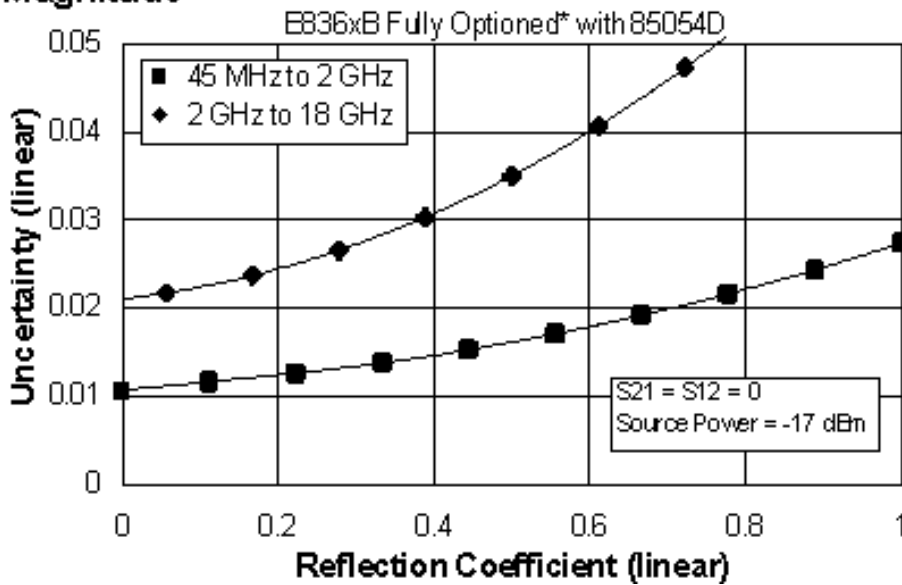

Phase

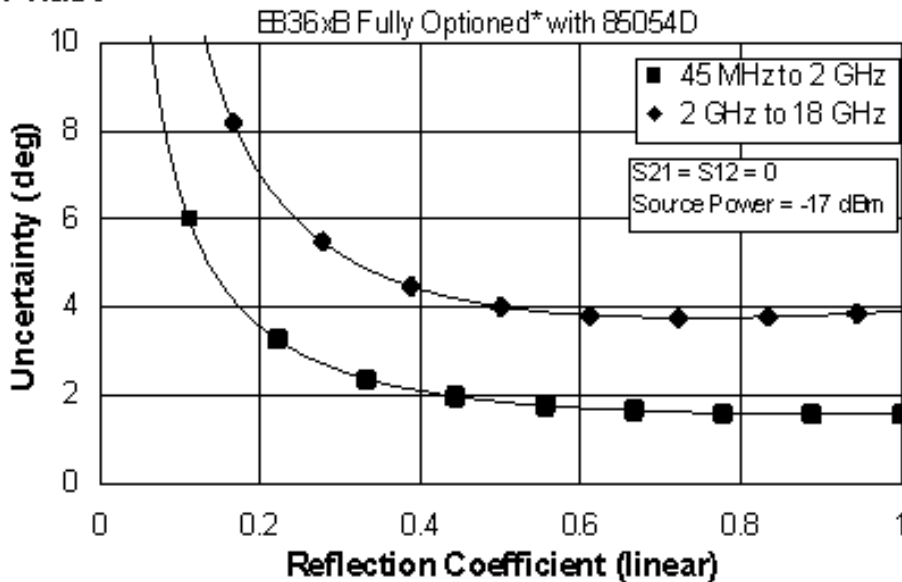

* Configurable Test Set, Extended Power Range & Bias-Tees, Receiver Attenuators, Frequency Offset Mode, and Reference Channel Transfer Switch (E836xB/C - Option 014, UNL, 016, 080, and 081)

E8363B/C AND E8364B/C Corrected System Performance with WR-28 Connectors

Table 25. R11644A Calibration Kit
Standard Configuration and Standard Power Range
(E8363B/C AND E8364B/C)

Applies to the, E8363B/C AND E8364B/C analyzers, R11644A (WR-28) calibration kit, 85133F flexible test port cable set with the R281A and R281B launch sets, and a full 2-port calibration. Also applies to the following condition:

Environmental temperature $23^{\circ} \pm 3^{\circ} \text{C}$, with $< 1^{\circ} \text{C}$ deviation from calibration temperature

| Description | Specification (dB) |
|-----------------------|---------------------------|
| | 26.5 to |
| | 40 GHz |
| Directivity | 50 |
| Source Match | 50 |
| Load Match | 50 |
| Reflection Tracking | ± 0.000 |
| | $+0.03/^{\circ}\text{C}$ |
| Transmission Tracking | ± 0.018 |
| | $+0.03/^{\circ}\text{C}$ |

NOTE: The following graphs also apply to the "C" model of the analyzers.

Transmission Uncertainty (Specifications)

Magnitude

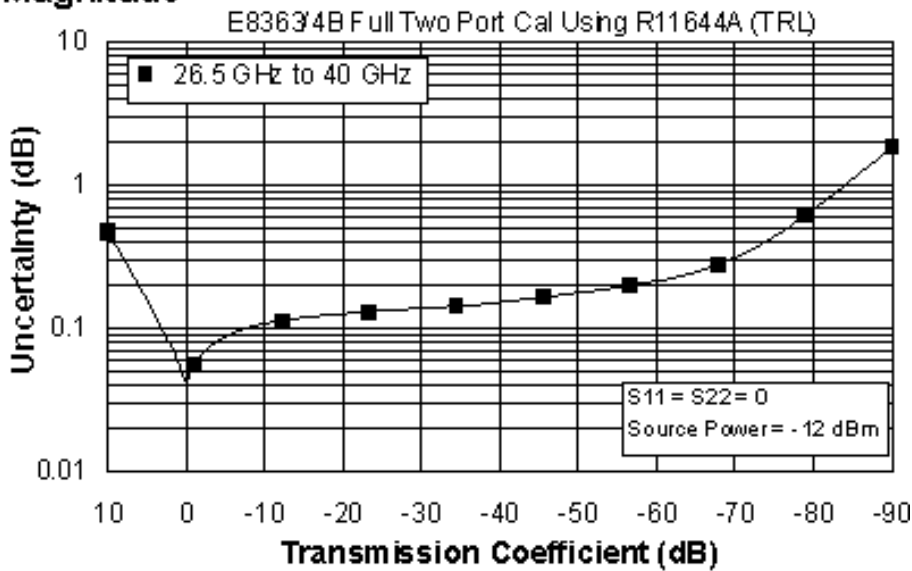

Phase

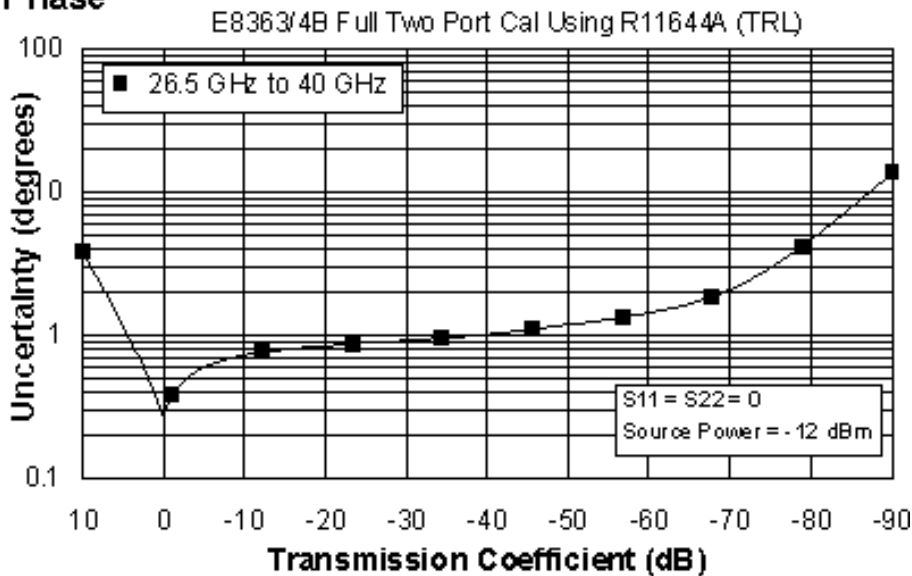

Reflection Uncertainty (Specifications)

Magnitude

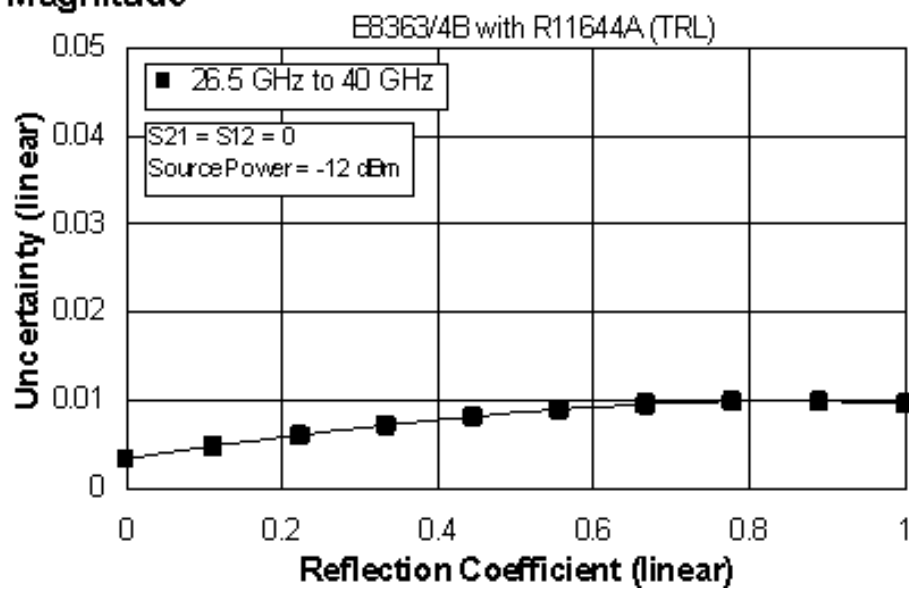

Phase

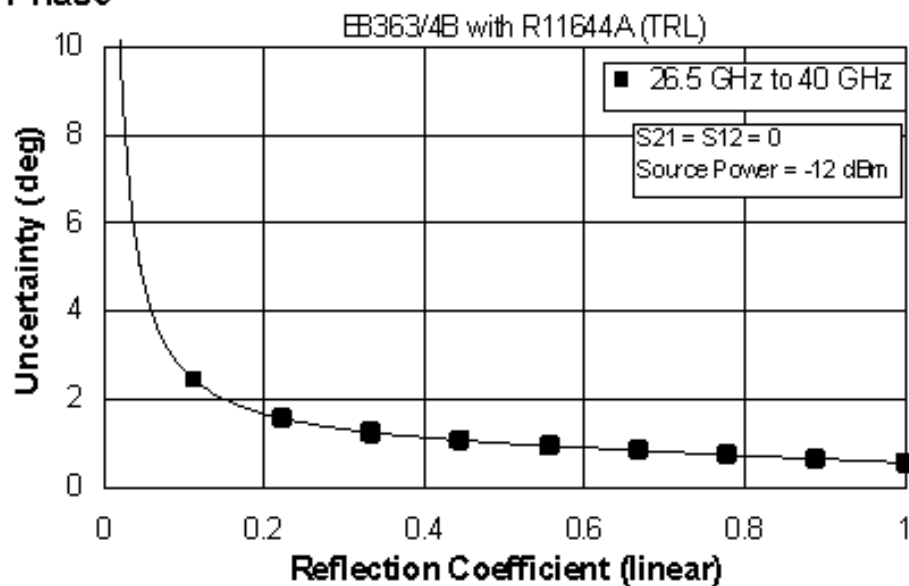

Table 26. R11644A Calibration Kit

Fully Optioned (E836xB/C - Option 014, UNL, 016, 080, and 081)

Configurable Test Set, Extended Power Range & Bias-Tees, Receiver Attenuators, Frequency Offset Mode, and Reference Channel Transfer Switch

Applies to the, E8363B/C AND E8364B/C analyzers, R11644A (WR-28) calibration kit, 85133F flexible test port cable set with the R281A and R281B launch sets, and a full 2-port calibration. Also applies to the following condition:

Environmental temperature 23° ±3 °C, with < 1 °C deviation from calibration temperature

| Description | Specification (dB) |
|-----------------------|---------------------------|
| | 26.5 to 40 GHz |
| Directivity | 50 |
| Source Match | 50 |
| Load Match | 50 |
| Reflection Tracking | ±0.000 |
| | +0.03/°C |
| Transmission Tracking | ±0.019 |
| | +0.03/°C |

NOTE: The following graphs also apply to the “C” model of the analyzers.

Transmission Uncertainty (Specifications)

Magnitude

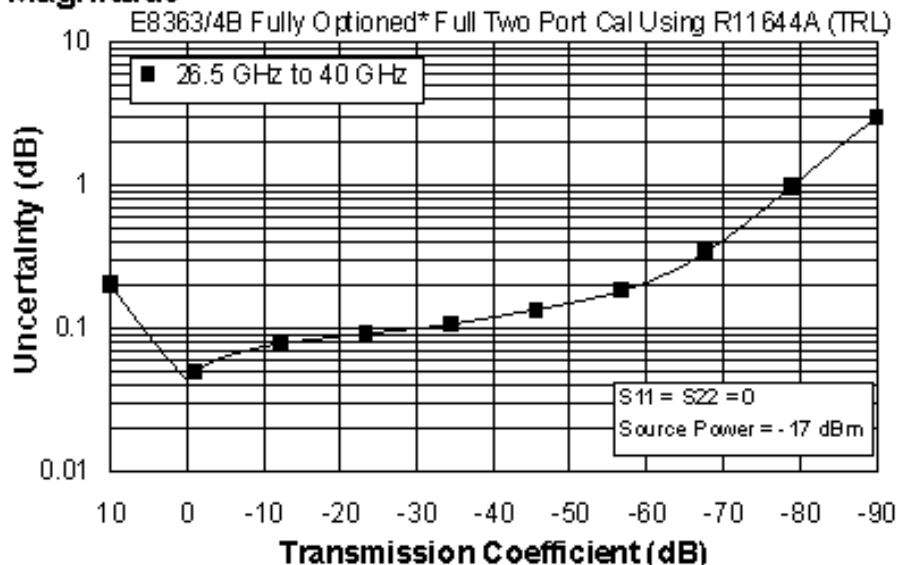

Phase

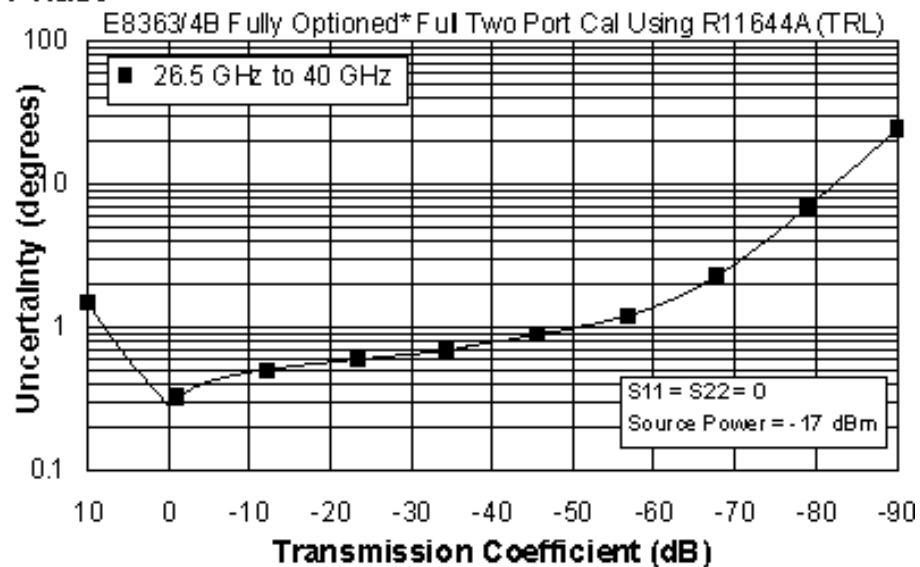

* Configurable Test Set, Extended Power Range & Bias-Tees, Receiver Attenuators, Frequency Offset Mode, and Reference Channel Transfer Switch (E836xB/C - Option 014, UNL, 016, 080, and 081)

Reflection Uncertainty (Specifications)

Magnitude

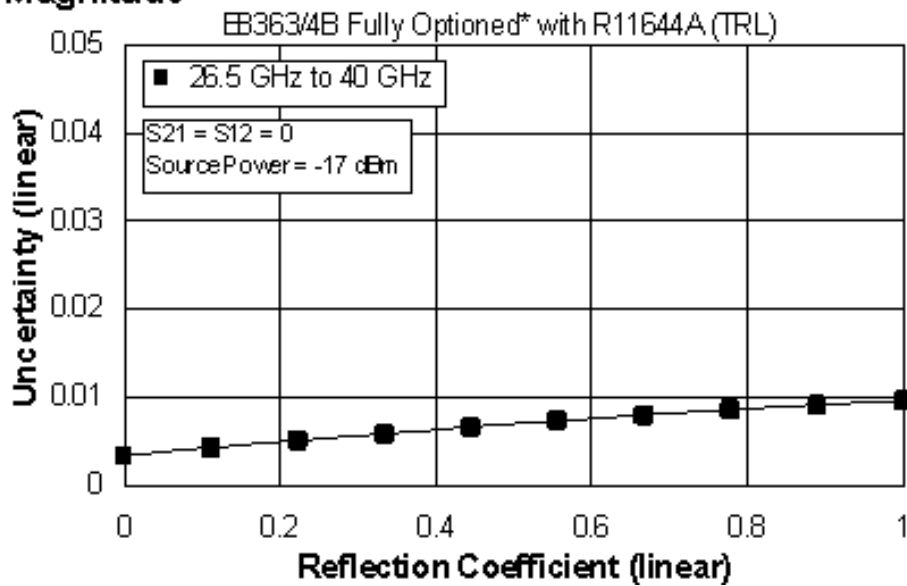

Phase

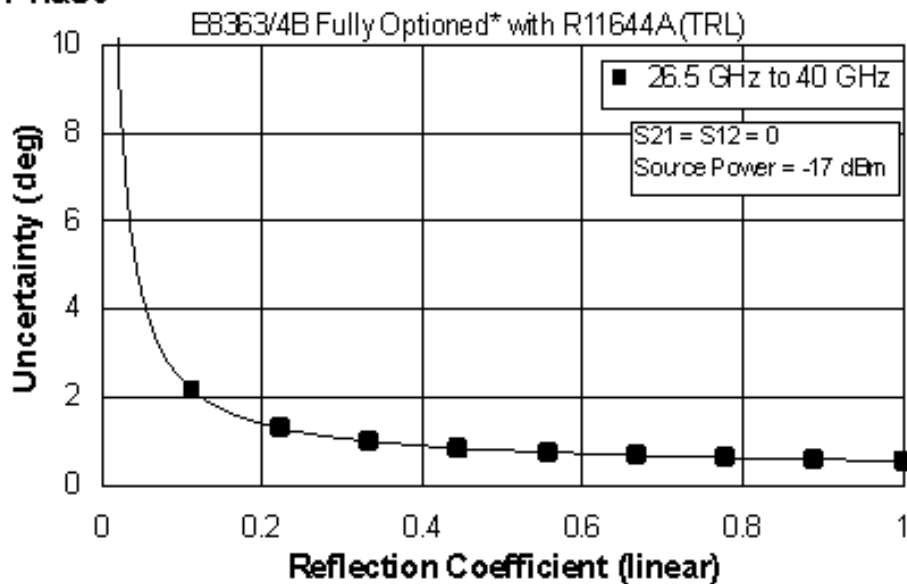

* Configurable Test Set, Extended Power Range & Bias-Tees, Receiver Attenuators, Frequency Offset Mode, and Reference Channel Transfer Switch (E836xB/C - Option 014, UNL, 016, 080, and 081)

E8363B/C AND E8364B/C Corrected System Performance with WR-42 Connectors

Table 27. K11644A Calibration Kit

Standard Configuration and Standard Power Range
(E8363B/C AND E8364B/C)

Applies to the, E8363B/C AND E8364B/C analyzers, K11644A (WR-42) calibration kit, 85134F flexible test port cable set with the K281C launch set, and a full 2-port calibration. Also applies to the following condition:

Environmental temperature $23^{\circ} \pm 3^{\circ} \text{C}$, with $< 1^{\circ} \text{C}$ deviation from calibration temperature

| Description | Specification (dB) | |
|-----------------------|---|---|
| | 18 to 20 GHz | 20 to 26.5 GHz |
| Directivity | 50 | 50 |
| Source Match | 50 | 50 |
| Load Match | 50 | 50 |
| Reflection Tracking | ± 0.000 $+0.02/^{\circ}\text{C}$ | ± 0.000 $+0.02/^{\circ}\text{C}$ |
| Transmission Tracking | ± 0.014 $+0.02/^{\circ}\text{C}$ | ± 0.018 $+0.02/^{\circ}\text{C}$ |

NOTE: The following graphs also apply to the “C” model of the analyzers.

Transmission Uncertainty (Specifications)

Magnitude

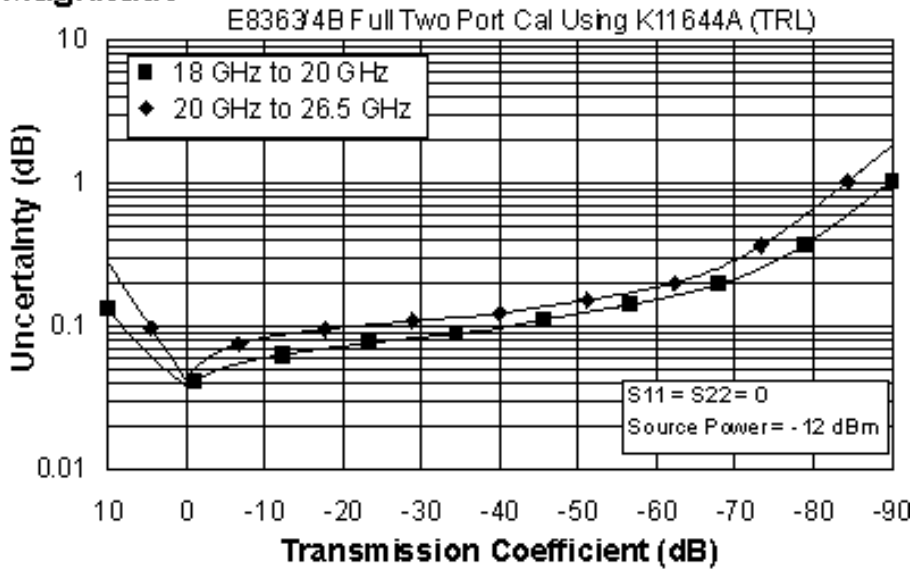

Phase

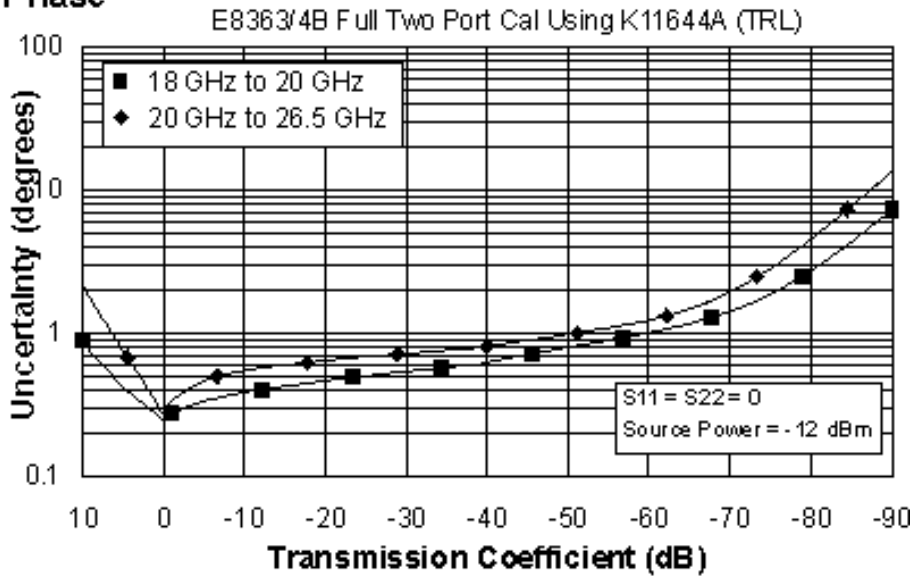

Reflection Uncertainty (Specifications)

Magnitude

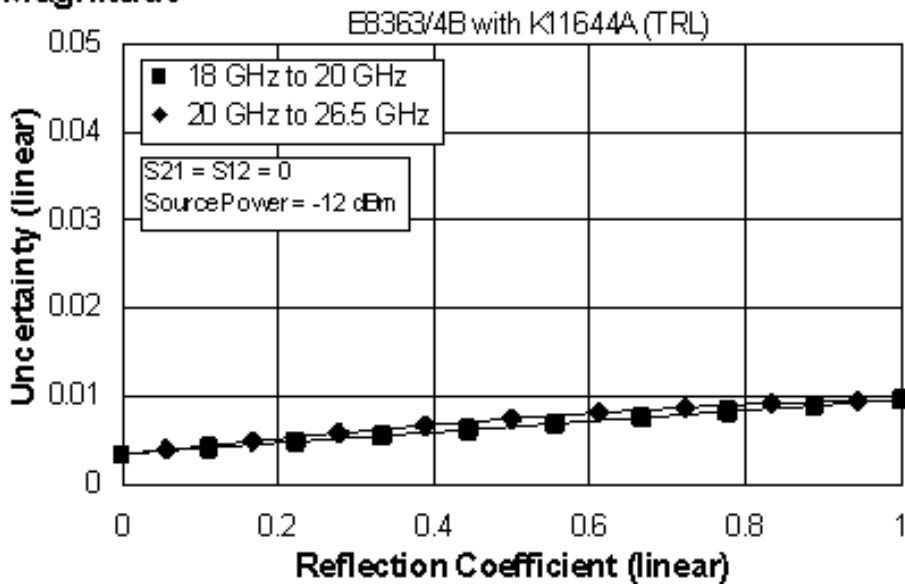

Phase

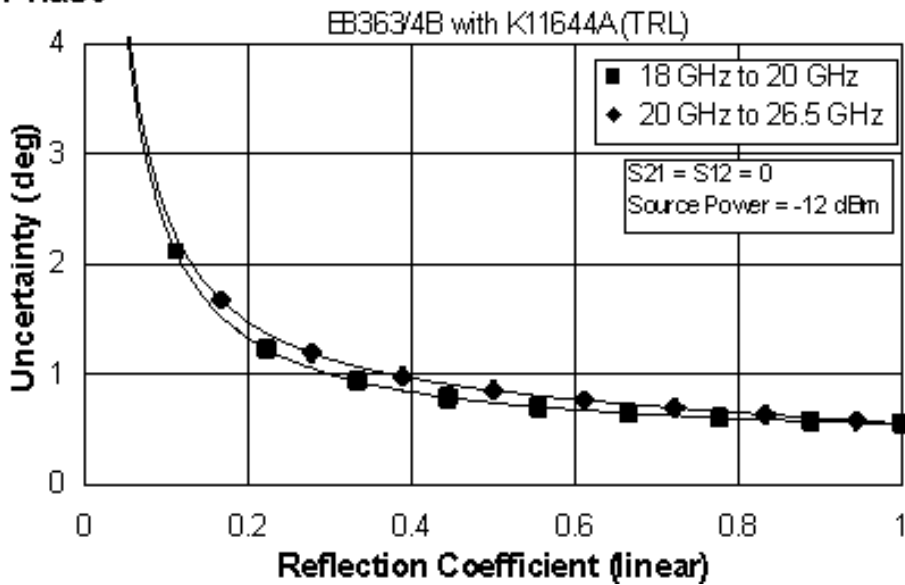

Table 28. K11644A Calibration Kit

Fully Optioned (E836xB/C - Option 014, UNL, 016, 080, and 081)

Configurable Test Set, Extended Power Range & Bias-Tees, Receiver Attenuators, Frequency Offset Mode, and Reference Channel Transfer Switch

Applies to the, E8363B/C AND E8364B/C analyzers, K11644A (WR-42) calibration kit, 85134F flexible test port cable set with the K281C launch set, and a full 2-port calibration. Also applies to the following condition:

Environmental temperature 23° ±3 °C, with < 1 °C deviation from calibration temperature

| Description | Specification (dB) | |
|-----------------------|--------------------|--------------------|
| | 18 to 20 GHz | 20 to 26.5 GHz |
| Directivity | 50 | 50 |
| Source Match | 50 | 50 |
| Load Match | 50 | 50 |
| Reflection Tracking | ±0.000 +0.02/°C | ±0.000 +0.02/°C |
| Transmission Tracking | ±0.016 +0.02/°C | ±0.019 +0.02/°C |

NOTE: The following graphs also apply to the “C” model of the analyzers.

Transmission Uncertainty (Specifications)

Magnitude

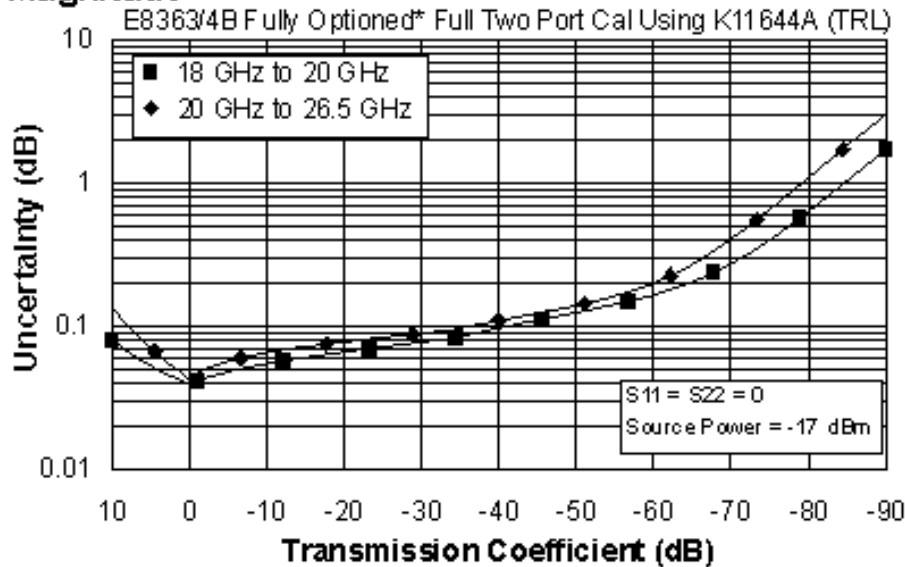

Phase

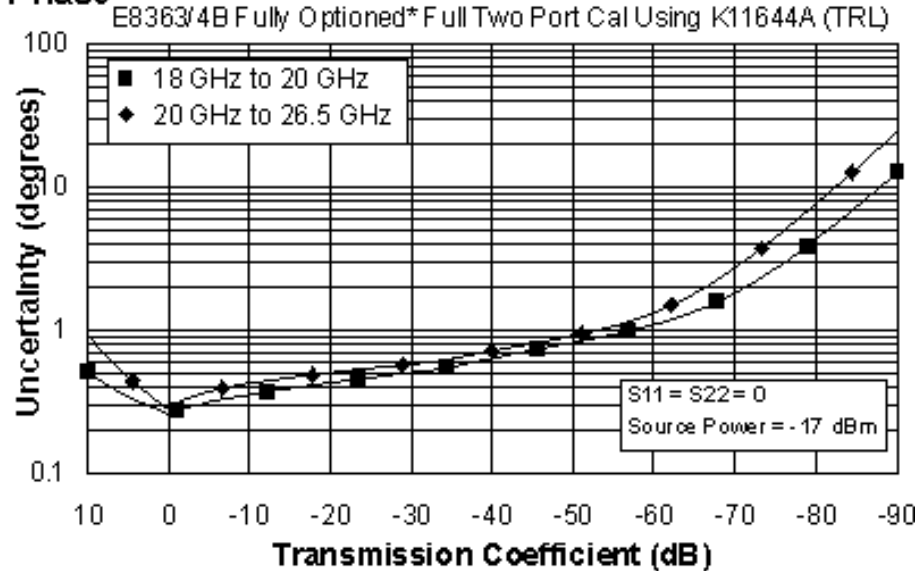

* Configurable Test Set, Extended Power Range & Bias-Tees, Receiver Attenuators, Frequency Offset Mode, and Reference Channel Transfer Switch (E836xB/C - Option 014, UNL, 016, 080, and 081)

Reflection Uncertainty (Specifications)

Magnitude

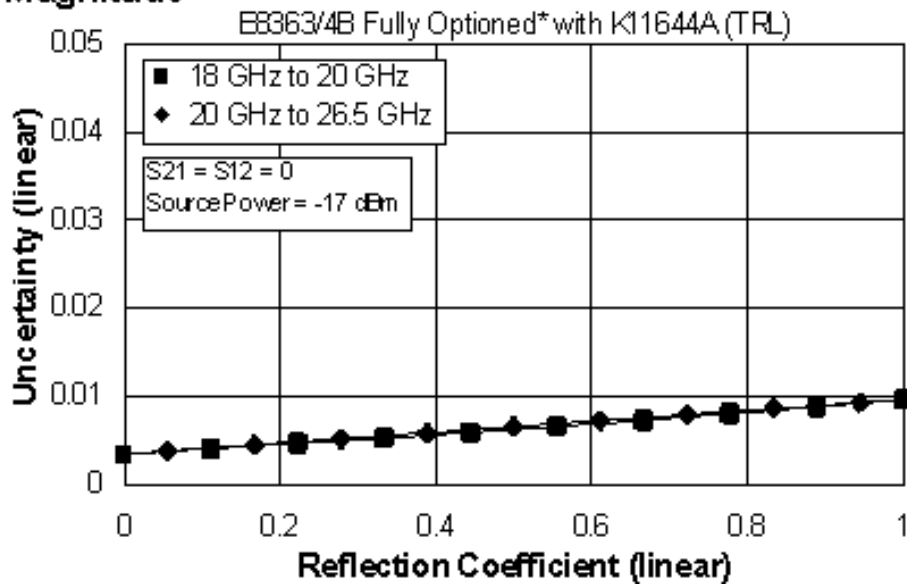

Phase

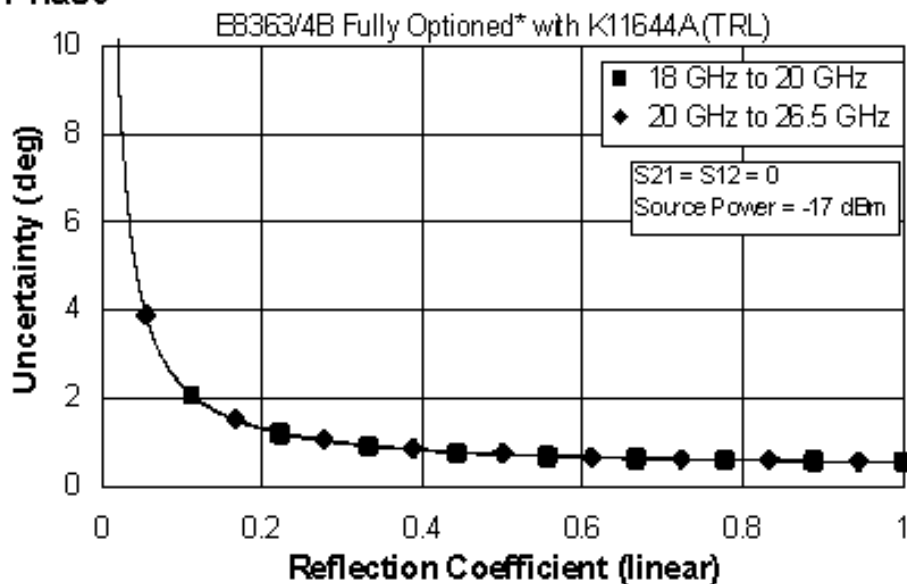

* Configurable Test Set, Extended Power Range & Bias-Tees, Receiver Attenuators, Frequency Offset Mode, and Reference Channel Transfer Switch (E836xB/C - Option 014, UNL, 016, 080, and 081)

E836xB/C Corrected System Performance with WR-62 Connectors

Table 29. P11644A Calibration Kit
Standard Configuration and Standard Power Range
(E836xB/C)

Applies to the, E836xB/C analyzers, P11644A (WR-62) calibration kit, 85132F flexible test port cable set with the P281B and P281C launch sets, and a full 2-port calibration. Also applies to the following condition:

Environmental temperature $23^{\circ} \pm 3^{\circ} \text{C}$, with $< 1^{\circ} \text{C}$ deviation from calibration temperature

| Description | Specification (dB) |
|-----------------------|---|
| | 12.4 to 18 GHz |
| Directivity | 50 |
| Source Match | 50 |
| Load Match | 50 |
| Reflection Tracking | ± 0.000 $+0.02/^{\circ}\text{C}$ |
| Transmission Tracking | ± 0.014 $+0.02/^{\circ}\text{C}$ |

NOTE: The following graphs also apply to the "C" model of the analyzers.

Transmission Uncertainty (Specifications)

Magnitude

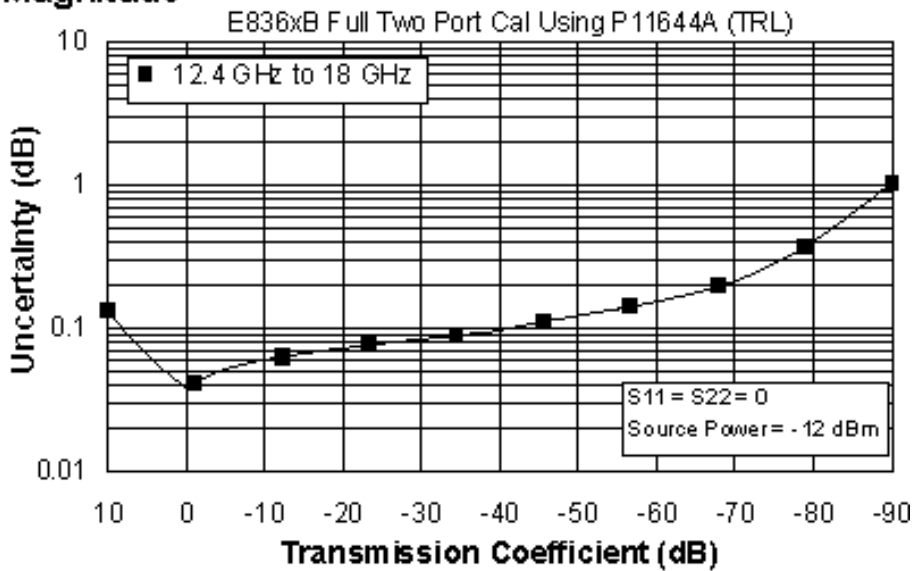

Phase

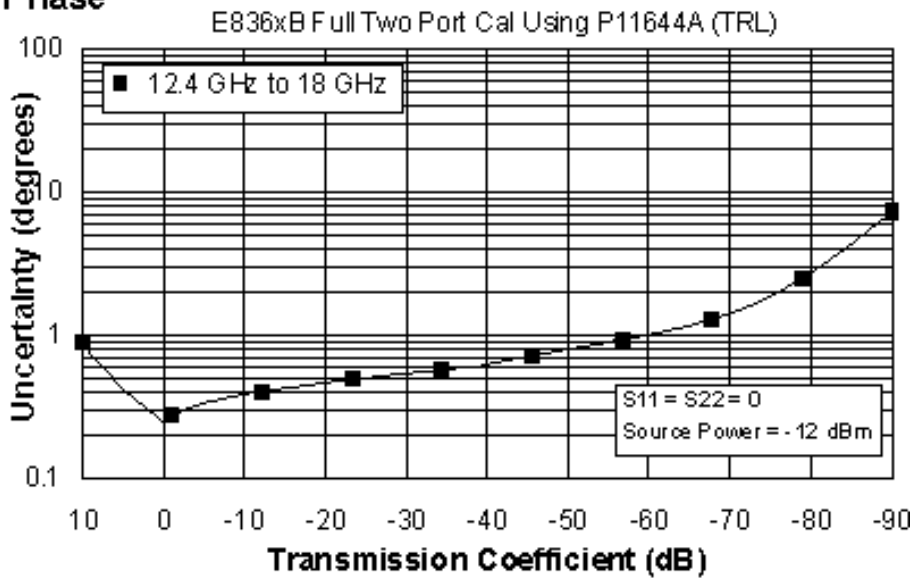

Reflection Uncertainty (Specifications)

Magnitude

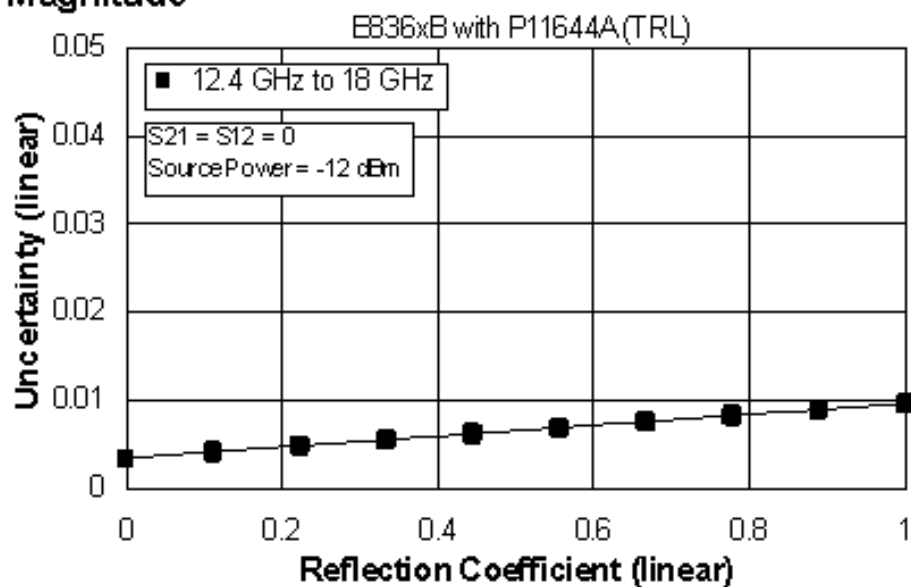

Phase

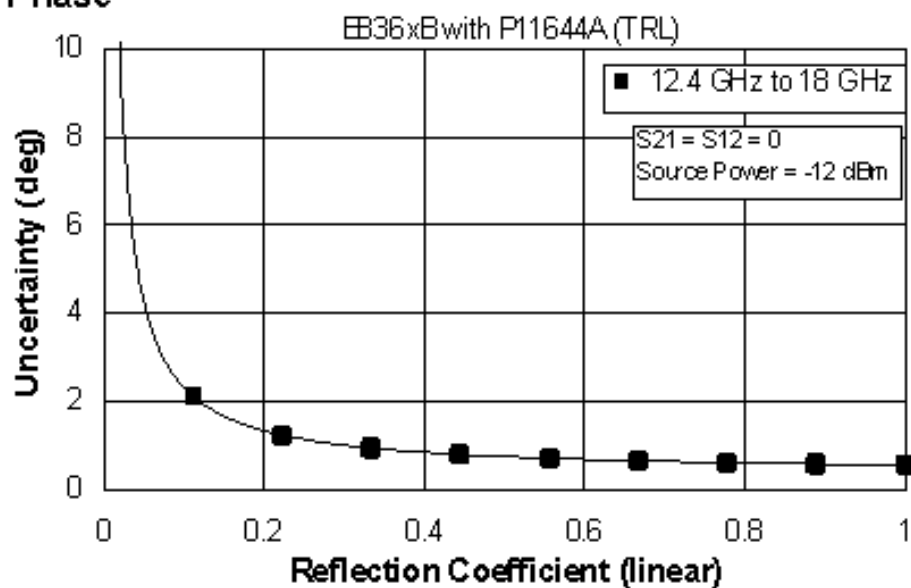

Table 30. P11644A Calibration Kit**Fully Optioned (E836xB/C - Option 014, UNL, 016, 080, and 081)**[Configurable Test Set, Extended Power Range & Bias-Tees, Receiver Attenuators, Frequency Offset Mode, and Reference Channel Transfer Switch](#)

Applies to the, E836xB/C analyzers, P11644A (WR-62) calibration kit, 85132F flexible test port cable set with the P281B and P281C launch sets, and a full 2-port calibration. Also applies to the following condition:

Environmental temperature 23° ±3 °C, with < 1 °C deviation from calibration temperature

| Description | Specification (dB) |
|-----------------------|---------------------------|
| | 12.4 to 18 GHz |
| Directivity | 50 |
| Source Match | 50 |
| Load Match | 50 |
| Reflection Tracking | ±0.000 +0.02/°C |
| Transmission Tracking | ±0.016 +0.02/°C |

NOTE: The following graphs also apply to the “C” model of the analyzers.

Transmission Uncertainty (Specifications)

Magnitude

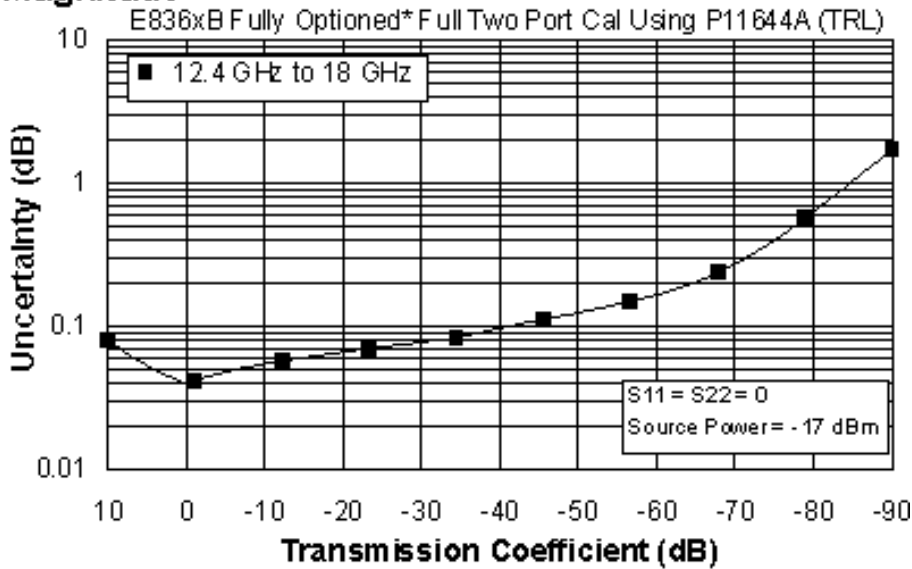

Phase

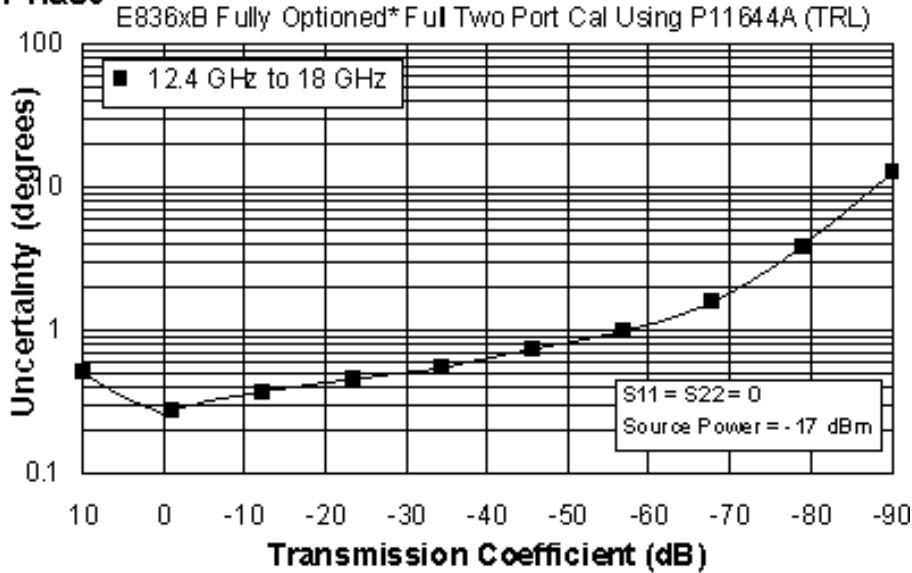

* Configurable Test Set, Extended Power Range & Bias-Tees, Receiver Attenuators, Frequency Offset Mode, and Reference Channel Transfer Switch (E836xB/C - Option 014, UNL, 016, 080, and 081)

Reflection Uncertainty (Specifications)

Magnitude

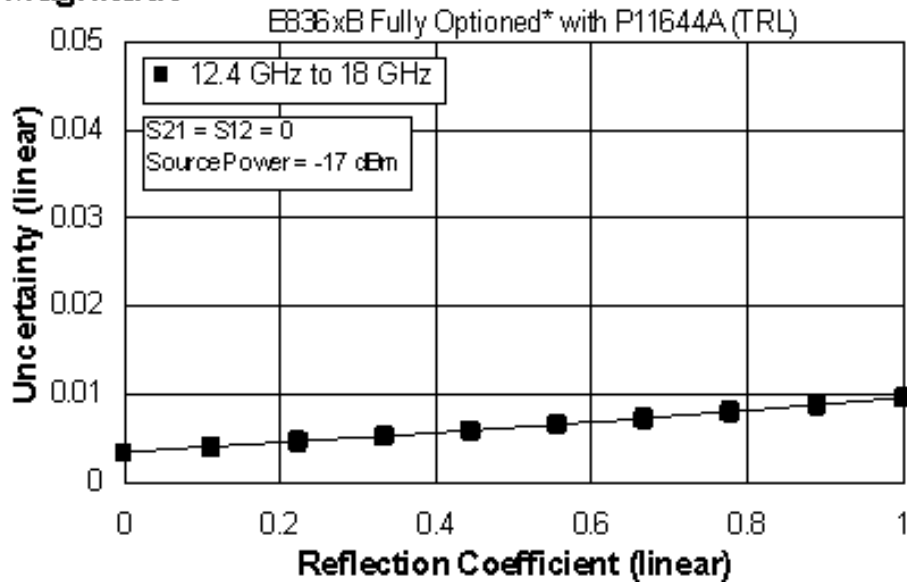

Phase

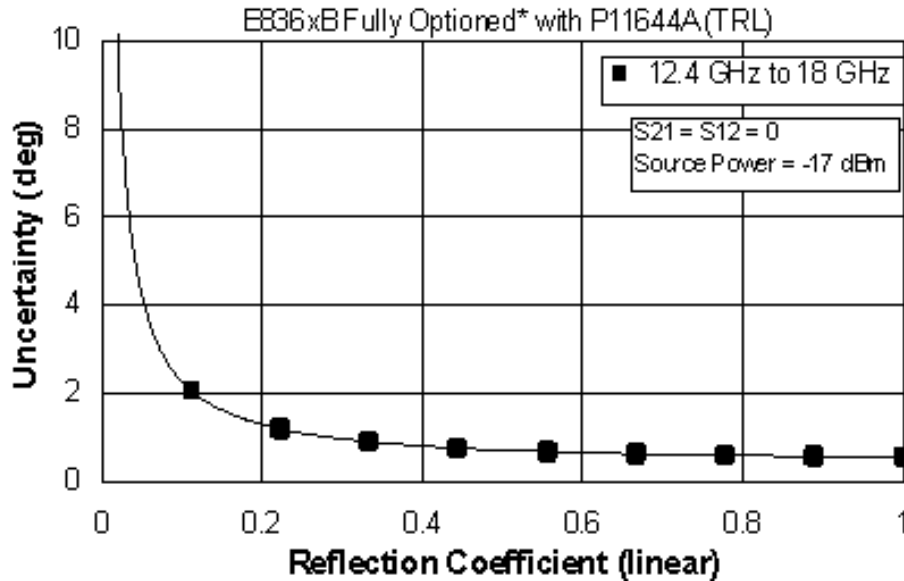

* Configurable Test Set, Extended Power Range & Bias-Tees, Receiver Attenuators, Frequency Offset Mode, and Reference Channel Transfer Switch (E836xB/C - Option 014, UNL, 016, 080, and 081)

E836xB/C Corrected System Performance with WR-90 Connectors

Table 31. X11644A Calibration Kit
Standard Configuration and Standard Power Range
(E836xB/C)

Applies to the, E836xB/C analyzers, X11644A (WR-90) calibration kit, 85133F flexible test port cable set with the X281A and X281C launch sets, and a full 2-port calibration. Also applies to the following condition:

Environmental temperature $23^{\circ} \pm 3^{\circ} \text{C}$, with $< 1^{\circ} \text{C}$ deviation from calibration temperature

| Description | Specification (dB) |
|-----------------------|---|
| | 8.2 to 12.4 GHz |
| Directivity | 50 |
| Source Match | 50 |
| Load Match | 50 |
| Reflection Tracking | ± 0.000 $+0.02/^{\circ}\text{C}$ |
| Transmission Tracking | ± 0.014 $+0.02/^{\circ}\text{C}$ |

NOTE: The following graphs also apply to the “C” model of the analyzers.

Transmission Uncertainty (Specifications)

Magnitude

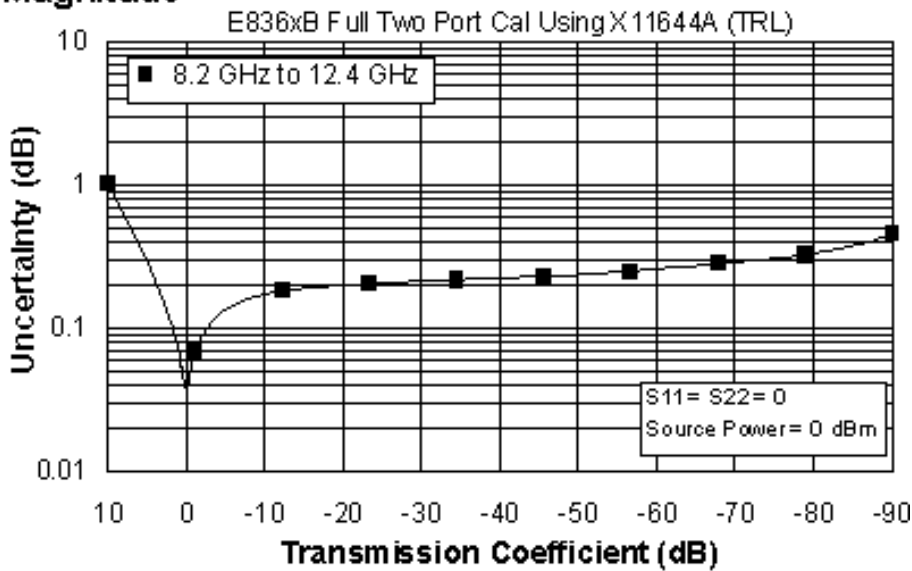

Phase

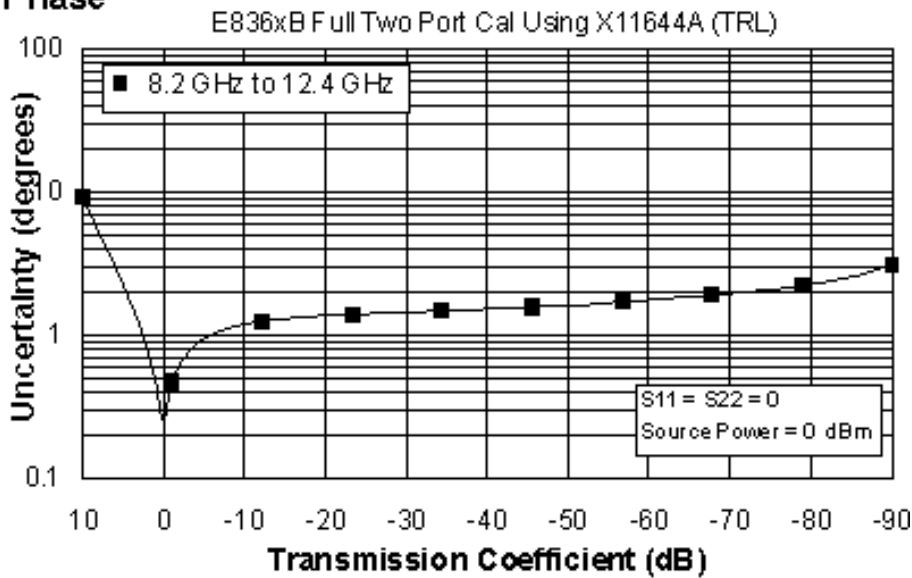

Reflection Uncertainty (Specifications)

Magnitude

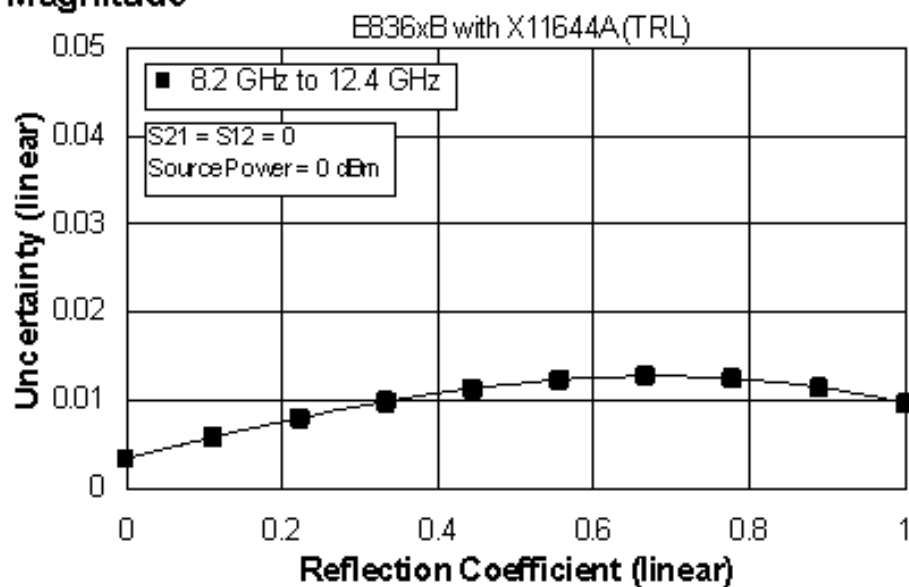

Phase

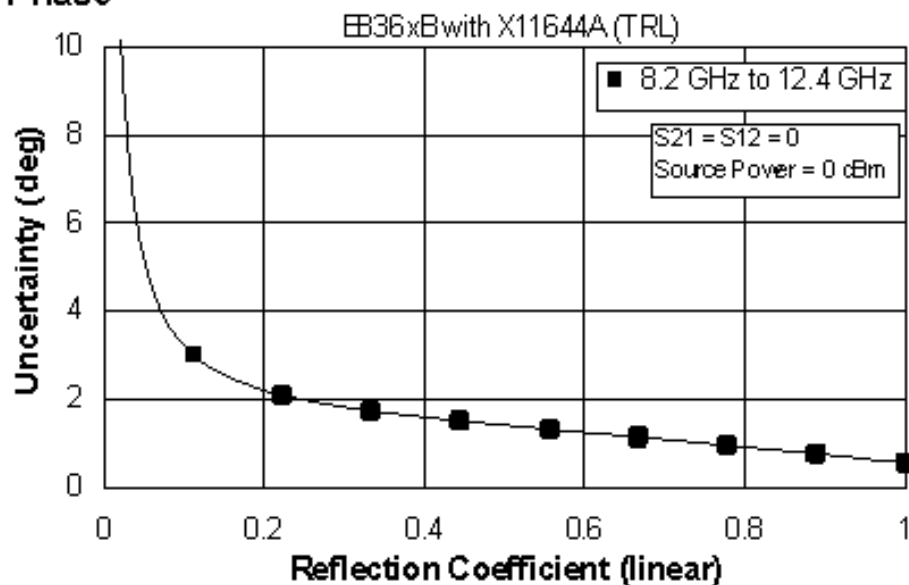

Table 32. X11644A Calibration Kit

Fully Optioned (E836xB/C - Option 014, UNL, 016, 080, and 081)

Configurable Test Set, Extended Power Range & Bias-Tees, Receiver Attenuators, Frequency Offset Mode, and Reference Channel Transfer Switch

Applies to the, E836xB/C analyzers, X11644A (WR-90) calibration kit, 85133F flexible test port cable set with the X281A and X281C launch sets, and a full 2-port calibration. Also applies to the following condition:

Environmental temperature 23° ±3 °C, with < 1 °C deviation from calibration temperature

| Description | Specification (dB) |
|-----------------------|----------------------------|
| | 8.2 to 12.4 GHz |
| Directivity | 50 |
| Source Match | 50 |
| Load Match | 50 |
| Reflection Tracking | ±0.000 +0.02/°C |
| Transmission Tracking | ±0.016 +0.02/°C |

NOTE: The following graphs also apply to the “C” model of the analyzers.

Transmission Uncertainty (Specifications)

Magnitude

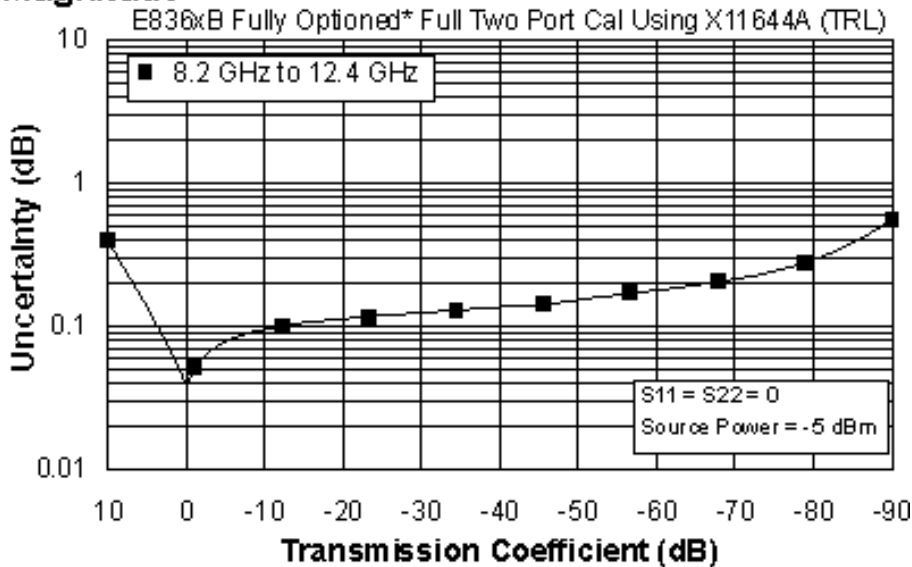

Phase

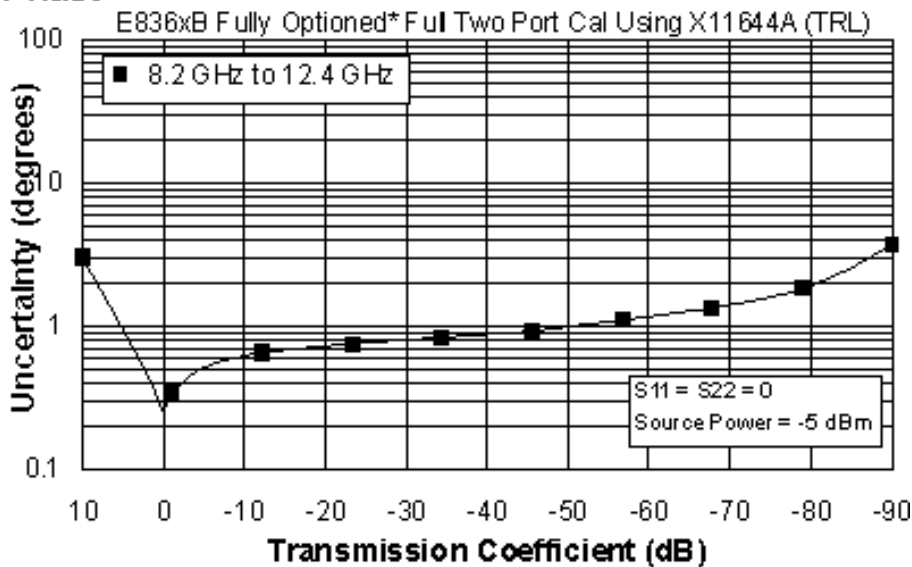

* Configurable Test Set, Extended Power Range & Bias-Tees, Receiver Attenuators, Frequency Offset Mode, and Reference Channel Transfer Switch (E836xB/C - Option 014, UNL, 016, 080, and 081)

Reflection Uncertainty (Specifications)

Magnitude

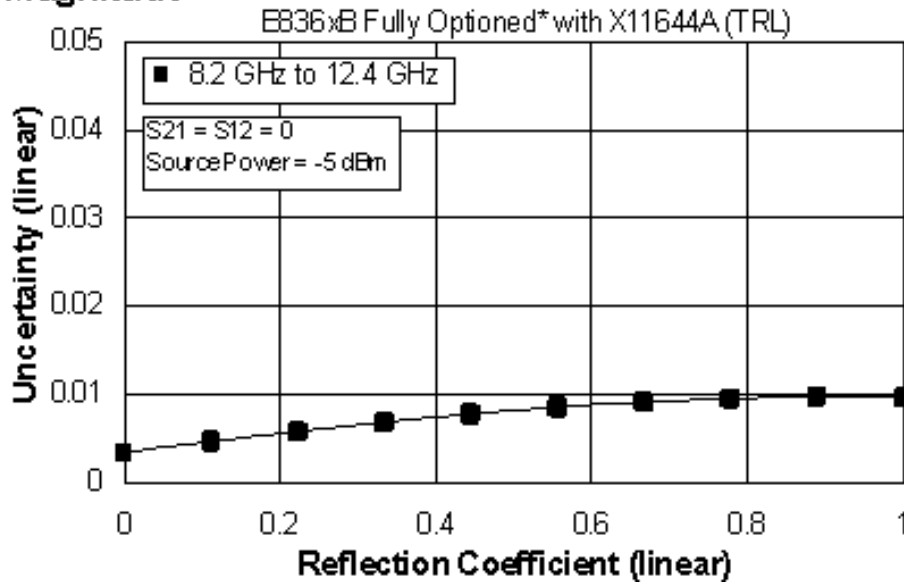

Phase

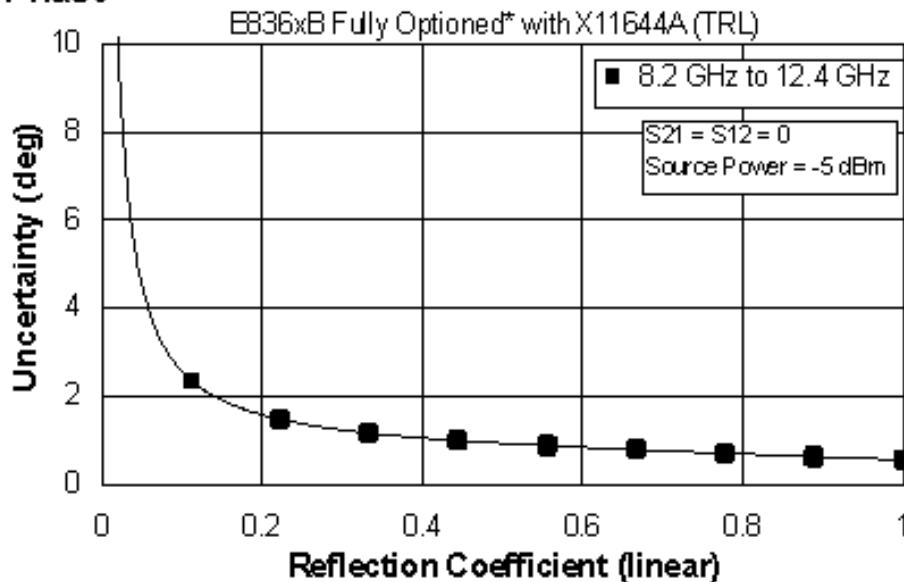

* Configurable Test Set, Extended Power Range & Bias-Tees, Receiver Attenuators, Frequency Offset Mode, and Reference Channel Transfer Switch (E836xB/C - Option 014, UNL, 016, 080, and 081)

Table 33. Uncorrected System Performance^a

Specifications apply over environmental temperature of 23° ±3 °C, with < 1 °C deviation from the calibration temperature

| Description | Specification | Supplemental Information |
|---|---------------|--------------------------|
| Directivity | | |
| 10 MHz to 45 MHz ^b | -- | 11 dB (typical) |
| 45 MHz to 2 GHz | 24 dB | -- |
| 2 GHz to 10 GHz | 22 dB | -- |
| 10 GHz to 20 GHz | 16 dB | -- |
| 20 GHz to 40 GHz | 16 dB | -- |
| 40 GHz to 45 GHz | 15 dB | -- |
| 45 GHz to 50 GHz | 13 dB | -- |
| Source Match - Standard | | |
| 10 MHz to 45 MHz ^b | -- | 11 dB (typical) |
| 45 MHz to 2 GHz | 23 dB | -- |
| 2 GHz to 10 GHz | 16 dB | -- |
| 10 GHz to 20 GHz | 14 dB | -- |
| 20 GHz to 40 GHz | 10 dB | -- |
| 40 GHz to 45 GHz | 9 dB | -- |
| 45 GHz to 50 GHz | 7.5 dB | -- |
| Source Match - Opt UNL, 014 or 014/UNL | | |
| 10 MHz to 45 MHz ^b | -- | 11 dB (typical) |
| 45 MHz to 2 GHz | 18 dB | -- |
| 2 GHz to 10 GHz | 14 dB | -- |
| 10 GHz to 20 GHz | 12 dB | -- |
| 20 GHz to 40 GHz | 9 dB | -- |
| 40 GHz to 45 GHz | 8 dB | -- |
| 45 GHz to 50 GHz | 6 dB | -- |
| Load Match - Standard | | |
| 10 MHz to 45 MHz ^b | -- | 11 dB (typical) |
| 45 MHz to 2 GHz | 23 dB | -- |
| 2 GHz to 10 GHz | 14 dB | -- |
| 10 GHz to 20 GHz | 10 dB | -- |
| 20 GHz to 40 GHz | 9 dB | -- |
| 40 GHz to 45 GHz | 9 dB | -- |
| 45 GHz to 50 GHz | 8 dB | -- |
| Load Match - Opt UNL, 014 or 014/UNL | | |
| 10 MHz to 45 MHz ^b | -- | -- |
| 45 MHz to 2 GHz | 17 dB | -- |
| 2 GHz to 10 GHz | 13 dB | -- |
| 10 GHz to 20 GHz | 10 dB | -- |
| 20 GHz to 40 GHz | 9 dB | -- |
| 40 GHz to 45 GHz | 9 dB | -- |
| 45 GHz to 50 GHz | 7 dB | -- |

Table 33 (Continued). Uncorrected System Performance^a

| Reflection Tracking | | |
|--|---------|------------------|
| | | Typical: |
| 10 MHz to 45 MHz ^b | -- | ±1.5 dB |
| 45 MHz to 20 GHz | -- | ±1.5 dB |
| 20 GHz to 40 GHz | -- | ±1.5 dB |
| 40 GHz to 50 GHz | -- | ±2.0 dB |
| Transmission Tracking^c | | |
| | | Typical: |
| 10 MHz to 45 MHz ^b | -- | ±3.0 dB |
| 45 MHz to 2 GHz | -- | ±1.5 dB |
| 2 GHz to 10 GHz | -- | ±2.0 dB |
| 10 GHz to 20 GHz | -- | ±2.5 dB |
| 20 GHz to 40 GHz | -- | ±3.5 dB |
| 40 GHz to 45 GHz | -- | ±4.0 dB |
| 45 GHz to 50 GHz | -- | ±4.5 dB |
| Crosstalk^d - Standard | | |
| 10 MHz to 45 MHz ^b | -- | -65 dB (typical) |
| 45 MHz to 1 GHz | -85 dB | -- |
| 1 GHz to 2 GHz | -100 dB | -- |
| 2 GHz to 20 GHz | -110 dB | -- |
| 20 GHz to 40 GHz | -108 dB | -- |
| 40 GHz to 45 GHz | -105 dB | -- |
| 45 GHz to 50 GHz | -100 dB | -- |
| Crosstalk^d - Option UNL or 014 | | |
| 10 MHz to 45 MHz ^b | -- | -65 dB (typical) |
| 45 MHz to 1 GHz | -85 dB | -- |
| 1 GHz to 2 GHz | -100 dB | -- |
| 2 GHz to 20 GHz | -109 dB | -- |
| 20 GHz to 40 GHz | -106 dB | -- |
| 40 GHz to 45 GHz | -103 dB | -- |
| 45 GHz to 50 GHz | -98 dB | -- |
| Crosstalk^d - Option 014/UNL | | |
| 10 MHz to 45 MHz ^b | -- | -65 dB (typical) |
| 45 MHz to 1 GHz | -85 dB | -- |
| 1 GHz to 2 GHz | -98 dB | -- |
| 2 GHz to 10 GHz | -108 dB | -- |
| 10 GHz to 20 GHz | -107 dB | -- |
| 20 GHz to 40 GHz | -104 dB | -- |
| 40 GHz to 45 GHz | -100 dB | -- |
| 45 GHz to 50 GHz | -95 dB | -- |

Table 33 (Continued). Uncorrected System Performance^a

| Crosstalk - Option 080 enabled^{b,e} | | |
|---|----|-----------------|
| | | Typical: |
| 10 MHz to 45 MHz | -- | -65 |
| 45 MHz to 1 GHz | -- | -85 |
| 1 GHz to 2 GHz | -- | -100 |
| 2 GHz to 10 GHz | -- | -109 |
| 10 GHz to 20 GHz | -- | -110 |
| 20 GHz to 40 GHz | -- | -106 |
| 40 GHz to 45 GHz | -- | -103 |
| 45 GHz to 50 GHz | -- | -98 |

^a Specifications apply over environment temperature of 23°C +/- 3°C, with less than 1°C deviation from the calibration temperature.

^b Typical performance.

^c Transmission tracking performance is strongly dependent on cable used. These typical specifications are based on the use of the Agilent thru cable (part number 85133-60016).

^d Measurement conditions: normalized to a thru, measured with two shorts, 10 Hz IF bandwidth, averaging factor of 16, alternate mode, source power set to the lesser of the maximum power out or the maximum receiver power.

^e 0 Hz offset.

Table 34. Test Port Output

| Description | Specification | | | | Supplemental |
|--|----------------------------------|---------------------|---------------------|---------------------|---|
| Frequency Range | | | | | |
| | Standard | Opt 014 | Opt UNL | Opt 014/UNL | |
| E8362B/C | 10 MHz to 20 GHz | | | | -- |
| E8363B/C | 10 MHz to 40 GHz | | | | -- |
| E8364B/C | 10 MHz to 50 GHz | | | | -- |
| Nominal Power^c | | | | | |
| E8362B/C | 0 dBm | -5 dBm | -5 dBm | -5 dBm | -- |
| E8363B/C AND E8364B/C | -12 dBm | -17 dBm | -17 dBm | -17 dBm | -- |
| Frequency Resolution | | | | | |
| | 1 Hz | | | | -- |
| CW Accuracy | | | | | |
| | +/-1 ppm | | | | -- |
| Frequency Stability | | | | | |
| | | | | | +/-0.05 ppm. -10° to 70° C, typical ^l ; +/-0.1 ppm/yr maximum, typical ^m |
| Power Level Accuracy^a | | | | | |
| 10 MHz to 45 MHz ^b | +/-2.0 dB (typical) | +/-2.0 dB (typical) | +/-2.0 dB (typical) | +/-2.0 dB (typical) | -- |
| 45 MHz to 10 GHz | +/-1.5 dB | +/-1.5 dB | +/-1.5 dB | +/-1.5 dB | Variation from nominal power in range 0 (step attenuator at 0 dB) |
| 10 GHz to 20 GHz | +/-2.0 dB | +/-2.0 dB | +/-2.0 dB | +/-2.0 dB | |
| 20 GHz to 40 GHz | +/-3.0 dB | +/-3.0 dB | +/-3.0 dB | +/-3.0 dB | |
| 40 GHz to 45 GHz | +/-3.0 dB | +/-3.5 dB | +/-3.0 dB | +/-3.5 dB | |
| 45 GHz to 50 GHz | +/-3.0 dB | +/-4.0 dB | +/-3.0 dB | +/-4.0 dB | |
| Power Level Linearity^d | | | | | |
| 10 MHz to 45 MHz ^b | +/-1.0 dB ^g (typical) | | | | Test reference is at the nominal power level (step attenuator at 0 dB) |
| 45 MHz to 20 GHz | +/-1.0 dB ^g | | | | |
| 20 GHz to 40 GHz | +/-1.0 dB ^g | | | | |
| 40 GHz to 50 GHz | +/-1.0 dB ^g | | | | |

Table 34 (Continued). Test Port Output

| Power Range^{a, e, f} | | | | | |
|--|-------------------------|-------------------------|-------------------------|----------------------------|---|
| 10 MHz to 45 MHz ^b | -25 to +2 dBm (typical) | -25 to +2 dBm (typical) | -87 to +2 dBm (typical) | -87 to +2 dBm (typical) | -- |
| 45 MHz to 10 GHz | -25 to +5 dBm | -25 to +5 dBm | -87 to +3 dBm | -87 to +3 dBm ^h | -- |
| 10 GHz to 20 GHz | -24 to +3 dBm | -25 to +2 dBm | -86 to +1 dBm | -87 to 0 dBm ⁱ | -- |
| 20 GHz to 30 GHz | -23 to 0 dBm | -25 to -2 dBm | -85 to -2 dBm | -87 to -4 dBm | -- |
| 30 GHz to 40 GHz | -23 to -4 dBm | -25 to -6 dBm | -85 to -6 dBm | -87 to -8 dBm | -- |
| 40 GHz to 45 GHz | -25 to -5 dBm | -27 to -7 dBm | -87 to -9 dBm | -87 to -11 dBm | -- |
| 45 GHz to 50 GHz | -25 to -10 dBm | -27 to -12 dBm | -87 to -15 dBm | -87 to -17 dBm | -- |
| Power Sweep Range (ALC) | | | | | |
| 10 MHz to 45 MHz ^b | 27 dB (typical) | 27 dB (typical) | 29 dB (typical) | 29 dB (typical) | |
| 45 MHz to 10 GHz | 30 dB | 30 dB | 30 dB | 30 dB ^j | ALC range starts at maximum leveled output power and decreases by power level indicated in the table. |
| 10 GHz to 20 GHz | 27 dB | 27 dB | 27 dB | 27 dB ^k | |
| 20 GHz to 30 GHz | 23 dB | 23 dB | 23 dB | 23 dB | |
| 30 GHz to 40 GHz | 19 dB | 19 dB | 19 dB | 19 dB | |
| 40 GHz to 45 GHz | 20 dB | 20 dB | 18 dB | 16 dB | |
| 45 GHz to 50 GHz | 15 dB | 15 dB | 12 dB | 10 dB | |
| | | | | | |
| Power Resolution | | | | | |
| | 0.01 dB | | | | -- |
| Phase Noise | | | | | |
| 1 kHz offset from center frequency, nominal power at test port | | | | | |
| | | | | | Typical: |
| 10 MHz to 10 GHz | -- | -- | -- | -- | -60 dBc |
| 10 GHz to 20 GHz | -- | -- | -- | -- | -55 dBc |
| 20 GHz to 50 GHz | -- | -- | -- | -- | -50 dBc |
| 1 kHz offset from center frequency, nominal power at test port - Option 080 enabled | | | | | |
| | | | | | Typical: |
| 10 MHz to 10 GHz | -- | -- | -- | -- | -60 dBc |
| 10 GHz to 20 GHz | -- | -- | -- | -- | -60 dBc |
| 20 GHz to 50 GHz | -- | -- | -- | -- | -50 dBc |

Table 34 (Continued). Test Port Output

| 10 kHz offset from center frequency, nominal power at test port | | | | | |
|--|----|----|----|----|-----------------|
| | | | | | Typical: |
| 10 MHz to 45 MHz | -- | -- | -- | -- | -70 dBc |
| 45 MHz to 10 GHz | -- | -- | -- | -- | -70 dBc |
| 10 GHz to 20 GHz | -- | -- | -- | -- | -65 dBc |
| 20 GHz to 40 GHz | -- | -- | -- | -- | -55 dBc |
| 40 GHz to 50 GHz | -- | -- | -- | -- | -55 dBc |
| 10 kHz offset from center frequency, nominal power at test port - Option 080 enabled | | | | | |
| | | | | | Typical: |
| 10 MHz to 45 MHz | -- | -- | -- | -- | -70 dBc |
| 45 MHz to 10 GHz | -- | -- | -- | -- | -70 dBc |
| 10 GHz to 20 GHz | -- | -- | -- | -- | -65 dBc |
| 20 GHz to 40 GHz | -- | -- | -- | -- | -55 dBc |
| 40 GHz to 50 GHz | -- | -- | -- | -- | -55 dBc |
| 100 kHz offset from center frequency, nominal power at test port | | | | | |
| | | | | | Typical: |
| 10 MHz to 10 GHz | -- | -- | -- | -- | -60 dBc |
| 10 GHz to 20 GHz | -- | -- | -- | -- | -55 dBc |
| 20 GHz to 50 GHz | -- | -- | -- | -- | -50 dBc |
| 100 kHz offset from center frequency, nominal power at test port - Option 080 enabled | | | | | |
| | | | | | Typical: |
| 10 MHz to 10 GHz | -- | -- | -- | -- | -75 dBc |
| 10 GHz to 20 GHz | -- | -- | -- | -- | -70 dBc |
| 20 GHz to 50 GHz | -- | -- | -- | -- | -65 dBc |
| 1 MHz offset from center frequency, nominal power at test port | | | | | |
| | | | | | Typical: |
| 10 MHz to 10 GHz | -- | -- | -- | -- | -106 dBc |
| 10 GHz to 20 GHz | -- | -- | -- | -- | -103 dBc |
| 20 GHz to 50 GHz | -- | -- | -- | -- | -90 dBc |

Table 34 (Continued). Test Port Output

| 1 MHz offset from center frequency, nominal power at test port - Option 080 enabled | | | | | |
|---|----|----|----|----|---|
| | | | | | Typical: |
| 10 MHz to 10 GHz | -- | -- | -- | -- | -103 dBc |
| 10 GHz to 20 GHz | -- | -- | -- | -- | -97 dBc |
| 20 GHz to 50 GHz | -- | -- | -- | -- | -85 dBc |
| Harmonics (2nd or 3rd) | | | | | |
| | | | | | -23 dBc typical, in power range 0 |
| Non-Harmonic Spurious (at Nominal Output Power) | | | | | |
| 10 MHz to 45 MHz | -- | -- | -- | -- | -50 dBc typical, for offset frequency > 1 kHz |
| 45 MHz to 20 GHz | -- | -- | -- | -- | -50 dBc typical, for offset frequency > 1 kHz |
| 20 GHz to 40 GHz | -- | -- | -- | -- | -30 dBc typical, for offset frequency > 1 kHz |
| 40 GHz to 50 GHz | -- | -- | -- | -- | -30 dBc typical, for offset frequency > 1 kHz |

^a Test port output is a specification when the source is set to Port 1, and a characteristic when the source is set to Port 2.

^b Typical performance.

^c Preset power.

^d Power Level Linearity is a specification when the source is set to Port 1, and a typical when the source is set to Port 2.

^e Test port power is specified into nominal 50 ohms.

^f Power to which the source can be set and phase lock is assured.

^g +/-1.5 dB for power <= -23 dBm.

^h E8362B/C only: Option H11 decreases maximum power level by 1 dB.

ⁱ E8362B/C only: Option H11 decreases maximum power level by 2 dB.

^j E8362B/C only: Option H11 decreases power level by 1 dB.

^k E8362B/C only: Option H11 decreases power level by 2 dB.

^l Assumes no variation in time.

^m Assumes no variation in temperature.

Table 35: Test Port Input

| Description | Specification | | | | Supplemental |
|--|--------------------|--------------------|--------------------|--------------------|--|
| | Standard | Opt 014 | Opt UNL | Opt 014/UNL | |
| Test Port Noise Floor^a | | | | | |
| 10 Hz IF Bandwidth | | | | | |
| 10 MHz to 45 MHz ^b | <-77 dBm (typical) | <-77 dBm (typical) | <-77 dBm (typical) | <-77 dBm (typical) | -- |
| 45 MHz to 500 MHz ^c | <-89 dBm | <-89 dBm | <-89 dBm | <-89 dBm | -- |
| 500 MHz to 2 GHz | <-114 dBm | <-114 dBm | <-114 dBm | <-114 dBm | -- |
| 2 GHz to 10 GHz | <-117 dBm | <-117 dBm | <-117 dBm | <-117 dBm | -- |
| 10 GHz to 20 GHz | <-120 dBm | <-119 dBm | <-120 dBm | <-119 dBm | -- |
| 20 GHz to 40 GHz | <-114 dBm | <-113 dBm | <-114 dBm | <-113 dBm | Option 016 degrades performance by 2 dB. |
| 40 GHz to 50 GHz | <-114 dBm | <-112 dBm | <-114 dBm | <-112 dBm | |
| 1 KHz IF Bandwidth | | | | | |
| 10 MHz to 45 MHz ^b | <-57 dBm (typical) | <-57 dBm (typical) | <-57 dBm (typical) | <-57 dBm (typical) | -- |
| 45 MHz to 500 MHz ^c | <-69 dBm | <-69 dBm | <-69 dBm | <-69 dBm | -- |
| 500 MHz to 2 GHz | <-94 dBm | <-94 dBm | <-94 dBm | <-94 dBm | -- |
| 2 GHz to 10 GHz | <-97 dBm | <-97 dBm | <-97 dBm | <-97 dBm | -- |
| 10 GHz to 20 GHz | <-100 dBm | <-99 dBm | <-100 dBm | <-99 dBm | -- |
| 20 GHz to 40 GHz | <-94 dBm | <-93 dBm | <-94 dBm | <-93 dBm | Option 016 degrades performance by 2 dB. |
| 40 GHz to 50 GHz | <-94 dBm | <-92 dBm | <-94 dBm | <-92 dBm | |

Table 35 (Continued). Test Port Input

| Test Port Noise Floor^{a,b} Option 080 enabled^d | | | | | |
|---|--------------------|--------------------|--------------------|--------------------|--|
| 10 Hz IF Bandwidth | | | | | |
| 10 MHz to 45 MHz ^b | <-77 dBm (typical) | <-77 dBm (typical) | <-77 dBm (typical) | <-77 dBm (typical) | -- |
| 45 MHz to 500 MHz ^c | <-88 dBm | <-88 dBm | <-88 dBm | <-88 dBm | -- |
| 500 MHz to 2 GHz | <-113 dBm | <-113 dBm | <-113 dBm | <-113 dBm | -- |
| 2 GHz to 10 GHz | <-116 dBm | <-116 dBm | <-116 dBm | <-116 dBm | -- |
| 10 GHz to 20 GHz | <-118 dBm | <-118 dBm | <-118 dBm | <-118 dBm | -- |
| 20 GHz to 40 GHz | <-112 dBm | <-112 dBm | <-112 dBm | <-112 dBm | Option 016 degrades performance by 2 dB. |
| 40 GHz to 50 GHz | <-111 dBm | <-111 dBm | <-111 dBm | <-111 dBm | |
| 1 KHz IF Bandwidth | | | | | |
| 10 MHz to 45 MHz ^b | <-57 dBm (typical) | <-57 dBm (typical) | <-57 dBm (typical) | <-57 dBm (typical) | -- |
| 45 MHz to 500 MHz ^c | <-68 dBm | <-68 dBm | <-68 dBm | <-68 dBm | -- |
| 500 MHz to 2 GHz | <-93 dBm | <-93 dBm | <-93 dBm | <-93 dBm | -- |
| 2 GHz to 10 GHz | <-96 dBm | <-96 dBm | <-96 dBm | <-96 dBm | -- |
| 10 GHz to 20 GHz | <-98 dBm | <-98 dBm | <-98 dBm | <-98 dBm | -- |
| 20 GHz to 40 GHz | <-92 dBm | <-92 dBm | <-92 dBm | <-92 dBm | Option 016 degrades performance by 2 dB. |
| 40 GHz to 50 GHz | <-91 dBm | <-91 dBm | <-91 dBm | <-91 dBm | |

Table 35 (Continued). Test Port Input

| Direct Receiver Access Input Noise Floor^{a,b} | | | | | |
|---|----|-----------|----|-----------|--|
| 10 Hz IF Bandwidth | | | | | |
| 10 MHz to 45 MHz | -- | <-127 dBm | -- | <-127 dBm | -- |
| 45 MHz to 500 MHz ^c | -- | <-127 dBm | -- | <-127 dBm | -- |
| 500 MHz to 2 GHz | -- | <-133 dBm | -- | <-133 dBm | -- |
| 2 GHz to 10 GHz | -- | <-132 dBm | -- | <-132 dBm | -- |
| 10 GHz to 20 GHz | -- | <-134 dBm | -- | <-134 dBm | -- |
| 20 GHz to 40 GHz | -- | <-125 dBm | -- | <-125 dBm | Option 016 degrades performance by 2 dB. |
| 40 GHz to 50 GHz | -- | <-123 dBm | -- | <-123 dBm | |
| 1 KHz IF Bandwidth | | | | | |
| 10 MHz to 45 MHz | -- | <-107 dBm | -- | <-107 dBm | -- |
| 45 MHz to 500 MHz ^c | -- | <-107 dBm | -- | <-107 dBm | -- |
| 500 MHz to 2 GHz | -- | <-113 dBm | -- | <-113 dBm | -- |
| 2 GHz to 10 GHz | -- | <-112 dBm | -- | <-112 dBm | -- |
| 10 GHz to 20 GHz | -- | <-114 dBm | -- | <-114 dBm | -- |
| 20 GHz to 40 GHz | -- | <-105 dBm | -- | <-105 dBm | Option 016 degrades performance by 2 dB. |
| 40 GHz to 50 GHz | -- | <-103 dBm | -- | <-103 dBm | |

Table 35 (Continued). Test Port Input

| Direct Receiver Access Input Noise Floor^{a,b} - Option 080 enabled^d | | | | | |
|--|--|-----------|----|-----------|--|
| 10 Hz IF Bandwidth | | | | | |
| 10 MHz to 45 MHz | -- | <-127 dBm | -- | <-127 dBm | -- |
| 45 MHz to 500 MHz ^c | -- | <-126 dBm | -- | <-126 dBm | -- |
| 500 MHz to 2 GHz | -- | <-132 dBm | -- | <-132 dBm | -- |
| 2 GHz to 10 GHz | -- | <-131 dBm | -- | <-131 dBm | -- |
| 10 GHz to 20 GHz | -- | <-133 dBm | -- | <-133 dBm | -- |
| 20 GHz to 40 GHz | -- | <-124 dBm | -- | <-124 dBm | Option 016 degrades performance by 2 dB. |
| 40 GHz to 50 GHz | -- | <-122 dBm | -- | <-122 dBm | |
| 1 KHz IF Bandwidth | | | | | |
| 10 MHz to 45 MHz | -- | <-107 dBm | -- | <-107 dBm | -- |
| 45 MHz to 500 MHz ^c | -- | <-106 dBm | -- | <-106 dBm | -- |
| 500 MHz to 2 GHz | -- | <-112 dBm | -- | <-112 dBm | -- |
| 2 GHz to 10 GHz | -- | <-111 dBm | -- | <-111 dBm | -- |
| 10 GHz to 20 GHz | -- | <-113 dBm | -- | <-113 dBm | -- |
| 20 GHz to 40 GHz | -- | <-104 dBm | -- | <-104 dBm | Option 016 degrades performance by 2 dB. |
| 40 GHz to 50 GHz | -- | <-102 dBm | -- | <-102 dBm | |
| Receiver Compression Level (Measured at Test Ports) | | | | | |
| 10 MHz to 20 GHz | <0.1 dB at -5 dBm ^g and <0.45 dB at +5 dBm | | | | -- |
| 20 GHz to 30 GHz | <0.1 dB at -9.5 dBm ^g and <0.45 dB at 0 dBm | | | | -- |
| 30 GHz to 40 GHz | <0.1 dB at -12.5 dBm ^g and <0.45 dB at -3 dBm | | | | -- |
| 40 GHz to 50 GHz | <0.1 dB at -12.5 dBm ^g and <0.45 dB at -3 dBm | | | | -- |
| System Compression Level | | | | | |
| | maximum output power | | | | See dynamic accuracy table |

Table 35 (Continued). Test Port Input

| Third Order Intercept - Tone spacing from 100 kHz - 5 MHz | | |
|--|---------------|-------------------------|
| | | Typical |
| 10 MHz to 150 MHz | -- | +33 dBm |
| 150 MHz to 300 MHz | -- | +34 dBm |
| 300 MHz to 500 MHz | -- | +30 dBm |
| 500 MHz to 20 GHz | -- | +24 dBm |
| 20 to 40 GHz | -- | +18 dBm |
| 40 to 50 GHz | -- | +15 dBm |
| Third Order Intercept - Tone spacing from 5 MHz - 20 MHz | | |
| | | Typical |
| 10 MHz to 500 MHz | -- | +20 dBm |
| 500 MHz to 20 GHz | -- | +20 dBm |
| 20 to 40 GHz | -- | +16 dBm |
| 40 to 50 GHz | -- | +15 dBm |
| Third Order Intercept - Tone spacing from 20 MHz - 50 MHz | | |
| | | Typical |
| 10 MHz to 500 MHz | -- | +26 dBm |
| 500 MHz to 20 GHz | -- | +26 dBm |
| 20 to 40 GHz | -- | +20 dBm |
| 40 to 50 GHz | -- | +19 dBm |
| Trace Noise Magnitude | | |
| 1 kHz IF bandwidth. Ratio measurement, nominal power at test port. | | |
| 10 MHz to 45 MHz ^b | -- | <0.050 dB rms (typical) |
| 45 MHz to 500 MHz ^e | <0.010 dB rms | -- |
| 500 MHz to 20 GHz | <0.006 dB rms | -- |
| 20 GHz to 40 GHz | <0.006 dB rms | -- |
| 40 GHz to 50 GHz | <0.006 dB rms | -- |

Table 35 (Continued). Test Port Input

| Trace Noise Magnitude - Option 080 enabled^{b,d} | | |
|--|-----------------------|----------------|
| 1 kHz IF bandwidth. Ratio measurement, nominal power at test port. | | Typical |
| 10 MHz to 45 MHz | -- | <0.060 dB rms |
| 45 MHz to 500 MHz ^e | -- | <0.010 dB rms |
| 500 MHz to 20 GHz | -- | <0.006 dB rms |
| 20 GHz to 40 GHz | -- | <0.007 dB rms |
| 40 GHz to 50 GHz | -- | <0.008 dB rms |
| Trace Noise Phase | | |
| 1 kHz IF bandwidth. Ratio measurement, nominal power at test port. | | |
| 10 MHz to 45 MHz ^b | <0.350° rms (typical) | -- |
| 45 MHz to 500 MHz | <0.100° rms | -- |
| 500 MHz to 20 GHz | <0.060° rms | -- |
| 20 GHz to 40 GHz | <0.100° rms | -- |
| 40 GHz to 50 GHz | <0.100° rms | -- |
| Trace Noise Phase - Option 080 enabled^{b,d} | | |
| 1 kHz IF bandwidth. Ratio measurement, nominal power at test port. | | Typical |
| 10 MHz to 45 MHz | -- | <0.350° rms |
| 45 MHz to 500 MHz ^e | -- | <0.100° rms |
| 500 MHz to 20 GHz | -- | <0.060° rms |
| 20 GHz to 40 GHz | -- | <0.100° rms |
| 40 GHz to 50 GHz | -- | <0.100° rms |
| Reference Level Magnitude | | |
| Range | +/-200 dB | -- |
| Resolution | 0.001 dB | -- |
| Reference Level Phase | | |
| Range | +/-500° | -- |
| Resolution | 0.01° | -- |

Table 35 (Continued). Test Port Input

| Stability Magnitude^d | | | | | |
|---|----|----|----|----|-------------------------------------|
| Typical ratio measurement, made at the test port. | | | | | |
| 10 MHz to 45 MHz | -- | -- | -- | -- | +/-0.05 dB/°C |
| 45 MHz to 20 GHz | -- | -- | -- | -- | +/-0.02 dB/°C |
| 20 GHz to 40 GHz | -- | -- | -- | -- | +/-0.03 dB/°C |
| 40 GHz to 50 GHz | -- | -- | -- | -- | +/-0.04 dB/°C |
| Stability Phase^d | | | | | |
| Typical ratio measurement, measured at the test port. | | | | | |
| 10 MHz to 45 MHz | -- | -- | -- | -- | +/-0.5°/°C |
| 45 MHz to 20 GHz | -- | -- | -- | -- | +/-0.2°/°C |
| 20 GHz to 40 GHz | -- | -- | -- | -- | +/-0.5°/°C |
| 40 GHz to 50 GHz | -- | -- | -- | -- | +/-0.8°/°C |
| Damage Input Level | | | | | |
| Test Port 1 and 2 | -- | -- | -- | -- | +30 dBm or +/-40 VDC, typical |
| R1, R2 in | -- | -- | -- | -- | +15 dBm or +/-15 VDC, typical |
| A, B in | -- | -- | -- | -- | +15 dBm or +/-15 VDC, typical |
| Coupler Thru (Option 014 or UNL/014) | -- | -- | -- | -- | +30 dBm or +/-40 VDC, typical |
| Coupler Arm (Option 014 or UNL/014) | -- | -- | -- | -- | +30 dBm or +/-7 VDC, typical |

^aTotal average (rms) noise power calculated as the mean value of a linear magnitude trace expressed in dBm.

^bTypical performance.

^cNoise floor may be degraded by 10 dB at particular frequencies (multiples of 5 MHz) due to spurious receiver residuals.

^d0 Hz offset

^eTrace noise magnitude may be degraded to 20 mdB rms at harmonic frequencies of the first IF (8.33 MHz) below 80 MHz.

^fStability is defined as a ratio measurement made at the test port.

^gThis compression level comes from the dynamic accuracy curve with -30 dBm reference test port power.

Table 36. Dynamic Accuracy (Specification^a)

Accuracy of the test port input power reading relative to the reference input power level.

NOTE: The following graphs also apply to the “C” model of the analyzers.

Magnitude*

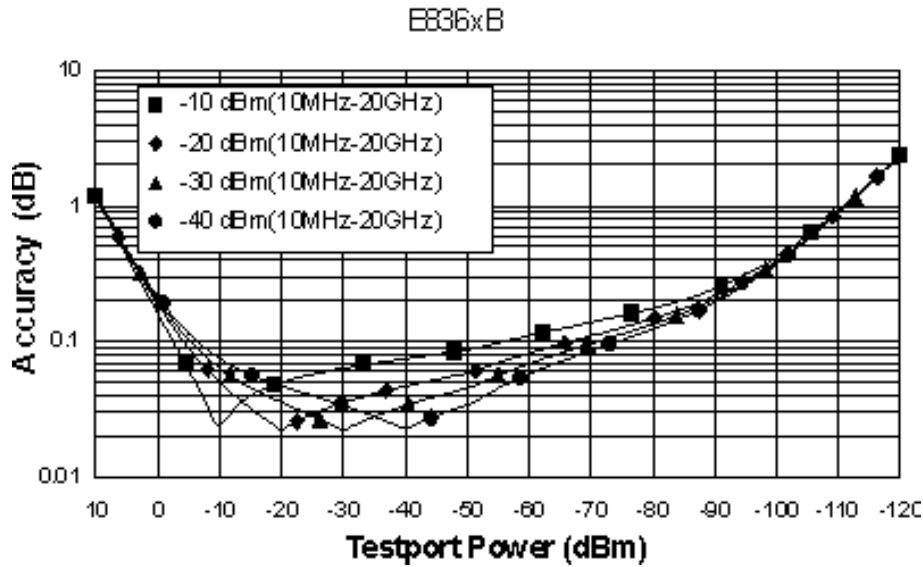

Phase*

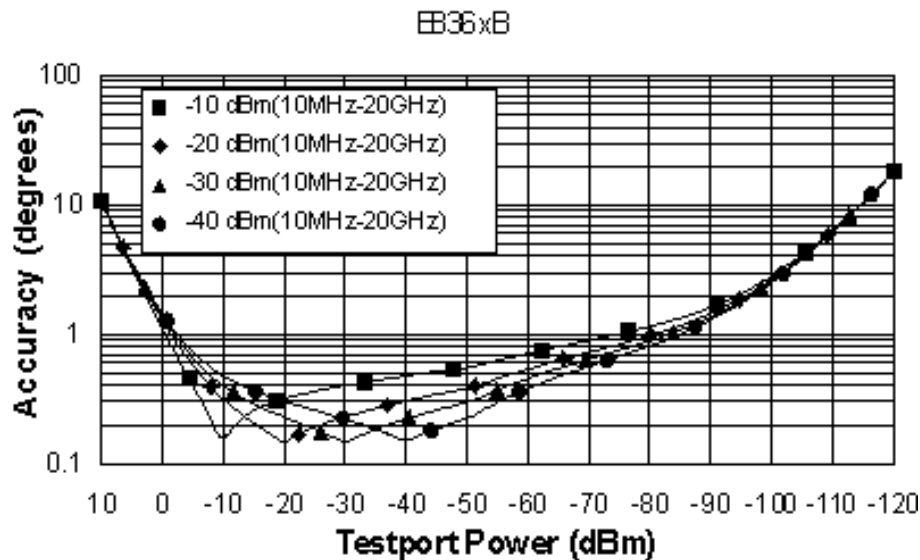

*Below 800 MHz the coupling factor rolls off 20 dB per decade causing a shift in the dynamic accuracy curves. Please see the Uncertainty Calculator (http://www.agilent.com/find/na_calculator) for detailed compression values.

Magnitude

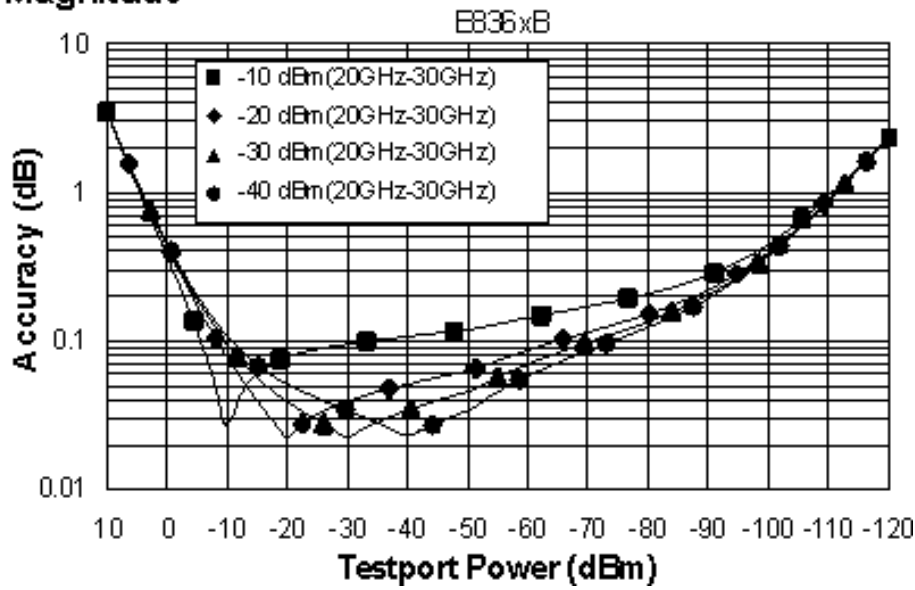

Phase

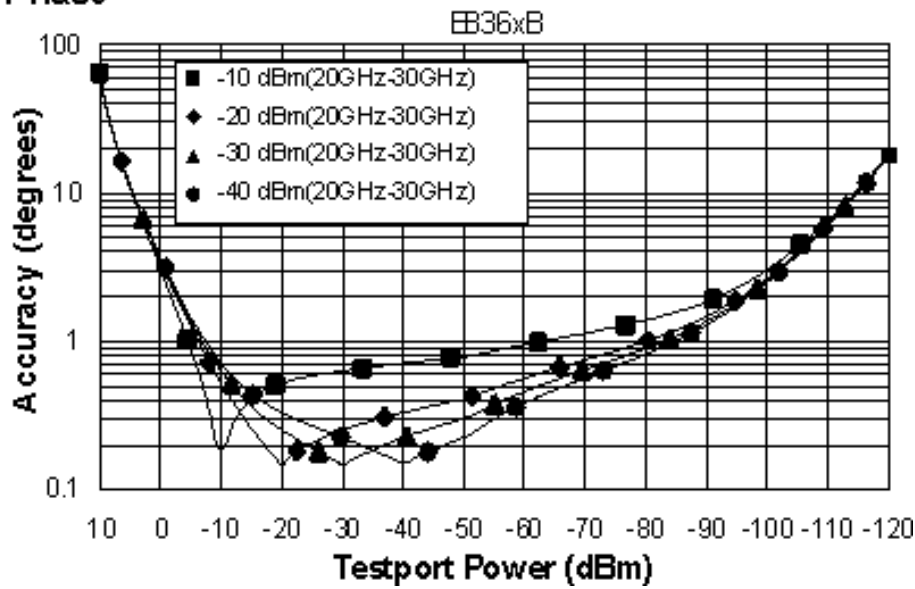

Magnitude

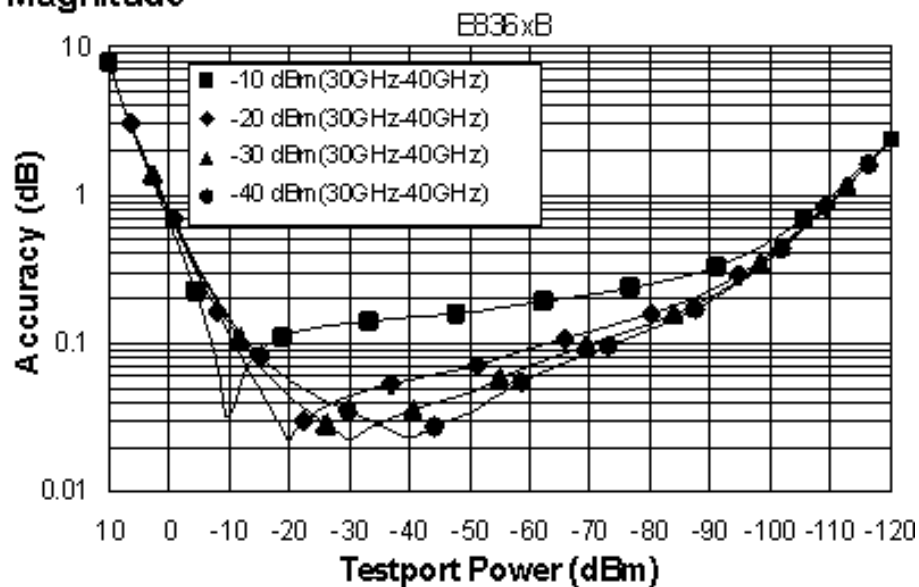

Phase

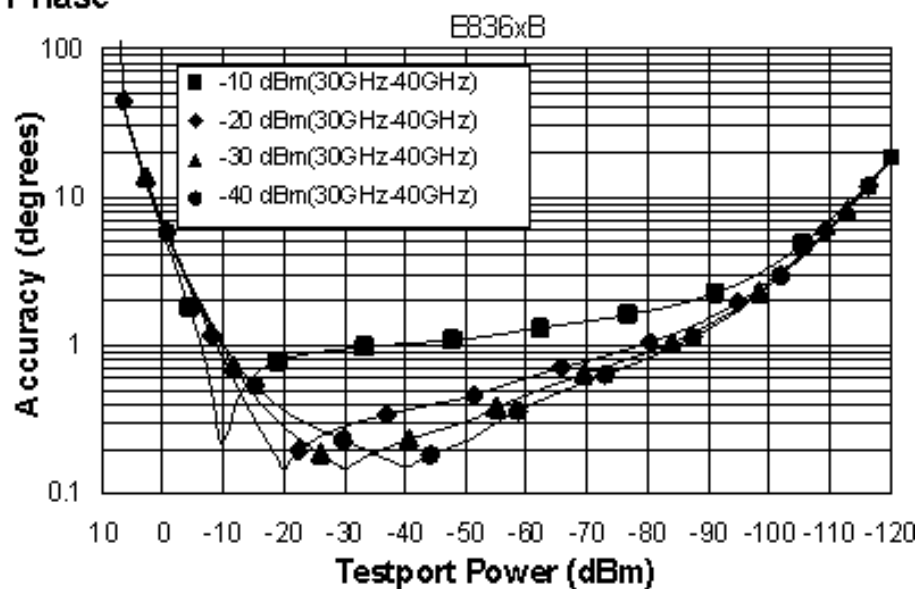

Magnitude

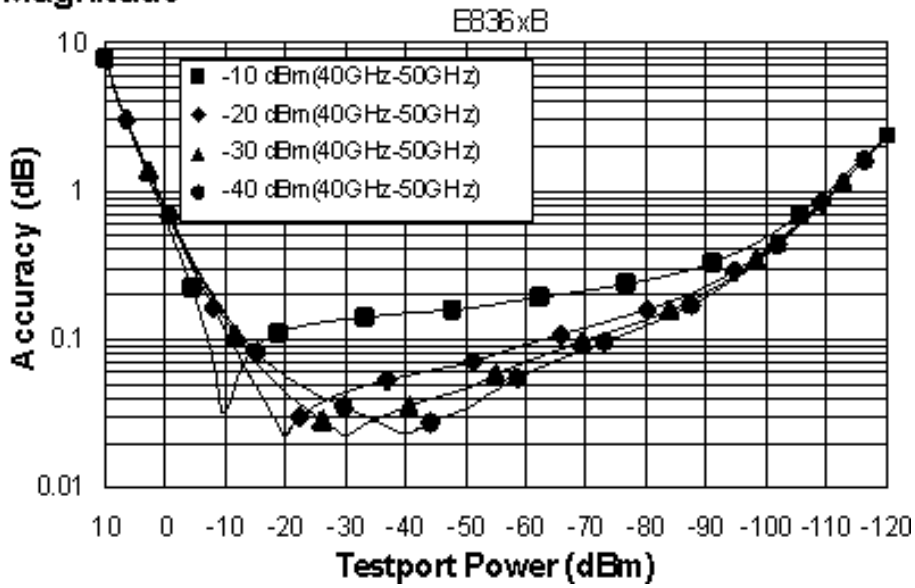

Phase

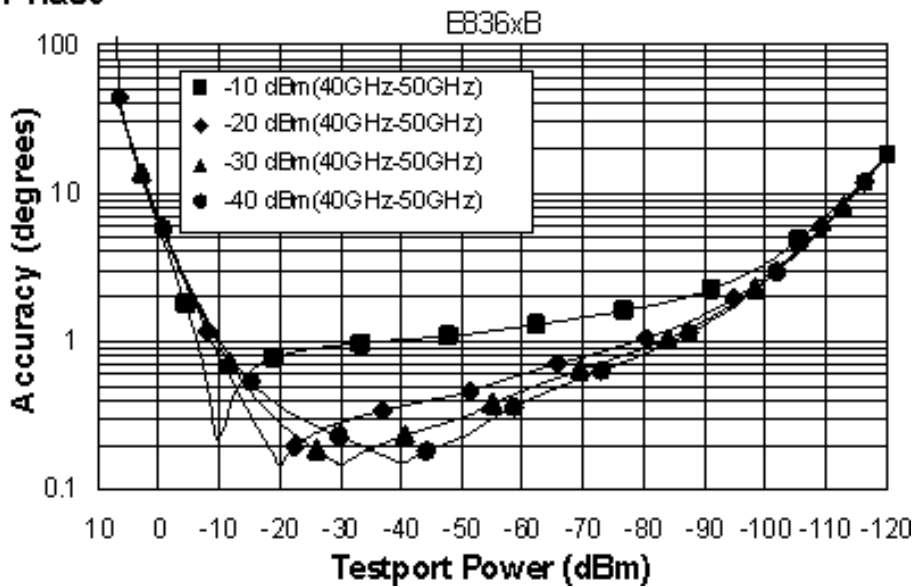

^a Dynamic accuracy is verified with the following measurements:

- Compression over frequency.
- IF linearity at a single frequency of 1.195 GHz and a reference level of -20 dBm for an input power range of 0 to -120 dBm.

Table 37. Test Port Input (Group Delay)^a

| Description | Specification | Supplemental Information (typ.) |
|-----------------------|---------------|--|
| Aperture (selectable) | | (frequency span)/(number of points - 1) |
| Maximum Aperture | | 20% of frequency span |
| Range | | 0.5 x (1/minimum aperture) |
| Maximum Delay | | Limited to measuring no more than 180° of phase change within the minimum aperture.) |
| Accuracy | | See graph below. Char. |

The following graph shows characteristic group delay accuracy with full 2-port calibration and a 10 Hz IF bandwidth. Insertion loss is assumed to be < 2 dB and electrical length to be ten meters.

NOTE: The following graph also applies to the “C” model of the analyzers.

Group Delay (Typical)

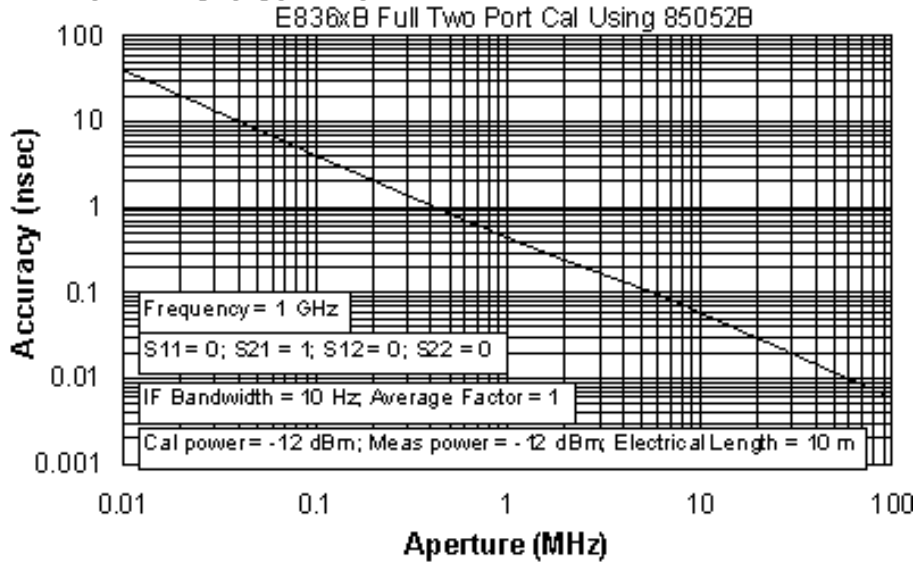

In general, the following formula can be used to determine the accuracy, in seconds, of specific group delay measurement:

$$\pm \text{Phase Accuracy (deg)} / [360 \times \text{Aperture (Hz)}]$$

Depending on the aperture and device length, the phase accuracy used is either incremental phase accuracy or worst case phase accuracy.

^a Group delay is computed by measuring the phase change within a specified frequency step (determined by the frequency span and the number of points per sweep).

General Information

Table 38. Miscellaneous Information

| Description | Specification | Supplemental Information |
|---------------------------|---------------|--|
| System IF Bandwidth Range | -- | 1 Hz to 40 kHz, nominal |
| CPU | -- | Intel® 1.1 GHz Pentium® M with 1 GByte RAM |

Table 39. Front Panel Information

| Description | Supplemental Information |
|--|---|
| RF Connectors | |
| E8362B/C | |
| Type | 3.5 mm (male), 50 ohm, (nominal) |
| Center Pin Recession | 0.002 in. (characteristic) |
| E8363B/C AND E8364B/C | |
| Type | 2.4 mm (male), 50 ohm, (nominal) |
| Center Pin Recession | 0.002 in. (characteristic) |
| Display | |
| NOTE: The PNA display must remain in the 16 bit color setting in order to comply with international emissions regulations. | |
| Size | 21.3 cm (8.4 in) diagonal color active matrix LCD; 640 (horizontal) X 480 (vertical) resolution; 59.83 Hz vertical refresh rate; 31.41 Hz horizontal refresh rate |
| Refresh Rate | Vertical 59.83 Hz; Horizontal 31.41 kHz |
| Pixels | <p>A display is considered faulty if:</p> <ul style="list-style-type: none"> • A complete row or column consists of “stuck” or “dark” pixels. • More than six “stuck on” pixels (but not more than three green) or more than 0.002% of the total pixels are within the LCD specifications. • More than twelve “dark” pixels (but no more than seven of the same color) or more than 0.004% of the total pixels are within the LCD specifications. • Two or more consecutive "stuck on" pixels or three or more consecutive "dark" pixel (but no more than one set of two consecutive dark pixels) • “Stuck on” “dark” pixels are less than 6.5 mm apart (excluding consecutive pixels) |
| Display Range | |
| Magnitude | ±200 dB (at 20 dB/div), max |
| Phase | ±500°, max |
| Polar | 10 pUnits, min 1000 Units, max |
| Display Resolution | |
| Magnitude | 0.001 dB/div, min |
| Phase | 0.01°/div, min |
| Marker Resolution | |
| Magnitude | 0.001 dB, min |
| Phase | 0.01°, min |
| Polar | 0.01 mUnit, min; 0.01°, min |

Table 40. Rear Panel Information

| Description | Supplemental Information |
|--|--|
| 10 MHz Reference In | |
| Connector | BNC, female |
| Input Frequency | 10 MHz \pm 10 ppm, typical |
| Input Level | -15 dBm to +20 dBm, typical |
| Input Impedance | 200 Ω , nom. |
| 10 MHz Reference Out | |
| Connector | BNC, female |
| Output Frequency | 10 MHz \pm 1 ppm, typical |
| Signal Type | Sine Wave, typical |
| Output Level | +10 dBm \pm 4 dB into 50 Ω , typical |
| Output Impedance | 50 Ω , nominal |
| Harmonics | <-40 dBc, typical |
| External Trigger Rear-Panel I/O (typical) | |
| Trigger Inputs/Outputs | BNC(f), TTL/CMOS compatible |
| Trigger Input | |
| Function | Measurement of next point, next channel, or next group of channels |
| Source | Aux I/O (pin 19) or I/O 1 (BNC (f) connector) |
| Signal Levels | TTL-compatible |
| Input impedance | 5 Kohm nominal |
| Minimum Trigger Width | 1 microsecond |
| Trigger modes | High or low level; positive or negative edge |
| Trigger Delay Range | 0 to 1 second |
| Trigger Delay Resolution | 6 microseconds (IF bandwidth => 15 kHz) or 6.2 microseconds (IF bandwidth < 15 kHz) |
| Trigger Output | |
| Function | Generate pulse before or after measurement (only active when trigger type is external) |
| Source | I/O 2 (BNC (f) connector) |
| Signal levels | TTL-compatible |
| Trigger Polarity | Positive or negative edge |
| Pulse Width | 1 microsecond |
| Option H11 Rear-Panel I/O (typical) | |
| External IF Inputs | |
| Function | Allows use of external IF signals from remote mixers, bypassing the PNA's first converters |
| Connectors | A, R1, R2, B receivers (BNC (f) Connectors) |
| Input Frequency | 8 1/3 MHz |
| Input Impedance | 50 Ω nominal |
| RF Damage Level | -20.0 dBm |
| DC Damage Level | 25 volts |
| 0.1 dB Compression Point | -27.0 dBm |
| Pulse Inputs (IF Gates)² | |
| Function | Internal receiver gates used for point-in-pulse and pulse-profile measurements |
| Connectors | A, R1, R2, B (BNC (f) Connectors) |
| Input Impedance | 1 Kohm nominal |
| Minimum Pulse Width | 20 ns for less than 1 dB deviation from theoretical performance ³ |
| DC Damage Level | 5.5 volts |
| Drive Voltage | TTL; 0 V (off), +5 V (on) nominal |

Table 40 (Continued). Rear Panel Information

| Test Set Drivers | |
|--|--|
| Function | Used for driving remote mixers |
| Connectors | SMA (f) for RF and LO outputs |
| RF, LO Output Frequency Range | 1.7 to 20 GHz |
| RF Output Power Levels | +5 dBm to -16 dBm, depending on frequency ¹ |
| LO Output Power Levels | -7 dBm to -16 dBm, depending on frequency |
| Rear Panel LO Power (Typical) | |
| 1.7 GHz- 20 GHz | -7 to -16 dBm |
| Rear Panel RF Power 8362B (Typical) | |
| 1.7 GHz to 20 GHz | -5 to -16 dBm (at -5 dBm test port power ⁴) |
| Rear Panel RF Power 8363B/8364B (Typical) | |
| 1.7 GHz to 10 GHz | -2 to -12 dBm (at -5 dBm test port power ⁴) |
| 10 GHz to 16 GHz | 0 to -8 dBm (at -5 dBm test port power ⁴) |
| 16 GHz to 20 GHz | +5 to -1 dBm (at -5 dBm test port power ⁴) |
| VGA Video Output | |
| Connector | 15-pin mini D-Sub; Drives VGA compatible monitors |
| Devices Supported: | |
| | Resolutions: |
| Flat Panel (TFT) | 1024 X 768, 800 X 600, 640 X 480 |
| Flat Panel (DSTN) | 800 X 600, 640 X 480 |
| CRT Monitor | 1280 X 1024, 1024 X 768, 800 X 600, 640 X 480 |
| | Simultaneous operation of the internal and external displays is allowed, but with 640 X 480 resolution only. If you change resolution, you can only view the external display (internal display will "white out"). |
| Bias Tee Input Connectors (Option UNL) | |
| Connectors | BNC (f), for port 1 and port 2 |
| Fuse | 500 mA, bi-pin style |
| Maximum bias current | +/-200 mA with no degradation of RF specifications |
| Maximum bias voltage | +/-40 Volts DC |
| Test Set IO | |
| | 25-pin D-Sub connector, available for external test set control. |
| Aux IO | |
| | 25-pin D-Sub connector, male, analog and digital IO. |
| Handler IO | |
| | 36-pin parallel I/O port; all input/output signals are default set to negative logic; can be reset to positive logic via GPIB command. |
| GPIB | |
| | 24-pin D-sub (Type D-24), female; compatible with IEEE-488. |
| Parallel Port (LPT1) | |
| | 25-pin D-Sub miniature connector, female; provides connection to printers or any other parallel port peripherals |
| Serial Port (COM 1) | |
| | 9-pin D-Sub, male; compatible with RS-232 |

Table 40 (Continued). Rear Panel Information

| USB Port | |
|-------------------------------|--|
| | One port on front panel and five ports on rear panel. Universal Serial Bus jack, Type A configuration (4 contacts inline, contact 1 on left); female |
| Contact 1 | Vcc: 4.75 to 5.25 VDC, 500 mA, maximum |
| Contact 2 | -Data |
| Contact 3 | +Data |
| Contact 4 | Ground |
| LAN | |
| | 10/100BaseT Ethernet, 8-pin configuration; auto selects between the two data rates |
| Line Power⁵ | |
| Frequency, Voltage | 50/60/400 Hz for 100 – 120 V 50/60 Hz for 220 – 240 V Power supply is auto switching |
| Max | 350 W |

¹ Measured at -5 dBm test port power.

² Pulse input connectors are operational only with Option H08 (Pulse Measurement Capability) enabled.

³ Based on deviation from signal reduction equation: Signal Reduction (dB) = $20\log_{10}(\text{Duty_cycle}) = 20\log_{10}(\text{pulse_width/pulse_repetition_interval})$. Measured at pulse repetition frequency of 1 MHz.

⁴ Test port power has to be at a high enough level such that the Drop Cal does not occur. If Drop Cal occurs then the power out of the rear panel RF connector will drop by about 15 dB.

⁵ A third-wire ground is required.

Table 41. Analyzer Dimensions and Weight

| Description | Supplemental Information | | |
|---|----------------------------|--------------------|--------------------|
| Cabinet Dimensions | | | |
| | Height | Width | Depth |
| Excluding front and rear panel hardware and feet | 267 mm 10.5 in | 426 mm 16.75 in | 427 mm 16.8 in |
| As shipped - includes front panel connectors, rear panel bumpers, and feet. | 280 mm 11.0 in | 435 mm 17.1 in | 470 mm 18.5 in |
| As shipped plus handles | 280 mm 11.0 in | 458 mm 18 in | 501 mm 19.70 in |
| As shipped plus rack-mount flanges | 280 mm 11.0 in | 483 mm 19 in | 470 mm 18.5 in |
| As shipped plus handles and flanges | 280 mm 11.0 in | 483 mm 19 in | 501 mm 19.70 in |
| Weight | | | |
| Net | | | |
| E8362B/C | 28.6 kg (63.5 lb), nominal | | |
| E8363B/C AND E8364B/C | 29 kg (64 lb), nominal | | |
| Shipping | | | |
| E8362B/C | 35.8 kg (79.5 lb), nominal | | |
| E8363B/C AND E8364B/C | 36.3 kg 80 lb), nominal | | |

Note: For Regulatory and Environmental information, refer to the PNA Series Installation and Quick Start Guide, located online at <http://cp.literature.agilent.com/litweb/pdf/E8356-90001.pdf>.

Measurement Throughput Summary

Table 42 Typical Cycle Time^{a,b} (ms) for Measurement Completion

| | Number of Points | | | |
|---|------------------|-----|------|--------|
| | 201 | 401 | 1601 | 16,001 |
| Start 28 GHz, Stop 30 GHz, 35 kHz IF bandwidth | | | | |
| Uncorrected, 1-port cal | 12 | 19 | 55 | 503 |
| 2-Port cal | 29 | 44 | 124 | 1112 |
| Start 10 MHz, Stop 10 GHz, 35 kHz IF bandwidth | | | | |
| Uncorrected, 1-port cal | 86 | 93 | 121 | 583 |
| 2-Port cal | 179 | 199 | 267 | 1301 |
| Start 10 MHz, Stop 20 GHz, 35 kHz IF bandwidth | | | | |
| Uncorrected, 1-port cal | 126 | 130 | 153 | 597 |
| 2-Port cal | 264 | 275 | 335 | 1321 |
| Start 10 MHz, Stop 40 GHz, 35 kHz IF bandwidth | | | | |
| Uncorrected, 1-port cal | 185 | 190 | 213 | 621 |
| 2-Port cal | 382 | 401 | 459 | 1374 |
| Start 10 MHz, Stop 50 GHz, 35 kHz IF bandwidth | | | | |
| Uncorrected, 1-port cal | 210 | 216 | 243 | 643 |
| 2-Port cal | 436 | 450 | 522 | 1405 |
| Start 10 MHz, Stop 67 GHz, 35 kHz IF bandwidth | | | | |
| Uncorrected 1-Port cal | 244 | 254 | 300 | 645 |
| 2-Port cal | 502 | 524 | 591 | 1423 |

^a Typical performance.

^b Includes sweep time, retrace time and band-crossing time. Analyzer display turned off with DISPLAY:ENABLE OFF. Add 21 ms for display on. Data for one trace (S11) measurement.

Table 43. Cycle Time vs IF Bandwidth^a

Applies to the Preset condition (201 points, correction off) except for the following changes:

- CF = 28 GHz
- Span = 100 MHz
- Display off (add 21 ms for display on)

| IF Bandwidth (Hz) | Cycle Time (ms) ^b | Cycle Time (ms) Option 080 enabled |
|-------------------|------------------------------|------------------------------------|
| 40,000 | 11 | 100 |
| 35,000 | 12 | 101 |
| 30,000 | 13 | 102 |
| 20,000 | 16 | 106 |
| 10,000 | 30 | 127 |
| 7000 | 38 | 138 |
| 5000 | 50 | 152 |
| 3000 | 74 | 182 |
| 1000 | 274 | 326 |
| 300 | 694 | 782 |
| 100 | 1905 | 2054 |
| 30 | 6091 | 6355 |
| 10 | 17916 | 18372 |

^a Typical performance.

^b Cycle time includes sweep and retrace time.

Table 44. Cycle Time vs Number of Points^a

Applies to the Preset condition (35 kHz IF bandwidth, correction off) except for the following changes:

- CF = 28 GHz
- Span = 100 MHz
- Display off (add 21 ms for display on)

| Number of Points | Cycle Time (ms) ^b |
|------------------|------------------------------|
| 3 | 6 |
| 11 | 6 |
| 51 | 7 |
| 101 | 9 |
| 201 | 12 |
| 401 | 18 |
| 801 | 30 |
| 1601 | 55 |
| 16,001 | 497 |

^a Typical performance.

^b Cycle time includes sweep and retrace time.

Table 45. Frequency Converter Application (option 083) Cycle Time for Fixed-IF Measurements (ms)¹

| | Number of Points | | |
|---|------------------|-----|-----|
| | 101 | 201 | 401 |
| Stimulus start = 1 GHz, stop = 11 GHz, IFBW = 35 kHz Response = 70 MHz, trace = SC21, cal = SMC_2P | | | |
| Hardware Trigger | 8.5 | 17 | 34 |
| Software Trigger | 31 | 62 | 124 |

Table 46. Data Transfer Time (ms)^a

| | Number of Points | | | |
|---|------------------|-----|------|--------|
| | 201 | 401 | 1601 | 16,001 |
| SCPI over GPIB (program executed on external PC) | | | | |
| 32-bit floating point | 7 | 12 | 43 | 435 |
| 64-bit floating point | 12 | 22 | 84 | 856 |
| ASCII | 64 | 124 | 489 | 5054 |
| SCPI (program executed in the analyzer) | | | | |
| 32-bit floating point | 1 | 2 | 3 | 30 |
| 64-bit floating point | 2 | 2 | 4 | 40 |
| ASCII | 29 | 56 | 222 | 2220 |
| COM (program executed in the analyzer) | | | | |
| 32-bit floating point | 1 | 1 | 1 | 6 |
| Variant type | 1 | 2 | 6 | 68 |
| DCOM over LAN (program executed on external PC) | | | | |
| 32-bit floating point | 1 | 1 | 2 | 121 |
| Variant type | 3 | 6 | 19 | 939 |

^a Typical performance

Note: Specifications for Recall & Sweep Speed are not provided for the E836xB/C analyzers.

Specifications: Front-Panel Jumpers

Models E8362B/C, E8363B/C, and E8364B/C Option 014

NOTE: The standard E8362/3/4A/B has no front-panel jumpers.

Table 47: Measurement Receiver Inputs (Rcvr A In, Rcvr B In)

| Description | Specification | Supplemental Information |
|----------------------------|---------------------------|--------------------------|
| Maximum Input Level | | |
| E8362B/C: | | Typical |
| 45 MHz to 500 MHz | -- | -15 dBm, typical |
| 500 MHz to 2 GHz | -- | -11 dBm, typical |
| 2 GHz to 10 GHz | -- | -11 dBm, typical |
| 10 GHz to 20 GHz | -- | -11 dBm, typical |
| E8363B/C: | | |
| 45 MHz to 500 MHz | -- | -14 dBm, typical |
| 500 MHz to 2 GHz | -- | -10 dBm, typical |
| 2 GHz to 10 GHz | -- | -10 dBm, typical |
| 10 GHz to 20 GHz | -- | -10 dBm, typical |
| 20 GHz to 30 GHz | -- | -14.5 dBm, typical |
| 30 GHz to 40 GHz | -- | -16.5 dBm, typical |
| E8364B/C: | | |
| 45 MHz to 500 MHz | -- | - 14 dBm, typical |
| 500 MHz to 2 GHz | -- | - 10 dBm, typical |
| 2 GHz to 10 GHz | -- | - 10 dBm, typical |
| 10 GHz to 20 GHz | -- | - 10 dBm, typical |
| 20 GHz to 30 GHz | -- | - 14.5 dBm, typical |
| 30 GHz to 40 GHz | -- | - 16.5 dBm, typical |
| 40 GHz to 45 GHz | -- | - 16 dBm, typical |
| 45 GHz to 50 GHz | -- | - 15 dBm, typical |
| Noise Floor | | |
| E8362B/C: | | |
| | 10 Hz IF Bandwidth | |
| 45 MHz to 500 MHz | < -109 dBm | -- |
| 500 MHz to 2 GHz | < -130 dBm | -- |
| 2 GHz to 10 GHz | < -133 dBm | -- |
| 10 GHz to 20 GHz | < -135 dBm | -- |
| | 1 kHz IF Bandwidth | |
| 45 MHz to 500 MHz | < -89 dBm | -- |
| 500 MHz to 2 GHz | < -110 dBm | -- |
| 2 GHz to 10 GHz | < -113 dBm | -- |
| 10 GHz to 20 GHz | < -115 dBm | -- |

| E8363B/C: | | |
|-------------------------|---------------------------|----------|
| | 10 Hz IF Bandwidth | |
| 45 MHz to 500 MHz | < -127 dBm | -- |
| 500 MHz to 2 GHz | < -133 dBm | -- |
| 2 GHz to 10 GHz | < -132 dBm | -- |
| 10 GHz to 20 GHz | < -134 dBm | -- |
| 20 GHz to 40 GHz | < -125 dBm | -- |
| | 1 kHz IF Bandwidth | |
| 45 MHz to 500 MHz | < -107 dBm | -- |
| 500 MHz to 2 GHz | < -113 dBm | -- |
| 2 GHz to 10 GHz | < -112 dBm | -- |
| 10 GHz to 20 GHz | < -114 dBm | -- |
| 20 GHz to 40 GHz | < -105 dBm | -- |
| E8364B/C: | | |
| | 10 Hz IF Bandwidth | -- |
| 45 MHz to 500 MHz | < - 127 dBm | -- |
| 500 MHz to 2 GHz | < - 133 dBm | -- |
| 2 GHz to 10 GHz | < - 132 dBm | -- |
| 10 GHz to 20 GHz | < - 134 dBm | -- |
| 20 GHz to 40 GHz | < - 125 dBm | -- |
| 40 GHz to 50 GHz | < - 123 dBm | -- |
| | 1 kHz IF Bandwidth | |
| 45 MHz to 500 MHz | < -107 dBm | -- |
| 500 MHz to 2 GHz | < -113 dBm | -- |
| 2 GHz to 10 GHz | < -112 dBm | -- |
| 10 GHz to 20 GHz | < -114 dBm | -- |
| 20 GHz to 40 GHz | < -105 dBm | -- |
| 40 GHz to 50 GHz | < -103 dBm | -- |
| Damage Level | | |
| E8362B/C | -- | + 15 dBm |
| E8363B/C | -- | + 15 dBm |
| E8364B/C | -- | + 15 dBm |
| Maximum DC Level | | |
| E8362B/C | -- | + 15 V |
| E8363B/C | -- | + 15 V |
| E8364B/C | -- | + 15 V |

Table 48: Reference Receiver Inputs (Rcvr R1, Rcvr R2)

| Description | Specification | Supplemental Information |
|------------------------------|---------------|--------------------------|
| Minimum Input Level | | |
| E8362B/C, E8363B/C, E8364B/C | -- | -25 dBm, typical |
| Maximum Input Level | | |
| E8362B/C: | | |
| 45 MHz to 500 MHz | -- | -15 dBm, typical |
| 500 MHz to 2 GHz | -- | -11 dBm, typical |
| 2 GHz to 10 GHz | -- | -11 dBm, typical |
| 10 GHz to 20 GHz | -- | -11 dBm, typical |
| E8363B/C: | | |
| 45 MHz to 500 MHz | -- | -14 dBm, typical |
| 500 MHz to 2 GHz | -- | -10 dBm, typical |
| 2 GHz to 10 GHz | -- | -10 dBm, typical |
| 10 GHz to 20 GHz | -- | -9.5 dBm, typical |
| 20 GHz to 30 GHz | -- | -14 dBm, typical |
| 30 GHz to 40 GHz | -- | -15.5 dBm, typical |
| E8364B/C: | | |
| 45 MHz to 500 MHz | -- | - 14 dBm, typical |
| 500 MHz to 2 GHz | -- | - 10 dBm, typical |
| 2 GHz to 10 GHz | -- | - 10 dBm, typical |
| 10 GHz to 20 GHz | -- | - 9.5 dBm, typical |
| 20 GHz to 30 GHz | -- | - 14 dBm, typical |
| 30 GHz to 40 GHz | -- | - 15.5 dBm, typical |
| 40 GHz to 45 GHz | -- | - 14 dBm, typical |
| 45 GHz to 50 GHz | -- | - 15 dBm, typical |
| Damage Level | | |
| E8362B/C | -- | + 15 dBm, typical |
| E8363B/C | -- | + 15 dBm, typical |
| E8364B/C | -- | + 15 dBm, typical |
| Maximum DC Level | | |
| E8362B/C | -- | +/- 15 V, typical |
| E8363B/C | -- | +/- 15 V, typical |
| E8364B/C | -- | +/- 15 V, typical |

Table 49: Reference Outputs (Reference 1 Source Out, Reference 2 Source Out)

| Description | Specification | Supplemental Information |
|-----------------------------|---------------|--------------------------|
| Maximum Output Level | | |
| E8362B/C: | | |
| 45 MHz to 500 MHz | -- | -24 dBm, typical |
| 500 MHz to 2 GHz | -- | -23 dBm, typical |
| 2 GHz to 10 GHz | -- | -23 dBm, typical |
| 10 GHz to 20 GHz | -- | -26 dBm, typical |
| E8363B/C: | | |
| 45 MHz to 500 MHz | -- | -11.5 dBm, typical |
| 500 MHz to 2 GHz | -- | -10.5 dBm, typical |
| 2 GHz to 10 GHz | -- | -11 dBm, typical |
| 10 GHz to 20 GHz | -- | -11 dBm, typical |
| 20 GHz to 30 GHz | -- | -11 dBm, typical |
| 30 GHz to 40 GHz | -- | -11 dBm, typical |
| E8364B/C: | | |
| 45 MHz to 500 MHz | -- | - 11.5 dBm, typical |
| 500 MHz to 2 GHz | -- | - 10.5 dBm, typical |
| 2 GHz to 10 GHz | -- | - 11 dBm, typical |
| 10 GHz to 20 GHz | -- | - 11 dBm, typical |
| 20 GHz to 30 GHz | -- | - 11 dBm, typical |
| 30 GHz to 40 GHz | -- | - 11 dBm, typical |
| 40 GHz to 45 GHz | -- | - 11 dBm, typical |
| 45 GHz to 50 GHz | -- | - 15 dBm, typical |
| Damage Level | | |
| E8362B/C | -- | + 20 dBm, typical |
| E8363B/C | -- | + 20 dBm, typical |
| E8364B/C | -- | + 20 dBm, typical |
| Maximum DC Level | | |
| E8362B/C | -- | +/- 15 V, typical |
| E8363B/C | -- | +/- 15 V, typical |
| E8364B/C | -- | +/- 15 V, typical |

Table 50: Source Outputs (Port 1 Source Out, Port 2 Source Out)

| Description | Specification | Supplemental Information |
|--------------------------------------|---------------|--------------------------|
| Maximum Output Level | | |
| E8362B/C, Option 014: | | |
| 45 MHz to 500 MHz | -- | 6 dBm, typical |
| 500 MHz to 2 GHz | -- | 7 dBm, typical |
| 2 GHz to 10 GHz | -- | 7 dBm, typical |
| 10 GHz to 20 GHz | -- | 4 dBm, typical |
| E8362B/C, Option 014 and UNL: | | |
| 45 MHz to 500 MHz | -- | 4 dBm, typical |
| 500 MHz to 2 GHz | -- | 5 dBm, typical |
| 2 GHz to 10 GHz | -- | 5 dBm, typical |
| 10 GHz to 20 GHz | -- | 2 dBm, typical |
| E8363B/C, Option 014: | | |
| 45 MHz to 500 MHz | -- | 5.5 dBm, typical |
| 500 MHz to 2 GHz | -- | 6.5 dBm, typical |
| 2 GHz to 10 GHz | -- | 6.5 dBm, typical |
| 10 GHz to 20 GHz | -- | 4 dBm, typical |
| 20 GHz to 30 GHz | -- | 10 dBm, typical |
| 30 GHz to 40 GHz | -- | -2 dBm, typical |
| E8363B/C, Option 014 and UNL: | | |
| 45 MHz to 500 MHz | -- | 3.5 dBm, typical |
| 500 MHz to 2 GHz | -- | 5 dBm, typical |
| 2 GHz to 10 GHz | -- | 5 dBm, typical |
| 10 GHz to 20 GHz | -- | 3.5 dBm, typical |
| 20 GHz to 30 GHz | -- | 0 dBm, typical |
| 30 GHz to 40 GHz | -- | -2.5 dBm, typical |
| E8364B/C, Option 014: | | |
| 45 MHz to 500 MHz | -- | 5.5 dBm, typical |
| 500 MHz to 2 GHz | -- | 6.5 dBm, typical |
| 2 GHz to 10 GHz | -- | 6.5 dBm, typical |
| 10 GHz to 20 GHz | -- | 4 dBm, typical |
| 20 GHz to 30 GHz | -- | 1 dBm, typical |
| 30 GHz to 40 GHz | -- | -2 dBm, typical |
| 40 GHz to 45 GHz | -- | -3 dBm, typical |
| 45 GHz to 50 GHz | -- | -7.5 dBm, typical |

| E8364B/C, Option 014 and UNL: | | |
|--------------------------------------|----|-------------------|
| 45 MHz to 500 MHz | -- | 3.5 dBm, typical |
| 500 MHz to 2 GHz | -- | 5 dBm, typical |
| 2 GHz to 10 GHz | -- | 5 dBm, typical |
| 10 GHz to 20 GHz | -- | 3.5 dBm, typical |
| 20 GHz to 30 GHz | -- | 0 dBm, typical |
| 30 GHz to 40 GHz | -- | -2.5 dBm, typical |
| 40 GHz to 45 GHz | -- | -5 dBm, typical |
| 45 GHz to 50 GHz | -- | -10 dBm, typical |
| Damage Level | | |
| E8362B/C | -- | 20 dBm, typical |
| E8363B/C | -- | 20 dBm, typical |
| E8364B/C | -- | 20 dBm, typical |
| Maximum DC Level | | |
| E8362B/C | -- | 0 V, typical |
| E8363B/C | -- | 0 V, typical |
| E8364B/C | -- | 0 V, typical |

Table 51: Coupler Inputs (Port 1 Cplr Thru, Port 2 Cplr Thru)

| Description | Specification | Supplemental Information |
|--------------------------------------|---------------|--------------------------|
| Insertion Loss to Test Port | | |
| E8362B/C, Option 014: | | |
| 45 MHz to 500 MHz | -- | 0.5 dB, typical |
| 500 MHz to 2 GHz | -- | 1.5 dB, typical |
| 2 GHz to 10 GHz | -- | 1.5 dB, typical |
| 10 GHz to 20 GHz | -- | 1.5 dB, typical |
| E8362B/C, Option 014 and UNL: | | |
| 45 MHz to 500 MHz | -- | 1 dB, typical |
| 500 MHz to 2 GHz | -- | 2 dB, typical |
| 2 GHz to 10 GHz | -- | 2 dB, typical |
| 10 GHz to 20 GHz | -- | 2 dB, typical |
| E8363B/C, Option 014: | | |
| 45 MHz to 500 MHz | -- | 0.5 dB, typical |
| 500 MHz to 2 GHz | -- | 0.5 dB, typical |
| 2 GHz to 10 GHz | -- | 1.5 dB, typical |
| 10 GHz to 20 GHz | -- | 2 dB, typical |
| 20 GHz to 30 GHz | -- | 3 dB, typical |
| 30 GHz to 40 GHz | -- | 3.5 dB, typical |
| E8363B/C, Option 014 and UNL: | | |
| 45 MHz to 500 MHz | -- | 0.5 dB, typical |
| 500 MHz to 2 GHz | -- | 1 dB, typical |
| 2 GHz to 10 GHz | -- | 2 dB, typical |
| 10 GHz to 20 GHz | -- | 3 dB, typical |
| 20 GHz to 30 GHz | -- | 4 dB, typical |
| 30 GHz to 40 GHz | -- | 5 dB, typical |
| E8364B/C, Option 014: | | |
| 45 MHz to 500 MHz | -- | 0.5 dB, typical |
| 500 MHz to 2 GHz | -- | 0.5 dB, typical |
| 2 GHz to 10 GHz | -- | 1.5 dB, typical |
| 10 GHz to 20 GHz | -- | 2 dB, typical |
| 20 GHz to 30 GHz | -- | 3 dB, typical |
| 30 GHz to 40 GHz | -- | 3.5 dB, typical |
| 40 GHz to 45 GHz | -- | 3.5 dB, typical |
| 45 GHz to 50 GHz | -- | 4 dB, typical |

| E8364B/C, Option 014 and UNL: | | |
|--------------------------------------|----|-------------------|
| 45 MHz to 500 MHz | -- | 0.5 dB, typical |
| 500 MHz to 2 GHz | -- | 1 dB, typical |
| 2 GHz to 10 GHz | -- | 2 dB, typical |
| 10 GHz to 20 GHz | -- | 3 dB, typical |
| 20 GHz to 30 GHz | -- | 4 dB, typical |
| 30 GHz to 40 GHz | -- | 5 dB, typical |
| 40 GHz to 45 GHz | -- | 5.5 dB, typical |
| 45 GHz to 50 GHz | -- | 6 dB, typical |
| Damage Level | | |
| E8362B/C | -- | + 30 dBm, typical |
| E8363B/C | -- | + 30 dBm, typical |
| E8364B/C | -- | + 30 dBm, typical |
| Maximum DC Level | | |
| E8362B/C | -- | +/- 40 V, typical |
| E8363B/C | -- | +/- 40 V, typical |
| E8364B/C | -- | +/- 40 V, typical |

Table 52: Coupler Outputs (Port 1 Cplr Arm, Port 2 Cplr Arm)

| Description | Specification | Supplemental Information |
|-------------------------|----------------------|---------------------------------|
| Damage Level | | |
| E8362B/C | -- | + 30 dBm, typical |
| E8363B/C | -- | + 30 dBm, typical |
| E8364B/C | -- | + 30 dBm, typical |
| Maximum DC Level | | |
| E8362B/C | -- | +/- 7 V, typical |
| E8363B/C | -- | +/- 7 V, typical |
| E8364B/C | -- | +/- 7 V, typical |

Test Set Block Diagrams

E836xB/C - Standard Configuration and Standard Power Range

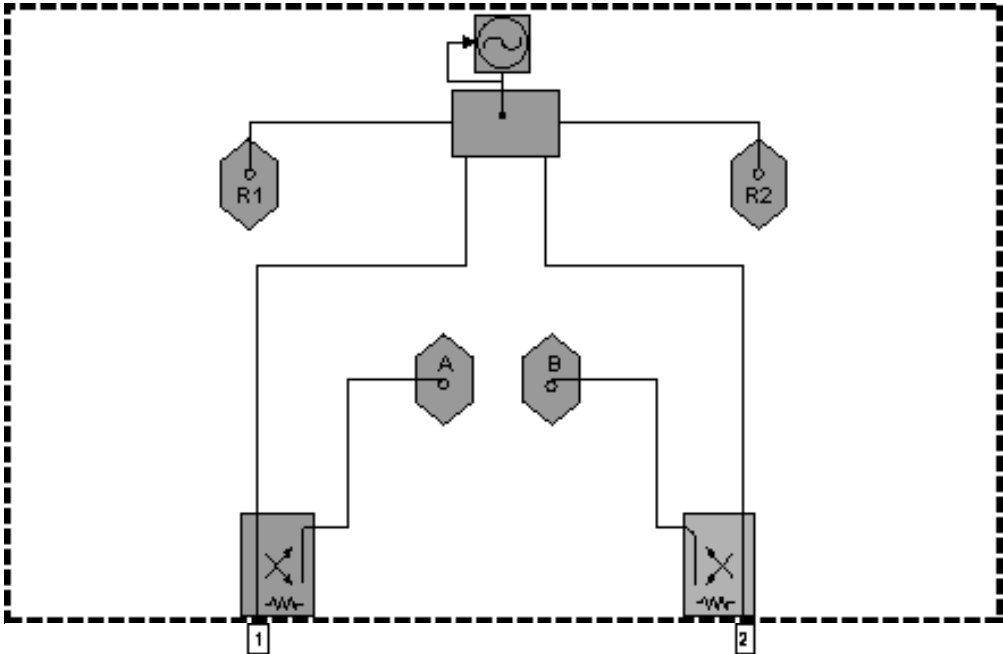

E836xB/C - Option UNL Standard Configuration with Extended Power Range and Bias - Tees

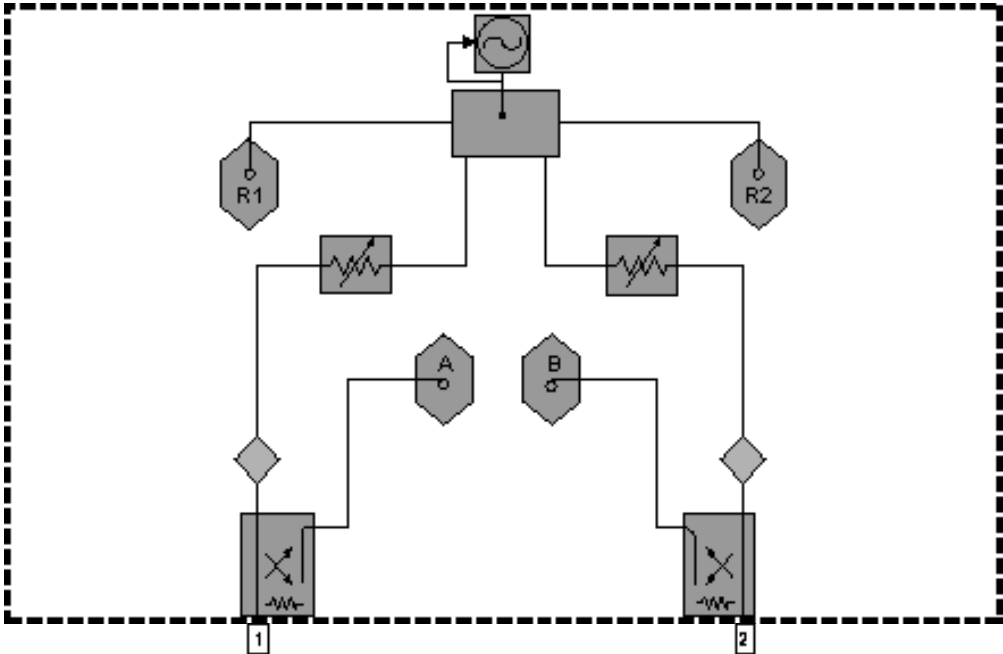

E836xB/C - Option UNL Standard Configuration with Extended Power Range and Bias - Tees, and Option 016, Receiver Attenuators

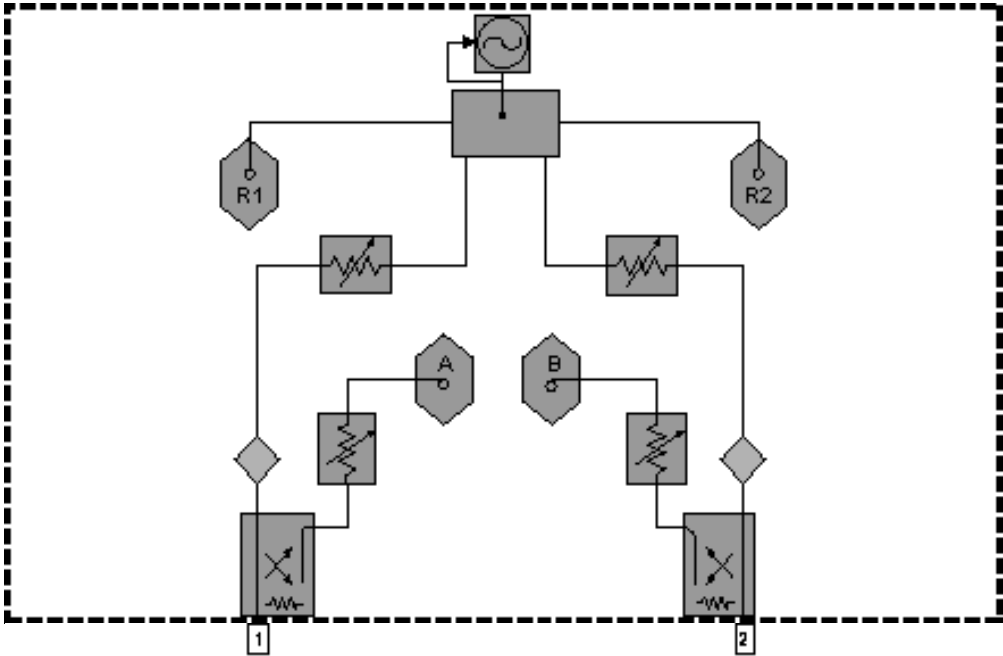

Test Set with Option 014 Block Diagrams

E836xB/C - Option 014 Configurable Test Set and Standard Power Range

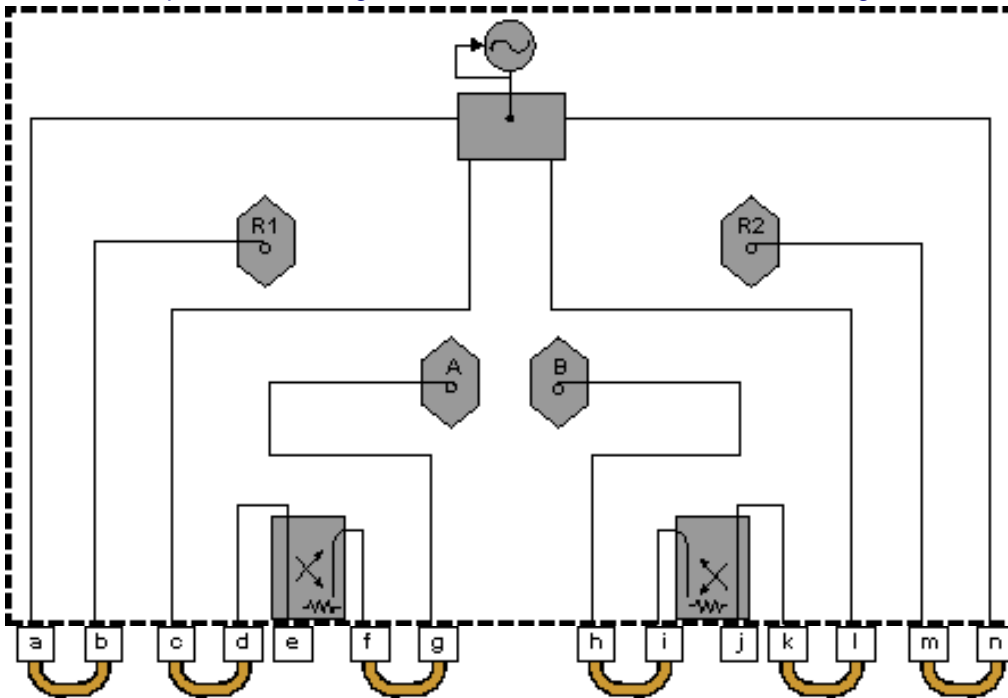

| Item | Description | Item | Description |
|------|-------------|------|-------------|
| a | SOURCE OUT | h | RCVR B IN |
| b | RCVR R1 IN | i | CPLR ARM |
| c | SOURCE OUT | j | PORT 2 |
| d | CPLR THRU | k | CPLR THRU |
| e | PORT 1 | l | SOURCE OUT |
| f | CPLR ARM | m | RCVR R2 IN |
| g | RCVR A IN | n | SOURCE OUT |

E836xB/C - Option 014 Configurable Test Set and Standard Power Range, and Option 081 Reference Channel Transfer Switch

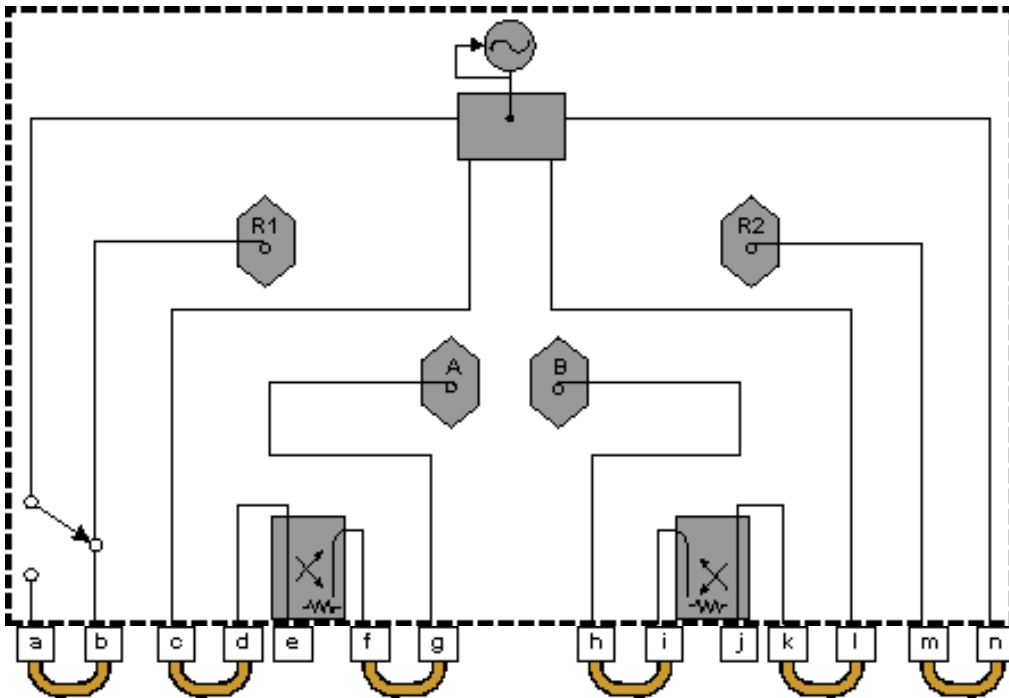

| Item | Description | Item | Description |
|------|-------------|------|-------------|
| a | SOURCE OUT | h | RCVR B IN |
| b | RCVR R1 IN | i | CPLR ARM |
| c | SOURCE OUT | j | PORT 2 |
| d | CPLR THRU | k | CPLR THRU |
| e | PORT 1 | l | SOURCE OUT |
| f | CPLR ARM | m | RCVR R2 IN |
| g | RCVR A IN | n | SOURCE OUT |

E836xB/C - Option 014 Configurable Test Set, and Option UNL Extended Power Range and Bias - Tees

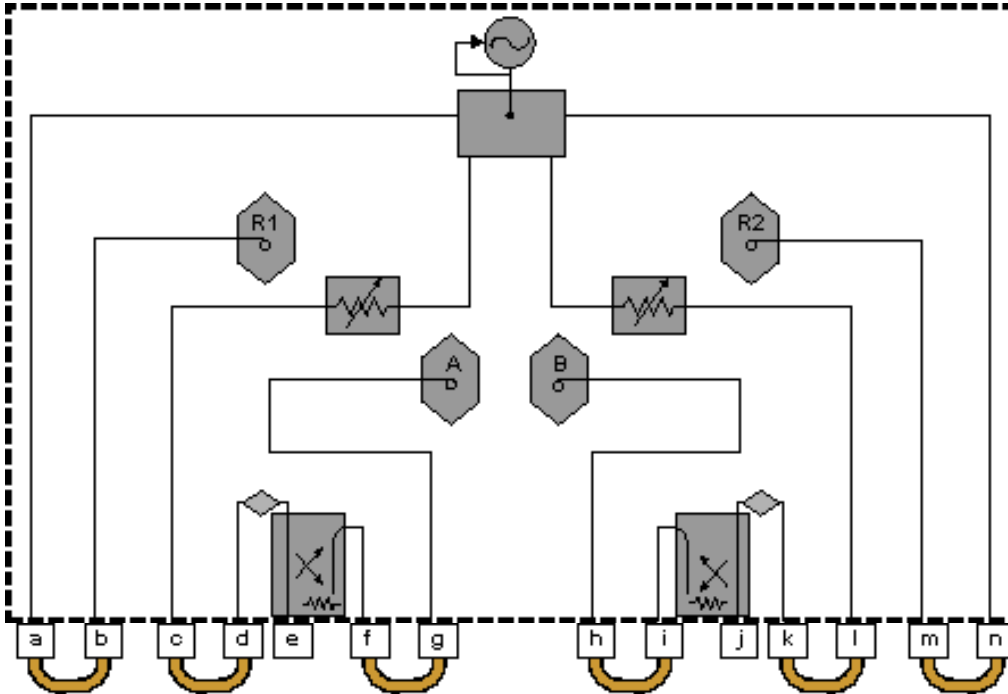

| Item | Description | Item | Description |
|------|-------------|------|-------------|
| a | SOURCE OUT | h | RCVR B IN |
| b | RCVR R1 IN | i | CPLR ARM |
| c | SOURCE OUT | j | PORT 2 |
| d | CPLR THRU | k | CPLR THRU |
| e | PORT 1 | l | SOURCE OUT |
| f | CPLR ARM | m | RCVR R2 IN |
| g | RCVR A IN | n | SOURCE OUT |

E836xB/C - Option 014 Configurable Test Set, and Option UNL Extended Power Range and Bias - Tees, and Option 081 Reference Channel Transfer Switch

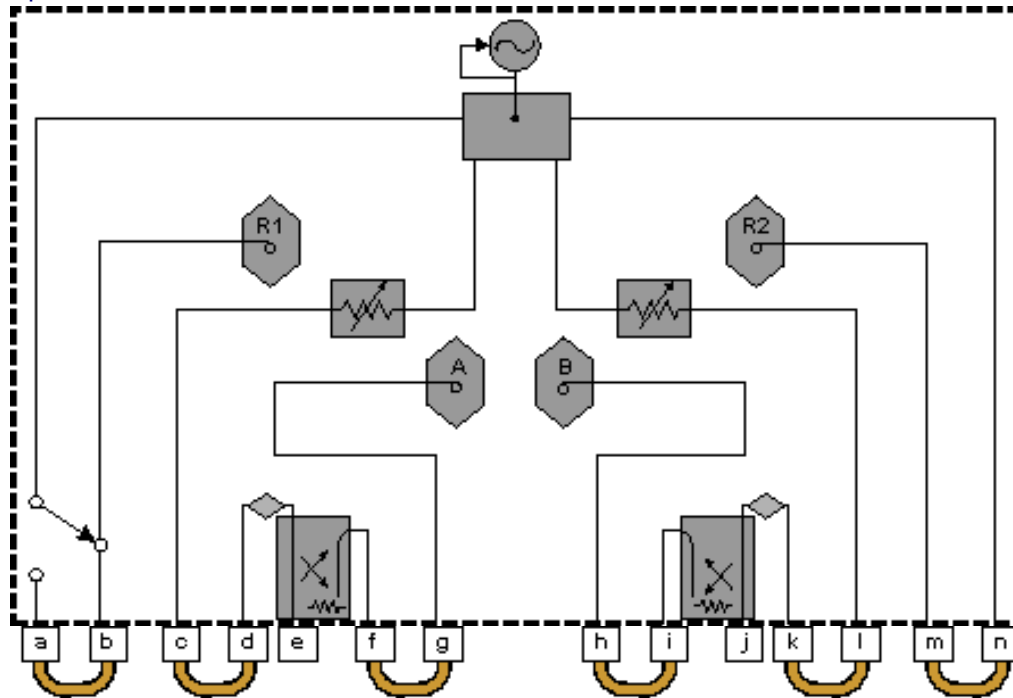

| Item | Description | Item | Description |
|------|-------------|------|-------------|
| a | SOURCE OUT | h | RCVR B IN |
| b | RCVR R1 IN | i | CPLR ARM |
| c | SOURCE OUT | j | PORT 2 |
| d | CPLR THRU | k | CPLR THRU |
| e | PORT 1 | l | SOURCE OUT |
| f | CPLR ARM | m | RCVR R2 IN |
| g | RCVR A IN | n | SOURCE OUT |

E836xB/C - Option 014 Configurable Test Set and Option UNL, Extended Power Range and Bias - Tees and Option 016 Receiver Attenuators

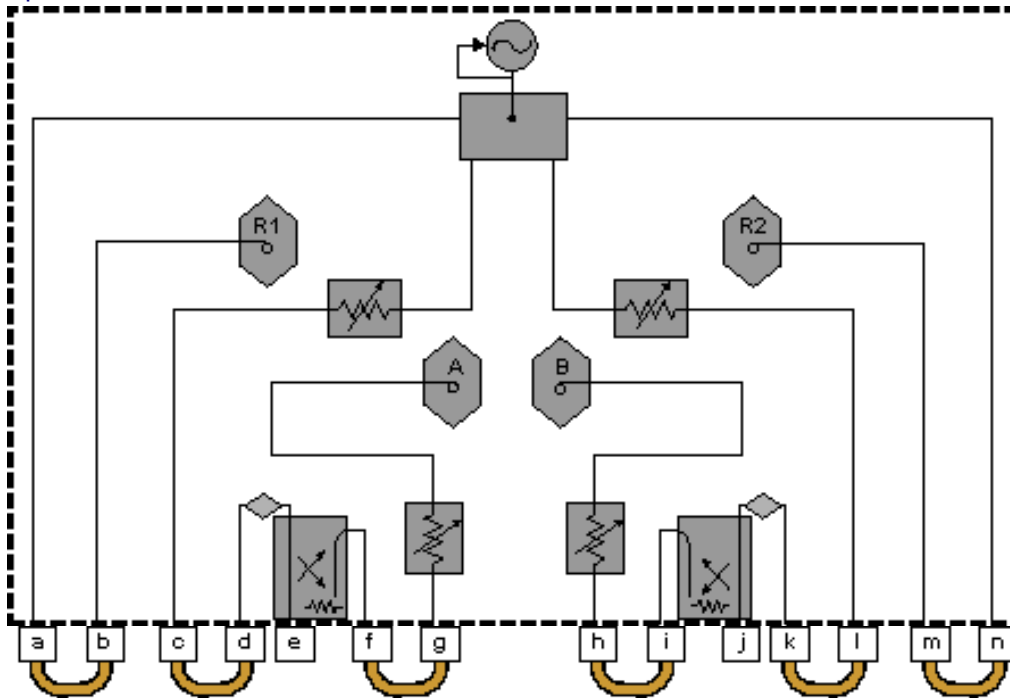

| Item | Description | Item | Description |
|------|-------------|------|-------------|
| a | SOURCE OUT | h | RCVR B IN |
| b | RCVR R1 IN | i | CPLR ARM |
| c | SOURCE OUT | j | PORT 2 |
| d | CPLR THRU | k | CPLR THRU |
| e | PORT 1 | l | SOURCE OUT |
| f | CPLR ARM | m | RCVR R2 IN |
| g | RCVR A IN | n | SOURCE OUT |

E836xB/C - Option 014 Configurable Test Set, and Option UNL Extended Power Range and Bias - Tees, and Option 016 Receiver Attenuators, and Option 081 Reference Channel Transfer Switch

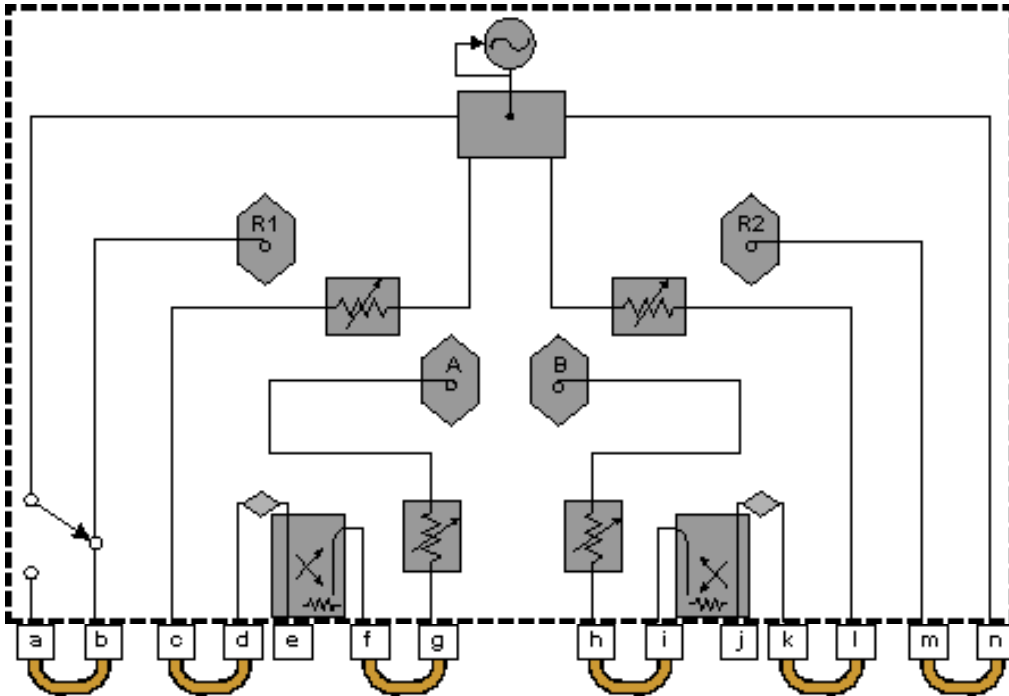

| Item | Description | Item | Description |
|------|-------------|------|-------------|
| a | SOURCE OUT | h | RCVR B IN |
| b | RCVR R1 IN | i | CPLR ARM |
| c | SOURCE OUT | j | PORT 2 |
| d | CPLR THRU | k | CPLR THRU |
| e | PORT 1 | l | SOURCE OUT |
| f | CPLR ARM | m | RCVR R2 IN |
| g | RCVR A IN | n | SOURCE OUT |