

Technical Specifications

Agilent Technologies PNA Series Network Analyzers E8362A, E8363A, and E8364A

Discontinued Product Information — For Support Reference Only —

Information herein, may refer to products/services no longer supported. We regret any inconvenience caused by obsolete information. For the latest information on Agilent's test and measurement products go to:
www.agilent.com/find/products

In the US, call Agilent Technologies at 1-800-829-4444
(any weekday between 8am–5pm in any U.S. time zone)

World-wide Agilent sales office contact information is available at:
www.agilent.com/find/contactus



Documentation Warranty

THE MATERIAL CONTAINED IN THIS DOCUMENT IS PROVIDED "AS IS," AND IS SUBJECT TO BEING CHANGED, WITHOUT NOTICE, IN FUTURE EDITIONS. FURTHER, TO THE MAXIMUM EXTENT PERMITTED BY APPLICABLE LAW, AGILENT DISCLAIMS ALL WARRANTIES, EITHER EXPRESS OR IMPLIED WITH REGARD TO THIS MANUAL AND ANY INFORMATION CONTAINED HEREIN, INCLUDING BUT NOT LIMITED TO THE IMPLIED WARRANTIES OF MERCHANTABILITY AND FITNESS FOR A PARTICULAR PURPOSE. AGILENT SHALL NOT BE LIABLE FOR ERRORS OR FOR INCIDENTAL OR CONSEQUENTIAL DAMAGES IN CONNECTION WITH THE FURNISHING, USE, OR PERFORMANCE OF THIS DOCUMENT OR ANY INFORMATION CONTAINED HEREIN. SHOULD AGILENT AND THE USER HAVE A SEPARATE WRITTEN AGREEMENT WITH WARRANTY TERMS COVERING THE MATERIAL IN THIS DOCUMENT THAT CONFLICT WITH THESE TERMS, THE WARRANTY TERMS IN THE SEPARATE AGREEMENT WILL CONTROL.

DFARS/Restricted Rights Notice

If software is for use in the performance of a U.S. Government prime contract or subcontract, Software is delivered and licensed as "Commercial computer software" as defined in DFAR 252.227-7014 (June 1995), or as a "commercial item" as defined in FAR 2.101(a) or as "Restricted computer software" as defined in FAR 52.227-19 (June 1987) or any equivalent agency regulation or contract clause. Use, duplication or disclosure of Software is subject to Agilent Technologies' standard commercial license terms, and non-DOD Departments and Agencies of the U.S. Government will receive no greater than Restricted Rights as defined in FAR 52.227-19(c)(1-2) (June 1987). U.S. Government users will receive no greater than Limited Rights as defined in FAR 52.227-14 (June 1987) or DFAR 252.227-7015 (b)(2) (November 1995), as applicable in any technical data.

Contacting Agilent

Online assistance: www.agilent.com/find/assist

Americas			
Brazil <i>(tel)</i> (+55) 11 4197 3600 <i>(fax)</i> (+55) 11 4197 3800	Canada <i>(tel)</i> 877 894 4414 <i>(fax)</i> (+1) 905 282-6495	Mexico <i>(tel)</i> (+52) 55 5081 9469 <i>(alt)</i> 01800 5064 800 <i>(fax)</i> (+52) 55 5081 9467	United States <i>(tel)</i> 800 829 4444 <i>(alt)</i> (+1) 303 662 3998 <i>(fax)</i> 800 829 4433
Asia Pacific and Japan			
Australia <i>(tel)</i> 1800 629 485 <i>(alt)</i> 1800 143 243 <i>(fax)</i> 1800 142 134	China <i>(tel)</i> 800 810 0189 <i>(alt)</i> (+86) 10800 650 0021 <i>(fax)</i> 800 820 2816	Hong Kong <i>(tel)</i> 800 930 871 <i>(alt)</i> (+852) 3197 7889 <i>(fax)</i> (+852) 2 506 9233	India <i>(tel)</i> 1600 112 929 <i>(fax)</i> 000800 650 1101
Japan <i>(tel)</i> 0120 421 345 <i>(alt)</i> (+81) 426 56 7832 <i>(fax)</i> 0120 421 678	Malaysia <i>(tel)</i> 1800 888 848 <i>(alt)</i> 1800 828 848 <i>(fax)</i> 1800 801 664	Singapore <i>(tel)</i> 1800 375 8100 <i>(alt)</i> (+65) 6 375 8100 <i>(fax)</i> (+65) 6836 0252	South Korea <i>(tel)</i> 080 769 0800 <i>(alt)</i> (+82) 2 2004 5004 <i>(fax)</i> (+82) 2 2004 5115
Taiwan <i>(tel)</i> 0800 047 866 <i>(alt)</i> 00801 651 317 <i>(fax)</i> 0800 286 331	Thailand <i>(tel)</i> 1800 226 008 <i>(alt)</i> (+66) 2 268 1345 <i>(fax)</i> (+66) 2 661 3714		
Europe			
Austria <i>(tel)</i> 0820 87 44 11* <i>(fax)</i> 0820 87 44 22	Belgium <i>(tel)</i> (+32) (0)2 404 9340 <i>(alt)</i> (+32) (0)2 404 9000 <i>(fax)</i> (+32) (0)2 404 9395	Denmark <i>(tel)</i> (+45) 7013 1515 <i>(alt)</i> (+45) 7013 7313 <i>(fax)</i> (+45) 7013 1555	Finland <i>(tel)</i> (+358) 10 855 2100 <i>(fax)</i> (+358) 10 855 2923
France <i>(tel)</i> 0825 010 700* <i>(alt)</i> (+33) (0)1 6453 5623 <i>(fax)</i> 0825 010 701*	Germany <i>(tel)</i> 01805 24 6333* <i>(alt)</i> 01805 24 6330* <i>(fax)</i> 01805 24 6336*	Ireland <i>(tel)</i> (+353) (0)1 890 924 204 <i>(alt)</i> (+353) (0)1 890 924 206 <i>(fax)</i> (+353) (0)1 890 924 024	Israel <i>(tel)</i> (+972) 3 9288 500 <i>(fax)</i> (+972) 3 9288 501
Italy <i>(tel)</i> (+39) (0)2 9260 8484 <i>(fax)</i> (+39) (0)2 9544 1175	Luxemburg <i>(tel)</i> (+32) (0)2 404 9340 <i>(alt)</i> (+32) (0)2 404 9000 <i>(fax)</i> (+32) (0)2 404 9395	Netherlands <i>(tel)</i> (+31) (0)20 547 2111 <i>(alt)</i> (+31) (0)20 547 2000 <i>(fax)</i> (+31) (0)20 547 2190	Russia <i>(tel)</i> (+7) 095 797 3963 <i>(alt)</i> (+7) 095 797 3900 <i>(fax)</i> (+7) 095 797 3901
Spain <i>(tel)</i> (+34) 91 631 3300 <i>(alt)</i> (+34) 91 631 3000 <i>(fax)</i> (+34) 91 631 3301	Sweden <i>(tel)</i> 0200 88 22 55* <i>(alt)</i> (+46) (0)8 5064 8686 <i>(fax)</i> 020 120 2266*	Switzerland (French) <i>(tel)</i> 0800 80 5353 opt. 2* <i>(alt)</i> (+33) (0)1 6453 5623 <i>(fax)</i> (+41) (0)22 567 5313	Switzerland (German) <i>(tel)</i> 0800 80 5353 opt. 1* <i>(alt)</i> (+49) (0)7031 464 6333 <i>(fax)</i> (+41) (0)1 272 7373
Switzerland (Italian) <i>(tel)</i> 0800 80 5353 opt. 3* <i>(alt)</i> (+39) (0)2 9260 8484 <i>(fax)</i> (+41) (0)22 567 5314	United Kingdom <i>(tel)</i> (+44) (0)7004 666666 <i>(alt)</i> (+44) (0)7004 123123 <i>(fax)</i> (+44) (0)7004 444555		
<i>(tel)</i> = primary telephone number; <i>(alt)</i> = alternate telephone number; <i>(fax)</i> = FAX number; * = in country number			

This page intentionally left blank.

Technical Specifications for the E836xA

Definitions	4-4
Corrected System Performance	4-5
Table 1. System Dynamic Range ^a	4-5
Table 2. Receiver Dynamic Range ^a	4-7
E8363/4A Corrected System Performance with 2.4mm Connectors	4-8
Table 3. 85056A Calibration Kit Standard Configuration and Standard Power Range (E8363/4A) ...	4-8
Table 4. 85056A Calibration Kit Extended Configuration and Standard Power Range (E8363/4A - Option 014) -OR- Standard Configuration and Extended Power Range & Bias-Tees (E8363/4A - Option UNL) -OR- Extended Configuration and Extended Power Range & Bias-Tees (E8363/4A - Option UNL&014)	4-9
Table 5. 85056D Calibration Kit Standard Configuration and Standard Power Range (E8363/4A) ..	4-10
Table 6. 85056D Calibration Kit Extended Configuration and Standard Power Range (E8363/4A - Option 014) -OR- Standard Configuration and Extended Power Range & Bias-Tees (E8363/4A - Option UNL) -OR- Extended Configuration and Extended Power Range & Bias-Tees (E8363/4A - Option UNL & 014)	4-11
E8363/4A Corrected System Performance with 2.92mm Connectors	4-12
Table 7. 85056K Calibration Kit Standard Configuration and Standard Power Range (E8363/4A) ..	4-12
Table 8. 85056K Calibration Kit Extended Configuration and Standard Power Range (E8363/4A - Option 014) -OR- Standard Configuration and Extended Power Range & Bias-Tees (E8363/4A - Option UNL) -OR- Extended Configuration and Extended Power Range & Bias-Tees (E8363/4A - Option UNL&014)	4-13
E836xA Corrected System Performance with 3.5mm Connectors	4-14
Table 9. 85052B Calibration Kit Standard Configuration and Standard Power Range (E836xA)	4-14
Table 10. 85052B Calibration Kit Extended Configuration and Standard Power Range (E836xA - Option 014) -OR- Standard Configuration and Extended Power Range & Bias-Tees (E836xA - Option UNL) -OR- Extended Configuration and Extended Power Range & Bias-Tees (E836xA - Option UNL&014)	4-15
Table 11. 85052C Calibration Kit Standard Configuration and Standard Power Range (E836xA) ..	4-16
Table 12. 85052C Calibration Kit Extended Configuration and Standard Power Range (E836xA - Option 014) -OR- Standard Configuration and Extended Power Range & Bias-Tees (E836xA - Option UNL) -OR- Extended Configuration and Extended Power Range & Bias-Tees (E836xA - Option UNL&014)	4-17
Table 13. 85052D Calibration Kit Standard Configuration and Standard Power Range (E836xA) ..	4-18
Table 14. 85052D Calibration Kit Extended Configuration and Standard Power Range (E836xA - Option 014) -OR- Standard Configuration and Extended Power Range & Bias-Tees (E836xA - Option UNL) -OR- Extended Configuration and Extended Power Range & Bias-Tees (E836xA - Option UNL&014)	4-19
E836xA Corrected System Performance with 7mm Connectors	4-20
Table 15. 85050B Calibration Kit Standard Configuration and Standard Power Range (E836xA) ..	4-20
Table 16. 85050B Calibration Kit Extended Configuration and Standard Power Range (E836xA - Option 014) -OR- Standard Configuration and Extended Power Range & Bias-Tees (E836xA - Option UNL) -OR- Extended Configuration and Extended Power Range & Bias-Tees (E836xA - Option UNL&014)	4-21
Table 17. 85050C Calibration Kit Standard Configuration and Standard Power Range (E836xA) ..	4-22
Table 18. 85050C Calibration Kit Extended Configuration and Standard Power Range (E836xA - Option 014) -OR- Standard Configuration and Extended Power Range & Bias-Tees (E836xA - Option UNL) -OR- Extended Configuration and Extended Power Range & Bias-Tees (E836xA - Option UNL&014)	4-23
Table 19. 85050D Calibration Kit Standard Configuration and Standard Power Range (E836xA) ..	4-24
Table 20. 85050D Calibration Kit Extended Configuration and Standard Power Range	

(E836xA - Option 014) -OR- Standard Configuration and Extended Power Range & Bias-Tees (E836xA - Option UNL) -OR- Extended Configuration and Extended Power Range & Bias-Tees (E836xA - Option UNL&014).....	4-25
E836xA Corrected System Performance with Type-N Connectors	4-26
Table 21. 85054B Calibration Kit Standard Configuration and Standard Power Range (E836xA) ..	4-26
Table 22. 85054B Calibration Kit Extended Configuration and Standard Power Range (E836xA - Option 014) -OR- Standard Configuration and Extended Power Range & Bias-Tees (E836xA - Option UNL) -OR- Extended Configuration and Extended Power Range & Bias-Tees (E836xA - Option UNL&014).....	4-27
Table 23. 85054D Calibration Kit Standard Configuration and Standard Power Range (E836xA) ..	4-28
Table 24. 85054D Calibration Kit Extended Configuration and Standard Power Range (E836xA - Option 014) -OR- Standard Configuration and Extended Power Range & Bias-Tees (E836xA - Option UNL) -OR- Extended Configuration and Extended Power Range & Bias-Tees (E836xA - Option UNL&014).....	4-29
E8363/4A Corrected System Performance with WR-28 Connectors	4-30
Table 25. R11644A Calibration Kit Standard Configuration and Standard Power Range (E8363/4A).....	4-30
Table 26. R11644A Calibration Kit Extended Configuration and Standard Power Range (E8363/4A - Option 014) -OR- Standard Configuration and Extended Power Range & Bias-Tees (E8363/4A - Option UNL) -OR- Extended Configuration and Extended Power Range & Bias-Tees (E8363/4A - Option UNL&014).....	4-31
E8363/4A Corrected System Performance with WR-42 Connectors	4-32
Table 27. K11644A Calibration Kit Standard Configuration and Standard Power Range (E8363/4A).....	4-32
Table 28. K11644A Calibration Kit Extended Configuration and Standard Power Range (E8363/4A - Option 014) -OR- Standard Configuration and Extended Power Range & Bias-Tees (E8363/4A - Option UNL) -OR- Extended Configuration and Extended Power Range & Bias-Tees (E8363/4A - Option UNL&014).....	4-33
E836xA Corrected System Performance with WR-62 Connectors	4-34
Table 29. P11644A Calibration Kit Standard Configuration and Standard Power Range (E836xA)	4-34
Table 30. P11644A Calibration Kit Extended Configuration and Standard Power Range (E836xA - Option 014) -OR- Standard Configuration and Extended Power Range & Bias-Tees (E836xA - Option UNL) -OR- Extended Configuration and Extended Power Range & Bias-Tees (E836xA - Option UNL&014).....	4-35
E836xA Corrected System Performance with WR-90 Connectors	4-36
Table 31. X11644A Calibration Kit Standard Configuration and Standard Power Range (E836xA).....	4-36
Table 32. X11644A Calibration Kit Extended Configuration and Standard Power Range (E836xA - Option 014) -OR- Standard Configuration and Extended Power Range & Bias-Tees (E836xA - Option UNL) -OR- Extended Configuration and Extended Power Range & Bias-Tees (E836xA - Option UNL&014).....	4-37
Table 33. Uncorrected System Performance	4-38
Table 34. Test Port Output ^a	4-40
Table 35. Test Port Input.....	4-42
Table 36. Dynamic Accuracy (Specification ^a)	4-45
Table 37. Test Port Input (Group Delay) ^a	4-46
General Information	4-46
Table 38. Miscellaneous Information.....	4-46
Table 39. Front Panel Information.....	4-47
Table 40. Rear Panel Information.....	4-47
Table 41. Analyzer Environment and Dimensions.....	4-49
Measurement Throughput Summary.....	4-50

Table 42. Typical Cycle Time ^{a,b} (ms) for Measurement Completion	4-50
Table 43. Cycle Time vs IF Bandwidth ^a	4-51
Table 44. Cycle Time vs Number of Points ^a	4-51
Table 45. Data Transfer Time (ms) ^a	4-52
Specifications: Front-Panel Jumpers	4-53
Table 46: Measurement Receiver Inputs (Rcvr A In, Rcvr B In).....	4-53
Table 47: Reference Receiver Inputs (Rcvr R1, Rcvr R2).....	4-55
Table 48: Reference Outputs (Reference 1 Source Out, Reference 2 Source Out).....	4-56
Table 49: Source Outputs (Port 1 Source Out, Port 2 Source Out).....	4-57
Table 50: Coupler Inputs (Port 1 Cplr Thru, Port 2 Cplr Thru)	4-58
Table 51: Coupler Outputs (Port 1 Cplr Arm, Port 2 Cplr Arm)	4-59
Test Set Block Diagrams	4-60
E836xA Standard Configuration and Standard Power Range.....	4-60
E836xA - Option UNL Standard Configuration with Extended Power Range and Bias - Tees	4-60
Test Set with Option 014 Block Diagrams	4-61
E836xA - Option 014 Extended Configuration and Standard Power Range	4-61
E836xA - Option UNL&014 Extended Configuration with Extended Power Range and Bias - Tees	4-62

This is a complete list of the E8362A, E8363A, and E8364A network analyzer technical specifications.

- To optimize viewing of uncertainty curves, click the Maximize button.
- To view or print the PNA Series Data Sheet (a condensed version of the specifications), visit our web site at <http://www.agilent.com/find/pna>, select your analyzer model, and click on the link for the data sheet.
- The uncertainty curves contained in this document apply only to the setup conditions listed. Please download our free Uncertainty Calculator from http://www.agilent.com/find/na_calculator to generate the curves for your PNA setup. View the [equations](#) used to generate the uncertainty curves.

See [Specs for other PNA models](#)

Definitions

All specifications and characteristics apply over a 25 °C \pm 5 °C range (unless otherwise stated) and 90 minutes after the instrument has been turned on.

Specification (spec.): Warranted performance. Specifications include guardbands to account for the expected statistical performance distribution, measurement uncertainties, and changes in performance due to environmental conditions.

Characteristic (char.): A performance parameter that the product is expected to meet before it leaves the factory, but that is not verified in the field and is not covered by the product warranty. A characteristic includes the same guardbands as a specification.

Typical (typ.): Expected performance of an average unit which does not include guardbands. It is not covered by the product warranty.

Nominal (nom.): A general, descriptive term that does not imply a level of performance. It is not covered by the product warranty.

Calibration: The process of measuring known standards to characterize a network analyzer's systematic (repeatable) errors.

Corrected (residual): Indicates performance after error correction (calibration). It is determined by the quality of calibration standards and how well "known" they are, plus system repeatability, stability, and noise.

Uncorrected (raw): Indicates instrument performance without error correction. The uncorrected performance affects the stability of a calibration.

Standard: When referring to the analyzer, this includes no options unless noted otherwise.

Corrected System Performance

The specifications in this section apply for measurements made with the E836xA analyzer with the following conditions:

- 10 Hz IF bandwidth
- No averaging applied to data
- Isolation calibration with an averaging factor of 8

Table 1. System Dynamic Range^a

Description	Specification (dB) at Test Port ^b	Typical (dB) at Direct Receiver Access Input ^c
Dynamic Range (in a 10 Hz BW)		
Standard Configuration and Standard Power Range (E836xA - Standard)		
45 MHz to 500 MHz ^d	94	NA
500 MHz to 2 GHz	119	NA
2 GHz to 10 GHz	122	NA
10 GHz to 20 GHz	123	NA
20 GHz to 30 GHz	114	NA
30 GHz to 40 GHz	110	NA
40 GHz to 45 GHz	109	NA
45 GHz to 50 GHz	104	NA
Extended Configuration and Standard Power Range (E836xA - Option 014)		
45 MHz to 500 MHz ^d	94	132
500 MHz to 2 GHz	119	138
2 GHz to 10 GHz	122	137
10 GHz to 20 GHz	122	137
20 GHz to 30 GHz	115	127
30 GHz to 40 GHz	107	119
40 GHz to 45 GHz	105	116
45 GHz to 50 GHz	100	111
Standard Configuration and Extended Power Range & Bias-Tees (E836xA - Option UNL)		
45 MHz to 500 MHz ^d	92	NA
500 MHz to 2 GHz	117	NA
2 GHz to 10 GHz	120	NA
10 GHz to 20 GHz	121	NA
20 GHz to 30 GHz	112	NA
30 GHz to 40 GHz	108	NA
40 GHz to 45 GHz	105	NA
45 GHz to 50 GHz	99	NA

Standard Configuration and Extended Power Range & Bias-Tees (E836xA - Option UNL&014)		
45 MHz to 500 MHz ^d	92	130
500 MHz to 2 GHz	117	136
2 GHz to 10 GHz	120	135
10 GHz to 20 GHz	119	134
20 GHz to 30 GHz	109	121
30 GHz to 40 GHz	105	117
40 GHz to 45 GHz	101	112
45 GHz to 50 GHz	95	108

^a The system dynamic range is calculated as the difference between the noise floor and the source maximum output power. The effective dynamic range must take measurement uncertainties and interfering signals into account.

^b The test port system dynamic range is calculated as the difference between the test port noise floor and the source maximum output power. The effective dynamic range must take measurement uncertainties and interfering signals into account.

^c The direct receiver access input system dynamic range is calculated as the difference between the receiver access input noise floor and the source maximum output power. The effective dynamic range must take measurement uncertainties and interfering signals into account. This set-up should only be used when the receiver input will never exceed its damage level. When the analyzer is in segment sweep mode, the analyzer can have predefined frequency segments which will output a higher power level when the extended dynamic range is required (i.e. devices with high insertion loss), and reduced power when receiver damage may occur (i.e. devices with low insertion loss). The extended range is only available in one-path transmission measurements.

^d May be degraded by 10 dB at particular frequencies (multiples of 5 MHz) below 500 MHz due to spurious receiver residuals. Methods are available to regain the full dynamic range.

Table 2. Receiver Dynamic Range^a

Description	Specification (dB) at Test Port ^b	Typical (dB) at Direct Receiver Access Input ^c
Dynamic Range (in a 10 Hz BW)		
Standard Configuration and Standard Power Range (E836xA - Standard)		
OR		
Standard Configuration and Extended Power Range & Bias Tees (E836xA - Option UNL)		
45 MHz to 500 MHz ^d	94	NA
500 MHz to 2 GHz	119	NA
2 GHz to 10 GHz	122	NA
10 GHz to 20 GHz	125	NA
20 GHz to 30 GHz	114	NA
30 GHz to 40 GHz	111	NA
40 GHz to 50 GHz	111	NA
Extended Configuration and Standard Power Range (E836xA - Option 014)		
OR		
Extended Configuration and Extended Power Range & Bias Tees (E836xA - Option UNL&014)		
45 MHz to 500 MHz ^d	94	132
500 MHz to 2 GHz	119	138
2 GHz to 10 GHz	122	137
10 GHz to 20 GHz	124	139
20 GHz to 30 GHz	113	125
30 GHz to 40 GHz	110	122
40 GHz to 50 GHz	109	120

^a The receiver dynamic range is calculated as the difference between the noise floor and the receiver maximum output power. The effective dynamic range must take measurement uncertainties and interfering signals into account.

^b The test port receiver dynamic range is calculated as the difference between the test port noise floor and the receiver maximum input level. The effective dynamic range must take measurement uncertainties and interfering signals into account.

^c The direct receiver access input receiver dynamic range is calculated as the difference between the direct receiver access input noise floor and the receiver maximum input level. The effective dynamic range must take measurement uncertainties and interfering signals into account. This set-up should only be used when the receiver input will never exceed its damage level. When the analyzer is in segment sweep mode, the analyzer can have predefined frequency segments which will output a higher power level when the extended dynamic range is required (i.e. devices with high insertion loss), and reduced power when receiver damage may occur (i.e. devices with low insertion loss). The extended range is only available in one-path transmission measurements.

^d May be degraded by 10 dB at particular frequencies (multiples of 5 MHz) below 500 MHz due to spurious receiver residuals. Methods are available to regain the full dynamic range.

Note: This E836xA document provides technical specifications for the following calibration kits only: 85056A, 85056D, 85056K, 85052B, 85052C, 85052D, 85050B, 85050C, 85050D, 85054B, 85054D, K11644A, P11644A, R11644A, and the X11644A.

E8363/4A Corrected System Performance with 2.4mm Connectors

**Table 3. 85056A Calibration Kit
Standard Configuration and Standard Power Range
(E8363/4A)**

Applies to the E8363/4A analyzers, 85056A (2.4mm) calibration kit, 85133F flexible test port cable set, and a full 2-port calibration. Also applies to the following condition:

Environmental temperature $23^{\circ} \pm 3^{\circ} \text{C}$, with $< 1^{\circ} \text{C}$ deviation from calibration temperature

Description	Specification (dB)				
	0.045 to 2 GHz	2 to 10 GHz	10 to 20 GHz	20 to 40 GHz	40 to 50 GHz
Directivity	42	42	42	38	36
Source Match	41	38	38	33	31
Load Match	42	42	42	37	35
Reflection Tracking	± 0.001 $+0.02/^{\circ}\text{C}$	± 0.008 $+0.02/^{\circ}\text{C}$	± 0.008 $+0.02/^{\circ}\text{C}$	± 0.020 $+0.03/^{\circ}\text{C}$	± 0.027 $+0.04/^{\circ}\text{C}$
Transmission Tracking	± 0.014 $+0.02/^{\circ}\text{C}$	± 0.033 $+0.02/^{\circ}\text{C}$	± 0.039 $+0.02/^{\circ}\text{C}$	± 0.105 $+0.03/^{\circ}\text{C}$	± 0.200 $+0.04/^{\circ}\text{C}$

Transmission Uncertainty (Specifications)

Phase

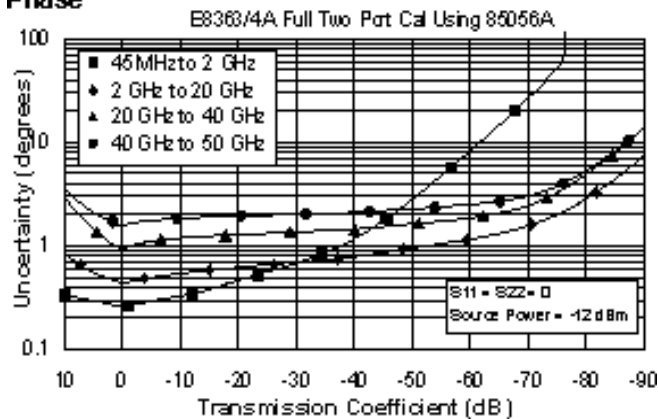

Magnitude

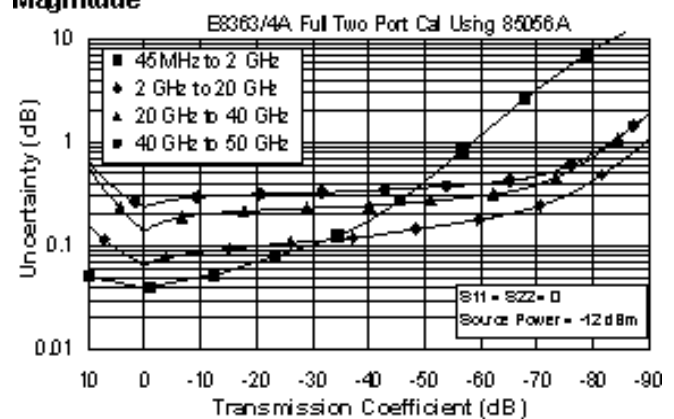

Reflection Uncertainty (Specifications)

Magnitude

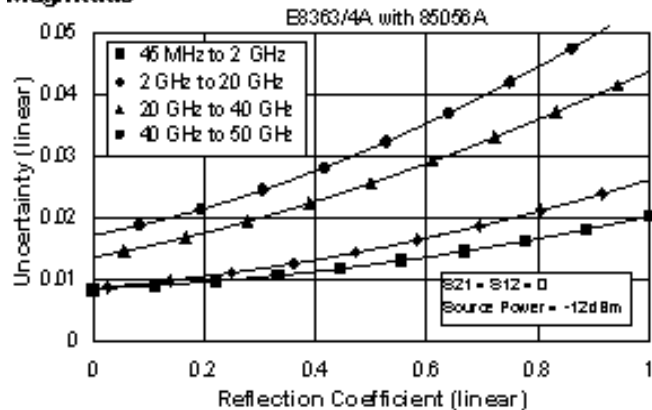

Phase

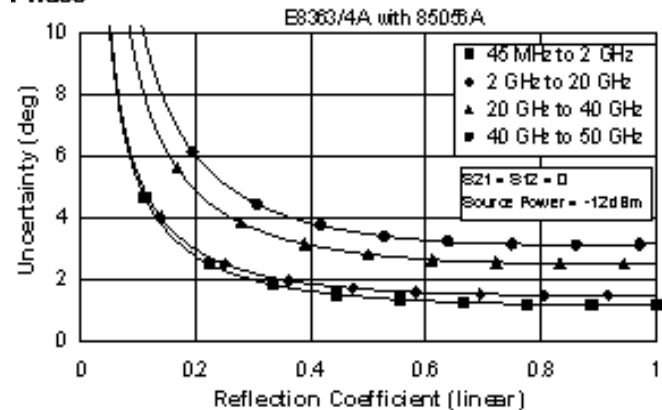

Table 4. 85056A Calibration Kit

Extended Configuration and Standard Power Range (E8363/4A - Option 014)

-OR-

Standard Configuration and Extended Power Range & Bias-Tees (E8363/4A - Option UNL)

-OR-

Extended Configuration and Extended Power Range & Bias-Tees (E8363/4A - Option UNL&014)

Applies to the, E8363/4A analyzers, 85056A (2.4mm) calibration kit, 85133F flexible test port cable set, and a full 2-port calibration. Also applies to the following condition:

Environmental temperature 23° ±3 °C, with < 1 °C deviation from calibration temperature

Description	Specification (dB)				
	0.045 to 2 GHz	2 to 10 GHz	10 to 20 GHz	20 to 40 GHz	40 to 50 GHz
Directivity	42	42	42	38	36
Source Match	41	38	38	33	31
Load Match	42	42	42	37	35
Reflection Tracking	±0.001 +0.02/°C	±0.008 +0.02/°C	±0.008 +0.02/°C	±0.020 +0.03/°C	±0.027 +0.04/°C
Transmission Tracking	±0.019 +0.02/°C	±0.039 +0.02/°C	±0.053 +0.02/°C	±0.114 +0.03/°C	±0.215 +0.04/°C

Transmission Uncertainty (Specifications)

Magnitude

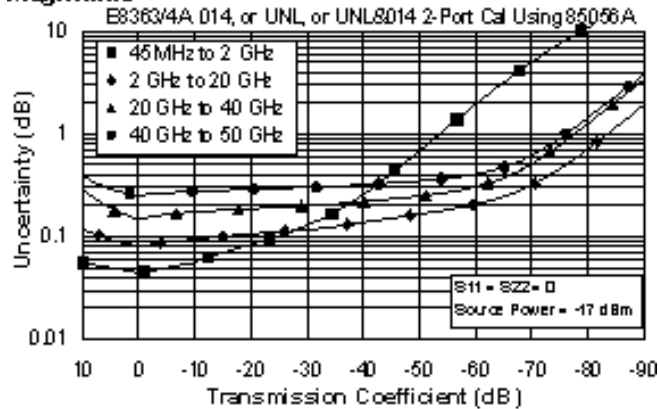

Phase

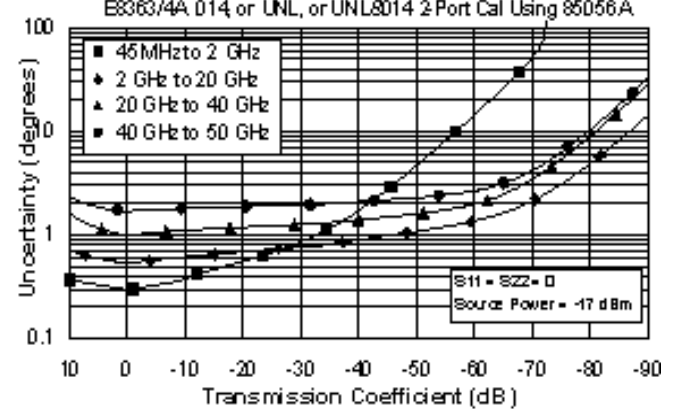

Reflection Uncertainty (Specifications)

Magnitude

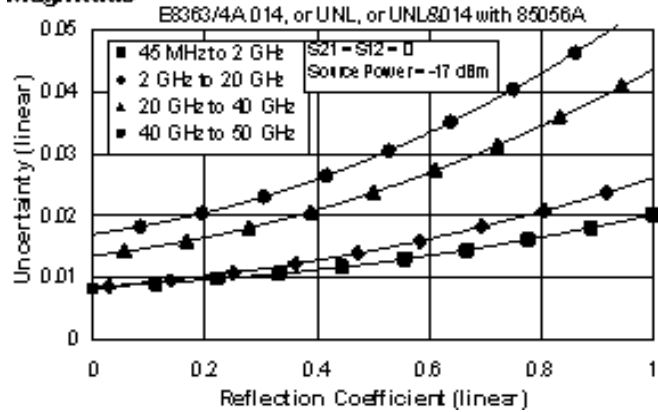

Phase

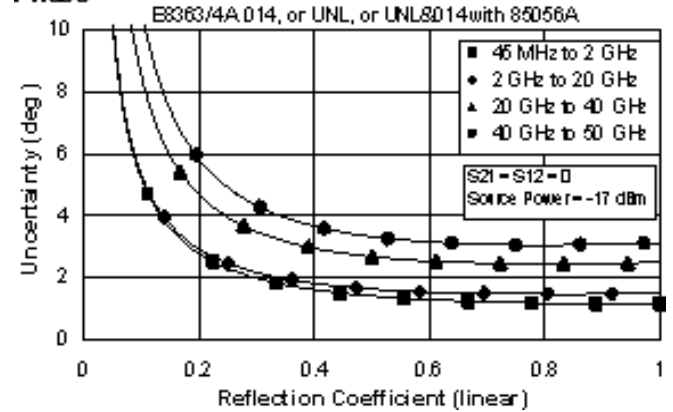

**Table 5. 85056D Calibration Kit
Standard Configuration and Standard Power Range
(E8363/4A)**

Applies to the, E8363/4A analyzers, 85056D (2.4mm) calibration kit, 85133F flexible test port cable set, and a full 2-port calibration. Also applies to the following condition:

Environmental temperature $23^{\circ} \pm 3^{\circ} \text{C}$, with $< 1^{\circ} \text{C}$ deviation from calibration temperature

Description	Specification (dB)			
	0.045 to 2 GHz	2 to 20 GHz	20 to 40 GHz	40 to 50 GHz
Directivity	42	34	34	26
Source Match	40	30	30	23
Load Match	42	34	34	25
Reflection Tracking	± 0.002 $+0.02/^{\circ}\text{C}$	± 0.029 $+0.02/^{\circ}\text{C}$	± 0.029 $+0.03/^{\circ}\text{C}$	± 0.075 $+0.04/^{\circ}\text{C}$
Transmission Tracking	± 0.016 $+0.02/^{\circ}\text{C}$	± 0.081 $+0.02/^{\circ}\text{C}$	± 0.095 $+0.03/^{\circ}\text{C}$	± 0.544 $+0.04/^{\circ}\text{C}$

Transmission Uncertainty (Specifications)

Magnitude

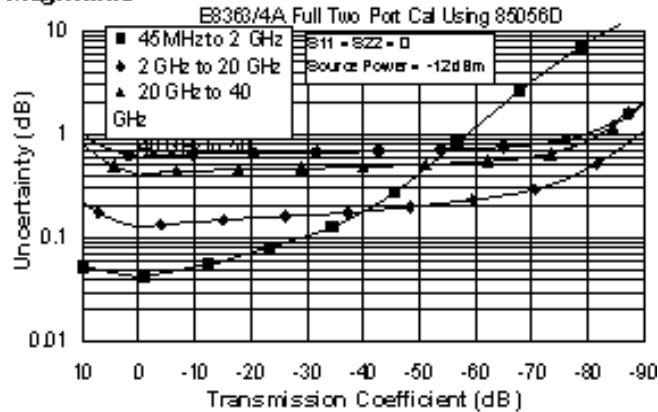

Phase

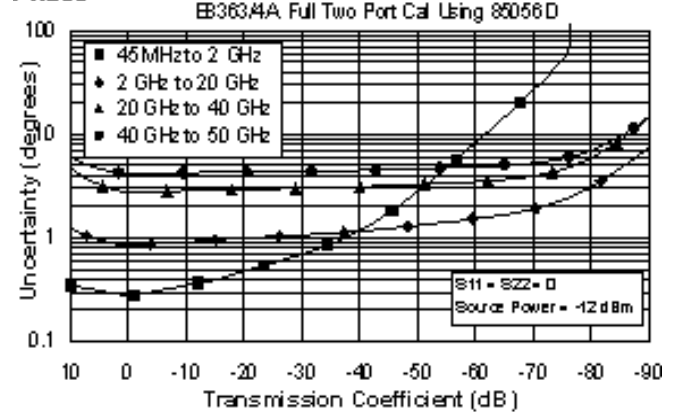

Reflection Uncertainty (Specifications)

Magnitude

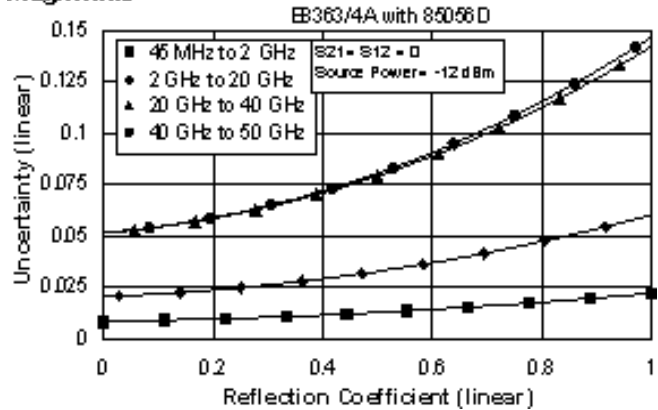

Phase

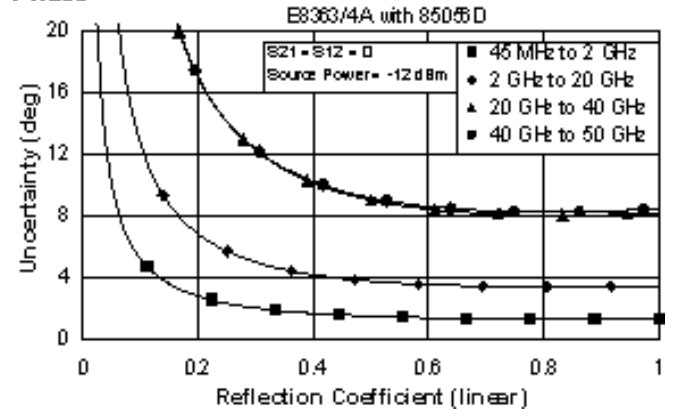

Table 6. 85056D Calibration Kit

Extended Configuration and Standard Power Range (E8363/4A - Option 014)

-OR-

Standard Configuration and Extended Power Range & Bias-Tees (E8363/4A - Option UNL)

-OR-

Extended Configuration and Extended Power Range & Bias-Tees (E8363/4A - Option UNL & 014)

Applies to the, E8363/4A analyzers, 85056D (2.4mm) calibration kit, 85133F flexible test port cable set, and a full 2-port calibration. Also applies to the following condition:

Environmental temperature 23° ±3 °C, with < 1 °C deviation from calibration temperature

Description	Specification (dB)			
	0.045 to 2 GHz	2 to 20 GHz	20 to 40 GHz	40 to 50 GHz
Directivity	42	34	26	26
Source Match	40	30	24	23
Load Match	42	33	25	25
Reflection Tracking	±0.002 +0.02/°C	±0.029 +0.02/°C	±0.079 +0.03/°C	0.075 +0.04/°C
Transmission Tracking	±0.022 +0.02/°C	±0.130 +0.02/°C	±0.384 +0.03/°C	0.589 +0.04/°C

Transmission Uncertainty (Specifications)

Magnitude

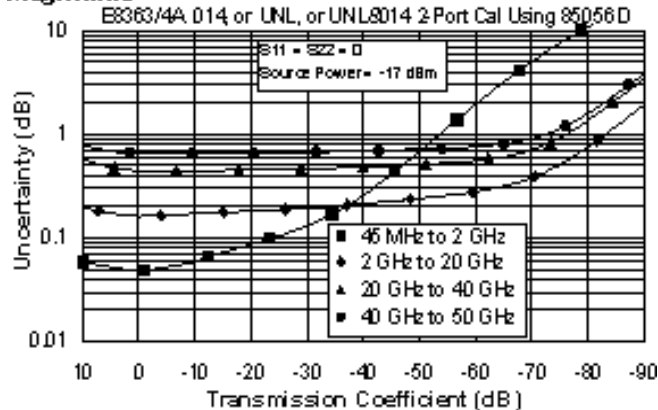

Phase

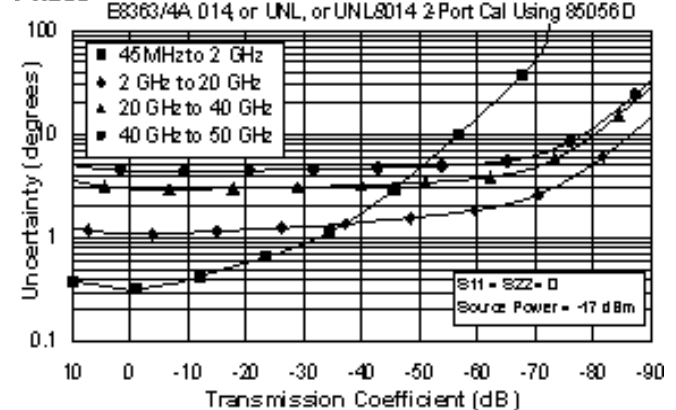

Reflection Uncertainty (Specifications)

Magnitude

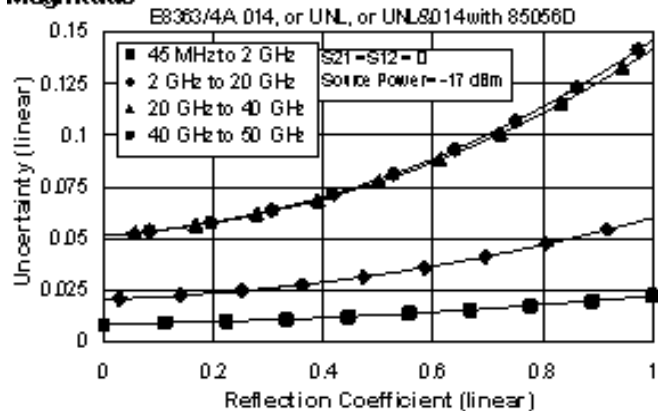

Phase

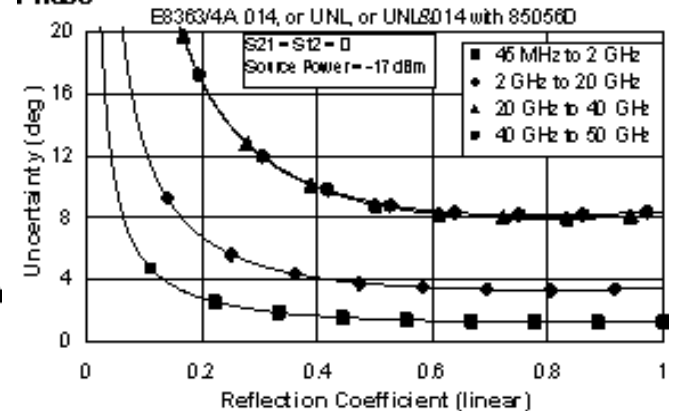

E8363/4A Corrected System Performance with 2.92mm Connectors

**Table 7. 85056K Calibration Kit
Standard Configuration and Standard Power Range
(E8363/4A)**

Applies to the, E8363/4A analyzers, 85056K (2.92mm) calibration kit, 85133F flexible test port cable set, and a full 2-port calibration. Also applies to the following condition:

Environmental temperature $23^{\circ} \pm 3^{\circ} \text{C}$, with $< 1^{\circ} \text{C}$ deviation from calibration temperature

Description	Specification (dB)			
	0.045 to 2 GHz	2 to 10 GHz	10 to 20 GHz	20 to 40 GHz
Directivity	42	42	42	40
Source Match	40	40	40	35
Load Match	42	42	42	38
Reflection Tracking	± 0.018 $+0.02/^{\circ}\text{C}$	± 0.018 $+0.02/^{\circ}\text{C}$	± 0.018 $+0.03/^{\circ}\text{C}$	± 0.067 $+0.04/^{\circ}\text{C}$
Transmission Tracking	± 0.016 $+0.02/^{\circ}\text{C}$	± 0.028 $+0.02/^{\circ}\text{C}$	± 0.033 $+0.03/^{\circ}\text{C}$	± 0.089 $+0.04/^{\circ}\text{C}$

Transmission Uncertainty (Specifications)

Magnitude

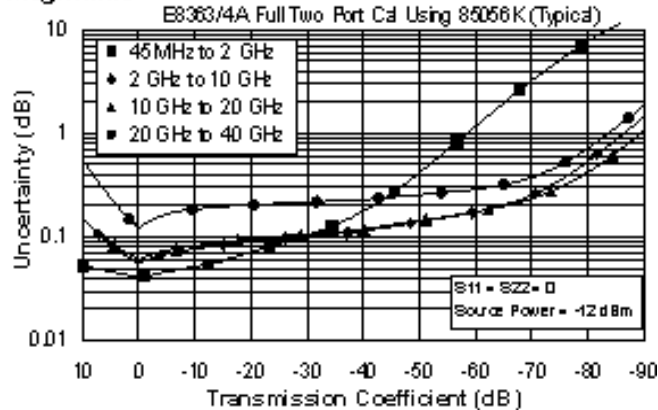

Phase

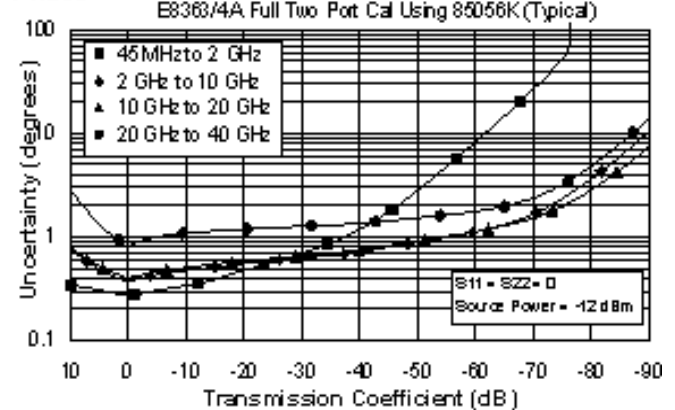

Reflection Uncertainty (Specifications)

Magnitude

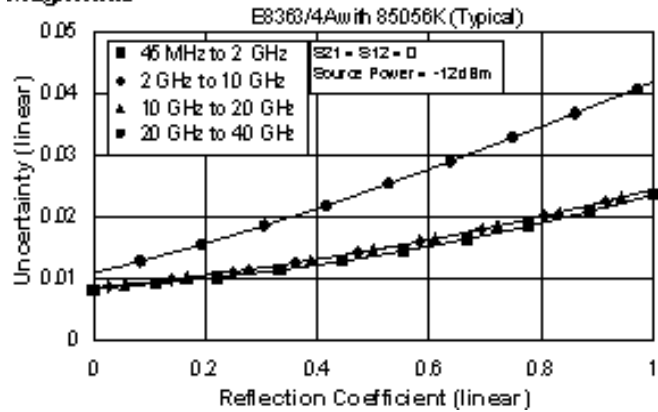

Phase

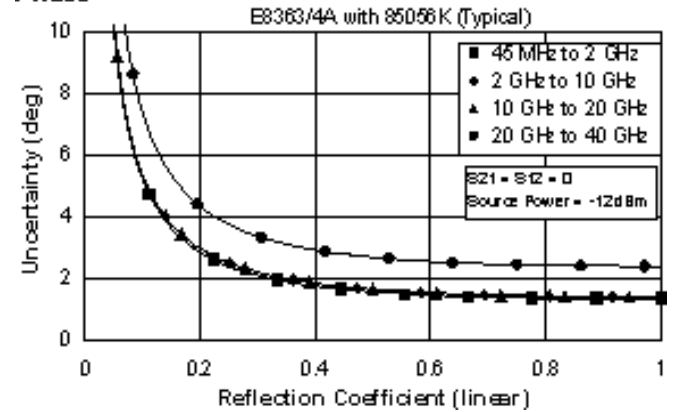

Table 8. 85056K Calibration Kit

Extended Configuration and Standard Power Range (E8363/4A - Option 014)

-OR-

Standard Configuration and Extended Power Range & Bias-Tees (E8363/4A - Option UNL)

-OR-

Extended Configuration and Extended Power Range & Bias-Tees (E8363/4A - Option UNL&014)

Applies to the, E8363/4A analyzers, 85056K (2.92mm) calibration kit, 85133F flexible test port cable set, and a full 2-port calibration. Also applies to the following condition:

Environmental temperature 23° ±3 °C, with < 1 °C deviation from calibration temperature

Description	Specification (dB)			
	0.045 to 2 GHz	2 to 10 GHz	10 to 20 GHz	20 to 40 GHz
Directivity	42	42	42	40
Source Match	40	40	40	35
Load Match	42	42	41	38
Reflection Tracking	±0.018 +0.02/°C	±0.018 +0.02/°C	±0.018 +0.03/°C	±0.067 +0.04/°C
Transmission Tracking	±0.021 +0.02/°C	±0.033 +0.02/°C	±0.046 +0.03/°C	±0.098 +0.04/°C

Transmission Uncertainty (Specifications)

Magnitude

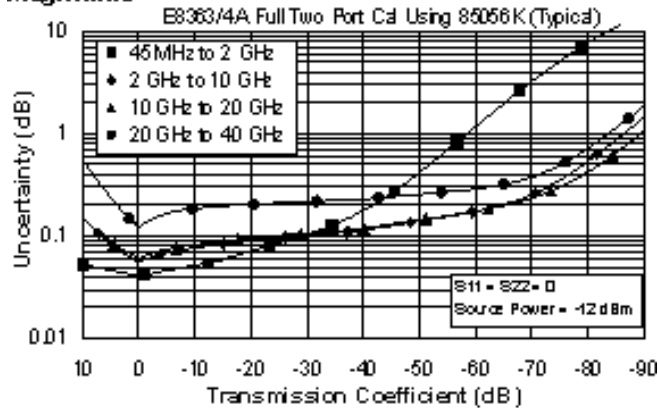

Phase

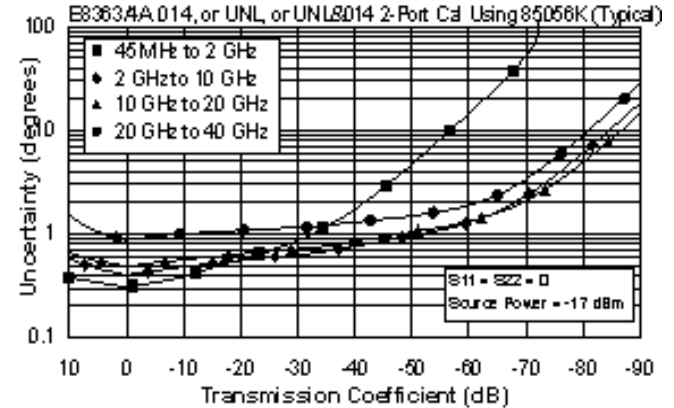

Reflection Uncertainty (Specifications)

Magnitude

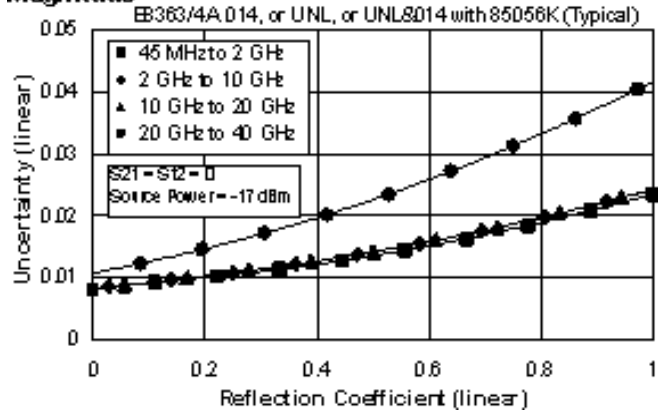

Phase

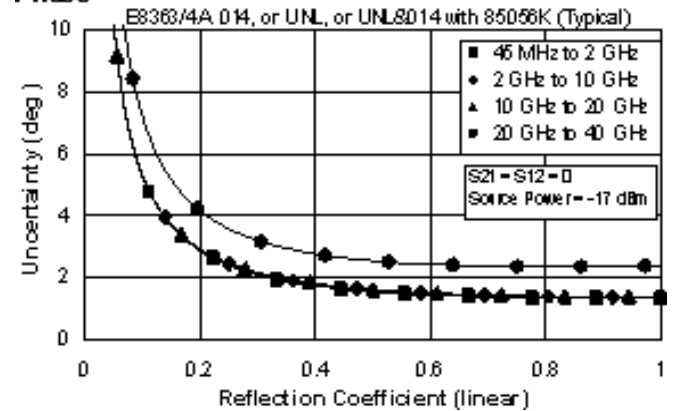

E836xA Corrected System Performance with 3.5mm Connectors

**Table 9. 85052B Calibration Kit
Standard Configuration and Standard Power Range
(E836xA)**

Applies to the, E836xA analyzers, 85052B (3.5mm) calibration kit, 85131F flexible test port cable set, and a full 2-port calibration. Also applies to the following condition:

Environmental temperature $23^{\circ} \pm 3^{\circ} \text{C}$, with $< 1^{\circ} \text{C}$ deviation from calibration temperature

Description	Specification (dB)			
	0.045 to 2 GHz	2 to 10 GHz	10 to 20 GHz	20 to 26.5 GHz
Directivity	48	44	44	44
Source Match	40	31	31	31
Load Match	48	44	44	44
Reflection Tracking	± 0.003 $+0.02/^{\circ}\text{C}$	± 0.006 $+0.02/^{\circ}\text{C}$	± 0.006 $+0.02/^{\circ}\text{C}$	± 0.006 $+0.03/^{\circ}\text{C}$
Transmission Tracking	± 0.013 $+0.02/^{\circ}\text{C}$	± 0.057 $+0.02/^{\circ}\text{C}$	± 0.065 $+0.02/^{\circ}\text{C}$	± 0.104 $+0.03/^{\circ}\text{C}$

Transmission Uncertainty (Specifications)

Magnitude

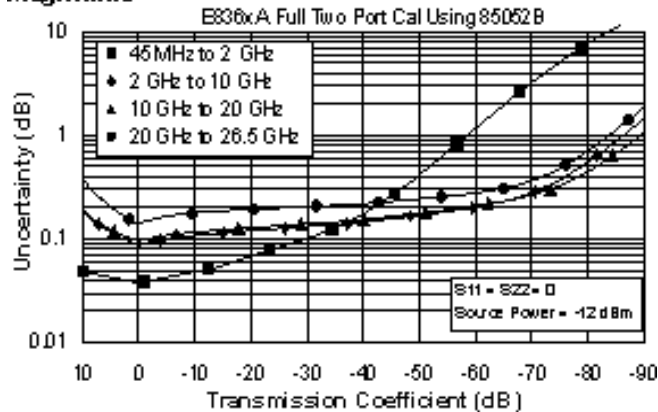

Phase

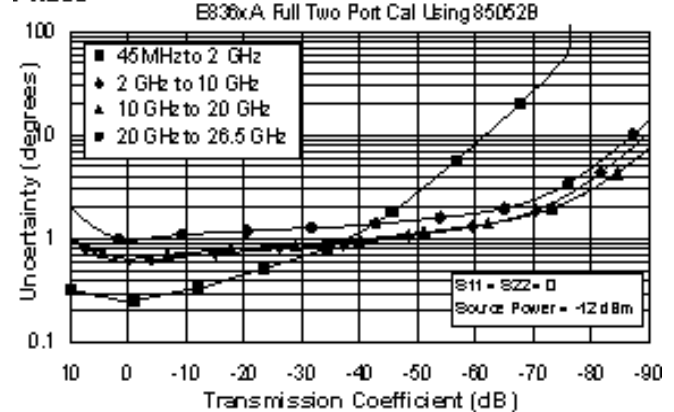

Reflection Uncertainty (Specifications)

Magnitude

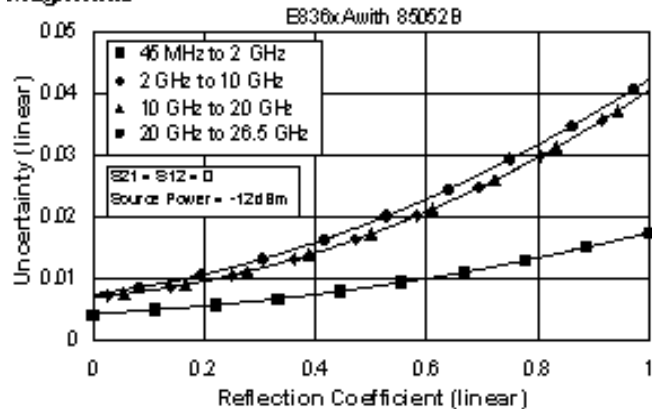

Phase

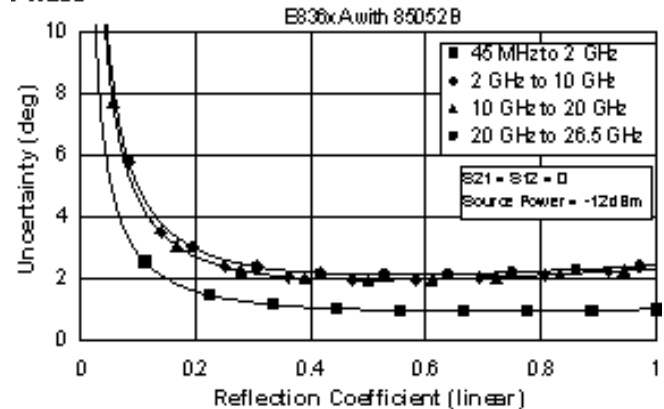

Table 10. 85052B Calibration Kit

Extended Configuration and Standard Power Range (E836xA - Option 014)

-OR-

Standard Configuration and Extended Power Range & Bias-Tees (E836xA - Option UNL)

-OR-

Extended Configuration and Extended Power Range & Bias-Tees (E836xA - Option UNL&014)

Applies to the, E836xA analyzers, 85052B (3.5mm) calibration kit, 85131F flexible test port cable set, and a full 2-port calibration. Also applies to the following condition:

Environmental temperature 23° ±3 °C, with < 1 °C deviation from calibration temperature

Description	Specification (dB)			
	0.045 to 2 GHz	2 to 10 GHz	10 to 20 GHz	20 to 26.5 GHz
Directivity	48	44	44	44
Source Match	40	31	31	31
Load Match	48	44	44	44
Reflection Tracking	±0.003 +0.02/°C	±0.006 +0.02/°C	±0.006 +0.02/°C	±0.006 +0.03/°C
Transmission Tracking	±0.017 +0.02/°C	±0.065 +0.02/°C	±0.091 +0.02/°C	±0.109 +0.03/°C

Transmission Uncertainty (Specifications)

Magnitude

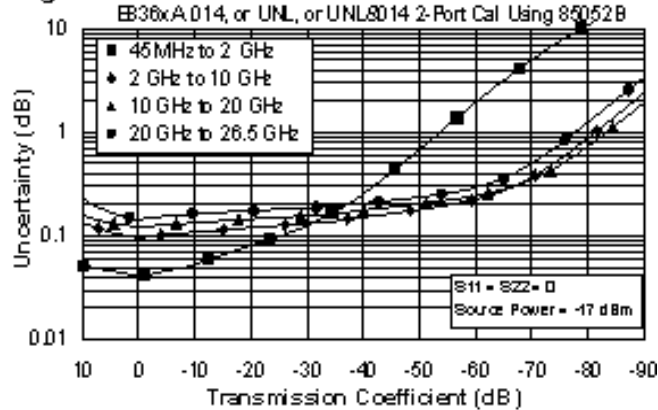

Phase

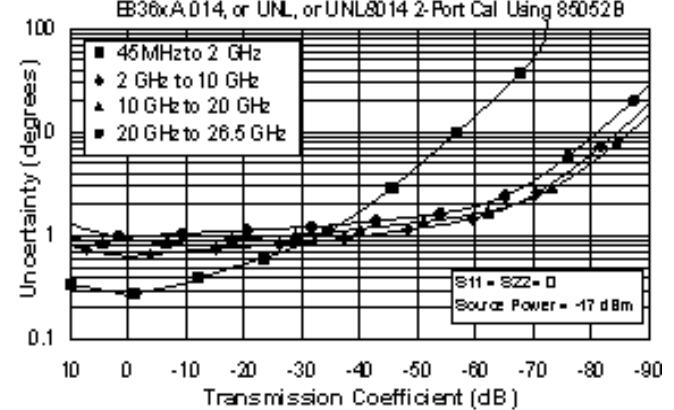

Reflection Uncertainty (Specifications)

Magnitude

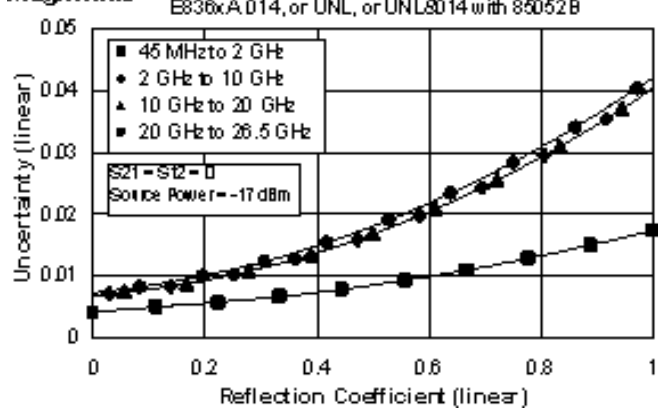

Phase

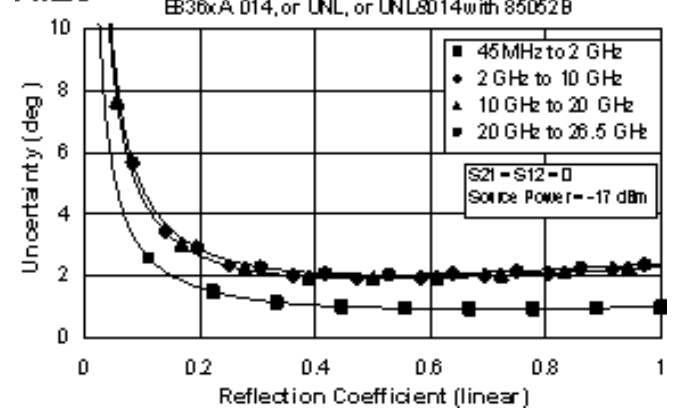

Table 11. 85052C Calibration Kit
Standard Configuration and Standard Power Range
(E836xA)

Applies to the, E836xA analyzers, 85052C (3.5mm) calibration kit, 85131F flexible test port cable set, and a full 2-port calibration. Also applies to the following condition:

Environmental temperature $23^{\circ} \pm 3^{\circ} \text{C}$, with $< 1^{\circ} \text{C}$ deviation from calibration temperature

Description	Specification (dB)			
	0.045 to 2 GHz	2 to 10 GHz	10 to 20 GHz	20 to 26.5 GHz
Directivity	48	50	50	50
Source Match	40	50	50	50
Load Match	48	50	50	50
Reflection Tracking	± 0.003 $+0.02/^{\circ}\text{C}$	± 0.000 $+0.02/^{\circ}\text{C}$	± 0.000 $+0.02/^{\circ}\text{C}$	± 0.000 $+0.03/^{\circ}\text{C}$
Transmission Tracking	± 0.013 $+0.02/^{\circ}\text{C}$	± 0.010 $+0.02/^{\circ}\text{C}$	± 0.012 $+0.02/^{\circ}\text{C}$	± 0.018 $+0.03/^{\circ}\text{C}$

Transmission Uncertainty (Specifications)

Magnitude

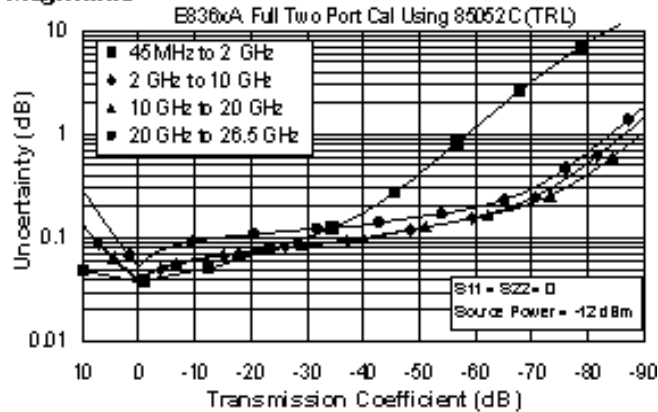

Phase

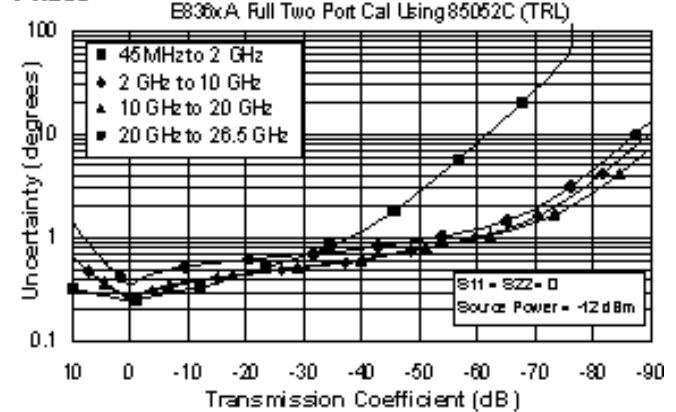

Reflection Uncertainty (Specifications)

Magnitude

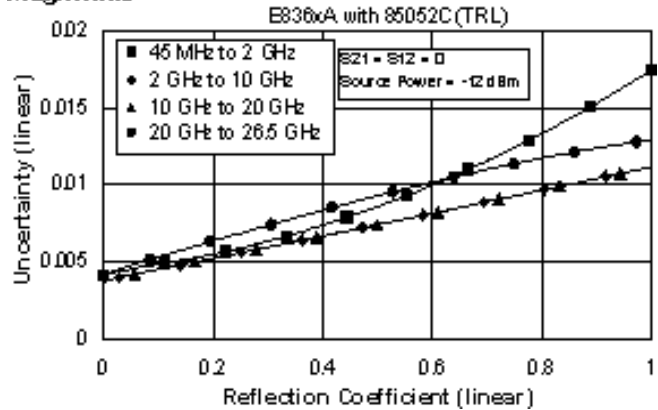

Phase

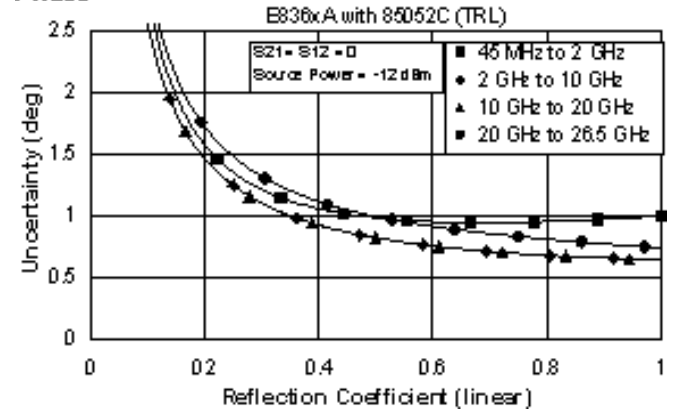

Table 12. 85052C Calibration Kit

Extended Configuration and Standard Power Range (E836xA - Option 014)

-OR-

Standard Configuration and Extended Power Range & Bias-Tees (E836xA - Option UNL)

-OR-

Extended Configuration and Extended Power Range & Bias-Tees (E836xA - Option UNL&014)

Applies to the, E836xA analyzers, 85052C (3.5mm) calibration kit, 85131F flexible test port cable set, and a full 2-port calibration. Also applies to the following condition:

Environmental temperature 23° ±3 °C, with < 1 °C deviation from calibration temperature

Description	Specification (dB)			
	0.045 to 2 GHz	2 to 10 GHz	10 to 20 GHz	20 to 26.5 GHz
Directivity	48	50	50	50
Source Match	40	50	50	50
Load Match	48	50	50	50
Reflection Tracking	±0.003 +0.02/°C	±0.000 +0.02/°C	±0.000 +0.02/°C	±0.000 +0.03/°C
Transmission Tracking	±0.017 +0.02/°C	±0.012 +0.02/°C	±0.016 +0.02/°C	±0.021 +0.03/°C

Transmission Uncertainty (Specifications)

Magnitude

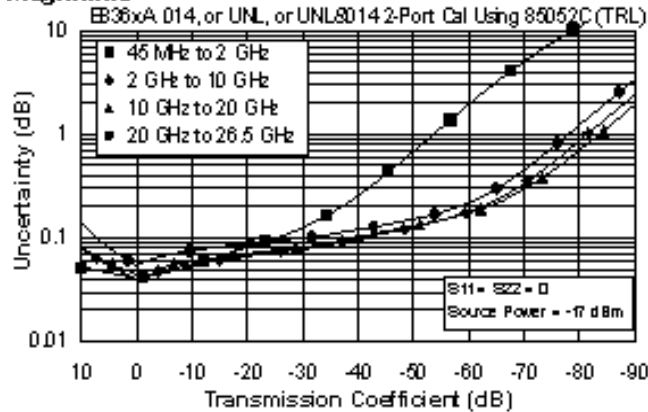

Phase

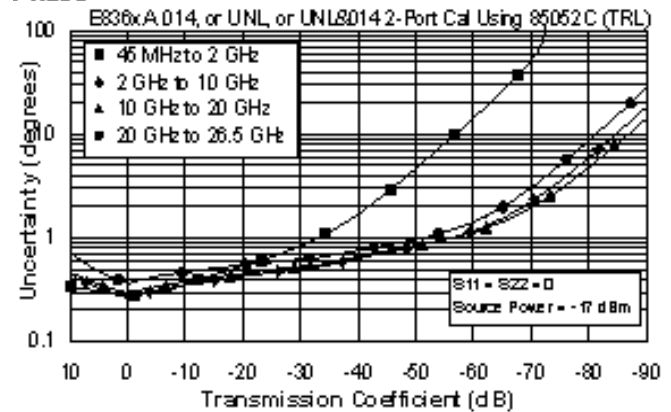

Reflection Uncertainty (Specifications)

Magnitude

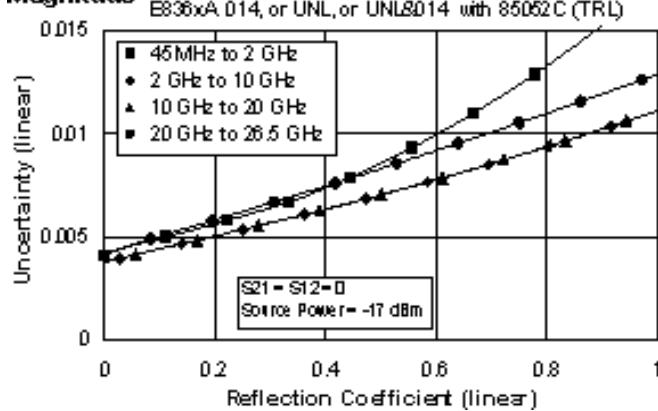

Phase

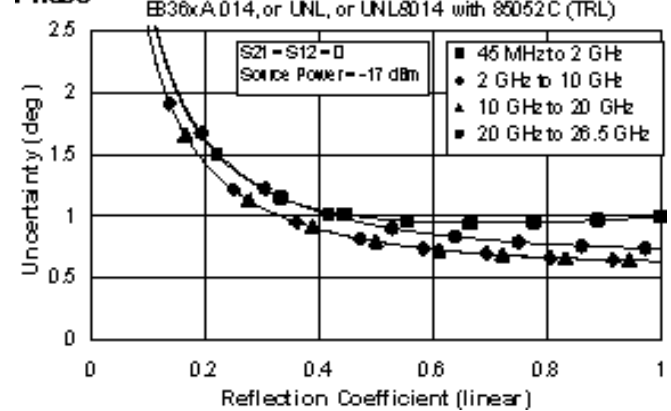

Table 13. 85052D Calibration Kit
Standard Configuration and Standard Power Range
(E836xA)

Applies to the, E836xA analyzers, 85052D (3.5mm) calibration kit, 85131F flexible test port cable set, and a full 2-port calibration. Also applies to the following condition:

Environmental temperature $23^{\circ} \pm 3^{\circ} \text{C}$, with $< 1^{\circ} \text{C}$ deviation from calibration temperature

Description	Specification (dB)			
	0.045 to 2 GHz	2 to 10 GHz	10 to 20 GHz	20 to 26.5 GHz
Directivity	42	36	36	30
Source Match	37	28	28	25
Load Match	42	36	36	30
Reflection Tracking	± 0.003 $+0.02/^{\circ}\text{C}$	± 0.008 $+0.02/^{\circ}\text{C}$	± 0.008 $+0.02/^{\circ}\text{C}$	± 0.011 $+0.03/^{\circ}\text{C}$
Transmission Tracking	± 0.020 $+0.02/^{\circ}\text{C}$	± 0.087 $+0.02/^{\circ}\text{C}$	± 0.101 $+0.02/^{\circ}\text{C}$	± 0.250 $+0.03/^{\circ}\text{C}$

Transmission Uncertainty (Specifications)

Magnitude

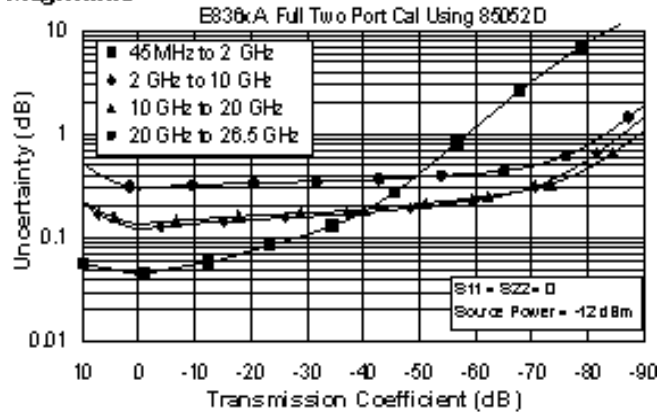

Phase

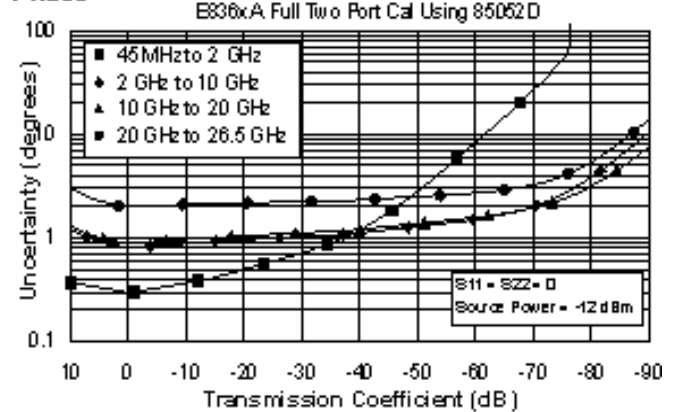

Reflection Uncertainty (Specifications)

Magnitude

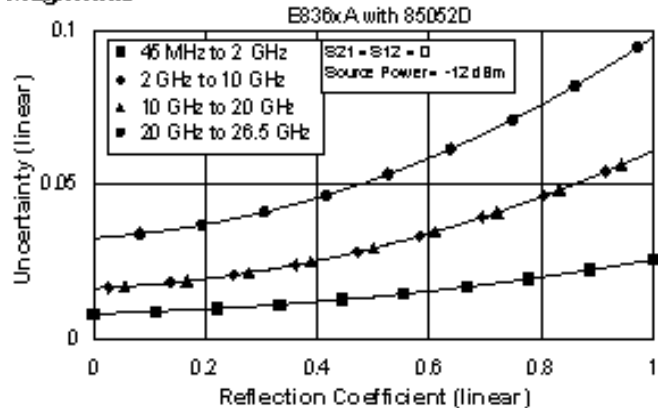

Phase

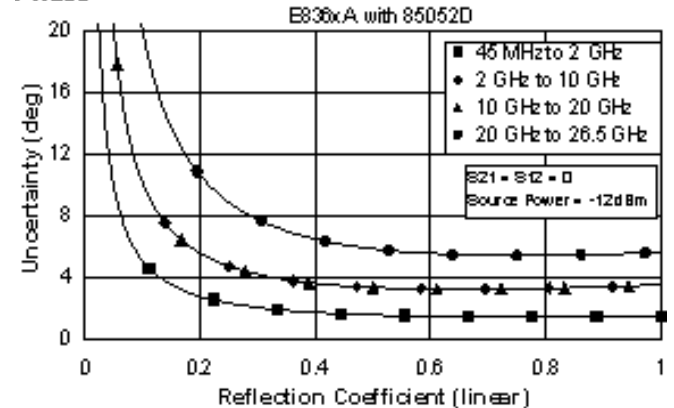

Table 14. 85052D Calibration Kit

Extended Configuration and Standard Power Range (E836xA - Option 014)

-OR-

Standard Configuration and Extended Power Range & Bias-Tees (E836xA - Option UNL)

-OR-

Extended Configuration and Extended Power Range & Bias-Tees (E836xA - Option UNL&014)

Applies to the, E836xA analyzers, 85052D (3.5mm) calibration kit, 85131F flexible test port cable set, and a full 2-port calibration. Also applies to the following condition:

Environmental temperature $23^{\circ} \pm 3^{\circ} \text{C}$, with $< 1^{\circ} \text{C}$ deviation from calibration temperature

Description	Specification (dB)			
	0.045 to 2 GHz	2 to 10 GHz	10 to 20 GHz	20 to 26.5 GHz
Directivity	42	36	36	30
Source Match	37	28	28	25
Load Match	42	36	36	30
Reflection Tracking	± 0.003 $+0.02/^{\circ}\text{C}$	± 0.008 $+0.02/^{\circ}\text{C}$	± 0.008 $+0.02/^{\circ}\text{C}$	± 0.011 $+0.03/^{\circ}\text{C}$
Transmission Tracking	± 0.026 $+0.02/^{\circ}\text{C}$	± 0.101 $+0.02/^{\circ}\text{C}$	± 0.138 $+0.02/^{\circ}\text{C}$	± 0.272 $+0.03/^{\circ}\text{C}$

Transmission Uncertainty (Specifications)

Magnitude

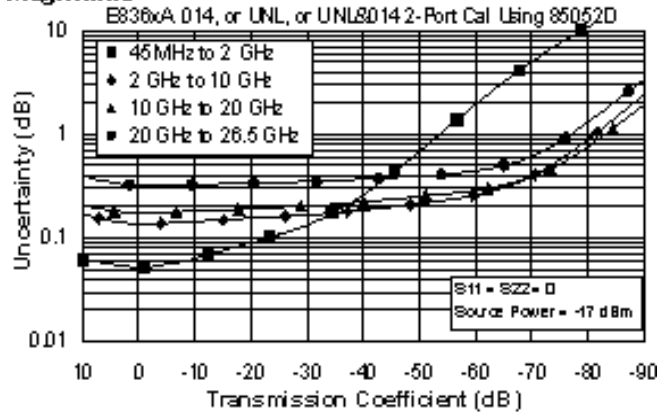

Phase

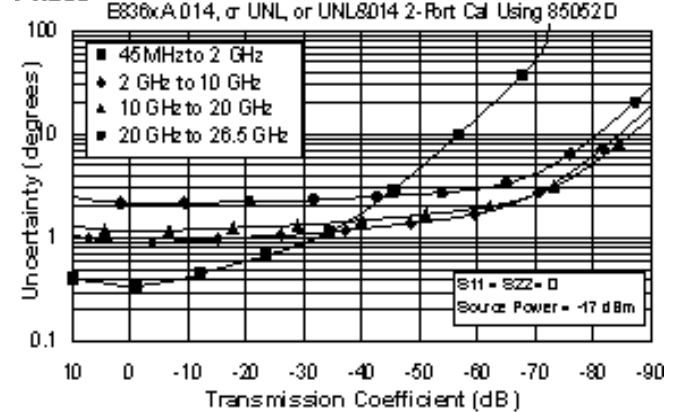

Reflection Uncertainty (Specifications)

Magnitude

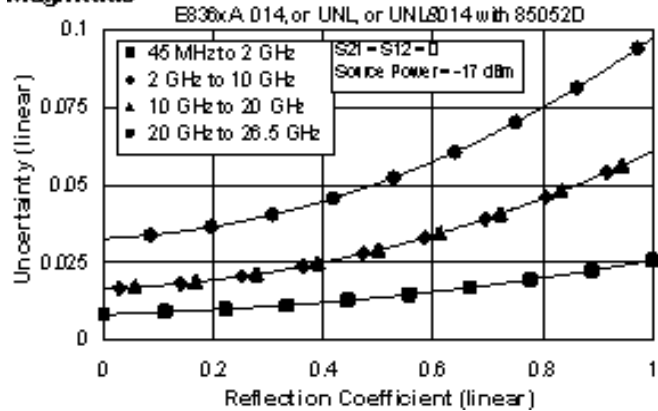

Phase

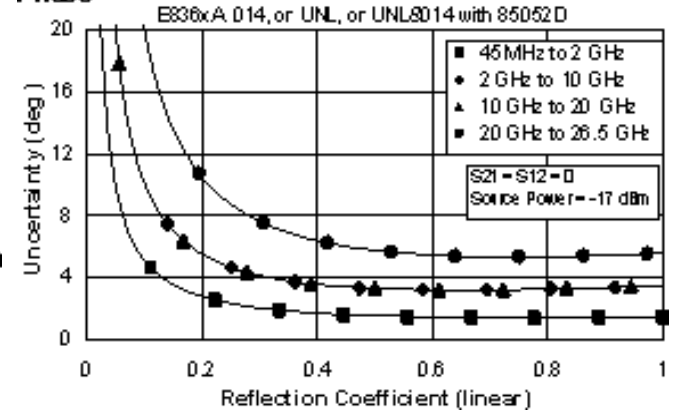

E836xA Corrected System Performance with 7mm Connectors

**Table 15. 85050B Calibration Kit
Standard Configuration and Standard Power Range
(E836xA)**

Applies to the, E836xA analyzers, 85050B (7mm) calibration kit, 85132F flexible test port cable set, and a full 2-port calibration. Also applies to the following condition:

Environmental temperature $23^{\circ} \pm 3^{\circ} \text{C}$, with $< 1^{\circ} \text{C}$ deviation from calibration temperature

Description	Specification (dB)		
	0.045 to 2 GHz	2 to 10 GHz	10 to 18 GHz
Directivity	52	52	52
Source Match	48	41	41
Load Match	52	52	52
Reflection Tracking	± 0.003 $+0.02/^{\circ}\text{C}$	± 0.047 $+0.02/^{\circ}\text{C}$	± 0.047 $+0.02/^{\circ}\text{C}$
Transmission Tracking	± 0.006 $+0.02/^{\circ}\text{C}$	± 0.019 $+0.02/^{\circ}\text{C}$	± 0.022 $+0.02/^{\circ}\text{C}$

Transmission Uncertainty (Specifications)

Magnitude

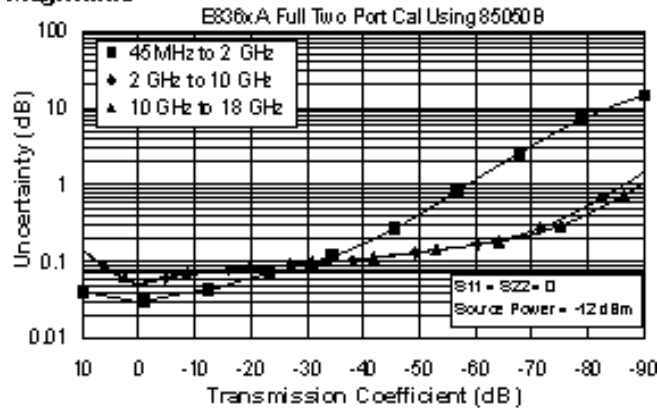

Phase

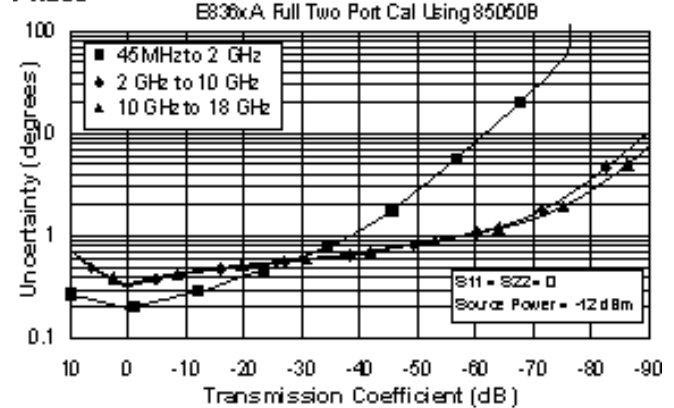

Reflection Uncertainty (Specifications)

Magnitude

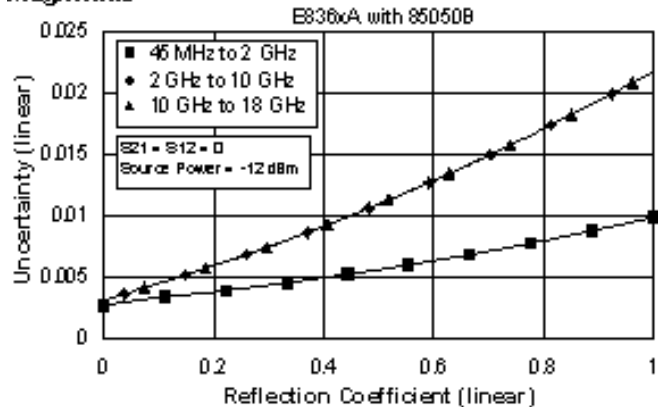

Phase

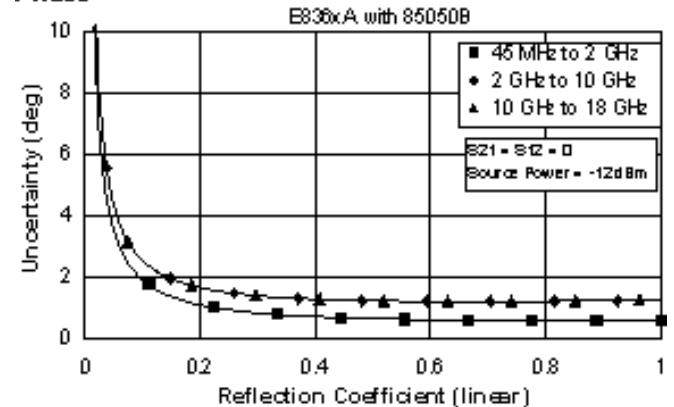

Table 16. 85050B Calibration Kit

Extended Configuration and Standard Power Range (E836xA - Option 014)

-OR-

Standard Configuration and Extended Power Range & Bias-Tees (E836xA - Option UNL)

-OR-

Extended Configuration and Extended Power Range & Bias-Tees (E836xA - Option UNL&014)

Applies to the, E836xA analyzers, 85050B (7mm) calibration kit, 85132F flexible test port cable set, and a full 2-port calibration. Also applies to the following condition:

Environmental temperature $23^{\circ} \pm 3^{\circ} \text{C}$, with $< 1^{\circ} \text{C}$ deviation from calibration temperature

Description	Specification (dB)		
	0.045 to 2 GHz	2 to 10 GHz	10 to 18 GHz
Directivity	52	52	52
Source Match	48	41	41
Load Match	52	52	47
Reflection Tracking	± 0.003 $+0.02/^{\circ}\text{C}$	± 0.047 $+0.02/^{\circ}\text{C}$	± 0.047 $+0.02/^{\circ}\text{C}$
Transmission Tracking	± 0.008 $+0.02/^{\circ}\text{C}$	± 0.022 $+0.02/^{\circ}\text{C}$	± 0.034 $+0.02/^{\circ}\text{C}$

Transmission Uncertainty (Specifications)

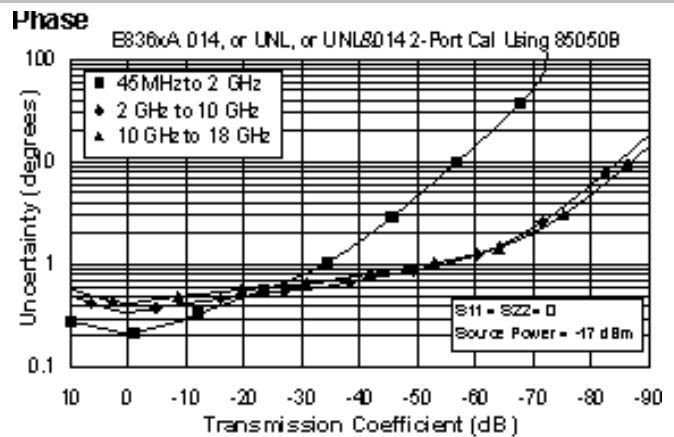
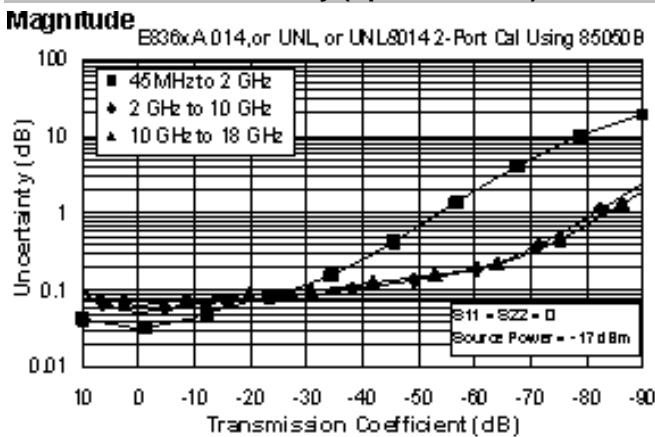

Reflection Uncertainty (Specifications)

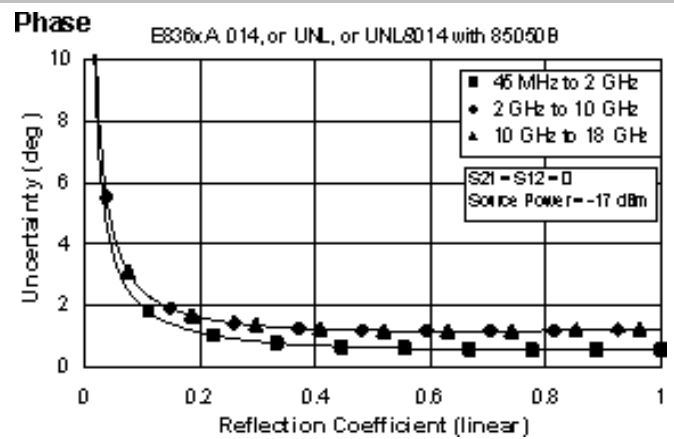
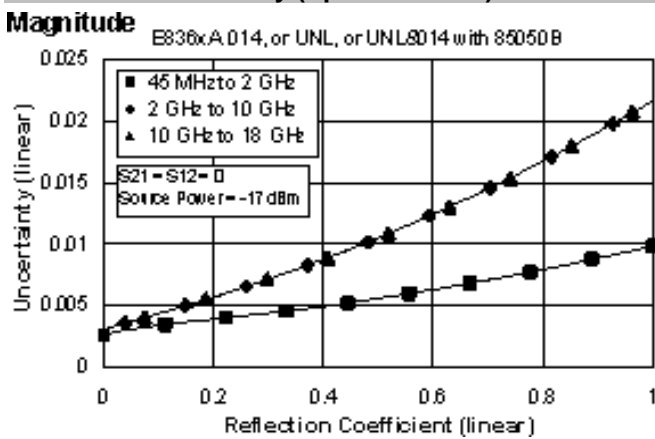

Table 17. 85050C Calibration Kit
Standard Configuration and Standard Power Range
(E836xA)

Applies to the, E836xA analyzers, 85050C (7mm) calibration kit, 85132F flexible test port cable set, and a full 2-port calibration. Also applies to the following condition:

Environmental temperature $23^{\circ} \pm 3^{\circ} \text{C}$, with $< 1^{\circ} \text{C}$ deviation from calibration temperature

Description	Specification (dB)		
	0.045 to 2 GHz	2 to 10 GHz	10 to 18 GHz
Directivity	52	60	60
Source Match	48	60	60
Load Match	52	60	60
Reflection Tracking	± 0.003 $+0.02/^{\circ}\text{C}$	± 0.000 $+0.02/^{\circ}\text{C}$	± 0.000 $+0.02/^{\circ}\text{C}$
Transmission Tracking	± 0.006 $+0.02/^{\circ}\text{C}$	± 0.003 $+0.02/^{\circ}\text{C}$	± 0.004 $+0.02/^{\circ}\text{C}$

Transmission Uncertainty (Specifications)

Magnitude

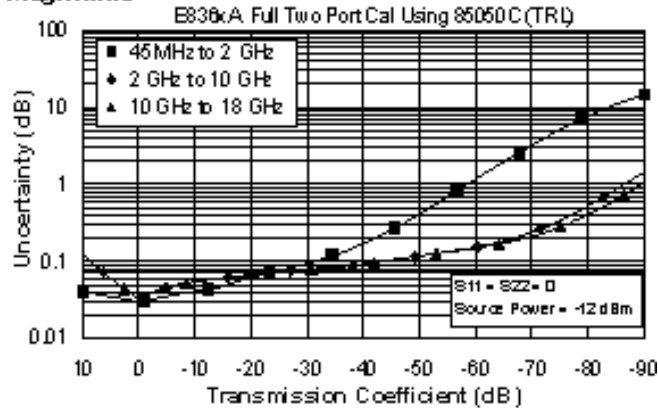

Phase

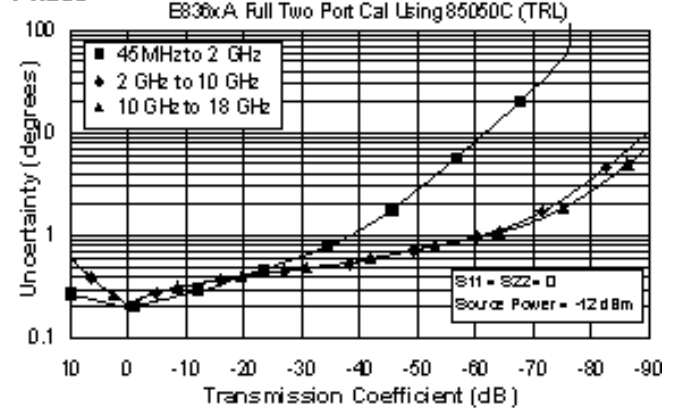

Reflection Uncertainty (Specifications)

Magnitude

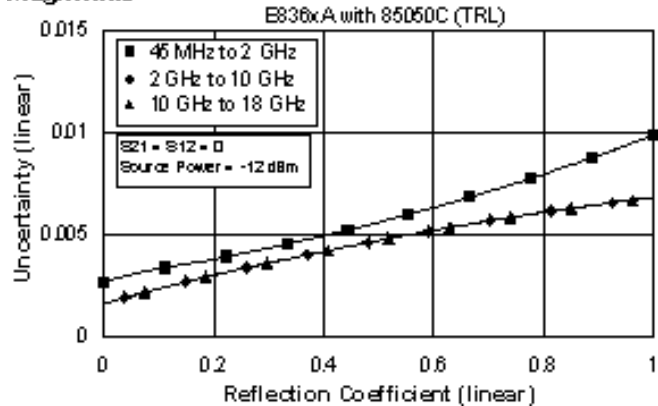

Phase

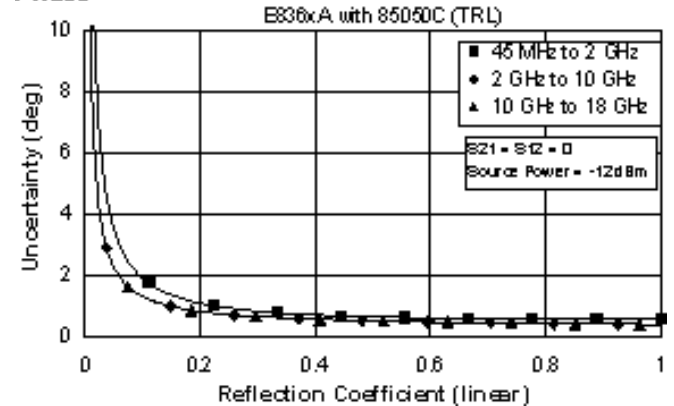

Table 18. 85050C Calibration Kit

Extended Configuration and Standard Power Range (E836xA - Option 014)

-OR-

Standard Configuration and Extended Power Range & Bias-Tees (E836xA - Option UNL)

-OR-

Extended Configuration and Extended Power Range & Bias-Tees (E836xA - Option UNL&014)

Applies to the, E836xA analyzers, 85050C (7mm) calibration kit, 85132F flexible test port cable set, and a full 2-port calibration. Also applies to the following condition:

Environmental temperature 23° ±3 °C, with < 1 °C deviation from calibration temperature

Description	Specification (dB)		
	0.045 to 2 GHz	2 to 10 GHz	10 to 18 GHz
Directivity	52	60	60
Source Match	48	60	60
Load Match	52	60	60
Reflection Tracking	±0.003 +0.02/°C	±0.000 +0.02/°C	±0.000 +0.02/°C
Transmission Tracking	±0.008 +0.02/°C	±0.004 +0.02/°C	±0.005 +0.02/°C

Transmission Uncertainty (Specifications)

Magnitude

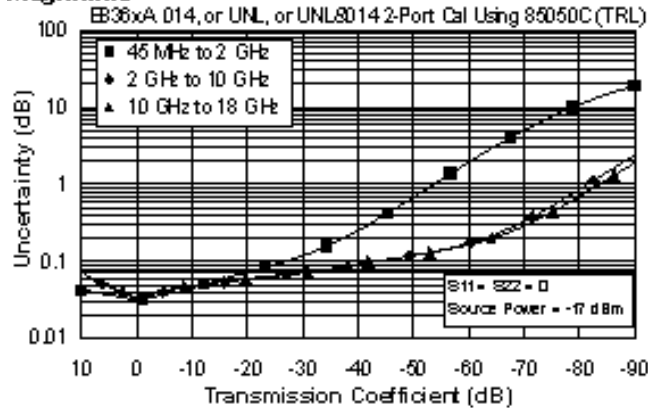

Phase

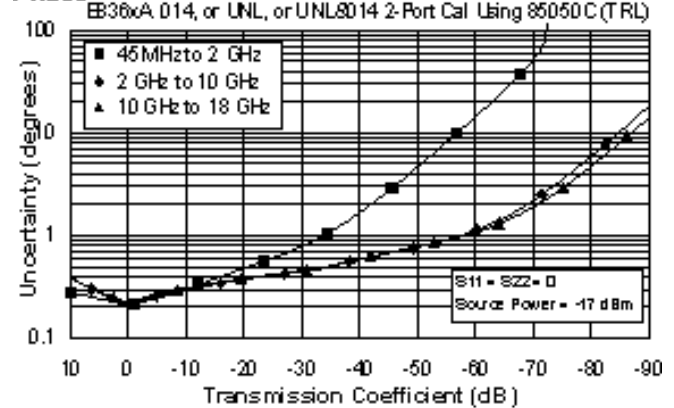

Reflection Uncertainty (Specifications)

Magnitude

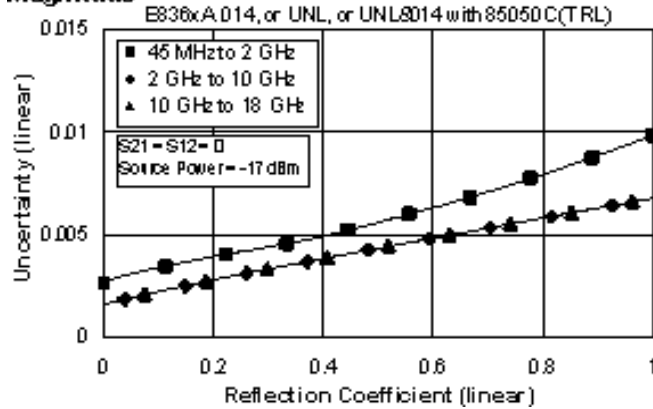

Phase

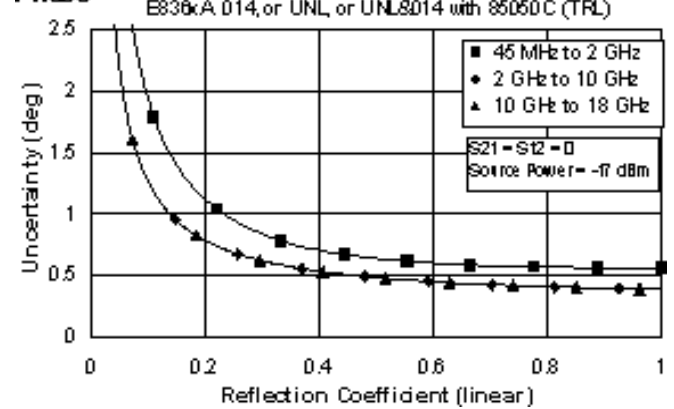

Table 19. 85050D Calibration Kit
Standard Configuration and Standard Power Range
(E836xA)

Applies to the, E836xA analyzers, 85050D (7mm) calibration kit, 85132F flexible test port cable set, and a full 2-port calibration. Also applies to the following condition:

Environmental temperature $23^{\circ} \pm 3^{\circ} \text{C}$, with $< 1^{\circ} \text{C}$ deviation from calibration temperature

Description	Specification (dB)		
	0.045 to 2 GHz	2 to 10 GHz	10 to 18 GHz
Directivity	40	40	40
Source Match	39	35	35
Load Match	40	40	40
Reflection Tracking	± 0.010 $+0.02/^{\circ}\text{C}$	± 0.100 $+0.02/^{\circ}\text{C}$	± 0.100 $+0.02/^{\circ}\text{C}$
Transmission Tracking	± 0.018 $+0.02/^{\circ}\text{C}$	± 0.044 $+0.02/^{\circ}\text{C}$	± 0.052 $+0.02/^{\circ}\text{C}$

Transmission Uncertainty (Specifications)

Magnitude

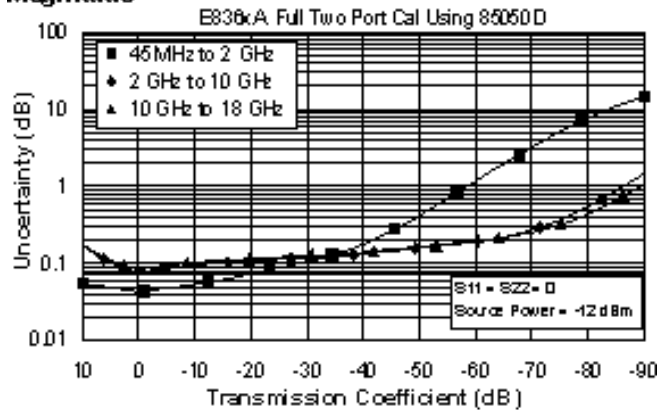

Phase

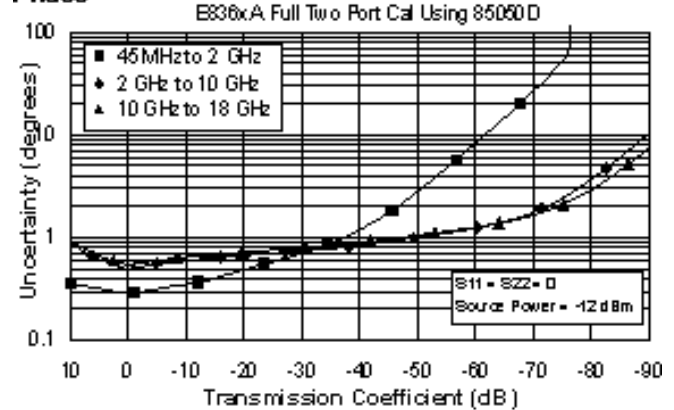

Reflection Uncertainty (Specifications)

Magnitude

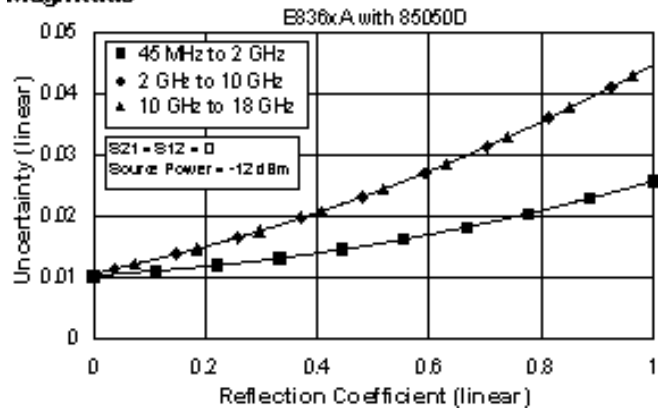

Phase

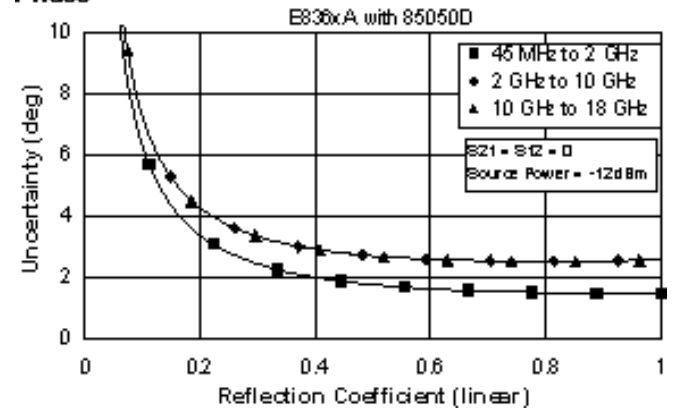

Table 20. 85050D Calibration Kit

Extended Configuration and Standard Power Range (E836xA - Option 014)

-OR-

Standard Configuration and Extended Power Range & Bias-Tees (E836xA - Option UNL)

-OR-

Extended Configuration and Extended Power Range & Bias-Tees (E836xA - Option UNL&014)

Applies to the, E836xA analyzers, 85050D (7mm) calibration kit, 85132F flexible test port cable set, and a full 2-port calibration. Also applies to the following condition:

Environmental temperature $23^{\circ} \pm 3^{\circ} \text{C}$, with $< 1^{\circ} \text{C}$ deviation from calibration temperature

Description	Specification (dB)		
	0.045 to 2 GHz	2 to 10 GHz	10 to 18 GHz
Directivity	40	40	40
Source Match	39	35	35
Load Match	40	40	37
Reflection Tracking	± 0.010 $+0.02/^{\circ}\text{C}$	± 0.100 $+0.02/^{\circ}\text{C}$	± 0.100 $+0.02/^{\circ}\text{C}$
Transmission Tracking	± 0.025 $+0.02/^{\circ}\text{C}$	± 0.052 $+0.02/^{\circ}\text{C}$	± 0.078 $+0.02/^{\circ}\text{C}$

Transmission Uncertainty (Specifications)

Magnitude

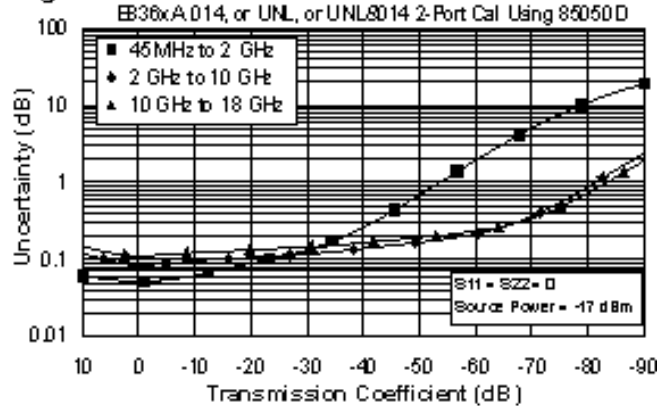

Phase

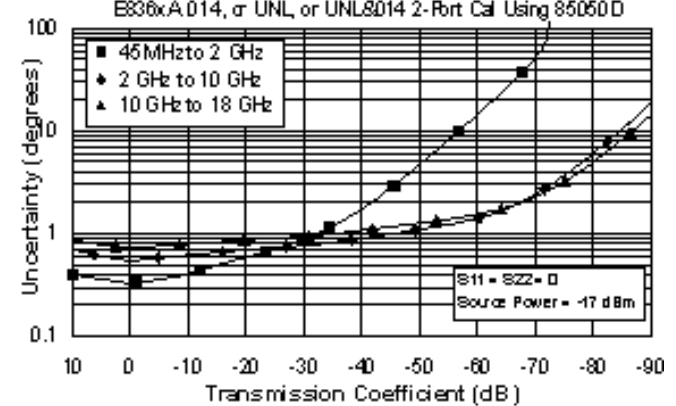

Reflection Uncertainty (Specifications)

Magnitude

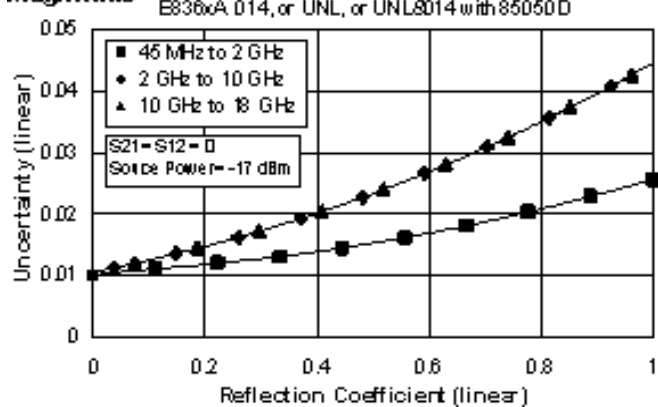

Phase

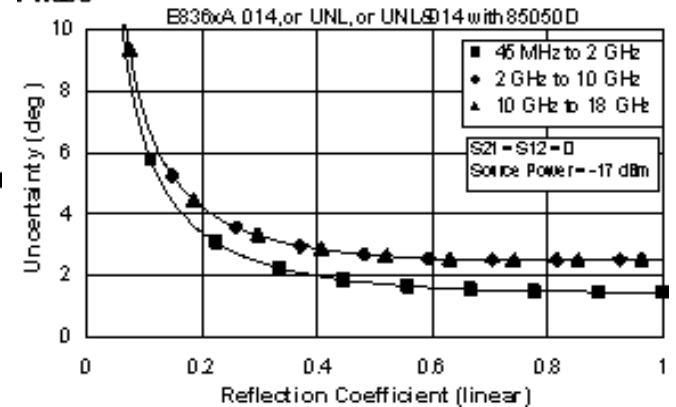

E836xA Corrected System Performance with Type-N Connectors

**Table 21. 85054B Calibration Kit
Standard Configuration and Standard Power Range
(E836xA)**

Applies to the, E836xA analyzers, 85054B (Type-N) calibration kit, 85132F flexible test port cable set with 85130C adapter set, and a full 2-port calibration. Also applies to the following condition:

Environmental temperature $23^{\circ} \pm 3^{\circ} \text{C}$, with $< 1^{\circ} \text{C}$ deviation from calibration temperature

Description	Specification (dB)		
	0.045 to 2 GHz	2 to 10 GHz	10 to 18 GHz
Directivity	48	42	42
Source Match	45	33	33
Load Match	48	42	42
Reflection Tracking	± 0.007 $+0.02/^{\circ}\text{C}$	± 0.096 $+0.02/^{\circ}\text{C}$	± 0.096 $+0.02/^{\circ}\text{C}$
Transmission Tracking	± 0.009 $+0.02/^{\circ}\text{C}$	± 0.052 $+0.02/^{\circ}\text{C}$	± 0.060 $+0.02/^{\circ}\text{C}$

Transmission Uncertainty (Specifications)

Magnitude

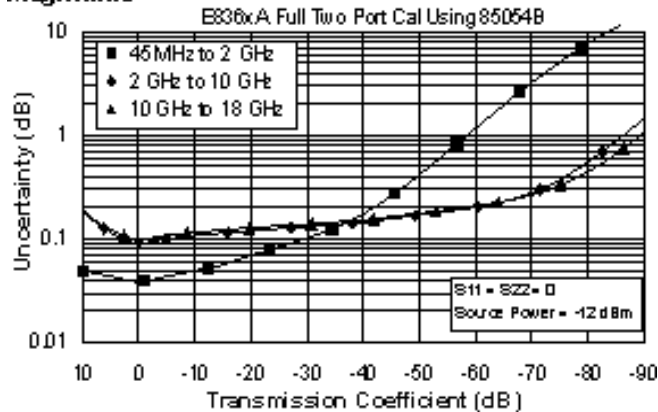

Phase

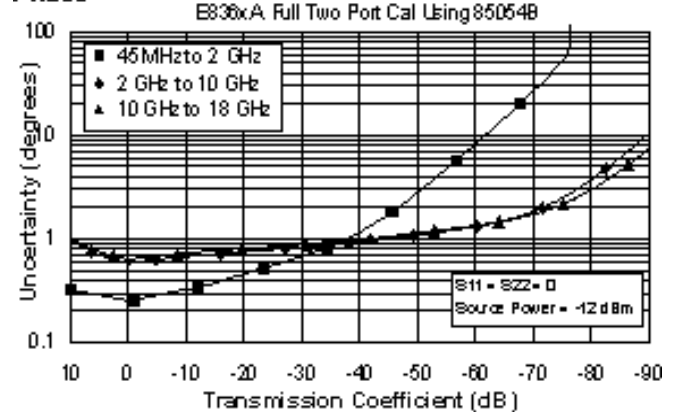

Reflection Uncertainty (Specifications)

Magnitude

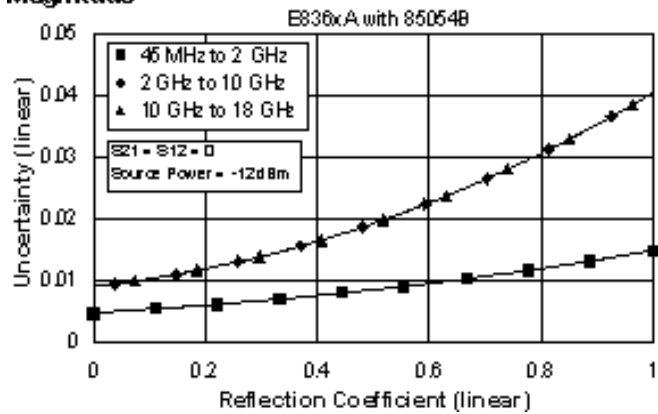

Phase

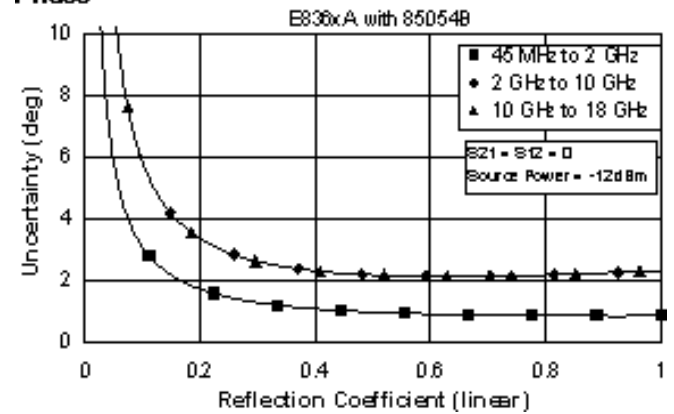

Table 22. 85054B Calibration Kit

Extended Configuration and Standard Power Range (E836xA - Option 014)

-OR-

Standard Configuration and Extended Power Range & Bias-Tees (E836xA - Option UNL)

-OR-

Extended Configuration and Extended Power Range & Bias-Tees (E836xA - Option UNL&014)

Applies to the, E836xA analyzers, 85054B (Type-N) calibration kit, 85132F flexible test port cable set with 85130C adapter set, and a full 2-port calibration. Also applies to the following condition:

Environmental temperature 23° ±3 °C, with < 1 °C deviation from calibration temperature

Description	Specification (dB)		
	0.045 to 2 GHz	2 to 10 GHz	10 to 18 GHz
Directivity	48	42	42
Source Match	45	33	33
Load Match	48	42	41
Reflection Tracking	±0.007 +0.02/°C	±0.096 +0.02/°C	±0.096 +0.02/°C
Transmission Tracking	±0.011 +0.02/°C	±0.060 +0.02/°C	±0.083 +0.02/°C

Transmission Uncertainty (Specifications)

Magnitude

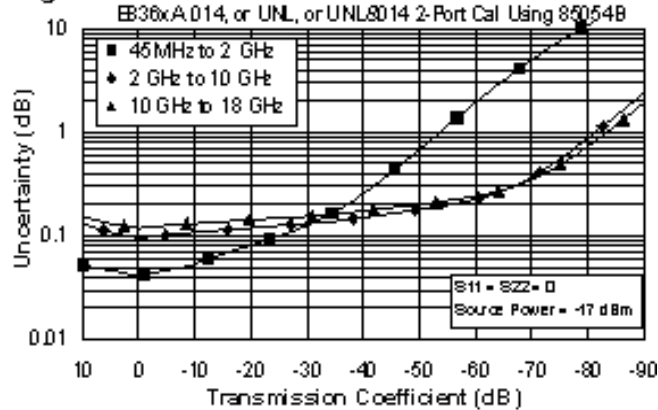

Phase

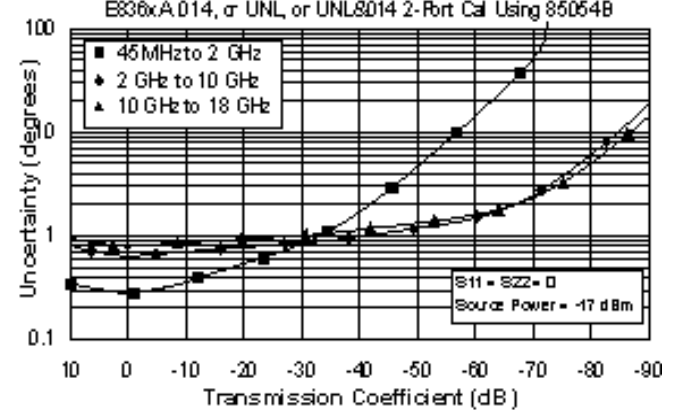

Reflection Uncertainty (Specifications)

Magnitude

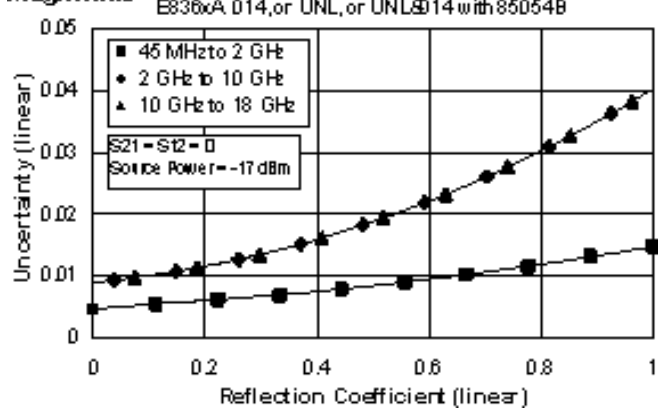

Phase

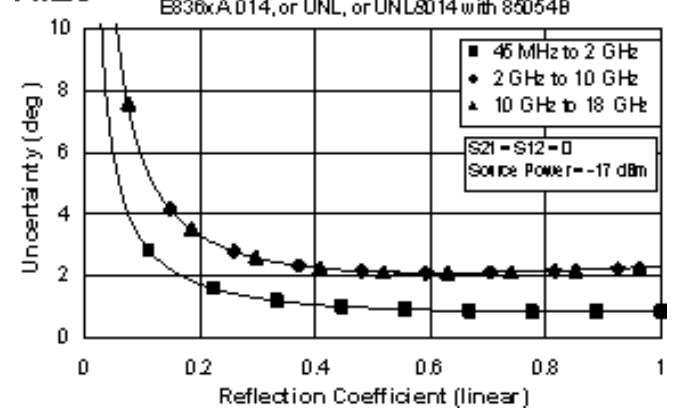

Table 23. 85054D Calibration Kit
Standard Configuration and Standard Power Range
(E836xA)

Applies to the, E836xA analyzers, 85054D (Type-N) calibration kit, 85132F flexible test port cable set with 85130C adapter set, and a full 2-port calibration. Also applies to the following condition:

Environmental temperature $23^{\circ} \pm 3^{\circ} \text{C}$, with $< 1^{\circ} \text{C}$ deviation from calibration temperature

Description	Specification (dB)		
	0.045 to 2 GHz	2 to 10 GHz	10 to 18 GHz
Directivity	40	34	34
Source Match	39	29	29
Load Match	40	34	34
Reflection Tracking	± 0.003 $+0.02/^{\circ}\text{C}$	± 0.027 $+0.02/^{\circ}\text{C}$	± 0.027 $+0.02/^{\circ}\text{C}$
Transmission Tracking	± 0.019 $+0.02/^{\circ}\text{C}$	± 0.091 $+0.02/^{\circ}\text{C}$	± 0.105 $+0.02/^{\circ}\text{C}$

Transmission Uncertainty (Specifications)

Magnitude

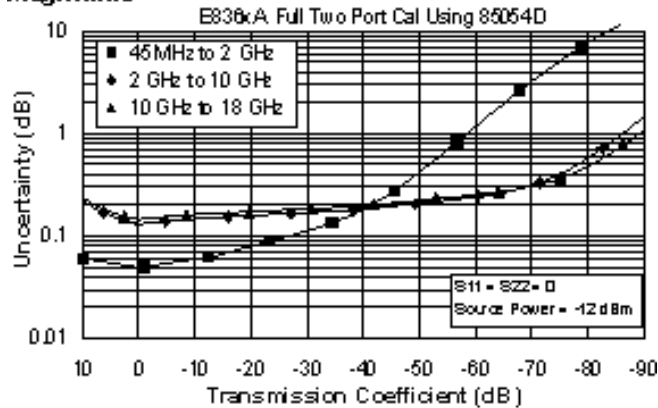

Phase

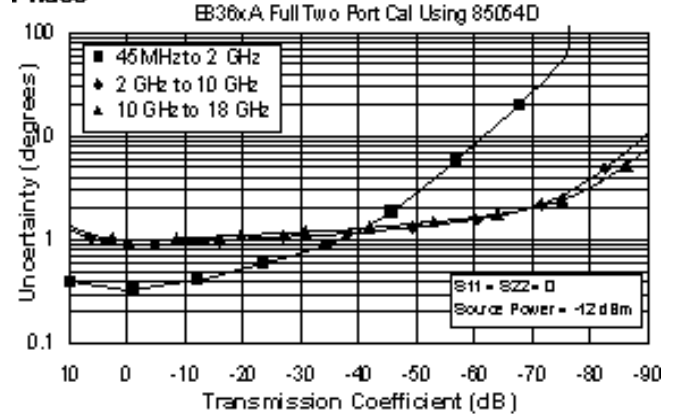

Reflection Uncertainty (Specifications)

Magnitude

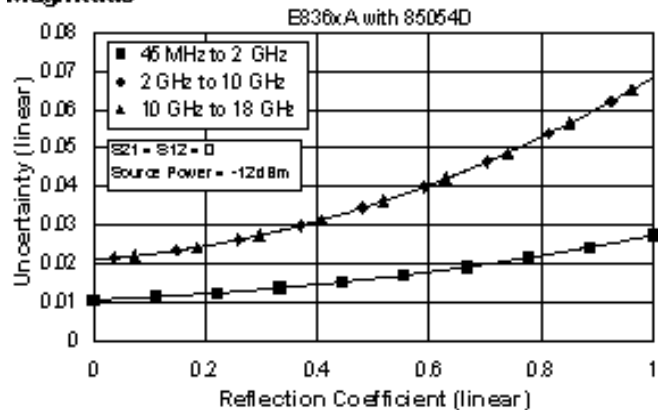

Phase

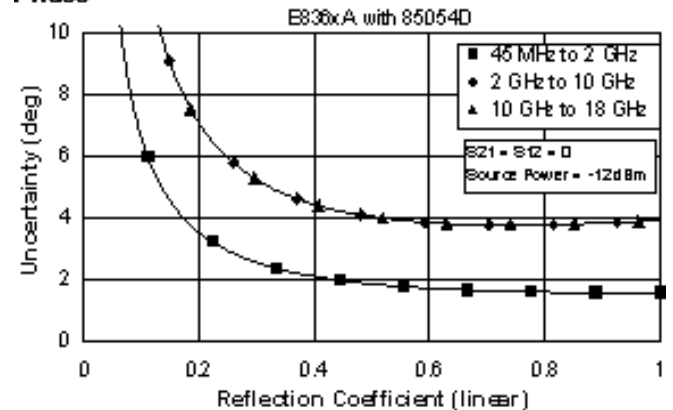

Table 24. 85054D Calibration Kit

Extended Configuration and Standard Power Range (E836xA - Option 014)

-OR-

Standard Configuration and Extended Power Range & Bias-Tees (E836xA - Option UNL)

-OR-

Extended Configuration and Extended Power Range & Bias-Tees (E836xA - Option UNL&014)

Applies to the, E836xA analyzers, 85054D (Type-N) calibration kit, 85132F flexible test port cable set with 85130C adapter set, and a full 2-port calibration. Also applies to the following condition:

Environmental temperature 23° ±3 °C, with < 1 °C deviation from calibration temperature

Description	Specification (dB)		
	0.045 to 2 GHz	2 to 10 GHz	10 to 18 GHz
Directivity	40	34	34
Source Match	39	29	29
Load Match	40	34	34
Reflection Tracking	±0.003 +0.02/°C	±0.027 +0.02/°C	±0.027 +0.02/°C
Transmission Tracking	±0.025 +0.02/°C	±0.105 +0.02/°C	±0.145 +0.02/°C

Transmission Uncertainty (Specifications)

Magnitude

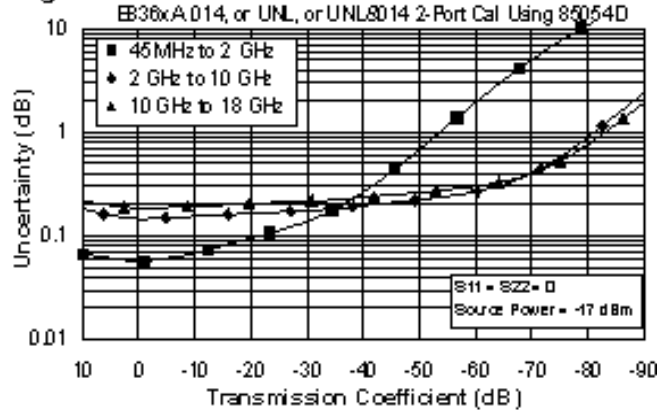

Phase

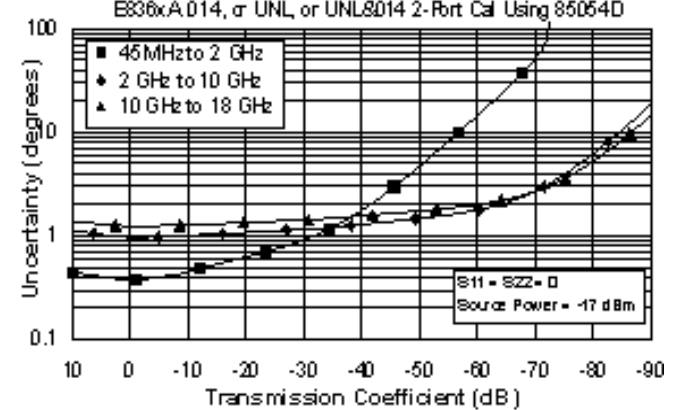

Reflection Uncertainty (Specifications)

Magnitude

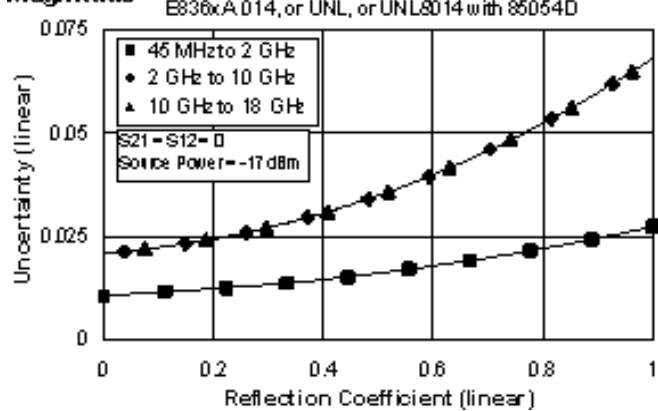

Phase

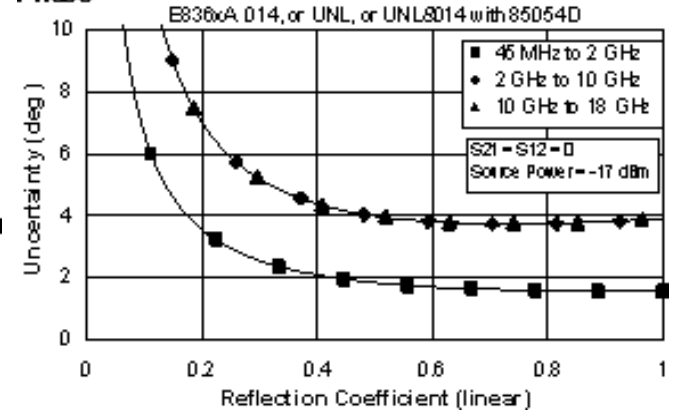

E8363/4A Corrected System Performance with WR-28 Connectors

**Table 25. R11644A Calibration Kit
Standard Configuration and Standard Power Range
(E8363/4A)**

Applies to the, E8363/4A analyzers, R11644A (WR-28) calibration kit, 85133F flexible test port cable set with the R281A and R281B launch sets with the R281A and R281B launch sets, and a full 2-port calibration. Also applies to the following condition:

Environmental temperature $23^{\circ} \pm 3^{\circ} \text{C}$, with $< 1^{\circ} \text{C}$ deviation from calibration temperature

Description	Specification (dB)
	26.5 to 40 GHz
Directivity	50
Source Match	50
Load Match	50
Reflection Tracking	± 0.000 $+0.03/^{\circ}\text{C}$
Transmission Tracking	± 0.018 $+0.03/^{\circ}\text{C}$

Transmission Uncertainty (Specifications)

Magnitude

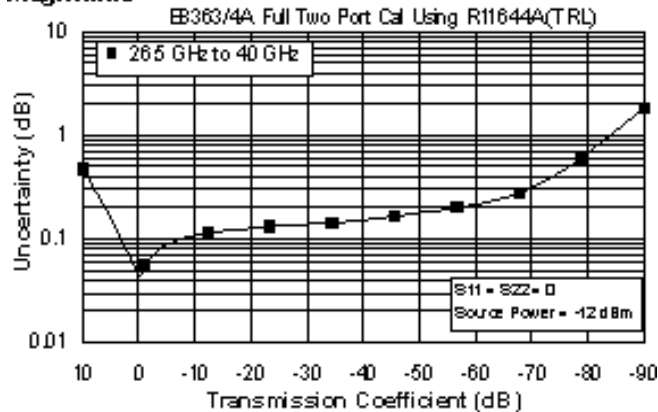

Phase

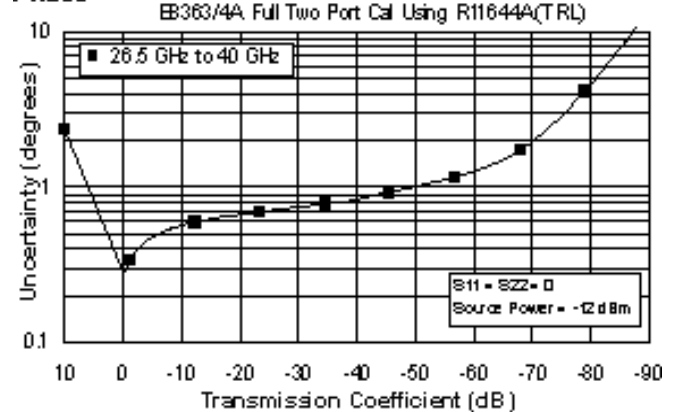

Reflection Uncertainty (Specifications)

Magnitude

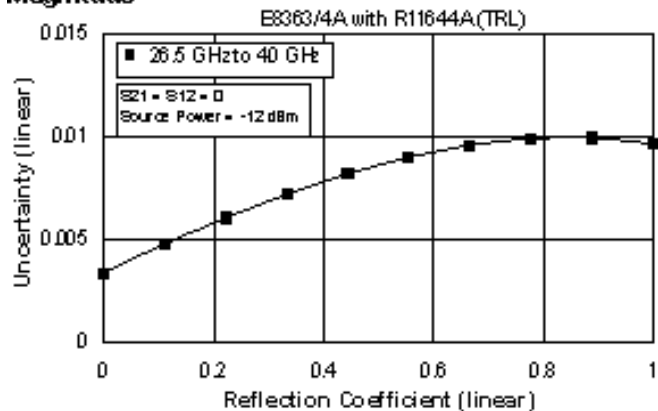

Phase

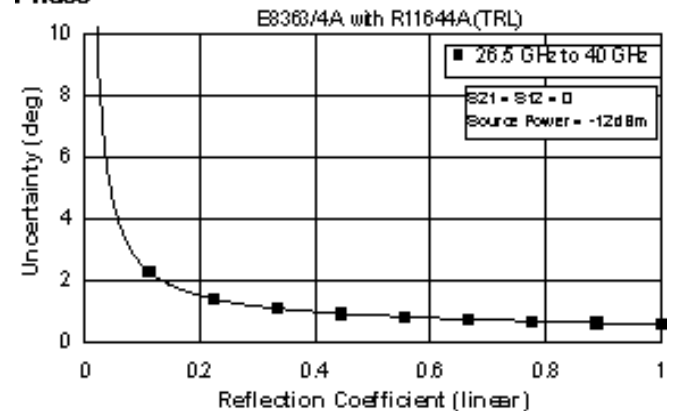

Table 26. R11644A Calibration Kit

Extended Configuration and Standard Power Range (E8363/4A - Option 014)

-OR-

Standard Configuration and Extended Power Range & Bias-Tees (E8363/4A - Option UNL)

-OR-

Extended Configuration and Extended Power Range & Bias-Tees (E8363/4A - Option UNL&014)

Applies to the, E8363/4A analyzers, R11644A (WR-28) calibration kit, 85133F flexible test port cable set with the R281A and R281B launch sets with the R281A and R281B launch sets, and a full 2-port calibration. Also applies to the following condition:

Environmental temperature 23° ±3 °C, with < 1 °C deviation from calibration temperature

Description	Specification (dB)
	26.5 to 40 GHz
Directivity	50
Source Match	50
Load Match	50
Reflection Tracking	±0.000 +0.03/°C
Transmission Tracking	±0.021 +0.03/°C

Transmission Uncertainty (Specifications)

Magnitude

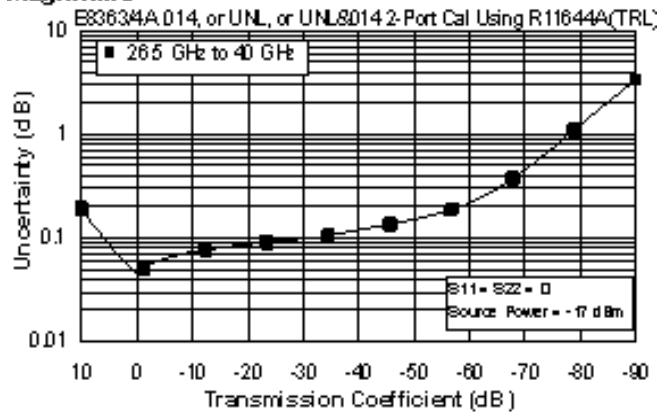

Phase

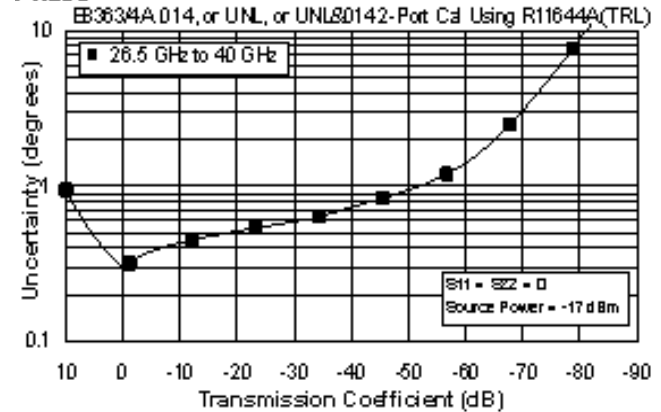

Reflection Uncertainty (Specifications)

Magnitude

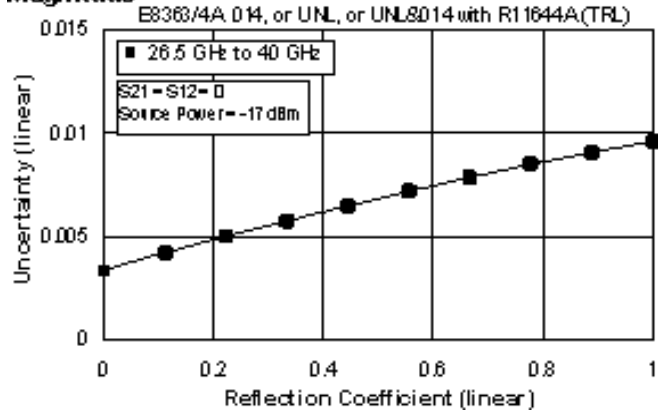

Phase

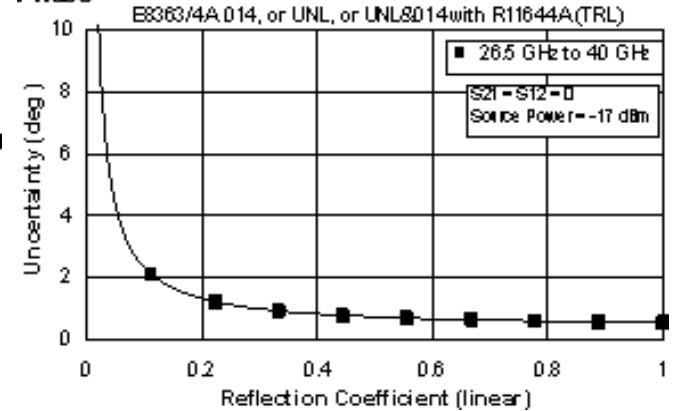

E8363/4A Corrected System Performance with WR-42 Connectors

**Table 27. K11644A Calibration Kit
Standard Configuration and Standard Power Range
(E8363/4A)**

Applies to the, E8363/4A analyzers, K11644A (WR-42) calibration kit, 85134F flexible test port cable set, and a full 2-port calibration. Also applies to the following condition:

Environmental temperature $23^{\circ} \pm 3^{\circ} \text{C}$, with $< 1^{\circ} \text{C}$ deviation from calibration temperature

Description	Specification (dB)	
	18 to 20 GHz	20 to 26.5 GHz
Directivity	50	50
Source Match	50	50
Load Match	50	50
Reflection Tracking	± 0.000 $+0.02/^{\circ}\text{C}$	± 0.000 $+0.02/^{\circ}\text{C}$
Transmission Tracking	± 0.010 $+0.02/^{\circ}\text{C}$	± 0.012 $+0.02/^{\circ}\text{C}$

Transmission Uncertainty (Specifications)

Magnitude

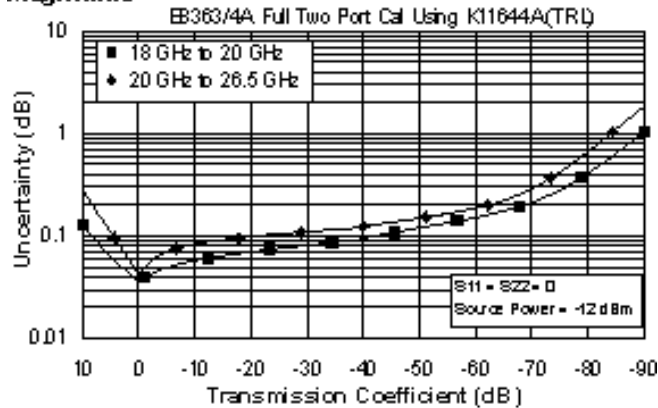

Phase

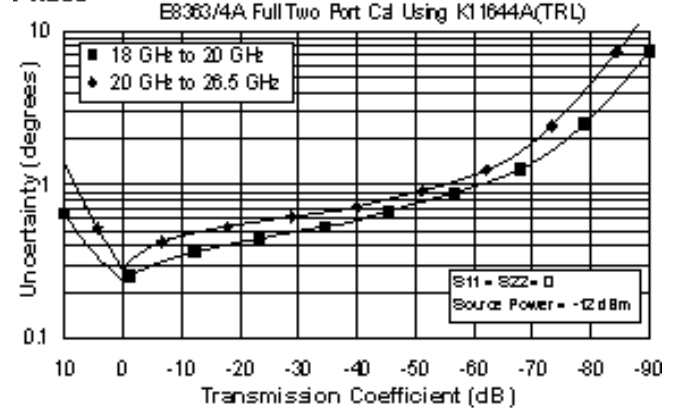

Reflection Uncertainty (Specifications)

Magnitude

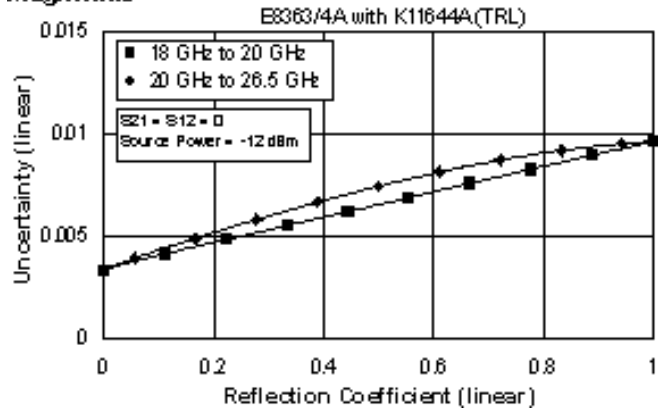

Phase

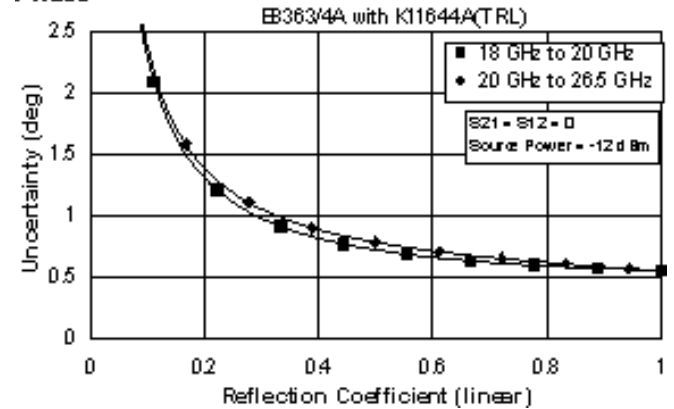

Table 28. K11644A Calibration Kit

Extended Configuration and Standard Power Range (E8363/4A - Option 014)

-OR-

Standard Configuration and Extended Power Range & Bias-Tees (E8363/4A - Option UNL)

-OR-

Extended Configuration and Extended Power Range & Bias-Tees (E8363/4A - Option UNL&014)

Applies to the, E8363/4A analyzers, K11644A (WR-42) calibration kit, 85134F flexible test port cable set, and a full 2-port calibration. Also applies to the following condition:

Environmental temperature 23° ±3 °C, with < 1 °C deviation from calibration temperature

Description	Specification (dB)	
	18 to 20 GHz	20 to 26.5 GHz
Directivity	50	50
Source Match	50	50
Load Match	50	50
Reflection Tracking	±0.000 +0.02/°C	±0.000 +0.02/°C
Transmission Tracking	±0.016 +0.02/°C	±0.021 +0.02/°C

Transmission Uncertainty (Specifications)

Magnitude

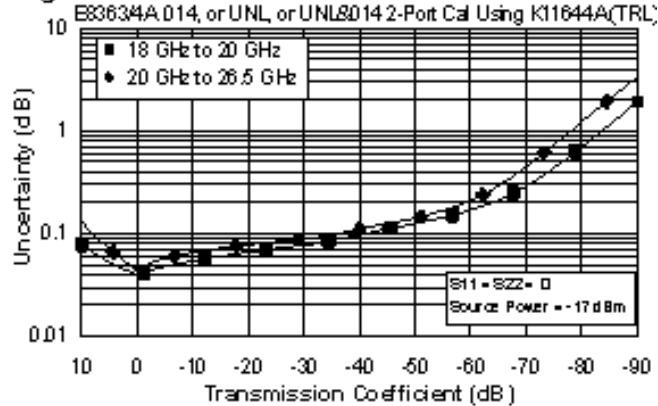

Phase

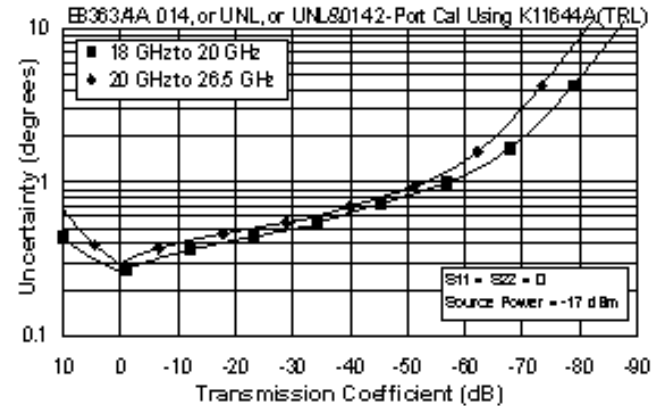

Reflection Uncertainty (Specifications)

Magnitude

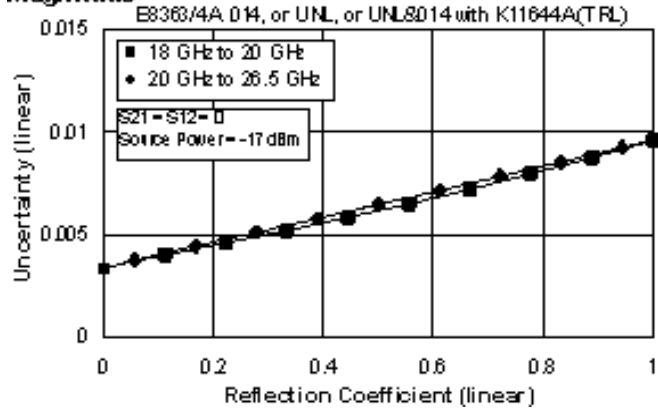

Phase

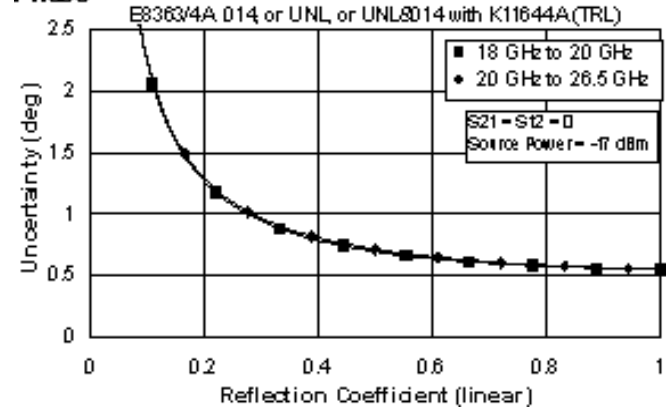

E836xA Corrected System Performance with WR-62 Connectors

**Table 29. P11644A Calibration Kit
Standard Configuration and Standard Power Range
(E836xA)**

Applies to the, E836xA analyzers, R11644A (WR-62) calibration kit, 85132F flexible test port cable set, and a full 2-port calibration. Also applies to the following condition:

Environmental temperature $23^{\circ} \pm 3^{\circ} \text{C}$, with $< 1^{\circ} \text{C}$ deviation from calibration temperature

Description	Specification (dB)
Directivity	50
Source Match	50
Load Match	50
Reflection Tracking	± 0.000 $+0.02/^{\circ}\text{C}$
Transmission Tracking	± 0.012 $+0.02/^{\circ}\text{C}$

Transmission Uncertainty (Specifications)

Magnitude

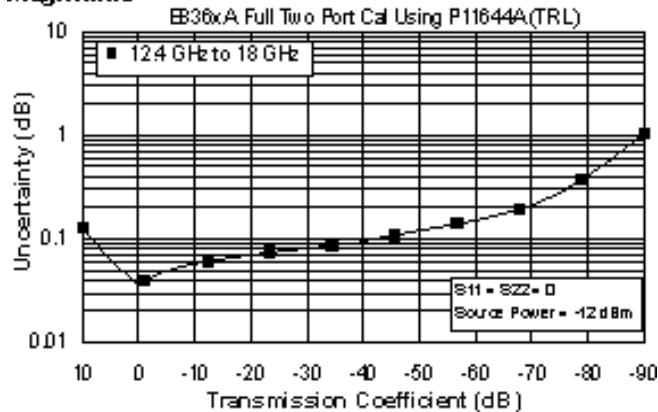

Phase

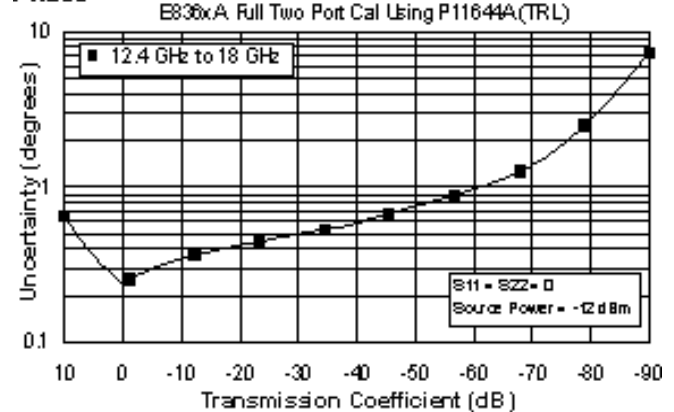

Reflection Uncertainty (Specifications)

Magnitude

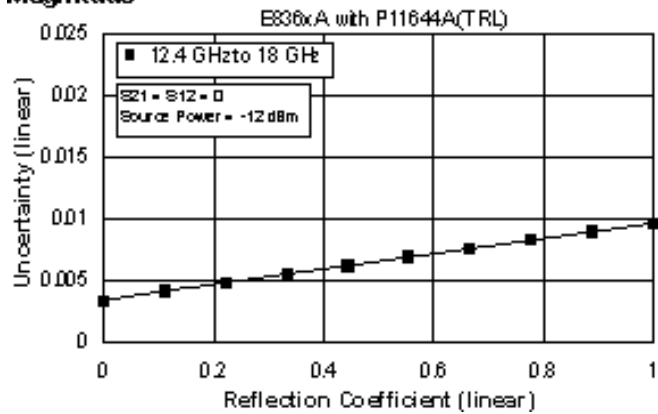

Phase

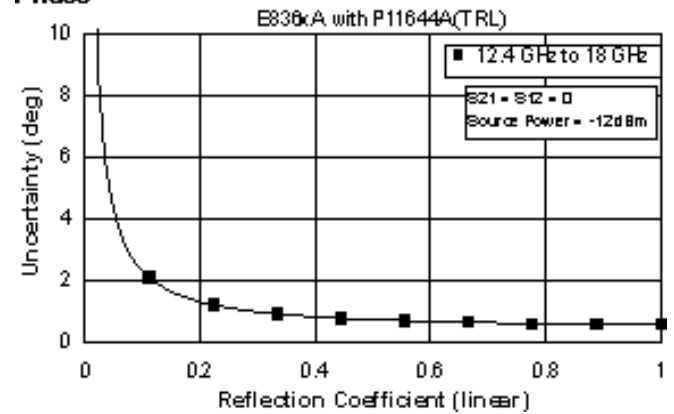

Table 30. P11644A Calibration Kit

Extended Configuration and Standard Power Range (E836xA - Option 014)

-OR-

Standard Configuration and Extended Power Range & Bias-Tees (E836xA - Option UNL)

-OR-

Extended Configuration and Extended Power Range & Bias-Tees (E836xA - Option UNL&014)

Applies to the, E836xA analyzers, P11644A (WR-62) calibration kit, 85132F flexible test port cable set, and a full 2-port calibration. Also applies to the following condition:

Environmental temperature $23^{\circ} \pm 3^{\circ} \text{C}$, with $< 1^{\circ} \text{C}$ deviation from calibration temperature

Description	Specification (dB)
	12.4 to 18 GHz
Directivity	50
Source Match	50
Load Match	50
Reflection Tracking	± 0.000 $+0.02/^{\circ}\text{C}$
Transmission Tracking	± 0.016 $+0.02/^{\circ}\text{C}$

Transmission Uncertainty (Specifications)

Magnitude

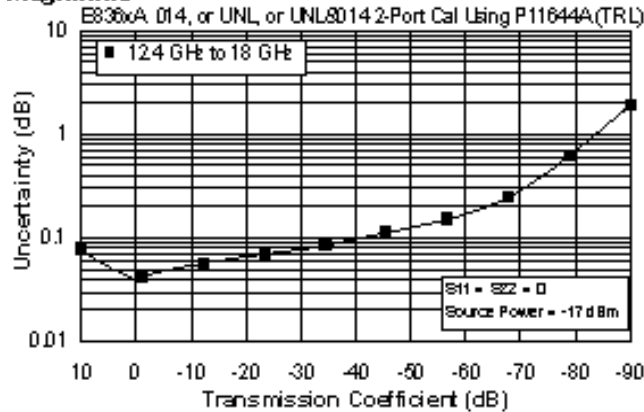

Phase

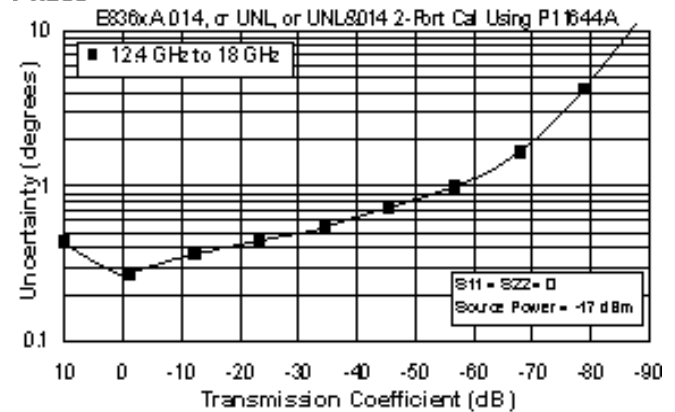

Reflection Uncertainty (Specifications)

Magnitude

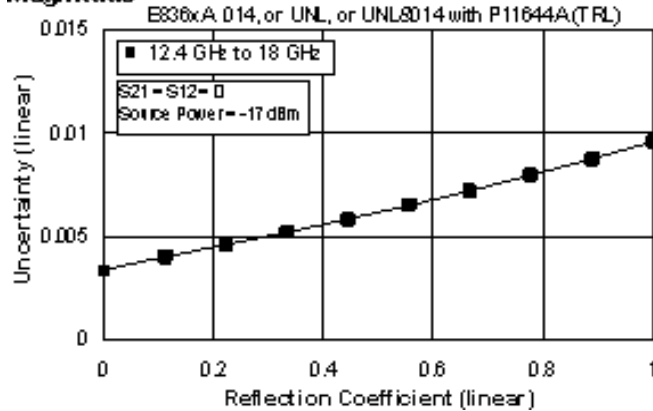

Phase

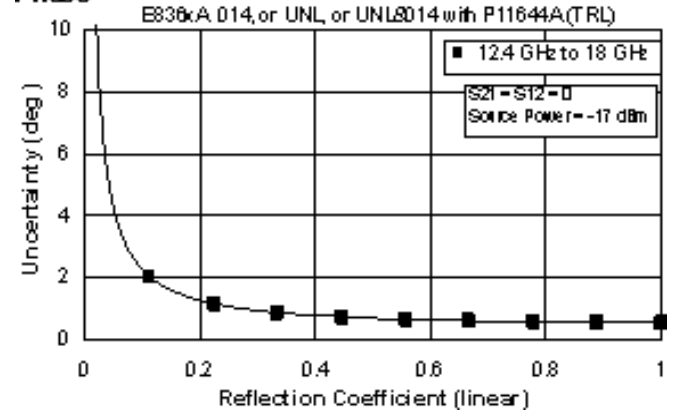

E836xA Corrected System Performance with WR-90 Connectors

**Table 31. X11644A Calibration Kit
Standard Configuration and Standard Power Range
(E836xA)**

Applies to the, E836xA analyzers, X11644A (WR-90) calibration kit, 85133F flexible test port cable set, and a full 2-port calibration. Also applies to the following condition:

Environmental temperature $23^{\circ} \pm 3^{\circ} \text{C}$, with $< 1^{\circ} \text{C}$ deviation from calibration temperature

Description	Specification (dB)	
	8.2 to 10 GHz	10 to 12.4 GHz
Directivity	50	50
Source Match	50	50
Load Match	50	50
Reflection Tracking	± 0.000 $+0.02/^{\circ}\text{C}$	± 0.000 $+0.02/^{\circ}\text{C}$
Transmission Tracking	± 0.010 $+0.02/^{\circ}\text{C}$	± 0.012 $+0.02/^{\circ}\text{C}$

Transmission Uncertainty (Specifications)

Magnitude

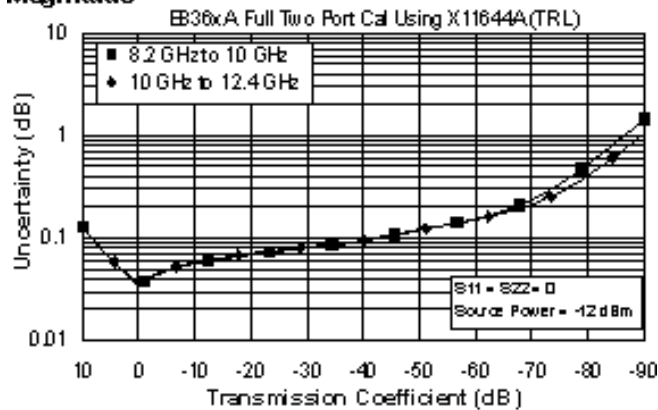

Phase

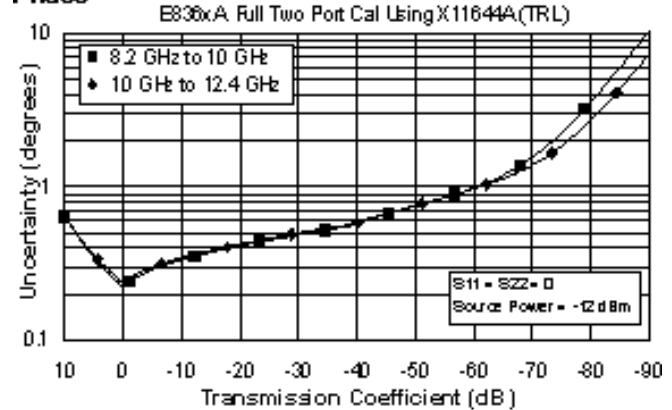

Reflection Uncertainty (Specifications)

Magnitude

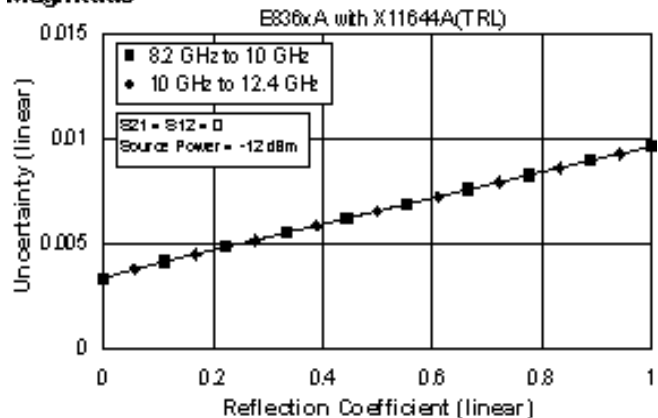

Phase

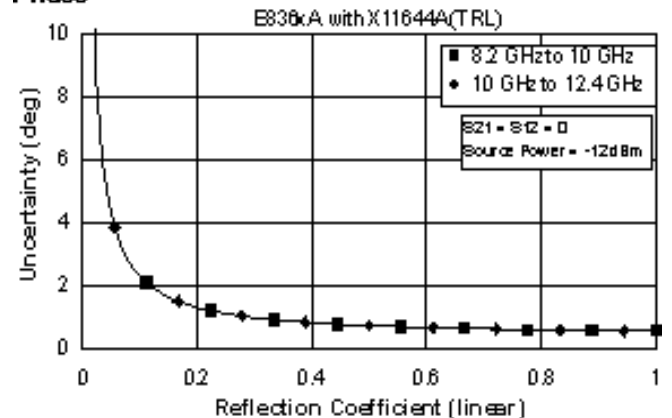

Table 32. X11644A Calibration Kit

Extended Configuration and Standard Power Range (E836xA - Option 014)

-OR-

Standard Configuration and Extended Power Range & Bias-Tees (E836xA - Option UNL)

-OR-

Extended Configuration and Extended Power Range & Bias-Tees (E836xA - Option UNL&014)

Applies to the, E836xA analyzers, X11644A (WR-90) calibration kit, 85133F flexible test port cable set, and a full 2-port calibration. Also applies to the following condition:

Environmental temperature 23° ±3 °C, with < 1 °C deviation from calibration temperature

Description	Specification (dB)	
	8.2 to 10 GHz	10 to 12.4 GHz
Directivity	50	50
Source Match	50	50
Load Match	50	50
Reflection Tracking	±0.000 +0.02/°C	±0.000 +0.02/°C
Transmission Tracking	±0.012 +0.02/°C	±0.016 +0.02/°C

Transmission Uncertainty (Specifications)

Magnitude

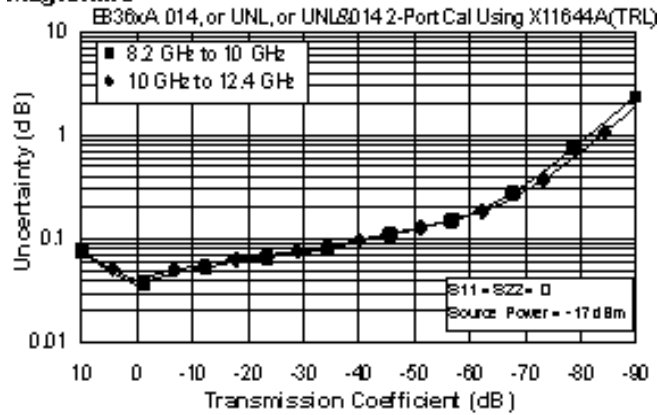

Phase

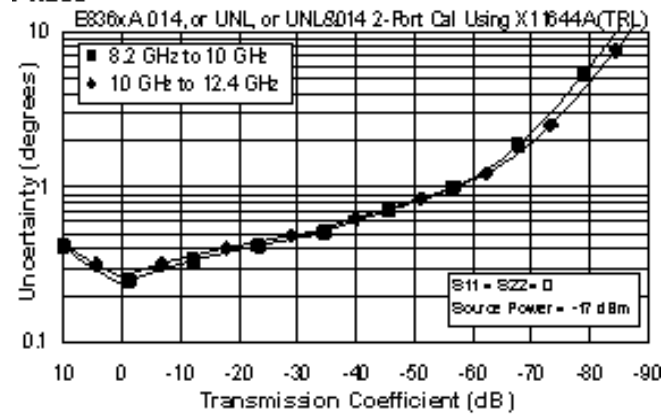

Reflection Uncertainty (Specifications)

Magnitude

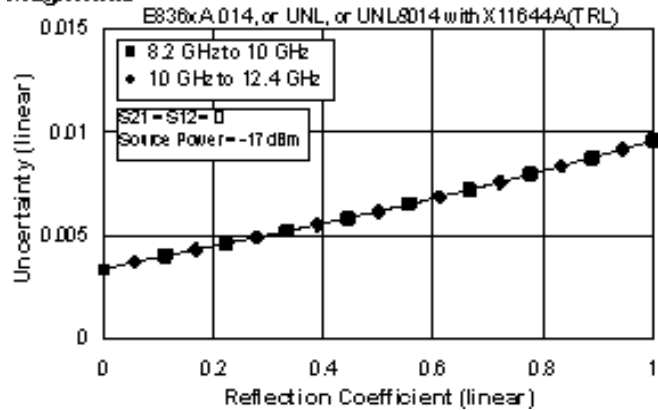

Phase

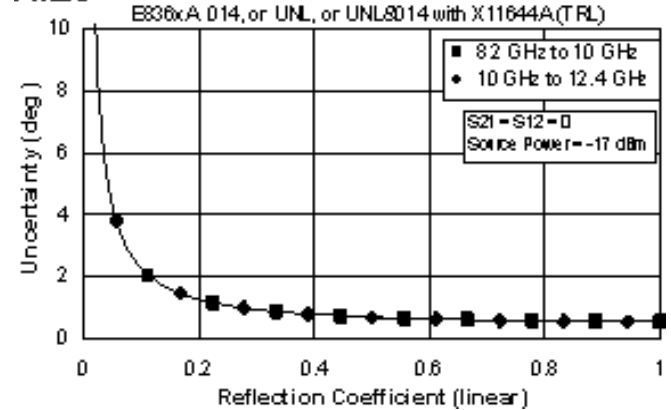

Table 33. Uncorrected System Performance

Specifications apply over environmental temperature of 23° ±3 °C, with < 1 °C deviation from the calibration temperature

Description	Specification	Supplemental Information
Directivity		
		Typical:
45 MHz to 2 GHz	24 dB	29 dB
2 GHz to 10 GHz	22 dB	25 dB
10 GHz to 20 GHz	16 dB	20 dB
20 GHz to 40 GHz	16 dB	20 dB
40 GHz to 45 GHz	15 dB	18 dB
45 GHz to 50 GHz	13 dB	18 dB
Source Match - Standard		
		Typical:
45 MHz to 2 GHz	23 dB	27 dB
2 GHz to 10 GHz	16 dB	19 dB
10 GHz to 20 GHz	14 dB	19 dB
20 GHz to 40 GHz	10 dB	14 dB
40 GHz to 45 GHz	9 dB	13.5 dB
45 GHz to 50 GHz	5.5 dB	9 dB
Source Match - Opt UNL, 014 or UNL&014		
		Typical:
45 MHz to 2 GHz	18 dB	22.5 dB
2 GHz to 10 GHz	14 dB	18 dB
10 GHz to 20 GHz	12 dB	15 dB
20 GHz to 40 GHz	8 dB	10 dB
40 GHz to 45 GHz	7 dB	10 dB
45 GHz to 50 GHz	4 dB	6.5 dB
Load Match - Standard		
		Typical:
45 MHz to 2 GHz	23 dB	29 dB
2 GHz to 10 GHz	14 dB	16 dB
10 GHz to 20 GHz	10 dB	12 dB
20 GHz to 40 GHz	9 dB	12 dB
40 GHz to 45 GHz	9 dB	13 dB
45 GHz to 50 GHz	7 dB	10 dB
Load Match - Opt UNL, 014 or UNL&014		
		Typical:
45 MHz to 2 GHz	17 dB	21.5 dB
2 GHz to 10 GHz	13 dB	16.5 dB
10 GHz to 20 GHz	10 dB	13 dB
20 GHz to 40 GHz	9 dB	11 dB
40 GHz to 45 GHz	8 dB	11 dB
45 GHz to 50 GHz	6 dB	8 dB
Reflection Tracking		
		Typical:
45 MHz to 20 GHz		±1.5
20 GHz to 40 GHz		±1.5
40 GHz to 50 GHz		±2.0

Transmission Tracking^a		
		Typical:
45 MHz to 2 GHz		±2.5 dB
2 GHz to 10 GHz		±2.0 dB
10 GHz to 20 GHz		±3.0 dB
20 GHz to 40 GHz		±4.5 dB
40 GHz to 45 GHz		±6.0 dB
45 GHz to 50 GHz		±6.0 dB
Crosstalk - Standard		
45 MHz to 1 GHz	-85 dB	
1 GHz to 2 GHz	-100 dB	
2 GHz to 20 GHz	-110 dB	
20 GHz to 40 GHz	-108 dB	
40 GHz to 45 GHz	-105 dB	
45 GHz to 50 GHz	-100 dB	
Crosstalk - Option UNL or 014		
45 MHz to 1 GHz	-85 dB	
1 GHz to 2 GHz	-100 dB	
2 GHz to 20 GHz	-109 dB	
20 GHz to 40 GHz	-106 dB	
40 GHz to 45 GHz	-103 dB	
45 GHz to 50 GHz	-98 dB	
Crosstalk - Option UNL&014		
45 MHz to 1 GHz	-85 dB	
1 GHz to 2 GHz	-98 dB	
2 GHz to 10 GHz	-108 dB	
10 GHz to 20 GHz	-107 dB	
20 GHz to 40 GHz	-104 dB	
40 GHz to 45 GHz	-100 dB	
45 GHz to 50 GHz	-95 dB	

^a Measurement conditions: normalized to a thru, measured with two shorts, 10 Hz IF bandwidth, averaging factor of 8, alternate mode, source power set to the lesser of the maximum power out or the maximum receiver power.

Table 34. Test Port Output^a

Description	Specification				Supplemental
Frequency Range					
	Standard	Opt 014	Opt UNL	Opt UNL&014	
E8362A	45 MHz to 20 GHz				
E8363A	45 MHz to 40 GHz				
E8364A	45 MHz to 50 GHz				
Nominal Power^b					
	-12 dBm	-17 dBm	-17 dBm	-17 dBm	
Frequency Resolution					
	1 Hz				
CW Accuracy					
	+/-1 ppm				
Frequency Stability					
					+/-1 ppm 0° to 40° C, typical +/-0.2 ppm/yr, typical
Power Level Accuracy					
45 MHz to 10 GHz	+/-1.5 dB	+/-1.5 dB	+/-1.5 dB	+/-1.5 dB	Variation from nominal power in range 0 (step attenuator at 0 dB)
10 GHz to 20 GHz	+/-2.0 dB	+/-2.0 dB	+/-2.0 dB	+/-2.0 dB	
20 GHz to 40 GHz	+/-3.0 dB	+/-3.0 dB	+/-3.0 dB	+/-3.0 dB	
40 GHz to 45 GHz	+/-3.0 dB	+/-3.5 dB	+/-3.0 dB	+/-3.5 dB	
45 GHz to 50 GHz	+/-3.0 dB	+/-4.0 dB	+/-3.0 dB	+/-4.0 dB	
Power Level Linearity					
45 MHz to 20 GHz	+/-1.0 dB	+/-1.0 dB	+/-1.0 dB ^c	+/-1.0 dB ^c	Test reference is at the nominal power level (step attenuator at 0 dB)
20 GHz to 40 GHz	+/-1.0 dB	+/-1.0 dB	+/-1.0 dB ^c	+/-1.0 dB ^c	
40 GHz to 50 GHz	+/-1.0 dB	+/-1.0 dB	+/-1.0 dB	+/-1.0 dB	
Power Range^d					
45 MHz to 10 GHz	-25 to +5 dBm	-25 to +5 dBm	-87 to +3 dBm	-87 to +3 dBm	
10 GHz to 20 GHz	-24 to +3 dBm	-25 to +2 dBm	-86 to +1 dBm	-87 to 0 dBm	
20 GHz to 30 GHz	-23 to 0 dBm	-25 to -2 dBm	-85 to -2 dBm	-87 to -4 dBm	
30 GHz to 40 GHz	-23 to -4 dBm	-25 to -6 dBm	-85 to -6 dBm	-87 to -8 dBm	
40 GHz to 45 GHz	-25 to -5 dBm	-27 to -7 dBm	-87 to -9 dBm	-87 to -11 dBm	
45 GHz to 50 GHz	-25 to -10 dBm	-27 to -12 dBm	-87 to -15 dBm	-87 to -17 dBm	

Power Sweep Range (ALC)					
45 MHz to 10 GHz	30 dB	30 dB	30 dB	30 dB	ALC range starts at maximum leveled output power and goes down to power level indicated by dB amount specified
10 GHz to 20 GHz	27 dB	27 dB	27 dB	27 dB	
20 GHz to 30 GHz	23 dB	23 dB	23 dB	23 dB	
30 GHz to 40 GHz	19 dB	19 dB	19 dB	19 dB	
40 GHz to 45 GHz	20 dB	20 dB	18 dB	16 dB	
45 GHz to 50 GHz	15 dB	15 dB	12 dB	10 dB	
Power Resolution					
	0.01 dB				
Phase Noise					
10 kHz offset from center frequency, nominal power at test port					
45 MHz to 10 GHz					-70 dBc, typical
10 GHz to 20 GHz					-65 dBc, typical
20 GHz to 40 GHz					-55 dBc, typical
40 GHz to 50 GHz					-55 dBc, typical
Harmonics (2nd or 3rd)					
					-23 dBc typical, in power range 0
Non-Harmonic Spurious (at Nominal Output Power)					
45 MHz to 20 GHz					-50 dBc typical, for offset frequency > 1 kHz
20 GHz to 40 GHz					-30 dBc typical, for offset frequency > 1 kHz
40 GHz to 50 GHz					-30 dBc typical, for offset frequency > 1 kHz

^a Source output performance on Port 1 only. Port 2 output performance is a characteristic.

^b Preset power.

^c 1.5 dB for power <= -23 dBm.

^d Power to which the source can be set and phase lock is assured.

Table 35: Test Port Input

Description	Specification				Supplemental
	Standard	Opt 014	Opt UNL	Opt UNL&014	
Test Port Noise Floor¹					
10 Hz IF Bandwidth					
45 MHz to 500 MHz ²	<-89 dBm	<-89 dBm	<-89 dBm	<-89 dBm	
500 MHz to 2 GHz	<-114 dBm	<-114 dBm	<-114 dBm	<-114 dBm	
2 GHz to 10 GHz	<-117 dBm	<-117 dBm	<-117 dBm	<-117 dBm	
10 GHz to 20 GHz	<-120 dBm	<-119 dBm	<-120 dBm	<-119 dBm	
20 GHz to 40 GHz	<-114dBm	<-113 dBm	<-114 dBm	<-113 dBm	
40 GHz to 50 GHz	<-114 dBm	<-112 dBm	<-114 dBm	<-112 dBm	
1 Hz IF Bandwidth					
45 MHz to 500 MHz ²	<-69 dBm	<-69 dBm	<-69 dBm	<-69 dBm	
500 MHz to 2 GHz	<-94 dBm	<-94 dBm	<-94 dBm	<-94 dBm	
2 GHz to 10 GHz	<-97 dBm	<-97 dBm	<-97 dBm	<-97 dBm	
10 GHz to 20 GHz	<-100 dBm	<-99 dBm	<-100 dBm	<-99 dBm	
20 GHz to 40 GHz	<-94 dBm	<-93 dBm	<-94 dBm	<-93 dBm	
40 GHz to 50 GHz	<-94 dBm	<-92 dBm	<-94 dBm	<-92 dBm	
Direct Receiver Access Input Noise Floor¹					
10 Hz IF Bandwidth					
45 MHz to 500 MHz ²		<-127 dBm		<-127 dBm	
500 MHz to 2 GHz		<-133 dBm		<-133 dBm	
2 GHz to 10 GHz		<-132 dBm		<-132 dBm	
10 GHz to 20 GHz		<-134 dBm		<-134 dBm	
20 GHz to 40 GHz		<-125 dBm		<-125 dBm	
40 GHz to 50 GHz		<-123 dBm		<-123 dBm	

1 Hz IF Bandwidth					
45 MHz to 500 MHz		<-107 dBm		<-107 dBm	
500 MHz to 2 GHz		<-113 dBm		<-113 dBm	
2 GHz to 10 GHz		<-112 dBm		<-112 dBm	
10 GHz to 20 GHz		<-114 dBm		<-114 dBm	
20 GHz to 40 GHz		<-105 dBm		<-105 dBm	
40 GHz to 50 GHz		<-103 dBm		<-103 dBm	
Receiver Compression Level					
45 MHz to 20 GHz	<0.6 dB compression at +5 dBm				
20 GHz to 30 GHz	<0.6 dB compression at 0 dBm				
30 GHz to 40 GHz	<0.6 dB compression at -3 dBm				
40 GHz to 50 GHz	<0.6 dB compression at -3 dBm				
System Compression Level					
	maximum output power			See dynamic accuracy table	
Trace Noise Magnitude					
1 kHz IF bandwidth. Ratio measurement, nominal power at test port.					
45 MHz to 500 MHz	<0.010 dB rms				
500 MHz to 20 GHz	<0.006 dB rms				
20 GHz to 40 GHz	<0.006 dB rms				
40 GHz to 50 GHz	<0.006 dB rms				
Trace Noise Phase					
1 kHz IF bandwidth. Ratio measurement, nominal power at test port.					
45 MHz to 500 MHz ³	<0.100° rms				
500 MHz to 20 GHz	<0.060° rms				
20 GHz to 40 GHz	<0.100° rms				
40 GHz to 50 GHz	<0.100° rms				

Reference Level Magnitude					
Range	+/-200 dB				
Resolution	0.001 dB				
Reference Level Phase					
Range	+/-500°				
Resolution	0.01°				
Stability Magnitude ⁴					
Typical ratio measurement, made at the test port.					
45 MHz to 20 GHz					+/-0.02 dB/°C
20 GHz to 40 GHz					+/-0.03 dB/°C
40 GHz to 50 GHz					+/-0.04 dB/°C
Stability Phase ⁴					
Typical ratio measurement, measured at the test port.					
45 MHz to 20 GHz					+/-0.2°/°C
20 GHz to 40 GHz					+/-0.5°/°C
40 GHz to 50 GHz					+/-0.8°/°C
Damage Input Level					
Test Port 1 and 2					+20 dBm or +/-40 VDC, typical
R1, R2 in					+15 dBm or +/-15 VDC, typical
A, B in					+15 dBm or +/-15 VDC, typical
Coupler Thru					+30 dBm or +/-40 VDC, typical
Coupler Arm					+30 dBm or +/-7 VDC, typical

¹Total average (rms) noise power calculated as the mean value of a linear magnitude trace expressed in dBm.

²Noise floor may be degraded by 10 dB at particular frequencies (multiples of 5 MHz) due to spurious receiver residuals.

³Trace noise magnitude may be degraded to 20 mdB rms at harmonic frequencies of the first IF (8.33 MHz) below 80 MHz.

⁴Stability is defined as a ratio measurement made at the test port.

Table 36. Dynamic Accuracy (Specification^a)

Accuracy of the test port input power reading is relative to the reference input power level. Applies to input ports 1 and 2 with the following conditions:

- IF bandwidth = 10 Hz
- Test port powers = > -50 dBm and < 0 dBm

Magnitude

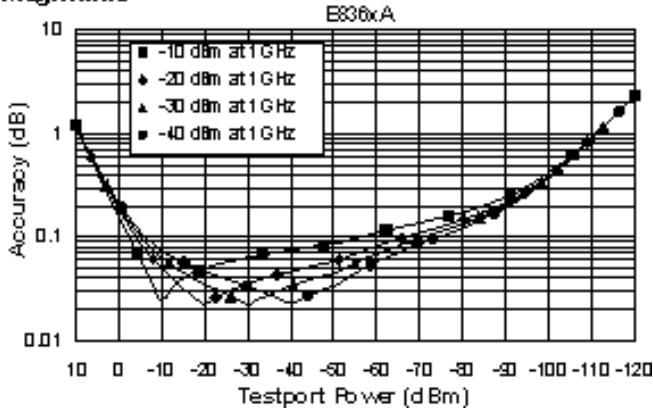

Phase

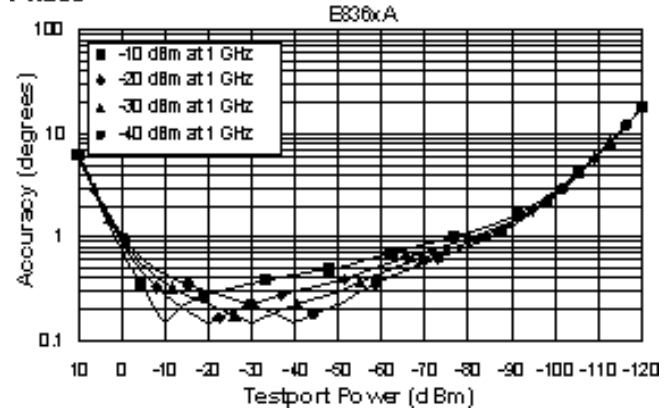

^a Dynamic accuracy is verified with the following measurements:

- compression over frequency
- IF linearity at a single frequency of 1.195 GHz and a reference level of -20 dBm

Table 37. Test Port Input (Group Delay)^a

Description	Specification	Supplemental Information
Aperture (selectable)	(frequency span)/(number of points - 1)	
Maximum Aperture	20% of frequency span	
Range	0.5 x (1/minimum aperture)	
Maximum Delay		Limited to measuring no more than 180° of phase change within the minimum aperture.)
Accuracy		See graph below. Char.

The following graph shows characteristic group delay accuracy with full 2-port calibration and a 10 Hz IF bandwidth. Insertion loss is assumed to be < 2 dB and electrical length to be ten meters.

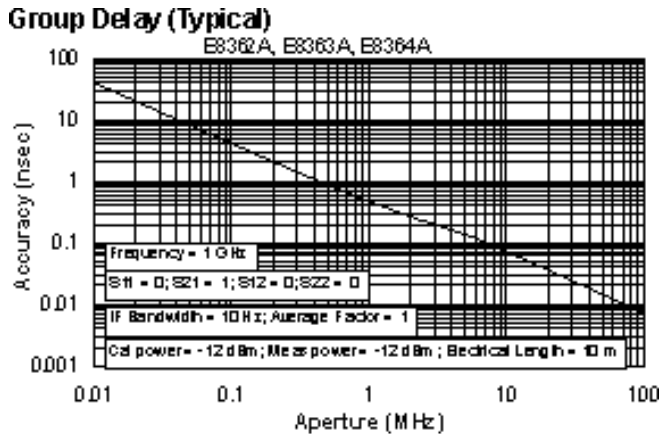

In general, the following formula can be used to determine the accuracy, in seconds, of specific group delay measurement:

$$\pm \text{Phase Accuracy (deg)} / [360 \times \text{Aperture (Hz)}]$$

Depending on the aperture and device length, the phase accuracy used is either incremental phase accuracy or worst case phase accuracy.

^a Group delay is computed by measuring the phase change within a specified frequency step (determined by the frequency span and the number of points per sweep).

General Information

Table 38. Miscellaneous Information

Description	Specification	Supplemental Information
System IF Bandwidth Range		1 Hz to 40 kHz, nominal
CPU		Intel® 500 MHz Pentium® III

Table 39. Front Panel Information

Description	Supplemental Information
RF Connectors	
E8362A	
Type	3.5 mm (male), 50 ohm, (nominal)
Center Pin Recession	0.002 in. (characteristic)
E8363/4A	
Type	2.4 mm (male), 50 ohm, (nominal)
Center Pin Recession	0.002 in. (characteristic)
Display	
Size	21.3 cm (8.4 in) diagonal color active matrix LCD; 640 (horizontal) X 480 (vertical) resolution; 59.83 Hz vertical refresh rate; 31.41 Hz horizontal refresh rate
Refresh Rate	Vertical 59.83 Hz; Horizontal 31.41 Hz
Display Range	
Magnitude	±200 dB (at 20 dB/div), max
Phase	±180°, max
Polar	10 pUnits, min 1000 Units, max
Display Resolution	
Magnitude	0.001 dB/div, min
Phase	0.01°/div, min
Marker Resolution	
Magnitude	0.001 dB, min
Phase	0.01°, min
Polar	0.01 mUnit, min; 0.01°, min

Table 40. Rear Panel Information

Description	Supplemental Information
10 MHz Reference In	
Connector	BNC, female
Input Frequency	10 MHz ± 10 ppm, typical
Input Level	-15 dBm to +20 dBm, typical
Input Impedance	200 Ω, nom.
10 MHz Reference Out	
Connector	BNC, female
Output Frequency	10 MHz ± 1 ppm, typical
Signal Type	Sine Wave, typical
Output Level	+10 dBm ± 4 dB into 50 Ω, typical
Output Impedance	50 Ω, nominal
Harmonics	<-40 dBc, typical
VGA Video Output	
Connector	15-pin mini D-Sub; Drives VGA compatible monitors
Devices Supported:	
	Resolutions:
Flat Panel (TFT)	1024 X 768, 800 X 600, 640 X 480
Flat Panel (DSTN)	800 X 600, 640 X 480
CRT Monitor	1280 X 1024, 1024 X 768, 800 X 600, 640 X 480
	Simultaneous operation of the internal and external displays is allowed, but with 640 X 480 resolution only. If you change resolution, you can only view the external display (internal display will "white out").
Test Set IO	
	25-pin D-Sub connector, available for external test set control

Aux IO	
	25-pin D-Sub connector, male, analog and digital IO
Handler IO	
	36-pin parallel I/O port; all input/output signals are default set to negative logic; can be reset to positive logic via GPIB command
GPIB	
	24-pin D-sub (Type D-24), female; compatible with IEEE-488.
Parallel Port (LPT1)	
	25-pin D-Sub miniature connector, female; provides connection to printers or any other parallel port peripherals
Serial Port (COM 1)	
	9-pin D-Sub, male; compatible with RS-232
USB Port	
	Universal Serial Bus jack, Type A configuration (4 contacts inline, contact 1 on left); female
Contact 1	Vcc: 4.75 to 5.25 VDC, 500 mA, maximum
Contact 2	-Data
Contact 3	+Data
Contact 4	Ground
LAN	
	10/100BaseT Ethernet, 8-pin configuration; auto selects between the two data rates
Line Power^a	
Frequency	48 Hz to 66 Hz
Voltage at 115 V Setting	90 to 132 VAC; 120 VAC, nominal
Voltage at 220 V Setting	198 to 264 VAC; 240 VAC, nominal
VA Max	600 VA maximum

^a A third-wire ground is required.

Table 41. Analyzer Environment and Dimensions

Description	Supplemental Information		
General Environmental			
RFI/EMI Susceptibility	Defined by CISPR Pub. 11, Group 1, Class A, and IEC 50082-1		
ESD	Minimize using static-safe work procedures and an antistatic bench mat		
Dust	Minimize for optimum reliability		
Operating Environment			
Temperature	0 °C to +40 °C Instrument powers up, phase locks, and displays no error messages within this temperature range (except for "source unlevelled" error message that may occur at temperature extremes when power approaches limits of ALC range).		
Error-Corrected Temperature Range	23°C ± 3°C with less than 1°C deviation from calibration temp.		
Humidity	5% to 95% at +40 °C		
Altitude	0 to 4500 m (14,760 ft.)		
Non-Operating Storage Environment			
Temperature	-40 °C to +70 °C		
Humidity	0% to 90% at +65 °C (non-condensing)		
Altitude	0 to 15,240 m (50,000 ft.)		
Cabinet Dimensions			
	Height	Width	Depth
Excluding front and rear panel hardware and feet	267 mm 10.5 in	425 mm 16.75 in	426 mm 16.8 in
As shipped - includes front panel connectors, rear panel bumpers, and feet.	305 mm 12.0 in	425 mm 16.75 in	470 mm 18.5 in
As shipped plus handles	305 mm 12.0 in	458 mm 18 in	502 mm 19.75 in
As shipped plus rack-mount flanges	305 mm 12.0 in	483 mm 19 in	470 mm 18.5 in
As shipped plus handles and flanges	305 mm 12.0 in	483 mm 19 in	502 mm 19.75 in
Weight			
Net			
E8362A	28.6 kg (63.5 lb), nominal		
E8363/4A	29 kg (64 lb), nominal		
Shipping			
E8362A	35.8 kg (79.5 lb), nominal		
E8363/4A	36.3 kg 80 lb), nominal		

Measurement Throughput Summary

Table 42. Typical Cycle Time^{a,b} (ms) for Measurement Completion

	Number of Points			
	51	201	401	1601
Start 13.5 GHz, Stop 16.5 GHz, 35 kHz IF bandwidth				
Uncorrected, 1-port cal	21	23	28	65
2-Port cal	52	57	70	152
Start 45 MHz, Stop 10 GHz, 35 kHz IF bandwidth				
Uncorrected, 1-port cal	71	79	84	110
2-Port cal	153	171	182	243
Start 45 MHz, Stop 20 GHz, 35 kHz IF bandwidth				
Uncorrected, 1-port cal	103	116	121	139
2-Port cal	216	245	256	303
Start 45 MHz, Stop 40 GHz, 35 kHz IF bandwidth				
Uncorrected, 1-port cal	145	181	190	232
2-Port cal	293	367	382	428
Start 45 MHz, Stop 50 GHz, 35 kHz IF bandwidth				
Uncorrected, 1-port cal	163	210	218	256
2-Port cal	332	425	442	487
Time Domain^c (increase over uncorrected sweep time)				
Conversions	< 1	< 1	4	13
Gating	< 1	< 1	4	17

^a Typical performance.

^b Includes sweep time, retrace time and band-crossing time. Analyzer display turned off with DISPLAY:ENABLE OFF. Add 21 ms for display on. Data for one trace (S11) measurement.

^c Option 010 only.

Table 43. Cycle Time vs IF Bandwidth^a

Applies to the Preset condition (201 points, correction off) except for the following changes:

- CF = 1 GHz
- Span = 100 MHz
- Display off (add 21 ms for display on)

IF Bandwidth (Hz)	Cycle Time (ms) ^b
40,000	8
35,000	9
30,000	11
20,000	13
10,000	28
7000	36
5000	48
3000	72
1000	196
300	620
100	3853
30	8041
10	19855

^a Typical performance.

^b Cycle time includes sweep and retrace time.

Table 44. Cycle Time vs Number of Points^a

Applies to the Preset condition (35 kHz IF bandwidth, correction off) except for the following changes:

- CF = 1 GHz
- Span = 100 MHz
- Display off (add 21 ms for display on)

Number of Points	Cycle Time (ms) ^b
3	4
11	4
51	5
101	6
201	9
401	16
801	29
1601	55

^a Typical performance.

^b Cycle time includes sweep and retrace time.

Table 45. Data Transfer Time (ms)^a

	Number of Points			
	51	201	401	1601
SCPI over GPIB				
(program executed on external PC)^a				
32-bit floating point	3	7	12	43
64-bit floating point	4	12	22	84
ASCII	18	64	124	489
SCPI over 100 Mbit/s LAN				
(program executed on external PC)^b				
32-bit floating point	1	1	1	1
64-bit floating point	1	1	1	2
ASCII	5	15	26	96
SCPI (program executed in the analyzer)^c				
32-bit floating point	1	1	2	3
64-bit floating point	1	2	2	4
ASCII	8	29	56	222
COM (program executed in the analyzer)^d				
32-bit floating point	1	1	1	1
Variant type	1	1	2	6
DCOM over 100 Mbit/s LAN				
(program executed on external PC)^f				
32-bit floating point	1	1	1	2
Variant type	1	3	6	19

^aTypical performance

Note: Specifications for Recall & Sweep Speed are not provided for the E836xA analyzers.

Specifications: Front-Panel Jumpers

Models E8362A, E8363A, and E8364A Option 014

See [Front-panel jumper](#) configurations.

NOTE: The standard E8362A /63A/ 64A has no front-panel jumpers.

Table 46: Measurement Receiver Inputs (Rcvr A In, Rcvr B In)

Description	Specification	Supplemental Information
Maximum Input Level		
E8362A:		
45 MHz to 500 MHz		-15 dBm, typical
500 MHz to 2 GHz		-11 dBm, typical
2 GHz to 10 GHz		-11 dBm, typical
10 GHz to 20 GHz		-11 dBm, typical
E8363A:		
45 MHz to 500 MHz		-14 dBm, typical
500 MHz to 2 GHz		-10 dBm, typical
2 GHz to 10 GHz		-10 dBm, typical
10 GHz to 20 GHz		-10 dBm, typical
20 GHz to 30 GHz		-14.5 dBm, typical
30 GHz to 40 GHz		-16.5 dBm, typical
E8364A:		
45 MHz to 500 MHz		- 14 dBm, typical
500 MHz to 2 GHz		- 10 dBm, typical
2 GHz to 10 GHz		- 10 dBm, typical
10 GHz to 20 GHz		- 10 dBm, typical
20 GHz to 30 GHz		- 14.5 dBm, typical
30 GHz to 40 GHz		- 16.5 dBm, typical
40 GHz to 45 GHz		- 16 dBm, typical
45 GHz to 50 GHz		- 15 dBm, typical
Noise Floor		
E8362A:		
	10 Hz IF Bandwidth	
45 MHz to 500 MHz	< -109 dBm	
500 MHz to 2 GHz	< -130 dBm	
2 GHz to 10 GHz	< -133 dBm	
10 GHz to 20 GHz	< -135 dBm	
	1 kHz IF Bandwidth	
45 MHz to 500 MHz	< -89 dBm	
500 MHz to 2 GHz	< -110 dBm	
2 GHz to 10 GHz	< -113 dBm	
10 GHz to 20 GHz	< -115 dBm	

E8363A:		
	10 Hz IF Bandwidth	
45 MHz to 500 MHz	< -127 dBm	
500 MHz to 2 GHz	< -133 dBm	
2 GHz to 10 GHz	< -132 dBm	
10 GHz to 20 GHz	< -134 dBm	
20 GHz to 40 GHz	< -125 dBm	
	1 kHz IF Bandwidth	
45 MHz to 500 MHz	< -107 dBm	
500 MHz to 2 GHz	< -113 dBm	
2 GHz to 10 GHz	< -112 dBm	
10 GHz to 20 GHz	< -114 dBm	
20 GHz to 40 GHz	< -105 dBm	
E8364A:		
	10 Hz IF Bandwidth	
45 MHz to 500 MHz	< - 127 dBm	
500 MHz to 2 GHz	< - 133 dBm	
2 GHz to 10 GHz	< - 132 dBm	
10 GHz to 20 GHz	< - 134 dBm	
20 GHz to 40 GHz	< - 125 dBm	
40 GHz to 50 GHz	< - 123 dBm	
	1 kHz IF Bandwidth	
45 MHz to 500 MHz	< -107 dBm	
500 MHz to 2 GHz	< -113 dBm	
2 GHz to 10 GHz	< -112 dBm	
10 GHz to 20 GHz	< -114 dBm	
20 GHz to 40 GHz	< -105 dBm	
40 GHz to 50 GHz	< -103 dBm	
Damage Level		
E8362A		+ 15 dBm, typical
E8363A		+ 15 dBm, typical
E8364A		+ 15 dBm, typical
Maximum DC Level		
E8362A		+ 15 V, typical
E8363A		+ 15 V, typical
E8364A		+ 15 V, typical

Table 47: Reference Receiver Inputs (Rcvr R1, Rcvr R2)

Description	Specification	Supplemental Information
Maximum Input Level		
E8362A:		
45 MHz to 500 MHz		-15 dBm, typical
500 MHz to 2 GHz		-11 dBm, typical
2 GHz to 10 GHz		-11 dBm, typical
10 GHz to 20 GHz		-11 dBm, typical
E8363A:		
45 MHz to 500 MHz		-14 dBm, typical
500 MHz to 2 GHz		-10 dBm, typical
2 GHz to 10 GHz		-10 dBm, typical
10 GHz to 20 GHz		-9.5 dBm, typical
20 GHz to 30 GHz		-14 dBm, typical
30 GHz to 40 GHz		-15.5 dBm, typical
E8364A:		
45 MHz to 500 MHz		- 14 dBm, typical
500 MHz to 2 GHz		- 10 dBm, typical
2 GHz to 10 GHz		- 10 dBm, typical
10 GHz to 20 GHz		- 9.5 dBm, typical
20 GHz to 30 GHz		- 14 dBm, typical
30 GHz to 40 GHz		- 15.5 dBm, typical
40 GHz to 45 GHz		- 14 dBm, typical
45 GHz to 50 GHz		- 15 dBm, typical
Damage Level		
E8362A		+ 15 dBm, typical
E8363A		+ 15 dBm, typical
E8364A		+ 15 dBm, typical
Maximum DC Level		
E8362A		+/- 15 V, typical
E8363A		+/- 15 V, typical
E8364A		+/- 15 V, typical

Table 48: Reference Outputs (Reference 1 Source Out, Reference 2 Source Out)

Description	Specification	Supplemental Information
Maximum Output Level		
E8362A:		
45 MHz to 500 MHz		-24 dBm, typical
500 MHz to 2 GHz		-23 dBm, typical
2 GHz to 10 GHz		-23 dBm, typical
10 GHz to 20 GHz		-26 dBm, typical
E8363A:		
45 MHz to 500 MHz		-11.5 dBm, typical
500 MHz to 2 GHz		-10.5 dBm, typical
2 GHz to 10 GHz		-11 dBm, typical
10 GHz to 20 GHz		-11 dBm, typical
20 GHz to 30 GHz		-11 dBm, typical
30 GHz to 40 GHz		-11 dBm, typical
E8364A:		
45 MHz to 500 MHz		- 11.5 dBm, typical
500 MHz to 2 GHz		- 10.5 dBm, typical
2 GHz to 10 GHz		- 11 dBm, typical
10 GHz to 20 GHz		- 11 dBm, typical
20 GHz to 30 GHz		- 11 dBm, typical
30 GHz to 40 GHz		- 11 dBm, typical
40 GHz to 45 GHz		- 11 dBm, typical
45 GHz to 50 GHz		- 15 dBm, typical
Damage Level		
E8362A		+ 20 dBm, typical
E8363A		+ 20 dBm, typical
E8364A		+ 20 dBm, typical
Maximum DC Level		
E8362A		+/- 15 V, typical
E8363A		+/- 15 V, typical
E8364A		+/- 15 V, typical

Table 49: Source Outputs (Port 1 Source Out, Port 2 Source Out)

Description	Specification	Supplemental Information
Maximum Output Level		
E8362A, Option 014:		
45 MHz to 500 MHz		6 dBm, typical
500 MHz to 2 GHz		7 dBm, typical
2 GHz to 10 GHz		7 dBm, typical
10 GHz to 20 GHz		4 dBm, typical
E8362A, Option 014 and UNL:		
45 MHz to 500 MHz		4 dBm, typical
500 MHz to 2 GHz		5 dBm, typical
2 GHz to 10 GHz		5 dBm, typical
10 GHz to 20 GHz		2 dBm, typical
E8363A, Option 014:		
45 MHz to 500 MHz		5.5 dBm, typical
500 MHz to 2 GHz		6.5 dBm, typical
2 GHz to 10 GHz		6.5 dBm, typical
10 GHz to 20 GHz		4 dBm, typical
20 GHz to 30 GHz		1- dBm, typical
30 GHz to 40 GHz		-2 dBm, typical
E8363A, Option 014 and UNL:		
45 MHz to 500 MHz		3.5 dBm, typical
500 MHz to 2 GHz		5 dBm, typical
2 GHz to 10 GHz		5 dBm, typical
10 GHz to 20 GHz		3.5- dBm, typical
20 GHz to 30 GHz		0 dBm, typical
30 GHz to 40 GHz		-2.5 dBm, typical
E8364A, Option 014:		
45 MHz to 500 MHz		5.5 dBm, typical
500 MHz to 2 GHz		6.5 dBm, typical
2 GHz to 10 GHz		6.5 dBm, typical
10 GHz to 20 GHz		4 dBm, typical
20 GHz to 30 GHz		1 dBm, typical
30 GHz to 40 GHz		-2 dBm, typical
40 GHz to 45 GHz		-3 dBm, typical
45 GHz to 50 GHz		-7.5 dBm, typical
E8364A, Option 014 and UNL:		
45 MHz to 500 MHz		3.5 dBm, typical
500 MHz to 2 GHz		5 dBm, typical
2 GHz to 10 GHz		5 dBm, typical
10 GHz to 20 GHz		3.5 dBm, typical
20 GHz to 30 GHz		0 dBm, typical
30 GHz to 40 GHz		-2.5 dBm, typical
40 GHz to 45 GHz		-5 dBm, typical
45 GHz to 50 GHz		-10 dBm, typical

Damage Level		
E8362A		20 dBm, typical
E8363A		20 dBm, typical
E8364A		20 dBm, typical
Maximum DC Level		
E8362A		0 V, typical
E8363A		0 V, typical
E8364A		0 V, typical

Table 50: Coupler Inputs (Port 1 Cplr Thru, Port 2 Cplr Thru)

Description	Specification	Supplemental Information
Insertion Loss to Test Port		
E8362A, Option 014:		
45 MHz to 500 MHz		0.5 dB, typical
500 MHz to 2 GHz		1.5 dB, typical
2 GHz to 10 GHz		1.5 dB, typical
10 GHz to 20 GHz		1.5 dB, typical
E8362A, Option 014 and UNL:		
45 MHz to 500 MHz		1 dB, typical
500 MHz to 2 GHz		2 dB, typical
2 GHz to 10 GHz		2 dB, typical
10 GHz to 20 GHz		2 dB, typical
E8363A, Option 014:		
45 MHz to 500 MHz		0.5 dB, typical
500 MHz to 2 GHz		0.5 dB, typical
2 GHz to 10 GHz		1.5 dB, typical
10 GHz to 20 GHz		2 dB, typical
20 GHz to 30 GHz		3 dB, typical
30 GHz to 40 GHz		3.5 dB, typical
E8363A, Option 014 and UNL:		
45 MHz to 500 MHz		0.5 dB, typical
500 MHz to 2 GHz		1 dB, typical
2 GHz to 10 GHz		2 dB, typical
10 GHz to 20 GHz		3 dB, typical
20 GHz to 30 GHz		4 dB, typical
30 GHz to 40 GHz		5 dB, typical
E8364A, Option 014:		
45 MHz to 500 MHz		0.5 dB, typical
500 MHz to 2 GHz		0.5 dB, typical
2 GHz to 10 GHz		1.5 dB, typical
10 GHz to 20 GHz		2 dB, typical
20 GHz to 30 GHz		3 dB, typical
30 GHz to 40 GHz		3.5 dB, typical
40 GHz to 45 GHz		3.5 dB, typical
45 GHz to 50 GHz		4 dB, typical

E8364A, Option 014 and UNL:		
45 MHz to 500 MHz		0.5 dB, typical
500 MHz to 2 GHz		1 dB, typical
2 GHz to 10 GHz		2 dB, typical
10 GHz to 20 GHz		3 dB, typical
20 GHz to 30 GHz		4 dB, typical
30 GHz to 40 GHz		5 dB, typical
40 GHz to 45 GHz		5.5 dB, typical
45 GHz to 50 GHz		6 dB, typical
Damage Level		
E8362A		+ 30 dBm, typical
E8363A		+ 30 dBm, typical
E8364A		+ 30 dBm, typical
Maximum DC Level		
E8362A		+/- 40 V, typical
E8363A		+/- 40 V, typical
E8364A		+/- 40 V, typical

Table 51: Coupler Outputs (Port 1 Cplr Arm, Port 2 Cplr Arm)

Description	Specification	Supplemental Information
Damage Level		
E8362A		+ 30 dBm, typical
E8363A		+ 30 dBm, typical
E8364A		+ 30 dBm, typical
Maximum DC Level		
E8362A		+/- 7 V, typical
E8363A		+/- 7 V, typical
E8364A		+/- 7 V, typical

Test Set Block Diagrams

E836xA Standard Configuration and Standard Power Range

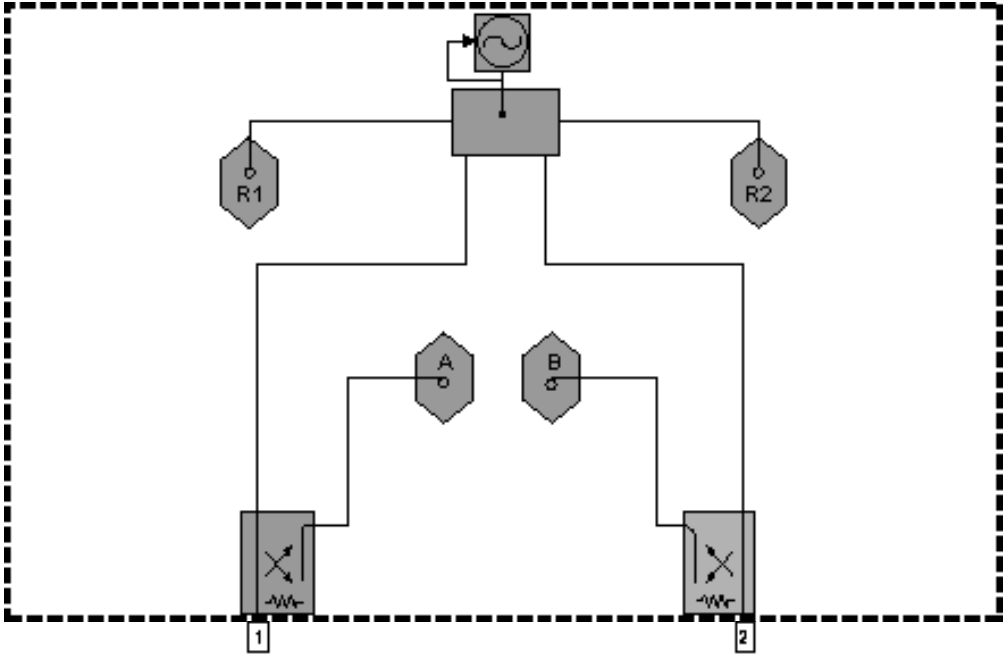

E836xA - Option UNL Standard Configuration with Extended Power Range and Bias - Tees

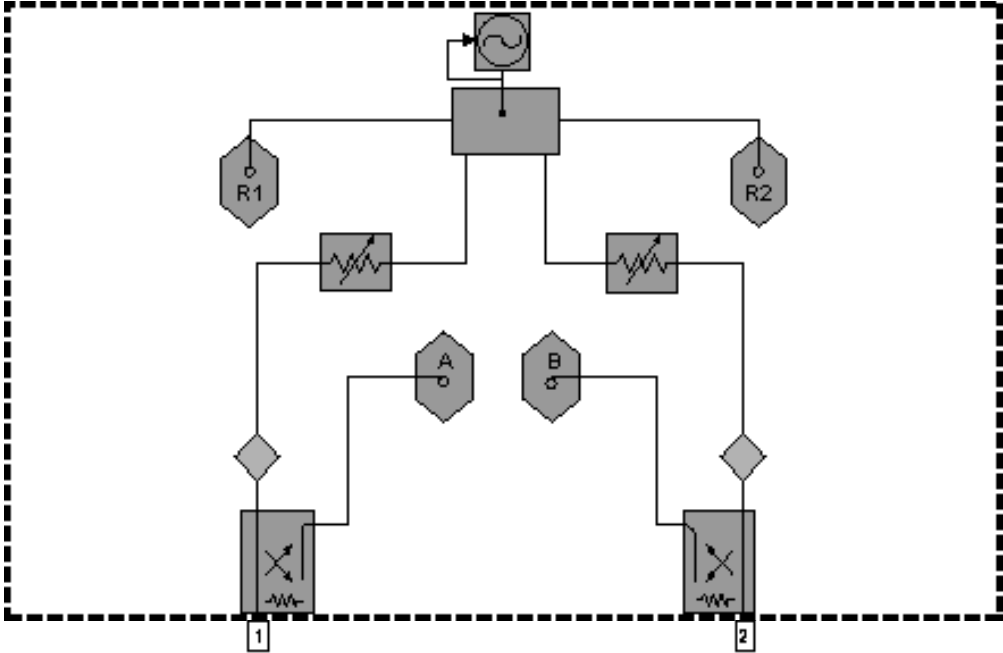

Test Set with Option 014 Block Diagrams

E836xA - Option 014 Extended Configuration and Standard Power Range

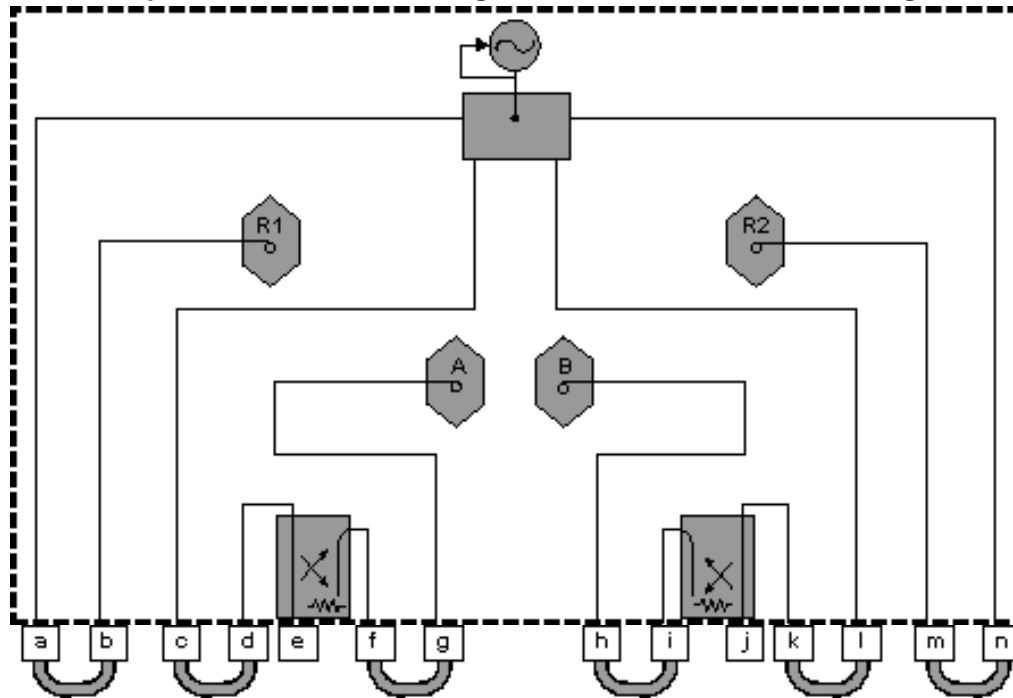

Item	Description	Item	Description
a	SOURCE OUT	h	RCVR B IN
b	RCVR R1 IN	i	CPLR ARM
c	SOURCE OUT	j	PORT 2
d	CPLR THRU	k	CPLR THRU
e	PORT 1	l	SOURCE OUT
f	CPLR ARM	m	RCVR R2 IN
g	RCVR A IN	n	SOURCE OUT

E836xA - Option UNL&014 Extended Configuration with Extended Power Range and Bias - Tees

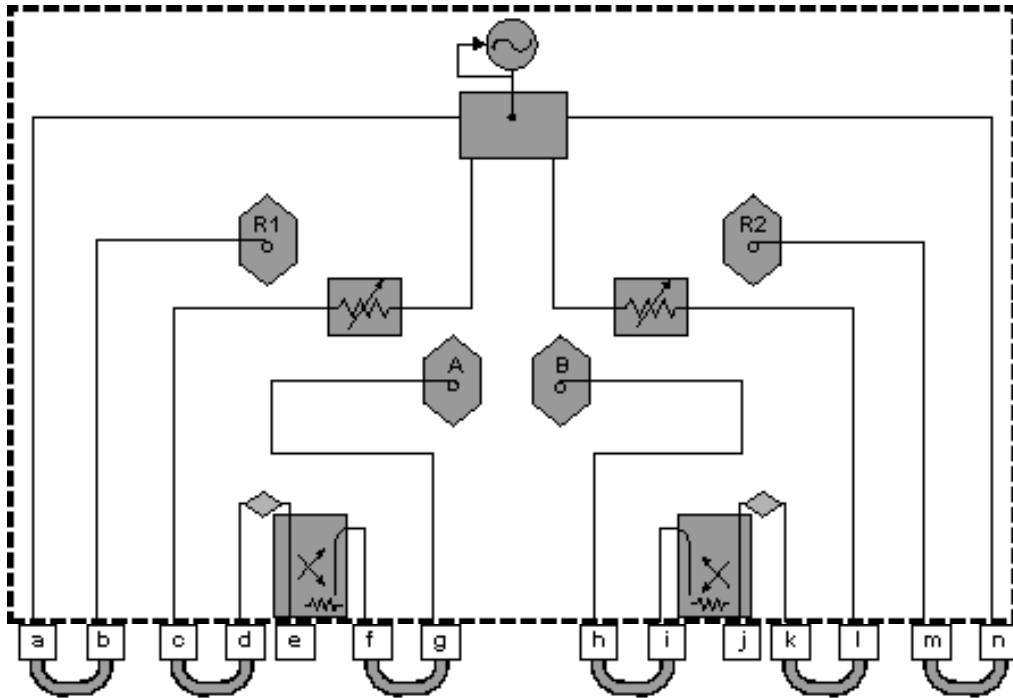

Item	Description	Item	Description
a	SOURCE OUT	h	RCVR B IN
b	RCVR R1 IN	i	CPLR ARM
c	SOURCE OUT	j	PORT 2
d	CPLR THRU	k	CPLR THRU
e	PORT 1	l	SOURCE OUT
f	CPLR ARM	m	RCVR R2 IN
g	RCVR A IN	n	SOURCE OUT



Agilent Email Updates

www.agilent.com/find/emailupdates

Get the latest information on the products and applications you select.



Agilent Direct

www.agilent.com/find/agilentdirect

Quickly choose and use your test equipment solutions with confidence.



www.agilent.com/find/open

Agilent Open simplifies the process of connecting and programming test systems to help engineers design, validate and manufacture electronic products. Agilent offers open connectivity for a broad range of system-ready instruments, open industry software, PC-standard I/O and global support, which are combined to more easily integrate test system development.

www.agilent.com

Agilent Technologies' Test and Measurement Support, Services, and Assistance

Agilent Technologies aims to maximize the value you receive, while minimizing your risk and problems. We strive to ensure that you get the test and measurement capabilities you paid for and obtain the support you need. Our extensive support resources and services can help you choose the right Agilent products for your applications and apply them successfully. Every instrument and system we sell has a global warranty. Two concepts underlie Agilent's overall support policy: "Our Promise" and "Your Advantage."

Our Promise

Our Promise means your Agilent test and measurement equipment will meet its advertised performance and functionality. When you are choosing new equipment, we will help you with product information, including realistic performance specifications and practical recommendations from experienced test engineers. When you receive your new Agilent equipment, we can help verify that it works properly and help with initial product operation.

Your Advantage

Your Advantage means that Agilent offers a wide range of additional expert test and measurement services, which you can purchase according to your unique technical and business needs. Solve problems efficiently and gain a competitive edge by contracting with us for calibration, extra-cost upgrades, out-of-warranty repairs, and onsite education and training, as well as design, system integration, project management, and other professional engineering services. Experienced Agilent engineers and technicians worldwide can help you maximize your productivity, optimize the return on investment of your Agilent instruments and systems, and obtain dependable measurement accuracy for the life of those products.

For more information on Agilent Technologies' products, applications or services, please contact your local Agilent office.

Phone or Fax

United States:

(tel) 800 829 4444
(fax) 800 829 4433

Canada:

(tel) 877 894 4414
(fax) 800 746 4866

China:

(tel) 800 810 0189
(fax) 800 820 2816

Europe:

(tel) 31 20 547 2111

Japan:

(tel) (81) 426 56 7832
(fax) (81) 426 56 7840

Korea:

(tel) (080) 769 0800
(fax) (080) 769 0900

Latin America:

(tel) (305) 269 7500

Taiwan:

(tel) 0800 047 866
(fax) 0800 286 331

Other Asia Pacific Countries:

(tel) (65) 6375 8100
(fax) (65) 6755 0042

Email: tm_ap@agilent.com

Contacts revised: 09/26/05

**The complete list is available at:
www.agilent.com/find/contactus**

Product specifications and descriptions in this document subject to change without notice.

© Agilent Technologies, Inc. 2004, 2006
Printed in USA, July 13, 2006
5989-1072EUS



Agilent Technologies