

Technical Specifications

Agilent Technologies PNA Series Network Analyzers E8361A/C



Manufacturing Part Number: E8361-90007

Printed in USA

Print Date: January 8, 2010

Supersedes: October 3, 2008

© Agilent Technologies, Inc. 2004-2008, 2010 All rights reserved.

Documentation Warranty

THE MATERIAL CONTAINED IN THIS DOCUMENT IS PROVIDED "AS IS," AND IS SUBJECT TO BEING CHANGED, WITHOUT NOTICE, IN FUTURE EDITIONS. FURTHER, TO THE MAXIMUM EXTENT PERMITTED BY APPLICABLE LAW, AGILENT DISCLAIMS ALL WARRANTIES, EITHER EXPRESS OR IMPLIED WITH REGARD TO THIS MANUAL AND ANY INFORMATION CONTAINED HEREIN, INCLUDING BUT NOT LIMITED TO THE IMPLIED WARRANTIES OF MERCHANTABILITY AND FITNESS FOR A PARTICULAR PURPOSE. AGILENT SHALL NOT BE LIABLE FOR ERRORS OR FOR INCIDENTAL OR CONSEQUENTIAL DAMAGES IN CONNECTION WITH THE FURNISHING, USE, OR PERFORMANCE OF THIS DOCUMENT OR ANY INFORMATION CONTAINED HEREIN. SHOULD AGILENT AND THE USER HAVE A SEPARATE WRITTEN AGREEMENT WITH WARRANTY TERMS COVERING THE MATERIAL IN THIS DOCUMENT THAT CONFLICT WITH THESE TERMS, THE WARRANTY TERMS IN THE SEPARATE AGREEMENT WILL CONTROL.

DFARS/Restricted Rights Notice

If software is for use in the performance of a U.S. Government prime contract or subcontract, Software is delivered and licensed as "Commercial computer software" as defined in DFAR 252.227-7014 (June 1995), or as a "commercial item" as defined in FAR 2.101(a) or as "Restricted computer software" as defined in FAR 52.227-19 (June 1987) or any equivalent agency regulation or contract clause. Use, duplication or disclosure of Software is subject to Agilent Technologies' standard commercial license terms, and non-DOD Departments and Agencies of the U.S. Government will receive no greater than Restricted Rights as defined in FAR 52.227-19(c)(1-2) (June 1987). U.S. Government users will receive no greater than Limited Rights as defined in FAR 52.227-14 (June 1987) or DFAR 252.227-7015 (b)(2) (November 1995), as applicable in any technical data.

Printing Copies of Documentation from the Web

To print copies of documentation from the Web, download the PDF file from the Agilent web site:

- Go to www.agilent.com.
 - Enter the document's part number (located on the title page) in the **Search** box.
 - Click **SEARCH**.
 - Click on the hyperlink for the document.
 - Click the printer icon located in the tool bar.
-

Contacting Agilent

Assistance with test and measurement needs and information on finding a local Agilent office are available on the Web at:

www.agilent.com/find/assist

If you do not have access to the Internet, please contact your Agilent field engineer.

NOTE In any correspondence or telephone conversation, refer to the Agilent product by its model number and full serial number. With this information, the Agilent representative can determine whether your product is still within its warranty period.

This page intentionally left blank.

Technical Specifications for the E8361A/C (Rev. 2010-01-08)

Definitions	3
Corrected System Performance	4
Table 1. System Dynamic Range.....	4
E8361A/C Corrected System Performance with 1.85mm Connectors	6
Table 2. 85058B Calibration Kit E8361A/C - Standard Configuration and Standard Power Range.....	6
Table 3. 85058B Calibration Kit E8361A/C - Fully Optioned (Option 014, UNL, 016, 080, and 081).....	11
Table 4. N4694A Electronic Calibration Module E8361A/C - Standard Configuration and Standard Power Range.....	16
Table 5. N4694A Electronic Calibration Module E8361A/C - Fully Optioned (Option 014, UNL, 016, 080, and 081)	21
E8361A/C Corrected System Performance with 2.4mm Connectors	26
Table 6. 85056A Calibration Kit E8361A/C - Standard Configuration and Standard Power Range.....	26
Table 7. 85056A Calibration Kit E8361A/C - Fully Optioned (Option 014, UNL, 016, 080, and 081)	29
Table 8. N4693A Electronic Calibration Module E8361A/C - Standard Configuration and Standard Power Range	32
Table 9. N4693A Electronic Calibration Module E8361A/C - Fully Optioned (Option 014, UNL, 016, 080, and 081)	35
Table 10. Uncorrected System Performance.....	38
Table 11. Test Port Output.....	42
Table 12: Test Port Input	46
Table 13. Dynamic Accuracy (Specification).....	54
Table 14. Test Port Input (Group Delay)	72
General Information	73
Table 15. Miscellaneous Information.....	73
Table 16. Front Panel Information	73
Table 17. Rear Panel Information.....	73
Table 18. Analyzer Dimensions and Weight	76
Measurement Throughput Summary	77
Table 19 Typical Cycle Time (ms) for Measurement Completion	77
Table 20. Cycle Time vs IF Bandwidth.....	78
Table 21. Cycle Time vs Number of Points	78
Table 22. Data Transfer Time (ms).....	79
Table 23: Measurement Receiver Inputs (Rcvr A In, Rcvr B In)	80
Table 25: Reference Outputs (Reference 1 Source Out, Reference 2 Source Out)	81
Table 26: Source Outputs (Port 1 Source Out, Port 2 Source Out)	82
Table 27: Coupler Inputs (Port 1 Cplr Thru, Port 2 Cplr Thru).....	83

Table 28: Coupler Outputs (Port 1 Cplr Arm, Port 2 Cplr Arm)	83
Test Set Block Diagrams	84
E8361A/C - Standard Configuration and Standard Power Range	84
E8361A/C - Option UNL Standard Configuration with Extended Power Range and Bias - Tees.....	84
E8361A/C - Option UNL Standard Configuration with Extended Power Range and Bias - Tees, and Option 016, Receiver Attenuators.....	85
Test Set with Option 014 Block Diagrams	86
E8361A/C - Option 014 Configurable Test Set and Standard Power Range.....	86
E8361A/C - Option 014 Configurable Test Set and Standard Power Range, and Option 081 Reference Channel Transfer Switch	87
E8361A/C - Option 014 Configurable Test Set, and Option UNL Extended Power Range and Bias - Tees.....	88
E8361A/C - Option 014 Configurable Test Set, and Option UNL Extended Power Range and Bias - Tees, and Option 081 Reference Channel Transfer Switch	89
E8361A/C - Option 014 Configurable Test Set and Option UNL, Extended Power Range and Bias - Tees and Option 016 Receiver Attenuators.....	90
E8361A/C - Option 014 Configurable Test Set, and Option UNL Extended Power Range and Bias - Tees, and Option 016 Receiver Attenuators, and Option 081 Reference Channel Transfer Switch	91

Definitions

All specifications and characteristics apply over a $25\text{ }^{\circ}\text{C} \pm 5\text{ }^{\circ}\text{C}$ range (unless otherwise stated) and 90 minutes after the instrument has been turned on.

Specification (spec.): Warranted performance. Specifications include guardbands to account for the expected statistical performance distribution, measurement uncertainties, and changes in performance due to environmental conditions.

Characteristic (char.): A performance parameter that the product is expected to meet before it leaves the factory, but that is not verified in the field and is not covered by the product warranty. A characteristic includes the same guardbands as a specification.

Typical (typ.): Expected performance of an average unit which does not include guardbands. It is not covered by the product warranty.

Nominal (nom.): A general, descriptive term that does not imply a level of performance. It is not covered by the product warranty.

Calibration: The process of measuring known standards to characterize a network analyzer's systematic (repeatable) errors.

Corrected (residual): Indicates performance after **error correction** (calibration). It is determined by the quality of calibration standards and how well "known" they are, plus system repeatability, stability, and noise.

Uncorrected (raw): Indicates instrument performance without error correction. The uncorrected performance affects the stability of a **calibration**.

Standard: When referring to the analyzer, this includes no options unless noted otherwise.

Corrected System Performance

The specifications in this section apply for measurements made with the E8361A/C analyzer with the following conditions:

- 10 Hz IF bandwidth
- No averaging applied to data

Table 1. System Dynamic Range^a

Description	Specification (dB) at Test Port ^b	Typical (dB) at Direct Receiver Access Input ^c	Supplemental Information
Dynamic Range (in a 10 Hz BW)			
Standard Configuration (E8361A/C - Standard)			
10 MHz to 45 MHz ^d	61 (typical)	NA	
45 MHz to 500 MHz ^e	87	NA	--
500 MHz to 750 MHz	112	NA	--
750 MHz to 2 GHz	111	NA	--
2 GHz to 10 GHz	111	NA	--
10 GHz to 24 GHz	114	NA	--
24 GHz to 30 GHz	103	NA	--
30 GHz to 40 GHz	104	NA	--
40 GHz to 45 GHz	96	NA	--
45 GHz to 50 GHz	100	NA	--
50 GHz to 60 GHz	97	NA	--
60 GHz to 67 GHz	94	NA	--
67 GHz to 70 GHz ^d	94 (typical)	NA	--
Configurable Test Set (E8361A/C - Option 014 or Option 014 and 080)			
10 MHz to 45 MHz ^d	61 (typical)	99 (typical)	--
45 MHz to 500 MHz ^e	87	102	--
500 MHz to 750 MHz	112	125.5	--
750 MHz to 2 GHz	111	125.5	--
2 GHz to 10 GHz	111	125	--
10 GHz to 24 GHz	112	128	--
24 GHz to 30 GHz	101	117.5	Option 016 degrades performance by 2 dB.
30 GHz to 40 GHz	102	115	
40 GHz to 45 GHz	94	109	
45 GHz to 50 GHz	98	110.5	
50 GHz to 60 GHz	95	107	Option 016 degrades performance by 3 dB.
60 GHz to 67 GHz	90	101	
67 GHz to 70 GHz ^d	90 (typical)	100 (typical)	

Table 1. System Dynamic Range^a (Continued)

Description	Specification (dB) at Test Port ^b	Typical (dB) at Direct Receiver Access Input ^c	Supplemental Information
Configurable Test Set & Extended Power Range (E8361A/C - Option 014 & UNL or Option 014 & UNL & 080)			
10 MHz to 45 MHz ^d	61 (typical)	99 (typical)	--
45 MHz to 500 MHz ^e	87	102	--
500 MHz to 750 MHz	112	125.5	--
750 MHz to 2 GHz	111	124	--
2 GHz to 10 GHz	111	124	--
10 GHz to 24 GHz	112	125	--
24 GHz to 30 GHz	101	114.5	Option 016 degrades performance by 2 dB.
30 GHz to 40 GHz	99	112	
40 GHz to 45 GHz	92	105	
45 GHz to 50 GHz	94	106.5	
50 GHz to 60 GHz	91	103	
60 GHz to 67 GHz	84	95	Option 016 degrades performance by 3 dB.
67 GHz to 70 GHz ^d	84 (typical)	94 (typical)	

^a The system dynamic range is calculated as the difference between the noise floor and the source maximum output power. System Dynamic Range is a specification when the source is set to Port 1, and a characteristic when the source is set to Port 2. The effective dynamic range must take measurement uncertainties and interfering signals into account as well as the insertion loss resulting from a thru cable connected between Port 1 and Port 2..

^b The test port system dynamic range is calculated as the difference between the test port noise floor and the source maximum output power. The effective dynamic range must take measurement uncertainties and interfering signals into account as well as the insertion loss resulting from a thru cable connected between Port 1 and Port 2..

^c The direct receiver access input system dynamic range is calculated as the difference between the receiver access input noise floor and the source maximum output power. The effective dynamic range must take measurement uncertainties and interfering signals into account. This set-up should only be used when the receiver input will never exceed its damage level. When the analyzer is in segment sweep mode, the analyzer can have predefined frequency segments which will output a higher power level when the extended dynamic range is required (i.e. devices with high insertion loss), and reduced power when receiver damage may occur (i.e. devices with low insertion loss). The extended range is only available in one-path transmission measurements.

^d Typical performance.

^e May be limited to 100 dB at particular frequencies below 500 MHz due to spurious receiver residuals. Methods are available to regain the full dynamic range.

Note: This E8361A/C document does NOT provide technical specifications for Receiver Dynamic Range.

Note: This E8361A/C document provides technical specifications for the following calibration kits and Ecal modules only: 85056A, 85058B, N4693A, N4694A. Please download our free Uncertainty Calculator from http://www.agilent.com/find/na_calculator to generate the curves for your PNA setup.

E8361A/C Corrected System Performance with 1.85mm Connectors

Table 2. 85058B Calibration Kit

E8361A/C - Standard Configuration and Standard Power Range

Applies to the E8361A/C analyzers, 85058B (1.85mm) calibration kit, N4697F flexible test port cable set, and a full 2-port calibration. Also applies to the following condition:

Environmental temperature $23^{\circ} \pm 3^{\circ} \text{C}$, with $< 1^{\circ} \text{C}$ deviation from calibration temperature

Description	Specification (dB)			
	10 to 45 MHz ¹	45 MHz to 2 GHz	2 to 10 GHz	10 to 20 GHz
Directivity	35	35	41	38
Source Match	34	34	44	40
Load Match	35	35	41	37
Reflection Tracking	± 0.019 $+0.02/^{\circ}\text{C}$	± 0.019 $+0.02/^{\circ}\text{C}$	± 0.010 $+0.02/^{\circ}\text{C}$	± 0.033 $+0.03/^{\circ}\text{C}$
Transmission Tracking	± 0.164 $+0.02/^{\circ}\text{C}$	± 0.081 $+0.02/^{\circ}\text{C}$	± 0.036 $+0.02/^{\circ}\text{C}$	± 0.063 $+0.03/^{\circ}\text{C}$

¹ Typical performance.

Description	Specification (dB)			
	20 to 35 GHz	35 to 50 GHz	50 to 60 GHz	60 to 67 GHz
Directivity	37	37	34	34
Source Match	34	34	44	40
Load Match	34	35	41	37
Reflection Tracking	± 0.019 $+0.02/^{\circ}\text{C}$	± 0.019 $+0.02/^{\circ}\text{C}$	± 0.010 $+0.02/^{\circ}\text{C}$	± 0.033 $+0.03/^{\circ}\text{C}$
Transmission Tracking	± 0.164 $+0.02/^{\circ}\text{C}$	± 0.081 $+0.02/^{\circ}\text{C}$	± 0.036 $+0.02/^{\circ}\text{C}$	± 0.063 $+0.03/^{\circ}\text{C}$

NOTE: The following graphs also apply to the “C” model of the analyzer.

Transmission Uncertainty (Specifications)

Magnitude

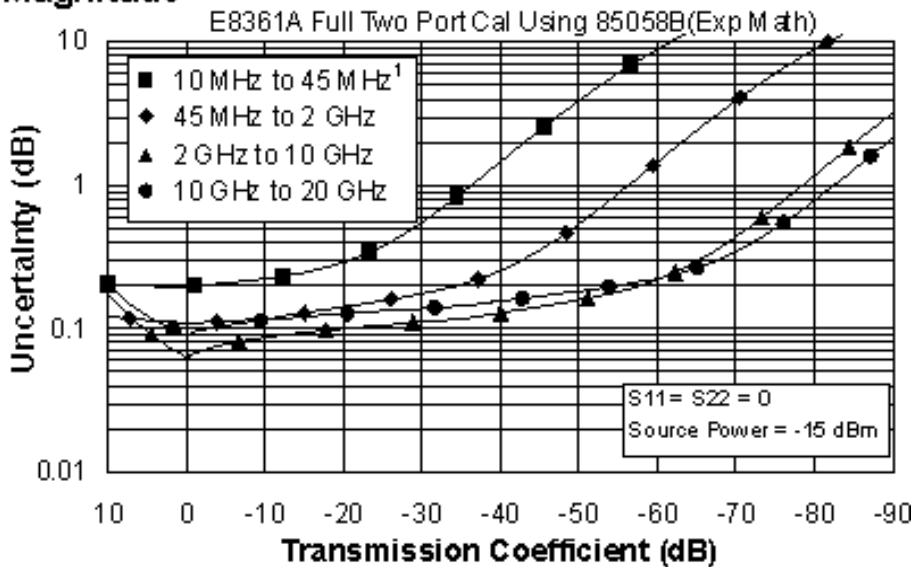

Magnitude

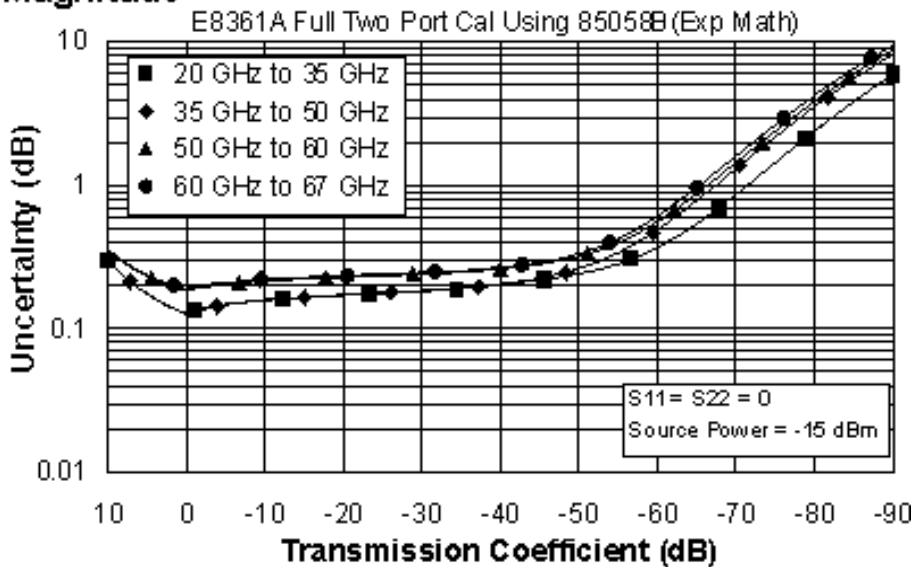

¹ Typical performance.

Phase

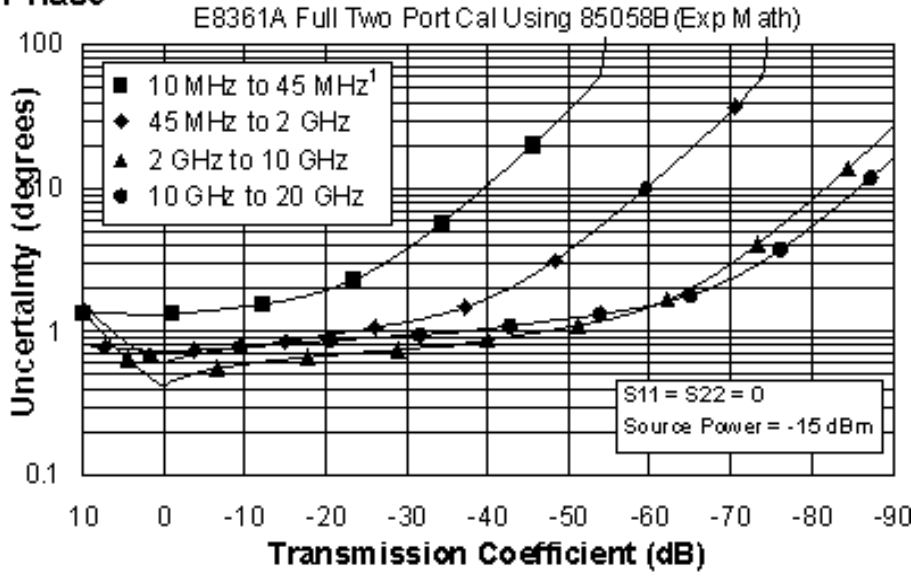

Phase

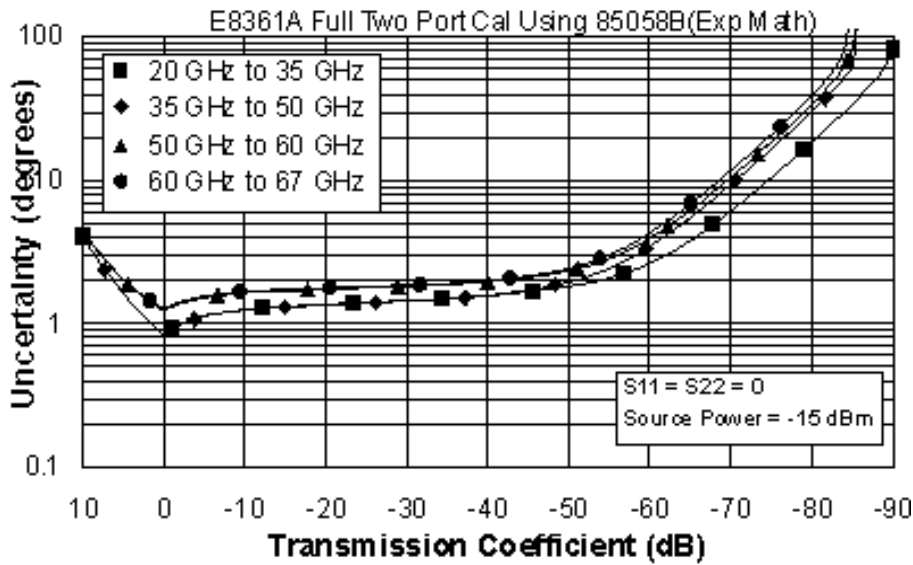

¹ Typical performance.

Reflection Uncertainty (Specifications)

Magnitude

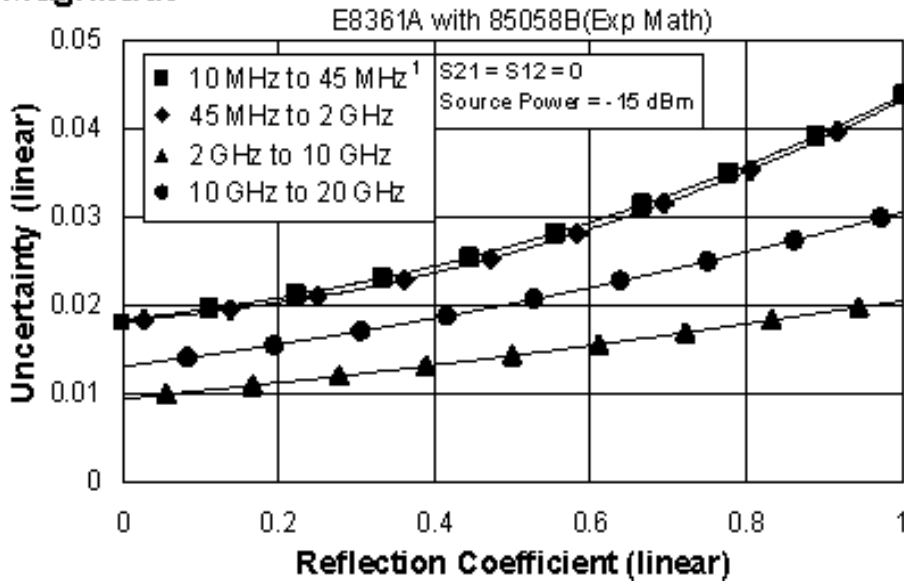

Magnitude

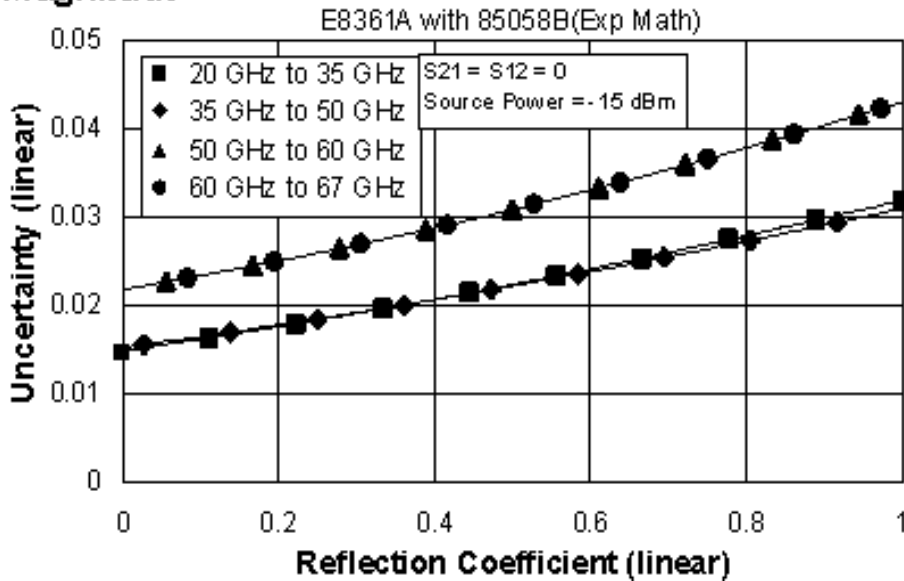

¹ Typical performance.

Phase

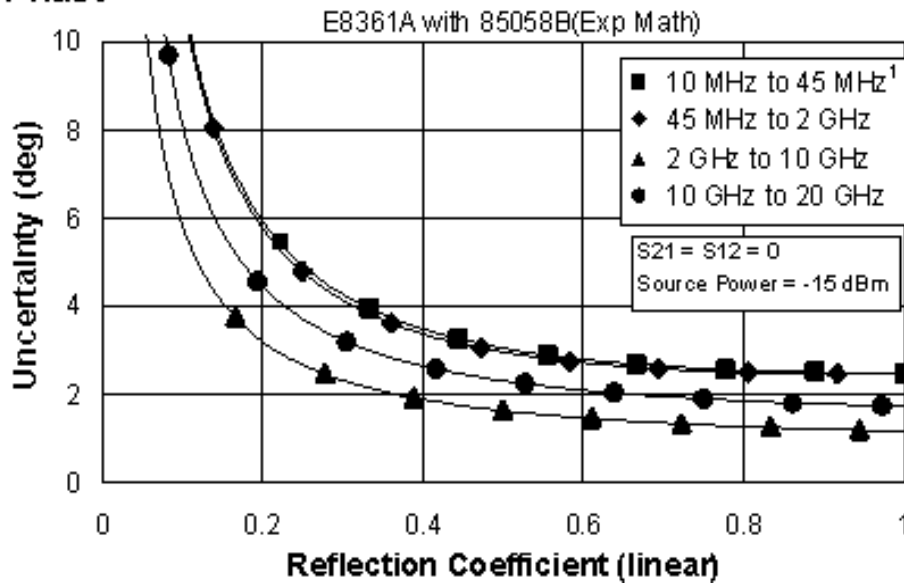

Phase

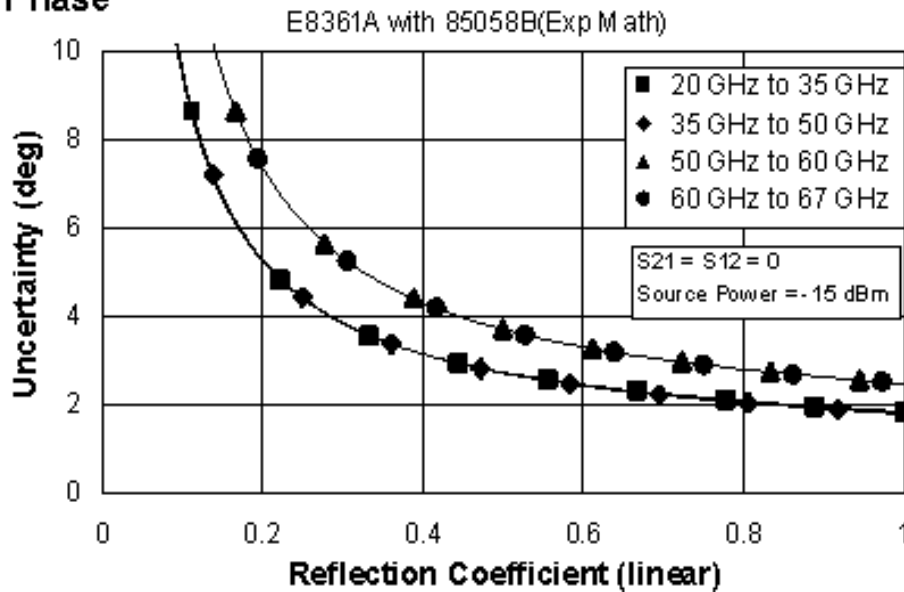

¹ Typical performance.

Table 3. 85058B Calibration Kit

E8361A/C - Fully Optioned (Option 014, UNL, 016, 080, and 081)

Configurable Test Set, Extended Power Range & Bias-Tees, Receiver Attenuators, Frequency Offset Mode, and Reference Channel Transfer Switch

Applies to the, E8361A/C analyzers, 85058B (1.85mm) calibration kit, N4697F flexible test port cable set, and a full 2-port calibration. Also applies to the following condition:

Environmental temperature 23° ±3 °C, with < 1 °C deviation from calibration temperature

Description	Specification (dB)			
	10 to 45 MHz ¹	45 MHz to 2 GHz	2 to 10 GHz	10 to 20 GHz
Directivity	35	35	41	38
Source Match	34	34	44	40
Load Match	34	35	41	37
Reflection Tracking	±0.019 +0.02/°C	±0.019 +0.02/°C	±0.010 +0.02/°C	±0.033 +0.03/°C
Transmission Tracking	±0.177 +0.02/°C	±0.093 +0.02/°C	±0.053 +0.02/°C	±0.096 +0.03/°C

¹ Typical performance.

Description	Specification (dB)			
	20 to 35 GHz	35 to 50 GHz	50 to 60 GHz	60 to 67 GHz
Directivity	37	37	34	34
Source Match	34	34	44	40
Load Match	34	35	41	37
Reflection Tracking	±0.019 +0.02/°C	±0.019 +0.02/°C	±0.010 +0.02/°C	±0.033 +0.03/°C
Transmission Tracking	±0.177 +0.02/°C	±0.093 +0.02/°C	±0.053 +0.02/°C	±0.096 +0.03/°C

NOTE: The following graphs also apply to the "C" model of the analyzer.

Transmission Uncertainty (Specifications)

Magnitude

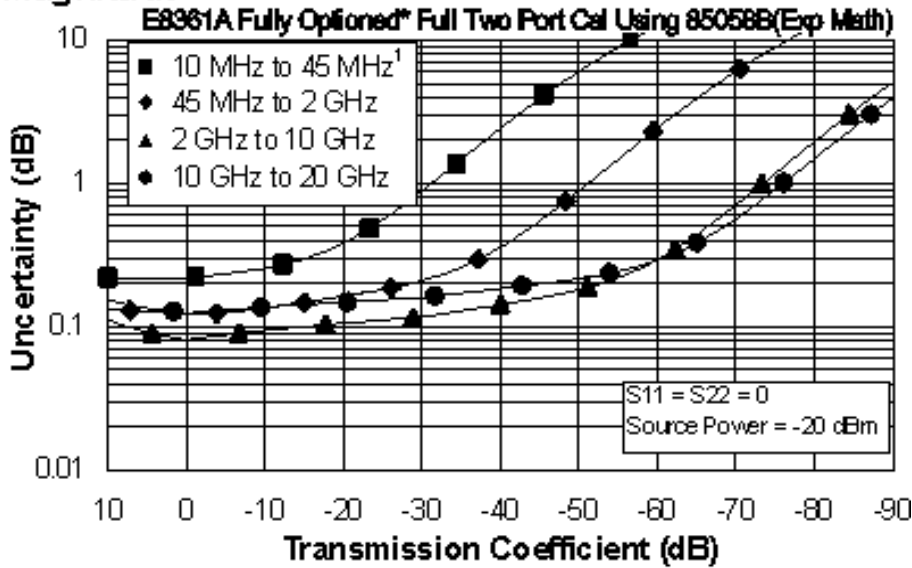

Magnitude

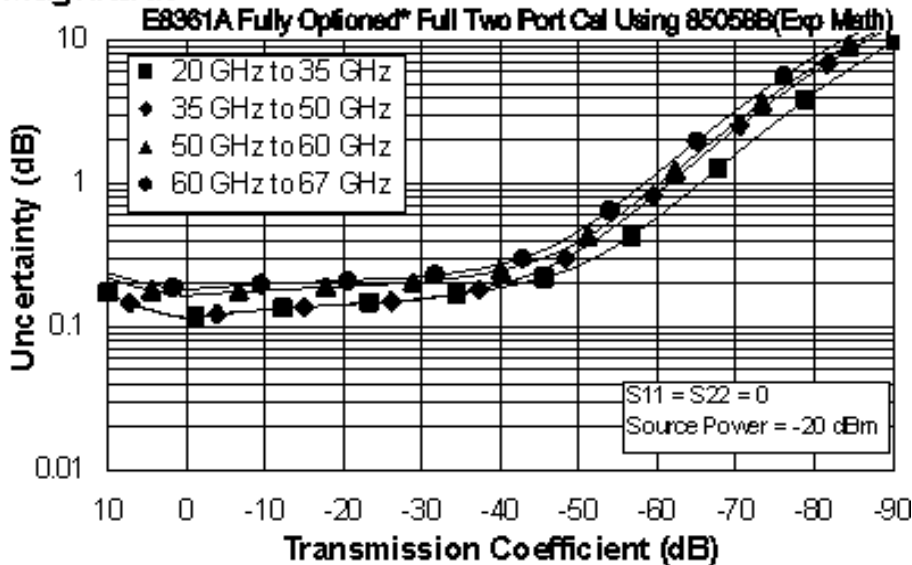

* Configurable Test Set, Extended Power Range & Bias-Tees, Receiver Attenuators, Frequency Offset Mode, and Reference Channel Transfer Switch (Option 014, UNL, 016, 080, and 081)

¹ Typical performance.

Phase

E8361A Fully Optioned* Full Two Port Cal Using 85058B(Exp Math)

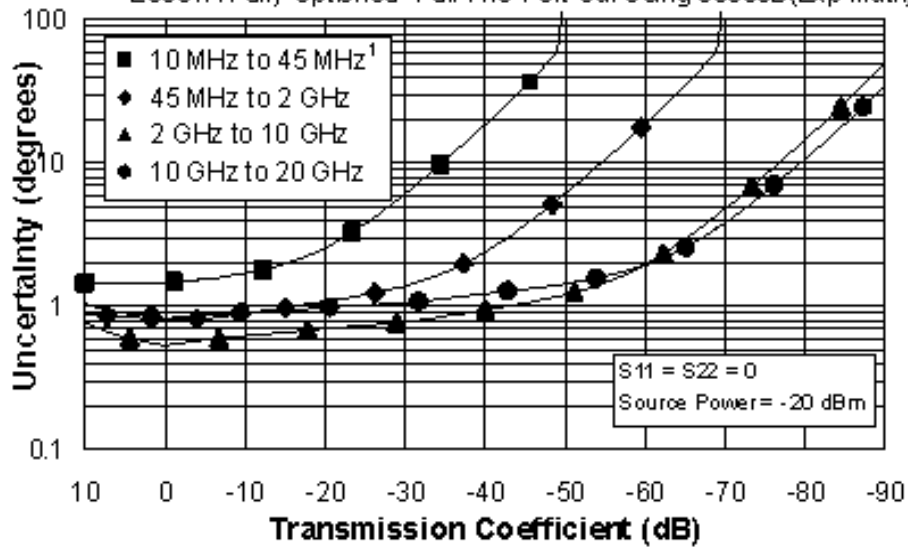

Phase

E8361A Fully Optioned* Full Two Port Cal Using 85058B(Exp Math)

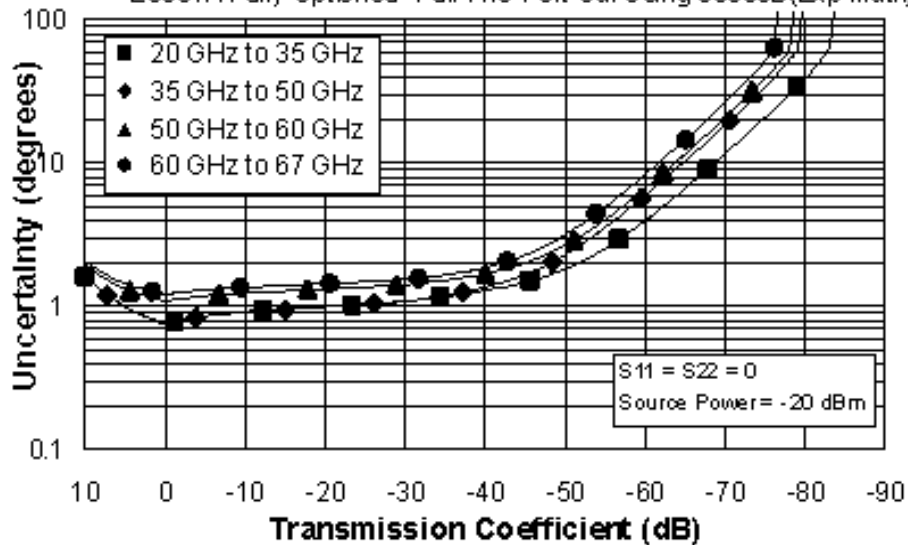

* Configurable Test Set, Extended Power Range & Bias-Tees, Receiver Attenuators, Frequency Offset Mode, and Reference Channel Transfer Switch (Option 014, UNL, 016, 080, and 081)

¹ Typical performance.

Reflection Uncertainty (Specifications)

Magnitude

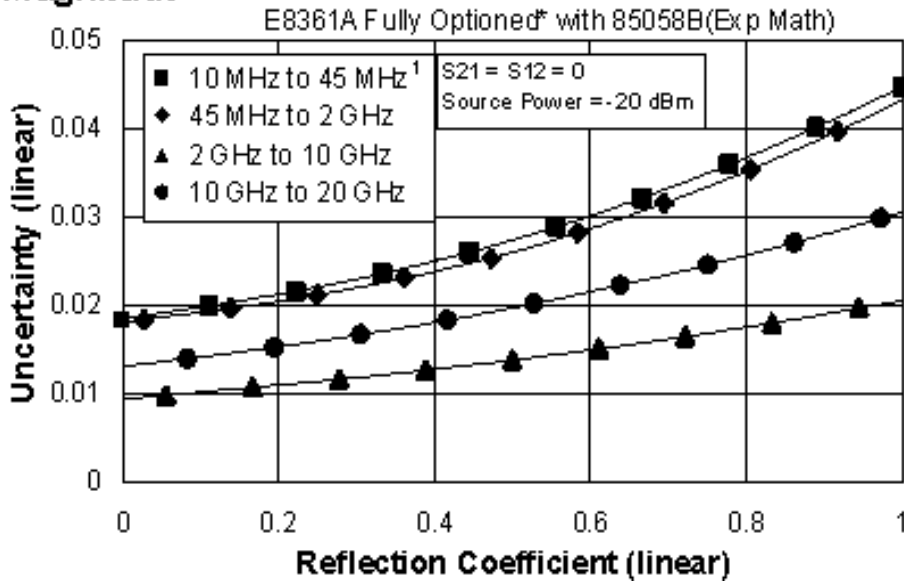

Magnitude

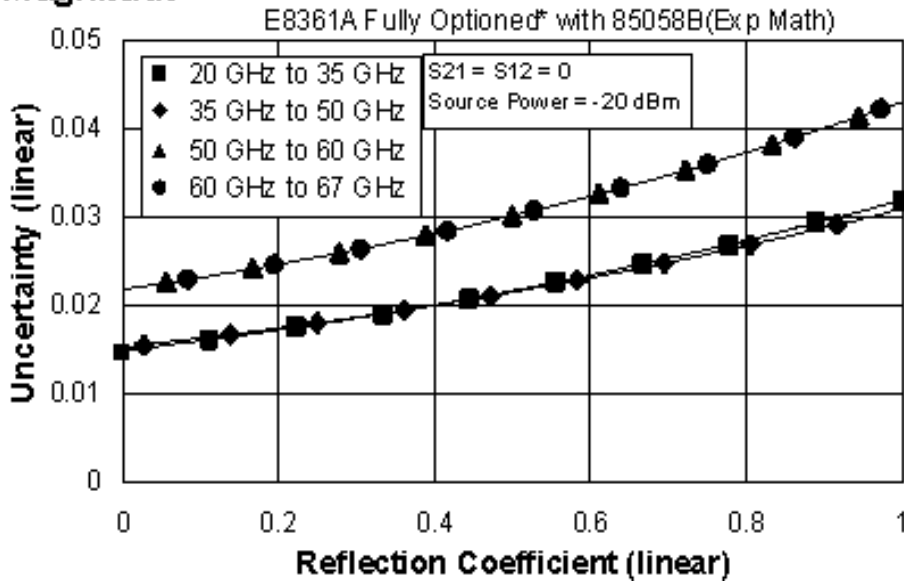

* Configurable Test Set, Extended Power Range & Bias-Tees, Receiver Attenuators, Frequency Offset Mode, and Reference Channel Transfer Switch (Option 014, UNL, 016, 080, and 081)

¹ Typical performance.

Phase

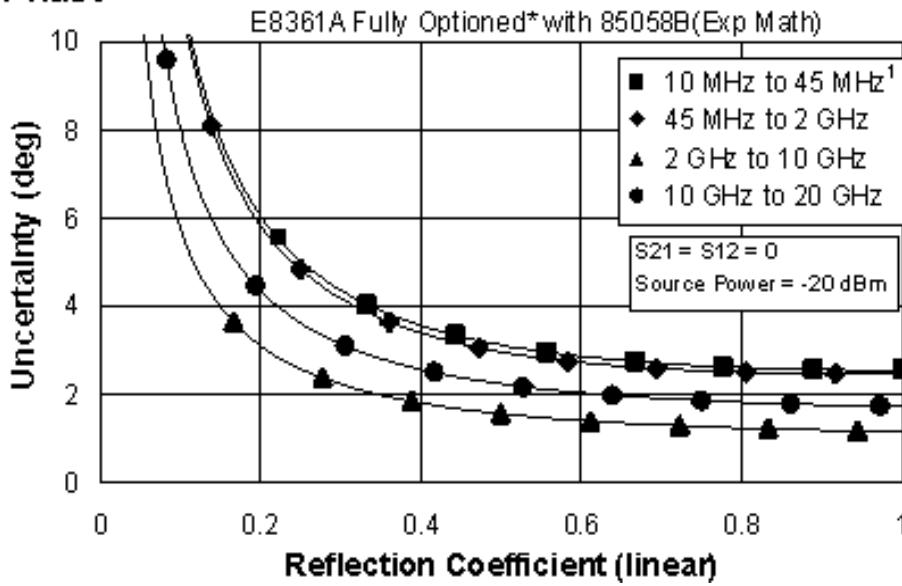

Phase

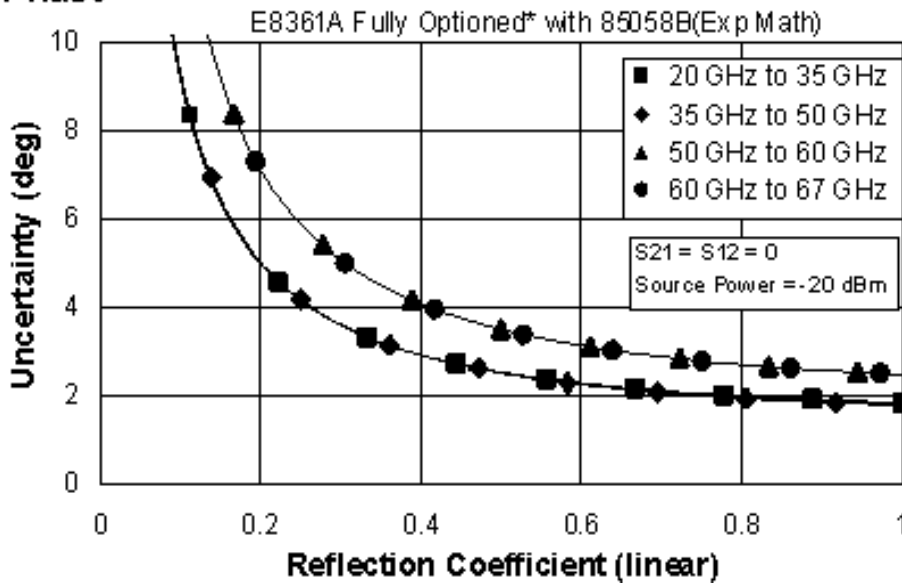

* Configurable Test Set, Extended Power Range & Bias-Tees, Receiver Attenuators, Frequency Offset Mode, and Reference Channel Transfer Switch (Option 014, UNL, 016, 080, and 081)

¹ Typical performance.

**Table 4. N4694A Electronic Calibration Module
E8361A/C - Standard Configuration and Standard Power Range**

Applies to the, E8361A/C analyzers, N4694A (1.85mm) ECal module, N4697F flexible test port cable set, and a full 2-port calibration. Also applies to the following condition:

Environmental temperature 23° ±3 °C, with < 1 °C deviation from calibration temperature

Description	Typical (dB)	Specification (dB)		
	10 to 200 MHz ¹	200 MHz to 2 GHz	2 to 20 GHz	20 to 30 GHz
Directivity	33	50	50	46
Source Match	25	38	39	35
Load Match	30	39	40	38
Reflection Tracking	±0.050 +0.02/°C	±0.040 +0.02/°C	±0.040 +0.02/°C	±0.050 +0.03/°C
Transmission Tracking	±0.255 +0.02/°C	±0.118 +0.02/°C	±0.135 +0.02/°C	±0.139 +0.03/°C

Description	Specification (dB)			
	30 to 40 GHz	40 to 50 GHz	50 to 60 GHz	60 to 67 GHz
Directivity	44	42	41	38
Source Match	25	38	39	35
Load Match	30	39	40	38
Reflection Tracking	±0.040 +0.02/°C	±0.040 +0.02/°C	±0.040 +0.02/°C	±0.050 +0.03/°C
Transmission Tracking	±0.105 +0.02/°C	±0.118 +0.02/°C	±0.135 +0.02/°C	±0.139 +0.03/°C

NOTE: The following graphs also apply to the “C” model of the analyzer.

Transmission Uncertainty (Specifications)

Magnitude

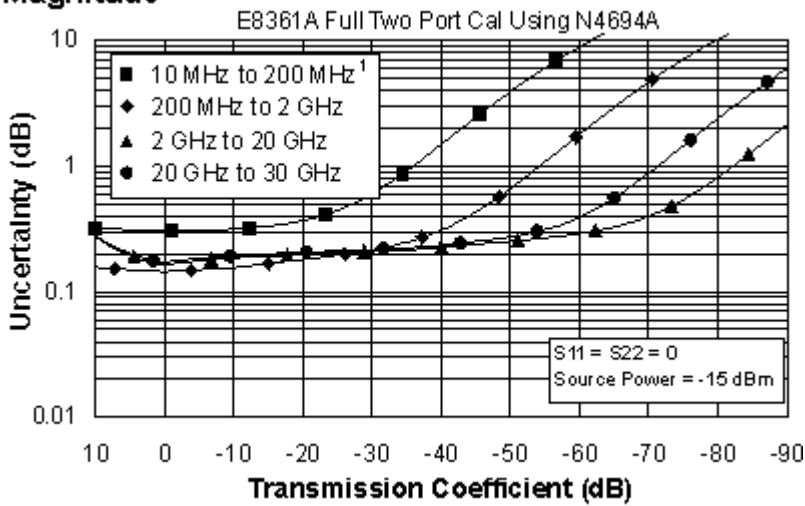

Magnitude

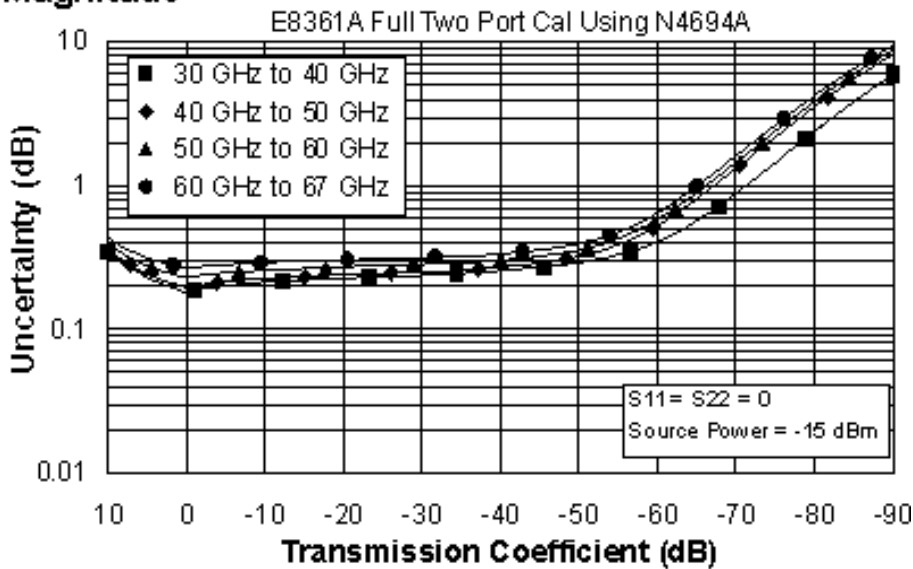

¹ Typical performance.

Phase

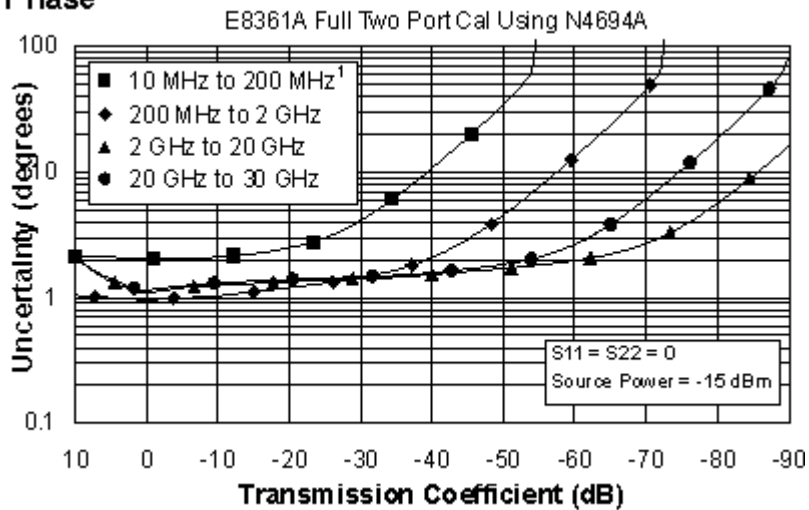

Phase

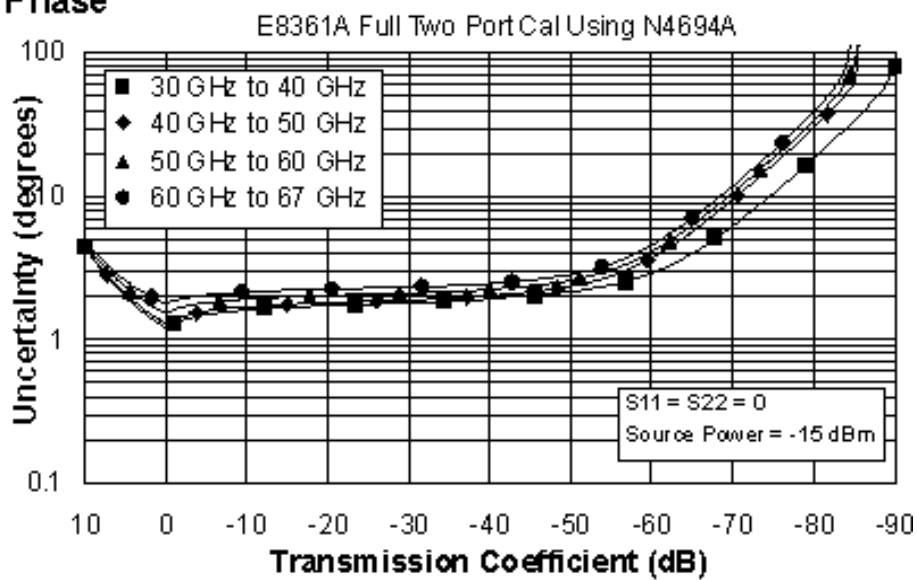

¹ Typical performance.

Reflection Uncertainty (Specifications)

Magnitude

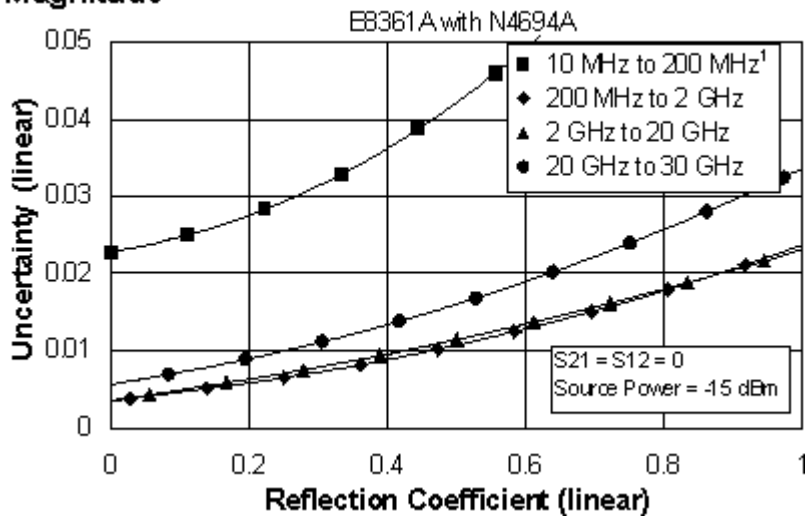

Magnitude

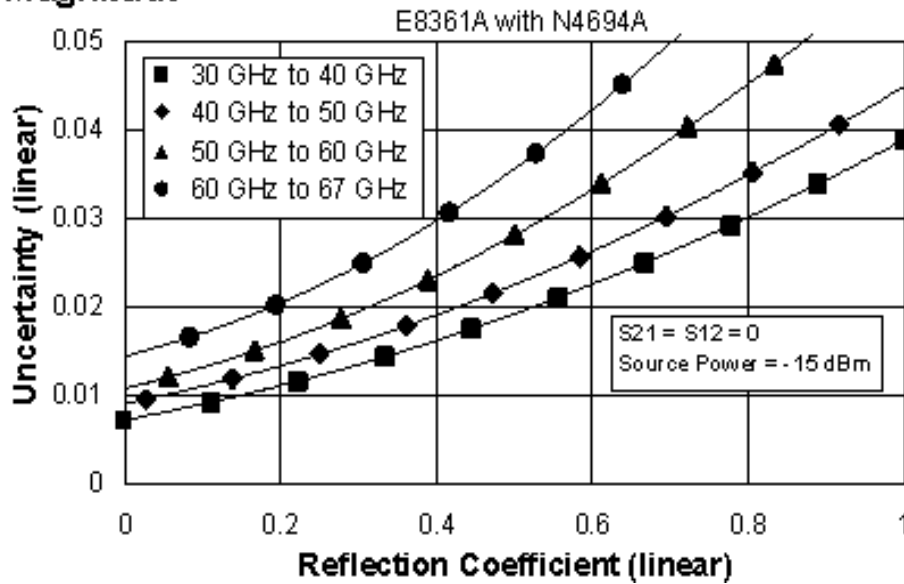

¹ Typical performance.

Phase

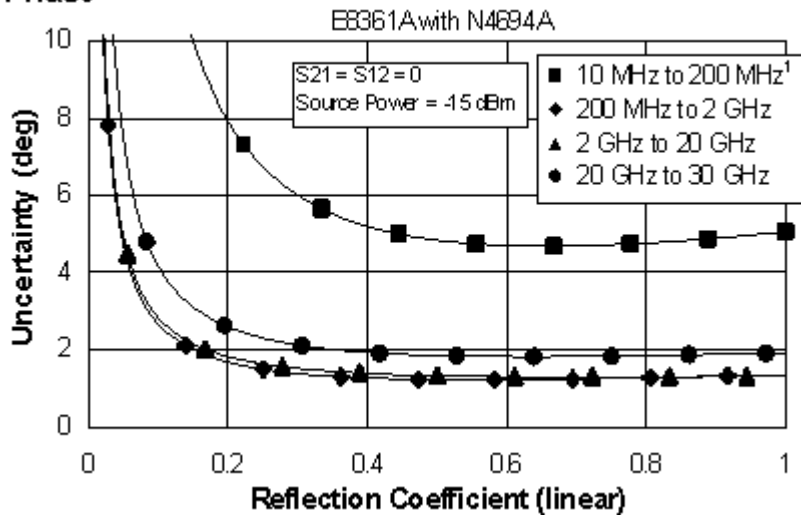

Phase

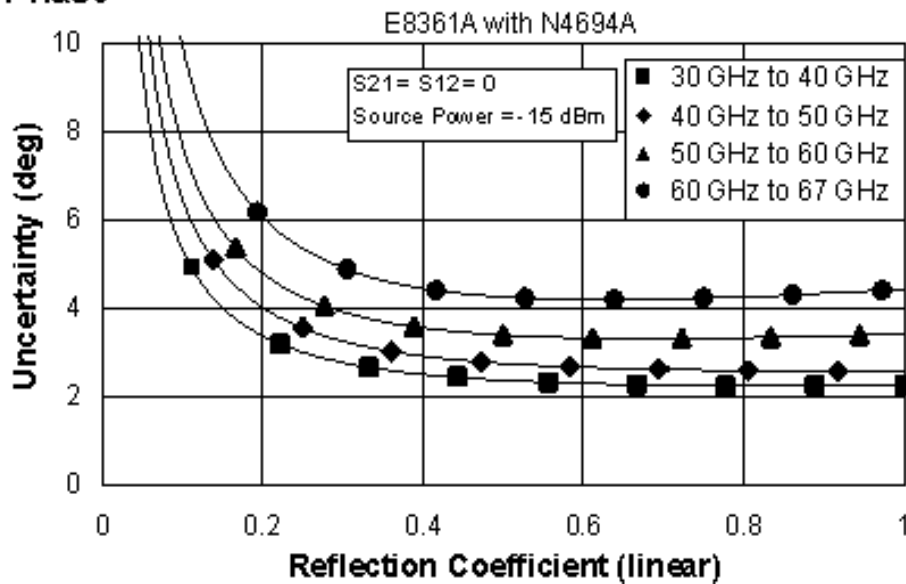

¹ Typical performance.

Table 5. N4694A Electronic Calibration Module
E8361A/C - Fully Optioned (Option 014, UNL, 016, 080, and 081)

Configurable Test Set, Extended Power Range & Bias-Tees, Receiver Attenuators, Frequency Offset Mode, and Reference Channel Transfer Switch

Applies to the, E8361A/C analyzers, N4694A (1.85mm) ECal module, N4697F flexible test port cable set, and a full 2-port calibration. Also applies to the following condition:

Environmental temperature 23° ±3 °C, with < 1 °C deviation from calibration temperature

Description	Typical (dB)			
	10 to 200 MHz ¹	200 MHz to 2 GHz	2 to 20 GHz	20 to 30 GHz
Directivity	33	50	50	46
Source Match	25	38	39	35
Load Match	30	39	39	38
Reflection Tracking	±0.050 +0.02/°C	±0.040 +0.02/°C	±0.040 +0.02/°C	±0.050 +0.03/°C
Transmission Tracking	±0.260 +0.02/°C	±0.121 +0.02/°C	±0.139 +0.02/°C	±0.138 +0.03/°C

¹ Typical performance.

Description	Specification (dB)			
	30 to 40 GHz	40 to 50 GHz	50 to 60 GHz	60 to 67 GHz
Directivity	44	42	41	38
Source Match	25	38	39	35
Load Match	30	39	39	38
Reflection Tracking	±0.050 +0.02/°C	±0.040 +0.02/°C	±0.040 +0.02/°C	±0.050 +0.03/°C
Transmission Tracking	±0.260 +0.02/°C	±0.121 +0.02/°C	±0.139 +0.02/°C	±0.138 +0.03/°C

NOTE: The following graphs also apply to the “C” model of the analyzer.

Transmission Uncertainty (Specifications)

Magnitude

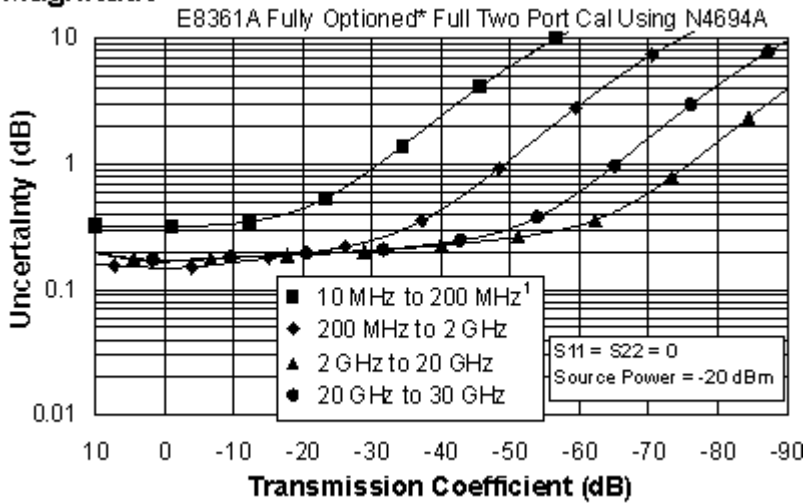

Magnitude

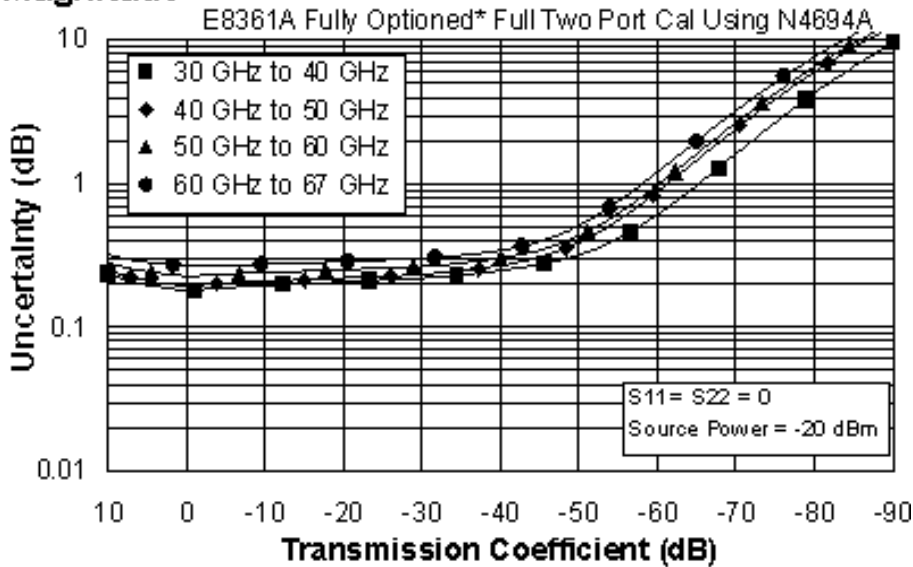

* Configurable Test Set, Extended Power Range & Bias-Tees, Receiver Attenuators, Frequency Offset Mode, and Reference Channel Transfer Switch (Option 014, UNL, 016, 080, and 081)

¹ Typical performance.

Phase

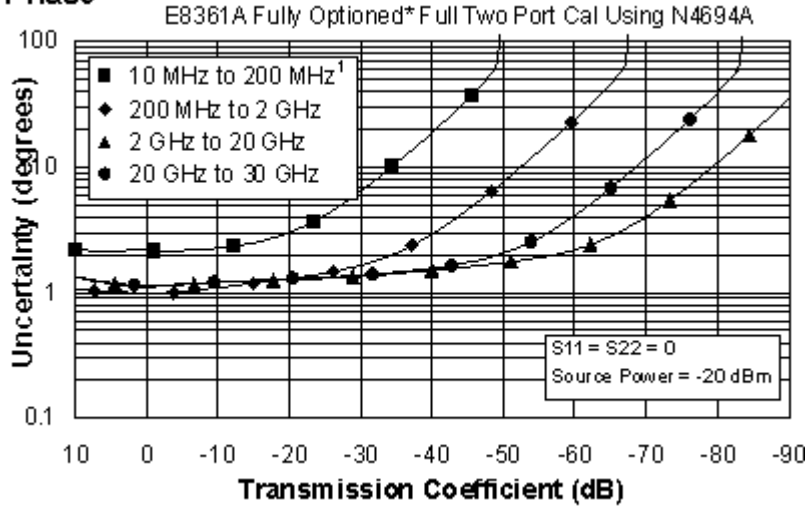

Phase

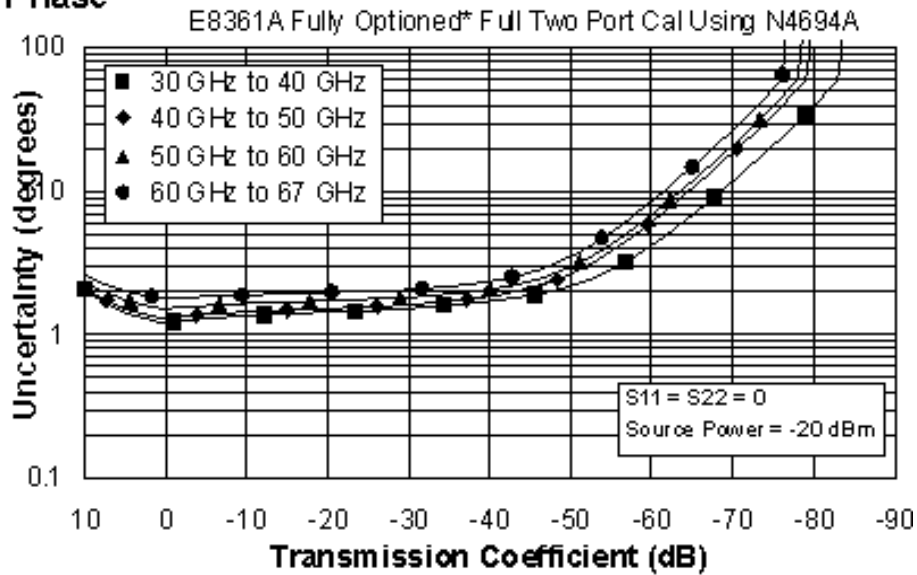

* Configurable Test Set, Extended Power Range & Bias-Tees, Receiver Attenuators, Frequency Offset Mode, and Reference Channel Transfer Switch (Option 014, UNL, 016, 080, and 081)

¹ Typical performance.

Reflection Uncertainty (Specifications)

Magnitude

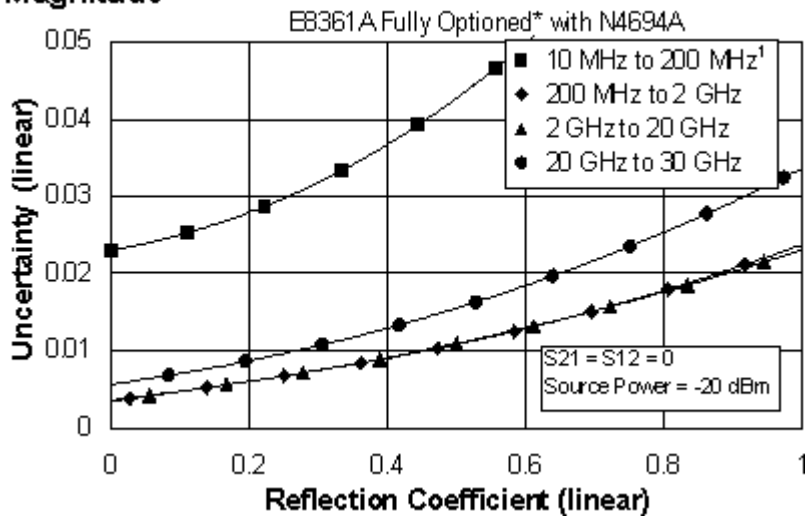

Magnitude

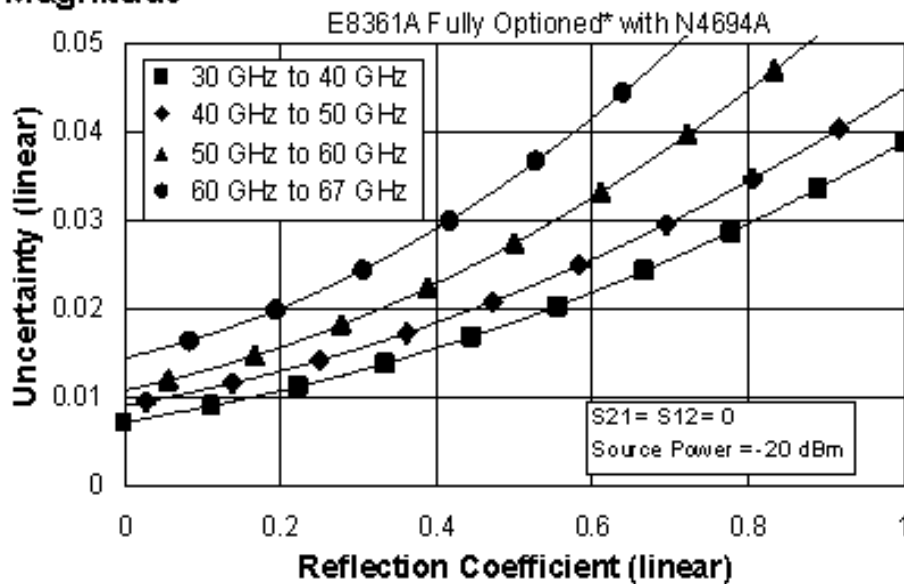

* Configurable Test Set, Extended Power Range & Bias-Tees, Receiver Attenuators, Frequency Offset Mode, and Reference Channel Transfer Switch (Option 014, UNL, 016, 080, and 081)

¹ Typical performance.

Phase

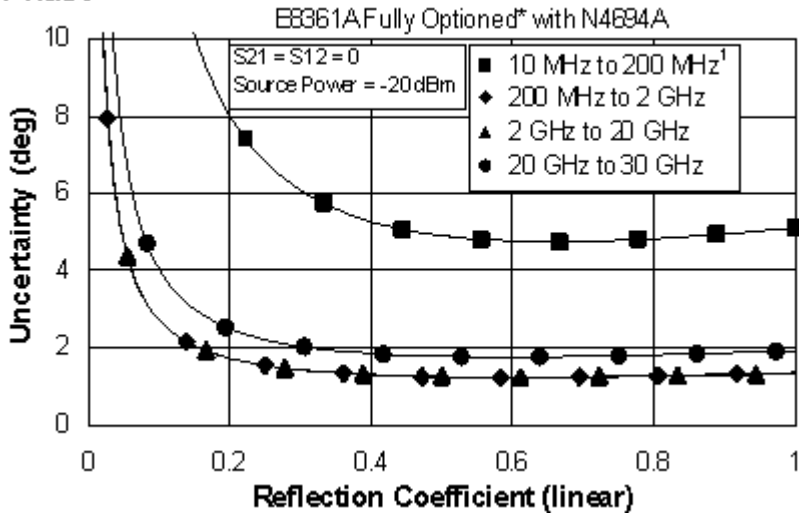

Phase

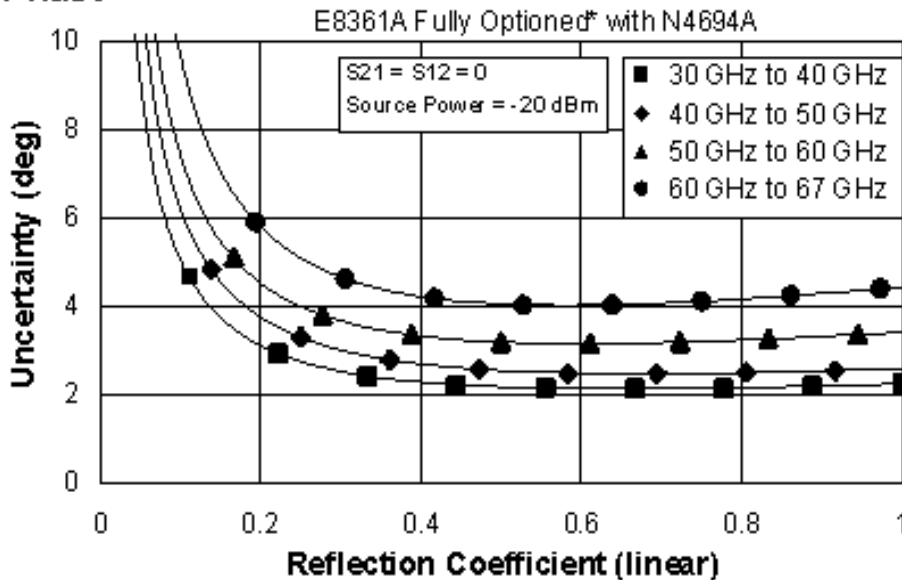

* Configurable Test Set, Extended Power Range & Bias-Tees, Receiver Attenuators, Frequency Offset Mode, and Reference Channel Transfer Switch (Option 014, UNL, 016, 080, and 081)

¹ Typical performance.

This document does not present specifications for the 85058E Calibration Kit. Please download our free Uncertainty Calculator from http://www.agilent.com/find/na_calculator to generate the data and curves for the 85058E Calibration Kit or your PNA setup. View the [equations](#) used to generate the uncertainty curve.

E8361A/C Corrected System Performance with 2.4mm Connectors

Table 6. 85056A Calibration Kit

E8361A/C - Standard Configuration and Standard Power Range

Applies to the E8361A/C analyzers, 85056A (2.4mm) Calibration Kit, 85133F flexible test port cable set, and a full 2-port calibration. (2.4 mm connectors are mateable with 1.85 mm connectors.) Also applies to the following condition:

Environmental temperature $23^{\circ} \pm 3^{\circ} \text{C}$, with $< 1^{\circ} \text{C}$ deviation from calibration temperature

Description	Specification (dB)			
	45 MHz to 2 GHz	2 to 20 GHz	20 to 40 GHz	40 to 50 GHz
Directivity	42	42	38	36
Source Match	41	38	33	31
Load Match	42	42	37	35
Reflection Tracking	± 0.001 $+0.02/^{\circ}\text{C}$	± 0.008 $+0.02/^{\circ}\text{C}$	± 0.020 $+0.02/^{\circ}\text{C}$	± 0.027 $+0.03/^{\circ}\text{C}$
Transmission Tracking	± 0.035 $+0.02/^{\circ}\text{C}$	± 0.060 $+0.02/^{\circ}\text{C}$	± 0.146 $+0.02/^{\circ}\text{C}$	± 0.181 $+0.03/^{\circ}\text{C}$

NOTE: The following graphs also apply to the "C" model of the analyzer.

Transmission Uncertainty (Specifications)

Magnitude

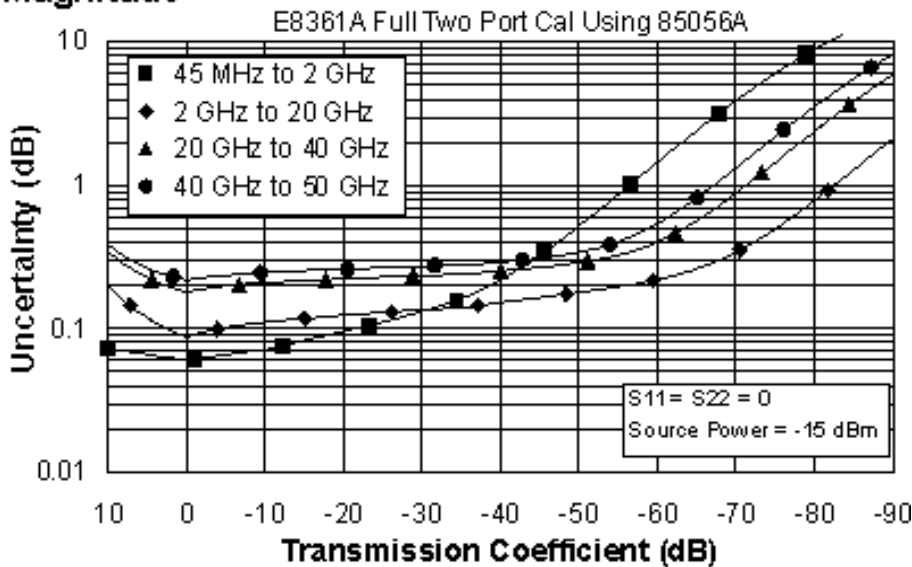

Phase

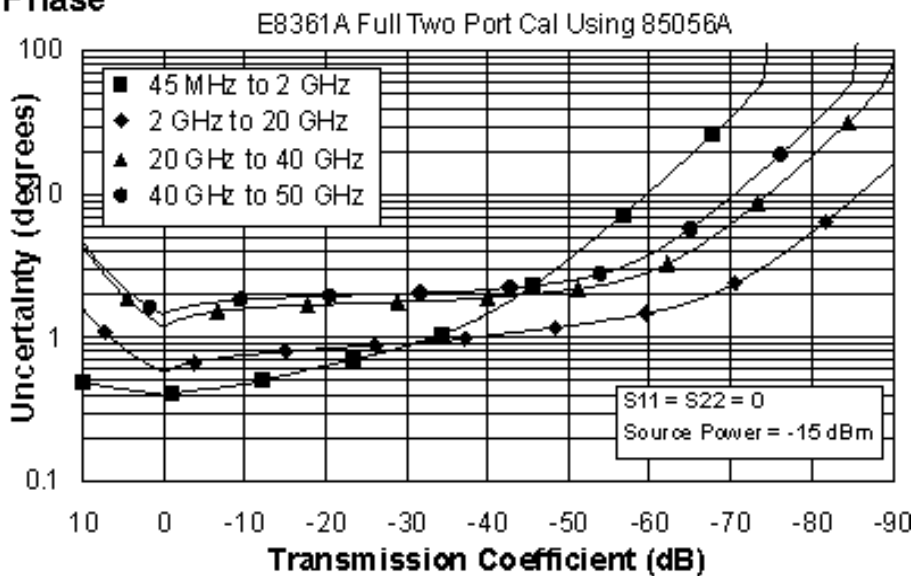

Reflection Uncertainty (Specifications)

Magnitude

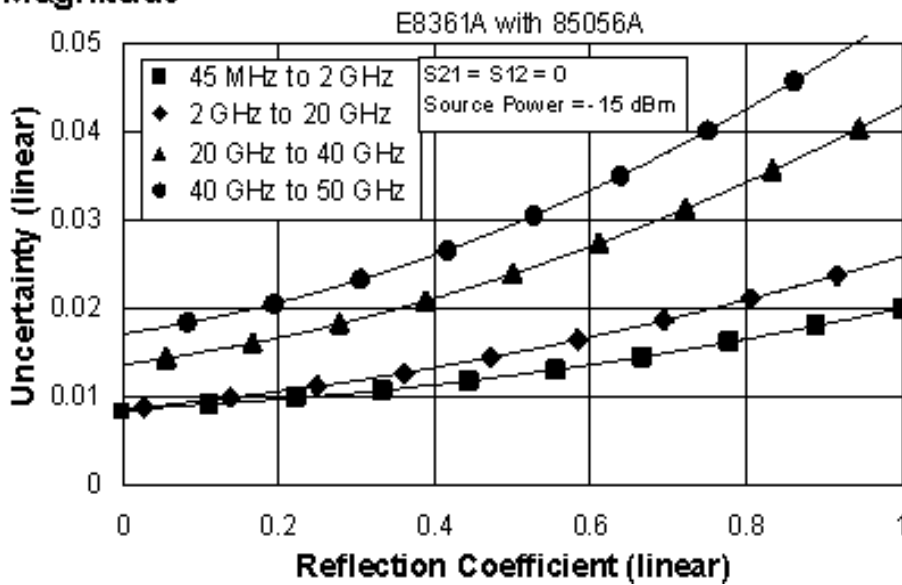

Phase

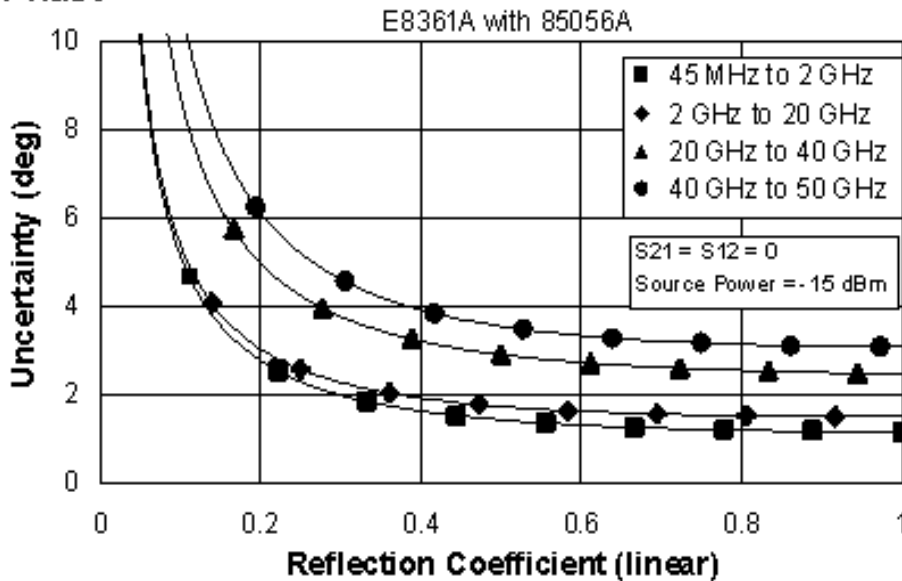

Table 7. 85056A Calibration Kit

E8361A/C - Fully Optioned (Option 014, UNL, 016, 080, and 081)

Configurable Test Set, Extended Power Range & Bias-Tees, Receiver Attenuators, Frequency Offset Mode, and Reference Channel Transfer Switch

Applies to the, E8361A/C analyzers, 85056A (2.4mm) Calibration Kit, 85133F flexible test port cable set, and a full 2-port calibration. (2.4 mm connectors are mateable with 1.85 mm connectors.) Also applies to the following condition:

Environmental temperature 23° ±3 °C, with < 1 °C deviation from calibration temperature

Description	Specification (dB)			
	45 MHz to 2 GHz	2 to 20 GHz	20 to 40 GHz	40 to 50 GHz
Directivity	42	42	38	36
Source Match	41	38	33	31
Load Match	42	41	37	35
Reflection Tracking	±0.001 +0.02/°C	±0.008 +0.02/°C	±0.020 +0.02/°C	±0.027 +0.03/°C
Transmission Tracking	±0.040 +0.02/°C	±0.086 +0.02/°C	±0.123 +0.02/°C	±0.155 +0.03/°C

NOTE: The following graphs also apply to the "C" model of the analyzer.

Transmission Uncertainty (Specifications)

Magnitude

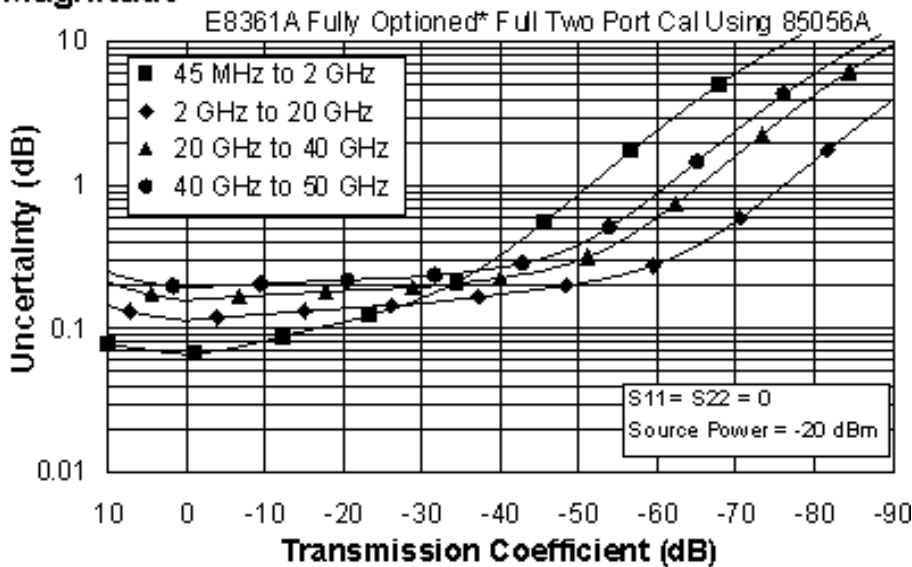

Phase

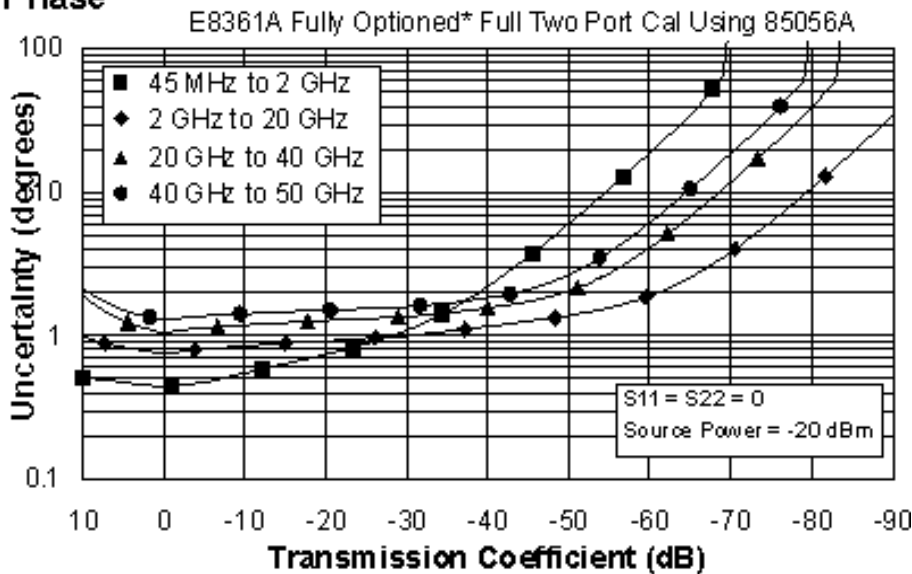

* Configurable Test Set, Extended Power Range & Bias-Tees, Receiver Attenuators, Frequency Offset Mode, and Reference Channel Transfer Switch (E8361A/C - Option 014, UNL, 016, 080, and 081)

Reflection Uncertainty (Specifications)

Magnitude

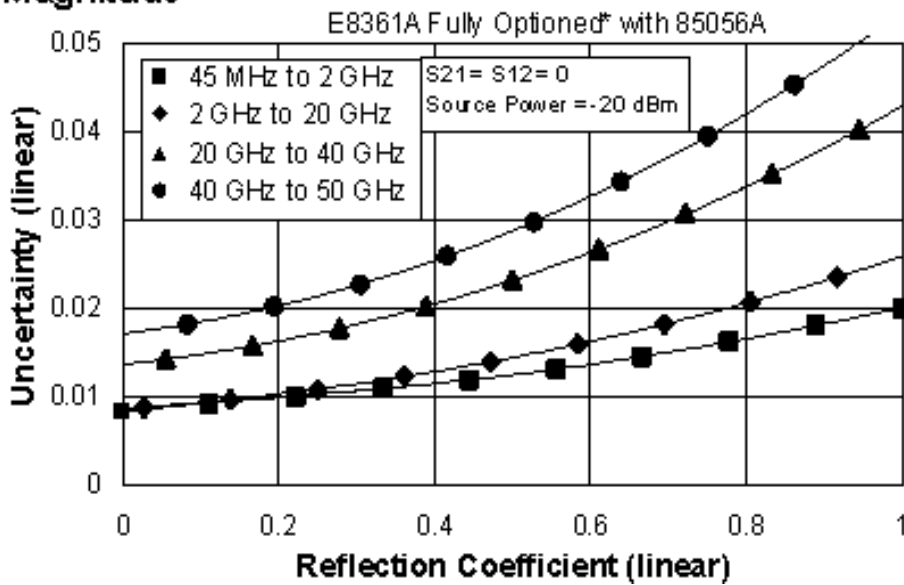

Phase

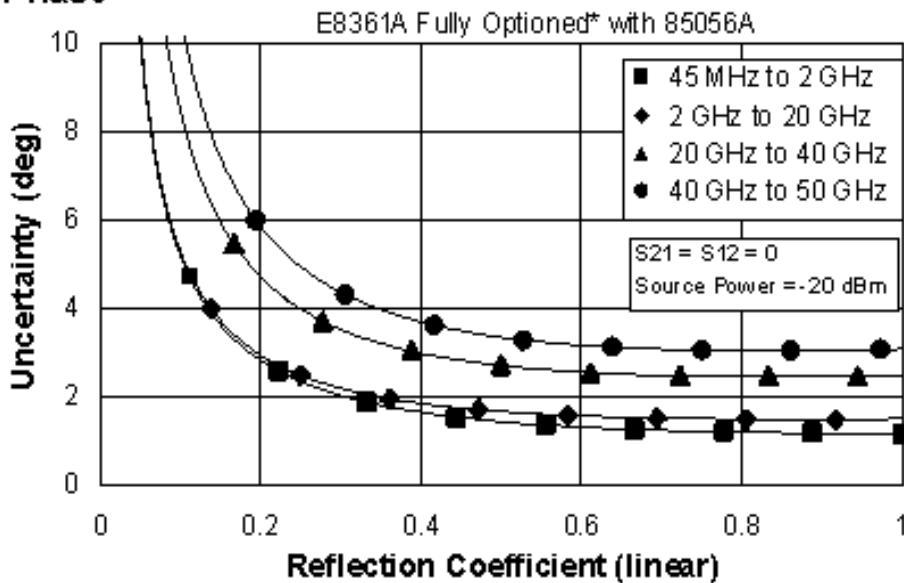

* Configurable Test Set, Extended Power Range & Bias-Tees, Receiver Attenuators, Frequency Offset Mode, and Reference Channel Transfer Switch (E8361A/C - Option 014, UNL, 016, 080, and 081)

**Table 8. N4693A Electronic Calibration Module
E8361A/C - Standard Configuration and Standard Power Range**

Applies to the, E8361A/C analyzers, N4693A (2.4mm) Electronic Calibration Module, 85133F flexible test port cable set, and a full 2-port calibration. (2.4 mm connectors are mateable with 1.85 mm connectors.) Also applies to the following condition:

Environmental temperature $23^{\circ} \pm 3^{\circ} \text{C}$, with $< 1^{\circ} \text{C}$ deviation from calibration temperature

Description	Typical (dB)	Specification (dB)			
	10 to 200 MHz	200 MHz to 2 GHz	2 to 20 GHz	20 to 40 GHz	40 to 50 GHz
Directivity	32	55	49	43	41
Source Match	25	46	42	35	30
Load Match	24	43	41	37	36
Reflection Tracking	± 0.05 $+0.02/^{\circ}\text{C}$	± 0.030 $+0.02/^{\circ}\text{C}$	± 0.040 $+0.02/^{\circ}\text{C}$	± 0.060 $+0.02/^{\circ}\text{C}$	± 0.080 $+0.03/^{\circ}\text{C}$
Transmission Tracking	± 0.10 $+0.02/^{\circ}\text{C}$	± 0.059 $+0.02/^{\circ}\text{C}$	± 0.079 $+0.02/^{\circ}\text{C}$	± 0.110 $+0.02/^{\circ}\text{C}$	± 0.125 $+0.03/^{\circ}\text{C}$

NOTE: The following graphs also apply to the "C" model of the analyzer.

Transmission Uncertainty (Specifications)

Magnitude

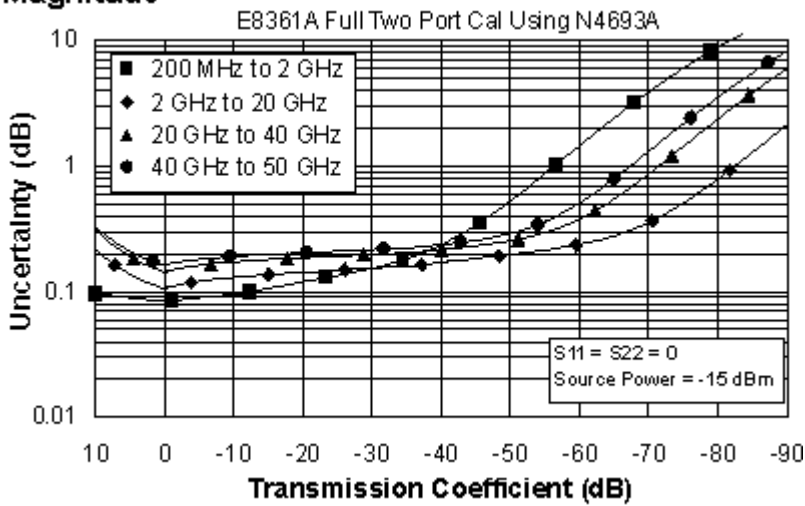

Phase

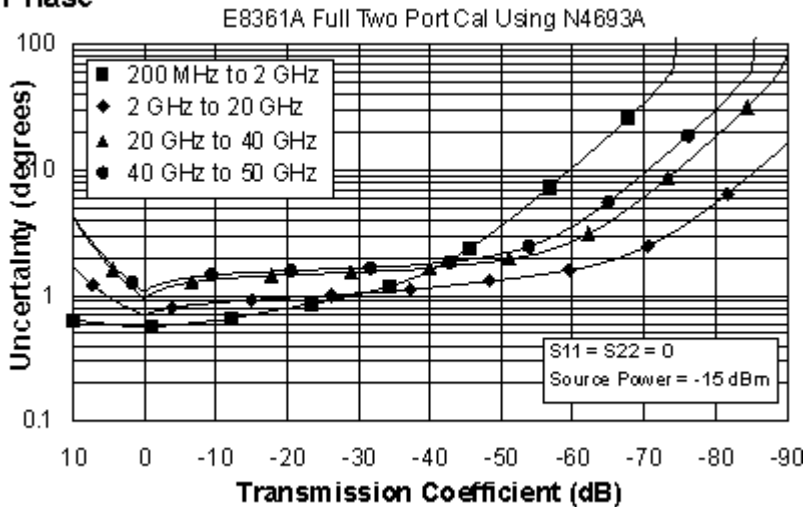

Reflection Uncertainty (Specifications)

Magnitude

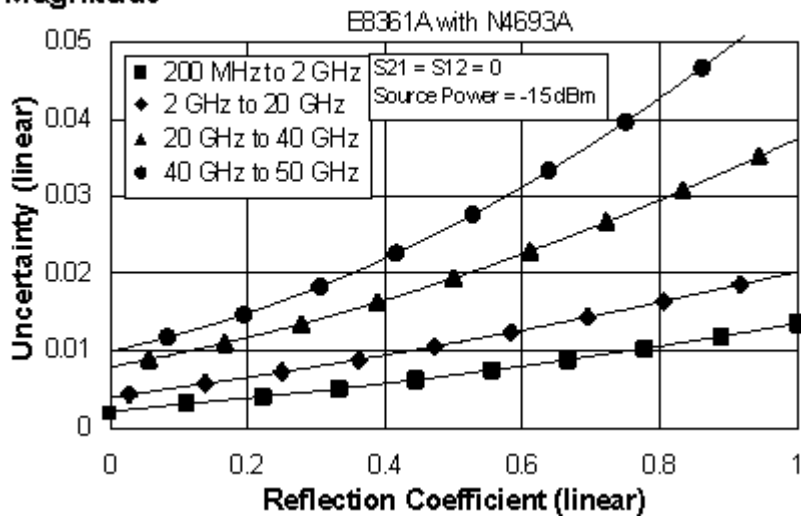

Phase

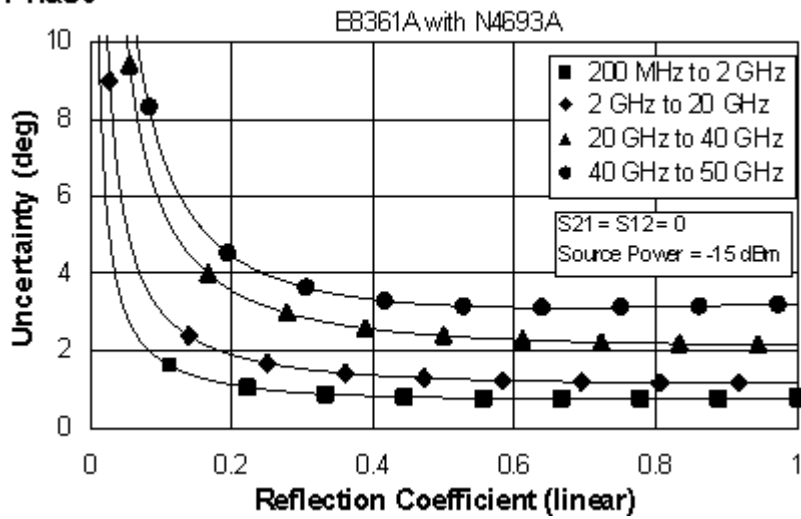

**Table 9. N4693A Electronic Calibration Module
E8361A/C - Fully Optioned (Option 014, UNL, 016, 080, and 081)**

Configurable Test Set, Extended Power Range & Bias-Tees, Receiver Attenuators, Frequency Offset Mode, and Reference Channel Transfer Switch

Applies to the, E8361A/C analyzers, N4693A(2.4mm) Electronic Calibration Module, 85133F flexible test port cable set, and a full 2-port calibration. (2.4 mm connectors are mateable with 1.85 mm connectors.) Also applies to the following condition:

Environmental temperature $23^{\circ} \pm 3^{\circ} \text{C}$, with $< 1^{\circ} \text{C}$ deviation from calibration temperature

Description	Typical (dB)	Specification (dB)			
	10 to 200 MHz	200 MHz to 2 GHz	2 to 20 GHz	20 to 40 GHz	40 to 50 GHz
Directivity	32	55	49	43	41
Source Match	25	46	42	35	30
Load Match	24	43	41	37	36
Reflection Tracking	± 0.05 $+0.02/^{\circ}\text{C}$	± 0.030 $+0.02/^{\circ}\text{C}$	± 0.040 $+0.02/^{\circ}\text{C}$	± 0.060 $+0.02/^{\circ}\text{C}$	± 0.080 $+0.03/^{\circ}\text{C}$
Transmission Tracking	± 0.10 $+0.02/^{\circ}\text{C}$	± 0.060 $+0.02/^{\circ}\text{C}$	± 0.082 $+0.02/^{\circ}\text{C}$	± 0.106 $+0.02/^{\circ}\text{C}$	± 0.121 $+0.03/^{\circ}\text{C}$

NOTE: The following graphs also apply to the "C" model of the analyzer.

Transmission Uncertainty (Specifications)

Magnitude

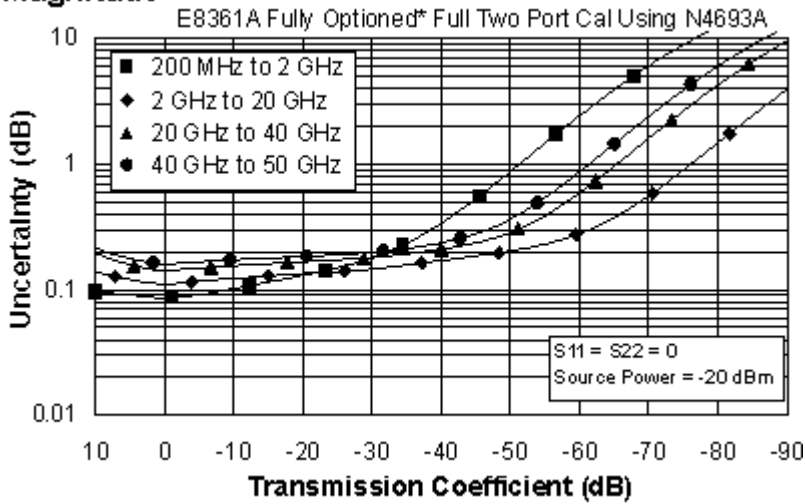

Phase

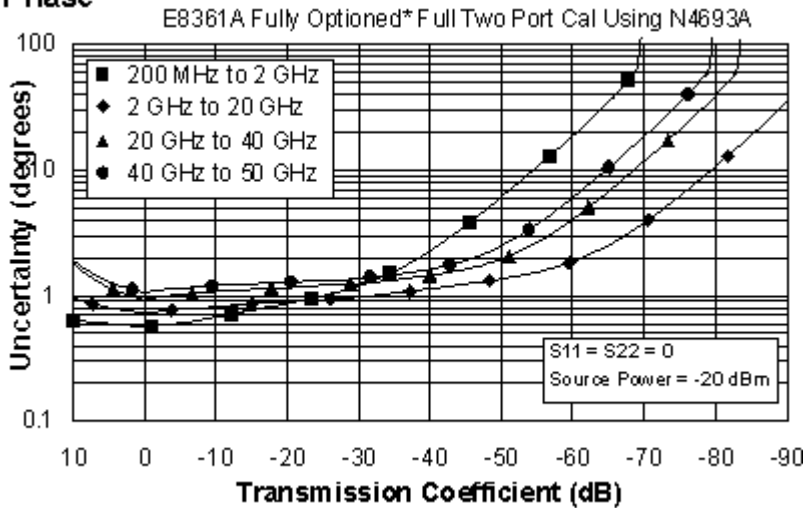

* Configurable Test Set, Extended Power Range & Bias-Tees, Receiver Attenuators, Frequency Offset Mode, and Reference Channel Transfer Switch (E8361A/C - Option 014, UNL, 016, 080, and 081)

Reflection Uncertainty (Specifications)

Magnitude

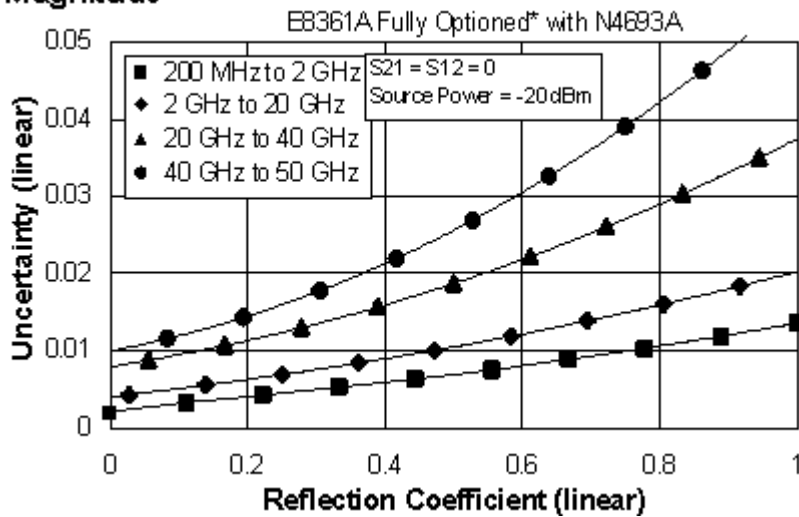

Phase

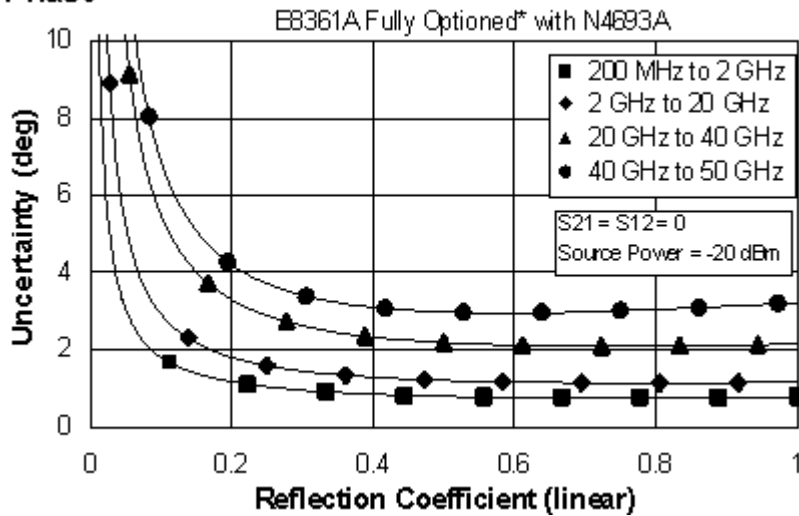

* Configurable Test Set, Extended Power Range & Bias-Tees, Receiver Attenuators, Frequency Offset Mode, and Reference Channel Transfer Switch (E8361A/C - Option 014, UNL, 016, 080, and 081)

This document does not present specifications for the 85056D or 85056K Calibration Kit. Please download our free Uncertainty Calculator from http://www.agilent.com/find/na_calculator to generate the data and curves for the 85056D or 85056K Calibration Kit or your PNA setup. View the [equations](#) used to generate the uncertainty curve

Table 10. Uncorrected System Performance^a

Specifications apply over environmental temperature of 23° ±3 °C, with < 1 °C deviation from the calibration temperature

Description	Specification	Supplemental Information
Directivity		
		typical:
10 MHz to 45 MHz ^b	--	22 dB
45 MHz to 2 GHz	24 dB	27 dB
2 GHz to 10 GHz	20 dB	24 dB
10 GHz to 20 GHz	16 dB	20 dB
20 GHz to 30 GHz	14 dB	17 dB
30 GHz to 50 GHz	13 dB	17 dB
50 GHz to 60 GHz	13 dB	17 dB
60 GHz to 67 GHz	10 dB	18 dB
67 GHz to 70 GHz ^b	--	14 dB
Source Match - Standard		
		typical:
10 MHz to 45 MHz ^b	--	7 dB
45 MHz to 2 GHz	18 dB	23 dB
2 GHz to 10 GHz	14 dB	18 dB
10 GHz to 20 GHz	12 dB	15 dB
20 GHz to 30 GHz	8 dB	11.5 dB
30 GHz to 40 GHz	7.5 dB	10 dB
40 GHz to 45 GHz	8 dB	11 dB
45 GHz to 50 GHz	7 dB	10 dB
50 GHz to 60 GHz	6 dB	8.5 dB
60 GHz to 67 GHz	5.5 dB	7.5 dB
67 GHz to 70 GHz ^b	--	7.5 dB
Source Match - Option 014		
		typical:
10 MHz to 45 MHz ^b	--	7 dB
45 MHz to 2 GHz	17 dB	21 dB
2 GHz to 10 GHz	12 dB	17 dB
10 GHz to 20 GHz	11 dB	14 dB
20 GHz to 30 GHz	10 dB	13 dB
30 GHz to 40 GHz	8.5 dB	11 dB
40 GHz to 45 GHz	8.5 dB	11 dB
45 GHz to 50 GHz	8.5 dB	11.5 dB
50 GHz to 60 GHz	6.5 dB	9 dB
60 GHz to 67 GHz	6 dB	8.5 dB
67 GHz to 70 GHz ^b	--	8.5 dB

Table 10. Uncorrected System Performance^a (Continued)

Description	Specification	Supplemental Information
Source Match - UNL & 014		
		typical:
10 MHz to 45 MHz ^b	--	5 dB
45 MHz to 2 GHz	15 dB	20 dB
2 GHz to 10 GHz	9 dB	13 dB
10 GHz to 20 GHz	7.5 dB	10.5 dB
20 GHz to 30 GHz	8.5 dB	11 dB
30 GHz to 40 GHz	8 dB	11 dB
40 GHz to 45 GHz	8.5 dB	12 dB
45 GHz to 50 GHz	8 dB	12 dB
50 GHz to 60 GHz	7 dB	11 dB
60 GHz to 67 GHz	6 dB	10 dB
67 GHz to 70 GHz ^b	--	10 dB
Load Match - Standard		
		typical:
10 MHz to 45 MHz ^b	--	5.5 dB
45 MHz to 2 GHz	9 dB	10 dB
2 GHz to 10 GHz	9 dB	11 dB
10 GHz to 20 GHz	8.5 dB	10 dB
20 GHz to 30 GHz	7 dB	9 dB
30 GHz to 40 GHz	6 dB	8 dB
40 GHz to 45 GHz	6.5 dB	9 dB
45 GHz to 50 GHz	6.5 dB	8.5 dB
50 GHz to 60 GHz	5.5 dB	7.5 dB
60 GHz to 67 GHz	5.5 dB	7.5 dB
67 GHz to 70 GHz ^b	--	5 dB
Load Match - Option 014		
		typical:
10 MHz to 45 MHz ^b	--	5.5 dB
45 MHz to 2 GHz	8.5 dB	10 dB
2 GHz to 10 GHz	8 dB	10 dB
10 GHz to 20 GHz	8 dB	10 dB
20 GHz to 30 GHz	7.5 dB	10 dB
30 GHz to 40 GHz	7 dB	9.5 dB
40 GHz to 45 GHz	7.5 dB	9.5 dB
45 GHz to 50 GHz	7.5 dB	10 dB
50 GHz to 60 GHz	6 dB	8.5 dB
60 GHz to 67 GHz	6 dB	8.5 dB
67 GHz to 70 GHz ^b	--	5 dB

Table 10. Uncorrected System Performance^a (Continued)

Description	Specification	Supplemental Information
Load Match - Option UNL & 014		
		typical:
10 MHz to 45 MHz ^b	--	6 dB
45 MHz to 2 GHz	8.5 dB	10 dB
2 GHz to 10 GHz	7 dB	9 dB
10 GHz to 20 GHz	6 dB	9 dB
20 GHz to 30 GHz	7.5 dB	11 dB
30 GHz to 40 GHz	8 dB	11.5 dB
40 GHz to 45 GHz	8 dB	12 dB
45 GHz to 50 GHz	8 dB	12 dB
50 GHz to 60 GHz	7.5 dB	11.5 dB
60 GHz to 67 GHz	6 dB	10 dB
67 GHz to 70 GHz ^b	--	13 dB
Reflection Tracking		
	--	typical:
10 MHz to 45 MHz	--	±1.5 dB
45 MHz to 20 GHz	--	±1.5 dB
20 GHz to 40 GHz	--	±2.0 dB
40 GHz to 50 GHz	--	±2.0 dB
50 GHz to 67 GHz	--	±3.0 dB
67 GHz to 70 GHz	--	±4.5 dB
Transmission Tracking^c		
	--	typical:
10 MHz to 45 MHz	--	±1.5 dB
45 MHz to 20 GHz	--	±1.5 dB
20 GHz to 40 GHz	--	±2.0 dB
40 GHz to 50 GHz	--	±2.0 dB
50 GHz to 67 GHz	--	±3.0 dB
67 GHz to 70 GHz	--	±4.5 dB
Crosstalk^d - Standard		
		typical:
10 MHz to 45 MHz ^b	--	-63 dB
45 MHz to 500 MHz	-87 dB	--
500 MHz to 2 GHz	-110 dB	--
2 GHz to 10 GHz	-105 dB	--
10 GHz to 24 GHz	-111 dB	--
24 GHz to 30 GHz	-106 dB	--
30 GHz to 40 GHz	-104 dB	--
40 GHz to 45 GHz	-98 dB	--
45 GHz to 50 GHz	-100 dB	--
50 GHz to 60 GHz	-97 dB	--
60 GHz to 67 GHz	-94 dB	--
67 GHz to 70 GHz ^b	--	-94 dB

Table 10. Uncorrected System Performance^a (Continued)

Description	Specification	Supplemental Information
Crosstalk^d - Option 014		
		typical (for Option 080 enabled ^e)
10 MHz to 45 MHz ^b	--	-63 dB
45 MHz to 500 MHz	-87 dB	-87 dB
500 MHz to 2 GHz	-110 dB	-110 dB
2 GHz to 10 GHz	-105 dB	-105 dB
10 GHz to 24 GHz	-111 dB	-111 dB
24 GHz to 30 GHz	-104 dB	-104 dB
30 GHz to 40 GHz	-102 dB	-102 dB
40 GHz to 45 GHz	-96 dB	-96 dB
45 GHz to 50 GHz	-98 dB	-98 dB
50 GHz to 60 GHz	-95 dB	-95 dB
60 GHz to 67 GHz	-90 dB	-90 dB
67 GHz to 70 GHz ^b	--	-90 dB
Crosstalk^d - Option 014 & UNL		
		typical (for Option 080 enabled ^e)
10 MHz to 45 MHz ^b	--	-63 dB
45 MHz to 500 MHz	-87 dB	-87 dB
500 MHz to 2 GHz	-110 dB	-110 dB
2 GHz to 10 GHz	-104 dB	-104 dB
10 GHz to 24 GHz	-108 dB	-108 dB
24 GHz to 30 GHz	-101 dB	-101 dB
30 GHz to 40 GHz	-99 dB	-99 dB
40 GHz to 45 GHz	-92 dB	-92 dB
45 GHz to 50 GHz	-94 dB	-94 dB
50 GHz to 60 GHz	-91 dB	-91 dB
60 GHz to 67 GHz	-84 dB	-84 dB
67 GHz to 70 GHz ^b	--	-84 dB

^a Specifications apply over environment temperature of 23°C +/- 3°C, with less than 1°C deviation from the calibration temperature.

^b Typical performance.

^c Transmission tracking performance noted here is normalized to the insertion loss characteristics of the cable used so that the indicated performance is independent of the cable used.

^d Measurement conditions: normalized to a thru, measured with two shorts, 10 Hz IF bandwidth, averaging factor of 16, alternate mode, source power set to the lesser of the maximum power out or the maximum receiver power.

^e 0 Hz offset.

Table 11. Test Port Output

Description		Specification		Supplemental
Frequency Range				
E8361A/C	10 MHz to 67 GHz Error-free operation		User-settable range - 10 MHz to 70 GHz. Performance above 67 GHz is not measured or guaranteed.	
Nominal Power^c				
	Std and Options without UNL	Options with UNL		
E8361A/C	-15 dBm	-17 dBm		--
Frequency Resolution				
	1 Hz		--	
CW Accuracy				
	+/-1 ppm		--	
Frequency Stability				
			+/-0.05 ppm. -10° to 70° C, typical ^h ; +/-0.1 ppm/yr maximum, typical ⁱ	
Power Level Accuracy^a				
	Standard	Opt 014	Opt 014 & UNL	
10 MHz to 45 MHz ^b	+/-1.5 dB (typical)	+/-1.5 dB (typical)	+/-1.5 dB (typical)	--
45 MHz to 10 GHz	+/-1.5 dB	+/-1.5 dB	+/-1.5 dB	Variation from nominal power in range 0 (step attenuator at 0 dB)
10 GHz to 20 GHz	+/-1.5 dB	+/-1.5 dB	+/-2.0 dB	
20 GHz to 30 GHz	+/-2.0 dB	+/-2.0 dB	+/-2.5 dB	
30 GHz to 40 GHz	+/-3.0 dB	+/-3.0 dB	+/-3 dB	
40 GHz to 45 GHz	+/-3.0 dB	+/-3.0 dB	+/-3 dB	
45 GHz to 50 GHz	+/-3.5 dB	+/-3.5 dB	+/-3.5 dB	
50 GHz to 60 GHz	+/-4.0 dB	+/-4.0 dB	+/-4.0 dB	
60 GHz to 67 GHz	+/-4.0 dB	+/-4.0 dB	+/-4.5 dB	
67 GHz to 70 GHz ^b	+/-4.0 dB (typical)	+/-4.0 dB (typical)	+/-4.5 dB (typical)	
Power Level Linearity^d				
			Any Option	
Test reference is at the nominal power level (step attenuator at 0 dB)				
10 MHz to 45 MHz ^b	+/-1.0 dB for power <=-5 dBm ^g (typical)		--	
45 MHz to 67 GHz	+/-1.0 dB for power <=-5 dBm ^g		--	
67 GHz to 70 GHz ^b	+/-1.0 dB for power <=-5 dBm ^g (typical)		--	

Table 11. Test Port Output (Continued)

Power Range^{a,e,f}				
Note: If the power is set above maximum specified leveled power, the test port output signal may show non-linear effects that are dependent on the DUT.				
	Standard	Opt 014	Opt 014 & UNL	
10 MHz to 45 MHz ^b	-25 to -9 dBm (typical)	-25 to -9 dBm (typical)	-75 to -9 dBm (typical)	--
45 MHz to 500 MHz	-25 to -3 dBm	-25 to -3 dBm	-75 to -3 dBm	--
500 MHz to 750 MHz	-25 to 0 dBm	-25 to 0 dBm	-75 to 0 dBm	--
750 MHz to 10 GHz	-27 to -1 dBm	-27 to -1 dBm	-77 to -1 dBm	--
10 GHz to 30 GHz	-27 to -2 dBm	-27 to -3 dBm	-77 to -3 dBm	--
30 GHz to 40 GHz	-27 to -1 dBm	-27 to -2 dBm	-77 to -5 dBm	--
40 GHz to 45 GHz	-27 to -7 dBm	-27 to -8 dBm	-77 to -10 dBm	--
45 GHz to 50 GHz	-27 to -1 dBm	-27 to -2 dBm	-77 to -6 dBm	--
50 GHz to 60 GHz	-27 to -3 dBm	-27 to -4 dBm	-77 to -8 dBm	--
60 GHz to 67 GHz	-27 to -5 dBm	-27 to -7 dBm	-77 to -13 dBm	
67 GHz to 70 GHz ^b	-27 to -5 dBm (typical)	-27 to -7 dBm (typical)	-77 to -13 dBm (typical)	--
Power Sweep Range (ALC)				
	Standard	Opt 014	Opt 014 & UNL	ALC range starts at maximum leveled output power and decreases by power level indicated in the table.
10 MHz to 45 MHz ^b	16 dB (typical)	16 dB (typical)	16 dB (typical)	
45 MHz to 500 MHz	22 dB	22 dB	22 dB	
500 MHz to 750 MHz	25 dB	25 dB	25 dB	
750 MHz to 10 GHz	26 dB	26 dB	26 dB	
10 GHz to 30 GHz	25 dB	24 dB	24 dB	
30 GHz to 40 GHz	26 dB	25 dB	22 dB	
40 GHz to 45 GHz	20 dB	19 dB	17 dB	
45 GHz to 50 GHz	26 dB	25 dB	21 dB	
50 GHz to 60 GHz	24 dB	23 dB	19 dB	

Table 11. Test Port Output (Continued)			
60 GHz to 67 GHz	22 dB	20 dB	14 dB
67 GHz to 70 GHz ^b	22 dB (typical)	20 dB (typical)	14 dB (typical)
Power Resolution			
	0.01 dB		
Phase Noise			
			Any Option
10 kHz offset from center frequency, nominal power at test port			
			typical:
10 MHz to 45 MHz	--	--	--
45 MHz to 10 GHz	--	--	--
10 GHz to 24 GHz	--	--	--
24 GHz to 70 GHz	--	--	--
			-80 dBc
			-70 dBc
			-60 dBc
			-55 dBc
10 kHz offset from center frequency, nominal power at test port - Option 080 enabled			
			typical:
10 MHz to 45 MHz	--	--	--
45 MHz to 10 GHz	--	--	--
10 GHz to 24 GHz	--	--	--
24 GHz to 70 GHz	--	--	--
			-80 dBc
			-70 dBc
			-60 dBc
			-55 dBc
100 kHz offset from center frequency, nominal power at test port			
			typical:
10 MHz to 45 MHz	--	--	--
45 MHz to 10 GHz	--	--	--
10 GHz to 24 GHz	--	--	--
24 GHz to 70 GHz	--	--	--
			-90 dBc
			-90 dBc
			-85 dBc
			-75 dBc
100 kHz offset from center frequency, nominal power at test port - Option 080 enabled			
			typical:
10 MHz to 45 MHz	--	--	--
45 MHz to 10 GHz	--	--	--
10 GHz to 24 GHz	--	--	--
24 GHz to 70 GHz	--	--	--
			-85 dBc
			-80 dBc
			-70 dBc
			-60 dBc

Table 11. Test Port Output (Continued)

1 MHz offset from center frequency, nominal power at test port				
				typical:
10 MHz to 45 MHz	--	--	--	-115 dBc
45 MHz to 10 GHz	--	--	--	-110 dBc
10 GHz to 24 GHz	--	--	--	-105 dBc
24 GHz to 70 GHz	--	--	--	-95 dBc
1 MHz offset from center frequency, nominal power at test port - Option 080 enabled				
				typical:
10 MHz to 45 MHz	--	--	--	-110 dBc
45 MHz to 10 GHz	--	--	--	-105 dBc
10 GHz to 24 GHz	--	--	--	-95 dBc
24 GHz to 70 GHz	--	--	--	-85 dBc
Harmonics (2nd or 3rd)				
				Any Option
				typical:
10 MHz to 500 MHz	--	--	--	-10 dBc
500 MHz to 10 GHz	--	--	--	-15 dBc
10 GHz to 24 GHz	--	--	--	-23 dBc
24 GHz to 50 GHz	--	--	--	-16 dBc
50 GHz to 60 GHz	--	--	--	-13 dBc
60 GHz to 70 GHz	--	--	--	-19 dBc
Non-Harmonic Spurious (at Nominal Output Power)				
10 MHz to 20 GHz	--	--	--	-50 dBc typical, for offset frequency > 1 kHz
20 GHz to 70 GHz	--	--	--	-30 dBc typical, for offset frequency > 1 kHz

^a Test port output is a specification when the source is set to Port 1, and a characteristic when the source is set to Port 2.

^b Typical performance.

^c Preset power.

^d Power Level Linearity is a specification when the source is set to Port 1, and a typical when the source is set to Port 2.

^e Test port power is specified into nominal 50 ohms.

^f Power to which the source can be set and phase lock is assured.

^g +/-1.6 dB for power > -5 dBm.

^h Assumes no variation in time.

ⁱ Assumes no variation in temperature.

Table 12: Test Port Input

Description	Specification		Supplemental
	Standard or UNL	Opt 014 or 014 & UNL	
Test Port Noise Floor¹			
10 Hz IF Bandwidth			
10 MHz to 45 MHz ²	<-70 dBm (typical)	<-70 dBm (typical)	--
45 MHz to 500 MHz ^{3,4}	<-90 dBm	<-90 dBm	--
500 MHz to 2 GHz	<-112 dBm	<-112 dBm	--
2 GHz to 10 GHz	<-112 dBm	<-112 dBm	--
10 GHz to 24 GHz	<-116 dBm	<-115 dBm	--
24 GHz to 30 GHz	<-105 dBm	<-104 dBm	Option 016 degrades performance by 2 dB.
30 GHz to 40 GHz	<-105 dBm	<-104 dBm	
40 GHz to 45 GHz	<-103 dBm	<-102 dBm	
45 GHz to 50 GHz	<-101 dBm	<-100 dBm	
50 GHz to 60 GHz	<-100 dBm	<-99 dBm	
60 GHz to 67 GHz	<-99 dBm	<-97 dBm	Option 016 degrades performance by 3 dB.
67 GHz to 70 GHz ²	<-99 dBm (typical)	<-97 dBm (typical)	
1 KHz IF Bandwidth			
10 MHz to 45 MHz ²	<-50 dBm (typical)	<-50 dBm (typical)	--
45 MHz to 500 MHz ^{3,4}	<-70 dBm	<-70 dBm	--
500 MHz to 2 GHz	<-92 dBm	<-92 dBm	--
2 GHz to 10 GHz	<-92 dBm	<-92 dBm	--
10 GHz to 24 GHz	<-96 dBm	<-95 dBm	--
24 GHz to 30 GHz	<-85 dBm	<-84 dBm	Option 016 degrades performance by 2 dB.
30 GHz to 40 GHz	<-85 dBm	<-84 dBm	
40 GHz to 45 GHz	<-83 dBm	<-82 dBm	
45 GHz to 50 GHz	<-81 dBm	<-80 dBm	
50 GHz to 60 GHz	<-80 dBm	<-79 dBm	
60 GHz to 67 GHz	<-79 dBm	<-77 dBm	Option 016 degrades performance by 3 dB.
67 GHz to 70 GHz ²	<-79 dBm (typical)	<-77 dBm (typical)	

Table 12: Test Port Input (Continued)

Description	Specification	Supplemental	
Test Port Noise Floor¹ Option 080 enabled⁵			
			Option 014 or 014 & UNL (typical)
10 Hz IF Bandwidth			
10 MHz to 45 MHz	--	--	<-70 dBm
45 MHz to 500 MHz ^{3,4}	--	--	<-90 dBm
500 MHz to 2 GHz	--	--	<-112 dBm
2 GHz to 10 GHz	--	--	<-112 dBm
10 GHz to 24 GHz	--	--	<-115 dBm
24 GHz to 30 GHz	--	Option 016 degrades performance by 2 dB.	<-104 dBm
30 GHz to 40 GHz	--		<-104 dBm
40 GHz to 45 GHz	--		<-102 dBm
45 GHz to 50 GHz	--		<-100 dBm
50 GHz to 60 GHz	--		<-99 dBm
60 GHz to 67 GHz	--	Option 016 degrades performance by 3 dB.	<-97 dBm
67 GHz to 70 GHz	--		<-97 dBm
1 KHz IF Bandwidth			
		--	typical:
10 MHz to 45 MHz	--	--	<-50 dBm
45 MHz to 500 MHz ^{3,4}	--	--	<-70 dBm
500 MHz to 2 GHz	--	--	<-92 dBm
2 GHz to 10 GHz	--	--	<-92 dBm
10 GHz to 24 GHz	--	--	<-95 dBm
24 GHz to 30 GHz	--	Option 016 degrades performance by 2 dB.	<-84 dBm
30 GHz to 40 GHz	--		<-84 dBm
40 GHz to 45 GHz	--		<-82 dBm
45 GHz to 50 GHz	--		<-80 dBm
50 GHz to 60 GHz	--		<-79 dBm
60 GHz to 67 GHz	--	Option 016 degrades performance by 3 dB.	<-77 dBm
67 GHz to 70 GHz	--		<-77 dBm

Table 12: Test Port Input (Continued)

Description	Specification	Supplemental	
Direct Receiver Access Input Noise Floor¹			
	Standard	Option 014 or 014 & UNL (typical)	
10 Hz IF Bandwidth			
10 MHz to 45 MHz	--	<-106 dBm	--
45 MHz to 500 MHz ^{3,4}	--	<-105 dBm	--
500 MHz to 2 GHz	--	<-125.5 dBm	--
2 GHz to 10 GHz	--	<-125 dBm	--
10 GHz to 24 GHz	--	<-128 dBm	--
24 GHz to 30 GHz	--	<-117.5 dBm	Option 016 degrades performance by 2 dB.
30 GHz to 40 GHz	--	<-117 dBm	
40 GHz to 45 GHz	--	<-115 dBm	
45 GHz to 50 GHz	--	<-112.5 dBm	
50 GHz to 60 GHz	--	<-111 dBm	
60 GHz to 67 GHz	--	<-108 dBm	Option 016 degrades performance by 3 dB.
67 GHz to 70 GHz	--	<-107 dBm	
1 KHz IF Bandwidth			
10 MHz to 45 MHz	--	<-86 dBm	--
45 MHz to 500 MHz ^{3,4}	--	<-85 dBm	--
500 MHz to 2 GHz	--	<-105.5 dBm	--
2 GHz to 10 GHz	--	<-105 dBm	--
10 GHz to 24 GHz	--	<-108 dBm	--
24 GHz to 30 GHz	--	<-97.5 dBm	Option 016 degrades performance by 2 dB.
30 GHz to 40 GHz	--	<-97 dBm	
40 GHz to 45 GHz	--	<-95 dBm	
45 GHz to 50 GHz	--	<-92.5 dBm	
50 GHz to 60 GHz	--	<-91 dBm	
60 GHz to 67 GHz	--	<-88 dBm	Option 016 degrades performance by 3 dB.
67 GHz to 70 GHz	--	<-87 dBm	

Table 12: Test Port Input (Continued)

Description	Specification		Supplemental
Direct Receiver Access Input Noise Floor¹ - Option 080 enabled⁵			
	Standard	Option 014	
10 Hz IF Bandwidth			
	--	--	typical:
10 MHz to 45 MHz	--	--	<-106 dBm
45 MHz to 500 MHz ^{3,4}	--	--	<-105 dBm
500 MHz to 2 GHz	--	--	<-125.5 dBm
2 GHz to 10 GHz	--	--	<-125 dBm
10 GHz to 24 GHz	--	--	<-128 dBm
24 GHz to 30 GHz	--	Option 016 degrades performance by 2 dB.	<-117.5 dBm
30 GHz to 40 GHz	--		<-117 dBm
40 GHz to 45 GHz	--		<-115 dBm
45 GHz to 50 GHz	--		<-112.5 dBm
50 GHz to 60 GHz	--	--	<-111 dBm
60 GHz to 67 GHz	--	Option 016 degrades performance by 3 dB.	<-108 dBm
67 GHz to 70 GHz	--		<-107 dBm
1 KHz IF Bandwidth			
		--	typical:
10 MHz to 45 MHz	--	--	<-86 dBm
45 MHz to 500 MHz ^{3,4}	--	--	<-85 dBm
500 MHz to 2 GHz	--	--	<-105.5 dBm
2 GHz to 10 GHz	--	--	<-105 dBm
10 GHz to 24 GHz	--	--	<-108 dBm
24 GHz to 30 GHz	--	Option 016 degrades performance by 2 dB.	<-97.5 dBm
30 GHz to 40 GHz	--		<-97 dBm
40 GHz to 45 GHz	--		<-95 dBm
45 GHz to 50 GHz	--		<-92.5 dBm
50 GHz to 60 GHz	--	--	<-91 dBm
60 GHz to 67 GHz	--	Option 016 degrades performance by 3 dB.	<-88 dBm
67 GHz to 70 GHz	--		<-87 dBm

Table 12: Test Port Input (Continued)

Description	Specification			Supplemental
Receiver Compression Level (measured at test ports)				
	Specifications			Supplemental Information
	Standard	Option 014	014 & UNL	Typical
10 MHz to 45 MHz ⁶	negligible			
45 MHz to 500 MHz ^{6,7}	<0.1 dB at -9.5 dBm ⁸ and <0.25 dB at -3 dBm	<0.1 dB at -9.5 dBm ⁸ and <0.25 dB at 0 dBm	<0.25 dB at +3 dBm	<0.1 dB at +0.5 dBm ⁸ and <0.25 dB at +8 dBm
500 MHz to 5 GHz	<0.1 dB at -8 dBm ⁸ and <0.25 dB at -1 dBm	<0.1 dB at -8.0 dBm ⁸ and <0.25 dB at 0 dBm	<0.1 dB at -7.0 dBm ⁸ and <0.25 dB at 0 dBm	<0.1 dB at -4.0 dBm ⁸ and <0.25 dB at +3 dBm
5 GHz to 30 GHz	<0.1 dB at -8.5 dBm ⁸ and <0.25 dB at -2 dBm	<0.1 dB at -8.5 dBm ⁸ and <0.25 dB at +1 dBm	<0.1 dB at -6.0 dBm ⁸ and <0.25 dB at +1 dBm	<0.1 dB at -1.0 dBm ⁸ and <0.25 dB at +6 dBm
30 GHz to 67 GHz	<0.1 dB at -10.5 dBm ⁸ and <0.15 dB at -7 dBm	<0.1 dB at -8.0 dBm ⁸ and <0.15 dB at -3 dBm	<0.1 dB at -9.5 dBm ⁸ and <0.15 dB at -6 dBm	<0.1 dB at -2.0 dBm ^{8,9} and <0.15 dB at +2 dBm ⁹
67 GHz to 70 GHz	NA			
System Compression Level				
	Standard	Option 014 or 014 & UNL		
	maximum leveled output power			See dynamic accuracy table
Third Order Intercept¹⁰ - Tone spacing from 100 kHz - 5 MHz				
				Any Option
				typical
10 MHz to 500 MHz	--	--	--	+30 dBm
500 MHz to 24 GHz	--	--	--	+24 dBm
24 GHz to 40 GHz	--	--	--	+23 dBm
40 to 50 GHz	--	--	--	+24 dBm
50 to 67 GHz	--	--	--	+26 dBm
Third Order Intercept¹⁰ - Tone spacing from 5 MHz - 20 MHz				
				Any Option
				typical
10 MHz to 500 MHz	--	--	--	NA
500 MHz to 24 GHz	--	--	--	+20 dBm
24 GHz to 40 GHz	--	--	--	+20 dBm
40 to 50 GHz	--	--	--	+22 dBm
50 to 67 GHz	--	--	--	+24 dBm

Table 12: Test Port Input (Continued)

Description	Specification		Supplemental
Third Order Intercept¹⁰ - Tone spacing from 20 MHz - 50 MHz			
			Any Option
			typical
10 MHz to 500 MHz	--	--	NA
500 MHz to 24 GHz	--	--	+26 dBm
24 to 40 GHz	--	--	+24 dBm
40 to 50 GHz	--	--	+25 dBm
50 to 67 GHz	--	--	+27 dBm
Trace Noise Magnitude			
1 kHz IF bandwidth. Ratio measurement, nominal power at test port.			
	Standard or 014	014 & UNL	
10 MHz to 45 MHz ²	<0.150 dB rms	<0.150 dB rms	--
45 MHz to 500 MHz ^{11, 4}	<0.010 dB rms	<0.010 dB rms	--
500 MHz to 24 GHz	<0.006 dB rms	<0.006 dB rms	--
24 GHz to 67 GHz	<0.006 dB rms	<0.009 dB rms	--
67 GHz to 70 GHz ²	<0.006 dB rms (typical)	<0.009 dB rms (typical)	--
Trace Noise Magnitude - Option 080 enabled^{2,5}			
1 kHz IF bandwidth. Ratio measurement, nominal power at test port.			
	Standard or 014	014 & UNL	
	typical:	typical:	
10 MHz to 45 MHz	<0.150 dB rms	<0.150 dB rms	--
45 MHz to 500 MHz ^{11, 4}	<0.010 dB rms	<0.010 dB rms	--
500 MHz to 24 GHz	<0.006 dB rms	<0.006 dB rms	--
24 GHz to 67 GHz	<0.009 dB rms	<0.012 dB rms	--
67 GHz to 70 GHz	<0.009 dB rms	<0.012 dB rms	--

Table 12: Test Port Input (Continued)

Description	Specification	Supplemental	
Trace Noise Phase			
1 kHz IF bandwidth. Ratio measurement, nominal power at test port.			
	Any Option		
10 MHz to 45 MHz ²	<0.800° rms (typical)	--	--
45 MHz to 500 MHz ⁴	<0.100° rms	--	--
500 MHz to 24 GHz	<0.060° rms	--	--
24 GHz to 67 GHz	<0.100° rms	--	--
67 GHz to 70 GHz ²	<0.100° rms (typical)	--	--
Trace Noise Phase - Option 080 enabled^{2, 5}			
1 kHz IF bandwidth. Ratio measurement, nominal power at test port.			
			typical:
10 MHz to 45 MHz	--	--	<0.800° rms
45 MHz to 500 MHz ⁴	--	--	<0.100° rms
500 MHz to 24 GHz	--	--	<0.060° rms
24 GHz to 67 GHz	--	--	<0.100° rms
67 GHz to 70 GHz	--	--	<0.100° rms
Reference Level Magnitude			
Range	+/-500 dB	--	--
Resolution	0.001 dB	--	--
Reference Level Phase			
Range	+/-500°	--	--
Resolution	0.01°	--	--
Stability Magnitude¹²			
			Any Option
Typical ratio measurement, made at the test port.			
10 MHz to 45 MHz	--	--	+/-0.05 dB/°C
45 MHz to 50 GHz	--	--	+/-0.02 dB/°C
50 GHz to 70 GHz	--	--	+/-0.04 dB/°C

Table 12: Test Port Input (Continued)

Description	Specification	Supplemental
Stability Phase¹²		
		Any Option
Typical ratio measurement, measured at the test port.		
10 MHz to 45 MHz	--	--
		+/-0.5°C
45 MHz to 20 GHz	--	--
		+/-0.2°C
20 GHz to 40 GHz	--	--
		+/-0.5°C
40 GHz to 70 GHz	--	--
		+/-0.8°C
Damage Input Level		
		typical:
Test Port 1 and 2	--	--
		+24 dBm or +/-40 VDC
R1, R2 in	--	--
		+15 dBm or +/-15 VDC
A, B in	--	--
		+15 dBm or +/-7 VDC
Coupler Thru (Option 014 or 014 & UNL)	--	--
		+27 dBm or +/-40 VDC
Coupler Arm (Option 014 or 014 & UNL)	--	--
		+30 dBm or +/-7 VDC

¹ Total average (rms) noise power calculated as the mean value of a linear magnitude trace expressed in dBm.

² Typical performance.

³ Noise floor may be degraded by 10 dB at particular frequencies (multiples of 5 MHz) due to spurious receiver residuals.

⁴ Specified value is for worst-case noise floor at 45 MHz

⁵ 0 Hz offset

⁶ Coupler roll-off will reduce compression below 500 MHz. Ultimately, at 45 MHz, compression is negligible.

⁷ Specified value is for worst-case compression at 500 MHz.

⁸ This compression level comes from the dynamic accuracy curve with -30 dBm reference test port power.

⁹ Option 016 degrades performance by 3 dB.

¹⁰ TOI is a typical specification that applies while the network analyzer receiver is in its linear range.

¹¹ Trace noise magnitude may be degraded to 20 mdB rms at harmonic frequencies of the first IF (8.33 MHz) below 80 MHz.

¹² Stability is defined as a ratio measurement made at the test port.

Table 13. Dynamic Accuracy (Specification^a)

Accuracy of the test port input power reading relative to the reference input power level.

NOTE 1: If the power is set above maximum specified leveled power, the test port output signal may show non-linear effects that are dependent on the DUT.

NOTE 2: The following graphs also apply to the “C” model of the analyzer.

Dynamic Accuracy, 0.045 GHz

Magnitude

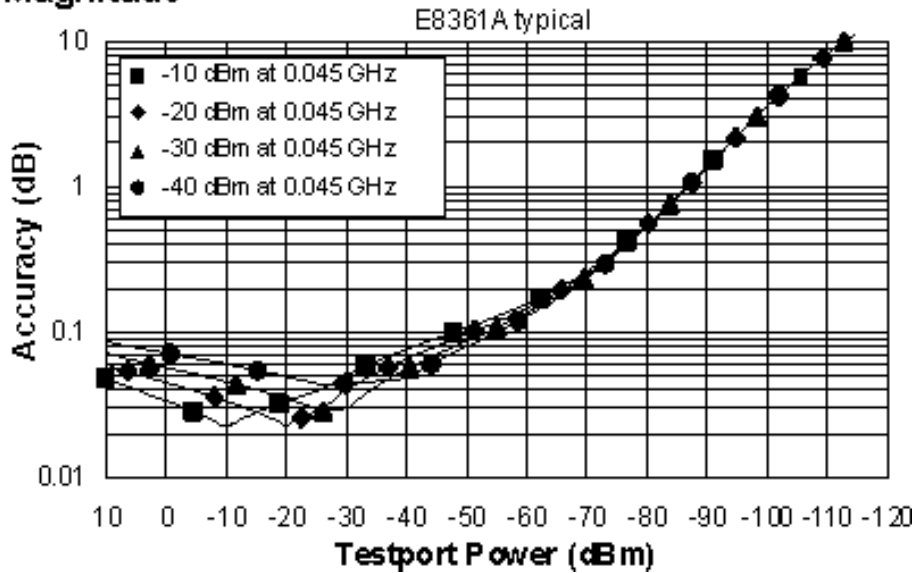

Phase

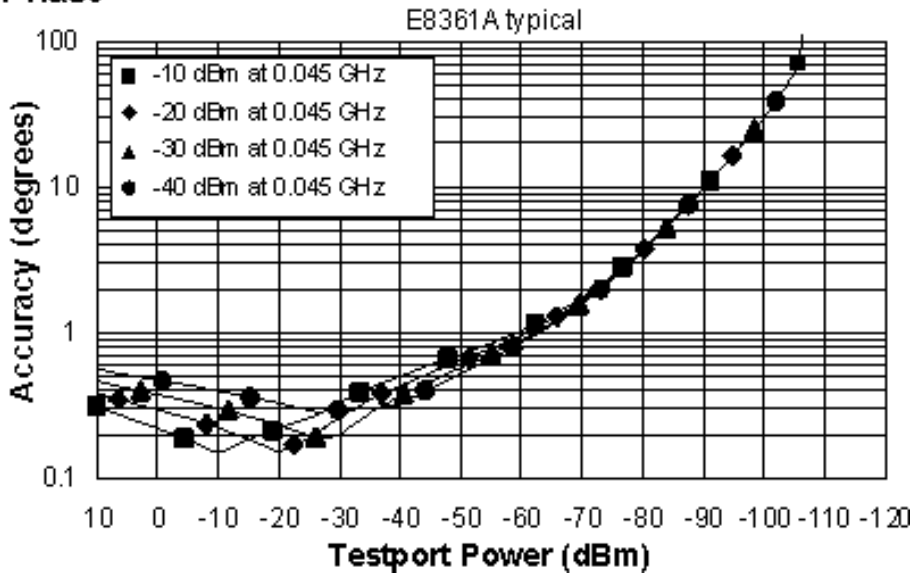

Table 13. Dynamic Accuracy (Specification^a)(Continued)

Accuracy of the test port input power reading relative to the reference input power level.

Note: If the power is set above maximum specified leveled power, the test port output signal may show non-linear effects that are dependent on the DUT.

Dynamic Accuracy, 0.500 GHz

Magnitude

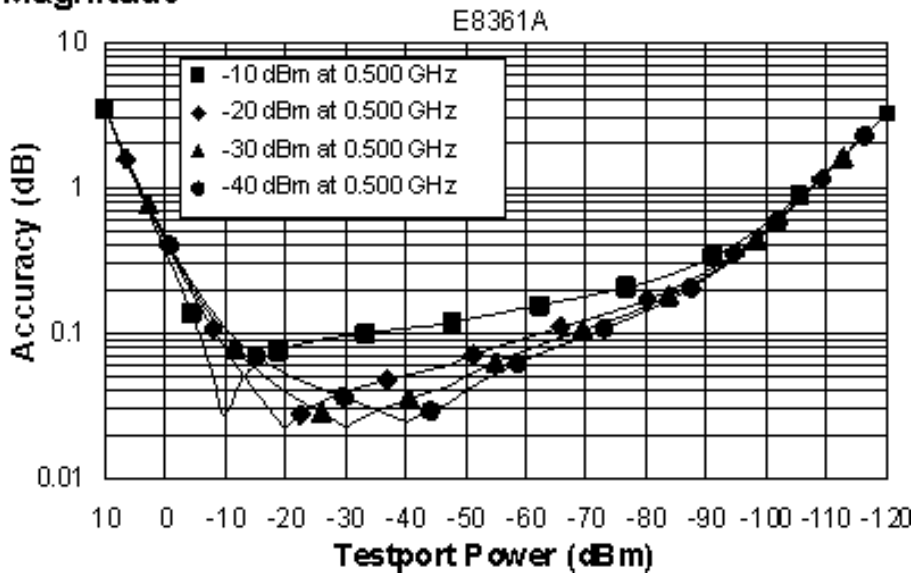

Phase

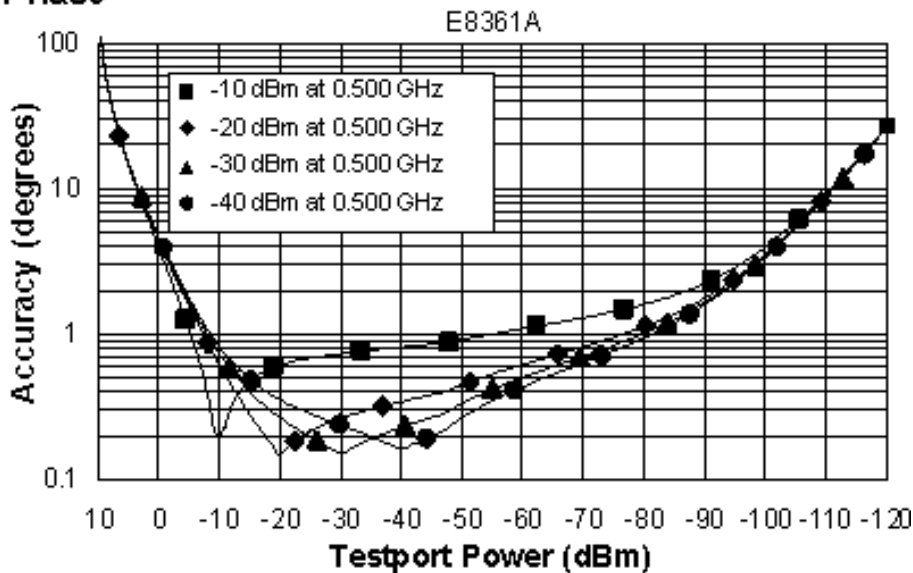
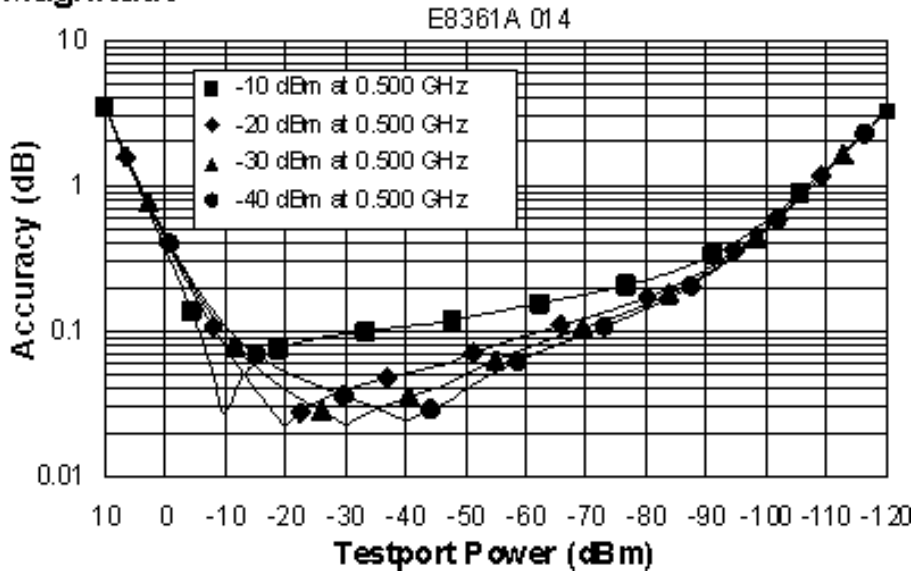

Table 13. Dynamic Accuracy (Specification^a)(Continued)

Accuracy of the test port input power reading relative to the reference input power level.

Note: If the power is set above maximum specified leveled power, the test port output signal may show non-linear effects that are dependent on the DUT.

Magnitude



Phase

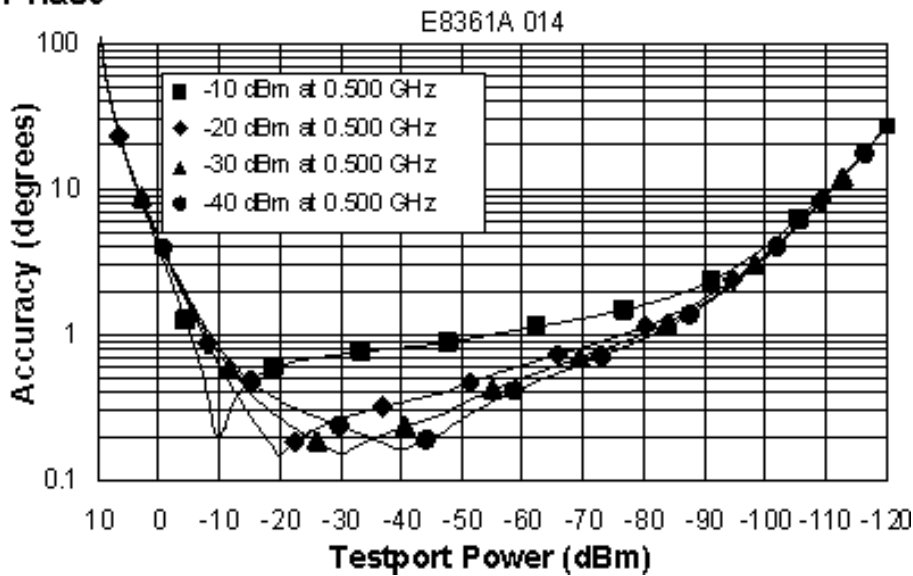
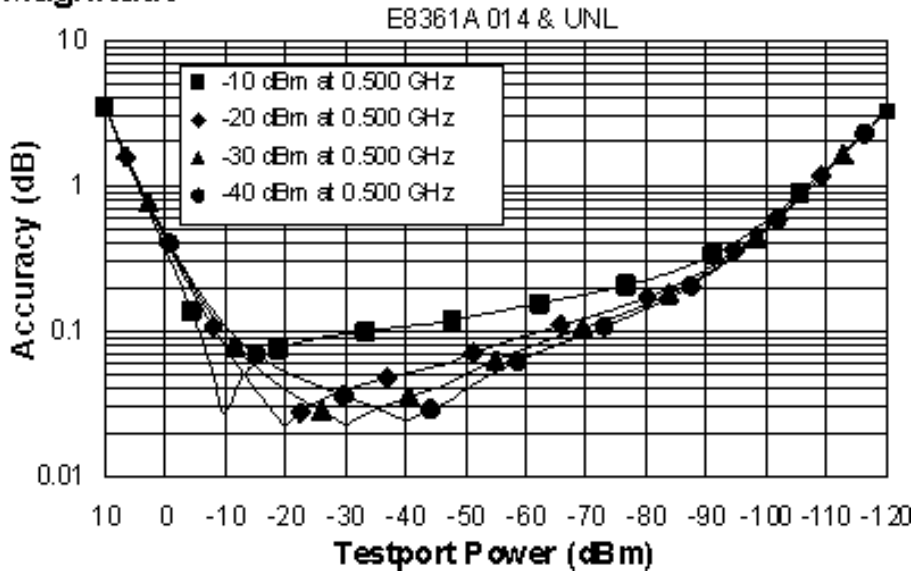

Table 13. Dynamic Accuracy (Specification^a)(Continued)

Accuracy of the test port input power reading relative to the reference input power level.

Note: If the power is set above maximum specified leveled power, the test port output signal may show non-linear effects that are dependent on the DUT.

Magnitude



Phase

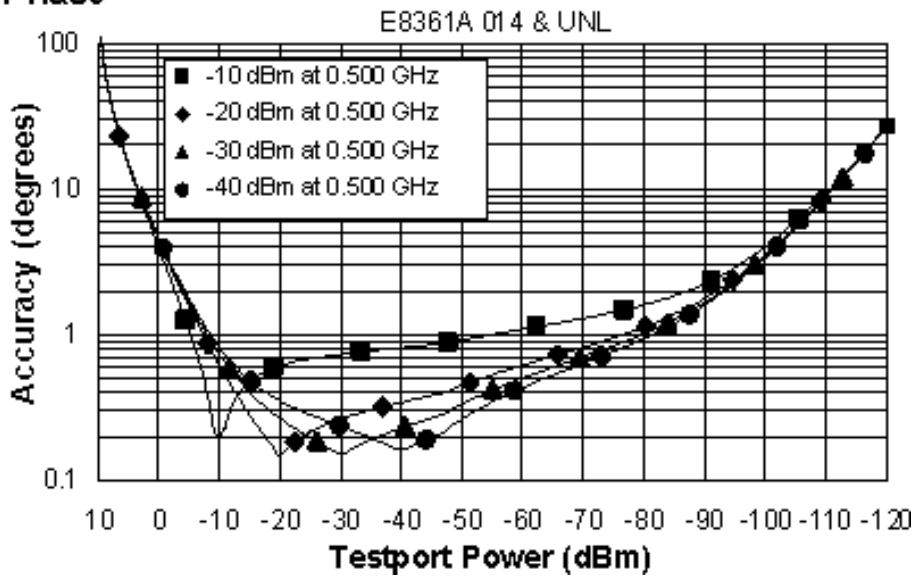
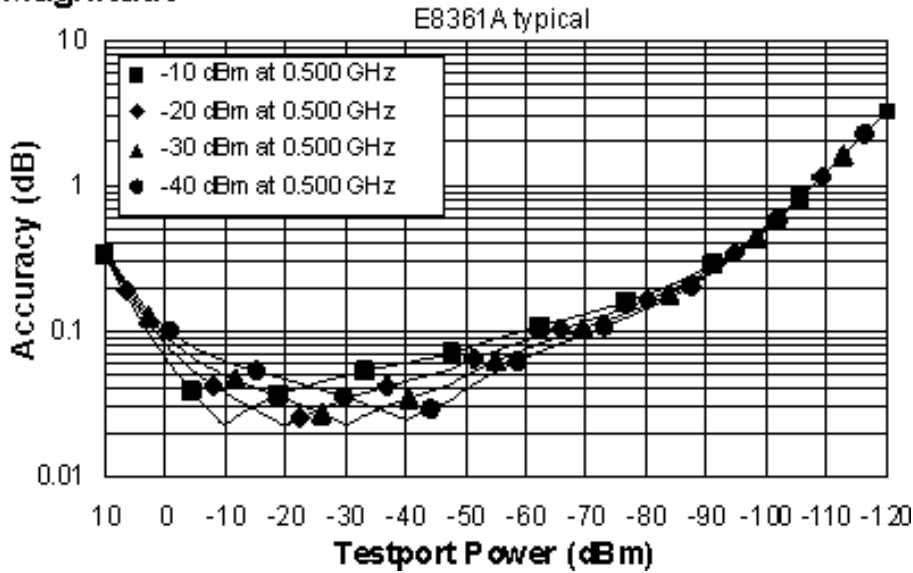

Table 13. Dynamic Accuracy (Specification^a)(Continued)

Accuracy of the test port input power reading relative to the reference input power level.

Note: If the power is set above maximum specified leveled power, the test port output signal may show non-linear effects that are dependent on the DUT.

Magnitude



Phase

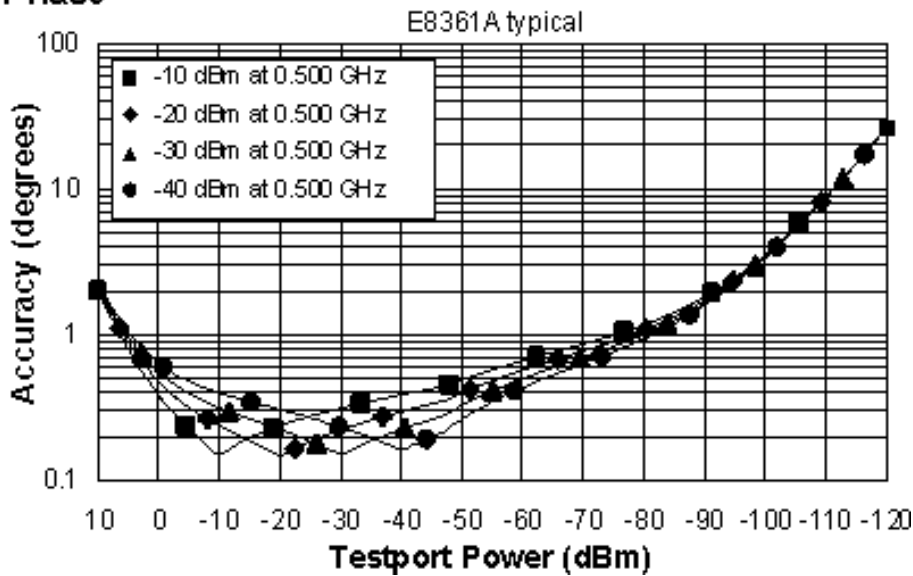

Table 13. Dynamic Accuracy (Specification^a)(Continued)

Accuracy of the test port input power reading relative to the reference input power level.

Note: If the power is set above maximum specified leveled power, the test port output signal may show non-linear effects that are dependent on the DUT.

Dynamic Accuracy, 0.500 - 5 GHz

Magnitude

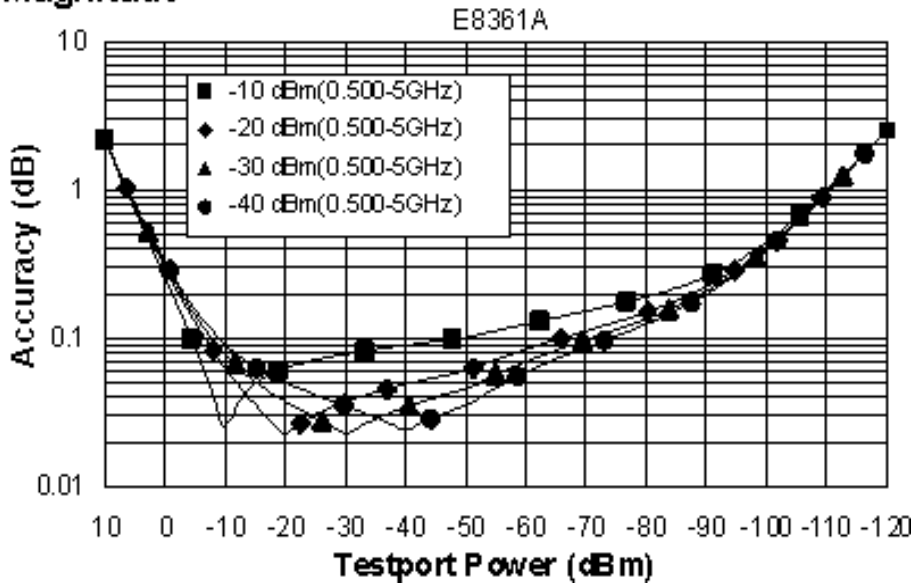

Phase

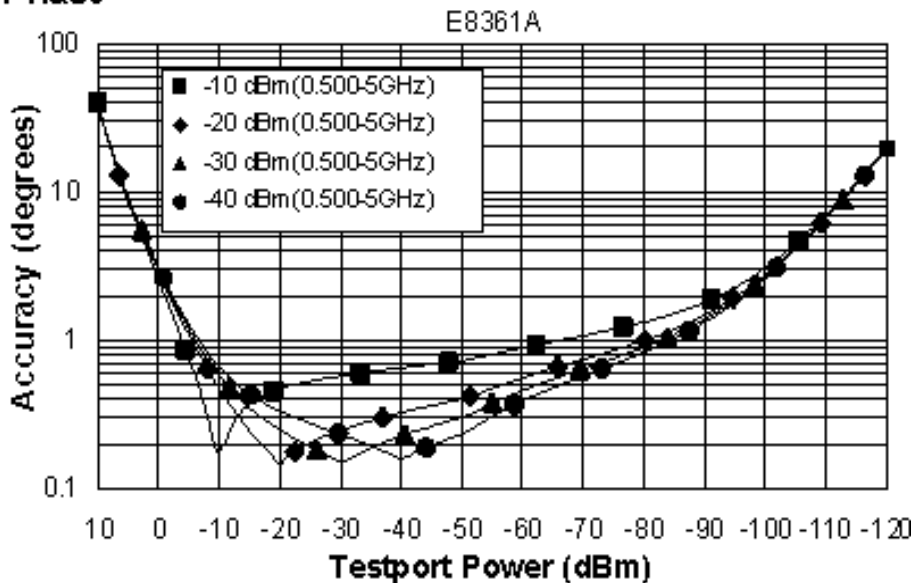
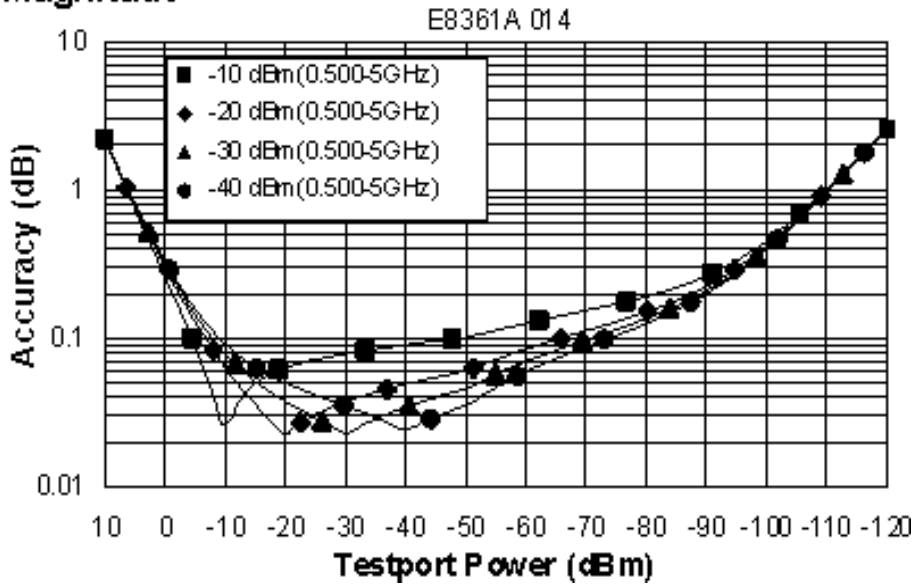

Table 13. Dynamic Accuracy (Specification^a)(Continued)

Accuracy of the test port input power reading relative to the reference input power level.

Note: If the power is set above maximum specified leveled power, the test port output signal may show non-linear effects that are dependent on the DUT.

Magnitude



Phase

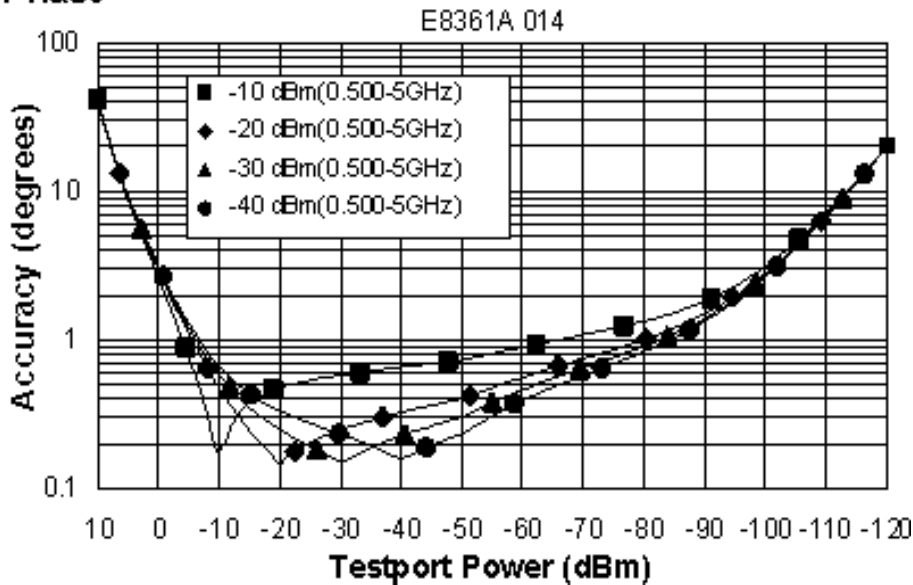
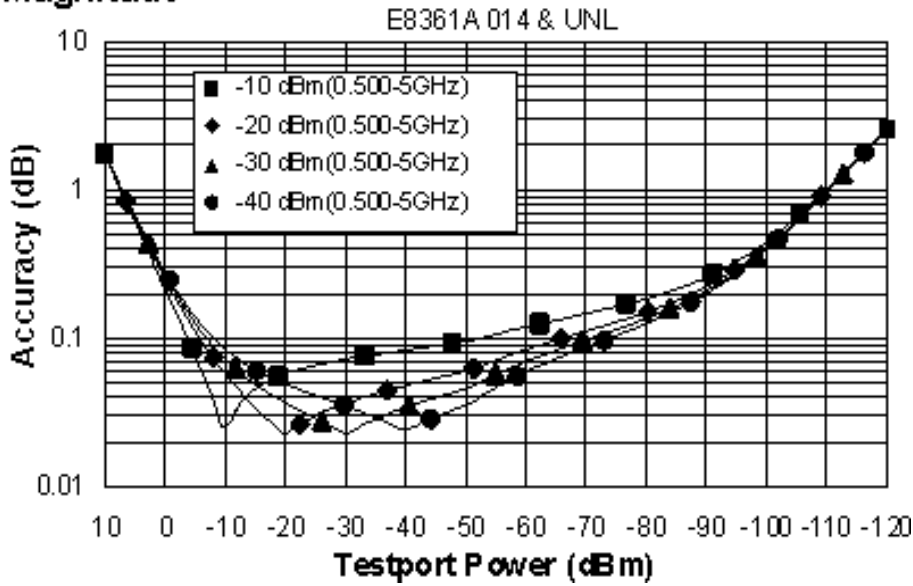

Table 13. Dynamic Accuracy (Specification^a)(Continued)

Accuracy of the test port input power reading relative to the reference input power level.

Note: If the power is set above maximum specified leveled power, the test port output signal may show non-linear effects that are dependent on the DUT.

Magnitude



Phase

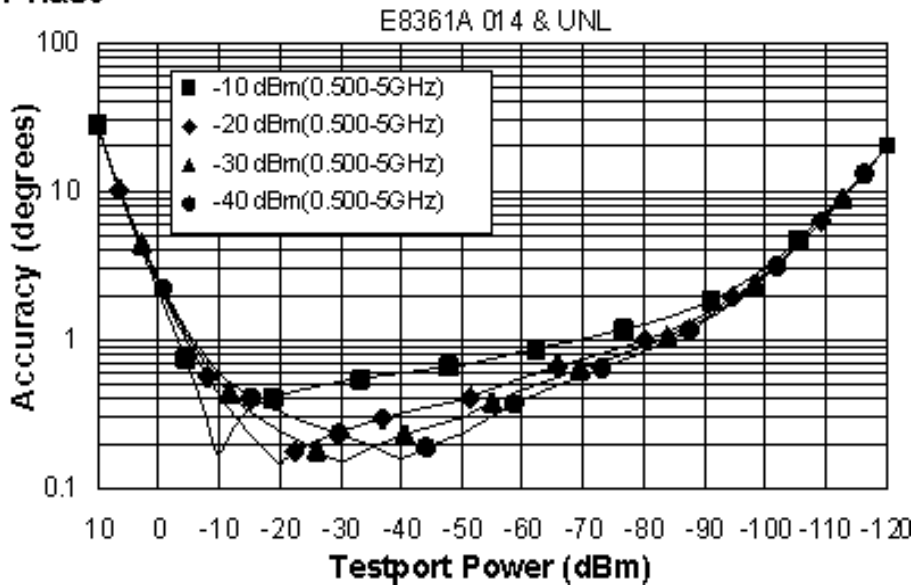
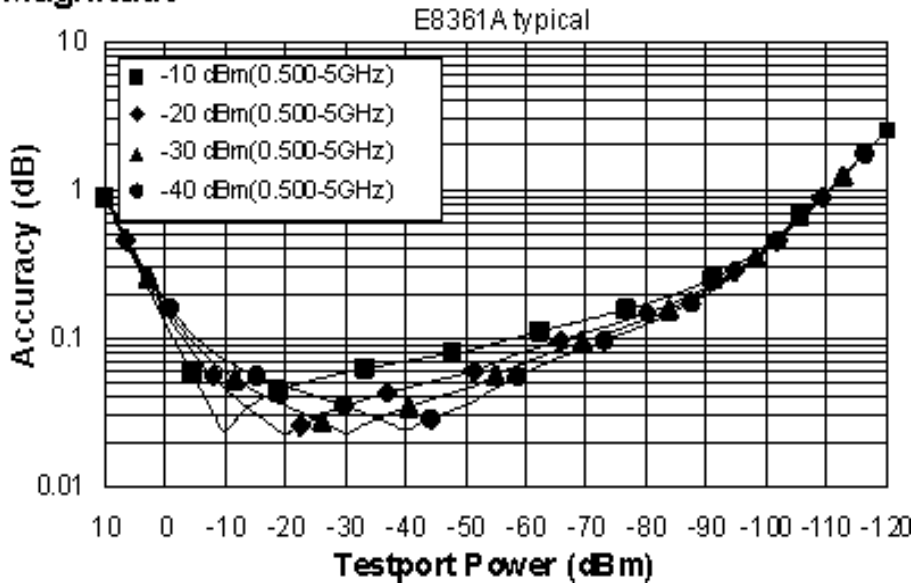

Table 13. Dynamic Accuracy (Specification^a)(Continued)

Accuracy of the test port input power reading relative to the reference input power level.

Note: If the power is set above maximum specified leveled power, the test port output signal may show non-linear effects that are dependent on the DUT.

Magnitude



Phase

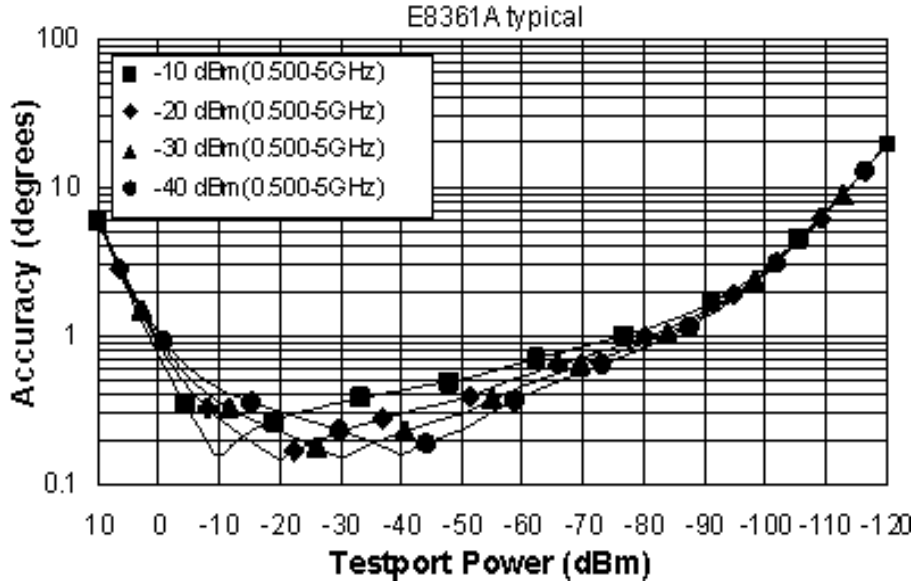

Table 13. Dynamic Accuracy (Specification^a)(Continued)

Accuracy of the test port input power reading relative to the reference input power level.

Note: If the power is set above maximum specified leveled power, the test port output signal may show non-linear effects that are dependent on the DUT.

Dynamic Accuracy, 5 - 30 GHz

Magnitude

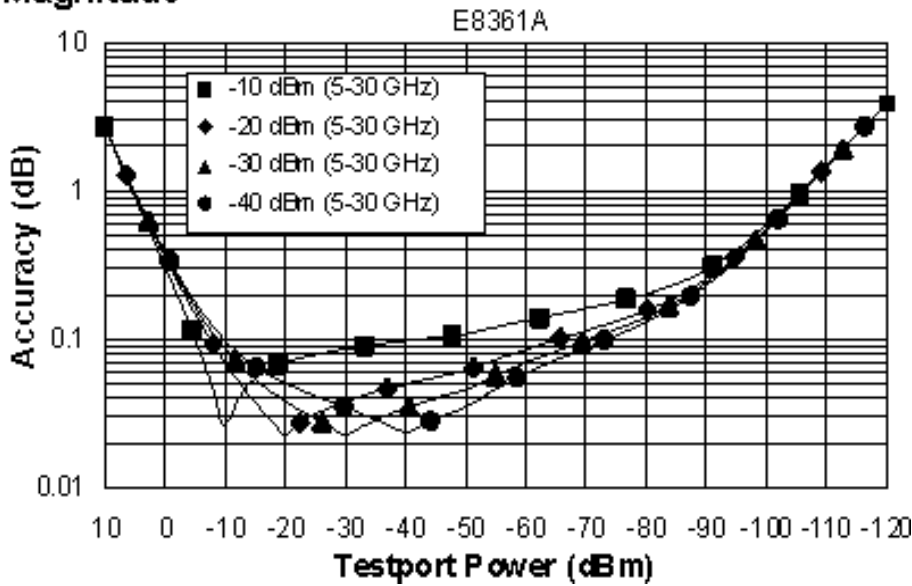

Phase

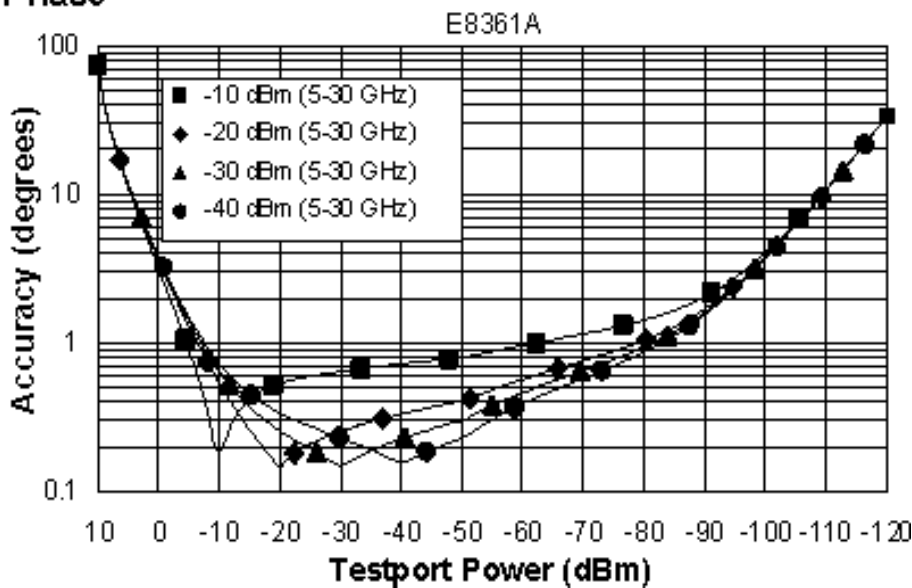
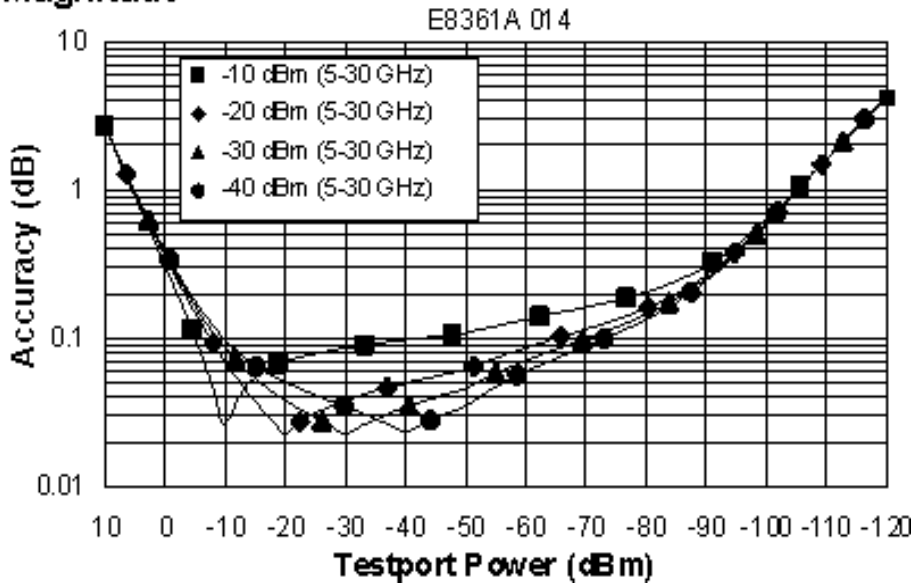

Table 13. Dynamic Accuracy (Specification^a)(Continued)

Accuracy of the test port input power reading relative to the reference input power level.

Note: If the power is set above maximum specified leveled power, the test port output signal may show non-linear effects that are dependent on the DUT.

Magnitude



Phase

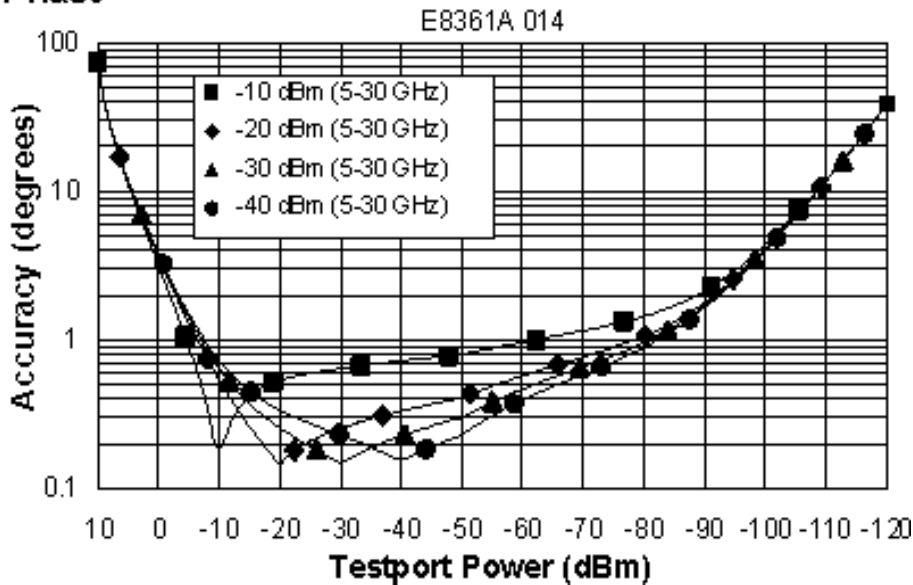
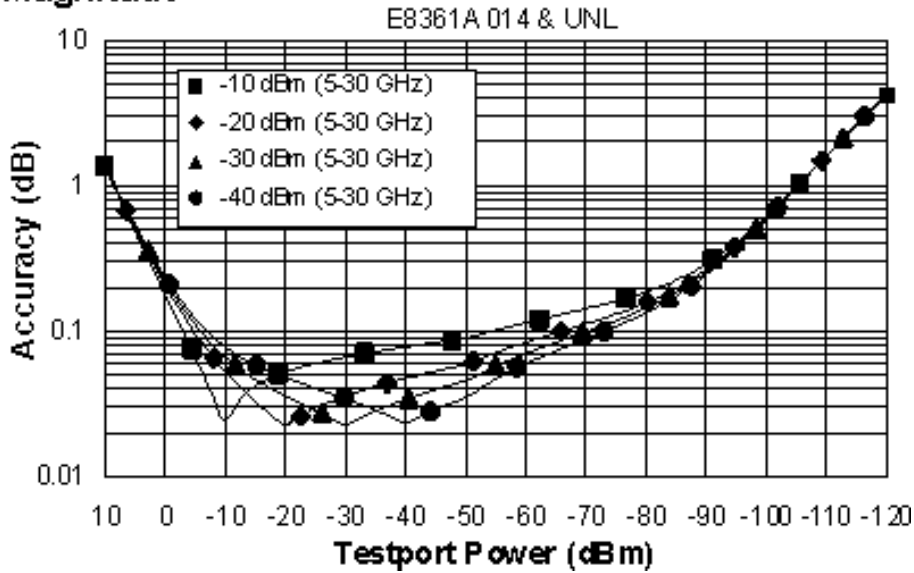

Table 13. Dynamic Accuracy (Specification^a)(Continued)

Accuracy of the test port input power reading relative to the reference input power level.

Note: If the power is set above maximum specified leveled power, the test port output signal may show non-linear effects that are dependent on the DUT.

Magnitude



Phase

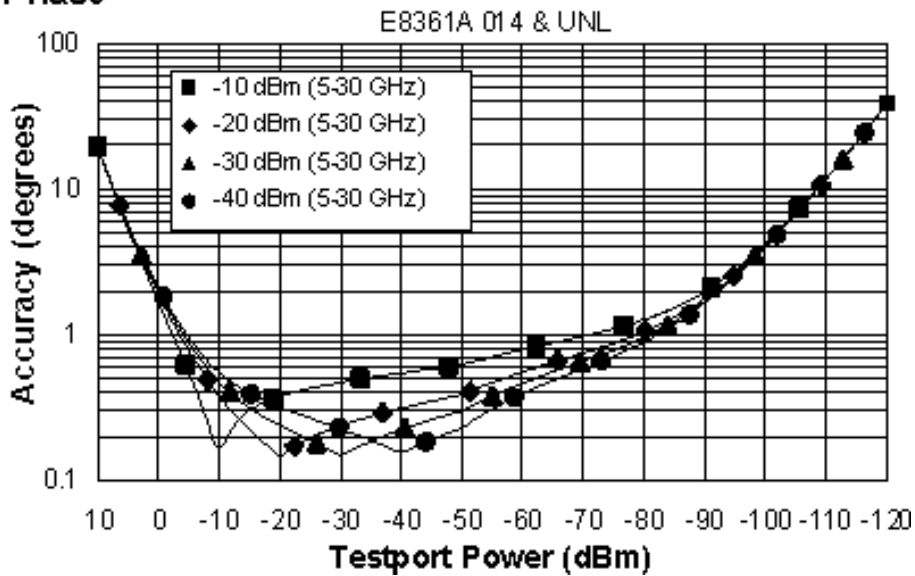
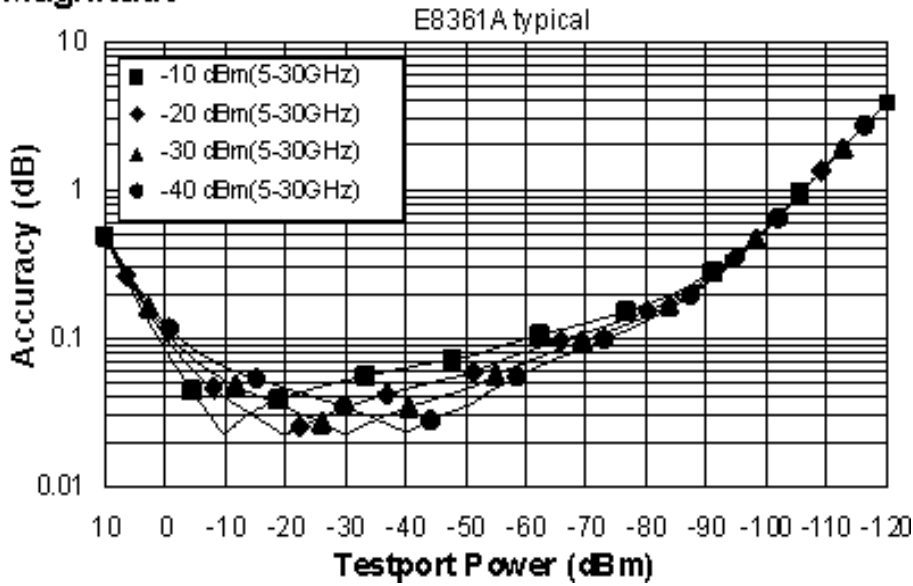

Table 13. Dynamic Accuracy (Specification^a)(Continued)

Accuracy of the test port input power reading relative to the reference input power level.

Note: If the power is set above maximum specified leveled power, the test port output signal may show non-linear effects that are dependent on the DUT.

Magnitude



Phase

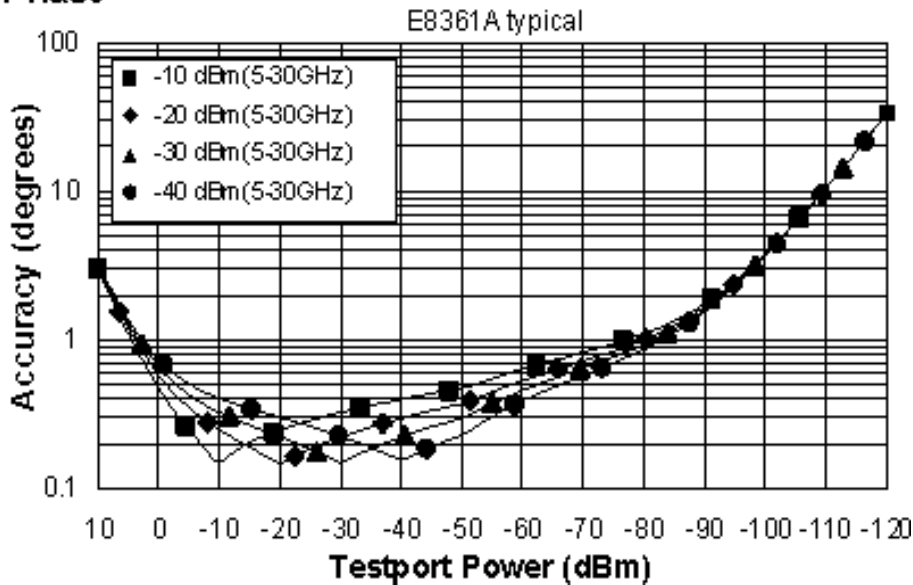

Table 13. Dynamic Accuracy (Specification^a)(Continued)

Accuracy of the test port input power reading relative to the reference input power level.

Note: If the power is set above maximum specified leveled power, the test port output signal may show non-linear effects that are dependent on the DUT.

Dynamic Accuracy, 30 - 67 GHz

Magnitude

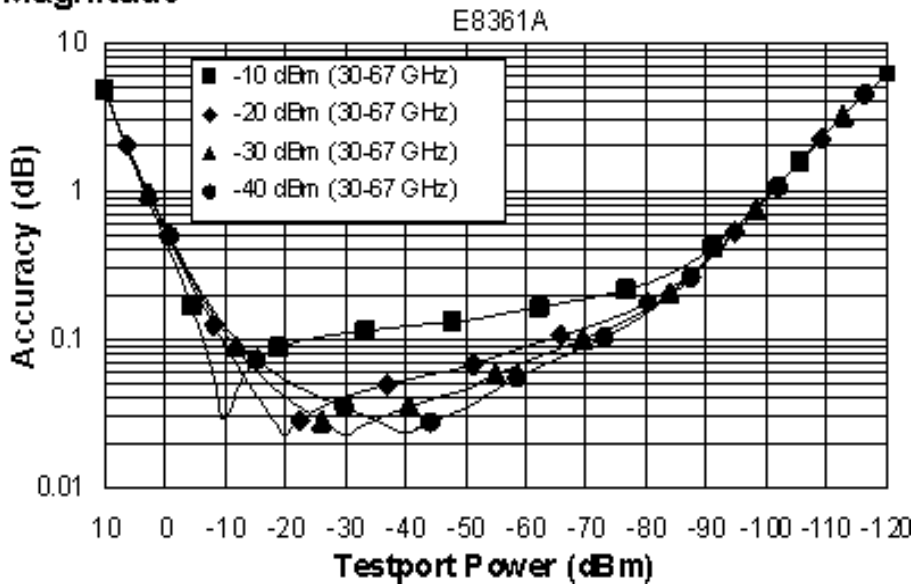

Phase

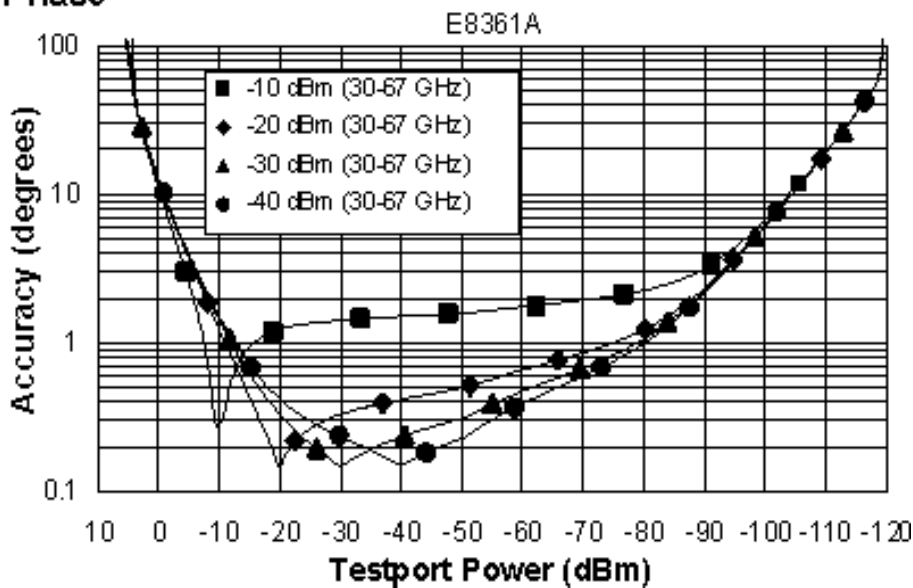
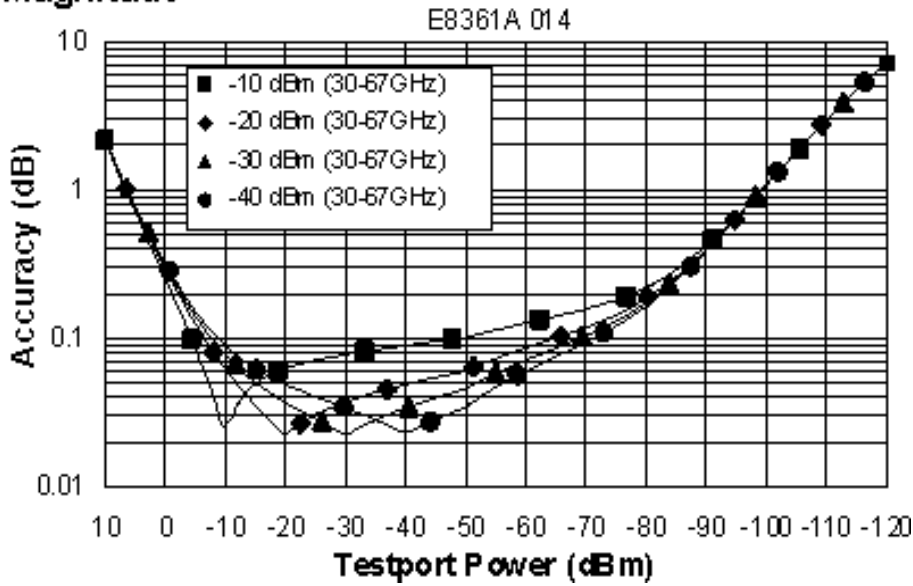

Table 13. Dynamic Accuracy (Specification^a)(Continued)

Accuracy of the test port input power reading relative to the reference input power level.

Note: If the power is set above maximum specified leveled power, the test port output signal may show non-linear effects that are dependent on the DUT.

Magnitude



Phase

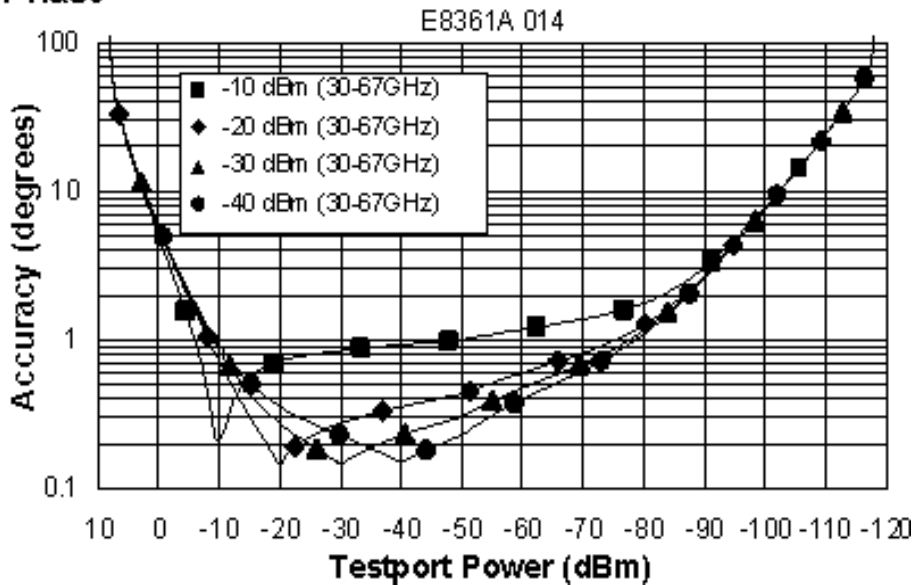
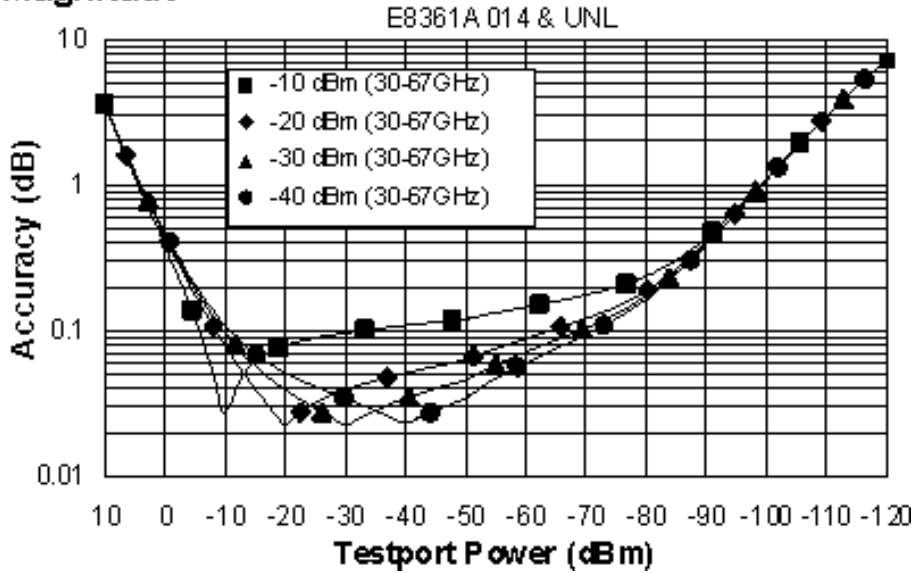

Table 13. Dynamic Accuracy (Specification^a)(Continued)

Accuracy of the test port input power reading relative to the reference input power level.

Note: If the power is set above maximum specified leveled power, the test port output signal may show non-linear effects that are dependent on the DUT.

Magnitude



Phase

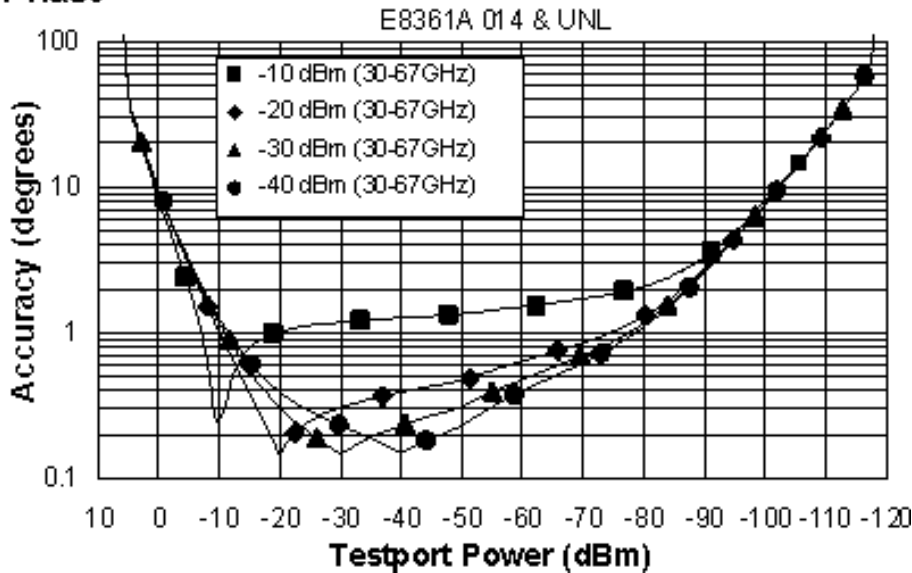
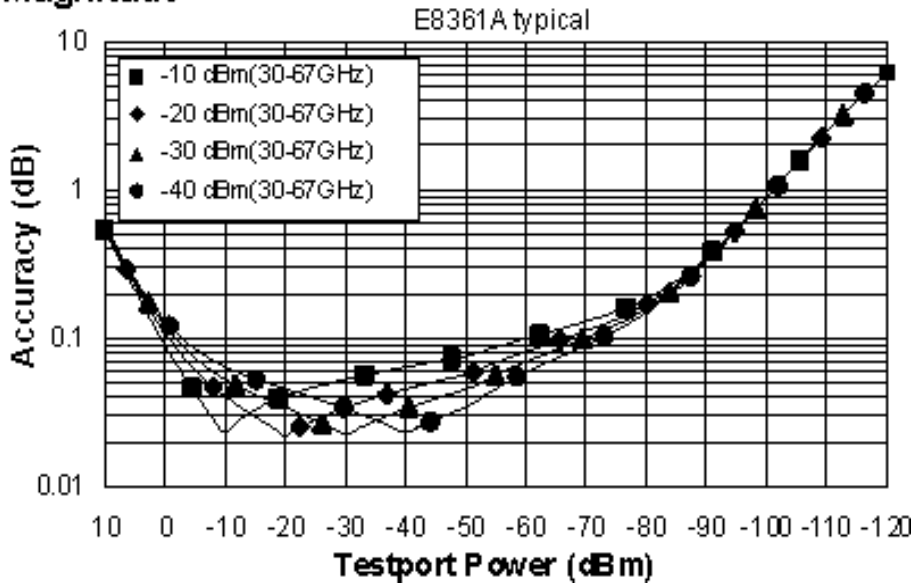

Table 13. Dynamic Accuracy (Specification^a)(Continued)

Accuracy of the test port input power reading relative to the reference input power level.

Note: If the power is set above maximum specified leveled power, the test port output signal may show non-linear effects that are dependent on the DUT.

Magnitude



Phase

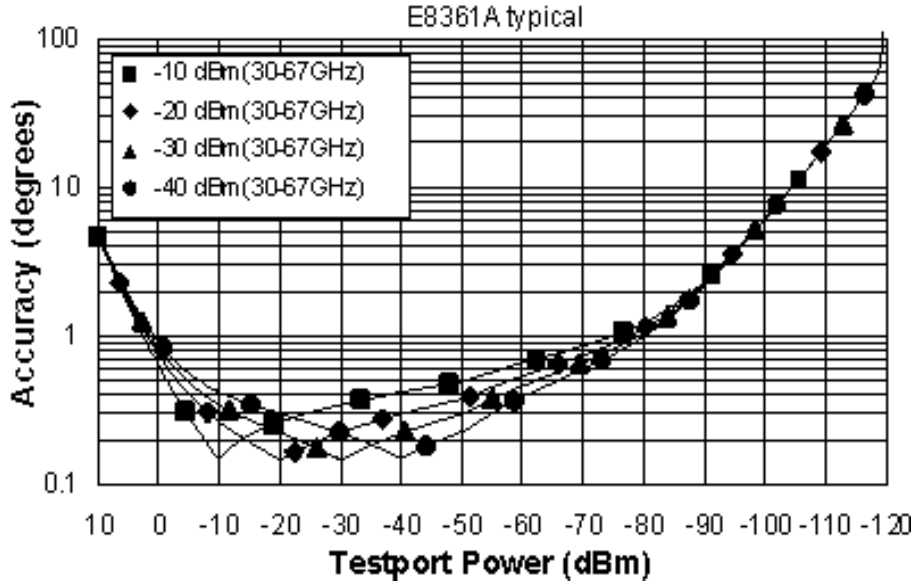

Table 13. Dynamic Accuracy (Specification^a)(Continued)

Accuracy of the test port input power reading relative to the reference input power level.

Note: If the power is set above maximum specified leveled power, the test port output signal may show non-linear effects that are dependent on the DUT.

Dynamic Accuracy, 67 - 70 GHz

Magnitude

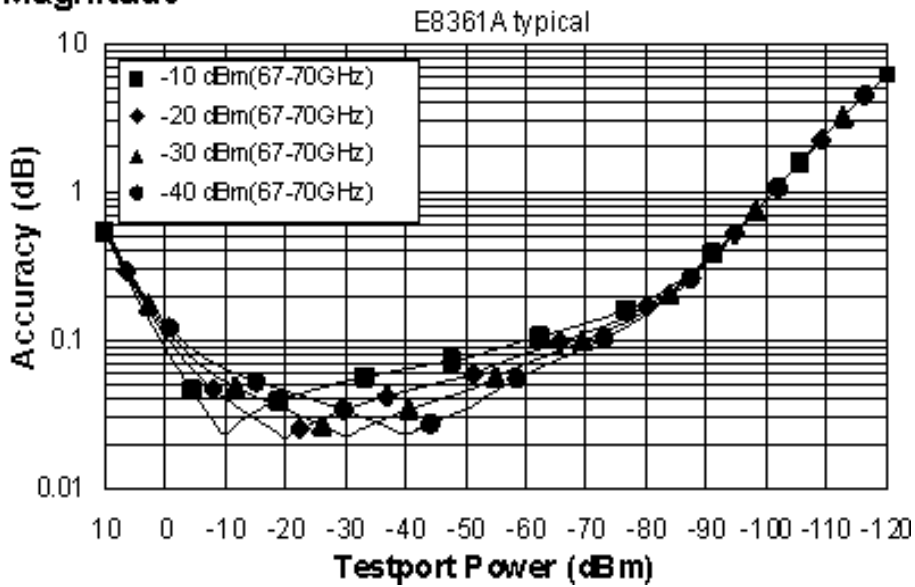

Phase

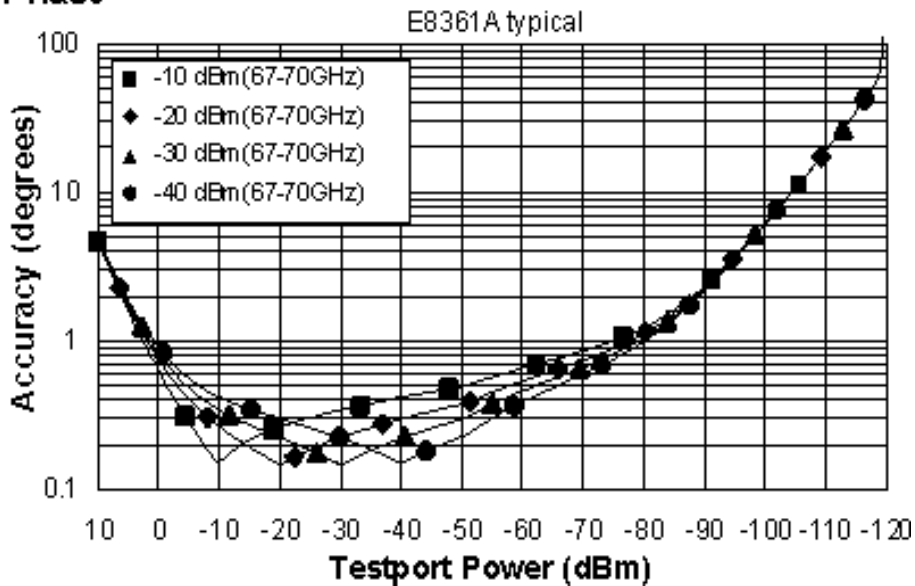

^a Dynamic accuracy is verified with the following measurements:

- compression over frequency
- IF linearity at a single frequency of 1.195 GHz and a reference level of -20 dBm for an input power range of 0 to -120 dBm.

Table 14. Test Port Input (Group Delay)^a

Description	Specification	Supplemental Information (typ.)
Aperture (selectable)	--	(frequency span)/(number of points - 1)
Maximum Aperture	--	20% of frequency span
Range	--	0.5 x (1/minimum aperture)
Maximum Delay	--	Limited to measuring no more than 180° of phase change within the minimum aperture.)
Accuracy	--	See graph below. Char.

The following graph shows characteristic group delay accuracy with full 2-port calibration and a 10 Hz IF bandwidth. Insertion loss is assumed to be < 2 dB and electrical length to be ten meters.

NOTE: The following graph also applies to the “C” model of the analyzer.

Group Delay (Typical)

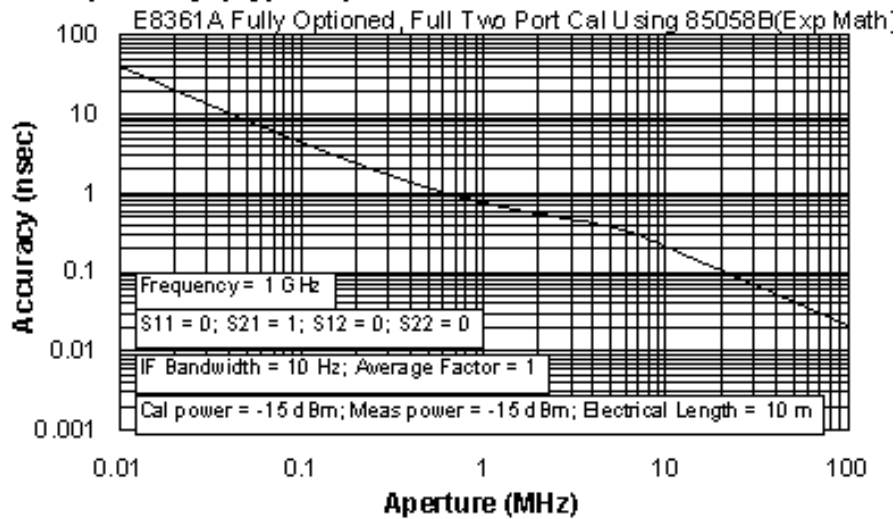

In general, the following formula can be used to determine the accuracy, in seconds, of specific group delay measurement:

$$\pm \text{Phase Accuracy (deg)} / [360 \times \text{Aperture (Hz)}]$$

Depending on the aperture and device length, the phase accuracy used is either incremental phase accuracy or worst case phase accuracy.

^a Group delay is computed by measuring the phase change within a specified frequency step (determined by the frequency span and the number of points per sweep).

General Information

Table 15. Miscellaneous Information

Description	Specification	Supplemental Information
System IF Bandwidth Range		1 Hz to 40 kHz, nominal
CPU	--	Intel® 1.1 GHz Pentium® M with 1 GByte RAM

Table 16. Front Panel Information

Description	Supplemental Information
RF Connectors	
E8361A/C	
Type	1.85 mm (male), 50 ohm, (nominal)
Center Pin Recession	0.002 in. (characteristic)
Display	
NOTE: The PNA display must remain in the 16 bit color setting in order to comply with international emissions regulations.	
Size	21.3 cm (8.4 in) diagonal color active matrix LCD; 640 (horizontal) X 480 (vertical) resolution
Refresh Rate	Vertical 59.83 Hz; Horizontal 31.41 kHz
Pixels	<p>A display is considered faulty if:</p> <ul style="list-style-type: none"> • A complete row or column consists of “stuck” or “dark” pixels. • More than six “stuck on” pixels (but not more than three green) or more than 0.002% of the total pixels are within the LCD specifications. • More than twelve “dark” pixels (but no more than seven of the same color) or more than 0.004% of the total pixels are within the LCD specifications. • Two or more consecutive "stuck on" pixels or three or more consecutive "dark" pixel (but no more than one set of two consecutive dark pixels) • “Stuck on” “dark” pixels are less than 6.5 mm apart (excluding consecutive pixels)
Display Range	
Magnitude	±200 dB (at 20 dB/div), max
Phase	±500°, max
Polar	10 pUnits, min 1000 Units, max
Display Resolution	
Magnitude	0.001 dB/div, min
Phase	0.01°/div, min
Marker Resolution	
Magnitude	0.001 dB, min
Phase	0.01°, min
Polar	0.01 mUnit, min; 0.01°, min

Table 17. Rear Panel Information

Description	Supplemental Information
Trigger Inputs/Outputs	BNC(f), TTL/CMOS compatible
10 MHz Reference In	
Connector	BNC, female
Input Frequency	10 MHz ± 10 ppm, typical
Input Level	-15 dBm to +20 dBm, typical
Input Impedance	200 Ω, nom.

10 MHz Reference Out	
Connector	BNC, female
Output Frequency	10 MHz \pm 1 ppm, typical
Signal Type	Sine Wave, typical
Output Level	+10 dBm \pm 4 dB into 50 Ω , typical
Output Impedance	50 Ω , nominal
Harmonics	<-40 dBc, typical

Table 17. Rear Panel Information (Continued)

Description	Supplemental Information
Option H08 & H11 Rear Panel Connectors (typical)	
IF Connectors	A, R1, R2, B (BNC Connectors)
IF Connector Input Frequency	8 1/3 MHz
Nominal Input Impedance at IF Inputs	50 Ω
RF Damage Level to IF Connector Inputs	-20.0 dBm
DC Damage Level to IF Connector Inputs	25 volts
0.1 dB Compression Point at IF Inputs	-27.0 dBm
Pulse Input Connectors ¹	A, R1, R2, B (BNC Connectors)
Nominal Input Impedance at Pulse Inputs	1 Kohm
Minimum IF Gate Width	20 ns for less than 1 dB deviation from theoretical performance ² .
DC Damage Level to Pulse Connector Inputs	5.5 volts
Drive Voltage	TTL (0, +5.0) Volts
Rear Panel LO Power - Test Port Frequency	
1.7 GHz to 20 GHz	-7 to -16 dBm
Rear Panel RF Power - Test Port Frequencies	
1.7 GHz to 20 GHz	-2 to -12 dBm (at -5 dBm test port power ³)
10 GHz to 16 GHz	0 to -8 dBm (at -5 dBm test port power ³)
16 GHz to 20 GHz	+5 to -1 dBm (at -5 dBm test port power ³)
VGA Video Output	
Connector	15-pin mini D-Sub; Drives VGA compatible monitors
Devices Supported:	
	Resolutions:
Flat Panel (TFT)	1024 X 768, 800 X 600, 640 X 480
Flat Panel (DSTN)	800 X 600, 640 X 480
CRT Monitor	1280 X 1024, 1024 X 768, 800 X 600, 640 X 480
	Simultaneous operation of the internal and external displays is allowed, but with 640 X 480 resolution only. If you change resolution, you can only view the external display (internal display will "white out").

Bias Tee Input Connectors (Option UNL)	
Connectors	BNC (f), for port 1 and port 2
Fuse	500 mA, bi-pin style
Maximum bias current	+/-200 mA with no degradation of RF specifications
Maximum bias voltage	+/-40 Volts DC
Test Set IO	
	25-pin D-Sub connector, available for external test set control
Aux IO	
	25-pin D-Sub connector, male, analog and digital IO
Handler IO	
	36-pin parallel I/O port; all input/output signals are default set to negative logic; can be reset to positive logic via GPIB command
GPIB	
	24-pin D-sub (Type D-24), female; compatible with IEEE-488.
Description	
	Supplemental Information
Parallel Port (LPT1)	
	25-pin D-Sub miniature connector, female; provides connection to printers or any other parallel port peripherals
Serial Port (COM 1)	
	9-pin D-Sub, male; compatible with RS-232
USB Port	
	One port on front panel and five ports on rear panel. Universal Serial Bus jack, Type A configuration (4 contacts inline, contact 1 on left); female
Contact 1	Vcc: 4.75 to 5.25 VDC, 500 mA, maximum
Contact 2	-Data
Contact 3	+Data
Contact 4	Ground
LAN	
	10/100BaseT Ethernet, 8-pin configuration; auto selects between the two data rates
Line Power³	
Frequency, Voltage	50/60/400 Hz for 100 – 120 V 50/60 Hz for 220 – 240 V Power supply is auto switching
Max	350 W

¹ Pulse input connectors are operational only with Option H08 (Pulse Measurement Capability) enabled.

² Based on deviation from signal reduction equation: Signal Reduction (dB) = $20\log_{10}(\text{Duty_cycle}) = 20\log_{10}(\text{pulse_width/period})$. Measured at Pulse Repetition Frequency (PRF) of 1 MHz.

³ Test port power has to be at a high enough level such that the “Drop Cal” does not occur. If Drop Cal occurs then the power out of the rear panel RF connector will drop by about 15 dB.

³ A third-wire ground is required.

Table 18. Analyzer Dimensions and Weight

Description	Supplemental Information		
Cabinet Dimensions			
	Height	Width	Depth
Excluding front and rear panel hardware and feet	267 mm 10.5 in	426 mm 16.75 in	427 mm 16.8 in
As shipped - includes front panel connectors, rear panel bumpers, and feet.	280 mm 11.0 in	435 mm 17.1 in	470 mm 18.5 in
As shipped plus handles	280 mm 11.0 in	458 mm 18 in	501 mm 19.7 in
As shipped plus rack-mount flanges	280 mm 11.0 in	483 mm 19 in	470 mm 18.5 in
As shipped plus handles and rack-mount flanges	280 mm 11.0 in	483 mm 19 in	501 mm 19.7 in
Weight			
Net			
E8361A/C	29 kg (64 lb), nominal		
Shipping			
E8361A/C	36.3 kg (80 lb), nominal		

Note: For Regulatory and Environmental information, refer to the PNA Series Installation and Quick Start Guide, located online at <http://cp.literature.agilent.com/litweb/pdf/E8356-90001.pdf>.

Measurement Throughput Summary

Table 19 Typical Cycle Time^{a,b} (ms) for Measurement Completion

	Number of Points			
	201	401	1601	16,001
Start 28 GHz, Stop 30 GHz, 35 kHz IF bandwidth				
Uncorrected, 1-port cal	12	19	55	503
2-Port cal	29	44	124	1112
Start 10 MHz, Stop 10 GHz, 35 kHz IF bandwidth				
Uncorrected, 1-port cal	86	93	121	583
2-Port cal	179	199	267	1301
Start 10 MHz, Stop 20 GHz, 35 kHz IF bandwidth				
Uncorrected, 1-port cal	126	130	153	597
2-Port cal	264	275	335	1321
Start 10 MHz, Stop 40 GHz, 35 kHz IF bandwidth				
Uncorrected, 1-port cal	185	190	213	621
2-Port cal	382	401	459	1374
Start 10 MHz, Stop 50 GHz, 35 kHz IF bandwidth				
Uncorrected, 1-port cal	210	216	243	643
2-Port cal	436	450	522	1405
Start 10 MHz, Stop 67 GHz, 35 kHz IF bandwidth				
Uncorrected 1-port cal	244	254	300	645
2-Port cal	502	524	591	1423

^a Typical performance.

^b Includes sweep time, retrace time and band-crossing time. Analyzer display turned off with DISPLAY:ENABLE OFF. Add 21 ms for display on. Data for one trace (S11) measurement.

Table 20. Cycle Time vs IF Bandwidth^a

Applies to the Preset condition (201 points, correction off) except for the following changes:

- CF = 28 GHz
- Span = 100 MHz
- Display off (add 21 ms for display on)

IF Bandwidth (Hz)	Cycle Time (ms) ^b	Cycle Time (ms) Option 080 enabled
40,000	11	100
35,000	12	101
30,000	13	102
20,000	16	106
10,000	30	127
7000	38	138
5000	50	152
3000	74	182
1000	274	326
300	694	782
100	1905	2054
30	6091	6355
10	17916	18372

^a Typical performance.

^b Cycle time includes sweep and retrace time.

Table 21. Cycle Time vs Number of Points^a

Applies to the Preset condition (35 kHz IF bandwidth, correction off) except for the following changes:

- CF = 28 GHz
- Span = 100 MHz
- Display off (add 21 ms for display on)

Number of Points	Cycle Time (ms) ^b
3	6
11	6
51	7
101	9
201	12
401	18
801	30
1601	55
16,001	497

^a Typical performance.

^b Cycle time includes sweep and retrace time.

Table 22. Data Transfer Time (ms)^a

	Number of Points			
	201	401	1601	16,001
SCPI over GPIB				
(program executed on external PC)				
32-bit floating point	7	12	43	435
64-bit floating point	12	22	84	856
ASCII	64	124	489	5054
SCPI				
(program executed in the analyzer)				
32-bit floating point	1	2	3	30
64-bit floating point	2	2	4	40
ASCII	29	56	222	2220
COM (program executed in the analyzer)				
32-bit floating point	<0.4	0.4	0.5	1.9
Variant type	0.7	1	3	32
DCOM over LAN				
(program executed on external PC)				
32-bit floating point	<0.8	1	1.5	7.1
Variant type	1.8	2.7	8.5	80

^aTypical performance

Note: Specifications for Recall & Sweep Speed are not provided for the E8361A/C analyzers.

Front Panel Jumpers

Table 23: Measurement Receiver Inputs (Rcvr A In, Rcvr B In)

Description	Specification	Supplemental Information
Maximum Input Level		
E8361A/C:		
	--	typical:
10 MHz to 45 MHz	--	- 12 dBm
45 MHz to 500 MHz	--	- 12 dBm
500 MHz to 2 GHz	--	- 10 dBm
2 GHz to 5 GHz	--	- 10 dBm
5 GHz to 10 GHz	--	- 7 dBm
10 GHz to 24 GHz	--	- 7 dBm
24 GHz to 30 GHz	--	- 7 dBm
30 GHz to 40 GHz	--	- 8 dBm
40 GHz to 45 GHz	--	- 8 dBm
45 GHz to 50 GHz	--	- 8 dBm
50 GHz to 60 GHz	--	- 8 dBm
60 GHz to 67 GHz	--	- 8 dBm
67 GHz to 70 GHz	--	- 8 dBm
Damage Level		
E8361A/C	--	+ 15 dBm
Maximum DC Level		
E8361A/C	--	+ 7 V

Table 24: Reference Receiver Inputs (Rcvr R1, Rcvr R2)

Description	Specification	Supplemental Information	
Minimum Input Level			
E8361A/C	--	-25 dBm, typical	
Maximum Input Level			
E8361A/C:			
			Rcvr R1 with Option 081
		typical:	
10 MHz to 45 MHz	--	- 10 dBm	- 5.5 dBm
45 MHz to 500 MHz	--	- 9.5 dBm	- 5.0 dBm
500 MHz to 2 GHz	--	- 9 dBm	- 4.0 dBm
2 GHz to 5 GHz	--	- 7.5 dBm	- 2.0 dBm
5 GHz to 10 GHz	--	- 2.5 dBm	3.0 dBm
10 GHz to 24 GHz	--	- 1.5 dBm	4.5 dBm
24 GHz to 30 GHz	--	- 0.50 dBm	5.5 dBm
30 GHz to 40 GHz	--	- 1 dBm	5.5 dBm
40 GHz to 45 GHz	--	- 0.5 dBm	6.5 dBm
45 GHz to 50 GHz	--	0 dBm	7.0 dBm
50 GHz to 60 GHz	--	0.5 dBm	7.50 dBm
60 GHz to 67 GHz	--	1.00 dBm	9.00 dBm
67 GHz to 70 GHz	--	1.50 dBm	10.50 dBm
Damage Level			
E8361A/C	--	+ 15 dBm	
Maximum DC Level			
E8361A/C	--	+/- 15 V	

Table 25: Reference Outputs (Reference 1 Source Out, Reference 2 Source Out)

Description	Specification	Supplemental Information		
Maximum Output Level				
E8361A/C:				
			Option 014 & UNL	
			Rcvr R1 with Option 081	Without Option 081
		typical:		
10 MHz to 45 MHz	--	- 43 dBm	- 38.5 dBm	- 43 dBm
45 MHz to 500 MHz	--	- 17.5 dBm	- 13 dBm	- 17.5 dBm
500 MHz to 2 GHz	--	- 12.5 dBm	- 8.5 dBm	- 13.5 dBm
2 GHz to 5 GHz	--	- 10.5 dBm	- 6 dBm	- 11.5 dBm
5 GHz to 10 GHz	--	- 10.5 dBm	- 6 dBm	- 11.5 dBm
10 GHz to 24 GHz	--	- 9.5 dBm	- 6.5 dBm	- 12.5 dBm
24 GHz to 30 GHz	--	- 9 dBm	- 6 dBm	- 12.0 dBm
30 GHz to 40 GHz	--	- 9.5 dBm	- 6 dBm	- 12.5 dBm
40 GHz to 45 GHz	--	- 13 dBm	- 10 dBm	- 17 dBm
45 GHz to 50 GHz	--	- 8.5 dBm	- 5.5 dBm	- 12.5 dBm
50 GHz to 60 GHz	--	- 9 dBm	- 6 dBm	- 13 dBm
60 GHz to 67 GHz	--	- 10.5 dBm	- 8.5 dBm	- 16.5 dBm
67 GHz to 70 GHz	--	- 9 dBm	- 6 dBm	- 15 dBm
Damage Level				
E8361A/C	--	+ 15 dBm		
Maximum DC Level				
E8361A/C	--	+/- 15 V		

Table 26: Source Outputs (Port 1 Source Out, Port 2 Source Out)

Description	Specification		Supplemental Information
Maximum Output Level			
E8361A/C			
			Option 014 & UNL
		typical:	
10 MHz to 45 MHz	--	-6.5 dBm	- 5 dBm
45 MHz to 500 MHz	--	-2.5 dBm	- 1 dBm
500 MHz to 2 GHz	--	-1 dBm	1.5 dBm
2 GHz to 5 GHz	--	-1.5 dBm	2.5 dBm
5 GHz to 10 GHz	--	-1.5 dBm	2.5 dBm
10 GHz to 24 GHz	--	-2 dBm	2 dBm
24 GHz to 30 GHz	--	-3 dBm	3 dBm
30 GHz to 40 GHz	--	-1 dBm	1.5 dBm
40 GHz to 45 GHz	--	-2.5 dBm	- 3.5 dBm
45 GHz to 50 GHz	--	-2 dBm	1 dBm
50 GHz to 60 GHz	--	0 dBm	- 0.5 dBm
60 GHz to 67 GHz	--	-2 dBm	- 4.5 dBm
67 GHz to 70 GHz	--	-0.5 dBm	- 1 dBm
Damage Level			
E8361A/C	--	27 dBm	
Maximum DC Level			
E8361A/C	--	+/- 5 V	

Table 27: Coupler Inputs (Port 1 Cplr Thru, Port 2 Cplr Thru)

Description	Specification		Supplemental Information
Insertion Loss to Test Port			
E8361A/C			
			Option 014 & UNL
		typical:	
10 MHz to 45 MHz	--	0.5 dB	2 dB
45 MHz to 500 MHz	--	0.5 dB	0.5 dB
500 MHz to 2 GHz	--	0.5 dB	0.5 dB
2 GHz to 5 GHz	--	1.5 dB	0.5 dB
5 GHz to 10 GHz	--	1.5 dB	0.5 dB
10 GHz to 24 GHz	--	2 dB	1 dB
24 GHz to 30 GHz	--	2.5 dB	1 dB
30 GHz to 40 GHz	--	3 dB	1 dB
40 GHz to 45 GHz	--	3 dB	1 dB
45 GHz to 50 GHz	--	3.5 dB	1 dB
50 GHz to 60 GHz	--	4 dB	1.5 dB
60 GHz to 67 GHz	--	4.5 dB	2.00 dB
67 GHz to 70 GHz	--	6 dB	3.50 dB
Damage Level			
E8361A/C	--	+ 27 dBm	
Maximum DC Level			
E8361A/C	--	+/- 40 V	

Table 28: Coupler Outputs (Port 1 Cplr Arm, Port 2 Cplr Arm)

Description	Specification	Supplemental Information
Damage Level		
E8361A/C	--	+ 30 dBm
Maximum DC Level		
E8361A/C	--	+/- 7 V

Test Set Block Diagrams

E8361A/C - Standard Configuration and Standard Power Range

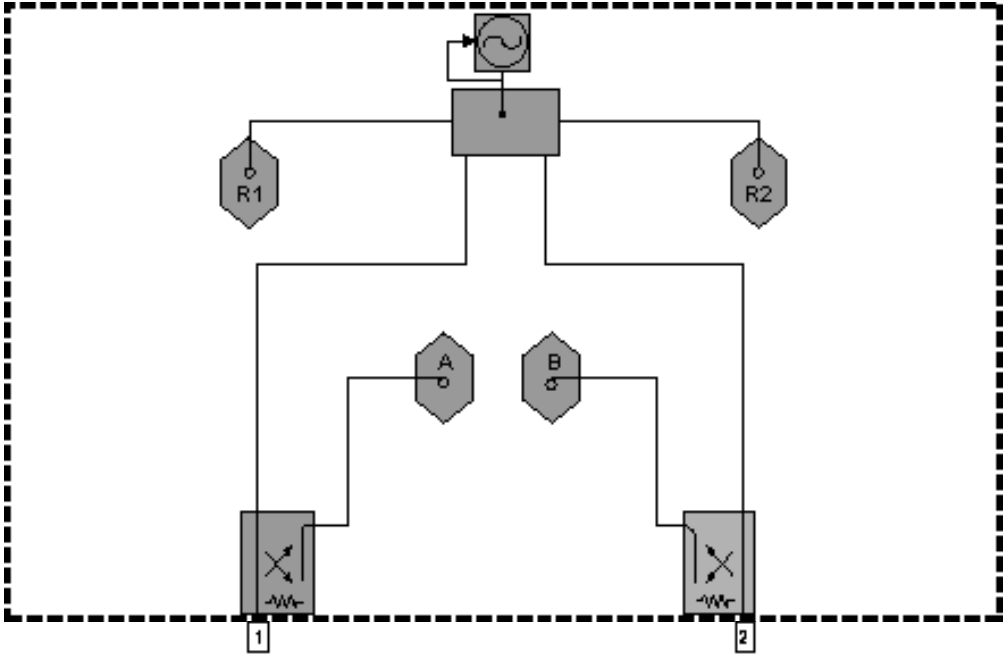

E8361A/C - Option UNL Standard Configuration with Extended Power Range and Bias - Tees

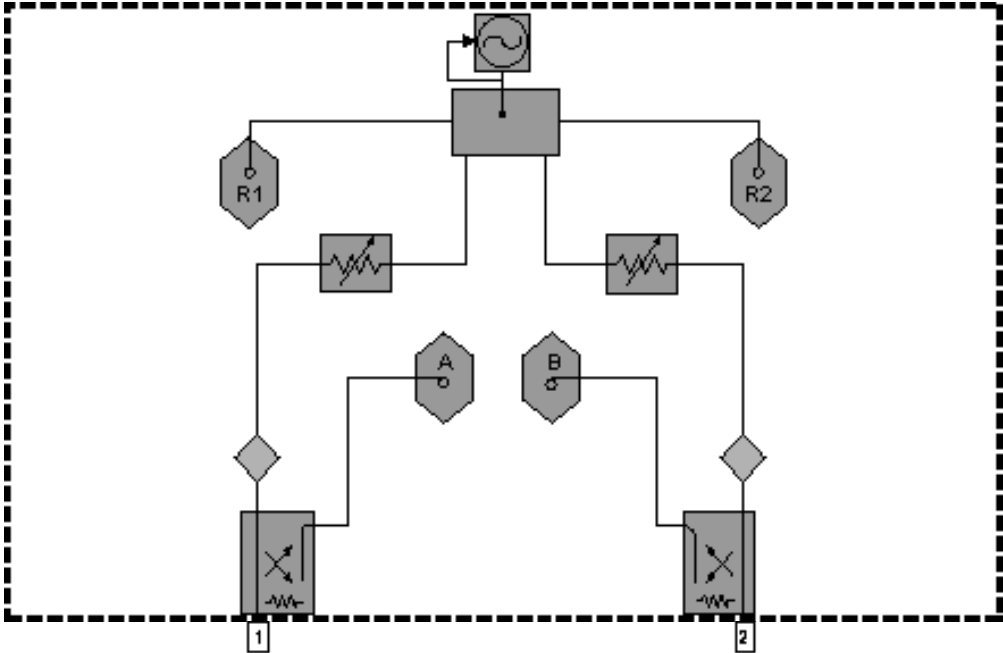

E8361A/C - Option UNL Standard Configuration with Extended Power Range and Bias - Tees, and Option 016, Receiver Attenuators

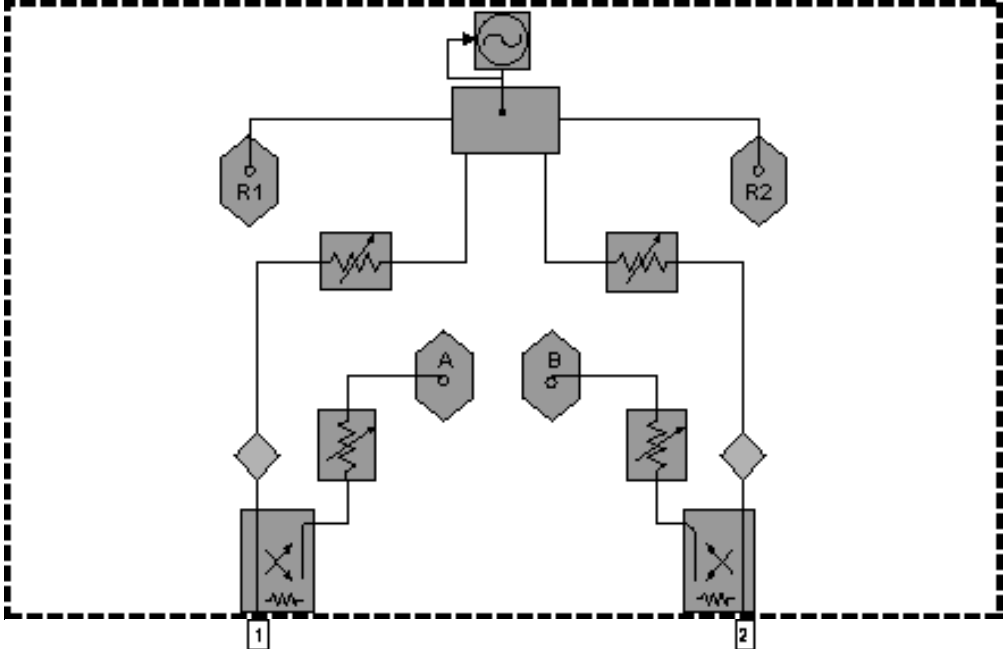

Test Set with Option 014 Block Diagrams

E8361A/C - Option 014 Configurable Test Set and Standard Power Range

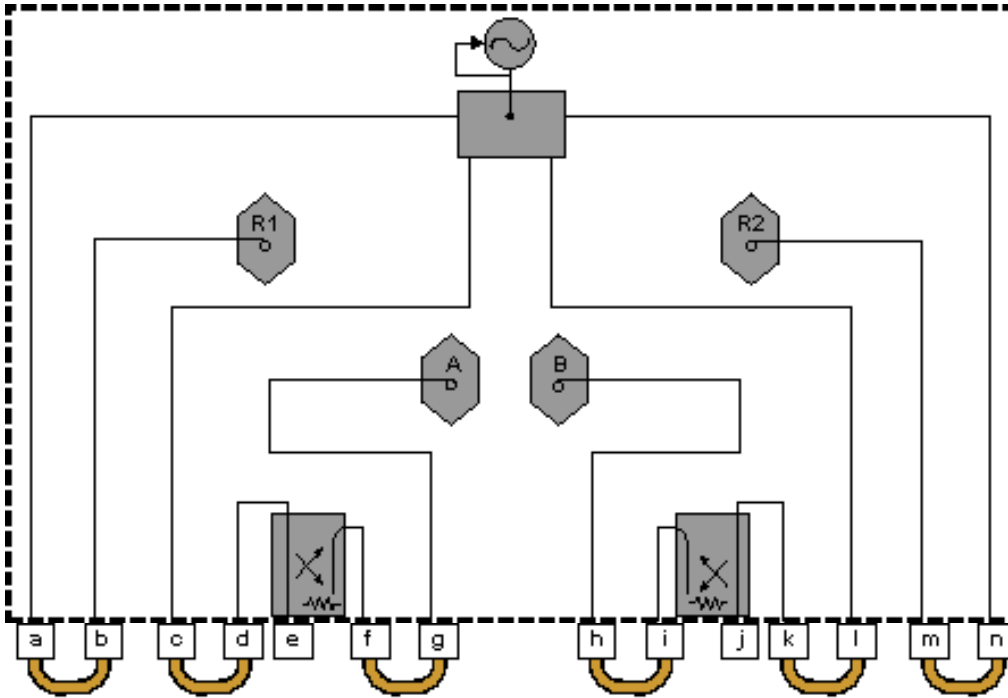

Item	Description	Item	Description
a	SOURCE OUT	h	RCVR B IN
b	RCVR R1 IN	i	CPLR ARM
c	SOURCE OUT	j	PORT 2
d	CPLR THRU	k	CPLR THRU
e	PORT 1	l	SOURCE OUT
f	CPLR ARM	m	RCVR R2 IN
g	RCVR A IN	n	SOURCE OUT

E8361A/C - Option 014 Configurable Test Set and Standard Power Range, and Option 081 Reference Channel Transfer Switch

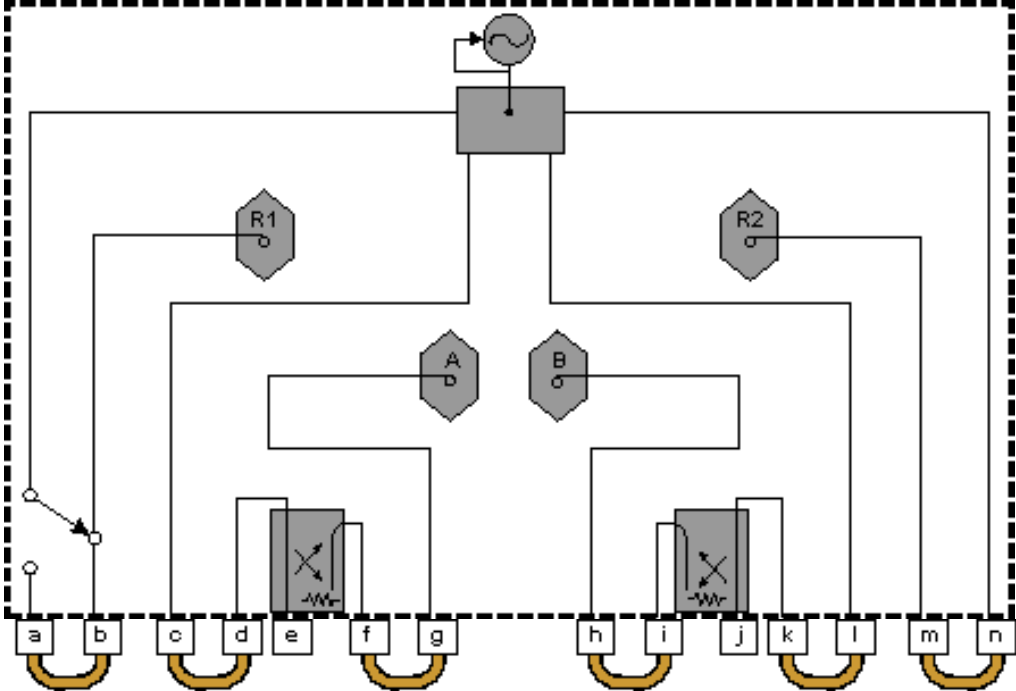

Item	Description	Item	Description
a	SOURCE OUT	h	RCVR B IN
b	RCVR R1 IN	i	CPLR ARM
c	SOURCE OUT	j	PORT 2
d	CPLR THRU	k	CPLR THRU
e	PORT 1	l	SOURCE OUT
f	CPLR ARM	m	RCVR R2 IN
g	RCVR A IN	n	SOURCE OUT

E8361A/C - Option 014 Configurable Test Set, and Option UNL Extended Power Range and Bias - Tees

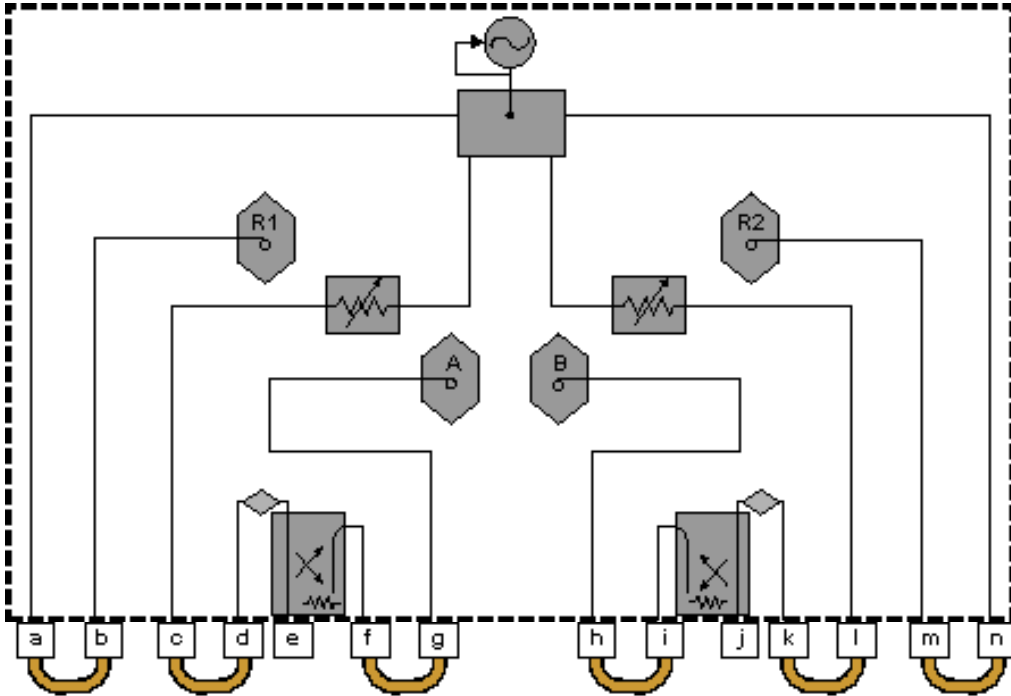

Item	Description	Item	Description
a	SOURCE OUT	h	RCVR B IN
b	RCVR R1 IN	i	CPLR ARM
c	SOURCE OUT	j	PORT 2
d	CPLR THRU	k	CPLR THRU
e	PORT 1	l	SOURCE OUT
f	CPLR ARM	m	RCVR R2 IN
g	RCVR A IN	n	SOURCE OUT

E8361A/C - Option 014 Configurable Test Set, and Option UNL Extended Power Range and Bias - Tees, and Option 081 Reference Channel Transfer Switch

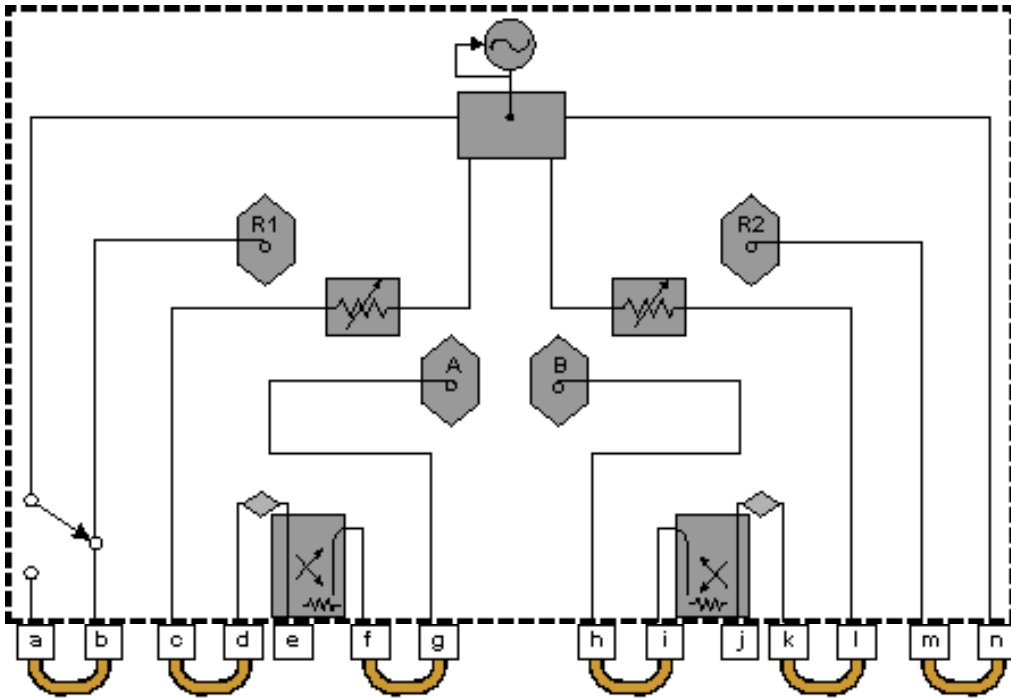

Item	Description	Item	Description
a	SOURCE OUT	h	RCVR B IN
b	RCVR R1 IN	i	CPLR ARM
c	SOURCE OUT	j	PORT 2
d	CPLR THRU	k	CPLR THRU
e	PORT 1	l	SOURCE OUT
f	CPLR ARM	m	RCVR R2 IN
g	RCVR A IN	n	SOURCE OUT

E8361A/C - Option 014 Configurable Test Set and Option UNL, Extended Power Range and Bias - Tees and Option 016 Receiver Attenuators

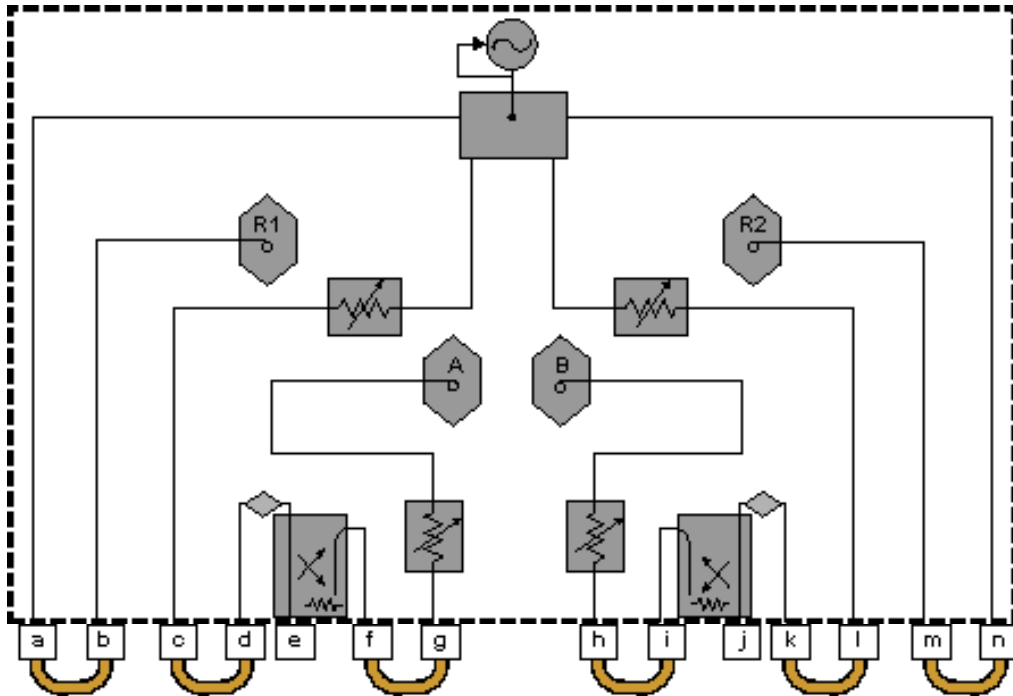

Item	Description	Item	Description
a	SOURCE OUT	h	RCVR B IN
b	RCVR R1 IN	i	CPLR ARM
c	SOURCE OUT	j	PORT 2
d	CPLR THRU	k	CPLR THRU
e	PORT 1	l	SOURCE OUT
f	CPLR ARM	m	RCVR R2 IN
g	RCVR A IN	n	SOURCE OUT

E8361A/C - Option 014 Configurable Test Set, and Option UNL Extended Power Range and Bias - Tees, and Option 016 Receiver Attenuators, and Option 081 Reference Channel Transfer Switch

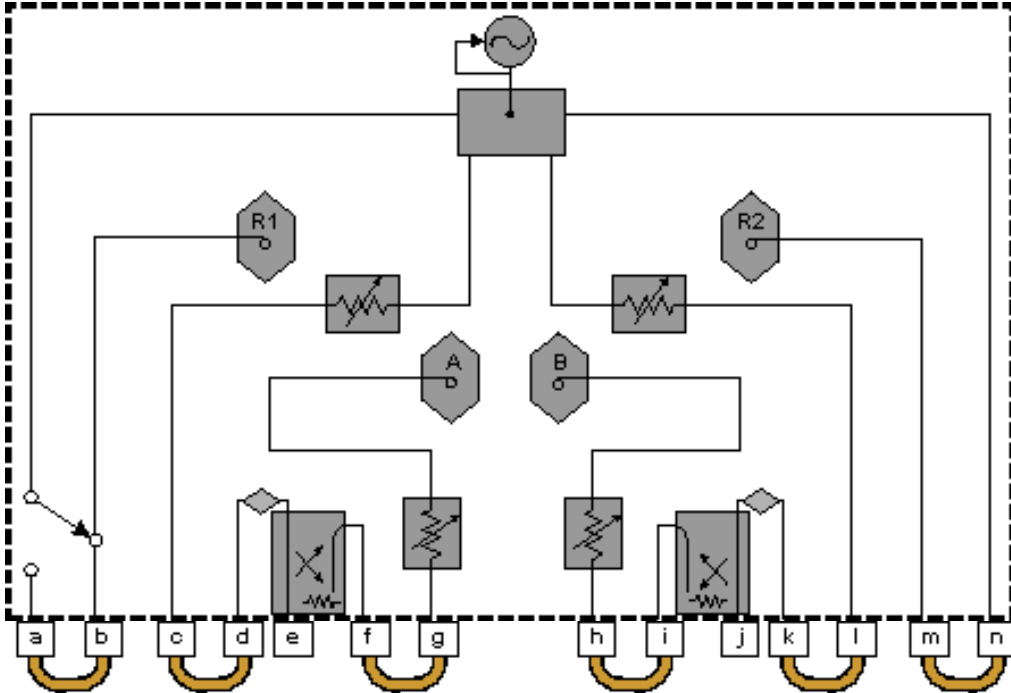

Item	Description	Item	Description
a	SOURCE OUT	h	RCVR B IN
b	RCVR R1 IN	i	CPLR ARM
c	SOURCE OUT	j	PORT 2
d	CPLR THRU	k	CPLR THRU
e	PORT 1	l	SOURCE OUT
f	CPLR ARM	m	RCVR R2 IN
g	RCVR A IN	n	SOURCE OUT