

# Agilent PNA Series RF Network Analyzers

Data Sheet

## Discontinued Product Information — For Support Reference Only —

Information herein, may refer to products/services no longer supported. We regret any inconvenience caused by obsolete information. For the latest information on Agilent's test and measurement products go to: [www.agilent.com/find/products](http://www.agilent.com/find/products)

**In the US, call Agilent Technologies at 1-800-829-4444**  
(any weekday between 8am–5pm in any U.S. time zone)

World-wide Agilent sales office contact information is available at: [www.agilent.com/find/contactus](http://www.agilent.com/find/contactus)

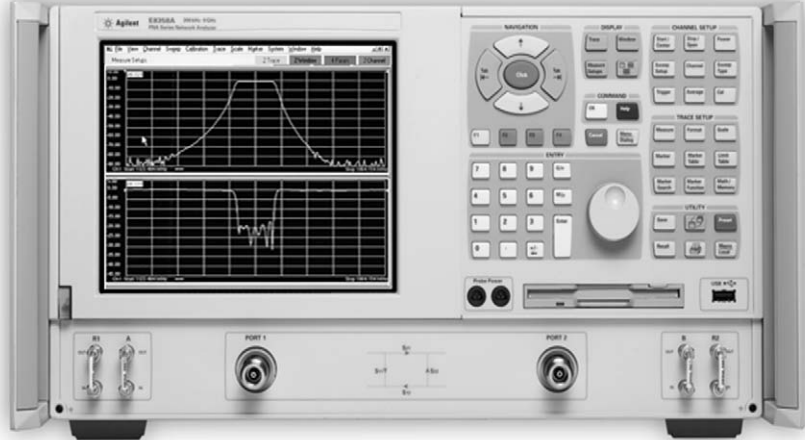

This document describes the performance and features of Agilent Technologies PNA Series RF network analyzers.

**E8356/7/8A**    **300 kHz – 3/6/9 GHz**  
**2-port, 4 receiver**  
**S-parameter vector network analyzer**

**E8801/2/3A**    **300 kHz – 3/6/9 GHz**  
**2-port, 3 receiver**  
**S-parameter vector network analyzer**

**N3381/2/3A**    **300 kHz – 3/6/9 GHz**  
**3-port, 4 receiver**  
**S-parameter vector network analyzer**



**Agilent Technologies**

# Definitions

All specifications and characteristics apply over a 25°C  $\pm$ 5°C range (unless otherwise stated) and 90 minutes after the instrument has been turned on.

**Specification (spec.):** Warranted performance. Specifications include guardbands to account for the expected statistical performance distribution, measurement uncertainties, and changes in performance due to environmental conditions.

**Characteristic (char.):** A performance parameter that the product is expected to meet before it leaves the factory, but that is not verified in the field and is not covered by the product warranty. A characteristic includes the same guardbands as a specification.

**Typical (typ.):** Expected performance of an average unit which does not include guardbands. It is not covered by the product warranty.

**Nominal (nom.):** A general, descriptive term that does not imply a level of performance. It is not covered by the product warranty.

**Calibration:** The process of measuring known standards to characterize a network analyzer's systematic (repeatable) errors.

**Corrected (residual):** Indicates performance after error correction (calibration). It is determined by the quality of calibration standards and how well “known” they are, plus system repeatability, stability, and noise.

**Uncorrected (raw):** Indicates instrument performance without error correction. The uncorrected performance affects the stability of a calibration.

**Standard:** When referring to the analyzer, this includes all options unless noted otherwise.

# Table of contents

Corrected system performance	.4
System dynamic range	.4
Corrected system performance with type-N connectors	.5
Corrected system performance with 3.5-mm connectors	.8
Corrected system performance with 7-16 connectors	.10
Uncorrected system performance	.11
Test port output	.12
Test port input	.13
General information	.19
Measurement throughput summary	.21
Cycle time vs. IF bandwidth	.21
Cycle time vs. number of points	.21
Cycle time	.21
Data transfer time	.22
PNA Series simplified test set block diagram	.23
E835xA	.23
E880xA	.24
N338xA	.25
Measurement capabilities	.26
Source control	.26
Trace functions	.26
Data accuracy enhancement	.27
Storage	.27
System capabilities	.28
Automation	.30
Key literature and web references	.31

# Corrected system performance

The specifications in this section apply for measurements made with the PNA Series analyzer with the following conditions:

- 10 Hz IF bandwidth
- No averaging applied to data
- Environmental temperature of 25°C ±5°C, with less than 1°C deviation from the calibration temperature
- Isolation calibration not omitted

Note: A sample of uncertainty curves are included in this Data Sheet. Please download our free uncertainty calculator ([www.agilent.com/find/na\\_calculator](http://www.agilent.com/find/na_calculator)) to generate the curves for your setup.

## System dynamic range

Description	Specification (dB)	Characteristic (dB)
<b>Dynamic range<sup>1</sup> (at test port)</b>		
<b>E835xA</b>		
300 kHz to 25 MHz <sup>2</sup>	125	
25 MHz to 3 GHz <sup>2</sup>	128	
3 GHz to 6 GHz	118	
6 GHz to 9 GHz	113	
<b>E880xA and N338xA<sup>3</sup></b>		
300 kHz to 25 MHz <sup>2</sup>	125	
25 MHz to 3 GHz <sup>2</sup>	128	
3 GHz to 6 GHz	118	
6 GHz to 9 GHz	115	
<b>Dynamic range<sup>4</sup> (at receiver input)</b>		
<b>E835xA</b>		
300 kHz to 25 MHz <sup>5</sup>		140
25 MHz to 3 GHz <sup>5</sup>		143
3 GHz to 6 GHz		133
6 GHz to 9 GHz		128
<b>E880xA and N338xA<sup>3</sup></b>		
300 kHz to 25 MHz <sup>5</sup>		140
25 MHz to 3 GHz <sup>5</sup>		143
3 GHz to 6 GHz		133
6 GHz to 9 GHz		130

1. The test port dynamic range is calculated as the difference between the test port rms noise floor and the source maximum output power. The effective dynamic range must take measurement uncertainties and interfering signals into account.
2. May be limited to 100 dB at particular frequencies below 750 MHz due to spurious receiver residuals.
3. Values based on power sourced from port 1. If power is sourced from either port 2 or port 3, dynamic range decreases by 3 dB.
4. The receiver input dynamic range is calculated as the difference between the receiver rms noise floor and the source maximum output power. The effective dynamic range must take measurement uncertainties and interfering signals into account. This set-up should only be used when the receiver input will never exceed its damage level. When the analyzer is in segment sweep mode, frequency segments can be defined with a higher power level when the extended dynamic range is required (i.e. the portion of the device's response with high insertion loss), and reduced power when receiver damage may occur (i.e. the portion of the device's response with low insertion loss).
5. May be limited to 115 dB at particular frequencies below 750 MHz due to spurious receiver residuals.

# Corrected system performance with type-N connectors

E880xA

Applies to PNA Series E880xA analyzer, 85032F (type-N, 50 Ω) calibration kit, and N6314A test port cable using full two-port error correction.

Description	Specification (dB)			
	300 kHz to 1.3 GHz	1.3 GHz to 3 GHz	3 to 6 GHz	6 to 9 GHz
Directivity	49	46	40	38
Source match	41	40	36	35
Load match	49	45	39	37
Reflection tracking	±0.011	±0.021	±0.032	±0.054
Transmission tracking	±0.012	±0.020	±0.055	±0.083

## Transmission uncertainty

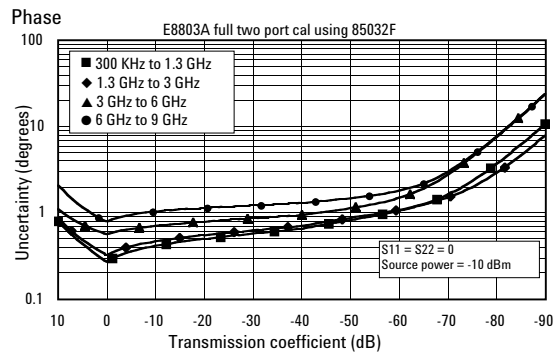
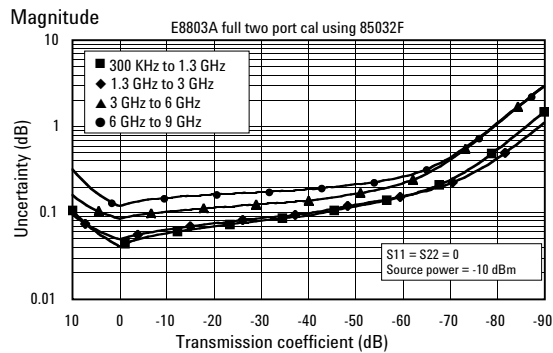

## Reflection uncertainty

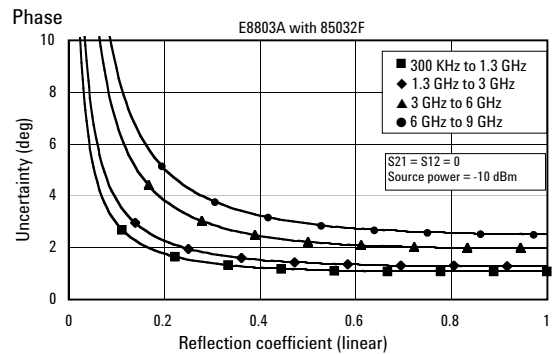
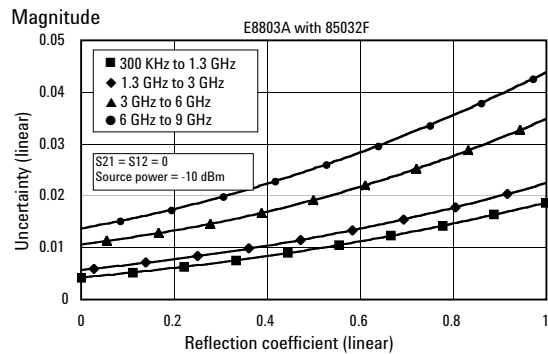

# Corrected system performance with type-N connectors

E880xA

Applies to PNA Series E880xA analyzer, 85092C (type-N, 50 Ω) Electronic Calibration (ECal) module, and N6314A test port cable using full two-port error correction.

Description	Specification (dB)			
	300 kHz to 1.3 GHz	1.3 GHz to 3 GHz	3 to 6 GHz	6 to 9 GHz
Directivity	52	54	52	47
Source match	45	44	41	36
Load match	47	47	44	39
Reflection tracking	±0.040	±0.040	±0.060	±0.070
Transmission tracking	±0.039	±0.039	±0.068	±0.136

## Transmission uncertainty

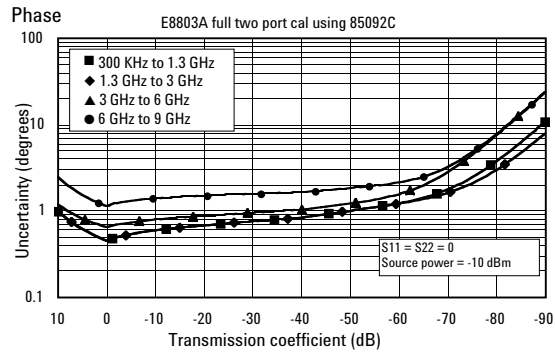
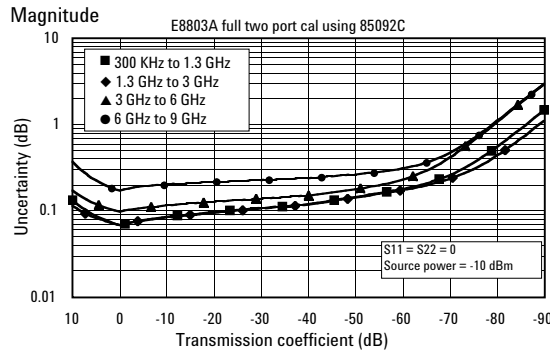

## Reflection uncertainty

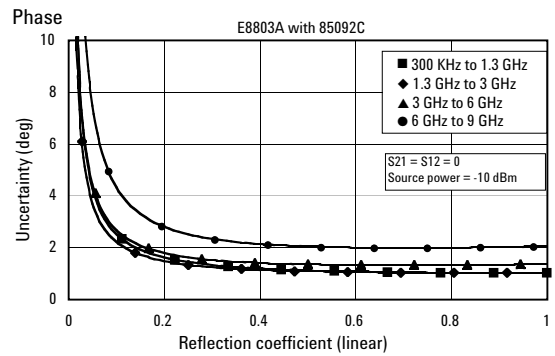
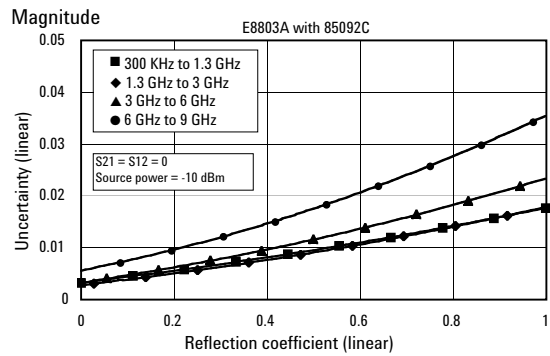

# Corrected system performance with type-N connectors

E835xA

Applies to PNA Series E835xA analyzer, 85092C (type-N, 50 Ω) Electronic Calibration (ECal) module, and N6314A test port cable using full two-port error correction.

Description	Specification (dB)			
	300 kHz to 1.3 GHz	1.3 GHz to 3 GHz	3 to 6 GHz	6 to 9 GHz
Directivity	52	54	52	47
Source match	45	44	41	36
Load match	47	47	44	39
Reflection tracking	±0.040	±0.040	±0.060	±0.070
Transmission tracking	±0.039	±0.039	±0.068	±0.135

## Transmission uncertainty

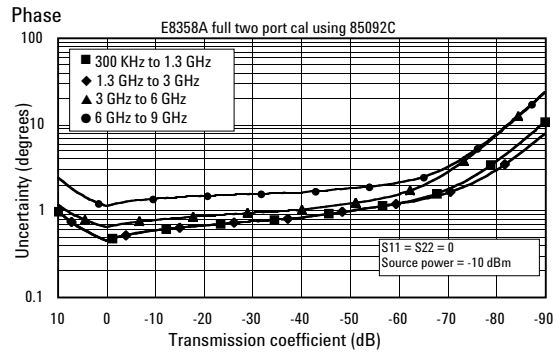
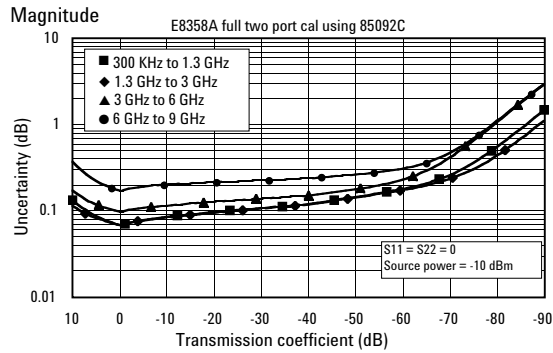

## Reflection uncertainty

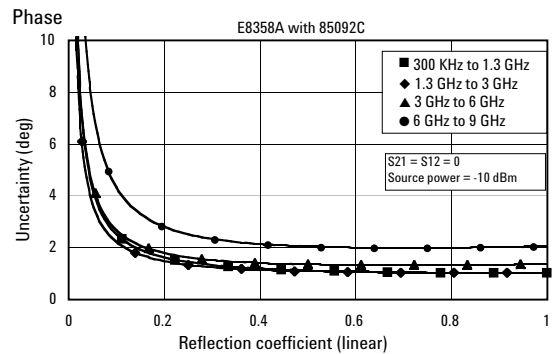
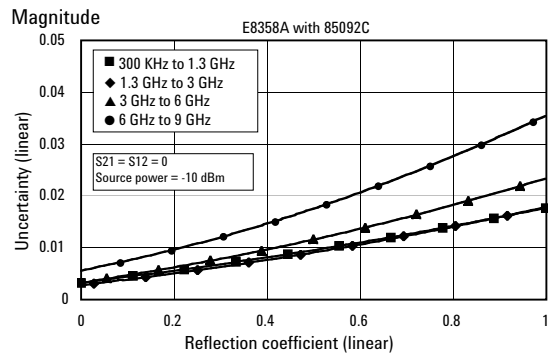

# Corrected system performance with 3.5-mm connectors

E835xA

Applies to PNA Series E835xA analyzer with 85033E (3.5 mm, 50 Ω) calibration kit, and N6314A test port cable using full two-port error correction.

Description	Specification (dB)			
	300 kHz to 1.3 GHz	1.3 GHz to 3 GHz	3 to 6 GHz	6 to 9 GHz
Directivity	46	44	38	38
Source match	43	40	37	36
Load match	46	44	38	38
Reflection tracking	±0.006	±0.007	±0.009	±0.010
Transmission tracking	±0.011	±0.020	±0.041	±0.047

## Transmission uncertainty

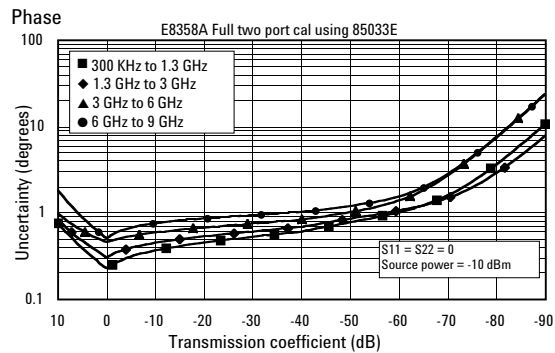
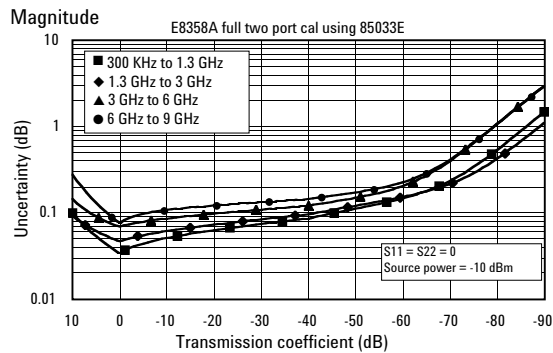

## Reflection uncertainty

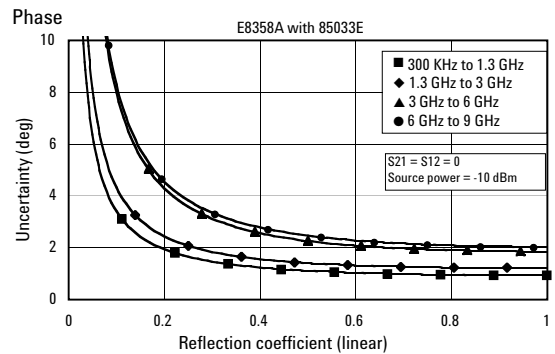
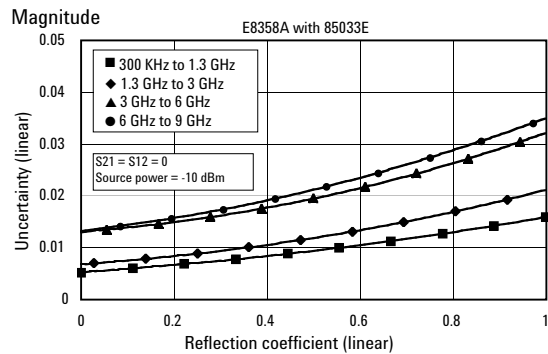



# Corrected system performance with 3.5-mm connectors

E880xA

Applies to PNA Series E880xA analyzer, 85093C (3.5 mm, 50 Ω) Electronic Calibration (ECal) module, and N6314A test port cable using full two-port error correction.

Description	Specification (dB)			
	300 kHz to 1.3 GHz	1.3 GHz to 3 GHz	3 to 6 GHz	6 to 9 GHz
Directivity	52	52	51	47
Source match	44	44	39	34
Load match	47	47	44	40
Reflection tracking	±0.030	±0.040	±0.050	±0.070
Transmission tracking	±0.039	±0.049	±0.068	±0.117

## Transmission uncertainty

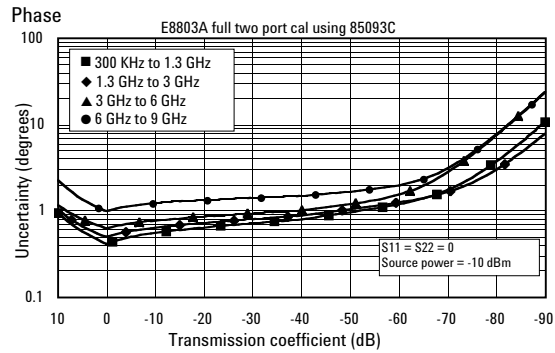
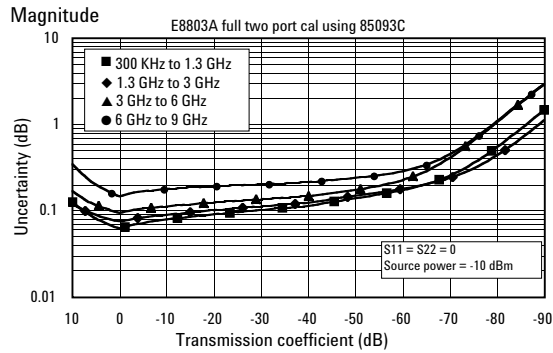

## Reflection uncertainty

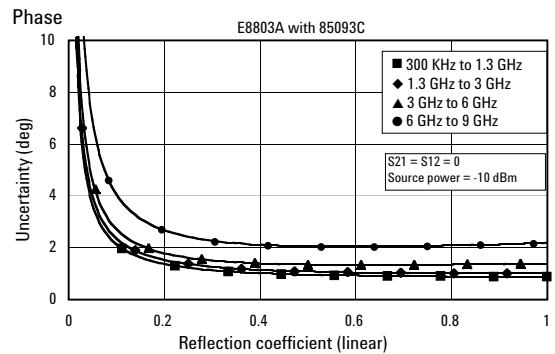
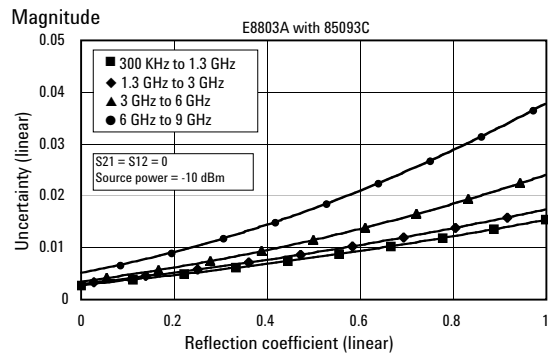

# Corrected system performance with 7-16 connectors

N338xA

Applies to PNA Series N338xA analyzer, 85038A (7-16, 50 Ω) calibration module, and N6314A test port cable using full two-port error correction.

Description	Specification (dB)			
	300 kHz to 1.3 GHz	1.3 GHz to 3 GHz	3 to 6 GHz	6 to 9 GHz
Directivity	40	40	36	36
Source match	37	37	34	34
Load match	39	39	35	35
Reflection tracking	±0.089	±0.089	±0.115	±0.115
Transmission tracking	±0.024	±0.033	±0.082	±0.103

## Transmission uncertainty

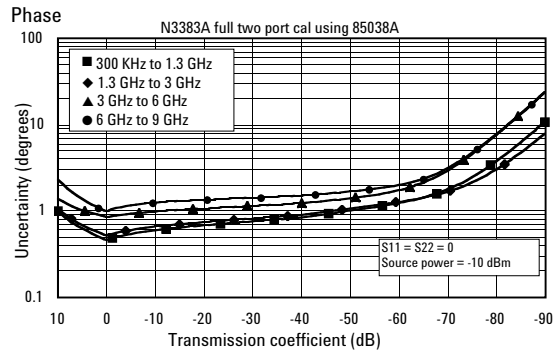
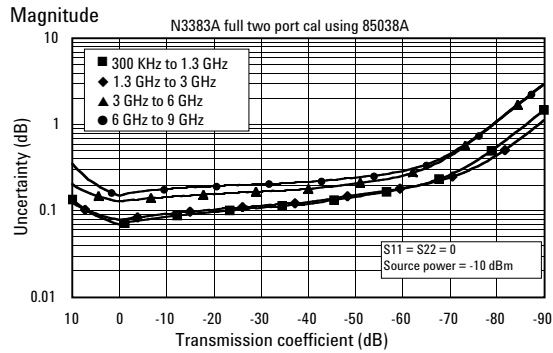

## Reflection uncertainty

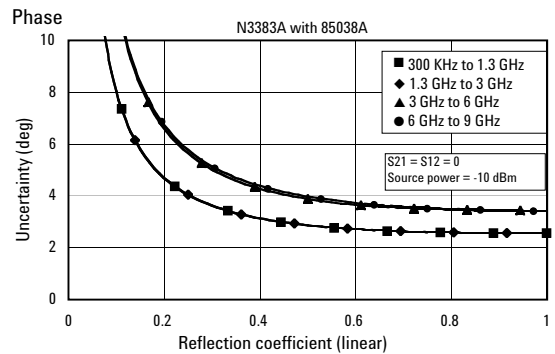
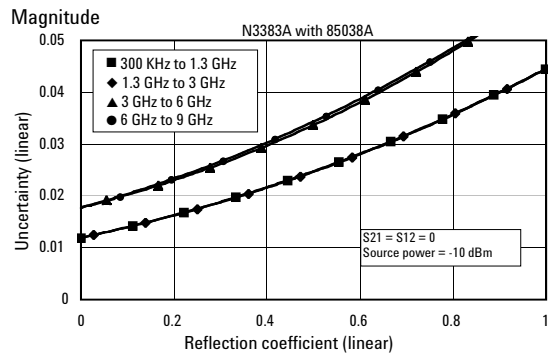

# Uncorrected system performance

Description	Specification (dB)				
	300 kHz to 1 MHz	1 MHz to 1.3 GHz	1.3 GHz to 3 GHz	3 to 6 GHz	6 to 9 GHz
Directivity	30	33	27	20	13
Source match					
E835x	20	20	17	15	14
E835x Option 015	20	20	15	13	12
E880xA	18	18	16	11	8
N338xA ports 1, 2	18	18	17	14	12
N338xA port 3	18	18	17	14	12
Load match					
E835x	20	20	17	15	15
E835x Option 015	20	20	15	13	13
E880xA	20	20	17	13.5	13
N338xA ports 1, 2	20	20	17	13.5	11.5
N338xA port 3	20	20	17	13.5	11.5
Reflection tracking	±1.5	±1.5	±1.5	±2.5	±3.0
Transmission tracking	±1.5	±1.5	±1.5	±2.5	±3.0

# Test port output<sup>1</sup>

Description	Specification	Supplemental information
<b>Frequency range</b>		
E8356A, E8801A, N3381A	300 kHz to 3.0 GHz	
E8357A, E8802A, N3382A	300 kHz to 6.0 GHz	
E8358A, E8803A, N3383A	300 kHz to 9.0 GHz	
<b>Frequency resolution</b>		
	1 Hz	
<b>CW accuracy</b>		
E835xA, E880xA Option 1E5, N338xA Option 1E5	±1 ppm	
E880xA, N338xA	±3 ppm	
<b>Frequency stability</b>		
E835xA		±1 ppm, -10°C to 70°C, typical ±2 ppm/year, typical
E880xA, N338xA		±0.01 ppm, 2°C to 30°C, typical ±0.1 ppm/year maximum
E880xA Option 1E5, N338xA Option 1E5		±1 ppm, -10°C to 70°C, typical ±2 ppm/year maximum
<b>Power level accuracy</b>		
300 kHz to 6 GHz	±1.0 dB	Variation from 0 dBm in power range 0 ±1.5 dB below 10 MHz
6 GHz to 9 GHz	±2.0 dB	
<b>Power level linearity</b>		
300 kHz to 9 GHz	±0.3 dB	Variation from 0 dBm in power range 0 -15 to +5 dBm
300 kHz to 1 MHz	±1.0 dB	+5 to +10 dBm
1 MHz to 6 GHz	±0.5 dB	+5 to +10 dBm
6 GHz to 9 GHz	±0.5 dB	+5 to +7 dBm <sup>3</sup>
<b>Power level range<sup>2</sup></b>		
E835xA, E880xA Option 1E1, N338xA Option 1E1		
300 kHz to 6 GHz	-85 to +10 dBm	
6 GHz to 9 GHz	-85 to +5 dBm	+7 dBm for E880xA and N338xA
E880xA, N338xA		
300 kHz to 6 GHz	-15 to +10 dBm	
6 GHz to 9 GHz	-15 to +7 dBm	
<b>Power sweep range</b>		
E835xA:		
	300 kHz to 6 GHz	25 dB
	6 GHz to 9 GHz	20 dB
E880xA, N338xA (port 1 only):		
	300 kHz to 6 GHz	25 dB
	6 GHz to 9 GHz	22 dB
<b>Power level resolution</b>		
	0.01 dB	
<b>Harmonics (2<sup>nd</sup> or 3<sup>rd</sup>)</b>		
at max output power (< 25 MHz)		< -25 dBc, typical
at max output power (25 MHz to 9 GHz)		< -25 dBc, characteristic <sup>4</sup>
at 0 dBm output		< -35 dBc, typical
at -10 dBm output		< -38 dBc, typical, in power range 0
<b>Non-harmonic spurious</b>		
at max output power		-30 dBc, typical for offset freq > 1 kHz
at -10 dBm output		-50 dBc, typical for offset freq > 1 kHz

1. Source output performance on port 1 only. Port 2 output performance is typical.
2. Power to which the source can be set and phase lock is assured.
3. For E880xA and N338xA only.
4. Typical below 25 MHz.

# Test port input

Description	Specification	Supplemental information
<b>Test port noise floor<sup>1</sup></b>		
300 kHz to 25 MHz <sup>2</sup>		
10 Hz IF bandwidth	-115 dBm	
1 kHz IF bandwidth	-95 dBm	
25 MHz to 3 GHz <sup>2</sup>		
10 Hz IF bandwidth	-118 dBm	
1 kHz IF bandwidth	-98 dBm	
3 GHz to 9 GHz		
10 Hz IF bandwidth	≤ -108 dBm	
1 kHz IF bandwidth	≤ -88 dBm	
<b>Receiver noise floor<sup>1</sup></b>		
300 kHz to 25 MHz <sup>3</sup>		
10 Hz IF bandwidth	≤ -130 dBm	
1 kHz IF bandwidth	≤ -110 dBm	
25 MHz to 3 GHz <sup>3</sup>		
10 Hz IF bandwidth	≤ -133 dBm	
1 kHz IF bandwidth	≤ -113 dBm	
3 GHz to 9 GHz		
10 Hz IF bandwidth	≤ -123 dBm	
1 kHz IF bandwidth	≤ -103 dBm	
<b>Crosstalk</b>		
E835xA:		
300 kHz to 1 MHz	< -120 dB	Between test ports 1 and 2 with short circuits on both ports
1 MHz to 25 MHz	< -125 dB	
25 MHz to 3 GHz	< -128 dB	
3 GHz to 6 GHz	< -118 dB	
6 GHz to 9 GHz	< -113 dB	
E880xA, N338xA (S <sub>21</sub> , S <sub>31</sub> ):		
300 kHz to 1 MHz	< -120 dB	
1 MHz to 25 MHz	< -125 dB	
25 MHz to 3 GHz	< -126 dB	
3 GHz to 6 GHz	< -117 dB	
6 GHz to 9 GHz	< -106 dB	
N338xA (S <sub>12</sub> , S <sub>13</sub> ):		
300 kHz to 1 MHz	< -120 dB	
1 MHz to 25 MHz	< -125 dB	
25 MHz to 3 GHz	< -126 dB	
3 GHz to 6 GHz	< -113 dB	
6 GHz to 9 GHz	< -106 dB	
N338xA (S <sub>23</sub> , S <sub>32</sub> ):		
300 kHz to 1 MHz	< -120 dB	
1 MHz to 3GHz	< -125 dB	
3 GHz to 6 GHz	< -115 dB	
6 GHz to 9 GHz	< -107 dB	
<b>Trace noise magnitude<sup>4</sup></b>		
1 kHz IF bandwidth	< 0.002 dB rms	
10 kHz IF bandwidth	< 0.005 dB rms	
<b>Trace noise phase<sup>4</sup></b>		
1 kHz IF bandwidth	< 0.010° rms	
10 kHz IF bandwidth	< 0.035° rms	

1. Total average (rms) noise power calculated as mean value of a linear magnitude trace expressed in dBm.
2. May be limited to -90 dBm at particular frequencies below 750 MHz due to spurious receiver residuals.
3. May be limited to -105 dBm at particular frequencies below 750 MHz due to spurious receiver residuals.
4. Trace noise is defined as a ratio measurement of a through or a full reflection, with the source set to +0 dBm.

## Test port input (continued)

Description	Specification	Supplemental information
<b>Reference level magnitude</b>		
Range	±200 dB	
Resolution	0.001 dB	
<b>Reference level phase</b>		
Range	±500°	
Resolution	0.01°	
<b>Stability magnitude<sup>1</sup></b>		
300 kHz to 3 GHz		0.02 dB/°C, typical
3 GHz to 6 GHz		0.04 dB/°C, typical
6 GHz to 9 GHz		0.06 dB/°C, typical
<b>Stability phase<sup>1</sup></b>		
300 kHz to 3 GHz		0.2°/°C, typical
3 GHz to 6 GHz		0.3°/°C, typical
6 GHz to 9 GHz		0.6°/°C, typical
<b>Maximum test port input level</b>		
E835xA (ports 1 and 2):		
300 kHz to 25 MHz	+10 dBm	< 0.6 dB compression
25 MHz to 3 GHz	+10 dBm	< 0.4 dB compression
3 GHz to 6 GHz	+10 dBm	< 0.7 dB compression
6 GHz to 9 GHz	+5 dBm	< 0.7 dB compression
E880xA, N338xA:		
300 kHz to 25 MHz	+10 dBm	< 0.6 dB compression
25 MHz to 3 GHz	+10 dBm	< 0.4 dB compression
3 GHz to 6 GHz	+10 dBm	< 0.7 dB compression
6 GHz to 9 GHz	+7 dBm	< 0.7 dB compression
<b>Maximum receiver input level</b>		
E835xA (A, B, R1, R2):		
300 kHz to 6 GHz		-6 dBm, typical
6 GHz to 9 GHz		-11 dBm, typical
E880xA (A, B, R), N338xA (A, B, R, C):		
300 kHz to 6 GHz		-6 dBm, typical
6 GHz to 9 GHz		-9 dBm, typical
<b>Maximum coupler input level</b> (E835xA Option 015, E880xA Option 014, N338xA Option 014)		
300 kHz to 9 GHz		+33 dBm, typical
<b>Reference input level</b> (R1, R2, R) <sup>2</sup>		
300 kHz to 9 GHz		-10 to -35 dBm, typical
<b>Damage input level</b>		
Test port 1, 2, 3 <sup>3</sup>		+30 dBm or ±30 VDC, typical
R1, R2 IN (E835xA)		+15 dBm or ±5 VDC, typical
R, A, B, C (E880xA Option 014, N338xA Option 014)		+15 dBm or ±5 VDC, typical
A, B IN (standard)		+15 dBm or ±5 VDC, typical
A, B IN (E835xA Option 015)		+15 dBm or 0 VDC, typical
Coupler IN (E835xA Option 015)		+33 dBm or ±0 VDC, typical
Coupler thru (E880xA Option 014, N338xA Option 014)		+33 dBm or ±0 VDC, typical

1. Stability is defined as a ratio measurement measured at the test port.

2. Input level to maintain phase-lock.

3. Only N338xA has third port.

# Test port input (continued)

## Group delay<sup>1</sup>

Description	Specification	Supplemental information
Aperture (selectable)	(frequency span)/(number of points - 1)	
Maximum aperture	20% of frequency span	
Range	0.5 x (1/minimum aperture)	
Maximum delay		Limited to measuring no more than 180° of phase change within the minimum aperture.

## Dynamic accuracy

Accuracy of the test port input power reading is relative to the reference input power level. Applies to input test ports 1 and 2 with 10 Hz IF bandwidth.

Specification

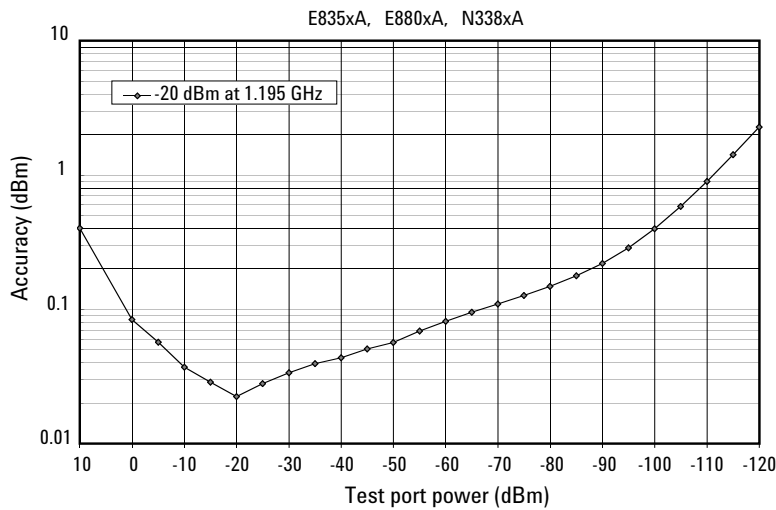

1. Group delay is computed by measuring the phase change within a specified frequency step (determined by the frequency span and the number of points per sweep).

# Test port input (continued)

## Typical dynamic accuracy

### E835xA

#### 300 kHz to 3 GHz

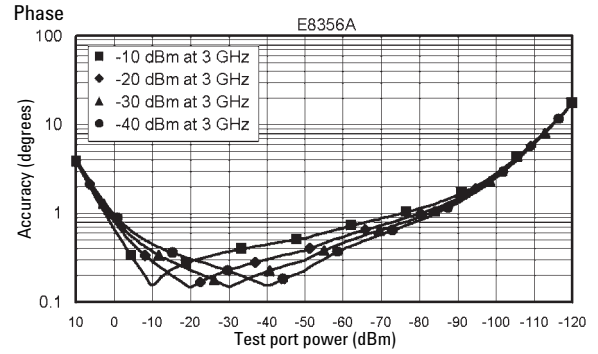
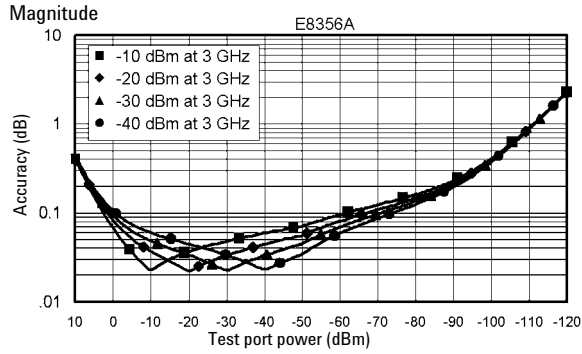

#### 300 kHz to 6 GHz

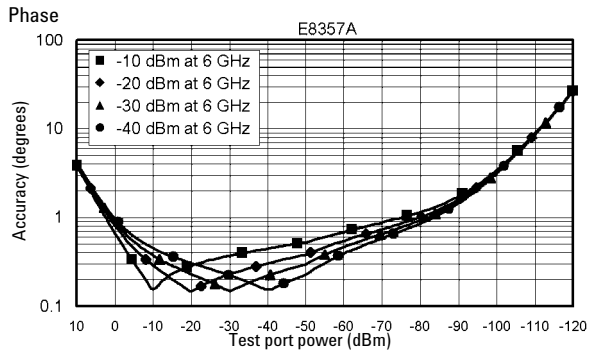
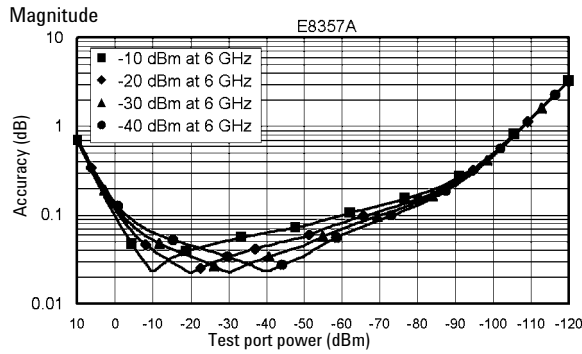

#### 300 kHz to 9 GHz

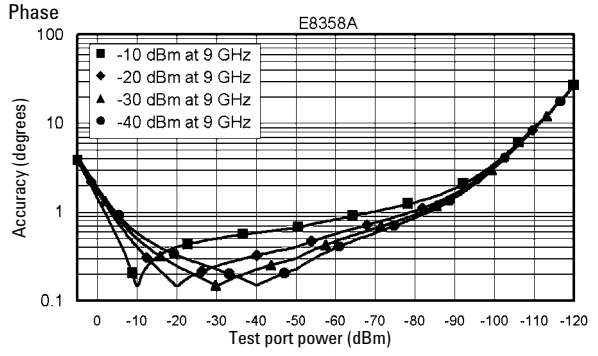
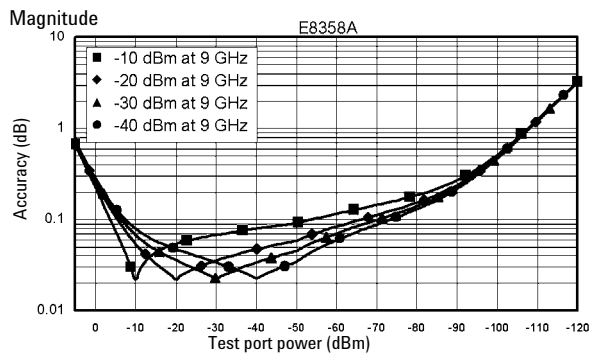



# Test port input (continued)

Typical dynamic accuracy

## E880xA

300 kHz to 3 GHz

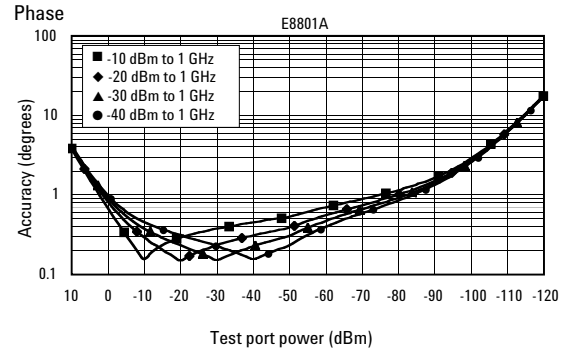
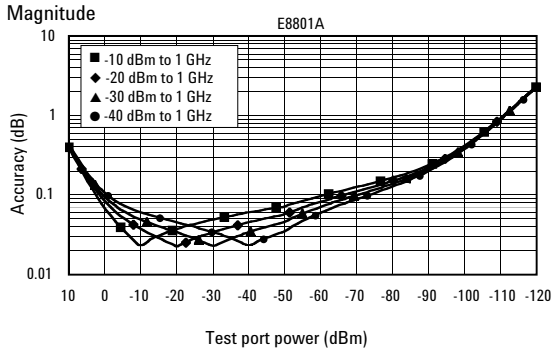

300 kHz to 6 GHz

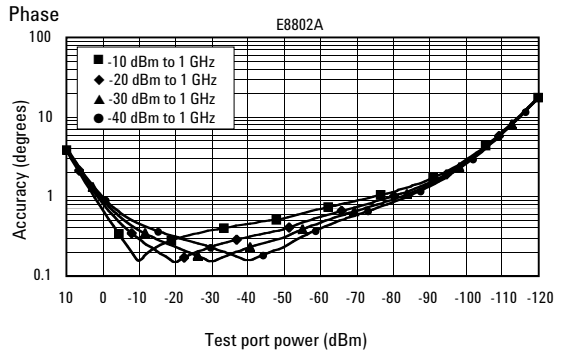
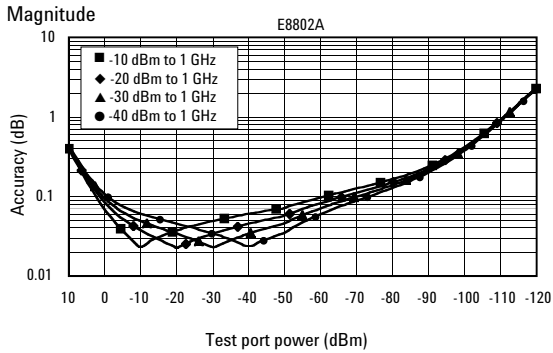

300 kHz to 9 GHz

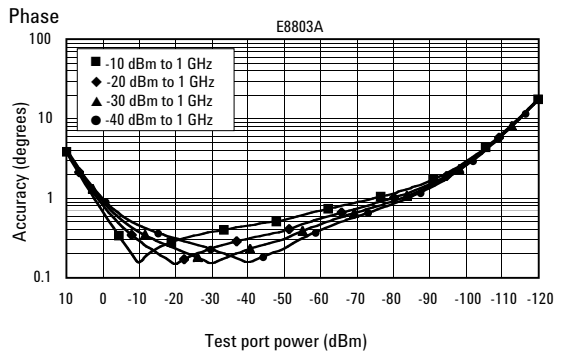
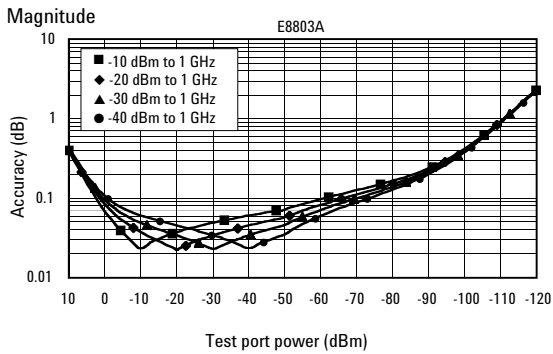

# Test port input (continued)

## Typical dynamic accuracy

### N338xA

#### 300 kHz to 3 GHz

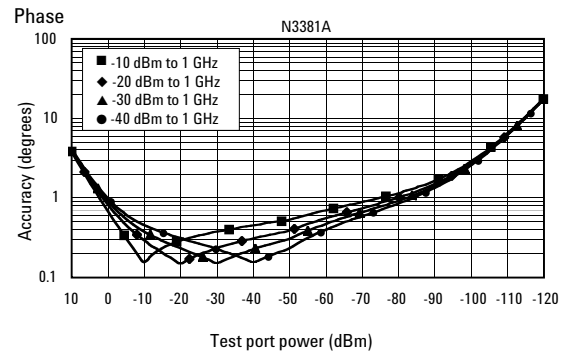
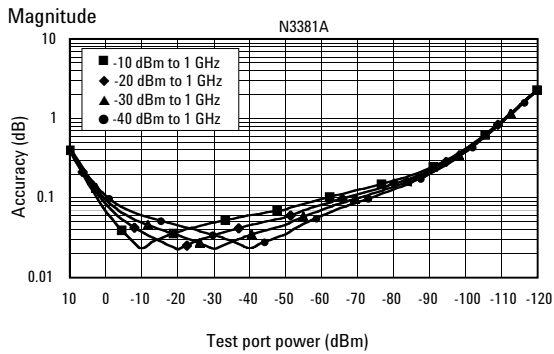

#### 300 kHz to 6 GHz

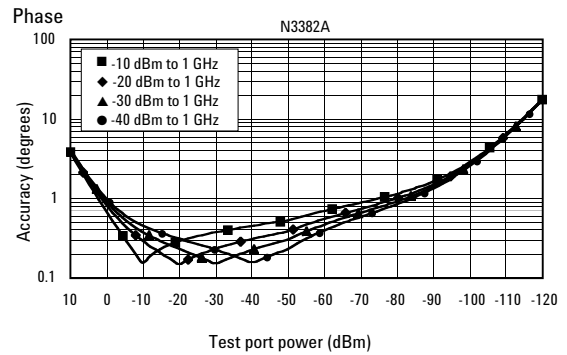
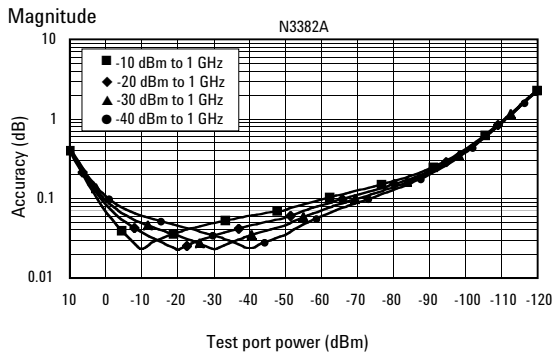

#### 300 kHz to 9 GHz

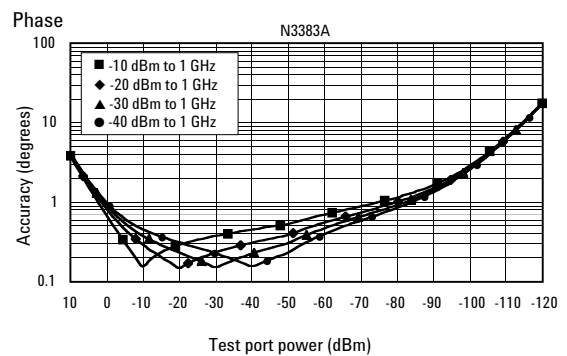
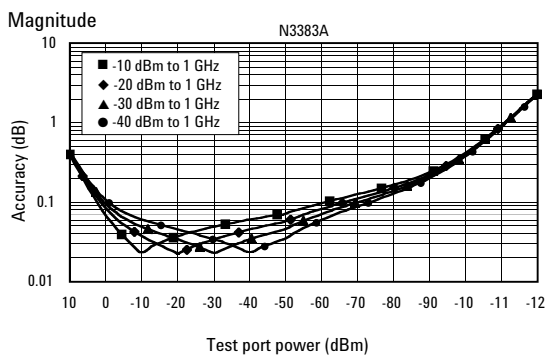

# General information

Description	Supplemental Information
<b>System IF bandwidth range</b>	1 Hz to 40 kHz in a 1, 2, 3, 5, 7, 10 sequence up to 30 kHz, 35 kHz, 40 kHz, nominal
<b>RF connectors</b>	Type-N, female; 50 $\Omega$ , nominal
Connector center pin protrusion	0.204 to 0.207 in, characteristic
<b>Probe power</b>	3-pin connector, male
Positive supply	+15 VDC $\pm$ 2%, 400 mA max, characteristic
Negative supply	-12.6 VDC $\pm$ 5%, 300 mA max, characteristic
<b>Display</b>	21.3 cm (8.4 in) diagonal color active matrix LCD; 640 (horizontal) x 480 (vertical) resolution; 59.83 Hz vertical refresh rate; 31.41 Hz horizontal refresh rate
<b>Display range</b>	
Magnitude	$\pm$ 200 dB (at 20 dB/div), max
Phase	$\pm$ 180°, max
Polar	10 p-units, min; 1000 units, max
<b>Display resolution</b>	
Magnitude	0.001 dB/div, min
Phase	0.01°/div, min
<b>Marker resolution</b>	
Magnitude	0.001 dB, min
Phase	0.01°, min
Polar	0.01 m-unit, min; 0.01°, min

## Rear panel

Description	Supplemental Information
<b>Test port bias input</b>	BNC, female
Maximum voltage	$\pm$ 30 VDC, typical
Maximum current (no degradation in RF specifications)	$\pm$ 200 mA, typical
Maximum current	$\pm$ 1 A, typical
<b>10 MHz reference in</b>	BNC, female
Input frequency	10 MHz $\pm$ 1 ppm, typical
Input level	-15 dBm to +20 dBm, typical
Input impedance	200 $\Omega$ , nominal
<b>10 MHz reference out</b>	BNC, female
Output frequency	10 MHz $\pm$ 1 ppm, typical
Signal type	Sine wave, typical
Output level	10 dBm $\pm$ 4 dB into 50 $\Omega$ , typical
Output impedance	50 $\Omega$ , nominal
Harmonics	< -40 dBc, typical
<b>VGA video output</b>	15-pin mini D-Sub, female; drives VGA-compatible monitors
<b>GPIO</b>	24-pin D-24, female; compatible with IEEE-488
<b>Parallel port (LPT1)</b>	25-pin D-Sub connector, female, provides connection to printers or any other parallel port peripheral
<b>Serial port (COM1)</b>	9-pin D-Sub, male; compatible with RS-232
<b>USB Port</b>	Type-A configuration (4 contacts inline, contact 1 on left), female
Contact 1	Vcc: 4.75 to 5.25 VDC, 500 mA max
Contact 2	-Data
Contact 3	+Data
Contact 4	Ground

# General information (continued)

Description	Supplemental Information		
<b>LAN</b>	10/100BaseT Ethernet; 8-pin configuration; auto selects between the two data rates		
<b>External detector input</b>	BNC, female; input from an external, negative polarity diode detector provides ALC for a test port remote from instrument's front panel		
Input sensitivity	–500 mV yields approximately –3 dBm at detector's input, typical		
Bandwidth	50 kHz, typical		
Input impedance	1 k $\Omega$ , nominal		
<b>Text set I/O</b>	25-pin D-sub connector, available for external test set control		
<b>Aux I/O</b>	25-pin D-sub connector, male, analog and digital I/O		
<b>Handler I/O</b>	36-pin IDC D-ribbon socket connector, all input/output signals are default set to negative logic, can be reset to positive logic via GPIB command		
<b>External AM input</b>	BNC, female; input provides low frequency AM modulation to test port output signal, or shifts the test port output. 0 V input gives the power level set by the instrument, a positive voltage gives a higher level, and a negative voltage gives a lower level.		
Input sensitivity	8 dB/V, typical		
Bandwidth	1 kHz, typical		
Input impedance	1 k $\Omega$ , nominal		
<b>Line Power<sup>1</sup></b>			
Frequency	50/60/400 Hz		
Voltage at 110/115 V setting	50/60/400 Hz		
Voltage at 230/240 V setting	50/60 Hz		
VA max	350 W		
<b>General environmental</b>			
RFI/EMI susceptibility	Defined by CISPR Pub. 11, Group 1, Class A, and IEC 50082-1		
ESD	Minimize using static-safe work procedures and an antistatic bench mat		
Dust	Minimize for optimum reliability		
<b>Operating environment</b>			
Temperature	0°C to +40°C; instrument powers up, phase locks, and displays no error messages within this temperature range.		
Error-corrected temperature range	System specifications valid from 25°C $\pm$ 5°C, with less than 1°C deviation from the calibration temperature, unless otherwise noted		
Humidity	5% to 95% at +40°C		
Altitude	0 to 4500 m (14,760 ft.)		
<b>Non-operating storage environment</b>			
Temperature	–40°C to +70°C		
Humidity	0 to 90% at +65°C (non-condensing)		
Altitude	0 to 15,240 m (50,000 ft.)		
<b>Cabinet dimensions</b>	<b>Height</b>	<b>Width</b>	<b>Depth</b>
Excluding front and rear panel hardware and feet	223 mm 8.75 in	426 mm 16.75	427 mm 16.8 in
As shipped - includes front panel connectors, rear panel bumpers, and feet.	235 mm 9.25 in	435 mm 17.10 in	470 mm 18.5 in
As shipped plus handles	235 mm 9.25 in	458 mm 18 in	501 mm 19.7 in
As shipped plus rack-mount flanges	235 mm 9.25 in	483 mm 19 in	470 mm 18.5 in
As shipped plus handles and rack-mount flanges	235 mm 9.25 in	483 mm 19 in	501 mm 19.7 in
<b>Weight</b>			
Net	24 kg (54 lb), nominal		
Shipping	32 kg (70 lb), nominal		

1. A third-wire ground is required.

# Measurement throughput summary

## Cycle time vs. IF bandwidth<sup>1</sup>

Instrument state: preset condition, 201 points, CF = 1 GHz, Span = 100 MHz, correction off, display off. Add 21 ms for display on. Cycle time includes sweep and re-trace time.

IF bandwidth (Hz)	Cycle time (ms)
40,000	8
35,000	9
30,000	11
20,000	13
10,000	28
7,000	36
5,000	48
3,000	72
1,000	196
300	620
100	1875
30	8062
10	17877

## Cycle time vs. number of points<sup>1</sup>

Instrument state: preset condition, 35 kHz IF bandwidth, CF = 1 GHz, Span = 100 MHz, correction off, display off. Add 21 ms for display on. Cycle time includes sweep and re-trace time.

Number of points	Cycle time (ms)
3	4
11	4
51	5
101	6
201	9
401	16
801	29
1601	52

## Cycle time <sup>1,2</sup> (ms)

	Number of points			
	101	201	401	1601
<b>Start 1.8 GHz, Stop 2 GHz, 35 kHz IF bandwidth</b>				
Uncorrected, 1-port cal	9	12	18	54
2-port cal	22	29	42	117
<b>Start 300 kHz, Stop 3 GHz, 35 kHz IF bandwidth</b>				
Uncorrected, 1-port cal	39	47	56	96
2-port cal	88	101	121	204
<b>Start 300 kHz, Stop 9 GHz, 35 kHz IF bandwidth</b>				
Uncorrected, 1-port cal	51	57	64	103
2-port cal	112	124	138	220

1. Typical performance.
2. Includes sweep time, retrace time and band-crossing time. Analyzer display turned off with DISPLAY:ENABLE OFF. Add 21 ms for display on. Data for one trace (S11) measurement.

## Data transfer time (ms)<sup>1</sup>

	Number of points			
	51	201	401	1601
<b>SCPI over GPIB</b>				
<b>(program executed on external PC)<sup>2</sup></b>				
32-bit floating point	3	7	12	43
64-bit floating point	4	12	22	84
ASCII	7	64	124	489
<b>SCPI over 100 Mbit/s LAN</b>				
<b>(program executed on external PC)<sup>3</sup></b>				
32-bit floating point	1	1	1	1
64-bit floating point	1	1	1	2
ASCII	5	15	26	96
<b>SCPI (program executed in the analyzer)<sup>4</sup></b>				
32-bit floating point	1	1	2	3
64-bit floating point	1	2	2	4
ASCII	8	29	56	222
<b>COM (program executed in the analyzer)<sup>5</sup></b>				
32-bit floating point <sup>7</sup>	1	1	1	1
Variant type <sup>8</sup>	1	1	2	6
<b>DCOM over 100 Mbits/s LAN</b>				
<b>(program executed on external PC)<sup>6</sup></b>				
32-bit floating point <sup>7</sup>	1	1	1	2
Variant type <sup>8</sup>	1	3	6	19

1. Typical performance of PNA Series analyzer with 500 MHz Pentium® III processor.
2. Measured using a VEE 5.0 program running on a 600 MHz HP Kayak, National Instruments™ GPIB card. Transferred complex S<sub>11</sub> data, using "CALC:DATA? SDATA".
3. Measured using a VEE 5.0 program running on a 600 MHz HP Kayak. Transferred complex S<sub>11</sub> data, using "CALC:DATA? SDATA". Speed dependent on LAN traffic, if connected to network.
4. Measured using a VEE 5.0 program running inside PNA Series analyzer. Transferred complex S<sub>11</sub> data, using "CALC:DATA? SDATA".
5. Measured using a Visual Basic 6.0 program running inside PNA Series analyzer. Transferred complex S<sub>11</sub> data.
6. Measured using a Visual Basic 6.0 program running on a 600 MHz HP Kayak. Transferred complex S<sub>11</sub> data. Speed dependent on LAN traffic, if connected to network.
7. Used array transfer (getComplex) for 32-bit floating point.
8. Used meas.GetData for Variant type.

# PNA Series simplified test set block diagram

## E835xA

### Standard

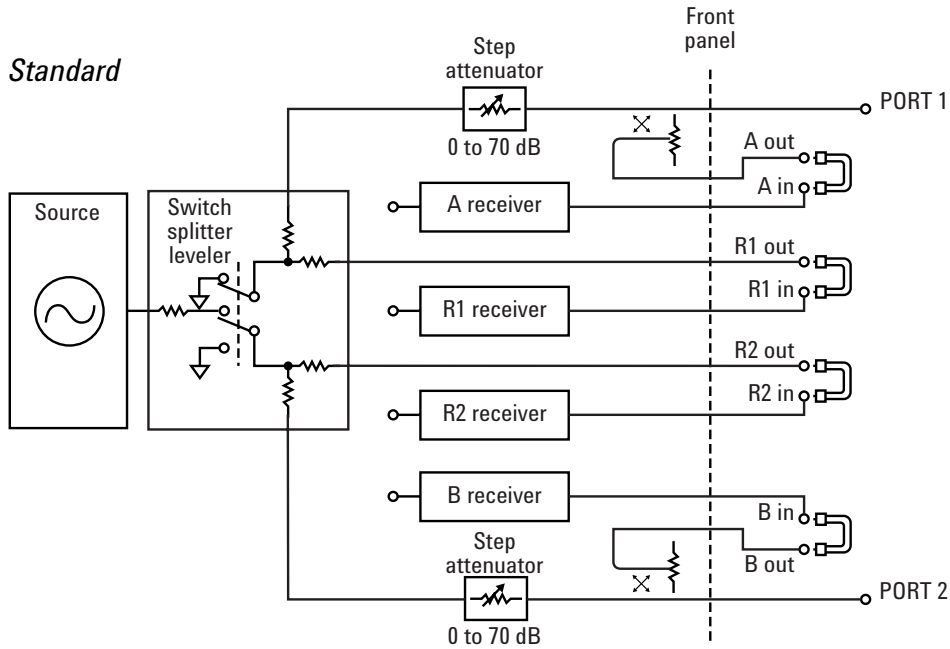

### Option 015

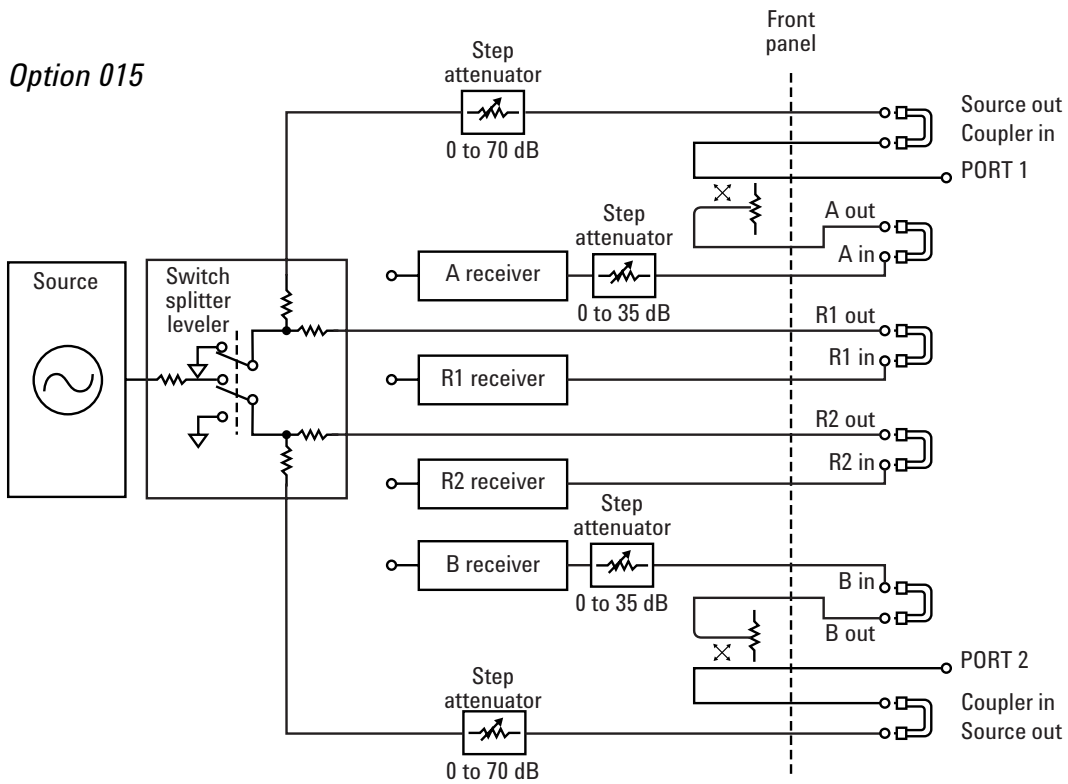

# PNA Series simplified test set block diagram (continued)

## E880xA

### Standard

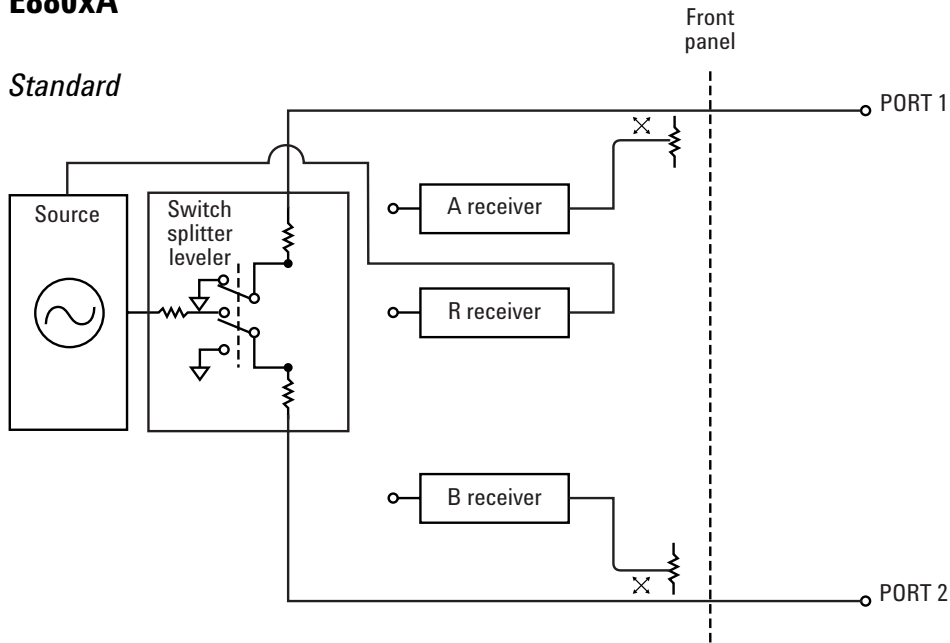

### Option 014

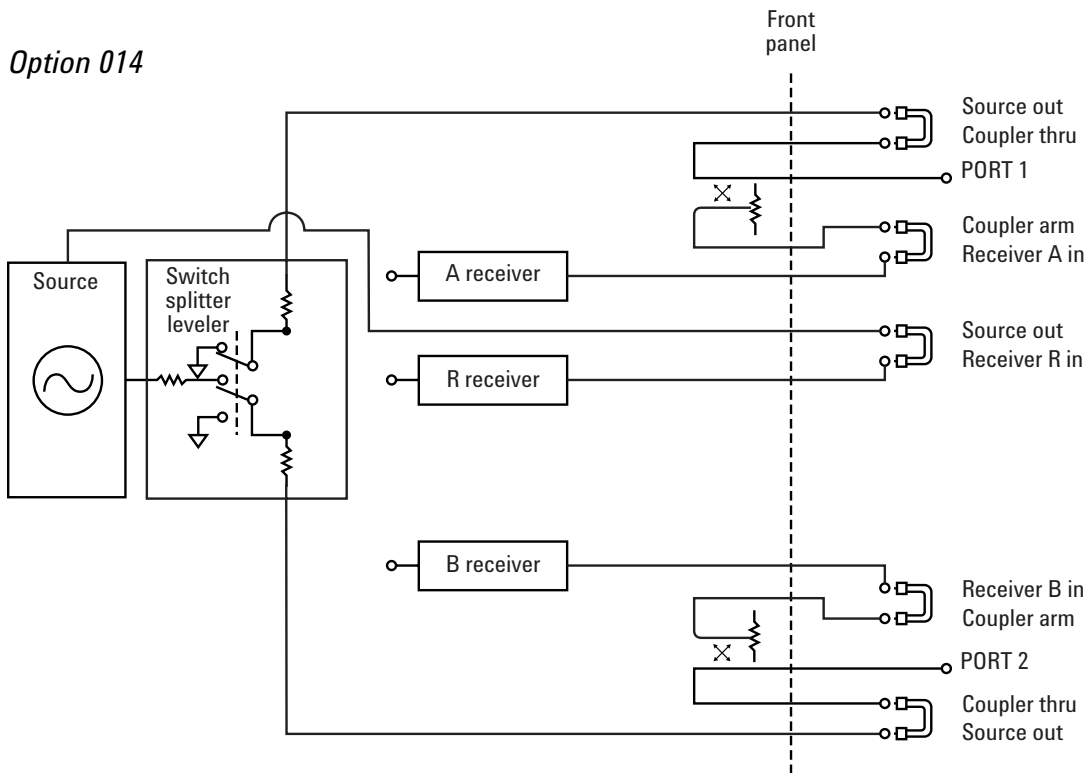

Note: Option 1E1 adds a 70-dB step attenuator between the source and the switch splitter leveler.



# PNA Series simplified test set block diagram (continued)

## N338xA

### Standard

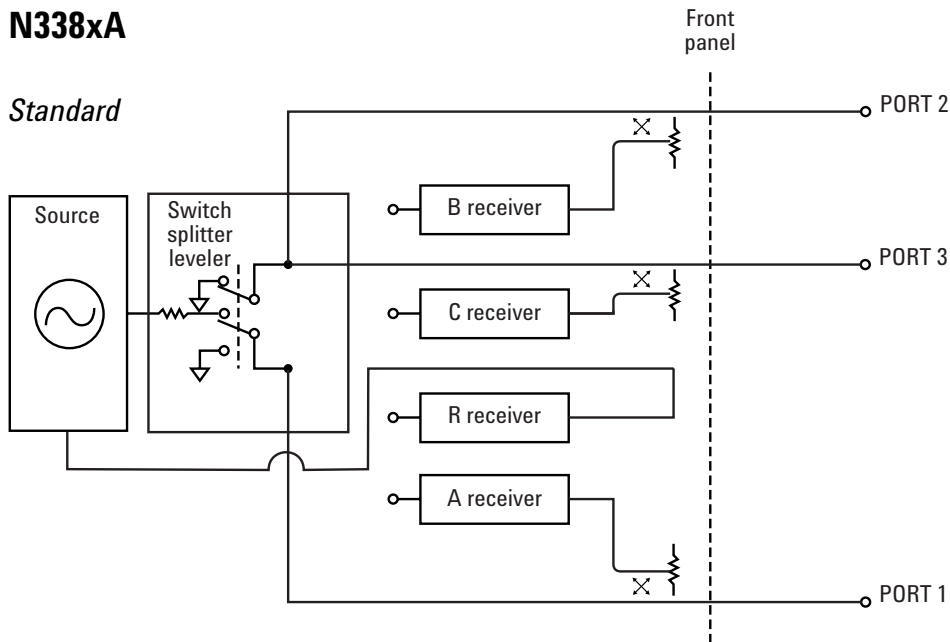

### Option 014

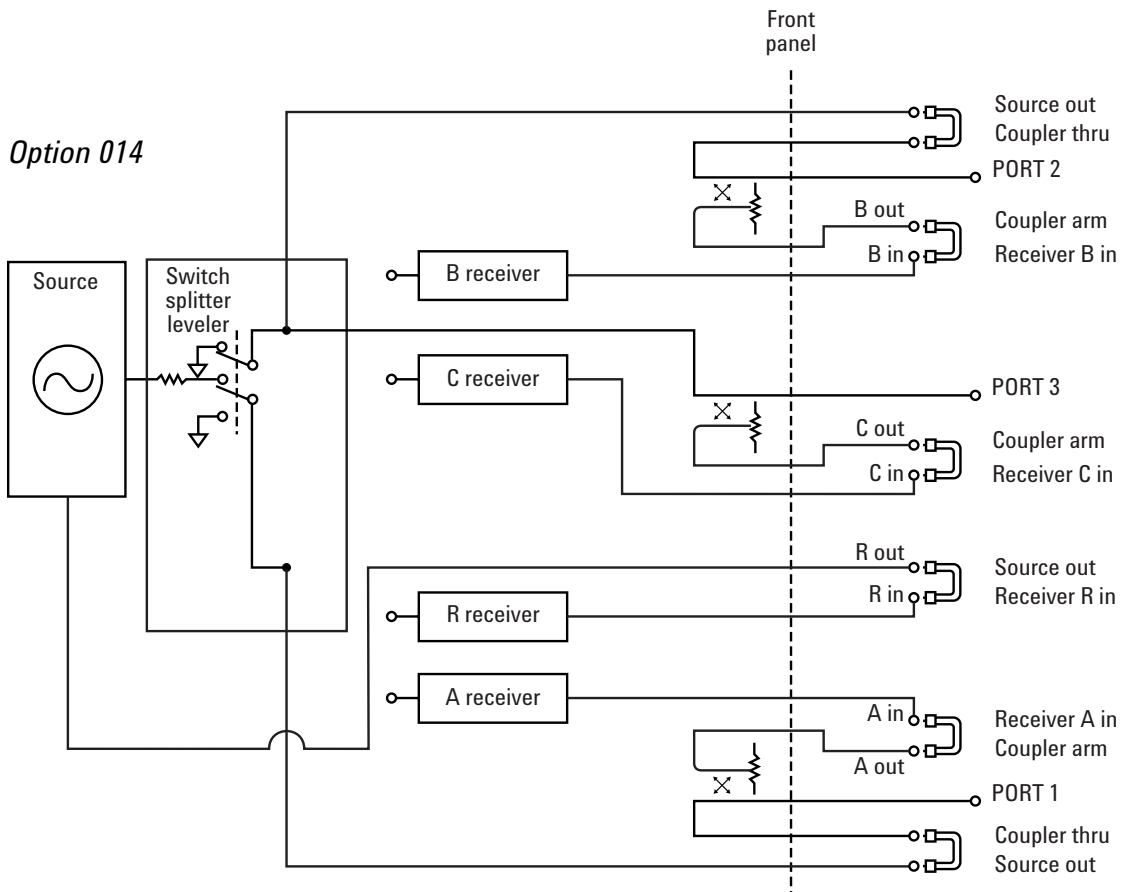

Note: Option 1E1 adds a 70-dB step attenuator between the source and the switch splitter leveler.

## Measurement capabilities

### Number of measurement channels

Up to 16 independent measurement channels. A measurement channel is coupled to stimulus response settings including frequency, IF bandwidth, power level, and number of points.

### Number of display windows

Up to 4 display windows. Each window can be sized and re-arranged. Up to 4 measurement channels can be displayed per window.

### Number of traces

Up to 4 active traces and 4 memory traces per window. Sixteen total active traces and 16 memory traces can be displayed using four windows. Measurement traces include S-parameters, as well as relative and absolute power measurements.

### Measurement choices

S11, S21, S12, S22, A/R1, A/R2, A/B, B/R1, B/R2, B/A, R1/A, R1/B, R1/R2, R2/A, R2/B, R2/R1, A, B, R1, R2. Additionally for N338xA models: S13, S32, S23, S31, S33

### Formats

Log or linear magnitude, SWR, phase, group delay, real and imaginary, Smith chart, polar.

### Data markers

Ten independent or coupled markers per trace. Reference marker available for delta marker operation. Marker formats include log or linear magnitude, phase, real, imaginary, SWR, delay,  $R + jX$ , and  $G + jB$ .

### Marker functions

#### *Marker search*

Max value, Min value, Target, Next Peak, Peak right, Peak left, Target, Bandwidth with user-defined target values

#### *Marker-to functions*

Set start, stop, center to active marker stimulus value; set reference to active marker response value; set electrical delay to value of slope of phase response at active marker.

#### *Tracking*

Performs marker search continuously or on demand.

## Source control

### Measured number of points per sweep

User definable from 2 to 1601.

### Sweep type

Linear, CW (single frequency), power or segment sweep

### Segment sweep

Define independent sweep segments. Set number of points, test port power levels, IF bandwidth, and sweep time independently for each segment.

### Sweep trigger

Set to continuous, hold, single, or group sweep with internal or external trigger.

### Power

Set source power from -85 to +10 dBm. Power slope can also be set in dBm/GHz. (Requires Option 1E1 for E880xA and N338xA)

## Trace functions

### Display data

Display current measurement data, memory data, or current measurement and memory data simultaneously.

### Trace math

Vector addition, subtraction, multiplication or division of measured complex values and memory data.

### Title

Add custom titles (50 characters maximum) to the display. Titles will be printed when making hardcopies of displayed measurements.

### Autoscale

Automatically selects scale resolution and reference value to vertically center the trace.

### Electrical delay

Offset measured phase or group delay by a defined amount of electrical delay, in seconds.

### Phase offset

Offset measured phase or group delay by a defined amount in degrees.

### Statistics

Calculates and displays mean, standard deviation and peak-to-peak deviation of the active data trace.

## Data accuracy enhancement

### Measurement calibration

Measurement calibration significantly reduces measurement uncertainty due to errors caused by system directivity, source and load match, tracking and cross-talk. Full two-port calibration removes all the systematic errors to obtain the most accurate measurements.

### Calibration types available

#### *Response*

Simultaneous magnitude and phase correction of frequency response errors for either reflection or transmission measurements

#### *Response and isolation*

Compensates for frequency response and crosstalk errors of transmission measurements.

#### *One-port calibration*

Available on test set port 1 or port 2 to correct for directivity, frequency response and source match errors.

#### *Two- and three-port calibrations*

Compensates for directivity, source match, reflection tracking, load match, transmission tracking and crosstalk. Crosstalk calibration can be omitted.

#### *TRL/TRM calibration*

*(not available on E880xA and N338xA)*

Compensates for directivity, reflection and transmission tracking, source match, load match and crosstalk in both forward and reverse directions. Provides the highest accuracy for both coaxial and non-coaxial environments, such as on-wafer probing, in-fixture or waveguide measurements.

### Interpolated error correction

With any type of accuracy enhancement applied, interpolated mode recalculates the error coefficients when the test frequencies are changed. The number of points can be increased or decreased and the start/stop frequencies can be changed, but the resulting frequency range must be within the original calibration frequency range. System performance is not specified for measurements with interpolated error correction applied.

### Velocity factor

Enter the velocity factor to calculate the equivalent physical length.

### Reference port extension

Redefine the measurement plane from the plane where the calibration was done.

## Storage

### Internal hard disk drive

Store and recall instrument states and calibration data on 6 GB, minimum, internal hard drive.

Instrument data can also be saved in binary or ASCII (including S2P) format. All files are MS-DOS®-compatible. Instrument states include all control settings, active limit lines, active segment sweep tables, and memory trace data.

### Disk drive

Instrument data, instrument states, and calibration data can be stored on an internal 3.5 inch 1.4MB floppy disk in MS-DOS®-compatible format.

### External storage options

Instrument data, instrument states and calibration data can also be stored on external CD-RW drive or servers using Windows® 2000 drive mapping.

### Data hardcopy

Printouts of instrument data are directly produced on any printer with the appropriate Windows® 2000 printer driver. The analyzer provides USB, parallel, serial and LAN interfaces.

# System capabilities

## Familiar graphical user interface

The PNA Series analyzer employs a graphical user interface based on Windows® 2000. There are two fundamental ways to operate the instrument manually: you can use a hardkey interface, or use drop-down-menus driven from a mouse (or another standard USB pointing device). Hardkey navigation brings up active toolbars that perform most of the operations required to configure and view measurements. Front-panel navigation keys allow control of dialog boxes for advanced features. In addition, mouse-driven pull-down menus and dialog boxes provide easy access to features.

## Built-in help system

Embedded documentation provides measurement assistance in five different languages (English, French, German, Japanese, and Spanish). A thorough index of help topics and context-sensitive help available from dialog boxes.

## Limit lines

Define test limit lines that appear on the display for pass/fail testing. Lines may be any combination of horizontal, sloping lines, or discrete data points.

## Time-domain (Option 010)

With the time-domain option, data from transmission or reflection measurements in the frequency domain are converted to the time domain using a Fourier transformation technique and presented on the display. The time-domain response shows the measured parameter value versus time. Markers may also be displayed in electrical length (or physical length if the relative propagation velocity is entered).

### *Time stimulus modes*

Two types of time excitation stimulus waveforms can be simulated during the transformations, a step and an impulse.

### *Low-pass step*

This stimulus, similar to a traditional time-domain reflectometer (TDR) waveform, is used to measure low-pass devices. The frequency-domain data is extended from DC (extrapolated value) to a higher value. The step response is typically used for reflection measurements only.

### *Low-pass impulse*

This stimulus is also used to measure low-pass devices. The impulse response can be calibrated for reflection or transmission measurements.

### *Bandpass impulse*

The bandpass impulse simulates a pulsed RF signal (with an impulse envelope) and is used to measure the time-domain response of band-limited devices. The start and stop frequencies are selectable by the user to any values within the limits of the instrument. Bandpass time-domain responses are useful for both reflection and transmission measurements.

### *Time-domain range*

The "alias-free" range over which the display is free of response repetition depends on the frequency span and the number of points. Range, in nanoseconds, is determined by:

$$\text{Time-domain-range} = (\text{number-of-points} - 1) / \text{frequency-span [in GHz]}$$

### *Range resolution*

The time resolution of a time-domain response is related to range as follows:

$$\text{Range-resolution} = \text{time-span} / (\text{number-of-points} - 1)$$

### *Windows*

The windowing function can be used to modify (filter) the frequency-domain data and thereby reduce over-shoot and ringing in the time-domain response. Kaiser Beta windows are available.

### *Gating*

The gating function can be used to selectively remove reflection or transmission time-domain responses. In converting back to the frequency-domain the effects of the responses outside the gate are removed.

### **Configurable test set for E835xA Option 015, E880xA Option 014, and N338xA Option 014**

With the configurable test set option, front panel access loops are provided to the signal path between the source output and coupler input. 35 dB step attenuators (5 dB steps) are also added in the receiver paths of both ports (E835xA only). This capability provides the ability to add components or other peripheral instruments for a variety of measurement applications or to make high dynamic range measurements with two-port calibration.

#### ***High power measurement configuration***

Add external power amplifier(s) between the source output and coupler input to provide up to +30 dBm of power at the test port(s). Full two-port error correction measurements possible. When the DUT output is expected to be less than +30 dBm, measure directly at the B input and use the internal step attenuators to prevent damage to the receiver. For measurements greater than +30 dBm, add external components such as couplers, attenuators, and isolators.

#### ***Extended dynamic range configuration***

Reverse the signal path in the coupler and bypass the loss typically associated with the coupled arm. Change the port 2 switch and coupler jumper configurations to increase the forward measurement dynamic range up to 143 dB. When making full two-port error corrected measurements, the reverse measurement is degraded by 15 dB.

# Automation

	<b>GPIB</b>	<b>LAN</b>	<b>Internal</b>
<b>SCPI</b>	X	X	X
<b>COM/DCOM</b>	X	X	

## Methods

### *Internal analyzer execution*

Write applications that can be executed from within the analyzer via COM (component object model) or using SCPI . These applications can be developed in a variety of languages, including Visual Basic, Visual C++, Agilent-VEE, or LabView™ programming languages.

### *Controlling via GPIB*

The GPIB interface operates to IEEE 488.2 and SCPI protocols. The analyzer can either be the system controller, or talker/listener.

### *Controlling via LAN*

The built-in LAN interface and firmware support data transfer and control via direct connection to a 10 or 100 Base-T network.

### *SICL/LAN interface*

The analyzer's support for SICL (standard instrument control library) over the LAN provides control of the network analyzer using a variety of computing platforms, and operating systems. With SICL/LAN, the analyzer is controlled remotely over the LAN with the same methods used for a local analyzer connected directly to the computer via a GPIB interface.

### *DCOM interface*

The analyzer's support for DCOM (Distributed Component Object Model) over the LAN provides control of the network analyzer using a variety of platforms. DCOM acts as an interface to the analyzer for external applications. With DCOM, applications can be developed or executed from an external computer. During development, the application can interface to the analyzer over the LAN through the DCOM interface. Once development is completed, the application can be executed on the analyzer using the COM interface.

## Key literature and web references

*Agilent PNA Series Brochure: 5968-8472E*

*Agilent PNA Series Configuration Guide: 5980-1235E*

Find us on the web at:

**[www.agilent.com/find/pna](http://www.agilent.com/find/pna)**

**[www.agilent.com/find/test](http://www.agilent.com/find/test)**



**www.agilent.com/find/emailupdates**

Get the latest information on the products and applications you select.



**www.agilent.com/find/agilentdirect**

Quickly choose and use your test equipment solutions with confidence.



**www.agilent.com/find/open**

Agilent Open simplifies the process of connecting and programming test systems to help engineers design, validate and manufacture electronic products. Agilent offers open connectivity for a broad range of system-ready instruments, open industry software, PC-standard I/O and global support, which are combined to more easily integrate test system development.

**www.agilent.com**

**Agilent Technologies' Test and Measurement Support, Services, and Assistance**

Agilent Technologies aims to maximize the value you receive, while minimizing your risk and problems. We strive to ensure that you get the test and measurement capabilities you paid for and obtain the support you need. Our extensive support resources and services can help you choose the right Agilent products for your applications and apply them successfully. Every instrument and system we sell has a global warranty. Two concepts underlie Agilent's overall support policy: "Our Promise" and "Your Advantage."

**Our Promise**

Our Promise means your Agilent test and measurement equipment will meet its advertised performance and functionality. When you are choosing new equipment, we will help you with product information, including realistic performance specifications and practical recommendations from experienced test engineers. When you receive your new Agilent equipment, we can help verify that it works properly and help with initial product operation.

**Your Advantage**

Your Advantage means that Agilent offers a wide range of additional expert test and measurement services, which you can purchase according to your unique technical and business needs. Solve problems efficiently and gain a competitive edge by contracting with us for calibration, extra-cost upgrades, out-of-warranty repairs, and onsite education and training, as well as design, system integration, project management, and other professional engineering services. Experienced Agilent engineers and technicians worldwide can help you maximize your productivity, optimize the return on investment of your Agilent instruments and systems, and obtain dependable measurement accuracy for the life of those products.

**United States:**

(tel) 800 829 4444  
(fax) 800 829 4433

**Canada:**

(tel) 877 894 4414  
(fax) 800 746 4866

**China:**

(tel) 800 810 0189  
(fax) 800 820 2816

**Europe:**

(tel) 31 20 547 2111

**Japan:**

(tel) (81) 426 56 7832  
(fax) (81) 426 56 7840

**Korea:**

(tel) (080) 769 0800  
(fax) (080) 769 0900

**Latin America:**

(tel) (305) 269 7500

**Taiwan:**

(tel) 0800 047 866  
(fax) 0800 286 331

**Other Asia Pacific**

**Countries:**

(tel) (65) 6375 8100  
(fax) (65) 6755 0042

Email: tm\_ap@agilent.com

Contacts revised: 09/28/05

**For more information on Agilent Technologies' products, applications or services, please contact your local Agilent office. The complete list is available at:**

**www.agilent.com/find/contactus**

Product specifications and descriptions in this document subject to change without notice.

© Agilent Technologies, Inc. 2001, 2004, 2006  
Printed in USA, July 13, 2006  
5980-1236E

Microsoft® Windows® and MS-DOS® are U.S. registered trademarks of Microsoft Corporation.

National Instruments™ and Labview™ are trademarks of National Instruments Corporation.

Pentium® is a U.S. registered trademark of Intel Corporation.



**Agilent Technologies**