Caution



Do not exceed the operating input power, voltage, and current level and signal type appropriate for the instrument being used, refer to your instrument's Function Reference.



Electrostatic discharge(ESD) can damage the highly sensitive microcircuits in your instrument. ESD damage is most likely to occur as the test fixtures are being connected or disconnected. Protect them from ESD damage by wearing a grounding strap that provides a high resistance path to ground. Alternatively, ground yourself to discharge any static charge built-up by touching the outer shell of any grounded instrument chassis before touching the test port connectors.

Safety Summary

When you notice any of the unusual conditions listed below, immediately terminate operation and disconnect the power cable.

Contact your local Agilent Technologies sales representative or authorized service company for repair of the instrument. If you continue to operate without repairing the instrument, there is a potential fire or shock hazard for the operator.

- Instrument operates abnormally.
- Instrument emits abnormal noise, smell, smoke or a spark-like light during operation.
- Instrument generates high temperature or electrical shock during operation.
- Power cable, plug, or receptacle on instrument is damaged.
- Foreign substance or liquid has fallen into the instrument.

Herstellerbescheinigung

GERÄUSCHEMISSION

LpA < 70 dB
am Arbeitsplatz
normaler Betrieb
nach DIN 45635 T. 19

Manufacturer's Declaration

ACOUSTIC NOISE EMISSION

LpA < 70 dB
operator position
normal operation
per ISO 7779

Regulatory compliance information

This product complies with the essential requirements of the following applicable European Directives, and carries the CE marking accordingly:

The Low Voltage Directive 73/23/EEC, amended by 93/68/EEC

The EMC Directive 89/336/EEC, amended by 93/68/EEC

To obtain Declaration of Conformity, please contact your local Agilent Technologies sales office, agent or distributor.

Safety notice supplement

- This equipment complies with EN/IEC61010-1:2001.
- This equipment is MEASUREMENT CATEGORY I (CAT I). Do not use for CAT II, III, or IV.
- Do not connect the measuring terminals to mains.
- This equipment is POLLUTION DEGREE 2, INDOOR USE product.
- This equipment is tested with stand-alone condition or with the combination with the accessories supplied by Agilent Technologies against the requirement of the standards described in the Declaration of Conformity. If it is used as a system component, compliance of related regulations and safety requirements are to be confirmed by the builder of the system.

Agilent E5091A Multiport Test Set

User's Guide

Third Edition



Agilent Part No. E5091-90020

November 2005

Notices

The information contained in this document is subject to change without notice.

This document contains proprietary information that is protected by copyright. All rights are reserved. No part of this document may be photocopied, reproduced, or translated to another language without the prior written consent of Agilent Technologies.

Microsoft®, MS-DOS®, Windows®, Visual C++®, Visual Basic®, VBA® and Excel® are registered

UNIX is a registered trademark in U.S. and other countries, licensed exclusively through X/Open Company Limited.

Portions ©Copyright 1996, Microsoft Corporation. All rights reserved.

© Copyright 2002, 2005 Agilent Technologies

Manual Printing History

The manual's printing date and part number indicate its current edition. The printing date changes when a new edition is printed (minor corrections and updates that are incorporated at reprint do not cause the date to change). The manual part number changes when extensive technical changes are incorporated.

April 2002 First Edition (part number: E5091-90000)

October 2002 Second Edition (part number: E5091-90010)

November 2005 Third Edition (part number: E5091-90020)

Safety Summary

The following general safety precautions must be observed during all phases of operation, service, and repair of this instrument. Failure to comply with these precautions or with specific WARNINGS elsewhere in this manual may impair the protection provided by the equipment. Such noncompliance would also violate safety standards of design, manufacture, and intended use of the instrument. Agilent Technologies assumes no liability for the customer's failure to comply with these precautions.

NOTE

The E5091A complies with INSTALLATION CATEGORY II as well as POLLUTION DEGREE 2 in IEC61010-1. The E5091A is an INDOOR USE product.

NOTE

The LEDs in the E5091A are Class 1 in accordance with IEC60825-1, CLASS 1 LED PRODUCT

NOTE

This equipment is MEASUREMENT CATEGORY I (CAT I). Do not use for CAT II, III, or IV.

NOTE

This equipment is tested with stand-alone condition or with the combination with the accessories supplied by Agilent Technologies against the requirement of the standards described in the Declaration of Conformity. If it is used as a system component, compliance of related regulations and safety requirements are to be confirmed by the builder of the system.

- **Ground the Instrument**

To avoid electric shock, the instrument chassis and cabinet must be grounded with the supplied power cable's grounding prong.
- **DO NOT Operate in an Explosive Atmosphere**

Do not operate the instrument in the presence of inflammable gasses or fumes. Operation of any electrical instrument in such an environment clearly constitutes a safety hazard.
- **Keep Away from Live Circuits**

Operators must not remove instrument covers. Component replacement and internal adjustments must be made by qualified maintenance personnel. Do not replace components with the power cable connected. Under certain conditions, dangerous voltage levels may remain even after the power cable has been disconnected. To avoid injuries, always disconnect the power and discharge circuits before touching them.
- **DO NOT Service or Adjust the Instrument Alone**

Do not attempt internal service or adjustment unless another person, capable of rendering first aid and resuscitation, is present.
- **DO NOT Substitute Parts or Modify the Instrument**

To avoid the danger of introducing additional hazards, do not install substitute parts or perform unauthorized modifications to the instrument. Return the instrument to an Agilent Technologies Sales and Service Office for service and repair to ensure that

safety features are maintained in operational condition.

- Dangerous Procedure Warnings

Warnings, such as the example below, precede potentially dangerous procedures throughout this manual. Instructions contained in the warnings must be followed.

WARNING

Dangerous voltage levels, capable of causing death, are present in this instrument. Use extreme caution when handling, testing, and adjusting this instrument.

Safety Symbols

General definitions of safety symbols used on the instrument or in manuals are listed below.



Instruction Manual symbol: the product is marked with this symbol when it is necessary for the user to refer to the instrument manual.



Alternating current.



Direct current.



On (Supply).



Off (Supply).



In-position of push-button switch.



Out-position of push-button switch.



A chassis terminal; a connection to the instrument's chassis, which includes all exposed metal structure.



Stand-by.

WARNING

This warning sign denotes a hazard. It calls attention to a procedure, practice, or condition that, if not correctly performed or adhered to, could result in injury or death to personnel.

CAUTION

This Caution sign denotes a hazard. It calls attention to a procedure, practice, or condition that, if not correctly performed or adhered to, could result in damage to or destruction of part or all of the instrument.

NOTE

This Note sign denotes important information. It calls attention to a procedure, practice, or condition that is essential for the user to understand.

Certification

Agilent Technologies certifies that this product met its published specifications at the time of shipment from the factory. Agilent Technologies further certifies that its calibration measurements are traceable to the United States National Institute of Standards and Technology, to the extent allowed by the Institution's calibration facility or by the calibration facilities of other International Standards Organization members.

Exclusive Remedies

The remedies provided herein are Buyer's sole and exclusive remedies. Agilent Technologies shall not be liable for any direct, indirect, special, incidental, or consequential damages, whether based on contract, tort, or any other legal theory.

Assistance

Product maintenance agreements and other customer assistance agreements are available for Agilent Technologies products.

For any assistance, contact your nearest Agilent Technologies Sales and Service Office. Addresses are provided at the back of this manual.

Typeface Conventions

Sample (bold)

Boldface type is used when a term is defined or emphasized.

Sample (Italic)

Italic type is used for emphasis and for titles of manuals and other publications.

Sample menu/button/box/tab

Indicates a menu/button/box/tab on the screen labeled “Sample” which can be selected/executed by clicking. “menu”, “button”, “box”, or “tab” may be omitted.

Sample key

Indicates a hardkey (key on the front panel or external keyboard) labeled “Sample.” “key” may be omitted.

[Sample]

Indicates the hardkey whose key label is “Sample”.

[Sample] - Item

Indicates a series of key operations in which you press the **[Sample]** key, make the item called “Item” on the displayed menu blink by using the [↓] or in other ways, and then press the **[Enter]** key.

1. Installation	
Incoming inspection	10
Requirements for installation environment	14
Operating environment	14
Heat dissipation clearance	15
Antistatic measures	16
Providing space to disconnect the plug of the power cable	16
Mounting front handles/flanges for rackmount	17
Mounting handle kit (Option 1CN)	18
Mounting rackmount kit (Option 1CM)	19
Mounting rackmount/handle kit (Option 1CP)	19
Power supply and fuse	20
Checking the supply of power	20
⚠ Setting up fuse	20
Checking and connecting power cable	21
Starting up E5091A	23
Turning ON/OFF the power	23
Cutting supply of power	23
2. Product Overview	
About this product	26
Name and function of each part	27
⚠ Front panel	27
Rear panel	30
3. Setting the Instrument	
Setting the ID	32
Correlation between Interconnection Port and Test Ports	33
Internal block diagram	34
Paths that can be measured	35
Setting control line	37
Pin assignment	37
Specifications	39
Setting the voltage of variable voltage output	39
Connection to a DUT	40
Connection to a DUT with an external dc power supply	40
Operation basics	42
4. Specifications and Supplemental Information	
Definitions	44
Test Set Input/Output Performance	45
Option 009	45
Option 016	46
General Information	47
5. Information on Maintenance	
Cleaning this Instrument	54
Maintenance of Interconnection Ports and Test Ports	54

Contents

Cleaning a Display Other than Interconnection Ports and Test Ports	54
Cautions Applicable to Requesting Repair, Replacement, Regular Calibration, etc.	55
Devices to be Sent Back for Repair or Regular Calibration	55
Recommended Calibration Period	55
A. Manual Changes	
Manual Changes	58
Change 1	58

1 Installation

This chapter describes the setup of this product.

Incoming inspection

When you receive the product, follow the below steps to perform the incoming inspection.

WARNING

If there are signs of shipping damage to any portion of the outer enclosure when opening the package (for example, the cover, front/rear panel, power switch, and port connectors), do not turn on the power. You may get an electrical shock.

Step 1. Check the shipping container and cushioning material for damage.

NOTE

If the shipping container or cushioning material is damaged, it should be kept until the following other inspections have been done.

Step 2. Check the contents of the package for mechanical damage or defects.

Step 3. Check that the E5091A's option is correct, referring to Figure 1-1.

Step 4. Check the contents of the shipment using Table 1-1 and Figure 1-2 to see if all your specified options are complete.

Step 5. If you detect any of the following in the inspection, contact you nearest Agilent Technologies sales office.

1. If the shipping container or cushioning material is damaged or the cushioning material shows signs of unusual stress.
2. If you find any mechanical damage or defect to the contents.
3. If the contents of the shipment is not complete.
4. If you find any fault on the product during operational checks described below.

In the case of 1, notify the carrier as well as your nearest Agilent Technologies sales office. Keep the shipping container, cushioning material, and the contents of the shipment for the carrier's inspection.

Figure 1-1

E5091A front panel

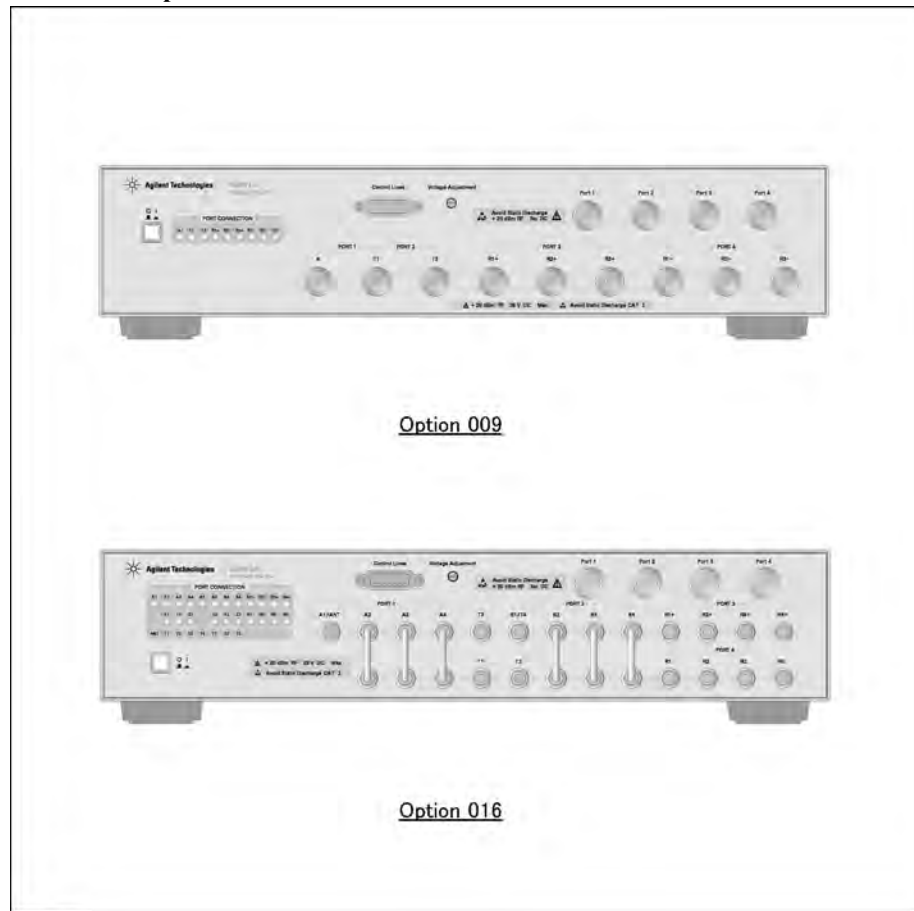

e5091aue001

Table 1-1 Contents of the E5091A package

Name	Agilent product/part number	Quantity
Standard contents		
<input type="checkbox"/> E5091A	E5091A	1
<input type="checkbox"/> N-type cable	8120-4782	4
<input type="checkbox"/> USB cable	8121-0770	1
<input type="checkbox"/> Power cable*1	See Figure 1-8	1
<input type="checkbox"/> CD-ROM (of the manual)*2	E5091-905xx	1
Option		
<input type="checkbox"/> Manual (Option ABA)*3		
• Operation Manual	E5091-900x0	1
<input type="checkbox"/> Handle kit (Option 1CN)*4	5063-9226	1
<input type="checkbox"/> Rackmount kit (Option 1CN)*4	5063-9212	1
<input type="checkbox"/> Rackmount/handle kit (Option 1CP)*4	5063-9219	1

*1. The cable differs depending the country. For an illustration of the power cable options, see Figure 1-8.

*2. The CD-ROM contains the same information as in the User's Guide. The 'xx' in the part number is a number that is incremented each time a revision is made, with '00' regarded as the first edition. The latest edition comes with the product.

*3. The number of 'x' in the part number of the manual, 0 for the first edition, is incremented by 1 each time a revision is made. The latest edition comes with the product.

*4. The contents of these accessories are not shown in Figure 1-2. For more information on them, refer to Table 1-6 on page 17.

Figure 1-2

Accessories E5091A-009

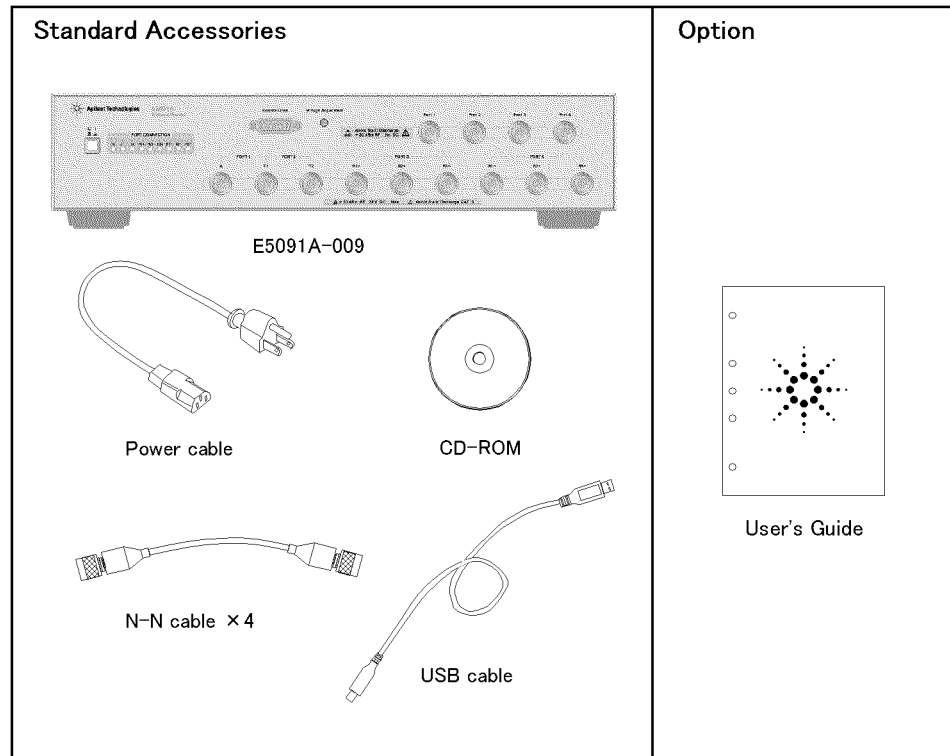

e5091aue3008

Figure 1-3

Accessories E5091A-016

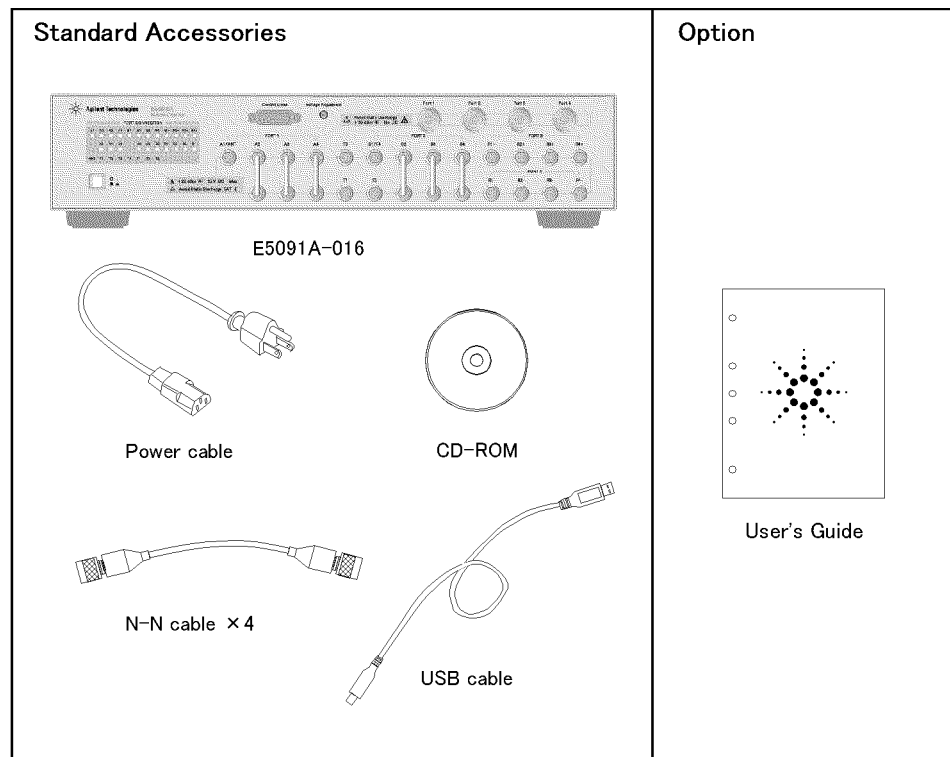

e5091aue3009

Requirements for installation environment

Install the E5091A under an environment that satisfies the following conditions.

Operating environment

Use the E5091A under the following environment.

Table 1-2

Temperature	5 °C to 40 °C
Temperature range during calibration	23 °C ± 5 °C (within 1 °C from the temperature when executing calibration)
Humidity	0 % RH < 90 % RH @<40 °C (no condensation)
Altitude	0 m to 2,000 m (0 feet to 6,561 feet)
Vibration	Up to 0.5 G, 5 Hz to 500 Hz

CAUTION

The above operating environment does not mean the conditions under which all the specifications and measurement accuracy of the E5091A are satisfied but those under which the E5091A operates normally.

Heat dissipation clearance

To satisfy the safety, specifications, and measurement accuracy of the product, you need to keep the temperature around the product within a specific range by providing proper heat dissipation clearance around the product or by air-cooling the inside of the rack forcefully when you mount the product in the rack. For information on ambient temperature to satisfy the specifications and measurement accuracy of the product, refer to the “Specifications and supplemental performance characteristics” Chapter in *Users Guide*.

When the temperature around the product is kept within the temperature range in the operating environmental specifications (see “Operating environment” on page 14), the product complies with the safety standards. Furthermore, when the product is installed providing the following heat dissipation clearance under the above temperature environment, the product complies with the safety standards.

Table 1-3

	Condition
Rear	≥ 180 mm
Sides	≥ 0 mm (each for right and left)

Figure 1-4

Providing heat dissipation clearance

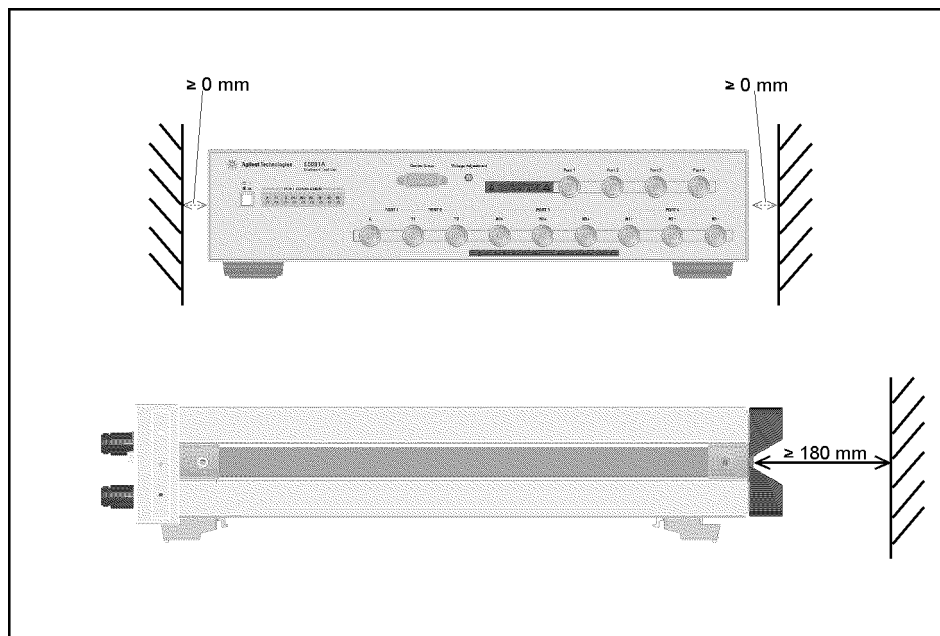

e5091auj011

Antistatic measures

To protect electronic components from static damage, take antistatic measures as shown in Figure 1-5. Table 1-4 shows antistatic accessories that Agilent Technologies provides.

Table 1-4

Antistatic accessories

Name	Agilent part number
Antistatic table mat	9300-0797
Wrist strap code	9300-0980
Wrist strap	9300-1383
Heel strap	9300-1169

Figure 1-5

Example of antistatic measures

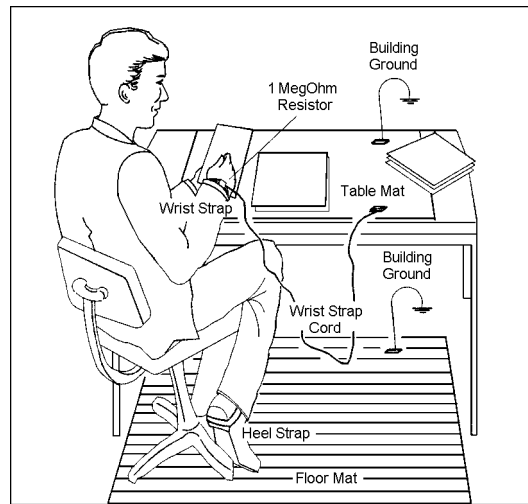

Providing space to disconnect the plug of the power cable

As described in “Cutting supply of power” on page 23, the disconnecting device (the device to cut the supply of power) of the E5091A is the plug of the power cable. When installing the E5091A, provide sufficient clearance not to hinder the operation of disconnecting the plug of the power cable (on the power outlet side or the E5091A side) in an emergency to cut the supply of power.

Mounting front handles/flanges for rackmount

You can use the E5091A on a workbench or mounted in a rack. This section describes how to mount the front handles used to move/transport it (Option 1CN) and how to mount it into a rack as part of a measurement system (Option 1CM: without handles/Option 1CP: with handles).

Table 1-5 Handle/rack options for the E5091A

Option	Name	Agilent part number
1CN	Handle kit	5063-9226
1CM	Rackmount kit	5063-9212
1CP	Rackmount/handle kit	5063-9219

Table 1-6 Contents of each option kit

Option	Contents	Quantity
1CN	Front handle	2
	Screw	4
	Trim strip	2
1CM	Flange for rackmount (side plate for securing)	2
	Screw	4
1CP	Flange for rackmount (side plate for securing)	2
	Front handle	2
	Screw	4

Figure 1-6 Mounting the handle/rackmount kit

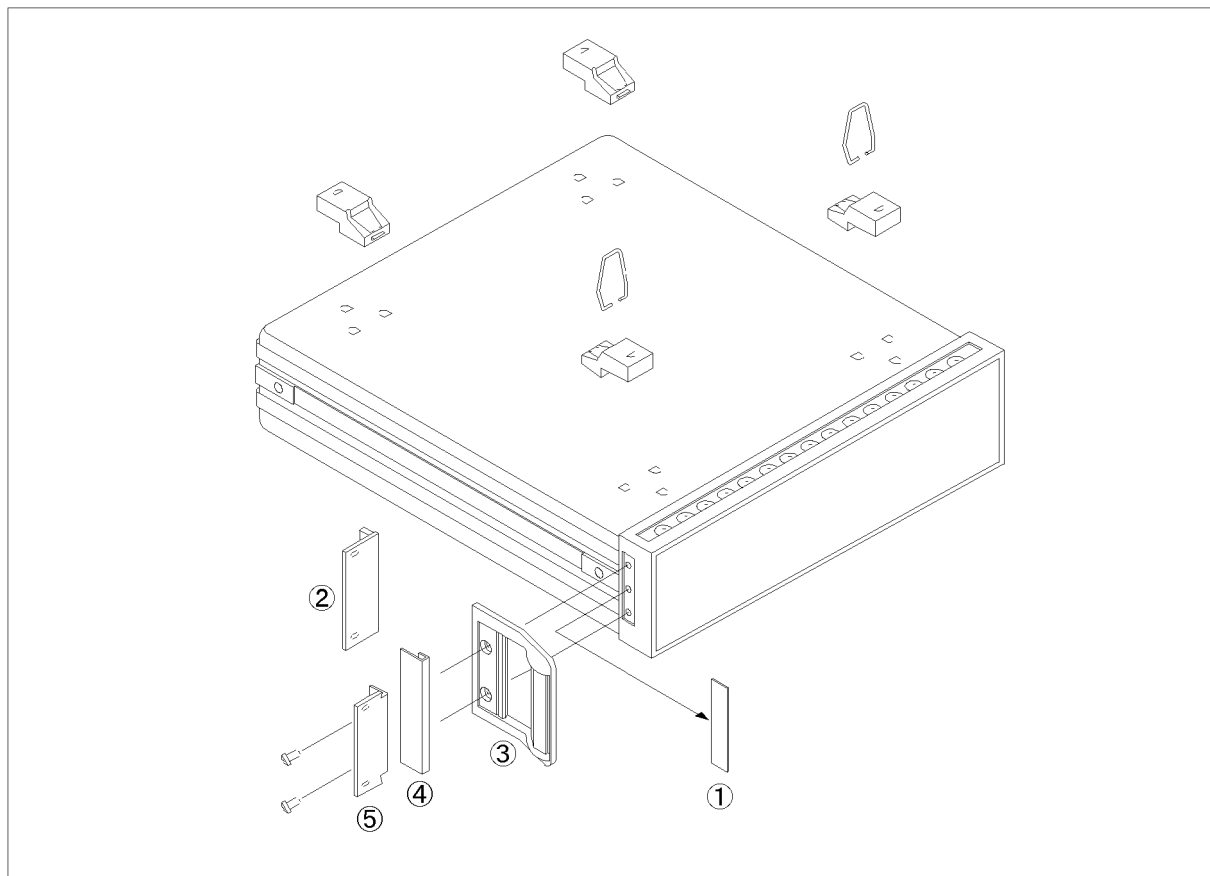

e5091auj007

Mounting handle kit (Option 1CN)

The handle kit is a kit that contains a pair of front handles used to move/transport the E5091A. Follow these steps to mount it, referring to the Figure 1-6.

- Step 1.** Remove the trim strips (1) stuck to both the sides of the front panel (stuck to the frame).
- Step 2.** Mount the front handles (3) to both the sides of the front panel of the E5091A with the attached screws.
- Step 3.** Attach the trim strips for the handle (4) so that they cover the screws securing the front handles.

WARNING

If a front handle you mounted is damaged, replace it with new one immediately. If you use a damaged front handle to move/transport the instrument, the handle may break, which may injure the operator or break the instrument.

Mounting rackmount kit (Option 1CM)

The rackmount kit is a kit that contains 2 flanges (side plates for securing) to mount the E5091A into the standard rack (width: 482.6 mm) of the EIA standard. Follow these steps to mount it, referring to the Figure 1-6.

- Step 1.** Remove the trim strips (1) stuck to both the sides of the front panel (stuck to the frame).
- Step 2.** Mount the flanges for rackmount (2) to both the sides of the front panel of the E5091A with the attached screws.
- Step 3.** Remove the four legs on the bottom of the E5091A (pull up the part with the **(TAB** indication and slide it to the arrow direction).
- Step 4.** Mount the E5091A into the rack.

Mounting rackmount/handle kit (Option 1CP)

The rackmount/handle kit is a kit that contains both the flanges for rackmount and the front handles for the E5091A. Follow these steps to mount it, referring to the Figure 1-6.

- Step 1.** Remove the trim strips (1) stuck to both the sides of the front panel (stuck to the frame).
- Step 2.** Mount the front handles (3) and the flanges for rackmount (5) to both the sides of the front panel of the E5091A with the attached screws.
- Step 3.** Remove the 4 legs on the bottom of the E5091A (pull up the part with the **(TAB** indication and slide it to the arrow direction).
- Step 4.** Mount the E5091A into the rack.

Power supply and fuse

Before turn ON the E5091A, check the following.

Checking the supply of power

Check that the power supplied to the E5091A satisfies the following conditions.

Table 1-7

	Condition
Voltage	90 to 132 Vac or 198 to 264 Vac *1
Frequency	47 to 63 Hz
Power consumption	Max. 150 VA

*1. The E5091A automatically switches between them depending on the voltage.

Setting up fuse

Use the fuse that meets the following specifications.

UL/CSA type, Slo-Blo, 5×20 mm miniature fuse, 3A 250V (Agilent part number: 2110-1017)

Spare fuses are available from Agilent Technologies sales office. To check or replace the fuse, disconnect the power cable and pull out the fuse holder.

Figure 1-7

Fuse holder and power cable inlet

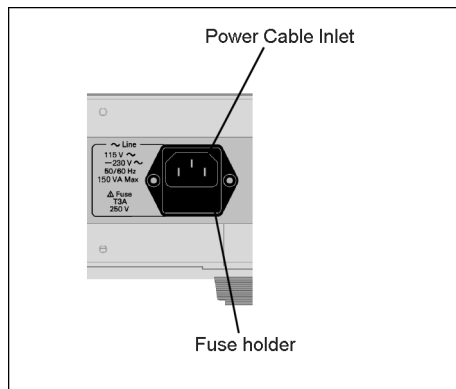

e5091aue016

Checking and connecting power cable

The power cable that comes with the E5091A has 3-wire structure and one of them is the grounding wire. This power cable grounds the E5091A through an outlet, protecting the operator from shock hazards.

Step 1. Check that the power cable you use for damage.

WARNING Never use a power cable that may be damaged. You may get an electrical shock.



Step 2. Connect the attached power cable between the power cable receptacle on the rear panel of the E5091A (see Figure 2-2 on page 30) and a 3-pole outlet whose grounding terminal is grounded securely.

WARNING Securely ground the E5091A with the attached 3-wire power cable with the grounding wire.

Figure 1-8 shows the power cable options.

Installation
Power supply and fuse

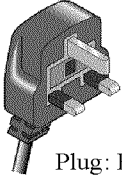
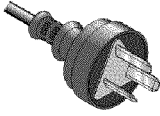
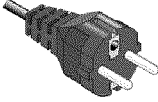
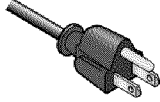
Figure 1-8 Power cable options

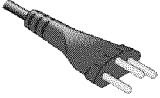
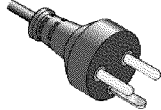
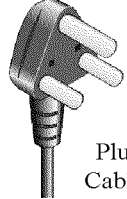
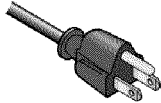
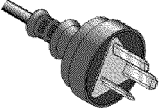
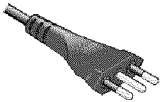
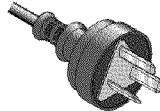
<p>OPTION 900</p>  <p>United Kingdom</p> <p>Plug: BS 1363/A, 250V, 10A Cable: 8120-1351, 8120-8705</p>	<p>OPTION 901</p>  <p>Australia/New Zealand</p> <p>Plug: AS 3112, 250V, 10A Cable: 8120-1369</p>
<p>OPTION 902</p>  <p>Continental Europe</p> <p>Plug: CEE 7 Standard Sheet VII, 250V, 10A Cable: 8120-1689</p>	<p>OPTION 903</p>  <p>U.S./Canada</p> <p>Plug: NEMA 5-15P, 125V, 10A Cable: 8120-1378</p>
<p>OPTION 904</p>  <p>U.S./Canada</p> <p>Plug: NEMA 6-15P, 250V, 6A Cable: 8120-0698</p>	<p>OPTION 906</p>  <p>Switzerland</p> <p>Plug: SEV Type 12, 250V, 10A Cable: 8120-2104</p>
<p>OPTION 912</p>  <p>Denmark</p> <p>Plug: SR 107-2-D, 250V, 10A Cable: 8120-2956</p>	<p>OPTION 917</p>  <p>India/Republic of S. Africa</p> <p>Plug: IEC 83-B1, 250V, 10A Cable: 8120-4211</p>
<p>OPTION 918</p>  <p>Japan</p> <p>Plug: JIS C 8303, 125V, 12A Cable: 8120-4753</p>	<p>OPTION 920</p>  <p>Argentina</p> <p>Plug: Argentine Resolution 63, Annex IV, 250V, 10A Cable: 8120-6870</p>
<p>OPTION 921</p>  <p>Chile</p> <p>Plug: CEI 23-16, 250V, 10A Cable: 8120-6978</p>	<p>OPTION 922</p>  <p>China</p> <p>Plug: GB 1002, 250V, 10A Cable: 8120-8376</p>

NOTE: Each option number includes a 'family' of cords and connectors of various materials and plug body configurations (straight, 90° etc.).





power_e

Starting up E5091A

This section describes how to turn ON/OFF the E5091A and how to cut the supply of power in an emergency.



Turning ON/OFF the power

Turning ON power

- Step 1.** Check that the line switch in the lower left part of the front panel is pulled up (). If it is pushed in () which means the power is OFF, push the standby switch to pull it up ().
- Step 2.** Push the line switch to push it in ().

Turning OFF power

To turn OFF the E5091A, do the following.

- Push the line switch in the lower left part of the front panel so that the switch pushed in () is pulled up ().

NOTE

To turn OFF the E5091A in normal times, press the line switch. **In normal times, never disconnect the power cable to cut the supply of power to the power cable receptacle on the rear panel.**

Cutting supply of power

For the E5091A, the disconnecting device (the device to cut the supply of power) is the plug of the power cable (on the power outlet side or the E5091A side). If you need to cut the supply of power to avoid danger of electric shocks, disconnect the plug of the power cable (on the power outlet side or the E5091A side).

NOTE

Follow the description in “Providing space to disconnect the plug of the power cable” on page 16 so that you can perform this operation reliably.

To turn OFF the power in normal times, be sure to follow the procedure in “Turning OFF power”.

Installation
Starting up E5091A

2 Product Overview

This chapter describes the overview of the E5091A ENA Series multiport test set.

About this product

Agilent The E5091A is a multiport test set used by connecting to the ENA Series RF Network Analyzers. The main features of this instrument are:

- The Agilent E5091A, controlled with the ENA Series RF Network Analyzers, lets you measure a multi-port DUT by making the connection once. This decreases the time to switch connections or wrong connections, improving the throughput significantly. The number of ports varies depending on options as follows:

Option 009 (E5091A-009) 9 ports

Option 016 (E5091A-016) 25 ports *1

- You can perform measurement in high frequencies (50 MHz to 8.5 GHz) required to test RF devices for mobile communications and so on.
- You can perform measurement while switching the paths of the DUT using the control line.
- The warm-up function stabilizes the internal temperature, improving the stability of measurement.
- The E5091A-016 provides the 13-port device, which executes measurements by connecting the SMA cable attached to the unit and the 16-port device, which executes measurement by removing the SMA cable.

NOTE The E5070B/E5071B firmware version A.06.00 or higher is required for control of the E5091A-016.

NOTE The E5070A/E5071A cannot control the E5091A-016.

*1. You cannot use all the ports simultaneously.

Name and function of each part

The section describes the name and overview of each part on the front panel and display area of the E5091A.

Front panel

The name and overview of each part on the front panel of the E5091A are as follows.

Figure 2-1

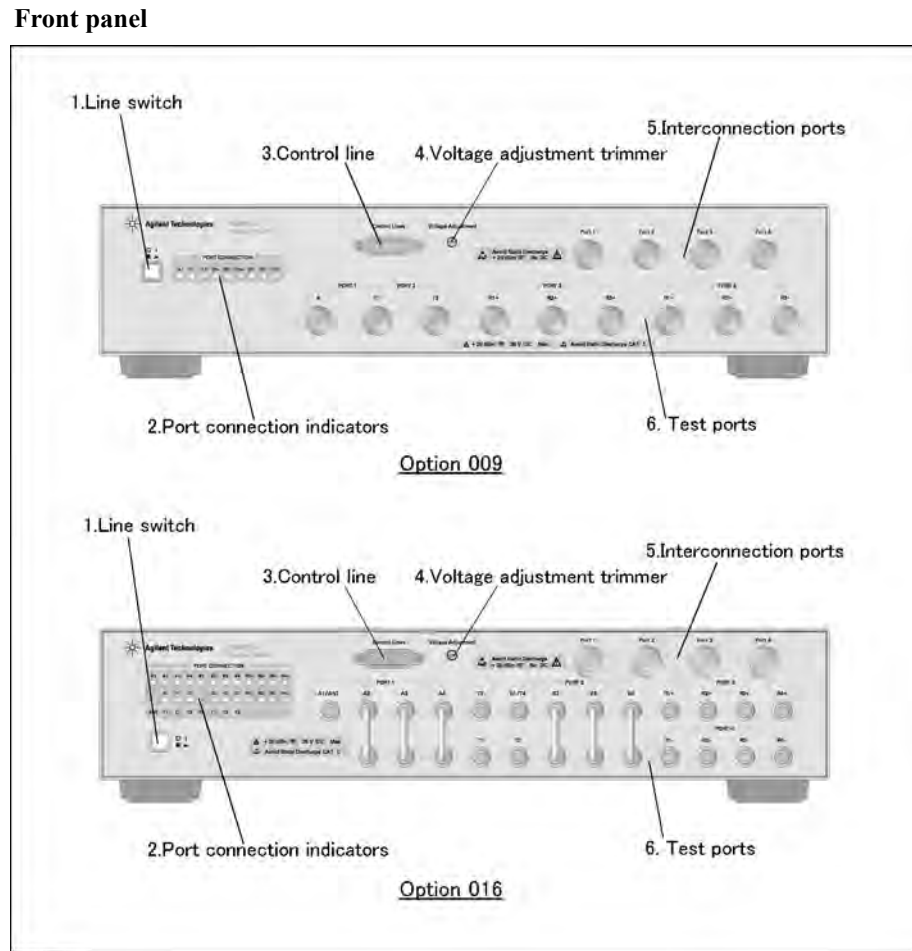

1. Line switch

Turns ON (I)/OFF (O) the E5091A.

2. Port connection indicator

Indicates the test ports connected to the interconnection ports when connected to the analyzer. For T1, T2, and T3 of the E5091A-016, the above two LEDs turn on. In the same way, A1 for ANT and B1 for T4 also turn on.

3. Control line

By connecting it to the DUT, you can control, for example, switching the switch of the DUT. For more information on how to set the control line, refer to *ENA Series RF Network Analyzers Users Guide*.

4. Voltage adjustment trimmer

The trimmer to adjust the output voltage of the pin 12 in the control line. The range of the output voltage is from +2 V to +5 V.

5. Interconnection ports

Used to connect to the test ports of the ENA Series RF Network Analyzers. The port numbers correspond to the test port numbers of the ENA Series RF Network Analyzers. The 50 Ω N-type connectors (female) are adopted.



Do not apply dc current or dc voltage to the interconnection ports. Applying dc current or dc voltage could damage this instrument. Do not connect the device under test (DUT) to these ports.

CAUTION

Take anti-static precautions before performing operation

Because semiconductor devices are used in the E5091A, electrostatic discharge could cause the inside of the instrument to be damaged. Therefore, take the anti-static precautions sufficiently before performing operation.

6. Test ports

Used to connect the DUT. The 50 Ω N-type connectors (female) are adopted for Option 009, and 50 Ω SMA-type connectors (female), for Option 016.



Do not apply dc voltage more than 25 V to the test ports. In particular, capacitors may be charged. Fully discharge the device under test (DUT) before connecting it to the test ports (or the cable and test fixture connected to the test ports).

NOTE

When using a semi-rigid cable, connect the semi-rigid cable to a test port with a specified torque using a torque wrench.

	SMA
Specified torque	5.7 kgf-cm/56 N-cm/5 in-lb
Recommended wrench	Wrench P/N 8710-1582

CAUTION

Take anti-static precautions before performing operation

Because semiconductor devices are used in the E5091A, electrostatic discharge could cause the inside of the instrument to be damaged. Therefore, take the anti-static precautions sufficiently before performing operation.

The test ports comply with Installation Category I as defined in IEC61010-1.

Rear panel

The name and overview of each part on the rear panel of the E5091A are as follows.

Figure 2-2

Rear panel

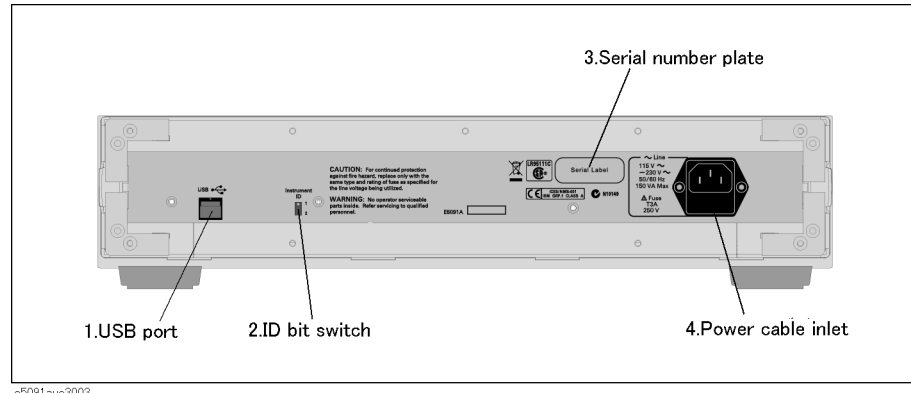

1. USB port

Used to connect the USB cable to the rear panel of the ENA Series RF Network Analyzers.

NOTE

Connecting devices other than the ENA Series RF Network Analyzers to the USB port is not supported.

2. ID bit switch

The bit switch to set the ID of the E5091A required for control from the ENA Series RF Network Analyzers. You can set it to 1 or 2. It is set to 1 when shipped from the factory.

3. Serial number plate

The serial number of the E5091A is printed.

4. Power cable inlet

The inlet to which the power cable is connected.

3 Setting the Instrument

This chapter describes the setting of the E5091A. For more information on the setting procedure, refer to *ENA Series RF Network Analyzers Users Guide*.

Setting the ID

In this section, the procedure to set the ID.

- Step 1.** Set the line switch to OFF if the E5091A has been turned on.
- Step 2.** Set the ID with the ID bit switch on the rear panel.

Figure 3-1

ID bit switch

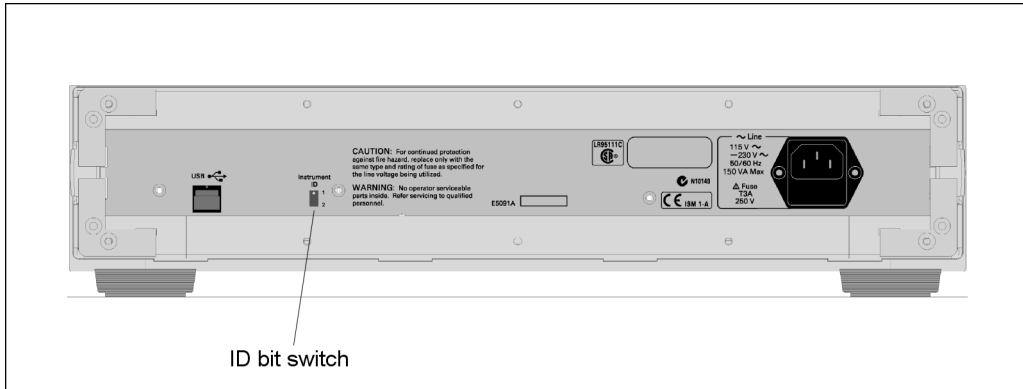

e5091a0e004

Correlation between Interconnection Port and Test Ports

The following table shows the correlation of the test ports (A to Z2) available to the interconnection ports (port 1 to port 7). Available test ports differ depending on the model used (E5091A-009/E5091A-016).

The E5091A-016 provides the 13-port device and 16-port device measurement, whose available test ports differ.

Table 3-1 Correlation of Interconnection Ports and Test Ports

Model	Softkey	Interconnection port	Test port
E5091A-009	E5091_9	Port 1	A,T1
		Port 2	T1,T2
		Port 3	R1+,R2+,R3+
		Port 4	R1-,R2-,R3-
E5091A-016	E5091_13	Port 1	A1,T1,T2,T3
		Port 2	T1,T2,T3,T4
		Port 3	R1+,R2+,R3+,R4+
		Port 4	R1-,R2-,R3-,R4-
	E5091_16	Port 1	A1(A),A2,A3,A4,T1,T2,T3
		Port 2	B1(T4),B2,B3,B4,T1,T2,T3
		Port 3	R1+,R2+,R3+,R4+
		Port 4	R1-,R2-,R3-,R4-
		Port 5*1	X1,X2
		Port 6*1	Y1,Y2
		Port 7*1	Z1,Z2

*1. By setting the interconnection ports 1 to 4, test ports switches automatically. When executing more than 16-port device measurement, you need to set the test port manually.

Internal block diagram

Figure 3-2 shows the block diagram inside the E5091A.

Figure 3-2

Block diagram of the E5091A

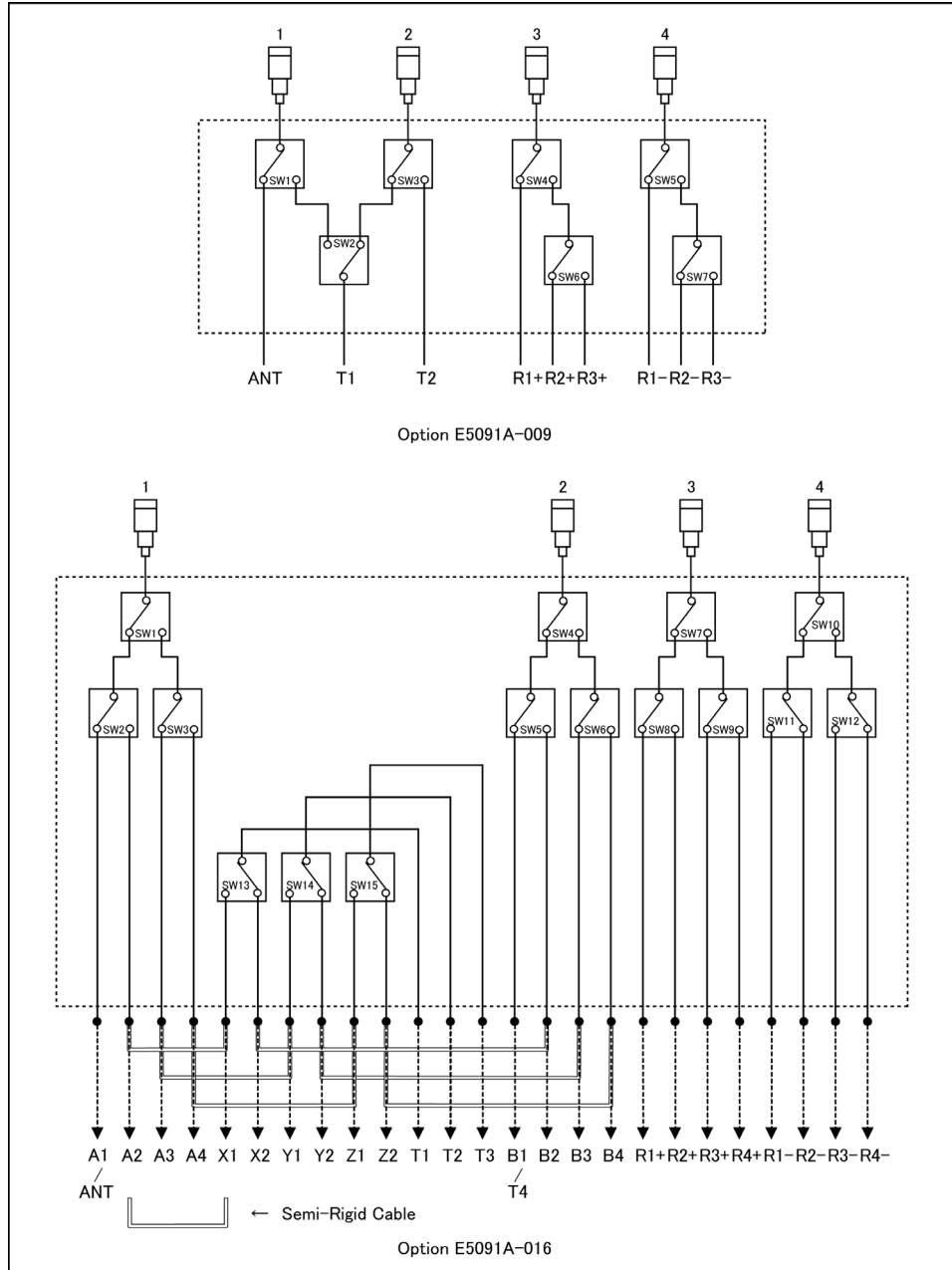

Paths that can be measured

Figure 3-2 shows the paths that the E5091A can measure based on Figure 3-3 or Figure 3-4.

Figure 3-3

Paths that can be measured (E5091A-009)

Input port \ Output port	R1+	R2+	R3+	T1	T2	A	R1-	R2-	R3-
R1+	○			○	○	○	○	○	○
R2+		○		○	○	○	○	○	○
R3+			○	○	○	○	○	○	○
T1	○	○	○	○	○	○	○	○	○
T2	○	○	○	○	○	○	○	○	○
A	○	○	○	○	○	○	○	○	○
R1-	○	○	○	○	○	○	○		
R2-	○	○	○	○	○	○		○	
R3-	○	○	○	○	○	○			○

○ : Measurement possible

e5091aue005

Figure 3-4

Paths that can be measured (E5091A-016)

		Input port												
		R1+	R2+	R3+	R4+	T1	T2	T3	T4	A	R1-	R2-	R3-	R4-
Output port	R1+	○				○	○	○	○	○	○	○	○	○
	R2+		○			○	○	○	○	○	○	○	○	○
	R3+			○		○	○	○	○	○	○	○	○	○
	R4+				○	○	○	○	○	○	○	○	○	○
	T1	○	○	○	○	○	○	○	○	○	○	○	○	○
	T2	○	○	○	○	○	○	○	○	○	○	○	○	○
	T3	○	○	○	○	○	○	○	○	○	○	○	○	○
	T4	○	○	○	○	○	○	○	○	○	○	○	○	○
	A	○	○	○	○	○	○	○	○	○	○	○	○	○
	R1-	○	○	○	○	○	○	○	○	○	○			
	R2-	○	○	○	○	○	○	○	○	○		○		
	R3-	○	○	○	○	○	○	○	○	○			○	
	R4-	○	○	○	○	○	○	○	○	○				○

○ : Measurement possible

e5091aue3004

Setting control line

This section describes the electrical characteristics of the control line and the connection to a DUT and an external dc power supply. For more information on the control procedure, refer to "Controlling the E5091A" in *ENA Series RF Network Analyzers Users Guide*.

Pin assignment

Figure 3-5 and Table 3-2 show the pin assignment of the control line.

Figure 3-5

Pin assignment of the control line

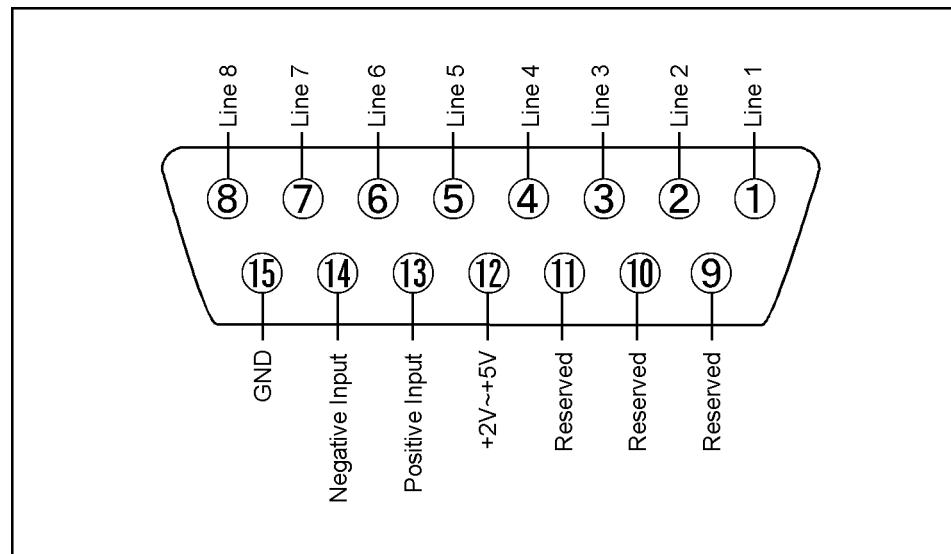

e5091auj014

Table 3-2

Pin assignment

Pin number	Signal name	Description
1	Line 1	The output port of Line 1.
2	Line 2	The output port of Line 2.
3	Line 3	The output port of Line 3.
4	Line 4	The output port of Line 4.
5	Line 5	The output port of Line 5.
6	Line 6	The output port of Line 6.
7	Line 7	The output port of Line 7.
8	Line 8	The output port of Line 8.
9	Reserved	Not used. Don't connect anything.
10	Reserved	Not used. Don't connect anything.
11	Reserved	Not used. Don't connect anything.
12	+2 V to +5 V	The voltage input to pin 13. The voltage can be varied by rotating the voltage adjustment trimmer on the front panel.
13	Positive Input	Input a signal that is outputted when each line is High from the pin 12 or external dc power supply.
14	Negative Input	Input a signal that is outputted when each line is Low from the external dc power supply. Able to output 0 V as LOW from the each line by connecting to the pin 15
15	GND	The ground terminal.

Figure 3-6 shows the block diagram of the control line.

Figure 3-6 Circuit diagram of the control line

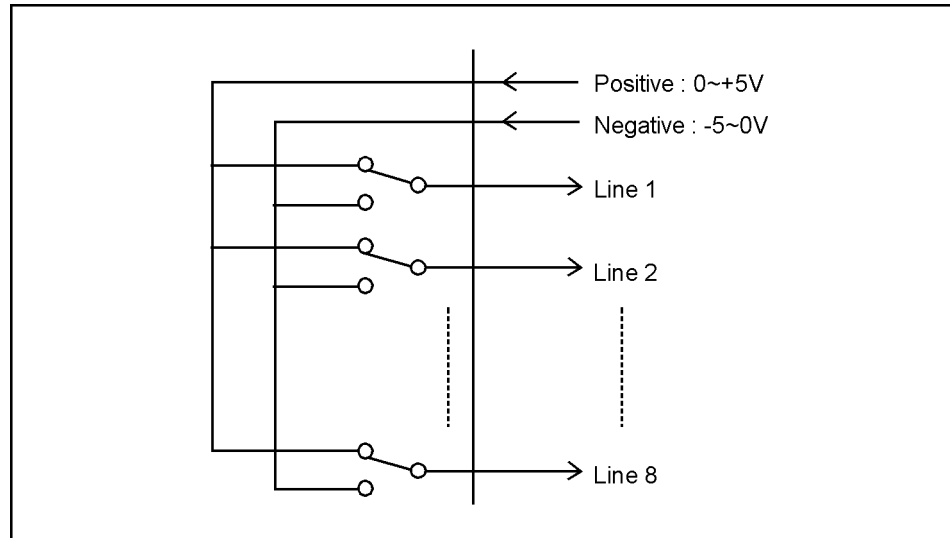

e5091auj015

Specifications

Item		Specifications
Connector shape		15-pin femal D-Sub
Voltage range	Positive Input	0 V to +5 V
	Negative Input	-5 V to 0 V
Maximum current		50 mA in total of each line
Impedance		< 10 Ω
Range of variable voltage		+2 V to +5 V

Setting the voltage of variable voltage output

The output voltage of the pin 12 can be varied from +2 V to +5 V. To set the vlotage, perform the following procedure.

- Step 1.** Turn on the E5091A.
- Step 2.** Measure the voltage between the pin 12 and 15 by a multimeter.
- Step 3.** Rotate the voltage adjustment trimmer on the front panel so that a multimeter show the voltage to be set.

Setting the Instrument

Setting control line

Connection to a DUT

The Figure 3-7 shows an example of the connection between the DUT and the E5091A without an external dc power supply. Input the signals from the pin 12 and 15 to Positive Input and Negative Input respectively and connect each line to the control terminal of the DUT.

CAUTION

The path that can be short is between the pin 12-13 and the the pin 14-15. Don't short-circuit another path because it may be cause of faults.

Figure 3-7

Connecting the E5091A to the DUT

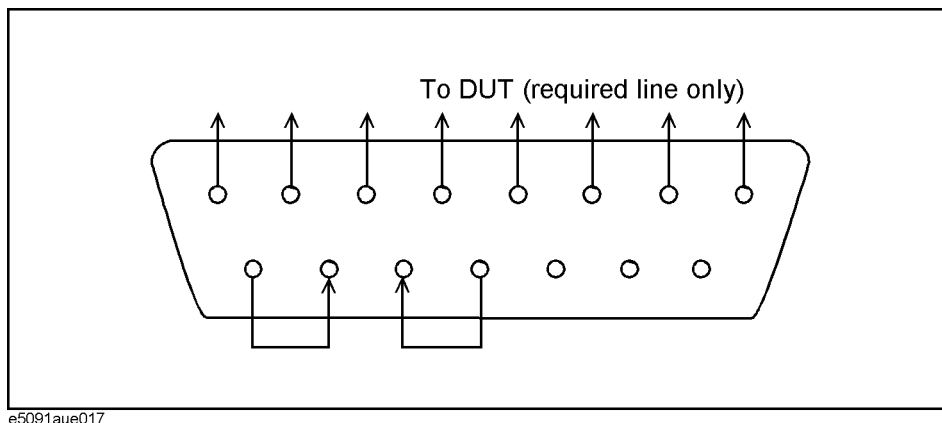

e5091aue017

Connection to a DUT with an external dc power supply

The Figure 3-8 shows an example of the connection between the DUT and the E5091A with an external dc power supply. Input the High and Low signals from the external power supply to Positive Input and Negative Input respectively and connect each line to the control terminal of the DUT.

CAUTION

Perform the procedure "Turning on the E5091A → Connecting the DUT → Turninig on the external power supply". To turning off, perform the reverse procedure of it. The E5091A may break down if a dc current pass through the E5091A when it is turned off.

CAUTION

Don't short-circuit between pins because it may be cause of faults.

Figure 3-8

Connecting the E5091A to the DUT and the external dc power supply

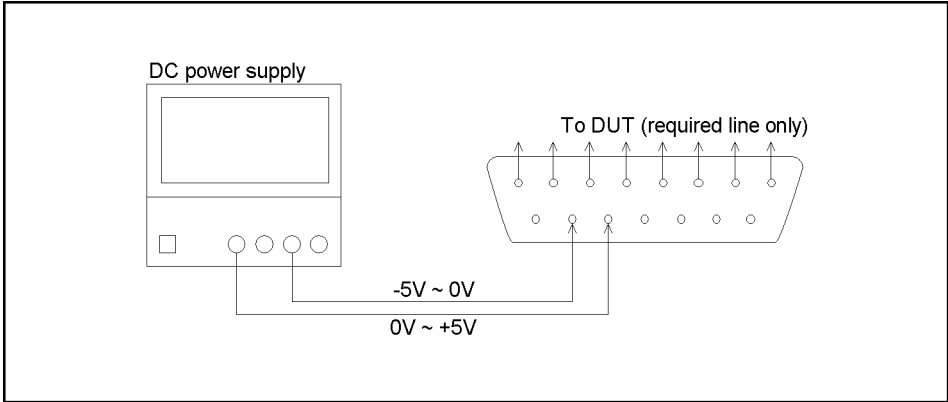

e5091aue018

Operation basics

For more information on the connection and operation, refer to "Controlling the E5091A" in *ENA Series RF Network Analyzers Users Guide*.

4

Specifications and Supplemental Information

This chapter provides specifications and supplemental information for the Agilent E5091A.

Definitions

All specifications apply over a 18°C to 28°C range (unless otherwise stated) and 90 minutes after the instrument has been turned on.

Specification (spec.): Warranted performance. Specifications include guardbands to account for the expected statistical performance distribution, measurement uncertainties, and changes in performance due to environmental conditions.

Supplemental information is intended to provide information that is helpful for using the instrument but that is not guaranteed by the product warranty. This information is denoted as either typical or nominal.

Typical (typ.): Expected performance of an average unit that does not include guardbands. It is not guaranteed by the product warranty.

Nominal (nom.): A general, descriptive term that does not imply a level of performance. It is not guaranteed by the product warranty.

Test Set Input/Output Performance

This section provides test set input/output performance without calibration by the ENA Series RF Network Analyzers.

Option 009

Description	Specification
Frequency Range	50 MHz to 8.5 GHz
Damage Level	20 dBm, ± 25 V DC (Typical)

Description		Frequency				
		50 MHz to 300 MHz	300 MHz to 1.3 GHz	1.3 GHz to 3 GHz	3 GHz to 6 GHz	6 GHz to 8.5 GHz
Load Match						
Test Port Selected (Specification)	A, T2, R1+, R1-	19 dB	20 dB	18 dB	12 dB	10 dB
	T1, R2+, R2-, R3+, R3-	15 dB	17 dB	15 dB	11 dB	8 dB
Test Port Unselected (Specification)	A, T2, R1+, R1-, R3+, R3-	23 dB	25 dB	19 dB	12 dB	11 dB
	T1, R2+, R2-	18 dB	20 dB	16 dB	12 dB	9 dB
Interconnect Port (Typical)	P1, P2, P3, P4	19 dB		17 dB	13 dB	9 dB
Insertion Loss						
Test Port (Specification)	A, T2, R1+, R1-	3 dB		4 dB	5 dB	6 dB
	T1, R2+, R2-, R3+, R3-	5 dB		7 dB	8 dB	9.5 dB
Stability (Typical)	0.005 dB/°C				0.01 dB/°C	0.015 dB/°C
Isolation						
Over Arbitrarily Test Ports (Specification)	-100 dB					-90 dB

Option 016

Description	Specification
Frequency Range	50 MHz to 8.5 GHz
Damage Level	20 dBm, ± 25 V DC (Typical)

Description		Frequency				
		50 MHz to 300 MHz	300 MHz to 1.3 GHz	1.3 GHz to 3 GHz	3 GHz to 6 GHz	6 GHz to 8.5 GHz
Load Match						
Test Port Selected (Specification)	A, T4, R1+, R2+, R3+, R4+, R1-, R2-, R3-, R4-	15 dB	17 dB	15 dB	9 dB	8 dB
	T1, T2, T3	12 dB	14 dB	14 dB	8 dB	6 dB
Test Port Unselected (Specification)	A, T4, R1+, R2+, R3+, R4+, R1-, R2-, R3-, R4-	18 dB	20 dB	16 dB	10 dB	9 dB
	T1, T2, T3	13 dB	15 dB	14 dB	8 dB	6 dB
Interconnect Port (Typical)	P1, P2, P3, P4	12 dB			9 dB	7 dB
Insertion Loss						
Test Port (Specification)	A, T4, R1+, R2+, R3+, R4+, R1-, R2-, R3-, R4-	6 dB		7 dB	8 dB	9.5 dB
	T1, T2, T3	9 dB		10.5 dB	12 dB	14.5 dB
Stability (Typical)		0.005 dB/°C			0.01 dB/°C	0.015 dB/°C
Isolation						
Over Arbitrarily Test Ports (Specification)		-100 dB				-80 dB

General Information

Table 4-1 Connector

Description		Supplemental Information
Front Panel		
RF Connector	Type	Option 009: Type-N, female, 50 Ω (nominal) Option 016: SMA, female, 50 Ω (nominal)
	Number of Ports	Option 009: 13 (Interconnect Port 4, Test Port 9) Option 016: 29 (Interconnect Port 4, Test Port 25)
Control Line		15 pin D-sub, female
Rear Panel		
Connector Type		USB Port, Type B-Receptacles, provides connection to the ENA Series RF Network Analyzers

Table 4-2 Power Requirement*1

Description	Supplemental Information
Frequency	47 Hz to 63 Hz
Voltage	90 to 132 VAC, or 198 to 264 VAC
VA Max	150 VA max.

*1. A third-wire ground is required.

Table 4-3 EMC, Safety and Environment





Description	Supplemental Information
EMC	
 ISM 1-A	<p>European Council Directive 89/336/EEC EN / IEC 61326-1:1997+A1:1998 CISPR 11:1997+A1:1999 / EN 55011:1998+A1:1999 Group 1, Class A IEC 61000-4-2:1995 / EN 61000-4-2:1995 +A1:1998 4 kV CD / 4 kV AD IEC 61000-4-3:1995 / EN 61000-4-3:1996 +A1:1998 3 V/m, 80-1000 MHz, 80% AM IEC 61000-4-4:1995 / EN 61000-4-4:1995 1 kV power / 0.5 kV Signal IEC 61000-4-5:1995 / EN 61000-4-5:1995 0.5 kV Normal / 1 kV Common IEC 61000-4-6:1996 / EN 61000-4-6:1996 3 V, 0.15-80 MHz, 80% AM IEC 61000-4-11:1994 / EN 61000-4-11:1994 100% 1cycle Canada ICES001:1998 Note: The performance of EUT will be within the specification over the RF immunity tests according to EN 61000-4-3 or EN 61000-4-6 except under the coincidence of measurement frequency and interference frequency.</p>
ICES/NMB-001	<p>This ISM device complies with Canadian ICES-001. Cet appareil ISM est conforme à la norme NMB-001 du Canada.</p>
 N10149	<p>AS/NZS 2064.1/2 Group 1, Class A</p>
Safety	
 ISM 1-A	<p>European Council Directive 73/23/EEC IEC 61010-1:1990+A1+A2 / EN 61010-1:1993+A2 INSTALLATION CATEGORY II, POLLUTION DEGREE 2 INDOOR USE IEC60825-1:1994 CLASS 1 LED PRODUCT</p>
 LR95111C	<p>CAN/CSA C22.2 No. 1010.1-92</p>
Environment	
	<p>This product complies with the WEEE Directive (2002/96/EC) marking requirements. The affixed label indicates that you must not discard this electrical/ electronic product in domestic household waste.</p> <p>Product Category : With reference to the equipment types in the WEEE Directive Annex I, this product is classed as a “Monitoring and Control instrumentation” product.</p> <p>Do not dispose in domestic household waste.</p> <p>To return unwanted products, contact your local Agilent office, or see www.agilent.com/environment/product/ for more information.</p>

Table 4-4 Test set Environment and Dimensions

Description	Supplemental Information
Operating Environment	
Temperature	+5 °C to +40 °C
Error-Corrected Temperature Range	23 °C ± 5 °C with < 1°C deviation from calibration temperature
Humidity	0 % RH to 90% @<40 °C (non-condensing)
Altitude	0 to 2,000 m (0 to 6,561 feet)
Vibration	0.2 G maximum, 5 Hz to 500 Hz
Non-Operating Storage Environment	
Temperature	-25 °C to +65 °C
Humidity	0 % RH to 95% @<+65 °C (non-condensing)
Altitude	0 to 4,572 m (0 to 15,000 feet)
Vibration	0.5 G maximum, 5 Hz to 500 Hz
Weight, Dimension	
Dimension	See Figure 4-1 through Figure 4-6.
Net	6 kg (Option 009, Nominal) 7 kg (Option 016, Nominal)

Figure 4-1 Dimensions (front view, with Option 009, in millimeters, nominal)

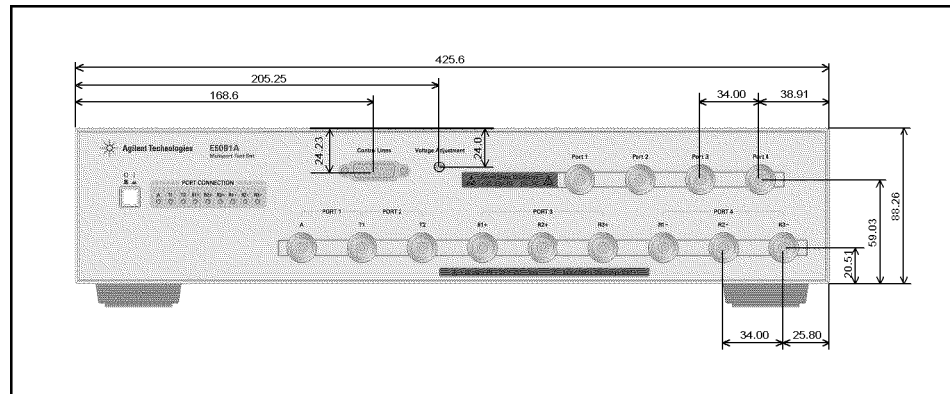

e5091auj009

Figure 4-2

Dimensions (rear view, with Option 009, in millimeters, nominal)

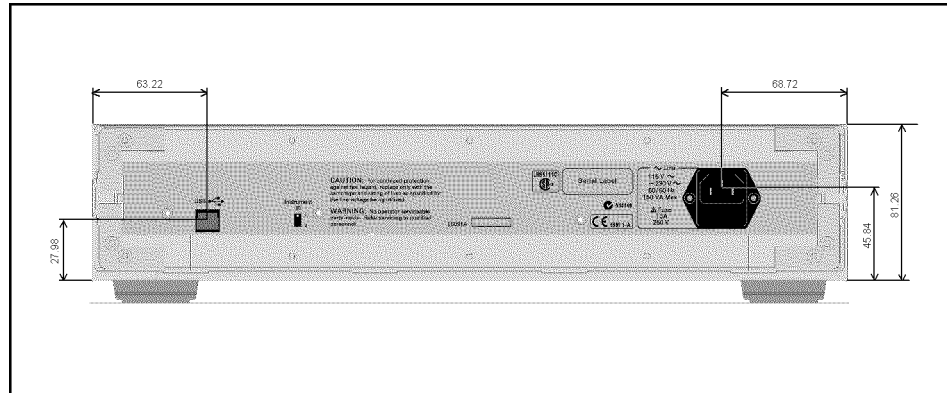

e5091auj010

Figure 4-3

Dimensions (side view, with Option 009, in millimeters, nominal)

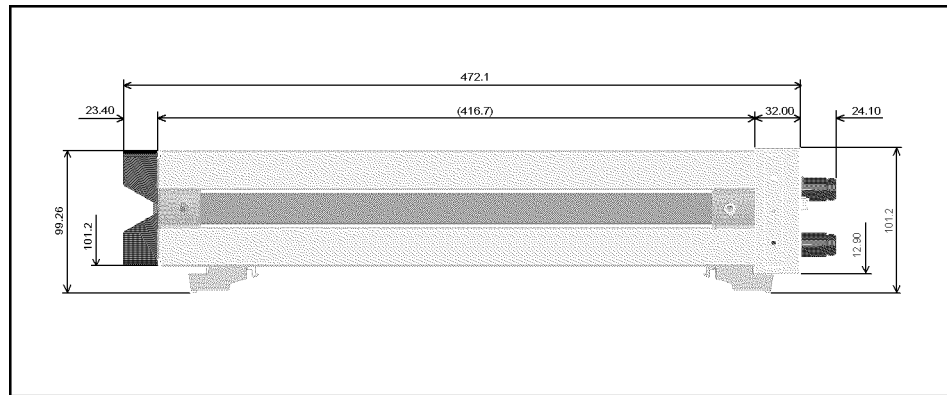

e5091auj008

Figure 4-4

Dimensions (front view, with Option 016, in millimeters, nominal)

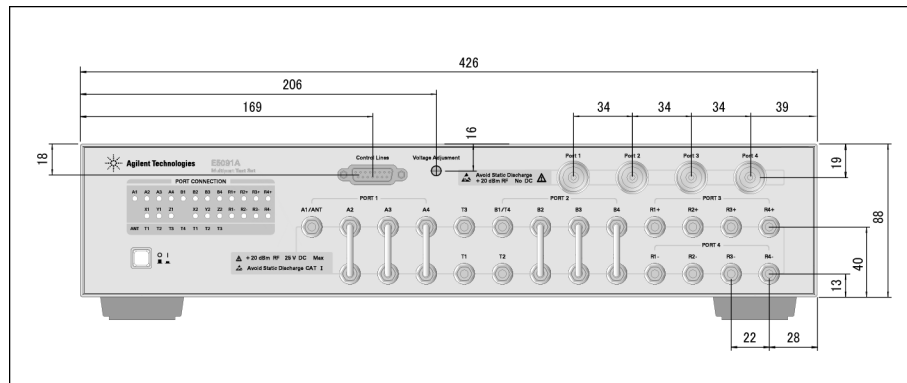

e5091au3005

Figure 4-5

Dimensions (rear view, with Option 016, in millimeters, nominal)

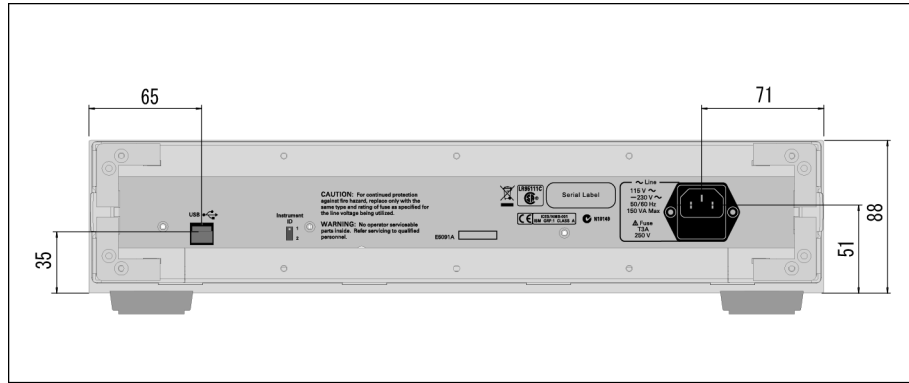

e5091au3006

Figure 4-6

Dimensions (side view, with Option 016, in millimeters, nominal)

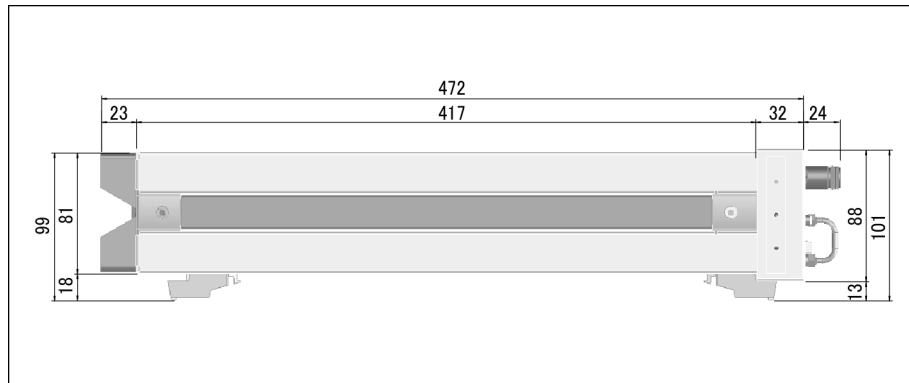

e5091au3007

5

Information on Maintenance

This chapter explains the measures you should take to maintain the Agilent E5091A.

Cleaning this Instrument

This section describes how to clean the instrument.

WARNING

To protect yourself from electrical shock, be sure to unplug the power cable from the outlet before cleaning the instrument.

Never clean the internal components of the instrument.

Maintenance of Interconnection Ports and Test Ports

Interconnection ports and test ports on the front panel of the E5091A are fitted with N Type connectors (f). Stains or other damage to these connectors would significantly affect the accuracy in measurements in the RF range. Always pay attention to the following precautions.

- Always keep the connectors free from stains and dust.
- Do not touch the contact surface on the connectors.
- Do not plug damaged or scratched connectors into the test ports.
- Use compressed air for cleaning connectors. Do not use abrasives under any circumstance.

Cleaning a Display Other than Interconnection Ports and Test Ports

To remove stains on parts other than Interconnection ports and test ports of the instrument, wipe them gently with a soft cloth that is dry or wetted with a small amount of water and wrung tightly.

Cautions Applicable to Requesting Repair, Replacement, Regular Calibration, etc.

Devices to be Sent Back for Repair or Regular Calibration

If it is necessary to send the unit to the Service Center of Agilent Technologies for repair or regular calibration, please follow the instructions below.

Equipment to be Sent

When requesting repair or regular calibration of the unit by our Service Center, send only the E5091A main unit without any installed option you may have ordered. Unless specifically instructed, it is not necessary to send accessories and calibration kits.

Packing

Use the original package and shock absorbers, or equivalent antistatic packing materials, when sending the unit.

Shipping Address

For the location of the nearest Agilent Technologies Service Center, contact the Customer Contact listed at the end of this brochure.

Recommended Calibration Period

The recommended calibration period for this instrument is one year. The user is recommended to request the Company's Service Center to perform regular calibration every year.

Information on Maintenance

Cautions Applicable to Requesting Repair, Replacement, Regular Calibration, etc.

A **Manual Changes**

This appendix contains the information required to adapt this manual to versions or configurations of the E5091A manufactured earlier than the current printing date of this manual.

Manual Changes

To adapt this manual to your E5091A, refer to Table A-1.

Table A-1 Manual Changes by Serial Number

Serial Prefix or Number	Make Manual Changes
All	Change 1

Agilent Technologies uses a two-part, ten-character serial number that is stamped on the serial number plate (Figure A-1). The first five characters are the serial prefix and the last five digits are the suffix.

Figure A-1 Example of Serial Number Plate

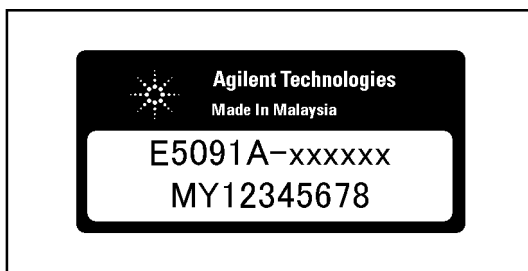

e5091auj3004

Change 1

Please note that option 007 (E5091A-007) is obsolete as of November 2005. To obtain the specifications of this product, refer to the following table. Option 016 (E5091A-016) is supported by the firmware version A.06.00 or higher of the ENA RF Network Analyzer (E5070B/E5071B).

Option 007 Specifications

Description	Specification
Frequency Range	50 MHz to 8.5 GHz
Damage Level	20 dBm, ± 25 V DC (Typical)

Description	Frequency					
	50 MHz to 300 MHz	300 MHz to 1.3 GHz	1.3 GHz to 3 GHz	3 GHz to 6 GHz	6 GHz to 8.5 GHz	
Load Match						
Test Port Selected (Specification)	A, T2, R1+, R1-, R2+, R2-	19 dB	20 dB	18 dB	12 dB	10 dB
	T1	15 dB	17 dB	15 dB	11 dB	8 dB

Description		Frequency				
		50 MHz to 300 MHz	300 MHz to 1.3 GHz	1.3 GHz to 3 GHz	3 GHz to 6 GHz	6 GHz to 8.5 GHz
Test Port Unselected (Specification)	A, T2, R1+, R1-, R2+, R2-	23 dB	25 dB	19 dB	12 dB	11 dB
	T1	18 dB	20 dB	16 dB	12 dB	9 dB
Interconnect Port (Typical)	P1, P2, P3, P4	19 dB		17 dB	13 dB	9 dB
Insertion Loss						
Test Port (Specification)	A, T2, R1+, R1-, R2+, R2-	3 dB		4 dB	5 dB	6 dB
	T1	5 dB		7 dB	8 dB	9.5 dB
Stability (Typical)		0.005 dB/°C			0.01 dB/°C	0.015 dB/°C
Isolation						
Over Arbitrarily Test Ports (Specification)		-100 dB				-90 dB

Option 007 General Information

Table A-2 Connector

Description		Supplemental Information
Front Panel		
RF Connector	Type	Type-N, female, 50 Ω (nominal)
	Number of Ports	11 (Interconnect Port 4, Test Port 7)
Control Line		15 pin D-sub, female
Rear Panel		
Connector Type		USB Port, Type B-Receptacles, provides connection to the ENA Series RF Network Analyzers

Table A-3 Power Requirement^{*1}

Description	Supplemental Information
Frequency	47 Hz to 63 Hz
Voltage	90 to 132 VAC, or 198 to 264 VAC
VA Max	150 VA max.

*1. A third-wire ground is required.

Table A-4 Test set Environment and Dimensions

Description	Supplemental Information
Operating Environment	
Temperature	+5 °C to +40 °C
Error-Corrected Temperature Range	23 °C ± 5 °C with < 1°C deviation from calibration temperature
Humidity	0 % RH to 90% @<40 °C (non-condensing)
Altitude	0 to 2,000 m (0 to 6,561 feet)
Vibration	0.5 G maximum, 5 Hz to 500 Hz
Non-Operating Storage Environment	
Temperature	-25 °C to +65 °C
Humidity	0 % RH to 95% @<+65 °C (non-condensing)
Altitude	0 to 4,572 m (0 to 15,000 feet)
Vibration	0.5 G maximum, 5 Hz to 500 Hz
Weight, Dimension	
Dimension	See Figure 4-1 on page 49 through Figure 4-3 on page 50.
Net	6 kg (Option 007, Nominal)

Figure A-2 Block diagram of the E5091A (Option 007)

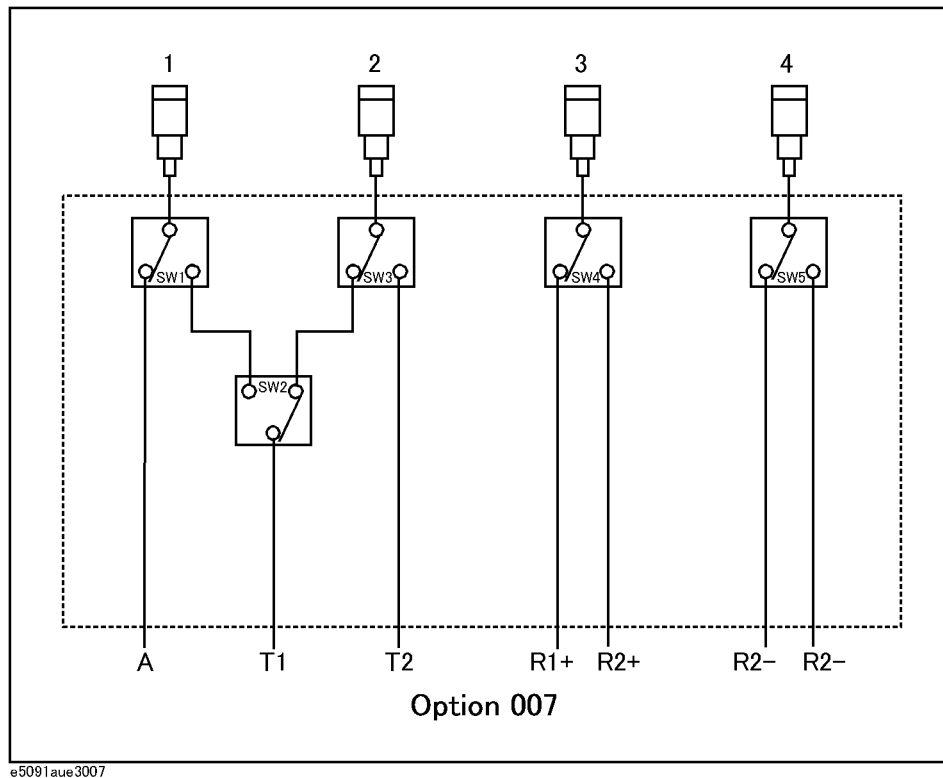

Figure A-3

Paths that the E5091A can be measured (Option 007)

Input port \ Output port	R1+	R2+	R3+	T1	T2	A	R1-	R2-
R1+	○			○	○	○	○	○
R2+		○		○	○	○	○	○
R3+			○	○	○	○	○	○
T1	○	○	○	○	○	○	○	○
T2	○	○	○	○	○	○	○	○
A	○	○	○	○	○	○	○	○
R1-	○	○	○	○	○	○	○	
R2-	○	○	○	○	○	○		○

○ : Measurement possible

e5091aue3010

Manual Changes
Manual Changes

A

accessories, 13
assistance, 5

B

block diagram, 34, 39

C

certification, 5
Cleaning, 54
connection, 40
Connectors
 Maintenance, 54
control line, 37, 39, 40

E

exclusive remedies, 5

F

flange for rackmount
 mounting, 17
front handle
 mounting, 18

H

handle kit
 mounting, 19
history,
 manual printing, 2

I

ID
 setting, 32
inspection
 incoming inspection, 10
interconnection port, 33
Interconnection Ports
 Maintenance, 54
introduction to instrument, 26

M

manual changes, 57
manual printing history, 2

N

name and function of each part, 27
nominal
 definitions, 44

O

operating environment, 14

P

path, 35
path that can be measured, 35
pin assignment, 37
power supply
 checking cable, 21
 checking the supply, 20
 connecting cable, 21
 cutting power, 23
 turning on/off, 23

R

rackmount kit
 mounting, 19
rackmount/handle kit
 mounting, 19

S

safety
 symbols, 4
safety summary, 3
serial number plate, 58
space to disconnect the plug, 16
specifications, 43
 definitions, 44
Specified Torque, 28
starting up E5091A, 23

T

test port, 33
Test Ports
 Maintenance, 54
typeface conventions, 6
typical
 definitions, 44

V

variable voltage output, 39

REGIONAL SALES AND SUPPORT OFFICES

For more information about Agilent Technologies test and measurement products, applications, services, and for a current sales office listing, visit our web site: <http://www.agilent.com/find/tmdir>. You can also contact one of the following centers and ask for a test and measurement sales representative. 21/01/2004

United States:

Test and Measurement Call Center
(tel) 1 800 452-4844
(fax) 1 888 900-8921

Australia/New Zealand:

(tel) (61 3) 9210-5555 (Australia)
(fax) (61 3) 9210-5899
(tel) (64 4) 939-0636 (New Zealand)
(fax) (64 4) 972-5364

Canada:

Test and Measurement Call Center
(tel) 1 877 894-4414
(fax) 1 888 900-8921

Asia Pacific:

(tel) (65) 6375-8100
(fax) (65) 6836-0252
Email: tm_asia@agilent.com

China:

(tel) 800 810-0189
(fax) 800 820-2816

Europe:

(tel) (31 20) 547-2323
(fax) (31 20) 547-2390

Japan:

Call Center
(tel) 0120 421-345
(tel) (81) 426 56-7832
(fax) (81) 426 56-7840

Korea:

(tel) (82 2) 2004-5004
(fax) (82 2) 2004-5115

Latin America:

(tel) (305) 269-7500
(fax) (305) 269-7599

Taiwan:

(tel) 0800 047 866
(fax) 0800 286 331